

---

# LOCATION SURVEY MANUAL

---

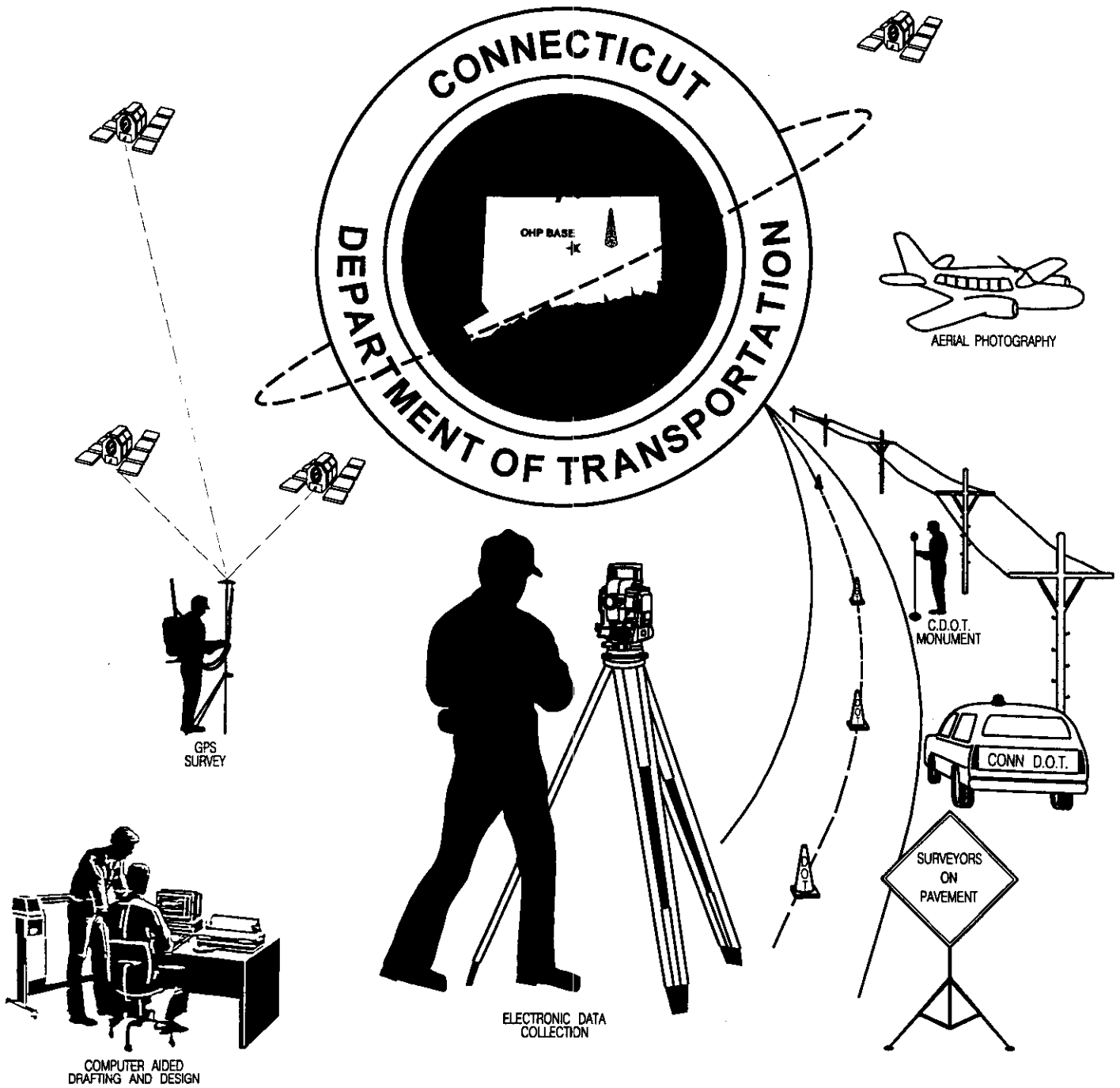

June 1997

---

## BUREAU OF HIGHWAYS

---

## **PREFACE**

The purpose of the Location Survey Manual is to maintain uniformity and conformance with CONNDOT's practices and procedures for all surveys being prepared by and for the State.

This manual has been revised to facilitate CONNDOT's metrication efforts as well as updated to reflect technological advances made in the surveying profession.

As directed by the Commissioner, all assignments are to be performed utilizing the Microstation design format as implemented by CONNDOT as the standard for all of its CADD/GRAPHIC related functions.

Section 1, *Specifications for Location Surveys*, addresses the requirements necessary for Location Surveys.

Section 2, *Specifications for Electronic Surveying*, addresses the preparation of survey mapping utilizing the CADD.

## **ACKNOWLEDGMENT**

The Connecticut Department of Transportation expresses their thanks and gratitude to the New York State Department of Transportation for their assistance and cooperation in the preparation of this manual. We would also like to acknowledge the concentrated efforts made by one of our retired CONNDOT survey managers, John R. Young, in the research and preparation of this manual.

**CONNECTICUT DEPARTMENT OF TRANSPORTATION**  
**STANDARDS FOR LOCATION AND ELECTRONIC SURVEYS**

**Section 1**

**Specifications For Location Surveys**

**Section 2**

**Specifications For Electronic Surveying**

First Edition	November 1953
Addendum Issued	June 1961
Second Edition (Revision)	January 1962
Addendum No. 1 to Second Edition	December 1966
Third Edition (Revision)	May 1968
Fourth Edition (Revision)	January 1990
Fifth Edition (Revision)	June 1997

# SECTION 1

## CONNECTICUT DEPARTMENT OF TRANSPORTATION STANDARDS FOR LOCATION SURVEYS

June 1997 Edition

### TABLE OF CONTENTS

	<u>Page</u>
<b>1.0 DEFINITION OF TERMS</b>	
<b>2.0 DESCRIPTION</b>	
2.1 Individual Project Scope . . . . .	2
2.2 Commissioner's Policy Statement . . . . .	3
2.3 Materials and Information to be Furnished by the State . . . . .	4
2.4 Supplies, Equipment, Engineering Services and Data to be Furnished and Completed by the Surveyor . . . . .	4
<b>3.0 PROJECT CONTROL</b>	
3.1 Description . . . . .	5
3.2 Horizontal Project Control . . . . .	6
3.3 Vertical Project Control . . . . .	13
3.4 Horizontal and Vertical Control Adjustment . . . . .	15
3.5 Type and Location of Permanent Horizontal and Vertical Control Points to be set . . . . .	17
3.6 Check by the State of Control Survey Work . . . . .	19
3.7 Horizontal and Vertical Control Data to be Furnished by the Surveyor . . . . .	19
3.8 Control Index Map . . . . .	20
3.9 Control Survey for Photogrammetry . . . . .	21

**4.0 3D ELECTRONIC MAPPING (FIELD)**

4.1 Description . . . . . 21  
4.2 Types of Detail to be Located . . . . . 23  
4.3 Location of CHD and Random Monuments . . . . . 24  
4.4 Degree of Accuracy Required . . . . . 25  
4.5 Plan and Accuracy Checks for Photogrammetric Mapping . . . . . 25  
4.6 Field Edit of Photogrammetric Mapping . . . . . 25

**5.0 MAPPING (OFFICE)**

5.1 Description . . . . . 26  
5.2 Diskettes . . . . . 27  
5.3 Map Scale Required . . . . . 27  
5.4 Coordinate Grid Lines . . . . . 27  
5.5 Matching Adjoining Digital Maps . . . . . 28  
5.6 Types of Detail to be Shown on the Digital Mapping . . . . . 28  
5.7 Manner of Depicting Detail and Explanatory Note  
on All Digital Mapping . . . . . 29  
5.8 Map Accuracy Required . . . . . 29  
5.9 Submission of the Digital Map . . . . . 30

**6.0 LOCATION STUDY**

6.1 Description . . . . . 31  
6.2 Planning the Base Line . . . . . 31  
6.3 Treatment of Streets, Railroads, Water Crossings  
and Interchanges . . . . . 32

**7.0 ESTABLISHING BASE LINE (FIELD)**

7.1 Description . . . . . 32  
7.2 Computing Base Line Coordinates . . . . . 33  
7.3 Type and Locations of Base Line Control Points  
to be set . . . . . 33  
7.4 Running and Stationing the Base Line . . . . . 34  
7.5 Base Line Data to be Furnished by the Surveyor . . . . . 34

**8.0 SPECIAL SURVEYS AND INVESTIGATIONS**

8.1	Description . . . . .	35
8.2	Street Relocations, Grade Separations and Interchanges . . . . .	35
8.3	Structures at Water Crossings . . . . .	36
8.4	Utilities - Surface and Sub-Surface . . . . .	36
8.5	Utilities - Private . . . . .	38
8.6	Railroads . . . . .	39
8.7	Hydraulic Surveys . . . . .	40

**9.0 FIELD CHECK AND INSPECTION**

9.1	Field Check . . . . .	43
9.2	Inspection . . . . .	44
9.3	Check List . . . . .	44

**10.0 SURVEYING ACTIVITIES**

10.1	Policy Regarding Private Property . . . . .	47
10.2	Railroad Requirements . . . . .	50
10.3	Cooperation With Others . . . . .	52
10.4	Historical Items . . . . .	52
10.5	Channel Encroachment Lines . . . . .	53
10.6	Wetlands and Watercourses . . . . .	53

**APPENDIX A** - List of Acronyms

**APPENDIX B** - List of File Extensions

**APPENDIX C** - Glossary of Terms

**APPENDIX D** - Exhibits

**APPENDIX E** - Metric Standards

**APPENDIX F** - Graphic Element Definitions

**APPENDIX G** - DTM Compilation and Guide Alignment Diagrams

DTM File Break and Mapping Limit

Using Guide Alignments

Major Culvert and Retaining Wall

Curbing

Bridge Abutment and Bridge Deck

**APPENDIX H** - MSFC-Existing Highway Features

## SECTION 1

### CONNECTICUT DEPARTMENT OF TRANSPORTATION SPECIFICATIONS FOR LOCATION SURVEYS

June 1997 Edition

#### 1.0 DEFINITION OF TERMS

Whenever in these Specifications the following terms, or pronouns in place of them, are used, the intent and meaning shall be interpreted as follows:

**1.1 AGREEMENT** - The signed covenant between the State and the Contracting Engineer covering the limits and scope of work to be performed by the Contracting Engineer. The Agreement, when at variance with these Specifications, shall take precedence.

**1.2 COMMISSIONER** - The Connecticut Department of Transportation Commissioner, acting directly or through his duly authorized representative.

**1.3 CONTRACTING ENGINEER** - The individual, firm, association or partnership named in the agreement to perform the survey and/or mapping project.

**1.4 ENGINEER OR REPRESENTATIVE** - An employee of the Department of Transportation duly authorized by the Commissioner to act as his representative in dealing with the Contracting Engineer, and who may make any and all inspections of the work, and who shall issue such special instructions to the Contracting Engineer as are necessary, from time to time, for the completion of the designated project.

**1.5 STATE** - The Connecticut Department of Transportation (CONNDOT)

**1.6 SUB-CONTRACTOR** - The individual, firm, association or partnership to whom the Contracting Engineer sublets or assigns any part or parts of the project covered by the Agreement.

**1.7 SURVEYOR** - The person or persons, the District, Unit, the Contracting Engineer, or Sub-contractor actually engaged in the performance of the survey and/or mapping operations for the Department of Transportation.

**1.8 DISTRICT-** The four (4) units of the Department of Transportation (Bureau of Engineering and Highway Operations) located as follows: (See Exhibits 1 and 2)

**DISTRICT 1**            1107 Cromwell Avenue  
Rocky Hill, CT 06067  
860-258-4576

**DISTRICT 2**            171 Salem Turnpike  
Norwich, CT 06360  
860-823-3276

**DISTRICT 3**            140 Pond Lily Avenue  
New Haven, CT 06515  
203-389-3115

**DISTRICT 4**            359 South Main Street  
Thomaston, CT 06787  
860-585-2720

**1.9 SECTION OF SURVEYS AND PLANS -** The survey unit in each of the Districts responsible for location surveys.

**1.10 CENTRAL SURVEYS -** The unit within the Department of Transportation that oversees and coordinates all of the survey activities in the Department.

Telephone: 860-594-2509

## **2.0 DESCRIPTION**

### **2.1 Individual Project Scope (IPS)**

The location and limits of the project are described in the contract agreement between the Contracting Engineer and the State or in an official Project Initiation Memorandum.

The Surveyor will be required to furnish the qualified personnel, equipment, office space and supplies, except as described hereinafter, to perform the field and office work for the completion of the survey and plans, to the extent covered in the agreement or initiation memorandum in accordance with the provisions of this manual.

The State will designate the project number(s) to be assigned to the project and such number(s) shall be used on all pertinent documents and correspondence.



The State reserves the right to inspect, review or check each field or office phase of the Surveyor's work to assure compliance with the standards and policies established by the State. Surveys by Contracting Engineers may be inspected by personnel from the Section of Surveys and Plans of the appropriate District.

For all surveys, whether by State Forces or Contracting Engineers, the Town Authorities shall be notified as to the extent and nature of the work. The CONNDOT Transportation Director of Communications shall, also, be notified so this information may be released to the news media.

The appropriate Principle Engineer of Survey and Plans will notify the Town Authorities and the Director of Communications for the State Forces.

The Division of Consultant Design will make the notifications for the Contracting Engineers. However, the Contracting Engineer shall notify the Division of Consultant Design of the actual survey start date in order that the notifications can be made prior to commencement of survey activities.

## **2.2 Commissioner's Policy Statement**

Commissioner Emil H. Frankel's Policy Statement - Policy No. ADMIN-24, dated March 16, 1993 states:

**Subject: Computer Aided Design and Drafting Standardization**

It is the policy of this Department to adopt the "Microstation file format as implemented by the Connecticut Department of Transportation" as the standard for all of its CADD/Graphic related functions. All future assignments are to be performed utilizing this technology. Exceptions to this directive will only be given at the discretion of the Deputy Commissioner, Bureau of Finance and Administration. This will assure that the Department achieves a total quality effort in its development of a Department-wide Geographic Information System. It should be emphasized that this standardization applies for the Department's entire business needs, whether performed by in-house staff or by consultants retained by the Department. (See Exhibit 3 for copy of this Policy Statement)

To comply with the Commissioner's Policy Statement, all survey location work - whether performed by in-house staff or by Contracting Engineers - shall be provided in *Microstation Design File Format*.

The Contracting Engineer must have a Microstation system in-house or arrange for translation of the digital data in order to provide CONNDOT with Microstation Design Files as a final product.

The Surveyor shall use a total station instrument and data collector to gather his field information. The gathered information is stored in the data collector and later downloaded into the *Microstation Design File Format* utilizing the standard CONNDOT symbols, features, levels, etc. as indicated in the *Existing Features Cell Library and Manual*.

The standards specified in this manual were selected to assure consistent precision and accuracy in all the coordinates, elevations and terrain models upon which design engineering is based.

### **2.3 Materials and Information to be Furnished by the State**

1. Maps showing location of the project area to be covered by the survey and sites of special surveys required.
2. Description of the location and the coordinate values of existing points to be used as the base for horizontal control.
3. Description of the location and the elevation of existing bench marks to be used as the base for vertical control.
4. Control monuments and/or discs (when required), standard field books and right of entry forms.
5. 3 ½" diskette containing survey and Photogrammetry cell library for existing features in Metric and English Units.
6. Copy of CONNDOT's Existing Feature Cell Manual.
7. Copy of Location Survey Manual.

### **2.4 Supplies, Equipment, Engineering Services and Data to be Furnished and Completed by the Surveyor**

1. All qualified personnel
2. Global Positioning Systems, total stations, transits, theodolites, electronic distance meters, prisms, targets, levels, calibrated steel tapes, thermometers, level rods, barometers, spring balances, vehicles, data collectors, and any other equipment necessary to complete the survey.
3. Drawing media, profile mylars, stakes, pins, flagging and other supplies.

4. Diskette(s) of completed project: If completed project diskette(s) have been compressed due to file size, then all compressed files must be self-extracting.
5. RAW Data File: All unedited data from electronic field book received from data collector.
6. All files relative to project:
  - a) Both planimetric and topographic mapping files in Microstation design file format. See Section 1 (5.2) and Section 2 (1.5)
  - b) All individual *graphic* x, y, z point locations as well as the corresponding electronic ASCII coordinate file.
  - c) 3D *graphic representation* of Surface Model in Microstation Format.
7. Topographic and planimetric maps completed, field books, original computations and all data described hereinafter.
8. All safety equipment and supplies as required by State or O.S.H.A. Regulations.

### **3.0 PROJECT CONTROL**

#### **3.1 Description**

When the term *project control* is used in this manual, it refers to the control traverses, base lines and level lines occurring within the area of a project. The purpose is to control the engineering work required for a project. Points established under these standards and procedures are generally within the work limits of the project and are assumed to be expendable but recoverable. In this manual, project control is not intended to include densification or extension of existing State geodetic control networks.

The establishment in the field of a control traverse shall be the basis for all future surveying activities, such as: topography, sub-loops, base lines and construction staking. The office computations required to adjust the field angles and distances shall be within the limits prescribed in Section 1 (3.2 and 3.4).

This traverse shall originate and terminate at two existing pairs of control points described in Section 1 (3.2).

Additional control may be required whenever the subject traverse intersects a previously established traverse or when additional control ties will improve the strength of the traverse on the Connecticut Coordinate System.

The project control shall be reviewed and approved by Central Surveys prior to the commencement of the mapping phase of either ground or photogrammetric surveys.

#### *Control Survey Data Collection*

It is recommended that all survey information be collected electronically. This is equally true for control surveys.

Any control collected electronically must still comply with all standards and procedures set forth in this manual (horizontally and/or vertically).

Additionally, the surveyor shall not run his or her control lines concurrently with that of topographic detail survey data collection. While "one pass" surveying techniques are not forbidden, they shall only be allowed under certain circumstances (such as a single intersection improvement survey).

Since conventional field books or abstract sheets, in most cases, will no longer be utilized as a matter of permanent record, all raw control survey data collected must be preserved. Therefore, the surveyor shall utilize such data collection equipment system(s) which will enable the Department to be provided with a hard copy and ASCII formatted diskette of this control survey.

It cannot be overemphasized that this control survey submission be the unadjusted (raw) data, and in such a format that any end-user can be assured that all accuracy and procedural parameters set forth in this manual have been met.

Field books will be used in areas where it is not possible to incorporate information into the data collector, such as control and network sketches, swing ties, etc.

Conventional control survey procedures will only be employed when authorized by the Engineer or Representative in which case abstract sheets will be utilized. (See Exhibits 4, 9-14).

### **3.2 Horizontal Project Control**

Horizontal project control will be established by conventional or GPS (Global Positioning System) methods. Begin and end horizontal control traverses on monuments of at least second order, Class II, where possible.

## **A. Horizontal Project Control By Conventional Traverse**

All horizontal coordinates shall be on the Connecticut State Coordinate System based on the North American Datum of 1983 (NAD 83).

In the event NAD 83 is unavailable or missing, the Surveyor shall notify the Central Surveys Section and they will advise the Surveyor how to proceed.

Primary project control, established by conventional techniques, shall be of at least third order, Class I, as defined in Standards and Specifications For Geodetic Control Networks, Federal Geodetic Control Committee, 1984.

The control survey traverse shall be established and measured by current Department of Transportation methods, so that each control loop will have an error in position closure, after distribution of azimuth errors, of 1:10,000 or better for primary control and 1:5,000 or better for secondary control.

**The surveyor shall use, in determining traverse angles and distances, total station instruments whose specifications and procedures for control surveys shall be as follows:**

1. Instrument accuracy or standard deviation must be capable of measuring horizontal and vertical angles to three (3) seconds of arc or less. Instruments shall be of the dual axis compensating type.
2. EDM's must have standard mean error of  $\pm (5\text{mm} + 5\text{PPM})$  or less.
3. The total station, tribrachs, prism targets, prism poles, tripods, etc. used for control surveys must be adjusted properly and maintained in good condition
4. Angular sets (2D/2R) shall be observed at each angle point of the control line, preferably closing the horizon (See Exhibit 4)
5. All horizontal control survey field measurements shall be employed using tripod mounted (fixed) targets and/or prisms.

### **Procedure For Turning Angle Sets 2D/2R**

1. With the telescope in the direct position Face 1 (F1) observe the first point with an initial angle of  $0^\circ \pm$
2. Turn and record the horizontal angle to the second point (first angle).

3. Repeat same procedure from point two to point one, closing horizon (second angle).
4. Reverse telescope, Face 2 (F2) and resight first point.
5. Turn and record horizontal angle to second point.
6. Repeat same procedure from point two to point one, closing horizon.
7. Mean the direct (F1) and reverse (F2) readings of the first set and mean the direct and reverse readings of the second set. The rejection limit for any angle from each mean is 5".
8. Mean the means of the first and second sets. The sum of the two (2) sets shall not deviate from 360° by more than 5.0 seconds.

### **Procedure For Measuring Distances**

Measured lines are to be corrected for slope, PPM (temperature and barometric pressure), sea level factor (ellipsoid) and grid factor.

The latitude required to determine the grid factor and the elevation required to determine the sea level factor may be scaled from U.S.G.S. Quadrangle Maps or other available mapping. The difference between the Geoid (Sea Level) and the Ellipsoid in Connecticut ranges from -29 to -31 meters. Therefore, -30 meters may be assumed as the basis between sea level and the ellipsoid for Connecticut D.O.T. project control surveys.

The total station instruments and data collectors that have the capability, shall measure distances in the direct (F1) and reverse (F2) positions from both ends of each line for a total of four (4) measurements (2 foresights - 2 backsights).

The distance (between adjacent control points) from foresight and backsight measurements should not differ by more than the amount that the precision of the total station EDM predicts.

The mean of the foresight and backsight measurement differentials of a line shall meet a minimum precision ratio of (1) part in 20,000.

Avoid placing adjacent control points so closely together that they render the total station EDM incapable of measuring the intervening distances to the required precision. (Typically, 100 meters for a 5mm instrument)

Account for prism offset in all distance measurements.

Total stations, which are to be used on a State project, shall be tested on a calibrated base line, using the procedure noted in Exhibit 5, or calibrated by the manufacturer. The base line observation sheets (Exhibits 6 and 7) or the calibration report, shall be forwarded to the Division of Central Surveys for approval, prior to measuring the control lines for every project.

Calibrated base lines have been established in West Hartford, South Windsor, Colchester, Winchester and New Haven to check the accuracy of the total station. However, the range located in South Windsor can only check distances.

## **B. Horizontal Control By GPS**

In instances where there is a significant lack of existing primary control available locally to a project, or when it has been deemed as not cost effective to run this control into a project area by conventional survey methods, the use of GPS (Global Positioning System) survey equipment will be authorized.

Prior approval from the Division of Central Surveys must be granted during the scoping phase of the project for which GPS survey control is proposed.

Should the use of GPS be agreed upon, coordinate positions shall be based upon Connecticut Coordinate Grid (NAD 83/87) and elevations (orthometric heights) based upon NAVD 88.

Any end user of GPS derived elevations should be aware, at the time of this writing, that these elevations will not be accurate enough for typical vertical project control. Success has been achieved for certain mapping applications. However, conventional leveling techniques will be required by the Department in providing primary vertical project control.

The following typical specifications are, hereby, noted. These specifications are to be utilized as a guideline for proposed GPS projects. Specific scope parameters will be identified on a project-by-project basis.

### **GPS Survey Specifications**

The final GPS survey control will conform to the standards defined as "*Group C, Second Order Class II*" in the preliminary FGCC (Federal Geodetic Control Committee) document entitled (dated September 1, 1989 and as modified in future FGCC publications) as a minimum Department of Transportation survey accuracy requirement. It should be noted, however, that these FGCC standards have been modified, as noted, in certain of the following specifications:

1. Only FGCC approved receiver types, such as "Trimble 4000SSE" shall be utilized.

2. The GPS survey control network may be observed by either conventional static or fast static methods. In the event that fast static methods are utilized, dual frequency receivers with P-Code installed on L1 and L2 frequencies shall be used. These receivers shall be equipped with a technique capable of solving the same base lines without degradation in accuracy and observation durations in the case of P-Code encryption.
3. In the event that orthometric heights will be supplied on any project the NGS GEOID 96 model, or the latest model supplied by NGS, shall be used. The adjustment software utilized must be capable of improving this model throughout the project area, based upon the locations of fixed vertical reference control points and their relationship with the GEOID 96 model.
4. A minimum of three (3) first or second order NGS, CTGS or USE triangulation stations or monuments shall be occupied and held fixed as the horizontal control basis for any project. (This specification will be precisely defined on a project-by-project basis.)
5. In the event that orthometric heights will be supplied, a minimum of five (5) first or second order NGS or CTGS bench marks will be occupied and held fixed as the vertical control basis for any project. It should be noted that these bench marks may be eccentric points (TBM's) having elevations derived by 3-wire differential spirit leveling transfers from obstructed primary bench marks. (This specification will be precisely defined on a project-by-project basis.)
6. As a rule of thumb, the network design will be such that the number of base lines observed from fixed reference control stations to **different** unknown points must be equal or greater than the number of fixed stations in the network.
7. Open-ended GPS traverses (spurs) will not be utilized.
8. For every "mated" or "intervisible" pair of unknown points, the GPS network will be supplemented by EDM measured distances (reduced to ellipsoid). These "ground" or "terrestrial" measurements must be incorporated during the project adjustment phase. Every reasonable attempt should be made to establish these unknown pairs at a minimum of 300m apart from one another.
9. The maximum distance between the project perimeter and an outside fixed point should not exceed 15km.
10. In no case will "eccentric" points be utilized for horizontal reference control. In other words, fixed horizontal control must actually be occupied during the observation phase of the project.



11. GPS planning services will be such that a minimum of five (5) common satellites (with healthy orbital conditions) will be simultaneously tracked at every receiver location.
12. GPS planning services shall, also, include proper consideration of point obstructions, multi-path error sources, miscellaneous atmospheric refraction errors such as power line, radio, microwave and cellular telephone transmitting sources, etc. All points which will be occupied having obstructions which break the 15° horizontal plane or may be subject to local error sources shall be properly documented during the project reconnaissance phase. Obstruction survey sheets (sky plots) should be made at any point having any of the above noted properties. (See Exhibit 8 for example)
13. In the network adjustment phase, only independent GPS base lines will be utilized. Each unknown GPS point shall be connected to a minimum of two (2) independent base lines. The ratio of redundant observations in the network to total number of observations shall be greater than or equal to one to two (1:2). Additionally, every reasonable attempt shall be made to observe two (2) sessions at each station in the network.
14. The final fully constrained network adjustment will disregard transformation parameters.
15. All network adjustments will pass the chi-square test at 95% confidence level.
16. As a statistical approach to network adjustment quality control related issues, the following accuracies expressed as standard deviations should be adhered to:
  - a) Minimally Constrained Adjustment  
  
Horizontal - cannot exceed 0.01m  
Vertical (Ellipsoidal heights) - cannot exceed 0.02m
  - b) Fully Constrained Adjustment  
  
Horizontal - cannot exceed 0.02m  
(Orthometric heights) - cannot exceed 0.03m

(It should be noted that these standard deviations are intended to gauge the overall network accuracy. Slight variances with these accuracies will most likely not be cause for rejection.)

**The following information shall be forwarded to the Department for review:**

1. Prior to the commencement of the actual GPS observations, a "hard copy" network diagram sketch and copies of all obstruction sheets (sky plots) shall be forwarded to the Division of Central Surveys for review.
2. Prior to acceptance by the Department of this GPS survey, the following information shall be forwarded to the Office of Central Surveys for review:
  - a) Statistical summary
  - b) Weighting strategy
  - c) Observation adjustment with listed "a priori" and "a posteriori" standard deviations
  - d) Coordinate adjustment with listed "a posteriori" standard deviations
  - e) Microstation drawing file (hard copy and diskette) containing station names/numbers, and GPS base lines (indicating the date and time of observations)
  - f) A tabular hard copy and ASCII file on 3 ½" diskette of all GPS observed points containing point names/numbers, state plane coordinates with mapping angle and scale factor, ellipsoidal and orthometric elevations, latitude and longitude for all GPS surveyed points
  - g) Any other data or information deemed necessary by the Office of Central Surveys for the purpose of final review and acceptance.

**A note on HARN and use of the published NGS data base:**

The CONNDOT Geodetic Section has found a significant variance between the values provided by NGS for the States five (5) existing HARN stations and previously published NAD 83/87 coordinate values. Therefore, CONNDOT is not utilizing the published NGS HARN coordinates in our geodetic adjustments.

Further, the Connecticut Geodetic Survey Section is aggressively densifying existing NAD 83/87 networks throughout the State. These network adjustments may not agree with all coordinate data included in the NGS published NAD 83 data base.

Considering these issues, all NAD 83 reference control proposed to be utilized on a project shall be researched through Central Surveys (Geodetic Section) prior to use.

### **3.3 Vertical Project Control**

This work includes the field survey and office computations necessary for establishing bench marks which will be used as the vertical control for all leveling operations connected with location and construction surveys.

Elevations shall be based on *North American Vertical Datum of 1988* (NAVD 88). In the event NAVD 88 is unavailable or missing, the Surveyor shall notify Central Surveys and they will advise the Surveyor how to proceed.

The datum must be clearly noted on the title sheet and/or each plan sheet to avoid any confusion with other datums.

Level runs shall begin and end on bench marks classified as *Second Order, Class II* or higher order, or as directed by either the Office of Central Surveys or the Principal Engineer of the District Survey and Plans Section.

The vertical control will be established by differential or trigonometric leveling.

#### **Recommended Procedure For Level Run**

The three wire leveling method, electronic precision digital leveling method or trigonometric leveling shall be used.

##### **A. Three Wire Leveling or Electronic Precision Digital Leveling**

The surveyor shall use the three wire method, being careful to balance backsights and foresights, for bench level runs.

The standard of accuracy for Class II, Second Order leveling is as follows:

1. Instruments that ensure Class II, Second Order accuracy
2. One piece invar scale rods or in case of digital levels, an invar bar code staff. All leveling should be done with rod or staff sets.
3. Maximum length of sight - 60 meters

4. Maximum closure for each run between previously established bench marks  $8\text{mm}\sqrt{K}$  when  $K = \text{kilometers}$  (See Exhibits 9-10)

## B. Trigonometric Leveling

Trigonometric leveling may be permitted under certain conditions using a total station whose specifications will produce Second Order Class II accuracy. (Minimum vertical angle accuracy 3 seconds.) Again, the instrument must be of the dual axis compensation type.

A basic "leapfrog" method using a prism and target mounted on a plumbing pole, steadied with a tripod or equivalent support, shall be used.

The following field procedures are to be used:

1. One observation shall consist of four (4) pointings in each face (4 direct and 4 reverse). When recording the zenith angles, the average of the four pointings in face 1 (direct) shall not differ from the average of the four pointings in face 2 (reverse) by more than four seconds. Any deviation greater than four (4) seconds shall be rejected and the pointings repeated.
2. When recording the vertical distances (differences in elevation), the average of the four distances in face 1 shall not differ from the average distance in face 2 by more than the following:

$$.00035\sqrt{M}$$

- Length of sight in meters

The rejection of one set of observations can be determined from a comparison of either the average of zenith angles or vertical distances, **not necessarily both.**

3. Adjust instrument for collimation error prior to level run
4. Backsights and foresights are to be kept approximately equal where practical.
5. Slope distances shall **not** exceed 200 meters.
6. Vertical angles shall **not** exceed six (6) degrees.
7. The target bubble on the plumbing poles are to be checked periodically.

8. If more than one plumbing pole is used, care shall be taken to ensure that both prisms are set at exactly the same height. Should it be required to alter either prism height for individual sightings, great care must be used in recording these changes through data collection or conventional means.
9. The following items are to be recorded for trigonometric leveling to verify the accuracy of the field work:
  - Temperature and barometric pressure (PPM)
  - All zenith angles (optional)
  - All vertical distances
  - Two slope distances (See Exhibit 11 and 12)

### **3.4 Horizontal and Vertical Control Adjustments**

#### **A. Horizontal Adjustment**

Current Department of Transportation methods of traverse closure adjustment shall be as follows:

1. COSMOS (in-house)
2. Simultaneous Traverse Adjustment (in-house)
3. Any PC based simultaneous least squares adjustment program which meets the following minimum standards:
  - (a) Simultaneously adjusts *all* field measurements observed during a control survey. This is true even if the horizontal control is comprised as a simple line traverse, or if it is a complex, multi-connected network.
  - (b) Capable of holding all control point(s) either occupied or located as a side shot during traverse operations as fixed reference control for a project.
  - (c) Allows for variable weighting strategies. As such, capable of varying control weights based upon instrument standard deviations, topographical site conditions and differences in reference control orders/classes.
  - (d) Provides a report which indicates residuals (corrections to observed

quantities) of all angles and distances observed for the adjusted traverse.

- e) Capable of running adjustments in meters and U.S. Survey Feet.
  - f) Capable of adjustment computations on both (NAD 83 and NAD 27).
  - g) Capable of batch file entry and editing which will allow for the re-use and interconnection of existing traverses for future applications.
  - h) Capable of providing an ASCII output file.
4. Weighted Least Squares
- a) The (Weighted Mean Junction Method) of balancing junction points must be used with the (Weighted Least Square Adjustment) for coordinate computation of a mean junction point. (See Exhibits 13 and 14)

**No other method of traverse adjustment will be acceptable.**

The average angular adjustment prior to position closure shall not exceed 3 seconds per angle or a total of 10 seconds times the square root of the number of angles ( $10\sqrt{N}$ ) the lessor of which shall govern.

It may be necessary for the control traverse to intersect with control traverses established on other projects to insure compatibility with adjacent projects. It may, also, be necessary to compute three - or -four way junctions to properly balance the various loops.

## **B. Vertical Adjustment**

The surveyor shall use such equipment and methods as noted hereinafter for all bench level runs to conform to Second Order Class II leveling, as prescribed by the *Standards & Specifications for Geodetic Control Networks*, FGCC, 1984.

The error of closure in each line, between State approved bench marks previously established, shall not exceed 8mm times the square root of the distance in kilometers ( $8\text{mm}\sqrt{K}$ ).

The Three Wire Leveling method, Trigonometric Leveling, Electronic Precision Digital Leveling Method, or equivalent, shall be used for this operation.

On separated roadways where bench marks are necessary for each roadway, either roadway may be used for the main bench level run. Auxiliary loops, run with the same degree of accuracy, not exceeding 1.5 kilometers in length, shall be used to determine the elevation of the bench marks for the other roadway.

*PRIOR TO ANY LEVELING OPERATIONS, WHERE BENCH MARKS ARE TO BE ESTABLISHED, THE EQUIPMENT AND METHODS OF RECORDING AND ADJUSTING, SHALL BE APPROVED BY THE STATE.*

### **3.5 Type and Location of Permanent Horizontal and Vertical Control Points to be Set**

#### **A. Horizontal Control**

The Surveyor, for new expressway or other major projects, shall set in the ground, at intervals of approximately 1.5km within the proposed taking lines, but outside the limits of construction, pairs of permanent intervisible monuments, both before and after construction, and separated by a minimum distance of approximately 250m. The location selected should, if possible, be at points of shallow cuts or fills. These monuments shall be angle points in the control traverse line from which points on the proposed base line or lines may be conveniently and accurately established on the ground, and shall be shown on the finished map with the coordinates.

All other control points shall be iron pins driven flush with the ground. Where possible, the pins should be spaced about 150 to 250 meters apart. They shall be a *minimum* of 0.02m stock and 1 meter in length. In establishing traverses through city streets, control discs can be set in concrete walks, and existing permanent street markers may be incorporated into the traverse network. However, good engineering judgment should be used where short distances between street markers are encountered.

There may be certain instances where auxiliary loops will be run well outside the limits of a project. In these instances, the use of less permanent control points may be used (P.K. nails etc.) if prior approval from the Office of Central Surveys is obtained.

All control points shall have three semi-permanent Reference Marks (RM's) from an adjacent control point to the R.M.'s. The R.M. distances should be less than 30 meters, if possible.

These control points shall be referenced to nearby and easily identified trees, buildings, or other substantial cultural features, so that they may readily be found at any future time.

Ninety degree in line ties shall be used if other tie points are not available.

The control traverse line shall be established with definite angle points. In no case shall any attempt be made to establish long tangent control lines by plunging, double centering or turning 180 degrees. No attempt shall be made to have the control line coincide with the proposed base line.

## **B. Vertical Control (Bench Marks)**

The Surveyor shall establish, near the proposed highway, bench marks to be used as check points during the leveling operations. These semi-permanent bench marks shall be easily identified and shall be definite points upon well marked, substantial objects that can be readily found at a later date.

The following are procedures to be followed for setting bench marks:

1. A complete description and location of each bench mark shall be recorded in the field notes
2. Each bench mark shall be used as a turning point in the level line
3. Bench marks shall be located at intervals not exceeding 250 meters along the entire line, or a maximum difference in elevation of 15 meters between benches, and at the location of bridge or grade separation structures
4. Bench marks shall be located outside of the area which is likely to be disturbed by construction, and on projects where separated roadways are proposed, the bench marks may be set approximately midway between the proposed roadways
5. Bench marks on separated roadways will be set for each roadway when the distance between the proposed roadways or elevation difference between roadways is excessive (15m or greater)
6. At the beginning and end of the project, bench mark discs on permanent objects or bench mark monuments will be set outside of the area, which is likely to be disturbed by construction, so that permanent vertical control will be available during and after construction



7. If suitable objects, which may be used as bench marks, do not exist on the project site, the Surveyor will be required to set monuments or other rigid and permanent points to be used as bench marks
8. Bench marks may also be established on:
  - a) Concrete bases or foundations
  - b) Discs or other well defined marks set in outcropping ledge
  - c) Drainage structures (excepting catch basins)
  - d) Railroad spikes in non-ornamental trees with a diameter in excess of 0.3m
  - e) Other semi-permanent points as approved by the Engineer
9. Unacceptable bench marks:
  - a) Objects driven into utility poles
  - b) Small shade trees or ornamental trees
  - c) Houses
  - d) Iron pins, etc.
  - e) Hydrants (Top nut or other movable valve caps)
  - f) Catch basins
  - g) Points set in sidewalks or curbing
  - h) A series of elevations taken along the tops of steel pins used for the control line or base line, shall **NOT** be acceptable as **BENCH MARKS**, even if level line has been closed and adjusted to the required degree of accuracy. While it is understood that elevations will most likely be established on control points for DTM surface locations, these elevations shall not be utilized as project bench marks.

### **3.6 Check By The State Of Control Survey Work**

The State may inspect, at anytime, during or after the control survey, any operation in the field or office.

### **3.7 Horizontal and Vertical Control Data to be Furnished by the Surveyor**

#### **A. Horizontal Control**

The Surveyor shall furnish to the State, before the submission of base map data, a control sketch of the traverse network, a copy of the traverse adjustment computations, and the raw horizontal and angular field measurements.

## **B. Vertical Control**

The Surveyor shall indicate on the detailed plan, the exact location of each bench mark and note the description and adjusted elevation of the bench mark.

The Surveyor shall submit to the State, prior to the completion of the location survey work, the following:

1. All original computations concerning the adjustment of bench levels
2. All original field books, Trigonometric Leveling Observation Sheets, or diskette of raw field data from data collector of the bench run
3. Notation shall be put in the plan stating that the elevations are based on the NAVD of 1988 or other applicable datum

### **3.8 Control Index Map**

A reproducible 1:2000 scale control index map and diskette is required for all major survey projects showing the horizontal and vertical control used for the project. All control must be referenced and tie boxes are to be shown on this index. A limited amount of topography shall be shown depicting the location of control points. State plane coordinate grid lines shall also be shown.

*The control index must include the following listed items:*

1. All adjusted horizontal control points shall be numbered, and a bearing or azimuth and distance shall be shown to each adjacent control points. Distances are to be denoted to the nearest millimeter (0.001m).  
  
Bearings or azimuths of the adjusted control traverse are to be shown to the nearest tenth (0.1) of a second. The coordinate values of horizontal control points are to be shown to the nearest millimeter (0.001m).
2. The bench mark descriptions must appear in the tie boxes. Adjusted bench mark elevations are to be shown to the nearest millimeter (0.001m).
3. Each tie box shall show a sketch of the control point, the ties and description of each tie, (i.e.: "X" cut on concrete head wall). Distances from the control point to each tie shall be denoted to the nearest millimeter (0.001m). Each control point shall be described (i.e.: 1.2 meter iron pin) and conform to the specifications noted in Section 1 (3.5).

### **3.9 Control Survey For Photogrammetry**

The control survey for a photogrammetric survey project follows the same format and specifications as described previously in this section.

The location of the necessary photo control points shall be determined by the photogrammetrist. Coordination between the surveyor and the photogrammetrist is essential prior to running control within the mapping project area.

On projects where aerial targets are to be placed prior to the actual flight and photography (pre-targeting), the surveyor shall attempt to incorporate these target locations into their traverse and level network rather than as a side shot. Where this is not possible, a sub-loop shall be run which closes into the precise traverse network to accepted standards of accuracy. "Spur" traverses are not an acceptable method of controlling targets.

On projects where the mapping is to be accomplished from photographs without pre-targeting, the photogrammetrist or the Department will provide the surveyor with photographically identifiable points (picture points) to be located. These picture points may be located as side shots from the traverse and level network. If picture point locations fall well outside the original networks, sub-loop traverses shall be run and closed into the original control traverse with a linear position closure of 1:5,000 or better.

While photogrammetric accuracies vary proportionately to flight altitudes/negative scales, as a rule of thumb all field survey *measurements* shall be recorded in accordance with the total station's least count reading ability. This rule holds true for horizontal and vertical position computations.

The Surveyor shall use such care as deemed appropriate for the type of survey project applicable to ensure that all measurements and computations provided for photogrammetric control points will enable the photogrammetrist to compile maps which conform to National Map Accuracy Standards.

## **4.0 3D ELECTRONIC MAPPING (Field)**

### **4.1 Description**

All field locations of topographic and cultural features described herein shall be done electronically with a total station instrument and a data collector. The information gathered in the data collector shall then be down loaded and edited for final map compilation in a Microstation File Format as directed in a Commissioner Policy Statement dated March 16, 1993. (See Exhibit 3)

All locations are to be made from existing or auxiliary traverse lines. The minimum area to be mapped shall be shown on a map provided by the State, or as authorized, in writing, by the Engineer or Representative.

Mapping shall be produced by electronic rather than by conventional methods. Therefore, conventional mapping will no longer be acceptable unless authorized by the Engineer or Representative.

However, field books may be used for sketches, swing ties, test pits or in situations where it is not possible or very inconvenient to gather information with the data collector.

Conventional surveying was a method of surveying that gathered cultural features for the preparation of a planimetric map (2D) with transit and tape. After the map was made by hand-drafting, a base line was run in the field from which elevations for cross sections and profiles were compiled. The cross sections were taken 90° to the base line every 50 feet. Field notes were reduced and the cross sections and profiles hand plotted.

Electronic surveying gathers information electronically with total station instruments, data collectors which are downloaded into a CADD system where the field information is edited and a 2D or 3D planimetric map, a topographic (contour) map and a Surface Model (DTM) is developed.

This information enables a designer to electronically develop a base line, cross sections, profiles, spot elevations and miscellaneous information on the CADD.

Three dimensional survey data collection enables the surveyor to collect two dimensional (2D) information for the planimetric mapping as well as 3D information for topographic mapping including a Surface Model by gathering x, y, z, coordinates for every point located.

3D surveying requires that the survey information be collected using individual x, y, z point locations in conjunction with breaklines (i.e., along roadway edges, roadway crowns, curb lines, sidewalks, bottom and top of slopes, bridges, culvert heads, brooks, ditches, etc.).

Breaklines control and/or restrict the triangulation which occurs between individual x, y, z point location. This triangular network, which represents the surface model, can be used to generate cross sections, profiles and contour mapping.

Areas defined by a 3-dimensional closed shape element which controls project perimeter triangulation are referred to as Boundary Areas. See Section 2 (1.5)

Areas where triangulation should not occur within the limits of the Surface Model are defined as Void Regions; e.g., Buildings, Lakes, Ponds, Dense Vegetation, etc. See Section 2 (1.5)

A good conception of breakline surveying, data collection and data collectors must be known before collecting 3D survey data.

The collected 3D survey must include enough survey data to generate an accurate Surface Model from which contours and cross sections at the required design intervals are developed.

#### **4.2 Types of Detail to be Located**

The Surveyor shall make all topographic and cultural feature locations with a total station instrument and data collector in a x, y, z coordinate (3D) format.

All locations must be at their proper or corresponding z value; e.g., manholes, trees, houses, etc., as well as points or line work; e.g., points along edge of road, curbing, sidewalks, spot shots, etc.

It will be extremely important to locate all breaklines in order that an accurate 3D Surface Model can be generated in a 3D Design File.

The following is a listing of detail that is to be located for mapping:

1. Waterways or swales, whether running or dry
2. Swampy and wooded areas
3. Streets and roads with their monumented or established highway lines
4. Railroads with their monumented center lines
5. Electric transmission, telephone and telegraph lines, private utilities
6. Bridges
7. Culverts
8. Manholes
9. Hydrants, Gas and Water Gates, etc.
10. Outstanding ornamental and shade trees
11. Houses, including house numbers, types and owner's name
12. Schools, churches and factory buildings
13. Wells
14. Sidewalks
15. Curbs
16. Joints in concrete pavement
17. Fences, walls and hedges
18. Town, city, state, National Geodetic Survey monuments
19. All visible property monumentation whether merestones, iron pins or pipes and stakes
20. Inland wetlands shall be located as marked (flagged) in field by a soils scientist
21. Tidal wetlands shall be shown, with an appropriate note, specifying whether it is

based on field delineation by a soil scientist or Federal, State or municipal record mapping

22. All other details necessary for the complete mapping of the area
23. All established project control points (horizontal and vertical)

Where subdivision areas occur within or immediately adjacent to the mapping area, sufficient points shall be located in order that the title searchers may plot the subdivision.

Note: Reference should be made to the Check List in Section 1 (9.3) and CONNDOT Existing Features Cell Manual. See APPENDIX H in the back of this manual for an aid to the specific mapping details.

### **4.3 Location of CHD And Random Monuments**

All highway line monumentation (CHD) and randoms found in the field are to be located. A concerted effort is to be made to find and locate CHDs that are not visible. Right of Way Maps are a valuable tool in helping to find CHD monumentation.

The practice of solely locating a minimum number of randoms (tying into the random line) and computing the highway line with Right of Way map information is unacceptable, dangerous and may lead to plotting erroneous highway lines. This is also true of locating a minimum number of CHDs and computing the highway line.

The goal is to locate the CHDs as they exist in the field and not an attempt to correct or make a new Right of Way map. Also, if the CHDs and property pins are field located prior to construction, they can be replaced in their original position after construction, if needed.

Many Right of Way maps are very old and may contain errors or discrepancies. Even more recent mapping may not be entirely errorless. The older maps have angles shown only to the nearest minute and extending these lines using those angles for just 1000 feet could lead to the line being off by 0.3 foot.

CHD monuments, as positioned in the field, depict the true lines of occupation. These CHDs have been recognized over the years by property owners, town officials, land surveyors etc., and have been the basis for land transactions and surveys.

*Although at times there may be slight discrepancies between the Right of Way mapping and the monuments, the position of the monument as located in the field prevails.*

#### **4.4. Degree of Accuracy Required**

Linear measurements to property, street and highway monuments, or other definite points on these lines, shall be made to the nearest millimeter (0.001m), and angular measurements of one/set (D/R) to the nearest 10 seconds or better. Linear measurements to other sharply defined topographic and cultural details shall be made to the nearest centimeter (0.01m), and angular measurements to the nearest 10 seconds. These measurements shall be made from either primary or auxiliary control lines which conform to the requirements hereinbefore stated. Details such as wooded areas, meandering streams, wetland flagging and ledge outcroppings may be located to the nearest decimeter (0.1m) from convenient traverse lines.

It should be noted that it is understood that most EDM's cannot actually measure to millimeter accuracy. The distance requirements set forth above are based upon desired accuracies pertaining to the order of importance of these measurements as referenced to the least count reading ability of the instrument utilized.

Picture point locations shall be carefully measured. Where possible, picture points should be located from more than one control point. Linear and angular measurements to picture points shall conform to the requirements for the location of property and street line monumentation (above). Vertical measurements shall be read to the nearest millimeter ( 0.001). See Section 1 (3.9)

Sub-loops shall be run when the cultural features are inconvenient to locate from the main control or exceed 150 meters. These sub-loops or auxiliary traverses established to locate topographic and cultural details are to be carefully run and the error in position closure after distribution of azimuth error shall be 1:5,000 or better.

#### **4.5 Plan and Accuracy Checks for Photogrammetric Mapping**

This phase of a photogrammetric mapping project is defined in detail in the Connecticut Department of Transportation Manual, "*Specifications For Checking Photogrammetric Mapping*", dated October 1976.

However, the methods of locating the details on a photogrammetric manuscript, or plot, are the same as noted hereinbefore in this section. See Section 1 (4.2, 4.3 and 4.4)

#### **4.6 Field Edit of Photogrammetric Mapping**

The field edit phase of a photogrammetric mapping project is comparable to the location survey phase of a ground survey mapping project.

Once it has been determined, during the plan and accuracy phase, that the project mapping meets the prescribed standards of accuracy, it is the responsibility of the Surveyor to describe the topography shown on the photogrammetric manuscript(s), and locate and describe any items of topography not shown on the photogrammetric manuscript(s), and locate and describe other items noted in Section 1 (4.2 and 5.6).

Additionally, the Surveyor shall be responsible for field edit locations and elevations of new subdivisions, office complexes and other new construction which is not shown on the manuscript sheet(s).

**All field location work shall be done with a total station instrument and a data collector in 3D which then can be incorporated with the photogrammetric digital mapping for the final map compilation in a MICROSTATION DESIGN FILE FORMAT. The semi-final diskettes shall be forwarded through proper departmental channels for review along with a paper plot for each digital map.**

The old method of showing the field edit information in red or color coded pencil on the mylar sheets for compilation and/or digitizing will no longer be acceptable unless authorized in writing by the Engineer or representative.

## **5.0 DIGITAL MAPPING (Office)**

### **5.1 Description**

This work shall consist of preparing a digital map in Microstation Design File Format for the particular project depicting accurately the planimetric (cultural) features and topographic (contour) features necessary for establishing the base line of the proposed highway and for the preparation of the property acquisition maps which will be done by the State.

The State must be supplied with means to reproduce a 3D drawing. The five basic graphic elements required for processing a 3D survey are:

1. Individual x, y, z field locations in the *graphic* 3D Microstation Design File.
2. Breaklines in the *graphic* 3D Microstation Design File.
3. Boundary Areas in the *graphic* 3D Microstation Design File.. See Section 2 (1.5)
4. Void Regions in the *graphic* 3D Microstation Design File.. See Section 2 (1.5)
5. Surface model triangulation in a separate *graphic* 3D Microstation Design File.



All files submitted are to be in Microstation P.C. Version 5.0, or current version, and must conform to CONNDOT Existing Feature Cell Manual. (See APPENDIX H)

## 5.2 Diskettes

The project shall be submitted on one or more 3 ½" diskettes containing the proper mapping file name with a ".GRN" extension.

There will be instances where a single diskette will not cover the entire project and additional diskettes will be required. *If completed projects diskette(s) have been compressed due to file size, then all compressed files must be self-extracting. All planimetric and topographic mapping shall be coincident.*

The planimetric and topographic features, previously located in the field, shall be plotted from the design file (. "GRN" File) on plastic film at least 0.1mm thick, 914mm wide. No single map shall be more than 3m in length. The average map sheet size should be between 1.5m - 2m.

## 5.3 Map Scale Required

The digital aerial and ground survey map, prepared for design and/or related construction activities, shall be 1:500, or as directed by the Engineer or Representative.

However, the following scales are also used for other surveys depending on the type of project for which it is intended:

<u>Mapping Scales</u>	<u>Contour Interval</u>
1:200	0.2m
1:500	0.5m
1:1000	1.0m
1:2000	2.0m

## 5.4 Coordinate Grid Lines

The coordinate grid lines shall be drawn so as to represent even 100 meter values on the Connecticut Coordinate Grid. The grid lines shall be depicted on the final plots as grid "ticks" which indicate their corresponding coordinate values. Special care in view rotation shall be taken to assure proper orientation of the map, so that each section of map will be as long as permitted by the alignment of the proposed highway and the map coverage required at all locations.

## 5.5 Matching Adjoining Digital Maps

Whenever it becomes necessary to end a section of a digital map due to length, changes in direction of the proposed highway etc., the drawing of detail shall end at a match mark roughly perpendicular to the proposed highways. Match marks must coincide from one file break to the next. See Section 2 (2.2, D)

Curve data and base line and/or center line bearings shall be shown on both sheets when crossing at the match mark.

The drawing of detail on the adjoining digital map shall be commenced at the match line so that all details are completely shown without duplications, or truncated text.

## 5.6 Types of Detail to be Shown on the Digital Mapping

Normally the same details listed below will appear on both the planimetric and topographic mapping. However, the Engineer or his Representative may authorize that the display of certain details from the *topographic* mapping be turned off due to congestion.

1. All topographic cultural details previously located in the field
2. The values of coordinate grid "ticks"
3. All monumentation including geodetic, base line, boundary and railroad
4. High water mark
5. Channel encroachment lines for rivers, where established
6. Inland-wetland limits
7. Tidal wetlands
8. The type of pavement or road surface on streets, roads and driveways
9. The type of surface on sidewalks
10. The type and material of curbs,
11. The ownership of utility structures
12. Pole numbers
13. Buildings with street numbers, sill elevations to 0.01M as requested by the designer
14. Direction of flow and types of streams, pipes and ditches
15. Size and type of conduits, ducts, sanitary and storm sewer systems including elevations on top, bottom or sump, pipe inverts, etc.
16. North arrows
17. State route numbers
18. Street names and street lines
19. Property owners' names of record and property lines
20. Pertinent details unable to be shown to scale shall be enlarged and shown separately.

Whenever a State Highway Line is shown, it shall carry a notation of the map number marked on the highway line; i.e., "R.O.W. Map #58-06, sheet 2 of 3", or "See Construction Project 116-84".

When a bridge of any type is located, whether it be over another highway, a stream or railroad, a full description should be noted on the plan, such as:

Type of Structure

Width from face of curb to face of curb (traveled way)

Square span

Skew span

Clear height

For railroads - highest rail to lowest member of bridge

For streams - bed of stream to lowest member

For roads - from crown or highest point to lowest member

If bridge has overhead trusses, the distance from deck to highest member is required

**5.7 Manner of Depicting Detail and Explanatory Note on All Digital Mapping**

All topographic and cultural details shall follow, maintain, and conform to CONNDOT's Existing Features Cell Library.

1. Level
2. Color
3. Weight
4. Text size
5. Patterns
6. Cells

A 3 ½" diskette containing the survey and photogrammetry Cell Library for Existing Features and a copy of the Existing Feature Manual will be furnished by the State.

**5.8 Map Accuracy Required**

**Horizontal Accuracy**

Ninety percent of all well-defined features, with the exception of those unavoidably displaced by exaggerated symbolization will be plotted within 0.5mm of their geographic positions.

## Vertical Accuracy

Ninety percent of all contours extracted from a digital file will be accurate within one-half of the basic contour interval, should a profile be run in the field.

To ensure an accurate surface model, all elevations shall be published to three decimal places and elevations shall be accurate to the nearest 0.005m for concrete pavement, walks etc.; 0.01m for bituminous pavement, walks, sills etc. (Typically any elevation normally depicted to the nearest conventional 0.1')

## 5.9 Submission of the Digital Mapping

The following items are to be submitted to the State after each digital map or maps have been field checked and the final map contains all the information required by the State.

1. Diskette(s) for completed project containing Microstation Design Files. It should be noted that digital submissions on large scale projects will most likely be on CD ROMS in the future. Consultants must verify if this media is acceptable prior to project finalization.
2. One mylar plot of each planimetric and topographic sheet generated by the diskette(s) shall be signed and sealed by a Connecticut Licensed Land Surveyor, and ASPRS registered photogrammetrist. Due care shall be used in the preparation and cleaning of the mylar. Where drafting procedures are secured by scribing, automatic pen plotters or electro-static printing devices, the choice of proper ink and its application must be considered so there will be no smearing, chipping, flaking or separation of the ink on the finished plans.
3. Raw Data File  

All unedited data from the electronic field book received from data collector. The actual raw data collected prior to any processing that may be used in a legal dispute as any conventional field book may be used.
4. The State must be supplied with means to reproduce a 3D drawing. The five basic graphic elements required for processing a 3D survey are:
  - a) Individual x, y, z field locations in the *graphic* 3D Microstation Design File.
  - b) Breaklines in the *graphic* 3D Microstation Design File.

- c) Boundary Areas in the *graphic* 3D Microstation Design File.. See Section 2 (1.5)
  - d) Void Regions in the *graphic* 3D Microstation Design File.. See Section 2 (1.5)
  - e) Surface model triangulation in a separate *graphic* 3D Microstation Design File.
5. All submitted mapping must follow and maintain the CONNDOT Existing Feature Cell Manual with respect to:
- a) Level
  - b) Color
  - c) Weight
  - d) Text size
  - e) Patterns
  - f) Cells

## **6.0 LOCATION STUDY**

### **6.1 Description**

State Engineers will make a study of the data submitted by the Surveyor and determine the location of the proposed highway base line and/or the directional roadway base lines, and all other details affecting the location and design of the project.

On an individual project basis, it may be necessary for the State to engage a Contracting Engineer to make a study of the data submitted by the Surveyor to determine the location of the proposed highway base line and/or directional roadway base lines.

### **6.2 Planning the Base Line**

The introduction of Electronic Surveying has, in most cases, changed the method by which base lines are placed on the final mapping.

The Surveyor is now required to supply the State with means to reproduce a 3D survey as previously stated.

The digital mapping, in 3D format, enables the State or Contracting Engineer to determine the location of the proposed highway base line and incorporate it into the digital mapping file(s).

The State or Contracting Engineer will, also, be able to develop cross sections from this base line.

### **6.3 Treatment of Streets, Railroads, Water Crossings and Interchanges**

State Engineers or Contracting Engineers will show the proposed center lines of intersecting streets, streets to be relocated and water crossings, on the digital mapping.

Wherever a recorded layout for intersecting streets is available, the center line shall be used as the center line of this layout, if possible. Also, at all railroad crossings, the railroad monumented center line is to be shown on the digital map.

The submitted digital mapping should provide enough information for the layout of the proposed center lines, without the need of special surveys, in the following areas:

1. Bridge sites
2. Proposed interchanges
3. Streets that are to cross the proposed highway
4. Streets to be relocated
5. Frontage roads
6. Waterways to be bridged
7. Proposed bridges at stream relocations
8. Interchange locations

However, it should be noted that there may be instances where additional survey data will be required due to insufficient mapping coverage or other unique situations encountered on a project-by-project basis.

## **7.0 ESTABLISHING BASE LINE**

### **7.1 Description**

The State or Contracting Engineer will now be responsible for the computations and placement on the digital mapping of the proposed highway base line, and/or directional roadway base lines, as planned by the State.

The actual establishment of the base line on the ground may not occur until the construction phase of the project.

However, there may be times when the Surveyor will be required to compute and establish the roadway base line on the ground. Therefore, an explanation of the computation and field work required to establish on the ground the proposed highway base line will be addressed.

## 7.2 Computing Base Line Coordinates

The base line shall be computed and shown in the metric system. The Engineer shall compute the coordinates of the base line points to be established on the ground.

However, the Surveyor, when required shall compute the coordinates of the base line points to be established on the ground from base line data furnished by the State.

The base line points to be set, tied-in and shown on the plan are as follows:

1. The beginning and ending points of the project.
2. The PCS, POCs and PTs of the horizontal curve.
3. The PIs (optional) and POTs

The coordinates and bearings shall be shown as follows:

1. Control line, base line, center line and curve data to the nearest 0.001m.
2. Bearings to the nearest tenth (0.1) of a second.
3. Distances (stations) to the nearest 0.001m.
4. Ties to the base line PCS, POC, PTs, POTs, PIs and beginning and ending points to the nearest 0.001m.

## 7.3 Type And Locations Of Base Line Control Points To Be Set

The Surveyor shall establish semi-permanent control points on the ground along the proposed base line, including P.I.s, P.O.T.s, P.C.s, P.T.s and P.O.C.s, as may be necessary so that each intermediate point will be visible from adjacent points. The distance between these points shall not exceed 250 meters. In the case of new expressway or "cross country" realignments, these control points will be either a sharply defined cross or drill hole in rock or concrete, or an iron pin firmly set in the ground and marked on the top with a drill hole. These iron pins shall be a *minimum* of 0.020m stock and 1 meter in length. All iron pins used for points, either on the control or base lines, shall be driven flush with the ground and the location marked by guard stake or stakes. All sub-control and intermediate points shall be referenced to nearby and easily identified trees, buildings or other substantial cultural features so that the original point may readily be found or re-established at any future time. **At least three ties shall be used for each point reference.**

## 7.4 Running and Stationing the Base Line

The Surveyor shall use the stationing indicated by the Engineer at the beginning of the

project. The Surveyor then shall use the tangent and curve lengths previously computed to compute the stationing of all curve points and intermediate points in curves and tangents. These computations shall be made before the base line is run in the field. (See Exhibit 15)

Base line stations determined by the base line field measurements will be corrected at each curve point and each intermediate point on curve or tangent, to agree with the stationing previously computed for these points.

Offset base lines shall be staked and marked accordingly to clear buildings, structures, ornamental trees and other obstructions.

The intersection point at all railroad crossings between the base line and railroad monumented center line shall be determined, coordinated, plotted and the angle between computed and shown on the plan.

The angle between the base line and the railroad, together with the base line station and the railroad monumented center line station, shall also be determined and shown on the plan.

#### **7.5 Base Line Data To Be Furnished By The Surveyor**

The Surveyor shall note on the digital plan, after the base line has been established in the field, the following base line information and curve information at each horizontal curve:

1. The coordinates of all base line control points
2. The delta angle
3. Radius
4. Length of curve
5. Tangent distance
6. External distance
7. Computed bearing on each tangent
8. Station of each P.C., P.T., P.O.C. and P.O.T.
9. Base lines will be set-up/established at one (1) kilometer intervals with (20) meter sub-stations. Thus 1+020.00 would be exactly twenty (20) meters beyond station 1+0
10. Location and coordinates of PI (if it is located within the mapped area)

The Surveyor shall submit to the State, at the completion of the location survey work, the following:

1. All original computations concerning the base line and the ties between the control survey line and the base line



2. The original field books and/or computer printout containing the base line staking notes
3. All base line control ties which are to be shown on the submitted mylar

The base line staking notes shall also show the following:

1. The base line station as determined by field measurements
2. The calculated station of each intermediate base line control point previously set

The comparison between the calculated and the field stationing shall have a minimum accuracy of 1:5000.

## **8.0 SPECIAL SURVEYS AND INVESTIGATIONS**

### **8.1 Description**

Special surveys are areas within a project where there are special concerns. Common types of these concerns are proposed streets that are to cross the highway, street relocations, frontage roads, waterways to be bridged, interchange locations and grade separations, and vertical structure projects.

The above pertains mainly to the Interstate Program which is now nearly complete. However, the above concerns also apply to new, relocated, and reconstructed roadways.

Other areas of concern are *utilities, railroads and hydraulic requirements*.

In instances where special surveys are required, the Surveyor shall do the field work and make the special investigations necessary to furnish information for the design by others of the special features heretofore described.

### **8.2 Street Relocations, Grade Separations and Interchanges**

There may be times when the Surveyor shall be required to establish, on the ground, coordinated base lines for the relocations and the preparation of 3D mapping from field information of the following:

1. Relocations of streets adjacent to the proposed highway
2. Streets to cross the proposed highway with grade separation structures
3. Proposed grade separation structures
4. Proposed interchange locations

Where grade separation structures are required at street and railroad crossings, bridge 3D site plans of the prescribed areas shall be prepared at the scale of 1:200 with contours at 0.5m intervals. It may become necessary, at certain locations, to change this contour interval as required by design engineers.

At proposed interchange locations, the Surveyor shall prepare 3D mapping at the same scale as the original mapping, or as directed, with contours at 0.5m intervals throughout the designated interchange area.

The planimetric and topographic 3D mapping shall be forwarded to the State upon completion of the location survey.

### **8.3 Structures at Water Crossings**

At locations indicated on the plans which are transmitted to the Surveyor by the State of proposed structures over waterways, bridge 3D site plans of the prescribed area shall be prepared to the scale of 1:200 with contours at 0.2m intervals.

### **8.4 Utilities - Surface and Sub-surface**

As previously described under Section 1 (4.2), "Type of Detail to be Located" Digitized Map" (Planimetric and Topographic), and Section 1 (5.6), "Type of Detail to be Shown on Map", the Surveyor shall locate in the field and plot on the base map all utility structures that are visible.

The surveyor shall obtain data available from each utility company relative to their underground facilities and shall place the information on the digital map. This can be accomplished by either of the following two (2) methods or a combination of both.

The first method is to send a letter with a short explanation of the project to each utility company who may have underground utilities in the project area. Enclose a copy from a portion of suitable location mapping depicting the project area. The utility company will send the requested mapping to you or notify you if they have no utilities in the project area.

The second method is to **(Call Before-U-Dig) @ 800-922-4455** requesting that the underground utilities be marked in the field. After the markings have been made, the Surveyor will make field locations of these markings.

The locations, names of owners of the installation, size and types of utilities shall be shown on the digital map.

When the vertical and horizontal location of underground utilities is established by digging test holes, the data shall be recorded on a *Test Pit* Form and forwarded to the designer for his information. The Surveyor shall retain a copy for his records for future reference. (See Exhibit 17)

*The data to be recorded on the Test Pit Form is as follows:*

1. Name of utility and utility company
2. Horizontal location either by base line stationing (Station - Offset) or coordinates
3. Top of pipe, duct, conduit elevation
4. Ground elevation
5. Small diagram if applicable
6. Vertical and horizontal location of other unknown utilities if uncovered
7. Utility Contractor, date and time of excavation

*The procedure for obtaining test pit information is as follows:*

1. The designer requests test pits at locations where there may be conflicts between the proposed construction and existing utility facilities on plan sheets with base line stationing.
2. The designer shall clearly specify those test pits which fall within federal participation.
3. The Designer shall notify the District or Surveyor of any change in the number or location of test pits as soon as possible so that these changes may be coordinated with the respective utility companies and agreements amended accordingly.
4. Prepare a letter agreement with the utility company or municipality if not covered under by the "Master Utility Agreement".
5. Check should be made with the Division of Design Services, Utility Section, during the letter agreement process to verify the percentages the State will participate in the reimbursement to the Utility Company for the test pit costs and, also, for the State Statute which should apply. (13a-126/13a-98f) See Exhibit 18
6. Determine the estimated costs of the test pits and request work order.
7. It shall be the responsibility of the utility company, or the municipality, to obtain the required permits.

8. Coordinate activities for the test pit excavation with utility company, municipality and contractor.
9. Record all data in a standard field book or data collector and prepare a CONNDOT Form CON-40 on a daily basis.
10. Billing is submitted by the utility company or municipality on a CONNDOT Form CLA-3.
11. The CLA-3 Form and submitted support documents are checked for accuracy and, if acceptable, are then forwarded to the Accounts Payable Unit.

### **8.5 Utilities - Private**

1. An investigation of local records shall be made to determine available underground utility information. This investigation could include a discussion with the local building inspector, public works director, or any other person who may have knowledge of these matters.
2. When detailed information is not available from the town records, the property owner shall be queried relating to his recollection of the location of wells, septic tanks, leaching fields, private services, etc., and shown on the plan and labeled approximate location.
3. After a base line has been determined, emphasis shall be placed on locating private utilities within an area determined by the designer.
4. The designer will evaluate this data with respect to his design and he will determine where more accurate locations are required. When more accurate information is required, the designer will request this as additional survey information through the Engineer in the same manner as utility test pits.
5. To minimize the State's exposure to liability, requests by the designer for specific information concerning private utilities, will be handled by the Surveyor according to the following procedures:
  - a) Obtain right of entry if not previously obtained.
  - b) Include a letter of agreement with the private utility for the test pits.
  - c) Engage a contractor to expose the utility using the annual bids obtained by the Office of Maintenance for equipment rental.

- d) Submit a budget cleared purchase requisition to the Director of Purchasing for the work to be provided under "B" above.
- e) Upon issuance of a purchase order coordinate activities with the contractor for accurate location of the facilities in question.
- f) After the contractor has completed his work (exposed and reviewed the utility) arrangements will be made with the Office of Maintenance for any loaming and seeding required in order to return the site to its original condition.
- g) A complete listing of public and private utility companies and the names of the officials in charge of that area shall be submitted to the State, together with the completed survey.

## 8.6 Railroad

Most railroad surveys conducted for the Department support the design for a highway crossing. Depending on the requirements of the designer, the extent of the survey varies from full definition of all features within the railroad right-of-way to defining a short stretch of alignment.

### *Railroad Monumented Center Line*

The monumentation for the railroad monumented center line shall be researched, located in the field, coordinated and shown on the plan.

The railroad monuments shall be shown as an equality station showing both metric and English values. The English values shall conform to the railroad "VALUATION" maps.

If the railroad monuments are beyond the limits of the mapped area, then a sketch shall be shown on the plan depicting the railroad monumentation.

The stationing of the railroad monumented center line shall be shown in metric at 20 meter intervals, and be coincident with the record center line geometry.

The intersection of the base line and monumented railroad center line shall be located, coordinated, and the angle of intersection measured. The intersection of the base line station and railroad monumented center line station shall also be measured. This information shall be shown on the map.

However, there will be instances when, after the railroad monumented center line has been researched and field studies made, **NO** railroad monumentation will be found.

Efforts should be made in these instances to check the railroad "Valuation" maps very carefully to find areas where monumented railroad stations appear at culverts, bridges, or other areas in order that a tie-in can be made with the railroad monumented center line and the base line. Also, old highway mapping, property surveys, etc., may be of help in depicting the railroad monumented center line.

This is important for the railroad because it will enable them to orient the highway design with their mapping.

### *Mapping*

The cultural features, railroad alignment and track profiles shall be surveyed 500m beyond the anticipated project limit or as indicated by the Engineer.

The survey will consist mostly of breaklines representing such features as both tops of rail on all tracks - **shots to be taken at the gauge edge of rail** - edge of ballast, toe of slope of ballast, edge of sub-ballast, toe of slope of embankment. The individual shots comprising these strings are taken at about 20m intervals. Shots should be taken at shorter intervals on alignment curves and transitions, highway design area or in other areas of special interest.

Points of switch and points of frog are important in defining horizontal alignment and shall be located. (See Exhibit 19)

Other areas of concern to be located are all catenary towers, bridges, culverts, signals and signal boxes, whistle posts, old railroad right-of-way fencing, telegraph poles and numbers and all other cultural features within the right-of-way.

## **8.7 Hydraulic Data For Waterway Requirements**

The design of highway culverts and bridges is a complex undertaking involving the application of hydrologic/hydraulic principles in order to achieve a design which is safe, efficient and compatible with environmental concerns. The acquisition of hydraulic survey data is a key element in this process. The following are basic survey requirements for transportation facilities at stream crossing sites. More detailed requirements may be outlined by the designer on a site specific basis. These requirements shall apply to all culverts and bridges which are to be modified or replaced within two general categories, as noted.

### **A. Culverts and Bridges With Tributary Areas Less Than One (1) Square Mile (259 Ha)**

1. Topographic Plan - A topographic plan shall be prepared to indicate the relationship of the proposed or existing facility to the watercourse being

crossed. In addition to the channel (top and bottom of bank and edge of water) limits, islands, bars and significant localized obstructions should be identified. Further, cultural features must be indicated and ground and sill elevations must be provided for specific structures as requested by the designer.

The topographic plan scale may vary unless otherwise indicated; however, in all cases sufficient detail must be provided to allow the designer to conveniently scale distances from this plan. The limits of the required topographic data shall be indicated in the survey request from the originating unit.

2. Channel Profile - A channel profile is required within limits specified by the designer, both upstream and downstream of the culvert or bridge crossing. For this purpose, all distances should be referenced to the inlet or outlet face of the culvert, and should increase in the upstream or downstream direction, as appropriate. This profile should define the channel thalweg (deepest portion of the channel) and should indicate all existing drainage crossings within the limits of survey. Invert grades of existing culverts shall be determined to the nearest 5 millimeters.

A formal base line is generally not necessary for this profile as horizontal distances are measured along the center line of the stream. Scales may vary at the discretion of the survey unit unless otherwise noted.

3. Roadway Profile(s) - Roadway profiles are required at all highway/stream crossings within limits as specified by the designer. This information is necessary to define roadway overflow sections or to establish the "hydraulic control", or maximum allowable flooding elevation.

On roadways with normal crowns, the profile shall be taken along the center line. On superelevated sections, the profile should define the high side of the banked roadway. Bridge parapets, if present, shall be superimposed on the roadway profile. (Parapets are low walls, normally concrete, along the outermost edge of the roadway to protect vehicles and pedestrians). Since this wall may block a portion of flood flows which overtop the roadway, it is important that the top of wall elevation be identified. If a rail system rather than a parapet exists, the top of rail should also be determined. This is important because debris may accumulate at the rail system during overtopping events, effectively blocking the flow between the ground and the top of rail.

Additional roadway, driveway, railway or berm profiles within the hydraulic study limits may be required as requested by the designer.

4. Hydraulic Cross Sections - Limited channel cross section information upstream and/or downstream of the crossing site may be required by the designer in order to compute tailwater (downstream water surface) elevations or to aide in the design of channel transitions. The location, orientation and length of these sections shall be provided by the designer. All sections shall conform to the vertical datum to which the project is referenced. Scales may vary at the discretion of the survey unit.
5. Additional Information -
  - a) Culverts - the size, type and invert elevations of all culverts within the limits of hydraulic survey shall be determined. Culvert dimensions shall be indicated using the conversion chart presented in APPENDIX D of this manual, and the invert elevations shall be determined to the nearest 5 millimeters.
  - b) Bridges - The waterway opening dimensions shall be provided for both the inlet and outlet fasciae (bridge face). This information shall be provided as "elevation" views of the openings, drawn to a convenient scale with the underside (lowest deck member) elevations, top of footing elevations ( if visible) and stream channel elevations indicated, as appropriate.

**B. Culverts and Bridges With Tributary Areas Greater Than One (1) Square Mile (259 Ha)**

1. Topographic Plan - A topographic plan as described in Section 1 (8.7, A, 1) shall be required.
2. Hydraulic Cross Sections - Detailed water surface profile computations are required for culverts and bridges within this category. Normally, computer programs are employed for this purpose, and channel/flood plain cross sections comprise a significant portion of the necessary input data. The hydraulic designer shall provide information regarding the location, length and orientation of all hydraulic cross sections.

Hydraulic cross sections for detailed studies under this category must be referenced to the requested vertical datum and should be drawn to



a convenient scale. The nature or character of the ground cover across the section shall be identified with the associated limits noted and the vegetation line within the channel side slope, where clearly discernible, should be shown on each applicable section.

The location, orientation and length of the required hydraulic cross sections shall be indicated on a topographic plan, where feasible. Each cross section shall be labeled by an appropriate identifier and shall further be labeled as "looking upstream" or "looking downstream".

Cross section locations are normally specified with reference to a fixed stream location (Ex. "500' downstream of the downstream bridge face") and stringent horizontal control is generally not required. If a survey base line is established for the purpose of obtaining hydraulic cross sections, it shall be indicated on the topographic plan.

Typical hydraulic cross section locations for structures within this category are indicated on Figure 1, Exhibit 20, with associated descriptions on Exhibit 21. Figure 2, Exhibit 22, depicts typical hydraulic section orientation with respect to the channel and flood plain.

For selected coastal structures or structures with tidal influence, supplemental cross sections or fathometric mapping may be required. Specific coastal survey requirements will be requested on a site specific basis.

3. Roadway Profile - Roadway profiles as described in Section 1 (8.7, A, 3) shall be required.
4. Additional Information - Additional data as outlined in Section 1 (8.7, A, 5) shall be required.

## **9.0 FIELD CHECK AND INSPECTION**

### **9.1 Field Check**

After the 3D map has been completed, including the base line, if applicable and bench mark data, the Surveyor shall thoroughly field check the map and make such corrections or additions as may be necessary before the final submittal as a completed project.

This field check should be made at a time sufficiently in advance of the schedule completion date of the project, in order that all errors or omissions may be corrected and the project submitted to the State on or before the official completion date. All prints of the maps used during the field check shall be included with the final submission to the State.

## **9.2 Inspection**

The State reserves the right to inspect, review or check each field or office phase of the Surveyor's work to assure compliance with standards and policies established by the State.

## **9.3 Check List**

As a guide and ready reference to all concerned, there is included the following check list: (It is a guide only and is not intended to supersede any instruction previously given or included in this manual. Depending on the nature and extent of the survey, all these items may not appear on any single project).

### Check List For Plans

1. North Point (use correct symbol for grid, geodetic, magnetic or true north)
2. Bearings of base lines, center lines and control lines
3. Title on each end of rolled plans
4. Title block as depicted in the CONNDOT Existing Feature Cell Manual
5. Mapping is to be signed and sealed by a Connecticut Licensed Land Surveyor when survey is performed by other than the State.
6. Show three ties to center line or base line angle points, P.C.'s, P.I.'s, P.O.T.'s, P.T.'s and ties to control points on plans. Use standard conventions for plans, existing structures and topography.
7. Stations to center line or base line, P.C.'s, P.T.'s, P.O.T.'s, P.O.C.'s, etc. No stations of control line to be shown.
8. The points of curvature or tangency shall break the solid line with a small circle and the stationing and coordinates of these points shall be noted. The P.I.'s of curves shall be indicated by a small delta and the tangent lines between the P.I. and the P.C. and P.T. shall be depicted with a light dash line for a short distance on both sides of the P.I.

Curve data shall be noted and shall be placed on the inside of the curve. When a curve extends onto more than one sheet, the survey data shall be shown on each sheet.

9. Bench marks shall be described adjacent to the objects used with leaders to their locations. Distance between benches should be 250m or less, never over 250m and not greater than 15m difference in elevation.
10. Property owners' names and property lines shall be depicted on plans using N/F Convention (Now or Formerly)
11. Direction and flow of brooks, streams, culverts, sanitary and storm sewers should be designated with an arrow. Write out on plan -- brook, watercourse or ditch.
12. Size and type of culverts, storm and sanitary sewers or other utilities -- 450mm R.C.P., 450mm C.M.P., 450mm C.I.P., concrete box 1.22m high x 1.83m wide. Compare sizes on plan with profile and cross sections along with all related elevations of these structures when applicable. Measure Box Culverts to nearest 0.005m.
13. Pipe sizes and their metric equivalents shall conform to the International Standards Organization (ISO) usage of nominal pipe sizes for field identification purposes (See APPENDIX E)
14. Pipes under 4", professional rounding shall be utilized to describe nominal sizes to the nearest 25mm (i.e. 1" = 25mm, 2" = 50mm).
15. Ditches -- describe the type, earth - riprap - bituminous, etc.
16. Bridge sizes -- type and span, railing skew width, square width, clear height and overhead clearance, if applicable.
17. Label houses, house numbers, buildings, garages; i.e. 1-story frame house, cinder block garage, stores, apartments, gas station, parking lot, etc. Show ornamental trees and shrubs (size and type).
18. Type of drives and walks (gravel, bituminous concrete, trap rock, concrete, etc.).
19. Type of roads (concrete, gravel, surface treated gravel, bituminous macadam, surface treated macadam, bituminous concrete, armor coated gravel, etc.).
20. At beginning and end of map, show where to, back and ahead: to Hartford, to New Britain, etc.

21. Show all woods, cultivation, open fields, lawns, tent tobacco, etc.
22. Highway and street lines. When highway lines shown on plans are based upon Right of Way Maps, the file number of the Right of Way Map should be shown along the highway line; i.e. "See R.O.W. Map #76-24, Sheet 1 of 2". When highway lines are based upon construction plan for yet unbound roadways, the appropriate construction project shall be noted.
23. Ledge outcrops should be cross hatched on plans.
24. All utilities are to be shown on the plan (water mains, gas mains, sanitary sewers, electrical and telephone conduits, private lines, septic systems, etc.). Show elevation of all intersecting pipes for sanitary and storm sewer systems and the lowest wire of high tension lines.
25. Coordinates of control points, P.O.T.'s, P.C.'s, P.T.'s and P.I.'s shall be shown.
26. Specify type of catch basins; i.e. Type "C", "CG", "CL", etc.
27. Note type of Wire Rope Railing and Guide Railing, whether wood or metal; and also metal beam railing and type.
28. Houses and buildings having street numbers, must be recorded in the original survey notes and shown on the plans.
29. The limit of the Inland Wetland and Tidal Wetland shall be shown, with an appropriate note, specifying whether it is based on field delineation by a soil scientist or mapping.
30. Show Channel Encroachment Lines where established.
31. On all surveys, the stations must extend from west to east and south to north.
32. Where separated roadways are not parallel, individual base lines shall be established for each roadway.
33. The stationing of the base lines shall be continuous for each line from the point of separation from a single base line. Where the two base lines again merge to a single base line, the stationing of the longer shall be carried forward and an equality placed in the shorter base line at this point.
34. Whenever plans are forwarded to the Manager of Surveys for the approval of a survey base line, three sets shall be sent for the Designer. The recommended line shall appear on only two of the four plots.

35. Plans for traffic projects shall also include the location and type of all signs, traffic signals with electrical and support wires, location of all line striping and overhead wires.
36. Joints in concrete pavement shall be located and shown where evident or as required.

## **10.0 SURVEYING ACTIVITIES**

### **10.1 Policy Regarding Private Property**

It is important that surveys shall be performed observing the rights and concerns of the property owners. To this end the following instructions are issued.

Surveyors shall not enter private property without first advising the land owners of their purpose and intended activities. This shall be done whether or not the owner actually resides at the location of the work. The Surveyors shall explain the work requirements without committing the State in any respect to any fixed highway location or matters relating to right of way acquisition. Although the Statutes of the State of Connecticut give us the necessary right of entry, this statutory right should be used only as a last resort. The Statute reads as follows:

#### **GENERAL STATUTES OF CONNECTICUT CONNECTICUT HIGHWAY LAWS SECTION 13A-60**

**"ENTRY UPON PRIVATE PROPERTY IN ALTERING OF HIGHWAYS.** The Commissioner or his agent may enter upon private property for the purpose of conducting surveys, inspections or geological investigations for the location, relocation, construction or reconstruction of any proposed or existing highway. After giving reasonable notice to the property owner or owners affected, he or his agent may also enter private property for the purpose of conducting surveys, inspections, soundings or other tests required to accomplish any of the foregoing objectives with respect to such highways. He shall use care so that no unnecessary damage shall result, and the State shall pay damages to the owner of any property from appropriations made to the Department of Transportation for any damage or injury he causes such owner by such entrance and use. If entry to any property for the purpose of performing borings, soundings or other tests is refused to the Commissioner or his agent after he has given reasonable notice to the owner or owners thereof, the Commissioner shall assess damages in the manner provided by statute for the taking of land for highway purposes, and, at any time after such assessment has been made by said Commissioner, may enter said property for the purpose of performing borings, soundings or other tests. If the owner accepts such assessment of damages, he shall notify the Commissioner in writing, and said Commissioner shall pay such sum to said

owner within thirty days or after the expiration of said thirty days, shall pay such sum with interest at six per cent. If the owner is aggrieved by such assessment, he shall notify the Commissioner in writing and may appeal to any court within its jurisdiction for a reassessment of such damages within six months from the date said Commissioner forwarded such assessment to such owner. This section shall not limit or modify rights of entry upon property otherwise provided for by law."

Because of public hearings, newspaper items, etc., all property owners should be fully aware of the purposes of the State surveys. In spite of this, it has become necessary that all those engaged in surveying activities make sure that one of their representatives personally visits each owner and/or tenant and explains the above reasons for survey and have the property owner sign a Right of Entry Form. In the case of absent owner or owners who live in other sections of the country, it may be necessary that the notification be made by mail, which will include a Right of Entry Form and letter of explanation.

In cases where right of entry cannot be obtained by a surveyor, it is requested that this Department be notified before final action is taken under the above statute.

If the property owner gives verbal permission, but will not sign the Right of Entry letter, the agent shall complete the Right of Entry letter with the notation that only verbal permission was granted. This notation shall also contain the name of the representative who actually interviewed the owner and the date of the interview. A confirming letter shall be mailed to the property owner within 24 hours.

If there is no response by the property owner to the right of entry requests, either by personal visits or by mail, the agent shall, by certified mail, request permission for entry onto the property and shall enclose a Right of Entry letter to be signed and returned if permission should be given for such entry.

If permission is again refused, the Commissioner will then request the Attorney General to apply for a Court Order for the condemnation of property. This request to the Attorney General will be processed by the Legislative and Administrative Advisor on the basis of a complete report with sufficient documentation submitted to him through established channels of communication.

The Right of Entry Form Letter, to be furnished by the Central Survey Section, shall be signed by all property owners involved on a project. (See Exhibit 23) **On State projects being performed by Consulting Engineers, the return addressed envelope shall be that of the Consultant.**

### **Damage To Private Property**

1. Damage to any part of any property shall be minimized and wanton tree cutting

and brush damage shall not occur. Where brush cutting is necessary, the surveyors are not to leave stubble that can be dangerous to humans or animals. Particular care shall be exercised in the unsightly trimming of trees for sight line purposes and the slashing or blazing of shade trees for tie or bench mark purposes.

2. Where surveyors must leave stakes in mowing lots, they shall be either flush with the ground or evidenced by higher stakes to preclude mowing machine damage.
3. Of particular importance is the regard for farm fences and walls. Extensive damages have resulted from livestock being freed to roam on properties beyond their confines through "survey or made" breaks in the fences and walls.
4. For the information of all - It should be noted that eating wilted wild cherry is **fatal** to cattle. If it is necessary to cut branches from such trees, they shall not be left at any location reachable by livestock. The State has knowledge of several instances where the eating of wilted wild cherry has taken the lives of cattle.
5. Of no small importance is the parking of surveyors' cars and trucks. Blocking of drives or passageways shall not be done. Neither shall traffic on a traveled highway be obstructed. Lunch wrappers, newspapers and uneaten food are not to be scattered along the road or left as unsightly debris on property.
6. Lines for traverse closure which are not run out as part of the permanent control shall be located away from private property where possible.

"Brushing out" a line remote from anticipated highway locations is generally unnecessary, is also unexplainable to the owner of damaged property and, although sometimes is convenient, is not an acceptable practice in Connecticut.

Claims for damage to private property by survey forces shall be referred to **The Bureau of Finance and Administration, Office of Property and Facilities Services, Claims Division for processing.**

Practices other than those cited hereinbefore, which could place the State in disfavor with land owners, shall be avoided by all concerned.

All dealings with persons in the working area are to be handled in a diplomatic, friendly and courteous manner. Explain the survey in general terms. Remember base lines can be, and sometimes are, revised at the last minute. Do not answer specific questions concerning private properties. These **MUST** be answered by the Office of Rights of Way. Do not tell a person that a line might go through their house or that a portion of their land will be taken.

It is to be remembered that, whether by our units or contracting engineers, the surveys are being performed on behalf of the State and that all persons working in the field must conduct themselves accordingly.

*Surveyors are reminded that the State has reserved the right to have any person removed from the work who is found to be unsatisfactory for any reason. This prerogative will be exercised by the State with respect to any person on any project found to be acting contrary to the established policies of the Department of Transportation in their dealings with the public.*

## **10.2 RAILROAD REQUIREMENTS**

### **A. Railroad Procedures**

Procedures for survey activities on railroad property in advance of proposed work are as follows:

1. Railroad Liability Insurance
  - a) Obtained yearly by Central Surveys for in-house survey personnel
  - b) Obtained by Contracting Engineer for their personnel when working on State projects
2. Preliminary Engineering Agreement for survey work on AMTRAK railroad
  - a) Obtained through the Utility Section, Division of Design Services, Bureau of Engineering and Highway Operations
3. Railroad Permit
  - a) To be obtained by Surveyor from railroad prior to entering their Right of Way
4. Railroad Flag Person
  - a) To be obtained by Surveyor from Railroad prior to entering their Right of Way

The surveyor will be billed by the railroad for services of the flag man.



The named insured includes the following:

National Railroad Passenger Corporation (AMTRAK)  
Consolidated Rail Corporation (CONRAIL)  
Metro North Commuter Railroad Company  
Central Vermont Railway, Inc.  
Boston & Maine Corporation  
Providence & Worcester Railroad Company  
Connecticut Central Railroad, Inc.  
Connecticut Valley Railroad Company  
Springfield Terminal Railway Company  
Branford Steam Train

**B. Railroad Safety**

All surveying personnel, whether State Forces or Contracting Engineers, are required to attend a **CONTRACTOR'S SAFETY ORIENTATION CLASS** provided by AMTRAK and METRO-North prior to entering upon their respective property.

Railroads have strict rules concerning trespassers that allow their police to arrest violators.

The scheduling of railroad safety classes can be obtained by contacting the *Division of Safety, Office of Personnel, Bureau of Finance and Administration*, as outlined in a memorandum by John McGill, Director of Safety, dated May 3, 1994, regarding rail safety class (see Exhibit 24).

**All railroads require that all personnel working on railroad property be accompanied by a qualified railroad flag person.**

The Surveyor shall wear all protective clothing as outlined by the *Railroad's* and the *CONNDOT Railroad Safety Awareness Booklet* from the Bureau of Public Transportation, Office of Rail, i.e. hard hats, approved safety vests, safety glasses, safety shoes while on railroad property.

The old directive to wear *NQ* red vests on railroad right of way no longer applies.

AMTRAK requires the wearing of a fluorescent orange vest and 6" high safety shoes. METRO-NORTH requires an approved reflectorized vest.

AMTRAK requires hard hats - displaying their safety sticker - and safety glasses with side shields.

METRO-NORTH requires approved hard hats and safety glasses. Only company furnished safety eyewear may be used.

Other railroads generally accept the protective clothing and safety requirements established by AMTRAK and METRO-NORTH. However, a check should be made of their safety requirements when scheduling the railroad flag person.

**All railroads require a qualified railroad flag person to accompany all personnel working on their railroad property.**

**C. Surveying Equipment**

All Railroads -

Measuring tape must be non-metallic to avoid shunting the signal system electric circuits. This will occur when a metallic object is laid across the top of two rails of any track.

Metro-North -

Electrically rated fiber glass elevation rods are to be used to avoid injury in the event contact is made with energized catenary or signal/communication lines. Elevations of catenary wires must be obtained by, or under direct supervision of, a qualified Railroad "Class "A" groundsman.

**10.3 Cooperation With Others**

The surveyor shall cooperate with other Contracting Engineers, Department personnel, municipal agencies, public utility companies and others who are engaged in survey and/or mapping within or adjacent to the project. They shall provide for a mutual exchange of coordinate points, bench mark points or other data, and shall assist in a mutual adjustment of coordinate values or bench mark elevations as may be necessary at common terminal points.

**10.4 Historical Items**

Every effort shall be made to locate all historical buildings, with appropriate dates, historical and landmark trees, isolated graves, small cemeteries with only fieldstone markers, and other items of historical or commemorative importance.

## **10.5 Channel Encroachment Lines**

Channel encroachment lines shall be shown on all survey maps and property maps where such lines have been established by the Water Resources Commission.

## **10.6 Wetland Boundaries**

Wetland boundaries shall be shown on all location surveys within the project limits as identified by a soils scientist and field location by the surveyor.

## SECTION 2

# CONNECTICUT DEPARTMENT OF TRANSPORTATION STANDARDS FOR ELECTRONIC DATA COLLECTION

June 1997 Edition

## TABLE OF CONTENTS

<b>1.0 GENERAL SPECIFICATIONS</b>		<b>Page</b>
1.1	Introduction . . . . .	54
1.2	Surveyor's Responsibilities . . . . .	54
1.3	Materials to be Provided to the Surveyor by the State . . . . .	55
1.4	Materials to be Provided to the State by the Surveyor . . . . .	55
1.5	File Requirements . . . . .	57
<b>2.0 MAPPING AND DTM COMPILATION SPECIFICATIONS</b>		
2.1	Planimetric Mapping Production Techniques . . . . .	60
2.2	Topographic Mapping Production Techniques . . . . .	61
2.3	Mapping and DTM Feature Compilation . . . . .	64
	Compilation Instructions . . . . .	64
	Compilation Process Diagram . . . . .	65
2.4	Selected Feature Descriptions . . . . .	65
	Manuscript Data . . . . .	65
	Survey Control . . . . .	66
	Selected Transportation Features . . . . .	67
	Signs . . . . .	71
	Drainage . . . . .	71
	Structures . . . . .	73
	Terrain Features . . . . .	74

- APPENDIX A** - List of Acronyms
- APPENDIX B** - List of File Extensions
- APPENDIX C** - Glossary of Terms
- APPENDIX D** - Exhibits
- APPENDIX E** - Metric Standards
- APPENDIX F** - Graphic Element Definitions
- APPENDIX G** - DTM Compilation and Guide Alignment Diagrams
  - DTM File Break and Mapping Limit
  - Using Guide Alignments
  - Major Culvert and Retaining Wall
  - Curbing
  - Bridge Abutment and Bridge Deck
- APPENDIX H** - MSFC-Existing Highway Features

## SECTION 2

### CONNECTICUT DEPARTMENT OF TRANSPORTATION SPECIFICATIONS FOR ELECTRONIC SURVEYING

June 1997 Edition

#### Part 1

### 1.0 GENERAL SPECIFICATIONS

#### 1.1 INTRODUCTION

These SPECIFICATIONS set forth the standards to be met and the general procedures to be followed in the production of digital ground mapping for the Connecticut Department of Transportation (CONNDOT). As used in this document, digital ground mapping refers to the preparation of small scale, electronically collected engineering maps to be used on CONNDOT's CADD system for highway and structures design. This mapping may or may not require the generation of a surface model, and may be a combination of field survey and photogrammetric technologies.

The Individual Project Scope (IPS) provides specific details for each digital ground mapping project and should be used in conjunction with this document. SPECIFICATIONS in the IPS have precedence when different or in conflict with this document.

All digital ground mapping, both planimetric and topographic (including surface models), provided to CONNDOT must be delivered in the Microstation Design File format specified. The surveyor must have an Microstation system in-house or arrange for translation of the digital data in order to provide CONNDOT with Microstation Design Files as a final product. It should be noted that where reference is made to Microstation specific items, this refers to "Version 5 or as upgraded and in use by CONNDOT. See Section 2 (1.5)

#### 1.2 SURVEYORS RESPONSIBILITIES

It is the surveyor's responsibility to be familiar with all specifications and guidelines provided by CONNDOT and to follow them in performing work for CONNDOT.

It is the surveyor's responsibility to consult with CONNDOT to resolve all discrepancies and ambiguities between these SPECIFICATIONS and the IPS prior to proceeding with work on the project.

It is the surveyor's responsibility to provide all labor, materials, equipment and other incidentals necessary to perform the work. Each of these items are to be of uniformly high quality and compatible with the quality and accuracy standards specified for the project.

### **1.3 MATERIALS TO BE PROVIDED TO THE SURVEYOR BY CONNDOT**

The Individual Project Scope (IPS) for each project awarded to the surveyor will include the following:

- A.) A detailed list of products to be delivered.
- B.) A written description of the project area.
- C.) A Mapping Limits Diagram.
- D.) Special project requirements.
- E.) A hard copy of town index sheets showing the locations of horizontal and vertical control points upon request.  
(Digital, if available)
- F.) A hard copy of all individual data cards showing horizontal and vertical control points and a corresponding ASCII coordinate file upon request.  
(Digital, if available)
- G.) 3.5 inch floppy diskettes containing CONNDOT's Existing Features Cell Library, Seed Files, and User Commands for use by surveyors with Microstation upon request.

### **1.4 MATERIALS TO BE PROVIDED TO CONNDOT BY THE SURVEYOR**

**First Mapping Review** - Materials to be provided to assure that the data files from the surveyor are in the specified format and can be loaded into CONNDOT's Microstation system and to detect possible data errors before the completion of the digital ground mapping. These materials shall be delivered to CONNDOT within a specified period of time after receipt of the CONNDOT materials.

The surveyor shall provide either a 3.5 inch floppy diskette(s), (or CD ROM on a project specific basis with the approval of Central Surveys) in the specified Microstation Design File format containing the digital ground mapping file(s) for a predetermined

portion of the project. If a surface model is required, a paper plot of the surface model generated contours, breaklines, and individual x,y,z point locations shall also be provided.

Upon receipt of the above mentioned mapping file(s), CONNDOT will promptly and thoroughly review the digital ground mapping for specification compliance. Included in the mapping review will be an evaluation of working units, color usage, level placement, line code and line weight assignment, text placement and portrayal, usage of correct cell library as well as placement and rotation, portrayal of line junctures, line patterning or custom line codes, number of vertices, etc. as dictated in the Existing Features Cell Library and Manual.

Included in the surface model review will be an evaluation of level placement, portrayal of terrain surface, breakline portrayal, density of data, etc.

See Section 2 (1.5)

**The Surveyor shall always inspect any three dimensional file in the "front" and "isometric" views to look for errors in 3D line placement before submission to CONNDOT. The main objective here is to check for line connections to and from unrelated elevations.**

CONNDOT will notify the surveyor of the results of the review.

- If there are no problems, or if the problems are minor and can easily be corrected, the surveyor will be advised to proceed with the project.
- If significant problems in compiled mapping or translations are evident the surveyor will be notified to make the necessary corrections and submit the revised file(s). CONNDOT will review the revised file(s) and notify the surveyor to proceed if required corrections were properly accomplished.

**Completed Project Review** - Materials to be provided within the allotted production time for checking and review by Central Surveys.

- A.) 3.5 inch diskette(s) containing Microstation Design Files.  
See Section 2 (1.5)
- B.) A printout listing of all file names and file sizes (in bytes) for all submitted files. One set of both planimetric and topographic mapping plotted on paper in "slow curve" mode from the Microstation design files at the requested map scale. Unless otherwise specified, all levels within the design file shall be plotted. The plots shall reflect the line codes and line weights in the file. If a surface model is required, a paper plot of the surface model generated 0.5 m contours and a paper plot of the breaklines and the individual x,y,z point locations shall also be provided.



## 1.5 FILE REQUIREMENTS

### 3D Mapping Files (Planimetric and Topographic)

- A.) All files shall be on a standard 3.5 inch floppy diskette(s) or CD ROM, if previously approved. If files are compressed to conserve file space they must be received in a self-extracting format.
- B.) All files shall be provided in Microstation 3D design file format.
- C.) Files shall be compiled with coordinate values to the nearest thousandth (1/1000) of a meter. Coordinate values for all features shall be based on the grid system indicated by the control data. The working units for the Microstation design files which are to be submitted at a mapping scale of 1:500 shall be:

Master Units = 1 M  
Sub Units = 1000 MM  
Positional Units = 2

For mapping scales other than 1:500 see APPENDIX E

- D.) The global origin for the map files shall be in the center of the design plane. This will be accomplished automatically by using the appropriate CONNDOT seed file. There will be several seed files available thru CONNDOT, each of which will automatically set many of CONNDOT'S mandatory file settings. Even though not recommended by CONNDOT the Surveyor may desire to work outside of the Microstation environment while compiling survey data. The Surveyor must maintain the same standards set forth by CONNDOT with the final output being in Microstation format. The coordinates placed shall be based on the same coordinate system used for the control data.
- E.) All files shall be delivered at the proper plot/view rotation angle, rounded to the nearest full degree, and saved that way when submitted. Once rotation has been determined the view must be saved for future retrieval. This will be accomplished by using Microstation save view command and saving the view with the name "PLOT". The plot rotation angle shall also be recorded in the space provided below the title block.
- F.) It shall be the surveyor's responsibility to keep a backup of all files for a minimum of 90 days after final acceptance by CONNDOT.

### **3D Planimetric/Topographic Mapping Files (Cultural and Natural Features)**

- A.) CONNDOT will provide the surveyor with a diagram and/or description of required mapping file limits. If a surface model is required, the mapping file limits of both the *planimetric* and *topographic* areas shall be coincident unless otherwise specified.
- B.) Planimetric/Topographic mapping files shall be submitted to CONNDOT as 3 dimensional (3D) *graphic* design files.
- C.) Each 3D Planimetric/Topographic mapping file shall be identified within the supplied CONNDOT Title Block Cell. The surveyor shall be responsible for the placement of the information in the title block data fields. A sample title block showing placement of the data will also be provided. See APPENDIX D
- D.) Each 3D Planimetric/Topographic file shall be named in the appropriate data fields of the title block using logical file names generated by the Surveyor. The names will be a unique number/letter designation with a ".GRN" extension. (Example: 146X123A.GRN). The actual file name and the file name placed in the title block will be the same.

### **3D Topographic Surface Model Elements (Point elements, Breaklines, Void regions and Boundary areas, Triangulated irregular networks)**

- 1.) **Point elements** which represent the actual field locations depicted as three dimensional **Microstation Point Elements**. These point elements will be placed in the 3D Microstation design file which **graphically** depicts the x,y,z point locations. Elements of this type shall be placed in accordance with the **Existing Features Cell Manual**.
- 2.) **Breaklines** are the three dimensional **Microstation Line Elements**, placed in the 3D Microstation design file, which **graphically** control internal triangle construction within the surface model. Elements of this type shall be placed in accordance with the **Existing Features Cell Manual**.
- 3.) **Void Regions** are three dimensional **Microstation Close Shape Elements**, placed in the 3D Microstation design file, which are comprised of **graphic** point to point connections defining all areas in which *triangulation shall not occur* within the limits of the surface model. (e.g., Buildings, Lakes & Ponds, Dense Vegetation etc.) Elements of this type shall be placed in accordance with the **Existing Features Cell Manual**.
- 4.) **Boundary Areas** are three dimensional **Microstation Closed Shape**

**Elements**, placed in the 3D Microstation design file, which are constructed to restrict triangulation to within project limits. It is imperative that surfaces information is not generated in areas where actual survey data was not collected. This is accomplished by placing a **graphic** point to point closed shape connection just outside the *perimeter* of the limits of the survey. This boundary area feature is used to restrict triangulation to areas within the closed shape. Elements of this type shall be placed in accordance with the **Existing Features Cell Manual**.

- 5.) **Trianguled Irregular Networks** are the three dimensional *software generated Microstation Line Elements*, placed in the 3D Microstation design file, which **graphically** display the surface model. Elements of this type shall be generated in accordance with the **Existing Features Cell Manual**.
- D.) A separate 3D Planimetric/Topographic Mapping File must be generated for any **bridges** within a project area. The primary Planimetric/Topographic Mapping File will contain *bridge abutment* data while the secondary file will contain *bridge deck* data.
- E.) **3D Bridge deck files** will be named using a unique number/letter designation. The ".BDX" extension will be added to the appropriate 3D Planimetric/Topographic Mapping Files names. (Example:146X123A.BD1). Additional bridges corresponding to the same primary 3D Planimetric/Topographic Mapping File should be designated BD2, BD3, etc. Since CONNDOT does not require the surveyor to supply a processed surface model, the actual 3D Planimetric/Topographic bridge deck files shall conform with all primary 3D Planimetric/Topographic file requirements. (e.g., Point Elements, Breaklines, Boundary areas, and Void Regions as well as an ASCII coordinate file specific to each individual bridge deck.)

**Inquiries may be relayed to CONNDOT at the following address:**

**Office of Central Surveys  
Connecticut Department of Transportation  
2800 Berlin Turnpike  
P.O. Box 317546  
Newington, Ct. 06131  
(203) 594-2510**

## SECTION 2

### CONNECTICUT DEPARTMENT OF TRANSPORTATION SPECIFICATIONS FOR ELECTRONIC SURVEYING

June 1997 Edition

#### Part 2

### 2.0 PLANIMETRIC AND TOPOGRAPHIC MAPPING COMPILATION SPECIFICATIONS

#### 2.1 PLANIMETRIC MAPPING PRODUCTION TECHNIQUES

- A.) Features shall be of the following Microstation element types as appropriate: cell, line, line string, curve string, connected (complex) strings, linear patterns, simple shapes, complex shapes, ellipse (includes circles) and text string. See APPENDIX F
- B.) Features to be labeled and the labels to be used, shall be as described in the **Existing Features Cell Manual**. Labels shall be orientated along linear features or parallel to the map border and view rotation angle. Planimetric mapping project orientation shall conform to the **east to west** and/or **south to north** standard mapping conventions.
- C.) Road alignments shall be carefully compiled in **slow curve mode** and consist of curve strings and tangent line strings. Enough points should be located to assure smooth curves. All points must be individually located and connected in a point to point mode. In the case of digitized mapping Stream digitizing is not allowed.
- D.) Match marks on adjacent map file edges shall coincide exactly. Planimetric and topographic limits separating mapping files shall be delineated. Project beginning and ending points shall also be delineated.
- E.) Planimetric Detail
  - 1.) All mapping shall show required planimetric features in accordance with the Existing Features Cell Manual provided by CONNDOT.
  - 2.) Particular attention shall be given to include all transportation and

transportation-related features such as roads, railroads, bridges, canals, streams, dams, utilities and drainage, etc., as well as other features along transportation corridors.

- 3.) Features not readily identifiable or not included in the Existing Features Cell Manual shall be shown and symbolized with the most equivalent symbol, level and color along with its associated label.
  - 4.) The widths of roads and streets shall be shown as the separation between curb faces or hard surface edges, or stabilized shoulder lines as appropriate. Curb types shall be individually located and symbolized at both top and bottom of curb.
- F.) Coordinate grid ticks for design scale mapping shall be taken from the Existing Features Cell Library and placed at 100 meter intervals. Grid tick placement and annotation can be automated with the use of the CONNDOT supplied *grid.ucm* program. Grid ticks shall only be labeled outside of the mapping limits and omitted in congested areas. Show 2 rows of grid ticks above and 2 rows below the mapping limit if possible.
- G.) Each design file shall include one of the supplied title blocks placed outside the mapping area, preferably located in the lower right corner.  
See Section 2 (1.5)

## **2.2 TOPOGRAPHIC MAPPING PRODUCTION TECHNIQUES**

- A.) Topographic elements consist of three dimensional data measured along surface specific features in the form of lines along terrain changes; as well as individual x,y,z point locations elsewhere. The field collection of this data is similar in concept to taking profiles where features are collected longitudinally rather than cross sectionally. Topographic mapping elements delineate both terrain and cultural features.
- B.) Surface Models shall not be generated from contour or cross sectional data. However, cross sectional data may be used to densify an existing surface model.
- C.) All three dimensional terrain and cultural features will be identified with the following Microstation element types as appropriate: cell, line, point, line string, and curve string and complex shapes. See APPENDIX F

Guidelines for feature portrayal and their corresponding levels are provided in the Existing Features Cell Manual.

- D.) A **Mapping File Break** is required between specified mapping files to divide a project into manageable file sizes. The Surveyor must calculate a *Break Scheme* indicating where these breaks should occur. Mapping File Breaks must coincide with Mapping File Limits and be compiled as perfectly straight lines. See Section 2 (2.4, A)
- E.) The Surveyor must collect a regular density of measurements in order to depict the ground surface accurately. A guideline for the number of shots required is to think of a conventional cross section layout. Section lines would not exceed 10-15 meter intervals along the alignment, and the same is true of breakline surveying. This is not to say that a measurement will be taken only at every 10-15 meter interval, but that measurements should not exceed this length. The Surveyor is still required to pick up any notable surface breaks between these intervals. See APPENDIX G
- F.) Terrain and cultural features will be compiled using *breaklines*. Breaklines define the slope and direction of the terrain changes. They delineate and portray the seams in the surface, the places where adjacent areas of constant slope change. Examples of breaklines are ridge tops, ditch bottoms, top and bottom of road cuts, curb lines, road crowns etc. **Breaklines are not contour lines, as elevations usually vary along breaklines.**
- G.) Breaklines will be compiled as linear elements with 3D data points located as often as needed to accurately portray the feature or terrain being defined. They must include sufficient data points to accurately portray the feature in 3D, based on CONNDOT accuracy standards. All data points will be directly located. Additional software generated or interpolated points are not to be included.
- H.) The greatest attention to detail should be at transportation features. Areas farther away from these features require less detailed topographic mapping portrayal as noted below.
  - 1. **Transportation surfaces**

This category includes such features as paved and unpaved roads, shoulders, parking lots and driveways; as well as curbs, bridges, retaining walls and sidewalks etc. These features should be portrayed using breaklines. Individual x,y,z point locations should rarely be used in defining these features except in areas such as parking lots. Along straight segments breakline point locations should not exceed 10 m to 15 m apart. Along tightly curved segments, intersections and complex areas additional breakline data points should be located at an interval

appropriate to accurately model the surface. Additional points shall be located at road and driveway intersections to show crowns and dips. Superelevation along curves should also be delineated.

2.) **Engineered Surfaces / Drainage**

This category includes such features as roadway embankments, drainage ditches, water body edges such as channels and well defined water courses, lawns etc. within the mapping limits. Drainage ditches and water body edges should be defined using breaklines. Embankments, lawns and other areas within the mapping limits shall be defined with breaklines at the slope changes and with individual x,y,z point locations elsewhere. Data points along breaklines which parallel transportation surfaces should be taken at the same 10 m to 15 m interval. Data points along other breaklines should generally be between 15 m to 20 m apart unless additional intermediate x,y,z point locations are required to correctly model the surface. Individual x,y,z point locations should also be taken between 15 m and 20 m apart in a “grid like” fashion to densify the model. The regular pattern need not be an exact grid. The Surveyor must be sure to locate all minimum and maximum elevations of the specific ground features. (High and low points)

3.) **Other surfaces**

This includes hillsides, fields, wooded areas and brush areas where only the general contour of the ground is required. These areas should be compiled with breaklines at **significant** slope changes and with individual x,y,z point locations elsewhere. Individual x,y,z point locations should generally be between 10 m and 25 m apart taken in a “grid like” fashion to densify the model.. The regular pattern need not be an exact grid. The Surveyor must be sure to locate all minimum and maximum elevations of the specific ground features. (High and low points)

4.) It is the responsibility of the Surveyor to ensure that the accuracy of individual point measurements and the density of those measurements is appropriate for the type of surface and associated cultural features to achieve CONNDOT accuracy standards.

I.) In the primary mapping file the roadway should be shown up to the bridge deck lines. A separate supplemental mapping file must be produced for each bridge deck within a project area. This bridge deck file shall contain all transportation features plus two 3D File Break lines located at each end of the bridge decking. These File Break lines must be coincident with the corresponding File Break lines found in the primary surface file containing the associated abutments.

See Section 2 (2.4,C)

- J.) Vertical features, such as curbs or walls, are to be compiled as though the vertical faces were slightly canted. CONNDOT's mapping software cannot handle perfectly vertical surfaces.  
See Section 2 (2.4,C)
- K.) Areas where the Surveyor physically cannot obtain accurate ground information (dense vegetation, buildings, water bodies, etc.) are designated as *Void Areas*. Void areas will be delineated with a closed shape polygon as prescribed by the Existing Features Cell Manual. If these breaklines are defined by joining together separately compiled segments they must be converted into a Microstation Closed Shape Element.
- L.) The mapping files submitted shall contain the edited 3D breaklines and the individual x,y,z point location data, as well as a 3D graphic representation of the processed or triangulated surface files. The Surveyor will produce a surface model and generate 0.5 m contours unless otherwise specified. Void regions and Boundary areas shall be included in the mapping files. All mapping features should be properly edge matched (free of gaps and overlaps). Particular attention should be paid to the shape and interval of contours along the road surfaces, drainage and vertical features. All above feature will be placed in accordance with the Existing Features Cell Manual.

Review of the contours will be an important part of the Surveyor's edit. Final contours from the edited surface model data will be plotted and submitted to CONNDOT for review. These contours will aid in the checking the quality of the surface model.

## **2.3 PLANIMETRIC AND TOPOGRAPHIC MAPPING FEATURE COMPILATION**

### **A.) Introduction**

The compilation of planimetric and topographic mapping features shall follow the instructions in Section 2 (2.4). These feature descriptions are listed by general category then alphabetically within each category. Refer to Existing Features Cell Manual for additional planimetric mapping and topographic mapping feature compilation requirements).

### **B.) Data Collection Compiling Techniques**

The following categories, topographic, planimetric or both are used to classify



where a feature will reside. All features fall under one of the following three categories. For each item listed in the following *Feature Description* the category is noted. (See also, Existing Features Cell Manual)

**(Topographic Mapping)**

Features compiled in the (3D) topographic mapping, but not shown in the planimetric mapping file.

**(Planimetric Mapping)**

Features compiled in the (3D) planimetric mapping, but not shown in the topographic mapping file.

**(Topographic and Planimetric Mapping)**

Features compiled in (3D) topographic mapping as well as (3D) planimetric mapping.

## 2.4 SELECTED FEATURE DESCRIPTIONS

### A.) MANUSCRIPT DATA

The following features may be added without the aid of electronic data collection.

**Mapping File Break (Topographic/Planimetric Mapping)**

File breaks between mapping files will be compiled using a 3D line approximately perpendicular to the major alignment feature. (e.g. roadway, border, etc.) This 3D line should follow the contour of the ground in a cross sectional format. When the mapping is being viewed from the top, or plan view, this 3D line must be a **perfectly straight line** and coincide with the *mapping limit* as the coincident *file break*. Each mapping file break 3D line should be copied into the adjoining mapping file, at the same location, to ensure identical elevation interpolation at the junction of both files. All breaklines which are intersected by the File Breakline must be separated at that point and snapped (x,y,z) to the file breakline in each mapping file. See APPENDIX G

**Topographic Mapping Limit (Topographic Mapping)**

Usually the topographic mapping limit will coincide with the planimetric mapping limit. For projects that require only partial topographic mapping compilation, the limits of topographic mapping compilation must fall within the limits of the planimetric mapping. See APPENDIX G

**Grid (Planimetric Mapping)**

The grid should be based on the control data provided and may be based on the Connecticut State Plane Coordinate System or an assumed coordinate system. Show 50 mm long grid cross ticks at 200 mm intervals at the requested map scale. Label all ticks in non-congested areas with grid coordinates. The labels should be placed such that when the file is rotated to its final plotting position each label is above its corresponding cross tick member and the text is in the mostly upright position. Do not place ticks such that they will overlap ticks within, above, or below the mapping limits of an adjacent file. The *grid.ucm* program will automate this process.

**Grid North Arrow (Planimetric Mapping)**

Rotate the file to VI=TOP, then place arrow indicating grid north, along with its label, in a non congested area.

**Title Block (Topographic/Planimetric Mapping)**

Place the title block in each file, horizontal with respect to the plan border, in lower right corner whenever possible. Fill in the "enter data fields" with the appropriate information in the mapping file title block.

**Scale Bar (Planimetric Mapping)**

Place appropriate scale bar in each file.

**B.) SURVEY CONTROL (Topographic/Planimetric Mapping)**

Horizontal and vertical control points shall be shown as in Section 1 (3.0). All control points shall be shown both inside and outside the mapping limits.

**Baseline (Planimetric Mapping) [Shown only when requested]**

See Section 1 (7.0)

**Baseline Points (Planimetric Mapping) [Shown only when requested]**

Surveyed points for establishment of project baseline.

**Horizontal Control Point (Topographic/Planimetric Mapping)**

Surveyed point for horizontal ground control. Show point symbol and label only with the point number. Show coordinates in tie boxes and align label and symbol with grid.

**Vertical Control Point (Topographic/Planimetric Mapping)**

Surveyed point for vertical ground control. This is a project bench mark. Show elevation, datum, and brief description in the template supplied in the Existing

Features Cell Manual. Place a leader from the bench mark template to the actual point on the plan.

## C.) SELECTED TRANSPORTATION FEATURES

### **Bridges (Topographic/Planimetric Mapping)**

Planimetric Mapping - Structure, including supports or piers, erected over a depression or an obstruction such as water, highway, or roadway.

**Bridge Abutments** - Locate abutments and parapet concrete or steel surface at edge of bridge platform). Locate piers when possible and bridge deck or clear span as indicated below.

**Bridge Deck** - usually indicated by change of pavement or expansion joint. Locate as bridge deck when a change of pavement or an expansion joint is evident. If the bridge deck is not visible locate the clear span. Clear span is the distance between the inner faces of the abutments. Show using bridge deck symbology.

**Bridge Piers** - clear span supports. Locate piers whenever possible.

Stop edge-of-pavement (EOP) and shoulder delineation at bridge deck or clear span as appropriate. Continue all other symbology (e.g., railroad tracks, guide rails, curbs, paved gutters, etc.) across bridge when present.

Topographic Mapping - In the primary topographic mapping surface file the roadway shall be shown up to the bridge deck lines. Each bridge deck will be shown in a separate file.

### **Bridge Abutment (Topographic/Planimetric Mapping)**

Bridge abutments have vertical or near vertical faces and require a minimum of two breaklines to be defined properly. A breakline is required at both the top and bottom of the structure and they must be slightly offset. Breaklines are used to show the edge of the clear span and the tops and bottoms of the wing walls. Show all structures that are part of the abutment. Locate the top of the wall lines first and then offset the bottom lines of the wing walls, outward slightly, using a terrain breakline at grade. See APPENDIX G

### **Bridge Deck (Topographic/Planimetric Mapping)**

The bridge deck file shall contain all transportation features breaklines for each road centerline, travel lane, pavement edges, curbs, shoulders, sidewalks, etc.) between the first and last expansion joints. Each end of the deck file will consist of a breakline which is coincident with a breakline located in the primary Surface Model file. These limits of the bridge deck will be along expansion joints or visible change of pavement at the outer edges of the bridge abutment. Locate all roadway features between the expansion joints, snapping to the two end breaklines. Each deck line must have a vertices at the intersection of all breaklines delineating other features such as pavement edges, shoulders, road centerline, etc.) to edge match properly. See APPENDIX G

### **Curb (Granite or Concrete) - (Planimetric and Topographic Mapping)**

Planimetric Mapping - Raised edging along a paved road defining the edge of pavement or outlining traffic islands (e.g. raised median). Show curb at all paved driveways where the curb is seen to continue through the drive without any appreciable height. Use edge of pavement symbology where curb stops at a drive and continues on the other side of drive. Curb symbology takes precedence over sidewalk and paved or unpaved drive/parking lot symbology when the features coincide.

Topographic Mapping - Curbs shall be located as two nearly parallel breaklines portraying the face of the curb. Locate the bottom line first then offset the top line away from the road slightly using a terrain breakline. (See APPENDIX G) Points should be measured at least every 15 m in a regular pattern. Additional points must be taken along curves and at intersections. The two breaklines must not overlap. Curbs at grade and handicapped sidewalk ramps can be shown by flaring the top-of-curb breakline into the bottom-of-curb breakline. Computer generated parallel lines are not to be used to generate tops or bottoms of curbs.

### **Paved Road (Planimetric and Topographic Mapping)**

Planimetric Mapping - Defined by the edge of pavement or the area between gutter lines. Where the edge of pavement changes between the surface types line work should reflect these changes. If the road appears to be straight, the EOP should be compiled as lines or line strings. If the road does not appear to be straight, the edge of pavement should be compiled as curves or curve strings, taking enough vertices to insure a smooth curve. Add road names from available source material.

Topographic Mapping - Use breaklines to locate the edge of pavement line. Breaklines should also be compiled along the road centerline and between each travel lane. Points should be measured at least every 15 m in a regular pattern with additional intermediate locations when required (such as dips and high points). Additional locations must also be taken along curves and at intersections.

### **Railroad (Planimetric and Topographic Mapping)**

Planimetric Mapping - Show all rail lines. Show all sidings tracks for passing, storage, etc., multiple lines and all rail yard tracks. Add railroad names from available source material.

Topographic Mapping - Railroads will be shown by locating the railroad bed itself as well as the ties. A minimum of six breaklines will be required. The first two will be along each rail. The next two will be along the top outside edges of the railroad tie and the last two will be along each side of the bottom outside edges of the railroad ties where it meets the ballast. Paved road features take precedence over railroad features with the exception of the rails themselves. Snap all railroad breaklines to the paved road edge with the exception of the breaklines defining the rails.

### **Retaining Wall (Planimetric and Topographic Mapping)**

Planimetric Mapping - Fixed structure of concrete, brick, stone, etc. retaining earth.

Topographic Mapping - Retaining walls shall be located with breaklines in a similar technique to other vertical features. First locate the top front and back of the retaining wall in its true horizontal location. Then locate the bottom of the wall as two breaklines slightly offset outward from the top two breaklines.

### **Road Centerline (Topographic Mapping only)**

Topographic Mapping - Road centerlines are located with breaklines at the pavement joint or road crown. In addition, a breakline should be located between each travel lane for all multi-lane highways. Points should be measured at least every 15 m in a regular pattern with additional intermediate shots taken as required.

### **Unpaved Road (Planimetric and Topographic Mapping)**

Planimetric Mapping - Dirt or gravel road maintained as a thoroughfare, usually found in rural areas. Define by edge of graded surface when visible. If not visible, or the surface is not graded, define by outside edges of travel way as indicated by tire wear. Use edge of grass where travel way is indistinguishable. At intersection with paved road, end unpaved road symbology at paved shoulder.

Topographic Mapping - Locate each side of the roadway with a breakline. In addition, a breakline should be compiled at the crown of the road. Points should be measured at least every 15 m in a regular pattern. Additional intermediate points must be taken along curves and at intersections.

### **Gas Island (Planimetric and Topographic Mapping)**

Planimetric Mapping - Raised and curbed concrete pad for gas pumps. Plot pumps, gas island, roof and light poles.

Topographic Mapping - Curb is located with two nearly parallel breaklines. Compile curbs as two separate breaklines along the top and bottom of the curb face. Locate the bottom breakline first. Offset the top breakline slightly to the interior of the island.

### **Paved Shoulder (Planimetric and Topographic Mapping)**

Planimetric Mapping - Pavement extending beyond the normal travel lanes.

Topographic Mapping - Locate the shoulder edge with breaklines when the shoulder extends beyond the normal travel lanes. Points should be taken at least every 15 m in a regular pattern. Add supplemental points where necessary to portray the contour of the shoulder taking points along the feature at changes in elevation and at intersections with driveways, catch basins, and sidewalks. At the intersection of the shoulder and a driveway, a terrain breakline should be added between the driveway flares. Terrain breaklines will not appear in planimetric mapping.

### **Sidewalk (Planimetric and Topographic Mapping)**

Planimetric Mapping - Show all walks, whether public and parallel to the road, or private and leading from road to house, or located adjacent to a building. Continue sidewalk delineation through drive only if it is a different pavement

type. Sidewalk symbology takes precedence over unpaved drive symbology when features coincide.

Topographic Mapping - When the sidewalk parallels the road, measure points at least every 15 m in a regular pattern. Additional points must be taken along curves and at corners. Other sidewalks, which are not parallel to the road, should be measured along the feature locating all changes in direction to accurately portray the walkways' extent and contour.

#### D.) SIGNS

##### **Billboard (Planimetric Mapping only)**

Plot centers of supporting posts with post symbol. Locate sign face with single line tangent to the post symbols.

##### **Overhead Sign (Planimetric Mapping only)**

Traffic sign supported by one, two or four poles over a highway. Plot centers of supporting poles with pole symbol. Locate horizontal support structure and identify location of sign faces. Manually draw sign faces if they exist on both sides of the support structure.

#### E.) DRAINAGE

##### **Catch Basin or Field Inlet (Planimetric and Topographic Mapping)**

Planimetric Mapping - Plot location of drainage grating. Catch basins along straight line curb segments should be parallel to the curb face and not be at off angles to the curb. Corners of catch basins should be snapped to straight line segments of curb or edge of pavement. Annotation should be placed near catch basin and off road surface if possible.

Topographic Mapping - Locate rectangular or circular drainage inlets in parking lots, along the sides of roads and at intersections. Catch basins represent a local depression in respect to the surrounding features. Locate curbed catch basins on the grate at the gutter line (throat) and all other basins at the center of the grate.

##### **Culvert (Planimetric and Topographic Mapping)**

Planimetric Mapping - Conduit for channeling water under a road, drive, or railroad embankment.

**Major Culvert** - Concrete structure. Locate concrete head walls, wing walls, and other visible structures to scale. Use cell for delineating culvert end sections.

**Minor Culvert** - Pipe culvert without concrete structures.

Small - culvert at drive. Plot location.

Large - culvert under road or railroad embankment. Plot location.

Topographic Mapping See APPENDIX G

**Major Culvert** - Concrete culverts and head walls should be located with two to four breaklines in a manner similar to bridge abutments. Locate the top edges (top back and top front) of the head wall first. The bottom face of the concrete walls should be measured along the ground using the top face of the head wall as a horizontal guide, offsetting the bottom breakline outward slightly. Snap all ditch lines to the culvert.

**Minor Culvert** - For pipe culverts and end sections caution must be used when collecting information about the flow line or outlet channel. When the outlet pipe is physically above the ground, the flow line elevation cannot be included in the surface model compilation or it will alter the appearance of the existing ground. This elevation will be important to design and must be separated from the surface model data by whatever means are available and shown with other drainage information. Also, locate the outlet channel and snap all ditch lines to the culvert.

### **Ditch (Planimetric and Topographic Mapping)**

Planimetric Mapping - Man-made channel for drainage. Each top edge of the ditch must be located using the "ditch" feature.

Topographic Mapping - Each top edge of the ditch located for planimetric display will act as a breakline in the topographic mapping. Locate length, depth and breadth of the drainage channel (regardless of width) with multiple terrain breaklines, as appropriate, to define the feature extent. Ditches with a "U" shape will have four or more breaklines and ditches with a "V" shape will have three breaklines. If water is present, the edge of water should be depicted with a "stream" breakline. Ditch points should be located at least every 15 m in a regular pattern.



### **Trench Grate (Planimetric and Topographic Mapping)**

Planimetric Mapping - Long grate in pavement for drainage (e.g., at bridges, driveways or parking lot entrances).

Topographic Mapping - Compile a breakline that clearly defines the corners of the grate taking points at each corner whether or not they appear to be visibly lower than the surrounding terrain.

### **Bituminous and Earth Leak offs (Planimetric and Topographic Mapping)**

Planimetric Mapping - Bituminous or earth channel for road water runoff. Locate outer edges of the leak off using the proper feature.

Topographic Mapping - Leak offs should be located at least every 15 m in a regular pattern. Additional points must be measured along curves and at corners. The trough of the leak off should be shown with one or more terrain breaklines running longitudinally.

## **F.) STRUCTURES**

### **Building (Planimetric and Topographic Mapping)**

Planimetric Mapping - Structures including dwellings, businesses, houses, garages, barns, etc. Locate building, including covered porches and attached structures. Make all near orthogonal corners square. Locate carports, decks, patios, stairs, etc. as part of structure. Building symbology takes precedence over other symbology when features coincide.

Topographic Mapping - Locate the building extent with breaklines measured along the ground. Locate the ground surface at the base of the building including all attached structures (e.g. porches, decks, loading docks, etc.). The breakline must follow ground contours as well defining the building outline. A single spot shot depicting the sill elevation may also be required.

### **Fence (Planimetric and Topographic Mapping)**

Planimetric Mapping - Locate feature, joining cleanly to other structures if appropriate. Do not show temporary snow fences. Locate gates as found in field and do not annotate them.

Topographic Mapping - It is important to follow ground breaks when collecting fence data as it will be used for compiling the Surface Model as well as for plotting purposes.

**Rip Rap (Planimetric Mapping only)**

Rock piled along a stream, shoreline or road to lessen erosion. Locate outline and add rip rap symbols.

**Stone Wall (Planimetric and Topographic Mapping)**

Planimetric Mapping - Loose rock wall, not retaining earth, usually located in farm fields or residential areas. Locate feature, joining cleanly to other structures if appropriate.

Topographic Mapping - Show loose stone walls with four breaklines. A "stonewall" breakline to define the top front face along with a terrain breakline to define the top back edge. Additionally, two terrain breaklines offset outwardly, will be used to define the bottom where it meets the ground. Locate the general form of the wall, including angle points, in a regular pattern.

**G.) TERRAIN FEATURES**

**Void Regions (Planimetric and Topographic Mapping)**

A void region is an irregularly shaped polygon inside of which precise and accurate vertical data cannot be measured within CONNDOT specifications. The void region limit is located with a breakline accurately representing the feature and ground surface at the edge of the undefinable area. This breakline must be a single line string closing onto itself as prescribed by the Existing Features Cell Manual.

**Terrain Breakline (Topographic Mapping only)**

Terrain breaklines may be isolated segments, closed figures or polygons used to locate any visual change in slope or aspect of a feature. They can be used to show feature forms and changes, general ground surface as well as other 3D mapping features. Terrain breaklines are needed at the tops and bottoms of cliffs, at the top and toe of slope, and in any area where breakline information is required but is not be displayed in the mapping. The ends of breaklines should be snapped (x,y,z) to vertices on other breaklines, where appropriate,

and may change direction as often as needed. Terrain breaklines can **never cross** one another. A node, with one common elevation, must be generated at the junction of the two breaklines where they can be joined together at a single point. Stream digitizing is not allowed. Breaklines should be compiled with sufficient 3D data points to meet accuracy standards. Data points along breaklines should never exceed 15 m apart. Tight curves, such as at curb corners, will require additional data points. (See APPENDIX G)

**APPENDIX A**

**Connecticut  
Department of Transportation**

**LIST OF ACRONYMS**

ASCII ..... AMERICAN STANDARD CODE FOR INFO. INTERCHANGE  
CADD ..... COMPUTER AIDED DRAFTING AND DESIGN  
CGS ..... CONNECTICUT GEODETIC SURVEYS  
DGN ..... MICROSTATION DESIGN FILE DEFAULT EXTENSION  
DTM ..... DIGITAL TERRAIN MODEL  
DXF ..... DATA TRANSFER FILE  
EDM ..... ELECTRONIC DISTANCE METER  
FGCC ..... FEDERAL GEODETIC CONTROL COMITY  
GPS ..... GLOBAL POSITIONING SYSTEM  
HARN ..... HIGH ACCURACY REFERENCE NETWORK  
HI ..... HEIGHT OF INSTRUMENT  
HT ..... HEIGHT OF TARGET  
IPS ..... INDIVIDUAL PROJECT SCOPE  
NAD27 ..... NORTH AMERICAN DATUM OF 1927  
NAD83 ..... NORTH AMERICAN DATUM OF 1983  
NGS ..... NATIONAL GEODETIC SURVEY  
NGVD29 ..... NATIONAL GEODETIC VERTICAL DATUM 1929  
NAVD88 ..... NORTH AMERICAN VERTICAL DATUM 1988  
ROW ..... RIGHTS OF WAY  
TIN ..... TRIANGULATION IRREGULAR NETWORK  
USE ..... UNITED STATES CORP OF ENGINEERS  
VLBI ..... VERY LINE BASELINE INTERFEROMETRY

**APPENDIX B**

**Connecticut  
Department of Transportation**

**LIST OF FILE EXTENSIONS**

CROSS SECTIONS .....	.XSC
SURFACE MODELING BRIDGE DECK FILES .....	.BDX
TOPOGRAPHIC/PLANIMETRIC MAPPING FILE .....	.GRN

### EXAMPLES AND DESCRIPTIONS

#### CROSS SECTION FILES:

EX. 999999AA.XSC

DESCRIPTION: These files are two dimensional Microstation Design Files and are usually generated automatically with the aid of a software package. These software packages require the construction of a surface model as a basis for cutting sections.

#### SURFACE MODELING BRIDGE DECK FILES:

EX. 999999AA.BD1

EX. 999999AA.BD2

DESCRIPTION: These files are topographic, three dimensional Microstation Design Files, which represent bridge decking only. The bridge deck areas are separated from the bridge abutments to eliminate the surface modeling dilemma which occurs if two surfaces overlap.

#### TOPOGRAPHIC/PLANIMETRIC MAPPING FILES:

EX. 999999AA.GRN

DESCRIPTION: These files are three dimensional Microstation Design Files which depict horizontal as well as verticle positions of the features represented. The natural features found in this type of mapping usually include rivers, lakes and seas; mountains, valleys, plains; and forests, prairies, marshes and deserts. The cultural features include cities, farms, transportation routes, and public-utility facilities; and political and private boundary lines.

**APPENDIX C**

**Connecticut  
Department of Transportation**

**GLOSSARY OF TERMS**



**Azimuth:**

The horizontal angle reckoned clockwise from the meridian -- from north in highway surveying.

**Backsight:**

The reference point from which horizontal angles are measured.

**Benchmark:**

The specific case of a vertical control point.

**Boundary Area Elements:**

A three dimensional Microstation Closed Shape Element which defines the field location limits. This feature is used to restrict triangulation to the area within the closed shape and prevent association between points which have no relation. Elements

of this type shall be placed in accordance with the Existing Features Cell Manual.

**Breaklines:**

The three dimensional graphic line elements which control and/or restrict triangulation during the processing of the surface model.

**Channel Limits:**

Top and bottom of bank as well as the edge of water.

**Contour Line:**

An imaginary line connecting the points on a land surface which have the same elevation; also, the line representing this feature on a map.

**Cultural Features:**

Man made structures e.g. (Roads, Buildings, Culverts, etc.)

**Data Collector:**

Portable computer, usually size to fit in one hand, that automatically records observations made with a total station.

**Direct (Face 1):**

Refers to the total station with its telescope in the normal orientation relative to the supporting instruments trunnions.

**Discrete Points:**

Additional individual x,y,z field locations used to densify the surface model.

**Design File:**

Refers to CADD File Format produced by the Microstation software products.

**Electronic Distance Meter (EDM):**

A device which measures reflected microwaves to accurately calculate distances.

**Elevation:**

Orthometric height. The height of a station above the geoid measure along the plumb line.

**Ellipsoid:**

A simple mathematical surface which best approximates the shape of the earth. It is the surface generated by an ellipse revolving about its minor axis which can be considered to be the polar axis of the earth.

**Ellipsoid Height:**

The height of the station above the ellipsoid surface defining the reference datum.

**Electronic Field book:**

The term referring to the raw survey data received by the electronic data collector.

**Face 1:**

(See Direct)

**Face 2:**

(See Reverse)

**Facia:**

Refers to the bridge face.

**Foresight:**

The station or location to which a horizontal angle (relative to the backsight), zenith angle, and distance are measured.

**GPS:**

Global Positioning System. A surveying technology using specialized radio receivers tuned to signals from military navigation satellites to position survey stations.

**HARN:**

High Accuracy Reference Network. This is a single horizontal network of GPS and VLBI stations based on the new continental network established by NGS.

**HI:**

Height of Instrument. The vertical distance from the station mark to the center of the trunnion axis of the total station or level.

**HT:**

Height of Target. The vertical distance from the station mark, or the ground, to the center of the object being sighted with the total station.

**Individual Point Locations:**

Any number of separate x,y,z point locations used to densify the surface model.

**NAD 27:**

North American Datum of 1927. Horizontal reference datum.

**NAD 83:**

North American Datum of 1983. Horizontal reference datum which superseded NAD 27.

**NAVD 29:**

National Geodetic Vertical Datum of 1929. Vertical reference datum.

**NAVD 88:**

North American Vertical Datum of 1988. Vertical reference datum which superseded NGVD 1929.

**Void Region Format:**

The three dimensional Microstation Close Shape Elements which defines areas in which triangulation should not occur within the limits of the surface model. (e.g., Buildings, Lakes & Ponds, Dense Vegetation etc.) Elements of this type shall be placed in accordance with the Existing Features Cell Manual.

**Photogrammetry:**

A procedure by which accurate maps and three dimensional surface models are made from aerial photographs.

**Position:**

The coordinates, in a horizontal reference system, of station mark or feature. Latitude and longitude, and northing and easting are examples of position coordinates in systems use in surveying.

**Point Element:**

The three dimensional graphical representation of an x,y,z field location.

**Reverse (Face 2):**

The telescope of the total station is "upside down" from its normal position relative to the supporting instruments trunnions.

**ROW:**

Right-of-Way. The strip of land around a state highway granted as easement or fee to the State and managed by DOT.

**Surface Model:**

A three dimensional mathematical and/or graphic representation which attempts to depict the existing ground through a series of triangular connections.  
(Also known as: DTM - Digital Terrain Model, TIN - Triangulation Irregular Network)

**Thalweg:**

The line following the lowest part of a channel or river, whether under water or not.

**Total Station:**

An electronic surveying instrument that combines angle and distance measuring capabilities in a single instrument.

**VLBI:**

Very Long Baseline Interferometry. The fundamental techniques and stations upon which the latest intercontinental horizontal and HARN networks are based.

**Zenith Angle:**

The angle, measured in a vertical plane, between straight up (zero) and the target of observation. Horizontal is, therefore,  $90^\circ$ .

**APPENDIX D**

**Connecticut  
Department of Transportation**

**EXHIBITS**

## **EXHIBITS**

<b><u>List of Exhibits</u></b>	<b><u>Exhibit No.</u></b>
CONNDOT Engineering District Map . . . . .	1
Town Listing By Districts . . . . .	2
Commissioner's CADD Policy Statement No. . . . .	3
Typical Total Station Observation Sheet . . . . .	4
Typical Procedure for a Calibrated Base Line . . . . .	5
Form for Electronic Distant Measurements on a Calibrated Base Line . . . . .	6
Form for Angle Measurements on a Calibrated Base Line . . . . .	7
GPS Obstruction Sheet . . . . .	8
Typical Three-Wire Leveling Notes . . . . .	9 - 10
Trigonometric Leveling Observations . . . . .	11 - 12
Form No. CGS 9 - Mean Junction Sheet . . . . .	13 - 14
Circular Curve Data . . . . .	15
Vertical Curve Data . . . . .	16
Test Pit Form . . . . .	17
Reimbursement Percentages by State to Utility Company Chart . . . . .	18
Railroad Turnout (Point of Switch & Frog) . . . . .	19
Hydraulic Surveys . . . . .	20 - 22
Sample Right of Entry Form Letter . . . . .	23
Rail Safety Class Memorandum . . . . .	24
Example of Title Block "Data Field" Entry . . . . .	25
Example of Field Edit Delineation . . . . .	26
Example of Standardized Sewer Labeling . . . . .	27

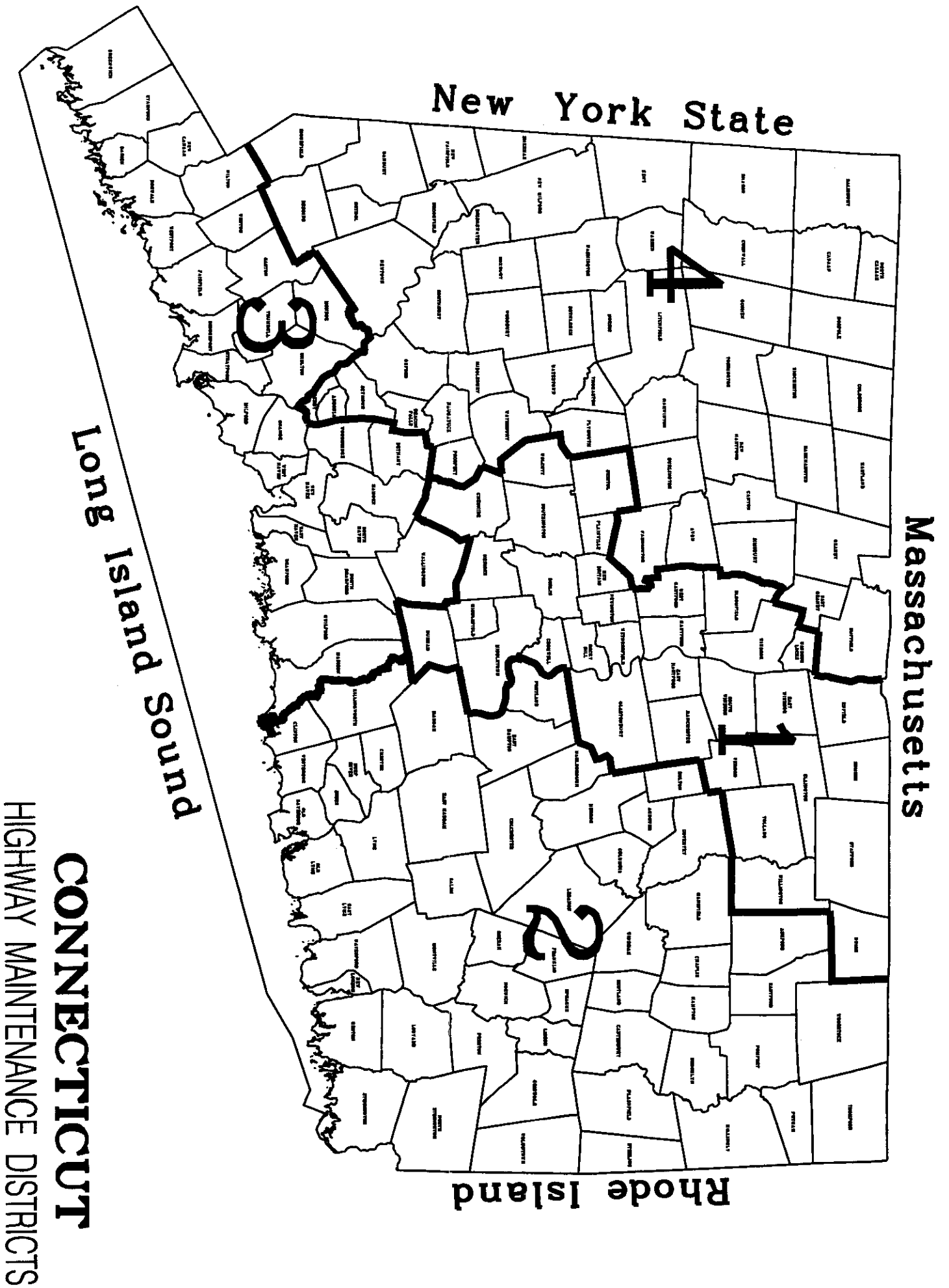

New York State

Massachusetts

Rhode Island

Long Island Sound

CONNECTICUT

HIGHWAY MAINTENANCE DISTRICTS

**LISTING OF TOWNS BY DISTRICTS  
AS OF JANUARY 1996**

<u>DISTRICT 1</u> <u>ROCKY HILL</u> <u>UNIT 601</u>	<u>DISTRICT 2</u> <u>NORWICH</u> <u>UNIT 701</u>	<u>DISTRICT 3</u> <u>NEW HAVEN</u> <u>UNIT 801</u>	<u>DISTRICT 4</u> <u>THOMASTON</u> <u>UNIT 901</u>
7 BERLIN	1 ANDOVER	8 BETHANY	2 ANSONIA
11 BLOOMFIELD	3 ASHFORD	14 BRANFORD	4 AVON
17 BRISTOL	12 BOLTON	15 BRIDGEPORT	5 BARKHAMSTED
25 CHESHIRE	13 BOZRAH	35 DARIEN	6 BEACON FALLS
33 CROMWELL	19 BROOKLYN	43 EAST HAVEN	9 BETHEL
37 DURHAM	22 CANTERBURY	45 EASTON	10 BETHLEHEM
42 EAST HARTFORD	24 CHAPLIN	50 FAIRFIELD	16 BRIDGEWATER
46 EAST WINDSOR	26 CHESTER	56 GREENWICH	18 BROOKFIELD
47 ELLINGTON	27 CLINTON	59 GUILFORD	20 BURLINGTON
48 ENFIELD	28 COLCHESTER	61 HAMDEN	21 CANAAN
53 GLASTONBURY	30 COLUMBIA	75 MADISON	23 CANTON
63 HARTFORD	32 COVENTRY	83 MILFORD	29 COLEBROOK
76 MANCHESTER	38 EASTFORD	84 MONROE	31 CORNWALL
79 MERIDEN	40 EAST HADDAM	89 NEW CANAAN	34 DANBURY
81 MIDDLEFIELD	41 EAST HAMPTON	92 NEW HAVEN	36 DERBY
82 MIDDLETOWN	44 EAST LYME	98 NORTH BRANFORD	39 EAST GRANBY
88 NEW BRITAIN	49 ESSEX	100 NORTH HAVEN	51 FARMINGTON
93 NEWINGTON	52 FRANKLIN	102 NORWALK	54 GOSHEN
109 PLAINVILLE	57 GRISWOLD	106 ORANGE	55 GRANBY
118 ROCKY HILL	58 GROTON	126 SHELTON	64 HARTLAND
129 SOMERS	60 HADDAM	135 STAMFORD	65 HARWINTON
131 SOUTHINGTON	62 HAMPTON	138 STRATFORD	67 KENT
132 SOUTH WINDSOR	66 HEBRON	144 TRUMBULL	73 LITCHFIELD
134 STAFFORD	68 KILLINGLY	148 WALLINGFORD	80 MIDDLEBURY
142 TOLLAND	69 KILLINGWORTH	156 WEST HAVEN	86 MORRIS
145 UNION	70 LEBANON	157 WESTON	87 NAUGATUCK
146 VERNON	71 LEDYARD	158 WESTPORT	90 NEW FAIRFIELD
155 WEST HARTFORD	72 LISBON	161 WILTON	91 NEW HARTFORD
159 WETHERSFIELD	74 LYME	167 WOODBRIDGE	95 NEW MILFORD
160 WILLINGTON	77 MANSFIELD		96 NEWTOWN
164 WINDSOR	78 MARLBOROUGH		97 NORFOLK
165 WINDSOR LOCKS	85 MONTVILLE		99 NORTH CANAAN
166 WOLCOTT	94 NEW LONDON		107 OXFORD
	101 NORTH STONINGTON		110 PLYMOUTH
	103 NORWICH		114 PROSPECT
	104 OLD LYME		116 REDDING
	105 OLD SAYBROOK		117 RIDGEFIELD
	108 PLAINFIELD		119 ROXBURY
	111 POMFRET		121 SALISBURY
	112 PORTLAND		124 SEYMOUR
	113 PRESTON		125 SHARON
	115 PUTNAM		127 SHERMAN
	120 SALEM		128 SIMSBURY
	122 DEEP RIVER (SAYBROOK)		130 SOUTHBURY
	123 SCOTLAND		139 SUFFIELD
	133 SPRAGUE		140 THOMASTON
	136 STERLING		143 TORRINGTON
	137 STONINGTON		149 WARREN
	141 THOMPSON		150 WASHINGTON
	147 VOLUNTOWN		151 WATERBURY
	152 WATERFORD		153 WATERTOWN
	154 WESTBROOK		162 WINCHESTER
	163 WINDHAM		168 WOODBURY
	169 WOODSTOCK		



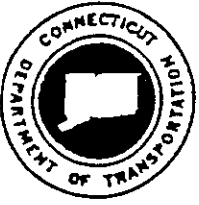

CONNECTICUT DEPARTMENT OF TRANSPORTATION  
POLICY STATEMENT

POLICY NO. ADMIN-24

March 16, 1993

SUBJECT: Computer Aided Design and Drafting Standardization

It is the policy of this Department to adopt the "Intergraph file format as implemented by the Connecticut Department of Transportation" as the standard for all of its CADD/Graphic related functions. All future assignments are to be performed utilizing this technology. Exceptions to this directive will only be given at the discretion of the Deputy Commissioner, Bureau of Finance and Administration. This will assure that the Department achieves a total quality effort in its development of a Department-wide Geographic Information System. It should be emphasized that this standardization applies for the Department's entire business needs, whether performed by in-house staff or by consultants retained by the Department.

A handwritten signature in black ink, appearing to read "E.H. Frankel", is written over a horizontal line.

Emil H. Frankel  
Commissioner

# TOTAL STATION OBSERVATIONS

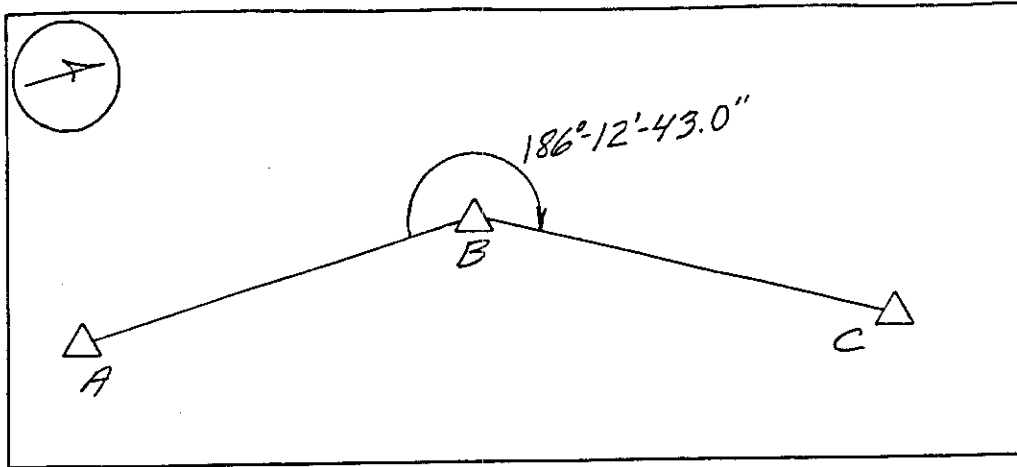

INSTRUMENT <u>AGA GEOD</u>	PRISM TYPE/ # <u>AGA 1P</u>	DATE <u>07-05-95</u>
MODEL <u>440</u>	OBSERVER <u>D. CHARTIER</u>	TOWN <u>ENFIELD</u>
INSTRUMENT # <u>32801</u>	RECORDER <u>S. McLUSKER</u>	PROJECT <u>TRAY LOOP</u>

STATION OCCUPIED <u>B</u>	ELV <u>38</u> m	AIR CONDITIONS . STILL <u>WINDY</u> ✓
BACKSIGHT STATION <u>A</u>	ELV <u>39</u> m	VISIBILITY . . . GOOD ✓ FAIR <u>POOR</u>
FORESIGHT STATION <u>C</u>	ELV <u>39</u> m	HUMIDITY . . . . DRY ✓ DAMP <u>WET</u>

## HORIZONTAL ANGLES

DIR (F1) <u>186°-12'-40"</u>	DIR (F1) <u>173°-47'-14"</u>
REV (F2) <u>186°-12'-44"</u>	REV (F2) <u>173°-47'-18"</u>
MEAN <u>186°-12'-42"</u>	MEAN <u>173°-47'-16"</u>
360° - MEAN <u>186°-12'-44"</u>	MEAN ANGLE <u>186°-12'-43.0"</u>

## HORIZONTAL DISTANCE TO BACKSIGHT STATION A

TEMP <u>22° C</u>	PRESSURE <u>766 mm</u>	PPM <u>-2</u>	DIR (F1) <u>407.198</u> m
B.S. <u>19.5° C</u>	<u>766 mm</u>	<u>Δ ELEV +0.701</u> m	REV (F2) <u>407.196</u> m
MEAN <u>21° C</u>	<u>766 mm</u>		MEAN <u>407.197</u> m
MEAN ELV <u>38</u> m ELV FACTOR <u>.9999940</u> x MEAN <u>407.197</u> m = MEAN GEODETIC <u>407.195</u> m			
MEAN GEODETIC OF 2 SHEETS <u>407.194</u> m			

## HORIZONTAL DISTANCE TO FORESIGHT STATION C

TEMP <u>22° C</u>	PRESSURE <u>766 mm</u>	PPM <u>-2</u>	DIR (F1) <u>523.013</u> m
F.S. <u>20° C</u>	<u>766 mm</u>	<u>Δ ELEV +0.744</u> m	REV (F2) <u>523.011</u> m
MEAN <u>21° C</u>	<u>766 mm</u>		MEAN <u>523.012</u> m
MEAN ELV <u>38</u> m ELV FACTOR <u>.9999940</u> x MEAN <u>523.012</u> m = MEAN GEODETIC <u>523.009</u> m			
MEAN GEODETIC OF 2 SHEETS <u>523.009</u> m			

ANGULAR BASELINE RANGE

(West Hartford Range)

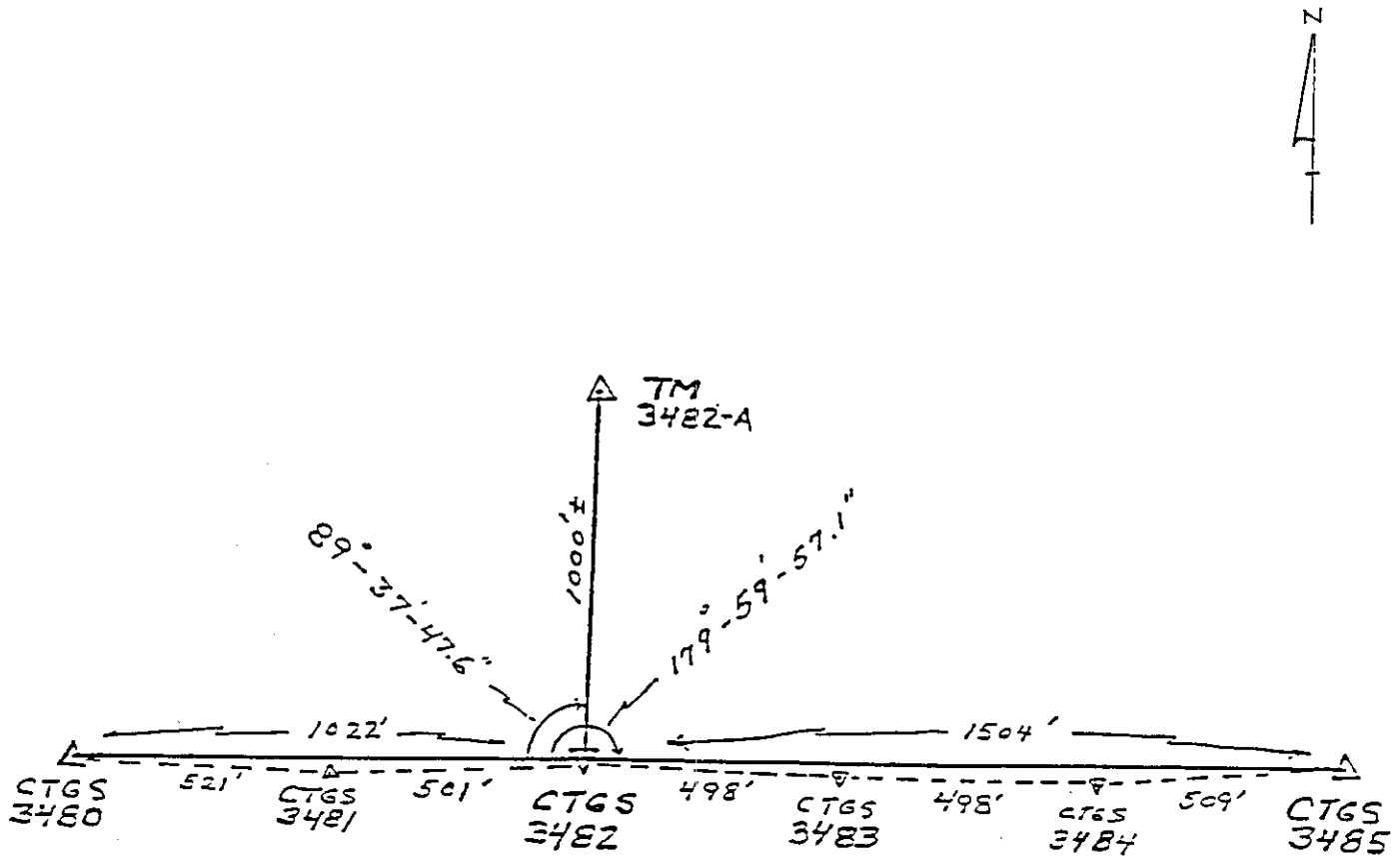

1. Measure line 3485 - 3480 (2526'). Record in Section 1.
2. Set instrument @ 3482. Measure lines 3482 - 3480 (1022') and 3482 - 3485 (1504'). Record in Section 2.
3. With instrument still @ 3482, observe 4 angular positions to check angles 3480 - 3482 - TM 3482-A and 3480 - 3482 - 3485.
4. Use forms provided by CDOT and record a minimum of 4 readings for each line measured. Fill out each form completely.
5. Be sure to keep the instrument and prism heights the same if slope distances are to be shown on forms.
6. Compute mean angles, distances and discrepancies. Submit a copy of the information to:

Manager of Survey Operations  
 Connecticut Department of Transportation  
 2800 Berlin Turnpike, P.O. Box 317546  
 Newington, CT 06131-7546

ELECTRONIC DISTANCE MEASUREMENTS ON CALIBRATED BASE LINES

INSTRUMENT \_\_\_\_\_ MODEL \_\_\_\_\_ INSTRUMENT NO. \_\_\_\_\_  
OBSERVER \_\_\_\_\_ LOCALITY \_\_\_\_\_ DATE \_\_\_\_\_

SECTION 1

STATION OCCUPIED \_\_\_\_\_ AIR CONDITIONS: STILL \_\_\_\_\_ WINDY \_\_\_\_\_  
VISIBILITY: GOOD \_\_\_\_\_ FAIR \_\_\_\_\_ POOR \_\_\_\_\_  
HUMIDITY: DRY \_\_\_\_\_ DAMP \_\_\_\_\_ WET \_\_\_\_\_

MEASUREMENT TO FORESIGHT STATION \_\_\_\_\_

TEMP. \_\_\_\_\_ PRESSURE \_\_\_\_\_ IN/FT. 1. \_\_\_\_\_

F.S. TEMP. \_\_\_\_\_ F.S. PRESSURE \_\_\_\_\_ IN/FT. 2. \_\_\_\_\_

MEAN TEMP. \_\_\_\_\_ MEAN PRESSURE \_\_\_\_\_ IN/FT. 3. \_\_\_\_\_

PPM SET \_\_\_\_\_ 4. \_\_\_\_\_

MEAN DISTANCE \_\_\_\_\_

BASE LINE DISTANCE \_\_\_\_\_

DISCREPANCY \_\_\_\_\_

SECTION 2

STATION OCCUPIED \_\_\_\_\_ AIR CONDITIONS: STILL \_\_\_\_\_ WINDY \_\_\_\_\_  
VISIBILITY: GOOD \_\_\_\_\_ FAIR \_\_\_\_\_ POOR \_\_\_\_\_  
HUMIDITY: DRY \_\_\_\_\_ DAMP \_\_\_\_\_ WET \_\_\_\_\_

MEASUREMENT TO BACKSIGHT STATION \_\_\_\_\_

TEMP. \_\_\_\_\_ PRESSURE \_\_\_\_\_ IN/FT. 1. \_\_\_\_\_

B.S. TEMP. \_\_\_\_\_ B.S. PRESSURE \_\_\_\_\_ IN/FT. 2. \_\_\_\_\_

MEAN TEMP. \_\_\_\_\_ MEAN PRESSURE \_\_\_\_\_ IN/FT. 3. \_\_\_\_\_

PPM SET \_\_\_\_\_ 4. \_\_\_\_\_

MEAN DISTANCE \_\_\_\_\_

BASE LINE DISTANCE \_\_\_\_\_

DISCREPANCY \_\_\_\_\_

MEASUREMENT TO BACKSIGHT STATION \_\_\_\_\_

TEMP. \_\_\_\_\_ PRESSURE \_\_\_\_\_ IN/FT. 1. \_\_\_\_\_

B.S. TEMP. \_\_\_\_\_ B.S. PRESSURE \_\_\_\_\_ IN/FT. 2. \_\_\_\_\_

MEAN TEMP. \_\_\_\_\_ MEAN PRESSURE \_\_\_\_\_ IN/FT. 3. \_\_\_\_\_

PPM SET \_\_\_\_\_ 4. \_\_\_\_\_

MEAN DISTANCE \_\_\_\_\_

BASE LINE DISTANCE \_\_\_\_\_

DISCREPANCY \_\_\_\_\_

ANGLE MEASUREMENTS ON CALIBRATED BASE LINES

INSTRUMENT \_\_\_\_\_ MODEL \_\_\_\_\_ INSTRUMENT NO. \_\_\_\_\_  
 OBSERVER \_\_\_\_\_ LOCALITY \_\_\_\_\_ DATE \_\_\_\_\_  
 RECORDER \_\_\_\_\_

STATION OCCUPIED \_\_\_\_\_ AIR CONDITIONS: STILL \_\_\_\_\_ WINDY \_\_\_\_\_  
 VISIBILITY: GOOD \_\_\_\_\_ FAIR \_\_\_\_\_ POOR \_\_\_\_\_  
 HUMIDITY: DRY \_\_\_\_\_ DAMP \_\_\_\_\_ WET \_\_\_\_\_

HORIZONTAL ANGLE TO STATION \_\_\_\_\_

ZERO SET ON STATION \_\_\_\_\_

DIRECT

REVERSE

1. _____	_____	MEAN ANGLE _____
2. _____	_____	BASE LINE ANGLE _____
3. _____	_____	DISCREPANCY _____
4. _____	_____	
_____	MEANS _____	

HORIZONTAL ANGLE TO STATION \_\_\_\_\_

ZERO SET ON STATION \_\_\_\_\_

DIRECT

REVERSE

1. _____	_____	MEAN ANGLE _____
2. _____	_____	BASE LINE ANGLE _____
3. _____	_____	DISCREPANCY _____
4. _____	_____	
_____	MEANS _____	

# GPS OBSTRUCTION SHEET

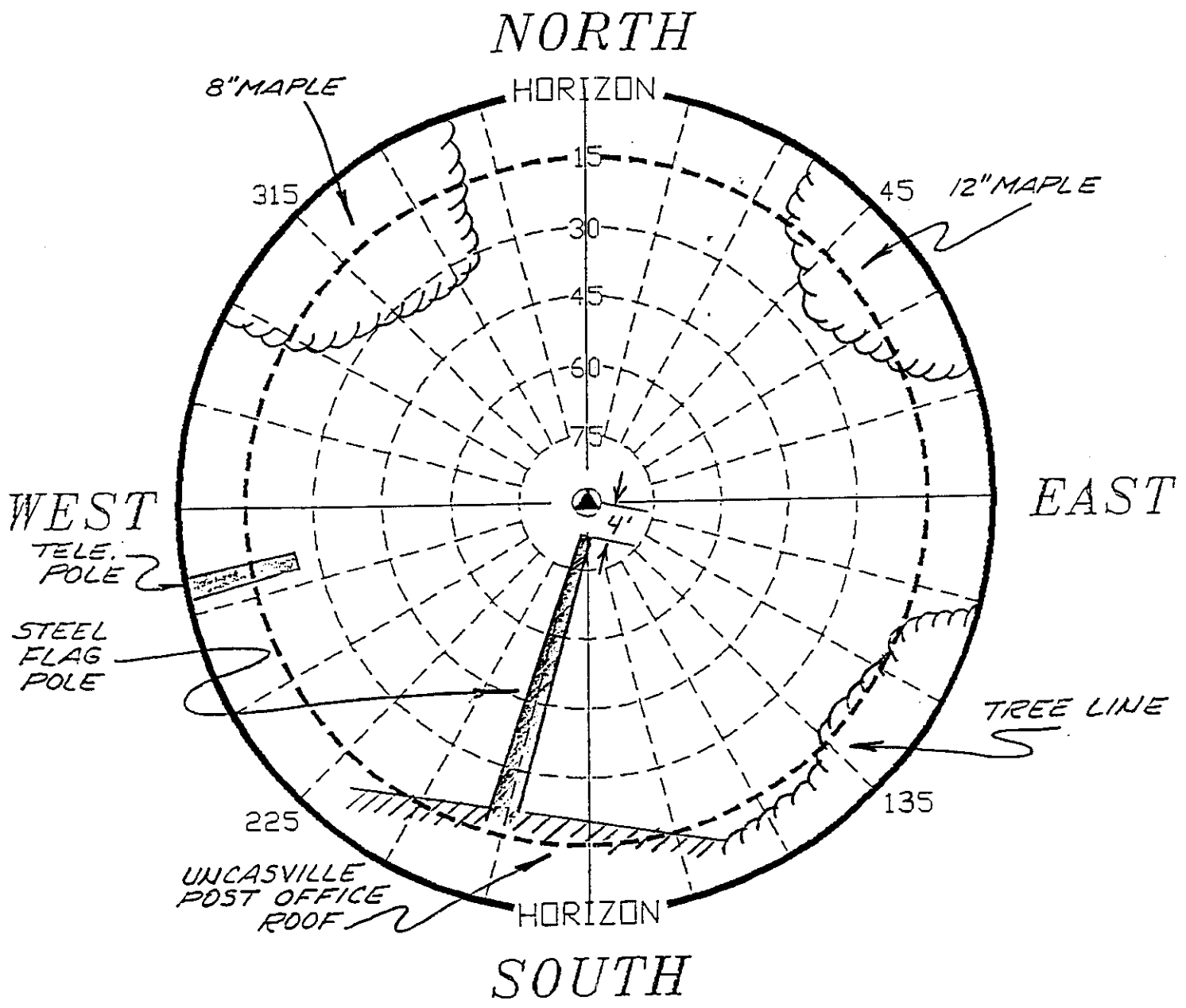

STATION NAME CTGS BM#2897 "R 97 1986" MATES  
 TOWN MONTVILLE  
 DATE 11/20/94  
 ORGANIZATION HARRIS & CLARK  
 OBSERVER R.B. & D.M.

DNA (VERT. REF. CONTROL ONLY)

LATITUDE 41 28 05 +/-" N \*  
 LONGITUDE 72 06 11 +/-" W \*  
 ELEVATION 70.720 m (NAVD 88)

~~NAD83~~  
 OR  
 \* NAD83

\* NOTE: GEO. POSITION IS APPROX. REFER TO NGS DATA BASE. PROVIDED FOR ORIENTATION PURPOSES ONLY.

THREE-WIRE LEVELING

Short Form of Field Notes  
for Yard Rod.

+ Rod	Stad.	- Rod	Stad.	Stad.	Elev.	Sra.
3.897 <sup>(1)</sup>	72 <sup>(4)</sup>	0.734	76		206.481	BM61
3.825 <sup>(2)</sup>		0.658				
3.751 <sup>(3)</sup>		0.581				
11.473 <sup>(10)</sup>	146 <sup>(7)</sup>	1.973 <sup>(9)</sup>	153 <sup>(8)</sup>	- 7 <sup>(18)</sup>	+ 9.500 <sup>(11)</sup>	
2.694	63	1.248	62		215.981	TP1
2.631		1.186				
2.569		1.125				
7.894	125	3.559	123	+ 2	+ 4.335	
3.174	55	2.648	60		220.316	TP2
3.119		2.588				
3.067		2.528				
9.360	107	7.764	120	- 13	+ 1.596	
				- 18	221.912	BM62
28.727	378	13.296	396			

Explanation. In this short form of field notes only five columns are used on the left-hand page of the field notebook, and two on the right.

(1), (2), (3) are wire readings.

(4) = (1) - (2), (5) = (2) - (3), (6) = (1) + (2) + (3), (7) = (4) + (5), (10) = (7) - (8), (11) = (6) - (9)

Sums. The sum 28.727 should be computed by adding all the rod readings and the sum 378 by adding all the half stadia intercepts. Similarly for 13.296 and 396. When properly combined, they are used to check the values for the final benchmark, viz:

	Elev.	Stad.
	28.727	378
	- 13.296	- 396
	+ 15.431	- 18
BM 61	206.481	0
BM 62	221.912	- 18

TYPICAL THREE-WIRE LEVEL NOTES  
WITH YARD ROD

TOWN OF NORTH HAVEN	BM 1548 TO	CGS 2415
1.1		
0.565	3.252	
0.395	3.088	164 3.36
0.225	2.923	165 0.27
1.185	9.263	324 3.09
340	324	
	TP# 1	
0.439	3.227	
0.273	3.086	141 3.36
0.108	2.945	141 0.27
0.820	9.258	282 3.09
331	282	
	TP# 2	
0.866	3.152	
0.700	2.809	343 3.36
0.534	2.467	342 0.54
2.100	8.428	685 282
332	685	
	TP# 3 to 2415 (CTGS)	
2.070	1.966	
1.926	1.868	098 3.36
1.783	1.772	096 1.49
5.779	5.606	194 1.87
2.87	194	
		149.0

7/24/86

WB	ELEV.	BM 1548
11.85		
11.250		
-9.263		
34.987	T.P.#1	
+0.820		
35.807		
-9.258		
26.549		
-2.100		
28.679		
8.428		
20.221		
+5.779		
26.000		
-5.606		
20.394	ELEV. @ 2415 (CTGS)	
+1.006		
20.400	FT ADJ	

CONT. ON NEXT PAGE

25



TRIGONOMETRIC LEVELING OBSERVATIONS

Back Sight CTGS-BM-1338 Air Conditions: Still  Windy   
 Foresight TP-1338-1 Visibility: Good  Fair  Poor   
 Humidity: Dry  Damp  Wet   
 Instrument AGA GEOD Model 440 Instrument No. 32801  
 Project No. 27-50 Town(s) or CLINTON  
 Date 07-05-95 Observer RPH Recorder ALS  
 Temp. 20°C Pressure 766 mm PPM Set -2

BACK SIGHT STATION

Zenith Angles

Direct (Face I)	Reverse (Face II)
<u>87°-12'-06"</u>	<u>87°-12'-12"</u>
<u>87°-12'-10"</u>	<u>87°-12'-14"</u>
<u>87°-12'-12"</u>	<u>87°-12'-08"</u>
<u>87°-12'-08"</u>	<u>87°-12'-10"</u>
<u>87°-12'-09.0"</u> Mean <u>87°-12'-11.0"</u>	
Dif = <u>00°-00'-02.0"</u>	
Allowable Dif 4"	

Mean of Face I & Face II

87°-12'-10.0"

Slope Distance 228.131 m

Vertical Distances

Direct (Face I)	Reverse (Face II)
<u>+ 11.137 m</u>	<u>+ 11.131 m</u>
<u>+ 11.133 m</u>	<u>+ 11.129 m</u>
<u>+ 11.131 m</u>	<u>+ 11.135 m</u>
<u>+ 11.135 m</u>	<u>+ 11.133 m</u>
<u>+ 11.134 m</u> Mean <u>+ 11.132 m</u>	
Dif = <u>0.002 m</u>	
Allowable Dif <u>0.005 m</u>	

Mean of Face I & Face II

+ 11.133 m (Change sign)

FORESIGHT STATION

Zenith Angles

Direct (Face I)	Reverse (Face II)
<u>91°-51'-12"</u>	<u>91°-51'-16"</u>
<u>91°-51'-10"</u>	<u>91°-51'-18"</u>
<u>91°-51'-20"</u>	<u>91°-51'-18"</u>
<u>91°-51'-14"</u>	<u>91°-51'-12"</u>
<u>91°-51'-14.0"</u> Mean <u>91°-51'-16.0"</u>	
Dif = <u>00°-00'-02.0"</u>	
Allowable Dif 4"	

Mean of Face I & Face II

91°-51'-15.0"

Slope Distance 230.188

Allowable difference of Vertical Distances  
 .00035  $\sqrt{M}$

Vertical Distances

Direct (Face I)	Reverse (Face II)
<u>-7.444 m</u>	<u>-7.449 m</u>
<u>-7.442 m</u>	<u>-7.451 m</u>
<u>-7.454 m</u>	<u>-7.451 m</u>
<u>-7.449 m</u>	<u>-7.444 m</u>
<u>-7.447 m</u> Mean <u>-7.449 m</u>	
Dif <u>0.002 m</u>	
Allowable Dif <u>0.005 m</u>	

Mean of Face I & Face II

+ 7.448 m

Elev. BM 1338 39.133 m  
 Backsight VD - 11.133 m  
 Foresight VD - 7.448 m  
 Elev. TP-1 20.552 m

TRIGONOMETRIC LEVELING OBSERVATIONS

Back Sight TP-1338-7 Air Conditions: Still X Windy \_\_\_\_\_  
 Foresight TP-1338-8 Visibility: Good X Fair \_\_\_\_\_ Poor \_\_\_\_\_  
 Humidity: Dry X Damp \_\_\_\_\_ Wet \_\_\_\_\_  
 Instrument AGA GEOD Model 440 Instrument No. 32801  
 Project No. 27-50 Town(s) of CLINTON  
 Date 07-05-95 Observer RPH Recorder ALS  
 Temp. 37° C Pressure 766 mm PPM Set -2

BACK SIGHT STATION

Zenith Angles		Vertical Distances	
Direct (Face I)	Reverse (Face II)	Direct (Face I)	Reverse (Face II)
<u>85°-00'-01"</u>	_____	<u>+ 26.564 m</u>	<u>+ 26.569 m</u>
_____	_____	<u>+ 26.561 m</u>	<u>+ 26.566 m</u>
_____	_____	<u>+ 26.560 m</u>	<u>+ 26.568 m</u>
_____	_____	<u>+ 26.563 m</u>	<u>+ 26.570 m</u>
Mean _____	_____	<u>+ 26.562 m</u>	Mean <u>+ 26.568 m</u>
Dif = _____	_____		Dif = <u>0.006 m</u>
Allowable Dif 4"	_____		Allowable Dif <u>0.006 m</u>
Mean of Face I & Face II _____	_____	Mean of Face I & Face II _____	_____
Slope Distance <u>304.801 m</u>	_____	<u>+ 26.565 m</u>	(Change sign)

FORESIGHT STATION

Zenith Angles		Vertical Distances	
Direct (Face I)	Reverse (Face II)	Direct (Face I)	Reverse (Face II)
<u>93°-59'-57"</u>	_____	<u>- 10.629 m</u>	<u>- 10.633 m</u>
_____	_____	<u>- 10.630 m</u>	<u>- 10.629 m</u>
_____	_____	<u>- 10.631 m</u>	<u>- 10.633 m</u>
_____	_____	<u>- 10.633 m</u>	<u>- 10.632 m</u>
Mean _____	_____	<u>- 10.631 m</u>	Mean <u>- 10.632 m</u>
Dif = _____	_____		Dif <u>0.001 m</u>
Allowable Dif 4"	_____		Allowable Dif <u>0.004 m</u>
Mean of Face I & Face II _____	_____	Mean of Face I & Face II _____	_____
Slope Distance <u>152.400 m</u>	_____	<u>-10.631 m</u>	_____
Allowable difference of Vertical Distances	_____	Elev. <u>TP-7</u>	<u>60.960 m</u>
<u>.00035</u> $\sqrt{M}$	_____	Backsight VD	<u>- 26.565 m</u>
	_____	Foresight VD	<u>- 10.631 m</u>
	_____	Elev. <u>TP-8</u>	<u>23.764 m</u>

M = Length of slope in meters

DATE <u>4-4-84</u>	FORM NO. CGS 9 DEPARTMENT OF TRANSPORTATION STATE OF CONNECTICUT	SHEET No. <u>1</u>
COMPUTER <u>A.B.C.</u>	MEAN JUNCTION - POINT COORDINATE COMPUTATION	LINE <u>I-86</u>
CHECKER <u>C.B.A.</u>		

TRAVERSE LINE	ORIGIN OF TRAVERSE LINE	LENGTH OF LINE IN FEET = L	$\frac{20,000}{L}$ WEIGHT OF LINE = W	EAST COORDINATE = X	VALUE OF WX	NORTH COORDINATE = Y	VALUE OF WY	
1	CGS 12	5079.1	3.9377	169,756.79	26.7370	526,893.91	15.3964	
2	CGS 42	13,535.2	1.4776	169,757.53	11.1263	526,894.91	7.2550	
3	A-3856	12,369.7	1.6168	169,756.35	10.2667	526,894.89	7.9061	
$\Sigma W =$			7.0321	$\Sigma WX$	48.1300	$\Sigma WY =$	30.5575	
$\frac{\Sigma WX}{\Sigma W} =$				6.84	$\frac{\Sigma WY}{\Sigma W} =$		4.35	
$\Sigma W$				7.0321	$\Sigma W$		7.0321	
$X =$					169,756.84	$Y =$		526,894.35

TRAVERSE LINE	ORIGIN OF TRAVERSE LINE	LENGTH OF LINE IN FEET = L	$\frac{100,000}{L}$ WEIGHT OF LINE = W	EAST COORDINATE = X	VALUE OF WX	NORTH COORDINATE = Y	VALUE OF WY
---------------	-------------------------	----------------------------	---	---------------------	-------------	----------------------	-------------

THE WEIGHT OF THE LINE IS AN ARBITRARY NUMBER LARGER THAN THE LONGEST LENGTH OF TRAVERSE, TRAVERSE LINE 2 WAS 13,535 FEET LONG SO 20,000 WAS CHOSEN.



# CIRCULAR CURVE DATA

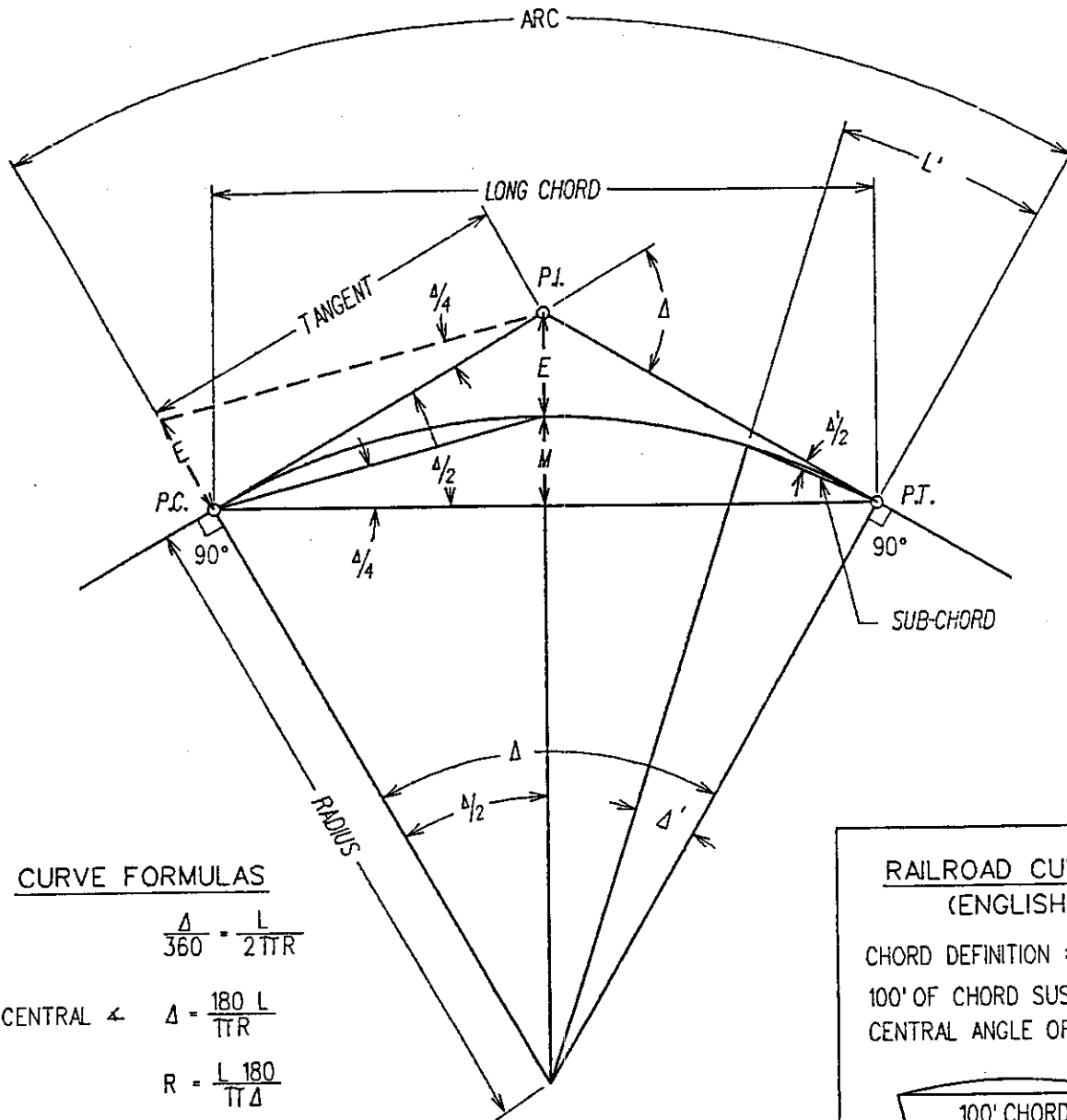

## CURVE FORMULAS

CIRCLE	$\frac{\Delta}{360} = \frac{L}{2\pi R}$
DELTA, I, CENTRAL $\Delta$	$\Delta = \frac{180 L}{\pi R}$
RADIUS	$R = \frac{L \cdot 180}{\pi \Delta}$
TANGENT	$T = R \tan (\Delta/2)$
LENGTH OR ARC	$L = \frac{\Delta \pi R}{180}$ or $\frac{\Delta R}{57.29578}$
LONG CHORD	$Ch = 2 R \sin (\Delta/2)$
EXTERNAL	$E = T \tan (\Delta/4)$
MIDDLE ORDINATE	$M = R [1 - \cos (\Delta/2)]$ or $T \sin (\Delta/2) - E$

## CURVE SEGMENTS FOR STATIONING

Deflection $\alpha$	$\alpha = \Delta/2$ For Curve Segment
DEFLECTION	$Defl \alpha = \Delta/2 = \frac{180 L'}{2\pi R}$
SUB-CHORD	$Sub-Ch = 2 R \sin (\Delta/2)$

## RAILROAD CURVES (ENGLISH)

CHORD DEFINITION :  
100' OF CHORD SUSTENDS A  
CENTRAL ANGLE OF 1°

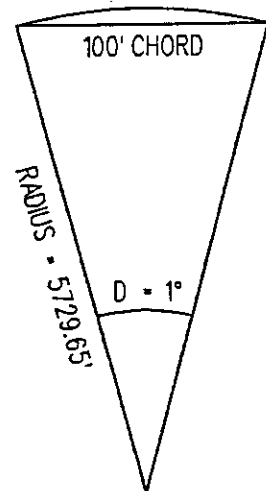

$$\sin (\Delta/2) = \frac{50}{R}$$

$$R = \frac{50}{\sin (\Delta/2)}$$

# VERTICAL CURVE

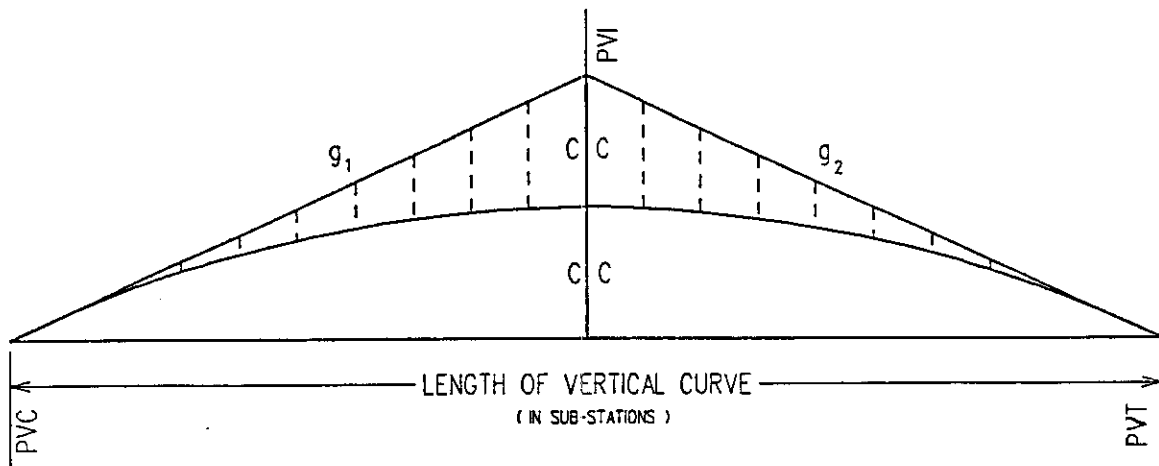

$$C C = \frac{ALG. DIFF. (IN GRADES) \times L}{8}$$

$$K = \frac{C C}{(\frac{1}{2} L)^2}$$

or

$$K = \frac{ALG. DIFF.}{2 L}$$

$K \times (\text{ANY DISTANCE FROM PVC AHEAD TO PVI OR FROM PVT BACK TO PVI})^2 = \pm \text{CORRECTION FROM TANGENT ELEV.}$

LOW ( OR HIGH ) POINT STATION = PVC STATION + D    where     $D = \frac{g_1 \times L}{ALG. DIFF.}$

IN WHICH :

ALG. DIFF. = ALGEBRAIC DIFFERENCE IN GRADES

D = DISTANCE FROM PVC TO LOW ( OR HIGH ) POINT ( IN SUB-STATIONS )

$g_1$  = BACK TANGENT GRADE

L = LENGTH OF VERTICAL CURVE ( IN SUB-STATIONS )

EXAMPLE :

GIVEN :

$g_1 = +2\%$

$g_2 = -2\%$

LENGTH = 400 M ( 4 SUB-STATIONS )

PVC STA. = 1 + 000

PVC ELEVATION = 50.000 M

PVI STA. = 1 + 200

PVT STA. = 1 + 400

SOLVE :

$$C C = \frac{ALG. DIFF. \times L}{8}$$

$$C C = \frac{[+2 - (-2)] \times 4}{8}$$

$$C C = 2.00 \text{ M}$$

SOLVE :

$$K = \frac{C C}{(\frac{1}{2} L)^2} \text{ or } \frac{ALG. DIFF.}{2 L}$$

$$K = \frac{2}{(2)^2} \text{ or } \frac{4}{8}$$

$$K = 0.5000 \text{ or } 0.5000$$

SUB-STATION	%	ELEV.	CORRECT.	TANGENT ELEV.	REMARKS	CURVE COMPUTATIONS
PVCI+000		50.000 m	0	50.000 m		
+020		50.400	-0.020 m	50.380		$(0.2)^2 \times 0.5000$
+040		50.800	-0.080	50.720		$(0.4)^2 \times 0.5000$
+060		51.200	-0.180	51.020		$(0.6)^2 \times 0.5000$
+080		51.600	-0.320	51.280		$(0.8)^2 \times 0.5000$
1+100		52.000	-0.500	51.500		$(1.0)^2 \times 0.5000$
+120		52.400	-0.720	51.680		$(1.2)^2 \times 0.5000$
+140		52.800	-0.980	51.820		$(1.4)^2 \times 0.5000$
+160		53.200	-1.280	51.920		$(1.6)^2 \times 0.5000$
+180		53.600	-1.620	51.980		$(1.8)^2 \times 0.5000$
PVI1+200		54.000	-2.000	56.000		$(2.0)^2 \times 0.5000$
+220		53.600	-1.620	51.980		$(1.8)^2 \times 0.5000$
+240		53.200	-1.280	51.920		$(1.6)^2 \times 0.5000$
+260		52.800	-0.980	51.820		$(1.4)^2 \times 0.5000$
+280		52.400	-0.720	51.680		$(1.2)^2 \times 0.5000$
1+300		52.000	-0.500	51.500		$(1.0)^2 \times 0.5000$
+320		51.600	-0.320	51.280		$(0.8)^2 \times 0.5000$
+340		51.200	-0.180	51.020		$(0.6)^2 \times 0.5000$
+360		50.800	-0.080	50.720		$(0.4)^2 \times 0.5000$
+380		50.400	-0.020 m	50.380		$(0.2)^2 \times 0.5000$
PVT1+400		50.000 m	0	50.000 m		

### CALCULATION OF HIGH POINT

SOLVE :

$$D = \frac{g_1 \times L \text{ (SUB-STATIONS)}}{ALG. DIFF.}$$

$$D = \frac{2 \times 4}{4}$$

$$D = 2 \text{ (SUB-STATIONS)}$$

STA. PVC = 1 + 000

D = + 200

STA. HIGH PT = 1 + 200

STATE OF CONNECTICUT

DEPARTMENT OF TRANSPORTATION

District - Test Pits

Town: <i>WESTPORT</i>			Utility Co.: <i>CL &amp; P</i>		
Project No.: <i>158-143</i>			Utility Official:		
Route: <i>CT 33 &amp; 57</i>			Excavator: <i>A-1 CONSTRUCTION</i>		
Date: <i>07/05/95</i>			Foreman: <i>BILL JONES</i>		
Field Book No.: <i>TEST PIT "C"</i> Page No.: <i>1-4</i>			Party Chief: <i>JOHN SMITH</i>		
NORTH STATION	EAST OFFSET	GROUND ELEV.	TOP OF PIPE ELEV.	SIZE & TYPE	STREET ROUTE
<i>6+439.8m</i>	<i>5.46 m</i>	<i>22.16 m</i>	<i>21.421 m</i>	<i>0.79m X 0.24m</i>	<i>CT 33</i>
<i>6+466.0 m</i>	<i>4.94 m</i>	<i>20.82 m</i>	<i>20.184 m</i>	<i>1.10m X 0.24m</i>	<i>CT 33</i>
<i>15+339.2 m</i>	<i>6.71 m</i>	<i>21.49 m</i>	<i>20.681 m</i>	<i>0.85m X 0.24m</i>	<i>CT 57</i>

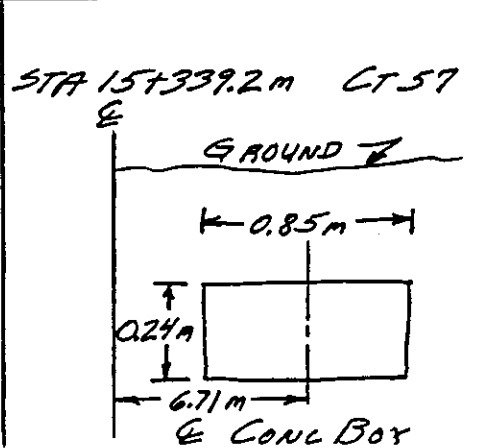
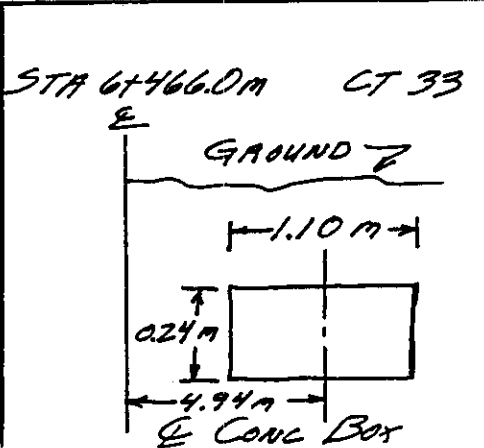
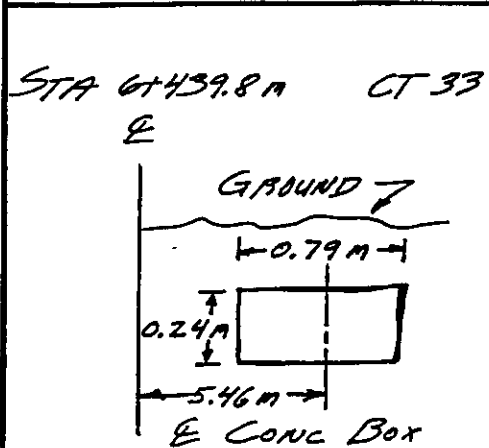

PERCENTAGE OF PARTICIPATION IN HIGHWAY RELOCATION PROJECTS  
(summarized below)

SECTION 13a-126 of C.G.S.	STATE ROADS	
	Unlimited Access Highway	Limited Access Highway
Private Utility Company	50%	100%
Municipal Utility (all classifications)	50% on non-federally funded projects	100%

SECTION 13a-98f of C.G.S.	STATE ROADS	LOCAL ROADS
	Private Utility Company	see Section 13a-126 of C.G.S
Municipal Utility (City or Town)	cost of apportionment	cost of apportionment
Other Municipalities (MDC, SCCRWA, etc.)	100%	100%



# RAILROAD TURNOUT

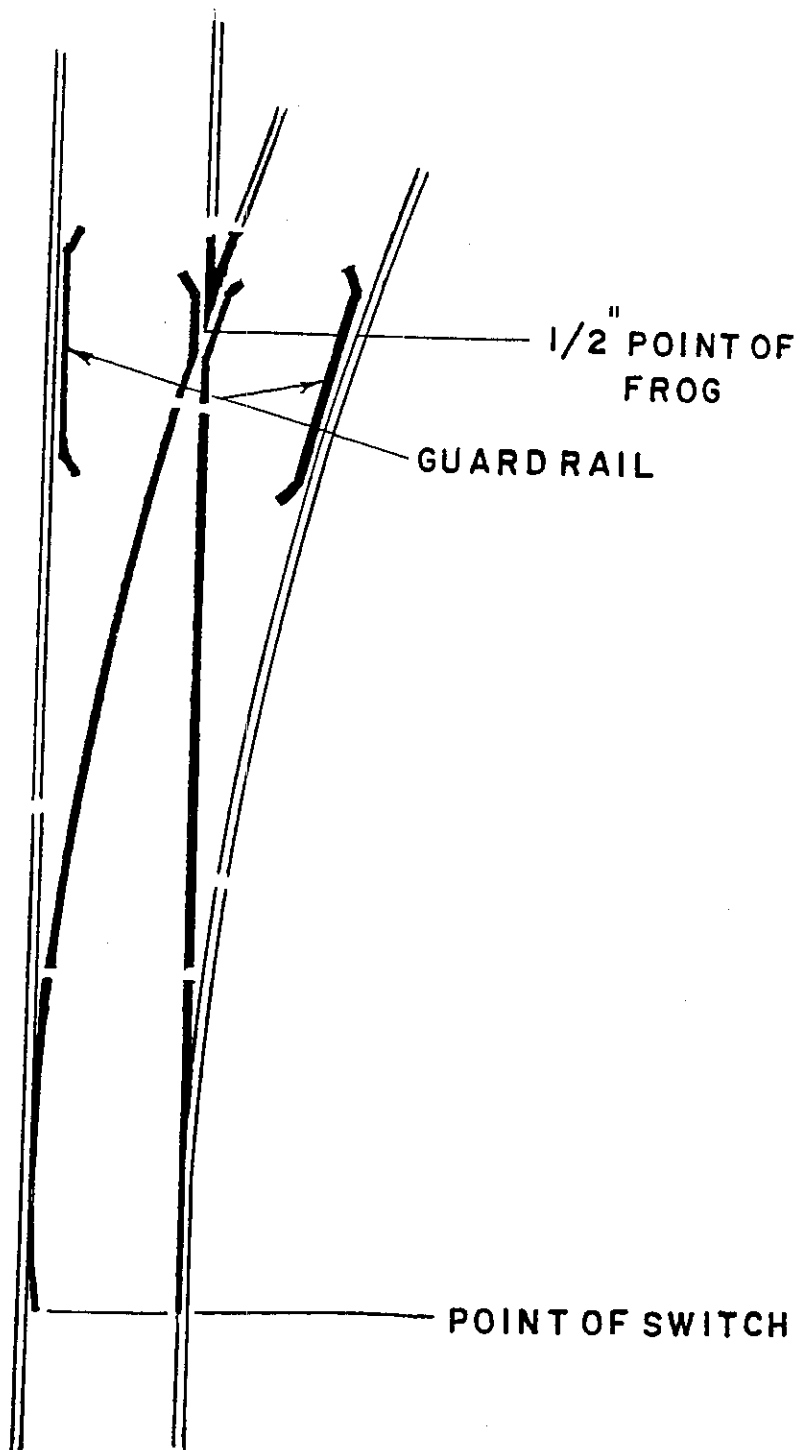

# TYPICAL HYDRAULIC CROSS-SECTION LOCATIONS

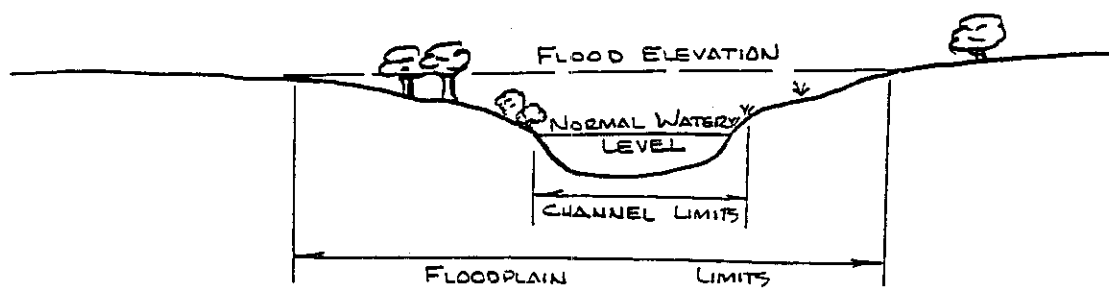
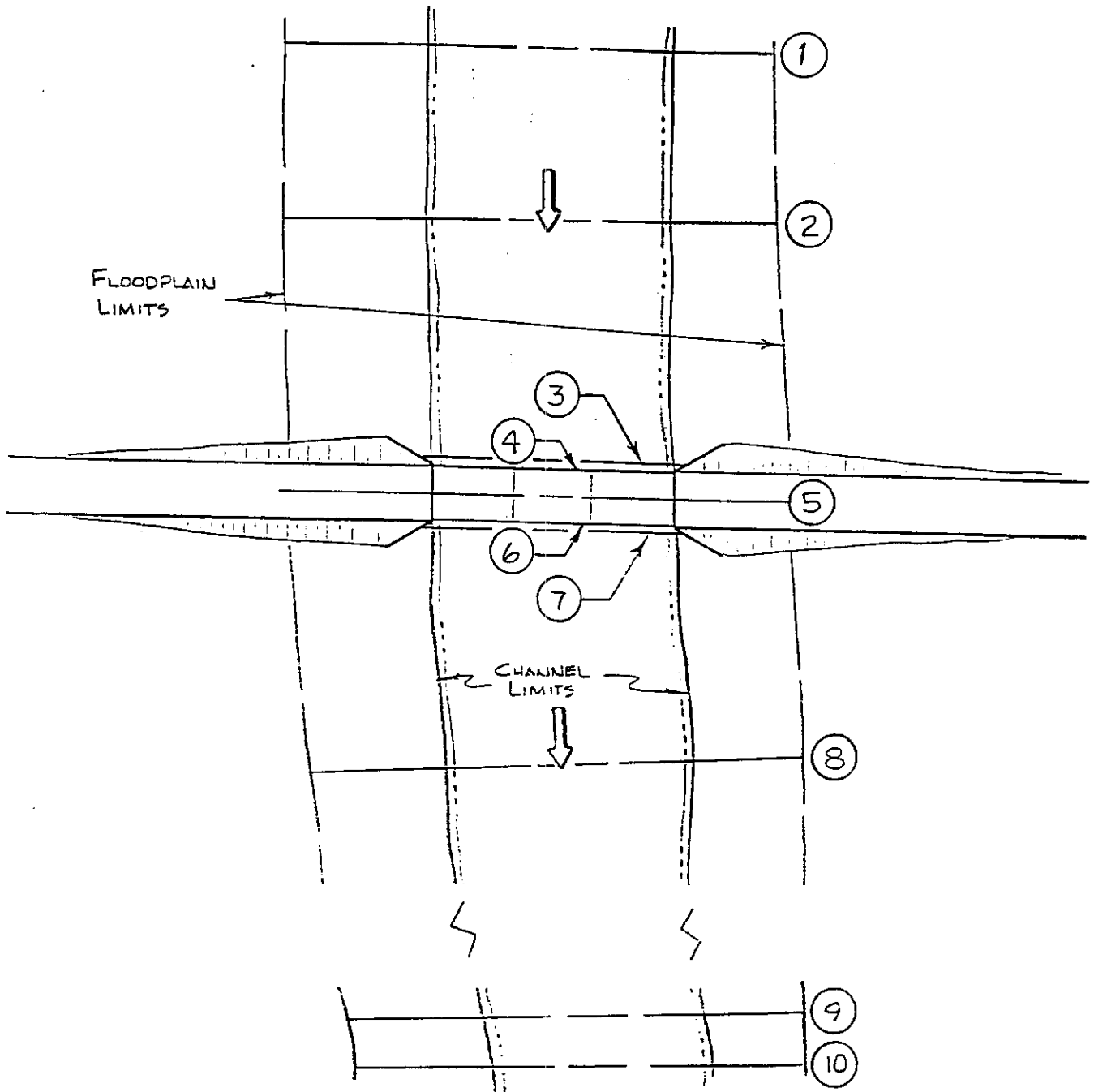

**TYPICAL HYDRAULIC  
CROSS-SECTION LOCATION LEGEND**

1. Upstream sections as required
2. Section one bridge opening width upstream of bridge
3. Section 0.3 meters upstream of bridge
4. Section at upstream bridge fascia
5. Section at centerline of roadway (roadway profile)
6. Section at downstream bridge fascia
7. Section 0.3 meters downstream of bridge
8. Section one bridge opening width downstream of bridge
9. Section four bridge opening widths downstream of bridge
10. Downstream sections as required

Note: The bridge opening width is the width as measured "along the roadway", perpendicular to the direction of flow.

**TYPICAL HYDRAULIC CROSS-SECTION ORIENTATION WITH RESPECT TO STREAM CHANNEL / FLOODPLAIN**

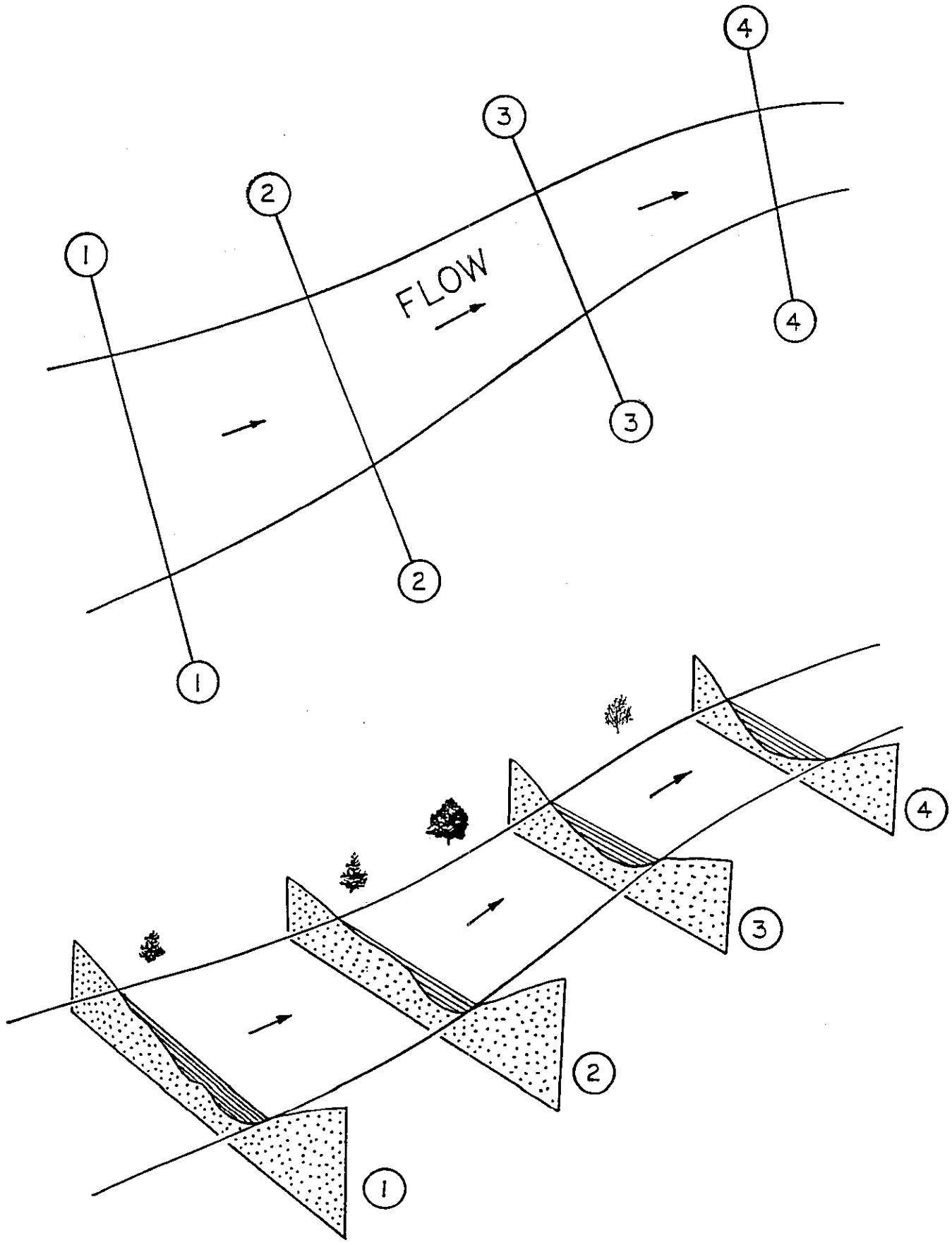



STATE OF CONNECTICUT  
DEPARTMENT OF TRANSPORTATION



2800 BERLIN TURNPIKE, P.O. BOX 317546  
NEWINGTON, CONNECTICUT 06131-7546

Phone: (203) \_\_\_\_\_

Town \_\_\_\_\_

Project \_\_\_\_\_

Name \_\_\_\_\_

Address \_\_\_\_\_

\_\_\_\_\_

Dear Property Owner:

Section 13a-60 of the General Statutes of Connecticut, as revised, provides that the Transportation Commissioner or his agent may enter upon private property for the purpose of conducting surveys, inspections or geological investigations for the location, relocation, construction or reconstruction of any proposed or existing highways.

In the course of performing a survey, inspection or geological investigation, it may be necessary to set markers of various types adjacent to or on your property. The emplacement of these markers does not necessarily indicate the location of a proposed highway or other facility to be constructed or reconstructed by the Department of Transportation.

Section 13a-60 provides that the Transportation Commissioner or his agent shall use care that no unnecessary damage shall result and that the State shall pay damage to the owner for any damage or injury he causes such owner by such entrance or use.

Your consent to the Transportation Commissioner or his agent to enter upon your property for the purpose of carrying out the provisions of this statute is requested.

A signature to authorize entrance upon your property does not indicate your approval or disapproval of the above-noted project.

Please sign in the space provided below and return in the enclosed self-addressed stamped envelope. Thank you for your cooperation.

Very truly yours,

James F. Byrnes, Jr., P.E.

Chief Engineer

Bureau of Engineering and Highway Operations

I hereby give my consent to the Transportation Commissioner or his agent to enter upon my property in order to carry out the provisions of Sec. 13a-60 of the 1969 Supplement to the General Statutes and for the purposes as checked.

\_\_\_\_ Survey  
\_\_\_\_ Borings,  
\_\_\_\_ Soundings or  
\_\_\_\_ Other Tests

Owner \_\_\_\_\_

Date \_\_\_\_\_

Interviewer \_\_\_\_\_

Date \_\_\_\_\_

STATE OF CONNECTICUT  
DEPARTMENT OF TRANSPORTATION*memorandum*

COM-09A REV. 2/91 Printed on Recycled or Recovered Paper

*subject* Rail Safety Class*date* May 3, 1994*to**from**ext.*

TO ALL CONCERNED

  
John P. McGill  
Director of Safety

It has come to my attention that Department of Transportation personnel are visiting construction or proposed construction sites where active railroad lines are involved without regard to proper railroad safety.

The Department's Guidelines for Safe Practices states, in part, that "Department of Transportation employees must be protected whenever it is necessary for personnel or equipment to work alongside railroad tracks." Also, DOT employees must wear proper protective equipment; for example, hard hats, approved safety vests, glasses and shoes while on railroad property.

Furthermore, railroads have strict rules concerning trespassers that allow their police to arrest violators. They also require that no person may enter upon their property until he/she has attended a respective Railroad's Safety Orientation Class or be accompanied by a qualified railroad flag person.

To insure the safety of Department personnel, employees who intend to visit active rail lines and have not attended a rail safety class should have their supervisor contact this Office so that information can be obtained from the Bureau of Public Transportation, Office of Rails, on how to receive training.

All employees that have attended a rail safety class should review their materials to update their awareness of safety procedures. Your compliance with these safety procedures is essential.

NOTES:

- 1.) DIGITAL FILE NAME: 11X258.DGN
- 2.) PLOT ROTATION ANGLE TO NEAREST FULL DEGREE: 41°
- 3.) SURVEY BY: LEWIS AND CLARK
- 4.) PLOTTED BY: GEORGE WASHINGTON
- 5.) CHECKED BY: MASON DIXON
- 6.) FIELD BOOKS: • 1
- 7.) 100 METER GRID BASED ON CONNECTICUT COORDINATE SYSTEM N. A. D. 1927
- 8.) VERTICAL DATUM BASED ON NGVD 1929
- 9.) DIMENSIONS AND DISTANCES DEPICTED WITH A DECIMAL POINT ARE IN METERS; THOSE WITHOUT ARE IN MILLIMETERS

(SAMPLE ONLY)  
 SUBJECT TO CHANGE

**STATE OF CONNECTICUT**  
 DEPARTMENT OF TRANSPORTATION  
**RECONSTRUCTION OF ROUTE 189**  
**AT MOUNTAIN AVE TO PARK AVE**  
 IN THE TOWNS OF  
**BLOOMFIELD, EAST WINDSOR,**  
**AND HARTFORD**

PROJECT NO. 11-258

SCALE: 1CM=5M SCALE IN METERS 1:500

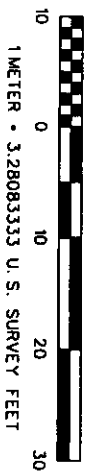

**TOPOGRAPHIC MAP**  
 CONTOUR INTERVAL 0.5 METER  
 INDEX TO ADJOINING SHEETS



SHEET 2 OF 3

MONTH 1997

# FIELD EDIT DELINEATION

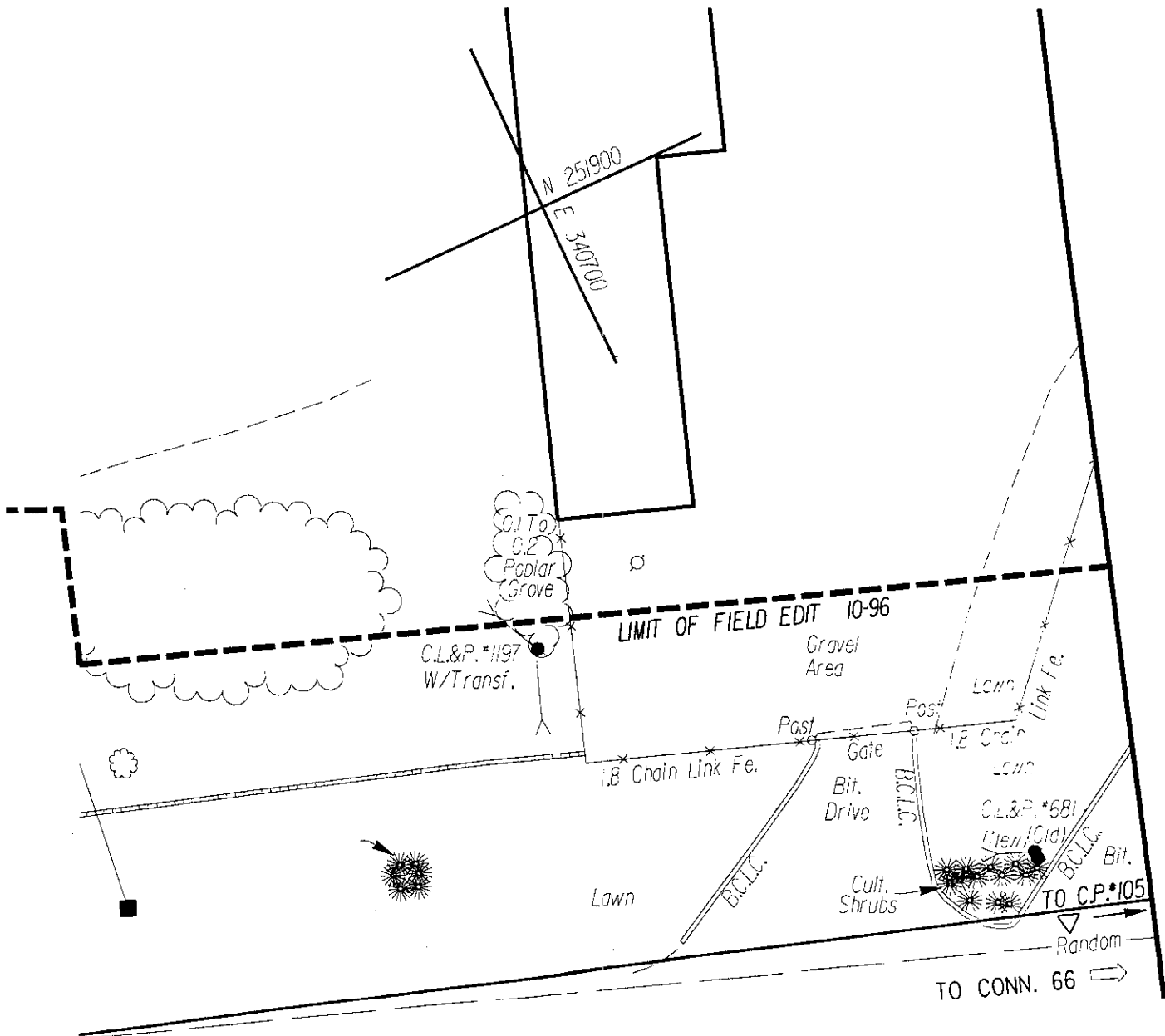



STANDARDIZED NOTATIONS  
FOR THE LABELING OF  
STORM & SANITARY SEWER SYSTEMS

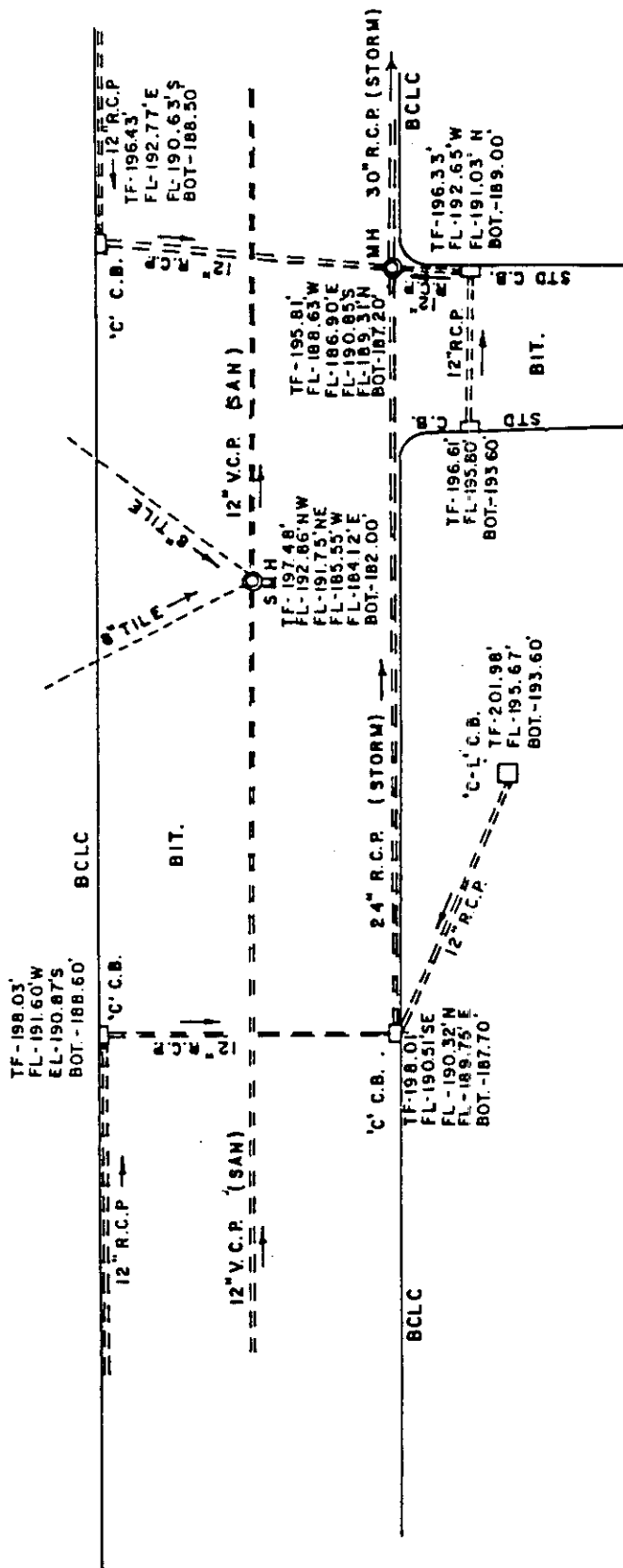

PREPARED BY  
THE CENTRAL SURVEY SECTION  
STATE OF CONN.  
DEPARTMENT OF TRANSPORTATION  
(NOT TO SCALE)      SEPTEMBER 20, 1986

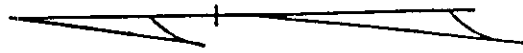

**APPENDIX E**

**Connecticut  
Department of Transportation**

**METRIC STANDARDS**

## METRICATION STANDARDS

### METRIC CONVERSIONS

*	1 meter (m)	=	39.37 inches (U.S. Survey Foot)
	1 meter (m)	=	3.2808333(3) feet (U.S. Survey Foot)
	1 kilometer (1m)	=	0.62137 miles
	1 hectare (ha)	=	2.471 acres
*	1 meter (m)	=	1000 millimeters (mm)
*	1 kilometer (km)	=	1000 meters (m)
*	1 hectare (ha)	=	10,000 square meters (m <sup>2</sup> )

### ADDITIONAL CONVERSIONS

*	1 rod, pole, perch	=	16.5 feet
*	1 chain (Gunter's)	=	66 feet
*	1 link	=	7.92 inches (0.66 foot)
*	1 mile	=	5280 feet
*	1 acre	=	43,560 feet <sup>2</sup>
*	1 station	=	1 kilometer (km)
*	1 staking interval	=	20 meters (m)

\* Denotes exact conversion values. All others correct to significant figures shown.

### INDIVIDUAL MEASUREMENTS

Horizontal Measurements    nearest 0.001m with EDM/Total Station  
                                      nearest 0.001m with steel chain  
                                      nearest 0.01m with cloth/fiberglass tape

Vertical Measurements -    nearest 0.001m on bench marks  
                                      nearest 0.005m on sanitary and storm sewer structures

nearest 0.005m on bridge structures/super structures  
nearest 0.005m on concrete pavement  
nearest 0.01m on bridge clearances  
nearest 0.01m on bituminous pavement, sill, pond/lake, dam  
elevations, etc. (Typically any elevation normally depicted to the  
nearest conventional 0.1 foot)

Trig Leveling - nearest 0.001 meters for H.I. and target height

NOTE: All surveying measurements will be made in meters and decimals of meters. Millimeters, centimeters and decimeters will not be used.

Computations - nearest 0.001 for all control traverse lines, traverse lines, base lines, boundary lines, property lines

Rule of Thumb if not shown above:

nearest 0.001m items which were previously called for to be shown to the nearest 0.01 foot, whether distances or elevations, would now be depicted, computed or set to the nearest 0.001m (unless otherwise directed by Engineer)

nearest 0.01m items which were previously called for the nearest 0.1 foot, whether distances or elevations, should be depicted, computed and set to the nearest 0.01m.

nearest 0.1m items which were previously called for to be shown to the nearest foot, should now be shown or measured to the nearest 0.1m.

## **PIPE SIZES**

Pipe sizes and their metric equivalents shall conform to the International Standards Organization (ISO) usage of nominal pipe sizes for field identification purposes. Also, for pipes under 4", professional rounding shall be utilized to describe nominal sizes to the nearest 25mm (i.e.: 1" = 25mm, 2" = 50mm).

The following guidelines should be used for classification of existing features.

<u>English</u>	<u>Metric</u>
4"	100mm
6"	150mm
8"	200mm
10"	250mm
12"	300mm
15"	375mm
18"	450mm
24"	600mm
30"	750mm
36"	900mm
42"	1050mm
48"	1200mm
54"	1350mm
60"	1500mm
66"	1650mm
72"	1800mm
78"	1950mm
84"	2100mm
90"	2250mm
96"	2400mm

**STATEWIDE METRICATION SURVEY STANDARDS**  
(Revised - September 7, 1994)

The following metric survey standards are currently being recommended for use by the Department in the preparation of Location Survey plans.

These standards were prepared and revised by the CONNDOT Central Survey Office.

It is the hope and intent of our office for these standards to be utilized for all location surveys. Should anyone who is preparing metric unit surveys encounter problems with these standards, or can further clarify or improve them, please notify our office accordingly.

Any comments, questions or suggestions, please contact:

John R. Puglisi  
Manager of Survey Operations  
Office of Central Surveys  
(203) 594-2509

We welcome any input you may have to assist us in meeting the Federal conversion criteria to Metric Units.

## SUGGESTED METRIC SURVEY STANDARDS

*(Revised - September 7, 1994)*

(1 meter = 3.28083333 U.S. survey feet)

A. Map scales shall be 1:500 (1" = 42'±) or 1cm = 5 meters as the standard; 1:200 (1" = 17'±) or 1cm = 2 meters.

B. Base lines will be set-up/established at one (1) kilometer intervals.

Example: Station 1+020.00 would be exactly twenty (20) meters beyond station 1+0.

C. Base line stationing shall be computed to the nearest millimeter (0.001 meter).

D. The stationing along these base lines will be depicted at twenty (20) meter intervals.

E. Cross sections will, therefore, be taken/plotted at twenty (20) meter intervals, and their scale will be 1:50 (1 cm = 0.5 m).

F. Profile scales will conform to the same horizontal mapping project scale and remain at an exaggerated scale ration of 10:1, as we are presently used to in English Units.

Example: 1:500/1:50 vs 40/4 (1 cm = 5m/1 cm = 0.5 m)  
1:200/1:20 vs 20/2 (1 cm = 2m/1 cm = 0.2m)

G. A one-hundred (100) meter coordinate mapping grid shall be used on all plans.

H. On topographic maps, a one-half (0.5 m) meter contour interval shall be used with index contours identified/accentuated at two (2) meter intervals. (1:500 scales)  
On 1:200 scale topo maps, 0.2 meter contour intervals with index contours accentuated at 1 meter intervals.

I. On topographic maps, spot elevations shall be depicted to the nearest (0.01 meter).

J. Tree sizes will be shown to the nearest decimeter (0.1m)

Example: A 20" maple is now a 0.5 maple

Note: Ornamental trees under a decimeter in diameter shall continue to be shown to the nearest 10mm

- K. Pipe sizes and their metric equivalents shall conform to the International Standards Organization (ISO) usage of nominal pipe sizes for field identification purposes (see attachment). Also, for pipes under 4", professional rounding shall be utilized to describe nominal sizes to the nearest 25mm (i.e.: 1" = 25mm, 2" = 50mm).
- L. Elevations typically critical to design shall be depicted as indicated:
- 1) sanitary and storm sewer structures - nearest 0.005 m
  - 2) bridge structure/superstructure - nearest 0.005 m
  - 3) concrete pavement - nearest 0.005 m
  - 4) bridge clearance - nearest 0.01 m
- M. Bench marks shall be adjusted and depicted to the nearest millimeter.
- N. Bituminous pavement, sill, pond/lake, dam elevations, etc. will be depicted on plans to the nearest centimeter (0.01 m). (Typically, any elevation normally depicted to the nearest conventional 0.1')
- O. Traverse point/base line control points -
- 1) show coordinates to the nearest millimeter
  - 2) show swing ties (to readily identifiable field points) to the nearest millimeter
- P. Curve data and control stationing shall be shown to the nearest millimeter.
- Example: P.C. Sta 1+021.999  
P.T. Sta 1+221.999  
L = 200.000 m  
 $\Delta = 6^{\circ}-59'-08''$   
R = 500.000 m
- Q. Currently, it is recommended that all angular measurements and published relationships continue to be depicted and obtained in Degrees, Minutes, and Seconds.
- R. There are other specifications, not covered in the above listing, which are covered in the D.O.T. Location Survey Manual. Rather than list these items in this text, the following rules of thumb shall be utilized:
1. Items which are called for to be shown to the nearest 0.01 foot, be they elevations or distances, would now be depicted, computed to or set to the nearest millimeter (0.001 m).



2. Items which are called for to be shown to the nearest 0.1 foot, be they elevations or distances should be depicted, computed or set to the nearest centimeter (0.01 m).
3. Items which are called for to be shown or measured to the nearest foot, should now be shown or measured to the nearest decimeter (0.1 m).

Example: If the average roadway width of a rural secondary or tertiary road was 18' it would now be described as 5.5 meters; or the distance measured to the edge of a swamp would now be recorded to the nearest 0.1 meter.

S. Other considerations:

- 1) Even if the survey is submitted in all metric units, many as-built references and design computations will still be mathematical conversion relationships to English Unit tabular design values and architectural standards.
- 2) Map sizes for filing, until approved by legislation (individual town and statewide) will have to conform to metrically converted standard English unit sizes.

Example:

<u>English</u>	<u>Metric</u>
12" x 18"	305 mm x 457 mm
18" x 24"	457 mm x 610 mm
24" x 36"	610 mm x 914 mm

- 3) These metric surveys should also be subject to the needs of the "end user". For example, would a private property owner or attorney be comfortable using a fully metric property map or deed description? There will, obviously, be cases where the combination of English and Metric Units will need to be provided. Only through usage and time will a complete metric product be acceptable to the "end user".
- 4) Cooperation and communication with non-federally funded entities (Utility Companies and Municipalities, etc.) will be needed to continue progress in the completion of current metric projects.

## CONNECTICUT DOT - INTERGRAPH WORKING UNIT SETTINGS FOR METRIC

MASTER UNITS = M  
 SUB UNITS = mm

### SURVEY AND HIGHWAY WORKING UNIT SETTINGS

SCALE	RESOLUTION		WORKING AREA
	mm/M	PU/mm	SQUARE METERS
1:1000	1000	1	4294967
1:500	"	2	2147484
1:250	"	4	1073742
1:200	"	5	858993
1:100	"	10	429497
1:50	"	20	214748
1:25	"	40	107374
1:20	"	50	85899
1:10	"	100	42950
1:5	"	200	21475
1:2.5	"	400	10737
1:2	"	500	8589
1:1	"	1000	4295

MASTER UNITS = mm  
 SUB UNITS =

### BRIDGE DESIGN WORKING UNIT SETTINGS

SCALE	RESOLUTION		WORKING AREA
	/mm	PU/mm	SQUARE METERS
1:1000	1	1	4294967295
1:500	"	2	2147483648
1:250	"	4	1073741824
1:200	"	5	858993459
1:100	"	10	429496730
1:50	"	20	214748365
1:25	"	40	107374182
1:20	"	50	85899345
1:10	"	100	42949673
1:5	"	200	21474836
1:2.5	"	400	10737418
1:2	"	500	8589935
1:1	"	1000	4294968

**APPENDIX F**

**Connecticut  
Department of Transportation**

**GRAPHIC ELEMENT DEFINITIONS**

- Line** A linear graphic element containing two vertices.
- Point** A special case of LINE where the location of both vertices are identical.
- Line string** A single linear graphic element containing between 2 and 101 vertices.
- Curve string** A single linear graphic element containing between 3 and 97 vertices that when displayed is shown as a smoothly interpolated representation between vertices.
- Polygon** As used by CONNDOT in this document, a Line string or Curve string which closes upon itself (i.e. the last vertex is identical to the first vertex).

LINE 1 ——— 2

POINT  $\begin{matrix} 1 \\ \cdot \\ 2 \end{matrix}$

LINESTRING 1  5

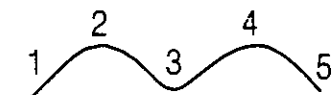
CURVESTRING 1  5

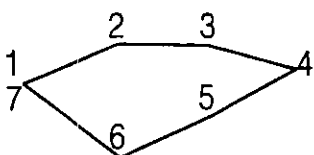
POLYGON 1  4

**APPENDIX G**

**Connecticut  
Department of Transportation**

**SURFACE MODEL COMPILATION  
AND GUIDE ALIGNMENT DIAGRAMS**



SURFACE MODEL COMPILATION DIAGRAM  
FOR  
BRIDGE DECKS AND ABUTMENTS

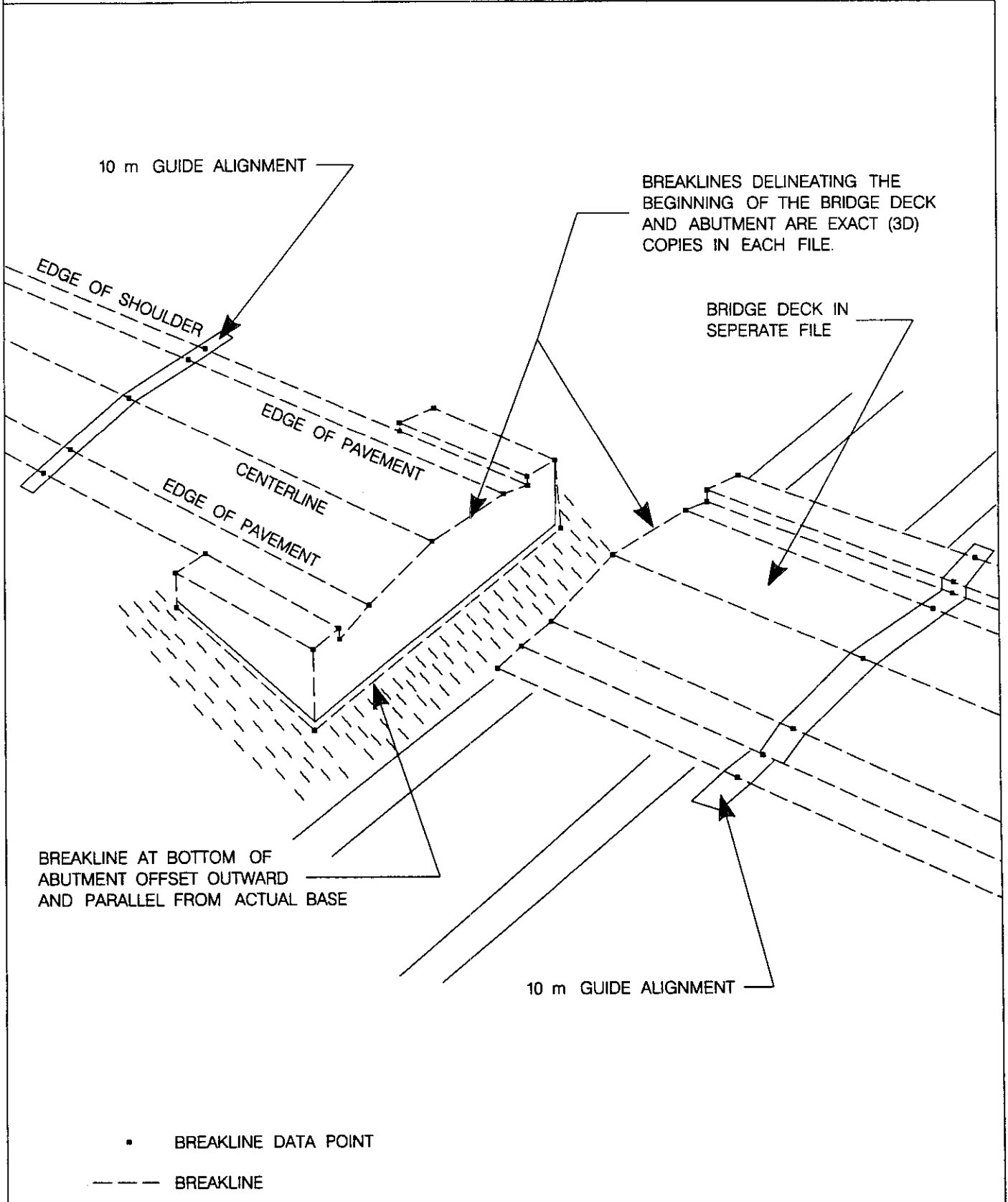



SURFACE MODEL COMPILATION DIAGRAM

FOR  
SURFACE MODEL LIMIT  
SURFACE MODEL FILE BREAK TOPOGRAPHIC MAPPING LIMIT

SURFACE MODEL FILE BREAKS MUST BE PLACED IN PERFECTLY STRAIGHT LINES

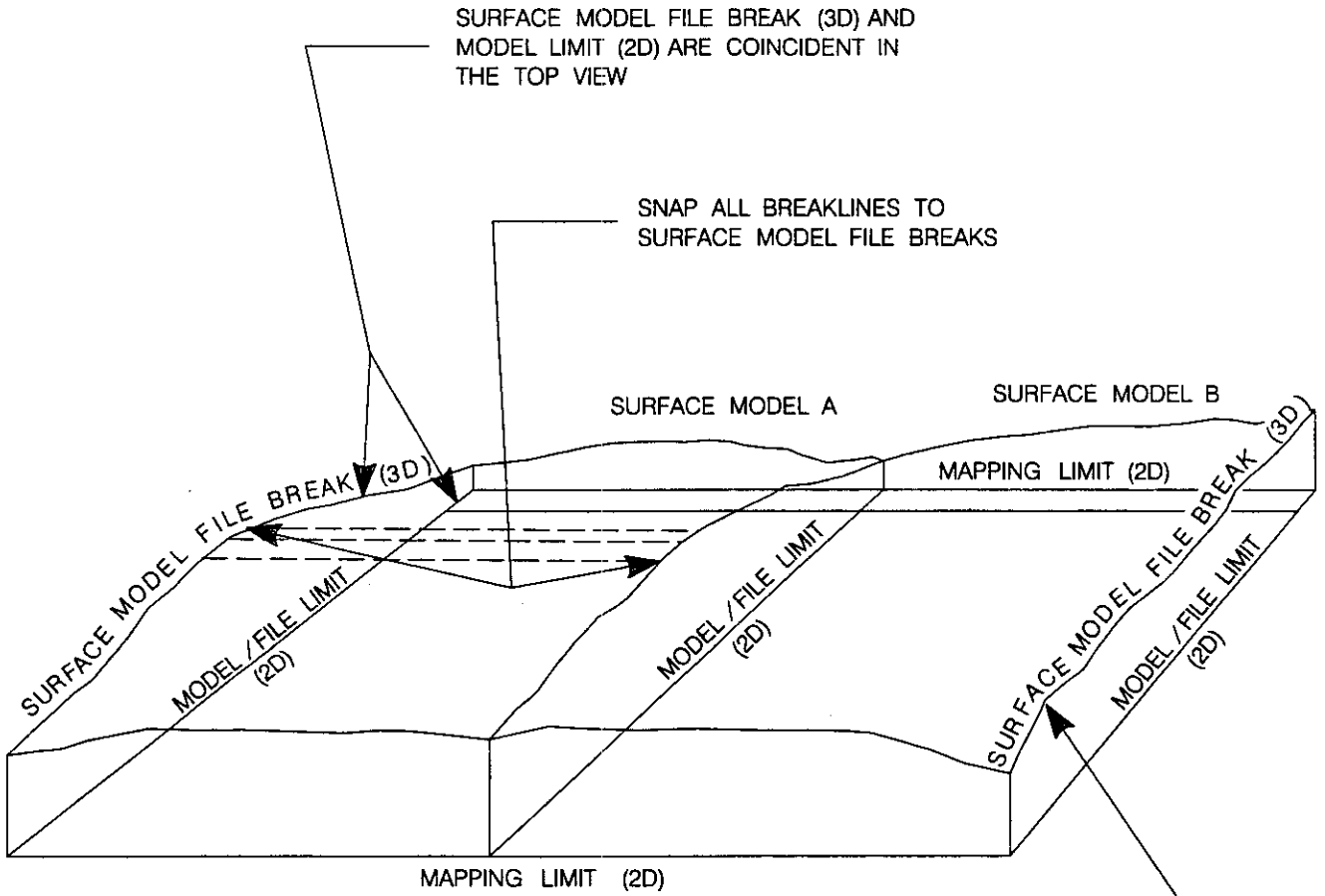

COPY SURFACE MODEL FILE BREAK INTO  
ADJOINING 3D SURFACE MODEL FILE



SURFACE MODEL COMPILATION DIAGRAM  
FOR  
BITUMINOUS CONCRETE LIP CURBING  
GRANITE CURBING CONCRETE CURBING

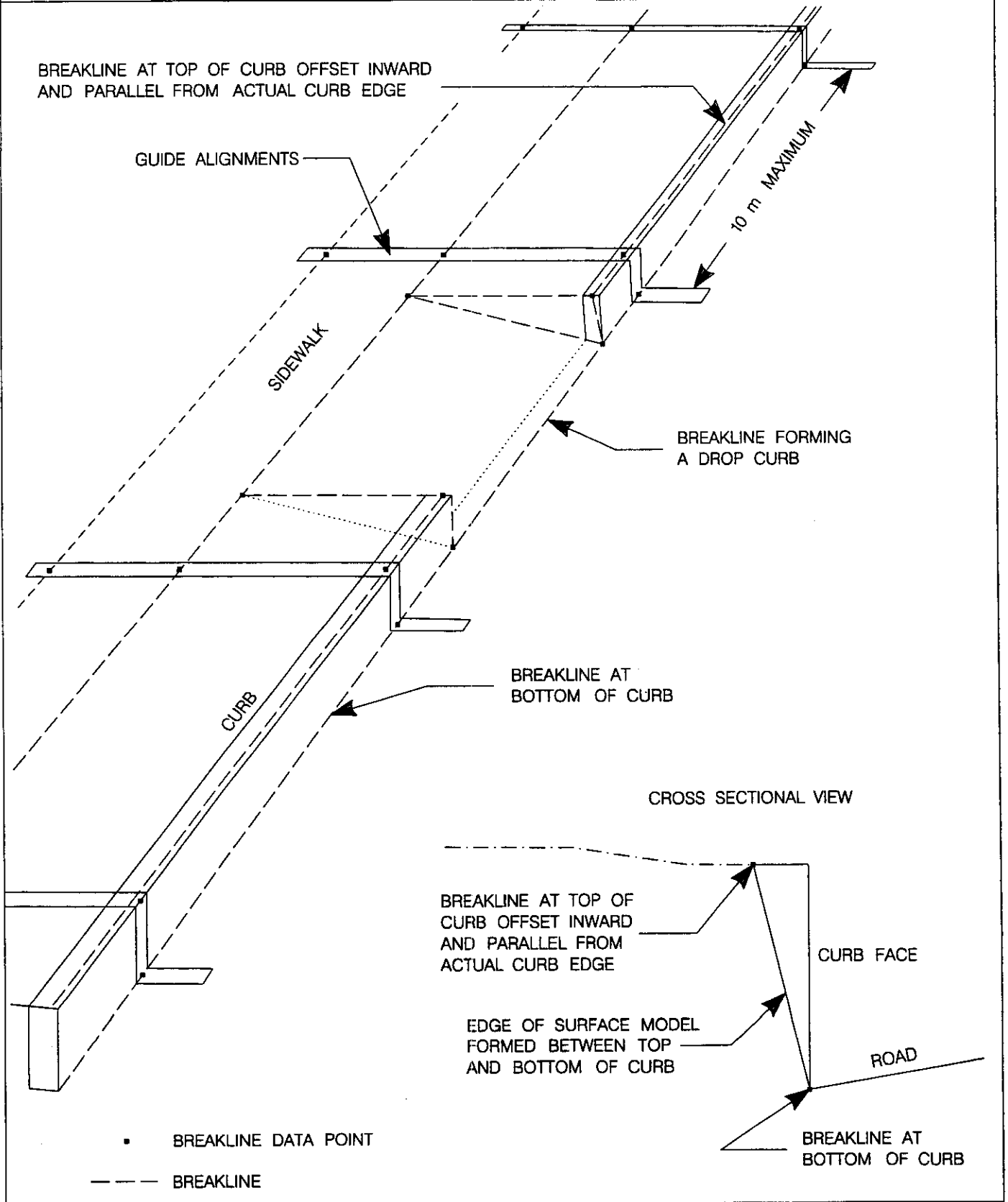





SURFACE MODEL COMPILATION DIAGRAM  
FOR  
MAJOR CULVERT AND RETAINING WALL

5 /97

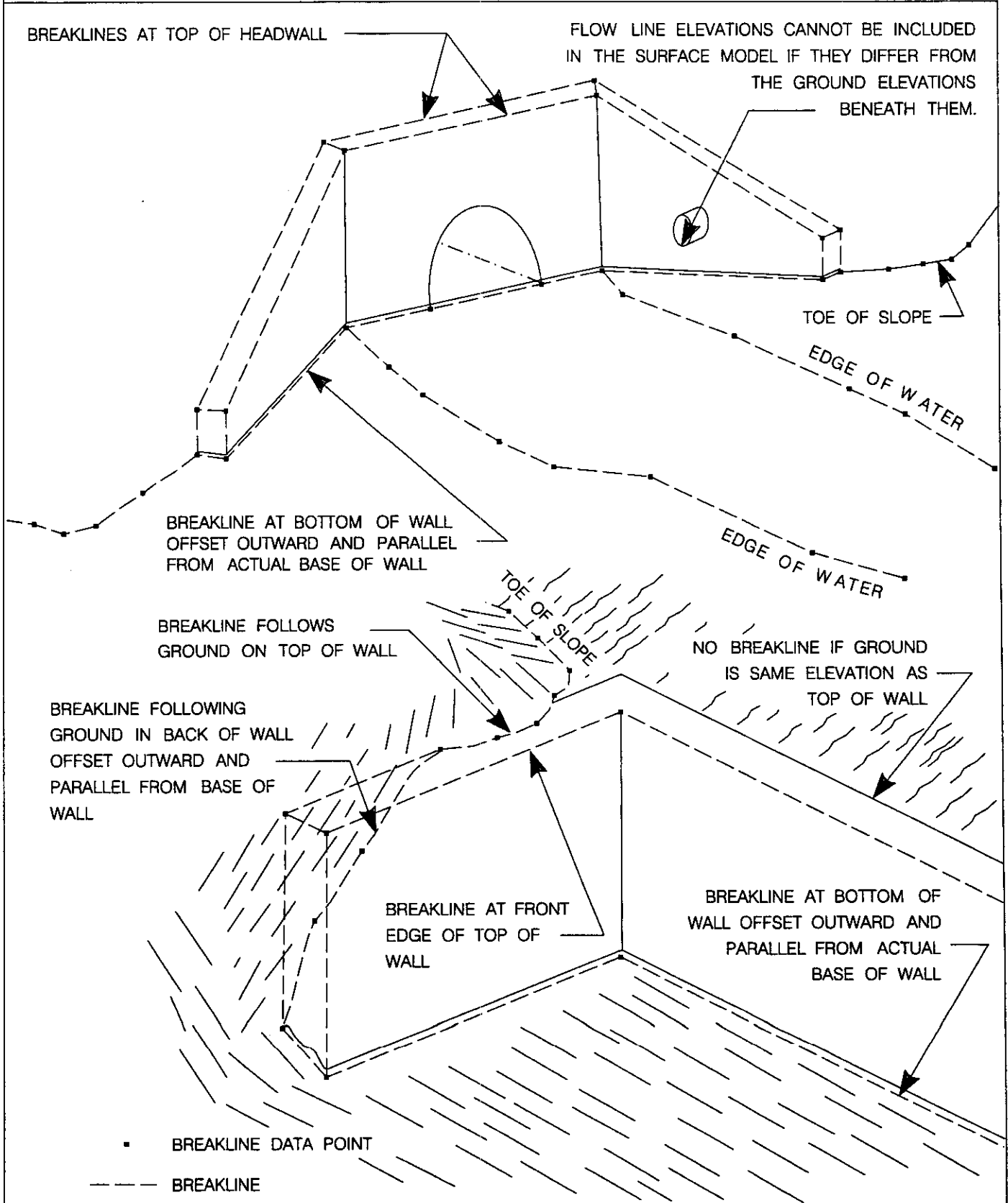

**APPENDIX H**

**Connecticut  
Department of Transportation**

**MSFC-EXISTING HIGHWAY FEATURES**

**See supplemental guide entitled:**

**“Digital mapping symbols for the Surveys and Photogrammetry Existing Features Cell  
Libraries”**



SURFACE MODEL COMPILATION DIAGRAM  
FOR  
USING GUIDE ALIGNMENTS

