



STATE OF CONNECTICUT

CONNECTICUT SITING COUNCIL

Ten Franklin Square, New Britain, CT 06051

Phone: (860) 827-2935 Fax: (860) 827-2950

E-Mail: siting.council@ct.gov

www.ct.gov/csc

VIA ELECTRONIC MAIL

August 9, 2018

Kri Pelletier
Property Specialist
SBA Communications Corporation
134 Flanders Rd., Suite 125
Westborough, MA 01581

RE: **EM-SPRINT-112-180719** – Sprint Spectrum, L.P. notice of intent to modify an existing telecommunications facility located at 398 Pomfret Street, Pomfret, Connecticut.

Dear Ms. Pelletier:

The Connecticut Siting Council (Council) is in receipt of your correspondence of August 8, 2018 submitted in response to the Council's July 25, 2018 notification of an incomplete request for exempt modification with regard to the above-referenced matter.

The submission renders the request for exempt modification complete and the Council will process the request in accordance with the Federal Communications Commission 60-day timeframe.

Thank you for your attention and cooperation.

Sincerely,

Melanie A. Bachman
Executive Director

MAB/IN/emr

Robidoux, Evan

From: Kri Pelletier <KPelletier@sbsite.com>
Sent: Wednesday, August 08, 2018 3:58 PM
To: Robidoux, Evan
Cc: CSC-DL Siting Council
Subject: RE: [External] Council Incomplete Letter for EM-SPRINT-112-180719
Attachments: em-sprint-112-180719_2nd_incomplltr_pomfretst_pomfret.pdf; CT33XC017-PASSING-MOUNT-STRUCTURAL-ANALYSIS-06-18-18-REV2.pdf; CT33XC017-Sprint NSB - Final CD.PDF

Good Afternoon Evan,

We are in receipt of Council's letter dated 7/25/18. Attached, please find the requested Drawings consistent with the new Mount Structural Analysis.

Thank you,

Kri Pelletier
Prop Spec - Svcs

508.251.0720 x3804 + T
508.366.2610 + F
203.446.7700 + C

From: Robidoux, Evan [mailto:Evan.Robidoux@ct.gov]
Sent: Thursday, July 26, 2018 2:57 PM
To: Kri Pelletier
Cc: CSC-DL Siting Council
Subject: [External] Council Incomplete Letter for EM-SPRINT-112-180719

Please see the attached correspondence.

Evan Robidoux
Clerk Typist
Connecticut Siting Council
10 Franklin Square
New Britain, CT 06051

Antenna Mount Structural Analysis



Source: SBA Date: 12.14.2017

SBA Site: CT02217-S Pomfret School
Sprint Site Number: CT33XC017
Project: Sprint DO Macro Upgrade

Prepared For: Sprint

Mount Description: (1) Platform

Site Location: 398 Pomfret St, Pomfret, CT
Windham County
41.89009444°, -71.95498611°

Design Codes: ANSI/TIA-222-G
IBC 2012 w/ 2016 CT State Code

Analysis Load Case: Sprint Final Configuration
Analysis Result: Adequate @ 87% - **Once Augmented**
See Conclusion



Revision 2
June 18, 2018

CT33XC017-PASSING-MOUNT-STRUCTURAL-ANALYSIS-06-18-18-REV2

1.0 Introduction

An antenna mount structural analysis has been performed on Sprint's existing mount assembly located at the CT02217-S Pomfret School communications site in Windham County, CT considering the final equipment loading configuration listed in Section 3.0.

2.0 Analysis Criteria

An elastic three-dimensional model of the mount structure has been analyzed pursuant to the following criteria:

- IBC 2012 - International Building Code.
- ANSI/TIA-222-G - Structural Standard for Antenna Supporting Structures and Antennas.
- AISC - Steel Construction Manual.
- ANSI/AWS D1.1 - Structural Welding Code.

Wind w/o ice = 128 mph (3-sec gust Ultimate Wind Speed)	
Wind w/o ice = 99 mph (3-sec gust Equivalent per TIA-222-G Tower Code)	
Wind with ice = 50 mph (3-sec gust, 1" Ice)	Topographic Category 1
Exposure Category C	Structure Class II

The following documents were provided:

<ul style="list-style-type: none"> • <u>Mount and Tower Record Documents</u> SBA • <u>Mount Evaluation</u> Trylon, 12/21/17. • <u>RF Design</u> Sprint DOMU Project, RFDS ID: 111250.
--

The results of the analysis are illustrated in Section 4.0. If any of the existing or proposed conditions reported in this analysis are not properly represented, please contact our office immediately to request an amended report.

3.0 Appurtenance Information

Table 3.1 – Sprint Final Configuration¹

COR	(Quantity) Appurtenance Make/Model	Mount Description
167.0'±	(3) RFS APXVTM14-ALU-I20	(1) Platform
	(3) COMMSCOPE NNVV-65B-R4	
	(6) ALU 800MHz RRH	
	(3) ALU 1900MHz RRH	
	(3) ALU 2500MHz RRH	

1. Refer to antenna installation Construction Drawings (by others, when applicable) for additional information regarding final antenna and equipment orientations.
2. Panel antennas to be installed in Positions 1 and 2, with the NNVV panel in Position 2. RRH units to be installed on mount pipes behind each panel antenna (maximum of two RRH per panel mount pipe).

4.0 Analysis Results

Table 4.1 – Existing Mount Capacity

Load Case	Governing Mount Component¹	% Capacity²	Result
Final Sprint Configuration	Bottom Rail	>200%	Inadequate³

1. Refer to the Calculations & Software Output portion of this report for mount component and structural information.
2. Listed results are expressed as a percentage of available mount member capacity based upon the assumed material strengths listed in Table 4.3. 105% is an acceptable allowable stress percentage for mount components.
3. Structural augments to the existing mount structure are required to obtain a mount structure capable of supporting the currently proposed final loading configuration in Table 3.1.

Table 4.2 – Augmented Mount Capacity

Load Case	Governing Mount Component ¹	% Capacity ²	Result
Final Sprint Configuration	Mount Pipe	87%	Adequate Once Augmented³

1. Refer to the Calculations & Software Output portion of this report for mount component and structural information.
2. Listed results are expressed as a percentage of available mount member capacity based upon the assumed material strengths listed in Table 4.3. 105% is an acceptable allowable stress percentage for mount components.
3. Refer to GeoStructural Mount Augmentation recommendations and Section 5.0 for information regarding required mount augments.

Table 4.3 – Structural Component Material Strengths

Structural Component	Nominal Strength/Material ⁴
Pipe	F _y = 35 ksi (A53, Gr. B)
Tube	F _y = 46 ksi (A500, Gr. B)
Structural Shapes (L, C, W, etc.), Plate / Bar	F _y = 36 ksi (A36)
Uni-Strut	F _y = 33 ksi (A570, Gr. 33)
Connection Bolts	A325
Stainless Steel Bolts	18-8 Stainless, Grade 316/304 F _y = 74 ksi (Yield) & F _u = 29 ksi (Tension)
U-Bolts / Threaded Rod	SAE J429 Grade 2 (Substitution: ASTM A449) F _y = 57 ksi (Yield) & F _u = 74 ksi (Tension)
Welds	E70XX Electrodes

1. Strengths listed were assumed for this analysis and are based upon ASTM, AISC, RCSC, AWS and ACI preferred specification values. Values and materials are consistent with industry standards. Material strengths were taken from original design documents when available.

5.0 Conclusion & Recommendations

Based on Sprint's final equipment loading configuration, the existing mount assembly does not have sufficient capacity to support the loading considered in this analysis pursuant to the listed standards. Structural augments (reinforcements) will be required and are briefly summarized below:

- Install **Platform Reinforcement Kit**; located 4' below the existing collar mount and attaching to the middle of the existing back-to-back angle platform member at the platform corners.
 - Sitepro1 PRK-1245L, (1) total.
- Install **Handrail Kit**; located 3.0' above the existing platform rail and attaching to the mount pipes.
 - Sitepro1 HRK14-U, (1) total. Attach all mount pipes to new handrail with kit-provided cross-over plates.
- Install **V-Brace Kit**; located 2.5' below the existing platform rail and attaching to the new bottom handrail kit.
 - Sitepro1 PRK-SFS-H-L, (1) total. Attach kit ring mount in kit to monopole shaft.
 - If the PRK-SFS-H-L kit is not available, provide (6) total L2-1/2x2-1/2x3/16 x ~8' long replacement angles, field-cut and drill to suit.
 - Pipe2.0STD x 14.0' Horizontal Rail, (3) total. Attach SFS-H-L kit angles to new horizontal bottom rail.
 - Pipe2.0STD x ~4' long corner braces, (3) total. Attach to new horizontal bottom rail w/ Sitepro1 PUCK brackets, (6) total.
 - Sitepro1 SCX_x-K, (9) total. Attach all mount pipes to new horizontal bottom rail.
- Panel antennas to be installed in Positions 1 and 2, with the NNVV panel in Position 2. RRH units to be installed on mount pipes behind each panel antenna (maximum of two RRH per panel mount pipe).

Once the recommended augments are successfully implemented, the **augmented** mount assembly has sufficient capacity to support the loading considered in this analysis pursuant to the listed standards.

Augmentation Requirements:

- **In order to obtain a mount structure capable of supporting the currently proposed final loading configuration, upgrade augments must be installed in accordance with GeoStructural's Mount Augmentation recommendations.**

This analysis only encompasses the antenna mount assembly. The tower, overall mount support structure, foundation, etc. are beyond the scope of this analysis. If any of the existing or proposed conditions (appurtenance loading, member sizes, etc.) reported in this analysis are not properly represented, please contact our office immediately to request an amended report.

Prepared by:



Jesse Drennen, PE, MLE
208.761.7986
jesse.drennen@geostructural.com

Reviewed and Approved by:

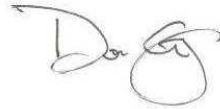

Don George, PE, SE, MLSE
208.602.6569
don.george@geostructural.com

6.0 Standard Conditions

- All data required to complete our structural analysis was furnished by our client and provided record data. GeoStructural has not conducted a site visit or independent study to verify existing conditions and the results of this analysis are based solely on the information provided. It has been assumed that the tower, antenna support structure and foundation have been constructed according to the provided existing drawings, previous structural analysis reports, mapping documents, etc.
- The default Structure Classification is Class II in accordance with ANSI/TIA-222-G §A.2.2 & §A.15.3 and has been assumed for this analysis. The owner shall verify this classification conforms with original or desired reliability criteria.
- This analysis assumes that the structure has been properly installed and maintained in accordance with ANSI/TIA-222-G §15.5 and that no physical deterioration has occurred in any of the components of the structure. Damaged, missing, or rusted members were not considered.
- This analysis verifies the adequacy of the main components of the structure. Not all connections, welds, bolts, plates, etc. were individually detailed and analyzed. Where not specifically analyzed, the existing connection plates, welds, bolts, etc. were assumed adequate to develop the full capacity of the main structural members.
- No consideration has been made for unusual or extreme wind events, rime/in-cloud ice loadings, harmonic or nodal vibration, vortex shedding or other similar conditions.
- It is the owner's responsibility to determine the appropriate design wind speed and amount of ice accumulation beyond code minimum values that should be considered in the analysis.
- This analysis report does not constitute a maintenance and condition assessment. No certifications regarding maintenance and condition are expressed or implied. If desired, GeoStructural can provide these services under a subsequent contract.
- This analysis only encompasses the antenna mount assembly. The tower, overall mount support structure, foundation, etc. are beyond the scope of this analysis. If desired, GeoStructural can provide these services under a subsequent contract.

7.0 Calculations & Software Output

This page intentionally left blank.

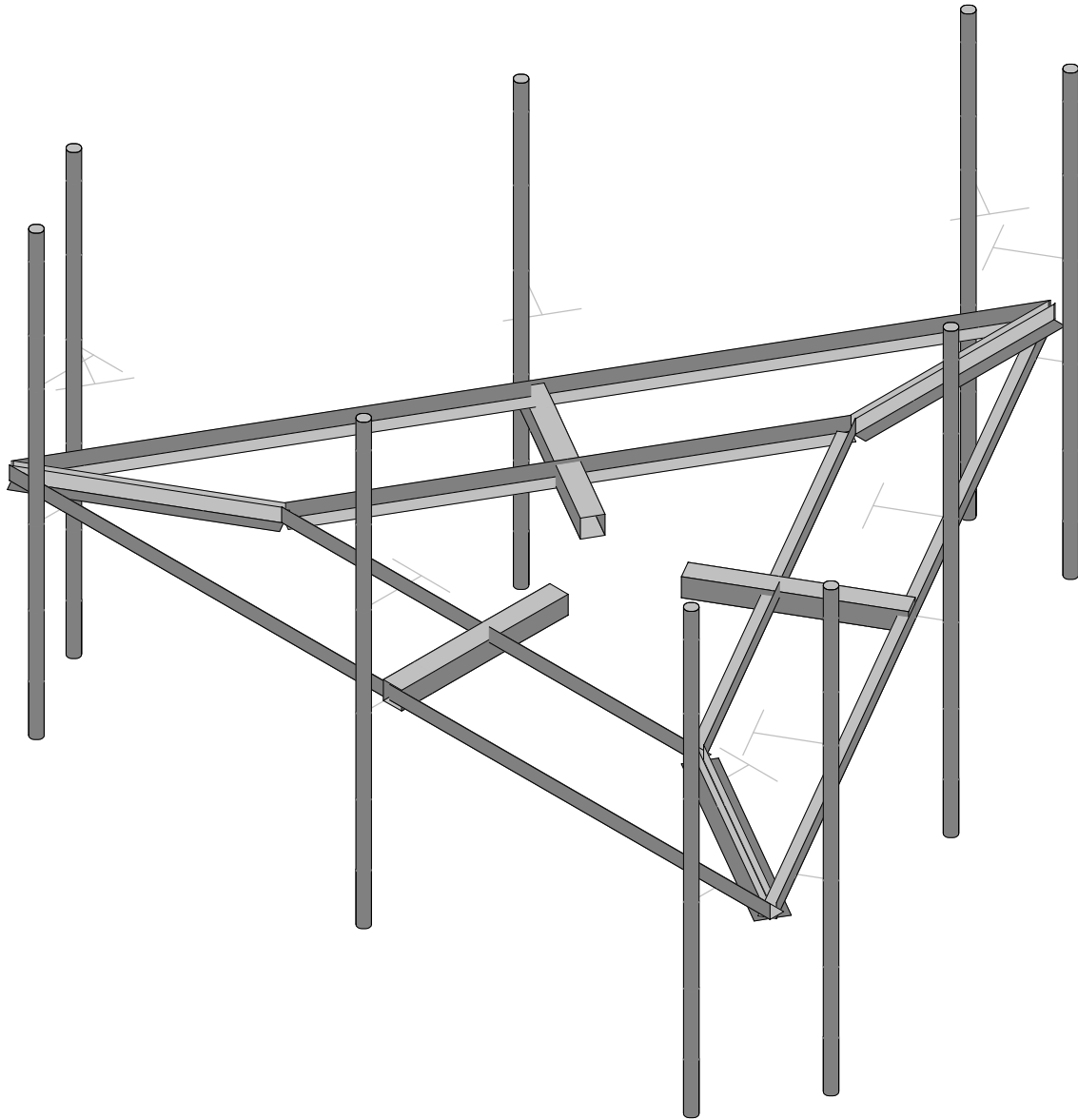
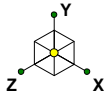

Envelope Only Solution

GeoStructural, LLC

Jesse Drennen, PE

CT33XC017

SK - 1

June 18, 2018 at 2:51 PM

CT33XC017_Mount Analysis_R2 1...

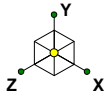

Code Check
(Env)

- █ No Calc
- █ > 1.0
- █ .90-1.0
- █ .75-.90
- █ .50-.75
- █ 0-.50

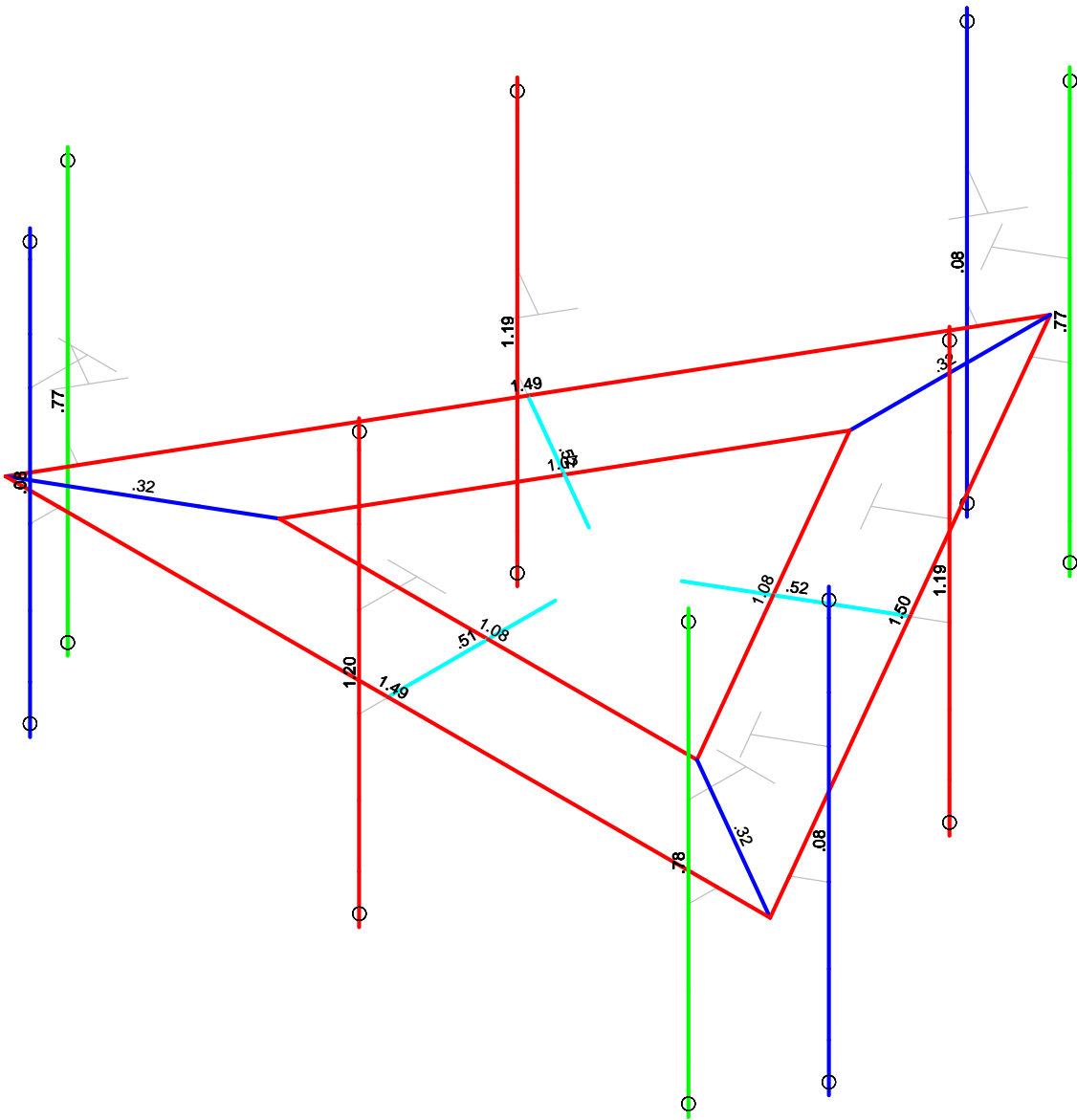

Member Code Checks Displayed (Enveloped)
Envelope Only Solution

GeoStructural, LLC

Jesse Drennen, PE

CT33XC017

SK - 2

June 18, 2018 at 2:51 PM

CT33XC017_Mount Analysis_R2 1...

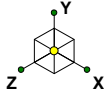

Shear Check (Env)

- No Calc
- > 1.0
- .90-1.0
- .75-.90
- .50-.75
- 0-.50

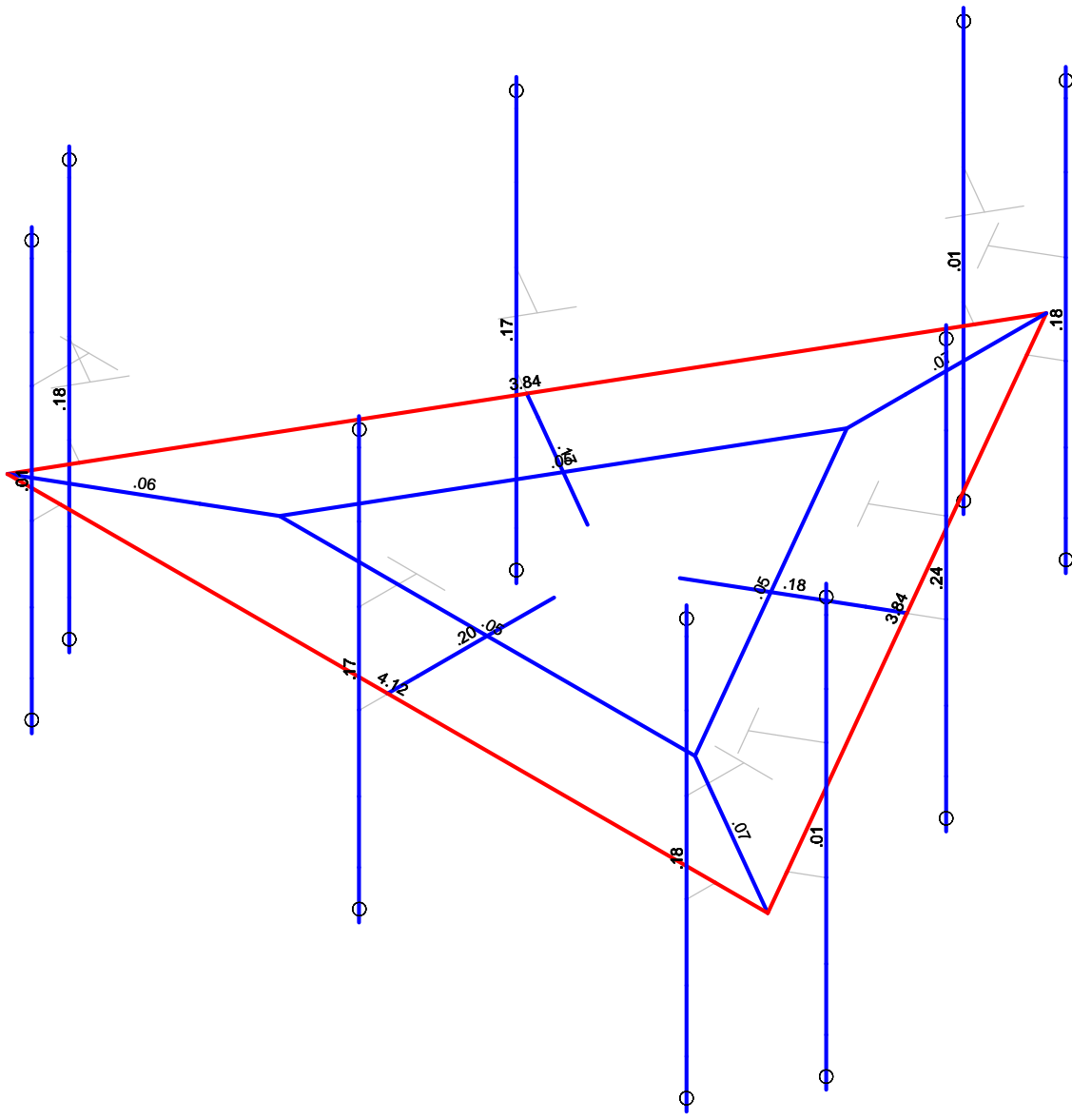

Member Shear Checks Displayed (Enveloped)
Envelope Only Solution

GeoStructural, LLC
Jesse Drennen, PE

CT33XC017

SK - 3
June 18, 2018 at 2:51 PM
CT33XC017_Mount Analysis_R2 1...

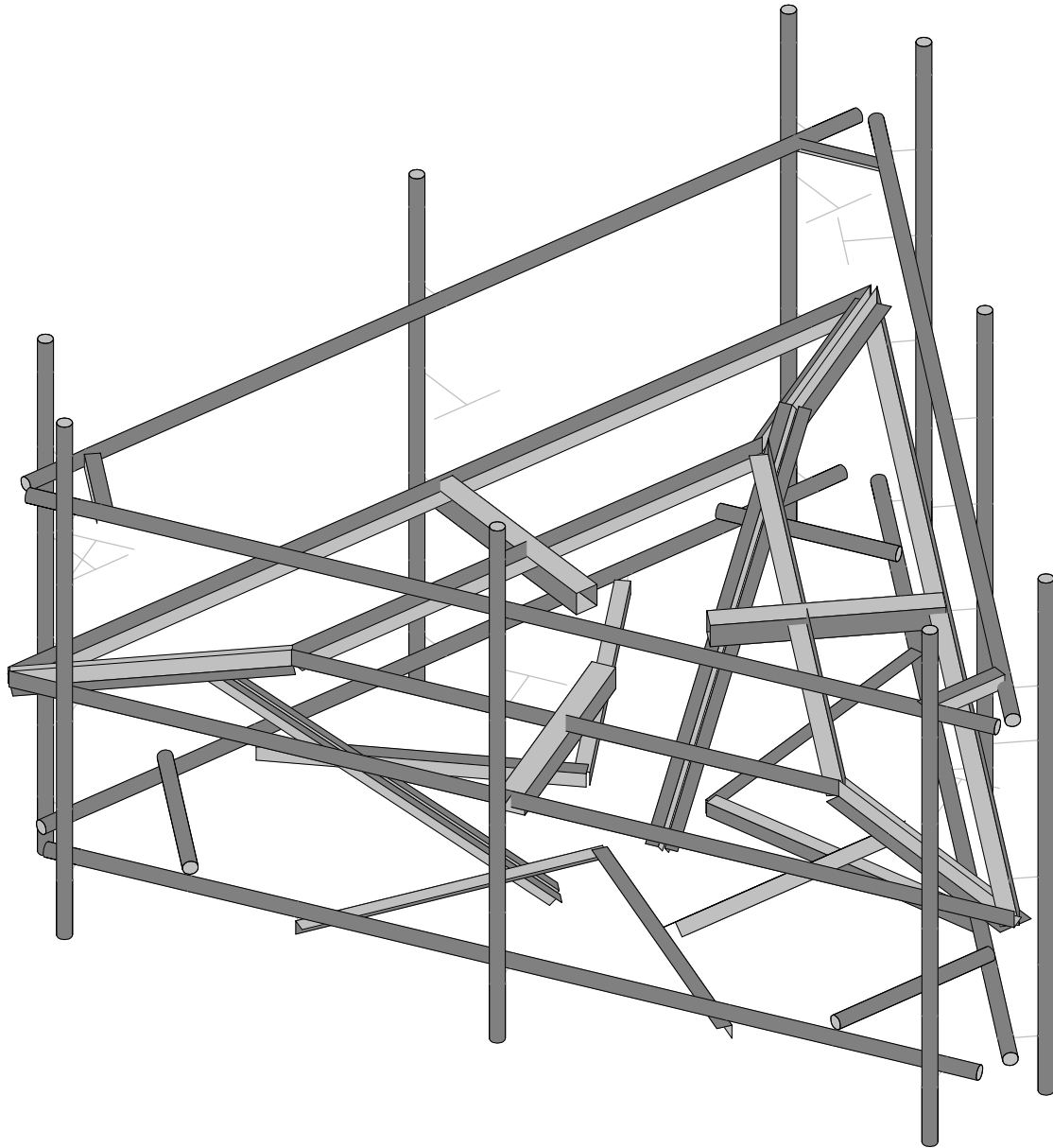
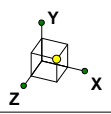

Envelope Only Solution

GeoStructural, LLC

Jesse Drennen, PE

CT33XC017

SK - 1

June 18, 2018 at 2:48 PM

CT33XC017_Mount Analysis_R2 1...

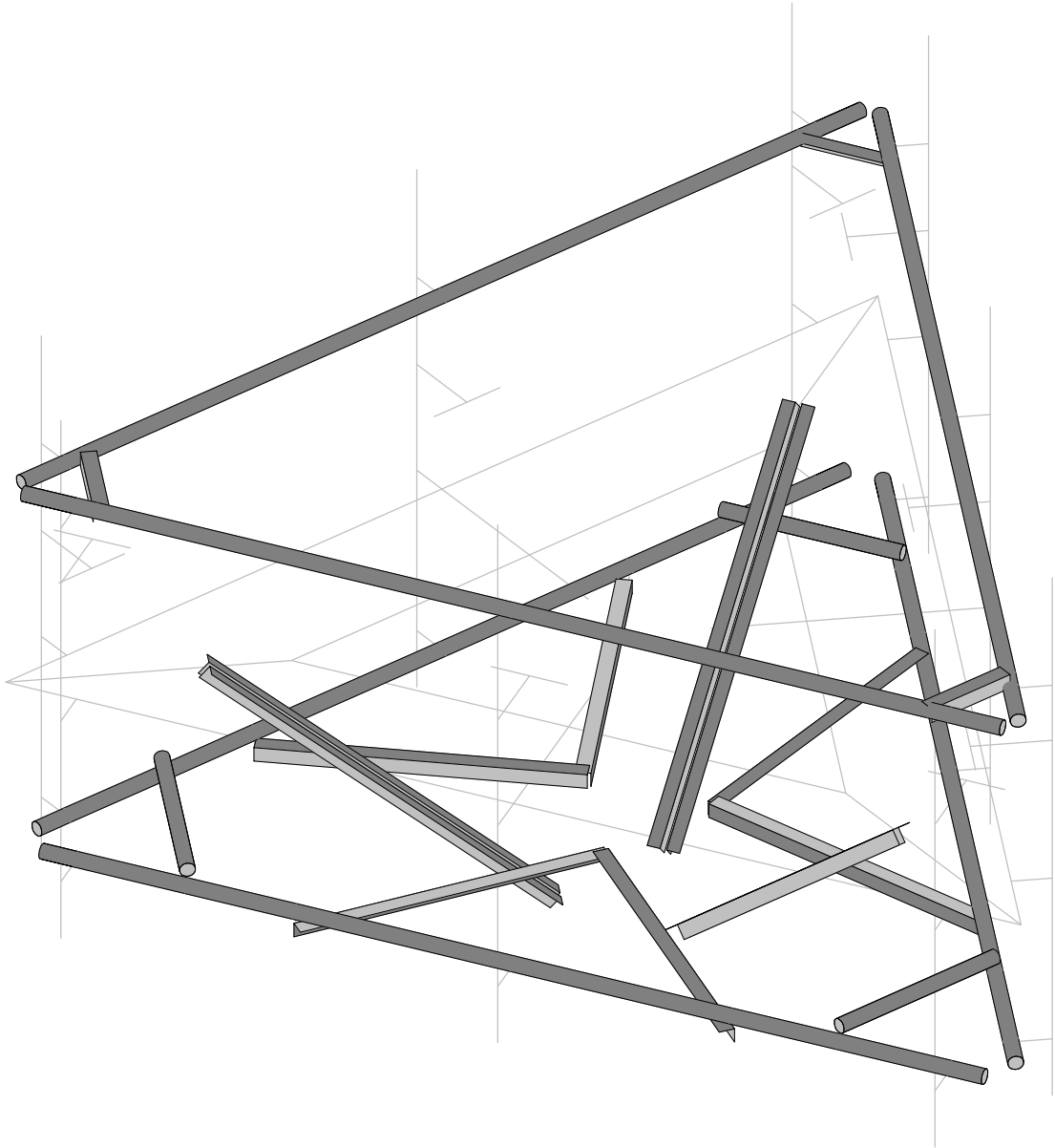
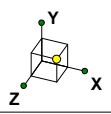

GeoStructural, LLC

Jesse Drennen, PE

CT33XC017

SK - 4

June 18, 2018 at 2:57 PM

CT33XC017_Mount Analysis_R2 1...

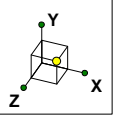

Shear Check (Env)

- No Calc
- > 1.0
- .90-1.0
- .75-.90
- .50-.75
- 0-.50

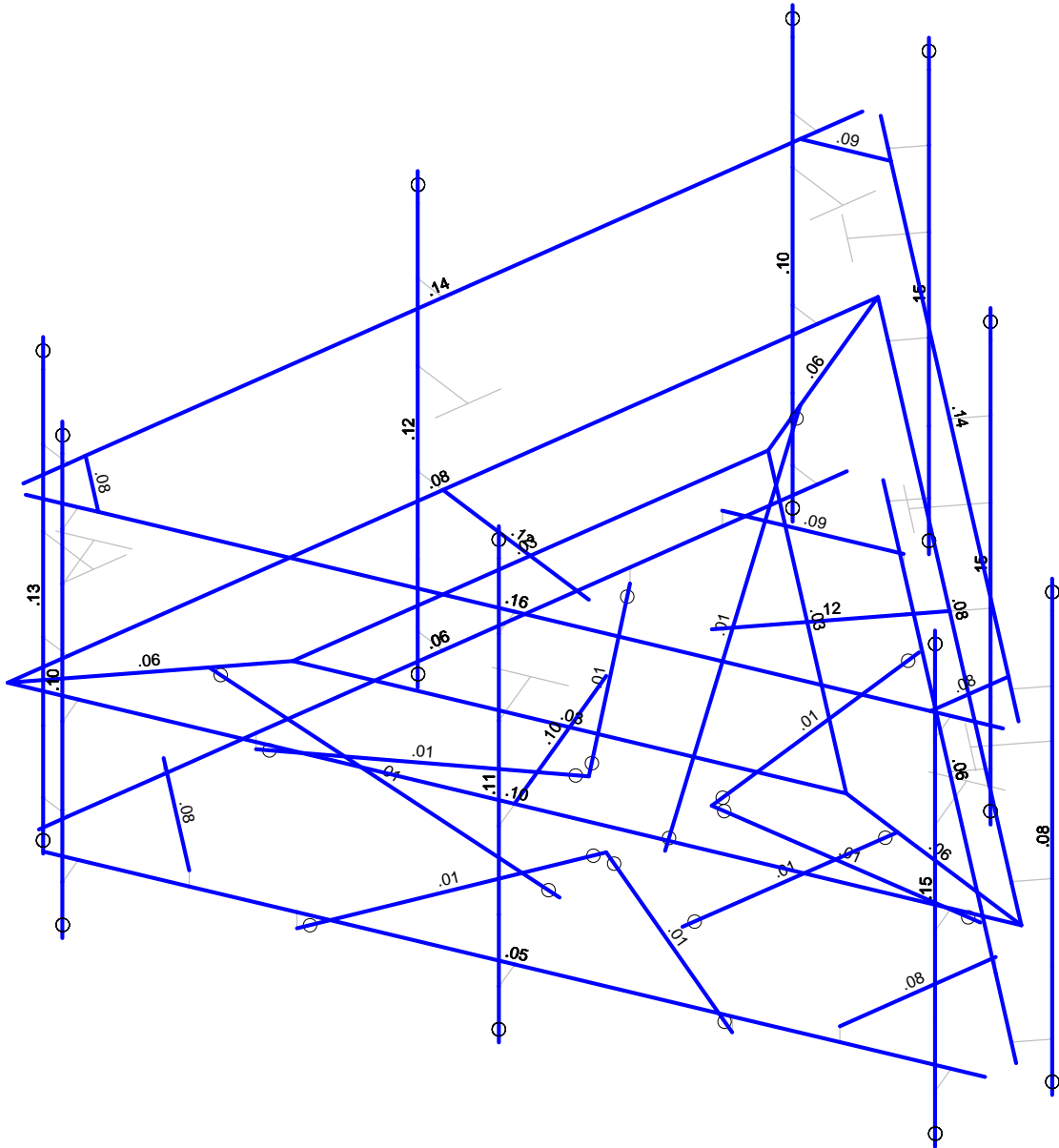

Member Shear Checks Displayed (Enveloped)
Envelope Only Solution

GeoStructural, LLC

Jesse Drennen, PE

CT33XC017

SK - 3

June 18, 2018 at 2:48 PM

CT33XC017_Mount Analysis_R2 1...

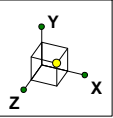

Section Sets	
Blue	PIPE_2.0
Green	HSS4x4x4
Red	LL3x3x4x0
Grey	L2.5x2.5x4
Magenta	L3x3x4
Cyan	LL2.5x2.5x3x3
Orange	L2.5x2.5x3
Yellow	RIGID

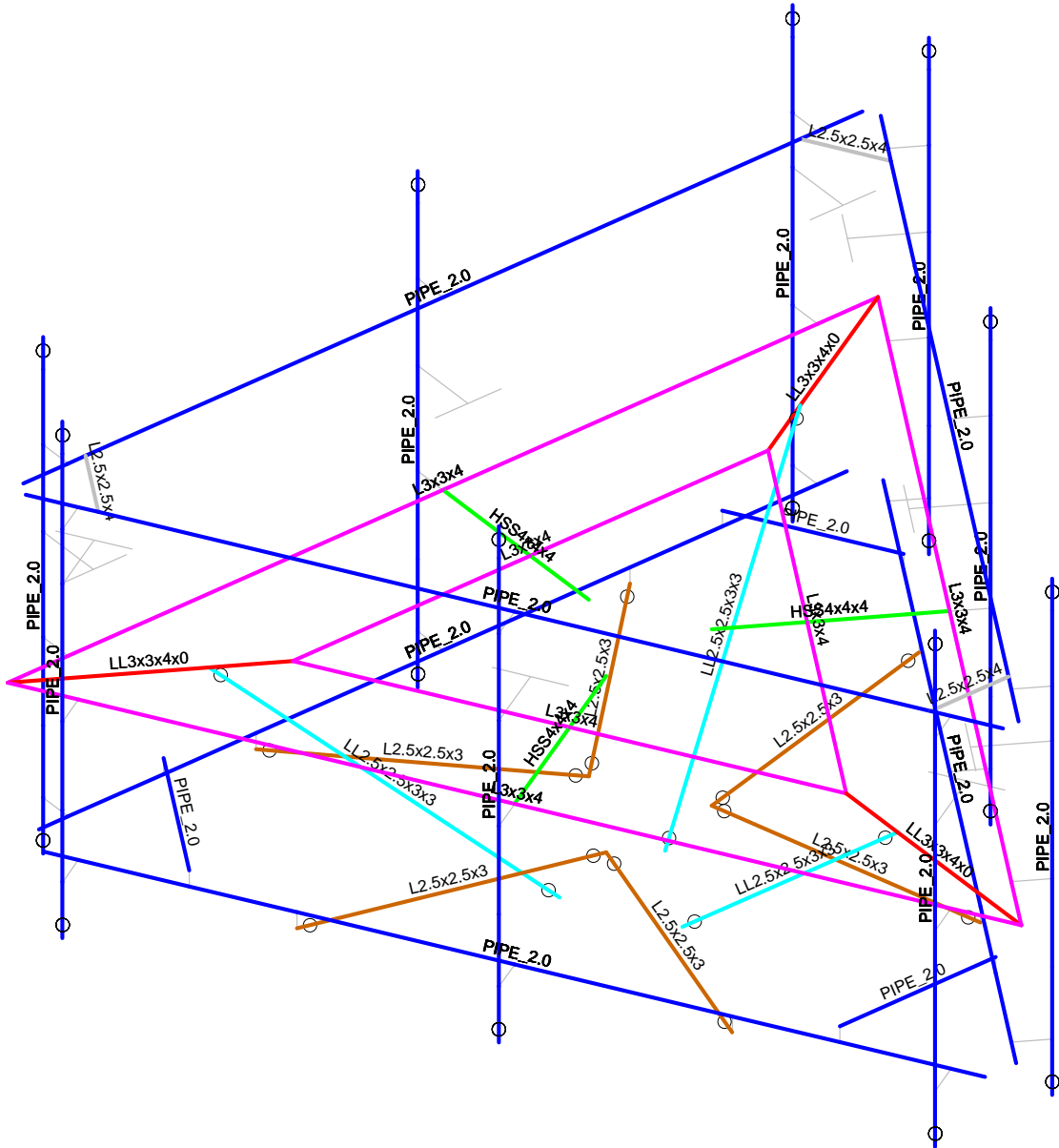

Envelope Only Solution

GeoStructural, LLC

Jesse Drennen, PE

CT33XC017

SK - 4

June 18, 2018 at 2:48 PM

CT33XC017_Mount Analysis_R2 1...

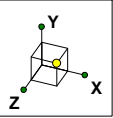

Material Sets	
Blue	RIGID
Green	A36 Gr.36
Red	A500 Gr.B Rect
Grey	A53 Gr.B

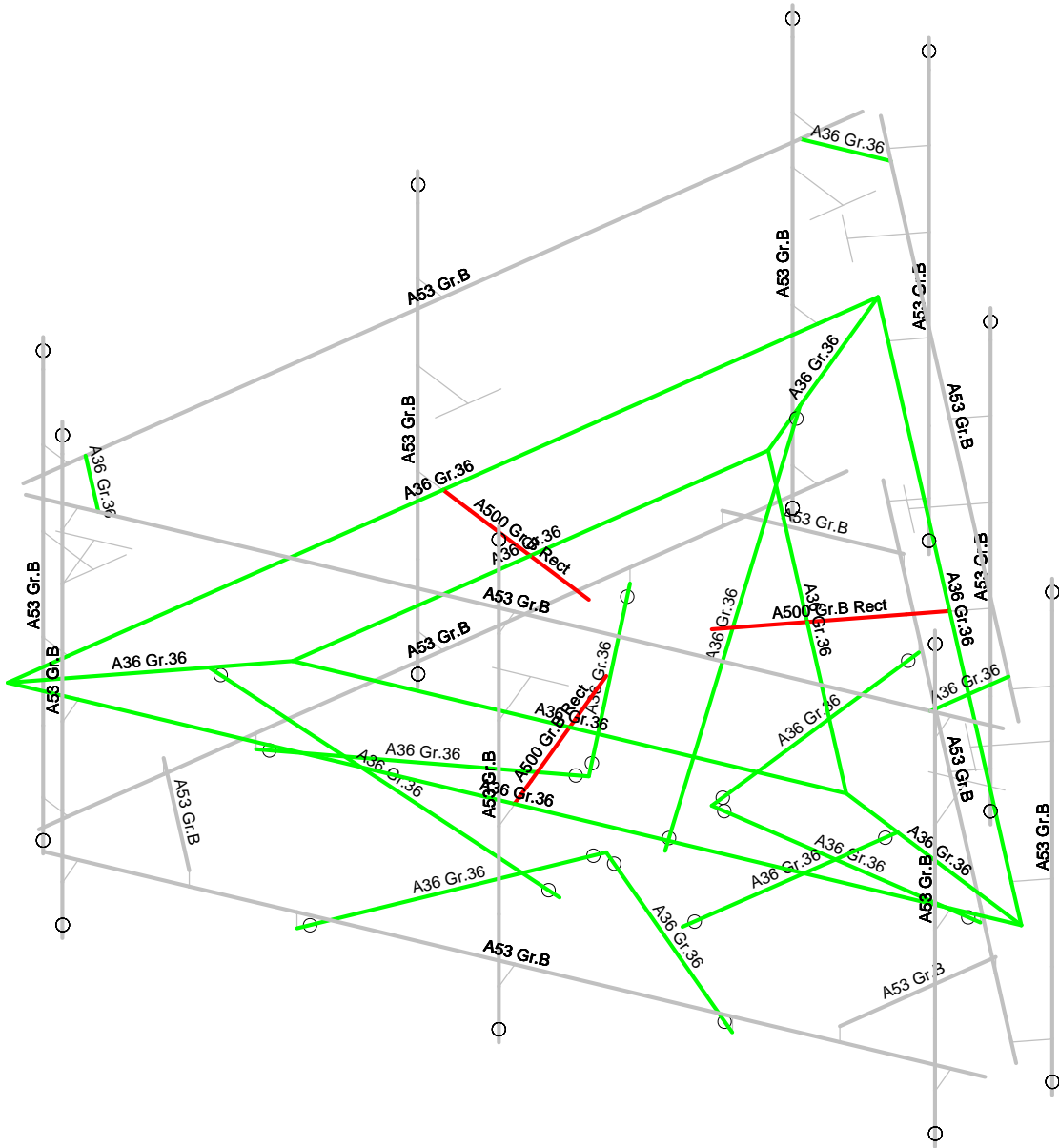

Envelope Only Solution

GeoStructural, LLC

Jesse Drennen, PE

CT33XC017

SK - 5

June 18, 2018 at 2:48 PM

CT33XC017_Mount Analysis_R2 1...

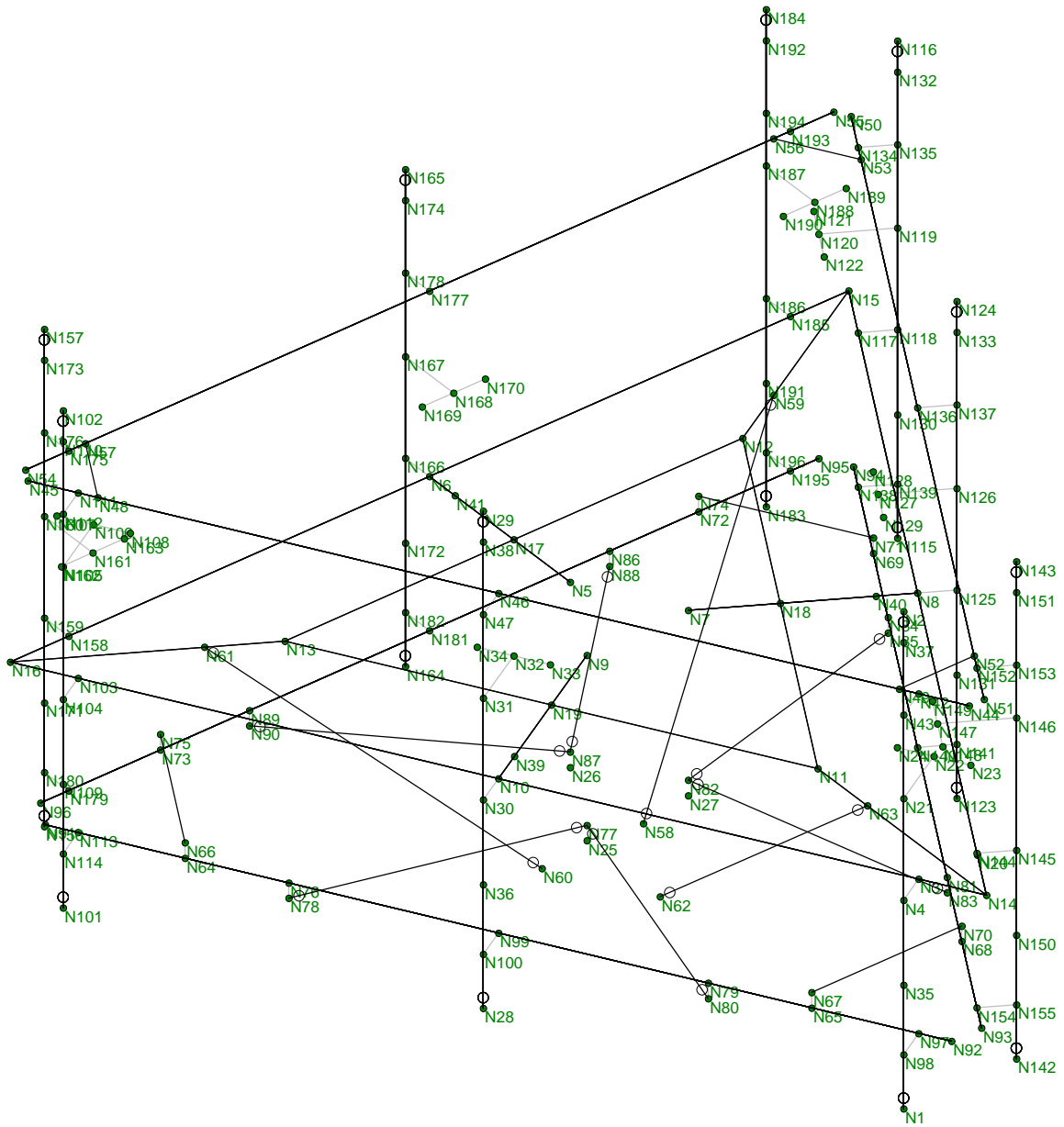
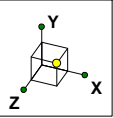

Envelope Only Solution

GeoStructural, LLC

Jesse Drennen, PE

CT33XC017

SK - 6

June 18, 2018 at 2:48 PM

CT33XC017_Mount Analysis_R2 1...

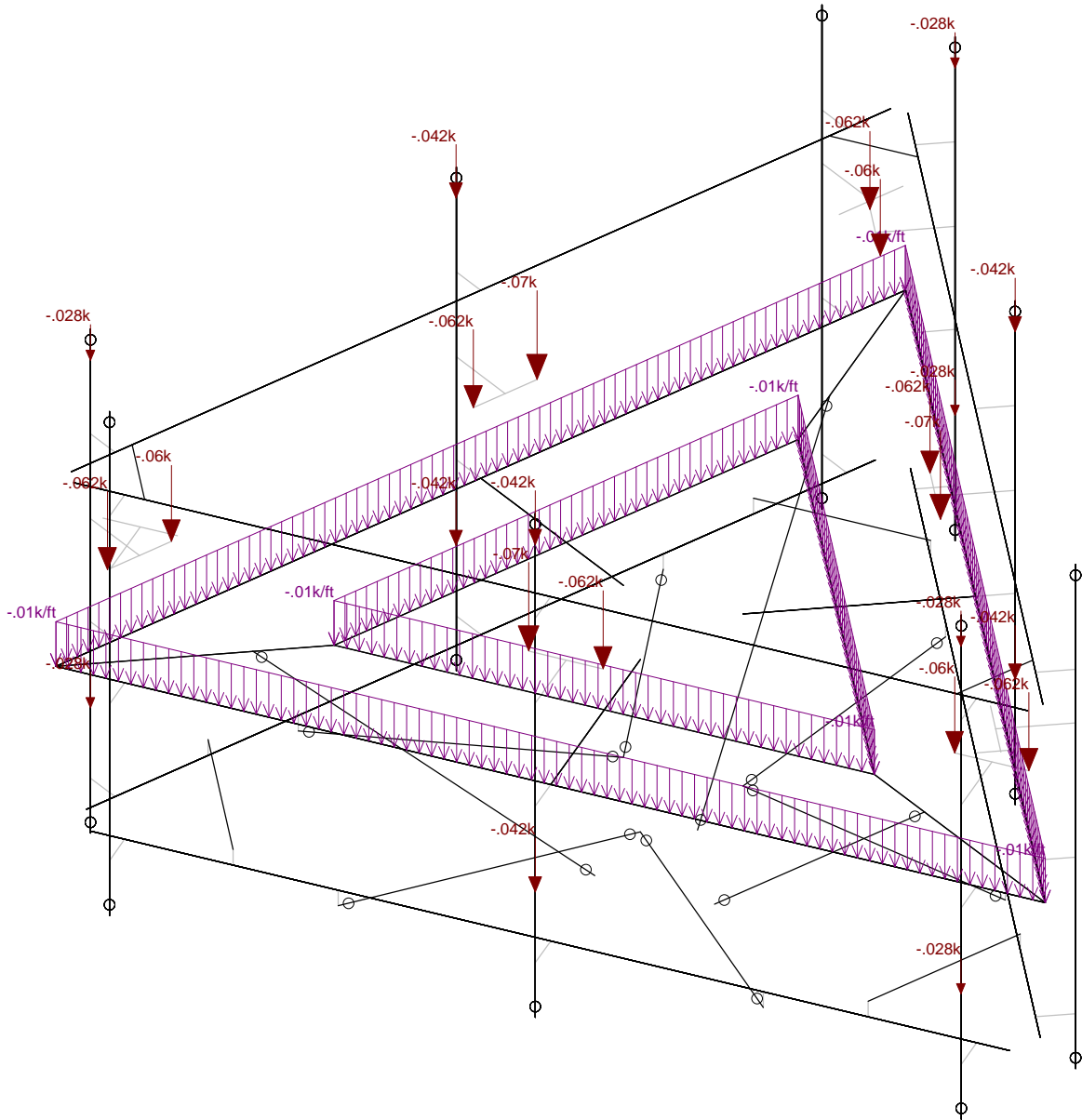
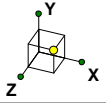

Loads: BLC 1, D
Envelope Only Solution

GeoStructural, LLC

Jesse Drennen, PE

CT33XC017

SK - 7

June 18, 2018 at 2:49 PM

CT33XC017_Mount Analysis_R2 1...

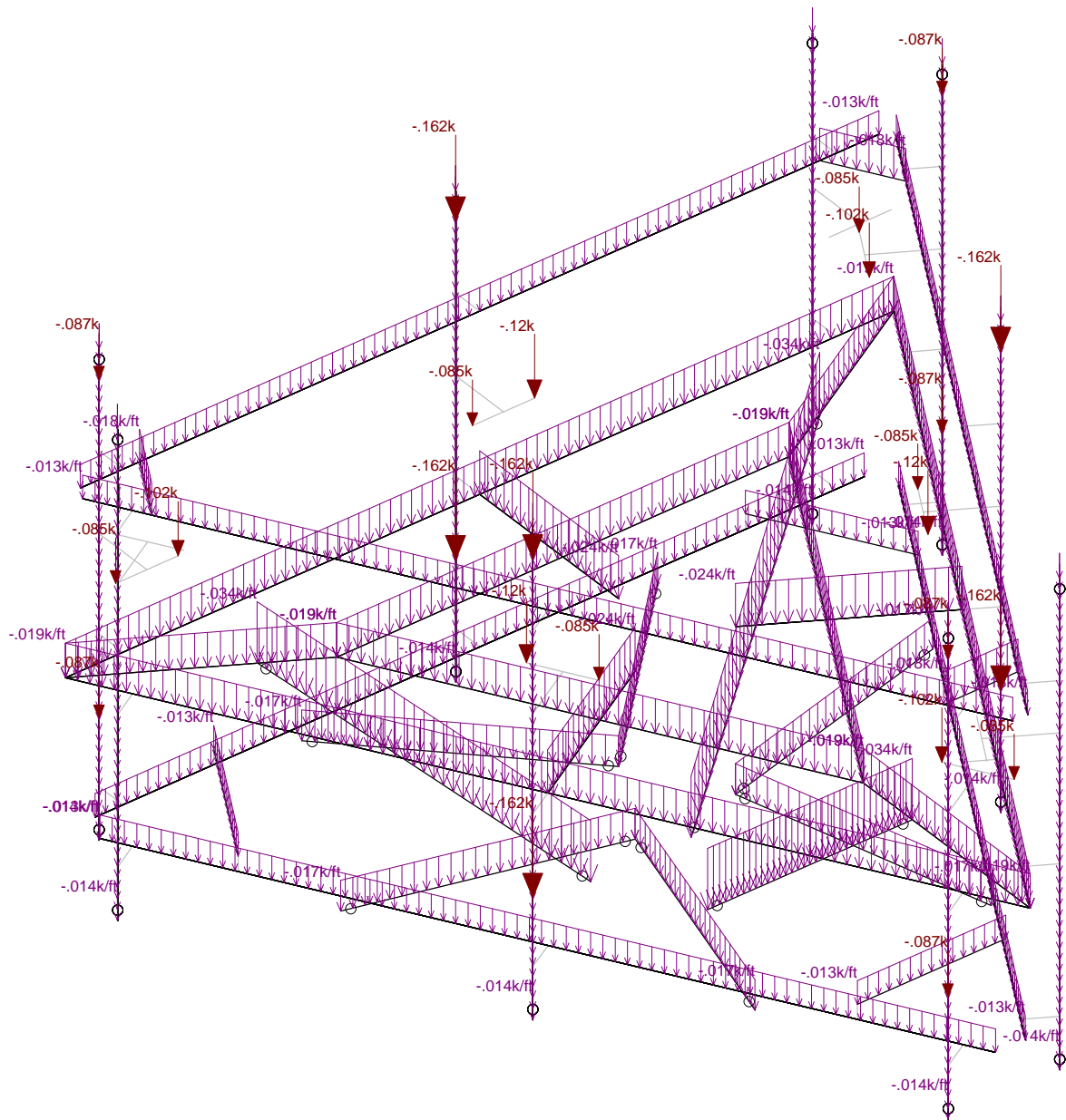
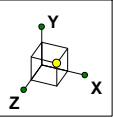

Loads: BLC 2, Di
Envelope Only Solution

GeoStructural, LLC

Jesse Drennen, PE

CT33XC017

SK - 8

June 18, 2018 at 2:49 PM

CT33XC017_Mount Analysis_R2 1...

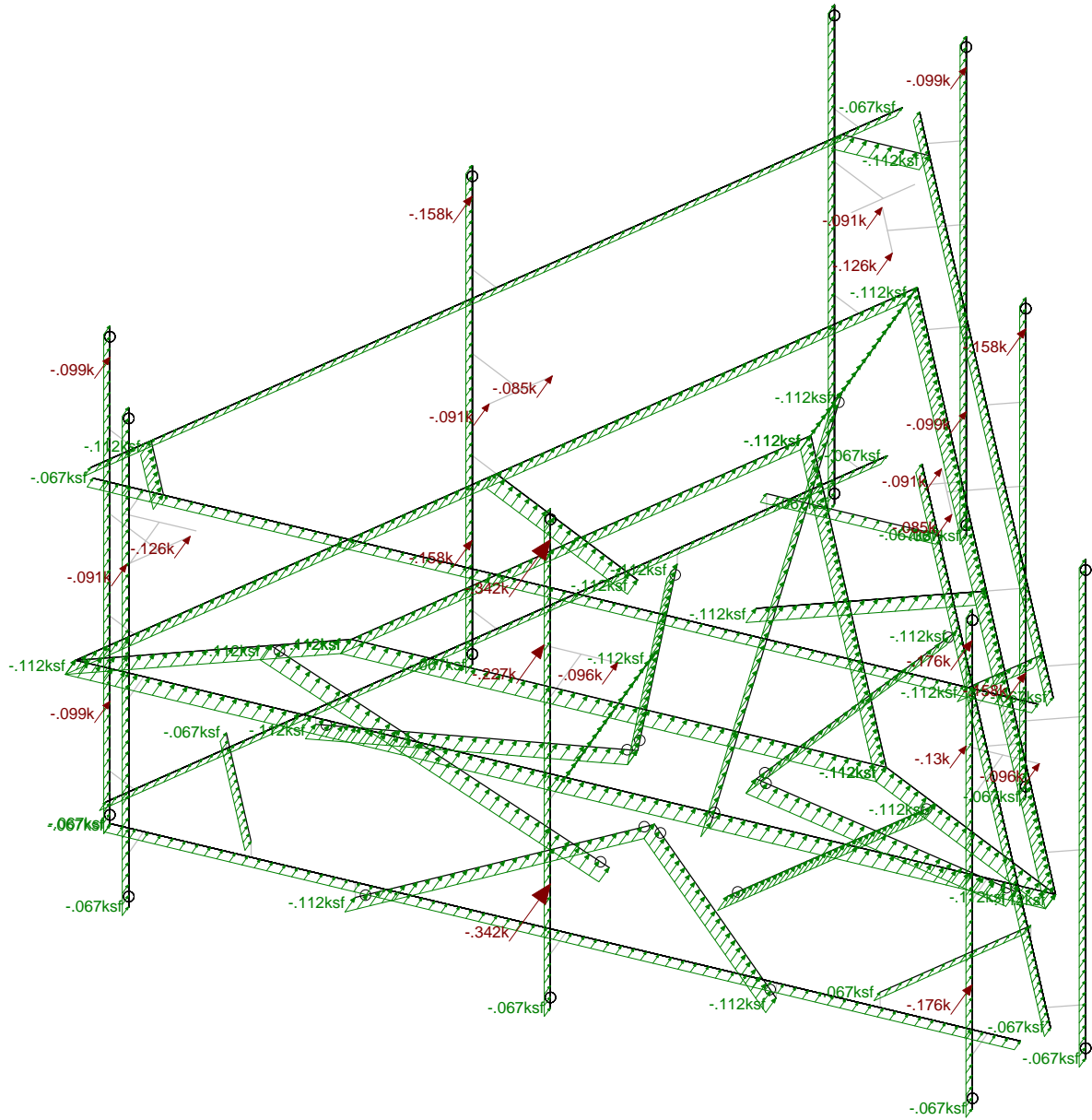
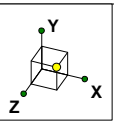

Loads: BLC 5, Woz
Envelope Only Solution

GeoStructural, LLC

Jesse Drennen, PE

CT33XC017

SK - 9

June 18, 2018 at 2:49 PM

CT33XC017_Mount Analysis_R2 1...

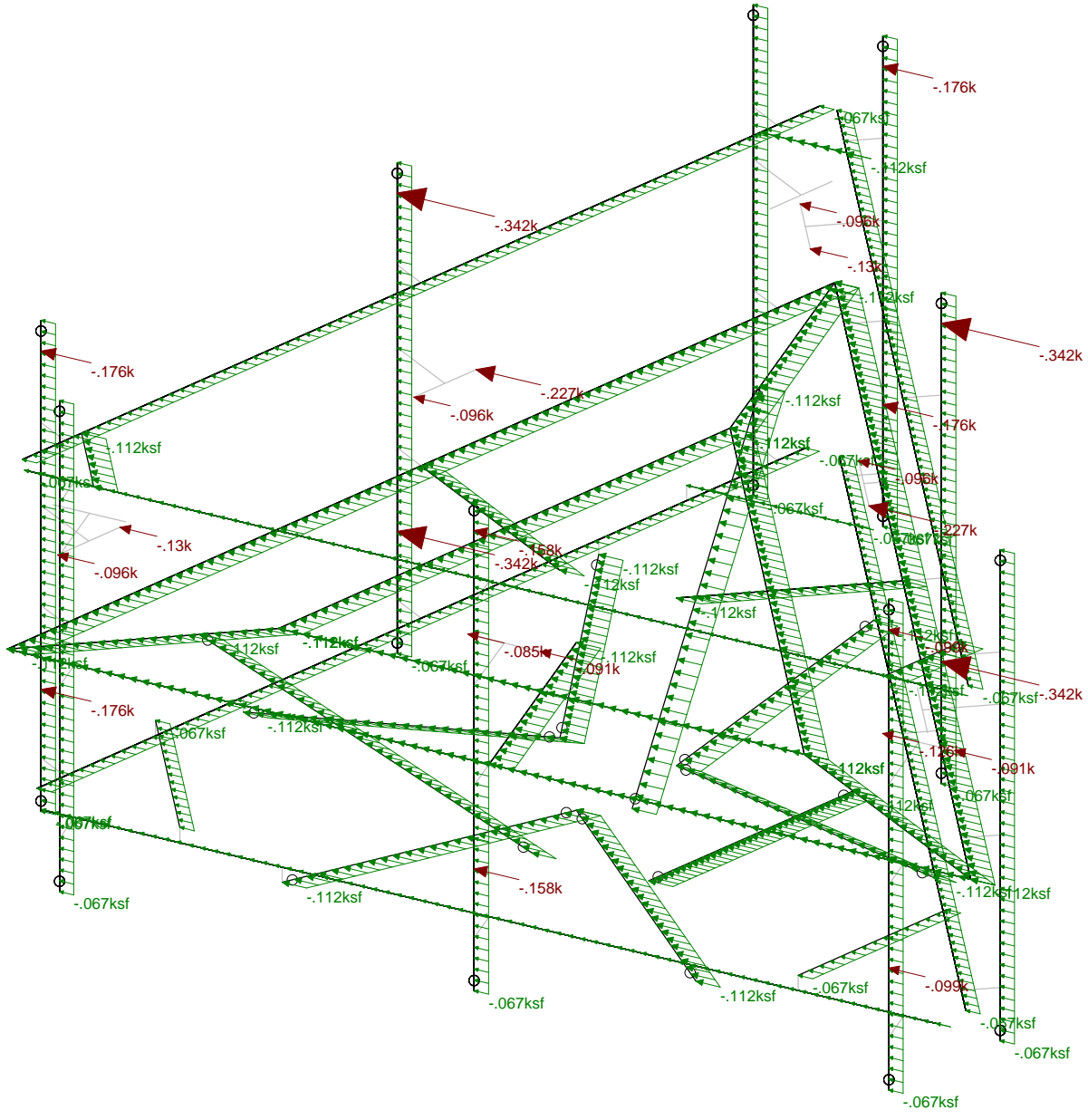
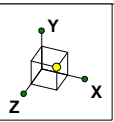

Loads: BLC 6, Wox
Envelope Only Solution

GeoStructural, LLC

Jesse Drennen, PE

CT33XC017

SK - 10

June 18, 2018 at 2:49 PM

CT33XC017_Mount Analysis_R2 1...

Basic Load Cases

	BLC Description	Category	X Gravity	Y Gravity	Z Gravity	Joint	Point	Distributed Area(Me...	Surface(P...
1	D	DL		-1		25		6	
2	Di	SL				25		51	
3	Lm [500]	LL				1			
4	Lv [250]	LL				2			
5	Woz	WL				25		45	
6	Wox	WL				25		45	
7	Wiz	WL				25		45	
8	Wix	WL				25		45	
9	Ez	EL				25			
10	Ex	EL				25			

Load Combination Design

	Description	ASIF	CD	Service	Hot Rol...	Cold Form...	Wood	Concrete	Masonry	Aluminum	Stainless	Connection
1	1) 1.4D				Yes	Yes	Yes	Yes	Yes	Yes	Yes	Yes
2	2) 1.2D+1.0...				Yes	Yes	Yes	Yes	Yes	Yes	Yes	Yes
3	2) 1.2D+1.0...				Yes	Yes	Yes	Yes	Yes	Yes	Yes	Yes
4	2) 1.2D+1.0...				Yes	Yes	Yes	Yes	Yes	Yes	Yes	Yes
5	2) 1.2D+1.0...				Yes	Yes	Yes	Yes	Yes	Yes	Yes	Yes
6	2) 1.2D+1.0...				Yes	Yes	Yes	Yes	Yes	Yes	Yes	Yes
7	2) 1.2D+1.0...				Yes	Yes	Yes	Yes	Yes	Yes	Yes	Yes
8	2) 1.2D+1.0...				Yes	Yes	Yes	Yes	Yes	Yes	Yes	Yes
9	2) 1.2D+1.0...				Yes	Yes	Yes	Yes	Yes	Yes	Yes	Yes
10	2) 1.2D+1.0...				Yes	Yes	Yes	Yes	Yes	Yes	Yes	Yes
11	2) 1.2D+1.0...				Yes	Yes	Yes	Yes	Yes	Yes	Yes	Yes
12	2) 1.2D+1.0...				Yes	Yes	Yes	Yes	Yes	Yes	Yes	Yes
13	2) 1.2D+1.0...				Yes	Yes	Yes	Yes	Yes	Yes	Yes	Yes
14	3) 0.9D+1.0...				Yes	Yes	Yes	Yes	Yes	Yes	Yes	Yes
15	3) 0.9D+1.0...				Yes	Yes	Yes	Yes	Yes	Yes	Yes	Yes
16	3) 0.9D+1.0...				Yes	Yes	Yes	Yes	Yes	Yes	Yes	Yes
17	3) 0.9D+1.0...				Yes	Yes	Yes	Yes	Yes	Yes	Yes	Yes
18	3) 0.9D+1.0...				Yes	Yes	Yes	Yes	Yes	Yes	Yes	Yes
19	3) 0.9D+1.0...				Yes	Yes	Yes	Yes	Yes	Yes	Yes	Yes
20	3) 0.9D+1.0...				Yes	Yes	Yes	Yes	Yes	Yes	Yes	Yes
21	3) 0.9D+1.0...				Yes	Yes	Yes	Yes	Yes	Yes	Yes	Yes
22	3) 0.9D+1.0...				Yes	Yes	Yes	Yes	Yes	Yes	Yes	Yes
23	3) 0.9D+1.0...				Yes	Yes	Yes	Yes	Yes	Yes	Yes	Yes
24	3) 0.9D+1.0...				Yes	Yes	Yes	Yes	Yes	Yes	Yes	Yes
25	3) 0.9D+1.0...				Yes	Yes	Yes	Yes	Yes	Yes	Yes	Yes
26	4) 1.2D+1.0...				Yes	Yes	Yes	Yes	Yes	Yes	Yes	Yes
27	4) 1.2D+1.0...				Yes	Yes	Yes	Yes	Yes	Yes	Yes	Yes
28	4) 1.2D+1.0...				Yes	Yes	Yes	Yes	Yes	Yes	Yes	Yes
29	4) 1.2D+1.0...				Yes	Yes	Yes	Yes	Yes	Yes	Yes	Yes
30	4) 1.2D+1.0...				Yes	Yes	Yes	Yes	Yes	Yes	Yes	Yes
31	4) 1.2D+1.0...				Yes	Yes	Yes	Yes	Yes	Yes	Yes	Yes
32	4) 1.2D+1.0...				Yes	Yes	Yes	Yes	Yes	Yes	Yes	Yes
33	4) 1.2D+1.0...				Yes	Yes	Yes	Yes	Yes	Yes	Yes	Yes
34	4) 1.2D+1.0...				Yes	Yes	Yes	Yes	Yes	Yes	Yes	Yes
35	4) 1.2D+1.0...				Yes	Yes	Yes	Yes	Yes	Yes	Yes	Yes
36	4) 1.2D+1.0...				Yes	Yes	Yes	Yes	Yes	Yes	Yes	Yes
37	4) 1.2D+1.0...				Yes	Yes	Yes	Yes	Yes	Yes	Yes	Yes
38	5) 1.2D+1.5L...				Yes	Yes	Yes	Yes	Yes	Yes	Yes	Yes
39	5) 1.2D+1.5L...				Yes	Yes	Yes	Yes	Yes	Yes	Yes	Yes
40	5) 1.2D+1.5L...				Yes	Yes	Yes	Yes	Yes	Yes	Yes	Yes
41	5) 1.2D+1.5L...				Yes	Yes	Yes	Yes	Yes	Yes	Yes	Yes

Load Combination Design (Continued)

	Description	ASIF	CD	Service	Hot Rol...	Cold Form...	Wood	Concrete	Masonry	Aluminum	Stainless	Connection
42	5) 1.2D+1.5L...				Yes	Yes	Yes	Yes	Yes	Yes	Yes	Yes
43	5) 1.2D+1.5L...				Yes	Yes	Yes	Yes	Yes	Yes	Yes	Yes
44	5) 1.2D+1.5L...				Yes	Yes	Yes	Yes	Yes	Yes	Yes	Yes
45	5) 1.2D+1.5L...				Yes	Yes	Yes	Yes	Yes	Yes	Yes	Yes
46	5) 1.2D+1.5L...				Yes	Yes	Yes	Yes	Yes	Yes	Yes	Yes
47	5) 1.2D+1.5L...				Yes	Yes	Yes	Yes	Yes	Yes	Yes	Yes
48	5) 1.2D+1.5L...				Yes	Yes	Yes	Yes	Yes	Yes	Yes	Yes
49	5) 1.2D+1.5L...				Yes	Yes	Yes	Yes	Yes	Yes	Yes	Yes
50	6) 1.2D+1.5Lv				Yes	Yes	Yes	Yes	Yes	Yes	Yes	Yes
51	7) (1.2+0.2Sd...				Yes	Yes	Yes	Yes	Yes	Yes	Yes	Yes
52	7) (1.2+0.2Sd...				Yes	Yes	Yes	Yes	Yes	Yes	Yes	Yes
53	7) (1.2+0.2Sd...				Yes	Yes	Yes	Yes	Yes	Yes	Yes	Yes
54	7) (1.2+0.2Sd...				Yes	Yes	Yes	Yes	Yes	Yes	Yes	Yes
55	7) (1.2+0.2Sd...				Yes	Yes	Yes	Yes	Yes	Yes	Yes	Yes
56	7) (1.2+0.2Sd...				Yes	Yes	Yes	Yes	Yes	Yes	Yes	Yes
57	7) (1.2+0.2Sd...				Yes	Yes	Yes	Yes	Yes	Yes	Yes	Yes
58	7) (1.2+0.2Sd...				Yes	Yes	Yes	Yes	Yes	Yes	Yes	Yes
59	7) (1.2+0.2Sd...				Yes	Yes	Yes	Yes	Yes	Yes	Yes	Yes
60	7) (1.2+0.2Sd...				Yes	Yes	Yes	Yes	Yes	Yes	Yes	Yes
61	7) (1.2+0.2Sd...				Yes	Yes	Yes	Yes	Yes	Yes	Yes	Yes
62	7) (1.2+0.2Sd...				Yes	Yes	Yes	Yes	Yes	Yes	Yes	Yes
63	8) (0.9-0.2Sd...				Yes	Yes	Yes	Yes	Yes	Yes	Yes	Yes
64	8) (0.9-0.2Sd...				Yes	Yes	Yes	Yes	Yes	Yes	Yes	Yes
65	8) (0.9-0.2Sd...				Yes	Yes	Yes	Yes	Yes	Yes	Yes	Yes
66	8) (0.9-0.2Sd...				Yes	Yes	Yes	Yes	Yes	Yes	Yes	Yes
67	8) (0.9-0.2Sd...				Yes	Yes	Yes	Yes	Yes	Yes	Yes	Yes
68	8) (0.9-0.2Sd...				Yes	Yes	Yes	Yes	Yes	Yes	Yes	Yes
69	8) (0.9-0.2Sd...				Yes	Yes	Yes	Yes	Yes	Yes	Yes	Yes
70	8) (0.9-0.2Sd...				Yes	Yes	Yes	Yes	Yes	Yes	Yes	Yes
71	8) (0.9-0.2Sd...				Yes	Yes	Yes	Yes	Yes	Yes	Yes	Yes
72	8) (0.9-0.2Sd...				Yes	Yes	Yes	Yes	Yes	Yes	Yes	Yes
73	8) (0.9-0.2Sd...				Yes	Yes	Yes	Yes	Yes	Yes	Yes	Yes
74	8) (0.9-0.2Sd...				Yes	Yes	Yes	Yes	Yes	Yes	Yes	Yes

Hot Rolled Steel Properties

	Label	E [ksi]	G [ksi]	Nu	Therm (1E...	Density[k/ft...	Yield[ksi]	Ry	Fu[ksi]	Rt
1	A36 Gr.36	29000	11154	.3	.65	.49	36	1.5	58	1.2
2	A572 Gr.50	29000	11154	.3	.65	.49	50	1.1	65	1.1
3	A992	29000	11154	.3	.65	.49	50	1.1	65	1.1
4	A500 Gr.B RND	29000	11154	.3	.65	.49	42	1.4	58	1.3
5	A500 Gr.B Rect	29000	11154	.3	.65	.49	46	1.4	58	1.3
6	A53 Gr.B	29000	11154	.3	.65	.49	35	1.6	60	1.2

Hot Rolled Steel Section Sets

	Label	Shape	Type	Design List	Material	Design R...	A [in2]	Iyy [in4]	Izz [in4]	J [in4]
1	PIPE 1.5	PIPE 1.5	Beam	Pipe	A53 Gr.B	Typical	.749	.293	.293	.586
2	PIPE 2.0	PIPE 2.0	Beam	Pipe	A53 Gr.B	Typical	1.02	.627	.627	1.25
3	PIPE 2.5	PIPE 2.5	Beam	Pipe	A53 Gr.B	Typical	1.61	1.45	1.45	2.89
4	PIPE 3.0	PIPE 3.0	Beam	Pipe	A53 Gr.B	Typical	2.07	2.85	2.85	5.69
5	PIPE 3.5	PIPE 3.5	Beam	Pipe	A53 Gr.B	Typical	2.5	4.52	4.52	9.04
6	PIPE 4.0	PIPE 4.0	Beam	Pipe	A53 Gr.B	Typical	2.96	6.82	6.82	13.6
7	PIPE 5.0	PIPE 5.0	Beam	Pipe	A53 Gr.B	Typical	4.01	14.3	14.3	28.6
8	HSS2x2x3	HSS2x2x3	Beam	Tube	A500 Gr.B R...	Typical	1.19	.641	.641	1.09
9	HSS3x3x3	HSS3x3x3	Beam	Tube	A500 Gr.B R...	Typical	1.89	2.46	2.46	4.03

Hot Rolled Steel Section Sets (Continued)

	Label	Shape	Type	Design List	Material	Design R...	A [in ²]	I _{yy} [in ⁴]	I _{zz} [in ⁴]	J [in ⁴]
10	HSS4x4x3	HSS4x4x3	Beam	Tube	A500 Gr.B R...	Typical	2.58	6.21	6.21	10
11	HSS4x4x4	HSS4x4x4	Beam	Tube	A500 Gr.B R...	Typical	3.37	7.8	7.8	12.8
12	HSS5x5x4	HSS5x5x4	Beam	Tube	A500 Gr.B R...	Typical	4.3	16	16	25.8
13	C3x3.5	C3x3.5	Beam	Channel	A36 Gr.36	Typical	1.09	.169	1.57	.023
14	C4x4.5	C4x4.5	Beam	Channel	A36 Gr.36	Typical	1.38	.289	3.65	.032
15	C5.62x3.88x3/8	C5.62x3.88x3/8	Beam	Channel	A36 Gr.36	Typical	4.736	7.118	23.657	.21
16	LL3x3x4x0	LL3x3x4x0	Beam	Double Angle (No ...	A36 Gr.36	Typical	2.88	4.5	2.46	.063
17	L2.5x2.5x4	L2.5x2.5x4	Beam	Single Angle	A36 Gr.36	Typical	1.19	.692	.692	.026
18	L3x3x3	L3x3x3	Beam	Single Angle	A36 Gr.36	Typical	1.09	.948	.948	.014
19	L3x3x4	L3x3x4	Beam	Single Angle	A36 Gr.36	Typical	1.44	1.23	1.23	.031
20	L3x3x6	L3x3x6	Beam	Single Angle	A36 Gr.36	Typical	2.11	1.75	1.75	.101
21	L3.5x3.5x4	L3.5x3.5x4	Beam	Single Angle	A36 Gr.36	Typical	1.7	2	2	.039
22	L4x4x4	L4x4x4	Beam	Single Angle	A36 Gr.36	Typical	1.93	3	3	.044
23	1/4" x 4"	4" x 1/4" Bar	Beam	BAR	A36 Gr.36	Typical	1	.005	1.333	.02
24	WT4.5x0.25	WT4.5x0.25	Beam	W Tee	A36 Gr.36	Typical	2.188	1.904	4.371	.046
25	LL3x3x3x6	LL3x3x3x6	Beam	Double Angle (3/8...	A36 Gr.36	Typical	2.18	4.97	1.9	.027
26	L6x6x5	L6x6x5	Beam	Single Angle	A36 Gr.36	Typical	3.67	13	13	.129
27	6" x 3/8" Bar	6" x 3/8" Bar	Beam	BAR	A36 Gr.36	Typical	2.25	.026	6.75	.101
28	LL2.5x2.5x3x3	LL2.5x2.5x3x3	Beam	Double Angle (3/8...	A36 Gr.36	Typical	1.8	2.46	1.07	.023
29	L2.5x2.5x3	L2.5x2.5x3	Beam	Single Angle	A36 Gr.36	Typical	.901	.535	.535	.011

Member Primary Data

	Label	I Joint	J Joint	K Joint	Rotate(deg)	Section/Shape	Type	Design List	Material	Design Rules
1	M1	N1	N2			PIPE 2.0	Beam	Pipe	A53 Gr.B	Typical
2	M2	N3	N4			RIGID	None	None	RIGID	Typical
3	M3	N5	N6		90	HSS4x4x4	Beam	Tube	A500 Gr.B...	Typical
4	M4	N7	N8		90	HSS4x4x4	Beam	Tube	A500 Gr.B...	Typical
5	M5	N12	N15		180	LL3x3x4x0	Beam	Double Angle (...	A36 Gr.36	Typical
6	M6	N11	N14		180	LL3x3x4x0	Beam	Double Angle (...	A36 Gr.36	Typical
7	M7	N13	N16		180	LL3x3x4x0	Beam	Double Angle (...	A36 Gr.36	Typical
8	M8	N9	N10		90	HSS4x4x4	Beam	Tube	A500 Gr.B...	Typical
9	M9	N13	N11		270	L3x3x4	Beam	Single Angle	A36 Gr.36	Typical
10	M10	N11	N12		270	L3x3x4	Beam	Single Angle	A36 Gr.36	Typical
11	M11	N12	N13		270	L3x3x4	Beam	Single Angle	A36 Gr.36	Typical
12	M12	N16	N14		270	L3x3x4	Beam	Single Angle	A36 Gr.36	Typical
13	M13	N14	N15		270	L3x3x4	Beam	Single Angle	A36 Gr.36	Typical
14	M14	N15	N16		270	L3x3x4	Beam	Single Angle	A36 Gr.36	Typical
15	M15	N21	N22			RIGID	None	None	RIGID	Typical
16	M16	N24	N23			RIGID	None	None	RIGID	Typical
17	M17	N28	N29			PIPE 2.0	Beam	Pipe	A53 Gr.B	Typical
18	M18	N10	N30			RIGID	None	None	RIGID	Typical
19	M19	N31	N32			RIGID	None	None	RIGID	Typical
20	M20	N34	N33			RIGID	None	None	RIGID	Typical
21	M21	N39	N25			LL2.5x2.5x3x3	Beam	Double Angle (...	A36 Gr.36	Typical
22	M22	N40	N27			LL2.5x2.5x3x3	Beam	Double Angle (...	A36 Gr.36	Typical
23	M23	N41	N26			LL2.5x2.5x3x3	Beam	Double Angle (...	A36 Gr.36	Typical
24	M24	N42	N43			RIGID	None	None	RIGID	Typical
25	M25	N45	N44		270	PIPE 2.0	Beam	Pipe	A53 Gr.B	Typical
26	M26	N46	N47			RIGID	None	None	RIGID	Typical
27	M27	N51	N50		270	PIPE 2.0	Beam	Pipe	A53 Gr.B	Typical
28	M28	N55	N54		270	PIPE 2.0	Beam	Pipe	A53 Gr.B	Typical
29	M29	N57	N48		180	L2.5x2.5x4	Beam	Single Angle	A36 Gr.36	Typical
30	M30	N49	N52		180	L2.5x2.5x4	Beam	Single Angle	A36 Gr.36	Typical
31	M31	N53	N56		180	L2.5x2.5x4	Beam	Single Angle	A36 Gr.36	Typical
32	M32	N59	N58			LL2.5x2.5x3x3	Beam	Double Angle (...	A36 Gr.36	Typical

Member Primary Data (Continued)

	Label	I Joint	J Joint	K Joint	Rotate(deg)	Section/Shape	Type	Design List	Material	Design Rules
33	M33	N61	N60			LL2.5x2.5x3x3	Beam	Double Angle (...)	A36 Gr.36	Typical
34	M34	N63	N62			LL2.5x2.5x3x3	Beam	Double Angle (...)	A36 Gr.36	Typical
35	M35	N91	N92		270	PIPE 2.0	Beam	Pipe	A53 Gr.B	Typical
36	M36	N66	N64			RIGID	None	None	RIGID	Typical
37	M37	N67	N65			RIGID	None	None	RIGID	Typical
38	M38	N70	N68			RIGID	None	None	RIGID	Typical
39	M39	N71	N69			RIGID	None	None	RIGID	Typical
40	M40	N74	N72			RIGID	None	None	RIGID	Typical
41	M41	N75	N73			RIGID	None	None	RIGID	Typical
42	M42	N75	N66			PIPE 2.0	Beam	Pipe	A53 Gr.B	Typical
43	M43	N67	N70			PIPE 2.0	Beam	Pipe	A53 Gr.B	Typical
44	M44	N71	N74			PIPE 2.0	Beam	Pipe	A53 Gr.B	Typical
45	M45	N76	N78			RIGID	None	None	RIGID	Typical
46	M46	N78	N77		90	L2.5x2.5x3	Beam	Single Angle	A36 Gr.36	Typical
47	M47	N79	N80			RIGID	None	None	RIGID	Typical
48	M48	N80	N77		180	L2.5x2.5x3	Beam	Single Angle	A36 Gr.36	Typical
49	M49	N81	N83			RIGID	None	None	RIGID	Typical
50	M50	N83	N82		90	L2.5x2.5x3	Beam	Single Angle	A36 Gr.36	Typical
51	M51	N84	N85			RIGID	None	None	RIGID	Typical
52	M52	N85	N82		180	L2.5x2.5x3	Beam	Single Angle	A36 Gr.36	Typical
53	M53	N86	N88			RIGID	None	None	RIGID	Typical
54	M54	N88	N87		90	L2.5x2.5x3	Beam	Single Angle	A36 Gr.36	Typical
55	M55	N89	N90			RIGID	None	None	RIGID	Typical
56	M56	N90	N87		180	L2.5x2.5x3	Beam	Single Angle	A36 Gr.36	Typical
57	M57	N93	N94		270	PIPE 2.0	Beam	Pipe	A53 Gr.B	Typical
58	M58	N95	N96		270	PIPE 2.0	Beam	Pipe	A53 Gr.B	Typical
59	M59	N97	N98			RIGID	None	None	RIGID	Typical
60	M60	N99	N100			RIGID	None	None	RIGID	Typical
61	M61	N101	N102			PIPE 2.0	Beam	Pipe	A53 Gr.B	Typical
62	M62	N103	N104			RIGID	None	None	RIGID	Typical
63	M63	N105	N106			RIGID	None	None	RIGID	Typical
64	M64	N108	N107			RIGID	None	None	RIGID	Typical
65	M65	N111	N112			RIGID	None	None	RIGID	Typical
66	M66	N113	N114			RIGID	None	None	RIGID	Typical
67	M67	N115	N116			PIPE 2.0	Beam	Pipe	A53 Gr.B	Typical
68	M68	N117	N118			RIGID	None	None	RIGID	Typical
69	M69	N119	N120			RIGID	None	None	RIGID	Typical
70	M70	N122	N121			RIGID	None	None	RIGID	Typical
71	M71	N123	N124			PIPE 2.0	Beam	Pipe	A53 Gr.B	Typical
72	M72	N8	N125			RIGID	None	None	RIGID	Typical
73	M73	N126	N127			RIGID	None	None	RIGID	Typical
74	M74	N129	N128			RIGID	None	None	RIGID	Typical
75	M75	N134	N135			RIGID	None	None	RIGID	Typical
76	M76	N136	N137			RIGID	None	None	RIGID	Typical
77	M77	N138	N139			RIGID	None	None	RIGID	Typical
78	M78	N140	N141			RIGID	None	None	RIGID	Typical
79	M79	N142	N143			PIPE 2.0	Beam	Pipe	A53 Gr.B	Typical
80	M80	N144	N145			RIGID	None	None	RIGID	Typical
81	M81	N146	N147			RIGID	None	None	RIGID	Typical
82	M82	N149	N148			RIGID	None	None	RIGID	Typical
83	M83	N152	N153			RIGID	None	None	RIGID	Typical
84	M84	N154	N155			RIGID	None	None	RIGID	Typical
85	M85	N156	N157			PIPE 2.0	Beam	Pipe	A53 Gr.B	Typical
86	M86	N158	N159			RIGID	None	None	RIGID	Typical
87	M87	N160	N161			RIGID	None	None	RIGID	Typical
88	M88	N163	N162			RIGID	None	None	RIGID	Typical
89	M89	N164	N165			PIPE 2.0	Beam	Pipe	A53 Gr.B	Typical

Member Primary Data (Continued)

	Label	I Joint	J Joint	K Joint	Rotate(deg)	Section/Shape	Type	Design List	Material	Design Rules
90	M90	N6	N166			RIGID	None	None	RIGID	Typical
91	M91	N167	N168			RIGID	None	None	RIGID	Typical
92	M92	N170	N169			RIGID	None	None	RIGID	Typical
93	M93	N175	N176			RIGID	None	None	RIGID	Typical
94	M94	N177	N178			RIGID	None	None	RIGID	Typical
95	M95	N179	N180			RIGID	None	None	RIGID	Typical
96	M96	N181	N182			RIGID	None	None	RIGID	Typical
97	M97	N183	N184			PIPE 2.0	Beam	Pipe	A53 Gr.B	Typical
98	M98	N185	N186			RIGID	None	None	RIGID	Typical
99	M99	N187	N188			RIGID	None	None	RIGID	Typical
100	M100	N190	N189			RIGID	None	None	RIGID	Typical
101	M101	N193	N194			RIGID	None	None	RIGID	Typical
102	M102	N195	N196			RIGID	None	None	RIGID	Typical

Envelope Joint Reactions

	Joint		X [k]	LC	Y [k]	LC	Z [k]	LC	MX [k-ft]	LC	MY [k-ft]	LC	MZ [k-ft]	LC
1	N7	max	2.762	16	1.279	30	3.805	3	2.281	36	4.091	21	3.925	36
2		min	-3.039	10	.262	74	-3.658	21	-.024	18	-4.106	3	.049	18
3	N5	max	3.025	6	1.281	35	3.617	13	2.272	28	3.869	24	-.063	22
4		min	-2.761	24	.262	66	-3.447	19	-.036	22	-3.878	6	-3.93	28
5	N9	max	3.408	5	1.282	26	1.475	14	-.044	14	2.336	17	.214	11
6		min	-3.394	23	.262	70	-1.79	8	-4.538	32	-2.349	11	-.205	17
7	N25	max	0	1	0	1	0	1	0	1	0	1	0	1
8		min	0	1	0	1	0	1	0	1	0	1	0	1
9	N26	max	0	1	0	1	0	1	0	1	0	1	0	1
10		min	0	1	0	1	0	1	0	1	0	1	0	1
11	N27	max	0	1	0	1	0	1	0	1	0	1	0	1
12		min	0	1	0	1	0	1	0	1	0	1	0	1
13	N58	max	.07	17	2.523	26	-.198	20	0	1	0	22	0	5
14		min	-.07	23	.11	20	-2.685	26	0	1	0	5	0	22
15	N60	max	-.123	24	2.534	30	1.348	29	0	4	0	22	0	22
16		min	-2.333	30	.039	24	.048	23	0	22	0	4	0	4
17	N62	max	2.333	34	2.534	34	1.348	34	0	23	0	23	0	23
18		min	.126	16	.043	16	.053	17	0	5	0	5	0	5
19	N77	max	.065	39	.087	26	.241	2	0	26	0	1	0	23
20		min	-.056	66	.009	69	-.102	20	0	20	0	1	0	5
21	N82	max	.197	36	.087	30	.039	69	0	14	0	1	0	22
22		min	-.041	66	.009	73	-.117	30	0	8	0	1	0	28
23	N87	max	.048	17	.087	34	.042	69	0	14	0	1	0	36
24		min	-.201	37	.009	65	-.115	27	0	8	0	1	0	18
25	Totals:	max	8.225	5	11.331	33	7.775	14						
26		min	-8.225	23	2.244	64	-7.775	8						

Envelope AISC 14th(360-10): LRFD Steel Code Checks

Member	Shape	Code Check	Loc[ft]	LC	Shear...Loc[ft]	Dir	LC	phi*Pnc...	phi*Pnt...	phi*Mn...	phi*Mn...	Cb	Eqn	
1	M17	PIPE 2.0	.874	3.438	2	.111	5.031	6	14.773	32.13	1.872	1.872	2...H1-1b	
2	M89	PIPE 2.0	.858	3.438	11	.120	3.438	6	14.773	32.13	1.872	1.872	2...H1-1b	
3	M71	PIPE 2.0	.826	3.438	6	.147	3.438	10	14.773	32.13	1.872	1.872	2...H1-1b	
4	M12	L3x3x4	.644	13.9...	33	.104	13.9...	z	44	15.778	46.656	1.688	3.016	1 H2-1
5	M13	L3x3x4	.643	13.9...	36	.077	13.9...	z	26	15.778	46.656	1.688	3.016	1 H2-1
6	M14	L3x3x4	.642	13.9...	29	.078	13.9...	z	30	15.778	46.656	1.688	3.016	1 H2-1
7	M5	LL3x3x4x0	.603	3.66	36	.057	1.105	y	36	79.399	93.312	6.48	3.069	1...H1-1b
8	M6	LL3x3x4x0	.601	3.66	32	.057	1.105	y	32	79.399	93.312	6.48	3.069	1...H1-1b
9	M7	LL3x3x4x0	.598	3.66	28	.057	1.105	y	28	79.399	93.312	6.48	3.069	1...H1-1b

Envelope AISC 14th(360-10): LRFD Steel Code Checks (Continued)

Member	Shape	Code Check	Loc[ft]	LC	Shear...	Loc[ft]	Dir	LC	phi*Pnc...	phi*Pnt...	phi*Mn...	phi*Mn...	Cb	Eqn
10	M31	L2.5x2.5x4	.385	0	6	.088	1.25	y	5	36.64	38.556	1.114	2.537	2... H2-1
11	M4	HSS4x4x4	.378	0	10	.122	0	y	3	134.174	139.518	16.181	16.181	3... H1-1b
12	M10	L3x3x4	.377	3.813	4	.033	0	z	35	13.292	46.656	1.688	3.487	2... H2-1
13	M30	L2.5x2.5x4	.373	0	2	.079	1.25	y	13	36.64	38.556	1.114	2.537	1... H2-1
14	M9	L3x3x4	.370	0	30	.033	0	z	30	13.292	46.656	1.688	3.525	2... H2-1
15	M3	HSS4x4x4	.370	0	6	.118	0	y	7	134.174	139.518	16.181	16.181	3... H1-1b
16	M11	L3x3x4	.366	0	26	.033	0	z	27	13.292	46.656	1.688	3.525	2... H2-1
17	M29	L2.5x2.5x4	.354	0	10	.077	1.25	y	9	36.64	38.556	1.114	2.537	1... H2-1
18	M85	PIPE 2.0	.334	3.438	12	.133	3.438		8	14.773	32.13	1.872	1.872	2... H1-1b
19	M67	PIPE 2.0	.314	3.354	11	.145	3.438		4	14.773	32.13	1.872	1.872	2... H1-1b
20	M1	PIPE 2.0	.314	3.438	4	.148	3.438		12	14.773	32.13	1.872	1.872	2... H1-1b
21	M8	HSS4x4x4	.306	0	34	.104	0	y	11	134.174	139.518	16.181	16.181	3... H1-1b
22	M79	PIPE 2.0	.291	3.438	4	.083	3.438		8	14.773	32.13	1.872	1.872	1... H1-1b
23	M27	PIPE 2.0	.285	6.732	10	.138	1.122		5	17.855	32.13	1.872	1.872	1 H1-1b
24	M97	PIPE 2.0	.271	3.438	7	.098	3.438		12	14.773	32.13	1.872	1.872	1... H1-1b
25	M28	PIPE 2.0	.269	6.732	6	.141	12.3...		11	17.855	32.13	1.872	1.872	1 H1-1b
26	M61	PIPE 2.0	.266	3.438	12	.101	3.438		4	14.773	32.13	1.872	1.872	1... H1-1b
27	M25	PIPE 2.0	.254	6.732	6	.156	1.122		2	17.855	32.13	1.872	1.872	1 H1-1b
28	M44	PIPE 2.0	.153	2.5	5	.095	2.5		11	29.81	32.13	1.872	1.872	2... H1-1b
29	M58	PIPE 2.0	.140	1.891	11	.058	2.026		5	17.855	32.13	1.872	1.872	1 H1-1b
30	M33	LL2.5x2.5x...	.140	3.01	5	.009	0	z	4	36.392	58.32	3.954	2.55	1... H1-1b
31	M34	LL2.5x2.5x...	.140	3.01	11	.009	0	z	6	36.392	58.32	3.954	2.55	1... H1-1b
32	M57	PIPE 2.0	.139	6.482	35	.060	10.9...		11	17.855	32.13	1.872	1.872	1 H1-1b
33	M35	PIPE 2.0	.138	6.482	31	.050	6.482		7	17.855	32.13	1.872	1.872	1 H1-1b
34	M43	PIPE 2.0	.118	2.5	13	.079	2.5		7	29.81	32.13	1.872	1.872	2... H1-1b
35	M42	PIPE 2.0	.115	0	3	.076	2.5		3	29.81	32.13	1.872	1.872	2... H1-1b
36	M32	LL2.5x2.5x...	.111	3.01	37	.006	6.021	y	26	36.392	58.32	3.954	2.55	1... H1-1b
37	M50	L2.5x2.5x3	.093	2.141	2	.010	0	y	8	15.939	29.192	.873	1.724	1... H2-1
38	M56	L2.5x2.5x3	.093	2.141	2	.010	0	z	8	15.939	29.192	.873	1.724	1... H2-1
39	M54	L2.5x2.5x3	.092	2.141	5	.010	4.282	y	11	15.939	29.192	.873	1.724	1... H2-1
40	M52	L2.5x2.5x3	.091	2.141	11	.010	4.282	z	5	15.939	29.192	.873	1.724	1... H2-1
41	M48	L2.5x2.5x3	.071	2.141	31	.009	0	z	12	15.939	29.192	.873	1.724	1... H2-1
42	M46	L2.5x2.5x3	.070	2.141	33	.009	0	y	4	15.939	29.192	.873	1.724	1... H2-1

Sprint®

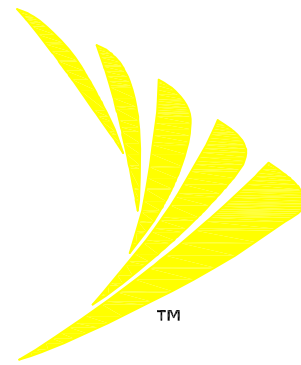

SITE NAME: POMFRET SCHOOL (SBA)
SITE NUMBER: CT33XC017
AUGMENT ID: CT33XC017Q17.2
SITE ADDRESS: 398 POMFRET STREET
 POMFRET, CT 06258
JURISDICTION: TOWN OF POMFRET/CT SITING COUNCIL
SITE TYPE: EXISTING 168' MONOPOLE
PROGRAM: DO MACRO UPGRADE EQUIPMENT DEPLOYMENT



1 INTERNATIONAL BLVD, SUITE 800
 MAHWAH, NJ 07495
 TEL: (800) 357-7641



SBA COMMUNICATIONS CORP.
 134 FLANDERS ROAD, SUITE 125
 WESTBOROUGH, MA 01581 TEL: (508) 251-0720



4 Bay Road, Building A
 Suite 200
 Hadley, MA 01035 Ph: (413) 320-4918

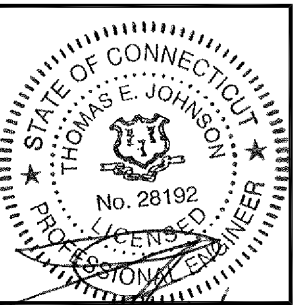

CHECKED BY: *G. J. J. / TEJ*

APPROVED BY: JMM/TEJ

SUBMITTALS			
REV.	DATE	DESCRIPTION	BY
1	06/19/18	CONSTRUCTION REVISED	PN
0	04/04/18	ISSUED FOR CONSTRUCTION	PN

SITE NUMBER:
CT33XC017
 SITE NAME:
POMFRET SCHOOL (SBA)
 SITE ADDRESS:
 398 POMFRET STREET
 POMFRET, CT 06258

SHEET TITLE
 TITLE SHEET

SHEET NUMBER
 T-1

PROJECT INFORMATION

SITE INFORMATION
 LATITUDE: 41° 53' 24.34" N (41.8901°)
 LONGITUDE: 71° 57' 18.03" W (-71.9550°)
 GROUND ELEVATION: 682'± AMSL (PER GOOGLE EARTH)
 STRUCTURE HEIGHT: 168'± AGL (FROM RECORD STRUCTURAL)
 STRUCTURE TYPE: MONOPOLE
 ZONING JURISDICTION: TOWN OF POMFRET/CT SITING COUNCIL
 ZONING DISTRICT/OCCUPANCY: POMFRET STREET RESIDENTIAL
 COUNTY: WINDHAM
APPLICANT
 SPRINT
 1 INTERNATIONAL BLVD. SUITE 800
 MAHWAH, NJ 07495
PROPERTY OWNER:
 N/F POMFRET SCHOOL INC.
 PO BOX 128
 POMFRET, CT 06258
TOWER OWNER:
 SBA PROPERTIES, LLC
 8051 CONGRESS AVENUE
 BOCA RATON, FL 33487
 (561) 995-7670
 SBA SITE ID: CT02217-S
 SBA SITE NAME: POMFRET SCHOOL
SBA CONTACT:
 STEPHEN ROTH
 (860) 539-4920
 SRoth@sbasite.com

LOCATION MAP N.T.S.

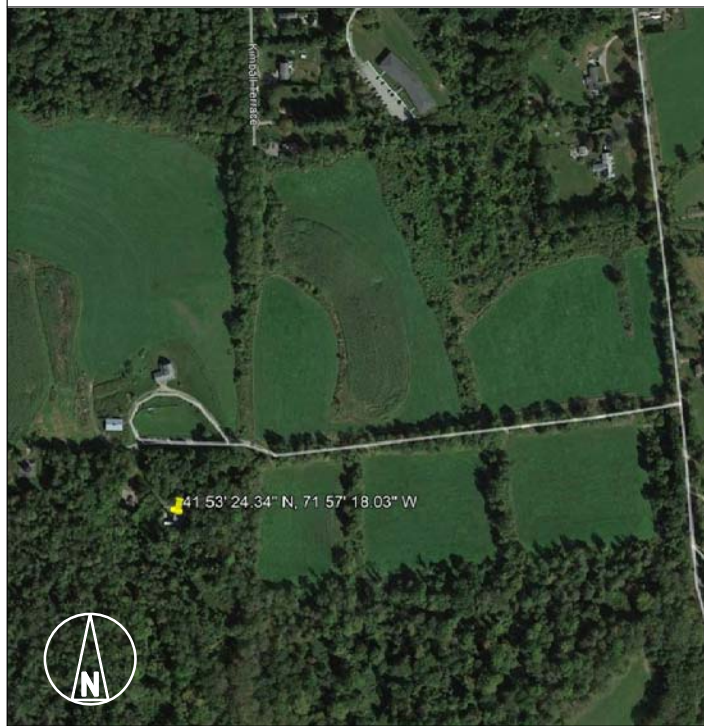

AREA MAP N.T.S.

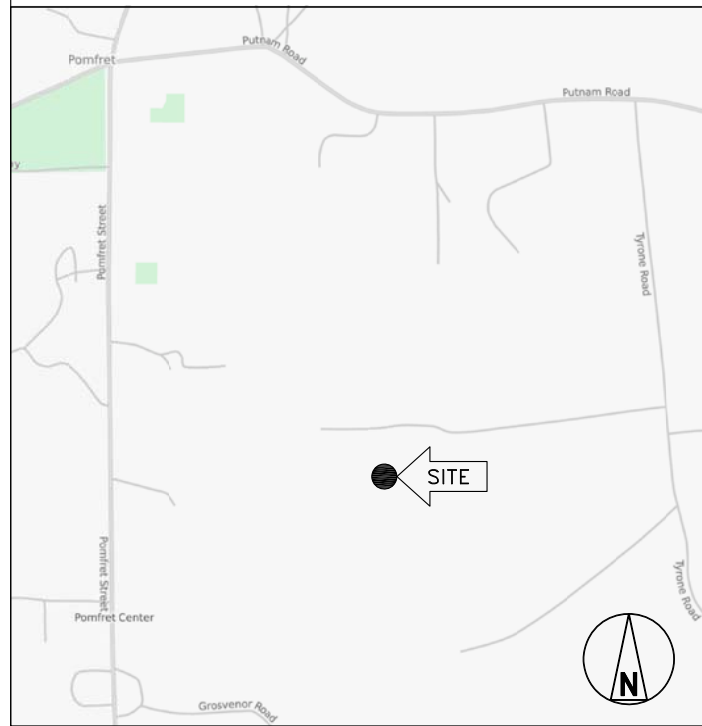

SCOPE OF WORK

- REMOVE AND REPLACE (6) EXISTING SPRINT ANTENNAS AND ANTENNA MOUNTING PIPE MASTS.
- REMOVE ALL EXISTING COAX CABLES.
- FURNISH AND INSTALL ANTENNA MOUNT STRUCTURAL AUGMENTS PER ANTENNA MOUNT STRUCTURAL ANALYSIS, (BY GEOSTRUCTURAL DATED 06/18/18) AND ANTENNA MOUNT CONSTRUCTION MODIFICATION DRAWINGS, (BY GEOSTRUCTURAL DATED 06-19-18).
- INSTALL (4) HYBRID CABLES IN ACCORDANCE WITH THE STRUCTURAL ANALYSIS (BY OTHERS).
- INSTALL (6) NEW SPRINT 800 MHz RRHS.
- RELOCATE (3) EXISTING SPRINT 1900 MHz RRHS FROM GROUND LEVEL TO THE ANTENNA LEVEL.
- INSTALL (3) NEW SPRINT 2500 MHz RRHS.

GENERAL NOTES

- THIS IS AN UNMANNED TELECOMMUNICATION FACILITY AND NOT FOR HUMAN HABITATION:
 • ADA COMPLIANCE NOT REQUIRED.
 • POTABLE WATER OR SANITARY SERVICE IS NOT REQUIRED.
 • NO OUTDOOR STORAGE OR ANY SOLID WASTE RECEPTACLES REQUIRED.
- CONTRACTOR SHALL VERIFY ALL PLANS, EXISTING DIMENSIONS, AND CONDITIONS ON JOB SITE. CONTRACTOR SHALL IMMEDIATELY NOTIFY THE ARCHITECT/ENGINEER IN WRITING OF ANY DISCREPANCIES BEFORE PROCEEDING WITH THE WORK. FAILURE TO NOTIFY THE ARCHITECT/ENGINEER PLACE THE RESPONSIBILITY ON THE CONTRACTOR TO CORRECT THE DISCREPANCIES AT THE CONTRACTOR'S EXPENSE.
- THIS DRAWING IS CONTINGENT ON THE COMPLETION OF A GLOBAL STRUCTURAL ANALYSIS OF THE TOWER AND MOUNT ANALYSIS TO BE COMPLETED BY THE TOWER OWNER, SBA PRIOR TO CONSTRUCTION. SEE SPECIAL CONSTRUCTION NOTES ON A-2 AND S-1 HEREIN.
- ALL AUGMENTS AS SPECIFIED IN THE ANTENNA MOUNT STRUCTURAL ANALYSIS FOR THIS SITE BY GEOSTRUCTURAL DATED 06/18/2018 (REV2) SHALL BE COMPLETED PRIOR TO ANTENNA INSTALLATION.

DRAWING INDEX

SHEET NO.	SHEET DESCRIPTION	REV. NO.
T-1	TITLE SHEET	1
SP-1	OUTLINE SPECIFICATIONS	1
SP-2	OUTLINE SPECIFICATIONS	1
SP-3	OUTLINE SPECIFICATIONS	1
A-1	COMPOUND PLAN	1
A-2	ELEVATION AND ANTENNA PLANS	1
A-3	TOWER EQUIPMENT DETAILS	1
A-4	EQUIPMENT DETAILS	1
S-1	ANTENNA AND RRH MOUNTING DETAILS	1
E-1	ELECTRICAL AND GROUNDING DETAILS	1
RF-1	RF DATA SHEET	1
RF-2	PLUMBING DIAGRAM AND RAN WIRING	1

CODE COMPLIANCE

- 2016 CONNECTICUT STATE BUILDING CODE WITH AMENDMENTS.
- 2014 NATIONAL ELECTRICAL CODE WITH AMENDMENTS
- TIA-EIA-222-G

BASED ON INFORMATION PROVIDED BY SPRINT, THIS TELECOMMUNICATIONS EQUIPMENT DEPLOYMENT IS CONSIDERED AN ELIGIBLE FACILITY UNDER THE TAX RELIEF ACT OF 2012, 47 USC 1455(A), AND IS SUBJECT TO AN EXPEDITED ELIGIBLE FACILITIES REQUEST/REVIEW AND ZONING PRE-EMPTION FOR LOCAL DISCRETIONARY PERMITS (VARIANCE, SPECIAL PERMIT, SITE PLAN REVIEW).

APPROVALS

TITLE	SIGNATURE	DATE
PROJECT MANAGER:		
CONSTRUCTION:		
RF ENGINEER:		
ZONING/SITE ACQ:		
OPERATIONS:		
TOWER OWNER:		

THE FOLLOWING PARTIES HEREBY APPROVE AND ACCEPT THESE DOCUMENTS AND AUTHORIZE THE CONTRACTOR TO PROCEED WITH THE CONSTRUCTION DESCRIBED HEREIN. ALL DOCUMENTS ARE SUBJECT TO REVIEW BY THE LOCAL BUILDING DEPARTMENT AND MAY IMPOSE CHANGES OR MODIFICATIONS.

CALL CONNECTICUT ONE CALL
 (800) 922-4455
 CALL 3 WORKING DAYS BEFORE YOU DIG!

Know what's below.
 Call before you dig.
 www.call811.com

THESE OUTLINE SPECIFICATIONS IN CONJUNCTION WITH THE SPRINT STANDARD CONSTRUCTION SPECIFICATIONS, INCLUDING CONTRACT DOCUMENTS AND THE CONSTRUCTION DRAWINGS DESCRIBE THE WORK TO BE PERFORMED BY THE CONTRACTOR.

SECTION 01 100 - SCOPE OF WORK

PART 1 - GENERAL

- 1.1 **THE WORK:** THESE STANDARD CONSTRUCTION SPECIFICATIONS IN CONJUNCTION WITH THE SPRINT CONSTRUCTION STANDARDS FOR WIRELESS SITES, CONTRACT DOCUMENTS AND THE CONSTRUCTION DRAWINGS DESCRIBE THE WORK TO BE PERFORMED BY THE CONTRACTOR.
- 1.2 **RELATED DOCUMENTS:**
- A. THE REQUIREMENTS OF THIS SECTION APPLY TO ALL SECTIONS IN THIS SPECIFICATION.
 - B. SPRINT "STANDARD CONSTRUCTION DETAILS FOR WIRELESS SITES" ARE INCLUDED IN AND MADE A PART OF THESE SPECIFICATIONS HEREWITH.
- 1.3 **PRECEDENCE:** SHOULD CONFLICTS OCCUR BETWEEN THE STANDARD CONSTRUCTION SPECIFICATIONS FOR WIRELESS SITES INCLUDING THE STANDARD CONSTRUCTION DETAILS FOR WIRELESS SITES AND THE CONSTRUCTION DRAWINGS, INFORMATION ON THE CONSTRUCTION DRAWINGS SHALL TAKE PRECEDENCE. NOTIFY SPRINT CONSTRUCTION MANAGER IF THIS OCCURS.
- 1.4 **NATIONALLY RECOGNIZED CODES AND STANDARDS:**
- A. THE WORK SHALL COMPLY WITH APPLICABLE NATIONAL AND LOCAL CODES AND STANDARDS, LATEST EDITION, AND PORTIONS THEREOF, INCLUDED BUT NOT LIMITED TO THE FOLLOWING:
 1. GR-78-CORE GENERIC REQUIREMENTS FOR THE PHYSICAL DESIGN AND MANUFACTURE OF TELECOMMUNICATIONS EQUIPMENT.
 2. GR-1089 CORE, ELECTROMAGNETIC COMPATIBILITY AND ELECTRICAL SAFETY -GENERIC CRITERIA FOR NETWORK TELECOMMUNICATIONS EQUIPMENT.
 3. NATIONAL FIRE PROTECTION ASSOCIATION CODES AND STANDARDS (NFPA) INCLUDING NFPA 70 (NATIONAL ELECTRICAL CODE - "NEC") AND NFPA 101 (LIFE SAFETY CODE).
 4. AMERICAN SOCIETY FOR TESTING OF MATERIALS (ASTM)
 5. INSTITUTE OF ELECTRONIC AND ELECTRICAL ENGINEERS (IEEE)
 6. AMERICAN CONCRETE INSTITUTE (ACI)
 7. AMERICAN WIRE PRODUCERS ASSOCIATION (AWPA)
 8. CONCRETE REINFORCING STEEL INSTITUTE (CRSI)
 9. AMERICAN ASSOCIATION OF STATE HIGHWAY AND TRANSPORTATION OFFICIALS (AASHTO)
 10. PORTLAND CEMENT ASSOCIATION (PCA)
 11. NATIONAL CONCRETE MASONRY ASSOCIATION (NCMA)
 12. BRICK INDUSTRY ASSOCIATION (BIA)
 13. AMERICAN WELDING SOCIETY (AWS)
 14. NATIONAL ROOFING CONTRACTORS ASSOCIATION (NRCA)
 15. SHEET METAL AND AIR CONDITIONING CONTRACTORS' NATIONAL ASSOCIATION (SMACNA)
 16. DOOR AND HARDWARE INSTITUTE (DHI)
 17. OCCUPATIONAL SAFETY AND HEALTH ACT (OSHA)
 18. APPLICABLE BUILDING CODES INCLUDING UNIFORM BUILDING CODE, SOUTHERN BUILDING CODE, BOCA, AND THE INTERNATIONAL BUILDING CODE.

- 1.5 **DEFINITIONS:**
- A. WORK: THE SUM OF TASKS AND RESPONSIBILITIES IDENTIFIED IN THE CONTRACT DOCUMENTS.
 - B. COMPANY: SPRINT CORPORATION
 - C. ENGINEER: SYNONYMOUS WITH ARCHITECT & ENGINEER AND "A&E". THE DESIGN PROFESSIONAL HAVING PROFESSIONAL RESPONSIBILITY FOR DESIGN OF THE PROJECT.
 - D. CONTRACTOR: CONSTRUCTION CONTRACTOR; CONSTRUCTION VENDOR; INDIVIDUAL OR ENTITY WHO AFTER EXECUTION OF A CONTRACT IS BOUND TO ACCOMPLISH THE WORK.
 - E. THIRD PARTY VENDOR OR AGENCY: A VENDOR OR AGENCY ENGAGED SEPARATELY BY THE COMPANY, A&E, OR CONTRACTOR TO PROVIDE MATERIALS OR TO ACCOMPLISH SPECIFIC TASKS RELATED TO BUT NOT INCLUDED IN THE WORK.
 - F. OFCI: OWNER FURNISHED, CONTRACTOR INSTALLED EQUIPMENT.
 - G. CONSTRUCTION MANAGER - ALL PROJECTS RELATED COMMUNICATION TO FLOW THROUGH SPRINT REPRESENTATIVE IN CHARGE OF PROJECT...

- 1.6 **SITE FAMILIARITY:** CONTRACTOR SHALL BE RESPONSIBLE FOR FAMILIARIZING HIMSELF WITH ALL CONTRACT DOCUMENTS, FIELD CONDITIONS AND DIMENSIONS PRIOR TO PROCEEDING WITH CONSTRUCTION. ANY DISCREPANCIES SHALL BE BROUGHT TO THE ATTENTION OF THE SPRINT CONSTRUCTION MANAGER PRIOR TO THE COMMENCEMENT OF WORK. NO COMPENSATION WILL BE AWARDED BASED ON CLAIM OF LACK OF KNOWLEDGE OR FIELD CONDITIONS.

- 1.7 **POINT OF CONTACT:** COMMUNICATION BETWEEN SPRINT AND THE CONTRACTOR SHALL FLOW THROUGH THE SINGLE SPRINT CONSTRUCTION MANAGER APPOINTED TO MANAGE THE PROJECT FOR SPRINT.

- 1.8 **ON-SITE SUPERVISION:** THE CONTRACTOR SHALL SUPERVISE AND DIRECT THE WORK AND SHALL BE RESPONSIBLE FOR CONSTRUCTION MEANS, METHODS, TECHNIQUES, SEQUENCES, AND PROCEDURES IN ACCORDANCE WITH THE CONTRACT DOCUMENTS. THE CONTRACTOR SHALL EMPLOY A COMPETENT SUPERINTENDENT WHO SHALL BE IN ATTENDANCE AT THE SITE AT ALL TIMES DURING PERFORMANCE OF THE WORK.

- 1.9 **DRAWINGS, SPECIFICATIONS AND DETAILS REQUIRED AT JOBSITE:** THE CONSTRUCTION CONTRACTOR SHALL MAINTAIN A FULL SET OF THE CONSTRUCTION DRAWINGS, STANDARD CONSTRUCTION DETAILS FOR WIRELESS SITES AND THE STANDARD CONSTRUCTION SPECIFICATIONS FOR WIRELESS SITES AT THE JOBSITE FROM MOBILIZATION THROUGH CONSTRUCTION COMPLETION.

- A. THE JOBSITE DRAWINGS, SPECIFICATIONS AND DETAILS SHALL BE CLEARLY MARKED DAILY IN RED PENCIL WITH ANY CHANGES IN CONSTRUCTION OVER WHAT IS DEPICTED IN THE DOCUMENTS. AT CONSTRUCTION COMPLETION, THIS JOBSITE MARKUP SET SHALL BE DELIVERED TO THE COMPANY OR COMPANY'S DESIGNATED REPRESENTATIVE TO BE FORWARDED TO THE COMPANY'S A&E VENDOR FOR PRODUCTION OF "AS-BUILT" DRAWINGS.
- B. DETAILS ARE INTENDED TO SHOW DESIGN INTENT. MODIFICATIONS MAY BE REQUIRED TO SUIT JOB DIMENSIONS OR CONDITIONS, AND SUCH MODIFICATIONS SHALL BE INCLUDED AS PART OF THE WORK. CONTRACTOR SHALL NOTIFY SPRINT CONSTRUCTION MANAGER OF ANY VARIATIONS PRIOR TO PROCEEDING WITH THE WORK.
- C. DIMENSIONS SHOWN ARE TO FINISH SURFACES UNLESS NOTED OTHERWISE. SPACING BETWEEN EQUIPMENT IS THE REQUIRED CLEARANCE. SHOULD THERE BE ANY QUESTIONS REGARDING THE CONTRACT DOCUMENTS, EXISTING CONDITIONS AND/OR DESIGN INTENT, THE CONTRACTOR SHALL BE RESPONSIBLE FOR OBTAINING A CLARIFICATION FROM THE SPRINT CONSTRUCTION MANAGER PRIOR TO PROCEEDING WITH THE WORK.

- 1.10 **USE OF JOB SITE:** THE CONTRACTOR SHALL CONFINE ALL CONSTRUCTION AND RELATED OPERATIONS INCLUDING STAGING AND STORAGE OF MATERIALS AND EQUIPMENT, PARKING, TEMPORARY FACILITIES, AND WASTE STORAGE TO THE LEASE PARCEL UNLESS OTHERWISE PERMITTED BY THE CONTRACT DOCUMENTS.

- 1.11 **UTILITIES SERVICES:** WHERE NECESSARY TO CUT EXISTING PIPES, ELECTRICAL WIRES, CONDUITS, CABLES, ETC., OF UTILITY SERVICES, OR OF FIRE PROTECTION OR COMMUNICATIONS SYSTEMS, THEY SHALL BE CUT AND CAPPED AT SUITABLE PLACES OR WHERE SHOWN. ALL SUCH ACTIONS SHALL BE COORDINATED WITH THE UTILITY COMPANY INVOLVED:
- 1.12 **PERMITS / FEES:** WHEN REQUIRED THAT A PERMIT OR CONNECTION FEE BE PAID TO A PUBLIC UTILITY PROVIDER FOR NEW SERVICE TO THE CONSTRUCTION PROJECT, PAYMENT OF SUCH FEE SHALL BE THE RESPONSIBILITY OF THE CONTRACTOR.
- 1.13 CONTRACTOR SHALL TAKE ALL MEASURES AND PROVIDE ALL MATERIAL NECESSARY FOR PROTECTING EXISTING EQUIPMENT AND PROPERTY.
- 1.14 **METHODS OF PROCEDURE (MOPS) FOR CONSTRUCTION:** CONTRACTOR SHALL PERFORM WORK AS DESCRIBED IN THE FOLLOWING INSTALLATION AND COMMISSIONING MOPS.
- A. TOP HAT
 - B. HOW TO INSTALL A NEW CABINET
 - C. BASE BAND UNIT IN EXISTING UNIT
 - D. INSTALLATION OF BATTERIES
 - E. INSTALLATION OF HYBRID CABLE
 - F. INSTALLATION OF RRH'S
 - G. CABLING
 - H. TS-0200 REV 4 - ANTENNA LINE ACCEPTANCE STANDARDS
 - I. SPRINT CELL SITE ENGINEERING NOTICE - EN 2012-001, REV 1.
 - J. COMMISSIONING MOPS
 - K. SPRINT CELL SITE ENGINEERING NOTICE - EN-2013-002
 - L. SPRINT ENGINEERING LETTER - EL-0504
 - M. SPRINT ENGINEERING LETTER - EL-0568
 - N. SPRINT TECHNICAL SPECIFICATION - TS-0193

- 1.15 **USE OF ELECTRONIC PROJECT MANAGEMENT SYSTEMS:**
- A. CONTRACTOR WILL UTILIZE ITS BEST EFFORTS TO WORK WITH SPRINT ELECTRONIC PROJECT MANAGEMENT SYSTEMS. CONTRACTOR UNDERSTANDS THAT SUFFICIENT INTERNET ACCESS, EQUIVALENT TO "BROADBAND" OR BETTER, IS REQUIRED TO TIMELY AND EFFECTIVELY UTILIZE SPRINT DATA AND DOCUMENT MANAGEMENT SYSTEMS AND AGREES TO MAINTAIN APPROPRIATE CONNECTIONS FOR CONTRACTOR'S STAFF AND OFFICES THAT ARE COMPATIBLE WITH SPRINT DATA AND DOCUMENT MANAGEMENT SYSTEMS

PART 2 - PRODUCTS (NOT USED)

PART 3 - EXECUTION

- 3.1 **TEMPORARY UTILITIES AND FACILITIES:** THE CONTRACTOR SHALL BE RESPONSIBLE FOR ALL TEMPORARY UTILITIES AND FACILITIES NECESSARY EXCEPT AS OTHERWISE INDICATED IN THE CONSTRUCTION DOCUMENTS. TEMPORARY UTILITIES AND FACILITIES INCLUDE POTABLE WATER, HEAT, HVAC, ELECTRICITY, SANITARY FACILITIES, WASTE DISPOSAL FACILITIES, AND TELEPHONE/COMMUNICATION SERVICES. PROVIDE TEMPORARY UTILITIES AND FACILITIES IN ACCORDANCE WITH OSHA AND THE AUTHORITY HAVING JURISDICTION. CONTRACTOR MAY UTILIZE THE COMPANY ELECTRICAL SERVICE IN THE COMPLETION OF THE WORK WHEN IT BECOMES AVAILABLE. USE OF THE LESSORS OR SITE OWNER'S UTILITIES OR FACILITIES IS EXPRESSLY FORBIDDEN EXCEPT AS OTHERWISE ALLOWED IN THE CONTRACT DOCUMENTS.
- 3.2 **ACCESS TO WORK:** THE CONTRACTOR SHALL PROVIDE ACCESS TO THE JOB SITE FOR AUTHORIZED COMPANY PERSONNEL AND AUTHORIZED REPRESENTATIVES OF THE ARCHITECT/ENGINEER DURING ALL PHASES OF THE WORK.
- 3.3 **TESTING: REQUIREMENTS FOR TESTING BY THIS CONTRACTOR SHALL BE AS INDICATED HEREWITH, ON THE CONSTRUCTION DRAWINGS, AND IN THE INDIVIDUAL SECTIONS OF THESE SPECIFICATIONS.** SHOULD COMPANY CHOOSE TO ENGAGE ANY THIRD-PARTY TO CONDUCT ADDITIONAL TESTING, THE CONTRACTOR SHALL COOPERATE WITH AND PROVIDE A WORK AREA FOR COMPANY'S TEST AGENCY.
- 3.4 **DIMENSIONS:** VERIFY DIMENSIONS INDICATED ON DRAWINGS WITH FIELD DIMENSIONS BEFORE FABRICATION OR ORDERING OF MATERIALS. DO NOT SCALE DRAWINGS.
- 3.5 **EXISTING CONDITIONS:** NOTIFY THE SPRINT CONSTRUCTION MANAGER OF EXISTING CONDITIONS DIFFERING FROM THOSE INDICATED ON THE DRAWINGS. DO NOT REMOVE OR ALTER STRUCTURAL COMPONENTS WITHOUT PRIOR WRITTEN APPROVAL FROM THE ARCHITECT AND ENGINEER.

SECTION 01 200 - COMPANY FURNISHED MATERIAL AND EQUIPMENT

PART 1 - GENERAL

- 1.1 **THE WORK:** THESE STANDARD CONSTRUCTION SPECIFICATIONS IN CONJUNCTION WITH THE OTHER CONTRACT DOCUMENTS AND THE CONSTRUCTION DRAWINGS DESCRIBE THE WORK TO BE PERFORMED BY THE CONTRACTOR.
- 1.2 **RELATED DOCUMENTS:**
- A. THE REQUIREMENTS OF THIS SECTION APPLY TO ALL SECTIONS IN THIS SPECIFICATION.
 - B. SPRINT "STANDARD CONSTRUCTION DETAILS FOR WIRELESS SITES" ARE INCLUDED IN AND MADE A PART OF THESE SPECIFICATIONS HEREWITH.

PART 2 - PRODUCTS (NOT USED)

PART 3 - EXECUTION

- 3.1 **RECEIPT OF MATERIAL AND EQUIPMENT:**
- A. COMPANY FURNISHED MATERIAL AND EQUIPMENT IS IDENTIFIED ON THE RF DATA SHEET IN THE CONSTRUCTION DOCUMENTS.
 - B. THE CONTRACTOR IS RESPONSIBLE FOR SPRINT PROVIDED MATERIAL AND EQUIPMENT AND UPON RECEIPT SHALL:
 1. ACCEPT DELIVERIES AS SHIPPED AND TAKE RECEIPT.
 2. VERIFY COMPLETENESS AND CONDITION OF ALL DELIVERIES.
 3. TAKE RESPONSIBILITY FOR EQUIPMENT AND PROVIDE INSURANCE PROTECTION AS REQUIRED IN AGREEMENT.
 4. RECORD ANY DEFECTS OR DAMAGES AND WITHIN TWENTY-FOUR HOURS AFTER RECEIPT, REPORT TO SPRINT OR ITS DESIGNATED PROJECT REPRESENTATIVE OF SUCH.
 5. PROVIDE SECURE AND NECESSARY WEATHER PROTECTED WAREHOUSING.
 6. COORDINATE SAFE AND SECURE TRANSPORTATION OF MATERIAL AND EQUIPMENT, DELIVERING AND OFF-LOADING FROM CONTRACTOR'S WAREHOUSE TO SITE.
- 3.2 **DELIVERABLES:**
- A. COMPLETE SHIPPING AND RECEIPT DOCUMENTATION IN ACCORDANCE WITH COMPANY PRACTICE.
 - B. IF APPLICABLE, COMPLETE LOST/STOLEN/DAMAGED DOCUMENTATION REPORT AS NECESSARY IN ACCORDANCE WITH COMPANY PRACTICE, AND AS DIRECTED BY COMPANY.
 - C. UPLOAD DOCUMENTATION INTO SPRINT SITE MANAGEMENT SYSTEM (SMS) AND/OR PROVIDE HARD COPY DOCUMENTATION AS REQUESTED.

SECTION 01 300 - CELL SITE CONSTRUCTION

PART 1 - GENERAL

- 1.1 **THE WORK:** THESE STANDARD CONSTRUCTION SPECIFICATIONS IN CONJUNCTION WITH THE OTHER CONTRACT DOCUMENTS AND THE CONSTRUCTION DRAWINGS DESCRIBE THE WORK TO BE PERFORMED BY THE CONTRACTOR.
- 1.2 **RELATED DOCUMENTS:**
- A. THE REQUIREMENTS OF THIS SECTION APPLY TO ALL SECTIONS IN THIS SPECIFICATION.
 - B. SPRINT "STANDARD CONSTRUCTION DETAILS FOR WIRELESS SITES" ARE INCLUDED IN AND MADE A PART OF THESE SPECIFICATIONS HEREWITH.
- 1.3 **NOTICE TO PROCEED:**
- A. NO WORK SHALL COMMENCE PRIOR TO COMPANY'S WRITTEN NOTICE TO PROCEED AND THE ISSUANCE OF THE WORK ORDER.
 - B. UPON RECEIVING NOTICE TO PROCEED, CONTRACTOR SHALL FULLY PERFORM ALL WORK NECESSARY TO PROVIDE SPRINT WITH AN OPERATIONAL WIRELESS FACILITY.

PART 2 - PRODUCTS (NOT USED)

PART 3 - EXECUTION

- 3.1 **FUNCTIONAL REQUIREMENTS:**
- A. THE ACTIVITIES DESCRIBED IN THIS PARAGRAPH REPRESENT MINIMUM ACTIONS AND PROCESSES REQUIRED TO SUCCESSFULLY COMPLETE THE WORK. THE ACTIVITIES DESCRIBED ARE NOT EXHAUSTIVE, AND CONTRACTOR SHALL TAKE ANY AND ALL ACTIONS AS NECESSARY TO SUCCESSFULLY COMPLETE THE CONSTRUCTION OF A FULLY FUNCTIONING WIRELESS FACILITY AT THE SITE IN ACCORDANCE WITH COMPANY PROCESSES.
 - B. SUBMIT SPECIFIC DOCUMENTATION AS INDICATED HEREIN, AND OBTAIN REQUIRED APPROVALS WHILE THE WORK IS BEING PERFORMED.
 - C. MANAGE AND CONDUCT ALL FIELD CONSTRUCTION SERVICE RELATED ACTIVITIES
 - D. PROVIDE CONSTRUCTION ACTIVITIES TO THE EXTENT REQUIRED BY THE CONTRACT DOCUMENTS, INCLUDING BUT NOT LIMITED TO THE FOLLOWING:
 1. PERFORM ANY REQUIRED SITE ENVIRONMENTAL MITIGATION.
 2. PREPARE GROUND SITES; PROVIDE DE-GRUBBING; AND ROUGH AND FINAL GRADING, AND COMPOUND SURFACE TREATMENTS.
 3. MANAGE AND CONDUCT ALL ACTIVITIES FOR INSTALLATION OF UTILITIES INCLUDING ELECTRICAL AND TELCO BACKHAUL.
 4. INSTALL UNDERGROUND FACILITIES INCLUDING UNDERGROUND POWER AND COMMUNICATIONS CONDUITS, AND UNDERGROUND GROUNDING SYSTEM.
 5. INSTALL ABOVE GROUND GROUNDING SYSTEMS.
 6. PROVIDE NEW HVAC INSTALLATIONS AND MODIFICATIONS.
 7. INSTALL "H-FRAMES", CABINETS AND SHELTERS AS INDICATED.
 8. INSTALL ROADS, ACCESS WAYS, CURBS AND DRAINS AS INDICATED.
 9. ACCOMPLISH REQUIRED MODIFICATION OF EXISTING FACILITIES.
 10. PROVIDE ANTENNA SUPPORT STRUCTURE FOUNDATIONS.
 11. PROVIDE SLABS AND EQUIPMENT PLATFORMS.
 12. INSTALL COMPOUND FENCING, SIGHT SHIELDING, LANDSCAPING AND ACCESS BARRIERS.
 13. PERFORM INSPECTION AND MATERIAL TESTING AS REQUIRED HEREINAFTER.
 14. CONDUCT SITE RESISTANCE TO EARTH TESTING AS REQUIRED HEREINAFTER
 15. INSTALL FIXED GENERATOR SETS AND OTHER STANDBY POWER SOLUTIONS.
 16. INSTALL TOWERS, ANTENNA SUPPORT STRUCTURES AND PLATFORMS ON EXISTING TOWERS AS REQUIRED.
 17. INSTALL CELL SITE RADIOS, MICROWAVE, GPS, COAXIAL MAINLINE, ANTENNAS, CROSS BAND COUPLERS, TOWER TOP AMPLIFIERS, LOW NOISE AMPLIFIERS AND RELATED EQUIPMENT.
 18. PERFORM, DOCUMENT, AND CLOSE OUT ANY CONSTRUCTION CONTROL DOCUMENTS THAT MAY BE REQUIRED BY GOVERNMENT AGENCIES AND LANDLORDS.
 19. PERFORM ANTENNAL AND COAX SWEEP TESTING AND MAKE ANY AND ALL NECESSARY CORRECTIONS.
 20. REMAIN ON SITE MOBILIZED THROUGHOUT HAND-OFF AND INTEGRATION TO ASSIST AS NEEDED UNTIL SITE IS DEEMED SUBSTANTIALLY COMPLETE AND PLACED "ON AIR."

3.2 **GENERAL REQUIREMENTS FOR CIVIL CONSTRUCTION:**

- A. CONTRACTOR SHALL KEEP THE SITE FREE FROM ACCUMULATING WASTE MATERIAL, DEBRIS, AND TRASH. AT THE COMPLETION OF THE WORK, CONTRACTOR SHALL REMOVE FROM THE SITE ALL REMAINING RUBBISH, IMPLEMENTS, TEMPORARY FACILITIES, AND SURPLUS MATERIALS.
- B. EQUIPMENT ROOMS SHALL AT ALL TIMES BE MAINTAINED "BROOM CLEAN" AND CLEAR OF DEBRIS.
- C. CONTRACTOR SHALL TAKE ALL REASONABLE PRECAUTIONS TO DISCOVER AND LOCATE ANY HAZARDOUS CONDITION.
 1. IN THE EVENT CONTRACTOR ENCOUNTERS ANY HAZARDOUS CONDITION WHICH HAS NOT BEEN ABATED OR OTHERWISE MITIGATED, CONTRACTOR AND ALL OTHER PERSONS SHALL IMMEDIATELY STOP WORK IN THE AFFECTED AREA AND NOTIFY COMPANY IN WRITING. THE WORK IN THE AFFECTED AREA SHALL NOT BE RESUMED EXCEPT BY WRITTEN NOTIFICATION BY COMPANY.
 2. CONTRACTOR AGREES TO USE CARE WHILE ON THE SITE AND SHALL NOT TAKE ANY ACTION THAT WILL OR MAY RESULT IN OR CAUSE THE HAZARDOUS CONDITION TO BE FURTHER RELEASED IN THE ENVIRONMENT, OR TO FURTHER EXPOSE INDIVIDUALS TO THE HAZARD.
- D. CONTRACTOR'S ACTIVITIES SHALL BE RESTRICTED TO THE PROJECT LIMITS. SHOULD AREAS OUTSIDE THE PROJECT LIMITS BE AFFECTED BY CONTRACTOR'S ACTIVITIES, CONTRACTOR SHALL IMMEDIATELY RETURN THEM TO ORIGINAL CONDITION
- E. CONDUCT TESTING AS REQUIRED HEREIN.

3.3 **DELIVERABLES:**

- A. CONTRACTOR SHALL REVIEW, APPROVE, AND SUBMIT TO SPRINT SHOP DRAWINGS, PRODUCT DATA, SAMPLES, AND SIMILAR SUBMITTALS AS REQUIRED HEREINAFTER
- B. PROVIDE DOCUMENTATION INCLUDING, BUT NOT LIMITED TO, THE FOLLOWING. DOCUMENTATION SHALL BE FORWARDED IN ORIGINAL FORMAT AND/OR UPLOADED INTO SMS.
 1. ALL CORRESPONDENCE AND PRELIMINARY CONSTRUCTION REPORTS.
 2. PROJECT PROGRESS REPORTS.
 3. CIVIL CONSTRUCTION START DATE (POPULATE FIELD IN SMS AND/OR FORWARD NOTIFICATION).
 4. ELECTRICAL SERVICE COMPLETION DATE (POPULATE FIELD IN SMS AND/OR FORWARD NOTIFICATION).
 5. LINES AND ANTENNA INSTALL DATE (POPULATE FIELD IN SMS AND/OR FORWARD NOTIFICATION).
 6. TOWER INSTALL DATE (POPULATE FIELD IN SMS AND/OR FORWARD NOTIFICATION).
 7. TELCO READY DATE (POPULATE FIELD IN SMS AND/OR FORWARD NOTIFICATION).
 8. PPC (OR SHELTER) INSTALL DATE (POPULATE FIELD IN SMS AND/OR FORWARD NOTIFICATION).
 9. TOWER CONSTRUCTION START DATE (POPULATE FIELD IN SMS AND/OR FORWARD NOTIFICATION).
 10. TOWER CONSTRUCTION COMPLETE DATE (POPULATE FIELD IN SMS AND/OR FORWARD NOTIFICATION).
 11. BTS AND RADIO EQUIPMENT DELIVERED AT SITE DATE (POPULATE FIELD IN SMS AND/OR FORWARD NOTIFICATION).
 12. NETWORK OPERATIONS HANDOFF CHECKLIST (HOC WALK) COMPLETE (UPLOAD FORM IN SMS)
 13. CIVIL CONSTRUCTION COMPLETE DATE (POPULATE FIELD IN SMS AND/OR FORWARD NOTIFICATION).
 14. SITE CONSTRUCTION PROGRESS PHOTOS UNLOADED INTO SMS.



1 INTERNATIONAL BLVD, SUITE 800
 MAHWAH, NJ 07495
 TEL: (800) 357-7641



SBA COMMUNICATIONS CORP.
 134 FLANDERS ROAD, SUITE 125
 WESTBOROUGH, MA 01581 TEL: (508) 251-0720



4 Bay Road, Building A
 Suite 200
 Hadley, MA 01035 Ph: (413)320-4918

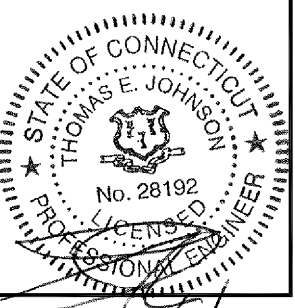

CHECKED BY: G. J. / TEJ

APPROVED BY: JMM/TEJ

SUBMITTALS

REV.	DATE	DESCRIPTION	BY
1	06/19/18	CONSTRUCTION REVISED	PN
0	04/04/18	ISSUED FOR CONSTRUCTION	PN

SITE NUMBER:
CT33XC017

SITE NAME:
POMFRET SCHOOL (SBA)

SITE ADDRESS:
 398 POMFRET STREET
 POMFRET, CT 06258

SHEET TITLE
**OUTLINE
 SPECIFICATIONS**

SHEET NUMBER
SP-1

CONTINUED FROM SP-1:

SECTION 01 400 - SUBMITTALS, TESTS, AND INSPECTIONS

PART 1 - GENERAL

1.1 THE WORK: THESE STANDARD CONSTRUCTION SPECIFICATIONS IN CONJUNCTION WITH THE OTHER CONTRACT DOCUMENTS AND THE CONSTRUCTION DRAWINGS DESCRIBE THE WORK TO BE PERFORMED BY THE CONTRACTOR.

1.2 RELATED DOCUMENTS:

- A. THE REQUIREMENTS OF THIS SECTION APPLY TO ALL SECTIONS IN THIS SPECIFICATION.
B. SPRINT "STANDARD CONSTRUCTION DETAILS FOR WIRELESS SITES" ARE INCLUDED IN AND MADE A PART OF THESE SPECIFICATIONS HEREWITH.

1.3 SUBMITTALS:

- A. THE WORK IN ALL ASPECTS SHALL COMPLY WITH THE CONSTRUCTION DRAWINGS AND THESE SPECIFICATIONS.
B. SUBMIT THE FOLLOWING TO COMPANY REPRESENTATIVE FOR APPROVAL.
1. CONCRETE MIX-DESIGNS FOR TOWER FOUNDATIONS, ANCHORS PIERS, AND CONCRETE PAVING.
2. CONCRETE BREAK TESTS AS SPECIFIED HEREIN.
3. SPECIAL FINISHES FOR INTERIOR SPACES, IF ANY.
4. ALL EQUIPMENT AND MATERIALS SO IDENTIFIED ON THE CONSTRUCTION DRAWINGS.
5. CHEMICAL GROUNDING DESIGN.
C. ALTERNATES: AT THE COMPANY'S REQUEST, ANY ALTERNATIVES TO THE MATERIALS OR METHODS SPECIFIED SHALL BE SUBMITTED TO SPRINT'S CONSTRUCTION MANAGER FOR APPROVAL PRIOR TO BEING SHIPPED TO SITE.

1.4 TESTS AND INSPECTIONS:

- A. THE CONTRACTOR SHALL BE RESPONSIBLE FOR ALL CONSTRUCTION TESTS, INSPECTIONS AND PROJECT DOCUMENTATION.
B. CONTRACTOR SHALL ACCOMPLISH TESTING INCLUDING BUT NOT LIMITED TO THE FOLLOWING:
1. COAX SWEEPS AND FIBER TESTS PER SPRINT TS-0200 CURRENT VERSION ANTENNA LINE ACCEPTANCE STANDARDS.
2. AGL, AZIMUTH AND DOWNTILT USING ELECTRONIC COMMERCIAL MADE-FOR-THE-PURPOSE ANTENNA ALIGNMENT TOOL.
3. CONTRACTOR SHALL BE RESPONSIBLE FOR ANY AND ALL CORRECTIONS TO ANY WORK IDENTIFIED AS UNACCEPTABLE IN SITE INSPECTION ACTIVITIES AND/OR AS A RESULT OF TESTING.
C. REQUIRED CLOSEOUT DOCUMENTATION INCLUDES, BUT IS NOT LIMITED TO THE FOLLOWING:
1. AZIMUTH, DOWNTILT, AGL - UPLOAD REPORT FROM ANTENNA ALIGNMENT TOOL TO SITERRA TASK 465.
2. SCANABLE BARCODE PHOTOGRAPHS OF TOWER TOP AND INACCESSIBLE SERIALIZED EQUIPMENT
3. ALL AVAILABLE JURISDICTIONAL INFORMATION
4. PDF SCAN OF REDLINES PRODUCED IN FIELD
5. ELECTRONIC AS-BUILT DRAWINGS IN AUTOCAD AND PDF FORMATS.
6. LIEN WAIVERS
7. FINAL PAYMENT APPLICATION
8. REQUIRED FINAL CONSTRUCTION PHOTOS
9. CONSTRUCTION AND COMMISSIONING CHECKLIST COMPLETE WITH NO DEFICIENT ITEMS
10. ALL POST NTP TASKS INCLUDING DOCUMENT UPLOADS COMPLETED IN SITERRA

1.5 COMMISSIONING: PERFORM ALL COMMISSIONING AS REQUIRED BY APPLICABLE MOPS

1.6 INTEGRATION: PERFORM ALL INTEGRATION ACTIVITIES AS REQUIRED BY APPLICABLE MOPS

PART 2 - PRODUCTS (NOT USED)

PART 3 - EXECUTION

3.1 REQUIREMENTS FOR TESTING:

- A. THIRD PARTY TESTING AGENCY: WHEN THE USE OF A THIRD PARTY INDEPENDENT TESTING AGENCY IS REQUIRED, THE AGENCY THAT IS SELECTED MUST PERFORM SUCH WORK ON A REGULAR BASIS IN THE STATE WHERE THE PROJECT IS LOCATED AND HAVE A THOROUGH UNDERSTANDING OF LOCAL AVAILABLE MATERIALS, INCLUDING THE SOIL, ROCK, AND GROUNDWATER CONDITIONS.
1. THE THIRD PARTY TESTING AGENCY IS TO BE FAMILIAR WITH THE APPLICABLE REQUIREMENTS FOR THE TESTS TO BE DONE, EQUIPMENT TO BE USED, AND ASSOCIATED HEALTH AND SAFETY ISSUES.
2. EXPERIENCE IN SOILS, CONCRETE, MASONRY, AGGREGATE, AND ASPHALT TESTING USING ASTM, AASJTO, AND OTHER METHODS IS NEEDED.
3. EXPERIENCE IN SOILS, CONCRETE, MASONRY, AGGREGATE, AND ASPHALT TESTING USING ASTM, AASJTO, AND OTHER METHODS IS NEEDED.

3.2 REQUIRED TESTS:

- A. CONTRACTOR SHALL ACCOMPLISH TESTING INCLUDING BUT NOT LIMITED TO THE FOLLOWING:
1. CONCRETE CYLINDER BREAK TESTS FOR THE TOWER AND ANCHOR FOUNDATIONS AS SPECIFIED IN SECTION: PORTLAND CEMENT CONCRETE PAVING.
2. ASPHALT ROADWAY COMPACTED THICKNESS, SURFACE SMOOTHNESS, AND COMPACTED DENSITY TESTING AS SPECIFIED IN SECTION: HOT MIX ASPHALT PAVING.
3. FIELD QUALITY CONTROL TESTING AS SPECIFIED IN SECTION: PORTLAND CEMENT CONCRETE PAVING.
4. TESTING REQUIRED UNDER SECTION: AGGREGATE BASE FOR ACCESS ROADS, PADS AND ANCHOR LOCATIONS
5. STRUCTURAL BACKFILL COMPACTION TESTS FOR THE TOWER FOUNDATION.
6. SITE RESISTANCE TO EARTH TESTING PER EXHIBIT: CELL SITE GROUNDING SYSTEM DESIGN.
7. ANTENNA AND COAX SWEEP TESTS PER EXHIBIT: ANTENNA TRANSMISSION LINE ACCEPTANCE STANDARDS.
8. GROUNDING AT ANTENNA MASTS FOR GPS AND ANTENNAS
9. ALL OTHER TESTS REQUIRED BY COMPANY OR JURISDICTION.

3.3 REQUIRED INSPECTIONS:

- A. SCHEDULE INSPECTIONS WITH COMPANY REPRESENTATIVE.
B. CONDUCT INSPECTIONS INCLUDING BUT NOT LIMITED TO THE FOLLOWING:
1. GROUNDING SYSTEM INSTALLATION PRIOR TO EARTH CONCEALMENT DOCUMENTED WITH DIGITAL PHOTOGRAPHS BY CONTRACTOR, APPROVED BY A&E OR SPRINT REPRESENTATIVE.
2. FORMING FOR CONCRETE AND REBAR PLACEMENT PRIOR TO POUR DOCUMENTED WITH DIGITAL PHOTOGRAPHS BY CONTRACTOR, APPROVED BY A&E OR SPRINT REPRESENTATIVE.
3. COMPACTION OF BACKFILL MATERIALS; AGGREGATE BASE FOR ROADS, PADS, AND ANCHORS; ASPHALT PAVING; AND SHAFT BACKFILL FOR CONCRETE AND WOOD POLES, BY INDEPENDENT THIRD PARTY AGENCY.
4. PRE- AND POST-CONSTRUCTION ROOFTOP AND STRUCTURAL INSPECTIONS ON EXISTING FACILITIES.
5. TOWER ERECTION SECTION STACKING AND PLATFORM ATTACHMENT DOCUMENTED BY DIGITAL PHOTOGRAPHS BY THIRD PARTY AGENCY.
6. ANTENNA AZIMUTH, DOWN TILT AND PER SUNLIGHT TOOL SUNSIGHT INSTRUMENTS - ANTENNALIGN ALIGNMENT TOOL (AAT)
7. VERIFICATION DOCUMENTED WITH THE ANTENNA CHECKLIST REPORT, BY A&E, SITE DEVELOPMENT REP, OR RF REP.
8. FINAL INSPECTION CHECKLIST AND HANDOFF WALK (HOC). SIGNED FORM SHOWING ACCEPTANCE BY FIELD OPS IS TO BE UPLOADED INTO SMS.
9. COAX SWEEP AND FIBER TESTING DOCUMENTS SUBMITTED VIA SMS FOR RF APPROVAL.
10. SCAN-ABLE BARCODE PHOTOGRAPHS OF TOWER TOP AND INACCESSIBLE SERIALIZED EQUIPMENT
11. ALL AVAILABLE JURISDICTIONAL INFORMATION
12. PDF SCAN OF REDLINES PRODUCED IN FIELD
E. THE CONTRACTOR SHALL BE RESPONSIBLE FOR ANY AND ALL CORRECTIONS TO ANY WORK IDENTIFIED AS UNACCEPTABLE IN SITE INSPECTION ACTIVITIES AND/OR AS A RESULT OF TESTING.
F. CONSTRUCTION INSPECTIONS AND CORRECTIVE MEASURES SHALL BE DOCUMENTED BY THE CONTRACTOR WITH WRITTEN REPORTS AND PHOTOGRAPHS. PHOTOGRAPHS MUST BE DIGITAL AND OF SUFFICIENT QUALITY TO CLEARLY SHOW THE SITE CONSTRUCTION. PHOTOGRAPHS MUST CLEARLY IDENTIFY THE PHOTOGRAPHED ITEM AND BE LABELED WITH THE SITE CASCADE NUMBER, SITE NAME, DESCRIPTION, AND DATE.

3.4 DELIVERABLES: TEST AND INSPECTION REPORTS AND CLOSEOUT DOCUMENTATION SHALL BE UPLOADED TO THE SMS AND/OR FORWARDED TO SPRINT FOR INCLUSION INTO THE PERMANENT SITE FILES.

- A. THE FOLLOWING TEST AND INSPECTION REPORTS SHALL BE PROVIDED AS APPLICABLE.
1. CONCRETE MIX AND CYLINDER BREAK REPORTS.
2. STRUCTURAL BACKFILL COMPACTION REPORTS.
3. SITE RESISTANCE TO EARTH TEST.
4. ANTENNA AZIMUTH AND DOWN TILT VERIFICATION
5. TOWER ERECTION INSPECTIONS AND MEASUREMENTS DOCUMENTING TOWER INSTALLED PER SUPPLIER'S REQUIREMENTS AND THE APPLICABLE SECTIONS HEREIN.
6. COAX CABLE SWEEP TESTS PER COMPANY'S "ANTENNA LINE ACCEPTANCE STANDARDS".
B. REQUIRED CLOSEOUT DOCUMENTATION INCLUDES THE FOLLOWING:
1. TEST WELLS AND TRENCHES: PHOTOGRAPHS OF ALL TEST WELLS; PHOTOGRAPHS SHOWING ALL OPEN EXCAVATIONS AND TRENCHING PRIOR TO BACKFILLING SHOWING A TAPE MEASURE VISIBLE IN THE EXCAVATIONS INDICATING DEPTH.
2. CONDUITS, CONDUCTORS AND GROUNDING: PHOTOGRAPHS SHOWING TYPICAL INSTALLATION OF CONDUCTORS AND CONNECTORS; PHOTOGRAPHS SHOWING TYPICAL BEND RADIUS OF INSTALLED GROUND WIRES AND GROUND ROD SPACING;
3. CONCRETE FORMS AND REINFORCING: CONCRETE FORMING AT TOWER AND EQUIPMENT/SHELTER PAD/FOUNDATIONS - PHOTOGRAPHS SHOWING ALL REINFORCING STEEL, UTILITY AND CONDUIT STUB OUTS; PHOTOGRAPHS SHOWING CONCRETE POUR OF SHELTER SLAB/FOUNDATION, TOWER FOUNDATION AND GUY ANCHORS WITH VIBRATOR IN USE; PHOTOGRAPHS SHOWING EACH ANCHOR ON GUYED TOWERS, BEFORE CONCRETE POUR.
4. TOWER, ANTENNAS AND MAINLINE: INSPECTION AND PHOTOGRAPHS OF SECTION STACKING; INSPECTION AND PHOTOGRAPHS OF PLATFORM COMPONENT ATTACHMENT POINTS; PHOTOGRAPHS OF TOWER TOP GROUNDING; PHOTOS OF TOWER COAX LINE COLOR CODING AT THE TOP AND AT GROUND LEVEL; INSPECTION AND PHOTOGRAPHS OF OPERATIONAL OF TOWER LIGHTING, AND PLACEMENT OF FAA REGISTRATION SIGN; PHOTOGRAPHS SHOWING ADDITIONAL GROUNDING POINTS FOR TOWERS GREATER THAN 200 FEET.; PHOTOS OF ANTENNA GROUND BAR, EQUIPMENT GROUND BAR, AND MASTER GROUND BAR; PHOTOS OF GPS ANTENNA(S); PHOTOS OF EACH SECTOR OF ANTENNAS; ONE PHOTOGRAPH LOOKING AT THE SECTOR AND ONE FROM BEHIND SHOWING THE PROJECTED COVERAGE AREA; PHOTOS OF COAX WEATHERPROOFING - TOP AND BOTTOM; PHOTOS OF COAX GROUNDING--TOP AND BOTTOM; PHOTOS OF ANTENNA AND MAST GROUNDING; PHOTOS OF COAX CABLE ENTRY INTO SHELTER; PHOTOS OF PLATFORM MECHANICAL CONNECTIONS TO TOWER/MONOPOLE.
5. ROOF TOPS: PRE-CONSTRUCTION AND POST-CONSTRUCTION VISUAL INSPECTION AND PHOTOGRAPHS OF THE ROOF AND INTERIOR TO DETERMINE AND DOCUMENT CONDITIONS; ROOF TOP CONSTRUCTION INSPECTIONS AS REQUIRED BY THE JURISDICTION; PHOTOGRAPHS OF CABLE TRAY AND/OR ICE BRIDGE; PHOTOGRAPHS OF DOGHOUSE/CABLE EXIT FROM ROOF;
6. SITE LAYOUT - PHOTOGRAPHS OF THE OVERALL COMPOUND, INCLUDING EQUIPMENT PLATFORM FROM ALL FOUR CORNERS.
7. FINISHED UTILITIES: CLOSE-UP PHOTOGRAPHS OF THE PPC BREAKER PANEL; CLOSE-UP PHOTOGRAPH OF THE INSIDE OF THE TELCO PANEL AND NIU; CLOSE-UP PHOTOGRAPH OF THE POWER METER AND DISCONNECT; PHOTOS OF POWER AND TELCO ENTRANCE TO COMPANY ENCLOSURE; PHOTOGRAPHS AT METER BOX AND/OR FACILITY DISTRIBUTION PANEL.
8. REQUIRED MATERIALS CERTIFICATIONS: CONCRETE MIX DESIGNS; MILL CERTIFICATION FOR ALL REINFORCING AND STRUCTURAL STEEL; AND ASPHALT PAVING MIX DESIGN.
9. ANY AND ALL SUBMITTALS BY THE JURISDICTION OR COMPANY.

SECTION 01 500 - PROJECT REPORTING

PART 1 - GENERAL

1.1 THE WORK: THESE STANDARD CONSTRUCTION SPECIFICATIONS IN CONJUNCTION WITH THE OTHER CONTRACT DOCUMENTS AND THE CONSTRUCTION DRAWINGS DESCRIBE THE WORK TO BE PERFORMED BY THE CONTRACTOR.

1.2 RELATED DOCUMENTS:

- A. THE REQUIREMENTS OF THIS SECTION APPLY TO ALL SECTIONS IN THIS SPECIFICATION.
B. SPRINT "STANDARD CONSTRUCTION DETAILS FOR WIRELESS SITES" ARE INCLUDED IN AND MADE A PART OF THESE SPECIFICATIONS HEREWITH.

PART 2 - PRODUCTS (NOT USED)

PART 3 - EXECUTION

3.1 WEEKLY REPORTS:

- A. CONTRACTOR SHALL PROVIDE SPRINT WITH WEEKLY REPORTS SHOWING PROJECT STATUS. THIS STATUS REPORT FORMAT WILL BE PROVIDED TO THE CONTRACTOR BY SPRINT. THE REPORT WILL CONTAIN SITE ID NUMBER, THE MILESTONES FOR EACH SITE, INCLUDING THE BASELINE DATE, ESTIMATED COMPLETION DATE AND ACTUAL COMPLETION DATE.

B. REPORT INFORMATION WILL BE TRANSMITTED TO SPRINT VIA ELECTRONIC MEANS AS REQUIRED. THIS INFORMATION WILL PROVIDE A BASIS FOR PROGRESS MONITORING AND PAYMENT.

3.2 PROJECT CONFERENCE CALLS:

- A. SPRINT MAY HOLD WEEKLY PROJECT CONFERENCE CALLS. CONTRACTOR WILL BE REQUIRED TO COMMUNICATE SITE STATUS, MILESTONE COMPLETIONS AND UPCOMING MILESTONE PROJECTIONS, AND ANSWER ANY OTHER SITE STATUS QUESTIONS AS NECESSARY.

3.3 PROJECT TRACKING IN SMS:

- A. CONTRACTOR SHALL PROVIDE SCHEDULE UPDATES AND PROJECTIONS IN THE SMS SYSTEM ON A WEEKLY BASIS.

3.4 ADDITIONAL REPORTING:

- A. ADDITIONAL OR ALTERNATE REPORTING REQUIREMENTS MAY BE ADDED TO THE REPORT AS DETERMINED TO BE REASONABLY NECESSARY BY COMPANY.

3.5 PROJECT PHOTOGRAPHS:

- A. FILE DIGITAL PHOTOGRAPHS OF COMPLETED SITE IN JPEG FORMAT IN THE SMS PHOTO LIBRARY FOR THE RESPECTIVE SITE. PHOTOGRAPHS SHALL BE CLEARLY LABELED WITH SITE NUMBER, NAME AND DESCRIPTION, AND SHALL INCLUDE AT A MINIMUM THE FOLLOWING AS APPLICABLE:
1. SHELTER AND TOWER OVERVIEW.
2. TOWER FOUNDATION(S) - FORMS AND STEEL BEFORE POUR (EACH ANCHOR ON GUYED TOWERS).
3. TOWER FOUNDATION(S) POUR WITH VIBRATOR IN USE (EACH ANCHOR ON GUYED TOWERS).
4. TOWER STEEL AS BEING INSTALLED INTO HOLE (SHOW ANCHOR STEEL ON GUYED TOWERS).
5. PHOTOS OF TOWER SECTION STACKING.
6. CONCRETE TESTING / SAMPLES.
7. PLACING OF ANCHOR BOLTS IN TOWER FOUNDATION.
8. BUILDING/WATER TANK FROM ROAD FOR TENANT IMPROVEMENTS OR COMMENTS.
9. SHELTER FOUNDATION--FORMS AND STEEL BEFORE POURING.
10. SHELTER FOUNDATION POUR WITH VIBRATOR IN USE.
11. COAX CABLE ENTRY INTO SHELTER.
12. PLATFORM MECHANICAL CONNECTIONS TO TOWER/MONOPOLE.
13. ROOFTOP PRE AND POST CONSTRUCTION PHOTOS TO INCLUDE PENETRATIONS AND INTERIOR CEILING.
14. PHOTOS OF TOWER TOP COAX LINE COLOR CODING AND COLOR CODING AT GROUND LEVEL.
15. PHOTOS OF ALL APPROPRIATE COMPANY OR REGULATORY SIGNAGE.
16. PHOTOS OF EQUIPMENT BOLT DOWN INSIDE SHELTER.
17. POWER AND TELCO ENTRANCE TO COMPANY ENCLOSURE AND POWER AND TELCO SUPPLY LOCATIONS INCLUDING METER/DISCONNECT.
18. ELECTRICAL TRENCH(S) WITH ELECTRICAL / CONDUIT BEFORE BACKFILL.
19. ELECTRICAL TRENCH(S) WITH FOIL-BACKED TAPE BEFORE FURTHER BACKFILL.
20. TELCO TRENCH WITH TELEPHONE / CONDUIT BEFORE BACKFILL.
21. TELCO TRENCH WITH FOIL-BACKED TAPE BEFORE FURTHER BACKFILL.
22. SHELTER GROUND-RING TRENCH WITH GROUND-WIRE BEFORE BACKFILL (SHOW ALL CAD WELDS AND BEND RADI).
23. TOWER GROUND-RING TRENCH WITH GROUND-WIRE BEFORE BACKFILL (SHOW ALL CAD WELDS AND BEND RADI).
24. FENCE GROUND-RING TRENCH WITH GROUND-WIRE BEFORE BACKFILL (SHOW ALL CAD WELDS AND BEND RADI).
25. ALL BTS GROUND CONNECTIONS.
26. ALL GROUND TEST WELLS.
27. ANTENNA GROUND BAR AND EQUIPMENT GROUND BAR.
28. ADDITIONAL GROUNDING POINTS ON TOWERS ABOVE 200'.
29. HVAC UNITS INCLUDING CONDENSERS ON SPLIT SYSTEMS.
30. GPS ANTENNAS.
31. CABLE TRAY AND/OR WAVEGUIDE BRIDGE.
32. DOGHOUSE/CABLE EXIT FROM ROOF.
33. EACH SECTOR OF ANTENNAS; ONE PHOTOGRAPH LOOKING AT THE SECTOR AND ONE FROM BEHIND SHOWING THE PROJECTED COVERAGE AREA.
34. MASTER BUS BAR.
35. TELCO BOARD AND NIU.
36. ELECTRICAL DISTRIBUTION WALL.
37. CABLE ENTRY WITH SURGE SUPPRESSION.
38. ENTRANCE TO EQUIPMENT ROOM.
39. COAX WEATHERPROOFING--TOP AND BOTTOM OF TOWER.
40. COAX GROUNDING --TOP AND BOTTOM OF TOWER.
41. ANTENNA AND MAST GROUNDING.
42. LANDSCAPING - WHERE APPLICABLE.
3.6 FINAL PROJECT ACCEPTANCE: COMPLETE ALL REQUIRED REPORTING TASKS PER CONTRACT, CONTRACT DOCUMENTS OR THE SPRINT INTEGRATED CONSTRUCTION STANDARDS FOR WIRELESS SITES AND UPLOAD INTO SITERRA.

SECTION 07 500 - ROOF CUTTING, PATCHING AND REPAIR

SUMMARY:

THIS SECTION SPECIFIES CUTTING AND PATCHING EXISTING ROOFING SYSTEMS WHERE CONDUIT OR CABLES EXIT THE BUILDING ONTO THE ROOF OR BUILDING-MOUNTED ANTENNAS, AND AS REQUIRED FOR WATERTIGHT PERFORMANCE. ROOFTOP ENTRY OPENINGS IN MEMBRANE ROOFTOPS SHALL BE CONSTRUCTED TO COMPLY WITH LANDLORD, ANY EXISTING WARRANTY, AND LOCAL JURISDICTIONAL STANDARDS.

1.4 SUBMITTALS:

- A. PRE-CONSTRUCTION ROOF PHOTOS: COMPLETE A ROOF INSPECTION PRIOR TO THE INSTALLATION OF SPRINT EQUIPMENT ON ANY ROOFTOP BUILD. AT A MINIMUM INSPECT AND PHOTOGRAPH (MINIMUM 3 EA.) ALL AREAS IMPACTED BY THE ADDITION OF THE SPRINT EQUIPMENT.
B. PROVIDE SIMILAR PHOTOGRAPHS SHOWING ROOF CONDITIONS AFTER CONSTRUCTION (MINIMUM 3 EA.)
C. ROOF INSPECTION PHOTOGRAPHS SHOULD BE UPLOADED WITH CLOSEOUT PHOTOGRAPHS.

SECTION 09 900 - PAINTING

QUALITY ASSURANCE:

- A. COMPLY WITH GOVERNING CODES AND REGULATIONS. PROVIDE PRODUCTS OF ACCEPTABLE MANUFACTURERS WHICH HAVE BEEN IN SATISFACTORY USE IN SIMILAR SERVICE FOR THREE YEARS. USE EXPERIENCED INSTALLERS. DELIVER, HANDLE, AND STORE MATERIALS IN ACCORDANCE WITH MANUFACTURER'S INSTRUCTIONS.
B. COMPLY WITH ALL ENVIRONMENTAL REGULATIONS FOR VOLATILE ORGANIC COMPOUNDS.

CONTINUE SHEET SP-3

Sprint logo and address: 1 INTERNATIONAL BLVD, SUITE 800 MAHWAH, NJ 07495 TEL: (800) 357-7641

SBA logo and address: SBA COMMUNICATIONS CORP. 134 FLANDERS ROAD, SUITE 125 WESTBOROUGH, MA 01581 TEL: (508) 251-0720

ProTerra DESIGN GROUP, LLC logo and address: 4 Bay Road, Building A Suite 200 Hadley, MA 01035 Ph: (413)320-4918

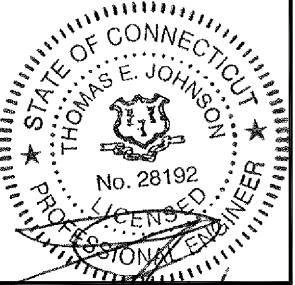

CHECKED BY: G/19/10/TEJ

APPROVED BY: JMM/TEJ

Table with 4 columns: REV., DATE, DESCRIPTION, BY. Row 1: 1, 06/19/18, CONSTRUCTION REVISED, PN. Row 2: 0, 04/04/18, ISSUED FOR CONSTRUCTION, PN.

SITE NUMBER: CT33XC017
SITE NAME: POMFRET SCHOOL (SBA)
SITE ADDRESS: 398 POMFRET STREET POMFRET, CT 06258

SHEET TITLE: OUTLINE SPECIFICATIONS

SHEET NUMBER: SP-2

CONTINUED FROM SP-2:

MATERIALS:

- A. MANUFACTURERS: BENJAMIN MOORE, ICI DEVOE COATINGS, PPG, SHERWIN WILLIAMS OR APPROVED EQUAL. PROVIDE PREMIUM GRADE, PROFESSIONAL-QUALITY PRODUCTS FOR COATING SYSTEMS.

PAINT SCHEDULE:

- A. EXTERIOR ANTENNAE AND ANTENNA MOUNTING HARDWARE: ONE COAT OF PRIMER AND TWO FINISH COATS. PAINT FOR ANTENNAE SHALL BE NON-METALLIC BASED AND CONTAIN NO METALLIC PARTICLES. PROVIDE COLORS AND PATTERNS AS REQUIRED TO MASK APPEARANCE OF ANTENNAE ON ADJACENT BUILDING SURFACES AND AS ACCEPTABLE TO THE OWNER. REFER TO ANTENNA MANUFACTURER'S INSTRUCTIONS WHENEVER POSSIBLE.
- B. ROOF TOP CONSTRUCTION: TOUCH UP - PREPARE SURFACES TO BE REPAIRED. FOLLOW INDUSTRY STANDARDS AND REQUIREMENTS OF OWNER TO MATCH EXISTING COATING AND FINISH.

PAINTING APPLICATION:

- 1. INSPECT SURFACES, REPORT UNSATISFACTORY CONDITIONS IN WRITING; BEGINNING WORK MEANS ACCEPTANCE OF SUBSTRATE.
- 2. COMPLY WITH MANUFACTURER'S INSTRUCTIONS AND RECOMMENDATIONS FOR PREPARATION, PRIMING AND COATING WORK. COORDINATE WITH WORK OF OTHER SECTIONS.
- 3. MATCH APPROVED MOCK-UPS FOR COLOR, TEXTURE, AND PATTERN. RE-COAT OR REMOVE AND REPLACE WORK WHICH DOES NOT MATCH OR SHOWS LOSS OF ADHESION.
- 4. CLEAN UP, TOUCH UP AND PROTECT WORK.

TOUCHUP PAINTING:

- 1. GALVANIZING DAMAGE AND ALL BOLTS AND NUTS SHALL BE TOUCHED UP AFTER TOWER ERECTION WITH "GALVANOX," "DRY GALV," OR "ZINC-IT."
- 2. FIELD TOUCHUP PAINT SHALL BE DONE IN ACCORDANCE WITH THE MANUFACTURER'S WRITTEN INSTRUCTIONS.
- 3. ALL METAL COMPONENTS SHALL BE HANDLED WITH CARE TO PREVENT DAMAGE TO THE COMPONENTS, THEIR PRESERVATIVE TREATMENT, OR THEIR PROTECTIVE COATINGS.

SECTION 11 700 - ANTENNA ASSEMBLY, REMOTE RADIO HEADS AND CABLE INSTALLATION

SUMMARY:

THIS SECTION SPECIFIES INSTALLATION OF ANTENNAS, RRH'S, AND CABLE EQUIPMENT, INSTALLATION, AND TESTING OF COAXIAL FIBER CABLE.

ANTENNAS AND RRH'S:

THE NUMBER AND TYPE OF ANTENNAS AND RRH'S TO BE INSTALLED IS DETAILED ON THE CONSTRUCTION DRAWINGS.

HYBRID CABLE:

HYBRID CABLE WILL BE DC/FIBER AND FURNISHED FOR INSTALLATION AT EACH SITE. CABLE SHALL BE INSTALLED PER THE CONSTRUCTION DRAWINGS AND THE APPLICABLE MANUFACTURER'S REQUIREMENTS.

JUMPERS AND CONNECTORS:

FURNISH AND INSTALL 1/2" COAX JUMPER CABLES BETWEEN THE RRH'S AND ANTENNAS. JUMPERS SHALL BE TYPE LDF 4, FLC 12-50, CR 540, OR FXL 540. SUPER-FLEX CABLES ARE NOT ACCEPTABLE. JUMPERS BETWEEN THE RRH'S AND ANTENNAS OR TOWER TOP AMPLIFIERS SHALL CONSIST OF 1/2 INCH FOAM DIELECTRIC, OUTDOOR RATED COAXIAL CABLE. DO NOT USE SUPERFLEX OUTDOORS. JUMPERS SHALL BE FACTORY FABRICATED IN APPROPRIATE LENGTHS WITH A MAXIMUM OF 4 FEET EXCESS PER JUMPER AND HAVE CONNECTORS AT EACH END, MANUFACTURED BY SUPPLIER. IF JUMPERS ARE FIELD FABRICATED, FOLLOW MANUFACTURER'S REQUIREMENTS FOR INSTALLATION OF CONNECTORS

REMOTE ELECTRICAL TILT (RET) CABLES:

MISCELLANEOUS:

INSTALL SPLITTERS, COMBINERS, FILTERS PER RF DATA SHEET, FURNISHED BY SPRINT.

ANTENNA INSTALLATION:

THE CONTRACTOR SHALL ASSEMBLE ALL ANTENNAS ONSITE IN ACCORDANCE WITH THE INSTRUCTIONS SUPPLIED BY THE MANUFACTURER. ANTENNA HEIGHT, AZIMUTH, AND FEED ORIENTATION INFORMATION SHALL BE A DESIGNATED ON THE CONSTRUCTION DRAWINGS.

- A. THE CONTRACTOR SHALL POSITION THE ANTENNA ON TOWER PIPE MOUNTS SO THAT THE BOTTOM STRUT IS LEVEL. THE PIPE MOUNTS SHALL BE PLUMB TO WITHIN 1 DEGREE.
- B. ANTENNA MOUNTING REQUIREMENTS: PROVIDE ANTENNA MOUNTING HARDWARE AS INDICATED ON THE DRAWINGS.

HYBRID CABLES INSTALLATION:

- A. THE CONTRACTOR SHALL ROUTE, TEST, AND INSTALL ALL CABLES AS INDICATED ON THE CONSTRUCTION DRAWINGS AND IN ACCORDANCE WITH THE MANUFACTURER'S RECOMMENDATIONS.
- B. THE INSTALLED RADIUS OF THE CABLES SHALL NOT BE LESS THAN THE MANUFACTURER'S SPECIFICATIONS FOR BENDING RADIII.
- C. EXTREME CARE SHALL BE TAKEN TO AVOID DAMAGE TO THE CABLES DURING HANDLING AND INSTALLATION.
 - 1. FASTENING MAIN HYBRID CABLES: ALL CABLES SHALL BE PERMANENTLY FASTENED TO THE COAX LADDER AT 4'-0" OC USING NON-MAGNETIC STAINLESS STEEL CLIPS.
 - 2. FASTENING INDIVIDUAL FIBER AND DC CABLES ABOVE BREAKOUT ENCLOSURE (MEDUSA), WITHIN THE MMBTS CABINET AND ANY INTERMEDIATE DISTRIBUTION BOXES:
 - a. FIBER: SUPPORT FIBER BUNDLES USING 1/2" VELCRO STRAPS OF THE REQUIRED LENGTH @ 18" OC. STRAPS SHALL BE UV, OIL AND WATER RESISTANT AND SUITABLE FOR INDUSTRIAL INSTALLATIONS AS MANUFACTURED BY TEXTOL OR APPROVED EQUAL.
 - b. DC: SUPPORT DC BUNDLES WITH ZIP TIES OF THE ADEQUATE LENGTH. ZIP TIES TO BE UV STABILIZED, BLACK NYLON, WITH TENSILE STRENGTH AT 12,000 PSI AS MANUFACTURED BY NELCO PRODUCTS OR EQUAL.
 - 3. FASTENING JUMPERS: SECURE JUMPERS TO THE SIDE ARMS OR HEAD FRAMES USING STAINLESS STEEL TIE WRAPS OR STAINLESS STEEL BUTTERFLY CLIPS.
 - 4. CABLE INSTALLATION:
 - a. INSPECT CABLE PRIOR TO USE FOR SHIPPING DAMAGE, NOTIFY THE CONSTRUCTION MANAGER.
 - b. CABLE ROUTING: CABLE INSTALLATION SHALL BE PLANNED TO ENSURE THAT THE LINES WILL BE PROPERLY ROUTED IN THE CABLE ENVELOP AS INDICATED ON THE DRAWINGS. AVOID TWISTING AND CROSSOVERS.
 - c. HOIST CABLE USING PROPER HOISTING GRIPS. DO NOT EXCEED MANUFACTURES RECOMMENDED MAXIMUM BEND RADIUS.

- 5. GROUNDING OF TRANSMISSION LINES: ALL TRANSMISSION LINES SHALL BE GROUNDED AS INDICATED ON DRAWINGS.
- 6. HYBRID CABLE COLOR CODING: ALL COLOR CODING SHALL BE AS REQUIRED PER SPRINT TS 0200 CURRENT VERSION.
- 7. HYBRID CABLE LABELING: INDIVIDUAL HYBRID AND DC BUNDLES SHALL BE LABELED ALPHA-NUMERICALLY ACCORDING TO SPRINT CELL SITE ENGINEERING NOTICE-EN 2012-001, REV 1

WEATHERPROOFING EXTERIOR CONNECTORS AND HYBRID CABLE GROUND KITS:

- A. ALL FIBER & COAX CONNECTORS AND GROUND KITS SHALL BE WEATHERPROOFED.
- B. WEATHERPROOFED USING ONE OF THE FOLLOWING METHODS. ALL INSTALLATIONS MUST BE DONE IN ACCORDANCE WITH THE MANUFACTURER'S RECOMMENDATIONS AND INDUSTRY BEST PRACTICES.

- 1. COLD SHRINK: ENCOMPASS CONNECTOR IN COLD SHRINK TUBING AND PROVIDE A DOUBLE WRAP OF 2" ELECTRICAL TAPE EXTENDING 2" BEYOND TUBING. PROVIDE 3M COLD SHRINK CXS SERIES OR EQUAL.
- 2. SELF-AMALGAMATING TAPE: CLEAN SURFACES. APPLY A DOUBLE WRAP OF SELF-AMALGAMATING TAPE 2" BEYOND CONNECTOR. APPLY A SECOND WRAP OF SELF-AMALGAMATING TAPE IN OPPOSITE DIRECTION. APPLY DOUBLE WRAP OF 2" WIDE ELECTRICAL TAPE EXTENDING 2" BEYOND THE SELF-AMALGAMATING TAPE.
- 3. 3M SLIM LOCK CLOSURE 716: SUBSTITUTIONS WILL NOT BE ALLOWED.
- 4. OPEN FLAME ON JOB SITE IS NOT ACCEPTABLE.

SECTION 11 800 - INSTALLATION OF MULTIMODAL BASE STATIONS (MMBTS) AND RELATED EQUIPMENT

SUMMARY:

- A. THIS SECTION SPECIFIES MMBTS CABINETS, POWER CABINETS, AND INTERNAL EQUIPMENT INCLUDING BY NOT LIMITED TO RECTIFIERS, POWER DISTRIBUTION UNITS, BASE BAND UNITS, SURGE ARRESTORS, BATTERIES, AND SIMILAR EQUIPMENT FURNISHED BY THE COMPANY FOR INSTALLATION BY THE CONTRACTOR (OFCI).
- B. CONTRACTOR SHALL PROVIDE AND INSTALL ALL MISCELLANEOUS MATERIALS AND PROVIDE ALL LABOR REQUIRED FOR INSTALLATION EQUIPMENT IN EXISTING CABINET OR NEW CABINET AS SHOWN ON DRAWINGS AND AS REQUIRE BY THE APPLICABLE INSTALLATION MOPS.
- C. COMPLY WITH MANUFACTURERS INSTALLATION AND START-UP REQUIREMENTS

DC CIRCUIT BREAKER LABELING

- A. LABEL CIRCUIT BREAKERS ACCORDING TO SPRINT CELL SITE ENGINEERING NOTICE - EN 2012-001, REV 1.

SECTION 11 800 - INSTALLATION OF MULTIMODAL BASE TRANSCIEVER STATIONS (MMBTS) AND RELATED EQUIPMENT

SUMMARY:

- A. THIS SECTION SPECIFIES MMBTS CABINETS, POWER CABINETS, AND INTERNAL EQUIPMENT INCLUDING BY NOT LIMITED TO RECTIFIERS, POWER DISTRIBUTION UNITS, BASE BAND UNITS, SURGE ARRESTORS, BATTERIES, AND SIMILAR EQUIPMENT FURNISHED BY THE COMPANY FOR INSTALLATION BY THE CONTRACTOR (OFCI).
- B. CONTRACTOR SHALL PROVIDE AND INSTALL ALL MISCELLANEOUS MATERIALS AND PROVIDE ALL LABOR REQUIRED FOR INSTALLATION EQUIPMENT IN EXISTING CABINET OR NEW CABINET AS SHOWN ON DRAWINGS AND AS REQUIRE BY THE APPLICABLE INSTALLATION MOPS.
- C. COMPLY WITH MANUFACTURERS INSTALLATION AND START-UP REQUIREMENTS

SUPPORTING DEVICES:

- A. MANUFACTURED STRUCTURAL SUPPORT MATERIALS: SUBJECT TO COMPLIANCE WITH REQUIREMENTS, PROVIDE PRODUCTS BY THE FOLLOWING:
 - 1. ALLIED TUBE AND CONDUIT
 - 2. B-LINE SYSTEM
 - 3. UNISTRUT DIVERSIFIED PRODUCTS
 - 4. THOMAS & BETTS
- B. FASTENERS: TYPES, MATERIALS, AND CONSTRUCTION FEATURES AS FOLLOWS:
 - 1. EXPANSION ANCHORS: CARBON STEEL WEDGE OR SLEEVE TYPE.
 - 2. POWER-DRIVEN THREADED STUDS: HEAT-TREATED STEEL, DESIGNED SPECIFICALLY FOR THE INTENDED SERVICE.
 - 3. FASTEN BY MEANS OF WOOD SCREWS ON WOOD.
 - 4. TOGGLE BOLTS ON HOLLOW MASONRY UNITS.
 - 5. CONCRETE INSERTS OR EXPANSION BOLTS ON CONCRETE OR SOLID MASONRY.
 - 6. MACHINE SCREWS, WELDED THREADED STUDS, OR SPRING-TENSION CLAMPS ON STEEL.
 - 7. EXPLOSIVE DEVICES FOR ATTACHING HANGERS TO STRUCTURE SHALL NOT BE PERMITTED.
 - 8. DO NOT WELD CONDUIT, PIPE STRAPS, OR ITEMS OTHER THAN THREADED STUDS TO STEEL STRUCTURES.
 - 9. IN PARTITIONS OF LIGHT STEEL CONSTRUCTION, USE SHEET METAL SCREWS.

SUPPORTING DEVICES:

- A. INSTALL SUPPORTING DEVICES TO FASTEN ELECTRICAL COMPONENTS SECURELY AND PERMANENTLY IN ACCORDANCE WITH NEC.
- B. COORDINATE WITH THE BUILDING STRUCTURAL SYSTEM AND WITH OTHER TRADES.
- C. UNLESS OTHERWISE INDICATED ON THE DRAWINGS, FASTEN ELECTRICAL ITEMS AND THEIR SUPPORTING HARDWARE SECURELY TO THE STRUCTURE IN ACCORDANCE WITH THE FOLLOWING:
- D. ENSURE THAT THE LOAD APPLIED BY ANY FASTENER DOES NOT EXCEED 25 PERCENT OF THE PROOF TEST LOAD.
- E. USE VIBRATION AND SHOCK-RESISTANT FASTENERS FOR ATTACHMENTS TO CONCRETE SLABS.

ELECTRICAL IDENTIFICATION:

- A. UPDATE AND PROVIDE TYPED CIRCUIT BREAKER SCHEDULES IN THE MOUNTING BRACKET, INSIDE DOORS OF AC PANEL BOARDS WITH ANY CHANGES MADE TO THE AC SYSTEM.
- B. BRANCH CIRCUITS FEEDING AVIATION OBSTRUCTION LIGHTING EQUIPMENT SHALL BE CLEARLY IDENTIFIED AS SUCH AT THE BRANCH CIRCUIT PANELBOARD.

SECTION 26 200 - ELECTRICAL MATERIALS AND EQUIPMENT

CONDUIT:

- A. RIGID GALVANIZED STEEL (RGS) CONDUIT SHALL BE USED FOR EXTERIOR LOCATIONS ABOVE GROUND AND IN UNFINISHED INTERIOR LOCATIONS AND FOR ENCASED RUNS IN CONCRETE. RIGID CONDUIT AND FITTINGS SHALL BE STEEL, COATED WITH ZINC EXTERIOR AND INTERIOR BY THE HOT DIP GALVANIZING PROCESS. CONDUIT SHALL BE PRODUCED TO ANSI SPECIFICATIONS C80.1, FEDERAL SPECIFICATION WW-C-581 AND SHALL BE LISTED WITH THE UNDERWRITERS' LABORATORIES. FITTINGS SHALL BE THREADED - SET SCREW OR COMPRESSION FITTINGS WILL NOT BE ACCEPTABLE. RGS CONDUITS SHALL BE MANUFACTURED BY ALLIED, REPUBLIC OR WHEATLAND.
- B. UNDERGROUND CONDUIT IN CONCRETE SHALL BE POLYVINYLCHLORIDE (PVC) SUITABLE FOR DIRECT BURIAL AS APPLICABLE. JOINTS SHALL BE BELLED, AND FLUSH SOLVENT WELDED IN ACCORDANCE WITH MANUFACTURER'S INSTRUCTIONS. CONDUIT SHALL BE CARLON ELECTRICAL PRODUCTS OR APPROVED EQUAL.
- C. TRANSITIONS BETWEEN PVC AND RIGID (RGS) SHALL BE MADE WITH PVC COATED METALLIC LONG SWEEP RADIUS ELBOWS.
- D. EMT OR RIGID GALVANIZED STEEL CONDUIT MAY BE USED IN FINISHED SPACES CONCEALED IN WALLS AND CEILINGS. EMT SHALL BE MILD STEEL, ELECTRICALLY WELDED, ELECTRO-GALVANIZED OR HOT-DIPPED GALVANIZED AND PRODUCED TO ANSI SPECIFICATION C80.3, FEDERAL SPECIFICATION WW-C-563, AND SHALL BE UL LISTED. EMT SHALL BE MANUFACTURED BY ALLIED, REPUBLIC OR WHEATLAND, OR APPROVED EQUAL. FITTINGS SHALL BE METALLIC COMPRESSION. SET SCREW CONNECTIONS SHALL NOT BE ACCEPTABLE.
- E. LIQUID TIGHT FLEXIBLE METALLIC CONDUIT SHALL BE USED FOR FINAL CONNECTION TO EQUIPMENT. FITTINGS SHALL BE METALLIC GLAND TYPE COMPRESSION FITTINGS, MAINTAINING THE INTEGRITY OF CONDUIT SYSTEM. SET SCREW CONNECTIONS SHALL NOT BE ACCEPTABLE. MAXIMUM LENGTH OF FLEXIBLE CONDUIT SHALL NOT EXCEED 6- FEET. LFMC SHALL BE PROTECTED AND SUPPORTED AS REQUIRE BY NEC. MANUFACTURERS OF FLEXIBLE CONDUITS SHALL BE CAROL, ANACONDA METAL HOSE OR UNIVERSAL METAL HOSE, OR APPROVED EQUAL.
- F. MINIMUM SIZE CONDUIT SHALL BE 3/4 INCH (21MM).

HUBS AND BOXES:

- A. AT ENTRANCES TO CABINETS OR OTHER EQUIPMENT NOT HAVING INTEGRAL THREADED HUBS PROVIDE METALLIC THREADED HUBS OF THE SIZE AND CONFIGURATION REQUIRED. HUB SHALL INCLUDE LOCKNUT AND NEOPRENE O-RING SEAL. PROVIDE IMPACT RESISTANT 105 DEGREE C PLASTIC BUSHINGS TO PROTECT CABLE INSULATION.
- B. CABLE TERMINATION FITTINGS FOR CONDUIT
 - 1. CABLE TERMINATORS FOR RGS CONDUITS SHALL BE TYPE CRC BY O-Z/GEDNEY OR EQUAL.
 - 2. CABLE TERMINATORS FOR LFMC SHALL BE ETCO - CL2075; OR MADE FOR THE PURPOSE PRODUCTS BY ROXTEC.
- C. EXTERIOR PULL BOXES AND PULL BOXES IN INTERIOR INDUSTRIAL AREAS SHALL BE PLATED CAST ALLOY, HEAVY DUTY, WEATHERPROOF, DUST PROOF, WITH GASKET, PLATED IRON ALLOY COVER AND STAINLESS STEEL COVER SCREWS, CROUSE-HINDS WAB SERIES OR EQUAL.
- D. CONDUIT OUTLET BODIES SHALL BE PLATED CAST ALLOY WITH SIMILAR GASKETED COVERS. OUTLET BODIES SHALL BE OF THE CONFIGURATION AND SIZE SUITABLE FOR THE APPLICATION. PROVIDE CROUSE-HINDS FORM 8 OR EQUAL.
- E. MANUFACTURER FOR BOXES AND COVERS SHALL BE HOFFMAN, SQUARE "D", CROUSE-HINDS, COOPER, ADALET, APPLETON, O-Z GEDNEY, RACO, OR APPROVED EQUAL.

SUPPLEMENTAL GROUNDING SYSTEM

- A. FURNISH AND INSTALL A SUPPLEMENTAL GROUNDING SYSTEM AS INDICATED ON THE DRAWINGS. SUPPORT SYSTEM WITH NON-MAGNETIC STAINLESS STEEL CLIPS WITH RUBBER GROMMETS. GROUNDING CONNECTORS SHALL BE TINNED COPPER WIRE, SIZES AS INDICATED ON THE DRAWINGS. PROVIDE STRANDED OR SOLID BARE OR INSULATED CONDUCTORS AS INDICATED.
- B. SUPPLEMENTAL GROUNDING SYSTEM: ALL CONNECTIONS TO BE MADE WITH CAD WELDS, EXCEPT AT EQUIPMENT USE LUGS OR OTHER AVAILABLE GROUNDING MEANS AS REQUIRED BY MANUFACTURER; AT GROUND BARS USE TWO HOLE SPADES WITH NO OX.
- C. STOLEN GROUND-BARS: IN THE EVENT OF STOLEN GROUND BARS, CONTACT SPRINT CM FOR REPLACEMENT INSTRUCTION USING THREADED ROD KITS.

EXISTING STRUCTURE:

- A. EXISTING EXPOSED WIRING AND ALL EXPOSED OUTLETS, RECEPTACLES, SWITCHES, DEVICES, BOXES, AND OTHER EQUIPMENT THAT ARE NOT TO BE UTILIZED IN THE COMPLETED PROJECT SHALL BE REMOVED OR DE-ENERGIZED AND CAPPED IN THE WALL, CEILING, OR FLOOR SO THAT THEY ARE CONCEALED AND SAFE. WALL, CEILING, OR FLOOR SHALL BE PATCHED TO MATCH THE ADJACENT CONSTRUCTION.

CONDUIT AND CONDUCTOR INSTALLATION:

- A. CONDUITS SHALL BE FASTENED SECURELY IN PLACE WITH APPROVED NON-PERFORATED STRAPS AND HANGERS. EXPLOSIVE DEVICES FOR ATTACHING HANGERS TO STRUCTURE WILL NOT BE PERMITTED. CLOSELY FOLLOW THE LINES OF THE STRUCTURE, MAINTAIN CLOSE PROXIMITY TO THE STRUCTURE AND KEEP CONDUITS IN TIGHT ENVELOPES. CHANGES IN DIRECTION TO ROUTE AROUND OBSTACLES SHALL BE MADE WITH CONDUIT OUTLET BODIES. CONDUIT SHALL BE INSTALLED IN A NEAT AND WORKMANLIKE MANNER, PARALLEL AND PERPENDICULAR TO STRUCTURE WALL AND CEILING LINES. ALL CONDUIT SHALL BE FISHED TO CLEAR OBSTRUCTIONS. ENDS OF CONDUITS SHALL BE TEMPORARILY CAPPED TO PREVENT CONCRETE, PLASTER OR DIRT FROM ENTERING. CONDUITS SHALL BE RIGIDLY CLAMPED TO BOXES BY GALVANIZED MALLEABLE IRON BUSHING ON INSIDE AND GALVANIZED MALLEABLE IRON LOCKNUT ON OUTSIDE AND INSIDE.
- B. CONDUCTORS SHALL BE PULLED IN ACCORDANCE WITH ACCEPTED GOOD PRACTICE.



1 INTERNATIONAL BLVD, SUITE 800
MAHWAH, NJ 07495
TEL: (800) 357-7641



SBA COMMUNICATIONS CORP.
134 FLANDERS ROAD, SUITE 125
WESTBOROUGH, MA 01581
TEL: (508) 251-0720



4 Bay Road, Building A
Suite 200
Hadley, MA 01035 Ph: (413)320-4918

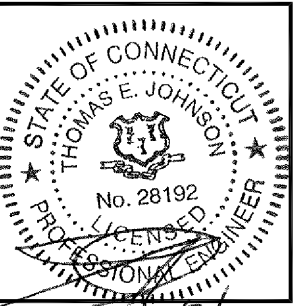

CHECKED BY: *G. J. J. / TEJ*

APPROVED BY: JMM/TEJ

SUBMITTALS			
REV.	DATE	DESCRIPTION	BY
1	06/19/18	CONSTRUCTION REVISED	PN
0	04/04/18	ISSUED FOR CONSTRUCTION	PN

SITE NUMBER:
CT33XC017
SITE NAME:
POMFRET SCHOOL (SBA)

SITE ADDRESS:
398 POMFRET STREET
POMFRET, CT 06258

SHEET TITLE
OUTLINE SPECIFICATIONS

SHEET NUMBER
SP-3



1 INTERNATIONAL BLVD, SUITE 800
MAHWAH, NJ 07495
TEL: (800) 357-7641



SBA COMMUNICATIONS CORP.
134 FLANDERS ROAD, SUITE 125
WESTBOROUGH, MA 01581 TEL: (508) 251-0720



4 Bay Road, Building A
Suite 200
Hadley, MA 01035 Ph: (413) 320-4918

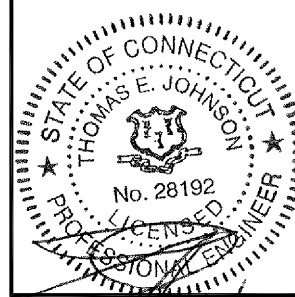

CHECKED BY: *G. J. J. / TEJ*

APPROVED BY: JMM/TEJ

SUBMITTALS			
REV.	DATE	DESCRIPTION	BY
1	06/19/18	CONSTRUCTION REVISED	PN
0	04/04/18	ISSUED FOR CONSTRUCTION	PN

SITE NUMBER:
CT33XC017
SITE NAME:
POMFRET SCHOOL (SBA)
SITE ADDRESS:
398 POMFRET STREET
POMFRET, CT 06258

SHEET TITLE
COMPOUND PLAN

SHEET NUMBER
A-1

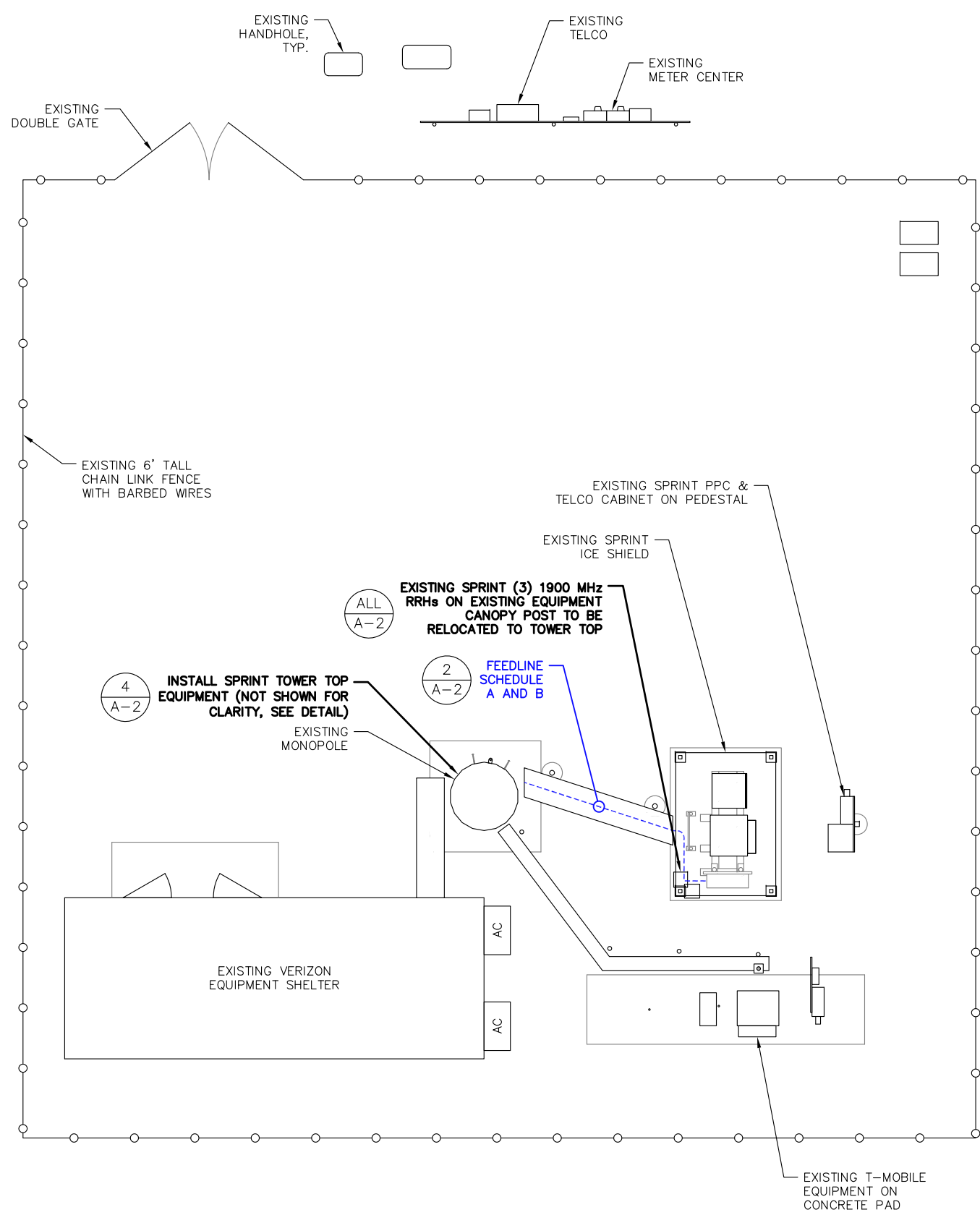

COMPOUND PLAN
SCALE: 1"=10' (11"x17")
1"=5' (22"x34")

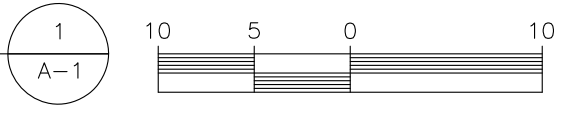

EXISTING SPRINT BBU CABINET
EXISTING SPRINT MMBTS CABINET
INSTALL RAN EQUIPMENT IN EXISTING CABINET
EXISTING SPRINT FIBER DISTRIBUTION BOX ON H-FRAME
EXISTING SPRINT (3) 1900 MHZ RRHs ON EXISTING EQUIPMENT CANOPY POST TO BE RELOCATED TO TOWER TOP
EXISTING SPRINT ICE SHIELD
EXISTING SPRINT TELCO CABINET
EXISTING SPRINT PPC



IMAGE SOURCE: PROVIDED BY SBA
(VIEW FROM SOUTHEAST)

EXISTING SPRINT MMBTS CABINET
INSTALL RAN EQUIPMENT IN EXISTING CABINET
EXISTING SPRINT BBU CABINET
EXISTING SPRINT ICE SHIELD
EXISTING SPRINT (3) 1900 MHZ RRHs ON EXISTING EQUIPMENT CANOPY POST TO BE RELOCATED TO TOWER TOP
EXISTING SPRINT ICE BRIDGE
FEEDLINE SCHEDULE A AND B

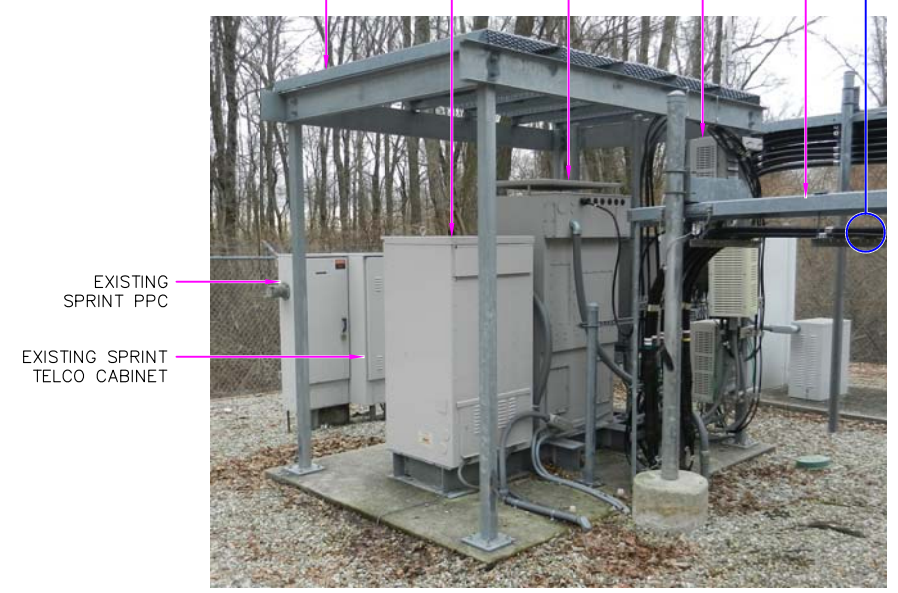
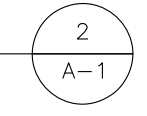

IMAGE SOURCE: PROVIDED BY SBA
(VIEW FROM NORTHWEST)

EQUIPMENT PLAN PHOTO DETAIL
SCALE: N.T.S.



SPECIAL PRE-CONSTRUCTION WORK NOTE (SBA-PROVIDED TOWER STRUCTURAL ANALYSIS SPECIAL EQUIPMENT INSTALLATION REQUIREMENTS):
 GENERAL CONTRACTOR SHALL FURNISH AND INSTALL ALL SPECIAL OR SUPPLEMENTAL ADDITIONAL TOWER-MOUNTED EQUIPMENT PER RECOMMENDATIONS FROM SBA-PROVIDED TOWER STRUCTURAL ANALYSIS FOR ANY SPECIAL SHIELDING OF TOWER TOP EQUIPMENT AND FOR ANY SPECIAL FEEDLINE BUNDLING OR RELOCATION.

SPECIAL CONSTRUCTION NOTE (SBA-PROVIDED ANTENNA MOUNT STRUCTURAL MOD SPECIAL EQUIPMENT INSTALLATION REQUIREMENTS):
 GENERAL CONTRACTOR SHALL FURNISH AND INSTALL ALL ANTENNA MOUNT STRUCTURAL AUGMENTS (STRUCTURAL MODIFICATIONS) AT THE SPRINT RAD/VERTICAL EQUIPMENT SPACE PER RECOMMENDATIONS FROM SBA-PROVIDED ANTENNA MOUNT STRUCTURAL ANALYSIS AND ANY SUPPLEMENTAL CONSTRUCTION DRAWINGS (PROVIDED BY GEOSTRUCTURAL DATED 06/18/18).

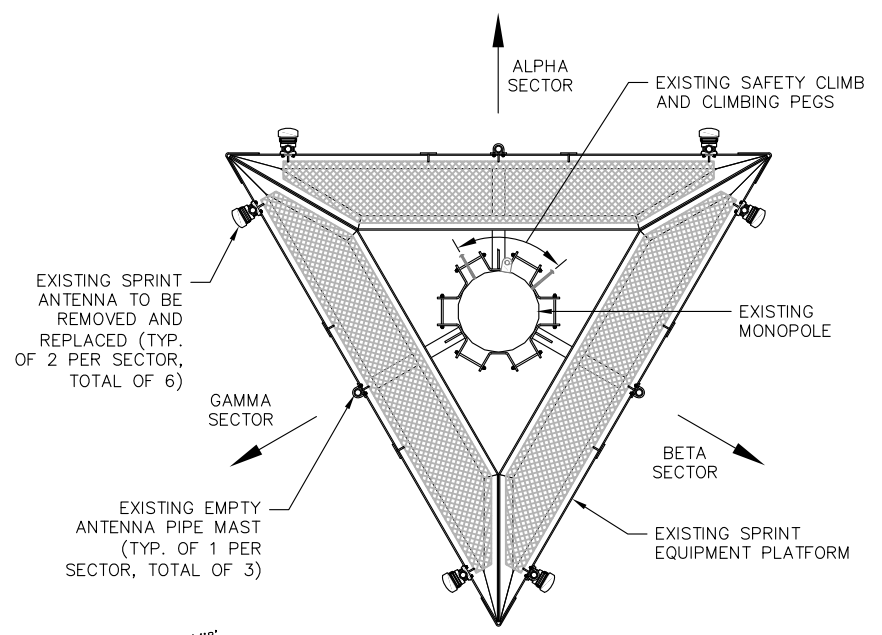

EXISTING ANTENNA PLAN 3
 SCALE: N.T.S. A-2

- ALL 3 S-1 A-3 INSTALL SPRINT RRH (800MHZ 2X50), (TYP. OF 2 PER SECTOR, TOTAL OF 6) MOUNTED TO PROPOSED DUAL SWIVEL MOUNT
- ALL 2 S-1 A-3 REMOVE AND REPLACE EXISTING SPRINT ANTENNA: INSTALL SPRINT ANTENNA (NNVV-65BR4), (TYP. OF 1 PER SECTOR, TOTAL OF 3) MOUNTED TO PROPOSED PIPE MAST
- ALL 4 S-1 A-3 REMOVE AND RELOCATE EXISTING SPRINT RRH (1900 4X45 65MHZ) (TYP. OF 1 PER SECTOR, TOTAL OF 3) FROM GROUND LEVEL TO PROPOSED DUAL SWIVEL MOUNT
- ALL 1 S-1 A-3 REMOVE AND REPLACE EXISTING SPRINT ANTENNA: INSTALL SPRINT ANTENNA (APXVTM14-ALU-I20), (TYP. OF 1 PER SECTOR, TOTAL OF 3) MOUNTED TO PROPOSED PIPE MAST
- ALL 5 S-1 A-3 INSTALL SPRINT RRH (TD-RRH8X20-25), (TYP. OF 1 PER SECTOR, TOTAL OF 3) MOUNTED TO PROPOSED DUAL SWIVEL MOUNT

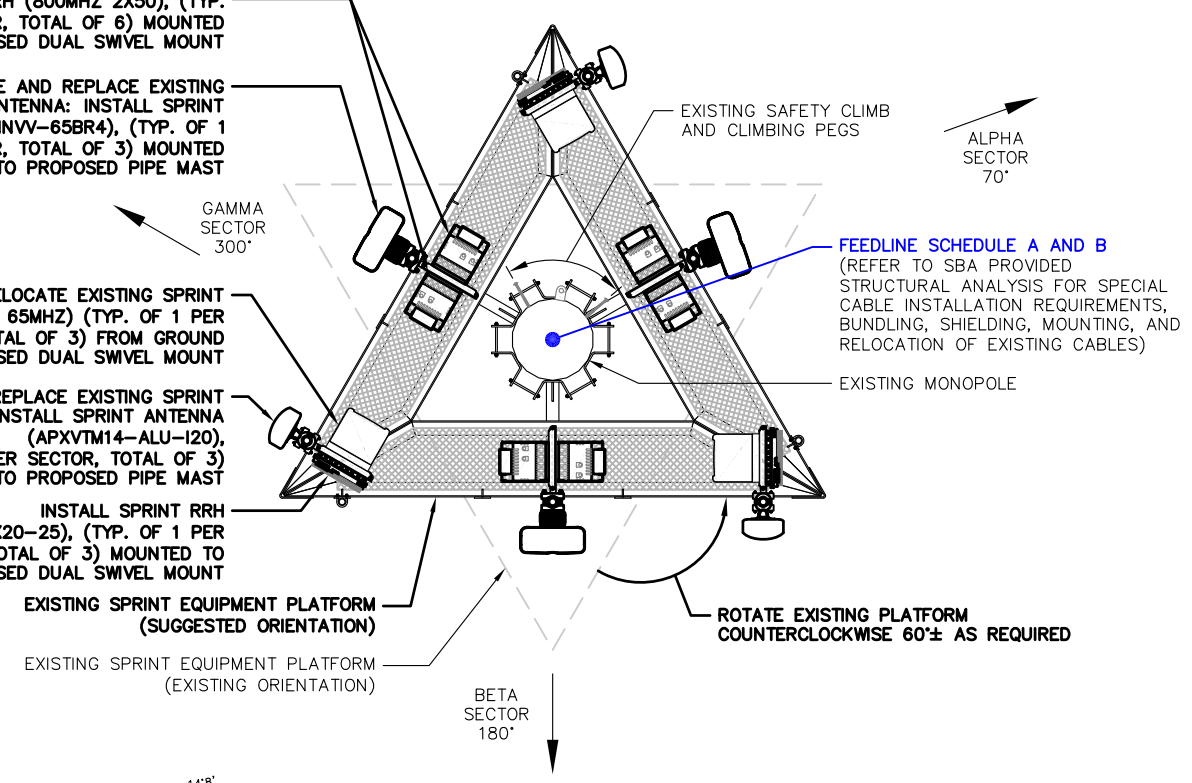

PROPOSED ANTENNA PLAN 4
 SCALE: N.T.S. A-2

SPECIAL INSTALLATION NOTE:
 JUMPERS FROM RRHS TO ANTENNA SHALL NOT EXCEED 15'. NOTIFY SPRINT CONSTRUCTION MANAGER OF ANY DISCREPANCY

NOTE:
 VERIFY PROPOSED AZIMUTHS WITH RF ENGINEER PRIOR TO INSTALLATION

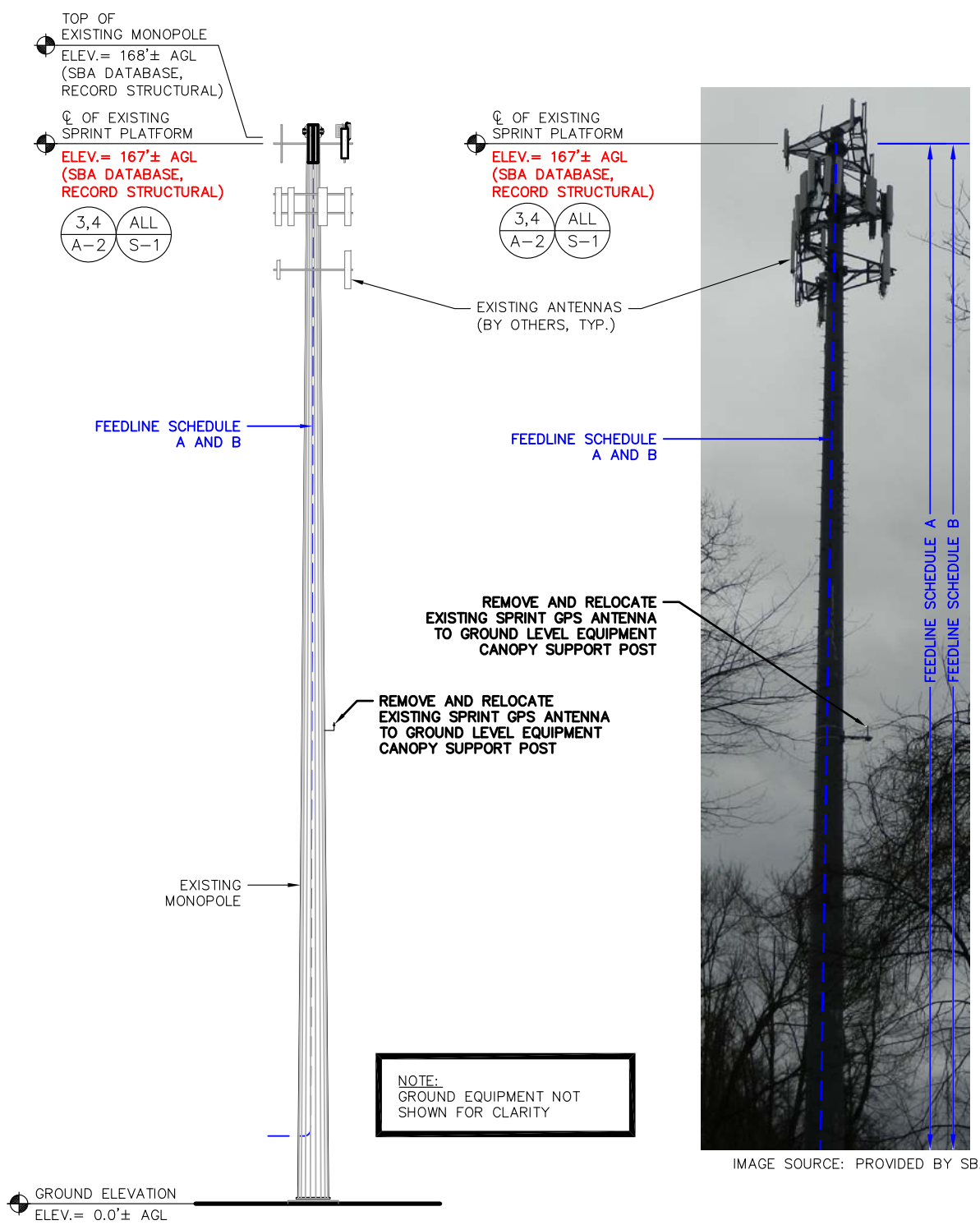

FEEDLINE SCHEDULE	FEEDLINE DESCRIPTION	LOCATION
A	EXISTING TO BE REMOVED: (6) 1/2" COAX TO 167' RAD & (1) 1/2" GPS CABLE RUN TO APPROXIMATELY 75' AGL.	UP INSIDE MONOPOLE TO RAD
B	PROPOSED: (4) HYBRID TO 167' RAD;	UP INSIDE MONOPOLE TO RAD

NOTE:
 EXISTING SPRINT EQUIPMENT FEEDLINE INVENTORY BASED ON OBSERVED FIELD CONDITIONS. RFDS AND FEEDLINE LEASING ENTITLEMENTS MAY DIFFER

TOWER ELEVATION PHOTO DETAIL 2
 SCALE: N.T.S. A-2

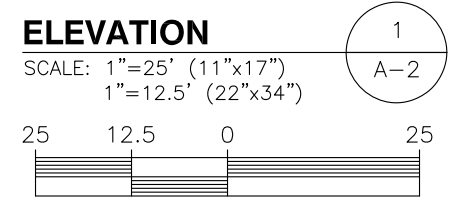

Sprint
 1 INTERNATIONAL BLVD, SUITE 800
 MAHWAH, NJ 07495
 TEL: (800) 357-7641

SBA
 SBA COMMUNICATIONS CORP.
 134 FLANDERS ROAD, SUITE 125
 WESTBOROUGH, MA 01581
 TEL: (508) 251-0720

ProTerra
 DESIGN GROUP, LLC
 4 Bay Road, Building A
 Suite 200
 Hadley, MA 01035 Ph: (413)320-4918

STATE OF CONNECTICUT
 THOMAS E. JOHNSON
 No. 28192
 LICENSED PROFESSIONAL ENGINEER

CHECKED BY: *G. J. [Signature]* / TEJ
 APPROVED BY: JMM/TEJ

SUBMITTALS

REV.	DATE	DESCRIPTION	BY
1	06/19/18	CONSTRUCTION REVISED	PN
0	04/04/18	ISSUED FOR CONSTRUCTION	PN

SITE NUMBER:
 CT33XC017
 SITE NAME:
 POMFRET SCHOOL (SBA)
 SITE ADDRESS:
 398 POMFRET STREET
 POMFRET, CT 06258

SHEET TITLE
 ELEVATION AND ANTENNA PLANS

SHEET NUMBER
 A-2

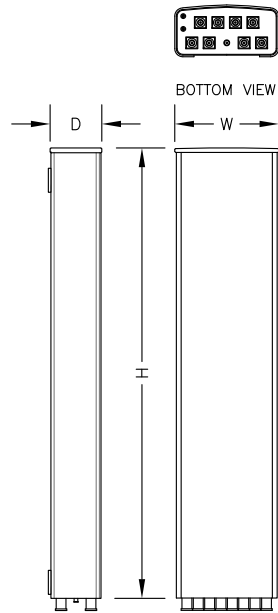

ANTENNA SPECIFICATIONS

MANUF.	RFS
MODEL #	APXVTM14-ALU-I20
HEIGHT	56.3"
WIDTH	12.6"
DEPTH	6.3"
WEIGHT	56.2± LBS.

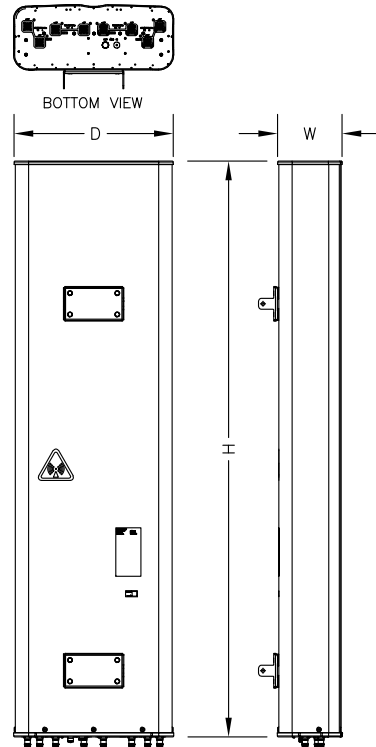

ANTENNA SPECIFICATIONS

MANUF.	COMMSCOPE
MODEL #	NNVV-65B-R4
HEIGHT	72.0"
WIDTH	19.6"
DEPTH	7.8"
WEIGHT	77.4± LBS.

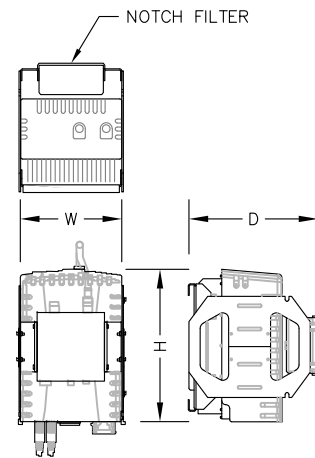

800 MHZ RRH SPECIFICATIONS

MANUF.	NOKIA (ALU)
MODEL #	800MHZ 2X50W
HEIGHT	16"
WIDTH	13"
DEPTH	13.7" (INCLUDING FILTER)
WEIGHT	69.1± LBS (INCLUDING FILTER)

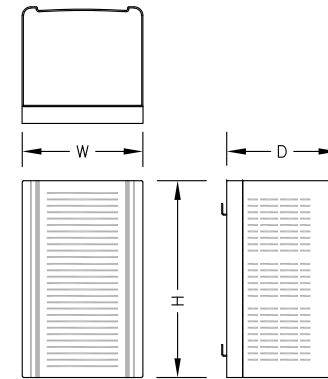

1900 MHZ RRH SPECIFICATIONS

MANUF.	NOKIA (ALU)
MODEL #	1900 4X45 65MHZ
HEIGHT	25"
WIDTH	11.1"
DEPTH	11.4"
WEIGHT	60± LBS

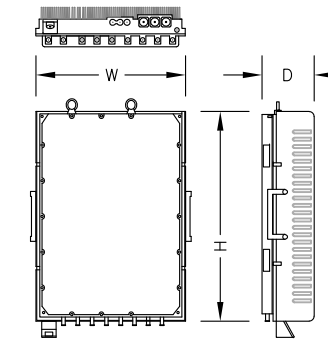

2.5 GHZ RRH SPECIFICATIONS

MANUF.	NOKIA (ALU)
MODEL #	TD-RRH8X20-25
HEIGHT	26.1"
WIDTH	18.6"
DEPTH	6.7"
WEIGHT	70± LBS

2.5 GHz ANTENNA DETAIL

SCALE: N.T.S.

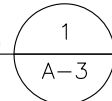

800 MHZ/1900 MHZ ANTENNA DETAIL

SCALE: N.T.S.

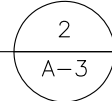

800 MHz RRH DETAIL

SCALE: N.T.S.

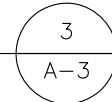

EXISTING 1900 MHz RRH DETAIL

SCALE: N.T.S.

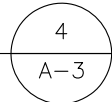

2.5 GHz RRH DETAIL

SCALE: N.T.S.

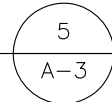

MAJOR RF EQUIPMENT LIST				
(GC SHALL FURNISH AND INSTALL ALL OTHER MATERIALS AND EQUIPMENT NOT SUPPLIED BY SPRINT)				
DESCRIPTION	QUANTITY	UNITS	MAKE/MODEL/MATERIAL	PROVIDED BY
ANTENNA	3	EA	RFS APXVTM14-ALU-I20	SPRINT
ANTENNA	3	EA	COMMSCOPE NNVV-65B-R4	SPRINT
2500 RRH	3	EA	NOKIA (ALU) TD-RRH8x20-25	SPRINT
1900 RRH (RELOCATE EXISTING)	3	EA	NOKIA (ALU) 1900 4X45 65MHZ	SPRINT (EXISTING)
800 RRH	6	EA	NOKIA (ALU) 800MHZ 2x50W	SPRINT
FIBER	4 @ 245'± FROM FIBER CABINET	LINEAR FEET LISTED [INCLUDES (2) 10' COILS]	1-1/4" HYBRIFLEX	SPRINT

SPRINT-PROVIDED EQUIPMENT SCHEDULE

SCALE: N.T.S.

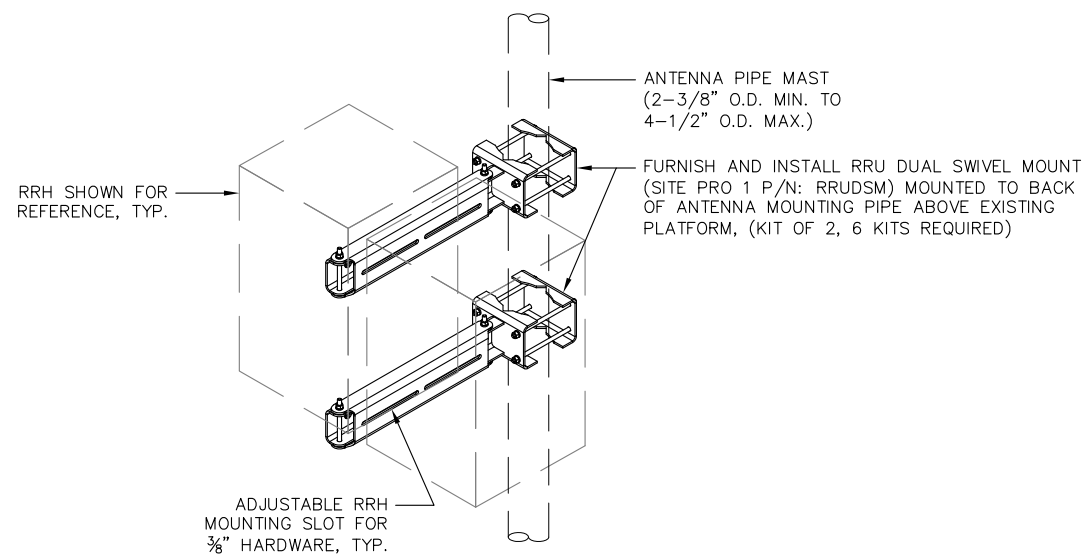
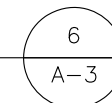

RRH DUAL SWIVEL MOUNT

SCALE: N.T.S.

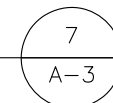

1 INTERNATIONAL BLVD, SUITE 800
MAHWAH, NJ 07495
TEL: (800) 357-7641



SBA COMMUNICATIONS CORP.
134 FLANDERS ROAD, SUITE 125
WESTBOROUGH, MA 01581 TEL: (508) 251-0720



4 Bay Road, Building A
Suite 200
Hadley, MA 01035 Ph: (413)320-4918

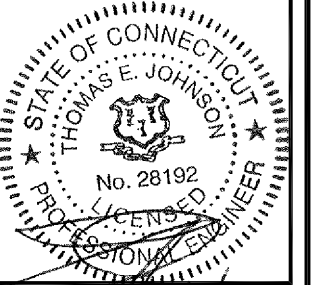

CHECKED BY: *G. J. Johnson* / TEJ

APPROVED BY: JMM/TEJ

SUBMITTALS

REV.	DATE	DESCRIPTION	BY
1	06/19/18	CONSTRUCTION REVISED	PN
0	04/04/18	ISSUED FOR CONSTRUCTION	PN

SITE NUMBER:
CT33XC017
SITE NAME:
POMFRET SCHOOL (SBA)

SITE ADDRESS:
398 POMFRET STREET
POMFRET, CT 06258

SHEET TITLE
TOWER EQUIPMENT DETAILS

SHEET NUMBER
A-3

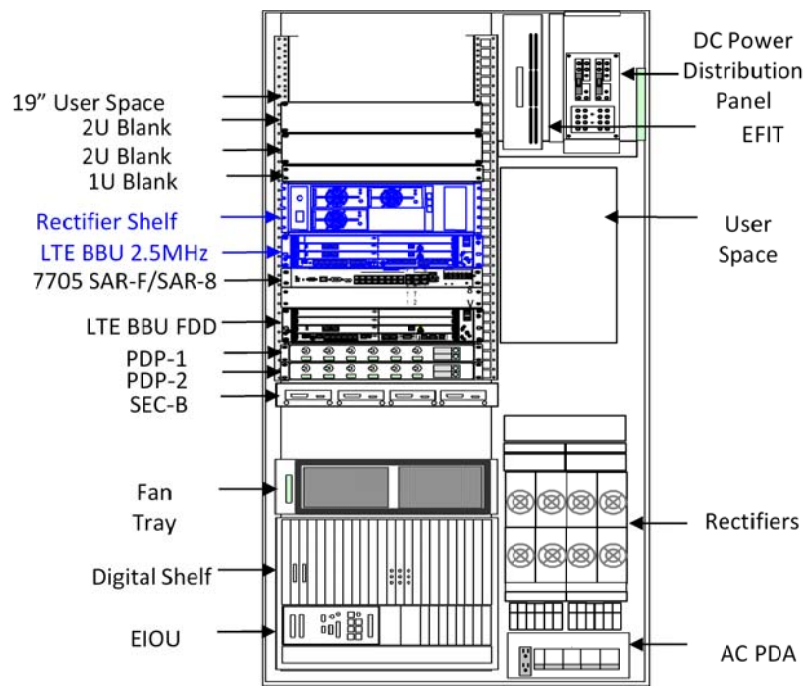

EXISTING MMBTS OUTDOOR CABINET WITH 2.5 EQUIPMENT

SCALE: N.T.S.

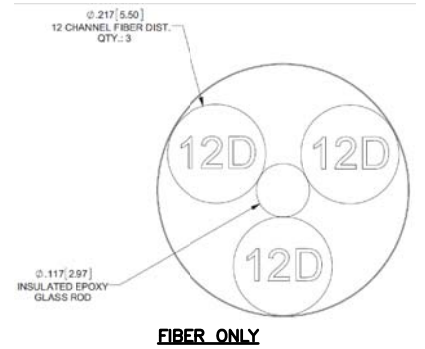
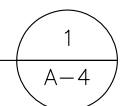

FIBER ONLY

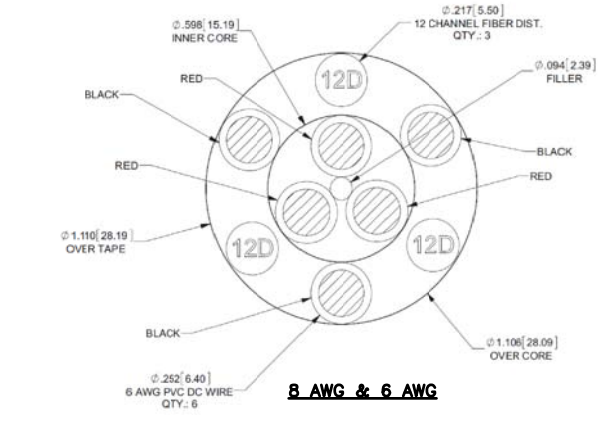

8 AWG & 6 AWG

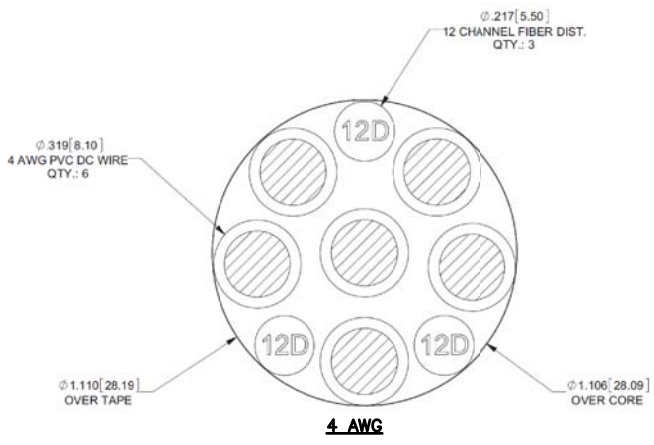

4 AWG

HYBRID CABLE DC CONDUCTOR SIZE GUIDELINE			
MANUF: RFS			
CABLE	LENGTH	DC CONDUCTOR	CABLE DIAMETER
FIBER ONLY	VARIES	USE NV HYBRIFLEX	7/8"
HYBRIFLEX	<200'	8 AWG	1-1/4"
HYBRIFLEX	225-300'	6 AWG	1-1/4"
HYBRIFLEX	325-375'	4 AWG	1-1/4"

(*)

RFS HYBRIFLEX RISER CABLE SCHEDULE

Power	Hybrid cable	Length
Fiber Only (Existing DC Power)	MN: HB058-M12-050F 12x multi-mode fiber pairs, Top: Outdoor protected connectors, Bottom: LC Connectors, 5/8 cable, 50 ft	50 ft
	MN: HB058-M12-075F	75 ft
	MN: HB058-M12-100F	100 ft
	MN: HB058-M12-125F	125 ft
	MN: HB058-M12-150F	150 ft
	MN: HB058-M12-175F	175 ft
8 AWG Power	MN: HB114-08U3M12-050F 3x 8 AWG power pairs, 12x multi-mode fiber pairs, Outdoor rated connectors & LC Connectors, 1 1/4 cable, 50 ft	50 ft
	MN: HB114-08U3M12-075F	75 ft
	MN: HB114-08U3M12-100F	100 ft
	MN: HB114-08U3M12-125F	125 ft
	MN: HB114-08U3M12-150F	150 ft
	MN: HB114-08U3M12-175F	175 ft
6 AWG Power (*)	MN: HB114-13U3M12-225F 3x 6 AWG power pair, 12x multi-mode fiber pairs, Outdoor rated connectors & LC Connectors, 1 1/4 cable, 225 ft	225 ft
	MN: HB114-13U3M12-250F	250 ft
	MN: HB114-13U3M12-275F	275 ft
	MN: HB114-13U3M12-300F	300 ft
4 AWG Power	MN: HB114-21U3M12-325F 3x 4 AWG power pair, 12x multi-mode fiber pairs, Outdoor rated connectors & LC Connectors, 1 1/4 cable, 325 ft	325 ft
	MN: HB114-21U3M12-350F	350 ft
	MN: HB114-21U3M12-375F	375 ft

RFS HYBRIFLEX JUMPER CABLE SCHEDULE

Power	Hybrid Jumper cable	Length
Fiber Only	MN: HBF012-M3-5F1 5 ft, 3x multi-mode fiber pairs, Outdoor & LC connectors, 1/2 cable	5 ft
	MN: HBF012-M3-10F1	10 ft
	MN: HBF012-M3-15F1	15 ft
8 AWG Power	MN: HBF058-08U1M3-5F1 5 ft, 1x 8 AWG power pair, 3x multi-mode fiber pairs, Outdoor & LC Connectors, 5/8 cable	5 ft
	MN: HBF058-08U1M3-10F1	10 ft
	MN: HBF058-08U1M3-15F1	15 ft
6 AWG Power (*)	MN: HBF058-13U1M3-5F1 5 ft, 1x 6 AWG power pair, 3x multi-mode fiber pairs, Outdoor & LC Connectors, 5/8 cable	5 ft
	MN: HBF058-13U1M3-10F1	10 ft
	MN: HBF058-13U1M3-15F1	15 ft
4 AWG Power	MN: HBF078-21U1M3-5F1 5 ft, 1x 4 AWG power pair, 3x multi-mode fiber pairs, Outdoor & LC Connectors, 7/8 cable	5 ft
	MN: HBF078-21U1M3-10F1	10 ft
	MN: HBF078-21U1M3-15F1	15 ft

2.5 HYBRID CABLE X-SECTION AND DATA

SCALE: N.T.S.

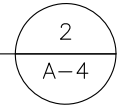

* NOTE: SPRINT CM TO CONFIRM HYBRID RISER CABLE AND HYBRID JUMPER CABLE MODEL NUMBERS BEFORE PREPARING BOM.

Sprint
1 INTERNATIONAL BLVD, SUITE 800
MAHWAH, NJ 07495
TEL: (800) 357-7641

SBA
SBA COMMUNICATIONS CORP.
134 FLANDERS ROAD, SUITE 125
WESTBOROUGH, MA 01581
TEL: (508) 251-0720

ProTerra
DESIGN GROUP, LLC
4 Bay Road, Building A
Suite 200
Hadley, MA 01035 Ph: (413)320-4918

STATE OF CONNECTICUT
THOMAS E. JOHNSON
No. 28192
PROFESSIONAL ENGINEER

CHECKED BY: *G. J. [Signature]* / TEJ

APPROVED BY: JMM/TEJ

SUBMITTALS			
REV.	DATE	DESCRIPTION	BY
1	06/19/18	CONSTRUCTION REVISED	PN
0	04/04/18	ISSUED FOR CONSTRUCTION	PN

SITE NUMBER:
CT33XC017
SITE NAME:
POMFRET SCHOOL (SBA)
SITE ADDRESS:
398 POMFRET STREET
POMFRET, CT 06258

SHEET TITLE
EQUIPMENT DETAILS

SHEET NUMBER
A-4

SPECIAL PRE-CONSTRUCTION WORK NOTE (SBA-PROVIDED TOWER STRUCTURAL ANALYSIS SPECIAL EQUIPMENT INSTALLATION REQUIREMENTS):
 GENERAL CONTRACTOR SHALL FURNISH AND INSTALL ALL SPECIAL OR SUPPLEMENTAL ADDITIONAL TOWER-MOUNTED EQUIPMENT PER RECOMMENDATIONS FROM SBA-PROVIDED TOWER STRUCTURAL ANALYSIS FOR ANY SPECIAL SHIELDING OF TOWER TOP EQUIPMENT AND FOR ANY SPECIAL FEEDLINE BUNDLING OR RELOCATION.

SPECIAL CONSTRUCTION NOTE (SBA-PROVIDED ANTENNA MOUNT STRUCTURAL MOD SPECIAL EQUIPMENT INSTALLATION REQUIREMENTS):
 GENERAL CONTRACTOR SHALL FURNISH AND INSTALL ALL ANTENNA MOUNT STRUCTURAL AUGMENTS (STRUCTURAL MODIFICATIONS) AT THE SPRINT RAD/VERTICAL EQUIPMENT SPACE PER RECOMMENDATIONS FROM SBA-PROVIDED ANTENNA MOUNT STRUCTURAL ANALYSIS AND ANY SUPPLEMENTAL CONSTRUCTION DRAWINGS (PROVIDED BY GEOSTRUCTURAL DATED 06/18/18).

3
A-3
INSTALL SPRINT RRH (800MHZ 2X50), (TYP. OF 2 PER SECTOR, TOTAL OF 6) MOUNTED TO PROPOSED DUAL SWIVEL MOUNT

2
A-3
REMOVE AND REPLACE EXISTING SPRINT ANTENNA: INSTALL SPRINT ANTENNA (NNVV-65BR4), (TYP. OF 1 PER SECTOR, TOTAL OF 3) MOUNTED TO PROPOSED PIPE MAST

EXISTING SPRINT EQUIPMENT PLATFORM (SUBJECT TO MOUNT AUGMENT DETAILS BY OTHERS)

REMOVE AND REPLACE EXISTING PIPE MAST: FURNISH AND INSTALL 2" SCH40 PIPE (2.375" O.D., 0.154" WALL, 8'-0" LONG), (TYP. OF 3 PER SECTOR, TOTAL OF 9)



5
A-3
INSTALL SPRINT RRH (TD-RRH8X20-25), (TYP. OF 1 PER SECTOR, TOTAL OF 3) MOUNTED TO PROPOSED DUAL SWIVEL MOUNT

4
A-3
REMOVE AND RELOCATE EXISTING SPRINT RRH (1900 4X45 65MHZ) (TYP. OF 1 PER SECTOR, TOTAL OF 3) FROM GROUND LEVEL TO PROPOSED DUAL SWIVEL MOUNT

1
A-3
REMOVE AND REPLACE EXISTING SPRINT ANTENNA: INSTALL SPRINT ANTENNA (APXVTM14-ALU-I20), (TYP. OF 1 PER SECTOR, TOTAL OF 3) MOUNTED TO PROPOSED PIPE MAST

IMAGE SOURCE: PROVIDED BY SBA

ANTENNA AND RRH MOUNT PHOTO DETAIL

SCALE: N.T.S.

1
S-1

7
A-3
FURNISH AND INSTALL RRU DUAL SWIVEL MOUNT (SITE PRO 1 P/N: RRDSM) MOUNTED TO BACK OF ANTENNA MOUNTING PIPE ABOVE EXISTING PLATFORM, (KIT OF 2, 8 KITS REQUIRED)

3
A-3
INSTALL SPRINT RRH (800MHZ 2X50), (TYP. OF 2 PER SECTOR, TOTAL OF 6) MOUNTED TO PROPOSED DUAL SWIVEL MOUNT

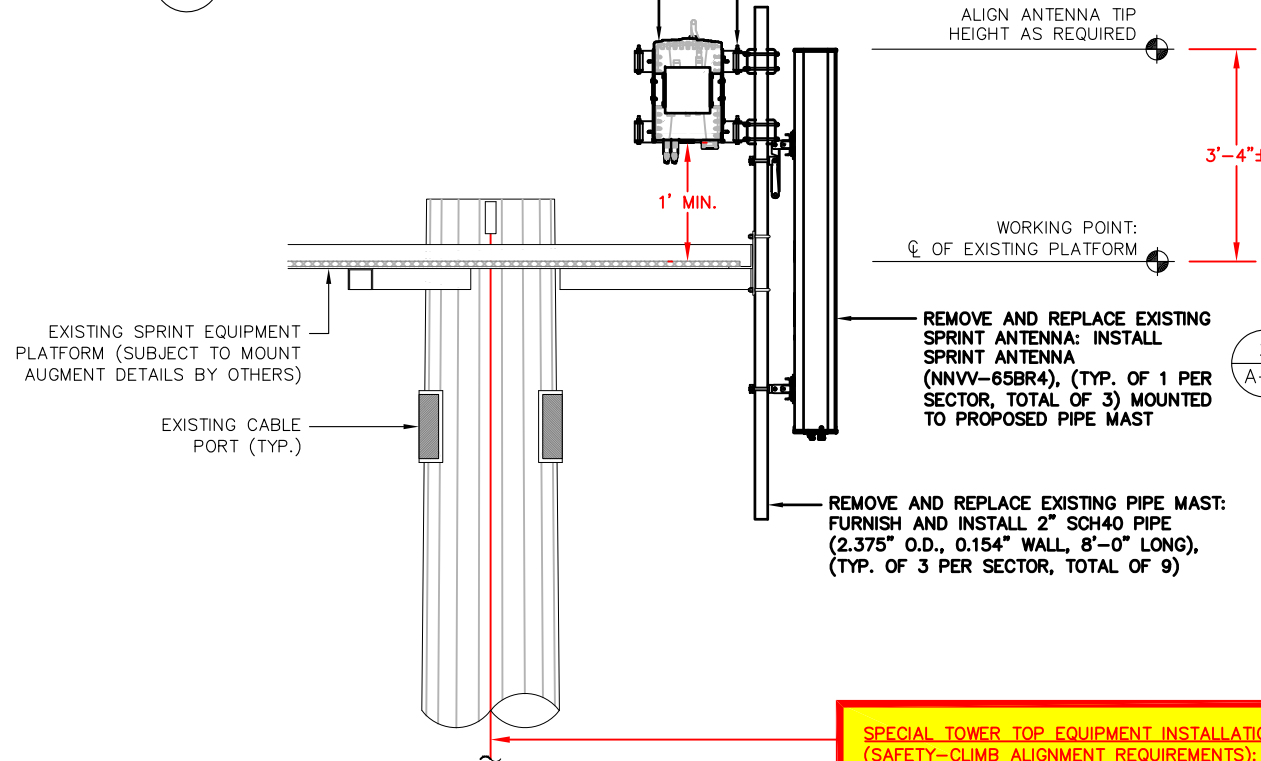

PROPOSED 800/1900 MHZ ANTENNA AND 800 MHZ RRH MOUNTING DETAIL

SCALE: N.T.S.

2
S-1

SPECIAL TOWER TOP EQUIPMENT INSTALLATION WORK NOTE (SAFETY-CLIMB ALIGNMENT REQUIREMENTS):
 GENERAL CONTRACTOR SHALL ORIENT PROPOSED SPRINT COLLAR-MOUNTS SO THAT EXISTING SAFETY CLIMB CABLE IS NOT OBSTRUCTED/RE-ROUTED FROM VERTICAL ALIGNMENT AND IS NOT IN PHYSICAL CONTACT WITH EXISTING OR PROPOSED COLLAR-MOUNT HARDWARE. GENERAL CONTRACTOR SHALL INSTALL NEW OR ADDITIONAL SAFETY-CLIMB CABLE GUIDES IF ADDITIONAL CLEARANCE IS REQUIRED. ADDITIONAL CABLE GUIDES SHALL BE ATTACHED SECURELY TO THE POLE USING MECHANICAL FASTENERS OR FIELD WELDED BY A CERTIFIED WELDING TECHNICIAN.

5
A-3
INSTALL SPRINT RRH (TD-RRH8X20-25), (TYP. OF 1 PER SECTOR, TOTAL OF 3) MOUNTED TO PROPOSED DUAL SWIVEL MOUNT

4
A-3
REMOVE AND RELOCATE EXISTING SPRINT RRH (1900 4X45 65MHZ) (TYP. OF 1 PER SECTOR, TOTAL OF 3) FROM GROUND LEVEL TO PROPOSED DUAL SWIVEL MOUNT

EXISTING SPRINT EQUIPMENT PLATFORM (SUBJECT TO MOUNT AUGMENT DETAILS BY OTHERS)

2
A-3
REMOVE AND REPLACE EXISTING SPRINT ANTENNA: INSTALL SPRINT ANTENNA (NNVV-65BR4), (TYP. OF 1 PER SECTOR, TOTAL OF 3) MOUNTED TO PROPOSED PIPE MAST

REMOVE AND REPLACE EXISTING PIPE MAST: FURNISH AND INSTALL 2" SCH40 PIPE (2.375" O.D., 0.154" WALL, 8'-0" LONG), (TYP. OF 3 PER SECTOR, TOTAL OF 9)

FURNISH AND INSTALL RRU DUAL SWIVEL MOUNT (SITE PRO 1 P/N: RRDSM) MOUNTED TO BACK OF ANTENNA MOUNTING PIPE ABOVE EXISTING PLATFORM, (KIT OF 2, 8 KITS REQUIRED)

7
A-3

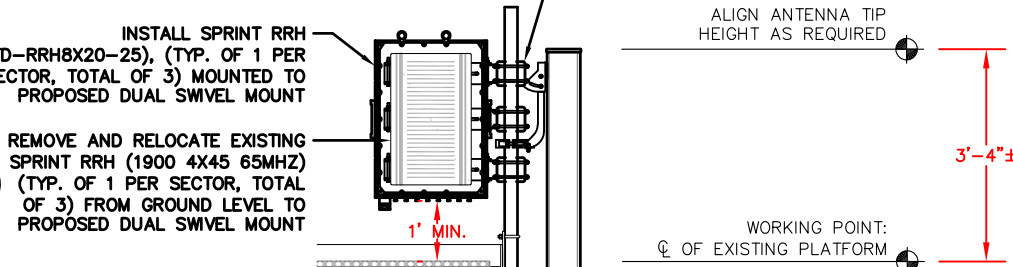

1
A-3
REMOVE AND REPLACE EXISTING SPRINT ANTENNA: INSTALL SPRINT ANTENNA (APXVTM14-ALU-I20), (TYP. OF 1 PER SECTOR, TOTAL OF 3) MOUNTED TO PROPOSED PIPE MAST

REMOVE AND REPLACE EXISTING PIPE MAST: FURNISH AND INSTALL 2" SCH40 PIPE (2.375" O.D., 0.154" WALL, 8'-0" LONG), (TYP. OF 3 PER SECTOR, TOTAL OF 9)

PROPOSED 2500 MHZ ANTENNA & 2500/1900 RRH MOUNTING DETAIL

SCALE: N.T.S.

3
S-1

Sprint
 1 INTERNATIONAL BLVD, SUITE 800
 MAHWAH, NJ 07495
 TEL: (800) 357-7641

SBA
 SBA COMMUNICATIONS CORP.
 134 FLANDERS ROAD, SUITE 125
 WESTBOROUGH, MA 01581
 TEL: (508) 251-0720

ProTerra
 DESIGN GROUP, LLC
 4 Bay Road, Building A
 Suite 200
 Hadley, MA 01035 Ph: (413)320-4918

STATE OF CONNECTICUT
 THOMAS E. JOHNSON
 No. 28192
 LICENSED PROFESSIONAL ENGINEER

CHECKED BY: *G. J. J. / TEJ*

APPROVED BY: JMM/TEJ

SUBMITTALS

REV.	DATE	DESCRIPTION	BY
1	06/19/18	CONSTRUCTION REVISED	PN
0	04/04/18	ISSUED FOR CONSTRUCTION	PN

SITE NUMBER:
 CT33XC017
 SITE NAME:
 POMFRET SCHOOL (SBA)
 SITE ADDRESS:
 398 POMFRET STREET
 POMFRET, CT 06258

SHEET TITLE
 ANTENNA AND RRH MOUNTING DETAILS

SHEET NUMBER
 S-1

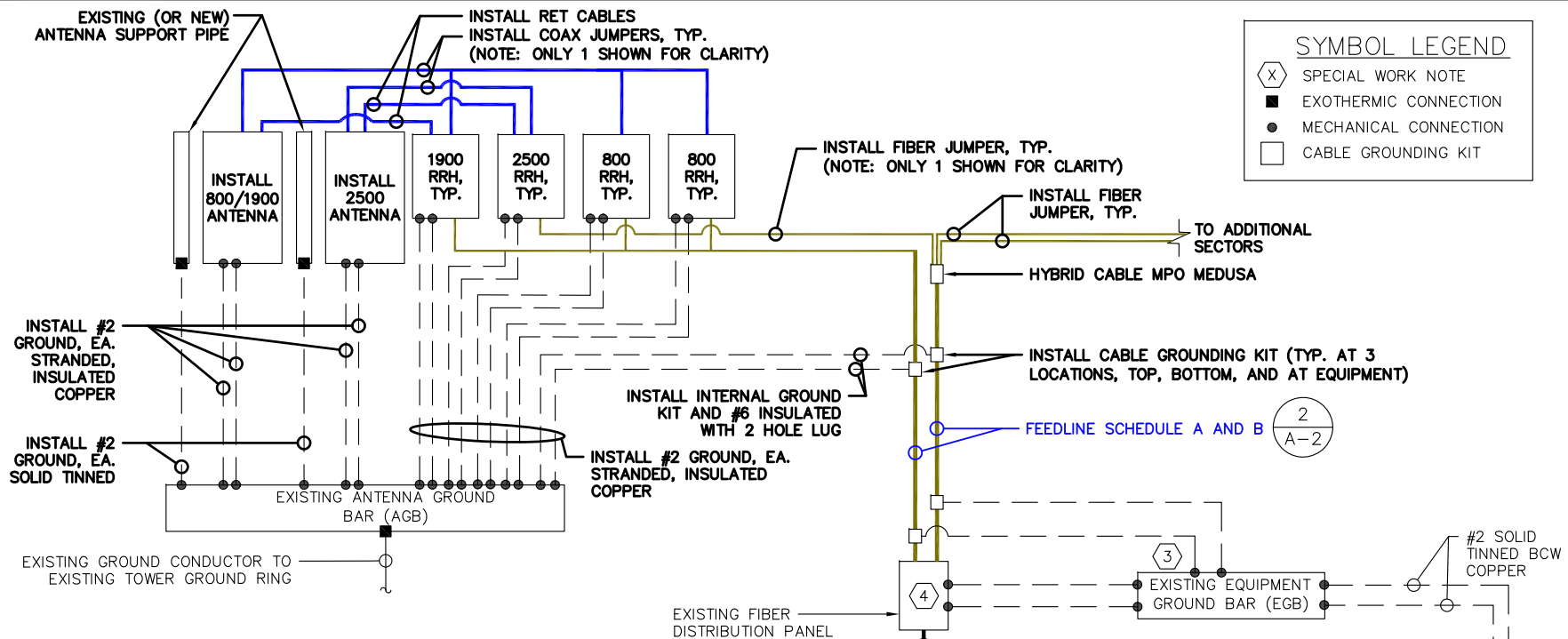

SPECIAL WORK NOTE:

1. FOR NEW OR REPAIRED GROUNDING EQUIPMENT, REFER TO SPRINT GROUNDING STANDARDS AND FOLLOWING (SUPPLEMENTS):
 -ANTI-THEFT UPDATE TO SPRINT GROUNDING DATED 08-24-12 (OR CURRENT VERSION)
 -SPRINT ENGINEERING LETTER EL-0504 DATED 04-20-12 (OR CURRENT VERSION)

2. USE SPARE DC CABLES COILED UP AT TOWER TOP NV ARRAY TO POWER UP 2.5 RRH. INSIDE EXISTING FIBER DISTRIBUTION BOX, TIE SPARE DC CONDUCTORS INTO EXISTING DC BREAKER PANEL PER APPROVED DC WIRING CONNECTIVITY OPTION (BASED ON NV HYBRIFLEX CABLE LENGTH). CONSULT WITH SPRINT CM TO DETERMINE APPROPRIATE DC CONNECTIVITY OPTION, PLUMBING DIAGRAM AND DC BREAKER SIZE.

ELECTRICAL NOTES

- 1) ALL ELECTRICAL WORK SHALL CONFORM TO THE REQUIREMENTS OF THE NATIONAL ELECTRICAL CODE (NEC) AS WELL AS APPLICABLE STATE AND LOCAL CODES.
- 2) THE ELECTRICAL CONTRACTOR SHALL COORDINATE ALL CONDUIT ROUTING WITH LOCAL UTILITY COMPANIES AND SPRINT CONSTRUCTION MANAGER.
- 3) ALL CONDUITS ROUTED BELOW GRADE SHALL TRANSITION TO RIGID GALVANIZED ELBOWS WITH RIGID GALVANIZED STEEL CONDUIT ABOVE GRADE.
- 4) ALL METAL CONDUITS SHALL BE PROVIDED WITH GROUNDING BUSHINGS.
- 5) GENERAL CONTRACTOR SHALL PROVIDE ALL DIRECT BURIED CONDUITS WITH PLASTIC WARNING TAPE IDENTIFYING CONTENTS. TAPE COLORS SHALL BE ORANGE FOR TELEPHONE AND RED FOR ELECTRIC.
- 6) ALL ELECTRICAL ITEMS SHALL BE U.L. APPROVED OR LISTED AND PROCURED PER SPECIFICATION REQUIREMENTS.
- 7) THE ELECTRICAL WORK INCLUDES ALL LABOR AND MATERIALS DESCRIBED BY DRAWINGS AND SPECIFICATIONS INCLUDING INCIDENTAL WORK TO PROVIDE COMPLETE OPERATING AND APPROVED ELECTRICAL SYSTEM.
- 8) GENERAL CONTRACTOR SHALL PAY FEES FOR PERMITS, AND IS RESPONSIBLE FOR OBTAINING SAID PERMITS AND COORDINATION OF INSPECTIONS.
- 9) ELECTRICAL AND TELCO WIRING OUTSIDE A BUILDING AND EXPOSED TO WEATHER SHALL BE IN WATER TIGHT GALVANIZED RIGID STEEL CONDUITS OR SCHEDULE 80 PVC (AS PERMITTED BY CODE) AND WHERE REQUIRED IN LIQUID TIGHT FLEXIBLE METAL OR NONMETALLIC CONDUITS.
- 10) BURIED CONDUIT SHALL BE SCHEDULE 40 PVC.
- 11) ELECTRICAL WIRING SHALL BE COPPER WITH TYPE XHHW, THWN, OR THIN INSULATION.
- 12) RUN ELECTRICAL CONDUIT OR CABLE BETWEEN ELECTRICAL UTILITY DEMARCATION POINT AND PROJECT OWNER CELL SITE PPC AS INDICATED ON THIS DRAWING. PROVIDE FULL LENGTH PULL ROPE. COORDINATE INSTALLATION WITH UTILITY COMPANY.
- 13) RUN TELCO CONDUIT OR CABLE BETWEEN TELEPHONE UTILITY DEMARCATION POINT AND PROJECT OWNER CELL SITE TELCO CABINET AND BTS CABINET AS INDICATED ON THIS DRAWING PROVIDE FULL LENGTH PULL ROPE IN INSTALLED TELCO CONDUIT. PROVIDE GREENLEE CONDUIT MEASURING TAPE AT EACH END.
- 14) FIBER OPTIC CIRCUITS SHALL BE IN ACCORDANCE WITH NEC ARTICLE 770-OPTICAL FIBER CABLES AND RACEWAYS.
- 15) COMMUNICATIONS CIRCUITS SHALL BE IN ACCORDANCE WITH NEC ARTICLE 800-COMMUNICATIONS SYSTEMS.

PROTECTIVE GROUNDING SYSTEMS GENERAL NOTES:

1. GROUNDING SHALL BE IN ACCORDANCE WITH NEC ARTICLE 250-GROUNDING AND BONDING.
2. GROUNDING SHALL BE IN ACCORDANCE WITH SPRINT SSEO DOCUMENTS 3.018.02.004 "BONDING, GROUNDING AND TRANSIENT PROTECTION FOR CELL SITES" AND 3.018.10.002 "SITE RESISTANCE TO EARTH TESTING".
3. PROVIDE GROUND CONNECTIONS FOR ALL METALLIC STRUCTURES, ENCLOSURES, RACEWAYS AND OTHER CONDUCTIVE ITEMS ASSOCIATED WITH THE INSTALLATION OF CARRIER'S EQUIPMENT.
4. GROUND CONNECTIONS: CLEAN SURFACES THOROUGHLY BEFORE APPLYING GROUND LUGS OR CLAMPS. IF SURFACE IS COATED, REMOVE THE COATING, APPLY A NON-CORROSIVE APPROVED COMPOUND TO CLEAN SURFACE AND INSTALL LUGS OR CLAMPS. WHERE GALVANIZING IS REMOVED FROM METAL, IT SHALL BE PAINTED OR TOUCHED UP WITH "GALVAMOX" OR EQUAL.
5. ALL GROUNDING WIRES SHALL PROVIDE A STRAIGHT, DOWNWARD PATH TO GROUND WITH GRADUAL BENDS AS REQUIRED. GROUND WIRES SHALL NOT BE LOOPED OR SHARPLY BENT.
6. ALL CLAMPS AND SUPPORTS USED TO SUPPORT THE GROUNDING SYSTEM CONDUCTORS AND PVC CONDUITS SHALL BE PVC TYPE (NON CONDUCTIVE). DO NOT USE METAL BRACKETS OR SUPPORTS WHICH WOULD FORM A COMPLETE RING AROUND ANY GROUNDING CONDUCTOR.
7. ALL GROUND WIRES SHALL BE #2 SOLID TINNED BCW UNLESS NOTED OTHERWISE.
8. PROVIDE DEDICATED #2 AWG COPPER GROUND WIRE FROM EACH ANTENNA MOUNTING PIPE TO ASSOCIATED CIGBE.
9. GROUND ANTENNA BASES, FRAMES, CABLE RACKS, AND OTHER METALLIC COMPONENTS WITH #2 INSULATED TINNED STRANDED COPPER GROUNDING CONDUCTORS AND CONNECT TO INSULATED SURFACE MOUNTED GROUND BARS. CONNECTION DETAILS SHALL FOLLOW MANUFACTURER'S SPECIFICATIONS FOR GROUNDING.
10. EACH EQUIPMENT CABINET SHALL BE CONNECTED TO THE MASTER ISOLATION GROUND BAR (MGB) WITH #2 SOLID TINNED BCW EQUIPMENT CABINETS WALL HAVE (2) CONNECTIONS.
11. GROUND HYBRIFLEX SHIELD AT TOP, BOTTOM AND AT TRANSITION TO HYBRIFLEX JUMPER CABLES AT EQUIPMENT CABINET ENTRANCE USING MANUFACTURER'S GUIDELINES. WHEN HYBRIFLEX CABLE EXCEEDS 200', GROUND AT INTERVALS NOT EXCEEDING 100'.
12. THE CONTRACTOR SHALL VERIFY THAT THE EXISTING GROUND BARS HAVE ENOUGH SPACE/HOLES FOR ADDITIONAL TWO HOLE LUGS.
13. EXOTHERMIC WELDING IS RECOMMENDED FOR GROUNDING CONNECTION WHERE PRACTICAL OTHERWISE. THE CONNECTION SHALL BE MADE USING COMPRESSION TYPE-2 HOLES, LONG BARREL LUGS OR DOUBLE CRIMP "C" CLAMP. THE COPPER CABLES SHALL BE COATED WITH AN ANTI-OXIDANT (THOMAS BETTS KOPR-SHILD) BEFORE MAKING THE CRIMP CONNECTIONS THE CONTRACTOR SHALL FOLLOW MANUFACTURER'S RECOMMENDED TORQUES ON THE BOLT ASSEMBLY TO SECURE CONNECTIONS.
14. AT ALL TERMINATIONS AT EQUIPMENT ENCLOSURES, PANEL, AND FRAMES OF EQUIPMENT AND WHERE EXPOSED FOR GROUNDING. CONDUCTOR TERMINATION SHALL BE PERFORMED UTILIZING TWO HOLE BOLTED TONGUE COMPRESSION TYPE LUGS WITH STAINLESS STEEL SELF-TAPPING SCREWS.
15. THE MASTER GROUND BAR (MGB) SHALL BE MADE OF BARE 1/4"x2" COPPER (FOR OUTDOOR APPLICATIONS IT SHALL BE TINNED COPPER) AND LARGE ENOUGH TO ACCOMMODATE THE REQUIRED NUMBER OF GROUND CONNECTIONS. THE HARDWARE SECURING THE MGB SHALL ELECTRICAL INSULATE THE MGB FROM ANY STRUCTURE TO WHICH IT IS FASTENED.
16. ALL BOLTS, WASHERS, AND NUTS USED ON GROUNDING CONNECTIONS SHALL BE STAINLESS STEEL.
17. ALL GROUNDING CONNECTIONS SHALL BE COATED WITH A COPPER SHIELD ANTI-CORROSIVE AGENT SUCH AS T&B KOPR SHIELD. VERIFY PRODUCT WITH SPRINT CONSTRUCTION MANAGER.
18. FOR NEW OR REPAIRED GROUNDING EQUIPMENT. REFER TO SPRINT GROUNDING STANDARDS AND FOLLOWING (SUPPLEMENTS):
 -ANTI-THEFT UPDATE TO SPRINT GROUNDING DATED 08-24-12 (OR CURRENT VERSION)
 -SPRINT ENGINEERING LETTER EL-0504 DATED 04-20-12 (OR CURRENT VERSION)

TYPICAL POWER AND GROUNDING ONE LINE DIAGRAMS

SCALE: N.T.S.

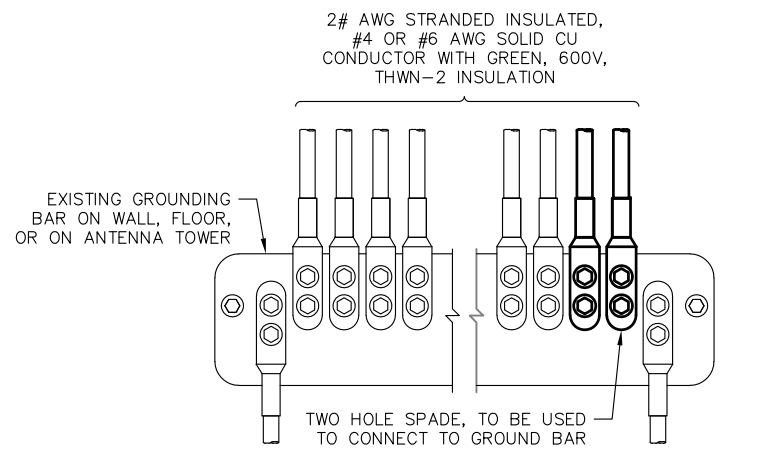

1. APPLY NO-OX TO LUG AND BAR CONTACT SURFACE. DO NOT COAT INLINE LUG.
 2. IF STOLEN GROUND BARS ARE ENCOUNTERED, CONTACT SPRINT CM FOR REPLACEMENT THREADED ROD KIT.

INSTALLATION OF GROUNDING CONDUCTOR TO GROUNDING BAR

SCALE: N.T.S.

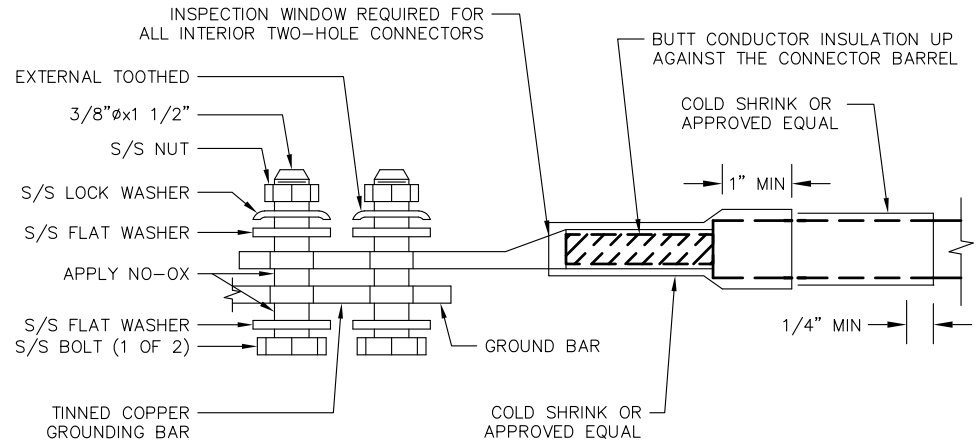

TWO HOLE LUG

SCALE: N.T.S.

Sprint

1 INTERNATIONAL BLVD, SUITE 800
 MAHWAH, NJ 07495
 TEL: (800) 357-7641

SBA

SBA COMMUNICATIONS CORP.
 134 FLANDERS ROAD, SUITE 125
 WESTBOROUGH, MA 01581
 TEL: (508) 251-0720

ProTerra
 DESIGN GROUP, LLC

4 Bay Road, Building A
 Suite 200
 Hadley, MA 01035 Ph: (413)320-4918

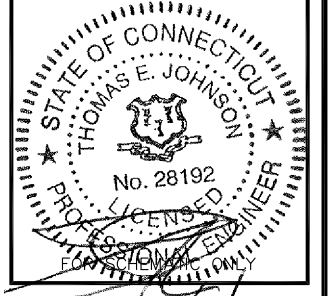

CHECKED BY: *G. J. Johnson* / TEJ
 APPROVED BY: JMM/TEJ

SUBMITTALS

REV.	DATE	DESCRIPTION	BY
1	06/19/18	CONSTRUCTION REVISED	PN
0	04/04/18	ISSUED FOR CONSTRUCTION	PN

SITE NUMBER:
CT33XC017

SITE NAME:
POMFRET SCHOOL (SBA)

SITE ADDRESS:
 398 POMFRET STREET
 POMFRET, CT 06258

SHEET TITLE
ELECTRICAL AND GROUNDING DETAILS

SHEET NUMBER
E-1

Site Identification table with fields: Cascade, SMS Schedule ID, SMS Schedule Name, PID, RRU OEM, Switch OEM, RFDS Issue Date, RFDS Revision Date, RFDS Revision

Contact Information table with fields: Engineer Email, Sprint Badged RF Engineer, RF Engineer Email, RF Manager, RF Manager Email, RF Manager Phone

Location Details table with fields: Latitude, Longitude, Market, Region, City, State, Zip Code, County

Battery Backup Cabinet Model table with fields: Model Number, Weight (Lbs.), Dimensions (In.), Manufacturer

UE Relay Model table with fields: Model Number, Weight (Lbs.), Dimensions (In.), UE Relay Azimuth, Manufacturer, UE Relay Cl Height (meters)

GPS Antenna Model table with fields: Model Number, Weight (Lbs.), Dimensions (In.), Manufacturer, GPS Antenna needed at site

Junction Box Model table with fields: Model Number, Weight (Lbs.), Dimensions (In.), Manufacturer, Junction Boxes needed at site

ALU Top Hat Model table with fields: Model Number, Weight (Lbs.), Dimensions (In.), Manufacturer, Top Hat Quantity

Repeater Model table with fields: Model Number, Weight (Lbs.), Dimensions (In.), Manufacturer

BTS #2 Model table with fields: Model Number, Weight (Lbs.), Dimensions (In.), Manufacturer, Needed at site

Power Protection Cabinet Model table with fields: Model Number, Weight (Lbs.), Dimensions (In.), Manufacturer, Power Protection Cabinet

Growth Cabinet Model table with fields: Model Number, Weight (Lbs.), Dimensions (In.), Manufacturer

BTS #1 Model table with fields: Model Number, Weight (Lbs.), Dimensions (In.), Manufacturer, Number of BTS #1

Table with columns: Band: 2500, Alpha, Beta, Gamma, Delta, Epsilon, Zeta. Rows include Antennat, Model Number, Weight (lbs), Dimensions, Manufacturer, Ant 1 Top Jumper, Ant 1 RF requested Diameter, Ant 1 RF requested Top Jumper Length(ft), Antenna 1 Azimuth, Antenna 1 Mechanical DT, Antenna 1 Center Line (ft), Antenna 1 Electrical DT, Antenna 1 Electrical DT 2, Antenna 1 Electrical DT 3, Antenna 1 Twist.

Table with columns: Band: 1900, Alpha, Beta, Gamma, Delta, Epsilon, Zeta. Rows include Antennat, Model Number, Weight (lbs), Dimensions, Manufacturer, Ant 1 Top Jumper, Ant 1 RF requested Diameter, Ant 1 RF requested Top Jumper Length(ft), Antenna 1 Azimuth, Antenna 1 Mechanical DT, Antenna 1 Center Line (ft), Antenna 1 Electrical DT, Antenna 1 Electrical DT 2, Antenna 1 Electrical DT 3, Antenna 1 Twist.

Table with columns: Band: 800, Alpha, Beta, Gamma, Delta, Epsilon, Zeta. Rows include Antennat, Model Number, Weight (lbs), Dimensions, Manufacturer, Ant 1 Top Jumper, Ant 1 RF requested Diameter, Ant 1 RF requested Top Jumper Length(ft), Antenna 1 Azimuth, Antenna 1 Mechanical DT, Antenna 1 Center Line (ft), Antenna 1 Electrical DT, Antenna 1 Electrical DT 2, Antenna 1 Electrical DT 3, Antenna 1 Twist.

NOTE: VERIFY PROPOSED AZIMUTHS WITH RF ENGINEER PRIOR TO INSTALLATION

NOTE: RFDS PROVIDED BY SPRINT DATED 09/07/2017. EXCERPTS TAKEN DEPICT RELEVANT RF DESIGN INFORMATION. A&E VENDOR SCOPE OF WORK LIMITED TO DESIGN OF MECHANICAL/STRUCTURAL EQUIPMENT ATTACHMENTS.

SPRINT CONSTRUCTION STANDARDS:

GENERAL CONTRACTOR SHALL ADHERE TO THE FOLLOWING SPRINT CONSTRUCTION STANDARDS.

- CONSTRUCTION STANDARDS: INTEGRATED CONSTRUCTION STANDARDS FOR WIRELESS SITES - CURRENT VERSION, INCLUDING EXHIBITS A-M.
- CONSTRUCTION SPECIFICATIONS: CONSTRUCTION STANDARDS EXHIBIT A - STANDARD CONSTRUCTION SPECIFICATIONS FOR WIRELESS SITES (CURRENT VERSION).
- GROUNDING STANDARDS: EXTERIOR GROUNDING SYSTEM DESIGN. GROUNDING STANDARDS (SUPPLEMENT): ANTI-THEFT UPDATE TO SPRINT GROUNDING 082412 AND SPRINT ENGINEERING LETTER EL-0504 DATED 04.20.12.
- WEATHER PROOFING STANDARDS: EXCERPT FROM CONSTRUCTION STANDARDS EXHIBIT A, SECTION 3.6 WEATHERPROOFING CONNECTORS AND GROUND KITS.
- COLOR CODING: SPRINT NEXTEL ANT AND LINE COLOR CODING PER SPRINT TS-0200 CURRENT VERSION.
- GENERAL CONTRACTOR TO FIELD VERIFY AZIMUTH AND CL HEIGHT AND MECHANICAL DOWNTILT. IF DIFFERENT THAN CALLED OUT IN RFDS, HALT ANTENNA WORK FOR ONE HOUR, CALL SPRINT RF ENGINEER (OR MANAGER IF RF ENGINEER DOES NOT ANSWER, BUT STILL LEAVE A MESSAGE TO RF ENGINEER) USING SPRINT-PROVIDED CONTACT INFORMATION FOR FURTHER INSTRUCTIONS. IF SPRINT DOES NOT RESPOND WITHIN ONE HOUR, PLACE ANTENNA AT SAME CL HEIGHT AS PLAN AND EMAIL CORRECT CL HEIGHT AND AZIMUTH TO SPRINT RF ENGINEER. UPDATE AS-BUILT DRAWING WITH CORRECT CL HEIGHT. ALSO EMAIL CORRECT ANTENNA CL HEIGHT, AZIMUTH AND MECHANICAL DOWNTILT TO RF ENGINEER.
- AISG TESTS TO VERIFY OPERATION IS TO BE PERFORMED AFTER FINAL INSTALLATION OF ANTENNAS AND AISG CABLES HAVE BEEN CONNECTED. VERIFY OPERATION OF ALL EXISTING SPRINT AISG EQUIPMENT INCLUDING 800MHZ, 1.9GHZ AND 2.5G. TEST INCLUDE COMPLETE DOWNTILT, AZIMUTH (IF APPLICABLE) AND BEAMWIDTH SWINGS (IF APPLICABLE). DOCUMENT AISG TEST RESULTS IN COAX SWEEP TEST SPREADSHEET.
- GENERAL CONTRACTOR MUST INSURE THAT NO OBJECT IS LOCATED IN FRONT OF ANTENNA. THIS MEANS NO OBJECT IS TO BE LOCATED 45 DEGREES LEFT AND RIGHT OF FRONT OF ANTENNA OR 7 DEGREES UP AND DOWN FROM CENTER OF ANTENNA. IF THIS IS NOT POSSIBLE, CONTACT RF ENGINEER FOR FURTHER INSTRUCTION.
- GENERAL CONTRACT IS REQUIRED TO USE A DIGITAL ALIGNMENT TOOL TO SET AZIMUTH, ROLL AND DOWNTILT. AZIMUTH ACCURACY IS TO BE WITHIN 1 DEGREE. DOWNTILT AND ROLL (LEFT TO RIGHT TILT) IS TO BE WITHIN 0.1 DEGREES. IF FOR SOME REASON THIS ACCURACY CANNOT BE ACHIEVED, UPDATE AS-BUILT DRAWINGS AND EMAIL SPRINT RF ENGINEER WITH AS-BUILT SETTINGS. USE 3Z RF ALIGNMENT TOOL OR EQUIVALENT TOOL.
HTTP://WWW.3ZTELECOM.COM/ANTENNA-ALIGNMENT-TOOL/.

Table with columns: Band: 2500, Alpha, Beta, Gamma, Delta, Epsilon, Zeta. Rows include Radio Model, Model Number, Weight (lbs), Dimensions, Manufacturer, Number of RRUs needed, Trunk Cable 1, Model Number, Weight (Lbs.), Dimensions (In.), Manufacturer, Trunk Cable 1 Qty.

Table with columns: Band: 1900, Alpha, Beta, Gamma, Delta, Epsilon, Zeta. Rows include Radio Model, Model Number, Weight (lbs), Dimensions, Manufacturer, Number of RRUs needed, Trunk Cable 1, Model Number, Weight (Lbs.), Dimensions (In.), Manufacturer, Trunk Cable 1 Qty.

Table with columns: Band: 800, Alpha, Beta, Gamma, Delta, Epsilon, Zeta. Rows include Radio Model, Model Number, Weight (lbs), Dimensions, Manufacturer, Number of RRUs needed.

Antenna 1 Upper Passive Component Model table with fields: Model Number, Weight (lbs), Dimensions (In.), Manufacturer, Ant 1 Upper Passive Comp Qty needed, Ant 1 Upper Pass Comp band combi with.



1 INTERNATIONAL BLVD, SUITE 800, MAHWAH, NJ 07495, TEL: (800) 357-7641



SBA COMMUNICATIONS CORP., 134 FLANDERS ROAD, SUITE 125, WESTBOROUGH, MA 01581, TEL: (508) 251-0720



4 Bay Road, Building A, Suite 200, Hadley, MA 01035, Ph: (413)320-4918

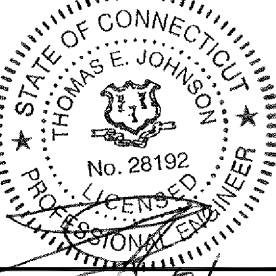

CHECKED BY: G. J. / J. / TEJ

APPROVED BY: JMM/TEJ

SUBMITTALS

Table with columns: REV., DATE, DESCRIPTION, BY. Rows include 1 06/19/18 CONSTRUCTION REVISED PN, 0 04/04/18 ISSUED FOR CONSTRUCTION PN.

SITE NUMBER: CT33XC017, SITE NAME: POMFRET SCHOOL (SBA), SITE ADDRESS: 398 POMFRET STREET, POMFRET, CT 06258

SHEET TITLE: RF DATA SHEET

SHEET NUMBER: RF-1

RF DATA SHEET

SCALE: N.T.S.

ALU 211 APXVTM14-ALU-I20 & NNVV-65B-R4 wo Filters

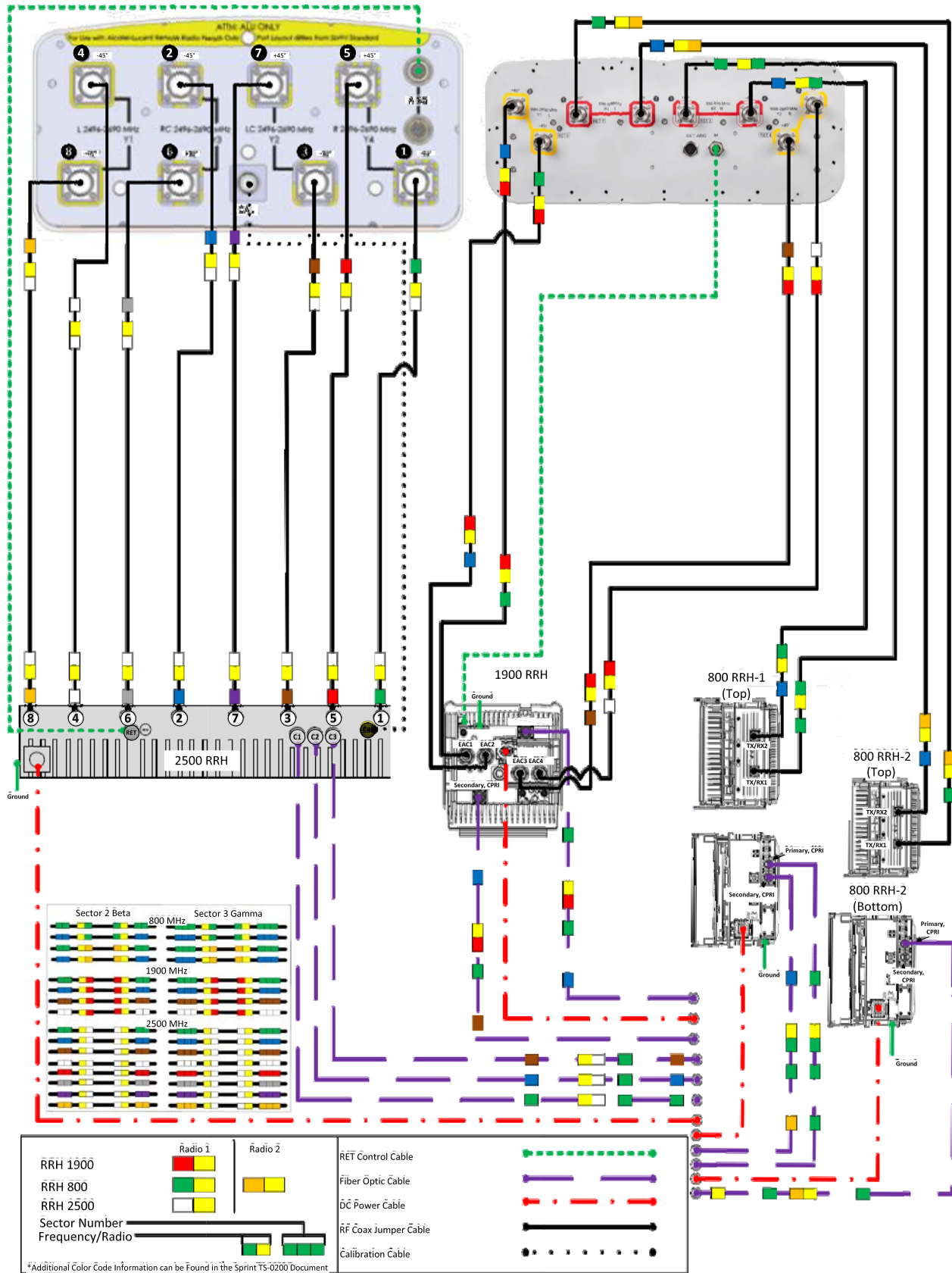

Not to Scale

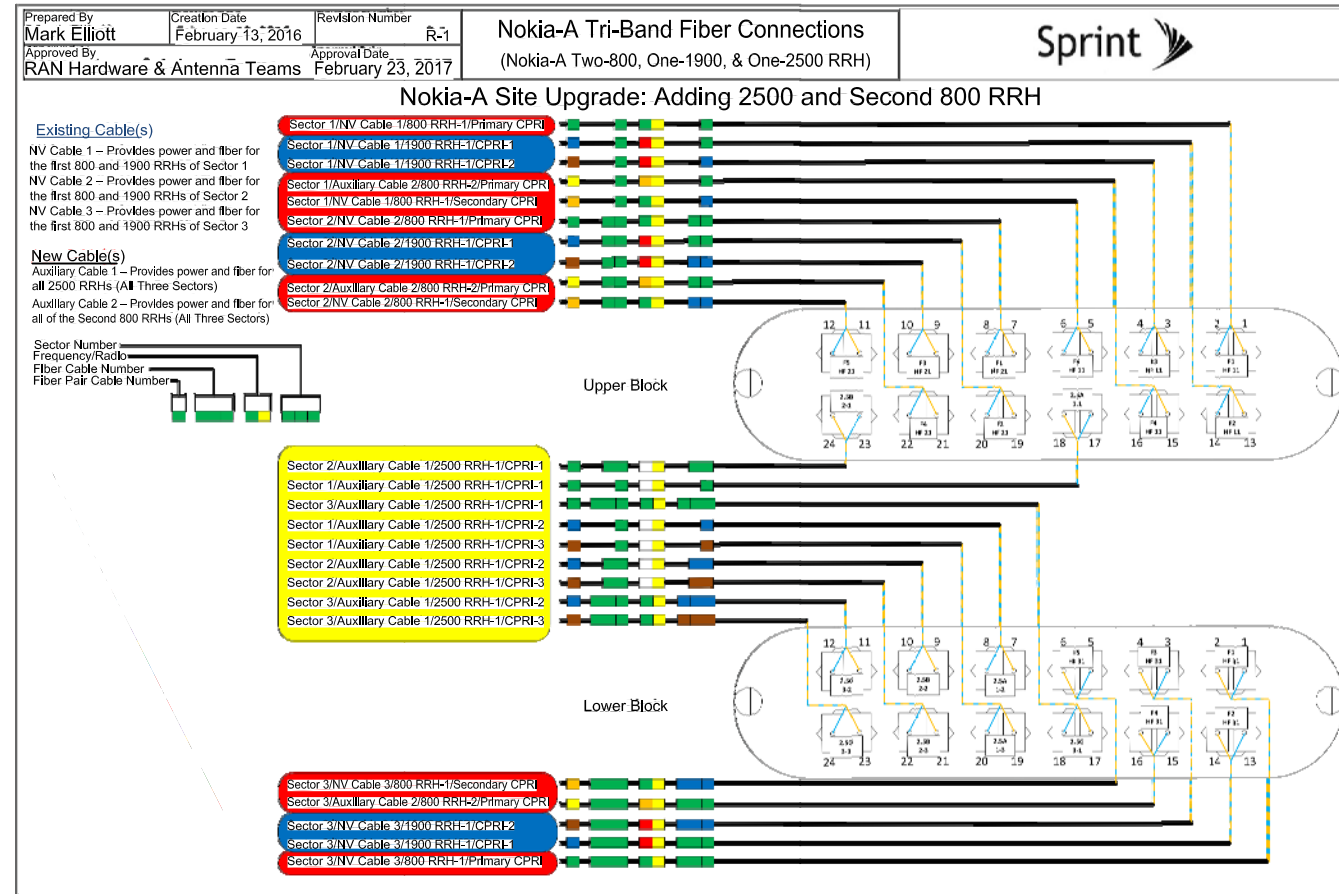

Sector	Cable	First Ring	Second Ring	Third Ring
1 Alpha	1	Green	No Tape	No Tape
1	2	Blue	No Tape	No Tape
1	3	Brown	No Tape	No Tape
1	4	White	No Tape	No Tape
1	5	Red	No Tape	No Tape
1	6	Gray	No Tape	No Tape
1	7	Purple	No Tape	No Tape
1	8	Orange	No Tape	No Tape
2 Beta	1	Green	Green	No Tape
2	2	Blue	Blue	No Tape
2	3	Brown	Brown	No Tape
2	4	White	White	No Tape
2	5	Red	Red	No Tape
2	6	Gray	Gray	No Tape
2	7	Purple	Purple	No Tape
2	8	Orange	Orange	No Tape
3 Gamma	1	Green	Green	Green
3	2	Blue	Blue	Blue
3	3	Brown	Brown	Brown
3	4	White	White	White
3	5	Red	Red	Red
3	6	Gray	Gray	Gray
3	7	Purple	Purple	Purple
3	8	Orange	Orange	Orange

Frequency/Radio	Indicator	ID
800 #1	Yellow	Green
800 #2	Yellow	Orange
1900 #1	Yellow	Red
1900 #2	Yellow	Brown
1900 #3	Yellow	Blue
2500 #1	Yellow	White
2500 #2	Yellow	Purple

1 INTERNATIONAL BLVD, SUITE 800
 MAHWAH, NJ 07495
 TEL: (800) 357-7641

SBA COMMUNICATIONS CORP.
 134 FLANDERS ROAD, SUITE 125
 WESTBOROUGH, MA 01581 TEL: (508) 251-0720

4 Bay Road, Building A
 Suite 200
 Hadley, MA 01035 Ph: (413) 320-4918

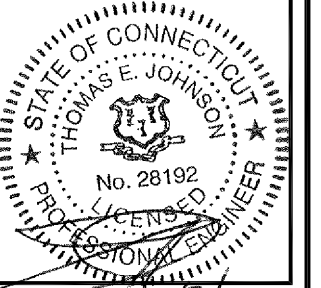

CHECKED BY: *G. J. Johnson* / TEJ

APPROVED BY: JMM/TEJ

SUBMITTALS			
REV.	DATE	DESCRIPTION	BY
1	06/19/18	CONSTRUCTION REVISED	PN
0	04/04/18	ISSUED FOR CONSTRUCTION	PN

SITE NUMBER:
CT33XC017
 SITE NAME:
POMFRET SCHOOL (SBA)
 SITE ADDRESS:
 398 POMFRET STREET
 POMFRET, CT 06258

SHEET TITLE
**PLUMBING DIAGRAM
 AND RAN WIRING**

SHEET NUMBER
RF-2

CT33XC017

DO MACRO EQUIPMENT DEPLOYMENT

MOUNT AUGMENTATION @ 167'

MONOPOLE TOWER

POMFRET, CT
WINDHAM COUNTY

Sprint

1 INTERNATIONAL BLVD., SUITE 800
MAHWAH, NJ 07495
P: 800.357.7641

SBA

134 FLANDERS RD., SUITE 125
WESTBOROUGH, MA 01581
P: 508.251.0720



GEOSTRUCTURAL

PO BOX 2621, BOISE, ID 83701
P: 530.539.4787
E: CONTACT@GEOSTRUCTURAL.COM
WWW.GEOSTRUCTURAL.COM

REVISIONS:

NO.	DATE	DESCRIPTION	BY
3	06/19/18	REVISED CENTERLINE	JAD
2	05/22/18	REVISED PLACEMENT	JAD
1	04/15/18	REVISED LOADING	JAD
0	02/19/18	ISSUE FOR CONSTRUCTION	JAD

CHECKED BY: _____ DWG

THE INFORMATION CONTAINED IN THIS SET OF DOCUMENTS IS PROPRIETARY BY NATURE. ANY USE OR DISCLOSURE OTHER THAN THAT WHICH RELATES TO THE CLIENT NAMES IS STRICTLY PROHIBITED.

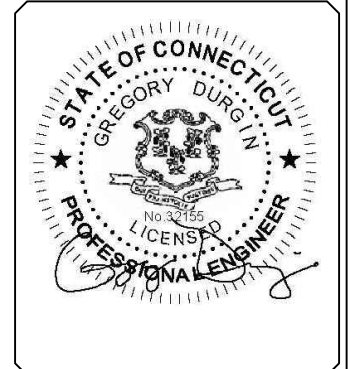

SITE INFORMATION:
MOUNT AUGMENTATION

CT33XC017

POMFRET, CT

LATITUDE: 41.89009444
LONGITUDE: -71.95498611

SHEET TITLE:
TITLE SHEET

SHEET NUMBER:
S1

SITE INFORMATION

STRUCTURE TYPE: MONOPOLE
MOUNT TYPE: PLATFORM
LATITUDE: 41.89009444 (NAD 83)
LONGITUDE: -71.95498611 (NAD 83)
CITY, STATE: POMFRET, CT
COUNTY: WINDHAM
SBA SITE: CT02217-S Pomfret School
COORDINATES ARE FOR NAVIGATIONAL PURPOSES ONLY, NOT TO 1A ACCURACY.

DO NOT SCALE DRAWINGS

CONTRACTOR SHALL VERIFY ALL PLANS, EXISTING DIMENSIONS, CONDITIONS ON THE JOB SITE & SHALL IMMEDIATELY NOTIFY THE ENGINEER IN WRITING OF ANY DISCREPANCIES BEFORE PROCEEDING WITH THE WORK OR BE RESPONSIBLE FOR THE LABOR & MATERIALS FOR THE DISCREPANCIES.

CODE COMPLIANCE

ALL WORK SHALL BE PERFORMED AND MATERIALS INSTALLED IN ACCORDANCE WITH THE CURRENT EDITIONS OF THE FOLLOWING CODES AS ADOPTED BY THE LOCAL GOVERNING AUTHORITIES.

BUILDING CODE AND DESIGN STANDARD: 2012 IBC / TIA-222-G / 2016 CT

RIGGING PLAN REQUIRED

THIS SET OF PLANS DOES "NOT" CONSTITUTE A RIGGING PLAN.

A PROPER RIGGING PLAN SHALL BE PERFORMED BY A LICENSED PROFESSIONAL ENGINEER PRIOR TO PROCEEDING ON ANY AUGMENTATIONS SHOWN HEREIN.

GENERAL DESIGN NOTES

1. THIS PLAN HAS BEEN DESIGNED UTILIZING THE CORRESPONDING MOUNT STRUCTURAL ANALYSIS.
2. THESE PLANS HAVE BEEN DESIGNED IN ACCORDANCE WITH THE GOVERNING PROVISIONS OF TIA/EIA-222, ASCE 7, AWS, ACI, AND AISC. MATERIALS AND SERVICES PROVIDED BY THE CONTRACTOR SHALL CONFORM TO THE ABOVE-MENTIONED CODES AND THE CONTRACT SPECIFICATIONS.
3. ALL STRUCTURE INFORMATION OBTAINED IN THE FORM OF FROM INFORMATION PROVIDED BY THE CLIENT. CONTRACTOR SHALL OBTAIN AND BECOME FAMILIAR WITH THE REFERENCED DOCUMENTS. CONTRACTOR SHALL ISSUE A REQUEST FOR INFORMATION (RFI) IN THE EVENT ANY DISCREPANCIES ARE DISCOVERED BETWEEN THESE DOCUMENTS AND THE AS-BUILT CONDITIONS IN THE FIELD IN A SITE VISIT THAT SHALL BE PERFORMED PRIOR TO STARTING FABRICATION OR CONSTRUCTION.
4. ALL MATERIALS UTILIZED FOR THIS PROJECT MUST BE NEW AND FREE OF ANY DEFECTS.
5. ALL PRODUCT OR MATERIAL SUBSTITUTIONS PROPOSED BY THE CONTRACTOR SHALL BE APPROVED IN WRITING BY THE ENGINEER. CONTRACTOR SHALL PROVIDE DOCUMENTATION TO ENGINEER SUITABLE TO DETERMINE IF SUBSTITUTE IS ACCEPTABLE FOR USE AND MEETS THE ORIGINAL DESIGN CRITERIA. DIFFERENCES FROM THE ORIGINAL DESIGN, INCLUDING MAINTENANCE, REPAIR AND REPLACEMENT, SHALL BE NOTED. ESTIMATES OF COSTS/CREDITS ASSOCIATED WITH THE SUBSTITUTION (INCLUDING RE-DESIGN COSTS AND COSTS TO SUB-CONTRACTORS) SHALL BE PROVIDED TO THE ENGINEER. CONTRACTOR SHALL PROVIDE ADDITIONAL DOCUMENTATION AND/OR SPECIFICATIONS TO THE ENGINEER AS REQUESTED.
6. PROVIDE STRUCTURAL STEEL SHOP DRAWING(S) TO THE ENGINEER OF RECORD FOR APPROVAL PRIOR TO FABRICATION (ONLY IF SPECIFICALLY REQUESTED BY ENGINEER).
7. UNLESS NOTED OTHERWISE, ALL NEW MEMBERS AND REINFORCING SHALL MAINTAIN THE EXISTING MEMBER WORK LINES AND NOT INTRODUCE ECCENTRICITIES INTO THE STRUCTURE.
8. ANY CONTRACTOR-CAUSED DAMAGE TO PROPERTY OF THE LAND OWNER, PROPERTY OF THE STRUCTURE OWNER, PROPERTY OF THE CUSTOMER, SITE FENCING OR GATES, ANY AND ALL UTILITY AND/OR SERVICE LINES, SHOWN OR NOT SHOWN ON THE PLANS, SHALL BE REPAIRED OR REPLACED AT THE SOLE COST OF THE CONTRACTOR AND SHALL BE ACCOMPLISHED BY THE CONTRACTOR OR SUBCONTRACTOR AS APPROVED BY THE ENGINEER OF RECORD AND LAND OWNER. DAMAGE TO EQUIPMENT OR PROPERTY OF ANY KIND BELONGING TO OTHER COMPANIES (BESIDES THE INDICATED CUSTOMER) SHALL BE ADDRESSED BY THE CONTRACTOR WITH THE COMPANIES THAT OWN THE DAMAGED ITEMS.

SHEET INDEX

SHEET	DESCRIPTION
S-1	TITLE SHEET
S-2	NOTES AND SPECIFICATIONS
S-3	AUGMENTATIONS, SECTIONS & DETAILS

MOUNT AUGMENTATION CONFIGURATION

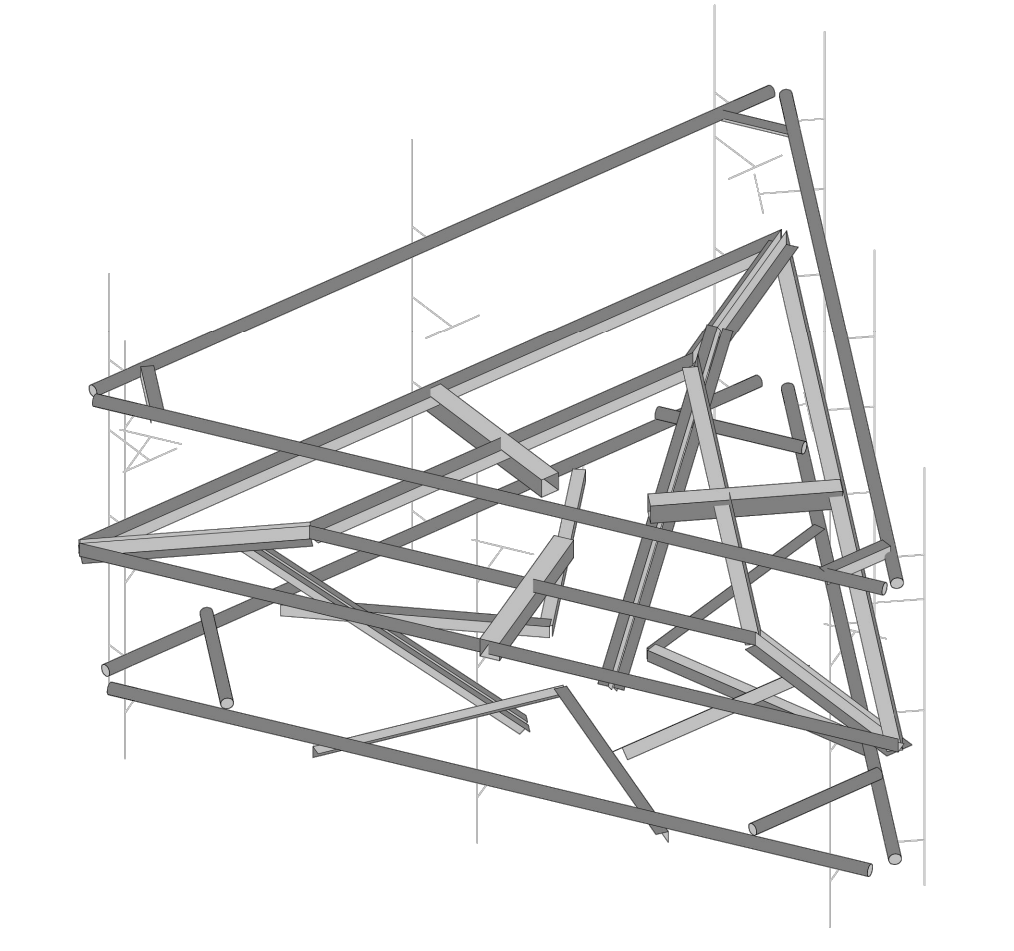

AUGMENTATION SCOPE
AUGMENT ALL SECTORS OF CARRIER'S EXISTING MOUNT INSTALLATION AS REQUIRED (UNLESS NOTED OTHERWISE)

CONTRACTOR NOTES

- PRIOR TO BEGINNING CONSTRUCTION, ALL CONTRACTORS AND SUBCONTRACTORS MUST ACKNOWLEDGE IN WRITING TO TOWER OWNER THAT THEY HAVE OBTAINED, UNDERSTAND, AND WILL FOLLOW STRUCTURE OWNER STANDARDS OF PRACTICE, CONSTRUCTION GUIDELINES, ALL SITE AND STRUCTURE/TOWER SAFETY PROCEDURES, ALL PRODUCT LIMITATIONS AND INSTALLATION PROCEDURES USED ON SITE, AND PROPOSED AUGMENTATIONS DESCRIBED. RECEIPT OF ACKNOWLEDGEMENT MUST OCCUR PRIOR TO BEGINNING CONSTRUCTION OR CLIMBING. IT IS THE RESPONSIBILITY OF THE GENERAL CONTRACTOR TO PROVIDE THIS DOCUMENTATION FOR STRUCTURE OWNER ON COMPANY LETTERHEAD AND THE RESPONSIBILITY OF THE GENERAL CONTRACTOR TO OBTAIN THIS DOCUMENTATION FROM ANY SUBCONTRACTORS (ON SUBCONTRACTOR LETTERHEAD) AND DELIVER IT TO THE STRUCTURE OWNER.
- IF THE CONTRACTOR DISCOVERS ANY EXISTING CONDITIONS THAT ARE NOT REPRESENTED ON THESE DRAWINGS, OR ANY CONDITIONS THAT WOULD INTERFERE WITH THE INSTALLATION OF THE AUGMENTATIONS, THE ENGINEER OF RECORD SHALL BE CONTACTED IMMEDIATELY TO EVALUATE THE SIGNIFICANCE OF THE DEVIATION.
- THE CONTRACTOR SHALL SOLICIT AND HIRE THE SERVICES OF A QUALIFIED AUGMENTATION INSPECTOR PRIOR TO BEGINNING CONSTRUCTION. THE AUGMENTATION INSPECTOR MAY BE AN EMPLOYEE OF THE CONTRACTOR'S FIRM, HOWEVER THE INSPECTOR'S ONLY DUTIES SHALL BE INSPECTION, TESTING, AND REPORT CREATION AS REQUIRED ON THE "AUGMENTATION INSPECTION NOTES" SHEET.
- THE CONTRACTOR SHALL NOTIFY THE TOWER OWNER OF THE PLANNED CONSTRUCTION & INSPECTION SCHEDULE, AS WELL AS ANY CHANGES TO THE SCHEDULE, WITHIN TWO BUSINESS DAYS OF THE COMPLETION OF THE SCHEDULE OR SCHEDULE REVISION BOTH PRIOR TO BEGINNING CONSTRUCTION AND DURING CONSTRUCTION AS THE SCHEDULE CHANGES. THE STRUCTURE OWNER WHEN THE WORK HAS BEEN COMPLETED WITHIN 2 BUSINESS DAYS OF THE COMPLETION OF THE WORK AND ASSOCIATED AUGMENTATION INSPECTIONS & TESTING (WHEN APPLICABLE).
- IT IS ASSUMED THAT ANY STRUCTURAL AUGMENTATION WORK SPECIFIED ON THESE PLANS WILL BE ACCOMPLISHED BY KNOWLEDGEABLE WORKMEN WITH TOWER CONSTRUCTION EXPERIENCE. THIS INCLUDES PROVIDING THE NECESSARY CERTIFICATIONS TO THE STRUCTURE OWNER AND ENGINEER INCLUDING BUT NOT LIMITED TO TOWER CLIMBER AND RESCUE CLIMBER CERTIFICATIONS, ET CETERA.
- THESE DRAWINGS DO NOT INDICATE THE METHOD OF CONSTRUCTION. THE CONTRACTOR SHALL SUPERVISE AND DIRECT THE WORK AND SHALL BE SOLELY RESPONSIBLE FOR ALL CONSTRUCTION METHODS, MEANS, TECHNIQUES, SEQUENCES AND PROCEDURES.
- CONTRACTOR SHALL WORK WITHIN THE LIMITS OF THE STRUCTURE OWNER'S PROPERTY OR LEASE AREA AND APPROVED EASEMENTS. IT IS THE RESPONSIBILITY OF THE CONTRACTOR TO VERIFY WORK IS WITHIN THESE BOUNDARIES. CONTRACTOR SHALL EMPLOY A SURVEYOR AS REQUIRED. ANY WORK OUTSIDE THESE BOUNDARIES SHALL BE APPROVED IN WRITING BY THE LAND OWNER PRIOR TO MOBILIZATION. CONSTRUCTION STAKING AND BOUNDARY MARKING IS THE RESPONSIBILITY OF THE CONTRACTOR.

STRUCTURAL ERECTION AND BRACING REQUIREMENTS

- THE STRUCTURAL DRAWINGS ILLUSTRATE THE COMPLETED STRUCTURE WITH ALL ELEMENTS IN THEIR FINAL POSITIONS, PROPERLY SUPPORTED AND BRACED.
- THE CONTRACTOR SHALL PROVIDE SHORING AND BRACING AS REQUIRED DURING CONSTRUCTION TO ENSURE STABILITY. DESIGN AND SEQUENCING OF CONSTRUCTION SHORING AND BRACING IS OUTSIDE THE SCOPE OF THIS WORK.
- THE CONTRACTOR IS RESPONSIBLE FOR THE DESIGN AND EXECUTION OF ALL MISCELLANEOUS SHORING, BRACING, TEMPORARY SUPPORTS, GUYING, ETC. NECESSARY TO PROVIDE A COMPLETE AND STABLE STRUCTURE AS SHOWN ON THESE DRAWINGS.

BOLTS

- ALL CONNECTIONS OF STRUCTURAL STEEL MEMBERS SHALL BE MADE USING SPECIFIED GALVANIZED HIGH STRENGTH ASTM A325 OR A490 BOLTS WITH THREADS EXCLUDED FROM SHEAR PLANE.
- FASTENERS SHALL BE INSTALLED IN PROPERLY ALIGNED HOLES, WITH BOLT HEADS FACING DOWN WHERE APPLICABLE.
- ALL BOLTS AT EVERY CONNECTION SHALL BE INSTALLED SNUG-TIGHT UNTIL THE SECTION IS FULLY COMPACTED AND ALL PLIES ARE JOINED, AND THEN TIGHTENED FURTHER BY AISC - "TURN OF THE NUT" METHOD. TIGHTENING SHALL PROGRESS SYSTEMATICALLY.
- BOLT LENGTHS UP TO AND INCLUDING 4 DIAMETERS SHALL BE TENSIONED 1/3 TURN BEYOND SNUG-TIGHT. BOLT LENGTHS OVER 4 DIAMETERS SHALL BE 1 1/2 TURNS BEYOND SNUG-TIGHT.
- ALL BOLTED CONNECTIONS SHALL USE LOCK WASHERS.

STRUCTURAL STEEL

- STRUCTURAL STEEL SHALL BE DETAILED, FABRICATED, AND ERECTED IN ACCORDANCE WITH THE CURRENT EDITION OF THE AISC STEEL CONSTRUCTION MANUAL AND SECTION 4 OF THE TIA CODE.
- PRE-QUALIFIED STRUCTURAL STEEL SHALL CONFORM TO THE FOLLOWING MINIMUM GRADES UNLESS OTHERWISE NOTED:
 - CHANNELS & ANGLES ASTM A36, (Fy = 36 KSI)
 - PLATES ASTM A36, (Fy = 36 KSI)
 - PIPES ASTM A53 GR.B, (Fy = 35 KSI)
 - HSS ROUND ASTM A500 GR.B, (Fy = 42 KSI)
 - HSS RECTANGULAR ASTM A500 GR.B, (Fy = 46 KSI)
 - STRUCTURAL BOLTS ASTM A325
 - U-BOLTS ASTM A307 GR.A
 - NUTS FOR BOLTS ASTM A563 (THREADING TO MATCH BOLT)
 - WASHERS FOR BOLTS ASTM F436
 - SEE TABLE 5-1 OF THE TIA CODE FOR ADDITIONAL SHAPES AND STANDARDS THAT ARE NOT LISTED ABOVE.
- NON PRE-QUALIFIED STRUCTURAL STEEL SHALL CONFORM TO THE FOLLOWING STANDARDS PER THE TIA CODE:
 - THE CARBON EQUIVALENT OF STEEL SHALL NOT EXCEED 0.65 PER SECTION 5.4.2 OF THE TIA CODE
 - ELONGATION OF STEEL SHALL NOT BE LESS THAN 18%
 - TEST REPORTS SHALL BE IN ACCORDANCE WITH ASTM A6 OR A568
 - TOLERANCES SHALL BE IN ACCORDANCE WITH ASTM A6
- FIELD CUT EDGES, EXCEPT DRILLED HOLES, SHALL BE GROUND SMOOTH AND COLD GALVANIZED.
- ALL WELDING WORK SHALL CONFORM TO THE AWS D1.1 STRUCTURAL WELDING CODE. ALL WELDING SHALL BE PERFORMED BY CERTIFIED WELDERS ONLY. WELDING ELECTRODES SHALL BE E70XX.
- ALL DETAILING, FABRICATION AND ERECTION OF STRUCTURAL STEEL SHALL CONFORM TO AISC SPECS AND CODES, LATEST EDITION.
- UPON REQUEST, THE CONTRACTOR SHALL SUBMIT DETAILED, ENGINEERED, COORDINATED AND CHECKED SHOP DRAWINGS FOR ALL STRUCTURAL STEEL TO THE ENGINEER OF RECORD TO REVIEW FOR COMPLIANCE WITH DESIGN INTENT PRIOR TO THE START OF FABRICATION AND/OR ERECTION.
- TORCH-CUTTING OF ANY KIND SHALL NOT BE PERMITTED.
- ALL BOLT HOLES SHALL BE STANDARD SIZE BOLT HOLES PER AISC 360, UNLESS OTHERWISE NOTED. ALL HOLES SHALL BE SHOP DRILLED OR SUB-PUNCHED AND REAMED. BURNING OF HOLES IS NOT PERMITTED. WHERE SLOTTED OR OVERSIZE HOLES ARE SPECIFIED ON THE DRAWINGS, EXTRA-THICK ASTM F436 PLATE WASHERS SHALL BE USED (3/16" MINIMUM THICKNESS) WITH A DIAMETER SUITABLE TO COVER THE EXTENTS OF THE SLOT OR HOLE. BOLTS SHALL BE HEAVY-HEX WHERE AVAILABLE IN THE SIZE AND GRADE SPECIFIED, OTHERWISE BOLTS SHALL BE HEX HEAD CAP SCREWS.
- ALL STEEL HARDWARE, INCLUDING ADHESIVE OR EMBEDDED ANCHOR BOLTS AND THEIR ACCESSORIES, SHALL BE HOT-DIP GALVANIZED IN ACCORDANCE WITH ASTM A153 (EXCEPT BOLTS SMALLER THAN 1/2" SHALL CONFORM TO FE/ZN 3 AT PER ASTM F1941 WHERE HOT-DIP GALVANIZED BOLTS ARE NOT AVAILABLE). ALL STEEL MEMBERS, INCLUDING WELDMENTS, SHALL BE HOT-DIP GALVANIZED IN ACCORDANCE WITH ASTM A123. REPAIR DAMAGE TO GALVANIZED COATINGS USING ASTM A780 PROCEDURES WITH A ZINC RICH PAINT (SUCH AS ZINC GALVILITE) FOR GALVANIZING DAMAGED BY HANDLING, TRANSPORTING, CUTTING, WELDING, OR BOLTING. DO NOT HEAT SURFACES TO WHICH REPAIR PAINT HAS BEEN APPLIED. CALL OUT HOLES REQUIRED FOR HOT-DIP GALVANIZING ON SHOP DRAWINGS.
- MEMBERS SHALL BE SHOP-FABRICATED AND WELDED TO THE EXTENT PRACTICABLE IN ORDER TO REDUCE FIELD INSTALLATION COSTS.

CONSTRUCTION INSPECTION CHECKLIST

CONSTRUCTION AND/OR INSTALLATION INSPECTIONS REQUIRED FOR REPORT? (CHECK=YES, BLANK=NO)	INSPECTION REPORT ITEM
√	CONSTRUCTION INSPECTIONS
	THIRD-PARTY CERTIFIED WELD INSPECTION (INCLUDING IBC SPECIAL INSPECTIONS)
√	GALVANIZING REPAIR MATERIAL PREPARATION, INSPECTION, & PAINT APPLICATION
√	PRIME CONTRACTOR'S AS-BUILT DOCUMENTS (SIGNED & DATED)
√	FABRICATION INSPECTION
√	MATERIAL TEST REPORT(S) / MILL CERTIFICATE(S)
√	PACKING SLIPS FOR STRUCTURAL MATERIALS

NOMINAL HOLE DIMENSIONS

BOLT Ø	STANDARD HOLE Ø
1/2"Ø	9/16"Ø
5/8"Ø	11/16"Ø
3/4"Ø	13/16"Ø
7/8"Ø	15/16"Ø
1"Ø	1 1/8"Ø

Sprint

1 INTERNATIONAL BLVD., SUITE 800
MAHWAH, NJ 07495
P: 800.357.7641



134 FLANDERS RD., SUITE 125
WESTBOROUGH, MA 01581
P: 508.251.0720



GEOSTRUCTURAL

PO BOX 2621, BOISE, ID 83701
P: 530.539.4787
E: CONTACT@GEOSTRUCTURAL.COM
WWW.GEOSTRUCTURAL.COM

REVISIONS:

NO.	DATE	DESCRIPTION	BY
3	06/19/18	REVISED CENTERLINE	JAD
2	05/22/18	REVISED PLACEMENT	JAD
1	04/15/18	REVISED LOADING	JAD
0	02/19/18	ISSUE FOR CONSTRUCTION	JAD

CHECKED BY: DWG

THE INFORMATION CONTAINED IN THIS SET OF DOCUMENTS IS PROPRIETARY BY NATURE. ANY USE OR DISCLOSURE OTHER THAN THAT WHICH RELATES TO THE CLIENT NAMES IS STRICTLY PROHIBITED.

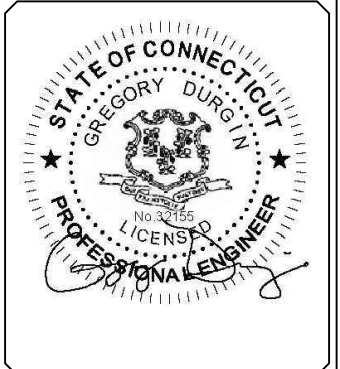

SITE INFORMATION:
MOUNT AUGMENTATION

CT33XC017

POMFRET, CT

LATITUDE: 41.89009444
LONGITUDE: -71.95498611

SHEET TITLE:
NOTES AND SPECIFICATIONS

SHEET NUMBER:
S2

NEW MOUNT AUGMENTATIONS

1. PLATFORM REINFORCEMENT KIT
SITEPRO1 PART# PRK-1245L. ATTACH PRK COLLAR TO MONOPOLE SHAFT ~4.0' BELOW EXISTING STANDOFF CENTERLINE AND DOUBLE ANGLE KICKER BRACKET TO BACK-TO-BACK ANGLES AT PLATFORM CORNERS AS SHOWN PER MANUF. SPECS. [(1) KIT TOTAL]
 2. HANDRAIL KIT COMPONENTS
SITEPRO1 PART# HRK12-U OR HRK14-U. ATTACH TO MOUNT PIPES ~3.0' ABOVE EXISTING STANDOFF CENTERLINE. VERIFY MOUNT FACE WIDTH IN FIELD PRIOR TO ORDERING. [(1) KIT TOTAL]
 3. HANDRAIL KIT COMPONENTS - V-BRACE KIT
SITEPRO1 PART# PRK-SFS-H-L. ATTACH COLLAR MOUNT TO MONOPOLE SHAFT ~2.5' BELOW EXISTING STANDOFF CENTERLINE. NOTE: IF THE PRK-SFS-H-L KIT IS NOT AVAILABLE, PROVIDE (6) TOTAL L2½x2½x¼ x ~8' LONG REPLACEMENT ANGLES, FIELD-CUT AND DRILL TO SUIT. [(1) KIT TOTAL]
 4. HANDRAIL KIT COMPONENTS - BOTTOM FACE RAIL
• PIPE2.0STD X 14.0' HORIZ. RAIL, [(3) TOTAL]. ATTACH SFS-H-L KIT ANGLES TO NEW HORIZ. RAIL.
• PIPE2.0STD X 4' LONG CORNER BRACE, [(3) TOTAL]. ATTACH TO NEW HORIZ. RAIL W/ (6) SITEPRO1 PART# PUCK BRACKETS.
• SITEPRO1 SCX x-K, [(9) TOTAL] CROSS-OVER PLATES. ATTACH ALL MOUNT PIPES TO EXISTING AND NEW HORIZ. RAILS.
 5. PANEL ANTENNAS TO BE INSTALLED IN POSITIONS 1 AND 2, WITH THE NNVV PANEL IN POSITION 2. RRH UNITS TO BE INSTALLED ON MOUNT PIPES BEHIND EACH PANEL ANTENNA (MAXIMUM OF TWO RRH PER PANEL MOUNT PIPE).
- AUGMENTATIONS SHALL BE COMPLETED PRIOR TO THE INSTALLATION OF ANY NEW EQUIPMENT.

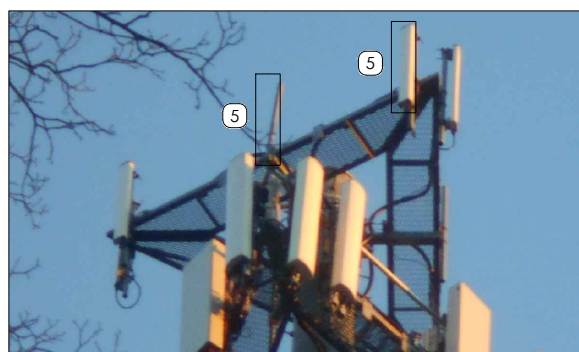

PLATFORM @ 167' AUGMENTATION

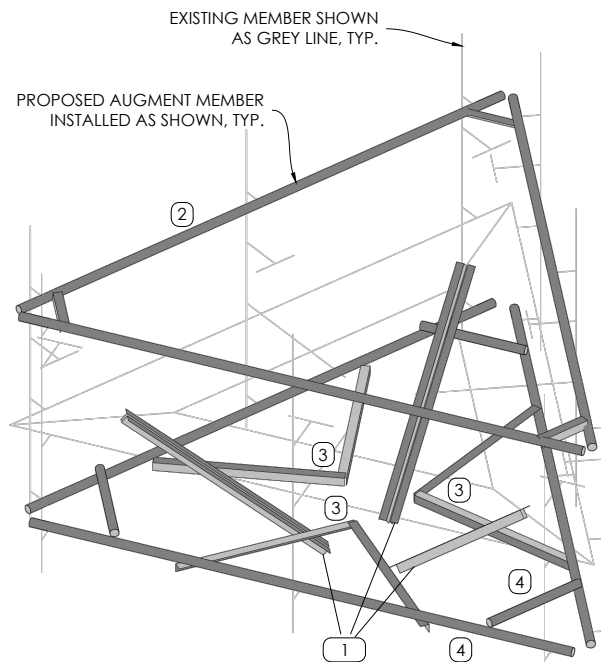

MOUNT AUGMENTATION ISOLATION
SCALE: N.T.S.

CONSTRUCTION NOTES

1. SCOPE OF WORK MUST BE COMPLETED AT WIND SPEEDS < 20 MPH.
2. ALL DIMENSIONS ARE APPROXIMATE. CONTRACTOR SHOULD FIELD-VERIFY ALL DIMENSIONS BEFORE FABRICATION OF STEEL AND COMMENCEMENT OF WORK. FIELD CUT MEMBERS AS REQUIRED.
3. CONTRACTOR TO COORDINATE THE TEMPORARY REMOVAL/RELOCATION/REPLACEMENT OF ELEMENTS (E.G. COAX, CLIPS, T.MAs, ETC.) CONNECTED TO, OR IN THE DIRECT PATH, OF NEW AUGMENTATION MEMBERS.

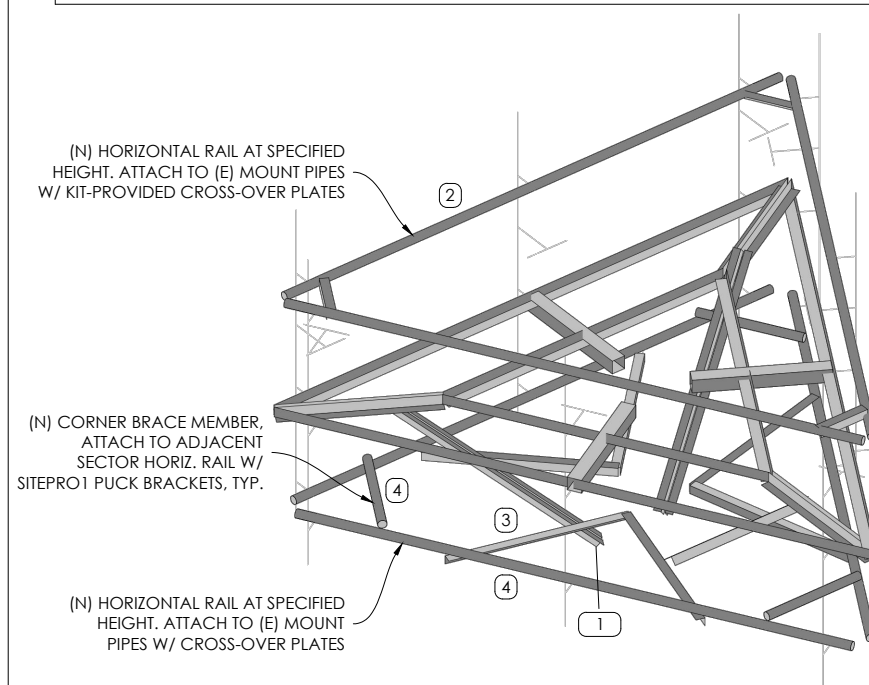

AUGMENTED MOUNT ISOMETRIC
SCALE: N.T.S.

INSTALLATION NOTES

1. AUGMENT MEMBER(S) MAY NEED TO BE FIELD-CUT TO LENGTH TO ACCOMMODATE THIS INSTALLATION. CONTRACTOR TO CUT AND DRILL TO SUIT AS REQUIRED AND APPLY (2) COATS OF COLD-GALV. COMPOUND TO CUT MEMBER ENDS.
2. CONTRACTOR TO CHECK ALL EXISTING MEMBER CONNECTION BOLTS, PARTICULARLY STANDOFF TO TOWER BOLTS, FOR PROPER INSTALLATION AND TIGHTNESS.
3. COORDINATE PLACEMENT OF NEW AUGMENT MEMBERS WITH EXISTING TOWER AND CLIMBING FACILITY ELEMENTS (E.G. STEP PEGS, COAX PORTS, ETC.)
4. REFER TO CONSTRUCTION DRAWINGS (BY OTHERS) AND MOUNT STRUCTURAL ANALYSIS FOR APPROVED INSTALLATION LOCATIONS AND QUANTITIES OF APPURTENANCES.

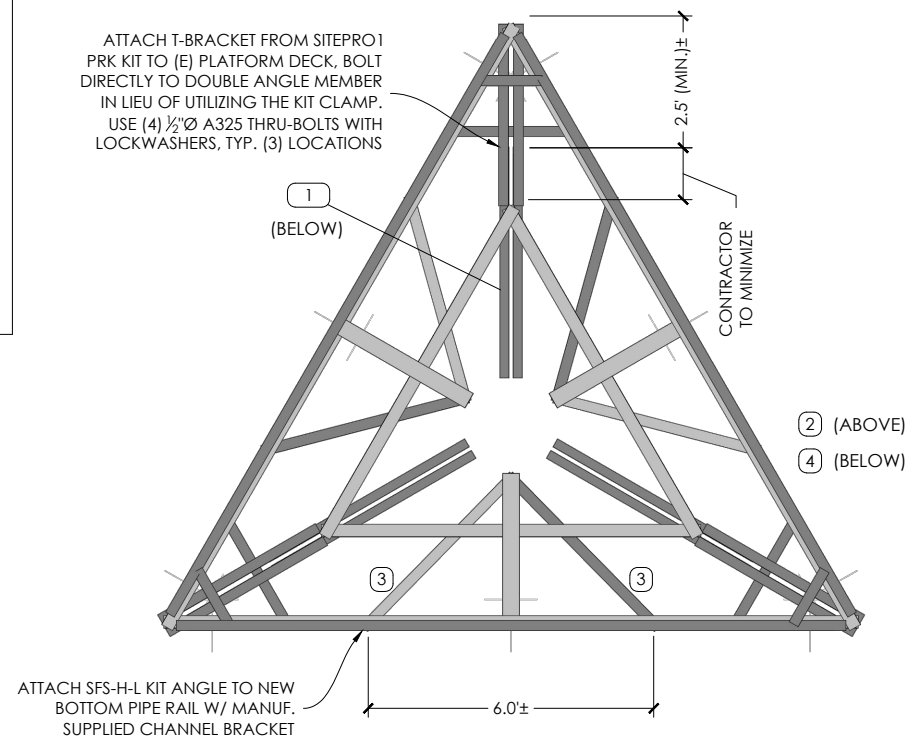

AUGMENTED MOUNT PLAN
SCALE: N.T.S.

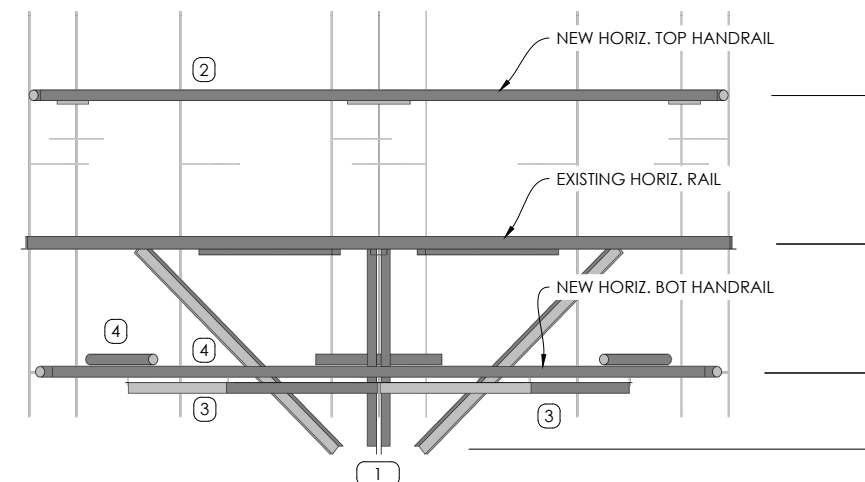

AUGMENTED MOUNT FRONT ELEVATION
SCALE: N.T.S.



REVISIONS:

NO.	DATE	DESCRIPTION	BY
3	06/19/18	REVISED CENTERLINE	JAD
2	05/22/18	REVISED PLACEMENT	JAD
1	04/15/18	REVISED LOADING	JAD
0	02/19/18	ISSUE FOR CONSTRUCTION	JAD

CHECKED BY: DWG

THE INFORMATION CONTAINED IN THIS SET OF DOCUMENTS IS PROPRIETARY BY NATURE. ANY USE OR DISCLOSURE OTHER THAN THAT WHICH RELATES TO THE CLIENT NAMES IS STRICTLY PROHIBITED.

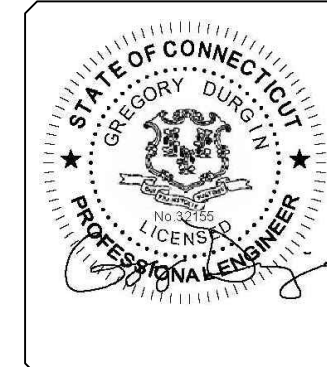

SITE INFORMATION:
MOUNT AUGMENTATION
CT33XC017
POMFRET, CT
LATITUDE: 41.89009444
LONGITUDE: -71.95498611

SHEET TITLE:
AUGMENTATIONS, SECTIONS & DETAILS

SHEET NUMBER:
S3