



T-Mobile Northeast LLC, a subsidiary of T-Mobile USA, Inc.

Connecticut Market

March 28, 2022

Honorable Robert Stein, Chairman, and
members of the Council
Connecticut Siting Council
10 Franklin Square
New Britain, CT 06051

Re: T-MOBILE Northeast LLC notice of intent to install a temporary cellular telephone facility located at 311 Thames Street Groton, Connecticut

Dear Ms. Bachman:

TRM is pleased to submit this Notice of Exempt Modification on behalf of T-MOBILE Northeast LLC

T-MOBILE Northeast LLC hereby notifies the Connecticut Siting Council of its intent for the temporary use of telecommunications equipment by placing a Cell On Light Truck (COLT) in the parking lot at 311 Thames Street owned by the City of Groton. This is a Special Event of state-wide importance. Please accept this Notice to the Connecticut Siting Council, Pursuant to RSCA Section 16-50j-73, of construction that constitutes an exempt modification under RSCA Section 16-50j-72 (d). In compliance with RSCA Section 16-50j-73, a copy of this Exempt Modification is being sent to Groton Mayor Keith Hedrick and Groton Planning and Zoning Inspector Joseph Summers. The City of Groton owns the property.

The proposed temporary cell site meets the criteria set forth in RSCA 16-50j-72(d) for temporary cellular service for events of statewide significance. The site is necessary to provide additional system capacity to accommodate the increased communication needs during Sailfest.

Sailfest is July 8-10, 2022 and T-Mobile will need to do testing beforehand to make sure the site is up and running before then.

Proposed Temporary Facility

The temporary site will be located at 311 Thames Street Groton, CT 06340 owned by the City of Groton. (See attached location map) Coordinates for the location are N 41.354469, W- 72.083847. A 15kw diesel generator will be used for power and the proposed temporary cell site will not increase the noise level by six decibels or more.

The proposal for the temporary equipment installation is July 5, 2022 and the site will be removed on July 11, 2022.

T-Mobile's temporary cell site will consist of a "Cell On Light Truck" ("COLT") (See attached photo) which needs a 30' x 25' footprint, contains three indoor RBS6201's and PBC6200 with battery backup, a backup generator, dual masts and can support 5 sector multi-beam antennas.

Power Density Calculations

T-Mobile's temporary cell site will not result in a total radio frequency electromagnetic radiation power density, measured at ground level at the COLT location, at or above State or Federal standards. The following table shows the power density at the site from the proposed temporary cellular transmissions from the COLT:

T-Mobile Sector	Power Density Value (%)
Sector A:	33.42%
Sector B:	33.42%
Sector C:	33.42%
Sector D:	33.42%
Sector E:	33.42%
T-Mobile Maximum MPE % (Sector A):	33.42%
Site Total:	33.42%
Site Compliance Status:	COMPLIANT

See attached full report

Conclusion

For the reasons above, we respectfully request the Council acknowledge T-Mobile's Notice of Exempt Modification for the temporary cell site to be operated during Sailfest pursuant to RCSA Section 16-50j-72(d).

Please call me with any questions concerning this Notice at 203-417-4446. Thank you.

Respectfully,

A handwritten signature in blue ink, appearing to read 'Thomas White', written in a cursive style.

Thomas White
Agent of T-Mobile

Cc: Groton Mayor Keith Hedrick
Building and Zoning Inspector Joseph Summers



T-Mobile Northeast LLC, a subsidiary of T-Mobile USA, Inc.

Connecticut Market

March 21, 2022

Mayor Keith Hedrick
City of Groton
295 Meridan Street
Groton, CT 06340

Re: STANDARD AGREEMENT by and between the City of Groton ("Landlord") and T-Mobile Northeast LLC as successor-in interest to Omnipoint Communications, Inc. ("Tenant").

Site Number: CTCLT06A
Site Address: 311 Thames Street Groton, CT ("Property")

Mayor Hedrick:

Tenant has the right to place a Cell On Lite Truck ("COLT") at 311 Thames Street Groton, CT from 7/4/22 to 7/11/22. The COLT will be removed by 7/11/22.

Please signify your approval by signing and dating one (1) original of this Consent Letter in the space provided below. Kindly return the Consent Letter via email to twhite@clinellc.com.

Should you have any questions, please contact Thomas White at 203-417-4446. Thank you in advance for your cooperation in this matter.

Very truly yours,

Thomas White
Agent for T-Mobile

Acknowledged, Accepted and Agreed:

By: *Keith Hedrick* Mayor, City of Groton

Date: 3/21/2022

COLT Location



COLT



**T-MOBILE
NORTHEAST LLC**

24 COTTAGE ROAD
ROCKWELL, CT 06867
PHONE: 860-441-1414

CENTERLINE
A DIVISION OF THE CENTERLINE GROUP

700 WEST CENTER ST. SUITE 307
WESTPORT, CT 06897
PHONE: 781.713.0725

NO.	DATE	ISSUED FOR REVIEW	DESCRIPTION
0	1/23/20	ISSUED FOR REVIEW	

DESIGNED BY: TC APPROVED BY: DC



SITE NAME:
CTCL-T01-SAIL
SAILFEST-GROTON
311 THAMES STREET
GROTON, CT 06479

SHEET TITLE: SITE PLAN &
ENLARGED SITE PLAN
DRAWING # LE-1
REVISIONS: 0

NOTES:

- CALL THE FOLLOWING FOR ALL PRE-CONSTRUCTION NOTIFICATION 72 HOURS PRIOR TO ANY EXCAVATION ACTIVITY:
DIG SAFE SYSTEM (MA, ME, NH, RI, VT): 1-800-932-4435
CALL BEFORE YOU DIG (CT): 1-800-932-4435
- CONTRACTOR TO FIELD VERIFY DESIGN AND NOTIFY THE CONSTRUCTION MANAGER AND ENGINEER OF ANY DISCREPANCIES.

APPROXIMATE COORDINATES OF SITE LOCATION:
LATITUDE: 41° 21' 16"
LONGITUDE: 72° 4' 59"

NOTE:
ALL EQUIPMENT LOCATIONS ARE APPROXIMATE AND ARE SUBJECT TO APPROVAL BY T-MOBILE NORTHEAST LLC. STRUCTURAL & RF REQUIREMENTS OF ALL UTILITIES ARE SUBJECT TO APPROVAL BY OTHER UTILITY COMPANIES.

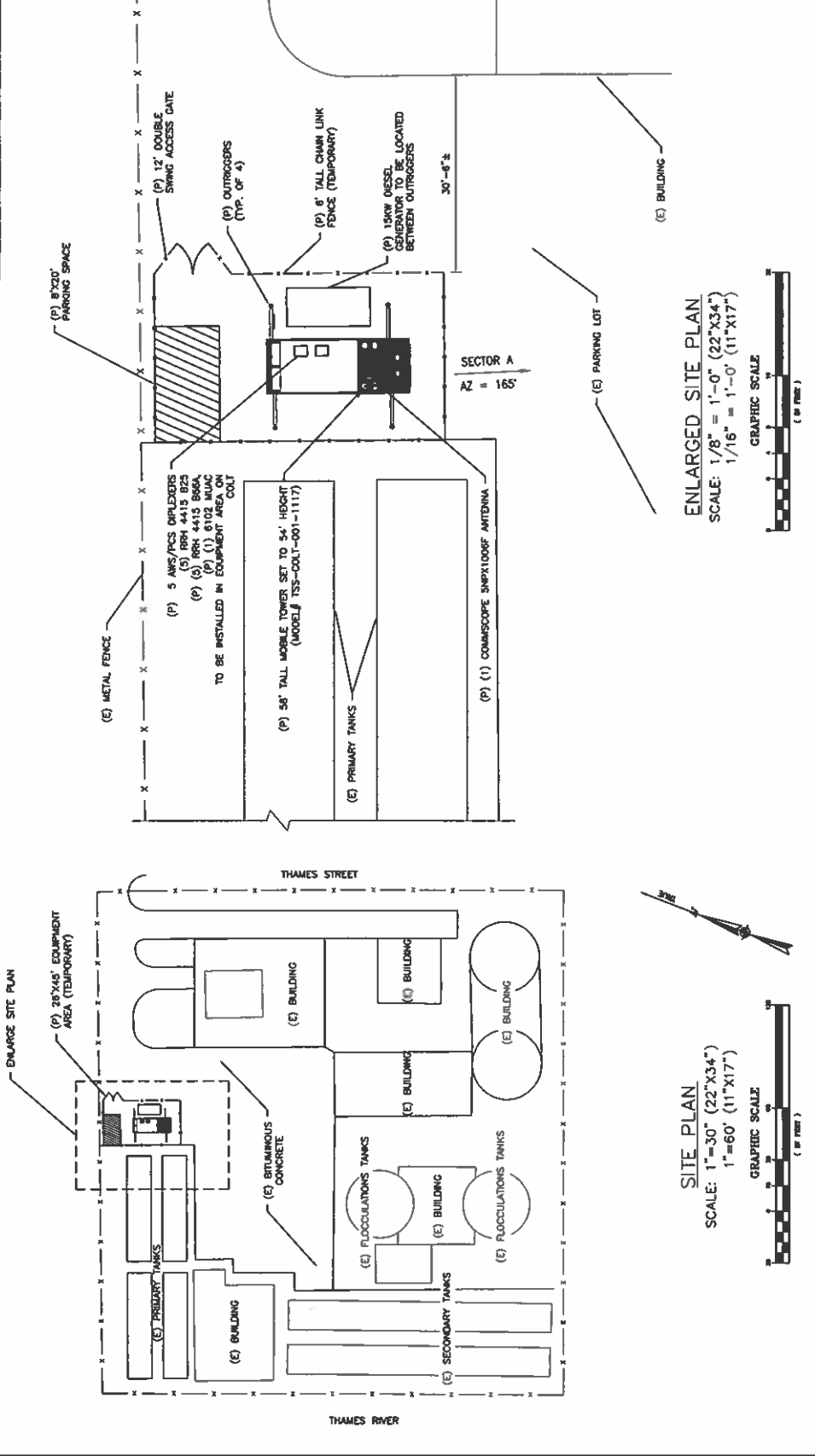

ENLARGED SITE PLAN
SCALE: 1/8" = 1'-0" (22"x34")
1/16" = 1'-0" (11"x17")



SITE PLAN
SCALE: 1"=30' (22"x34")
1"=60' (11"x17")



**T-MOBILE
NORTHEAST LLC**

11 CROWN ROAD SOUTH
SCOTTSDALE, CT 06472
CONTACT: JIM JENKINS



710 WEST CENTER ST. SUITE 300
WEST HARTFORD, CT 06107
PHONE: 781.713.6729

REVISIONS

NO.	DATE	DESCRIPTION
0	4/29/20	ISSUED FOR REVIEW

DESIGNED BY: TC
APPROVED BY: DC

811
CALL BEFORE YOU DIG
CT 811



SITE NAME:
**CTCLT01 - SAIL
SAILFEST-GROTON
311 THAMES STREET
GROTON, CT 06479**

SHEET TITLE: EAST ELEVATION
DRAWING # **LE-2** PROJECT # **0**

NOTE:
ALL EQUIPMENT LOCATIONS ARE APPROXIMATE AND ARE SUBJECT TO APPROVAL BY T-MOBILE NORTHEAST, LLC STRUCTURAL & RF ENGINEERS. LOCATIONS OF POWER & TELEPHONE FACILITIES ARE SUBJECT TO APPROVAL BY OTHER UTILITY COMPANIES.

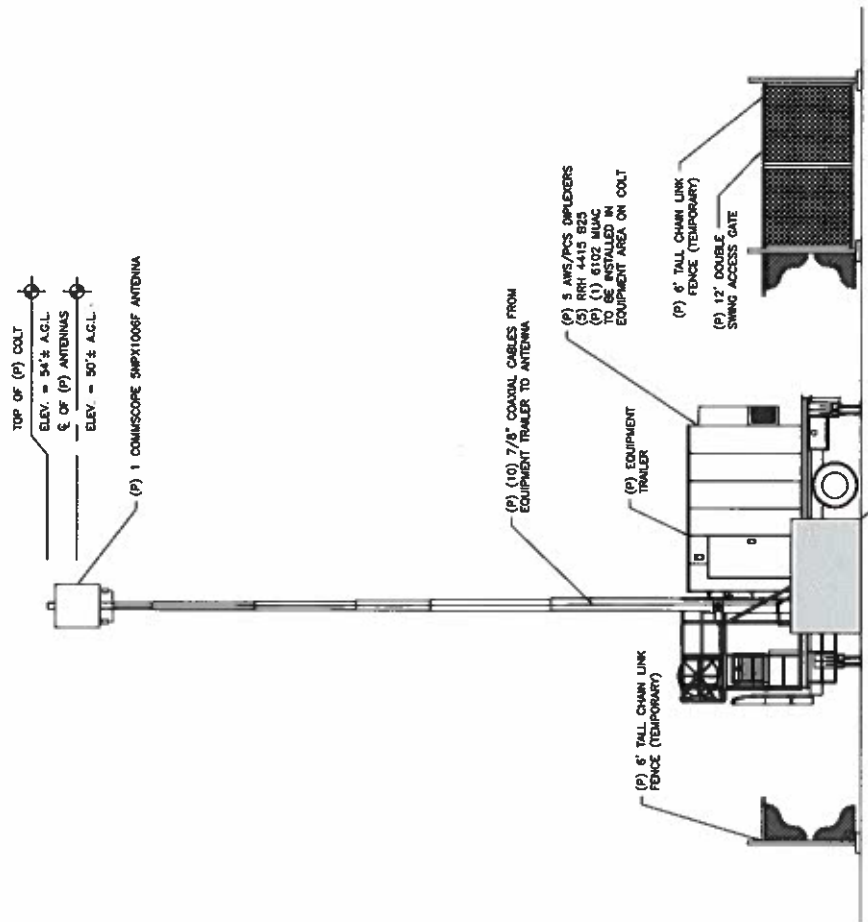

EAST ELEVATION
SCALE: 1/4" = 1'-0" (22"x34")
1/8" = 1'-0" (11"x17")





EBI Consulting

environmental | engineering | due diligence

RADIO FREQUENCY EMISSIONS ANALYSIS REPORT EVALUATION OF HUMAN EXPOSURE POTENTIAL TO NON-IONIZING EMISSIONS

T-Mobile Existing Facility

Site ID: CTCLT01-Sailfest

Sailfest

311 Thames Street

Groton, Connecticut 06340

March 23, 2022

EBI Project Number: 6220001936

Site Compliance Summary	
Compliance Status:	COMPLIANT
Site total MPE% of FCC general population allowable limit:	33.42%

March 23, 2022

T-Mobile

Attn: Jason Overbey, RF Manager
35 Griffin Road South
Bloomfield, Connecticut 06002

Emissions Analysis for Site: CTCLT01-Sailfest - Sailfest

EBI Consulting was directed to analyze the proposed T-Mobile facility located at **311 Thames Street in Groton, Connecticut** for the purpose of determining whether the emissions from the Proposed T-Mobile Antenna Installation located on this property are within specified federal limits.

All information used in this report was analyzed as a percentage of current Maximum Permissible Exposure (% MPE) as listed in the FCC OET Bulletin 65 Edition 97-01 and ANSI/IEEE Std C95.1. The FCC regulates Maximum Permissible Exposure in units of microwatts per square centimeter ($\mu\text{W}/\text{cm}^2$). The number of $\mu\text{W}/\text{cm}^2$ calculated at each sample point is called the power density. The exposure limit for power density varies depending upon the frequencies being utilized. Wireless Carriers and Paging Services use different frequency bands each with different exposure limits; therefore, it is necessary to report results and limits in terms of percent MPE rather than power density.

All results were compared to the FCC (Federal Communications Commission) radio frequency exposure rules, 47 CFR 1.1307(b)(1) – (b)(3), to determine compliance with the Maximum Permissible Exposure (MPE) limits for General Population/Uncontrolled environments as defined below.

General population/uncontrolled exposure limits apply to situations in which the general population may be exposed or in which persons who are exposed as a consequence of their employment may not be made fully aware of the potential for exposure or cannot exercise control over their exposure. Therefore, members of the general population would always be considered under this category when exposure is not employment related, for example, in the case of a telecommunications tower that exposes persons in a nearby residential area.

Public exposure to radio frequencies is regulated and enforced in units of microwatts per square centimeter ($\mu\text{W}/\text{cm}^2$). The general population exposure limits for the 600 MHz and 700 MHz frequency bands are approximately $400 \mu\text{W}/\text{cm}^2$ and $467 \mu\text{W}/\text{cm}^2$, respectively. The general population exposure limit for the 1900 MHz (PCS), 2100 MHz (AWS) and 11 GHz frequency bands is $1000 \mu\text{W}/\text{cm}^2$. Because each carrier will be using different frequency bands, and each frequency band has different exposure limits, it is necessary to report percent of MPE rather than power density.

Occupational/controlled exposure limits apply to situations in which persons are exposed as a consequence of their employment and in which those persons who are exposed have been made fully aware of the potential for exposure and can exercise control over their exposure. Occupational/controlled exposure limits also apply where exposure is of a transient nature as a result of incidental passage through a location where exposure levels may be above general population/uncontrolled limits (see below), as long as the exposed person has been made fully aware of the potential for exposure and can exercise control over his or her exposure by leaving the area or by some other appropriate means.

Additional details can be found in FCC OET 65.

CALCULATIONS

Calculations were done for the proposed T-Mobile Wireless antenna facility located at 55 West Street in Stafford Springs, Connecticut using the equipment information listed below. All calculations were performed per the specifications under FCC OET 65. Since T-Mobile is proposing highly focused directional panel antennas, which project most of the emitted energy out toward the horizon, all calculations were performed assuming a lobe representing the maximum gain of the antenna per the antenna manufacturer's supplied specifications, minus 10 dB for directional panel antennas and 20 dB for highly focused parabolic microwave dishes, was focused at the base of the tower. For this report, the sample point is the top of a 6-foot person standing at the base of the tower.

For all calculations, all equipment was calculated using the following assumptions:

- 1) 2 LTE channels (PCS Band - 1900 MHz) were considered for each sector of the proposed installation. These Channels have a transmit power of 60 Watts per Channel.
- 2) 2 LTE channels (AWS Band – 2100 MHz) were considered for each sector of the proposed installation. These Channels have a transmit power of 60 Watts per Channel.
- 3) All radios at the proposed installation were considered to be running at full power and were uncombined in their RF transmissions paths per carrier prescribed configuration. Per FCC OET Bulletin No. 65 - Edition 97-01 recommendations to achieve the maximum anticipated value at each sample point, all power levels emitting from the proposed antenna installation are increased by a factor of 2.56 to account for possible in-phase reflections from the surrounding environment. This is rarely the case, and if so, is never continuous.

- 4) The **Commscope 5NPXI006F** is a multi-beam antenna that covers approximately 100 degrees utilizing 5 separate narrow beams per band separated by 20 degrees of azimuth orientation between each adjacent beam. For T-Mobile's installation, this antenna will be utilized to broadcast 5 separate sectors. Configuration and power data is shown below in the ***T-Mobile Site Inventory and Power Data*** table and is broken down by sector. The maximum gain of the antenna per the antenna manufacturer's supplied specifications, minus 10 dB for directional panel antennas and 20 dB for highly focused parabolic microwave dishes, was used for all calculations. This value is a very conservative estimate as gain reductions for these particular antennas are typically much higher in this direction.
- 5) The antenna mounting height centerline of the proposed antennas is 50 feet above ground level (AGL).
- 6) Emissions values for additional carriers were taken from the Connecticut Siting Council active database. Values in this database are provided by the individual carriers themselves.
- 7) Emissions from additional carriers were not included because emissions data for the site location are not available.
- 8) All calculations were done with respect to uncontrolled / general population threshold limits.



EBI Consulting

environmental | engineering | due diligence

T-Mobile Site Inventory and Power Data

Sector	Azimuth	Antenna Make / Model	Antenna Height (ft)	Frequency Band (MHz)	Technology	TX Power per Channel (W)	Number of Channels	Composite ERP (W)	Power Density Value ($\mu\text{w}/\text{cm}^2$)	FCC General Population Limit ($\mu\text{w}/\text{cm}^2$)	% Allowable FCC General Population Limit	Composite Sector % Allowable FCC General Population Limit
A	80	Commscope 5NPXI006F	50	1900	LTE	60	2	10,819	155.6	1000	15.56	33.42%
	80	Commscope 5NPXI006F	50	2100	LTE	60	2	12,422	178.6	1000	17.86	
B	100	Commscope 5NPXI006F	50	1900	LTE	60	2	10,819	155.6	1000	15.56	33.42%
	100	Commscope 5NPXI006F	50	2100	LTE	60	2	12,422	178.6	1000	17.86	
C	120	Commscope 5NPXI006F	50	1900	LTE	60	2	10,819	155.6	1000	15.56	33.42%
	120	Commscope 5NPXI006F	50	2100	LTE	60	2	12,422	178.6	1000	17.86	
D	140	Commscope 5NPXI006F	50	1900	LTE	60	2	10,819	155.6	1000	15.56	33.42%
	140	Commscope 5NPXI006F	50	2100	LTE	60	2	12,422	178.6	1000	17.86	
E	160	Commscope 5NPXI006F	50	1900	LTE	60	2	10,819	155.6	1000	15.56	33.42%
	160	Commscope 5NPXI006F	50	2100	LTE	60	2	12,422	178.6	1000	17.86	



EBI Consulting

environmental | engineering | due diligence

Site Composite MPE %	
Carrier	MPE %
T-Mobile (Per Sector Max)	33.42%
No Additional Carriers at This Facility	N/A
Site Total MPE % :	33.42%

T-Mobile Maximum MPE Power Values (Sector A)							
T-Mobile Frequency Band / Technology (Sector A)	# Channels	Watts ERP (Per Channel)	Height (feet)	Total Power Density ($\mu\text{W}/\text{cm}^2$)	Frequency (MHz)	Allowable MPE ($\mu\text{W}/\text{cm}^2$)	Calculated % MPE
T-Mobile 1900 MHz LTE	2	5409.43	50.0	155.58	1900 MHz LTE	1000	15.56%
T-Mobile 2100 MHz LTE	2	6210.85	50.0	178.63	2100 MHz LTE	1000	17.86%
						Total:	33.42%

• NOTE: Totals may vary by approximately 0.01% due to summation of remainders in calculations.

Summary

All calculations performed for this analysis yielded results that were **within** the allowable limits for general population exposure to RF Emissions.

The anticipated maximum composite contributions from the T-Mobile facility as well as the site composite emissions value with regards to compliance with FCC's allowable limits for general population exposure to RF Emissions are shown here:

T-Mobile Sector	Power Density Value (%)
Sector A:	33.42%
Sector B:	33.42%
Sector C:	33.42%
Sector D:	33.42%
Sector E:	33.42%
T-Mobile Maximum MPE % (Sector A):	33.42%
Site Total:	33.42%
Site Compliance Status:	COMPLIANT

The anticipated composite MPE value for this site assuming all carriers present is **33.42%** of the allowable FCC established general population limit sampled at the ground level. This is based upon values listed in the Connecticut Siting Council database for existing carrier emissions.

FCC guidelines state that if a site is found to be out of compliance (over allowable thresholds), that carriers over a 5% contribution to the composite value will require measures to bring the site into compliance. For this facility, the composite values calculated were well within the allowable 100% threshold standard per the federal government.



Empowering Real People

Magnum Mobile Lite Generator – MLG15 Specifications

ENGINE

- Mitsubishi® S4L2-Y461ML - naturally aspirated, diesel engine ◦ Prime - 22.3 hp @ 1800 rpm ◦ 4 cylinder ◦ 1.8 L displacement ◦ Interim Tier IV approved
- Polyethylene fuel tank ◦ 56 gal. capacity ◦ 43 hr. run time – full load ◦ 3 ½” fill port
- Fuel consumption at prime:
 - 100% - 1.30 gph (4.92 Lph) ◦ 75% - 0.98 gph (3.71 Lph) ◦ 50% - 0.65 gph (2.46 Lph)
- Cooling system capable of operating at 120°F ambient
- Rubber vibration dampers isolate engine/generator from frame
- Full flow oil filter, spin on type
- Fuel filter with replaceable element
- Dry type cartridge air filter
- 60 Hz engine/generator

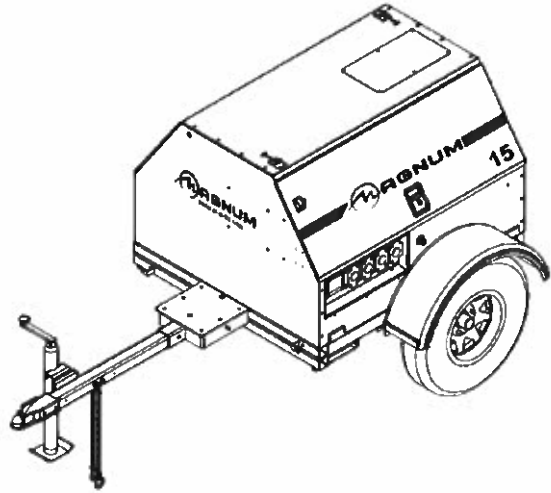

ENGINE CONTROLS

- Engraved aluminum punched and anodized control panel
- Four position keyed switch – glow plugs (preheat, off, run, start)
- Hour meter
- Automatic low oil/high temperature shutdown system

GENERATOR

- Marathon Electric® ◦ Brushless ◦ 4 pole ◦ Class H insulation
- Single phase output ◦ Prime - 13 kW / 13 kVA (54A @ 240V) ◦ Standby - 14 kW / 14 kVA (58A @ 240V)
- Voltage regulation +/- 1% with Marathon SE350 Voltage Regulator



MLG15 Specifications Continued:

ELECTRICAL SYSTEM AND CONTROLS

- 70A start limit breaker (assures no load condition exists before starting)
- Convenience receptacles with individual breakers ○ (2) 120V 20 Amp GFCI duplex outlets (Nema 5-20R type) ○ (2) 240V 30 Amp twistlock outlets (Nema L6-30R type) ○ (2) 240V 50 Amp twistlock outlets (Non-Nema 6369)
- 440 CCA wet cell battery

ENCLOSURE

- Steel, 14-gauge, sound attenuated enclosure ○ UV & fade resistant, high temperature cured, white polyester powder paint ○ Insulated and baffled ○ 70 dB(A) at 23 feet – prime power
- Fully lockable enclosure
- Stainless steel hinges, door latches and exterior hardware
- Emergency stop switch located on front panel
- License plate holder with light
- Multi-lingual operating/safety decals
- Document holder with operating/parts manuals including AC/DC wiring diagrams

TRAILER

- DOT approved tail, side, brake, and directional lights ○ Recessed rear lights
- Transportation tie downs
- Safety chains with spring loaded safety hooks
- Single wall polyethylene fenders
- 2" ball hitch
- 2200 lb. leaf spring axle
- 2000 lb. tongue jack with footplate
- ST205/75R15 tubeless tires – 6 ply
- 48" track width

WEIGHTS & DIMENSIONS

- Dry weight: 1425 lbs (646 kg)
- Operating weight: 1823 lbs (827 kg)
- 105 x 68 x 56 in
(2.67 x 1.73 x 1.42 m)

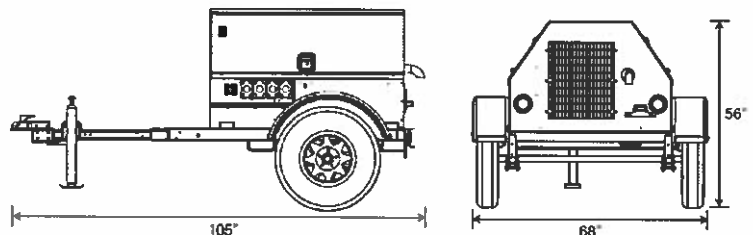

WARRANTY

- Engine and generator covered under OEM warranty – consult factory for details

CERTIFICATIONS

- CSA certified



MLG15 Specifications Continued:

MLG15 Options

ENGINE OPTIONS

- ◆ Heated fuel filter
- ◆ Lower radiator hose – engine heater
- ◆ Oil drain valve kit

ELECTRICAL CONTROLS OPTIONS

- ◆ 720 CCA gel cell battery
- ◆ 720 CCA wet cell battery
- ◆ 685 CCA gel cell battery
- ◆ Battery disconnect
- ◆ Battery charger – 2A trickle

VOLTAGE OUTPUT OPTIONS

- ◆ Alternative receptacle panel – consult factory for configurations

COOLANT OPTIONS

- ◆ 60/40 Coolant – cold weather applications

ENCLOSURE OPTIONS

- ◆ Interior cabinet light
- ◆ Level indicator
- ◆ Tamper pack
- ◆ Liquid containment / Quiet pack
- ◆ Lift structure



FUEL TANK OPTIONS

- ◆ 56 gal. fuel tank
- ◆ Tethered fuel tank cap

TRAILER OPTIONS

- ◆ 6 pin or 7 spade electrical connectors
- ◆ Outrigger package
- ◆ Tube and sleeve jack
- ◆ Spare tire/wheel kit

HITCH OPTIONS

- ◆ 2.5" lunette ring
- ◆  3" lunette ring
- ◆  3" HD lunette ring

- ◆ 2 5/16" ball
- ◆ Combination hitch – 2.5" lunette ring / 2" ball

05/09



Town of Groton, CT - GIS Viewer

By Shape By Value By Spatial

Results

Features selected: 1

- Property Type: EXEMPT
- District: CITY OF GROTON
- PIN: 168918209427 E
- Property Location: 311 THAMES ST
- Owner: GROTON CITY OF
- Owner Two: NEW SEWER PLANT
- In Care Of:
- Mailing Address: PO BOX 820
- City: GROTON
- State: CT
- Zip: 06340
- Acreage: 1.96
- Zoning: WBR
- Use Code: MUNICIPALITY
- CT Grand List Code: COMMERCIAL
- Living Units:
- Neighborhood: 3020
- Deed Book: 210
- Deed Page: 679
- Land Value: \$2,107,500
- Building Value: \$2,405,900
- Total Value: \$4,513,400
- Gross Assessed Value: \$3,159,380

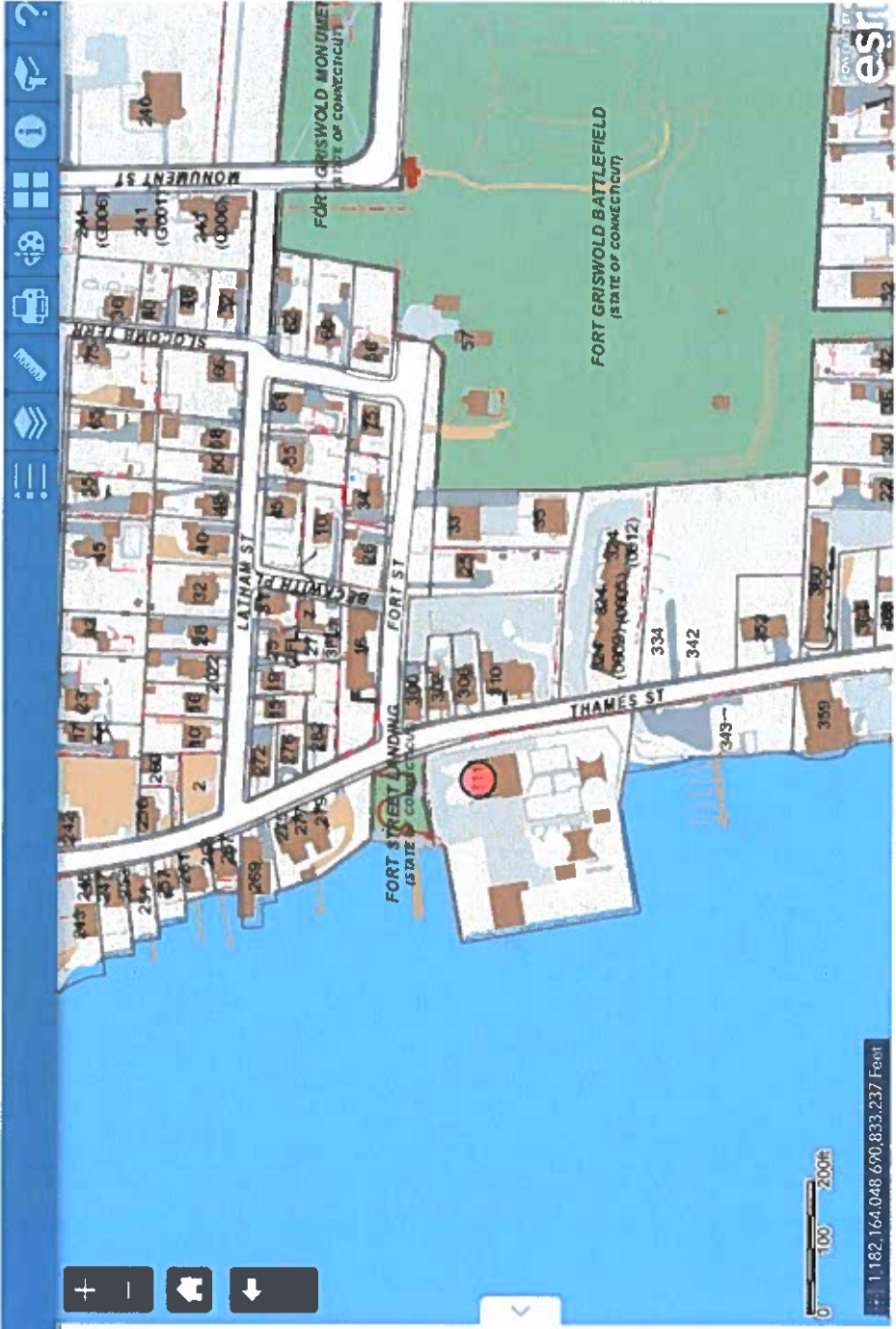



SWANSEA
 1278 GAR HWY
 SWANSEA, MA 02777-9998
 (800)275-8777

03/28/2022 02:35 PM

Product	Qty	Unit Price	Price
---------	-----	------------	-------

Priority Mail® 2-Day 1			\$8.95
Flat Rate Env			
Groton, CT 06340			
Flat Rate			
Expected Delivery Date			
Thu 03/31/2022			
Tracking #:			
9505 5102 6316 2087 6746 29			
Insurance			\$0.00
Up to \$50.00 included			
Total			\$8.95

Priority Mail® 2-Day 1			\$8.95
Flat Rate Env			
Groton, CT 06340			
Flat Rate			
Expected Delivery Date			
Thu 03/31/2022			
Tracking #:			
9505 5102 6316 2087 6746 36			
Insurance			\$0.00
Up to \$50.00 included			
Total			\$8.95

Grand Total: \$17.90

Debit Card Remitted \$17.90
 Card Name: VISA
 Account #: XXXXXXXXXXXX7068
 Approval #: 033525
 Transaction #: 479
 Receipt #: 038078
 Debit Card Purchase: \$17.90
 AID: A0000000980840 Chip
 AL: US DEBIT
 PIN: Verified
