

## SBJAHH-1 D65B-DL

**Multiband Antenna, 698–787, 824–894 and 2x 1695–2360 MHz, 65° horizontal beamwidth, internal RETs and low bands have diplexers**

- Interleaved dipole technology providing for attractive, low wind load mechanical package
- Independent tilt for high bands and single tilt for low bands

### Electrical Specifications

Frequency Band, MHz	698–787	824–894	1695–1880	1850–1990	1920–2200	2300–2360
Gain, dBi	14.5	14.3	17.7	18.1	18.7	18.6
Beamwidth, Horizontal, degrees	68	65	70	66	62	57
Beamwidth, Vertical, degrees	12.1	10.6	5.6	5.2	4.9	4.5
Beam Tilt, degrees	0–14	0–14	0–7	0–7	0–7	0–7
USLS (First Lobe), dB	13	13	17	16	17	15
Front-to-Back Ratio at 180°, dB	27	28	30	28	30	31
CPR at Boresight, dB	23	21	20	19	19	21
CPR at Sector, dB	14	10	14	11	10	2
Isolation, dB	25	25	25	25	25	25
Isolation, Intersystem, dB	30	30	30	30	30	30
VSWR   Return Loss, dB	1.5   14.0	1.5   14.0	1.5   14.0	1.5   14.0	1.5   14.0	1.5   14.0
PIM, 3rd Order, 2 x 20 W, dBc	-153	-153	-153	-153	-153	-153
Input Power per Port, maximum, watts	250	250	300	300	300	300
Polarization	±45°	±45°	±45°	±45°	±45°	±45°
Impedance	50 ohm	50 ohm	50 ohm	50 ohm	50 ohm	50 ohm

### Electrical Specifications, BASTA\*

Frequency Band, MHz	698–787	824–894	1695–1880	1850–1990	1920–2200	2300–2360
Gain by all Beam Tilts, average, dBi	14.2	13.7	17.3	17.9	18.2	18.4
Gain by all Beam Tilts Tolerance, dB	±0.4	±0.8	±0.4	±0.3	±0.5	±0.3
Gain by Beam Tilt, average, dBi	0°   14.2	0°   13.9	0°   17.3	0°   17.8	0°   18.1	0°   18.2
	7°   14.3	7°   13.9	3°   17.4	3°   17.9	3°   18.3	3°   18.6
	14°   13.8	14°   13.2	7°   17.2	7°   17.9	7°   18.2	7°   18.5
Beamwidth, Horizontal Tolerance, degrees	±2.1	±2.4	±2.5	±4.4	±4.6	±3.4
Beamwidth, Vertical Tolerance, degrees	±1.7	±0.7	±0.3	±0.2	±0.3	±0.2
USLS, beampeak to 20° above beampeak, dB	21	20	15	15	16	14
Front-to-Back Total Power at 180° ± 30°, dB	24	24	28	27	27	26
CPR at Boresight, dB	23	21	20	19	19	21
CPR at Sector, dB	14	10	14	11	10	2

\* CommScope® supports NGMN recommendations on Base Station Antenna Standards (BASTA). To learn more about the benefits of BASTA, [download the whitepaper Time to Raise the Bar on BSAs.](#)

### General Specifications

Antenna Type	Sector with internal RET
Band	Multiband
Brand	DualPol®
Operating Frequency Band	1695 – 2360 MHz   698 – 787 MHz   824 – 894 MHz
Performance Note	Outdoor usage

### Mechanical Specifications

SBJAHH-1D65B-DL

Color	Light gray
Lightning Protection	dc Ground
Radiator Material	Copper   Low loss circuit board
Radome Material	Fiberglass, UV resistant
Reflector Material	Aluminum
RF Connector Interface	7-16 DIN Female
RF Connector Location	Bottom
RF Connector Quantity, total	8
Wind Loading, maximum	618.0 N @ 150 km/h 138.9 lbf @ 150 km/h
Wind Speed, maximum	241 km/h   150 mph

## Dimensions

Depth	180.5 mm   7.1 in
Length	1850.7 mm   72.9 in
Width	301.0 mm   11.9 in
Net Weight, without mounting kit	21.4 kg   47.2 lb

## Remote Electrical Tilt (RET) Information

Input Voltage	10–30 Vdc
Internal RET	High band (2)   Low band (1)
Power Consumption, idle state, maximum	2.0 W
Power Consumption, normal conditions, maximum	13.0 W
Protocol	3GPP/AISG 2.0 (Multi-RET)
RET Interface	8-pin DIN Female   8-pin DIN Male
RET Interface, quantity	1 female   1 male

## Packed Dimensions

Depth	299.0 mm   11.8 in
Length	1970.0 mm   77.6 in
Width	409.0 mm   16.1 in
Shipping Weight	34.0 kg   75.0 lb

## Regulatory Compliance/Certifications

### Agency

RoHS 2011/65/EU  
China RoHS SJ/T 11364-2006  
ISO 9001:2008

### Classification

Compliant by Exemption  
Above Maximum Concentration Value (MCV)  
Designed, manufactured and/or distributed under this quality management system



## Included Products

BSAMNT-1 — Wide Profile Antenna Downtilt Mounting Kit for 2.4 - 4.5 in (60 - 115 mm) OD round members. Kit contains one

SBJAHH-1D65B-DL

scissor top bracket set and one bottom bracket set.

## \* **Footnotes**

Performance Note      Severe environmental conditions may degrade optimum performance

# ALCATEL-LUCENT B13 RRH4X30-4R

Alcatel-Lucent B13 Remote Radio Head 4x30-4R is the newest addition of Remote Radio Head to the extended product line of Alcatel-Lucent's distributed Base Station solutions, aimed at facilitating smooth RF site acquisition and related civil engineering.

**Supporting 2Tx/4Tx MIMO and 4-way Rx diversity**, Alcatel-Lucent B13 RRH4x30-4R allows operators to have a compact radio solution to deploy LTE in the 700U band (700 MHz, 3GPP band 13), providing them with the means to achieve high capacity, high quality and high coverage with minimum site requirements.

The Alcatel-Lucent B13 RRH4x30-4R product has four transmit RF paths, offering the possibility to **select, via software only, 2Tx or 4Tx MIMO configurations** with either 2x60 W or 4x30 W RF output power. It supports also 4-way Rx diversity and up to 10MHz instantaneous bandwidth.

The Alcatel-Lucent B13 RRH4x30-4R is a near zero-footprint solution and operates noise free, simplifying negotiations with site property owners and minimizing environmental impacts.

Its compactness and slim design makes the Alcatel-Lucent B13 RRH4x30-4R easy to install close to the antenna: operators can therefore locate this Remote Radio Head where RF design conditions are deemed ideal, minimizing trade-offs between available sites and RF optimum sites, together with reducing the RF feeder needs and installation costs.



## FEATURES

- Supporting LTE in 700 MHz band (700U, 3GPP band 13)
- LTE 2Tx or 4Tx MIMO (SW switchable)
- Output power: Up to 2x60W or 4x30W
- 10MHz LTE carrier with 4Rx Diversity
- Convection-cooled (fan-less)
- Supports AISG 2.0 ALD devices (RET, TMA) through RS485 or RF ports

## BENEFITS

- Compact to reduce additional footprint when adding LTE in 700U band
- MIMO scheme operation selection (2Tx or 4Tx) by software only
- Improves downlink spectral efficiency through MIMO4
- Increases LTE coverage thanks to 4Rx diversity capability and best in class Rx sensitivity
- Flexible mounting options: Pole or Wall

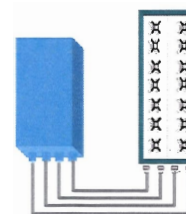

4x30W with 4T4R  
or  
2x60W with 2T4R  
Can be switched between  
modes via SW w/o site  
visit



## TECHNICAL SPECIFICATIONS

Features & performance	
<b>Number of TX/RX paths</b>	4 duplexed (either 4T4R or 2T4R by SW)
<b>Frequency band</b>	U700 (C) (3GPP bands 13): DL: 746 - 756 MHz / UL: 777 - 787 MHz
<b>Instantaneous bandwidth - #carriers</b>	10MHz – 1 LTE carrier (in 10MHz occupied bandwidth)
<b>LTE carrier bandwidth</b>	10 MHz
<b>RF output power</b>	2x60W or 4x30W (by SW)
<b>Noise figure – RX Diversity scheme</b>	2 dB typ. (<2.5 dB max) – 2 or 4 way Rx diversity
<b>Sizes (HxWxD) in mm (in.)</b>	550 x 305 x 230 (21.6" x 12.0" x 9") (with solar shield)
<b>Volume in L</b>	38 (with solar shield)
<b>Weight in kg (lb) (w/o mounting HW)</b>	26 (57.2) (with solar shield)
<b>DC voltage range</b>	-40.5 to -57V at full performance, -38 to -57V with relaxation on power consumption
<b>DC power consumption</b>	550W typical @100% RF load ( in 2Tx or 4TX mode)
<b>Environmental conditions</b>	-40°C (-40°F) / +55°C (+131°F)
<b>Wind load (@150km/h or 93mph)</b>	IP65 Frontal:<200N / Lateral :<150N
<b>Antenna ports</b>	4 ports 7/16 DIN female (50 ohms) VSWR < 1.5
<b>CPRI ports</b>	2 CPRI ports (HW ready for Rate7, 9.8 Gbps) SFP single mode dual fiber
<b>AISG interfaces</b>	1 AISG2.0 output (RS485) Integrated Smart Bias Tees (x2)
<b>Misc. Interfaces</b>	4 external alarms (1 connector) – 4 RF Tx & 4 RF Rx monitor ports - 1 DC connector (2 pins)
<b>Installation conditions</b>	Pole and wall mounting
<b>Regulatory compliance</b>	3GPP 36.141 / 3GPP 36.113 / GR-1089-CORE / GR-3108-CORE / UL 60950-1 / FCC Part 27

[www.alcatel-lucent.com](http://www.alcatel-lucent.com) Alcatel, Lucent, Alcatel-Lucent and the Alcatel-Lucent logo are trademarks of Alcatel-Lucent. All other trademarks are the property of their respective owners. The information presented is subject to change without notice. Alcatel-Lucent assumes no responsibility for inaccuracies contained herein.  
Copyright © 2014 Alcatel-Lucent. All Rights Reserved

# ALCATEL-LUCENT B25 RRH4X30

Alcatel-Lucent Band 25 Remote Radio Head 4x30W is the new addition of Remote Radio Head to the extended product line of Alcatel-Lucent's distributed Base Station solutions, aimed at facilitating smooth RF site acquisition and related civil engineering.

**Supporting 2Tx/4Tx MIMO and 4-way Rx diversity**, Alcatel-Lucent B25 RRH4x30 allows operators to have a compact radio solution to deploy LTE in the PCS band (1.9 GHz, 3GPP band 25), providing them with the means to achieve high capacity, high quality and high coverage with minimum site requirements.

The Alcatel-Lucent B25 RRH4x30 product has four transmit RF paths, offering the possibility to **select, via software only, 2Tx or 4Tx MIMO configurations** with either 2x60 W or 4x30 W RF output power. It supports also 4-way Rx diversity, LTE carriers from 3 MHz up to 20 MHz and up to 65 MHz instantaneous bandwidth.

The Alcatel-Lucent B25 RRH4x30 is a near zero-footprint solution and operates noise free, simplifying negotiations with site property owners and minimizing environmental impacts.

Its compactness and slim design makes the Alcatel-Lucent B25 RRH4x30 easy to install close to the antenna: operators can therefore locate this Remote Radio Head where RF design conditions are deemed ideal, minimizing trade-offs between available sites and RF optimum sites, together with reducing the RF feeder needs and installation costs.



## FEATURES

- Supporting LTE in 1.9 GHz band (PCS, 3GPP band 2 & 25)
- LTE 2Tx or 4Tx MIMO (SW switchable)
- Output power: Up to 2x60W or 4x30W
- Ready for 3, 5, 10, 15 or 20MHz LTE carrier operation with 4Rx Diversity
- Ready to support up to 4 carriers anywhere in 65MHz instantaneous bandwidth
- Convection-cooled (fan-less)
- Supports AISG 2.0 devices (RET, TMA) through RS485 or RF ports

## BENEFITS

- Compact to reduce additional footprint when adding LTE in PCS band
- MIMO scheme operation selection (2Tx or 4Tx) by software only
- Full flexibility for multiple carriers operation over entire PCS spectrum
- Improves downlink spectral efficiency and cell edge throughput through MIMO4
- Increases LTE coverage thanks to 4-way Rx diversity capability and best in class Rx sensitivity
- Flexible mounting options (Pole or Wall)

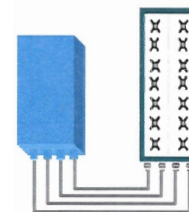

4x30W with 4T4R  
or  
2x60W with 2T4R

Can be switched between modes via SW w/o site visit



## TECHNICAL SPECIFICATIONS

Features & performance	
<b>Number of TX/RX paths</b>	4 duplexed (either 4T4R or 2T4R by SW)
<b>Frequency band</b>	3GPP bands 2 & 25 (PCS-G) DL: 1930 - 1995 MHz UL: 1850 - 1915 MHz
<b>Instantaneous bandwidth - #carriers</b>	65MHz – Up to 4 LTE carriers (in 40MHz occupied bandwidth)
<b>LTE carrier bandwidth</b>	3, 5, 10, 15 or 20 MHz
<b>RF output power</b>	2x60W or 4x30W (by SW)
<b>Noise figure (3GPP band 2)</b>	2.0 dB typ. (<2.5 dB max)
<b>RX Diversity scheme</b>	2 or 4 way Rx diversity
<b>Sizes (HxWxD)(w/ solar shield) in mm (in.)</b>	538 x 304 x 182 (21.2" x 12.0" x 7.2")
<b>Volume (w/ solar shield) in L</b>	30
<b>Weight (w/ solar shield) in kg (lb)</b>	24 (53)
<b>DC voltage range</b>	-40.5 to -57V at full performance, -38 to -57V with relaxation on power consumption
<b>DC power consumption</b>	580W typical @100% RF load
<b>Environmental conditions</b>	-40°C (-40°F) / +55°C (+131°F) IP65
<b>Wind load (@150km/h or 93mph)</b>	Frontal: <200N / Lateral : <150N
<b>Antenna ports</b>	4 ports 7/16 DIN female (50 ohms) VSWR < 1.5 (> 14dB)
<b>CPRI ports</b>	2 CPRI ports (HW ready for Rate7 / 9.8 Gbps)
<b>AISG interfaces</b>	1 AISG2.0 output (RS485), +24V/2A DC power Integrated Smart Bias Tees (x2)
<b>Misc. Interfaces</b>	1 external alarms connector (4 alarms) 4 RF Tx & 4 RF Rx monitor ports 1 DC connector (2 pins)
<b>Installation conditions</b>	Pole and wall mounting
<b>Regulatory compliance</b>	3GPP 36.141 / 3GPP 36.113 / GR-1089-CORE / GR-3108-CORE / UL 60950-1 / FCC Part 27

[www.alcatel-lucent.com](http://www.alcatel-lucent.com) Alcatel, Lucent, Alcatel-Lucent and the Alcatel-Lucent logo are trademarks of Alcatel-Lucent. All other trademarks are the property of their respective owners. The information presented is subject to change without notice. Alcatel-Lucent assumes no responsibility for inaccuracies contained herein. Copyright © 2014 Alcatel-Lucent. All Rights Reserved

# ALCATEL-LUCENT B66A RRH4X45

The Alcatel-Lucent B66a Remote Radio Head 4x45 is the newest addition of Remote Radio Head to the extended product line of Alcatel-Lucent's distributed Base Station solutions, aimed at facilitating smooth RF site acquisition and related civil engineering. Its operational range covers beyond that of B4 (AWS) and B10 (AWS+).

**Supporting 2Tx/4Tx MIMO and 2-way/4-way Rx diversity**, the Alcatel-Lucent B66a RRH4x45 allows operators to have a compact radio solution to deploy LTE in the 2100 band (3GPP band 4, 10, and 66), providing them with the means to achieve high capacity, high quality, high reliability, large instantaneous bandwidth, and high coverage with minimum site requirements.

The Alcatel-Lucent B66a RRH4x45 product has four transmit RF paths, offering the possibility to **select, via software only, 2Tx or 4Tx MIMO configurations** with either 2x90W or 4x45W RF output power. It also supports 4-way Rx diversity at the 70 MHz instantaneous bandwidth.



The Alcatel-Lucent B66a RRH4x45 is a compact (near zero-footprint) solution and operates noise free, simplifying negotiations with site property owners and minimizing environmental impacts.

Its compactness and slim design makes the Alcatel-Lucent B66a RRH4x45 easy to install close to the antenna: operators can therefore locate this Remote Radio Head where RF design conditions are deemed ideal, minimizing trade-offs between available sites and RF optimum sites, together with reducing the RF feeder needs and installation costs.

## FEATURES

- Supporting LTE in 2110 - 2180 MHz band/DL, 1710-1780MHz/UL (3GPP band 4, 10, and 66a)
- LTE 2Tx or 4Tx MIMO (SW selectable)
- Configuration: 2T2R/2T4R/4T4R
- Output power: Up to 2x90W or 4x45W (SW configurable)
- 70MHz LTE carrier with 4Rx Diversity
- Convection-cooled (fan-less)
- Supports AISG 2.0 ALD devices (RET, TMA) through RS485 or RF ports

## BENEFITS

- Compact to reduce additional footprint when adding LTE in AWS 1-3 band
- Selection of MIMO configuration (2Tx or 4Tx) by software only
- Improves downlink spectral efficiency through 4Tx MIMO
- Increases LTE coverage thanks to 4Rx diversity capability and best in class Rx sensitivity
- Flexible mounting options: Pole or Wall

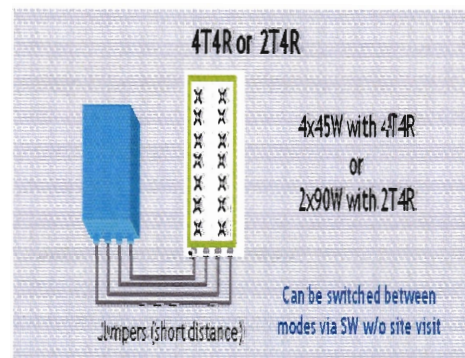



## TECHNICAL SPECIFICATIONS

Features & Performance	
<b>Number of TX/RX paths</b>	4 duplexed (either 4T4R or 2T4R selectable by SW)
<b>Frequency band</b>	AWS 1-3, B4/B66a DL: 2110-2180 MHz / UL: 1710-1780 MHz
<b>Instantaneous bandwidth - #carriers</b>	70 MHz – 4 LTE MIMO carriers (in 70 MHz occupied bandwidth)
<b>LTE carrier bandwidth</b>	5, 10, 15, 20 MHz
<b>RF output power</b>	2x90W or 4x45W (selectable by SW)
<b>Noise figure – RX Diversity scheme Receiver Sensivity (FRC A1-3)</b>	2 dB typical (<2.5 dB max) – 2 or 4 way Rx diversity -104.5 dBm maximum
<b>Sizes (HxWxD) in mm (in.)</b>	655x299x182 (25.8x11.8x7.2) (with solar shield) 640x290x160 (25.2x11.4x6.3) (without solar shield)
<b>Volume in Liters</b>	35.5 (with solar shield) 29.7 (without solar shield)
<b>Weight in kg (lb) (w/o mounting HW)</b>	25.8kg (56.8lb) (with solar shield)
<b>DC voltage range</b>	Nominal: -48V, -40.5 to -57V at full performance, -38 to -57V with relaxation on power consumption
<b>DC power consumption</b>	750W typical @100% RF load (in 2Tx or 4Tx mode); Add 58W for 2A*29V for AISG
<b>Environmental conditions</b>	-40°C (-40°F) / +55°C (+131°F) UL50E Type 4 Enclosure
<b>Wind load (@150km/h or 93mph)</b>	250N (56lb) Frontal/150N (34lb) Lateral
<b>Antenna ports</b>	4 ports 4.3-10 female (50 ohms) VSWR < 1.5
<b>CPRI ports</b>	2 CPRI ports (HW ready for Rate 7, 9.8 Gbps) SFP: SMDF (HW supports also SMSF and MMDF)
<b>AISG interfaces</b>	1 AISG 2.0 output (RS485) Integrated Smart Bias Tees (x2)
<b>Misc. Interfaces</b>	4 external alarms (1 connector) 1 DC connector (2 pins)
<b>Installation conditions</b>	Pole and wall mounting
<b>Regulatory compliance</b>	3GPP 36.141 / 3GPP 36.113 / GR-487 / GR-1089-CORE / GR-3108-CORE / UL 60950-1 / FCC Part 27 / FCC Part 15 / GR-3178-CORE

www.alcatel-lucent.com Alcatel, Lucent, Alcatel-Lucent and the Alcatel-Lucent logo are trademarks of Alcatel-Lucent. All other trademarks are the property of their respective owners. The information presented is subject to change without notice. Alcatel-Lucent assumes no responsibility for inaccuracies contained herein.  
Copyright © 2016 Alcatel-Lucent. All Rights Reserved



**HYBRIFLEX™ RRH Hybrid Feeder Cabling Solution, 1-5/8", Single-Mode Fiber**

**Product Description**

RFS' HYBRIFLEX Remote Radio Head (RRH) hybrid feeder cabling solution combines optical fiber and DC power for RRHs in a single lightweight aluminum corrugated cable, making it the world's most innovative solution for RRH deployments.

It was developed to reduce installation complexity and costs at Cellular sites. HYBRIFLEX allows mobile operators deploying an RRH architecture to standardize the RRH installation process and eliminate the need for and cost of cable grounding. HYBRIFLEX combines optical fiber (multi-mode or single-mode) and power in a single corrugated cable. It eliminates the need for junction boxes and can connect multiple RRHs with a single feeder. Standard RFS CELLFLEX® accessories can be used with HYBRIFLEX cable. Both pre-connectorized and on-site options are available.

**Features/Benefits**

- Aluminum corrugated armor with outstanding bending characteristics - minimizes installation time and enables mechanical protection and shielding
- Same accessories as 1 5/8" coaxial cable
- Outer conductor grounding - Eliminates typical grounding requirements and saves on installation costs
- Lightweight solution and compact design - Decreases tower loading
- Robust cabling - Eliminates need for expensive cable trays and ducts
- Installation of tight bundled fiber optic cable pairs directly to the RRH - Reduces CAPEX and wind load by eliminating need for interconnection
- Optical fiber and power cables housed in single corrugated cable - Saves CAPEX by standardizing RRH cable installation and reducing installation requirements
- Outdoor polyethylene jacket - Ensures long-lasting cable protection

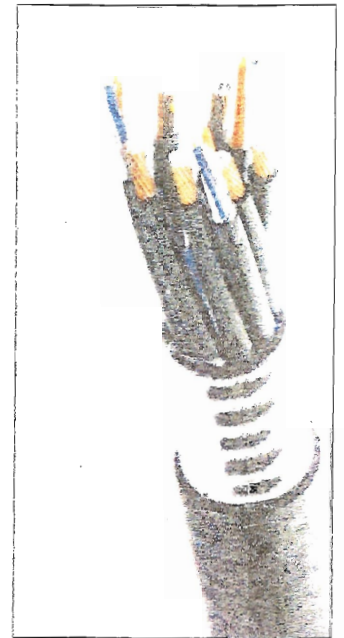

Figure 1: HYBRIFLEX Series

**Technical Specifications**

Outer Conductor Armor	Corrugated Aluminum	[mm (in)]	46.5 (1.83)
Jacket	Polyethylene, PE	[mm (in)]	50.3 (1.98)
UV-Protection	Individual and External Jacket		Yes

Weight, Approximate		[kg/m (lb/ft)]	1.9 (1.30)
Minimum Bending Radius, Single Bending		[mm (in)]	200 (8)
Minimum Bending Radius, Repeated Bending		[mm (in)]	500 (20)
Recommended/Maximum Clamp Spacing		[m (ft)]	1.0 / 1.2 (3.25 / 4.0)

DC-Resistance Outer Conductor Armor		[Ω/km (Ω/1000ft)]	068 (0.205)
DC-Resistance Power Cable, 8.4mm <sup>2</sup> (8AWG)		[Ω/km (Ω/1000ft)]	2.1 (0.307)

Version			Single-mode OM3
Quantity, Fiber Count			16 (8 pairs)
Core/Clad		[μm]	50/125
Primary Coating (Acrylate)		[μm]	245
Buffer Diameter, Nominal		[μm]	900
Secondary Protection, Jacket, Nominal		[mm (in)]	2.0 (0.08)
Minimum Bending Radius		[mm (in)]	104 (4.1)
Insertion Loss @ wavelength 850nm		dB/km	3.0
Insertion Loss @ wavelength 1310nm		dB/km	1.0
Standards (Meets or exceeds)			UL94-V0, UL1666 RoHS Compliant

Size (Power)		[mm (AWG)]	8.4 (8)
Quantity, Wire Count (Power)			16 (8 pairs)
Size (Alarm)		[mm (AWG)]	0.8 (18)
Quantity, Wire Count (Alarm)			4 (2 pairs)
Type			UV protected
Strands			19
Primary Jacket Diameter, Nominal		[mm (in)]	6.8 (0.27)
Standards (Meets or exceeds)			NFPA 130, ICEA S-95-658 UL Type XHHW-2, UL 44 UL-LS Limited Smoke, UL VW-1 IEEE-383 (1974), IEEE1202/FT4 RoHS Compliant

Installation Temperature		[°C (°F)]	-40 to +65 (-40 to 149)
Operation Temperature		[°C (°F)]	-40 to +65 (-40 to 149)

\* This data is provisional and subject to change

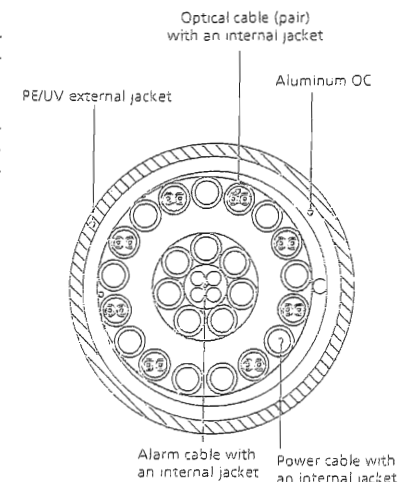

Figure 2: Construction Detail

All information contained in the present datasheet is subject to confirmation at time of ordering.



**STANDBY POWER RATING**

25 kW, 31 kVA, 60 Hz

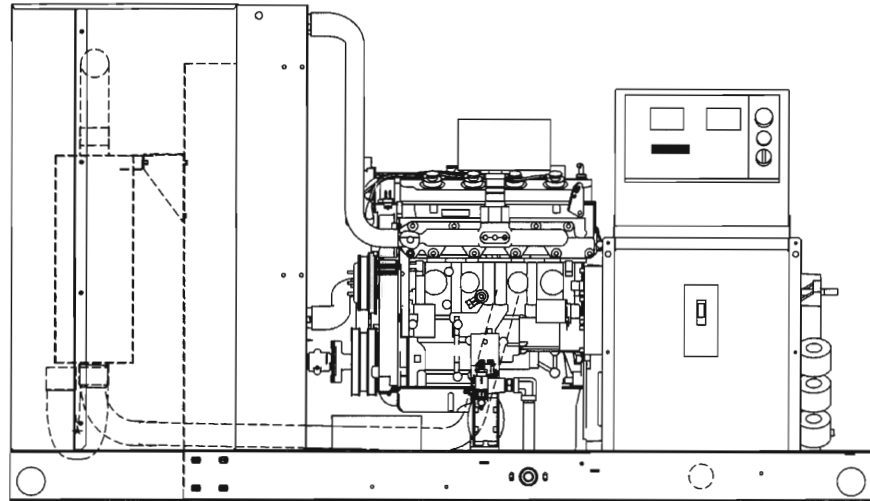
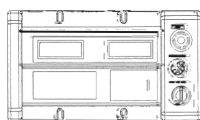
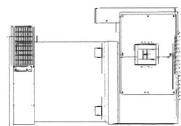
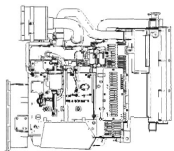
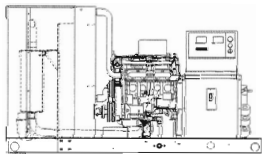

Image used for illustration purposes only



**Features**

**Benefits**

**Generator Set**

- PROTOTYPE & TORSIONALLY TESTED
- UL2200 TESTED
- RHINOCOAT PAINT SYSTEM
- ▶ PROVIDES A PROVEN UNIT
- ▶ ENSURES A QUALITY PRODUCT
- ▶ IMPROVES RESISTANCE TO ELEMENTS

**Engine**

- EPA COMPLIANT
- INDUSTRIAL TESTED, GENERAC APPROVED
- POWER-MATCHED OUTPUT
- INDUSTRIAL GRADE
- ▶ ENVIRONMENTALLY FRIENDLY
- ▶ ENSURES INDUSTRIAL STANDARDS
- ▶ ENGINEERED FOR PERFORMANCE
- ▶ IMPROVES LONGEVITY AND RELIABILITY

**Alternator**

- TWO-THIRDS PITCH
- LAYER WOUND ROTOR & STATOR
- CLASS H MATERIALS
- DIGITAL 3-PHASE VOLTAGE CONTROL
- ▶ ELIMINATES HARMFUL 3RD HARMONIC
- ▶ IMPROVES COOLING
- ▶ HEAT TOLERANT DESIGN
- ▶ FAST AND ACCURATE RESPONSE

**Controls**

- ENCAPSULATED BOARD W/ SEALED HARNESS
- 4-20mA VOLTAGE-TO-CURRENT SENSORS
- SURFACE-MOUNT TECHNOLOGY
- ADVANCED DIAGNOSTICS & COMMUNICATIONS
- ▶ EASY, AFFORDABLE REPLACEMENT
- ▶ NOISE RESISTANT 24/7 MONITORING
- ▶ PROVIDES VIBRATION RESISTANCE
- ▶ HARDENED RELIABILITY



**QT025A | 2.4L | 25 kW**  
**INDUSTRIAL SPARK-IGNITED GENERATOR SET**  
 EPA Certified Stationary Emergency

**APPLICATION AND ENGINEERING DATA**

**ENGINE SPECIFICATIONS**

General

Make	Generac
EPA Emissions Compliance	Stationary Emergency
EPA Emissions Engine Reference	See Emissions Data Sheet
Cylinder #	4
Type	In-line
Displacement - L (cu In)	2.4
Bore - mm (in)	86.61 (3.41)
Stroke - mm (in)	100.08 (3.94)
Compression Ratio	9.5:1
Intake Air Method	Naturally Aspirated
Number of Main Bearings	5
Connecting Rods	Forged
Cylinder Head	Aluminum
Cylinder Liners	No
Ignition	High Energy
Piston Type	Aluminum Alloy
Crankshaft Type	Cast
Lifter Type	Overhead Cam
Intake Valve Material	Steel Alloy
Exhaust Valve Material	Hardened Steel
Hardened Valve Seats	yes

Engine Governing

Governor	Electronic
Frequency Regulation (Steady State)	+/- 0.25%

\*Fuel pressure must remain within specified range and not drop more than 1 in. w.c from static (no-load) to full load.

Lubrication System

Oil Pump Type	Gear
Oil Filter Type	Full-Flow sping-on Cartridge
Crankcase Capacity - L (qts)	3.8 (4)

Cooling System

Cooling System Type	Pressurized Closed
Water Pump Flow -gal/min	11
Fan Type	Pusher
Fan Speed (rpm)	2150
Fan Diameter mm (in)	457 (18)
Coolant Heater Wattage	1500
Coolant Heater Standard Voltage	120 VAC

Fuel System

Fuel Type	Natural Gas, Propane Vapor
Carburetor	Down Draft
Secondary Fuel Regulator	Standard
Fuel Shut Off Solenoid	Standard
Operating Fuel Pressure (Standard)	5" - 14" H <sub>2</sub> O*

Engine Electrical System

System Voltage	12 VDC
Battery Charging Alternator (Amps)	30
Battery Size	See Battery Index 0161970SBY
Battery Voltage	12 VDC
Ground Polarity	Negative

**ALTERNATOR SPECIFICATIONS**

Standard Model	390mm	Standard Excitation	Brush Type
Poles	4	Bearings	Sealed Ball
Field Type	Revolving	Coupling	Flexible Disc
Insulation Class - Rotor	H	Load Capacity - Standby	100%
Insulation Class - Stator	H	Prototype Short Circuit Test	Yes
Total Harmonic Distortion	<5%	Voltage Regulator Type	Full Digital
Telephone Interference Factor (TIF)	<50	Number of Sensed Phases	3
		Regulation Accuracy (Steady State)	±0.25%

**CODES AND STANDARDS COMPLIANCE (WHERE APPLICABLE)**

NFPA 99	BS5514
NFPA 110	SAE J1349
ISO 8528-5	DIN6271
ISO 1708A.5	IEEE C62.41 TESTING
ISO 3046	NEMA ICS 1
	UL2200

Rating Definitions:

Standby – Applicable for a varying emergency load for the duration of a utility power outage with no overload capability. (Max. load factor = 70%)

**QT025A** | **2.4L** | **25 kW**  
**INDUSTRIAL SPARK-IGNITED GENERATOR SET**  
 EPA Certified Stationary Emergency

**OPERATING DATA**

**POWER RATINGS**

		Natural Gas	Propane Vapor
Single-Phase 120/240 VAC @1.0pf	25 kW	Amps: 104	Amps: 104
Three-Phase 120/208 VAC @0.8pf	25 kW	Amps: 87	Amps: 87
Three-Phase 120/240 VAC @0.8pf	25 kW	Amps: 75	Amps: 75
Three-Phase 277/480 VAC @0.8pf	25 kW	Amps: 38	Amps: 38

**STARTING CAPABILITIES (sKVA)**

		sKVA vs. Voltage Dip													
		480 VAC							208/240 VAC						
Alternator	kW	10%	15%	20%	25%	30%	35%	10%	15%	20%	25%	30%	35%		
Standard	25	16	25	33	41	49	57	12	19	25	31	37	43		

**FUEL CONSUMPTION RATES\***

Natural Gas				Propane Vapor			
Percent Load	ft <sup>3</sup> /hr	m <sup>3</sup> /hr		Percent Load	ft <sup>3</sup> /hr	m <sup>3</sup> /hr	
25%	140	3.9		25%	56	1.6	
50%	220	6.2		50%	87	2.5	
75%	300	8.5		75%	119	3.4	
100%	380	10.8		100%	151	4.3	

\* Fuel supply installation must accommodate fuel consumption rates at 100% load.

**COOLING**

		Standby
Air Flow (inlet air combustion and radiator)	ft <sup>3</sup> /min(m <sup>3</sup> /min)	1500 (42.48)
System Coolant Capacity	gal (Liters)	2.5 (9.46)
Heat Rejection to Coolant	BTU/hr	95,000
Max. Operating Ambient Temperature	°F (°C)	122 (50)
Max. Ambient Temperature	°F (°C)	104 (40)
Maximum Radiator Backpressure	in H <sub>2</sub> O	0.5

**COMBUSTION AIR REQUIREMENT**

	Standby
Flow at Rated Power cfm (m <sup>3</sup> /min)	70

**ENGINE**

		Standby
Rated Engine Speed	rpm	1800
Horsepower at Rated kW**	hp	40
Piston Speed	ft/min	1182
BMEP	psi	120

**EXHAUST**

		Standby
Exhaust Flow (Rated Output)	cfm (m <sup>3</sup> /min)	220 (6.2)
Max. Backpressure (Post Turbo)	inHg (Kpa)	1.5 (5.1)
Exhaust Temp (Rated Output - post silencer)	°F (°C)	975 (524)
Exhaust Outlet Size (Open Set)	mm (in)	63.5 (2.5)

\*\* Refer to "Emissions Data Sheet" for maximum bHP for EPA and SCAQMD permitting purposes.

Deration – Operational characteristics consider maximum ambient conditions. Derate factors may apply under atypical site conditions. Please consult a Generac Power Systems Industrial Dealer for additional details. All performance ratings in accordance with ISO3046, BS5514, ISO8528 and DIN6271 standards.

**STANDARD FEATURES AND OPTIONS**

**GENERATOR SET**

● Genset Vibration Isolation	Std
○ Extended warranty	Opt
○ Gen-Link™ Communications Software	Opt
○ Steel Enclosure	Opt
○ Aluminum Enclosure	Opt

**ENGINE SYSTEM**

<u>General</u>	
● Oil Drain Extension	Std
● Critical Exhaust Silencer	Std
● Air cleaner	Std
● Fan guard	Std
● Radiator duct adapter	Std
<u>Fuel System</u>	
● Fuel lockoff solenoid	Std
● Secondary Fuel Regulator	Std
● Flexible fuel lines	Std
<u>Cooling System</u>	
● 120VAC Coolant Heater	Std
● Closed Coolant Recovery System	Std
● UV/Ozone resistant hoses	Std
● Factory-Installed Radiator	Std
● Radiator Drain Extension	Std
<u>Engine Electrical System</u>	
● Battery charging alternator	Std
● Battery cables	Std
● Battery tray	Std
● Solenoid activated starter motor	Std
● 10A UL float/equalize battery charger	Std
● Rubber-booted engine electrical connections	Std

**ALTERNATOR SYSTEM**

● UL2200 GENprotect™	Std
● Main Line Circuit Breaker	Std

**CONTROL SYSTEM**

<u>Control Panel</u>	
● Digital H Control Panel - Dual 4x20 Display	Std
● Programmable Crank Limiter	Std
○ 21-Light Remote Annunciator	Opt
○ Remote Relay Panel (8 or 16)	Opt
● 7-Day Programmable Exerciser	Std
● Special Applications Programmable PLC	Std
● RS-232 Communications	Std
● RS-485 Communications	Std
● All-Phase Sensing DVR	Std
● Full System Status	Std
● Utility Monitoring (Req. H-Transfer Switch)	Std
● 2-Wire Start Compatible	Std
● Power Output (kW)	Std
● Power Factor	Std
● Reactive Power	Std
● All phase AC Voltage	Std
● All phase Currents	Std
● Oil Pressure	Std
● Coolant Temperature	Std
● Coolant Level	Std
● Fuel Pressure	Std
● Engine Speed	Std
● Battery Voltage	Std
● Frequency	Std
● Isochronous Governor Control	Std
● -40deg C - 70deg C Operation	Std
● Waterproof Plug-In Connectors	Std
● Audible Alarms and Shutdowns	Std
● Not in Auto (Flashing Light)	Std
● Auto/Off/Manual Switch	Std
● E-Stop (Red Mushroom-Type)	Std
● NFPA 110 Level I and II (Programmable)	Std
● Remote Communication - RS232	Std
<u>Alarms (Programmable Tolerances, Pre-Alarms and Shutdowns)</u>	
● Low Fuel Pressure	Std
● Oil Pressure (Pre-programmed Low Pressure Shutdown)	Std
● Coolant Temperature (Pre-programmed High Temp Shutdown)	Std
● Coolant Level (Pre-programmed Low Level Shutdown)	Std
● Engine Speed (Pre-programmed Overspeed Shutdown)	Std
● Voltage (Pre-programmed Overvoltage Shutdown)	Std
● Battery Voltage	Std



**DIMENSIONS AND WEIGHTS\***

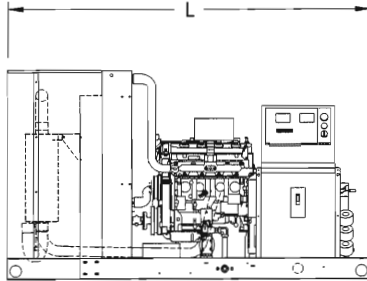
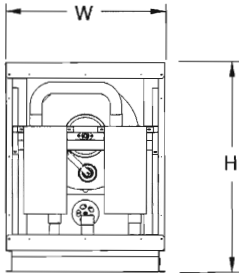

**OPEN SET (Includes Exhaust Flex)**

L x W x H in (mm)	77 (1956) x 34 (864) x 43 (1092)
Weight (lbs)	1163
dBA*	83

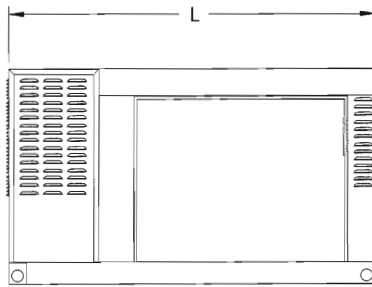
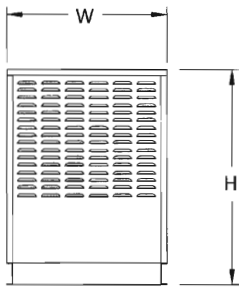

**LEVEL 1 ACOUSTIC ENCLOSURE**

L x W x H in (mm)	77 (1956) x 34 (864) x 46 (1168)
Weight (lbs)	1414
dBA*	60

\*All measurements are approximate and for estimation purposes only. Sound levels measured at 23ft (7m) under normal operation and do not account for ambient site conditions.

<b>YOUR FACTORY RECOGNIZED GENERAC INDUSTRIAL DEALER</b>

Specification characteristics may change without notice. Please consult a Generac Power Systems Industrial Dealer for detailed installation drawings.