

Figure 9. Digital map depicting the locations of previously National Register of Historic Places properties in the vicinity of the proposed tower location in East Lyme, Connecticut.

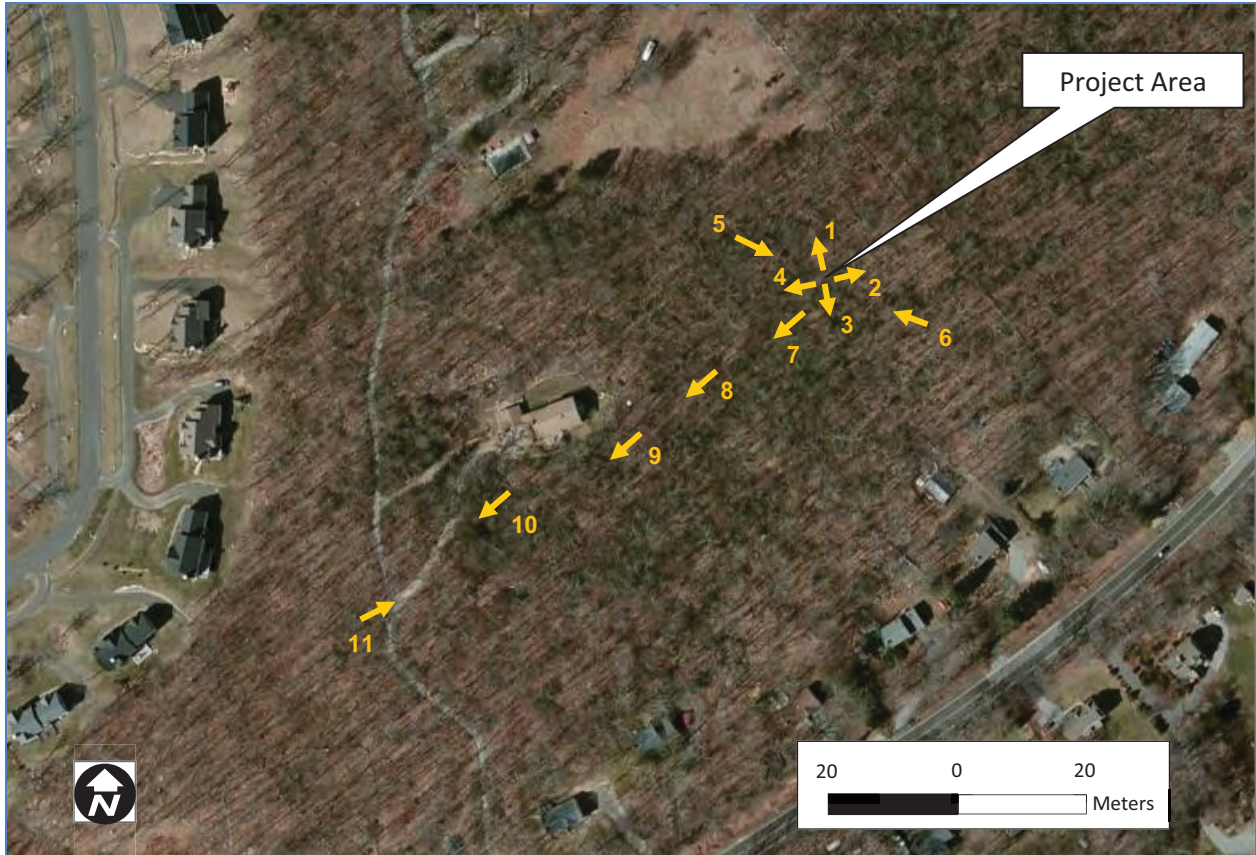

Figure 10. Aerial view of the location of the proposed telecommunications tower in East Lyme, Connecticut depicting the location and direction of each the following photographs.

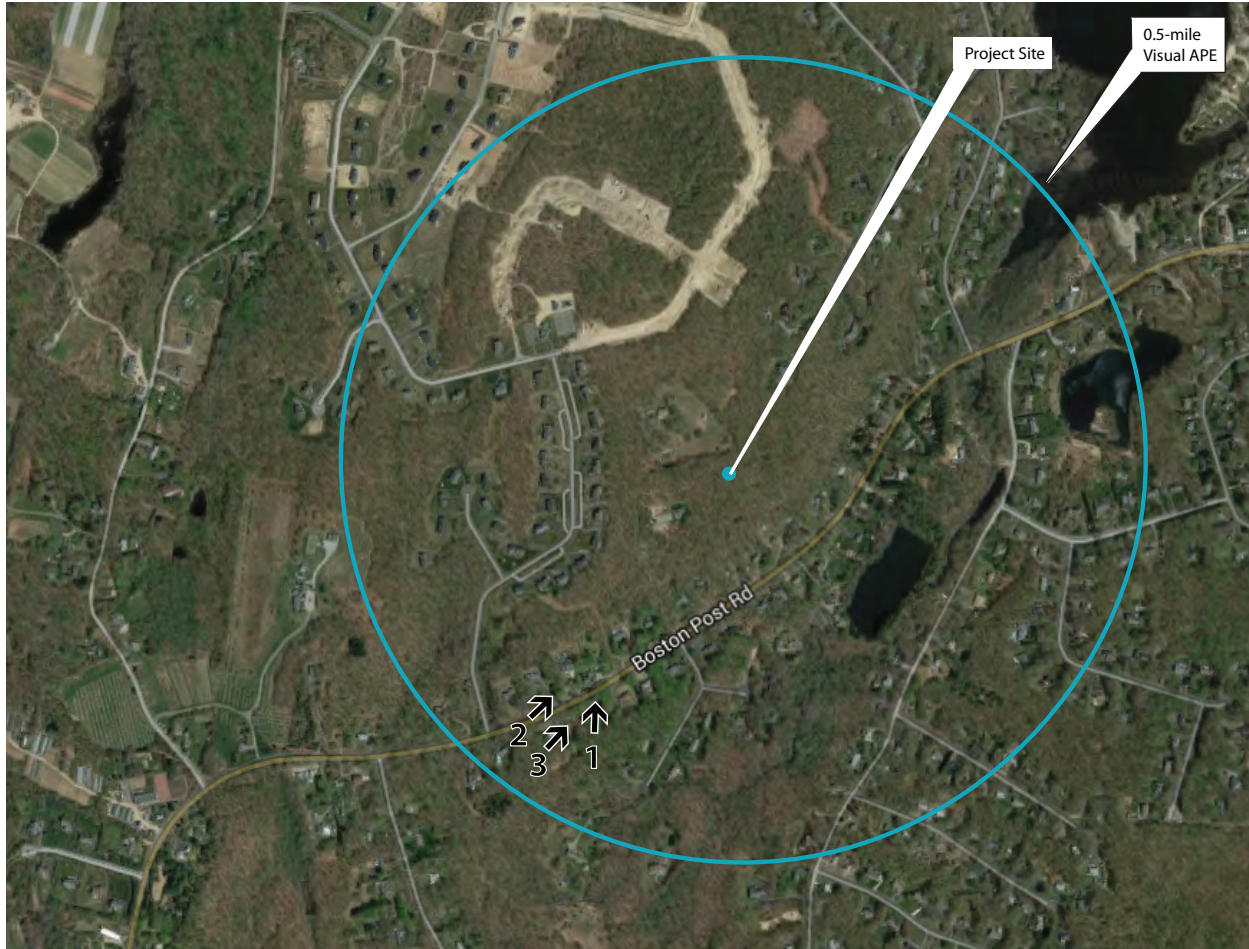

Figure 11: Photograph Directions Map #2.

Applicant: New Cingular Wireless PCS, LLC
Project Number: CT1931401
Project Location: 351A Boston Post Road, East Lyme, CT, 06333

CO SUBMISSION PACKET – FCC FORM 620



Figure 12: Bird's Eye View Aerial Photograph.

Applicant: New Cingular Wireless PCS, LLC
Project Number: CT1931401
Project Location: 351A Boston Post Road, East Lyme, CT, 06333

CO SUBMISSION PACKET – FCC FORM 620

Attachment 4 – Site Information – Additional Site Information

Additional Site Information and Recommendations:

Describe any additional structures, access roads, utility lines, fences, easements, or other construction planned for the site in conjunction with the proposed collocation and related facilities. Use this attachment to provide additional details needed to provide a full and accurate description of any structural alterations, additions, or other construction activities that will take place to complete the collocation.

The Subject Property is located at 351A Boston Post Road in East Lyme, Connecticut, and is situated on the north side of Boston Post Road (CT Route 1) opposite Naomi Lane. The proposed site is approximately 0.38-mile southwest of Pattagansett Lake; 1.52-miles west of Boston Post Road's intersection with Flanders Road (Ct Route 161), also known as Flanders Four Corners; and 1.26-miles northwest of Interstate 84. The Subject Property sits on the lower third of the southeastern slope of Pond Hill, which descends steeply before leveling out along a course roughly aligned with Boston Post Road and rolling gently to the south and east. The area in the vicinity of the site was formerly agricultural yet gave way to primarily suburban residential development during the twentieth century. The present building stock consists of residential structures dating from the mid-eighteenth to the late-twentieth century, however, the vast majority are of modern construction.

The Subject Property consists of an approximately 6.24-acre parcel that is the site of a two-story house (built in 1974) with an attached garage. Small lawns surround the house, while the remainder of the parcel is wooded.

New Cingular Wireless PCS, LLC, doing business as "AT&T", is proposing to construct a 194'-tall Monopole Communications Tower facility in a northeastern section of the parcel. The proposed telecommunications facility consists of the 194'-tall monopole communications tower with antennas, which will be set within a 60' x 100' fenced (chain link) equipment compound. Utilities will be routed through a proposed underground conduit to an existing utility pole located on Boston Post Road. Access to the site is proposed to be gained via a 12' wide access/utilities easement originating approximately 725' to the west along an existing driveway leading northeast from Boston Post Road to the house located on the property.

Site Plans/Lease Exhibits provided by AT&T are included in this attachment.

Applicant: New Cingular Wireless PCS, LLC

Project Number: CT1931401

Project Location: 351A Boston Post Road, East Lyme, CT, 06333



WIRELESS COMMUNICATIONS FACILITY
CT1345
EAST LYME RELO.
(CANDIDATE C)
351A BOSTON POST ROAD
EAST LYME, CT 06333

SITE DIRECTIONS	
FROM: 99 EAST RIVER DRIVE EAST HARTFORD, CONNECTICUT	TO: 351A BOSTON POST RD EAST LYME, CT
1. HEAD NORTHEAST ON ENTERPRISE DR TOWARD CAPITAL BLVD	0.3 MI.
2. TURN LEFT ONTO CAPITAL BLVD	0.2 MI.
3. TURN LEFT ONTO WEST ST	0.3 MI.
4. TURN LEFT TO MERGE ONTO I-91 S	1.2 MI.
5. MERGE ONTO I-91 S	29.2 MI.
6. TAKE EXIT 225 ON THE LEFT TO MERGE ONTO CT-9 S TOWARD MIDDLETOWN/OLD SAYBROOK	5.7 MI.
7. TAKE THE EXIT ON THE LEFT ONTO I-95 N/US-1 N TOWARD NEW LONDON/PROVIDENCE	0.3 MI.
8. TAKE EXIT 71 FOR 4 MILE RIVER RD	1.5 MI.
9. TURN RIGHT ONTO 4 MILE RIVER RD	2.0 MI.
10. TURN RIGHT ONTO US-1 N	0.0 MI.
11. END AT 351A BOSTON POST RD	

GENERAL NOTES
1. PROPOSED ANTENNA LOCATIONS AND HEIGHTS PROVIDED BY AT&T.

SITE INFORMATION
THE SCOPE OF WORK SHALL INCLUDE:
1. THE INSTALLATION OF A SHARED WIRELESS COMMUNICATION TOWER, AN AT&T EQUIPMENT SHELTER & T-MOBILE EQUIPMENT ON A CONC. PAD WITHIN A ±120'x70' GRAVEL FENCED COMPOUND AREA.
2. THE PROPOSED WIRELESS FACILITY INSTALLATION WILL BE DESIGNED IN ACCORDANCE WITH THE 2003 INTERNATIONAL BUILDING CODE AS MODIFIED BY THE 2009 CONNECTICUT SUPPLEMENT.
3. POWER AND TELCO UTILITIES SHALL BE ROUTED UNDERGROUND FROM RESPECTIVE DEMARCS TO THE PROPOSED UTILITY BACKBOARD. FINAL DEMARC LOCATION AND UTILITY ROUTING TO PROPOSED BACKBOARD WILL BE VERIFIED/DETERMINED BY LOCAL UTILITY COMPANIES. UTILITIES WILL BE ROUTED UNDERGROUND FROM UTILITY BACKBOARD TO THE PROPOSED NOMINAL 12'-20" TEMPORARY AT&T WIRELESS EQUIPMENT SHELTER AND TO T-MOBILES EQUIPMENT CABINETS LOCATED WITHIN FENCED COMPOUND AREA.

MISCELLANEOUS SITE INFORMATION	
SCHOOL/DAYCARE FACILITY:	DISTANCE:
1. FLANDERS ELEMENTARY SCHOOL	1.24 MI.
2. EAST LYME HIGH SCHOOL	1.39 MI.
3. EAST LYME MIDDLE SCHOOL	1.59 MI.
4. CARELOT CHILDREN'S CENTER	1.59 MI.
5. KIDDIE CAMPUS LEARNING CENTER	1.61 MI.
6. CREATIVE PLAY/SCHOOL, INC.	1.80 MI.
7. CHILDREN'S GATHERING	2.69 MI.
8. LYME FAMILY DAY CARE	2.93 MI.



PROJECT SUMMARY	
SITE NAME:	EAST LYME RELO. - CT1345 (PROPOSED TOWER INSTALL)
SITE ADDRESS:	351A BOSTON POST RD EAST LYME, CT 06333
PROPERTY OWNER:	A. JAMES & BONNIE L. DECOSTA 351A BOSTON POST RD EAST LYME, CT 06333
LESSEE/TENANT:	AT&T MOBILITY 500 ENTERPRISE DRIVE, SUITE 3A ROCKY HILL, CT 06067
CONTACT PERSON:	DAVID VIVAN S&I COMMUNICATIONS (413) 218-5042
ENGINEER:	CEN TEK ENGINEERING 63-2 NORTH BRANFORD ROAD, BRANFORD, CT 06404 (203) 488-0580
TEMPORARY TOWER COORDINATES:	LATITUDE: 41°-21'-48.131" LONGITUDE: 72°-14'-20.279" EX. GROUND ELEVATION: 199.4'S A.M.S.L. COORDINATES AND GROUND ELEVATION BASED ON FAA 1-A SURVEY CERTIFICATION PREPARED BY MARTINEZ COUGH AND ASSOCIATES, DATED OCTOBER 10, 2014.

SHEET INDEX		
SHT. NO.	DESCRIPTION	REV. NO.
T-1	TITLE SHEET	0
C-1.0	ABUTTERS AND SITE ACCESS MAP	0
C-2.0	COMPOUND PLAN AND ELEVATION	0

REV.	DATE	ISSUED FOR	BY	DESCRIPTION

PROFESSIONAL ENGINEER SEAL

REVIEW SET
 NOT FOR CONSTRUCTION



CEN TEK ENGINEERING
Contract on hold
 100 WILSON HILL ROAD
 EAST LYME, CT 06333
 www.CentekEng.com

AT&T MOBILITY
 WIRELESS COMMUNICATIONS FACILITY
EAST LYME RELO.
CT1345 (CANDIDATE C)
351A BOSTON POST ROAD
EAST LYME, CT 06333

DATE: 04/24/15
 SCALE: AS NOTED
 JOB NO: 15046.000

TITLE SHEET

T-1
 Sheet No. 1 of 3

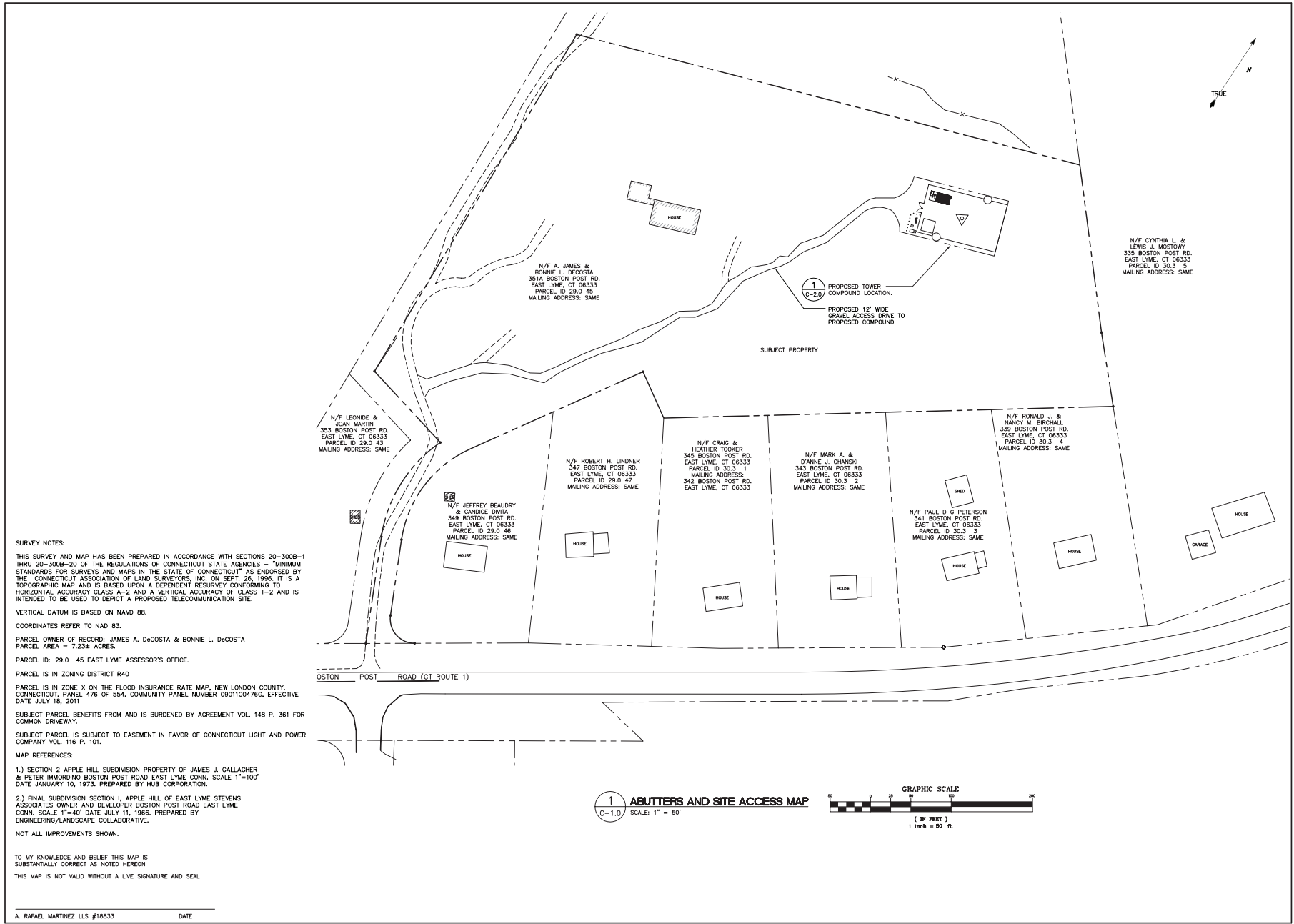

SURVEY NOTES:
 THIS SURVEY AND MAP HAS BEEN PREPARED IN ACCORDANCE WITH SECTIONS 20-300B-1 THRU 20-300B-20 OF THE REGULATIONS OF CONNECTICUT STATE AGENCIES - MINIMUM STANDARDS FOR SURVEYS AND MAPS IN THE STATE OF CONNECTICUT AS ENDORSED BY THE CONNECTICUT ASSOCIATION OF LAND SURVEYORS, INC. ON SEPT. 26, 1996. IT IS A TOPOGRAPHIC MAP AND IS BASED UPON A DEPENDENT RESURVEY CONFORMING TO HORIZONTAL ACCURACY CLASS A-2 AND A VERTICAL ACCURACY OF CLASS 1-2 AND IS INTENDED TO BE USED TO DEPICT A PROPOSED TELECOMMUNICATION SITE.

VERTICAL DATUM IS BASED ON NAVD 88.
 COORDINATES REFER TO NAD 83.

PARCEL OWNER OF RECORD: JAMES A. DeCOSTA & BONNIE L. DeCOSTA
 PARCEL AREA = 7.234 ACRES.

PARCEL ID: 29.0 45 EAST LYME ASSESSOR'S OFFICE.

PARCEL IS IN ZONING DISTRICT R40

PARCEL IS IN ZONE X ON THE FLOOD INSURANCE RATE MAP, NEW LONDON COUNTY, CONNECTICUT, PANEL 476 OF 554, COMMUNITY PANEL NUMBER 0901C0476G, EFFECTIVE DATE JULY 18, 2011

SUBJECT PARCEL BENEFITS FROM AND IS BURDENED BY AGREEMENT VOL. 148 P. 361 FOR COMMON DRIVEWAY.

SUBJECT PARCEL IS SUBJECT TO EASEMENT IN FAVOR OF CONNECTICUT LIGHT AND POWER COMPANY VOL. 116 P. 101.

MAP REFERENCES:

1.) SECTION 2 APPLE HILL SUBDIVISION PROPERTY OF JAMES J. GALLAGHER & PETER IMORDINO BOSTON POST ROAD EAST LYME CONN. SCALE 1"=100' DATE JANUARY 10, 1973. PREPARED BY HUB CORPORATION.

2.) FINAL SUBDIVISION SECTION 1, APPLE HILL OF EAST LYME STEVENS ASSOCIATES OWNER AND DEVELOPER BOSTON POST ROAD EAST LYME CONN. SCALE 1"=40' DATE JULY 11, 1966. PREPARED BY ENGINEERING/LANDSCAPE COLLABORATIVE.

NOT ALL IMPROVEMENTS SHOWN.

TO MY KNOWLEDGE AND BELIEF THIS MAP IS SUBSTANTIALLY CORRECT AS NOTED HEREON

THIS MAP IS NOT VALID WITHOUT A LIVE SIGNATURE AND SEAL.

1
 C-1.0
ABUTTERS AND SITE ACCESS MAP
 SCALE: 1" = 50'

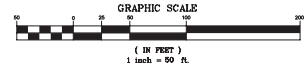

REV.	DATE	BY	CHK'D BY	DESCRIPTION

REVIEW SET
NOT FOR CONSTRUCTION

at&t

SAI

CENTEK Engineering
 Created on **Autodesk**
 FILED IN: **Autodesk**
 PROJECT NO: **150446.000**
 DRAWING NO: **C-1.0**
 www.Centek.com

AT&T MOBILITY
 WIRELESS COMMUNICATIONS FACILITY
EAST LYME RELO.
 CT1945 (CANDIDATE C)
 951A BOSTON POST ROAD
 EAST LYME, CT 06333

DATE:	04/24/15
SCALE:	AS NOTED
JOB NO.:	150446.000

C-1.0

Sheet No. 2 of 3

A. RAFAEL MARTINEZ LLS #18833 DATE

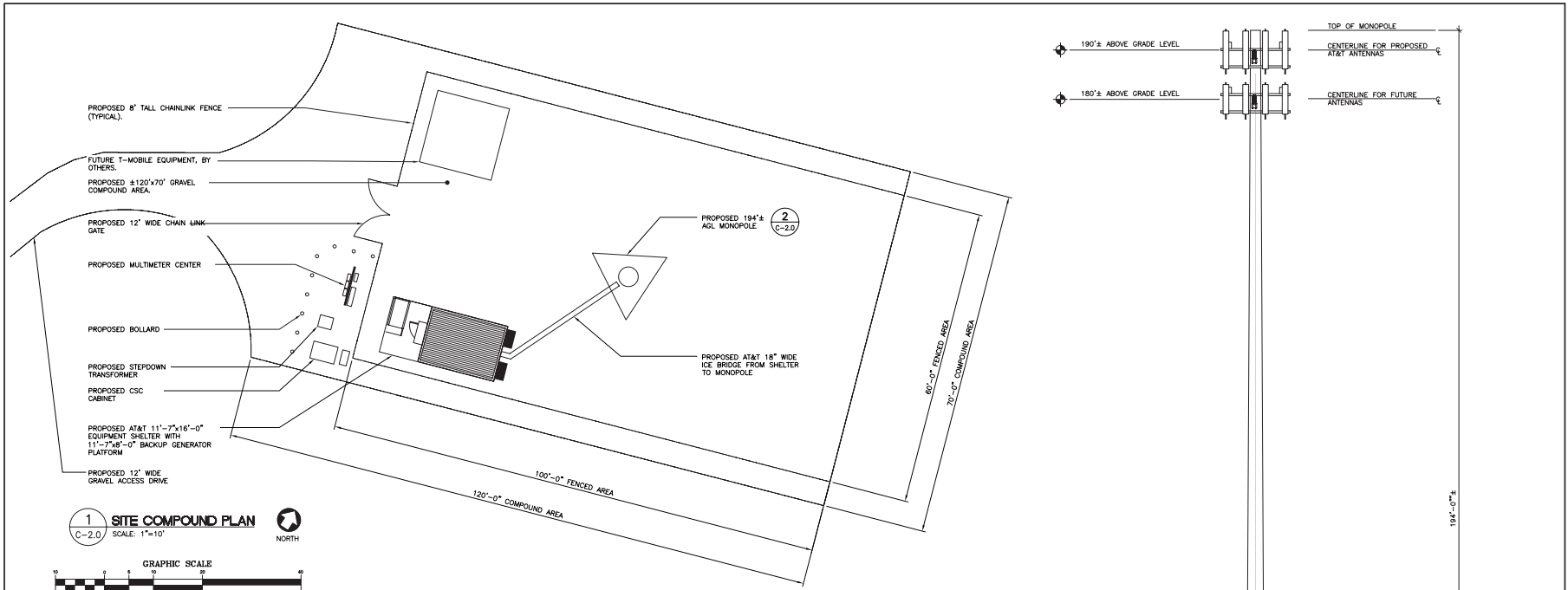

1 SITE COMPOUND PLAN
SCALE: 1"=10'
NORTH

GRAPHIC SCALE
1 inch = 10 ft.

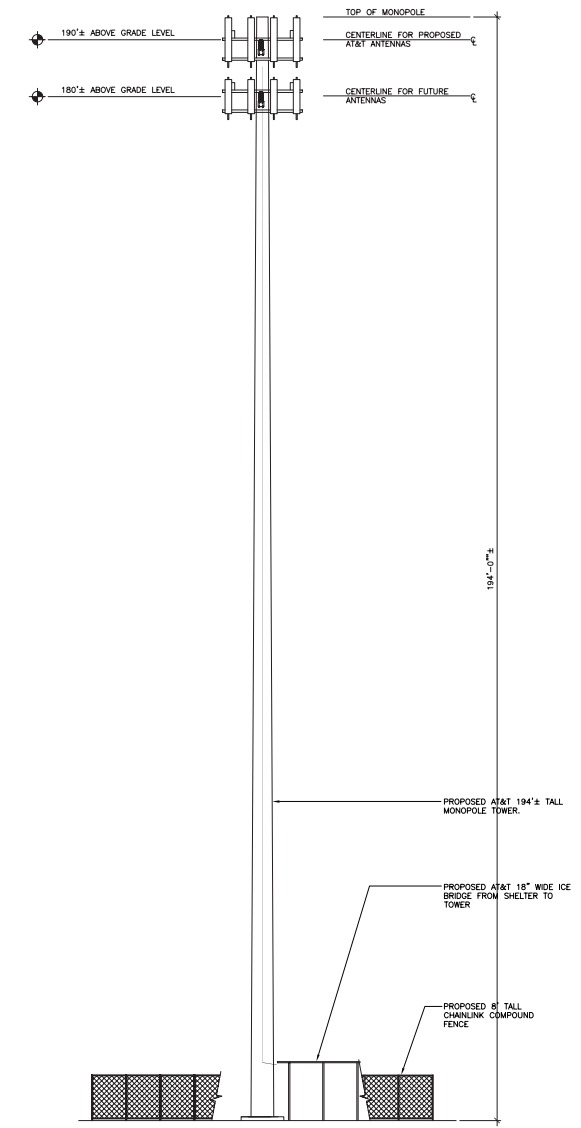

2 TOWER EAST ELEVATION
SCALE: 1"=10'
NORTH

GRAPHIC SCALE
1 inch = 10 ft.

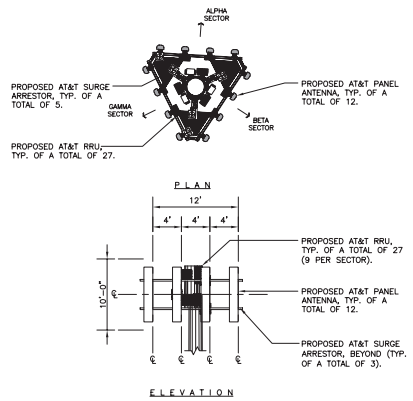

3 ANTENNA MOUNTING CONFIGURATION
SCALE: 1/8"=1'-0"

PROFESSIONAL ENGINEER SEAL	DATE	DESCRIPTION
REVIEW SET NOT FOR CONSTRUCTION		
at&t		
SAIL		
CENTEK Engineering CORPORATION 1000 WASHINGTON ST. SUITE 200 BOSTON, MA 02108 www.Centek.com		
AT&T MOBILITY WIRELESS COMMUNICATIONS FACILITY EAST LYME RELO. CT 0845 (CANDIDATE C) 951A BOSTON POST ROAD EAST LYME, CT 06533	DATE: 04/24/15	
	SCALE: AS NOTED	
	JOB NO.: 15046.000	
SITE DEVELOPMENT PLAN AND MISC. SITE DETAILS		
C-2.0		
Sheet No. 3 of 3		

CO SUBMISSION PACKET – FCC FORM 620

Attachment 5 – Determination of Effect Attachments

You are required to provide two attachments regarding the Determination of Effect: Areas of Potential Effect and Mitigation of Effect (if applicable).

Areas of Potential Effect (APE) Guidelines:

Direct Effects

a. Describe the APE for direct effects and explain how this APE was determined.

The APE for Direct Effects is limited to the area of potential ground disturbance and any property, or any portion thereof, that will be physically altered or destroyed by the construction of the proposed telecommunications facility. Mr. Lucas Karmazinas, Architectural Historian with FuturePast Preservation, reviewed a field survey completed on June 4, 2015 by Mr. David George, Archaeologist with Heritage Consultants, LLC, and determined that the APE for direct effects is limited to the Subject Property building, which includes the lease area as well as the utility and access easements.

No Historic Properties¹ previously listed or formally deemed eligible for the National Register of Historic Places were identified within the APE for Direct Effects.

Visual Effects

b. Describe the APE for visual effects and explain how this APE was determined.

The APE for Visual Effects is the geographic area in which the Undertaking has the potential to introduce visual elements that diminish or alter the setting, including the landscape, where the setting is a character-defining feature of a Historic Property that makes it eligible for listing on the National Register. Mr. Karmazinas reviewed the field survey completed by Mr. George on June 4, 2015 and determined that the APE for visual effects for this project is limited to an area within a 0.5-mile radius of the Project Area.

No Historic Properties previously listed or formally deemed eligible for the National Register of Historic Places were identified within the APE for Visual Effects.

Mitigation of Effect Guidelines:

In the case where an Adverse Visual Effect or Adverse Direct Effect has been determined you must provide the following:

- 1. Copies of any correspondence and summaries of any oral communications with the SHPO/THPO and any consulting parties.
As of the date of this report, there has been no correspondence with the SHPO/THPO.*
- 2. Describe any alternatives that have been considered that might avoid, minimize, or mitigate any adverse effects. Explain the Applicant's conclusion regarding the feasibility of each alternative.*

¹ The Nationwide Programmatic Agreement defines a "Historic Property" as "Any prehistoric or historic district, site, building, structure, or object included in, or eligible for inclusion in, the National Register maintained by the Secretary of the Interior. This term includes artifacts, records, and remains that are related to and located within such properties. The term includes properties of traditional religious and cultural importance to an Indian tribe or NHO that meet the National Register criteria."

Applicant: New Cingular Wireless PCS, LLC

Project Number: CT1931401

Project Location: 351A Boston Post Road, East Lyme, CT, 06333

CO SUBMISSION PACKET – FCC FORM 620

No Historic Properties are present in the APE; therefore alternatives that might avoid, minimize, or mitigate any adverse effects need not be considered. As such, as of the date of this report, there has been no correspondence with the SHPO/THPO regarding mitigation of effect.

Applicant: New Cingular Wireless PCS, LLC

Project Number: CT1931401

Project Location: 351A Boston Post Road, East Lyme, CT, 06333

CO SUBMISSION PACKET – FCC FORM 620

Attachment 6 – Historic Properties Attachment

File reviews of the National Register Database and Massachusetts Cultural Resource Information System were conducted by Lucas Karmazinas, architectural historian with FuturePast Preservation, and Mr. William Keegan, Historical Geographer & GIS Specialist, with Heritage Consultants, LLC, to identify Historic Properties within the APEs for Visual and Direct Effects. Mr. Karmazinas also completed an evaluation of NRHP eligibility, according to the NRHP criteria of eligibility (36 C.F.R. Part 63), for any additional properties identified within the APE for direct or visual effects that may not have been identified during a review of the aforementioned files. The results of these reviews are discussed below, as necessary.

A preliminary archaeological assessment prepared by Mr. David George, archaeologist with Heritage Consultants, LLC, on May 5, 2015, for All-Points Technology corporation, P.C. is also included with these attachments.

Historic Properties Identified within the APE for Direct Effects:

1. *List all properties identified within the APE for direct effects.*
2. *Provide the name and address (including U.S. Postal Service ZIP Code) of each property in the APE for direct effects, not listed in part “a”, that the Applicant considers to be eligible for listing in the National Register as a result of the Applicant’s research. For each such property, describe how it satisfies the criteria of eligibility (36 C.F.R. Part 63). For each property that was specifically considered and determined not to be eligible, describe why it does not satisfy the criteria of eligibility.*
3. *Describe the techniques and the methodology, including any field survey, used to identify historic properties within the APE for direct effects. If no archeological field survey was performed, provide a report substantiating that: i) the depth of previous disturbance exceeds the proposed construction depth (excluding footings and other anchoring mechanisms) by at least 2 feet; or, ii) geomorphological evidence indicates that cultural resource-bearing soils do not occur within the project area or may occur but at depths that exceed 2 feet below the proposed construction depth.*

No Historic Properties previously listed or formally deemed eligible for the National Register of Historic Places were identified within the APE for Direct Effects.

Historic Properties Identified within the APE for Visual Effects:

1. *Provide the name and address (including U.S. Postal Service ZIP Code) of each property in the APE for visual effects that is listed in the National Register, has been formally determined eligible for listing by the Keeper of the National Register, or is identified as considered eligible for listing in the records of the SHPO/THPO, pursuant to Section VI.D.1.a. of the Nationwide Agreement.6*
2. *Provide the name and address (including U.S. Postal Service ZIP Code) of each Historic Property in the APE for visual effects, not listed in part “a”, identified through the comments of Indian Tribes, NHOs, local governments, or members of the public. Identify each individual or group whose comments led to the inclusion of a Historic Property in this attachment. For each such property, describe how it satisfies the criteria of eligibility (36 C.F.R. Part 63).*
3. *For any properties listed in part “a”, that the Applicant considers no longer eligible for inclusion in the National Register, explain the basis for this recommendation.*

Applicant: New Cingular Wireless PCS, LLC

Project Number: CT1931401

Project Location: 351A Boston Post Road, East Lyme, CT, 06333

CO SUBMISSION PACKET – FCC FORM 620

No Historic Properties previously listed or deemed eligible for the National Register of Historic Places were identified within the APE for Visual Effects.

No Historic Properties would be impacted as a result of the proposed facility; therefore alternatives that might avoid, minimize, or mitigate any adverse effects need not be considered.

As of the date of this report, All-Points Technology has not received comments from Indian Tribes, NHOs, local governments, or members of the public that identify Historic Properties in the APE for Direct or Visual Effects.

Applicant: New Cingular Wireless PCS, LLC

Project Number: CT1931401

Project Location: 351A Boston Post Road, East Lyme, CT, 06333



INTEGRATED HISTORIC PRESERVATION PLANNING

May 5, 2015

Ms. Nicole Castro
All-Points Technology Corporation
3 Saddlebrook Drive
Killingworth, CT 06419

RE: Preliminary Archeological Assessment of a Proposed Telecommunications Tower Located at 351A Boston Post Road in East Lyme, Connecticut

Ms. Castro:

Heritage Consultants, LLC, is pleased to have this opportunity to provide All-Points Technology Corporation with the following preliminary archeological assessment of a proposed telecommunications tower located 351A Boston Post Road in East Lyme, Connecticut (Figure 1). The current project entailed completion of an existing conditions cultural resources summary based on the examination of GIS data obtained from the Connecticut State Historic Preservation Office, as well as historical data, aerial photographs, and topographic quadrangles maintained by Heritage Consultants, LLC. This investigation did not consider the effects of the proposed construction upon built resources, and it is based upon project location information provided to Heritage Consultants, LLC by All-Points Technology Corporation. The objectives of this study were to gather and present data regarding previously identified cultural resources situated within 0.8 km (0.5 mi) of the proposed tower location and to investigate the proposed project parcel in terms of its natural and historical characteristics so that the need for completing additional cultural resources investigations could be evaluated.

Figures 2 and 3 show that, although the Boston Post Road crossed the area from east to west near the proposed tower location, the project parcel was unoccupied as of the mid to late nineteenth century. This area consisted of an outlying parcel of land that was likely used as a woodlot. This interpretation is confirmed by Figure 4, an aerial image dating from 1934, which shows the proposed tower location was located within a large wooded parcel of land situated to the northwest of the Boston Post Road. Figure 5, which is an aerial image taken in 1965, documents that no large scale changes had occurred in immediate vicinity of the proposed tower location during the first half of the twentieth century. Figure 6, an aerial image captured in 1990, shows that between 1965 and that time significant development of the project region had taken place, and that the proposed project parcel now is occupied by a residential structure. This home is situated to the west of the proposed tower location. The subsequent aerial image, as seen in Figure 7, shows the area surrounding the proposed tower location in its essentially modern state. This image shows that additional development has occurred around the proposed tower location; however, it remains and forested.

In addition, a review of previously recorded cultural resources on file with the Connecticut State Historic Preservation Office revealed that no archaeological sites or National Register of Historic Places properties have been identified within 0.8 km (0.5 mi) of the proposed tower location (Figures 9 and 10). A

Nicole Castro
May 5, 2015
Page 2

pedestrian survey of the proposed tower location and the associated access road by representatives of Heritage Consultants, LLC was completed on March 28, 2015 (Photos 1 through 11). Visual inspection of the proposed associated access road revealed that it consisted of a previously cleared and disturbed route characterized by very rocky soils and moderate to steep slopes in the east. In addition, a pedestrian survey of the tower location revealed the local topography to be moderately sloping and containing Canton and Charlton soils with slopes of 15 to 35 percent. These soils are extremely rocky and underdeveloped. Thus, the proposed access road and tower location retain little, if any, potential to yield intact prehistoric or historic period cultural deposits. Given the low archaeological potential of the proposed project items, it is the professional opinion of Heritage Consultants, LLC that no additional archaeological research is recommended prior to construction of the proposed tower and its associated facilities.

If you have any questions regarding this Technical Memorandum, or if we may be of additional assistance with this or any other projects you may have, please do not hesitate to call us at 860-667-3001 or email me dgeorge@heritage-consultants.com. We are at your service.

Sincerely,

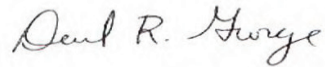

David R. George, M.A., R.P.A

CO SUBMISSION PACKET – FCC FORM 620

Attachment 7 – Tribal and NHO Involvement

At an early stage in the planning process, the Nationwide Agreement requires the Applicant to gather information from appropriate Indian Tribes or Native Hawaiian Organizations (NHOs) to assist in the identification of Historic Properties of religious and cultural significance to them. Describe measures taken to identify Indian tribes and NHOs that may attach religious and cultural significance to Historic Properties that may be affected by the collocation within the Areas of Potential Effects (APE) for direct and visual effects. If such Indian tribes or NHOs were identified, list them and provide a summary of contacts by either the FCC, the Applicant, or the Applicant's representative. Provide copies of relevant documents, including correspondence. If no such Indian tribes or NHOs were identified, please explain.

All-Points Technology Corporation, P.C. completed the Tower Construction Notification System (TCNS) on April 29, 2015. The attached FCC Notification email lists the Tribes identified through the TCNS process. Follow up correspondence, when necessary, will be completed via the methods listed on the attached email considered acceptable to each Tribe.

Applicant: New Cingular Wireless PCS, LLC

Project Number: CT1931401

Project Location: 351A Boston Post Road, East Lyme, CT, 06333

Nicole Castro

From: towernotifyinfo@fcc.gov
Sent: Friday, May 08, 2015 3:01 AM
To: Nicole Castro
Cc: Jonathan.Jonas@fcc.gov; diane.dupert@fcc.gov
Subject: NOTICE OF ORGANIZATION(S) WHICH WERE SENT PROPOSED TOWER CONSTRUCTION NOTIFICATION INFORMATION - Email ID #4195984

Dear Sir or Madam:

Thank you for using the Federal Communications Commission's (FCC) Tower Construction Notification System (TCNS). The purpose of this electronic mail message is to inform you that the following authorized persons were sent the information you provided through TCNS, which relates to your proposed antenna structure. The information was forwarded by the FCC to authorized TCNS users by electronic mail and/or regular mail (letter).

Persons who have received the information that you provided include leaders or their designees of federally-recognized American Indian Tribes, including Alaska Native Villages (collectively "Tribal Nations"), Native Hawaiian Organizations (NHOs), and State Historic Preservation Officers (SHPOs). For your convenience in identifying the referenced Tribal Nations and NHOs and in making further contacts, the City and State of the Seat of Government for each Tribal Nation and NHO, as well as the designated contact person, is included in the listing below. We note that Tribal Nations may have Section 106 cultural interests in ancestral homelands or other locations that are far removed from their current Seat of Government. Pursuant to the Commission's rules as set forth in the Nationwide Programmatic Agreement for Review of Effects on Historic Properties for Certain Undertakings Approved by the Federal Communications Commission (NPA), all Tribal Nations and NHOs listed below must be afforded a reasonable opportunity to respond to this notification, consistent with the procedures set forth below, unless the proposed construction falls within an exclusion designated by the Tribal Nation or NHO. (NPA, Section IV.F.4).

The information you provided was forwarded to the following Tribal Nations and NHOs. If a Tribal Nation or NHO does not respond within a reasonable time, you should make a reasonable effort at follow-up contact, unless the Tribal Nation or NHO has agreed to different procedures (NPA, Section IV.F.5). In the event a Tribal Nation or NHO does not respond to a follow-up inquiry, or if a substantive or procedural disagreement arises between you and a Tribal Nation or NHO, you must seek guidance from the Commission (NPA, Section IV.G). These procedures are further set forth in the FCC's Declaratory Ruling released on October 6, 2005 (FCC 05-176).

1. THPO Marissa Turnbull - Mashantucket Pequot Tribe - Mashantucket, CT - electronic mail
Details: The Mashantucket Pequot Tribal Nation will charge a \$500.00 research fee for all proposed Cell Tower projects and, as of Monday May 26, 2014 will also charge a \$500.00 research fee for all Positive Train Control (PTC) projects.

Please make your check payable to the "Mashantucket Pequot Tribal Nation," and mail to:

Mashantucket Pequot Tribal Nation
Natural Resources Protection & Regulatory Affairs
550 Trolley Line Blvd.

P.O. Box 3202
Mashantucket, CT 06338-3202

For every proposed cell tower project, and for every Positive Train Control (PTC) project, the Mashantucket Pequot Tribal Nation requires a site location map, information regarding project ground disturbance, site plans and a detailed description of the proposed site and project & a copy of any archaeology surveys completed - If the proposed project is to be located on an already existing building, we would like to be informed of that as well.

After we have received the research fee, we will commence our research & review of the proposed cell tower project, and / or the Positive Train Control (PTC) project & make every effort to respond to you within thirty days.

Marissa Turnbull, THPO
Mashantucket Pequot Tribal Nation
mturnbull@mptn-nsn.gov
860-396-7570

2. Deputy THPO Elaine Thomas - Mohegan Indian Tribe - Uncasville, CT - electronic mail and regular mail
Details: The Mohegan Indian Tribe of Connecticut has an interest in all Cell Tower Projects and Positive Train Control Projects that are within the State of Connecticut.

Beginning May 26, 2014 The Mohegan Indian Tribe of Connecticut will charge a \$500.00 research fee per all proposed Cell Tower Projects and Positive Train Control Projects that are within the State of Connecticut. After we have received the research fee, we will commence our research of the proposed Project. The Mohegan Tribe is interested in all notifications of proposed Cell Tower Projects and Positive Train Control Projects that are within the State of Connecticut and will respond to all notifications.

Please make checks payable to The Mohegan THPO, and include, 4990-0300, AA code 52, on all checks along with the TCNS#. Please send checks to: The Mohegan THPO c/o James Quinn, 13 Crow Hill Road, Uncasville, CT 06382.

3. Program Manager-Cell Tower Division Sequahna Mars - Narragansett Indian Tribe - Wyoming, RI - electronic mail and regular mail
Details: NITHPO respectfully requests that additional contacts following initial TCNS notification be made via e-mail to Sequahna Mars, at sequahna@yahoo.com.

NITHPO respectfully requests a site map and photographs for all projects that involve ground disturbance.

Please note that NITHPO's current review fees are as follows:

For projects in which there is to be no ground disturbance the review fee is \$500.

For ALL projects which include ground disturbance, the review fee is \$1000.

4. THPO/NAGPRA Technician Minogheezhig Sandman-Shelifoe - Keweenaw Bay Indian Community - Baraga, MI - electronic mail

Details: The KBIC THPO reviews all projects within historic homelands for the presence of cultural resources with significance to the Anishinaabe. Your request will go through a preliminary review by our THPO/NAGPRA Technician, the review consists of relevant studies submitted by the applicant regarding cultural resources documentation, in house literature search, database search and GIS search for further information. If any cultural resources are identified during this process, the file will be turned over to the Tribal Historic Preservation Officer in order to make a determination of effects.

Information required in order to complete this process are as follows:

Project Name

Project Location

Physical Address

Latitude and Longitude

State, County, Township, Range, Section quarters Brief Project Description Existing studies for archaeological sites, and cultural resources.

As of June 11, 2014 the KBIC THPO will be charging a fee of \$500.00 per review/collocation unless the review covers more than one section of land in which case the fee is \$500.00 per section. Fees in this process cover the research and other activities required to provide you with a timely response so your project can stay on track. Please submit payment of \$500.00 for each project application submitted, checks should be made payable to KBIC THPO, 16429 Beartown Road, Baraga, Michigan 49908. Any questions can be directed to: Minogheezhig Sandman -Shelifoe via email thpo@kbic-nsn.gov, minogheezhig@kbic-nsn.gov or by phone: 906-353-6623 ext. 4278. (Please note that Juliet Goyen is no longer a contact within the KBIC-THPO office)

If the applicant/tower builder receives no response from the Keweenaw Bay Indian Community within 30 days after notification through TCNS, the Keweenaw Bay Indian Community has no interest in participating in pre-construction review for the proposed site. The Applicant/tower builder, however,

must immediately notify the Keweenaw Bay Indian Community in the event archaeological properties or human remains are discovered during construction, consistent with Section IX of the Nationwide Programmatic Agreement and applicable law.

5. THPO and NAGPRA Representative Giiwegiizhigookway Martin - Lac Vieux Desert Band of Lake Superior Chippewa Indians - Watersmeet, MI - electronic mail

Details: Effective May 7, 2014:

To enable us to participate fully, the Ketegitigaaning Ojibwe Nations fee for such services is \$300. The fee must be submitted so that the research can be done. At that time we will review and make our determinations with the appropriate information that we have on file with our Tribe pertaining to this area.

All Collocation Projects will be handled in the same manner as new projects UNLESS the Ketegitigaaning Ojibwe Nation commented on the original project.

Please forward the following information: a short summary of the proposed ground disturbing activity, Legal Description of the Area of Potential Effects, Topo maps identifying the proposed area, and copies of any studies that have already been conducted regarding cultural resources and archaeology in their full format, including reports on archaeological and cultural sites identified.

Should you have any questions, please feel free to contact me at 906-358-0137.

Miigwetch,

giiwegiizhigookway Martin, THPO

Fee can be sent along with the requested information to:

Make Check Payable to:

Ketegitigaaning Ojibwe Nation THPO

P.O. 249

Watersmeet, Michigan 49969

Office: 906-358-0137

Fax: 906-358-4850 Email: gmartin@lvdtribal.com

The information you provided was also forwarded to the following SHPOs in the State in which you propose to construct and neighboring States. The information was provided to these SHPOs as a courtesy for their information and planning. You need make no effort at this time to follow up with any SHPO that does not respond to this notification. Prior to construction, you must provide the SHPO of the State in which you propose to construct (or the Tribal Historic Preservation Officer, if the project will be located on certain Tribal lands), with a Submission Packet pursuant to Section VII.A of the NPA.

6. SHPO Cara Metz - Massachusetts Historical Commission - Boston, MA - electronic mail

7. SHPO Frederick C Williamson - Rhode Island Historic Preservation & Heritage Comm - Providence, RI - regular mail

8. Deputy SHPO Edward F Sanderson - Rhode Island Historic Preservation & Heritage Comm - Providence, RI - electronic mail

9. SHPO Karen J Senich - Connecticut Commission on Culture and Tourism - Hartford, CT - electronic mail

"Exclusions" above set forth language provided by the Tribal Nation or SHPO. These exclusions may indicate types of PTC wayside pole notifications that the Tribal Nation or SHPO does not wish to review. TCNS automatically forwards all notifications to all Tribal Nations and SHPOs that have an expressed interest in the geographic area of a proposal. However, if a proposal falls within a designated exclusion, you need not expect any response and need not pursue any additional process with that Tribal Nation or SHPO. Exclusions may also set forth policies or procedures of a particular Tribal Nation or SHPO (for example, types of information that a Tribal Nation routinely requests, or a policy that no response within 30 days indicates no interest in participating in pre-construction review).

Please be advised that the FCC cannot guarantee that the contact(s) listed above opened and reviewed an electronic or regular mail notification. The following information relating to the proposed tower was forwarded to the person(s) listed above:

Notification Received: 04/29/2015

Notification ID: 126348

Tower Owner Individual or Entity Name: AT&T Mobility d/b/a New Cingular Wireless PCS, LLC (AT&T)

Consultant Name: Nicole Castro Mrs

Street Address: All-Points Technology Corp., P.C.

3 Saddlebrook Drive

City: Killingworth

State: CONNECTICUT

Zip Code: 06419

Phone: 860-663-1697

Email: ncastro@allpointstech.com

Structure Type: MTOWER - Monopole

Latitude: 41 deg 21 min 48.1 sec N

Longitude: 72 deg 14 min 20.2 sec W

Location Description: 351A Boston Post Road

City: East Lyme

State: CONNECTICUT

County: NEW LONDON

Detailed Description of Project: Refer to Site Plans

Ground Elevation: 60.8 meters

Support Structure: 59.1 meters above ground level

Overall Structure: 59.1 meters above ground level

Overall Height AMSL: 119.9 meters above mean sea level

If you have any questions or comments regarding this notice, please contact the FCC using the electronic mail form located on the FCC's website at:

<http://wireless.fcc.gov/outreach/notification/contact-fcc.html>.

You may also call the FCC Support Center at (877) 480-3201 (TTY 717-338-2824). Hours are from 8 a.m. to 7:00 p.m. Eastern Time, Monday through Friday (except Federal holidays). To provide quality service and ensure security, all telephone calls are recorded.

Thank you,
Federal Communications Commission

CO SUBMISSION PACKET – FCC FORM 620

Attachment 8 – Local Government, Other Consulting Parties, and Public Notice

1. *If any local government been contacted and invited to become a consulting party pursuant to Section V.A. of the Nationwide Programmatic Agreement, list the local government agencies contacted. Provide a summary of contacts and copies of any relevant documents (e.g., correspondence or notices).*

All-Points Technology Corporation, P.C. contacted relevant local government agencies on April 30, 2015. The respective correspondence is attached.

2. *If a local government agency will be contacted but has not been to date, explain why and when such contact will take place.*

N/A.

3. *List additional consulting parties that were invited to participate by the Applicant, or independently requested to participate. Provide any relevant correspondence or other documents.*

N/A.

4. *You are required to provide a Public Notice Attachment.*

Attached, please find a copy of the legal notice regarding the proposed telecommunications installation that was posted in *The Day* on May 4, 2015. As of the date of this submission packet, no comments regarding this notice have been received by All-Points Technology Corporation, P.C. Should a response be received, copies will be forwarded to all consulting parties as an addendum to this submission packet.

Applicant: New Cingular Wireless PCS, LLC

Project Number: CT1931401

Project Location: 351A Boston Post Road, East Lyme, CT, 06333



MEMORANDUM

Date: April 30, 2015

To: Mr. Mark C. Nickerson, First Selectman
East Lyme Town Hall
P.O. Box 519
108 Pennsylvania Avenue
Niantic, CT 06357
mnickerson@eltownhall.com
860-739-6931 x110

Re: Proposed Wireless Telecommunications Facility
First Candidate: Property off of Ancient Highway
Second Candidate: 351 Boston Post Road
East Lyme, New London County, CT 06333

To comply with Section 106 of the National Historic Preservation Act (NHPA) of 1966, as amended, AT&T Mobility d/b/a New Cingular Wireless PCS, LLC (AT&T), has retained All-Points Technology Corporation, P.C. (APT) to evaluate wireless telecommunications facilities for any adverse effect it may have on historic properties. As part of this evaluation, and in conformance with the Nationwide Programmatic Agreement (NPA) for review of effects on historic properties for proposed undertakings, APT is submitting this communications tower notification to the Town of East Lyme, Offices of the First Selectman, Town Planner, Zoning Commission, and Historical Properties Commission.

AT&T is proposing to construct a new wireless telecommunications facility at one of two locations in East Lyme, New London County, Connecticut, 06333. The first candidate location is situated off of Ancient Highway and would consist of a 175' tall monopole tower within a 50'x50' fenced gravel equipment compound/lease area. The second candidate is located at 351 Boston Post Road and would consist of a 194' tall monopole tower within a 120'x70' fenced gravel equipment compound/lease area.

The purpose of this letter is to notify you that a revised public notice of this proposed new wireless telecommunications facility will be published in the Day newspaper on May 4, 2015 and to invite comments regarding any potential effects that the facility may have upon historic properties from relevant individuals or groups that you may be aware of.

Parties interested in submitting comments regarding any potential effects of the proposed facility on historic properties may do so by sending them to All-Points Technology Corporation at 3 Saddlebrook Drive, Killingworth, CT 06419, to the attention of Nicole Castro. Questions about this proposed project may be submitted via regular mail to the above address, emailed to ncastro@allpointstech.com, or by calling (860) 663-1697 x213.

APT will be accepting comments and/or questions within 30 days of the date of this publication.



MEMORANDUM

Date: April 30, 2015

To: Mr. Gary A. Goeschel, II
Director of Planning
East Lyme Town Hall
P.O. Box 519
108 Pennsylvania Avenue
Niantic, CT 06357
ggoeschel@eltownhall.com
860-691-4114

Re: Proposed Wireless Telecommunications Facility
First Candidate: Property off of Ancient Highway
Second Candidate: 351 Boston Post Road
East Lyme, New London County, CT 06333

To comply with Section 106 of the National Historic Preservation Act (NHPA) of 1966, as amended, AT&T Mobility d/b/a New Cingular Wireless PCS, LLC (AT&T), has retained All-Points Technology Corporation, P.C. (APT) to evaluate wireless telecommunications facilities for any adverse effect it may have on historic properties. As part of this evaluation, and in conformance with the Nationwide Programmatic Agreement (NPA) for review of effects on historic properties for proposed undertakings, APT is submitting this communications tower notification to the Town of East Lyme, Offices of the First Selectman, Town Planner, Zoning Commission, and Historical Properties Commission.

AT&T is proposing to construct a new wireless telecommunications facility at one of two locations in East Lyme, New London County, Connecticut, 06333. The first candidate location is situated off of Ancient Highway and would consist of a 175' tall monopole tower within a 50'x50' fenced gravel equipment compound/lease area. The second candidate is located at 351 Boston Post Road and would consist of a 194' tall monopole tower within a 120'x70' fenced gravel equipment compound/lease area.

The purpose of this letter is to notify you that public notice of this proposed new wireless telecommunications facility will be published in the Day newspaper on May 4, 2015 and to invite comments regarding any potential effects that the facility may have upon historic properties from relevant individuals or groups that you may be aware of.

Parties interested in submitting comments regarding any potential effects of the proposed facility on historic properties may do so by sending them to All-Points Technology Corporation at 3 Saddlebrook Drive, Killingworth, CT 06419, to the attention of Nicole Castro. Questions about this proposed project may be submitted via regular mail to the above address, emailed to ncastro@allpointstech.com, or by calling (860) 663-1697 x213.

APT will be accepting comments and/or questions within 30 days of the date of this publication.



MEMORANDUM

Date: April 30, 2015

To: Mr. William Mulholland
Zoning Official
East Lyme Town Hall
P.O. Box 519
108 Pennsylvania Avenue
Niantic, CT 06357
billm@eltownhall.com
860-691-4114

Re: Proposed Wireless Telecommunications Facility
First Candidate: Property off of Ancient Highway
Second Candidate: 351 Boston Post Road
East Lyme, New London County, CT 06333

To comply with Section 106 of the National Historic Preservation Act (NHPA) of 1966, as amended, AT&T Mobility d/b/a New Cingular Wireless PCS, LLC (AT&T), has retained All-Points Technology Corporation, P.C. (APT) to evaluate wireless telecommunications facilities for any adverse effect it may have on historic properties. As part of this evaluation, and in conformance with the Nationwide Programmatic Agreement (NPA) for review of effects on historic properties for proposed undertakings, APT is submitting this communications tower notification to the Town of East Lyme, Offices of the First Selectman, Town Planner, Zoning Commission, and Historical Properties Commission.

AT&T is proposing to construct a new wireless telecommunications facility at one of two locations in East Lyme, New London County, Connecticut, 06333. The first candidate location is situated off of Ancient Highway and would consist of a 175' tall monopole tower within a 50'x50' fenced gravel equipment compound/lease area. The second candidate is located at 351 Boston Post Road and would consist of a 194' tall monopole tower within a 120'x70' fenced gravel equipment compound/lease area.

The purpose of this letter is to notify you that public notice of this proposed new wireless telecommunications facility will be published in the Day newspaper on May 4, 2015 and to invite comments regarding any potential effects that the facility may have upon historic properties from relevant individuals or groups that you may be aware of.

Parties interested in submitting comments regarding any potential effects of the proposed facility on historic properties may do so by sending them to All-Points Technology Corporation at 3 Saddlebrook Drive, Killingworth, CT 06419, to the attention of Nicole Castro. Questions about this proposed project may be submitted via regular mail to the above address, emailed to ncastro@allpointstech.com, or by calling (860) 663-1697 x213.

APT will be accepting comments and/or questions within 30 days of the date of this publication.



MEMORANDUM

Date: April 30, 2015

To: Ms. Luane Lange, CLG, Chair
East Lyme Historical Properties Commission
East Lyme Town Hall
P.O. Box 519
108 Pennsylvania Avenue
Niantic, CT 06357
llange@sbcglobal.net
860-739-6949

Re: Proposed Wireless Telecommunications Facility
First Candidate: Property off of Ancient Highway
Second Candidate: 351 Boston Post Road
East Lyme, New London County, CT 06333

To comply with Section 106 of the National Historic Preservation Act (NHPA) of 1966, as amended, AT&T Mobility d/b/a New Cingular Wireless PCS, LLC (AT&T), has retained All-Points Technology Corporation, P.C. (APT) to evaluate wireless telecommunications facilities for any adverse effect it may have on historic properties. As part of this evaluation, and in conformance with the Nationwide Programmatic Agreement (NPA) for review of effects on historic properties for proposed undertakings, APT is submitting this communications tower notification to the Town of East Lyme, Offices of the First Selectman, Town Planner, Zoning Commission, and Historical Properties Commission.

AT&T is proposing to construct a new wireless telecommunications facility at one of two locations in East Lyme, New London County, Connecticut, 06333. The first candidate location is situated off of Ancient Highway and would consist of a 175' tall monopole tower within a 50'x50' fenced gravel equipment compound/lease area. The second candidate is located at 351 Boston Post Road and would consist of a 194' tall monopole tower within a 120'x70' fenced gravel equipment compound/lease area.

The purpose of this letter is to notify you that public notice of this proposed new wireless telecommunications facility will be published in the Day newspaper on May 4, 2015 and to invite comments regarding any potential effects that the facility may have upon historic properties from relevant individuals or groups that you may be aware of.

Parties interested in submitting comments regarding any potential effects of the proposed facility on historic properties may do so by sending them to All-Points Technology Corporation at 3 Saddlebrook Drive, Killingworth, CT 06419, to the attention of Nicole Castro. Questions about this proposed project may be submitted via regular mail to the above address, emailed to ncastro@allpointstech.com, or by calling (860) 663-1697 x213.

APT will be accepting comments and/or questions within 30 days of the date of this publication.

ALL-POINTS TECHNOLOGY CORPORATION, P.C.

3 SADDLEBROOK DRIVE · KILLINGWORTH, CT 06419 · PHONE 860-663-1697 · FAX 860-663-0935

ATTACHMENT 12

June 5, 2015

VIA FEDERAL EXPRESS

First Selectman Mark C. Nickerson
Town of East Lyme
P.O. Box 519
108 Pennsylvania Avenue
Niantic, Connecticut 06357

Re: American Tower Company & Ancient Highway Towers, LLC
AT&T & T-Mobile Wireless Services
One Proposed Wireless Telecommunications Tower Facility
Site A: Ancient Highway, East Lyme, Connecticut, or
Site B: 351 Boston Post Road, East Lyme, Connecticut

Dear First Selectman Nickerson:

We are writing to you on behalf of our client New Cingular Wireless PCS, LLC ("AT&T") and American Tower Company, Ancient Highway Towers, LLC and T-Mobile with respect to the above captioned matter. This project involves a proposed wireless telecommunications tower facility at one of two locations and would replace service from an existing tower site located in The Orchards development. The purpose of our letter is to formally commence a municipal consultation process prior to an application being filed with the State Siting Council in accordance with state statutes.

As you know from the proceedings in Petition 1152 before the State Siting Council, the existing tower in The Orchards is slated for decommissioning when the lease term expires. It is our understanding that the property owners in The Orchards have elected not to enter into long term renewal of the lease necessitating removal of this existing tower site.¹ AT&T and T-Mobile both provide services to the public from this existing tower site location and are pursuing long term replacement facilities to avoid interruptions in service and continue to provide reliable mobile connectivity in this part of East Lyme.

Enclosed you will find two (2) detailed Technical Reports for two alternative tower site locations. The first involves a tower site located off of Ancient Highway on a parcel of land that is undeveloped and controlled by Ancient Highway Towers, LLC ("Site A"). The second is located on a residential parcel of land along Boston Post Road and controlled by American Tower Company ("Site B"). AT&T and T-Mobile would both locate wireless facilities at either Site A or Site B to provide services to the public in this area of East Lyme, Connecticut.

The Technical Reports contain detailed information on the wireless services that would be provided by a replacement tower at either Site A or Site B, the approximately 30 sites evaluated as part of the siting process to date, a process which was undertaken by several different companies. Additionally, the Technical Reports contain plans, preliminary viewshed maps,

¹ The lease as just recently amended provides for 1 additional year of term and expires in 2016.

wetland reports and other information on the environmental effects of the tower sites. As noted therein, other state and federal environmental consultations are ongoing.

The enclosed Technical Reports are being filed in accordance with Section 16-50I of the Connecticut General Statutes, which requires consultation with a municipality in which a tower facility is proposed. State law also requires our correspondence be sent directly to your office and several municipal agencies that are copied on this letter. We have also copied the Town's counsel as well.

The purpose of local consultation is to give the municipality in which a facility has been proposed an opportunity to provide the prospective applicants with information it may have prior to the filing of an application with the Siting Council. Consultation also affords an opportunity for public input. Because jurisdiction over any proposed cellular tower facility ultimately rests exclusively with the Connecticut Siting Council and would be in lieu of local zoning, wetlands and other types of municipal land use review and approvals, the consultation process is also intended to facilitate discussion of any municipal recommendations or siting preferences before a State application is filed.

To start off the consultation process, the project team would like to schedule a meeting in East Lyme with you and/or other municipal officials to discuss procedural next steps. Ideally, we would meet in the next two weeks, coordinate a date for a publicly noticed balloon test and also discuss a time and location for a public information session sometime in July as permitted by Section 16-50I(g) of state statutes. Since there are certain timing requirements related to municipal consultations, I will follow this submission with a phone call to your counsel in an effort to coordinate further including our request to meet with you and other Town officials.

In the interim, thank you for your consideration of this letter and its enclosures.

Very truly yours,



Christopher B. Fisher

Enclosures

cc: Tracy Collins, Esq., Town Attorney
Planning Commission, Town of East Lyme
Zoning Commission, Town of East Lyme
Inland Wetlands Commission, Town of East Lyme
Conservation and Natural Resources Commission, Town of East Lyme
American Tower Company
Ancient Highway Tower, LLC
AT&T
T-Mobile

June 29, 2015

VIA EMAIL

First Selectman Mark C. Nickerson
Town of East Lyme
P.O. Box 519
108 Pennsylvania Avenue
Niantic, Connecticut 06357

Re: Proposed Wireless Telecommunications Tower Facility – Balloon Floats
Site A: Ancient Highway, East Lyme, Connecticut, or
Site B: 351 Boston Post Road, East Lyme, Connecticut

Dear First Selectman Nickerson:

We are writing to you on behalf of our client New Cingular Wireless PCS, LLC (“AT&T”) and American Tower Company, Ancient Highway Towers, LLC and T-Mobile with respect to the above captioned matter in furtherance of our initial consultation this past Thursday. AT&T’s consultants have advised us that the weather conditions look favorable for a balloon test tomorrow, June 30, 2015. As such, they are planning to do some field work, including a balloon test at each site starting in the morning. Balloons will be floated in order for AT&T’s consultants to collect field data and prepare further visual information, including photosimulations, for presentation at the July 29, 2015 public information session being scheduled for this project. AT&T’s consultants may also be collecting visual data on a potential third tower site location while in the field tomorrow. If Mr. Goeschel has any suggested viewpoints he would like, photo documented, he may email those directly to Mr. Michael Libertine at milibertine@allpointstech.com. At your request, we are also copying counsel for various East Lyme residents that have expressed an interest in this project.

Very truly yours,

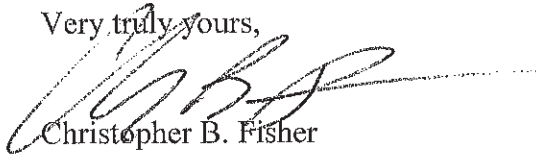

Christopher B. Fisher

cc: Tracy Collins, Esq.
Gary Goeschel
Keith Ainsworth, Esq.
American Tower Company
Ancient Highway Tower, LLC
AT&T
T-Mobile

ATTACHMENT 13

CERTIFICATION OF SERVICE

I hereby certify that on the 29th of September 2015, a copy of the foregoing notice was mailed by certified mail, return receipt requested to each of the abutting properties owners on the accompanying list.

9/29/15
Date



Christopher B. Fisher
Cuddy & Feder LLP
445 Hamilton Avenue, 14th Floor
White Plains, New York 10601

Attorneys for:
American Tower Corp. ("ATC") and
New Cingular Wireless PCS, LLC ("AT&T")

ADJACENT PROPERTY OWNERS
351A Boston Post Road

Orchards at East Lyme, Inc. PO Box 55071 # 16230 Boston, MA 02205	Heather Tooker 342 Boston Post Rd East Lyme, CT 06333
Howard C & Diane R. Cioci 359 Boston Post Rd East Lyme, CT 06333	Jeanette D'Anne Lefebvre PO Box 646 East Lyme, CT 06333
Leonide & Joan Martin 353 Boston Post Rd East Lyme, CT 06333	Richard W. & Evelyn A. Perry 351B Boston Post Rd East Lyme, CT 06333
Bonnie L. Decosta 351A Boston Post Rd East Lyme, CT 06333	Kirk Peterson 341 Boston Post Rd East Lyme, CT 06333
Jeffrey Beaudry & Candice Divita 349 Boston Post Rd East Lyme, CT 06333	Nancy M. Birchall 339 Boston Post Rd East Lyme, CT 06333
Robert H. Lindner 347 Boston Post Rd East Lyme, CT 06333	Cynthia L. & Lewis J. Mostowy 335 Boston Post Rd East Lyme, CT 06333

September __, 2015

VIA CERTIFIED MAIL

[addressee]

Re: New Cingular Wireless PCS, LLC (“AT&T”) & American Tower Corporation (“ATC”)
Proposed Wireless Telecommunications Tower Facility
351A Boston Post Road, East Lyme Connecticut

Dear _____:

We are writing to you on behalf of New Cingular Wireless PCS, LLC (“AT&T”) and American Tower Corp. (“ATC”) with respect to the above referenced matter and the companies’ intent to file an application with the State of Connecticut Siting Council for approval of a proposed wireless communications tower facility (the “Facility”) within the Town of East Lyme.

State law requires that record owners of property abutting a parcel on which a facility is proposed be sent notice of an applicant’s intent to file an application with the Siting Council. The tower facility is proposed at 351A Boston Post Road and would replace the existing nearby tower in the Orchards development.

Included with this letter please find a Notice with details of the proposed Facility and the Applicants’ intent to file an application with the State. Of note, the location, height and other features of the Facility are subject to review and potential change by the Connecticut Siting Council under the provisions of Connecticut General Statutes §16-50g et seq.

If you have any questions concerning this application, please contact the Connecticut Siting Council or the undersigned after October 2, 2015, the date which the application is expected to be on file.

Very truly yours,

Christopher B. Fisher
Enclosure

NOTICE

Notice is hereby given, pursuant to Section 16-50l(b) of the Connecticut General Statutes and Section 16-50l-1(e) of the Regulations of Connecticut State Agencies of an Application to be filed with the Connecticut Siting Council (“Siting Council”) on or after October 1, 2015 by American Tower Corp. and New Cingular Wireless PCS, LLC (the “Applicants”) for a certificate of environmental compatibility and public need for the construction and maintenance of a replacement wireless telecommunications tower facility in East Lyme, Connecticut.

A replacement tower is being proposed by the Applicants for service that will be disrupted when an existing 150’ tall tower located off of Scott Road and Plum Hill Road is decommissioned. The replacement tower facility is proposed on property located at 351A Boston Post Road in East Lyme. The proposed facility consists of a 194-foot tall self-supporting monopole tower and a 7,000 square foot tower compound in the northern portion of the parcel. AT&T would install up to twelve (12) panel antennas and related equipment at a centerline height of 190’ above grade level (AGL) on the tower. An associated 11’ 5” x 16’ unmanned equipment shelter would be installed together with a back-up power generator in the compound. The proposed tower and equipment compound will be enclosed by an eight (8) foot tall fence. The compound and tower will be designed to accommodate space for other carriers including T-Mobile. Vehicular access to the facility will be provided from Boston Post Road over an existing access drive, then over a proposed gravel access drive a total distance of approximately 650’ to the tower compound.

The location, height and other features of the Facility are subject to review and potential change under provisions of the Connecticut General Statutes Sections 16-50g et. seq. The Facility is being proposed to allow AT&T to replace wireless services in this area of the State from the tower site to be decommissioned. The Application will explain the need, purpose and benefits of the Facility and also describe the environmental effects of the proposed Facility. The Facility will be available for co-location by other wireless carriers.

A balloon, representative of the height of the proposed Facility, will be flown at the proposed site on the first day of the Siting Council public hearing on the Application, or such other date specified by the Siting Council and a time to be determined by the Siting Council, but anticipated to be between the hours of 12pm and 5pm.

Interested parties and residents are invited to review the Application during normal business hours after October 2, 2015 at any of the following offices:

Connecticut Siting Council
10 Franklin Square
New Britain, Connecticut 06051

Town of East Lyme
Town Clerk
PO Box 519
Niantic, CT 06357

or the offices of the undersigned. All inquiries should be addressed to the Connecticut Siting Council or to the undersigned.

Christopher B. Fisher, Esq.
Cuddy & Feder LLP
445 Hamilton Ave, 14th Floor
White Plains, New York 10601
(914) 761-1300
Attorneys for the Applicants

ATTACHMENT 14

CERTIFICATION OF SERVICE

I hereby certify that on the ___ day of _____ 2015, copies of this Application and Attachments for a Certificate of Environmental Compatibility and Public Need for the Construction, Maintenance and Operation of a Wireless Telecommunications Facility were sent by certified mail, return receipt requested, to the following:

Dated _____

Cuddy & Feder LLP
445 Hamilton Avenue, 14th Floor
White Plains, New York 10601
Attorneys for the Applicants:
American Tower Corp (“ATC”) and
New Cingular Wireless PCS LLC (“AT&T”)

State and Regional

The Honorable George Jepsen
Attorney General
Office of the Attorney General
55 Elm Street
Hartford, CT 06106

Connecticut Department of Emergency
Services & Public Protection
Division of Emergency Management and
Homeland Security
Dora B. Schiro, Commissioner
25 Sigourney Street, 6th Floor
Hartford, CT 06106-5042

Department of Energy & Environmental
Protection
Rob Klee, Commissioner
79 Elm Street
Hartford, CT 06106

Department of Economic & Community
Development
Catherine Smith, Commissioner
505 Hudson Street
Hartford, CT 06106

Department of Public Health
Dr. Jewel Mullen, Commissioner
410 Capitol Avenue
P.O. Box 340308
Hartford, CT 06134

Department of Transportation
James P. Redeker, Commissioner
2800 Berlin Turnpike
Newington, CT 06111

Council on Environmental Quality
Susan D. Merrow, Chair
79 Elm Street
Hartford, CT 06106

Department of Agriculture
Steven Reviczky, Commissioner
165 Capitol Avenue
Hartford, CT 06106

Department of Energy & Environmental
Protection
Public Utilities Regulatory Authority
Chairman Arthur House
Ten Franklin Square
New Britain, CT 06051

State House Representative 37th District
Ed Jutila
Connecticut House Democrats
L.O.B. Room 4046
Hartford, CT 06106

Office of Policy and Management
Benjamin Barnes, Secretary
450 Capitol Avenue
Hartford, CT 06106-1379

State Senator District S20
Paul M. Formica
Legislative Office Building
Room 3400
Hartford, CT 06106

Department of Economic and Community
Development-Offices of Culture and
Tourism
Daniel Forrest, State Historic Preservation
Officer
One Constitution Plaza, 2nd Floor
Hartford, CT 06103

James S. Butler, Executive Director
Southeastern Connecticut Council of
Governments
5 Connecticut Avenue
Norwich, CT 06360

Federal

Federal Aviation Administration
800 Independence Avenue, SW
Washington, DC 20591

United States Senator Richard Blumenthal
90 State House Square, 10th Floor
Hartford, CT 06103

Federal Communications Commission
445 12th Street SW
Washington, D.C. 20554

United States Senator Christopher S.
Murphy
One Constitution Plaza, 7th Fl.
Hartford, Connecticut 06103

Congressman Joe Courtney
2nd Congressional District
55 Main Street, Suite 250
Norwich, CT 06360

Town of East Lyme

First Selectman Mark C. Nickerson
Town of East Lyme
P.O. Box 519
108 Pennsylvania Avenue
Niantic, CT 06357

Lesley Blais, Town Clerk
Town of East Lyme
P.O. Box 519
108 Pennsylvania Avenue
Niantic, CT 06357

Inland Wetlands Agency
Cheryl Lozanov, Chairwoman
Town of East Lyme
P.O. Box 519
108 Pennsylvania Avenue
Niantic, CT 06357

Planning Commission
Brian Schuch, Chairman
Town of East Lyme
P.O. Box 519
108 Pennsylvania Avenue
Niantic, CT 06357

Conservation of Natural Resources
Commission
Arthur Carlson, Chairman
Town of East Lyme
P.O. Box 519
108 Pennsylvania Avenue
Niantic, CT 06357

Zoning Commission
Marc Salerno, Chairman
Town of East Lyme
P.O. Box 519
108 Pennsylvania Avenue
Niantic, CT 06357

ATTACHMENT 15

Application Guideline	Location in Application
(A) An Executive Summary on the first page of the application with the address, proposed height, and type of tower being proposed. A map showing the location of the proposed site should accompany the description;	1.B: Executive Summary, page 1 Attachment 3: Description and Design of Proposed Facility
(B) A brief description of the proposed facility, including the proposed locations and heights of each of the various proposed sites of the facility, including all candidates referred to in the application;	1.B: Executive Summary, page 1 4.C: Facility Design: page 15
(C) A statement of the purpose for which the application is made;	1.A: Purpose and Authority, page 1
(D) A statement describing the statutory authority for such application;	1.A: Purpose and Authority, page 1
(E) The exact legal name of each person seeking the authorization or relief and the address or principle place of business of each such person. If any applicant is a corporation, trust, or other organized group, it shall also give the state under the laws of which it was created or organized;	1.C: The Applicant, page 5-6
(F) The name, title, address, and telephone number of the attorney or other person to whom correspondence or communications in regard to the application are to be addressed. Notice, orders, and other papers may be served upon the person so named, and such service shall be deemed to be service upon the applicant;	1.C: The Applicant, page 5-6
(G) A statement of the need for the proposed facility with as much specific information as is practicable to demonstrate the need including a description of the proposed system and how the proposed facility would eliminate or alleviate any existing deficiency or limitation;	3.A: Statement of Need, page 7 Attachment 1: Statement of Need with Report
(H) A statement of the benefits expected from the proposed facility with as much specific information as is practicable;	3.B: Statement of Benefits, page 12
(I) A description of the proposed facility at the proposed prime and alternative sites including: <ol style="list-style-type: none"> (1) Height of the tower and its associated antennas including a maximum "not to exceed height" for the facility, which may be higher than the height proposed by the Applicant; (2) Access roads and utility services; (3) Special design features; (4) Type, size, and number of transmitters and receivers, as well as the signal frequency and conservative worst-case and estimated operational level approximation of electro magnetic radiofrequency power density levels (facility using FCC Office of Engineering and Technology Bulletin 65, August 1997) at the base of the tower base, site compound boundary where persons are likely to be exposed to maximum power densities from the facility; (5) A map showing any fixed facilities with which the proposed facility would interact; (6) The coverage signal strength, and integration of the proposed facility with any adjacent fixed facility, to be accompanied by multi-colored propagation maps of red, green and yellow (exact colors may differ depending on computer modeling used, but a legend is required to explain each color used) showing interfaces with any adjacent service areas, including a map scale and north arrows; and (7) For cellular systems, a forecast of when maximum capability would be reached for the proposed facility and for facilities that would be integrated with the proposed facility. 	1.B. Executive Summary, page 1 4.C: Facility Design, page 15 Attachments 3 and 4: Description and Design of Proposed Facility Attachment 5: Environmental Assessment 6.C: Power Density, page 18, Attachment 7 Attachment 1: Statement of Need with Report Attachment 1: Statement of Need with Report
(J) A description of the named sites, including : <ol style="list-style-type: none"> (1) The most recent U.S.G.S. topographic quadrangle map (scale 1 inch = 2000 feet) marked to show the site of the facility and any significant 	Attachments 3 and 4: Description and Design of Proposed Facility

Application Guideline	Location in Application
<p>changes within a one mile radius of the site;</p> <p>(2) A map (scale not less than 1 inch = 200 feet) of the lot or tract on which the facility is proposed to be located showing the acreage and dimensions of such site, the name and location of adjoining public roads or the nearest public road, and the names of abutting owners and the portions of their lands abutting the site;</p> <p>(3) A site plan (scale not less than 1 inch = 40 feet) showing the proposed facility, set back radius, existing and proposed contour elevations, 100 year flood zones, waterways, and all associated equipment and structures on the site;</p> <p>(4) Where relevant, a terrain profile showing the proposed facility and access road with existing and proposed grades; and</p> <p>(5) The most recent aerial photograph (scale not less than 1 inch = 1000 feet) showing the proposed site, access roads, and all abutting properties.</p>	<p>Attachments 8: Visual Analysis Report</p>
<p>(K) A statement explaining mitigation measures for the proposed facility including:</p> <p>(1) Construction techniques designed to specifically minimize adverse effects on natural areas and sensitive areas;</p> <p>(2) Special design features made specifically to avoid or minimize adverse effects on natural areas and sensitive areas, including but not limited to a yield point, if applicable;</p> <p>(3) Establishment of vegetation proposed near residential, recreation, and scenic areas; and</p> <p>(4) Methods for preservation of vegetation for wildlife habitat and screening; and</p> <p>(5) Other environmental concerns identified by the applicant, the Council, or any public agency, including but not limited to, where applicable: Coastal Consistency Analysis, Connecticut Heritage Areas, Ridgeline Protection Zones, DOT Scenic Lands, State Parks and Forests, Agricultural Lands, Wild and Scenic Rivers, Protected Rivers, Endangered, Threatened or Special Concern Species</p>	<p>Attachments 3 and 4: Description and Design of Proposed Facility</p> <p>Attachment 5: Environmental Assessment</p> <p>6: Environmental Effects, page 16-17</p> <p>Attachments 6, 9-11</p>
<p>(L) A description of the proposed site and any alternative sites, including the zoning classification, planned land uses and surrounding areas;</p>	<p>7.C.: Planned and Existing Land Uses, page 23</p>
<p>(M) A description of the scenic, natural, historic, and recreational characteristics of the proposed sites and any alternative sites and surrounding areas including but not limited to officially designated nearby hiking trails, nature preserves and scenic roads;</p>	<p>6: Environmental Effects, page 16-19</p> <p>Attachment 5: Environmental Assessment</p> <p>Attachments 8: Visual Analysis Report</p>
<p>(N) Visibility Analyses of the proposed site area and any alternative site areas including, but not limited to:</p> <p>(1) A viewshed analysis consisting of a two-mile radius from visually impacted areas such as residential developments, recreational areas, and historic sites;</p> <p>(2) Photographic documentation;</p> <p>(3) Balloon float photographs;</p> <p>(4) Photographic simulations in "leaf-on" and "leaf-off" conditions, where possible, and;</p> <p>(5) If proposed in close proximity to a shoreline, including lakes and rivers, photographic documentation from open waters, where possible.</p> <p>(N-a) An affidavit for each balloon float conducted at the proposed site and any alternative sites including the date, time and demonstrated height.</p>	<p>Attachment 8: Visual Analysis Report</p> <p>6.A. Visual Assessment, page 17</p>
<p>(O) A list describing the type and height of all existing and proposed towers and facilities within a four mile radius within the site search area,</p>	<p>Attachment 2: Existing Facilities List</p>

Application Guideline	Location in Application
or within any other area from which use of the proposed towers might be feasible from a location standpoint for purposes of the application;	
(P) A description of efforts to share existing towers, including but not limited to installations on electric transmission poles, or to consolidate telecommunications antennas of public and private services onto the proposed facility including efforts to offer tower space, where feasible, at no charge for space for municipal antennas;	1.B: Executive Summary, page 1 4.A: Site Selection, page 14 4.B: Tower Sharing, page 15 5: Facility Design, page 15 Attachment 2: Site Search Summary
(Q) A description of the technological alternatives and a statement containing justification for the proposed facility;	3.C: Technological Alternatives, page 13 Attachment 1: Statement of Need with Report
(R) A description of rejected sites with a U.S.G.S. topographic quadrangle map (scale 1 inch = 2,000 feet) marked to show the location of rejected sites;	4.A: Site Selection, page 14 Attachment 2: Site Search Summary
(S) A detailed description and justification for the site(s) selected, including a description of siting criteria and the narrowing process by which other possible sites were considered and eliminated, including, but not limited to, environmental effects, cost differential, coverage lost or gained, potential interference with other facilities, and signal loss due to geographical features compared to the proposed site(s);	4.A: Site Selection, page 14 Attachment 2: Site Search Summary
(T) A statement describing hazards to human health, if any, with such supporting data including signal frequency, power density and references to regulatory standards;	6: Environmental Effects, page 16-19
(U) A statement of estimated costs for site acquisition, construction, and equipment for a facility at the various proposed sites of the facility, including all candidates referred to in the application;	9.A: Overall Estimated Cost, page 24
(V) A schedule showing the proposed program of site acquisition, construction, completion, operation and relocation or removal of existing facilities for the named sites;	9.B: Overall Scheduling, page 25
(W) A statement indicating that, weather permitting, the applicant will raise a balloon with a diameter of at least three feet, at the sites of the various proposed sites of the facility, including all candidates referred to in the application, on the day of the Council's first hearing session on the application or at a time otherwise specified by the Council. For the convenience of the public, this event shall be publicly noticed at least 30 days prior to the hearing on the application as scheduled by the Council; An affidavit of the balloon float conducted on the day of the first hearing session including the date, time, demonstrated height and weather condition shall be filed with the Council as soon as is practicable; and	6.A: Visual Assessment, page 17
(X) Such information as any department or agency of the state exercising environmental controls may, by regulation, require including: 1. A listing of any Federal, State, regional, district, and municipal agencies, including but not limited to the Federal Aviation Administration; Federal Communications Commission; State Historic Preservation Officer; State Department of Environmental Protection; and local conservation, inland wetland, and planning and zoning commissions with which reviews were conducted concerning the facility, including a copy of any agency	6: Environmental Effects, page 16-19 Attachment 9: CTDEEP Correspondence 7: Consistency with Town of East Lyme's Land Use Regulations, page 20-23

Application Guideline	Location in Application
<p>position or decision with respect to the facility; and</p> <p>2. The most recent conservation, inland wetland, zoning, and plan of development documents of the municipality, including a description of the zoning classification of the site and surrounding areas, and a narrative summary of the consistency of the project with the Town's regulations and plans.</p>	Bulk Filing
<p>(Y) Description of proposed site clearing for access road and compound including type of vegetation scheduled for removal and quantity of trees greater than six inches diameter at breast height and involvement with wetlands;</p>	<p>5: Facility Design, page 15</p> <p>Attachments 3 and 4</p>
<p>(Z) Such information as the applicant may consider relevant.</p>	Attachment 1-Docket 67 Findings of Fact, Opinion and Decision and Order