

65° Single Band Panel Antenna, 6'

Antenna	
Single Band (MHz)	698–894
Dual Polarization	X
HPBW	65°
Adj. Electrical Downtilt <small>Manual or optional remote control</small>	0°–10°

General specifications:

Frequency range	698–894 MHz
VSWR	<1.5:1
Impedance	50 ohms
Intermodulation (2x20w)	IM3: <-150 dBc
Polarization	+45° and -45°
Maximum input power	500 watts per input (at 50°C)
Connector	2 x 7-16 DIN female (long neck) (bottom mounted)
Isolation	>30 dB
Electrical downtilt	0–10 degrees (continuously adjustable)

See reverse for order information.

Specifications:	698–806 MHz	824–894 MHz
Gain	15.5 dBi	16 dBi
Front-to-back ratio	>30 dB (co-polar) 35 dB (average)	>30 dB (co-polar) 35 dB (average)
+45° and -45° polarization horizontal beamwidth	67° (half-power)	65° (half-power)
+45° and -45° polarization vertical beamwidth	11.3° (half-power)	10° (half-power)
Min. sidelobe suppression for first sidelobe above main beam average	0° 5° 10° T 16 17 17 dB 16 19 20 dB	0° 5° 10° T 18 17 16 dB 20 20 20 dB
Cross polar ratio		
Main direction 0°	25 dB (typical)	25 dB (typical)
Sector ±60°	>11 dB, Average: 15 dB	>11 dB, Average: 15 dB

IRT specifications:

Logical interface ex factory ¹	3GPP/AISG 2.0
Protocols	AISG 1.1 and 3GPP/AISG 2.0 compliant
Hardware interface ²	2 x 8 pin connector acc. IEC 60130-9; according to AISG: – IRT in (male): Control / Daisy chain in – IRT in (female): Daisy chain out
Power supply	10–30 V
Power consumption	<1 watt (standby) <8.5 watts (motor activated)
Adjustment time (full range)	40 sec.
Adjustment cycles	>50,000
Certification	FCC 15.107 Class B Computing Devices

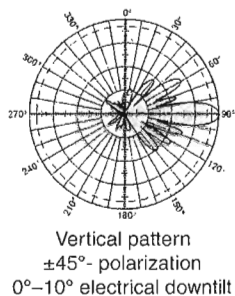
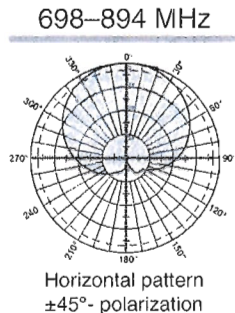

¹⁾ The protocol of the logical interface can be switched from 3GPP/AISG 2.0 to AISG 1.1 and vice versa with a vendor specific command. Start-up operation of the RCU 86010149 is possible in an RET system supporting AISG 1.1 or supporting 3GPP/AISG 2.0 after performing a layer 2 reset before address assignment. The protocol can also be changed as follows: AISG 1.1 to 3GPP: Enter "3GPP" into the additional data field "Installer's ID" and perform a layer 7 reset or a power reset. 3GPP to AISG 1.1: Enter "AISG 1" into the additional data field "Installer's ID" and perform a layer 2 reset or a power reset. After switching the protocol any other information can be entered into the "Installer's ID" field.

²⁾ The tightening torque for fixing the connector must be 0.5–1.0 Nm ("hand-tightened"). The connector should be tightened by hand only!

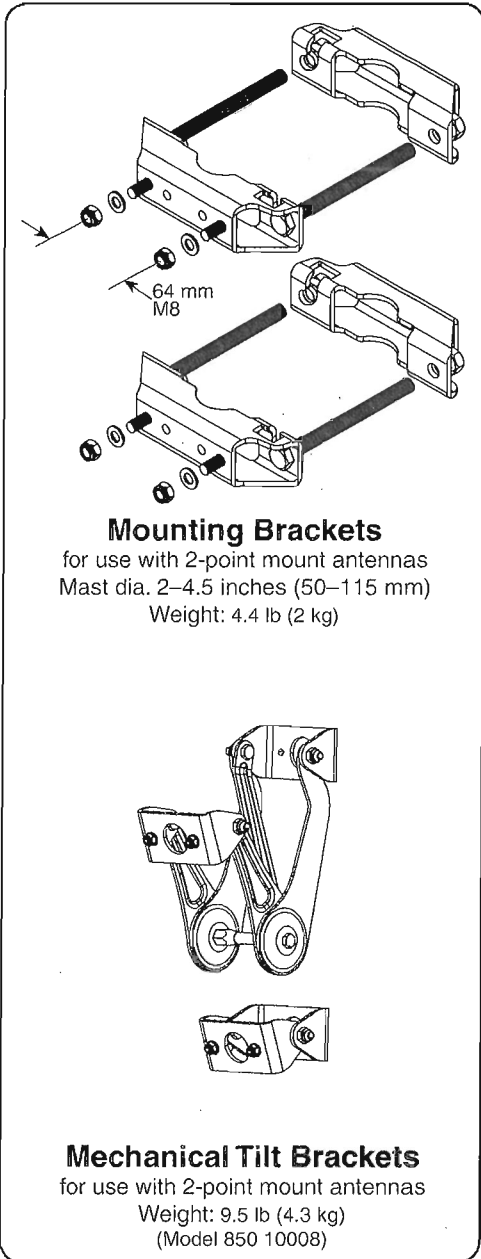

Mechanical specifications:

Weight	30.9 lb (14 kg)	35.3 lb (16 kg) clamps included
Dimensions H x W x D	76.1 x 11.9 x 3.9 inches (1934 x 303 x 99 mm)	
Wind load	at 93 mph (150kph)	
Front/Side/Rear	203 lbf / 70 lbf / 232 lbf (900 N / 310 N / 1030 N)	
Mounting category	H (Heavy)	
Wind survival rating*	150 mph (240 kph)	
Shipping dimensions	81.1 x 12.4 x 4.5 inches (2060 x 315 x 115 mm)	
Shipping weight	39.7 lb (18 kg)	
Mounting bracket	2-point hot-dip galvanized with stainless steel hardware for 2 to 4.5 inch (50 to 115 mm) OD masts.	

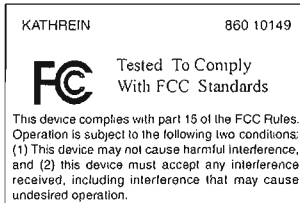

Note: Refer to part number 860 10149 for the specifications of the remote control actuator.

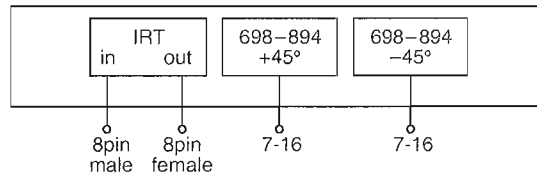
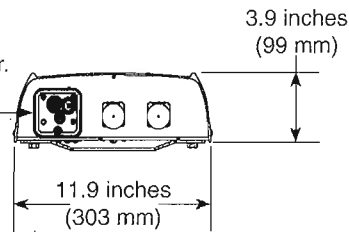
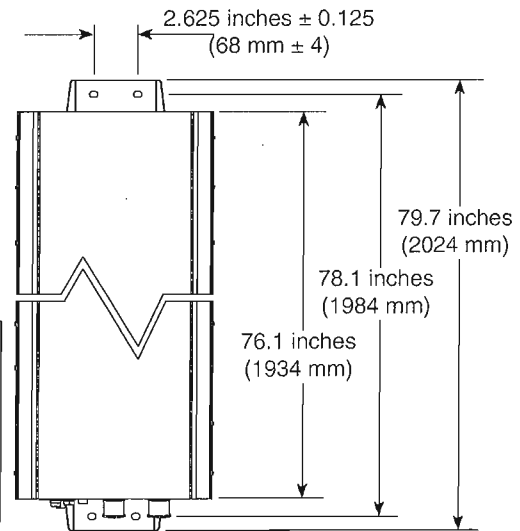

Order Information:

Model	Description
800 10735V01	Antenna with mounting bracket 0°–10° electrical downtilt
800 10735V01K	Antenna with mounting bracket and mechanical tilt bracket 0°–10° electrical downtilt

* Mechanical design is based on environmental conditions as stipulated in TIA-222-G-2 (December 2009) and/or ETS 300 019-1-4 which include the static mechanical load imposed on an antenna by wind at maximum velocity. See the Engineering Section of the catalog for further details.

All specifications are subject to change without notice. The latest specifications are available at www.kathrein-scala.com.

Kathrein Inc., Scala Division Post Office Box 4580 Medford, OR 97501 (USA) Phone: (541) 779-6500 Fax: (541) 779-3991
Email: communications@kathrein.com Internet: www.kathrein-scala.com



HBXX-6516DS-VTM

Andrew® Quad Port Antenna, 1710–2180 MHz, 65° horizontal beamwidth, RET compatible

- Each DualPol® array can be independently adjusted for greater flexibility
- Excellent gain, VSWR, front-to-back ratio, and PIM specifications for robust network performance
- Ideal choice for site collocations and tough zoning restrictions
- Great solution to maximize network coverage and capacity

Electrical Specifications

Frequency Band, MHz	1710–1880	1850–1990	1920–2180
Gain, dBi	17.7	18.0	18.0
Beamwidth, Horizontal, degrees	67	66	64
Beamwidth, Vertical, degrees	7.5	7.0	6.6
Beam Tilt, degrees	0–10	0–10	0–10
USLS, dB	18	18	18
Front-to-Back Ratio at 180°, dB	30	30	30
CPR at Boresight, dB	22	22	21
CPR at Sector, dB	8	9	9
Isolation, dB	30	30	30
VSWR Return Loss, dB	1.4 15.6	1.4 15.6	1.4 15.6
PIM, 3rd Order, 2 x 20 W, dBc	-153	-153	-153
Input Power per Port, maximum, watts	350	350	350
Polarization	±45°	±45°	±45°
Impedance	50 ohm	50 ohm	50 ohm

Electrical Specifications, BASTA*

Frequency Band, MHz	1710–1880	1850–1990	1920–2180
Gain by all Beam Tilts, average, dBi	17.2	17.2	17.5
Gain by all Beam Tilts Tolerance, dB	±0.3	±0.3	±0.5
	0 ° 17.0	0 ° 17.1	0 ° 17.4
Gain by Beam Tilt, average, dBi	5 ° 17.3	5 ° 17.4	5 ° 17.7
	10 ° 17.0	10 ° 17.0	10 ° 17.2
Beamwidth, Horizontal Tolerance, degrees	±2.7	±2.3	±3.5
Beamwidth, Vertical Tolerance, degrees	±0.5	±0.4	±0.4
USLS, dB	18	19	19
Front-to-Back Total Power at 180° ± 30°, dB	26	26	26
CPR at Boresight, dB	22	22	22
CPR at Sector, dB	9	9	9

* CommScope® supports NGMN recommendations on Base Station Antenna Standards (BASTA). To learn more about the benefits of BASTA, [download the whitepaper Time to Raise the Bar on BSAs.](#)

General Specifications

Antenna Brand	Andrew®
Antenna Type	DualPol® quad
Band	Single band
Brand	DualPol® Teletilt®
Operating Frequency Band	1710 – 2180 MHz

Product Specifications

COMMSCOPE®

HBXX-6516DS-VTM

POWERED BY



Mechanical Specifications

Color	Light gray
Lightning Protection	dc Ground
Radiator Material	Low loss circuit board
Radome Material	PVC, UV resistant
RF Connector Interface	7-16 DIN Female
RF Connector Location	Bottom
RF Connector Quantity, total	4
Wind Loading, maximum	419.0 N @ 150 km/h 94.2 lbf @ 150 km/h
Wind Speed, maximum	241.0 km/h 149.8 mph

Dimensions

Depth	166.0 mm 6.5 in
Length	1297.0 mm 51.1 in
Width	305.0 mm 12.0 in
Net Weight	13.9 kg 30.6 lb

Remote Electrical Tilt (RET) Information

Model with Factory Installed AISG 2.0 Actuator	HBXX-6516DS-A2M
RET System	Teletilt®

Regulatory Compliance/Certifications

Agency

RoHS 2011/65/EU
China RoHS SJ/T 11364-2006
ISO 9001:2008

Classification

Compliant by Exemption
Above Maximum Concentration Value (MCV)
Designed, manufactured and/or distributed under this quality management system



Included Products

600899A-2 — Downtilt Mounting Kit for 2.4 - 4.5 in (60 - 115 mm) OD round members. Kit contains one scissor top bracket set and one bottom bracket set.

ALCATEL-LUCENT B13 RRH4X30-4R

Alcatel-Lucent B13 Remote Radio Head 4x30-4R is the newest addition of Remote Radio Head to the extended product line of Alcatel-Lucent's distributed Base Station solutions, aimed at facilitating smooth RF site acquisition and related civil engineering.

Supporting 2Tx/4Tx MIMO and 4-way Rx diversity, Alcatel-Lucent B13 RRH4x30-4R allows operators to have a compact radio solution to deploy LTE in the 700U band (700 MHz, 3GPP band 13), providing them with the means to achieve high capacity, high quality and high coverage with minimum site requirements.

The Alcatel-Lucent B13 RRH4x30-4R product has four transmit RF paths, offering the possibility to **select, via software only, 2Tx or 4Tx MIMO configurations** with either 2x60 W or 4x30 W RF output power. It supports also 4-way Rx diversity and up to 10MHz instantaneous bandwidth.

The Alcatel-Lucent B13 RRH4x30-4R is a near zero-footprint solution and operates noise free, simplifying negotiations with site property owners and minimizing environmental impacts.

Its compactness and slim design makes the Alcatel-Lucent B13 RRH4x30-4R easy to install close to the antenna: operators can therefore locate this Remote Radio Head where RF design conditions are deemed ideal, minimizing trade-offs between available sites and RF optimum sites, together with reducing the RF feeder needs and installation costs.



FEATURES

- Supporting LTE in 700 MHz band (700U, 3GPP band 13)
- LTE 2Tx or 4Tx MIMO (SW switchable)
- Output power: Up to 2x60W or 4x30W
- 10MHz LTE carrier with 4Rx Diversity
- Convection-cooled (fan-less)
- Supports AISG 2.0 ALD devices (RET, TMA) through RS485 or RF ports

BENEFITS

- Compact to reduce additional footprint when adding LTE in 700U band
- MIMO scheme operation selection (2Tx or 4Tx) by software only
- Improves downlink spectral efficiency through MIMO4
- Increases LTE coverage thanks to 4Rx diversity capability and best in class Rx sensitivity
- Flexible mounting options: Pole or Wall

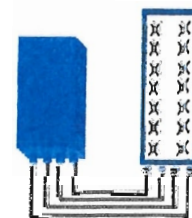

4x30W with 4T4R
or
2x60W with 2T4R

Can be switched between modes via SW w/o site visit

TECHNICAL SPECIFICATIONS

Features & performance	
Number of TX/RX paths	4 duplexed (either 4T4R or 2T4R by SW)
Frequency band	U700 (C) (3GPP bands 13): DL: 746 - 756 MHz / UL: 777 - 787 MHz
Instantaneous bandwidth - #carriers	10MHz - 1 LTE carrier (in 10MHz occupied bandwidth)
LTE carrier bandwidth	10 MHz
RF output power	2x60W or 4x30W (by SW)
Noise figure - RX Diversity scheme	2 dB typ. (<2.5 dB max) - 2 or 4 way Rx diversity
Sizes (HxWxD) in mm (in.)	550 x 305 x 230 (21.6" x 12.0" x 9") (with solar shield)
Volume in L	38 (with solar shield)
Weight in kg (lb) (w/o mounting HW)	26 (57.2) (with solar shield)
DC voltage range	-40.5 to -57V at full performance, -38 to -57V with relaxation on power consumption
DC power consumption	550W typical @100% RF load (in 2Tx or 4Tx mode)
Environmental conditions	-40°C (-40°F) / +55°C (+131°F) IP65
Wind load (@150km/h or 93mph)	Frontal: <200N / Lateral : <150N
Antenna ports	4 ports 7/16 DIN female (50 ohms) VSWR < 1.5
CPRI ports	2 CPRI ports (HW ready for Rate7, 9.8 Gbps) SFP single mode dual fiber
AISG interfaces	1 AISG2.0 output (RS485) Integrated Smart Bias Tees (x2)
Misc. Interfaces	4 external alarms (1 connector) - 4 RF Tx & 4 RF Rx monitor ports - 1 DC connector (2 pins)
Installation conditions	Pole and wall mounting
Regulatory compliance	3GPP 36.141 / 3GPP 36.113 / GR-1089-CORE / GR-3108-CORE / UL 60950-1 / FCC Part 27

www.alcatel-lucent.com Alcatel, Lucent, Alcatel-Lucent and the Alcatel-Lucent logo are trademarks of Alcatel-Lucent. All other trademarks are the property of their respective owners. The information presented is subject to change without notice. Alcatel-Lucent assumes no responsibility for inaccuracies contained herein. Copyright © 2014 Alcatel-Lucent. All Rights Reserved

PCS RF MODULES

RRH1900 2X60 - HW CHARACTERISTICS

LA6.0.1/13.3

RRH2x60	
RF Output Power	2x60W
Instantaneous Bandwidth	20MHz
Transmitter	2 TX
Receiver	1900 HW version 1900A HW version
Features	2 Branch RX – LA6.0.1 4 Branch RX – LR13.3 AISG 2.0 for RET/TMA
Power	Internal Smart Bias-T -48VDC
CPRI Ports	2 CPRI Rate 3 Ports
External Alarms	4 External User Alarms
Monitor Ports	TX
Environmental	GR487 Compliance
RF Connectors	7/16 DIN (top mounted)

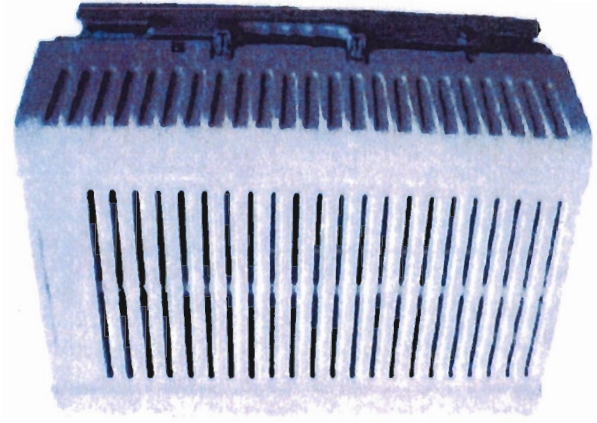

** Not a Verizon Wireless deployed product

ALCATEL-LUCENT – CONFIDENTIAL – SOLELY FOR AUTHORIZED PERSONS HAVING A NEED TO KNOW – PROPRIETARY – USE PUSLIANT TO COMPANY INSTRUCTION

NEW PCS RF MODULES FOR VZW

RRH2X60 - HW CHARACTERISTICS

LR14.3

	RRH2x60
RF Output Power	2x60W (4x30W HW Ready)
Instantaneous Bandwidth	60MHz
Target Reliability (Annual Return Rate)	<2%
Receiver	4 Branch Rx
Features	AISG 2.0 for RET/TMA
Power	-48VDC Internal Smart Bias-T
CPRI Ports	2 CPRI Rate 5 Ports
External Alarms	4 External User Alarms
Monitor Ports	TX, RX
Environmental	GR487 Compliance
RF Connectors	7/16 DIN (downward facing)
Dimensions	22"(h) x 12"(w) x 9.4" (d)**
Weight	55lb**

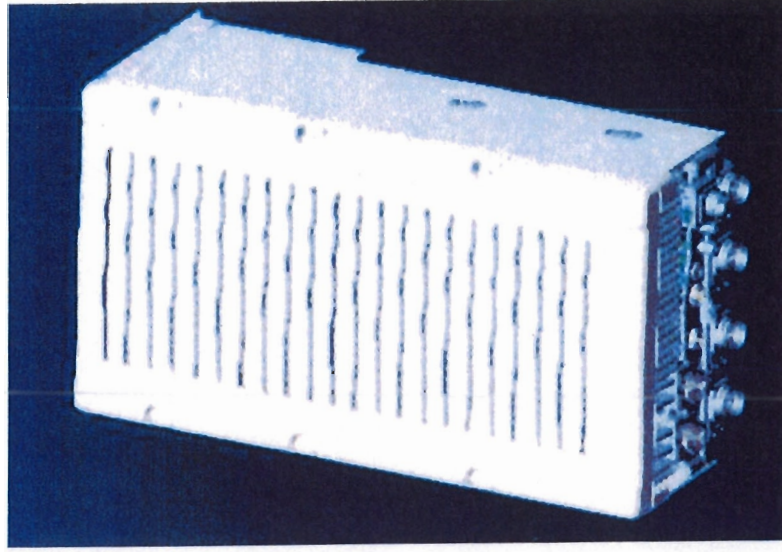

** - Includes solar shield but not mounting brackets (8 lbs.)

ALCATEL-LUCENT WIRELESS PRODUCT DATASHEET RRH2X60-AWS FOR BAND 4 APPLICATIONS

The Alcatel-Lucent RRH2x60-AWS is a high power, small form factor Remote Radio Head operating in the AWS frequency band (3GPP Band 4) for LTE technology. It is designed with an eco-efficient approach, providing operators with the means to achieve high quality and high capacity coverage with minimum site requirements and efficient operation.

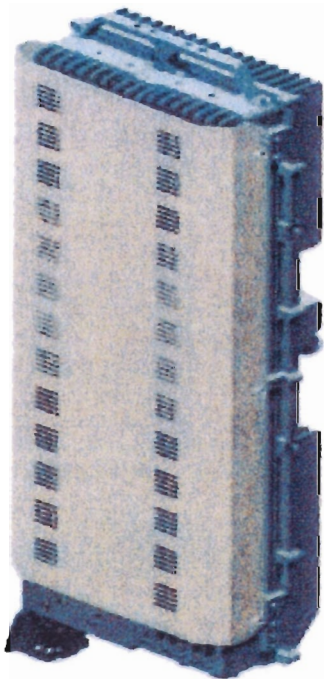

A distributed Node B expands the deployment options by using two components, a Base Band Unit (BBU) containing the digital assets and a separate RRH containing the radio-frequency (RF) elements. This modular design optimizes available space and allows the main components of a Node B to be installed separately, within the same site or several kilometers apart.

The Alcatel-Lucent RRH2x60-AWS is linked to the BBU by an optical-fiber connection carrying downlink and uplink digital radio signals

along with operations, administration and maintenance (OA&M) information.

SUPERIOR RF PERFORMANCE

The Alcatel-Lucent RRH2x60-AWS integrates all the latest technologies. This allows to offer best-in-class characteristics.

It delivers an outstanding 120 watts of total RF power thanks to its two transmit RF paths of 60 W each.

It is ideally suited to support multiple-input multiple-output (MIMO) 2x2 operation.

It includes four RF receivers to natively support 4-way uplink reception diversity. This improves the radio uplink coverage and this can be used to extend the cell radius commensurate with 2x2MIMO 2x60 W for the downlink.

It supports multiple discontinuous LTE carriers within an instantaneous bandwidth of 45 MHz corresponding to the entire AWS B4 spectrum.

The latest generation power amplifiers (PA) used in this product achieve high efficiency (>40%), resulting in improved power consumption figures.

OPTIMIZED TCO

The Alcatel-Lucent RRH2x60-AWS is designed to make available all the benefits of a distributed Node B, with excellent RF characteristics, with low capital expenditures (CAPEX) and low operating expenditures (OPEX).

The Alcatel-Lucent RRH2x60-AWS is a very cost-effective solution to deploy LTE MIMO.

EASY INSTALLATION

The RRH2x60-AWS includes a reversible mounting bracket which allows for ease of installation behind an antenna, or on a rooftop knee wall while providing easy access to the mid body RF connectors.

The limited space available in some sites may prevent the installation of traditional single-cabinet BTS equipment. However, many of these sites can host an Alcatel-Lucent RRH2x60-AWS installation, providing more flexible site selection and improved network quality along with greatly reduced installation time and costs.

The Alcatel-Lucent RRH2x60-AWS is a zero-footprint solution and is convection cooled without fans for silent operation, simplifying negotiations with site property owners and minimizing environmental impacts.

Installation can easily be done by a single person as the Alcatel-Lucent RRH2x60-AWS is compact and weighs about 20 kg, eliminating the need for a crane to hoist the BTS cabinet to the rooftop. A site can be in operation in less than one day.

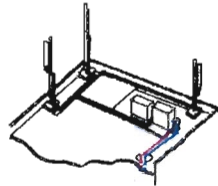

Macro

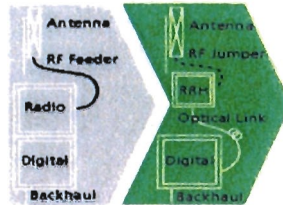

RRH for space-constrained cell sites

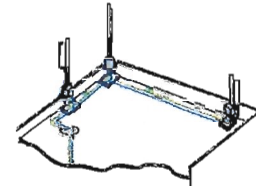

Distributed

FEATURES

- RRH2x60-AWS integrates two power amplifiers of 60W rating (at each antenna connector)
- Support multiple carriers over the entire 3GPP band 4
- RRH2x60-AWS is optimized for LTE operation
- RRH2x60-AWS is a very compact and lightweight product
- Advanced power management techniques are embedded to provide power savings, such as PA bias control

BENEFITS

- MIMO LTE operation with only one single unit per sector
- Improved uplink coverage with built-in 4-way receive diversity capability
- RRH can be mounted close to the antenna, eliminating nearly all losses in RF cables and thus reducing power consumption by 50% compared to conventional solutions
- Distributed configurations provide easily deployable and cost-effective solutions, near zero footprint and

silent solutions, with minimum impact on the neighborhood, which ease the deployment

- RETA and TMA support without additional hardware thanks to the AISG v2.0 port and the integrated Bias-Tees. Bias-Tees support AISG DC supply and signaling.

TECHNICAL SPECIFICATIONS

Specifications listed are hardware capabilities. Some capabilities depend on support in a specific software release or future release.

Dimensions and weights

- HxWxD : 510x285x186mm (27 l with solar shield)
- Weight : 20 kg (44 lbs)

Electrical Data

- Power Supply : -48V DC (-40.5 to -57V)
- Power Consumption (ETSI average traffic load reference) : 250W @2x60W

RF Characteristics

- Frequency band: 1710-1755, UL / 2110-2155 MHz, DL (3GPP band 4)
- Output power: 2x60W at antenna connectors
- Technology supported: LTE
- Instantaneous bandwidth: 45 MHz
- Rx diversity: 2-way and 4-way uplink reception
- Typical sensitivity without Rx diversity: -105 dBm for LTE

Connectivity

- Two CPRI optical ports for daisy chaining and up to six RRHs per fiber
- Type of optical fiber: Single-Mode (SM) and Multi-Mode (MM) SFPs
- Optical fiber length: up to 500m using MM fiber, up to 20km using SM fiber
- TMA/RETA : AISG 2.0 (RS485 connector and internal Bias-Tee)
- Six external alarms
- Surge protection for all external ports (DC and RF)

Safety and Regulatory Data

- EMC : 3GPP 25113, EN 301 489-1, EN 301 489-23, GR 1089, GR 3108, OET-65
- Safety : IEC60950-1, EN 60825-1, UL, ANSI/NFPA 70, CAN/CSA-C22.2
- Regulatory : FCC Part 15 Class B, CE Mark – European Directive : 2002/95/EC (ROHS); 2002/96/EC (WEEE); 1999/5/EC (R&TTE)
- Health : EN 50385

Environmental specifications

- Operating temperature: -40°C to 55°C including solar load
- Operating relative humidity: 8% to 100%
- Environmental Conditions : ETS 300 019-1-4 class 4.1E
- Ingress Protection : IEC 60529 IP65
- Acoustic Noise : Noiseless (natural convection cooling)

www.alcatel-lucent.com Alcatel, Lucent, Alcatel-Lucent and the Alcatel-Lucent logo are trademarks of Alcatel-Lucent. All other trademarks are the property of their respective owners. The information presented is subject to change without notice. Alcatel-Lucent assumes no responsibility for inaccuracies contained herein.

Copyright © 2012 Alcatel-Lucent. All rights reserved. M2012XXXXXX (March)

SG035

5.4L

Industrial Spark-Ignited Generator Set

EPA Certified Stationary Emergency

Standby Power Rating
35 kW 44 kVA 60 Hz

Prime Power Rating*
32 kW 39 kVA 60 Hz

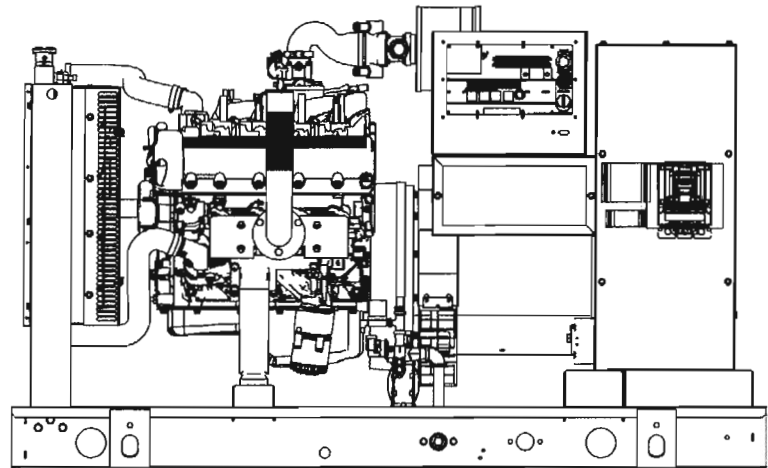

*EPA Certified Prime ratings are not available in the U.S. or its Territories

Image used for illustration purposes only

Codes and Standards

Generac products are designed to the following standards:



UL2200, UL508, UL142, UL498



NFPA70, 99, 110, 37



NEC700, 701, 702, 708



ISO9001, 8528, 3046, 7637, Pluses #2b, 4



NEMA ICS10, MG1, 250, ICS6, AB1



ANSI C62.41

American National Standards Institute



IBC 2009, CBC 2010, IBC 2012, ASCE 7-05,
ASCE 7-10, ICC-ES AC-156 (2012)

Powering Ahead

For over 50 years, Generac has led the industry with innovative design and superior manufacturing.

Generac ensures superior quality by designing and manufacturing most of its generator components, including alternators, enclosures and base tanks, control systems and communications software.

Generac's gensets utilize a wide variety of options, configurations and arrangements, allowing us to meet the standby power needs of practically every application.

Generac searched globally to ensure the most reliable engines power our generators. We choose only engines that have already been proven in heavy-duty industrial application under adverse conditions.

Generac is committed to ensuring our customers' service support continues after their generator purchase.

SG035

Standard Features

ENGINE SYSTEM

General

- Oil Drain Extension
- Air Cleaner
- Fan Guard
- Stainless Steel flexible exhaust connection
- Critical Exhaust Silencer (enclosed only)
- Factory Filled Oil
- Radiator duct adapter (open set only)

Fuel System

- Primary and Secondary Fuel Shutoff
- Flexible Fuel Line - NPT Connection

Cooling System

- Closed Coolant Recovery System
- UV/Ozone resistant hoses
- Factory-installed Radiator
- Radiator drain extension
- 50/50 Ethylene glycol antifreeze

Engine Electrical System

- Battery charging alternator
- Battery Cables
- Battery Tray
- Solenoid activated starter motor
- Rubber-booted engine electrical connections

ALTERNATOR SYSTEM

- UL2200 GENprotect™
- Class H insulation material
- 2/3 Pitch
- Skewed Stator
- Brushless Excitation
- Sealed Bearings
- Amortisseur winding
- Full load capacity alternator

GENERATOR SET

- Internal Genset Vibration Isolation
- Separation of circuits - high/low voltage
- Separation of circuits - multiple breakers
- Wrapped Exhaust Piping
- Standard Factory Testing
- 2 Year Limited Warranty (Standby rated Units)
- 1 Year Warranty (Prime rated units)
- Silencer mounted in the discharge hood (enclosed only)

ENCLOSURE (if selected)

- Rust-proof fasteners with nylon washers to protect finish
- High performance sound-absorbing material
- Gasketed doors
- Stamped air-intake louvers
- Air discharge hoods for radiator-upward pointing
- Stainless steel lift off door hinges
- Stainless steel lockable handles
- Rhino Coat™ - Textured polyester powder coat

CONTROL SYSTEM



Control Panel

- Digital H Control Panel - Dual 4x20 Display
- Programmable Crank Limiter
- 7-Day Programmable Exerciser
- Special Applications Programmable PLC RS-232/485
- All-Phase Sensing DVR
- Full System Status
- Utility Monitoring
- Low Fuel Pressure Indication
- 2-Wire Start Compatible
- Power Output (kW)
- Power Factor
- kW Hours, Total & Last Run

- Real/Reactive/Apparent Power
 - All Phase AC Voltage
 - All Phase Currents
 - Oil Pressure
 - Coolant Temperature
 - Coolant Level
 - Engine Speed
 - Battery Voltage
 - Frequency
 - Date/Time Fault History (Event Log)
 - Isochronous Governor Control
 - Waterproof/sealed Connectors
 - Audible Alarms and Shutdowns
 - Not in Auto (Flashing Light)
 - Auto/Off/Manual Switch
 - E-Stop (Red Mushroom-Type)
 - NFPA110 Level I and II (Programmable)
 - Customizable Alarms, Warnings, and Events
 - Modbus protocol
 - Predictive Maintenance algorithm
 - Sealed Boards
 - Password parameter adjustment protection
 - Single point ground
 - 15 channel data logging
 - 0.2 msec high speed data logging
 - Alarm information automatically comes up on the display
- #### Alarms
- Oil Pressure (Pre-programmable Low Pressure Shutdown)
 - Coolant Temperature (Pre-programmed High Temp Shutdown)
 - Coolant Level (Pre-programmed Low Level Shutdown)
 - Low Fuel Pressure Alarm
 - Engine Speed (Pre-programmed Over speed Shutdown)
 - Battery Voltage Warning
 - Alarms & warnings time and date stamped
 - Alarms & warnings for transient and steady state conditions
 - Snap shots of key operation parameters during alarms & warnings
 - Alarms and warnings spelled out (no alarm codes)

SG035

Configurable Options

ENGINE SYSTEM

- General
- Engine Block Heater
- Oil Heater
- Air Filter Restriction Indicator
- Stone Guard (Open Set Only)
- Critical Exhaust Silencer (Open Set Only / Standard on Ultra Low Emissions Option)

Engine Electrical System

- 10A UL battery charger
- 2.5A UL battery charger
- Battery Warmer

ALTERNATOR SYSTEM

- Alternator Upsizing
- Anti-Condensation Heater
- Tropical coating
- Permanent Magnet Excitation

GENERATOR SET

- Gen-Link Communications Software (English Only)
- Extended Factory Testing (3 Phase Only)
- IBC Seismic Certification
- 8 Position Load Center
- 2 Year Extended Warranty
- 5 Year Warranty
- 5 Year Extended Warranty

CIRCUIT BREAKER OPTIONS

- Main Line Circuit Breaker
- 2nd Main Line Circuit Breaker
- Shunt Trip and Auxiliary Contact
- Electronic Trip Breakers

ENCLOSURE

- Standard Enclosure
- Level 1 Sound Attenuation
- Level 2 Sound Attenuation
- Steel Enclosure
- Aluminum Enclosure
- 150 MPH Wind Kit
- 12 VDC Enclosure Lighting Kit
- 120 VAC Enclosure Lighting Kit
- AC/DC Enclosure Lighting Kit
- Door Alarm Switch

CONTROL SYSTEM

- | | | |
|--|--|--|
| <ul style="list-style-type: none"> <input type="checkbox"/> 21-Light Remote Annunciator <input type="checkbox"/> Remote Relay Panel (8 or 16) <input type="checkbox"/> Oil Temperature Sender with Indication Alarm | <ul style="list-style-type: none"> <input type="checkbox"/> Remote E-Stop (Break Glass-Type, Surface Mount) <input type="checkbox"/> Remote E-Stop (Red Mushroom-Type, Surface Mount) <input type="checkbox"/> Remote E-Stop (Red Mushroom-Type, Flush Mount) | <ul style="list-style-type: none"> <input type="checkbox"/> Remote Communication - Modem <input type="checkbox"/> Remote Communication - Ethernet <input type="checkbox"/> 10A Run Relay <input type="checkbox"/> Ground fault indication and protection functions |
|--|--|--|

Engineered Options

ENGINE SYSTEM

- Coolant heater ball valves
- Fluid containment pans

ALTERNATOR SYSTEM

- 3rd Breaker Systems

GENERATOR SET

- Special Testing
- Battery Box

ENCLOSURE

- Motorized Dampers
- Enclosure Ambient Heaters

CONTROL SYSTEM

- Spare inputs (x4) / outputs (x4) - H Panel Only
- Battery Disconnect Switch

Rating Definitions

Standby – Applicable for a varying emergency load for the duration of a utility power outage with no overload capability.

Prime – Applicable for supplying power to a varying load in lieu of utility for an unlimited amount of running time. A 10% overload capacity is available for 1 out of every 12 hours. The Prime Power option is only available on International applications.

Power ratings in accordance with ISO 8528-1, Second Edition dated 2005-06-01, definitions for Prime Power (PRP) and Emergency Standby Power (ESP).

SG035

application and engineering data

ENGINE SPECIFICATIONS

General

Make	Generac
Cylinder #	8
Type	V
Displacement - L (Cu In)	5.4 (329.53)
Bore - mm (in)	90.17 (3.55)
Stroke - mm (in)	105.92 (4.17)
Compression Ratio	9:1
Intake Air Method	Naturally Aspirated
Number of Main Bearings	4
Connecting Rods	Forged
Cylinder Head	Aluminum
Cylinder Liners	No
Ignition	Single Fire
Pistons	Aluminum Alloy
Crankshaft	Nodular Iron
Lifter Type	Hydraulic
Intake Valve Material	Steel Alloy
Exhaust Valve Material	Hardened Steel
Hardened Valve Seats	Yes

Engine Governing

Governor	Electronic
Frequency Regulation (Steady State)	+/- 0.25%

Lubrication System

Oil Pump Type	Gear
Oil Filter Type	Full-flow spin-on cartridge
Crankcase Capacity - L (qts)	5.7 (6)

Cooling System

Cooling System Type	Pressurized Closed Recovery
Water Pump Flow - gpm (lpm)	38 (144)
Fan Type	Pusher
Fan Speed (rpm)	2143
Fan Diameter mm (in)	508 (20)
Coolant Heater Wattage	1500
Coolant Heater Standard Voltage	120 V

Fuel System

Fuel Type	Natural Gas, Propane Vapor
Carburetor	Down Draft
Secondary Fuel Regulator	Standard
Fuel Shut Off Solenoid	Standard
Operating Fuel Pressure	8" - 14" H2O

Engine Electrical System

System Voltage	12 VDC
Battery Charging Alternator	Standard
Battery Size	See Battery Index 0161970SBY
Battery Voltage	12 VDC
Ground Polarity	Negative

ALTERNATOR SPECIFICATIONS

Standard Model	390
Poles	4
Field Type	Revolving
Insulation Class - Rotor	H
Insulation Class - Stator	H
Total Harmonic Distortion	< 5%
Telephone Interference Factor (TIF)	< 50
Standard Excitation	Brushless
Bearings	Sealed Ball
Coupling	Flexible Disc
Prototype Short Circuit Test	Yes

Voltage Regulator Type	Full Digital
Number of Sensed Phases	All
Regulation Accuracy (Steady State)	+/- 0.25%

SG035

operating data

POWER RATINGS

	Natural Gas		Propane Vapor	
	kW	Amps	kW	Amps
Single-Phase 120/240 VAC @1.0pf	35 kW	146	35 kW	146
Three-Phase 120/208 VAC @0.8pf	35 kW	121	35 kW	121
Three-Phase 120/240 VAC @0.8pf	35 kW	105	35 kW	105
Three-Phase 277/480 VAC @0.8pf	35 kW	53	35 kW	53
Three-Phase 346/600 VAC @0.8pf	35 kW	42	35 kW	42

STARTING CAPABILITIES (skVA)

		skVA vs. Voltage Dip											
		480 VAC						208/240 VAC					
Alternator	kW	10%	15%	20%	25%	30%	35%	10%	15%	20%	25%	30%	35%
Standard	35	24	36	48	60	72	84	18	27	36	45	54	63
Upsize 1	40	27	41	54	68	81	95	20	31	41	51	61	71
Upsize 2	50	34	52	69	86	103	120	26	39	52	65	77	90
Upsize 3	60	42	63	83	104	125	146	32	47	62	78	94	110

FUEL CONSUMPTION RATES*

Natural Gas – ft ³ /hr (m ³ /hr)		Propane Vapor – ft ³ /hr (m ³ /hr)	
Percent Load	Standby	Percent Load	Standby
25%	239 (6.8)	25%	69.8 (2.0)
50%	409 (11.6)	50%	119.7 (3.4)
75%	553 (15.7)	75%	161.6 (4.6)
100%	682 (19.3)	100%	219.8 (6.2)

*Fuel supply installation must accommodate fuel consumption rates at 100% load.

COOLING

		Standby
Air Flow (inlet air combustion and radiator)	ft ³ /min (m ³ /min)	2460 (69.7)
Coolant Flow per Minute	gpm (lpm)	38 (144)
Coolant System Capacity	gal (L)	3 (11.36)
Heat Rejection to Coolant	BTU/hr	144,000
Max. Operating Air Temp on Radiator	°F (°C)	122 (50)
Max. Operating Ambient Temperature (before derate)	°F (°C)	110 (43.3)
Maximum Radiator Backpressure	in H ₂ O	0.5

COMBUSTION AIR REQUIREMENTS

Flow at Rated Power	Standby
cfm (m ³ /min)	87 (2.5)

ENGINE

		Standby
Rated Engine Speed	rpm	1800
Horsepower at Rated kW**	hp	54
Piston Speed	ft/min (m/min)	1251 (381)
BMEP	psi	72

** Refer to "Emissions Data Sheet" for maximum bHP for EPA and SCAQMD permitting purposes.

EXHAUST

		Standby
Exhaust Flow (Rated Output)	cfm (m ³ /min)	260 (7.4)
Maximum Recommended Back Pressure	inHg	1.5
Exhaust Temp (Rated Output)	°F (°C)	900 (482)
Exhaust Outlet Size (Open Set)	in	2.5" I.D. Flex (No muffler)

Deration – Operational characteristics consider maximum ambient conditions. Derate factors may apply under atypical site conditions. Please consult a Generac Power Systems Industrial Dealer for additional details. All performance ratings in accordance with ISO3046, BS5514, ISO8528 and DIN6271 standards.

SG035

dimensions and weights

SG035 35 KW

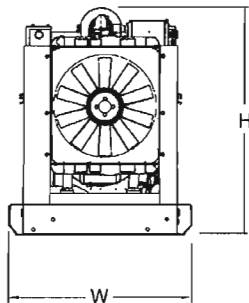
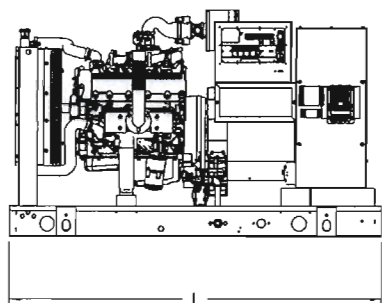

OPEN SET (Includes Exhaust Flex)

L x W x H in (mm)	76 (1930) x 37.4 (949.9) x 47 (1193.8)
Weight lbs (kg)	1575 (714)

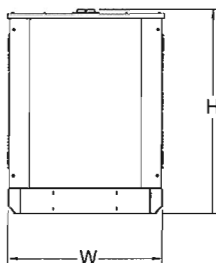
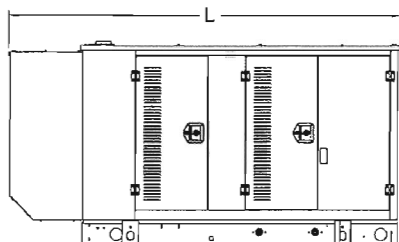

STANDARD ENCLOSURE

L x W x H in (mm)	94.8 (2408.9) x 38 (965.1) x 49.5 (1258.1)
Weight lbs (kg)	Steel: 2100 (952) Aluminum: 1754 (795)

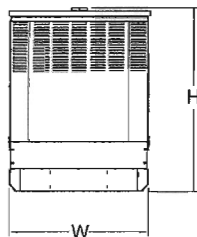
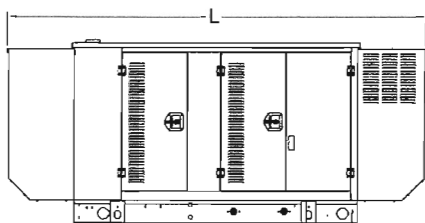

LEVEL 1 ACOUSTIC ENCLOSURE

L x W x H in (mm)	112.5 (2857.1) x 38 (965.1) x 49.5 (1258.1)
Weight lbs (kg)	Steel: 2140 (970) Aluminum: 1767 (801)

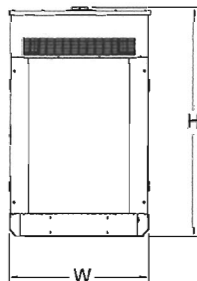
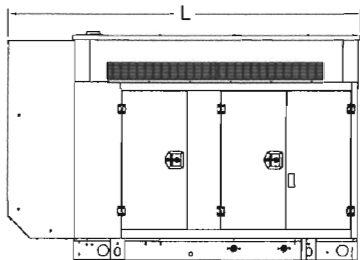

LEVEL 2 ACOUSTIC ENCLOSURE

L x W x H in (mm)	94.8 (2407) x 38 (965.1) x 62 (1573.9)
Weight lbs (kg)	Steel: 2328 (1056) Aluminum: 1831 (830)

YOUR FACTORY RECOGNIZED GENERAC INDUSTRIAL DEALER

Specification characteristics may change without notice. Please consult a Generac Power Systems Industrial Dealer for detailed installation drawings.