

LNX-6514DS-VTM

Andrew® Antenna, 698–896 MHz, 65° horizontal beamwidth, RET compatible

- Great solution to maximize network coverage and capacity
- Excellent gain, VSWR, front-to-back ratio, and PIM specifications for robust network performance
- Ideal choice for site collocations and tough zoning restrictions
- Excellent solution for site sharing and maximizing capacity
- Fully compatible with Andrew remote electrical tilt system for greater OpEx savings
- The RF connectors are designed for IP67 rating and the radome for IP56 rating

Electrical Specifications

Frequency Band, MHz	698–806	806–896
Gain, dBi	15.7	16.3
Beamwidth, Horizontal, degrees	65	65
Beamwidth, Horizontal Tolerance, degrees	±3	±3
Beamwidth, Vertical, degrees	12.5	11.2
Beam Tilt, degrees	0–10	0–10
USLS, typical, dB	17	18
Front-to-Back Ratio at 180°, dB	32	30
CPR at Boresight, dB	20	20
CPR at Sector, dB	10	10
Isolation, dB	30	30
VSWR Return Loss, dB	1.4 15.6	1.4 15.6
PIM, 3rd Order, 2 x 20 W, dBc	-153	-153
Input Power per Port, maximum, watts	400	400
Polarization	±45°	±45°
Impedance	50 ohm	50 ohm

General Specifications

Antenna Brand	Andrew®
Antenna Type	DualPol®
Band	Single band
Brand	DualPol® Teletilt®
Operating Frequency Band	698 – 896 MHz

Mechanical Specifications

Color	Light gray
Lightning Protection	dc Ground
Radiator Material	Aluminum
Radome Material	Fiberglass, UV resistant
RF Connector Interface	7-16 DIN Female
RF Connector Location	Bottom
RF Connector Quantity, total	2
Wind Loading, maximum	617.7 N @ 150 km/h 138.9 lbf @ 150 km/h
Wind Speed, maximum	241.0 km/h 149.8 mph

Product Specifications

COMMScope®

LNx-6514DS-VTM

POWERED BY



Dimensions

Depth	181.0 mm 7.1 in
Length	1847.0 mm 72.7 in
Width	301.0 mm 11.9 in
Net Weight	17.6 kg 38.8 lb

Remote Electrical Tilt (RET) Information

Model with Factory Installed AISG 1.1 Actuator LNX-6514DS-R2M

Model with Factory Installed AISG 2.0 Actuator LNX-6514DS-A1M

RET System Teletilt®

Regulatory Compliance/Certifications

Agency

RoHS 2011/65/EU
China RoHS SJ/T 11364-2006
ISO 9001:2008

Classification

Compliant by Exemption
Above Maximum Concentration Value (MCV)
Designed, manufactured and/or distributed under this quality management system



Included Products

DB380 — Pipe Mounting Kit for 2.4"-4.5" (60-115mm) OD round members on wide panel antennas. Includes 2 clamp sets and double nuts.

DB5083 — Downtilt Mounting Kit for 2.4"-4.5" (60 - 115 mm) OD round members. Includes a heavy-duty, galvanized steel downtilt mounting bracket assembly and associated hardware. This kit is compatible with the DB380 pipe mount kit for panel antennas that are equipped with two mounting brackets.

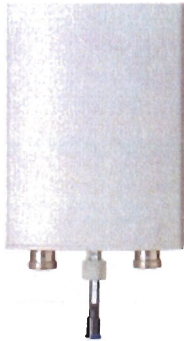

HBX-6516DS-VTM

Andrew® Teletilt® Antenna, 1710–2170 MHz, 65° horizontal beamwidth, RET compatible

- Superior azimuth tracking and pattern symmetry to minimize any sector overlap
- Rugged, reliable design with excellent passive Intermodulation suppression
- The values presented on this datasheet have been calculated based on N-P-BASTA White Paper version 9.6 by the NGMN Alliance

Electrical Specifications

Frequency Band, MHz	1710–1880	1850–1990	1920–2170
Gain by all Beam Tilts, average, dBi	17.1	17.3	17.5
Gain by all Beam Tilts Tolerance, dB	±0.2	±0.3	±0.4
Gain by Beam Tilt, average, dBi	0 ° 17.1 5 ° 17.2 10 ° 16.9	0 ° 17.3 5 ° 17.5 10 ° 17.0	0 ° 17.6 5 ° 17.7 10 ° 17.1
Beamwidth, Horizontal, degrees	68	65	64
Beamwidth, Horizontal Tolerance, degrees	±1.9	±1.6	±2.1
Beamwidth, Vertical, degrees	7.5	7.0	6.7
Beamwidth, Vertical Tolerance, degrees	±0.4	±0.3	±0.4
Beam Tilt, degrees	0–10	0–10	0–10
USLS, dB	19	19	19
Front-to-Back Total Power at 180° ± 30°, dB	25	26	26
CPR at Boresight, dB	22	22	22
CPR at Sector, dB	11	9	9
Isolation, dB	30	30	30
VSWR Return Loss, dB	1.4 15.6	1.4 15.6	1.4 15.6
PIM, 3rd Order, 2 x 20 W, dBc	-153	-153	-153
Input Power per Port, maximum, watts	350	350	350
Polarization	±45°	±45°	±45°
Impedance	50 ohm	50 ohm	50 ohm

General Specifications

Antenna Brand	Andrew®
Antenna Type	DualPol®
Band	Single band
Brand	DualPol® Teletilt®
Operating Frequency Band	1710 – 2170 MHz
Number of Ports, all types	2

Mechanical Specifications

Color	Light gray
Lightning Protection	dc Ground
Radiator Material	Low loss circuit board
Radome Material	PVC, UV resistant
RF Connector Interface	7-16 DIN Female
RF Connector Location	Bottom

Product Specifications

COMMSCOPE®

HBX-6516DS-VTM

POWERED BY



RF Connector Quantity, total	2
Wind Loading, maximum	257.0 N @ 150 km/h 57.8 lbf @ 150 km/h
Wind Speed, maximum	241.0 km/h 149.8 mph

Dimensions

Depth	83.0 mm 3.3 in
Length	1306.0 mm 51.4 in
Width	166.0 mm 6.5 in
Net Weight	4.7 kg 10.4 lb

Remote Electrical Tilt (RET) Information

Model with Factory Installed AISG 1.1 Actuator HBX-6516DS-R2M

Model with Factory Installed AISG 2.0 Actuator HBX-6516DS-A1M

RET System Teletilt®

Regulatory Compliance/Certifications

Agency

RoHS 2011/65/EU
China RoHS SJ/T 11364-2006
ISO 9001:2008

Classification

Compliant by Exemption
Above Maximum Concentration Value (MCV)
Designed, manufactured and/or distributed under this quality management system



Included Products

DB390 — Pipe Mounting Kit for 2.4 - 4.5 in (60 - 115 mm) OD round members. Use for narrow panel antennas. Includes two pipe mounts.

DB5098E — Downtilt Mounting Kit for 2.4 - 4.5 in (60 - 115 mm) OD round members

HBX-6516DS-VTM

POWERED BY



Horizontal Pattern

Vertical Pattern

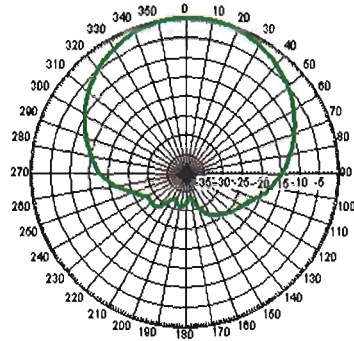

Freq: 1785 MHz, Tilt: 0

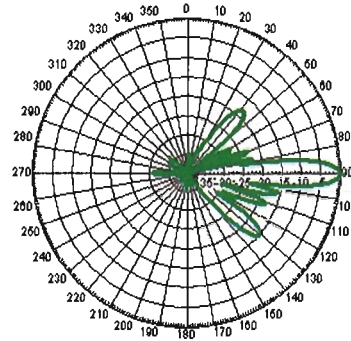

Freq: 1785 MHz, Tilt: 0

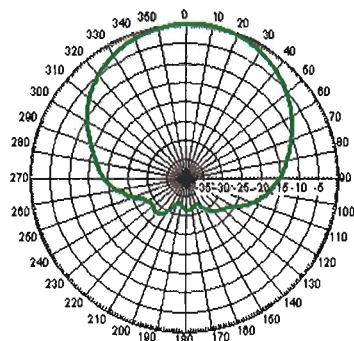

Freq: 1910 MHz, Tilt: 0

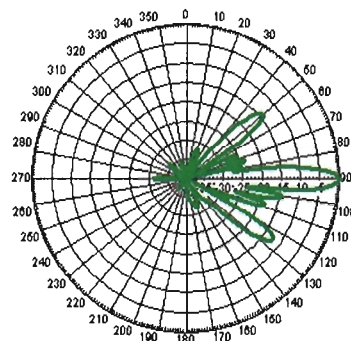

Freq: 1910 MHz, Tilt: 0

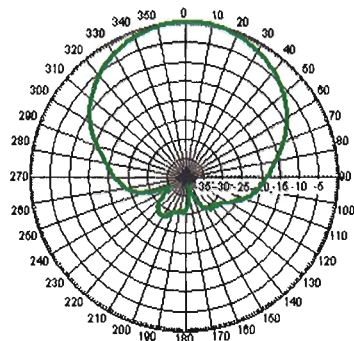

Freq: 2110 MHz, Tilt: 0

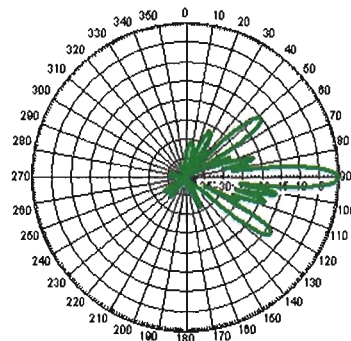

Freq: 2110 MHz, Tilt: 0

POWERED BY



DB390

Pipe Mounting Kit for 2.4 - 4.5 in (60 - 115 mm) OD round members. Use for narrow panel antennas. Includes two pipe mounts.

General Specifications

Antenna Brand	Andrew®
Mount Type	Pipe mounts
Application	Outdoor
Includes	Brackets Hardware
Package Quantity	2

Mechanical Specifications

Color	Silver
Material Type	Galvanized steel

Dimensions

Compatible Diameter, maximum	114.3 mm 4.5 in
Compatible Diameter, minimum	61.0 mm 2.4 in
Net Weight	2.0 kg 4.4 lb

Regulatory Compliance/Certifications

Agency	Classification
RoHS 2011/65/EU	Compliant
China RoHS SJ/T 11364-2006	Below Maximum Concentration Value (MCV)
ISO 9001:2008	Designed, manufactured and/or distributed under this quality management system



POWERED BY



DB5098E

Downtilt Mounting Kit for 2.4 - 4.5 in (60 - 115 mm) OD round members

General Specifications

Antenna Brand	Andrew®
Mount Type	Downtilt mounts
Application	Outdoor
Includes	Brackets Hardware
Package Quantity	1

Mechanical Specifications

Color	Silver
Material Type	Galvanized steel

Dimensions

Compatible Diameter, maximum	114.3 mm 4.5 in
Compatible Diameter, minimum	61.0 mm 2.4 in
Net Weight	1.2 kg 2.6 lb

Regulatory Compliance/Certifications

Agency	Classification
RoHS 2011/65/EU	Compliant
China RoHS SJ/T 11364-2006	Below Maximum Concentration Value (MCV)
ISO 9001:2008	Designed, manufactured and/or distributed under this quality management system



Alcatel-Lucent RRH2x40-07-U

REMOTE RADIO HEAD

The Alcatel-Lucent RRH2x40-07-U is a high-power, small form-factor Remote Radio Head (RRH) operating in the North American Digital Dividend / 700MHz frequency band (3GPP Band 13). The Alcatel-Lucent RRH2x40-07-U is designed with an eco-efficient approach, providing operators with the means to achieve high quality and capacity coverage with minimum site requirements.

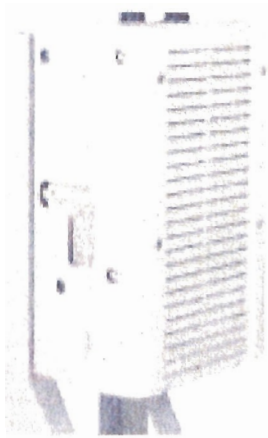

A distributed eNodeB expands deployment options by using two components, a Base Band Unit (BBU) containing the digital assets and a separate RRH containing the radio-frequency (RF) elements. This modular design optimizes available space and allows the main components of an eNodeB to be installed separately, within the same site or several kilometres apart.

The Alcatel-Lucent RRH2x40-07-U is linked to the BBU by an optical-fiber connection carrying downlink and uplink digital radio signals along with operations, administration and maintenance (OA&M) information. The Alcatel-Lucent RRH2x40-07-U has two transmit RF paths, 40 W RF output power per transmit path, and is designed to manage up to two-way receive diversity. The device is ideally suited to support macro coverage, with multiple-input multiple-output (MIMO) 2x2 operation in up to 10 MHz of bandwidth.

The Alcatel-Lucent RRH2x40-07-U is designed to make available all the benefits of a distributed eNodeB, with excellent RF characteristics, with low

capital expenditures (CAPEX) and low operating expenditures (OPEX). The limited space available in some sites may prevent the installation of traditional single-cabinet BTS equipment or require costly cranes to be employed, leaving coverage holes. However, many of these sites can host an Alcatel-Lucent RRH2x40-07-U installation, providing more flexible site selection and improved network quality along with greatly reduced installation time and costs.

Fast, low-cost installation and deployment

The Alcatel-Lucent RRH2x40-07-U is a zero-footprint solution and operates noise-free, simplifying negotiations with site property owners and minimizing environmental impacts. Installation can easily be done by a single person because the Alcatel-Lucent RRH2x40-07-U is compact and weighs less than 23 kg (50 lb), eliminating the need for a crane to hoist the BTS cabinet to the rooftop. A site can be in operation in less than one day — a fraction of the time required for a traditional BTS.

Excellent RF performance

Because of its small size and weight, the Alcatel-Lucent RRH2x40-07-U can be installed close to the antenna. Operators can therefore locate the Alcatel-Lucent RRH2x40-07-U where RF engineering is deemed ideal, minimizing trade-offs between available sites and RF optimum sites. The RF feeder cost and installation costs are reduced or eliminated, and there is no need for a Tower Mounted Amplifier (TMA) because losses introduced by the RF feeder are greatly reduced. The Alcatel-Lucent RRH2x40-07-U provides more RF power while at the same time consuming less electricity.

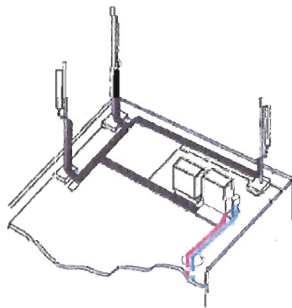

Macro

Features

- Zero-footprint deployment
- Easy installation, with a lightweight unit can be carried and set up by one person
- Optimized RF power, with flexible site selection and elimination of a TMA
- Convection-cooled (fanless), noise-free, and heaterless unit
- Best-in-class power efficiency, with significantly reduced energy consumption

Benefits

- Leverages existing real estate with lower site costs
- Reduces installation costs, with fewer installation materials and simplified logistics
- Decreases power costs and minimizes environmental impacts, with the potential for eco-sustainable power options
- Improves RF performance and adds flexibility to network planning

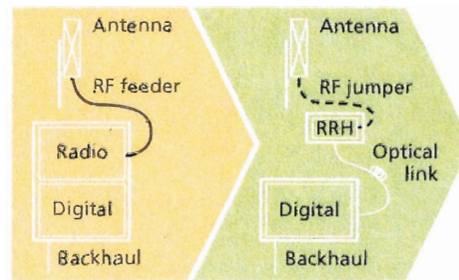

RRH for space-constrained cell sites

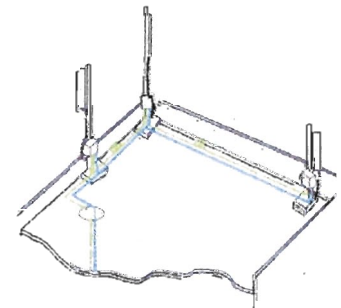

Distributed

Technical specifications

Physical dimensions

- Height: 390 mm (15.4 in.)
- Width: 380 mm (15 in.)
- Depth: 210 mm (8.2 in.)
- Weight (without mounting kit): less than 23 kg (50 lb)

Power

- Power supply: -48V

Operating environment

- Outdoor temperature range:
 - With solar load: -40°C to +50°C (-40°F to +122°F)
 - Without solar load: -40°C to +55°C (-40°F to +131°F)
- Passive convection cooling (no fans)

- Enclosure protection
 - IP65 (International Protection rating)

RF characteristics

- Frequency band: 700 MHz; 3GPP Band 13
- Bandwidth: up to 10 MHz
- RF output power at antenna port:
 - 40 W nominal RF power for each Tx port
- Rx diversity: 2-way or 4-way
- Noise figure: below 2.5 dB typical
- ALD features
 - TMA
 - Remote electrical tilt (RET) support (AISG v2.0)

Optical characteristics

Type/number of fibers

- Up to 3.12 Gb/s line bit rate
- Single-mode variant
 - One SM fiber (9/125 μm) per RRH2x, carrying UL and DL using CWDM (at 1550/1310 nm)
- Multi-mode variant
 - Two MM fibers (50/125 μm) per RRH2x: one carrying UL, the other carrying DL (at 850 nm)

Optical fiber length

- Up to 500 m (0.31 mi), using MM fiber
- Up to 20 km (12.43 mi), using SM fiber

Alarms and ports

- Six external alarms
- Two optical ports to support daisy-chaining

www.alcatel-lucent.com Alcatel, Lucent, Alcatel-Lucent and the Alcatel-Lucent logo are trademarks of Alcatel-Lucent. All other trademarks are the property of their respective owners. The information presented is subject to change without notice. Alcatel-Lucent assumes no responsibility for inaccuracies contained herein. Copyright © 2010 Alcatel-Lucent. All rights reserved. CP62809100913 (09)

Alcatel-Lucent RRH2x40-AWS

REMOTE RADIO HEAD

The Alcatel-Lucent RRH2x40-AWS is a high-power, small form-factor Remote Radio Head (RRH) operating in the AWS frequency band (1700/2100MHz - 3GPP Band 4). The Alcatel-Lucent RRH2x40-AWS is designed with an eco-efficient approach, providing operators with the means to achieve high quality and capacity coverage with minimum site requirements.

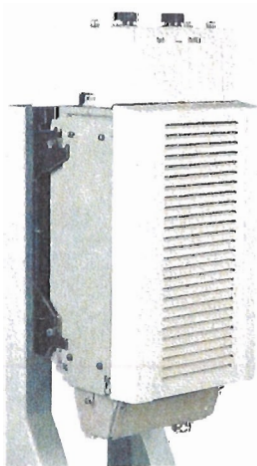

A distributed eNodeB expands deployment options by using two components, a Base Band Unit (BBU) containing the digital assets and a separate RRH containing the radio-frequency (RF) elements. This modular design optimizes available space and allows the main components of an eNodeB to be installed separately, within the same site or several kilometres apart.

The Alcatel-Lucent RRH2x40-AWS is linked to the BBU by an optical-fiber connection carrying downlink and uplink digital radio signals along with operations, administration and maintenance (OA&M) information. The Alcatel-Lucent RRH2x40-AWS has two transmit RF paths, 40 W RF output power per transmit path, and is designed to manage up to four-way receive diversity. The device is ideally suited to support macro coverage, with multiple-input multiple-output (MIMO) 2x2 operation in up to 20 MHz of bandwidth.

The Alcatel-Lucent RRH2x40-AWS is designed to make available all the benefits of a distributed eNodeB, with excellent RF characteristics, with low

capital expenditures (CAPEX) and low operating expenditures (OPEX). The limited space available in some sites may prevent the installation of traditional single-cabinet BTS equipment or require costly cranes to be employed, leaving coverage holes. However, many of these sites can host an Alcatel-Lucent RRH2x40-AWS installation, providing more flexible site selection and improved network quality along with greatly reduced installation time and costs.

Fast, low-cost installation and deployment

The Alcatel-Lucent RRH2x40-AWS is a zero-footprint solution and operates noise-free, simplifying negotiations with site property owners and minimizing environmental impacts. Installation can easily be done by a single person because the Alcatel-Lucent RRH2x40-AWS is compact and weighs less than 20 kg (44 lb), eliminating the need for a crane to hoist the BTS cabinet to the rooftop. A site can be in operation in less than one day — a fraction of the time required for a traditional BTS.

Excellent RF performance

Because of its small size and weight, the Alcatel-Lucent RRH2x40-AWS can be installed close to the antenna. Operators can therefore locate the Alcatel-Lucent RRH2x40-AWS where RF engineering is deemed ideal, minimizing trade-offs between available sites and RF optimum sites. The RF feeder cost and installation costs are reduced or eliminated, and there is no need for a Tower Mounted Amplifier (TMA) because losses introduced by the RF feeder are greatly reduced. The Alcatel-Lucent RRH2x40-AWS provides more RF power while at the same time consuming less electricity.

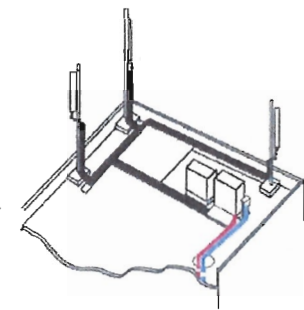

Macro

Features

- Zero-footprint deployment
- Easy installation, with a lightweight unit can be carried and set up by one person
- Optimized RF power, with flexible site selection and elimination of a TMA
- Convection-cooled (fanless)
- Noise-free
- Best-in-class power efficiency, with significantly reduced energy consumption

Benefits

- Leverages existing real estate with lower site costs
- Reduces installation costs, with fewer installation materials and simplified logistics
- Decreases power costs and minimizes environmental impacts, with the potential for eco-sustainable power options
- Improves RF performance and adds flexibility to network planning

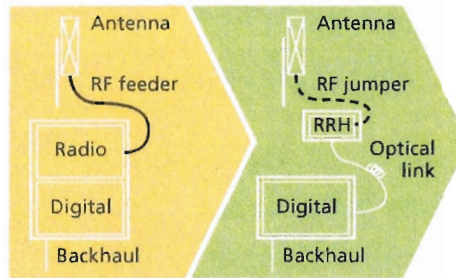

RRH for space-constrained cell sites

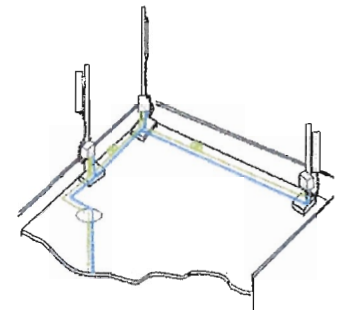

Distributed

Technical specifications

Physical dimensions

- Height: 620 mm (24.4 in.)
- Width: 270 mm (10.63 in.)
- Depth: 170mm (6.7 in.)
- Weight (without mounting kit): less than 20 kg (44 lb)

Power

- Power supply: -48VDC

Operating environment

- Outdoor temperature range:
 - With solar load: -40°C to +50°C (-40°F to +122°F)
 - Without solar load: -40°C to +55°C (-40°F to +131°F)

- Passive convection cooling (no fans)
- Enclosure protection
 - IP65 (International Protection rating)

RF characteristics

- Frequency band: 1700/2100 MHz (AWS); 3GPP Band 4
- Bandwidth: up to 20 MHz
- RF output power at antenna port: 40 W nominal RF power for each Tx port
- Rx diversity: 2-way or 4-way with optional Rx Diversity module
- Noise figure: below 2.0 dB typical
- Antenna Line Device features
 - TMA and Remote electrical tilt (RET) support via AISG v2.0

Optical characteristics

Type/number of fibers

- Single-mode variant
 - One Single Mode Single Fiber per RRH2x, carrying UL and DL using CWDM
 - Single mode dual fiber (SM/DF)
- Multi-mode variant
 - Two Multi-mode fibers per RRH2x: one carrying UL, the other carrying DL

Optical fiber length

- Up to 500 m (0.31 mi), using MM fiber
- Up to 20 km (12.43 mi), using SM fiber

Digital Ports and Alarms

- Two optical ports to support daisy-chaining
- Six external alarms

www.alcatel-lucent.com Alcatel, Lucent, Alcatel-Lucent and the Alcatel-Lucent logo are trademarks of Alcatel-Lucent. All other trademarks are the property of their respective owners. The information presented is subject to change without notice. Alcatel-Lucent assumes no responsibility for inaccuracies contained herein. Copyright © 2010 Alcatel-Lucent. All rights reserved. CPG2809100912 (09)



HYBRIFLEX™ RRH Hybrid Feeder Cabling Solution, 1-5/8", Single-Mode Fiber

Product Description

RFS' HYBRIFLEX Remote Radio Head (RRH) hybrid feeder cabling solution combines optical fiber and DC power for RRHs in a single lightweight aluminum corrugated cable, making it the world's most innovative solution for RRH deployments.

It was developed to reduce installation complexity and costs at Cellular sites. HYBRIFLEX allows mobile operators deploying an RRH architecture to standardize the RRH installation process and eliminate the need for and cost of cable grounding. HYBRIFLEX combines optical fiber (multi-mode or single-mode) and power in a single corrugated cable. It eliminates the need for junction boxes and can connect multiple RRHs with a single feeder. Standard RFS CELLFLEX® accessories can be used with HYBRIFLEX cable. Both pre-connectorized and on-site options are available.

Features/Benefits

- Aluminum corrugated armor with outstanding bending characteristics - minimizes installation time and enables mechanical protection and shielding
- Same accessories as 1 5/8" coaxial cable
- Outer conductor grounding - Eliminates typical grounding requirements and saves on installation costs
- Lightweight solution and compact design - Decreases tower loading
- Robust cabling - Eliminates need for expensive cable trays and ducts
- Installation of tight bundled fiber optic cable pairs directly to the RRH - Reduces CAPEX and wind load by eliminating need for interconnection
- Optical fiber and power cables housed in single corrugated cable - Saves CAPEX by standardizing RRH cable installation and reducing installation requirements
- Outdoor polyethylene jacket - Ensures long-lasting cable protection

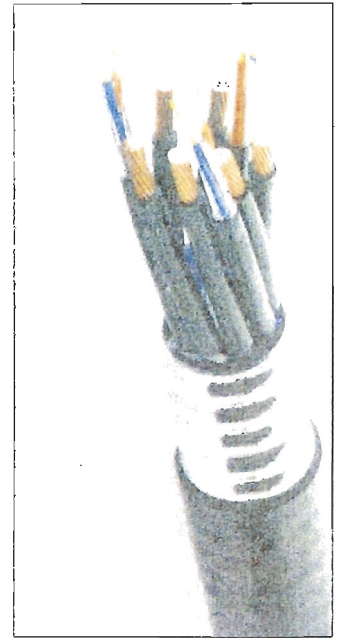

Figure 1: HYBRIFLEX Series

Technical Specifications

Outer Conductor Armor	Corrugated Aluminum	[mm (in)]	46.5 (1.83)
Jacket:	Polyethylene, PE	[mm (in)]	50.3 (1.98)
UV-Protection	Individual and External Jacket		Yes
Mechanical Properties			
Weight, Approximate		[kg/m (lb/ft)]	1.9 (1.30)
Minimum Bending Radius, Single Bending		[mm (in)]	200 (8)
Minimum Bending Radius, Repeated Bending		[mm (in)]	500 (20)
Recommended/Maximum Clamp Spacing		[m (ft)]	1.0 / 1.2 (3.25 / 4.0)
Electrical Properties			
DC-Resistance Outer Conductor Armor		[Ω/km (Ω/1000ft)]	0.68 (0.205)
DC-Resistance Power Cable, 8.4mm ² (8AWG)		[Ω/km (Ω/1000ft)]	2.1 (0.307)
Optical Properties			
Version			Single-mode OM3
Quantity, Fiber Count			16 (8 pairs)
Core/Clad		[μm]	50/125
Primary Coating (Acrylate)		[μm]	245
Buffer Diameter, Nominal		[μm]	900
Secondary Protection, Jacket, Nominal		[mm (in)]	2.0 (0.08)
Minimum Bending Radius		[mm (in)]	104 (4.1)
Insertion Loss @ wavelength 850nm		dB/km	3.0
Insertion Loss @ wavelength 1310nm		dB/km	1.0
Standards (Meets or exceeds)			UL94-V0, UL1666 RoHS Compliant
DC Power Cable Properties			
Size (Power)		[mm (AWG)]	8.4 (8)
Quantity, Wire Count (Power)			16 (8 pairs)
Size (Alarm)		[mm (AWG)]	0.8 (18)
Quantity, Wire Count (Alarm)			4 (2 pairs)
Type			UV protected
Strands			19
Primary Jacket Diameter, Nominal		[mm (in)]	6.8 (0.27)
Standards (Meets or exceeds)			NFPA 130, ICEA S-95-658 UL Type XHHW-2, UL 44 UL-LS Limited Smoke, UL VW 1 IEEE-383 (1974), IEEE1202/FT4 RoHS Compliant
Environment			
Installation Temperature		[°C (°F)]	-40 to +65 (-40 to 149)
Operation Temperature		[°C (°F)]	-40 to +65 (-40 to 149)

* This data is provisional and subject to change

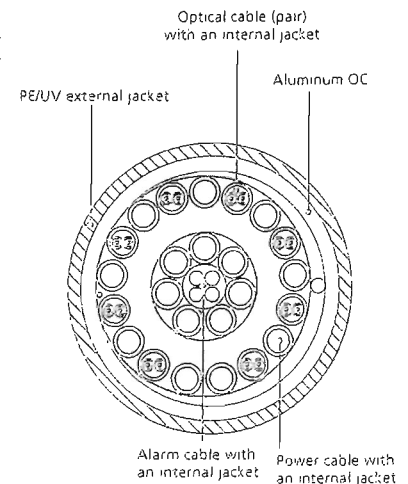
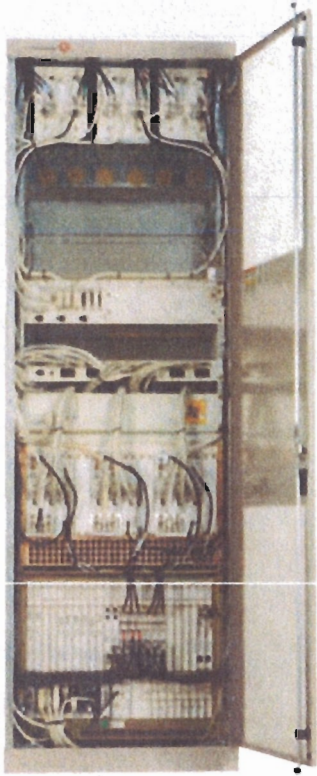

Figure 2: Construction Detail

All information contained in the present datasheet is subject to confirmation at time of ordering.

Lucent CDMA Modular Cell 4.0B Indoor

For CDMA Networks



Lucent CDMA Modular Cell 4.0B is a high capacity base station equipped with the state-of-the-art technologies developed by Bell Labs. The product brings you outstanding carrier density and immediate OPEX savings. This indoor product can support up to 8 carriers/3 sectors per frame. It is twice the density of Modular Cell 4.0 (indoor). Modular Cell 4.0B offers full spectrum coverage in a single frame, dramatically simplifying growth patterns. As the leader in spread spectrum technology, Lucent Technologies continues to introduce innovations to the market: Multi-Carrier Radio (15MHz), Block Filters/Wideband Filters, and 40W Power Amplifier Modules are the latest assets integrated in the base station.

Features

The Modcell 4.0B indoor version offers a small footprint with exceptional carrier density in a standard ETSI cabinet.

- Indoor Single Frame Configuration
- 1-8 carriers per frame at 3 sectors (will support up to 11 carriers with Auxiliary Amplifier Frame)
- Dual Band: one cell to the ECP & mobile
- Close Loop Gain Control
- Timing and Controller Redundancy
- Integrated Power option
- Support CDMA2000™1X, and EV-DO Rev.0, with future support to EV-DO Rev. A
- IP Backhaul and Ethernet Backhaul capable
- 6-Sector option ready
- Intelligent Antenna option ready

Benefits

- Optimized for highest carrier density, smooth growth in one frame
- Conserves indoor footprint, reducing hardware and floor space requirements
- Minimizes configuration complexity
- Software-Only Carrier Add at certain carrier counts
- Flexible channel growth planning
- Designed to use existing power supply
- Grow CDMA carriers on only 2 antennas/sector
- Multi-Carrier Radio (15MHz), Block Filters/Wideband Filters, and 40W Power Amplifier Modules



Technical Specifications

Description	Specification
1. Configurations	
a. Sectors	3, 4 and 6
b. Carriers	1–8 per frame at 3 sectors (up to 11 with Auxiliary Amplifier Frame)
2. CDMA Channel Card Capacity	12 slots; CMU IVB capable
3. T1, E1 Facilities	Maximum of 20 per cabinet when equipped with URC-II's
4. User Alarms	7 Power Alarms, 25 User Alarms
5. GPS Antenna	Yes
6. Air Interface Standards	T1A/E1A 95-A plus TSB-74; T1A/E1A 95-B for 850 MHz; CDMA 2000
7. Frequency Bands	850MHz/1900 MHz; 300 to 2100 MHz capable
8. Vocoder	8 Kbps; 8 Kbps EVRC; 13 Kbps; SMV-ready
9. Environmental Cabinet Housing	Standard ETSI cabinet; UL50 compliant; zero rear clearance
10. Cabinet Access	Front Access
11. Operating Temperature Range	Range: -5 to +40°C (continuous)
12. Dimensions	600 mm W x 600 mm D x 1880 mm H (23.6 x 23.6 x 74) inches
13. Estimated Installed Weight	365 kg (785 lbs.) DC [8 carriers in one cabinet]
14. Power Options	Integrated Power, AC 120/240 Volt Input, -48V or +24 V DC Conversion Non-integrated Power requires either + 24 VDC Input or - 48 VDC Input
15. Power Consumption	
a. 3 Carrier/3 Sectors	2167 W
b. 6 Carrier/3 Sectors	5449 W
c. 11 Carrier/3 Sectors	10026 W
16. RF Power (at J4)	25 W per carrier (850) FCC Rated short-term average 20 W per carrier (850) FCC Rated long-term average 20 W per carrier (1900) FCC Rated short-term average 16 W per carrier (1900) FCC Rated long-term average
17. Minimal Antenna Configuration	2 antennas/sector
18. Filter	Block and Wide Band Dual Duplex
19. Growth Frame	PCS AUX Frame, Dual Band Growth Frame
20. Operational Accessories	Integrated Power
21. Channel Elements	Channel pooling across sectors or carriers

To learn more about our comprehensive portfolio, please contact your Lucent Technologies Sales Representative or visit our web site at <http://www.lucent.com>.

This document is for informational or planning purposes only, and is not intended to create, modify or supplement any Lucent Technologies specifications or warranties relating to these products or services. Information and/or technical specifications supplied within this document do not waive (directly or indirectly) any rights or licenses — including but not limited to patents or other protective rights — of Lucent Technologies or others. Specifications are subject to change without notice.

CDMA2000 is a trademark of the Telecommunication Industry Association

Copyright © 2006
Lucent Technologies Inc.
All rights reserved

MOB-Mod4B-i 0106



SD050

3.4L

Industrial Diesel Generator Set

EPA Certified Stationary Emergency

SD050 50 kW

1 of 6

Standby Power Rating
50 kW 63 kVA 60 Hz

Prime Power Rating*
45 kW 56 kVA 60 Hz

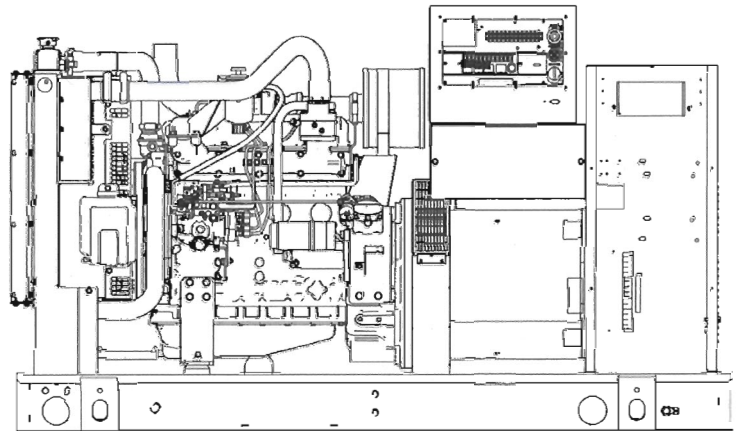

Image used for illustration purposes only

*EPA Certified Prime ratings are not available in the U.S. or its Territories

Codes and Standards

Generac products are designed to the following standards:



UL2200, UL508, UL142, UL498



NFPA70, 99, 110, 37



NEC700, 701, 702, 708



ISO9001, 8528, 3046, 7637, Pluses #2b, 4



NEMA ICS10, MG1, 250, ICS6, AB1



ANSI C62.41
American National Standards Institute

Powering Ahead

For over 50 years, Generac has led the industry with innovative design and superior manufacturing.

Generac ensures superior quality by designing and manufacturing most of its generator components, including alternators, enclosures and base tanks, control systems and communications software.

Generac's gensets utilize a wide variety of options, configurations and arrangements, allowing us to meet the standby power needs of practically every application.

Generac searched globally to ensure the most reliable engines power our generators. We choose only engines that have already been proven in heavy-duty industrial application under adverse conditions.

Generac is committed to ensuring our customers' service support continues after their generator purchase.

SD050

Standard Features

ENGINE SYSTEM

General

- Oil Drain Extension
- Air Cleaner
- Fan Guard
- Stainless Steel flexible exhaust connection
- Critical Exhaust Silencer (enclosed only)
- Factory Filled Oil
- Radiator Duct Adapter (open set only)

Fuel System

- Fuel lockoff solenoid
- Primary fuel filter

Cooling System

- Closed Coolant Recovery System
- UV/Ozone resistant hoses
- Factory-Installed Radiator
- Radiator Drain Extension
- 50/50 Ethylene glycol antifreeze
- 120 VAC Coolant Heater

Engine Electrical System

- Battery charging alternator
- Battery cables
- Battery tray
- Solenoid activated starter motor
- Rubber-booted engine electrical connections

ALTERNATOR SYSTEM

- UL2200 GENprotect™
- 12 leads (3-phase, non 600 V)
- Class H insulation material
- Vented rotor
- 2/3 pitch
- Skewed slator
- Auxiliary voltage regulator power winding
- Amortisseur winding
- Brushless Excitation
- Sealed Bearings
- Automated manufacturing (winding, insertion, lacing, varnishing)
- Rotor dynamically spin balanced (get tolerance)
- Full load capacity alternator
- Protective thermal switch

GENERATOR SET

- Internal Genset Vibration Isolation
- Separation of circuits - high/low voltage
- Separation of circuits - multiple breakers
- Silencer Heat Shield
- Wrapped Exhaust Piping
- Silencer housed in discharge hood (enclosed only)
- Standard Factory Testing
- 2 Year Limited Warranty (Standby rated Units)
- 1 Year Limited Warranty (Prime rated units)
- Silencer mounted in the discharge hood (enclosed only)

ENCLOSURE (if selected)

- Rust-proof fasteners with nylon washers to protect finish
- High performance sound-absorbing material
- Gasketed doors
- Stamped air-intake louvers
- Air discharge hoods for radiator-upward pointing
- Stainless steel lift off door hinges
- Stainless steel lockable handles
- Rhino Coat™ - Textured polyester powder coat

TANKS (if selected)

- UL 142
- Double wall
- Vents
- Sloped top
- Sloped bottom
- Factory pressure tested (2 psi)
- Rupture basin alarm
- Fuel level
- Check valve in supply and return lines
- Rhino Coat™ - Textured polyester powder coat
- Stainless hardware

CONTROL SYSTEM



Control Panel

- Digital H Control Panel - Dual 4x20 Display
- Programmable Crank Limiter
- 7-Day Programmable Exerciser
- Special Applications Programmable PLC
- RS-232/485
- All-Phase Sensing DVR
- Full System Status
- Utility Monitoring
- Low Fuel Pressure Indication
- 2-Wire Start Compatible
- Power Output (kW)
- Power Factor
- kW Hours, Total & Last Run

- Real/Reactive/Apparent Power
- All Phase AC Voltage
- All Phase Currents
- Oil Pressure
- Coolant Temperature
- Coolant Level
- Engine Speed
- Battery Voltage
- Frequency
- Date/Time Fault History (Event Log)
- Isochronous Governor Control
- Waterproof/sealed Connectors
- Audible Alarms and Shutdowns
- Not in Auto (Flashing Light)
- Auto/Off/Manual Switch
- E-Stop (Red Mushroom-Type)
- NFPA110 Level I and II (Programmable)
- Customizable Alarms, Warnings, and Events
- Modbus protocol
- Predictive Maintenance algorithm
- Sealed Boards
- Password parameter adjustment protection
- Single point ground

- 15 channel data logging
- 0.2 msec high speed data logging
- Alarm information automatically comes up on the display

Alarms

- Oil Pressure (Pre-programmable Low Pressure Shutdown)
- Coolant Temperature (Pre-programmed High Temp Shutdown)
- Coolant Level (Pre-programmed Low Level Shutdown)
- Low Fuel Pressure Alarm
- Engine Speed (Pre-programmed Over speed Shutdown)
- Battery Voltage Warning
- Alarms & warnings time and date stamped
- Alarms & warnings for transient and steady state conditions
- Snap shots of key operation parameters during alarms & warnings
- Alarms and warnings spelled out (no alarm codes)

SD050

Configurable Options

ENGINE SYSTEM

- General
- Oil Make-Up System
 - Oil Heater
 - Industrial Exhaust Silencer

Fuel System

- Flexible fuel lines
- Primary fuel filter

Engine Electrical System

- 10A UL battery charger
- 2.5A UL battery charger
- Battery Warmer

ALTERNATOR SYSTEM

- Alternator Upsizing
- Anti-Condensation Heater
- Tropical coating
- Permanent Magnet Excitation

CIRCUIT BREAKER OPTIONS

- Main Line Circuit Breaker
- 2nd Main Line Circuit Breaker
- Shunt Trip and Auxiliary Contact
- Electronic Trip Breakers

GENERATOR SET

- Gen-Link Communications Software (English Only)
- 8 Load Position Load Center
- 2 Year Extended Warranty
- 5 Year Warranty
- 5 Year Extended Warranty

ENCLOSURE

- Weather Protected
- Level 1 Sound Attenuation
- Level 2 Sound Attenuation
- Steel Enclosure
- Aluminum Enclosure
- 150 MPH Wind Kit
- 12 VDC Enclosure Lighting Kit
- 120 VAC Enclosure Lighting Kit
- AC/DC Enclosure Lighting Kit
- Door Alarm Switch

TANKS (Size on last page)

- Electrical Fuel Level
- Mechanical Fuel Level
- 54 Gal (204.4 L) Usable Capacity
- 132 Gal (499.7 L) Usable Capacity
- 211 Gal (798.7 L) Usable Capacity
- 300 Gal (1135.6 L) Usable Capacity
- 8" Vent Extension
- 13" Vent Extension
- 19" Vent Extension

CONTROL SYSTEM

- 21-Light Remote Annunciator
- Remote Relay Panel (8 or 16)
- Oil Temperature Sender with Indication Alarm
- Remote E-Stop (Break Glass-Type, Surface Mount)

- Remote E-Stop (Red Mushroom-Type, Surface Mount)
- Remote E-Stop (Red Mushroom-Type, Flush Mount)
- Remote Communication - Modem

- Remote Communication - Ethernet
- 10A Run Relay
- Ground fault indication and protection functions

Engineered Options

ENGINE SYSTEM

- Coolant heater ball valves
- Block Heaters
- Fluid containment pans

ALTERNATOR SYSTEM

- 3rd Breaker System

GENERATOR SET

- Special Testing
- IBC Seismic Certification

ENCLOSURE

- Motorized Dampers
- Door switched for intrusion alert
- Enclosure ambient heaters

TANKS

- Overfill protection valve
- UL2085 Tank
- ULC S-601 Tank
- Stainless Steel Tank
- Special Fuel Tanks (MIDEQ and FL DEP/DERM, etc.)
- Vent Extensions

CONTROL SYSTEM

- Spare inputs (x4) / outputs (x4) - H Panel Only
- Battery Disconnect Switch

Rating Definitions

Standby – Applicable for a varying emergency load for the duration of a utility power outage with no overload capability.

Prime – Applicable for supplying power to a varying load in lieu of utility for an unlimited amount of running time. A 10% overload capacity is available for 1 out of every 12 hours. The Prime Power option is only available on International applications.

Power ratings in accordance with ISO 8528-1, Second Edition dated 2005-06-01, definitions for Prime Power (PRP) and Emergency Standby Power (ESP).

SD050

application and engineering data

ENGINE SPECIFICATIONS

General

Make	Generac
EPA Emissions Compliance	Stationary Emergency
EPA Emissions Reference	See Emissions Data Sheet
Cylinder #	4
Type	In-Line
Displacement - L (cu in)	3.4 (207.48)
Bore - mm (in)	98 (3.86)
Stroke - mm (in)	113 (4.45)
Compression Ratio	18.5:1
Intake Air Method	Turbocharged/Aftercooled
Cylinder Head Type	Cast Iron OHV
Piston Type	Aluminum
Crankshaft Type	Forged Steel

Engine Governing

Governor	Electronic Isochronous
Frequency Regulation (Steady State)	± 0.25%

Lubrication System

Oil Pump Type	Gear
Oil Filter Type	Full Flow Cartridge
Crankcase Capacity - L (qts)	7 (7.4)

Cooling System

Cooling System Type	Closed Recovery
Water Pump Flow	Pre-Lubed, Self Sealing
Fan Type	Pusher
Fan Speed (rpm)	NA
Fan Diameter mm (in)	560 (22)
Coolant Heater Wattage	1500
Coolant Heater Standard Voltage	120 V /240 V

Fuel System

Fuel Type	Ultra Low Sulfur Diesel Fuel
Fuel Specifications	ASTM
Fuel Filtering (microns)	10
Fuel Inject Pump	Bosch (VE)
Fuel Pump Type	Engine Driven Gear
Injector Type	Pintel - 2100 PSI
Fuel Supply Line - mm (in)	7.92 (0.312)
Fuel Return Line - mm (in)	7.92 (0.312)

Engine Electrical System

System Voltage	12 VDC
Battery Charging Alternator	20 A
Battery Size	See Battery Index 0161970SBY
Battery Voltage	12 VDC
Ground Polarity	Negative

ALTERNATOR SPECIFICATIONS

Standard Model	390
Poles	4
Field Type	Revolving
Insulation Class - Rotor	H
Insulation Class - Stator	H
Total Harmonic Distortion	< 3%
Telephone Interference Factor (TIF)	< 50
Standard Excitation	Synchronous
Bearings	Single Sealed Cartridge
Coupling	Direct, Flexible Disc
Load Capacity - Standby	100%
Prototype Short Circuit Test	Yes

Voltage Regulator Type	Digital
Number of Sensed Phases	All
Regulation Accuracy (Steady State)	± 0.25%

SD050

operating data

POWER RATINGS

	Standby	
Single-Phase 120/240 VAC @1.0pf	50 kW	Amps: 208
Three-Phase 120/208 VAC @0.8pf	50 kW	Amps: 173
Three-Phase 120/240 VAC @0.8pf	50 kW	Amps: 150
Three-Phase 277/480 VAC @0.8pf	50 kW	Amps: 75
Three-Phase 346/600 VAC @0.8pf	50 kW	Amps: 60

STARTING CAPABILITIES (sKVA)

sKVA vs. Voltage Dip

Alternator	kW	480 VAC						208/240 VAC					
		10%	15%	20%	25%	30%	35%	10%	15%	20%	25%	30%	35%
Standard	50	34	52	69	86	103	120	26	39	52	65	77	90
Upsize 1	60	42	63	83	104	125	146	32	47	62	78	94	110

FUEL CONSUMPTION RATES*

Fuel Pump Lift - ft (m)		Diesel - gph (lph)	
3 (1)		Percent Load	gph (lph)
Total Fuel Pump Flow (Combustion + Return)		25%	1.3 (4.92)
5.5 gph		50%	2.3 (8.71)
		75%	3.3 (12.50)
		100%	4.3 (16.36)

* Fuel supply installation must accommodate fuel consumption rates at 100% load.

COOLING

	Standby	
Coolant Flow per Minute	gpm (lpm)	12.2 (46)
Coolant System Capacity	gal (L)	2.5 (9.5)
Heat Rejection to Coolant	BTU/hr	135,900
Inlet Air	cfm (m ³ /hr)	7500 (212)
Max. Operating Radiator Air Temp	F° (C°)	122 (50)
Max. Ambient Temperature (before derate)	F° (C°)	104 (40)
Maximum Radiator Backpressure	in H ₂ O	0.5

COMBUSTION AIR REQUIREMENTS

	Standby
Flow at Rated Power cfm (m ³ /min)	166 (4.7)

ENGINE

	Standby	
Rated Engine Speed	rpm	1800
Horsepower at Rated kW**	hp	86
Piston Speed	ft/min (m/min)	1335
BMEP	psi	169

** Refer to "Emissions Data Sheet" for maximum bHP for EPA and SCAQMD permitting purposes.

EXHAUST

	Standby	
Exhaust Flow (Rated Output)	cfm (m ³ /min)	448 (12.7)
Max. Backpressure (Post Silencer)	inHg (Kpa)	1.5 (5.1)
Exhaust Temp (Rated Output)	°F (°C)	1044 (562)
Exhaust Outlet Size (Open Set)	mm (in)	63.5 (2.5)

Deration -- Operational characteristics consider maximum ambient conditions. Derate factors may apply under atypical site conditions. Please consult a Generac Power Systems Industrial Dealer for additional details. All performance ratings in accordance with ISO3046, BS5514, ISO8528 and DIN6271 standards.

SD050

dimensions and weights*

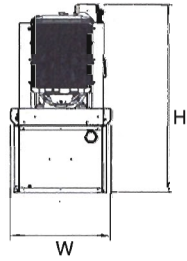
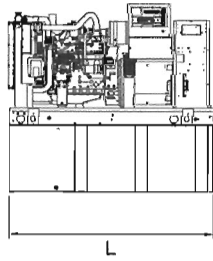

OPEN SET

RUN TIME HOURS	USABLE CAPACITY GAL (L)	L x W x H in (mm)	WT lbs (kg) - Tank & Open Set	
			Steel	Aluminum
NO TANK	-	76 (1930.4) x 38 (914.4) x 45 (1143)	1756 (796)	
13	54 (204.4)	76 (1930.4) x 38 (914.4) x 58 (1473.2)	2236 (1014)	
31	132 (499.7)	76 (1930.4) x 38 (914.4) x 70 (1778)	2466 (1119)	
49	211 (798.7)	76 (1930.4) x 38 (914.4) x 82 (2082.8)	2675 (1213)	
70	300 (1135.6)	93 (2362.2) x 38 (914.4) x 86 (2184.4)	2738 (1242)	

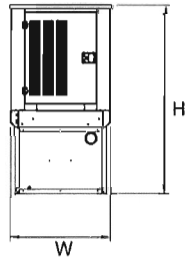
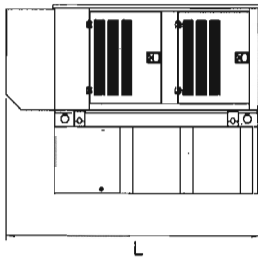

STANDARD ENCLOSURE

RUN TIME HOURS	USABLE CAPACITY GAL (L)	L x W x H in (mm)	WT lbs (kg) - Enclosure Only	
			Steel	Aluminum
NO TANK	-	95 (2413) x 38 (965.2) x 50 (1270)	334 (152)	115 (52)
13	54 (204.4)	95 (2413) x 38 (965.2) x 63 (1600.2)		
31	132 (499.7)	95 (2413) x 38 (965.2) x 75 (1905)		
49	211 (798.7)	95 (2413) x 38 (965.2) x 87 (2209.8)		
70	300 (1135.6)	95 (2413) x 38 (965.2) x 91 (2311.4)		

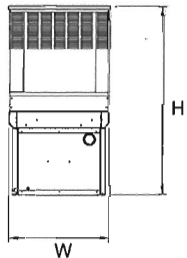
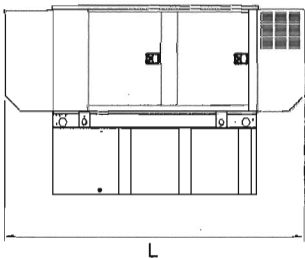

LEVEL 1 ACOUSTIC ENCLOSURE

RUN TIME HOURS	USABLE CAPACITY GAL (L)	L x W x H in (mm)	WT lbs (kg) - Enclosure Only	
			Steel	Aluminum
NO TANK	-	113 (2870.2) x 38 (965.2) x 50 (1270)	435 (198)	150 (68)
13	54 (204.4)	113 (2870.2) x 38 (965.2) x 63 (1600.2)		
31	132 (499.7)	113 (2870.2) x 38 (965.2) x 75 (1905)		
49	211 (798.7)	113 (2870.2) x 38 (965.2) x 87 (2209.8)		
70	300 (1135.6)	113 (2870.2) x 38 (965.2) x 91 (2311.4)		

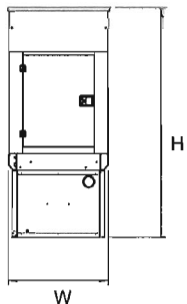
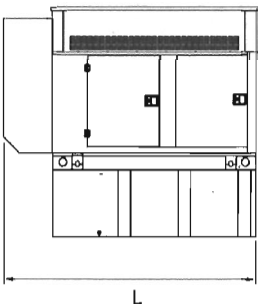

LEVEL 2 ACOUSTIC ENCLOSURE

RUN TIME HOURS	USABLE CAPACITY GAL (L)	L x W x H in (mm)	WT lbs (kg) - Enclosure Only	
			Steel	Aluminum
NO TANK	-	95 (2413) x 38 (965.2) x 62 (1574.8)	520 (236)	179 (81)
13	54 (204.4)	95 (2413) x 38 (965.2) x 75 (1905)		
31	132 (499.7)	95 (2413) x 38 (965.2) x 87 (2209.8)		
49	211 (798.7)	95 (2413) x 38 (965.2) x 99 (2514.6)		
70	300 (1135.6)	95 (2413) x 38 (965.2) x 103 (2616.2)		

*All measurements are approximate and for estimation purposes only. Sound dBA can be found on the sound data sheet. Enclosure Only weight is added to Tank & Open Set weight to determine total weight.

YOUR FACTORY RECOGNIZED GENERAC INDUSTRIAL DEALER

Specification characteristics may change without notice. Dimensions and weights are for preliminary purposes only. Please consult a Generac Power Systems Industrial Dealer for detailed installation drawings.

Generac Power Systems, Inc. • S45 W29290 HWY. 59, Waukesha, WI 53189 • generac.com

©2013 Generac Power Systems, Inc. All rights reserved. All specifications are subject to change without notice. Bulletin OK5090-B / Printed in U.S.A. 12/06/13