

Development and Management Plan

(Construction--- Phase 3 Final)

For

SONO Substation

Norwalk, Connecticut

The South Norwalk Electric and Water (SNEW) hereby submits a Development and Management (“D&M”) Plan, for the SONO Substation to the Connecticut Siting Council (“Council”). A D&M Plan for the tree removal, soil remediation, site grading, soil erosion & sedimentation controls measures and foundation plans have previously been submitted and approved.

The Development and Management Plan consists of the following:

- I. Introduction
- II. General Project Description
- III. Development and Management Plan Narrative
- IV. Appendix A: Figure 1, Site Location Map, USGS
 - Appendix B: Plan Drawings – CL&P
 - Appendix C: Plan Drawings – SNEW
 - Appendix D: Stormwater Best Management

Section I

Introduction

This D&M plan for the SONO Substation was prepared to comply with a condition in the Council's Decision and Order in Docket No. 431, dated March 21, 2013. In accordance with that condition, the D&M Plan is in compliance with Sections 16-50j-60 through 16-50j-62 of the Regulations of Connecticut State Agencies which includes the following specific elements:

- A final site plan showing the placement of all substation equipment, structures, and building within the permanent tap structures;
- Erosion and sediment controls consistent with the 2002 *Connecticut Guidelines for Soil Erosion and Sediment Controls*;
- Provisions for storm water management and transformer oil containment.
- Details of the Connecticut Light and Power Company's transmission interconnection design, including new transmission structures

Section II

General Project Description

The Applicant, The Second Taxing District of the City of Norwalk, Fairfield County, Connecticut, South Norwalk Electric and Water (SNEW), is proposing to construct a 115-kilovolt (“kV”) to 13.8-kV bulk supply substation that would be directly connected to an existing CL&P 115 kV transmission Line. The substation is proposed on an approximately 1.07 acre site owned by SNEW. The Site includes two adjoining parcels located adjacent to and west of Dr. Martin Luther King, Jr. Drive in the southwestern portion of Norwalk's Second Taxing District.

This location is zoned for industrial purposes. The site is triangular shaped and abuts the Metro-North/Amtrak rail corridor and existing CL&P electric transmission easement to the west, Dr. Martin Luther King Junior Drive to the east and a delivery distribution facility to the south (United Parcel Service- UPS). The site does not have any watercourses, known critical habitats or sites identified as having rare or endangered plant or animal species listed by federal and state government agencies, or underground facilities or utilities.

The proposed Project will involve the construction and operation of the substation, as well as the establishment of a new interconnection to CL&P's adjacent 115 kV transmission line, and the addition of three steel pole structures in the Metro-North corridor.

The overall purpose of the Project is to add capacity in response to the increasing demand for electricity in South Norwalk and its surrounding area and by so doing, improving electric distribution system reliability in the City of Norwalk.

Section III
Development and Management Plan Narrative
(Construction)

The intent of this D&M Plan is to describe the final designs of the substation and provide SNEW's stormwater best management practices for the site. With this final submission of the D&M plan SNEW has complied with Sections 16-50j-60 through 16-50j-62 of the Regulations of Connecticut State Agencies.

Key Map

A key map can be found in Section IV, Appendix A, *Figure 1, Site Location Map, USGS*

Plan Drawings

The Plan Drawings can be found in Section IV, Appendix B and C. Appendix B has Connecticut Light and Power drawings and Appendix C has South Norwalk Electric and Water drawings.

Land Ownership

The proposed SONO Substation is entirely located on land owned in fee by the Second Taxing District of the City of Norwalk

Public Roads and Land

The property is surrounded by Dr. Martin Luther King Junior Drive to the east, a transmission and railroad corridor to the west and a delivery distribution center, United Postal Service (UPS), to the south. There are no public roads or land crossing the property.

Grading Plan

A grading plan previously submitted and approved.

Topographic Features

Topographic features including one-foot contours are depicted on the plan drawings contained in Appendix B, *Topographic Survey Prepared For Second Taxing District City of Norwalk*.

Substation Structure Location and Details

SNEW proposes to construct the new substation on the 1.07-acre St. Ann's Site, which interconnects to CL&P's 115 kV 1890 Line and the Metro-North railroad corridor to the west, and is located adjacent to Dr. Martin Luther King, Jr. Drive on the east. The distribution portion of the substation will be owned, operated and maintained by SNEW. The transmission (PTF) portion of the substation will be owned, operated and maintained by CL&P. In the vicinity of the site, CL&P's 115 kV transmission line is built on or over Metro-North's railroad structures and conductor facilities.

The substation fence would be set back approximately three feet from the site boundary on the south and part of the east and west boundaries. On the northern portion of the property, the fence is offset from the property boundary to allow for landscaping adjacent to Martin Luther King, Jr. Drive.

CL&P's existing 1890 Line will be looped into the new substation to provide transmission service. A circuit breaker, which will normally be closed, will separate the existing 1890 Line

into two new circuits. In the event of an outage on either of the new 115 kV circuits, this looped arrangement will allow SNEW to obtain power from the other circuit.

The proposed substation and transmission/distribution line interconnections are designed in accordance with the National Electric Safety Code, and standards of the Institute of Electrical and Electronics Engineers, and the American National Standards Institute. Appendix B and C has the Plan Drawings which identify the proposed substation development plan and layout, respectively. The substation will consist of the following major components:

SNEW Owned and Operated

- Two 24/32/40 MVA power transformers, with a base rating of 24 MVA and a peak of 40 MVA (fan-cooled). The transformers will be installed on concrete pads. Each transformer will contain approximately 5,500 gallons of insulating oil. To minimize or avert the potential for spills, each transformer will include an oil containment system, consisting of a sump with the capacity to contain 110% of the oil volume.
- Appropriate circuit breakers, circuit switchers and disconnect switches.
- Connection (i.e., a high voltage tap) for a mobile transformer, in the event that one is ever needed.
- SNEW control house. This fabricated metal will house the distribution substation's relaying, control, metering, substation batteries and chargers and monitoring equipment, including the distribution Supervisory Control and Data Acquisition (SCADA) system. The building also will include heating, ventilation, and air conditioning. The control house will contain the automatic transfer switch (ATS) for the Alternating Current (AC) power from the two station service transformers.

The same building will house the 15kV metal clad distribution switchgear. CL&P Owned and Operated

- Three new transmission line steel support poles will be installed in the railroad right-of-way (with two adjacent to the site) to alter the existing transmission lines to improve the transmission line alignment prior to the transition to a horizontal configuration in the substation.
- Two new steel A-frame terminal structures will be installed within the new substation. The steel frame terminal structures will complete the transition of the transmission lines from the vertical arrangement in the Connecticut Department of Transportation (ConnDOT) Right-of-Way, to a horizontal arrangement within the new substation. The structures will stand approximately 60-70 feet and support line disconnect and line monitoring and protection equipment.
- CL&P control house will contain the transmission communication, control, and monitoring and protection systems. A transmission SCADA system for control, status reporting and recording. Power panels for the station AC system and its own DC power system, including DC panels, batteries and charger. The building also will include heating, ventilation, and air conditioning.

The transformers will be connected to CL&P's 115 kV transmission line via high current rated circuit switchers and 115 kV disconnect switches. The power transformers will be provided with automatic load tap changers to regulate low-side voltages. The low voltage (i.e., 13.8 kV) switchgear will include a circuit breaker for each transformer, a tie circuit breaker (which will normally be open), and distribution circuit breakers.

Should one side of the 115 kV transmission line experience power supply problems, the substation's 115 kV tie circuit breaker will open. Only a momentary outage is expected, until the 115 kV tie circuit breaker is re-closed. If the fault persists and the 115 kV tie breaker cannot be re-closed, then the 13.8 kV tie circuit breaker will close. This process will be performed automatically with relays. Matched equipment on each side of the substation is designed to

assure continuity in operations and maintenance procedures. Each transformer is capable of carrying the entire expected substation load of 40 MVA.

SNEW and CL&P have worked together to identify and evaluate options for interconnecting the substation to the 115 kV 1890 Line. The plan for the interconnection includes the following primary components:

For the entry of the 1890W line into the new substation:

- *Install a new steel pole structure*, planned for location approximately 50 feet south of the existing railroad/CL&P Tower #512. The new steel pole will be located on railroad property.
- *Install a new steel pole structure*, planned for location approximately 20 feet south of the existing railroad/CL&P Tower #B513. The new steel pole will be located partially on SNEW property and partially on railroad property (i.e., land owned by the Connecticut Department of Transportation and used by the railroad).
- *Reposition CL&P conductors and shield wire*. The existing CL&P mast is located 11 feet out, on the catenary bridge over the railroad tracks. The new steel pole for the 1890W circuit will be located clear of all railroad conductors and communications cables, with the exception of four railroad power and signal supply conductors. The new steel pole arms will be designed to extend over the tracks to the existing position of the CL&P conductors and shield wire. The CL&P wires will be moved from the mast onto the steel pole arms, and the mast will then be removed. This will allow the railroad conductors to be repositioned on the catenary bridge.

For the entry of the 1890E line into the new substation:

- *Install a new steel pole structure*, to be located approximately 200 feet south of CL&P's existing tower #8-514W.S. This new steel pole is expected to be located partially on railroad property and partially on SNEW property.
- *Modify existing CL&P facilities* to accommodate conductor loops to the new steel pole and the new span into the substation.

In addition to the 115 kV interconnection to the proposed substation, CL&P will provide fiber optic cable, and implement minor modifications to primary and backup protection relays at its Sasco Creek, Glenbrook, and Norwalk Harbor substations. Such work is expected to include minor changes to relay settings, communication cards, and control circuits.

SNEW will extend its existing distribution feeders to connect to the substation. The distribution lines will be installed underground and located in duct banks. New underground distribution duct will be required to link to SNEW's existing distribution system. The existing duct bank ends just at the north end of the parcel.

The level portions of the site not occupied by equipment will be graded and finished with a gravel surface (known as trap rock). Sloped areas will be appropriately stabilized to prevent erosion. See Appendix C, Soil and Erosion Control Plan. The entire perimeter of the substation facility will be fenced. Landscaping will occur for screening purposes, particularly along Martin Luther King, Jr. Drive, as appropriate.

The substation equipment and supporting infrastructure would have a service life of approximately 40 years and would be capable of supporting the forecasted increased demand during this time.

Points of Access

Access to the site will be via Martin Luther King, Jr. Drive with two separate driveways and access gates; one to access the area owned and operated by SNEW and the other to access the separate area operated by CL&P. These gates will be located on the eastern portion of the site, and are accessible from Dr. Martin Luther King, Jr. Drive and a short driveway.

Proposed Clearing

Previously submitted in the Development and Management Plan – Phase One, Vegetation Removal and Soil Remediation.

Sensitive Areas

- A Soil Erosion and Control plan was previously submitted in the Development and Management Plan – Phase Two.
- There are no wetlands or watercourses within or near the project site.
- There are no known critical habitats or areas identified as having rare, endangered, threatened or special concern plant or animal species listed by federal and state governmental agencies.
- There are no underground utilities or resources within the site
- There are no significant environmental, historic or ecological features of local interest.
- There are no public recreation areas or activities within or adjacent to the site.

Landscape Plan

A landscape plan can be found in Appendix C. All landscaping will be conducted outside of the fence of the substation. The plantings include 13 Japanese Flowering Cherries and 45 Green Giant Arborvitaes.

Section IV
Appendix

Appendix A: Figure 1, Site Location Map, USGS



South Norwalk Electric and Water

Figure 1
Site Location Map
180-184 Dr. Martin Luther King Jr. Drive
Norwalk, Connecticut

Appendix B: Plan Drawings – CL&P

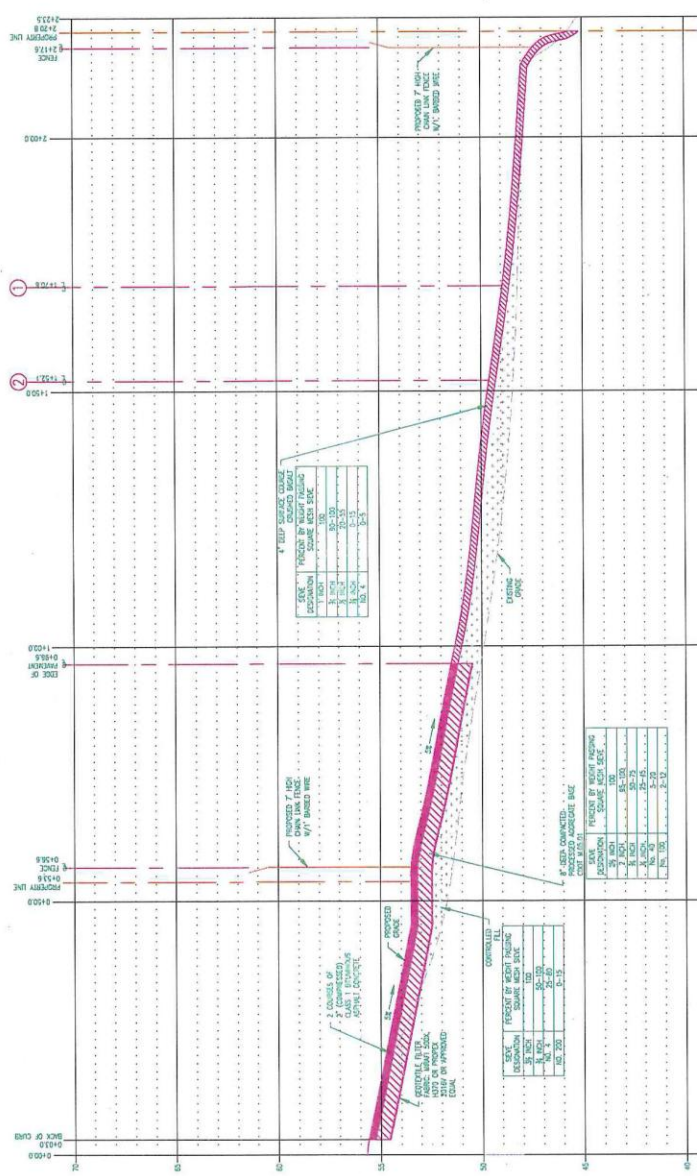

PROFILE #1
ACCESS ROAD

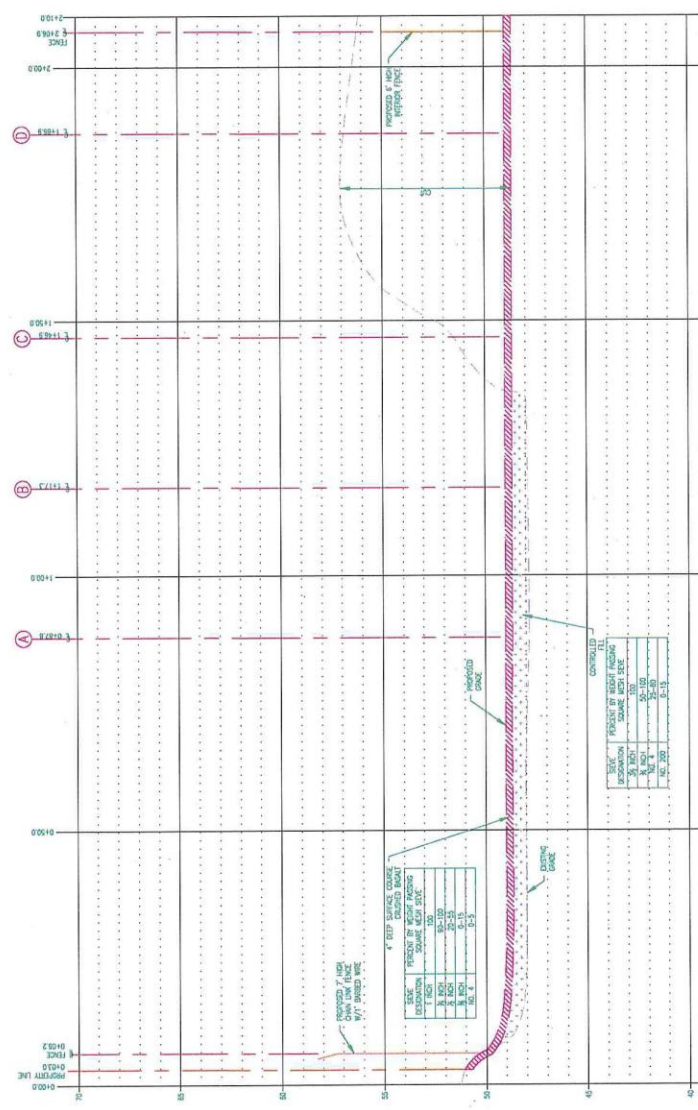

PROFILE #2
YARD CUT

REFERENCE DRAWING:
SEE 2003-1003 FOR THE EQUIPMENT PARKING PAD

REV A - NEW DRAWING

DATE	DESCRIPTION	BY	CHK
10/20/11	REVISED FOR THE EQUIPMENT PARKING PAD

Northeast Utilities Service Co.
THE CONNECTICUT LIGHT AND POWER COMPANY

SONO ZAP
SITE DEVELOPMENT
NORWALK, CT

NO.	DATE	BY	CHK	DESCRIPTION
1	10/20/11	REVISED FOR THE EQUIPMENT PARKING PAD

20322-10003

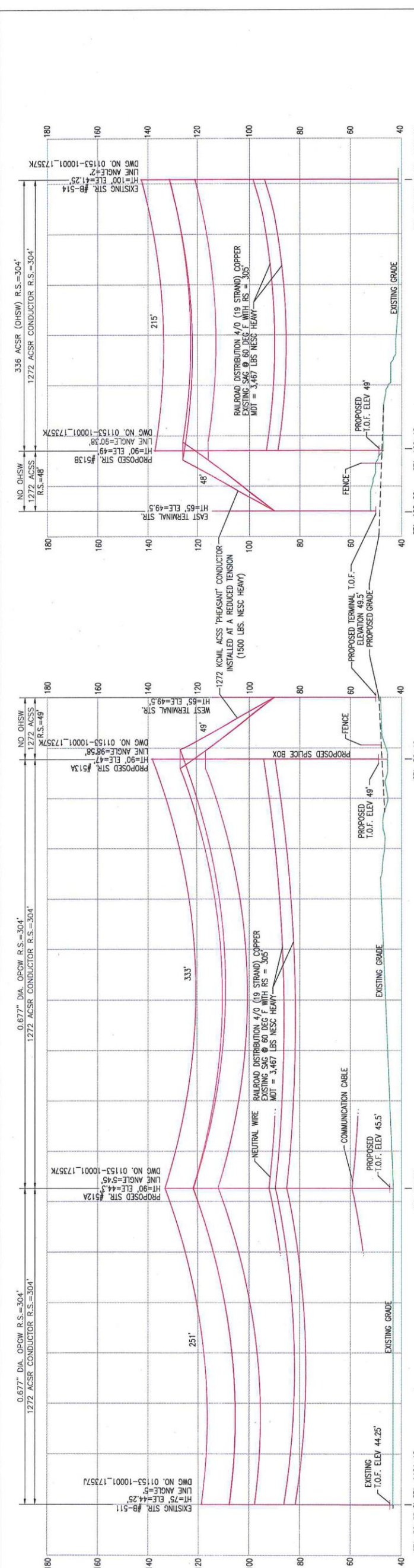

1608 LINE HEADING SOUTH PROFILE
 V-SCALE: 1" = 20'
 H-SCALE: 1" = 40'

1146 LINE HEADING NORTH PROFILE
 V-SCALE: 1" = 20'
 H-SCALE: 1" = 40'

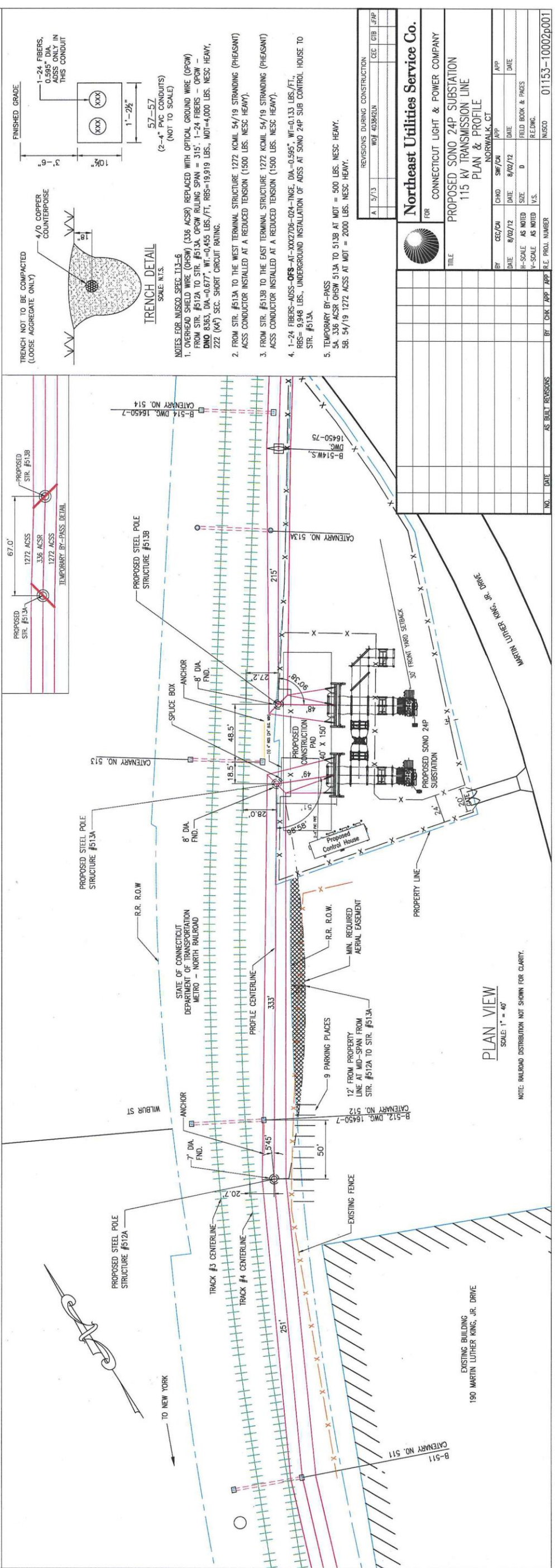

PLAN VIEW
 SCALE: 1" = 40'

NOTE: RAILROAD DISTRIBUTION NOT SHOWN FOR CLARITY.

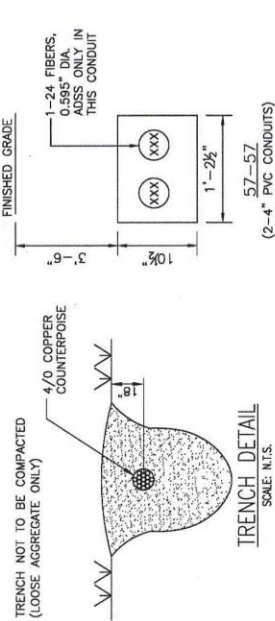

- NOTES FOR INVOICE SPEC I13-B
 SCALE: N.T.S.
- OVERHEAD SHIELD WIRE (OHSW) (336 ACSR) REPLACED WITH OPTICAL GROUND WIRE (OPGW) FROM STR. #512A TO STR. #513A. OPGW RULING SPAN = 315'. 1-24 FIBERS - OPGW - DMD 8363, DA=0.677", WT.=0.455 LBS./FT., RBS=19.919 LBS., MDT=4,000 LBS., NESC HEAVY, 222 (K4) SEC. SHORT CIRCUIT RATING.
 - FROM STR. #513A TO THE WEST TERMINAL STRUCTURE 1272 KOMIL 54/19 STRANDING (PHEASANT) ACSR CONDUCTOR INSTALLED AT A REDUCED TENSION (1500 LBS. NESC HEAVY).
 - FROM STR. #513B TO THE EAST TERMINAL STRUCTURE 1272 KOMIL 54/19 STRANDING (PHEASANT) ACSR CONDUCTOR INSTALLED AT A REDUCED TENSION (1500 LBS. NESC HEAVY).
 - 1-24 FIBERS-ADSS-0F8-AT-XXX2706-024-TN02, DA=0.595", WT=0.133 LBS./FT., RBS= 9,948 LBS., UNDERGROUND INSTALLATION OF ADSS AT SONO 24P SUB CONTROL HOUSE TO STR. #513A.
 - TEMPORARY BT-PASS
 - SA 336 ACSR OHSW 513A TO 513B AT MDT = 500 LBS. NESC HEAVY.
 - SA 336 ACSR OHSW 513A TO 513B AT MDT = 2000 LBS. NESC HEAVY.

REVISIONS DURING CONSTRUCTION	
A	5/13
	WOF 403826L
	CEE GIB LFP

Northeast Utilities Service Co.
 FOR CONNECTICUT LIGHT & POWER COMPANY

PROPOSED SONO 24P SUBSTATION
 115 KV TRANSMISSION LINE
 PLAN & PROFILE

NORWALK, CT

NO.	DATE	AS BUILT REVISIONS	BY	CHK	APP	APP

Appendix C: Plan Drawings – SNEW

Notes

- FOR COORDINATE LOCATION OF NEW FOUNDATION, SEE ELECTRICAL GENERAL.
- FOR GENERAL NOTES, SEE DRAWING C-2.
- FOR CONCRETE NOTES, SEE DRAWING C-2.
- FOR STRUCTURAL NOTES, SEE DRAWING S-1.
- FOR EMBEDDED PIPING AND/OR PIPE SLEEVES, SEE MECHANICAL DRAWING.
- ELECTRICAL AND ELECTRICAL CONDUIT AND/OR GROUNDING, SEE ELECTRICAL DRAWING.
- TOP OF TRANSFORMER AND SHALL HAVE A STEEL TROUSLER FINISH TO PROVIDE A LEVEL IMPROVED SURFACE LEVEL TO LIMIT THE RISK OF TRIPPING. PROVIDE A 1/4" RADIUS CHAMFER TO ALL CORNERS OF TRANSFORMER FOUNDATION CONSTRUCTION WITH MECHANICAL UNDERGROUND PIPING AND ELECTRICAL CONDUIT.
- REINFORCING BARS SHALL BE CHANGED FROM 6" TO 4" ON TRANSFORMER FOUNDATION CONSTRUCTION. PROVIDE 4" DIA. REINFORCING BARS TO ALL CORNERS OF TRANSFORMER FOUNDATION CONSTRUCTION. PROVIDE 4" DIA. REINFORCING BARS TO ALL CORNERS OF TRANSFORMER FOUNDATION CONSTRUCTION. PROVIDE 4" DIA. REINFORCING BARS TO ALL CORNERS OF TRANSFORMER FOUNDATION CONSTRUCTION.
- CONCRETE FINISH SHALL BE AT FINISH TOP OF CONCRETE FOUNDATION ELEVATION AT 72'.

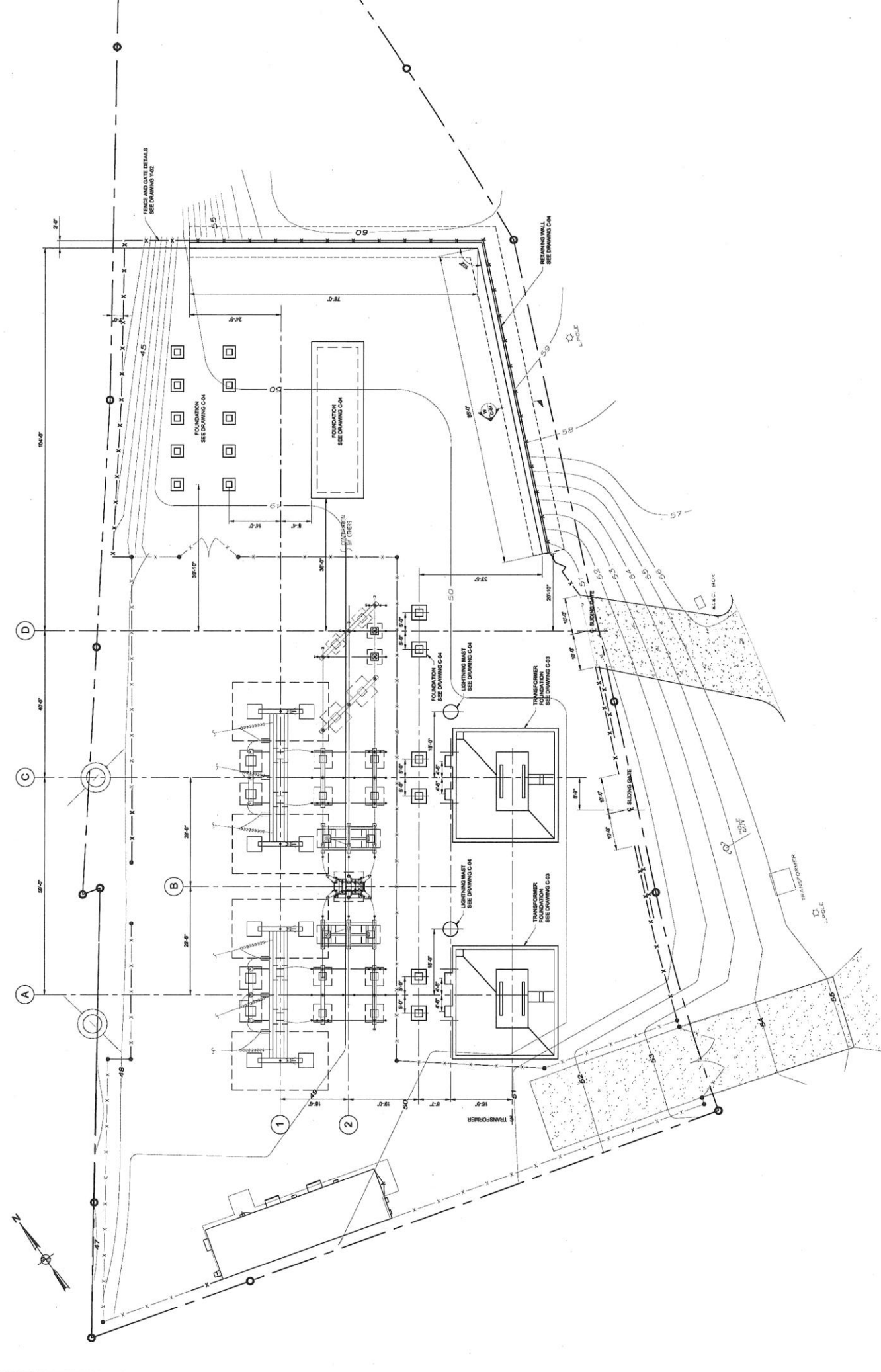

FOUNDATION LOCATION PLAN
SCALE 1" = 10'-0"



Legend

Reference Drawings

No.	Date	Drawn	Description	Checked	Appr'd
1			ISSUED FOR BIDD	CK	CD
2			ISSUED FOR PERMIT	CK	CD



Client: South Norwalk Electric and Water
(SNEW)
164 Water Street
Norwalk CT 06856

FOUNDATION LOCATION PLAN

Designated	Design	Drawn	Checked	Appr'd	Project Stage	File
Design	Design	Design	Design	Design	Design	Design

Drawing Number: 312307-C-01

Mott MacDonald
1000 North 17th Street
Norwalk, CT 06856
Tel: 203.881.1000
Fax: 203.881.1001
www.mottmac.com

NOTES

- FOR FOUNDATION LOCATION PLAN, SEE DRAWING C-1.
- FOR GENERAL NOTES, SEE DRAWING C-2.
- FOR CONCRETE NOTES, SEE DRAWING C-3.
- FOR STRUCTURAL NOTES, SEE DRAWING S-1.

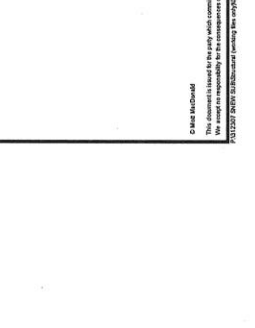
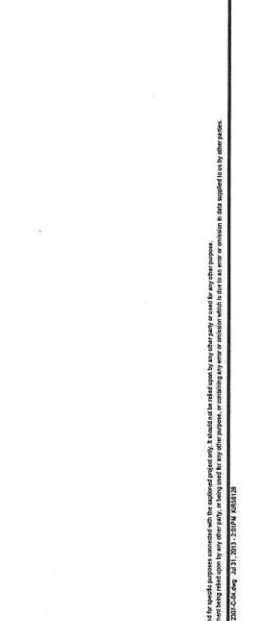
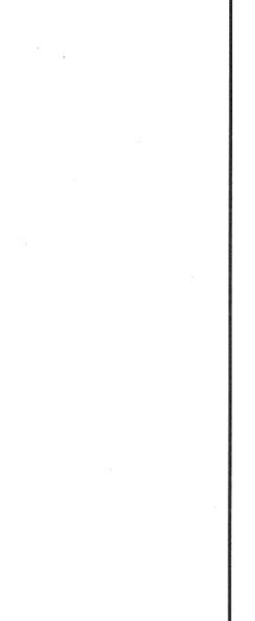
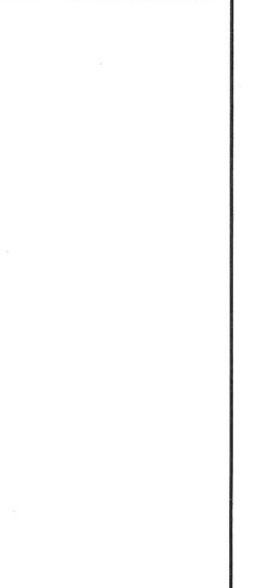
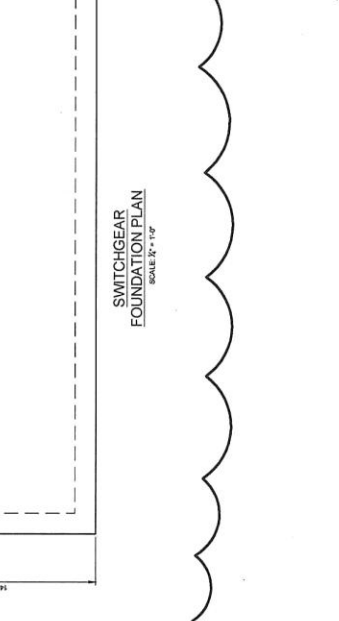
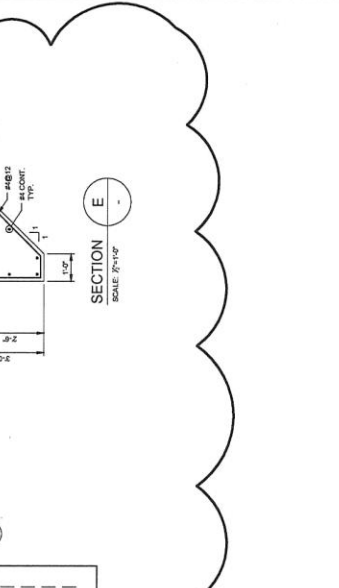
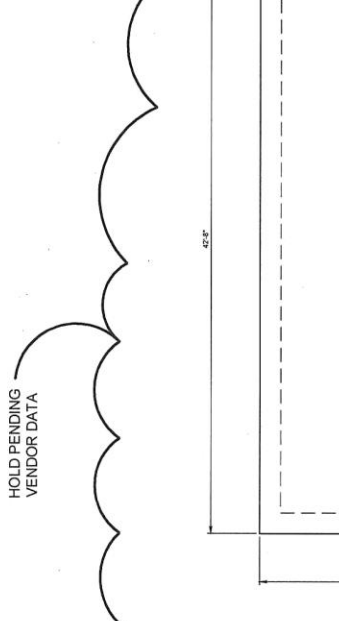
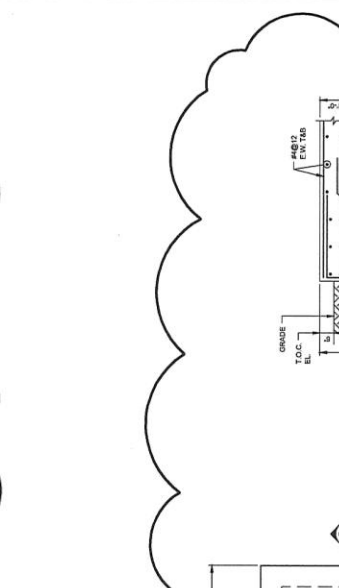
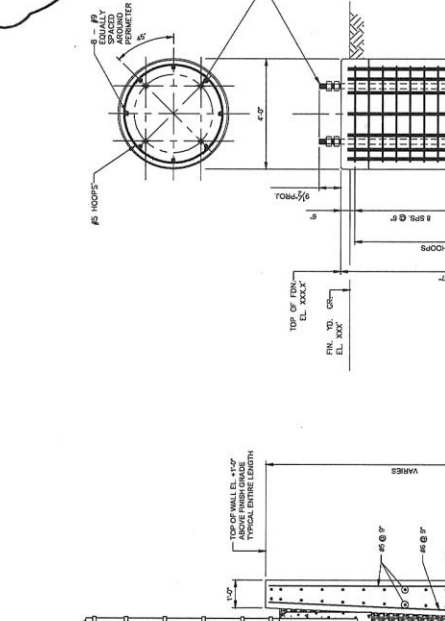
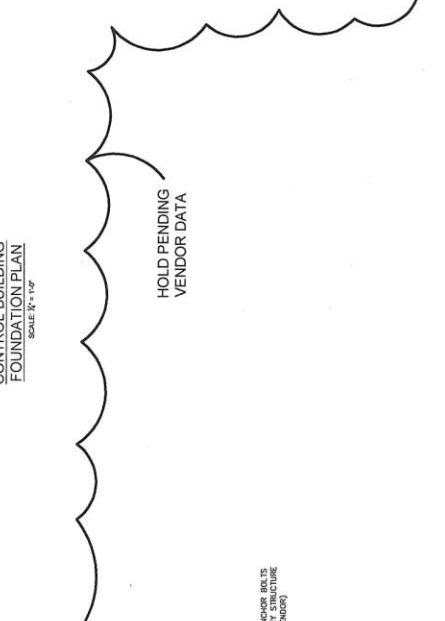
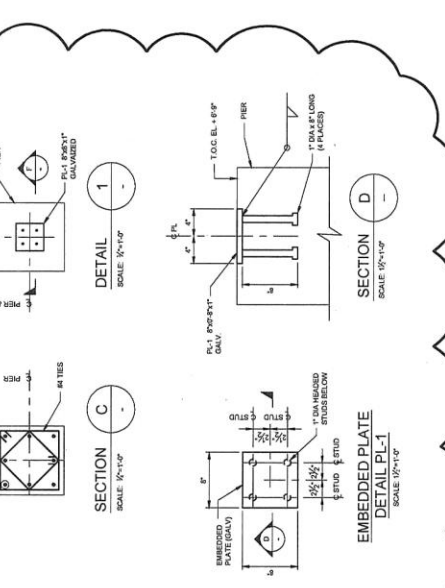
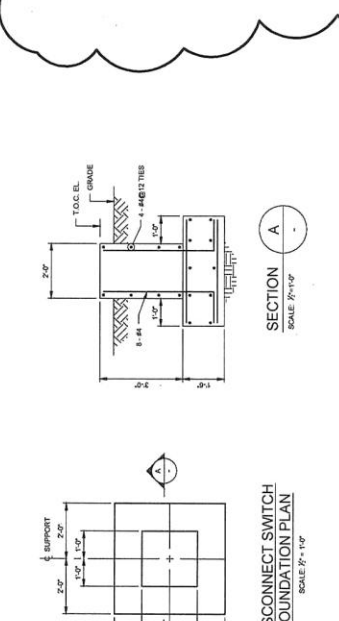
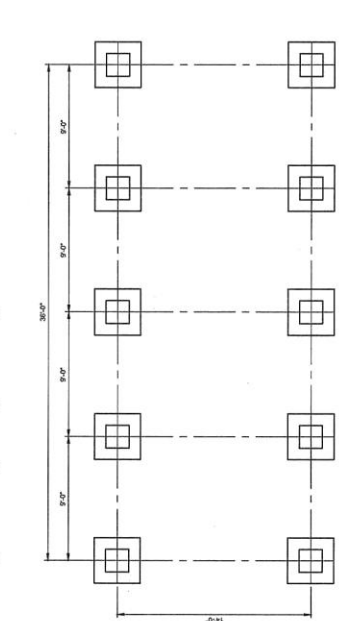
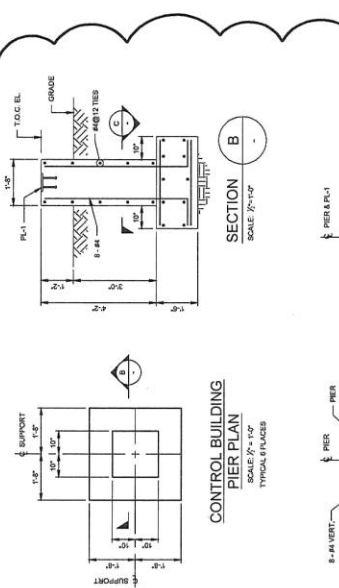

REVISIONS

No.	Date	By	Description

Client: South Norwalk Electric and Water (SNEW)
164 Water Street
Norwalk CT 06856

FOUNDATION PLANS, SECTIONS AND DETAILS

PRELIMINARY
NOT FOR
CONSTRUCTION

Design	Check	Eng. Check	OK

DESIGNED BY: [Signature]
CHECKED BY: [Signature]
DATE: [Date]

312307-C-04

McDonald
488 New Britain
Suite 100, New Britain
Connecticut 06053
Tel: (860) 339-1000
Fax: (860) 339-1001
www.mcdonald.com

South Norwalk Electric and Water
(SNEW)
164 Water Street
Norwalk CT 06856

FOUNDATION PLANS, SECTIONS AND DETAILS

PRELIMINARY
NOT FOR
CONSTRUCTION

Design	Check	Eng. Check	OK

DESIGNED BY: [Signature]
CHECKED BY: [Signature]
DATE: [Date]

312307-C-04

Notes

1. FOR FOUNDATION LOCATION PLAN, SEE DRAWING C-1.
2. FOR GENERAL NOTES, SEE DRAWING S-1.
3. FOR STRUCTURAL NOTES, SEE DRAWING S-1.
4. FOR CONCRETE NOTES, SEE DRAWING C-2.

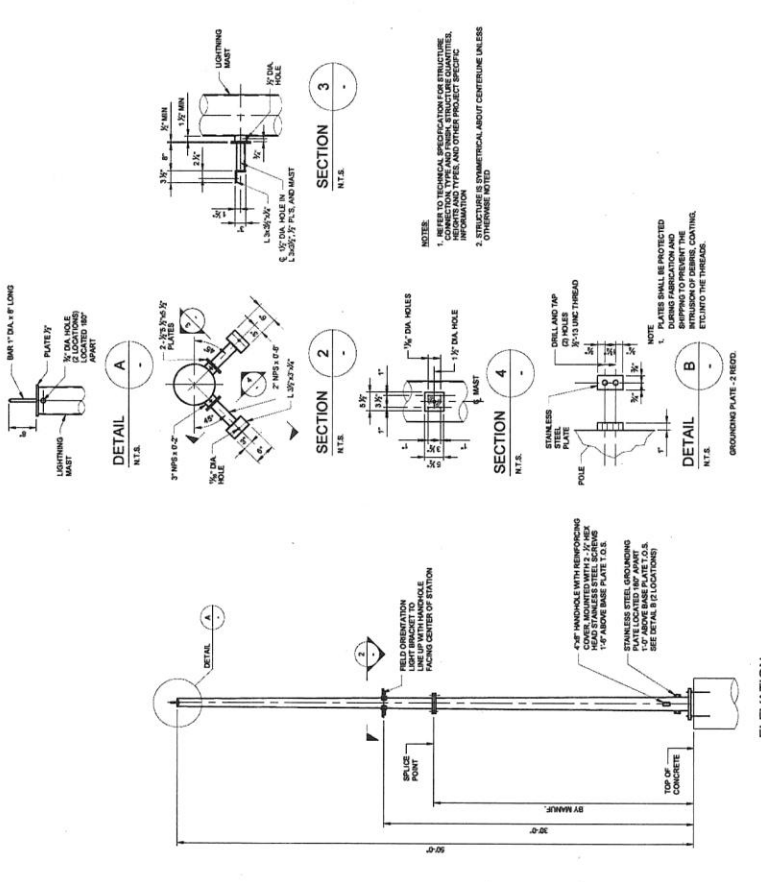

NOTE:
1. REFER TO TECHNICAL SPECIFICATION FOR STRUCTURE, CONCRETE AND TYPE AND SIZE OF REINFORCEMENT. INFORMATION SHALL BE PROVIDED TO THE CONTRACTOR BY THE DESIGNER.
2. DIMENSIONS NOTED OTHERWISE NOTED

NOTE: WELDS SHALL BE PROTECTED BY SPRAYING TO PREVENT THE DURING FABRICATION AND ETC INTO THE THREADED

Revisions

No.	Date	Drawn	Description	CK	CD
A	7/20/13	DFP	ISSUED FOR BID		City of Norwalk

Project

Client

Address

City

State

Zip

Phone

Fax

Website

Project No.

Sheet No.

Scale

Date

Author

Checker

Approver

Project Mgr

Date

Sheet

Total

Project

Sheet

Total

Mott MacDonald

South Norwalk Electric and Water
(SNEW)
164 Water Street
Norwalk CT 06856

STATIC POLE DETAILS

312307-S-02

Checked	Drawn	Design	Project Mgr	Date	Sheet	Total

PRELIMINARY CONSTRUCTION
REPLACE WITH PROPER PERMANENT FABRICATION AND/OR FABRICATION PROJECT ADMINISTRATION

This document is issued by the City of Norwalk, Connecticut. It is intended for use by the City of Norwalk only. It is not to be used for any other purpose. The City of Norwalk is not responsible for any errors or omissions in this document. It is the responsibility of the user to verify the accuracy of the information contained herein. The City of Norwalk is not responsible for any damages, including consequential damages, arising from the use of this document. The City of Norwalk is not responsible for any claims, including consequential claims, arising from the use of this document. The City of Norwalk is not responsible for any claims, including consequential claims, arising from the use of this document.

STATE OF CONNECTICUT
DEPARTMENT OF TRANSPORTATION
METRO - NORTH RAILROAD

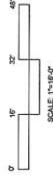
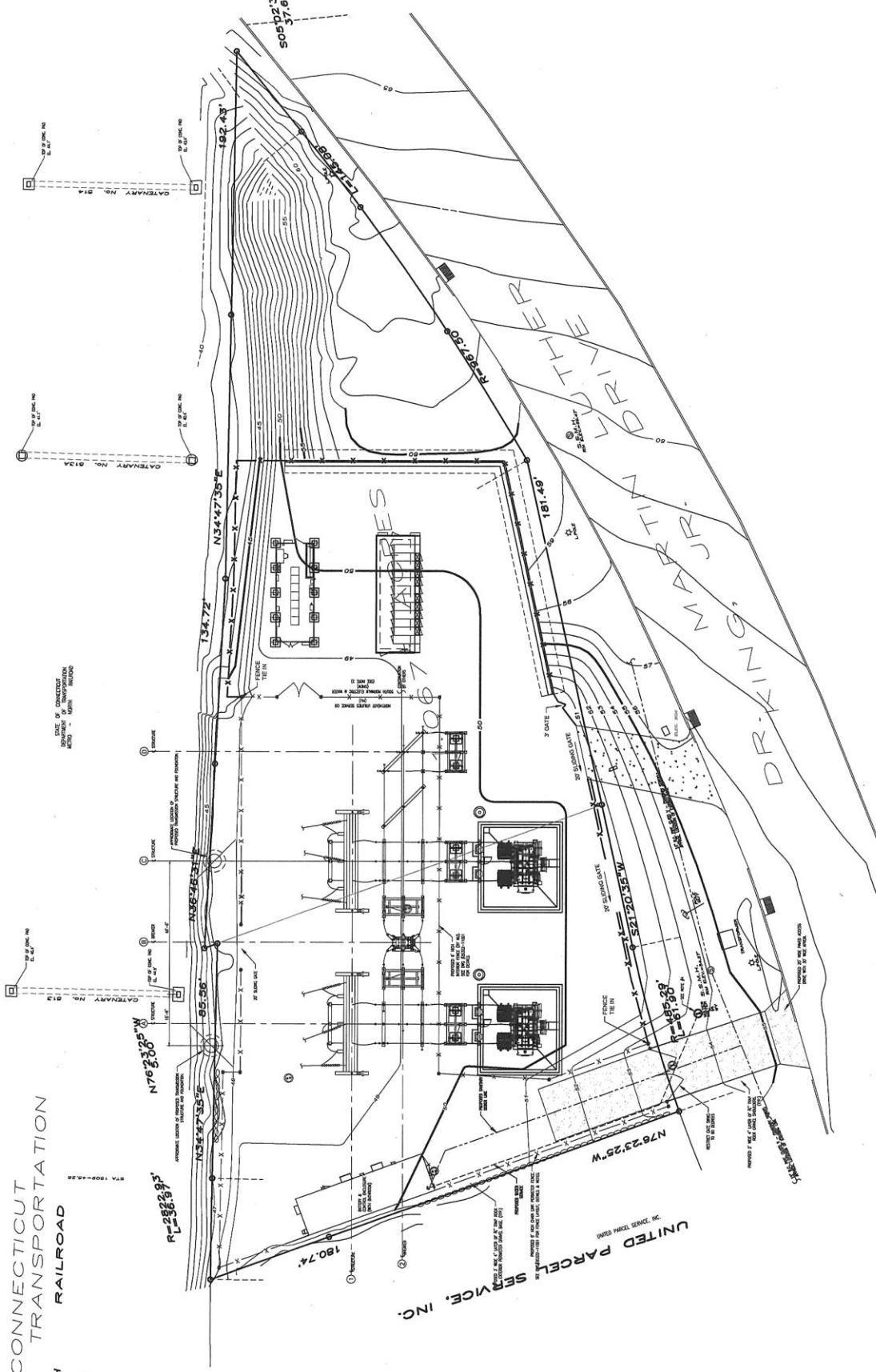
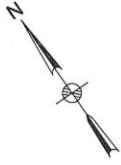

Reference Drawings:
MUSCO DRAWING 2002-2003 "LOADING PLAN SITE DEVELOPMENT"

Rev.	Date	Drawn	Description	Checked	Appr'd
C	05-24-11	CDP	ISSUED FOR BID	CD	CD
B	04-28-11	CDP	ISSUED FOR PERMIT	CD	CD
A	04-28-11	CDP	ISSUED FOR REVIEW	CD	CD



Client:
South Norwalk Electric and Water
(SNEW)
164 Water Street
Norwalk, CT 06856
MM_CLIENTS

SITE GRADING PLAN

Prepared	By	For Review	By
PRELIMINARY	CDP	CD	CD
NOT FOR CONSTRUCTION	CDP	CD	CD
REPLACE WITH PROPOSED	CDP	CD	CD
AND/OR FABRICATION	CDP	CD	CD
PROJECT ADMINISTRATION	CDP	CD	CD
MANUAL	CDP	CD	CD

312307-Y-01

This document is based on the data provided by the client and the client warrants that the data is accurate and reliable. Mott MacDonald is not responsible for any errors or omissions in this document or its use. This document is the property of Mott MacDonald and is not to be distributed, copied, or reproduced without the written consent of Mott MacDonald.

NOTES

1. FOR FENCE LOCATION PLAN, SEE DRAWING C-1.
2. FOR GENERAL NOTES, SEE DRAWING C-1.
3. FOR STRUCTURAL NOTES, SEE DRAWING S-1.
4. FOR CONCRETE NOTES, SEE DRAWING C-2.

Legend

Minimum Drawings

No.	Date	Drawn	Description	CHKD	APPD
A	7/20/13	LOP	REVISION FOR BID	CHW	LOP
				CHW	LOP

400 West 10th Street
 South Norwalk, CT 06858
 (203) 833-1100
 www.mcdonaldmfg.com

South Norwalk Electric and Water
 (SNEW)
 164 Water Street
 Norwalk CT 06856

FENCE AND GATE DETAILS

Designed	Shop	Eng. check	OK
Drawn	Job	Approved	OK
Checked	Field check	OK	
Reviewed	As-built	OK	
Noted	NOTED		
Project No.	312307-Y-02		
Sheet No.	1		

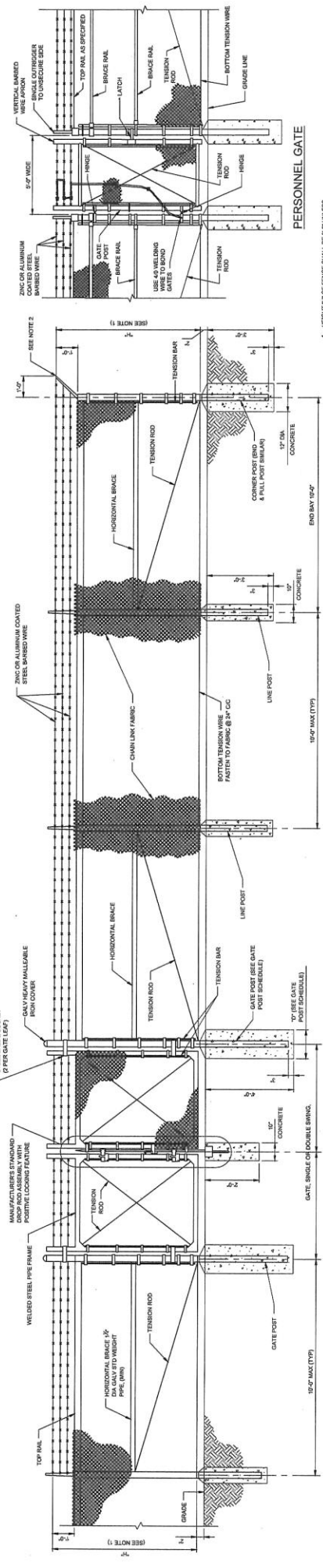

GATE POST SCHEDULE

POST SIZE	DOUBLE GATE OPENING	POST HOLE DIAMETER
2 1/2"	10' TO 12'4"	12"
3 1/2"	12'4" TO 16'4"	14"
4"	16'4" TO 20'4"	16"
4"	20'4" TO 24'4"	18"
4"	24'4" TO 28'4"	20"

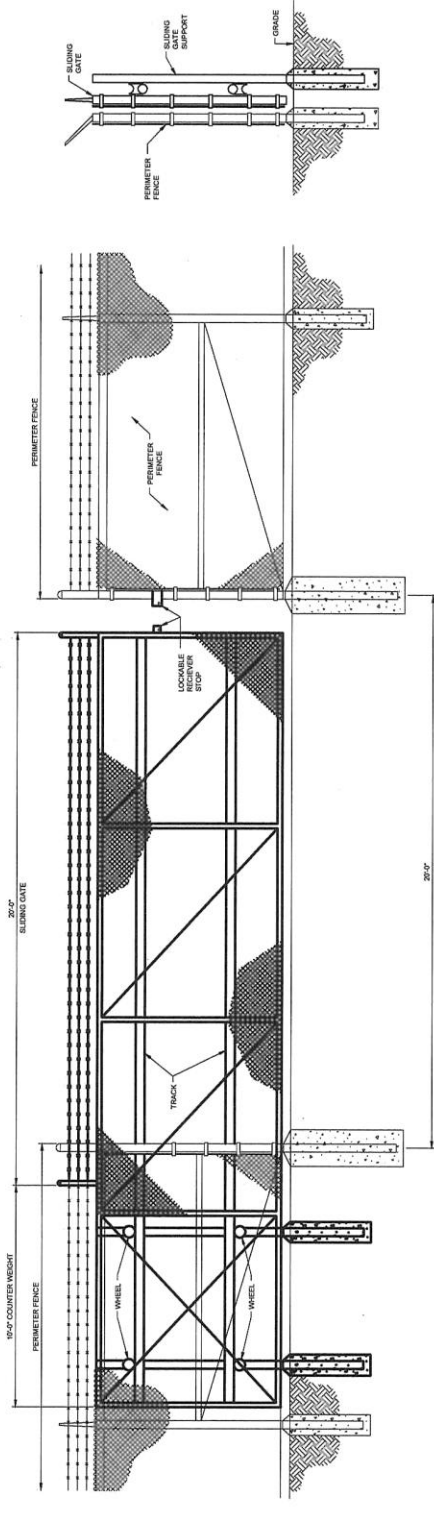
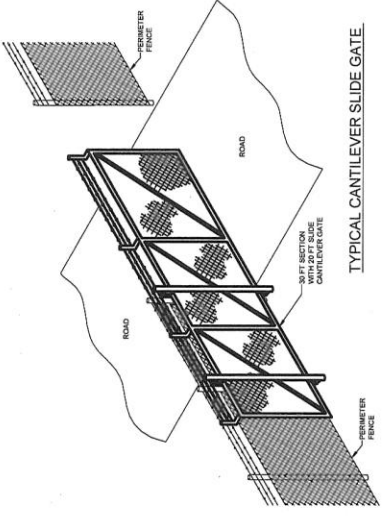
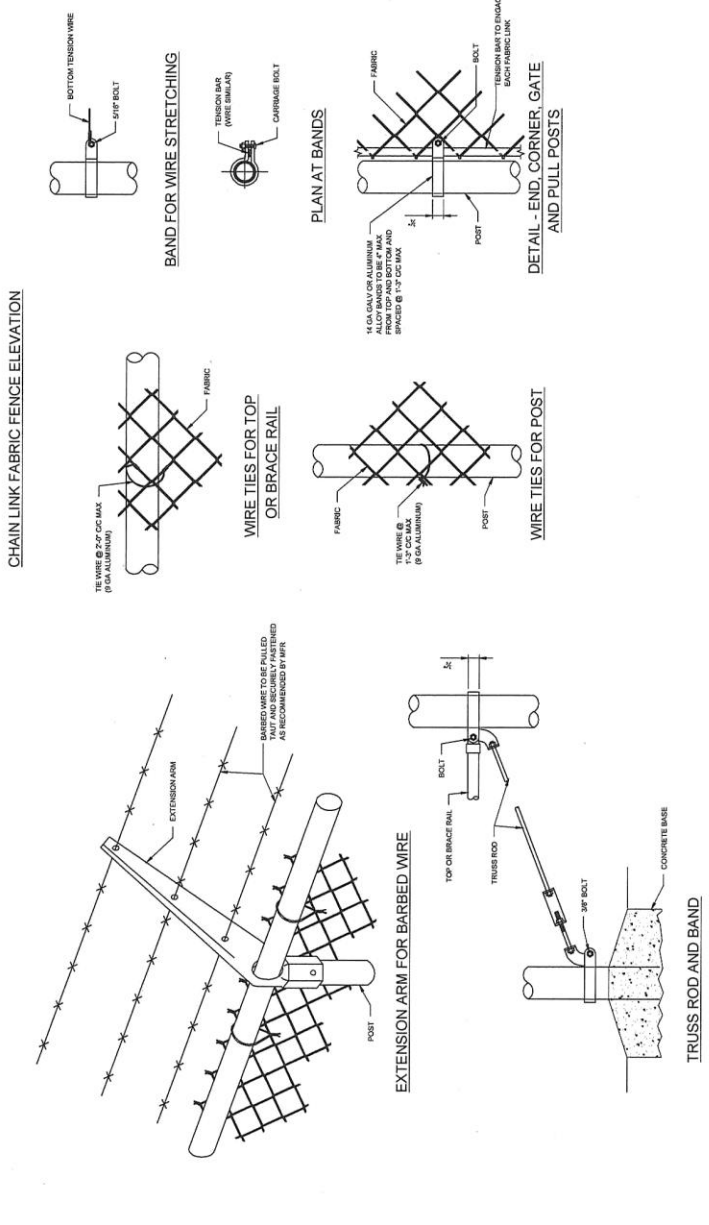

© 2013 MCDONALD
 This document is based on the data and information provided and is specific to the project. It is not to be used for any other project.
 The contractor is responsible for any construction errors, omissions, or deviations from the drawings which may occur in the field or in the shop, regardless of the cause.

Distribution Improvements: Substation Getaways



Appendix D: Stormwater Best Management

**STORMWATER BEST MANAGEMENT PRACTICES
SOUTH NORWALK ELECTRIC AND WATER SUBSTATION
180-184 DR. MARTIN LUTHER KING JR. DRIVE
NORWALK, CONNECTICUT**

Prepared For:

South Norwalk Electric and Water

August 2013

Prepared By:

LEGGETTE, BRASHEARS & GRAHAM, INC.
Professional Groundwater and Environmental Engineering Services
4 Research Drive, Suite 301
Shelton, CT 06484

TABLE OF CONTENTS

	<u>Page</u>
1.0 INTRODUCTION	1
1.1 Objective and Scope	1
1.2 General Responsibilities	2
2.0 FACILITY INFORMATION	2
2.1 Physical Description	2
2.2 Pollution Prevention Team	3
2.3 Potential Pollutant Sources	3
2.3.1 Surface Drainage.....	3
2.3.2 Inventory of Exposed Materials.....	3
2.3.3 Materials Management Practices for Potential Pollutants	3
3.0 CONTROL MEASURES	5
3.1 Good Housekeeping	5
3.2 Vehicle and Equipment Washing	5
3.3 Floor Drains and Roof Areas.....	5
3.4 Minimize Exposure	6
3.5 Sediment and Erosion Control	6
3.6 Management of Runoff	6
3.7 Preventative Maintenance	6
3.8 Spill Prevention and Response	7
3.8.1 Stationary Above-Ground Storage Tank Secondary Containment.....	7
3.8.2 Portable Containers Secondary Containment	7
3.8.3 Dumpsters	8
3.8.4 Loading Docks	8
3.9 Employee Training	8
3.10 Non-Stormwater Discharges	9
3.11 Solid De-icing Material Storage.....	9
4.0 FUTURE CONSTRUCTION.....	9
5.0 INSPECTIONS	9
5.1 Routine (Monthly) Inspections	10
5.2 Inspection Reports and Recordkeeping	10
6.0 STORMWATER BMP AMENDMENTS	10

LIST OF TABLES
(at end of report)

Table

- 1 Pollution Prevention Team
- 2 Inventory of Exposed Materials
- 3 Annual Training Agenda and Roster
- 4 Checklist/Report for Routine (Monthly) Maintenance Inspections

FIGURE
(at end of report)

Figure

- 1 Site Location Map

LIST OF APPENDICES
(at end of report)

Appendix

- I Emergency Spill Response Procedures

PLATE
(at end of report)

Plate

- 1 Site Plan with Facility Drainage

**-DRAFT-
STORMWATER
BEST MANAGEMENT PRACTICES
SOUTH NORWALK ELECTRIC AND WATER SUB-STATION
180-184 DR. MARTIN LUTHER KING JR. DRIVE
NORWALK, CONNECTICUT**

1.0 INTRODUCTION

This Stormwater Best Management Practices (BMP) Document shall be used after construction activities have been completed for the proposed new electric substation by South Norwalk Electric and Water Company (SNEW). The Property is comprised of two parcels of land, which together occupy 1.07 acres of land that is triangular in shape and is located at 180-184 on Dr. Martin Luther King Jr. Drive, Norwalk, CT (Property, Figure 1). The substation shall be used to reduce the incoming electric voltage and distribute the electricity to the surrounding area. SNEW owns the Property, however, the operation of the northern and eastern portion (0.75 acres) of the Property shall be managed by SNEW (Site) while the operation of the southern and western portion (0.45 acres) of the Property shall be managed by Northeast Utilities Service Co (NUS Site) (Plate 1). This BMP incorporates applicable and appropriate portions of the Connecticut Department of Energy and Environmental Protection (CTDEEP) “General Permit for the Discharge of Stormwater Associated with Industrial Activities” (Permit). The Property falls under Standard Industrial Classification Code 4911 (Definition No. 7 for “Industrial Activity” in the Permit), which is defined as “Electrical Services”. As such, the Property would normally be subject to the requirements of Sector F (Steam Electric Power Generation) and the baseline requirements of the Permit. However, because there is no active generation of electricity or active steam generating units, the Property is not subject to the Permit unless CTDEEP specifically instructs otherwise.

The Property is subject to the CTDEEP General Permit for the Discharge of Stormwater and Dewatering Wastewaters from Construction Activities because more than one (1) acre of land is proposed to be disturbed during construction activities. Registration of the aforementioned permit to CTDEEP is not required for construction activities that disturb between one and five acres of land if SNEW receives written approval of the Soil Erosion and Sediment Control (SESC) plan from the City of Norwalk and the SESC plan is prepared in accordance with the Connecticut 2002 Guidelines for Soil Erosion and Sediment Control. If a review of the SESC Plan is not conducted by the City of Norwalk, then SNEW must register and

comply with Section 6 of the General Permit for the Discharge of Stormwater and Dewatering Wastewaters from Construction Activities.

1.1 Objective and Scope

The objective of this BMP document is to identify possible pollutant sources to stormwater and to identify control measures that, when implemented, will reduce or eliminate any possible water-quality impacts once substation operations have begun. Control measures are physical, structural and/or managerial practices that, when used singly or in combination, prevent or reduce pollution of stormwater.

This BMP document shall focus on the control measures that SNEW will implement for the operation of their portion of the Property. NUS shall be responsible for developing their own Stormwater BMPs, however, NUS can use this document as general guidance for their stormwater management practices if they wish.

This BMP document contains an inventory of materials exposed to stormwater on SNEW's portion of the Property and outlines stormwater pollution prevention measures, inspection protocols, employee training, and reporting responsibilities. This BMP document provides a means for organizing related activities and records.

1.2 General Responsibilities

As the Owner and Operator of the SNEW portion of the property, SNEW has overall management responsibility for maintaining the Stormwater BMP Document. The Manager of Technical Services (MTS) has the general responsibility of conducting activities in a way that is consistent with this BMP document and each designated employee of SNEW is responsible for conducting daily activities in a way that is consistent with this BMP document.

2.0 FACILITY INFORMATION

2.1 Physical Description

An eight-foot high security fence is planned for construction to enclose both SNEW's and NUS's electric equipment. A six-foot high interior security fence shall be used as a boundary to separate the SNEW and NUS operations. The Site will contain transformers, circuit breakers and control houses.

2.2 Pollution Prevention Team

The SNEW Pollution Prevention Team has one environmental consultant, one Administrator and the staff at the Technical Services Department, who will perform the work necessary to implement the stormwater management practices described in this document. The titles and/or departments presently assigned to the team, and the activities for which they are responsible, are listed in Table 1.

2.3 Potential Pollutant Sources

A Property inspection was completed on May 2, 2013 to:

- identify stormwater drainage areas; and
- assess Property conditions prior to construction activities.

2.3.1 Surface Drainage

The surface-water drainage on the property is shown on Plate 1 and all surface water exits via sheetflow to the northwest in the direction of the railroad tracks as shown on Plate 2. A point source surface water discharge does not exist at the Property nor are there plans to construct a stormwater management structure that would create a point source discharge. Three (3) catch basins, which are connected to the municipal separate storm sewer system (MS4), are located on Dr. Martin Luther King Jr. Drive in close proximity to the Property. However, the planned elevation of the substation will be lower than the three catch basin grates, therefore, surface water drainage from the Site is not expected to impact these catch basins. The MS4 ultimately discharges to the Norwalk Harbor.

2.3.2 Inventory of Exposed Materials

Table 2 is a list of materials that can be exposed and potentially introduced to the stormwater onsite. The list of exposed materials in Table 2 includes the materials in the bulleted list provided below that may be exposed to stormwater once operations begin:

- storage and transfer of transformer oil in tanks; loading and unloading operations; and
- storage and loading/unloading of batteries.

2.3.3 Materials Management Practices for Potential Pollutants

This section presents a narrative summary of the materials management practices for the inventory of exposed materials listed in Table 2 and discusses:

1. a method and location of onsite storage or disposal;
2. materials management practices;
3. the location and a description of existing structural and non-structural control measures to reduce pollutants in the stormwater runoff; and
4. a description of any treatment the stormwater receives.

With the exposed materials described below, the non-structural control measures will include the use of spill supplies in the event of a minor spill and an inspection and training program to reduce the potential for adverse impacts to stormwater quality. The locations of the items described below are shown on Plate 1.

1. Routine Sampling and Storing Transformer Oil to Tanks 1 and 2

Once constructed, the Site will contain two non-bulk power transformers that use non-polychlorinated biphenyl (PCB) mineral insulating oil having a storage capacity of 5,038 gallons in three areas within the transformer; the main tank (4,341 gallons), the load tap changer (LTC) compartment (270 gallons) and the radiator (427 gallons).. The mineral insulating oil contains less than 1 ppm of polychlorinated biphenyls (PCBs) at the time of manufacture. Each transformer will be resting on a concrete pad. The transformer main tank and LTC chamber are integral to the transformer housing the transformer core/coils and LTC mechanism respectively, and will be constructed of single-walled steel. The area around the transformer pads will be designed with secondary containment that has a sufficient storage capacity to contain at least 110% of the total oil storage capacity of each transformer. The final design of the secondary containment has not been finalized and once a design is selected, this Stormwater BMP document can be amended to describe the secondary containment design. A Supervisory Control and Data Acquisition (SCADA) monitoring system is planned for use to monitor key parameters for the proper operation of the substation. If parameters become out-of-tolerance compared to desired operating conditions, then the monitoring system shall alert staff at SNEW's Technical Services Department. A trained SNEW employee will evaluate the Site condition that triggered the alarm and will subsequently determine the appropriate course of action.

2. Transfer and Storage of Lead-Acid Batteries

Lead-acid batteries are used for the substation operations and are stored in a dedicated location in the SNEW control house. The stored batteries will be inspected periodically for leaks or damage as described in Section 5.0 of this BMP document.

3.0 CONTROL MEASURES

The control measures described in this section are used to assist with the prevention of non-stormwater discharges at the Site.

3.1 Good Housekeeping

Each designated employee who has duties at the substation involving maintenance, solid or hazardous waste handling, or movement of maintenance materials outdoors is to conduct work activities in such a way that:

- no drums or pails are left anywhere outside unless they are empty and properly stored with the tops securely fastened;
- storage areas and work areas in the yard or building exteriors are kept neat and picked up on a regular basis (i.e. litter, debris, and miscellaneous materials shall be removed and disposed of properly and in a timely manner);
- stored materials shall not obstruct normal pathways for people or vehicles;
- no change-outs of vehicle or equipment fluids (crankcase, transmission, radiator, hydraulic systems) are conducted at the Site;
- no chemicals, fuels, oils, solvents, paints or similar substances are poured onto the ground or into catch basins; and
- employees are to be instructed to store and dispose of chemicals properly. Good labeling practices and Material Safety Data Sheets (MSDS) for chemicals shall be maintained at the Site.

3.2 Vehicle and Equipment Washing

Vehicle and equipment washing is not conducted at the Site and shall not be permitted.

3.3 Floor Drains and Roof Areas

Floor drains do not exist at the Site nor are there any floor drains planned for the construction of the substation. Stormwater drainage from the roof of the control house is not anticipated to cause adverse impacts to stormwater quality.

3.4 Minimize Exposure

SNEW shall make every effort to effectively minimize stormwater pollution by inspecting and maintaining transformers, materials and equipment which are exposed to rain, snow, snowmelt and runoff. As eluded to in Section 2.3.3, the transformers shall be equipped with secondary containment to contain the mineral oil in the event of a spill.

3.5 Sediment and Erosion Control

Surfaces with low permeability and minimal chance for erosion include the paved portions of the maintenance access roads, the footprint of the control houses and locations where electric equipment is resting on concrete pads. A majority of the Site will have a four-inch layer of crushed stone on the surface, which is underlain by a controlled fill layer on top of native soil. This area of the Site will be relatively flat and has no exposed soil; therefore, the chances for soil erosion are low. However, as part of the inspection program, the yard will be inspected for signs of erosion, subsidence or sediment deposits. In the event that erosion, subsidence or sediment deposition is observed during routine inspections, then this condition shall be reported to SNEW trained staff in the Technical Services Department, who will evaluate the situation and determine the best course of action. In addition, a retaining wall is planned for construction on the northern and eastern portion of the Site and this wall shall be inspected for damage or deterioration as part of the inspection program described in Section 5 of this BMP document.

3.6 Management of Runoff

As discussed previously, all surface water runoff will exit the Property via sheetflow and no plans for stormwater structures, other than the items discussed in Section 2.3.3 and Table 2, are being constructed for the substation.

During snow removal activities in the winter, snow will be plowed and moved to locations that will not be near electrical structures/wires or block maintenance access roads.

3.7 Preventative Maintenance

The preventative maintenance program consists of inspection and maintenance that is designed to identify and remove potential sources of pollution that may impact stormwater quality. The inspection of areas at the Site that are prone to pollution or require periodic assessment are discussed in Section 5 (inspections) and include the following:

- substation transformers and electrical equipment;
- lead-acid battery storage area; and
- fence, retaining wall and yard;

Any issues or problems identified in the preventative maintenance program will be promptly addressed.

3.8 Spill Prevention and Response

SNEW maintains a SPCC Plan pursuant to 40 CFR 112, which includes Emergency Spill Response Procedures that identify and minimize the risk of spills. The Emergency Spill Response Procedures are presented in Appendix I. The Emergency Spill Response Procedures are in place to insure that SNEW is capable of dealing with leaks or spills in an effective manner that is also protective of surface waters. When the construction of the substation is completed, the SPCC Plan shall be amended accordingly.

3.8.1 Stationary Above-Ground Storage Tank Secondary Containment

Following construction activities, above-ground storage tanks (ASTs) at the Site will consist of two transformers each containing 5,038-gallons of oil. As discussed in Section 2.3.3, secondary containment shall be designed to accommodate at least 110% of the total oil storage capacity of the tanks (5,550 gallons) and will be sufficiently impervious.

The secondary containment structure will be exposed to stormwater, therefore, inspections and maintenance of this structure will be required as part of the BMPs. If oil is detected in any quantity within secondary containment or more than three inches of stormwater accumulates inside the secondary containment structure during routine inspections, then these conditions shall be reported to trained SNEW Technical Services Department employees immediately. Any oil, oily water or liquid with an oil sheen detected within secondary containment shall be containerized and disposed of off-site according to applicable CTDEEP and Resource Conservation and Recovery Act (RCRA) regulations. If inspections reveal that there is

no oil, oily water or liquid with an oil sheen inside secondary containment, then this accumulated water may be discharged to the ground surface.

3.8.2 Portable Container Secondary Containment

Drums and portable containers of liquids are not planned for storage at the substation. If this condition should change, then this BMP document shall be amended accordingly.

3.8.3 Dumpsters and Waste Disposal

Dumpsters will not be stored on-site.

3.8.4 Loading Docks

The Site does not have loading docks, however, loading/off-loading of batteries or other supplies will be conducted at a dedicated location on-site. Training is provided to personnel so that proper loading/off-loading of supplies is practiced to minimize the likelihood of spills. The loading/off-loading area will be monitored for spills as part of the inspection program.

3.9 Employee Training

A large part of the success of the Stormwater BMP document is the capability and interest of personnel responsible for implementing and maintaining the BMP document. Personnel need to understand the importance of the program and the goals of the Stormwater BMP document. Personnel will be trained in the techniques of response, removal and documentation.

Each person whose activities may affect stormwater quality will receive training within 90 days of employment and at least once per year thereafter to make them familiar with the components and goals of the pollution control measures outlined in this BMP document. Annual personnel training workshops will be implemented, at which time participation and input should be encouraged. Training will be conducted by a member of the Stormwater Pollution Prevention Team or other qualified person. Training activities will be recorded in Table 3 and retained with the Stormwater BMP document. Training topics should include:

- knowing how to respond to and clean up spills;
- emergency equipment location and use;
- stormwater pollution control measures;
- inspection requirements;
- good housekeeping; and

- materials management practices.

The SNEW inspectors used to conduct inspections will be trained according to the requirements discussed in Sections 5 of this BMP document.

3.10 Non-Stormwater Discharges

Based on inspections and discussions with the SNEW representative, no non-stormwater discharges are present at the Site nor are there any non-stormwater discharges expected during the operation of the substation.

3.11 Solid De-icing Material Storage

Solid de-icing material is not stored at the Site.

4.0 FUTURE CONSTRUCTION

Future activity to construct a new substation is planned. The construction activities may disturb greater than one acre of land, therefore, these construction activities may be subject to the General Permit for the Discharge of Stormwater and Dewatering Wastewaters from Construction Activities. All construction activities, regardless of the amount of disturbed area, must comply with the 2002 Connecticut Guidelines for Soil Erosion and Sediment Control during construction and the 2004 Connecticut Stormwater Quality Manual for the design and implementation of post-construction stormwater management measures.

5.0 INSPECTIONS

An inspection and preventive maintenance program is to be followed to assure that all outdoor equipment and materials at the Site are properly stored and maintained. The purpose of this program is to reduce the potential for release of pollutants onto the railroad tracks, into the adjacent MS4 catch basins, or infiltration to the groundwater. The inspection and preventive maintenance program consists of routine (monthly) inspections and semi-annual reporting to document its implementation and findings.

The SNEW Technical Services Department is responsible for implementing the preventive maintenance program for the items discussed below. The SNEW Technical Services Department may delegate some of this responsibility to a trained SNEW employee familiar with this Stormwater BMP document. If conditions are observed during inspections that warrant

attention, then trained SNEW employees will address these situations and take appropriate actions in a timely manner. The monthly inspection checklist is included as Table 4. This inspection and maintenance program constitutes an ongoing and reasonably comprehensive compliance evaluation of the Site.

5.1 Routine (Monthly) Inspections

SNEW shall conduct routine inspections of the Site for potential pollutant discharges to stormwater on a monthly basis. The inspection form provided in Table 4 shall be used to document the monthly inspection and shall include the listed items:

- the Maintenance Access Road for erosion or damage;
- the tanks for the transformer oil and their associated secondary containment structures for leaks, spills or damage;
- spill supplies are intact and do not need to be replenished;
- the fence, gate and retaining wall for damage;
- the yard for good housekeeping and erosion/subsidence or excessive sediment deposits; and
- the lead-acid batteries for leaks or damage.

5.2 Inspection Reports and Recordkeeping

A semi-annual inspection report shall be prepared by a trained SNEW Technical Services Department employee or designated alternate that documents the implementation of the inspection program and, its findings, and that comment about the effectiveness of the stormwater management practices. The report shall include identification of the personnel conducting the inspections, the dates of the inspections, a summary of major observations and findings, actions taken, and updates made to the Stormwater BMP document as a result of any observations or actions taken.

All records, including inspection documents, reports, training documents and maintenance records associated with this Stormwater BMP document shall be retained onsite for a minimum of five years following the date a particular document was prepared.

6.0 STORMWATER BMP AMENDMENTS

The Stormwater BMP is to be amended when there is an operational change that alters the potential for stormwater pollution, when the actions specified herein fail to protect against pollution, or when the results of inspections indicate changes are necessary. Minor amendments to the Stormwater BMP pages are to be indicated by a letter after the revision number (e.g., Revision 2a), with the date of change. Major amendments of the entire document are to be given the next sequential revision number. The basis for each amendment is to be documented and kept in the stormwater folder. Outdated revisions of the Stormwater BMP document also are to be retained in the stormwater folder for five years following the date of issuance of the revised Stormwater BMP.

TABLE 1

**STORMWATER BEST MANAGEMENT PRACTICES
SOUTH NORWALK ELECTRIC AND WATER SUBSTATION
180-184 DR. MARTIN LUTHER KING DRIVE
NORWALK, CONNECTICUT**

Pollution Prevention Team

Position	Company Name Contact Name and Title	Phone Numbers	Responsibilities
Environmental Consultant	Leggette, Brashears & Graham, Inc.	(203) 929-8555 (W)	<ul style="list-style-type: none">• Developing the Stormwater Best Management Practices (BMP) Document• Amending the Stormwater BMP when necessary
Administrator	SNEW General Manager	(203) 866-4446 (W)	<ul style="list-style-type: none">• Overall management responsibility for the SNEW portion of the Site
Owner and Operator	SNEW Technical Services Department	(203) 866-4446 (W)	<ul style="list-style-type: none">• Reviewing Stormwater BMP periodically for currency• Reporting spills to appropriate agencies and spill response contractors• Acting as spill incident commander unless or until other authorized agencies arrive on the scene.• Reporting any errors to agencies• Filing records and documents appropriately to the appropriate regulatory agencies• Managing inspections and training• Conduct Routine (Monthly) Inspections• Spill Response• Addressing any concerns as a result of routine inspections

W=Work Phone

TABLE 2

**STORMWATER BEST MANAGEMENT PRACTICES
SOUTH NORWALK ELECTRIC AND WATER SUBSTATION
180-184 DR. MARTIN LUTHER KING DRIVE
NORWALK, CONNECTICUT**

Inventory of Exposed Materials

ID No.	Activity/Exposed Materials ^{1/}	Onsite Location of Activity/Material	Potential Pollutants Associated with Exposed Materials	Description of Storage Tank or Container (Tank type, size, AST, UST, etc.)	Structural Control Measures used to Minimize Exposure	Non-structural Control Measures used to Minimize Exposure
1.	Routine Sampling and storing dielectric oil in transformers 1 and 2	Outdoors within fenced Substation	Non-PCB dielectric oil	Two transformers that contain single-walled steel tanks with a storage capacity of 5,038 gallons each meeting IEEE enclosure integrity Standards	Concrete dike wall and floor that is sufficient to contain at least 110% of the storage capacity of each transformer	Spill supplies; proper loading and unloading procedures followed; inspections and training
2.	Transport and storage of lead-acid batteries	Inside SNEW control house	Lead and acid	N/A	Batteries stored in a dedicated storage area indoors	Spill supplies; proper loading and unloading procedures followed; inspections and training

Note: 1. Refer to Plate 1 for locations of exposed materials.

TABLE 4

**STORMWATER BEST MANAGEMENT PRACTICES
SOUTH NORWALK ELECTRIC AND WATER SUBSTATION
180-184 DR. MARTIN LUTHER KING DRIVE
NORWALK, CONNECTICUT**

Checklist/Report for Routine (Monthly)

Maintenance Inspections

<u>Inspection Area</u>	<u>Inspection Item</u>	<u>Check</u>	<u>Possible Follow-Up Action Required if "*" follows answer</u>
Transformers 1 and 2	Any leaks, spills or stains?	[]*YES []NO	_____
	Any damage to transformer?	[]*YES []NO	_____
	Any oil, oily water or sheen inside secondary containment?	[]*YES []NO	_____
	Are there more than three (3) inches of liquid in secondary containment?	[]*YES []NO	_____
Maintenance Road and Yard	Any signs of erosion or damage to access road or retaining wall?	[]*YES []NO	_____
	Good housekeeping maintained at the Site?	[]YES []*NO	_____
	Any leaks or spills in loading/unloading area?	[]*YES []NO	_____
Control House	Lead-Acid batteries leaking or damaged?	[]*YES []NO	_____
	Any replenishment of spill supplies required?	[]*YES []NO	_____
	Good housekeeping maintained?	[]YES []*NO	_____
	Does SCADA monitoring system indicate operational issues?	[]*YES []NO	_____
Fence and Gate	Any Damage to Fence or Gate?	[]*YES []NO	_____

Inspector:(Print)_____ (Sign)_____ Date: ___/___/___

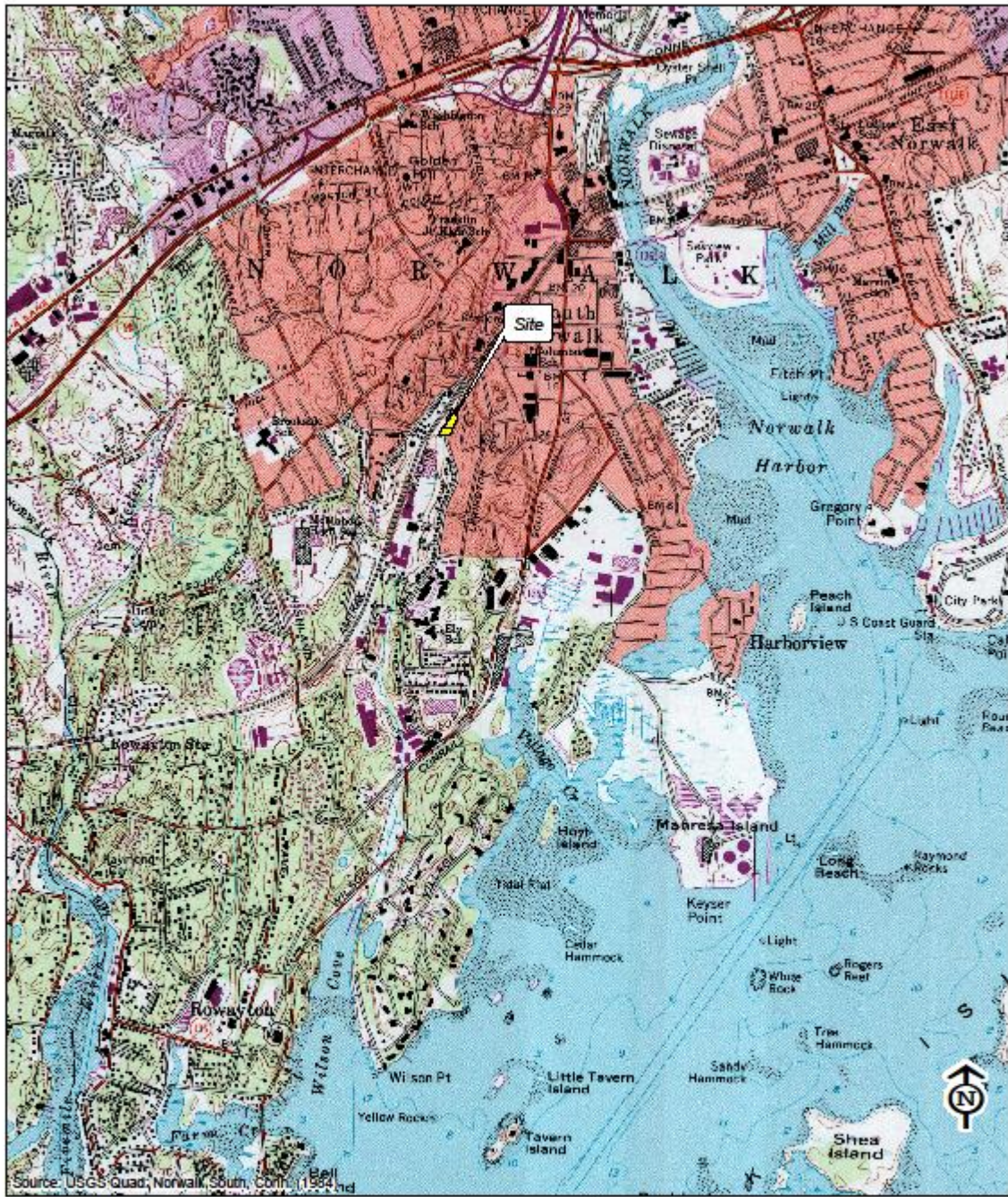

Source: USGS Quad, Norwalk, South, Conn. (1984)

South Norwalk Electric and Water



Figure 1
Site Location Map
 180-184 Dr. Martin Luther King Jr. Drive
 Norwalk, Connecticut

APPENDIX I
EMERGENCY SPILL RESPONSE PROCEDURES

EMERGENCY SPILL RESPONSE PROCEDURES

(SNEW)

This section presents a set of procedures to be followed in the event of a spill. These procedures are not intended to encompass all aspects of any spill that could possibly occur; rather, they have been developed for use as a guide for persons involved in control and countermeasures operations. In the event of a release, a quick response is important to the protection of employees and the environment. However, the responsibility of employees to respond to a spill is based on multiple factors consisting of:

- the level of employee training;
- the nature of the spill;
- the quantity of material spilled;
- the type of material spilled;
- the location of employees relative to the immediate release area; and
- other safety considerations that could put employees at risk of injury during spill response activities.

Before describing the procedures to be taken in response to a spill, the following definitions must be understood. These definitions are an integral part of the spill response procedures.

- Release: Any spill, discharge or leak of a substance from its assigned container or storage unit.
- Immediate Release Area: A 50-foot radius around the release.
- Significant Release: A release that meets any one of the following criteria:
 - a spill in excess of 5 gallons
 - a spill of any size that employees cannot reach safely because of another hazard (fire, explosion, electrical, chemical, physical, etc.)
- Incidental (Minor) Release: A release that is not considered a significant release based on the criteria stated above.

PROCEDURES

In the event of a release, employees who first notice the release must evaluate the nature and extent of the release to determine if the release is “incidental (minor)” or “significant” and immediately notify the Technical Services Department Manager or designated alternate.

Incidental (Minor) Release Response Procedures

For any incidental (minor) release, trained employees will undertake the following procedures:

- Absorb, neutralize, or otherwise control the release using the available solid absorbent materials. This includes placing catch basin mats and orange cones over catch basins as needed.
- Determine if additional response help is necessary.
- Collect and use absorbent material and place the collected material in the dedicated container adjacent to the absorbent materials.

Incidental (Minor) Release Procedures for the Technical Services Department Manager or Designated Representative

- Act as the SNEW spill Incident Commander (IC).
- If additional incidental (minor) release response help is deemed necessary, contact a licensed spill response company (i.e., Moran Environmental).
- Instruct untrained employees **not** to enter the immediate release area.
- Document the release and the release response. The spill response document should contain the following: the date, time, location, material spilled, quantity spilled, source, cleanup methods, name of contractor responding to the spill (if applicable), corrective actions taken, injuries sustained (if applicable) and damage estimate.
- As part of the spill response notification procedures, the Technical Services will notify the CTDEEP – Oil and Chemical Spill Response Division (860) 484-3338.
- When the release response is complete, make the necessary arrangements to have the waste material transported and disposed of by an authorized waste handler in accordance with federal, state and local regulations.

Significant Release Response Procedure

For an uncontrolled release, employees will take **no response action beyond the following**:

- Notify employees in the immediate area (loud voice) and initiate evacuation procedures in accordance with the SNEW emergency evacuation plan.

- Activate the alarms and secure the area if it is safe to do so.
- Follow the instructions of Technical Services.
- If possible and safe, place catch basin mats over catch basins close to and/or downgradient of the release and have the mats held in place with orange safety cones.

Depending on the location of the release, Technical Services will designate a Spill Incident Commander.

- From a safe area, notify the following companies or agencies:
 - Spill Response Contractor (Moran Environmental): (800) 562-7611
 - CTDEEP: Oil and Spill Response Division (860) 424-3338
 - Norwalk Fire and Police Departments: 911
 -
 - If the spill impacts the metro-north train tracks, then notify MTA metro-north: (212) 340-2050
 - If the spill reaches stormwater catch basins, then notify the NRC: (800) 424-8802
- Have the following information compiled and available upon request:
 - Where the spill occurred;
 - When the spill occurred;
 - The type and amount of material spilled;
 - The cause of the incident; and
 - The corrective action being taken.
- Update local, state and federal responders on the status of all employees and site conditions when they arrive.
- Document the release and the release response.

RELEASE DOCUMENTATION

Unless specifically requested by CTDEEP, a written submission of a spill incident report is not required. If such documentation is requested by CTDEEP, then this report shall be sent to CTDEEP within the timeframe they specify and one copy will be retained at the Site.

