

LPA-80063/4CF

When ordering replace "___" with connector type.

Mechanical specifications

Length	1205 mm	47.4 in
Width	386 mm	15.2 in
Depth	335 mm	13.2 in
Depth with z-bracket	375 mm	14.8 in
4) Weight	9.1 kg	20.0 lbs
Wind Area		
Fore/Aft	0.47 m ²	5.0 ft ²
Side	0.40 m ²	4.4 ft ²
Rated Wind Velocity (Safety factor 2.0)		
	>351 km/hr	>218 mph
Wind Load @ 100 mph (161 km/hr)		
Fore/Aft	665 N	149.5 lbs
Side	577 N	129.6 lbs

Antenna consisting of aluminum alloy with brass feedlines covered by a UV safe fiberglass radome.

Mounting and Downtilting

Mounting brackets attach to a pipe diameter of Ø50-102 mm (2.0-4.0 in). If the lock-down brace is used, the maximum diameter is Ø88.9 mm (3.5 in)

Mounting Bracket and Downtilt Bracket Kit #21699999

Electrical specifications

Frequency Range	806-960 MHz
Impedance	50Ω
3) Connector(s)	NE or E-DIN 1 port / center
1) VSWR	≤ 1.4:1
Polarization	Vertical
1) Gain	13 dBd
2) Power Rating	500 W
1) Half Power Angle	
H-Plane	63°
E-Plane	15°
1) Electrical Downtilt	0°
1) Null Fill	10%
Lightning Protection	Direct Ground

Radiation pattern¹⁾

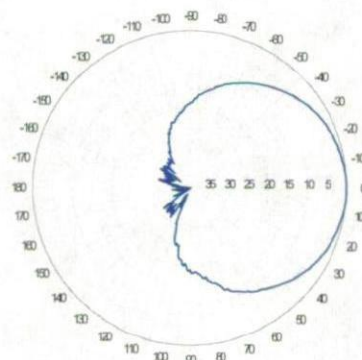

Horizontal

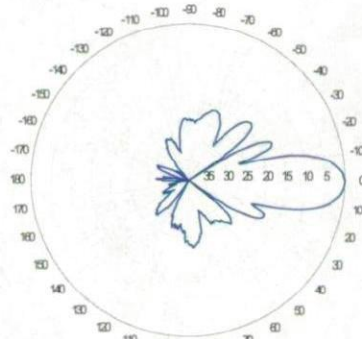

Vertical

Featuring upper side lobe suppression.

Radiation patterns for all antennas are measured with the antenna mounted on a fiberglass pole.

Mounting on a metal pole will typically improve the Front-to-Back ratio.

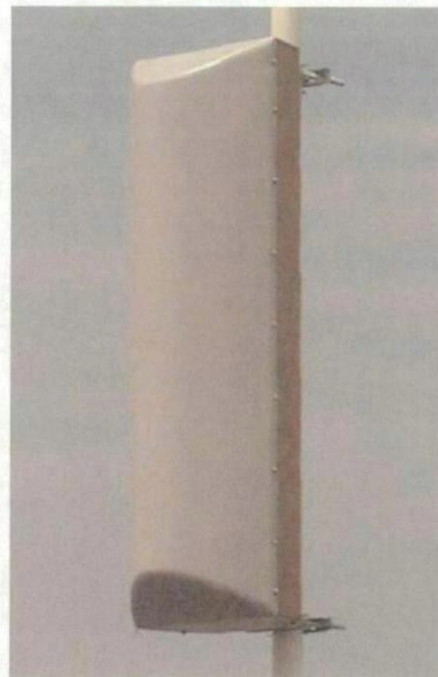

Amphenol Antel's Exclusive 3T (True Transmission Line Technology) Antenna Design:

- True log-periodic design allows for superior front-to-side characteristics to minimize sector overlap.
- Unique feedline design eliminates the need for conventional solder joints in the signal path.
- A non-collinear system with access to every radiating element for broad bandwidth and superior performance.
- Air as insulation for virtually no internal signal loss.

This Amphenol Antel antenna is under a five-year limited warranty for repair or replacement.

Antenna available with center-fed connector only.

CF Denotes a Center-Fed Connector.

806-960 MHz

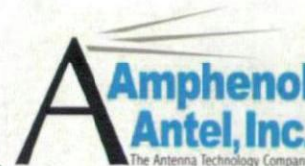

Revision Date: 7/5/07

1) Typical values.
2) Power rating limited by connector only.
3) NE indicates an elongated N connector. E-DIN indicates an elongated DIN connector.
4) The antenna weight listed above does not include the bracket weight.

Improvements to mechanical and/or electrical performance of the antenna may be made without notice.

Vertically Polarized, Log Periodic 63° / 18 dBi

LPA-185063/8CF __ 2°

When ordering replace " __ " with connector type.

Mechanical specifications

Length	1200 mm	47.2 in
Width	167 mm	6.6 in
Depth	148 mm	5.8 in
Depth with t-bracket	176 mm	6.9 in
4) Weight	4.1 kg	9.0 lbs
Wind Area		
Fore/Aft	0.20 m ²	2.2 ft ²
Side	0.18 m ²	1.9 ft ²
Rated Wind Velocity (Safety factor 2.0)	>548 km/hr	>341 mph
Wind Load @ 100 mph (161 km/hr)		
Fore/Aft	299 N	67.2 lbs
Side	267 N	60.0 lbs

Antenna consisting of aluminum alloy with brass feedlines covered by a UV safe fiberglass radome.

Mounting and Downtilting

Mounting brackets attach to a pipe diameter of Ø50-102 mm (2.0-4.0 in).

Mounting bracket kit #26799997
Downtilt bracket kit #26799999

The downtilt bracket kit includes the mounting bracket kit.

Electrical specifications

Frequency Range	1850-1990 MHz
Impedance	50Ω
3) Connector(s)	NE or E-DIN 1 port / center
1) VSWR	≤ 1.4:1
Polarization	Vertical
1) Gain	18 dBi
2) Power Rating	250 W
1) Half Power Angle	
H-Plane	63°
E-Plane	8°
1) Electrical Downtilt	2°
1) Null Fill	10-20%
Lightning Protection	Direct Ground

- 1) Typical values.
2) Power rating limited by connector only.
3) NE indicates an elongated N connector.
E-DIN indicates an elongated DIN connector.
4) The antenna weight listed above does not include the bracket weight.

Improvements to mechanical and/or electrical performance of the antenna may be made without notice.

Radiation pattern¹⁾

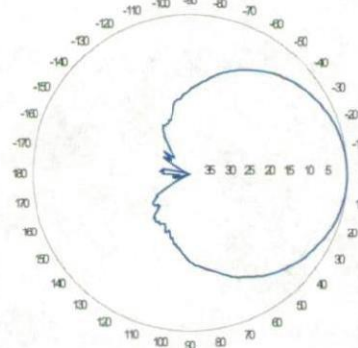

Horizontal

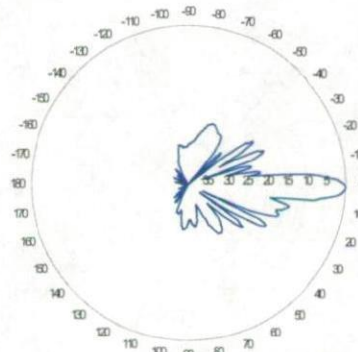

Vertical

Radiation patterns for all antennas are measured with the antenna mounted on a fiberglass pole.

Mounting on a metal pole will typically improve the Front-to-Back ratio.

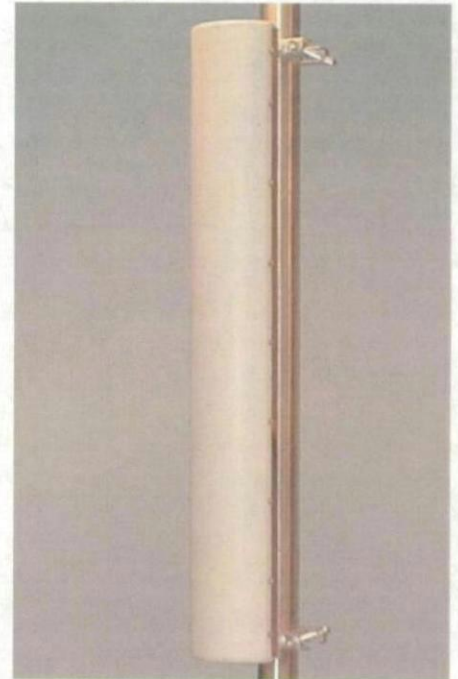

Amphenol Antel's Exclusive 3T (True Transmission Line Technology) Antenna Design:

- True log-periodic design allows for superior front-to-side characteristics to minimize sector overlap.
- Unique feedline design eliminates the need for conventional solder joints in the signal path.
- A non-collinear system with access to every radiating element for broad bandwidth and superior performance.
- Air as insulation for virtually no internal signal loss.

This Amphenol Antel antenna is under a five-year limited warranty for repair or replacement.

Antenna available with center-fed connector only.

CF Denotes a Center-Fed Connector.

1850-1990 MHz

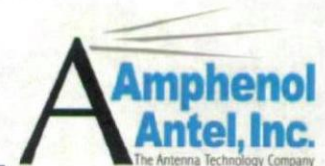

Revision Date: 7/12/07

Lucent CDMA Modular Cell 4.0B Indoor

For CDMA Networks

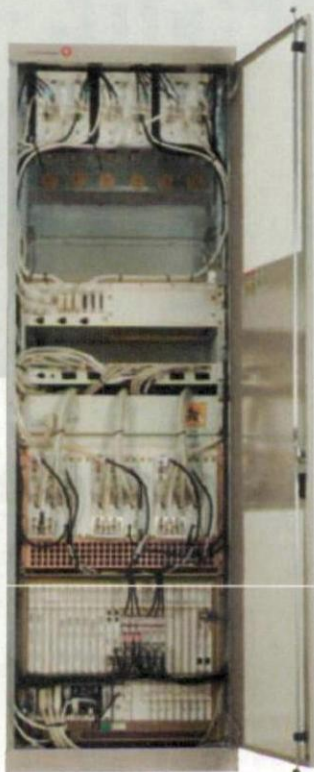

Lucent CDMA Modular Cell 4.0B is a high capacity base station equipped with the state-of-the-art technologies developed by Bell Labs. The product brings you outstanding carrier density and immediate OPEX savings. This indoor product can support up to 8 carriers/3 sectors per frame. It is twice the density of Modular Cell 4.0 (indoor). Modular Cell 4.0B offers full spectrum coverage in a single frame, dramatically simplifying growth patterns. As the leader in spread spectrum technology, Lucent Technologies continues to introduce innovations to the market: Multi-Carrier Radio (15MHz), Block Filters/Wideband Filters, and 40W Power Amplifier Modules are the latest assets integrated in the base station.

Features

The Modcell 4.0B indoor version offers a small footprint with exceptional carrier density in a standard ETSI cabinet.

- Indoor Single Frame Configuration
- 1-8 carriers per frame at 3 sectors (will support up to 11 carriers with Auxiliary Amplifier Frame)
- Dual Band: one cell to the ECP & mobile
- Close Loop Gain Control
- Timing and Controller Redundancy
- Integrated Power option
- Support CDMA2000™1X, and EV-DO Rev.0, with future support to EV-DO Rev. A
- IP Backhaul and Ethernet Backhaul capable
- 6-Sector option ready
- Intelligent Antenna option ready

Benefits

- Optimized for highest carrier density, smooth growth in one frame
- Conserves indoor footprint, reducing hardware and floor space requirements
- Minimizes configuration complexity
- Software-Only Carrier Add at certain carrier counts
- Flexible channel growth planning
- Designed to use existing power supply
- Grow CDMA carriers on only 2 antennas/sector
- Multi-Carrier Radio (15MHz), Block Filters/Wideband Filters, and 40W Power Amplifier Modules



Technical Specifications

Description	Specification
1. Configurations	
a. Sectors	3, 4 and 6
b. Carriers	1-8 per frame at 3 sectors (up to 11 with Auxiliary Amplifier Frame)
2. CDMA Channel Card Capacity	12 slots; CMU IVB capable
3. T1, E1 Facilities	Maximum of 20 per cabinet when equipped with URC-II's
4. User Alarms	7 Power Alarms, 25 User Alarms
5. GPS Antenna	Yes
6. Air Interface Standards	T1A/E1A 95-A plus TSB-74; T1A/E1A 95-B for 850 MHz; CDMA 2000
7. Frequency Bands	850MHz/1900 MHz; 300 to 2100 MHz capable
8. Vocoder	8 Kbps; 8 Kbps EVRC; 13 Kbps; SMV-ready
9. Environmental Cabinet Housing	Standard ETSI cabinet; UL50 compliant; zero rear clearance
10. Cabinet Access	Front Access
11. Operating Temperature Range	Range: -5 to +40°C (continuous)
12. Dimensions	600 mm W x 600 mm D x 1880 mm H (23.6 x 23.6 x 74) inches
13. Estimated Installed Weight	365 kg (785 lbs.) DC [8 carriers in one cabinet]
14. Power Options	Integrated Power, AC 120/240 Volt Input, -48V or +24 V DC Conversion Non-integrated Power requires either + 24 VDC Input or - 48 VDC Input
15. Power Consumption	
a. 3 Carrier/3 Sectors	2167 W
b. 6 Carrier/3 Sectors	5449 W
c. 11 Carrier/3 Sectors	10026 W
16. RF Power (at J4)	25 W per carrier (850) FCC Rated short-term average 20 W per carrier (850) FCC Rated long-term average 20 W per carrier (1900) FCC Rated short-term average 16 W per carrier (1900) FCC Rated long-term average
17. Minimal Antenna Configuration	2 antennas/sector
18. Filter	Block and Wide Band Dual Duplex
19. Growth Frame	PCS AUX Frame, Dual Band Growth Frame
20. Operational Accessories	Integrated Power
21. Channel Elements	Channel pooling across sectors or carriers

To learn more about our comprehensive portfolio, please contact your Lucent Technologies Sales Representative or visit our web site at <http://www.lucent.com>.

This document is for informational or planning purposes only, and is not intended to create, modify or supplement any Lucent Technologies specifications or warranties relating to these products or services. Information and/or technical specifications supplied within this document do not waive (directly or indirectly) any rights or licenses — including but not limited to patents or other protective rights — of Lucent Technologies or others. Specifications are subject to change without notice.

CDMA2000 is a trademark of the Telecommunication Industry Association

Copyright © 2006
Lucent Technologies Inc.
All rights reserved

MOB-Mod4B-i 0106



60 kW @ 60 Hz. Stand-By Power **60F*G4** 45 kW @ 60 Hz. Prime Power

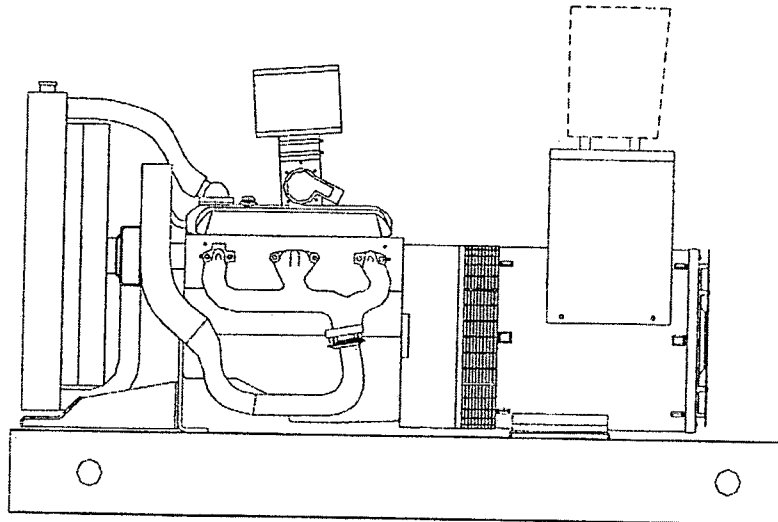

- ▶ Katolight's commitment to quality has been an industry standard since 1952
- ▶ Katolight specializes in custom designing any application to meet the most difficult specifications
- ▶ Each and every unit is factory tested. This can eliminate costly startup and installation delays
- ▶ Katolight supplies a broad range of accessories to match any requirement worldwide
- ▶ Katolight generator sets come standard with a 2 year, 1500 hour limited warranty
- ▶ Optional warranty periods are also available, contact factory for details
- ▶ This model accepts 100% of nameplate rating, per NFPA 110

Model #	Volts	Hz	Phase	Power Factor	Natural Gas Standby Ratings		Natural Gas Prime Ratings		LP Gas Standby Ratings		LP Gas Prime Ratings		Connection
					Amps	kW/kVA	Amps	kW/kVA	Amps	kW/kVA	Amps	kW/kVA	
					60FRG4	277/480	60	3	0.8	90	60/75	68	
60FPG4	120/208	60	3	0.8	208	60/75	156	45/56.25	208	60/75	156	45/56.25	12 LEAD LOW WYE
60FJG4	120/240	60	3	0.8	180	60/75	135	45/56.25	180	60/75	135	45/56.25	12 LEAD HI DELTA
60FNG4	347/600	60	3	0.8	72	60/75	54	45/56.25	72	60/75	54	45/56.25	4 LEAD WYE
60FGG4	120/240	60	1	1.0	250	60/60	188	45/45	250	60/60	188	45/45	12 LEAD ZIG-ZAG
* 60FDG4	120/240	60	1	1.0	250	60/60	188	45/45	250	60/60	188	45/45	4 LEAD

60F*G4 LPG/NG Gen-Set

STANDARD EQUIPMENT

CONTROL PANEL

- Model #45 control panel
- AC voltmeter, 3 1/2", 2% accuracy
- AC ammeter, 3 1/2", 2% accuracy
- Combination VM/AM selector switch, 4 position
- Frequency meter, 3 1/2", 55-65 Hz.
- Vibration shock mounts (4)
- Engine control - KASSEC-12 VDC, with cyclic cranking timer
- 4 engine shutdowns with separate failure lights
 - * High water temperature
 - * Low oil pressure
 - * Engine overspeed
 - * Engine overcrank
- Engine gauges - 2"
 - * Battery voltmeter
 - * Water temperature
 - * Oil pressure
 - * Running time meter - 5 digits
- 3 position mode switch (auto-off-manual)

ENGINE

- Air cleaner
- Oil pump
- Full flow oil filter
- Jacket water pump
- Thermostat
- Exhaust manifold - dry
- Blower fan & fan drive
- Radiator - unit mounted
- Vibration isolators - pad type
- Electric starting motor - 12V

ENGINE (cont.)

- Governor - Electric Isochronous
- Base - formed steel
- Flywheel & Enclosure
- Charging alternator - 12V
- Battery box & cables
- Flexible fuel & exhaust connectors

GENERATOR

- A.C. Generator
- Brushless design
- Single bearing
- Direct connection with flex plate
- Class H insulation
- All models manufactured to meet NEMA MG1- 22.4 and CSA standards
- Telephone influence factor is well within NEMA standards
- Wave form deviation factor is no more than 5%, well within NEMA standards
- Harmonic content is 3.0% maximum
- Permanently lubricated ball type bearings
- Generator is self-ventilated
- Drip-proof construction

VOLTAGE REGULATOR

- Voltage adjust rheostat
- EMI filter (Internal Electromagnetic Interference)
- Underspeed protection
- Overexcitation protection
- Fully encapsulated
- Regulation - 1%

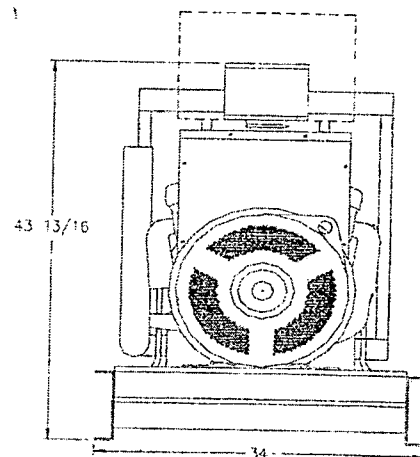
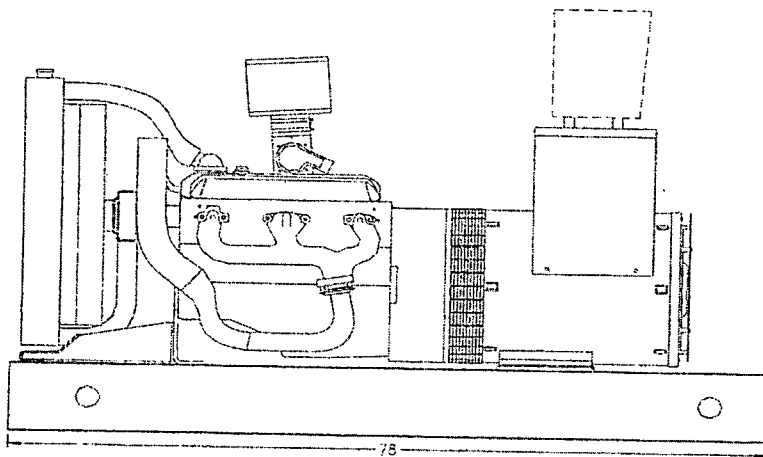

Drawing above for illustration purposes only, based on standard open power 480 volt generator. Lengths may vary with other voltages.

ENGINE TECHNICAL DATA

Model.....	60 Hz	
Type.....	5.7L	
Aspiration.....	4-Cycle	
Cylinder Arrangement: (Number, inline, V, etc.).....	Naturally	
Displacement - Cu. In. (lit).....	8-V	
Bore - in. (cm) x stroke - in. (cm).....	350 (5.7)	
Compression Ratio:.....	4.0 (10.2) x 3.5 (8.8)	
Rated RPM.....	9.1:1	
Rating.....	1800	
BMEP: psi (kPa).....	Standby.....	Prime
Maximum Power at Rated RPM - bhp (kW).....	110 (758).....	107 (737)
	88 (66).....	85 (64)

INSTALLATION DATA *

Exhaust System			
Gas Temp. (Stack): °F (°C).....	1,403 (762).....	1,306 (708)	
Gas Volume at Stack Temp.: CFM (m ³ /min).....	571 (16.2).....	532 (15.1)	
Maximum Allowable Back Pressure: in. H ₂ O (kPa).....	40.7 (10.1).....	40.7 (10.1)	
Cooling System			
Ambient Capacity of Radiator: °F (°C).....	122 (50).....	122 (50)	
Maximum Allowable Static Pressure on Rad. Exhaust: in. H ₂ O (kPa).....	1.5 (0.37).....	1.5 (0.37)	
Water Pump Capacity: gpm (lit/min).....	31 (117).....	31 (117)	
Heat Rejection to Coolant: BTUM (kW).....	2,999 (52.7).....	2,793 (49.1)	
Heat Radiated to Ambient: BTUM (kW).....	2,429 (42.7).....	2,328 (40.9)	
Air Requirements			
Aspirating: CFM (m ³ /min).....	180 (5.1).....	172 (4.9)	
Air Flow Required for Rad. Cooled Unit: CFM (m ³ /min).....	7,115 (201).....	7,059 (200)	
Air Flow Required for Heat Exchanger/Remote Rad. based on 20°F Rise: CFM (m ³ /min).....	6,747 (191).....	6,467 (183)	
Fuel Consumption: (NG-1000 BTU/ft³ / LP-2500 BTU/ft³)			
At 100% of Power Rating: ft ³ /hr (m ³ /hr).....	NG 748 (21.2).....	LPG 299 (8.5).....	NG 726 (20.6).....
At 75% of Power Rating: ft ³ /hr (m ³ /hr).....	639 (18.1).....	256 (7.2).....	615 (17.4).....
At 50% of Power Rating: ft ³ /hr (m ³ /hr).....	510 (14.4).....	204 (5.8).....	486 (13.8).....
			194 (5.5)
Sound Level Data ■			
Sound level at:	Full Load	No Load	Full Load
23 ft (7m) opu w/ critical grade muffler (dBA).....	79	75	78
23 ft (7m) Sound Attenuated Enclosure (dBA).....	73	68	72

Dimensions & Weight

Length: in. (cm).....	78 (198)
Width: in. (cm).....	34 (86)
Height: in. (cm).....	43.8 (111)
Weight (dry): lb. (kg).....	1,366 (620)

Liquid Capacity

Total oil system: gal (lit).....	1.6 (6.1)
Engine jacket water capacity: gal (lit).....	2.0 (7.6)
System coolant capacity: gal (lit).....	5.3 (20.1)

Fuel Inlet

Fuel connection size:.....	¾" NPT
Fuel supply pressure in H ₂ O (mm H ₂ O).....	7-11 (178-279)

Electrical System

Electric volts DC.....	12
Cold cranking Amps under 0°F (-17.8°C).....	600

Remote Radiator System

Connection sizes:	
Jacket water radiator inlet in. (cm).....	2 (5.1)
Jacket water radiator outlet in. (cm).....	2 (5.1)
Static head allowable above engine ft H ₂ O (kPa).....	
	17 (50.8)
Total system friction pressure max. allowable psi (kPa).....	
	C/F

Heat Exchanger System

Connection sizes:	
Heat ex. inlet in. (cm).....	1.5 (3.8)
Heat ex. outlet in. (cm).....	1.5 (3.8)
Water consumption: @ 60°F (16°C) gpm (lit/min).....	
	7 (26.5)

*Installation data based on 480 volt, 60 HZ. application and open power unit.

■ For sound level readings with other enclosures, please contact factory.

Sound level data acquired per Test Method SAE J1074. Installation factors and site conditions can affect sound levels.

Deration Factor: Altitude: Derate: 3% per 1,000 ft (305 m) above 328 ft (100 m). Temperature: Derate: 1% per 10°F (5.5°C) above 77°F (25°C)

Control Panel

** NOTE: #45 series control panel is standard on all units, see page 2 of spec sheet for standard features.

- o Model #45 Series Control Panel Options
 - o Emergency stop button
 - o Alarm buzzer with silencing switch
 - o Auxiliary relay for dry contacts (2 max.)
 - o A separate low water level light is optional
 - o Hooded panel lights (2) and on/off switch
 - o NEMA 12 Panel Face
 - o Additional LED lights (4 max.) One or two of the following conditions may be indicated:
 - unit not in auto
 - low fuel level
 - low water level
 - low water temp.
 - EPS supplying load
 - pre-alarm oil
 - pre-alarm temp.
 - charger malfunction
- o Model #50 Series Control Panel

STANDARD FEATURES: same as #45 series control panel except for these added features:

 - o Hooded panel lights (2) and on/off switch
 - o 4 Engine shutdowns
 - o 12 light engine control package meeting NFPA-110 requirement
 - o Repetitive alarm buzzer and silencing switch
 - o Light and alarm press to test

#50 SERIES OPTIONS

 - o Emergency stop button
 - o Additional space for one 3 1/2" meter
 - o Auxiliary relay for dry contacts (2 max.)
 - o A separate low water level light is optional
 - o Additional LED lights (4 max.) One to four additional conditions may be indicated: customer to specify
 - o NEMA 12 Panel Face
- o Model #60 and #80 Series Custom Control Panels

It may be necessary to use a 60 or 80 series control panel on certain units where numerous options are required.
- o Microprocessor Control Panel – KDGC

GEN-SET OPTIONS

Cooling System

- o Remote Radiator
- o High Ambient Radiator
- o Heat Exchanger Cooling
- o Radiator Duct Flange

DISTRIBUTED BY:

Fuel System

- o Fuel Strainer
- o Dual Fuel
 - o Manual Change-over
 - o Auto Change-over

Exhaust System

- o Residential Grade Muffler
- o Critical Grade Muffler
- o Hospital Grade Muffler
- o Rain Cap

Engine Electrical System

- o Battery
 - o Lead-Acid
 - o NiCad
- o Battery Warmer Plate
- o Battery Rack
- o Battery Charger
 - o Automatic
 - o Trickle
 - o Mounted & Wired

Generator

- o Main Line Circuit Breaker
 - o Shunt trip
 - o Auxiliary switch
- o PMG Excitation & DVR 2000 Regulator
- o Space Heaters 120/240 volt
- o Special Testing
- o Additional Temperature Rise Generators Available (80°C, 105°C, & 130°C)

Additional Optional Equipment

- o Spring vibration isolators
- o Oil Drain Extension
- o Enclosures
 - o Sound Attenuated
 - o Weather Proof
 - o Aluminum
 - o Interior lights AC or DC
 - o Floor Plate
- o Jacket Water Heater
- o Crankcase Oil Heater
- o Remote Annunciator
- o 12 Light Annunciator
 - o Flush Mounted
 - o Surface Mounted
 - o 4 additional lights, if needed
- o Export Boxing
- o Warranties
 - o 2 Year
 - o 5 Year
- o Operating instructions under plexi-glass
- o Service indicator light
- o Wind rated enclosure