



# STATE OF CONNECTICUT

## CONNECTICUT SITING COUNCIL

Ten Franklin Square  
New Britain, Connecticut 06051  
Phone: (860) 827-2935  
Fax: (860) 827-2950

July 18, 2002

Christopher B. Fisher, Esq.  
Cuddy & Feder & Worby LLP  
90 Maple Avenue  
White Plains, NY 10601-5196

RE: **EM-AT&T-124-020628** - AT&T Wireless notice of intent to modify an existing telecommunications facility located at 6 Progress Avenue, Seymour, Connecticut.

Dear Attorney Fisher:

At a public meeting held on July 11, 2002, the Connecticut Siting Council (Council) acknowledged your notice to modify this existing telecommunications facility, pursuant to Section 16-50j-73 of the Regulations of Connecticut State Agencies with the conditions that 1) the physical condition of the tower be assessed by a professional engineer, 2) tower and foundation modifications be made in accordance with the "Tower Reanalysis Report" prepared by Pirod Inc., June 20, 2002, and 3) prior to the installation of any additional antennas on this tower, a certified copy of the inspection report prepared by a professional engineer and engineering plans of the structural modifications must be sent to the Council prior to antenna installation.

The proposed modifications are to be implemented as specified here and in your notice received June 28, 2002. The modifications are in compliance with the exception criteria in Section 16-50j-72 (b) of the Regulations of Connecticut State Agencies as changes to an existing facility site that would not increase tower height, extend the boundaries of the tower site, increase noise levels at the tower site boundary by six decibels, and increase the total radio frequencies electromagnetic radiation power density measured at the tower site boundary to or above the standard adopted by the State Department of Environmental Protection pursuant to General Statutes § 22a-162. This facility has also been carefully modeled to ensure that radio frequency emissions are conservatively below State and federal standards applicable to the frequencies now used on this tower.

This decision is under the exclusive jurisdiction of the Council. Any additional change to this facility will require explicit notice to this agency pursuant to Regulations of Connecticut State Agencies Section 16-50j-73. Such notice shall include all relevant information regarding the proposed change with cumulative worst-case modeling of radio frequency exposure at the closest point of uncontrolled access to the tower base, consistent with Federal Communications Commission, Office of Engineering and Technology, Bulletin 65. Any deviation from this format may result in the Council implementing enforcement proceedings pursuant to General Statutes § 16-50u including, without limitation, imposition of expenses resulting from such failure and of civil penalties in an amount not less than one thousand dollars per day for each day of construction or operation in material violation.

Thank you for your attention and cooperation.

Very truly yours,

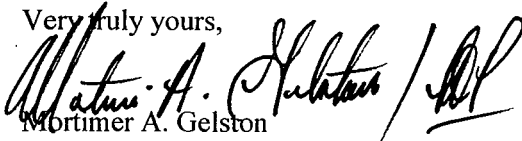

Mortimer A. Gelston  
Chairman

MAG/laf

c: Honorable Scott A. Barton, First Selectman, Town of Seymour  
James Baldwin, Sr., Zoning Enforcement Officer, Town of Seymour  
EMAC Communications Co.  
Stephen J. Humes, Esq., LeBoeuf, Lamb, Greene, and MacRae  
Julie M. Donaldson, Esq., Hurwitz & Sagarin LLC

**EM-AT&T-124-020628**  
**6 Progress Avenue**  
**Seymour 7/3/02**

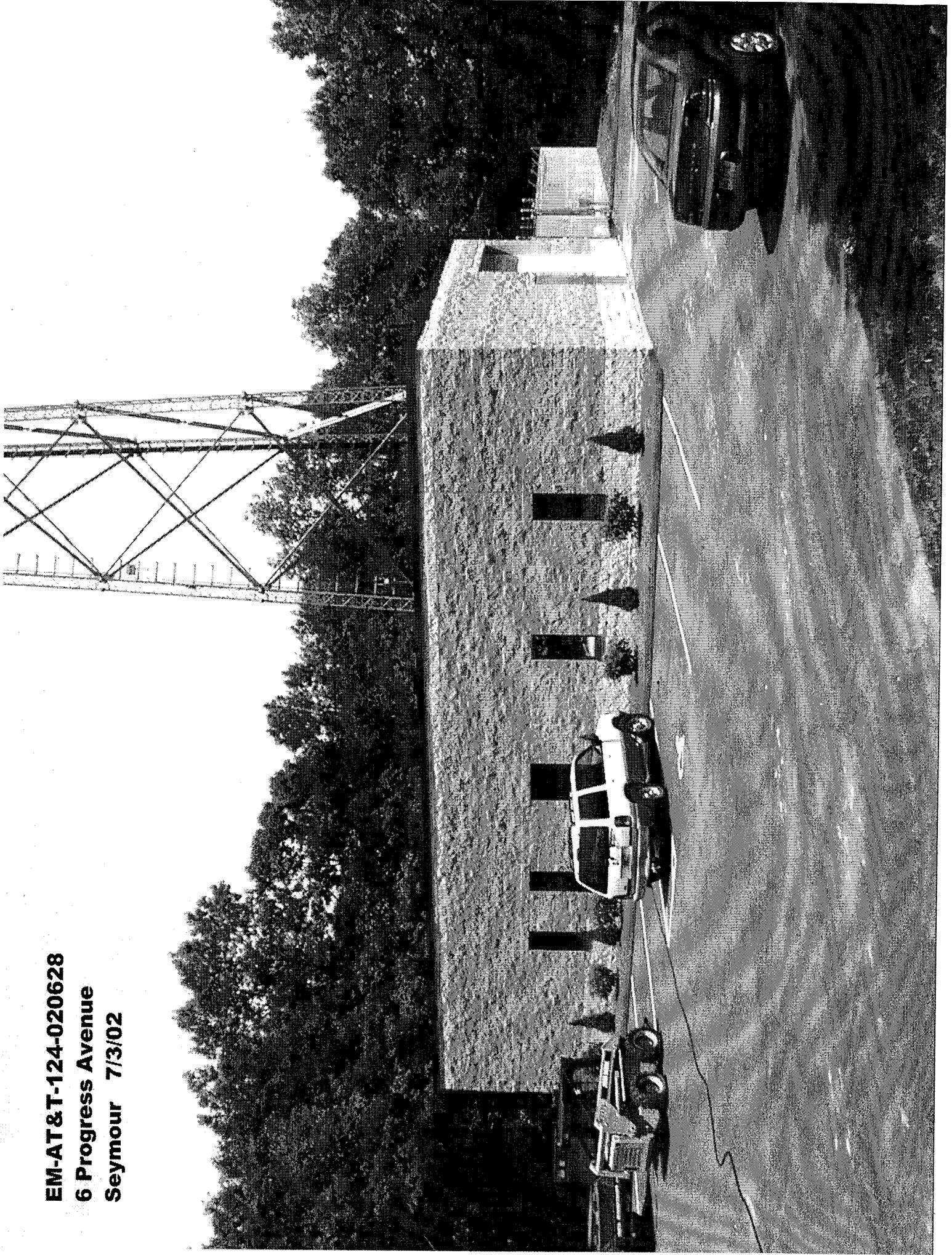

**EM-AT&T-124-020628**

**6 Progress Avenue**

**Seymour 7/3/02**

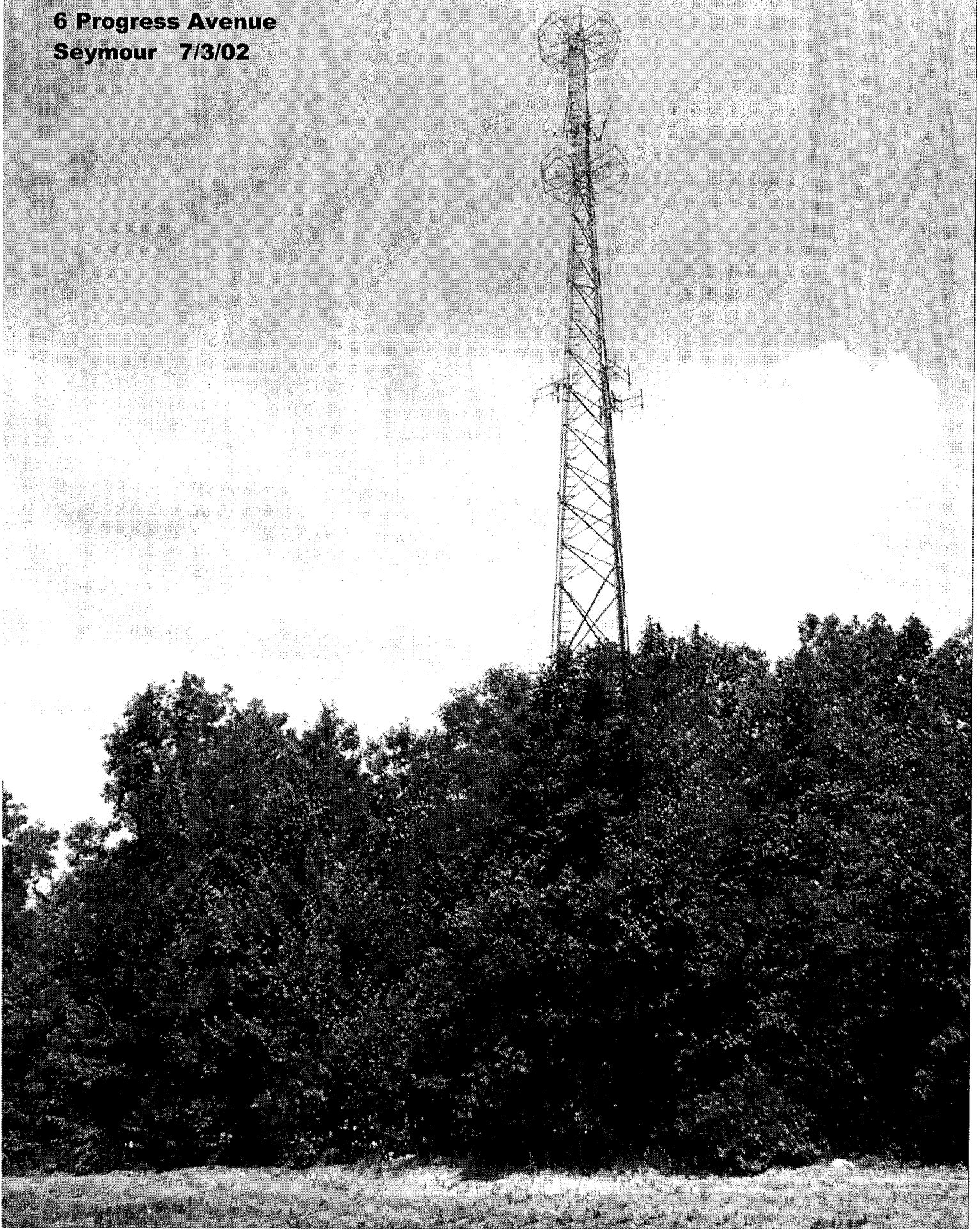



# STATE OF CONNECTICUT

## CONNECTICUT SITING COUNCIL

Ten Franklin Square, New Britain, CT 06051

Phone: (860) 827-2935 Fax: (860) 827-2950

E-Mail: [siting.council@po.state.ct.us](mailto:siting.council@po.state.ct.us)

Web Site: [www.state.ct.us/csc/index.htm](http://www.state.ct.us/csc/index.htm)

June 28, 2002

Honorable Scott A. Barton  
First Selectman  
Town of Seymour  
Town Hall  
One First Street  
Seymour, CT 06483

RE: **EM-AT&T-124-020628** - AT&T Wireless notice of intent to modify an existing telecommunications facility located at 6 Progress Avenue, Seymour, Connecticut

Dear Mr. Barton:

The Connecticut Siting Council (Council) received this request to modify an existing telecommunications facility, pursuant to Regulations of Connecticut State Agencies Section 16-50j-72.

The Council will consider this item at the next meeting scheduled for July 11, 2002 at 1:30 p.m. in Hearing Room One, Ten Franklin Square, New Britain, Connecticut.

Please call me or inform the Council if you have any questions or comments regarding this proposal.

Thank you for your cooperation and consideration.

Very truly yours,

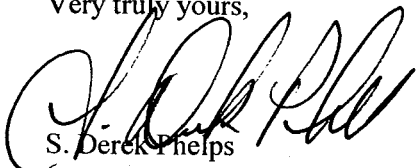

S. Derek Phelps  
Executive Director

SDP/dsj

Enclosure: Notice of Intent

c: James Baldwin, Sr., Zoning Enforcement Officer, Town of Seymour

**NOTICE OF INTENT TO MODIFY AN  
EXISTING TELECOMMUNICATIONS FACILITY AT  
6 PROGRESS AVENUE, SEYMOUR, CONNECTICUT**

Pursuant to the Public Utility Environmental Standards Act, Connecticut General Statutes § 16-50g et. seq. ("PUESA"), and Sections 16-50j-72(b) of the Regulations of Connecticut State Agencies adopted pursuant to the PUESA, AT&T Wireless PCS, LLC d/b/a AT&T Wireless ("AT&T Wireless") hereby notifies the Connecticut Siting Council of its intent to modify an existing facility located at 6 Progress Avenue, Seymour, Connecticut (the "Progress Avenue Facility"), owned by Natcomm, LLC. AT&T Wireless and the tower owner have agreed to share the use of the Progress Avenue Facility, as detailed below.

**RECEIVED  
JUN 28 2002**

**The Progress Avenue Facility**

**CONNECTICUT  
SITING COUNCIL**

The Progress Avenue Facility consists of an approximately two hundred eighty (280) foot lattice tower (the "Tower") and associated equipment currently being used for wireless communications by VoiceStream, Sprint, private users and the municipality. A chain link fence surrounds the Tower compound. The Tower is located in an industrial park.

**AT&T Wireless' Facility**

As shown on the enclosed plans prepared by Natcomm, LLC, including a site plan and tower elevation of the Progress Avenue Facility, AT&T Wireless proposes shared use of the Facility by placing antennas on the Tower and equipment cabinets needed to provide personal communications services ("PCS") within the existing fenced compound. AT&T Wireless will install 6 panel antennas at approximately the 160 foot level of the Tower and associated equipment cabinets (2 proposed, 2 future, each 76"H x 30" W x 30" D) located on a concrete pad within the fenced compound. As evidenced in the structural report prepared by Pirod, Inc., annexed hereto as Exhibit A, AT&T has confirmed that the tower is structurally capable of supporting the addition of AT&T Wireless' antennas.

**AT&T Wireless' Facility Constitutes An Exempt Modification**

The proposed addition of AT&T Wireless' antennas and equipment to the Progress Avenue Facility constitutes an exempt "modification" of an existing facility as defined in Connecticut General Statutes Section 16-50i(d) and Council regulations promulgated pursuant thereto. Addition of AT&T Wireless' antennas and equipment to the Tower will not result in an increase of the Tower's height nor extend the site boundaries. Further, there will be no increase in noise levels by six (6) decibels or more at the Tower site's boundary. As set forth in an Emissions Report prepared by Prabhakar K. Rughoobur, Radio Frequency Engineer, annexed hereto as Exhibit B, the total radio frequency electromagnetic radiation power density at the Tower site's

boundary will not be increased to or above the standard adopted by the Connecticut Department of Environmental Protection as set forth in Section 22a-162 of the Connecticut General Statutes and MPE limits established by the Federal Communications Commission. For all the foregoing reasons, addition of AT&T Wireless' facility to the Tower constitutes an exempt modification which will not have a substantially adverse environmental effect.

**Conclusion**

Accordingly, AT&T Wireless requests that the Connecticut Siting Council acknowledge that its proposed modification to the Progress Avenue Facility meets the Council's exemption criteria.

Respectfully Submitted,

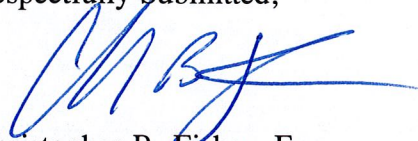
A handwritten signature in blue ink, appearing to read 'CB Fisher', with a long horizontal flourish extending to the right.

Christopher B. Fisher, Esq.  
On behalf of AT&T Wireless

cc: First Selectman, Town of Seymour  
RJ Wetzel, Bechtel

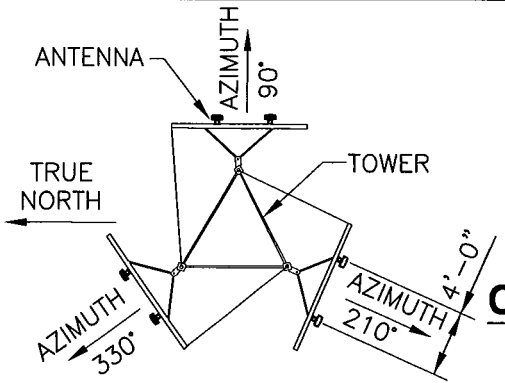

NOTE:  
 STRUCTURAL ANALYSIS BY PIROD, INC. OF A 280'  
 PIROD U-28.0 TOWER WOODBRIDGE/SEYMOUR-  
 PROGRESS AVE, 6 PROGRESS AVE, SEYMOUR, CT 06483  
 (CT-633) DATED JUNE 20, 2002 BY JOHN R. ERICHSEN  
 LICENSE #17134

## ANTENNA CONFIGURATION

EL. 280'-0"± ABOVE TOP OF BASE R

EL. 250'-0"± ABOVE TOP OF BASE R

EL. 235'-0"± ABOVE TOP OF BASE R

EL. 200'-0"± ABOVE TOP OF BASE R

EL. 190'-0"± ABOVE TOP OF BASE R

EL. 180'-0"± ABOVE TOP OF BASE R

EL. 170'-0"± ABOVE TOP OF BASE R

EL. 160'-0"± ABOVE TOP OF BASE R

EXISTING 280' PIROD  
 SELF-SUPPORTING TOWER

PROPOSED AT&T ELEC/TELCO  
 UTILITY SUPPORT FRAME

PROPOSED AT&T (LEASE AREA) RADIO  
 CABINETS MOUNTED ON AN EXISTING  
 CONCRETE PAD WITH ICE BRIDGE AND  
 POSTS

EXISTING SPRINT PCS  
 EQUIPMENT AND COVER

EXISTING 8'-0" HIGH  
 CHAIN LINK FENCE

FINISH GRADE

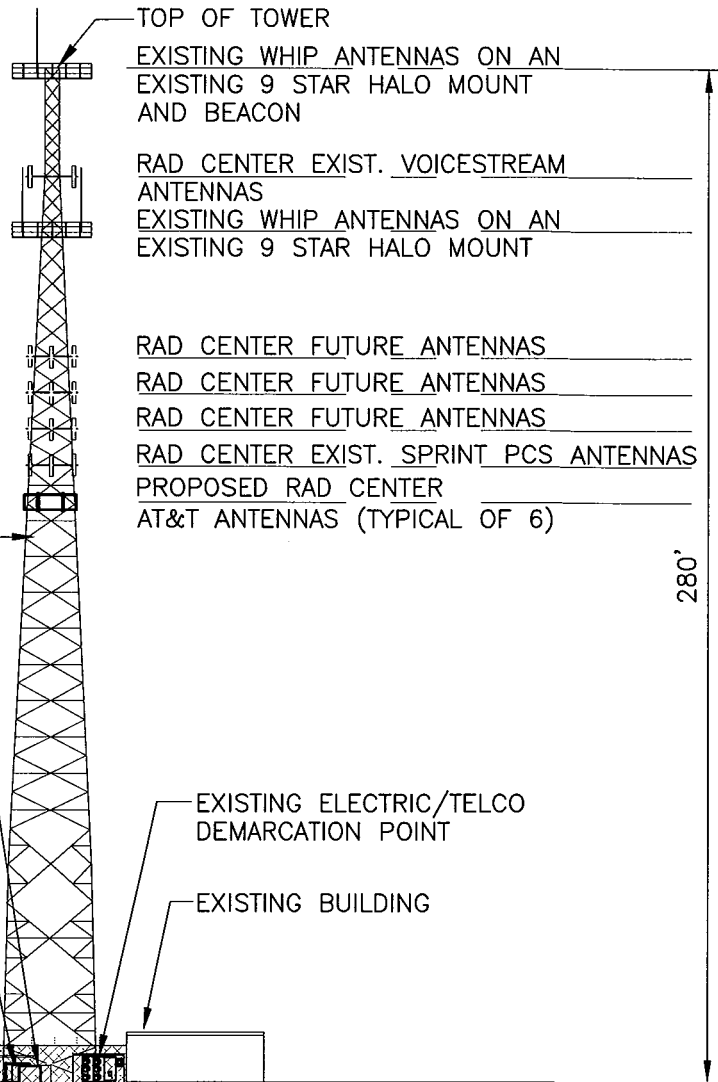

280'

**2**

## TOWER ELEVATION

SCALE: 1" = 50'-0"

"ISSUED FOR SITING COUNCIL"



**Natcomm, LLC**

63-2 North Branford Road  
 Branford, Connecticut 06405

Tel. (203) 488-0580  
 Fax (203) 488-8587

Consulting Engineers · Project Management  
 Civil · Structural · Mechanical · Electrical



**AT&T**

AT&T WIRELESS PCS LLC  
 12 OMEGA DRIVE  
 STAMFORD, CONNECTICUT 06907

DRAWING TITLE:

SITING COUNCIL

PROJECT INFORMATION:

WOODBRIDGE-SEYMOUR  
 CT-633  
 6 PROGRESS AVENUE  
 SEYMOUR, CT 06483

LESSOR:

EMAC COMMUNICATIONS  
 6 PROGRESS AVENUE  
 SEYMOUR, CT 06483

DRAWING NO.

**913-008-633A-SC2**

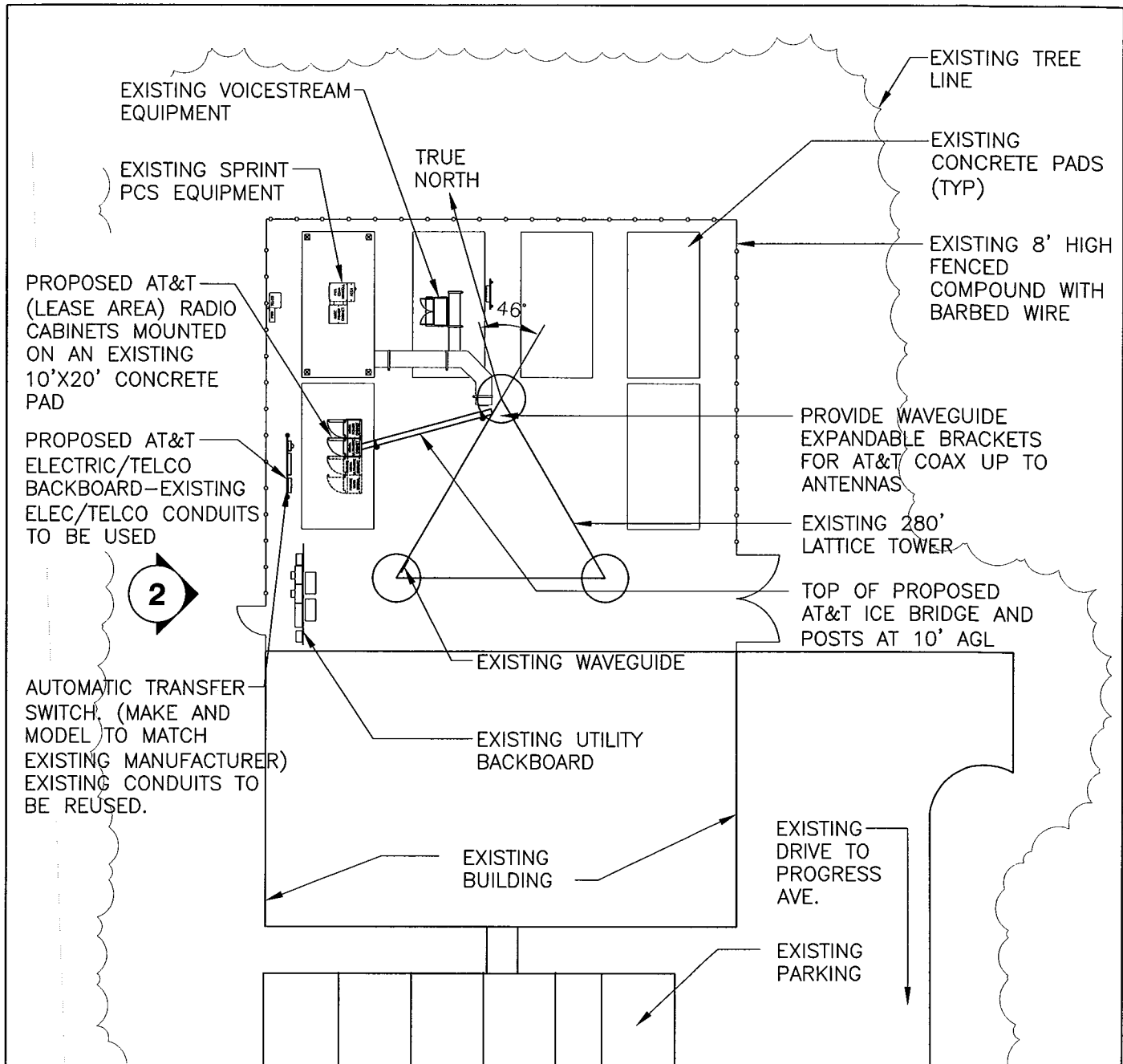

REVISION NO. 0	DRAWN BY: CMS
DATE ISSUED: 06/24/02	CHECKED BY: JJP
SCALE: AS NOTED	APPROVED BY: CFC
	SHEET NO. 2 OF 2
A/E PROJECT NO: 02554	



**1** **COMPOUND PLAN**  
SCALE: 1" = 20'-0"

NOTE:  
LATITUDE: 41.3915°  
LONGITUDE: 73.0533°

**"ISSUED FOR SITING COUNCIL"**

 <p><b>Natcomm, LLC</b> 63-2 North Branford Road Branford, Connecticut 06405 Tel. (203) 488-0580 Fax (203) 488-8587 Consulting Engineers - Project Management Civil - Structural - Mechanical - Electrical</p>	 <p><b>AT&amp;T</b> AT&amp;T WIRELESS PCS LLC 12 OMEGA DRIVE STAMFORD, CONNECTICUT 06907</p>	<p><b>DRAWING TITLE:</b> SITING COUNCIL</p> <p><b>PROJECT INFORMATION:</b> WOODBIDGE-SEYMOUR CT-633 6 PROGRESS AVENUE SEYMOUR, CT 06483</p>	<p style="text-align: right;"><b>DRAWING NO.</b> <b>913-008-633A-SC1</b></p>							
		<p><b>LESSOR:</b> EMAC COMMUNICATIONS 6 PROGRESS AVENUE SEYMOUR, CT 06483</p>	<table border="1" style="width: 100%; border-collapse: collapse;"> <tr> <td style="width: 50%;">REVISION NO. 0</td> <td style="width: 50%;">DRAWN BY: CMS</td> </tr> <tr> <td>DATE ISSUED: 06/24/02</td> <td>CHECKED BY: JJP</td> </tr> <tr> <td>SCALE: AS NOTED</td> <td>APPROVED BY: CFC</td> </tr> <tr> <td colspan="2" style="text-align: right;">SHEET NO. 1 OF 2</td> </tr> </table> <p>A/E PROJECT NO: 02554</p>		REVISION NO. 0	DRAWN BY: CMS	DATE ISSUED: 06/24/02	CHECKED BY: JJP	SCALE: AS NOTED	APPROVED BY: CFC
REVISION NO. 0	DRAWN BY: CMS									
DATE ISSUED: 06/24/02	CHECKED BY: JJP									
SCALE: AS NOTED	APPROVED BY: CFC									
SHEET NO. 1 OF 2										



SCANNED



**PIROD INC.**

A Valmont Industries Company

## **Tower Reanalysis Report**

**Proposal PR-2002-05-050**

**June 20, 2002**

*CT-633*

U-28.0 x 280' Tower  
Seymour, CT  
PiRod Engineering File A-116966

Prepared for  
Natcomm, LLC  
Attn: Jennifer Coombs  
63-2 North Branford Road  
Branford, CT 06405

Authorization Provided by  
EMAC Communications, LLC  
Attn: Edward MacConnie  
2702 Forest View Lane  
Kissimmee, FL 34744

*J:\reanalysis\116\116966.doc*

## Tower Reanalysis Report Proposal PR-2002-05-050

U-28.0 x 280' Tower  
Seymour, CT  
PiRod Engineering File A-116966

Contact Person:

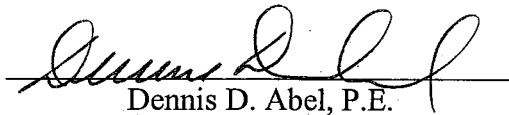

Dennis D. Abel, P.E.

Manager of Reanalysis Services  
e-mail: dabel@pirod.com  
telephone extension: 5257

Completed under the Supervision and Approval by  
John R. Erichsen, P.E., S.E.  
Vice President of Technology  
e-mail: jerichsen@pirod.com  
telephone extension: 5221

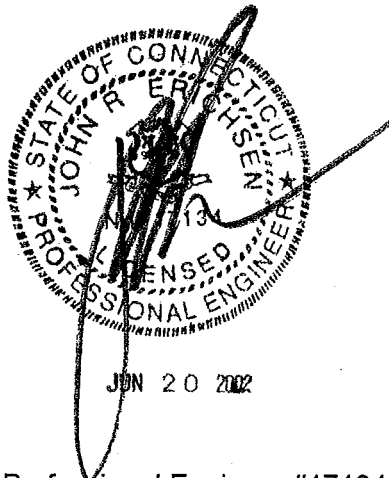

John R Erichsen CT Professional Engineer #17134

## TABLE OF CONTENTS

Description	Page No.
1.0 EXECUTIVE SUMMARY.....	1
2.0 ASSUMPTIONS.....	1
3.0 TOWER HISTORY.....	2
4.0 CURRENT WIND LOAD REQUIREMENT.....	3
5.0 ANTENNA LOADING.....	4
6.0 RESULTS.....	5
6.1 Tower Modifications.....	5
6.2 Foundation Modifications.....	5
7.0 LIST OF APPENDICES.....	6

## 1.0 EXECUTIVE SUMMARY

This reanalysis was performed by PiRod to determine if the structure is capable of accommodating loading that is different than previous design specifications. This engineering report gives the tower history, details how the loading changes affect the tower, specifies feasible modifications, and proposes modification materials. PiRod's engineering study concludes that the tower requires modifications. See section 6.0 for details.

## 2.0 ASSUMPTIONS

**This engineering study is based on the theoretical capacity of the structure. It is not a condition assessment of the tower.** This report is being provided by PiRod without the benefit of an inspection by PiRod personnel and is based on information supplied by the customer to PiRod. PiRod has made no independent determination, nor is required to, of the accuracy of the information provided. Therefore, unless specifically informed to the contrary by the customer in writing, PiRod assumes the following:

1. The subsoil characteristics exist as stated on the tower drawing or stated elsewhere in this report;
2. The tower is erected and maintained in accordance with the manufacturer's plans and specifications and is plumb;
3. There is no damage, natural or manmade, to the structure, either gradual or sudden;
4. All connections and guy cables are properly installed;
5. The information concerning the components, existing and proposed, is accurate; and
6. There are no modifications to the tower itself, except as may be disclosed elsewhere in this report.

PiRod recommends that qualified personnel assess the physical condition of the tower, preferably under the direction of a licensed professional engineer. Following is a list of the general areas that PiRod recommends to be inspected. Contact PiRod for a complete checklist.

<u>Tower Structure</u>	<u>Guyed Towers</u>	<u>Foundations</u>	<u>Appurtenances</u>
Tower Sections	Guy Cables	Cracking	Antennas
Bolted Connections	Turnbuckles	Drainage	Mounts
Welded Connections	Preforms	Spalling	Transmission Lines
Plumbness	Guy Lugs	Anchor Bolts	Line Brackets
Corrosion	Thimbles	Settling	Cable Hangers
Linearity	Torque Arms	Grounding	Lighting
Galvanization	Ice Clips	Grout	
Paint	Guy Tensions	Subsoil	
	Anchor Rods	Characteristics	
	Shackles	Erosion	
	Insulators		

### 3.0 TOWER HISTORY

Date of Origination: April of 2000  
 PiRod Model: U-28.0 x 280' Tower  
 Sold to: EMAC Communications

ORIGINAL DESIGN CRITERIA				
Code/Standard	Wind Loading	Radial Ice	Wind Load Reduction Used	Allowable Stress Increase Used
TIA/EIA-222-F	90 mph fastest mile	no	none	yes
TIA/EIA-222-F	90 mph fastest mile	½" solid	25%	yes

The original design is based on the following antenna loading. This may not truly represent the antennas that have actually been placed on the tower.

HEIGHT (FT)	ANTENNAS		ASSUMED CAAC (SQ.FT.)	MOUNTS		LINES	
	QTY.	MODEL		QTY.	MODEL	QTY.	SIZE
Top	1	Beacon		1	Beacon Extender	1	1"
	1	Lightning Rod Extender					
280'	30	Antel BCD8707		1	9-Arm Halo Mount	30	1-5/8"
235'	30	Antel BCD8707		1	9-Arm Halo Mount	30	1-5/8"
200'	9	Decibel DB980H		3	T-Frames	9	1-5/8"

For the structural analysis, the tower and foundation are assumed to exist as shown on the enclosed tower drawing, which is PiRod's latest revision.

## 4.0 CURRENT WIND LOAD REQUIREMENT

The TIA/EIA Standard is currently at version F. New Haven County is designated as an 85-mph basic wind speed zone by the current TIA/EIA Standard. We have taken the opportunity to reanalyze this structure using the following wind speed and ice load conditions.

Code/Standard	Wind Loading	Radial Ice	Wind Load Reduction Used <sup>(1)</sup>	Allowable Stress Increase Used <sup>(2)</sup>
2000 Connecticut Building Code	85 mph fastest mile	no	none	yes
2000 Connecticut Building Code	85 mph fastest mile	½" solid	25%	yes
TIA/EIA-222-F	85 mph fastest mile	no	none	yes
TIA/EIA-222-F	85 mph fastest mile	½" solid	25%	yes

(1) The wind load reduction is permitted by the TIA/EIA-222-F Standard section 2.3.16 and most other codes to account for the minimal chance that the maximum wind speed will occur simultaneously with the ice load.

(2) The allowable stress increase is permitted by the TIA/EIA-222-F Standard and most other codes in accordance with the AISC-ASD Manual of Steel Construction.

**Note: The analysis wind speed is less than the original design wind speed.**

Note: Some localities stipulate wind load requirements that are different from that required by the TIA/EIA Standard. Please check with your local building department and verify the required wind load.

## 5.0 ANTENNA LOADING

The tower analysis uses the following antenna loading, which was provided on May 28, 2002 and per telephone conversation with Edward MacConnie on June 13, 2002.

HEIGHT (FT)	ANTENNAS		CARRIER	MOUNTS		LINES		BRKT *
	QTY	MODEL		QTY	MODEL	QTY	SIZE	
Existing Loading								
Top	1	Beacon Lightning Rod Extender #806011				1	1"	
280'	20	Antel BCD8707	EMAC	1 10	9-Arm Halo Mount 2" x 84" Antenna Pipe	20	1-5/8"	A
250'	12	EMS RR90-17-02DP	Voice- Stream	3 12	15' T-Frame (#801511) 2" x 84" Antenna Pipe	24	1-5/8"	C
235'	20	Antel BCD8707	EMAC	1 10	9-Arm Halo Mount 2" x 84" Antenna Pipe	20	1-5/8"	A
170'	9	Decibel DB980-H-90	Sprint	3 9	15' T-Frame (#801511) 2" x 60" Antenna Pipe	9	1-5/8"	B
Future Additional Loading								
200'	9	Decibel DB980 – <i>Future</i>	EMAC	3 9	10' Lightweight T-Frame 2" x 60" Antenna Pipe	9	1-5/8"	C
190'	9	Decibel DB980 – <i>Future</i>	EMAC	3 9	10' Lightweight T-Frame 2" x 60" Antenna Pipe	9	1-5/8"	C
180'	9	Decibel DB980 – <i>Future</i>	EMAC	3 9	10' Lightweight T-Frame 2" x 60" Antenna Pipe	9	1-5/8"	C
Proposed Additional Loading								
160'	6 6	Allgon 7250.03 Extra Transmission Line	AT&T	3 6	15' T-Frame (#801511) 2" x 84" Antenna Pipe	12	1-5/8"	D

These antennas, mounts, and lines represent our understanding of the antenna loading required. Please contact us if any discrepancies are evident. If different antennas, mounts, or lines are installed on this structure, this analysis is invalid.

### \* Line Brackets

A – 1st Run of PiRod Expandable Line Brackets

B – 1st Run of PiRod Extended Double-T Line Brackets

C – 2nd Run of PiRod Expandable Line Brackets (extra brackets required if all lines are used)

D – 2nd Run of PiRod Extended Double-T Line Brackets

## **6.0 RESULTS**

---

With the antennas listed in section 5.0, the following modifications are required for the tower to comply with the indicated code and TIA/EIA Standard listed in section 4.0.

### **6.1 Tower Modifications**

1. Replace the existing diagonal bracing from 140' to 160' with 3-1/2" x 3-1/2" x 5/16" angles.
2. Install horizontal angle bracing at the 160', 170', 180', and 190' levels.
3. The transmission lines must be installed on the brackets listed in section 5.0 for the proper wind sheltering effect. Please note that not all runs of the brackets can be placed on the inside face of the breakdown legs. When future loading is added, some runs of line brackets will need to be placed directly on the inside legs of the breakdown legs.

The modification materials, associated hardware, and updated engineering documentation are priced on the appended Reanalysis Parts Pricing Proposal.

### **6.2 Foundation Modifications**

The foundation analysis is based on the soil report by Advanced Engineering Technologies, Inc., dated March 31, 2000, file #42GT2K.

1. Verify that the backfill above the foundation has been compacted to a minimum unit weight of 135 pcf. If this density has not been achieved, the backfill must be replaced with new material or the existing material must be recompact. See the attached drawing for details.
2. According to the records of EMAC Communications, the foundation was installed with six foot square piers, and therefore, no modifications are required to the piers.

Foundation modifications must occur prior to any installing any proposed antennas, lines, or tower modifications. These modifications outline the scope of work only and are not intended to imply sequence of work or construction procedures. Once the above modifications have been installed, the structure will comply with the indicated code and TIA/EIA Standard.



## 7.0 LIST OF APPENDICES

---

Reanalysis Parts Pricing Proposal	
Main Tower Drawing, latest revision	206292-B
15' Universal T-Frame	141262
10' Lightweight T-Frame	141260
Transmission Line Hanging Brackets	140576
Foundation Modification Drawing	

Note: The tower drawing included with this report is PiRod's latest revision and depicts the tower as we understand it to currently exist. It has not been updated to show the existing or proposed antenna loading or any modifications required as a result of this analysis.



## Reanalysis Parts Pricing Proposal

**Proposal Number:** PR-2002-05-050  
**Engineering File:** A-116966  
**Customer:** Natcomm, LLC  
**Site:** Seymour, Connecticut  
**Tower Model:** U-28.0 x 280'

**Customer Discount:** 15%

#	Qty.	Part Number	Description	Use At/For	Catalog Price	Discount	Discounted Price	Total
1	1	800306	Horizontal Angle Brace, Tapered Section, 1" Bolts, 9' - 0", U-10.0 Lower	190'	\$292.00	15%	\$248.20	\$248.20
2	1	800317	Horizontal Angle Brace, Tapered Section, 1-1/4" Bolts, 10' - 0", U-12.0 Upper	180'	\$386.00	15%	\$328.10	\$328.10
3	1	800318	Horizontal Angle Brace, Tapered Section, 1-1/4" Bolts, 11' - 0", U-12.0 Lower	170'	\$408.00	15%	\$346.80	\$346.80
4	3	860110	15' Universal T-Frame, For 4" Pipe Mount, (two 84" antenna mounts included)	160'	\$1,070.00	15%	\$909.50	\$2,728.50
5	3	851306	4" x 63" Tubular Arm Pipe Mount Kit, 12" BD Legs, 1-1/2" to 2-3/4"	160'	\$326.00	15%	\$277.10	\$831.30
6	1	800319	Horizontal Angle Brace, Tapered Section, 1-1/4" Bolts, 12' - 0", U-14.0 Upper	160'	\$639.00	15%	\$543.15	\$543.15
7	6	105578	Diagonal Angle, U-14.0 Upper, 3-1/2" x 3-1/2" x 5/16"	140' - 160'	\$96.12	15%	\$81.70	\$490.21
8	6	105581	Diagonal Angle, U-14.0 Lower, 3-1/2" x 3-1/2" x 5/16"	140' - 160'	\$101.30	15%	\$86.11	\$516.63
9	1	1000020	Hardware for Diagonal Bracing	140' - 160'	\$150.00	15%	\$127.50	\$127.50
10	60	802179	Extended Double-T Line Bracket, BD Legs	10' - 160'	\$32.00	15%	\$27.20	\$1,632.00
11	1	1000000	Updated Engineering Documentation		\$500.00	0%	\$500.00	\$500.00
<b>Total</b>								<b>\$8,292.39</b>

**Price Firm Until:** September 30, 2002  
**Terms:** Cash Before Shipment (or to be arranged at time of order)  
**Delivery:** 2 to 6 weeks from receipt of order (subject to production backlog)  
**Freight:** Prepaid and Add; F.O.B., Plymouth, Indiana  
**Taxes:** Prices do not include sales tax.

**Notes:** - Updated engineering documentation must be ordered with any modification materials.  
 - The parts quoted are NOT PAINTED. Please contact us for a revised quote if painting is required.  
 - Part numbers given above 999999 are not actual part numbers, but are used for reference only.

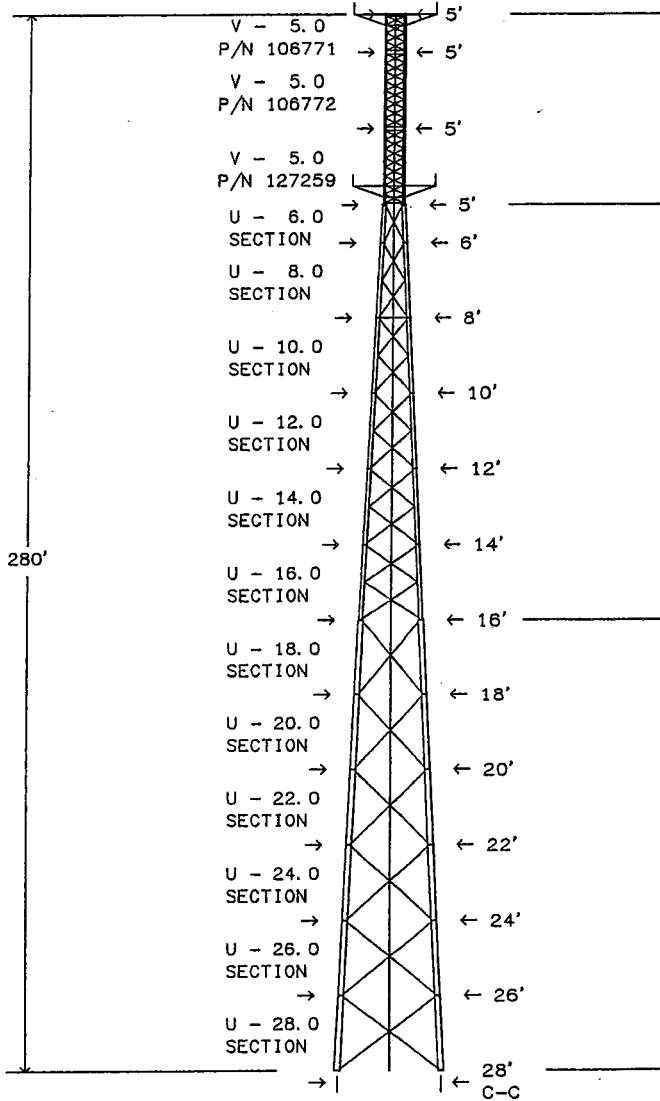
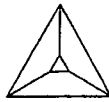

FABRICATED SECTIONS  
SEE PAGE 2

12" BREAKDOWN  
LEG SECTIONS  
SEE PAGES 3 AND 4

18" BREAKDOWN LEG  
DOUBLE ANGLE SECTIONS  
SEE PAGE 4

				EMAC COMMUNICATIONS SEYMOUR, CT U - 28.0 X 280' SELF-SUPPORTING TOWER	
				CONNECTICUT C. O. A. PEC. 797	
				APPROVED/ENG.	WBR 4/21/00
B	ADDED SQUARE PIER AND CHAMFER NOTES.	WBR	04/21/2000	APPROVED/FOUND.	N/A
A	ADDED FOUNDATIONS	WBR	04/21/2000	COPYRIGHT	2002
REV	DESCRIPTION OF REVISIONS	INI	DATE	DRAWN BY	MDB
From F0088942.DFT - 04/21/2000 09:55				ENG. FILE NO. A-116966-	
Printed from: 2062921B.DWG - 04/21/2000 15:23 @ 05/29/2002 14:03				DRAWING NO. 206292-B	
				ARCHIVE F-0088942	
				PAGE 1 OF 9	

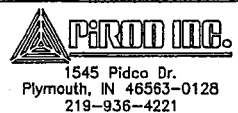

FABRICATED SECTION DATA 230' - 280' ELEVATION							
SECT LEN	SEC #	SECTION PART#	LEG SIZE	BRACE SIZE	SECT WT.*	BOLTS AT BOTTOM	
						DIAM	LENGTH #
10'	V- 5.0	106771+	1- 3/4 "	7/8 "	577#	5/8"	4-1/2" 15
20'	V- 5.0	106772	2 "	7/8 "	1302#	3/4"	5-1/2" 15
20'	V- 5.0	127259	2- 1/2 "	1 "	2003#	1 "	3-1/2" 18

\* THE WEIGHTS LISTED ARE THEORETICAL. THE ACTUAL WEIGHTS WILL VARY. ALL WEIGHTS SHOULD BE CONFIRMED IN THE FIELD PRIOR TO ERECTION.

PLATFORM DATA			
HT.	DESCRIPTION	BRACKET PART#	BRACKET C-C
280'	9 ARM HALO	125421	42.00"
235'	9 ARM HALO	125424	42.00"

FABRICATED SECTIONS  
TYPICAL SLEEVE TYPE  
LEG CONNECTION

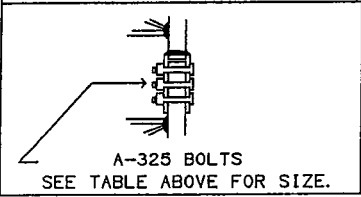

FABRICATED SECTIONS  
TRANSITION SIDE VIEW  
AT 230' ELEVATION

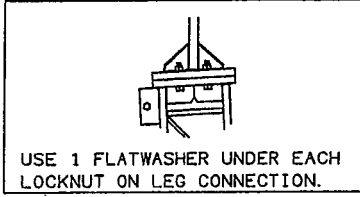

FABRICATED SECTIONS  
GENERAL SECTION ASSEMBLY  
TOP VIEW

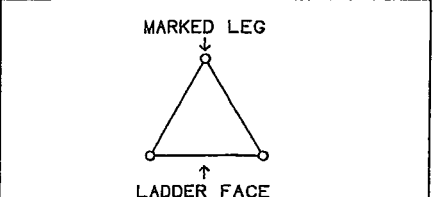

THE MARKED LEG OF EACH SECTION IS STAMPED WITH THE 6 DIGITS OF THE TOWER SERIAL #. ASSEMBLE THE TOWER WITH MARKED LEGS TOGETHER. THE MARKED LEG MAY ALSO CONTAIN JOINT NUMBERS STARTING WITH 1 AT THE TOP OF THE BASE SECTION. IF SO, ERECT WITH JOINTS IN THE PROPER SEQUENCE.

From: F0088942.DFT - 04/21/2000 09:55 Printed from: 20629220.DWG - 04/21/2000 10:00 @ 05/29/2002 14:03		EMAC COMMUNICATIONS SEYMOUR, CT U - 28.0 X 280' SELF-SUPPORTING TOWER	
		CONNECTICUT C. O. A. REG. 797	APPROVED/ENG. WBR 4/21/00
		APPROVED/FOUND. N/A	 1545 Pidco Dr. Plymouth, IN 46563-0128 219-936-4221
		COPYRIGHT 2002	
		DRAWN BY MDB	ENG. FILE NO. A-116966-
		ARCHIVE F-0088942	DRAWING NO. 206292-B PAGE 2 OF 9

**BREAKDOWN SECTION DATA (12" LEG) 120' - 230' ELEVATION**

SEC #	SECTION LENGTH	LEG SIZE	LEG PART#	TOP DIAG PART#	BOT DIAG PART#	DIAGONAL ANGLE		EQTY HOR	SECTION WEIGHT	LEG CONNECT+		DIAG CONNECT**	
						FACE	THICK			DIAM	LENGTH	DIAM	LENGTH
U- 6.0	10'	1- 1/2"	105245		105556	2-1/2"	3/16"		1047#	1 "	3-1/2"	1 "	2-1/4"
U- 8.0	20'	1- 3/4"	105218	105559	105562	3"	3/16"		2586#	1 "	3-1/2"	1 "	2-1/4"
U-10.0	20'	1- 3/4"	105218	105565	105568	3"	3/16"	1	2707#	1 "	4-1/4"	1 "	2-1/4"
U-12.0	20'	2 "	105219	116494	116495	3"	5/16"		3688#	1-1/4"	4-1/2"	1-1/4"	2-3/4"
U-14.0	20'	2- 1/4"	105220	113409	113410	3"	5/16"		4301#	1-1/4"	4-1/2"	1-1/4"	2-3/4"
U-16.0	20'	2- 1/4"	105220	128223	128224	3-1/2"	5/16"		4625#	1-1/4"	5"	1-1/4"	2-3/4"

\* THE WEIGHTS LISTED ARE THEORETICAL. THE ACTUAL WEIGHTS WILL VARY. ALL WEIGHTS SHOULD BE CONFIRMED IN THE FIELD PRIOR TO ERECTION.  
 \*\* SEE ANGLE HORIZONTAL DATA TABLE FOR BOLT SIZE AT LEVELS WITH TYPE 1 HORIZONTALS.  
 + USE 1 FLATWASHER UNDER EACH LOCKNUT, FOR LEG CONNECTION ONLY. ALSO USE 1 FLATWASHER UNDER EACH BOLT HEAD WHERE BUSHINGS ARE REQUIRED.

**ANGLE HORIZONTAL DATA (12" LEG)**

HORIZ HT	IN SEC#	HORIZ PART#	HORIZ TYPE	BOLTS	
				DIAM	LENGTH
200	U-10.0	105942	1	1 "	3-1/2"

**TYPICAL BREAKDOWN SECTION ASSEMBLY (12" LEG) 120' - 230' ELEVATION**

TYPE 1 HORIZONTALS AS REQ'D. SEE HORIZONTAL TABLE ABOVE FOR ELEVATION AND PART #.

DIAGONAL BRACES - SEE TABLE ABOVE FOR PART #.

DIAGONAL CENTER CONNECTION IS 3/4" X 3" BOLT.

LEG ASSEMBLY - SEE TABLE ABOVE FOR PART #.

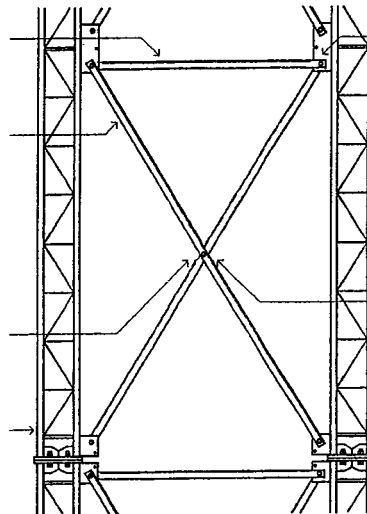

DIAGONAL CONNECTION BOLT - SEE SECTION TABLE ABOVE FOR SIZE. AT LEVELS WITH TYPE 1 HORIZONTALS, SEE HORIZONTAL TABLE ABOVE FOR BOLT SIZE.

USE SPACER PART # 104291 BETWEEN DIAGONAL ANGLES.

LEG CONNECTION - SEE TABLE ABOVE FOR BOLT SIZE. USE 1 FLATWASHER UNDER EACH LOCKNUT FOR LEG CONNECTION. ALSO USE 1 FLATWASHER UNDER EACH BOLT HEAD WHERE BUSHINGS ARE REQUIRED.

EMAC COMMUNICATIONS

SEYMOUR, CT

U - 28.0 X 280' SELF-SUPPORTING TOWER

CONNECTICUT C. O. A. PEC. 797

APPROVED/ENG. WBR 4/21/00

APPROVED/FOUND. N/A

COPYRIGHT 2002

DRAWN BY MOB



1545 Pideo Dr.  
Plymouth, IN 46563-0128  
219-936-4221

LEG TRANSITION FROM 12" TO 18" SECTIONS AT 120' ELEVATION

ADAPTER PLATE PART # 128693.  
USE 1 FLATWASHER UNDER EACH LOCKNUT FOR LEG CONNECTION.

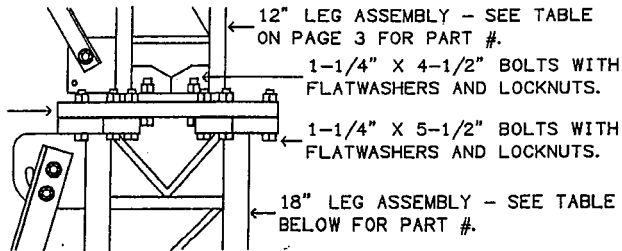

BREAKDOWN SECTION DATA (18" LEG WITH DOUBLE ANGLES) 0' - 120' ELEVATION

SEC #	SECTION LENGTH	LEG SIZE	LEG PART#	DIAGONAL PART #			DIAG ANGLE		SECTION WEIGHT	LEG CONNECT+		DIAG CONNECT	
				UPPER	LOWER	LONG	FACE	THICK		DIAM	LENGTH	DIAM	LENGTH
U-18.0	20'	2- 1/2"	112743	114366	114367	114362	3-1/2"	5/16"	6925#	1-1/4"	5-1/2"	1 "	3-1/2"
U-20.0	20'	2- 1/2"	112743	112909	112904	112817	3-1/2"	5/16"	7033#	1-1/4"	5-1/2"	1 "	3-1/2"
U-22.0	20'	2- 3/4"	112744	112899	112894	112812	3-1/2"	5/16"	7771#	1-1/4"	5-1/2"	1 "	3-1/2"
U-24.0	20'	2- 3/4"	112744	112889	112885	112807	3-1/2"	5/16"	7895#	1-1/4"	5-1/2"	1 "	3-1/2"
U-26.0	20'	3 "	112745	112881	112877	112803	3-1/2"	5/16"	8706#	1-1/4"	5-1/2"	1 "	3-1/2"
U-28.0	20'	3 "	112740	112873	112869	112799	3-1/2"	5/16"	8840#			1 "	3-1/2"

\* THE WEIGHTS LISTED ARE THEORETICAL. THE ACTUAL WEIGHTS WILL VARY. ALL WEIGHTS SHOULD BE CONFIRMED IN THE FIELD PRIOR TO ERECTION.

+ USE 1 FLATWASHER UNDER EACH LOCKNUT, FOR LEG CONNECTION ONLY.

TYPICAL BREAKDOWN SECTION ASSEMBLY (18" LEG WITH DOUBLE ANGLES) 0' - 120' ELEVATION

DIAGONAL CONNECTION BOLTS - SEE SECTION TABLE ABOVE FOR SIZE.

"UPPER" DIAGONAL BRACES (BACK TO BACK ANGLES) - SEE TABLE ABOVE FOR PART #

THIS HOLE REMAINS OPEN.

"LOWER" DIAGONAL BRACES (BACK TO BACK ANGLES) - SEE TABLE ABOVE FOR PART #

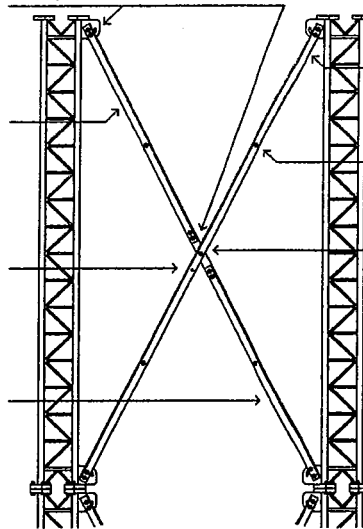

"LONG" DIAGONAL BRACE (BACK TO BACK ANGLES) - SEE TABLE ABOVE FOR PART #

INTERMEDIATE DIAGONAL BOLTS AT 4 LOCATIONS PER PANEL ON EACH FACE. USE 2 SPACERS PART # 104293 WITH EACH BOLT.

DIAGONAL CENTER PLATE - USE PART # 112756.

LEG CONNECTION - SEE TABLE ABOVE FOR BOLT SIZE. USE 1 FLATWASHER UNDER EACH LOCKNUT FOR LEG CONNECTION.

EMAC COMMUNICATIONS  
SEYMOUR, CT

U - 28.0 X 280' SELF-SUPPORTING TOWER

CONNECTICUT C. O. A. PEC. 797

APPROVED/ENG. WBR 4/21/00

APPROVED/FOUND. N/A

COPYRIGHT 2002

DRAWN BY MDB

ENG. FILE NO. A-116966-

ARCHIVE F-0088942



1545 Pidco Dr.  
Plymouth, IN 46563-0128  
219-936-4221

DRAWING NO.

PAGE

206292-B

4 OF 9

### GENERAL NOTES

1. TOWER DESIGN CONFORMS TO STANDARD EIA/TIA-222-F FOR 90 MPH BASIC WIND SPEED WITH 0.50" RADIAL ICE WITH LOAD DUE TO WIND REDUCED BY 25% WHEN CONSIDERED SIMULTANEOUSLY WITH ICE.  
TOWER DESIGN CONFORMS TO STANDARD EIA/TIA-222-F FOR 90 MPH BASIC WIND SPEED WITH NO ICE.
2. MATERIAL: (A) SOLID RODS CONFORM TO ASTM A-572 GRADE 50 REQUIREMENTS.  
(B) ANGLES CONFORM TO ASTM A-36 REQUIREMENTS.  
(C) PIPE CONFORMS TO ASTM A500 TYPE E, GRADE B REQUIREMENTS. (MIN YIELD STRENGTH=42 KSI)  
(D) ALL STEEL PLATES CONFORM TO ASTM A-36 REQUIREMENTS.  
(E) ANCHOR BOLTS CONFORM TO ASTM A-687 REQUIREMENTS.
3. BASE REACTIONS PER EIA/TIA-222-F FOR 90 MPH BASIC WIND SPEED WITH 0.50" RADIAL ICE:  

TOTAL WEIGHT =	122.3 KIPS.	MAXIMUM COMPRESSION =	705.7 KIPS PER LEG.
MOMENT =	16122.7 KIP-FT.	MAXIMUM UPLIFT =	624.2 KIPS PER LEG.
MAXIMUM SHEAR = 105.6 KIPS TOTAL.			
4. BASE REACTIONS PER EIA/TIA-222-F FOR 90 MPH BASIC WIND SPEED WITH NO ICE.  

TOTAL WEIGHT =	83.1 KIPS.	MAXIMUM COMPRESSION =	550.5 KIPS PER LEG.
MOMENT =	12677.9 KIP-FT.	MAXIMUM UPLIFT =	495.1 KIPS PER LEG.
MAXIMUM SHEAR = 81.8 KIPS TOTAL.			
5. FINISH: HOT DIPPED GALVANIZED AFTER FABRICATION.
6. ANTENNAS: 280' - THIRTY ANTEL BCD8707 ANTENNAS ON A 9-ARM HALO MOUNT WITH 1-5/8" LINES.  
235' - THIRTY ANTEL BCD8707 ANTENNAS ON A 9-ARM HALO MOUNT WITH 1-5/8" LINES.  
200' - NINE DECIBEL DB980H ANTENNAS ON THREE T-FRAMES WITH 1-5/8" LINES.
7. ALL TRANSMISSION LINES MUST BE PLACED ON PIROD SUPPLIED LINE BRACKETS PART # 127247.
8. REMOVE FOUNDATION TEMPLATE PRIOR TO ERECTING TOWER. INSTALL BASE SECTION WITH MINIMUM OF 2" CLEARANCE ABOVE CONCRETE. GROUT NUTS BELOW BASE SECTION WITH NON-SHRINK GROUT AFTER LEVELING TOWER.
9. MIN. WELDS 5/16" UNLESS OTHERWISE SPECIFIED. ALL WELDING TO CONFORM TO AWS SPECIFICATIONS.
10. ALL BOLTS AND NUTS MUST BE IN PLACE BEFORE THE ADJOINING SECTION(S) ARE INSTALLED.
11. ALL A-325 BOLTS ARE TO BE TIGHTENED TO A SNUG TIGHT CONDITION AS DEFINED BY AISC SPECIFICATION UNLESS OTHERWISE NOTED. A MORE QUANTITATIVE ALTERNATIVE APPROACH TO ACHIEVING A SNUG TIGHT CONDITION IS TO TIGHTEN USING THE TORQUE VALUES FROM DRAWING 123107-A.
12. EIA GROUNDING FOR TOWER.
13. LIGHTS BY OTHERS.

EMAC COMMUNICATIONS SEYMOUR, CT		U - 28.0 X 280' SELF-SUPPORTING TOWER	
CONNECTICUT C. O. A. PEC. 797		 1545 Pidco Dr. Plymouth, IN 46563-0128 219-936-4221	
APPROVED/ENG.	WBR 4/21/00		
APPROVED/FOUND.	N/A		
COPYRIGHT 2002			
DRAWN BY	MOB		
From: F0088942.DFT - 04/21/2000 09:55	ENG. FILE NO. A-116966-	DRAWING NO.	206292-B
Printed from: 2062925@.DWG - 04/21/2000 10:00 @ 05/29/2002 14:03	ARCHIVE F-0088942	PAGE	5 OF 9

### FOUNDATION NOTES

1. SOIL AS PER REPORT BY AET, INC. DATED 3/31/00 (FILE #42GT2K).
2. CONCRETE TO BE 4000 PSI @28 DAYS. REINFORCING BAR TO CONFORM TO ASTM A615 GRADE 60 SPECIFICATIONS. CONCRETE INSTALLATION TO CONFORM TO ACI-318 BUILDING REQUIREMENTS FOR REINFORCED CONCRETE. ALL CONCRETE TO BE PLACED AGAINST UNDISTURBED EARTH FREE OF WATER AND ALL FOREIGN OBJECTS AND MATERIALS. A MINIMUM OF THREE INCHES OF CONCRETE SHALL COVER ALL REINFORCEMENT. WELDING OF REBAR NOT PERMITTED.
3. A COLD JOINT IS PERMISSIBLE UPON CONSULTATION WITH PIROD. ALL COLD JOINTS SHALL BE COATED WITH BONDING AGENTS PRIOR TO SECOND POUR.
4. ALL FILL SHOULD BE PLACED IN LOOSE LEVEL LIFTS OF NO MORE THAN 12" THICK. FILL MATERIALS SHOULD BE CLEAN AND FREE OF ORGANIC AND FROZEN MATERIALS OR ANY OTHER DELETERIOUS MATERIALS. COMPACT FILL TO 97% OF STANDARD PROCTOR MAXIMUM DRY DENSITY IN ACCORDANCE WITH ASTM D698.
5. BENDING, STRAIGHTENING OR REALIGNING (HOT OR COLD) OF THE ANCHOR BOLTS BY ANY METHOD IS PROHIBITED.
6. CROWN TOP OF FOUNDATION FOR PROPER DRAINAGE.
7. THE FOUNDATION MUST BEAR ENTIRELY ON EITHER SOIL OR ROCK. THE FOUNDATION IS NOT TO BEAR ON ANY COMBINATION OF SOIL AND BEDROCK AS THIS MAY CAUSE EXCESSIVE DIFFERENTIAL SETTLEMENT.
8. DIFFICULTIES DURING EXCAVATION MAY ARISE DUE TO THE PRESENCE OF SHALLOW BEDROCK. PNEUMATIC HAMMERS, RIPPERS, AND/OR BLASTING MAY BE REQUIRED TO REMOVE MATERIAL FROM THE EXCAVATION.
9. IF THE DIFFICULTIES WITH ROCK ARE TO CUMBERSOME, IT MAY BE DEEMED NECESSARY TO RELOCATE THE FOUNDATION TO A POINT AT WHICH THE ROCK LIES AT A GREATER DEPTH. THE FOUNDATION SHOULD NOT BE RELOCATED WITHOUT THE CONSENT OF THE GEOTECHNICAL ENGINEERING FIRM AND PIROD, INC.

		EMAC COMMUNICATIONS SEYMOUR, CT		U - 28.0 X 280' SELF-SUPPORTING TOWER		
		CONNECTICUT C. O. A. P.E.C. 797		 1545 Pldco Dr. Plymouth, IN 46563-0128 219-938-4221		
		APPROVED/ENG.	WBR			4/21/00
		APPROVED/FOUND.	WBR			4/21/00
A	ADDED FOUNDATIONS	WBR	04/21/2000	COPYRIGHT 2002		
REV	DESCRIPTION OF REVISIONS	INI	DATE	DRAWN BY	MDS	
From: F0088942.DFT - 04/21/2000 15:22				ENG. FILE NO.	A-116966-	
Printed from: 2062926A.DWG - 04/21/2000 15:23 @ 05/29/2002 14:03				ARCHIVE	F-0088942	
				DRAWING NO.	206292-B	
				PAGE	6 OF 9	



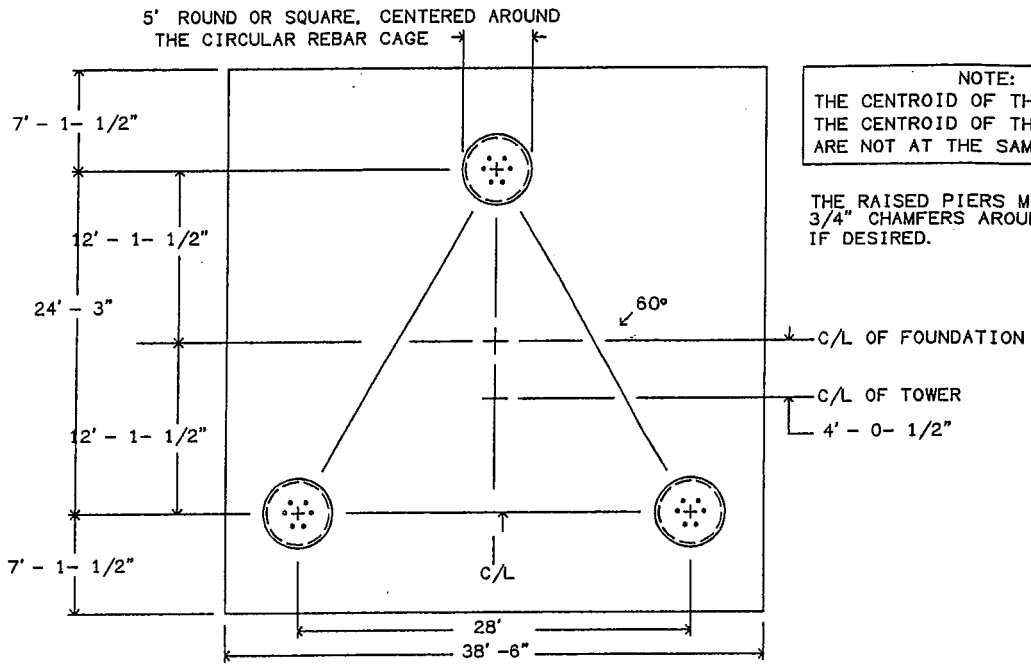

# 9 VERTICAL REBAR -  
SEE (C) ON PAGE 8.  
23 PIECES REQ. PER PIER,  
EQUALLY SPACED, TO BE  
PLACED INSIDE TIES.  
0'-8"

FOR ANCHOR STEEL IDENTIFICATION AND  
PLACEMENT INFORMATION, SEE PAGE 9  
OF THIS DRAWING.

# 4 TIES - SEE (D) ON PAGE 8.  
7 PIECES REQ. PER PIER

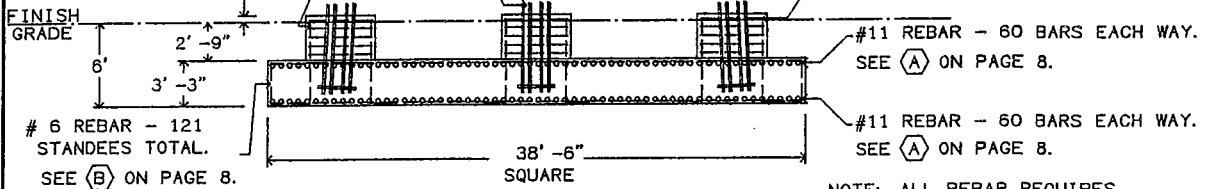

### TOWER FOUNDATION

185.5 CUBIC YARDS CONCRETE REQUIRED  
FOR INSTALLATION SPECIFICATIONS AND  
ADDITIONAL INFORMATION, SEE PAGE 6  
OF THIS DRAWING.

				EMAC COMMUNICATIONS SEYMOUR, CT U - 28.0 X 280' BASE FOUNDATION	
				CONNECTICUT C. O. A. PEC. 797	
				APPROVED/ENG.	WBR 4/21/00
				APPROVED/FOUND.	WBR 4/21/00
				COPYRIGHT 2002	
				DRAWN BY	MDB
REV	DESCRIPTION OF REVISIONS	INI	DATE		
B	ADDED SQUARE PIER AND CHAMFER NOTES.	WBR	04/21/2000		
A	ADDED FOUNDATIONS	WBR	04/21/2000		
From: F0088942.DFT - 04/21/2000 15:22				ENG. FILE NO.	A-116966-
Printed from: 2062927B.DWG * 04/21/2000 15:26 @ 05/29/2002 14:03				ARCHIVE	F-0088942
				DRAWING NO.	206292-B
				PAGE	7 OF 9

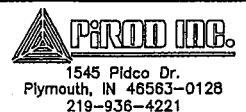

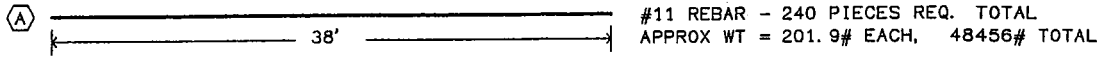

REBAR SUPPORTS MAY CONSIST OF ANY ACCEPTABLE MEANS OF SECURELY SUPPORTING THE TOP REINFORCEMENT GRID ABOVE THE BOTTOM REINFORCEMENT GRID WHILE MAINTAINING A SEPARATION OF 2'-9" (OUTSIDE REBAR TO OUTSIDE REBAR).

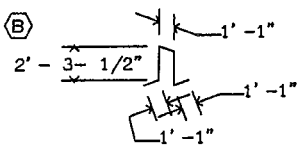

# 6 REBAR - 121 PIECES REQUIRED TOTAL  
TYPE 26 STANDEE PLACED BETWEEN REBAR GRIDS ON NOMINAL 4' SPACING THROUGHOUT  
APPROX UNBENT LENGTH = 7'-9-1/4"  
APPROX WT = 11.7# EACH, 1416# TOTAL

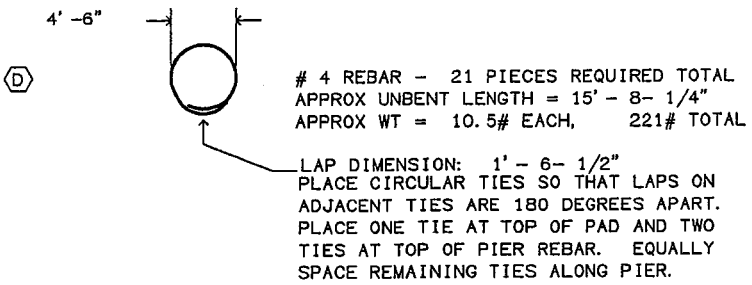
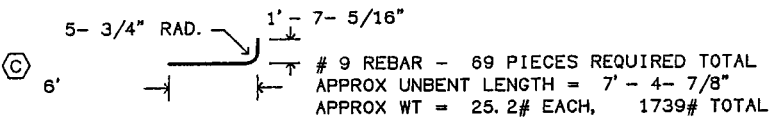

REBAR DETAIL

TOTAL APPROX REBAR WEIGHT = 51832#  
REINFORCING BAR TO CONFORM TO  
ASTM A615 GRADE 60 SPECIFICATIONS.

		EMAC COMMUNICATIONS SEYMOUR, CT U - 28.0 X 280' REBAR DETAIL	
		CONNECTICUT C. O. A. PEC. 797	
		APPROVED/ENG. WBR 4/21/00	
		APPROVED/FOUND. WBR 4/21/00	
		COPYRIGHT 2002	
		DRAWN BY MDB	
A ADDED FOUNDATIONS		WBR	04/21/2000
REV	DESCRIPTION OF REVISIONS	INI	DATE
From: F0088942.DFT - 04/21/2000 15:22		ENG. FILE NO. A-116966--	
Printed from: 2062928A.DWG - 04/21/2000 15:23 @ 05/29/2002 14:03		ARCHIVE F-0088942	
		DRAWING NO. 206292-B	
		PAGE 8 OF 9	

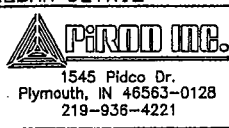

CENTER OF TEMPLATE MUST BE PLACED AS SHOWN.  
 EACH LEG MUST BE CENTERED IN PIER WITHIN +/- 10% OF PIER DIAMETER  
 ASSEMBLE TEMPLATE WITH 7/8" X 3-1/2" BOLT. SEE DWG # 113590-B.

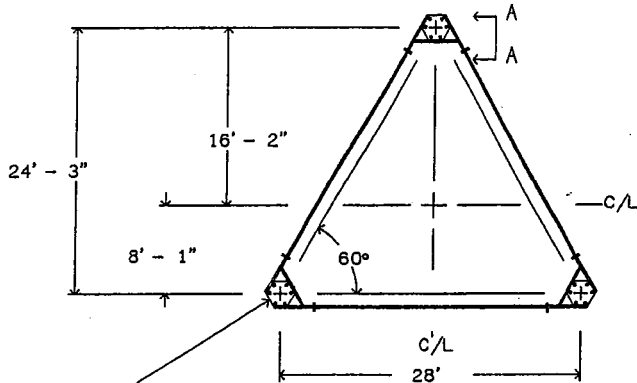

REFERENCE ANGLE = 3.30 DEGREES  
 TEMPLATE MUST BE UTILIZED TO INSURE CORRECT PLACEMENT.

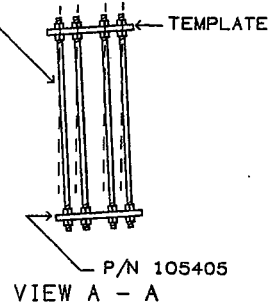

TEMPLATE P/N 103620 IS REQUIRED FOR INSTALLATION. TEMPLATE MUST BE SECURELY DOUBLE-NUTTED TO ANCHOR BOLTS DURING CONCRETE INSTALLATION AND MUST BE LEVEL +/- 1/2".  
 INSTALL TEMPLATE WITH WELDED LIFTING ANGLES FACING UPWARD.  
 INSTALL TEMPLATE WITH SUFFICIENT SPACE BENEATH TO PERMIT FINISHING OF CONCRETE AND TO FACILITATE TEMPLATE REMOVAL PRIOR TO TOWER ERECTION.

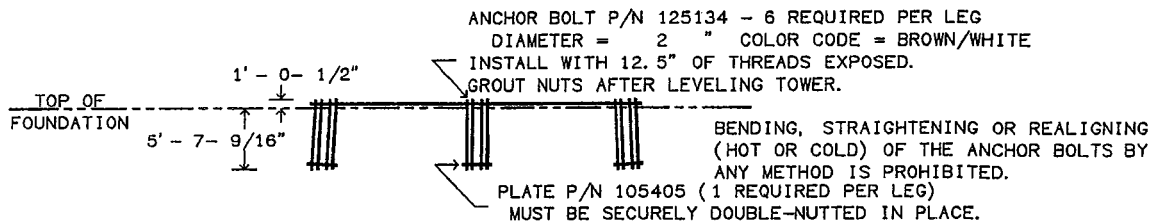

**ATTENTION INSTALLER**

**2" DIAMETER ANCHOR STEEL**

THE ANCHOR BOLTS PROVIDED FOR THIS PROJECT ARE 2" DIA. AND COLOR CODED BROWN & WHITE. THE CORNER TEMPLATE IS PART NUMBER 103620 FOR A TAPERED TOWER AND SHOULD HAVE THREE SETS OF 2-1/16" DIA. HOLES ON 10" CENTERS. EMBEDMENT PLATES ARE PART NUMBER 105405.

IF THERE ARE ANY DISCREPANCIES, PLEASE NOTIFY PIROD, INC., PRIOR TO INSTALLATION.

**TOWER ANCHOR STEEL PLACEMENT**

				EMAC COMMUNICATIONS SEYMOUR, CT U - 28.0 X 280' ANCHOR INSTALLATION	
				CONNECTICUT C. O. A. PEC. 797	
				APPROVED/ENG.	WBR 4/21/00
				APPROVED/FOUND.	WBR 4/21/00
				COPYRIGHT 2002	
				DRAWN BY	MOB
A		ADDED FOUNDATIONS		WBR	04/21/2000
REV	DESCRIPTION OF REVISIONS			INI	DATE
From: F0088942.DFT - 04/21/2000 15:22				ENG. FILE NO. A-116966-	
Printed from: 2062929A.DWG - 04/21/2000 15:24 @ 05/29/2002 14:03				ARCHIVE F-0088942	
				DRAWING NO. 206292-B	
				PAGE 9 OF 9	

# 15' T-FRAME

(Dwg. # 141262 Rev. C / 02/05/2002)



T-frame mounts are ideal for sectorized applications using all types of antennas. Approximate mount capacity would be 80 sq. ft. distributed across the face of the mount considering 90 mph basic windspeed with 1/2" radial ice at 200' elevation<sup>1</sup>.

<sup>1</sup> Capacity of mount is provided for comparison purposes only and is valid for conditions specified. Call PiRod for capacity on your specific installation. Actual load capacity is dependent on basic windspeed, ice load, height of mount and other factors specific to individual installations. All PiRod antenna mounts are designed and manufactured in accordance with ANSI/TIA/EIA-222-F standards. See page 37 for additional mount capacity information.

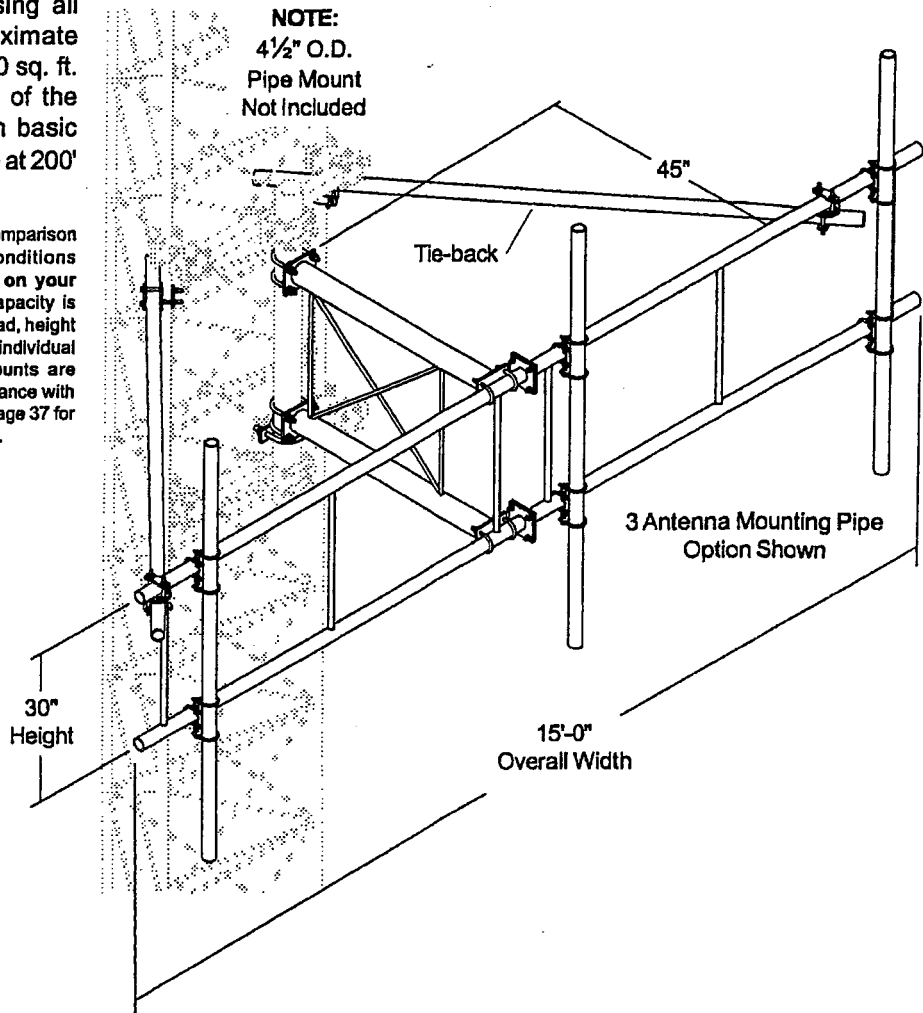

Description	Part Number	Price
15' T-frame without antenna mounting pipes	860109	930.00
15' T-frame including two 84" antenna mounting pipes	860110	1,070.00
15' T-frame including three 84" antenna mounting pipes	860111	1,140.00
15' T-frame including four 84" antenna mounting pipes	860112	1,210.00

Weight and Areas <sup>2</sup>	Weight, No Ice (lbs.)	Weight, 1/2" Ice (lbs.)	Area, No Ice (C.A.)	Area, 1/2" Ice (C.A.)
15' T-frame	387	530	13.9 sq. ft.	20.0 sq. ft.

<sup>2</sup>All areas presented are computed in accordance with ANSI/TIA/EIA-222-F 1996. All areas do not include cross arms, pipe mounts or antenna mounting pipes.

All of the above information, including but not limited to: prices, areas, dimensions, is subject to change without notice.

1545 Pidco Drive, P.O. Box 128, Plymouth, IN 46563 • Phone (574) 936-4221 • Fax (574) 936-8925 • www.pirod.com

# 10' LIGHTWEIGHT T-FRAME

(Dwg. # 141260 Rev E / 01/29/2002)

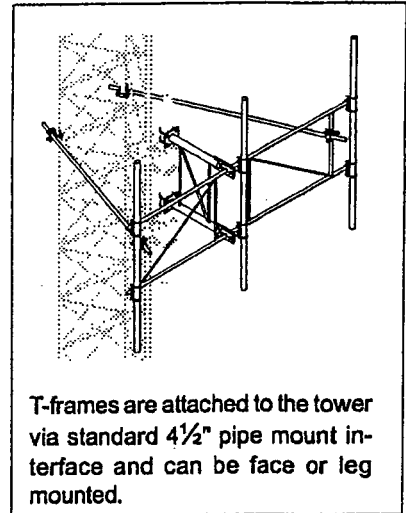
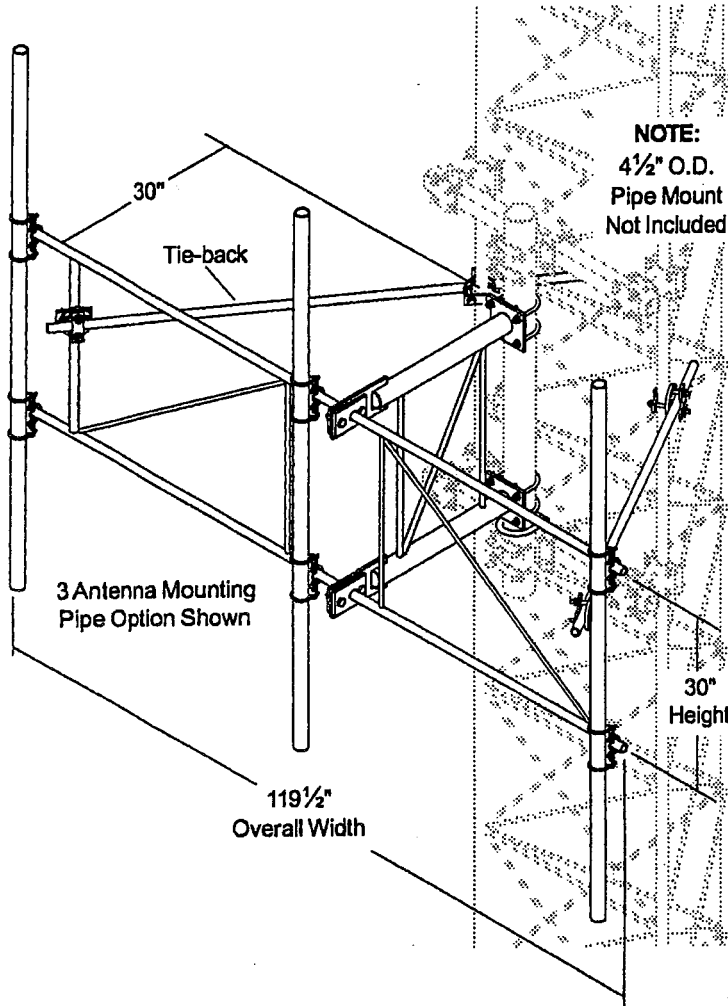

**Lightweight T-frame** mounts are ideal for sectorized applications using smaller antennas. Approximate mount capacity would be 80 sq. ft. distributed across the face of the mount considering 90 mph basic windspeed with 1/2" radial ice at 200' elevation<sup>1</sup>.

<sup>1</sup> Capacity of mount is provided for comparison purposes only and is valid for conditions specified. Call PIRod for capacity on your specific installation. Actual load capacity is dependent on basic windspeed, ice load, height of mount and other factors specific to individual installations. All PIRod antenna mounts are designed and manufactured in accordance with ANSI/TIA/EIA-222-F standards. See page 37 for additional mount capacity information.

Description	Part Number	Price
10' Lightweight T-frame without antenna mounting pipes	800089	630.00
10' Lightweight T-frame including two 84" antenna mounting pipes	800090	770.00
10' Lightweight T-frame including three 84" antenna mounting pipes	800091	840.00
10' Lightweight T-frame including four 84" antenna mounting pipes	800092	910.00

Weight and Areas <sup>2</sup>	Weight, No Ice (lbs.)	Weight, 1/2" Ice (lbs.)	Area, No Ice (C.A.)	Area, 1/2" Ice (C.A.)
10' Lightweight T-frame	251	344	9.3 sq. ft.	14.5 sq. ft.

<sup>2</sup>All areas presented are computed in accordance with ANSI/TIA/EIA-222-F 1996. All areas do not include cross arms, pipe mounts or antenna mounting pipes.

All of the above information, including but not limited to: prices, areas, dimensions, is subject to change without notice.

1545 Pidco Drive, P.O. Box 128, Plymouth, IN 46563 • Phone (574) 936-4221 • Fax (574) 936-8925 • www.pirod.com

# TRANSMISSION LINE HANGING BRACKETS

(Dwg. # 140576 Rev. A / 09/21/2000)

Add transmission lines to new or existing towers

Transmission line brackets are designed with 3/4" holes to accept Andrew Snap-in clips, 7/16" holes accept butterfly type clips. Holes spaced for maximum line size of 1 5/8". Part numbers include mounting hardware.

## Single T Line Bracket

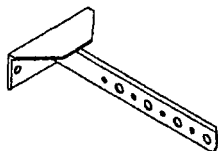

(4 line capacity)

Leg Size	Number of 3/4" Holes	Number of 7/16" Holes	Part Number	Catalog List Price
7/8" to 1 1/4"	4	4	802151	15.00
1 1/2" to 2 3/4"	4	4	802152	15.00
3" to 4"	4	4	802153	15.00
4 1/2" to 5 1/2"	4	4	802154	15.00
Knockdown Legs	4	4	802155	13.00

## Double T Line Bracket

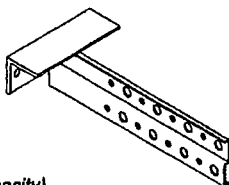

(8 line capacity)

7/8" to 1 1/4"	8	8	802171	18.00
1 1/2" to 2 3/4"	8	8	802172	18.00
3" to 4"	8	8	802173	18.00
4 1/2" to 5 1/2"	8	8	802174	18.00
Knockdown Legs	8	8	802187	16.00

## Extended Double T Line Bracket

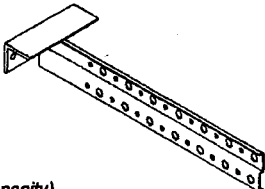

(14 line capacity)

7/8" to 1 1/4"	14	12	802175	34.00
1 1/2" to 2 3/4"	14	12	802176	34.00
3" to 4"	14	12	802177	34.00
4 1/2" to 5 1/2"	14	12	802178	34.00
Knockdown Legs	14	12	802179	32.00

## Banjo Line Bracket

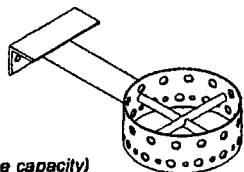

(14-1 5/8" line capacity)  
(28-7/8" line capacity)

7/8" to 1 1/4"	28	14	802156	44.00
1 1/2" to 2 3/4"	28	14	802157	44.00
3" to 4"	28	14	802158	44.00
4 1/2" to 5 1/2"	28	14	802159	44.00
Knockdown Legs	28	14	802160	42.00

## Expandable Double T Line Bracket

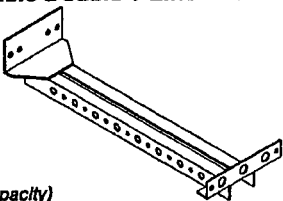

(16 line capacity)

7/8" to 1 1/4"	16	14	802165	33.00
1 1/2" to 2 3/4"	16	14	802166	33.00
3" to 4"	16	14	802167	33.00
4 1/2" to 5 1/2"	16	14	802168	33.00
Knockdown Legs	16	14	802146	30.00

## Expandable Double T Line Bracket Add-on Hangers

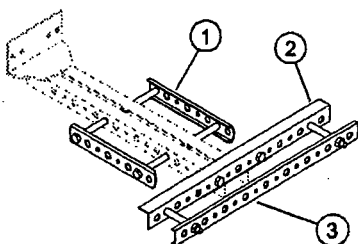

(40 line capacity shown)

Add-on hangers attach to Expandable Double T line brackets. Order one add-on bracket for each increase in line capacity desired, i.e. for 40 line capacity, order one Expandable Double T bracket and one each single, double and triple level add-on brackets.

① Add-on single level	24 total line capacity	802143	16.00
② Add-on double level	31 total line capacity	802144	19.00
③ Add-on triple level	40 total line capacity	802145	22.00



1545 Pidco Drive, P.O. Box 128, Plymouth, IN 46563 • Phone (877) GO PIROD • Fax (219) 936-6796 • www.pirod.com

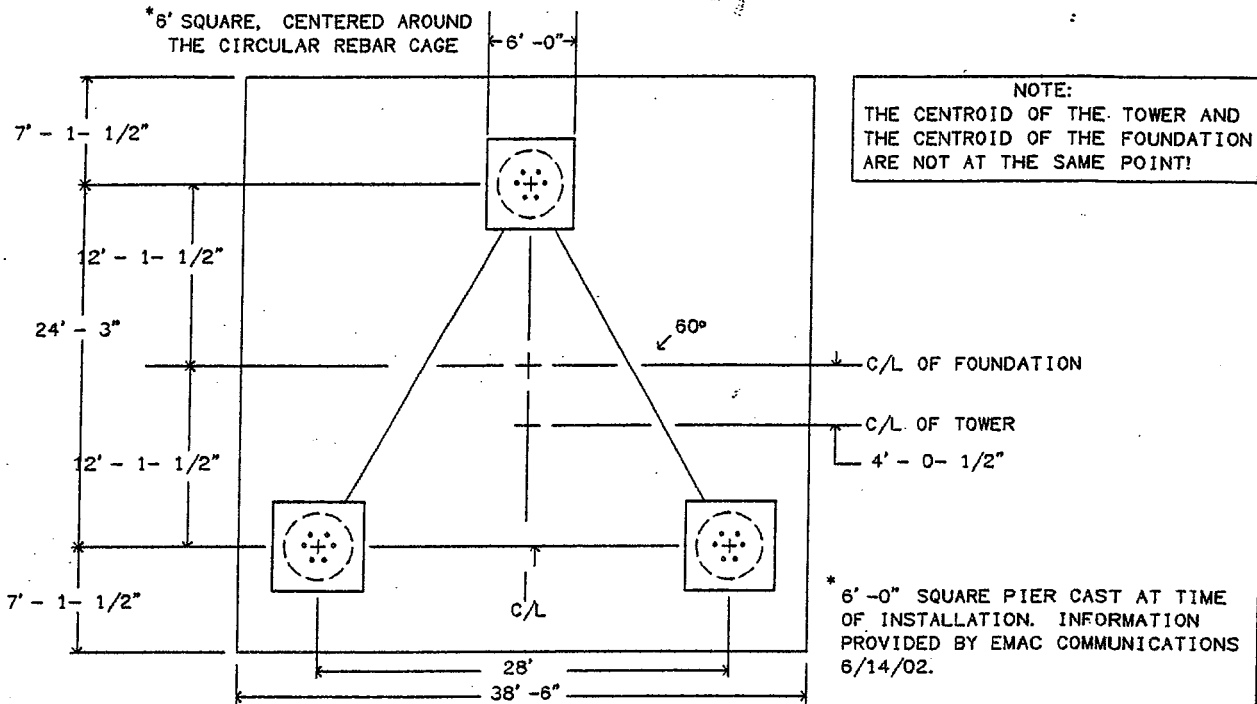

**MODIFICATION NOTES:**

1. DENSITY TESTS MUST BE PERFORMED AT MULTIPLE LOCATIONS ACROSS THE FOUNDATION AREA TO DETERMINE THE UNIT WEIGHT OF THE EXISTING BACKFILL. ONE (1) TEST PER FT. OF DEPTH DOWN TO TOP OF PAD (EACH LOCATION).
2. MATERIAL NOT EXHIBITING A 135 PCF UNIT WEIGHT MUST BE RECOMPACTED TO ACHIEVE 135 PCF FOR FULL DEPTH OR BE REPLACED WITH COMPACTED CRUSHED STONE.

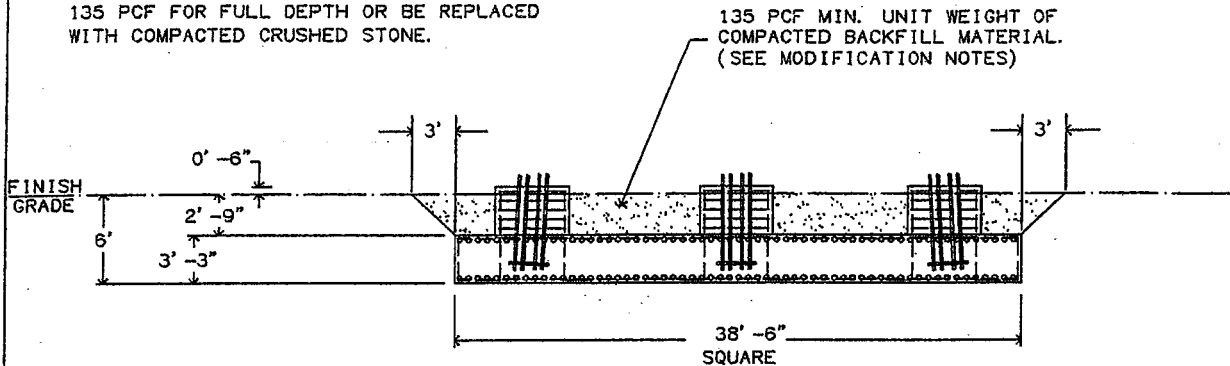

**TOWER FOUNDATION**

185.5 CUBIC YARDS CONCRETE REQUIRED FOR INSTALLATION SPECIFICATIONS AND ADDITIONAL INFORMATION, SEE PAGE 6 OF THIS DRAWING.

**PRELIMINARY DESIGN  
DO NOT BUILD**

**FOUNDATION MODIFICATION**

A-116966; PR-2002-05-050  
Seymour, CT U-28.0 x 280'

EMAC COMMUNICATIONS SEYMOUR, CT U - 28.0 X 280' BASE FOUNDATION	
APPROVED/ENG.	
APPROVED/FOUND.	
DRAWN BY	NDB
 1545 Pidco Dr. Plymouth, IN 46563-0128 219-936-4221	



---

## **RF Exposure Analysis for Proposed AT&T Wireless Antenna Facility**

SITE ID: 913-008-633

June 24, 2002

**Prepared by AT&T Wireless Services, Inc.**  
Prabhakar K. Rughoobur, **RF Engineer**



## Table of Contents

1. INTRODUCTION .....	3
2. SITE DATA .....	3
3. RF EXPOSURE PREDICTION .....	3
4. FCC GUIDELINES FOR EVALUATING THE ENVIRONMENTAL EFFECTS OF RF RADIATION 4	
5. COMPARISON WITH STANDARDS.....	4
6. CONCLUSION .....	4
7. FCC LIMITS FOR MAXIMUM PERMISSIBLE EXPOSURE .....	5
8. EXHIBIT A.....	6
9. FOR FURTHER INFORMATION.....	7
10. REFERENCES.....	7

### 1. Introduction

This report constitutes an RF exposure analysis for the proposed AT&T Wireless antenna facility to be located at 6 Progress Ave, Seymour, CT 06483. This analysis uses site-specific engineering data to determine the predicted levels of radio frequency (RF) electromagnetic energy in the vicinity of the proposed facility and compares those levels with the Maximum Permissible Exposure (MPE) limits established by the Federal Communications Commission.

### 2. Site Data

Site Name: <b>Woodbridge-Seymour</b>	
Number of simultaneously operating channels	<b>12</b>
Type of antenna	<b>Allgon 7250.03</b>
Power per channel (Watts ERP)	250.0 Watts
Height of antenna (feet AGL)	<b>160.00</b> feet
Antenna Aperture Length	<b>5</b> feet

### 3. RF Exposure Prediction

The following equations established by the FCC, in conjunction with the site data, were used to determine the levels of RF electromagnetic energy present in the vicinity of the proposed facility<sup>1</sup>:

$$PowerDensity = \frac{0.64 * N * EIRP(\theta)}{\pi * R^2} (mW/cm^2) \quad Eq. 1-Far-field$$

Where, *N*= Number of channels, *R*= distance in cm from the RC (Radiation Center) of antenna, and *EIRP(θ)* = The isotropic power expressed in milliwatts in the direction of prediction point. This is the correct equation for antennas which have their gain expressed in dBi, which is the usual case for the PCS bands.

$$PowerDensity = \frac{P_{in} / ch * N * 10^3}{2 * \pi * R * h * \alpha / 360} (mW/cm^2) \quad Eq. 2-Near-field$$

Where *P<sub>in</sub>/ch* = Input power to antenna terminals in watts/ch, *R* = distance to center of radiation, *h* = aperture height in meters, *α* = 3 dB beam-width of horizontal pattern.

<sup>1</sup> RF exposure is measured and predicted in terms of power density in units of milliwatts (mW), a thousandth of a watt, or microwatts (μW), a millionth of a watt, per square centimeter (cm<sup>2</sup>). Data comparing predictive analysis with on site measurements has demonstrated that power density can be effectively predicted at given locations in the vicinity of a wireless antenna facility.

#### 4. FCC Guidelines for Evaluating the Environmental Effects of RF Radiation

In 1985, the FCC established rules to regulate radio frequency (RF) exposure from FCC licensed antenna facilities. In 1996, the FCC updated these rules, which were further amended in August 1997 by a Second Memorandum Opinion and Order. These new rules represent a consensus of the federal agencies responsible for the protection of public health and the environment, including the Environmental Protection Agency (EPA), the Food and Drug Administration (FDA), the National Institute for Occupational Health and Safety (NIOSH), and the Occupational Safety and Health Administration (OSHA).

Under the laws that govern the delivery of wireless communications services in the United States, as amended by the Telecommunications Act of 1996, the FCC has exclusive jurisdiction over RF emissions from personal wireless antenna facilities, which include cellular, PCS, messaging and aviation sites.<sup>2</sup> Pursuant to its authority under federal law, the FCC has established rules to regulate the safety of emissions from these facilities.

#### 5. Comparison with Standards

Exhibit A shows the levels of RF electromagnetic energy as one moves away from the antenna facility. As shown in Exhibit A, the maximum power density is 0.000729 mW/cm<sup>2</sup> which occurs at 180 feet from the antenna facility. The chart in exhibit A also shows that the power density is only 0.000184 mW/cm<sup>2</sup> at a distance of 4 feet. Table 1 below shows the Maximum Permissible Exposure (MPE) limits established by the FCC. There are different MPE limits for public/uncontrolled and occupational/controlled environments.

*Table 1: Maximum Permissible Exposure limits for RF radiation*

<i>Frequency</i>	<i>Public/Uncontrolled</i>	<i>Occupational/controlled</i>	<i>Maximum power density at Accessible location</i>
Cellular	.580 mW/cm <sup>2</sup>	2.9 mW/cm <sup>2</sup>	0.000729 mW/cm <sup>2</sup>
PCS	1 mW/cm <sup>2</sup>	5 mW/cm <sup>2</sup>	

The maximum power density at the proposed facility represents only 0.19% of the public MPE limit for PCS frequencies.

#### 6. Conclusion

This analysis show that the maximum power density in accessible areas at this location is 0.000729 mW/cm<sup>2</sup>, a level of RF energy that is well below the Maximum Permissible Exposure limit established by the FCC.

<sup>2</sup> 47 U.S. C. Section 332 ( c ) (7)(B)(iv) states that “[n]o State or local government or instrumentality thereof may regulate the placement, construction, and modification of personal wireless service facilities on the basis of the environmental effects of radio frequency emissions to the extent that such facilities comply with the Commission’s regulations concerning such emissions.”

### 7. FCC Limits for Maximum Permissible Exposure

FCC Limits for Maximum Permissible Exposure (MPE)  
*Plane-wave Equivalent Power Density*

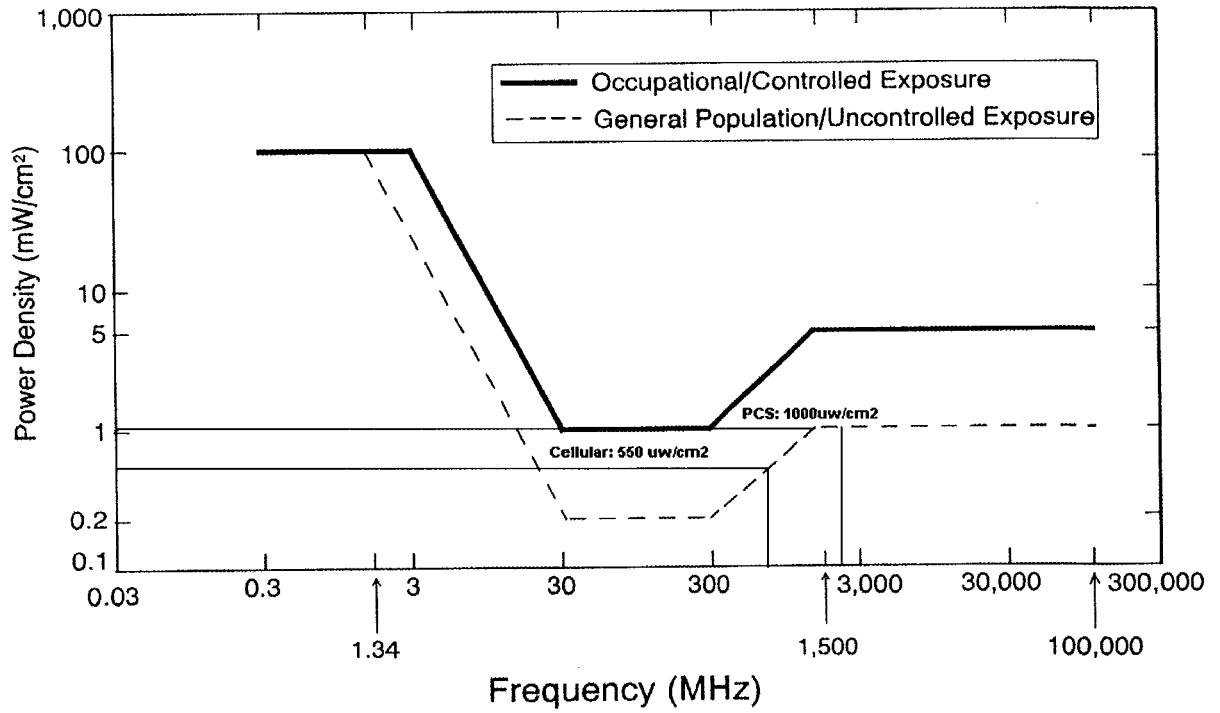

*AT&T Wireless Services, Inc.*

**8. Exhibit A**

**Heading**

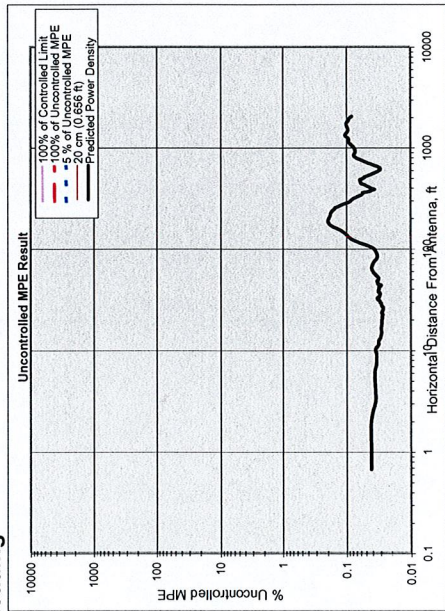

Number of Antenna Systems: 5

Meets FCC Controlled Limits for The Antennas Systems.

Meets FCC Uncontrolled Limits for The Antenna Systems.

Meets 5% of FCC Uncontrolled Limits for The Antenna Systems.

No Further Maximum Permissible Exposure (MPE) Analysis Required.

Maximum Power Density =	Power Density	@Hortz. Dist.
522.69 times lower than the MPE limit for uncontrolled environment	mW/cm <sup>2</sup>	feet
0.000729	0.19	180.00
Composite Power (ERP) =	11,280.00	Watts

Site ID: 913-008-633  
 Site Name: Woodbridge-Seymour  
 Site Location: 8 Progress Ave  
 Seymour, CT 06483

Performed By: Prabhakar Rughhoor  
 Date: 6/24/02

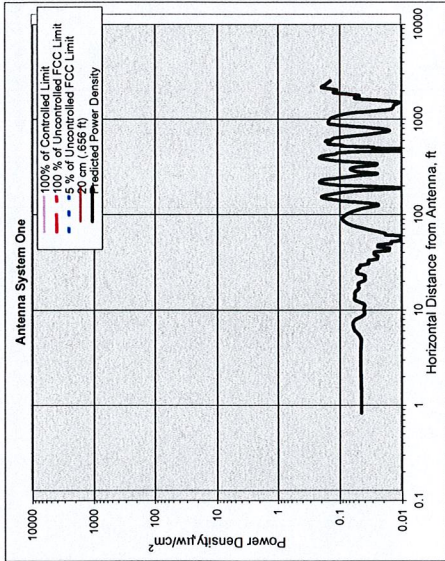

**Antenna System One**

Parameter	units	Value
Frequency	MHz	1945.00
# of Channels	#	12
Max ERP/Ch	Watts	250.00
Max Pwr/Ch Into Ant.	Watts	5.86
(Center of Radiator)	feet	160.00
Calculation Point	feet	0.00
(above ground or roof surface)	feet	0.00
Antenna Model No.		Aligon 7250.03
Max Ant Gain	dBd	16.30
Down tilt	degrees	0.00
Miscellaneous Att.	dB	0.00
Height of aperture	feet	5.11
Ant HBW	degrees	65.00
Distance to Ant <sub>beam</sub>	feet	157.45
WOS?	Y/N?	n

Ant System ONE Owner: AT&T  
 Sector: 3  
 Azimuth: 90/210/330

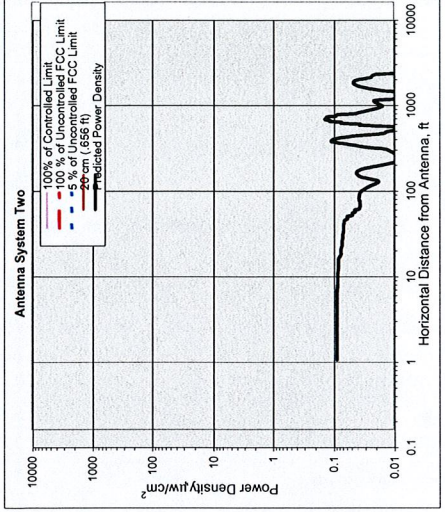

**Antenna System Two**

Parameter	units	Value
Frequency	MHz	1950.00
# of Channels	#	12
Max ERP/Ch	Watts	250.00
Max Pwr/Ch Into Ant.	Watts	7.73
(Center of Radiator)	feet	170.00
Calculation Point	feet	0.00
(above ground or roof surface)	feet	0.00
Antenna Model No.		DB980G390
Max Ant Gain	dBd	15.10
Down tilt	degrees	0.00
Miscellaneous Att.	dB	0.00
Height of aperture	feet	5.00
Ant HBW	degrees	90.00
Distance to Ant <sub>beam</sub>	feet	167.50
WOS?	Y/N?	n

Ant System TWO Owner: Sprint  
 Sector: 3  
 Azimuth: 30/150/270

# Heading

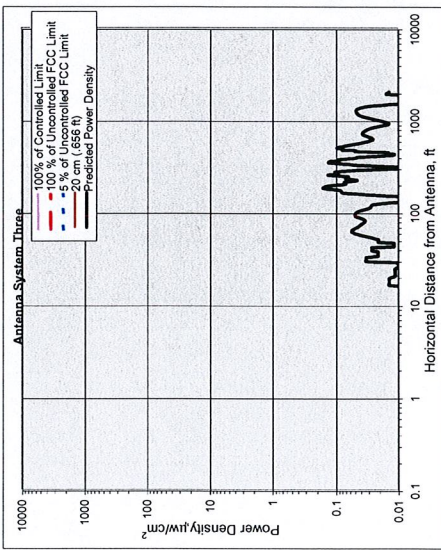

Antenna System Three

Frequency	units	Value
1980.00	MHz	1980.00
12	# of Channels	12
250.00	Max ERP/Ch	250.00
9.08	Max Pwr/Ch Into Ant.	9.08
250.00	Max Pwr/Ch Into Ant. (Center of Radiator)	250.00
0.00	Calculation Point (above ground or roof surface)	0.00
0.00	Calculation Point (above ground or roof surface)	0.00
RR901702	Antenna Model No.	RR901702
14.40	Max Ant Gain	14.40
0.00	Down tilt	0.00
0.00	Miscellaneous Att.	0.00
4.66	Height of aperture	4.66
90.00	Ant. HBW	90.00
247.67	Distance to Ant. Base	247.67
Y/N?		n

Ant System Three Owner: Voicestream  
Sector: 3  
Azimuth: 30/150/270

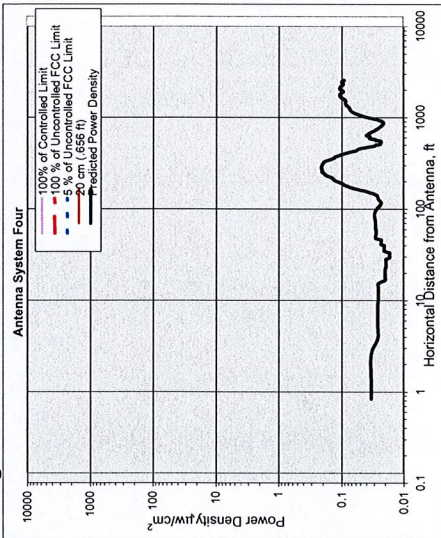

Antenna System Four

Frequency	units	Value
461.00	MHz	461.00
12	# of Channels	12
110.00	Max ERP/Ch	110.00
24.63	Max Pwr/Ch Into Ant.	24.63
280.00	Max Pwr/Ch Into Ant. (Center of Radiator)	280.00
0.00	Calculation Point (above ground or roof surface)	0.00
0.00	Calculation Point (above ground or roof surface)	0.00
BCD-8707	Antenna Model No.	BCD-8707
6.50	Max Ant Gain	6.50
0.00	Down tilt	0.00
0.00	Miscellaneous Att.	0.00
7.08	Height of aperture	7.08
360.00	Ant. HBW	360.00
276.46	Distance to Ant. Base	276.46
Y/N?		n

Ant System Four Owner: Private(Mike Gardella)  
Sector: 1  
Azimuth: Omni

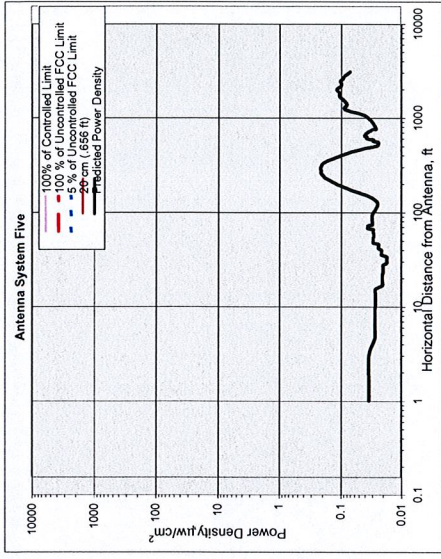

Antenna System Five

Frequency	units	Value
155.00	MHz	155.00
12	# of Channels	12
80.00	Max ERP/Ch	80.00
17.91	Max Pwr/Ch Into Ant.	17.91
235.00	Max Pwr/Ch Into Ant. (Center of Radiator)	235.00
0.00	Calculation Point (above ground or roof surface)	0.00
0.00	Calculation Point (above ground or roof surface)	0.00
BCD-8707	Antenna Model No.	BCD-8707
6.50	Max Ant Gain	6.50
0.00	Down tilt	0.00
0.00	Miscellaneous Att.	0.00
7.08	Height of aperture	7.08
360.00	Ant. HBW	360.00
231.46	Distance to Ant. Base	231.46
Y/N?		n

Ant System Five Owner: Town of Seymour  
Sector: 1  
Azimuth: Omni

## 9. For Further Information

Additional information about the environmental impact of RF energy from personal wireless antenna facilities can be obtained from the Federal Communications Commission:

Dr. Robert Cleveland  
Federal Communications Commission  
Office of Engineering and Technology  
Washington, DC 20554

RF Safety Program: 202-418-2464  
Internet address: [rfsafety@fcc.gov](mailto:rfsafety@fcc.gov)  
RF Safety Web Site: [www.fcc.gov/oet/rfsafety](http://www.fcc.gov/oet/rfsafety)

## 10. References

- [1] The Communications Act of 1934, as amended by the Telecommunications Act of 1996, 47 U.S.C. Section 332 (c)(7)(B)(iv).
- [2] *Guidelines for Evaluating the Environmental Effects of Radio frequency Radiation*, Notice of Proposed Rulemaking, ET Docket 93-62, 8 FCC Rcd 2849 (1993).
- [3] *Guidelines for Evaluating the Environmental Effects of Radio frequency Radiation*, Report and Order, ET Docket 93-62, FCC 96-326, adopted August 1, 1996. 61 Federal Register 41006 (1996).
- [4] *Guidelines for Evaluating the Environmental Effects of Radio frequency Radiation*, Second Memorandum Opinion and Order, ET Docket 93-62, adopted August 25, 1997.
- [5] *Evaluating Compliance with FCC Guidelines for Human Exposure to Radio frequency Electromagnetic Fields*, OET Bulletin 65, August, 1997.