

50 SERIES

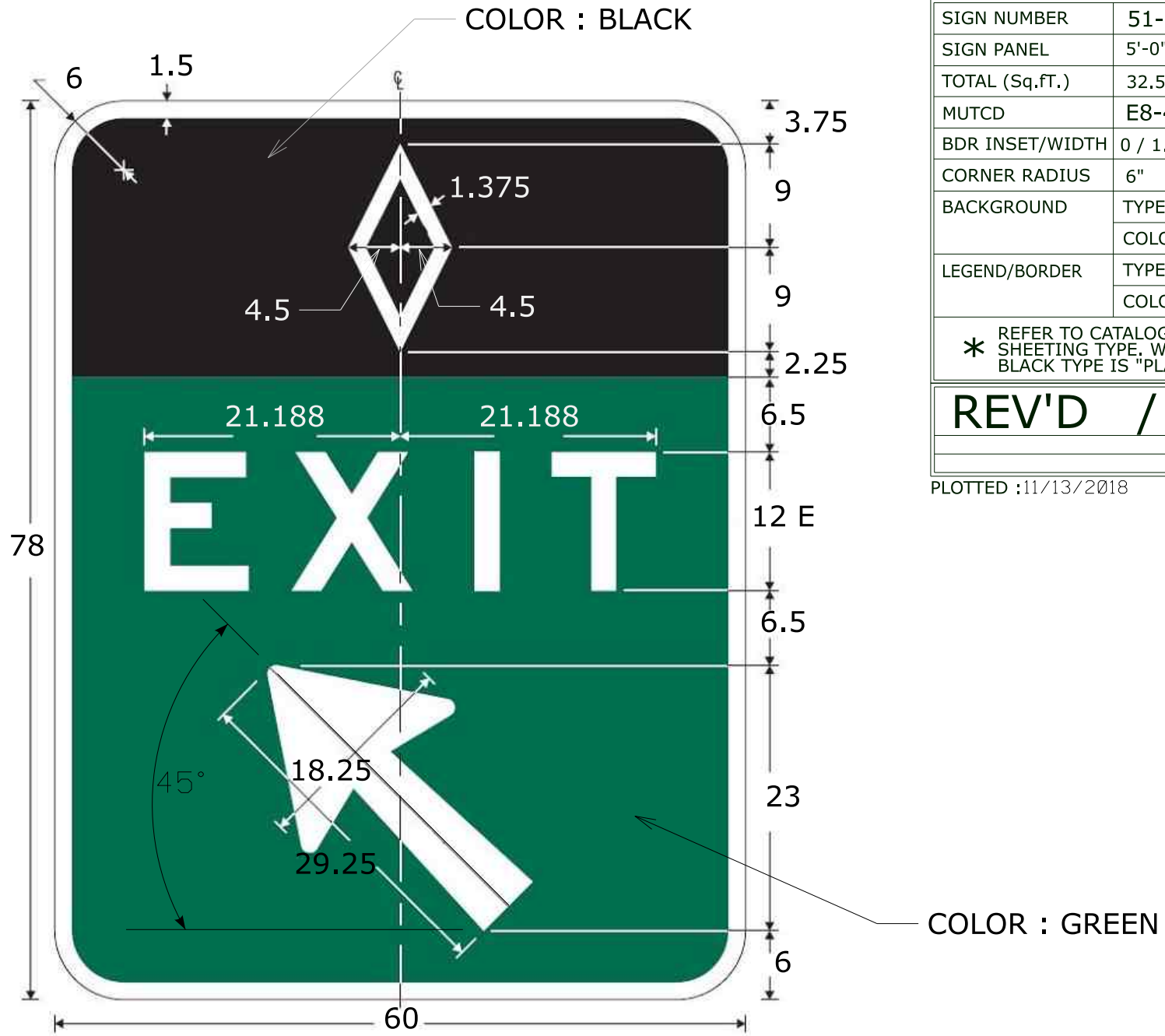

GUIDE & INFORMATIONAL SIGNS

SIGN DETAIL



SIGN NUMBER	51-9023
SIGN PANEL	5'-0" x 6'-6"
TOTAL (Sq.ft.)	32.5
MUTCD	E8-4
BDR INSET/WIDTH	0 / 1.5"
CORNER RADIUS	6"
BACKGROUND	TYPE: * COLOR: See Sign
LEGEND/BORDER	TYPE: * COLOR: White/White
* REFER TO CATALOG OF SIGNS FOR SHEETING TYPE, WHEN COLOR IS BLACK TYPE IS "PLAIN".	
REV'D /	

PLOTTED :11/13/2018

Dimensions are in inches.
 Material : .080 Thk. Sheet Aluminum
 Side Mounted
 Engineer : B. Schilling / Designed By : J. Fascione / Checked By :

SIGN DETAIL

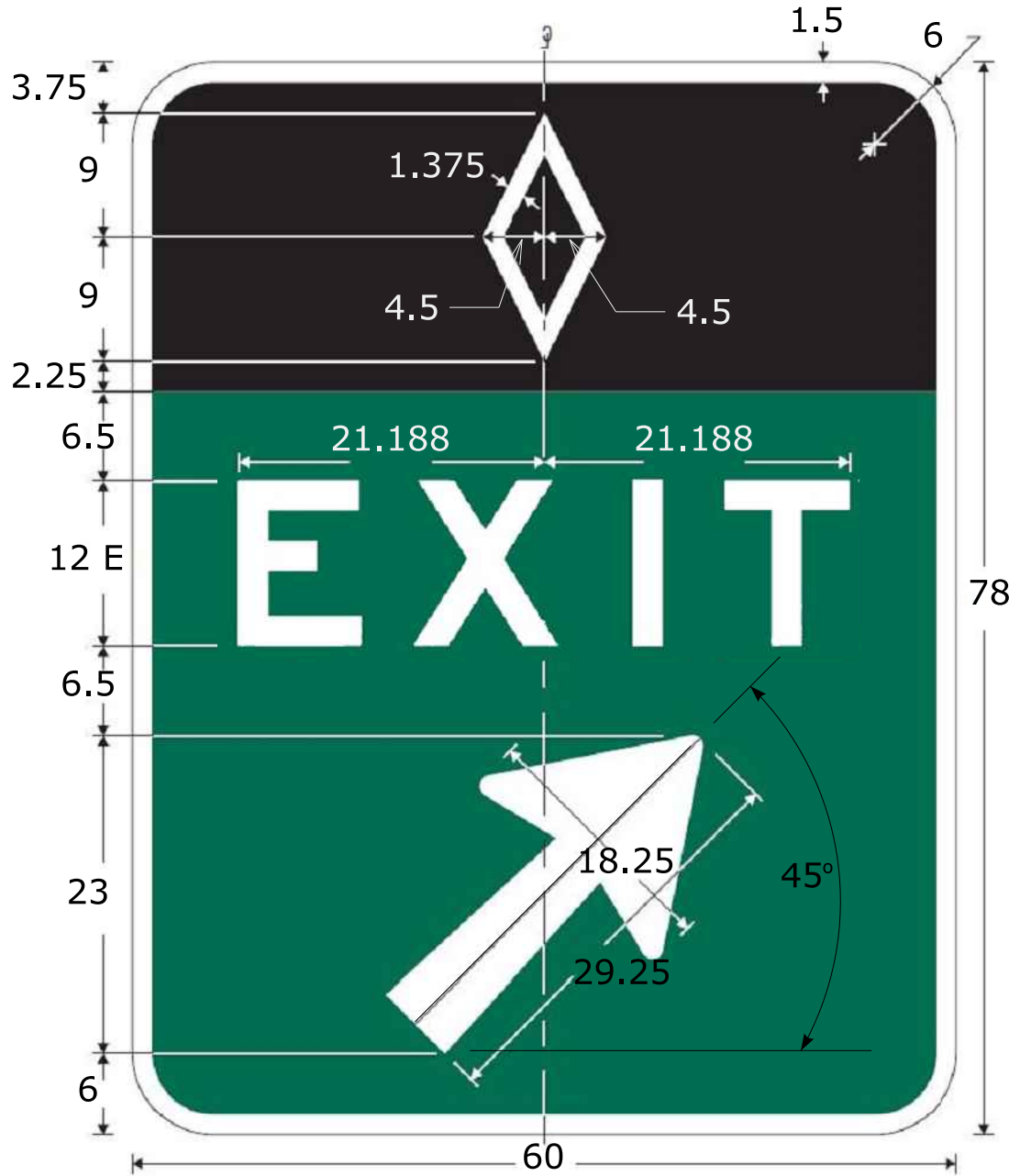

SIGN NUMBER	51-9024
SIGN PANEL	5'-0" x 6'-6"
TOTAL (Sq.ft.)	32.5
MUTCD	E8-4
BDR INSET/WIDTH	0 / 1.5"
CORNER RADIUS	6"
BACKGROUND	TYPE: * COLOR: See Sign
LEGEND/BORDER	TYPE: * COLOR: See Sign
* REFER TO CATALOG OF SIGNS FOR SHEETING TYPE, WHEN COLOR IS BLACK TYPE IS "PLAIN".	

REV'D /

PLOTTED : 11/13/2018

Dimensions are in inches.

Material : .080 Thk. Sheet Aluminum

Side Mounted

Engineer : B. Schilling / Designed By : J. Fascione / Checked By :

SIGN DETAIL

FOR USE WITH SIGN #51-1377

SIGN NUMBER	51-1376
SIGN PANEL	12.0
EXIT CROWN	--
TOTAL (Sq.Ft.)	12.0
BDR INSET/WIDTH	.75" / 1.25"
CORNER RADIUS	3"
BACKGROUND	TYPE: *
	COLOR: Brown
LEGEND/BORDER	TYPE: *
	COLOR: White/White
* REFER TO CATALOG OF SIGNS FOR SHEETING TYPE. WHEN COLOR IS BLACK TYPE IS "PLAIN".	

NOTES :

HINGE TYPE ;
CONTINUOUS TYPE CONSTRUCTED OF OF ALUMINUM ALLOY 5052 H34 WITH OVERALL LENGTH OF 36", THICKNESS OF 0.062", OPEN WIDTH OF 2", AND A PIN DIAMETER OF 0.125"

HASP & STAPLES:
CONSTRUCTED OF ALLUMINUM ALLOY WITH LENGTH, WIDTH AND THICKNESS RECOMMENDED BY THE SIGN MANUFACTURER. HASP & STAPLES SHALL BE COMPATABLE WITH EACH OTHER SO THAT THE SIGN PANEL CAN BE SECURLEY LOCKED INTO POSITION.

THE HINGE, HASP & STAPLES SHALL BE FASTEN TO THE SHEET ALUMINUM WITH ALUMINUM RIVETS. RIVETS SHALL BE PULL-THROUGH TYPE OF THE SIZE & NUMBER DESIGNATED BY THE SIGN MANUFACTURER.

HINGE SHALL BE COVERED WITH BROWN TYPE IV TAPE WITH A 1" BORDER ON THE TOP AND BOTTOM AS SHOWN.

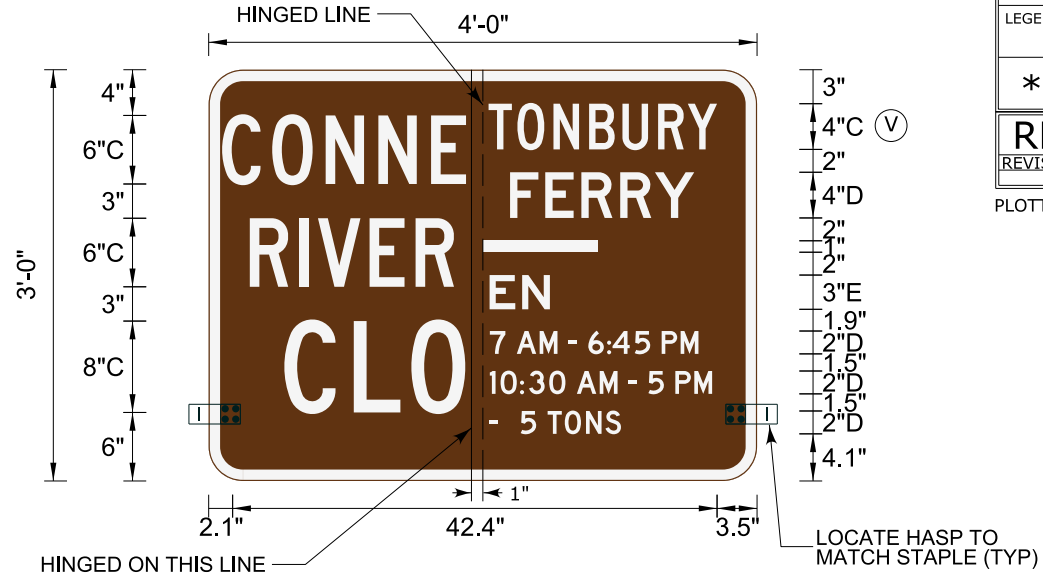

REV'D 07/13
REVISED LEGEND.

PLOTTED : \$DATE\$

(V) VARIABLE LEGEND

LOCATIONS :

- CHESTER ROUTE 148 E.B. MILEAGE :14.082 (↑ HADLYME)
- LYME ROUTE 82 W.B. MILEAGE :9.264 (↑ CHESTER)
- GLASTONBURY ROUTE 17 N.B. MILEAGE :32.618 (← ROCKY HILL)
- BACK TO BACK WITH
- GLASTONBURY ROUTE 17 S.B MILEAGE :32.624 (ROCKY HILL →)
- ROCKY HILL ROUTE 99 N.B. :MILEAGE :5.843 (GLASTONBURY →)
- ROCKY HILL ROUTE 99 S.B. MILEAGE :6.029 (← GLASTONBURY)
- ROCKY HILL ROUTE 160 E.B. MILEAGE :5.468 (↑ GLASTONBURY)

DIMENSIONS ARE IN INCHES

MATERIAL : .125 THK.SHEET ALUMINUM

SIDE MOUNTED

SIGN SUPPORT NO. N/A

ENGINEER : TLF DESIGNED BY : GMF CHECKED BY : _____

LETTER POSITIONS (X)																LENGTH	SERIES/SIZE
T	O	N	B	U	R	Y										20	C 2000
24.5	27	30.2	33.3	36.2	39.3	41.9										4	
C	O	N	N	E												21.4	C 2000
2.5	6.6	11	15.2	19.5												6	
F	E	R	R	Y												16.1	D 2000
26.4	29.5	32.6	36	39.1												4	
R	I	V	E	R												18.4	C 2000
3.6	7.9	9.6	14.1	18.1	21.5											6	
E	N															5.3	E 2000
24.6	27.4															3	
7		A	M		-	6	:	4	5		P	M				18.3	D 2000
24.6	26	27	29	30.5	31.5	32.2	33.2	34.9	35.4	37.3	38.7	39.7	41.3			2	
1	0	:	3	0		A	M		-		5		P	M		19.5	D 2000
24.6	25.6	27.3	28.1	29.8	31.2	32.2	34.2	35.8	36.8	37.5	38.5	39.9	40.9	42.5		2	
C	L	O														15.8	C 2000
6.6	12.7	17.7														8	
-			5		T	O	N	S								11.5	D 2000
24.6	25.3	26.3	27.3	28.7	29.7	31.2	33	34.7								2	

SIGN DETAIL

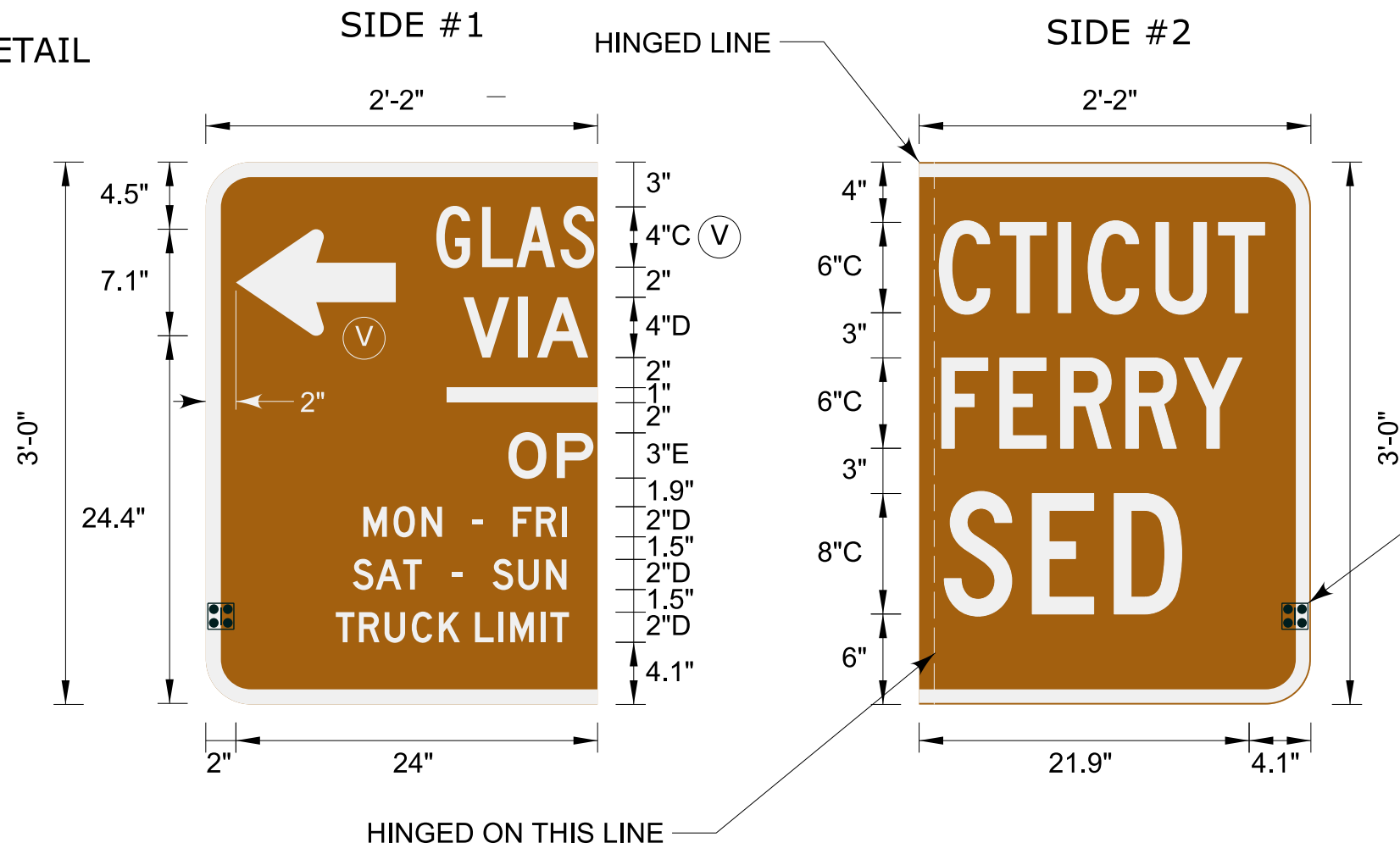

FOR USE WITH SIGN #51-1376

SIGN NUMBER	51-1377
SIGN PANEL	6.5/6.5
TOTAL (Sq.ft.)	10.99
MUTCD	I-9(CT)
BDR INSET/WIDTH	0.625" / 0.875"
CORNER RADIUS	2.25"
BACKGROUND	TYPE: *
	COLOR: Brown
LEGEND/BORDER	TYPE: *
	COLOR: White/White

* REFER TO CATALOG OF SIGNS FOR SHEETING TYPE, WHEN COLOR IS BLACK TYPE IS "PLAIN".

REV'D 07/13

REVISED LEGEND.

PLOTTED : 9/19/2018

LETTER POSITIONS (X) SIDE #2							LENGTH	SERIES/SIZE
C	T	I	C	U	T			C 2000
1.3	5.4	9.2	11.2	15.7	19.9		21.6	6
F	E	R	R	Y				C 2000
1.5	5.4	9.4	13.7	17.6			19.9	6
S	E	D						C 2000
1.7	7.5	12.9					15.8	8

LOCATE STAPLE TO MATCH HASP (TYP)

(V) VARIABLE LEGEND & ARROW DIRECTION

- LOCATIONS :
- CHESTER ROUTE 148 E.B. MILEAGE :14.082 (↑ HADLYME)
 - LYME ROUTE 82 W.B. MILEAGE :9.264 (↑ CHESTER)
 - GLASTONBURY ROUTE 17 N.B. MILEAGE :32.618 (← ROCKY HILL)
 - BACK TO BACK WITH
 - GLASTONBURY ROUTE 17 S.B MILEAGE :32.624 (ROCKY HILL →)
 - ROCKY HILL ROUTE 99 N.B. :MILEAGE :5.843 (GLASTONBURY →)
 - ROCKY HILL ROUTE 99 S.B. MILEAGE :6.029 (← GLASTONBURY)
 - ROCKY HILL ROUTE 160 E.B. MILEAGE :5.468 (↑ GLASTONBURY)

DIMENSIONS ARE IN INCHES
 MATERIAL : .125 THK.SHEET ALUMINUM
 SIDE MOUNTED
 SIGN SUPPORT NO. N/A
 ENGINEER : TLF DESIGNED BY : GMF CHECKED BY : _____

LETTER POSITIONS (X) SIDE #1											LENGTH	SERIES/SIZE	
G	L	A	S										C 2000
15.3	18.3	20.6	23.5									10.5	4
V	I	A											D 2000
17.1	20.7	22										8.3	4
O	P												E 2000
20.1	23.3											5.6	3
M	O	N		-			F	R	I				D 2000
10.5	12.5	14.3	15.7	16.7	17.7	18.4	19.4	20.4	21.9	23.6	23.9	13.7	2
S	A	T		-			S	U	N				D 2000
9.8	11.3	13.1	14.3	15.3	16.3	17	18	19	20.7	22.6	23.9	14.3	2
T	R	U	C	K		L	I	M	I	T			D 2000
8.6	10.2	11.9	13.7	15.5	16.9	17.9	19.4	20.2	22.2	22.9		15.5	2

SIGN DETAIL

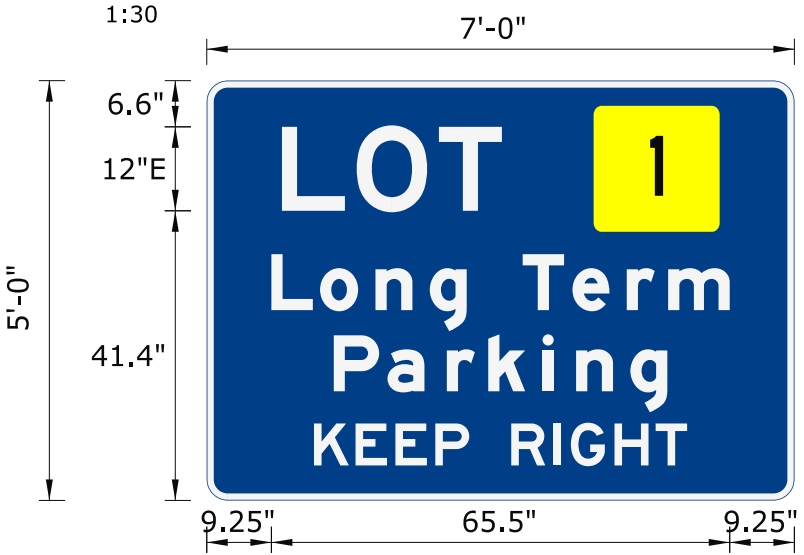

VARIABLE OPTIONS

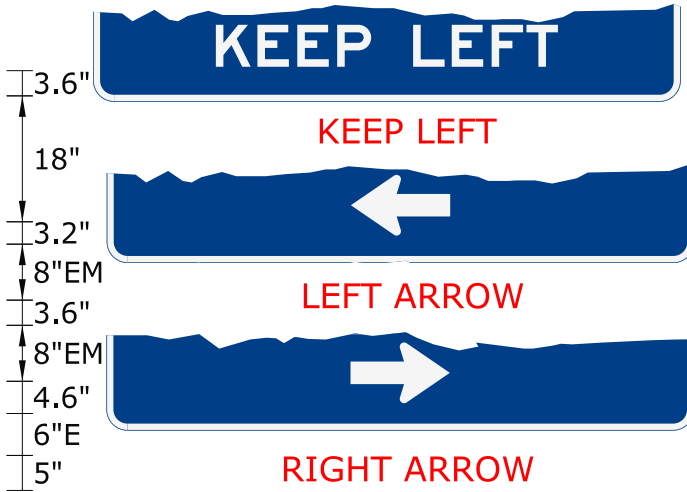

SIGN NUMBER	51-1401
PANEL SIZE	7'-0" x 5'-0"
SIGN AREA	35.0 Sq.Ft.
MUTCD	I-5 (CT)
BDR INSET/WIDTH	0" / 1.0"
CORNER RADIUS	3"
BACKGROUND	TYPE: *
	COLOR: Blue
LEGEND/BORDER	TYPE: *
	COLOR: White/White
* REFER TO CATALOG OF SIGNS FOR SHEETING TYPE. WHEN COLOR IS BLACK TYPE IS "PLAIN".	

Dimensions are in Inches
 Material : .080 Thick Sheet Aluminum
 Engineer : B. Schilling / Designed By: J. Fascione / Checked By: _____
 Ground Mounted

REV'D /

SYMBOL	ROT	X	Y	WID	HT
Lot Symbol	0	55.5	38.4	18	18
AR_Type D LT	90	34.9	3.9	8.7	14.2
AR_Type D RT	270	34.9	3.9	8.7	14.2

FILE : 51-1401 Dec 05, 2018

LETTER POSITIONS (X)												LENGTH	SERIES/SIZE
	L	O	T										E 2000
10.7	10.7	11.8	9	41.8								31.4	12
	L	o	n	g		T	e	r	m				EM 2000
9.2	7	7.9	7.8	5.3	8	7.1	7.8	5.9	8.8	9.2		65.5	8/6
	P	a	r	k	i	n	g						EM 2000
18.2	7.7	8.5	5.9	7.8	4.8	7.8	5.3	18.2				47.7	8/6
	K	E	E	P		R	I	G	H	T			E 2000
15.3	5.9	5.7	5.7	4.9	6	6.1	2.5	6.2	5.9	4.5	15.3	53.3	6
	K	E	E	P		L	E	F	T				E 2000
17.6	5.9	5.7	5.7	4.9	6	5.5	5.7	5	4.5	17.6		48.9	6

SIGN DETAIL

1:8

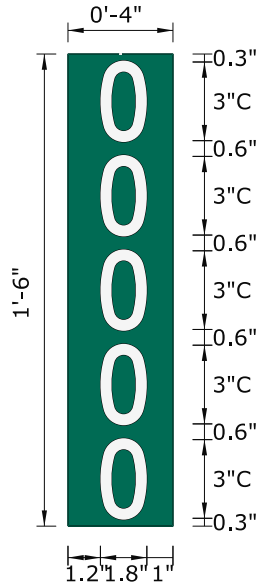

Dimensions are in Inches
 Material : .040 Thick Sheet Aluminum
 Engineer : B. Schilling / Designed By: J. Fascione / Checked By: _____
 Ground Mounted

REV'D /

SIGN NUMBER	51-2014
PANEL SIZE	0'-4" x 1'-6"
SIGN AREA	0.5 Sq.Ft.
MUTCD	
BDR INSET/WIDTH	0" / 0"
CORNER RADIUS	0"
BACKGROUND	TYPE: *
	COLOR: Green
LEGEND/BORDER	TYPE: *
	COLOR: White/ N/A
* REFER TO CATALOG OF SIGNS FOR SHEETING TYPE. WHEN COLOR IS BLACK TYPE IS "PLAIN".	

SYMBOL	ROT	X	Y	WID	HT

FILE :51-2015 Oct 29, 2020

LETTER POSITIONS (X)													LENGTH	SERIES/SIZE
														C 2000
1.2	1.8	1											1.8	3
														C 2000
1.2	1.8	1											1.8	3
														C 2000
1.2	1.8	1											1.8	3
														C 2000
1.2	1.8	1											1.8	3

SIGN DETAIL

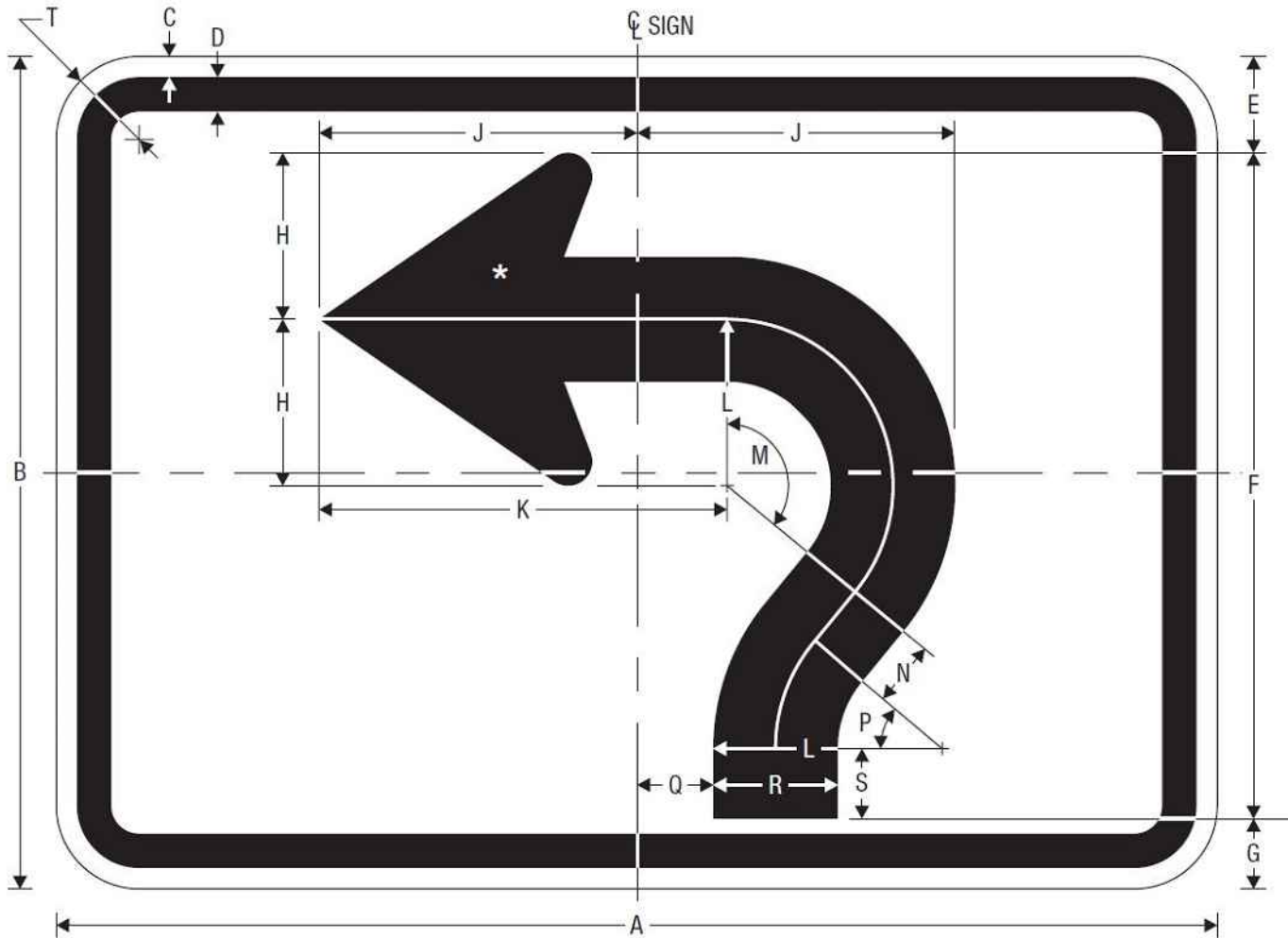

A	B	C	D	E	F	G	H	J
21	15	.375	.625	1.563	11.813	1.625	3.063	5.75
K	L	M	N	P	Q	R	S	T
7.375	3	130°	1.125	40°	1.375	2.25	1	1.5

SIGN NUMBER	51-2617
SIGN PANEL	1'-9" x 1'-3"
TOTAL (Sq.ft.)	2.1875
MUTCD	M5-3
BDR INSET/WIDTH	.375 / .625
CORNER RADIUS	1.5
BACKGROUND	TYPE: *
	COLOR: White
LEGEND/BORDER	TYPE: *
	COLOR: Black/Black
* REFER TO CATALOG OF SIGNS FOR SHEETING TYPE. WHEN COLOR IS BLACK TYPE IS "PLAIN".	

REV'D /

PLOTTED : 12/5/2018

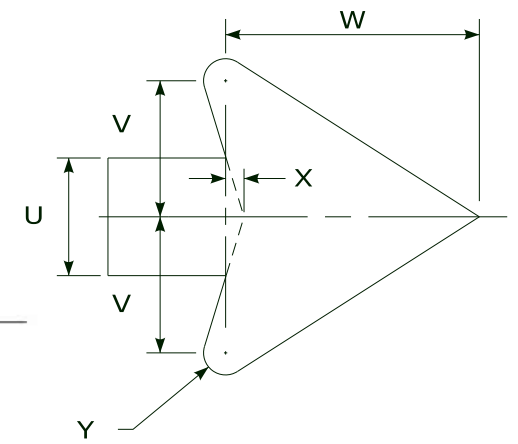

ARROWHEAD DETAIL
N.T.S.

U	V	W	X	Y
2.25	2.625	4.5	.375	.4375

Dimensions are in inches.

Material : .080 Thk. Sheet Aluminum

Side Mounted

Location : N/A

Engineer : B. Schilling / Designed By : J. Fascione / Checked By :

SIGN DETAIL

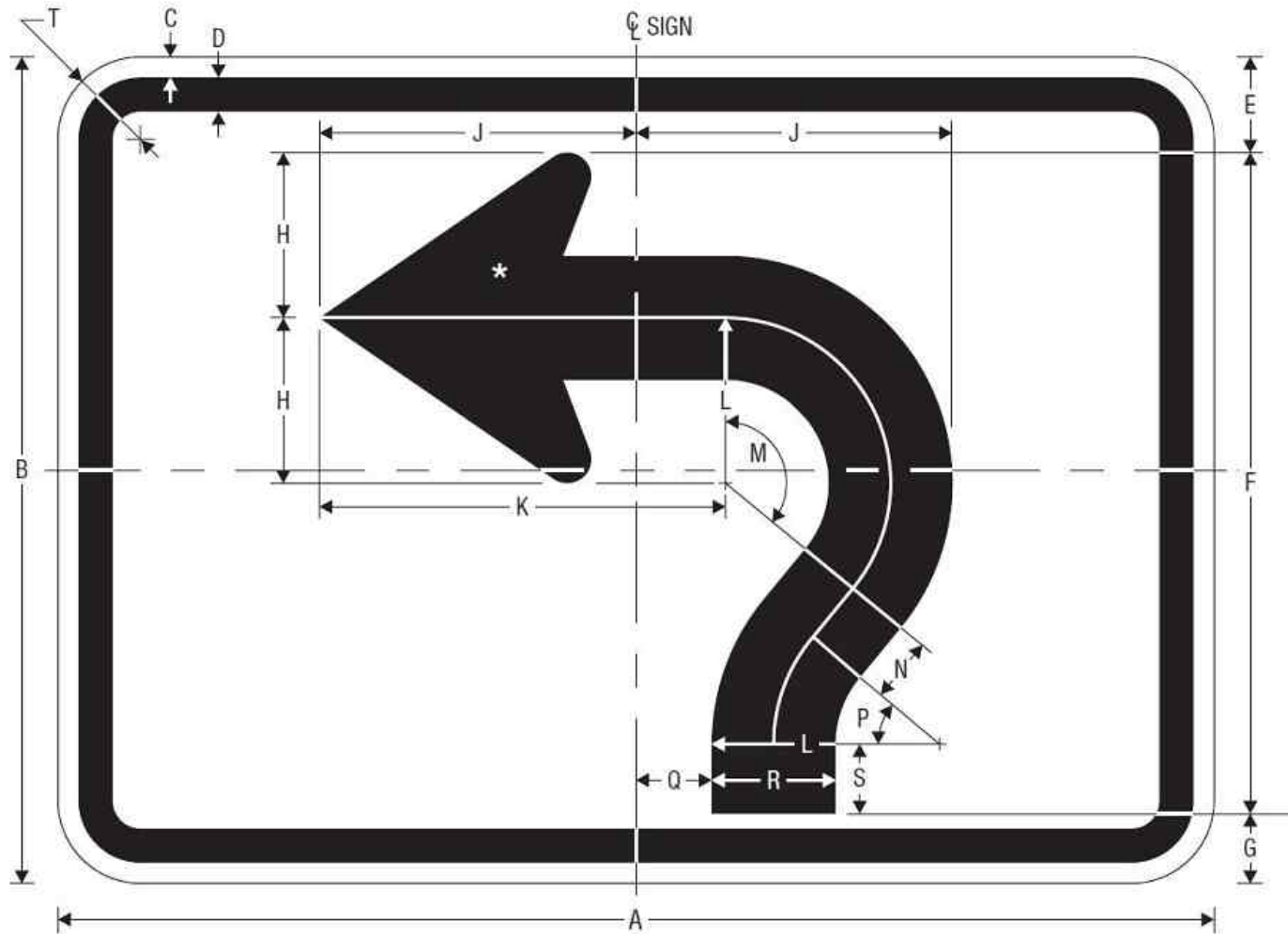

SIGN NUMBER	51-2618
SIGN PANEL	1'-9" x 1'-3"
TOTAL (Sq.ft.)	2.1875
MUTCD	M5-3
BDR INSET/WIDTH	.375 / .625
CORNER RADIUS	1.5
BACKGROUND	TYPE: * COLOR: Blue
LEGEND/BORDER	TYPE: * COLOR: White/White
* REFER TO CATALOG OF SIGNS FOR SHEETING TYPE. WHEN COLOR IS BLACK TYPE IS "PLAIN".	
REV'D /	

PLOTTED : 2/19/20

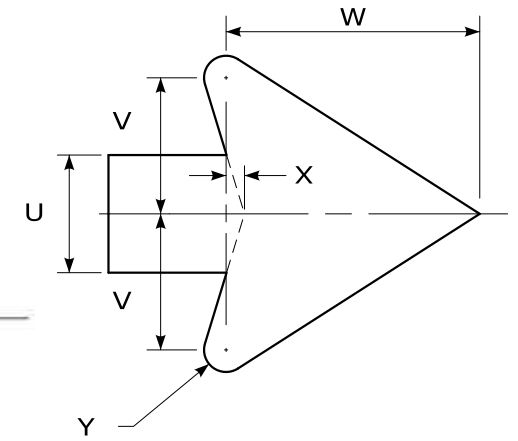

ARROWHEAD DETAIL
N.T.S.

A	B	C	D	E	F	G	H	J
21	15	.375	.625	1.563	11.813	1.625	3.063	5.75
K	L	M	N	P	Q	R	S	T
7.375	3	130°	1.125	40°	1.375	2.25	1	1.5

U	V	W	X	Y
2.25	2.625	4.5	.375	.4375

Dimensions are in inches.
 Material : .080 Thk. Sheet Aluminum
 Side Mounted
 Location : N/A
 Engineer : B. Schilling / Designed By : J. Fascione / Checked By :

SIGN DETAIL

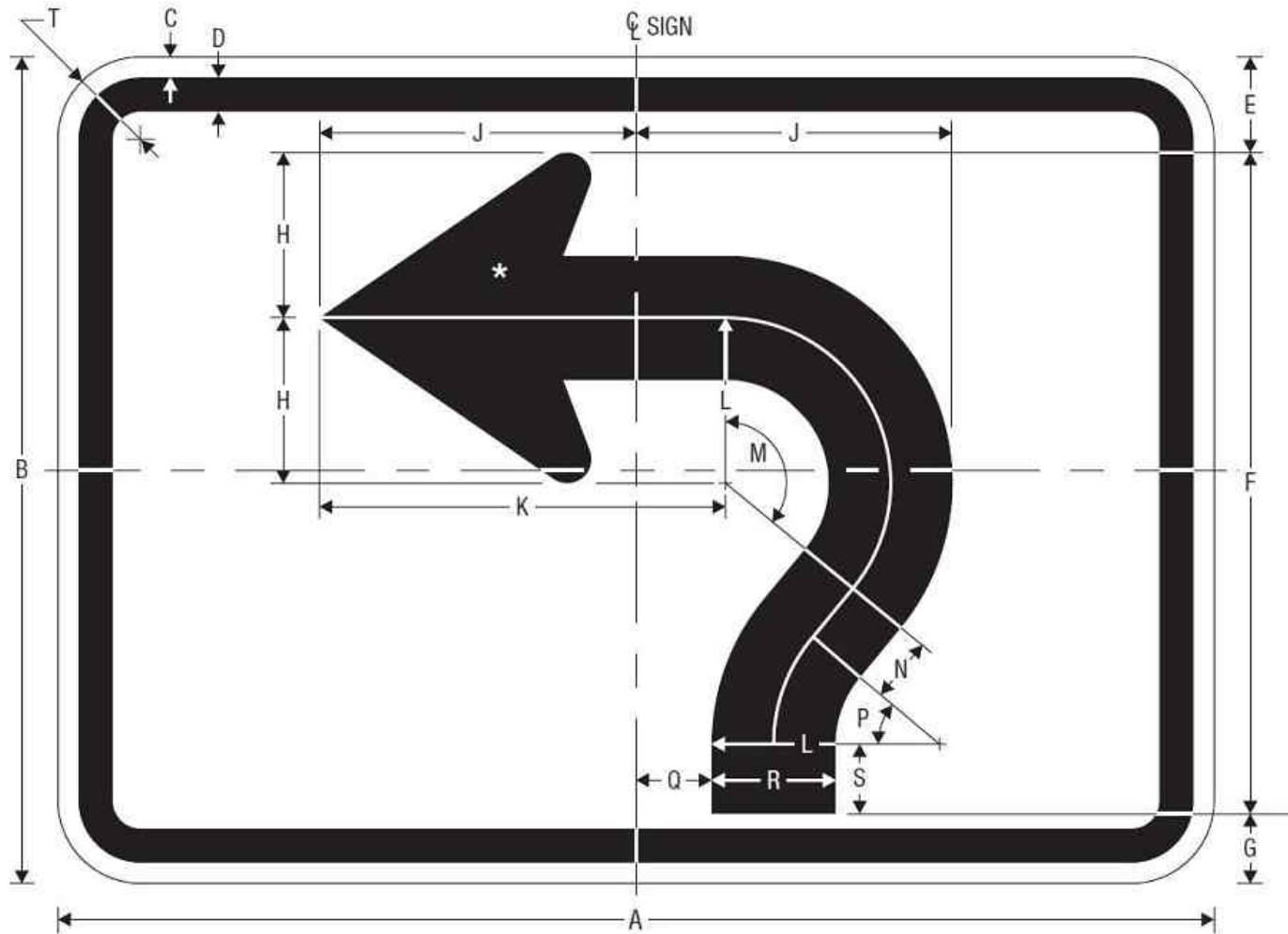

SIGN NUMBER	51-2619
SIGN PANEL	1'-9" x 1'-3"
TOTAL (Sq.ft.)	2.1875
MUTCD	M5-3
BDR INSET/WIDTH	.375 / .625
CORNER RADIUS	1.5
BACKGROUND	TYPE: * COLOR: Brown
LEGEND/BORDER	TYPE: * COLOR: White/White
* REFER TO CATALOG OF SIGNS FOR SHEETING TYPE. WHEN COLOR IS BLACK TYPE IS "PLAIN".	
REV'D /	

PLOTTED : 2/19/20

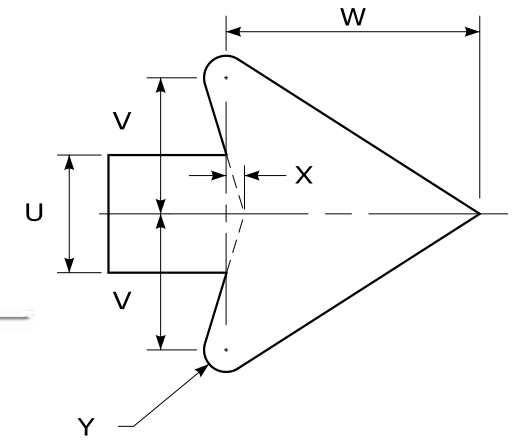

ARROWHEAD DETAIL
N.T.S.

A	B	C	D	E	F	G	H	J
21	15	.375	.625	1.563	11.813	1.625	3.063	5.75
K	L	M	N	P	Q	R	S	T
7.375	3	130°	1.125	40°	1.375	2.25	1	1.5

U	V	W	X	Y
2.25	2.625	4.5	.375	.4375

Dimensions are in inches.
 Material : .080 Thk. Sheet Aluminum
 Side Mounted
 Location : N/A
 Engineer : B. Schilling / Designed By : J. Fascione / Checked By :

SIGN DETAIL

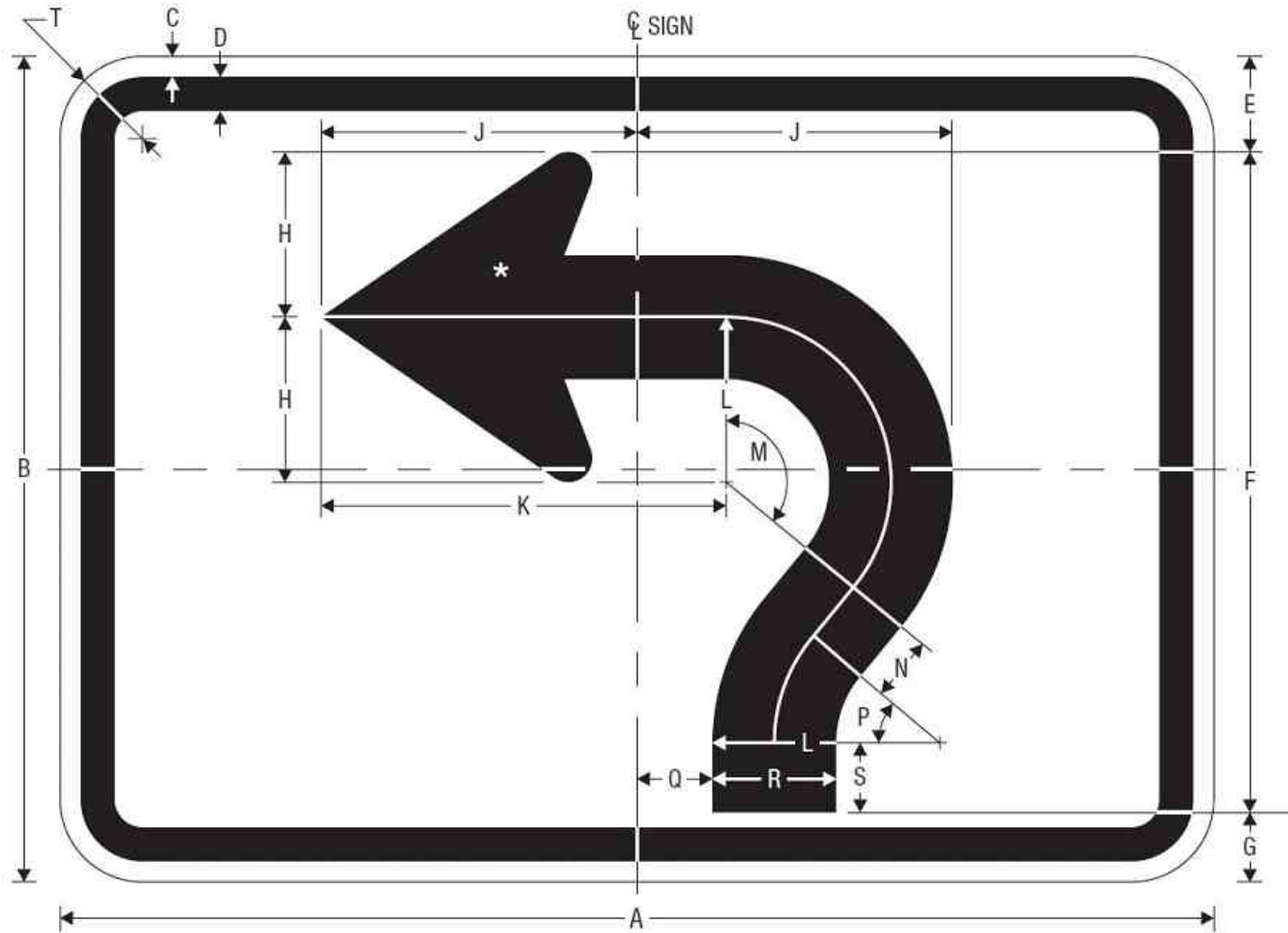

A	B	C	D	E	F	G	H	J
21	15	.375	.625	1.563	11.813	1.625	3.063	5.75
K	L	M	N	P	Q	R	S	T
7.375	3	130°	1.125	40°	1.375	2.25	1	1.5

SIGN NUMBER	51-2621
SIGN PANEL	1'-9" x 1'-3"
TOTAL (Sq.ft.)	2.1875
MUTCD	M5-3
BDR INSET/WIDTH	.375 / .625
CORNER RADIUS	1.5
BACKGROUND	TYPE: * COLOR: Green
LEGEND/BORDER	TYPE: * COLOR: White/White
* REFER TO CATALOG OF SIGNS FOR SHEETING TYPE. WHEN COLOR IS BLACK TYPE IS "PLAIN".	
REV'D /	

PLOTTED : 2/19/20

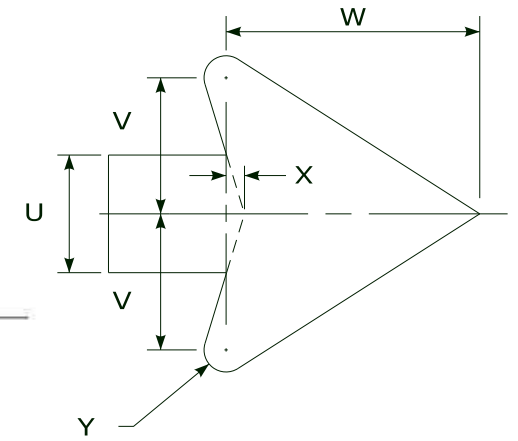

ARROWHEAD DETAIL
N.T.S.

U	V	W	X	Y
2.25	2.625	4.5	.375	.4375

Dimensions are in inches.

Material : .080 Thk. Sheet Aluminum

Side Mounted

Location : N/A

Engineer : B. Schilling / Designed By : J. Fascione / Checked By :

SIGN DETAIL
1:3

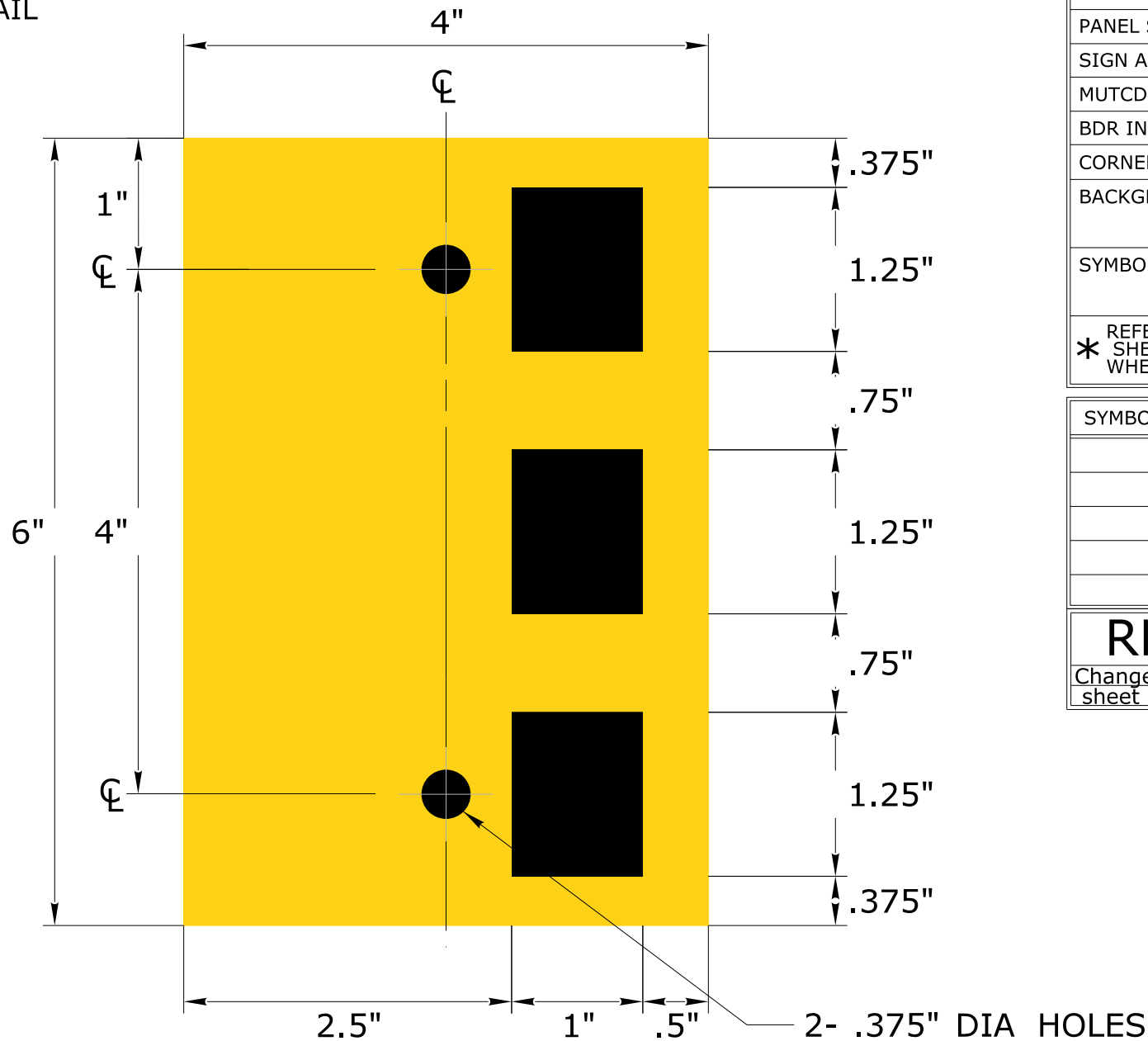

SIGN NUMBER	51-5007
PANEL SIZE	0'-4" x 0'-6"
SIGN AREA	0.166 Sq.Ft.
MUTCD	
BDR INSET/WIDTH	0" / 0"
CORNER RADIUS	0"
BACKGROUND	TYPE: *
	COLOR: Yellow
SYMBOL/BORDER	TYPE: *
	COLOR: Black/
* REFER TO CATALOG OF SIGNS FOR SHEETING TYPE. WHEN COLOR IS BLACK TYPE IS "PLAIN".	

SYMBOL	ROT	X	Y	WID	HT

REV'D 8/17
 Changed material from plywood to sheet aluminum.

Dimension are in Inches
 Material : .080 Thick Sheet Aluminum
 Engineer : B. Schilling / Designed By: J. Fascione / Checked By: _____
 Ground Mounted

SIGN DETAIL
1:3

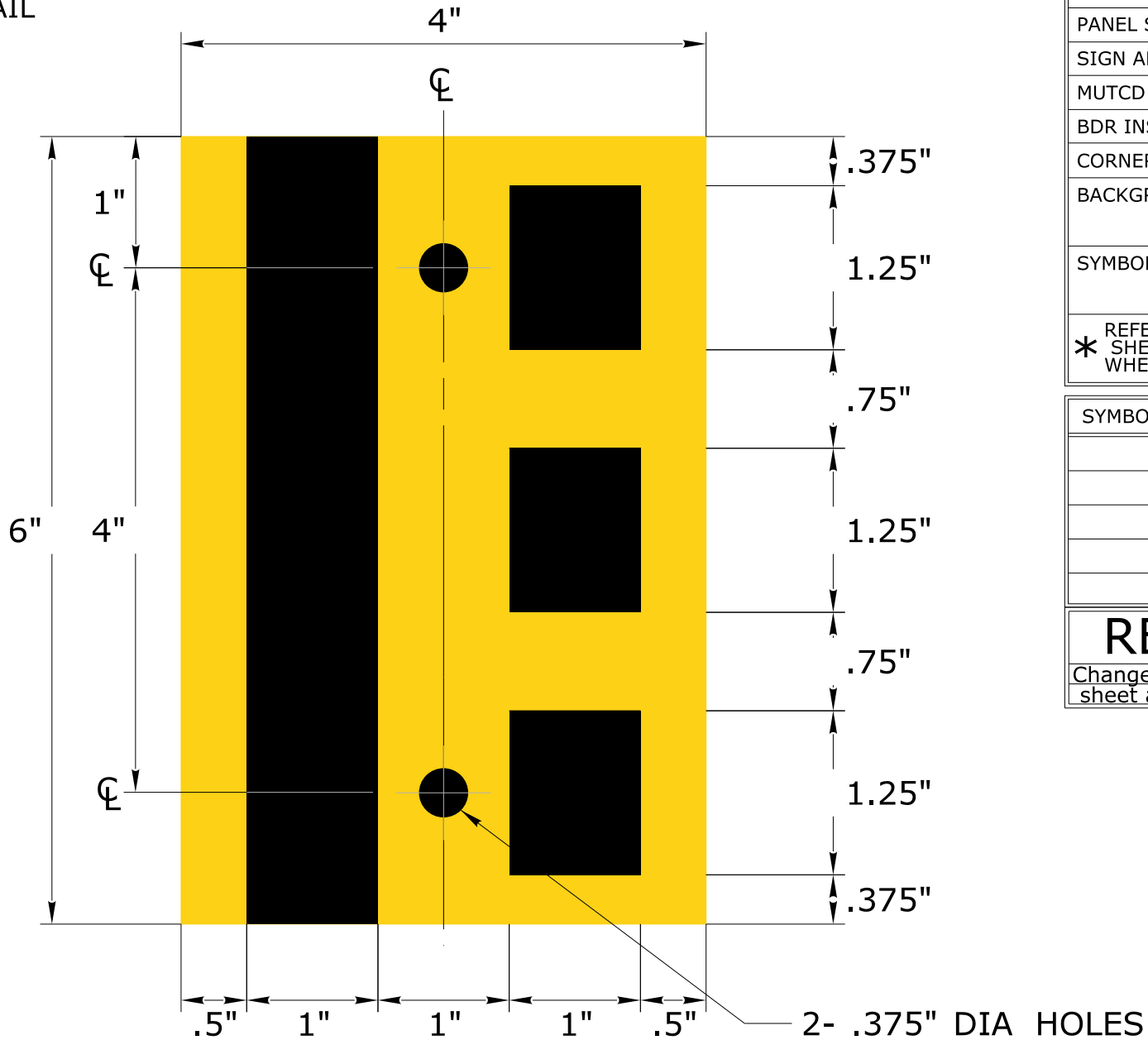

SIGN NUMBER	51-5008
PANEL SIZE	0'-4" x 0'-6"
SIGN AREA	0.166 Sq.Ft.
MUTCD	
BDR INSET/WIDTH	0" / 0"
CORNER RADIUS	0"
BACKGROUND	TYPE: *
	COLOR: Yellow
SYMBOL/BORDER	TYPE: *
	COLOR: Black/
* REFER TO CATALOG OF SIGNS FOR SHEETING TYPE. WHEN COLOR IS BLACK TYPE IS "PLAIN".	

SYMBOL	ROT	X	Y	WID	HT

REV'D 8/17
Changed material from plywood to sheet aluminum.

Dimension are in Inches
 Material : .080 Thick Sheet Aluminum
 Engineer : B. Schilling / Designed By: J. Fascione / Checked By: _____
 Ground Mounted

SIGN DETAIL
1:3

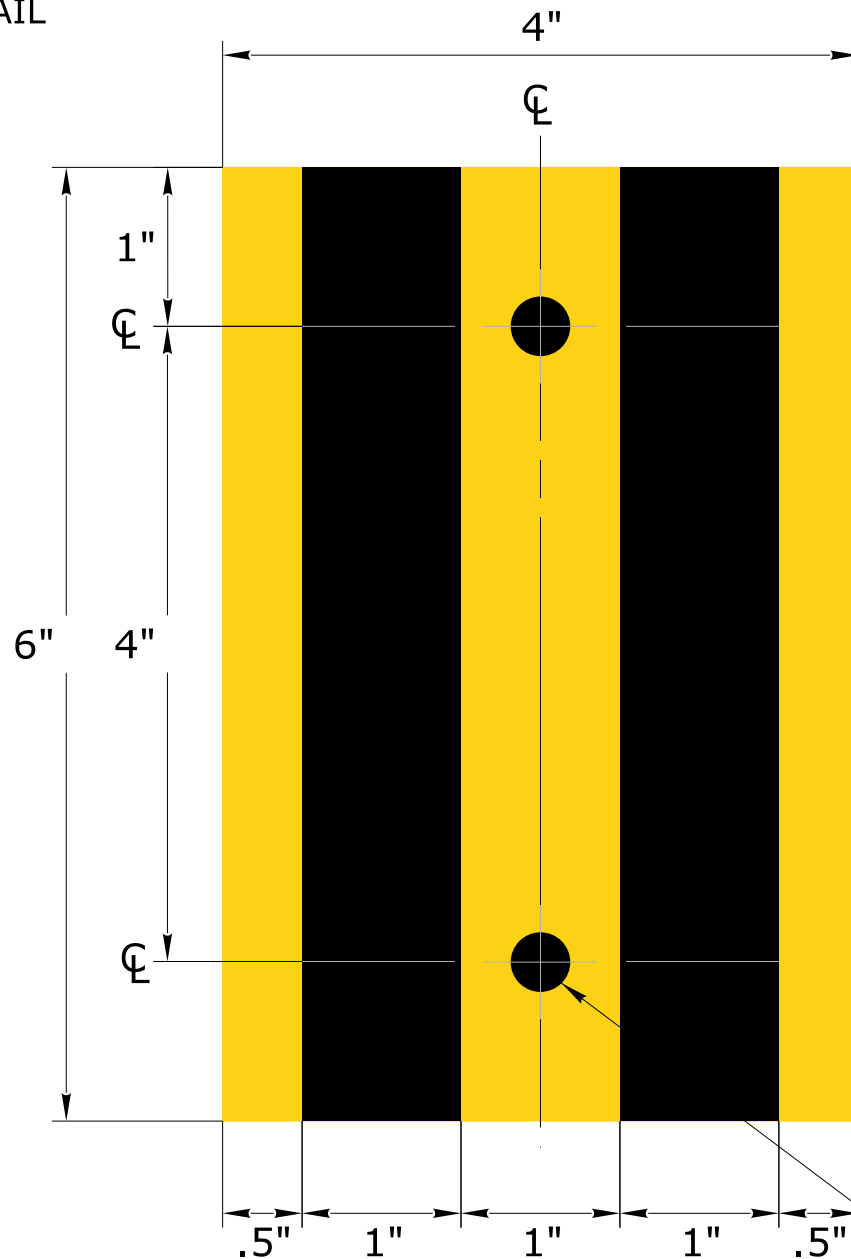

2- .375" DIA HOLES

SIGN NUMBER	51-5009
PANEL SIZE	0'-4" x 0'-6"
SIGN AREA	0.166 Sq.Ft.
MUTCD	
BDR INSET/WIDTH	0" / 0"
CORNER RADIUS	0"
BACKGROUND	TYPE: *
	COLOR: Yellow
SYMBOL/BORDER	TYPE: *
	COLOR: Black/
* REFER TO CATALOG OF SIGNS FOR SHEETING TYPE. WHEN COLOR IS BLACK TYPE IS "PLAIN".	

SYMBOL	ROT	X	Y	WID	HT

REV'D 8/17

Changed material from plywood to sheet aluminum.

Dimension are in Inches
 Material : .080 Thick Sheet Aluminum
 Engineer : B. Schilling / Designed By: J. Fascione / Checked By: _____
 Ground Mounted

SIGN DETAIL

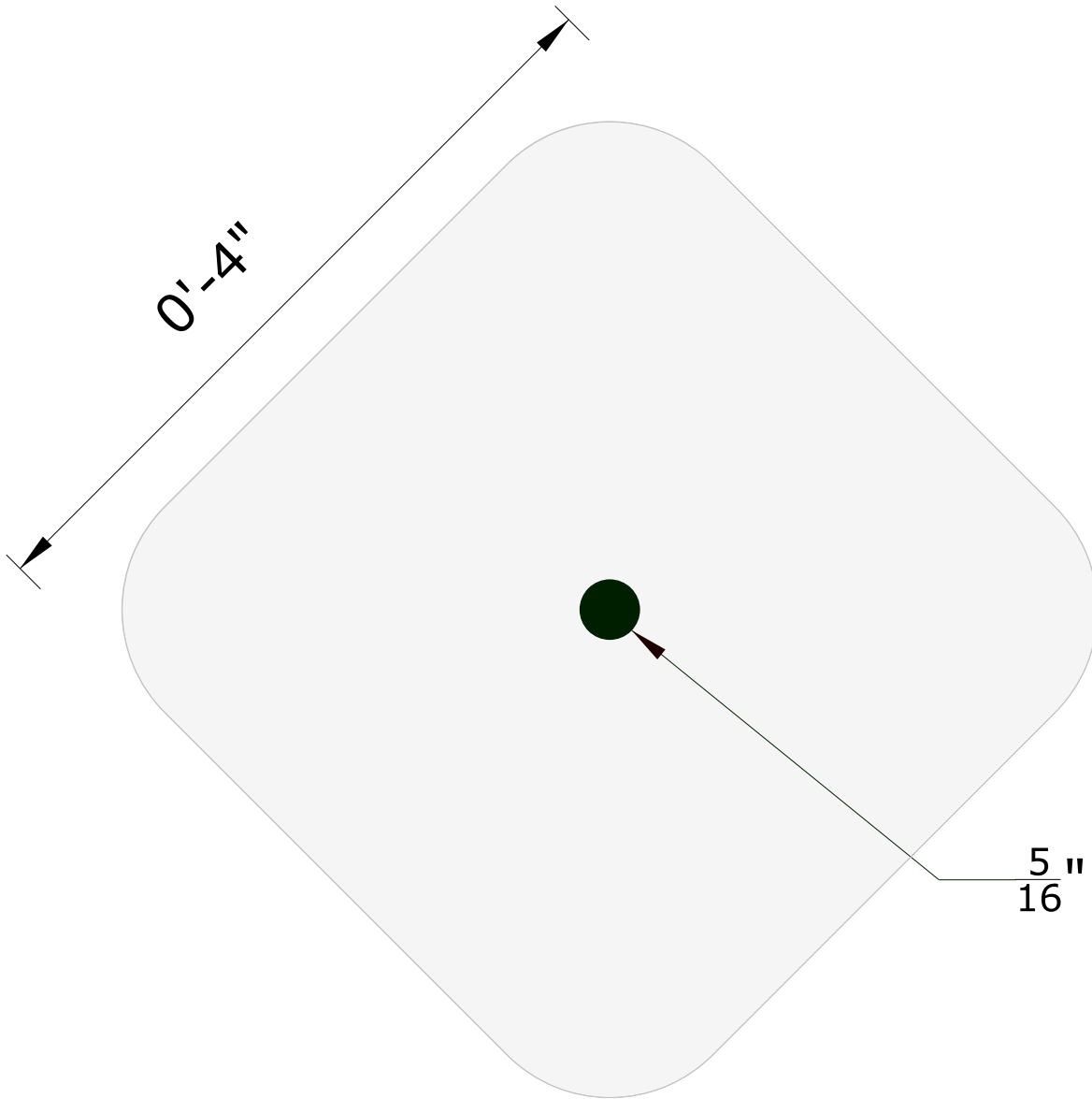

SIGN NUMBER	51-5028
SIGN PANEL	0'-4" x 0'-4"
TOTAL (Sq.ft.)	0.1078
MUTCD	
BDR INSET/WIDTH	N/A
CORNER RADIUS	0.75
BACKGROUND	TYPE: *
	COLOR: White
LEGEND/BORDER	TYPE: *
	COLOR: Black/Black
* REFER TO CATALOG OF SIGNS FOR SHEETING TYPE. WHEN COLOR IS BLACK TYPE IS "PLAIN".	

REV'D /

PLOTTED : 5/12/2018

5/16" DIA HOLE ON CENTER

Dimensions are in inches.

Material : .063 Thk. Sheet Aluminum

Side Mounted

Location : N/A

Engineer : B. Schilling / Designed By : J. Fascione / Checked By :

SIGN DETAIL

SIGN NUMBER	51-5029
SIGN PANEL	0'-4" x 0'-4"
TOTAL (Sq.ft.)	0.1078
MUTCD	
BDR INSET/WIDTH	N/A
CORNER RADIUS	0.75
BACKGROUND	TYPE: *
	COLOR: Yellow
LEGEND/BORDER	TYPE: *
	COLOR: Black/Black
* REFER TO CATALOG OF SIGNS FOR SHEETING TYPE, WHEN COLOR IS BLACK TYPE IS "PLAIN".	

REV'D /

PLOTTED : 5/12/2018

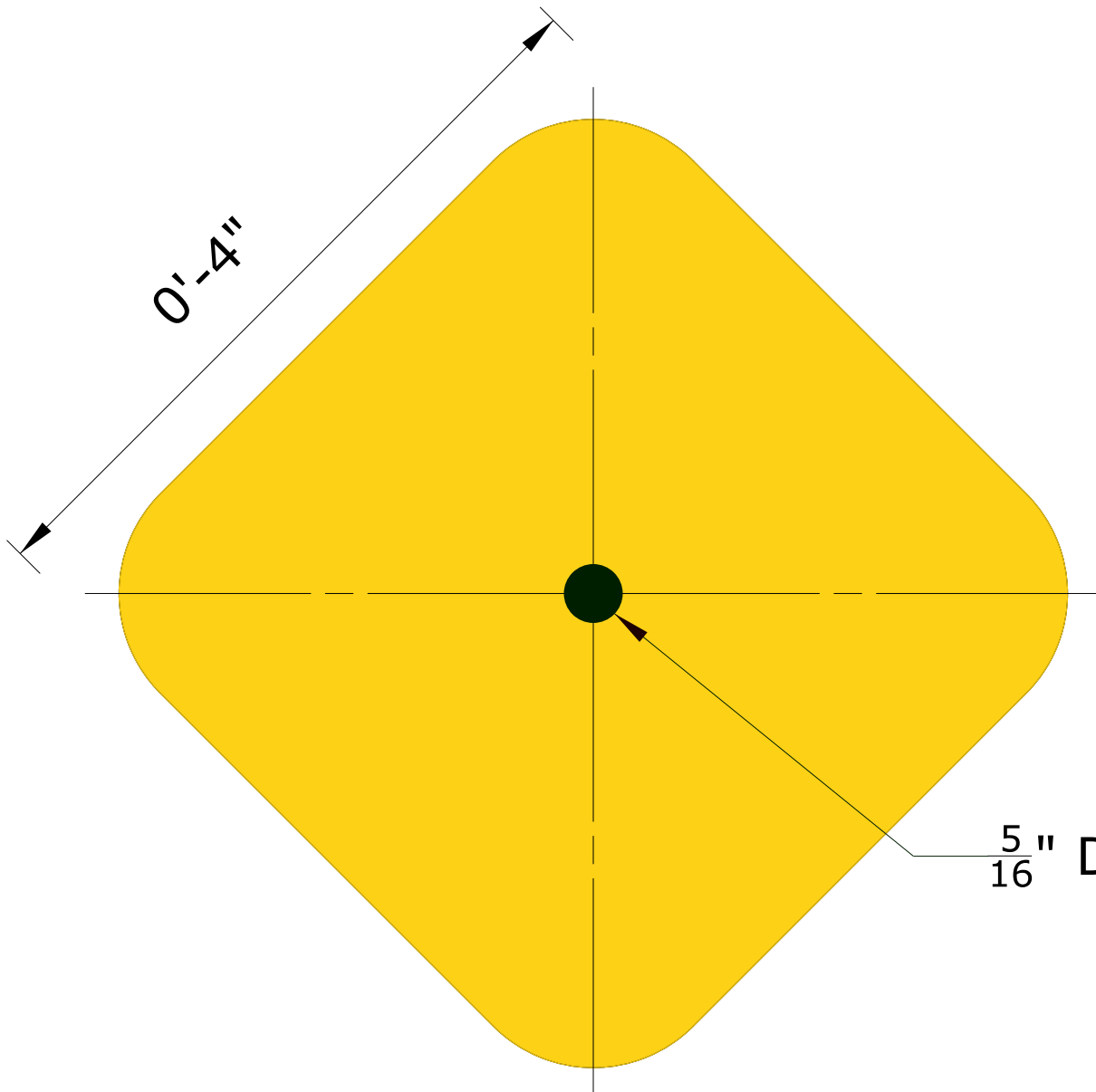

$\frac{5}{16}$ " DIA HOLE ON CENTER

Dimensions are in inches.
 Material : .063 Thk. Sheet Aluminum
 Side Mounted
 Location : N/A
 Engineer : B. Schilling / Designed By : J. Fascione / Checked By :

SIGN DETAIL

1:45

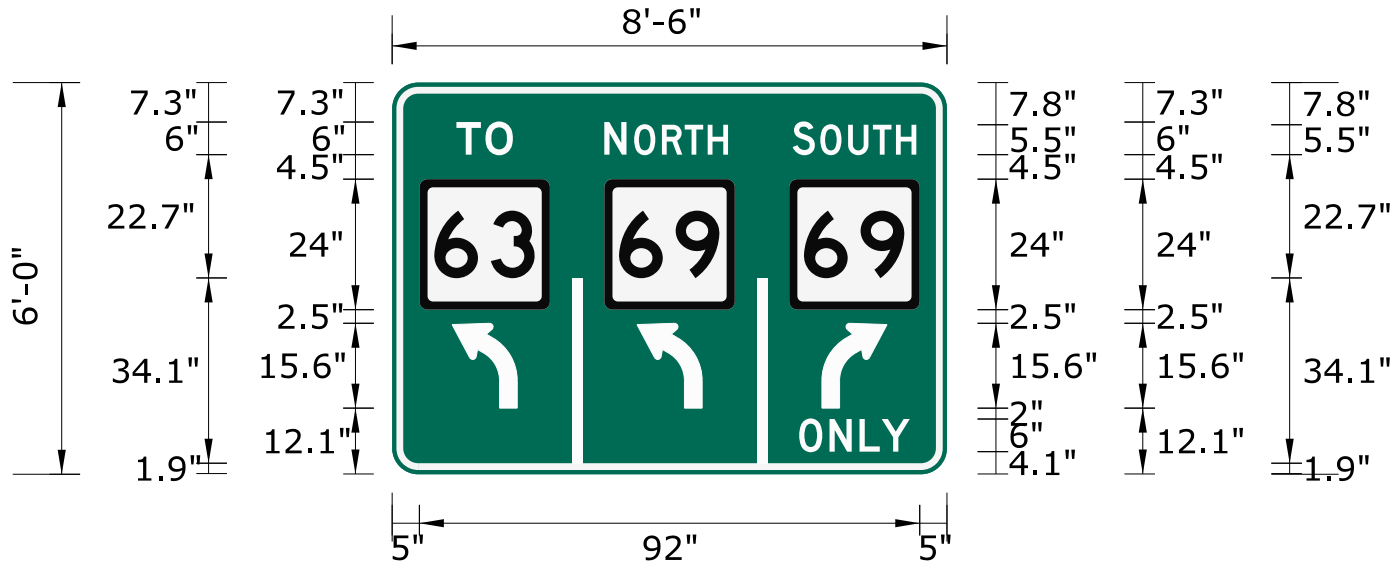

SIGN NUMBER	515294
PANEL SIZE	8'-6" x 6'-0"
SIGN AREA	51.0 Sq.Ft.
MUTCD	
BDR INSET/WIDTH	0.625" / 1.25"
CORNER RADIUS	4"
BACKGROUND	TYPE: *
	COLOR: Green
LEGEND/BORDER	TYPE: *
	COLOR: Black/White
* REFER TO CATALOG OF SIGNS FOR SHEETING TYPE. WHEN COLOR IS BLACK TYPE IS "PLAIN".	

SYMBOL	ROT	X	Y	WID	HT
M1_5_1	0	5	30.3	24	24
M1_5_1	0	39	30.3	24	24
M1_5_1	0	73	30.3	24	24
D6LFT	0	11	12.2	12	15.6
D6LFT	0	45	12.2	12	15.6
D6LFT	180	79	12.2	12	15.6

REV'D /

FILE :515294

Oct 16, 2017

Dimensions are in Inches

Material : .080 Thick Sheet Aluminum

Engineer : B. Schilling / Designed By: J. Fascione / Checked By:-----

Ground Mounted

LETTER POSITIONS (X)															LENGTH	SERIES/SIZE						
	T	O															E 2000					
11.8	5.3	5	79.8														10.4	6				
	N		O	R	T	H													D 2000			
39	4.1	1.4	5.1	4.2	4.2	3.7	40.2												22.8	6,5.5		
	S		O	U	T	H														D 2000		
73.6	4.1	1	5.1	4.6	4.2	3.7	5.6													22.7	6,5.5	
	O	N	L	Y																	D 2000	
74.8	5.6	5.5	4.1	5.2	6.8																20.3	6

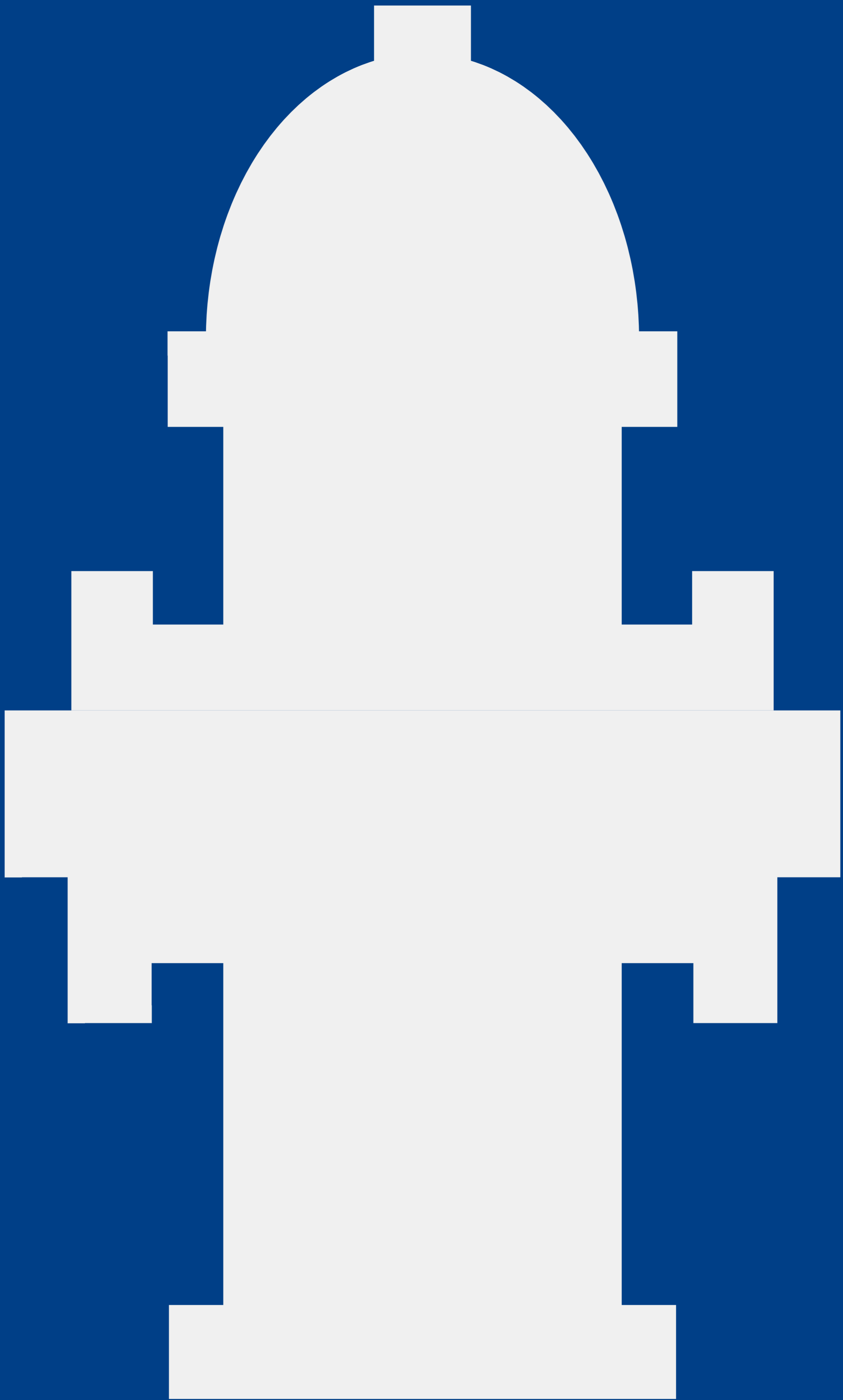

SIGN DETAIL

1:15

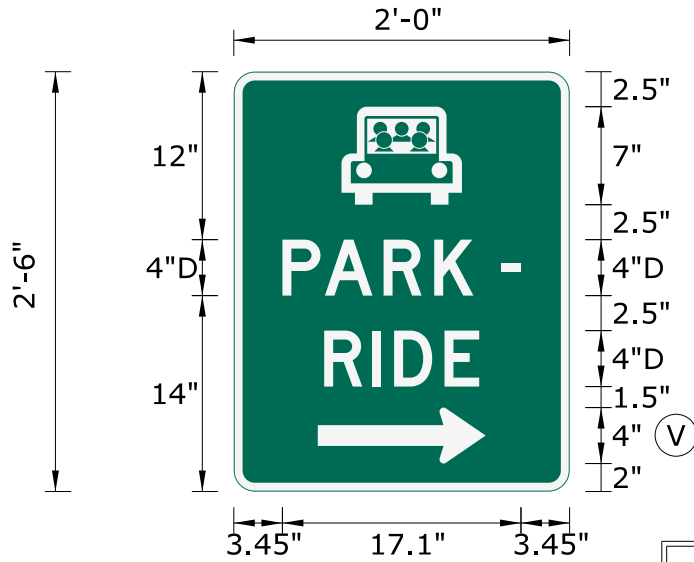

SIGN NUMBER	51-6006
PANEL SIZE	2'-0" x 2'-6"
SIGN AREA	5.0 Sq.Ft.
MUTCD	D4-2
BDR INSET/WIDTH	0" / 0.63"
CORNER RADIUS	1.5"
BACKGROUND	TYPE: *
	COLOR: Green
LEGEND/BORDER	TYPE: *
	COLOR: White/White
* REFER TO CATALOG OF SIGNS FOR SHEETING TYPE. WHEN COLOR IS BLACK TYPE IS "PLAIN".	

SYMBOL	ROT	X	Y	WID	HT
Park & Ride	0	7.7	20.5	8.6	7
ARUP	270	6	2	4	12

(V) Left or Right Arrow

Dimensions are in Inches
 Material : .080 Thick Sheet Aluminum
 Engineer : B. Schilling / Designed By: J. Fascione / Checked By: _____
 Ground Mounted

REV'D /

FILE : 51-6006

May 21, 2018

LETTER POSITIONS (X)															LENGTH	SERIES/SIZE	
	P	A	R	K		-										D 2000	
3.5	3	4.2	3.6	2.8	2	1.4	3.5									17.1	4
	R	I	D	E												D 2000	
6.5	3.4	1.6	3.6	2.5	6.5											11.1	4

SIGN DETAIL

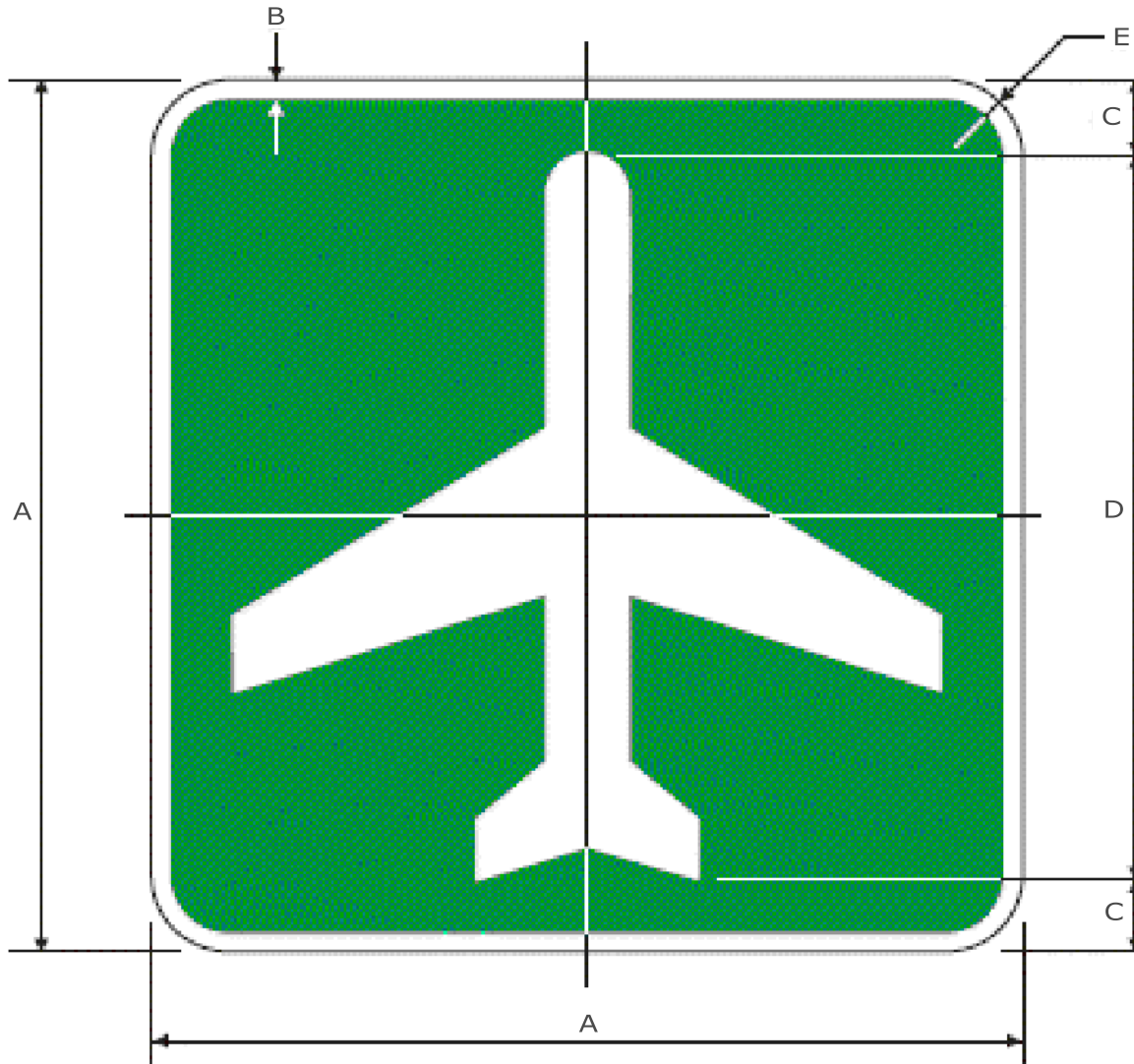

SIGN NUMBER	51-6094
SIGN PANEL	6.25
TOTAL (Sq.ft.)	6.25
MUTCD	I-5
BDR INSET/WIDTH	N/A
CORNER RADIUS	1.875"
BACKGROUND	TYPE: *
	COLOR: Green
SYMBOL	TYPE: *
	COLOR: White
* REFER TO CATALOG OF SIGNS FOR SHEETING TYPE, WHEN COLOR IS BLACK TYPE IS "PLAIN".	

REV'D /

DATE CREATED : 9/13/11
 DIMENSIONS ARE IN INCHES
 MATERIAL : .040 THK.SHEET ALUMINUM
 OVERLAY PANEL
 CONTACT CONNECTICUT D.O.T., DIVISION OF TRAFFIC ENGINEERING
 FOR FULL SIZE DETAIL OF LOGO
 ENGINEER : PJC DESIGNED BY : GMF CHECKED BY : PJC

A	B	C	D	E
30	.75	2.5	25	1.875



NOTES:

SIGN PANEL - .080 Thk. SHEET ALUMINUM
 BACKGROUND - BLUE ENCLOSED LENS - PMS 281 BLUE, NO BLACK ADDED IN MIXTURE
 COPY & BORDER - SILVER ENCLOSED LENS
 COPY - LETTER SERIES IS STONE SEMI-BOLD
 FOR FULL SIZE DETAIL - CONTACT THE CONN. DEPT. OF TRANSPORTATION,
 DIVISION OF TRAFFIC ENGINEERING
 MOUNTAIN LAUREL COLORS AS FOLLOWS:

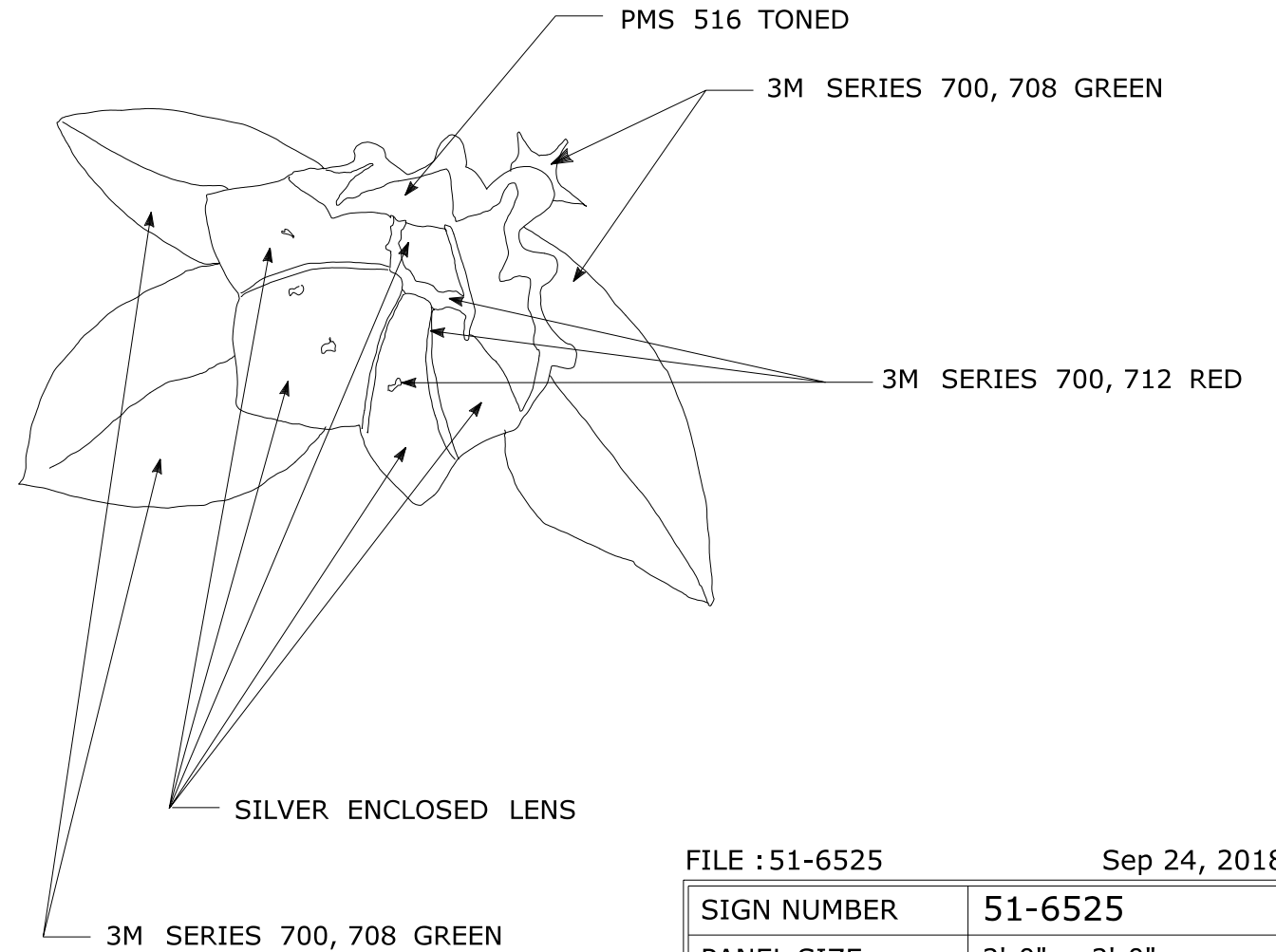

FILE :51-6525

Sep 24, 2018

SIGN NUMBER	51-6525
PANEL SIZE	2'-0" x 2'-0"
SIGN AREA	4.0 Sq.Ft.
MUTCD	M1-10(ct)
BDR INSET/WIDTH	0" / 0.75"
CORNER RADIUS	N/A
BACKGROUND	TYPE: * COLOR: See Sign
LEGEND/BORDER	TYPE: * COLOR: See Sign

* REFER TO CATALOG OF SIGNS FOR SHEETING TYPE. WHEN COLOR IS BLACK TYPE IS "PLAIN".

Dimensions are in Inches

Material : .080 Thick Sheet Aluminum

Engineer : B. Schilling / Designed By: J. Fascione / Checked By: _____

Ground Mounted

SIGN DETAIL

1:18

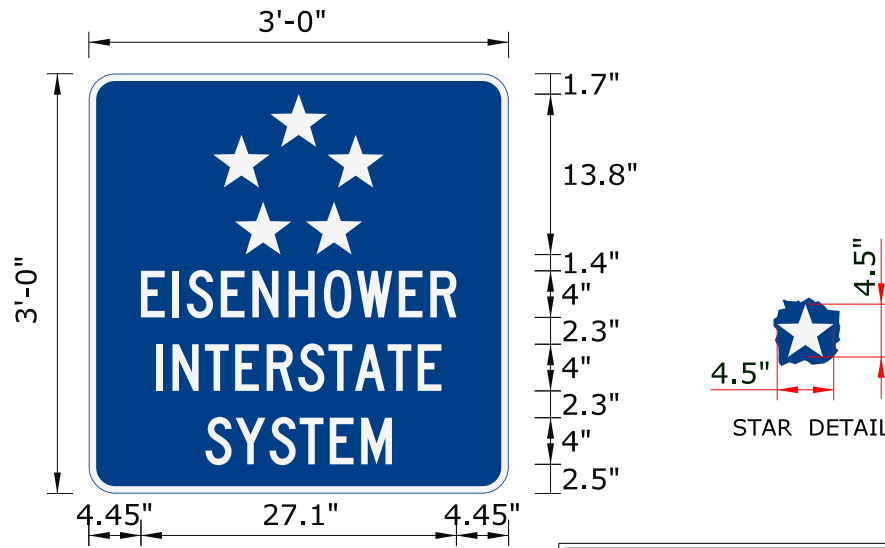

SIGN NUMBER	51-6560
PANEL SIZE	3'-0" x 3'-0"
SIGN AREA	9.0 Sq.Ft.
MUTCD	M1-10
BDR INSET/WIDTH	0" / 0.63"
CORNER RADIUS	2.25"
BACKGROUND	TYPE: *
	COLOR: Blue
LEGEND/BORDER	TYPE: *
	COLOR: White/White
* REFER TO CATALOG OF SIGNS FOR SHEETING TYPE. WHEN COLOR IS BLACK TYPE IS "PLAIN".	

SYMBOL	ROT	X	Y	WID	HT
STARS	0	10.7	20.5	14.6	13.8

Dimensions are in Inches
 Material : .080 Thick Sheet Aluminum
 Engineer : B. Schilling / Designed By: J. Fascione / Checked By: _____
 Ground Mounted

REV'D /

FILE : 51-6560

Sep 27, 2018

LETTER POSITIONS (X)										LENGTH	SERIES/SIZE
E	I	S	E	N	H	O	W	E	R		C 2000
4.5	7.2	8.4	11.3	14	17.1	20.2	23	26.6	29.3	27.1	4
I	N	T	E	R	S	T	A	T	E		C 2000
5.8	7.2	10	12.5	15.3	18	20.6	22.8	25.6	28.2	24.5	4
S	Y	S	T	E	M						C 2000
10	12.6	15.5	18.1	20.7	23.4					16	4

SIGN DETAIL

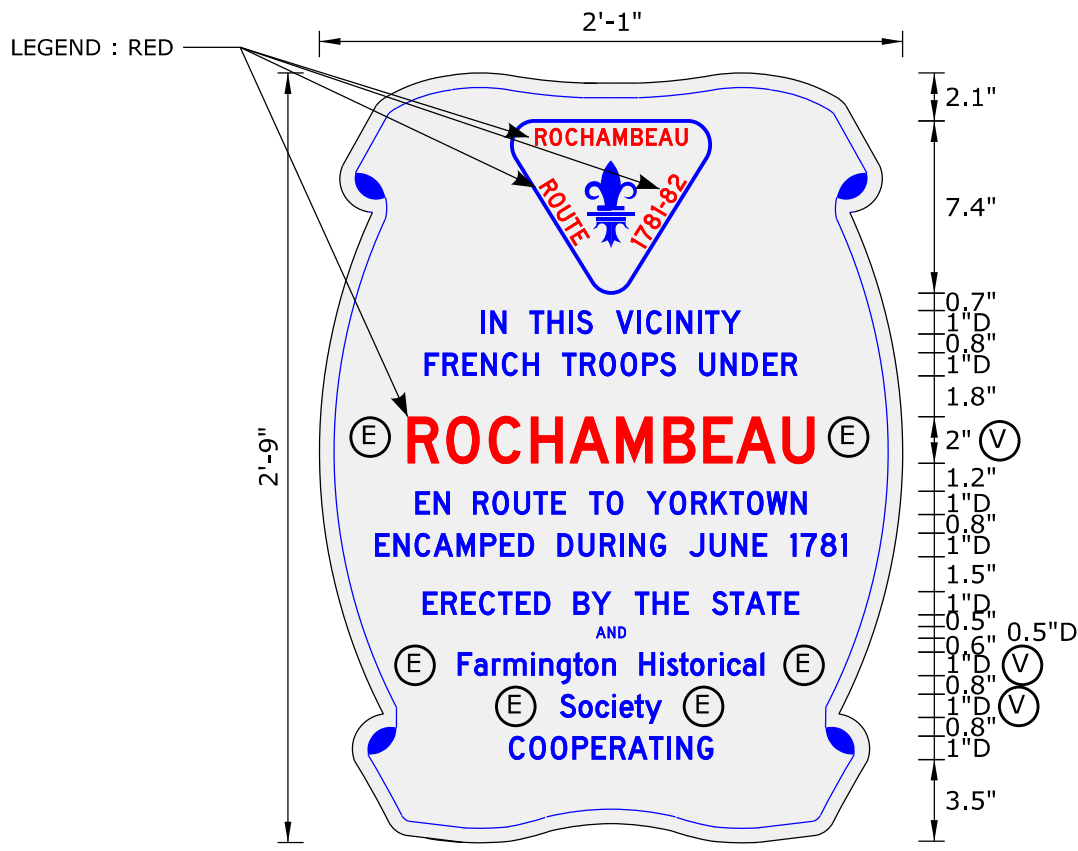

LEGEND/BORDER : BLUE (EXCEPT WHERE NOTED)
BACKGROUND : WHITE
LEGEND ON BOTH SIDES OF SIGN

SIGN NUMBER	51-6588
SIGN PANEL	5.73
EXIT CROWN	--
TOTAL (Sq.ft.)	5.73
BDR INSET/WIDTH	.625" / .25"
CORNER RADIUS	N/A
BACKGROUND	TYPE: * COLOR: See Sign
LEGEND/BORDER	TYPE: * COLOR: See Sign
* REFER TO CATALOG OF SIGNS FOR SHEETING TYPE, WHEN COLOR IS BLACK TYPE IS "PLAIN".	
REV'D /11	

- (E) EQUAL SPACING
- (V) VARIABLE LEGEND

SYMBOLS AND BARS ARE SOLID
DIMENSIONS ARE IN INCHES
MATERIAL : .080 THK.SHEET ALUMINUM
SIDE MOUNTED
SIGN SUPPORT NO. N/A
LOCATION :N/A
ENGINEER : PIO DESIGNED BY : GMF CHECKED BY : _____

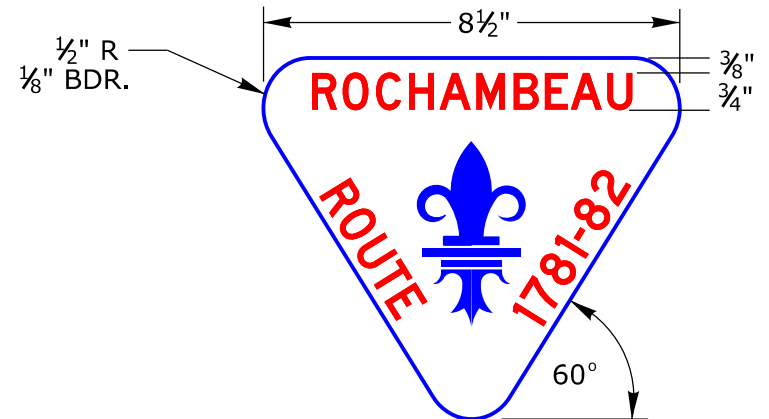

SIGN DETAIL

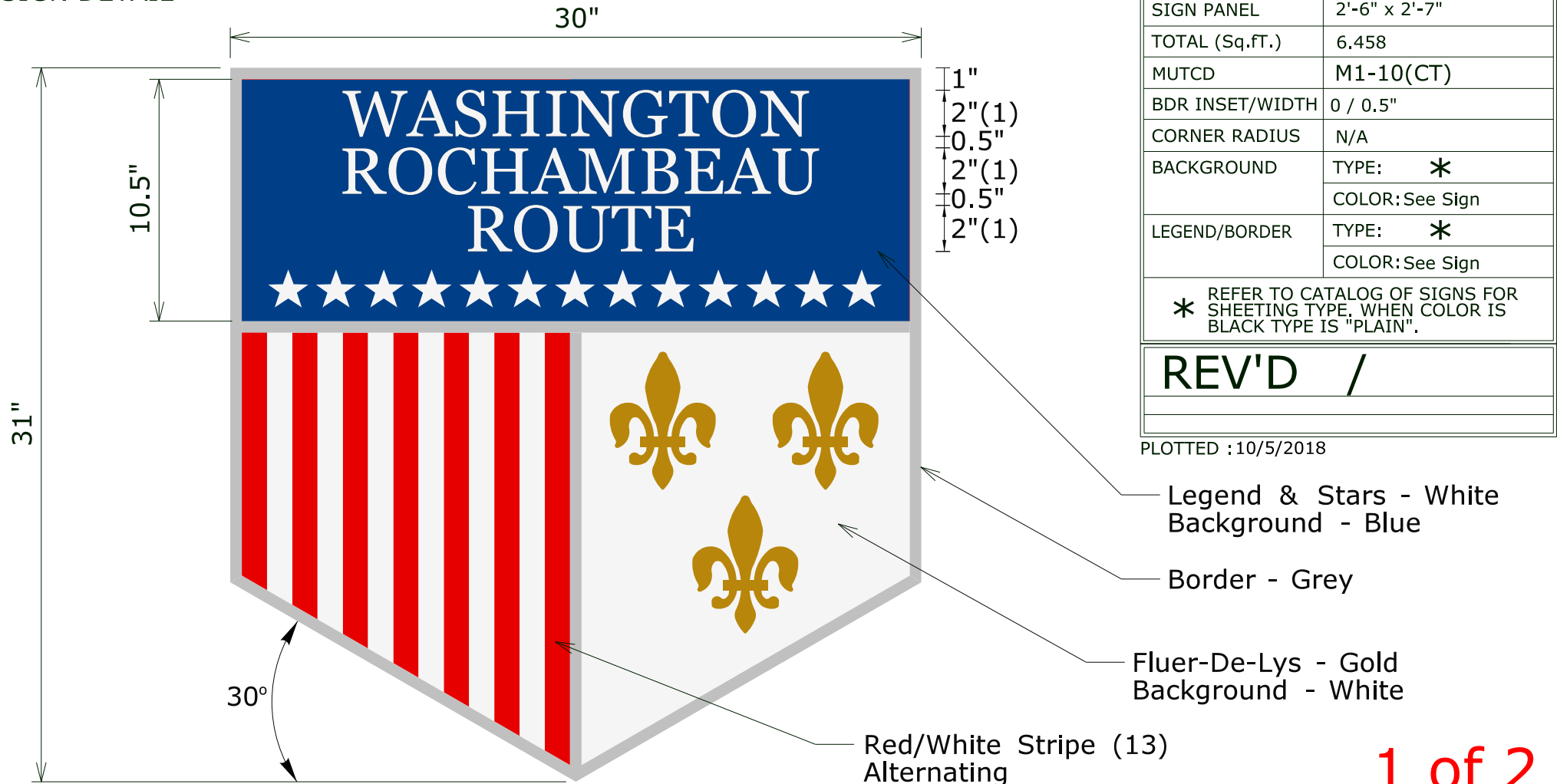

SIGN NUMBER	51-6589
SIGN PANEL	2'-6" x 2'-7"
TOTAL (Sq.ft.)	6.458
MUTCD	M1-10(CT)
BDR INSET/WIDTH	0 / 0.5"
CORNER RADIUS	N/A
BACKGROUND	TYPE: * COLOR: See Sign
LEGEND/BORDER	TYPE: * COLOR: See Sign
* REFER TO CATALOG OF SIGNS FOR SHEETING TYPE. WHEN COLOR IS BLACK TYPE IS "PLAIN".	

REV'D /

PLOTTED :10/5/2018

- Legend & Stars - White Background - Blue
- Border - Grey
- Fluer-De-Lys - Gold Background - White
- Red/White Stripe (13) Alternating

1 of 2

LETTER POSITIONS (X)										LENGTH	SERIES/SIZE
W	A	S	H	I	N	G	T	O	N		Vani
4.9	7.6	9.8	11.4	13.7	14.8	17	19.1	20.9	23	20.3	2
R	O	C	H	A	M	B	E	A	U		Vani
4.9	6.9	9	10.9	13.1	15.1	17.9	19.7	21.4	23.5	20.7	2
R	O	U	T	E							Vani
10.3	12.3	14.5	16.6	18.4						9.8	2

Dimensions are in inches.
 Material : .080 Thk. Sheet Aluminum
 Side Mounted
 Location : N/A
 Engineer : B. Schilling / Designed By : J. Fascione / Checked By :

WASHINGTON ROCHAMBEAU ROUTE

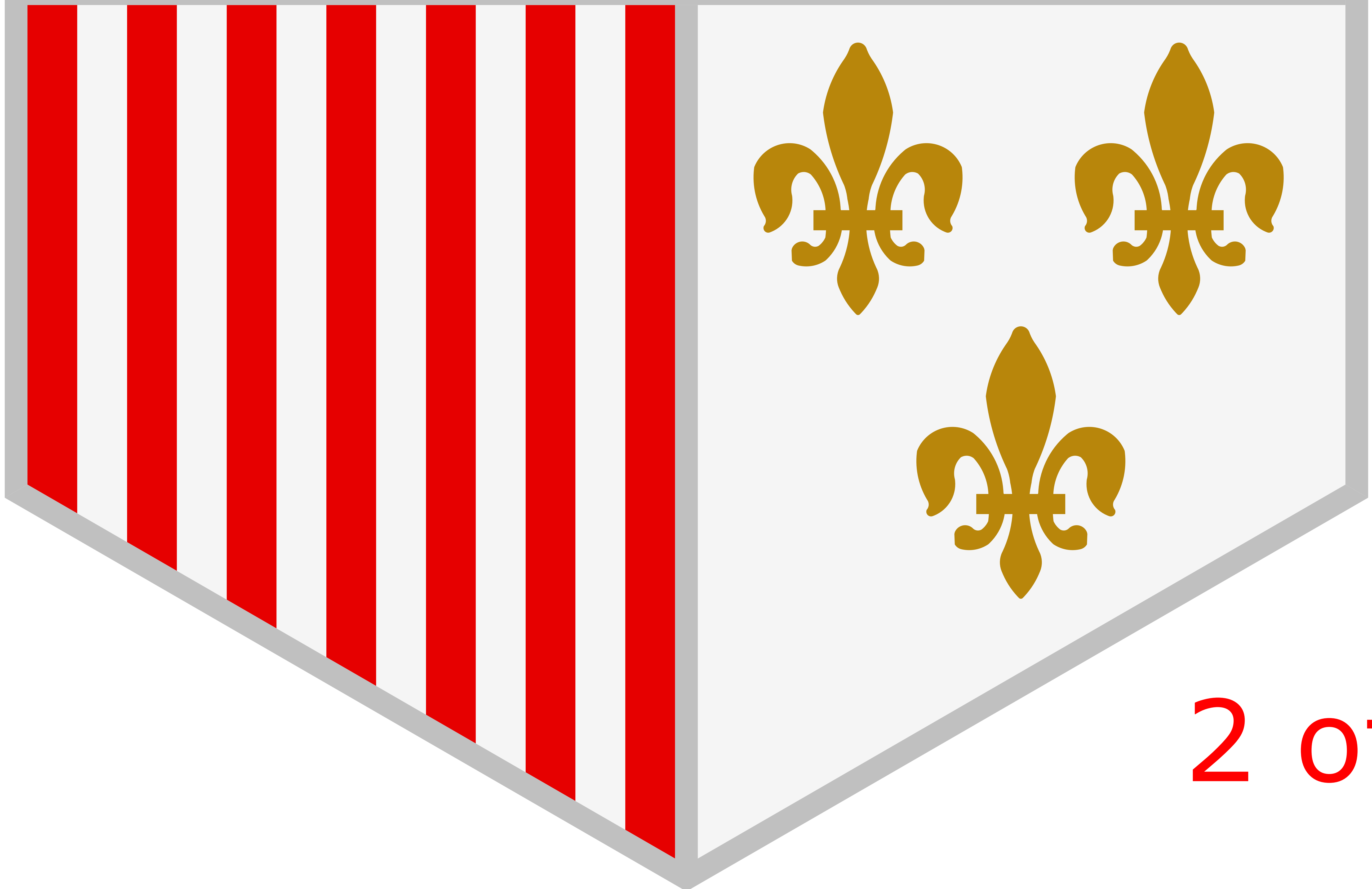

SIGN DETAIL

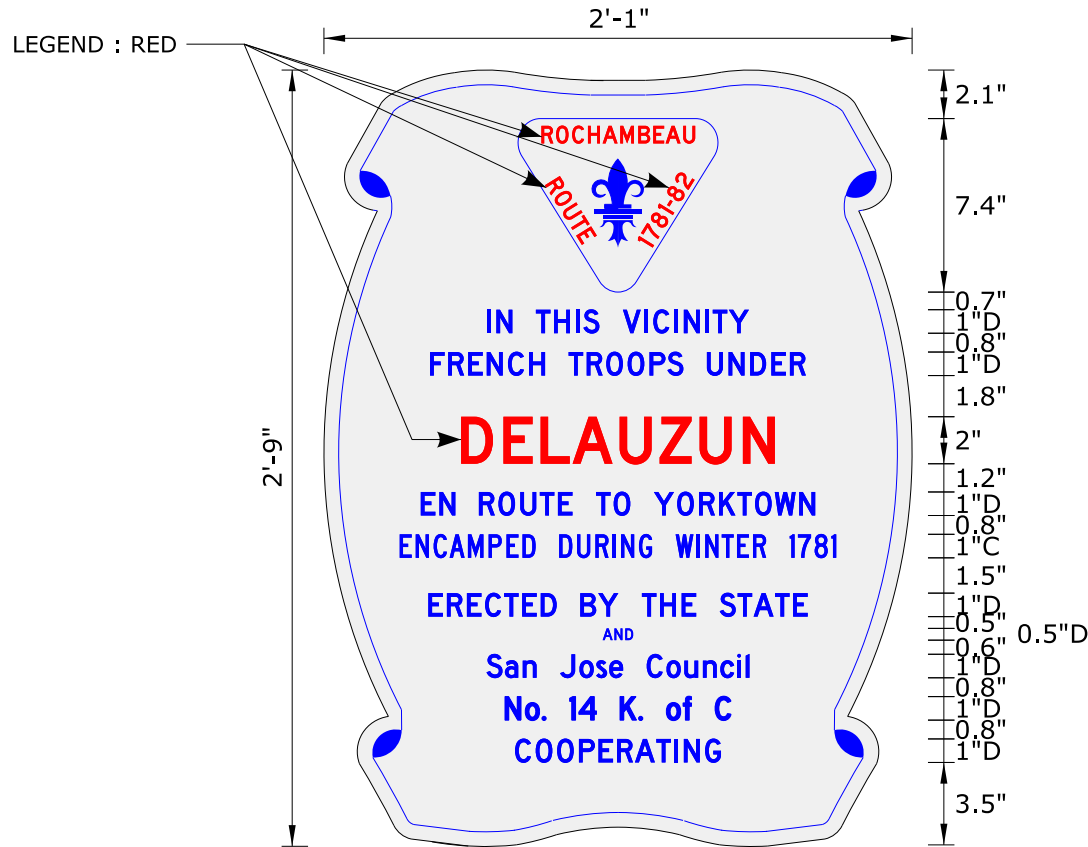

LEGEND/BORDER : BLUE (EXCEPT WHERE NOTED)
BACKGROUND : WHITE
LEGEND ON BOTH SIDES OF SIGN

SIGN NUMBER	51-6593
SIGN PANEL	5.73
TOTAL (Sq.ft.)	5.73
MUTCD	5.73
BDR INSET/WIDTH	M1-10 (CT)
CORNER RADIUS	N/A
BACKGROUND	TYPE: * COLOR: See Sign
LEGEND/BORDER	TYPE: * COLOR: See Sign
* REFER TO CATALOG OF SIGNS FOR SHEETING TYPE. WHEN COLOR IS BLACK TYPE IS "PLAIN".	

REV'D /11

DATE PLOTTED : 10/6/2018

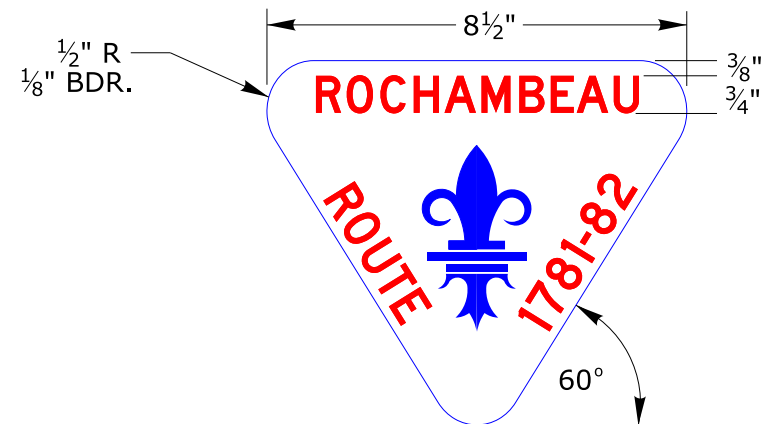

DIMENSIONS ARE IN INCHES
MATERIAL : .080 THK.SHEET ALUMINUM
SIDE MOUNTED
SIGN SUPPORT NO. N/A
LOCATION :N/A
ENGINEER : PIO DESIGNED BY : GMF CHECKED BY : _____

SIGN DETAIL

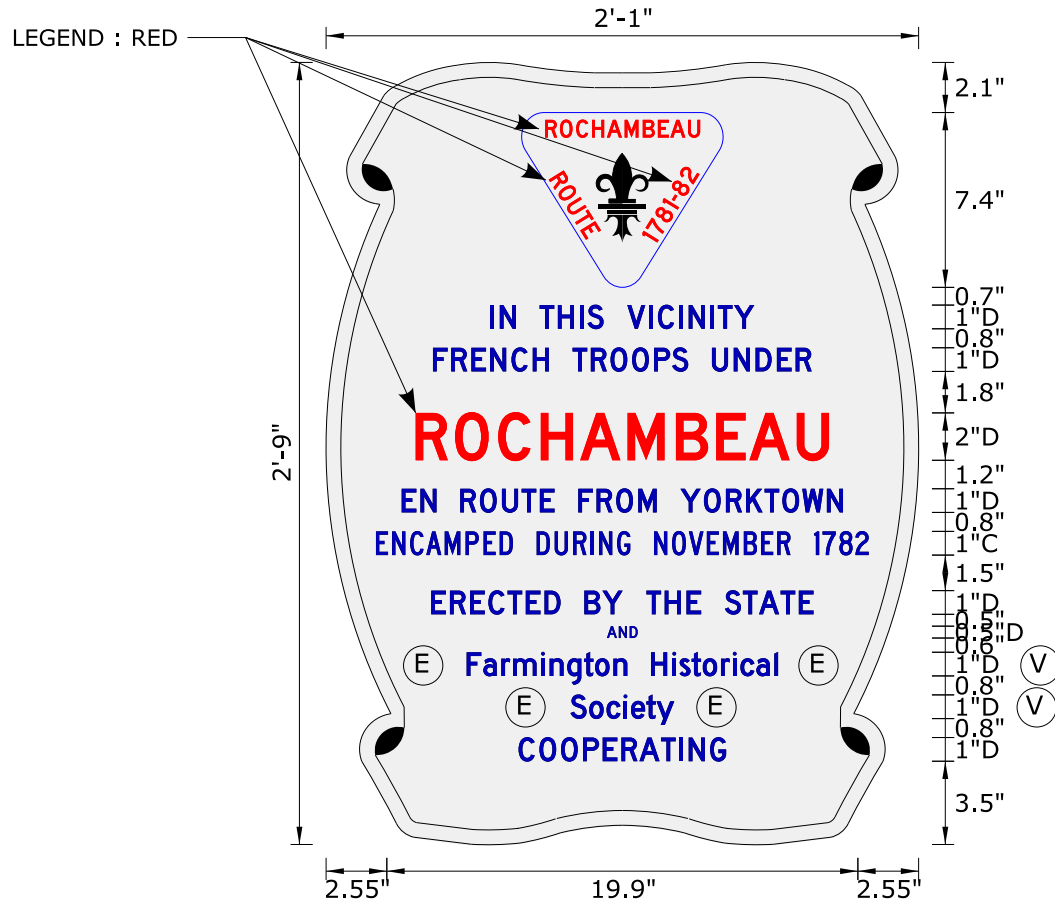

LEGEND/BORDER : BLUE (EXCEPT WHERE NOTED)
BACKGROUND : WHITE
LEGEND ON BOTH SIDES OF SIGN

SIGN NUMBER	51-6595
SIGN PANEL	5.73
TOTAL (Sq.ft.)	5.73
MUTCD	M1-10 (CT)
BDR INSET/WIDTH	.625" / .25"
CORNER RADIUS	N/A
BACKGROUND	TYPE: * COLOR: See Sign
LEGEND/BORDER	TYPE: * COLOR: See Sign
* REFER TO CATALOG OF SIGNS FOR SHEETING TYPE. WHEN COLOR IS BLACK TYPE IS "PLAIN".	

REV'D /11

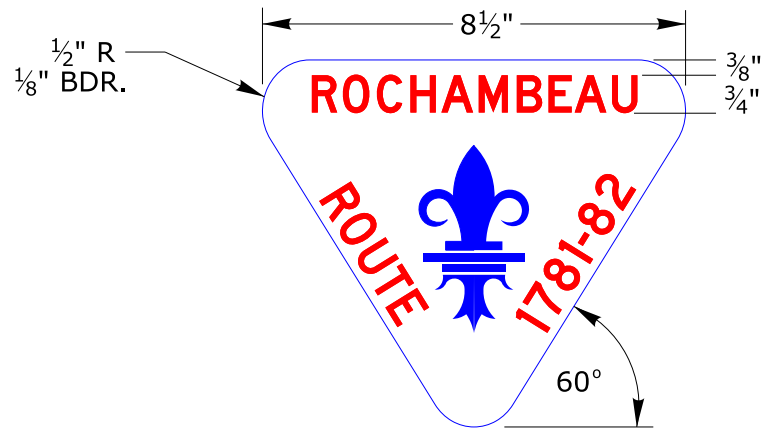

- (E) EQUAL SPACING
- (V) VARIABLE LEGEND
- SYMBOLS AND BARS ARE SOLID
- DIMENSIONS ARE IN INCHES
- MATERIAL : .080 THK.SHEET ALUMINUM
- SIDE MOUNTED
- SIGN SUPPORT NO. N/A
- LOCATION :N/A
- ENGINEER : PIO DESIGNED BY : GMF CHECKED BY : _____

SIGN DETAIL

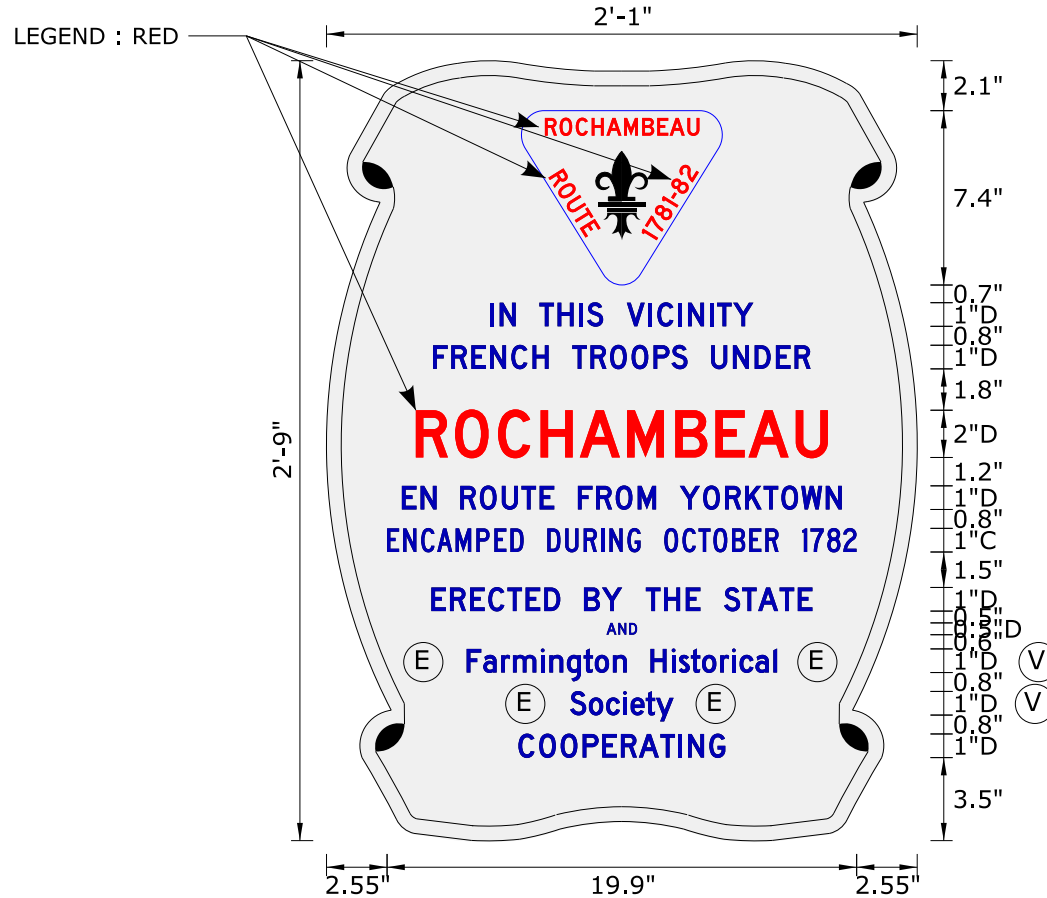

LEGEND/BORDER : BLUE (EXCEPT WHERE NOTED)
BACKGROUND : WHITE
LEGEND ON BOTH SIDES OF SIGN

SIGN NUMBER	51-6599
SIGN PANEL	5.73
TOTAL (Sq.ft.)	5.73
MUTCD	M1-10 (CT)
BDR INSET/WIDTH	.625" / .25"
CORNER RADIUS	N/A
BACKGROUND	TYPE: * COLOR: See Sign
LEGEND/BORDER	TYPE: * COLOR: See Sign
* REFER TO CATALOG OF SIGNS FOR SHEETING TYPE, WHEN COLOR IS BLACK TYPE IS "PLAIN".	

REV'D /11

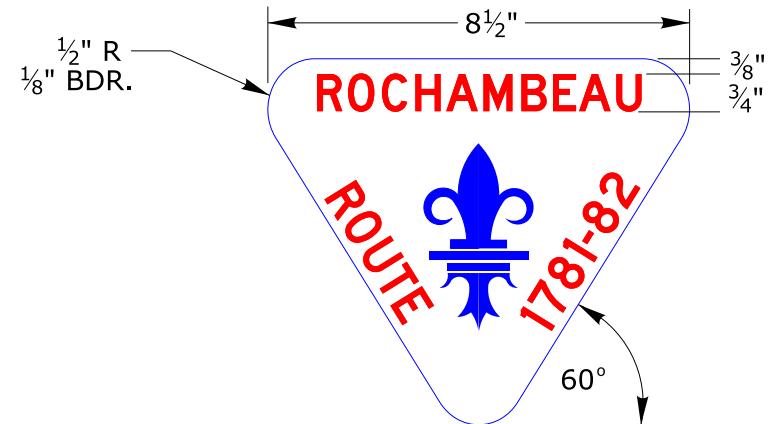

(E) EQUAL SPACING

(V) VARIABLE LEGEND

SYMBOLS AND BARS ARE SOLID

DIMENSIONS ARE IN INCHES

MATERIAL : .080 THK.SHEET ALUMINUM

SIDE MOUNTED

SIGN SUPPORT NO. N/A

LOCATION :N/A

ENGINEER : PIO DESIGNED BY : GMF CHECKED BY : _____

SIGN DETAIL

SIGN NUMBER	51-6615
SIGN PANEL	2'-0" x 2'-0"
TOTAL (Sq.ft.)	4.0
MUTCD	M1-4
BDR INSET/WIDTH	N/A
CORNER RADIUS	1.5"
BACKGROUND	TYPE: * COLOR: See Sign
LEGEND/SHIELD	TYPE: * COLOR: See Sign
* REFER TO CATALOG OF SIGNS FOR SHEETING TYPE, WHEN COLOR IS BLACK TYPE IS "PLAIN".	

REV'D /

PLOTTED : 5/31/2018

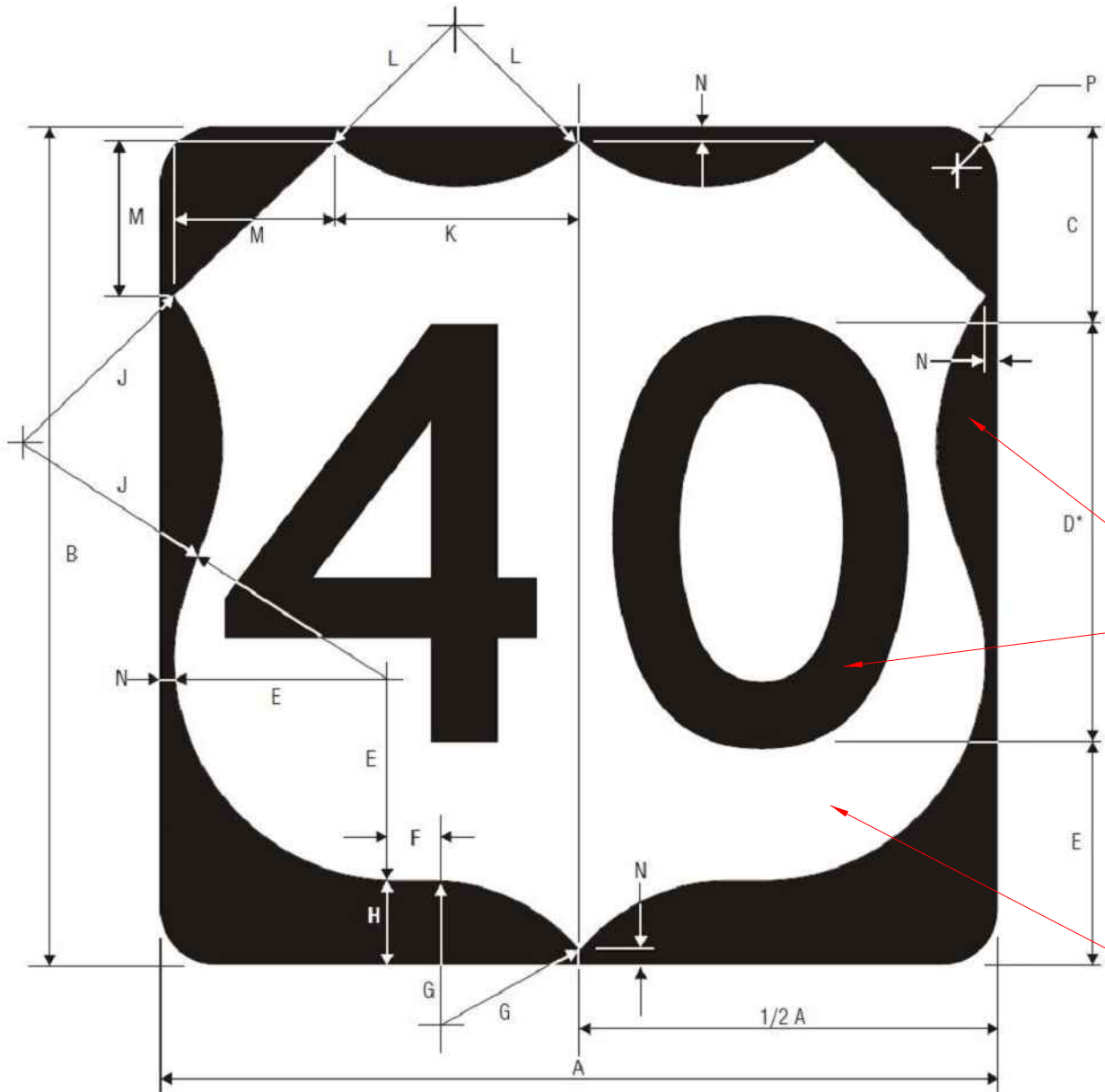

Color : Black

Color : White

A	B	C	D	E	F	G	H	J	K	L	M	N	P
24	24	5.5	12D	6.5	1	5.5	2.5	7.5	7	5.5	4.5	.5	1.5

Dimensions are in inches.
 Material : .080 Thk. Sheet Aluminum
 Side Mounted
 Location : N/A
 Engineer : B. Schilling / Designed By : J. Fascione / Checked By :

SIGN DETAIL

SIGN NUMBER	51-6635
SIGN PANEL	3'-0" x 3'-0"
TOTAL (Sq.ft.)	4.0
MUTCD	M1-4
BDR INSET/WIDTH	N/A
CORNER RADIUS	1.5"
BACKGROUND	TYPE: * COLOR: See Sign
LEGEND/SHIELD	TYPE: * COLOR: See Sign
* REFER TO CATALOG OF SIGNS FOR SHEETING TYPE, WHEN COLOR IS BLACK TYPE IS "PLAIN".	

REV'D /

PLOTTED : 6/1/2018

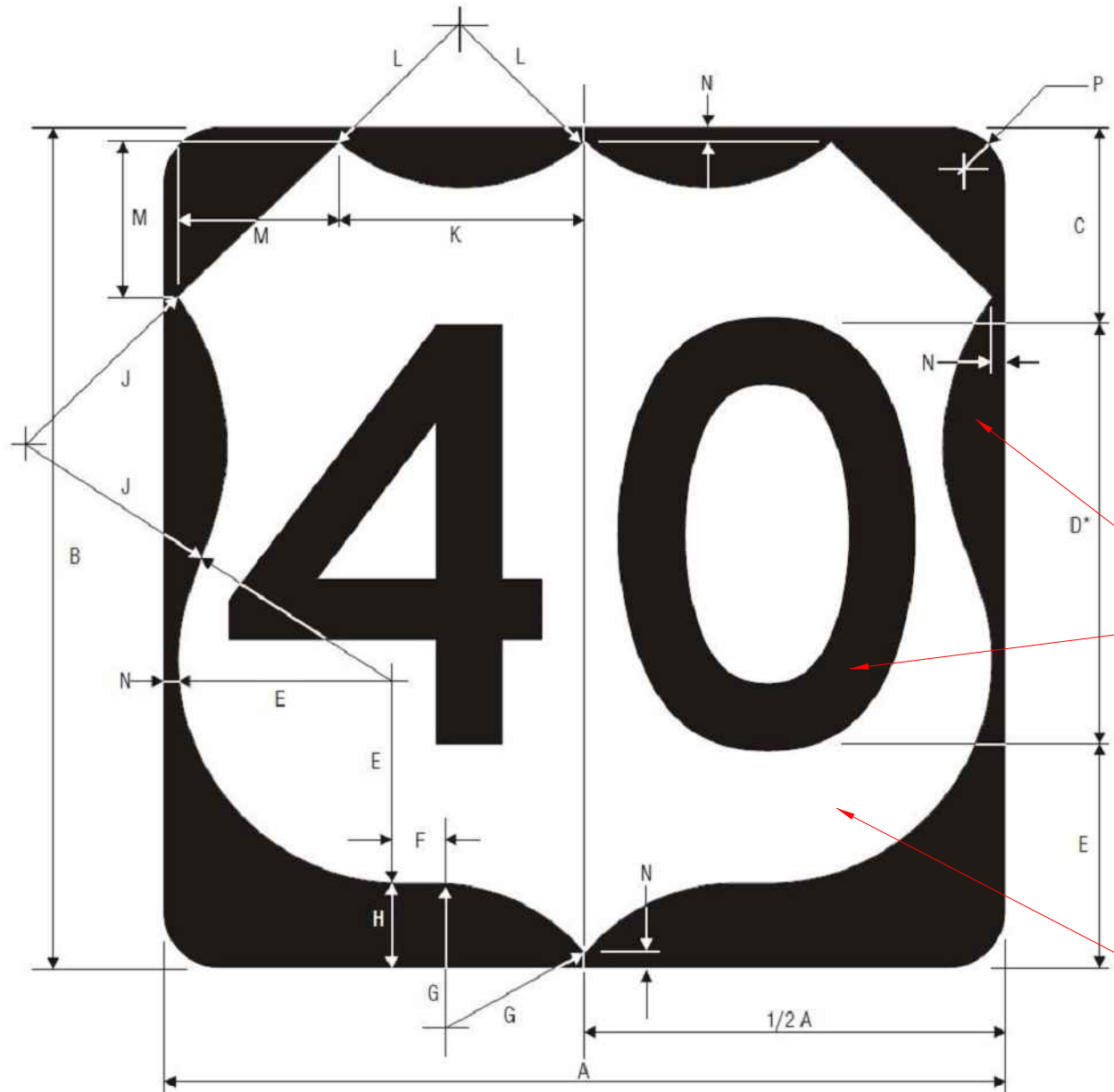

Color : Black

Color : White

A	B	C	D	E	F	G	H	J	K	L	M	N	P
36	36	8.25	18D	9.75	1.5	8.25	3.75	11.25	10.5	8.25	6.5	.75	2.25

Dimensions are in inches.

Material : .080 Thk. Sheet Aluminum

Side Mounted

Location : N/A

Engineer : B. Schilling / Designed By : J. Fascione / Checked By :

SIGN DETAIL
1:15

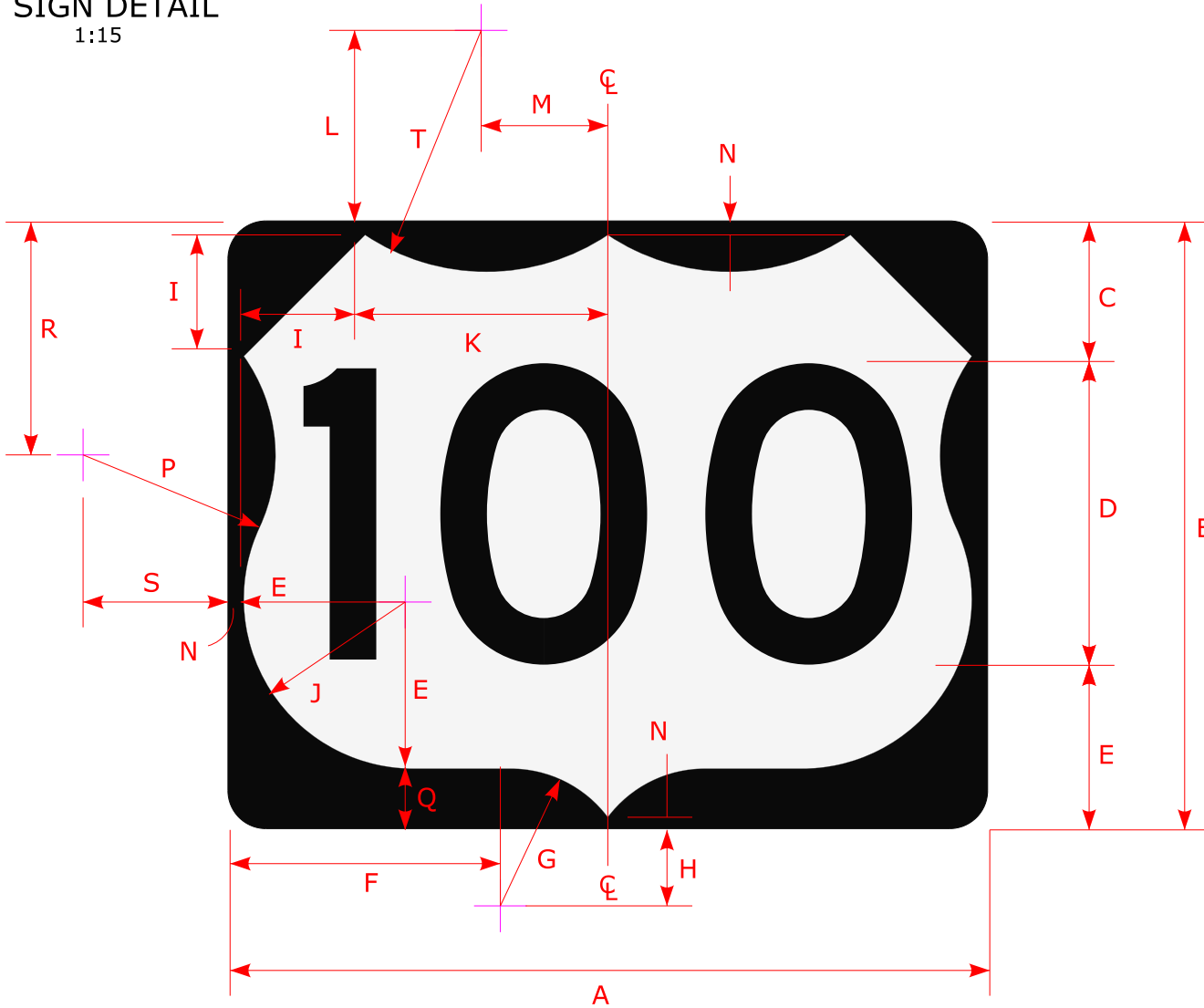

A	B	C	D	E	F	G	H	J	K	L	M	N	P
45	36	8.25	18d	9.75	5.5	8.25	3.75	11.25	15	14.25	605	.75	2.25

SIGN NUMBER	51-6645
PANEL SIZE	4'-9" X 3'-0"
SIGN AREA	11.25
MUTCD	M1-4
BDR INSET/WIDTH	0/0
CORNER RADIUS	2.25"
SHIELD	TYPE: *
	COLOR: White
LEGEND/ BACKGROUND	TYPE: *
	COLOR: Black/Black
* REFER TO CATALOG OF SIGNS FOR SHEETING TYPE. WHEN COLOR IS BLACK TYPE IS "PLAIN".	

SYMBOL	ROT	X	Y	WID	HT

FILE :\$FILES\$

REV'D /

\$DATE\$

Dimensions are in Inches
 Material : .080 Thick Sheet Aluminum
 Engineer : B. Schilling / Designed By: J. Fascione / Checked By: _____
 Ground Mounted

SIGN DETAIL



A	B	C	D	E	F	G	H	J	K	L	M
24	24	.5	7.625	10D	6.375	5	15	15	2	2.5C	7.658

SIGN NUMBER	51-6662
SIGN PANEL	2'-0" x 2'-0"
TOTAL (Sq.ft.)	4.0
MUTCD	M1-1
BDR INSET/WIDTH	See Sign
CORNER RADIUS	N/A
BACKGROUND	TYPE: * COLOR: See Sign
LEGEND/BORDER	TYPE: * COLOR: White/White

* REFER TO CATALOG OF SIGNS FOR SHEETING TYPE, WHEN COLOR IS BLACK TYPE IS "PLAIN".

REV'D /

PLOTTED : 6/7/2018

Dimensions are in inches.
 Material : .080 Thk. Sheet Aluminum
 Side Mounted
 Location : N/A
 Engineer : B. Schilling / Designed By : J. Fascione / Checked By :

SIGN DETAIL

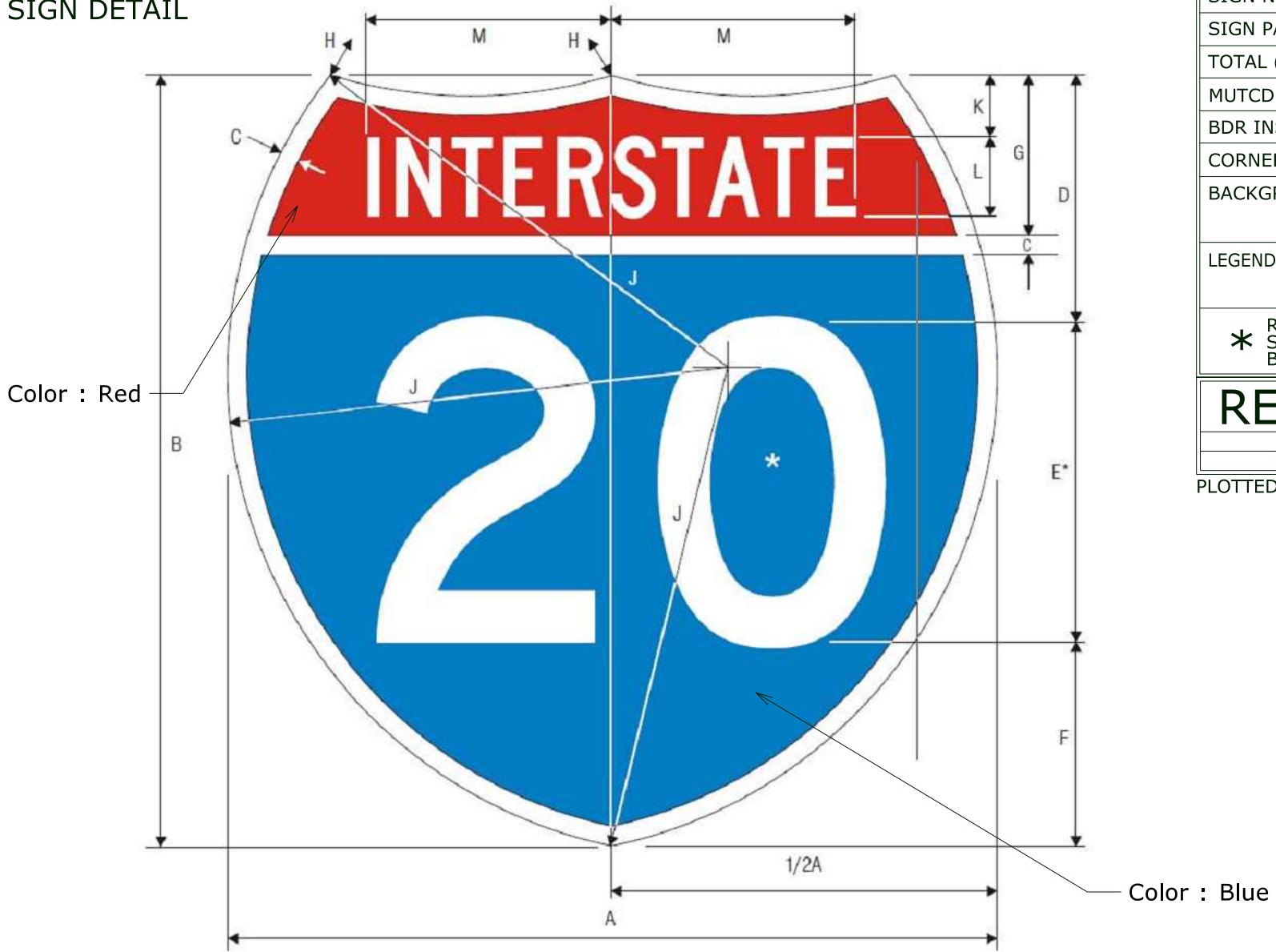

A	B	C	D	E	F	G	H	J	K	L	M
36	36	.75	11.5	15D	9.5	7.5	22.5	22.5	2.75	4C	12.246

SIGN NUMBER	51-6666
SIGN PANEL	3'-0" x 3'-0"
TOTAL (Sq.ft.)	9.0
MUTCD	M1-1
BDR INSET/WIDTH	See Sign
CORNER RADIUS	N/A
BACKGROUND	TYPE: * COLOR: See Sign
LEGEND/BORDER	TYPE: * COLOR: White/White
* REFER TO CATALOG OF SIGNS FOR SHEETING TYPE, WHEN COLOR IS BLACK TYPE IS "PLAIN".	

REV'D /

PLOTTED : 6/8/2018

Dimensions are in inches.
 Material : .080 Thk. Sheet Aluminum
 Side Mounted
 Location : N/A
 Engineer : B. Schilling / Designed By : J. Fascione / Checked By :

SIGN DETAIL

1:8

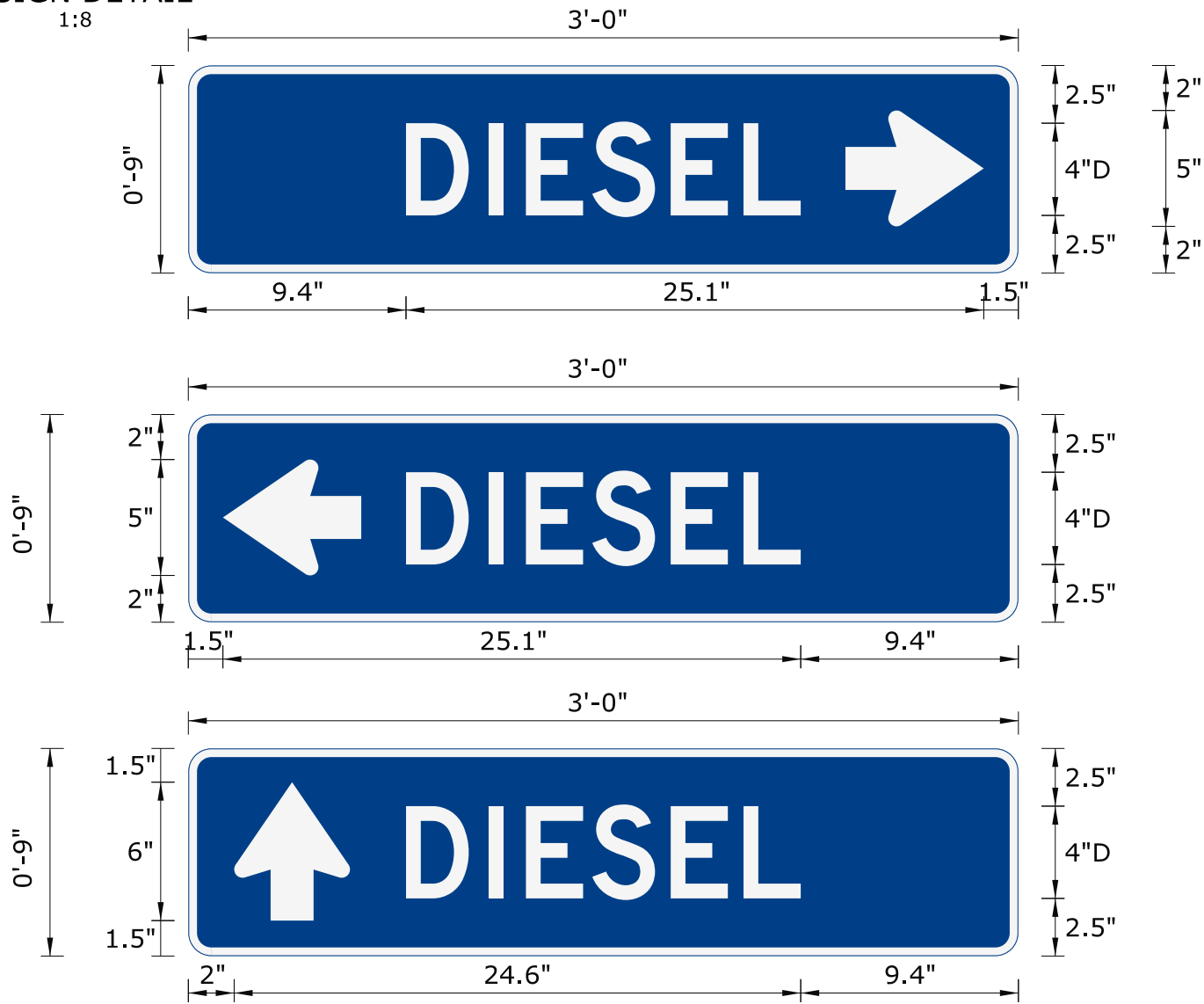

SIGN NUMBER	51-6705
PANEL SIZE	3'-0" x 0'-9"
SIGN AREA	2.3 Sq.Ft.
MUTCD	D9-11 (CT)
BDR INSET/WIDTH	0" / 0.38"
CORNER RADIUS	1"
BACKGROUND	TYPE: *
	COLOR: Blue
LEGEND/BORDER	TYPE: *
	COLOR: White/White
* REFER TO CATALOG OF SIGNS FOR SHEETING TYPE. WHEN COLOR IS BLACK TYPE IS "PLAIN".	

SYMBOL	ROT	X	Y	WID	HT
AR_Type D4 RT	270	28.5	2	5	6
AR_Type D4 LT	90	1.5	2	5	6
AR_Type D4 ST	0	2	1.5	5	6

FILE : 51-6705

Dec 08, 2018

Dimensions are in Inches

Material : .080 Thick Sheet Aluminum

Engineer : B. Schilling / Designed By: J. Fascione / Checked By: _____

Ground Mounted

LETTER POSITIONS (X)																	LENGTH	SERIES/SIZE	
	D	I	E	S	E	L												D 2000	
9.4	3.6	1.6	2.9	3.4	3.2	2.5	9.4											17.1	4

SIGN DETAIL

1:8

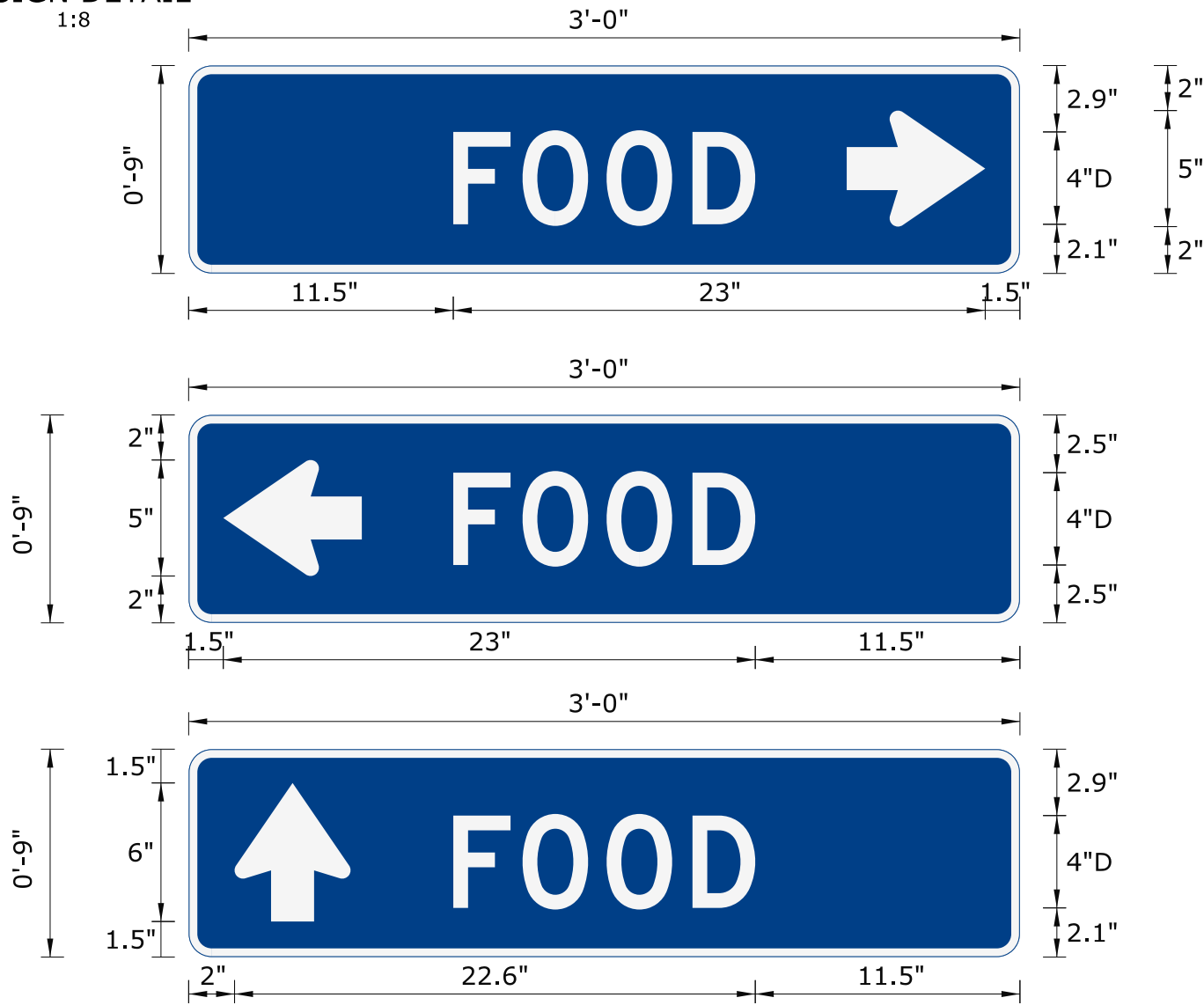

SIGN NUMBER	51-6706
PANEL SIZE	3'-0" x 0'-9"
SIGN AREA	2.3 Sq.Ft.
MUTCD	D9-8 (CT)
BDR INSET/WIDTH	0" / 0.38"
CORNER RADIUS	1"
BACKGROUND	TYPE: *
	COLOR: Blue
LEGEND/BORDER	TYPE: *
	COLOR: White/White
* REFER TO CATALOG OF SIGNS FOR SHEETING TYPE. WHEN COLOR IS BLACK TYPE IS "PLAIN".	

SYMBOL	ROT	X	Y	WID	HT
AR_Type D4 RT	270	28.5	2	5	6
AR_Type D4 LT	90	1.5	2	5	6
AR_Type D4 ST	0	2	1.5	5	6

FILE : 51-6706

Dec 08, 2018

Dimensions are in Inches

Material : .080 Thick Sheet Aluminum

Engineer : B. Schilling / Designed By: J. Fascione / Checked By: _____

Ground Mounted

LETTER POSITIONS (X)															LENGTH	SERIES/SIZE	
	F	O	O	D												D 2000	
11.5	3	3.6	3.7	2.7	11.5											13.1	4

SIGN DETAIL
1:12

**BUSINESS PANEL
FOR FREEWAY**

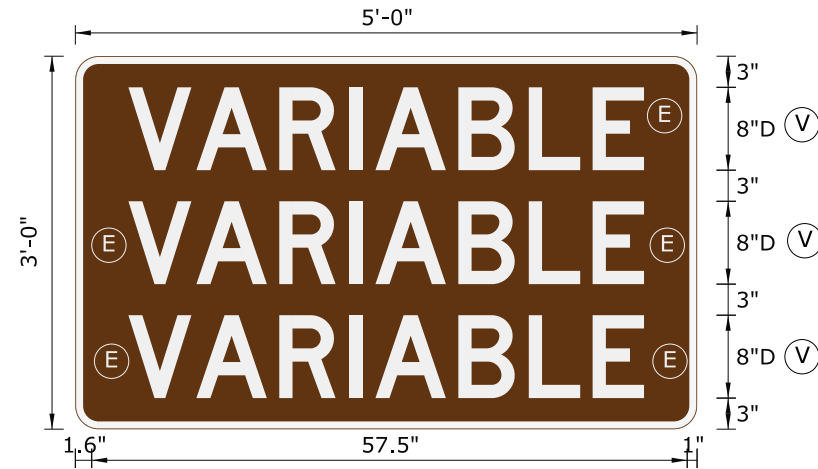
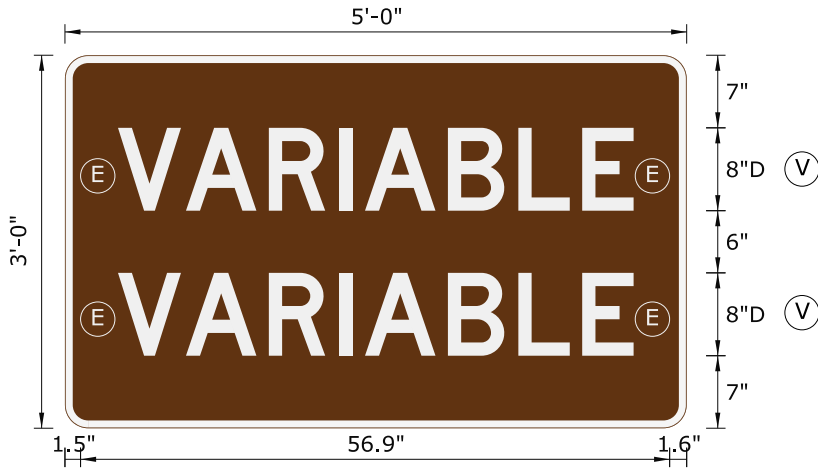

NOTES FOR NON-LOGO BUSINESS PANEL

BACKGROUND COLOR :

- BROWN : AMUSEMENT PARK, CULTURAL CENTER, RECREATIONAL AREA, MUSEUM, ETC.

NOTES FOR LOGO BUSINESS PANEL

- SUBMIT TO THE DIVISION OF TRAFFIC ENGINEERING FOR REVIEW AND APPROVAL.

SIGN NUMBER	51-6731
SIGN PANEL	15.0
EXIT CROWN	--
TOTAL (Sq.ft.)	15.0
BDR INSET/WIDTH	0" / 0.75"
CORNER RADIUS	2.25"
BACKGROUND FOR NON-LOGO BUSINESS PANEL	TYPE: * COLOR: Brown
LEGEND/BORDER FOR NON-LOGO BUSINESS PANEL	TYPE: * COLOR: White/White
BACKGROUND FOR LOGO BUSINESS PANEL	TYPE: * COLOR: Variable
LEGEND/BORDER FOR LOGO BUSINESS PANEL	TYPE: * COLOR: Variable
* REFER TO CATALOG OF SIGNS FOR SHEETING TYPE, WHEN COLOR IS BLACK TYPE IS "PLAIN".	

SYMBOL	ROT	X	Y	WID	HT

REV'D 6/18
Revised letter Series from B to D.

PLOTTED : 12/27/2018

- (E) EQUAL SPACING
- (V) VARIABLE LEGEND OR LOGO TO FIT 60" x 36" SIGN :
 - * SERIES "D" UP TO 8 CHARACTERS MAX PER LINE.
 - * SERIES "C" UP TO 9 OR 10 CHARACTERS MAX PER LINE.

DIMENSIONS ARE IN INCHES

MATERIAL : .040 THK.SHEET ALUMINUM

OVERLAY PANEL

SIGN SUPPORT NO. N/A

LOCATION : TO BE USED WITH 52-6747, 52-6748, 52-6750, 52-6756, & TP-1283

ENGINEER : B. SCHILLING DESIGNED BY : J. FASCIONE CHECKED BY : _____

SIGN DETAIL
1:35

TRAILBLAZER FOR RAMPS

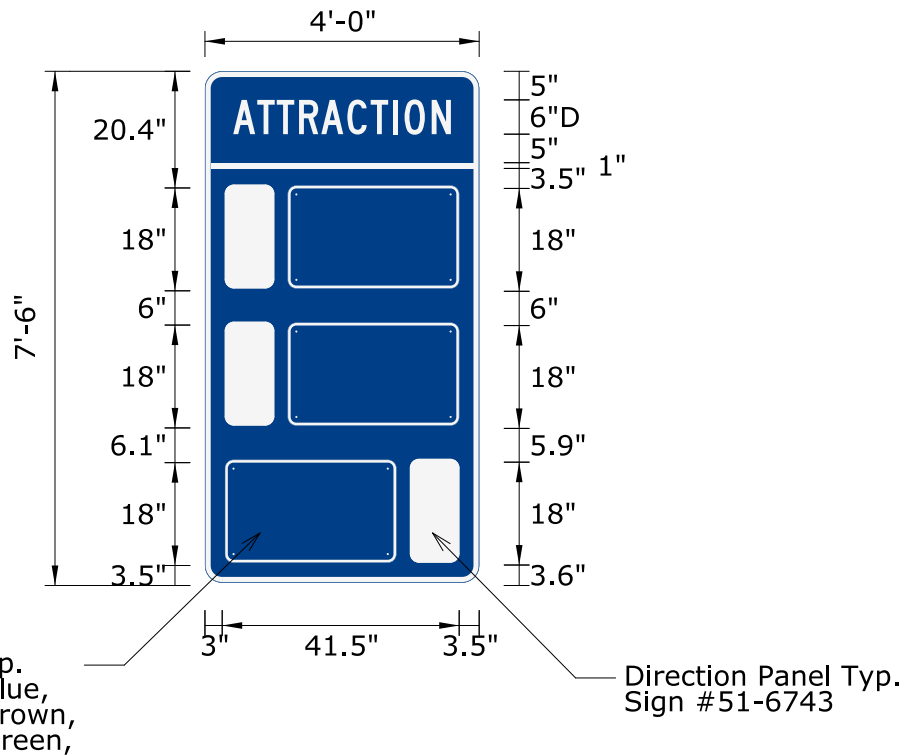

SIGN NUMBER	51-6732
PANEL SIZE	4'-0" x 7'-6"
SIGN AREA	30.0 Sq.Ft.
MUTCD	
BDR INSET/WIDTH	0" / 1"
CORNER RADIUS	3"
BACKGROUND	TYPE: *
	COLOR: Blue
LEGEND/BORDER	TYPE: *
	COLOR: White/White
* REFER TO CATALOG OF SIGNS FOR SHEETING TYPE. WHEN COLOR IS BLACK TYPE IS "PLAIN".	

SYMBOL	ROT	X	Y	WID	HT
Direction Panel	0	3.5	51.6	8.5	18
Business Panel	0	14.5	51.5	30	18
Direction Panel	0	3	27.6	8.5	18
Business Panel	0	14.5	27.5	30	18
Business Panel	0	4	3.5	30	18
Direction Panel	0	36	3.6	8.5	18

PANEL PLACEMENT ORDER:

1. DIRECTIONAL PANELS FOR THROUGH AND LEFT TURN MOVEMENTS (SIGN #51-6743) SHALL BE INSTALLED TO THE LEFT OF THE BUSINESS PANELS.
2. DIRECTIONAL PANELS FOR RIGHT TURN MOVEMENTS (SIGN #51-6743) SHALL BE INSTALLED TO THE RIGHT OF THE BUSINESS PANELS.
3. BUSINESS PANELS SHALL BE INSTALLED BASED ON DIRECTION OF TRAVEL AND DISTANCE TO THE DESTINATION IN THE FOLLOWING ORDER:
 - A. THROUGH (FROM NEAREST TO FARTHEST)
 - B. LEFT (FROM NEAREST TO FARTHEST)
 - C. RIGHT (FROM NEAREST TO FARTHEST)

Dimensions are in Inches
 Material : .125 Thick Sheet Aluminum
 Mounted : Ground
 Division of Traffic Engineering

FILE :51-6732

July 2, 2019

LETTER POSITIONS (X)

	A	T	T	R	A	C	T	I	O	N											LENGTH	SERIES/SIZE
																						C 2000
5	4.2	3.4	3.9	3.9	4.6	4.1	3.9	2	4.7	3.4	4.9										38.1	6

SIGN DETAIL
1:12

**BUSINESS PANEL
FOR FREEWAY**

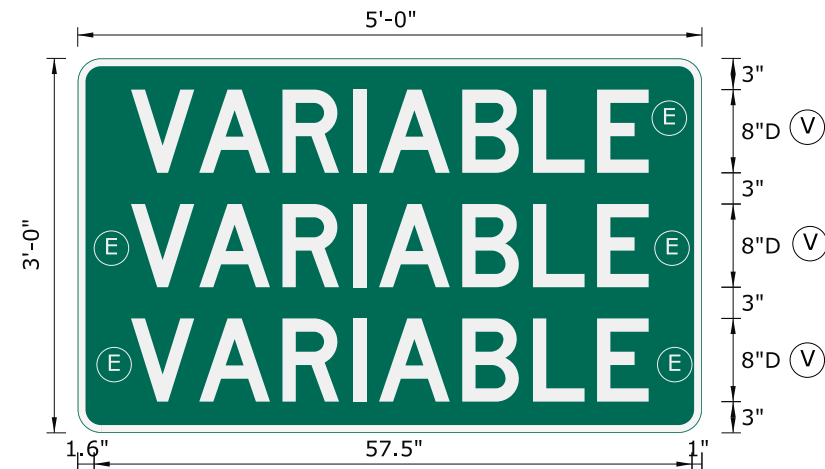
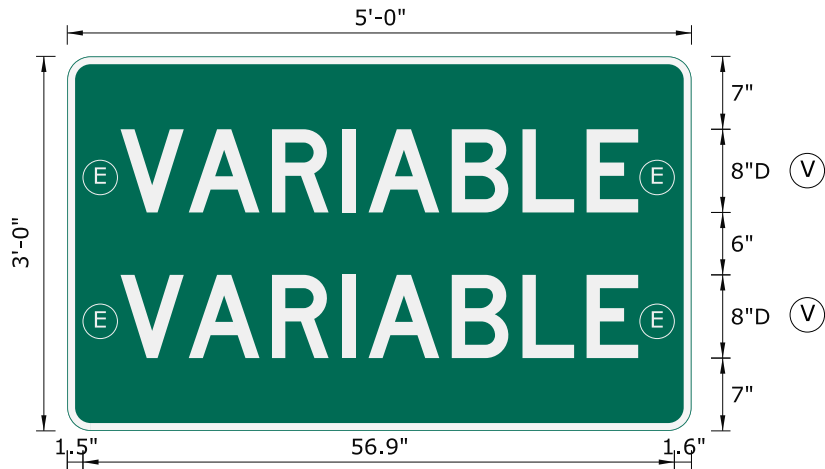

NOTES FOR NON-LOGO BUSINESS PANEL

BACKGROUND COLOR :

- GREEN : COLLEGE, UNIVERSITY, ETC.

NOTES FOR LOGO BUSINESS PANEL

- SUBMIT TO THE DIVISION OF TRAFFIC ENGINEERING FOR REVIEW AND APPROVAL.

SIGN NUMBER	51-6733
SIGN PANEL	15.0
EXIT CROWN	--
TOTAL (Sq.ft.)	15.0
BDR INSET/WIDTH	0" / 0.75"
CORNER RADIUS	2.25"
BACKGROUND FOR NON-LOGO BUSINESS PANEL	TYPE: *
	COLOR: Green
LEGEND/BORDER FOR NON-LOGO BUSINESS PANEL	TYPE: *
	COLOR: White/White
BACKGROUND FOR LOGO BUSINESS PANEL	TYPE: *
	COLOR: Variable
LEGEND/BORDER FOR LOGO BUSINESS PANEL	TYPE: *
	COLOR: Variable
* REFER TO CATALOG OF SIGNS FOR SHEETING TYPE, WHEN COLOR IS BLACK TYPE IS "PLAIN".	

SYMBOL	ROT	X	Y	WID	HT

REV'D 6/18
Revised letter Series from B to D.

PLOTTED : 12/27/2018

- (E) EQUAL SPACING
- (V) VARIABLE LEGEND OR LOGO TO FIT 60" x 36" SIGN :
 - * SERIES "D" UP TO 8 CHARACTERS MAX PER LINE.
 - * SERIES "C" UP TO 9 OR 10 CHARACTERS MAX PER LINE.

DIMENSIONS ARE IN INCHES
 MATERIAL : .040 THK.SHEET ALUMINUM
 OVERLAY PANEL
 SIGN SUPPORT NO. N/A
 LOCATION : TO BE USED WITH 52-6747, 52-6748, 52-6750, 52-6756, & TP-1283
 ENGINEER : B. SCHILLING DESIGNED BY : J. FASCIONE CHECKED BY : _____

SIGN DETAIL
1:12

**BUSINESS PANEL FOR
RAMPS & COVENTIONAL
ROADWAYS**

2 LINES USE 4" B OR C LETTERS.

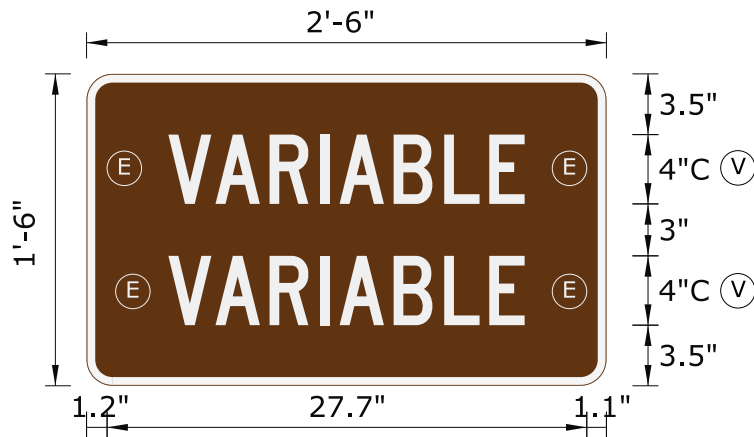

3 LINES USE 3" B OR C LETTERS.

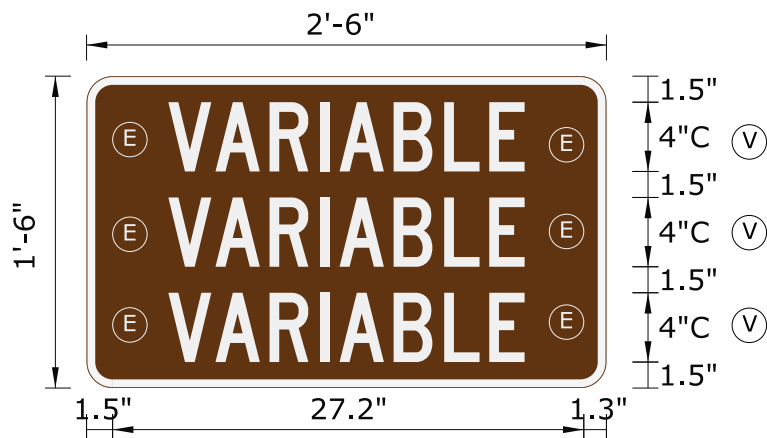

NOTES FOR NON-LOGO BUSINESS PANEL

BACKGROUND COLOR :

- BROWN : AMUSEMENT PARK, CULTURAL CENTER, RECREATIONAL AREA, MUSEUM, ETC.

NOTES FOR LOGO BUSINESS PANEL

- SUBMIT TO THE DIVISION OF TRAFFIC ENGINEERING FOR REVIEW AND APPROVAL.

SIGN NUMBER	51-6737
SIGN PANEL	3.75
EXIT CROWN	--
TOTAL (Sq.ft.)	3.75
BDR INSET/WIDTH	0" / 0.5"
CORNER RADIUS	1.5"
BACKGROUND FOR NON-LOGO BUSINESS PANEL	TYPE: *
	COLOR: Brown
LEGEND/BORDER FOR NON-LOGO BUSINESS PANEL	TYPE: *
	COLOR: White/White
BACKGROUND FOR LOGO BUSINESS PANEL	TYPE: *
	COLOR: Variable
LEGEND/BORDER FOR LOGO BUSINESS PANEL	TYPE: *
	COLOR: Variable
* REFER TO CATALOG OF SIGNS FOR SHEETING TYPE. WHEN COLOR IS BLACK TYPE IS "PLAIN".	

SYMBOL	ROT	X	Y	WID	HT

REV'D 6/14

ADDED NOTES FOR LOGO PANEL AND UPDATED BORDER FOR LOGO PANEL.

(E) EQUAL SPACING

(V) VARIABLE LEGEND OR LOGO TO FIT 30" x 18" SIGN :

- * SERIES "C" UP TO 8 CHARACTERS MAX PER LINE.
- * SERIES "B" UP TO 9 OR 10 CHARACTERS MAX PER LINE.

DIMENSIONS ARE IN INCHES

MATERIAL : .040 THK.SHEET ALUMINUM

OVERLAY PANEL TO BE USED WITH 51-6752 AND 51-6755

SIGN SUPPORT NO. N/A

LOCATION : N/A

ENGINEER : B. SCHILLING DESIGNED BY : J. FASCIONE CHECKED BY : _____

SIGN DETAIL

1:45

TRAILBLAZER FOR RAMPS

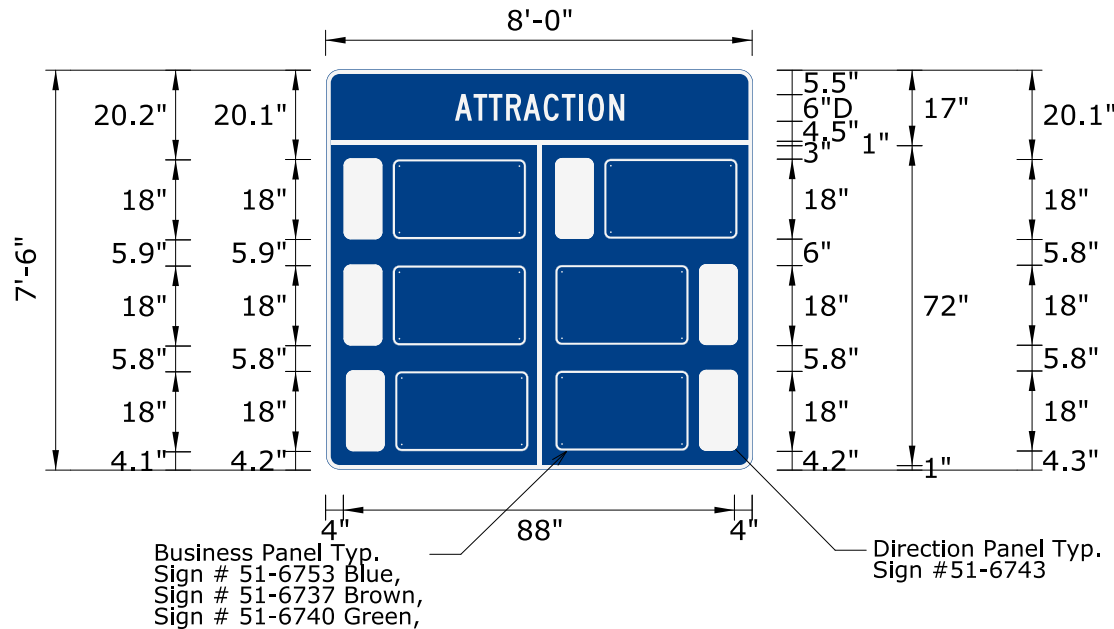

SIGN NUMBER	51-6739
PANEL SIZE	8'-0" x 7'-6"
SIGN AREA	60.0 Sq.Ft.
MUTCD	
BDR INSET/WIDTH	0" / 1"
CORNER RADIUS	3"
BACKGROUND	TYPE: * COLOR: Blue
LEGEND/BORDER	TYPE: * COLOR: White/White
* REFER TO CATALOG OF SIGNS FOR SHEETING TYPE. WHEN COLOR IS BLACK TYPE IS "PLAIN".	

SYMBOL	ROT	X	Y	WID	HT
Direction Panel	0	4	51.9	8.5	18
Business Panel	0	15	51.8	30	18
Direction Panel	0	51.1	52	8.5	18
Business Panel	0	62	51.9	30	18
Direction Panel	0	4	28	8.5	18
Business Panel	0	15	27.9	30	18
Business Panel	0	51.5	28	30	18
Direction Panel	0	83.5	28.1	8.5	18
Direction Panel	0	4	4.2	8.5	18
Business Panel	0	15	4.1	30	18
Business Panel	0	51.5	4.2	30	18
Direction Panel	0	83.5	4.3	8.5	18

PANEL PLACEMENT ORDER:

1. DIRECTIONAL PANELS FOR THROUGH AND LEFT TURN MOVEMENTS (SIGN #51-6743) SHALL BE INSTALLED TO THE LEFT OF THE BUSINESS PANELS.
2. DIRECTIONAL PANELS FOR RIGHT TURN MOVEMENTS (SIGN #51-6743) SHALL BE INSTALLED TO THE RIGHT OF THE BUSINESS PANELS.
3. BUSINESS PANELS SHALL BE INSTALLED BASED ON THE DIRECTION OF TRAVEL AND DISTANCE TO THE DESTINATION IN THE FOLLOWING ORDER FROM NEAREST TO FARTHEST:
 - A. THROUGH MOVEMENT: ON THE TOP OF THE SIGN FROM LEFT TO RIGHT, AND FROM TOP TO BOTTOM, STARTING IN THE LEFT CORNER. IF APPLICABLE, THE THIRD AND FOURTH THROUGH PANELS TO BE INSTALLED IN THE SECOND ROW FROM LEFT TO RIGHT. IF APPLICABLE, THE FIFTH AND SIXTH THROUGH PANELS TO BE INSTALLED IN THE THIRD ROW FROM LEFT TO RIGHT.
 - B. LEFT TURN MOVEMENT: STARTING IN THE LEFT COLUMN BELOW THE THROUGH PANELS, FROM TOP TO BOTTOM. IF NOT ENOUGH SPACE IS AVAILABLE IN THE LEFT COLUMN, REMAINING LEFT PANELS TO BE INSTALLED IN THE RIGHT COLUMN BELOW THE THROUGH AND RIGHT PANELS.
 - C. RIGHT TURN MOVEMENT: STARTING IN THE RIGHT COLUMN BELOW THE THROUGH PANELS, FROM TOP TO BOTTOM. IF NOT ENOUGH SPACE IS AVAILABLE IN THE RIGHT COLUMN, REMAINING RIGHT PANELS TO BE INSTALLED IN THE LEFT COLUMN BELOW THE THROUGH AND LEFT PANELS.

Dimensions are in Inches
 Material : .125 Thick Sheet Aluminum
 Mounted : Ground
 Division of Traffic Engineering

FILE :51-6739

July 2, 2019

LETTER POSITIONS (X)

	A	T	T	R	A	C	T	I	O	N												LENGTH	SERIES/SIZE
																							C 2000
29	4.2	3.4	3.9	3.9	4.6	4.1	3.9	2	4.7	3.4	29											38.1	6

SIGN DETAIL

1:12

**BUSINESS PANEL FOR
RAMPS & COVENTIONAL
ROADWAYS**

2 LINES USE 4" B OR C LETTERS.

2'-6"

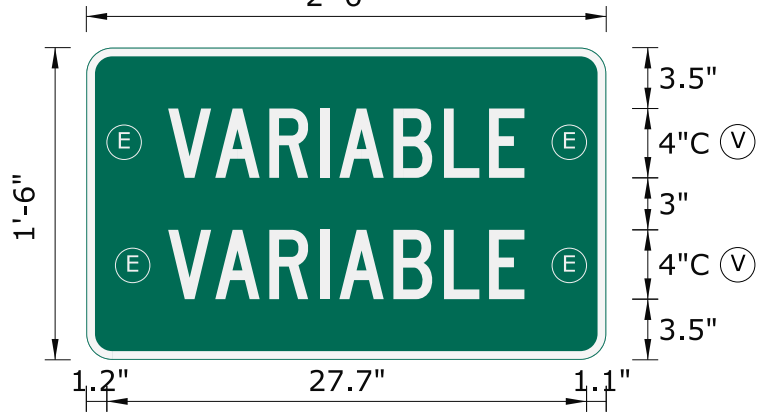

3 LINES USE 3" B OR C LETTERS.

2'-6"

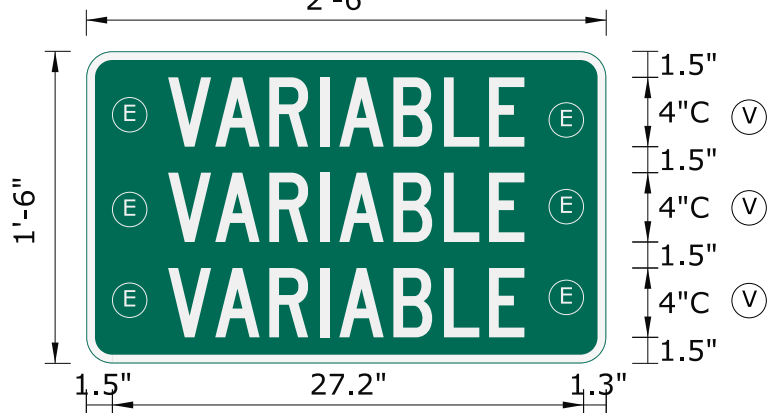

NOTES FOR NON-LOGO BUSINESS PANEL

BACKGROUND COLOR :

- GREEN : COLLEGE, UNIVERSITY, ETC.

NOTES FOR LOGO BUSINESS PANEL

- SUBMIT TO THE DIVISION OF TRAFFIC ENGINEERING FOR REVIEW AND APPROVAL.

SIGN NUMBER	51-6740
SIGN PANEL	3.75
EXIT CROWN	--
TOTAL (Sq.ft.)	3.75
BDR INSET/WIDTH	0" / 0.5"
CORNER RADIUS	1.5"
BACKGROUND FOR NON-LOGO BUSINESS PANEL	TYPE: *
	COLOR: Green
LEGEND/BORDER FOR NON-LOGO BUSINESS PANEL	TYPE: *
	COLOR: White/White
BACKGROUND FOR LOGO BUSINESS PANEL	TYPE: *
	COLOR: Variable
LEGEND/BORDER FOR LOGO BUSINESS PANEL	TYPE: *
	COLOR: Variable
* REFER TO CATALOG OF SIGNS FOR SHEETING TYPE, WHEN COLOR IS BLACK TYPE IS "PLAIN".	

SYMBOL	ROT	X	Y	WID	HT

REV'D 6/14

ADDED NOTES FOR LOGO PANEL AND UPDATED BORDER FOR LOGO PANEL.

(E) EQUAL SPACING

(V) VARIABLE LEGEND OR LOGO TO FIT 30" x 18" SIGN :

* SERIES "C" UP TO 8 CHARACTERS MAX PER LINE.

* SERIES "B" UP TO 9 OR 10 CHARACTERS MAX PER LINE.

DIMENSIONS ARE IN INCHES

MATERIAL : .040 THK.SHEET ALUMINUM

OVERLAY PANEL TO BE USED WITH 51-6752 AND 51-6755

SIGN SUPPORT NO. N/A

LOCATION : N/A

ENGINEER : B. SCHILLING DESIGNED BY : J. FASCIONE CHECKED BY : _____

SIGN DETAIL

1:20

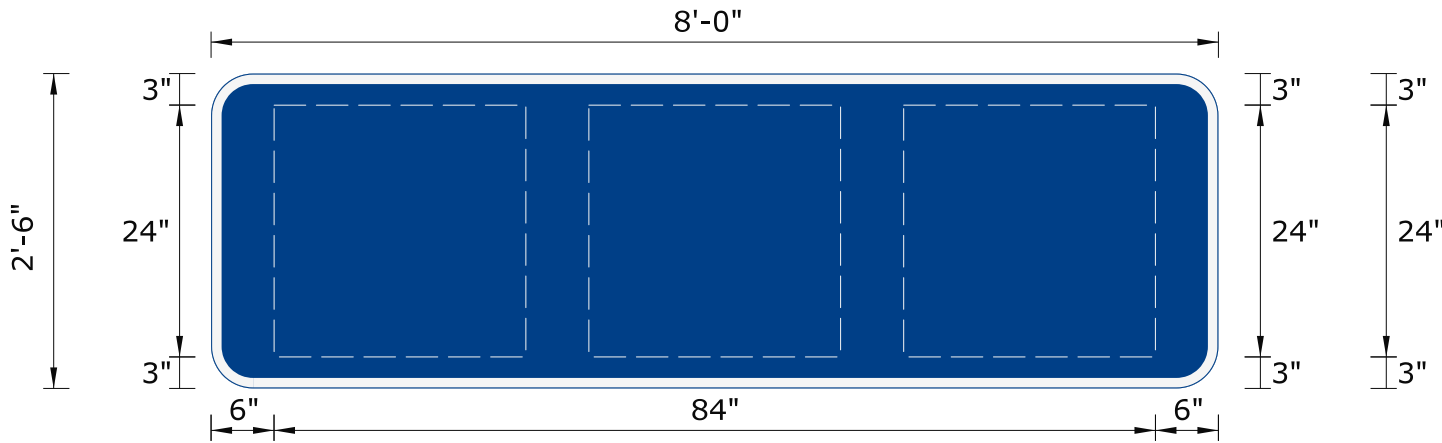

SIGN NUMBER	51-6741
PANEL SIZE	8'-0" x 2'-6"
SIGN AREA	20.0 Sq.Ft.
MUTCD	D9-18
BDR INSET/WIDTH	0" / 1"
CORNER RADIUS	4"
BACKGROUND	TYPE: *
	COLOR: Blue
LEGEND/BORDER	TYPE: *
	COLOR: /White
* REFER TO CATALOG OF SIGNS FOR SHEETING TYPE. WHEN COLOR IS BLACK TYPE IS "PLAIN".	

SYMBOL	ROT	X	Y	WID	HT
FUTURE	0	6	3	24	24
FUTURE	0	36	3	24	24
FUTURE	0	66	3	24	24

REV'D /

FILE :51-6741

Apr 22, 2019

Dimensions are in Inches

Material : .125 Thick Sheet Aluminum

Engineer : A. Mermelstein / Designed By: J. Fascione / Checked By: _____

Ground Mounted

SIGN DETAIL

1:20

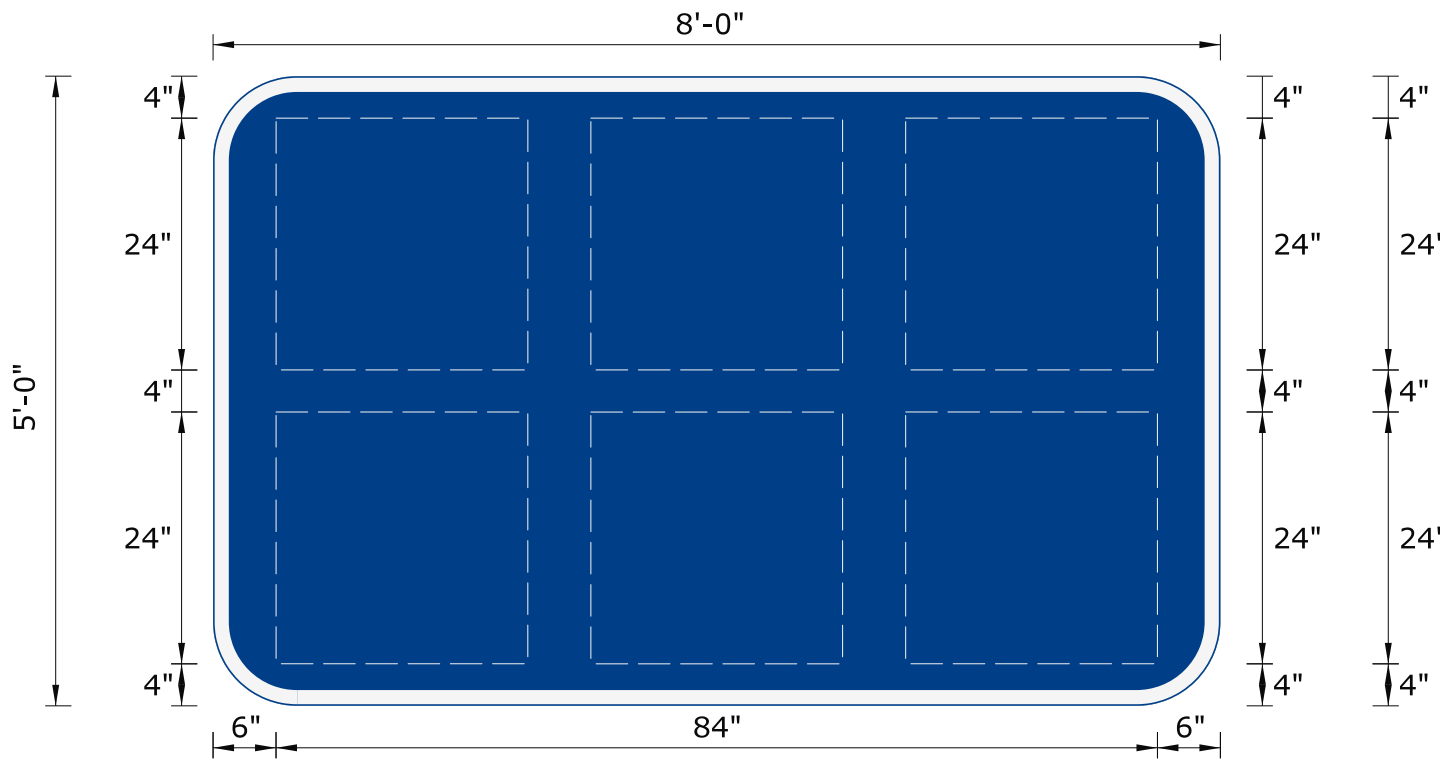

SIGN NUMBER	51-6742
PANEL SIZE	8'-0" x 5'-0"
SIGN AREA	40.0 Sq.Ft.
MUTCD	D9-18
BDR INSET/WIDTH	0" / 1.5"
CORNER RADIUS	8"
BACKGROUND	TYPE: *
	COLOR: Blue
LEGEND/BORDER	TYPE: *
	COLOR: /White
* REFER TO CATALOG OF SIGNS FOR SHEETING TYPE. WHEN COLOR IS BLACK TYPE IS "PLAIN".	

SYMBOL	ROT	X	Y	WID	HT
FUTURE	0	6	32	24	24
FUTURE	0	36	32	24	24
FUTURE	0	66	32	24	24
FUTURE	0	6	4	24	24
FUTURE	0	36	4	24	24
FUTURE	0	66	4	24	24

REV'D /

FILE :51-6742

Apr 22, 2019

Dimensions are in Inches
 Material : .125 Thick Sheet Aluminum
 Engineer : A. Mermelstein / Designed By: J. Fascione / Checked By: _____
 Ground Mounted

SIGN DETAIL

1:15

DIRECTION PANEL FOR RAMPS :

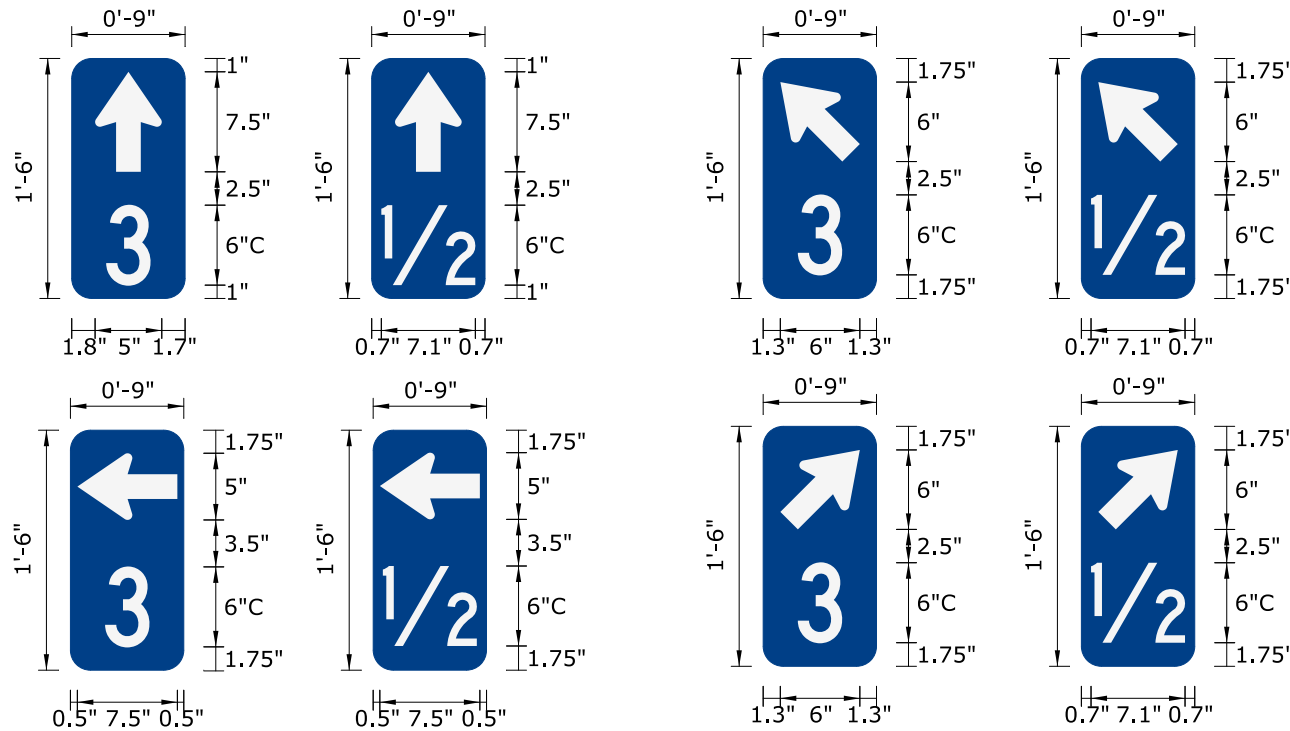

SIGN NUMBER	51-6743
PANEL SIZE	0'-9" x 1'-6"
SIGN AREA	1.1 Sq.Ft.
MUTCD	
BDR INSET/WIDTH	0" / 0"
CORNER RADIUS	1.5"
BACKGROUND	TYPE: * COLOR: Blue
LEGEND/BORDER	TYPE: * COLOR: White/Blue
* REFER TO CATALOG OF SIGNS FOR SHEETING TYPE. WHEN COLOR IS BLACK TYPE IS "PLAIN".	

SYMBOL	ROT	X	Y	WID	HT

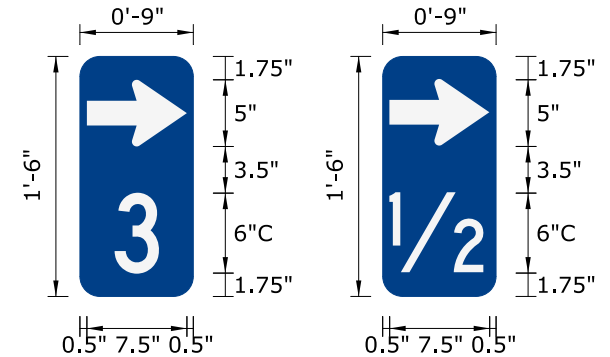

Dimensions are in Inches
 Material : .040 Thick Sheet Aluminum
 Division of Traffic Engineering
 Overlay Panel

SIGN DETAIL
1:12

**BUSINESS PANEL
FOR FREEWAY**

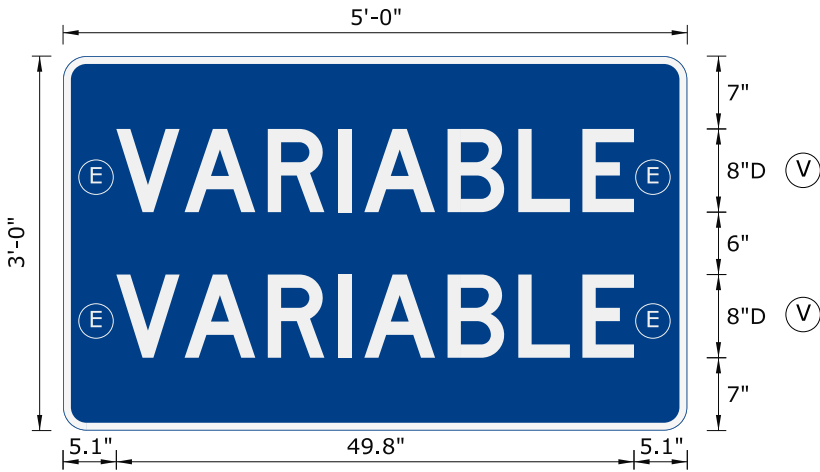

NOTES FOR NON-LOGO BUSINESS PANEL

BACKGROUND COLOR :

- BLUE : MAJOR SHOPPING CENTER, ETC.

NOTES FOR LOGO BUSINESS PANEL

- SUBMIT TO THE DIVISION OF TRAFFIC
ENGINEERING FOR REVIEW AND
APPROVAL.

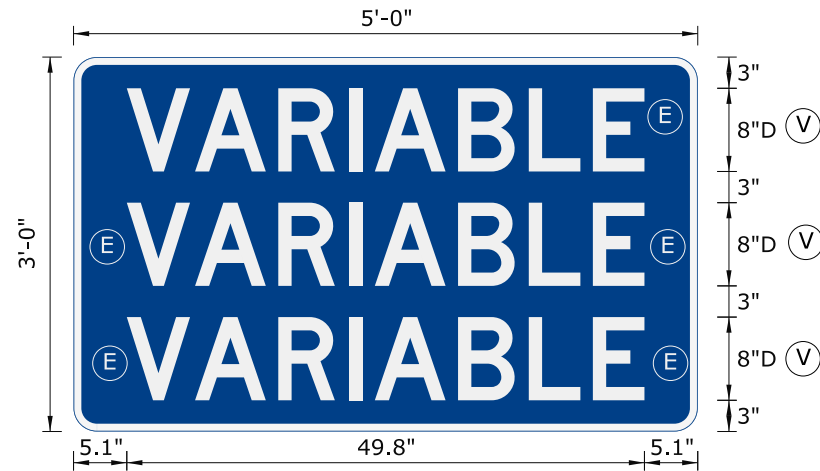

SIGN NUMBER	51-6749
SIGN PANEL	15.0
EXIT CROWN	--
TOTAL (Sq.FT.)	15.0
BDR INSET/WIDTH	0" / 0.75"
CORNER RADIUS	2.25"
BACKGROUND FOR NON-LOGO BUSINESS PANEL	TYPE: *
	COLOR: Blue
LEGEND/BORDER FOR NON-LOGO BUSINESS PANEL	TYPE: *
	COLOR: White/White
BACKGROUND FOR LOGO BUSINESS PANEL	TYPE: *
	COLOR: Variable
LEGEND/BORDER FOR LOGO BUSINESS PANEL	TYPE: *
	COLOR: Variable
* REFER TO CATALOG OF SIGNS FOR SHEETING TYPE. WHEN COLOR IS BLACK TYPE IS "PLAIN".	

SYMBOL	ROT	X	Y	WID	HT

REV'D 6/18
Revised letter Series from B to D.

PLOTTED : 12/27/2018

(E) EQUAL SPACING

(V) VARIABLE LEGEND OR LOGO TO FIT 60" x 36" SIGN :

* SERIES "D" UP TO 8 CHARACTERS MAX PER LINE.

* SERIES "C" UP TO 9 OR 10 CHARACTERS MAX PER LINE.

DIMENSIONS ARE IN INCHES

MATERIAL : .040 THK.SHEET ALUMINUM

OVERLAY PANEL

SIGN SUPPORT NO. N/A

LOCATION : TO BE USED WITH 52-6747, 52-6748, 52-6750, 52-6756, & TP-1283

ENGINEER : B. SCHILLING DESIGNED BY : J. FASCIONE CHECKED BY : _____

SIGN DETAIL
1:15

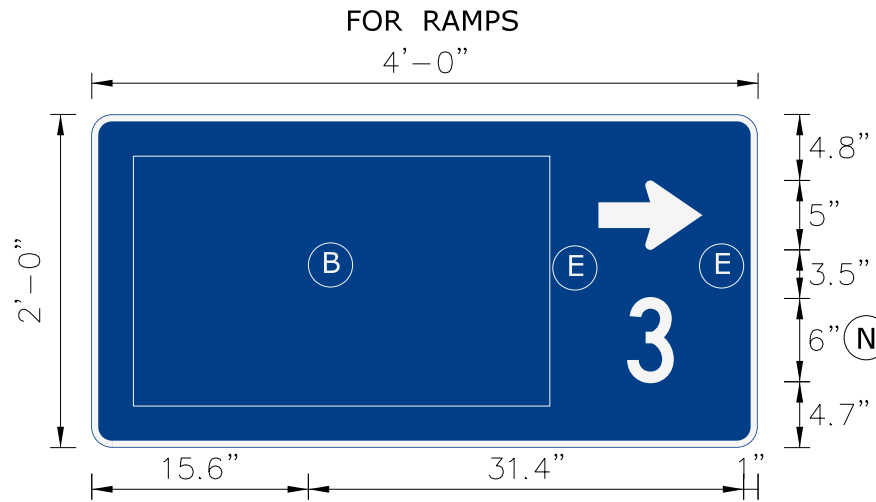

LETTER POSITIONS (X)							LENGTH	SERIES/SIZE
	3						C 2000	
38.6	3.4	6.1				3.4	6	

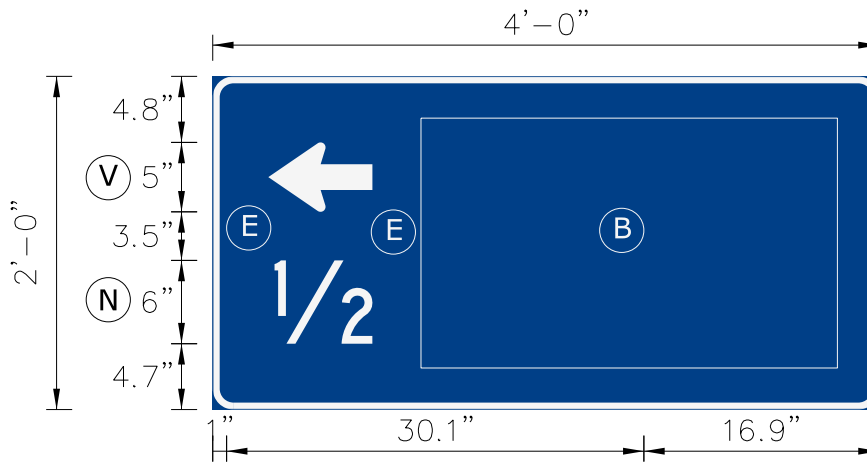

LETTER POSITIONS (X)							LENGTH	SERIES/SIZE
	1/2						C 2000	
4.5	7.1	36.5				7.1	6	

DIMENSIONS ARE IN INCHES
MATERIAL : .100 THK.SHEET ALUMINUM
SIDE MOUNTED
SIGN SUPPORT NO.
LOCATION : N/A
ENGINEER : B. SCHILLING DESIGNED BY : J. FASCIONE CHECKED BY : _____

NOTE :
FOR CONVENTIONAL HIGHWAY
SIGN SEE 51-6755.

SIGN NUMBER	51-6752
SIGN PANEL	8.0
EXIT CROWN	--
TOTAL (Sq.FT.)	8.0
BDR INSET/WIDTH	0" / 0.5"
CORNER RADIUS	1.5"
BACKGROUND	TYPE: *
	COLOR: Blue
LEGEND/BORDER	TYPE: *
	COLOR: White/White
* REFER TO CATALOG OF SIGNS FOR SHEETING TYPE. WHEN COLOR IS BLACK TYPE IS "PLAIN".	

REV'D 12/18

Revised Business Panel note (B) to reflect different sign #'s for different color panels.

ARROW & NUMBER ON RIGHT

SYMBOL	ROT	X	Y	WID	HT
AR_Type D	270	36.5	14.3	5	7.5
BUSINESS	0	3	3	30	18

ARROW & NUMBER ON LEFT

SYMBOL	ROT	X	Y	WID	HT
AR Type D	270	4	14.3	5	7.5
BUSINESS	0	15	3	30	18

- (B) BUSINESS PANEL 51-6753 BLUE, 51-6737 BROWN AND 51-6740 GREEN.
- (E) EQUAL SPACING FOR ARROW AND NUMBER (DISTANCE).
- (N) VARIABLE NUMBER (DISTANCE).
- (V) VARIABLE ARROW (DIRECTION).

51-6752 SUBMOUNTED BELOW 51-6751.

SIGN DETAIL
1:12

**BUSINESS PANEL FOR
RAMPS & COVENTIONAL
ROADWAYS**

2 LINES USE 4" B OR C LETTERS.

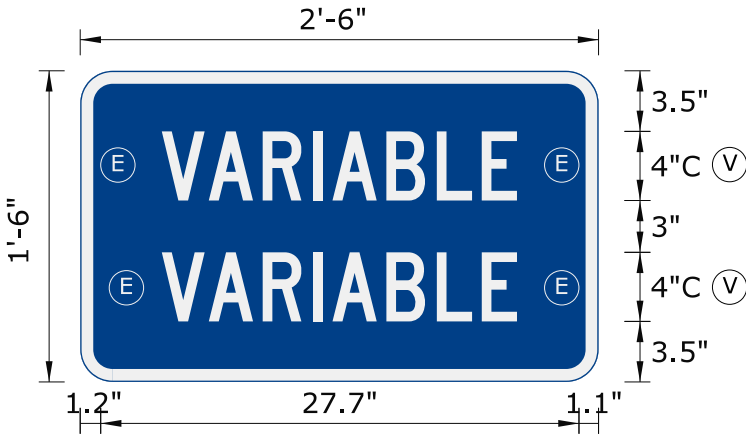

NOTES FOR NON-LOGO BUSINESS PANEL

BACKGROUND COLOR :

- BLUE : MAJOR SHOPPING CENTER, ETC.

NOTES FOR LOGO BUSINESS PANEL

- SUBMIT TO THE DIVISION OF TRAFFIC
ENGINEERING FOR REVIEW AND
APPROVAL.

3 LINES USE 3" B OR C LETTERS.

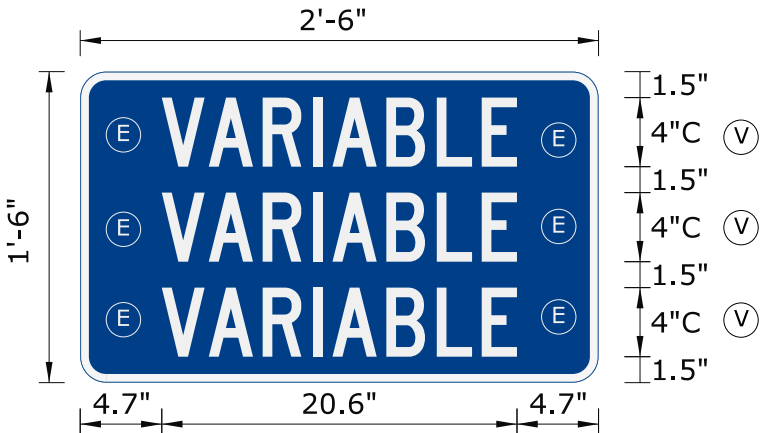

(E) EQUAL SPACING

(V) VARIABLE LEGEND OR LOGO TO FIT 30" x 18" SIGN :

* SERIES "C" UP TO 8 CHARACTERS MAX PER LINE.

* SERIES "B" UP TO 9 OR 10 CHARACTERS MAX PER LINE.

DIMENSIONS ARE IN INCHES

MATERIAL : .040 THK.SHEET ALUMINUM

OVERLAY PANEL TO BE USED WITH 51-6752 AND 51-6755

SIGN SUPPORT NO. N/A

LOCATION : N/A

ENGINEER : B. SCHILLING DESIGNED BY : J. FASCIONE CHECKED BY : _____

SIGN NUMBER	51-6753
SIGN PANEL	3.75
EXIT CROWN	--
TOTAL (Sq.FT.)	3.75
BDR INSET/WIDTH	0" / 0.5"
CORNER RADIUS	1.5"
BACKGROUND FOR NON-LOGO BUSINESS PANEL	TYPE: *
	COLOR: Blue
LEGEND/BORDER FOR NON-LOGO BUSINESS PANEL	TYPE: *
	COLOR: White/White
BACKGROUND FOR LOGO BUSINESS PANEL	TYPE: *
	COLOR: Variable
LEGEND/BORDER FOR LOGO BUSINESS PANEL	TYPE: *
	COLOR: Variable
* REFER TO CATALOG OF SIGNS FOR SHEETING TYPE. WHEN COLOR IS BLACK TYPE IS "PLAIN".	

SYMBOL	ROT	X	Y	WID	HT

REV'D 6/14
ADDED NOTES FOR LOGO PANEL AND
UPDATED BORDER FOR LOGO PANEL.

SIGN DETAIL

1:15

FOR CONVENTIONAL ROADWAYS

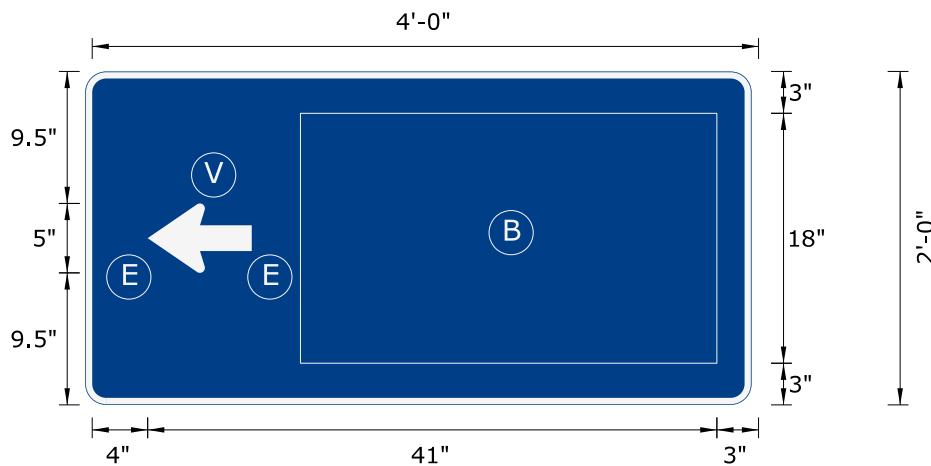
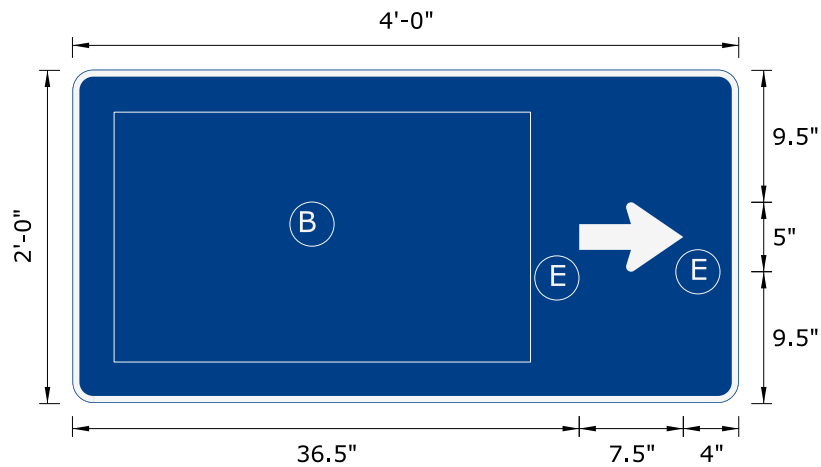

NOTE :
FOR RAMP SIGN SEE 51-6752.

DIMENSIONS ARE IN INCHES
MATERIAL : .100 THK.SHEET ALUMINUM
SIDE MOUNTED
SIGN SUPPORT NO.
LOCATION : N/A
ENGINEER : B. SCHILLING DESIGNED BY : J. FASCIONE CHECKED BY : _____

SIGN NUMBER	51-6755
SIGN PANEL	8.0
EXIT CROWN	--
TOTAL (Sq.ft.)	8.0
BDR INSET/WIDTH	0" / 0.5"
CORNER RADIUS	1.5"
BACKGROUND	TYPE: *
	COLOR: Blue
LEGEND/BORDER	TYPE: *
	COLOR: White/White
* REFER TO CATALOG OF SIGNS FOR SHEETING TYPE, WHEN COLOR IS BLACK TYPE IS "PLAIN".	

REV'D 12/18

Revised Business Panel note (B) to reflect different sign #'s for different color panels.

ARROW ON RIGHT

SYMBOL	ROT	X	Y	WID	HT
AR_Type D	270	36.5	9.5	5	7.5
BUSINESS	0	3	3	30	18

ARROW ON LEFT

SYMBOL	ROT	X	Y	WID	HT
AR Type D	270	4	9.5	5	7.5
BUSINESS	0	15	3	30	18

- (B) BUSINESS PANEL 51-6753 BLUE, 51-6737 BROWN AND 51-6740 GREEN.
- (E) EQUAL SPACING FOR ARROW.
- (V) VARIABLE ARROW (DIRECTION).

PLOTTED : 12/28/2018

SIGN DETAIL

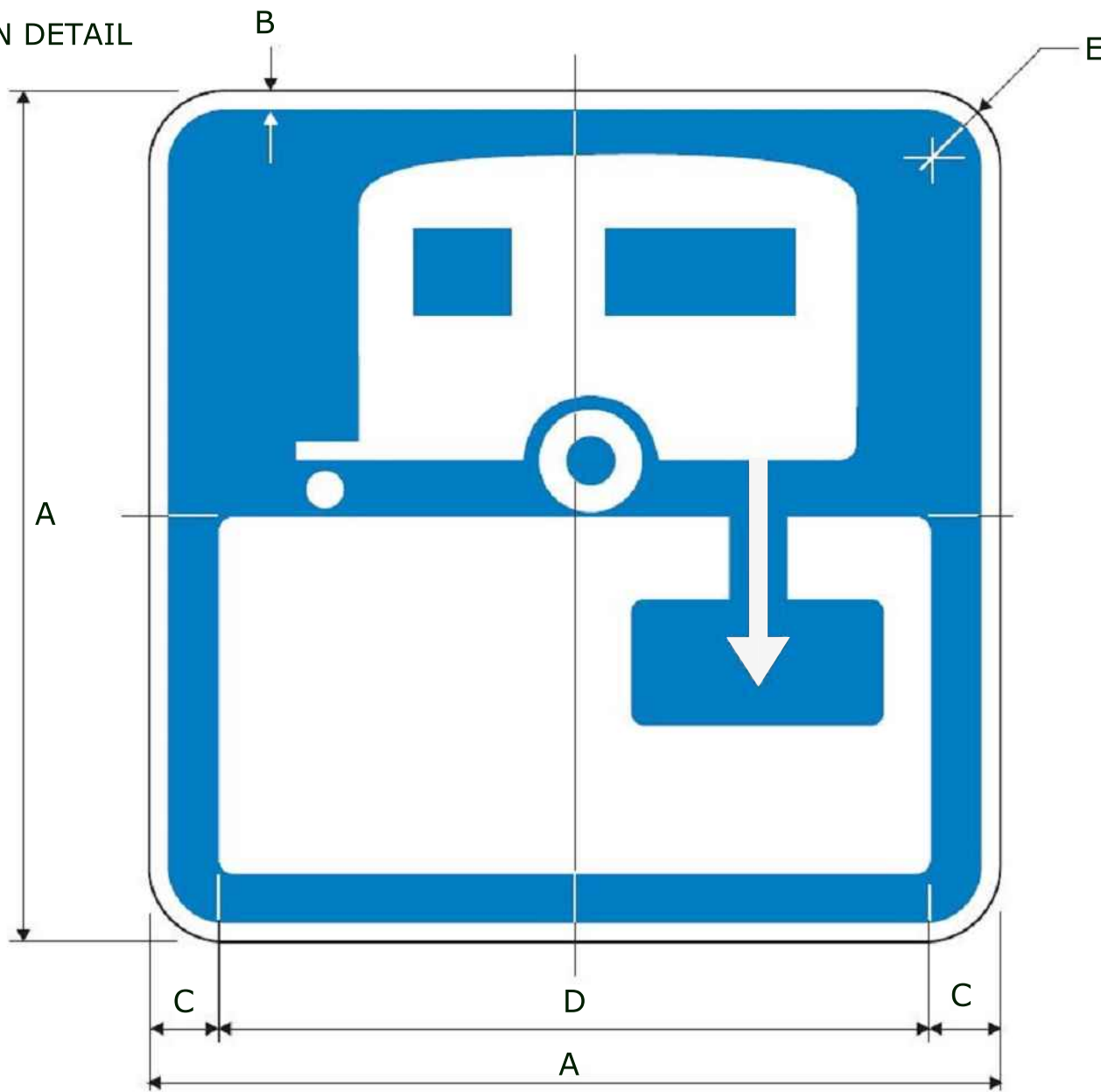

SIGN NUMBER	51-6816
SIGN PANEL	2'-0" x 2'-0"
TOTAL (Sq.ft.)	4.0
MUTCD	D9-12
BDR INSET/WIDTH	/ 0.5"
CORNER RADIUS	1.5"
BACKGROUND	TYPE: * COLOR: Blue
SYMBOL/BORDER	TYPE: * COLOR: White/White
* REFER TO CATALOG OF SIGNS FOR SHEETING TYPE. WHEN COLOR IS BLACK TYPE IS "PLAIN".	

REV'D 11/18
 Revised to match MUTCD R9-12.

PLOTTED :11/19/2018

A	B	C	D	E
24	.5	2	20	1.5

Dimensions are in inches.
 Material : .080 Thk. Sheet Aluminum
 Side Mounted
 Location : N/A
 Engineer : B. Schilling / Designed By : J. Fascione / Checked By :

SIGN DETAIL

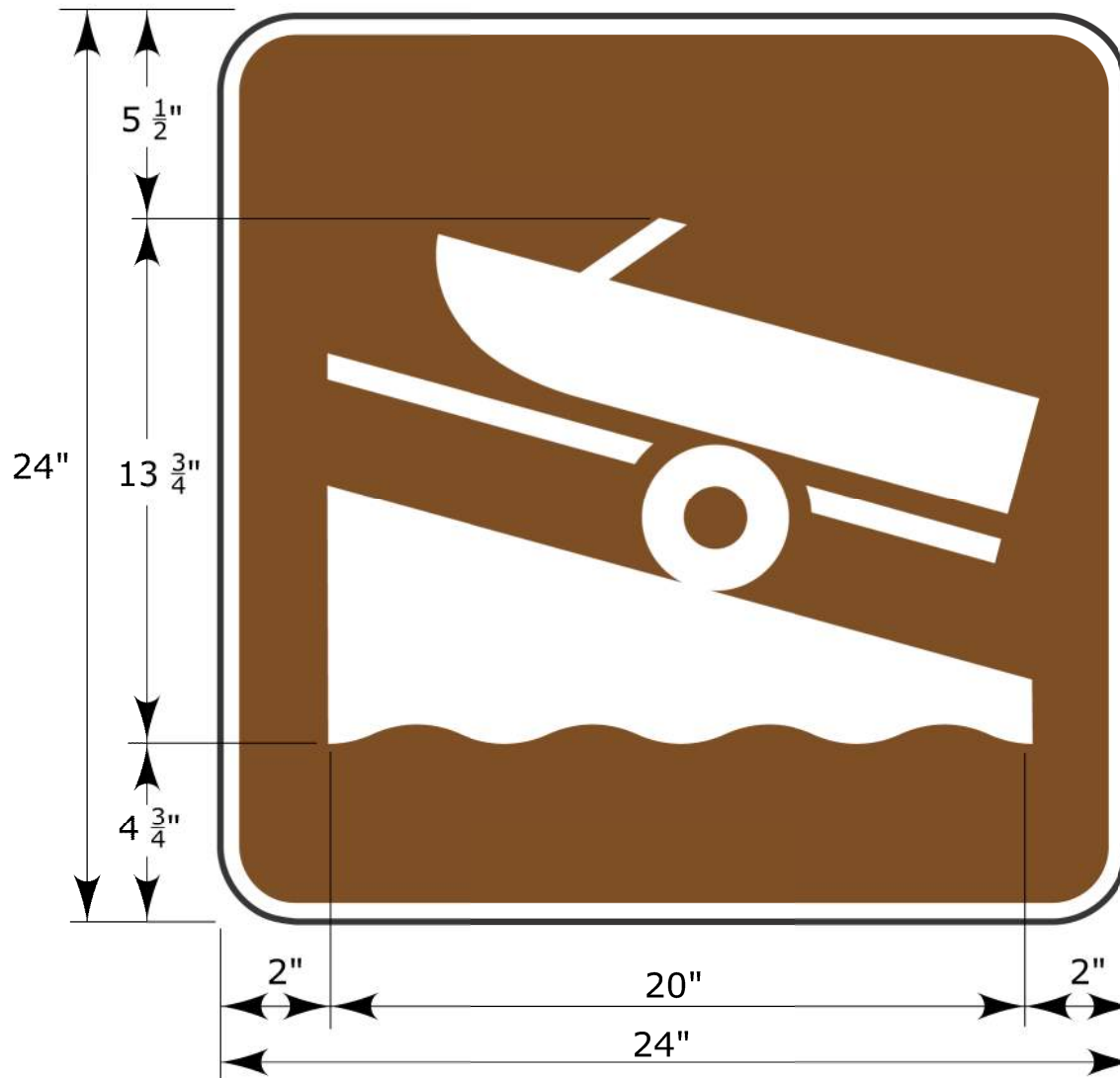

RS-054
BOAT RAMP

DIMENSIONS ARE IN INCHES
 MATERIAL : .080 THK.SHEET ALUMINUM
 SIDE MOUNTED
 SIGN SUPPORT NO. N/A
 LOCATION :N/A
 ENGINEER : TLF DESIGNED BY : JMF CHECKED BY : _____

SIGN NUMBER	51-6873
SIGN PANEL	4.0
EXIT CROWN	--
TOTAL (Sq.ft.)	4.0
BDR INSET/WIDTH	0 / .5"
CORNER RADIUS	1.5"
BACKGROUND	TYPE: *
	COLOR: Brown
LEGEND/BORDER	TYPE: *
	COLOR: White/White
* REFER TO CATALOG OF SIGNS FOR SHEETING TYPE. WHEN COLOR IS BLACK TYPE IS "PLAIN".	

REV'D 8/12
 UPDATED TO MATCH MUTCD.

PLOTTED : 8/24/2012



FULL SCALE 24" x 24"

PAGE 2 OF 2



FULL SCALE 24" X 24"

PAGE 2 OF 2

SIGN DETAIL

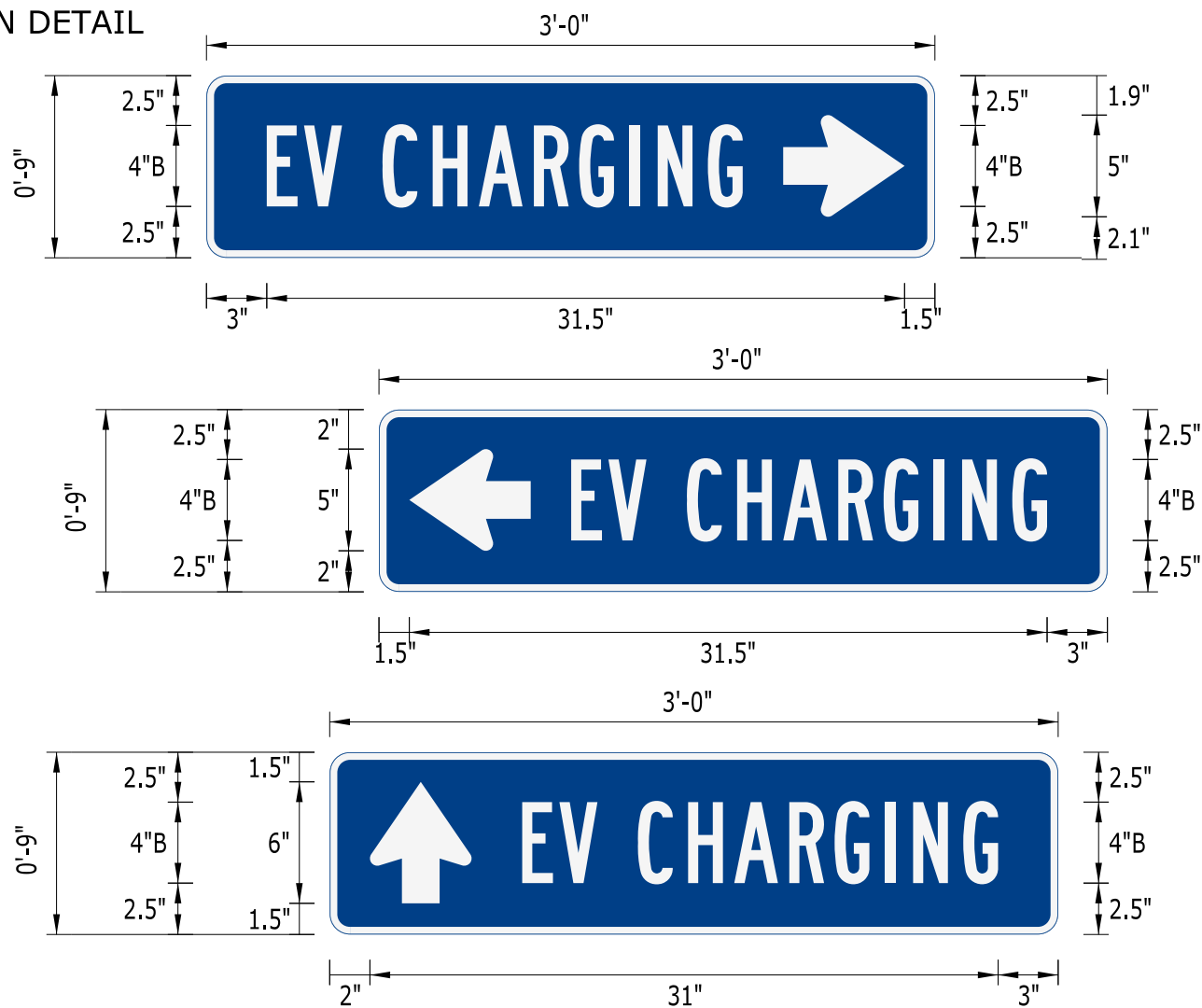

SIGN NUMBER	51-6961
PANEL SIZE	3'-0" x 0'-9"
SIGN AREA	2.3 Sq.Ft.
MUTCD	D9-10 (CT)
BDR INSET/WIDTH	0" / 0.38"
CORNER RADIUS	1"
BACKGROUND	TYPE: *
	COLOR: Blue
LEGEND/BORDER	TYPE: *
	COLOR: White/White
* REFER TO CATALOG OF SIGNS FOR SHEETING TYPE. WHEN COLOR IS BLACK TYPE IS "PLAIN".	

SYMBOL	ROT	X	Y	WID	HT
AR_Type D4 RT	270	28.5	2	5	6
AR_Type D4 LT	90	1.5	2	5	6
AR_Type D4 ST	180	2	1.5	5	6

FILE :51-6961

June 25, 2019

Dimensions are in Inches
 Material : .080 Thick Sheet Aluminum
 Engineer : B. Schilling / Designed By: J. Fascione / Checked By: _____
 Ground Mounted

LETTER POSITIONS (X)													LENGTH	SERIES/SIZE					
	E	V		C	H	A	R	G	I	N	G								B 2000
3	1.8	1.9	2	2.5	2.3	2.7	2.2	2.5	1.4	2.5	1.7	9.5	RIGHT ARROW ON RIGHT SIDE					23.5	4
	E	V		C	H	A	R	G	I	N	G								B 2000
9.5	1.8	1.9	2	2.5	2.3	2.7	2.2	2.5	1.4	2.5	1.7	3	LEFT ARROW ON LEFT SIDE					23.5	4
	E	V		C	H	A	R	G	I	N	G								B 2000
9.5	1.8	1.9	2	2.5	2.3	2.7	2.2	2.5	1.4	2.5	1.7	3	STRAIGHT ARROW UP ON LEFT SIDE					23.5	4

SIGN DETAIL

1:15

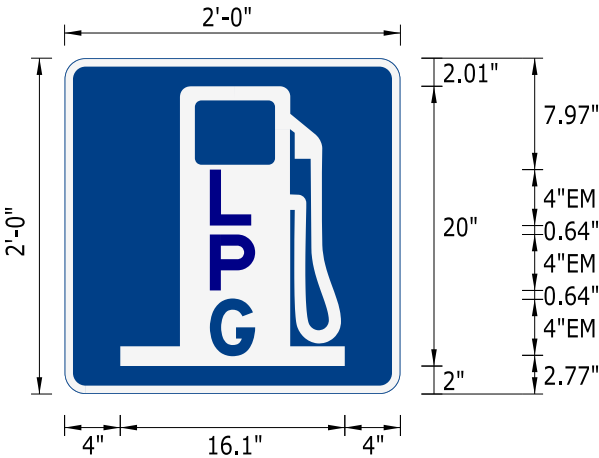

SIGN NUMBER	51-7762
PANEL SIZE	2'-0" x 2'-0"
SIGN AREA	4.0 Sq.Ft.
MUTCD	
BDR INSET/WIDTH	0" / 0.8"
CORNER RADIUS	1.5"
BACKGROUND	TYPE: IX
	COLOR: Blue
LEGEND/BORDER	TYPE: IX
	COLOR: White/White

SYMBOL	ROT	X	Y	WID	HT
RM-060	0	4	2	16.1	20

REV'D /

Dimensions are in Inches
 Material : .080 Thick Sheet Aluminum
 Engineer : B. Schilling / Designed By: J. Fascione / Checked By: _____
 Ground Mounted

FILE :51-7762 Nov 12, 2020

LETTER POSITIONS (X)																LENGTH	SERIES/SIZE
L																3	EM 2000
10.4																4	
P																3.2	EM 2000
10.4																4	
G																3.2	EM 2000
10.4																4	

SIGN DETAIL



SIGN NUMBER	51-7828
SIGN PANEL	2'-0" x 2'-0"
TOTAL (Sq.ft.)	4.0
MUTCD	RS-117
BDR INSET/WIDTH	/ 0.625"
CORNER RADIUS	1.5"
BACKGROUND	TYPE: *
	COLOR: Brown
LEGEND/BORDER	TYPE: *
	COLOR: White/White
* REFER TO CATALOG OF SIGNS FOR SHEETING TYPE, WHEN COLOR IS BLACK TYPE IS "PLAIN".	

REV'D /

PLOTTED : 4/27/2018

Dimensions are in inches.
 Material : .080 Thk. Sheet Aluminum
 Side Mounted
 Location : N/A
 Engineer : B. Schilling / Designed By : J. Fascione / Checked By :



