

MASONRY CHIMNEYS & FIREPLACES

CHAPTER 10, 2009 INTERNATIONAL
RESIDENTIAL CODE
PRESENTED BY
Brian W. Platz

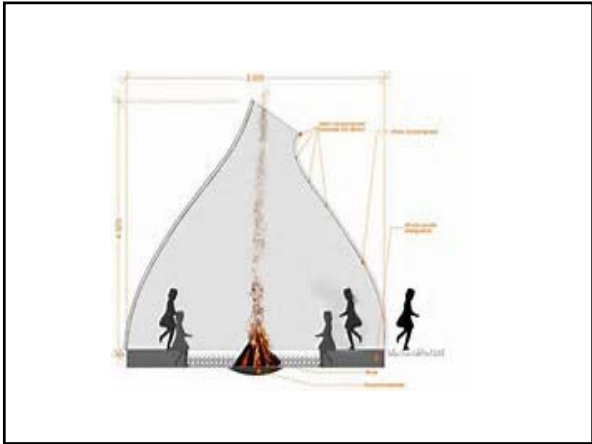







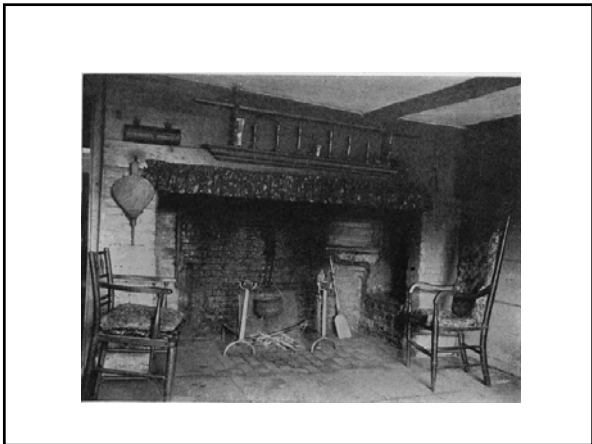

Sec R1001.2.1 Ash dump cleanout

- Cleanout openings located within foundation walls below fireboxes, when provided, shall be equipped with ferrous metal or masonry doors and frames constructed to remain tightly closed except when in use. Cleanouts shall be accessible and located so that ash removal will not create a hazard to combustible materials.



note

- Ash dumps **CAN** be used to run gas lines provided the ash dump at the floor of the firebox is sealed to prevent the escape of any leaked gas into the building. Keep in mind that the code governs other issues regarding fuel gas piping in concealed locations one of which is protecting the line from being in contact with corrosive material.

Sec R1001.5 Firebox walls

- Masonry fireboxes shall be constructed of **SOLID** masonry units, hollow masonry units shall be grouted **SOLID**. The minimum thickness of back and side walls shall be 8 inches.
- Note this dimension refers to the firebox walls **NOT** the entire chimney or walls surrounding the length of the flue.







Sec R1001.6 Firebox dimensions

- The firebox of a concrete or masonry fireplace shall have a minimum depth of 20 inches. The throat shall be not less than 8 inches above the fireplace opening. The throat opening shall not be less than 4 inches deep. The cross-sectional area of the passageway above the firebox including the throat, damper, and smoke chamber, shall not be less than the cross-sectional area of the flue.

Exception

- Rumford fireplaces shall be permitted provided the depth of the fireplace is at least 12 inches and at least one-third of the width of the fireplace opening.

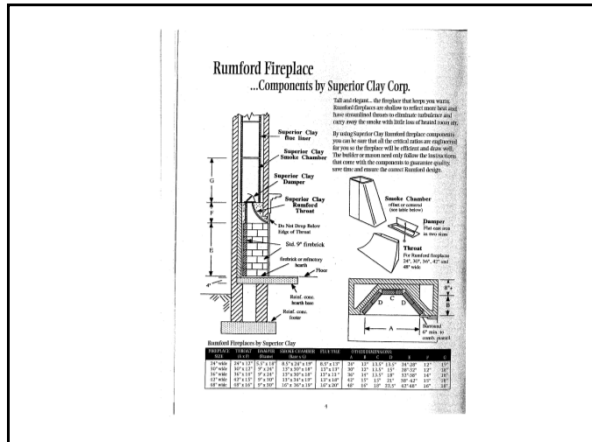

Sec R1001.8 Smoke chamber

- Smoke chamber walls shall be constructed of **SOLID** masonry units, hollow masonry units grouted **SOLID**, stone or concrete. The total minimum thickness of front, back and side walls shall be 8 inches of **SOLID** masonry. The inside surface shall be parged smooth with refractory mortar conforming to ASTM C 1261.

Sec R1001.9 Hearth & hearth ext.

- Masonry fireplace hearth & hearth ext. shall be constructed of concrete or masonry, supported by noncombustible materials, and reinforced to carry their own weight and all imposed loads. No combustible material shall remain against the underside of hearths and hearth extensions after construction.
- R1001.9.1 Hearth thickness min 4 inches
- R1001.9.2 Hearth ext. thickness min 2 inches

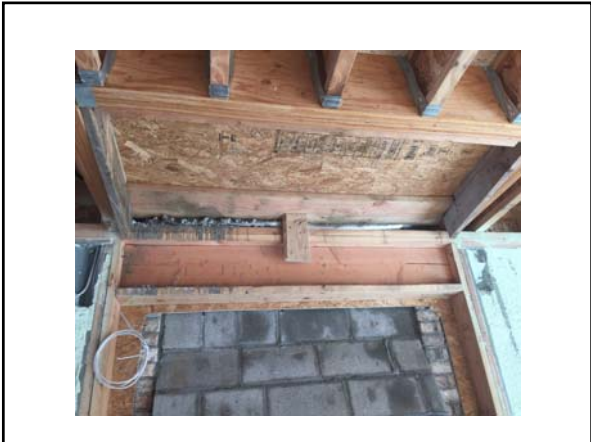

NOTE

- The code does not give a specific design criteria regarding the construction of the hearth ext. for the size or spacing of rebar etc.

Sec R1001.10 Hearth ext. dimensions

- Hearth extensions shall extend at least 16" in front of and at least 8" beyond each side of the fireplace opening. Where the fireplace opening is 6 square feet or larger, the hearth ext. shall extend at least 20" in front of and at least 12" beyond each side of the fireplace opening.

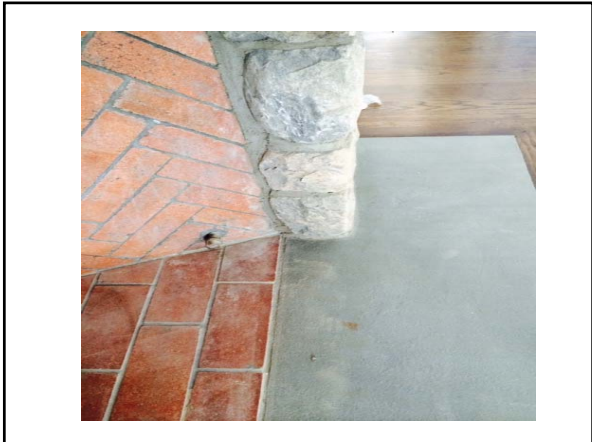

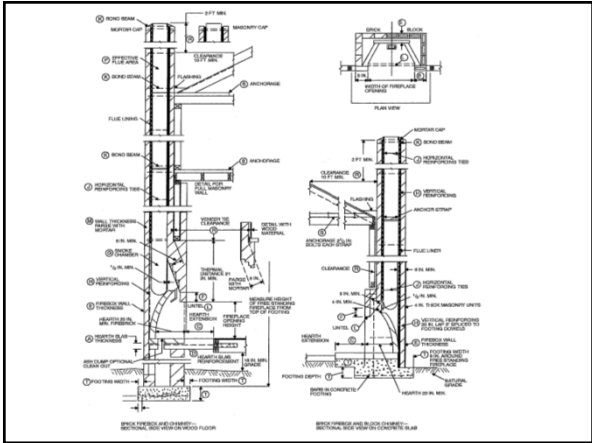

TABLE R1001.1 SUMMARY OF REQUIREMENTS FOR MASONRY FIREPLACES AND CHIMNEYS	
ITEM	LETTER REQUIREMENTS
Hearth slab thickness	A 4"
Hearth extension (back side of opening)	B 8" fireplace opening < 6 square foot. 12" fireplace opening ≥ 6 square foot
Hearth extension (front of opening)	C 16" fireplace opening < 6 square foot. 20" fireplace opening ≥ 6 square foot
Hearth slab reinforcing	D Reinforced to carry its own weight and all imposed loads.
Thickness of wall of fluebox	R 10" solid brick or 8" where a firebrick lining is used. Form in firebrick 1/2" maximum.
Distance from top of opening to throat	F 6"
Smoked chamber wall thickness Unlined walls	G 6"
Chimney Vertical reinforcing ^a	H Four No. 4 full-length bars for chimney up to 40' wide. Add two No. 4 bars for each additional 40' or fraction of width on each additional line.
Horizontal reinforcing	J 1/2" size at 18" and two size at each band in vertical stack.
Band beams	K No specified requirements.
Fireplace lintel	L Noncombustible material.
Chimney walls with fire lining	M Solid masonry with or hollow masonry units grouted solid with at least 4 inch nominal thickness.
Distances between adjacent flues	N See Section R1001.1.3.
Reflection free area (based on area of fireplace opening)	P See Section R1001.1.5.
Clearances: Combustible material Metal and iron Above roof	R See Sections R1001.1.1 and R1001.1.6. See Section R1001.1.1, Description 4. 2" at roofline and 2" at 10'.
Anchorages ^b String Number Embedment into chimney Header to Bulbs	S 1/2" x 1" Two 12" hooked around outer bar with 6" extension. 4 joints. Two 1/2" diameter.
Footings: Thickness Width	T 12" min. 6" each side of fireplace wall.

Note: 1 inch = 25.4 mm, 1 foot = 304.8 mm, 1 square foot = 0.0929m².

Note: This table provides a summary of major requirements for the construction of masonry chimneys and fireplaces. Refer references to Figure R1001.1, which shows examples of typical construction. This table does not cover all requirements, so learn some aspects of the indicated requirements. For the actual code requirements of fire codes, see the indicated section of text.

^a The letters refer to Figure R1001.1.

^b See required in Seismic Design Category A, B or C.

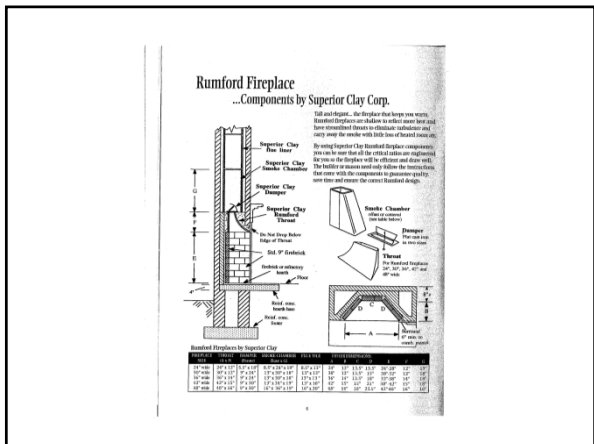

Sec R1001.11 Fireplace clearance

- All wood beams, joists, studs and other combustible material shall have a clearance of not less than 2” from the front faces and sides, and not less than 4” from the back faces of masonry fireplaces. The air space shall not be filled, except to provide fire blocking in accordance with sec R1001.12

Note

- There is no mention of a clearance to combustibles for the front or sides of the hearth extension.

Exceptions

- 1) Masonry fireplaces listed and labeled for use in contact with combustibles.
- 2) When masonry fireplaces are part of masonry or concrete walls, combustible materials shall not be in contact with the masonry or concrete walls less than 12" from the inside surface of the nearest firebox lining.

Exceptions continued

- 3) Exposed combustible trim and the edges of sheathing materials such as wood siding, flooring and drywall shall be permitted to abut the masonry fireplace side walls and hearth extension, provided such combustible trim or sheathing is a minimum of 12" from the nearest firebox lining.





Exceptions continued

- 4) Exposed combustible mantels or trim may be placed directly on the masonry fireplace front surrounding the fireplace opening providing such combustible materials are not placed within 6" of a fireplace opening. Combustible material within 12" of the fireplace opening shall not project more than 1/8" for each 1-inch distance from such an opening.

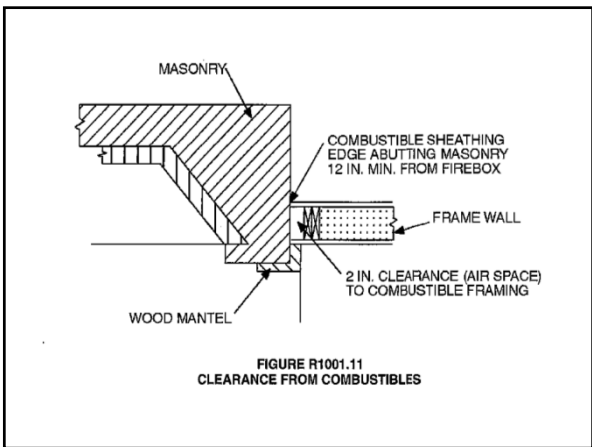

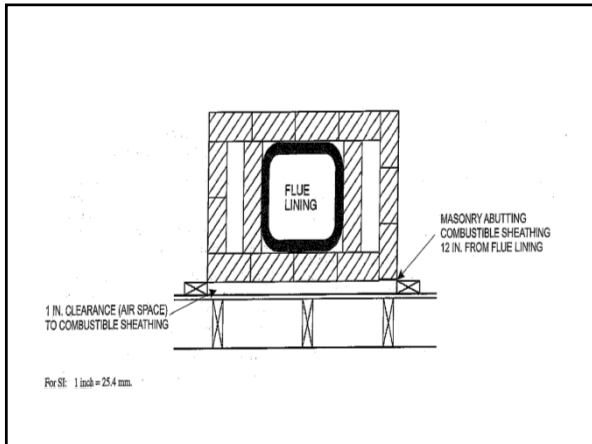

Sec R1001.12 Fireplace fireblocking

- You're gonna love this!!!!!!!!!!!!!!
- Fireplace fireblocking shall comply with the provisions of sec R602.8

Sec R602.8 Fireblocking required

- Fireblocking shall be provided in accordance with sec R302.11

Sec R302.11 Fireblocking

- In combustible construction, fireblocking shall be provided to cut off all concealed draft openings (both vertical & horizontal) and to form an effective fire barrier between stories, and between a top story and the roof space.
 - Fireblocking shall be provided in wood frame construction in the following locations;
- #5. For fireblocking of chimneys and fireplaces, see section R1003.19

Sec R1003.19 Chimney fireblocking

- **FINALLY WE'VE ARRIVED**
- **All spaces between chimneys and floors and ceilings through which chimneys pass shall be fireblocked with noncombustible material securely fastened in place. The fireblocking of spaces between chimneys and wood joists, beams, or headers shall be self-supporting or be placed on strips of metal or metal lath laid across the spaces between combustible material and the chimney.**

Note

- The code offers several code compliant methods, it is not our function to tell them how to achieve compliance.







Sec R1003.8 Additional load

- Chimneys shall not support loads other than their own weight unless they are designed and constructed to support the additional load. Construction of masonry chimneys as part of the masonry walls or reinforced concrete walls of the building shall be permitted.
- This brings us back to R1001.11 fireplace clearance exception #2 which reads “when masonry fireplaces are part of masonry or concrete walls, combustible materials shall not be in contact with the masonry or concrete walls less than 12” from the inside surface of the nearest firebox lining.”
- This language is repeated in sec R1003.18 exception 2.





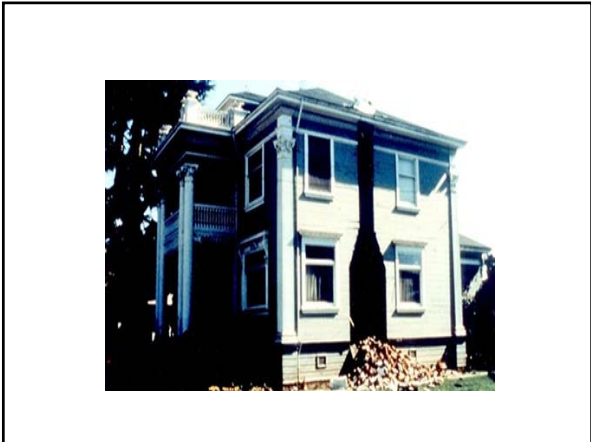

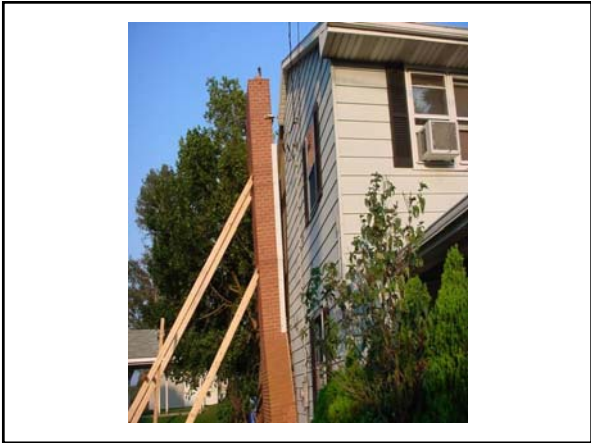

Sec R1003.8 Commentary (not code)

- Chimneys are subject to considerable stress resulting from thermal effects and therefore should not support any structural load other than their own weight, unless specifically designed as a supporting member for the additional load. Also because of its heavy mass, a chimney will tend to settle more than the building structures. As a consequence the chimney and any part of the building that it supports will settle at a greater rate and to a greater degree than the rest of the building, resulting in damage.



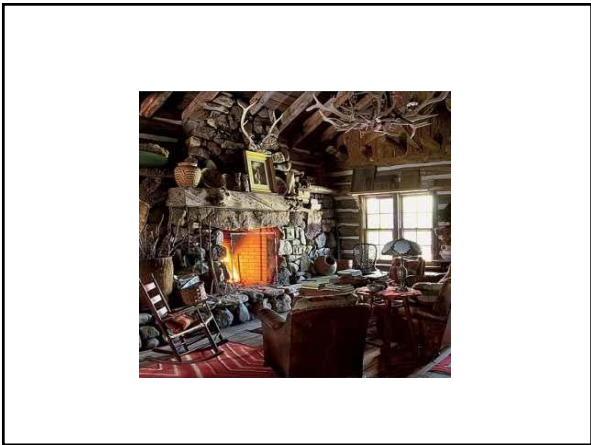



Note

- We do **NOT** determine whether or not they can impose additional loads this should be referred to the design professional of record and you should get his/her approval in writing.

Sec R1003.9 Termination

- Chimneys shall extend at least 2 feet higher than any portion of the building within 10 feet, but shall not be less than 3 feet above the highest point where the chimney passes through the roof.

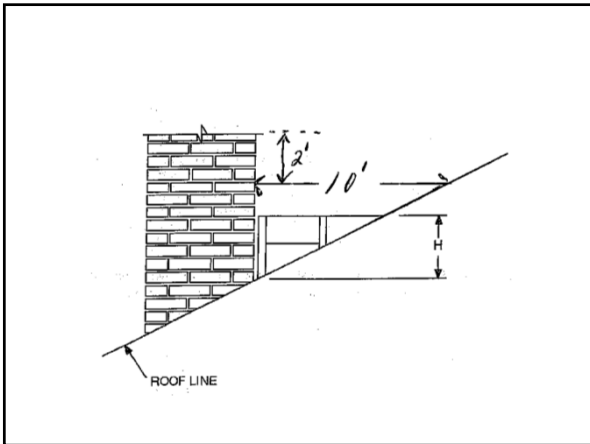

Sec R905.2.8.4 Other Flashing

- Flashing against a vertical front wall, as well as soil stack, vent pipe and chimney flashing, shall be applied according to the asphalt shingle manufacturer's printed instructions.
- Note; the code does not require flashing to the flue unless the manufacturer specifies such. In my limited research most manufacturer's **DO NOT**.

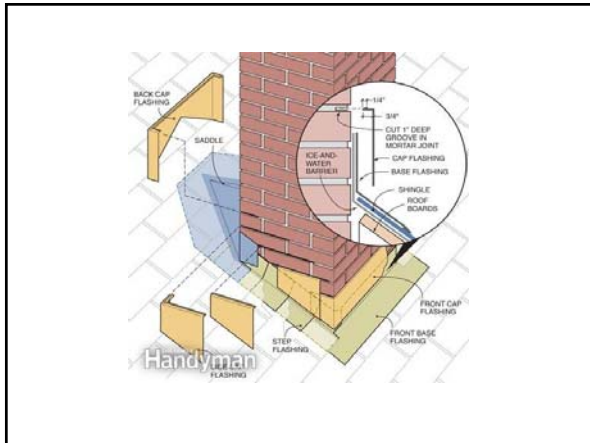

Cedar Shake & Shingle Bureau (referenced standard)

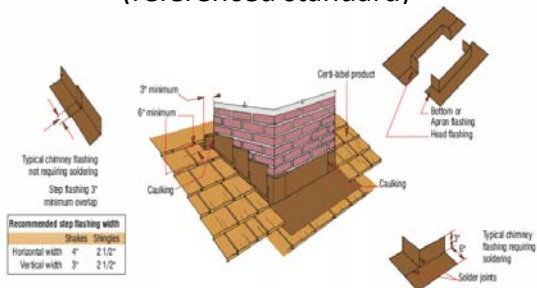
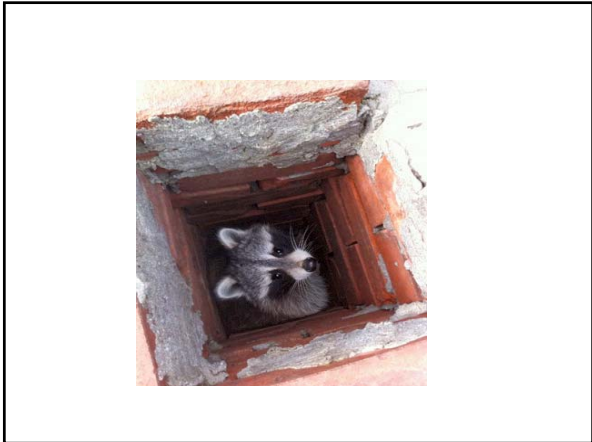

Figure 14c: Typical Projection Flashing

Sec R1003.12 Clay flue lining

- Clay flue liners shall be laid in medium-duty water insoluble refractory mortar conforming to ASTM C 199 with tight mortar joints left smooth on the inside and installed to maintain an air space or insulation not exceed the thickness of the flue liners from the interior face of the chimney masonry walls. Only enough mortar shall be placed to make the joint and hold the liners in position.





Sec R1003.13 Multiple flues

- When two or more flues are located in the same chimney, masonry wythes shall be at least 4 inches thick and bonded into the walls of the chimney.





Note

- Keep in mind we have three or more very dissimilar materials in masonry chimney construction. These materials react very differently to temperature, time, and moisture.
- CMU's
- Mortar
- Brick
- Clay tile
- Stone and or marble veneers



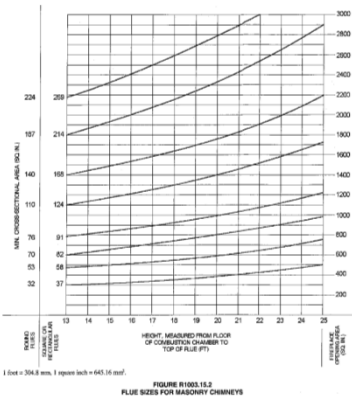

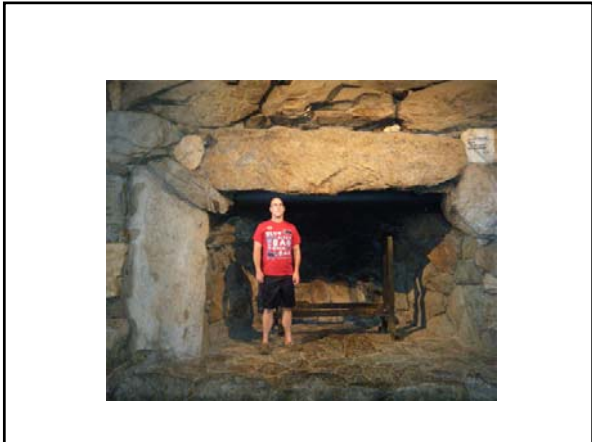

FLUE SIZE, INSIDE DIAMETER (inches)	CROSS-SECTIONAL AREA (square inches)
6	28
7	38
8	50
10	78
10 ³ / ₄	90
12	113
15	176
18	254

For SI: 1 inch = 25.4 mm, 1 square inch = 645.16 mm².
a. Flue sizes are based on ASTM C 315.

FLUE SIZE, OUTSIDE NOMINAL DIMENSIONS (inches)	CROSS-SECTIONAL AREA (square inches)
4.5 x 8.5	23
4.5 x 13	34
8 x 8	42
8.5 x 8.5	49
8 x 12	67
8.5 x 13	76
12 x 12	102
8.5 x 18	101
13 x 13	127
12 x 16	131
13 x 18	173
16 x 16	181
16 x 20	222
18 x 18	233
20 x 20	298
20 x 24	335
24 x 24	431

For SI: 1 inch = 25.4 mm, 1 square inch = 645.16 mm².

Sec R1006.0 Exterior air

- Factory built or masonry fireplaces covered in this chapter shall be equipped with an exterior air supply to assure proper fuel combustion unless the room is mechanically ventilated and controlled so that the indoor pressure is neutral or positive.



Sec R1006.1.2

- Listed combustion air ducts for masonry fireplaces shall be installed according to the terms of their listing and the manufacturer's instructions.

Sec R1006.2 Exterior air intake

- The exterior air intake shall be capable of supplying all combustion air from the exterior of the dwelling or from spaces within the dwelling ventilated with outside air such as non mechanically ventilated crawl or attic spaces. The exterior air intake shall **NOT** be located within the garage or basement of the dwelling nor shall the air intake be located at an elevation higher than the firebox (see sec R1006.5.) The exterior air intake shall be covered with a corrosion-resistant screen of ¼" mesh.

Sec R1006.3 Clearance

- Unlisted combustion air ducts shall be installed with a minimum 1-inch clearance to combustibles for all parts of the duct within 5 feet of the duct outlet.

Sec R1006.4 Passageway

- The combustion air passageway shall be a minimum of 6 square inches (Pi 3.14-R squared) and not more than 55 square inches, except that combustion air systems for listed fireplaces shall be constructed according to the fireplace manufacturer's instructions.

Sec R1006.5 Outlet

- Locating the exterior air outlet in the back (change from CABO) or sides of the firebox chamber or within 24 of the firebox opening on or near the floor is permitted. The outlet shall be closable and designed to prevent burning material from dropping into concealed combustible spaces.

Sec N1102.4.3 Fireplaces

- New wood-burning fireplaces shall have gasketed doors and outdoor combustion air.

2009 IECC sec 402.4.3 Fireplaces

- New wood-burning fireplaces shall have gasketed doors and outdoor combustion air.

“I don’t want no stinkin doors on my fireplace!!!!!!!!!!!!!!”



First flue inspection

- Depth of the firebox.
- Fresh air intake, material and inlet/outlet.
- Smoke chamber, parged smooth.
- Clearance to combustibles.
- **Solid** masonry where required.
- Offset of damper to flue.
- Air space between combustible sheathing & chimney.
- Hearth extension dimensions.
- These are tough violations to correct if not noted until the C of O inspection!

Final inspection

- Veneer is solidly grouted and sealed to face of fireplace.
- Hearth extension.
- Remove combustibles from underside of hearth extension.
- Access to ash dump cleanout.
- Combustible mantel and trim.
- Smoke curtain 8" from damper opening to firebox opening.
- Gasketed doors.

THANK YOU

•THE AGONY IS OVER!!
