

Office of Education  
and Data Management

Fall 2017  
Career Development

September  
**ICC/ANSI A117.1 and the  
Top 20 Frequently Asked Questions**  
(With revisions September 15, 2017)  
Harwood W. Loomis, R.A., B.O., Consulting Architect

Use of Office of Education and Data Management (OEDM) training materials must be approved in writing by the State of Connecticut, Department of Administrative Services' Office of Communications.

---

---

---

---

---

---

---

---



DEPARTMENT OF ADMINISTRATIVE SERVICES  
OFFICE OF EDUCATION AND DATA MANAGEMENT

**#1:**

How do I know how many accessible means of egress are required from a space / building?

Where do I look for the answer?

2

---

---

---

---

---

---

---

---



DEPARTMENT OF ADMINISTRATIVE SERVICES  
OFFICE OF EDUCATION AND DATA MANAGEMENT

- ICC/ANSI A117.1 provides *technical* requirements. The IBC provides scoping.
- 2012 IBC Section 1101.1 - Scope:
  - The Provisions of IBC Chapter 11 controls the design and construction of facilities for accessibility to physically disabled persons.
- 2012 IBC Section 1101.2 - Design:
  - Buildings and facilities shall be designed and constructed to be accessible in accordance to the IBC and **ICC A117.1**
- For numbers of required, accessible, means of egress, we look at the IBC.

3

---

---

---

---

---

---

---

---



DEPARTMENT OF ADMINISTRATIVE SERVICES  
OFFICE OF EDUCATION AND DATA MANAGEMENT

**1021.1 General.** Each story and occupied roof shall have the minimum number of *exits*, or access to exits, as specified in this section. The required number of *exits*, or *exit access stairways* or *ramps* providing access to exits, from any story shall be maintained until arrival at grade or a *public way*. *Exits* or access to exits from any story shall be configured in accordance with this section. Each story above the second story of a building shall have a minimum of one interior or exterior *exit stairway*, or interior or exterior *exit ramp*. At each story above the second story that requires a minimum of three or more *exits*, or access to *exits*, a minimum of 50 percent of the required *exits* shall be interior or exterior *exit stairways*, or interior or exterior *exit ramps*.

4

---

---

---

---

---

---

---

---



DEPARTMENT OF ADMINISTRATIVE SERVICES  
OFFICE OF EDUCATION AND DATA MANAGEMENT

**1021.2 Exits from stories.** Two exits from any story or occupied roof shall be provided where one of the following conditions exists:

1. The occupant load or number of dwelling units exceeds one of the values in Table 1021.2(1) or 1021.2(2).
2. The exit access travel distance exceeds that specified in Table 1021.2(1) or 1021.2(2) as determined in accordance with the provisions of Section 1016.1.

5

---

---

---

---

---

---

---

---



DEPARTMENT OF ADMINISTRATIVE SERVICES  
OFFICE OF EDUCATION AND DATA MANAGEMENT

TABLE 1021.2(1)  
STORIES WITH ONE EXIT OR ACCESS TO ONE EXIT FOR R-2 OCCUPANCIES

STORY	OCCUPANCY	MAXIMUM NUMBER OF DWELLING UNITS	MAXIMUM EXIT ACCESS TRAVEL DISTANCE
Basement, first, second or third story	R-2 <sup>a,b</sup>	4 dwelling units	125 feet
Fourth story and above	NP	NA	NA

For SI: 1 foot = 304.8 mm.  
NP - Not Permitted  
NA - Not Applicable

<sup>a</sup> Buildings classified as Group R-2 equipped throughout with an automatic sprinkler system in accordance with Section 903.3.1.1 or 903.3.1.2 and provided with emergency escape and rescue openings in accordance with Section 1029.

<sup>b</sup> This table is used for R-2 occupancies consisting of dwelling units. For R-2 occupancies consisting of sleeping units, use Table 1021.2(2).

6

---

---

---

---

---

---

---

---

DEPARTMENT OF ADMINISTRATIVE SERVICES  
OFFICE OF EDUCATION AND DATA MANAGEMENT

**TABLE 1021.2(2)  
STORIES WITH ONE EXIT OR ACCESS TO ONE EXIT FOR OTHER OCCUPANCIES**

STORY	OCCUPANCY	MAXIMUM OCCUPANTS PER STORY	MAXIMUM EXIT ACCESS TRAVEL DISTANCE
First story or basement	A, B <sup>1</sup> , E, F <sup>2</sup> , M, U, S <sup>3</sup>	49 occupants	75 feet
	H-2, H-3	3 occupants	25 feet
	H-4, H-5, I, R-1, R-2 <sup>4</sup> , R-4	10 occupants	75 feet
	S	29 occupants	100 feet
Second story	B, F, M, S	29 occupants	75 feet
Third story and above	NP	NA	NA

For SI: 1 foot = 304.8 mm.  
NP = Not Permitted  
NA = Not Applicable  
a. Buildings classified as Group R-2 equipped throughout with an automatic sprinkler system in accordance with Section 903.3.1.1 or 903.3.1.2 and provided with emergency escape and rescue openings in accordance with Section 1029.  
b. Group B, F and S occupancies in buildings equipped throughout with an automatic sprinkler system in accordance with Section 903.3.1.1 shall have a maximum travel distance of 100 feet.  
c. This table is used for R-2 occupancies consisting of sleeping units. For R-2 occupancies consisting of dwelling units, use Table 1021.2(3).

---

---

---

---

---

---

---

---

---

---

DEPARTMENT OF ADMINISTRATIVE SERVICES  
OFFICE OF EDUCATION AND DATA MANAGEMENT

At least two exits are required from each story *unless* the condition falls within the parameters set forth in one of these two tables.

But ... that's total exits. What about *accessible* exits (or means of egress)?

↓

**SECTION 1007  
ACCESSIBLE MEANS OF EGRESS**

---

---

---

---

---

---

---

---

---

---

DEPARTMENT OF ADMINISTRATIVE SERVICES  
OFFICE OF EDUCATION AND DATA MANAGEMENT

**1007.1 Accessible means of egress required.** *Accessible means of egress* shall comply with this section. *Accessible* spaces shall be provided with not less than one *accessible means of egress*. Where more than one means of egress are required by Section 1015.1 or 1021.1 from any accessible space, each accessible portion of the space shall be served by not less than two accessible means of egress.

---

---

---

---

---

---

---

---

---

---

 DEPARTMENT OF ADMINISTRATIVE SERVICES  
OFFICE OF EDUCATION AND DATA MANAGEMENT

**WHEN DO WE NEED MORE THAN TWO?**

10

---

---

---

---

---

---

---

---

 DEPARTMENT OF ADMINISTRATIVE SERVICES  
OFFICE OF EDUCATION AND DATA MANAGEMENT

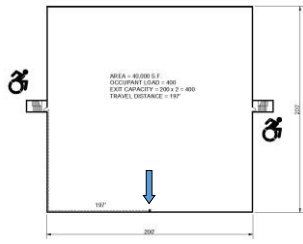

11

---

---

---

---

---

---

---

---

 DEPARTMENT OF ADMINISTRATIVE SERVICES  
OFFICE OF EDUCATION AND DATA MANAGEMENT

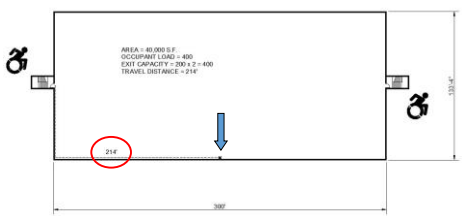

12

---

---

---

---

---

---

---

---

 DEPARTMENT OF ADMINISTRATIVE SERVICES  
OFFICE OF EDUCATION AND DATA MANAGEMENT

If the maximum allowable travel distance is 200 feet ...  
We need to add a third exit.

Does the third exit have to be an accessible exit?

43

---

---

---

---

---

---

---

---

 DEPARTMENT OF ADMINISTRATIVE SERVICES  
OFFICE OF EDUCATION AND DATA MANAGEMENT

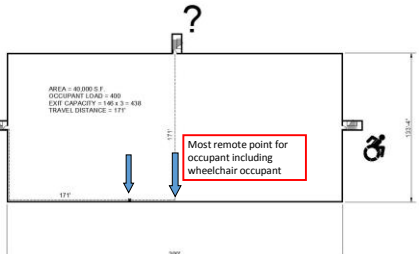

AREA = 40,000 S.F.  
OCCUPANT LOAD = 400  
EXIT CAPACITY = 194.2 = 430  
TRAVEL DISTANCE = 177'

Most remote point for occupant including wheelchair occupant

14

---

---

---

---

---

---

---

---

 DEPARTMENT OF ADMINISTRATIVE SERVICES  
OFFICE OF EDUCATION AND DATA MANAGEMENT

**MAYBE!**

It depends on the type of exits and the particulars of the building

Here's what we have:

45

---

---

---

---

---

---

---

---

 DEPARTMENT OF ADMINISTRATIVE SERVICES  
OFFICE OF EDUCATION AND DATA MANAGEMENT

The commentary for 1007.1 addresses this:

"In new construction and additions, accessible means of egress are required in the same number as the general means of egress, up to a maximum of two. In buildings, stories or spaces required by Section 1025.1 or 1021 to have three or more exits or exit access doors, a minimum of two accessible means of egress is required. The number of exits or exit access doors is based on occupant load; therefore, no matter how large the total occupant load of the space, two fully complying accessible means of egress are considered to provide sufficient net capacity for those building occupants with a mobility impairments." It goes on to say "While no disbursement requirements specific to accessible means of egress or travel distance limitations..."

So **no** according to 1007.1, in the example only two of the three means of egress are required to be accessible. **But Wait >>**

---

---

---

---

---

---

---

---

 DEPARTMENT OF ADMINISTRATIVE SERVICES  
OFFICE OF EDUCATION AND DATA MANAGEMENT

**IBC Section 1007.1 States...**

- Where more than one means of egress are required by Section 1015.1 and 1021.1 from any accessible space, each accessible portion of the space shall be served by not less than two accessible means of egress.
  - Section 1015.1 deals with Exit and Exit Access Doorways and
  - Section 1021 deals with Number of Exits and Exit Configuration
  - There are three Exceptions to this section dealing with existing buildings, accessible mezzanine and assembly areas with sloped or stepped aisles.

**BUT WAIT - WE ARE NOT DONE YET!!!**

17

---

---

---

---

---

---

---

---

 DEPARTMENT OF ADMINISTRATIVE SERVICES  
OFFICE OF EDUCATION AND DATA MANAGEMENT

**Waiting for it >>**

- The Exits Shown in our example are **STAIRS.**

**Section 1007.3 Stairways.** In order to be considered part of an *accessible means of egress*, a stairway between stories shall have a clear width of 48 inches minimum between *handrails* and shall either incorporate an area of refuge within an enlarged floor-level landing or shall be accessed from either an area of refuge complying with Section 1007.6 or a horizontal exit. Exit access stairways that connect levels in the same story are not permitted as part of an accessible means of egress.

- Section 1007.3 has six exceptions two that addresses automatic sprinkler systems.

18

---

---

---

---

---

---

---

---

 DEPARTMENT OF ADMINISTRATIVE SERVICES  
OFFICE OF EDUCATION AND DATA MANAGEMENT

**1007.6 Areas of refuge.** Every required *area of refuge* shall be *accessible* from the space it serves by an *accessible means of egress*. The maximum travel distance from any *accessible space* to an *area of refuge* shall not exceed the *travel distance* permitted for the occupancy in accordance with Section 1016.1. Every required *area of refuge* shall have direct access to a *stairway* complying with Sections 1007.3 or an elevator complying with Section 1007.4. Where an elevator lobby is used as an *area of refuge*, the shaft and lobby shall comply with Section 1022.10 for smokeproof enclosures except where the elevators are in an *area of refuge* formed by a *horizontal exit* or smoke barrier.

19

---

---

---

---

---

---

---

---

 DEPARTMENT OF ADMINISTRATIVE SERVICES  
OFFICE OF EDUCATION AND DATA MANAGEMENT

According to 1007.6 the Third Exit stairway would be required to have an Area of Refuge to satisfy the Exit Access Travel Distance Requirements referenced in Section 1016.2

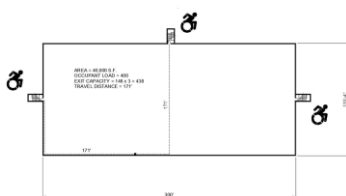

20

---

---

---

---

---

---

---

---

 DEPARTMENT OF ADMINISTRATIVE SERVICES  
OFFICE OF EDUCATION AND DATA MANAGEMENT

**CONCLUSION:**

- We need to look at all of the requirements.
- In this example the travel distance requirements applies only to Areas of Refuge under Section 1007.6.
- For this example to satisfy the exit access travel distance requirements of Section 1007.6, third exit stairway would be required to have an Area of Refuge in order to be an accessible means of egress.
  - Remember that in this case Section 1007.6 references Section 1016 and Table 1016.2 for travel distance.

21

---

---

---

---

---

---

---

---

 DEPARTMENT OF ADMINISTRATIVE SERVICES  
OFFICE OF EDUCATION AND DATA MANAGEMENT

else

So ... when ARE more than two accessible means of egress required?

22

---

---

---

---

---

---

---

---

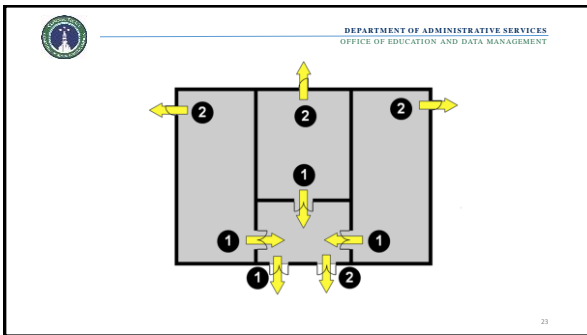

---

---

---

---

---

---

---

---

 DEPARTMENT OF ADMINISTRATIVE SERVICES  
OFFICE OF EDUCATION AND DATA MANAGEMENT

**SECTION 1007**  
**ACCESSIBLE MEANS OF EGRESS**

**1007.1 Accessible means of egress required.** *Accessible means of egress shall comply with this section. Accessible spaces shall be provided with not less than one accessible means of egress. Where more than one means of egress are required by Section 1015.1 or 1021.1 from any accessible space, each accessible portion of the space shall be served by not less than two accessible means of egress.*

24

---

---

---

---

---

---

---

---



 DEPARTMENT OF ADMINISTRATIVE SERVICES  
OFFICE OF EDUCATION AND DATA MANAGEMENT

**#2:**

Why is an enclosed stair in a fully sprinklered building exempt from the width and area of refuge requirements?

25

---

---

---

---

---

---

---

---

 DEPARTMENT OF ADMINISTRATIVE SERVICES  
OFFICE OF EDUCATION AND DATA MANAGEMENT

**1007.2 Continuity and components.** Each required accessible means of egress shall be continuous to a public way and shall consist of one or more of the following components:

1. Accessible routes complying with Section 1104.
2. Interior exit stairways complying with Sections 1007.3 and 1022.
3. Interior exit access stairways complying with Sections 1007.3 and 1009.3.
4. Exterior exit stairways complying with Sections 1007.3 and 1026 and serving levels other than the level of exit discharge.
5. Elevators complying with Section 1007.4.
6. Platform lifts complying with Section 1007.5.
7. Horizontal exits complying with Section 1025.
8. Ramps complying with Section 1010.
9. Areas of refuge complying with Section 1007.6.
10. Exterior area for assisted rescue complying with Section

26

---

---

---

---

---

---

---

---

 DEPARTMENT OF ADMINISTRATIVE SERVICES  
OFFICE OF EDUCATION AND DATA MANAGEMENT

**1007.6 Areas of refuge.** Every required area of refuge shall be accessible from the space it serves by an accessible means of egress. The maximum travel distance from any accessible space to an area of refuge shall not exceed the travel distance permitted for the occupancy in accordance with Section 1016.1. Every required area of refuge shall have direct access to a stairway complying with Sections 1007.3 or an elevator complying with Section 1007.4. Where an elevator lobby is used as an area of refuge, the shaft and lobby shall comply with Section 1022.10 for smokeproof enclosures except where the elevators are in an area of refuge formed by a horizontal exit or smoke barrier.

27

---

---

---

---

---

---

---

---

 DEPARTMENT OF ADMINISTRATIVE SERVICES  
OFFICE OF EDUCATION AND DATA MANAGEMENT

**1007.3 Stairways.** In order to be considered part of an *accessible means of egress*, a stairway between stories shall have a clear width of 48 inches (1219 mm) minimum between *handrails* and shall either incorporate an *area of refuge* within an enlarged floor-level landing or shall be accessed from either an *area of refuge* complying with Section 1007.6 or a *horizontal exit*. *Exit access stairways* that connect levels in the same story are not permitted as part of an *accessible means of egress*.

**Exceptions:**

1. The clear width of 48 inches (1219 mm) between *handrails* is not required in buildings equipped throughout with an *automatic sprinkler system* installed in accordance with Section ~~903.3.1.1~~ or 903.3.1.2.
2. *Areas of refuge* are not required at stairways in buildings equipped throughout by an *automatic sprinkler system* installed in accordance with Section 903.3.1.1 or 903.3.1.2.

28

---

---

---

---

---

---

---

---

 DEPARTMENT OF ADMINISTRATIVE SERVICES  
OFFICE OF EDUCATION AND DATA MANAGEMENT

**#3:**

What is the minimum clear width of a component of an accessible route?

Technical ... where do we look?

↓

ICC/ANSI A117.1

29

---

---

---

---

---

---

---

---

 DEPARTMENT OF ADMINISTRATIVE SERVICES  
OFFICE OF EDUCATION AND DATA MANAGEMENT

**403.5 Clear Width.** The clear width of an accessible route shall be 36 inches (915 mm) minimum.

**EXCEPTION:** The clear width shall be permitted to be reduced to 32 inches (815 mm) minimum for a length of 24 inches (610 mm) maximum provided the reduced width segments are separated by segments that are 48 inches (1220 mm) minimum in length and 36 inches (915 mm) minimum in width.

30

---

---

---

---

---

---

---

---

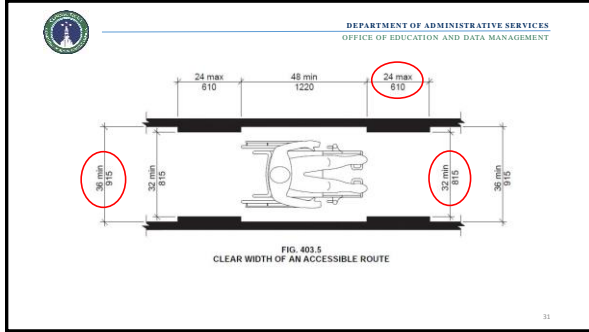

---

---

---

---

---

---

---

---

DEPARTMENT OF ADMINISTRATIVE SERVICES  
OFFICE OF EDUCATION AND DATA MANAGEMENT

**403.5.1 Clear Width at 180 Degree Turn.** Where an accessible route makes a 180 degree turn around an object that is less than 48 inches (1220 mm) in width, clear widths shall be 42 inches (1065 mm) minimum approaching the turn, 48 inches (1220 mm) minimum during the turn, and 42 inches (1065 mm) minimum leaving the turn.

**EXCEPTION:** Section 403.5.1 shall not apply where the clear width during the turn is 60 inches (1525 mm) minimum.

32

---

---

---

---

---

---

---

---

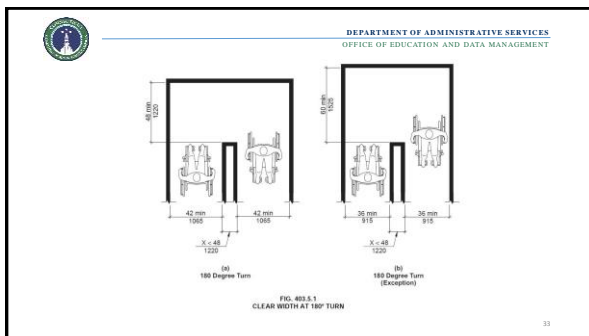

---

---

---

---

---

---

---

---

 DEPARTMENT OF ADMINISTRATIVE SERVICES  
OFFICE OF EDUCATION AND DATA MANAGEMENT

**#4:**

Is a 36-inch door the minimum door width allowed in an accessible route?

34

---

---

---

---

---

---

---

---

 DEPARTMENT OF ADMINISTRATIVE SERVICES  
OFFICE OF EDUCATION AND DATA MANAGEMENT

**NO!**

**404.2.2 Clear Width.** Doorways shall have a clear opening width of 32 inches (815 mm) minimum. Clear opening width of doorways with swinging doors shall be measured between the face of door and stop, with the door open 90 degrees. Openings more than 24 inches (610 mm) in depth at doors and doorways without doors shall provide a clear opening width of 36 inches (915 mm) minimum. There shall be no projections into the clear opening width lower than 34 inches (865 mm) above the floor. Projections into the clear opening width between 34 inches (865 mm) and 80 inches (2030 mm) above the floor shall not exceed 4 inches (100 mm).

35

---

---

---

---

---

---

---

---

 DEPARTMENT OF ADMINISTRATIVE SERVICES  
OFFICE OF EDUCATION AND DATA MANAGEMENT

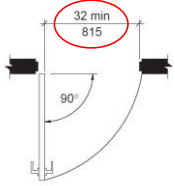

(a) Hinged Door

FIG. 404.2.2  
CLEAR WIDTH OF DOORWAYS

36

---

---

---

---

---

---

---

---

 DEPARTMENT OF ADMINISTRATIVE SERVICES  
OFFICE OF EDUCATION AND DATA MANAGEMENT

**#5:**

Can an elevator be used as an accessible means of egress?

17

---

---

---

---

---

---

---

 DEPARTMENT OF ADMINISTRATIVE SERVICES  
OFFICE OF EDUCATION AND DATA MANAGEMENT

**YES**

**1007.2 Continuity and components.** Each required *accessible means of egress* shall be continuous to a *public way* and shall consist of one or more of the following components:

1. *Accessible routes* complying with Section 1104.
2. *Interior exit stairways* complying with Sections 1007.3 and 1022.
3. *Interior exit access stairways* complying with Sections 1007.3 and 1009.3.
4. *Exterior exit stairways* complying with Sections 1007.3 and 1026 and ~~and serving levels other than the level of exit discharge.~~
5. Elevators complying with Section 1007.4.

...

18

---

---

---

---

---

---

---

 DEPARTMENT OF ADMINISTRATIVE SERVICES  
OFFICE OF EDUCATION AND DATA MANAGEMENT

**PLUS ...**

**1007.2.1 Elevators required.** In buildings where a required *accessible floor* is four or more stories above or below a *level of exit discharge*, at least one required *accessible means of egress* shall be an elevator complying with Section 1007.4.

19

---

---

---

---

---

---

---

 DEPARTMENT OF ADMINISTRATIVE SERVICES  
OFFICE OF EDUCATION AND DATA MANAGEMENT

**BUT ...**

**Exceptions:**

1. In buildings equipped throughout with an *automatic sprinkler system* installed in accordance with Section 903.3.1.1 or 903.3.1.2, the elevator shall not be required on floors provided with a *horizontal exit* and located at or above the *levels of exit discharge*.

40

---

---

---

---

---

---

---

---

 DEPARTMENT OF ADMINISTRATIVE SERVICES  
OFFICE OF EDUCATION AND DATA MANAGEMENT

2. In buildings equipped throughout with an *automatic sprinkler system* installed in accordance with Section 903.3.1.1 or 903.3.1.2, the elevator shall not be required on floors provided with a *ramp* conforming to the provisions of Section 1010.

41

---

---

---

---

---

---

---

---

 DEPARTMENT OF ADMINISTRATIVE SERVICES  
OFFICE OF EDUCATION AND DATA MANAGEMENT

**#6:**

When can a vertical wheelchair lift (platform lift) be used for providing access? Egress?

42

---

---

---

---

---

---

---

---

 DEPARTMENT OF ADMINISTRATIVE SERVICES  
OFFICE OF EDUCATION AND DATA MANAGEMENT

**Access**

**1109.8 Lifts.** Platform (wheelchair) lifts are permitted to be a part of a required *accessible route* in new construction where indicated in Items 1 through 10. Platform (wheelchair) lifts shall be installed in accordance with ASME A18.1.

1. An *accessible route* to a performing area and speaker platforms in Group A occupancies.
2. An *accessible route* to *wheelchair spaces* required to comply with the *wheelchair space* dispersion requirements of Sections 1108.2.2 through 1108.2.6.

43

---

---

---

---

---

---

---

---

 DEPARTMENT OF ADMINISTRATIVE SERVICES  
OFFICE OF EDUCATION AND DATA MANAGEMENT

3. An *accessible route* to spaces that are not open to the general public with an *occupant load* of not more than five.
4. An *accessible route* within a *dwelling* or *sleeping unit*.
5. An *accessible route* to wheelchair seating spaces located in outdoor dining terraces in Group A-5 occupancies where the *means of egress* from the dining terraces to a *public way* are open to the outdoors.
6. An *accessible route* to jury boxes and witness stands; raised courtroom stations including judges' benches, clerks' stations, bailiffs' stations, deputy clerks' stations and court reporters' stations; and to depressed areas such as the well of the court.

44

---

---

---

---

---

---

---

---

 DEPARTMENT OF ADMINISTRATIVE SERVICES  
OFFICE OF EDUCATION AND DATA MANAGEMENT

7. An *accessible route* to load and unload areas serving amusement rides.
8. An *accessible route* to play components or soft contained play structures.
9. An *accessible route* to team or player seating areas serving areas of sport activity.
10. An *accessible route* where existing exterior *site* constraints make use of a ramp or elevator infeasible.

45

---

---

---

---

---

---

---

---

 DEPARTMENT OF ADMINISTRATIVE SERVICES  
OFFICE OF EDUCATION AND DATA MANAGEMENT

**Egress**

**1007.2 Continuity and components.** Each required *accessible means of egress* shall be continuous to a *public way* and shall consist of one or more of the following components:

...

6. Platform lifts complying with Section 1007.5.

...

46

---

---

---

---

---

---

---

---

 DEPARTMENT OF ADMINISTRATIVE SERVICES  
OFFICE OF EDUCATION AND DATA MANAGEMENT

**1007.5 Platform lifts.** Platform (wheelchair) lifts shall not serve as part of an *accessible means of egress*, except where allowed as part of a required *accessible route* in Section 1109.8, Items 1 through 9. Standby power shall be provided in accordance with Chapter 27 for platform lifts permitted to serve as part of a *means of egress*.

47

---

---

---

---

---

---

---

---

 DEPARTMENT OF ADMINISTRATIVE SERVICES  
OFFICE OF EDUCATION AND DATA MANAGEMENT

**1109.8 Lifts.** Platform (wheelchair) lifts are permitted to be a part of a required *accessible route* in new construction where indicated in Items 1 through 10. Platform (wheelchair) lifts shall be installed in accordance with ASME A18.1.

1. An *accessible route* to a performing area and speaker platforms in Group A occupancies.
2. An *accessible route* to *wheelchair spaces* required to comply with the *wheelchair space* dispersion requirements of Sections 1108.2.2 through 1108.2.6.

48

---

---

---

---

---

---

---

---



 DEPARTMENT OF ADMINISTRATIVE SERVICES  
OFFICE OF EDUCATION AND DATA MANAGEMENT

3. An *accessible route* to spaces that are not open to the general public with an *occupant load* of not more than five.
4. An *accessible route* within a *dwelling* or *sleeping unit*.
5. An *accessible route* to wheelchair seating spaces located in outdoor dining terraces in Group A-5 occupancies where the *means of egress* from the dining terraces to a *public way* are open to the outdoors.
6. An *accessible route* to jury boxes and witness stands; raised courtroom stations including judges' benches, clerks' stations, bailiffs' stations, deputy clerks' stations and court reporters' stations; and to depressed areas such as the well of the court.

49

---

---

---

---

---

---

---

---

 DEPARTMENT OF ADMINISTRATIVE SERVICES  
OFFICE OF EDUCATION AND DATA MANAGEMENT

7. An *accessible route* to load and unload areas serving amusement rides.
8. An *accessible route* to play components or soft contained play structures.
9. An *accessible route* to team or player seating areas serving areas of sport activity.
10. An *accessible route* where existing exterior *site constraints* make use of a ramp or elevator infeasible.

50

---

---

---

---

---

---

---

---

 DEPARTMENT OF ADMINISTRATIVE SERVICES  
OFFICE OF EDUCATION AND DATA MANAGEMENT

**#7:**

When can I use a less than 36 inch rear grab bar (24 inches) at a commercial water closet?

51

---

---

---

---

---

---

---

---

 DEPARTMENT OF ADMINISTRATIVE SERVICES  
OFFICE OF EDUCATION AND DATA MANAGEMENT

ICC/ANSI A117.1-2009

**604.5 Grab Bars.** Grab bars for water closets shall comply with Section 609 and shall be provided in accordance with Sections 604.5.1 and 604.5.2. Grab bars shall be provided on the rear wall and on the side wall closest to the water closet.

**604.5.2 Rear Wall Grab Bars.** The rear wall grab bar shall be 36 inches (915 mm) minimum in length, and extend from the centerline of the water closet 12 inches (305 mm) minimum on the side closest to the wall, and 24 inches (610 mm) minimum on the transfer side.

52

---

---

---

---

---

---

---

---

 DEPARTMENT OF ADMINISTRATIVE SERVICES  
OFFICE OF EDUCATION AND DATA MANAGEMENT

**EXCEPTIONS:**

1. The rear grab bar shall be permitted to be 24 inches (610 mm) minimum in length, centered on the water closet, where wall space does not permit a grab bar 36 inches (915 mm) minimum in length due to the location of a recessed fixture adjacent to the water closet.
2. Where an administrative authority requires flush controls for flush valves to be located in a position that conflicts with the location of the rear grab bar, that grab bar shall be permitted to be split or shifted to the open side of the toilet area.

53

---

---

---

---

---

---

---

---

 DEPARTMENT OF ADMINISTRATIVE SERVICES  
OFFICE OF EDUCATION AND DATA MANAGEMENT

**#8:**

What is the required height of a mirror over an accessible lavatory, and to where is it measured?

54

---

---

---

---

---

---

---

---

 DEPARTMENT OF ADMINISTRATIVE SERVICES  
OFFICE OF EDUCATION AND DATA MANAGEMENT

ICC/ANSI A117.1-2009

**603.3 Mirrors.** Where mirrors are located above lavatories, a mirror shall be located over the accessible lavatory and shall be mounted with the bottom edge of the reflecting surface 40 inches (1015 mm) maximum above the floor. Where mirrors are located above counters that do not contain lavatories, the mirror shall be mounted with the bottom edge of the reflecting surface 40 inches (1015 mm) maximum above the floor.

55

---

---

---

---

---

---

---

---

 DEPARTMENT OF ADMINISTRATIVE SERVICES  
OFFICE OF EDUCATION AND DATA MANAGEMENT

**#9:**

In a toilet room, can I have hand driers that project more than 4 inches from the wall?

**NO!**

56

---

---

---

---

---

---

---

---

 DEPARTMENT OF ADMINISTRATIVE SERVICES  
OFFICE OF EDUCATION AND DATA MANAGEMENT

ICC/ANSI A117.1-2009

**307 Protruding Objects**

**307.1 General.** Protruding objects on circulation paths shall comply with Section 307.

**307.2 Protrusion Limits.** Objects with leading edges more than 27 inches (685 mm) and not more than 80 inches (2030 mm) above the floor shall protrude 4 inches (100 mm) maximum horizontally into the circulation path.

57

---

---

---

---

---

---

---

---

 DEPARTMENT OF ADMINISTRATIVE SERVICES  
OFFICE OF EDUCATION AND DATA MANAGEMENT

**#10:**  
Is the new CT adopted Symbol of Accessibility acceptable for compliance with the federal ADA?

68

---

---

---

---

---

---

---

---

 DEPARTMENT OF ADMINISTRATIVE SERVICES  
OFFICE OF EDUCATION AND DATA MANAGEMENT

What are we talking about?

Does this ...  Equal this? 

59

---

---

---

---

---

---

---

---

 DEPARTMENT OF ADMINISTRATIVE SERVICES  
OFFICE OF EDUCATION AND DATA MANAGEMENT

Public Act 16-78

**AN ACT MODERNIZING THE SYMBOL OF ACCESS FOR PERSONS WITH DISABILITIES.**  
Be it enacted by the Senate and House of Representatives in General Assembly convened:

Section 1. (NEW) *(Effective from passage)* Not later than January 1, 2017, the Commissioner of Administrative Services shall promulgate a policy and adopt regulations, in accordance with the provisions of chapter 54 of the general statutes, designating the symbol of access to be used on signage indicating access for persons with disabilities. Such symbol shall depict a logo with a dynamic character leaning forward with a sense of movement, be readily identifiable and be simply designed with no secondary meaning. Such symbol shall signify equivalent facilitation and accessibility as the previously used international symbol of access.

Sec. 2. (NEW) *(Effective from passage)* Beginning January 1, 2017, any reference to the international symbol of accessibility in the State Building Code shall be deemed to mean the symbol of access, as defined in subsection (a) of section 14-253a of the general statutes, as amended by this act. The symbol of access shall be used for all buildings and structures constructed, substantially renovated or expanded on or after January 1, 2017.

Sec. 3. Subsection (a) of section 14-253a of the 2016 supplement to the general statutes is repealed and the following is substituted in lieu thereof *(Effective January 1, 2017)*:

60

---

---

---

---

---

---

---

---

 DEPARTMENT OF ADMINISTRATIVE SERVICES  
OFFICE OF EDUCATION AND DATA MANAGEMENT

State Building Inspector formal interpretation:

The dynamic symbol of access adopted by Connecticut in Public Act 16-78, codified in Connecticut General Statutes section 29-269b, complies with the requirements of 2010 Americans with Disabilities Act (ADA) Standards. Section 103 of 2010 ADA Standards provides for equivalent facilitation and states "Nothing in these requirements prevents the use of designs, products, or technologies as alternatives to those prescribed, provided they result in substantially equivalent or greater accessibility and usability." The last sentence of CGS 29-269b was included to specifically address this requirement "Such symbol shall signify equivalent facilitation and accessibility as the previously used international symbol of access." As a result of this law, the 2016 Connecticut State Building Code amended section 703.6.3.1 of ANSI A117.1 to identify the dynamic symbol as the symbol of accessibility in Connecticut.

61

---

---

---

---

---

---

---

---

 DEPARTMENT OF ADMINISTRATIVE SERVICES  
OFFICE OF EDUCATION AND DATA MANAGEMENT

As building officials, we enforce the Connecticut State Building Code, so we have to require the new symbol.

**Question:**

Is the new symbol required for projects permitted under the old code, or under the new code but prior to January 1, 2017?

62

---

---

---

---

---

---

---

---

 DEPARTMENT OF ADMINISTRATIVE SERVICES  
OFFICE OF EDUCATION AND DATA MANAGEMENT

Statute 14-253a:

(h) Parking spaces designated for persons who are blind and persons with disabilities on or after October 1, 1979, and prior to October 1, 2004, shall be as near as possible to a building entrance or walkway and shall be fifteen feet wide including three feet of cross hatch, or parallel to a sidewalk on a public highway. On and after October 1, 2004, parking spaces for passenger motor vehicles designated for persons who are blind and persons with disabilities shall be as near as possible to a building entrance or walkway and shall be fifteen feet wide including five feet of cross hatch. On and after October 1, 2004, parking spaces for passenger vans designated for persons who are blind and persons with disabilities shall be as near as possible to a building entrance or walkway and shall be sixteen feet wide including eight feet of cross hatch. Such spaces shall be designated by above grade signs with white lettering against a blue background and shall bear the words "handicapped parking permit required" and "violators will be fined". Such sign shall also bear the international symbol of access. On and after January 1, 2017, whenever such a sign is replaced, repaired or erected it shall bear the words "reserved parking permit required" and "violators will be fined", bear the symbol of access and indicate the minimum fine for a violation of subsection (f) of this section. Such indicator may be in the form of a notice affixed to such a sign.

63

---

---

---

---

---

---

---

---



---

---

---

---

---

---

---

---



---

---

---

---

---

---

---

---

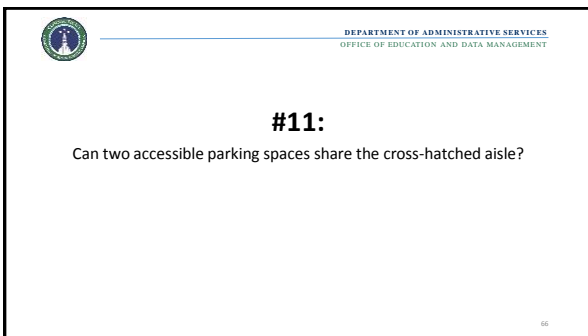

---

---

---

---

---

---

---

---

 DEPARTMENT OF ADMINISTRATIVE SERVICES  
OFFICE OF EDUCATION AND DATA MANAGEMENT

**Yes and No !**  
**Two Cars May Share**  
**Two Vans May Share**  
**A Car and A Van Shall Not Share**

Connecticut General Statute 14-253a

↓

CSBC 1106.1.1 and 1106.5.1

67

---

---

---

---

---

---

---

---

 DEPARTMENT OF ADMINISTRATIVE SERVICES  
OFFICE OF EDUCATION AND DATA MANAGEMENT

**1106.1.1 Automobile accessible parking spaces.** Pursuant to subsection (h) of section 14-253a of the Connecticut General Statutes, parking spaces for passenger motor vehicles designated for persons who are blind and persons with disabilities shall be as near as possible to a building entrance or walkway and shall be 15 feet wide including 5 feet of cross hatch.

**1106.5.1 Van accessible parking spaces.** Pursuant to subsection (h) of section 14-253a of the Connecticut General Statutes, parking spaces for passenger vans designated for persons who are blind and persons with disabilities shall be as near as possible to a building entrance or walkway and shall be 16 feet wide including 8 feet of cross hatch.

68

---

---

---

---

---

---

---

---

 DEPARTMENT OF ADMINISTRATIVE SERVICES  
OFFICE OF EDUCATION AND DATA MANAGEMENT

Compare Connecticut statute to ICC/ANSI A117.1 and to the ADA:

69

---

---

---

---

---

---

---

---

 DEPARTMENT OF ADMINISTRATIVE SERVICES  
OFFICE OF EDUCATION AND DATA MANAGEMENT

ICC/ANSI A117.1-2009

**502.4 Access Aisle.** Car and van parking spaces shall have an adjacent access aisle complying with Section 502.4.

(Amd) **502.4.1 Location.** Access aisles (cross hatch) shall adjoin an accessible route. Parking spaces for two cars or two vans may share a common access aisle. A car and van shall not share a common access aisle. Access aisles shall not overlap with the vehicular way. Parking spaces may have access aisles placed on either side of the car or van parking space. Van parking spaces that are angled shall have access aisles located on the passenger side of the parking space.

(Amd) **502.4.2 Width.** Access aisles (cross hatch) serving car parking spaces shall be 60 inches (1525 mm) minimum in width. Access aisles serving van parking spaces shall be 96 inches (2440 mm) minimum in width.

20

---

---

---

---

---

---

---

---

 DEPARTMENT OF ADMINISTRATIVE SERVICES  
OFFICE OF EDUCATION AND DATA MANAGEMENT

Connecticut Amendments

(Amd) **502.2 Vehicle space size.** Parking spaces designated for persons with disabilities shall be as near as possible to a building entrance or walkway. Accessible automobile parking spaces shall be 15 feet in width including 5 feet of cross hatch. Accessible van spaces shall be 16 feet in width including 8 feet of cross hatch.

(Del) **Fig. 502.2 Vehicle parking space size.** Delete figure without substitution.

(Del) **Fig. 502.4 Parking space access aisle.** Delete figure without substitution.

71

---

---

---

---

---

---

---

---

 DEPARTMENT OF ADMINISTRATIVE SERVICES  
OFFICE OF EDUCATION AND DATA MANAGEMENT

**#12:**

When does a sidewalk have to be treated as an exterior ramp?

72

---

---

---

---

---

---

---

---



 DEPARTMENT OF ADMINISTRATIVE SERVICES  
OFFICE OF EDUCATION AND DATA MANAGEMENT

CSBC 2016

**SECTION 202  
DEFINITIONS**

**RAMP.** A walking surface that has a running slope steeper than one unit vertical in 20 units horizontal (5-percent slope).

23

---

---

---

---

---

---

---

---

 DEPARTMENT OF ADMINISTRATIVE SERVICES  
OFFICE OF EDUCATION AND DATA MANAGEMENT

ICC/ANSI A117.1-2009

**303.4 Ramps.** Changes in level greater than 1/2 inch (13 mm) in height shall be ramped and shall comply with Section 405 or 406.

**405 Ramps**

**405.1 General.** Ramps along accessible routes shall comply with Section 405.  
**EXCEPTION:** In assembly areas, aisle ramps adjacent to seating and not serving elements required to be on an accessible route shall not be required to comply with Section 405.

**405.2 Slope.** Ramp runs shall have a running slope greater than 1:20 and not steeper than 1:12.

24

---

---

---

---

---

---

---

---

 DEPARTMENT OF ADMINISTRATIVE SERVICES  
OFFICE OF EDUCATION AND DATA MANAGEMENT

**Any walking surface with a slope/gradient steeper than 1:20 is a ramp.**

Once it is a ramp, it must meet all requirements for a ramp:

- Maximum rise
- Minimum width
- Handrails on both sides
- Edge run-off protection

25

---

---

---

---

---

---

---

---



DEPARTMENT OF ADMINISTRATIVE SERVICES  
OFFICE OF EDUCATION AND DATA MANAGEMENT

**#13:**

If a building is equipped with a platform lift for access, can the management keep the key in the office to prevent unauthorized use of the lift?

26

---

---

---

---

---

---

---

---



DEPARTMENT OF ADMINISTRATIVE SERVICES  
OFFICE OF EDUCATION AND DATA MANAGEMENT

**NO!**

From the U.S. Access Board web site:

<https://www.access-board.gov/guidelines-and-standards/buildings-and-sites/about-the-ada-standards/guide-to-the-ada-standards/chapter-4-elevators-and-platform-lifts>

27

---

---

---

---

---

---

---

---



DEPARTMENT OF ADMINISTRATIVE SERVICES  
OFFICE OF EDUCATION AND DATA MANAGEMENT

*Can platform lifts be locked?*

The Standards require “unassisted” entry and exit from lifts (§410.1). Situations in which platform lifts are locked and require users to request or retrieve a key for operation will not satisfy this requirement for independent operation. Platform lifts can be locked during those times when the space or facility they serve is closed.

28

---

---

---

---

---

---

---

---

 DEPARTMENT OF ADMINISTRATIVE SERVICES  
OFFICE OF EDUCATION AND DATA MANAGEMENT

**#14:**

Where and when do the doors to accessible toilet stalls need to have pull handles to close the door?

79

---

---

---

---

---

---

---

---

 DEPARTMENT OF ADMINISTRATIVE SERVICES  
OFFICE OF EDUCATION AND DATA MANAGEMENT

ICC/ANSI A117.1 - 2009

**604.9.3 Doors.** Toilet compartment doors, including door hardware, shall comply with Section 404, except if the approach is to the latch side of the compartment door clearance between the door side of the stall and any obstruction shall be 42 inches (1065 mm) minimum. The door shall be self-closing. A door pull complying with Section 404.2.6 shall be placed on both sides of the door near the latch. Toilet compartment doors shall not swing into the required minimum area of the compartment.

80

---

---

---

---

---

---

---

---

 DEPARTMENT OF ADMINISTRATIVE SERVICES  
OFFICE OF EDUCATION AND DATA MANAGEMENT

CSBC 2016

**1109.2.2.1 Pull handle.** Where accessible water closet compartments or single occupancy toilet rooms are provided, the compartment or room doors shall have a pull handle mounted 6 inches from the hinge side on the compartment or room side of the door. This handle shall be between 26 inches and 36 inches from the floor and shall meet the requirements of Section 404.2.6 of ICC/ANSI A117.1.

**Exceptions:**

81

---

---

---

---

---

---

---

---

 DEPARTMENT OF ADMINISTRATIVE SERVICES  
OFFICE OF EDUCATION AND DATA MANAGEMENT

CSBC 2016

**Exceptions:**

1. Compartments or rooms with self-closing, self-latching doors.
2. Doors that swing into the compartment or room.

62

---

---

---

---

---

---

---

---

 DEPARTMENT OF ADMINISTRATIVE SERVICES  
OFFICE OF EDUCATION AND DATA MANAGEMENT

Near the latch –  
Satisfies ICC/ANSI  
A117.1



63

---

---

---

---

---

---

---

---

 DEPARTMENT OF ADMINISTRATIVE SERVICES  
OFFICE OF EDUCATION AND DATA MANAGEMENT

Near hinge –  
Satisfies CSBC



64

---

---

---

---

---

---

---

---

 DEPARTMENT OF ADMINISTRATIVE SERVICES  
OFFICE OF EDUCATION AND DATA MANAGEMENT

One near hinge, one near latch –  
Both are necessary for full code compliance



65

---

---

---

---

---

---

---

---

 DEPARTMENT OF ADMINISTRATIVE SERVICES  
OFFICE OF EDUCATION AND DATA MANAGEMENT

**#15:**  
Are egress stairs serving areas of refuge required to provide 48 inches clear between handrails?

66

---

---

---

---

---

---

---

---

 DEPARTMENT OF ADMINISTRATIVE SERVICES  
OFFICE OF EDUCATION AND DATA MANAGEMENT

**YES**

**1007.2 Continuity and components.** Each required *accessible means of egress* shall be continuous to a *public way* and shall consist of one or more of the following components:

...

9. *Areas of refuge* complying with **Section 1007.6.**

...

67

---

---

---

---

---

---

---

---

 DEPARTMENT OF ADMINISTRATIVE SERVICES  
OFFICE OF EDUCATION AND DATA MANAGEMENT

**1007.6 Areas of refuge.** Every required *area of refuge* shall be *accessible* from the space it serves by an *accessible means of egress*. The maximum travel distance from any *accessible* space to an *area of refuge* shall not exceed the travel distance permitted for the occupancy in accordance with Section 1016.1. Every required *area of refuge* shall have direct access to a *stairway* complying with Sections 1007.3 or an elevator complying with Section 1007.4. Where an elevator lobby is used as an *area of refuge*, the shaft and lobby shall comply with Section 1022.10 for smokeproof enclosures except where the elevators are in an *area of refuge* formed by a *horizontal exit* or smoke barrier.

68

---

---

---

---

---

---

---

---

 DEPARTMENT OF ADMINISTRATIVE SERVICES  
OFFICE OF EDUCATION AND DATA MANAGEMENT

**1007.3 Stairways.** In order to be considered part of an *accessible means of egress*, a *stairway* between stories shall have a clear width of 48 inches (1219 mm) minimum between *handrails* and shall either incorporate an *area of refuge* within an enlarged floor-level landing or shall be accessed from either an *area of refuge* complying with Section 1007.6 or a *horizontal exit*. *Exit access stairways* that connect levels in the same story are not permitted as part of an *accessible means of egress*.

69

---

---

---

---

---

---

---

---

 DEPARTMENT OF ADMINISTRATIVE SERVICES  
OFFICE OF EDUCATION AND DATA MANAGEMENT

**Exceptions:**

1. The clear width of 48 inches (1219 mm) between *handrails* is not required in buildings equipped throughout with an *automatic sprinkler system* installed in accordance with Section 903.3.1.1 or 903.3.1.2.
2. *Areas of refuge* are not required at *stairways* in buildings equipped throughout by an *automatic sprinkler system* installed in accordance with Section 903.3.1.1 or 903.3.1.2.
3. The clear width of 48 inches (1219 mm) between *handrails* is not required for *stairways* accessed from a *horizontal exit*.

...

90

---

---

---

---

---

---

---

---

 DEPARTMENT OF ADMINISTRATIVE SERVICES  
OFFICE OF EDUCATION AND DATA MANAGEMENT

**#16:**

What's the difference between an area of refuge, and an area of rescue assistance?

91

---

---

---

---

---

---

---

---

 DEPARTMENT OF ADMINISTRATIVE SERVICES  
OFFICE OF EDUCATION AND DATA MANAGEMENT

CSBC 2016

**SECTION 202  
DEFINITIONS**

**AREA OF REFUGE.** An area where persons unable to use *stairways* can remain temporarily to await instructions or assistance during emergency evacuation.

**AREA OF RESCUE ASSISTANCE.** *Not defined under Section 202*

BUT ...

92

---

---

---

---

---

---

---

---

 DEPARTMENT OF ADMINISTRATIVE SERVICES  
OFFICE OF EDUCATION AND DATA MANAGEMENT

CSBC Chapter 10

**1007.2 Continuity and components.** Each required *accessible means of egress* shall be continuous to a *public way* and shall consist of one or more of the following components:

1. *Accessible* routes complying with Section 1104.
- ....
9. *Areas of refuge* complying with Section 1007.6.
10. Exterior area for assisted rescue complying with Section 1007.7.

93

---

---

---

---

---

---

---

---

 DEPARTMENT OF ADMINISTRATIVE SERVICES  
OFFICE OF EDUCATION AND DATA MANAGEMENT

**AREA OF REFUGE**

- Accessed by an accessible means of egress
- Direct access to a stairway complying with 1007.3, or an elevator
- Sized for one wheelchair space per each 200 occupants
- Separated from the remainder of the story
- Equipped with a two-way communication system

58

---

---

---

---

---

---

---

---

 DEPARTMENT OF ADMINISTRATIVE SERVICES  
OFFICE OF EDUCATION AND DATA MANAGEMENT

**AREA OF ASSISTED RESCUE**  
**Exterior Area for Assisted Rescue - Section 1007.7**

- Exterior
- Accessed by an accessible route from area served
- Sized for one wheelchair space per each 200 occupants
- Used where exit discharge does not include an accessible path to grade
- Separated from the interior of the building
- Open to outside air
- Served by stairway providing at least 48" clear between handrails

55

---

---

---

---

---

---

---

---

 DEPARTMENT OF ADMINISTRATIVE SERVICES  
OFFICE OF EDUCATION AND DATA MANAGEMENT

Courtesy of  
Kim Paarlberg,  
ICC

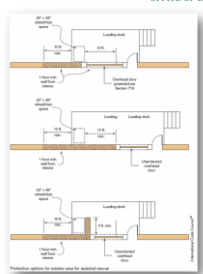

56

---

---

---

---

---

---

---

---



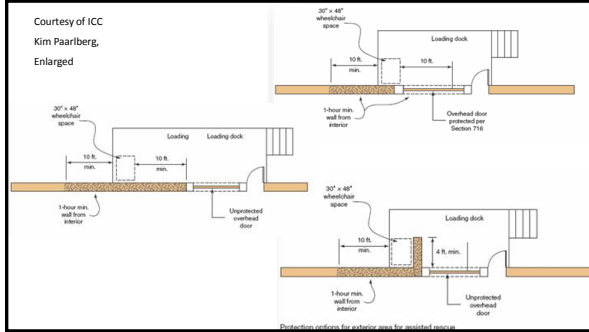

---

---

---

---

---

---

---

---

DEPARTMENT OF ADMINISTRATIVE SERVICES  
OFFICE OF EDUCATION AND DATA MANAGEMENT

**#17:**  
How deeply can a door be recessed into a thick wall?

58

---

---

---

---

---

---

---

---

DEPARTMENT OF ADMINISTRATIVE SERVICES  
OFFICE OF EDUCATION AND DATA MANAGEMENT

ICC/ANSI A117.1 - 2009

**404.2.3 Maneuvering Clearances.** Minimum maneuvering clearances at doors shall comply with Section 404.2.3 and shall include the full clear opening width of the doorway. Required door maneuvering clearances shall not include knee and toe clearance.

(Amd) **404.2.3.5 Recessed doors.** Where any obstruction within 24 inches of the latch side of a doorway projects more than 8 inches beyond the face of the door, measured perpendicular to the face of the door, maneuvering clearances for a forward approach shall be provided.

59

---

---

---

---

---

---

---

---

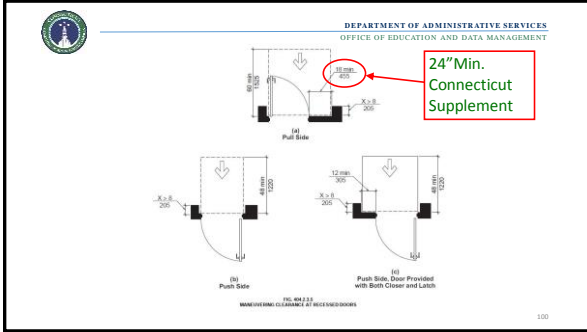

---

---

---

---

---

---

---

---

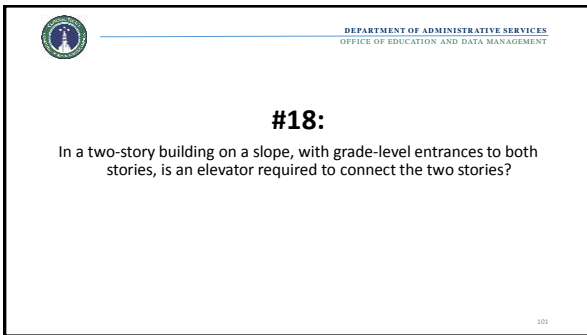

---

---

---

---

---

---

---

---

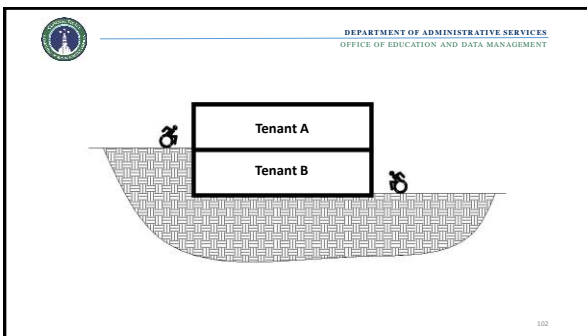

---

---

---

---

---

---

---

---

 DEPARTMENT OF ADMINISTRATIVE SERVICES  
OFFICE OF EDUCATION AND DATA MANAGEMENT

**NO** elevator required.

CSBC 2016

**1104.2 Within a site.** At least one *accessible route* shall connect *accessible buildings*, *accessible facilities*, *accessible elements* and *accessible spaces* that are on the same *site*.

**Exception:** An *accessible route* is not required between *accessible buildings*, *accessible facilities*, *accessible elements* and *accessible spaces* that have, as the only means of access between them, a vehicular way not providing for pedestrian access.

103

---

---

---

---

---

---

---

---

 DEPARTMENT OF ADMINISTRATIVE SERVICES  
OFFICE OF EDUCATION AND DATA MANAGEMENT

**BUT ...**

↓

**1104.5 Location.** *Accessible routes* shall coincide with or be located in the same area as a general *circulation path*. Where the *circulation path* is interior, the *accessible route* shall also be interior. Where only one *accessible route* is provided, the *accessible route* shall not pass through kitchens, storage rooms, restrooms, closets or similar spaces.

104

---

---

---

---

---

---

---

---

 DEPARTMENT OF ADMINISTRATIVE SERVICES  
OFFICE OF EDUCATION AND DATA MANAGEMENT

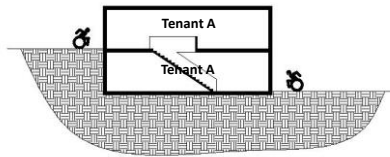

105

---

---

---

---

---

---

---

---

 DEPARTMENT OF ADMINISTRATIVE SERVICES  
OFFICE OF EDUCATION AND DATA MANAGEMENT

Now an elevator is required.

Once an interior path of circulation is provided between two spaces required to be accessible, there must also be an interior **accessible** path of circulation.

106

---

---

---

---

---

---

---

---

 DEPARTMENT OF ADMINISTRATIVE SERVICES  
OFFICE OF EDUCATION AND DATA MANAGEMENT

**#19:**

I'm doing a renovation and alteration to a municipal town hall. Does an accessible route have to be provided to all offices on all floors?

107

---

---

---

---

---

---

---

---

 DEPARTMENT OF ADMINISTRATIVE SERVICES  
OFFICE OF EDUCATION AND DATA MANAGEMENT

Yes

No

Maybe

It depends

I don't have any idea

108

---

---

---

---

---

---

---

---



DEPARTMENT OF ADMINISTRATIVE SERVICES  
OFFICE OF EDUCATION AND DATA MANAGEMENT

CSBC 2016  
Chapter 34 – Existing Buildings

**SECTION 3411**  
**ACCESSIBILITY FOR EXISTING BUILDINGS**

**3411.6 Alterations.** A facility that is altered shall comply with the applicable provisions in Chapter 11 of this code, unless *technically infeasible*. Where compliance with this section is *technically infeasible*, the alteration shall provide access to the maximum extent technically feasible.

109

---

---

---

---

---

---

---

---



DEPARTMENT OF ADMINISTRATIVE SERVICES  
OFFICE OF EDUCATION AND DATA MANAGEMENT

**Exceptions:**

1. The altered element or space is not required to be on an *accessible route*, unless required by Section 3411.7.
2. *Accessible means of egress* required by Chapter 10 are not required to be provided in existing facilities.

110

---

---

---

---

---

---

---

---



DEPARTMENT OF ADMINISTRATIVE SERVICES  
OFFICE OF EDUCATION AND DATA MANAGEMENT

**3411.7 Alterations affecting an area containing a primary function.** Where an alteration affects the accessibility to, or contains an area of *primary function*, the route to the *primary function* area shall be *accessible*. The *accessible route* to the *primary function* area shall include toilet facilities or drinking fountains serving the area of *primary function*.

111

---

---

---

---

---

---

---

---

 DEPARTMENT OF ADMINISTRATIVE SERVICES  
OFFICE OF EDUCATION AND DATA MANAGEMENT

↓

Chapter 11

**1103.1 Where required.** *Sites, buildings, structures, facilities,* elements and spaces, temporary or permanent, shall be *accessible* to persons with physical disabilities.

**1103.2 General exceptions.** *Sites, buildings, structures, facilities,* elements and spaces shall be exempt from this chapter to the extent specified in this section.

112

---

---

---

---

---

---

---

---

 DEPARTMENT OF ADMINISTRATIVE SERVICES  
OFFICE OF EDUCATION AND DATA MANAGEMENT

**1103.2.1 Specific requirements.** *Accessibility* is not required in buildings and *facilities,* or portions thereof, to the extent permitted by Sections 1104 through 1110.

**1103.2.2 Existing buildings.** Existing buildings shall comply with Section 3411.

**1103.2.3 Employee work areas.** Spaces and elements within employee work areas shall only be required to comply with Sections 907.5.2.3.2, 1007 and 1104.3.1 and shall be designed and constructed so that individuals with disabilities can approach, enter and exit the work area. Work areas, or portions of work areas, that are less than 300 square feet (30 m<sup>2</sup>) in area and located 7 inches (178 mm) or more above or below the ground or finish floor where the change in elevation is essential to the function of the space shall be exempt from all requirements.

113

---

---

---

---

---

---

---

---

 DEPARTMENT OF ADMINISTRATIVE SERVICES  
OFFICE OF EDUCATION AND DATA MANAGEMENT

*What was the question again?*

Does an accessible route have to be provided to all offices on all floors?

↓

Is an office an area containing a primary function?

114

---

---

---

---

---

---

---

---

 DEPARTMENT OF ADMINISTRATIVE SERVICES  
OFFICE OF EDUCATION AND DATA MANAGEMENT

CSBC 2016 – Chapter 2  
DEFINITIONS

**PRIMARY FUNCTION.** A primary function is a major activity for which the facility is intended. Areas that contain a primary function include, but are not limited to, the customer service lobby of a bank, the dining area of a cafeteria, the meeting rooms in a conference center, as well as offices and other work areas in which the activities of the public accommodation or other private entity using the facility are carried out. Mechanical rooms, boiler rooms, supply storage rooms, employee lounges or locker rooms, janitorial closets, entrances, *corridors* and restrooms are not areas containing a primary function.

145

---

---

---

---

---

---

---

---

 DEPARTMENT OF ADMINISTRATIVE SERVICES  
OFFICE OF EDUCATION AND DATA MANAGEMENT

- Offices are areas containing a primary function (Chapter 2, Definitions)
- Where an *alteration* affects the accessibility to, or contains an area of *primary function*, the route to the *primary function* area shall be *accessible*. (Chapter 34, Section 3411.7)

↓

Answer: Yes ... for all floors involved in the alteration/renovation

146

---

---

---

---

---

---

---

---

 DEPARTMENT OF ADMINISTRATIVE SERVICES  
OFFICE OF EDUCATION AND DATA MANAGEMENT

**#20:**

In applying the “20-percent” rule for alterations to existing buildings, what work is included in the project cost for calculating the 20 percent, and what work is excluded?

147

---

---

---

---

---

---

---

---

 DEPARTMENT OF ADMINISTRATIVE SERVICES  
OFFICE OF EDUCATION AND DATA MANAGEMENT

CSBC 2016 – Chapter 34

**3411.7 Alterations affecting an area containing a primary function.**  
Where an *alteration* affects the accessibility to, or contains an area of *primary function*, the route to the *primary function* area shall be *accessible*. The *accessible route* to the *primary function* area shall include toilet facilities or drinking fountains serving the area of *primary function*.

118

---

---

---

---

---

---

---

---

 DEPARTMENT OF ADMINISTRATIVE SERVICES  
OFFICE OF EDUCATION AND DATA MANAGEMENT

**Exceptions:**

1. The costs of providing the *accessible route* are not required to exceed 20 percent of the costs of the alterations affecting the area of *primary function*.

119

---

---

---

---

---

---

---

---

 DEPARTMENT OF ADMINISTRATIVE SERVICES  
OFFICE OF EDUCATION AND DATA MANAGEMENT

2012 IBC Commentary

An area containing a primary function is one in which a major activity for which the building or facility is intended is carried out. For example, the lobby of a hotel in which the registration and check-out desk is located would be a primary function area. Other examples would be the dining area of a restaurant, the meeting rooms or exhibition halls in a conference center, **virtually all office and work areas in a business building** and retail display areas in a mercantile occupancy.

120

---

---

---

---

---

---

---

---



 DEPARTMENT OF ADMINISTRATIVE SERVICES  
OFFICE OF EDUCATION AND DATA MANAGEMENT

2012 IBC Commentary

The requirement for a complete accessible route does not apply when the cost of providing it exceeds 20 percent of the cost of the alterations or addition to the primary function area. These costs are intended to be based on the actual costs of the planned alterations or addition to the primary function area before consideration of the cost of providing an accessible route.

120

---

---

---

---

---

---

---

---

 DEPARTMENT OF ADMINISTRATIVE SERVICES  
OFFICE OF EDUCATION AND DATA MANAGEMENT

EXAMPLE:  
Office Building

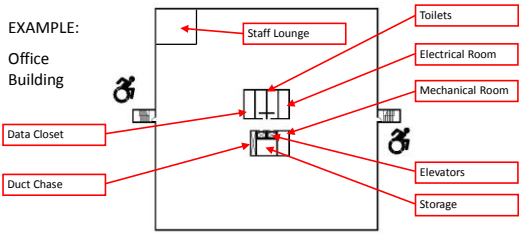

122

---

---

---

---

---

---

---

---

 DEPARTMENT OF ADMINISTRATIVE SERVICES  
OFFICE OF EDUCATION AND DATA MANAGEMENT

The times, they are a changin'

123

---

---

---

---

---

---

---

---



DEPARTMENT OF ADMINISTRATIVE SERVICES  
OFFICE OF EDUCATION AND DATA MANAGEMENT

1996 BOCA	2012 IBC
<p><b>1110.2.1 Alterations affecting an area containing a primary function.</b> Where an <i>alteration</i> affects the usability of, or access to, an area containing a primary function, an accessible route to the primary function area shall be provided. The accessible route to the primary function area shall include any restrooms or drinking fountains serving the primary function area.</p>	<p><b>3411.7 Alterations affecting an area containing a primary function.</b> Where an alteration affects the accessibility to, or contains an area of <i>primary function</i>, the route to the primary function area shall be accessible. The accessible route to the <i>primary function</i> area shall include toilet facilities or drinking fountains serving the area of primary function.</p>

124

---

---

---

---

---

---

---

---



DEPARTMENT OF ADMINISTRATIVE SERVICES  
OFFICE OF EDUCATION AND DATA MANAGEMENT

1996 BOCA	2012 IBC
<p><b>Exceptions</b></p> <ol style="list-style-type: none"> <li>1. Where the cost of providing the accessible route exceeds 20 percent of the costs of the <i>alterations</i> affecting the primary function area.</li> <li>2. <i>Alterations</i> to windows, hardware, operating controls electrical outlets and signage.</li> </ol>	<p><b>Exceptions:</b></p> <ol style="list-style-type: none"> <li>1. The costs of providing the <i>accessible route</i> are not required to exceed 20 percent of the costs of the <i>alterations</i> affecting the area of <i>primary function</i>.</li> <li>2. This provision <b>does not</b> apply to <i>alterations</i> limited solely to windows, hardware, operating controls, electrical outlets and signs.</li> </ol>

125

---

---

---

---

---

---

---

---



DEPARTMENT OF ADMINISTRATIVE SERVICES  
OFFICE OF EDUCATION AND DATA MANAGEMENT

1996 BOCA	2012 IBC
<p><b>Exceptions</b></p> <ol style="list-style-type: none"> <li>3. <i>Alterations</i> to mechanical systems, electrical systems, installations or <i>alterations of fire protection systems</i>, and abatement of hazardous materials.</li> <li>4. <i>Alterations</i> undertaken for the primary purpose of increasing the accessibility of an existing building, facility or element.</li> </ol>	<p><b>Exceptions (Cont.):</b></p> <ol style="list-style-type: none"> <li>3. This provision <b>does not</b> apply to <i>alterations</i> limited solely to mechanical systems, electrical systems, installation or alteration of fire protection systems and abatement of hazardous materials.</li> <li>4. This provisions <b>does not</b> apply to <i>alterations</i> undertaken for the primary purpose of increasing the accessibility of a <i>facility</i>.</li> </ol>

126

---

---

---

---

---

---

---

---



---

---

---

---

---

---

---

---