

Fire Protection Requirements and Features per the 2012 IRC

*Presented by
James Quish, Trainer, OEDM*

*Office of Education and Data Management
Fall 2015 Career Development Series*

**Fire Protection
1 & 2 Family Residential**

Based on the 2012 IRC
Model Code for the Residential Portion of the
2016? State Building Code





**Fire Protection
1 & 2 Family Residential**

- Disclaimer:
 - The following is a ‘best effort’ interpretation of selected pieces of the 2016 Residential Code Portion of the Connecticut State Building Code.
 - Draft** Connecticut amendments have been included.
- CGS 29- 252 Office of the State Building Inspector
 - Responsible for interpretation of Code
 - The official ‘word’
 - (CT)R104.1.1 ‘Codification’ of State’s authority



Fire Protection 1 & 2 Family Residential

- Intentions:
 - For the Building Officials / Residential Inspectors
 - Review / overview selected key IRC fire safety items.
 - Highlight the role of the Building Department in relation to fire safety in 1 & 2 family residential.
 - Highlight the importance of the IRC in relation to building occupant fire protection and life safety.
 - Provide some explanation of selected fire safety items in relation to fire service mitigation activities.
 - For the Fire Officials / Code Compliance Inspectors
 - Compare IRC requirements to familiar CSFSC & CSFPC requirements.
 - Provide an overview of the arrangement of fire / life safety items within the Residential portion of the State Building Code.
 - Better prepare operational fire personnel for handling fire mitigation within residential 1 & 2 family dwellings.
 - Understand and appreciate the vital role of the local Building Department in ensuring life safety within 1 & 2 family residential structures.

Fire Protection 1 & 2 Family Residential 'Warm-up' Exercise

- 1) In what classification of structure is a US citizen most likely to become a fire fatality?
- 2) What classification of structure presents the greatest threat of death or injury to a US firefighter?
- 3) What classification of Connecticut structure is not subject to periodic fire safety inspections?
- 4) What classification of Connecticut structure relies primarily upon the Building Code to ensure a fire safe environment?



Fire Protection 1 & 2 Family Residential

- Most prevalent building:
 - 1) Not subject to FD fire inspections
 - Exempt from periodic inspections
 - 2) Greatest hazard to life loss
 - Occupants & fire service
- Therefore:
 - Issuance of a Building Permit will provide the only opportunity to examine and formally enforce the fire safety features of these structures.
 - Residential Building Code is the *de facto* fire code' for this type of building



Fire Protection 1 & 2 Family Residential

- R101.2 Scope
 - 2015 Residential Portion of the SBC
 - Applicable to:
 - Up to 3 stories
 - 1 & 2 family dwellings
 - Includes ‘townhouses’
 - Structures accessory to the above dwellings
 - » Sheds, garages, gazebos, studios, etc.
 - » Same lot



Fire Protection 1 & 2 Family Residential

- R101.3 Code Intent
 - Minimum requirements for:
 - Safeguarding public safety
 - Structural strength
 - Maintaining MOE
 - Life safety
 - Protection of property from fire
 - Safety for firefighters / emergency responders



Fire Protection 1 & 2 Family Residential

- Fire Protection ‘goals’ of Code (Based on R101.3)
 - **Prevent fires from occurring**
 - Equipment installation , combustible materials limits
 - **Minimize the impact of fires that do occur**
 - Draft stopping, fire stopping, smoke development
 - **Reasonable occupant warning / protection**
 - Smoke and CO detection
 - **Provide effective occupant exiting**
 - Component dimensional criteria, arrangement
 - **Provide emergency egress for occupants**
 - Second way out, dimensional criteria
 - **Provide reasonable safety for emergency responders**
 - Maintain reasonable building tenability for suppression efforts
- Everything we discuss today will support one of these goals!
 - Very much like the Fire Code & Prevention Code goals



Residential 1 & 2 Family Fire Protection -IRC Topic Overview-

- Focus Topics – 2012 IRC Fire Safety / Mitigation Issues
 - **Building design features**
 - Fire separation requirements
 - Fire Blocking / Draft stopping / Specific structural component protection
 - Means of Egress
 - Emergency Escape & Rescue Openings
 - Fire sprinkler systems
 - Smoke Alarms
 - CO Alarms
 - Finishes & Materials
 - Mitigation issues
 - Chimneys and fireplaces
 - Mechanical / HVAC equipment installations
 - Fuel gas systems and appliances
 - Electrical installation concerns



Residential 1 & 2 Family Fire Protection -Building Design Features-

- Building Height & Area
 - Height regulated
 - R101.2 Scope
 - 3 stories above grade plane
 - R602.3 Prescriptive Bearing Stud Height Limit
 - 10' prescriptive laterally unsupported stud limitation
 - Section R602.10 Wall Bracing
 - Wall height related to lateral bracing length

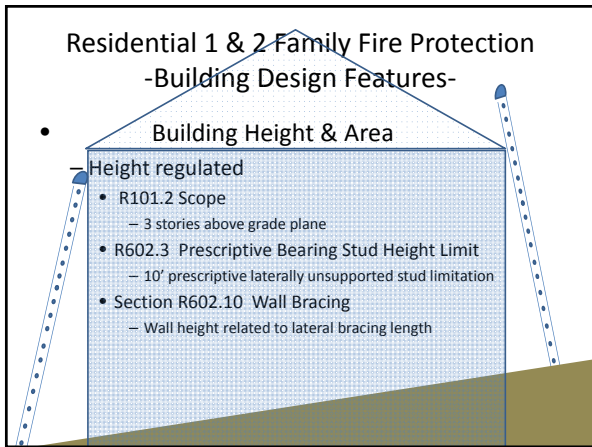

Residential 1 & 2 Family Fire Protection -Emergency Escape & Rescue Openings-

- Building Area
 - Not specifically addressed
 - R303.1 'Habitable room' requirements
 - Glazing area - 8% of floor area.
 - » Some exceptions
 - Outdoor vent - 4% of floor area
 - » Some impact on controlling 'area'
 - Large rooms = lotta' glass
 - May be a local zoning issue



Residential 1 & 2 Family Fire Protection -Building Design Features-

- 2012 IRC Chapter 3 – Several Fire Safety Topics!
 - Regulates
 - 1) Building design
 - Load resistance
 - Height
 - Wind, flood, & decomposition
 - 2) Fire protection
 - Passive
 - Active
 - 3) Human comfort
 - Interior room dimensions
 - Heat, cooling, ventilation & lighting
 - Sanitation
 - 4) Occupant safety
 - Egress / emergency egress
 - Separation of hazards
 - CO alarms
 - Safety glazing



Residential 1 & 2 Family Fire Protection -Emergency Escape & Rescue Openings-

- R303.8 Required Glazing
 - Open directly onto street, public alley, yard, or court.
 - Exceptions:
 - 1) Porch
 - 2) Overhanging eaves
 - 3) Under decks, cantilevered areas with 36" vertical maintained
 - We are rarely more than 15' from a window or door!



Residential 1 & 2 Family Fire Protection -Building Design Features-

R301.1 Constructed to support all loads

- Dead Loads
 - 301.1.2 Prescriptive Builds
 - Western platform
 - Balloon
 - Log
 - Steel frame
 - Masonry wall
 - R301.1.3 Performance
 - Engineered

- Prescriptive Live loads
 - Table 301.5

TYPE	LIVE LOAD
Uninhabitable attics without storage ^a	10
Uninhabitable attics with limited storage ^a	20
Habitable attics and attics served with fixed stairs	30
Balconies (exterior) and decks ^b	40
Fire escapes	40
Guardrails and handrails ^c	200 ^d
Guardrail in-fill components ^e	50 ^f
Passenger vehicle garages ^g	50 ^f
Rooms other than sleeping room	40
Sleeping rooms	30
Stairs	40 ^f

Residential 1 & 2 Family Fire Protection
-Building Design Features-

- Section 301 Design Criteria
 - R301.1 Application
 - Constructed to withstand all anticipated loads
 - Gravity loads
 - » Static loads (Dead loads)
 - » Dynamic loads (Live loads)
 - Lateral loads
 - » Wind
 - » Seismic
 - » Flooding
 - Not included are:
 - Fire stresses
 - Fire mitigation efforts



Residential 1 & 2 Family Fire Protection
-Building Design Features-

R301.1 Constructed to support all loads

- R907 Reroofing
 - R907.2 Structure must handle additional dead load
 - Maximum 2 layers !
 - 1 bundle weighs 60#-80#
 - Each layer adds 1.8 to 3.2 psf
 - 10 – 20 psf roof dead load
 - Deck
 - Framing
 - Covering(s)



Residential 1 & 2 Family Fire Protection
-Fire Separation Requirements-

- Focus Topics – 2012 IRC Fire Safety / Mitigation Issues
 - Building design features
 - **Fire separation requirements**
 - Fire Blocking / Draft stopping / Specific structural component protection
 - Means of Egress
 - Emergency Escape & Rescue Openings
 - Fire sprinkler systems
 - Smoke Alarms
 - CO Alarms
 - Finishes & Materials
 - Mitigation issues
 - Chimneys and fireplaces
 - Mechanical / HVAC equipment installations
 - Fuel gas systems and appliances
 - Electrical installation concerns



Fire Protection 1 & 2 Family Residential

- R101.2 Scope
 - 2015 Residential Portion of the SBC
 - All dwelling units must be:
 - 1) Fire separated from other dwelling units by either:
 - » Open space
 - » Fire rated construction
 - 2) Provide independent MOE to the building exterior
 - » Single family dwelling
 - » Two family dwelling
 - » Townhouse dwelling units



Residential 1 & 2 Family Fire Protection -Fire Separation Requirements-

- Fire Separation Distance
 - Table R302.1(1) Exterior Walls relative to lot line or other structures.
 - In general:
 - Less than 5' – 1 hour rated
 - Greater than >5' – 0 hour

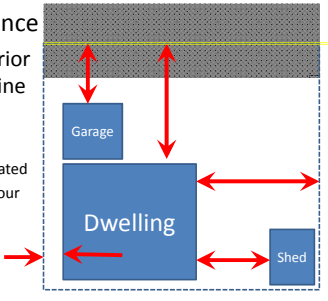

Residential 1 & 2 Family Fire Protection -Fire Separation Requirements-



- Spacing Reduction for AS
 - Table R302.1(2) Exterior Walls relative to lot line or other structures.
 - 0' – 1 hour
 - $\geq 3'$ – 0 hour

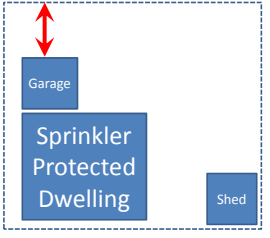

Residential 1 & 2 Family Fire Protection -Fire Separation Requirements-

- Fire Separation distance also looks at :
 - Projections
 - Overhangs
 - Openings
 - Doors ,windows
 - Glazing size restricted
 - Wall penetrations
 - Pipe, wire, exhaust duct, etc.

- Separation distance may be reduced with AS

Residential 1 & 2 Family Fire Protection -Fire Separation Requirements-

Table R302.1(1) Separation Distance

Code	Minimum Separation Distance (ft)	Minimum Separation Distance (m)
1. Single-family dwellings	10	3.05
2. Two-family dwellings	10	3.05
3. Townhouses	10	3.05
4. Multi-family dwellings	10	3.05
5. Detached garages	10	3.05
6. Detached sheds	10	3.05
7. Detached accessory structures	10	3.05
8. Detached swimming pools	10	3.05
9. Detached swimming pool enclosures	10	3.05
10. Detached swimming pool sheds	10	3.05
11. Detached swimming pool cabanas	10	3.05
12. Detached swimming pool gazebos	10	3.05
13. Detached swimming pool pergolas	10	3.05
14. Detached swimming pool patios	10	3.05
15. Detached swimming pool decks	10	3.05
16. Detached swimming pool fences	10	3.05
17. Detached swimming pool gates	10	3.05
18. Detached swimming pool stairs	10	3.05
19. Detached swimming pool ladders	10	3.05
20. Detached swimming pool slides	10	3.05
21. Detached swimming pool spas	10	3.05
22. Detached swimming pool hot tubs	10	3.05
23. Detached swimming pool saunas	10	3.05
24. Detached swimming pool cabanas	10	3.05
25. Detached swimming pool gazebos	10	3.05
26. Detached swimming pool pergolas	10	3.05
27. Detached swimming pool patios	10	3.05
28. Detached swimming pool decks	10	3.05
29. Detached swimming pool fences	10	3.05
30. Detached swimming pool gates	10	3.05
31. Detached swimming pool stairs	10	3.05
32. Detached swimming pool ladders	10	3.05
33. Detached swimming pool slides	10	3.05
34. Detached swimming pool spas	10	3.05
35. Detached swimming pool hot tubs	10	3.05
36. Detached swimming pool saunas	10	3.05

Table R302.1(2) Separation Distance with Sprinklers

Code	Minimum Separation Distance (ft)	Minimum Separation Distance (m)
1. Single-family dwellings	5	1.52
2. Two-family dwellings	5	1.52
3. Townhouses	5	1.52
4. Multi-family dwellings	5	1.52
5. Detached garages	5	1.52
6. Detached sheds	5	1.52
7. Detached accessory structures	5	1.52
8. Detached swimming pools	5	1.52
9. Detached swimming pool enclosures	5	1.52
10. Detached swimming pool sheds	5	1.52
11. Detached swimming pool cabanas	5	1.52
12. Detached swimming pool gazebos	5	1.52
13. Detached swimming pool pergolas	5	1.52
14. Detached swimming pool patios	5	1.52
15. Detached swimming pool decks	5	1.52
16. Detached swimming pool fences	5	1.52
17. Detached swimming pool gates	5	1.52
18. Detached swimming pool stairs	5	1.52
19. Detached swimming pool ladders	5	1.52
20. Detached swimming pool slides	5	1.52
21. Detached swimming pool spas	5	1.52
22. Detached swimming pool hot tubs	5	1.52
23. Detached swimming pool saunas	5	1.52

Residential 1 & 2 Family Fire Protection -Fire Separation Requirements-

- Our 'rule book' deals with fire separation
 - Section R302
- Local Zoning Regulations
 - (CT) R105.3.1.1 Zoning Officer check-off required
 - Zoning may increase separation distance requirements

Residential 1 & 2 Family Fire Protection -Fire Separation Requirements-

- R302.2 Townhouse Fire Separation
 - Each townhouse is a separate dwelling when:
 - 1 hour vertical separation wall for each unit
 - Common 1 hour OK with AS

- R101.2 Compliant
 - Separate MOE to exterior
 - 3 story maximum
- R202 Defined
 - Open yard or street on 2+ sides



Residential 1 & 2 Family Fire Protection -Fire Separation Requirements-

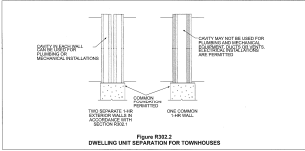



Figure R302.2
DWELLING UNIT SEPARATION FOR TOWNHOUSES

Townhouse Options:

- Two 1 hour walls
- Common 2 hour wall

Tested design
Cavity use restricted
Offset electrical boxes



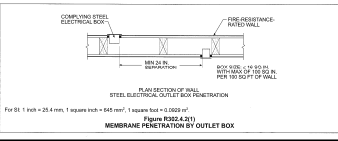

For 01, 1 inch = 25.4 mm, 1 square inch = 645 mm², 1 square foot = 0.0929 m²
Figure R302.2(1)
MEMBRANE PENETRATION BY OUTLET BOX

Residential 1 & 2 Family Fire Protection -Fire Separation Requirements-

- R302.2 Townhouses
 - R302.2.1 Continuity
 - Rated wall is continuous
 - Foundation to roof decking

Wall integrity is often violated by future communication system installations



Residential 1 & 2 Family Fire Protection -Fire Separation Requirements-

- R302.2 Townhouses
 - R302.2.2 Parapets
 - 30" vertical wall extension above roofs
 - Parapet exceptions:
 - Class c roof covering / fire resistant decking
 - X Gypsum properly applied to underside of deck
 - 5' open separation distance







Residential 1 & 2 Family Fire Protection -Fire Separation Requirements-

- R302.2.4 Townhouse Structural Independence
 - Constructed to permit an organized burn-out of one unit without impacting the stability of adjacent units.
 - Life safety issue
 - Adjacent occupants
 - Monetary issue
 - 350K not 3.5 M loss

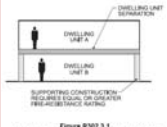
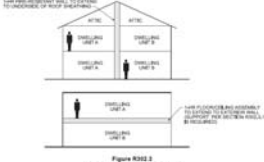

Residential 1 & 2 Family Fire Protection -Fire Separation Requirements-

- R302.3 Two family dwelling separation
 - Separation between dwelling units / attics
 - 1 hour tested assembly
 - ½ hour with NFPA 13 system
 - Supported by a 1 hour assembly
 - Separation from common areas
 - 1 hour wall or floor assemblies
 - ½ with NFPA 13 system

Residential 1 & 2 Family Fire Protection
-Fire Separation Requirements-

- R302.5 Dwelling / garage separation
 - Steel or Solid wood doors
 - 1.375" minimum thickness
 - 20 minute fire-rated also OK
 - Self closing device
- R302.6 Separation
 - 5/8" type X gypsum
 - Separation ceiling
 - Separation walls(s)
 - Supporting structure



Residential 1 & 2 Family Fire Protection
-Fire Separation Requirements-

- R302.5 Dwelling / garage openings
 - R302.5.1 – Sleeping Rooms
 - May not open to garage
 - R302.5.2 – Minimum requirements for ducts
 - 26 gage steel or other approved material
 - Plastic duct may not run through garage
 - R302.5.3 – Penetrations properly fire stopped
 - Annular space filled
 - "Approved" material
 - M 1601.6 No 'air share'
 - Garage & dwelling HVAC must be separate



Pre-Licensure Training Program
-Residential Portion of the State Building Code-

- R302.6 Dwelling / garage separation exercise

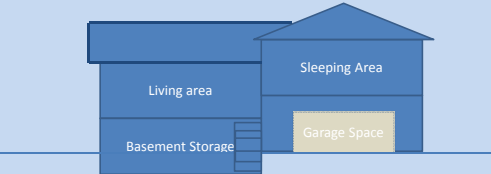

Determine the fire separation protection required between the garage space and adjacent dwelling areas. Note that a passage door exists between the garage and stairwell to the living area. A second door connects the garage with the basement storage area. The rear garage wall abuts the rear yard. A third door is found in this wall.

Pre-Licensure Training Program

-Residential Portion of the State Building Code-

- R302.6 Dwelling / garage separation

Solution:

- 1) 5/8" type X gypsum wall required between living area and garage space.
- 2) That 5/8" type X gypsum would also be required between the garage and basement storage as the storage isn't separated from the living space above.
- 3) 5/8" gypsum ceiling would be required.
- 4) 5/8" type X gypsum wall would be required on right side wall of garage due to protect the wall which is supporting the required ceiling.
- 5) The door open to the stairwell must be 1-3/8" solid wood, 1-3/8" steel, or 20 minute rated.
- 6) The door open to the basement must be 1-3/8" solid wood, 1-3/8" steel, or 20 minute rated.
- 7) The door opening to the rear yard requires not rating as it is not separating the dwelling from garage.

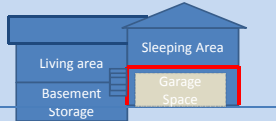

Residential 1 & 2 Family Fire Protection

-Fire Separation Requirements-

- Table R302.6 Dwelling / garage separation
 - Applies to garages proximal to dwelling unit
 - Less than 10' separation

SEPARATION	MATERIAL
From the residence and attics	Not less than 1/2 inch Type X gypsum board or equivalent applied to the garage side
From all habitable rooms above the garage	Not less than 1/2 inch Type X gypsum board or equivalent
Structure(s) supporting floor/ceiling assemblies used for separation required by this section	Not less than 1/2 inch Type X gypsum board or equivalent
Garages located less than 10 feet from a dwelling unit on the same lot	Not less than 1/2 inch Type X gypsum board or equivalent applied to the interior side of exterior walls that are within this area



Residential 1 & 2 Family Fire Protection

-Frame Void Fire Protection-

- Focus Topics – 2012 IRC Fire Safety / Mitigation Issues
 - Building design features
 - Fire separation requirements
 - **Fire Blocking / Draft stopping / Specific structural component protection**
 - Means of Egress
 - Emergency Escape & Rescue Openings
 - Fire sprinkler systems
 - Smoke Alarms
 - CO Alarms
 - Finishes & Materials
 - Mitigation issues
 - Chimneys and fireplaces
 - Mechanical / HVAC equipment installations
 - Fuel gas systems and appliances
 - Electrical installation concerns





Residential 1 & 2 Family Fire Protection -Frame Void Fire Protection-

- R302.11 Fireblocking
 - Frame void blocking
 - Limit fire travel in voids
 - Limits vertical fire growth rate
 - Minimize 'chimney effect'
 - Limits available fuel
- R302.12 Draftstopping
 - Division of larger void areas
 - Limit fuel
 - Limit oxidation rate

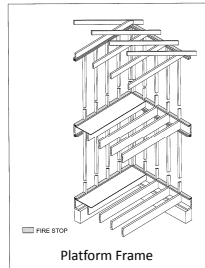
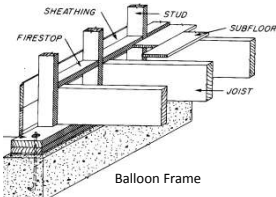

Residential 1 & 2 Family Fire Protection -Frame Void Fire Protection-

- R302.11 Fire blocking requirements
 - Each framed 'story'
 - 10' vertical intervals maximum
 - 10' horizontally



Residential 1 & 2 Family Fire Protection -Frame Void Fire Protection-

- R302.11 Fire blocking requirements
 - Item 1 - Soffit voids
 - Stud channel connections

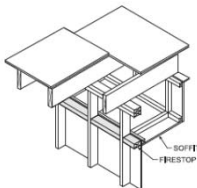

Residential 1 & 2 Family Fire Protection
-Frame Void Fire Protection-

- R302.11 Fire blocking requirements
 - Item 2 – Ceiling / Wall juncture voids
 - Drop / vaulted
 - Opens floor to ceiling fire communication
 - Coved ceiling voids
 - Stud channel connection

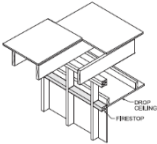

Residential 1 & 2 Family Fire Protection
-Frame Void Fire Protection-

- 302.11 Fireblocking
 - Item 3 - Stairs
 - Top & bottom of the stair run
 - Stair voids must not convey fire / smoke

- Stair frame protection is vital
 - Occupant escape
 - Suppression efforts

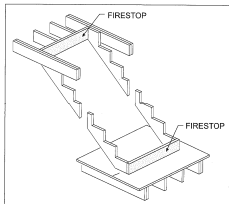

Residential 1 & 2 Family Fire Protection
-Frame Void Fire Protection-

- R302.11 Fire blocking
 - Item 4 - Around Vents & Pipes
 - At ceiling and floor levels
 - "Approved material"
 - Caulk
 - Mortar
 - Gypsum panels
 - Fiberglass insulation
 - Others deemed OK by BO
 - 'Fire caulk'
 - Not a requirement

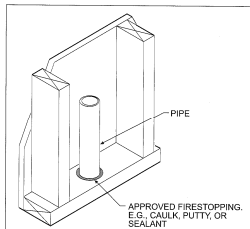

Residential 1 & 2 Family Fire Protection -Frame Void Fire Protection-

- R302.11 Fire blocking
 - Item 4 - Around Vents & Pipes

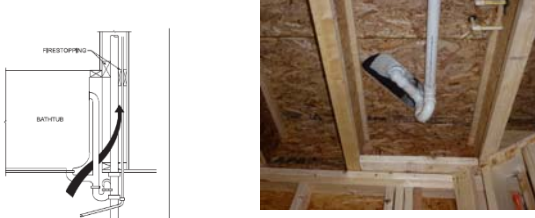

Residential 1 & 2 Family Fire Protection -Frame Void Fire Protection-

- R302.11 Fire blocking - "Approved materials"
 - Dimensional lumber
 - Structural panels
 - Particleboard
 - Cement board
 - Caulk
 - Mortar
 - Gypsum panels
 - Fiberglass insulation filled wall cavities
 - Others deemed OK by BO
- Combustible materials may be approved
 - 'Fire caulk' is NOT a requirement

Residential 1 & 2 Family Fire Protection -Frame Void Fire Protection-

- R302.11 Fire blocking
 - Item 5 - Chimney Fire Stopping
 - R 1003.19 Chapter 10
 - Non-combustible firestop materials required
 - Each floor level
 - Combustible frame spaced 2"

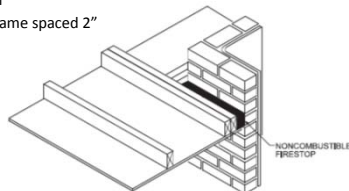

Residential 1 & 2 Family Fire Protection
-Frame Void Fire Protection-

- R302.11 Fire blocking
 - Item 6 – Two Family Dwelling Cornice
 - Cornice voids must be fire blocked at the unit separation line



Residential 1 & 2 Family Fire Protection
-Frame Void Fire Protection-

- 302.12 Draftstopping
 - Divide ceiling / floor voids
 - Required when supporting floor above
 - 1000 ft² maximum volume
 - Approximately equal areas

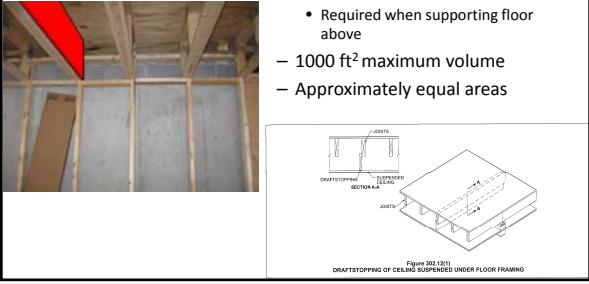

Figure 302.12(1)
DRAFTSTOPPING OF CEILING SUPPORTED UNDER FLOOR FRAMING



Residential 1 & 2 Family Fire Protection
-Frame Void Fire Protection-

- R302.12.1 Draft Stop Materials
 - ½" gypsum
 - 3/8" wood structural panels
 - Yep, wood is cool
 - Similar approved materials



Residential 1 & 2 Family Fire Protection -Frame Void Fire Protection-

- R302.13 Thermal / Sound Insulation
 - 3" spacing to heat producing devices
 - Luminaries
 - Motors
 - Transformers
 - Exceptions
 - Listed fixtures & devices
 - Installed per listing



Residential 1 & 2 Family Fire Protection -Frame Void Fire Protection-

- Chapter 5 - R501.3 Under-floor fire protection
 - Minimum basement ceiling / floor protection
 - ½ gypsum
 - 5/8" wood structural panel
 - Equivalent
 - Exceptions
 - Sprinkler protection
 - Floor over crawl space with no fuel or appliance or storage
 - Small areas properly fire blocked from remainder of frame
 - Floors of 2 by 10 or greater dimensional lumber
 - Cover or mass provides some floor integrity
 - Some degree of safety for fire personnel



Residential 1 & 2 Family Fire Protection -Frame Void Fire Protection-

- R302.7 Under-stair protection
 - Closet storage space under stairs
 - ½" gypsum stair protection
 - Underside of stringer / stairs
 - Walls adjacent
 - Soffits
- Not applicable to:
 - Space under open stairs
 - Inaccessible enclosed space under stairs



Residential 1 & 2 Family Fire Protection -Means of Egress-

- Focus Topics – 2012 IRC Fire Safety / Mitigation Issues
 - Building design features
 - Fire separation requirements
 - Fire Blocking / Draft stopping / Specific structural component protection
 - **Means of Egress**
 - Emergency Escape & Rescue Openings
 - Fire sprinkler systems
 - Smoke Alarms
 - CO Alarms
 - Finishes & Materials
 - Mitigation issues
 - Chimneys and fireplaces
 - Mechanical / HVAC equipment installations
 - Fuel gas systems and appliances
 - Electrical installation concerns



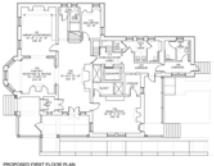

Residential 1 & 2 Family Fire Protection -Means of Egress-



- R311.1 Means of egress (M-O-E)
 - A continuous and unobstructed path of vertical and horizontal travel from all portions of the dwelling, to an exit, without travel through a garage.
- The primary escape route
 - Travel distance not limited

Residential 1 & 2 Family Fire Protection -Means of Egress-

- Chapter 3 M-O-E Topics
 - R305.1 Ceiling height
 - R311.2 Doors
 - R311.3 Floors
 - R311.4 Elevation change
 - R311.5 Construction
 - R311.6 Hallways
 - R311.7 Stairways
 - R311.8 Ramps



Residential 1 & 2 Family Fire Protection
-Means of Egress-

- **R305 Ceiling Height**
 - R305.1 Habitable space ceiling minimums
 - 7' minimum ceiling height
 - Some reduction for permitted for pipes, girders, ducts, etc.
 - 50% of habitable room may have ceiling slope between 5' to 7'
 - 6'-8" required over bathtubs, showers, fixture use areas
 - R305.1.1 Basement ceiling height
 - 6'-8" minimum for non-habitable space
 - 6'-4" permitted under obstructions
 - 6'-10" minimum for basement habitable space conversion
 - 6'-4" permitted under obstructions

Residential 1 & 2 Family Fire Protection
-Means of Egress-

- **R311.2 Egress Door**
 - Side Hinged
 - ONE required
 - 32" clear width
 - Stop to door face, at 90° open
 - 78" high
 - Threshold to stop
 - Operable from the interior
 - Readily operable
 - No special knowledge or tools
 - No interior key permitted
- **Other doors**
 - Requirements do not apply

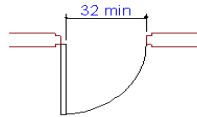

Residential 1 & 2 Family Fire Protection
-Means of Egress-

- **R311.3 Floors at egress door**
 - Landings required
 - Both sides of exterior MOE door
 - Width based on door dimension
 - Projection of landing 36" minimum
 - With exception for balcony stairs
 - Level walking surface
 - 2% maximum drainage slope on exterior landing



Residential 1 & 2 Family Fire Protection
-Means of Egress-

- R311.3.1 Floor elevations at egress door
 - 1.5" threshold 'speed bump' permitted
 - Exterior surface may be 8.25" lower than threshold
 - With typical in-swinging door

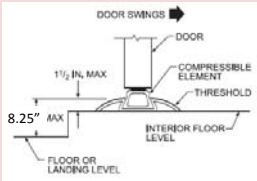

Residential 1 & 2 Family Fire Protection
-Means of Egress-

- R311.3.2 Other than MOE door
 - Short stairs may eliminate the landing requirement
 - Three or fewer risers
 - The 8.25" 'dropdown' counts as a riser!



Residential 1 & 2 Family Fire Protection
-Means of Egress-

- R311.4 Vertical egress from habitable areas
 - Stair or ramp required
 - Must meet dimensional criteria
 - Not permitted:
 - Ladders
 - Slides
 - Alternating treads
 - Ship's ladder
 - Fire pole
 - other nonsense



Residential 1 & 2 Family Fire Protection
-Means of Egress-

• R311.5 Construction requirements

– Exterior egress components

- Landings
- Balconies
- Decks



- Positively anchored to the primary structure

OR

- Self-supporting

Residential 1 & 2 Family Fire Protection
-Means of Egress-

• R311.6 Hallways

- 3' width, minimum
- 7' headroom
- Section R305



Residential 1 & 2 Family Fire Protection
-Means of Egress-

• R311.7.1 Stairway / Landing Width

- 36" clear width
- From the handrail to the required headroom height
- Several exceptions
 - Spiral stairways
 - Replacement stairs
 - Stairway lift system

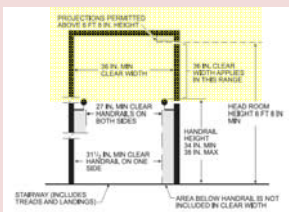

Residential 1 & 2 Family Fire Protection
-Means of Egress-

• R311.7.1
Stairway Width

- Below the handrail

- Handrails may project 4.5"
 - Single handrail - 31.5" minimum stairway width
 - Dual handrails - 27" minimum width

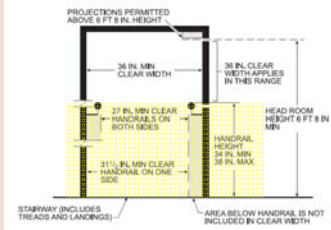

Residential 1 & 2 Family Fire Protection
-Means of Egress-

• R311.7.2 Stairway headroom

- 6'-8" minimum

- Measured from sloped line connecting stair nosing

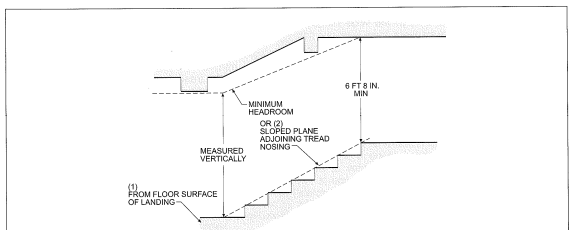

Residential 1 & 2 Family Fire Protection
-Means of Egress-

• R311.7.2 Stairway headroom

- Exception 1 to the 6'-8" Requirement

- Typical of stair with parallel open floor above
 - Handrail portion of tread permitted below wall

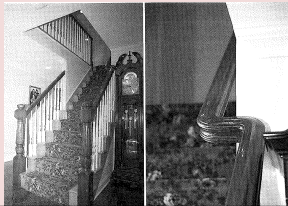

Residential 1 & 2 Family Fire Protection
-Means of Egress-

• R311.7.2 Stairway headroom

– 6'6" headroom permitted for:

- Existing / replacement stairs to unfinished attics
- Existing unfinished basements becoming habitable space



Residential 1 & 2 Family Fire Protection
-Means of Egress-

• R311.7.5.1 Risers

– Maximum riser height 8-1/4" inch

- Attics 9" by exception

– Minimum riser height 4"

– Maximum variation 3/8"

- Within *flight*

– 'Open riser' maximum – 4" sphere

– Exception for short stairs



Residential 1 & 2 Family Fire Protection
-Means of Egress-

• R311.7.5.2 Treads

– Minimum tread depth 9"

- 8" for attics and basements

– Maximum depth variation 3/8"

- Within *flight*

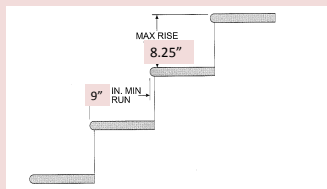

Residential 1 & 2 Family Fire Protection
-Means of Egress-

- R311.7.5.2.1 Winders
 - 10" tread depth at "walk line"
 - 12" from inside radius
 - 6" minimum depth at any point
 - 3/8" consistency between winders

Residential 1 & 2 Family Fire Protection
-Means of Egress-

- R311.7.5.2.1 Circular stairs
 - "Walk line"
 - 10" minimum tread depth
 - 6" minimum at edge
 - Dimensional consistency 3/8"

Residential 1 & 2 Family Fire Protection
-Means of Egress-

- R311.7.10 Special Stairways
 - R311.7.10.1 Spiral Stairways
 - Permitted egress component
 - "Relaxed" dimensional requirements
 - Less stair width
 - Less tread depth
 - Greater rise
 - Less headroom
 - 'Identical' treads
 - No dimensional tolerance

**Residential 1 & 2 Family Fire Protection
-Means of Egress-**

- R311.7.5.3 Stair Nosing Profiles
 - Specified profiles
 - Dimensional restrictions

**Residential 1 & 2 Family Fire Protection
-Means of Egress-**

- R311.7.8 Handrails
 - Required on at least one side of each stair flight
 - When 4 or more risers
 - Height
 - 34”-38” from nosing line

**Residential 1 & 2 Family Fire Protection
-Means of Egress-**

- R311.7.8.2 Handrail Continuity
 - Continuous
 - from top riser to bottom tread of each flight
 - May turn at a newel post

Residential 1 & 2 Family Fire Protection
-Means of Egress-

- **R311.7.8.2 Handrail Continuity**
 - Return to wall or post termination
 - At top and bottom
 - Eliminate clothing snag hazard
 - Various options at bottom step
 - Post
 - Volute



Residential 1 & 2 Family Fire Protection
-Means of Egress-

- **R311.7.8.3 Handrail Grasp**

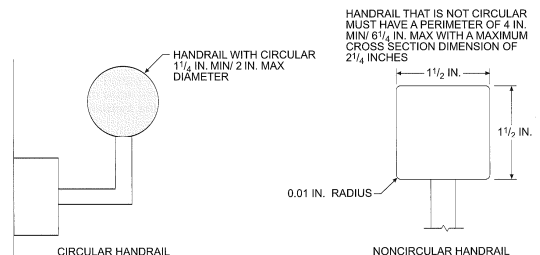

CIRCULAR HANDRAIL

NONCIRCULAR HANDRAIL

Residential 1 & 2 Family Fire Protection
-Means of Egress-

- **R311.7.8.2 Handrail Continuity**
 - Non-complaint handrail
 - Wall termination
 - Clothing catcher
 - Grasp-ability issue
 - Grip size



Residential 1 & 2 Family Fire Protection
-Means of Egress-

- **R311.7.8.3 Handrail Grasp**
– Standard profiles

Residential 1 & 2 Family Fire Protection
-Means of Egress-

- **R311.7.5.4 Exterior Stairs**
– Comply with live load requirements
- **R311.7.8.4 Exterior Handrails**
– ASTM D 7032
- **Items of concern:**
 - Strength & durability
 - UV Resistance
 - Slip resistance
 - Support
 - Span of materials

Residential 1 & 2 Family Fire Protection
-Means of Egress-

- **Stairway Lighting – Required !**
 - R311.7.9 **All** MOE stairs shall be illuminated
 - R303.7 **All interior & exterior stairs** shall be illuminated
 - Specific proximal locations for artificial lighting
 - Specific illumination level
 - 1 foot candle
 - E3903.3 Switched lighting - all interior & exterior stairs
 - Occupancy sensor OK in some locations
 - Continuous illumination option
 - R303.7
- **In short; All stairs must be illuminated**
– But wait.....

Residential 1 & 2 Family Fire Protection
-Means of Egress-

• R311.7.10.2 Lighting Bulkhead Stairs

– Requirements -based on the bulkhead function

- Not part of building egress and <8' to grade
 - Adjacent interior area illumination adequate
 - No headroom requirement
 - No handrail requirement
 - Landings not required
 - No stairway dimensional restrictions

- Part of the building emergency egress
 - Section R310 dimensional requirements
 - Peripheral stair illumination OK



Residential 1 & 2 Family Fire Protection
-Means of Egress-

• R311.8 Ramps

- 1:12 rise / run maximum
 - Exception permits 1:8 slope
- 3' by 3' Landings
 - Top / bottom
 - Doors open onto ramp
 - Direction change
- Handrails (if required)
 - Similar to stair requirements



Residential 1 & 2 Family Fire Protection
-Means of Egress-

• R312.1.1 Guards – Required when:

- Greater than 30" vertical drop
 - as measured from walking surface within 1/2 fathom

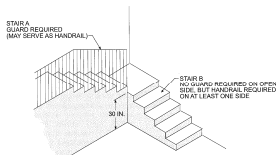

- Section R312 Applicable to all walking surfaces
 - NOT just MOE !

Residential 1 & 2 Family Fire Protection
-Means of Egress-

- R312.1.2 Guards – Height
 - 36" all walking surfaces
 - Decks, balconies, landings, interior stairs, exterior stairs, porches, etc.
 - 36" above fixed seating

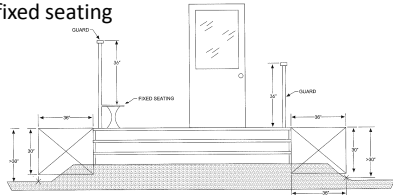

Residential 1 & 2 Family Fire Protection
-Means of Egress-

- R312.1.2 Guard / handrail combination
 - OK by exception
 - 34" to 38" top rail may serve as guard

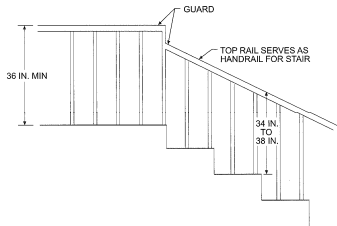

Residential 1 & 2 Family Fire Protection
-Means of Egress-

- R312.1.3 Guard opening dimensions
 - Walking surfaces – 4" sphere
 - Side of stair – 4-3/8" sphere
 - Stair triangulation – 6" sphere



Residential 1 & 2 Family Fire Protection -Means of Egress-

- R312.1.4 Exterior plastic guards
 - Same rules apply to all exterior components



Residential 1 & 2 Family Fire Protection -Emergency Escape & Rescue Openings-

- Focus Topics – 2012 IRC Fire Safety / Mitigation Issues
 - Building design features
 - Fire separation requirements
 - Fire Blocking / Draft stopping / Specific structural component protection
 - Means of Egress
 - **Emergency Escape & Rescue Openings**
 - Fire sprinkler systems
 - Smoke Alarms
 - CO Alarms
 - Finishes & Materials
 - Mitigation issues
 - Chimneys and fireplaces
 - Mechanical / HVAC equipment installations
 - Fuel gas systems and appliances
 - Electrical installation concerns



Residential 1 & 2 Family Fire Protection -Means of Egress-

- R310 Emergency Escape & Rescue Openings (R202 Definition)
 - An operable exterior window, door, or similar device that provides for a means of escape and access for rescue in the event of an emergency
 - R310 compliance
- In short; a second way out
 - “Plan B”



Residential 1 & 2 Family Fire Protection
-Emergency Escape & Rescue Openings-

- **R310.1 – General Requirements**
 - Emergency escape rescue openings required in:
 - Basements
 - Exception for two remote stairs / openings
 - Exception of existing w/wo sleeping
 - Habitable spaces in attics
 - Exception for existing buildings w/o sleeping
 - All sleeping rooms – All levels
 - Occupant out-hole
 - Plan B escape
 - Firefighter in-hole
 - Vent-Enter-Search



V-E-S

Residential 1 & 2 Family Fire Protection
-Emergency Escape & Rescue Openings-

- **R310.1 – Egress Dimensional Requirements**
 - R310.1.1 5.7 ft² minimum net clear opening
 - 5.0 ft² for grade level openings
 - R310.1.2 24" minimum clear opening height
 - Based on dimensions of firefighter with SCBA
 - R310.1.3 20" minimum clear opening width
 - Permits ladder nest & firefighter entry
- Applies to any opening used to meet egress requirement
 - Windows
 - Hatches
 - Bulkheads

Residential 1 & 2 Family Fire Protection
-Emergency Escape & Rescue Openings-

- **R310.1 – Requirements**
 - 44" maximum sill height
 - Finished floor to bottom of opening
 - Platform OK by exception
 - Applies only to required egress window(s) !
 - No such restriction on other window openings

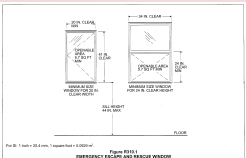



FIGURE B101.1 EMERGENCY ESCAPE AND RESCUE WINDOWS

Residential 1 & 2 Family Fire Protection
-Emergency Escape & Rescue Openings-

- R310 – Additional Requirements
 - R310.1.4 Simple operation of egress opening
 - No tools, special knowledge, keys
 - Removable sash OK for replacement windows
 - No tools permitted!
 - Applicable to Egress windows only
 - Other windows exempt



Residential 1 & 2 Family Fire Protection
-Emergency Escape & Rescue Openings-

- R310.4 Bars, grills, screens
 - Permitted
 - No tools, keys, special knowledge
 - Releasable from the interior
 - May not reduce required clear opening
 - R310.1 minimum dimensions
 - » 24" high
 - » 20" wide
 - » 5.7 ft² open
- Applicable only to emergency escape & rescue openings!
 - Other openings may be outfitted with fixed grills



Residential 1 & 2 Family Fire Protection
-Emergency Escape & Rescue Openings-

- R310.2 – Window well requirements
 - 3' by 3' window well minimum
 - Exception for stairs, ladder
 - Must permit egress window to open fully
 - Window dimensions must be met
 - Ladder or stairs required
 - When greater than 44" deep
 - Drainage
 - Not an aquarium



Residential 1 & 2 Family Fire Protection
-Emergency Escape & Rescue Openings-

- R310.3 – Bulkhead enclosures
 - Permitted means of emergency access
 - Must meet dimensional criteria
 - 5.7 ft² clear opening
 - 42" maximum sill height
 - Less than 8' from floor to grade
 - Exemption from common stairwell requirements
 - » Handrails
 - » Proximal lighting
 - » Riser height
 - » Tread dimensions



Residential 1 & 2 Family Fire Protection
-Emergency Escape & Rescue Openings-

- R310.5 – Under deck & porch egress
 - Emergency Escape Openings under decks
 - 36" minimum height to facilitate escape & FD access
 - Parallel requirements covered in R303.8
 - » As related to required natural lighting & ventilation

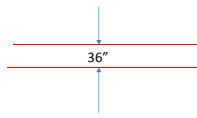

Residential 1 & 2 Family Fire Protection
-Emergency Escape & Rescue Openings-

- R312.2 Window Fall protection
 - Required when exterior drop is 6' +
 - Window opening limited to 4"
 - Applies to operable windows with 2' or less sill height
- R310 Egress Conflict?
 - ASTM F 2090 device
 - Permits egress use
 - Simple operation

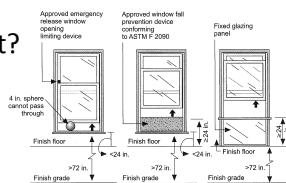

Residential 1 & 2 Family Fire Protection -Fire Sprinkler Systems-

- Focus Topics – 2012 IRC Fire Safety / Mitigation Issues
 - Building design features
 - Fire separation requirements
 - Fire Blocking / Draft stopping / Specific structural component protection
 - Means of Egress
 - Emergency Escape & Rescue Openings
 - **Fire sprinkler systems**
 - Smoke Alarms
 - CO Alarms
 - Finishes & Materials
 - Mitigation issues
 - Chimneys and fireplaces
 - Mechanical / HVAC equipment installations
 - Fuel gas systems and appliances
 - Electrical installation concerns



Residential 1 & 2 Family Fire Protection -Fire Sprinkler Systems-

- Section 313
 - As amended by CT
 - (Most likely)
- CT Amendment (Assumed)
 - R313.1 WHEN an automatic residential sprinkler system is to be installed in townhouses, it shall be designed and installed in accordance with P2904 or NFPA 13D.
 - R313.2 WHEN an automatic residential sprinkler system is to be installed in one & two family dwelling, it shall be designed and installed in accordance with Section P2904 or NFPA 13D



Residential 1 & 2 Family Fire Protection -Fire Sprinkler Systems-

- P2904 Dwelling Unit Sprinkler Systems
 - Connecticut Consumer Protection Concerns:
 - CGS 29-263a - AS must be professionally designed
 - AS Layout tech or engineer
 - R106.1 does NOT permit waiver of design
 - CGS 20-338a - Systems must be installed by F License holder
 - Homeowner exception
 - Owner & occupant
 - Single family dwelling only



Residential 1 & 2 Family Fire Protection -Materials & Finishes-

- Focus Topics – 2012 IRC Fire Safety / Mitigation Issues
 - Building design features
 - Fire separation requirements
 - Fire Blocking / Draft stopping / Specific structural component protection
 - Means of Egress
 - Emergency Escape & Rescue Openings
 - Fire sprinkler systems
 - **Smoke Alarms**
 - CO Alarms
 - Finishes & Materials
 - Mitigation issues
 - Chimneys and fireplaces
 - Mechanical / HVAC equipment installations
 - Fuel gas systems and appliances
 - Electrical installation concerns





Residential 1 & 2 Family Fire Protection -Smoke Alarms-

- R314.1 Smoke Detection Requirements
 - UL listed devices
 - NFPA 72 Compliance
- R314.2 Smoke Detection System Alternative
 - 'upgrade' system
 - Smoke
 - Heat
 - Gas
 - CO

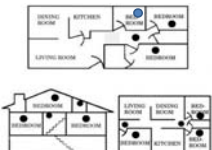

Residential 1 & 2 Family Fire Protection -Smoke Alarms-

- R314.3 Minimum Smoke Alarm Locations
 - Based on NFPA 72:
 - Inside each sleeping room
 - Outside each sleeping area
 - At least one on each habitable level of the dwelling
 - Basement



Residential 1 & 2 Family Fire Protection -Smoke Alarms-

– R314.3.1 Updating smoke alarms - existing buildings

- When permit is taken for:
 - Repairs
 - Alterations
 - Addition or repurposing an area to sleeping rooms
 - » Exceptions:
 - 1. Roofing, residing, window replacement, etc.
 - 2. Plumbing, mechanical, electrical work
 - 3. Porch & deck additions
- Dwelling unit smoke detection must be 'upgraded'
 - Current Code requirements to the extent reasonably possible

Residential 1 & 2 Family Fire Protection -Smoke Alarms-

- R314.4 Power for smoke alarms
 - Primary - AC from the dwelling source
 - No switching of circuit permitted excepting breaker
 - Backup - DC battery
 - Exception for 'off-grid' power source
 - DC becomes permitted primary

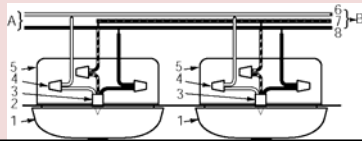

Residential 1 & 2 Family Fire Protection -Smoke Alarms-

– R314.5 Interconnection of Smoke Alarms

- Required for new – hard-wired interconnection
 - Larger dwellings may require NFPA72 system
 - » Based on interconnection listing limitations
 - Wireless connection
 - » not currently acceptable for new dwelling units
- Hardwire interconnection
 - Required for existing building alteration / repair
 - » Exception for practical difficulty
 - No frame exposure



Residential 1 & 2 Family Fire Protection -Materials & Finishes-

- Focus Topics – 2012 IRC Fire Safety / Mitigation Issues
 - Building design features
 - Fire separation requirements
 - Fire Blocking / Draft stopping / Specific structural component protection
 - Means of Egress
 - Emergency Escape & Rescue Openings
 - Fire sprinkler systems
 - Smoke Alarms
 - **CO Alarms**
 - Finishes & Materials
 - Mitigation issues
 - Chimneys and fireplaces
 - Mechanical / HVAC equipment installations
 - Fuel gas systems and appliances
 - Electrical installation concerns



Residential 1 & 2 Family Fire Protection -Carbon Monoxide Alarms-

- R315.1 CO alarms for new construction
 - Located outside each sleeping area
 - Located on all habitable levels
 - Interconnected with all other CO alarms
- R315.2 Alternative system
 - Household alarm system OK
 - Listed & labeled system
- CO alarms not required where:
 - No fuel burning appliances
 - No fireplace
 - No attached garage



Residential 1 & 2 Family Fire Protection -Carbon Monoxide Alarms-

- R315.1.1 CO Alarm Power
 - AC primary with DC back-up for new
 - No switching except breaker
 - DC may be primary for non-commercial power supply



Residential 1 & 2 Family Fire Protection -Carbon Monoxide Alarms-

- R315.3 CO Alarms - Existing Buildings
 - Repairs, alterations, sleeping quarters addition
 - Upgrade CO detection to 'new' with exceptions:
 - DC Power Ok if wall / ceiling not removed
 - Interconnection required if practical
 - » Wireless interconnection OK
 - Exterior alterations exempt from upgrade
 - Not required where no interior fuel burning or attached garage
 - Electrical, plumbing, mechanical work exempt



Residential 1 & 2 Family Fire Protection -Smoke & Carbon Monoxide Alarms-

- Sec. 29-453 - Connecticut General Statutes
 - Residential Smoke & CO Detection Equipment
 - Applicable to Residential with permit prior to 10/1/2005
 - 1 and 2 family included
 - Requires CO / Smokes at time of real property transfer
 - Properly installed
 - Makes 'transferor' responsible for equipment install
 - Affidavit required
 - \$250 "option"
 - CO detectors standard exemption
 - No combustion, fireplace, or attached garage
 - Some property transfers are exempt
 - Family, court order, government, foreclosure, etc.
 - An attempt to update smoke & fire detection



Residential 1 & 2 Family Fire Protection -Materials & Finishes-

- Focus Topics – 2012 IRC Fire Safety / Mitigation Issues
 - Building design features
 - Fire separation requirements
 - Fire Blocking / Draft stopping / Specific structural component protection
 - Means of Egress
 - Emergency Escape & Rescue Openings
 - Fire sprinkler systems
 - Smoke Alarms
 - CO Alarms
 - **Finishes & Materials**
 - Mitigation issues
 - Chimneys and fireplaces
 - Mechanical / HVAC equipment installations
 - Fuel gas systems and appliances
 - Electrical installation concerns



Residential 1 & 2 Family Fire Protection -Materials & Finishes-

- R302.9 Wall and ceiling finishes

- R302.9.1 Flame spread
 - 200 maximum
- R302.9.2 Smoke development
 - 450 maximum



Residential 1 & 2 Family Fire Protection -Materials & Finishes-

- Floor Finishes

- R309.1 Garage floors
 - Approved non-combustible
 - Sloped to drain
- R309.2 Carports
 - Asphalt floors OK
- Interior floor finish
 - Not addressed



Residential 1 & 2 Family Fire Protection -Materials & Finishes-

- R302.10 Building Insulation

- Used in Concealed & Uninhabited areas
 - Flame spread requirements
 - 25 unless intimately installed in concealed cavity
 - Smoke development requirements
 - 450
 - Heat flux testing
- Variations based on type and location
 - Loose
 - Cellulose
 - Exposed attic

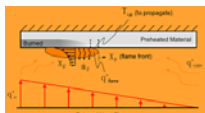

Residential 1 & 2 Family Fire Protection
-Materials & Finishes-

• R316 Foam Plastics

– Concern for plastics used as:

- Insulation
- Trim
- Finished surfaces

– Focus on:

- Flame spread
- Smoke development
- Protection of plastics from fire

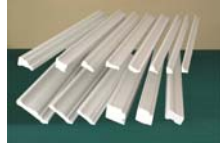

Residential 1 & 2 Family Fire Protection
-Materials & Finishes-

• R316.3 Plastics - Smoke & Flame Ratings

– Exposed Plastic Materials

- Flame spread 75
 - Steiner Tunnel Test
- Smoke development 450



Residential 1 & 2 Family Fire Protection
-Materials & Finishes-

• R316.2 Insulation Labeling & Identification

– Label requirements

- Manufacturer's name
- Product listing
- Product identification
- Info required to determine proper end use
 - Locations
 - Fire covering



**Residential 1 & 2 Family Fire Protection
-Materials & Finishes-**

• **R316.4 Thermal barrier**

– Unless specifically allowed in R316, plastics must be protected from building interior by minimum ½” gypsum

• R316.5 permits several common exceptions

- Concealed locations
- Properly installed roofing
- Uninhabited / non-storage attics & crawlspaces
- Under siding & flooring
- Garage door backer
- Trim and moldings
- Sill plate area

» Specific material requirements



**Residential 1 & 2 Family Fire Protection
-Materials & Finishes-**

• **R316.5.9 Molded Plastic Trim & Moldings**

- 20# ft³ minimum density requirement
- Thickness restriction
- 8” Width restricted
- 10% Area restriction
- Index 75 Flame spread limit



**Residential 1 & 2 Family Fire Protection
-Materials & Finishes-**

• **R902.1 Roofing Materials**

- Several prescribed materials
 - Common residential roof coverings
- Classified roof required when <3’ from lot line
 - Class A – Severe fire resistance
 - Class B – Moderate fire resistance
 - Class C – Light fire exposure resistance

• Installed per:

- Listing of materials
- Prescriptive Code requirements



Residential 1 & 2 Family Fire Protection
-Coffee Break-



15 minutes

Residential 1 & 2 Family Fire Protection
-Mitigation Issues-

- Focus Topics – 2012 IRC Fire Safety / Mitigation Issues
 - Building design features
 - Fire separation requirements
 - Fire Blocking / Draft stopping / Specific structural component protection
 - Means of Egress
 - Emergency Escape & Rescue Openings
 - Fire sprinkler systems
 - Smoke Alarms
 - CO Alarms
 - Finishes & Materials
 - **Mitigation issues**
 - Chimneys and fireplaces
 - Mechanical / HVAC equipment installations
 - Fuel gas systems and appliances
 - Electrical installation concerns



Residential 1 & 2 Family Fire Protection
-Mitigation Issues-

- R319.1 Address number
 - Legible from street or road
 - Arabic
 - Contrast with background
 - 4" high
 - ½" stroke



Residential 1 & 2 Family Fire Protection
-Mitigation Issues-

- R507.1 Deck anchoring / attachment
 - Structure supported or self supported
 - Lateral load resistance
 - Vertical load resistance
 - Wind 'uplift' resistance
- R311.5 MOE Specific
 - Decks & stairs



Residential 1 & 2 Family Fire Protection
-Mitigation Issues-

- R507.1 Deck anchoring
 - Specific lateral attachment requirements
 - No toe nailing
 - No nails 'subject to withdrawal'



Residential 1 & 2 Family Fire Protection
-Mitigation Issues-

- Other Mitigation Issues
 - Building access maintenance
 - Local issue
 - Water supply
 - Ignored
 - Exception for sprinkler supply
 - Active and passive protection maintenance
 - Exists with impractical application
 - Mechanical / Electrical system maintenance
 - Exists with impractical application
 - Trash accumulation / hoarding
 - Local ordinance
 - Improper, non- permit building modifications
 - Possible



Residential 1 & 2 Family Fire Protection -Chimneys & Fireplaces-

- Focus Topics – 2012 IRC Fire Safety / Mitigation Issues
 - Building design features
 - Fire separation requirements
 - Fire Blocking / Draft stopping / Specific structural component protection
 - Means of Egress
 - Emergency Escape & Rescue Openings
 - Fire sprinkler systems
 - Smoke Alarms
 - CO Alarms
 - Finishes & Materials
 - Mitigation issues
 - **Chimneys and fireplaces**
 - Mechanical / HVAC equipment installations
 - Fuel gas systems and appliances
 - Electrical installation concerns



Residential 1 & 2 Family Fire Protection -Fireplaces-

- Prescriptive Requirements
 - R1001.9 & .10 Hearth extension
 - Minimum thickness
 - 4" Hearth floor
 - 2" Hearth extension
 - 16" min. projection
 - 20" for fireplace over 6 ft²
 - 8" minimum extension from sides
 - 12" for fireplace over 6 ft²

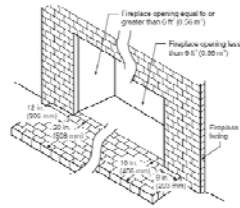

Residential 1 & 2 Family Fire Protection -Fireplaces-

- R109.1.6 Final Inspection Checklist Item:
 - Remove combustible hearth extension forms



Residential 1 & 2 Family Fire Protection -Fireplaces-

- R1001.11 Fireplace clearance to wood
 - 2" front & sides
 - 4" rear of firebox
 - Exceptions:
 - Listed zero clearance
 - Masonry wall fireplaces
 - Sheathing & siding materials
 - Combustible mantels & trim

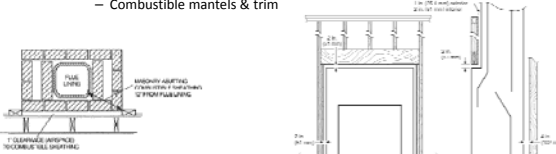

Residential 1 & 2 Family Fire Protection -Masonry Chimneys & Fireplaces-

- R1003.9 Masonry Chimney Termination
 - Termination
 - 3' extension through high point of roof penetration
 - 2' higher than any building portion within 10'
 - Includes any building within 10'

Especially important with chimneys serving solid fuel appliances !

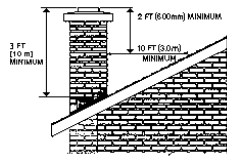

Residential 1 & 2 Family Fire Protection -Masonry Chimneys & Fireplaces-



- Section 1001
 - Masonry Fireplaces
- Section 1002
 - Masonry heaters
- Section 1003
 - Masonry chimneys
- Prescriptive language based on empirical design

Residential 1 & 2 Family Fire Protection
-Masonry Chimneys & Fireplaces-



Residential 1 & 2 Family Fire Protection
-Masonry Chimneys & Fireplaces-



Residential 1 & 2 Family Fire Protection
-Masonry Chimneys & Fireplaces-

- R1003.11 Masonry Chimneys
 - Masonry chimneys must be lined
 - R1003.11.1 general options
 - Clay tiles
 - Lining systems
 - Other 1800° F materials
 - Specific options
 - Gas appliances
 - Pellet fuel
 - Oil fuel
 - A change of appliance must prompt an evaluation of the chimney liner



Residential 1 & 2 Family Fire Protection -Mechanical Equipment Installation-

- Focus Topics – 2012 IRC Fire Safety / Mitigation Issues
 - Building design features
 - Fire separation requirements
 - Fire Blocking / Draft stopping / Specific structural component protection
 - Means of Egress
 - Emergency Escape & Rescue Openings
 - Fire sprinkler systems
 - Smoke Alarms
 - CO Alarms
 - Finishes & Materials
 - Mitigation issues
 - Chimneys and fireplaces
 - **Mechanical / HVAC equipment installations**
 - Fuel gas systems and appliances
 - Electrical installation concerns



Residential 1 & 2 Family Fire Protection -Mechanical Equipment Installation-

- M1202.1 & M1202.2 Existing mechanicals
 - If it ain't broke – don't fix it
 - Existing mechanicals need **not** comply with current Code
 - Fixing or changing systems must be done safely
 - Systems may not be rendered unsafe due to repair or alterations
 - The old ways work – unless unsafe
 - System repairs may be conducted in same fashion as in existence unless rendered unsafe



Residential 1 & 2 Family Fire Protection -Mechanical Equipment Installation-

- M1202.3 Maintenance required
 - Systems must be maintained in good working condition
 - M1202.3 Re-inspection authority
 - R104.6 Right of entry
 - » FD can be a good friend to BO



Residential 1 & 2 Family Fire Protection
-Mechanical Equipment Installation-

- M1301.1 Mechanical Scope

- Installed per Code
 - Listed & labeled equipment
 - Installed per manufacturer
- If not covered by this Code
 - Go to the other rule books



Residential 1 & 2 Family Fire Protection
-Mechanical Equipment Installation-

- M1302 Listing & Labeling of Appliances

- Listed & labeled for installed application / use
- OR**
- Installed and used in an 'approved' fashion
 - Alternatives per R104.11
 - » BO's judgement



Photo by R. Goldberg

Residential 1 & 2 Family Fire Protection
-Mechanical Equipment Installation-

- M1303.1 Appliance Labeling Requirements

- All appliances:
 - Permanent, factory applied label
 - Manufacturer's identification
 - Model number
 - Serial number
 - Testing agency mark
- Specific appliances
 - Additional information based on type of appliance



Residential 1 & 2 Family Fire Protection
-Mechanical Equipment Installation-

- M1304.1 Fuel type

- Proper fuel supply identification required
- Conversion permitted per listing
- Dual fuel permitted per listing



Residential 1 & 2 Family Fire Protection
-Mechanical Equipment Installation-

- M1305.1.1 Furnace & Air Handler Clearance

- Alcove / compartment installations:
 - Heat separation distances maintained
 - Service clearances maintained



Residential 1 & 2 Family Fire Protection
-Mechanical Equipment Installation-

- M1305.1.2 Appliances in Rooms

- 24" minimum door width
- Appliances must be removable
- Service space maintained



**Residential 1 & 2 Family Fire Protection
-Mechanical Equipment Installation-**

-M1305.1.3 Appliances in Attics

- Passage dimensional limitations
 - 22" wide
 - 30" height
 - 20' maximum length
- Solid flooring, minimum 24" wide
- 30" by 30" area on all serviceable sides of appliance
- Hatch dimension 20" by 30" minimum
- All dimensions must permit removal of largest appliance

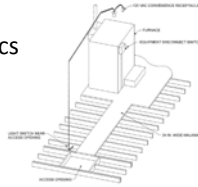

**Residential 1 & 2 Family Fire Protection
-Mechanical Equipment Installation-**

-M1305.1.4 Under-floor Appliances

- Passageway to permit removal
 - Area specific
 - Travel length restriction
 - 30" by 30" service space
 - Protective curbing



**Residential 1 & 2 Family Fire Protection
-Mechanical Equipment Installation-**

-M1307.3 Garage Appliance Installation

- M1307.3 - 18" ignition source elevation
 - Garages & rooms opening into garages
- M1307.3.1 Vehicle impact protection
 - Bollards
 - Wheel stops
 - Elevated platform

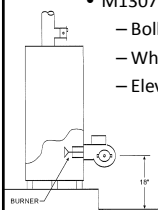

Residential 1 & 2 Family Fire Protection
-Mechanical Equipment Installation-

–M1308 Wood Butcherin’

- M1308.1 Prescriptive Limits of Drilling & Notching
 - Impacts frame load transfer capabilities
 - Impacts fire conveyance through frame voids

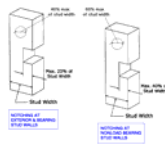

– R109.1.4 Frame inspection

- Conducted after trades have modified frame

Residential 1 & 2 Family Fire Protection
-Mechanical Equipment Installation-

– M1502 .4 Clothing Dryer Exhaust Ducts

- M1502.4.1 Smooth interior finish
 - Metal
 - .0157, 28 gage
 - 4” nominal diameter
- M1502.4.2 Installation
 - 12’ support intervals
 - Male insert towards termination
 - M1601.4.1 sealed joints
 - Mechanically connected sections
 - 1/8” fastener protrusion into airstream



Residential 1 & 2 Family Fire Protection
-Mechanical Equipment Installation-

- M1502 .4.3 Transition ducts
 - 8’ maximum length
 - UL2158A Listed & Labeled



– Installed per UL & Manufacturer’s Requirements:

- Not concealed by construction
- Not supported by the structure
- Fully within room with appliance
- Cut to proper length
- No kinks or excessive bends



Residential 1 & 2 Family Fire Protection
-Mechanical Equipment Installation-

- 1601.1.1 Above-ground duct systems
 - Item 7 – Frame voids as air conveyance
 - CT eliminated this option
 - Many in existence

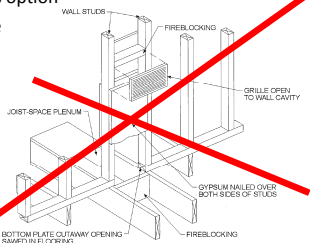

Residential 1 & 2 Family Fire Protection
-Mechanical Equipment Installation-

- M 1601.6 Independent Garage HVAC
 - Shared HVAC Air
 - Dwelling & Garage
 - 4 really good reasons not to permit shared air:
 - A) 'Cause the Code says so in M1601.6
 - 2) Taking return air from an area where flammable vapors are present is not a good idea (K-boom)
 - d) Because supplying air to a garage, with no return air taken, would create a relative low pressure in the dwelling. This may cause airflow from an attached garage into the dwelling. (CO & Vapors)
 - iii) Recall the R302.6 separation requirement.

Residential 1 & 2 Family Fire Protection
-Mechanical Equipment Installation-

– M1801 General

- M1801.4 Space around lining
 - Not used for venting
 - » Possible exception for combustion air
 - Listed & labeled appliance
 - Multiple liners permitted
 - Follow listed item instructions!



Residential 1 & 2 Family Fire Protection
-Mechanical Equipment Installation-

-M1801 Chimneys & Vents

- M1801.12 Solid Fuel Dedicated Flue
 - Matched to the appliance exhaust
 - May not share with any other appliance !
 - » Listed multiple fuel appliance OK



Residential 1 & 2 Family Fire Protection
-Mechanical Equipment Installation-

-M1803 Appliance Connectors

- M1803.3 Installation
 - Short & straight as possible
 - Minimum RISE of 1/4" per foot of run
 - Adequately supported
 - Mechanically fastened joints
 - Installed per appliance manufacturer's
 - No devices obstructing connector pipe
 - » Unless listed & label devices



Residential 1 & 2 Family Fire Protection
-Mechanical Equipment Installation-

-M1803 Connectors

- M1803.3.1 Penetrations
 - » No ceiling penetrations
 - » Wall penetrations for oil fired
 - Single wall pipe
 - L&L thimble
 - Type L
 - Minimum clearances



Residential 1 & 2 Family Fire Protection
-Mechanical Equipment Installation-

-M1803 Connectors

- M1803.3.2 Connector maximum length
 - Un-insulated connector pipe
 - » 75% of the height of the vertical portion of chimney above the connector
 - Listed connector pipe
 - » 100% of the height of the vertical portion of chimney above connection

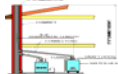

Residential 1 & 2 Family Fire Protection
-Mechanical Equipment Installation-

• M1901 Ranges & Ovens

- M1901.1 Clearances
 - Manufacturer's instructions
 - Generally 0" side and rear
- M1901.2 Listed & labeled for household use
 - Referenced UL Standards
- M1901.3 Commercial cooking appliances
 - Not permitted



Residential 1 & 2 Family Fire Protection
-Mechanical Equipment Installation-

- M2001.1.1 Boiler Standards
 - Oil - UL 726
 - Electric - UL 834
 - Solid fuel - UL 2523
 - Gas - G2404

• Key: Listed and labeled appliance installed in accordance with manufacturer's instructions.



Residential 1 & 2 Family Fire Protection -Mechanical Equipment Installation-

- Fuel Oil Storage Tanks

- Chapter 22 Requirements

- Materials
 - Permitted locations
 - Distance to burner
 - Multiple tanks
 - Connections
 - Venting and fills
 - Valves & pumps
 - Maximum quantity

- Over 660 gallons goes to NFPA 31



Residential 1 & 2 Family Fire Protection -Mechanical Equipment Installation-

- M2301.1 Solar Systems

- Design
 - Construction
 - Alteration
 - Repair



- M2301.2 Installation

- M2301.2.1 Equipment must be accessible
 - M2301.2.2 Roof issues
 - Roof must support loads
 - Collectors as roof covering must meet single requirements
 - Non-combustible or limited combustible components

- R101.4.6 Photovoltaic Electrical Installations

- National Electrical Code

Residential 1 & 2 Family Fire Protection -Fuel Gas & Equipment Installation-

- Focus Topics – 2012 IRC Fire Safety / Mitigation Issues

- Building design features
 - Fire separation requirements
 - Fire Blocking / Draft stopping / Specific structural component protection
 - Means of Egress
 - Emergency Escape & Rescue Openings
 - Fire sprinkler systems
 - Smoke Alarms
 - CO Alarms
 - Finishes & Materials
 - Mitigation issues
 - Chimneys and fireplaces
 - Mechanical / HVAC equipment installations
 - Fuel gas systems and appliances
 - Electrical installation concerns



Residential 1 & 2 Family Fire Protection -Fuel Gas & Equipment Installation-

- G2401.1 Applicable to 1 & 2 Family Dwellings
 - Chapter 24 is an "extraction" of the ICC Fuel Gas Code
 - Close cousin of NFPA 54
- R101.4.1 ICC Fuel Gas Code not adopted
 - CT Gas Equipment & Piping Code adopted
 - NFPA 54 Natural Gas
 - NFPA 58 Propane & propane accessories

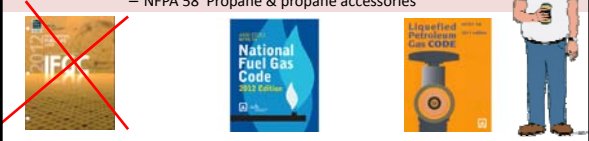

Residential 1 & 2 Family Fire Protection -Fuel Gas & Equipment Installation-

• Gas Fueled Appliance Location

- G2406.1 General
 - Per listing and this Code
 - Done correctly!
- G2406.2 Prohibited Locations
 - Sleeping Rooms
 - Bath & toilet rooms
 - Rooms opening only into bath & sleeping rooms
 - Not compete with people for combustion air!
- G2406.3 Outdoor locations
 - Listed for the exposed location or protected from weather
 - Able to handle the installation environment



Residential 1 & 2 Family Fire Protection -Fuel Gas & Equipment Installation-

- G2407.2 Appliance location
 - May not impede combustion air
- G2407.4 Other air movers
 - Fans
 - Fireplaces
 - R1006.1 Exterior air exception
 - Vented appliances
- Concern is proper venting and supply air for appliances without separation.

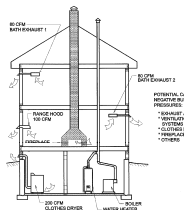

Residential 1 & 2 Family Fire Protection -Fuel Gas & Equipment Installation-

– G2408.2 Elevation of ignition source

- 18" elevation required in 'hazardous locations'
 - Garages
 - Areas opening into garage
 - » Not part of the living area
 - Furnace room
 - Utility room
 - Laundry room



- Exception for appliances listed as 'vapor ignition resistant' (sealed combustion)

Residential 1 & 2 Family Fire Protection -Fuel Gas & Equipment Installation-

– G2412.5 Identification – other than steel pipe

- Yellow label w/ black letters
- 5 foot intervals
- Not required within room containing the gas appliance
- Not required on concealed pipe



– G2412.9 Identification of pipe

- Manufacturer markings required

– G2412.10 Testing & certification

- Required of all gas piping components

Residential 1 & 2 Family Fire Protection -Fuel Gas & Equipment Installation-

• G2411.1.1 CSST (Corrugated Stainless Steel Tube)

- History of problems related to lightning strikes
- Bond in accordance with manufacturer's instructions

• E3609.7.1 'Ditto'

Fig. 4-89 - Bonding Clamp on Gasite CSST fitting. (Clamp #CWP1JSH, CWP2JSH or CWP3JSH)

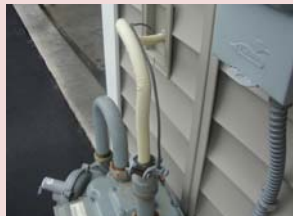
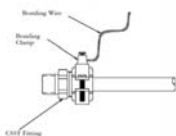

**Residential 1 & 2 Family Fire Protection
-Fuel Gas & Equipment Installation-**

- G2422 – Appliance Fuel Connectors
 - 6’ maximum length
 - Proper diameter
 - Manufacturer’s instructions
 - Not concealed
 - No wall or partition openings
- Rigid connection
 - As permitted by appliance L & L

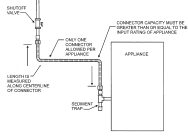

**Residential 1 & 2 Family Fire Protection
-Fuel Gas & Equipment Installation-**

- G2426 Vents for condensing appliances
 - Matched to appliance
 - Non-corrosive materials
 - Aluminum
 - Stainless steel
 - Galvanized steel
 - PVC
 - CPVC

**Residential 1 & 2 Family Fire Protection
-Fuel Gas & Equipment Installation-**

- G2427.6 Gas vents
 - B, BW vents
 - Less restrictive
 - Lower heat
 - No chimney fire issue

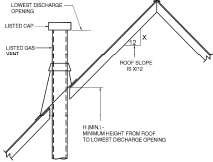

AREA TO BE VENTED	MINIMUM CLEARANCE
Electrical	1.0
Overhead	1.25
Overhead	1.5
Overhead	2.0
Overhead	2.5
Overhead	3.25
Overhead	4.0
Overhead	5.0
Overhead	6.0
Overhead	7.0
Overhead	7.5
Overhead	8.0

FIG. 11.1 (a) - 504.10.1

Residential 1 & 2 Family Fire Protection -Fuel Gas & Equipment Installation-

- G1417.6.7 Exterior wall openings
 - Not under eaves or parapets
 - Exception for direct vent appliances
 - Manufacturer's instructions !
 - Based on L&L



Residential 1 & 2 Family Fire Protection -Dwelling Electrical Systems-

- Focus Topics – 2012 IRC Fire Safety / Mitigation Issues
 - Building design features
 - Fire separation requirements
 - Fire Blocking / Draft stopping / Specific structural component protection
 - Means of Egress
 - Emergency Escape & Rescue Openings
 - Fire sprinkler systems
 - Smoke Alarms
 - CO Alarms
 - Finishes & Materials
 - Mitigation issues
 - Chimneys and fireplaces
 - Mechanical / HVAC equipment installations
 - Fuel gas systems and appliances
 - **Electrical installation concerns**



Residential 1 & 2 Family Fire Protection -Dwelling Electrical Systems-

- R101.4.6 Electrical Installation Options
 - IRC Part VIII (Chapters 34-42)
 - OR
 - NFPA70 NEC (2014)



- Applicant must indicate option at time of application.
- Installations not IRC covered, must follow NEC
 - Vehicle charging stations
 - Standby power systems
 - Solar photovoltaic systems
 - Electric welders
 - LULAs / Elevators
 - Fuel cells
 - Wind generators
 - Large fire pumps



Residential 1 & 2 Family Fire Protection -Dwelling Electrical Systems-

- E3401.3 Not Covered
 - Utility distribution equipment
 - Utility service conductors
 - Overhead – to drip loop
 - Underground – to meter box
 - Meters
- Utility distribution system equipment exempt
 - R105.2.3 “don’t touch that”

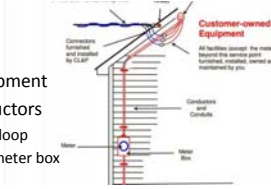

Residential 1 & 2 Family Fire Protection -Dwelling Electrical Systems-

- E3402.3 Penetrations - Fire & Draft stops
 - Integrity maintained
 - R302.11.2
- R109.1.4 Frame inspection
 - After rough-ins
 - After fire & draft stopping



Residential 1 & 2 Family Fire Protection -Dwelling Electrical Systems-

- P3404.7 Integrity of Equipment
 - Free of contamination
 - No cleaning chemicals , paint, etc.
 - Damaged parts not permitted
 - No corrosion
 - No debris

HELLO MICKEY!



Residential 1 & 2 Family Fire Protection -Dwelling Electrical Systems-

- P3404.9 Energized parts
 - 50 volts or more - protected by enclosure
 - Conductors operating under 50 volts
 - Open terminals permitted
 - » Doorbell transformers
 - » Skylight motor transformer
 - » Heating equipment control circuit
 - » Communications equipment



Residential 1 & 2 Family Fire Protection -Dwelling Electrical Systems-

- P3404.10 Physical Damage Prevention
 - Electrical equipment guarding as required
 - Electrical equipment mounted in garage
 - Transfer switch mounted exterior



Residential 1 & 2 Family Fire Protection -Dwelling Electrical Systems-

- E3404.12 Identification of Disconnecting Means
 - Each disconnecting means
 - E3706.2 requires panel board marking
 - Legibly marked
 - Exception for obvious purpose



Residential 1 & 2 Family Fire Protection
-Dwelling Electrical Systems-

- E3601.6 Service Disconnect
 - Properly identified per E3601.6.1
 - Readily accessible per E3601.6.2
 - Exterior or Interior, near point of entrance
 - Not in bathrooms
 - Occupants must have access
 - Not locked
 - 'Occupants' include FD



Residential 1 & 2 Family Fire Protection
-Dwelling Electrical Systems-

- E3405.1 General
- E3405.2 Energized equipment working space
 - 36" depth
 - 30" width
 - Min. 6-1/2' height OR to equipment
 - Some 'wiggle' for existing
 - Panel doors must open 90° min.

NOTE: Working space is intended to permit access to equipment for service & rapid shut-down



Residential 1 & 2 Family Fire Protection
-Dwelling Electrical Systems-

- E3405.4 Location of 'Working Space'
 - Panel space shall not be used for storage
 - Not located in:
 - Bathrooms
 - Clothing closets
 - Over steps of a stairway
- E3405.5 Access
 - Working space must be accessible
- E3405.6 Working space illumination
 - Lighting needed
 - Adjacent room lighting OK



Residential 1 & 2 Family Fire Protection -Dwelling Electrical Systems-

- E3604 Service Installation
 - E3604.1 3' Clearance to building openings
 - Open and unsheathed conductors
 - Does not applied to jacketed cables

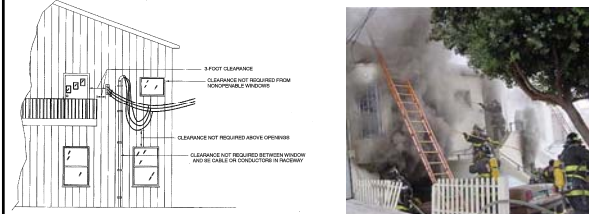

Residential 1 & 2 Family Fire Protection -Dwelling Electrical Systems-

- E3604.2 Vertical Service Conductor Clearances
 - E3604.2.1 8' above 'walkable' roofs
 - 10' if roof used for pedestrian way
 - 3' if > 4:12 pitch
 - 1.5' if overhang area
 - 0' if attached to gable or rake
 - 3' if guarded

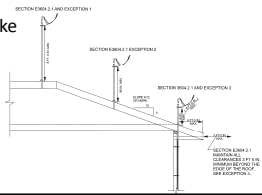

Residential 1 & 2 Family Fire Protection -Dwelling Electrical Systems-

- E3801.2 Allowable methods
 - Table E3801.2
 - Specifics for each method
 - Permitted uses
 - Support
 - Protection
 - Connections
 - Clamps

TABLE E3801.2
ALLOWABLE WIRING METHODS

ALLOWABLE WIRING METHOD	DESIGNATED ABBREVIATION
Aerosteel cable	AC
Electrical metallic tubing	EMT
Electrical nonmetallic tubing	ENT
Flexible metal conduit	FMC
Intermediate metal conduit	IMC
Liquidtight flexible conduit	LJFC
Metal-clad cable	MC
Nonmetallic sheathed cable	NMS
Rigid polyvinyl chloride conduit (Type PVC)	RNC
Rigid metallic conduit	RMC
Service entrance cable	SE
Surface raceways	SR
Underground feeder cable	UF
Underground service cable	USE

Residential 1 & 2 Family Fire Protection
-Dwelling Electrical Systems-

- E3802.3.2 Conductor protection
 - Deep in frame or plate protected
 - Protection from subsequent:
 - Picture hanging
 - Base & cove trim
 - Book shelves



Residential 1 & 2 Family Fire Protection
-Dwelling Electrical Systems-

- E3802.2 NM Cable Protection
 - Exposed OK
 - Protected from foot traffic
 - Storage attics



Residential 1 & 2 Family Fire Protection
-Dwelling Electrical Systems-

- E3802.4 Unfinished basements
 - Special requirements for plastic sheath cable
 - Cables may not be attached to bottom of joists
 - Larger cables exempt
 - Bored hole installation OK
 - Ceiling cover eliminates the issue

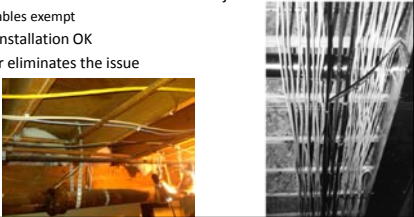

Residential 1 & 2 Family Fire Protection -Dwelling Electrical Systems-

- E3802.5 NM & SE Bends
 - 5X cable diameter maximum bend
 - May not be corrected by straightening



Residential 1 & 2 Family Fire Protection -Dwelling Electrical Systems-

- Section E3901 Receptacle Outlet Placement
 - E3901.2 Living area receptacle placement
 - E3901.4 Kitchen counter receptacle placement
 - E3901.5 Laundry equipment receptacles
 - E3901.6 Bathroom receptacles
 - E3901.9 Basement & garage receptacles
 - E3901.10 Hallway receptacles
 - E3901.11 Foyer area receptacles
- Rules intend to limit the need for extension cords as permanent wiring.



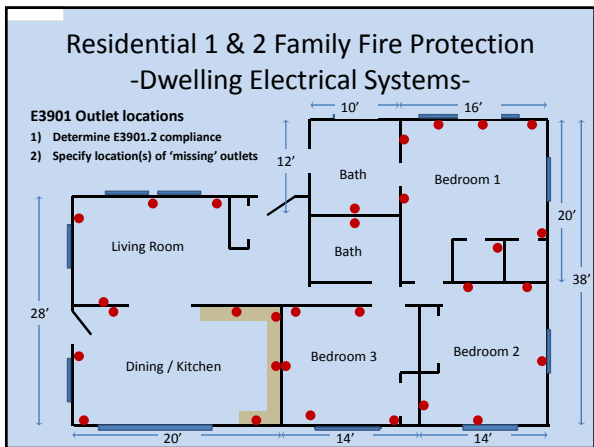

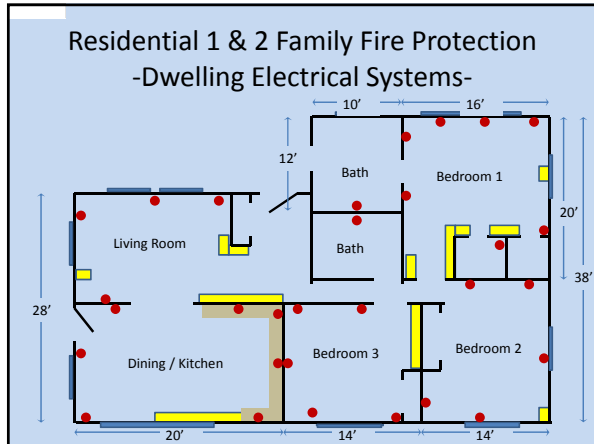

Residential 1 & 2 Family Fire Protection -Dwelling Electrical Systems-

- E3901.7 Outdoor Outlet Locations
 - Prevents the extension door pinched in the storm door effect.
 - Porch
 - Deck
 - Front
 - Rear
 - Proximal to HVAC equipment

Residential 1 & 2 Family Fire Protection -Dwelling Electrical Systems-

- E4101 Cords contacting electric baseboard
 - E4101.2 Appliance Installation
 - Installed per manufacturer's instructions
 - E4101.3 Flexible Cords for Appliances & Equipment
 - Arranged to avoid physical damage
 - E3403.3 Listing & Labeling
 - Installed & used per listing

Residential 1 & 2 Family Fire Protection -Dwelling Electrical Systems-

- E3904.2 Mechanical Continuity
 - Applies to plastic raceway, metal raceway, & cable
 - Uninterrupted physical protection between boxes
 - Protects conductor electrical insulation
 - Prevents moisture intrusion
 - Prevents vermin
 - Maintains problems inside the enclosure



Residential 1 & 2 Family Fire Protection -Dwelling Electrical Systems-

- E3905.4.2 Box Depth / Device Size
- Performance requirements:
 - Deep enough to accommodate devices
 - Conductors may not be crushed
 - Extension rings and plaster rings permitted
- Prescriptive requirements:
 - At least ¼" space behind device for large equipment
 - Specified minimum box depth for large conductors
 - Box depth related to wire size



Residential 1 & 2 Family Fire Protection -Dwelling Electrical Systems-

- E3905.12 Box Fill
 - Sufficient to permit free space
 - Calculated



Residential 1 & 2 Family Fire Protection
-Dwelling Electrical Systems-

- E3906 Installation Issues
 - E3906.6 Perimeter opening
 - 1/8" around box
 - Gaps may be repaired



Residential 1 & 2 Family Fire Protection
-Dwelling Electrical Systems-

- E3905.5 Flush mounted devices
 - Contained within the box
 - No exposed parts after cover plate installation
 - Screws for support of box may not support devices
 - Intention:
 - Prevent contact
 - Maintain device integrity



Residential 1 & 2 Family Fire Protection
-Dwelling Electrical Systems-

- E3906 Installation Issues
 - E3906.3 Metal Boxes & Conduit Bodies
 - Cables entering must generally be clamped
 - Proximal cable stapling permitted for some single gang boxes
 - E3906.1 Abrasion protection
 - Larger conductors must be bushed





Residential 1 & 2 Family Fire Protection -Dwelling Electrical Systems-

- E3906 Installation Issues
 - E3906.4 Unused Openings
 - Must be filled
 - Same degree of protection as the enclosure
 - E3404.6 Ditto





Chapter 40 Devices & Luminaires

- E4003.12 Luminaires in Clothing Storage Closets
 - A significant fire cause

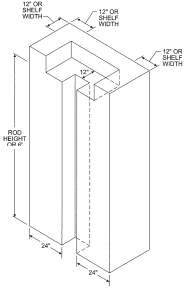

Chapter 40 Devices & Luminaires

- E4003.12 Clothing Closets
 - "Storage space" defined
 - As diagrammed
 - Not permitted in defined space:
 - Open bulb fixtures
 - Partially open fixtures
 - Pendant fixtures
 - Bare lamp holders



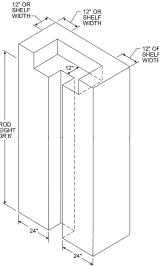

Chapter 40
Devices & Luminaires

- E4003.12 Clothing Closets
 - Item 1: Surface incandescent / LED
 - Permitted on wall above door / ceiling
 - Completely enclosed bulb
 - Minimum 12" spacing to storage space



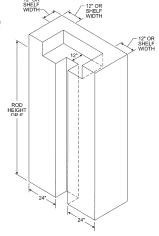

Chapter 40
Devices & Luminaires

- E4003.12 Clothing Closets
 - Item 2: Surface fluorescent
 - Wall above door or ceiling
 - 6" minimum spacing to designated space

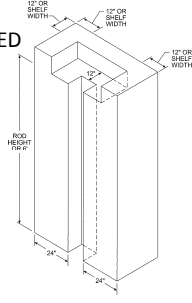

Chapter 40
Devices & Luminaires

- E4003.12 Clothing Closets
 - Item 3: Recessed incandescent / LED
 - Enclosed light source
 - Cover lens
 - Mounted on any wall or ceiling
 - 6" spacing to storage space



Chapter 40
Devices & Luminaires

- E4003.12 Clothing Closets
 - Item 4: Recessed Fluorescent
 - Mounted on any wall or ceiling
 - 6" spacing to storage space

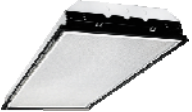

Chapter 40
Devices & Luminaires

- E4003.12 Clothing Closets
 - Item 5: Closet Storage Space Fixtures
 - E3403.3 Listed & Labeled for such application
 - E3403.2 Installed per manufacturer's instructions
 - May be used within the storage space

Residential 1 & 2 Family Fire Protection
-Review-

- 2012 IRC Based Fire Safety & Mitigation Issues
 - Building design features
 - Fire separation requirements
 - Fire Blocking / Draft stopping / Specific structural component protection
 - Means of Egress
 - Emergency Escape & Rescue Windows
 - Fire sprinkler system
 - Smoke Alarms
 - CO Alarms
 - Finishes & Materials
 - Mitigation Issues
 - Chimneys and fireplaces
 - Mechanical / HVAC equipment installations
 - Fuel gas systems and appliances
 - Electrical installation concerns



Residential 1 & 2 Family Fire Protection

- Questions?