

CONNECTICUT PUBLIC HEALTH CODE
REGULATIONS AND TECHNICAL STANDARDS
FOR SUBSURFACE SEWAGE DISPOSAL SYSTEMS

- Section 19-13-B100 (Conversions, Changes in Use, Additions)
Effective October 25, 1976
- Section 19-13-B103 (Discharges 5,000 Gallons Per Day or Less)
Effective August 16, 1982
- Technical Standards (Pursuant to Section 19-13-B103)
Effective August 16, 1982
Revised January 1, 1986
- Section 19-13-B104 (Discharges Greater Than 5,000 Gallons Per Day)
Effective August 16, 1982

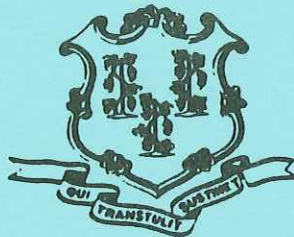

STATE OF CONNECTICUT
DEPARTMENT OF HEALTH SERVICES
150 Washington St
Hartford, Connecticut 06106

TABLE OF CONTENTS

<u>SECTION</u>	<u>PAGE</u>
19-13-B100	Building Conversion, Changes in Use, Additions 1
19-13-B103	DISCHARGES 5,000 GALLONS PER DAY OR LESS
19-13-B103a	Scope 2
19-13-B103b	Definitions. 2
19-13-B103c	General Provisions 3
19-13-B103d	Minimum Requirements 4
19-13-B103e	Procedures and Conditions for the Issuance of . . . 8 Permits and Approvals
19-13-B103f	Non-discharging Sewage Disposal Systems. 13
 TECHNICAL STANDARDS	
I	Definitions. 15
II	Location of Subsurface Sewage Disposal System. . . 16
III	Piping 17
IV	Estimated Sewage Flows 27
V	Septic Tanks 28
VI	Distribution of Sewage Effluent. 31
VII	Percolation Tests. 33
VIII	Leaching Systems 35
IX	Groundwater, Roof, Cellar and Yard Draining. . . . 43
X	Other Wastewaters. 43
XI	Non-discharging Sewage Disposal Systems. 44
FORM #1	Application for Permit to Construct or Repair. . . 46 A Sewage Disposal System
FORM #2	Investigation for Sewage Disposal System 47
FORM #3	Check List: Review of Plan/Inspection of. 49 Sewage Disposal System
 19-13-B104 DISCHARGES GREATER THAN 5,000 GALLONS PER DAY	
19-13-B104a	Scope. 50
19-13-B104b	Definitions. 50
19-13-B104c	General Provisions 51
19-13-B104d	Minimum Requirements 52

CONNECTICUT STATE DEPARTMENT OF HEALTH

PUBLIC HEALTH CODE REGULATION

Sec. 19-13-B100. Building Conversion. (a) If public sewers are not available, no building shall be converted so as to enable its use year round nor shall its use be changed unless after the said conversion or use change the lot satisfies all the current requirements of the Public Health Code for the installation of subsurface sewage disposal facilities except for the one hundred percent reserve area. (h) If public sewers are not available, no addition for any building which reduces the lot area available for subsurface sewage disposal shall be constructed unless after he said addition the lot satisfies all the current requirements of the Public Health Code for the installation of subsurface sewage disposal facilities except for the one hundred percent reserve area. If the lot does not satisfy all the current requirements except for the one hundred percent reserve area, an addition shall be permitted only if it adds only one room beyond the number of rooms existing at the time the subsurface sewage disposal system was installed and does not reduce the area of the lot available for said subsurface sewage disposal facilities.

Effective 10/25/76

SEC. 19-13-B103

The regulations of Connecticut State agencies are amended by adding Sections 19-13-B103a through 19-13-B103f, inclusive, as follows: (NEW)

Sec. 19-13-B103a. Scope These regulations establish minimum requirements for household and small commercial subsurface sewage disposal systems with a capacity of 5,000 gallons per day or less, non-discharging toilet systems and procedures for the issuance of permits or approvals of such systems by the director of health or registered sanitarian, as required by Section 25-54i(g) of the General Statutes.

Sec. 19-13-B103b. Definitions. The following definitions shall apply for the purposes of Sections 19-13-B103c to 19-13-B103f, inclusive:

- (a) "Sewage" means domestic sewage consisting of water and human excretions or other waterborne wastes incidental to the occupancy of a residential building or a non-residential building, as may be detrimental to the public health or the environment, but not including manufacturing process water, cooling water, waste water from water softening equipment, blow down from heating or cooling equipment, water from cellar or floor drains or surface water from roofs, paved surface or yard drains.
- (b) "Septic tank" means a water-tight receptacle which is used for the treatment of sewage and is designed and constructed so as to permit the settling of solids, the digestion of organic matter by detention and the discharge of the liquid portion to a leaching system;
- (c) "Subsurface sewage disposal system" means a system consisting of a house sewer; a septic tank followed by a leaching system, any necessary pumps and siphons, and any ground water control system on which the operation of the leaching system is dependent.
- (d) "Residential building" means any house, apartment, trailer or mobile home, or other structure occupied by individuals permanently or temporarily as a dwelling place but not including residential institutions;
- (e) "Residential institution" means any institutional or commercial building occupied by individuals permanently or temporarily as a dwelling, including dormitories, boarding houses, hospitals, nursing homes, jails, and residential hotels or motels;
- (f) "Nonresidential building" means any commercial, industrial, institutional, public or other building not occupied as a dwelling, including transient hotels and motels;
- (g) "Impervious soil" means soil that has a minimum percolation rate slower than one inch in sixty minutes when the ground water level is at least eighteen inches below the bottom of the percolation test hole;
- (h) "Suitable soil" means soil having a minimum percolation rate of one inch in one to sixty minutes when the ground water level is at least eighteen inches below the bottom of the percolation test hole;

- (i) "Maximum ground water level" means the level to which ground water rises for a duration of one month or longer during the wettest season of the year;
- (j) "Open watercourse" means a well defined surface channel, produced wholly or in part by a definite flow of water and through which water flows continuously or intermittently and includes any ditch, canal, aquaduct or other artificial channel for the conveyance of water to or away from a given place, but not including gutters for storm drainage formed as an integral part of a paved roadway; or any lake, pond, or other surface body of water, fresh or tidal; or other surface area intermittently or permanently covered with water.
- (k) "Local director of health" means the local director of health or his authorized agent;
- (l) "Technical Standards" means the standards established by the commissioner of health services in the most recent revision of the publication entitled "Technical Standards for Subsurface Sewage Disposal Systems" available from the State Department of Health Services;
- (m) "Department" means the State Department of Health Services;
- (n) "Gray water" means domestic sewage containing no fecal material or toilet wastes.
- (o) "Drawdown area" means that area adjacent to a well in which the water table is lowered by withdrawal of water from the well by pumping at a rate not exceeding the recharge rate of the aquifer.

Sec. 19-13-B103c. General Provisions.

- (a) All sewage shall be disposed of by connection to public sewers, by subsurface sewage disposal systems, or by other methods approved by the Commissioner of Health Services, in accordance with the following requirements.
- (b) All sewers, subsurface sewage disposal systems, privies and toilet or sewage plumbing systems shall be kept in a sanitary condition at all times and be so constructed and maintained as to prevent the escape of odors and to exclude animals and insects.
- (c) The contents of a septic tank, subsurface sewage disposal system or privy vault shall only be disposed of in the following manner.
 - (1.) If the contents are to be disposed of on the land of the owner, disposal shall be by burial or other method which does not present a health hazard or nuisance; or
 - (2.) If the contents are to be disposed of on land of other than the owner;
 - (A.) The contents shall be transferred and removed by a cleaner licensed pursuant to Connecticut General Statutes S 20-341, and
 - (B.) Only on the application for and an issuance of a written permit from the local director of health in accordance with the provisions of this section;

- (3.) If the contents are to be dispersed on a public water supply watershed, only on the application and issuance of a written permit by the Commissioner of Health Services in accordance with the provisions of this section.

Each application for a permit under (c) (2) and (3) shall be in writing and designate where and in what manner the material shall be disposed of.

- (d) All material removed from any septic tank, privy, sewer, subsurface sewage disposal system, sewage holding tank, toilet or sewage plumbing system shall be transported in water-tight vehicles or containers in such a manner that no nuisance or public health hazard is presented. All vehicles used for the transportation of such material shall bear the name of the company or licensee and shall be maintained in a clean exterior condition at all times. No defective or leaking equipment shall be used in cleaning operations. All vehicles or equipment shall be stored in a clean condition when not in use. Water used for rinsing such vehicles or equipment shall be considered sewage and shall be disposed of in a sanitary manner approved by the local director of health.
- (e) Septic tanks shall be cleaned by first lowering the liquid level sufficiently below the outlet to prevent sludge or scum from overflowing to the leaching system where it could cause clogging and otherwise damage the system. Substantially all of the sludge and scum accumulation shall be removed whenever possible, and the inlet and outlet baffles shall be inspected for damage or clogging. Cleaners shall use all reasonable precaution to prevent damaging the sewage disposal system with their vehicle or equipment. Accidental spillages of sewage, sludge or scum shall be promptly removed or otherwise abated so as to prevent a nuisance or public health hazard.
- (f) No sewage shall be allowed to discharge or flow into any storm drain, gutter, street, roadway or public place, nor shall such material discharge onto any private property so as to create a nuisance or condition detrimental to health. Whenever it is brought to the attention of the local director of health that such a condition exists on any property, he shall investigate and cause the abatement of this condition.

Sec. 19-13-B103d. Minimum Requirements.

- (a) Each subsurface sewage disposal system shall be constructed, repaired, altered or extended pursuant to the requirements of this section unless an exception is granted in accordance with the following provisions:
- (1.) A local director of health may grant an exception, except with respect to the requirements of Section 19-13-B103d(d) and Technical Standard IIA, for the repair, alteration, or extension of an existing subsurface sewage disposal system where he determines the repair, alteration or extension cannot be effected in compliance with the requirements of this section and upon a finding that such an exception is unlikely to cause a nuisance or health hazard. All exceptions granted by the local director of health shall be submitted to the Commissioner of Health Services within thirty days after issuance on forms provided by the Department.

(2.) The Commissioner of Health Services may grant an exception to the requirements of Section 19-13-B103d(d) upon written application and upon a finding that:

(A.) A central subsurface sewage disposal system serving more than one building is technically preferable for reasons of site limitations, or to facilitate construction, maintenance or future connection to public sewers, or;

(B.) A subsurface sewage disposal system not located on the same lot as the building served is located on an easement attached thereto. Such easement shall be properly recorded on the land records and shall be revokable only by agreement of both property owners and the Commissioner of Health Services.

(3.) The Commissioner of Health Services may grant an exception to the requirements of Technical Standard IIA, upon written application and upon a finding that such an exception is unlikely to pollute the well in such a manner as to cause a health hazard.

(b) Technical Standards.

Subsurface sewage disposal systems within the scope of this regulation shall be designed, installed and operated in accordance with the technical standards established in the "Technical Standards for Subsurface Sewage Disposal Systems" published by the Commissioner of Health Services. The Technical Standards shall be reviewed annually and changes to the Technical Standards shall be available on January 1st of each year.

(c) Large Subsurface Disposal Systems.

The Commissioner of Health Services shall approve plans for subsurface sewage disposal systems serving a building with a designed sewage flow of two thousand gallons per day or greater, and no such systems shall be constructed, repaired, altered or extended unless the plans for such systems are approved by the Commissioner in accordance with the following:

1. Plans for the system are submitted at least twenty days prior to approval to construct by the local director of health.
- (2.) The plans are designed by a professional engineer registered in the State of Connecticut.
- (3.) The plans submitted contain:
 - (A.) The basis of design,
 - (B.) Soil conditions and test pit locations,
 - (C.) Maximum ground water and ledge rock elevations,
 - (D.) Original and finished surface contours and elevations,
 - (E.) Property lines, and

(F.) Locations of buildings, open water courses, ground and surface water drains, nearby wells and water service lines.

(d) Location.

Each building shall be served by a separate subsurface sewage disposal system. Each such system shall be located on the same lot as the building served.

(e) Disposal of Sewage in Areas of Special Concern.

(1.) Disposal systems for areas of special concern shall merit particular investigation and special design, and meet the special requirements of this subsection. The following are determined to be areas of special concern:

(A.) A minimum soil percolation rate faster than one inch per minute, or

(B.) Slower than one inch in thirty minutes, or

(C.) Maximum ground water less than three feet below ground surface, or

(D.) Ledge rock less than five feet below ground surface, or

(E.) Soils with slopes exceeding twenty-five per cent, or

(F.) Consisting of soil types interpreted as having severe limitations for on-site sewage disposal by most recent edition of the National Cooperative Soil Survey of the Soil Conservation Service, or

(G.) Designated as wetland under the provisions of Sections 22a-36 through 22a-45 of the Connecticut General Statutes, as amended.

(H.) Located within the drawdown area of an existing public water supply well with a withdrawal rate in excess of fifty gallons per minute, or within five hundred feet of land owned by a public water supply utility and approved for a future wellsite by the Commissioner of Health Services.

(2.) In such areas of special concern, the local director of health may require investigation for maximum ground water level to be made between February 1 and May 31, or such other times when the ground water level is determined by the Commissioner of Health Services to be near its maximum level.

(3.) (A.) Plans for new subsurface systems in areas of special concern shall:

i. Be prepared by a professional engineer registered in the State of Connecticut;

ii. Include all pertinent information as to the basis of design, and soil conditions, test pit locations, ground water and ledge rock elevations, both original and finished surface contours and elevation, property lines, building locations, open water courses, ground and surface water drains, nearby wells and water service lines;

iii. Demonstrate an ability to solve the particular difficulty or defect associated with the area of special concern and which caused its classification. The Commissioner or local director of health, as the case may be, may require a study of the capacity of the surrounding natural soil to absorb or disperse the expected volume of sewage effluent without overflow, breakout, or detrimental effect on ground or surface waters if in their opinion such may occur.

(B.) The plans for new subsurface disposal systems in areas of special concern shall be submitted to the local director of health and the Commissioner of Health Services for a determination as to whether the requirements of the subsection have been met, except that such submission need not be made to the Commissioner of Health Services if the local director or authorized agent has been approved to review such plans by the Commissioner of Health Services in accordance with Section B103e(b). All submissions to the Commissioner of Health Services shall be made at least 20 days prior to issuance of an approval to construct by the local director of health.

(4.) If application is made for the repair, alteration or extension of an existing subsurface disposal system in an area of special concern, the local director of health may require that the applicant comply with the requirement of Subdivision (3) if he determines that the contemplated repair, alteration or extension involves technical complexities which cannot reasonably be addressed by himself, his authorized agent or the system installer.

(5.) While a sewage disposal system in an area of special concern is under construction, the local director of health may require that the construction be supervised by a professional engineer registered in the State of Connecticut, if in the opinion of the local director of health it is necessary to insure conformance to the plans approved or because of the difficulties likely to be encountered. The engineer shall make a record drawing of the sewage disposal system, as installed, which he shall submit to the local director of health prior to issuance of a discharge permit.

(6.) In such areas of special concern, the Commissioner of Health Services or the local director of health who has been approved by the Commissioner to review engineering plans in areas of special concern pursuant to Section 19-13-B103e(b) may require a study of the capacity of the surrounding natural soil to absorb or disperse the expected volume of sewage effluent without overflow, breakout, or detrimental effect on ground or surface waters.

(f) Gray Water Systems.

Disposal systems for sinks, tubs, showers, laundries and other gray water from residential buildings, where no water flush toilet fixtures are connected, shall be constructed with a septic tank and leaching system at least one-half the capacity specified for the required residential sewage disposal system.

Sec. 19-13-B103e. Procedures and Conditions for the Issuance of Permits and Approvals. No subsurface sewage disposal system shall be constructed, altered, repaired or extended without an approval to construct issued in accordance with this section. No discharge shall be initiated to a subsurface sewage disposal system without a discharge permit issued in accordance with this section. Such permits and approvals shall be issued and administered by the local director of health.

(a) No permit or approval shall be issued:

- (1.) For any subsurface sewage disposal system which is designed to discharge or overflow any sewage or treated effluent to any watercourse;
- (2.) For any new subsurface sewage disposal system until it is demonstrated to the satisfaction of the local director of health that there is a public water supply available or a satisfactory location for a water supply well complying with Sections 19-13-B51a through 19-13-B51m of the Public Health Code;
- (3.) For any new subsurface sewage disposal system where the soil conditions in the area of the leaching system are unsuitable for sewage disposal purposes at the time of the site investigation made pursuant to this section. Unsuitable conditions occur where the existing soil is impervious, or where there is less than four feet depth of suitable existing soil over ledge rock, two feet of which is naturally occurring soil, or where there is less than 18 inches depth of suitable existing soil over impervious soil, or where the ground water level is less than 18 inches below the surface of the ground for a duration of one month or longer during the wettest season of the year;
- (4.) For any new subsurface sewage disposal system where the surrounding naturally occurring soil cannot adequately absorb or disperse the expected volume of sewage effluent without overflow, breakout or detrimental effect on ground or surface water.

(b) Approval of Agents by Commissioner of Health Services

- (1.) A local director of health shall authorize only persons approved by the Commissioner of Health Services to investigate, inspect and approve plans relating to subsurface sewage disposal systems.
- (2.) The Commissioner of Health Services shall approve agents of the local director of health whose qualifications to investigate, inspect and approve plans relating to subsurface sewage disposal systems have been established by attending training courses and passing examinations given by the Department of Health Services, as follows:
 - (A.) Agents who have attended training courses and passed examinations relative to Sections 19-13-B100, 19-13-B103 and 19-13-B104 of the Public Health Code and the Technical Standards shall be approved to investigate, inspect and approve all plans for subsurface sewage disposal systems except those prepared by a professional engineer registered in the State of Connecticut pursuant to Sections 19-13-B103d(c) or (e).

(B.) Agents who have attended training courses and passed examinations relative to the engineering design of subsurface sewage disposal systems shall be approved to investigate, inspect and approve plans for such systems prepared by a professional engineer registered in the State of Connecticut pursuant to Section 19-13-B103d(e).

(c) Application for Permit or Approval.

(1.) No investigation, inspection or approval of a subsurface sewage disposal system shall be made, or permit issued without an application by the owner in accordance with the following requirements.

(2.) Applications for permits shall:

(A.) Be on forms identical to Form #1 in the Technical Standards;
or

(B.) Be on forms prepared by the local director of health and deemed by the Commissioner of Health Services as equivalent to Form #1 in the Technical Standards; and

(C.) Have attached a plot plan of the lot, which shall be a surveyor's plan if available or one prepared from information on the deed or land records.

(3.) All the requested information shall be provided. If the information is not provided, it shall be indicated why it is not available or the application may be determined incomplete, and be rejected.

(d) Site Investigation.

(1.) The local director of health or a professional engineer registered in the State of Connecticut representing the applicant shall make an investigation of the site proposed for the subsurface sewage disposal system and report the findings and recommendations of the investigation on a form identical to Form #2 in the Technical Standards to include:

(A.) A record of soil test location, measures and observations.

(B.) Soil percolation results.

(C.) Observations of ground water and ledge rock.

(D.) A conclusion as to the suitability of the site for subsurface sewage disposal.

(E.) Special requirements for design of the system, or further testing which shall be in accordance with the most recent edition of the Technical Standards.

(2.) Prior to the site investigation, the applicant shall:

(A.) Provide for the digging of a suitable number of percolation test holes and deep observation pits in the area of the proposed leaching system and extending at least four feet below the bottom of the proposed leaching system, at the direction of the local director of health;

(B.) Provide water for performing the percolation tests;

(C.) If required by the local director of health, locate by field stakes or markers the sewage disposal system, house, well or property lines.

(3.) The site investigation shall be made within ten working days of application unless otherwise required by subsection 19-13-B103d(e).

(4.) The local director of health shall:

(A.) Assure the accuracy of the findings of soil tests and deep observation pits; and

(B.) When the maximum ground water level is in doubt the local director of health shall investigate pursuant to Section 19-13-B103d(e).

(5.) The size of the leaching system shall be based on the results of soil percolation tests made in the area of the proposed leaching system or on other methods of determining the soil absorption capacity in accordance with the Technical Standards.

(6.) In areas of special concern, or for leaching systems with a design sewage flow of 2,000 gallons per day or greater, the local director of health may require from the applicant whatever further testing or data necessary to assure that the sewage disposal system will function properly. Further testing may be required prior to or subsequent to issuance of the approval to construct. Such tests may include permeability tests, sieve analysis or compaction tests of natural soil or fill materials, and the installation of ground water level monitoring wells, or pipes, as well as additional observation pits and soil percolation tests.

(e) Submission of Plan.

(1.) Every plan for a subsurface sewage disposal system shall be submitted to the local director of health.

(2.) Every plan for a subsurface sewage disposal system shall include all information necessary to assure compliance with the requirements of Section 19-13-B103d of these regulations, and contain as a minimum the following information: the location of the house sewer, the location and size of the septic tank, the location and description of the leaching system, property lines, building locations, water-courses, ground and surface water drains, nearby wells and water service lines.

- (3.) Where required by the local director of health under subsections 19-13-B103d (c) and (e) of these regulations, the plan shall be prepared by a professional engineer, registered in the State of Connecticut, and shall be forwarded by the local director to the Commissioner of Health Services, together with his comments and recommendations.
- (4.) No plan shall be submitted directly by the applicant or engineer to the Commissioner of Health Services, unless requested by the local director of health.

(f) Approval to Construct.

- (1.) Upon determination that the subsurface sewage disposal system has been designed in compliance with the requirements of Section 19-13-B103d of these regulations, the local director of health shall issue an approval to construct. Approvals to construct shall be valid for a period of one year from the date of their issuance and shall terminate and expire upon a failure to start construction within that period. Approvals to construct may be renewed for an additional one year period by the local director of health upon a demonstration of reasonable cause for the failure to start construction within the one year period.
- (2.) Each subsurface sewage disposal system shall be constructed by a person licensed pursuant to Section 20-341 of the General Statutes. Such person shall notify the local director of health at least twenty-four hours prior to commencement of construction.
- (3.) The Commissioner of Health Services shall approve in accordance with Subsection 19-13-B103d(c) plans for a subsurface sewage disposal system to serve a building, the design sewage flow from which is two thousand gallons a day or greater prior to issuance of an approval to construct by the local director of health.
- (4.) Approval to construct a subsurface sewage disposal system in an area of special concern shall not be issued until twenty days following submission of the plans to the Commissioner of Health Services in accordance with subsection 19-13-B103d(e), unless earlier approved by the Commissioner.

(g) Inspection.

- (1.) The local director of health shall inspect all subsurface sewage disposal systems for compliance with Subsection 19-13-B103d and the approved plans for construction prior to covering and at such other times as deemed necessary.
- (2.) After construction, and prior to covering, the subsurface sewage disposal system installer shall notify the local director of health the site is prepared for inspection. Such inspection shall take place as soon thereafter as feasible, but not later than two (2) working days after receipt of the request unless the owner agrees to an extension.

(3.) A final inspection report shall be prepared by the local director of health on forms deemed by the Commissioner of Health Services as equivalent to Form #3 in the Technical Standards.

(4.) A record plan of the sewage disposal system, as built, shall be required by the local director of health.

(h) Permit to Discharge.

(1.) Upon determination that the subsurface sewage disposal system has been installed in compliance with the requirements of Section 19-13-B103d of these regulations and the approved plans, the local director of health shall issue a permit to discharge. A copy of such permit shall be sent to the local building official. No permit to discharge shall be issued until all required forms are completed and an approved as-built plan or record drawing is received.

(2.) Any permit to discharge issued by the Commissioner of Health Services or a local director of health for a household or small commercial subsurface sewage disposal system with a capacity of five thousand gallons per day or less shall be deemed equivalent to a permit issued under Subsection 25-54i(b) of the Connecticut General Statutes. Such permits shall:

(A.) specify the manner, nature and volume of discharge;

(B.) require proper operation and maintenance of any pollution abatement facility required by such permit;

(C.) be subject to such other requirements and restrictions as the commissioner deems necessary to comply fully with the purposes of this chapter and the Federal Water Pollution Control Act; and

(D.) be issued on forms approved by the Commissioner of Health Services.

(3.) The local director of health shall record the granting of an exception from any requirement of Section 19-13-B103d on the permit to discharge.

(i) Enforcement.

(1.) A permit to discharge to a subsurface sewage disposal system shall not be construed to permit any sewage overflow, nuisance, or similar condition or the maintenance thereof.

(2.) If such a condition is found to exist, the permit to discharge may be revoked, suspended, modified or otherwise limited and any such condition is subject to an order to abate the condition pursuant to Connecticut General Statutes Section 19-79.

(j) Records.

Copies of completed applications, investigation reports, review and inspection forms and as-built plans or record drawings of each sewage disposal system, certified as complying with this Section, shall be kept in the files of the town or health district for a minimum of ten years.

(k) Rights of Applicant.

- (1.) All site investigations, inspections, review of plans and issuance of permits or approvals by the local director of health shall be made without unreasonable delay.
- (2.) When requested in writing by the applicant, the local director of health shall designate in writing within 20 working days the requirement(s) of Section 19-13-B103d or 19-13-B103e of these regulations which prevents such investigation, inspection, review, permit or approval.
- (3.) Any final decision of the local director of health made in regard to these sections shall be made in writing and sent to the applicant. Any decision adverse to the applicant or which limits the application shall set forth the facts and conclusions upon which the decision is based. Such written decision shall be deemed equivalent to an order, and may be appealed pursuant to Section 19-103 of the General Statutes.

Sec. 19-13-B103f Non-discharging Sewage Disposal Systems

- (a) All non-discharging sewage disposal systems shall be designed, installed and operated in accordance with the Technical Standards and the requirements of this section, unless an exception is granted by the Commissioner upon a determination that system shall provide for the proper and complete disposal and treatment of toilet wastes or gray water.
- (b) Composting Toilets.
 - (1.) The local director of health may approve the use of a large capacity composting toilet or a heat-assisted composting toilet for replacing an existing privy or failing subsurface sewage disposal system, or for any single-family residential building where application is made by the owner and occupant, and the lot on which the building will be located is tested by the local director of health and found suitable for a subsurface sewage disposal system meeting all the requirements of Section 19-13-B103d of these regulations.
 - (2.) All wastes removed from composting toilets shall be disposed of by burial or other methods approved by the local director of health.
- (c) Incineration Toilets.

The local director of health may approve the use of incineration toilets for non-residential buildings or for existing single-family residential dwellings for the purpose of abating existing sewage problems or replacing the existing non-water carriage toilets.
- (d) Chemical Flush Toilets and Chemical Privies.
 - (1.) The local director of health may approve chemical flush toilets or chemical privies for nonresidential use where they are located outside of buildings used for human habitation. Chemical flush toilets or chemical privies located inside human habitations shall be approved by the Commissioner of Health Services and the local director of health.

(2.) Liquid waste from chemical flush toilets or chemical privies shall be disposed of in a location and manner approved by the local director of health. Such liquid shall not be disposed of on a public water supply watershed or within five hundred feet of any water supply well unless approved by the Commissioner of Health Services.

(e) Dry Vault Privies.

(1.) The local director of health may approve dry vault privies for nonresidential use where they are located outside of buildings used as human habitation.

(2.) Wastes removed from dry privy vaults shall be disposed of by burial or other methods approved by the local director of health.

STATEMENT OF PURPOSE:

These regulations up-date existing Public Health Code requirements for the design of subsurface sewage disposal with design flows of 5,000 gallons per day or less and non-discharge toilet systems. Sewage disposal systems conforming to this regulation and designed in compliance with published technical standards will provide for the preservation and improvement of public health.

TECHNICAL STANDARDS FOR THE DESIGN AND CONSTRUCTION
OF SUBSURFACE SEWAGE DISPOSAL SYSTEMS
PURSUANT TO SECTION 19-13-B103

EFFECTIVE AUGUST 16, 1982
REVISED JANUARY 1, 1986

I. DEFINITIONS

- A. "Leaching trench" means a level excavation, not exceeding three feet in width, with vertical sides and flat bottoms partially filled with stone or gravel and equipped with a single distribution line running the entire length of the trench.
- B. "Leaching pit" means a hollow, covered pit constructed with a perforated lining surrounded by stone or gravel;
- C. "Leaching bed" means a level excavated area partially filled with stone or gravel and equipped with a series of distribution pipes;
- D. "Leaching gallery" means a level hollow, covered structure not less than four feet in width, constructed with a perforated lining surrounded by stone or gravel on the sides;
- E. "Leaching system" means a structure, excavation or other facility designed to allow settled sewage to percolate into the underlying soil without overflow and to mix with the ground water;
- F. "House sewer" means a tight sewer pipe extending from the building served to the septic tank;
- G. "One-inch broken stone" or "one-inch screened gravel" means not less than three-quarters inch and not larger than two inches and free of silt, dirt or debris;
- H. "Tight pipe" means pipe which has no loose or open joints, perforations, slots or porous openings which would allow seepage to escape from, or water to enter the pipe;

II. LOCATION OF SUBSURFACE SEWAGE DISPOSAL SYSTEMS

No subsurface sewage disposal system shall be laid in areas where high ground water, surface flooding or ledge rock will interfere with its effective operation. The following minimum separating distances between any part of the sewage disposal system which carries or treats sewage or septic tank effluent and the items listed in Table No. 1 shall be provided for sewage disposal systems serving individual dwellings.

TABLE NO. 1

ITEM	SEPARATING DISTANCE	SPECIAL PROVISION
A. well, spring or domestic water suction pipe. Required withdrawal rate under 10 gal. per minute 10 to 50 gal. per minute over 50 gal. per minute	75 feet 150 feet 200 feet	(1) Separation distance shall be doubled where the soil has a minimum percolation rate faster than 1 inch per minute (Also see Standard VIII A) (2) Separation distance shall be increased as necessary to protect the sanitary quality of a public water supply well.
B. Human habitation on adjacent property	25 feet	
C. Building served	15 feet	Building shall have no footing or foundation drains
D. Any open water course	50 feet	When not located on a public water supply watershed, this distance shall be reduced as necessary to not less than 25 feet on lots in subdivision plans approved prior to the effective date of this regulation and thereafter recorded as required by statute.
E. Public water supply reservoir	100 feet	
F. Any surface or ground water drain constructed of tight pipe	25 feet	Drains constructed of cast iron pipe with rubber gasketed joints or accepted equal (see Table 2) are exempted from this requirement, except that no such drain shall cross a leaching system.
G. Groundwater intercepting drains, footing or foundation drain located up gradient from leaching system.	25 feet	
H. Loose or open jointed, perforated, slotted or pervious pipe drain located down gradient from leaching system	50 feet	No such drain shall be constructed down gradient from the leaching system on the same property for the purpose of collecting sewage effluent no matter what the separating distance
I. Top of embankment	15 feet	
J. Property line	10 feet	
K. Potable water line which flows under pressure	10 feet	
L. Below ground swimming pool	25 feet	
M. Above ground swimming pool	10 feet	

III. PIPING

A. House sewers

House sewers shall be not less than four inches in diameter. The grade shall be at least one-quarter inch per foot for four-inch sewers and shall be not less than one-eighth inch per foot for larger sizes. House sewers shall be laid with tight joints to a septic tank and in a straight line and on a uniform grade wherever possible. Accessible manholes or surface cleanouts shall be provided at changes of directions exceeding 45° (see figure no. 1). Pipe for such sewers shall be of cast iron with rubber gasketed joints or accepted equal* to a point at least twenty-five feet beyond the foundation wall of any cellar or basement. Portions of house sewers within seventy-five feet of a well shall be of cast iron with rubber gasketed joints or accepted equal,* but no portion of such sewer, however constructed, shall be within twenty-five feet of a well. No sewer shall be located within twenty-five feet of a cellar drain or ground or surface water drain unless the pipe is of cast iron with rubber gasketed joints or accepted equal.* Long sewer lines shall be avoided to reduce the danger of ground water infiltration, and sewer blockages.

*See Table No. 2

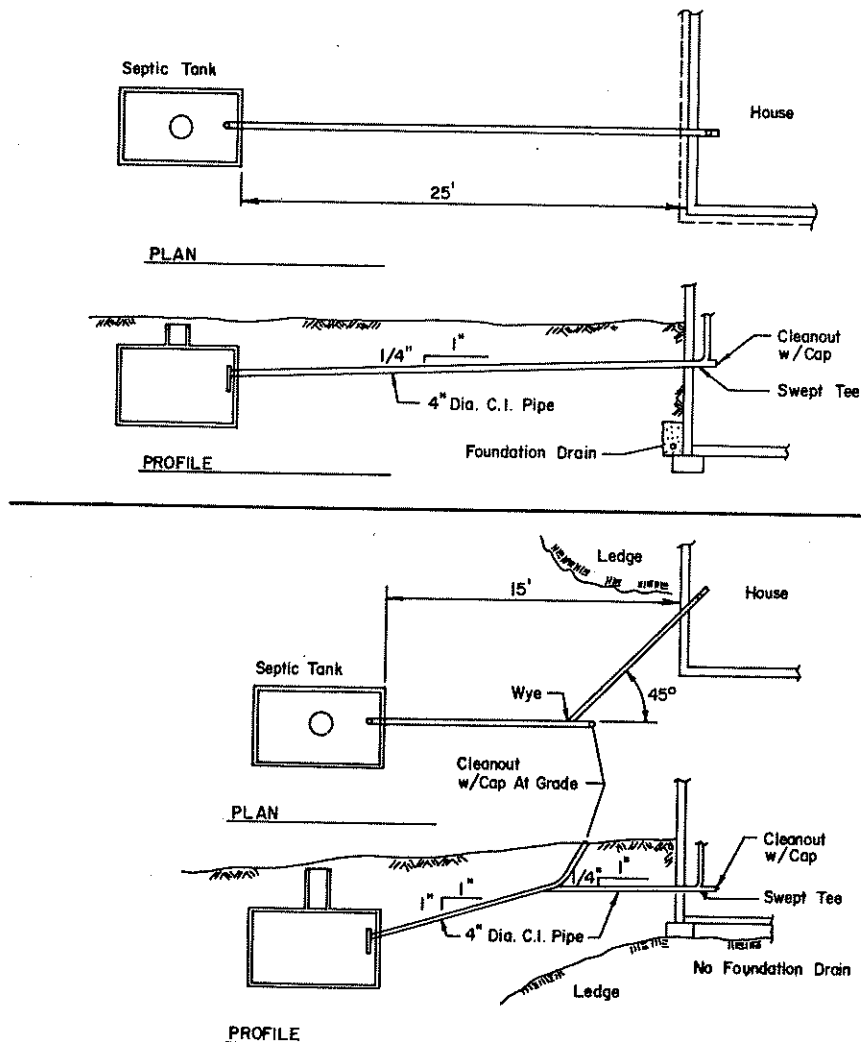

FIGURE NO. 1 HOUSE SEWERS

TABLE NO. 2 - ACCEPTED SEWER PIPE FOR USE FROM FOUNDATION WALL TO SEPTIC TANK

USE	PIPE DESCRIPTION	ACCEPTABLE JOINT	REMARKS
House sewer from foundation wall to septic tank within 25 ft. of building served.	Centrifugally cast iron hubless ASTM A 74	Cast iron split sleeve bolted joint with rubber gasket, MG or coupling or equal <u>OR</u> 3"-wide, heavy-duty, stainless steel banded coupling with rubber gasket; camp-all, ANACO SD 4000, or equal	"10"-ring gaskets, not acceptable if connection is within 25 ft. of foundation wall. Pipe must be properly bedded, laid in straight line on uniform grade.
	Centrifugally cast iron bell and spigot ASTM A 74	Rubber compression gaskets Leaded joints	
	PVC Schedule 40 ASTM D 1785 pressure water pipe	Rubber compression gasketed couplings, Harco Mfg., ASTM D 3139 or equal*	*Use of 3"-wide approved stainless steel banded couplings on PVC scheduled 40 ASTM D 1785 is acceptable. ABS Schedule 40 not acceptable, solvent weld joints not acceptable
	Ductile Iron ANSI A 21.51 Extra Strength PVC pressure water pipe AWA C-900 75-100psi	Rubber compression gaskets Rubber compression gaskets	Connection to cast iron building sewer must be made with compression gaskets. "10"-ring gasket not acceptable.

NOTE: All sewer lines and joints shall be visually inspected by the Director of Health or his agent prior to covering.

TABLE 2-A

ACCEPTED SEWER PIPE FOR INSTALLING SEWER CONNECTIONS TO PUBLIC SEWERS WITHIN 75 FT. OF PRIVATE WATER SUPPLY WELLS

All building sewer lines installed within 75 ft. but no closer than 25 ft. of a private well should be inspected and approved by the Director of Health or sewer inspector prior to backfilling.

USE	PIPE DESCRIPTION	ACCEPTABLE JOINT	REMARKS
Building sewer connection to public sewers or other sewer line within 75 ft. of a private water supply well, spring, or water suction pipe serving a single-family dwelling. <u>NO</u> sewer line shall be located within 25 ft. of a private well Greater separating distances are required for wells with withdrawal rates 10 GPM or greater. See Sec. 19-13-B51d of the Public Health Code.	Centrifugally cast iron No-Hub ASTM A-74	Cast iron split sleeve bolted connector with rubber gasket, MG coupling or equal of 3" wide, heavy-duty stainless steel banded coupling with rubber gasket; Clamp-all, Anaco SD 4000, or equal.	"0"-ring gaskets not acceptable, if used within 75 ft. of well. Pipe must be properly bedded in accordance with pipe manufacturer's specifications, laid in a straight line on a uniform grade.
	Centrifugally cast iron bell and spigot ASTM A-74	Rubber compression gasket	
	Ductile iron ANSI 21.51	Rubber compression gasket	
	Extra strength PVC pressure water pipe AWWA C-900 75-100 psi	Rubber compression gasket	
	PVC Schedule 40 ASTM D 1785 pressure water pipe	Rubber compression gasketed couplings, Harco Mfg., ASTM D 3139 or equal.	Use of 3" wide approved stainless steel banded couplings on PVC schedule 40 ASTM D 1785 is acceptable. ABS Schedule 40 NOT acceptable solvent weld joints not acceptable.
	PVC sewer pipe ASTM D-3033 or D-3034 SDR-35, ASTM F 789, 6" min. diam.	Integral rubber compression gasket or roll-on compression gaskets. 4" C.I. to 6" PVC use Fernco #490 compression gasket or equal.	Joints must meet ASTM D3212-76 specifications. Bedding in accordance with ASTM D2321 or PVC pipe.

TABLE 2-B - ACCEPTED SEWER PIPE FOR USE IN CONSTRUCTING PUBLIC SEWER LINES WITHIN 75 FT. OF PRIVATE WATER SUPPLY WELLS

All public sewer lines installed within 75 ft. but no closer than 25 ft. of private wells serving single-family residences should be low pressure air tested in the presence of the design engineer who should submit a report of the test results to the local health department.

USE	PIPE DESCRIPTION	ACCEPTABLE JOINT	REMARKS
Public sewer line within 75 ft. of a private water supply well, spring or water suction pipe serving single-family residences but no closer than 25 ft.	Centrifugally cast iron No-Hub pipe ASTM A-74	Cast iron split sleeve bolted connector with rubber gasket MG coupling or equal or 3"-wide heavy-duty stainless steel banded coupling with rubber gasket; Clamp-All ANACO SD 4000 or equal	10"-ring gaskets not acceptable if used within 75 ft of well. Pipe must be properly bedded, in accordance with pipe manufacturer's specifications, laid in a straight line on a uniform grade.
Note: Greater separating distances are required for wells with withdrawal rates 10 GPM or greater. See Standard 11 A	Centrifugally cast iron bell and spigot ASTM A-74	Rubber compression gaskets	
	Ductile iron ANSI A21.51	Rubber compression gaskets	
	Extra strength PVC pressure water pipe AWWA C-900 75-100 psi	Rubber compression gaskets	
	Reinforced concrete water pipe, steel cylinder type, not prestressed AWWA C-300	Rubber compression gaskets	
	Reinforced concrete water pipe, steel cylinder type, prestressed AWWA C301	Rubber compression grade	
	PVC Schedule 40 ASTM D 1785 pressure water pipe	Rubber compression gasketed couplings, Harco Mfg., ASTM D 3139 or equal*	*Use of 3"-wide approved stainless steel banded couplings on PVC schedule 40 ASTM D 1785 is acceptable. ABS Schedule 40 not acceptable, solvent weld joints not acceptable.
PVC sewer pipe ASTM D3033 or D3034 SDR 35, and ASTM F 789		Integral rubber compression gasket on roll-on compression gasket.	Joints must meet ASTM D3212-76 specifications. Bedding in accordance with ASTM D2321 for PVC pipe.

TABLE 2-C - ACCEPTED SEWER PIPE FOR USE WITHIN 25 FT. OF WATERCOURSE AND DRAINS
OR CLEAN WATER DRAIN WITHIN 25 FT. OF SEWAGE DISPOSAL SYSTEMS

USE	PIPE DESCRIPTION	ACCEPTABLE JOINT	REMARKS
PRIVATE building sewer, house sewer or effluent distribution line within 25 ft. of any open watercourse, surface or ground-water drain, cellar, footing or foundation drain.	Centrifugally cast iron No-Hub ASTM A-74	Cast iron split sleeve bolted connector with rubber gasket MG coupling or 3"-wide, heavy duty stainless steel banded coupling with rubber gasket; Clamp-all Anaco SD4000, or equal.	10"-ring gaskets not acceptable if used within 25 ft. of watercourse. Pipe must be properly bedded in accordance with manufacturer's specifications, laid in a straight line on a uniform grade.
and ground and surface water drainage pipes within 25 ft. of a subsurface sewage disposal system.	Centrifugally cast iron bell and spigot ASTM A-74	Rubber compression gaskets	
	Ductile iron ANSI A21.51	Rubber compression gaskets	
	Extra strength PVC pressure water pipe AWWA C-900 75-100psi	Rubber compression gaskets	
	PVC Schedule 40 ASTM D1785 pressure water pipe.	Rubber compression gasketed couplings, Harco Mfg., ASTM D 3139 or equal*	*Use of 3"-wide approved stainless steel banded couplings on PVC schedule 40 ASTM D 1785 is acceptable. ABS schedule 40 not acceptable, solvent weld joints not acceptable
	PVC sewer pipe ASTM D3033 or D3034 SDR-35 and ASTM F 709	Integral rubber compression gaskets or rubber roll-on compression gaskets	Joints must meet ASTM D3212-76 specifications. Bedding in accordance with ASTM D2321 for PVC pipe

TABLE NO. 2-D - ACCEPTED SEWER PIPE FOR USE AS SEWER FORCE MAIN FROM PUMP STATION TO SEWAGE DISPOSAL SYSTEM WITHIN 75 FT. OF PRIVATE WATER SUPPLY WELL.

USE	PIPE DESCRIPTION	ACCEPTABLE JOINT	REMARKS
Sewage force main within 75 ft. of a private water supply well, spring or water suction pipe serving a single family dwelling (no sewer line shall be located within 25 ft. of a private well) or Sewage force main within 25 ft. of an open watercourse, surface or groundwater drain, cellar, footing or foundation drain.	Ductile iron pressure pipe ANSI A 21.51	Bell and spigot with compression rubber gaskets	
	PVC plastic pressure pipe ASTM D2241		
	PVC plastic pressure water pipe AWMA C-900	Solvent welded, threaded joints or gasketed couplings.	
	Polyethylene plastic flexible pressure pipe	No joints within 75 ft. of well or 25 ft. of open watercourse, ground or surface water drains.	Pipe available in 100-ft. long coiled lengths.

B. Water pipe trenches

Whenever possible, water service and house sewer lines shall be located in separate trenches at least ten feet apart. Where laid in the same trench, the water pipe shall be laid on a bench at least eighteen inches above the top of the sewer pipe and at least twelve inches, and preferably eighteen inches, from the side of the sewer trench (see figure no. 2). However, in no case shall house sewer pipes be located less than seventy-five feet from water suction pipes.

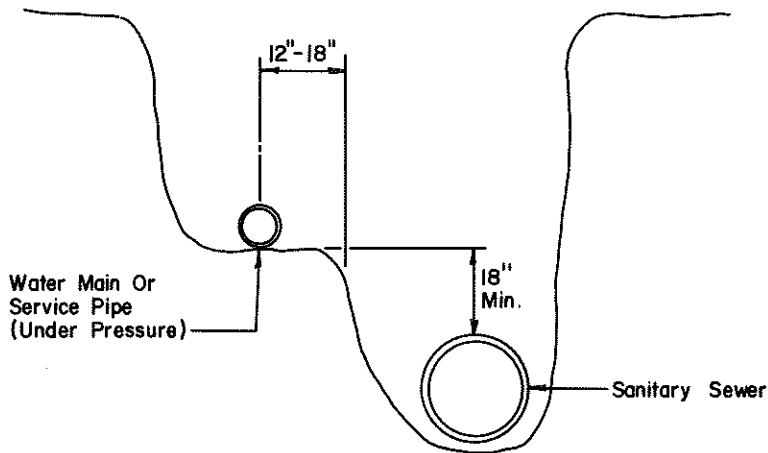

FIGURE NO. 2 WATER PIPE TRENCHES

C. Procedure for Air Pressure Testing of Sewer Pipe

1. Test is conducted between two (2) consecutive manholes, as directed by the engineer.
2. The test section of the sewer line is plugged at each end. One of the plugs used at the manhole must be tapped and equipped for the air inlet connection for filling the line from the air compressor.
3. All service laterals, stubs and fittings into the sewer test section should be properly capped or plugged, and carefully braced against the internal pressure to prevent air leakage by slippage and blowouts.
4. Connect air hole to tapped plug selected for the air inlet. Then connect the other end of the air hose to the portable air control equipment which consists of valves and pressure gages used to control:
 - a.) the air entry rate to the sewer test section, and
 - b.) to monitor the air pressure in the pipe line.

More specifically, the air control equipment includes a shut-off valve, pressure regulating valve, pressure reduction valve and a monitoring pressure gage having a pressure range from 0 to 5 psi. The gage should have minimum divisions of .10 psi and an accuracy of $\pm .04$ psi. Figure No. 3 illustrates diagrammatically a typical control equipment apparatus.
5. Connect another air hose between the air compressor (or other source of compressed air) and the air control equipment. This completes the test equipment set-up. Test operations may commence.
6. Supply air to the test section slowly, filling the pipe line until a constant pressure of 3.5 psig is maintained. The air pressure must be regulated to prevent the pressure inside the pipe from exceeding 5.0 psig.
7. When constant pressure of 3.5 psig is reached, throttle the air supply to maintain the internal pressure above 3.0 psig for at least 5 minutes. This time permits the temperature of the entering air to equalize with the temperature of the pipe wall. During this stabilization period, it is advisable to check all capped and plugged fittings with a soap solution to detect any leakage at these connections.

If leakage is detected at any cap or plug, release the pressure in the line and tighten all leaky caps and plugs. Then start the test operation again by supplying air. When it is necessary to bleed off the air to tighten or repair a faulty plug, a new 5-minute interval must be allowed after the pipe line has been refilled.

8. After the stabilization period, adjust the air pressure to 3.5 psig and shut off or disconnect the air supply. Observe the gage until the air pressure reaches 3.0 psig. At 3.0 psig, commence timing with a stop watch which is allowed to run until the line pressure drops to 2.5 psig at which time the stop watch is stopped. The time required, as shown on the stop watch, for a pressure loss of 0.5 psig is used to compute the air loss. Most authorities consider it unnecessary to determine the air temperature inside the pipe line and the barometric pressure at the time of the test.
9. If the time, in minutes and seconds, for the air pressure to drop from 3.0 to 2.5 psig is greater than that shown on Table No. 3 for the designated pipe size, the section undergoing test shall have passed and shall be presumed to be free of defects. The test may be discontinued at that time.
10. If the time, in minutes and seconds, for the 0.5 psig drop is less than that shown in Table No. 3 for the designated pipe size, the section of pipe shall not have passed the test; therefore, adequate repairs must be made and the line retested.

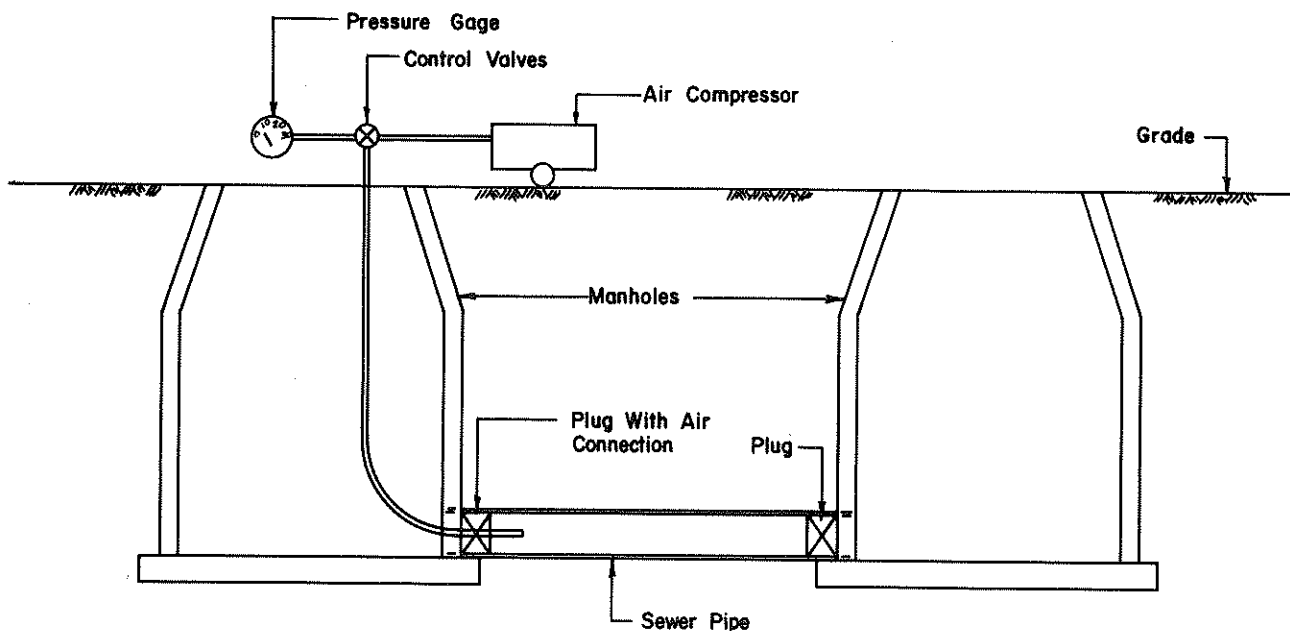

FIGURE NO. 3 **TYPICAL AIR TEST EQUIPMENT**
FOR AIR TESTING OF SEWER PIPE

TIME REQUIREMENTS FOR AIR TESTING		
PIPE SIZE (IN INCHES)	TIME	
	MIN.	SEC.
4	2	32
6	3	50
8	5	6
10	6	22
12	7	39
14	8	56
15	9	35
16	10	12
18	11	34
20	12	45
21	13	30

(For larger diameter pipe use the following:
Minimum time in seconds = 462 x pipe diameter in feet)

TABLE NO. 3

10. (Continued)

- a.) Pipe sizes with their respective Recommended Minimum Times, in Minutes and Seconds, for Acceptance by the Air Test Method.
- b.) For eight (8) inch and smaller pipe, only: if, during the 5-minute saturation period, pressure drops less than 0.5 psig after the initial pressurization and air is not added, the pipe section undergoing tests shall have passed.
- c.) Multi Pipe Sizes: When the sewer line undergoing test is 8" or larger diameter pipe and includes 4" or 6" laterals, the figures in Table 3 for uniform sewer main sizes will not give reliable or accurate criteria for the test. Where multi-pipe sizes are to undergo the air test, the engineer can compute the "average" size in inches which is then multiplied by 38.2 seconds. The results will give the minimum time in seconds acceptable for a pressure drop of 0.5 psig for the "averaged" diameter pipe.

IV. ESTIMATED SEWAGE FLOWS

Table No. 4 shall be used for the estimated daily sewage flow from non-residential buildings and residential institutions unless specific water use data is available for the facility.

Table No. 4 - Estimated Sewage Flow from Non-Residential Buildings and Residential Institutions:

<u>SCHOOLS, PER PUPIL</u>	<u>GALLONS PER DAY</u>
TOILET	12
KITCHEN	3
SHOWERS	3 to 5
RESIDENTIAL	100
KINDERGARTEN	10
DAY CARE CENTER (NO MEALS PREPARED)	10
<u>EMPLOYEES, PER EMPLOYEE</u>	
FACTORY	25
FACTORY (WITH SHOWERS)	35
OFFICE (AVERAGE 150 SQ.FT./PERSON)	20
RETAIL	20
<u>CAMPS</u>	
RESIDENTIAL CAMPS (SEMI PERMANENT), PER PERSON	50
CAMPGROUND WITH CENTRAL SANITARY FACILITIES, PER PERSON	35
WITH FLUSH TOILETS (NO SHOWERS), PER PERSON	25
PER CAMP SPACE (WATER AND SEWER HOOK-UPS)	100
DAY CAMPS, PER PERSON	15
LUXURY CAMPS, PER PERSON	75
PICNIC PARKS (TOILET WASTES ONLY), PER PERSON	5
PICNIC PARKS WITH BATHHOUSES, SHOWERS, FLUSH TOILETS, PER PERSON	10
<u>HEALTH CARE FACILITIES</u>	
HOSPITALS, PER BED	250
CONVALESCENT HOMES, PER BED	150
REST HOMES, PER BED	150
INSTITUTIONS, PER RESIDENT	100
<u>RESTAURANTS</u>	
PER MEAL SERVED, WITH TOILETS	10
PER MEAL SERVED, WITHOUT TOILETS	5
BARS AND COCKTAIL LOUNGES (NO MEALS) PER PATRON	5
<u>RECREATIONAL FACILITIES</u>	
SWIMMING POOLS , PER BATHER	10
INDOOR TENNIS COURTS, PER COURT	400
OUTDOOR TENNIS COURTS, PER COURT	150
THEATERS, SPORTING EVENTS, PER SEAT	3.5

(Continued)

CHURCHES

WORSHIP SERVICE ONLY, PER SEAT	1
SUNDAY SCHOOL, PER PUPIL	2
SOCIAL EVENTS (MEALS SERVED) PER PERSON	5

MISCELLANEOUS

BEAUTY SALON, PER CHAIR	200
AUTO SERVICE STATIONS, PER CARS SERVICED	5
KENNEL DOG RUNS, PER RUN --ROOF MUST BE PROVIDED	25
LARGE SHOPPING CENTERS, PER SQ. FT. OF RETAIL AREA	.1
LAUNDROMATS, PER MACHINE	400
MOTELS, PER ROOM, (NO FOOD SERVICE OR WASHING MACHINES)	75

V. SEPTIC TANKS

A. General

(1) All subsurface sewage disposal systems shall be provided with a septic tank (see figure no. 4). Such septic tank shall be made of concrete or other durable material, with watertight walls and bottom, with inlet baffled or submerged for a depth of twelve to eighteen inches and outlet baffled or submerged to a depth of at least eighteen inches below the surface of liquid in the tank, but not more than half the liquid depth. Baffles shall extend six inches above the liquid level. The outlet invert shall be three inches lower than the inlet invert. All septic tanks two thousand gallons and over shall have two compartments. With a two-compartment tank, there shall be adequate connection at mid-depth, and approximately two-thirds of the required capacity shall be in the first compartment(see figure no. 5).

(2) A septic tank shall have a removable cover or manhole so as to provide access to the tank for the purposes of inspection and cleaning. Manholes shall be located at a depth not greater than twelve to eighteen inches below final grade level. On septic tanks of two thousand gallons or more, manholes shall extend to grade. At least two manholes shall be provided for a tank ten feet long and at least one manhole per compartment. A manhole shall be provided for each additional ten feet of length. If a manhole is not located over the inlet and outlet, inspection openings shall be provided at those points. No septic tank shall have a liquid capacity of less than one thousand gallons below the outlet invert. The minimum liquid depth of septic tanks shall be thirty-six inches, measured from the bottom of the tank to the outlet invert. There shall be a minimum of eight inches between the liquid level and the underside of the tank cover. Additional septic tank capacity over one thousand gallons may be obtained by joining two prefabricated tanks together. In no case may more than two septic tanks be placed in series. In any case, the overall length shall not be greater than four times either the width or the depth.

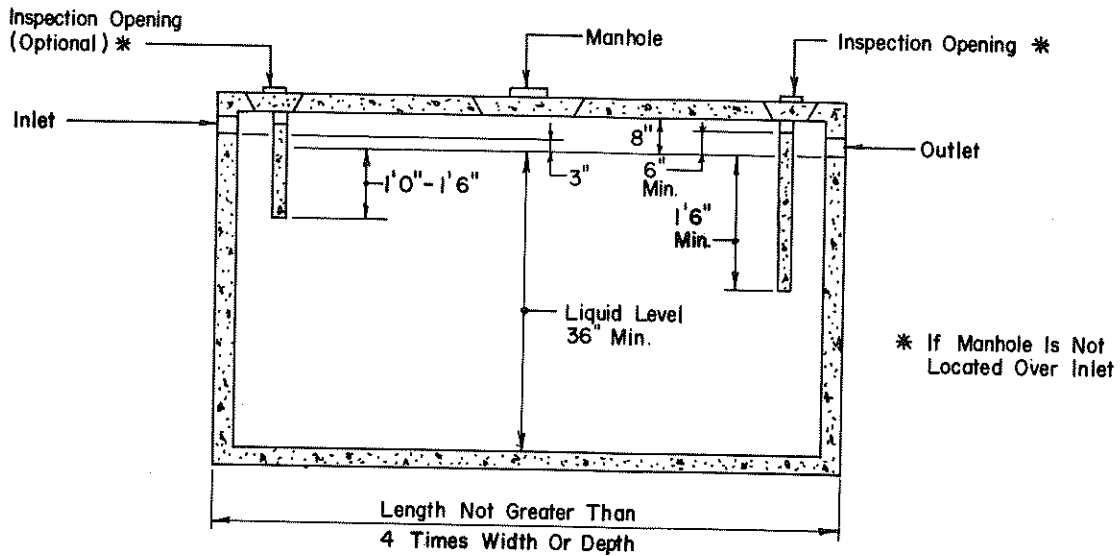

FIGURE NO. 4 SEPTIC TANK (UNDER 2000 GAL.)

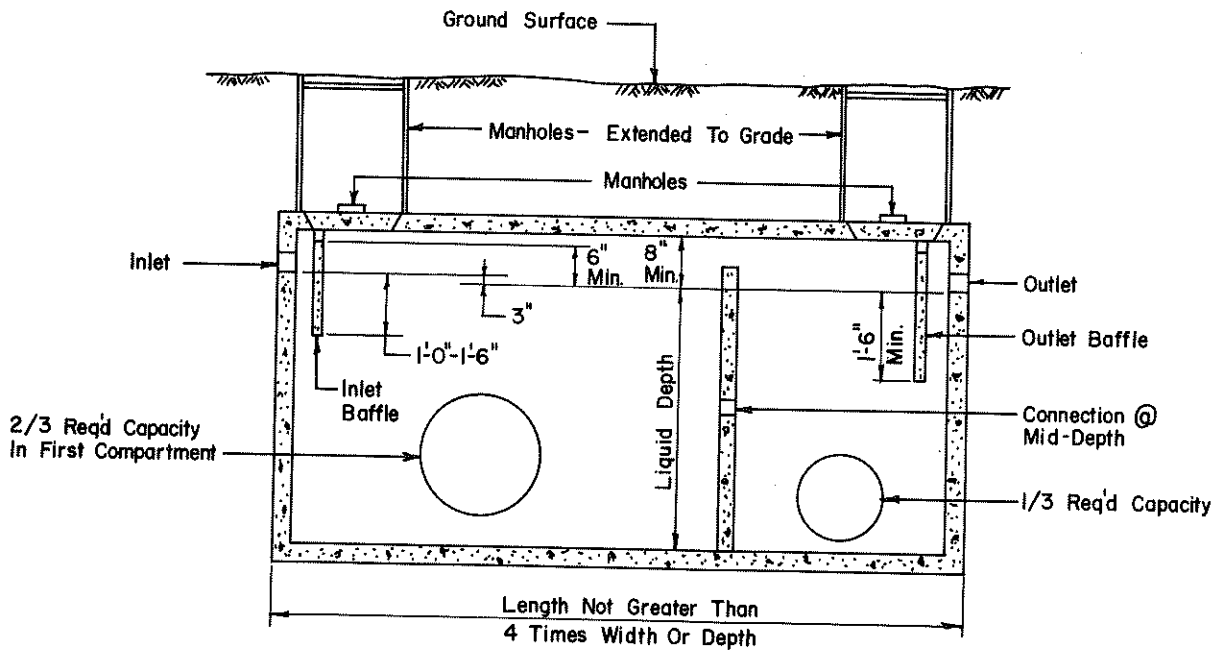

FIGURE NO. 5 SEPTIC TANK (2000 GAL. AND OVER)

B. Septic tank capacities

- (1) The minimum liquid capacity of septic tanks serving residential buildings shall be based on the number of bedrooms in the building. For three bedrooms or less, one thousand gallons; and another two hundred and fifty gallons per additional bedroom.
- (2) The minimum liquid capacity of septic tanks serving nonresidential buildings shall be equal to the twenty-four hour estimated sewage flow (see table no. 4). In no case shall a septic tank be installed with a liquid capacity of less than one thousand gallons. In cases of nonresidential buildings which are subject to high peak sewage flows, the liquid capacity of the septic tank shall be such as to provide a minimum detention time of 2 hours under peak flow conditions.

C. Grease traps

For new construction, repair or replacement of subsurface sewage disposal systems serving restaurants and food service establishments with a design flow of 2000 gallons per day or greater, external grease traps shall be provided on all kitchen waste lines for separation of grease (see figure no. 6). Such external grease traps shall have a liquid volume of approximately one-third of the required liquid volume of the septic tank, and shall have inlet and outlet baffles submerged to a depth of twelve inches above the trap bottom. Effluent discharged from the grease trap shall be directed to the inlet end of the septic tank serving the establishment. All manholes and clean outs on external grease traps shall be extended to grade to facilitate cleaning.

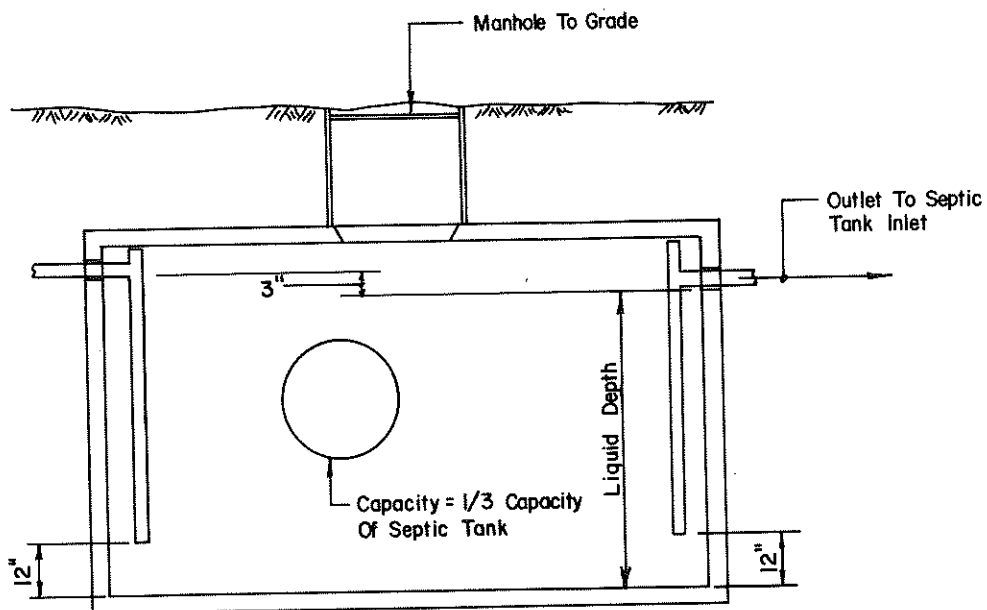

FIGURE NO. 6 EXTERNAL GREASE TRAP

VI. DISTRIBUTION OF SEWAGE EFFLUENT

A. Flows under two thousand gallons per day:

The septic tank effluent shall be distributed in such manner as to assure dosing all parts of the leaching system. When leaching trenches are at the same elevation, ends of trenches shall be connected wherever feasible (see figure no. 7). When leaching trenches are on different elevations, serial distribution with high level overflows is required (see figures nos. 8, 9 and 10). Where pumping is required, duplicate alternating pumps or single pump with emergency storage volume in the pump chamber equal to at least the daily volume of sewage normally received shall be provided above the normal operating level. All pumps shall be equipped with high level indicators and access manholes to grade.

B. Flows of two thousand gallons per day and over:

Intermittent dosing arrangements, using siphons or pumps, shall be used to assure distribution in the case of leaching trenches or leaching beds where the total length of distribution pipes is six hundred feet or greater. Siphon or pump chambers shall be equipped with manholes extending to grade. Chambers shall be sized to discharge at least fifty per cent of the volume of the distributing pipes. Alternating siphons shall not be used. Leaching systems at the same elevation shall have ends of trenches connected wherever feasible. Where pumping is required, duplicate alternating pumps with an alarm shall be provided.

FIGURE NO. 7

CONNECTION OF ENDS OF TRENCHES
FOR TRENCHES AT SAME ELEVATIONS

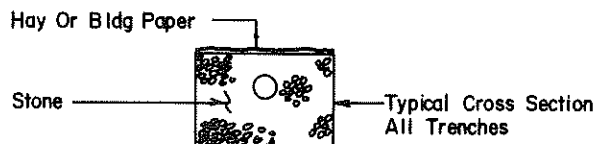
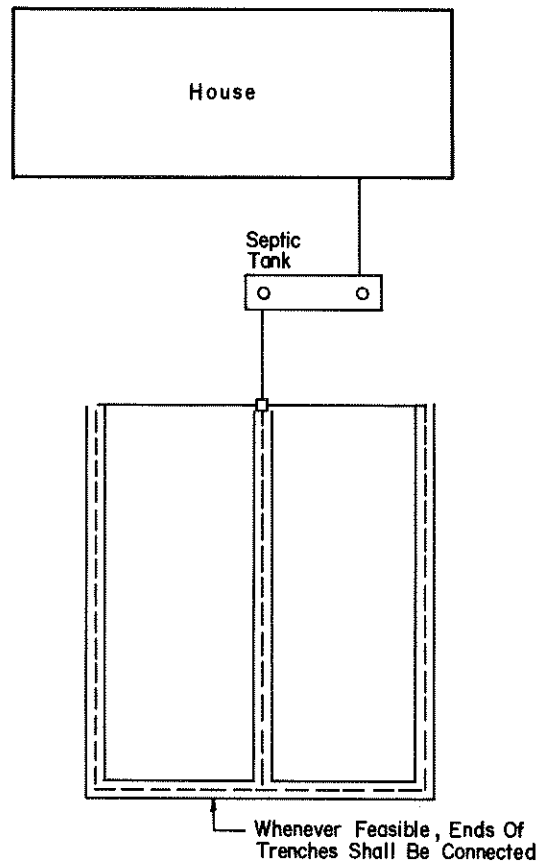

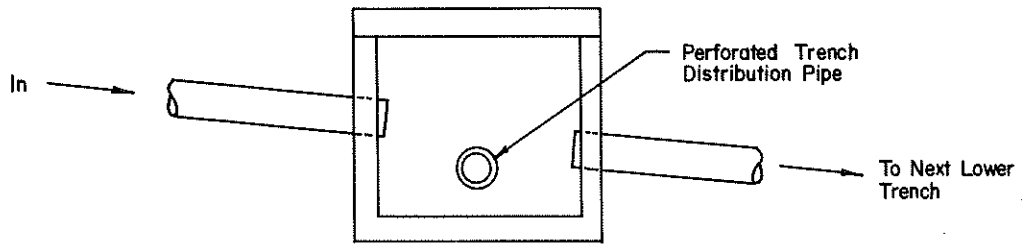

High Level Overflow D. Box

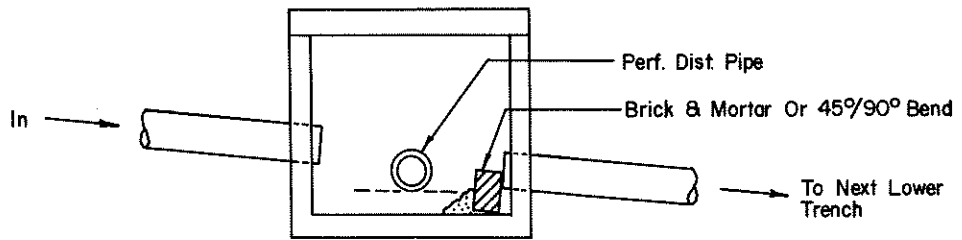

Baffled D. Box

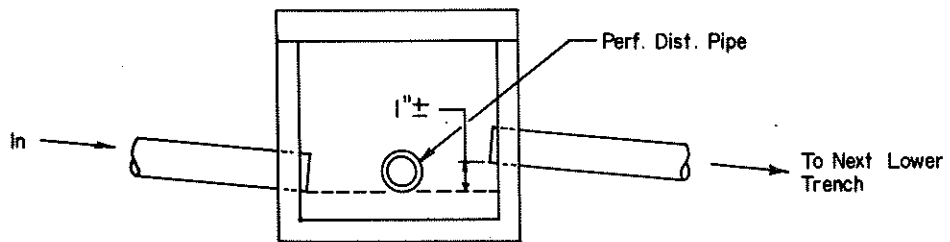

Reversed D. Box

FIGURE NO. 8 SERIAL DISTRIBUTION

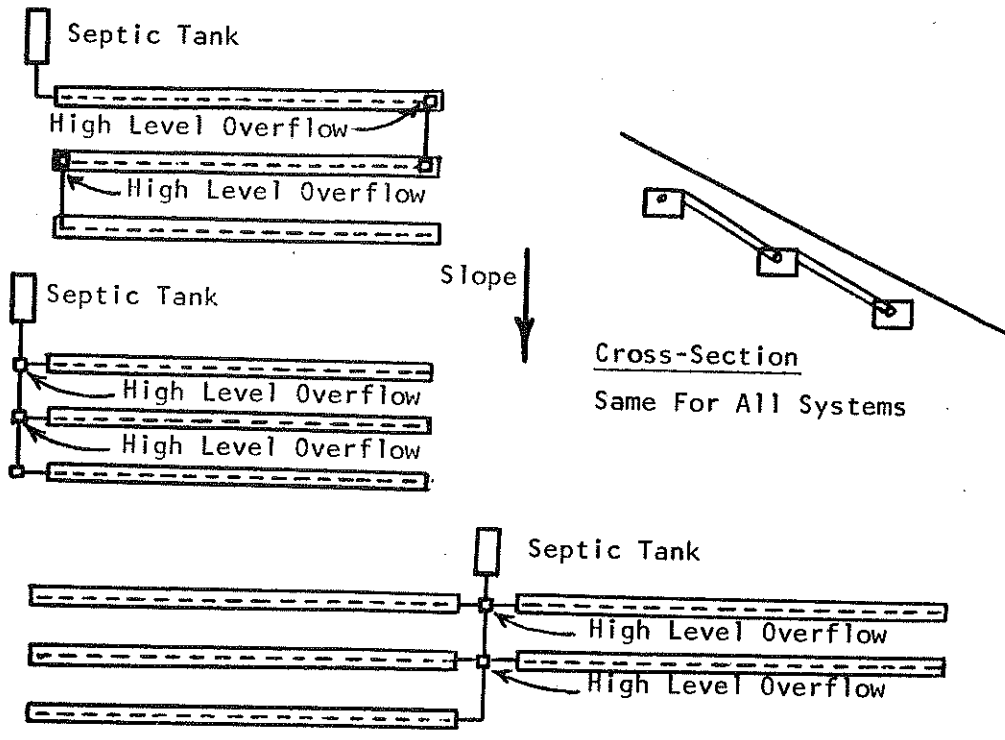

SERIAL DISTRIBUTION SYSTEMS

FIGURE NO. 9

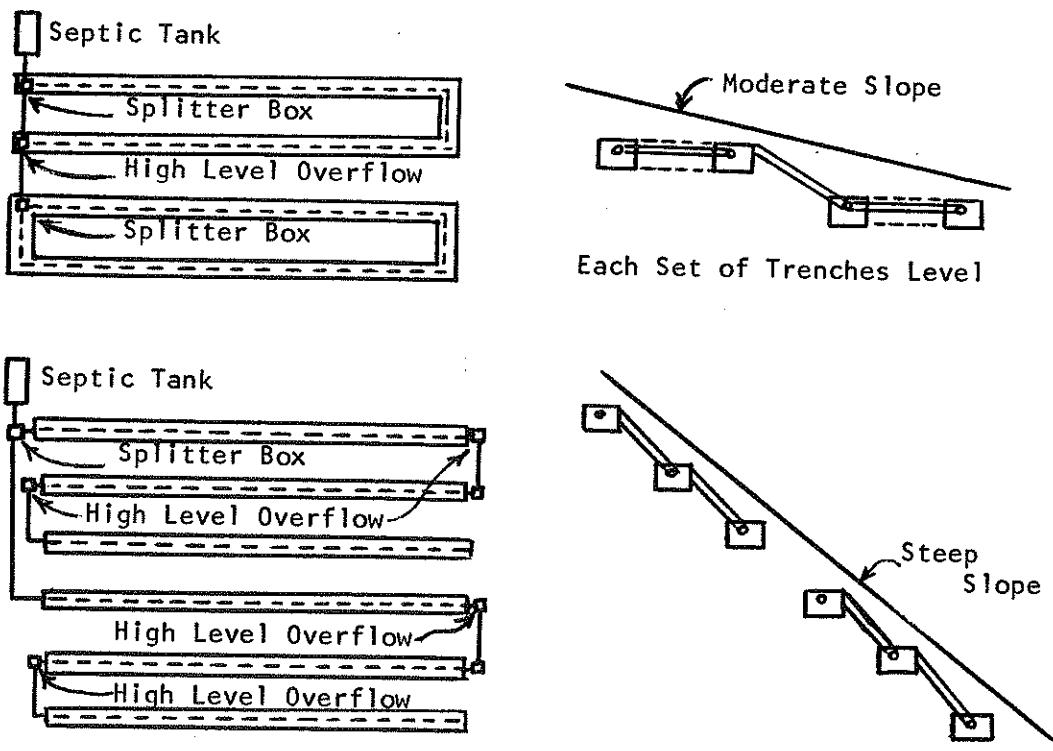

ALTERNATIVE DISTRIBUTION SYSTEMS

FIGURE NO. 10

VII. PERCOLATION TESTS

A correct percolation test consists of three steps: 1) presoaking the test hole, 2) refilling and allowing the hole to saturate for 30 to 60 minutes under certain conditions and 3) determining the minimum uniform percolation rate after saturation.

The purpose of the presoak is to allow sufficient soil-water contact time. During presoaking, swelling clays which may be present in the soil will expand thereby reducing the void space in the soil. Also, sufficient presoaking will allow the advancing capillary wetting front, which controls the rate of water flow in unsaturated soils, to move sufficiently far away from the test hole so that an apparent equilibrium flow rate is reached.

The required presoaking time will vary depending on the soil and its moisture content. All soils shall be presoaked by filling the test hole with 12 inches of water. If the water seeps away in less than 2 hours, the hole may be refilled to the 12-inch depth and the percolation test begun. If any water remains in the hole after 2 hours, it normally shall be refilled to the 12-inch depth and allowed to presoak for at least 2 additional hours before the percolation test is begun. However, such extended presoaking shall not be required where it is determined that the soil contains no significant amount of swelling clays. Any test hole which has continuously contained water for 4 hours or longer shall be considered adequately presoaked.

Once clay particles have become swollen, they will remain so for a period of time. Therefore, it is not necessary to perform the percolation test immediately, although tests performed at the end of the presoaking period yield the most accurate results. If tests cannot be performed immediately, test holes may be presoaked in the morning and tested in the afternoon, or presoaked on one day and tested the following day. If more than 30 hours have elapsed following initial presoaking, the test hole shall be presoaked once again.

Following presoaking, the hole shall be refilled and allowed to percolate for 30 to 60 minutes in order to fill the voids in the soil surrounding the test hole with water. Presoaking does not eliminate this requirement since the large voids surrounding the test hole will drain rapidly when the test hole goes dry. There is an initial rapid drop of the water level in the test hole as the water enters the voids in the soil. The rate of drop will diminish rapidly until after 30 to 60 minutes an apparent equilibrium rate will be attained. Only this minimum uniform rate following saturation shall be used in calculating the size of the leaching system. Readings taken prior to 30 to 60 minutes after refilling normally shall not be used in calculating the minimum percolation rate. However, if after presoaking the refilled hole goes dry before 30 minutes, the readings which have been taken may be used without a second refilling.

Percolation tests shall be made in an 6 to 12 inch diameter hole dug to the depth of the proposed leaching system. For normal leaching trenches, test holes shall be at least 3 feet deep. If leaching pits are used, the test holes shall normally be 6 to 10 feet below the existing grade. At locations where there appears to be 2 or more soil stratas of different texture or structure, each strata shall be tested separately with holes of comparable depths. In calculating the required leaching area, only representative test results in the area and at the depth of the proposed leaching system shall be used, but all percolation tests and observation pits which were made on the site shall be reported.

VIII. LEACHING SYSTEMS

A. General

No leaching system shall be constructed in areas where high ground water, surface flooding or ledge rock will interfere with its effective operation. The bottom of any leaching system shall be at least eighteen inches above the maximum ground water level and shall be at least four feet above ledge rock, except that when the soil has a minimum percolation rate faster than one inch per minute, the bottom of any leaching system shall be not less than ten feet above ledge rock or five hundred feet from any well. Leaching systems constructed in areas where there is no definite schedule for the extension of public sewers within five years shall be laid out in such a manner that an acceptable reserve area of suitable soil is provided equal in area to that occupied by the leaching system, for the purpose of enlargement or replacement of the leaching system in the event of failure, except that no reserve area shall be required for repairs, alterations or extensions of existing leaching systems. No single family residential dwelling shall be required to fill a reserve area at the time of construction of an approved system. Reserve areas for multi-family dwellings and commercial buildings without exceptions shall be prepared with necessary fill and all designated reserve areas, whether residential or commercial, shall be identified on a plan to be filed at the Local Health Authority and Building Authority.

The ground surface over the entire subsurface sewage disposal system shall be graded and maintained to lead surface water away from the area. All leaching systems shall be protected from siltation or erosion during and after construction. Leaching systems shall be covered with a minimum of six inches of soil and finished in a condition which will prevent erosion over or adjacent to the leaching system.

MINIMUM SEPARATING DISTANCES ABOVE LEDGEROCK AND GROUNDWATER

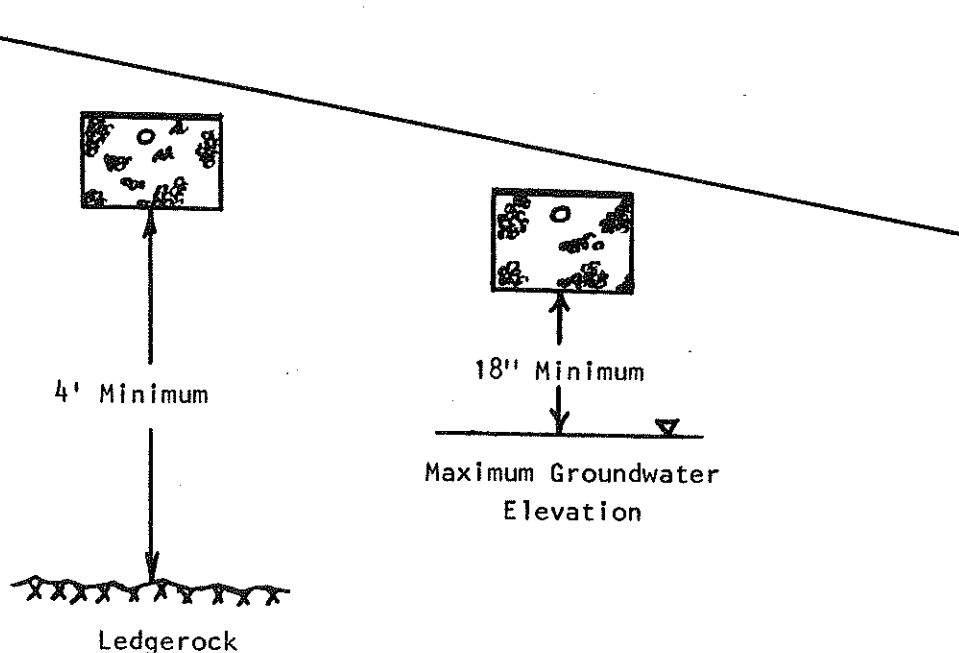

B. Leaching trenches (See figure no. 11)

All leaching trenches shall follow ground contours. The depth of the trenches shall normally be not more than three to four feet but greater depths may be used if warranted by the results of the soil investigation. The width of the leaching trench shall not exceed thirty-six inches and the center-to-center spacing between trenches shall be at least four times the width of the trench. The length of individual trenches shall not exceed seventy-five feet measured from the inlet, except that in installations where intermittent dosing is used, a maximum length of one hundred feet may be used. The trenches shall contain a depth of at least eighteen inches of one-inch broken stone or one-inch screened gravel. A distribution pipe shall be laid the entire length of the trench near the top layer of stone. Distribution pipes shall be of acceptable material with suitable perforations or open joints. (see table 4) Distribution pipes shall be laid level or on a grade not exceeding two to four inches per one hundred feet. The distribution pipes shall be covered with at least two inches of one-inch broken stone or one-inch screened gravel, and there shall be at least twelve inches of this material under the distribution pipe. A layer of hay, untreated building paper filter fabric or other suitably previous barrier shall be placed over the stone or gravel before backfilling the trenches. For the purposes of Standard VIII F the effective leaching area of leaching trenches shall consist of the bottom area of the excavated trench only.

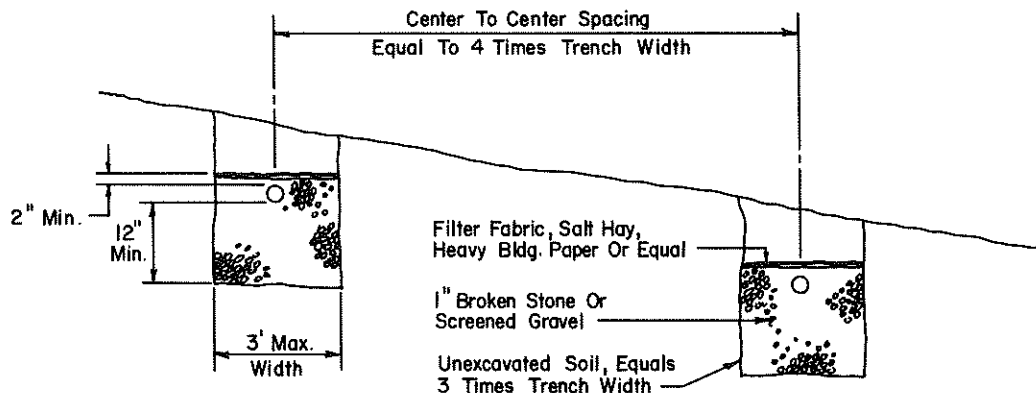

FIGURE NO. 11 LEACHING TRENCHES

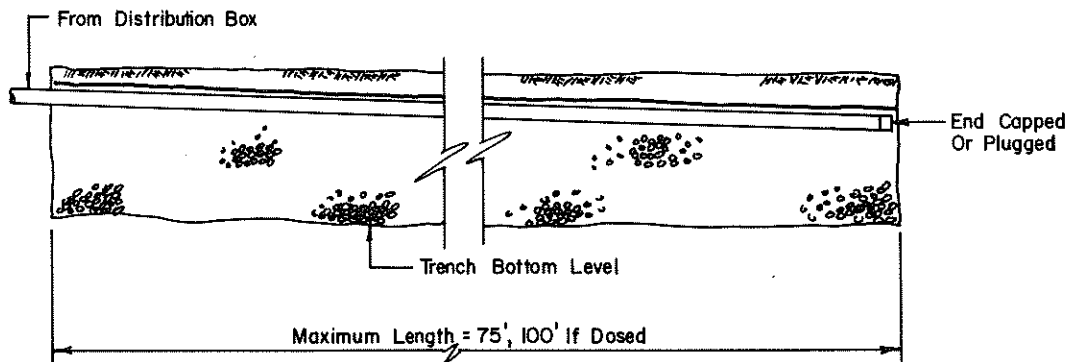
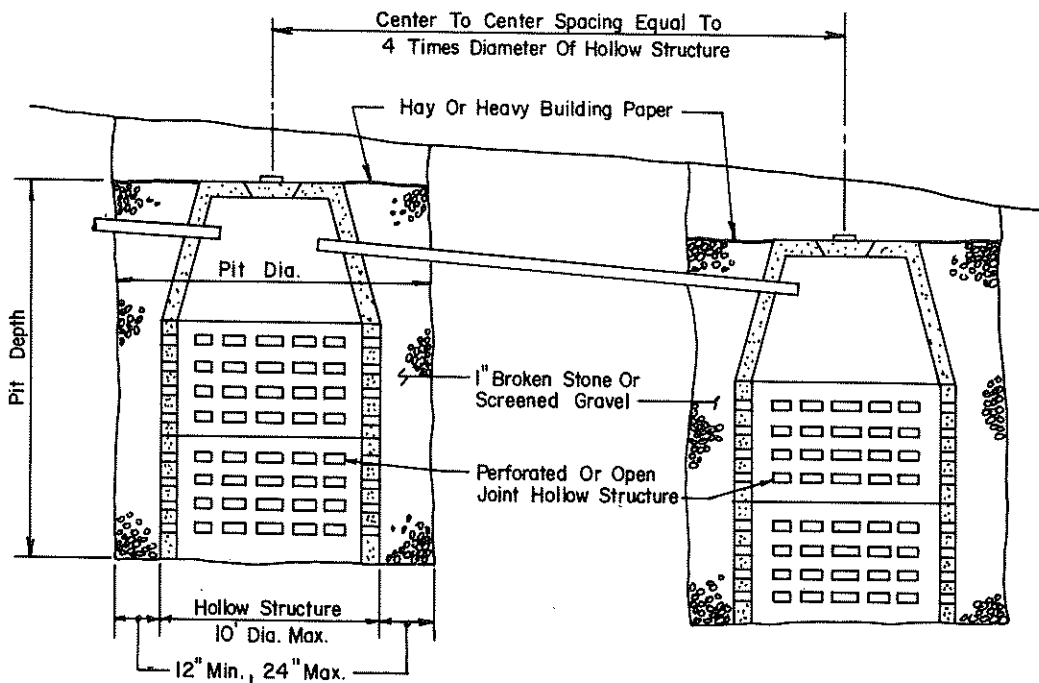

TABLE NO. 4 - DISTRIBUTION PIPE

USE	PIPE DESCRIPTION	TYPE OF JOINT	REMARKS
Solid and perforated effluent distribution pipe used after the septic tank for leaching system (Also see Table 2D for sewage force main)	PVC plastic pipe ASTM D3033 or 3034	Rubber compression gasket bell and spigot	Heavy duty plastic pipe for shallow pipe installation
	PVC plastic pipe ASTM D2729	Bell and Spigot, no gaskets	Must be bedded in 6" min. of 1" diameter stone and covered with 2" min. of 1" size stone or with other special bedding requirements to protect against crushing.
	Polyethylene plastic pipe ASTM D3350	Bell and Spigot, no gaskets	
	Polyethylene plastic corrugated rigid pipe ASTM 1248 (coil pipe not acceptable)	Sleeve joints	
	Extra strength unglazed clay pipe ASTM C278	Leaching trench construction $\frac{1}{4}$ " to $\frac{1}{2}$ " open joints with tar paper strips laid over open joints	Pipe lengths not to exceed 3' unless perforated. Either bell and spigot or square end pipe acceptable.

C. Leaching pits (See figure no. 12)

Leaching pits shall be hollow structures with perforated or open-joint walls and tight covers. The side walls shall be surrounded by at least twelve inches, but not more than twenty-four inches, of one-inch broken stone or one-inch screened gravel and the hollow structure shall be no less than five feet in diameter nor greater than ten feet in diameter. The covers shall be equipped with a cleanout manhole. Center to center spacing of leaching pits shall be at least four times the diameter of the hollow structure. No more than two such leaching pits shall be connected in series. Leaching pits shall not be used where ground water may interfere with their operation or where soil of better leaching quality is found at shallow depth. Leaching pits shall not be used where the minimum percolation rate is slower than one inch in twenty minutes. For the purposes of Standard VIII F, the effective leaching area of leaching pits shall consist of only the side area of the stone-filled excavation, provided the top of the effective area is no higher than the outlet invert level of the septic tank or distribution box.



Pits At Different Elevations - High Level Overflow
No More Than Two Pits In Series

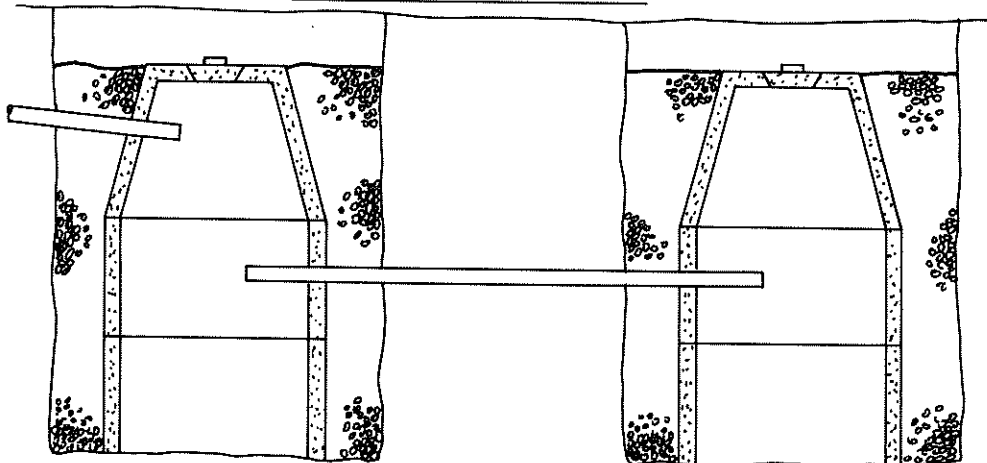

Pits At Same Elevation - Connection At Mid-Depth
Effective Area - Pit Depth x Pit Diameter x π

FIGURE NO. 12 LEACHING PITS

D. Leaching beds (See figure 13)

Leaching beds shall be constructed in a manner similar to leaching trenches except that the space between the trenches also shall be excavated and backfilled with one-inch stone or one-inch screened gravel. Distribution pipes shall be laid on six to eight-foot centers throughout the bed. The installation of stone and distribution pipe shall be the same as that required for leaching trenches. The bottom of the entire bed shall be at the same elevation. For the purposes of Standard VIII F the effective area of leaching beds shall consist of one-third of the total bottom area of the leaching bed.

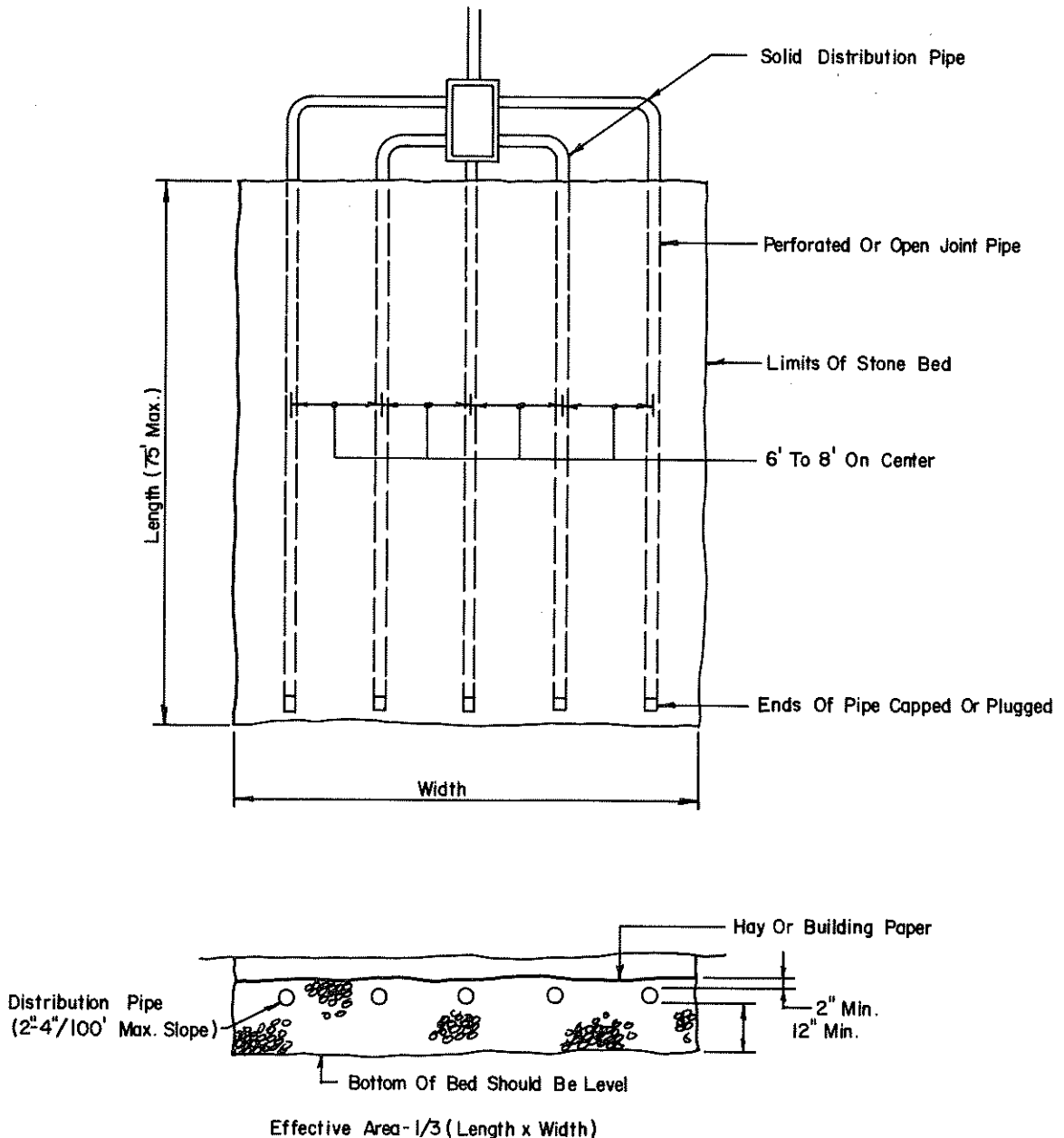

FIGURE NO. 13 LEACHING BEDS

E. Leaching galleries (See figures nos. 14 and 15)

Leaching galleries shall be hollow structures, open at the bottom with perforated or open joint sides and tight covers. The side walls shall have minimum depth of eighteen inches and a maximum depth of four feet, and shall be surrounded by at least twelve inches of one-inch broken stone or one-inch screened gravel to the top of the structure. The width of the structure shall be not less than four feet, and the center-to-center spacing of adjacent galleries shall be not less than six times the depth of the structure, with a minimum spacing of sixteen feet center-to-center. The length of the gallery shall not exceed seventy-five feet measured from the inlet. The bottom of each leaching gallery shall be level. For the purposes of Standard VIII F, the effective leaching area of the leaching gallery shall consist of the side area of the stone-filled excavation, with a minimum effective area of four square feet per linear foot of gallery, provided the top of the effective area shall be no higher than the outlet invert level of the septic tank or distribution box. Leaching galleries with a depth of over thirty inches shall not be used where the minimum percolation rate is slower than twenty minutes per inch.

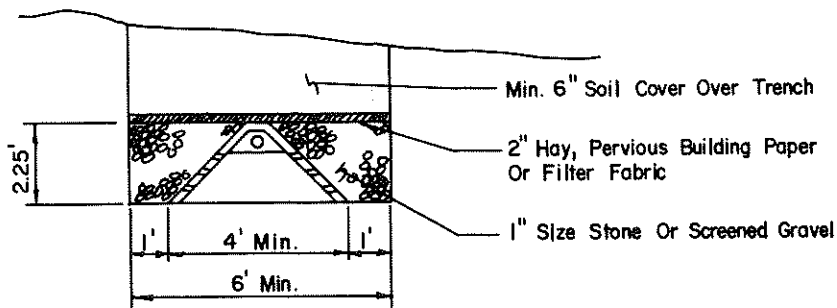
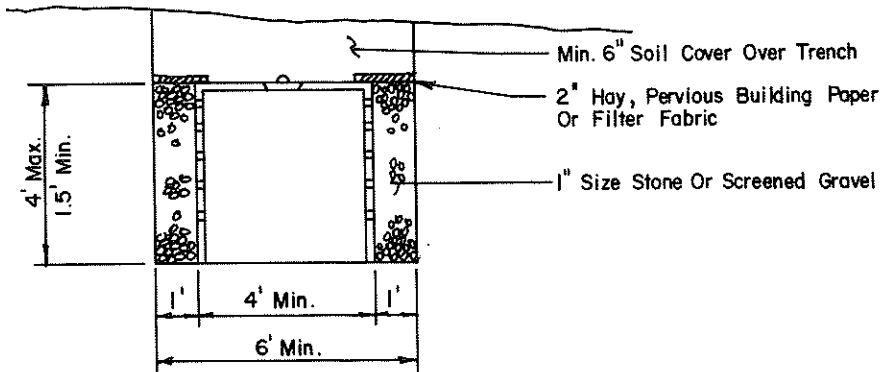
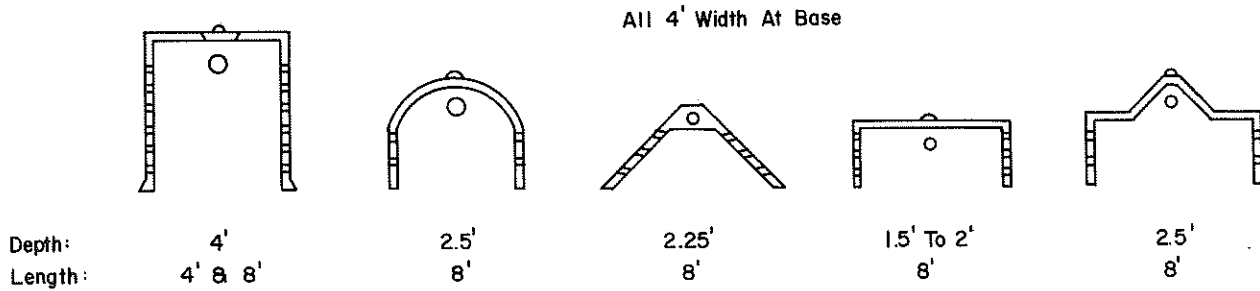
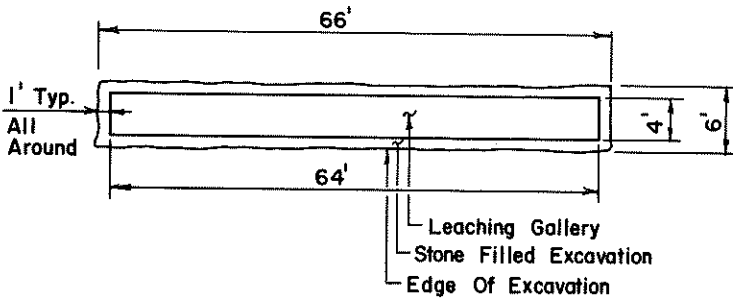

FIGURE NO. 14 TYPICAL LEACHING GALLERY STRUCTURES

1. Example Of Calculating Effective Area Of Leaching Galleries :



Effective Area = Side Area Of Stone Filled Excavation

For Example Shown , Effective Area =

$$\begin{aligned}
 &66' \text{ (Length)} \\
 &+ 66' \text{ (Length)} \\
 &+ 6' \text{ (Width)} \\
 &+ 6' \text{ (Width)}
 \end{aligned}$$

144' x Depth Of Stone = Effective Area

2. Gallery Spacing

Gallery Depth (Inches)	Undisturbed Soil Between Trenches (Feet)	Center To Center Spacing (Feet)
18	10	16
24	10	16
30	10	16
36	12	18
48	18	24

FIGURE NO. 15 LEACHING GALLERY SYSTEMS

F. Capacity of leaching systems

- (1) Leaching systems for residential buildings shall be designed on the basis of the number of bedrooms in accordance with Table 5:

TABLE 5 - RESIDENTIAL BUILDINGS

MINIMUM UNIFORM PERCOLATION RATE	SQUARE FEET OF EFFECTIVE AREA REQUIRED			
	2 BR House	3 BR House	4 BR House	Additional area for Each BR Above Four
Minutes to Drop One Inch				
Less than 1 minute	300	375	500	125 (area of special concern)
1 - 5 minutes	300	375	500	125
5.1 - 10 minutes	375	495	660	165
10.1 - 20 minutes	500	675	900	225
20.1 - 30 minutes	565	750	1000	250
30.1 - 45 minutes	675	900	1200	300 (area of special concern)
45.1 - 60 minutes	745	990	1320	330 (area of special concern)
over 60 minutes	unsuitable for leaching systems			

- (2) Leaching system for restaurants, laundromats and residential institutions shall be designed on the basis of estimated daily sewage flow in accordance Table 6:

TABLE 6 - RESTAURANTS, LAUNDROMATS AND RESIDENTIAL INSTITUTIONS

MINIMUM UNIFORM PERCOLATION RATE Minutes to Drop One Inch	SEWAGE APPLICATION RATE Gallons per day to one square foot of Effective Leaching Area
Less than 1 minute	1.0 Area of Special concern
1 to 5 minutes	1.0
5.1 to 10 minutes	0.8
10.1 to 20 minutes	0.7
20.1 to 30 minutes	0.6
30.1 to 45 minutes	0.5 area of special concern
45.1 to 60 minutes	0.4 area of special concern
over 60 minutes	unsuitable for leaching system

- (3) Leaching systems for nonresidential buildings other than restaurants and laundromats shall be designed on the basis of estimated daily sewage flow in accordance with Table 7:

TABLE 7 - NON-RESIDENTIAL BUILDINGS

MINIMUM UNIFORM PERCOLATION RATE Minutes to Drop One Inch	SEWAGE APPLICATION RATE Gallons per day to one square foot of effective leaching area
Less than 1 minute	2.0 area of special concern
1 to 5 minutes	2.0
5.1 to 10 minutes	1.6
10.1 to 20 minutes	1.1
20.1 to 30 minutes	0.9
30.1 to 45 minutes	0.7 area of special concern
45.1 to 60 minutes	0.6 area of special concern
over 60 minutes	unsuitable for leaching systems

IX. GROUND WATER, ROOF, CELLAR AND YARD DRAINAGE

No ground water drainage or drainage from roofs, cellars, roads or yards shall discharge into or within twenty-five feet of any portion of a sub-surface sewage disposal system. Separate facilities shall be provided for such drainage. The separating distance between such drains and sub-surface sewage disposal systems shall be as designated in Table I. Ground water control drains or curtain drains, if used, shall be located on the uphill side of leaching systems and on the sides if necessary, and shall be separated from these systems as specified in Table No. 1. The depth of these drains shall be such as to lower the ground water at least two feet below the bottom of the entire leaching system. Each drain shall be equipped with a collection pipe located 6 to 12 inches above the bottom of the trench carrying collected ground water around and discharging below the leaching system (see figure no. 16). This collection pipe shall have a minimum diameter of four inches and shall consist of open-joint tile, porous or perforated pipe. Collection pipe shall be surrounded by clean stone or gravel to a depth necessary to control ground water.

X. OTHER WASTEWATERS

No oils, greases, industrial or commercial wastes, toxic chemicals, waste from water treatment, or other liquids that will adversely affect the operation of the subsurface sewage disposal systems or which may pollute wells shall discharge to any subsurface disposal system. Large volumes of cooling or process water shall not be discharged to a subsurface sewage disposal system and separate facilities shall be provided for the disposal of such waste.

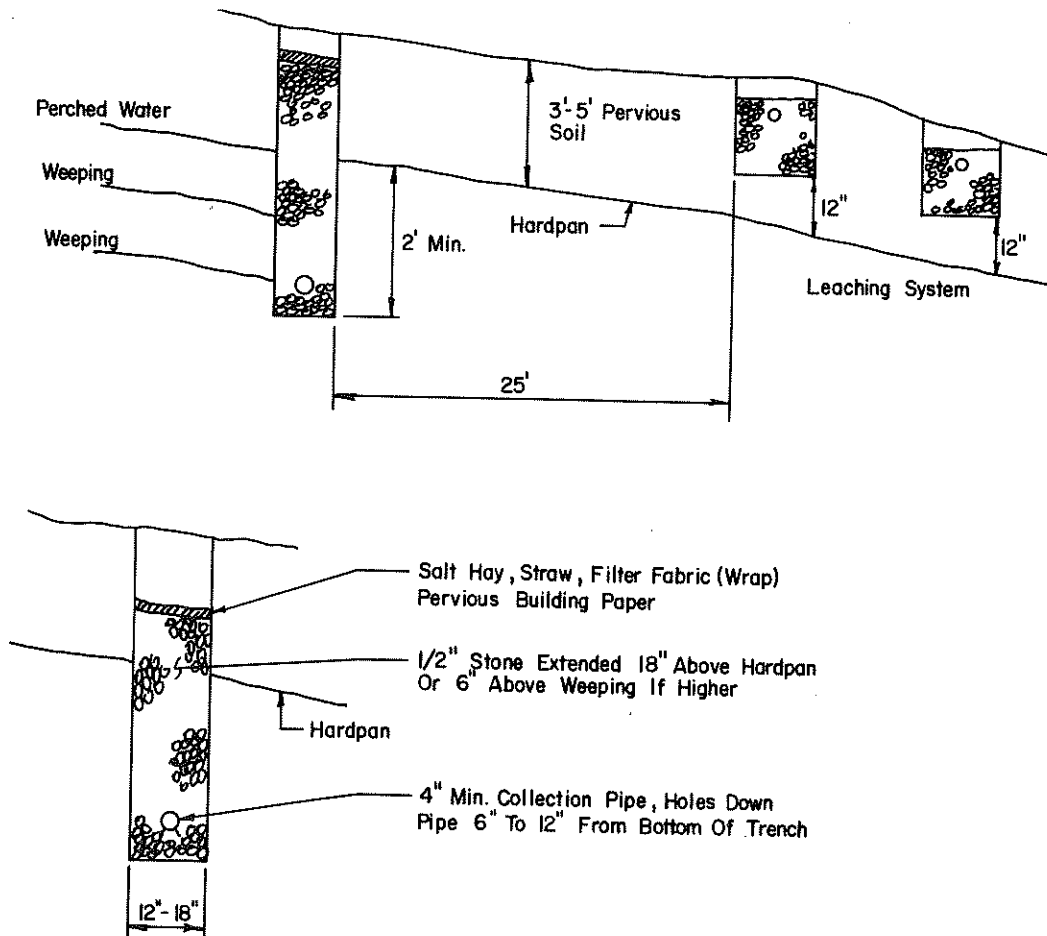

FIGURE NO. 16 TYPICAL CURTAIN DRAIN CONSTRUCTION

XI. NON DISCHARGING SEWAGE DISPOSAL SYSTEMS

A. Large Capacity Composting Toilets

Large capacity composting toilets shall have separate receiving, composting and storage compartments, arranged so that the contents are moved from one compartment to another without spillage, or escape of odors within the dwelling. No large capacity composting toilets shall have an interior volume of less than sixty-four cubic feet. All toilet waste shall be deposited in the receiving chamber, which shall be furnished with a tight self-closing toilet lid. Food waste or other materials necessary to the composting action shall be deposited in the composting compartment through a separate opening with a tight fitting lid. The final composting material shall be removed from the storage compartment through a cleanout opening fitted with a tight door or lid. The cleanout shall not be located in a food storage or preparation area. The receiving and composting compartments shall be connected to the outside atmosphere by a screened vent. The vent shall be a minimum of six inches in diameter and shall extend at least twenty feet above the openings in the receiving and composting compartments, unless mechanical ventilation is provided. Air inlets shall be connected to the storage compartment only, and shall be screened.

B. Heat Assisted Composting Toilets

Heat assisted composting toilets shall have a single compartment furnished with a tight, self-closing toilet lid. The compartment shall be connected to the outside atmosphere by a screened vent. There shall be a mechanical ventilation fan arranged to control the humidity in the compartment and provide positive venting of odors to the outside atmosphere at all times. A heating unit shall be provided to maintain temperature in the optimum range for composting.

C. Incineration Toilets

Gas or oil fired or electrical incineration toilets shall meet applicable fire and building codes. No ignition or incineration shall occur unless the toilet lid is closed, and the blower shall operate continuously during incineration. A combustion temperature of 1,400°F or higher shall be maintained during incineration.

D. Chemical Flush Toilets

Chemical flush toilets shall have toilet bowls which may be flushed when required by chemicals or chemical solutions. The liquid shall be discharged to a holding tank for removal of solids by settlement or other means prior to recirculation. The toilet bowl shall be trapped or otherwise constructed to exclude odors, and the holding tank shall be vented to the outside atmosphere. The holding tank shall be emptied or additional chemicals added when odors or other objectionable conditions occur.

E. Dry Vault Privies

Dry vault privies shall be constructed with adequate storage space for excreta, and a fly-tight vault with a screened vent to the outside atmosphere. Self-closing, fly tight doors or self-closing seat covers shall be provided. Dry vault privies shall be constructed so as to permit ready cleaning. Separating distances shall comply with Table No. 1.

F. Chemical Privies

Chemical privies shall be constructed with a water-tight vault with a screened vent to the outside atmosphere. Separating distances shall comply with Table No. 1. Chemicals shall be added to the liquid in the pit through a covered opening outside the toilet building. The vault shall be emptied or additional chemicals added when odors or other objectionable conditions occur.

FAS/ch
li

APPLICATION FOR PERMIT TO CONSTRUCT OR REPAIR A SEWAGE DISPOSAL SYSTEM

(Office Use Only)

APPLICATION NO. _____

TO THE DIRECTOR OF HEALTH
TOWN OF _____

DATE _____

Application is hereby made for permit to construct a sewage disposal system for a

(Residence, Store, Restaurant, Etc.)

Located at _____
(Street Address, Lot Number, Subdivision Name; Map, Block, Lot, Etc.)

New System _____ Addition _____ Repair _____ Other _____

Owner _____ Address _____ Tel.No. _____

Installer _____ Address _____ Tel.No. _____

Installer License No. _____

In accordance with detailed information stated below

Signed _____
(Owner or duly authorized representative)

Application fee paid _____

GENERAL INFORMATION

Subdivision Approved _____ Date _____ Lot size _____ Sq. Ft. _____

On Public Water Supply Watershed _____ On Designated Wetland _____

SCS Soil Classification _____ Public Sewer Scheduled _____
(Date)

If residential, number of bedrooms _____ Flood zone _____

If non-residential, design criteria:

(Sanitary Facilities, No. of Employees, Meals Served, Etc.)

Basement Fixtures _____ Foundation Drains _____

Special Equipment _____

ENGINEER'S PLAN REQUIRED	
TEST DURING WET SEASON	

Water Supply _____ Type Well _____

Well Location Approved _____ Yield _____ Satisfactory Sample _____
(Date)

Well Driller's Name _____ Address _____

WATER SUPPLY APPROVED	
-----------------------	--

INVESTIGATION FOR SEWAGE DISPOSAL SYSTEM

Owner _____ LOCATION _____

PERCOLATION TESTS: (Record all tests) _____ SOIL MOISTURE: _____
 (Date) (high, med., low, etc.)

TEST READINGS

HOLE #1		HOLE #2		HOLE #3		HOLE #4	
Time	Reading	Time	Reading	Time	Reading	Time	Reading

TABULATION OF TEST RESULTS

Hole	Location	Depth (Inches)	Presoak (Hrs.)	Minimum Percolation Rate (Mins./Inch)
1				
2				
3				
4				

OBSERVATION PITS: (Record all pits) _____ Ground Water Table: _____
 (Date) (Near Max., Below Max., Etc)

SOIL DESCRIPTIONS

PIT A	PIT B	PIT C	PIT D

TABULATION OF OBSERVATION PITS

Pit	Location	Depth	Ledge At	Ground Water At	Soil Mottling At
A					
B					
C					
D					

Over)

SPECIAL CONDITIONS

System design larger than 2,000 g.p.d. _____ Water supply watershed _____
 High ground water (less than 3 ft.) _____ Possible seasonal high ground water _____
 Watercourse, marsh or pond _____ Possible seasonal flooding _____
 Limited suitable area _____ Excessive slope (over 25%) _____
 Marginal soil (30 - 60 mins./inch) _____ Shallow ledge (less than 5 ft.) _____
 Underlying tight soil (less than 4 ft) _____ Other _____

CONCLUSION

Suitable for sewage disposal _____
 Unsuitable for sewage disposal _____
 Additional investigation required _____
 Retest during wet season _____
 Engineer's plan required _____

DESIGN RECOMMENDATIONS

Investigated by _____ Title _____
 Confirmed/Witnessed by _____ Title _____

Comments:

Bench mark location _____ Elevation _____

CHECK LIST

REVIEW OF PLAN/INSPECTION OF SEWAGE DISPOSAL SYSTEM

Owner _____ Location _____ Date Rec'd. _____

Plan prepared by _____ Title _____ Address _____

Site Investigation _____ Investigated by _____
(Date)

Bench mark location _____ Elevation _____

Design Percolation Rate _____ Mins./inch at hole(s) _____

If residential, number of bedrooms _____ If non-residential, estimated daily flow _____

HOUSE SEWER (INVERT LEVELS)

Depth at foundation wall _____ Depth at septic tank _____

SEPTIC TANK

Cleanout located _____ ft. from _____ and _____ ft. from _____

Manufacturer _____ Size _____ gals. Depth to cleanout _____

LEACHING SYSTEM

Description _____

Effective area _____ sq. ft. Required effective area _____ sq. ft.

Spacing between units _____ ft. 100% reserve area provided _____

Bottom of leaching system 18 inches above maximum water table _____

Bottom of leaching system 4 feet above ledge rock _____

Bottom of leaching system _____ inches below final grade.

Pumping required _____ Curtain drain required _____

Serial distribution _____ Level system _____

SEPARATING DISTANCES

Well located _____ ft. from _____ and _____ ft. from _____

Distance sewage system to well on property _____ ft. To water service _____ ft.

To well on adjacent property _____ ft. To property line _____ ft.

To house served _____ ft. To dwelling adjacent property _____ ft.

To nearest watercourse _____ ft. To nearest ground or surface water drain _____ ft.

Reviewed/Inspected by _____ Title _____

PLAN/INSTALLATION APPROVED _____ DATE _____

INSPECTION FEE PAID _____

SEC. 19-13-B104

Section 1. The regulations of Connecticut State agencies are amended by adding sections 19-13-B104a through 19-13-B104d, inclusive: (NEW)

Sec. 19-13-B104a - Scope These regulations set standards for domestic sewage disposal systems receiving flows greater than 5,000 gallons per day; community sewage systems as defined in Section 7-245, Connecticut General Statutes, which utilize land treatment and disposal, alternative on-site sewage treatment systems; and septage disposal systems which utilize land treatment and disposal.

Sec. 19-13-B104b - Definitions

- (a) "Alternative on-site sewage treatment systems" means a system serving one or more buildings on one property which utilizes a method of treatment other than a subsurface sewage disposal system and which involves a discharge to the waters of the state.
- (b) "Domestic sewage" means sewage that consists of water and human excretions or other waterborne wastes incidental to the occupancy of the residential buildings or a nonresidential building but not including manufacturing process water, cooling water, wastewater from water softening equipment, commercial laundry wastewater, blowdown from heating or cooling equipment, water from cellars or floor drains or surface water from roofs, paved surfaces or yard drains.
- (c) "House sewer" means a tight sewer pipe extending from the building served by a subsurface sewage disposal system.
- (d) "Land treatment and disposal" means a system which utilizes soil materials for the treatment of domestic sewage and disposes of the treated effluent by percolation into underlying soil and mixing with the groundwater.
- (e) "Local Director of Health" means the local director of health or his authorized agent.
- (f) "Person" means any individual, partnership, association, firm, corporation or other entity, except a municipality, and includes the federal government, the state or any instrumentality of the state and any officer or governing or managing body of any partnership, association, firm or corporation.
- (g) "Septage" means any water or material withdrawn from a septic tank used to treat domestic sewage.
- (h) "Subsurface sewage disposal system" means a system consisting of a house or collection sewer, a septic tank followed by a leaching system, any necessary pumps or siphons, and any groundwater control system on which the operation of the leaching system is dependent.

Sec. 19-13-B104c - General Provisions

- (a) All sewers, sewage disposal systems, toilets, or sewage plumbing systems shall be kept in a sanitary condition at all times and be so constructed and maintained as to prevent the escape of odors and to exclude animals and insects. All such systems shall adhere to the requirements set forth in section 25-54i of the Connecticut General Statutes.
- (b) The contents of the septic tank, subsurface sewage disposal system or privy vault shall only be disposed of in the following manner.
 - (1.) If the contents are to be disposed of on the land of the owner, disposal shall be by burial or other method which does not present a health hazard or nuisance; or
 - (2.) If the contents are to be disposed of on land of other than the owner;
 - (A.) The contents shall be transferred and removed by a cleaner licensed pursuant to Connecticut General Statutes S 20-341, and
 - (B.) Only on the application for and an issuance of a written permit from the local director of health in accordance with the provisions of this section;
 - (3.) If the contents are to be disposed of on a public water supply water-shed, only on the application and issuance of a written permit by the Commissioner of Health Services in accordance with the provisions of this section.

Each application for a permit under subdivisions (2) and (3) of subsection (b) shall be in writing and designate where and in what manner the material shall be disposed of.

- (c) All material removed from any septic tank, privy, sewer, subsurface sewage disposal system, sewage holding tank, toilet or sewage plumbing system shall be transported in watertight vehicles or containers in such a manner that no nuisance or public health hazard is presented. All vehicles used for transportation of such material shall bear the name of the company or licensee and shall be maintained and a clean exterior conditions at all times. No defective or leaking equipment shall be used in cleaning operations. All vehicles or equipment shall be stored in a clean condition when not in use. Water used for rinsing such vehicles or equipment shall be considered sewage and shall be disposed of in a sanitary manner approved by the local director of health.
- (d) Septic tanks shall be cleaned by first lowering the liquid level sufficiently below the outlet to prevent sludge or scum from overflowing to the leaching system where it could cause clogging or otherwise damage the system. Substantially all of the sludge or scum acculation shall be removed when-ever possible, and the inlet and outlet baffles shall be inspected for damage or clogging. Cleaners shall use all reasonable precautions to prevent damaging the sewage disposal system with vehicles or equipment. Accidental spillages of sewage, sludge, or scum be promptly removed or otherwise abated so as to prevent a nuisance or public health hazard.

- (e) No sewage shall be allowed to discharge or flow into any storm drain, gutter, street, roadway or public place, nor shall such material discharge onto any private property so as to create a nuisance or condition detrimental to health. Whenever it is brought to the attention of the local director of health that such a condition exists on any property, he shall investigate and cause the abatement of this condition.
- (f) Persons who intend to conduct site investigations for the purpose of designing or constructing any septage or sewage disposal system within the scope of these regulations shall notify the local director of health of the time and place of such site investigations. Notice shall be provided to the local director of health in a timely manner to allow attendance at such site investigations by the director of health.
- (g) Persons who propose sewage or septage disposal systems within the scope of this regulation shall submit plans for such systems to the Commissioner of Health Services and the local director of health. Plans shall be submitted in a timely manner to allow review and comment on such plans to be directed to the Commissioner of Environmental Protection. Such plans shall be prepared by a professional engineer registered in the State of Connecticut and shall include a report of the findings of all site investigations, the basis of design, a preliminary or final design and other information necessary for the preservation and improvement of public health.
- (h) Persons who intend to construct sewage or septage disposal systems within the scope of these regulations shall file final construction plans with the local director of health at least two working days prior to the start of construction. All such systems shall be inspected during construction by the local director of health. Persons constructing such systems shall give prior notification to the local director of health of any changes which are proposed or required during construction. Persons constructing such systems shall provide the local director of health with a record drawing of the system, as-built, prior to utilizing the system.

Sec. 19-13-B104d - Minimum Requirements

- (a) All sewage or septage disposal systems under the scope of these regulations shall meet the following minimum requirements necessary for the preservation and improvement of public health, unless an exception is granted by the Commissioner of Health Services upon his determination that public health shall not be impaired by such exception.
- (b) All structures or facilities for the treatment or disposal of sewage or septage shall be located at least 50 feet from any open water source and 100 feet from any public supply reservoir, unless designed and constructed to prevent the leakage or overflow of raw or treated sewage to the ground or surface water.
- (c) All structures, facilities or locations containing sewage or septage which is exposed to the atmosphere shall be located at least 150 feet from any school, residential building or institution, and shall be fenced or otherwise made inaccessible to the public.

(d) The following minimum separating distances shall be maintained between any discharge or overflow of raw or treated sewage or septage to the ground waters and any drinking water supply well or spring.

<u>Required Withdrawal Rate</u>	<u>Minimum Separating Distance</u>
Under 10 gal. per minute	75 feet
10 to 50 gal. per minute	150 feet
Over 50 gal. per minute	200 feet

(e) The following minimum separating distances shall be maintained between any sewer, structure or facility for the conveyance or treatment of sewage or septage and any drinking water supply well or spring.

<u>Required Withdrawal Rate</u>	<u>Minimum Separating Distance</u>
Under 10 gal. per minute	25 feet
10 to 50 gal. per minute	75 feet
Over 50 gal. per minute	100 feet

Section 2. Sections are repealed, 19-13-B20a through 19-13-B20s, inclusive,

Statement of Purpose:

The regulations up date existing Public Health Code requirements for the design and installation of large subsurface sewage disposal systems, the design flow of which exceed 5,000 gallons per day. Sewage disposal systems conforming to this regulation and designed to include the latest State-of-the-Art technology will provide for the preservation and improvement of public health.

