

APPENDIX C
Traffic Study

This page intentionally left blank

Traffic Impact Study

**Seaside State Park Redevelopment
Environmental Impact Evaluation
Waterford, Connecticut**

May 2017



This page intentionally left blank

TABLE OF CONTENTS

I.	Introduction	1
II.	No Build Conditions	3
III.	Destination Park	6
IV.	Ecological and Passive Park	8
V.	Hybrid Park	10
VI.	Pedestrian and Bicycle Access	12
VII.	Conclusions	12

Figures

1	Project Location Map	3
---	----------------------	---

Appendix

Traffic Flow Diagrams

Traffic Counts

Capacity Analyses – 2027 No Build Conditions

Capacity Analyses – 2027 Destination Park

Capacity Analyses – 2027 Ecological and Passive Park

Capacity Analyses – 2027 Hybrid Park

This page intentionally left blank

I. INTRODUCTION

The purpose of this study is to evaluate the traffic impact of the proposed development alternatives for Seaside State Park in Waterford, Connecticut (see Figure 1). There are five different alternatives that are being considered for the site:

1. **No-Build (Do Nothing)** - This alternative would involve leaving the Site in its current state and continuing to operate as it has for the past two years since the Site was designated a State Park.
2. **Destination Park** – This alternative involves restoration and reuse of the existing buildings on site and the enhancement of the waterfront for ecological and recreational purposes. A 63 room hotel is proposed.
3. **Ecological Park** – This alternative involves maximizing ecological restoration of the site while providing passive recreational opportunities. This alternative would not involve demolition of the Main Hospital Building but retainage/restoration of the other buildings on site. No Lodging is proposed.
4. **Passive Park** – This alternative involves minimal alterations to the site grounds; however, all the historic buildings would be removed and, therefore, there would be no lodging as part of this alternative.
5. **Hybrid Park** – This alternative combines many of the features of the Destination Park, Ecological Park and Passive Park concepts. A 100 room hotel is proposed.

Throughout this report, many terms unique of traffic engineering are used. Below are definitions of many of these items.

Trip is a one-way movement to or from a site. One car entering and leaving site constitutes two trips.

Traffic Generation is the actual number of vehicle movements that may reasonably be expected to be attracted by a specific development. Usually traffic generation is expressed as a number of trips.

Average Weekday Trip Generation is the total traffic generation of a development on a typical working weekday.

Peak Hourly Generation is traffic generation that may be anticipated during the highest volume hour for the particular development. This analysis parameter may vary as to the time of day, depending on the type of facility being proposed.

Capacity and Level of Service are terms utilized to describe the ability of a roadway to handle its traffic assignment.



○ = STUDY AREA INTERSECTIONS

<p>Seaside State Park EIE Study Waterford, Connecticut</p>		
<p>Project Location Map</p>		
SCALE: N.T.S.	DATE: May 2017	Figure 1



Capacity is defined as the maximum volume of vehicles that may be expected to be carried by a specific roadway or intersection at a given Level of Service. The usual unit of capacity is vehicles per hour.

Level of Service is a measure of the quality of flow and overall congestion on a particular section of road or at a specific intersection.

Levels of Service (LOS) are defined in the Highway Capacity Manual (Special Report 209 of the Highway Research Board, 1994). LOS ratings are classified by letters from A to F, and are as follows:

Rating	Description	Traffic
A	Free Flow	Drivers feel no restrictions.
B	Stable Flow	Drivers feel some restrictions.
C	Stable Flow	Drivers somewhat restricted, but not objectionably so.
D	Approaching Unstable Flow	Increased restriction and congestion.
E	Capacity	Substantial restriction, serious delays.
F	Forced Flow	Stop and go conditions - extreme delays.

II. NO BUILD CONDITIONS

Seaside State Park is located along the south side of Shore Drive between Magonk Point Road and Woodsea Place. Shore Road is a two lane residential street beginning at Great Neck Road (Route 213) to the east, traveling west past the site then turning to the north, ending at Lamphere Road near Great Neck Country Club (Figure 1). In the vicinity of the site the posted speed limit along Shore road is 25 mph. The drive into the site is a two lane driveway with the approach to Shore Road stop controlled. The available sight distance along Shore Road from the site drive exceeds 500 feet in each direction which is adequate for a speed of 45 mph, 20 miles over the posted speed limit. The regional approach routes to the park include Interstate 95 and Route 1 which lead to Rope Ferry Road (Route 156) the closest major arterial roadway to the site. The following seven intersections (Figure 1) were studied between the site and Rope Ferry Road:

- Rope Ferry Road (Route 156) at Gardeners Wood Road (Signalized)
- Jordan Cove Road at Shore Road (Unsignalized)
- Palmer Drive at Shore Drive (Unsignalized)

- Shore Drive at Seaside State Park Drive (Unsignalized)
- Shore Drive at Great Neck Road (Unsignalized)
- Great Neck Road (Route 213) at Lamphere Road / Braman Road (Unsignalized)
- Rope Ferry Road (Route 156) at Great Neck Road (Route 213) / Avery Lane (Signalized)

Turning movement counts were made during the weekday AM and PM peak periods in March 2017 at each of the locations. The peak hour volumes are summarized in the Traffic Flow Diagram – 2017 Existing Conditions.

Review of seasonal adjustment factors available from the Connecticut Department of Transportation indicate that March traffic volumes tend to be 10% below the average traffic volumes in southeastern Connecticut. To account for this variation the existing counts were expanded by 10% prior to adjusting for general background growth. A design year of 2027 was chosen for this development and to account for general background growth, the 2017 Seasonally Adjusted Volumes were expanded by 2% per year for 10 years. The seasonally adjusted volumes and design year volumes are presented in the Traffic Flow Diagram – 2017 Seasonally Adjusted Volumes and Traffic Flow Diagram – 2027 No Build Volumes.

Capacity analyses for the 2027 No Build Conditions were conducted for the study intersections in the vicinity of Seaside State Park using the Synchro Professional Software, version 9.1 according to the methods described in the 2010 Highway Capacity Manual, published by the Transportation Research Board. The results of the analyses are presented below:

Anticipated Levels of Service – No Build

	AM Peak		PM Peak	
	LOS	Delay	LOS	Delay
Rope Ferry Road at Gardeners Wood Road	B	13.9	B	16.7
Jordan Cove Road at Shore Road	A	7.2	A	7.5
Northbound	A	7.6	A	7.9
Southbound	A	6.7	A	7.3
Eastbound	A	6.9	A	7.4
Palmer Drive at Shore Drive	A	7.0	A	7.2
Northbound	A	7.2	A	7.3
Southbound	A	6.5	A	6.9
Eastbound	A	7.3	A	7.4
Westbound	A	7.1	A	7.2
Shore Drive at Seaside State Park Drive				
Westbound Left	A	7.3	A	7.3
Northbound	A	8.5	A	8.6
Shore Drive at Great Neck Road				
Northbound Left	A	7.4	A	7.4
Eastbound	A	9.4	A	9.2
Great Neck Road at Lamphere Road / Braman Road				
Northbound	A	0.0	A	8.0
Southbound	A	0.0	A	7.9
Eastbound	C	17.9	D	34.2
Westbound	B	10.8	B	12.9
Rope Ferry Road at Great Neck Road / Avery Lane	B	14.5	C	24.2

The analyses indicate that each of the signalized intersections will operate at a Level of Service (LOS) C or better throughout the day for the 2027 No-Build Conditions. The analyses also show that the side street approaches for the unsignalized intersections will operate at an LOS D or better for the 2027 No-Build Conditions.

III. DESTINATION PARK

The traffic impact of a proposed development is determined by calculating the number of new trips that are expected to be generated by the development. The trip generation volumes represent the number of trips expected to be added to the roadway during the peak hours of the development. The anticipated site generated traffic volumes for the proposed Destination Park alternative are calculated using existing empirical data from the Institute of Transportation Engineers (ITE) Trip Generation, 9th Edition, 2012. This publication contains trip generation rates for each of the various types of parks and hotels. Reviewing the data, Land Use 310, “Hotel” is the use most closely matching the proposed hotel. This data used to generate these rates utilized studies of hotels which include such amenities as fitness centers, conference rooms and food services. Land Use 417 “Regional Park” represents the land use most closely matching the park amenities. The number of new trips that are anticipated to be added to the adjacent roadway network are:

Generated Trips – Destination Park			
Land Use	310	417	
Description		Regional	
Rooms / Acres	Hotel	Park	
	63	32	
ADT	562	148	Total 710
AM Peak Traffic	19	5	24
Entering	11	3	14
Exiting	8	2	10
PM Peak Traffic	44	8	53
Entering	22	4	25
Exiting	22	5	27

The above figures indicate the expected impact of the proposed Destination Park is 14 vehicles entering and 10 vehicles exiting during the morning peak hour with 25 vehicles entering and 27 vehicles exiting the during the afternoon peak hour.

Local travel patterns to the site were determined based on the geographical location of the development and the local roadway network. The peak hour trip distribution percentages and site generated traffic volumes are presented in Traffic Flow Diagram – Trip Distribution and Traffic Flow Diagram – Generated Trips –Destination Park, respectively. The generated trips were then added to the 2027 No Build Volumes to calculate the 2027 Build Volumes which are presented in the Traffic Flow Diagram – 2027 Build Volumes –Destination Park.

Capacity analyses for the 2027 Build Volumes – Destination Park Conditions were conducted for the study intersections in the vicinity of Seaside State Park using the Synchro Professional Software, version 9.1 according to the methods described in the 2010 Highway Capacity Manual, published by the Transportation Research Board. The results of the analyses are presented below:

	AM Peak		PM Peak	
	LOS	Delay	LOS	Delay
Rope Ferry Road at Gardeners Wood Road	B	13.9	B	16.6
Jordan Cove Road at Shore Road	A	7.3	A	7.6
Northbound	A	7.7	A	8.0
Southbound	A	6.7	A	7.4
Eastbound	A	7.0	A	7.5
Palmer Drive at Shore Drive	A	7.0	A	7.3
Northbound	A	7.2	A	7.4
Southbound	A	6.7	A	7.1
Eastbound	A	7.3	A	7.5
Westbound	A	6.9	A	7.1
Shore Drive at Seaside State Park Drive				
Westbound Left	A	7.3	A	7.3
Northbound	A	8.6	A	8.8
Shore Drive at Great Neck Road				
Northbound Left	A	7.4	A	7.4
Eastbound	A	9.5	A	9.4
Great Neck Road at Lamphere Road / Braman Road				
Northbound	A	0.0	A	8.0
Southbound	A	0.0	A	8.0
Eastbound	C	18.3	E	36.5
Westbound	B	10.8	B	13.1
Rope Ferry Road at Great Neck Road / Avery Lane	B	14.6	C	25.1

The analyses indicate that each of the signalized intersections will operate at a Level of Service (LOS) C or better throughout the day for the 2027 Build Conditions. The analyses also show that

the side street approaches for the unsignalized intersections will operate at an LOS C or better for the 2027 Build Conditions except for the Lamphere Road approach to Great Neck Road which will operate at an LOS E during the afternoon peak hour. A level of service E is considered acceptable for a side street approach to a heavily traveled collector road such as Great Neck Road. The increase of the average delay per vehicle experienced by this approach is only 2.3 sec/veh.

IV. ECOLOGICAL and PASSIVE PARK

The traffic impact of a proposed development is determined by calculating the number of new trips that are expected to be generated by the development. The trip generation volumes represent the number of trips expected to be added to the roadway during the peak hours of the development. The anticipated site generated traffic volumes for the proposed Ecological Park and Passive Park alternatives are the same. The number of trips are calculated using existing empirical data from the Institute of Transportation Engineers (ITE) Trip Generation, 9th Edition, 2012. This publication contains trip generation rates for each of the various types of parks. Land Use 417 “Regional Park” represents the land use most closely matching the park amenities. The number of new trips that are anticipated to be added to the adjacent roadway network are:

Generated Trips – Ecological and Passive Park

Land Use	417
Description	Regional Park
Acres	32
ADT	148
AM Peak Traffic	5
Entering	3
Exiting	2
PM Peak Traffic	8
Entering	4
Exiting	5

The above figures indicate the expected impact of the proposed Ecological and Passive Park is 3 vehicles entering and 2 vehicles exiting during the morning peak hour with 4 vehicles entering and 5 vehicles exiting the during the afternoon peak hour.

Local travel patterns to the site were determined based on the geographical location of the development and the local roadway network. The peak hour trip distribution percentages and site generated traffic volumes are presented in Traffic Flow Diagram – Trip Distribution and Traffic Flow Diagram – Generated Trips – Ecological / Passive Park, respectively. The generated

trips were then added to the 2027 No Build Volumes to calculate the 2027 Build Volumes which are presented in the Traffic Flow Diagram – 2027 Build Volumes – Ecological / Passive Park.

Capacity analyses for the 2027 Build Volumes – Ecological and Passive Park Conditions were conducted for the study intersections in the vicinity of Seaside State Park using the Synchro Professional Software, version 9.1 according to the methods described in the 2010 Highway Capacity Manual, published by the Transportation Research Board. The results of the analyses are presented below:

Anticipated Levels of Service – Ecological and Passive Park

	AM Peak		PM Peak	
	LOS	Delay	LOS	Delay
Rope Ferry Road at Gardeners Wood Road	B	13.9	B	16.7
Jordan Cove Road at Shore Road	A	7.2	A	7.5
Northbound	A	7.6	A	7.9
Southbound	A	6.7	A	7.3
Eastbound	A	6.9	A	7.4
Palmer Drive at Shore Drive	A	7.0	A	7.3
Northbound	A	7.2	A	7.3
Southbound	A	6.6	A	6.9
Eastbound	A	7.3	A	7.5
Westbound	A	7.0	A	7.2
Shore Drive at Seaside State Park Drive				
Westbound Left	A	7.3	A	7.3
Northbound	A	8.5	A	8.6
Shore Drive at Great Neck Road				
Northbound Left	A	7.4	A	7.4
Eastbound	A	9.4	A	9.3
Great Neck Road at Lamphere Road / Braman Road				
Northbound	A	0.0	A	8.0
Southbound	A	0.0	A	7.9
Eastbound	C	18.0	D	34.7
Westbound	B	10.8	B	12.9
Rope Ferry Road at Great Neck Road / Avery Lane	B	14.5	C	24.4

The analyses indicate that each of the signalized intersections will operate at a Level of Service (LOS) C or better throughout the day for the 2027 Build Conditions. The analyses also show that the side street approaches for the unsignalized intersections will operate at an LOS D or better for the 2027 Build Conditions.

V. HYBRID PARK

The traffic impact of a proposed development is determined by calculating the number of new trips that are expected to be generated by the development. The trip generation volumes represent the number of trips expected to be added to the roadway during the peak hours of the development. The anticipated site generated traffic volumes for the proposed Hybrid Park alternative are calculated using existing empirical data from the Institute of Transportation Engineers (ITE) Trip Generation, 9th Edition, 2012. This publication contains trip generation rates for each of the various types of parks and hotels. Reviewing the data, Land Use 310, “Hotel” is the use most closely matching the proposed hotel. This data used to generate these rates utilized studies of hotels which include such amenities as fitness centers, conference rooms and food services. Land Use 417 “Regional Park” represents the land use most closely matching the park amenities. The number of new trips that are anticipated to be added to the adjacent roadway network are:

Generated Trips – Hybrid Park			
Land Use	310	417	
Description		Regional	
Rooms / Acres	Hotel	Park	
	100	32	
ADT	892	148	Total 1,040
AM Peak Traffic	48	5	53
Entering	28	3	31
Exiting	20	2	22
PM Peak Traffic	70	8	78
Entering	34	4	38
Exiting	36	5	40

The above figures indicate the expected impact of the proposed Hybrid Park is 31 vehicles entering and 22 vehicles exiting during the morning peak hour with 38 vehicles entering and 40 vehicles exiting the during the afternoon peak hour.

Local travel patterns to the site were determined based on the geographical location of the development and the local roadway network. The peak hour trip distribution percentages and site generated traffic volumes are presented in Traffic Flow Diagram – Trip Distribution and

Traffic Flow Diagram – Generated Trips – Hybrid Park, respectively. The generated trips were then added to the 2027 No Build Volumes to calculate the 2027 Build Volumes which are presented in the Traffic Flow Diagram – 2027 Build Volumes – Hybrid Park.

Capacity analyses for the 2027 Build Volumes – Hybrid Park Conditions were conducted for the study intersections in the vicinity of Seaside State Park using the Synchro Professional Software, version 9.1 according to the methods described in the 2010 Highway Capacity Manual, published by the Transportation Research Board. The results of the analyses are presented below:

Anticipated Levels of Service – Hybrid Park

	AM Peak		PM Peak	
	LOS	Delay	LOS	Delay
Rope Ferry Road at Gardeners Wood Road	B	14.0	B	16.4
Jordan Cove Road at Shore Road	A	7.3	A	7.7
Northbound	A	7.7	A	8.1
Southbound	A	6.8	A	7.4
Eastbound	A	7.0	A	7.5
Palmer Drive at Shore Drive	A	7.0	A	7.3
Northbound	A	7.2	A	7.4
Southbound	A	6.9	A	7.2
Eastbound	A	7.3	A	7.5
Westbound	A	6.9	A	7.1
Shore Drive at Seaside State Park Drive				
Westbound Left	A	7.3	A	7.3
Northbound	A	8.8	A	8.9
Shore Drive at Great Neck Road				
Northbound Left	A	7.4	A	7.4
Eastbound	A	9.5	A	9.5
Great Neck Road at Lamphere Road / Braman Road				
Northbound	A	0.0	A	8.1
Southbound	A	0.0	A	8.0
Eastbound	C	18.7	E	37.9
Westbound	B	10.9	B	13.3
Rope Ferry Road at Great Neck Road / Avery Lane	B	14.6	C	25.8

The analyses indicate that each of the signalized intersections will operate at a Level of Service (LOS) C or better throughout the day for the 2027 Build Conditions. The analyses also show that the side street approaches for the unsignalized intersections will operate at an LOS C or better for the 2027 Build Conditions except for the Lamphere Road approach to Great Neck Road which will operate at an LOS E during the afternoon peak hour. A level of service E is considered acceptable for a side street approach to a heavily traveled collector road such as Great Neck Road. The increase of the average delay per vehicle experienced by this approach is only 3.7 sec/veh.

VI. PEDESTRIAN and BICYCLE ACCESS

Pedestrian access to the site is accomplished via sidewalks along Shore Road and Great Neck Road. The sidewalk along Shore Road is along the south side of the road beginning at Magonk Point Road to the west of the site, traveling east ending at Great Neck Road. There is a sidewalk along the west side of Great Neck Road traveling north beginning at Shore Road. There is no sidewalk along the Seaside State Park drive.

There are no dedicated bicycle facilities along the roadways in the immediate vicinity of the park. There is no bike path or marked bicycle lane on the Seaside State Park drive.

VII. CONCLUSION

The State of Connecticut is considering various development alternatives for Seaside State Park in Waterford, Connecticut. There are five different alternatives that are being considered for the site:

1. **No-Build (Do Nothing)** - This alternative would involve leaving the Site in its current state and continuing to operate as it has for the past two years since the Site was designated a State Park.
2. **Destination Park** – This alternative involves restoration and reuse of the existing buildings on site and the enhancement of the waterfront for ecological and recreational purposes. A 63 room hotel is proposed.
3. **Ecological Park** – This alternative involves maximizing ecological restoration of the site while providing passive recreational opportunities. This alternative would not involve demolition of the Main Hospital Building but retainage/restoration of the other buildings on site. No Lodging is proposed.
4. **Passive Park** – This alternative involves minimal alterations to the site grounds; however, all the historic buildings would be removed and, therefore, there would be no lodging as part of this alternative.
5. **Hybrid Park** – This alternative combines many of the features of the Destination Park, Ecological Park and Passive Park concepts. A 100 room hotel is proposed.

Traffic analyses were completed for each of the various alternatives with the anticipated 2027 traffic volumes at seven intersections between the site and Rope Ferry Road (Route 156). The analyses indicate that each of the intersections studied has sufficient capacity to accommodate each of the alternatives being considered without the need to construct any improvements. However, pedestrian and bicycle access to and on the site is limited and improving access for these users should be considered in the future.

APPENDIX

TRAFFIC FLOW DIAGRAMS

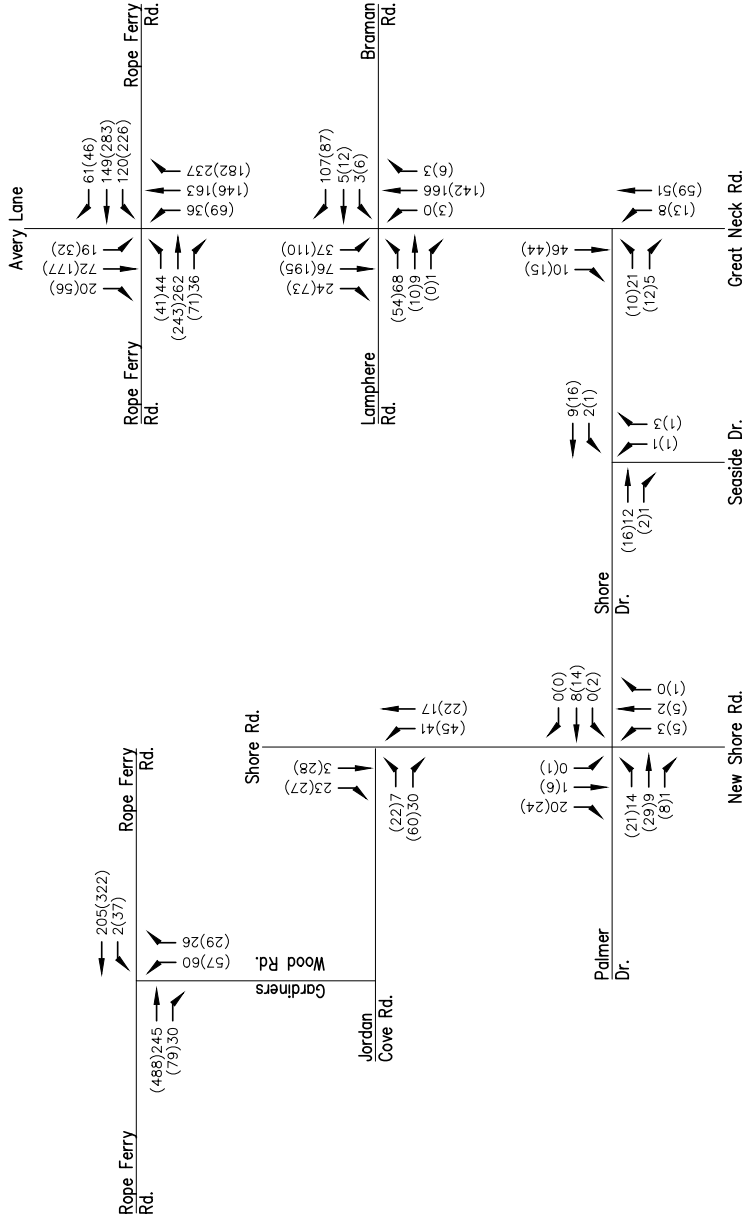

Seaside State Park EIE Study Waterford, Connecticut	
Traffic Flow Diagram 2017 Existing Conditions	
SCALE: N.T.S.	DATE: May 2017

Legend
 xx = AM Peak Hour
 (xx) = PM Peak Hour



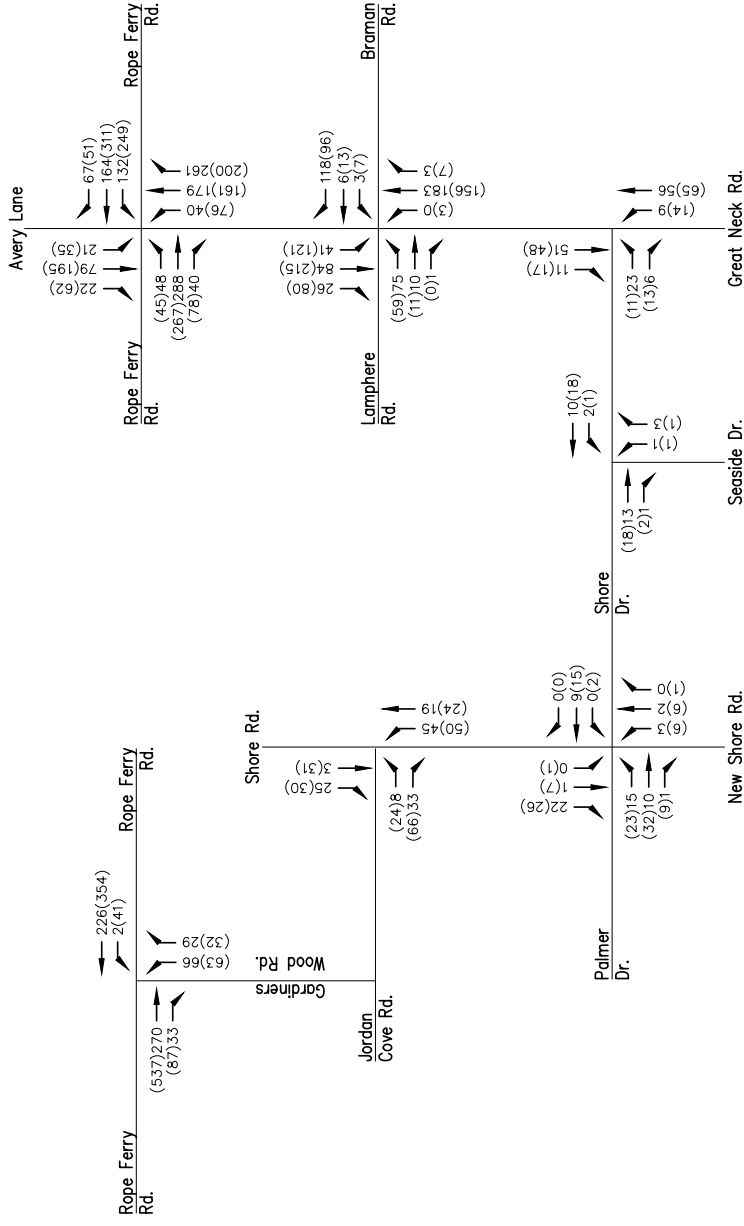

Seaside State Park EIE Study Waterford, Connecticut	
Traffic Flow Diagram 2017 Seasonally Adjusted Volumes	
SCALE: N.T.S.	DATE: May 2017

Legend
 xx = AM Peak Hour
 (xx) = PM Peak Hour



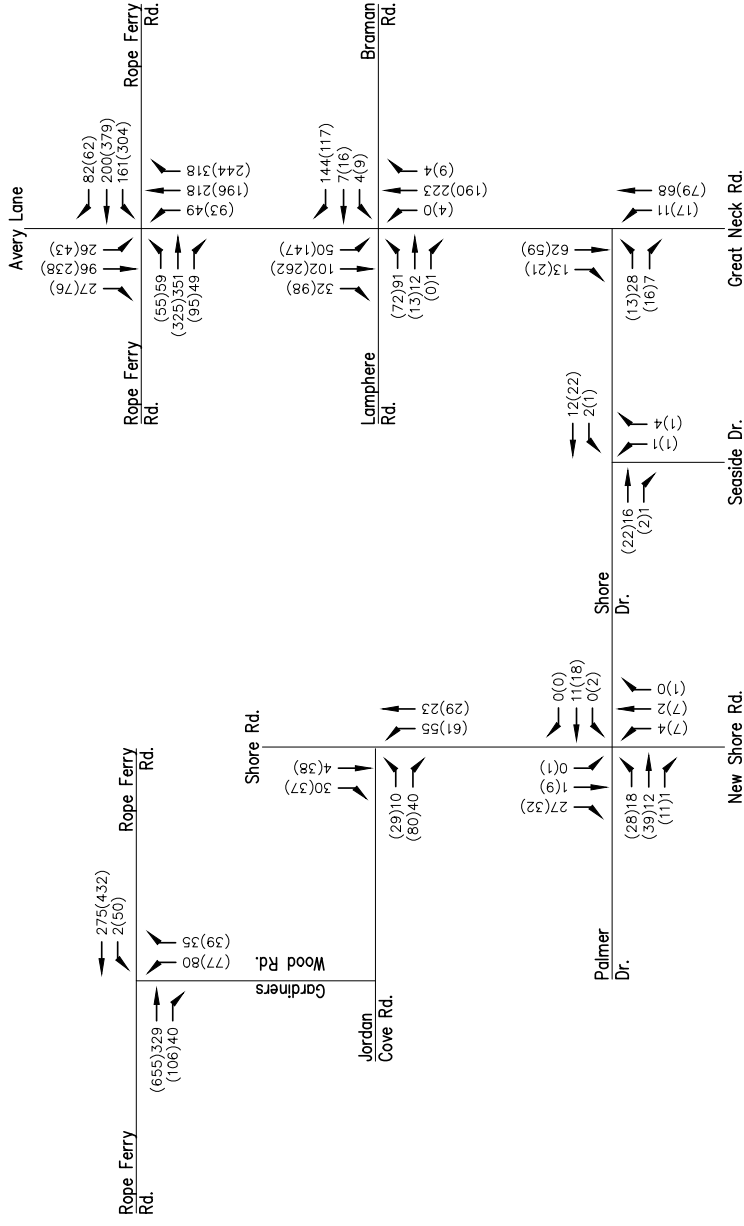

Seaside State Park EIE Study Waterford, Connecticut	
Traffic Flow Diagram 2027 No Build Volumes	
SCALE: N.T.S.	DATE: May 2017

Legend
 xx = AM Peak Hour
 (xx) = PM Peak Hour



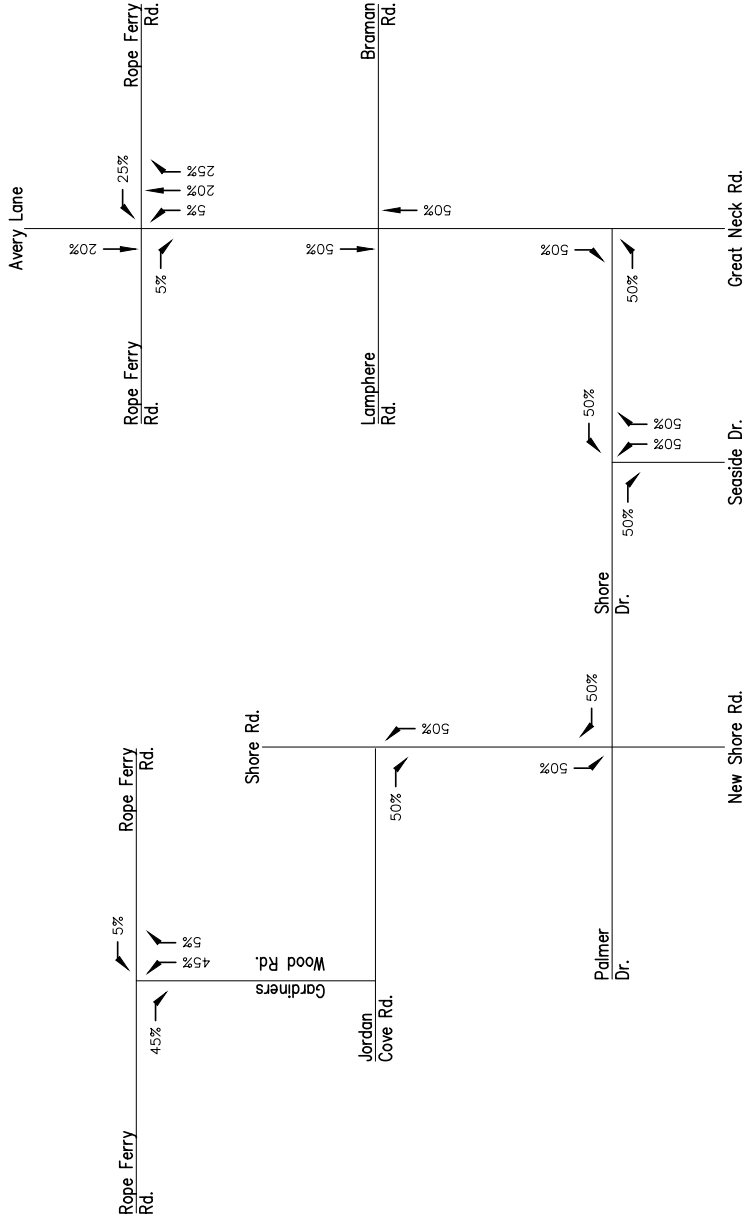

Seaside State Park EIE Study Waterford, Connecticut	
Traffic Flow Diagram Trip Distribution	
SCALE: N.T.S.	DATE: May 2017

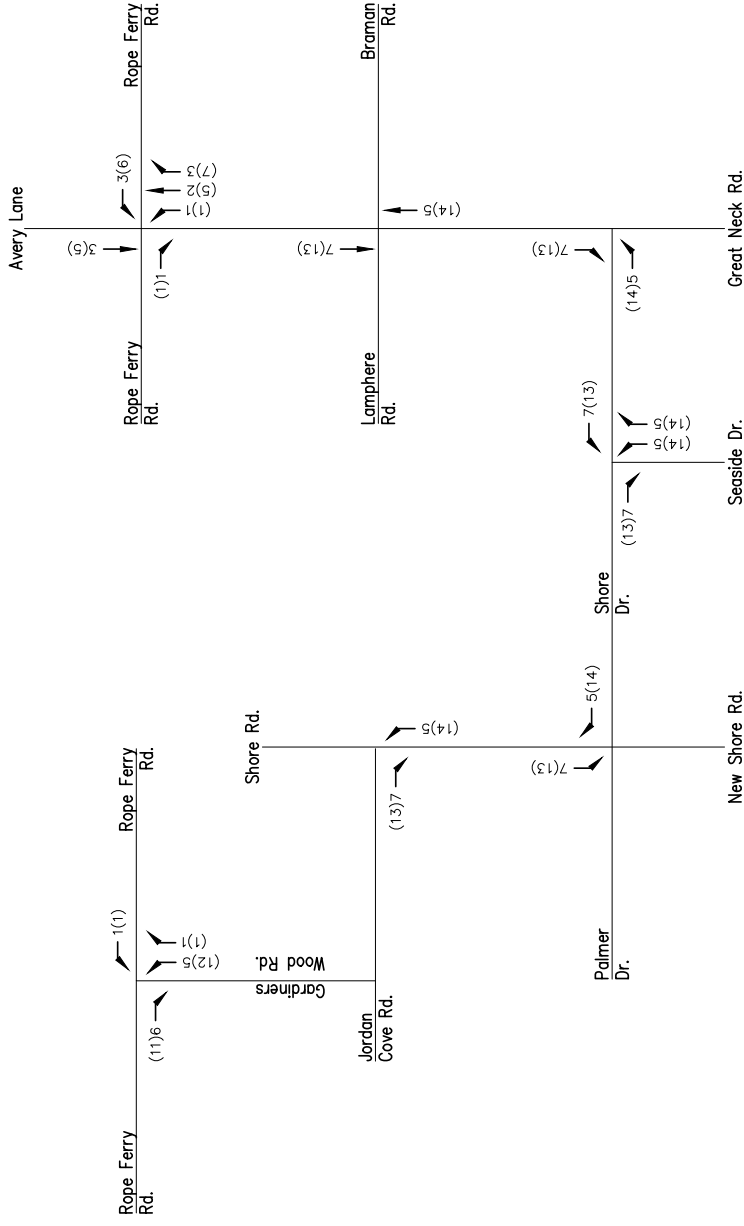

Seaside State Park EIE Study Waterford, Connecticut	
Traffic Flow Diagram Generated Trips Destination Park	
SCALE: N.T.S.	DATE: May 2017

Legend
 xx = Friday PM Peak Hour
 (xx) = Saturday Midday Peak Hour



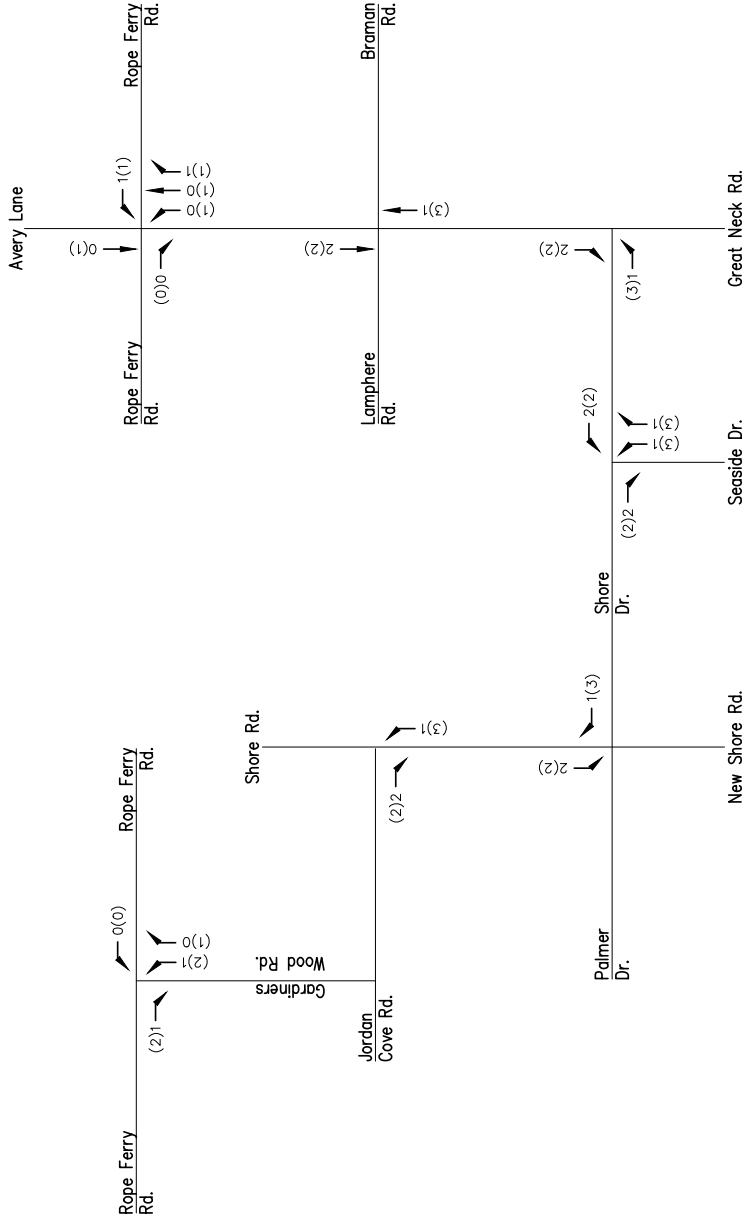

Seaside State Park EIE Study Waterford, Connecticut	
Traffic Flow Diagram Generated Trips Ecological / Passive Park	
SCALE: N.T.S.	DATE: May 2017

Legend
 xx = Friday PM Peak Hour
 (xx) = Saturday Midday Peak Hour



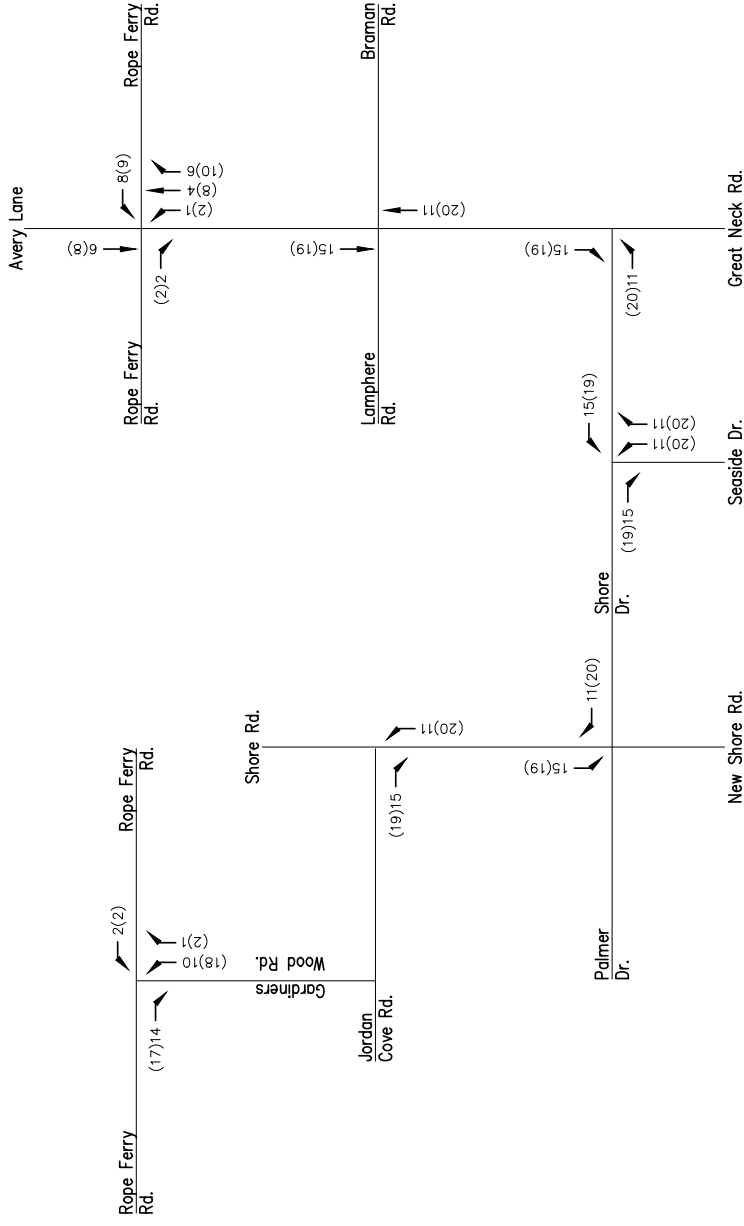

Seaside State Park EIE Study Waterford, Connecticut	
Traffic Flow Diagram Generated Trips Hybrid Park	
SCALE: N.T.S.	DATE: May 2017

Legend
 xx = Friday PM Peak Hour
 (xx) = Saturday Midday Peak Hour



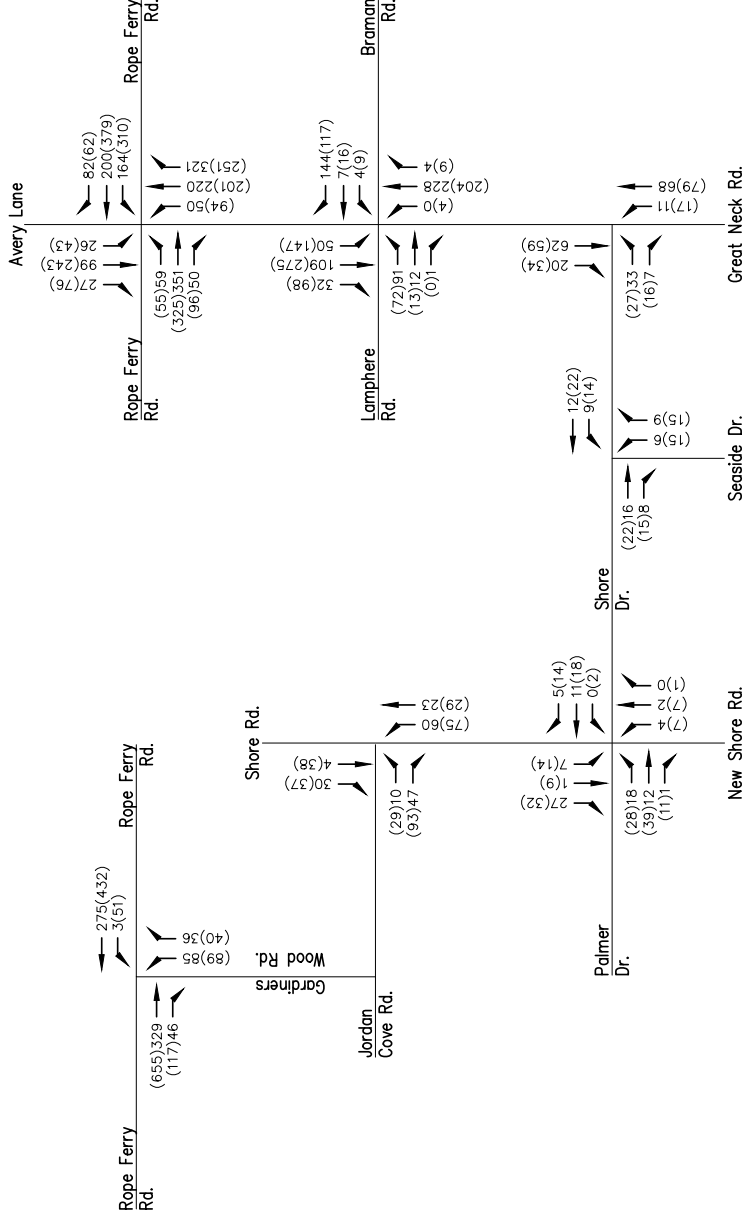

Seaside State Park EIE Study Waterford, Connecticut	
Traffic Flow Diagram 2027 Build Volumes Destination Park	
SCALE: N.T.S.	DATE: May 2017

Legend
 xx = Friday PM Peak Hour
 (xx) = Saturday Midday Peak Hour



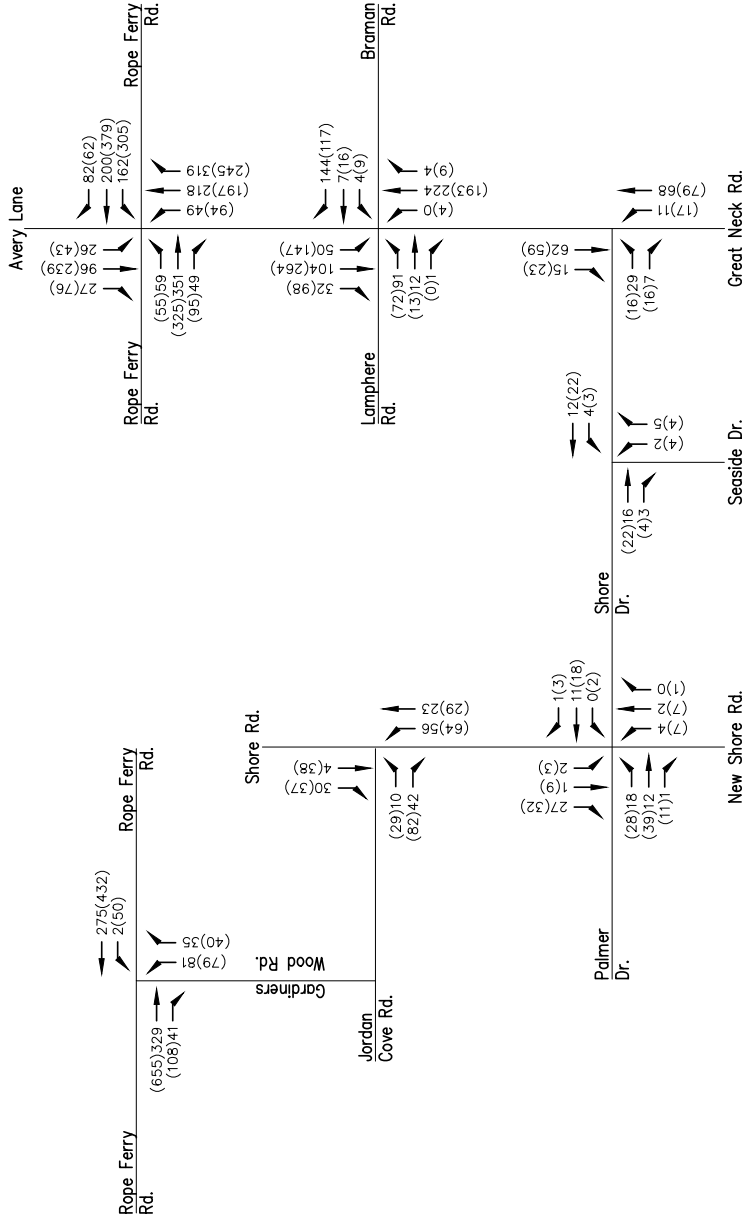

Seaside State Park EIE Study Waterford, Connecticut	
Traffic Flow Diagram 2027 Build Volumes Ecological / Passive Park	
SCALE: N.T.S.	DATE: May 2017

Legend
 xx = Friday PM Peak Hour
 (xx) = Saturday Midday Peak Hour



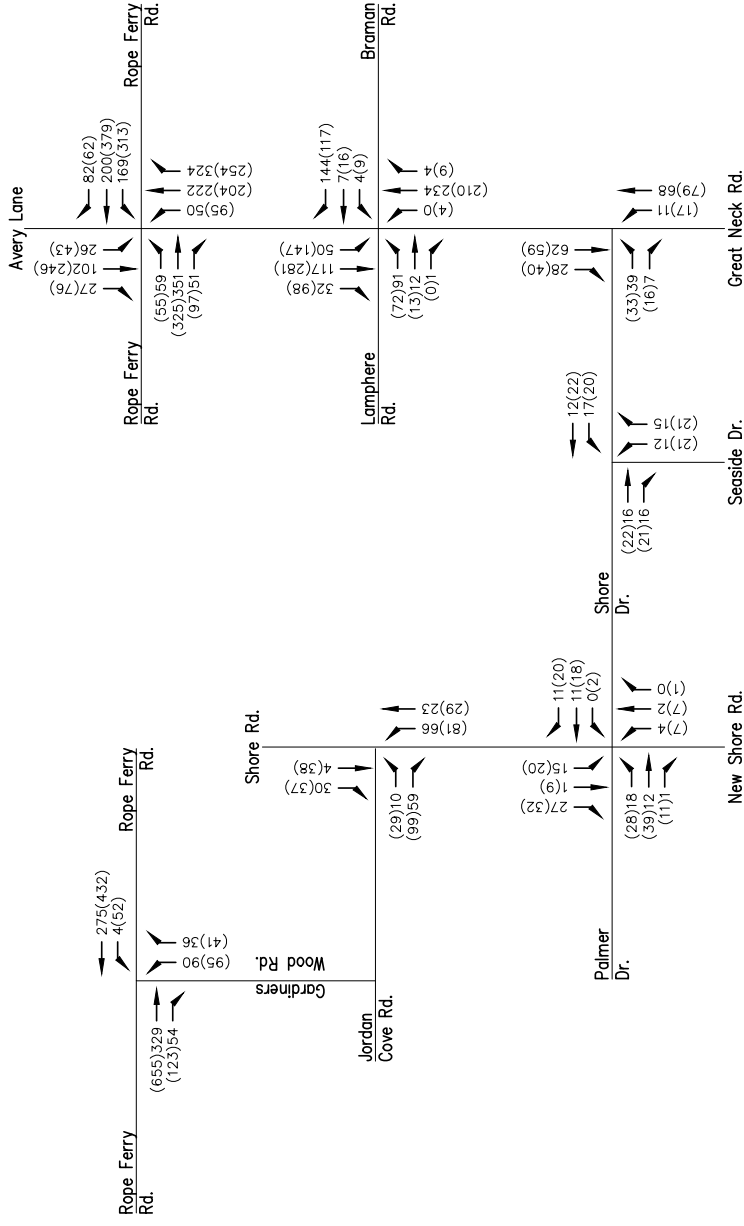

Seaside State Park EIE Study Waterford, Connecticut	
Traffic Flow Diagram 2027 Build Volumes Hybrid Park	
SCALE: N.T.S.	DATE: May 2017

Legend
 xx = Friday PM Peak Hour
 (xx) = Saturday Midday Peak Hour



TURNING MOVEMENT COUNTS

Connecticut Counts LLC
Kensington, Connecticut 06037
(860) 828-1693

Shore Road at Seaside Drive
 Waterford, Connecticut

File Name : 15195
 Site Code : 15195
 Start Date : 2/8/2017
 Page No : 1

Groups Printed- Unshifted - Bank 1 - Bank 2

Start Time	From North					Shore Road From East					Seaside Drive From South					Shore Road From West					Int. Total
	Right	Thru	Left	Peds	App. Total	Right	Thru	Left	Peds	App. Total	Right	Thru	Left	Peds	App. Total	Right	Thru	Left	Peds	App. Total	
07:00 AM	0	0	0	0	0	0	2	2	0	4	0	0	0	0	0	0	2	0	0	2	6
07:15 AM	0	0	0	0	0	0	2	1	0	3	0	0	0	0	0	1	2	0	0	3	6
07:30 AM	0	0	0	0	0	1	3	0	0	4	0	0	0	0	0	0	3	0	0	3	7
07:45 AM	0	0	0	0	0	0	1	0	0	1	1	0	0	0	1	0	3	0	0	3	5
Total	0	0	0	0	0	1	8	3	0	12	1	0	0	0	1	1	10	0	0	11	24
08:00 AM	0	0	0	0	0	0	2	0	0	2	1	0	0	0	1	1	3	0	0	4	7
08:15 AM	0	0	0	0	0	0	1	1	0	2	1	0	1	0	2	0	5	0	0	5	9
08:30 AM	0	0	0	0	0	0	5	1	0	6	0	0	0	1	1	0	1	0	0	1	8
08:45 AM	0	0	0	0	0	0	3	0	0	3	1	0	0	0	1	0	1	0	0	1	5
Total	0	0	0	0	0	0	11	2	0	13	3	0	1	1	5	1	10	0	0	11	29
Grand Total	0	0	0	0	0	1	19	5	0	25	4	0	1	1	6	2	20	0	0	22	53
Apprch %	0	0	0	0		4	76	20	0		66.7	0	16.7	16.7		9.1	90.9	0	0		
Total %	0	0	0	0	0	1.9	35.8	9.4	0	47.2	7.5	0	1.9	1.9	11.3	3.8	37.7	0	0	41.5	
Unshifted	0	0	0	0	0	1	16	4	0	21	3	0	0	1	4	2	19	0	0	21	46
% Unshifted	0	0	0	0	0	100	84.2	80	0	84	75	0	0	100	66.7	100	95	0	0	95.5	86.8
Bank 1	0	0	0	0	0	0	0	1	0	1	1	0	0	0	1	0	0	0	0	0	2
% Bank 1	0	0	0	0	0	0	0	20	0	4	25	0	0	0	16.7	0	0	0	0	0	3.8
Bank 2	0	0	0	0	0	0	3	0	0	3	0	0	1	0	1	0	1	0	0	1	5
% Bank 2	0	0	0	0	0	0	15.8	0	0	12	0	0	100	0	16.7	0	5	0	0	4.5	9.4

Connecticut Counts LLC

Kensington, Connecticut 06037
(860) 828-1693

Shore Road at Seaside Drive
Waterford, Connecticut

File Name : 15195
Site Code : 15195
Start Date : 2/8/2017
Page No : 2

Start Time	From North					Shore Road From East					Seaside Drive From South					Shore Road From West					Int. Total
	Right	Thru	Left	Peds	App. Total	Right	Thru	Left	Peds	App. Total	Right	Thru	Left	Peds	App. Total	Right	Thru	Left	Peds	App. Total	
Peak Hour Analysis From 07:00 AM to 08:45 AM - Peak 1 of 1																					
Peak Hour for Entire Intersection Begins at 07:45 AM																					
07:45 AM	0	0	0	0	0	0	1	0	0	1	1	0	0	0	1	0	3	0	0	3	5
08:00 AM	0	0	0	0	0	0	2	0	0	2	1	0	0	0	1	1	3	0	0	4	7
08:15 AM	0	0	0	0	0	0	1	1	0	2	1	0	1	0	2	0	5	0	0	5	9
08:30 AM	0	0	0	0	0	0	5	1	0	6	0	0	0	1	1	0	1	0	0	1	8
Total Volume	0	0	0	0	0	0	9	2	0	11	3	0	1	1	5	1	12	0	0	13	29
% App. Total	0	0	0	0	0	0	81.8	18.2	0		60	0	20	20		7.7	92.3	0	0		
PHF	.000	.000	.000	.000	.000	.000	.450	.500	.000	.458	.750	.000	.250	.250	.625	.250	.600	.000	.000	.650	.806

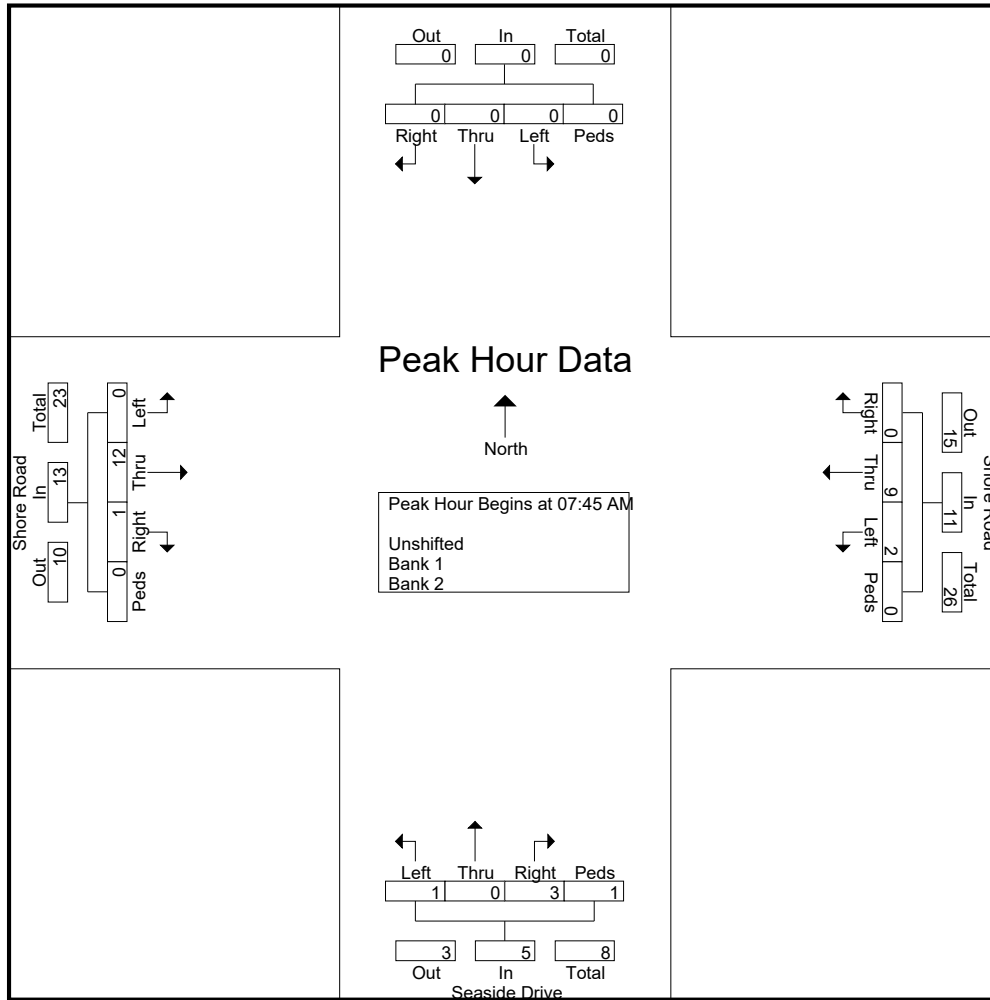

Connecticut Counts LLC

Kensington, Connecticut 06037
(860) 828-1693

Shore Road at Seaside Drive
Waterford, Connecticut

File Name : 15195
Site Code : 15195
Start Date : 2/8/2017
Page No : 3

Start Time	From North					Shore Road From East					Seaside Drive From South					Shore Road From West					Int. Total
	Right	Thru	Left	Peds	App. Total	Right	Thru	Left	Peds	App. Total	Right	Thru	Left	Peds	App. Total	Right	Thru	Left	Peds	App. Total	

Peak Hour Analysis From 07:00 AM to 08:45 AM - Peak 1 of 1

Peak Hour for Each Approach Begins at:

	07:00 AM					08:00 AM					07:45 AM					07:30 AM				
+0 mins.	0	0	0	0	0	0	2	0	0	2	1	0	0	0	1	0	3	0	0	3
+15 mins.	0	0	0	0	0	0	1	1	0	2	1	0	0	0	1	0	3	0	0	3
+30 mins.	0	0	0	0	0	0	5	1	0	6	1	0	1	0	2	1	3	0	0	4
+45 mins.	0	0	0	0	0	0	3	0	0	3	0	0	0	1	1	0	5	0	0	5
Total Volume	0	0	0	0	0	0	11	2	0	13	3	0	1	1	5	1	14	0	0	15
% App. Total	0	0	0	0	0	0	84.6	15.4	0		60	0	20	20		6.7	93.3	0	0	
PHF	.000	.000	.000	.000	.000	.000	.550	.500	.000	.542	.750	.000	.250	.250	.625	.250	.700	.000	.000	.750

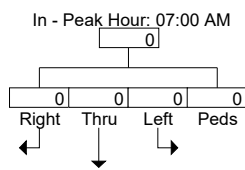
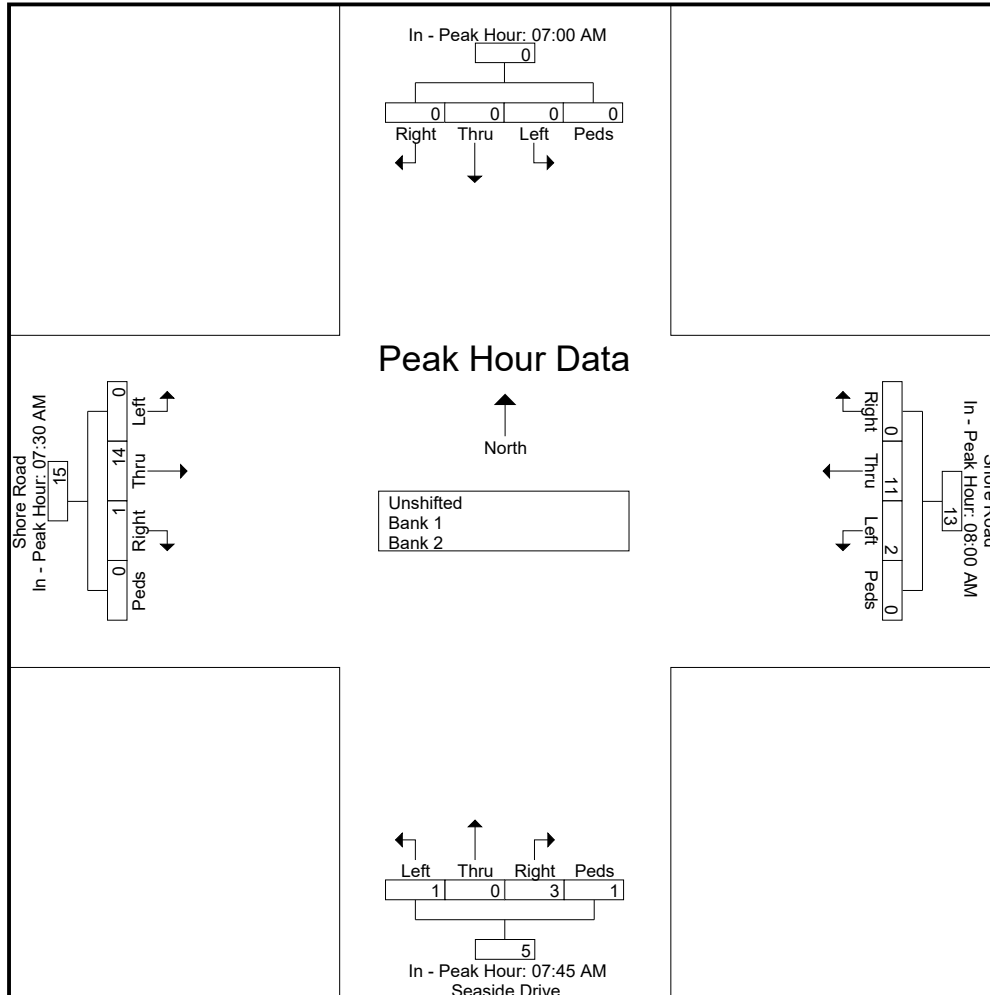

Connecticut Counts LLC
Kensington, Connecticut 06037
(860) 828-1693

Shore Road at Seaside Drive
 Waterford, Connecticut

File Name : 15196
 Site Code : 15196
 Start Date : 2/8/2017
 Page No : 1

Groups Printed- Unshifted - Bank 1 - Bank 2

Start Time	From North					Shore Road From East					Shore Road From South					Shore Road From West					Int. Total
	Right	Thru	Left	Peds	App. Total	Right	Thru	Left	Peds	App. Total	Right	Thru	Left	Peds	App. Total	Right	Thru	Left	Peds	App. Total	
04:00 PM	0	0	0	0	0	0	5	0	0	5	0	0	1	0	1	0	4	0	0	4	10
04:15 PM	0	0	0	0	0	1	5	1	0	7	1	1	0	0	2	1	3	0	0	4	13
04:30 PM	0	0	0	0	0	0	3	0	0	3	0	0	0	5	5	0	5	0	0	5	13
04:45 PM	0	0	0	0	0	1	3	0	0	4	0	0	0	0	0	1	4	0	0	5	9
Total	0	0	0	0	0	2	16	1	0	19	1	1	1	5	8	2	16	0	0	18	45
05:00 PM	0	0	0	0	0	0	3	0	0	3	0	0	0	0	0	0	4	0	0	4	7
05:15 PM	0	0	0	0	0	0	2	0	0	2	0	0	1	0	1	0	1	0	0	1	4
05:30 PM	0	0	0	0	0	0	4	0	0	4	0	0	0	0	0	0	5	0	0	5	9
05:45 PM	0	0	0	0	0	0	2	1	0	3	0	0	1	0	1	0	3	0	0	3	7
Total	0	0	0	0	0	0	11	1	0	12	0	0	2	0	2	0	13	0	0	13	27
Grand Total	0	0	0	0	0	2	27	2	0	31	1	1	3	5	10	2	29	0	0	31	72
Apprch %	0	0	0	0		6.5	87.1	6.5	0		10	10	30	50		6.5	93.5	0	0		
Total %	0	0	0	0	0	2.8	37.5	2.8	0	43.1	1.4	1.4	4.2	6.9	13.9	2.8	40.3	0	0	43.1	
Unshifted	0	0	0	0	0	2	27	2	0	31	0	1	3	5	9	2	29	0	0	31	71
% Unshifted	0	0	0	0	0	100	100	100	0	100	0	100	100	100	90	100	100	0	0	100	98.6
Bank 1	0	0	0	0	0	0	0	0	0	0	0	0	0	0	0	0	0	0	0	0	0
% Bank 1	0	0	0	0	0	0	0	0	0	0	0	0	0	0	0	0	0	0	0	0	0
Bank 2	0	0	0	0	0	0	0	0	0	0	1	0	0	0	1	0	0	0	0	0	1
% Bank 2	0	0	0	0	0	0	0	0	0	0	100	0	0	0	10	0	0	0	0	0	1.4

Connecticut Counts LLC

Kensington, Connecticut 06037
(860) 828-1693

Shore Road at Seaside Drive
Waterford, Connecticut

File Name : 15196
Site Code : 15196
Start Date : 2/8/2017
Page No : 2

Start Time	From North					Shore Road From East					Shore Road From South					Shore Road From West					Int. Total
	Right	Thru	Left	Peds	App. Total	Right	Thru	Left	Peds	App. Total	Right	Thru	Left	Peds	App. Total	Right	Thru	Left	Peds	App. Total	
Peak Hour Analysis From 04:00 PM to 05:45 PM - Peak 1 of 1																					
Peak Hour for Entire Intersection Begins at 04:00 PM																					
04:00 PM	0	0	0	0	0	0	5	0	0	5	0	0	1	0	1	0	4	0	0	4	4
04:15 PM	0	0	0	0	0	1	5	1	0	7	1	1	0	0	2	1	3	0	0	4	13
04:30 PM	0	0	0	0	0	0	3	0	0	3	0	0	0	5	5	0	5	0	0	5	13
04:45 PM	0	0	0	0	0	1	3	0	0	4	0	0	0	0	0	1	4	0	0	5	9
Total Volume	0	0	0	0	0	2	16	1	0	19	1	1	1	5	8	2	16	0	0	18	45
% App. Total	0	0	0	0	0	10.5	84.2	5.3	0		12.5	12.5	12.5	62.5		11.1	88.9	0	0		
PHF	.000	.000	.000	.000	.000	.500	.800	.250	.000	.679	.250	.250	.250	.250	.400	.500	.800	.000	.000	.900	.865

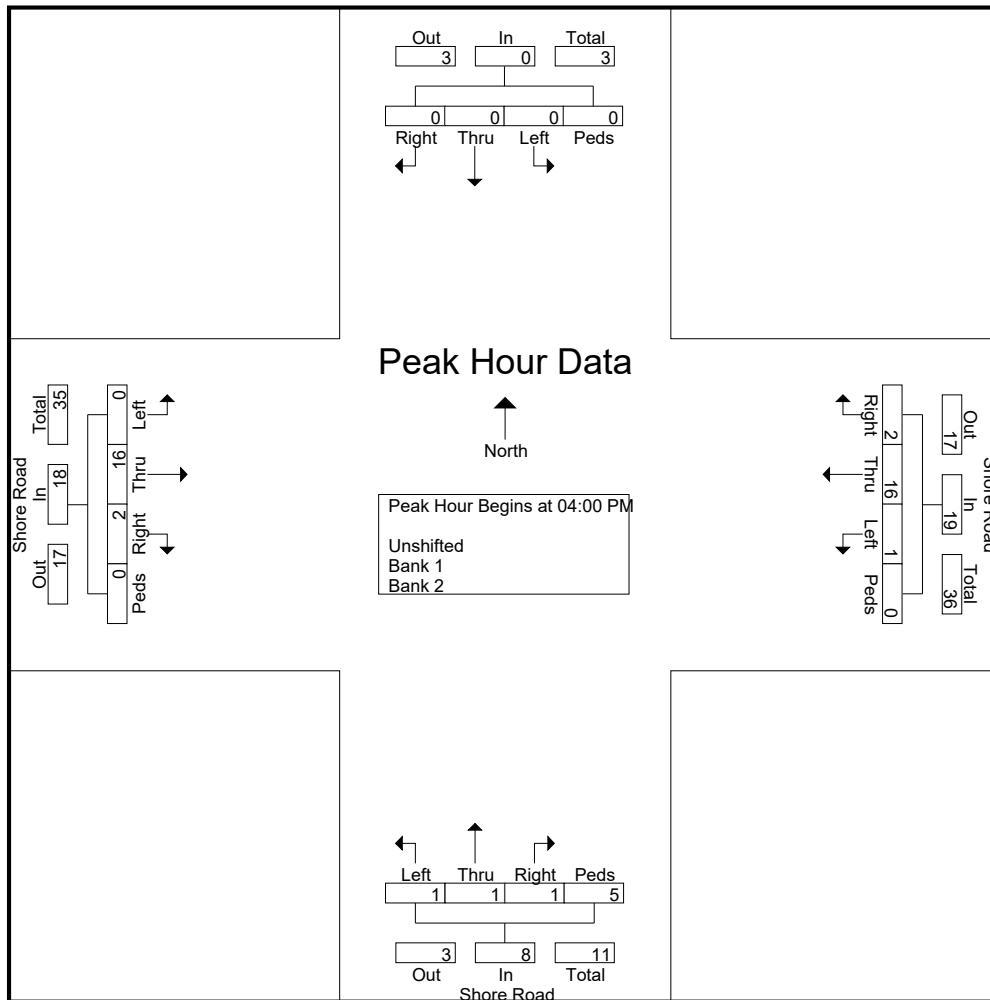

Connecticut Counts LLC

Kensington, Connecticut 06037
(860) 828-1693

Shore Road at Seaside Drive
Waterford, Connecticut

File Name : 15196
Site Code : 15196
Start Date : 2/8/2017
Page No : 3

Start Time	From North					Shore Road From East					Shore Road From South					Shore Road From West					Int. Total
	Right	Thru	Left	Peds	App. Total	Right	Thru	Left	Peds	App. Total	Right	Thru	Left	Peds	App. Total	Right	Thru	Left	Peds	App. Total	

Peak Hour Analysis From 04:00 PM to 05:45 PM - Peak 1 of 1

Peak Hour for Each Approach Begins at:

	04:00 PM					04:00 PM					04:00 PM					04:00 PM					
+0 mins.	0	0	0	0	0	0	5	0	0	5	0	0	1	0	1	0	4	0	0	4	
+15 mins.	0	0	0	0	0	1	5	1	0	7	1	1	0	0	2	1	3	0	0	4	
+30 mins.	0	0	0	0	0	0	3	0	0	3	0	0	0	5	5	0	5	0	0	5	
+45 mins.	0	0	0	0	0	1	3	0	0	4	0	0	0	0	0	1	4	0	0	5	
Total Volume	0	0	0	0	0	2	16	1	0	19	1	1	1	5	8	2	16	0	0	18	
% App. Total	0	0	0	0	0	10.5	84.2	5.3	0	12.5	12.5	12.5	62.5	11.1	88.9	0	0				
PHF	.000	.000	.000	.000	.000	.500	.800	.250	.000	.679	.250	.250	.250	.250	.400	.500	.800	.000	.000	.900	

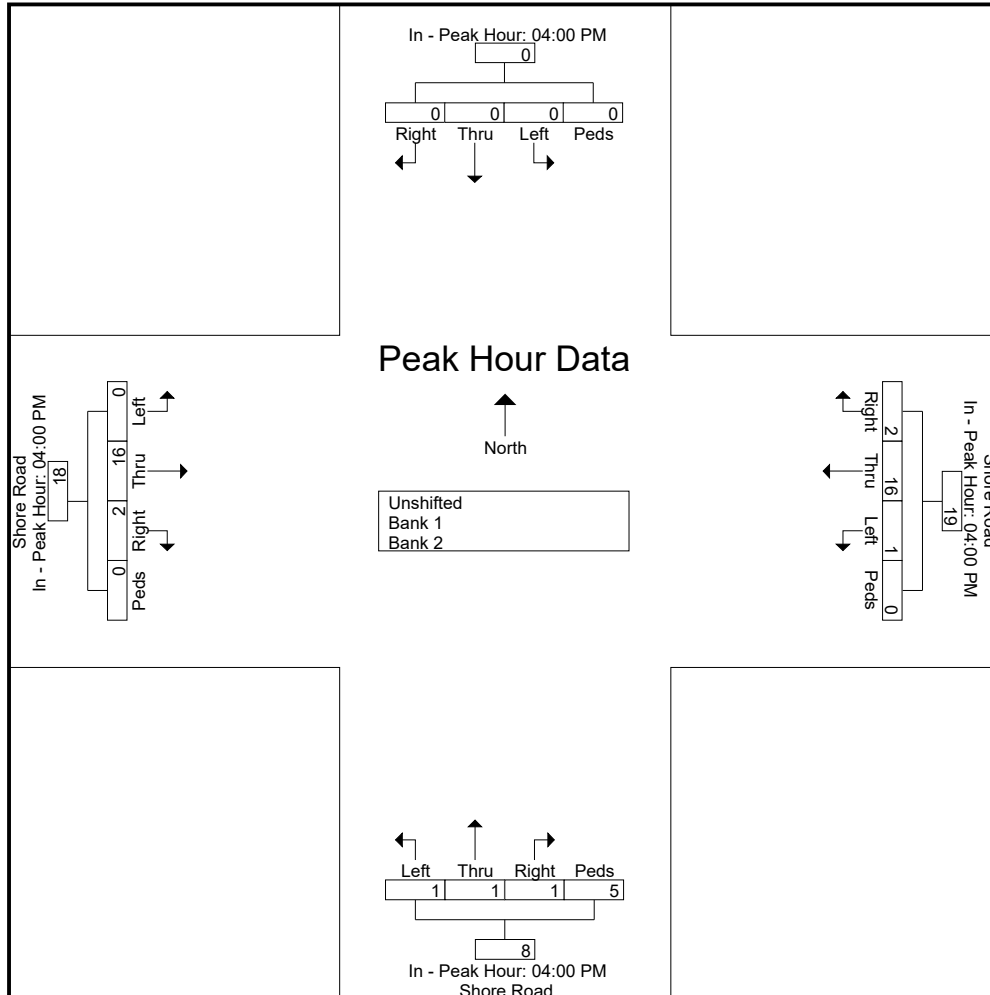

Connecticut Counts LLC
Kensington, Connecticut 06037
(860) 828-1693

Shore Road at Great Neck Road
 Waterford, Connecticut

File Name : 15197
 Site Code : 15197
 Start Date : 2/8/2017
 Page No : 1

Groups Printed- Unshifted - Bank 1 - Bank 2

Start Time	Great Neck Road From North					From East					Great Neck Road From South					Shore Road From West					Int. Total
	Right	Thru	Left	Peds	App. Total	Right	Thru	Left	Peds	App. Total	Right	Thru	Left	Peds	App. Total	Right	Thru	Left	Peds	App. Total	
07:00 AM	3	6	0	0	9	0	0	0	0	0	0	5	2	0	7	1	0	11	0	12	28
07:15 AM	4	6	0	0	10	0	0	0	0	0	0	3	0	0	3	0	0	6	0	6	19
07:30 AM	1	5	0	0	6	0	0	0	0	0	0	11	2	0	13	4	0	3	0	7	26
07:45 AM	1	7	0	0	8	0	0	0	0	0	0	6	1	0	7	3	0	1	0	4	19
Total	9	24	0	0	33	0	0	0	0	0	0	25	5	0	30	8	0	21	0	29	92
08:00 AM	0	7	0	0	7	0	0	0	0	0	0	15	2	0	17	2	0	12	0	14	38
08:15 AM	5	12	0	0	17	0	0	0	0	0	0	16	0	0	16	1	0	5	0	6	39
08:30 AM	3	17	0	0	20	0	0	0	0	0	0	9	3	0	12	1	0	2	0	3	35
08:45 AM	2	10	0	0	12	0	0	0	0	0	0	11	3	0	14	1	0	2	1	4	30
Total	10	46	0	0	56	0	0	0	0	0	0	51	8	0	59	5	0	21	1	27	142
Grand Total	19	70	0	0	89	0	0	0	0	0	0	76	13	0	89	13	0	42	1	56	234
Apprch %	21.3	78.7	0	0		0	0	0	0		0	85.4	14.6	0		23.2	0	75	1.8		
Total %	8.1	29.9	0	0	38	0	0	0	0	0	0	32.5	5.6	0	38	5.6	0	17.9	0.4	23.9	
Unshifted	18	66	0	0	84	0	0	0	0	0	0	74	9	0	83	13	0	40	1	54	221
% Unshifted	94.7	94.3	0	0	94.4	0	0	0	0	0	0	97.4	69.2	0	93.3	100	0	95.2	100	96.4	94.4
Bank 1	1	1	0	0	2	0	0	0	0	0	0	0	0	0	0	0	0	1	0	1	3
% Bank 1	5.3	1.4	0	0	2.2	0	0	0	0	0	0	0	0	0	0	0	0	2.4	0	1.8	1.3
Bank 2	0	3	0	0	3	0	0	0	0	0	0	2	4	0	6	0	0	1	0	1	10
% Bank 2	0	4.3	0	0	3.4	0	0	0	0	0	0	2.6	30.8	0	6.7	0	0	2.4	0	1.8	4.3

Connecticut Counts LLC

Kensington, Connecticut 06037
(860) 828-1693

Shore Road at Great Neck Road
Waterford, Connecticut

File Name : 15197
Site Code : 15197
Start Date : 2/8/2017
Page No : 2

Start Time	Great Neck Road From North					From East					Great Neck Road From South					Shore Road From West					Int. Total
	Right	Thru	Left	Peds	App. Total	Right	Thru	Left	Peds	App. Total	Right	Thru	Left	Peds	App. Total	Right	Thru	Left	Peds	App. Total	
Peak Hour Analysis From 07:00 AM to 08:45 AM - Peak 1 of 1																					
Peak Hour for Entire Intersection Begins at 08:00 AM																					
08:00 AM	0	7	0	0	7	0	0	0	0	0	0	15	2	0	17	2	0	12	0	14	38
08:15 AM	5	12	0	0	17	0	0	0	0	0	0	16	0	0	16	1	0	5	0	6	39
08:30 AM	3	17	0	0	20	0	0	0	0	0	0	9	3	0	12	1	0	2	0	3	35
08:45 AM	2	10	0	0	12	0	0	0	0	0	0	11	3	0	14	1	0	2	1	4	30
Total Volume	10	46	0	0	56	0	0	0	0	0	0	51	8	0	59	5	0	21	1	27	142
% App. Total	17.9	82.1	0	0		0	0	0	0	0	0	86.4	13.6	0		18.5	0	77.8	3.7		
PHF	.500	.676	.000	.000	.700	.000	.000	.000	.000	.000	.000	.797	.667	.000	.868	.625	.000	.438	.250	.482	.910

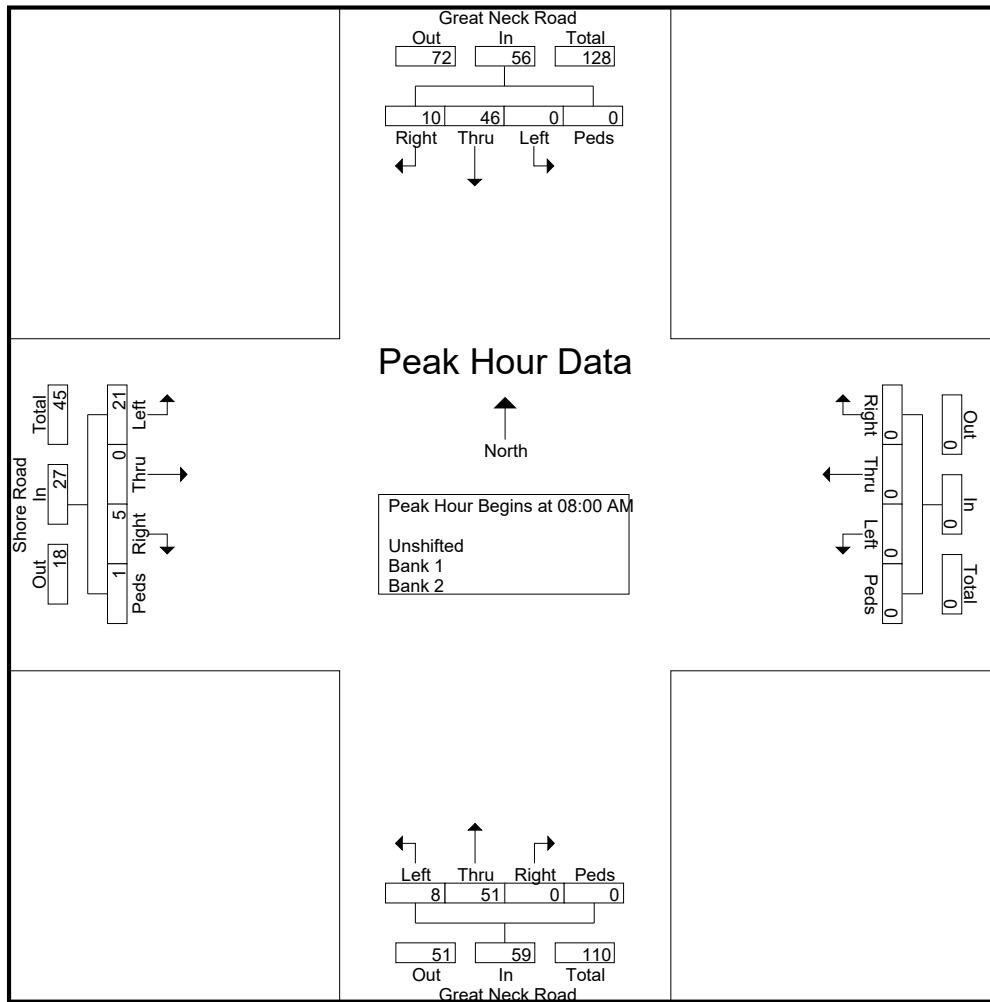

Connecticut Counts LLC

Kensington, Connecticut 06037
(860) 828-1693

Shore Road at Great Neck Road
Waterford, Connecticut

File Name : 15197
Site Code : 15197
Start Date : 2/8/2017
Page No : 3

Start Time	Great Neck Road From North					From East					Great Neck Road From South					Shore Road From West					Int. Total
	Right	Thru	Left	Peds	App. Total	Right	Thru	Left	Peds	App. Total	Right	Thru	Left	Peds	App. Total	Right	Thru	Left	Peds	App. Total	

Peak Hour Analysis From 07:00 AM to 08:45 AM - Peak 1 of 1

Peak Hour for Each Approach Begins at:

	08:00 AM					07:00 AM					08:00 AM					07:15 AM				
+0 mins.	0	7	0	0	7	0	0	0	0	0	0	15	2	0	17	0	0	6	0	6
+15 mins.	5	12	0	0	17	0	0	0	0	0	0	16	0	0	16	4	0	3	0	7
+30 mins.	3	17	0	0	20	0	0	0	0	0	0	9	3	0	12	3	0	1	0	4
+45 mins.	2	10	0	0	12	0	0	0	0	0	0	11	3	0	14	2	0	12	0	14
Total Volume	10	46	0	0	56	0	0	0	0	0	0	51	8	0	59	9	0	22	0	31
% App. Total	17.9	82.1	0	0		0	0	0	0		0	86.4	13.6	0		29	0	71	0	
PHF	.500	.676	.000	.000	.700	.000	.000	.000	.000	.000	.000	.797	.667	.000	.868	.563	.000	.458	.000	.554

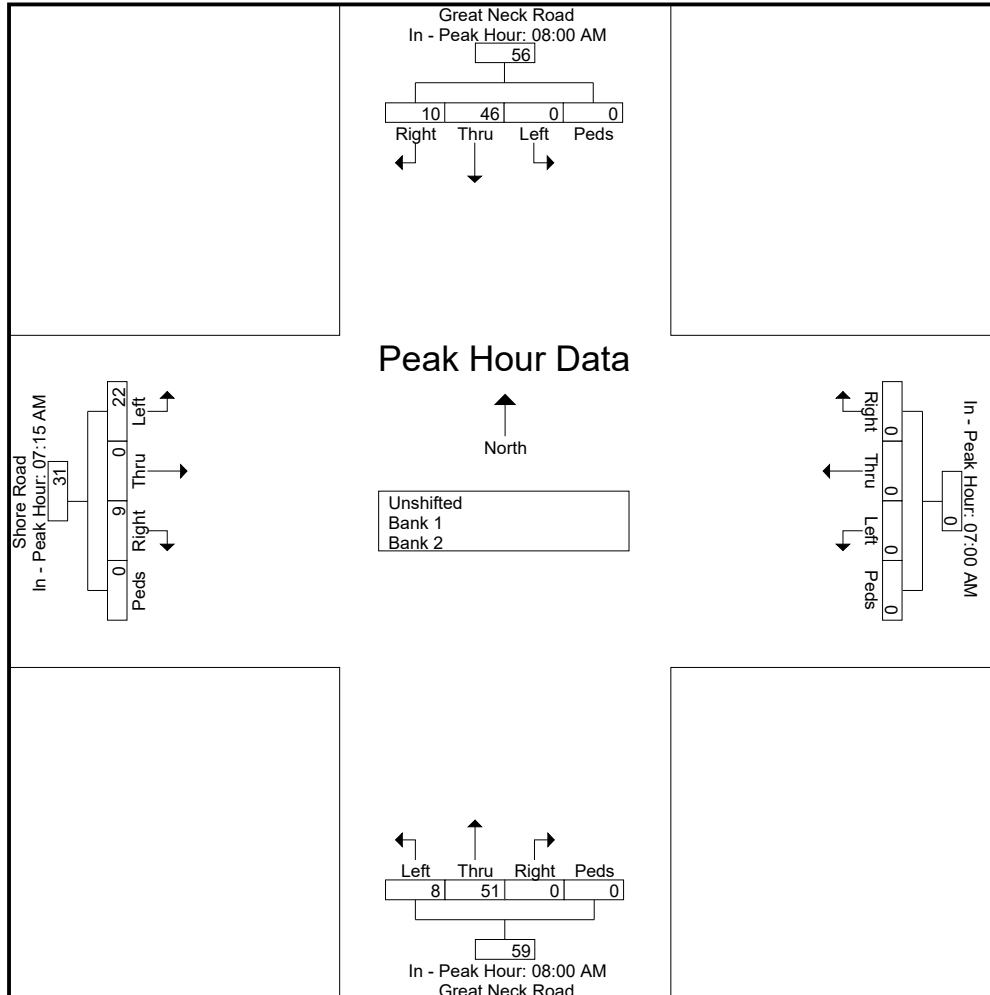

Connecticut Counts LLC
Kensington, Connecticut 06037
(860) 828-1693

Shore Road at Great Neck Road
Waterford, Connecticut

File Name : 15198
Site Code : 15198
Start Date : 2/8/2017
Page No : 1

Groups Printed- Unshifted - Bank 1 - Bank 2

Start Time	Great Neck Road From North					From East					Great Neck Road From South					Shore Road From West					Int. Total
	Right	Thru	Left	Peds	App. Total	Right	Thru	Left	Peds	App. Total	Right	Thru	Left	Peds	App. Total	Right	Thru	Left	Peds	App. Total	
04:00 PM	6	11	0	0	17	0	0	0	0	0	0	8	2	0	10	3	0	0	2	5	32
04:15 PM	4	12	0	0	16	0	0	0	0	0	0	16	4	0	20	5	0	0	2	7	43
04:30 PM	6	8	0	0	14	0	0	0	0	0	0	5	3	0	8	1	0	5	0	6	28
04:45 PM	3	12	1	1	17	0	0	0	0	0	0	20	4	0	24	3	0	2	0	5	46
Total	19	43	1	1	64	0	0	0	0	0	0	49	13	0	62	12	0	7	4	23	149
05:00 PM	2	12	0	0	14	0	0	0	0	0	0	18	2	0	20	3	0	3	2	8	42
05:15 PM	2	15	0	0	17	0	0	0	0	0	0	19	2	0	21	2	0	3	0	5	43
05:30 PM	3	8	0	0	11	0	0	0	0	0	0	6	2	0	8	1	0	2	0	3	22
05:45 PM	5	10	0	0	15	0	0	0	0	0	0	4	3	0	7	1	0	5	0	6	28
Total	12	45	0	0	57	0	0	0	0	0	0	47	9	0	56	7	0	13	2	22	135
Grand Total	31	88	1	1	121	0	0	0	0	0	0	96	22	0	118	19	0	20	6	45	284
Apprch %	25.6	72.7	0.8	0.8		0	0	0	0	0	0	81.4	18.6	0		42.2	0	44.4	13.3		
Total %	10.9	31	0.4	0.4	42.6	0	0	0	0	0	0	33.8	7.7	0	41.5	6.7	0	7	2.1	15.8	
Unshifted	30	87	1	1	119	0	0	0	0	0	0	95	22	0	117	18	0	20	6	44	280
% Unshifted	96.8	98.9	100	100	98.3	0	0	0	0	0	0	99	100	0	99.2	94.7	0	100	100	97.8	98.6
Bank 1	0	1	0	0	1	0	0	0	0	0	0	0	0	0	0	0	0	0	0	0	1
% Bank 1	0	1.1	0	0	0.8	0	0	0	0	0	0	0	0	0	0	0	0	0	0	0	0.4
Bank 2	1	0	0	0	1	0	0	0	0	0	0	1	0	0	1	1	0	0	0	1	3
% Bank 2	3.2	0	0	0	0.8	0	0	0	0	0	0	1	0	0	0.8	5.3	0	0	0	2.2	1.1

Connecticut Counts LLC

Kensington, Connecticut 06037
(860) 828-1693

Shore Road at Great Neck Road
Waterford, Connecticut

File Name : 15198
Site Code : 15198
Start Date : 2/8/2017
Page No : 2

Start Time	Great Neck Road From North					From East					Great Neck Road From South					Shore Road From West					Int. Total
	Right	Thru	Left	Peds	App. Total	Right	Thru	Left	Peds	App. Total	Right	Thru	Left	Peds	App. Total	Right	Thru	Left	Peds	App. Total	
Peak Hour Analysis From 04:00 PM to 05:45 PM - Peak 1 of 1																					
Peak Hour for Entire Intersection Begins at 04:15 PM																					
04:15 PM	4	12	0	0	16	0	0	0	0	0	0	16	4	0	20	5	0	0	2	7	43
04:30 PM	6	8	0	0	14	0	0	0	0	0	0	5	3	8	1	0	5	0	6	28	
04:45 PM	3	12	1	1	17	0	0	0	0	0	0	20	4	24	3	0	2	0	5	46	
05:00 PM	2	12	0	0	14	0	0	0	0	0	0	18	2	20	3	0	3	2	8	42	
Total Volume	15	44	1	1	61	0	0	0	0	0	0	59	13	72	12	0	10	4	26	159	
% App. Total	24.6	72.1	1.6	1.6		0	0	0	0	0	0	81.9	18.1	0	46.2	0	38.5	15.4			
PHF	.625	.917	.250	.250	.897	.000	.000	.000	.000	.000	.000	.738	.813	.750	.600	.000	.500	.500	.813	.864	

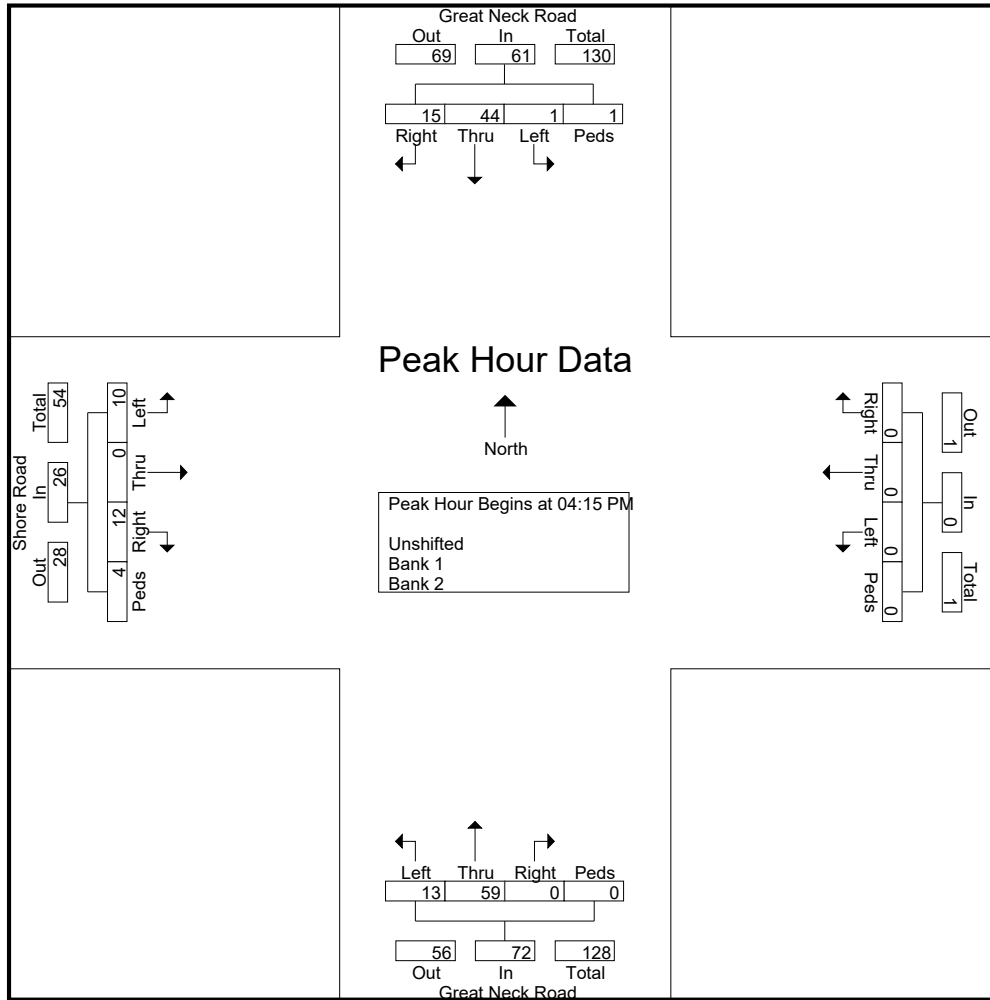

Connecticut Counts LLC

Kensington, Connecticut 06037
(860) 828-1693

Shore Road at Great Neck Road
Waterford, Connecticut

File Name : 15198
Site Code : 15198
Start Date : 2/8/2017
Page No : 3

Start Time	Great Neck Road From North					From East					Great Neck Road From South					Shore Road From West					Int. Total
	Right	Thru	Left	Peds	App. Total	Right	Thru	Left	Peds	App. Total	Right	Thru	Left	Peds	App. Total	Right	Thru	Left	Peds	App. Total	

Peak Hour Analysis From 04:00 PM to 05:45 PM - Peak 1 of 1

Peak Hour for Each Approach Begins at:

	04:00 PM					04:00 PM					04:30 PM					04:15 PM				
+0 mins.	6	11	0	0	17	0	0	0	0	0	0	5	3	0	8	5	0	0	2	7
+15 mins.	4	12	0	0	16	0	0	0	0	0	0	20	4	0	24	1	0	5	0	6
+30 mins.	6	8	0	0	14	0	0	0	0	0	0	18	2	0	20	3	0	2	0	5
+45 mins.	3	12	1	1	17	0	0	0	0	0	0	19	2	0	21	3	0	3	2	8
Total Volume	19	43	1	1	64	0	0	0	0	0	0	62	11	0	73	12	0	10	4	26
% App. Total	29.7	67.2	1.6	1.6		0	0	0	0		0	84.9	15.1	0		46.2	0	38.5	15.4	
PHF	.792	.896	.250	.250	.941	.000	.000	.000	.000	.000	.000	.775	.688	.000	.760	.600	.000	.500	.500	.813

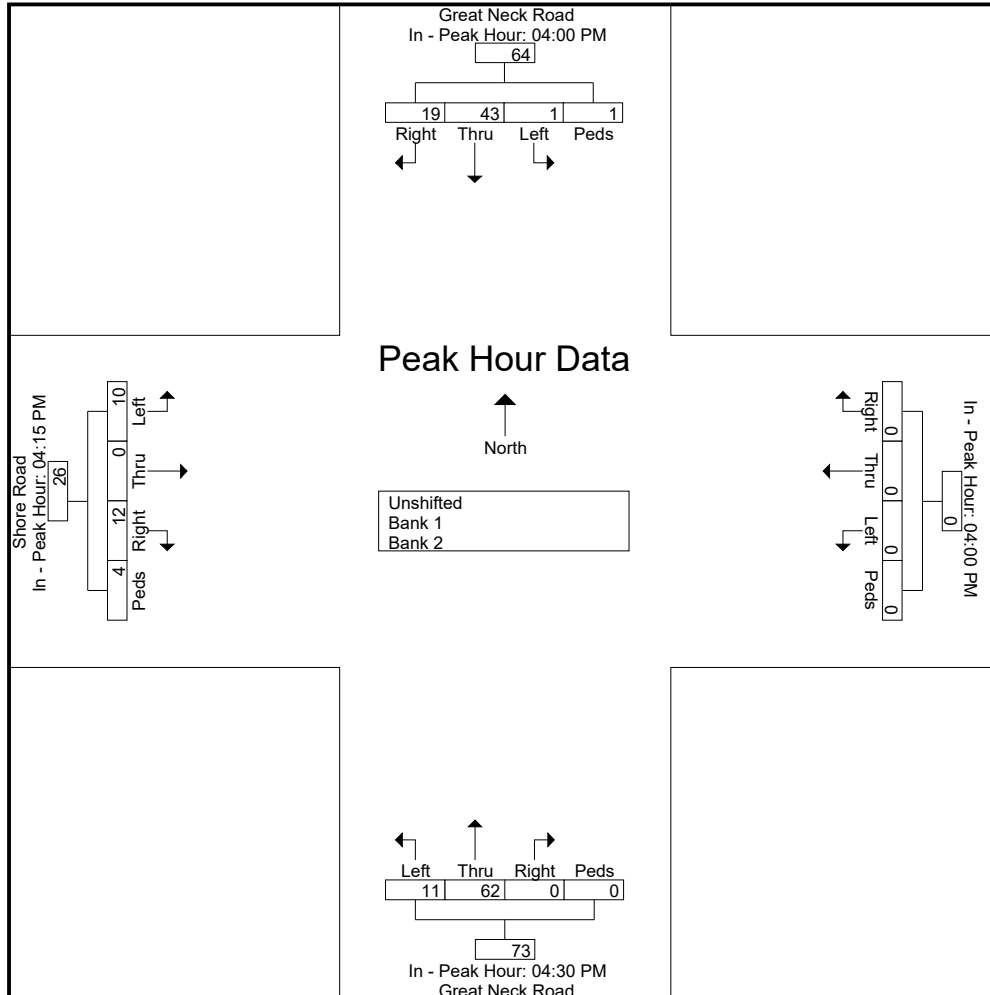

Connecticut Counts LLC
Kensington, Connecticut 06037
(860) 828-1693

Shore Road at Jordan Cove Road
 Waterford, Connecticut

File Name : 15199
 Site Code : 15199
 Start Date : 2/8/2017
 Page No : 1

Groups Printed- Unshifted - Bank 1 - Bank 2

Start Time	Shore Road From North					From East					Shore Road From South					Jordan Cove Road From West					Int. Total
	Right	Thru	Left	Peds	App. Total	Right	Thru	Left	Peds	App. Total	Right	Thru	Left	Peds	App. Total	Right	Thru	Left	Peds	App. Total	
07:00 AM	3	2	0	0	5	1	0	0	0	1	0	3	6	0	9	2	0	3	0	5	20
07:15 AM	5	0	1	0	6	0	0	0	0	0	0	5	4	0	9	3	0	2	0	5	20
07:30 AM	4	0	0	0	4	0	0	0	0	0	0	5	15	0	20	4	0	3	0	7	31
07:45 AM	4	3	0	0	7	0	0	0	0	0	0	3	8	0	11	10	0	1	0	11	29
Total	16	5	1	0	22	1	0	0	0	1	0	16	33	0	49	19	0	9	0	28	100
08:00 AM	10	0	0	0	10	0	1	0	0	1	0	4	14	0	18	13	0	1	0	14	43
08:15 AM	3	0	0	0	3	0	0	0	0	0	0	1	8	0	9	3	0	1	0	4	16
08:30 AM	5	0	0	0	5	0	0	0	0	0	0	1	9	0	10	5	0	3	0	8	23
08:45 AM	5	1	0	0	6	0	0	0	0	0	0	2	10	0	12	5	0	4	0	9	27
Total	23	1	0	0	24	0	1	0	0	1	0	8	41	0	49	26	0	9	0	35	109
Grand Total	39	6	1	0	46	1	1	0	0	2	0	24	74	0	98	45	0	18	0	63	209
Apprch %	84.8	13	2.2	0		50	50	0	0		0	24.5	75.5	0		71.4	0	28.6	0		
Total %	18.7	2.9	0.5	0	22	0.5	0.5	0	0	1	0	11.5	35.4	0	46.9	21.5	0	8.6	0	30.1	
Unshifted	37	6	1	0	44	1	1	0	0	2	0	24	71	0	95	43	0	17	0	60	201
% Unshifted	94.9	100	100	0	95.7	100	100	0	0	100	0	100	95.9	0	96.9	95.6	0	94.4	0	95.2	96.2
Bank 1	0	0	0	0	0	0	0	0	0	0	0	0	0	0	0	0	0	0	0	0	0
% Bank 1	0	0	0	0	0	0	0	0	0	0	0	0	0	0	0	0	0	0	0	0	0
Bank 2	2	0	0	0	2	0	0	0	0	0	0	0	3	0	3	2	0	1	0	3	8
% Bank 2	5.1	0	0	0	4.3	0	0	0	0	0	0	0	4.1	0	3.1	4.4	0	5.6	0	4.8	3.8

Connecticut Counts LLC

Kensington, Connecticut 06037
(860) 828-1693

Shore Road at Jordan Cove Road
Waterford, Connecticut

File Name : 15199
Site Code : 15199
Start Date : 2/8/2017
Page No : 2

Start Time	Shore Road From North					From East					Shore Road From South					Jordan Cove Road From West					Int. Total
	Right	Thru	Left	Peds	App. Total	Right	Thru	Left	Peds	App. Total	Right	Thru	Left	Peds	App. Total	Right	Thru	Left	Peds	App. Total	
Peak Hour Analysis From 07:00 AM to 08:45 AM - Peak 1 of 1																					
Peak Hour for Entire Intersection Begins at 07:15 AM																					
07:15 AM	5	0	1	0	6	0	0	0	0	0	0	5	4	0	9	3	0	2	0	5	20
07:30 AM	4	0	0	0	4	0	0	0	0	0	0	5	15	0	20	4	0	3	0	7	31
07:45 AM	4	3	0	0	7	0	0	0	0	0	0	3	8	0	11	10	0	1	0	11	29
08:00 AM	10	0	0	0	10	0	1	0	0	1	0	4	14	0	18	13	0	1	0	14	43
Total Volume	23	3	1	0	27	0	1	0	0	1	0	17	41	0	58	30	0	7	0	37	123
% App. Total	85.2	11.1	3.7	0		0	100	0	0		0	29.3	70.7	0		81.1	0	18.9	0		
PHF	.575	.250	.250	.000	.675	.000	.250	.000	.000	.250	.000	.850	.683	.000	.725	.577	.000	.583	.000	.661	.715

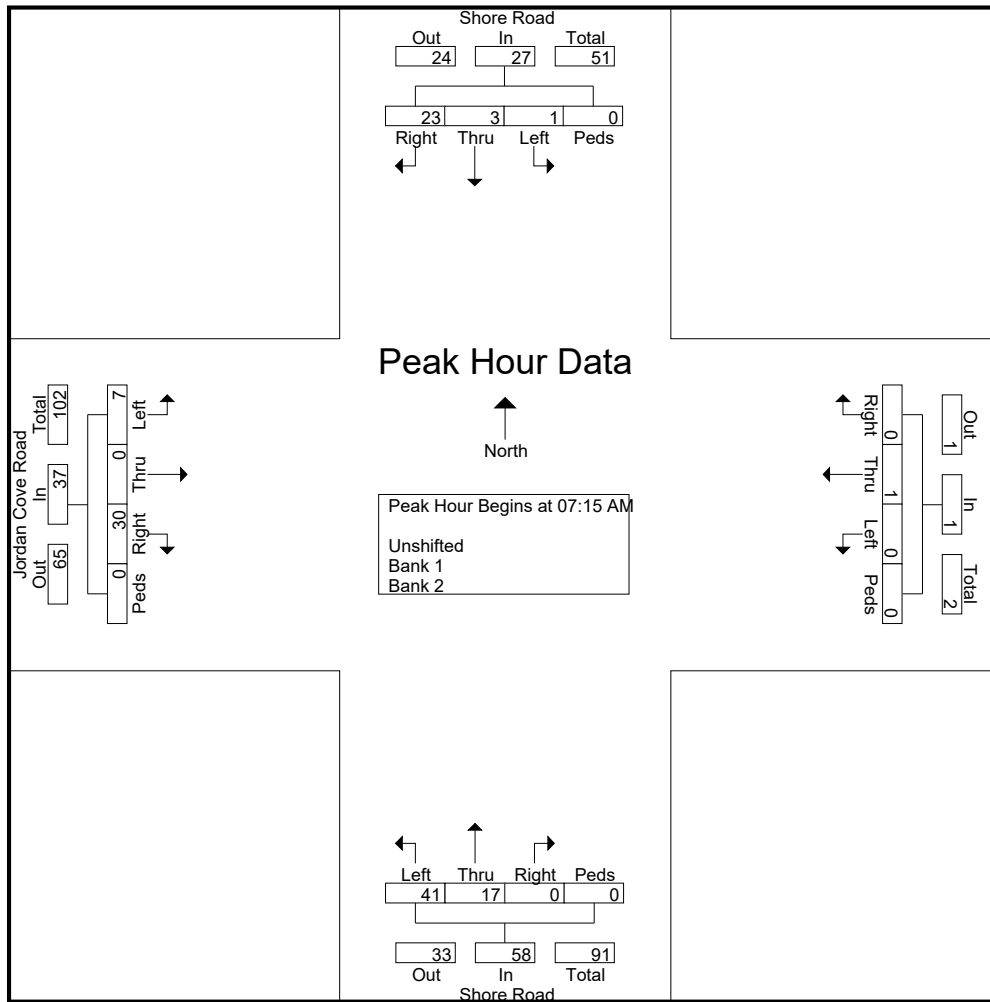

Connecticut Counts LLC

Kensington, Connecticut 06037
(860) 828-1693

Shore Road at Jordan Cove Road
Waterford, Connecticut

File Name : 15199
Site Code : 15199
Start Date : 2/8/2017
Page No : 3

Start Time	Shore Road From North					From East					Shore Road From South					Jordan Cove Road From West					Int. Total
	Right	Thru	Left	Peds	App. Total	Right	Thru	Left	Peds	App. Total	Right	Thru	Left	Peds	App. Total	Right	Thru	Left	Peds	App. Total	

Peak Hour Analysis From 07:00 AM to 08:45 AM - Peak 1 of 1

Peak Hour for Each Approach Begins at:

	07:15 AM					07:00 AM					07:15 AM					07:15 AM				
+0 mins.	5	0	1	0	6	1	0	0	0	1	0	5	4	0	9	3	0	2	0	5
+15 mins.	4	0	0	0	4	0	0	0	0	0	0	3	15	0	20	4	0	3	0	7
+30 mins.	4	3	0	0	7	0	0	0	0	0	0	4	8	0	11	10	0	1	0	11
+45 mins.	10	0	0	0	10	0	0	0	0	0	0	4	14	0	18	13	0	1	0	14
Total Volume	23	3	1	0	27	1	0	0	0	1	0	17	41	0	58	30	0	7	0	37
% App. Total	85.2	11.1	3.7	0		100	0	0	0		0	29.3	70.7	0		81.1	0	18.9	0	
PHF	.575	.250	.250	.000	.675	.250	.000	.000	.000	.250	.000	.850	.683	.000	.725	.577	.000	.583	.000	.661

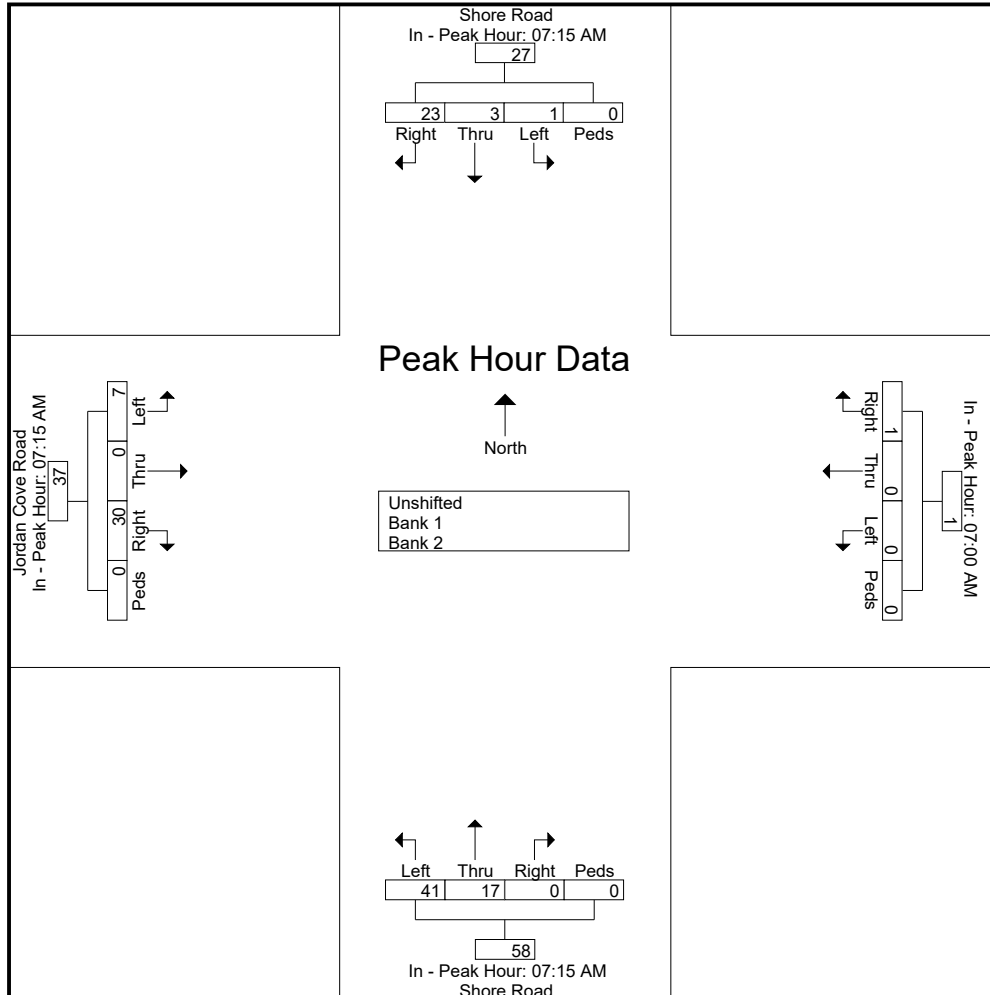

Connecticut Counts LLC
Kensington, Connecticut 06037
(860) 828-1693

Shore Road at Jordan Cove Road
 Waterford, Connecticut

File Name : 15200
 Site Code : 15200
 Start Date : 2/8/2017
 Page No : 1

Groups Printed- Unshifted - Bank 1 - Bank 2

Start Time	Shore Road From North					From East					Shore Road From South					Jordan Cove Road From West					Int. Total
	Right	Thru	Left	Peds	App. Total	Right	Thru	Left	Peds	App. Total	Right	Thru	Left	Peds	App. Total	Right	Thru	Left	Peds	App. Total	
04:00 PM	9	4	0	0	13	0	0	0	0	0	0	5	12	0	17	11	0	7	0	18	48
04:15 PM	8	9	0	0	17	0	0	0	0	0	0	5	9	0	14	10	0	5	0	15	46
04:30 PM	5	8	0	0	13	0	0	0	0	0	0	8	10	0	18	13	0	6	0	19	50
04:45 PM	5	7	0	0	12	0	0	0	0	0	0	4	14	0	18	26	0	4	0	30	60
Total	27	28	0	0	55	0	0	0	0	0	0	22	45	0	67	60	0	22	0	82	204
05:00 PM	1	4	0	0	5	0	0	0	0	0	0	0	7	0	7	15	0	11	0	26	38
05:15 PM	2	7	0	0	9	0	0	0	0	0	0	2	15	1	18	13	0	6	1	20	47
05:30 PM	6	5	0	0	11	0	0	0	0	0	0	3	10	0	13	7	0	8	0	15	39
05:45 PM	5	4	0	0	9	0	0	0	0	0	0	4	8	0	12	16	0	3	0	19	40
Total	14	20	0	0	34	0	0	0	0	0	0	9	40	1	50	51	0	28	1	80	164
Grand Total	41	48	0	0	89	0	0	0	0	0	0	31	85	1	117	111	0	50	1	162	368
Apprch %	46.1	53.9	0	0		0	0	0	0		0	26.5	72.6	0.9		68.5	0	30.9	0.6		
Total %	11.1	13	0	0	24.2	0	0	0	0	0	0	8.4	23.1	0.3	31.8	30.2	0	13.6	0.3	44	
Unshifted	40	48	0	0	88	0	0	0	0	0	0	30	85	1	116	111	0	50	1	162	366
% Unshifted	97.6	100	0	0	98.9	0	0	0	0	0	0	96.8	100	100	99.1	100	0	100	100	100	99.5
Bank 1	1	0	0	0	1	0	0	0	0	0	0	0	0	0	0	0	0	0	0	0	1
% Bank 1	2.4	0	0	0	1.1	0	0	0	0	0	0	0	0	0	0	0	0	0	0	0	0.3
Bank 2	0	0	0	0	0	0	0	0	0	0	0	1	0	0	1	0	0	0	0	0	1
% Bank 2	0	0	0	0	0	0	0	0	0	0	0	3.2	0	0	0.9	0	0	0	0	0	0.3

Connecticut Counts LLC

Kensington, Connecticut 06037
(860) 828-1693

Shore Road at Jordan Cove Road
Waterford, Connecticut

File Name : 15200
Site Code : 15200
Start Date : 2/8/2017
Page No : 2

Start Time	Shore Road From North					From East					Shore Road From South					Jordan Cove Road From West					Int. Total
	Right	Thru	Left	Peds	App. Total	Right	Thru	Left	Peds	App. Total	Right	Thru	Left	Peds	App. Total	Right	Thru	Left	Peds	App. Total	
Peak Hour Analysis From 04:00 PM to 05:45 PM - Peak 1 of 1																					
Peak Hour for Entire Intersection Begins at 04:00 PM																					
04:00 PM	9	4	0	0	13	0	0	0	0	0	0	5	12	0	17	11	0	7	0	18	48
04:15 PM	8	9	0	0	17	0	0	0	0	0	0	5	9	0	14	10	0	5	0	15	46
04:30 PM	5	8	0	0	13	0	0	0	0	0	0	8	10	0	18	13	0	6	0	19	50
04:45 PM	5	7	0	0	12	0	0	0	0	0	0	4	14	0	18	26	0	4	0	30	60
Total Volume	27	28	0	0	55	0	0	0	0	0	0	22	45	0	67	60	0	22	0	82	204
% App. Total	49.1	50.9	0	0		0	0	0	0	0	0	32.8	67.2	0		73.2	0	26.8	0		
PHF	.750	.778	.000	.000	.809	.000	.000	.000	.000	.000	.000	.688	.804	.000	.931	.577	.000	.786	.000	.683	.850

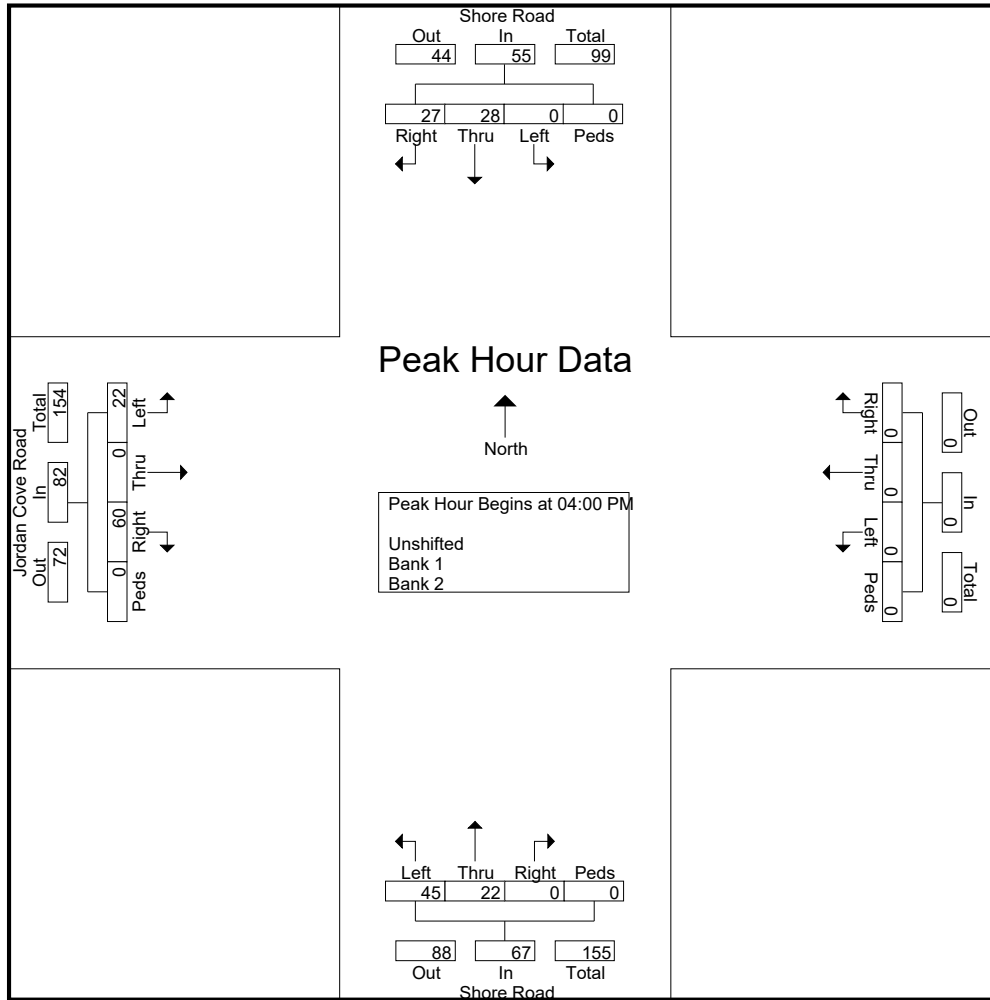

Connecticut Counts LLC

Kensington, Connecticut 06037
(860) 828-1693

Shore Road at Jordan Cove Road
Waterford, Connecticut

File Name : 15200
Site Code : 15200
Start Date : 2/8/2017
Page No : 3

Start Time	Shore Road From North					From East					Shore Road From South					Jordan Cove Road From West					Int. Total
	Right	Thru	Left	Peds	App. Total	Right	Thru	Left	Peds	App. Total	Right	Thru	Left	Peds	App. Total	Right	Thru	Left	Peds	App. Total	

Peak Hour Analysis From 04:00 PM to 05:45 PM - Peak 1 of 1

Peak Hour for Each Approach Begins at:

	04:00 PM					04:00 PM					04:00 PM					04:30 PM				
+0 mins.	9	4	0	0	13	0	0	0	0	0	0	5	12	0	17	13	0	6	0	19
+15 mins.	8	9	0	0	17	0	0	0	0	0	0	5	9	0	14	26	0	4	0	30
+30 mins.	5	8	0	0	13	0	0	0	0	0	0	8	10	0	18	15	0	11	0	26
+45 mins.	5	7	0	0	12	0	0	0	0	0	0	4	14	0	18	13	0	6	1	20
Total Volume	27	28	0	0	55	0	0	0	0	0	0	22	45	0	67	67	0	27	1	95
% App. Total	49.1	50.9	0	0		0	0	0	0		0	32.8	67.2	0		70.5	0	28.4	1.1	
PHF	.750	.778	.000	.000	.809	.000	.000	.000	.000	.000	.000	.688	.804	.000	.931	.644	.000	.614	.250	.792

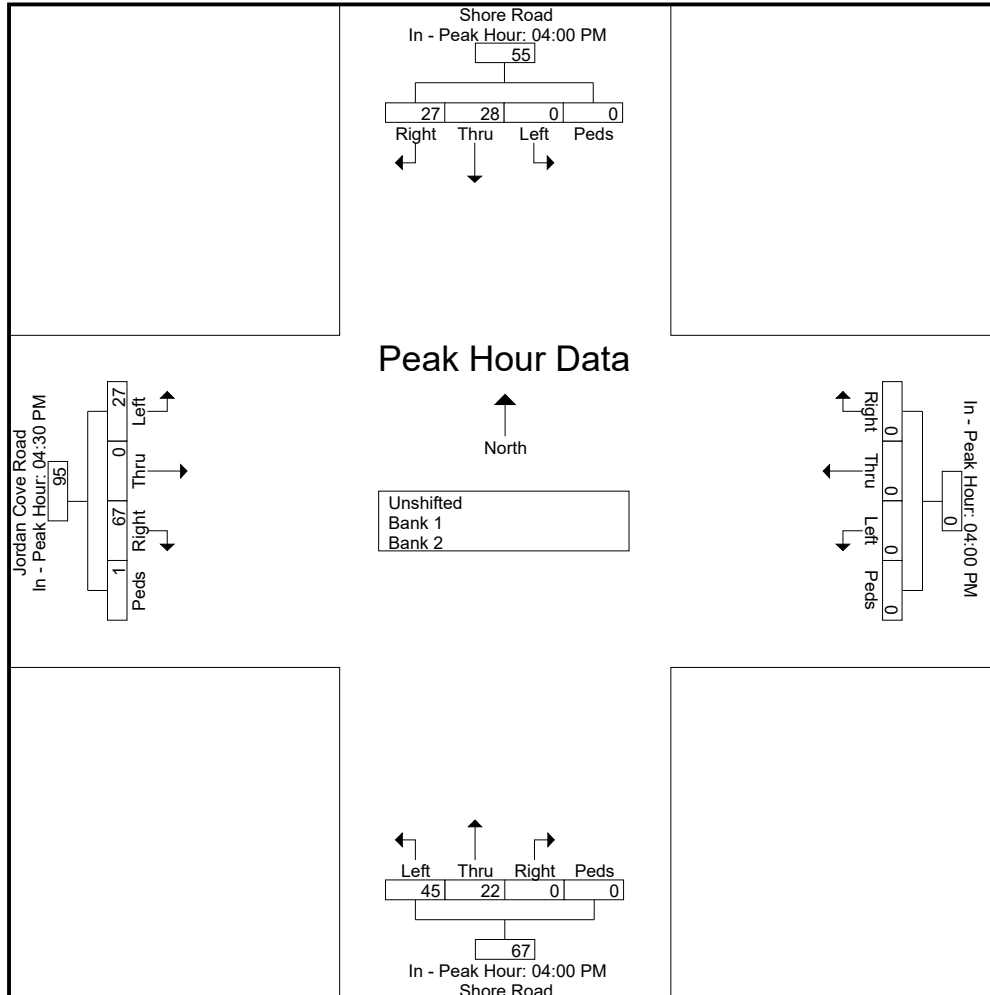

Connecticut Counts LLC
Kensington, Connecticut 06037
(860) 828-1693

Shore Road at Palmer Road
 Waterford, Connecticut

File Name : 15201
 Site Code : 15201
 Start Date : 2/8/2017
 Page No : 1

Groups Printed- Unshifted - Bank 1 - Bank 2

Start Time	Shore Road From North					Palmer Road From East					Shore Road From South					Palmer Road From West					Int. Total
	Right	Thru	Left	Peds	App. Total	Right	Thru	Left	Peds	App. Total	Right	Thru	Left	Peds	App. Total	Right	Thru	Left	Peds	App. Total	
07:00 AM	3	0	0	0	3	0	2	0	0	2	0	0	0	0	0	0	0	0	0	0	5
07:15 AM	2	0	0	0	2	0	1	0	0	1	0	0	0	1	1	0	0	2	0	2	6
07:30 AM	6	0	0	0	6	0	1	0	0	1	0	0	2	1	3	0	2	2	0	4	14
07:45 AM	4	0	0	0	4	0	2	0	0	2	0	1	1	0	2	1	2	4	0	7	15
Total	15	0	0	0	15	0	6	0	0	6	0	1	3	2	6	1	4	8	0	13	40
08:00 AM	3	0	0	0	3	0	4	0	0	4	0	0	0	0	0	0	4	4	0	8	15
08:15 AM	7	1	0	0	8	0	1	0	1	2	0	1	0	1	2	0	1	4	0	5	17
08:30 AM	5	1	0	0	6	0	1	0	0	1	0	0	0	3	3	0	2	2	0	4	14
08:45 AM	4	0	0	0	4	1	2	0	0	3	0	1	2	0	3	2	0	3	0	5	15
Total	19	2	0	0	21	1	8	0	1	10	0	2	2	4	8	2	7	13	0	22	61
Grand Total	34	2	0	0	36	1	14	0	1	16	0	3	5	6	14	3	11	21	0	35	101
Apprch %	94.4	5.6	0	0		6.2	87.5	0	6.2		0	21.4	35.7	42.9		8.6	31.4	60	0		
Total %	33.7	2	0	0	35.6	1	13.9	0	1	15.8	0	3	5	5.9	13.9	3	10.9	20.8	0	34.7	
Unshifted	30	2	0	0	32	1	14	0	1	16	0	3	5	6	14	3	10	20	0	33	95
% Unshifted	88.2	100	0	0	88.9	100	100	0	100	100	0	100	100	100	100	100	90.9	95.2	0	94.3	94.1
Bank 1	0	0	0	0	0	0	0	0	0	0	0	0	0	0	0	0	0	0	0	0	0
% Bank 1	0	0	0	0	0	0	0	0	0	0	0	0	0	0	0	0	0	0	0	0	0
Bank 2	4	0	0	0	4	0	0	0	0	0	0	0	0	0	0	0	1	1	0	2	6
% Bank 2	11.8	0	0	0	11.1	0	0	0	0	0	0	0	0	0	0	0	9.1	4.8	0	5.7	5.9

Connecticut Counts LLC

Kensington, Connecticut 06037
(860) 828-1693

Shore Road at Palmer Road
Waterford, Connecticut

File Name : 15201
Site Code : 15201
Start Date : 2/8/2017
Page No : 2

Start Time	Shore Road From North					Palmer Road From East					Shore Road From South					Palmer Road From West					Int. Total
	Right	Thru	Left	Peds	App. Total	Right	Thru	Left	Peds	App. Total	Right	Thru	Left	Peds	App. Total	Right	Thru	Left	Peds	App. Total	
Peak Hour Analysis From 07:00 AM to 08:45 AM - Peak 1 of 1																					
Peak Hour for Entire Intersection Begins at 07:30 AM																					
07:30 AM	6	0	0	0	6	0	1	0	0	1	0	0	2	1	3	0	2	2	0	4	4
07:45 AM	4	0	0	0	4	0	2	0	0	2	0	1	1	0	2	1	2	4	0	7	15
08:00 AM	3	0	0	0	3	0	4	0	0	4	0	0	0	0	0	0	4	4	0	8	15
08:15 AM	7	1	0	0	8	0	1	0	1	2	0	1	0	1	2	0	1	4	0	5	17
Total Volume	20	1	0	0	21	0	8	0	1	9	0	2	3	2	7	1	9	14	0	24	61
% App. Total	95.2	4.8	0	0		0	88.9	0	11.1		0	28.6	42.9	28.6		4.2	37.5	58.3	0		
PHF	.714	.250	.000	.000	.656	.000	.500	.000	.250	.563	.000	.500	.375	.500	.583	.250	.563	.875	.000	.750	.897

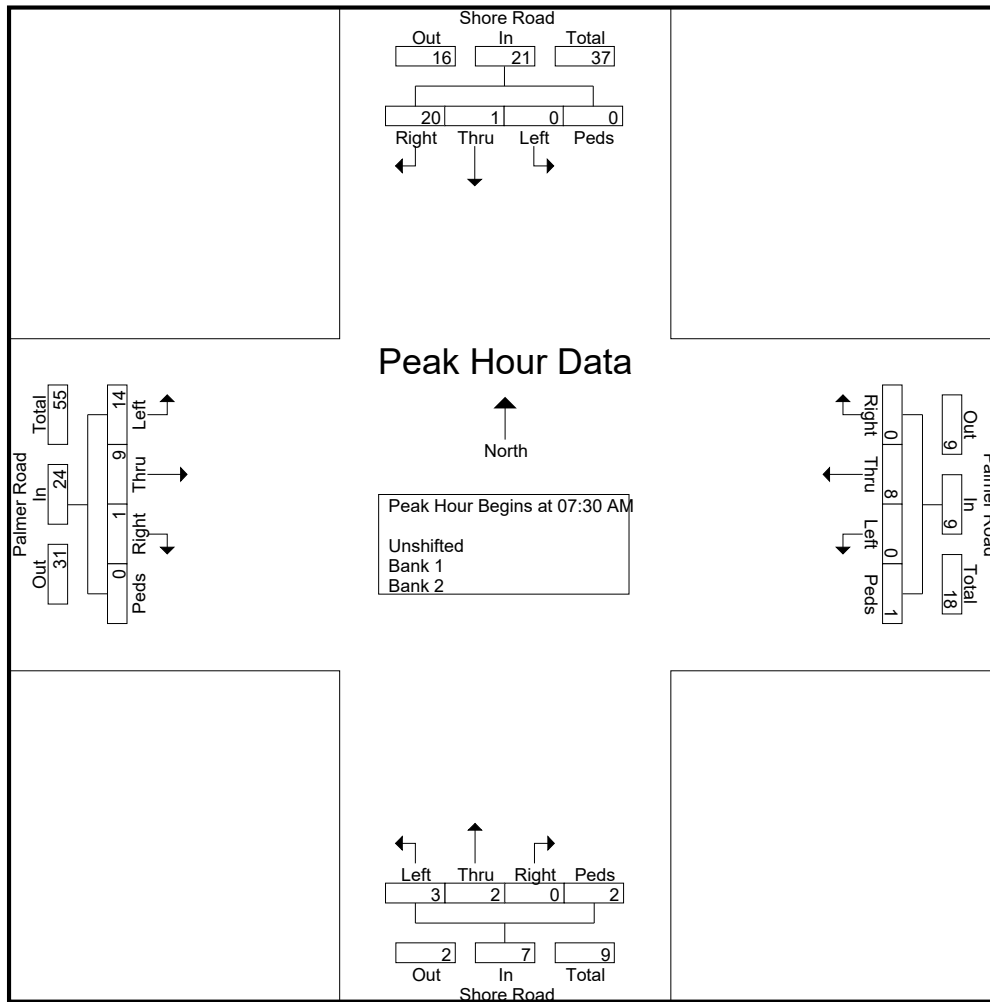

Connecticut Counts LLC

Kensington, Connecticut 06037
(860) 828-1693

Shore Road at Palmer Road
Waterford, Connecticut

File Name : 15201
Site Code : 15201
Start Date : 2/8/2017
Page No : 3

Start Time	Shore Road From North					Palmer Road From East					Shore Road From South					Palmer Road From West					Int. Total
	Right	Thru	Left	Peds	App. Total	Right	Thru	Left	Peds	App. Total	Right	Thru	Left	Peds	App. Total	Right	Thru	Left	Peds	App. Total	

Peak Hour Analysis From 07:00 AM to 08:45 AM - Peak 1 of 1

Peak Hour for Each Approach Begins at:

	07:30 AM					08:00 AM					08:00 AM					07:30 AM				
+0 mins.	6	0	0	0	6	0	4	0	0	4	0	0	0	0	0	0	2	2	0	4
+15 mins.	4	0	0	0	4	0	1	0	1	2	0	1	0	1	2	1	2	4	0	7
+30 mins.	3	0	0	0	3	0	1	0	0	1	0	0	0	3	3	0	4	4	0	8
+45 mins.	7	1	0	0	8	1	2	0	0	3	0	1	2	0	3	0	1	4	0	5
Total Volume	20	1	0	0	21	1	8	0	1	10	0	2	2	4	8	1	9	14	0	24
% App. Total	95.2	4.8	0	0		10	80	0	10		0	25	25	50		4.2	37.5	58.3	0	
PHF	.714	.250	.000	.000	.656	.250	.500	.000	.250	.625	.000	.500	.250	.333	.667	.250	.563	.875	.000	.750

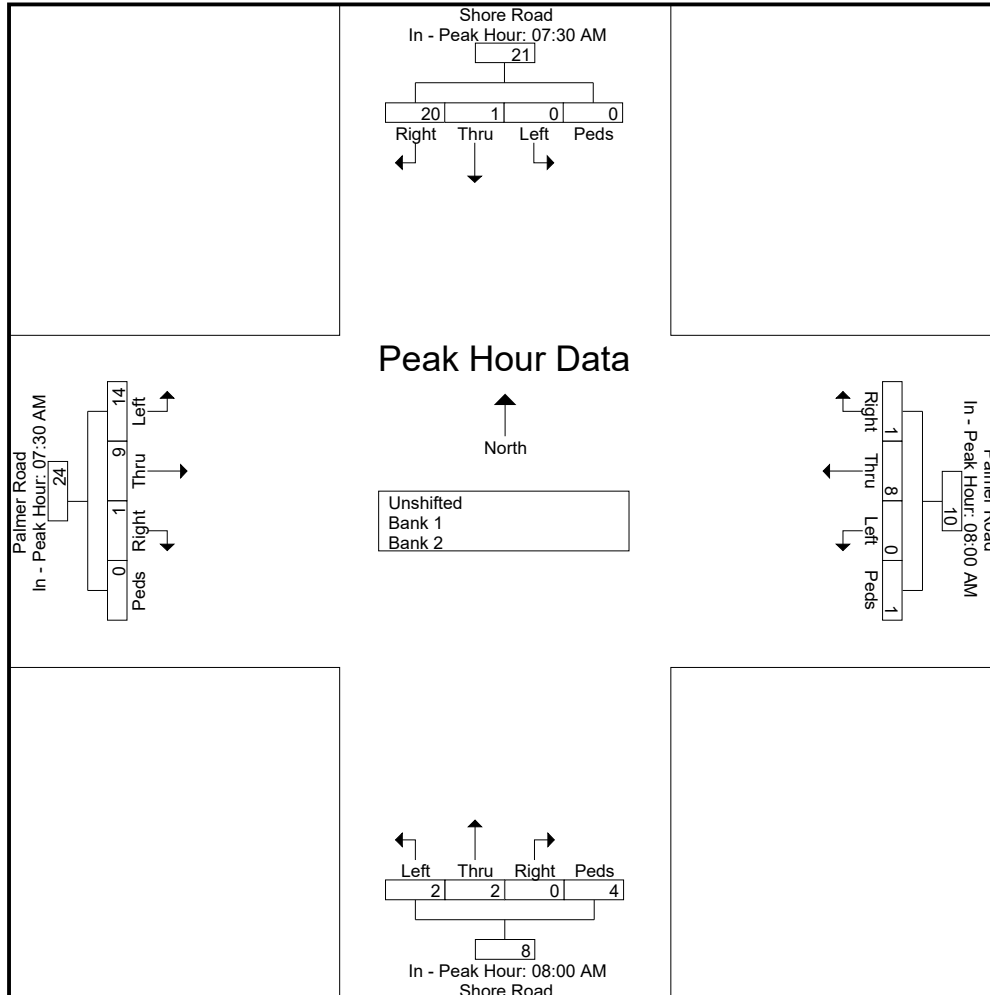

Connecticut Counts LLC

Kensington, Connecticut 06037
(860) 828-1693

Shore Road at Palmer Road
Waterford, Connecticut

File Name : 15202
Site Code : 15202
Start Date : 2/8/2017
Page No : 2

Start Time	Shore Road From North					Palmer Road From East					Shore Road From South					Palmer Road From West					Int. Total
	Right	Thru	Left	Peds	App. Total	Right	Thru	Left	Peds	App. Total	Right	Thru	Left	Peds	App. Total	Right	Thru	Left	Peds	App. Total	
Peak Hour Analysis From 04:00 AM to 05:45 AM - Peak 1 of 1																					
Peak Hour for Entire Intersection Begins at 04:15 AM																					
04:15 AM	7	2	0	1	10	0	5	0	0	5	1	1	0	0	2	1	8	4	0	13	30
04:30 AM	3	0	0	1	4	0	4	0	0	4	0	0	4	0	4	0	2	6	0	8	20
04:45 AM	8	3	1	0	12	0	3	1	0	4	0	2	1	0	3	4	15	8	0	27	46
05:00 AM	6	1	0	1	8	0	2	1	0	3	0	2	0	1	3	3	4	3	0	10	24
Total Volume	24	6	1	3	34	0	14	2	0	16	1	5	5	1	12	8	29	21	0	58	120
% App. Total	70.6	17.6	2.9	8.8		0	87.5	12.5	0		8.3	41.7	41.7	8.3		13.8	50	36.2	0		
PHF	.750	.500	.250	.750	.708	.000	.700	.500	.000	.800	.250	.625	.313	.250	.750	.500	.483	.656	.000	.537	.652

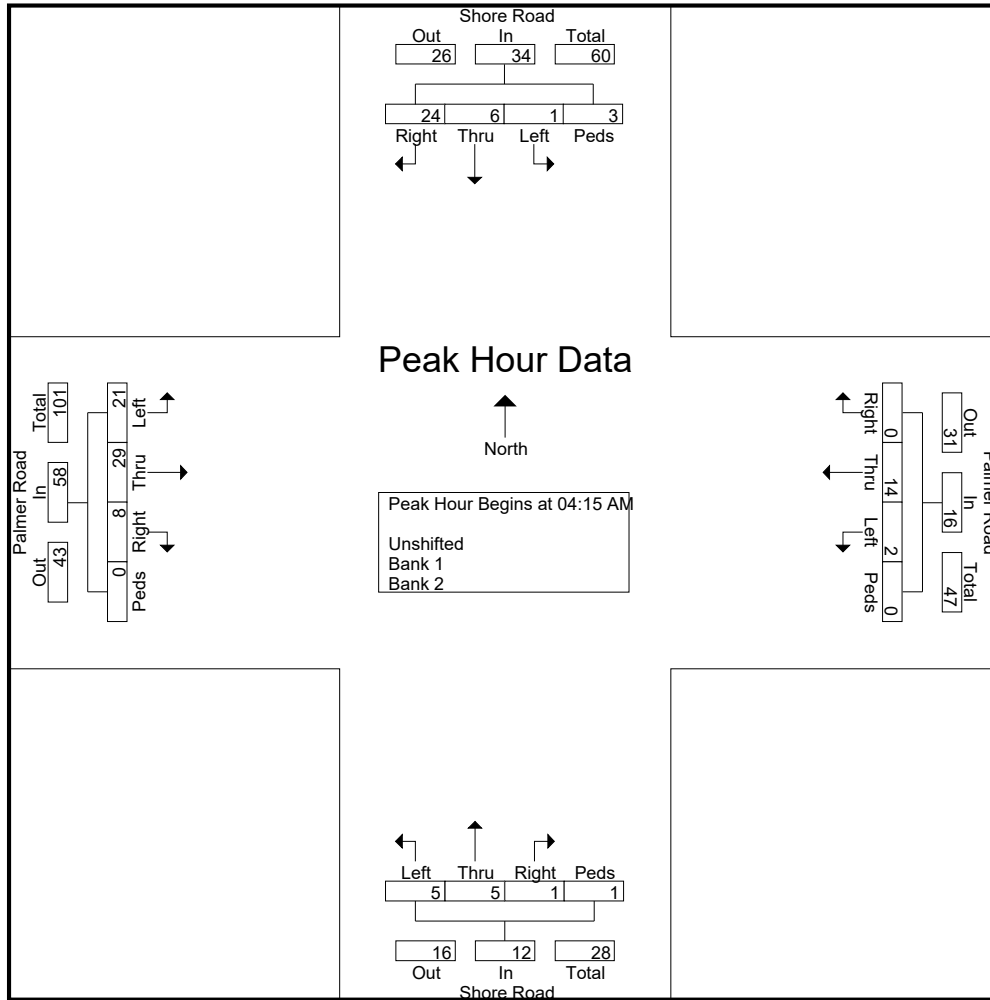

Connecticut Counts LLC

Kensington, Connecticut 06037
(860) 828-1693

Shore Road at Palmer Road
Waterford, Connecticut

File Name : 15202
Site Code : 15202
Start Date : 2/8/2017
Page No : 3

Start Time	Shore Road From North					Palmer Road From East					Shore Road From South					Palmer Road From West					Int. Total
	Right	Thru	Left	Peds	App. Total	Right	Thru	Left	Peds	App. Total	Right	Thru	Left	Peds	App. Total	Right	Thru	Left	Peds	App. Total	

Peak Hour Analysis From 04:00 AM to 05:45 AM - Peak 1 of 1

Peak Hour for Each Approach Begins at:

	04:15 AM					04:00 AM					04:15 AM					04:15 AM				
+0 mins.	7	2	0	1	10	0	3	0	0	3	1	1	0	0	2	1	8	4	0	13
+15 mins.	3	0	0	1	4	0	5	0	0	5	0	0	4	0	4	0	2	6	0	8
+30 mins.	8	3	1	0	12	0	4	0	0	4	0	2	1	0	3	4	15	8	0	27
+45 mins.	6	1	0	1	8	0	3	1	0	4	0	2	0	1	3	3	4	3	0	10
Total Volume	24	6	1	3	34	0	15	1	0	16	1	5	5	1	12	8	29	21	0	58
% App. Total	70.6	17.6	2.9	8.8		0	93.8	6.2	0		8.3	41.7	41.7	8.3		13.8	50	36.2	0	
PHF	.750	.500	.250	.750	.708	.000	.750	.250	.000	.800	.250	.625	.313	.250	.750	.500	.483	.656	.000	.537

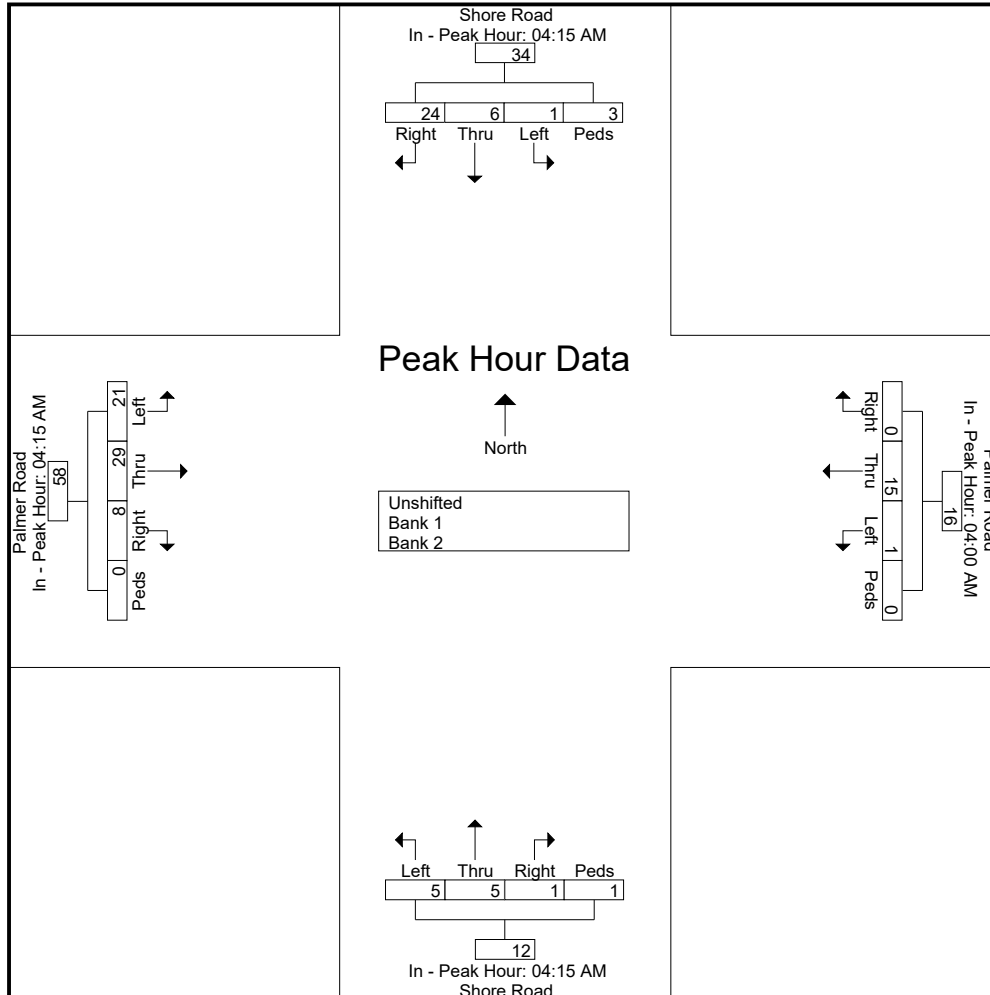

Connecticut Counts LLC

Kensington, Connecticut 06037
(860) 828-1693

File Name : 15322
Site Code : 15322
Start Date : 2/8/2017
Page No : 2

Start Time	Rope Ferry Rd From East				Gardiners Wood Rd From South				Rope Ferry Rd From West				Int. Total
	Thru	Left	Peds	App. Total	Right	Left	Peds	App. Total	Right	Thru	Peds	App. Total	
Peak Hour Analysis From 07:00 AM to 08:45 AM - Peak 1 of 1													
Peak Hour for Entire Intersection Begins at 07:30 AM													
07:30 AM	61	0	0	61	5	22	0	27	6	59	0	65	153
07:45 AM	56	1	0	57	7	10	0	17	11	66	0	77	151
08:00 AM	44	1	0	45	10	16	0	26	8	50	0	58	129
08:15 AM	44	0	0	44	4	12	0	16	5	70	0	75	135
Total Volume	205	2	0	207	26	60	0	86	30	245	0	275	568
% App. Total	99	1	0		30.2	69.8	0		10.9	89.1	0		
PHF	.840	.500	.000	.848	.650	.682	.000	.796	.682	.875	.000	.893	.928

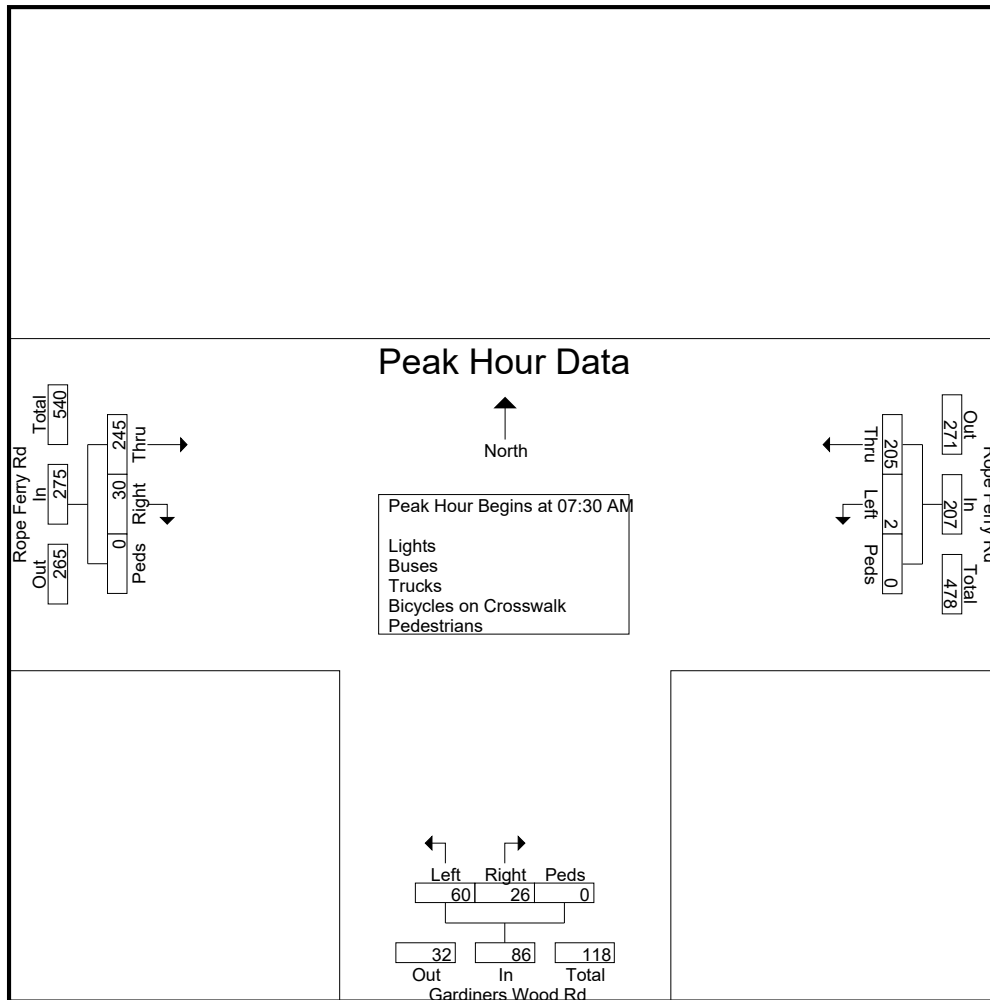

Connecticut Counts LLC

Kensington, Connecticut 06037
(860) 828-1693

File Name : 15322
Site Code : 15322
Start Date : 2/8/2017
Page No : 3

Start Time	Rope Ferry Rd From East				Gardiners Wood Rd From South				Rope Ferry Rd From West				Int. Total
	Thru	Left	Peds	App. Total	Right	Left	Peds	App. Total	Right	Thru	Peds	App. Total	
Peak Hour Analysis From 07:00 AM to 08:45 AM - Peak 1 of 1													
Peak Hour for Each Approach Begins at:													
	07:00 AM				07:15 AM				07:45 AM				
+0 mins.	47	1	0	48	8	9	0	17	11	66	0	77	
+15 mins.	52	2	0	54	5	22	0	27	8	50	0	58	
+30 mins.	61	0	0	61	7	10	0	17	5	70	0	75	
+45 mins.	56	1	0	57	10	16	0	26	6	61	0	67	
Total Volume	216	4	0	220	30	57	0	87	30	247	0	277	
% App. Total	98.2	1.8	0		34.5	65.5	0		10.8	89.2	0		
PHF	.885	.500	.000	.902	.750	.648	.000	.806	.682	.882	.000	.899	

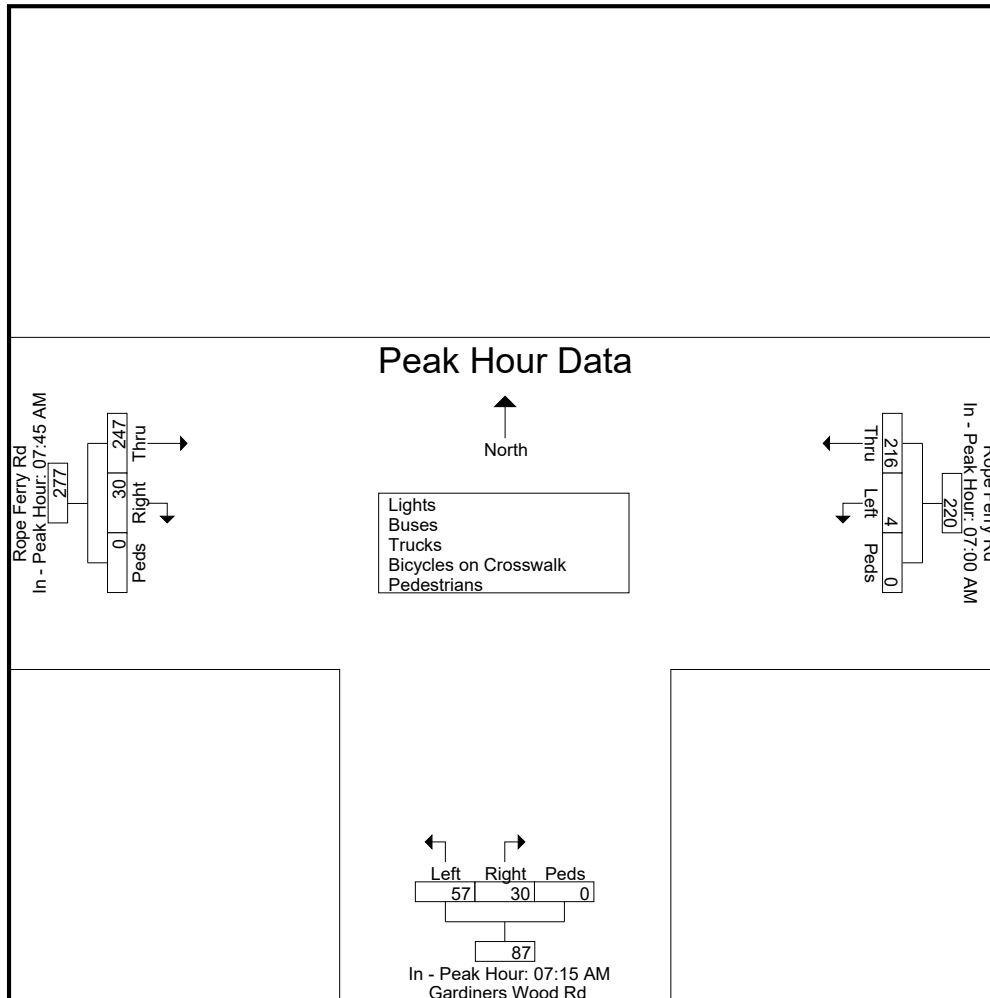

Connecticut Counts LLC
Kensington, Connecticut 06037
(860) 828-1693

Rope Ferry Road at Gardiners Wood Road
 Waterford, Connecticut

File Name : 15323
 Site Code : 15323
 Start Date : 2/8/2017
 Page No : 1

Groups Printed- Lights - Buses - Trucks - Bicycles on Crosswalk - Pedestrians

Start Time	Westbound St. From East				Northbound St. From South				Eastbound St. From West				Int. Total
	Thru	Left	Peds	App. Total	Right	Left	Peds	App. Total	Right	Thru	Peds	App. Total	
04:00 PM	80	10	0	90	5	14	0	19	19	131	1	151	260
04:15 PM	95	6	0	101	7	14	0	21	12	129	0	141	263
04:30 PM	65	10	2	77	7	16	0	23	18	127	0	145	245
04:45 PM	82	11	0	93	10	13	0	23	30	101	0	131	247
Total	322	37	2	361	29	57	0	86	79	488	1	568	1015
05:00 PM	89	12	0	101	7	4	0	11	22	90	0	112	224
05:15 PM	103	4	0	107	10	17	0	27	18	80	0	98	232
05:30 PM	84	7	0	91	4	11	0	15	22	77	0	99	205
05:45 PM	72	11	0	83	4	11	0	15	10	69	0	79	177
Total	348	34	0	382	25	43	0	68	72	316	0	388	838
Grand Total	670	71	2	743	54	100	0	154	151	804	1	956	1853
Apprch %	90.2	9.6	0.3		35.1	64.9	0		15.8	84.1	0.1		
Total %	36.2	3.8	0.1	40.1	2.9	5.4	0	8.3	8.1	43.4	0.1	51.6	
Lights	664	70	0	734	52	99	0	151	150	796	0	946	1831
% Lights	99.1	98.6	0	98.8	96.3	99	0	98.1	99.3	99	0	99	98.8
Buses	2	0	0	2	0	0	0	0	0	1	0	1	3
% Buses	0.3	0	0	0.3	0	0	0	0	0	0.1	0	0.1	0.2
Trucks	4	1	0	5	2	1	0	3	1	7	0	8	16
% Trucks	0.6	1.4	0	0.7	3.7	1	0	1.9	0.7	0.9	0	0.8	0.9
Bicycles on Crosswalk	0	0	0	0	0	0	0	0	0	0	0	0	0
% Bicycles on Crosswalk	0	0	0	0	0	0	0	0	0	0	0	0	0
Pedestrians	0	0	2	2	0	0	0	0	0	0	1	1	3
% Pedestrians	0	0	100	0.3	0	0	0	0	0	0	100	0.1	0.2

Connecticut Counts LLC

Kensington, Connecticut 06037
(860) 828-1693

File Name : 15323
Site Code : 15323
Start Date : 2/8/2017
Page No : 2

Start Time	Westbound St. From East				Northbound St. From South				Eastbound St. From West				Int. Total
	Thru	Left	Peds	App. Total	Right	Left	Peds	App. Total	Right	Thru	Peds	App. Total	
Peak Hour Analysis From 04:00 PM to 05:45 PM - Peak 1 of 1													
Peak Hour for Entire Intersection Begins at 04:00 PM													
04:00 PM	80	10	0	90	5	14	0	19	19	131	1	151	260
04:15 PM	95	6	0	101	7	14	0	21	12	129	0	141	263
04:30 PM	65	10	2	77	7	16	0	23	18	127	0	145	245
04:45 PM	82	11	0	93	10	13	0	23	30	101	0	131	247
Total Volume	322	37	2	361	29	57	0	86	79	488	1	568	1015
% App. Total	89.2	10.2	0.6		33.7	66.3	0		13.9	85.9	0.2		
PHF	.847	.841	.250	.894	.725	.891	.000	.935	.658	.931	.250	.940	.965

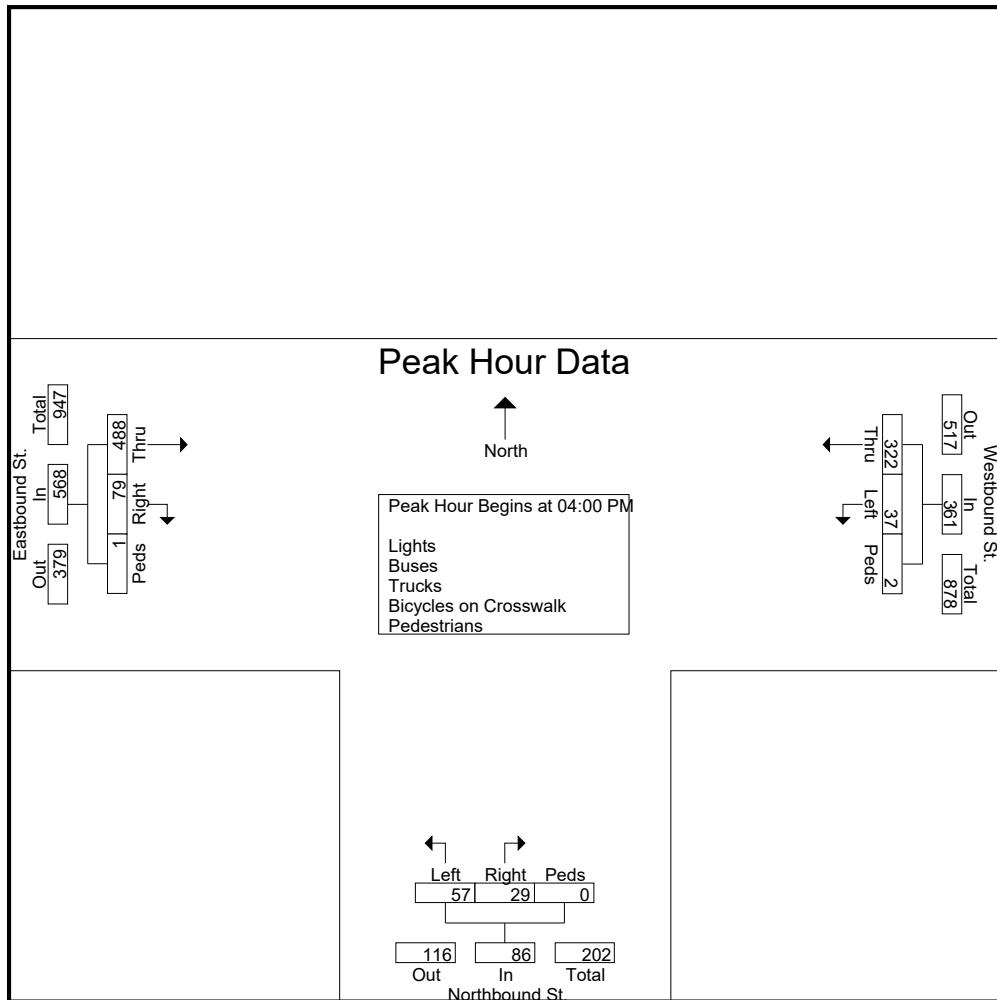

Connecticut Counts LLC

Kensington, Connecticut 06037

(860) 828-1693

File Name : 15323
 Site Code : 15323
 Start Date : 2/8/2017
 Page No : 3

Start Time	Westbound St. From East				Northbound St. From South				Eastbound St. From West				Int. Total
	Thru	Left	Peds	App. Total	Right	Left	Peds	App. Total	Right	Thru	Peds	App. Total	
Peak Hour Analysis From 04:00 PM to 05:45 PM - Peak 1 of 1													
Peak Hour for Each Approach Begins at:													
	04:45 PM				04:00 PM				04:00 PM				
+0 mins.	82	11	0	93	5	14	0	19	19	131	1	151	
+15 mins.	89	12	0	101	7	14	0	21	12	129	0	141	
+30 mins.	103	4	0	107	7	16	0	23	18	127	0	145	
+45 mins.	84	7	0	91	10	13	0	23	30	101	0	131	
Total Volume	358	34	0	392	29	57	0	86	79	488	1	568	
% App. Total	91.3	8.7	0		33.7	66.3	0		13.9	85.9	0.2		
PHF	.869	.708	.000	.916	.725	.891	.000	.935	.658	.931	.250	.940	

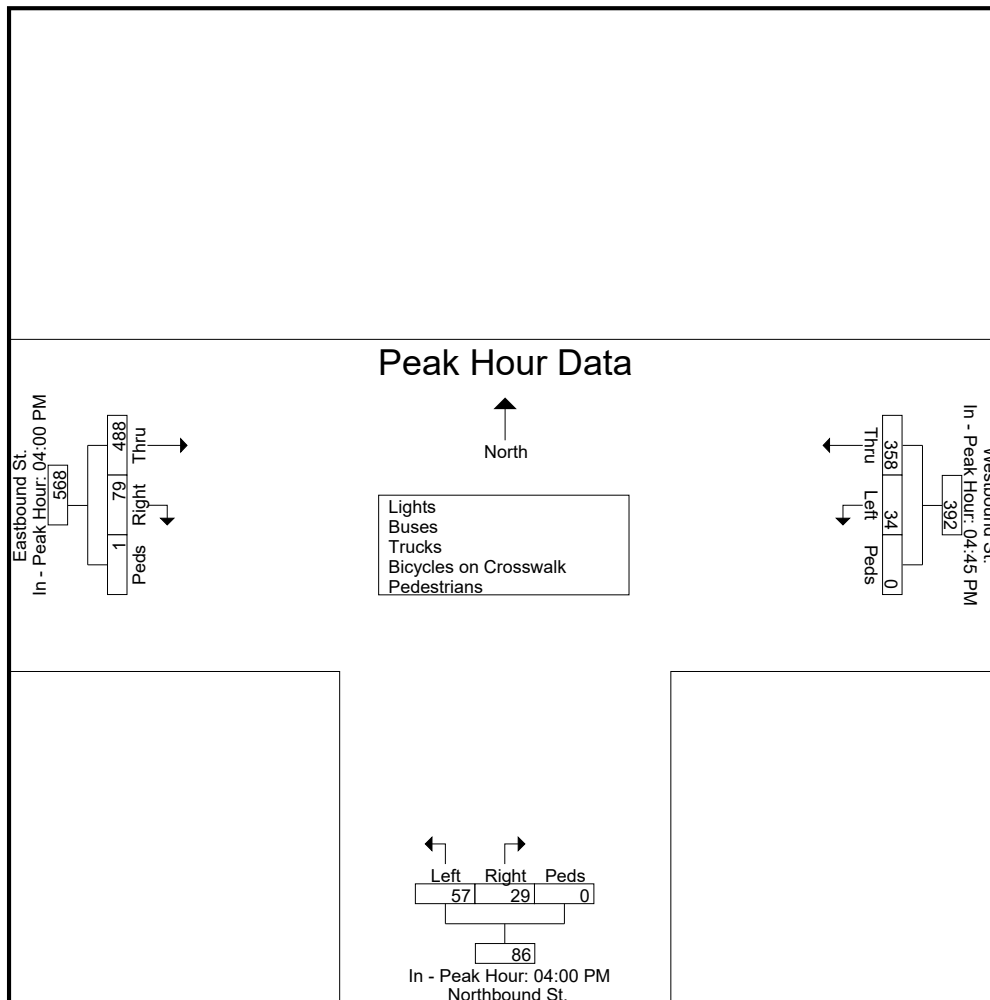

Connecticut Counts LLC
Kensington, Connecticut 06037
(860) 828-1693

Rope Ferry Road at Great Neck Road
 Waterford, Connecticut

File Name : 15324
 Site Code : 15324
 Start Date : 2/8/2017
 Page No : 1

Groups Printed- Lights - Buses - Trucks - Bicycles on Crosswalk - Pedestrians

Start Time	Avery Lane From North					Rope Ferry Rd From East					Great Neck Rd From South					Rope Ferry Rd From West					Int. Total
	Right	Thru	Left	Peds	App. Total	Right	Thru	Left	Peds	App. Total	Right	Thru	Left	Peds	App. Total	Right	Thru	Left	Peds	App. Total	
07:00 AM	2	10	9	0	21	18	42	37	0	97	106	45	9	1	161	11	84	11	0	106	385
07:15 AM	8	22	3	0	33	30	40	26	0	96	40	47	11	0	98	4	55	18	0	77	304
07:30 AM	5	17	5	0	27	7	36	25	0	68	51	39	10	0	100	6	56	9	0	71	266
07:45 AM	5	23	2	0	30	6	31	32	0	69	40	32	6	1	79	15	67	6	0	88	266
Total	20	72	19	0	111	61	149	120	0	330	237	163	36	2	438	36	262	44	0	342	1221
08:00 AM	4	16	7	0	27	6	30	20	0	56	56	39	11	0	106	10	47	5	0	62	251
08:15 AM	5	19	8	0	32	3	28	25	0	56	44	42	9	0	95	8	60	4	0	72	255
08:30 AM	3	15	4	1	23	6	29	18	0	53	50	39	19	0	108	6	70	10	0	86	270
08:45 AM	7	24	8	0	39	3	44	18	0	65	36	34	7	0	77	10	63	7	0	80	261
Total	19	74	27	1	121	18	131	81	0	230	186	154	46	0	386	34	240	26	0	300	1037
Grand Total	39	146	46	1	232	79	280	201	0	560	423	317	82	2	824	70	502	70	0	642	2258
Apprch %	16.8	62.9	19.8	0.4		14.1	50	35.9	0		51.3	38.5	10	0.2		10.9	78.2	10.9	0		
Total %	1.7	6.5	2	0	10.3	3.5	12.4	8.9	0	24.8	18.7	14	3.6	0.1	36.5	3.1	22.2	3.1	0	28.4	
Lights	36	134	45	0	215	73	265	195	0	533	415	307	80	0	802	67	490	68	0	625	2175
% Lights	92.3	91.8	97.8	0	92.7	92.4	94.6	97	0	95.2	98.1	96.8	97.6	0	97.3	95.7	97.6	97.1	0	97.4	96.3
Buses	1	4	1	0	6	5	6	3	0	14	7	6	0	0	13	1	6	1	0	8	41
% Buses	2.6	2.7	2.2	0	2.6	6.3	2.1	1.5	0	2.5	1.7	1.9	0	0	1.6	1.4	1.2	1.4	0	1.2	1.8
Trucks	2	8	0	0	10	1	9	3	0	13	1	4	2	0	7	2	6	1	0	9	39
% Trucks	5.1	5.5	0	0	4.3	1.3	3.2	1.5	0	2.3	0.2	1.3	2.4	0	0.8	2.9	1.2	1.4	0	1.4	1.7
Bicycles on Crosswalk																					
% Bicycles on Crosswalk	0	0	0	0	0	0	0	0	0	0	0	0	0	0	0	0	0	0	0	0	0
Pedestrians	0	0	0	1	1	0	0	0	0	0	0	0	0	2	2	0	0	0	0	0	3
% Pedestrians	0	0	0	100	0.4	0	0	0	0	0	0	0	0	100	0.2	0	0	0	0	0	0.1

Connecticut Counts LLC

Kensington, Connecticut 06037
(860) 828-1693

File Name : 15324
Site Code : 15324
Start Date : 2/8/2017
Page No : 2

Start Time	Avery Lane From North					Rope Ferry Rd From East					Great Neck Rd From South					Rope Ferry Rd From West					Int. Total
	Right	Thru	Left	Peds	App. Total	Right	Thru	Left	Peds	App. Total	Right	Thru	Left	Peds	App. Total	Right	Thru	Left	Peds	App. Total	
Peak Hour Analysis From 07:00 AM to 08:45 AM - Peak 1 of 1																					
Peak Hour for Entire Intersection Begins at 07:00 AM																					
07:00 AM	2	10	9	0	21	18	42	37	0	97	106	45	9	1	161	11	84	11	0	106	385
07:15 AM	8	22	3	0	33	30	40	26	0	96	40	47	11	0	98	4	55	18	0	77	304
07:30 AM	5	17	5	0	27	7	36	25	0	68	51	39	10	0	100	6	56	9	0	71	266
07:45 AM	5	23	2	0	30	6	31	32	0	69	40	32	6	1	79	15	67	6	0	88	266
Total Volume	20	72	19	0	111	61	149	120	0	330	237	163	36	2	438	36	262	44	0	342	1221
% App. Total	18	64.9	17.1	0		18.5	45.2	36.4	0		54.1	37.2	8.2	0.5		10.5	76.6	12.9	0		
PHF	.625	.783	.528	.000	.841	.508	.887	.811	.000	.851	.559	.867	.818	.500	.680	.600	.780	.611	.000	.807	.793

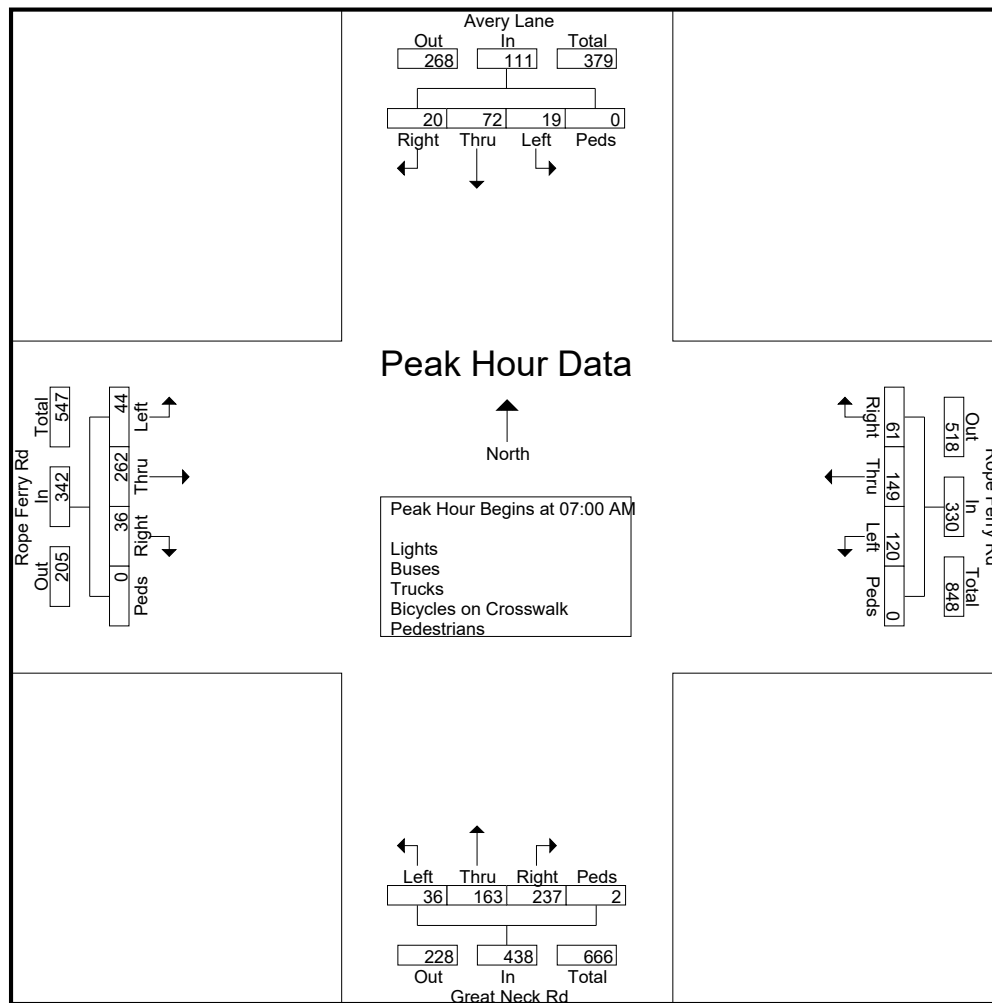

Connecticut Counts LLC

Kensington, Connecticut 06037

(860) 828-1693

File Name : 15324
 Site Code : 15324
 Start Date : 2/8/2017
 Page No : 3

Start Time	Avery Lane From North					Rope Ferry Rd From East					Great Neck Rd From South					Rope Ferry Rd From West					Int. Total
	Right	Thru	Left	Peds	App. Total	Right	Thru	Left	Peds	App. Total	Right	Thru	Left	Peds	App. Total	Right	Thru	Left	Peds	App. Total	
Peak Hour Analysis From 07:00 AM to 08:45 AM - Peak 1 of 1																					
Peak Hour for Each Approach Begins at:																					
	08:00 AM					07:00 AM					07:00 AM					07:00 AM					
+0 mins.	4	16	7	0	27	18	42	37	0	97	106	45	9	1	161	11	84	11	0	106	
+15 mins.	5	19	8	0	32	30	40	26	0	96	40	47	11	0	98	4	55	18	0	77	
+30 mins.	3	15	4	1	23	7	36	25	0	68	51	39	10	0	100	6	56	9	0	71	
+45 mins.	7	24	8	0	39	6	31	32	0	69	40	32	6	1	79	15	67	6	0	88	
Total Volume	19	74	27	1	121	61	149	120	0	330	237	163	36	2	438	36	262	44	0	342	
% App. Total	15.7	61.2	22.3	0.8		18.5	45.2	36.4	0		54.1	37.2	8.2	0.5		10.5	76.6	12.9	0		
PHF	.679	.771	.844	.250	.776	.508	.887	.811	.000	.851	.559	.867	.818	.500	.680	.600	.780	.611	.000	.807	

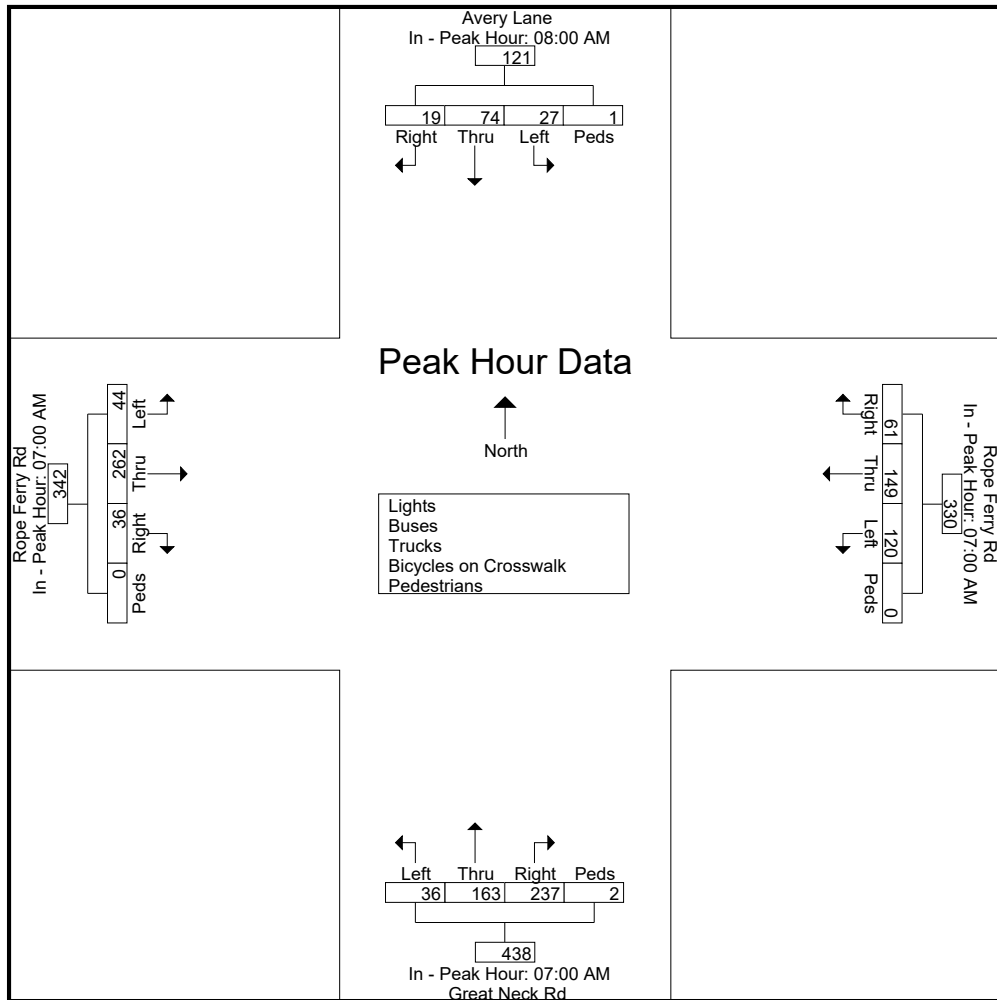

Connecticut Counts LLC
Kensington, Connecticut 06037
(860) 828-1693

Rope Ferry Road at Great Neck Road
 Waterford, Connecticut

File Name : 15325
 Site Code : 15325
 Start Date : 2/8/2017
 Page No : 1

Groups Printed- Lights - Buses - Trucks - Bicycles on Crosswalk - Pedestrians

Start Time	Avery Lane From North					Rope Ferry Rd From East					Great Neck Rd From South					Rope Ferry Rd From West					Int. Total
	Right	Thru	Left	Peds	App. Total	Right	Thru	Left	Peds	App. Total	Right	Thru	Left	Peds	App. Total	Right	Thru	Left	Peds	App. Total	
04:00 PM	10	42	9	1	62	19	76	52	0	147	33	25	16	0	74	20	68	15	0	103	386
04:15 PM	11	32	4	0	47	35	84	70	0	189	23	24	10	0	57	20	54	15	0	89	382
04:30 PM	13	41	7	1	62	12	57	51	0	120	41	45	17	1	104	16	57	6	0	79	365
04:45 PM	16	50	9	0	75	8	78	55	1	142	44	29	19	0	92	18	57	17	0	92	401
Total	50	165	29	2	246	74	295	228	1	598	141	123	62	1	327	74	236	53	0	363	1534
05:00 PM	13	40	7	0	60	10	73	68	0	151	49	44	20	0	113	26	70	9	0	105	429
05:15 PM	14	46	9	3	72	16	75	52	0	143	48	28	13	0	89	11	59	9	0	79	383
05:30 PM	4	40	6	0	50	7	68	45	0	120	53	40	10	0	103	16	58	8	0	82	355
05:45 PM	17	38	10	0	65	22	74	58	0	154	44	30	8	0	82	22	46	9	0	77	378
Total	48	164	32	3	247	55	290	223	0	568	194	142	51	0	387	75	233	35	0	343	1545
Grand Total	98	329	61	5	493	129	585	451	1	1166	335	265	113	1	714	149	469	88	0	706	3079
Apprch %	19.9	66.7	12.4	1		11.1	50.2	38.7	0.1		46.9	37.1	15.8	0.1		21.1	66.4	12.5	0		
Total %	3.2	10.7	2	0.2	16	4.2	19	14.6	0	37.9	10.9	8.6	3.7	0	23.2	4.8	15.2	2.9	0	22.9	
Lights	98	320	59	0	477	128	576	449	0	1153	331	261	111	0	703	147	464	85	0	696	3029
% Lights	100	97.3	96.7	0	96.8	99.2	98.5	99.6	0	98.9	98.8	98.5	98.2	0	98.5	98.7	98.9	96.6	0	98.6	98.4
Buses	0	2	1	0	3	1	2	0	0	3	0	1	1	0	2	1	0	1	0	2	10
% Buses	0	0.6	1.6	0	0.6	0.8	0.3	0	0	0.3	0	0.4	0.9	0	0.3	0.7	0	1.1	0	0.3	0.3
Trucks	0	7	1	0	8	0	7	2	0	9	4	3	1	0	8	1	5	2	0	8	33
% Trucks	0	2.1	1.6	0	1.6	0	1.2	0.4	0	0.8	1.2	1.1	0.9	0	1.1	0.7	1.1	2.3	0	1.1	1.1
Bicycles on Crosswalk																					
% Bicycles on Crosswalk	0	0	0	20	0.2	0	0	0	0	0	0	0	0	0	0	0	0	0	0	0	0
Pedestrians	0	0	0	4	4	0	0	0	1	1	0	0	0	1	1	0	0	0	0	0	6
% Pedestrians	0	0	0	80	0.8	0	0	0	100	0.1	0	0	0	100	0.1	0	0	0	0	0	0.2

Connecticut Counts LLC

Kensington, Connecticut 06037
(860) 828-1693

File Name : 15325
Site Code : 15325
Start Date : 2/8/2017
Page No : 2

Start Time	Avery Lane From North					Rope Ferry Rd From East					Great Neck Rd From South					Rope Ferry Rd From West					Int. Total
	Right	Thru	Left	Peds	App. Total	Right	Thru	Left	Peds	App. Total	Right	Thru	Left	Peds	App. Total	Right	Thru	Left	Peds	App. Total	
Peak Hour Analysis From 04:00 PM to 05:45 PM - Peak 1 of 1																					
Peak Hour for Entire Intersection Begins at 04:30 PM																					
04:30 PM	13	41	7	1	62	12	57	51	0	120	41	45	17	1	104	16	57	6	0	79	365
04:45 PM	16	50	9	0	75	8	78	55	1	142	44	29	19	0	92	18	57	17	0	92	401
05:00 PM	13	40	7	0	60	10	73	68	0	151	49	44	20	0	113	26	70	9	0	105	429
05:15 PM	14	46	9	3	72	16	75	52	0	143	48	28	13	0	89	11	59	9	0	79	383
Total Volume	56	177	32	4	269	46	283	226	1	556	182	146	69	1	398	71	243	41	0	355	1578
% App. Total	20.8	65.8	11.9	1.5		8.3	50.9	40.6	0.2		45.7	36.7	17.3	0.3		20	68.5	11.5	0		
PHF	.875	.885	.889	.333	.897	.719	.907	.831	.250	.921	.929	.811	.863	.250	.881	.683	.868	.603	.000	.845	.920

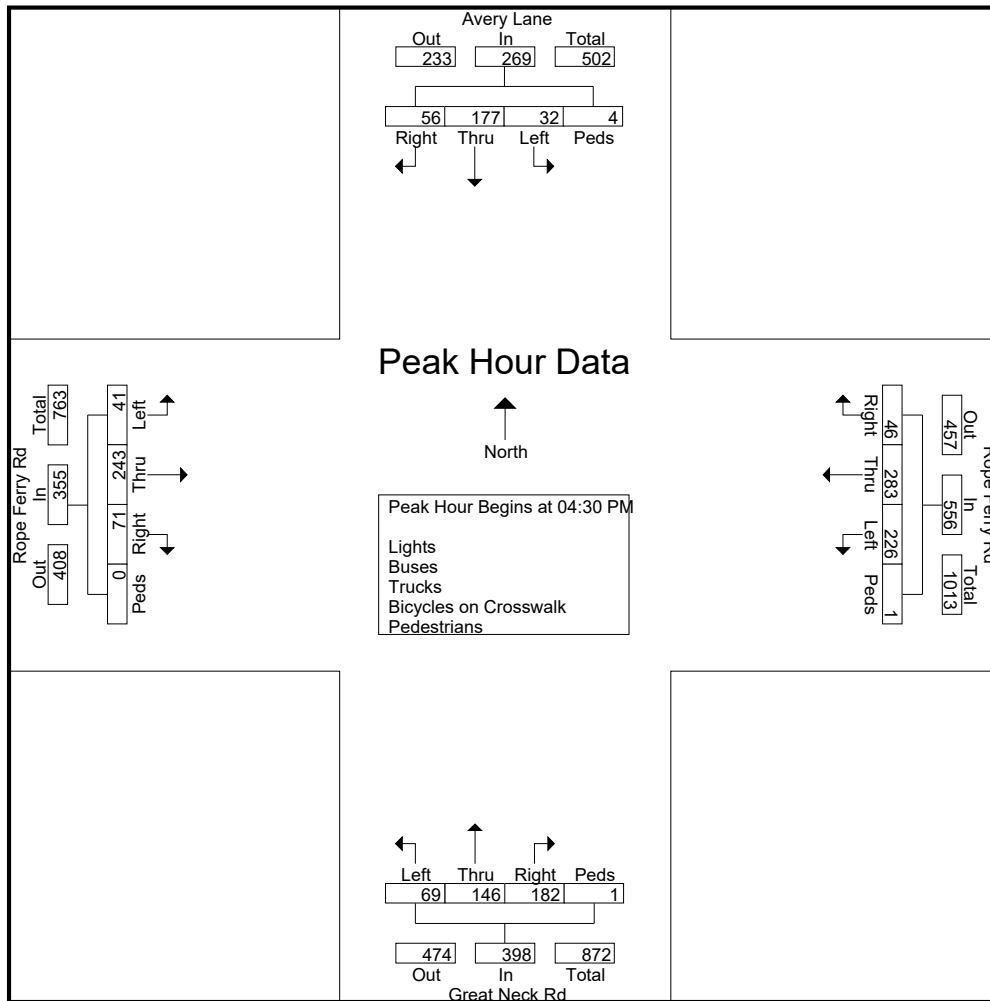

Connecticut Counts LLC

Kensington, Connecticut 06037
(860) 828-1693

File Name : 15325
Site Code : 15325
Start Date : 2/8/2017
Page No : 3

Start Time	Avery Lane From North					Rope Ferry Rd From East					Great Neck Rd From South					Rope Ferry Rd From West					Int. Total
	Right	Thru	Left	Peds	App. Total	Right	Thru	Left	Peds	App. Total	Right	Thru	Left	Peds	App. Total	Right	Thru	Left	Peds	App. Total	
Peak Hour Analysis From 04:00 PM to 05:45 PM - Peak 1 of 1																					
Peak Hour for Each Approach Begins at:																					
	04:30 PM					04:15 PM					04:30 PM					04:15 PM					
+0 mins.	13	41	7	1	62	35	84	70	0	189	41	45	17	1	104	20	54	15	0	89	
+15 mins.	16	50	9	0	75	12	57	51	0	120	44	29	19	0	92	16	57	6	0	79	
+30 mins.	13	40	7	0	60	8	78	55	1	142	49	44	20	0	113	18	57	17	0	92	
+45 mins.	14	46	9	3	72	10	73	68	0	151	48	28	13	0	89	26	70	9	0	105	
Total Volume	56	177	32	4	269	65	292	244	1	602	182	146	69	1	398	80	238	47	0	365	
% App. Total	20.8	65.8	11.9	1.5		10.8	48.5	40.5	0.2		45.7	36.7	17.3	0.3		21.9	65.2	12.9	0		
PHF	.875	.885	.889	.333	.897	.464	.869	.871	.250	.796	.929	.811	.863	.250	.881	.769	.850	.691	.000	.869	

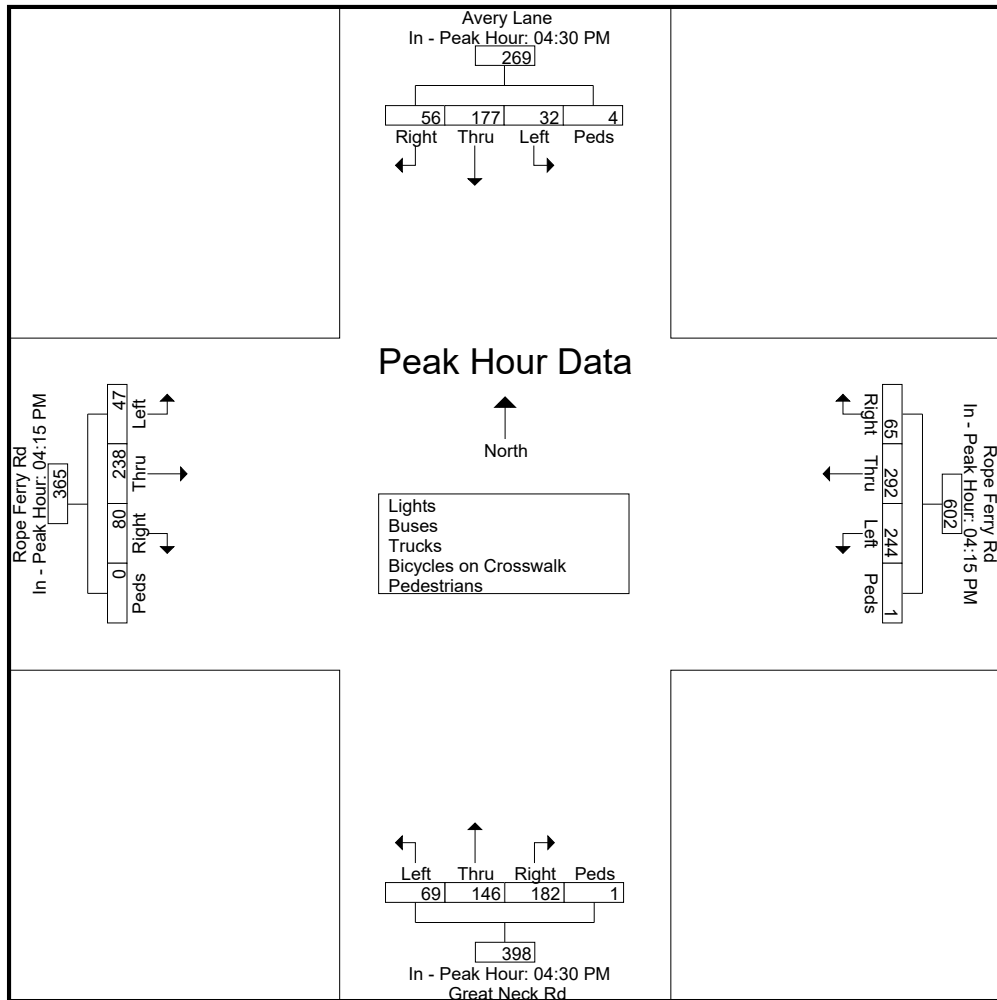

Connecticut Counts LLC
Kensington, Connecticut 06037
(860) 828-1693

Great Neck Rd at Lamphere/Braman Road
 Waterford, Connecticut

File Name : 15326
 Site Code : 15326
 Start Date : 2/8/2017
 Page No : 1

Groups Printed- Lights - Buses - Trucks - Bicycles on Crosswalk - Pedestrians

Start Time	Great Neck Rd From North					Braman Road From East					Great Neck Rd From South					Lamphere Road From West					Int. Total
	Right	Thru	Left	Peds	App. Total	Right	Thru	Left	Peds	App. Total	Right	Thru	Left	Peds	App. Total	Right	Thru	Left	Peds	App. Total	
07:00 AM	4	13	7	0	24	34	1	0	0	35	1	74	0	0	75	0	3	22	0	25	159
07:15 AM	10	20	11	0	41	29	2	0	0	31	0	34	0	0	34	0	3	19	0	22	128
07:30 AM	3	21	7	0	31	23	1	1	0	25	0	30	0	0	30	1	1	18	0	20	106
07:45 AM	7	22	12	0	41	21	1	2	0	24	2	28	0	0	30	0	2	9	0	11	106
Total	24	76	37	0	137	107	5	3	0	115	3	166	0	0	169	1	9	68	0	78	499
08:00 AM	2	20	7	0	29	25	6	0	0	31	0	38	1	0	39	1	0	15	1	17	116
08:15 AM	7	30	8	0	45	23	1	3	0	27	2	55	1	0	58	2	0	7	0	9	139
08:30 AM	2	22	3	0	27	29	0	0	0	29	1	49	1	0	51	0	1	13	0	14	121
08:45 AM	6	18	10	0	34	16	2	1	0	19	0	34	2	0	36	0	3	8	0	11	100
Total	17	90	28	0	135	93	9	4	0	106	3	176	5	0	184	3	4	43	1	51	476
Grand Total	41	166	65	0	272	200	14	7	0	221	6	342	5	0	353	4	13	111	1	129	975
Apprch %	15.1	61	23.9	0	27.9	90.5	6.3	3.2	0	22.7	1.7	96.9	1.4	0	36.2	3.1	10.1	86	0.8	13.2	
Total %	4.2	17	6.7	0	27.9	20.5	1.4	0.7	0	22.7	0.6	35.1	0.5	0	36.2	0.4	1.3	11.4	0.1	13.2	
Lights	39	155	58	0	252	196	14	6	0	216	6	329	3	0	338	3	13	110	0	126	932
% Lights	95.1	93.4	89.2	0	92.6	98	100	85.7	0	97.7	100	96.2	60	0	95.8	75	100	99.1	0	97.7	95.6
Buses	2	3	4	0	9	3	0	1	0	4	0	9	1	0	10	1	0	1	0	2	25
% Buses	4.9	1.8	6.2	0	3.3	1.5	0	14.3	0	1.8	0	2.6	20	0	2.8	25	0	0.9	0	1.6	2.6
Trucks	0	8	3	0	11	1	0	0	0	1	0	4	1	0	5	0	0	0	0	0	17
% Trucks	0	4.8	4.6	0	4	0.5	0	0	0	0.5	0	1.2	20	0	1.4	0	0	0	0	0	1.7
Bicycles on Crosswalk																					
% Bicycles on Crosswalk	0	0	0	0	0	0	0	0	0	0	0	0	0	0	0	0	0	0	0	0	0
Pedestrians	0	0	0	0	0	0	0	0	0	0	0	0	0	0	0	0	0	0	1	1	1
% Pedestrians	0	0	0	0	0	0	0	0	0	0	0	0	0	0	0	0	0	0	100	0.8	0.1

Connecticut Counts LLC

Kensington, Connecticut 06037
(860) 828-1693

File Name : 15326
Site Code : 15326
Start Date : 2/8/2017
Page No : 2

Start Time	Great Neck Rd From North					Braman Road From East					Great Neck Rd From South					Lamphere Road From West					Int. Total
	Right	Thru	Left	Peds	App. Total	Right	Thru	Left	Peds	App. Total	Right	Thru	Left	Peds	App. Total	Right	Thru	Left	Peds	App. Total	
Peak Hour Analysis From 07:00 AM to 08:45 AM - Peak 1 of 1																					
Peak Hour for Entire Intersection Begins at 07:00 AM																					
07:00 AM	4	13	7	0	24	34	1	0	0	35	1	74	0	0	75	0	3	22	0	25	159
07:15 AM	10	20	11	0	41	29	2	0	0	31	0	34	0	0	34	0	3	19	0	22	128
07:30 AM	3	21	7	0	31	23	1	1	0	25	0	30	0	0	30	1	1	18	0	20	106
07:45 AM	7	22	12	0	41	21	1	2	0	24	2	28	0	0	30	0	2	9	0	11	106
Total Volume	24	76	37	0	137	107	5	3	0	115	3	166	0	0	169	1	9	68	0	78	499
% App. Total	17.5	55.5	27	0		93	4.3	2.6	0		1.8	98.2	0	0		1.3	11.5	87.2	0		
PHF	.600	.864	.771	.000	.835	.787	.625	.375	.000	.821	.375	.561	.000	.000	.563	.250	.750	.773	.000	.780	.785

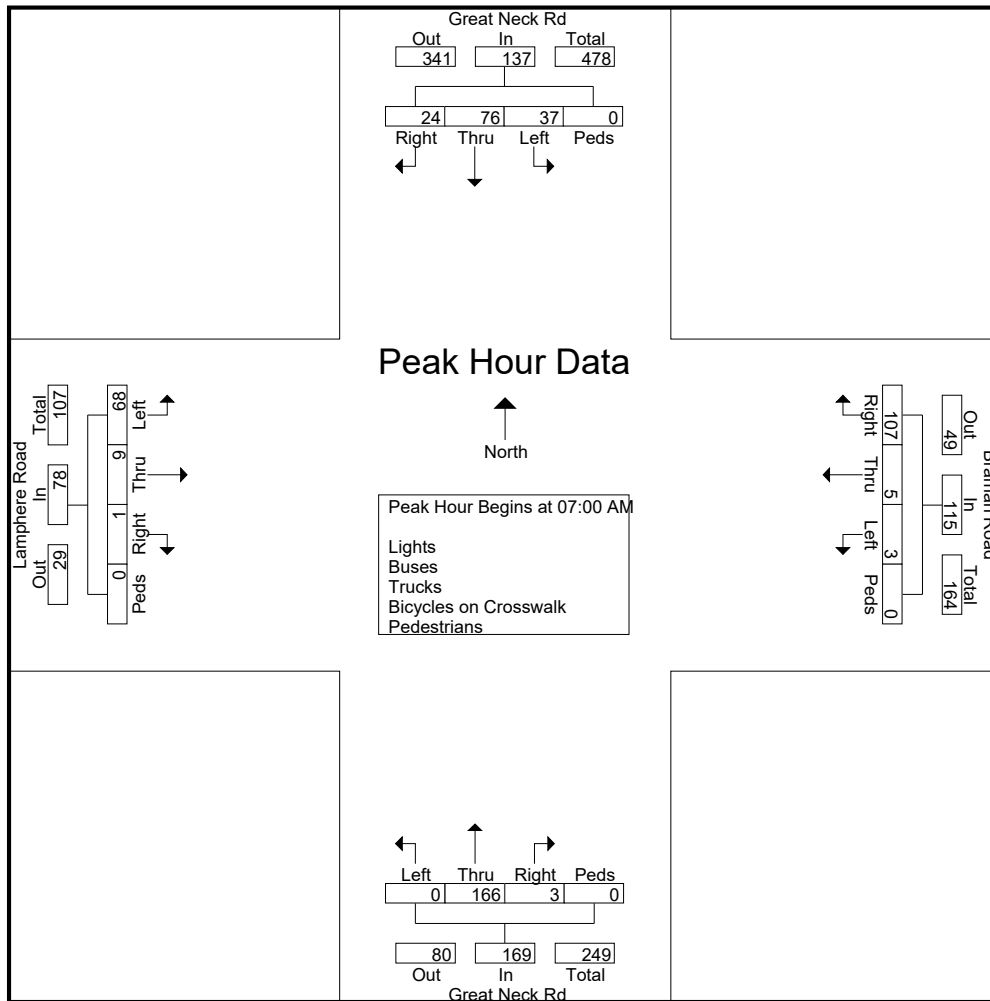

Connecticut Counts LLC

Kensington, Connecticut 06037

(860) 828-1693

File Name : 15326
 Site Code : 15326
 Start Date : 2/8/2017
 Page No : 3

Start Time	Great Neck Rd From North					Braman Road From East					Great Neck Rd From South					Lamphere Road From West					Int. Total
	Right	Thru	Left	Peds	App. Total	Right	Thru	Left	Peds	App. Total	Right	Thru	Left	Peds	App. Total	Right	Thru	Left	Peds	App. Total	
Peak Hour Analysis From 07:00 AM to 08:45 AM - Peak 1 of 1																					
Peak Hour for Each Approach Begins at:																					
	07:30 AM					07:00 AM					08:00 AM					07:00 AM					
+0 mins.	3	21	7	0	31	34	1	0	0	35	0	38	1	0	39	0	3	22	0	25	
+15 mins.	7	22	12	0	41	29	2	0	0	31	2	55	1	0	58	0	3	19	0	22	
+30 mins.	2	20	7	0	29	23	1	1	0	25	1	49	1	0	51	1	1	18	0	20	
+45 mins.	7	30	8	0	45	21	1	2	0	24	0	34	2	0	36	0	2	9	0	11	
Total Volume	19	93	34	0	146	107	5	3	0	115	3	176	5	0	184	1	9	68	0	78	
% App. Total	13	63.7	23.3	0		93	4.3	2.6	0		1.6	95.7	2.7	0		1.3	11.5	87.2	0		
PHF	.679	.775	.708	.000	.811	.787	.625	.375	.000	.821	.375	.800	.625	.000	.793	.250	.750	.773	.000	.780	

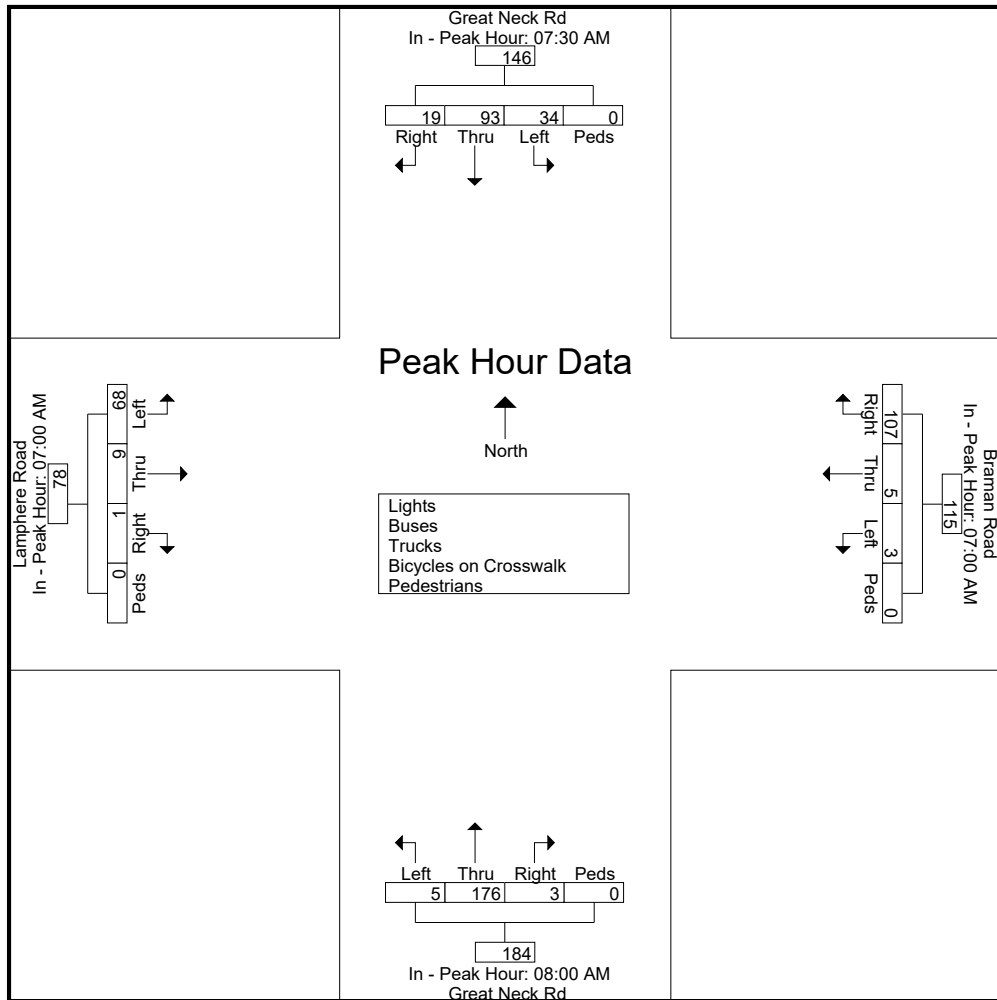

Connecticut Counts LLC
Kensington, Connecticut 06037
(860) 828-1693

Great Neck Rd at Lamphere/Braman Road
 Waterford, Connecticut

File Name : 15327
 Site Code : 15327
 Start Date : 2/8/2017
 Page No : 1

Groups Printed- Lights - Buses - Trucks - Bicycles on Crosswalk - Pedestrians

Start Time	Great Neck Rd From North					Braman Road From East					Great Neck Rd From South					Lamphere Road From West					Int. Total	
	Right	Thru	Left	Peds	App. Total	Right	Thru	Left	Peds	App. Total	Right	Thru	Left	Peds	App. Total	Right	Thru	Left	Peds	App. Total		
04:00 PM	17	43	31	1	92	14	5	2	0	21	1	28	1	0	30	4	3	13	0	20	163	
04:15 PM	27	46	28	0	101	19	5	2	0	26	3	21	1	0	25	0	1	6	3	10	162	
04:30 PM	13	32	30	0	75	22	3	0	0	25	3	37	2	0	42	2	3	14	0	19	161	
04:45 PM	19	53	29	0	101	27	5	1	0	33	1	24	2	0	27	0	3	14	0	17	178	
Total	76	174	118	1	369	82	18	5	0	105	8	110	6	0	124	6	10	47	3	66	664	
05:00 PM	24	51	32	0	107	30	2	3	0	35	3	38	1	0	42	0	1	9	1	11	195	
05:15 PM	20	41	31	0	92	19	2	2	0	23	1	31	0	0	32	0	1	12	0	13	160	
05:30 PM	10	50	18	0	78	11	3	0	0	14	1	49	0	0	50	0	5	19	0	24	166	
05:45 PM	21	45	28	0	94	21	3	3	0	27	2	29	1	0	32	0	3	10	0	13	166	
Total	75	187	109	0	371	81	10	8	0	99	7	147	2	0	156	0	10	50	1	61	687	
Grand Total	151	361	227	1	740	163	28	13	0	204	15	257	8	0	280	6	20	97	4	127	1351	
Apprch %	20.4	48.8	30.7	0.1		79.9	13.7	6.4	0		5.4	91.8	2.9	0		4.7	15.7	76.4	3.1			
Total %	11.2	26.7	16.8	0.1	54.8	12.1	2.1	1	0	15.1	1.1	19	0.6	0	20.7	0.4	1.5	7.2	0.3	9.4		
Lights	151	357	226	0	734	161	28	13	0	202	15	252	8	0	275	6	19	96	0	121	1332	
% Lights	100	98.9	99.6	0	99.2	98.8	100	100	0	99	100	98.1	100	0	98.2	100	95	99	0	95.3	98.6	
Buses	0	2	1	0	3	1	0	0	0	1	0	1	0	0	1	0	1	0	0	0	1	6
% Buses	0	0.6	0.4	0	0.4	0.6	0	0	0	0.5	0	0.4	0	0	0.4	0	5	0	0	0.8	0.4	
Trucks	0	2	0	0	2	1	0	0	0	1	0	4	0	0	4	0	0	1	0	1	8	
% Trucks	0	0.6	0	0	0.3	0.6	0	0	0	0.5	0	1.6	0	0	1.4	0	0	1	0	0.8	0.6	
Bicycles on Crosswalk																						
% Bicycles on Crosswalk	0	0	0	0	0	0	0	0	0	0	0	0	0	0	0	0	0	0	25	0.8	0.1	
Pedestrians	0	0	0	1	1	0	0	0	0	0	0	0	0	0	0	0	0	0	3	3	4	
% Pedestrians	0	0	0	100	0.1	0	0	0	0	0	0	0	0	0	0	0	0	0	75	2.4	0.3	

Connecticut Counts LLC

Kensington, Connecticut 06037
(860) 828-1693

File Name : 15327
Site Code : 15327
Start Date : 2/8/2017
Page No : 2

Start Time	Great Neck Rd From North					Braman Road From East					Great Neck Rd From South					Lamphere Road From West					Int. Total
	Right	Thru	Left	Peds	App. Total	Right	Thru	Left	Peds	App. Total	Right	Thru	Left	Peds	App. Total	Right	Thru	Left	Peds	App. Total	
Peak Hour Analysis From 04:00 PM to 05:45 PM - Peak 1 of 1																					
Peak Hour for Entire Intersection Begins at 04:45 PM																					
04:45 PM	19	53	29	0	101	27	5	1	0	33	1	24	2	0	27	0	3	14	0	17	178
05:00 PM	24	51	32	0	107	30	2	3	0	35	3	38	1	0	42	0	1	9	1	11	195
05:15 PM	20	41	31	0	92	19	2	2	0	23	1	31	0	0	32	0	1	12	0	13	160
05:30 PM	10	50	18	0	78	11	3	0	0	14	1	49	0	0	50	0	5	19	0	24	166
Total Volume	73	195	110	0	378	87	12	6	0	105	6	142	3	0	151	0	10	54	1	65	699
% App. Total	19.3	51.6	29.1	0		82.9	11.4	5.7	0		4	94	2	0		0	15.4	83.1	1.5		
PHF	.760	.920	.859	.000	.883	.725	.600	.500	.000	.750	.500	.724	.375	.000	.755	.000	.500	.711	.250	.677	.896

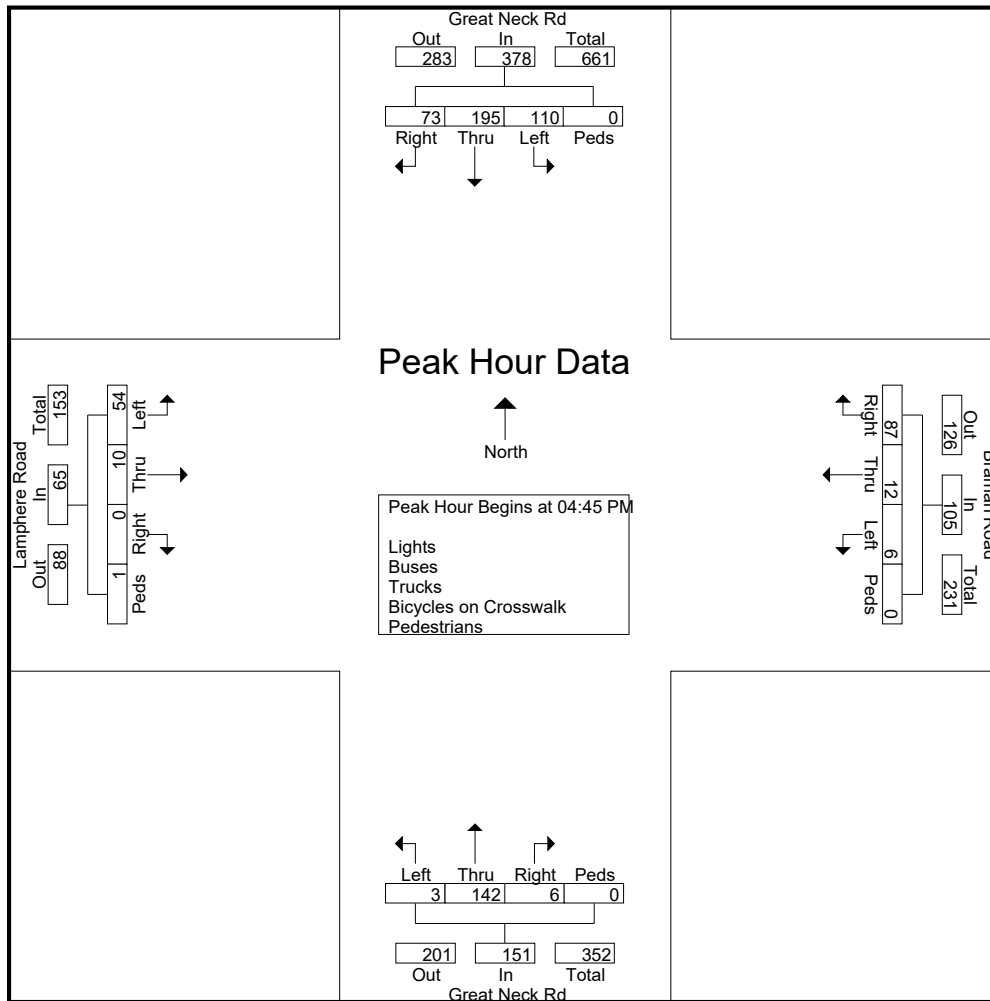

Connecticut Counts LLC

Kensington, Connecticut 06037

(860) 828-1693

File Name : 15327
 Site Code : 15327
 Start Date : 2/8/2017
 Page No : 3

Start Time	Great Neck Rd From North					Braman Road From East					Great Neck Rd From South					Lamphere Road From West					Int. Total
	Right	Thru	Left	Peds	App. Total	Right	Thru	Left	Peds	App. Total	Right	Thru	Left	Peds	App. Total	Right	Thru	Left	Peds	App. Total	
Peak Hour Analysis From 04:00 PM to 05:45 PM - Peak 1 of 1																					
Peak Hour for Each Approach Begins at:																					
	04:15 PM					04:15 PM					05:00 PM					04:00 PM					
+0 mins.	27	46	28	0	101	19	5	2	0	26	3	38	1	0	42	4	3	13	0	20	
+15 mins.	13	32	30	0	75	22	3	0	0	25	1	31	0	0	32	0	1	6	3	10	
+30 mins.	19	53	29	0	101	27	5	1	0	33	1	49	0	0	50	2	3	14	0	19	
+45 mins.	24	51	32	0	107	30	2	3	0	35	2	29	1	0	32	0	3	14	0	17	
Total Volume	83	182	119	0	384	98	15	6	0	119	7	147	2	0	156	6	10	47	3	66	
% App. Total	21.6	47.4	31	0		82.4	12.6	5	0		4.5	94.2	1.3	0		9.1	15.2	71.2	4.5		
PHF	.769	.858	.930	.000	.897	.817	.750	.500	.000	.850	.583	.750	.500	.000	.780	.375	.833	.839	.250	.825	

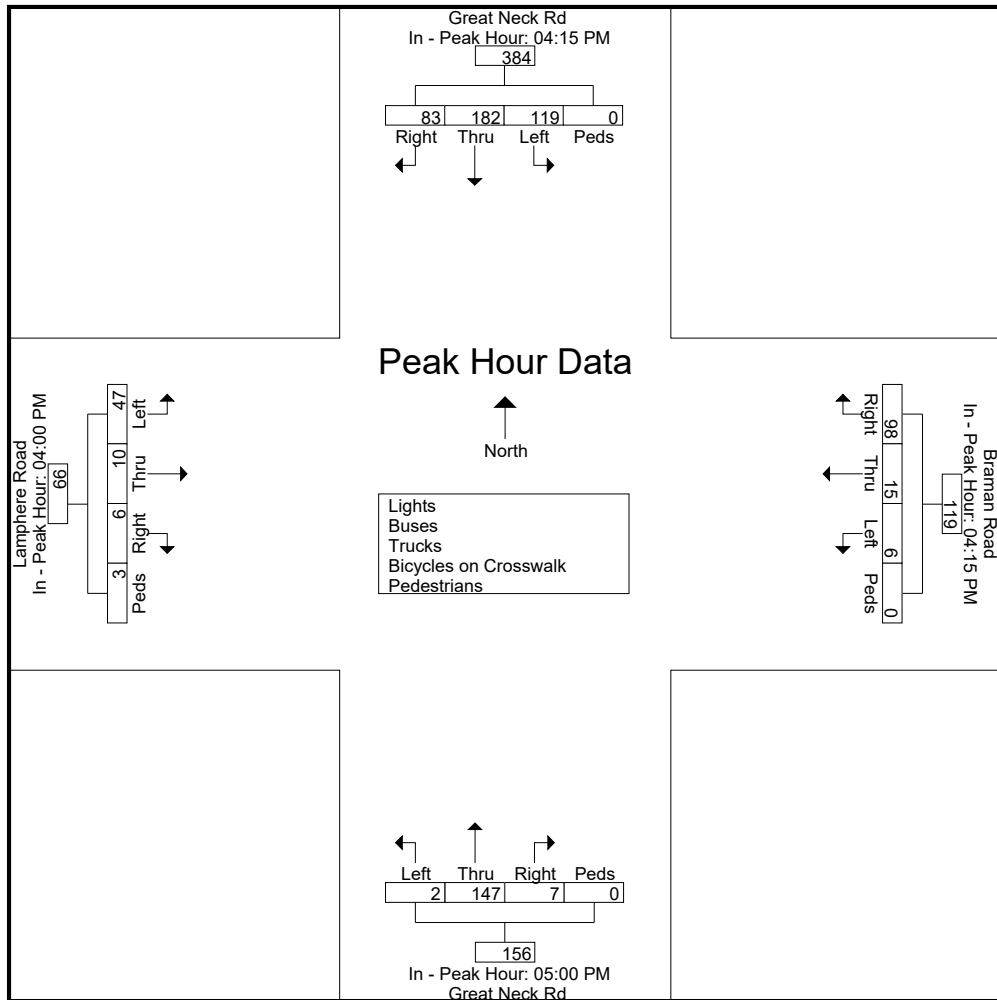

CAPACITY ANALYSES 2027 NO BUILD VOLUMES

Lanes, Volumes, Timings
1: Gardiners Wood Road & Rope Ferry Road

2027 No-Build - AM Peak
05/09/2017



Lane Group	EBT	EBR	WBL	WBT	NBL	NBR
Lane Configurations	↷			↶	↷	
Traffic Volume (vph)	329	40	2	275	80	35
Future Volume (vph)	329	40	2	275	80	35
Ideal Flow (vphpl)	1900	1900	1900	1900	1900	1900
Lane Util. Factor	1.00	1.00	1.00	1.00	1.00	1.00
Frt	0.986				0.959	
Flt Protected					0.966	
Satd. Flow (prot)	1837	0	0	1863	1726	0
Flt Permitted				0.997	0.966	
Satd. Flow (perm)	1837	0	0	1857	1726	0
Right Turn on Red		Yes				Yes
Satd. Flow (RTOR)	12				38	
Link Speed (mph)	30			30	30	
Link Distance (ft)	512			589	834	
Travel Time (s)	11.6			13.4	19.0	
Peak Hour Factor	0.92	0.92	0.92	0.92	0.92	0.92
Adj. Flow (vph)	358	43	2	299	87	38
Shared Lane Traffic (%)						
Lane Group Flow (vph)	401	0	0	301	125	0
Turn Type	NA		pm+pt	NA	Prot	
Protected Phases	2		1	6	8	
Permitted Phases			6			
Detector Phase	2		1	6	8	
Switch Phase						
Minimum Initial (s)	5.0		5.0	5.0	5.0	
Minimum Split (s)	22.5		9.5	22.5	22.5	
Total Split (s)	23.0		9.5	32.5	22.5	
Total Split (%)	41.8%		17.3%	59.1%	40.9%	
Yellow Time (s)	3.5		3.5	3.5	3.5	
All-Red Time (s)	1.0		1.0	1.0	1.0	
Lost Time Adjust (s)	0.0			0.0	0.0	
Total Lost Time (s)	4.5			4.5	4.5	
Lead/Lag	Lag		Lead			
Lead-Lag Optimize?	Yes		Yes			
Recall Mode	None		None	None	Max	
Act Effct Green (s)	13.5			13.5	18.1	
Actuated g/C Ratio	0.33			0.33	0.44	
v/c Ratio	0.65			0.49	0.16	
Control Delay	16.4			13.5	6.7	
Queue Delay	0.0			0.0	0.0	
Total Delay	16.4			13.5	6.7	
LOS	B			B	A	
Approach Delay	16.4			13.5	6.7	
Approach LOS	B			B	A	
Queue Length 50th (ft)	72			52	11	
Queue Length 95th (ft)	135			100	38	
Internal Link Dist (ft)	432			509	754	
Turn Bay Length (ft)						
Base Capacity (vph)	847			1286	789	

Lanes, Volumes, Timings
 1: Gardiners Wood Road & Rope Ferry Road

2027 No-Build - AM Peak
 05/09/2017

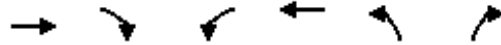

Lane Group	EBT	EBR	WBL	WBT	NBL	NBR
Starvation Cap Reductn	0			0	0	
Spillback Cap Reductn	0			0	0	
Storage Cap Reductn	0			0	0	
Reduced v/c Ratio	0.47			0.23	0.16	

Intersection Summary

Area Type:	Other
Cycle Length:	55
Actuated Cycle Length:	40.7
Natural Cycle:	55
Control Type:	Semi Act-Uncoord
Maximum v/c Ratio:	0.65
Intersection Signal Delay:	13.9
Intersection LOS:	B
Intersection Capacity Utilization	33.8%
ICU Level of Service	A
Analysis Period (min)	15

Splits and Phases: 1: Gardiners Wood Road & Rope Ferry Road

Ø1	Ø2		
9.5 s	23 s		
Ø6	Ø8		
32.5 s	22.5 s		

Lanes, Volumes, Timings
5: Shore Road & Jordan Cove Road

2027 No-Build - AM Peak
05/09/2017



Lane Group	EBL	EBR	NBL	NBT	SBT	SBR
Lane Configurations						
Traffic Volume (vph)	10	40	55	23	4	30
Future Volume (vph)	10	40	55	23	4	30
Ideal Flow (vphpl)	1900	1900	1900	1900	1900	1900
Lane Util. Factor	1.00	1.00	1.00	1.00	1.00	1.00
Frt	0.892				0.881	
Flt Protected	0.990			0.966		
Satd. Flow (prot)	1645	0	0	1799	1641	0
Flt Permitted	0.990			0.966		
Satd. Flow (perm)	1645	0	0	1799	1641	0
Link Speed (mph)	30			30	30	
Link Distance (ft)	348			365	291	
Travel Time (s)	7.9			8.3	6.6	
Peak Hour Factor	1.00	1.00	1.00	1.00	1.00	1.00
Adj. Flow (vph)	10	40	55	23	4	30
Shared Lane Traffic (%)						
Lane Group Flow (vph)	50	0	0	78	34	0
Sign Control	Stop			Stop	Stop	

Intersection Summary

Area Type:	Other
Control Type:	Unsignalized
Intersection Capacity Utilization	20.9%
Analysis Period (min)	15
	ICU Level of Service A

Intersection	
Intersection Delay, s/veh	7.2
Intersection LOS	A

Movement	EBU	EBL	EBR	NBU	NBL	NBT	SBU	SBT	SBR
Lane Configurations		Y				4		4	
Traffic Vol, veh/h	0	10	40	0	55	23	0	4	30
Future Vol, veh/h	0	10	40	0	55	23	0	4	30
Peak Hour Factor	1.00	1.00	1.00	1.00	1.00	1.00	1.00	1.00	1.00
Heavy Vehicles, %	2	2	2	2	2	2	2	2	2
Mvmt Flow	0	10	40	0	55	23	0	4	30
Number of Lanes	0	1	0	0	0	1	0	1	0

















Approach	EB	NB	SB
Opposing Approach		SB	NB
Opposing Lanes	0	1	1
Conflicting Approach Left	SB	EB	
Conflicting Lanes Left	1	1	0
Conflicting Approach Right	NB		EB
Conflicting Lanes Right	1	0	1
HCM Control Delay	6.9	7.6	6.7
HCM LOS	A	A	A

Lane	NBLn1	EBLn1	SBLn1
Vol Left, %	71%	20%	0%
Vol Thru, %	29%	0%	12%
Vol Right, %	0%	80%	88%
Sign Control	Stop	Stop	Stop
Traffic Vol by Lane	78	50	34
LT Vol	55	10	0
Through Vol	23	0	4
RT Vol	0	40	30
Lane Flow Rate	78	50	34
Geometry Grp	1	1	1
Degree of Util (X)	0.091	0.051	0.034
Departure Headway (Hd)	4.188	3.685	3.549
Convergence, Y/N	Yes	Yes	Yes
Cap	857	965	1005
Service Time	2.205	1.735	1.582
HCM Lane V/C Ratio	0.091	0.052	0.034
HCM Control Delay	7.6	6.9	6.7
HCM Lane LOS	A	A	A
HCM 95th-tile Q	0.3	0.2	0.1

Lanes, Volumes, Timings
9: Shore Road & Palmer Road

2027 No-Build - AM Peak

05/09/2017

												
Lane Group	EBL	EBT	EBR	WBL	WBT	WBR	NBL	NBT	NBR	SBL	SBT	SBR
Lane Configurations												
Traffic Volume (vph)	18	12	1	0	11	0	4	2	0	0	1	27
Future Volume (vph)	18	12	1	0	11	0	4	2	0	0	1	27
Ideal Flow (vphpl)	1900	1900	1900	1900	1900	1900	1900	1900	1900	1900	1900	1900
Lane Util. Factor	1.00	1.00	1.00	1.00	1.00	1.00	1.00	1.00	1.00	1.00	1.00	1.00
Frt		0.996									0.870	
Flt Protected		0.972						0.968				
Satd. Flow (prot)	0	1803	0	0	1863	0	0	1803	0	0	1621	0
Flt Permitted		0.972						0.968				
Satd. Flow (perm)	0	1803	0	0	1863	0	0	1803	0	0	1621	0
Link Speed (mph)		30			30			30			30	
Link Distance (ft)		357			396			205			196	
Travel Time (s)		8.1			9.0			4.7			4.5	
Peak Hour Factor	1.00	1.00	1.00	1.00	1.00	1.00	1.00	1.00	1.00	1.00	1.00	1.00
Adj. Flow (vph)	18	12	1	0	11	0	4	2	0	0	1	27
Shared Lane Traffic (%)												
Lane Group Flow (vph)	0	31	0	0	11	0	0	6	0	0	28	0
Sign Control		Stop			Stop			Stop			Stop	

Intersection Summary

Area Type:	Other
Control Type:	Unsignalized
Intersection Capacity Utilization	18.7%
Analysis Period (min)	15
	ICU Level of Service A

Intersection	
Intersection Delay, s/veh	7
Intersection LOS	A

Movement	EBU	EBL	EBT	EBR	WBU	WBL	WBT	WBR	NBU	NBL	NBT	NBR
Lane Configurations			↕				↕				↕	
Traffic Vol, veh/h	0	18	12	1	0	0	11	0	0	4	2	0
Future Vol, veh/h	0	18	12	1	0	0	11	0	0	4	2	0
Peak Hour Factor	1.00	1.00	1.00	1.00	1.00	1.00	1.00	1.00	1.00	1.00	1.00	1.00
Heavy Vehicles, %	2	2	2	2	2	2	2	2	2	2	2	2
Mvmt Flow	0	18	12	1	0	0	11	0	0	4	2	0
Number of Lanes	0	0	1	0	0	0	1	0	0	0	1	0

Approach	EB	WB	NB
Opposing Approach	WB	EB	SB
Opposing Lanes	1	1	1
Conflicting Approach Left	SB	NB	EB
Conflicting Lanes Left	1	1	1
Conflicting Approach Right	NB	SB	WB
Conflicting Lanes Right	1	1	1
HCM Control Delay	7.3	7.1	7.2
HCM LOS	A	A	A

Lane	NBLn1	EBLn1	WBLn1	SBLn1
Vol Left, %	67%	58%	0%	0%
Vol Thru, %	33%	39%	100%	4%
Vol Right, %	0%	3%	0%	96%
Sign Control	Stop	Stop	Stop	Stop
Traffic Vol by Lane	6	31	11	28
LT Vol	4	18	0	0
Through Vol	2	12	11	1
RT Vol	0	1	0	27
Lane Flow Rate	6	31	11	28
Geometry Grp	1	1	1	1
Degree of Util (X)	0.007	0.035	0.012	0.027
Departure Headway (Hd)	4.163	4.098	4.016	3.434
Convergence, Y/N	Yes	Yes	Yes	Yes
Cap	861	877	893	1043
Service Time	2.182	2.108	2.03	1.453
HCM Lane V/C Ratio	0.007	0.035	0.012	0.027
HCM Control Delay	7.2	7.3	7.1	6.5
HCM Lane LOS	A	A	A	A
HCM 95th-tile Q	0	0.1	0	0.1

Intersection

Intersection Delay, s/veh
 Intersection LOS

Movement	SBU	SBL	SBT	SBR
Lane Configurations			↕	
Traffic Vol, veh/h	0	0	1	27
Future Vol, veh/h	0	0	1	27
Peak Hour Factor	1.00	1.00	1.00	1.00
Heavy Vehicles, %	2	2	2	2
Mvmt Flow	0	0	1	27
Number of Lanes	0	0	1	0

Approach	SB
Opposing Approach	NB
Opposing Lanes	1
Conflicting Approach Left	WB
Conflicting Lanes Left	1
Conflicting Approach Right	EB
Conflicting Lanes Right	1
HCM Control Delay	6.5
HCM LOS	A

Lanes, Volumes, Timings
 14: Seaside Park Drive & Shore Road

2027 No-Build - AM Peak
 05/09/2017

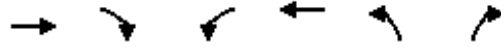

Lane Group	EBT	EBR	WBL	WBT	NBL	NBR
Lane Configurations						
Traffic Volume (vph)	16	1	2	12	1	4
Future Volume (vph)	16	1	2	12	1	4
Ideal Flow (vphpl)	1900	1900	1900	1900	1900	1900
Lane Util. Factor	1.00	1.00	1.00	1.00	1.00	1.00
Frt	0.992			0.892		
Flt Protected				0.993	0.990	
Satd. Flow (prot)	1848	0	0	1850	1645	0
Flt Permitted				0.993	0.990	
Satd. Flow (perm)	1848	0	0	1850	1645	0
Link Speed (mph)	30			30	30	
Link Distance (ft)	504			461	476	
Travel Time (s)	11.5			10.5	10.8	
Peak Hour Factor	1.00	1.00	1.00	1.00	1.00	1.00
Adj. Flow (vph)	16	1	2	12	1	4
Shared Lane Traffic (%)						
Lane Group Flow (vph)	17	0	0	14	5	0
Sign Control	Free			Free	Stop	

Intersection Summary

Area Type:	Other
Control Type:	Unsignalized
Intersection Capacity Utilization	13.3% ICU Level of Service A
Analysis Period (min)	15

Intersection

Int Delay, s/veh 1.6

Movement	EBT	EBR	WBL	WBT	NBL	NBR
Lane Configurations	↕		↕		↕	
Traffic Vol, veh/h	16	1	2	12	1	4
Future Vol, veh/h	16	1	2	12	1	4
Conflicting Peds, #/hr	0	0	0	0	0	0
Sign Control	Free	Free	Free	Free	Stop	Stop
RT Channelized	-	None	-	None	-	None
Storage Length	-	-	-	-	0	-
Veh in Median Storage, #	0	-	-	0	0	-
Grade, %	0	-	-	0	0	-
Peak Hour Factor	100	100	100	100	100	100
Heavy Vehicles, %	2	2	2	2	2	2
Mvmt Flow	16	1	2	12	1	4

Major/Minor	Major1		Major2		Minor1	
Conflicting Flow All	0	0	17	0	33	17
Stage 1	-	-	-	-	17	-
Stage 2	-	-	-	-	16	-
Critical Hdwy	-	-	4.12	-	6.42	6.22
Critical Hdwy Stg 1	-	-	-	-	5.42	-
Critical Hdwy Stg 2	-	-	-	-	5.42	-
Follow-up Hdwy	-	-	2.218	-	3.518	3.318
Pot Cap-1 Maneuver	-	-	1600	-	980	1062
Stage 1	-	-	-	-	1006	-
Stage 2	-	-	-	-	1007	-
Platoon blocked, %	-	-	-	-	-	-
Mov Cap-1 Maneuver	-	-	1600	-	979	1062
Mov Cap-2 Maneuver	-	-	-	-	979	-
Stage 1	-	-	-	-	1006	-
Stage 2	-	-	-	-	1006	-

Approach	EB	WB	NB
HCM Control Delay, s	0	1	8.5
HCM LOS			A

Minor Lane/Major Mvmt	NBLn1	EBT	EBR	WBL	WBT
Capacity (veh/h)	1044	-	-	1600	-
HCM Lane V/C Ratio	0.005	-	-	0.001	-
HCM Control Delay (s)	8.5	-	-	7.3	0
HCM Lane LOS	A	-	-	A	A
HCM 95th %tile Q(veh)	0	-	-	0	-

Lanes, Volumes, Timings
 18: Great Neck Road & Shore Road

2027 No-Build - AM Peak
 05/09/2017



Lane Group	EBL	EBR	NBL	NBT	SBT	SBR
Lane Configurations						
Traffic Volume (vph)	28	7	11	68	62	13
Future Volume (vph)	28	7	11	68	62	13
Ideal Flow (vphpl)	1900	1900	1900	1900	1900	1900
Lane Util. Factor	1.00	1.00	1.00	1.00	1.00	1.00
Frt	0.973				0.977	
Flt Protected	0.962			0.993		
Satd. Flow (prot)	1744	0	0	1850	1820	0
Flt Permitted	0.962			0.993		
Satd. Flow (perm)	1744	0	0	1850	1820	0
Link Speed (mph)	30			30	30	
Link Distance (ft)	471			248	380	
Travel Time (s)	10.7			5.6	8.6	
Peak Hour Factor	1.00	1.00	1.00	1.00	1.00	1.00
Adj. Flow (vph)	28	7	11	68	62	13
Shared Lane Traffic (%)						
Lane Group Flow (vph)	35	0	0	79	75	0
Sign Control	Stop			Free	Free	

Intersection Summary

Area Type:	Other
Control Type:	Unsignalized
Intersection Capacity Utilization	20.9%
Analysis Period (min)	15
	ICU Level of Service A

Intersection

Int Delay, s/veh 2.2

Movement	EBL	EBR	NBL	NBT	SBT	SBR
Lane Configurations	Y			4	1	
Traffic Vol, veh/h	28	7	11	68	62	13
Future Vol, veh/h	28	7	11	68	62	13
Conflicting Peds, #/hr	0	0	0	0	0	0
Sign Control	Stop	Stop	Free	Free	Free	Free
RT Channelized	-	None	-	None	-	None
Storage Length	0	-	-	-	-	-
Veh in Median Storage, #	0	-	-	0	0	-
Grade, %	0	-	-	0	0	-
Peak Hour Factor	100	100	100	100	100	100
Heavy Vehicles, %	2	2	2	2	2	2
Mvmt Flow	28	7	11	68	62	13

Major/Minor	Minor2	Major1		Major2	
Conflicting Flow All	159	69	75	0	0
Stage 1	69	-	-	-	-
Stage 2	90	-	-	-	-
Critical Hdwy	6.42	6.22	4.12	-	-
Critical Hdwy Stg 1	5.42	-	-	-	-
Critical Hdwy Stg 2	5.42	-	-	-	-
Follow-up Hdwy	3.518	3.318	2.218	-	-
Pot Cap-1 Maneuver	832	994	1524	-	-
Stage 1	954	-	-	-	-
Stage 2	934	-	-	-	-
Platoon blocked, %				-	-
Mov Cap-1 Maneuver	825	994	1524	-	-
Mov Cap-2 Maneuver	825	-	-	-	-
Stage 1	954	-	-	-	-
Stage 2	927	-	-	-	-

Approach	EB	NB	SB
HCM Control Delay, s	9.4	1	0
HCM LOS	A		

Minor Lane/Major Mvmt	NBL	NBT	EBLn1	SBT	SBR
Capacity (veh/h)	1524	-	854	-	-
HCM Lane V/C Ratio	0.007	-	0.041	-	-
HCM Control Delay (s)	7.4	0	9.4	-	-
HCM Lane LOS	A	A	A	-	-
HCM 95th %tile Q(veh)	0	-	0.1	-	-

Lanes, Volumes, Timings
 24: Lamphere Road & Great Neck Road

2027 No-Build - AM Peak
 05/09/2017



Lane Group	EBL	EBT	EBR	WBL	WBT	WBR	NBL	NBT	NBR	SBL	SBT	SBR
Lane Configurations		↕			↕			↕			↕	
Traffic Volume (vph)	91	12	1	4	7	144	0	223	4	50	102	32
Future Volume (vph)	91	12	1	4	7	144	0	223	4	50	102	32
Ideal Flow (vphpl)	1900	1900	1900	1900	1900	1900	1900	1900	1900	1900	1900	1900
Lane Util. Factor	1.00	1.00	1.00	1.00	1.00	1.00	1.00	1.00	1.00	1.00	1.00	1.00
Frt		0.999			0.875			0.998			0.977	
Flt Protected		0.958			0.999						0.987	
Satd. Flow (prot)	0	1783	0	0	1628	0	0	1859	0	0	1796	0
Flt Permitted		0.958			0.999						0.987	
Satd. Flow (perm)	0	1783	0	0	1628	0	0	1859	0	0	1796	0
Link Speed (mph)		30			30			30			30	
Link Distance (ft)		536			649			512			388	
Travel Time (s)		12.2			14.8			11.6			8.8	
Peak Hour Factor	1.00	1.00	1.00	1.00	1.00	1.00	1.00	1.00	1.00	1.00	1.00	1.00
Adj. Flow (vph)	91	12	1	4	7	144	0	223	4	50	102	32
Shared Lane Traffic (%)												
Lane Group Flow (vph)	0	104	0	0	155	0	0	227	0	0	184	0
Sign Control		Stop			Stop			Free			Free	

Intersection Summary

Area Type:	Other
Control Type:	Unsignalized
Intersection Capacity Utilization	50.6%
Analysis Period (min)	15
	ICU Level of Service A

Intersection

Int Delay, s/veh 5.9

Movement	EBL	EBT	EBR	WBL	WBT	WBR	NBL	NBT	NBR	SBL	SBT	SBR
Lane Configurations	↕			↕			↕			↕		
Traffic Vol, veh/h	91	12	1	4	7	144	0	223	4	50	102	32
Future Vol, veh/h	91	12	1	4	7	144	0	223	4	50	102	32
Conflicting Peds, #/hr	0	0	0	0	0	0	0	0	0	0	0	0
Sign Control	Stop	Stop	Stop	Stop	Stop	Stop	Free	Free	Free	Free	Free	Free
RT Channelized	-	-	None	-	-	None	-	-	None	-	-	None
Storage Length	-	-	-	-	-	-	-	-	-	-	-	-
Veh in Median Storage, #	-	0	-	-	0	-	-	0	-	-	0	-
Grade, %	-	0	-	-	0	-	-	0	-	-	0	-
Peak Hour Factor	100	100	100	100	100	100	100	100	100	100	100	100
Heavy Vehicles, %	2	2	2	2	2	2	2	2	2	2	2	2
Mvmt Flow	91	12	1	4	7	144	0	223	4	50	102	32

Major/Minor	Minor2			Minor1			Major1			Major2		
Conflicting Flow All	519	445	118	450	459	225	134	0	0	227	0	0
Stage 1	218	218	-	225	225	-	-	-	-	-	-	-
Stage 2	301	227	-	225	234	-	-	-	-	-	-	-
Critical Hdwy	7.12	6.52	6.22	7.12	6.52	6.22	4.12	-	-	4.12	-	-
Critical Hdwy Stg 1	6.12	5.52	-	6.12	5.52	-	-	-	-	-	-	-
Critical Hdwy Stg 2	6.12	5.52	-	6.12	5.52	-	-	-	-	-	-	-
Follow-up Hdwy	3.518	4.018	3.318	3.518	4.018	3.318	2.218	-	-	2.218	-	-
Pot Cap-1 Maneuver	467	508	934	519	499	814	1451	-	-	1341	-	-
Stage 1	784	723	-	778	718	-	-	-	-	-	-	-
Stage 2	708	716	-	778	711	-	-	-	-	-	-	-
Platoon blocked, %												
Mov Cap-1 Maneuver	369	488	934	493	479	814	1451	-	-	1341	-	-
Mov Cap-2 Maneuver	369	488	-	493	479	-	-	-	-	-	-	-
Stage 1	784	694	-	778	718	-	-	-	-	-	-	-
Stage 2	577	716	-	733	683	-	-	-	-	-	-	-

Approach	EB	WB	NB	SB
HCM Control Delay, s	17.9	10.8	0	2.1
HCM LOS	C	B		

Minor Lane/Major Mvmt	NBL	NBT	NBR	EBLn1	WBLn1	SBL	SBT	SBR
Capacity (veh/h)	1451	-	-	382	776	1341	-	-
HCM Lane V/C Ratio	-	-	-	0.272	0.2	0.037	-	-
HCM Control Delay (s)	0	-	-	17.9	10.8	7.8	0	-
HCM Lane LOS	A	-	-	C	B	A	A	-
HCM 95th %tile Q(veh)	0	-	-	1.1	0.7	0.1	-	-

Lanes, Volumes, Timings
28: Great Neck Road/Avery Lane & Rope Ferry Road

2027 No-Build - AM Peak
05/09/2017



Lane Group	EBL	EBT	EBR	WBL	WBT	WBR	NBL	NBT	NBR	SBL	SBT	SBR
Lane Configurations												
Traffic Volume (vph)	59	351	49	161	200	82	49	218	318	26	96	27
Future Volume (vph)	59	351	49	161	200	82	49	218	318	26	96	27
Ideal Flow (vphp)	1900	1900	1900	1900	1900	1900	1900	1900	1900	1900	1900	1900
Storage Length (ft)	100		0	200		0	0		250	0		0
Storage Lanes	1		0	1		0	0		1	0		0
Taper Length (ft)	25			25			25			25		
Lane Util. Factor	1.00	1.00	1.00	1.00	1.00	1.00	1.00	1.00	1.00	1.00	1.00	1.00
Frt		0.982			0.956				0.850		0.976	
Flt Protected	0.950			0.950				0.991			0.991	
Satd. Flow (prot)	1770	1829	0	1770	1781	0	0	1846	1583	0	1802	0
Flt Permitted	0.507			0.338				0.918			0.914	
Satd. Flow (perm)	944	1829	0	630	1781	0	0	1710	1583	0	1662	0
Right Turn on Red			Yes			Yes			Yes			Yes
Satd. Flow (RTOR)		13			40				346			19
Link Speed (mph)		30			30			30				30
Link Distance (ft)		662			691			557				483
Travel Time (s)		15.0			15.7			12.7				11.0
Peak Hour Factor	0.92	0.92	0.92	0.92	0.92	0.92	0.92	0.92	0.92	0.92	0.92	0.92
Adj. Flow (vph)	64	382	53	175	217	89	53	237	346	28	104	29
Shared Lane Traffic (%)												
Lane Group Flow (vph)	64	435	0	175	306	0	0	290	346	0	161	0
Turn Type	pm+pt	NA		pm+pt	NA		Perm	NA	Perm	Perm	NA	
Protected Phases	5	2		1	6			8				4
Permitted Phases	2			6			8		8	4		
Minimum Split (s)	9.5	22.5		9.5	22.5		22.5	22.5	22.5	22.5	22.5	22.5
Total Split (s)	9.6	27.2		10.0	27.6		22.8	22.8	22.8	22.8	22.8	22.8
Total Split (%)	16.0%	45.3%		16.7%	46.0%		38.0%	38.0%	38.0%	38.0%	38.0%	38.0%
Yellow Time (s)	3.5	3.5		3.5	3.5		3.5	3.5	3.5	3.5	3.5	3.5
All-Red Time (s)	1.0	1.0		1.0	1.0		1.0	1.0	1.0	1.0	1.0	1.0
Lost Time Adjust (s)	0.0	0.0		0.0	0.0			0.0	0.0		0.0	
Total Lost Time (s)	4.5	4.5		4.5	4.5			4.5	4.5		4.5	
Lead/Lag	Lead	Lag		Lead	Lag							
Lead-Lag Optimize?	Yes	Yes		Yes	Yes							
Act Effect Green (s)	27.8	22.7		28.6	23.1			18.3	18.3		18.3	
Actuated g/C Ratio	0.46	0.38		0.48	0.38			0.30	0.30		0.30	
v/c Ratio	0.13	0.62		0.43	0.43			0.56	0.48		0.31	
Control Delay	7.3	19.4		10.7	14.0			22.4	4.8		16.1	
Queue Delay	0.0	0.0		0.0	0.0			0.0	0.0		0.0	
Total Delay	7.3	19.4		10.7	14.0			22.4	4.8		16.1	
LOS	A	B		B	B			C	A		B	
Approach Delay		17.9			12.8			12.8			16.1	
Approach LOS		B			B			B			B	
Queue Length 50th (ft)	10	120		29	67			87	0		39	
Queue Length 95th (ft)	24	205		56	125			154	50		81	
Internal Link Dist (ft)		582			611			477			403	
Turn Bay Length (ft)	100			200					250			
Base Capacity (vph)	507	700		404	710			521	723		520	
Starvation Cap Reductn	0	0		0	0			0	0		0	

Lanes, Volumes, Timings
 28: Great Neck Road/Avery Lane & Rope Ferry Road

2027 No-Build - AM Peak
 05/09/2017



Lane Group	EBL	EBT	EBR	WBL	WBT	WBR	NBL	NBT	NBR	SBL	SBT	SBR
Spillback Cap Reductn	0	0		0	0			0	0		0	
Storage Cap Reductn	0	0		0	0			0	0		0	
Reduced v/c Ratio	0.13	0.62		0.43	0.43			0.56	0.48		0.31	

Intersection Summary

Area Type:	Other
Cycle Length:	60
Actuated Cycle Length:	60
Offset:	0 (0%), Referenced to phase 2:EBTL and 6:WBTL, Start of Green
Natural Cycle:	60
Control Type:	Pretimed
Maximum v/c Ratio:	0.62
Intersection Signal Delay:	14.5
Intersection LOS:	B
Intersection Capacity Utilization	67.7%
ICU Level of Service	C
Analysis Period (min)	15

Splits and Phases: 28: Great Neck Road/Avery Lane & Rope Ferry Road

Ø1	Ø2 (R)	Ø4
10 s	27.2 s	22.8 s
Ø5	Ø6 (R)	Ø8
9.6 s	27.6 s	22.8 s

Lanes, Volumes, Timings
1: Gardiners Wood Road & Rope Ferry Road

2027 No-Build - PM Peak

05/09/2017

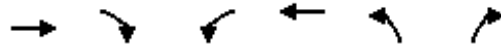

Lane Group	EBT	EBR	WBL	WBT	NBL	NBR
Lane Configurations						
Traffic Volume (vph)	655	106	50	432	77	39
Future Volume (vph)	655	106	50	432	77	39
Ideal Flow (vphpl)	1900	1900	1900	1900	1900	1900
Lane Util. Factor	1.00	1.00	1.00	1.00	1.00	1.00
Frt	0.981				0.955	
Flt Protected				0.995	0.968	
Satd. Flow (prot)	1827	0	0	1853	1722	0
Flt Permitted				0.694	0.968	
Satd. Flow (perm)	1827	0	0	1293	1722	0
Right Turn on Red		Yes				Yes
Satd. Flow (RTOR)	16				32	
Link Speed (mph)	30			30	30	
Link Distance (ft)	512			589	834	
Travel Time (s)	11.6			13.4	19.0	
Peak Hour Factor	0.92	0.92	0.92	0.92	0.92	0.92
Adj. Flow (vph)	712	115	54	470	84	42
Shared Lane Traffic (%)						
Lane Group Flow (vph)	827	0	0	524	126	0
Turn Type	NA		pm+pt	NA	Prot	
Protected Phases	2		1	6	8	
Permitted Phases			6			
Detector Phase	2		1	6	8	
Switch Phase						
Minimum Initial (s)	5.0		5.0	5.0	5.0	
Minimum Split (s)	22.5		9.5	22.5	22.5	
Total Split (s)	43.0		9.5	52.5	22.5	
Total Split (%)	57.3%		12.7%	70.0%	30.0%	
Yellow Time (s)	3.5		3.5	3.5	3.5	
All-Red Time (s)	1.0		1.0	1.0	1.0	
Lost Time Adjust (s)	0.0			0.0	0.0	
Total Lost Time (s)	4.5			4.5	4.5	
Lead/Lag	Lag		Lead			
Lead-Lag Optimize?	Yes		Yes			
Recall Mode	None		None	None	Max	
Act Effct Green (s)	35.6			35.6	18.5	
Actuated g/C Ratio	0.56			0.56	0.29	
v/c Ratio	0.80			0.72	0.24	
Control Delay	17.0			16.1	17.8	
Queue Delay	0.0			0.0	0.0	
Total Delay	17.0			16.1	17.8	
LOS	B			B	B	
Approach Delay	17.0			16.1	17.8	
Approach LOS	B			B	B	
Queue Length 50th (ft)	215			129	27	
Queue Length 95th (ft)	346			228	79	
Internal Link Dist (ft)	432			509	754	
Turn Bay Length (ft)						
Base Capacity (vph)	1232			1006	525	

Lanes, Volumes, Timings
 1: Gardiners Wood Road & Rope Ferry Road

2027 No-Build - PM Peak
 05/09/2017

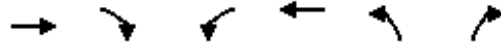

Lane Group	EBT	EBR	WBL	WBT	NBL	NBR
Starvation Cap Reductn	0			0	0	
Spillback Cap Reductn	0			0	0	
Storage Cap Reductn	0			0	0	
Reduced v/c Ratio	0.67			0.52	0.24	

Intersection Summary

Area Type:	Other
Cycle Length:	75
Actuated Cycle Length:	63.3
Natural Cycle:	75
Control Type:	Semi Act-Uncoord
Maximum v/c Ratio:	0.80
Intersection Signal Delay:	16.7
Intersection LOS:	B
Intersection Capacity Utilization	78.7%
ICU Level of Service	D
Analysis Period (min)	15

Splits and Phases: 1: Gardiners Wood Road & Rope Ferry Road

Ø1	Ø2	
9.5 s	43 s	
Ø6		Ø8
52.5 s		22.5 s

Lanes, Volumes, Timings
5: Shore Road & Jordan Cove Road

2027 No-Build - PM Peak
05/09/2017



Lane Group	EBL	EBR	NBL	NBT	SBT	SBR
Lane Configurations						
Traffic Volume (vph)	29	80	61	29	38	37
Future Volume (vph)	29	80	61	29	38	37
Ideal Flow (vphpl)	1900	1900	1900	1900	1900	1900
Lane Util. Factor	1.00	1.00	1.00	1.00	1.00	1.00
Frt	0.901				0.933	
Flt Protected	0.987			0.967		
Satd. Flow (prot)	1657	0	0	1801	1738	0
Flt Permitted	0.987			0.967		
Satd. Flow (perm)	1657	0	0	1801	1738	0
Link Speed (mph)	30			30	30	
Link Distance (ft)	348			365	291	
Travel Time (s)	7.9			8.3	6.6	
Peak Hour Factor	1.00	1.00	1.00	1.00	1.00	1.00
Adj. Flow (vph)	29	80	61	29	38	37
Shared Lane Traffic (%)						
Lane Group Flow (vph)	109	0	0	90	75	0
Sign Control	Stop			Stop	Stop	

Intersection Summary

Area Type:	Other
Control Type:	Unsignalized
Intersection Capacity Utilization	24.8%
Analysis Period (min)	15
	ICU Level of Service A

Intersection	
Intersection Delay, s/veh	7.5
Intersection LOS	A

Movement	EBU	EBL	EBR	NBU	NBL	NBT	SBU	SBT	SBR
Lane Configurations		Y				4		4	
Traffic Vol, veh/h	0	29	80	0	61	29	0	38	37
Future Vol, veh/h	0	29	80	0	61	29	0	38	37
Peak Hour Factor	1.00	1.00	1.00	1.00	1.00	1.00	1.00	1.00	1.00
Heavy Vehicles, %	2	2	2	2	2	2	2	2	2
Mvmt Flow	0	29	80	0	61	29	0	38	37
Number of Lanes	0	1	0	0	0	1	0	1	0

















Approach	EB	NB	SB
Opposing Approach		SB	NB
Opposing Lanes	0	1	1
Conflicting Approach Left	SB	EB	
Conflicting Lanes Left	1	1	0
Conflicting Approach Right	NB		EB
Conflicting Lanes Right	1	0	1
HCM Control Delay	7.4	7.9	7.3
HCM LOS	A	A	A

Lane	NBLn1	EBLn1	SBLn1
Vol Left, %	68%	27%	0%
Vol Thru, %	32%	0%	51%
Vol Right, %	0%	73%	49%
Sign Control	Stop	Stop	Stop
Traffic Vol by Lane	90	109	75
LT Vol	61	29	0
Through Vol	29	0	38
RT Vol	0	80	37
Lane Flow Rate	90	109	75
Geometry Grp	1	1	1
Degree of Util (X)	0.108	0.116	0.081
Departure Headway (Hd)	4.32	3.829	3.899
Convergence, Y/N	Yes	Yes	Yes
Cap	825	922	910
Service Time	2.37	1.909	1.961
HCM Lane V/C Ratio	0.109	0.118	0.082
HCM Control Delay	7.9	7.4	7.3
HCM Lane LOS	A	A	A
HCM 95th-tile Q	0.4	0.4	0.3

Lanes, Volumes, Timings
9: Shore Road & Palmer Road

2027 No-Build - PM Peak

05/09/2017

												
Lane Group	EBL	EBT	EBR	WBL	WBT	WBR	NBL	NBT	NBR	SBL	SBT	SBR
Lane Configurations												
Traffic Volume (vph)	28	39	11	2	18	0	7	7	1	1	9	32
Future Volume (vph)	28	39	11	2	18	0	7	7	1	1	9	32
Ideal Flow (vphpl)	1900	1900	1900	1900	1900	1900	1900	1900	1900	1900	1900	1900
Lane Util. Factor	1.00	1.00	1.00	1.00	1.00	1.00	1.00	1.00	1.00	1.00	1.00	1.00
Frt		0.981						0.991			0.897	
Flt Protected		0.982			0.995			0.977			0.999	
Satd. Flow (prot)	0	1794	0	0	1853	0	0	1804	0	0	1669	0
Flt Permitted		0.982			0.995			0.977			0.999	
Satd. Flow (perm)	0	1794	0	0	1853	0	0	1804	0	0	1669	0
Link Speed (mph)		30			30			30			30	
Link Distance (ft)		357			396			205			196	
Travel Time (s)		8.1			9.0			4.7			4.5	
Peak Hour Factor	1.00	1.00	1.00	1.00	1.00	1.00	1.00	1.00	1.00	1.00	1.00	1.00
Adj. Flow (vph)	28	39	11	2	18	0	7	7	1	1	9	32
Shared Lane Traffic (%)												
Lane Group Flow (vph)	0	78	0	0	20	0	0	15	0	0	42	0
Sign Control		Stop			Stop			Stop			Stop	

Intersection Summary

Area Type:	Other
Control Type:	Unsignalized
Intersection Capacity Utilization	22.0%
Analysis Period (min)	15
	ICU Level of Service A

Intersection	
Intersection Delay, s/veh	7.2
Intersection LOS	A

Movement	EBU	EBL	EBT	EBR	WBU	WBL	WBT	WBR	NBU	NBL	NBT	NBR
Lane Configurations			↕				↕				↕	
Traffic Vol, veh/h	0	28	39	11	0	2	18	0	0	7	7	1
Future Vol, veh/h	0	28	39	11	0	2	18	0	0	7	7	1
Peak Hour Factor	1.00	1.00	1.00	1.00	1.00	1.00	1.00	1.00	1.00	1.00	1.00	1.00
Heavy Vehicles, %	2	2	2	2	2	2	2	2	2	2	2	2
Mvmt Flow	0	28	39	11	0	2	18	0	0	7	7	1
Number of Lanes	0	0	1	0	0	0	1	0	0	0	1	0

Approach	EB	WB	NB
Opposing Approach	WB	EB	SB
Opposing Lanes	1	1	1
Conflicting Approach Left	SB	NB	EB
Conflicting Lanes Left	1	1	1
Conflicting Approach Right	NB	SB	WB
Conflicting Lanes Right	1	1	1
HCM Control Delay	7.4	7.2	7.3
HCM LOS	A	A	A

Lane	NBLn1	EBLn1	WBLn1	SBLn1
Vol Left, %	47%	36%	10%	2%
Vol Thru, %	47%	50%	90%	21%
Vol Right, %	7%	14%	0%	76%
Sign Control	Stop	Stop	Stop	Stop
Traffic Vol by Lane	15	78	20	42
LT Vol	7	28	2	1
Through Vol	7	39	18	9
RT Vol	1	11	0	32
Lane Flow Rate	15	78	20	42
Geometry Grp	1	1	1	1
Degree of Util (X)	0.017	0.087	0.023	0.043
Departure Headway (Hd)	4.189	4.034	4.111	3.662
Convergence, Y/N	Yes	Yes	Yes	Yes
Cap	849	888	869	971
Service Time	2.24	2.058	2.146	1.71
HCM Lane V/C Ratio	0.018	0.088	0.023	0.043
HCM Control Delay	7.3	7.4	7.2	6.9
HCM Lane LOS	A	A	A	A
HCM 95th-tile Q	0.1	0.3	0.1	0.1

Intersection

Intersection Delay, s/veh
 Intersection LOS

Movement	SBU	SBL	SBT	SBR
Lane Configurations			↔	
Traffic Vol, veh/h	0	1	9	32
Future Vol, veh/h	0	1	9	32
Peak Hour Factor	1.00	1.00	1.00	1.00
Heavy Vehicles, %	2	2	2	2
Mvmt Flow	0	1	9	32
Number of Lanes	0	0	1	0

Approach	SB
Opposing Approach	NB
Opposing Lanes	1
Conflicting Approach Left	WB
Conflicting Lanes Left	1
Conflicting Approach Right	EB
Conflicting Lanes Right	1
HCM Control Delay	6.9
HCM LOS	A

Lanes, Volumes, Timings
 14: Seaside Park Drive & Shore Road

2027 No-Build - PM Peak
 05/09/2017

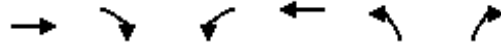

Lane Group	EBT	EBR	WBL	WBT	NBL	NBR
Lane Configurations	↻			↻		
Traffic Volume (vph)	22	2	1	22	1	1
Future Volume (vph)	22	2	1	22	1	1
Ideal Flow (vphpl)	1900	1900	1900	1900	1900	1900
Lane Util. Factor	1.00	1.00	1.00	1.00	1.00	1.00
Frt	0.989			0.932		
Flt Protected				0.998	0.976	
Satd. Flow (prot)	1842	0	0	1859	1694	0
Flt Permitted				0.998	0.976	
Satd. Flow (perm)	1842	0	0	1859	1694	0
Link Speed (mph)	30			30	30	
Link Distance (ft)	504			461	476	
Travel Time (s)	11.5			10.5	10.8	
Peak Hour Factor	1.00	1.00	1.00	1.00	1.00	1.00
Adj. Flow (vph)	22	2	1	22	1	1
Shared Lane Traffic (%)						
Lane Group Flow (vph)	24	0	0	23	2	0
Sign Control	Free			Free	Stop	

Intersection Summary

Area Type:	Other
Control Type:	Unsignalized
Intersection Capacity Utilization	13.3%
Analysis Period (min)	15
	ICU Level of Service A

Intersection

Int Delay, s/veh 0.5

Movement	EBT	EBR	WBL	WBT	NBL	NBR
Lane Configurations	↑		↑		↑	
Traffic Vol, veh/h	22	2	1	22	1	1
Future Vol, veh/h	22	2	1	22	1	1
Conflicting Peds, #/hr	0	0	0	0	0	0
Sign Control	Free	Free	Free	Free	Stop	Stop
RT Channelized	-	None	-	None	-	None
Storage Length	-	-	-	-	0	-
Veh in Median Storage, #	0	-	-	0	0	-
Grade, %	0	-	-	0	0	-
Peak Hour Factor	100	100	100	100	100	100
Heavy Vehicles, %	2	2	2	2	2	2
Mvmt Flow	22	2	1	22	1	1

Major/Minor	Major1		Major2		Minor1	
Conflicting Flow All	0	0	24	0	47	23
Stage 1	-	-	-	-	23	-
Stage 2	-	-	-	-	24	-
Critical Hdwy	-	-	4.12	-	6.42	6.22
Critical Hdwy Stg 1	-	-	-	-	5.42	-
Critical Hdwy Stg 2	-	-	-	-	5.42	-
Follow-up Hdwy	-	-	2.218	-	3.518	3.318
Pot Cap-1 Maneuver	-	-	1591	-	963	1054
Stage 1	-	-	-	-	1000	-
Stage 2	-	-	-	-	999	-
Platoon blocked, %	-	-	-	-	-	-
Mov Cap-1 Maneuver	-	-	1591	-	962	1054
Mov Cap-2 Maneuver	-	-	-	-	962	-
Stage 1	-	-	-	-	1000	-
Stage 2	-	-	-	-	998	-

Approach	EB	WB	NB
HCM Control Delay, s	0	0.3	8.6
HCM LOS			A

Minor Lane/Major Mvmt	NBLn1	EBT	EBR	WBL	WBT
Capacity (veh/h)	1006	-	-	1591	-
HCM Lane V/C Ratio	0.002	-	-	0.001	-
HCM Control Delay (s)	8.6	-	-	7.3	0
HCM Lane LOS	A	-	-	A	A
HCM 95th %tile Q(veh)	0	-	-	0	-

Lanes, Volumes, Timings
 18: Great Neck Road & Shore Road

2027 No-Build - PM Peak
 05/09/2017



Lane Group	EBL	EBR	NBL	NBT	SBT	SBR
Lane Configurations						
Traffic Volume (vph)	13	16	17	79	59	21
Future Volume (vph)	13	16	17	79	59	21
Ideal Flow (vphpl)	1900	1900	1900	1900	1900	1900
Lane Util. Factor	1.00	1.00	1.00	1.00	1.00	1.00
Frt	0.926				0.965	
Flt Protected	0.978			0.991		
Satd. Flow (prot)	1687	0	0	1846	1798	0
Flt Permitted	0.978			0.991		
Satd. Flow (perm)	1687	0	0	1846	1798	0
Link Speed (mph)	30			30	30	
Link Distance (ft)	471			248	380	
Travel Time (s)	10.7			5.6	8.6	
Peak Hour Factor	1.00	1.00	1.00	1.00	1.00	1.00
Adj. Flow (vph)	13	16	17	79	59	21
Shared Lane Traffic (%)						
Lane Group Flow (vph)	29	0	0	96	80	0
Sign Control	Stop			Free	Free	

Intersection Summary

Area Type:	Other
Control Type:	Unsignalized
Intersection Capacity Utilization	21.8%
Analysis Period (min)	15
	ICU Level of Service A

Intersection

Int Delay, s/veh 1.9

Movement	EBL	EBR	NBL	NBT	SBT	SBR
Lane Configurations	Y			4	1	
Traffic Vol, veh/h	13	16	17	79	59	21
Future Vol, veh/h	13	16	17	79	59	21
Conflicting Peds, #/hr	0	0	0	0	0	0
Sign Control	Stop	Stop	Free	Free	Free	Free
RT Channelized	-	None	-	None	-	None
Storage Length	0	-	-	-	-	-
Veh in Median Storage, #	0	-	-	0	0	-
Grade, %	0	-	-	0	0	-
Peak Hour Factor	100	100	100	100	100	100
Heavy Vehicles, %	2	2	2	2	2	2
Mvmt Flow	13	16	17	79	59	21

Major/Minor	Minor2	Major1		Major2	
Conflicting Flow All	183	70	80	0	0
Stage 1	70	-	-	-	-
Stage 2	113	-	-	-	-
Critical Hdwy	6.42	6.22	4.12	-	-
Critical Hdwy Stg 1	5.42	-	-	-	-
Critical Hdwy Stg 2	5.42	-	-	-	-
Follow-up Hdwy	3.518	3.318	2.218	-	-
Pot Cap-1 Maneuver	806	993	1518	-	-
Stage 1	953	-	-	-	-
Stage 2	912	-	-	-	-
Platoon blocked, %				-	-
Mov Cap-1 Maneuver	796	993	1518	-	-
Mov Cap-2 Maneuver	796	-	-	-	-
Stage 1	953	-	-	-	-
Stage 2	901	-	-	-	-

Approach	EB	NB	SB
HCM Control Delay, s	9.2	1.3	0
HCM LOS	A		

Minor Lane/Major Mvmt	NBL	NBT	EBLn1	SBT	SBR
Capacity (veh/h)	1518	-	894	-	-
HCM Lane V/C Ratio	0.011	-	0.032	-	-
HCM Control Delay (s)	7.4	0	9.2	-	-
HCM Lane LOS	A	A	A	-	-
HCM 95th %tile Q(veh)	0	-	0.1	-	-

Lanes, Volumes, Timings
 24: Lamphere Road & Great Neck Road

2027 No-Build - PM Peak
 05/09/2017



Lane Group	EBL	EBT	EBR	WBL	WBT	WBR	NBL	NBT	NBR	SBL	SBT	SBR
Lane Configurations		↕			↕			↕			↕	
Traffic Volume (vph)	72	13	0	9	16	117	4	190	9	147	262	98
Future Volume (vph)	72	13	0	9	16	117	4	190	9	147	262	98
Ideal Flow (vphpl)	1900	1900	1900	1900	1900	1900	1900	1900	1900	1900	1900	1900
Lane Util. Factor	1.00	1.00	1.00	1.00	1.00	1.00	1.00	1.00	1.00	1.00	1.00	1.00
Frt					0.889			0.994			0.974	
Flt Protected		0.959			0.997			0.999			0.986	
Satd. Flow (prot)	0	1786	0	0	1651	0	0	1850	0	0	1789	0
Flt Permitted		0.959			0.997			0.999			0.986	
Satd. Flow (perm)	0	1786	0	0	1651	0	0	1850	0	0	1789	0
Link Speed (mph)		30			30			30			30	
Link Distance (ft)		536			649			512			388	
Travel Time (s)		12.2			14.8			11.6			8.8	
Peak Hour Factor	1.00	1.00	1.00	1.00	1.00	1.00	1.00	1.00	1.00	1.00	1.00	1.00
Adj. Flow (vph)	72	13	0	9	16	117	4	190	9	147	262	98
Shared Lane Traffic (%)												
Lane Group Flow (vph)	0	85	0	0	142	0	0	203	0	0	507	0
Sign Control		Stop			Stop			Free			Free	

Intersection Summary

Area Type:	Other
Control Type:	Unsignalized
Intersection Capacity Utilization	65.2%
Analysis Period (min)	15
	ICU Level of Service C

Intersection												
Int Delay, s/veh	6.3											

Movement	EBL	EBT	EBR	WBL	WBT	WBR	NBL	NBT	NBR	SBL	SBT	SBR
Lane Configurations	↕			↕			↕			↕		
Traffic Vol, veh/h	72	13	0	9	16	117	4	190	9	147	262	98
Future Vol, veh/h	72	13	0	9	16	117	4	190	9	147	262	98
Conflicting Peds, #/hr	0	0	0	0	0	0	0	0	0	0	0	0
Sign Control	Stop	Stop	Stop	Stop	Stop	Stop	Free	Free	Free	Free	Free	Free
RT Channelized	-	-	None	-	-	None	-	-	None	-	-	None
Storage Length	-	-	-	-	-	-	-	-	-	-	-	-
Veh in Median Storage, #	-	0	-	-	0	-	-	0	-	-	0	-
Grade, %	-	0	-	-	0	-	-	0	-	-	0	-
Peak Hour Factor	100	100	100	100	100	100	100	100	100	100	100	100
Heavy Vehicles, %	2	2	2	2	2	2	2	2	2	2	2	2
Mvmt Flow	72	13	0	9	16	117	4	190	9	147	262	98

Major/Minor	Minor2			Minor1			Major1			Major2		
Conflicting Flow All	874	812	311	815	857	195	360	0	0	199	0	0
Stage 1	605	605	-	203	203	-	-	-	-	-	-	-
Stage 2	269	207	-	612	654	-	-	-	-	-	-	-
Critical Hdwy	7.12	6.52	6.22	7.12	6.52	6.22	4.12	-	-	4.12	-	-
Critical Hdwy Stg 1	6.12	5.52	-	6.12	5.52	-	-	-	-	-	-	-
Critical Hdwy Stg 2	6.12	5.52	-	6.12	5.52	-	-	-	-	-	-	-
Follow-up Hdwy	3.518	4.018	3.318	3.518	4.018	3.318	2.218	-	-	2.218	-	-
Pot Cap-1 Maneuver	270	313	729	296	295	846	1199	-	-	1373	-	-
Stage 1	485	487	-	799	733	-	-	-	-	-	-	-
Stage 2	737	731	-	480	463	-	-	-	-	-	-	-
Platoon blocked, %	-	-	-	-	-	-	-	-	-	-	-	-
Mov Cap-1 Maneuver	198	269	729	255	254	846	1199	-	-	1373	-	-
Mov Cap-2 Maneuver	198	269	-	255	254	-	-	-	-	-	-	-
Stage 1	483	421	-	796	730	-	-	-	-	-	-	-
Stage 2	619	728	-	402	400	-	-	-	-	-	-	-

Approach	EB	WB	NB	SB
HCM Control Delay, s	34.2	12.9	0.2	2.3
HCM LOS	D	B		

Minor Lane/Major Mvmt	NBL	NBT	NBR	EBLn1	WBLn1	SBL	SBT	SBR
Capacity (veh/h)	1199	-	-	206	600	1373	-	-
HCM Lane V/C Ratio	0.003	-	-	0.413	0.237	0.107	-	-
HCM Control Delay (s)	8	0	-	34.2	12.9	7.9	0	-
HCM Lane LOS	A	A	-	D	B	A	A	-
HCM 95th %tile Q(veh)	0	-	-	1.9	0.9	0.4	-	-

Lanes, Volumes, Timings
 28: Great Neck Road/Avery Lane & Rope Ferry Road

2027 No-Build - PM Peak

05/09/2017



Lane Group	EBL	EBT	EBR	WBL	WBT	WBR	NBL	NBT	NBR	SBL	SBT	SBR
Lane Configurations												
Traffic Volume (vph)	55	325	95	304	379	62	93	196	244	43	238	76
Future Volume (vph)	55	325	95	304	379	62	93	196	244	43	238	76
Ideal Flow (vphp)	1900	1900	1900	1900	1900	1900	1900	1900	1900	1900	1900	1900
Storage Length (ft)	100		0	200		0	0		250	0		0
Storage Lanes	1		0	1		0	0		1	0		0
Taper Length (ft)	25			25			25			25		
Lane Util. Factor	1.00	1.00	1.00	1.00	1.00	1.00	1.00	1.00	1.00	1.00	1.00	1.00
Frt		0.966			0.979				0.850		0.971	
Flt Protected	0.950			0.950				0.984			0.994	
Satd. Flow (prot)	1770	1799	0	1770	1824	0	0	1833	1583	0	1798	0
Flt Permitted	0.307			0.315				0.674			0.921	
Satd. Flow (perm)	572	1799	0	587	1824	0	0	1255	1583	0	1666	0
Right Turn on Red			Yes			Yes			Yes			Yes
Satd. Flow (RTOR)		28			16				265			23
Link Speed (mph)		30			30			30				30
Link Distance (ft)		662			691			557				483
Travel Time (s)		15.0			15.7			12.7				11.0
Peak Hour Factor	0.92	0.92	0.92	0.92	0.92	0.92	0.92	0.92	0.92	0.92	0.92	0.92
Adj. Flow (vph)	60	353	103	330	412	67	101	213	265	47	259	83
Shared Lane Traffic (%)												
Lane Group Flow (vph)	60	456	0	330	479	0	0	314	265	0	389	0
Turn Type	pm+pt	NA		pm+pt	NA		Perm	NA	Perm	Perm	NA	
Protected Phases	5	2		1	6			8				4
Permitted Phases	2			6			8		8	4		
Minimum Split (s)	9.5	22.5		9.5	22.5		22.5	22.5	22.5	22.5	22.5	22.5
Total Split (s)	9.6	27.2		10.0	27.6		22.8	22.8	22.8	22.8	22.8	22.8
Total Split (%)	16.0%	45.3%		16.7%	46.0%		38.0%	38.0%	38.0%	38.0%	38.0%	38.0%
Yellow Time (s)	3.5	3.5		3.5	3.5		3.5	3.5	3.5	3.5	3.5	3.5
All-Red Time (s)	1.0	1.0		1.0	1.0		1.0	1.0	1.0	1.0	1.0	1.0
Lost Time Adjust (s)	0.0	0.0		0.0	0.0			0.0	0.0		0.0	
Total Lost Time (s)	4.5	4.5		4.5	4.5			4.5	4.5		4.5	
Lead/Lag	Lead	Lag		Lead	Lag							
Lead-Lag Optimize?	Yes	Yes		Yes	Yes							
Act Effect Green (s)	27.8	22.7		28.6	23.1			18.3	18.3		18.3	
Actuated g/C Ratio	0.46	0.38		0.48	0.38			0.30	0.30		0.30	
v/c Ratio	0.16	0.65		0.85	0.67			0.82	0.40		0.74	
Control Delay	7.8	19.8		33.9	20.5			40.3	4.5		28.5	
Queue Delay	0.0	0.0		0.0	0.0			0.0	0.0		0.0	
Total Delay	7.8	19.8		33.9	20.5			40.3	4.5		28.5	
LOS	A	B		C	C			D	A		C	
Approach Delay		18.4			25.9			23.9			28.5	
Approach LOS		B			C			C			C	
Queue Length 50th (ft)	9	123		60	134			104	0		117	
Queue Length 95th (ft)	23	213		#158	228			#229	44		#239	
Internal Link Dist (ft)		582			611			477			403	
Turn Bay Length (ft)	100			200					250			
Base Capacity (vph)	366	698		388	712			382	666		524	
Starvation Cap Reductn	0	0		0	0			0	0		0	

Lanes, Volumes, Timings
 28: Great Neck Road/Avery Lane & Rope Ferry Road

2027 No-Build - PM Peak
 05/09/2017



Lane Group	EBL	EBT	EBR	WBL	WBT	WBR	NBL	NBT	NBR	SBL	SBT	SBR
Spillback Cap Reductn	0	0		0	0			0	0		0	
Storage Cap Reductn	0	0		0	0			0	0		0	
Reduced v/c Ratio	0.16	0.65		0.85	0.67			0.82	0.40		0.74	

Intersection Summary

Area Type: Other
 Cycle Length: 60
 Actuated Cycle Length: 60
 Offset: 0 (0%), Referenced to phase 2:EBTL and 6:WBTL, Start of Green
 Natural Cycle: 65
 Control Type: Pretimed
 Maximum v/c Ratio: 0.85
 Intersection Signal Delay: 24.2
 Intersection LOS: C
 Intersection Capacity Utilization 89.7%
 ICU Level of Service E
 Analysis Period (min) 15
 # 95th percentile volume exceeds capacity, queue may be longer.
 Queue shown is maximum after two cycles.

Splits and Phases: 28: Great Neck Road/Avery Lane & Rope Ferry Road

Ø1	Ø2 (R)	Ø4
10 s	27.2 s	22.8 s
Ø5	Ø6 (R)	Ø8
9.6 s	27.6 s	22.8 s

**CAPACITY ANALYSES
2027 BUILD VOLUMES
DESTINATION PARK**

Lanes, Volumes, Timings
1: Gardiners Wood Road & Rope Ferry Road

2027 Build - Destination Park - AM Peak

05/09/2017



Lane Group	EBT	EBR	WBL	WBT	NBL	NBR
Lane Configurations	↩			↩	↩	
Traffic Volume (vph)	329	46	3	275	85	36
Future Volume (vph)	329	46	3	275	85	36
Ideal Flow (vphpl)	1900	1900	1900	1900	1900	1900
Lane Util. Factor	1.00	1.00	1.00	1.00	1.00	1.00
Frt	0.983				0.960	
Flt Protected					0.966	
Satd. Flow (prot)	1831	0	0	1863	1727	0
Flt Permitted				0.995	0.966	
Satd. Flow (perm)	1831	0	0	1853	1727	0
Right Turn on Red		Yes				Yes
Satd. Flow (RTOR)	14				39	
Link Speed (mph)	30			30	30	
Link Distance (ft)	512			589	834	
Travel Time (s)	11.6			13.4	19.0	
Peak Hour Factor	0.92	0.92	0.92	0.92	0.92	0.92
Adj. Flow (vph)	358	50	3	299	92	39
Shared Lane Traffic (%)						
Lane Group Flow (vph)	408	0	0	302	131	0
Turn Type	NA		pm+pt	NA	Prot	
Protected Phases	2		1	6	8	
Permitted Phases			6			
Detector Phase	2		1	6	8	
Switch Phase						
Minimum Initial (s)	5.0		5.0	5.0	5.0	
Minimum Split (s)	22.5		9.5	22.5	22.5	
Total Split (s)	23.0		9.5	32.5	22.5	
Total Split (%)	41.8%		17.3%	59.1%	40.9%	
Yellow Time (s)	3.5		3.5	3.5	3.5	
All-Red Time (s)	1.0		1.0	1.0	1.0	
Lost Time Adjust (s)	0.0			0.0	0.0	
Total Lost Time (s)	4.5			4.5	4.5	
Lead/Lag	Lag		Lead			
Lead-Lag Optimize?	Yes		Yes			
Recall Mode	None		None	None	Max	
Act Effct Green (s)	13.7			13.7	18.1	
Actuated g/C Ratio	0.33			0.33	0.44	
v/c Ratio	0.66			0.49	0.17	
Control Delay	16.6			13.4	6.8	
Queue Delay	0.0			0.0	0.0	
Total Delay	16.6			13.4	6.8	
LOS	B			B	A	
Approach Delay	16.6			13.4	6.8	
Approach LOS	B			B	A	
Queue Length 50th (ft)	73			53	11	
Queue Length 95th (ft)	137			100	40	
Internal Link Dist (ft)	432			509	754	
Turn Bay Length (ft)						
Base Capacity (vph)	842			1278	787	

Lanes, Volumes, Timings
 1: Gardiners Wood Road & Rope Ferry Road

2027 Build - Destination Park - AM Peak

05/09/2017

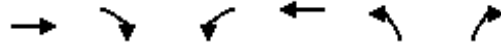

Lane Group	EBT	EBR	WBL	WBT	NBL	NBR
Starvation Cap Reductn	0			0	0	
Spillback Cap Reductn	0			0	0	
Storage Cap Reductn	0			0	0	
Reduced v/c Ratio	0.48			0.24	0.17	

Intersection Summary

Area Type:	Other
Cycle Length:	55
Actuated Cycle Length:	40.9
Natural Cycle:	55
Control Type:	Semi Act-Uncoord
Maximum v/c Ratio:	0.66
Intersection Signal Delay:	13.9
Intersection LOS:	B
Intersection Capacity Utilization	34.5%
ICU Level of Service	A
Analysis Period (min)	15

Splits and Phases: 1: Gardiners Wood Road & Rope Ferry Road

Ø1	Ø2	
9.5 s	23 s	
Ø6	Ø8	
32.5 s	22.5 s	

Lanes, Volumes, Timings
5: Shore Road & Jordan Cove Road

2027 Build - Destination Park - AM Peak

05/09/2017



Lane Group	EBL	EBR	NBL	NBT	SBT	SBR
Lane Configurations						
Traffic Volume (vph)	10	47	60	23	4	30
Future Volume (vph)	10	47	60	23	4	30
Ideal Flow (vphpl)	1900	1900	1900	1900	1900	1900
Lane Util. Factor	1.00	1.00	1.00	1.00	1.00	1.00
Frt	0.889				0.881	
Flt Protected	0.991			0.965		
Satd. Flow (prot)	1641	0	0	1798	1641	0
Flt Permitted	0.991			0.965		
Satd. Flow (perm)	1641	0	0	1798	1641	0
Link Speed (mph)	30			30	30	
Link Distance (ft)	348			365	291	
Travel Time (s)	7.9			8.3	6.6	
Peak Hour Factor	1.00	1.00	1.00	1.00	1.00	1.00
Adj. Flow (vph)	10	47	60	23	4	30
Shared Lane Traffic (%)						
Lane Group Flow (vph)	57	0	0	83	34	0
Sign Control	Stop			Stop	Stop	

Intersection Summary

Area Type:	Other
Control Type:	Unsignalized
Intersection Capacity Utilization	21.3%
Analysis Period (min)	15
	ICU Level of Service A

Intersection	
Intersection Delay, s/veh	7.3
Intersection LOS	A

Movement	EBU	EBL	EBR	NBU	NBL	NBT	SBU	SBT	SBR
Lane Configurations		Y				4		4	
Traffic Vol, veh/h	0	10	47	0	60	23	0	4	30
Future Vol, veh/h	0	10	47	0	60	23	0	4	30
Peak Hour Factor	1.00	1.00	1.00	1.00	1.00	1.00	1.00	1.00	1.00
Heavy Vehicles, %	2	2	2	2	2	2	2	2	2
Mvmt Flow	0	10	47	0	60	23	0	4	30
Number of Lanes	0	1	0	0	0	1	0	1	0

















Approach	EB	NB	SB
Opposing Approach		SB	NB
Opposing Lanes	0	1	1
Conflicting Approach Left	SB	EB	
Conflicting Lanes Left	1	1	0
Conflicting Approach Right	NB		EB
Conflicting Lanes Right	1	0	1
HCM Control Delay	7	7.7	6.7
HCM LOS	A	A	A

Lane	NBLn1	EBLn1	SBLn1
Vol Left, %	72%	18%	0%
Vol Thru, %	28%	0%	12%
Vol Right, %	0%	82%	88%
Sign Control	Stop	Stop	Stop
Traffic Vol by Lane	83	57	34
LT Vol	60	10	0
Through Vol	23	0	4
RT Vol	0	47	30
Lane Flow Rate	83	57	34
Geometry Grp	1	1	1
Degree of Util (X)	0.097	0.058	0.034
Departure Headway (Hd)	4.205	3.675	3.568
Convergence, Y/N	Yes	Yes	Yes
Cap	854	967	1000
Service Time	2.222	1.727	1.601
HCM Lane V/C Ratio	0.097	0.059	0.034
HCM Control Delay	7.7	7	6.7
HCM Lane LOS	A	A	A
HCM 95th-tile Q	0.3	0.2	0.1

Lanes, Volumes, Timings
9: Shore Road & Palmer Road

2027 Build - Destination Park - AM Peak

05/09/2017

												
Lane Group	EBL	EBT	EBR	WBL	WBT	WBR	NBL	NBT	NBR	SBL	SBT	SBR
Lane Configurations												
Traffic Volume (vph)	18	12	1	0	11	5	4	2	0	7	1	27
Future Volume (vph)	18	12	1	0	11	5	4	2	0	7	1	27
Ideal Flow (vphpl)	1900	1900	1900	1900	1900	1900	1900	1900	1900	1900	1900	1900
Lane Util. Factor	1.00	1.00	1.00	1.00	1.00	1.00	1.00	1.00	1.00	1.00	1.00	1.00
Frt		0.996			0.958							0.896
Flt Protected		0.972						0.968				0.990
Satd. Flow (prot)	0	1803	0	0	1785	0	0	1803	0	0	1652	0
Flt Permitted		0.972						0.968				0.990
Satd. Flow (perm)	0	1803	0	0	1785	0	0	1803	0	0	1652	0
Link Speed (mph)		30			30			30			30	
Link Distance (ft)		357			396			205			196	
Travel Time (s)		8.1			9.0			4.7			4.5	
Peak Hour Factor	1.00	1.00	1.00	1.00	1.00	1.00	1.00	1.00	1.00	1.00	1.00	1.00
Adj. Flow (vph)	18	12	1	0	11	5	4	2	0	7	1	27
Shared Lane Traffic (%)												
Lane Group Flow (vph)	0	31	0	0	16	0	0	6	0	0	35	0
Sign Control		Stop			Stop			Stop			Stop	

Intersection Summary

Area Type:	Other
Control Type:	Unsignalized
Intersection Capacity Utilization	18.4%
Analysis Period (min)	15
	ICU Level of Service A

Intersection	
Intersection Delay, s/veh	7
Intersection LOS	A

Movement	EBU	EBL	EBT	EBR	WBU	WBL	WBT	WBR	NBU	NBL	NBT	NBR
Lane Configurations			↕				↕				↕	
Traffic Vol, veh/h	0	18	12	1	0	0	11	5	0	4	2	0
Future Vol, veh/h	0	18	12	1	0	0	11	5	0	4	2	0
Peak Hour Factor	1.00	1.00	1.00	1.00	1.00	1.00	1.00	1.00	1.00	1.00	1.00	1.00
Heavy Vehicles, %	2	2	2	2	2	2	2	2	2	2	2	2
Mvmt Flow	0	18	12	1	0	0	11	5	0	4	2	0
Number of Lanes	0	0	1	0	0	0	1	0	0	0	1	0

Approach	EB	WB	NB
Opposing Approach	WB	EB	SB
Opposing Lanes	1	1	1
Conflicting Approach Left	SB	NB	EB
Conflicting Lanes Left	1	1	1
Conflicting Approach Right	NB	SB	WB
Conflicting Lanes Right	1	1	1
HCM Control Delay	7.3	6.9	7.2
HCM LOS	A	A	A

Lane	NBLn1	EBLn1	WBLn1	SBLn1
Vol Left, %	67%	58%	0%	20%
Vol Thru, %	33%	39%	69%	3%
Vol Right, %	0%	3%	31%	77%
Sign Control	Stop	Stop	Stop	Stop
Traffic Vol by Lane	6	31	16	35
LT Vol	4	18	0	7
Through Vol	2	12	11	1
RT Vol	0	1	5	27
Lane Flow Rate	6	31	16	35
Geometry Grp	1	1	1	1
Degree of Util (X)	0.007	0.035	0.017	0.035
Departure Headway (Hd)	4.176	4.113	3.841	3.597
Convergence, Y/N	Yes	Yes	Yes	Yes
Cap	857	873	933	995
Service Time	2.199	2.127	1.858	1.618
HCM Lane V/C Ratio	0.007	0.036	0.017	0.035
HCM Control Delay	7.2	7.3	6.9	6.7
HCM Lane LOS	A	A	A	A
HCM 95th-tile Q	0	0.1	0.1	0.1

Intersection

Intersection Delay, s/veh

Intersection LOS

Movement	SBU	SBL	SBT	SBR
Lane Configurations			↕	
Traffic Vol, veh/h	0	7	1	27
Future Vol, veh/h	0	7	1	27
Peak Hour Factor	1.00	1.00	1.00	1.00
Heavy Vehicles, %	2	2	2	2
Mvmt Flow	0	7	1	27
Number of Lanes	0	0	1	0

Approach	SB
Opposing Approach	NB
Opposing Lanes	1
Conflicting Approach Left	WB
Conflicting Lanes Left	1
Conflicting Approach Right	EB
Conflicting Lanes Right	1
HCM Control Delay	6.7
HCM LOS	A

Lanes, Volumes, Timings
 14: Seaside Park Drive & Shore Road

2027 Build - Destination Park - AM Peak

05/09/2017

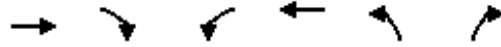

Lane Group	EBT	EBR	WBL	WBT	NBL	NBR
Lane Configurations						
Traffic Volume (vph)	16	8	9	12	6	9
Future Volume (vph)	16	8	9	12	6	9
Ideal Flow (vphpl)	1900	1900	1900	1900	1900	1900
Lane Util. Factor	1.00	1.00	1.00	1.00	1.00	1.00
Frt	0.955			0.919		
Flt Protected				0.979	0.980	
Satd. Flow (prot)	1779	0	0	1824	1678	0
Flt Permitted				0.979	0.980	
Satd. Flow (perm)	1779	0	0	1824	1678	0
Link Speed (mph)	30			30	30	
Link Distance (ft)	504			461	476	
Travel Time (s)	11.5			10.5	10.8	
Peak Hour Factor	1.00	1.00	1.00	1.00	1.00	1.00
Adj. Flow (vph)	16	8	9	12	6	9
Shared Lane Traffic (%)						
Lane Group Flow (vph)	24	0	0	21	15	0
Sign Control	Free			Free	Stop	

Intersection Summary

Area Type:	Other
Control Type:	Unsignalized
Intersection Capacity Utilization	17.8%
Analysis Period (min)	15
	ICU Level of Service A

Intersection

Int Delay, s/veh 3.2

Movement	EBT	EBR	WBL	WBT	NBL	NBR
Lane Configurations	↕		↕		↕	
Traffic Vol, veh/h	16	8	9	12	6	9
Future Vol, veh/h	16	8	9	12	6	9
Conflicting Peds, #/hr	0	0	0	0	0	0
Sign Control	Free	Free	Free	Free	Stop	Stop
RT Channelized	-	None	-	None	-	None
Storage Length	-	-	-	-	0	-
Veh in Median Storage, #	0	-	-	0	0	-
Grade, %	0	-	-	0	0	-
Peak Hour Factor	100	100	100	100	100	100
Heavy Vehicles, %	2	2	2	2	2	2
Mvmt Flow	16	8	9	12	6	9

Major/Minor	Major1		Major2		Minor1	
Conflicting Flow All	0	0	24	0	50	20
Stage 1	-	-	-	-	20	-
Stage 2	-	-	-	-	30	-
Critical Hdwy	-	-	4.12	-	6.42	6.22
Critical Hdwy Stg 1	-	-	-	-	5.42	-
Critical Hdwy Stg 2	-	-	-	-	5.42	-
Follow-up Hdwy	-	-	2.218	-	3.518	3.318
Pot Cap-1 Maneuver	-	-	1591	-	959	1058
Stage 1	-	-	-	-	1003	-
Stage 2	-	-	-	-	993	-
Platoon blocked, %	-	-	-	-	-	-
Mov Cap-1 Maneuver	-	-	1591	-	953	1058
Mov Cap-2 Maneuver	-	-	-	-	953	-
Stage 1	-	-	-	-	1003	-
Stage 2	-	-	-	-	987	-

Approach	EB	WB	NB
HCM Control Delay, s	0	3.1	8.6
HCM LOS			A

Minor Lane/Major Mvmt	NBLn1	EBT	EBR	WBL	WBT
Capacity (veh/h)	1013	-	-	1591	-
HCM Lane V/C Ratio	0.015	-	-	0.006	-
HCM Control Delay (s)	8.6	-	-	7.3	0
HCM Lane LOS	A	-	-	A	A
HCM 95th %tile Q(veh)	0	-	-	0	-

Lanes, Volumes, Timings
18: Great Neck Road & Shore Road

2027 Build - Destination Park - AM Peak

05/09/2017



Lane Group	EBL	EBR	NBL	NBT	SBT	SBR
Lane Configurations						
Traffic Volume (vph)	33	7	11	68	62	20
Future Volume (vph)	33	7	11	68	62	20
Ideal Flow (vphpl)	1900	1900	1900	1900	1900	1900
Lane Util. Factor	1.00	1.00	1.00	1.00	1.00	1.00
Frt	0.976				0.967	
Flt Protected	0.960			0.993		
Satd. Flow (prot)	1745	0	0	1850	1801	0
Flt Permitted	0.960			0.993		
Satd. Flow (perm)	1745	0	0	1850	1801	0
Link Speed (mph)	30			30	30	
Link Distance (ft)	471			248	380	
Travel Time (s)	10.7			5.6	8.6	
Peak Hour Factor	1.00	1.00	1.00	1.00	1.00	1.00
Adj. Flow (vph)	33	7	11	68	62	20
Shared Lane Traffic (%)						
Lane Group Flow (vph)	40	0	0	79	82	0
Sign Control	Stop			Free	Free	

Intersection Summary

Area Type:	Other
Control Type:	Unsignalized
Intersection Capacity Utilization	20.9%
Analysis Period (min)	15
	ICU Level of Service A

Intersection

Int Delay, s/veh 2.3

Movement	EBL	EBR	NBL	NBT	SBT	SBR
Lane Configurations	Y			4	1	
Traffic Vol, veh/h	33	7	11	68	62	20
Future Vol, veh/h	33	7	11	68	62	20
Conflicting Peds, #/hr	0	0	0	0	0	0
Sign Control	Stop	Stop	Free	Free	Free	Free
RT Channelized	-	None	-	None	-	None
Storage Length	0	-	-	-	-	-
Veh in Median Storage, #	0	-	-	0	0	-
Grade, %	0	-	-	0	0	-
Peak Hour Factor	100	100	100	100	100	100
Heavy Vehicles, %	2	2	2	2	2	2
Mvmt Flow	33	7	11	68	62	20

Major/Minor	Minor2	Major1		Major2	
Conflicting Flow All	162	72	82	0	-
Stage 1	72	-	-	-	-
Stage 2	90	-	-	-	-
Critical Hdwy	6.42	6.22	4.12	-	-
Critical Hdwy Stg 1	5.42	-	-	-	-
Critical Hdwy Stg 2	5.42	-	-	-	-
Follow-up Hdwy	3.518	3.318	2.218	-	-
Pot Cap-1 Maneuver	829	990	1515	-	-
Stage 1	951	-	-	-	-
Stage 2	934	-	-	-	-
Platoon blocked, %				-	-
Mov Cap-1 Maneuver	822	990	1515	-	-
Mov Cap-2 Maneuver	822	-	-	-	-
Stage 1	951	-	-	-	-
Stage 2	927	-	-	-	-

Approach	EB	NB	SB
HCM Control Delay, s	9.5	1	0
HCM LOS	A		

Minor Lane/Major Mvmt	NBL	NBT	EBLn1	SBT	SBR
Capacity (veh/h)	1515	-	847	-	-
HCM Lane V/C Ratio	0.007	-	0.047	-	-
HCM Control Delay (s)	7.4	0	9.5	-	-
HCM Lane LOS	A	A	A	-	-
HCM 95th %tile Q(veh)	0	-	0.1	-	-

Lanes, Volumes, Timings
 24: Lamphere Road & Great Neck Road

2027 Build - Destination Park - AM Peak

05/09/2017



Lane Group	EBL	EBT	EBR	WBL	WBT	WBR	NBL	NBT	NBR	SBL	SBT	SBR
Lane Configurations		↕			↕			↕			↕	
Traffic Volume (vph)	91	12	1	4	7	144	0	228	4	50	109	32
Future Volume (vph)	91	12	1	4	7	144	0	228	4	50	109	32
Ideal Flow (vphpl)	1900	1900	1900	1900	1900	1900	1900	1900	1900	1900	1900	1900
Lane Util. Factor	1.00	1.00	1.00	1.00	1.00	1.00	1.00	1.00	1.00	1.00	1.00	1.00
Frt		0.999			0.875			0.998			0.977	
Flt Protected		0.958			0.999						0.987	
Satd. Flow (prot)	0	1783	0	0	1628	0	0	1859	0	0	1796	0
Flt Permitted		0.958			0.999						0.987	
Satd. Flow (perm)	0	1783	0	0	1628	0	0	1859	0	0	1796	0
Link Speed (mph)		30			30			30			30	
Link Distance (ft)		536			649			512			388	
Travel Time (s)		12.2			14.8			11.6			8.8	
Peak Hour Factor	1.00	1.00	1.00	1.00	1.00	1.00	1.00	1.00	1.00	1.00	1.00	1.00
Adj. Flow (vph)	91	12	1	4	7	144	0	228	4	50	109	32
Shared Lane Traffic (%)												
Lane Group Flow (vph)	0	104	0	0	155	0	0	232	0	0	191	0
Sign Control		Stop			Stop			Free			Free	

Intersection Summary

Area Type:	Other
Control Type:	Unsignalized
Intersection Capacity Utilization	51.2%
Analysis Period (min)	15
	ICU Level of Service A

Intersection

Int Delay, s/veh 5.8

Movement	EBL	EBT	EBR	WBL	WBT	WBR	NBL	NBT	NBR	SBL	SBT	SBR
Lane Configurations	↕			↕			↕			↕		
Traffic Vol, veh/h	91	12	1	4	7	144	0	228	4	50	109	32
Future Vol, veh/h	91	12	1	4	7	144	0	228	4	50	109	32
Conflicting Peds, #/hr	0	0	0	0	0	0	0	0	0	0	0	0
Sign Control	Stop	Stop	Stop	Stop	Stop	Stop	Free	Free	Free	Free	Free	Free
RT Channelized	-	-	None	-	-	None	-	-	None	-	-	None
Storage Length	-	-	-	-	-	-	-	-	-	-	-	-
Veh in Median Storage, #	-	0	-	-	0	-	-	0	-	-	0	-
Grade, %	-	0	-	-	0	-	-	0	-	-	0	-
Peak Hour Factor	100	100	100	100	100	100	100	100	100	100	100	100
Heavy Vehicles, %	2	2	2	2	2	2	2	2	2	2	2	2
Mvmt Flow	91	12	1	4	7	144	0	228	4	50	109	32

Major/Minor	Minor2			Minor1			Major1			Major2		
Conflicting Flow All	531	457	125	462	471	230	141	0	0	232	0	0
Stage 1	225	225	-	230	230	-	-	-	-	-	-	-
Stage 2	306	232	-	232	241	-	-	-	-	-	-	-
Critical Hdwy	7.12	6.52	6.22	7.12	6.52	6.22	4.12	-	-	4.12	-	-
Critical Hdwy Stg 1	6.12	5.52	-	6.12	5.52	-	-	-	-	-	-	-
Critical Hdwy Stg 2	6.12	5.52	-	6.12	5.52	-	-	-	-	-	-	-
Follow-up Hdwy	3.518	4.018	3.318	3.518	4.018	3.318	2.218	-	-	2.218	-	-
Pot Cap-1 Maneuver	459	500	926	510	491	809	1442	-	-	1336	-	-
Stage 1	778	718	-	773	714	-	-	-	-	-	-	-
Stage 2	704	713	-	771	706	-	-	-	-	-	-	-
Platoon blocked, %	-	-	-	-	-	-	-	-	-	-	-	-
Mov Cap-1 Maneuver	361	480	926	484	471	809	1442	-	-	1336	-	-
Mov Cap-2 Maneuver	361	480	-	484	471	-	-	-	-	-	-	-
Stage 1	778	689	-	773	714	-	-	-	-	-	-	-
Stage 2	573	713	-	726	677	-	-	-	-	-	-	-

Approach	EB	WB	NB	SB
HCM Control Delay, s	18.3	10.8	0	2
HCM LOS	C	B		

Minor Lane/Major Mvmt	NBL	NBT	NBR	EBLn1	WBLn1	SBL	SBT	SBR
Capacity (veh/h)	1442	-	-	374	771	1336	-	-
HCM Lane V/C Ratio	-	-	-	0.278	0.201	0.037	-	-
HCM Control Delay (s)	0	-	-	18.3	10.8	7.8	0	-
HCM Lane LOS	A	-	-	C	B	A	A	-
HCM 95th %tile Q(veh)	0	-	-	1.1	0.7	0.1	-	-

Lanes, Volumes, Timings
28: Great Neck Road/Avery Lane & Rope Ferry Road

2027 Build - Destination Park - AM Peak

05/09/2017



Lane Group	EBL	EBT	EBR	WBL	WBT	WBR	NBL	NBT	NBR	SBL	SBT	SBR
Lane Configurations												
Traffic Volume (vph)	59	351	50	164	200	82	50	220	321	26	99	27
Future Volume (vph)	59	351	50	164	200	82	50	220	321	26	99	27
Ideal Flow (vphp)	1900	1900	1900	1900	1900	1900	1900	1900	1900	1900	1900	1900
Storage Length (ft)	100		0	200		0	0		250	0		0
Storage Lanes	1		0	1		0	0		1	0		0
Taper Length (ft)	25			25			25			25		
Lane Util. Factor	1.00	1.00	1.00	1.00	1.00	1.00	1.00	1.00	1.00	1.00	1.00	1.00
Frt		0.981			0.956				0.850		0.976	
Flt Protected	0.950			0.950				0.991			0.992	
Satd. Flow (prot)	1770	1827	0	1770	1781	0	0	1846	1583	0	1803	0
Flt Permitted	0.507			0.337				0.916			0.915	
Satd. Flow (perm)	944	1827	0	628	1781	0	0	1706	1583	0	1664	0
Right Turn on Red			Yes			Yes			Yes			Yes
Satd. Flow (RTOR)		14			40				349			18
Link Speed (mph)		30			30				30			30
Link Distance (ft)		662			691				557			483
Travel Time (s)		15.0			15.7				12.7			11.0
Peak Hour Factor	0.92	0.92	0.92	0.92	0.92	0.92	0.92	0.92	0.92	0.92	0.92	0.92
Adj. Flow (vph)	64	382	54	178	217	89	54	239	349	28	108	29
Shared Lane Traffic (%)												
Lane Group Flow (vph)	64	436	0	178	306	0	0	293	349	0	165	0
Turn Type	pm+pt	NA		pm+pt	NA		Perm	NA	Perm	Perm	NA	
Protected Phases	5	2		1	6			8				4
Permitted Phases	2			6			8		8	4		
Minimum Split (s)	9.5	22.5		9.5	22.5		22.5	22.5	22.5	22.5	22.5	22.5
Total Split (s)	9.6	27.2		10.0	27.6		22.8	22.8	22.8	22.8	22.8	22.8
Total Split (%)	16.0%	45.3%		16.7%	46.0%		38.0%	38.0%	38.0%	38.0%	38.0%	38.0%
Yellow Time (s)	3.5	3.5		3.5	3.5		3.5	3.5	3.5	3.5	3.5	3.5
All-Red Time (s)	1.0	1.0		1.0	1.0		1.0	1.0	1.0	1.0	1.0	1.0
Lost Time Adjust (s)	0.0	0.0		0.0	0.0			0.0	0.0		0.0	
Total Lost Time (s)	4.5	4.5		4.5	4.5			4.5	4.5		4.5	
Lead/Lag	Lead	Lag		Lead	Lag							
Lead-Lag Optimize?	Yes	Yes		Yes	Yes							
Act Effect Green (s)	27.8	22.7		28.6	23.1			18.3	18.3		18.3	
Actuated g/C Ratio	0.46	0.38		0.48	0.38			0.30	0.30		0.30	
v/c Ratio	0.13	0.62		0.44	0.43			0.56	0.48		0.32	
Control Delay	7.3	19.4		10.9	14.0			22.5	4.8		16.3	
Queue Delay	0.0	0.0		0.0	0.0			0.0	0.0		0.0	
Total Delay	7.3	19.4		10.9	14.0			22.5	4.8		16.3	
LOS	A	B		B	B			C	A		B	
Approach Delay		17.9			12.9			12.9			16.3	
Approach LOS		B			B			B			B	
Queue Length 50th (ft)	10	120		29	67			88	0		40	
Queue Length 95th (ft)	24	205		56	125			156	50		83	
Internal Link Dist (ft)		582			611			477			403	
Turn Bay Length (ft)	100			200					250			
Base Capacity (vph)	507	699		404	710			520	725		520	
Starvation Cap Reductn	0	0		0	0			0	0		0	

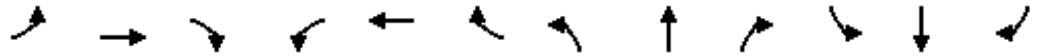

Lane Group	EBL	EBT	EBR	WBL	WBT	WBR	NBL	NBT	NBR	SBL	SBT	SBR
Spillback Cap Reductn	0	0		0	0			0	0		0	
Storage Cap Reductn	0	0		0	0			0	0		0	
Reduced v/c Ratio	0.13	0.62		0.44	0.43			0.56	0.48		0.32	

Intersection Summary

Area Type:	Other
Cycle Length:	60
Actuated Cycle Length:	60
Offset:	0 (0%), Referenced to phase 2:EBTL and 6:WBTL, Start of Green
Natural Cycle:	60
Control Type:	Pretimed
Maximum v/c Ratio:	0.62
Intersection Signal Delay:	14.6
Intersection LOS:	B
Intersection Capacity Utilization	68.2%
ICU Level of Service	C
Analysis Period (min)	15

Splits and Phases: 28: Great Neck Road/Avery Lane & Rope Ferry Road

Ø1	Ø2 (R)	Ø4
10 s	27.2 s	22.8 s
Ø5	Ø6 (R)	Ø8
9.6 s	27.6 s	22.8 s

Lanes, Volumes, Timings
1: Gardiners Wood Road & Rope Ferry Road

2027 Build - Destination Park - PM Peak

05/09/2017

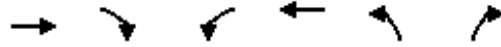

Lane Group	EBT	EBR	WBL	WBT	NBL	NBR
Lane Configurations	↩			↩	↩	
Traffic Volume (vph)	655	117	51	432	89	40
Future Volume (vph)	655	117	51	432	89	40
Ideal Flow (vphpl)	1900	1900	1900	1900	1900	1900
Lane Util. Factor	1.00	1.00	1.00	1.00	1.00	1.00
Frt	0.980				0.959	
Flt Protected				0.995	0.967	
Satd. Flow (prot)	1825	0	0	1853	1727	0
Flt Permitted				0.689	0.967	
Satd. Flow (perm)	1825	0	0	1283	1727	0
Right Turn on Red		Yes				Yes
Satd. Flow (RTOR)	18				28	
Link Speed (mph)	30			30	30	
Link Distance (ft)	512			589	834	
Travel Time (s)	11.6			13.4	19.0	
Peak Hour Factor	0.92	0.92	0.92	0.92	0.92	0.92
Adj. Flow (vph)	712	127	55	470	97	43
Shared Lane Traffic (%)						
Lane Group Flow (vph)	839	0	0	525	140	0
Turn Type	NA		pm+pt	NA	Prot	
Protected Phases	2		1	6	8	
Permitted Phases			6			
Detector Phase	2		1	6	8	
Switch Phase						
Minimum Initial (s)	5.0		5.0	5.0	5.0	
Minimum Split (s)	22.5		9.5	22.5	22.5	
Total Split (s)	43.0		9.5	52.5	22.5	
Total Split (%)	57.3%		12.7%	70.0%	30.0%	
Yellow Time (s)	3.5		3.5	3.5	3.5	
All-Red Time (s)	1.0		1.0	1.0	1.0	
Lost Time Adjust (s)	0.0			0.0	0.0	
Total Lost Time (s)	4.5			4.5	4.5	
Lead/Lag	Lag		Lead			
Lead-Lag Optimize?	Yes		Yes			
Recall Mode	None		None	None	Max	
Act Effct Green (s)	37.0			37.0	18.5	
Actuated g/C Ratio	0.57			0.57	0.29	
v/c Ratio	0.80			0.72	0.27	
Control Delay	16.7			15.8	19.3	
Queue Delay	0.0			0.0	0.0	
Total Delay	16.7			15.8	19.3	
LOS	B			B	B	
Approach Delay	16.7			15.8	19.3	
Approach LOS	B			B	B	
Queue Length 50th (ft)	221			130	35	
Queue Length 95th (ft)	355			231	90	
Internal Link Dist (ft)	432			509	754	
Turn Bay Length (ft)						
Base Capacity (vph)	1217			976	512	

Lanes, Volumes, Timings
 1: Gardiners Wood Road & Rope Ferry Road

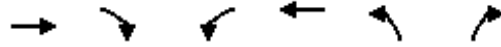

Lane Group	EBT	EBR	WBL	WBT	NBL	NBR
Starvation Cap Reductn	0			0	0	
Spillback Cap Reductn	0			0	0	
Storage Cap Reductn	0			0	0	
Reduced v/c Ratio	0.69			0.54	0.27	

Intersection Summary

Area Type:	Other
Cycle Length:	75
Actuated Cycle Length:	64.7
Natural Cycle:	75
Control Type:	Semi Act-Uncoord
Maximum v/c Ratio:	0.80
Intersection Signal Delay:	16.6
Intersection LOS:	B
Intersection Capacity Utilization	80.3%
ICU Level of Service	D
Analysis Period (min)	15

Splits and Phases: 1: Gardiners Wood Road & Rope Ferry Road

Ø1	Ø2		
9.5 s	43 s		
Ø6		Ø8	
52.5 s		22.5 s	

Lanes, Volumes, Timings
5: Shore Road & Jordan Cove Road

2027 Build - Destination Park - PM Peak

05/09/2017



Lane Group	EBL	EBR	NBL	NBT	SBT	SBR
Lane Configurations						
Traffic Volume (vph)	29	93	75	29	38	37
Future Volume (vph)	29	93	75	29	38	37
Ideal Flow (vphpl)	1900	1900	1900	1900	1900	1900
Lane Util. Factor	1.00	1.00	1.00	1.00	1.00	1.00
Frt	0.897				0.933	
Flt Protected	0.988			0.965		
Satd. Flow (prot)	1651	0	0	1798	1738	0
Flt Permitted	0.988			0.965		
Satd. Flow (perm)	1651	0	0	1798	1738	0
Link Speed (mph)	30			30	30	
Link Distance (ft)	348			365	291	
Travel Time (s)	7.9			8.3	6.6	
Peak Hour Factor	1.00	1.00	1.00	1.00	1.00	1.00
Adj. Flow (vph)	29	93	75	29	38	37
Shared Lane Traffic (%)						
Lane Group Flow (vph)	122	0	0	104	75	0
Sign Control	Stop			Stop	Stop	

Intersection Summary

Area Type:	Other
Control Type:	Unsignalized
Intersection Capacity Utilization	26.3%
Analysis Period (min)	15
	ICU Level of Service A

Intersection	
Intersection Delay, s/veh	7.6
Intersection LOS	A

Movement	EBU	EBL	EBR	NBU	NBL	NBT	SBU	SBT	SBR
Lane Configurations		Y				4		4	
Traffic Vol, veh/h	0	29	93	0	75	29	0	38	37
Future Vol, veh/h	0	29	93	0	75	29	0	38	37
Peak Hour Factor	1.00	1.00	1.00	1.00	1.00	1.00	1.00	1.00	1.00
Heavy Vehicles, %	2	2	2	2	2	2	2	2	2
Mvmt Flow	0	29	93	0	75	29	0	38	37
Number of Lanes	0	1	0	0	0	1	0	1	0

















Approach	EB	NB	SB
Opposing Approach		SB	NB
Opposing Lanes	0	1	1
Conflicting Approach Left	SB	EB	
Conflicting Lanes Left	1	1	0
Conflicting Approach Right	NB		EB
Conflicting Lanes Right	1	0	1
HCM Control Delay	7.5	8	7.4
HCM LOS	A	A	A

Lane	NBLn1	EBLn1	SBLn1
Vol Left, %	72%	24%	0%
Vol Thru, %	28%	0%	51%
Vol Right, %	0%	76%	49%
Sign Control	Stop	Stop	Stop
Traffic Vol by Lane	104	122	75
LT Vol	75	29	0
Through Vol	29	0	38
RT Vol	0	93	37
Lane Flow Rate	104	122	75
Geometry Grp	1	1	1
Degree of Util (X)	0.126	0.13	0.082
Departure Headway (Hd)	4.351	3.83	3.931
Convergence, Y/N	Yes	Yes	Yes
Cap	818	920	900
Service Time	2.408	1.922	2.005
HCM Lane V/C Ratio	0.127	0.133	0.083
HCM Control Delay	8	7.5	7.4
HCM Lane LOS	A	A	A
HCM 95th-tile Q	0.4	0.4	0.3

Lanes, Volumes, Timings
9: Shore Road & Palmer Road

2027 Build - Destination Park - PM Peak

05/09/2017

												
Lane Group	EBL	EBT	EBR	WBL	WBT	WBR	NBL	NBT	NBR	SBL	SBT	SBR
Lane Configurations												
Traffic Volume (vph)	28	39	11	2	18	14	7	7	1	14	9	32
Future Volume (vph)	28	39	11	2	18	14	7	7	1	14	9	32
Ideal Flow (vphpl)	1900	1900	1900	1900	1900	1900	1900	1900	1900	1900	1900	1900
Lane Util. Factor	1.00	1.00	1.00	1.00	1.00	1.00	1.00	1.00	1.00	1.00	1.00	1.00
Frt		0.981			0.944			0.991			0.921	
Flt Protected		0.982			0.997			0.977			0.987	
Satd. Flow (prot)	0	1794	0	0	1753	0	0	1804	0	0	1693	0
Flt Permitted		0.982			0.997			0.977			0.987	
Satd. Flow (perm)	0	1794	0	0	1753	0	0	1804	0	0	1693	0
Link Speed (mph)		30			30			30			30	
Link Distance (ft)		357			396			205			196	
Travel Time (s)		8.1			9.0			4.7			4.5	
Peak Hour Factor	1.00	1.00	1.00	1.00	1.00	1.00	1.00	1.00	1.00	1.00	1.00	1.00
Adj. Flow (vph)	28	39	11	2	18	14	7	7	1	14	9	32
Shared Lane Traffic (%)												
Lane Group Flow (vph)	0	78	0	0	34	0	0	15	0	0	55	0
Sign Control		Stop			Stop			Stop			Stop	

Intersection Summary

Area Type:	Other
Control Type:	Unsignalized
Intersection Capacity Utilization	21.1%
Analysis Period (min)	15
	ICU Level of Service A

Intersection	
Intersection Delay, s/veh	7.3
Intersection LOS	A

Movement	EBU	EBL	EBT	EBR	WBU	WBL	WBT	WBR	NBU	NBL	NBT	NBR
Lane Configurations			↕				↕				↕	
Traffic Vol, veh/h	0	28	39	11	0	2	18	14	0	7	7	1
Future Vol, veh/h	0	28	39	11	0	2	18	14	0	7	7	1
Peak Hour Factor	1.00	1.00	1.00	1.00	1.00	1.00	1.00	1.00	1.00	1.00	1.00	1.00
Heavy Vehicles, %	2	2	2	2	2	2	2	2	2	2	2	2
Mvmt Flow	0	28	39	11	0	2	18	14	0	7	7	1
Number of Lanes	0	0	1	0	0	0	1	0	0	0	1	0

Approach	EB	WB	NB
Opposing Approach	WB	EB	SB
Opposing Lanes	1	1	1
Conflicting Approach Left	SB	NB	EB
Conflicting Lanes Left	1	1	1
Conflicting Approach Right	NB	SB	WB
Conflicting Lanes Right	1	1	1
HCM Control Delay	7.5	7.1	7.4
HCM LOS	A	A	A

Lane	NBLn1	EBLn1	WBLn1	SBLn1
Vol Left, %	47%	36%	6%	25%
Vol Thru, %	47%	50%	53%	16%
Vol Right, %	7%	14%	41%	58%
Sign Control	Stop	Stop	Stop	Stop
Traffic Vol by Lane	15	78	34	55
LT Vol	7	28	2	14
Through Vol	7	39	18	9
RT Vol	1	11	14	32
Lane Flow Rate	15	78	34	55
Geometry Grp	1	1	1	1
Degree of Util (X)	0.018	0.088	0.037	0.059
Departure Headway (Hd)	4.223	4.068	3.879	3.839
Convergence, Y/N	Yes	Yes	Yes	Yes
Cap	841	878	918	925
Service Time	2.283	2.103	1.925	1.894
HCM Lane V/C Ratio	0.018	0.089	0.037	0.059
HCM Control Delay	7.4	7.5	7.1	7.1
HCM Lane LOS	A	A	A	A
HCM 95th-tile Q	0.1	0.3	0.1	0.2

Intersection

Intersection Delay, s/veh

Intersection LOS

Movement	SBU	SBL	SBT	SBR
Lane Configurations			↕	
Traffic Vol, veh/h	0	14	9	32
Future Vol, veh/h	0	14	9	32
Peak Hour Factor	1.00	1.00	1.00	1.00
Heavy Vehicles, %	2	2	2	2
Mvmt Flow	0	14	9	32
Number of Lanes	0	0	1	0

Approach	SB
Opposing Approach	NB
Opposing Lanes	1
Conflicting Approach Left	WB
Conflicting Lanes Left	1
Conflicting Approach Right	EB
Conflicting Lanes Right	1
HCM Control Delay	7.1
HCM LOS	A

Lanes, Volumes, Timings
 14: Seaside Park Drive & Shore Road

2027 Build - Destination Park - PM Peak

05/09/2017

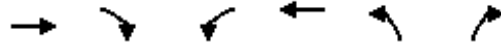

Lane Group	EBT	EBR	WBL	WBT	NBL	NBR
Lane Configurations	↻			↻	↻	
Traffic Volume (vph)	22	15	14	22	15	15
Future Volume (vph)	22	15	14	22	15	15
Ideal Flow (vphpl)	1900	1900	1900	1900	1900	1900
Lane Util. Factor	1.00	1.00	1.00	1.00	1.00	1.00
Frt	0.945				0.932	
Flt Protected				0.981	0.976	
Satd. Flow (prot)	1760	0	0	1827	1694	0
Flt Permitted				0.981	0.976	
Satd. Flow (perm)	1760	0	0	1827	1694	0
Link Speed (mph)	30			30	30	
Link Distance (ft)	504			461	476	
Travel Time (s)	11.5			10.5	10.8	
Peak Hour Factor	1.00	1.00	1.00	1.00	1.00	1.00
Adj. Flow (vph)	22	15	14	22	15	15
Shared Lane Traffic (%)						
Lane Group Flow (vph)	37	0	0	36	30	0
Sign Control	Free			Free	Stop	

Intersection Summary

Area Type:	Other
Control Type:	Unsignalized
Intersection Capacity Utilization	18.6% ICU Level of Service A
Analysis Period (min)	15

Intersection

Int Delay, s/veh 3.5

Movement	EBT	EBR	WBL	WBT	NBL	NBR
Lane Configurations	↑		↑		↑	
Traffic Vol, veh/h	22	15	14	22	15	15
Future Vol, veh/h	22	15	14	22	15	15
Conflicting Peds, #/hr	0	0	0	0	0	0
Sign Control	Free	Free	Free	Free	Stop	Stop
RT Channelized	-	None	-	None	-	None
Storage Length	-	-	-	-	0	-
Veh in Median Storage, #	0	-	-	0	0	-
Grade, %	0	-	-	0	0	-
Peak Hour Factor	100	100	100	100	100	100
Heavy Vehicles, %	2	2	2	2	2	2
Mvmt Flow	22	15	14	22	15	15

Major/Minor	Major1		Major2		Minor1	
Conflicting Flow All	0	0	37	0	80	30
Stage 1	-	-	-	-	30	-
Stage 2	-	-	-	-	50	-
Critical Hdwy	-	-	4.12	-	6.42	6.22
Critical Hdwy Stg 1	-	-	-	-	5.42	-
Critical Hdwy Stg 2	-	-	-	-	5.42	-
Follow-up Hdwy	-	-	2.218	-	3.518	3.318
Pot Cap-1 Maneuver	-	-	1574	-	922	1044
Stage 1	-	-	-	-	993	-
Stage 2	-	-	-	-	972	-
Platoon blocked, %	-	-	-	-	-	-
Mov Cap-1 Maneuver	-	-	1574	-	914	1044
Mov Cap-2 Maneuver	-	-	-	-	914	-
Stage 1	-	-	-	-	993	-
Stage 2	-	-	-	-	963	-

Approach	EB	WB	NB
HCM Control Delay, s	0	2.8	8.8
HCM LOS			A

Minor Lane/Major Mvmt	NBLn1	EBT	EBR	WBL	WBT
Capacity (veh/h)	975	-	-	1574	-
HCM Lane V/C Ratio	0.031	-	-	0.009	-
HCM Control Delay (s)	8.8	-	-	7.3	0
HCM Lane LOS	A	-	-	A	A
HCM 95th %tile Q(veh)	0.1	-	-	0	-

Lanes, Volumes, Timings
18: Great Neck Road & Shore Road

2027 Build - Destination Park - PM Peak

05/09/2017



Lane Group	EBL	EBR	NBL	NBT	SBT	SBR
Lane Configurations						
Traffic Volume (vph)	27	16	17	79	59	34
Future Volume (vph)	27	16	17	79	59	34
Ideal Flow (vphpl)	1900	1900	1900	1900	1900	1900
Lane Util. Factor	1.00	1.00	1.00	1.00	1.00	1.00
Frt	0.950				0.951	
Flt Protected	0.970			0.991		
Satd. Flow (prot)	1717	0	0	1846	1771	0
Flt Permitted	0.970			0.991		
Satd. Flow (perm)	1717	0	0	1846	1771	0
Link Speed (mph)	30			30	30	
Link Distance (ft)	471			248	380	
Travel Time (s)	10.7			5.6	8.6	
Peak Hour Factor	1.00	1.00	1.00	1.00	1.00	1.00
Adj. Flow (vph)	27	16	17	79	59	34
Shared Lane Traffic (%)						
Lane Group Flow (vph)	43	0	0	96	93	0
Sign Control	Stop			Free	Free	

Intersection Summary

Area Type:	Other
Control Type:	Unsignalized
Intersection Capacity Utilization	21.8%
Analysis Period (min)	15
	ICU Level of Service A

Intersection

Int Delay, s/veh 2.3

Movement	EBL	EBR	NBL	NBT	SBT	SBR
Lane Configurations	Y			4	1	
Traffic Vol, veh/h	27	16	17	79	59	34
Future Vol, veh/h	27	16	17	79	59	34
Conflicting Peds, #/hr	0	0	0	0	0	0
Sign Control	Stop	Stop	Free	Free	Free	Free
RT Channelized	-	None	-	None	-	None
Storage Length	0	-	-	-	-	-
Veh in Median Storage, #	0	-	-	0	0	-
Grade, %	0	-	-	0	0	-
Peak Hour Factor	100	100	100	100	100	100
Heavy Vehicles, %	2	2	2	2	2	2
Mvmt Flow	27	16	17	79	59	34

Major/Minor	Minor2		Major1		Major2	
Conflicting Flow All	189	76	93	0	-	0
Stage 1	76	-	-	-	-	-
Stage 2	113	-	-	-	-	-
Critical Hdwy	6.42	6.22	4.12	-	-	-
Critical Hdwy Stg 1	5.42	-	-	-	-	-
Critical Hdwy Stg 2	5.42	-	-	-	-	-
Follow-up Hdwy	3.518	3.318	2.218	-	-	-
Pot Cap-1 Maneuver	800	985	1501	-	-	-
Stage 1	947	-	-	-	-	-
Stage 2	912	-	-	-	-	-
Platoon blocked, %				-	-	-
Mov Cap-1 Maneuver	790	985	1501	-	-	-
Mov Cap-2 Maneuver	790	-	-	-	-	-
Stage 1	947	-	-	-	-	-
Stage 2	901	-	-	-	-	-

Approach	EB	NB	SB
HCM Control Delay, s	9.4	1.3	0
HCM LOS	A		

Minor Lane/Major Mvmt	NBL	NBT	EBLn1	SBT	SBR
Capacity (veh/h)	1501	-	853	-	-
HCM Lane V/C Ratio	0.011	-	0.05	-	-
HCM Control Delay (s)	7.4	0	9.4	-	-
HCM Lane LOS	A	A	A	-	-
HCM 95th %tile Q(veh)	0	-	0.2	-	-

Lanes, Volumes, Timings
 24: Lamphere Road & Great Neck Road

2027 Build - Destination Park - PM Peak

05/09/2017



Lane Group	EBL	EBT	EBR	WBL	WBT	WBR	NBL	NBT	NBR	SBL	SBT	SBR
Lane Configurations		↕			↕			↕			↕	
Traffic Volume (vph)	72	13	0	9	16	117	4	204	9	147	275	98
Future Volume (vph)	72	13	0	9	16	117	4	204	9	147	275	98
Ideal Flow (vphpl)	1900	1900	1900	1900	1900	1900	1900	1900	1900	1900	1900	1900
Lane Util. Factor	1.00	1.00	1.00	1.00	1.00	1.00	1.00	1.00	1.00	1.00	1.00	1.00
Frt					0.889			0.994			0.975	
Flt Protected		0.959			0.997			0.999			0.986	
Satd. Flow (prot)	0	1786	0	0	1651	0	0	1850	0	0	1791	0
Flt Permitted		0.959			0.997			0.999			0.986	
Satd. Flow (perm)	0	1786	0	0	1651	0	0	1850	0	0	1791	0
Link Speed (mph)		30			30			30			30	
Link Distance (ft)		536			649			512			388	
Travel Time (s)		12.2			14.8			11.6			8.8	
Peak Hour Factor	1.00	1.00	1.00	1.00	1.00	1.00	1.00	1.00	1.00	1.00	1.00	1.00
Adj. Flow (vph)	72	13	0	9	16	117	4	204	9	147	275	98
Shared Lane Traffic (%)												
Lane Group Flow (vph)	0	85	0	0	142	0	0	217	0	0	520	0
Sign Control		Stop			Stop			Free			Free	

Intersection Summary

Area Type:	Other
Control Type:	Unsignalized
Intersection Capacity Utilization	66.6%
Analysis Period (min)	15
	ICU Level of Service C

Intersection

Int Delay, s/veh 6.4

Movement	EBL	EBT	EBR	WBL	WBT	WBR	NBL	NBT	NBR	SBL	SBT	SBR
Lane Configurations	↕			↕			↕			↕		
Traffic Vol, veh/h	72	13	0	9	16	117	4	204	9	147	275	98
Future Vol, veh/h	72	13	0	9	16	117	4	204	9	147	275	98
Conflicting Peds, #/hr	0	0	0	0	0	0	0	0	0	0	0	0
Sign Control	Stop	Stop	Stop	Stop	Stop	Stop	Free	Free	Free	Free	Free	Free
RT Channelized	-	-	None	-	-	None	-	-	None	-	-	None
Storage Length	-	-	-	-	-	-	-	-	-	-	-	-
Veh in Median Storage, #	-	0	-	-	0	-	-	0	-	-	0	-
Grade, %	-	0	-	-	0	-	-	0	-	-	0	-
Peak Hour Factor	100	100	100	100	100	100	100	100	100	100	100	100
Heavy Vehicles, %	2	2	2	2	2	2	2	2	2	2	2	2
Mvmt Flow	72	13	0	9	16	117	4	204	9	147	275	98

Major/Minor	Minor2			Minor1			Major1			Major2		
Conflicting Flow All	901	839	324	842	884	209	373	0	0	213	0	0
Stage 1	618	618	-	217	217	-	-	-	-	-	-	-
Stage 2	283	221	-	625	667	-	-	-	-	-	-	-
Critical Hdwy	7.12	6.52	6.22	7.12	6.52	6.22	4.12	-	-	4.12	-	-
Critical Hdwy Stg 1	6.12	5.52	-	6.12	5.52	-	-	-	-	-	-	-
Critical Hdwy Stg 2	6.12	5.52	-	6.12	5.52	-	-	-	-	-	-	-
Follow-up Hdwy	3.518	4.018	3.318	3.518	4.018	3.318	2.218	-	-	2.218	-	-
Pot Cap-1 Maneuver	259	302	717	284	284	831	1185	-	-	1357	-	-
Stage 1	477	481	-	785	723	-	-	-	-	-	-	-
Stage 2	724	720	-	473	457	-	-	-	-	-	-	-
Platoon blocked, %	-	-	-	-	-	-	-	-	-	-	-	-
Mov Cap-1 Maneuver	189	259	717	244	244	831	1185	-	-	1357	-	-
Mov Cap-2 Maneuver	189	259	-	244	244	-	-	-	-	-	-	-
Stage 1	475	414	-	782	720	-	-	-	-	-	-	-
Stage 2	606	717	-	394	393	-	-	-	-	-	-	-

Approach	EB	WB	NB	SB
HCM Control Delay, s	36.5	13.1	0.1	2.3
HCM LOS	E	B		

Minor Lane/Major Mvmt	NBL	NBT	NBR	EBLn1WBLn1	SBL	SBT	SBR
Capacity (veh/h)	1185	-	-	197	584	1357	-
HCM Lane V/C Ratio	0.003	-	-	0.431	0.243	0.108	-
HCM Control Delay (s)	8	0	-	36.5	13.1	8	0
HCM Lane LOS	A	A	-	E	B	A	A
HCM 95th %tile Q(veh)	0	-	-	2	0.9	0.4	-

Lanes, Volumes, Timings
 28: Great Neck Road/Avery Lane & Rope Ferry Road

2027 Build - Destination Park - PM Peak

05/09/2017

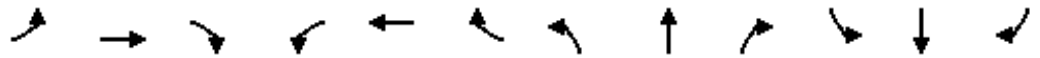

Lane Group	EBL	EBT	EBR	WBL	WBT	WBR	NBL	NBT	NBR	SBL	SBT	SBR
Lane Configurations												
Traffic Volume (vph)	55	325	96	310	379	62	94	201	251	43	243	76
Future Volume (vph)	55	325	96	310	379	62	94	201	251	43	243	76
Ideal Flow (vphp)	1900	1900	1900	1900	1900	1900	1900	1900	1900	1900	1900	1900
Storage Length (ft)	100		0	200		0	0		250	0		0
Storage Lanes	1		0	1		0	0		1	0		0
Taper Length (ft)	25			25			25			25		
Lane Util. Factor	1.00	1.00	1.00	1.00	1.00	1.00	1.00	1.00	1.00	1.00	1.00	1.00
Frt		0.966			0.979				0.850			0.972
Flt Protected	0.950			0.950				0.984				0.994
Satd. Flow (prot)	1770	1799	0	1770	1824	0	0	1833	1583	0	1800	0
Flt Permitted	0.307			0.314				0.670				0.911
Satd. Flow (perm)	572	1799	0	585	1824	0	0	1248	1583	0	1649	0
Right Turn on Red			Yes			Yes			Yes			Yes
Satd. Flow (RTOR)		28			16				273			23
Link Speed (mph)		30			30			30				30
Link Distance (ft)		662			691			557				483
Travel Time (s)		15.0			15.7			12.7				11.0
Peak Hour Factor	0.92	0.92	0.92	0.92	0.92	0.92	0.92	0.92	0.92	0.92	0.92	0.92
Adj. Flow (vph)	60	353	104	337	412	67	102	218	273	47	264	83
Shared Lane Traffic (%)												
Lane Group Flow (vph)	60	457	0	337	479	0	0	320	273	0	394	0
Turn Type	pm+pt	NA		pm+pt	NA		Perm	NA	Perm	Perm	NA	
Protected Phases	5	2		1	6			8				4
Permitted Phases	2			6			8		8	4		
Minimum Split (s)	9.5	22.5		9.5	22.5		22.5	22.5	22.5	22.5	22.5	22.5
Total Split (s)	9.6	27.2		10.0	27.6		22.8	22.8	22.8	22.8	22.8	22.8
Total Split (%)	16.0%	45.3%		16.7%	46.0%		38.0%	38.0%	38.0%	38.0%	38.0%	38.0%
Yellow Time (s)	3.5	3.5		3.5	3.5		3.5	3.5	3.5	3.5	3.5	3.5
All-Red Time (s)	1.0	1.0		1.0	1.0		1.0	1.0	1.0	1.0	1.0	1.0
Lost Time Adjust (s)	0.0	0.0		0.0	0.0			0.0	0.0			0.0
Total Lost Time (s)	4.5	4.5		4.5	4.5			4.5	4.5			4.5
Lead/Lag	Lead	Lag		Lead	Lag							
Lead-Lag Optimize?	Yes	Yes		Yes	Yes							
Act Effect Green (s)	27.8	22.7		28.6	23.1			18.3	18.3			18.3
Actuated g/C Ratio	0.46	0.38		0.48	0.38			0.30	0.30			0.30
v/c Ratio	0.16	0.65		0.87	0.67			0.84	0.41			0.76
Control Delay	7.8	19.8		36.7	20.5			42.7	4.6			29.7
Queue Delay	0.0	0.0		0.0	0.0			0.0	0.0			0.0
Total Delay	7.8	19.8		36.7	20.5			42.7	4.6			29.7
LOS	A	B		D	C			D	A			C
Approach Delay		18.4			27.2			25.1				29.7
Approach LOS		B			C			C				C
Queue Length 50th (ft)	9	124		62	134			107	0			120
Queue Length 95th (ft)	23	213		#165	228			#236	45			#246
Internal Link Dist (ft)		582			611			477				403
Turn Bay Length (ft)	100			200					250			
Base Capacity (vph)	366	698		387	712			380	672			518
Starvation Cap Reductn	0	0		0	0			0	0			0

Lanes, Volumes, Timings
 28: Great Neck Road/Avery Lane & Rope Ferry Road

2027 Build - Destination Park - PM Peak

05/09/2017

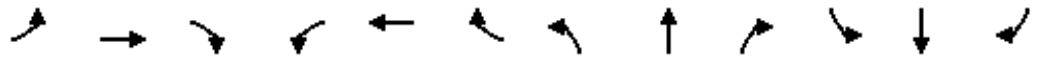

Lane Group	EBL	EBT	EBR	WBL	WBT	WBR	NBL	NBT	NBR	SBL	SBT	SBR
Spillback Cap Reductn	0	0		0	0			0	0		0	
Storage Cap Reductn	0	0		0	0			0	0		0	
Reduced v/c Ratio	0.16	0.65		0.87	0.67			0.84	0.41		0.76	

Intersection Summary

Area Type: Other
 Cycle Length: 60
 Actuated Cycle Length: 60
 Offset: 0 (0%), Referenced to phase 2:EBTL and 6:WBTL, Start of Green
 Natural Cycle: 60
 Control Type: Pretimed
 Maximum v/c Ratio: 0.87
 Intersection Signal Delay: 25.1
 Intersection LOS: C
 Intersection Capacity Utilization 90.7%
 ICU Level of Service E
 Analysis Period (min) 15
 # 95th percentile volume exceeds capacity, queue may be longer.
 Queue shown is maximum after two cycles.

Splits and Phases: 28: Great Neck Road/Avery Lane & Rope Ferry Road

Ø1	Ø2 (R)	Ø4
10 s	27.2 s	22.8 s
Ø5	Ø6 (R)	Ø8
9.6 s	27.6 s	22.8 s

**CAPACITY ANALYSES
2027 BUILD VOLUMES
ECOLOGICAL / PASSIVE PARK**

Lanes, Volumes, Timings
1: Gardiners Wood Road & Rope Ferry Road

2027 Build - Ecological / Passive Park - AM Peak

05/10/2017

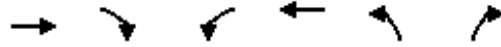

Lane Group	EBT	EBR	WBL	WBT	NBL	NBR
Lane Configurations	↩			↩	↩	
Traffic Volume (vph)	329	41	2	275	81	35
Future Volume (vph)	329	41	2	275	81	35
Ideal Flow (vphpl)	1900	1900	1900	1900	1900	1900
Lane Util. Factor	1.00	1.00	1.00	1.00	1.00	1.00
Flt	0.985				0.959	
Flt Protected					0.966	
Satd. Flow (prot)	1835	0	0	1863	1726	0
Flt Permitted				0.997	0.966	
Satd. Flow (perm)	1835	0	0	1857	1726	0
Right Turn on Red		Yes				Yes
Satd. Flow (RTOR)	12				38	
Link Speed (mph)	30			30	30	
Link Distance (ft)	512			589	834	
Travel Time (s)	11.6			13.4	19.0	
Peak Hour Factor	0.92	0.92	0.92	0.92	0.92	0.92
Adj. Flow (vph)	358	45	2	299	88	38
Shared Lane Traffic (%)						
Lane Group Flow (vph)	403	0	0	301	126	0
Turn Type	NA		pm+pt	NA	Prot	
Protected Phases	2		1	6	8	
Permitted Phases			6			
Detector Phase	2		1	6	8	
Switch Phase						
Minimum Initial (s)	5.0		5.0	5.0	5.0	
Minimum Split (s)	22.5		9.5	22.5	22.5	
Total Split (s)	23.0		9.5	32.5	22.5	
Total Split (%)	41.8%		17.3%	59.1%	40.9%	
Yellow Time (s)	3.5		3.5	3.5	3.5	
All-Red Time (s)	1.0		1.0	1.0	1.0	
Lost Time Adjust (s)	0.0			0.0	0.0	
Total Lost Time (s)	4.5			4.5	4.5	
Lead/Lag	Lag		Lead			
Lead-Lag Optimize?	Yes		Yes			
Recall Mode	None		None	None	Max	
Act Effect Green (s)	13.6			13.6	18.1	
Actuated g/C Ratio	0.33			0.33	0.44	
v/c Ratio	0.65			0.49	0.16	
Control Delay	16.5			13.5	6.8	
Queue Delay	0.0			0.0	0.0	
Total Delay	16.5			13.5	6.8	
LOS	B			B	A	
Approach Delay	16.5			13.5	6.8	
Approach LOS	B			B	A	
Queue Length 50th (ft)	73			52	11	
Queue Length 95th (ft)	136			100	38	
Internal Link Dist (ft)	432			509	754	
Turn Bay Length (ft)						
Base Capacity (vph)	845			1284	788	

Lanes, Volumes, Timings
 1: Gardiners Wood Road & Rope Ferry Road

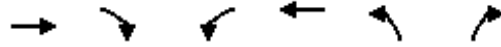

Lane Group	EBT	EBR	WBL	WBT	NBL	NBR
Starvation Cap Reductn	0			0	0	
Spillback Cap Reductn	0			0	0	
Storage Cap Reductn	0			0	0	
Reduced v/c Ratio	0.48			0.23	0.16	

Intersection Summary

Area Type:	Other
Cycle Length:	55
Actuated Cycle Length:	40.8
Natural Cycle:	55
Control Type:	Semi Act-Uncoord
Maximum v/c Ratio:	0.65
Intersection Signal Delay:	13.9
Intersection LOS:	B
Intersection Capacity Utilization	33.9%
ICU Level of Service	A
Analysis Period (min)	15

Splits and Phases: 1: Gardiners Wood Road & Rope Ferry Road

Ø1	Ø2		
9.5 s	23 s		
Ø6	Ø8		
32.5 s	22.5 s		

Lanes, Volumes, Timings
5: Shore Road & Jordan Cove Road

2027 Build - Ecological / Passive Park - AM Peak

05/10/2017



Lane Group	EBL	EBR	NBL	NBT	SBT	SBR
Lane Configurations						
Traffic Volume (vph)	10	42	56	23	4	30
Future Volume (vph)	10	42	56	23	4	30
Ideal Flow (vphpl)	1900	1900	1900	1900	1900	1900
Lane Util. Factor	1.00	1.00	1.00	1.00	1.00	1.00
Frt	0.891				0.881	
Flt Protected	0.990			0.966		
Satd. Flow (prot)	1643	0	0	1799	1641	0
Flt Permitted	0.990			0.966		
Satd. Flow (perm)	1643	0	0	1799	1641	0
Link Speed (mph)	30			30	30	
Link Distance (ft)	348			365	291	
Travel Time (s)	7.9			8.3	6.6	
Peak Hour Factor	1.00	1.00	1.00	1.00	1.00	1.00
Adj. Flow (vph)	10	42	56	23	4	30
Shared Lane Traffic (%)						
Lane Group Flow (vph)	52	0	0	79	34	0
Sign Control	Stop			Stop	Stop	

Intersection Summary

Area Type:	Other
Control Type:	Unsignalized
Intersection Capacity Utilization	21.0%
Analysis Period (min)	15
	ICU Level of Service A

Intersection	
Intersection Delay, s/veh	7.2
Intersection LOS	A

Movement	EBU	EBL	EBR	NBU	NBL	NBT	SBU	SBT	SBR
Lane Configurations		Y				4		4	
Traffic Vol, veh/h	0	10	42	0	56	23	0	4	30
Future Vol, veh/h	0	10	42	0	56	23	0	4	30
Peak Hour Factor	1.00	1.00	1.00	1.00	1.00	1.00	1.00	1.00	1.00
Heavy Vehicles, %	2	2	2	2	2	2	2	2	2
Mvmt Flow	0	10	42	0	56	23	0	4	30
Number of Lanes	0	1	0	0	0	1	0	1	0

















Approach	EB	NB	SB
Opposing Approach		SB	NB
Opposing Lanes	0	1	1
Conflicting Approach Left	SB	EB	
Conflicting Lanes Left	1	1	0
Conflicting Approach Right	NB		EB
Conflicting Lanes Right	1	0	1
HCM Control Delay	6.9	7.6	6.7
HCM LOS	A	A	A

Lane	NBLn1	EBLn1	SBLn1
Vol Left, %	71%	19%	0%
Vol Thru, %	29%	0%	12%
Vol Right, %	0%	81%	88%
Sign Control	Stop	Stop	Stop
Traffic Vol by Lane	79	52	34
LT Vol	56	10	0
Through Vol	23	0	4
RT Vol	0	42	30
Lane Flow Rate	79	52	34
Geometry Grp	1	1	1
Degree of Util (X)	0.092	0.053	0.034
Departure Headway (Hd)	4.192	3.681	3.554
Convergence, Y/N	Yes	Yes	Yes
Cap	856	966	1004
Service Time	2.21	1.731	1.587
HCM Lane V/C Ratio	0.092	0.054	0.034
HCM Control Delay	7.6	6.9	6.7
HCM Lane LOS	A	A	A
HCM 95th-tile Q	0.3	0.2	0.1

Lanes, Volumes, Timings
9: Shore Road & Palmer Road

2027 Build - Ecological / Passive Park - AM Peak

05/10/2017

												
Lane Group	EBL	EBT	EBR	WBL	WBT	WBR	NBL	NBT	NBR	SBL	SBT	SBR
Lane Configurations												
Traffic Volume (vph)	18	12	1	0	11	1	4	2	0	2	1	27
Future Volume (vph)	18	12	1	0	11	1	4	2	0	2	1	27
Ideal Flow (vphpl)	1900	1900	1900	1900	1900	1900	1900	1900	1900	1900	1900	1900
Lane Util. Factor	1.00	1.00	1.00	1.00	1.00	1.00	1.00	1.00	1.00	1.00	1.00	1.00
Frt		0.996			0.989							0.878
Flt Protected		0.972						0.968				0.997
Satd. Flow (prot)	0	1803	0	0	1842	0	0	1803	0	0	1631	0
Flt Permitted		0.972						0.968				0.997
Satd. Flow (perm)	0	1803	0	0	1842	0	0	1803	0	0	1631	0
Link Speed (mph)		30			30			30			30	
Link Distance (ft)		357			396			205			196	
Travel Time (s)		8.1			9.0			4.7			4.5	
Peak Hour Factor	1.00	1.00	1.00	1.00	1.00	1.00	1.00	1.00	1.00	1.00	1.00	1.00
Adj. Flow (vph)	18	12	1	0	11	1	4	2	0	2	1	27
Shared Lane Traffic (%)												
Lane Group Flow (vph)	0	31	0	0	12	0	0	6	0	0	30	0
Sign Control		Stop			Stop			Stop			Stop	

Intersection Summary

Area Type:	Other
Control Type:	Unsignalized
Intersection Capacity Utilization	18.4%
Analysis Period (min)	15
	ICU Level of Service A

Intersection	
Intersection Delay, s/veh	7
Intersection LOS	A

Movement	EBU	EBL	EBT	EBR	WBU	WBL	WBT	WBR	NBU	NBL	NBT	NBR
Lane Configurations			↕				↕				↕	
Traffic Vol, veh/h	0	18	12	1	0	0	11	1	0	4	2	0
Future Vol, veh/h	0	18	12	1	0	0	11	1	0	4	2	0
Peak Hour Factor	1.00	1.00	1.00	1.00	1.00	1.00	1.00	1.00	1.00	1.00	1.00	1.00
Heavy Vehicles, %	2	2	2	2	2	2	2	2	2	2	2	2
Mvmt Flow	0	18	12	1	0	0	11	1	0	4	2	0
Number of Lanes	0	0	1	0	0	0	1	0	0	0	1	0

Approach	EB	WB	NB
Opposing Approach	WB	EB	SB
Opposing Lanes	1	1	1
Conflicting Approach Left	SB	NB	EB
Conflicting Lanes Left	1	1	1
Conflicting Approach Right	NB	SB	WB
Conflicting Lanes Right	1	1	1
HCM Control Delay	7.3	7	7.2
HCM LOS	A	A	A

Lane	NBLn1	EBLn1	WBLn1	SBLn1
Vol Left, %	67%	58%	0%	7%
Vol Thru, %	33%	39%	92%	3%
Vol Right, %	0%	3%	8%	90%
Sign Control	Stop	Stop	Stop	Stop
Traffic Vol by Lane	6	31	12	30
LT Vol	4	18	0	2
Through Vol	2	12	11	1
RT Vol	0	1	1	27
Lane Flow Rate	6	31	12	30
Geometry Grp	1	1	1	1
Degree of Util (X)	0.007	0.035	0.013	0.029
Departure Headway (Hd)	4.167	4.103	3.97	3.487
Convergence, Y/N	Yes	Yes	Yes	Yes
Cap	860	876	904	1027
Service Time	2.186	2.112	1.984	1.507
HCM Lane V/C Ratio	0.007	0.035	0.013	0.029
HCM Control Delay	7.2	7.3	7	6.6
HCM Lane LOS	A	A	A	A
HCM 95th-tile Q	0	0.1	0	0.1

Intersection

Intersection Delay, s/veh
 Intersection LOS

Movement	SBU	SBL	SBT	SBR
Lane Configurations			↕	
Traffic Vol, veh/h	0	2	1	27
Future Vol, veh/h	0	2	1	27
Peak Hour Factor	1.00	1.00	1.00	1.00
Heavy Vehicles, %	2	2	2	2
Mvmt Flow	0	2	1	27
Number of Lanes	0	0	1	0

Approach	SB
Opposing Approach	NB
Opposing Lanes	1
Conflicting Approach Left	WB
Conflicting Lanes Left	1
Conflicting Approach Right	EB
Conflicting Lanes Right	1
HCM Control Delay	6.6
HCM LOS	A

Lanes, Volumes, Timings
 14: Seaside Park Drive & Shore Road

2027 Build - Ecological / Passive Park - AM Peak

05/10/2017

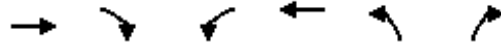

Lane Group	EBT	EBR	WBL	WBT	NBL	NBR
Lane Configurations						
Traffic Volume (vph)	16	3	4	12	2	5
Future Volume (vph)	16	3	4	12	2	5
Ideal Flow (vphpl)	1900	1900	1900	1900	1900	1900
Lane Util. Factor	1.00	1.00	1.00	1.00	1.00	1.00
Frt	0.979			0.904		
Flt Protected				0.988	0.986	
Satd. Flow (prot)	1824	0	0	1840	1660	0
Flt Permitted				0.988	0.986	
Satd. Flow (perm)	1824	0	0	1840	1660	0
Link Speed (mph)	30			30	30	
Link Distance (ft)	504			461	476	
Travel Time (s)	11.5			10.5	10.8	
Peak Hour Factor	1.00	1.00	1.00	1.00	1.00	1.00
Adj. Flow (vph)	16	3	4	12	2	5
Shared Lane Traffic (%)						
Lane Group Flow (vph)	19	0	0	16	7	0
Sign Control	Free			Free	Stop	

Intersection Summary

Area Type:	Other
Control Type:	Unsignalized
Intersection Capacity Utilization	14.1% ICU Level of Service A
Analysis Period (min)	15

Intersection

Int Delay, s/veh 2.1

Movement	EBT	EBR	WBL	WBT	NBL	NBR
Lane Configurations	↕		↕		↕	
Traffic Vol, veh/h	16	3	4	12	2	5
Future Vol, veh/h	16	3	4	12	2	5
Conflicting Peds, #/hr	0	0	0	0	0	0
Sign Control	Free	Free	Free	Free	Stop	Stop
RT Channelized	-	None	-	None	-	None
Storage Length	-	-	-	-	0	-
Veh in Median Storage, #	0	-	-	0	0	-
Grade, %	0	-	-	0	0	-
Peak Hour Factor	100	100	100	100	100	100
Heavy Vehicles, %	2	2	2	2	2	2
Mvmt Flow	16	3	4	12	2	5

Major/Minor	Major1		Major2		Minor1	
Conflicting Flow All	0	0	19	0	38	18
Stage 1	-	-	-	-	18	-
Stage 2	-	-	-	-	20	-
Critical Hdwy	-	-	4.12	-	6.42	6.22
Critical Hdwy Stg 1	-	-	-	-	5.42	-
Critical Hdwy Stg 2	-	-	-	-	5.42	-
Follow-up Hdwy	-	-	2.218	-	3.518	3.318
Pot Cap-1 Maneuver	-	-	1597	-	974	1061
Stage 1	-	-	-	-	1005	-
Stage 2	-	-	-	-	1003	-
Platoon blocked, %	-	-	-	-	-	-
Mov Cap-1 Maneuver	-	-	1597	-	971	1061
Mov Cap-2 Maneuver	-	-	-	-	971	-
Stage 1	-	-	-	-	1005	-
Stage 2	-	-	-	-	1000	-

Approach	EB	WB	NB
HCM Control Delay, s	0	1.8	8.5
HCM LOS			A

Minor Lane/Major Mvmt	NBLn1	EBT	EBR	WBL	WBT
Capacity (veh/h)	1034	-	-	1597	-
HCM Lane V/C Ratio	0.007	-	-	0.003	-
HCM Control Delay (s)	8.5	-	-	7.3	0
HCM Lane LOS	A	-	-	A	A
HCM 95th %tile Q(veh)	0	-	-	0	-

Lanes, Volumes, Timings
18: Great Neck Road & Shore Road

2027 Build - Ecological / Passive Park - AM Peak

05/10/2017



Lane Group	EBL	EBR	NBL	NBT	SBT	SBR
Lane Configurations						
Traffic Volume (vph)	29	7	11	68	62	15
Future Volume (vph)	29	7	11	68	62	15
Ideal Flow (vphpl)	1900	1900	1900	1900	1900	1900
Lane Util. Factor	1.00	1.00	1.00	1.00	1.00	1.00
Frt	0.974				0.974	
Flt Protected	0.961			0.993		
Satd. Flow (prot)	1744	0	0	1850	1814	0
Flt Permitted	0.961			0.993		
Satd. Flow (perm)	1744	0	0	1850	1814	0
Link Speed (mph)	30			30	30	
Link Distance (ft)	471			248	380	
Travel Time (s)	10.7			5.6	8.6	
Peak Hour Factor	1.00	1.00	1.00	1.00	1.00	1.00
Adj. Flow (vph)	29	7	11	68	62	15
Shared Lane Traffic (%)						
Lane Group Flow (vph)	36	0	0	79	77	0
Sign Control	Stop			Free	Free	

Intersection Summary

Area Type:	Other
Control Type:	Unsignalized
Intersection Capacity Utilization	20.9%
Analysis Period (min)	15
	ICU Level of Service A

Intersection

Int Delay, s/veh 2.2

Movement	EBL	EBR	NBL	NBT	SBT	SBR
Lane Configurations	Y			4	1	
Traffic Vol, veh/h	29	7	11	68	62	15
Future Vol, veh/h	29	7	11	68	62	15
Conflicting Peds, #/hr	0	0	0	0	0	0
Sign Control	Stop	Stop	Free	Free	Free	Free
RT Channelized	-	None	-	None	-	None
Storage Length	0	-	-	-	-	-
Veh in Median Storage, #	0	-	-	0	0	-
Grade, %	0	-	-	0	0	-
Peak Hour Factor	100	100	100	100	100	100
Heavy Vehicles, %	2	2	2	2	2	2
Mvmt Flow	29	7	11	68	62	15

Major/Minor	Minor2		Major1		Major2	
Conflicting Flow All	160	70	77	0	-	0
Stage 1	70	-	-	-	-	-
Stage 2	90	-	-	-	-	-
Critical Hdwy	6.42	6.22	4.12	-	-	-
Critical Hdwy Stg 1	5.42	-	-	-	-	-
Critical Hdwy Stg 2	5.42	-	-	-	-	-
Follow-up Hdwy	3.518	3.318	2.218	-	-	-
Pot Cap-1 Maneuver	831	993	1522	-	-	-
Stage 1	953	-	-	-	-	-
Stage 2	934	-	-	-	-	-
Platoon blocked, %				-	-	-
Mov Cap-1 Maneuver	824	993	1522	-	-	-
Mov Cap-2 Maneuver	824	-	-	-	-	-
Stage 1	953	-	-	-	-	-
Stage 2	927	-	-	-	-	-

Approach	EB	NB	SB
HCM Control Delay, s	9.4	1	0
HCM LOS	A		

Minor Lane/Major Mvmt	NBL	NBT	EBLn1	SBT	SBR
Capacity (veh/h)	1522	-	852	-	-
HCM Lane V/C Ratio	0.007	-	0.042	-	-
HCM Control Delay (s)	7.4	0	9.4	-	-
HCM Lane LOS	A	A	A	-	-
HCM 95th %tile Q(veh)	0	-	0.1	-	-

Lanes, Volumes, Timings
 24: Lamphere Road & Great Neck Road

2027 Build - Ecological / Passive Park - AM Peak

05/10/2017



Lane Group	EBL	EBT	EBR	WBL	WBT	WBR	NBL	NBT	NBR	SBL	SBT	SBR
Lane Configurations		↕			↕			↕			↕	
Traffic Volume (vph)	91	12	1	4	7	144	0	224	4	50	104	32
Future Volume (vph)	91	12	1	4	7	144	0	224	4	50	104	32
Ideal Flow (vphpl)	1900	1900	1900	1900	1900	1900	1900	1900	1900	1900	1900	1900
Lane Util. Factor	1.00	1.00	1.00	1.00	1.00	1.00	1.00	1.00	1.00	1.00	1.00	1.00
Frt		0.999			0.875			0.998				0.977
Flt Protected		0.958			0.999							0.987
Satd. Flow (prot)	0	1783	0	0	1628	0	0	1859	0	0	1796	0
Flt Permitted		0.958			0.999							0.987
Satd. Flow (perm)	0	1783	0	0	1628	0	0	1859	0	0	1796	0
Link Speed (mph)		30			30			30				30
Link Distance (ft)		536			649			512				388
Travel Time (s)		12.2			14.8			11.6				8.8
Peak Hour Factor	1.00	1.00	1.00	1.00	1.00	1.00	1.00	1.00	1.00	1.00	1.00	1.00
Adj. Flow (vph)	91	12	1	4	7	144	0	224	4	50	104	32
Shared Lane Traffic (%)												
Lane Group Flow (vph)	0	104	0	0	155	0	0	228	0	0	186	0
Sign Control		Stop			Stop			Free				Free

Intersection Summary

Area Type:	Other
Control Type:	Unsignalized
Intersection Capacity Utilization	50.8%
Analysis Period (min)	15
	ICU Level of Service A

Intersection												
Int Delay, s/veh	5.8											
Movement	EBL	EBT	EBR	WBL	WBT	WBR	NBL	NBT	NBR	SBL	SBT	SBR
Lane Configurations	↕			↕			↕			↕		
Traffic Vol, veh/h	91	12	1	4	7	144	0	224	4	50	104	32
Future Vol, veh/h	91	12	1	4	7	144	0	224	4	50	104	32
Conflicting Peds, #/hr	0	0	0	0	0	0	0	0	0	0	0	0
Sign Control	Stop	Stop	Stop	Stop	Stop	Stop	Free	Free	Free	Free	Free	Free
RT Channelized	-	-	None	-	-	None	-	-	None	-	-	None
Storage Length	-	-	-	-	-	-	-	-	-	-	-	-
Veh in Median Storage, #	-	0	-	-	0	-	-	0	-	-	0	-
Grade, %	-	0	-	-	0	-	-	0	-	-	0	-
Peak Hour Factor	100	100	100	100	100	100	100	100	100	100	100	100
Heavy Vehicles, %	2	2	2	2	2	2	2	2	2	2	2	2
Mvmt Flow	91	12	1	4	7	144	0	224	4	50	104	32

Major/Minor	Minor2			Minor1			Major1			Major2		
Conflicting Flow All	522	448	120	453	462	226	136	0	0	228	0	0
Stage 1	220	220	-	226	226	-	-	-	-	-	-	-
Stage 2	302	228	-	227	236	-	-	-	-	-	-	-
Critical Hdwy	7.12	6.52	6.22	7.12	6.52	6.22	4.12	-	-	4.12	-	-
Critical Hdwy Stg 1	6.12	5.52	-	6.12	5.52	-	-	-	-	-	-	-
Critical Hdwy Stg 2	6.12	5.52	-	6.12	5.52	-	-	-	-	-	-	-
Follow-up Hdwy	3.518	4.018	3.318	3.518	4.018	3.318	2.218	-	-	2.218	-	-
Pot Cap-1 Maneuver	465	506	931	517	497	813	1448	-	-	1340	-	-
Stage 1	782	721	-	777	717	-	-	-	-	-	-	-
Stage 2	707	715	-	776	710	-	-	-	-	-	-	-
Platoon blocked, %	-	-	-	-	-	-	-	-	-	-	-	-
Mov Cap-1 Maneuver	367	485	931	491	477	813	1448	-	-	1340	-	-
Mov Cap-2 Maneuver	367	485	-	491	477	-	-	-	-	-	-	-
Stage 1	782	691	-	777	717	-	-	-	-	-	-	-
Stage 2	576	715	-	730	681	-	-	-	-	-	-	-

Approach	EB	WB	NB	SB
HCM Control Delay, s	18	10.8	0	2.1
HCM LOS	C	B		

Minor Lane/Major Mvmt	NBL	NBT	NBR	EBLn1	WBLn1	SBL	SBT	SBR
Capacity (veh/h)	1448	-	-	380	775	1340	-	-
HCM Lane V/C Ratio	-	-	-	0.274	0.2	0.037	-	-
HCM Control Delay (s)	0	-	-	18	10.8	7.8	0	-
HCM Lane LOS	A	-	-	C	B	A	A	-
HCM 95th %tile Q(veh)	0	-	-	1.1	0.7	0.1	-	-

Lanes, Volumes, Timings

2027 Build - Ecological / Passive Park - AM Peak

28: Great Neck Road/Avery Lane & Rope Ferry Road

05/10/2017

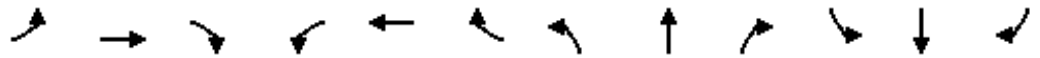

Lane Group	EBL	EBT	EBR	WBL	WBT	WBR	NBL	NBT	NBR	SBL	SBT	SBR
Lane Configurations												
Traffic Volume (vph)	59	351	49	162	200	82	49	218	319	26	96	27
Future Volume (vph)	59	351	49	162	200	82	49	218	319	26	96	27
Ideal Flow (vphp)	1900	1900	1900	1900	1900	1900	1900	1900	1900	1900	1900	1900
Storage Length (ft)	100		0	200		0	0		250	0		0
Storage Lanes	1		0	1		0	0		1	0		0
Taper Length (ft)	25			25			25			25		
Lane Util. Factor	1.00	1.00	1.00	1.00	1.00	1.00	1.00	1.00	1.00	1.00	1.00	1.00
Frt		0.982			0.956				0.850		0.976	
Flt Protected	0.950			0.950				0.991			0.991	
Satd. Flow (prot)	1770	1829	0	1770	1781	0	0	1846	1583	0	1802	0
Flt Permitted	0.507			0.338				0.918			0.914	
Satd. Flow (perm)	944	1829	0	630	1781	0	0	1710	1583	0	1662	0
Right Turn on Red			Yes			Yes			Yes			Yes
Satd. Flow (RTOR)		13			40				347			19
Link Speed (mph)		30			30			30				30
Link Distance (ft)		662			691			557				483
Travel Time (s)		15.0			15.7			12.7				11.0
Peak Hour Factor	0.92	0.92	0.92	0.92	0.92	0.92	0.92	0.92	0.92	0.92	0.92	0.92
Adj. Flow (vph)	64	382	53	176	217	89	53	237	347	28	104	29
Shared Lane Traffic (%)												
Lane Group Flow (vph)	64	435	0	176	306	0	0	290	347	0	161	0
Turn Type	pm+pt	NA		pm+pt	NA		Perm	NA	Perm	Perm	NA	
Protected Phases	5	2		1	6			8				4
Permitted Phases	2			6			8		8	4		
Minimum Split (s)	9.5	22.5		9.5	22.5		22.5	22.5	22.5	22.5	22.5	22.5
Total Split (s)	9.6	27.2		10.0	27.6		22.8	22.8	22.8	22.8	22.8	22.8
Total Split (%)	16.0%	45.3%		16.7%	46.0%		38.0%	38.0%	38.0%	38.0%	38.0%	38.0%
Yellow Time (s)	3.5	3.5		3.5	3.5		3.5	3.5	3.5	3.5	3.5	3.5
All-Red Time (s)	1.0	1.0		1.0	1.0		1.0	1.0	1.0	1.0	1.0	1.0
Lost Time Adjust (s)	0.0	0.0		0.0	0.0			0.0	0.0		0.0	
Total Lost Time (s)	4.5	4.5		4.5	4.5			4.5	4.5		4.5	
Lead/Lag	Lead	Lag		Lead	Lag							
Lead-Lag Optimize?	Yes	Yes		Yes	Yes							
Act Effect Green (s)	27.8	22.7		28.6	23.1			18.3	18.3		18.3	
Actuated g/C Ratio	0.46	0.38		0.48	0.38			0.30	0.30		0.30	
v/c Ratio	0.13	0.62		0.44	0.43			0.56	0.48		0.31	
Control Delay	7.3	19.4		10.8	14.0			22.4	4.8		16.1	
Queue Delay	0.0	0.0		0.0	0.0			0.0	0.0		0.0	
Total Delay	7.3	19.4		10.8	14.0			22.4	4.8		16.1	
LOS	A	B		B	B			C	A		B	
Approach Delay		17.9			12.8			12.8			16.1	
Approach LOS		B			B			B			B	
Queue Length 50th (ft)	10	120		29	67			87	0		39	
Queue Length 95th (ft)	24	205		56	126			154	50		81	
Internal Link Dist (ft)		582			611			477			403	
Turn Bay Length (ft)	100			200					250			
Base Capacity (vph)	507	700		404	710			521	723		520	
Starvation Cap Reductn	0	0		0	0			0	0		0	



Lane Group	EBL	EBT	EBR	WBL	WBT	WBR	NBL	NBT	NBR	SBL	SBT	SBR
Spillback Cap Reductn	0	0		0	0			0	0		0	
Storage Cap Reductn	0	0		0	0			0	0		0	
Reduced v/c Ratio	0.13	0.62		0.44	0.43			0.56	0.48		0.31	

Intersection Summary

Area Type:	Other
Cycle Length:	60
Actuated Cycle Length:	60
Offset:	0 (0%), Referenced to phase 2:EBTL and 6:WBTL, Start of Green
Natural Cycle:	60
Control Type:	Pretimed
Maximum v/c Ratio:	0.62
Intersection Signal Delay:	14.5
Intersection LOS:	B
Intersection Capacity Utilization	67.7%
ICU Level of Service	C
Analysis Period (min)	15

Splits and Phases: 28: Great Neck Road/Avery Lane & Rope Ferry Road

Ø1	Ø2 (R)	Ø4
10 s	27.2 s	22.8 s
Ø5	Ø6 (R)	Ø8
9.6 s	27.6 s	22.8 s

Lanes, Volumes, Timings
1: Gardiners Wood Road & Rope Ferry Road

2027 Build - Ecological / Passive Park - PM Peak

05/09/2017

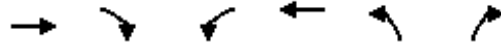

Lane Group	EBT	EBR	WBL	WBT	NBL	NBR
Lane Configurations	↔			↕	↕	
Traffic Volume (vph)	655	108	50	432	79	40
Future Volume (vph)	655	108	50	432	79	40
Ideal Flow (vphpl)	1900	1900	1900	1900	1900	1900
Lane Util. Factor	1.00	1.00	1.00	1.00	1.00	1.00
Frt	0.981			0.955		
Flt Protected				0.995	0.968	
Satd. Flow (prot)	1827	0	0	1853	1722	0
Flt Permitted				0.693	0.968	
Satd. Flow (perm)	1827	0	0	1291	1722	0
Right Turn on Red	Yes			Yes		
Satd. Flow (RTOR)	16				32	
Link Speed (mph)	30			30	30	
Link Distance (ft)	512			589	834	
Travel Time (s)	11.6			13.4	19.0	
Peak Hour Factor	0.92	0.92	0.92	0.92	0.92	0.92
Adj. Flow (vph)	712	117	54	470	86	43
Shared Lane Traffic (%)						
Lane Group Flow (vph)	829	0	0	524	129	0
Turn Type	NA		pm+pt	NA	Prot	
Protected Phases	2			1	6	8
Permitted Phases				6		
Detector Phase	2			1	6	8
Switch Phase						
Minimum Initial (s)	5.0		5.0	5.0	5.0	
Minimum Split (s)	22.5		9.5	22.5	22.5	
Total Split (s)	43.0		9.5	52.5	22.5	
Total Split (%)	57.3%		12.7%	70.0%	30.0%	
Yellow Time (s)	3.5		3.5	3.5	3.5	
All-Red Time (s)	1.0		1.0	1.0	1.0	
Lost Time Adjust (s)	0.0			0.0	0.0	
Total Lost Time (s)	4.5			4.5	4.5	
Lead/Lag	Lag		Lead			
Lead-Lag Optimize?	Yes		Yes			
Recall Mode	None		None	None	Max	
Act Effct Green (s)	35.8		35.8		18.5	
Actuated g/C Ratio	0.56		0.56		0.29	
v/c Ratio	0.80		0.72		0.25	
Control Delay	17.0		16.1		18.0	
Queue Delay	0.0		0.0		0.0	
Total Delay	17.0		16.1		18.0	
LOS	B		B		B	
Approach Delay	17.0		16.1		18.0	
Approach LOS	B		B		B	
Queue Length 50th (ft)	216		129		28	
Queue Length 95th (ft)	347		228		80	
Internal Link Dist (ft)	432		509		754	
Turn Bay Length (ft)						
Base Capacity (vph)	1231		1001		523	

Lanes, Volumes, Timings
 1: Gardiners Wood Road & Rope Ferry Road

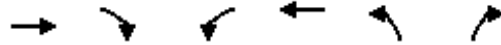

Lane Group	EBT	EBR	WBL	WBT	NBL	NBR
Starvation Cap Reductn	0			0	0	
Spillback Cap Reductn	0			0	0	
Storage Cap Reductn	0			0	0	
Reduced v/c Ratio	0.67			0.52	0.25	

Intersection Summary

Area Type:	Other
Cycle Length:	75
Actuated Cycle Length:	63.5
Natural Cycle:	75
Control Type:	Semi Act-Uncoord
Maximum v/c Ratio:	0.80
Intersection Signal Delay:	16.7
Intersection LOS:	B
Intersection Capacity Utilization	78.9%
ICU Level of Service	D
Analysis Period (min)	15

Splits and Phases: 1: Gardiners Wood Road & Rope Ferry Road

Ø1	Ø2	
9.5 s	43 s	
Ø6		Ø8
52.5 s		22.5 s

Lanes, Volumes, Timings
5: Shore Road & Jordan Cove Road

2027 Build - Ecological / Passive Park - PM Peak

05/09/2017



Lane Group	EBL	EBR	NBL	NBT	SBT	SBR
Lane Configurations						
Traffic Volume (vph)	29	82	64	29	38	37
Future Volume (vph)	29	82	64	29	38	37
Ideal Flow (vphpl)	1900	1900	1900	1900	1900	1900
Lane Util. Factor	1.00	1.00	1.00	1.00	1.00	1.00
Frt	0.900				0.933	
Flt Protected	0.987			0.967		
Satd. Flow (prot)	1655	0	0	1801	1738	0
Flt Permitted	0.987			0.967		
Satd. Flow (perm)	1655	0	0	1801	1738	0
Link Speed (mph)	30			30	30	
Link Distance (ft)	348			365	291	
Travel Time (s)	7.9			8.3	6.6	
Peak Hour Factor	1.00	1.00	1.00	1.00	1.00	1.00
Adj. Flow (vph)	29	82	64	29	38	37
Shared Lane Traffic (%)						
Lane Group Flow (vph)	111	0	0	93	75	0
Sign Control	Stop			Stop	Stop	

Intersection Summary

Area Type:	Other
Control Type:	Unsignalized
Intersection Capacity Utilization	25.1%
Analysis Period (min)	15
	ICU Level of Service A

Intersection	
Intersection Delay, s/veh	7.5
Intersection LOS	A

Movement	EBU	EBL	EBR	NBU	NBL	NBT	SBU	SBT	SBR
Lane Configurations		↕				↕		↕	
Traffic Vol, veh/h	0	29	82	0	64	29	0	38	37
Future Vol, veh/h	0	29	82	0	64	29	0	38	37
Peak Hour Factor	1.00	1.00	1.00	1.00	1.00	1.00	1.00	1.00	1.00
Heavy Vehicles, %	2	2	2	2	2	2	2	2	2
Mvmt Flow	0	29	82	0	64	29	0	38	37
Number of Lanes	0	1	0	0	0	1	0	1	0

















Approach	EB	NB	SB
Opposing Approach		SB	NB
Opposing Lanes	0	1	1
Conflicting Approach Left	SB	EB	
Conflicting Lanes Left	1	1	0
Conflicting Approach Right	NB		EB
Conflicting Lanes Right	1	0	1
HCM Control Delay	7.4	7.9	7.3
HCM LOS	A	A	A

Lane	NBLn1	EBLn1	SBLn1
Vol Left, %	69%	26%	0%
Vol Thru, %	31%	0%	51%
Vol Right, %	0%	74%	49%
Sign Control	Stop	Stop	Stop
Traffic Vol by Lane	93	111	75
LT Vol	64	29	0
Through Vol	29	0	38
RT Vol	0	82	37
Lane Flow Rate	93	111	75
Geometry Grp	1	1	1
Degree of Util (X)	0.112	0.118	0.081
Departure Headway (Hd)	4.326	3.831	3.905
Convergence, Y/N	Yes	Yes	Yes
Cap	824	921	908
Service Time	2.376	1.913	1.969
HCM Lane V/C Ratio	0.113	0.121	0.083
HCM Control Delay	7.9	7.4	7.3
HCM Lane LOS	A	A	A
HCM 95th-tile Q	0.4	0.4	0.3

Lanes, Volumes, Timings
9: Shore Road & Palmer Road

2027 Build - Ecological / Passive Park - PM Peak

05/09/2017

												
Lane Group	EBL	EBT	EBR	WBL	WBT	WBR	NBL	NBT	NBR	SBL	SBT	SBR
Lane Configurations												
Traffic Volume (vph)	28	39	11	2	18	3	7	7	1	3	9	32
Future Volume (vph)	28	39	11	2	18	3	7	7	1	3	9	32
Ideal Flow (vphpl)	1900	1900	1900	1900	1900	1900	1900	1900	1900	1900	1900	1900
Lane Util. Factor	1.00	1.00	1.00	1.00	1.00	1.00	1.00	1.00	1.00	1.00	1.00	1.00
Frt		0.981			0.982			0.991			0.902	
Flt Protected		0.982			0.996			0.977			0.997	
Satd. Flow (prot)	0	1794	0	0	1822	0	0	1804	0	0	1675	0
Flt Permitted		0.982			0.996			0.977			0.997	
Satd. Flow (perm)	0	1794	0	0	1822	0	0	1804	0	0	1675	0
Link Speed (mph)		30			30			30			30	
Link Distance (ft)		357			396			205			196	
Travel Time (s)		8.1			9.0			4.7			4.5	
Peak Hour Factor	1.00	1.00	1.00	1.00	1.00	1.00	1.00	1.00	1.00	1.00	1.00	1.00
Adj. Flow (vph)	28	39	11	2	18	3	7	7	1	3	9	32
Shared Lane Traffic (%)												
Lane Group Flow (vph)	0	78	0	0	23	0	0	15	0	0	44	0
Sign Control		Stop			Stop			Stop			Stop	

Intersection Summary

Area Type:	Other
Control Type:	Unsignalized
Intersection Capacity Utilization	20.9%
Analysis Period (min)	15
	ICU Level of Service A

Intersection	
Intersection Delay, s/veh	7.3
Intersection LOS	A

Movement	EBU	EBL	EBT	EBR	WBU	WBL	WBT	WBR	NBU	NBL	NBT	NBR
Lane Configurations			↕				↕				↕	
Traffic Vol, veh/h	0	28	39	11	0	2	18	3	0	7	7	1
Future Vol, veh/h	0	28	39	11	0	2	18	3	0	7	7	1
Peak Hour Factor	1.00	1.00	1.00	1.00	1.00	1.00	1.00	1.00	1.00	1.00	1.00	1.00
Heavy Vehicles, %	2	2	2	2	2	2	2	2	2	2	2	2
Mvmt Flow	0	28	39	11	0	2	18	3	0	7	7	1
Number of Lanes	0	0	1	0	0	0	1	0	0	0	1	0

Approach	EB	WB	NB
Opposing Approach	WB	EB	SB
Opposing Lanes	1	1	1
Conflicting Approach Left	SB	NB	EB
Conflicting Lanes Left	1	1	1
Conflicting Approach Right	NB	SB	WB
Conflicting Lanes Right	1	1	1
HCM Control Delay	7.5	7.2	7.3
HCM LOS	A	A	A

Lane	NBLn1	EBLn1	WBLn1	SBLn1
Vol Left, %	47%	36%	9%	7%
Vol Thru, %	47%	50%	78%	20%
Vol Right, %	7%	14%	13%	73%
Sign Control	Stop	Stop	Stop	Stop
Traffic Vol by Lane	15	78	23	44
LT Vol	7	28	2	3
Through Vol	7	39	18	9
RT Vol	1	11	3	32
Lane Flow Rate	15	78	23	44
Geometry Grp	1	1	1	1
Degree of Util (X)	0.017	0.088	0.026	0.045
Departure Headway (Hd)	4.195	4.04	4.034	3.695
Convergence, Y/N	Yes	Yes	Yes	Yes
Cap	847	887	885	961
Service Time	2.249	2.065	2.07	1.747
HCM Lane V/C Ratio	0.018	0.088	0.026	0.046
HCM Control Delay	7.3	7.5	7.2	6.9
HCM Lane LOS	A	A	A	A
HCM 95th-tile Q	0.1	0.3	0.1	0.1

Intersection

Intersection Delay, s/veh
 Intersection LOS

Movement	SBU	SBL	SBT	SBR
Lane Configurations			↕	
Traffic Vol, veh/h	0	3	9	32
Future Vol, veh/h	0	3	9	32
Peak Hour Factor	1.00	1.00	1.00	1.00
Heavy Vehicles, %	2	2	2	2
Mvmt Flow	0	3	9	32
Number of Lanes	0	0	1	0

Approach	SB
Opposing Approach	NB
Opposing Lanes	1
Conflicting Approach Left	WB
Conflicting Lanes Left	1
Conflicting Approach Right	EB
Conflicting Lanes Right	1
HCM Control Delay	6.9
HCM LOS	A

Lanes, Volumes, Timings
 14: Seaside Park Drive & Shore Road

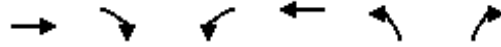

Lane Group	EBT	EBR	WBL	WBT	NBL	NBR
Lane Configurations						
Traffic Volume (vph)	22	4	3	22	4	4
Future Volume (vph)	22	4	3	22	4	4
Ideal Flow (vphpl)	1900	1900	1900	1900	1900	1900
Lane Util. Factor	1.00	1.00	1.00	1.00	1.00	1.00
Frt	0.979			0.932		
Flt Protected				0.994	0.976	
Satd. Flow (prot)	1824	0	0	1852	1694	0
Flt Permitted				0.994	0.976	
Satd. Flow (perm)	1824	0	0	1852	1694	0
Link Speed (mph)	30			30	30	
Link Distance (ft)	504			461	476	
Travel Time (s)	11.5			10.5	10.8	
Peak Hour Factor	1.00	1.00	1.00	1.00	1.00	1.00
Adj. Flow (vph)	22	4	3	22	4	4
Shared Lane Traffic (%)						
Lane Group Flow (vph)	26	0	0	25	8	0
Sign Control	Free			Free	Stop	

Intersection Summary

Area Type:	Other
Control Type:	Unsignalized
Intersection Capacity Utilization	13.7%
Analysis Period (min)	15
	ICU Level of Service A

Intersection

Int Delay, s/veh 1.5

Movement	EBT	EBR	WBL	WBT	NBL	NBR
Lane Configurations	↑		↑		↑	
Traffic Vol, veh/h	22	4	3	22	4	4
Future Vol, veh/h	22	4	3	22	4	4
Conflicting Peds, #/hr	0	0	0	0	0	0
Sign Control	Free	Free	Free	Free	Stop	Stop
RT Channelized	-	None	-	None	-	None
Storage Length	-	-	-	-	0	-
Veh in Median Storage, #	0	-	-	0	0	-
Grade, %	0	-	-	0	0	-
Peak Hour Factor	100	100	100	100	100	100
Heavy Vehicles, %	2	2	2	2	2	2
Mvmt Flow	22	4	3	22	4	4

Major/Minor	Major1		Major2		Minor1	
Conflicting Flow All	0	0	26	0	52	24
Stage 1	-	-	-	-	24	-
Stage 2	-	-	-	-	28	-
Critical Hdwy	-	-	4.12	-	6.42	6.22
Critical Hdwy Stg 1	-	-	-	-	5.42	-
Critical Hdwy Stg 2	-	-	-	-	5.42	-
Follow-up Hdwy	-	-	2.218	-	3.518	3.318
Pot Cap-1 Maneuver	-	-	1588	-	957	1052
Stage 1	-	-	-	-	999	-
Stage 2	-	-	-	-	995	-
Platoon blocked, %	-	-	-	-	-	-
Mov Cap-1 Maneuver	-	-	1588	-	955	1052
Mov Cap-2 Maneuver	-	-	-	-	955	-
Stage 1	-	-	-	-	999	-
Stage 2	-	-	-	-	993	-

Approach	EB	WB	NB
HCM Control Delay, s	0	0.9	8.6
HCM LOS			A

Minor Lane/Major Mvmt	NBLn1	EBT	EBR	WBL	WBT
Capacity (veh/h)	1001	-	-	1588	-
HCM Lane V/C Ratio	0.008	-	-	0.002	-
HCM Control Delay (s)	8.6	-	-	7.3	0
HCM Lane LOS	A	-	-	A	A
HCM 95th %tile Q(veh)	0	-	-	0	-

Lanes, Volumes, Timings
18: Great Neck Road & Shore Road

2027 Build - Ecological / Passive Park - PM Peak

05/09/2017



Lane Group	EBL	EBR	NBL	NBT	SBT	SBR
Lane Configurations						
Traffic Volume (vph)	16	16	17	79	59	23
Future Volume (vph)	16	16	17	79	59	23
Ideal Flow (vphpl)	1900	1900	1900	1900	1900	1900
Lane Util. Factor	1.00	1.00	1.00	1.00	1.00	1.00
Frt	0.932				0.962	
Flt Protected	0.976			0.991		
Satd. Flow (prot)	1694	0	0	1846	1792	0
Flt Permitted	0.976			0.991		
Satd. Flow (perm)	1694	0	0	1846	1792	0
Link Speed (mph)	30			30	30	
Link Distance (ft)	471			248	380	
Travel Time (s)	10.7			5.6	8.6	
Peak Hour Factor	1.00	1.00	1.00	1.00	1.00	1.00
Adj. Flow (vph)	16	16	17	79	59	23
Shared Lane Traffic (%)						
Lane Group Flow (vph)	32	0	0	96	82	0
Sign Control	Stop			Free	Free	

Intersection Summary

Area Type:	Other
Control Type:	Unsignalized
Intersection Capacity Utilization	21.8%
Analysis Period (min)	15
	ICU Level of Service A

Intersection

Int Delay, s/veh 2

Movement	EBL	EBR	NBL	NBT	SBT	SBR
Lane Configurations	Y			4	1	
Traffic Vol, veh/h	16	16	17	79	59	23
Future Vol, veh/h	16	16	17	79	59	23
Conflicting Peds, #/hr	0	0	0	0	0	0
Sign Control	Stop	Stop	Free	Free	Free	Free
RT Channelized	-	None	-	None	-	None
Storage Length	0	-	-	-	-	-
Veh in Median Storage, #	0	-	-	0	0	-
Grade, %	0	-	-	0	0	-
Peak Hour Factor	100	100	100	100	100	100
Heavy Vehicles, %	2	2	2	2	2	2
Mvmt Flow	16	16	17	79	59	23

Major/Minor	Minor2	Major1		Major2
Conflicting Flow All	184	71	82	0
Stage 1	71	-	-	-
Stage 2	113	-	-	-
Critical Hdwy	7.12	6.22	4.12	-
Critical Hdwy Stg 1	6.12	-	-	-
Critical Hdwy Stg 2	6.12	-	-	-
Follow-up Hdwy	3.518	3.318	2.218	-
Pot Cap-1 Maneuver	777	991	1515	-
Stage 1	939	-	-	-
Stage 2	892	-	-	-
Platoon blocked, %				-
Mov Cap-1 Maneuver	770	991	1515	-
Mov Cap-2 Maneuver	770	-	-	-
Stage 1	928	-	-	-
Stage 2	881	-	-	-

Approach	EB	NB	SB
HCM Control Delay, s	9.3	1.3	0
HCM LOS	A		

Minor Lane/Major Mvmt	NBL	NBT	EBLn1	SBT	SBR
Capacity (veh/h)	1515	-	867	-	-
HCM Lane V/C Ratio	0.011	-	0.037	-	-
HCM Control Delay (s)	7.4	0	9.3	-	-
HCM Lane LOS	A	A	A	-	-
HCM 95th %tile Q(veh)	0	-	0.1	-	-

Lanes, Volumes, Timings
 24: Lamphere Road & Great Neck Road

2027 Build - Ecological / Passive Park - PM Peak

05/09/2017



Lane Group	EBL	EBT	EBR	WBL	WBT	WBR	NBL	NBT	NBR	SBL	SBT	SBR
Lane Configurations		↕			↕			↕			↕	
Traffic Volume (vph)	72	13	0	9	16	117	4	193	9	147	264	98
Future Volume (vph)	72	13	0	9	16	117	4	193	9	147	264	98
Ideal Flow (vphpl)	1900	1900	1900	1900	1900	1900	1900	1900	1900	1900	1900	1900
Lane Util. Factor	1.00	1.00	1.00	1.00	1.00	1.00	1.00	1.00	1.00	1.00	1.00	1.00
Frt					0.889			0.994			0.974	
Flt Protected		0.959			0.997			0.999			0.986	
Satd. Flow (prot)	0	1786	0	0	1651	0	0	1850	0	0	1789	0
Flt Permitted		0.959			0.997			0.999			0.986	
Satd. Flow (perm)	0	1786	0	0	1651	0	0	1850	0	0	1789	0
Link Speed (mph)		30			30			30			30	
Link Distance (ft)		536			649			512			388	
Travel Time (s)		12.2			14.8			11.6			8.8	
Peak Hour Factor	1.00	1.00	1.00	1.00	1.00	1.00	1.00	1.00	1.00	1.00	1.00	1.00
Adj. Flow (vph)	72	13	0	9	16	117	4	193	9	147	264	98
Shared Lane Traffic (%)												
Lane Group Flow (vph)	0	85	0	0	142	0	0	206	0	0	509	0
Sign Control		Stop			Stop			Free			Free	

Intersection Summary

Area Type:	Other
Control Type:	Unsignalized
Intersection Capacity Utilization	65.5%
Analysis Period (min)	15
	ICU Level of Service C

Intersection

Int Delay, s/veh 6.4

Movement	EBL	EBT	EBR	WBL	WBT	WBR	NBL	NBT	NBR	SBL	SBT	SBR
Lane Configurations	↕			↕			↕			↕		
Traffic Vol, veh/h	72	13	0	9	16	117	4	193	9	147	264	98
Future Vol, veh/h	72	13	0	9	16	117	4	193	9	147	264	98
Conflicting Peds, #/hr	0	0	0	0	0	0	0	0	0	0	0	0
Sign Control	Stop	Stop	Stop	Stop	Stop	Stop	Free	Free	Free	Free	Free	Free
RT Channelized	-	-	None	-	-	None	-	-	None	-	-	None
Storage Length	-	-	-	-	-	-	-	-	-	-	-	-
Veh in Median Storage, #	-	0	-	-	0	-	-	0	-	-	0	-
Grade, %	-	0	-	-	0	-	-	0	-	-	0	-
Peak Hour Factor	100	100	100	100	100	100	100	100	100	100	100	100
Heavy Vehicles, %	2	2	2	2	2	2	2	2	2	2	2	2
Mvmt Flow	72	13	0	9	16	117	4	193	9	147	264	98

Major/Minor	Minor2			Minor1			Major1			Major2		
Conflicting Flow All	879	817	313	820	862	198	362	0	0	202	0	0
Stage 1	607	607	-	206	206	-	-	-	-	-	-	-
Stage 2	272	210	-	614	656	-	-	-	-	-	-	-
Critical Hdwy	7.12	6.52	6.22	7.12	6.52	6.22	4.12	-	-	4.12	-	-
Critical Hdwy Stg 1	6.12	5.52	-	6.12	5.52	-	-	-	-	-	-	-
Critical Hdwy Stg 2	6.12	5.52	-	6.12	5.52	-	-	-	-	-	-	-
Follow-up Hdwy	3.518	4.018	3.318	3.518	4.018	3.318	2.218	-	-	2.218	-	-
Pot Cap-1 Maneuver	268	311	727	294	293	843	1197	-	-	1370	-	-
Stage 1	483	486	-	796	731	-	-	-	-	-	-	-
Stage 2	734	728	-	479	462	-	-	-	-	-	-	-
Platoon blocked, %												
Mov Cap-1 Maneuver	196	268	727	253	252	843	1197	-	-	1370	-	-
Mov Cap-2 Maneuver	196	268	-	253	252	-	-	-	-	-	-	-
Stage 1	481	420	-	793	728	-	-	-	-	-	-	-
Stage 2	616	725	-	401	399	-	-	-	-	-	-	-

Approach	EB	WB	NB	SB
HCM Control Delay, s	34.7	12.9	0.2	2.3
HCM LOS	D	B		

Minor Lane/Major Mvmt	NBL	NBT	NBR	EBLn1WBLn1	SBL	SBT	SBR
Capacity (veh/h)	1197	-	-	204	597	1370	-
HCM Lane V/C Ratio	0.003	-	-	0.417	0.238	0.107	-
HCM Control Delay (s)	8	0	-	34.7	12.9	7.9	0
HCM Lane LOS	A	A	-	D	B	A	A
HCM 95th %tile Q(veh)	0	-	-	1.9	0.9	0.4	-

Lanes, Volumes, Timings

2027 Build - Ecological / Passive Park - PM Peak

28: Great Neck Road/Avery Lane & Rope Ferry Road

05/09/2017



Lane Group	EBL	EBT	EBR	WBL	WBT	WBR	NBL	NBT	NBR	SBL	SBT	SBR
Lane Configurations												
Traffic Volume (vph)	55	325	95	305	379	62	94	197	245	43	239	76
Future Volume (vph)	55	325	95	305	379	62	94	197	245	43	239	76
Ideal Flow (vphp)	1900	1900	1900	1900	1900	1900	1900	1900	1900	1900	1900	1900
Storage Length (ft)	100		0	200		0	0		250	0		0
Storage Lanes	1		0	1		0	0		1	0		0
Taper Length (ft)	25			25			25			25		
Lane Util. Factor	1.00	1.00	1.00	1.00	1.00	1.00	1.00	1.00	1.00	1.00	1.00	1.00
Frt		0.966			0.979				0.850		0.971	
Flt Protected	0.950			0.950				0.984			0.994	
Satd. Flow (prot)	1770	1799	0	1770	1824	0	0	1833	1583	0	1798	0
Flt Permitted	0.307			0.315				0.671			0.918	
Satd. Flow (perm)	572	1799	0	587	1824	0	0	1250	1583	0	1660	0
Right Turn on Red			Yes			Yes			Yes			Yes
Satd. Flow (RTOR)		28			16				266			23
Link Speed (mph)		30			30			30				30
Link Distance (ft)		662			691			557				483
Travel Time (s)		15.0			15.7			12.7				11.0
Peak Hour Factor	0.92	0.92	0.92	0.92	0.92	0.92	0.92	0.92	0.92	0.92	0.92	0.92
Adj. Flow (vph)	60	353	103	332	412	67	102	214	266	47	260	83
Shared Lane Traffic (%)												
Lane Group Flow (vph)	60	456	0	332	479	0	0	316	266	0	390	0
Turn Type	pm+pt	NA		pm+pt	NA		Perm	NA	Perm	Perm	NA	
Protected Phases	5	2		1	6			8				4
Permitted Phases	2			6			8		8	4		
Minimum Split (s)	9.5	22.5		9.5	22.5		22.5	22.5	22.5	22.5	22.5	22.5
Total Split (s)	9.6	27.2		10.0	27.6		22.8	22.8	22.8	22.8	22.8	22.8
Total Split (%)	16.0%	45.3%		16.7%	46.0%		38.0%	38.0%	38.0%	38.0%	38.0%	38.0%
Yellow Time (s)	3.5	3.5		3.5	3.5		3.5	3.5	3.5	3.5	3.5	3.5
All-Red Time (s)	1.0	1.0		1.0	1.0		1.0	1.0	1.0	1.0	1.0	1.0
Lost Time Adjust (s)	0.0	0.0		0.0	0.0			0.0	0.0		0.0	
Total Lost Time (s)	4.5	4.5		4.5	4.5			4.5	4.5		4.5	
Lead/Lag	Lead	Lag		Lead	Lag							
Lead-Lag Optimize?	Yes	Yes		Yes	Yes							
Act Effect Green (s)	27.8	22.7		28.6	23.1			18.3	18.3		18.3	
Actuated g/C Ratio	0.46	0.38		0.48	0.38			0.30	0.30		0.30	
v/c Ratio	0.16	0.65		0.86	0.67			0.83	0.40		0.75	
Control Delay	7.8	19.8		34.5	20.5			41.2	4.5		28.8	
Queue Delay	0.0	0.0		0.0	0.0			0.0	0.0		0.0	
Total Delay	7.8	19.8		34.5	20.5			41.2	4.5		28.8	
LOS	A	B		C	C			D	A		C	
Approach Delay		18.4			26.2			24.4			28.8	
Approach LOS		B			C			C			C	
Queue Length 50th (ft)	9	123		61	134			105	0		118	
Queue Length 95th (ft)	23	213		#160	228			#232	45		#242	
Internal Link Dist (ft)		582			611			477			403	
Turn Bay Length (ft)	100			200					250			
Base Capacity (vph)	366	698		388	712			381	667		522	
Starvation Cap Reductn	0	0		0	0			0	0		0	

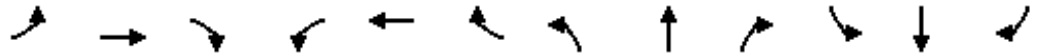

Lane Group	EBL	EBT	EBR	WBL	WBT	WBR	NBL	NBT	NBR	SBL	SBT	SBR
Spillback Cap Reductn	0	0		0	0			0	0		0	
Storage Cap Reductn	0	0		0	0			0	0		0	
Reduced v/c Ratio	0.16	0.65		0.86	0.67			0.83	0.40		0.75	

Intersection Summary

Area Type:	Other
Cycle Length:	60
Actuated Cycle Length:	60
Offset:	0 (0%), Referenced to phase 2:EBTL and 6:WBTL, Start of Green
Natural Cycle:	65
Control Type:	Pretimed
Maximum v/c Ratio:	0.86
Intersection Signal Delay:	24.4
Intersection LOS:	C
Intersection Capacity Utilization	89.9%
ICU Level of Service	E
Analysis Period (min)	15
# 95th percentile volume exceeds capacity, queue may be longer. Queue shown is maximum after two cycles.	

Splits and Phases: 28: Great Neck Road/Avery Lane & Rope Ferry Road

Ø1	Ø2 (R)	Ø4
10 s	27.2 s	22.8 s
Ø5	Ø6 (R)	Ø8
9.6 s	27.6 s	22.8 s

**CAPACITY ANALYSES
2027 BUILD VOLUMES
HYBRID PARK**

Lanes, Volumes, Timings
1: Gardiners Wood Road & Rope Ferry Road

2027 Build - Hybrid Park - AM Peak

05/09/2017

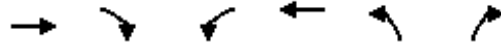

Lane Group	EBT	EBR	WBL	WBT	NBL	NBR
Lane Configurations	↷			↶		
Traffic Volume (vph)	329	54	4	275	90	36
Future Volume (vph)	329	54	4	275	90	36
Ideal Flow (vphpl)	1900	1900	1900	1900	1900	1900
Lane Util. Factor	1.00	1.00	1.00	1.00	1.00	1.00
Frt	0.981			0.962		
Flt Protected				0.999	0.965	
Satd. Flow (prot)	1827	0	0	1861	1729	0
Flt Permitted				0.994	0.965	
Satd. Flow (perm)	1827	0	0	1852	1729	0
Right Turn on Red	Yes			Yes		
Satd. Flow (RTOR)	16				39	
Link Speed (mph)	30			30	30	
Link Distance (ft)	512			589	834	
Travel Time (s)	11.6			13.4	19.0	
Peak Hour Factor	0.92	0.92	0.92	0.92	0.92	0.92
Adj. Flow (vph)	358	59	4	299	98	39
Shared Lane Traffic (%)						
Lane Group Flow (vph)	417	0	0	303	137	0
Turn Type	NA		pm+pt	NA	Prot	
Protected Phases	2			1	6	8
Permitted Phases				6		
Detector Phase	2			1	6	8
Switch Phase						
Minimum Initial (s)	5.0		5.0	5.0	5.0	
Minimum Split (s)	22.5		9.5	22.5	22.5	
Total Split (s)	23.0		9.5	32.5	22.5	
Total Split (%)	41.8%		17.3%	59.1%	40.9%	
Yellow Time (s)	3.5		3.5	3.5	3.5	
All-Red Time (s)	1.0		1.0	1.0	1.0	
Lost Time Adjust (s)	0.0			0.0	0.0	
Total Lost Time (s)	4.5			4.5	4.5	
Lead/Lag	Lag		Lead			
Lead-Lag Optimize?	Yes		Yes			
Recall Mode	None		None	None	Max	
Act Effct Green (s)	13.9			13.9	18.1	
Actuated g/C Ratio	0.34			0.34	0.44	
v/c Ratio	0.67			0.48	0.17	
Control Delay	16.7			13.4	7.0	
Queue Delay	0.0			0.0	0.0	
Total Delay	16.7			13.4	7.0	
LOS	B			B	A	
Approach Delay	16.7			13.4	7.0	
Approach LOS	B			B	A	
Queue Length 50th (ft)	75			53	12	
Queue Length 95th (ft)	141			101	41	
Internal Link Dist (ft)	432			509	754	
Turn Bay Length (ft)						
Base Capacity (vph)	837			1271	785	

Lanes, Volumes, Timings
 1: Gardiners Wood Road & Rope Ferry Road

2027 Build - Hybrid Park - AM Peak

05/09/2017

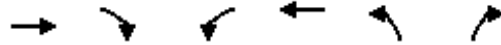

Lane Group	EBT	EBR	WBL	WBT	NBL	NBR
Starvation Cap Reductn	0			0	0	
Spillback Cap Reductn	0			0	0	
Storage Cap Reductn	0			0	0	
Reduced v/c Ratio	0.50			0.24	0.17	

Intersection Summary

Area Type:	Other
Cycle Length:	55
Actuated Cycle Length:	41.1
Natural Cycle:	55
Control Type:	Semi Act-Uncoord
Maximum v/c Ratio:	0.67
Intersection Signal Delay:	14.0
Intersection LOS:	B
Intersection Capacity Utilization	35.3%
ICU Level of Service	A
Analysis Period (min)	15

Splits and Phases: 1: Gardiners Wood Road & Rope Ferry Road

Ø1	Ø2		
9.5 s	23 s		
Ø6	Ø8		
32.5 s	22.5 s		

Lanes, Volumes, Timings
5: Shore Road & Jordan Cove Road

2027 Build - Hybrid Park - AM Peak

05/09/2017



Lane Group	EBL	EBR	NBL	NBT	SBT	SBR
Lane Configurations						
Traffic Volume (vph)	10	59	66	23	4	30
Future Volume (vph)	10	59	66	23	4	30
Ideal Flow (vphpl)	1900	1900	1900	1900	1900	1900
Lane Util. Factor	1.00	1.00	1.00	1.00	1.00	1.00
Frt	0.885				0.881	
Flt Protected	0.993			0.964		
Satd. Flow (prot)	1637	0	0	1796	1641	0
Flt Permitted	0.993			0.964		
Satd. Flow (perm)	1637	0	0	1796	1641	0
Link Speed (mph)	30			30	30	
Link Distance (ft)	348			365	291	
Travel Time (s)	7.9			8.3	6.6	
Peak Hour Factor	1.00	1.00	1.00	1.00	1.00	1.00
Adj. Flow (vph)	10	59	66	23	4	30
Shared Lane Traffic (%)						
Lane Group Flow (vph)	69	0	0	89	34	0
Sign Control	Stop			Stop	Stop	

Intersection Summary

Area Type:	Other
Control Type:	Unsignalized
Intersection Capacity Utilization	22.4%
Analysis Period (min)	15
	ICU Level of Service A

Intersection	
Intersection Delay, s/veh	7.3
Intersection LOS	A

Movement	EBU	EBL	EBR	NBU	NBL	NBT	SBU	SBT	SBR
Lane Configurations		Y				4		4	
Traffic Vol, veh/h	0	10	59	0	66	23	0	4	30
Future Vol, veh/h	0	10	59	0	66	23	0	4	30
Peak Hour Factor	1.00	1.00	1.00	1.00	1.00	1.00	1.00	1.00	1.00
Heavy Vehicles, %	2	2	2	2	2	2	2	2	2
Mvmt Flow	0	10	59	0	66	23	0	4	30
Number of Lanes	0	1	0	0	0	1	0	1	0

Approach	EB	NB	SB
Opposing Approach		SB	NB
Opposing Lanes	0	1	1
Conflicting Approach Left	SB	EB	
Conflicting Lanes Left	1	1	0
Conflicting Approach Right	NB		EB
Conflicting Lanes Right	1	0	1
HCM Control Delay	7	7.7	6.8
HCM LOS	A	A	A

Lane	NBLn1	EBLn1	SBLn1
Vol Left, %	74%	14%	0%
Vol Thru, %	26%	0%	12%
Vol Right, %	0%	86%	88%
Sign Control	Stop	Stop	Stop
Traffic Vol by Lane	89	69	34
LT Vol	66	10	0
Through Vol	23	0	4
RT Vol	0	59	30
Lane Flow Rate	89	69	34
Geometry Grp	1	1	1
Degree of Util (X)	0.105	0.07	0.034
Departure Headway (Hd)	4.229	3.66	3.592
Convergence, Y/N	Yes	Yes	Yes
Cap	848	969	992
Service Time	2.25	1.718	1.632
HCM Lane V/C Ratio	0.105	0.071	0.034
HCM Control Delay	7.7	7	6.8
HCM Lane LOS	A	A	A
HCM 95th-tile Q	0.4	0.2	0.1

Lanes, Volumes, Timings
9: Shore Road & Palmer Road

2027 Build - Hybrid Park - AM Peak

05/09/2017



Lane Group	EBL	EBT	EBR	WBL	WBT	WBR	NBL	NBT	NBR	SBL	SBT	SBR
Lane Configurations		↕			↕			↕			↕	
Traffic Volume (vph)	18	12	1	0	11	11	4	2	0	15	1	27
Future Volume (vph)	18	12	1	0	11	11	4	2	0	15	1	27
Ideal Flow (vphpl)	1900	1900	1900	1900	1900	1900	1900	1900	1900	1900	1900	1900
Lane Util. Factor	1.00	1.00	1.00	1.00	1.00	1.00	1.00	1.00	1.00	1.00	1.00	1.00
Frt		0.996			0.932							0.915
Flt Protected		0.972						0.968				0.983
Satd. Flow (prot)	0	1803	0	0	1736	0	0	1803	0	0	1675	0
Flt Permitted		0.972						0.968				0.983
Satd. Flow (perm)	0	1803	0	0	1736	0	0	1803	0	0	1675	0
Link Speed (mph)		30			30			30				30
Link Distance (ft)		357			396			205				196
Travel Time (s)		8.1			9.0			4.7				4.5
Peak Hour Factor	1.00	1.00	1.00	1.00	1.00	1.00	1.00	1.00	1.00	1.00	1.00	1.00
Adj. Flow (vph)	18	12	1	0	11	11	4	2	0	15	1	27
Shared Lane Traffic (%)												
Lane Group Flow (vph)	0	31	0	0	22	0	0	6	0	0	43	0
Sign Control		Stop			Stop			Stop				Stop

Intersection Summary

Area Type:	Other
Control Type:	Unsignalized
Intersection Capacity Utilization	18.4%
Analysis Period (min)	15
	ICU Level of Service A

Intersection	
Intersection Delay, s/veh	7
Intersection LOS	A

Movement	EBU	EBL	EBT	EBR	WBU	WBL	WBT	WBR	NBU	NBL	NBT	NBR
Lane Configurations			↕				↕				↕	
Traffic Vol, veh/h	0	18	12	1	0	0	11	11	0	4	2	0
Future Vol, veh/h	0	18	12	1	0	0	11	11	0	4	2	0
Peak Hour Factor	1.00	1.00	1.00	1.00	1.00	1.00	1.00	1.00	1.00	1.00	1.00	1.00
Heavy Vehicles, %	2	2	2	2	2	2	2	2	2	2	2	2
Mvmt Flow	0	18	12	1	0	0	11	11	0	4	2	0
Number of Lanes	0	0	1	0	0	0	1	0	0	0	1	0

Approach	EB	WB	NB
Opposing Approach	WB	EB	SB
Opposing Lanes	1	1	1
Conflicting Approach Left	SB	NB	EB
Conflicting Lanes Left	1	1	1
Conflicting Approach Right	NB	SB	WB
Conflicting Lanes Right	1	1	1
HCM Control Delay	7.3	6.9	7.2
HCM LOS	A	A	A

Lane	NBLn1	EBLn1	WBLn1	SBLn1
Vol Left, %	67%	58%	0%	35%
Vol Thru, %	33%	39%	50%	2%
Vol Right, %	0%	3%	50%	63%
Sign Control	Stop	Stop	Stop	Stop
Traffic Vol by Lane	6	31	22	43
LT Vol	4	18	0	15
Through Vol	2	12	11	1
RT Vol	0	1	11	27
Lane Flow Rate	6	31	22	43
Geometry Grp	1	1	1	1
Degree of Util (X)	0.007	0.036	0.023	0.044
Departure Headway (Hd)	4.194	4.132	3.742	3.725
Convergence, Y/N	Yes	Yes	Yes	Yes
Cap	853	868	957	961
Service Time	2.22	2.15	1.764	1.748
HCM Lane V/C Ratio	0.007	0.036	0.023	0.045
HCM Control Delay	7.2	7.3	6.9	6.9
HCM Lane LOS	A	A	A	A
HCM 95th-tile Q	0	0.1	0.1	0.1

Intersection

Intersection Delay, s/veh

Intersection LOS

Movement	SBU	SBL	SBT	SBR
Lane Configurations			↕	
Traffic Vol, veh/h	0	15	1	27
Future Vol, veh/h	0	15	1	27
Peak Hour Factor	1.00	1.00	1.00	1.00
Heavy Vehicles, %	2	2	2	2
Mvmt Flow	0	15	1	27
Number of Lanes	0	0	1	0

Approach	SB
Opposing Approach	NB
Opposing Lanes	1
Conflicting Approach Left	WB
Conflicting Lanes Left	1
Conflicting Approach Right	EB
Conflicting Lanes Right	1
HCM Control Delay	6.9
HCM LOS	A

Lanes, Volumes, Timings
 14: Seaside Park Drive & Shore Road

2027 Build - Hybrid Park - AM Peak

05/09/2017

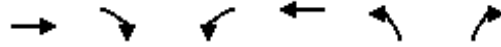

Lane Group	EBT	EBR	WBL	WBT	NBL	NBR
Lane Configurations						
Traffic Volume (vph)	16	16	17	12	12	15
Future Volume (vph)	16	16	17	12	12	15
Ideal Flow (vphpl)	1900	1900	1900	1900	1900	1900
Lane Util. Factor	1.00	1.00	1.00	1.00	1.00	1.00
Frt	0.932			0.925		
Flt Protected				0.972	0.978	
Satd. Flow (prot)	1736	0	0	1811	1685	0
Flt Permitted				0.972	0.978	
Satd. Flow (perm)	1736	0	0	1811	1685	0
Link Speed (mph)	30			30	30	
Link Distance (ft)	504			461	476	
Travel Time (s)	11.5			10.5	10.8	
Peak Hour Factor	1.00	1.00	1.00	1.00	1.00	1.00
Adj. Flow (vph)	16	16	17	12	12	15
Shared Lane Traffic (%)						
Lane Group Flow (vph)	32	0	0	29	27	0
Sign Control	Free			Free	Stop	

Intersection Summary

Area Type:	Other
Control Type:	Unsignalized
Intersection Capacity Utilization	18.2%
Analysis Period (min)	15
	ICU Level of Service A

Intersection

Int Delay, s/veh 4.1

Movement	EBT	EBR	WBL	WBT	NBL	NBR
Lane Configurations	↑		↑		↑	
Traffic Vol, veh/h	16	16	17	12	12	15
Future Vol, veh/h	16	16	17	12	12	15
Conflicting Peds, #/hr	0	0	0	0	0	0
Sign Control	Free	Free	Free	Free	Stop	Stop
RT Channelized	-	None	-	None	-	None
Storage Length	-	-	-	-	0	-
Veh in Median Storage, #	0	-	-	0	0	-
Grade, %	0	-	-	0	0	-
Peak Hour Factor	100	100	100	100	100	100
Heavy Vehicles, %	2	2	2	2	2	2
Mvmt Flow	16	16	17	12	12	15

Major/Minor	Major1		Major2		Minor1	
Conflicting Flow All	0	0	32	0	70	24
Stage 1	-	-	-	-	24	-
Stage 2	-	-	-	-	46	-
Critical Hdwy	-	-	4.12	-	7.12	6.22
Critical Hdwy Stg 1	-	-	-	-	6.12	-
Critical Hdwy Stg 2	-	-	-	-	6.12	-
Follow-up Hdwy	-	-	2.218	-	3.518	3.318
Pot Cap-1 Maneuver	-	-	1580	-	922	1052
Stage 1	-	-	-	-	994	-
Stage 2	-	-	-	-	968	-
Platoon blocked, %	-	-	-	-	-	-
Mov Cap-1 Maneuver	-	-	1580	-	914	1052
Mov Cap-2 Maneuver	-	-	-	-	914	-
Stage 1	-	-	-	-	994	-
Stage 2	-	-	-	-	957	-

Approach	EB	WB	NB
HCM Control Delay, s	0	4.3	8.8
HCM LOS			A

Minor Lane/Major Mvmt	NBLn1	EBT	EBR	WBL	WBT
Capacity (veh/h)	986	-	-	1580	-
HCM Lane V/C Ratio	0.027	-	-	0.011	-
HCM Control Delay (s)	8.8	-	-	7.3	0
HCM Lane LOS	A	-	-	A	A
HCM 95th %tile Q(veh)	0.1	-	-	0	-

Lanes, Volumes, Timings
18: Great Neck Road & Shore Road

2027 Build - Hybrid Park - AM Peak

05/09/2017



Lane Group	EBL	EBR	NBL	NBT	SBT	SBR
Lane Configurations						
Traffic Volume (vph)	39	7	11	68	62	28
Future Volume (vph)	39	7	11	68	62	28
Ideal Flow (vphpl)	1900	1900	1900	1900	1900	1900
Lane Util. Factor	1.00	1.00	1.00	1.00	1.00	1.00
Frt	0.979				0.958	
Flt Protected	0.959			0.993		
Satd. Flow (prot)	1749	0	0	1850	1785	0
Flt Permitted	0.959			0.993		
Satd. Flow (perm)	1749	0	0	1850	1785	0
Link Speed (mph)	30			30	30	
Link Distance (ft)	471			248	380	
Travel Time (s)	10.7			5.6	8.6	
Peak Hour Factor	1.00	1.00	1.00	1.00	1.00	1.00
Adj. Flow (vph)	39	7	11	68	62	28
Shared Lane Traffic (%)						
Lane Group Flow (vph)	46	0	0	79	90	0
Sign Control	Stop			Free	Free	

Intersection Summary

Area Type:	Other
Control Type:	Unsignalized
Intersection Capacity Utilization	20.9%
Analysis Period (min)	15
	ICU Level of Service A

Intersection

Int Delay, s/veh 2.4

Movement	EBL	EBR	NBL	NBT	SBT	SBR
Lane Configurations	Y			4	1	
Traffic Vol, veh/h	39	7	11	68	62	28
Future Vol, veh/h	39	7	11	68	62	28
Conflicting Peds, #/hr	0	0	0	0	0	0
Sign Control	Stop	Stop	Free	Free	Free	Free
RT Channelized	-	None	-	None	-	None
Storage Length	0	-	-	-	-	-
Veh in Median Storage, #	0	-	-	0	0	-
Grade, %	0	-	-	0	0	-
Peak Hour Factor	100	100	100	100	100	100
Heavy Vehicles, %	2	2	2	2	2	2
Mvmt Flow	39	7	11	68	62	28

Major/Minor	Minor2		Major1		Major2	
Conflicting Flow All	166	76	90	0	-	0
Stage 1	76	-	-	-	-	-
Stage 2	90	-	-	-	-	-
Critical Hdwy	6.42	6.22	4.12	-	-	-
Critical Hdwy Stg 1	5.42	-	-	-	-	-
Critical Hdwy Stg 2	5.42	-	-	-	-	-
Follow-up Hdwy	3.518	3.318	2.218	-	-	-
Pot Cap-1 Maneuver	824	985	1505	-	-	-
Stage 1	947	-	-	-	-	-
Stage 2	934	-	-	-	-	-
Platoon blocked, %				-	-	-
Mov Cap-1 Maneuver	817	985	1505	-	-	-
Mov Cap-2 Maneuver	817	-	-	-	-	-
Stage 1	947	-	-	-	-	-
Stage 2	927	-	-	-	-	-

Approach	EB	NB	SB
HCM Control Delay, s	9.5	1	0
HCM LOS	A		

Minor Lane/Major Mvmt	NBL	NBT	EBLn1	SBT	SBR
Capacity (veh/h)	1505	-	839	-	-
HCM Lane V/C Ratio	0.007	-	0.055	-	-
HCM Control Delay (s)	7.4	0	9.5	-	-
HCM Lane LOS	A	A	A	-	-
HCM 95th %tile Q(veh)	0	-	0.2	-	-

Lanes, Volumes, Timings
 24: Lamphere Road & Great Neck Road

2027 Build - Hybrid Park - AM Peak

05/09/2017



Lane Group	EBL	EBT	EBR	WBL	WBT	WBR	NBL	NBT	NBR	SBL	SBT	SBR
Lane Configurations		↕			↕			↕			↕	
Traffic Volume (vph)	91	12	1	4	7	144	0	234	4	50	117	32
Future Volume (vph)	91	12	1	4	7	144	0	234	4	50	117	32
Ideal Flow (vphpl)	1900	1900	1900	1900	1900	1900	1900	1900	1900	1900	1900	1900
Lane Util. Factor	1.00	1.00	1.00	1.00	1.00	1.00	1.00	1.00	1.00	1.00	1.00	1.00
Frt		0.999			0.875			0.998			0.978	
Flt Protected		0.958			0.999						0.988	
Satd. Flow (prot)	0	1783	0	0	1628	0	0	1859	0	0	1800	0
Flt Permitted		0.958			0.999						0.988	
Satd. Flow (perm)	0	1783	0	0	1628	0	0	1859	0	0	1800	0
Link Speed (mph)		30			30			30			30	
Link Distance (ft)		536			649			512			388	
Travel Time (s)		12.2			14.8			11.6			8.8	
Peak Hour Factor	1.00	1.00	1.00	1.00	1.00	1.00	1.00	1.00	1.00	1.00	1.00	1.00
Adj. Flow (vph)	91	12	1	4	7	144	0	234	4	50	117	32
Shared Lane Traffic (%)												
Lane Group Flow (vph)	0	104	0	0	155	0	0	238	0	0	199	0
Sign Control		Stop			Stop			Free			Free	

Intersection Summary

Area Type:	Other
Control Type:	Unsignalized
Intersection Capacity Utilization	52.0%
Analysis Period (min)	15
	ICU Level of Service A

Intersection												
Int Delay, s/veh	5.8											
Movement	EBL	EBT	EBR	WBL	WBT	WBR	NBL	NBT	NBR	SBL	SBT	SBR
Lane Configurations	↕			↕			↕			↕		
Traffic Vol, veh/h	91	12	1	4	7	144	0	234	4	50	117	32
Future Vol, veh/h	91	12	1	4	7	144	0	234	4	50	117	32
Conflicting Peds, #/hr	0	0	0	0	0	0	0	0	0	0	0	0
Sign Control	Stop	Stop	Stop	Stop	Stop	Stop	Free	Free	Free	Free	Free	Free
RT Channelized	-	-	None	-	-	None	-	-	None	-	-	None
Storage Length	-	-	-	-	-	-	-	-	-	-	-	-
Veh in Median Storage, #	-	0	-	-	0	-	-	0	-	-	0	-
Grade, %	-	0	-	-	0	-	-	0	-	-	0	-
Peak Hour Factor	100	100	100	100	100	100	100	100	100	100	100	100
Heavy Vehicles, %	2	2	2	2	2	2	2	2	2	2	2	2
Mvmt Flow	91	12	1	4	7	144	0	234	4	50	117	32

Major/Minor	Minor2			Minor1			Major1			Major2		
Conflicting Flow All	545	471	133	476	485	236	149	0	0	238	0	0
Stage 1	233	233	-	236	236	-	-	-	-	-	-	-
Stage 2	312	238	-	240	249	-	-	-	-	-	-	-
Critical Hdwy	7.12	6.52	6.22	7.12	6.52	6.22	4.12	-	-	4.12	-	-
Critical Hdwy Stg 1	6.12	5.52	-	6.12	5.52	-	-	-	-	-	-	-
Critical Hdwy Stg 2	6.12	5.52	-	6.12	5.52	-	-	-	-	-	-	-
Follow-up Hdwy	3.518	4.018	3.318	3.518	4.018	3.318	2.218	-	-	2.218	-	-
Pot Cap-1 Maneuver	449	491	916	499	482	803	1432	-	-	1329	-	-
Stage 1	770	712	-	767	710	-	-	-	-	-	-	-
Stage 2	699	708	-	763	701	-	-	-	-	-	-	-
Platoon blocked, %	-	-	-	-	-	-	-	-	-	-	-	-
Mov Cap-1 Maneuver	353	471	916	474	462	803	1432	-	-	1329	-	-
Mov Cap-2 Maneuver	353	471	-	474	462	-	-	-	-	-	-	-
Stage 1	770	683	-	767	710	-	-	-	-	-	-	-
Stage 2	568	708	-	718	672	-	-	-	-	-	-	-

Approach	EB	WB	NB	SB
HCM Control Delay, s	18.7	10.9	0	2
HCM LOS	C	B		

Minor Lane/Major Mvmt	NBL	NBT	NBR	EBLn1WBLn1	SBL	SBT	SBR
Capacity (veh/h)	1432	-	-	366	764	1329	-
HCM Lane V/C Ratio	-	-	-	0.284	0.203	0.038	-
HCM Control Delay (s)	0	-	-	18.7	10.9	7.8	0
HCM Lane LOS	A	-	-	C	B	A	A
HCM 95th %tile Q(veh)	0	-	-	1.2	0.8	0.1	-

Lanes, Volumes, Timings
28: Great Neck Road/Avery Lane & Rope Ferry Road

2027 Build - Hybrid Park - AM Peak

05/09/2017



Lane Group	EBL	EBT	EBR	WBL	WBT	WBR	NBL	NBT	NBR	SBL	SBT	SBR
Lane Configurations												
Traffic Volume (vph)	59	351	51	169	200	82	50	222	324	26	102	27
Future Volume (vph)	59	351	51	169	200	82	50	222	324	26	102	27
Ideal Flow (vphp)	1900	1900	1900	1900	1900	1900	1900	1900	1900	1900	1900	1900
Storage Length (ft)	100		0	200		0	0		250	0		0
Storage Lanes	1		0	1		0	0		1	0		0
Taper Length (ft)	25			25			25			25		
Lane Util. Factor	1.00	1.00	1.00	1.00	1.00	1.00	1.00	1.00	1.00	1.00	1.00	1.00
Frt		0.981			0.956				0.850		0.977	
Flt Protected	0.950			0.950				0.991			0.992	
Satd. Flow (prot)	1770	1827	0	1770	1781	0	0	1846	1583	0	1805	0
Flt Permitted	0.507			0.336				0.916			0.916	
Satd. Flow (perm)	944	1827	0	626	1781	0	0	1706	1583	0	1667	0
Right Turn on Red			Yes			Yes			Yes			Yes
Satd. Flow (RTOR)		14			40				352			18
Link Speed (mph)		30			30			30				30
Link Distance (ft)		662			691			557				483
Travel Time (s)		15.0			15.7			12.7				11.0
Peak Hour Factor	0.92	0.92	0.92	0.92	0.92	0.92	0.92	0.92	0.92	0.92	0.92	0.92
Adj. Flow (vph)	64	382	55	184	217	89	54	241	352	28	111	29
Shared Lane Traffic (%)												
Lane Group Flow (vph)	64	437	0	184	306	0	0	295	352	0	168	0
Turn Type	pm+pt	NA		pm+pt	NA		Perm	NA	Perm	Perm	NA	
Protected Phases	5	2		1	6			8				4
Permitted Phases	2			6			8		8	4		
Minimum Split (s)	9.5	22.5		9.5	22.5		22.5	22.5	22.5	22.5	22.5	22.5
Total Split (s)	9.6	27.2		10.0	27.6		22.8	22.8	22.8	22.8	22.8	22.8
Total Split (%)	16.0%	45.3%		16.7%	46.0%		38.0%	38.0%	38.0%	38.0%	38.0%	38.0%
Yellow Time (s)	3.5	3.5		3.5	3.5		3.5	3.5	3.5	3.5	3.5	3.5
All-Red Time (s)	1.0	1.0		1.0	1.0		1.0	1.0	1.0	1.0	1.0	1.0
Lost Time Adjust (s)	0.0	0.0		0.0	0.0			0.0	0.0		0.0	
Total Lost Time (s)	4.5	4.5		4.5	4.5			4.5	4.5		4.5	
Lead/Lag	Lead	Lag		Lead	Lag							
Lead-Lag Optimize?	Yes	Yes		Yes	Yes							
Act Effect Green (s)	27.8	22.7		28.6	23.1			18.3	18.3		18.3	
Actuated g/C Ratio	0.46	0.38		0.48	0.38			0.30	0.30		0.30	
v/c Ratio	0.13	0.63		0.46	0.43			0.57	0.48		0.32	
Control Delay	7.3	19.5		11.2	14.0			22.6	4.8		16.4	
Queue Delay	0.0	0.0		0.0	0.0			0.0	0.0		0.0	
Total Delay	7.3	19.5		11.2	14.0			22.6	4.8		16.4	
LOS	A	B		B	B			C	A		B	
Approach Delay		17.9			13.0			12.9			16.4	
Approach LOS		B			B			B			B	
Queue Length 50th (ft)	10	120		30	67			89	0		41	
Queue Length 95th (ft)	24	205		58	125			158	50		85	
Internal Link Dist (ft)		582			611			477			403	
Turn Bay Length (ft)	100			200					250			
Base Capacity (vph)	507	699		403	710			520	727		520	
Starvation Cap Reductn	0	0		0	0			0	0		0	



Lane Group	EBL	EBT	EBR	WBL	WBT	WBR	NBL	NBT	NBR	SBL	SBT	SBR
Spillback Cap Reductn	0	0		0	0			0	0		0	
Storage Cap Reductn	0	0		0	0			0	0		0	
Reduced v/c Ratio	0.13	0.63		0.46	0.43			0.57	0.48		0.32	

Intersection Summary

Area Type:	Other
Cycle Length:	60
Actuated Cycle Length:	60
Offset:	0 (0%), Referenced to phase 2:EBTL and 6:WBTL, Start of Green
Natural Cycle:	60
Control Type:	Pretimed
Maximum v/c Ratio:	0.63
Intersection Signal Delay:	14.6
Intersection LOS:	B
Intersection Capacity Utilization	68.8%
ICU Level of Service	C
Analysis Period (min)	15

Splits and Phases: 28: Great Neck Road/Avery Lane & Rope Ferry Road

Ø1	Ø2 (R)	Ø4
10 s	27.2 s	22.8 s
Ø5	Ø6 (R)	Ø8
9.6 s	27.6 s	22.8 s

Lanes, Volumes, Timings
1: Gardiners Wood Road & Rope Ferry Road

2027 Build - Hybrid Park - PM Peak

05/09/2017

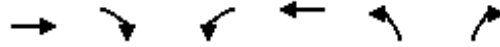

Lane Group	EBT	EBR	WBL	WBT	NBL	NBR
Lane Configurations	↔			↕	↕	
Traffic Volume (vph)	655	123	52	432	95	41
Future Volume (vph)	655	123	52	432	95	41
Ideal Flow (vphpl)	1900	1900	1900	1900	1900	1900
Lane Util. Factor	1.00	1.00	1.00	1.00	1.00	1.00
Frt	0.979			0.959		
Flt Protected				0.995	0.966	
Satd. Flow (prot)	1824	0	0	1853	1726	0
Flt Permitted				0.686	0.966	
Satd. Flow (perm)	1824	0	0	1278	1726	0
Right Turn on Red	Yes			Yes		
Satd. Flow (RTOR)	19				28	
Link Speed (mph)	30			30	30	
Link Distance (ft)	512			589	834	
Travel Time (s)	11.6			13.4	19.0	
Peak Hour Factor	0.92	0.92	0.92	0.92	0.92	0.92
Adj. Flow (vph)	712	134	57	470	103	45
Shared Lane Traffic (%)						
Lane Group Flow (vph)	846	0	0	527	148	0
Turn Type	NA		pm+pt	NA	Prot	
Protected Phases	2				1	6
Permitted Phases				6		
Detector Phase	2				1	6
Switch Phase						
Minimum Initial (s)	5.0		5.0	5.0	5.0	
Minimum Split (s)	22.5		9.5	22.5	22.5	
Total Split (s)	43.0		9.5	52.5	22.5	
Total Split (%)	57.3%		12.7%	70.0%	30.0%	
Yellow Time (s)	3.5		3.5	3.5	3.5	
All-Red Time (s)	1.0		1.0	1.0	1.0	
Lost Time Adjust (s)	0.0			0.0	0.0	
Total Lost Time (s)	4.5			4.5	4.5	
Lead/Lag	Lag		Lead			
Lead-Lag Optimize?	Yes		Yes			
Recall Mode	None		None	None	Max	
Act Effct Green (s)	38.2		38.2		18.4	
Actuated g/C Ratio	0.58			0.58	0.28	
v/c Ratio	0.79			0.71	0.29	
Control Delay	16.4			15.5	20.0	
Queue Delay	0.0			0.0	0.0	
Total Delay	16.4			15.5	20.0	
LOS	B			B	C	
Approach Delay	16.4			15.5	20.0	
Approach LOS	B			B	C	
Queue Length 50th (ft)	224			131	41	
Queue Length 95th (ft)	361			234	95	
Internal Link Dist (ft)	432			509	754	
Turn Bay Length (ft)						
Base Capacity (vph)	1215			953	502	

Lanes, Volumes, Timings
 1: Gardiners Wood Road & Rope Ferry Road

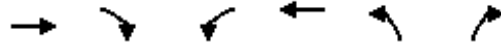

Lane Group	EBT	EBR	WBL	WBT	NBL	NBR
Starvation Cap Reductn	0			0	0	
Spillback Cap Reductn	0			0	0	
Storage Cap Reductn	0			0	0	
Reduced v/c Ratio	0.70			0.55	0.29	

Intersection Summary

Area Type:	Other
Cycle Length:	75
Actuated Cycle Length:	65.9
Natural Cycle:	75
Control Type:	Semi Act-Uncoord
Maximum v/c Ratio:	0.79
Intersection Signal Delay:	16.4
Intersection LOS:	B
Intersection Capacity Utilization	81.5%
ICU Level of Service	D
Analysis Period (min)	15

Splits and Phases: 1: Gardiners Wood Road & Rope Ferry Road

Ø1	Ø2		
9.5 s	43 s		
Ø6		Ø8	
52.5 s		22.5 s	

Lanes, Volumes, Timings
5: Shore Road & Jordan Cove Road

2027 Build - Hybrid Park - PM Peak

05/09/2017



Lane Group	EBL	EBR	NBL	NBT	SBT	SBR
Lane Configurations						
Traffic Volume (vph)	29	99	81	29	38	37
Future Volume (vph)	29	99	81	29	38	37
Ideal Flow (vphpl)	1900	1900	1900	1900	1900	1900
Lane Util. Factor	1.00	1.00	1.00	1.00	1.00	1.00
Frt	0.896				0.933	
Flt Protected	0.989			0.964		
Satd. Flow (prot)	1651	0	0	1796	1738	0
Flt Permitted	0.989			0.964		
Satd. Flow (perm)	1651	0	0	1796	1738	0
Link Speed (mph)	30			30	30	
Link Distance (ft)	348			365	291	
Travel Time (s)	7.9			8.3	6.6	
Peak Hour Factor	1.00	1.00	1.00	1.00	1.00	1.00
Adj. Flow (vph)	29	99	81	29	38	37
Shared Lane Traffic (%)						
Lane Group Flow (vph)	128	0	0	110	75	0
Sign Control	Stop			Stop	Stop	

Intersection Summary

Area Type:	Other
Control Type:	Unsignalized
Intersection Capacity Utilization	27.1%
Analysis Period (min)	15
	ICU Level of Service A

Intersection	
Intersection Delay, s/veh	7.7
Intersection LOS	A

Movement	EBU	EBL	EBR	NBU	NBL	NBT	SBU	SBT	SBR
Lane Configurations		Y				4		4	
Traffic Vol, veh/h	0	29	99	0	81	29	0	38	37
Future Vol, veh/h	0	29	99	0	81	29	0	38	37
Peak Hour Factor	1.00	1.00	1.00	1.00	1.00	1.00	1.00	1.00	1.00
Heavy Vehicles, %	2	2	2	2	2	2	2	2	2
Mvmt Flow	0	29	99	0	81	29	0	38	37
Number of Lanes	0	1	0	0	0	1	0	1	0

















Approach	EB	NB	SB
Opposing Approach		SB	NB
Opposing Lanes	0	1	1
Conflicting Approach Left	SB	EB	
Conflicting Lanes Left	1	1	0
Conflicting Approach Right	NB		EB
Conflicting Lanes Right	1	0	1
HCM Control Delay	7.5	8.1	7.4
HCM LOS	A	A	A

Lane	NBLn1	EBLn1	SBLn1
Vol Left, %	74%	23%	0%
Vol Thru, %	26%	0%	51%
Vol Right, %	0%	77%	49%
Sign Control	Stop	Stop	Stop
Traffic Vol by Lane	110	128	75
LT Vol	81	29	0
Through Vol	29	0	38
RT Vol	0	99	37
Lane Flow Rate	110	128	75
Geometry Grp	1	1	1
Degree of Util (X)	0.133	0.136	0.082
Departure Headway (Hd)	4.366	3.832	3.948
Convergence, Y/N	Yes	Yes	Yes
Cap	815	919	896
Service Time	2.423	1.926	2.024
HCM Lane V/C Ratio	0.135	0.139	0.084
HCM Control Delay	8.1	7.5	7.4
HCM Lane LOS	A	A	A
HCM 95th-tile Q	0.5	0.5	0.3

Lanes, Volumes, Timings
9: Shore Road & Palmer Road

2027 Build - Hybrid Park - PM Peak

05/09/2017

												
Lane Group	EBL	EBT	EBR	WBL	WBT	WBR	NBL	NBT	NBR	SBL	SBT	SBR
Lane Configurations												
Traffic Volume (vph)	28	39	11	2	18	20	7	7	1	20	9	32
Future Volume (vph)	28	39	11	2	18	20	7	7	1	20	9	32
Ideal Flow (vphpl)	1900	1900	1900	1900	1900	1900	1900	1900	1900	1900	1900	1900
Lane Util. Factor	1.00	1.00	1.00	1.00	1.00	1.00	1.00	1.00	1.00	1.00	1.00	1.00
Frt		0.981			0.932			0.991			0.929	
Flt Protected		0.982			0.998			0.977			0.984	
Satd. Flow (prot)	0	1794	0	0	1733	0	0	1804	0	0	1703	0
Flt Permitted		0.982			0.998			0.977			0.984	
Satd. Flow (perm)	0	1794	0	0	1733	0	0	1804	0	0	1703	0
Link Speed (mph)		30			30			30			30	
Link Distance (ft)		357			396			205			196	
Travel Time (s)		8.1			9.0			4.7			4.5	
Peak Hour Factor	1.00	1.00	1.00	1.00	1.00	1.00	1.00	1.00	1.00	1.00	1.00	1.00
Adj. Flow (vph)	28	39	11	2	18	20	7	7	1	20	9	32
Shared Lane Traffic (%)												
Lane Group Flow (vph)	0	78	0	0	40	0	0	15	0	0	61	0
Sign Control		Stop			Stop			Stop			Stop	

Intersection Summary

Area Type:	Other
Control Type:	Unsignalized
Intersection Capacity Utilization	21.6%
Analysis Period (min)	15
	ICU Level of Service A

Intersection	
Intersection Delay, s/veh	7.3
Intersection LOS	A

Movement	EBU	EBL	EBT	EBR	WBU	WBL	WBT	WBR	NBU	NBL	NBT	NBR
Lane Configurations			↕				↕				↕	
Traffic Vol, veh/h	0	28	39	11	0	2	18	20	0	7	7	1
Future Vol, veh/h	0	28	39	11	0	2	18	20	0	7	7	1
Peak Hour Factor	1.00	1.00	1.00	1.00	1.00	1.00	1.00	1.00	1.00	1.00	1.00	1.00
Heavy Vehicles, %	2	2	2	2	2	2	2	2	2	2	2	2
Mvmt Flow	0	28	39	11	0	2	18	20	0	7	7	1
Number of Lanes	0	0	1	0	0	0	1	0	0	0	1	0

Approach	EB	WB	NB
Opposing Approach	WB	EB	SB
Opposing Lanes	1	1	1
Conflicting Approach Left	SB	NB	EB
Conflicting Lanes Left	1	1	1
Conflicting Approach Right	NB	SB	WB
Conflicting Lanes Right	1	1	1
HCM Control Delay	7.5	7.1	7.4
HCM LOS	A	A	A

Lane	NBLn1	EBLn1	WBLn1	SBLn1
Vol Left, %	47%	36%	5%	33%
Vol Thru, %	47%	50%	45%	15%
Vol Right, %	7%	14%	50%	52%
Sign Control	Stop	Stop	Stop	Stop
Traffic Vol by Lane	15	78	40	61
LT Vol	7	28	2	20
Through Vol	7	39	18	9
RT Vol	1	11	20	32
Lane Flow Rate	15	78	40	61
Geometry Grp	1	1	1	1
Degree of Util (X)	0.018	0.088	0.043	0.066
Departure Headway (Hd)	4.239	4.083	3.834	3.9
Convergence, Y/N	Yes	Yes	Yes	Yes
Cap	837	874	928	911
Service Time	2.301	2.122	1.884	1.955
HCM Lane V/C Ratio	0.018	0.089	0.043	0.067
HCM Control Delay	7.4	7.5	7.1	7.2
HCM Lane LOS	A	A	A	A
HCM 95th-tile Q	0.1	0.3	0.1	0.2

Intersection

Intersection Delay, s/veh

Intersection LOS

Movement	SBU	SBL	SBT	SBR
Lane Configurations			↕	
Traffic Vol, veh/h	0	20	9	32
Future Vol, veh/h	0	20	9	32
Peak Hour Factor	1.00	1.00	1.00	1.00
Heavy Vehicles, %	2	2	2	2
Mvmt Flow	0	20	9	32
Number of Lanes	0	0	1	0

Approach	SB
Opposing Approach	NB
Opposing Lanes	1
Conflicting Approach Left	WB
Conflicting Lanes Left	1
Conflicting Approach Right	EB
Conflicting Lanes Right	1
HCM Control Delay	7.2
HCM LOS	A

Lanes, Volumes, Timings
 14: Seaside Park Drive & Shore Road

2027 Build - Hybrid Park - PM Peak

05/09/2017

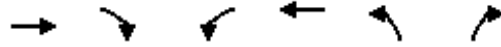

Lane Group	EBT	EBR	WBL	WBT	NBL	NBR
Lane Configurations						
Traffic Volume (vph)	22	21	20	22	21	21
Future Volume (vph)	22	21	20	22	21	21
Ideal Flow (vphpl)	1900	1900	1900	1900	1900	1900
Lane Util. Factor	1.00	1.00	1.00	1.00	1.00	1.00
Frt	0.934			0.932		
Flt Protected				0.977	0.976	
Satd. Flow (prot)	1740	0	0	1820	1694	0
Flt Permitted				0.977	0.976	
Satd. Flow (perm)	1740	0	0	1820	1694	0
Link Speed (mph)	30			30	30	
Link Distance (ft)	504			461	476	
Travel Time (s)	11.5			10.5	10.8	
Peak Hour Factor	1.00	1.00	1.00	1.00	1.00	1.00
Adj. Flow (vph)	22	21	20	22	21	21
Shared Lane Traffic (%)						
Lane Group Flow (vph)	43	0	0	42	42	0
Sign Control	Free			Free	Stop	

Intersection Summary

Area Type:	Other
Control Type:	Unsignalized
Intersection Capacity Utilization	18.9%
Analysis Period (min)	15
	ICU Level of Service A

Intersection

Int Delay, s/veh 4.1

Movement	EBT	EBR	WBL	WBT	NBL	NBR
Lane Configurations	↑		↑		↑	
Traffic Vol, veh/h	22	21	20	22	21	21
Future Vol, veh/h	22	21	20	22	21	21
Conflicting Peds, #/hr	0	0	0	0	0	0
Sign Control	Free	Free	Free	Free	Stop	Stop
RT Channelized	-	None	-	None	-	None
Storage Length	-	-	-	-	0	-
Veh in Median Storage, #	0	-	-	0	0	-
Grade, %	0	-	-	0	0	-
Peak Hour Factor	100	100	100	100	100	100
Heavy Vehicles, %	2	2	2	2	2	2
Mvmt Flow	22	21	20	22	21	21

Major/Minor	Major1		Major2		Minor1	
Conflicting Flow All	0	0	43	0	95	33
Stage 1	-	-	-	-	33	-
Stage 2	-	-	-	-	62	-
Critical Hdwy	-	-	4.12	-	6.42	6.22
Critical Hdwy Stg 1	-	-	-	-	5.42	-
Critical Hdwy Stg 2	-	-	-	-	5.42	-
Follow-up Hdwy	-	-	2.218	-	3.518	3.318
Pot Cap-1 Maneuver	-	-	1566	-	905	1041
Stage 1	-	-	-	-	989	-
Stage 2	-	-	-	-	961	-
Platoon blocked, %	-	-	-	-	-	-
Mov Cap-1 Maneuver	-	-	1566	-	893	1041
Mov Cap-2 Maneuver	-	-	-	-	893	-
Stage 1	-	-	-	-	989	-
Stage 2	-	-	-	-	949	-

Approach	EB	WB	NB
HCM Control Delay, s	0	3.5	8.9
HCM LOS			A

Minor Lane/Major Mvmt	NBLn1	EBT	EBR	WBL	WBT
Capacity (veh/h)	961	-	-	1566	-
HCM Lane V/C Ratio	0.044	-	-	0.013	-
HCM Control Delay (s)	8.9	-	-	7.3	0
HCM Lane LOS	A	-	-	A	A
HCM 95th %tile Q(veh)	0.1	-	-	0	-

Lanes, Volumes, Timings
 18: Great Neck Road & Shore Road

2027 Build - Hybrid Park - PM Peak

05/09/2017



Lane Group	EBL	EBR	NBL	NBT	SBT	SBR
Lane Configurations						
Traffic Volume (vph)	33	16	17	79	59	40
Future Volume (vph)	33	16	17	79	59	40
Ideal Flow (vphpl)	1900	1900	1900	1900	1900	1900
Lane Util. Factor	1.00	1.00	1.00	1.00	1.00	1.00
Frt	0.956				0.945	
Flt Protected	0.967			0.991		
Satd. Flow (prot)	1722	0	0	1846	1760	0
Flt Permitted	0.967			0.991		
Satd. Flow (perm)	1722	0	0	1846	1760	0
Link Speed (mph)	30			30	30	
Link Distance (ft)	471			248	380	
Travel Time (s)	10.7			5.6	8.6	
Peak Hour Factor	1.00	1.00	1.00	1.00	1.00	1.00
Adj. Flow (vph)	33	16	17	79	59	40
Shared Lane Traffic (%)						
Lane Group Flow (vph)	49	0	0	96	99	0
Sign Control	Stop			Free	Free	

Intersection Summary

Area Type:	Other
Control Type:	Unsignalized
Intersection Capacity Utilization	21.8%
Analysis Period (min)	15
	ICU Level of Service A

Intersection

Int Delay, s/veh 2.4

Movement	EBL	EBR	NBL	NBT	SBT	SBR
Lane Configurations	Y			4	1	
Traffic Vol, veh/h	33	16	17	79	59	40
Future Vol, veh/h	33	16	17	79	59	40
Conflicting Peds, #/hr	0	0	0	0	0	0
Sign Control	Stop	Stop	Free	Free	Free	Free
RT Channelized	-	None	-	None	-	None
Storage Length	0	-	-	-	-	-
Veh in Median Storage, #	0	-	-	0	0	-
Grade, %	0	-	-	0	0	-
Peak Hour Factor	100	100	100	100	100	100
Heavy Vehicles, %	2	2	2	2	2	2
Mvmt Flow	33	16	17	79	59	40

Major/Minor	Minor2		Major1		Major2	
Conflicting Flow All	192	79	99	0	-	0
Stage 1	79	-	-	-	-	-
Stage 2	113	-	-	-	-	-
Critical Hdwy	6.42	6.22	4.12	-	-	-
Critical Hdwy Stg 1	5.42	-	-	-	-	-
Critical Hdwy Stg 2	5.42	-	-	-	-	-
Follow-up Hdwy	3.518	3.318	2.218	-	-	-
Pot Cap-1 Maneuver	797	981	1494	-	-	-
Stage 1	944	-	-	-	-	-
Stage 2	912	-	-	-	-	-
Platoon blocked, %				-	-	-
Mov Cap-1 Maneuver	787	981	1494	-	-	-
Mov Cap-2 Maneuver	787	-	-	-	-	-
Stage 1	944	-	-	-	-	-
Stage 2	901	-	-	-	-	-

Approach	EB	NB	SB
HCM Control Delay, s	9.5	1.3	0
HCM LOS	A		

Minor Lane/Major Mvmt	NBL	NBT	EBLn1	SBT	SBR
Capacity (veh/h)	1494	-	841	-	-
HCM Lane V/C Ratio	0.011	-	0.058	-	-
HCM Control Delay (s)	7.4	0	9.5	-	-
HCM Lane LOS	A	A	A	-	-
HCM 95th %tile Q(veh)	0	-	0.2	-	-

Lanes, Volumes, Timings
 24: Lamphere Road & Great Neck Road

2027 Build - Hybrid Park - PM Peak

05/09/2017



Lane Group	EBL	EBT	EBR	WBL	WBT	WBR	NBL	NBT	NBR	SBL	SBT	SBR
Lane Configurations		↕			↕			↕			↕	
Traffic Volume (vph)	72	13	0	9	16	117	4	210	9	147	281	98
Future Volume (vph)	72	13	0	9	16	117	4	210	9	147	281	98
Ideal Flow (vphpl)	1900	1900	1900	1900	1900	1900	1900	1900	1900	1900	1900	1900
Lane Util. Factor	1.00	1.00	1.00	1.00	1.00	1.00	1.00	1.00	1.00	1.00	1.00	1.00
Frt					0.889			0.995			0.975	
Flt Protected		0.959			0.997			0.999			0.986	
Satd. Flow (prot)	0	1786	0	0	1651	0	0	1852	0	0	1791	0
Flt Permitted		0.959			0.997			0.999			0.986	
Satd. Flow (perm)	0	1786	0	0	1651	0	0	1852	0	0	1791	0
Link Speed (mph)		30			30			30			30	
Link Distance (ft)		536			649			512			388	
Travel Time (s)		12.2			14.8			11.6			8.8	
Peak Hour Factor	1.00	1.00	1.00	1.00	1.00	1.00	1.00	1.00	1.00	1.00	1.00	1.00
Adj. Flow (vph)	72	13	0	9	16	117	4	210	9	147	281	98
Shared Lane Traffic (%)												
Lane Group Flow (vph)	0	85	0	0	142	0	0	223	0	0	526	0
Sign Control		Stop			Stop			Free			Free	

Intersection Summary

Area Type:	Other
Control Type:	Unsignalized
Intersection Capacity Utilization	67.3%
Analysis Period (min)	15
	ICU Level of Service C

Intersection

Int Delay, s/veh 6.4

Movement	EBL	EBT	EBR	WBL	WBT	WBR	NBL	NBT	NBR	SBL	SBT	SBR
Lane Configurations	↕			↕			↕			↕		
Traffic Vol, veh/h	72	13	0	9	16	117	4	210	9	147	281	98
Future Vol, veh/h	72	13	0	9	16	117	4	210	9	147	281	98
Conflicting Peds, #/hr	0	0	0	0	0	0	0	0	0	0	0	0
Sign Control	Stop	Stop	Stop	Stop	Stop	Stop	Free	Free	Free	Free	Free	Free
RT Channelized	-	-	None	-	-	None	-	-	None	-	-	None
Storage Length	-	-	-	-	-	-	-	-	-	-	-	-
Veh in Median Storage, #	-	0	-	-	0	-	-	0	-	-	0	-
Grade, %	-	0	-	-	0	-	-	0	-	-	0	-
Peak Hour Factor	100	100	100	100	100	100	100	100	100	100	100	100
Heavy Vehicles, %	2	2	2	2	2	2	2	2	2	2	2	2
Mvmt Flow	72	13	0	9	16	117	4	210	9	147	281	98

Major/Minor	Minor2			Minor1			Major1			Major2		
Conflicting Flow All	913	851	330	854	896	215	379	0	0	219	0	0
Stage 1	624	624	-	223	223	-	-	-	-	-	-	-
Stage 2	289	227	-	631	673	-	-	-	-	-	-	-
Critical Hdwy	7.12	6.52	6.22	7.12	6.52	6.22	4.12	-	-	4.12	-	-
Critical Hdwy Stg 1	6.12	5.52	-	6.12	5.52	-	-	-	-	-	-	-
Critical Hdwy Stg 2	6.12	5.52	-	6.12	5.52	-	-	-	-	-	-	-
Follow-up Hdwy	3.518	4.018	3.318	3.518	4.018	3.318	2.218	-	-	2.218	-	-
Pot Cap-1 Maneuver	254	297	712	279	280	825	1179	-	-	1350	-	-
Stage 1	473	478	-	780	719	-	-	-	-	-	-	-
Stage 2	719	716	-	469	454	-	-	-	-	-	-	-
Platoon blocked, %	-	-	-	-	-	-	-	-	-	-	-	-
Mov Cap-1 Maneuver	184	254	712	239	240	825	1179	-	-	1350	-	-
Mov Cap-2 Maneuver	184	254	-	239	240	-	-	-	-	-	-	-
Stage 1	471	411	-	777	716	-	-	-	-	-	-	-
Stage 2	601	713	-	391	390	-	-	-	-	-	-	-

Approach	EB	WB	NB	SB
HCM Control Delay, s	37.9	13.3	0.1	2.2
HCM LOS	E	B		

Minor Lane/Major Mvmt	NBL	NBT	NBR	EBLn1	WBLn1	SBL	SBT	SBR
Capacity (veh/h)	1179	-	-	192	577	1350	-	-
HCM Lane V/C Ratio	0.003	-	-	0.443	0.246	0.109	-	-
HCM Control Delay (s)	8.1	0	-	37.9	13.3	8	0	-
HCM Lane LOS	A	A	-	E	B	A	A	-
HCM 95th %tile Q(veh)	0	-	-	2.1	1	0.4	-	-

Lanes, Volumes, Timings
 28: Great Neck Road/Avery Lane & Rope Ferry Road

2027 Build - Hybrid Park - PM Peak

05/09/2017

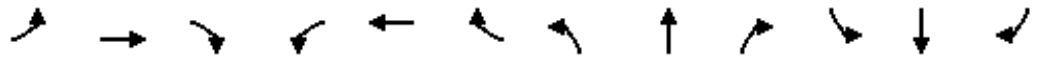

Lane Group	EBL	EBT	EBR	WBL	WBT	WBR	NBL	NBT	NBR	SBL	SBT	SBR
Lane Configurations												
Traffic Volume (vph)	55	325	97	313	379	62	95	204	254	43	246	76
Future Volume (vph)	55	325	97	313	379	62	95	204	254	43	246	76
Ideal Flow (vphp)	1900	1900	1900	1900	1900	1900	1900	1900	1900	1900	1900	1900
Storage Length (ft)	100		0	200		0	0		250	0		0
Storage Lanes	1		0	1		0	0		1	0		0
Taper Length (ft)	25			25			25			25		
Lane Util. Factor	1.00	1.00	1.00	1.00	1.00	1.00	1.00	1.00	1.00	1.00	1.00	1.00
Frt		0.966			0.979				0.850		0.972	
Flt Protected	0.950			0.950				0.984			0.994	
Satd. Flow (prot)	1770	1799	0	1770	1824	0	0	1833	1583	0	1800	0
Flt Permitted	0.307			0.313				0.667			0.902	
Satd. Flow (perm)	572	1799	0	583	1824	0	0	1242	1583	0	1633	0
Right Turn on Red			Yes			Yes			Yes			Yes
Satd. Flow (RTOR)		29			16				276			23
Link Speed (mph)		30			30			30				30
Link Distance (ft)		662			691			557				483
Travel Time (s)		15.0			15.7			12.7				11.0
Peak Hour Factor	0.92	0.92	0.92	0.92	0.92	0.92	0.92	0.92	0.92	0.92	0.92	0.92
Adj. Flow (vph)	60	353	105	340	412	67	103	222	276	47	267	83
Shared Lane Traffic (%)												
Lane Group Flow (vph)	60	458	0	340	479	0	0	325	276	0	397	0
Turn Type	pm+pt	NA		pm+pt	NA		Perm	NA	Perm	Perm	NA	
Protected Phases	5	2		1	6			8				4
Permitted Phases	2			6			8		8	4		
Minimum Split (s)	9.5	22.5		9.5	22.5		22.5	22.5	22.5	22.5	22.5	22.5
Total Split (s)	9.6	27.2		10.0	27.6		22.8	22.8	22.8	22.8	22.8	22.8
Total Split (%)	16.0%	45.3%		16.7%	46.0%		38.0%	38.0%	38.0%	38.0%	38.0%	38.0%
Yellow Time (s)	3.5	3.5		3.5	3.5		3.5	3.5	3.5	3.5	3.5	3.5
All-Red Time (s)	1.0	1.0		1.0	1.0		1.0	1.0	1.0	1.0	1.0	1.0
Lost Time Adjust (s)	0.0	0.0		0.0	0.0			0.0	0.0		0.0	
Total Lost Time (s)	4.5	4.5		4.5	4.5			4.5	4.5		4.5	
Lead/Lag	Lead	Lag		Lead	Lag							
Lead-Lag Optimize?	Yes	Yes		Yes	Yes							
Act Effect Green (s)	27.8	22.7		28.6	23.1			18.3	18.3		18.3	
Actuated g/C Ratio	0.46	0.38		0.48	0.38			0.30	0.30		0.30	
v/c Ratio	0.16	0.66		0.88	0.67			0.86	0.41		0.77	
Control Delay	7.8	19.8		38.2	20.5			45.0	4.6		30.6	
Queue Delay	0.0	0.0		0.0	0.0			0.0	0.0		0.0	
Total Delay	7.8	19.8		38.2	20.5			45.0	4.6		30.6	
LOS	A	B		D	C			D	A		C	
Approach Delay		18.4			27.8			26.4			30.6	
Approach LOS		B			C			C			C	
Queue Length 50th (ft)	9	124		62	134			109	0		121	
Queue Length 95th (ft)	23	214		#169	228			#242	45		#251	
Internal Link Dist (ft)		582			611			477			403	
Turn Bay Length (ft)	100			200					250			
Base Capacity (vph)	366	698		386	712			378	674		514	
Starvation Cap Reductn	0	0		0	0			0	0		0	

28: Great Neck Road/Avery Lane & Rope Ferry Road

05/09/2017

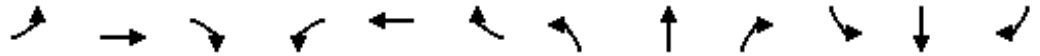

Lane Group	EBL	EBT	EBR	WBL	WBT	WBR	NBL	NBT	NBR	SBL	SBT	SBR
Spillback Cap Reductn	0	0		0	0			0	0		0	
Storage Cap Reductn	0	0		0	0			0	0		0	
Reduced v/c Ratio	0.16	0.66		0.88	0.67			0.86	0.41		0.77	

Intersection Summary

Area Type: Other
 Cycle Length: 60
 Actuated Cycle Length: 60
 Offset: 0 (0%), Referenced to phase 2:EBTL and 6:WBTL, Start of Green
 Natural Cycle: 60
 Control Type: Pretimed
 Maximum v/c Ratio: 0.88
 Intersection Signal Delay: 25.8
 Intersection LOS: C
 Intersection Capacity Utilization 91.3%
 ICU Level of Service F
 Analysis Period (min) 15
 # 95th percentile volume exceeds capacity, queue may be longer.
 Queue shown is maximum after two cycles.

Splits and Phases: 28: Great Neck Road/Avery Lane & Rope Ferry Road

Ø1	Ø2 (R)	Ø4
10 s	27.2 s	22.8 s
Ø5	Ø6 (R)	Ø8
9.6 s	27.6 s	22.8 s