

The Bedrock Geology  
of the  
Norwalk North and Norwalk South  
Quadrangles

WITH MAPS

Plate 1   Plate 2   Plate 3   Plate 4   Plate 5

RICHARD L. KROLL



STATE GEOLOGICAL AND NATURAL HISTORY SURVEY  
OF CONNECTICUT

DEPARTMENT OF ENVIRONMENTAL PROTECTION

1977

QUADRANGLE REPORT NO. 34

STATE GEOLOGICAL AND NATURAL HISTORY SURVEY  
OF CONNECTICUT

DEPARTMENT OF ENVIRONMENTAL PROTECTION

---

The Bedrock Geology  
of the  
Norwalk North and Norwalk South  
Quadrangles

WITH MAPS

RICHARD L. KROLL  
*Kean College of New Jersey*



1977

QUADRANGLE REPORT NO. 34

---

STATE GEOLOGICAL AND NATURAL HISTORY SURVEY  
OF CONNECTICUT  
DEPARTMENT OF ENVIRONMENTAL PROTECTION

Honorable Ella T. Grasso, *Governor of Connecticut*

Stanley J. Pac, *Commissioner of the Department of  
Environmental Protection*

STATE GEOLOGIST  
DIRECTOR, NATURAL RESOURCES CENTER  
Hugo F. Thomas, Ph.D.  
Hartford, Connecticut

EDITOR  
Lou Williams Page, Ph.D.

DISTRIBUTION AND EXCHANGE AGENT  
Charles E. Funk, *State Librarian*  
State Library, Hartford

---

The price of this Quadrangle Report is \$1.00. Additional copies may be ordered from Sales and Publications, State Library, Hartford, Connecticut 06115 (postpaid: Connecticut residents must add sales tax). A List of Publications of the State Survey is available from the State Library on request.

## ACKNOWLEDGMENTS

Geologic mapping of the Norwalk North quadrangle was done during the summers of 1967-69; the Norwalk South quadrangle was mapped during the summers of 1972 and 1973. Field expenses were paid by the Connecticut Geological and Natural History Survey. Locations in the field, simplified by the large number of roads and buildings in the area, were facilitated by aerial photographs supplied by the Survey.

The Connecticut Geological and Natural History Survey paid for thin sections and photographic supplies. The use of laboratory facilities and photographic equipment was part of my privilege as a graduate student at Syracuse University and as a faculty member of Kean College of New Jersey.

I am grateful to John J. Prucha of Syracuse University for his advice in the field and in conference, to Gary M. Boone of Syracuse University, who aided me with laboratory and petrologic problems, and to Leo M. Hall of the University of Massachusetts, who helped me to gain perspective on the field relations of the complexly deformed Norwalk area rocks and helped me develop a framework to interpret their structure.

Thanks are also extended to two members of the Connecticut Geological and Natural History Survey: to Joe Webb Peoples, who was its Director during the period of this study, for his support of the work, and to Sidney Quarrier, who aided me in the preparation of the manuscript.

Field conferences with Robert W. Schnabel of the U.S. Geological Survey and Harold Bannerman, and numerous discussions with Charles M. Frank of Southern Illinois University were helpful.

Richard L. Kroll

Union, New Jersey  
November 1976

## TABLE OF CONTENTS

	Page
Abstract . . . . .	1
Introduction . . . . .	1
Location . . . . .	1
Topography, drainage, and culture . . . . .	3
Geologic setting . . . . .	3
Previous work . . . . .	3
Laboratory and descriptive methods . . . . .	4
Stratigraphy . . . . .	4
Introduction . . . . .	4
Biotite-plagioclase-quartz gneiss . . . . .	5
Mixed felsic gneiss . . . . .	6
General . . . . .	6
Microcline-quartz-plagioclase gneiss . . . . .	6
Biotite-muscovite-plagioclase-quartz schist . . . . .	8
Amphibolites . . . . .	9
Garnet-plagioclase-muscovite-biotite-quartz schist . . . . .	9
Porphyroblastic biotite gneiss . . . . .	10
Calc-silicate gneiss . . . . .	10
Minor schists . . . . .	12
Origin of the mixed felsic gneiss . . . . .	12
Interlayered schist and granulite . . . . .	13
Mafic gneisses . . . . .	15
General . . . . .	15
Unit I . . . . .	16
Unit II . . . . .	18
Unit III . . . . .	19
Mafic gneisses in the Norwalk South quadrangle . . . . .	19
Minor rock types in mafic gneiss unit I . . . . .	21
Origin of the mafic gneisses and associated rocks . . . . .	24
Porphyroblastic microcline-quartz-plagioclase gneiss . . . . .	26
Massive felsic gneiss . . . . .	27
Granodiorite gneiss . . . . .	28
Hornblendite . . . . .	29
Pegmatites . . . . .	29
Diabase . . . . .	29
Stratigraphic order . . . . .	29
Age and correlation . . . . .	31
Structure . . . . .	34
Structural framework . . . . .	34
Major folds . . . . .	34
Wilton fold . . . . .	34
South Norwalk fold . . . . .	41
A doubly plunging fold model . . . . .	42
The Norwalk-Stamford dome . . . . .	42
Fractures . . . . .	43
Comparison with structures in surrounding areas . . . . .	43
Ages of the deformations . . . . .	44
Metamorphism . . . . .	44

Introduction . . . . .	44
Metamorphic facies and isograds . . . . .	44
Temperature and pressure of metamorphism . . . . .	46
Geologic history . . . . .	49
Economic geology . . . . .	49
References . . . . .	50
Appendix: Analytical techniques for mineral determinations . . . . .	53

## ILLUSTRATIONS

	Page
Plate 1. Geologic map of the Norwalk North quadrangle . . . . .	(in pocket)
2. Cross sections of the Norwalk North quadrangle . . . . .	(in pocket)
3. Geologic map of the Norwalk South quadrangle . . . . .	(in pocket)
4. Cross sections of the Norwalk South quadrangle . . . . .	(in pocket)
5. Lithologic maps and descriptive rock chart . . . . .	(in pocket)
Figure 1. Map of Connecticut showing location of the Norwalk North and Norwalk South quadrangles and other published quadrangle maps . . . . .	2
2. Outcrop of unit I of the mafic gneisses . . . . .	18
3. Mafic pod in unit I of the mafic gneisses . . . . .	19
4. Cross-laminations in unit I of the mafic gneisses . . . . .	20
5. Outcrop of unit II of the mafic gneisses . . . . .	21
6. Photomicrographs of microcline porphyroblasts in unit II of the mafic gneisses . . . . .	23
7. Mafic granular pods in unit I of the mafic gneisses . . . . .	24
8. Proposed correlations . . . . .	32
9. Structural-domain map of the Norwalk North quadrangle . . . . .	35
10. Two east-west cross-sectional interpretations of the Wilton fold . . . . .	36
11. Orientation diagrams of foliation and lineations of the Wilton fold . . . . .	37
12. Development of a doubly plunging fold . . . . .	38
13. View of F <sub>3</sub> crenulations . . . . .	40
14. Block diagram of part of Norwalk South quadrangle . . . . .	41
15. Location of the Norwalk-Stamford dome . . . . .	42
16. Orientation diagram of slickensides . . . . .	43
17. ACF and A'F'K diagrams . . . . .	45
18. Metamorphic subfacies transition in the Norwalk South quadrangle . . . . .	46
19. P-T diagram of metamorphic conditions in the Norwalk North quadrangle . . . . .	47
20. P-T diagram for the system K <sub>2</sub> O-MgO-Al <sub>2</sub> O <sub>3</sub> -SiO <sub>2</sub> -H <sub>2</sub> O . . . . .	48

## TABLES

Table 1.	Mineral abbreviations used in this report . . . . .	4
	2. Metamorphic rock units . . . . .	5
	3. Modal analyses of biotite-plagioclase-quartz gneiss . . . . .	7
	4. Modal analyses of microcline-quartz-plagioclase gneiss in mixed felsic gneiss . . . . .	7
	5. Modal analyses of biotite-muscovite-plagioclase-quartz schist in mixed felsic gneiss . . . . .	8
	6. Modal analyses of amphibolite in mixed felsic gneiss . . . . .	8
	7. Modal analyses of garnet-plagioclase-biotite-quartz schist in mixed felsic gneiss . . . . .	11
	8. Modal analyses of calc-silicate gneiss in mixed felsic gneiss . . . . .	11
	9. Modal analyses of minor schists in mixed felsic gneiss . . . . .	13
	10. Modal analyses of interlayered schist and granulite . . . . .	13
	11. Modal analyses of mafic gneiss unit I . . . . .	16
	12. Modal analyses of mafic gneiss unit II . . . . .	16
	13. Modal analyses of mafic gneiss unit III . . . . .	17
	14. Modal analyses of felsic interlayers in mafic gneiss units I and II . . . . .	17
	15. Modal analyses of mafic gneiss in the Norwalk South quadrangle . . . . .	22
	16. Modal analysis of a granular mafic pod . . . . .	22
	17. Modal analyses of porphyroblastic microcline-quartz-plagioclase gneiss . . . . .	26
	18. Modal analyses of massive felsic gneiss . . . . .	26
	19. Modal analyses of granodiorite gneiss . . . . .	28

# The Bedrock Geology of the Norwalk North and Norwalk South Quadrangles

by Richard L. Kroll

## ABSTRACT

The Norwalk North and Norwalk South quadrangles are underlain by metamorphosed sedimentary, volcanic, and igneous rocks intruded by synkinematic granitic rocks. In stratigraphic order from oldest to youngest, the major units are: biotite-plagioclase-quartz gneiss of probable volcanic origin, mixed felsic gneiss of volcanic or sedimentary origin, interlayered schist and granulite of sedimentary origin, and mafic gneisses which are subdivided into three volcanic and one intrusive unit. Massive felsic gneiss forms a large intrusive body in the Norwalk North quadrangle and three smaller ones in the Norwalk South quadrangle. Minor rock types include ultramafic rocks, coarse garnet-gedrite schist in the mafic gneisses, cross-cutting hornblendite, and porphyroblastic felsic gneiss and granodiorite gneiss.

The rocks correlate lithologically with part of the sequence in the Long Hill and Bridgeport quadrangles and part of an inverted sequence in the Westport quadrangle. Lithologic correlation with an established sequence in Vermont suggests a Cambro-Ordovician age.

An initial phase of deformation produced a large isoclinal fold which initially plunged westward in the Norwalk North quadrangle. A later deformation caused the western limb to override the eastern limb in the Norwalk North quadrangle along a gently N-plunging axis. This later axis plunges southward in the Norwalk South quadrangle. A later brittle deformation produced SW-plunging crenulations and kinks and NW-striking, nearly vertical, slickensided surfaces.

Metamorphism reached a peak of 660-680°C at about 6 kb ( $P_{H_2O}$ ) in the Norwalk North quadrangle but was somewhat less in the southern part of the Norwalk South quadrangle, as indicated by the kyanite-sillimanite isograd.

## INTRODUCTION

### *Location*

The Norwalk North and Norwalk South quadrangles are bounded by 41°00' and 41°15' N latitude, and 73°22'30" and 73°30' W longitude. The Norwalk South quadrangle is entirely within Connecticut; the northwestern part of the Norwalk North quadrangle includes a small part of the state of New York (fig. 1). The major towns are Norwalk, Wilton, Darien, and New Canaan, Connecticut.



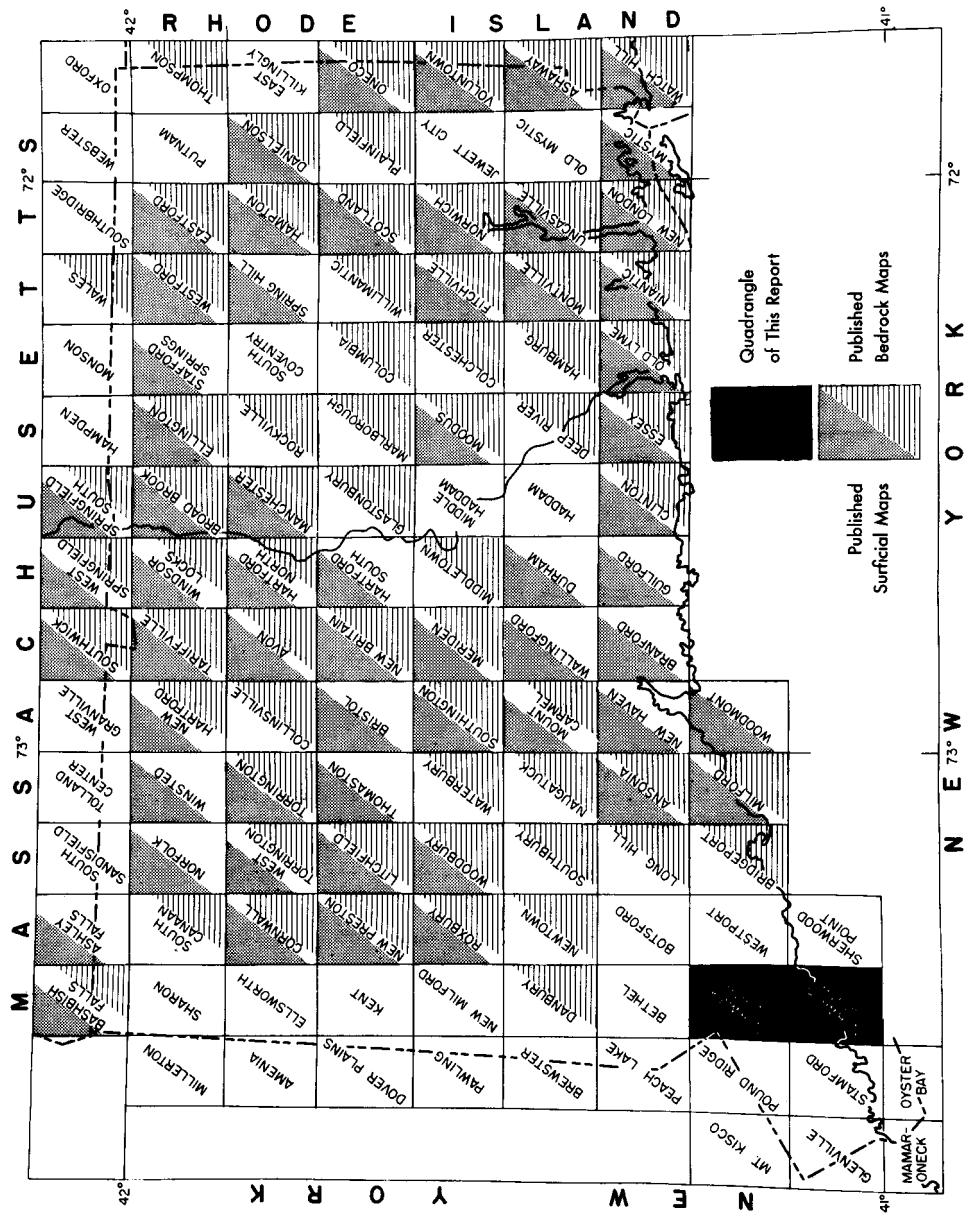

Fig. 1. Index map of Connecticut, showing the locations of the Norwalk North and Norwalk South quadrangles and of other published quadrangle maps.

### *Topography, drainage, and culture*

The quadrangles lie within the Western Highlands of Connecticut. Elevation rises from sea level along the shore of Long Island Sound to slightly over 730 ft in the town of Ridgefield in the Norwalk North quadrangle. Relief is low to moderate. Maximum local relief of about 250 ft occurs along the Norwalk River valley in the northern part of the Norwalk North quadrangle.

Most higher elevations are drumlinoid hills with a northwest orientation, but locally hills trend northeastward, reflecting local bedrock control of the topography. In general, the relief increases from low to moderate from south to north. Narrow valleys of moderate relief occur along some geologic contacts; a few of these valleys have been dammed for water supplies. Relief of the bedrock surface is masked by glacial deposits.

The drainage pattern is dendritic but has a marked NW-SE trend. Drainage is in part interrupted by glacial deposits, and several swamps and small ponds have developed. In the northern half of the Norwalk North quadrangle the Norwalk River occupies a steep-sided valley that parallels the contact between mafic gneisses and schist and granulite. Farther south, the river crosses the contact between massive and mixed felsic gneisses. Most other streams follow local bedrock structures. Definition of structures in areas of poor outcrop and low relief is uncertain and the relation of drainage and bedrock is unknown in these areas.

The quadrangles are urban and suburban. Remaining woodlands are either natural preserves, water-supply properties or parts of private estates. Continuing commercial and residential construction exposes new outcrops and buries some old ones. Outcrops shown on the geologic maps (pls. 1, 3) are those observed by the writer during field work and in later field checks up to 1973.

### *Geologic setting*

Metamorphosed sedimentary, volcanic, and intrusive igneous rocks occur throughout southwestern Connecticut. Their position in the stratigraphic sequences of New England and New York State, and their petrology and structure are being studied by geologists of the Connecticut Geological and Natural History Survey and the U.S. Geological Survey.

Rocks to the east of the quadrangles are considered to be metamorphosed eugeosynclinal-facies rocks (Stanley, 1968, p. 3) and form large-scale, refolded and recumbent folds and nappes (Dieterich, 1968a; Crowley, 1968). Rocks to the west are metamorphosed miogeosynclinal-facies rocks (Stanley, 1968, p. 3) and form attenuated, refolded, steeply inclined isoclinal folds (Hall, 1968a; Prucha and others, 1968). This places the Norwalk area near the transition zone between rocks of contrasting sedimentary facies and structural styles.

### *Previous work*

The first published description of rocks in this area was by Percival (1842). Later workers (Rice and Gregory, 1906; Gregory and Robinson, 1907) considered the region a complex of schist, gneiss, and marble intruded by dioritic and granitic magmas. Dale and Gregory (1911) included it in a study of the granites of Connecticut. Agar (1934) mapped rocks in the north-central part of the Norwalk North quadrangle as diorites and pyroxene diorites. Cameron and his associates (1956) included the area's rocks in the Hartland Formation and

granite of southwestern Connecticut. Clark and Kulp (1968) collected samples here as part of a suite for isotopic age studies.

### *Laboratory and descriptive methods*

Locations of samples, photographs, and specific outcrops are given by the Connecticut Grid System coordinates.

Table 1 lists the mineral abbreviations used in figures and plates.

Standard petrographic techniques were used for laboratory study of the rocks. The method of Chayes (1956) was used for the mineral modal analyses shown in tables 3-19. Where necessary, x-ray diffraction and chemical-analysis techniques were also utilized. The specific determination technique used for each mineral is described in the Appendix.

Rock types are designated according to major mineral content. A biotite-plagioclase-quartz gneiss is a gneiss containing biotite, plagioclase, and quartz, listed in order of *increasing* abundance.

All rock units have been descriptively termed; new formal names are not proposed. Rocks in the quadrangles closely resemble formations in surrounding areas and when the continuity of units is validated, appropriate names can be assigned to rock units in these quadrangles.

On plate 5 are maps outlining areas of differing lithology, together with a chart summarizing the lithologic characteristics of the various rock types. Because of this chart, much rock-descriptive material is not included in the text.

Table 1.—Mineral abbreviations used in figures and plates.

Adr	andradite	Gr	grossularite
And	andalusite	Hb	hornblende
At	anthophyllite	Ky	kyanite
Bi	biotite	Mi	microcline
Cal	calcite	Mu	muscovite
Cd	cordierite	Phl	phlogopite
Cpx	clinopyroxene	Plag	plagioclase
Cum	cummingtonite	Qtz	quartz
Czo	clinozoisite	Si	sillimanite
Di	diopside	St	staurolite
Ga	garnet	Zo	zoisite
Ged	gedrite		

## STRATIGRAPHY

### *Introduction*

Biotite-plagioclase-quartz gneiss, felsic gneisses, interlayered schist and granulite, and mafic gneisses are the major metamorphic rock units in the quadrangles. The biotite-plagioclase-quartz gneiss occurs in the western part of the Norwalk South quadrangle and, although not exposed, possibly extends into the southwestern part of the Norwalk North quadrangle.

The felsic gneisses are divided into massive and mixed types. The massive type forms one large body in the Norwalk North quadrangle and three smaller ones in the Norwalk South quadrangle. The mixed felsic gneiss, which underlies large areas of both quadrangles, contains subordinate amounts of schists, gneisses, and amphibolites not found in the massive felsic gneiss.

Interlayered schist and granulite form a large body in the Norwalk North quadrangle but are exposed only on a few islands and a few inland outcrops in the Norwalk South quadrangle.

The mafic gneisses form several large bodies that are erosional remnants of a horizon which forms a large doubly-plunging fold. The largest continuous body of mafic gneiss, in the town of Wilton, is divided into three units on a textural basis. Other mafic-gneiss bodies resemble parts of the mafic gneisses in Wilton.

Other rock types include a porphyroblastic felsic-gneiss body in the interlayered schist and granulite, ultramafic rocks, granodiorite gneiss, pegmatites, and one outcrop of diabase. Table 2 lists the major metamorphic rock units in stratigraphic order, with the oldest at the bottom.

Table 2—Metamorphic rock units.<sup>1</sup>

Mafic gneiss
Unit III
Unit II
Unit I
Interlayered schist and granulite
Mixed felsic gneiss
Biotite-plagioclase-quartz gneiss

<sup>1</sup> All Cambro-Ordovician (?)

### *Biotite-plagioclase-quartz gneiss*

Biotite-plagioclase-quartz-gneiss (pl. 5; table 3) occurs in the western part of the Norwalk South quadrangle (pl. 3). Its contact with the amphibolite-bearing portion of the mixed felsic gneiss is not exposed and is only approximately located. The trend of this contact, where it can be located, parallels that of magnetic-intensity lines on the aeromagnetic map (U.S. Geological Survey, 1971b). Continuation of the contact to areas of poor outcrop follows the trend of the aeromagnetic pattern but is placed west of the amphibolite outcrops.

This rock type is medium- to coarse-grained, gray-to-buff, poorly to moderately foliated gneiss. Outcrops are characterized by irregularly spaced, dark, biotite-rich folia, separated by layers rich in plagioclase and quartz and containing small disseminated biotite flakes. Cross-cutting and commonly contorted quartz-feldspar pegmatites are characterized by dark-pink feldspar.

Because magnetite is the principal opaque mineral, the magnetic intensity of this gneiss is higher than that of other rock units in the quadrangles. Rocks farther east contain pyrite or ilmenite as the principal opaque mineral.

The biotite-plagioclase-quartz gneiss is not well exposed. Primary features

which might give information on its origin are lacking. Based on composition alone, the rocks can be either sedimentary or igneous. If they are igneous, the relatively high quartz content suggests a volcanogenic origin, at a site probably far from the volcanic source.

Where probable equivalents are better exposed than these rocks, other workers (Crowley, 1968; Scott, 1974, p. 22) believe them to be volcanic. Chemical data, obtained directly or by calculation from mineralogic modes, are of questionable reliability in suggesting the origin of highly metamorphosed rocks. However, chemical data can be used in conjunction with such primary features as amphibolites and layering characteristics, which, if not definitive, at least suggest a volcanic origin. Based on its correlation with the Collinsville Formation (fig. 7), a volcanic origin is suggested for the Norwalk biotite-plagioclase-quartz gneiss.

### *Mixed felsic gneiss*

#### GENERAL

Mixed felsic gneiss underlies large areas of both quadrangles and consists mainly of massive to well foliated microcline-quartz-plagioclase granitic gneiss. About 10 percent of the unit is composed of other gneisses, schists, amphibolites, and calc-silicate rocks. Most of these subordinate rock types could not be traced beyond a few outcrops. The most persistent are amphibolites near the biotite-plagioclase-quartz gneiss (bpgq, pl. 3) in the western part of the Norwalk South quadrangle and biotite-muscovite-plagioclase-quartz schist (bms, pl. 1) in the town of New Canaan, mostly in the Norwalk North quadrangle.

The varieties of rock within the mixed felsic gneiss are discussed in order of decreasing abundance.

#### MICROCLINE-QUARTZ-PLAGIOCLASE GNEISS

Microcline-quartz-plagioclase gneiss (pl. 5; table 4) is the major rock type of the mixed felsic gneiss. It occurs throughout the area mapped as mixed felsic gneiss (mxg, pls. 1, 3) and also in minor amounts within the separately mapped subdivisions. In individual outcrops it commonly forms about 90 percent of the rock, the remainder being generally more schistose. A separate body of microcline-quartz-plagioclase gneiss lies in the north-central part of the Norwalk North quadrangle.

The contact between the mixed (mxg) and massive (msg) felsic gneisses is not exposed, but outcrops close to the contact belong distinctively to one or the other unit. Contact relations with the minor subdivisions are discussed under each rock type.

The microcline-quartz-plagioclase gneiss is medium-to-coarse grained. Although there is a range in the proportions of the major minerals, a systematic variation could not be mapped. The outcrops appear coarse grained to very coarse grained due to aggregates of quartz and feldspar up to a few centimeters long. Microcline porphyroblasts are locally a few centimeters long and exhibit well developed Carlsbad twins. Garnet commonly forms concentrations of xenoblastic and idioblastic grains but most appear fragmented, with chlorite along fractures and rims.

Table 3.—Modal analyses of biotite-plagioclase-quartz gneiss.<sup>1</sup>

Mineral	Volume percent <sup>2</sup>	
	Range	Average
Quartz	43-57	49
Plagioclase	22-33	30
Biotite	7-17	11
Microcline	2-14	6
Magnetite	T-3	2
Muscovite	0.3-3	1
Apatite	T-0.4	0.2
Garnet	T-0.2	0.1
Zircon	T-0.1	0.1
Chlorite	T-5	1
		100.4 <sup>3</sup>

Table 4.—Modal analyses of microcline-quartz-plagioclase gneiss in mixed felsic gneiss.<sup>1</sup>

Mineral	Volume percent <sup>2</sup>	
	Range	Average
Plagioclase <sup>4</sup>	22-46	32
Quartz	21-36	29
Microcline	14-34	27
Muscovite	1-13	7
Biotite	2-7	4
Opaque <sup>5</sup>	0.1-0.5	0.3
Chlorite	0-1	0.5
Apatite	T-0.4	0.2
Garnet	0-0.4	0.2
Zircon	T-0.1	0.1
		100.3 <sup>3</sup>

<sup>1</sup> Samples from five outcrops.

<sup>2</sup> Figures are rounded to the nearest whole number; those less than 1 percent are rounded to the nearest one-tenth. T = trace amount; present in thin section but not encountered in point count.

<sup>3</sup> Average amounts do not total 100 percent because of the rounding of figures and because samples with trace amounts were not included in the averaging.

<sup>4</sup> Anorthite content of plagioclase is 20-27 percent by weight.

<sup>5</sup> Magnetite and ilmenite.

Outcrops contain discontinuous layers and streaks of darker rocks up to a few centimeters thick. Many dark streaks are bluish and most are slightly rusty. Small pegmatitic lenses, large cross-cutting pegmatite bodies, and thin pegmatite dikes are common. Fresh surfaces are gray, yellow, or buff. Mafic streaks are slightly rusty on weathered surfaces but nonrusty on fresh surfaces. Amphibolite layers are nonrusty and schistose layers are rusty.

Foliation is well developed in outcrops with abundant micas but poor to absent in massive coarse-grained rocks. Pegmatitic lenses are poorly foliated and cross-cutting pegmatites are unfoliated. The foliation follows compositional boundaries and is commonly folded. Lineations are formed by inequant mica grains and rods of quartz and feldspar. Outcrops are well fractured and yield large, nearly rectangular blocks up to several meters on a side. Many fractures are slickensided and coated with fine-grained black tourmaline.

The proportion of gneissic to schistose rocks is commonly about ten to one. The schistose portions are rich in mica and commonly weather rusty. Many of the schistose segments resemble parts of the schist and granulite unit (sg, pls. 1,3) in layering and weathering characteristics. The most common schistose rock contains interlayers of biotite-plagioclase-quartz rock and muscovite-biotite-rich schist. The layering is commonly on a scale of 1-2 cm.

The schistose segments generally appear as conformable interlayers within the

microcline-quartz-plagioclase gneiss and commonly feather laterally into the granitic rock. Cross-cutting relationships between the two rock types are not common and both have undergone simultaneous deformation.

#### BIOTITE-MUSCOVITE-PLAGIOCLASE-QUARTZ SCHIST

This sub-unit (pl. 5; table 5) occurs mostly in New Canaan and extends into Norwalk. The southern termination of the unit is placed south of the numerous amphibolite boulders at the Ferndale Seminary (105,500 N; 407,800 E). The western contact with granitic gneisses of the mixed felsic gneiss parallels Marvin Ridge in New Canaan and is in a valley between numerous amphibolite and granite-gneiss boulders at the Ferndale Seminary.

The sub-unit is composed mostly of well laminated schist with discontinuous quartz layers 2-5 mm thick and 5-20 cm long, separated by mica-rich layers a few millimeters thick. Quartz lenses, averaging 2 x 6 cm in long dimension, are common features. Mica-rich layers contain abundant sericite lenses a few millimeters thick. Many muscovite flakes are at angles to the foliation and show

Table 5.—Modal analyses of biotite-muscovite-plagioclase-quartz schist in mixed felsic gneiss.<sup>1</sup>

Mineral	Volume percent <sup>2</sup>	
	Range	Average
Plagioclase <sup>3</sup>	25-36	30
Quartz	25-35	31
Microcline	0-2	0.3
Muscovite	4-21	15
Biotite	1-30	13
Opaque <sup>4</sup>	1-5	3
Chlorite	0.1-16	8
Apatite	T-0.2	0.2
Garnet	0.1-3	2
Zircon	T-0.1	0.1
Sphene	0-0.7	0.2
		102.8 <sup>5</sup>

Table 6.—Modal analyses of amphibolite in mixed felsic gneiss.<sup>1</sup>

Mineral	Volume percent <sup>2</sup>	
	Range	Average
Plagioclase <sup>6</sup>	14-27	21
Quartz	1-13	6
Hornblende	57-70	67
Biotite	0-3	1
Opaque <sup>7</sup>	0.1-3	2
Chlorite	0-2	0.8
Apatite	0.1-0.5	0.2
Garnet <sup>8</sup>	0-4	1
Zircon	0-T	—
Sphene	T-0.4	0.2
Allanite	0-T	—
		99.2 <sup>5</sup>

<sup>1</sup> Samples from four outcrops.

<sup>2</sup> Figures are rounded to the nearest whole number; those less than 1 percent are rounded to the nearest one-tenth. T = trace amount; present in thin section but not encountered in point count.

<sup>3</sup> Anorthite content of plagioclase is 25-32 percent by weight.

<sup>4</sup> Magnetite and ilmenite; one sample with graphite.

<sup>5</sup> Average amounts do not total 100 percent because of the rounding of figures and because samples with trace amounts were not included in the averaging.

<sup>6</sup> Anorthite content of plagioclase is 34-53 percent by weight.

<sup>7</sup> Magnetite and ilmenite; locally pyrite.

<sup>8</sup> Locally up to 30 percent.

no preferred orientation. Felsic quartz-feldspar lenses up to a few meters long occur sporadically.

Within the sub-unit there are also outcrops of more thickly layered rocks, commonly weathered yellow green, in which mica-poor, quartzo-feldspathic layers alternate with mica-rich layers on a scale from a few millimeters to a few centimeters.

The thinly laminated rocks form outcrops with jagged edges normal to the foliation. They weather rusty red; the more thickly layered rocks weather rusty yellow. Fresh surfaces are banded black and gray or are buff. Quartz layers are dark, with rusty grain boundaries. Chlorite-rich layers are bluish.

Foliation is well developed in the thinly laminated rocks, and less well developed in the more thickly layered rocks. Inequant mica grains on foliation surfaces form a moderately well developed lineation. Outcrops fracture to produce massive blocks a few meters on a side, with jagged edges.

The schist is medium-to-coarse grained but local felsic lenses are pegmatitic.

#### AMPHIBOLITES

Amphibolites (pl. 5; table 6) occur throughout the mixed felsic gneiss, commonly making up entire outcrops or as thin layers within other rocks. These two types of occurrence are indicated on the geologic maps (pls. 1, 3). Amphibolites are most common in the southwestern part of the Norwalk South quadrangle, east of the contact between the biotite-plagioclase-quartz gneiss and the mixed felsic gneiss. Individual outcrops of amphibolite in this area are up to 50 m wide across strike. The concentration of amphibolites here represents the lowest part of the mixed felsic gneiss. Poor outcrops farther north along the zone make their presence there uncertain. If the amphibolites are a persistent stratigraphic feature, they would be expected east of the contact between the biotite-plagioclase-quartz gneiss and the mixed felsic gneiss.

The amphibolites are medium-to-coarse grained. Outcrops are dark and massive with thin, subparallel felsic stringers throughout. Quartz lenses are common. Garnet and/or biotite appear locally as conspicuous porphyroblasts. Weathered surfaces are gray; the garnet and biotite weather brown. In detail, the feldspar weathers white or buff and the amphibole dull black. Fresh surfaces are shiny black, with red-brown garnets and clear gray feldspar. Cleavage faces of amphiboles are shiny black.

Foliation is poorly developed but lineation is strong, due to parallelism of amphibole prisms. Outcrops fracture to produce large rectangular blocks several meters on a side.

#### GARNET-PLAGIOCLASE-MUSCOVITE-BIOTITE-QUARTZ SCHIST

This rock (pl. 5; table 7) forms several outcrops in the southeastern part of the Norwalk North quadrangle and the northeastern part of the Norwalk South quadrangle. The sub-unit is named according to the five most abundant minerals in its schist layers.

Contacts are not exposed; the nearest outcrops are of calc-silicate gneiss.

Outcrops are layered, with quartzo-feldspathic layers, 0.5-2 cm thick, separating coarse garnet-plagioclase-muscovite-biotite-quartz schist layers up to several



meters thick. In the schist layers, garnet forms conspicuous porphyroblasts up to 3 cm in diameter. Small quartz lenses and larger, more irregular masses are common. Porphyroblasts of tourmaline, up to 1 cm long, are common on foliation surfaces and in quartz lenses. Sillimanite is locally abundant.

Weathered surfaces are nonrusty to slightly rusty; however, most of these surfaces have only recently been exposed by construction. Fresh surfaces are lustrous where mica rich and gray and white to buff where more feldspathic.

In the schist layers, foliation is well developed and commonly crenulated. In the granular layers, mica orientation produces a poor foliation. Mineral lineation is formed by inequant micas. Tourmaline exhibits a moderately well developed preferred orientation. Available exposures are inadequate to determine the fracture characteristics. The rock is difficult to break with a hammer and hand-size samples tend to fall apart along foliation planes.

The schist layers are coarse grained and the granular layers medium grained. Garnets are conspicuously large, 3 mm to 3 cm in diameter.

#### PORPHYROBLASTIC BIOTITE GNEISS

Porphyroblastic biotite gneiss (pl. 5) forms several outcrops in the north-central part of the Norwalk South quadrangle (pl. 3). Contacts with surrounding rocks are not exposed.

Porphyroblastic biotite gneiss is a medium- to coarse-grained, well foliated dark rock with abundant xenoblastic microcline porphyroblasts 1-2 cm long. The rock is composed of biotite, plagioclase, microcline, and quartz with local pyroxene. Accessory minerals are apatite, zircon, and opaques.

In outcrop, the appearance is similar to that of the mafic gneisses. However, this rock type has a much higher biotite content than the mafic gneisses and lacks hornblende and sphene.

Modal analyses of this rock are not available.

#### CALC-SILICATE GNEISS

Calc-silicate gneiss (pl. 5; table 8) occurs at several localities within the mixed felsic gneiss. Its contact with the microcline-quartz-plagioclase gneiss is exposed, poorly, at only one locality, in the southeastern part of the Norwalk North quadrangle. The contact is conformable; layering and foliation in the calc-silicate gneiss is parallel to the foliation and mafic streaks in the microcline-plagioclase-quartz gneiss. The content of dark interlayers increases in the latter rock toward the calc-silicate gneiss, but that gneiss does not occur within this felsic gneiss nor are there layers of the felsic gneiss within the calc-silicate gneiss.

Calc-silicate gneiss is layered; light-green and dark-green layers are separated by rusty micaceous layers. A few layers are pink and white. Within the layers are laminae of different shades of green, buff, or white, and pink and white. Layers are 1-8 cm thick and rarely continuous for more than 2 m. Cavities occur sporadically and are commonly concentrated in layers on the noses of minor folds. Some fresh surfaces fizz when dilute hydrochloric acid is applied. Quartz pods and quartz-feldspar pegmatites are locally developed in the gneiss.

Weathered surfaces are rusty, dull green, or buff and pink. Fresh surfaces are

Table 7.—Modal analyses of garnet-plagioclase-muscovite-biotite-quartz schist in mixed felsic gneiss.<sup>1</sup>

Mineral	Volume percent	
	Schist layer	Granular layer
Plagioclase <sup>2</sup>	19.0	1.4
Quartz	27.7	69.0
Muscovite	23.7	21.7
Biotite	24.1	6.4
Opaque <sup>3</sup>	1.1	1.0
Chlorite	0.2	—
Apatite	0.2	0.2
Garnet	3.9	0.3
Zircon	0.1	T <sup>5</sup>
Tourmaline <sup>4</sup>	—	—
Sillimanite <sup>4</sup>	—	—
	100.0	100.0

Table 8.—Modal analyses of calc-silicate gneiss in mixed felsic gneiss.<sup>6</sup>

Mineral	Volume percent <sup>7</sup>	
	Range	Average
Plagioclase <sup>8</sup>	11-52	29
Quartz	24-46	31
Clinopyroxene	0-50	23
Hornblende	0-12	3
Clinozoisite	0-14	5
Garnet	0-13	2
Calcite	0-1	0.7
Biotite	0-8	2
Opaque <sup>9</sup>	0-6	2
Chlorite	0-0.1	0.1
Apatite	T-0.3 <sup>5</sup>	0.2
Zircon	0-0.2	— <sup>10</sup>
Sphene	0-2	1
Microcline	0-0.8	0.1
Sericite	0-5	1
		100.1 <sup>11</sup>

<sup>1</sup> Samples from one outcrop.

<sup>2</sup> Anorthite content of plagioclase in the granular layer is 24-28 percent by weight.

<sup>3</sup> Ilmenite

<sup>4</sup> Not present in thin section but present in outcrop.

<sup>5</sup> T = trace amount; present in thin section but not encountered in point count.

<sup>6</sup> Samples from three outcrops.

<sup>7</sup> Figures are rounded to the nearest whole number; those less than 1 percent are rounded to the nearest one-tenth.

<sup>8</sup> Range of anorthite content of plagioclase in two samples: 46-53, 82-87.

<sup>9</sup> Pyrite, magnetite, and ilmenite.

<sup>10</sup> Average less than 0.05 percent.

<sup>11</sup> Average amounts do not total 100 percent because of the rounding of figures and because samples with trace amounts were not included in the averaging.

light green, dark green, pink-and-white laminated, and shiny on biotite-rich surfaces. In detail, the rock color is caused by the variations in the ratio of mafic and felsic laminae within any layer.

Foliation is poorly developed except in the mica-rich interlayers. On the noses of minor folds local foliation crosses compositional boundaries and the foliation is an axial-plane foliation. The calc-silicate gneiss body in the southeastern part of the Norwalk North quadrangle is isoclinally folded on a small interlayer scale; because the axial surface is almost horizontal, this produces the appearance of flat-lying beds.

Lineation, formed by inequant mica grains, is evident only on micaceous surfaces between the calc-silicate layers. Fold-axis lineations are visible in cavities on the noses of minor folds.

All outcrops are artificially exposed and natural fracturing characteristics could not be determined.

The calc-silicate gneisses are fine-to-medium grained. There is a range in the proportions of essential minerals in the layers and laminae, with darker rocks richer in amphiboles than lighter ones. Pink layers are garnet rich. Biotite-rich layers are biotite-quartz-plagioclase schist. Brown, weathered layers contain abundant calcite.

#### MINOR SCHISTS

Minor amounts of schist (pl. 5; table 9) occur throughout the mixed felsic gneiss, generally as layers and lenses in microcline-quartz-plagioclase gneiss, where the two rock types are in conformable contact and commonly grade and feather laterally into each other. Foliated microcline-quartz-plagioclase gneiss was not observed to cut across the various schist bodies. Locally the minor schists occur in closely spaced outcrops, with no other rocks between them, and have been mapped as a sub-unit. More commonly, however, the minor-schist outcrops are so widely spaced and the attitudes of foliation and layering so diverse that they could not be incorporated into a sub-unit and are shown as isolated occurrences.

The minor schists are well layered to massive in the same outcrops. Layers of more granular rock vary from less than 1 cm to several centimeters thick and are separated by dark schist layers of the same thickness range. Some outcrops are entirely of massive schist. Lenses of gray, microcline-quartz-plagioclase gneiss from a few centimeters to 25 m long are common features. Many schist layers contain garnet porphyroblasts and are locally graphitic. Biotite appears to predominate over muscovite in most outcrops and the rocks are characteristically dark.

Outcrops weather red or yellow green. Fresh surfaces are shiny but all are slightly rusty. Outcrops are commonly crumbly and hand samples easily fall apart along foliation planes.

The rock is well foliated except in the more massive granular layers. Lineation is moderately to well developed and is formed by inequant mica grains. Outcrops fracture poorly and irregularly. Many fractures are slickensided and many contain cavities lined with fine-grained pyrite.

The rocks are medium-to-coarse grained. Local lenses of microcline-quartz-plagioclase gneiss are pegmatitic.

#### ORIGIN OF THE MIXED FELSIC GNEISS

The microcline-quartz-plagioclase gneiss, which makes up most of the mixed felsic gneiss, is of granitic composition. The schist bodies within the gneiss are aluminous metasedimentary rocks. The amphibolites and porphyroblastic biotite schist are meta-igneous rocks.

The felsic portions probably represent one of the following: 1) granitic magma which invaded a predominantly metasedimentary unit, 2) the product of partial melting of a predominantly metasedimentary unit, 3) the granitic parts of a

Table 9.—Modal analyses of minor schists in mixed felsic gneiss.<sup>1</sup>

Mineral	Volume percent <sup>2</sup>	
	Range	Average
Plagioclase <sup>3</sup>	4-34	15
Quartz	18-41	33
Microcline	0-17	4
Muscovite	2-40	23
Biotite	14-32	22
Opaque <sup>4</sup>	0.3-2	1
Chlorite	T-6	2
Apatite	T-1	0.6
Garnet	T-3	2
Zircon	T-0.1	0.1
Sphene	0-0.1	—
Sillimanite	0-0.1	—
		102.7 <sup>5</sup>

Table 10.—Modal analyses of interlayered schist and granulite.<sup>6</sup>

Mineral	Volume percent <sup>2</sup>	
	Range	Average
Plagioclase <sup>7</sup>	0.5-53	23
Quartz	25-62	42
Microcline	0-28 <sup>8</sup>	—
Muscovite	2-36	19
Biotite	0.2-22	8
Garnet	0-5	0.1
Sillimanite	0-5	0.9
Opaque <sup>9</sup>	0.1-2	0.8
Apatite	T-4 <sup>8</sup>	—
Zircon	0-0.1	0.1
Sphene	0-0.1	—
Chlorite	0-2	0.7
		94.6 <sup>5</sup>

<sup>1</sup> Samples from six outcrops.

<sup>2</sup> Figures are rounded to the nearest whole number; those less than 1 percent are rounded to the nearest one-tenth. T = trace amount; present in thin section but not encountered in point count.

<sup>3</sup> Anorthite content of plagioclase is 23-51 percent by weight.

<sup>4</sup> Pyrite, magnetite, ilmenite, and graphite.

<sup>5</sup> Average amounts do not total 100 percent because of the rounding of figures and because samples with trace amounts were not included in the averaging.

<sup>6</sup> Samples from seven outcrops.

<sup>7</sup> Anorthite content of plagioclase is 31-32 percent by weight.

<sup>8</sup> Single samples contain large amounts; average not calculated.

<sup>9</sup> Magnetite and ilmenite; locally pyrite and/or graphite.

mixed felsic metavolcanic and metasedimentary unit, or 4) the arkosic portions of a metasedimentary unit originally composed of arkoses, shales, carbonates, and basic volcanics.

The lack of clear-cut discordance between the granitic and the metasedimentary and meta-igneous parts of the unit argues against an intrusive magmatic origin of the felsic parts. Origin as a mixed arkosic or felsic volcanic rock with shaly, carbonate, and basaltic portions best explains the observed character of this unit.

### *Interlayered schist and granulite<sup>1</sup>*

This unit<sup>2</sup> (pl. 5; table 10) includes several lithic types which have in common a distinct interlayering of poorly foliated, mica-poor granulite and well foliated

<sup>1</sup> Granulite, as used here, refers to metamorphic rocks with subequant grains, poor foliation, and a granular texture.

<sup>2</sup> Referred to hereafter in the text as "schist and granulite."

medium- or coarse-grained schist. Layering thickness is commonly 1-2 cm; layers up to 1 m occur locally. Granular layers are generally thicker than the intervening schist layers.

In the Norwalk North quadrangle the rocks included in the schist and granulite are: biotite-muscovite-quartz-plagioclase granulite and biotite-muscovite-quartz schist  $\pm$  garnet and sillimanite, calc-silicate granulite and thin rusty biotite schist, coticule-bearing granulite and biotite-muscovite-plagioclase-quartz granulite and muscovite-biotite-quartz schist, amphibolite, mafic gneisses, and coarse gedrite schist.

Some of the rocks are locally graphitic, weather rusty or nonrusty, and locally contain tourmaline. However, none of these characteristics constitutes a criterion for separating mappable sub-units. The calc-silicates, coticule granulite, and mafic gneiss are the only rock types within the schist and granulite that are distinctive enough to be mapped continuously for any distance.

In the few outcrops of schist and granulites on the small islands in the Norwalk South quadrangle, the unit maintains a well layered appearance but, due to a change in the metamorphic grade, the mineralogy is different. Assemblages here are: zoisite-staurolite-biotite-plagioclase-quartz-muscovite schist, quartz-garnet-muscovite-biotite schist, coticule granulite, and muscovite-biotite-plagioclase-quartz granulite. Quartz-kyanite pegmatite pods occur on Calf Pasture Island but kyanite was not observed in the schist or granulite.

In the Norwalk North quadrangle, the contact of the schist and granulite with the unit-I mafic gneiss exhibits interlayering of the two units on a scale of a few centimeters to 2 m. The contact is drawn at the point beyond which no schist and granulite is found in the mafic gneiss. Near the contact the schist and granulite unit is locally thinly layered (0.25-0.50 cm), with sharp boundaries between the layers, and the rock is distinctly striped. Along the contact (near the northern edge of the Norwalk North quadrangle, 155,000 N, 411,500 E), coarse gedrite-bearing schist occurs.

Porphyroblastic quartz-plagioclase-microcline gneiss locally cross-cuts the schist and granulite on Honey Hill in the Norwalk North quadrangle; contacts with the massive felsic gneiss are not exposed.

The distinguishing feature of the schist and granulite unit is the interlayering, on a scale of 1-2 cm, of granular and schistose layers. Except for the interlayers of amphibolite and mafic gneiss on Honey Hill in the Norwalk North quadrangle, all subordinate rock types exhibit this interlayering. Differential weathering of the layers of schist and granulite enhances the layered appearance in outcrop, with gray-to-buff granulite layers standing in low-to-moderate relief above the darker schist layers. Most outcrops display some degree of folding, either broad, open undulations or sharp crenulations.

Quartz pods are a common feature. In the Norwalk North quadrangle they locally contain coarse sillimanite; one in the Norwalk South quadrangle contains kyanite. Foliated pegmatitic lenses are also common; however, cross-cutting pegmatite bodies are unfoliated.

Colors of fresh surfaces depend on rock type: quartz-and-plagioclase granulite layers are dark gray; layers with microcline are tan to buff; calc-silicate layers are white, pink, or light and dark green; amphibolites are dark green to black; the mafic gneiss is dark; coticule granulites are light pink; gedrite schist is dark

brown. The schists are generally rusty but, near the coticule gneiss, are distinctly nonrusty. Entire outcrops appear rusty, although detailed inspection shows that only the schist layers are rusty.

Foliation, defined by compositional boundary surfaces, is well developed. Within the granulite layers it is poorly developed; however, local layers that are coarser and more micaceous are better foliated. All the schist layers are well foliated; the foliation formed by alignment of micas follows compositional boundaries and is also folded.

Mineral lineations are formed by inequant mica grains. Crinkles in micaceous layers form a weak lineation.

Fractures are poorly developed, probably because deep weathering of exposures has corroded planar surfaces. A few fractures are slickensided.

The granulites are generally medium grained and the schists coarse grained to very coarse. Garnets are locally as much as 2 cm in diameter. Gedrite blades in the gedrite schist reach 4 cm in length.

The schist and granulite unit is a metamorphic unit which was originally interlayered sands or silts and shales with calc-silicates that represent impure carbonate rocks. The origin of the amphibolites is uncertain; they may have been igneous or sedimentary.

### *Mafic gneisses*

#### GENERAL

On a textural basis, the mafic gneisses are separated into porphyroblastic and nonporphyroblastic types. In the Norwalk North quadrangle, the mafic gneisses form six separately mappable areas, three of them in a large fold in Wilton. In this Wilton fold, units I and III of the mafic gneisses are nonporphyroblastic and are separated by porphyroblastic unit II. Depending on the structural interpretation (fig. 10), units I and III may be part of the same unit or may be two separate units. Although the mafic-gneiss body in the vicinity of Cannondale and the wedge-shaped mafic-gneiss body in the north-central part of the quadrangle are similar to unit I, the stratigraphic equivalence is uncertain. The relation of the mafic gneiss in the Devil's Den to the other mafic-gneiss bodies is not known.

In the Norwalk South quadrangle there are eight areas where mafic gneisses occur. Because it is possible that some of these were originally part of unit I of the Norwalk North quadrangle, they are similarly designated on the geologic map, plate 3. The remaining mafic gneisses in the Norwalk South quadrangle are considered intrusive and are separately designated (mg<sub>1</sub>).

Assuming the structure shown in figure 10a, the mafic gneisses near Wilton comprise three stratigraphic units. They are continuously mappable in the quadrangle and their configuration defines a large fold. Unit I is in contact with the schist and granulite unit and with the massive parts of the felsic gneiss unit and contains three minor rock types (pz, gg, um, pl. 1), mapped separately. At one locality, the contact with the schist and granulite unit exhibits vertical interlayering of schist and granulite with mafic gneiss. The number of thin (1-4 cm) mafic-gneiss layers increases upward. Within the schist and granulite in this zone are gedrite schists.

At another locality, 2 m of schist and granulite occur in the mafic gneiss but the lower part of the mafic gneiss is buried and its thickness is unknown. At another locality the contact is sharp and no mafic gneiss occurs within the schist and granulite.

The contact between the mafic gneiss and massive felsic gneiss along the western limb of the Wilton fold is marked by a valley. Mafic gneiss near the contact contains more and larger bodies of felsic gneiss than elsewhere. The contact is drawn at the geographic limit of the mafic gneiss.

#### UNIT I

Unit I of the mafic gneiss (pl. 5; table 11) averages 180 m in thickness and reaches 300 m locally. Within it (pls. 1, 3) are mafic granular pods (pz), ultramafic rocks (um), garnet-gedrite schist (gg), and one thin layer of calc-

Table 11.—Modal analyses of mafic gneiss unit I.<sup>1</sup>

Mineral	Volume percent <sup>2</sup>	
	Range	Average
Plagioclase <sup>3</sup>	3-47	36
Quartz	0-30	12
Microcline	0-48	13
Biotite	0-33	21
Hornblende	0-40	14
Clinopyroxene	0-9	5 <sup>4</sup>
Sphene	0.3-4	2
Apatite	0.5-1	0.9
Zircon	0-0.3	0.1
Allanite	0-0.9	0.3
Opaque <sup>5</sup>	T-1	0.2
Chlorite	0-1	0.6 <sup>6</sup>
Calcite	0-0.5	0.3 <sup>6</sup>
		105.4 <sup>7</sup>

Table 12.—Modal analyses of mafic gneiss unit II.<sup>8</sup>

Mineral	Volume percent <sup>2</sup>	
	Range	Average
Plagioclase <sup>9</sup>	19-41	32
Quartz	3-29	17
Microcline	4-25	15
Biotite	9-29	20
Hornblende	0-42	11
Clinopyroxene	0-6	4 <sup>4</sup>
Sphene	0.3-5	2
Apatite	0.1-1	0.7
Zircon	0-0.2	--
Allanite	0-0.4	0.1
Opaque <sup>5</sup>	T-0.7	0.3
Chlorite	0-0.6	0.1 <sup>10</sup>
		102.2 <sup>7</sup>

<sup>1</sup> Samples from 13 outcrops.

<sup>2</sup> Figures are rounded to the nearest whole number; those less than 1 percent are rounded to the nearest one-tenth. T = trace amount; present in thin section but not encountered in point count.

<sup>3</sup> Anorthite content of plagioclase is 27-42 percent by weight.

<sup>4</sup> Average for the four samples in which clinopyroxene was found.

<sup>5</sup> Pyrite, magnetite, ilmenite, and locally hematite.

<sup>6</sup> Average for the three samples in which this mineral was found.

<sup>7</sup> Average amounts do not total 100 percent because of the rounding of figures and because samples with trace amounts were not included in the averaging.

<sup>8</sup> Samples from 10 outcrops.

<sup>9</sup> Anorthite content of plagioclase is 19-43 percent by weight.

<sup>10</sup> Five samples only.

silicate rock. The contact between units I and II is gradational over a 5-m interval and is marked by the appearance of more massive mafic gneiss with microcline porphyroblasts. The porphyroblastic gneiss occurs as lenses and layers within unit I but above the contact the gneiss almost everywhere is porphyroblastic. Along this contact are scattered outcrops of garnet-gedrite rocks.

Unit I is equigranular, medium-grained to coarse, and only locally contains porphyroblasts of plagioclase and hornblende. The rock is commonly layered and laminated, with layers of more granular medium-grained rock, up to 10 cm thick, interlayered with better foliated, coarse-grained layers several centimeters to several meters thick. Individual outcrops show a range in grain size, foliation, and color but, with the exception of the granular pod zone (pz), ultramafics (um), and garnet-gedrite schist (gg), mappable characteristics could not be distinguished.

Felsic interlayers (table 14) are abundant in the hinge zone and western part of the Wilton fold but are uncommon along the eastern part. The felsic

Table 13.—Modal analyses of mafic gneiss unit III.<sup>1</sup>

Mineral	Volume percent <sup>2</sup>	
	Range	Average
Plagioclase <sup>3</sup>	43-48	46
Quartz	11-23	17
Microcline	0-2	1
Biotite	21-28	25
Hornblende	4-15	9
Sphene	1-2	1
Apatite	0.6-0.9	0.8
Zircon	T	—
Opaque <sup>4</sup>	0.1-0.5	0.3
		100.1 <sup>5</sup>

Table 14.—Modal analyses of felsic interlayers in mafic gneiss units I and II.<sup>6</sup>

Mineral	Volume percent <sup>2</sup>	
	Range	Average
Plagioclase <sup>7</sup>	17-55	33
Quartz	12-36	28
Microcline	11-69	33
Biotite	0-20	5
Hornblende	0-T	—
Clinopyroxene	—	—
Sphene	0-1	0.4
Apatite	0.1-0.7	0.3
Zircon	0-0.1	—
Allanite	0-T	—
Opaque <sup>4</sup>	0-0.1	—
Chlorite	0-3	1 <sup>8</sup>
Garnet	0-1	0.8 <sup>9</sup>
		101.5 <sup>5</sup>

<sup>1</sup> Samples from two outcrops.

<sup>2</sup> Figures are rounded to the nearest whole number; those less than 1 percent are rounded to the nearest one-tenth. T = trace amount; present in thin section but not encountered in point count.

<sup>3</sup> Anorthite content of plagioclase is 25-36 percent by weight

<sup>4</sup> Pyrite, magnetite, ilmenite, and locally hematite.

<sup>5</sup> Average amounts do not total 100 percent because of the rounding of figures and because samples with trace amounts were not included in the averaging.

<sup>6</sup> Samples from 10 outcrops.

<sup>7</sup> Anorthite content of plagioclase is 22-34 percent by weight.

<sup>8</sup> Average for the three samples in which chlorite was found.

<sup>9</sup> Average for the two samples in which garnet was found.



interlayers, commonly 0.5-4 cm thick, are granular and poorly foliated (fig. 2). Darker, more mafic, foliated pods and layers, with long axes parallel to foliation, are found throughout the unit but are most abundant close to the contact with the schist and granulite in the north-central part of the quadrangle. The pods have axes 1 cm-0.5 m long and may be extended in the *b* tectonic direction, as in figure 3.

Locally, along the eastern part of the Wilton fold, unit I exhibits compositional and foliation cross-laminations with concave surfaces facing upward (fig. 4). Along the western part of the Wilton fold, where unit I is generally better foliated than elsewhere, foliation surfaces are lustrous and black, due to coarse biotite. The more granular hornblende-rich layers in this area are less well foliated.

#### UNIT II

Unit II of the mafic gneisses (pl. 5; table 12) is 60-300 m thick and more massive and less well layered than unit I. Locally, microcline porphyroblasts form up to 10 percent of the rock and are its most distinctive characteristic (fig. 5). The gray, subhedral microcline porphyroblasts display Carlsbad twinning and have inclusion-rich cores (mostly biotite flakes) with inclusion-poor rims (fig. 6). Most porphyroblasts are 1-2 cm long and show no preferred orientation.

Mafic foliated pods and layers occur in unit II and are up to 1 m long in sections parallel to foliation. One mafic layer, 2 m long and 30 cm thick, was observed at an angle to the foliation in the host rock. Unit II is better foliated

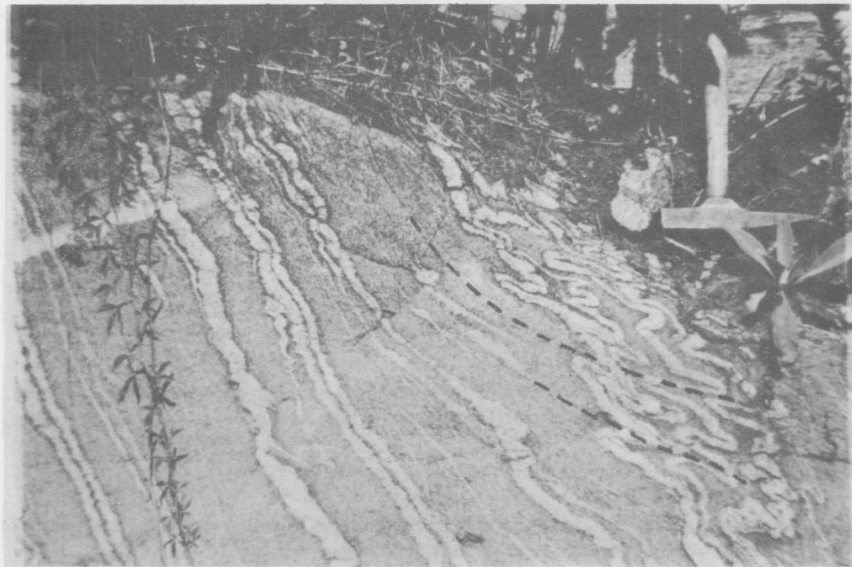

Fig. 2. Outcrop of unit I of the mafic gneisses. Foliation (dashed lines) is locally at divergent angles to compositional boundaries. Poor foliation in the felsic layers parallels these boundaries. (Norwalk North quadrangle, Cheese Spring Road, 135,200 N, 406,300 E)

along the western limb of the Wilton fold, and microcline porphyroblasts occur as augen in many places there.

### UNIT III

Although unit III (pl. 5; table 13) resembles unit I, it is uncertain that they are the same unit in the Norwalk North quadrangle. This uncertainty permits two different structural interpretations (figs. 10a, b).

### MAFIC GNEISSES IN THE NORWALK SOUTH QUADRANGLE

Mafic gneisses in the Norwalk South quadrangle (pl. 5; table 15) resemble units I and III in Norwalk North but lack the granular mafic pods and the garnet-gedrite schists. The few isolated outcrops of porphyroblastic mafic gneiss observed in Norwalk South do not constitute a separate unit.

The mafic-gneiss bodies in the Tokeneke area in the southwestern part of Norwalk South are more massive than the bodies to the east and, in map pattern, appear to truncate metasedimentary rocks and to lack the stratiform character of the other mafic-gneiss bodies.

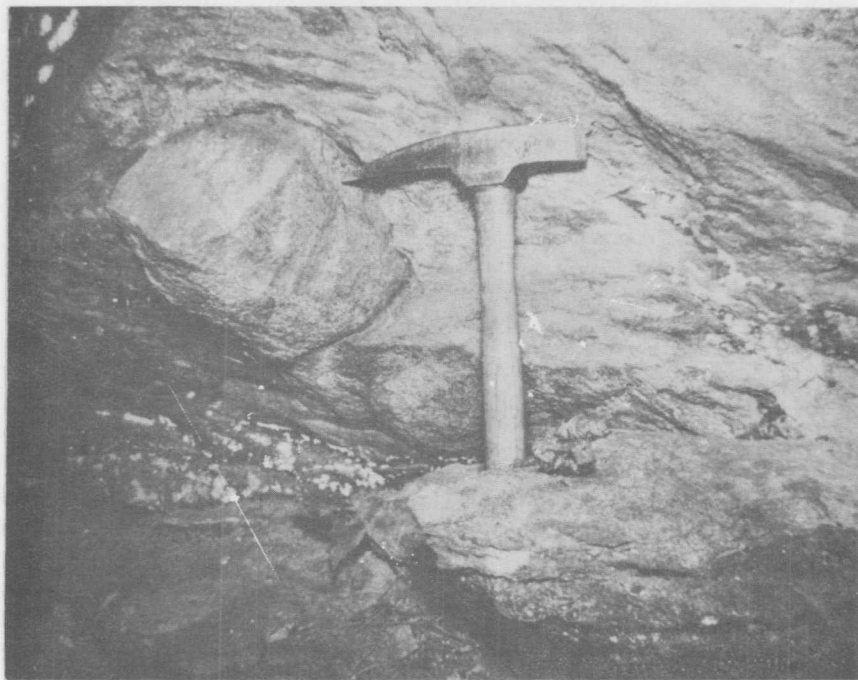

Fig. 3. Mafic pod in unit I of the mafic gneisses, close to the contact with the underlying schist and granulite unit. The pod is elongated parallel to the  $L_1$  mineral lineation. (Norwalk North quadrangle, off Hulda Hill Road, 151,900 N, 409,900 E)

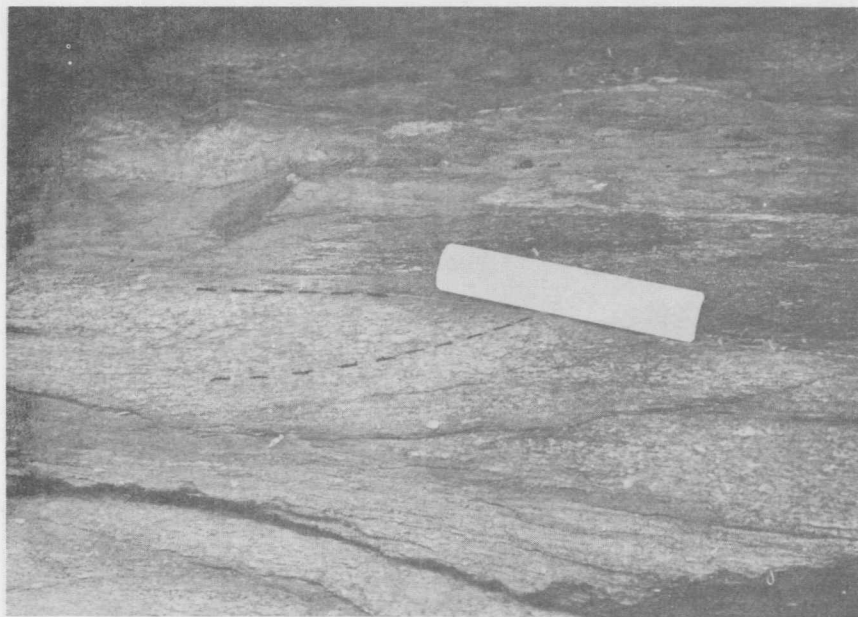
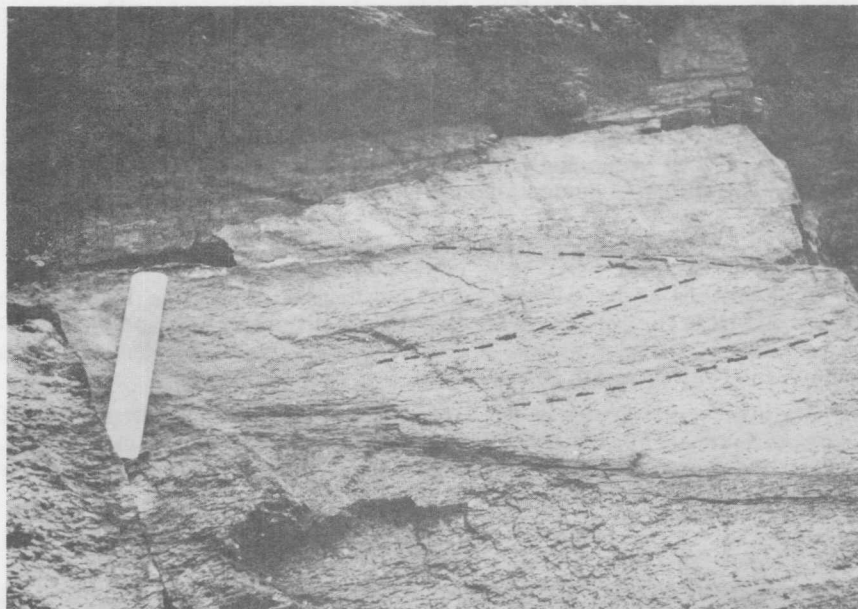

Fig. 4. Two views of cross-laminations in unit I of the mafic gneisses. Dashed lines parallel the compositional layering and foliation. Upward concavity indicates primary upward direction. (Norwalk North quadrangle, behind Wilton High School, 146,900 N, 412,100 E)

#### MINOR ROCK TYPES IN MAFIC GNEISS UNIT I

*General.* Mafic granular pods, ultramafic rocks, and garnet-gedrite schists occur in unit I of the mafic gneisses in the Norwalk North quadrangle. The pods and ultramafics are at or near the contact between the mafic gneisses and the schist and granulite unit. Within unit I a continuous layer of folded garnet-gedrite schist occurs along the western limb of the Wilton fold. Along the eastern limb of that fold are garnet-gedrite rocks, locally containing cordierite, at the contact between units I and II (gg, pl. 1).

*Mafic granular pods.* Spherical to ellipsoidal pods of medium-grained, nonfoliated, granular rock occur within a zone in unit I along the eastern limb of the Wilton fold (pz, pl. 1; table 16). The zone, up to 20 m thick, contains either continuous pods of granular rock or widely scattered pods in a matrix of unit-I gneiss. In places the rock is massive, and individual pods are not easily distinguished. The pods (fig. 7) are light green or white on weathered surfaces and black and vitreous on fresh surfaces. Some have thin, brown-weathered rims. The pods range from 4 cm to 1 m long. In sections parallel to the foliation of the surrounding rock the smaller ones are generally oblate and the larger ones almost round.

*Ultramafic rocks.* Enstatite- and serpentine-bearing rocks occur near the contact

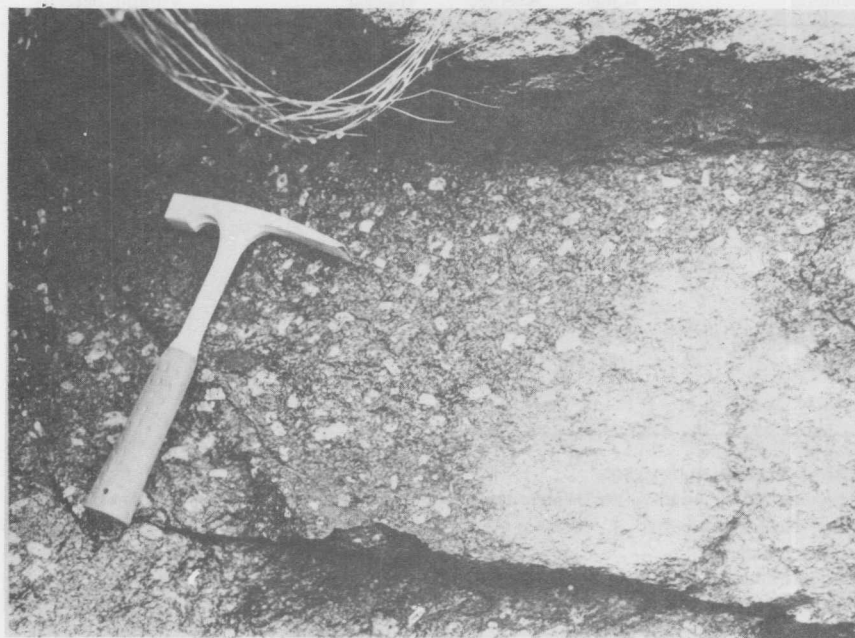

Fig. 5. Outcrop of unit II of the mafic gneisses. Here (152,500 N, 408,200 E) microcline porphyroblasts constitute 10 percent of the rock.

between the schist and granulite unit and the mafic gneisses in the Norwalk North quadrangle near the Strong Comstock School in Wilton (um, pl. 1). The rocks immediately south of the school occupy the center of a small N-plunging syncline and follow the strike of the nearby schist and granulite, suggesting a conformable relationship.

Two rock types occur here: chlorite-talc-enstatite rock and talc-serpentine-tremolite rock. The enstatite occurs as subrounded, well cleaved, coarse grains in a dark-green matrix. The rock is soft and outcrop surfaces are jagged. The tremolite-bearing rocks are at the northern limit of the ultramafic exposures and form nearly monomineralic outcrops. Fresh surfaces are light green, fibrous, and moderately well foliated. Within exposures of both types are areas of massive, soft, green rock composed mostly of serpentine. Within the enstatite-bearing rocks are veins of cross-fiber asbestos. The asbestos is tremolite and it occurs both as coarse-grained and as asbestosform varieties.

*Garnet-gedrite rocks.* Coarse garnet-gedrite schist occurs within unit I of the mafic gneisses and between units I and II. The rocks form massive, poorly to

Table 15.—Modal analyses of mafic gneiss in the Norwalk South quadrangle.<sup>1</sup>

Mineral	Volume percent <sup>2</sup>	
	Range	Average
Plagioclase <sup>3</sup>	13-53	37
Quartz	0.4-22	13
Microcline	0.4-41	7
Biotite	0.5-36	19
Hornblende	0-58	22
Clinopyroxene	0-1	0.9 <sup>4</sup>
Sphene	0-2	0.9
Apatite	T-1	0.6
Zircon	T-0.3	0.1
Opaque <sup>5</sup>	T-0.9	0.4
Garnet	0-9	3 <sup>6</sup>
Muscovite	0-2	1 <sup>4</sup>
Zoisite	0-1	0.4 <sup>4</sup>
		105.3 <sup>7</sup>

Table 16.—Modal analysis of a granular mafic pod.

Mineral	Volume percent
Plagioclase	16.8
Microcline	6.1
Hornblende	7.1
Pyroxene	55.3
Sphene	2.8
Apatite	0.5
Zircon	0.1
Opaque	0.1
Calcite	0.7
Clinzoisite	9.2
Uncertain	0.3
100.0	

<sup>1</sup> Samples from 10 outcrops.

<sup>2</sup> Figures are rounded to the nearest whole number; those less than 1 percent are rounded to the nearest one-tenth. T = trace amount; present in thin section but not encountered in point count.

<sup>3</sup> Anorthite content of plagioclase is 23-54 percent by weight.

<sup>4</sup> Three samples only.

<sup>5</sup> Magnetite, ilmenite, and pyrite.

<sup>6</sup> Three samples only.

<sup>7</sup> Average amounts do not total 100 percent because of the rounding of figures and because samples with trace amounts were not included in the average.

well foliated outcrops characterized by conspicuously large garnets standing in moderate relief on weathered surfaces. The garnets are poikilitic, idioblastic to ellipsoidal, and average 2-4 cm in diameter. Locally, clusters of smaller garnets are the dominant mode of occurrence. The largest garnet observed was ellipsoidal and measured 8 x 4 x 4 cm. Where gedrite and sillimanite are abundant, the rock is coarse schist. Cordierite, present locally in the garnet-gedrite rocks between mafic-gneiss units I and II, could be distinguished only in thin section.

*Mafic gneisses of uncertain stratigraphic position.* Areas of mafic gneisses which are not readily assigned to units I, II, or III, have been designated mg<sub>0</sub> on plate 1. In outcrop and petrographic characteristics these rocks are similar to those of unit I. However, structural and stratigraphic information does not warrant a positive correlation.

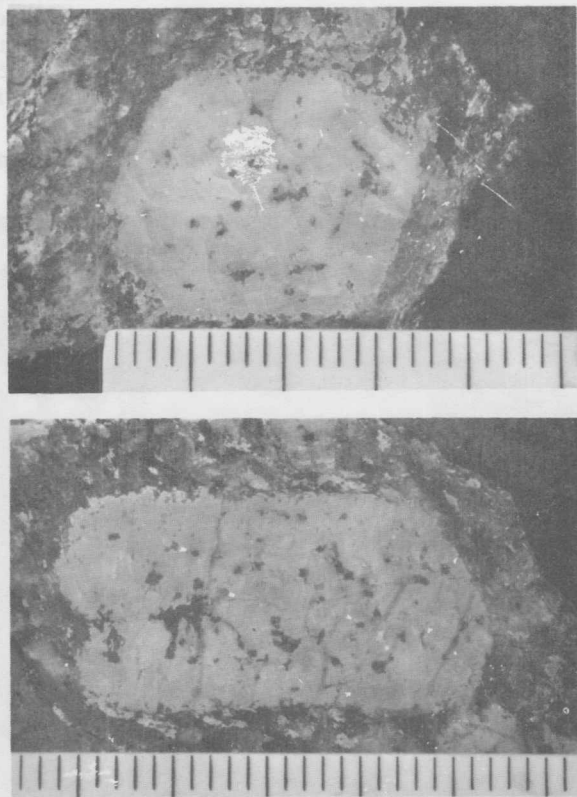

Fig. 6. Photomicrograph of microcline porphyroblasts in unit II of the mafic gneisses. *Upper*: normal to *c* crystallographic axes; *lower*: parallel to *c* crystallographic axis. Scale is in millimeters (small subdivisions). (152,500 N, 408,200 E)

#### ORIGIN OF THE MAFIC GNEISSES AND ASSOCIATED ROCKS

Agar (1934) considered the mafic gneisses to be intrusive diorites. They are mineralogically similar to plutonic igneous rocks of dioritic composition. However, the same mineralogy can be produced by metamorphism of volcanic or sedimentary rocks of the proper composition. The bulk chemistry of the rocks would tell very little about their origin; to determine that, primary features that can be compared to those in unmetamorphosed rocks must be identified.

Firm field evidence of intrusion was not observed in either quadrangle. However, in the Tokeneke area of Norwalk South, the mafic-gneiss bodies, in map pattern, appear to truncate metasedimentary rocks. The more massive character of these bodies and their scattered, nonstratiform map pattern, does suggest an intrusive origin.

In the Norwalk North quadrangle, thin layers of mafic gneiss were observed in the schist and granulite near the contact of these two units, suggesting an interlayered relationship rather than an injection of mafic rock. Evidence from the few available exposures favors a conformable contact. It is unlikely that intrusive magma could produce thin, continuous sills without the development of some local disruption or cross-cutting relationships. The contact is interpreted as conformable interlayering of the different lithologies.

Unit I of the mafic gneisses is layered, cross laminated in places, and contains

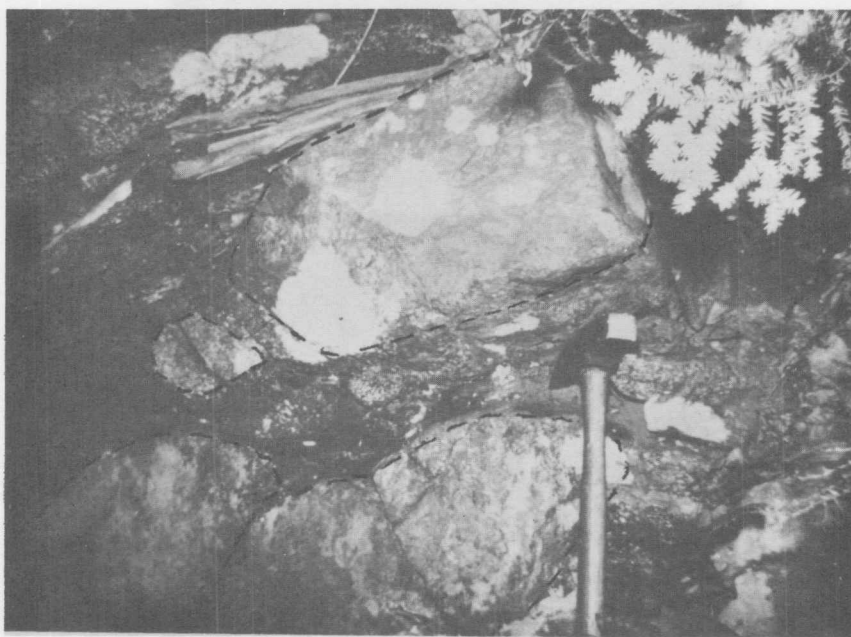

Fig. 7. Mafic granular pods (dashed outlines) in unit I of the mafic gneisses. (Norwalk North quadrangle, 149,000 N, 411,400 E)

a basal zone of pods of varied lithology, mafic granular pods, and foliated mafic pods of a considerable size range. The cross-laminations can be considered primary cross-beds; there are almost identical ones in the andesitic Absaroka volcanic rocks in parts of Wyoming. The mafic granular pods can be considered as pillow structures, the foliated mafic pods as volcanic clasts, and the basal pod zone as a sedimentary basal agglomerate. Although several alternative origins for each of these features are possible, the over-all interpretation which best fits the entire group is that unit I was a volcanoclastic assemblage, probably mostly water deposited but also partly subaerial.

The mafic gneisses can be compared with the rocks of such volcanic islands as Puerto Rico and the Virgin Islands (Donnelly, 1966; Whetten, 1966; Pease, 1968). In these localities a variety of submarine and subaerial volcanic rock types, mainly of andesitic composition, are found in close association with volcanoclastic debris and local calcareous deposits. Of interest are the lateral facies changes in volcanic materials; such changes may account for the local interlayering of the mafic gneisses and the schist-and-granulite unit along the eastern limb of the Wilton fold.

The garnet-gedrite rocks associated with the mafic gneisses are of uncertain origin. For some time chemically similar anthophyllite-cordierite rocks have been discussed, mainly because of the apparent lack of sedimentary-rock types of a composition, which, upon metamorphism, could produce this mineralogy.

Eskola (1914) and Tilley (1937) favored a metasomatic origin involving the introduction of iron and magnesium and the removal of sodium, calcium, and potassium. Grant (1968) hypothesized that anthophyllite-cordierite rocks could be produced by partial melting, filter pressing, and subsequent recrystallization of ordinary sedimentary rocks.

The hypotheses of metasomatism and partial melting both have a major drawback: neither the source of the introduced components nor the depository of the removed components has been recorded in the rocks. Although both theories should be maintained as possibilities, a third alternative for the origin of the garnet-gedrite rocks in Norwalk North seems more likely.

Vallance (1967) has accumulated field evidence and chemical evidence showing that anthophyllite-cordierite rocks can be produced by the metamorphism of altered basic volcanic rocks. The interpretation of the Norwalk mafic gneisses as volcanic allows for the possibility of premetamorphic alteration. The position of garnet-gedrite rocks, at the contact between units I and II, suggests that the upper surface of unit I was altered before the deposition of unit II. The body of garnet-gedrite rocks within unit I along the western side of the Wilton fold may represent a surface exposed for a time between spurts of volcanic activity.

In contrast to unit I, unit II is massive and porphyroblastic. The interlayering of the two units at the contact suggests a sedimentary contact. The absence of layering in unit II suggests that it originated as a massive unit, possibly as lava-flow material. The felsic interlayers in the mafic gneisses are metamorphic in origin; such interlayers are not found in unmetamorphosed volcanic rocks of approximately the same compositional range as those in the Norwalk area. The folding of the felsic interlayers indicates that they developed early in the metamorphism and were folded during later deformation.

The ultramafic rocks near the Strong-Comstock School are probably of igneous origin, as suggested by the presence of coarse enstatite. Whether the



rock is intrusive or extrusive, however, is not clear. Field evidence to support either mode of origin is inadequate, although their stratigraphic position, consistently at the base of the volcanic rocks, adds weight to the theory of an extrusive origin.

### *Porphyroblastic microcline-quartz-plagioclase gneiss*

This rock type (pg, pl. 1; table 17) occurs in the Honey Hill area in the north-central part of the Norwalk North quadrangle. Near its contacts, the gneiss commonly contains selvages of the surrounding rocks. In one locality the gneiss truncates interlayered schist and granulite at a high angle and at another it forms a dike in the mafic gneiss layer (mg<sub>0</sub>, pl. 1) of the schist and granulite. Although two separate bodies of this rock are shown, they may be connected below the surface.

Porphyroblastic microcline-quartz-plagioclase gneiss forms massive outcrops. Except for minor schistose layers, the gneiss is unlayered. Fresh surfaces are gray to buff and weathered surfaces are gray and nonrusty. Foliation is poorly

Table 17.—Modal analyses of porphyroblastic microcline-quartz-plagioclase gneiss.<sup>1</sup>

Mineral	Volume percent <sup>2</sup>	
	Range	Average
Plagioclase <sup>3</sup>	31-42	35
Quartz	24-31	28
Microcline	21-30	27
Muscovite	1-2	2
Biotite	3-11	7
Garnet	0-0.3	0.3 <sup>4</sup>
Opaque <sup>5</sup>	0.1-0.4	0.3
Apatite	T-0.5	0.5
Zircon	T-0.5	0.3
Chlorite	0.2-0.7	0.5
Calcite	0-0.1	0.1 <sup>4</sup>
		101.0 <sup>6</sup>

Table 18.—Modal analyses of massive felsic gneiss.<sup>7</sup>

Mineral	Volume percent <sup>2</sup>	
	Range	Average
Plagioclase <sup>8</sup>	15-35	25
Quartz	22-43	30
Microcline	19-59	34
Muscovite	1-12	6
Biotite	0-8	4
Opaque <sup>9</sup>	T-0.7	0.3
Chlorite	0-2	0.4
Apatite	T-0.7	0.2
Garnet	T-0.3	0.9
Zircon	T-0.1	—
Sillimanite	0-0.2	—
		100.8 <sup>6</sup>

<sup>1</sup> Samples from four outcrops.

<sup>2</sup> Figures are rounded to the nearest whole number; those less than 1 percent are rounded to the nearest one-tenth. T = trace amount; present in thin section but not encountered in point count.

<sup>3</sup> Anorthite content of plagioclase is 21-31 percent by weight.

<sup>4</sup> One sample only.

<sup>5</sup> Magnetite, ilmenite, and locally hematite.

<sup>6</sup> Average amounts do not total 100 percent because of the rounding of figures and because samples with trace amounts were not included in the average.

<sup>7</sup> Samples from 15 outcrops.

<sup>8</sup> Anorthite content of plagioclase is 23-35 percent by weight; in one sample 0-9 percent.

<sup>9</sup> Magnetite, ilmenite, pyrite, and hematite.

developed and local pegmatitic zones are unfoliated. A prominent lineation is formed by the alignment of the long axes of microcline porphyroblasts. Outcrops are well fractured and commonly have N-trending shear faces on their eastern sides.

The rock is medium grained to coarse, with microcline porphyroblasts commonly 1-2 cm long; the largest observed is 3 cm.

This porphyroblastic gneiss is granitic in composition and cross cuts schist and granulite. However, it is well foliated and was intruded before or during the metamorphism and deformation.

### *Massive felsic gneiss*

Massive felsic gneiss (pl. 5; table 18) forms a broad zone that arcs across the Norwalk North quadrangle; three smaller bodies of this rock are present in the Norwalk South quadrangle. Its contact with the mixed felsic gneiss is not exposed. In the Norwalk North quadrangle, the contact with mafic gneiss is along a zone where the felsic gneiss forms cross-cutting dikes or concordant pods and layers which are increasingly abundant toward the felsic-gneiss side of the contact. Felsic-gneiss bodies extend about 120 m into the mafic gneiss. Near Spectacle Brook in the Norwalk North quadrangle, a large re-entrant of massive felsic gneiss occurs within the mafic gneiss. The contact between massive felsic gneiss and the schist and granulite unit is not exposed. However, locally the massive gneiss occurs within 60 m of the schist and granulite.

Massive felsic gneiss locally contains conspicuous mica-rich layers, although most of the rock is a poorly foliated granitic gneiss. Outcrops exhibit thin mica-rich folia which separate mica-poor quartzo-feldspathic layers. The layering is poor to locally well developed; individual discontinuous layers are from a few millimeters to several centimeters thick. In any outcrop, the thickness of some layers is consistent but more commonly it is variable. Layers are discontinuous over short distances and blend into nearby layers as the separating mica folia disappear. Some dark schistose layers occur within the massive felsic gneiss, although not in the abundance typical of the mixed felsic gneiss. Microcline and, less commonly, plagioclase porphyroblasts occur locally. Pegmatite pods and veins and small garnets are common features.

The weathered rock is gray, buff, or orange, with rusty surfaces uncommon. Fresh surfaces are pink and gray or white, buff and gray or white, or yellow and gray.

Except in locally occurring micaceous rocks, foliation is poorly developed. Lineation is absent to poor throughout. Outcrops fracture to produce blocks commonly 1-4 m on a side. Many fractures are slickensided and most are coated with fine-grained tourmaline.

The rocks are medium grained to pegmatitic; feldspar crystals in pegmatites are up to 15 cm long. Mica books up to 0.5 cm in diameter are common in the finer grained (nonpegmatitic) rocks. Garnets reach 1 cm in diameter, although most are only a few millimeters and form lenses of fragmented garnet. Apatite is locally visible as light-green grains up to 2 mm in diameter.

The massive felsic gneiss has a granitic composition and occurs as cross-cutting bodies in the mafic gneisses along the western part of the Wilton fold and in the porphyroblastic microcline-quartz-plagioclase gneiss on Honey Hill in the

Norwalk North quadrangle. In Norwalk South the massive felsic gneiss occurs as three separate bodies contacting mafic gneisses, interlayered schist and granulite, and mixed felsic gneiss. The composition, cross-cutting relationships, and lack of a persistent stratigraphic position indicates an intrusive origin for the massive felsic gneiss.

Alternatively, the massive felsic gneiss in the Norwalk North quadrangle might be considered a sedimentary or volcanic rock unit that was partially remobilized during metamorphism. However, an intrusive origin for all the massive felsic gneiss bodies is favored because: a) at map scale the massive felsic gneiss truncates the schist and granulite in both quadrangles; b) it forms lithologically homogeneous bodies; and c) it lacks metamorphic structures found in the schist and granulite unit and the mafic gneisses, suggesting that it developed later than these structures.

### *Granodiorite gneiss*

Several outcrops of pink, poorly foliated rock with the modal composition of a granodiorite occur within the interlayered schist and granulite in the Honey Hill area (gog, pl. 1). Contacts are not exposed. Outcrops are gray to pink on weathered surfaces. The rock is massive, very poorly foliated, and light pink on fresh surfaces. Lineation could not be distinguished. The rock is medium grained to coarse grained and equigranular.

Modal analyses are given in table 19.

Table 19.—Modal analyses of granodiorite gneiss.<sup>1</sup>

Mineral	Volume percent <sup>2</sup>	
	Range	Average
Plagioclase <sup>3</sup>	51-63	57
Quartz	22-33	27
Microcline	8-9	9
Muscovite	2	2
Biotite	3-7	5
Garnet	0.1-0.7	0.4
Zircon	T	--
Apatite	T	--
Opaque <sup>4</sup>	0.2	0.2
Chlorite	T-0.1	0.1
		100.7 <sup>5</sup>

<sup>1</sup> Samples from two outcrops.

<sup>2</sup> Figures are rounded to the nearest whole number; those less than 1 percent are rounded to the nearest one-tenth. T = trace amount; present in thin section but not encountered in point count.

<sup>3</sup> Anorthite content of plagioclase is 23-28 percent by weight.

<sup>4</sup> Magnetite, ilmenite, and hematite.

<sup>5</sup> Average amounts do not total 100 percent because of the rounding of figures and because samples with trace amounts were not included in the average.

Although cross-cutting relationships were not observed, the composition and lack of clear foliation suggest that the granodiorite gneiss is of intrusive origin and probably was emplaced late in the metamorphism and deformation.

### *Hornblendite*

One large exposure of hornblendite (h, pl. 1) occurs approximately at the contact between the mafic gneiss and the schist and granulite unit. Its structural relation to either of these units could not be determined. One small vertical dike of hornblendite (4 cm wide) occurs farther south in the mafic gneiss.

On both fresh and weathered surfaces the hornblendite is a massive, poorly foliated black rock. Thin layers of felsic rock are sparse.

The mineralogic composition and the presence of a hornblendite dike suggest that this rock is of intrusive origin.

### *Pegmatites*

Pegmatites occur throughout both quadrangles. Two types, foliated and unfoliated, occur in the felsic gneisses and in the schist and granulite. The foliated pegmatites are in lenses and are mineralogically similar to felsic parts of the host rock. Unfoliated pegmatites form dikes and sills composed of quartz, microcline, plagioclase (oligoclase), biotite, muscovite, and black tourmaline. In the mafic gneisses the pegmatites are unfoliated and are composed of plagioclase (oligoclase) and quartz.

### *Diabase*

Diabase forms one small outcrop in the Norwalk North quadrangle and cross-cuts quartz-plagioclase-microcline gneiss in the mixed felsic gneiss (112,400 N; 414,300 E). It is dark, fine grained, and weathers slightly rusty.

### *Stratigraphic order*

Metamorphism complicates the determination of the stratigraphic order in metasedimentary or metavolcanic rocks. The metamorphic textures may eradicate primary sedimentary structures as well as the fossils upon which relative ages are commonly based. In addition, the redistribution of isotopes dates the metamorphism rather than yielding primary ages of minerals. Long-range lithologic correlations have been made between Connecticut rocks and an established sequence in Vermont (Rodgers and others, 1959; Fritts, 1962, Hall, 1971). However, these correlations are based on the gross features of rock sequences and are still being debated. Rocks similar to those of the Norwalk North and Norwalk South quadrangles occur farther east in Connecticut, where, although there is a wealth of stratigraphic, structural, and radiometric data, the relative ages of the major units have still not been agreed upon (Armstrong and others, 1970) and contrasting stratigraphic columns are presented (compare Dieterich, 1968a,b, with Crowley, 1968).

In the Norwalk North quadrangle several primary sedimentary structures have been preserved, most of them along the eastern part of the Wilton fold. Here, such features as cross-laminations, basal agglomerate, pillow structures, and graded beds define the primary stratigraphic positions of the units. Because these

units are lithologically correlative with others farther to the east and west, determination of the original tops of these beds may aid in defining the stratigraphic succession in areas where sedimentary structures have not been preserved.

Primary sedimentary structures can be used for determining the relative ages of units only if these structures occur at a contact between units, or close enough to a contact that folding can be discounted. Structures within a unit, removed from a contact, indicate stratigraphic tops only for single outcrops or local areas. Because of this, only one outcrop in the Norwalk North quadrangle can be used for bedding-top determination. It is at the intersection of Hulda Hill Road and Olmstead Hill Road (142,000 N, 412,000 E). Here the contact between mafic gneiss unit I and the schist and granulite unit is well exposed, and a section of schist and granulite, 2-m thick, lies within the mafic gneiss. Cross-laminations in the mafic gneiss are concave upward, indicating that these rocks remain in their original position.

Additional structures and stratigraphic criteria along the eastern limb of the Wilton fold support this conclusion. In an exposure 5-10 m high are well preserved cross-laminations within unit I of the mafic gneiss about 20 m above its contact with the schist and granulite. Where they can be interpreted unambiguously as primary structures, as can those shown in figure 4, they also indicate that the original succession of beds has not been reversed. In the northern part of the Norwalk North quadrangle, at the contact between unit I and the schist and granulite, is a zone of pods of varied lithology (fig. 3), including mafic and felsic pods and one cotecule granulite fragment. This zone is interpreted as a basal agglomerate, indicating that the mafic gneiss is stratigraphically above the schist and granulite. The pods are surrounded by the mafic gneiss and the contact is sharp. Alternatively, the pod zone could be interpreted as the top of the mafic gneiss. If this were the case, however, an external source must be inferred for the fragments, which are, in part, schist and granulite. Hence, it is more reasonable to conclude that the schist and granulite fragments formed a bed over which unit I volcanic material spread, picking up these fragments and incorporating them into its basal portion.

In addition to these small-scale features, there is other evidence to suggest that unit I overlies the schist and granulite. Unit I ranges in thickness from 5 m at the northern border of the Norwalk North quadrangle to hundreds of meters farther south. Tectonic thickening could not be substantiated in the field but should be maintained as a probable explanation. Alternatively, this thickness range may be a primary feature, due to the fact that unit I was deposited on a surface with local topographic relief. In contrast, the contact between units I and II is a smooth surface. This may mean that unit I, after filling a local topographic depression, built up to a common level and was then overlain by unit II along this level. An alternative interpretation must also be considered: that unit I overlies unit II along a surface with little primary relief but built up to a surface with considerable relief. Although not an impossible hypothesis, evidence from primary structures does not support it.

Sedimentary and stratigraphic evidence, therefore, strongly suggests that, along the eastern limb of the Wilton fold, unit I of the mafic gneiss overlies the schist and granulite unit and underlies mafic gneiss unit II. In succession, then, unit III overlies unit II, massive felsic gneiss is *structurally* below the schist and granulite and the mafic gneiss units, and the mixed felsic gneiss is *stratigraphically*

below them. The relative age of the massive felsic gneiss is uncertain; it depends on whether it was intrusive or sedimentary-volcanic.

In places, unit I is interlayered with schist and granulite. This might indicate that they are merely lateral facies of the same unit, thus invalidating the use of original top-and-bottom determinations to establish their stratigraphic order. However, the interlayering is limited to the basal portion of unit I, weakening the facies interpretation. Also, in other areas, Dieterich (1968a,b) and Hall (1971) found that rocks equated with the schist and granulite and the mafic gneiss form successive, individual units with no interlayering. Regional evidence thus indicates that the schist and granulite and the mafic gneiss equivalents are successive units, not facies of the same unit.

On the basis of stratigraphic correlation and structural position, Hall (1971) also places the schist and granulite stratigraphically below the mafic gneiss. However, Dieterich (1968a,b) places it above the mafic gneiss. If the stratigraphic succession determined in the Norwalk North quadrangle is valid and if the lithologic correlation proposed in the following section of this report is eventually demonstrated, then Dieterich's proposed stratigraphic order of the Fairfield and Prospect formations is upside down. If it is, it would help to explain the apparent "upside-down unconformity" described by Dieterich (1968a, p. 143), where the Prospect Formation truncates the Fairfield Formation and, in one place, is in direct contact with Straits Schist.

On the islands in the eastern part of the Norwalk South quadrangle are excellent exposures of schist and granulite and mafic gneisses. Here the schist and granulite rock is identical to that in the Norwalk North quadrangle, except where local mineralogy reflects a different metamorphic grade. The mafic gneiss body west of South Norwalk is similar to unit I of the mafic gneisses in the Norwalk North quadrangle and includes cross-laminations in one outcrop. Schist and granulite occurs on the western side of this body, with mixed felsic gneiss farther to the west underlying the schist and granulite. This makes the biotite-plagioclase-quartz gneiss in the western part of the quadrangle the oldest unit in the two quadrangles (see table 1).

### *Age and correlation*

Fossils were not found in the quadrangles, so the time correlation with rocks in adjacent areas is uncertain. Three episodes of metamorphism have been recognized in southwestern Connecticut and adjacent parts of New York by isotopic age studies (Clark and Kulp, 1968). The earliest metamorphism, 460-480 m.y. ago, is indicated by remnant K-Ar apparent ages. The intermediate metamorphism occurred about 360 m.y. ago and is considered the major metamorphic event (Clark and Kulp, 1968; Stanley, 1968, p. 1; Rodgers, 1967, p. 427). The youngest, 260 m.y. ago, was a mild heating event.

In the Norwalk North quadrangle two K-Ar dates on biotite are reported by Clark and Kulp (1968, table 1, p. 871, specimen nos. L990B and L991B).<sup>3</sup> The ages are  $255 \pm 10$  m.y. for biotite from granitic gneiss (the mixed felsic gneiss of this report). In the Norwalk South quadrangle, they (1968, table 1,

---

<sup>3</sup> Author's note: Specimen L991 was placed by Clark and Kulp at two locations on their map (fig. 2, p. 874). One of them, the L991 schist sample in New Canaan, is actually their schist sample L990.

p. 871, specimen nos. L870M and L872M) report K-Ar ages on muscovite. The ages are  $290 \pm 8$  m.y. for muscovite from schistose rocks and  $285 \pm 11$  m.y. for muscovite from granitic rocks.

Rocks in these quadrangles probably predate the metamorphism of 460-480 m.y. ago which affected the region. On the basis of lithologic similarities to rocks of an established sequence in Vermont, Hall (1968a, p. 1; 1971) assigned a probable Cambro-Ordovician age to those in southwestern Connecticut and Stanley (1968 p. 3) a similar age to those in western Connecticut. The author has no independent information to refute this correlation and it is accepted in this report.

With a Cambro-Ordovician age and a major metamorphism at 360 m.y. ago, the younger ages determined for biotite and muscovite in the two quadrangles probably represent a resetting of the K-Ar clock during the later thermal event.

A sequence of rocks in the Norwalk North and Norwalk South quadrangles closely resembles one in the Long Hill and Bridgeport quadrangles (Crowley, 1968). The correlation between the two areas is indicated in figure 8. Correlation with rocks in the Westport and Sherwood Point quadrangles is

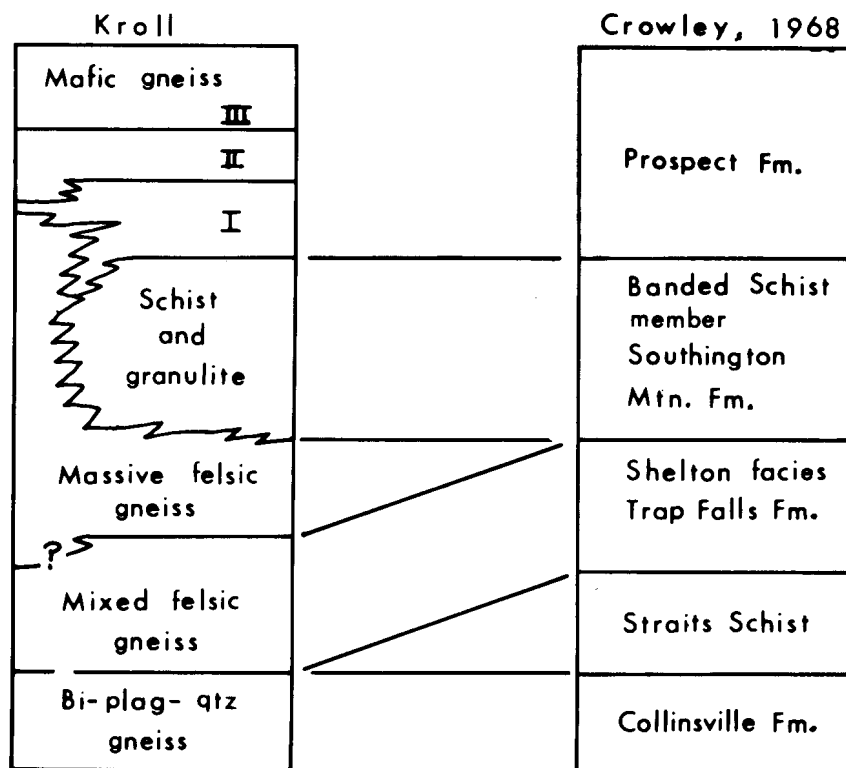

Fig. 8. Proposed correlation of rocks in the Norwalk North and Norwalk South quadrangles with rocks in the Bridgeport and Long Hill quadrangles.

uncertain. As previously stated, the sequence there, Fairfield Formation-Prospect Formation (Dieterich, 1968a,b) is lithologically similar to the sequence of schist and granulite-mafic gneiss of this report. Dieterich, however, places the Fairfield Formation above the Prospect Formation, thus inverting the sequence relative to that in the Norwalk North, Norwalk South, Long Hill, and Bridgeport quadrangles.

The mafic gneisses resemble the Brookfield Plutonic Series in the Danbury quadrangle (Clarke, 1958) but consideration of the Brookfield as intrusive causes problems in stratigraphic correlation. However, whether the Brookfield Series is intrusive or extrusive, their lithologic similarity at least suggests that they were formed at approximately the same time.

The mafic gneisses also resemble the Harrison Gneiss of southeastern New York (Hall, 1971) and mafic gneisses in the Stamford quadrangle (C.O. Frank, personal communication, 1971). The Harrison Gneiss was first described by Ries (1895) at its occurrence near Harrison, in Westchester County, New York. The similarity of rocks designated Harrison in southwestern Connecticut and Brookfield farther to the north is confusing. The name Harrison has historical precedence and, since Harrison-type and Brookfield-type rocks probably represent the same igneous event, it is suggested that the name Harrison Gneiss be applied to all gneisses in southwestern Connecticut representing this event. The distinction between intrusive and extrusive rocks (or rocks of uncertain origin) should be made clear in all designations.

The massive felsic gneiss in the northwestern part of the Norwalk North quadrangle is continuous with the Siscowit Granite-Gneiss of Fairfield County, Connecticut, and Putnam and Westchester Counties, New York (Prucha and others, 1968).

Scott (1974) summarized several reports concerning the amphibolite, quartzite, and marble at the contact between the Straits Schist and the Collinsville Formation. Rocks resembling Straits Schist were not found in the Norwalk South quadrangle. If it were present there, the Straits Schist would underlie the mixed felsic gneiss of this report (the Trap Falls Formation of Crowley, 1968).

Beneath the Straits Schist in the Bridgeport and Long Hill quadrangles (Crowley, 1968), and in the Southbury quadrangle (Scott, 1974) lies the Collinsville Formation. The biotite-plagioclase-quartz-gneiss unit of this report resembles the Bristol Member of the Collinsville Formation, as described by Scott (1974). Several features suggest a correlation of that unit with the Collinsville Formation. Both have similar composition in terms of biotite, quartz, and plagioclase. Both contain magnetite rather than ilmenite as their principal opaque mineral. It is this magnetite which gives rise to the magnetic high in the western part of Norwalk South and the southwestern part of Norwalk North (U.S. Geological Survey, 1971b,a). In the Norwalk South quadrangle, amphibolite is abundant near the contact of the biotite-plagioclase-quartz gneiss with the mixed felsic gneiss. Although quartzite and marble were not found in this zone, the abundance of amphibolite is in accord with Scott's (1974) summary of this contact zone. In addition, Stanley (1964, p. 23) found that granitic rocks in the Bristol member of the Collinsville Formation commonly contain pink feldspar; so do the pegmatitic and granitic rocks in the biotite-plagioclase-quartz gneisses in the Norwalk South quadrangle.



The lithologic similarities and the stratigraphic correlations suggest that the biotite-plagioclase-quartz gneiss is correlative with the Collinsville Formation (fig. 8), with the Straits Schist absent in the Norwalk South quadrangle.

The age of the pegmatites is unknown. In Connecticut and New York two pegmatite ages are indicated, one at about 360 m.y. (Wasserburg, Hayden, and Jensen, 1956) and another at about 260 m.y. (Brookins, 1970).

The age of basaltic rocks in Connecticut and New Jersey is about 190 m.y. (Erickson and Kulp, 1961; de Boer, 1968, p. 612). de Boer's paleomagnetic data indicate that the basaltic rocks in Connecticut, both extrusive and intrusive, represent a single, although extended, event. The one outcrop of Triassic diabase (in the Norwalk North quadrangle) may represent a part of this event.

## STRUCTURE

### *Structural framework*

Bedrock in the Norwalk North and Norwalk South quadrangles was previously considered to consist mainly of metasedimentary schists and gneisses together with abundant dioritic and granitic orthogneisses (Rice and Gregory 1906; Gregory and Robinson, 1907; Dale and Gregory, 1911; Agar, 1934; Rodgers and others, 1959). Structural details have not been previously described.

To the east, in the Westport and Sherwood Point quadrangles (Dieterich, 1968a,b) and in the Long Hill and Bridgeport quadrangles (Crowley, 1968), are NE-trending refolded recumbent folds and nappes. To the north, in the Danbury and Bethel quadrangles (Clarke, 1958; personal communication, 1968) consideration of the mafic gneisses as intrusive precludes a fold interpretation. To the northwest (Scotford, 1956; Prucha and others, 1968) and west (Hall, 1968b) are refolded NE-trending isoclinal folds developed in the New York City Group and equivalents of the schist and granulite and the mafic gneiss (Hall, 1968a). In the southeastern part of the Peach Lake quadrangle, the New York City Group is truncated against Siscowit Granite-Gneiss by a NE-striking, NW-dipping fault of uncertain movement sense (Scotford, 1956, p. 1194). To the west, in the Stamford quadrangle (C.O. Frank, personal communication, 1971) is a mafic and felsic-gneiss complex with few recognizable large-scale folds.

### *Major folds*

#### WILTON FOLD

This large fold occupies the north-central part of the Norwalk North quadrangle and lies mostly within the Town of Wilton. It extends from the northern border of the quadrangle southward for 6 km to its termination against felsic gneisses at Rock Lake and the South Norwalk Reservoir. Units included in the fold are the schist and granulite and the mafic gneisses. For structural analysis, the fold has been divided into three domains (fig. 9) by a study of the structural trends on the geologic map (pl. 1).

Because the interpretation of the stratigraphic relation of mafic gneiss units I and III is ambiguous, two cross-sectional interpretations are possible, as illustrated in figure 10. The simpler one (fig. 10a) is preferred at present because it is more consistent with the interpretation of folding in the Norwalk South quadrangle.

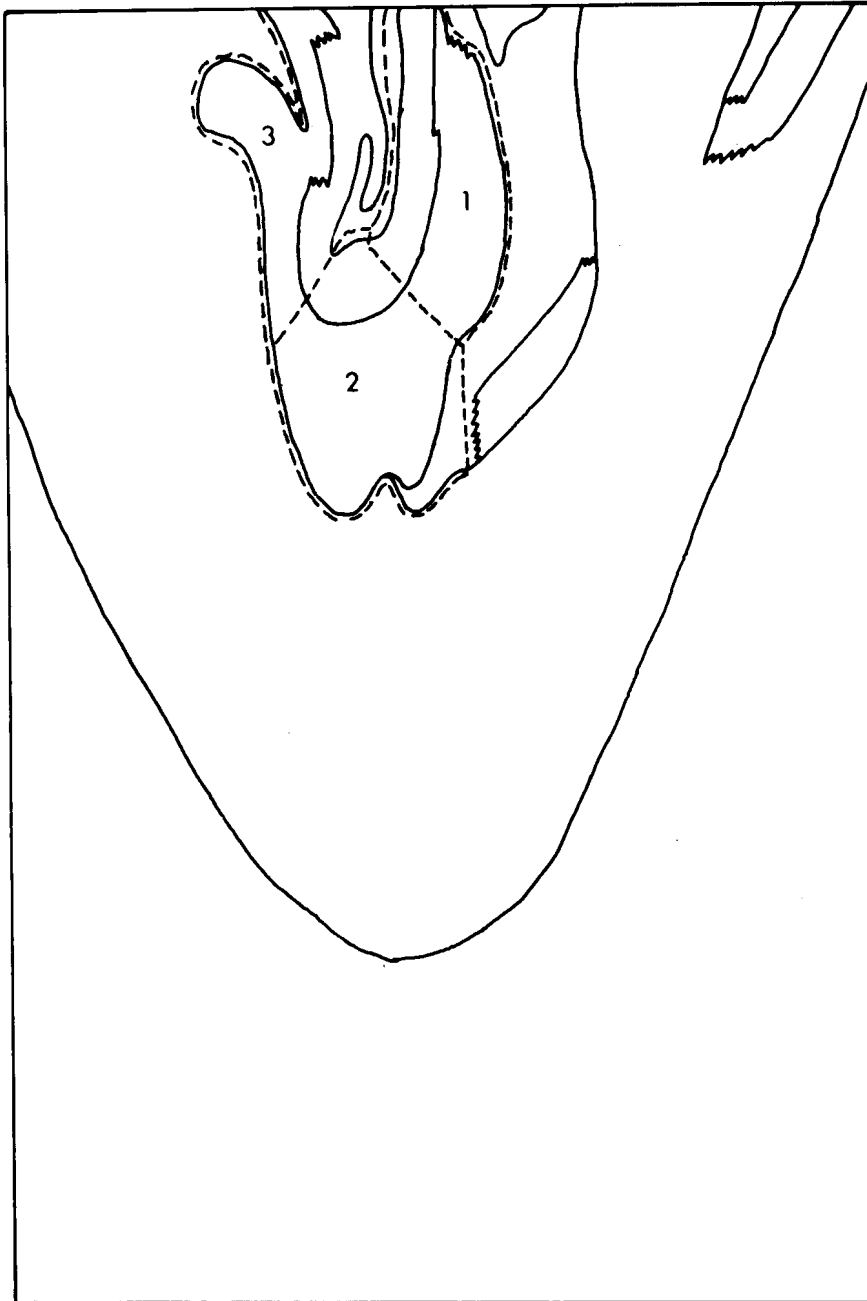

Fig. 9. Geologic sketch map of the Norwalk North quadrangle, showing subdivisions of the Wilton fold into three structural domains. (Not to scale.)

Where bedding is observed within structural domains 1-3, foliation  $S_2$  is almost universally parallel to bedding surfaces  $S_1$ . The fold nose, along Nod Hill

Road (140,000 N, 406,600 E), is based on the map pattern of the mafic-gneiss units.  $S_2$  foliation here is not folded parallel to the unit boundaries but crosses them and is an axial-plane foliation.

Mineral lineations  $L_1$  are well developed in the schist and granulite and in the mafic gneisses. Minor fold axes  $F_1$  parallel  $L_1$  but a later crenulation axis  $F_3$  locally folds  $L_1$ .

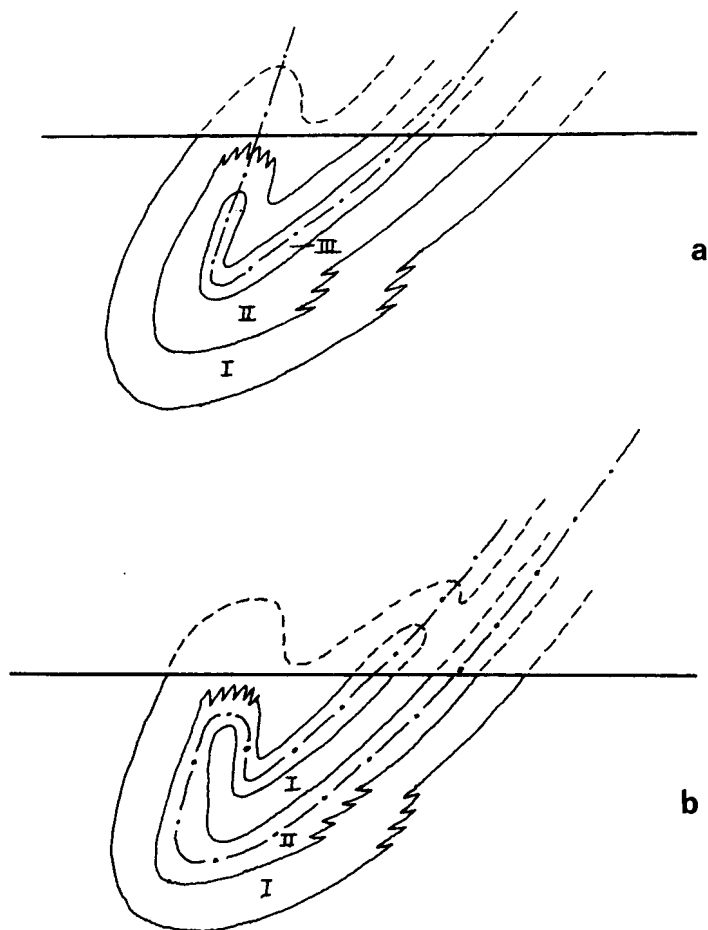

Fig. 10. Two E-W cross-sectional interpretations of the Wilton fold (not to scale). *a* assumes three volcanic units simply refolded; *b* assumes two volcanic units more complexly refolded. The line of the cross section is the northern boundary of the Norwalk North quadrangle. The dash-dot line is the trace of the axial surface of the  $F_1$  isoclinal fold.

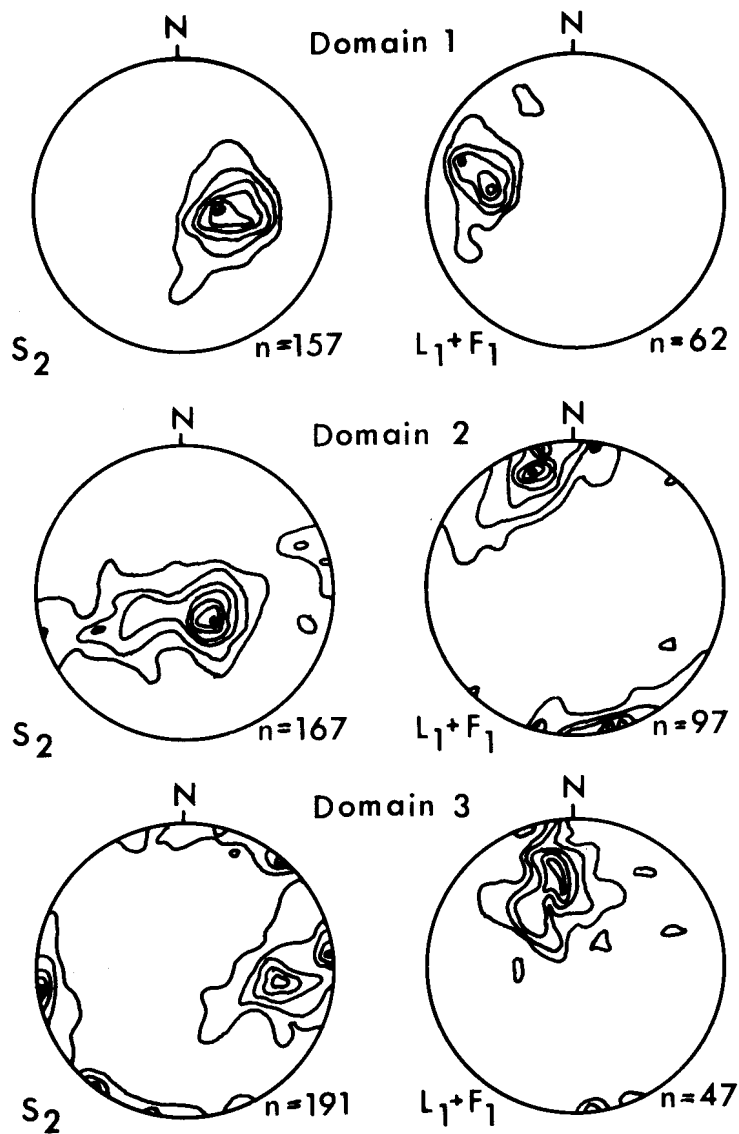

Fig. 11. Orientation diagrams of poles to foliation  $S_2$  and  $L_1$  mineral lineations and  $F_1$  minor-fold axes in domains 1, 2, and 3. *Domain 1:*  $S_2$  contours are 1-3-6-9-12-15 percent per 1-percent area.  $L_1 + F_1$  contours are 1-2-4-6-8 percent per 1-percent area. *Domain 2:*  $S_2$  contours are 1-2-4-8-12-16-20 percent per 1-percent area.  $L_1$  and  $F_1$  contours are 1-4-8-12-16-20-25 percent per 1-percent area. *Domain 3:*  $S_2$  contours are 1-3-5-7-9 percent per 1-percent area.  $L_1$  and  $F_1$  contours are 1-3-6-9-12 percent per 1-percent area.

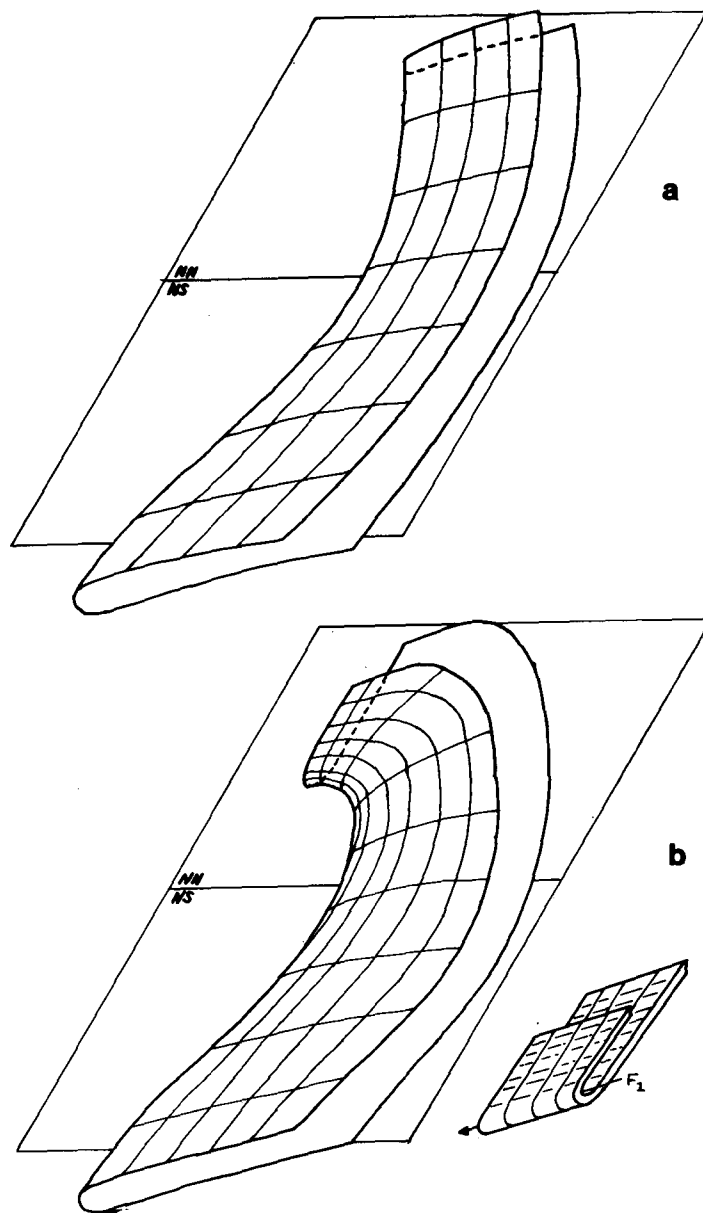
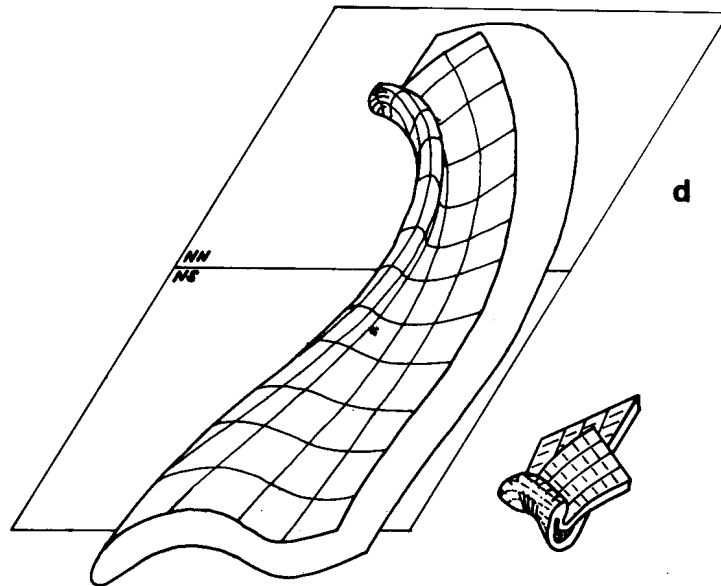
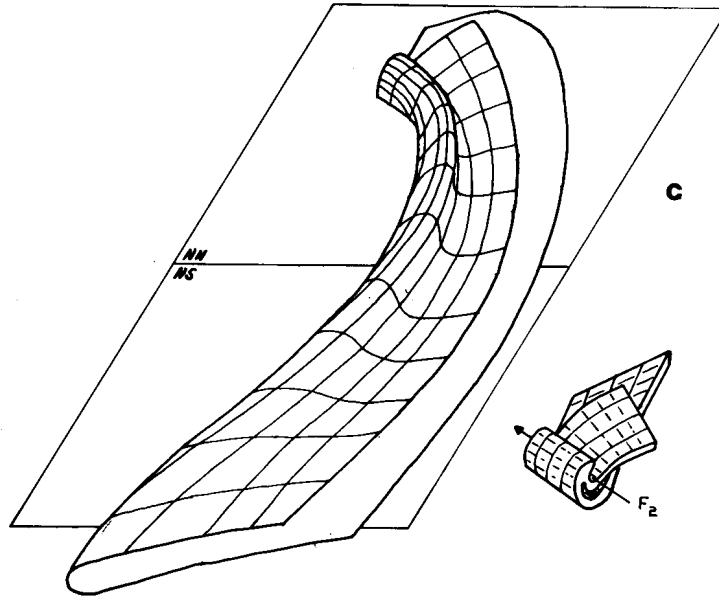

Fig. 12. Development of the doubly plunging fold which forms the Wilton fold and the South Norwalk fold.

- a. N-S-trending recumbent isoclinal fold.
- b. Refolding of the northern part. Inset shows Wilton fold plunging westward.
- c. Refolding of the northern part along an axis plunging gently west of north. Inset shows refolding of Wilton fold along  $F_2$  axis, plunging gently west of north.
- d. Refolding of the southern part, probably along the southern extension of  $F_2$  of the Wilton fold. Inset shows warping of the Wilton fold to near-vertical plunge. It is possible that *c* was coincident with *d*.



$F_1$  minor-fold axes are developed locally in domains 1-3 and appear as folds of  $S_1$  and  $S_2$ , which suggests that  $F_1$  is later than development of the foliation  $S_2$ . Minor-fold planes are parallel to local  $S_2$  foliation and only rarely does  $S_2$  transect  $S_1$  bedding on minor-fold noses.

Examination of the stereograms (fig. 11) indicates that, in domains 1-3,  $L_1$  and  $F_1$  are not constant in orientation. The rotation of these lineations suggests the following interpretation of the folding:

1. A W-plunging isoclinal fold, developed during metamorphism, produced  $S_2$ ,  $L_1$ , and  $F_1$ . The latter two inferred as  $b$ -lineations (fig. 12b, inset).

2. Refolding occurred along a gently N-plunging axis, designated  $F_2$  (fig. 12c, inset). The W-plunging lineations were rotated to plunge northward, and foliation generally trends E-W in the hinge zone. New linear or planar structures apparently did not develop at this time. The only minor structures which may be related to  $F_2$  are the microcline augen in unit II of the mafic gneisses and the generally better developed foliation in rocks along the western part of the fold. The preservation of W-plunging lineations and primary sedimentary structures along the eastern limb of the fold suggests that this limb was not dynamically involved in the refolding, which was limited to the southern and western parts of the fold.

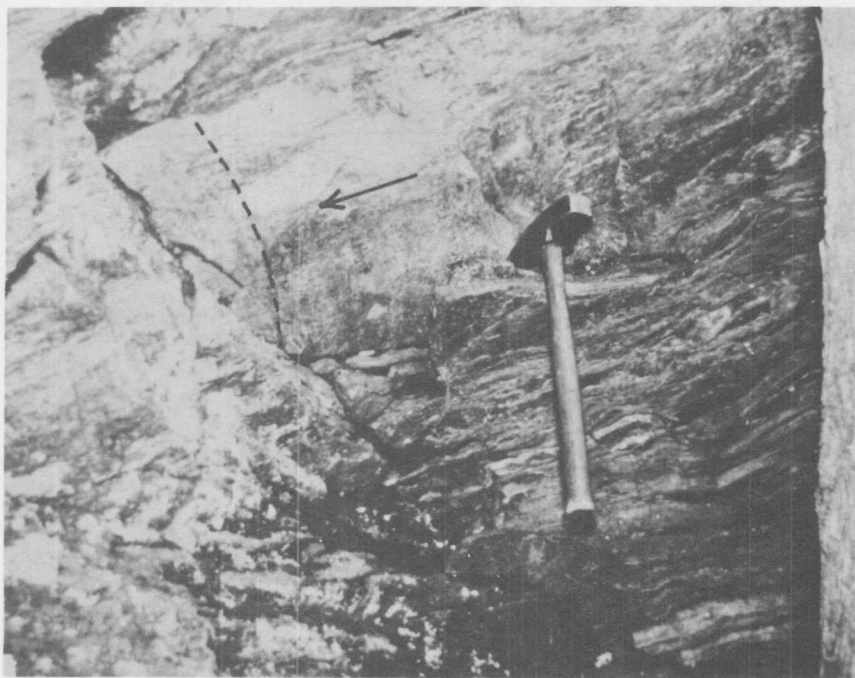

Fig. 13. View of  $F_3$  crenulation plunging southwestward (arrow to left) which folds  $L_1$  mineral lineations (dashed line) in the schist and granulite. (Norwalk North quadrangle, 120 m south of road to Wilton town dump, 147,800 N, 413,400 E)

3. The northwestern part of the fold was warped to a near-vertical plunge (fig. 12D, inset) and the lineations are at steep angles in the stereogram for domain 3 (fig. 11). This may have been coincident with  $F_2$ , but possibly represents a later deformation.

4. A later deformation occurred when the rocks had been removed from a plastic environment of deformation to a brittle environment and SW-plunging  $F_3$  crenulation developed (pl. 1). In some outcrops in the schist and granulite, these crenulations visibly fold  $L_1$  (fig. 13).

#### SOUTH NORWALK FOLD

In the Norwalk South quadrangle, massive felsic gneiss cuts out much of the metasedimentary stratigraphy and complicates the interpretation of major folds. Nevertheless, evidence suggests a major fold, here designated the South Norwalk fold, near the Town of South Norwalk.

Mineral lineations and minor-fold axes in the mafic gneisses, the schist and granulite remnants, and parts of the mixed felsic gneiss plunge southward and southwestward, in contrast to similar rocks in the Norwalk North quadrangle, where the linear structures plunge northward, northwestward, and westward. Schist and granulite, which strikes northeastward on the islands and approximately northward just west of the mafic gneiss in the vicinity of the Town of Rowayton, suggests a fold nose in the schist and granulite offshore. Whether or not this unit occurs there is not known, however; it may have been cut out by the massive felsic gneiss. The aeromagnetic pattern here (U.S. Geological Survey, 1971b) follows the hypothetical fold nose.

Outcrops, in conjunction with the aeromagnetic pattern, as well as the stratigraphy developed in the Norwalk North quadrangle, suggest that the mafic gneiss and the schist and granulite in this area have been isoclinally folded and then refolded. Structure sections of the Norwalk South quadrangle (pl. 4) show the fold as it would appear if all the schist and granulite were restored.

The map pattern (pl. 3) of the mafic gneisses is due to erosion of the folded fold, as indicated in figure 14.

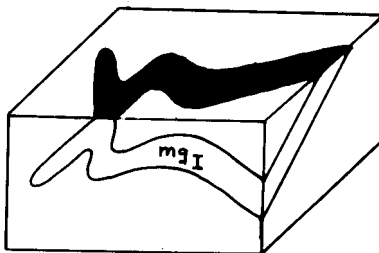

Fig. 14. Block diagram relating outcrop pattern of the South Norwalk fold to the cross sections in plate 4. Shaded area is the idealized outcrop pattern of mafic gneiss unit I before being cut by the massive felsic gneiss.



#### A DOUBLY PLUNGING FOLD MODEL

The close similarity of rocks in the Wilton fold to those in the South Norwalk fold suggests that these folds were continuous before erosion. Figure 14 shows a possible reconstruction of the complete fold. Parts of the schist and granulite unit have been cut out by intrusive bodies of massive felsic gneiss, and it is no longer continuous around the mafic gneisses.

Trends of foliation and lineation on plates 1 and 3 are consistent with a doubly plunging fold. In such a fold, the foliation would strike northeastward in the mafic gneisses and in the schist and granulite along the eastern limb of the Wilton fold but, in the Norwalk South quadrangle, east of the mafic gneisses (and the hypothetical schist and granulite), it would strike northwestward. On the western side of the Wilton fold, the foliation would strike northwestward but, west of the South Norwalk fold, would be to the northeast. The foliation trends in both quadrangles conform to this model, forming an "hour-glass" pattern, in which foliation trends converge in the vicinity of the northern termination of the mafic gneiss (mg<sub>1</sub>, pl. 3) in the Norwalk South quadrangle.

#### THE NORWALK-STAMFORD DOME

Rice and Gregory (1906) indicate a possible dome between Norwalk and Stamford. In the southwestern part of the Norwalk South quadrangle the foliation strikes northeastward but swings to the north and, finally, to the northwest in the northwestern part of the quadrangle. Foliation trends in the

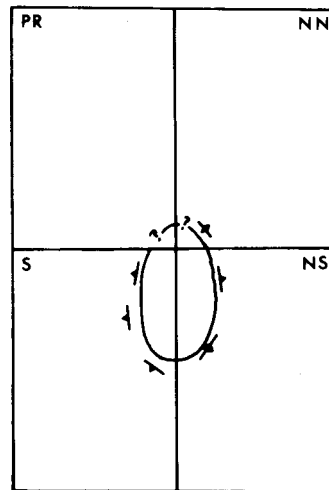

Fig. 15. Location of the Norwalk-Stamford dome in four quadrangles. NN = Norwalk North, NS = Norwalk South, S = Stamford, PR = Pound Ridge. Queried outline in Norwalk North and Pound Ridge quadrangles is in an area of sparse outcrops. (Data for the Stamford quadrangle is from C.O. Frank, personal communication, 1971.)

Stamford quadrangle (C.O. Frank, personal communication, 1971) are almost a mirror image of this trend (fig. 15). The regional aeromagnetic-map pattern (U.S. Geological Survey, 1971b,a, and an unpublished regional compilation) follows this foliation trend. Both suggest a domical structure with near-bilateral symmetry across the boundary between the Norwalk South and Stamford quadrangles. In the Norwalk South quadrangle the dome rocks are equivalent to the Collinsville Formation.

### *Fractures*

Almost all outcrops in the quadrangles are fractured. A systematic analysis of these fractures was not made; however, their general properties appear on the descriptive rock chart (pl. 5).

Slickensides were observed throughout the quadrangles. The azimuth and plunge of each set are plotted in figure 16, where it can be seen that most slickensides plunge gently in the southeastern and northwestern quadrants. The majority of the slickensides are on steeply dipping NW-trending fractures.

Experimental deformation of brittle rocks indicates that shear fractures form at approximately  $30^\circ$  to the maximum fracture (Heard, 1960; Handin, 1966). The occurrence of gently plunging slickensides on near-vertical surfaces suggests that these are shear fractures which developed in response to a stress system with a near-horizontal maximum compression and a near-vertical intermediate compression. The direction of maximum stress, inferred from a single shear fracture, may be ambiguously located within about  $30^\circ$  on either side of the fracture. Most of the slickensides plot in the southeastern and northwestern quadrants; although a wide range of maximum-stress directions is possible, most would also lie within these quadrants.

The relation of the slickensided surfaces to the crenulations in the schist and granulite is uncertain. Both are brittle features and the crenulation axes are approximately normal to the directions of maximum compression inferred above. However, it could not be determined whether these structures are contemporaneous or formed in separate events.

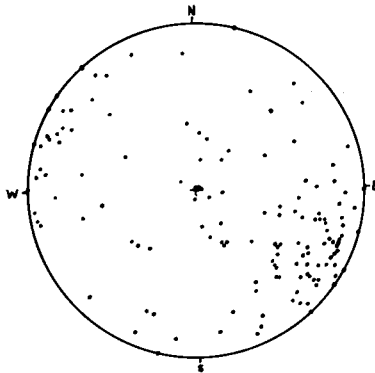

Fig. 16. Orientation diagram of 133 sets of slickensides in the Norwalk North and Norwalk South quadrangles.

### *Comparison with structures in surrounding areas*

Several structures in adjacent areas approximate the style-of-movement sense of those found in the Norwalk North and Norwalk South quadrangles. The nearest structures described are the recumbent folds and nappes in the Westport quadrangle (Dieterich, 1968a,b). There, the overturning of recumbent folds in the western part of the quadrangle is similar to the refolding of the western part of the Wilton fold. A similar sense was suggested by Scotford (1856, p. 1193) for movement in the Highlands gneiss southeastward toward the Siscowit Granite-Gneiss in the Pound Ridge quadrangle, New York.

Kink-band axes described by Dieterich (1968a, p. 23) are similar to those in the schist and granulite in the Norwalk North quadrangle. He suggested a N-S compression for these late features, which approximates the direction of compression inferred for brittle structures in the Norwalk North and Norwalk South quadrangles.

### *Ages of the deformations*

The major folding is assumed to be coincident with the major metamorphism, which took place about 360 m.y. ago. No structures that might be considered to be remnants of the metamorphism of 460-480 m.y. ago were observed, and it seems unlikely that any major structures developed during or after this event could have been unaffected by the event 360 m.y. ago.

The brittle deformation cannot be dated with certainty. It may represent late metamorphic deformation or be unrelated to the major metamorphism. As yet, no structural features related to the thermal event 260 m.y. ago have been described in this part of Connecticut. If any movement was associated with this event, then possibly the brittle features indicate this movement. The relation between the brittle structures and textural features indicating retrograde metamorphism is uncertain.

## METAMORPHISM

### *Introduction*

From central to western Connecticut there is a regional increase in metamorphic grade, as shown by Fritts (1962), Crowley (1968), Rodgers and others (1956), and Dieterich (1968a). The rocks range from chlorite grade near New Haven to sillimanite grade near Bridgeport, with isograds trending NNE. West of Bridgeport, sillimanite and muscovite coexist in pelitic rocks all the way to the Hudson River, through the Norwalk North quadrangle (Hall, 1968a,b; Prucha and others, 1968; Wissig, 1970).

### *Metamorphic facies and isograds*

Figure 17 is a compilation of the observed mineral assemblages in the Norwalk North quadrangle presumed to represent equilibrium. Except for the preference of the plagioclase-biotite tie line (Kroll, 1971, p. 137), the assemblages are typical of the sillimanite-almandine-muscovite subfacies of the almandine-amphibolite facies of metamorphism (Turner and Verhoogen, 1960, p. 549).

In the Norwalk South quadrangle, a change in metamorphic facies is indicated

by the appearance of staurolite and kyanite in pelitic gneisses and of zoisite in mafic gneisses. On Calf Pasture Island, staurolite is found in metasedimentary rocks. Kyanite also occurs on the island but is restricted to quartz-kyanite pegmatic pods and is not part of the metasedimentary assemblage. Farther north, kyanite and sillimanite are both present in an outcrop of pelitic rocks within the mixed felsic gneiss southwest of Brookside School (92,800 N, 409,300 E). The kyanite appears stable and the sillimanite forms long needles cutting across other minerals.

The assemblages on Calf Pasture Island indicate metamorphism at the staurolite-almandine subfacies of the almandine-amphibolite facies of metamorphism (Turner and Verhoogen, 1960, p. 546). The rocks near the Brookside School indicate metamorphism at the kyanite-almandine subfacies of the almandine-amphibolite facies and the sillimanite indicates the beginning of the sillimanite-almandine-muscovite subfacies (Turner and Verhoogen, 1960, p. 548-549). The transition of subfacies is illustrated in figure 18. Outcrops which might show the subfacies transition more precisely are not exposed between Calf Pasture Island and the Brookside School.

The disappearance of zoisite from mafic-rock mineral assemblages is considered diagnostic of the transition from the kyanite-almandine-muscovite subfacies to the sillimanite-almandine-muscovite subfacies (Turner and Verhoogen, 1960, p. 549). The mafic gneisses in the South Norwalk fold contain zoisite but the mafic gneisses farther west do not. This places the boundary between the kyanite-almandine-muscovite subfacies and the sillimanite-almandine-muscovite subfacies between the mafic gneiss bodies.

North of the Brookside School area, zoisite is also absent from the mafic gneisses but sillimanite is present in the pelitic rocks.

All these data suggest that the kyanite-sillimanite isograd trends northward,

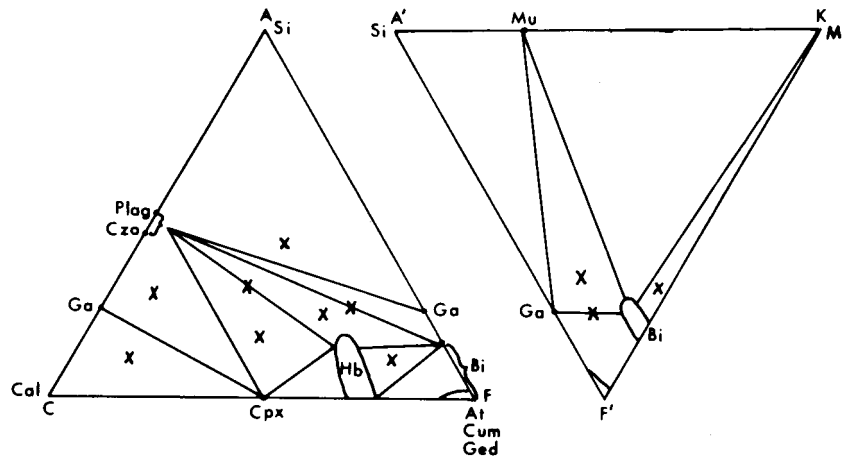

Fig. 17. ACF and A'F'K diagrams of mineral assemblages in quartz-saturated rocks in the Norwalk North quadrangle. Positions of assemblages, each marked by an X, are based only on observed assemblages; total rock composition is only grossly implied.

west of the mafic gneisses in the South Norwalk fold but has an E-W trend through the Brookside School area (pl. 1). Other isograds cannot be located.

### Temperature and pressure of metamorphism

The temperature (T) and pressure (P) of metamorphism can be estimated by comparing observed mineral assemblages with experimentally produced assemblages. The most diagnostic assemblages in these quadrangles are in the kyanite-muscovite, sillimanite-muscovite, and cordierite-bearing rocks. The presence of sillimanite as the stable aluminosilicate polymorph in the Norwalk North quadrangle limits the low temperature of the peak of metamorphism to 622°C at  $P_{H_2O}$  of 5.5 kb, using the triple-point determination of Richardson, Gilbert, and Bell (1969, fig. 4, p. 269). Coexisting muscovite and quartz indicate that the temperature was on the low side of the reaction  $muscovite + quartz \cong potassium\ feldspar + sillimanite + H_2O$ , as reported by Evans (1965, fig. 10, p. 660). Figure 19 shows these two curves and indicates a wide range of possible conditions for the sillimanite-muscovite-bearing rocks.

The P-T estimates may be refined by considering the cordierite-bearing rocks. It has been shown (Kroll, 1971) that the cordierite in the garnet-gedrite schists is probably highly magnesian and that, in the presence of increasing amounts of  $K^+$ , it became unstable. Schreyer and Seifert (1969, fig. 3, p. 382) indicate that, in  $K_2O$ -poor rocks, cordierite-biotite-sillimanite can coexist at high temperatures and pressures, but that in  $K_2O$ -bearing rocks the reaction  $cordierite + muscovite \cong phlogopite + sillimanite + quartz$  takes place. This part of their diagram is reproduced in figure 20.

Muscovite was not found in the cordierite-bearing rocks in the Norwalk North quadrangle. If small amounts of muscovite were there at one time, and if the above reaction proceeded from left to right, possibly the presence of cordierite, biotite, sillimanite, and quartz (plus staurolite and gedrite) in local

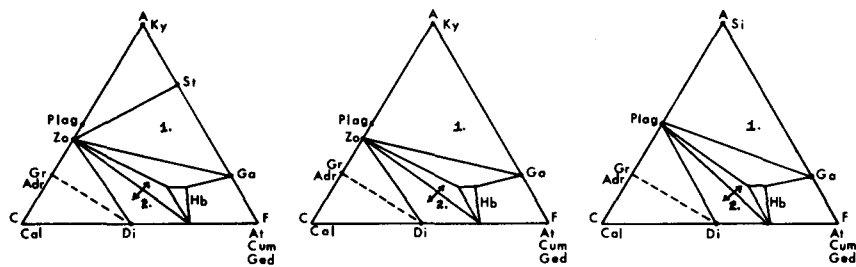

Fig. 18. Metamorphic subfacies transition in the Norwalk South quadrangle.

*Left:* Staurolite-almandine subfacies of the almandine-amphibolite facies. Assemblage 1 occurs in pelitic rocks on Calf Pasture Island. Assemblage 2 occurs in mafic gneisses on the kyanite side of the kyanite-sillimanite isograd. Arrow indicates the possibility of zoisite + hornblende  $\pm$  diopside (augite in the mafic gneisses).

*Center:* Assemblages at 1 are devoid of staurolite at the Brookside School and indicate the kyanite-almandine subfacies of the almandine-amphibolite facies.

*Right:* Appearance of sillimanite at the Brookside School indicates the beginning of the sillimanite-almandine-muscovite subfacies of the almandine-amphibolite facies.

(All facies designations are from Turner and Verhoogen, 1960, p. 546-549.)

areas is explained. The important point is that cordierite became unstable in the presence of increased  $K^+$  but remained stable in  $K^+$ -deficient parts of the rocks. This places the rocks on the high-temperature and high-pressure side of the reaction curve. This curve, added to figure 19, indicates a minimum temperature of 660°C.

Experimental work by Hirschberg and Winkler (1968) indicates that in pelitic rocks cordierite and almandine are incompatible at high temperatures and pressures. The curve representing the upper stability limit of cordierite + almandine (plus biotite and sillimanite) has been added to figure 19. This curve must be viewed with reservation in its application here, as it is the absence of cordierite which suggests that the P-T conditions lie on the high side of the curves. The absence of a phase is a poor criterion for evaluating environmental conditions, unless the disappearance of the phase can be traced across an isograd. The curve is used here because garnet, sillimanite, and biotite are common in pelitic rocks in the Norwalk North quadrangle, suggesting an approximation to the experimental bulk-composition studies and because it offers some refinement, although on poorly established grounds, of the P-T conditions.

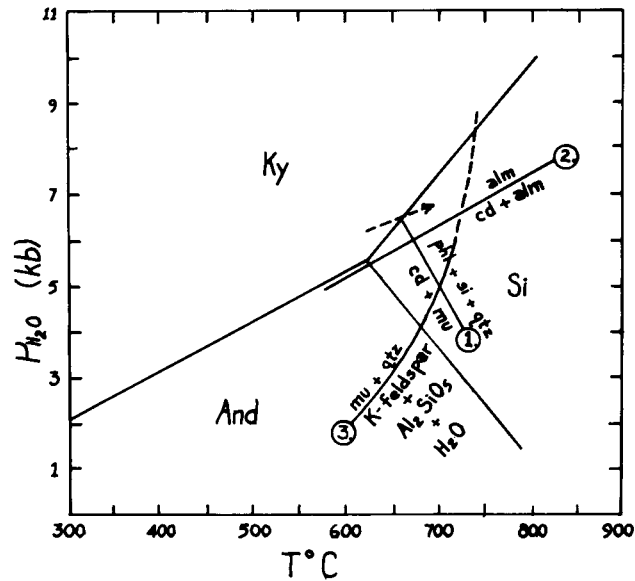

Fig. 19.  $P_{H_2O}$ -T diagram showing univariant reaction curves which limit P-T conditions in the Norwalk North quadrangle and the probable P-T path (arrow) from Long Island Sound to the Norwalk North quadrangle.

1. Schreyer and Seifert (1969, fig. 3, p. 382)
2. Hirschberg and Winkler (1968, abb. 1, p. 30)
3. Evans (1965, fig. 10, p. 660)

A further suggestion concerning the metamorphic environment is found in textures involving plagioclase, muscovite, and microcline. Many plagioclase grains contain muscovite as an inclusion phase but, where in contact with microcline, the plagioclase is muscovite free and reverse zoned. Sillimanite was not positively identified in the rims richer in Ca but, in some instances, thin, unidentified needles were observed. Guidotti (1963, p. 786) has suggested the reaction *muscovite + quartz + Na-rich plagioclase*  $\cong$  *sillimanite + Na-bearing potash feldspar + more calcic plagioclase + H<sub>2</sub>O* to explain similar textures. There is as yet no experimental evidence concerning this reaction. Winkler (1965, p. 93) equates it with others terminal to muscovite, and suggests that a temperature of 700°C may be necessary at the high temperatures inferred above.

It seems that 700°C is an upper limit to the temperature reached during metamorphism. Widespread anatexis could not be verified, but local, foliated pegmatitic lenses of uncertain origin may be evidence of partial melting. If this is so, temperatures approached the beginning of anatexis. Winkler (1965, p. 199) concludes that temperatures of 650-700°C are adequate for the partial melting of rocks approximating graywackes in composition provided that an adequate amount of H<sub>2</sub>O is available.

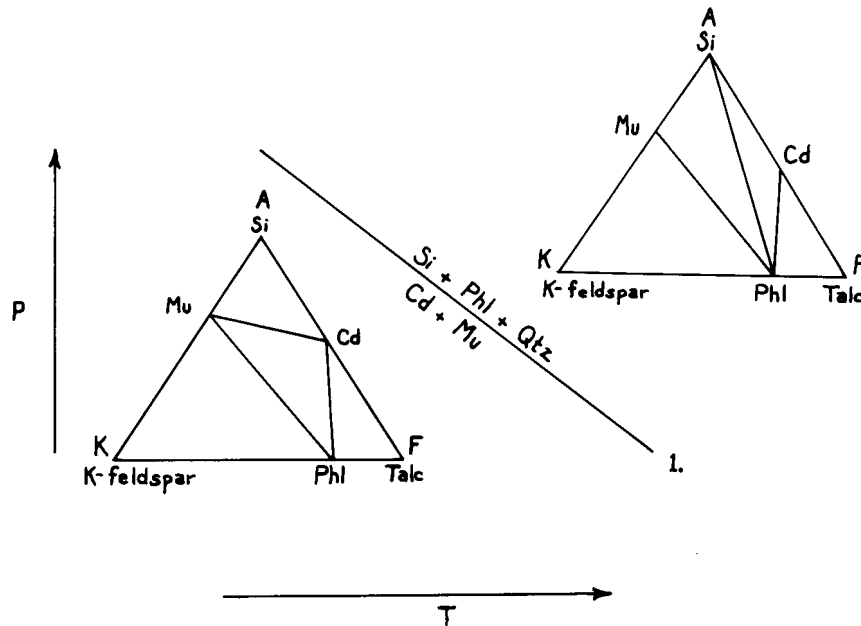

Fig. 20. Part of the P-T diagram for the system  $K_2O-MgO-Al_2O_3-SiO_2-H_2O$  (Schreyer and Seifert, 1969, fig. 3, p. 382). Cordierite-bearing rocks in the Norwalk North quadrangle do not contain muscovite, indicating that the rocks are  $K_2O$  poor and that metamorphic conditions lie on the high P-T side of the curve: cordierite + muscovite  $\cong$  sillimanite + phlogopite + quartz.

From the above discussion it is suggested that the peak of metamorphic temperatures and pressures were in the vicinity of 660-680°C and  $P_{H_2O}$  about 6 kb. Inasmuch as the pressure estimate assumes  $P_{H_2O} = P_{total}$ , future work relating to the fluid-pressure problem in rocks may lead to revisions of this estimate.

The path of changes in metamorphic temperature and pressure, from south to north in the two quadrangles, is suggested by the dashed arrow in figure 19, based primarily on the kyanite-sillimanite transition.

## GEOLOGIC HISTORY

During Cambro-Ordovician time, volcanic and sedimentary rocks were deposited in a eugeosynclinal environment, similar perhaps to modern volcanic-island environments. These rocks were deeply buried and, during the Acadian orogeny of Middle to Late Devonian time, underwent high-grade metamorphism and deformation. Granitic magmas were generated during this orogeny and were syntectonically intruded, chiefly as stratiform bodies. The temperature of metamorphism may have been as high as 660-680°C at a  $P_{H_2O}$  of 6 kb. In late or post-orogenic time, a brittle deformation occurred, possibly coincident with a thermal event 260 m.y. ago, producing slickensided surfaces and small crenulations in the foliation.

Evidence of a Taconic event (at the end of the Ordovician Period) is absent.

The next recorded event is the intrusion of a small diabase dike, most likely in the Triassic Period.

The post-Triassic history is almost unknown. Pleistocene glaciation smoothed the bedrock surface and left a mantle of stratified and unstratified drift.

## ECONOMIC GEOLOGY

At present there is no mining or quarrying in the Norwalk North or Norwalk South quadrangles. Mapping revealed no potential economic mineral reserves.

In the past, the major mineral extraction was the now lost Wilton lead or silver mine. Attempts to locate the abandoned mine were futile. Numerous authors (Shepard, 1837; Sanford and Stone, 1914; Schairer, 1931; Sohon, 1951) state that silver, lead, pyrite, chalcopyrite, arsenopyrite, sphalerite, and galena were found there. However, rocks in the approximate area of the mine contain no metalliferous-bearing veins or horizons.

The town of Silvermine is named after a mining operation that was a hoax (Hurd, 1881). At its approximate location as pointed out by an elderly local resident, is a shallow pit about 3 m across. Although of no geologic importance, this "mine" has local historical interest.

According to Shepard (1837, p. 164) talcose slate was quarried in the Norwalk area, ground, and presumably used as a paint pigment. This rock appears to be the talc-serpentine-trenolite rock near the Strong-Comstock School (Norwalk North quadrangle). No sign of the quarry remains; it has been destroyed or buried.

Dale and Gregory (1911) described the Hall Quarry in Norwalk, from which granite-gneiss was removed for use in walls and underpinnings. No sign of the location of this quarry remains.



## REFERENCES

- Agar, W.A., 1934, The granites and related intrusives of western Connecticut: *Am. Jour. Sci.*, v. 27, p. 254-373.
- Armstrong, R.L., Barton, J.M., Carmalt, S.W., and Crowley, W.P., 1970, Geochronologic studies of the Prospect, Ansonia, and Milford formations, southern Connecticut *in* Contributions to geochronology in Connecticut: Connecticut Geol. Nat. History Survey Rept. Invest. 5, p. 19-27.
- Brookins, D.G., 1970, A summary of geochronological data for pegmatites of the Middletown, Connecticut, area, accumulated mainly since 1952 *in* Contributions to geochronology in Connecticut: Connecticut Geol. Nat. History Survey Rept. Invest. 5, p. 10-18.
- Chayes, F., 1956, Petrographic modal analyses: New York, John Wiley and Sons, Inc., 113 p.
- Clark, G.S., and Kulp, J.L., 1968, Isotopic age study of metamorphism and intrusion in western Connecticut and southeastern New York: *Am. Jour. Sci.*, v. 266, p. 865-894.
- Clarke, J.W., 1958, The bedrock geology of the Danbury quadrangle: Connecticut Geol. Nat. History Survey Quad. Rept. 7, 46 p.
- Crowley, W.P., 1968, The bedrock geology of the Long Hill and Bridgeport quadrangles: Connecticut Geol. Nat. History Survey Quad. Rept. 24, 81 p.
- Dalc, T.N., and Gregory, H.E., 1911, The granites of Connecticut: U.S. Geol. Survey Bull. 484, 137 p.
- de Boer, J., 1968, Paleomagnetic differentiation and correlation of the Late Triassic volcanic rocks in the central Appalachians (with special reference to the Connecticut Valley): *Bull. Geol. Soc. America*, v. 79, p. 609-626.
- Dieterich, J.H., 1968a, Sequence and mechanics of folding in the area of New Haven, Naugatuck, and Westport, Connecticut: unpub. Ph.D. dissertation, Yale Univ., 153 p.
- , 1968b, Multiple folding in western Connecticut: A reinterpretation of structure in the New Haven-Naugatuck-Westport area: Connecticut Geol. Nat. History Survey Guidbk. 2, Trip D-2, 13 p.
- Donnelly, T.H., 1966, Geology of St. Thomas and St. John, U.S. Virgin Islands *in* Caribbean geological investigations, H.H. Hess, ed.: *Geol. Soc. America Mem.* 98, p. 85-176.
- Erickson, G.F., and Kulp, J.L., 1961, Potassium-argon dates on basaltic rocks: *Annals New York Acad. Sci.*, v. 91, art. 2, p. 321-323.
- Eskola, Pentti, 1914, On the petrology of the Orjarvi region in southwestern Finland: *Finlande Comm. Geol. Bull.* 40, p. 1-277.
- Evans, B.W., 1965, Application of a reaction-rate method to the breakdown equilibria of muscovite and muscovite plus quartz: *Am. Jour. Sci.*, v. 263, p. 647-667.
- Fritts, C.E., 1962, Age and sequence of metasedimentary and metavolcanic formations northwest of New Haven, Connecticut: U.S. Geol. Survey Prof. Paper 450-D, art. 128, 5 p.
- Grant, J.A., 1968, Partial melting of common rocks as a possible source of cordierite-anthophyllite-bearing assemblages: *Am. Jour. Sci.*, v. 266, p. 908-931.
- Gregory, H.E., and Robinson, H.H., 1907, Preliminary geological map of Connecticut: Connecticut Geol. Nat. History Survey Bull. 7, 39 p.
- Guidotti, C.V., 1963, Metamorphism of the pelitic schists in the Bryant Pond quadrangle, Maine: *Am. Mineralogist*, v. 48, p. 772-791.
- Hall, L.M., 1968a, Geology in the Glenville area, southwesternmost Connecticut and southeastern New York: Connecticut Geol. Nat. History Survey Guidbk. 2, Trip D-6, 12 p.

- , 1968b, Times of origin and deformation of bedrock in the Manhattan prong *in* Studies of Appalachian geology, Zen, E-An, White, W.S., Hadley, J.B., and Thompson, J.B., Jr., eds.: New York, Interscience Publishers, p. 117-127.
- 1971, Preliminary correlation of rocks in southwestern Connecticut (Abs.): Geol. Soc. America Abstr. with Programs, v. 3, no. 1, p. 34.
- Handin, J., 1966, Strength and ductility *in* Handbook of physical constants: Geol. Soc. America Mem. 97, p. 223-289.
- Heard, H.C., 1960, Transition from brittle fracture to ductile flow in Solenhofen Limestone as a function of temperature, confining pressure, and interstitial fluid pressure *in* Rock deformation, Griggs, D., and Handin, J., eds., Geol. Soc. America Mem. 79, p. 193-226.
- Hirschberg, A., and Winkler, H.G.F., 1968, Stabilitätsbeziehungen zwischen chlorit, cordierit, and almandin bei der metamorphose: Contr. to Mineral. and Petrol., v. 18, p. 17-42.
- Hurd, D.H., 1881, History of Fairfield County: Philadelphia, J.L. Lewis and Co.
- Kroll, R.L., 1971, Bedrock Geology of the Norwalk North quadrangle, Connecticut-New York: unpub. Ph.D. dissertation, Syracuse Univ., 183 p.
- Pease, M.H., Jr., 1968, Cretaceous and Lower Tertiary stratigraphy of the Naranjito and Aguas Buenos quadrangles and adjacent areas, Puerto Rico: U.S. Geol. Survey Bull. 1253, 57 p.
- Percival, J.G., 1842, A Report on the geology of the state of Connecticut: New Haven, Osborn and Baldwin, 497 p.
- Prucha, J.J., Scotford, D.M., and Sneider, R.M., 1968, Bedrock geology of parts of Putnam and Westchester Counties, New York, and Fairfield County, Connecticut: New York State Museum and Sci. Serv. Map and Chart Ser., no. 11, 26 p.
- Rice, W.N., and Gregory, H.E., 1906, Manual of the geology of Connecticut: Connecticut Geol. Nat. History Survey Bull. 6, 273 p.
- Richardson, S.W., Gilbert, M.C., and Bell, P.M., 1969, The experimental determination of kyanite-andalusite and andalusite-sillimanite equilibria; the aluminum silicate triple point: Am. Jour. Sci., v. 267, p. 259-272.
- Ries, H., 1895, On a granite-diorite near Harrison, Westchester County, N.Y.: N.Y. Acad. Sci. Trans., Ser. 1, v. 14, p. 80-86.
- Rodgers, John, 1967, Chronology of tectonic movements in the Appalachian region of eastern North America: Am. Jour. Sci., v. 265, p. 408-427.
- Rodgers, John, Gates, R.M., Cameron, E.N., and Ross, R.J., Jr., 1956, A preliminary geological map of Connecticut: Connecticut Geol. Nat. History Survey.
- Rodgers, John, Gates, R.M., and Rosenfeld, J.L., 1959, Explanatory text for preliminary geological map of Connecticut, 1956; Connecticut Geol. Nat. History Survey Bull. 84, 64 p.
- Sanford, S., and Stone, R.W., 1914, Useful minerals of the U.S.: U.S. Geol. Survey Bull. No. 585.
- Schairer, J.F., 1931, The minerals of Connecticut: Connecticut Geol. Nat. History Survey Bull. 51, 121 p.
- Schreyer, W., and Seifert, F., 1969, Compatibility relations of the aluminum silicates in the systems  $MgO-Al_2O_3-SiO_2-H_2O$  and  $K_2O-MgO-Al_2O_3-SiO_2-H_2O$  at high pressures: Am. Jour. Sci., v. 267, p. 371-388.
- Scotford, D.M., 1956, Metamorphism and axial-plane folding in the Poundridge area, New York: Geol. Soc. America Bull., v. 67, p. 1155-1198.

- Scott, R.B., 1974, The bedrock geology of the Southbury quadrangle: Connecticut Geol. Nat. History Survey Quad. Rept. 30, 63 p.
- Shepard, C.U., 1837, A report on the geological survey of Connecticut: New Haven, B.L. Hamlen, 188 p.
- Sohon, J.A., 1951, Connecticut minerals, their properties and occurrence: Connecticut Geol. Nat. History Survey Bull. 77, 133 p.
- Stanley, R.S., 1964, The bedrock geology of the Collinsville quadrangle: Connecticut Geol. Nat. History Survey Quad. Rept. 16, 99 p.
- , 1968, Bedrock geology of western Connecticut: Connecticut Geol. Nat. History Survey Guidbk. 2, Trip D, 5 p.
- Tilley, C.E., 1937, Anthophyllite-cordierite granulites of the Lizard: Geol. Mag., v. 74, p. 300-309.
- Turner, F.J., and Verhoogen, J., 1960, Igneous and metamorphic petrology: New York, McGraw-Hill, 694 p.
- U.S. Geological Survey, 1971a, Aeromagnetic map of the Norwalk North quadrangle, Fairfield County, Connecticut, and Westchester County, New York: Geophys. Invest. Map GP-822.
- , 1971b, Aeromagnetic map of parts of the Norwalk South and Sherwood Point quadrangles, Fairfield County, Connecticut: Geophys. Invest. Map GP-827.
- Vallance, R.G., 1967, Mafic-rock alteration and isochemical development of some cordierite-anthophyllite rocks: Jour. Petrology, v. 8, p. 84-96.
- Wasserburg, G.J., Hayden, R.J., and Jensen, K.J., 1956, A<sup>40</sup>K-<sup>40</sup>Ar dating of igneous rocks and sediments: Geochim. et Cosmochim. Acta, v. 10, p. 153-165.
- Whetten, J.T., 1966, Geology of St. Croix, U.S. Virgin Islands in Caribbean Geological Investigations, H.H. Hess, ed., Geol. Soc. America Mem. 98, p. 176-240.
- Winkler, H.G.F., 1965, Petrogenesis of metamorphic rocks: New York, Springer-Verlag, 220 p.
- Wissig, G.C., 1970, Bedrock geology of the Ossining, New York, quadrangle: unpub. Ph.D. dissertation, Syracuse Univ., 186 p.

## APPENDIX

### ANALYTICAL TECHNIQUES FOR MINERAL DETERMINATIONS

#### *Modal analysis*

Modal analysis was done on standard thin sections stained for plagioclase and potassium feldspar. A Leitz micrometer stage was used, with a point spacing of 0.33 x 0.66 mm. All analyses conform to a standard deviation of 2 percent. The number of thin sections necessary for this precision was determined from Chayes' figure 12 (1956, p. 82).

#### *Mineral identification*

Identification of nonopaque minerals is based on optical properties in plain and polarized light. Indices of refraction in sodium light were determined, using a universal stage equipped with an Emmons cell for temperature variation. Indices reported are considered precise to within  $\pm 0.0005$ , the minimum difference that I could detect. Indices of the immersion oils were checked on an Abbe refractometer, attached in line with the water system attached to the Emmons cell.

For the opaque minerals, magnetic fractions from crushed samples were considered to be magnetite and the remaining nonmagnetic fractions to be ilmenite. Graphite was identified by smears on fingers.

The following techniques were used for compositional determination of solid-solution-series minerals.

#### Biotite

The  $\alpha = \beta$  index of refraction of biotite from the garnet-gedrite rocks was determined by oil immersion, using oils of 0.004 graduations checked at room temperature on a Leitz refractometer. The index ( $1.614 \pm 0.002$ ) indicates an iron/magnesium ratio of approximately 0.34, assuming 1.33 tetrahedral aluminum atoms per formula unit, as suggested by Robinson and Jaffe (1969, p. 407), shown by Hall (1970, table 6, p. 35), and plotted on the quadrilateral of Winchell and Winchell (1961, fig. 257, p. 374).

#### Cordierite

Cordierite was recognized by faint-yellow pleochroic haloes around tiny zircons (?) and by staining with trypan blue (Boone and Wheeler, 1968). Exact compositional determinations were not attempted.

#### Gedrite

The optical properties of the anthophyllite-gedrite series change with the substitutions  $\text{Mg} \rightleftharpoons \text{Fe}$  and  $\text{MgSi} \rightleftharpoons \text{Al}_2\text{Al}$ . Optical properties alone cannot be used for compositional determinations unless the iron content is known (Deer, Howie, and Zussman, v. 2, 1963, p. 221).

The FeO content of gedrite from a monomineralic layer in the schist and granulite (near sample location 782) was determined on a hand-picked sample of screen-mesh size 80-100 by titration with potassium-dichromate solution in acid solution, using barium diphenylamine sulfonate as an indicator. FeO content for two separate samples yielded values of 12.45 and 13.78 weight percent. Although the picked gedrite was clean as possible, it was brown and contained micro-inclusions. The difference in FeO content is not

considered unreasonable for these two samples, considering the nature of the samples and the general problems with FeO determinations.

A plot of the iron content against optical properties on figure 5 of Seki and Yamasaki (1957, p. 518) indicates an iron-enriched anthophyllite with approximately 20 mole percent of gedrite. The optics and FeO content of the analyzed samples are similar to a gedrite reported by Robinson and Jaffe (1969, specimen no. W95JS, table 1, p. 392) and it is suggested that this mineral is a gedrite close in composition to W95JX of Robinson and Jaffe.

Indices of refraction of gedrite from garnet-gedrite rock in the mafic gneiss approximate those of specimen no. I34JX of Robinson and Jaffe and a similar chemistry is inferred.

#### Plagioclase

Plagioclase composition was determined by the Rittman zone method of Emmons (1943) for plagioclase of less than An<sub>50</sub>. For more calcic plagioclase the  $n_{\alpha'}$  index of refraction cleavage fragments was determined and the composition read from figure 173 of Winchell and Winchell (1961, p. 280).

#### Pyroxene

Clinopyroxene composition was determined by plots of  $n_{\beta}$  against  $2V$  on figures 165-167 of Troger (1959, p. 62). Orthopyroxene composition was determined by the value of  $n_{\gamma}$  plotted on figure 164 of Troger (1959, p. 59).

#### Staurolite

The composition of the staurolite is uncertain, as optical properties apparently do not vary systematically with composition, and the effect of various ionic substitutions on optical properties is poorly known. The indices of refraction of staurolite from the garnet-gedrite rocks in the mafic gneisses approximate those of a zinc and magnesium-rich staurolite reported by Deer, Howie, and Zussman (1962, v. 1, table 26, No. 8, p. 155). The indices are close to specimen no. I34I of Robinson and Jaffe (1969, p. 408).

#### Tourmaline

The  $N_E$  and  $N_O$  indices of refraction of tourmaline were determined, and compositions read from figure 356 of Winchell and Winchell (1961, p. 468). Tourmaline from the garnet-gedrite schist is a sodic uvite with 16 mole percent of calcium schorlrite.

### *References*

- Boone, G.M., and Wheeler, E.P., II, 1968, Staining for cordierite and feldspars in thin section: *Am. Mineralogist*, v. 53, p. 327-331.
- Chayes, F., 1956, *Petrographic modal analyses*: New York, John Wiley and Sons, Inc., 113 p.
- Deer, W.A., Howie, R.A., and Zussman, J., 1962, 1963, *Rock-forming minerals*, v. 1 and v. 2: New York, John Wiley and Sons, Inc., 333, 379 p.
- Emmons, R.C., 1943, The universal stage: *Geol. Soc. America Mem.* 8, 204 p.

- Hall, D.J., 1970, Compositional variations in biotites and garnets from kyanite- and sillimanite-zone mica schists, Orange County area, Massachusetts and New Hampshire: Dept. of Geology, Univ. Massachusetts Contrib. 4, 110 p.
- Robinson, P., and Jaffe, H.W., 1969, Aluminous enclaves in gedrite-cordierite gneiss from southwestern New Hampshire; Am. Jour. Sci., v. 267, p. 389-421.
- Seki, Y., and Yamasaki, M., 1957, Aluminous ferroanthophyllite from Kitkami mountainland, northeastern Japan: Am. Mineralogist, v. 42, p. 506-520.
- Troger, W.E., 1959, Optische Bestimmung der gesteinsbildenden Minerale, Teil 1, Bestimmungstabellen: Stuttgart, E. Schweizerbartsche Verlagsbuchhandlung, 147 p.
- Winchell, A.N., and Winchell, H., 1961, Elements of optical mineralogy, pt. 2, Description of minerals: New York, John Wiley and Sons, Inc., 551 p.