

Guidebook for Fieldtrips in Connecticut
New England Intercollegiate Geological Conference

60th Annual Meeting

Yale University, New Haven, Connecticut

October 25-27, 1968

Conservation & Survey
Division

DEC 1968

University of Nebraska

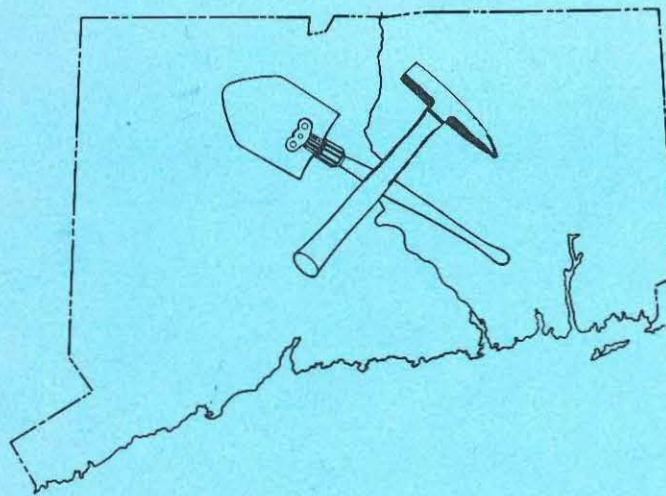

State Geological and Natural History Survey of Connecticut
A Division of the Department of Agriculture and Natural Resources

1968

Guidebook No. 2

STATE GEOLOGICAL AND NATURAL HISTORY SURVEY
OF CONNECTICUT

A Division of the Department of Agriculture and Natural Resources

NEW ENGLAND INTERCOLLEGIATE GEOLOGICAL CONFERENCE

60th Annual Meeting

at Yale University, New Haven, Connecticut 25, 26, 27 October 1968

GUIDEBOOK FOR FIELDTRIPS IN CONNECTICUT

Editor

Philip M. Orville

Yale University

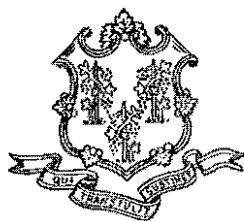

1968

GUIDEBOOK No. 2

STATE GEOLOGICAL AND NATURAL HISTORY SURVEY
OF CONNECTICUT

A Division of the Department of Agriculture
and Natural Resources

Honorable John N. Dempsey, Governor of Connecticut
Joseph N. Gill, Commissioner of the Department of
Agriculture and Natural Resources

COMMISSIONERS

Honorable John N. Dempsey, Governor of Connecticut
Dr. J. Wendell Burger, Department of Biology, Trinity College
Dr. Richard H. Goodwin, Department of Botany, Connecticut College
Dr. Joe Webb Peoples, Department of Geology, Wesleyan University
Dr. John Rodgers, Department of Geology, Yale University
Dr. James A. Slater, Department of Zoology and Entomology,
University of Connecticut

DIRECTOR

Joe Webb Peoples, Ph.D.
Wesleyan University, Middletown, Connecticut

DISTRIBUTION AND EXCHANGE AGENT

Walter Brahm, State Librarian

The price of this Bulletin is \$2.50. Additional copies may be ordered from the State Librarian, Hartford, Connecticut 06115 (postpaid; Connecticut residents must add 3½ percent sales tax). Like all publications of the Connecticut Geological and Natural History Survey, one copy is available, free of charge, to public officials, exchange libraries, scientists, and teachers, who indicate to the State Librarian, under their official letterhead, that it is required for professional work. A List of Publications of the State Survey is also available from the State Librarian on request.

Special Note

The fact that a locality is described in this guidebook does not imply that the public has access to the locality. In certain cases the stops are on limited access highways. In other instances stops on private property require permission of the owner. Stops on limited access highways are forbidden by a recent regulation of the State Traffic Commission which prohibits all vehicles to stop or park on any part of the highway. These regulations also prohibit pedestrians on any limited access highway. In some cases the fieldtrip feature on the highway can be viewed from other ground. Anyone planning to go on one of these fieldtrips should check carefully the suggested stops.

Joe Webb Peoples, Director
State of Connecticut
Geological and Natural
History Survey

Errata

- p. iv Trip Leaders and Authors. John Ostrom, Department of Geology and Geophysics, Yale University, was omitted from the list.
- p. vi Table of Contents. The leaders of Trip D-5 are Robert M. Gates, Robert M. Cassie and Charles W. Martin.
- Section D-6 The captions for the figures on pages 2 and 7 should be exchanged.

NEW ENGLAND INTERCOLLEGIATE GEOLOGICAL CONFERENCE

60th Annual Meeting

at Yale University, New Haven, Connecticut 25, 26, 27 October 1968

Guidebook for Fieldtrips in Connecticut

Philip M. Orville, Editor

Trip Leaders and Authors

Harold M. Bannerman, Connecticut Geological and Natural History Survey,
Middletown, Conn.

Robert A. Berner, Department of Geology and Geophysics, Yale University,
New Haven, Conn.

Arthur L. Bloom, Department of Geological Science, Cornell University,
Ithaca, N.Y.

H. Robert Burger, Department of Geology and Geography, Smith College,
Northampton, Mass.

John B. Byrnes, Department of Geology and Geography, University of Conn.,
Storrs, Conn.; present address: Geology Department, University of
North Carolina, Chapel Hill, N.C.

Robert M. Cassie, Department of Geology, S.U.N.Y. College at Brockport,
Brockport, N.Y.

Jelle deBoer, Department of Geology, Wesleyan University, Middletown, Conn.

James Dieterich, Department of Geology and Geophysics, Yale University,
New Haven, Conn.; present address: Office of Earthquake and Crustal
Studies, U.S.G.S., Menlo Park, California.

H. Roberta Dixon, New England Branch, U.S.G.S., Boston, Mass.

Gordon P. Eaton, Geophysics Branch, U.S.G.S., Denver, Colo.

Robert M. Gates, Department of Geology, University of Wisconsin, Madison, Wis.

Richard Goldsmith, New England Branch, U.S.G.S., Boston, Mass.

Leo M. Hall, Department of Geology, University of Massachusetts, Amherst, Mass.

David B. Hewitt, Department of Geology and Geophysics, Yale University,
New Haven, Conn.

George deVries Klein, Department of Geology, University of Pennsylvania,
Philadelphia, Penna.

Lawrence Lundgren Jr., Department of Geological Sciences, University of Rochester, Rochester; N.Y.

Charles W. Martin, Department of Geology, Earlham College, Richmond, Indiana.

M. H. Pease, Jr., New England Branch, U.S.G.S., Boston, Mass.

Joe W. Peoples, Department of Geology, Wesleyan University and Connecticut Geological and Natural History Survey, Middletown, Conn.

John D. Peper, New England Branch, U.S.G.S., Boston, Mass.

Fred Pessl, New England Branch, U.S.G.S., Boston, Mass.

Sidney S. Quarrier, Connecticut Geological and Natural History Survey, Middletown, Conn.

Robert B. Ryder, Water Resources Branch, U.S.G.S., Hartford, Conn.

Donald Rhoads, Department of Geology and Geophysics, Yale University, New Haven, Conn.

John Rodgers, Department of Geology and Geophysics, Yale University, New Haven, Conn.

John E. Sanders, Hudson Laboratories, Dobbs Ferry, N.Y.

John P. Schafer, New England Branch, U.S.G.S., Boston, Mass.

Richard Schooner, Woodstock, Conn.

Harry L. Siebert, Connecticut Highway Department, Wethersfield, Conn.

Rolfe S. Stanley, Department of Geology, University of Vermont, Burlington, Vt

C. E. Thomas, Jr., Water Resources Branch, U.S.G.S., Hartford, Conn.

Rosemarie J. Vidale, Department of Geology and Geophysics, Yale University, New Haven, Conn.; present address: S.U.N.Y. at Binghamton, Binghamton, N.Y.

W. E. Wilson, Water Resources Branch, U.S.G.S., Hartford, Conn.

Dabney W. Caldwell
Secretary, N.E.I.G.C.

Joe W. Peoples
Director, Connecticut Geological and Natural History Survey

Brian J. Skinner
Chairman, Department of Geology and Geophysics, Yale University

TABLE OF CONTENTS

	<u>Section</u>	<u>Pages</u>
Editor's Preface		iix-ix
<u>A Brief History of Geology in Connecticut;</u> Joe Webb Peoples.		x-xv
Trip A-1 <u>Postglacial Geology of the</u> <u>Connecticut Shoreline;</u> Arthur L. Bloom.	A-1	1-9
Trip B-1 <u>Two-till Problem in Naugatuck-</u> <u>Torrington Area, Western Connecticut;</u> Fred Pessl, Jr., and J. P. Schafer.	B-1	1-25
Trip B-2 <u>Periglacial Features and Pre-</u> <u>Wisconsin Weathered Rock in the Oxford-</u> <u>Waterbury-Thomaston Area, Western</u> <u>Connecticut;</u> J. P. Schafer.	B-2	1-5
Trip B-3 <u>Hydrogeology of Southwestern</u> <u>Connecticut;</u> W. E. Wilson, R. B. Ryder, and C. E. Thomas, Jr.	B-3	1-33
Trip B-4 <u>Engineering Geology as Applied</u> <u>to Highway Construction;</u> Harry L. Siebert.	B-4	1-8
<u>Introduction to the Triassic Rocks of</u> <u>Connecticut;</u> John Rodgers.	C-0	1-2
Trip C-1 <u>Sedimentology of Triassic Rocks</u> <u>in the Lower Connecticut Valley;</u> George deVries Klein.	B-4	1-19
Trip C-2 <u>General Geology of the Triassic</u> <u>Rocks of Central and Southern Connecticut;</u> John Rodgers.	C-2	1-9
Trip C-3 <u>Geology of Dinosaur Park, Rocky</u> <u>Hill, Connecticut:</u> Introduction, Sidney S. Quarrier; The Rocky Hill Dinosaurs, John H. Ostrom. (Additional material on the geology of this area is being prepared by John Byrnes and Larry Frankel and will be available at the NEIGC meeting in New Haven.)	C-3	1-12

	<u>Section</u>	<u>Pages</u>
<u>Summary of Trip C-4 Stratigraphy and Structure of the Triassic Strata of the Gaillard Graben, South-Central Connecticut;</u> J. E. Sanders. (Complete text will be available at the NEIGC Meeting in New Haven.)	C-4	1
<u>Trip C-5 Late Triassic Volcanism in the Connecticut Valley and Related Structure;</u> Jelle deBoer. (Not given as a separate trip, but all stops are included as part of Trip C-2.)	C-5	1-12
<u>Bedrock Geology of Western Connecticut;</u> Rolfe S. Stanley.	D-0	1-5
<u>Trip D-1 Progressive Metamorphism of Pelitic, Carbonate, and Basic Rocks in South-Central Connecticut;</u> H. Robert Burger and David A. Hewitt with a supplementary stop description by Rosemary J. Vidale.	D-1	1-19
<u>Trip D-2 Multiple Folding in Western Connecticut: A Reinterpretation of Structure in the Naugatuck-New Haven-Westport Area;</u> James Dieterich.	D-2	1-13
<u>Trip D-4 Metamorphic Geology of the Collinsville Area;</u> Rolfe Stanley.	D-4	1-17
<u>Trip D-5 The Bedrock Geology of the Waterbury and Thomaston Quadrangles;</u> Robert M. Cassie and Charles W. Martin.	D-5	1-12
<u>Trip D-6 Geology of the Glenville Area, Southwesternmost Connecticut and Southeastern New York;</u> Leo M. Hall.	D-6	1-12
<u>Trip E-1 Animal-Sediment Relationships and Early Sediment Diagenesis in Long Island Sound;</u> Donald C. Rhoads and Robert A. Berner.	E-1	1-11
<u>Bedrock Geology of Eastern Connecticut;</u> Richard Goldsmith and H. R. Dixon.	F-0	1-9

	<u>Section</u>	<u>Pages</u>
Trip F-1 <u>The Honey Hill and Lake Char Faults; Lawrence W. Lundgren, Jr.</u>	F-1	1-8
<u>Summary of Trip F-3 Stratigraphy and Structure of the Metamorphic Rocks of the Stony Creek Antiform (A "Folded Fold") and Related Structural Features, Southwestern Side of the Killingworth Dome; J. E. Sanders (Complete text will be available at the NEIGC Meeting in New Haven.)</u>	F-3	1
Trip F-4 <u>A Structural and Stratigraphic Cross-Section Traverse across Eastern Connecticut; Roberta Dixon, Gordon Eaton, and Lawrence Lundgren, Jr.</u>	F-4	1-23
Trip F-5 <u>The Brimfield(?) and Paxton(?) Formations in Northeastern Connecticut; M. H. Pease, Jr., and John D. Peper.</u>	F-5	1-18
Trip F-6 <u>Mineral Deposits of the Central Connecticut Pegmatite District; Harold M. Bannermann, Sid Quarrier, and Richard Schooner.</u>	F-6	1-7

EDITOR'S PREFACE

This Guidebook has been published as a cooperative effort by the Connecticut Geological and Natural History Survey and the New England Intercollegiate Geological Conference. Initial distribution will be made to those attending the 60th Annual Meeting of the N.E.I.G.C., at Yale University, New Haven, Connecticut, October 25-27, 1968. Copies will thereafter be available from the State Librarian at Hartford where it may be ordered as Guidebook No. 2 of the Connecticut Guidebook Series. I am grateful to Joe W. Peoples for both the original suggestion and for his aid in carrying through to the final printed volume. Sidney Quarrier and Louise Henney of the Connecticut Survey and Barbara Narendra of Yale University have contributed valuable editorial assistance for which I am deeply appreciative. John Rodgers has been a continuing source of advice and encouragement.

An effort has been made to provide a sufficient number and variety of field trips that everyone can find several trips in which he can be an active and understanding participant. Twenty different trips are being given -- of these, 8 will be given both Saturday and Sunday. It should be possible to run all but 2 or 3 of the Saturday trips with a single bus (40-50 people).

The variety and type of trips offered is, I think, ample testimony to the large number of worthwhile and exciting geological investigations that have been carried on in Connecticut in recent years and that are continuing at the present time. The present and past affiliations of the guidebook authors and trip leaders listed on the credits page indicate the variety of organizations supporting geological work in Connecticut. I am delighted that a large proportion of the people who are presently or recently involved in active work in Connecticut are represented.

The organization of the Guidebook is self-evident; field trips are grouped according to subject or area and several groups of trips (C, geology in the Triassic valley; D, bedrock geology in Western Connecticut; F, bedrock geology in Eastern Connecticut) are introduced by a review of the geology of the area.

Use of the Connecticut Coordinate System

All stop locations have been given both in terms of geographical or cultural features and the Connecticut coordinate system. The Connecticut coordinate system uses a reference point located to the south and west of the state. All 7½ minute topographic quadrangle maps and most geologic quadrangle maps have guide marks on the margin at 10,000 foot and 1000 meter intervals (black tickmarks indicate

10,000 foot grid, blue tickmarks indicate 1000 meter grid). Any point in the state can be located in feet north and east of the reference point. Interpolation between grid marks for 1/24,000 scale maps is easily done using an ordinary ruler because 5 inches = 10,000 feet. In order to facilitate use and recording, the decimal point in the coordinate numbers has been moved four places to the left, so that a point with the coordinates 288,200 feet NORTH, and 603,300 feet EAST, would be recorded as 28.82 N - 60.33 E.

In the guidebook, the coordinate location is given in parenthesis following the stop number. The complete stop location includes the quadrangle name and the location relative to geographical or cultural features. Thus the above location would read:

Stop 1 (28.82 N - 60.33 E) Middletown quadrangle. Roadcut on Route 72; 0.2 miles east of intersection of Routes 5 and 72.

A BRIEF HISTORY OF GEOLOGY IN CONNECTICUT

by

Joe Webb Peoples

Those who attend the 60th Annual Meeting of the New England Inter-collegiate Geological Conference under the sponsorship of Yale University will have an opportunity to see some of the current geological work in progress in Connecticut. It seems appropriate to give here a brief history of geological work in the state.

State Survey of Percival, 1835-1842

Some thirty years after college training in geology was initiated in the United States by the appointment of Benjamin Silliman as Professor of Chemistry and Natural History at Yale, James G. Percival was appointed State Geologist to make a geological survey of the state. Prof. C. U. Shepard was appointed at the same time to report on the mineralogy of the state. His report was published in 1837 but Percival's very detailed work took longer and his report and geologic map were not published until 1842. Percival's map was a remarkable piece of work which has won the respect of all geologists who have mapped any part of Connecticut in detail.

Period 1842 to 1879

After Percival's work there was a long period of little systematic mapping. The American Journal of Science published papers on the drift, on stratigraphy and also descriptions of new minerals from the pegmatites of the state, but it was not a period of great progress in understanding the basic geology. During this period the dinosaur tracks found in the Connecticut Valley were much discussed.

Work of the U. S. Geological Survey 1879-1903

A few years after the formation of the U. S. Geological Survey in 1879, field work began in Connecticut. Professor W. M. Davis directed the work on the Triassic from 1885 to 1893 and was assisted by H. B. Kimmel, W. N. Rice, L. S. Griswold, E. O. Hovey, S. W. Loper et al. W. H. Hobbs mapped most of the Western Highlands, H. E. Gregory and others mapped the Eastern Highlands, N. S. Shaler and others mapped the glacial geology, and Gregory and Ellis studied the underground waters. Unfortunately most of this work of the U.S.G.S. was not published at the time. There were notable exceptions, e.g. papers by Davis (1898), Hobbs (1901), Gregory (1901 and 1905). However, a good portion of the U.S.G.S. material was used later by Rice and Gregory (1906).

Connecticut Geological and Natural History Survey 1903-1968

The Geological and Natural History Survey was authorized by the General Assembly June 3, 1903. The law establishing the Survey stated three aims: "first, the advancement of our knowledge of the geology, botany, and zoology of the state as a matter of pure science; second, the acquisition and publication of such knowledge of the resources and products of the state as will serve its industrial and economic interests; third, the presentation of the results of investigations in such form as to be useful in the educational work carried on in the various schools of the state." (Rice, 1904)

In view of the small appropriations and the lack of a full time employee until 1967, the Survey has had a surprising record of accomplishment. Some of the notable geological publications are:

Bulletin 6, Manual of the Geology of Connecticut by William North Rice and Herbert Ernest Gregory, 1906.

Bulletin 7, Preliminary Geological Map of Connecticut by Herbert Ernest Gregory and Henry Hollister Robinson, 1907.

The manual and the map brought together much previously unpublished work and represent the only general summary of the geology of the state and the only full color geologic map of the state so far published.

Bulletin 23, Central Connecticut in the Geologic Past by Joseph Barrell, 1915.

Bulletin 24, Triassic Life of the Connecticut Valley by Richard Swann Lull, 1915.

Bulletin 47, The Glacial Geology of Connecticut by Richard Foster Flint, 1929.

This report contained a map of the glacial geology of the state on a scale of 1:125,000.

Bulletin 51, The Minerals of Connecticut by John Frank Schairer, 1931.

All of the above reports are now out of print.

Unfortunately funds for publication were inadequate for a number of years and two reports were published nearly 15 years after the original manuscripts were prepared. These are:

Bulletin 73, Petrology, Stratigraphy, and Origin of the Triassic Sedimentary Rocks of Connecticut by Paul D. Krynine, 1950.

Bulletin 74, The geology of Eastern Connecticut by Wilbur G. Foye, 1949. (Professor Foye died in 1935 and his manuscript was edited by Prof. Knopf.)

Geologic Mapping

The conference held at Yale on May 8, 1948 was a turning point in the history of geological work in Connecticut. This meeting, arranged by the Commissioners of the Survey, was attended by a good cross section of the geologists of the state and others interested in the geological program of the Survey. Those present were emphatic in urging quadrangle mapping of both the bedrock and surficial geology of the state and of prompt publication of the geological reports. The Commissioners sought to implement this recommendation. R. M. Gates of the University of Wisconsin began field work on the bedrock geology of the Litchfield quadrangle in 1949 and his report with map was published in 1951. The New Preston bedrock map was published in 1952 but it was apparent from the beginning that the state could not be mapped in a reasonable time with part time personnel, and arrangements were made for a cooperative program with the U. S. Geological Survey. This work started in the fiscal year beginning July 1, 1955. Since then mapping has accelerated both by part time personnel working for the Connecticut Survey and U.S.G.S. personnel under the cooperative agreement. Also the surficial geology of some quadrangles has been mapped by U.S.G.S. geologists working with the Connecticut Water Resources Commission and some quadrangles have been mapped as theses at the universities. To July 1, 1968 the Connecticut Geological and Natural History Survey had published 24 quadrangle reports, the U.S.G.S. had published 47 geologic quadrangles and one bulletin. (See published quadrangles on index map, figure 1).

The quadrangle mapping has been a stimulus to geologic research directed to Connecticut problems by university geologists and others. This has been true not only at the University of Connecticut, Wesleyan, and Yale but Drs. Gates of Wisconsin, Martin of Earlham, and Lundgren of Rochester have brought students to Connecticut to work on special problems. Students from the University of Massachusetts, Columbia, and Cincinnati have done thesis projects in Connecticut. Dr. Brookins of Kansas State has continued the geochronologic work he started at M.I.T.

A number of field trips are being conducted by U.S.G.S. geologists or university geologists who have mapped or are mapping quadrangles in the above mapping program.

Geologic mapping combined with aeromagnetic maps, gravity studies, and geochronologic analyses promise to add much to the understanding of Connecticut geology in the next few years.

In 1955 a provisional geologic map of the state was published as a stimulus to more mapping and the preparation of a more detailed map.

In 1967 a new topographic base on the scale of 1:125,000 was published by the U.S.G.S. in cooperation with the State Survey. Both a bedrock map and a surficial map on this scale are planned. Dr. Rodgers will compile the bedrock map and Dr. Flint the surficial map.

Geochronology

When Boltwood in 1907 followed Lord Rutherford's suggestion that the uranium radioactive series might be useful in dating minerals, he found that Hillebrand of the U.S.G.S. had made more dependable analyses of uraninite than anyone and that many of the specimens were from Connecticut. Thus it was that some of the pegmatites of Connecticut were among the first to be given ages by this new method. As recently as 1957 Kulp cited the Middletown area as one of the five areas in the world where the rocks were dated to within 5% in years. Unfortunately the rocks of Connecticut are not well dated geologically. There are few fossils except the dinosaur tracks in the central lowland. The unraveling of the stratigraphy of the metasedimentary and metavolcanic rocks with limited criteria for determining tops and bottoms of beds is a slow and tedious job. The recent radiometric studies by Brookins of Kansas State, Zartman of U.S.G.S., George Clark of Columbia, Armstrong and his students at Yale are all helpful and promise to be of even greater help in the future as they are combined with field mapping. Another promising tool is paleomagnetism as demonstrated in a recent paper by deBoer (1968).

Water Resources

Between 1911 and 1917 the Geological and Natural History Survey had a cooperative agreement with the U. S. Geological Survey and a number of water supply papers were published. In the post war period the U.S.G.S. has had a cooperative program with the Water Resources Commission. Several water supply papers have been published and more recently the state has published inventory studies of water in two basins under the ten year inventory program. Also U.S.G.S. geologists have prepared as a by product of this program several surficial quadrangle maps. Field trip B-3 presents some of the work done under this program.

For the last several years the Highway Department has had two geologists on its staff. Mr. Siebert on Field Trip B-4 will present some of the engineering geology problems of the state.

REFERENCES

- Davis, W. M., 1898, The Triassic formation of Connecticut: U. S. Geol. Survey, 18th Ann. Rept., pt. 2, p. 9-192.
- deBoer, Jelle, 1968, Paleomagnetic differentiation and correlation of the late Triassic volcanic rocks in the central Appalachians (with special reference to the Connecticut Valley): G.S.A. Bull., v. 79, p. 609-626.
- Gregory, H. E., 1904, Connecticut (Well and Spring Records): U. S. Geol. Survey, Water-Supply Paper no. 103, p. 127-159.
- _____, 1905, Underground Waters of Eastern United States, Connecticut: U. S. Geol. Survey, Water-Supply Paper no. 114, p. 76-81.
- Hobbs, W. H., 1901, The Newark system of the Pomperaug Valley: U. S. Geol. Survey, 21st Ann. Rept., pt. 3, p. 7-160.
- Percival, J. G., 1842, Report on the geology of the state of Connecticut: New Haven, Osborn and Baldwin, 495 p.
- Rice, W. N., 1904, First biennial report of the commissioners of the State Geological and Natural History Survey: Conn. Geol. Nat. History Survey Bull. no. 1.



Trip A-1

Postglacial Stratigraphy and Morphology of Central Connecticut

by

Arthur L. Bloom

This fieldtrip guide is a reprinting of the first six pages of Guidebook No. 1 of the Connecticut Geological and Natural History Survey by Arthur L. Bloom and Charles W. Ellis, Jr.

PALUDAL STRATIGRAPHY AND MORPHOLOGY

Introduction

There were before human intervention an estimated 43 sq. mi. of tidal marsh along the 98-mi. straight-line length of the Connecticut coast. In the last decades B.P. (before physics) some work had been done on the paludal stratigraphy and morphology, but no regional study had been attempted. Brown (1930) described a section in a now-flooded clay pit near North Haven and discussed its significance. Knight (1934) described a small marsh in Branford that "revealed a section preserving the hitherto unrecorded early stages of a New England salt marsh developed in accordance with Shaler's classic theory, coupled with later stages developed in accordance with the theory first proposed by Mudge and later repropounded and elaborated by Davis."

In 1960, encouraged by preliminary work and the reports of Brown and Knight, a systematic study of the Connecticut coastal marshes was begun by Bloom. The initial goal was to collect sufficient samples for radiocarbon dating so that the age and rate of postglacial submergence could be determined. Field work was supported in part during 1960 by the Connecticut Geological and Natural History Survey, and since 1960 by the Office of Naval Research, Project NR 388-065. Since the initial goal was achieved (Bloom and Stuiver, 1963) the project has been modified to include research on sedimentation rates and shoreline erosion of the coastal marshes.

Consideration of the relationship between sedimentation and submergence pervades the interpretation of the Connecticut coastal marsh environment. Three significant paludal environments can be distinguished, wherein the interaction of the two variables has produced three distinct stratigraphic records.

(a) *The estuarine "fresh-water" marsh.* Where a sufficiently large river enters an estuarine marsh, the fall and rise of the tide causes alternate accelerated stream flow and slack water. The salinity is low, but the nutrient content of the water is apparently high. A dense growth of *Typha* (cattail), *Phragmites* (reed), and *Scirpus* (bulrush), commonly more than 6 ft tall, characterizes this environment. Harshberger (in Nichols, 1920, p. 540) likened these marshes to the British "fens." Production and accumulation

of organic debris has kept pace with submergence, and a thick layer of sedge peat has been built up to the local high-tide level in the marsh.

(b) *The former deep (9-50 ft) bay or lagoon.* During rapid submergence, until about 3,000 years ago, the sea transgressed into coastal valleys and produced bays or lagoons. In an environment of generally low wave energy and low sediment supply, early submergence exceeded the rate of sedimentation, and open water of near-normal salinity persisted in the embayments. However, during the last 3,000 years submergence has been slow enough to be equaled by the sedimentation rate, and salt marshes have filled former bays and lagoons. A typical stratigraphic section of these salt marshes is composed of a veneer of muddy salt-marsh peat, 9 ft or less in thickness, overlying a thick wedge of mud that has an open-bay fauna. Below the mud in many marshes there is a thin layer of sedge peat in sharp contact with the substratum. This peat represents the fringe of "fresh-water" rushes and reeds that grew at the transgressing shoreline.

(c) *The shallow (less than 9 ft) coastal marsh.* A coastal embayment less than 9 ft deep below present high-tide level was not affected by submergence prior to 3,000 years ago. Many of the shallow marshes are on submerged coastal lowlands, especially outwash plains, which continue their gentle seaward slope up to a mile beyond the high-water line. Many of these low-relief areas were marshy even before submergence raised the water table. The vegetation on these marshes is zoned landward from salt marsh through belts of progressively lower salinity tolerance to either normal upland vegetation or fresh-water marsh. The stratigraphy of a shallow marsh is similar to that of the upper 9 ft of a salt marsh in a former deep bay, except that lenses and tongues of sedge peat complexly alternate with salt-marsh peat. The alternations reflect shifts of vegetation belts across the marsh as seasons of abnormal high tides or excessive fresh-water runoff displaced the zone of salt marsh respectively landward or seaward. Deeper parts of the marsh apparently represent former topographic basins that filled with sedge peat as a result of the rising ground-water table prior to marine inundation. A normal upland soil profile on glacial drift commonly underlies a shallow coastal marsh.

Three marshes (fig. 1) have been chosen to represent the three paludal environments outlined.

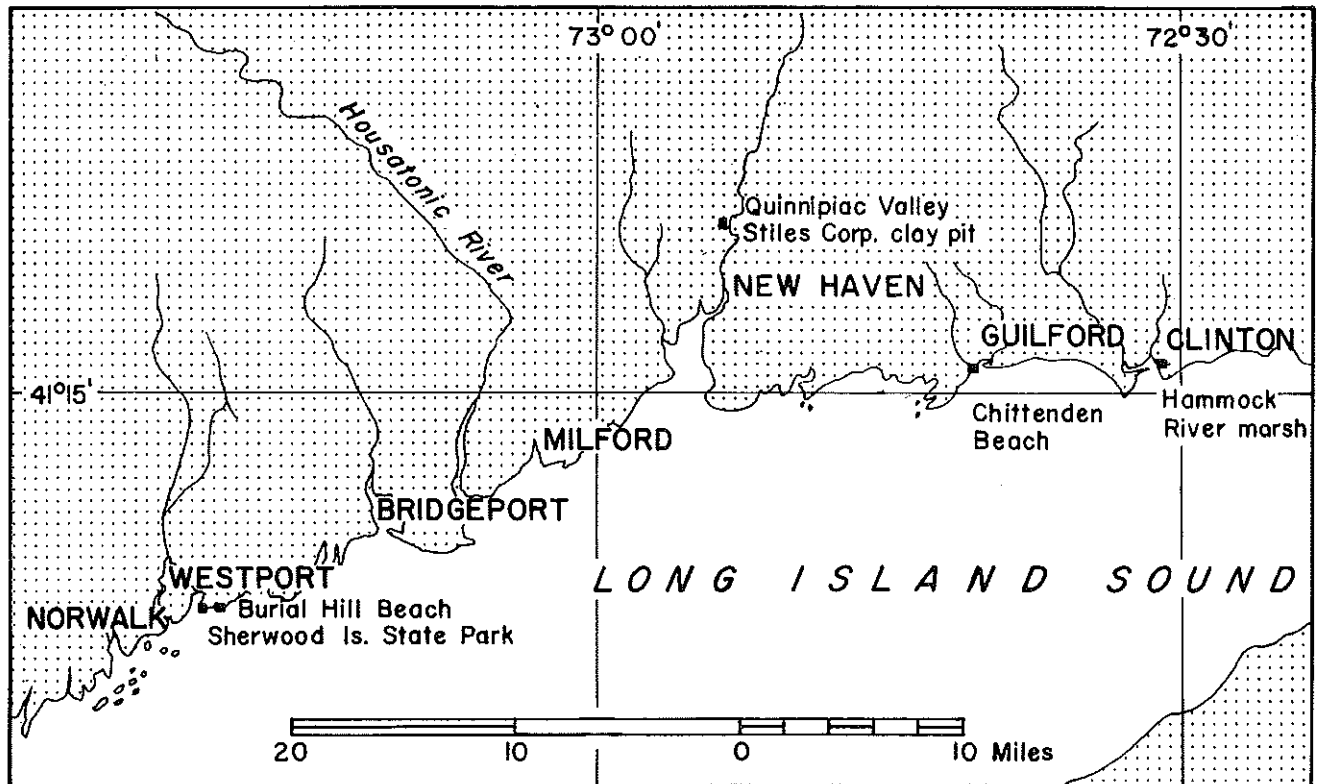

Fig. 1. Index map of the central Connecticut coast

Quinnipiac Valley, Hamden — an estuarine "fresh-water" marsh

Excellent exposures of late-glacial and postglacial deposits have been available for many years in the brickyard clay pits of the Quinnipiac Valley, near New Haven. The section described by Brown (1930, p. 263-266) was obtained from a now-flooded pit north of the Stiles Corporation brickyard. However, a similar section (fig. 2) is currently exposed in the pit south of the brickyard.

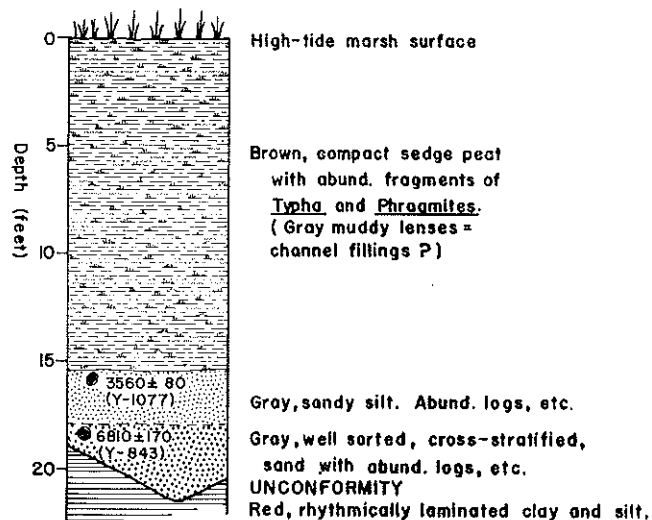

Fig. 2. Generalized stratigraphy of the Stiles Corporation clay pit, Hamden, Connecticut

The postglacial stratigraphy of the Quinnipiac Valley begins at the erosional unconformity between underlying glacial deposits and overlying alluvium. An episode of stream erosion to a lower-than-present base level followed deposition of the late-glacial lacustrine New Haven Clay. Erosion was followed or accompanied by fluvial deposition of cross-stratified sand and gravel. In other parts of the Quinnipiac Valley yellowish-gray outwash unconformably overlies the channeled upper surface of the New Haven Clay (Porter, 1960, p. 18). The alluvium in the Stiles clay pit is not outwash, as is evidenced by (1) the arkosic composition of the alluvium, (2) the dominantly hardwood composition of the enclosed logs and leaf mats, and (3) a radiocarbon age of 6810 ± 170 years B.P. for a log from the alluvium (Y-843). Postglacial erosion in the southern end of the Quinnipiac Valley apparently not only removed the outwash that formed the final glacial deposit of the valley, but cut into the underlying reddish, arkose-derived ice-contact stratified drift and lacustrine clay and silt. This unconformity represents a hiatus of approximately 6,000-7,000 years prior to 6800 B.P.

The basal alluvium of the postglacial section exposed in the Stiles Corporation clay pit grades upward into gray sandy silt of questionable origin. The silt represents the loss of former stream transporting power. It is a slack-water deposit but whether it is a fresh-, brackish-, or salt-water deposit has not been determined. Foraminifera or sponge spicules are not present. The silt contains abundant logs, twigs, nuts, and leaf trash of species similar to those preserved in the underlying alluvium. A log from the top of the silt was radiocarbon dated at 3560 ± 80 years B.P. (Y-1077).

Brown sedge peat, 12 to 17 ft thick and similar to that which is presently accumulating on the marsh surface, immediately overlies the silt. The nature of the contact indicates an abrupt change in the depositional environment from the time of silt accumulation to the time of peat accumulation, although no erosional unconformity is apparent. Old reports (Davis, 1913, p. 700; Brown, 1930, p. 265) described a "forest soil" and tree stumps rooted in place beneath the peat of the Quinnipiac Valley, but no recent observers have verified these reports. At the Stiles Corporation clay pit, the transition from silt deposition to peat accumulation represents only a change in depositional environment without an interval of weathering and soil formation. This change took place shortly after 3560 B.P. Since then, the Quinnipiac Valley has had its present appearance, with a cattail, sedge, and reed marsh growing to high-tide level in an estuarine environment of low salinity. Salt-marsh grasses do not now enter the valley in significant quantity north of the railroad yards, 2 mi. south of the clay pit.

Depth measurements on the pit face are subject to error because of compaction of the clay-pit wall by an overlying earth dike. Figure 3 shows a section through the south face of the Stiles Corporation clay pit on June 16, 1962, shortly after the earth dike had been moved back for a new cut in the pit. A shallow sag pond parallel to the outer edge of the dike and tension cracks on the inner slope indicated that compaction was in progress. The peat at boring 1 had been compressed from an original thickness of 15.7 ft to 13 ft, or to about 83 percent of its original thickness. That much compaction was accomplished by earth fill about 12 ft deep on the boring site for an estimated 2 months. At the pit face, where the dike is believed to have lain through the preceding winter, the compaction was to about 63 percent of original peat thickness. To further complicate depth

measurements, some "heave" or relaxation at the site of boring 1 seemed to have resulted from the removal of the dike. Vertical faults in the New Haven Clay, parallel to the pit face and upthrown on the pit side, suggested that both compression under the load of the dike and subsequent relaxation also may take place in the underlying silt-clay rhythmites. Thus, the depths of radiocarbon-dated samples from the clay pit are not considered as reliable as those of samples collected by coring undisturbed marshes.

Hammock River Marsh, Clinton — a former deep bay or lagoon

The Hammock River marsh in Clinton (fig. 4) has the appearance and stratigraphy typical of many Connecticut salt marshes. The surface is a thick mat of short, wiry salt-marsh grasses, especially *Spartina patens*. Along the banks of channels, the taller salt thatch, *S. alterniflora*, grows. Whereas *Spartina patens* can tolerate only a brief wetting by salt water at normal high tide, *S. alterniflora* can tolerate submergence of its roots for 5 to 16 hours daily. The combined effect of these two plants and similar species has been to build and maintain the marsh surface very close to the local mean high-water level.

(A tidal gate installed under the Hammock River bridge of Route 145 now inhibits the inflow of salt water to the northeastern part of this marsh, and reeds, shrubs, and weeds are rapidly destroying the smooth beauty of the salt meadow. The southwestern arm of the salt marsh is flooded by high tides through a drainage ditch extending through Hammock Point Beach to the southwest, and has not yet degenerated.)

Prior to submergence, the Hammock River probably flowed west on a flood plain about 38 ft below the present marsh surface. A tributary valley sloped northeast toward

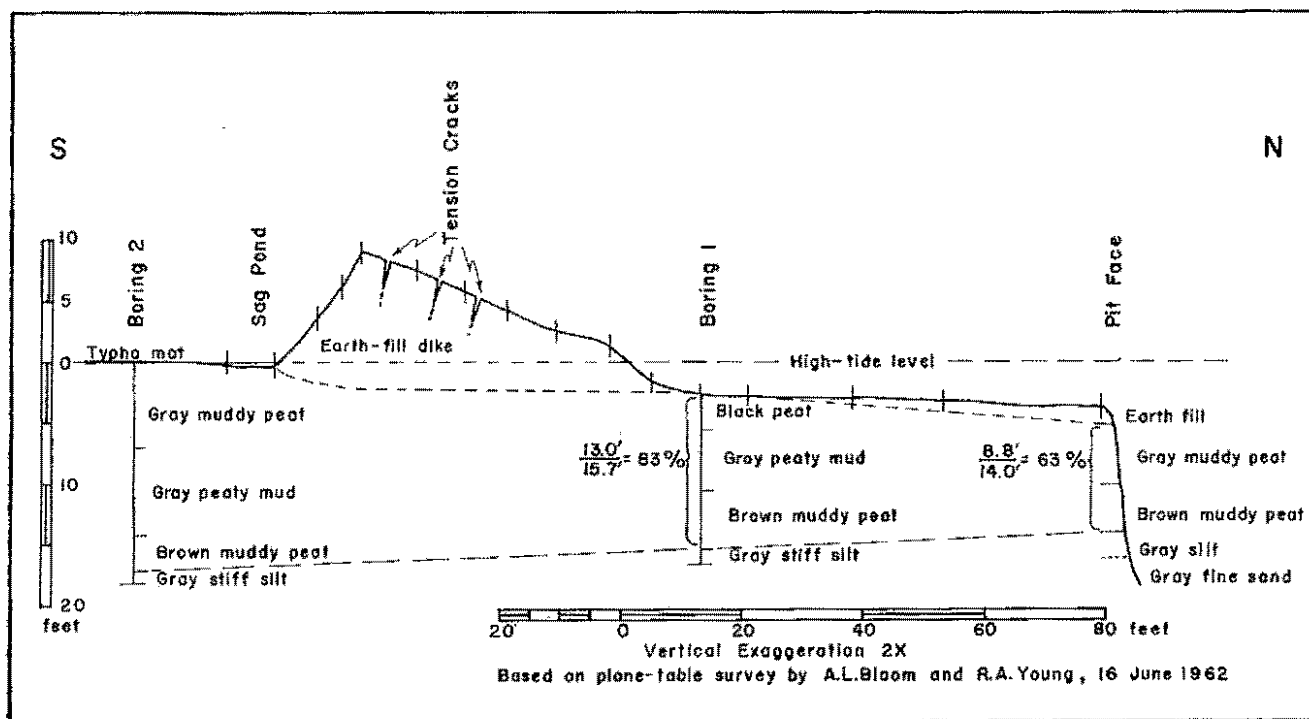

Fig. 3. Section through south face of Stiles Corporation clay pit, Hamden, Connecticut

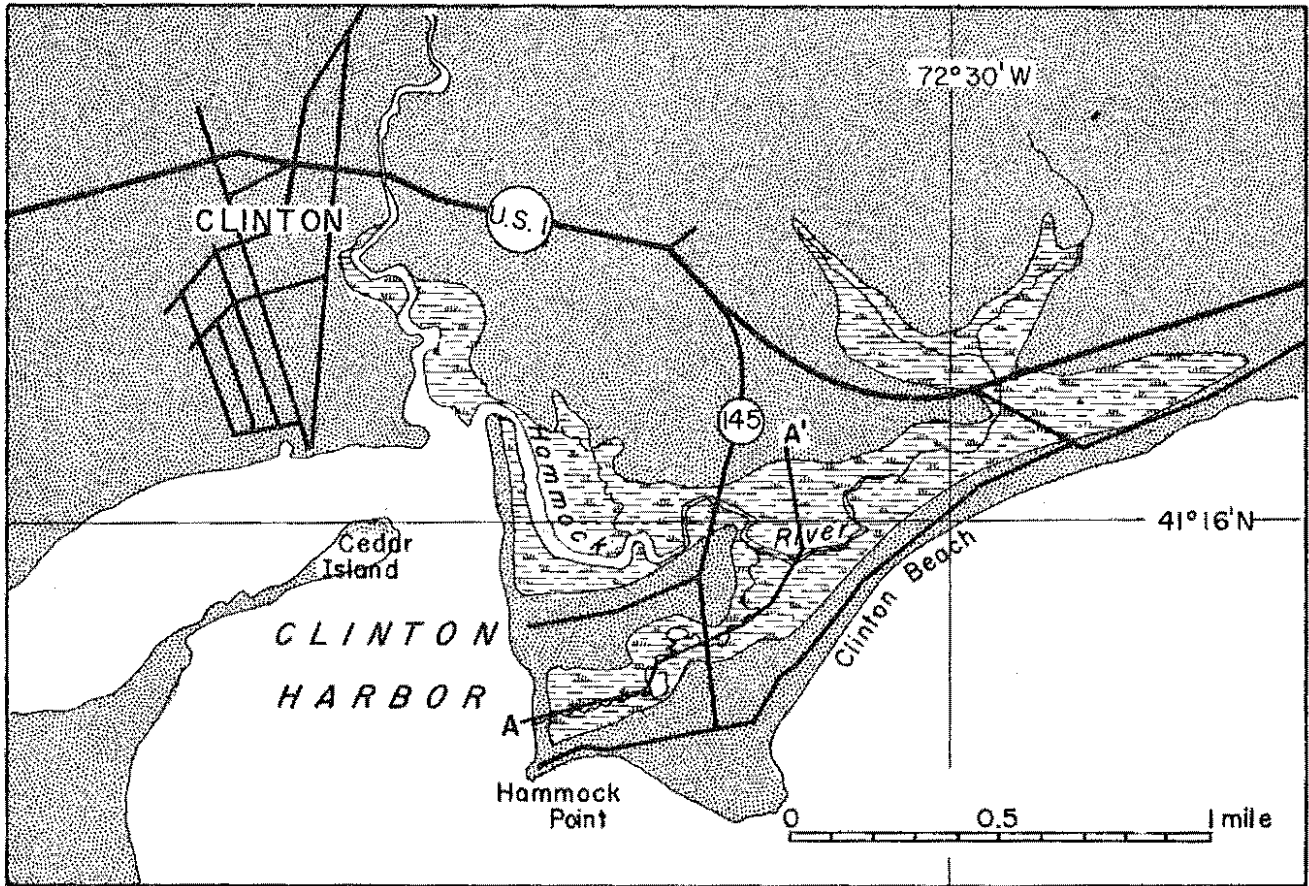

Fig. 4. Hammock River marsh and vicinity, Clinton, Connecticut

the river along line of section A-A' (fig. 4). Figure 5 shows the stratigraphy of section A-A'. The base of the section is the sand and gravel of the former valley floor, which had a northeastward gradient of about one percent.

As the sea transgressed eastward into the Hammock River valley, then southwestward into the tributary valley along the line of section, the shoreline was fringed by rushes and sedges. The basal unit of the stratigraphic section is a layer of sedge peat that accumulated at the transgressing high-tide

shoreline. The sedge peat is overlain by mud of a shallow open-bay environment. The mud contains an abundant shallow-water, muddy-bottom fauna of snails, clams, and Foraminifera. Frances L. Parker (1962, personal communication) reported the following notes on the Foraminifera of boring 15 of the section:

The upper 8 samples (8 ft.) contain a marsh fauna, either tidal marsh or shallow marsh pools. With sample 8, a rather meager bay fauna appears. I would guess that the

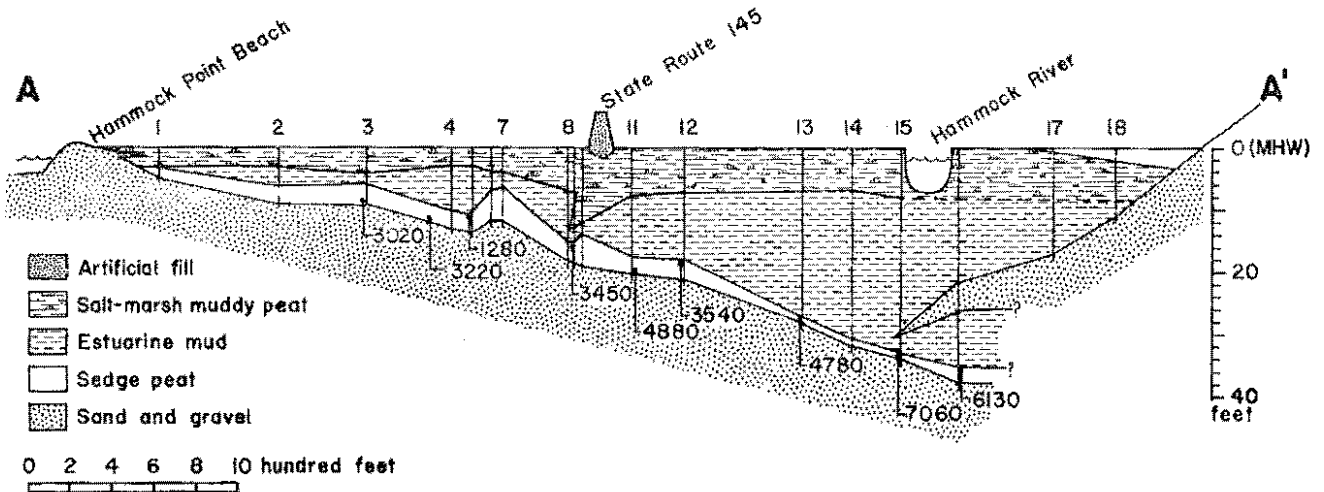

Fig. 5. Cross section of the Hammock River tidal marsh, Clinton, Connecticut

water was probably shallow and conditions not too good for the Foraminifera. In one or two samples, there was evidence of solution of the CaCO_3 tests. The bay fauna is best developed at about samples 12-17. By bay, I don't mean a nice big open bay but rather some kind of semi-enclosed bay, probably with salinities somewhat lower than truly marine ones.

Sedimentation in the Hammock River estuary or lagoon (the nature of the embayment and the distribution of former barriers has not been determined) did not keep pace with submergence prior to 3,000 years ago, and open-water conditions persisted. However, when the rate of submergence decreased about 3,000 years ago, mudflats built up to the mid-tide level and were populated by *Spartina alterniflora*. The mid-tide marsh that developed was an efficient sediment trap, and in a short time the marsh surface had been built to high-tide level, where *S. patens* and related species became established. The lower third of the "salt-marsh muddy peat" of figure 5 consists of strawlike *S. alterniflora* fragments in mud, whereas the upper two-thirds consists of the fibrous roots of *S. patens* and similar high-tide species. Submergence of about 9 ft during the 3,000 years of marsh formation produced the thick section of peat derived from plants that live in a narrow vertical range near high tide (the "Mudge-Davis" type of salt marsh).

The positions and radiocarbon ages of peat samples from the Hammock River marsh are shown in figure 5. Table 1 is a list of radiocarbon-dated samples from coastal Connecticut (after Bloom and Stuiver, 1963, p. 333). The dates are plotted against sample depth in figure 6 (Bloom and Stuiver, 1963, p. 333) and a curve is drawn through the samples whose depths have not been affected by compaction. The most reliable samples used in preparing the submergence curve came from the base of the sedge peat in the Hammock River marsh, where a nearly ideal combination of permeable substratum and sloping valley floor per-

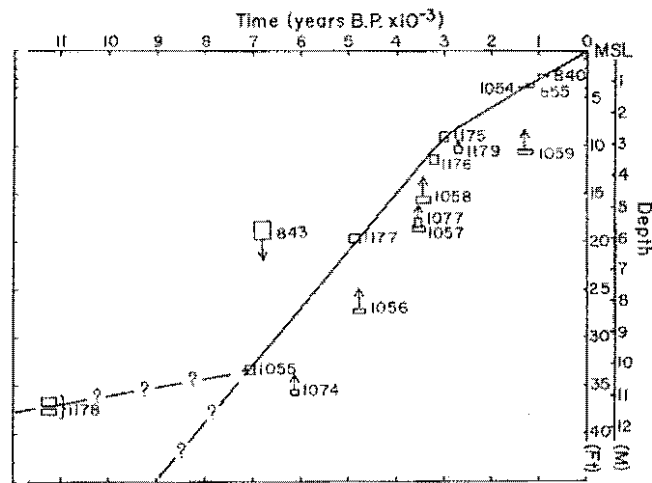

Fig. 6. Submergence of the Connecticut coast (Bloom and Stuiver, 1963). The line is the locus of a point now at mean sea level.

mitted the accumulation of sedge peat only very near the high-water shoreline of the transgressing sea. The depth of these samples below the present high-tide marsh surface in the same embayment is an accurate measure of the relative change of level since peat accumulation began. Samples collected from the top of the buried sedge-peat bed plot below the curve of submergence by an amount equal to the compaction of the peat. The displacement by compaction plus the present thickness of peat equals the original thickness, and the ratio of present to original thickness can be calculated. The sedge-peat bed beneath the Hammock River marsh has been compacted to between 13 and 44 percent of original thickness. Older and deeper samples (6,130 yrs. = 22 percent; 4,780 yrs. = 13 percent) show greater compaction.

Table 1. Radiocarbon-dated samples from coastal Connecticut¹

Laboratory No.	Locality	Sample	Depth (ft)	Age (years before present)
Y-840 ²	Branford	Cedar root	2.7 ± 0.2	910 ± 120
Y-843	North Haven	Log	18.5 ± 1.0	6,810 ± 170
Y-855 ²	Guilford	Oak log	3.8 ± 0.2	1,180 ± 80
Y-1054 ²	East Norwalk	Tree root	4.0 ± 0.2	1,400 ± 70
Y-1055 ²	Clinton	Peaty sand	33.3 ± 0.4	7,060 ± 100
Y-1056	Clinton	Sedge peat	27.2 ± 0.3	4,780 ± 130
Y-1057	Clinton	Sedge peat	18.6 ± 0.3	3,540 ± 130
Y-1058	Clinton	Sedge peat	15.6 ± 0.3	3,450 ± 160
Y-1059	Clinton	Sedge peat	10.7 ± 0.3	1,280 ± 150
Y-1074	Clinton	Sedge peat	35.7 ± 0.4	6,130 ± 90
Y-1077	North Haven	Log	18.0 ± 0.5	3,560 ± 80
Y-1175 ²	Clinton	Sedge peat	9.1 ± 0.6	3,020 ± 90
Y-1176 ²	Clinton	Sedge peat	11.4 ± 0.5	3,220 ± 90
Y-1177 ²	Clinton	Wood and bark	19.6 ± 0.5	4,880 ± 120
Y-1178 ²	Clinton	Sedge peat (combined)	36.6 ± 0.5	11,240 ± 160
Y-1179	Westport	Sedge peat	10.4 ± 0.4	2,710 ± 90

¹ Bloom and Stuiver, 1963, p. 333

² Samples whose depth range does not require correction because of compaction

Chittenden Beach, Guilford — a shallow coastal marsh

The small marsh at the back of Chittenden Beach formed on an outwash plain. The outwash appears to be thin, as numerous bedrock knobs protrude through it. The smooth profile offshore indicates that the outwash plain formerly extended at least a mile seaward of the present shoreline. Whether or not a barrier beach formerly protected the marsh has not been determined. The present beach is undernourished, and is little more than a fringe of sand and shells being "bulldozed" landward over the marsh by storm waves. The marsh in back of the eastern part of the beach is now only about half as wide as it was in 1960.

It is possible that the marsh formerly extended thousands of feet seaward, and at its outer edge a barrier beach extended from headland to headland. If so, the present marsh and beach remnants represent the final stage of landward retreat of a barrier beach across a filled lagoon. However, development of this marsh may not have been the result of a protecting barrier. Former glacial deposits, now submerged or eroded, may have provided protection for the early marsh. In that case, the present beach is only a reworked remnant of drift, rather than of a former barrier beach. As a third possibility, it may be that no more protection has ever been provided for this marsh than it now has. Erosional retreat of the marsh edge has been at the rate of 10 ft or more per year since 1960, and at least 2 to 3 ft per year during recent decades, according to local residents; however, these rates may not be typical of erosional retreat during the several thousand years of marsh history. The widespread destruction of eel-grass beds offshore in the early 1930s may have exposed this shoreline to more rapid erosion. Late spring storms of the past two years have been responsible in large part for the recent erosion, but their frequency in the past has not been investigated in this study. Furthermore, the submergence of the New York City tide gauge between 1893 and 1953 averaged 0.011 ft per year (Disney, 1955), about four times the average rate of submergence in Connecticut of 0.3 ft per century through the last 3,000 years. If submergence has accelerated in the past century, the effects would be most noticeable on exposed peat shorelines such as Chittenden Beach.

Some indications of a change in shoreline development at Chittenden Beach appeared in 1963. Formerly, the wave-cut intertidal peat cliff fronted on a barren tidal flat, but in 1963 a heavy growth of *Spartina alterniflora* covered much of the flat. If this vegetation persists, it may trap enough sediment from the river mouth and offshore to rebuild the marsh to high-tide level, leaving the present beach as a "chenier" across the marsh. Future years will determine the validity of this hypothesis.

The stratigraphy of Chittenden Beach marsh has been studied by coring, and is also exposed in the wave-cut cliff at low tide. The pollen profile of a 270 cm (9 ft) core from a site now beneath the beach was prepared by Sears (1963, p. 59). Figure 7 is reproduced from his report. The oxidized peat zone at the base of the section probably represents chemical activity by ground water from the underlying drift, but it could have paleoclimatic significance. The transition from underlying sedge peat to overlying salt-marsh peat was 95 cm (3.1 ft) below the marsh surface. The arboreal pollen content of the core shows a general shift upward from oak to pine and hemlock. Sears (1963,

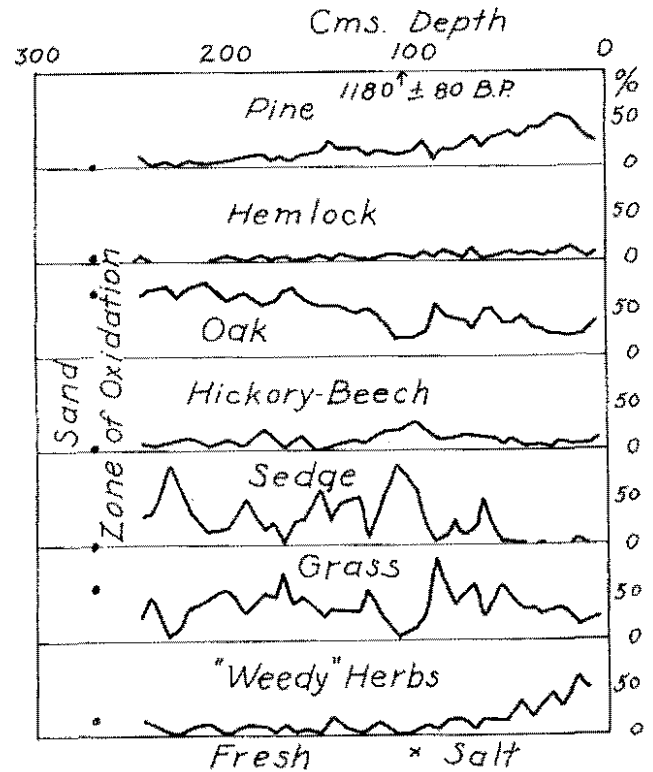

Fig. 7. Pollen diagram of important indicators in the Guilford, Connecticut, coastal marsh (Sears, 1963)

p. 59) interpreted this as a trend toward a cooler and moister climate during the time of marsh accumulation. Superimposed on the climatic change inferred from the arboreal pollen are a series of reciprocal alternations between sedge and grass pollen. Sears (1963, p. 59) interpreted these recurrent fluctuations as showing a pulsating rather than steady rise of the water table during submergence on the hypothesis that "slight rises in the water table normally favor sedges at the expense of grasses." However, in coastal marshes salt-marsh grasses normally displace sedges during growing seasons of abnormally high tides, the reverse of Sears' hypothesis. Most of the sedge-to-grass fluctuations are recorded in the sedge-peat part of the core, but some are shown in the upper salt-marsh peat as well. Because the environment has been in delicate balance with several variables, climatic interpretation is not easy.

In the wave-cut cliff of peat, sedge peat is interbedded with salt-marsh muddy peat. The best indicator of accumulation in a low-salinity marsh is the distinctive curved-triangular culm of *Scirpus maritimus*, the common coastal bulrush. Fibrous, wiry mats of roots represent growth of *Spartina patens* and related high-salinity salt-marsh plants. An oak log from the base of the wave-cut bank at Chittenden Beach was 1,180 \pm 80 years old (Y-855). It came from a layer of black "fresh-water" peat 115 cm (3.8 ft) below present high tide, nearly at the contact with underlying sand.

REFERENCES

- Bloom, A. L., and Stuiver, Minze, 1963, Submergence of the Connecticut coast: *Science*, v. 139, p. 332-334.
- Brown, R. W., 1930, Section at Stiles (North Haven Brick Co.) clay pit, opposite Montowese: *in* Flint, R. F., *Glacial geology of Connecticut*: Conn. Geol. Nat. History Survey Bull. 47, p. 263-266.
- Davis, C. A., 1913, Peat deposit of geological interest near New Haven, Connecticut (abs.): *Geol. Soc. America Bull.*, v. 24, p. 700.
- Disney, L. P., 1955, Tide heights along the coasts of the United States: *Am. Soc. Civil Engineers Proc.*, v. 81, no. 666, 9 p.
- Knight, J. B., 1934, A salt-marsh study: *Am. Jour. Sci.*, v. 28, p. 161-181.
- Nichols, G. E., 1920, The vegetation of Connecticut. VII. The associations of depositing areas along the seacoast: *Torrey Bot. Club Bull.*, v. 47, p. 511-548.
- Porter, S. C., 1960, Surficial geology of the Wallingford quadrangle: *Conn. Geol. Nat. History Survey Quad. Rept.* 10, 42 p.
- Sears, P. B., 1963, Vegetation, climate, and coastal submergence in Connecticut: *Science*, v. 140, p. 59-60.

Trip B-1

TWO-TILL PROBLEM IN NAUGATUCK-TORRINGTON
AREA, WESTERN CONNECTICUT *

by

Fred Pessl, Jr. and J. P. Schafer
U.S. Geological Survey, Boston, Massachusetts

INTRODUCTION

Two texturally and structurally distinct tills have long been recognized in the crystalline-rock areas of southern New England (for example, Upham, 1878; Flint, 1930, p. 71). More recent references include localities in New Hampshire (Denny, 1958; Koteff, in press), western Massachusetts (Segerstrom, 1955, 1959), eastern Massachusetts (Koteff, 1964; Oldale, 1962, 1964), southern Connecticut (Flint, 1961, 1962, p. 9), and northeastern Connecticut (Pessl, 1966).

Several terms have been used to distinguish the two tills, both in the field and in the literature. "Gray" and "brown", "upper" and "lower" are descriptive terms based on generally acceptable field observations. "New" till and "old" till are less objective terms reflecting an interpretation not acceptable to all geologists.

Although the occurrence of these tills is widely recognized, their origin remains controversial and involves consideration of relative age and mode of deposition. Some geologists regard the tills as contemporaneous deposits laid down by a single ice sheet, one as lodgement till, the other as ablation till. In this hypothesis, physical differences between the tills are considered to reflect differences in mineral composition, mode of deposition, and oxidation by texturally controlled circulation of ground water. Other geologists interpret the two tills as deposits of separate ice sheets, differing in age and possibly also in mode of deposition. The contrast in color and staining of the tills is explained, in this view, as the result of subaerial weathering of the lower till before deposition of the upper till.

DESCRIPTION OF TILLS

Tills in this part of the crystalline-rock uplands of western Connecticut constitute two widespread, discontinuous units. Because of their consistent stratigraphic relationship, we call them the upper and lower tills. Tills in many parts of southern New England are closely comparable to those in the study area (fig. 1), but there are local differences in details. For example, the uppermost few feet of upper till in some exposures in southern Rhode Island is jointed; some drumlins in southeastern Massachusetts are composed of upper till; no lower till is known in large areas of southeastern Massachusetts and southern Rhode Island.

* Publication authorized by the Director, U.S. Geological Survey

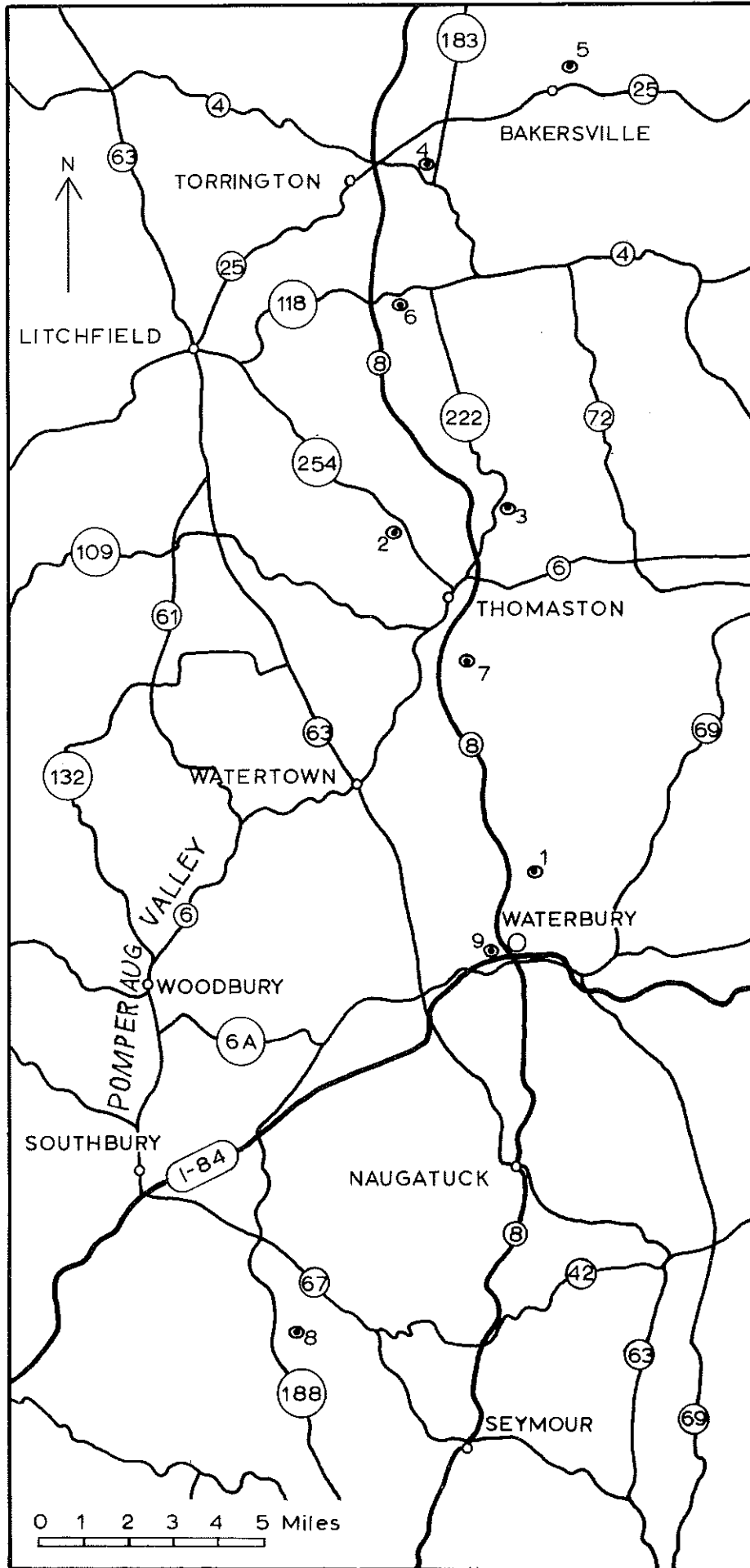

Fig. 1. Sketch map of Naugatuck-Torrington area, Connecticut, showing till localities.

The characteristics of the two tills in the study area are summarized in the table below.

Comparison of upper and lower tills

	<u>Upper till</u>	<u>Lower till</u>
Texture of matrix (finer than $\frac{1}{2}$ in.)	Relatively sandy; contains 60-80% sand and coarser particles, and 20-40% silt and clay. Commonly mottled or streaked with light-colored sandy bodies.	Finer grained; contains 40-75% sand and coarser particles, and 25-60% silt and clay; generally uniform.
Stone content (larger than $\frac{1}{2}$ in.)	Commonly more than 20%.	Commonly less than 20%.
Weathering	Postglacial soil developed in upper 2.5-3.5 ft of late-glacial eolian sandy silt, colluvium, till, etc.; but very little or no yellowish staining deeper in till.	Pervasive oxidation in most exposures; at locality 3, oxidized zone is about 37 ft thick. Dark iron staining occurs on joints and around stones, but generally does not extend as deep as does pervasive oxidation.
Color (of naturally moist material, from Munsell (1954) soil color charts)	Olive-gray to light-olive-gray to olive (5Y 4-5/2-3 to 6/2) in silty matrix. Sandy layers are lighter, or locally stained rusty or yellowish.	Olive to olive-gray to olive-brown (5Y 4-5/2-3 to 2.5Y 4-5/3-5) in oxidized zone (not including stained joints). Dark-gray (5Y 3.5-5/1) in nonoxidized zone beneath.
Compactness	Slight to moderate; almost all collected samples disaggregate during collection or as they dry out.	Moderate to extreme; collected samples dry out as hard coherent fragments.

Comparison of upper and lower tills -- Continued

	<u>Upper till</u>	<u>Lower till</u>
Layering	Textural layering common, generally subparallel to topographic surface. Layering is expressed mostly as lighter colored sandy layers interbedded with darker silty material. Some lenses of well-bedded waterlaid sand or gravel. In deep exposures, layering is generally more abundant in upper than in lower part. At some places, moderate to strong deformation of layering (localities 4,7).	Textural layering and lensing are not common. Exceptional layering at locality 2, and a few deformed lenses at locality 3.
Jointing	None. Preferred subhorizontal direction of breaking, probably caused by fabric of till matrix, noted at only a few localities, in relatively compact and massive, silty phases of till.	Well-developed in most exposures. Subhorizontal joints more closely spaced than subvertical joints; both sets less closely spaced downward. In upper parts of some exposures, subhorizontal joints are so closely spaced as to produce platiness or even fissility. In lower parts of some deep exposures, till lacks jointing. Subhorizontal joints in some places controlled by textural layering. Preferred subhorizontal direction of breaking generally present within joint blocks and in nonjointed till.
Stone fabric (preferred orientations of long axes of elongate stones).	Commonly northeast; ranges from north-northeast to east-northeast.	Commonly north-northwest; ranges from north to northwest.

Comparison of upper and lower tills -- Continued

	<u>Upper till</u>	<u>Lower till</u>
Thickness	Commonly less than 10 ft; rarely 30 ft or more.	Commonly more than 10 ft; more than 100 ft in some drumlins.
Distribution	Lies directly on bedrock in areas of irregular topography controlled by bedrock relief; forms discontinuous and generally thin mantle on lower till.	Constitutes drumlins, and generally underlies smooth hilltops and slopes; almost entirely absent from areas of irregular topography controlled by bedrock relief.

Texture. Both tills have a rather wide range in texture, and cumulative curves overlap considerably (fig. 2, 3). However, textural differences between upper and lower tills are readily apparent in the field, and the curves show the most consistent differences in the silt and clay range. Median-curve values for upper and lower till are, respectively, 27 percent and 37 percent combined silt and clay, and 6 percent and 12 percent clay-size particles alone.

Weathering. The postglacial soil profile seldom is more than 2.5-3.5 feet thick, and in till areas it is developed in colluvium, eolian material, till, or mixtures of these materials. The upper till shows no profile development beneath this soil; however, ground-water oxidation has produced slight iron staining in permeable sandy or gravelly layers at some places. The lower till bears an oxidized zone so thick that only a few exposures in this area (locality 3) reach nonoxidized lower till.

Although Munsell (1954) color designations given in the table are close together on the color charts, the differences between the two tills are conspicuous in the field. The notably gray appearance of the upper till compared to the oxidized lower till is accentuated by the light-colored sandy segregations with which the upper till is generally mottled and streaked. Although the color designations overlap in the area, the differences are systematic at any one locality; the oxidized lower till has higher chroma (more "color"), commonly lower value (darker), and in some places browner hue than does the silty matrix of the upper till. The nonoxidized lower till has even lower chroma than does the upper till.

The oxidized zone of the lower till shows some color differentiation (principally downward decrease in chroma) at some places. In a few large exposures, this color differentiation seems to be partly truncated by the present top of the till; such truncation is indicated also by contrasts in till colors in small exposures. These phenomena do not seem to be related to topographic position, or to presence or absence of overlying upper till, and are believed to result from erosion

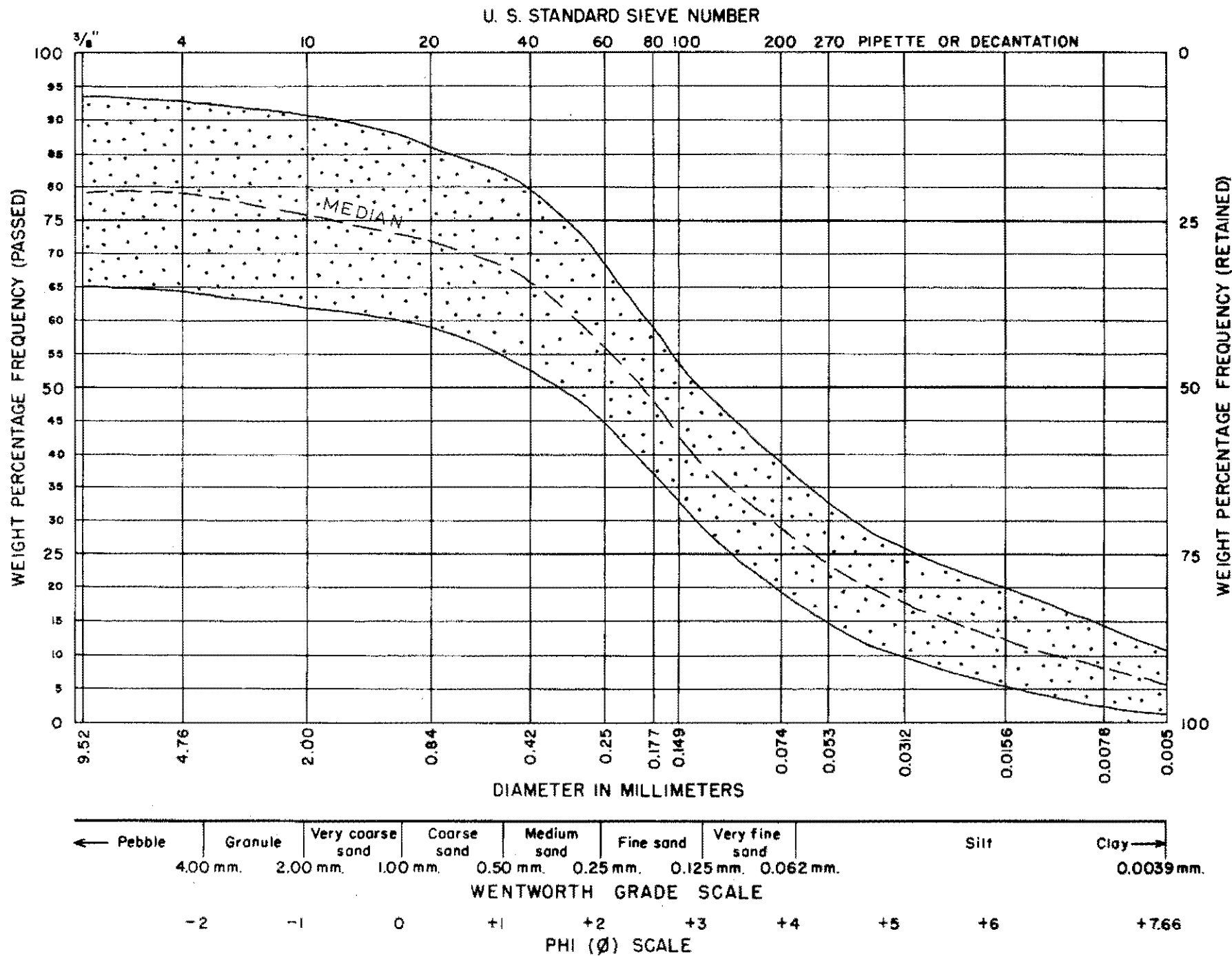

Fig. 2. Range in grain size (cumulative curves, 5 samples) of upper till from the Pomperaug Valley area and vicinity.

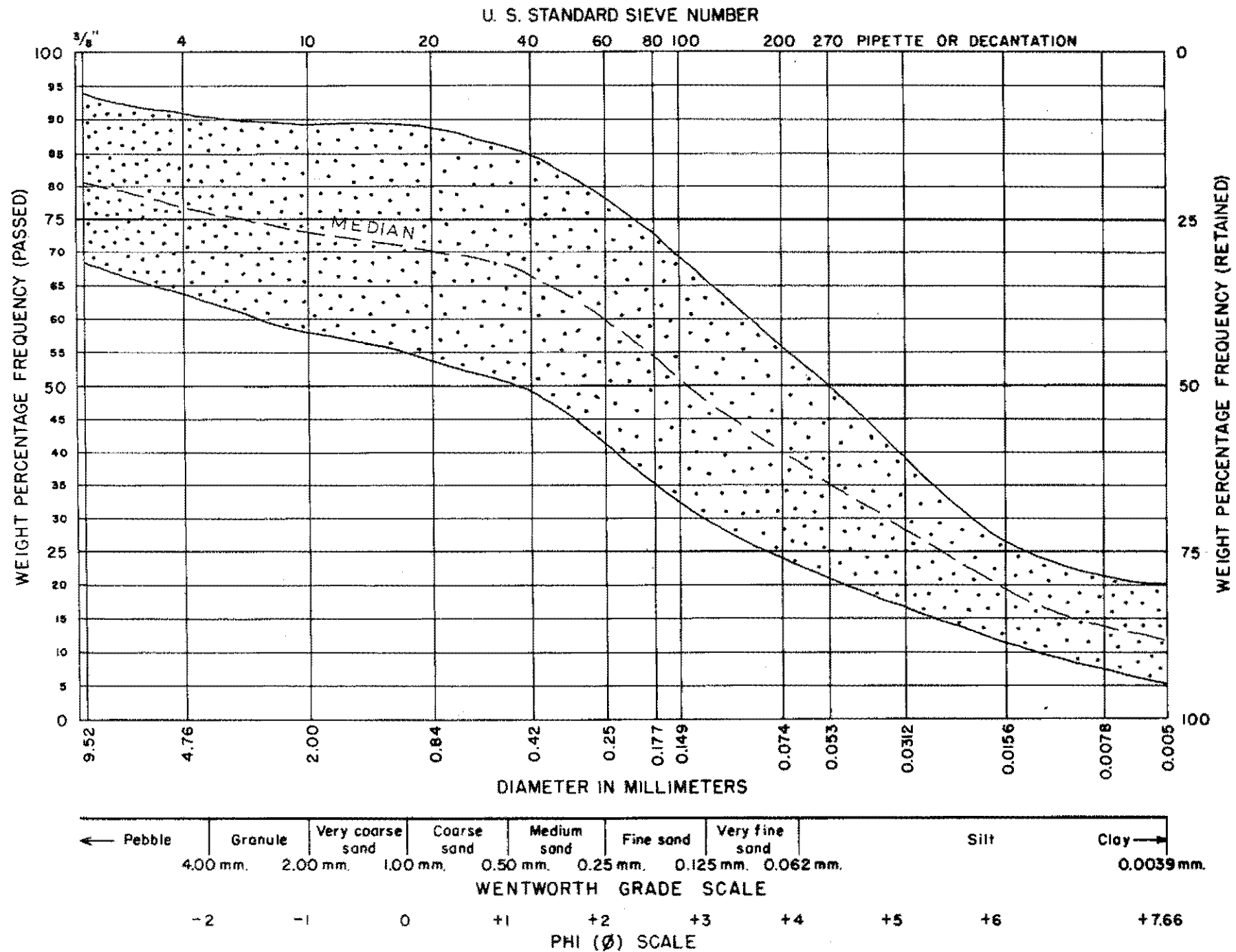

Fig. 3. Range in grain size (cumulative curves, 5 samples) of lower till from the Pompeaug Valley area and vicinity.

of the lower till to variable depth by the ice from which the upper till was deposited. In no exposure in this area did erosion completely remove the oxidized zone of the lower till.

Compactness, jointing. As far as is known, the compactness of the lower till is the result mainly of its particle-size distribution, and perhaps also of water content at time of deposition and of subglacial pressure. No cementing agent has been identified. The carbonate-mineral content of the crystalline rocks from which the tills of this area were derived is slight. Walter Lyford (Harvard Forest; written communication, 1968) found only 1 percent or less of carbonate in samples of nonoxidized lower till from the study area.

Because jointing in the lower till is farther apart with depth and finally dies out, it evidently was developed after, rather than during, deposition of the till. Truncation of the jointing by the contact between the two tills demonstrates that the jointing predates glacial erosion of the lower till and deposition of the upper till. Perhaps the jointing is related in origin to weathering of the lower till. Fitzpatrick (1956) has suggested that similar structure in till might have been produced by growth of ground-ice veins in permafrost.

Stone fabrics and other directional data. The difference in fabric orientation between upper and lower tills in the study area (see table) is similar to that reported from localities elsewhere in Connecticut (Flint, 1961; Pessl, 1966). However, other directional data do not generally indicate any significant ice flow from the northeast. The dominant trend of striations and streamline-hill axes in western Connecticut is north-northwest (for example, see fig. 4). Northeast directional data are very rare, except along the west border of the Connecticut Valley where northeast to east striae and southwest transport of erratics are reported; however, these directions probably reflect increased lobation of the wasting ice sheet in response to local topographic control by the valley.

Preliminary study of several fabric samples from a thick section of upper till (locality 5) suggests that a gradual shift in ice-flow direction from west of north to east of north may have occurred late in the depositional history of the upper till. Such an interpretation could explain the consistent northeast preferred orientation of fabric samples taken from the uppermost, youngest part of the upper till at other localities and could also explain the relative scarcity of other northeast directional data from western Connecticut.

The great majority of stones in till in this area are of various locally derived gneisses and schists and some granite and pegmatite. However, several indicator types give evidence of regional direction of ice movement from west of north. (Distances given below are measured from Thomaston, near the center of the study area.)

(1) Triassic rocks of the Pomperaug Valley at the west edge of the study area produce an indicator fan, the axis of which trends N 25°W. Locality 8 is within the area of the fan, and the tills there contain Triassic erratics.

(2) The commonest distant erratic type within the study area is white, yellowish, and reddish glassy quartzite, derived from Cambrian quartzite that outcrops in a belt from eastern New York across north-

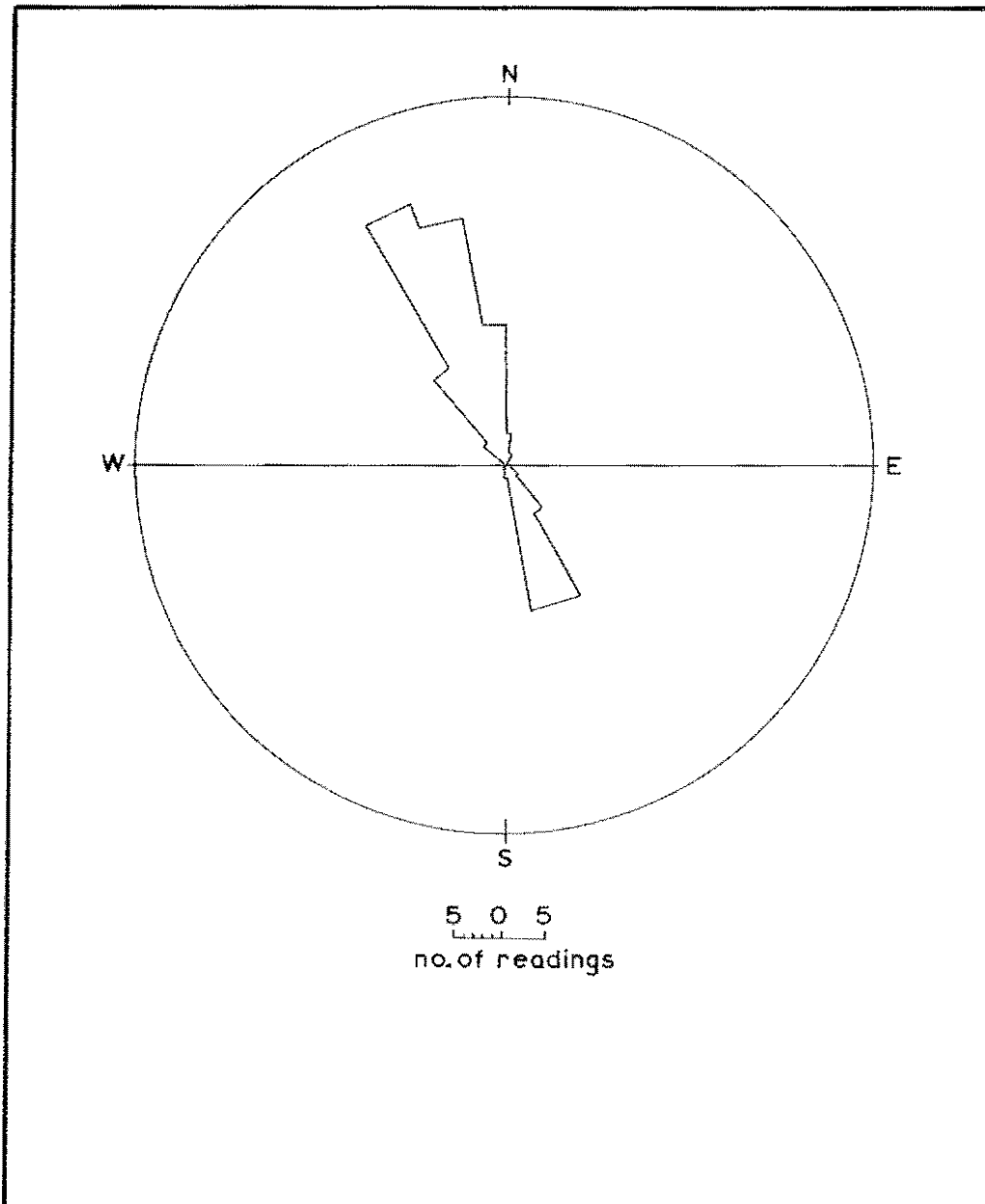

Fig. 4. Trends of streamline-hill axes (91) and average trends of striations (39 localities) in the Pomperaug Valley area. Streamline-hill axes plotted on upper half of diagram; striations plotted on lower half of diagram. Data grouped in 10° classes.

western Connecticut (Poughquag Quartzite), western Massachusetts (Cheshire Quartzite), and western Vermont. The nearest source areas are about 20 mi. NW.

(3) Erratics of hard limonite are rare, but widespread; they are very similar to material from the former iron-mining areas near Salisbury, Connecticut (about 28 mi. NW) and Richmond, Massachusetts (about 50 mi. NNW). Quartzite breccia cemented with limonite closely resembles a fault breccia in the Windsor quadrangle, Massachusetts, about 65 mi. N (Stephen Norton, U.S. Geological Survey, oral communication, 1968).

(4) At every locality a few representatives may be found of a suite of sedimentary and low-grade metamorphic rocks that include red quartzite of several types, red argillite, gray grit and pebble conglomerate, dark-gray phyllite, light-green phyllite, black or red chert, and others. These rocks are derived from the Taconic terrane that occurs in a belt in eastern New York, northward from about 35 mi. northwest of the study area.

Contact between the two tills. More than a dozen exposures of the two tills in superposition have been seen in and near this area (localities 1,2). In these exposures, the top of the lower till is sharply defined and not gradational into the upper till. All long exposures of the contact show that it truncates the structure (jointing, or less commonly textural layering) within the lower till. The contact is commonly subparallel to the topography, but it is locally irregular and has a relief of a few feet. We believe that this irregular contact is the result of erosion by the ice that deposited the upper till. At several places (localities 1,2) the upper part of the lower till is cut by fractures that dip generally south and are filled with sand or upper till; these may have been produced by basal drag of the later ice.

A zone of upper till that contains more or less material derived from the lower till is exposed at several localities, both where the underlying lower till is exposed in place (locality 1) and where the excavation does not reach the lower till (locality 4). Some inclusions of lower till have sharp contacts and are internally unmodified, retaining their original compactness, jointing, and oxidized color. The close similarity of such inclusions to adjacent, undisturbed lower till indicates that those properties existed before separation of the inclusions. Other inclusions seem to have been deformed or crushed, are less compact, and lack jointing. Still others probably have undergone some mixture with upper till, resulting in materials intermediate in appearance between the two tills. Inclusions, where present, may occur only within the lowermost foot (or less) of the upper till, or may be distributed through a thickness of more than 15 feet.

Where both tills are exposed, the base of the upper till is commonly very sandy, and in many places it is marked by a bed of fairly well sorted sand.

Ages of tills. The upper till was deposited by the last ice sheet to reach southern New England, in Wisconsin time, probably about 20,000-14,000 years ago (Schafer and Hartshorn, 1965, p. 120). We believe that the lower till was deposited during an earlier ice advance; however, the only evidence of the length of the interval between the two advances is the depth of the oxidized zone on the lower till. It has been suggested (Schafer and Hartshorn, 1965, p. 119) that this earlier advance was of

early Wisconsin ("pre-classical Wisconsin") and post-Sangamon age, but evidence for this conclusion is not strong.

Summary and conclusions. Observations in the study area lead to the following conclusions which we believe to be applicable elsewhere in southern New England.

(1) Till fabrics and the orientation of striations and streamline-hill axes indicate that the lower till was deposited by glacier ice flowing from the north and northwest. Strong development of fabric lineation and the presence of lower till as the major constituent in most drumlins suggest that the lower till is a subglacial deposit.

(2) The depth of oxidation and pervasiveness of oxidation and staining in the lower till indicate that a subaerial weathering interval followed deposition of the lower till. The lack of marginal staining around lower-till inclusions in the upper till indicates that oxidation of the inclusions predated deposition of the upper till.

(3) The erosional nature of the contact between the two tills as demonstrated by truncation of joints at the contact, the apparent truncation of color differentiation at the top of the lower till, and the distribution of lower till inclusions in the upper till indicates that the upper till was deposited by a readvance of glacier ice.

(4) The upward change in fabric lineation in an exposure of thick upper till (locality 5) suggests a gradual easterly shift in the direction from which the ice flowed, late in the depositional history of the upper till.

(5) The upper till may include subglacial and superglacial facies. Strongly developed fabric lineation and nearly massive structure of upper till at some exposures suggest subglacial deposition. At other places, the continuity of fluvial layering and a preferred fabric orientation in the plane of the fluvial bedding (locality 5) suggest subglacial deposition under conditions of increased water flow. Deformed fluvial layers, coarser texture, and lack of preferred fabric orientation in other, commonly upper, parts of the upper till suggest superglacial deposition.

Miscellany. The localities described are on the Southbury, Thomaston, Torrington, and Waterbury topographic quadrangle maps. Of course, exposures of glacial deposits may quickly become graded over or covered by slump, but at least some of the exposures should be accessible for some years. All these localities are on private property. Many till pits are very muddy throughout much of the year, and appropriate footgear is desirable.

REFERENCES

- Denny, C.S., 1958, Surficial geology of the Canaan area, New Hampshire: U.S. Geol. Survey Bull. 1061-C, p. 73-100.
- Fitzpatrick, E.A., 1956, An indurated soil horizon formed by permafrost: Jour. Soil Sci., v. 7, no. 2.
- Flint, R.F., 1930, The glacial geology of Connecticut: Connecticut Geol. and Nat. History Survey Bull. 47, 294 p.
- , 1961, Two tills in southern Connecticut: Geol. Soc. America Bull., v. 72, no. 11, p. 1687-1692.
- , 1962, Surficial geology of the Mount Carmel quadrangle, Connecticut: Connecticut Geol. and Nat. History Survey Quad. Report 12, 25 p.
- Koteff, Carl, 1964, Surficial geology of the Concord quadrangle, Massachusetts: U.S. Geol. Survey Geol. Quad. Map GQ-331.
- , Surficial geology of the Milford quadrangle, New Hampshire: U.S. Geol. Survey Geol. Quad. Map, in press.
- Munsell Color Company, 1954, Munsell Soil Color Chart: Baltimore, Md., Munsell Color Co., Inc.
- Oldale, R.N., 1962, Surficial geology of the Reading quadrangle, Massachusetts: U.S. Geol. Survey Geol. Quad. Map GQ-168.
- , 1964, Surficial geology of the Salem quadrangle, Massachusetts: U.S. Geol. Survey Geol. Quad. GQ-271.
- Pessl, Fred, Jr., 1966, A two-till locality in northeastern Connecticut: U.S. Geol. Survey Prof. Paper 550-D, p. D89-D93.
- Schafer, J.P., and Hartshorn, J.H., 1965, The Quaternary of New England, in Wright, H.E., Jr., and Frey, D.G., eds., The Quaternary of the United States: Princeton Univ. Press, p. 113-128.
- Segerstrom, Kenneth, 1955, Surficial geology of the Williamsburg quadrangle, Massachusetts: U.S. Geol. Survey Geol. Quad. Map GQ-80.
- , 1959, Surficial geology of the Shelburne Falls quadrangle, Massachusetts: U.S. Geol. Survey Geol. Quad. Map GQ-116.
- Upham, Warren, 1878, Modified drift in New Hampshire in Hitchcock, C.H., The geology of New Hampshire, pt. 3: Concord, N.H., p. 3-176.

FIELD LOCALITIES

Locality 1. (27.1N-51.83E) Pit at east side of Willow St. immediately south of its intersection with Waterville St.; 0.6 mi. south of BM 286; Waterbury (Waterbury quadrangle).

Both tills are exposed in this pit. The lower till is mostly covered by slump, and is most easily reached on the west side of the main salient in the middle of the pit. Figure 5 shows contact relations for a length of about 35 ft along this face. Both the layering in the upper till and the dominant subhorizontal jointing in the lower till dip gently westward, approximately parallel to the hillslope. The section is :

- 7-8 ft upper till, layered; much very stony material; many sand layers.
- 1-4 ft upper till, more or less mixed with lower till; highly variable and gradational laterally and vertically. Variation in thickness is result of southward rise of contact with lower till. At north end of diagram this material is mostly disturbed lower till; jointing has been lost and compactness decreased, and it is more or less mixed with sandy upper-till material and is cut by irregular lenses of sand. Southward this unit grades into material composed mostly of upper till mixed with a little lower till material; it contains compact jointed inclusions of lower till that have sharp contacts. Near the middle of the diagram, sandy material penetrates at least 3 ft downward into lower till along a south-dipping fracture.
- 4 ft lower till, compact, jointed, oxidized. Within vertical range of exposure, jointing is more closely spaced upward, approaching fissility. This jointing is distinctly truncated by the upper contact of the lower till.

Locality 2. (31.24N-50.40E). Pit west of relocated State Route 254, about 2 mi. northwest of Thomaston (Thomaston quadrangle), reached by a foot trail that begins on the west side of Route 254 just south of the intersection of Knife Shop Road.

The pit is in the southeast flank of a streamline hill and exposes a section, about 20 feet thick, of olive-brown to olive (2.5Y 4/4 - 4Y 4/3), compact till. Thin platy jointing occurs within thick layers that contain linear concentrations of stones; these structures are subparallel to the topographic slope, but appear to be truncated by it near the north end of the face.

At the north end of the pit, about 3 feet of olive-gray (5Y 4/2.5-3.0) friable till overlies compact olive-brown till. The basal part of the upper till here contains both disaggregated lower-till material and discrete inclusions of lower till. Fillings of upper till penetrate between slabs of lower till that have been displaced, but not entirely detached from the undisturbed lower till below. An iron-stained rind is locally well developed at the contact between the two tills.

Locality 3. (31.51N-51.65E) The pit is on the east side of relocated State Route 222, about 2 mi. north-northeast of Thomaston and 0.3 mi. south of the intersection of Leadmine Road (Thomaston quadrangle). Bedrock is exposed in the pit floor and at the crest of the hill.

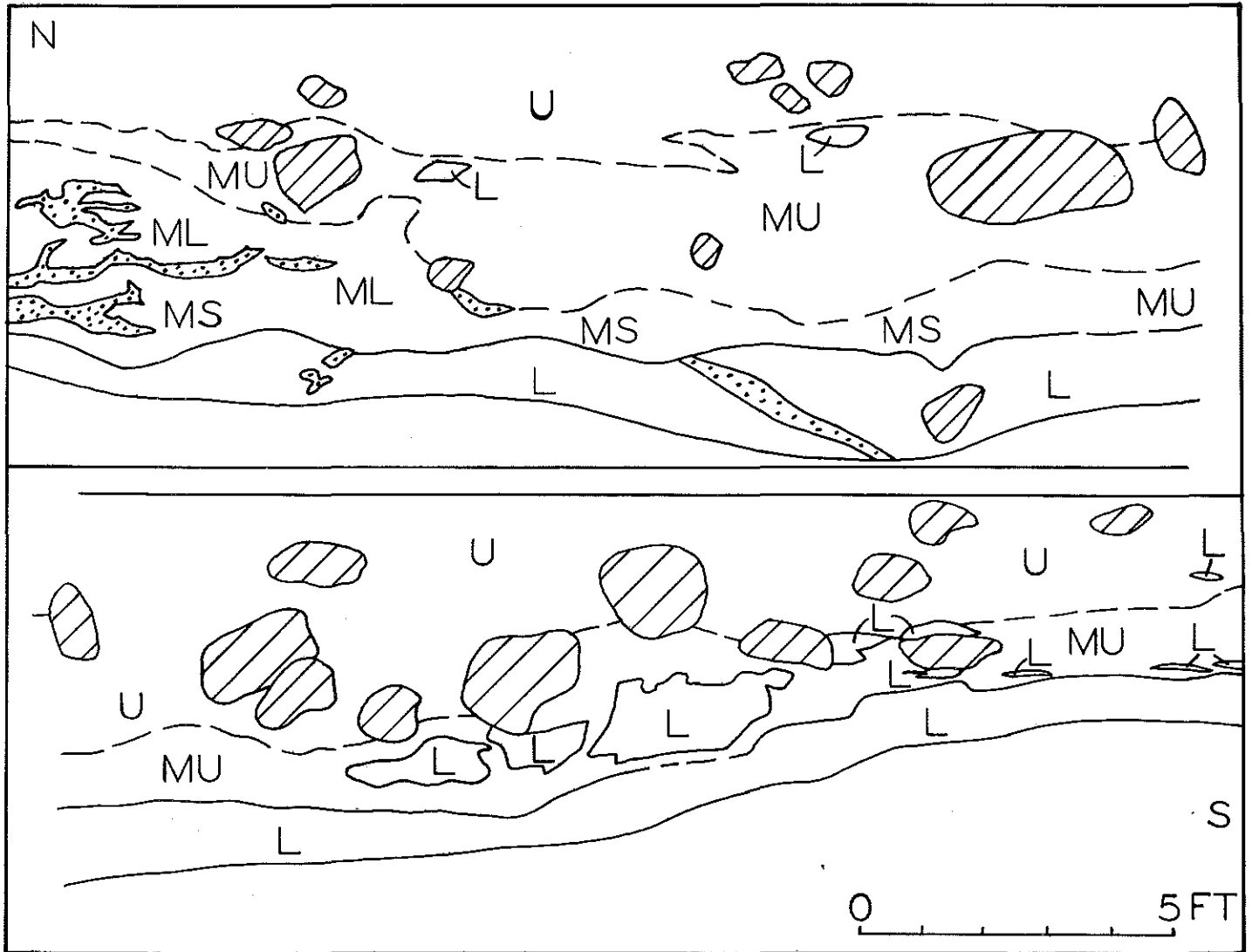

Fig. 5. Section at locality 1, contact between upper and lower tills, Waterbury quadrangle.

L - lower till in place; also inclusions of compact jointed lower till in upper till

M - mixed zone; ML, dominantly lower till; MU, dominantly upper till; MS, much sand mixed with till

U - upper till

Crosslined - boulders

Dotted - sand

Striations on bedrock in the pit floor trend about N 15° W.

The section near the south end of the pit is:

- 0.5 ft "A" horizon of soil profile.
- 1.6 ft "B" horizon of soil profile; upper part is dark yellowish brown (10YR 4.5/3.5).
- 1.3 ft disrupted brown till with iron-stained joint faces.
- 2.0 ft loose structureless olive (5Y 4.5/3) material; perhaps derived from reworked upper till.
- 1.5 ft disintegrated rotten bedrock rubble with coarse mica flakes.
- 8.0 ft blocky compact olive (5Y 4/3) till with closely spaced subvertical and subhorizontal joints; iron staining prominent on joint faces.
- 8.0 ft blocky compact olive-gray to olive (5Y 4/2.5) till; joints less closely spaced than above.
- 11.0 ft compact olive-gray (5Y 4/2) till with subhorizontal and subvertical joints; faint iron staining on joint faces increases in intensity upward.
- 10.0 ft compact olive-gray (5Y 4/2) till with texturally controlled, locally deformed, layering.
- 21.0 ft compact dark-gray (5Y 3.5/1) till with texturally controlled, subhorizontal layering.

The upper 7 ft of the section is interpreted as colluvium overlying the till. Because of its unusual depth, this exposure demonstrates the gradual disappearance of jointing and the gradual color change from olive to dark gray with depth. These changes are interpreted as the result of prolonged exposure of the till to subaerial weathering.

Locality 4. (35.32N-50.81E). Pit on west side of State Highway 183, about 800 ft north of intersection with State Highway 4 (72 on topographic map), Torrington (Torrington quadrangle).

This pit at the southeast corner of a drumlin shows upper till containing much lower till material; undisturbed lower till is not exposed. The face shown in figure 6 trends northeast, nearly normal to the long axis of the drumlin.

The upper 3-4 ft is upper till, somewhat layered; some is nearly massive, loose, and sandy (olive-gray, 5Y 5/2), and some is much inter-lensed with sand. A brownish, finer grained lens is interpreted as deformed inclusion of lower till.

The rest of the exposure contains numerous sharp-bordered inclusions of compact, jointed lower till, the largest of which is 8 ft long and 1.5 ft thick (olive, 5Y 4.5/3). There are also numerous bodies of well-bedded sand, some of which are strongly deformed. The remaining material ranges from typical upper till through various intermediate mixtures to lower till that lacks jointing. Some of this lower till constitutes distinct inclusions, but the only ones shown on the diagram are the undeformed ones that retain the original compactness and jointing.

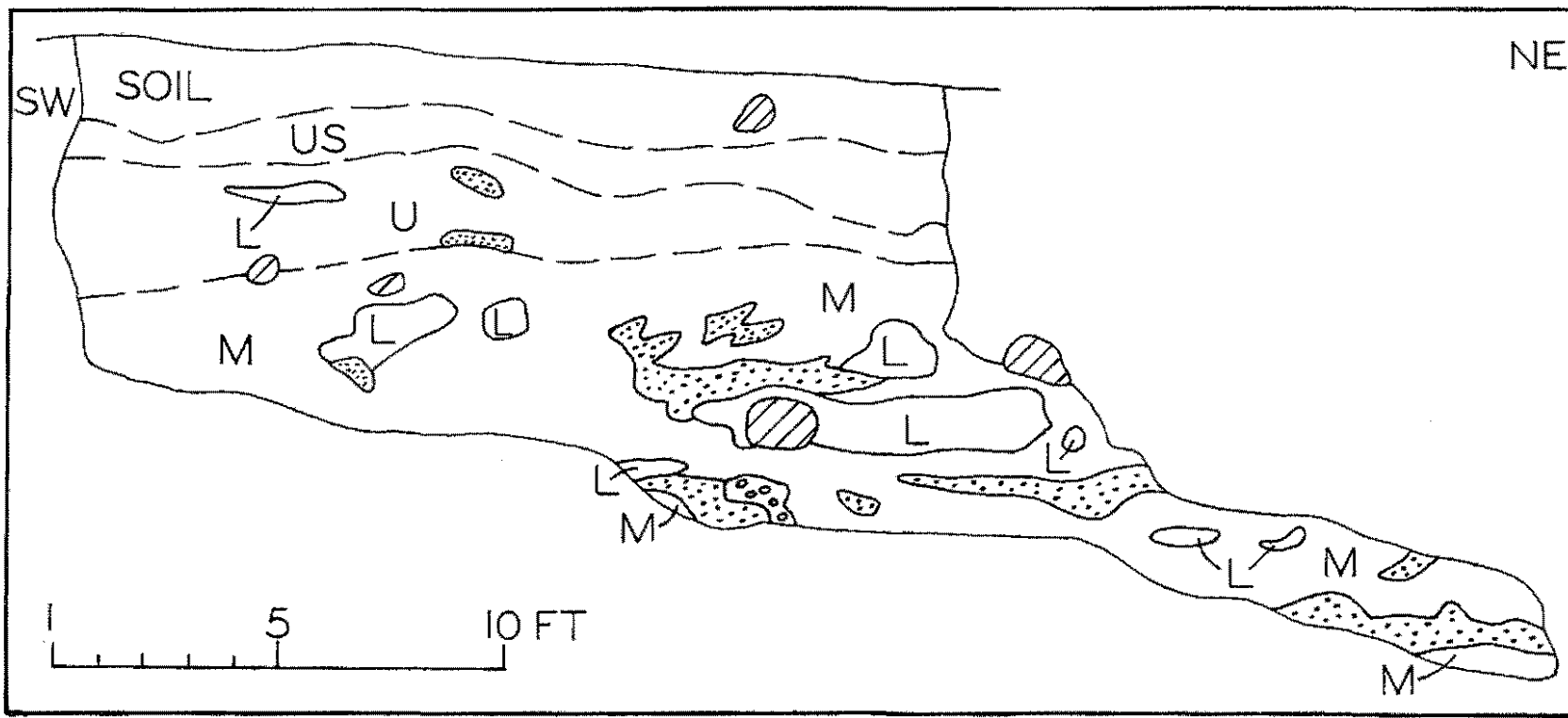

Fig. 6. Section at locality 4, upper till and mixed zone, Torrington quadrangle.

- L - inclusions of compact jointed lower till in upper till (uppermost inclusion has lost compactness and jointing)
- M - mixed zone; ranges from typical upper till through various intermediate mixtures to lower till that has lost compactness and jointing
- U - upper till
- US - upper till, much interlensed with sand
- Crosslined - boulders
- Dotted - sand
- Small circles - pebble gravel

A somewhat deformed, smeared inclusion of lower till, 2-7 in. thick and at least 30 ft long, lies 3 ft below the top of the upper till, about 40 ft southwest of the diagrammed exposure. Numerous clasts of pre-glacially weathered rock occur in both tills, and some of these clasts were deformed during or after deposition.

Locality 5. (36.62N-52.38E). The exposure is located in a stream-cut bank on the south side of Bakersville Brook, 0.5 mile north-northeast of Bakersville (Torrington quadrangle). Access is from the south side of Winchester Road which intersects Maple Hollow Road 0.2 mile southwest of Maple Hollow village.

The exposure is 30-35 ft deep and about 200 ft long. In general, the till can be divided into three units:

(1) an upper, discontinuous unit composed of nonlayered, poorly sorted, very stony till. This unit is absent in the western part of the exposure.

(2) a middle unit which is stony and crudely layered, and containing a conspicuous amount of stratified sand and gravel.

(3) a lower unit which is more massive and less stony than the overlying units, and which contains only minor beds of fluvial sediments. The section given below is in the central part of the exposure.

- 1.0 ft Eolian sand and silt mixed with till; 1-2-inch-thick organic zone at top.
- 4.0 ft Stony nonlayered till (5Y 6.5/2) with lenses of small pebble- to granule-size gravel; some iron staining around isolated pebbles and roots.
- 4.0 ft Layered stony till (5Y 6/2) with lenses of well-sorted coarse- to medium-grained sand and granule gravel; iron staining in some sand and gravel lenses.
- 1.0 ft Crossbedded medium- to coarse-grained sand and granule gravel with small-scale folds and thrusts.
- 2.0 ft Contorted sand layers interbedded with lenses of pebble gravel and stony till-like masses.
- 1.5 ft Well-sorted coarse- to medium-grained sand and granule gravel.
- 11.0 ft Stony massive till (5Y 6.5/2 to 5.5/3); texturally controlled mottling with light-colored sandy zones and dark-colored silty zones; sandy partings common.
- 3.0 ft Covered interval.
- 0.5 ft Well-sorted, nonoxidized, crossbedded, medium- to coarse-grained sand.
- 2.5 ft Massive stony till similar to the next higher till unit.

Five till-fabric samples were collected in vertical sequence at this locality; three from the lower massive unit, one from the layered middle unit, and one from the upper nonlayered unit (fig. 7). The lower three fabric samples show a well-developed preferred lineation of the pebble

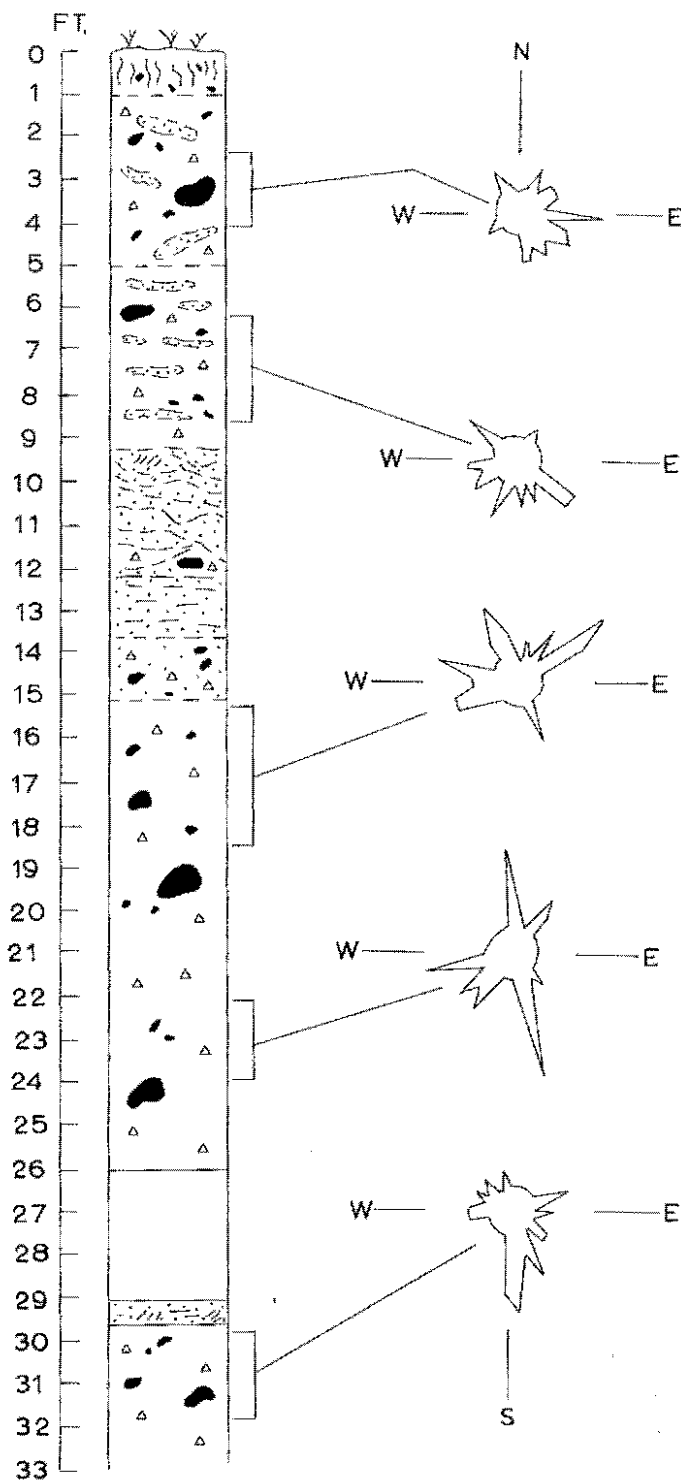

Fig. 7. Generalized stratigraphic column and fabric diagrams from till at locality 5, Torrington quadrangle. Each fabric diagram shows strike of long axes of 50 elongate pebbles measured in the direction of plunge and grouped in 10° classes.

axes. Axes of pebbles from the upper two units show no well-defined preferred lineation, but the axes of pebbles from the middle unit, 6-8 ft deep, have low-angle plunges and appear to lie in the plane of the fluvial bedding in that unit. The lowest sample, 30-31 ft deep, has an A lineation oriented S 10° E and a B lineation oriented about S 80° W. A gradual increase in strength of the southwest lineation at the expense of the southeast lineation occurs in the next two samples at depths of 23 ft and 16 ft. At 16 ft, the A lineation is S 55-65° W and the B lineation is S 25° E.

These data suggest that a gradual shift in ice-flow direction from east of south to west of south may have occurred during deposition of the till. The massiveness and well-defined fabric lineation in the lower unit of the section suggest that this part is subglacial till. The presence of a preferred fabric orientation in the plane of the fluvial bedding and the prominence and continuity of layering in waterlaid sediments in the middle unit suggest that it was deposited as subglacial till at a time of increased water flow at the base of the ice. The absence of a well-defined fabric orientation and the presence of fluvial sediments lacking continuity of stratification in the upper unit suggest that it was deposited as supraglacial till.

Locality 6. (33.89N-50.33E). A pit on the northwest slope of Scoville Hill (southwest corner of the Torrington quadrangle), reached via an access road on the south side of State Route 118 (116 on the topographic map), about 0.75 mi. east of State Route 8 at East Litchfield.

The pit shows 30-35 ft of gray stony till, in which the lower 15-20 ft contains thin stringers and smears of olive-brown, compact till.

The upper 12-15 ft of the exposed section is composed of very stony, layered gray till with prominent sand and gravel lenses. Some zones of noticeably browner material occur near the top of the section, but no recognizable discrete bodies of brown compact till were observed. This brown color may reflect the presence of disaggregated lower-till material mixed with upper-till matrix in this part of the section.

The lower 15-20 ft of the exposure is composed of less stony, less coarsely layered gray till with somewhat finer grained sand and gravel lenses, and interstratified layers of coherent olive-brown till.

Layering in the pit face commonly parallels the topographic surface, except at the southeast corner of the pit where cobble-boulder layers in the upper part of the exposure are truncated by the surface slope. Oversteepening of the topography here, relative to the layering in the till, is the result of erosion of the till surface and formation of a low stream terrace in the drainage channel immediately east of the pit.

Locality 7. (29.66N-51.16E). Pit on south side of West Hill Rd., 1200 ft east of intersection with Waterbury Rd. (State Highway 8 on topographic map), about 0.7 mi. south-southeast of Reynolds Bridge (Thomaston quadrangle).

This pit shows only upper till, with no indication of mixing of lower-till material. The till is more than 13 ft thick, but bedrock is probably not far beneath the base of the exposure. This till has a smaller proportion of stones than is usual in upper till. It is loose and sandy, and the silty finer parts are mostly olive gray (5Y 5.5/2.5).

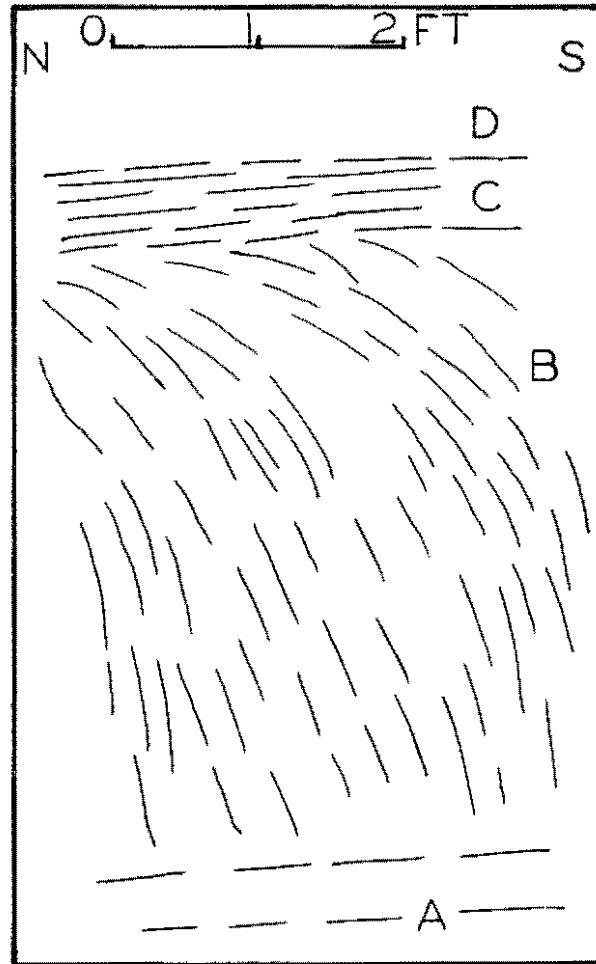

Fig. 8. Section at locality 7, structure of upper till, Thomaston quadrangle.

A and D - massive to slightly layered till

B - till with closely spaced thin sandy layers; strongly deformed

C - mostly layered sand, some sandy till

The major layering of the till dips gently west, subparallel to the hill-slope.

The section shown in figure 8, near the middle of the pit, is:

- 6.0 ft Subhorizontally layered; ranges from nearly massive till to sandy, fairly well bedded material.
- 4.5 ft Till with generally closely spaced, light-colored, thin sandy layers. Layering is gently dipping at top of unit, but steepens abruptly downward to steeply dipping SSE or SE. Layering is indistinct at bottom of unit, but probably is truncated by base.
- 1.5 ft Till, subhorizontally layered.

Except for the lowest unit, which is exposed only at one place, the diagram would serve for the several exposures along the 200-250 ft length of the pit from north to south. The southward steepening of dip of layering in the middle unit is consistent throughout. This structure does not seem to fit closely with hypothesis either of collapse of super-glacial drift or of thrust or drag by southward-moving ice. At one place, the inclined layering is cut by several northwest-dipping thrust faults; drag and displacement on these faults shows thrusting southeastward.

One exposure in this pit, shortly south of that in figure 8, shows within the south-dipping till an irregular small body of horizontally bedded, undeformed sand and pebble gravel. This sand and gravel appears to have been deposited by water in an opening formed in the till after its present dip was formed.

Locality 8. (21.74N-49.10E). The exposure is located on the north side of Hogback Road, 0.5 mile east of State Route 188 (east-central part of the Southbury quadrangle).

About 18 ft of sandy friable gray till overlies an exposed thickness of 2-3 ft of compact brown till. The lower 9 ft of the upper till contains thin stringers and lenses of lower till. Concentration of lower-till material within the upper till increases with depth. The main face of the pit strikes approximately north and slopes gently west. The section is:

- 0.1-
- 0.3 ft Organic-rich "A" horizon of soil profile.
- 2.0 ft "B" horizon of soil profile; upper part is dark brown (10YR 3.5/3); lower part is dark yellowish brown (10YR 4.5/4).
- 7.0 ft Sandy, stony, friable, olive to pale-olive (5Y 5.5/3) till with irregular discontinuous iron-stained zones. Mottling is locally well developed with light-colored sandy phases and darker silty phases. A thin lens (4-in. maximum exposed thickness) of iron-stained, granule- to small pebble-size gravel occurs 2 ft above base.

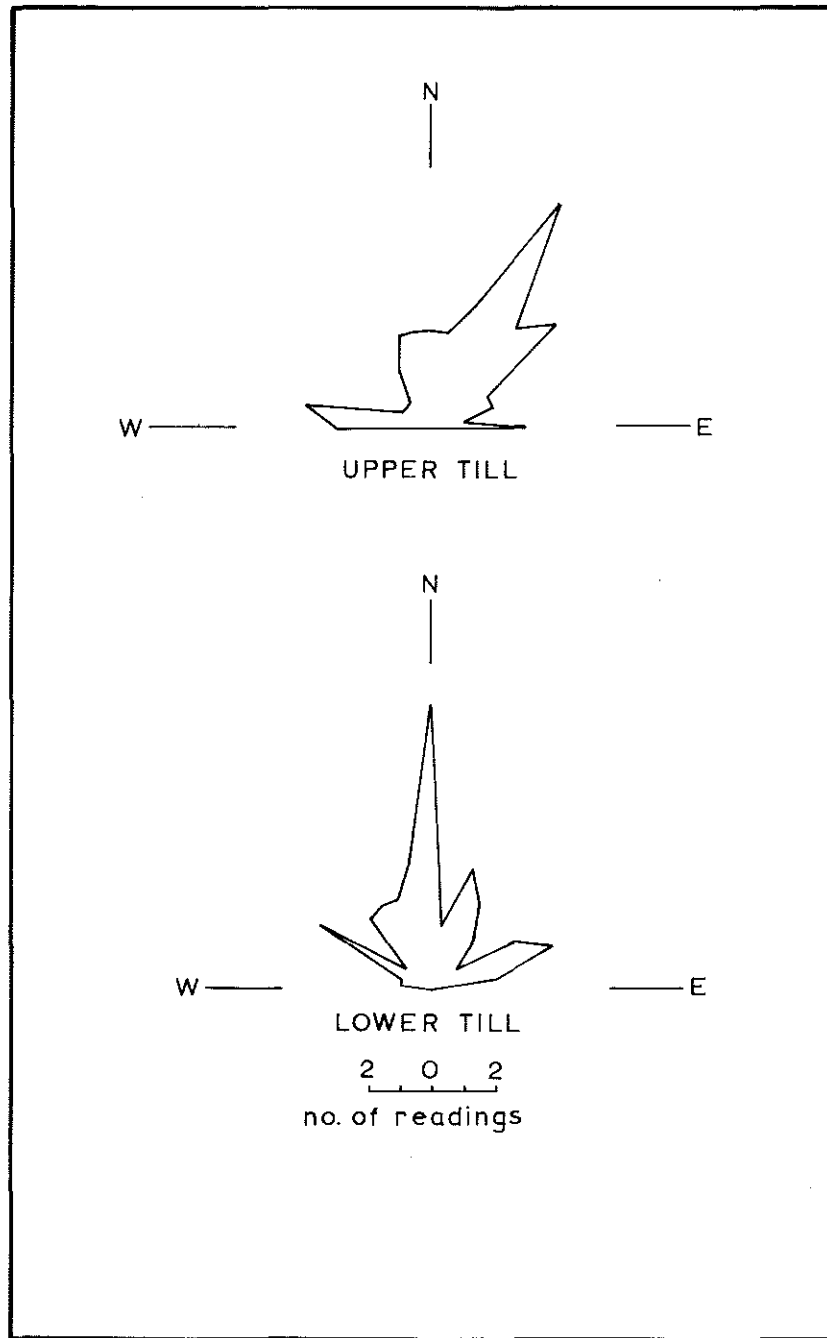

Fig. 9. Till-fabric diagrams from locality 8, Southbury quadrangle. each fabric diagram shows strike of long axes of 50 elongate pebbles grouped in 10° classes.

- 6.0 ft Sandy stony till similar to that above but with more light-colored sandy material, and mixed with thin (0.5-0.75 in.) irregular-shaped layers of compact olive-brown (2.5Y 4.5/4) till. Spacing of lower-till layers decreases from top (6-10 in. apart) to bottom (2-4 in. apart) of the unit. Upper till becomes somewhat brittle and less friable with admixing of lower till.
- 3.0 ft Compact light-olive-brown (2.5Y 5/4) till with prominent iron-stained joints; mixed with lenses and pods of gray sandy till. Amount of gray till mixed with brown till decreases with depth.
- 2.0 ft Compact light-olive-brown (2.5Y 5/4) till with iron-stained joints and irregularly distributed light-yellowish-brown to light-olive-brown (2.5Y 5.5/4) sandy zones.

At the south end of the pit, where the face strikes northeast, about 5 ft of gray sandy till overlies 2-3 ft of compact brown till. The contact between the tills here is more sharply defined than in the section described above, and less mixing of the tills occurs in the base of the upper till. Till-fabric samples were collected from this exposure. The fabric data (fig. 9) indicate an ice-flow direction generally due south during deposition of the lower till, and southwest during deposition of the upper till.

Locality 9. (26.16N-51.57E). Highway cut on the north side of Interstate Highway 84, immediately west of the Highland Avenue overpass, Waterbury (Waterbury quadrangle). This exposure is now grass covered, but during construction it was described as follows:

- 0.3 ft "A" horizon of soil profile; dark-gray-brown (2.5Y 3.5/4); developed in eolian material mixed with underlying drift.
- 1.0 ft "B" horizon of soil profile, developed in similar mixed material as above; upper part yellowish-brown (10YR 5/6), lower part light-olive-brown (2.5Y 5.5/6). Yellowish color extends irregularly as much as one foot into the underlying till.
- 3.6 ft Loose sandy-silty mottled till; silty fines are olive (5Y 4.5/3). Contact is knife-edge sharp and tightly folded, accentuated by a thin oxidation rind. Immediately above the contact is a 4-18-inch-thick zone in which tongues and lenses of lower till extend into the base of the upper till.
- 7.0 ft Compact olive-brown (2.5Y 4.5/4) till showing some textural variation in which silty phases are more compact (almost platy in places) and darker; sandy phases are less compact and yellower. Light-gray bleached(?) lenses with rusty selvages are present in upper 3 feet.
- 6.0 ft Compact, olive to olive-gray (5Y 4.5/2.5 near top, 5Y 4.5/2 near bottom), massive till with relatively few stones and no boulders. Includes some strongly deformed, yellowish-brown, layered sand bodies. A 10-12-inch-thick layer of brown compact till occurs at base of section, directly overlying bedrock.

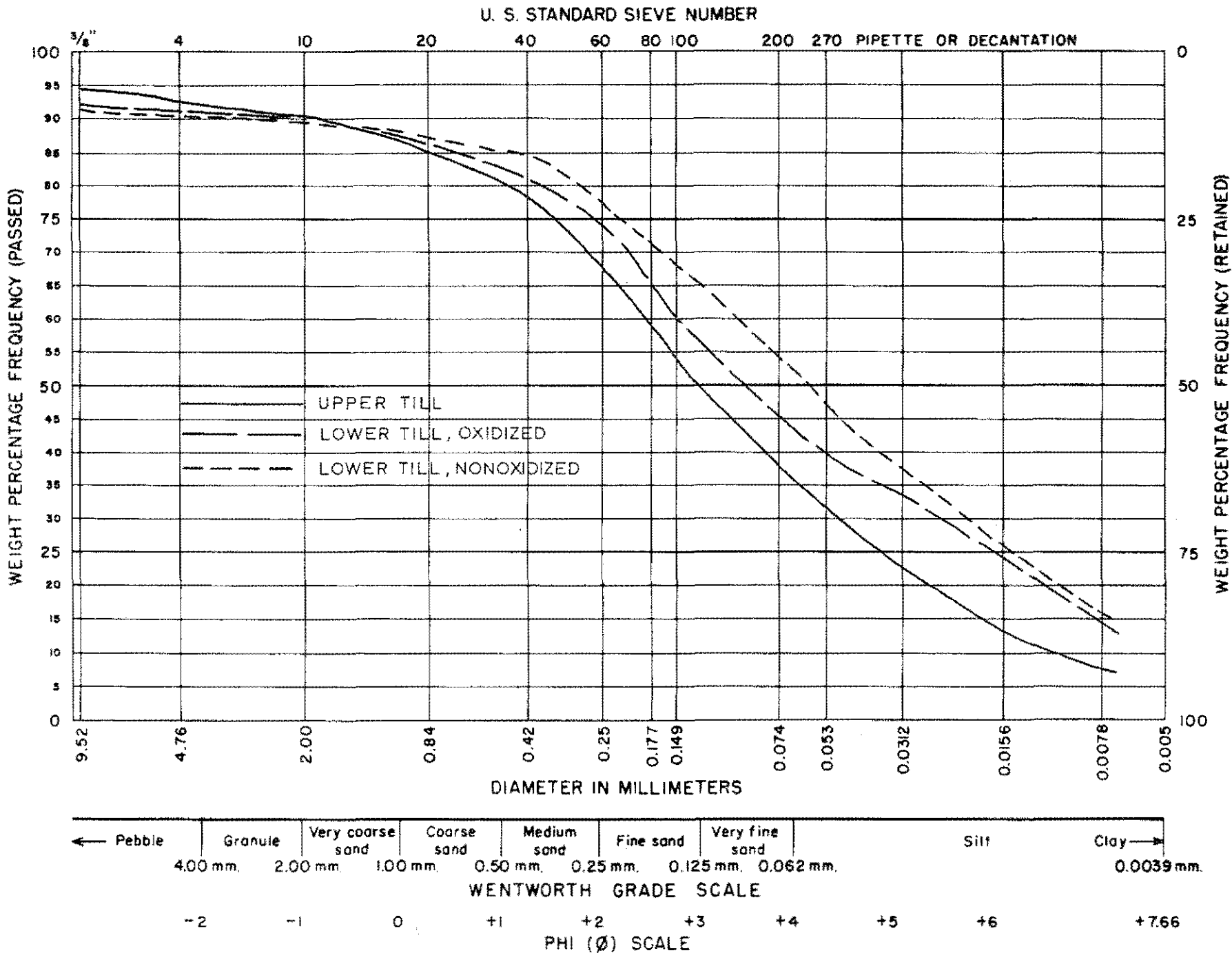

Fig. 10 Cumulative curves from mechanical analysis of tills at locality 9, waterway quadrangle.

Cumulative curves from mechanical analysis of the upper and lower tills at this locality are shown in figure 10. Differences in grain-size distribution between the two tills are in general agreement with results from similar tills elsewhere in Connecticut.

Till-fabric data from the upper and lower tills at this locality are shown in figure 11. In neither is there a strongly developed fabric lineation, but the generally preferred orientations, northeast in the upper till, northwest in the lower till, are consistent with fabric data from other samples of similar tills.

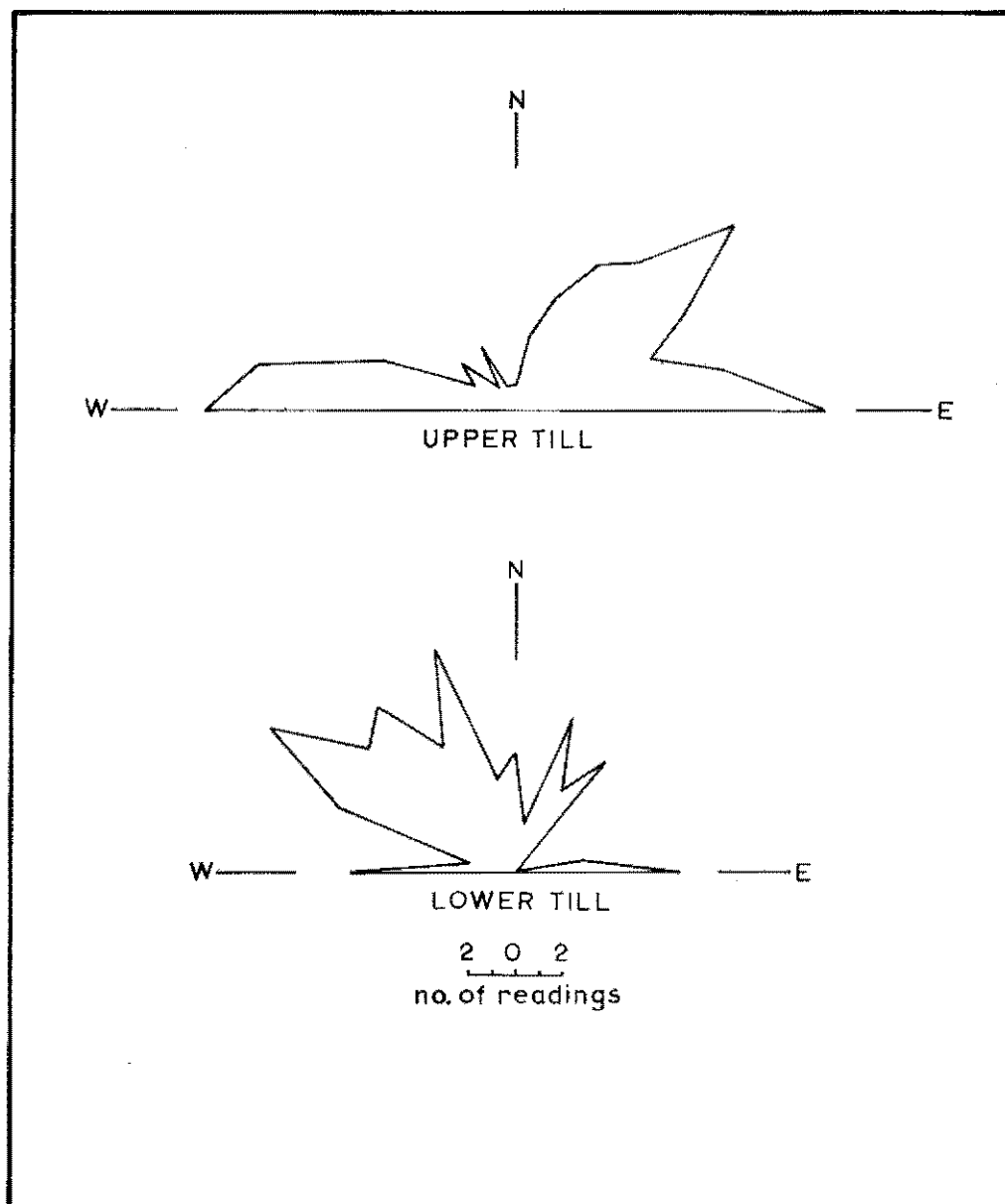

Fig. 11. Till-fabric diagrams from locality 9, Waterbury quadrangle. Each fabric diagram shows strike of long axes of 100 elongate pebbles grouped in 10° classes.

Trip B-2

PERIGLACIAL FEATURES AND PRE-WISCONSIN WEATHEREDROCK IN THE OXFORD-WATERBURY-THOMASTONAREA, WESTERN CONNECTICUT

by

J. P. Schafer
U. S. Geological Survey

INTRODUCTION

The most widespread periglacial phenomenon here is the mantle of late-glacial, wind-deposited sandy silt. However, it is thinner (commonly 1-3 ft) and less widely recognizable than in parts of southern New England where stratified drift is more extensive. No ventifacts have been found in the area.

Periglacial frost features in the area are of the following types:

- 1) Involutions generally occur as deformations of the eolian material and the immediately underlying drift, whether stratified drift (Stop 1) or till (Stop 3). They occur in a zone as much as 4 ft thick immediately beneath the present soil, and presumably were formed in the active zone of annual freeze and thaw. They are the commonest frost features here as elsewhere in southern New England.
- 2) Ideal ice-wedge and frost-crack structures have been found in this area at only one place (Stop 1), in stratified drift.
- 3) Clastic dikes of material derived from overlying drift occur in weathered rock at several places in the area (Stops 2 and 5), and are believed to be replacements of ice veins developed in perennially frozen ground.
- 4) Periglacial colluvial or solifluction zones occur in many places on slopes underlain by weathered rock (Stop 4). Layers of weathered-rock debris from higher on a slope commonly overlie or are interlayered with drift. The distribution of these zones and the form of structures within them show that movement was down the local slope rather than in the southeast to southwest direction of glacier movement. In some places, at least several tens of feet of downslope movement occurred, affecting a thickness of at least 12 ft of material. This extensive slope movement is restricted to areas of weathered rock, as far as is known. There is no evidence, such as deformation of the present soil zone, of modern movement of these zones, and they are believed to be periglacial.

Because some of the frost features require the presence of perennially frozen ground for their development, the mean annual temperature,

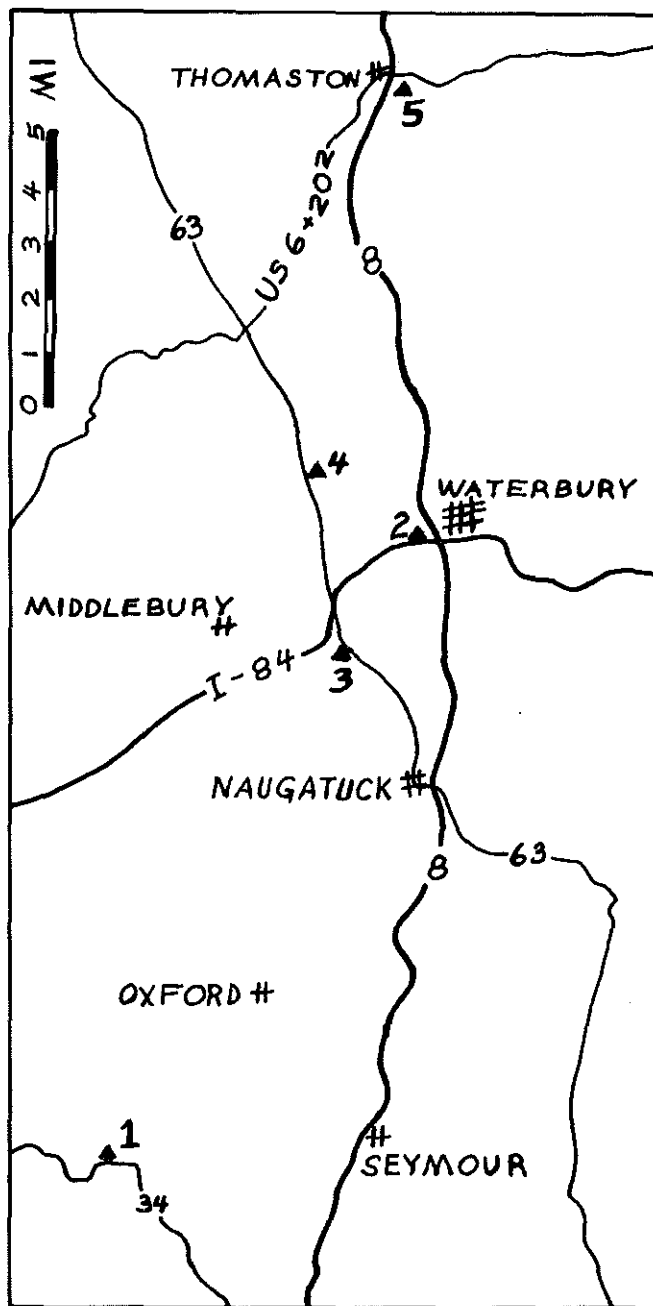

Fig. 1. Sketch map of Oxford-Waterbury-Thomaston area, Connecticut, showing trip stops.

now about 49° F. in the trip area, must once have been somewhat more than 17° lower. The size and depth of penetration of the clastic dikes at Stop 2 have led A. L. Washburn (in a field discussion, November 1967) to suggest that they record the more rigorous frost climate of the time of ice advance rather than late-glacial time.

The abundant weathered rock in this area includes granitoid rocks, gneiss, and schist disintegrated to depths of as much as 25 ft. It is commonly overlain by unweathered drift, and postglacial weathering is slight except perhaps in sulfidic gneisses. The deep weathering, I believe, predates not only the last glaciation but also the older ice advance represented by the lower till of the area (see description of Trip B-1).

Stop 2 is on an interstate highway, and permission of the State Police is required for field trip visits to the exposure. The other localities are on private property.

STOP DESCRIPTIONS

Stop 1 (20.16 N - 48.48 E) Southbury quadrangle. Gravel pit on north side of Route 34, north side of Housatonic River at Stevenson Dam, Riverside, town of Oxford.

Periglacial features are exposed at the extreme north end of this pit, near the power line. Two ice-wedge structures are immediately east of the power line. Two similar but very narrow structures west of the power line may be frost-crack structures. Involutions with amplitudes of as much as 4 ft are developed in the eolian material and upper part of sand and gravel. At several places the bedding in sand beneath the involution zone, but separated from that zone by undeformed beds, is deformed by load structures, which were formed by movement of the sediment under its own weight at the time of its deposition. Confusion between load and frost structures has led both to misinterpretation of load structures as frost structures, and to denial that either type is related to frost action.

Stop 2 (26.16 N - 51.57 E) Waterbury quadrangle. Cut on north side of Interstate 84, just east of Highland Avenue overpass, west of intersection of 84 and Route 8, Waterbury.

In this cut, bedrock is exposed for about 600 ft eastward from the overpass; the western 250 ft is Waterbury Gneiss, and the remainder is quartz diorite. Both rocks are deeply weathered; the quartz diorite in places is disintegrated to a depth of at least 25 ft. Near the east end of the exposure, weathered bedrock underlies part of the graded and grass-covered slope above the exposed bedrock. The weathered rock is penetrated to depths of at least 20 ft by irregular clastic dikes of silt and sand that form an anastomosing network. The dikes are

generally thinner downward, as much as 8 in. thick near top of rock and 0.2 in. thick at a depth of 20 ft. These small dikes are most easily seen at the east end of the rock cut, 550-600 ft east of the overpass. The dikes are thinly bedded parallel to their walls, and their material is identical to material of comparable grain sizes in the overlying till.

A much larger clastic dike occurs about 250 ft east of the overpass, along an outward-dipping contact between gneiss and quartz diorite. This dike is about 30 in. thick, and extends about 20 ft downward in rock. Like the smaller dikes, it consists of bedded sand and silt derived from the overlying till. About 80 ft farther east is another large dike, very poorly exposed.

Stop 3 (25.04 N - 50.91 E) Waterbury quadrangle. Till pit on small 420 ft hill, on west side of relocated Route 63, 1000 ft south of Bradleyville, town of Middlebury.

The northwest side of pit exposes:

- 2 ft eolian sandy silt, yellowish-brown; some stones mixed in from till.
- 0-38 in. involution zone.
- 7 ft till, sandy, olive-gray (upper till)

The involution zone consists of silt and very fine sand interpenetrated with till. Much of the involuted silt and sand is weakly bedded, as is commonly true of the lower part of the eolian material where it is more than 3 ft thick. As this exposure is at the flat top of the hill, the involutions are not systematically overturned. However, at a former exposure 3500 ft southeast, on a 10° slope, similar materials were inter-layered parallel to the slope, as a result of downslope movement.

Stop 4 (26.76 N - 50.48 E) Waterbury quadrangle. Pit on east side of Route 63, 4500 ft north of intersection with Park Road, town of Middlebury.

At the southeast corner of pit is exposed this section of materials stratified parallel to the 18° westward slope of the hillside (thicknesses measured normal to the slope):

- 24-30 in. sandy silt with scattered stones, yellowish-brown; mostly eolian material, the lower part with underlying material.
- 20-26 in. colluvium, olive-gray; interbedded sandy, silty, and till-like material; probably derived from till and from disintegrated gneiss.
- 11-17 in. till-like material, olive-brown.
- 14-20 in. colluvium, thin-bedded, yellowish brown; mostly derived from disintegrated gneiss.
- 36 in. disintegrated gneiss, in place; penetrated by irregular bodies of colluvium, which presumably are replacements of ice bodies in perennially frozen ground.

A former exposure about 80 ft west, lower on the slope, showed a layer of compact jointed till between the colluvium and disintegrated gneiss. The till and adjacent rock and colluvium were in a nearly recumbent fold with an amplitude of about 6 ft, overturned downslope (nearly opposite to direction of glacial movement).

Stop 5 (30.46 N - 51.30 E) Thomaston quadrangle. Pit on east side of Prospect Street, 1800 ft south of U.S. Routes 6 and 202, just east of new Route 8, Thomaston.

The floor of the upper level of this pit is cut in weathered gneiss, which in the north part of that level is intruded by two bodies of granite. The completely disintegrated granite in the south part of the south body is cut by a network of clastic dikes of silt and sand derived from the overlying till. The dikes are identical to the small ones at Stop 2, but are exposed mainly in horizontal rather than vertical section.

Trip B-3

HYDROGEOLOGY OF SOUTHWESTERN CONNECTICUT *

by

W. E. Wilson, R. B. Ryder, and C. E. Thomas, Jr.
Hydrologists, U. S. Geological Survey, Hartford, Connecticut

INTRODUCTION

Geology affects the quantity and quality of water available in southwestern Connecticut, and the variability of both in time and space. Aquifers in the area are stratified drift, till, and bedrock; each has distinctive distribution, geometry, and water-bearing characteristics, all of which influence the type and extent of ground-water development. Mineral composition of rocks affects the quality of ground water and thus affects the quality of water available from streams, into which ground water discharges, as well as from aquifers. In addition, the extent of stratified drift and till in a drainage basin and geomorphic parameters of the basin affect the magnitude and variability of stream-flow. Thus the hydrogeologist can apply a wide range of geologic knowledge in evaluating the water resources.

In this report, "southwestern Connecticut" refers to that part of the state drained by the Housatonic River and its tributaries downstream from Lake Lillinonah (Shepaug Dam) and all basins southwest of the Housatonic River that drain to Long Island Sound (figs. 1 and 2). As such, it includes two areas in which the U. S. Geological Survey has been conducting water-resources investigations, the lower Housatonic River basin and the southwestern coastal river basins. These studies have been made in cooperation with the State Water Resources Commission.

The authors acknowledge the cooperation of many industries and water companies who provided information used in this report. In addition we wish to thank personnel of those companies and organizations who kindly made their facilities available for the 1968 NEIGC field trip: the Naugatuck Chemical Division of UniRoyal, Inc., the Bridgeport Hydraulic Company, and the U. S. Army Corps of Engineers.

THE STRATIFIED-DRIFT AQUIFER

In southwestern Connecticut, stratified drift is the principal aquifer in terms of large scale ground-water development, and the discussion in this report will deal principally with this aquifer. Wells tapping bedrock far outnumber those tapping stratified drift, but the yields of individual bedrock and till wells are generally adequate to serve only homes and small commercial establishments. For example, the median yield of 725 wells drilled in bedrock in southwestern Connecticut is 5.3 gpm (gallons per minute), and only a few individual well yields exceed 50 gpm. On the other hand, the median yield of 64 wells tapping stratified drift is 262 gpm; individual yields generally exceed 100 gpm, and a few exceed 2,000 gpm.

* Publication authorized by the Director, U. S. Geological Survey

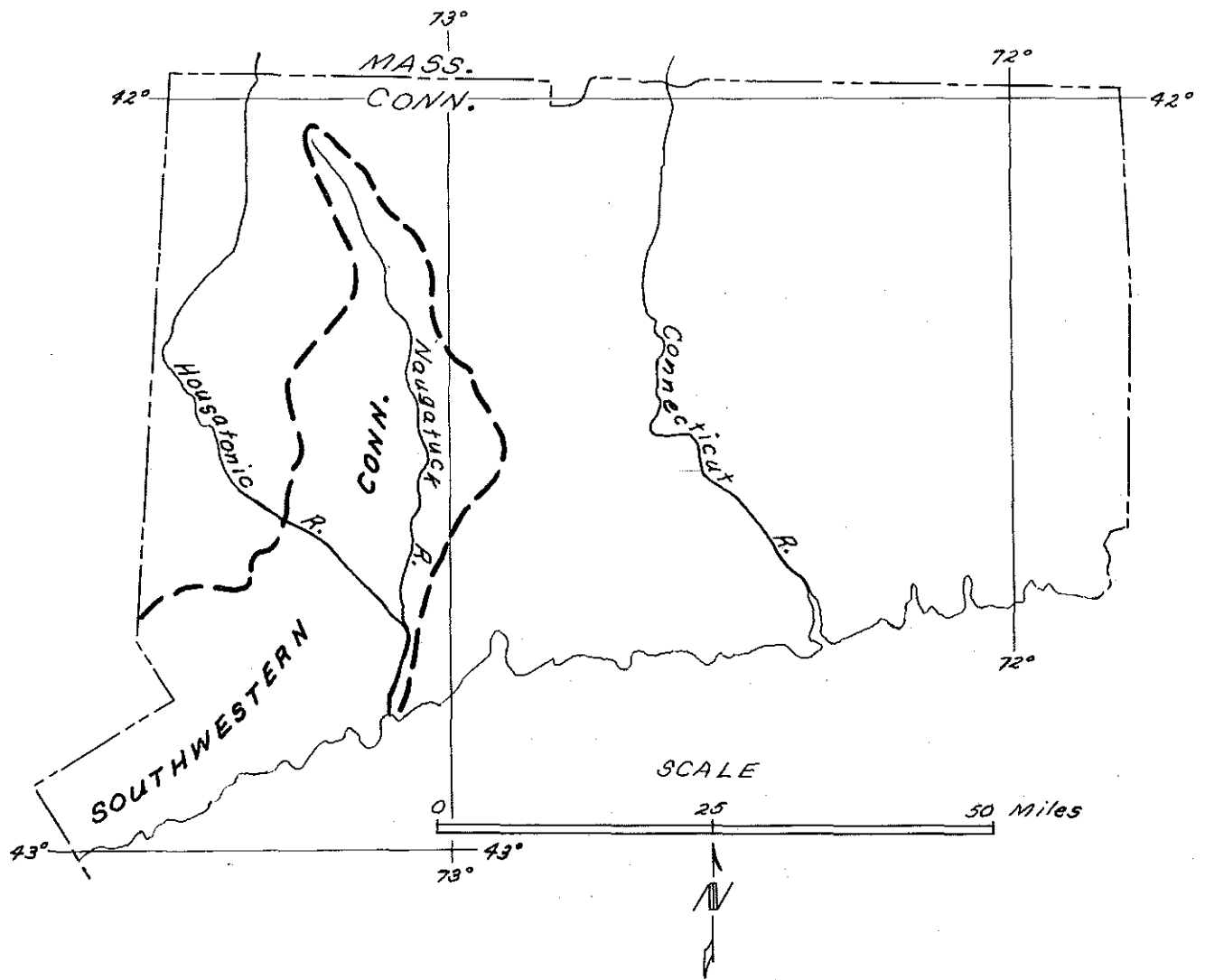

Fig. 1. Map showing location of southwestern Connecticut area.

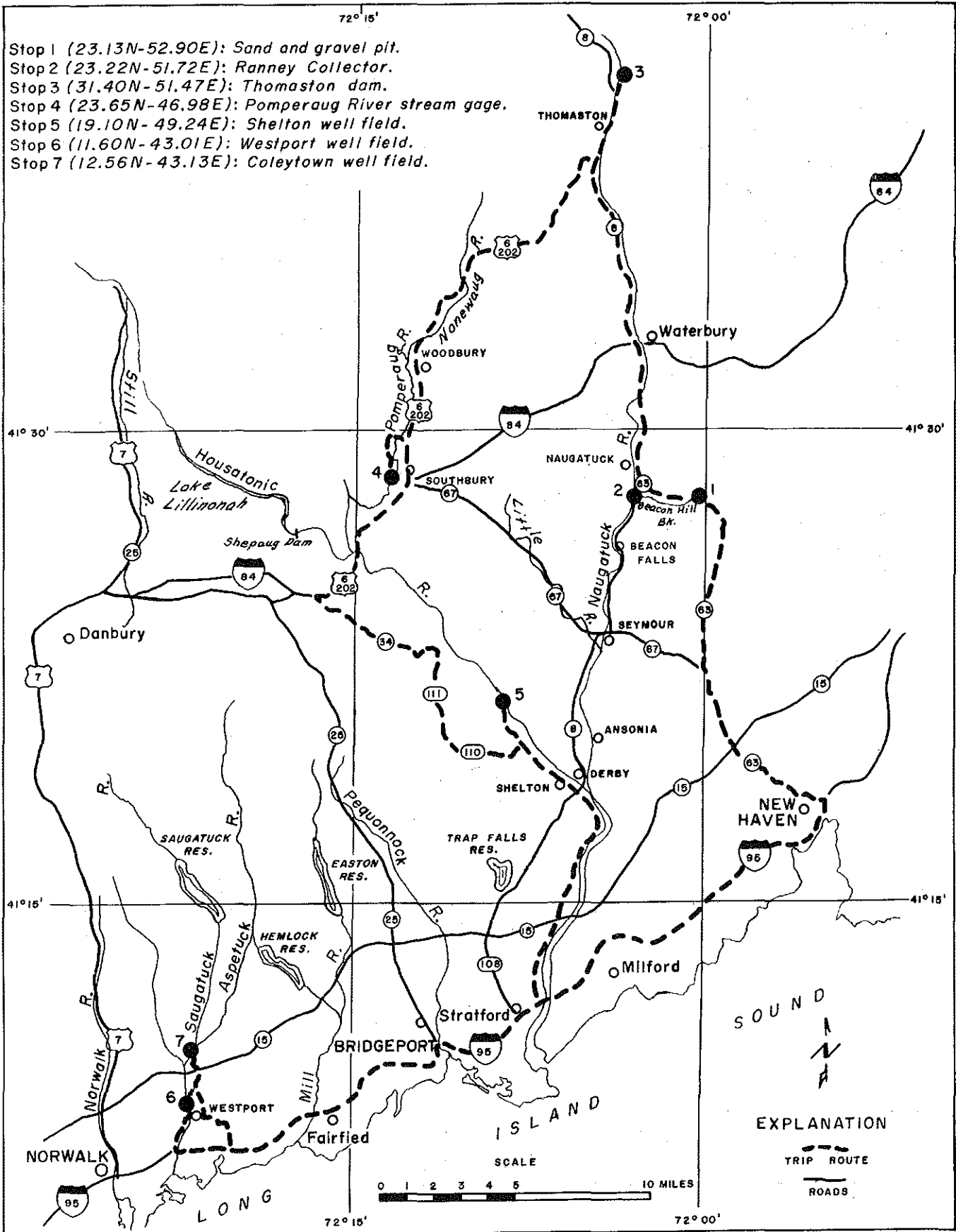

Fig. 2. Map showing route of hydrogeology field trip, southwestern Connecticut.

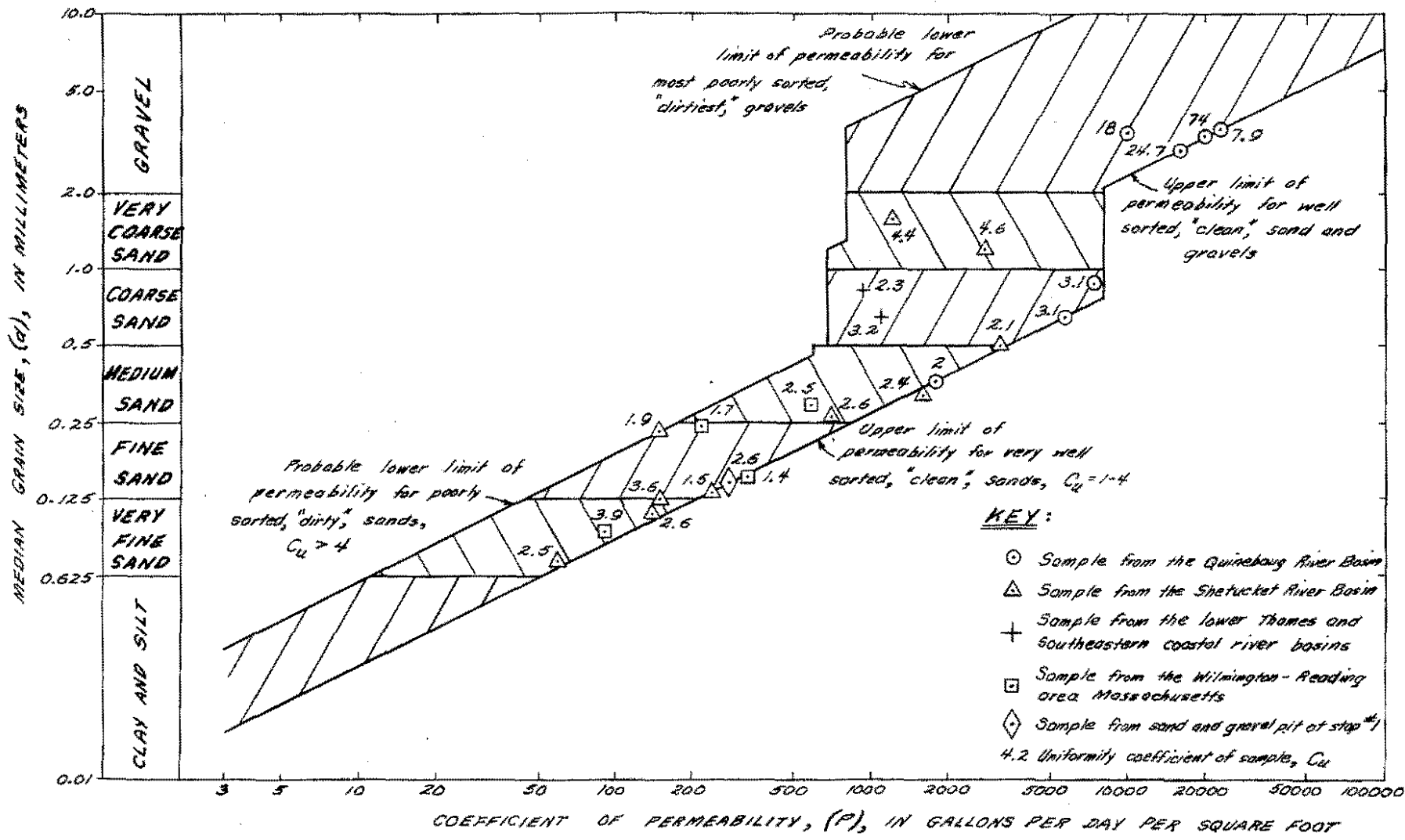

Fig. 3. Graph showing relation between median grain size and permeability of sediments.

Description

The stratified-drift aquifer consists of ice-contact and outwash deposits. Its texture is varied but is generally coarse, with pronounced stratification. In map view the aquifer is generally long and narrow, following the trends of the principal valleys, except along the shore of Long Island Sound between Stratford and Norwalk, where most of the aquifer consists of a sheet-like deposit. Relatively impermeable till-bedrock valley walls bound the aquifer laterally, and effluent streams flow across it roughly parallel to these boundaries. In most places, the stratified-drift aquifer overlies pre-glacial drainage systems and is at least several tens of feet thick; maximum known thickness in southwestern Connecticut is 222 feet at the Shelton well field (Stop 5).

Water-Bearing Characteristics

Lithology and degree of stratification largely determine the water-bearing characteristics of the stratified-drift aquifer. These characteristics are most commonly evaluated by interpreting logs of wells and test borings and by analyzing the results of pumping tests.

The use of well logs in evaluating aquifer characteristics is based on the relationship shown on figure 3 between permeability and the median grain size and sorting of component sediments. At any site where a log of a well or test hole is available, median grain size and sorting are estimated for each lithologic unit below the water table. From figure 3, the permeability of each unit is estimated, and is multiplied by its thickness to determine the transmissibility. The transmissibility of the entire saturated section is obtained by adding the transmissibilities of all the units. To illustrate, imagine that the following section of stratified drift, exposed in a sand and gravel pit near Naugatuck (Stop 1) is below the water table and represents the entire aquifer thickness; then an estimate of transmissibility is made as follows:

Section Description	Thickness of unit (m) ft	Estimated permeability (P) ₂ gpd/ft ²	Estimated transmissibility (T) gpd/ft
Pebble to cobble gravel and medium to very coarse sand	5.0	4,000	20,000
Very fine to well sorted sand	0.5	100	50
Poorly sorted pebble to cobble gravel with medium to very coarse sand and some boulders	5.0	1,000	5,000
Well sorted very fine and fine sand with some medium sand	4.0	280 <u>1/</u>	1,120
Pebble to cobble gravel with boulders, little very coarse and coarse sand	4.5	1,000	4,500
Well sorted very fine sand, some fine sand	3.5	150	525
Silt and very fine sand	20.0	45	900
	m = 42.5		T = 32,095

1/ Permeability determined in laboratory from horizontal undisturbed sample. See plot on figure 3.

Stratification similar to that seen in this and many other sand and gravel pits results in differences in permeability in the horizontal and vertical directions. For example, the vertical permeability of the 4-foot sand bed described above (Stop 1) was only 31 gpd/ft² (gallons per day per square foot) compared to the horizontal permeability of 280 gpd/ft² (a ratio of 1:9) despite the uniform texture of the sand. Even greater permeability differences can be expected between beds of contrasting texture; perhaps in a complete section of sand and gravel the horizontal permeability is as much as 100 times the vertical permeability.

Differences in horizontal and vertical permeability reduce substantially the potential specific capacities of wells screened in only part of the aquifer. Pumping from partially screened wells causes flow lines to converge vertically toward the screens, thus bringing

the relatively low vertical component of permeability into play. In southwestern Connecticut, the combined effect of partial penetration and relatively low vertical permeability may account for more than one half of the drawdown in a typical screened well.

The pumping test is one of the most useful tools available to the hydrogeologist for quantitatively evaluating aquifer characteristics. However, the abrupt changes in both vertical and lateral directions within the stratified-drift aquifer often make it difficult to obtain meaningful results. Some of these difficulties are illustrated by the results of a pumping test conducted by the U. S. Geological Survey in the Pomperaug River valley, Southbury (just north of Stop 4). During this test, a production well screened in the lower one-third of the aquifer was pumped at a rate of 278 gpm for 4 days, and water levels were measured in 8 observation wells.

As shown in the time-drawdown pattern on figure 4, the aquifer responds initially after pumping begins as if under artesian conditions. Then the effects of either delayed gravity drainage or vertical flow components, or a combination of both, cause the rate of drawdown to diminish. These effects may last for days or weeks, during which drawdown may be erratic and may even appear to have stabilized. However, if the test lasts long enough, drawdown rates again increase and the distribution of drawdown with time approaches the Theis model (Theis, 1935).

On a plot of time versus drawdown, the Theis type curve must be fitted to those points representing times after the effects of delayed gravity yield or vertical flow components have dissipated. It is sometimes difficult to judge from the data plot of a single observation well, such as that shown on figure 4, just when -- or whether -- these effects have ceased. However, when data from a number of observation wells are plotted together, they may appear to approach a single Theis type curve. If transmissibility is computed from the best fit of these data to the type curve, it will usually be in close agreement with a value of transmissibility estimated from logs and specific capacity. Analyses of the data from the test at Southbury indicated that about ten more days of pumping would be required to insure a definitive match of time-drawdown data from one observation well to the Theis type curve.

Most pumping tests conducted by well drillers in southwestern Connecticut last a day or less. As can be seen from the above discussion, such tests are difficult to interpret using the Theis method. Thus, prerequisites to obtaining meaningful results from pumping tests include a familiarity with geologic conditions at the site, an understanding of how these conditions may affect drawdowns, and a close control on test conditions.

Induced Infiltration

Many water companies in southwestern Connecticut derive part of their ground-water supply from induced infiltration of streamflow. In Woodbury, for example, the Watertown Fire District derives much ground water from infiltration of water from the Nonewaug River, which has been diverted into a gravel-lined canal that passes through the well field. At periods of low flow, streamflow is augmented by releasing water from an upstream dam and reservoir. Similarly, the Seymour Water Company has placed its Oxford wells alongside the Little River and

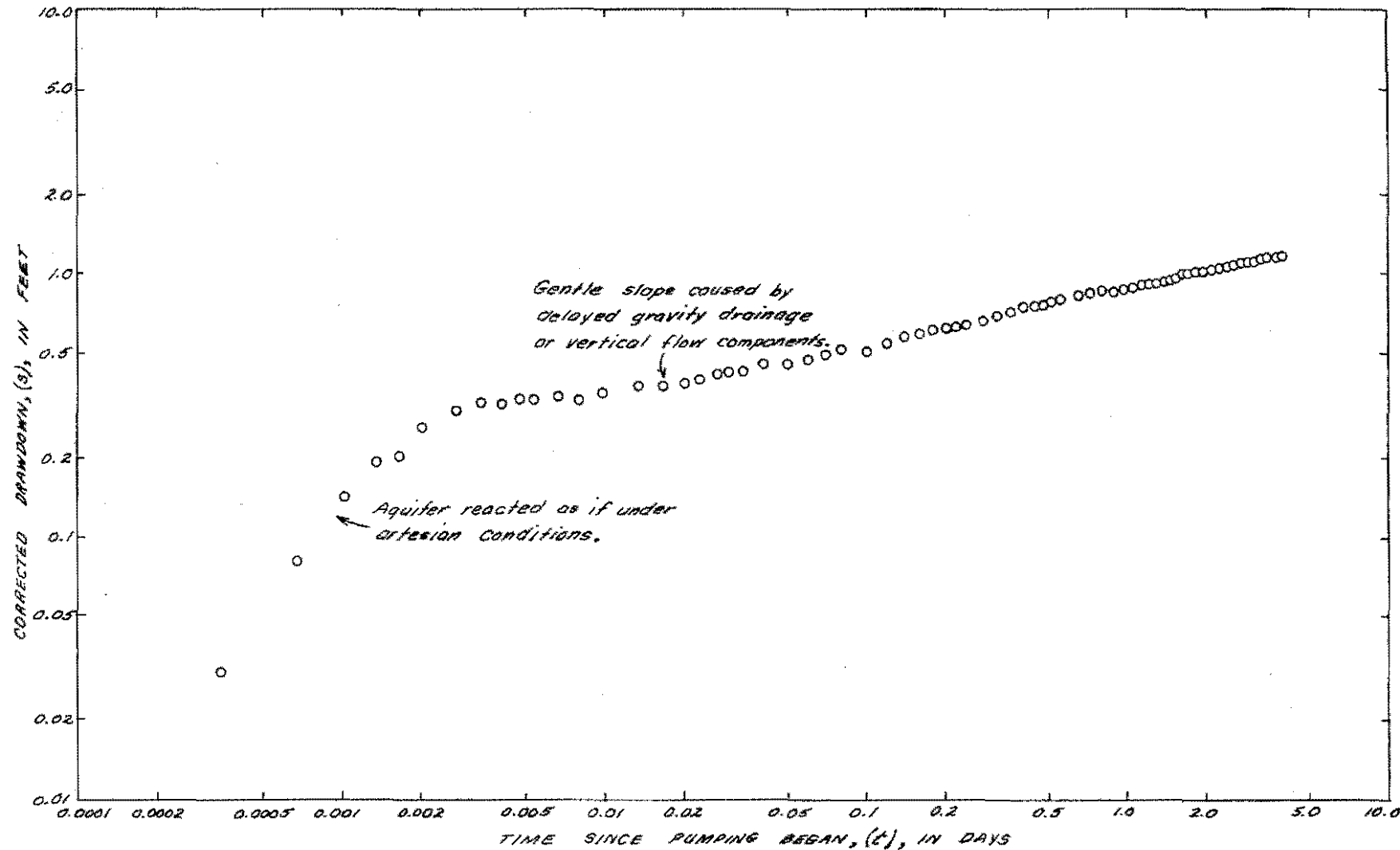

Fig. 4. Graph of time-drawdown data from an observation well, Southbury pumping test.

various man-made side channels. At the Shelton well field (Stop 5), the Bridgeport Hydraulic Company has placed its eight production wells in a line 50-100 feet from the Housatonic River. These wells, which pumped about 3,100 mg (million gallons) during 1965, derive much of their supply from the river. Both the Westport well field (Stop 6) and the Coleytown well field (Stop 7) of the Bridgeport Hydraulic Company derive much of their pumpage, which totaled 737 mg in 1965, from the Saugatuck River.

The yearly amount of water available for induced infiltration from a stream depends not only on the amount and time distribution of streamflow, but more importantly on (1) the vertical transmission capacities of the streambed deposits; (2) the area of the streambed under which the cones of depression from pumping wells have extended; and (3) the depth and temperature of the water. Of these, the physical properties that determine streambed transmission capacities--thickness and vertical permeability--are the most difficult to evaluate. Little quantitative information is available in Connecticut, but in some cases it has been possible to determine the combined effects of permeability and thickness and thereby determine a potential infiltration rate.

A field variable-head permeameter has been used by U. S. Geological Survey personnel to determine approximate potential infiltration rates. Many problems limit the reliability of this method, but the results suggest that in the Pomperaug River valley the infiltration rates of the upper foot of gravely streambed deposits are in the range of 100-400 gpd/ft² per foot of stream depth.

The infiltration rate of the streambed of Beacon Hill Brook was determined from pumping-test and streamflow data. Loss of streamflow over a 640-foot reach of stream was measured twice during a 3-month pumping test of 2 Connecticut Water Company wells. Assuming the water level was drawn down below the stream bottom over this reach, and considering a possible ± 5 percent error in the streamflow measurements, the calculated average infiltration rate is between 70 and 150 gpd/ft² per foot of stream depth at 16°C. Using a similar but somewhat less accurate method, the infiltration rate of the streambeds of the Saugatuck and Aspetuck Rivers in the vicinity of the Coleytown well field was estimated at 68 gpd/ft² per foot of depth at 16°C.

Knowledge of the importance of stream geometry and streambed characteristics has been utilized to improve infiltration rates at some sites. Examples of channel diversions in Woodbury and Oxford are mentioned above. At the Westport well field (Stop 6) periodic dredging of the Saugatuck River bottom removes fine-grained material that gradually accumulates behind a dam situated downstream. An immediate rise in pumping levels results as gravely streambed deposits are exposed. On the other hand, dredging of the Naugatuck River streambed near the Ranney Collector (Stop 2) has failed to produce any noticeable increase in infiltration rate. Downstream from the Coleytown well field (Stop 7) small dams have been built across the two infiltrating streams. The dams have increased the depths and surface areas of the streams, thereby increasing the amount of infiltration.

Development of Ground Water

Historical Development

The stratified-drift aquifer in southwestern Connecticut has been tapped by dug wells for homes and shops since the earliest times of settlement. However, during the 20th century, the popularity of dug wells has declined considerably. Many dug wells have been replaced by drilled bedrock wells, and most new homes are supplied by individual bedrock wells, or by a public-supply system.

Industries have tapped the stratified-drift aquifer in southwestern Connecticut with drilled wells since the early 1900's. Much of the development took place in the highly industrialized Naugatuck River valley and in areas along Long Island Sound. Some industrial wells were drilled in the Naugatuck River valley in the 1920's and 1930's, but the major development occurred during World War II, when increased industrial output spurred exploration for additional water. During 1940-47, at least 22 industrial wells tapping stratified drift were drilled in the valley.

The large and generally haphazard development of ground water during the 1940's contributed to water-quality problems which have largely been responsible for the subsequent decline in ground-water use from private industrial wells. Along the southwestern Connecticut coast, especially in the Bridgeport area, salt water encroachment led to the eventual abandonment of most industrial wells. In the Naugatuck River valley, highly mineralized ground water caused problems of screen encrustation, declining yields, and water treatment.

In the 20 years following 1947, only seven new industrial wells tapped the stratified-drift aquifer in the Naugatuck River valley, and 12 of the war-time wells were abandoned. Many industries have found it uneconomical to develop or continue with their own supplies. Still, the valley remains the major center of industrial pumpage. In 1965, approximately 7.2 mgd (million gallons per day) were pumped from industrial wells in southwestern Connecticut, most of which (6.2 mgd) came from the Naugatuck valley.

In contrast to declining development of ground water by private industries, development by public-supply water companies has increased markedly over the last two decades. Of 47 public-supply wells in use during the mid-1960's only a few were drilled prior to 1950. The stimulus for this development results from increased demands for water and rising costs for obtaining and developing the few available reservoir sites that remain. In some towns of southwestern Connecticut, the Bridgeport Hydraulic Company turned to ground water when their service area expanded to areas above their reservoirs and to areas underlain by relatively large aquifers. The water companies are more flexible than industries in their choice of sites, and they have been able to place wells in areas where the quality of water is relatively unaffected by man and in areas remote from possible salt-water contamination.

In 1965, 12 water companies (or their subsidiaries) pumped an average of 17.7 mgd from wells tapping stratified-drift in southwestern Connecticut.

Of this amount, nearly half (8.5 mgd) came from Bridgeport Hydraulic Company's Shelton well field, which is located along the Housatonic River at Shelton (Stop 5). Almost all of these companies utilize ground water as a supplement to, or in combination with surface-water reservoirs. A few large public water supplies such as those of the Water Department of the City of Waterbury and the Greenwich Water Company, continue to use surface supplies exclusively.

Exploration and development of ground-water supplies from the stratified-drift aquifer has largely been undertaken by individual companies, with each firm utilizing drillers, private consultants, or their own personnel. More recently the U. S. Geological Survey has conducted basin-wide water-resources investigations, and Regional Planning Agencies have sponsored regional studies and plans. These studies provide a basis for planning systematic development and use of the ground-water resource.

Examples of Development

Several installations for ground-water withdrawal are described below to illustrate some of the conditions and problems encountered in developing ground water from the stratified-drift aquifer in southwestern Connecticut. Each installation has certain features that make it particularly interesting or distinctive.

Ranney Collector (Stop 2). One of three Ranney Collectors in Connecticut is located in Naugatuck next to the Naugatuck River (fig. 5). The well was installed in 1949 for the Naugatuck Chemical Company, now a division of UniRoyal, Inc.

A Ranney Collector is specifically designed to induce stream infiltration over a large area by utilizing slotted horizontal laterals extending radially from the base of a large-diameter vertical caisson. The installation at Naugatuck consists of a 13-foot diameter concrete caisson, 87 feet deep, with eight laterals ranging in length from 4 feet to 400 feet. (See fig. 5.) The laterals are 8 inches in diameter and have half-inch slots. Results of tests conducted during the first year of operation indicated a maximum sustained pumping capacity of 1,830 gpm at a drawdown of about 68 feet.

During the two decades following the installation of the Ranney Collector, several problems arose, including withdrawal of relatively highly mineralized water, encrustation of the laterals, pumping of sand and silt, and a decline in operating yield.

Commercial analyses of water samples from the collector during 1952-66 showed an average concentration of 342 mg/l (milligrams per liter) total dissolved solids, including an average of 7.3 mg/l iron and 5.7 mg/l manganese. Iron concentrations as high as 14.0 mg/l were reported, and in some samples reported manganese concentrations exceeded those of iron. Neither the Naugatuck River nor the natural ground water in the area is known to have such large concentrations of iron and manganese. The high concentrations of these elements in the collector water may be due to the solution of iron and manganese from the sand and gravel aquifer by infiltrating river water of low pH. The pH of most samples of the river at Beacon Falls ranged between 3.1 and 6.0.

In 1967, an inspection of the collector showed that the insides of the laterals were coated with a slimy encrustation 2 inches thick,

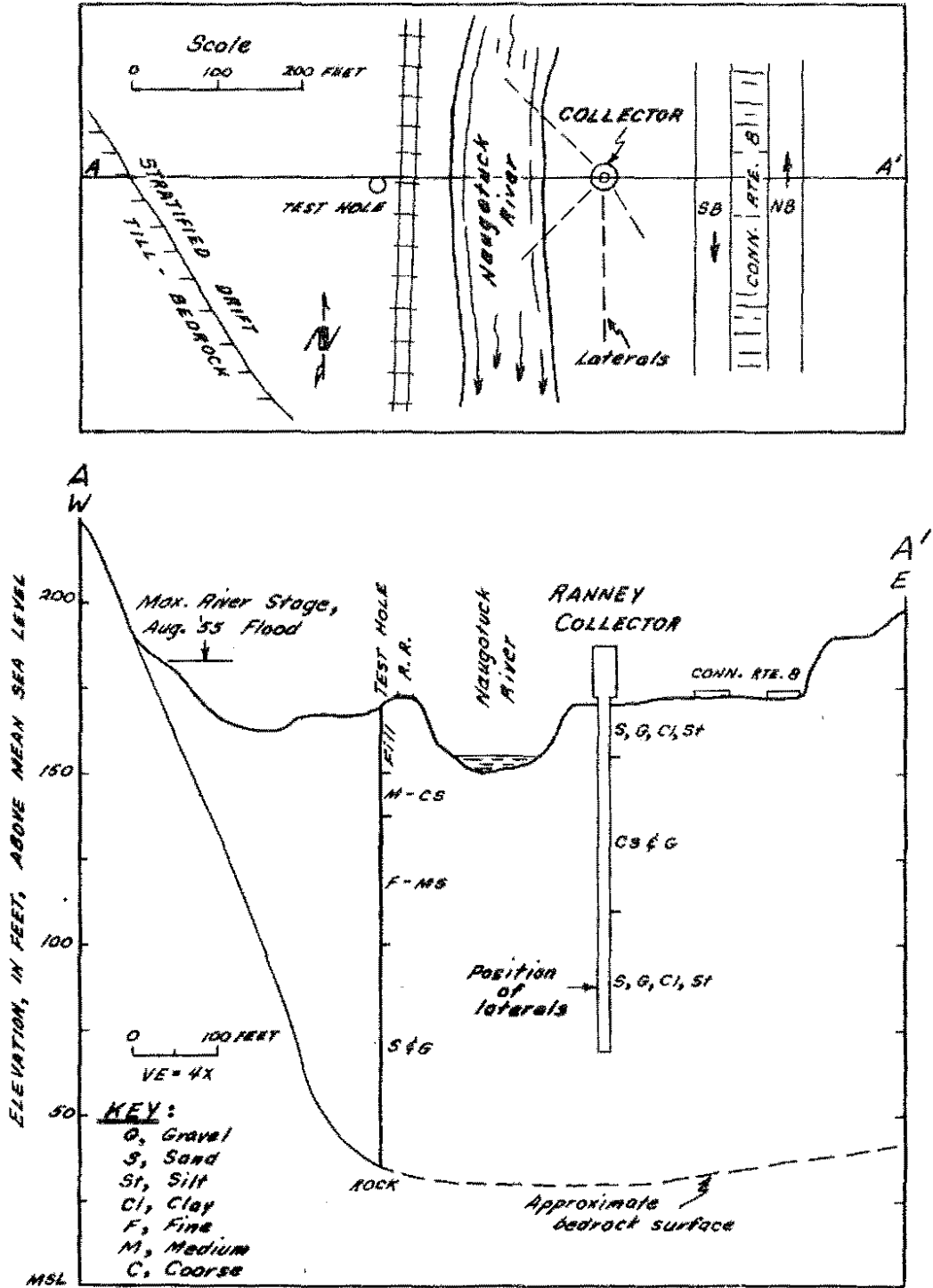

Fig. 5. Map and cross section at site of Ranney Collector, Naugatuck.

which thus reduced the diameter by half. As a result, entrance velocities increased and sand and silt entering the laterals were carried into the caisson. By reducing the pumping rate, a higher pumping level is maintained, turbulence is reduced, and the amount of suspended sediment carried into the system is minimized.

Since the fall of 1965, the supply from the Ranney Collector has been augmented by water piped into the well from the mouth of Beacon Hill Brook, 700 feet to the south. During the first three months of 1967, pumpage from the brook averaged about 1.0 mgd, and total withdrawal from the Ranney Collector averaged about 1.5 mgd. The addition of relatively good quality brook water results in a blend more satisfactory for plant operation. In one sample of the blended water, the concentration of total dissolved solids was reported as 125 mg/l, iron as 3.9 mg/l, and manganese as 1.4 mg/l.

Shelton well field. The Shelton well field (also called the Housatonic well field) probably is the largest of its kind in New England. It consists of a line of eight wells, each capable of pumping 3 mgd, located on a low terrace adjacent to the Housatonic River (fig. 6).

The Shelton well field is part of the extensive water-supply system of the Bridgeport Hydraulic Company. The wells pump nearly full time during the summer months and operate at a reduced schedule during the remainder of the year. Water is pumped uphill to Trap Falls Reservoir in Shelton, where it is distributed, along with water from other sources, to several towns in Fairfield County. In 1965, approximately 3,100 mg (million gallons) were pumped from the well field, representing nearly half of the total amount of water distributed from Trap Falls Reservoir.

The first extensive test drilling of this area was started in 1951. The logs of many of these holes record "refusal" at about 100 feet; the deepest test hole was 111 feet. Refusal was believed to be bedrock, and therefore three production wells were drilled with depths averaging 95 feet. However, seismic studies made in 1953 and 1957 suggested that bedrock was more than 200 feet below the surface in many parts of the area. Additional test drilling verified the geophysical results and indicated that "refusal" in the earlier test holes was in fact boulders. In 1954 two deeper production wells were drilled, and during 1964-67, eight additional deeper wells were drilled and five of the older wells abandoned.

The eight wells in use in 1968 average 207 feet in depth. All are 24 inches in diameter and are finished with 30 feet of 250-slot screen. The wells were tested at rates ranging from 2,118 to 2,513 gpm, averaging 2,360 gpm. Specific capacities varied widely from 16.9 to 50.3 gpm/ft (gallons per minute per foot).

The large individual well yields at the Shelton well field are the consequence of the high transmissibility of the aquifer, the availability of large drawdowns, and the large potential for induced infiltration. The section at the Shelton well field consists of interbedded sand and gravel (fig. 6) whose average permeability, estimated from well logs, is probably in the range of 700-1000 gpd/ft². The exceptionally great thickness of the aquifer is the result of glacial overdeepening of the bedrock floor of the valley. Thus, whereas the specific capacities are about average for wells tapping the stratified-drift aquifer, the availability of large drawdowns permits high pumping rates. In yield

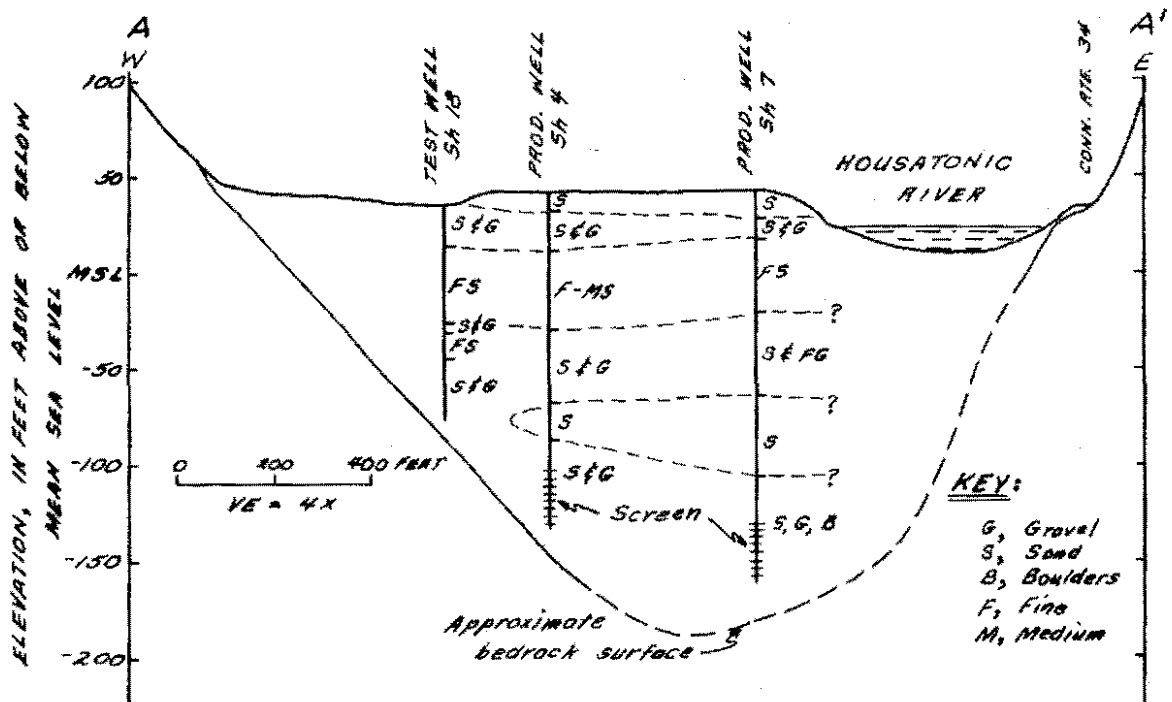
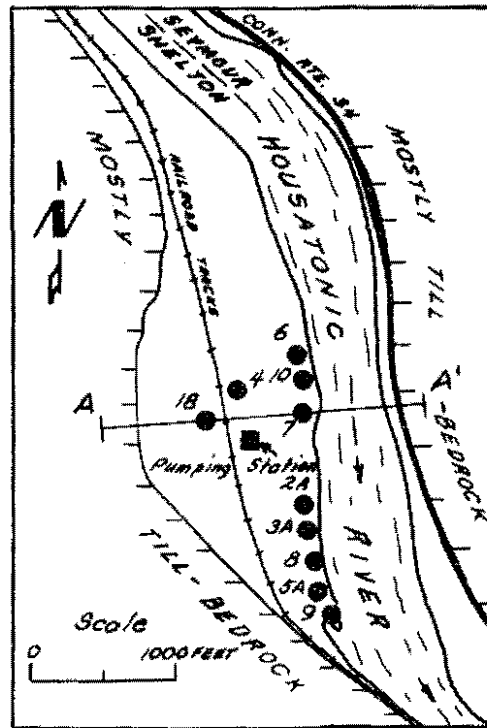

Fig. 6. Map and cross section at Shelton well field.

tests of eight wells, average pumping level was 97 feet, and maximum was 135 feet. The natural recharge area to the aquifer is restricted, and it is assumed that a large part of the pumpage is derived from induced infiltration, despite the presence of fine-grained river channel deposits. The Housatonic River at the site is of good quality and has a large volume of water potentially available. Near the well field the river is about 600 feet wide and 10 feet deep, and only rarely does average daily flow drop below the expected maximum pumpage of 25-30 mgd. The large drawdowns near the river probably permit maximum potential infiltration to occur under prevailing conditions.

Westport well field. The Westport well field (Stop 6) of the Bridgeport Hydraulic Company dates back to the early 1900's when a shallow dug well was the only public water supply for the town. The well field is located along the Saugatuck River in the Town of Westport (see location map, fig. 7). It consists of four wells spaced upstream from a low dam that marks the upstream extent of salt water. Well Wp 9 (No. 3), dug in 1953, is on the east side of the river about 150 feet upstream from the dam. This well is 20 feet deep, 48 inches in diameter, and has 12 feet of screen. Wells Wp 10 (No. 4), Wp 11 (No. 5) and Wp 12 (No. 6), are spaced about 450, 650, and 100 feet, respectively, upstream from the dam on the west side of the river (fig. 7). Well Wp 10 was constructed by the caisson method in 1953 and wells Wp 11 and Wp 12 were drilled in 1953 and 1957, respectively. Wells Wp 10, Wp 11, and Wp 12 are gravel packed, 69, 68, and 90 feet deep, respectively, and are finished with screens 37, 25, and 26 feet long set to the bottom of the stratified-drift aquifer.

Yields of individual wells range from 700 to 2,100 gpm. The maximum pumping rate of the well field is 8.1 mgd; total pumpage during 1966 was 293 mg and in 1967 it was 340 mg. Originally designed as a peaking facility, the well field in 1968 operated almost continuously. The continuous operation sometimes causes salt water from below the dam to intrude the aquifer. The concentration of chloride in samples of water analyzed by the U. S. Geological Survey in August 1964 ranged from 36 mg/l at well Wp 11 to 1,280 mg/l at well Wp 12. Reduced pumpage from well Wp 12 and channeling of the Saugatuck River around wells Wp 10, Wp 11, and Wp 12 has apparently halted further encroachment of salt water.

Coleytown well field. The Coleytown well field (Stop 3) is situated in Westport about 400 feet upstream from the confluence of the Aspetuck River and the East Branch of the Saugatuck River (see location map, fig. 8). It consists of production wells Wp 29 (No. 1) and Wp 30 (No. 2). Both wells are gravel packed, 59 feet deep, 24 inches in diameter and are finished with 250-slot screens 20 and 25 feet long. Because silty sand makes up the bottom of the stratified-drift aquifer, neither well is finished to bedrock; the log of well Wp 29 indicates that bedrock is 84 feet below land surface. Well Wp 29 was tested at a yield of 1,520 gpm with 34 feet of drawdown and well Wp 30 was tested at a yield of 1,100 gpm. The maximum pumping rate of the well field is 3.5 mgd, and the wells supplied 696 mg in 1966 and 205 mg in 1967. Much of the water is derived from induced infiltration of both rivers; in fact, pumpage has so greatly reduced streamflow at U. S. Geological Survey continuous-record gaging station 2095, about 2,000 feet downstream from the well field, that the station was discontinued in 1967.

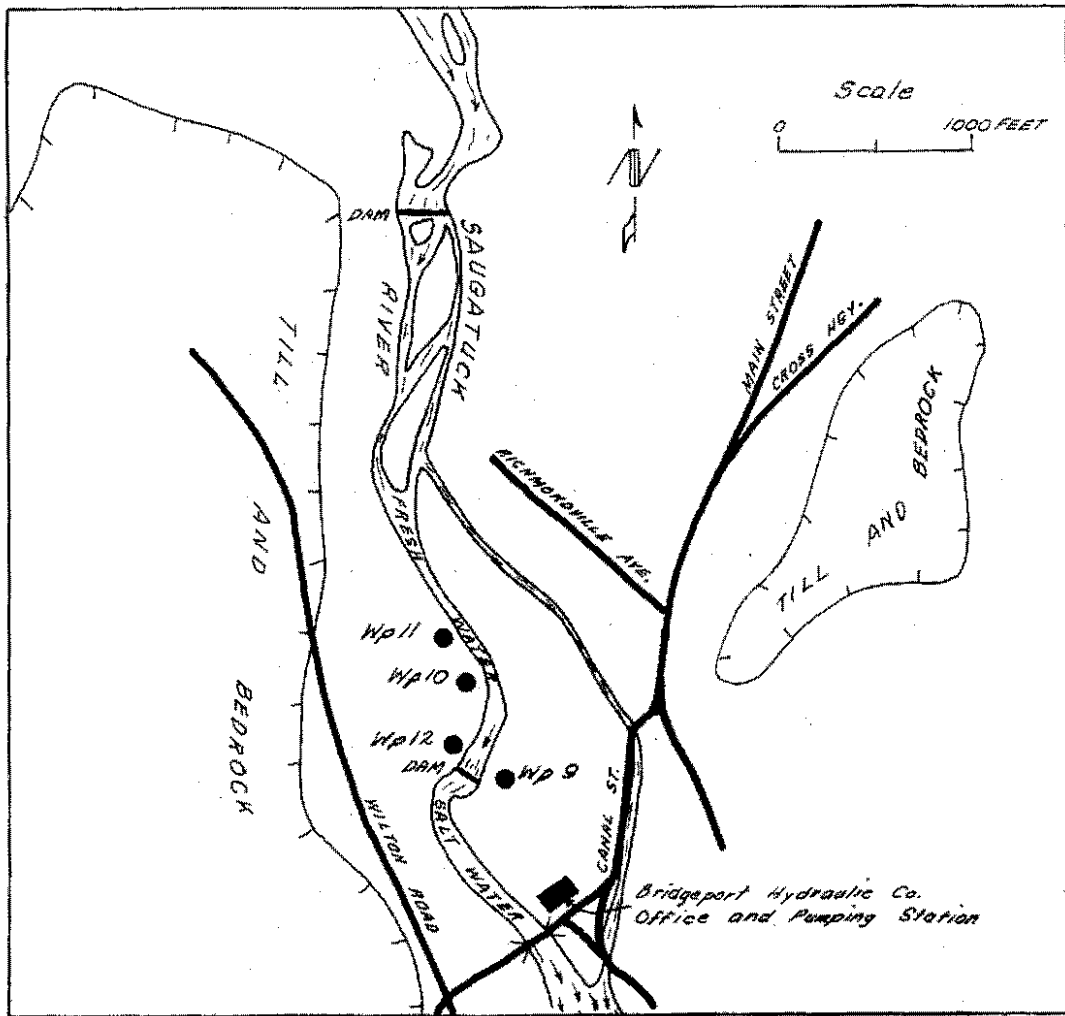

Fig. 7. Map of Westport well field.

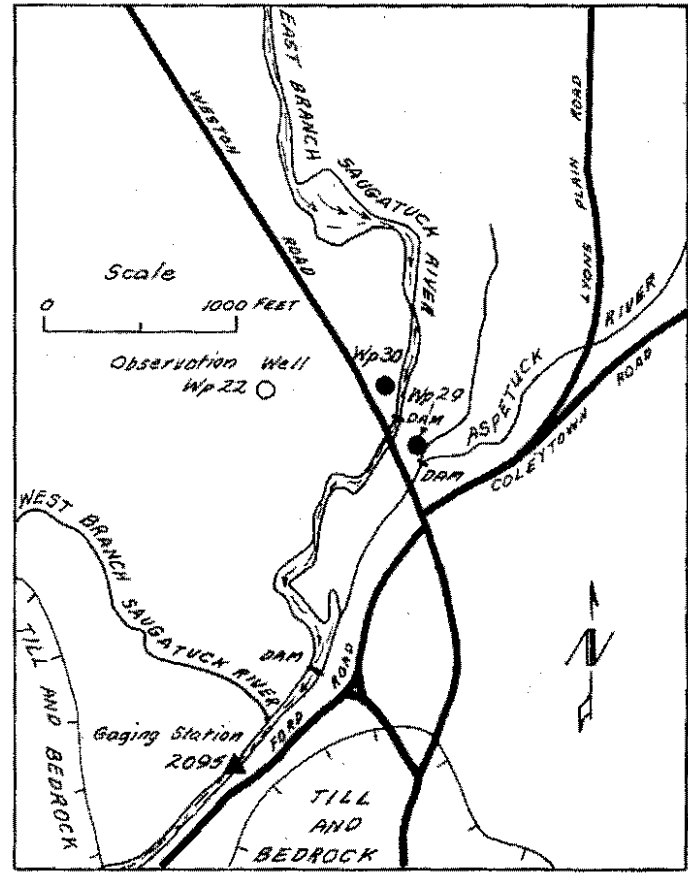

Fig. 8. Map of Coleytown well field.

WATER QUALITY

When water reaches the land surface it contains small amounts of dissolved solids. For example, monthly samples of precipitation in southwestern Connecticut had a dissolved-solids content that ranged from 6 to 96 mg/l, and the median value was 21 mg/l. Most samples were acidic; median pH was 4.6

As water moves over and through earth materials, it generally becomes more highly mineralized. In rural areas of southwestern Connecticut, water quality reflects principally the natural effects of climate and geology; in urban and industrialized areas its quality reflects the activities of man. Contrasts between the quality of water in natural environments and in environments affected by man are illustrated for water in streams on figure 9 and for water from wells on figure 12.

Under natural conditions, the quality of water in streams varies with stream discharge, as shown on figure 10, reflecting various mixtures of overland runoff and ground-water runoff. Specific conductance (a measure of the dissolved-solids concentrations) of water in streams is highest at low stream discharges when most of the streamflow is derived from ground water. The quality of water in streams during periods of low discharge can be used to determine areal variations in the quality of ground water and the relationship of geology to water quality.

Water samples collected from streams during periods of low discharge at 44 sites in southwestern Connecticut show that, under natural conditions, the quality of water from various noncarbonate rocks and sediments derived from them is generally similar, is soft, and is relatively low in dissolved solids. The sample collected from the Pomperaug River, which shows a hardness of 56 mg/l and maximum dissolved-solids content of 105 mg/l (see fig. 9), is representative of samples collected from noncarbonate rock terranes. On the other hand, a sample collected from Ridgefield Brook, which drains an area largely underlain by carbonate rocks and sediments derived from them, had a hardness measured at 215 mg/l and a dissolved-solids content of 268 mg/l.

In industrial and urban areas of southwestern Connecticut, the chemical characteristics of streams are determined more by man's activities than by climate and geology. Addition of domestic and industrial wastes to the streams alters the pH and increases the concentrations of such constituents as sulfate, chloride, iron, and total dissolved solids. The Naugatuck River is one of the most heavily contaminated streams in the State. Ranges in concentrations of various constituents in this river, based on 23 samples taken at Beacon Falls, are shown on figure 9 in comparison with stream quality under natural conditions as represented by the Pomperaug River.

Continuous records of specific conductance of the Naugatuck River at Beacon Falls, as shown on figure 11, indicate that at times the dissolved-solids concentration and streamflow vary inversely in the same relationship as shown for the uncontaminated Pomperaug River. However, figure 11 shows, for a 12-day period in July 1966, that specific conductance fluctuates widely several times during the course of a single day. During the same 12-day period, there was practically no variation in specific conductance in the water of Hall Meadow Brook, a natural stream in the headwaters of the Naugatuck River basin (fig. 11).

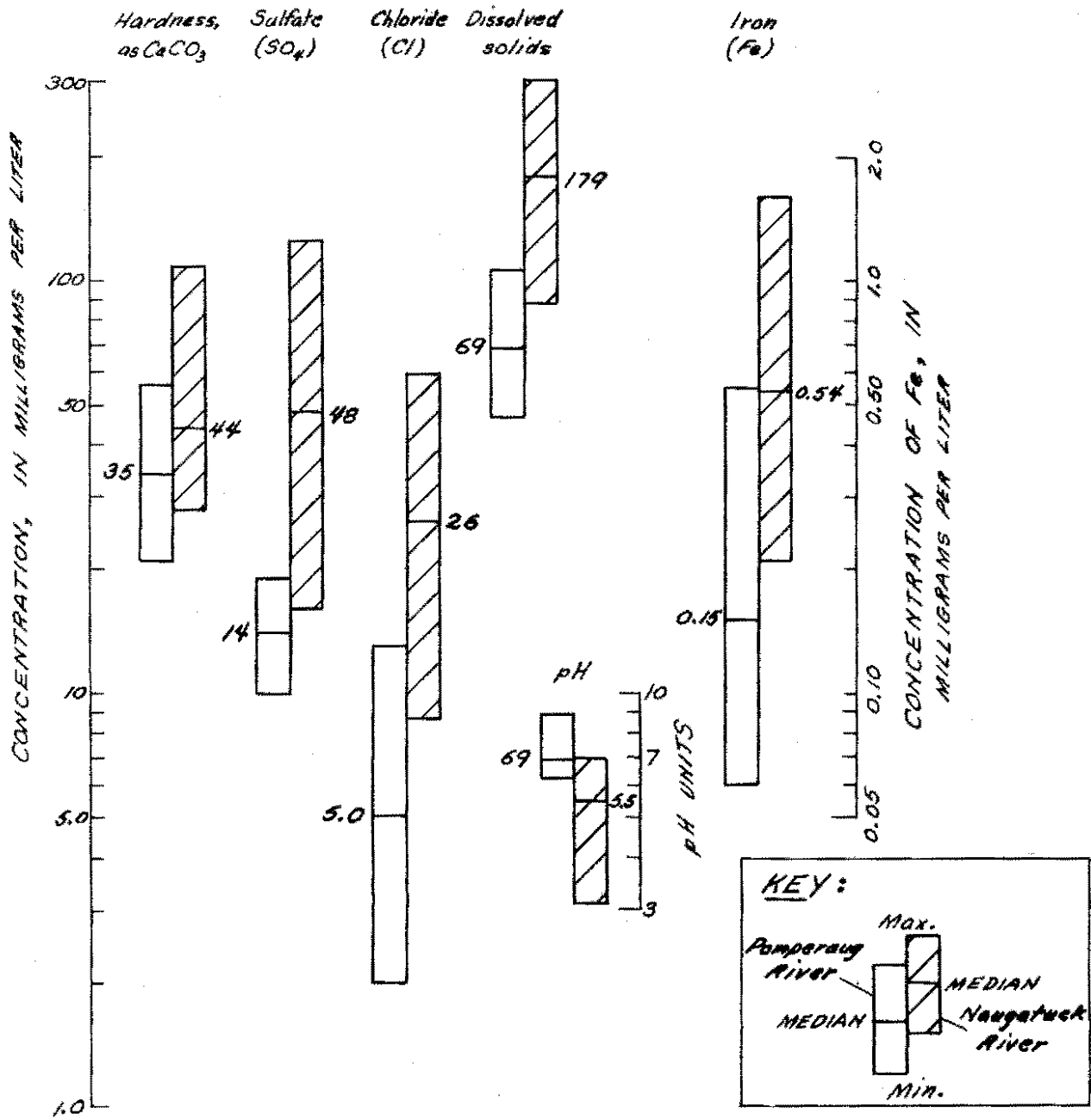

Fig. 9. Graph showing ranges in concentrations of selected constituents in water samples of the Naugatuck River and Pomperaug River.

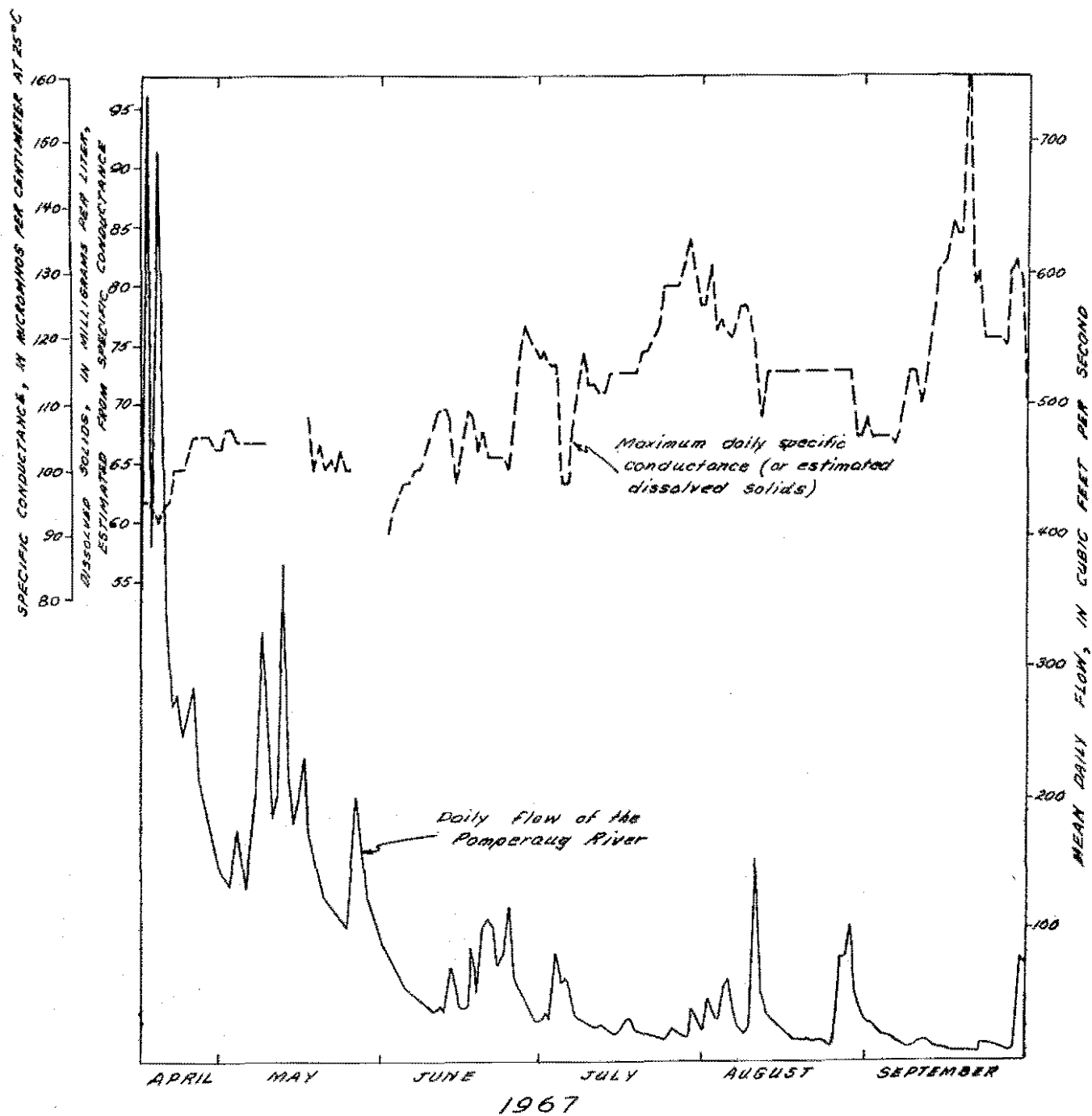

Fig. 10. Graph of specific conductance and streamflow, Pomperaug River at Southbury.

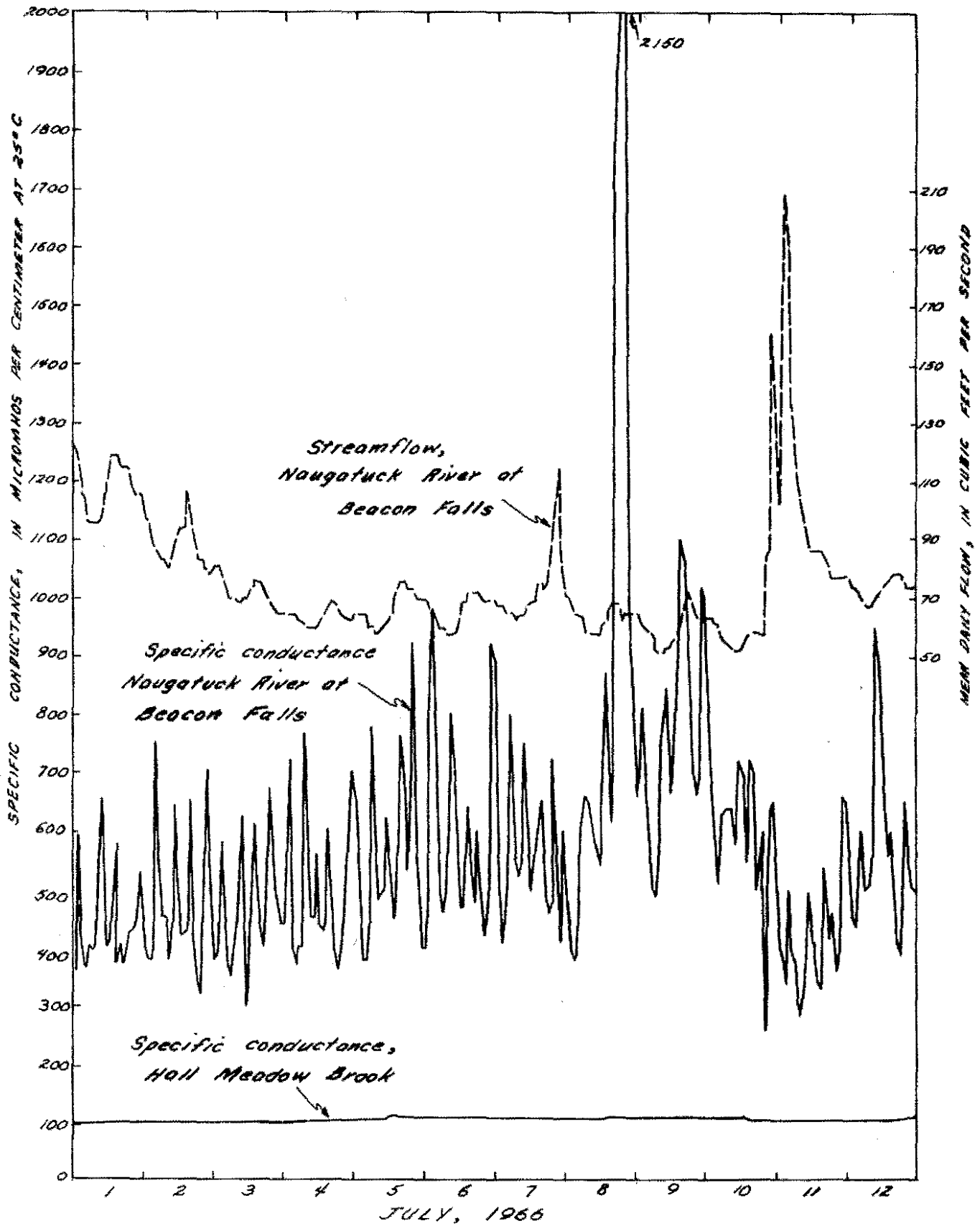

Fig. 11. Graph of specific conductance and streamflow, Naugatuck River at Beacon Falls.

The wide fluctuations in specific conductance of water in the Naugatuck River are in response to periodic discharges of industrial wastes upstream, and these fluctuations are superposed on the natural variations related to changes in the origin of the water in the stream.

Under natural conditions, ground water sampled from wells in the stratified-drift aquifer is generally more highly mineralized than water in contiguous streams, but the well water and stream water contain about the same relative proportions of the same constituents. Figure 12 shows that most samples of natural (uncontaminated) ground water from the stratified-drift aquifer were soft (hardness of less than 61 mg/l); the hardest were classed as "moderately hard" (hardness of 61-120 mg/l). As in the stream water, the quality of water from wells is related to the geology, and the samples with the highest hardness and the highest dissolved-solids concentrations came from parts of southwestern Connecticut where the stratified-drift aquifer includes material derived from carbonate bedrock.

Locally throughout southwestern Connecticut, aside from salt water encroachment along the coast, ground water has become contaminated by downward percolation of water laden with septic tank effluent and road salts, and through the induced infiltration of contaminated stream water. Figure 12 summarizes the quality of contaminated as compared to uncontaminated well water.

Induced infiltration of contaminated water from the Naugatuck River is largely responsible for the poor quality of ground water pumped from parts of the stratified-drift aquifer in the Naugatuck valley. For example, water from well Wb 10a in Waterbury, 250 feet from the Naugatuck River, has shown a range in sulfate content from 67 to 243 mg/l. Monthly samples taken from August 1966 to September 1967 averaged 95 mg/l sulfate, which is equal to 35 percent of the dissolved solids. Variations in sulfate content can be attributed principally to changes in the proportion of water induced from the river and to variations in chemical composition of the river. As noted previously, the high iron and manganese concentrations in water from the Ranney Collector at Naugatuck are attributed to interaction of poor quality river water with aquifer materials.

GEOLOGY AND STREAMFLOW

Streamflow variability

Streamflow in Connecticut varies from day to day, season to season, and year to year. The degree of variability in flow of a particular stream is controlled by many complex factors, including those related to geology, geomorphology, and climate. Continuing studies in Connecticut suggest that the underlying stratified drift and till in a drainage basin integrate many of the geologic and geomorphic parameters that affect streamflow variability.

The variation in rate of streamflow may be expressed conveniently by means of flow-duration curves; the curves in figure 13 are examples. They show the percentage of time any particular mean daily flow was equaled or exceeded during 1931-60. They are adjusted to a statewide average flow of 1.80 cubic feet per second per square mile to reduce

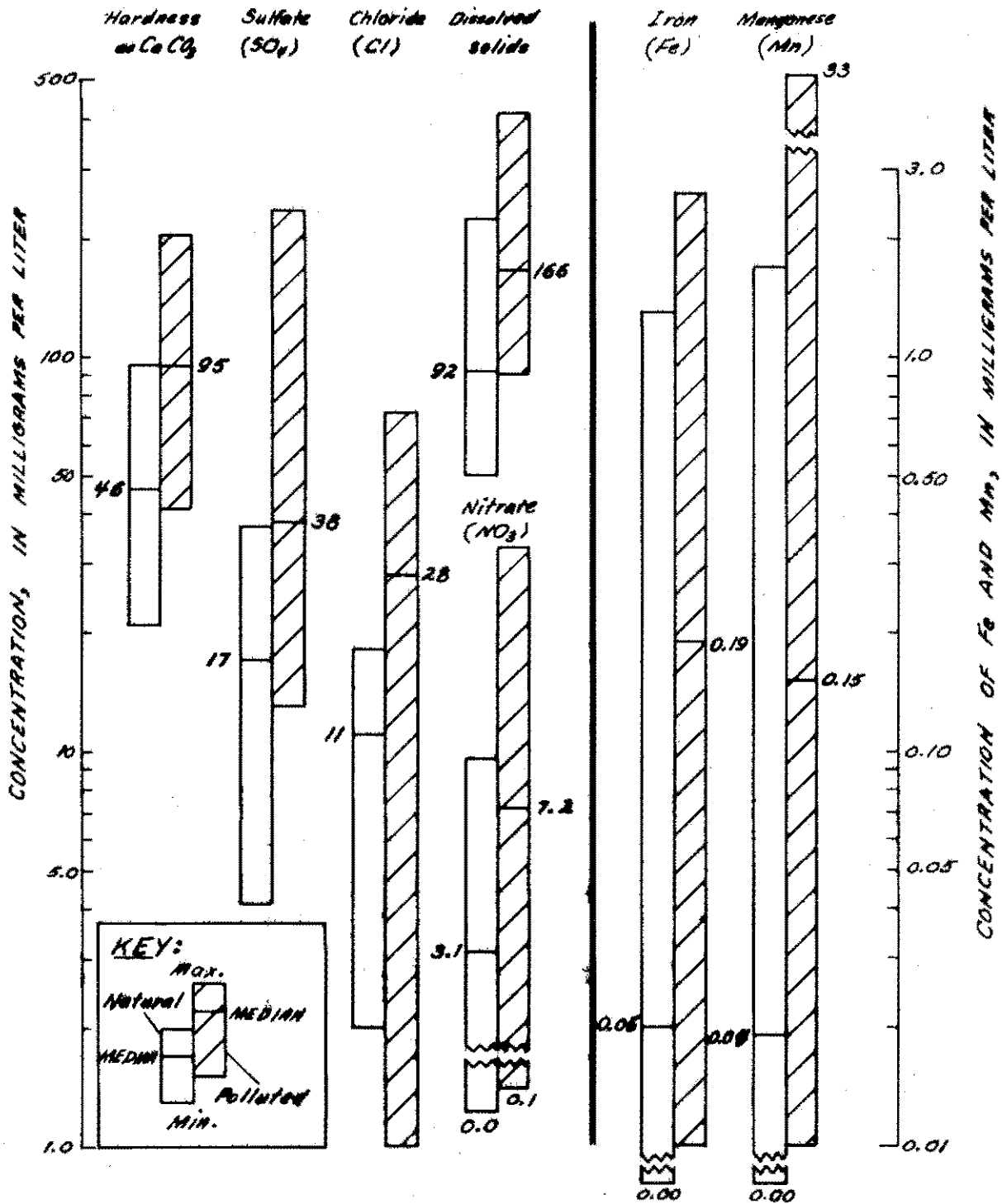

Fig. 12. Graph showing ranges in concentration of selected constituents in samples of contaminated and uncontaminated ground water.

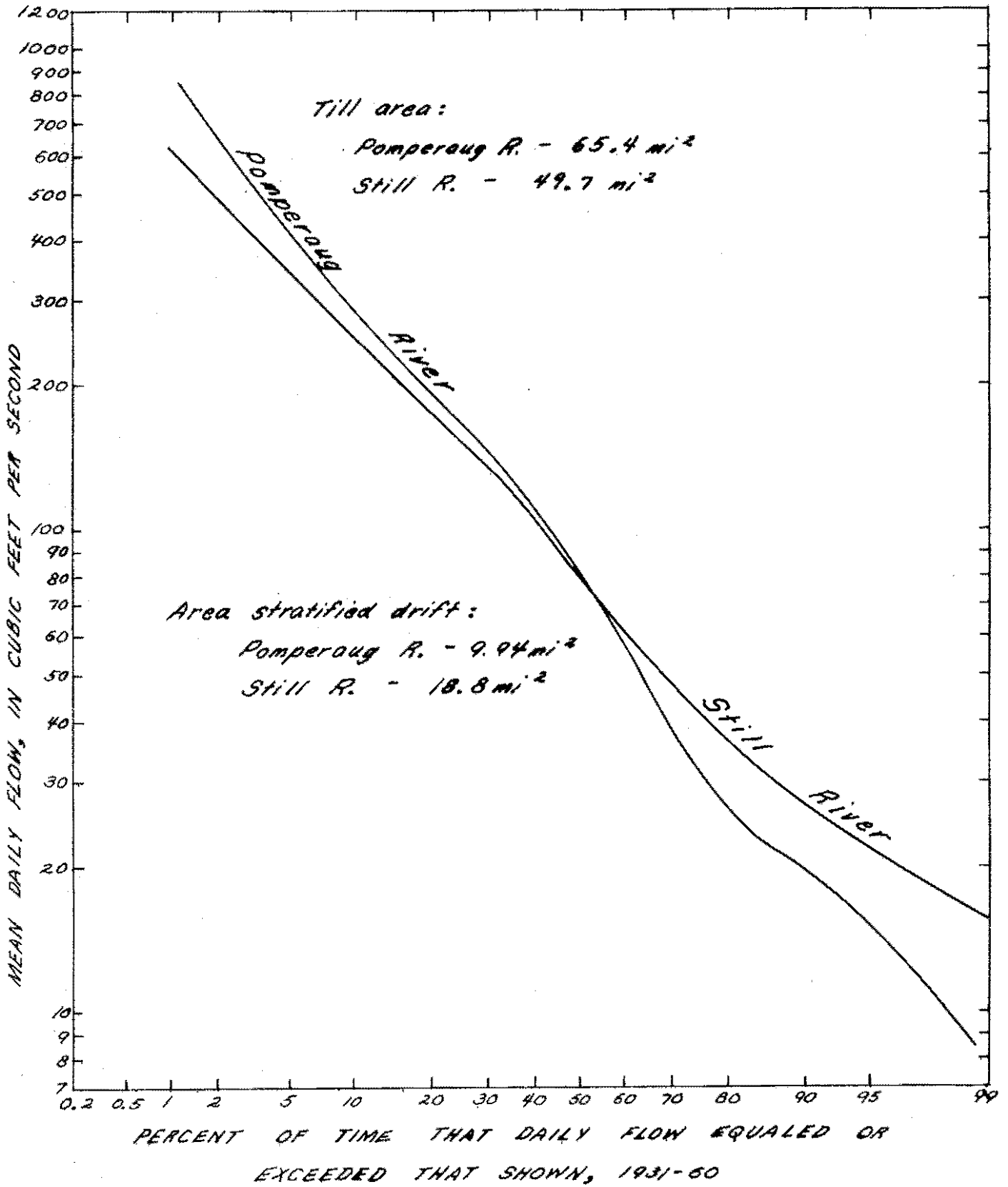

Fig. 13. Flow-duration curves of the Still River at Lanesville and Pomperaug River at Southbury.

differences in flow resulting from regional variations in climate during 1931-60.

Analysis of the flow-duration curves of 28 long-term gaging stations in Connecticut has shown that basins having large areas underlain by till and small areas underlain by stratified drift have steep flow-duration curves, indicating great variability--very low flows and large high flows. On the other hand, basins having large areas of stratified drift and small areas of till have gently sloping flow-duration curves. In these basins, streamflow is less variable from month to month and is more likely to be sustained during dry seasons. These differences are accounted for by differences in infiltration, storage, and transmitting capacities, all of which are greater in stratified drift than in till.

The relative influences of till and stratified drift are illustrated by the two duration curves in figure 13. The Still River (in northwestern Connecticut), because it has a larger amount of stratified drift, has higher low flows and smaller high flows than the Pomperaug River.

Floods

When streamflows become so great that floods occur, instantaneous peak discharge is of more interest than mean daily discharge. B. L. Bigwood and M. P. Thomas (1955) have developed a "flood-flow formula" for Connecticut that relates peak discharge to the basin parameters of drainage area and channel slope. Drainage area obviously affects the amount of water available in a basin from a particular flood-producing event, and channel slope is a measure of the effectiveness of a basin in concentrating flow. From the "flood-flow formula," estimates can be made of the magnitude of the mean annual flood and the magnitude of flood discharges for various recurrence intervals.

The Naugatuck River basin has been particularly hard hit by floods. This large basin (312 square miles) is long and narrow (50 miles long by a maximum of 12 miles wide). The main valley floor is also narrow and is bounded by steep rock walls along much of its length. Channel slopes are steeper than the Connecticut average. In addition, the valley floor is in many places highly industrialized and urbanized. All of these conditions have contributed in the past to highly destructive floods.

The most devastating flood in the Naugatuck River valley occurred in August 1955. Industries were paralyzed, 40 lives were lost, and total loss in the valley amounted to \$230,000,000. Total destruction exceeded that of any other recorded flood in all of New England.

The severity of the flood of 1955 was aggravated by a sequence of events that served to prime the watershed. During August 11-14, Hurricane "Connie" dumped 4-5 inches of rain at the river's mouth, and 8-9 inches in the headwaters. The rains soaked in because the summer of 1955 had been an especially dry one, and only a very slight rise was noted on the streams. Hurricane "Diane" followed within a few days. During the morning and afternoon of August 18, 3-4 inches fell on the upper part of the Naugatuck River basin, producing an immediate runoff from the saturated watershed and a rapid rise in river flows. Heavy rains fell again during the late evening of the 18th and continued

into the early morning of the 19th. Eight to nine inches fell within this period, and the rivers rose with phenomenal rapidity. At Thomaston the river rose 19 feet in seven hours and at Naugatuck 19 feet in ten hours, peaking at 10:30 am with a discharge of 106,000 cfs (cubic feet per second). Peak discharges were over four times the previous floods of record, and the stage of 25.7 feet (elevation 182.9 feet) at the gage at Naugatuck (at Stop 2; see fig. 5) was almost twice the old record of 13.9 feet.

The floods of 1955 triggered a flood-control program which has resulted in a series of dams and channel improvements in southwestern Connecticut designed to prevent the recurrence of a flood of such a magnitude. In the Naugatuck River basin, the system includes seven dams built by the U. S. Army Corps of Engineers. The largest of these is the dam on the main stem at Thomaston (Stop 3); it has a storage capacity of 13.7 billion gallons (42,000 acre-feet).

REFERENCES

- Bigwood, B. L., and Thomas, M. P., 1955, A flood-flow formula for Connecticut: U. S. Geol. Survey Circ. 365, 16 p.
- Theis, C. V., 1935, Relation between the lowering of the piezometric surface and the rate and duration of discharge of a well using ground-water storage: Am. Geophys. Union Trans., pt. 2, p. 519-524.

ROAD LOG FOR TRIP B-3

Topographic Quadrangles, 1:24,000, 7½ minutes:

Ansonia	Newtown
Bridgeport	Sherwood Point
Long Hill	Southbury
Milford	Thomaston
Mount Carmel	Waterbury
Naugatuck	Westport
New Haven	Woodbury

MILES Start Kline Geology Laboratory, NEW HAVEN QUADRANGLE

- 0.0 Start mileage count, leave parking lot, turn left (north) onto Whitney Ave.
- 0.4 Turn left (west) onto Edwards St.
- 0.6 Turn right (north) onto Prospect St. and then immediately left (west) onto Hillside Pl.
- 1.0 N.Y., N.H. and H. Railroad tracks, bear left onto Henry St.
- 1.5 Turn left (south) onto Sherman Ave.
- 1.9 Turn right (west) onto Rt. 69, Whalley Ave.
- 4.1 Bear left (northwest) onto Rts. 63 and 67.
- 7.2 NAUGATUCK QUADRANGLE.
- 7.5 Junction Rt. 67, proceed straight (north) on Rt. 63.
- 9.9 MOUNT CARMEL QUADRANGLE, on Rt. 63.
- 13.9 NAUGATUCK QUADRANGLE, on Rt. 63.
- 14.4 Stop 1. (23.13N-52.90E): Sand and gravel pit to the right (north) of Rt. 63, 1.5 miles west of intersection of Rts. 63 and 42.
 - Topics to be discussed:
 - Aquifer materials.
 - Aquifer coefficients.
 - Effect of aquifer materials on aquifer characteristics.
- 14.4 Continue west on Rt. 63.
- 14.6 Wells of Connecticut Water Co. (Naugatuck Div.) on left (south) tap sand and gravel. Normally used only to supplement reservoir supplies during summer months, but operated continuously during drought of 1965-66. Pumpage results in measurable induced infiltration of Beacon Hill Brook. Water samples collected monthly from one of the wells for complete analysis.
- 16.1 Wells at Peter Paul, Inc. on left (south) tap sand and gravel.
- 17.4 Junction Rt. 8, turn left (south) onto Rt. 8; two left hand turns necessary.
- 17.7 UniRoyal, Inc. (Chemical Div.) on right (west) across Naugatuck River. Industrial wastes discharged into river.

- 18.6 Stop 2. (23.22N-51.72E): Ranney Collector, UniRoyal, Inc., 1.2 miles south of intersection of Rts. 8 and 63.

Topics to be discussed:

Aquifer characteristics in Naugatuck River valley.
Effect of induced infiltration on quality of ground water.

Variations of the quality of the Naugatuck River.
Construction characteristics of a collector well.

- 18.6 Go south on Rt. 8 to run-around at weighing station, proceed north on Rt. 8 following Naugatuck River upstream.
- 20.7 WATERBURY QUADRANGLE.
- 22.5 Cross Naugatuck River on Rt. 8.
- 22.9 Town of Waterbury sewage treatment plant and incinerator.
- 23.7 Several industrial wells on flood plain of the Naugatuck River on the right (east). Most have problems of screen incrustation, declining yield, and highly mineralized ground water. Water from well Wb 10a has been analyzed for sulfate since 1944.
- 25.0 Mixmaster junction of Interstate Rt. 84 and Rt. 8, proceed north on Rt. 8.
- 25.7 City of Waterbury. Few active wells in the city. Municipal water company supplies water for industrial and domestic purposes entirely from extensive reservoir system.
- 28.3 Chase Brass Co. on right (east) uses 4.5 mgd (million gallons per day) mostly from the Naugatuck River, except in warm months when three wells supply about 1.5 mgd of cooler ground water. Downstream from this point the Naugatuck River receives an increased amount of industrial pollution from the Waterbury-Naugatuck urban area.
- 29.1 Deeply weathered crystalline bedrock in road cut on the left (west).
- 30.3 U.S.G.S. test boring at drive-in theater on right (east) penetrated 75 ft. of saturated gravel.
- 30.8 THOMASTON QUADRANGLE.
- 31.1 Dredging operation for sand and gravel in channel of Naugatuck River to the right (east). Agitation by dredging causes aeration of the water, dissolved oxygen was 18% higher than upstream site in October 1967.
- 33.3 Reynolds Bridge, to the left (west) large outcrop of intricately folded and layered crystalline bedrock.
- 34.5 Seth Thomas Clock Co. (now a division of General Time Corp.) on left (west). Well drilled there in 1936 was reportedly tested at 1,300 gpm (gallons per minute) with a drawdown of 24 ft.
- 35.5 Exit Rt. 8 to Rts 6 and 202 west and cross Naugatuck River, U.S.G.S. stream gage 2069.
- 35.8 Turn right (north) in Thomaston onto Rt. 222.
- 36.4 Turn right (east) off Rt. 222 at sign to Thomaston Dam.

- 37.1 Stop 3. (31.40N-51.47E): Thomaston Dam, U. S. Army Corps of Engineers, 1.3 miles northeast of Thomaston.

Topics to be discussed:

Variation of streamflow with time and geology.
Variation of natural quality of streamflow.
Flooding in Naugatuck River valley.

- 37.1 Return to Rt. 8 south.
- 40.2 On Rt. 8, exit at Rts. 6 and 202 west, proceed southwest on these routes.
- 40.8 Junction Rt. 109, proceed on Rts. 6 and 202.
- 41.0 Thomaston Water Co. wells on left (south). Bedrock overdeepened by glacial scour; at least 104 ft. of stratified drift at one site.
- 41.5 Black Rock Pond State Park to the right; LUNCH STOP.
- 43.5 WATERBURY QUADRANGLE.
- 45.7 WOODBURY QUADRANGLE.
- 46.4 Drainage divide of Pomperaug River basin. Meinzer and Stearns published a classic study of the hydrologic budget of this basin in 1929.
- 48.5 Junction Rt. 61, proceed southwest on Rts. 6 and 202. Yields of Watertown Water Co. wells 0.5 mi. to north in Nonewaug River valley are augmented by induced infiltration from a stream that is diverted into a channel; flow in the channel is regulated by an upstream reservoir.
- 50.1 U.S.G.S. stream gage 2036 on Nonewaug River to the left (south).
- 52.2 Nonewaug River; U.S.G.S. test hole to the right (west) penetrated 62 ft. of sand and gravel overlying reddish till.
- 53.4 Center of Woodbury, proceed on Rts. 6 and 202.
- 53.8 Outcrop of Triassic trap on left (east).
- 54.0 U.S.G.S. observation well Wy 1 on left (east) used by Meinzer and Stearns in their study of the Pomperaug River basin and measured regularly since 1944.
- 55.7 Gravel pits and dredging operation across valley to the right (west).
- 56.6 SOUTHBURY QUADRANGLE.
- 56.7 Turn right (west) onto Rt. 67.
- 57.0 WOODBURY QUADRANGLE. U.S.G.S. test holes penetrated 60-70 ft. of stratified drift beneath the flood plain. Section is predominantly fine sand, which at eastern margin of flood plain is underlain by gravel.
- 57.2 Pomperaug River. Measurements with field permeameter indicate permeabilities of 300-400 gpd/sq. ft. for streambed materials.
- 57.5 Turn left (south) onto Poverty Road.
- 57.7 SOUTHBURY QUADRANGLE.

- 58.0 Ice-contact morphological features to the left (east).
- 58.5 Heritage Village, recipient of several architectural awards. Developers have constructed a waste-water disposal system and a water supply system consisting of two screened wells tapping sand and gravel with individual yields of 275 gpm.
- 59.1 Stop 4. (23.65N-46.98E): Pomperaug River stream gage 2040, 0.7 mi. west of Southbury.

Topics to be discussed:

Effects of evapotranspiration on ground-water levels and streamflow.

Continuous records of quality of the Pomperaug River. Meinzer's hydrologic budget as compared to new data.

Permeabilities of streambed materials.

Aquifer characteristics as demonstrated by controlled long-term pumping test.

- 59.1 Return to Rts. 6 and 202.
- 61.3 SOUTHURY QUADRANGLE.
- 61.6 Turn right (south) onto Rts. 6 and 202.
- 62.8 Bear left onto Rt. 67, proceed to Interstate Rt. 84 south.
- 63.1 Turn right (southwest) onto I-84 south toward Danbury.
- 65.5 Approach narrow gap. Former channel of Pomperaug River plugged with at least 100 ft. of till and stratified drift. To north, bedrock valley overdeepened by glacial scour; altitude of bedrock surface is less than 50 ft. above msl (mean sea level).
- 66.7 Housatonic River (Lake Zoar); algal blooms are common in late summer. At deepest point altitude of bedrock surface is below msl.
- 67.5 NEWTOWN QUADRANGLE.
- 69.4 Exit I-84 to Rt. 34 - Sandy Hook.
- 69.6 Turn left (southeast) at I-84 ramp onto Rt. 34. Pootatuck River basin upstream from Sandy Hook is underlain by about 33 percent stratified drift.
- 70.0 Exposure of coarse-grained stratified drift in large gravel pits.
- 71.7 SOUTHURY QUADRANGLE.
- 75.7 Turn right (south) onto Rt. 111.
- 76.7 LONG HILL QUADRANGLE.
- 77.6 Turn left (southeast) onto Barn Hill Rd.
- 79.1 Top of Bran Hill, a drumlin; one well penetrates 120 ft. of till overlying bedrock.
- 79.7 Turn left (east) onto unnamed road.
- 80.1 Turn left (east) onto Rt. 110.
- 80.4 Cross Means Brook.
- 83.0 ANSONIA QUADRANGLE.
- 83.1 Housatonic River valley to left (east).

- 83.3 Turn sharp left (northwest) onto Indian Well Rd. at sign to Indian Wells State Park.
- 83.8 LONG HILL QUADRANGLE.
- 85.3 Turn right across railroad tracks, Shelton well field on right (east).
- 85.5 Stop 5. (19.10N-49.24E): Shelton well field pumping station, Bridgeport Hydraulic Co., 2.2 mi. northeast of intersection of Rt. 110 and Indian Well Rd.

Topic to be discussed:

Development of largest well field in New England.
 Areal extent, thickness, and lithology of stratified-drift aquifer at site.
 Induced infiltration.
 Quality of Housatonic River.

- 85.5 Return to Rt. 110 via Indian Well Rd.
- 87.6 ANSONIA QUADRANGLE.
- 87.9 Bear left onto Rt. 110.
- 89.1 Head of estuary of Housatonic River is at the Shelton-Derby dam across Housatonic River on left (northeast). Oldest dam on Housatonic River, built in 1806.
- 89.8 Center of Shelton.
- 91.8 - 92.2 Upstream extent of salt water in Housatonic River fluctuates within this reach depending upon flow of the river and height of tides.
- 92.6 Well next to the river at Industrial Lofting and Manufacturing Co. on left (southeast) reportedly does not pump salt water.
- 95.3 Sikorsky Aircraft on left (east). Test holes in stratified drift yielded salt water; plant supplied by Bridgeport Hydraulic Co.
- 95.7 MILFORD QUADRANGLE.
- 98.2 Junction Rts. 113 and 110, bear left (south) onto Rt. 110.
- 99.6 Junction U.S. Rt. 1, turn right (southwest) of traffic circle onto Rt. 1 and proceed to Interstate-95, Connecticut Turnpike, west.
- 99.9 Rt. I-95, west.
- 100.1 BRIDGEPORT QUADRANGLE.
- 100.2 Toll booths.
- 102.7 Wells at Town of Stratford incinerator penetrated 52 to 58 ft. of sand and silt overlying bedrock. U.S.G.S. test hole 1 mi. southeast penetrated 107 ft. of very fine sand and silt grading down to clay and did not reach bedrock.
- 103.7 Cross Yellow Mill Channel, Bridgeport Harbor to left (south). Test hole for bridge reached bedrock at 85 ft. below msl and penetrated 81 ft. of silt and clay. Low-lying areas of Bridgeport underlain by fine-grained outwash plain deposits.

- 104.3
- 104.5 Cross Poquonock River estuary, Long Island Sound to left (south), salt water extends about 1.5 miles upstream to the right (north). During the 1930's and 1940's, a number of industrial wells located along the river tapping stratified drift as well as bedrock produced salty water and were abandoned. Most industries in the city are now supplied water by the Bridgeport Hydraulic Co.; no data are available as to the present extent of salt water in these aquifers. Test hole at east end of bridge reached bedrock at 121 ft. below msl and penetrated 97 ft. of very fine sand and silt overlain by 15 ft. of estuarine deposits.

108.4 WESTPORT QUADRANGLE.

- 109.8 Cross Mill River estuary, salt water extends about 1.5 mi. upstream to a small dam that also marks the head of tide. Model analysis of a relatively extensive stratified drift aquifer upstream from the dam indicates that an annual ground-water withdrawal of 3.7 mgd is available 7 years out of 10. Well tapping bedrock at DuPont Co. on left (south) was abandoned because it yielded salty water. Maximum known depth of bedrock at I-95 is 96 ft. below msl where a State Highway test hole penetrated 110 ft. of very fine sand and silt.

112.0 SHERWOOD POINT QUADRANGLE.

- 116.1 Cross Saugatuck River estuary, salt water extends about 2 mi. upstream to a small dam that also marks the head of tide. Maximum known depth of bedrock at I-95 is 70 ft. below msl where a State Highway test hole penetrated 60 ft. of fine to very coarse sand. Bedrock valley is glacially overdeepened upstream.
- 116.4 Exit I-95 at exit 17 to Rt. 33 north.
- 116.6 Turn left (north) off exit ramp onto Rt. 33.
- 116.9 WESTPORT QUADRANGLE, at traffic circle proceed north on Rt. 33 at western edge of Saugatuck River estuary.
- 118.2 Junction U.S. Rt. 1, proceed north on Rt. 33.
- 118.6 Junction Rt. 136, proceed north on Rt. 33.
- 119.0 Turn right (east) onto Boltan Lane to dirt road on right.
- 119.1 Stop 6. (11.60N-43.01E): Westport well field, Bridgeport Hydraulic Co., 0.5 mi. north of Junction Rts. 136 and 33.

Topics to be discussed:

Development of well field including artificial recharge to offset salt water intrusion.
Effects of induced infiltration on quality of pumped water.

- 119.1 Return to Rt. 33 and turn left (south).
- 119.5 Turn left (east) onto Rt. 136 and cross Saugatuck River estuary. State Highway test hole at west end of bridge penetrated 101 ft. of sand and gravel without reaching bedrock although large outcrop is visible to the right on a small island in middle of the river.
- 119.6 Westport well field pumping station.

- 119.7 Proceed northeast on Canal St. at traffic circle.
- 119.9 Turn left at traffic light onto Rt. 57, Main St.
- 120.1 Bear left at "Y", proceed on Rt. 57.
- 120.4 Turn left (northwest) at traffic light onto Clinton Ave.
- 121.7 Stream-gaging station 2095 on Saugatuck River on the left, abandoned because of regulation upstream by Saugatuck Reservoir as well as loss of streamflow at Coleytown well field. Thickness of stratified drift aquifer is 0 ft. here, bedrock exposed in small outcrop on river bank immediately downstream.
- 121.8 Bear left at small traffic circle.
- 121.9 Turn left onto Rt. 57, Weston Rd., cross Aspetuck River, production well no. 1, Coleytown well field, on right.
- 122.1 Cross Saugatuck River and turn right onto dirt road.
Stop 7. (12.56N-43.13E): Coleytown well field, Bridgeport Hydraulic Co., at Rt. 57 bridges over Aspetuck River and Saugatuck River.

Topics to be discussed;

Development of well field, need, method of development.
 Effect of induced infiltration on streamflow.
 Field measurement of rate of streambed infiltration.
 Effects of long-term pumping on ground-water levels.

- 122.1 Return to Rt. 57.
- 122.2 Turn left (southeast) onto Rt. 57.
- 123.3 Bear left (south) onto Rts. 136 and 57.
- 123.7 Turn left onto Rt. 136.
- 125.0 Turn left (east) onto U.S. Rt. 1.
- 126.1 Turn right (south) onto Sherwood Island Connection at sign to Sherwood Island State Park.
- 127.0 SHERWOOD POINT QUADRANGLE.
- 127.3 Cross I-95, turn left onto I-95 eastbound entrance ramp to New Haven.
- 128.6 WESTPORT QUADRANGLE.
- 132.2 BRIDGEPORT QUADRANGLE.
- 141.2 Toll booths.
- 141.3 MILFORD QUADRANGLE.
- 142.5 Cross Housatonic River. Bedrock outcrops on west bank; maximum depth of rock beneath river is at 115 ft below msl.
- 144.4 Milford Water Co. wells to the right (southeast); two wells supplied about 0.6 mgd in 1965.
- 148.4 ANSONIA QUADRANGLE.
- 150.1 NEW HAVEN QUADRANGLE.
- 152.7 Toll booths, proceed east on I-95.

- 156.1 Turn left (north) onto I-91 exit north, proceed north on I-91.
- 157.0 Turn right onto exit 3, Trumbull St. in New Haven, proceed west on Trumbull St.
- 157.7 Turn right (northeast) onto Whitney Ave.
- 158.0 Turn left (west) into parking lot, proceed to Kline Geology Laboratory.

Trip B-4

ENGINEERING GEOLOGY AS APPLIED TO HIGHWAY CONSTRUCTION

by

Harry L. Siebert
Connecticut Highway Department

Highway design of rock slopes is based on standards, Fig. 1. These standards incorporate geometrics, safety, and rock competency towards developing the ultimate design. Falling rock landing on the traveled portion of a highway is unsafe.

In general, the design of rock slopes is based on detailed geologic mapping and full depth rock coring. No laboratory testing of rock is done. Rock cores, outcrops, and the mica:feldspar-quartz ratio ($m/f+q$) are utilized for slope analysis. Testing of metamorphic rock in Connecticut will yield numbers, but the application of the numbers is questionable. Other methods like the Rock Quality Determination (RQD) (Deere and others, 1967) are useful in the more competent gneisses. The crux of the problem is: we need information on what does not come up in the core barrel. In situ testing is needed to be successful in designing slopes; unfortunately, existing methods such as the flat-jack or pressure chamber are too expensive. Inexpensive methods of in situ rock testing are desperately needed for the design of rock slopes in civil works projects.

Determination of the proper construction method to achieve a design slope can be a problem. The methods utilized to excavate mass rock can determine the actual slope to be produced. Controlled slope holes to develop slopes in many rock masses may only produce a temporary slope, in which failure can occur. The nicely developed slope with exposed half holes can end up in the adjacent embankments if failure occurs during construction. Therefore, in some rock formations, presplitting of slope holes may result in the temporary retention of potentially unstable rock. In such cases, controlled blasting without the slope line holes will dislocate the unstable rock and result in a less regular but more stable slope. Otherwise, progressive failure along discontinuities, Fig. 2, described as rock fall, may occur after the roadway is open to traffic. These discontinuities are classed as first order irregularities (joint couplets or faults, etc.) and second order irregularities (joints and fractures, etc.).

No commentary on the design and construction of rock slopes would be complete without mentioning Mr. Andrew Bednar of Hercules, Inc. Innumerable discussions with him have led to many improvements in slope design and construction.

A problem with deep excavations in rock is that the detonation of explosives subjects the rock mass to new loads. Fortunately explosive energy dies out with time and distance from the detonation point. If the rock mass contains numerous structural discontinuities which reduce the competency and are subjected to explosive energy, irregularities can be dislocated resulting in failure or unstable slopes. Proper design and construction are necessary for stable slopes. It may be stated that our significant slope problems are due to poor construction.

301.08
July 1961

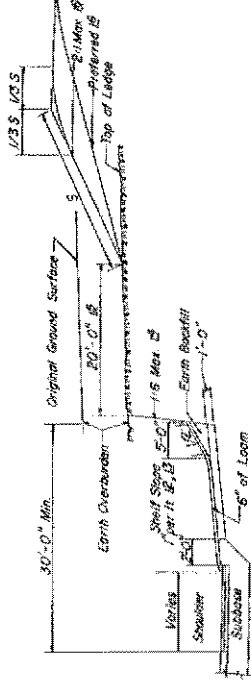

PARTIAL SECTION IN ROCK CUT WITH
SHELF SLOPE UPWARD FROM SHOULDER

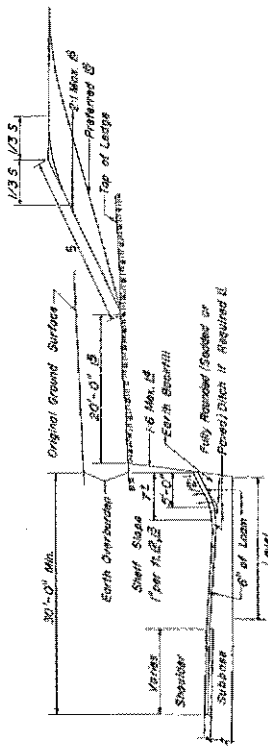

PARTIAL SECTION IN ROCK CUT WITH
SHELF SLOPE DOWNWARD FROM SHOULDER

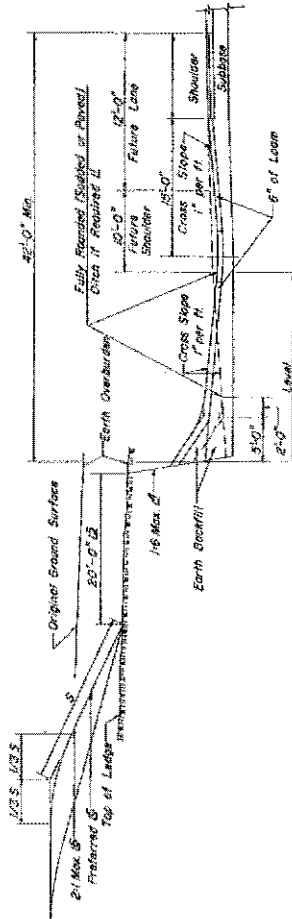

PARTIAL SECTION IN ROCK CUT IN THE MEDIAN

(Revised March 1968)

- 1) Fully rounded (Shoulder or Paved) ditches if required. Ditch construction shall be 2" of sand on a 4" of lean or 2" Bituminous Concrete Cap and Paved Ditch Minimums 4" of additional subbase. Width of ditch to be determined by the designer. If curbing is required, entire shaft area is to be resurfaced accordingly where ditch is utilized, the 5'-5" rounding is not required.
- 2) In general, slope towards gutter where drainage is a minor consideration. Slope away from gutter. (a) on high side of super-elevated curves; (b) where drainage is a major consideration, (c) where slope conditions are prevalent or (d) severe rock fall may occur.
- 3) To be increased as rock competence decreases or as height of rock cut increases.
- 4) To be decreased as rock competence decreases or as height of rock cut increases.
- 5) When rock is encountered in the field at an elevation lower than anticipated during design, the width of the top shelf may be reduced from 20'-0" to a minimum of 5'-0".
- 6) Slopes flatter than the 2:1 maximum are preferred and shall be used where site conditions allow. Generally a uniform rate of slope shall be held throughout a section where site conditions dictate a change from one rate of slope to another within a cut section, the length of transition shall be as long as possible to effect a natural appearing cut.
- 7) Site conditions and aesthetic considerations will determine the desirability of the total removal of rock in the median.

FIG. 1 DESIGN STANDARD
CONN. HIGHWAY DEPT.
MISCELLANEOUS DETAILS
VARIOUS CLASSES

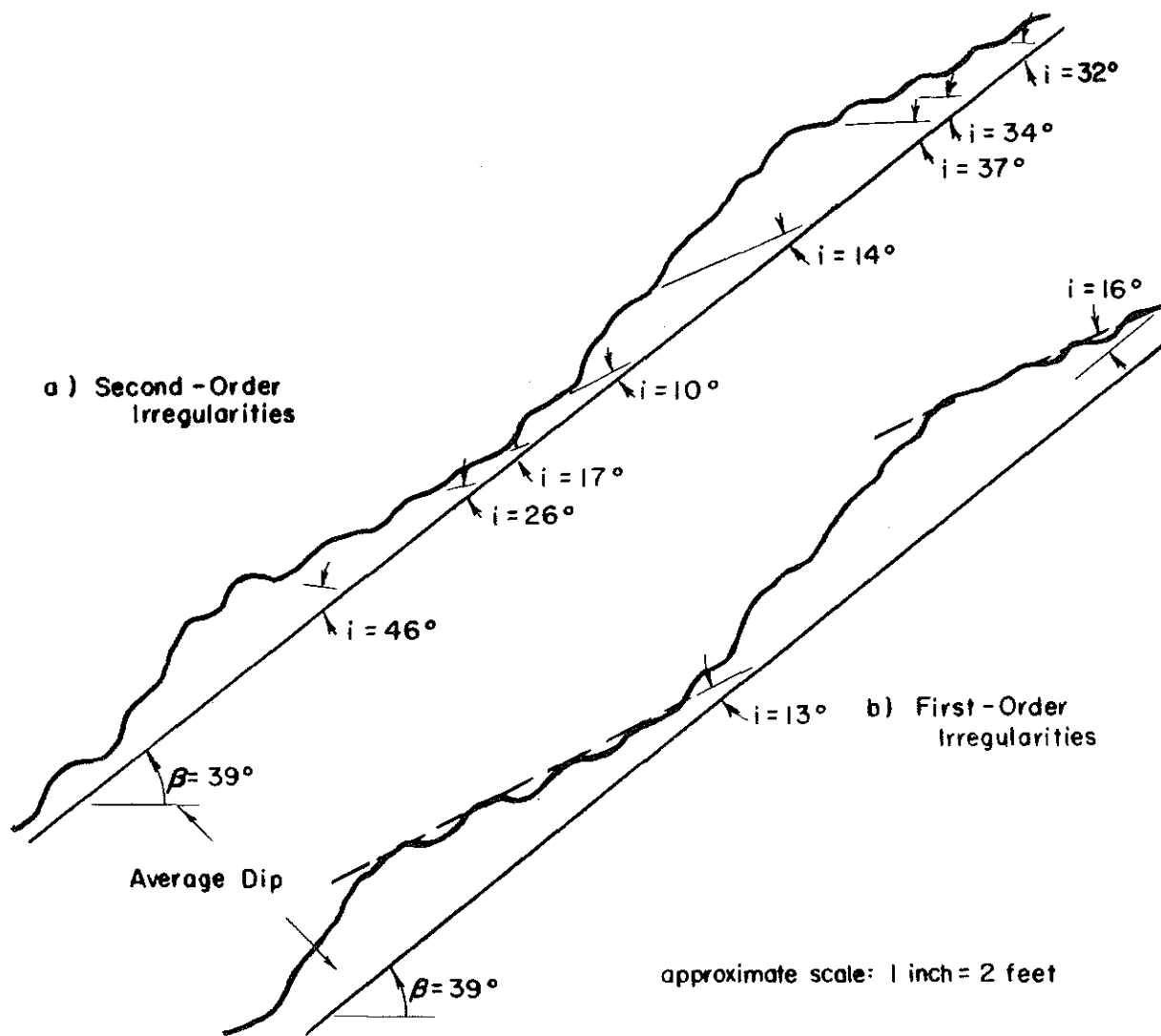

FIG. 2 AN EXAMPLE OF A ROCK SLOPE ILLUSTRATING FIRST AND SECOND-ORDER IRREGULARITIES, MODIFIED FROM DEERE (1967).

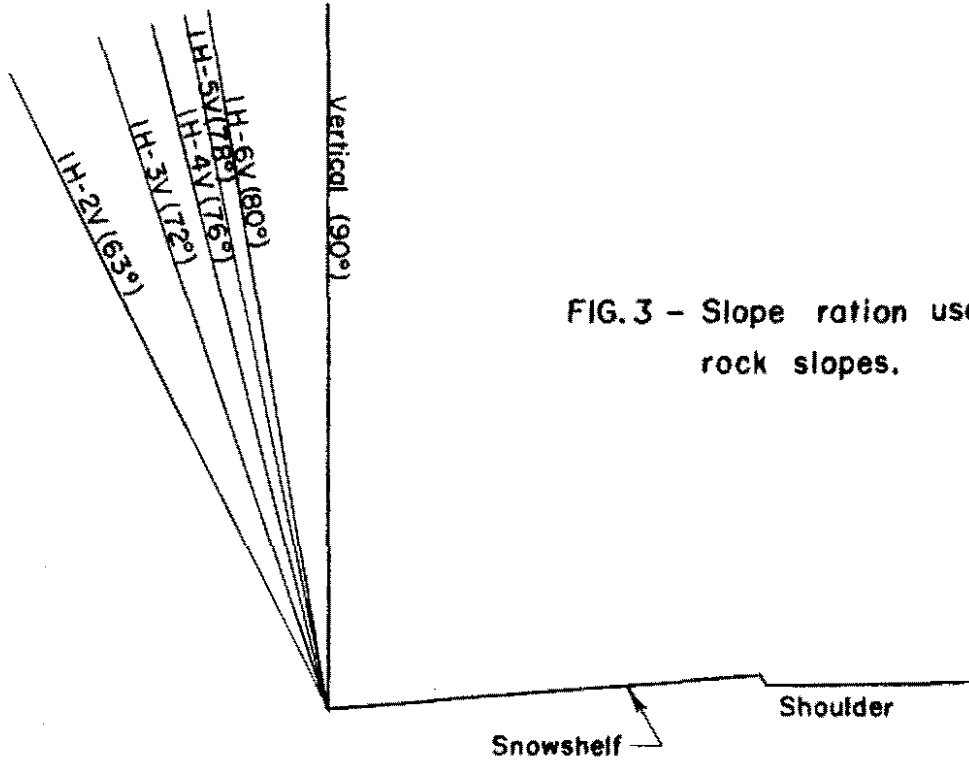

FIG.3 - Slope ratios used in designing rock slopes.

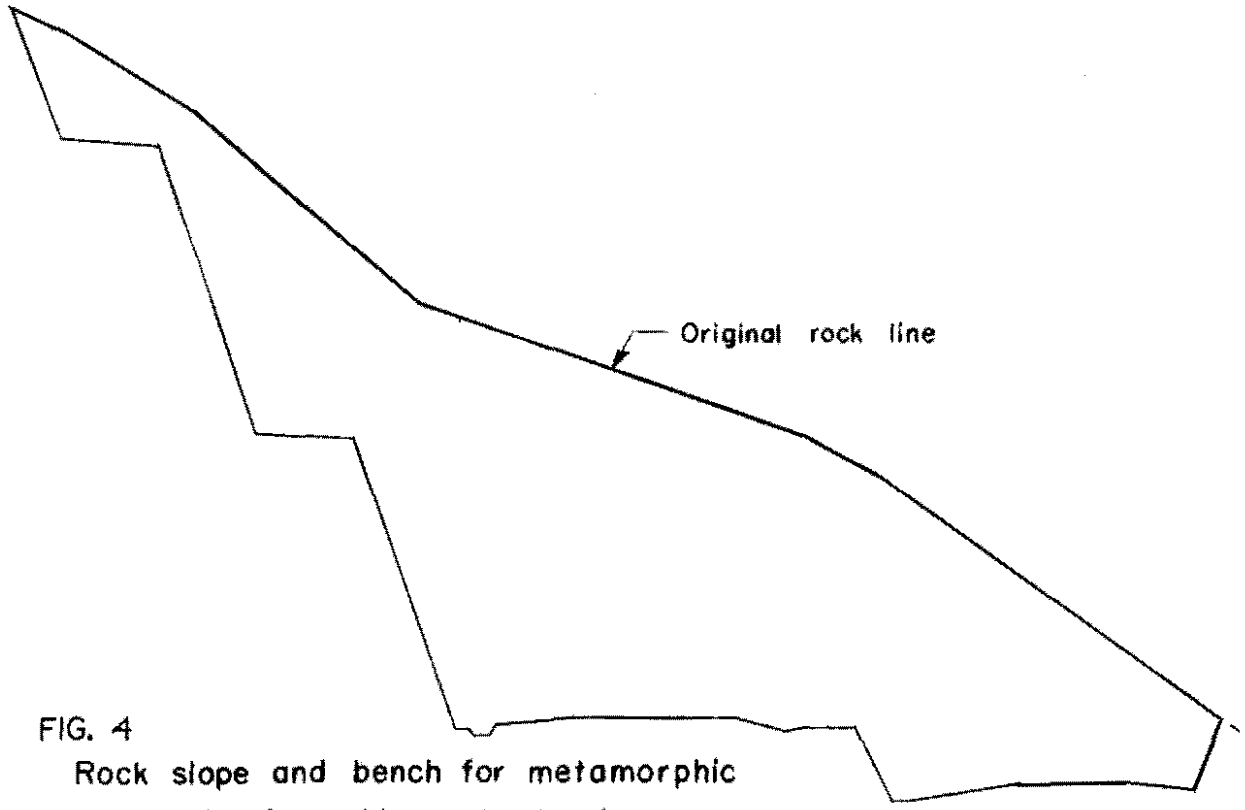

FIG. 4
Rock slope and bench for metamorphic rocks with favorable rock structure.

Stop #1 (26.14 N - 51.55 E) Roadcut on I-84; 0.3 miles east of the intersection of Rte. 8 and I-84 westbound lane.

This rock cut is in the Waterbury Formation. The rock type is a gneiss with interbedded thin schistose zones. The difference between the excavation axis and strike of the foliation is 70° dipping 70° with the excavation axis (Siebert and Raftt, 1967). Generally, the rock substance (D. F. Coates, 1965) is competent. Numerous joints and folds reduce the rock competency of the rock mass. Extensive weathering in the upper portions of the rock slope has occurred along joints. Design rock slopes were 1H:2V, Fig. 3. The second order irregularities, Fig. 2 (Deere and others, 1967) have caused rock fall with some instability. Slope control holes were spaced 4 ft on center.

The brook relocation in the median was made as a separate operation to preserve the rock in a nearly undamaged state. This was necessary to prevent undermining of the adjacent roadways and to provide an inexpensive channel for a brook location.

Stop #1A (26.14 N - 51.70 E) Roadcut on a ramp, Exit 19; 0.2 miles east of the intersection of Rte. 8 and I-84 eastbound.

Progressive failure will occur on the rock slopes due to intersecting joints obliquely intersecting the slope.

Relocated Rte. 6 over I-84 - This grade separation structure has perched abutments founded on badly weathered rock. In spite of the incompetent rock, slopes were developed by controlled slope hole methods (Siebert and Raftt, 1966). Slope holes were spaced one foot on center.

Stop #2 (27.52 N - 51.56 E) Roadcut on Rte. 8; 1.3 miles south of Frost Bridge Road and the intersection of Rte. 8.

This rock cut is in the Hartland Unit I Member, light grey-tan, fine-grained granulitic gneiss with thin interbedded schist units. A competent rock from rock core descriptions. The competency of the rock mass is reduced by the number of closely spaced (frequency 1 in. to 1 ft), near vertical joints intersecting the strike of the foliation. Design slope was 1H:2V with controlled slope holes to prevent overbreak. A construction problem was to hold the design slope to reduce property take in an urbanized area of the city of Waterbury. Difficulty was encountered in drilling the rock for blasting due to the steep dip of the foliation. Some control of mass blasting was necessary because of proximity of dwellings. Fall area is inadequate because of off-ramp. Rock has weathered very rapidly since exposure to the atmosphere.

Side note: Highway bridges and retaining walls are founded on friction and end bearing piles to protect against scour. There was some difficulty in driving due to coarse gravels in the floodplain.

Stop #3 (27.89 N - 51.33 E) Roadcut on Rte. 8; 0.2 miles south of Frost Bridge Road and Rte. 8 intersection.

Rock cut in The Straits Schist Member, Hartland Formation. This cut was designed with: a 1H:3V west slope with a 20 ft bench 60 ft above the roadway; a 1H:2V east slope with a 10 ft bench 60 ft above the roadway, and 110 ft maximum height above the roadway. The rock bench on the west slope was constructed with controlled slope hole methods 6 in. on center.

About one year after the cut was made but prior to the placing of pavement, the bench on the west slope was removed due to unstable conditions. This was a simple case of failure along faults and intersecting joints after removal of the lateral support from the rock mass. The fall area between toe of slope and the roadway is adequate to retain small rock fall. The cut slope is subject to progressive failure. The 10 foot bench on the east slope was not successfully constructed. Failure frequently occurs along fault surfaces dipping into the roadway. Smaller falls are due to second order irregularities and larger falls, to first order irregularities. Remedial rock excavation is necessary to stabilize both slopes. The rock substance is weak due to the high percentage of coarse mica. Competency is further reduced by the occurrence of first and second order discontinuities. To hedge against progressive failure the east slope should be cut back to a 1H:1V slope and the west slope to a 1H:1½V or 1H:1V. Total rock excavated in this cut, including ramps, was about 475,000 cubic yards. Controlled slope holes varied from 6 in., 3 ft, and 4 ft on center.

Stop #4 Cut #2 (29.22 N - 50.99 E) Roadcut on Rte. 8, 2.3 miles north of the intersection of Frost Bridge Road and Rte. 8. See also Stops 16 and 17 of Trip D-5.

Two high rock cuts: Cut #1, maximum height 180 ft, and Cut #2, height 220 ft with 20 ft benches every 60 ft above roadway. Design rock slopes were 1H:3V. In Cut #2 a bench was eliminated during construction, but the shelf area at the toe of slope was not widened. Benches were designed to reduce rockfall, Fig. 4. Benches were not constructed to plans and no access was provided, hence they will become ineffective with time. Cuts are in The Straits Schist and the Hitchcock Lake Member. Rock competency is high, but reduced by second order discontinuities. A problem is rock slopes yielding along joints at the ends of the cuts due to changes in natural loads. The west slope of the lower roadway was active and some movement occurred after the cut was made. The number of cubic yards of rock removed from Cut #1 was 202,100 and from Cut #2, 221,300; neither cut is over 500 ft long. Slope hole spacing varied from 2 to 4 ft on center.

These cuts will require remedial work to stabilize the benches, where joint intersections produce a plane of weakness.

Stop #5 (29.81 N - 50.99 E) Roadcut on Rte. 8; 2 miles south of the intersection of Rte. 6-202 and Rte. 8.

Rock cut in the Reynolds Bridge Formation, a highly contorted gneiss. The rock substance is dense and competent, with few second order discontinuities. All joints appear to be healed, yielding a strong rock mass. Average cut height is 80 feet. This is the best rock we will see for developing slopes. Slope hole spacing varies from 6 in. to 5 ft on center.

The front portion of the bench was distorted by subsequent mass blasting. Distortion occurred in the area of the stemming. Generally bench construction is difficult as mass blasting tends to lift the intersection of the face and bench floor. Depending on rock conditions, one-half of the bench may be lost.

Stop #6 (30.18 N - 50.22 E) Roadcut on Rte. 109; 1.5 miles west of intersection of rtes. 109 and 8. See also Stop 14 of Trip D-5.

The rock in this cut varies from schist to gneiss. The problems of developing stable slopes in rocks are similar to those seen at Stop #3. Here a sliding failure along a fault in the north slope illustrates the problems of stability of schist-gneiss sequences with structural discontinuities. The slide area was partially stabilized by removing some of the rock in front of the fault. This was not the best rock mechanics solution, but was the least expensive.

Stop #7 (30.49 N - 51.27 E) Roadcut on Rte. 8; 0.3 miles south of intersection of rtes. 6-202 and 8.

The rock cut on the northbound lane is in a pegmatite, schist, and gneiss sequence. The schist and gneiss were weathered. The rock cut has a gravel overburden which constantly supplies water to joints and foliation. Addition of water and exposure to the atmosphere have increased the rate of weathering. Numerous minor slides of weathered material have occurred. The dip of the foliation is 60° and the difference between the strike of the foliation and excavation axis is 80° . The dominant joint dips 30° towards the roadway and its strike is 50° from the excavation axis. All slopes were pre-split with good initial results. As weathering continues, failures occur as flows along second order discontinuities. The slope could be stabilized by reducing water infiltration and the rate of weathering without changing the cut slope.

Stop #8 (33.11 N - 50.08 E) Roadcut on Rte. 8; 1 mile south of intersection of rtes. 118 and 8.

This cut was made in a highly contorted schist and gneiss sequence without modern slope control methods. The difference between the excavation axis and the foliation or joint system is

foliation: 35° (dip of 55° towards the roadway)

Joint 1: 65° (dip of 65° into slope)

Joint 2: 30° (dip of 55° into slope)

This is a case of the foliation being truncated by the excavation axis. In the lower portion of the cut slope, rock was left in place, acting as a buttress and holding some of the joint intersections intact. This rock cut has been made over nine years. Generally, it is stable and only a few falls have taken place. The excavation by older blasting methods left the rock intact. A fault-associated pegmatite occurs on the north end of the cut, and presents a potential zone of instability, but any failure should be minor.

Stop #9 (33.86 N - 50.05 E) at the intersections of rtes. 118 and 8.

This multiple cut is in a gneiss sequence and produces a three-dimensional view of the steeply dipping planar features in the rock. Dips of joints and foliation vary from vertical to 45° . The rock substance is competent, but the competency of the rock mass is reduced by the planar features. These two intersecting cuts were designed with a 1H:2V slope with a 20 ft bench 35 ft above the ramp. The relocated Rte. 118 also was designed with a 1H:2V slope and a transitional bench from the ramp which

varies from 0 to 35 ft above the roadway. Controlled slope holes on 4, 5, and 6 ft centers were utilized by the contractor to control overbreak. Irregular slopes were developed due to incorrect slope hole spacings. Good slopes can be made in this rock if proper blasting techniques are used. Jointing and rock competency are generally favorable. This cut was designed under old standards. A larger snowshelf and steeper slopes should have been utilized, with the elimination of the bench.

BIBLIOGRAPHY

Coates, D. V., 1965, Rock mechanics principles: Canada Dept. Mines Tech. Surveys, Mines Branch Mon. 874.

Deere, D. U., Hendron, A. J., Patton, F. D., and Cording, E. J., 1967, Design of surface and near-surface construction in rock, in Failure and Breakage of Rock, Eighth Symposium on Rock Mechanics: New York, Soc. Mining Engineers, p. 237-302.

Gates, R. M., and Martin, C. W., 1967, The bedrock geology of the Waterbury quadrangle: Conn. Geol. Nat. History Survey, Quad. Rept. 22, 36 p.

Siebert, H. L., and Raitt, G., 1966, Development of slopes in metamorphic rock: Mining Eng., v. 18, p. 77-80.

_____ 1967, The effect of strike and dip in pre-splitting rock, in Economic Geology in Massachusetts: Univ. Mass. Graduate School, p. 355-358.

GENERAL GEOLOGY OF THE TRIASSIC ROCKS
OF CENTRAL AND SOUTHERN CONNECTICUT

by

John Rodgers
Yale University

The Triassic rocks of the Connecticut Valley fill a large half-graben in the states of Connecticut and Massachusetts; their present outcrop area is 167 kilometers (103 miles) in length and 33 kilometers (21 miles) in greatest width. They are a typical member of a series of such half-graben fillings exposed from Nova Scotia to the Carolinas and, along with the larger Newark basin, the best known.

The thick Triassic deposits of eastern North America were specifically cited by Dana when he first coined the word "geosynclinal" and were taken by Kay as types of the taphrogeosyncline. In all the half-grabens, one border is a fault that was active during deposition, and the deposits next to it include fanglomerate derived from highlands that lay beyond it. Nevertheless most of the strata dip toward that border, although near it at least they must originally have sloped away. In the Connecticut Valley, the active border fault was along the east side; the western border is also a fault for at least half its extent, but there is no evidence that that fault was active during deposition. Neither apparently were the faults in western Connecticut that downdrop the Triassic outliers in the Pomperaug River and Cherry Brook valleys; doubtless these outliers were originally part of the Connecticut Valley Triassic basin, since isolated by erosion. Additional faults cut and offset the strata in the main basin, but again the faults we see at the surface do not appear to have affected deposition.

Because of the fairly regular east dip, calculation of the total thickness of the Triassic strata in Connecticut would seem to be a simple matter, requiring only estimates of the throws of the faults within the basin; such a calculation gives a thickness of nearly 5 km (3 miles), and if the materials in the basin were mostly derived from the erosion of uplifted highlands of crystalline rock just east of the border fault, the total displacement on that fault could be twice that much. The situation along the eastern border fault turns out not to be that simple, however; first in Massachusetts (and Pennsylvania) and now in Connecticut, evidence has accumulated that with time the sediments lapped over the border fault and the active fault itself shifted eastward (in Pennsylvania northwestward), so that blocks between earlier and later active faults received only the upper part of the sedimentary sequence. In other words, the bottom of the basin probably does not slope regularly eastward; its actual slope can presumably be worked out by detailed mapping or by geophysics.

The Triassic deposits in all the half-grabens are dominated by red beds, ranging from fanglomerate through arkosic and micaceous sandstone to red siltstone and silty shale. Subordinate sedimentary rock types include pale sandstone and conglomerate, gray argillite and shale, local limestone, and coal. All the sediments are continental; the coarser and redder deposits are fluvial, the darker finer ones lacustrine or paludal.

The mineralogy of these deposits is turning out to be very complex, commonly involving zeolites and related minerals that suggest a considerable alteration bordering on metamorphism.

Interlayered with the sedimentary strata of the northern basins are mappable units of basaltic lava — three in the Connecticut Valley and New Jersey, fewer in Nova Scotia and Pennsylvania. In several areas, these units are demonstrably compound, consisting of several individual flows, with or without intervening sediments. Intrusive masses of similar chemistry, mainly saucer-shaped sills within the Triassic strata, dikes in the underlying and surrounding rocks, are known from Nova Scotia to Georgia and Alabama.

Defining the middle one by the lava units, Krynine divided the Connecticut Triassic into three formations; since then, the three lava units and the two groups of sedimentary strata between have each been mapped as a formation. The intrusives have also been divided into two groups: a possibly older group forming the sills and probably contemporaneous with the lava flows, and a possibly younger group including the dikes. The present stratigraphic scheme is as follows:

Newark Group

Intrusive	Extrusive		Sedimentary
Buttress Dolerite			Portland Formation
	Hampden Basalt	Meriden Formation	East Berlin Formation
West Rock Dolerite?	Holyoke Basalt		Shuttle Meadow Formation
	Talcott Basalt		New Haven Formation

Fossils are not abundant in the Triassic, but they are not completely lacking. Most abundant and conspicuous are tracks of dinosaurs and other reptiles. Other fossils include the dinosaurs themselves, amphibians, fish, estherian crustaceans, fresh-water molluscs, and petrified wood and other plant remains. Judging by these fossils, the age of the Newark Group is Late Triassic, either in the earlier part or extending through most of that epoch; the dikes may well be younger. Radiometrically, the age has generally been given as 195 ± 5 m.y., and this date has served indeed as a tie point for some recent time scales. Apparently, however, the number is too low, because of alteration of the dated basalt and related rocks; the true age is probably nearer 225 m.y.

Trip C-1

SEDIMENTOLOGY OF TRIASSIC ROCKS IN THE LOWER CONNECTICUT VALLEY

by

George deVries Klein
University of PennsylvaniaINTRODUCTION

Triassic sedimentary rocks occur in a series of fault trough basins in eastern North America from Nova Scotia in the north to North Carolina in the south. One of the better studied Triassic sedimentary successions occurs in the lower Connecticut Valley

Previous sedimentological work by Krynine (1950), Lehmann (1959) and Sanders (1968) has yielded a stratigraphic framework (fig. 1; table 1), petrographic history and a broad understanding about depositional environments. Krynine's work emphasized the mineralogy and petrology of the sedimentary rocks and the climatic significance of the red color of the sediments. Lehmann (1959) revised the stratigraphy, whereas Sanders (1968) developed a lacustrine model of deposition for the fine-grained sedimentary rocks in the middle part of the stratigraphic succession.

STRATIGRAPHY

Triassic rocks in the Connecticut Valley consist of a series of interbedded red clastic sedimentary rocks and basaltic lava flows. These are intruded in several localities by dolerite dikes (fig. 1).

In the past stratigraphic subdivision in these rocks has used the basaltic lava flows as marker beds (table 1). Sedimentary formations are classified according to their stratigraphic position in relation to the three major lava flows as well as by certain physical and mineralogical characteristics (Krynine, 1950). The sedimentary rocks consist of interbedded and intertonguing fanglomerates, conglomerates, sandstones, mudstones, siltstones and claystones, which are organized into a series of environmentally controlled lithofacies.

SEDIMENTARY FACIES

Four environmentally controlled sedimentary facies occur in the Triassic sedimentary rocks of the lower Connecticut Valley. These facies are the proximal alluvial fan facies, the distal alluvial fan facies, the floodplain facies and the mixed facies. The mixed facies represents alternating lacustrine and fluvial mudflat deposition.

PROXIMAL ALLUVIAL FAN FACIES

The proximal alluvial fan facies is characterized by poorly sorted boulder and cobble conglomerates, with a matrix of granule-sized conglomerate and coarse-grained, arkosic sandstone. It occurs in all the stratigraphic units along the Eastern Border Fault (Stops 8, 9), and in the basal portion of the New Haven Arkose (Stop 1).

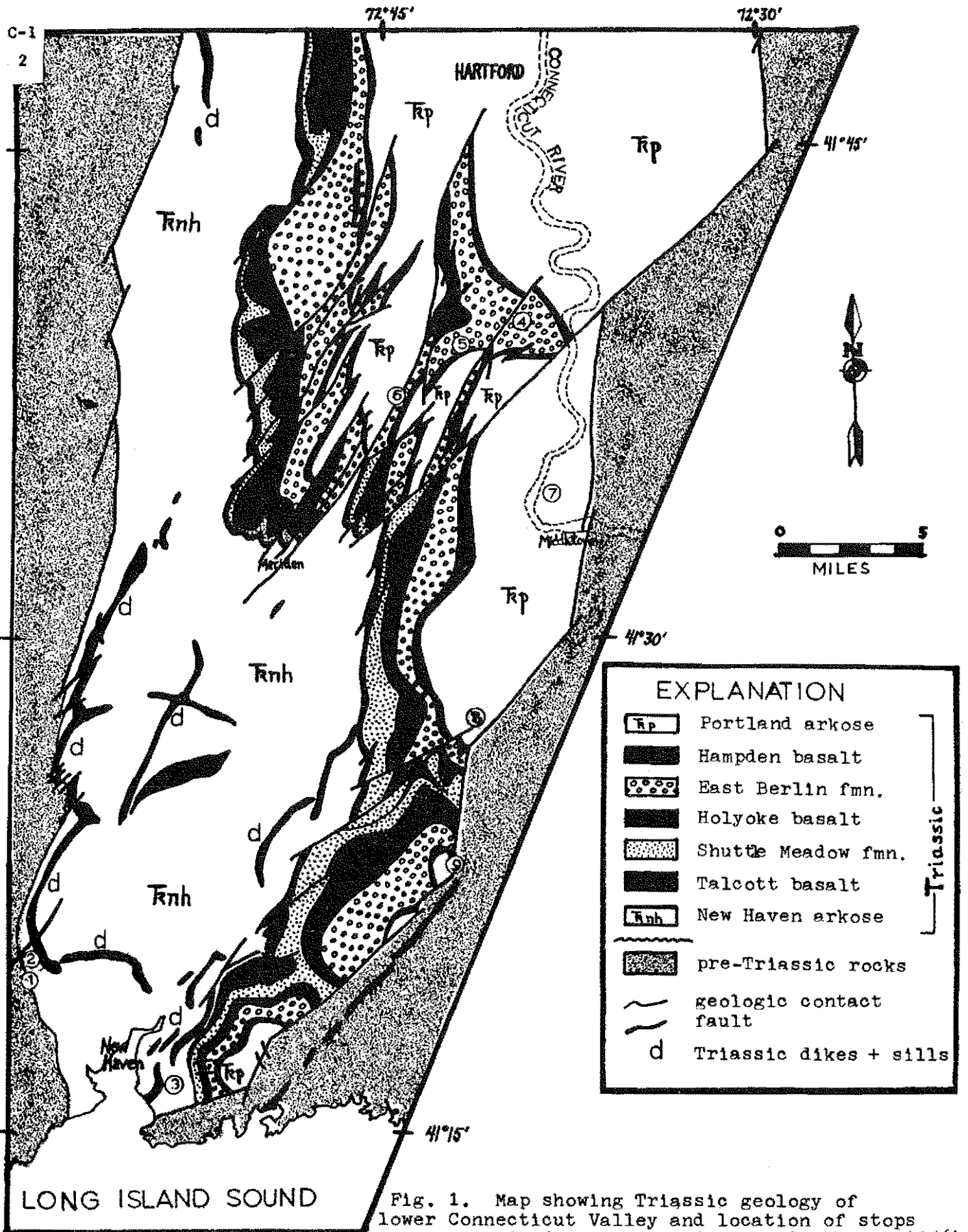

Fig. 1. Map showing Triassic geology of lower Connecticut Valley and location of stops for Trip C-1. (map after Rodgers and others, 1956).

Table 1. Triassic stratigraphy of Connecticut (after Krynine, 1950; Lehmann, 1959; Sanders, 1968).

Formation	Lithologies	Thickness	Environments
Portland Arkose	Fanglomerate, arkosic sandstone, mudstone	>450 meters	Alluvial fan, floodplain
MERIDEN GROUP			
Hampden Basalt	Basaltic lava	100 meters	
East Berlin Formation	Siltstone, mudstone, sandstone, claystone	183-485 meters	Lake and alluvial mudflat intertonguing into alluvial fan
Holyoke Basalt	Basaltic lava	200 meters	
Shuttle Meadow Formation	Siltstone, mudstone, sandstone, claystone	95-275 meters	Lake, alluvial mudflats, alluvial fans
Talcott Formation	Basaltic lava and interbedded sandstone, mudstone	150 meters	Lake, alluvial fan
New Haven Arkose	Fanglomerate, arkosic sandstone, mudstone	3,350 meters	Alluvial fans, floodplains

Evidence for an alluvial fan origin comes from previous comparisons by Krynine (1950) to modern alluvial fans and comparison to more recent studies by Blissenbach (1954) and Hooke (1967). The major evidence is the poor sorting and broad size range of the component particles, the crude stratification of the conglomerates, and the planar bedding of the sandstones. The crude sorting and bedding indicate rapid sediment dumping and burial because of the decrease in stream velocity reflecting a reduction in the depositional slope from the fault scarp to basin floor environment. Associated sandstone lenses with planar bedding indicate that, most likely, the streams building the fans flowed as sheet floods operating under the hydraulic conditions of the upper flow regime (cf. Simons and others, 1965). Patchy conglomerates and poor sorting of conglomerates may be the result of sieve deposition (Hooke, 1967), where the porous nature of the deposits resulted in the disappearance of streams from the fan surfaces into the porous interior of the fan. The cobble-, pebble-, and boulder-sized materials were left as a sieve-lag deposit. These deposits must have been formed by streams with a high sediment concentration. The presence of imbricated fanglomerates does suggest that there were episodes of deposition involving lower concentrations of sediment which permitted greater sediment reworking.

DISTAL ALLUVIAL FAN FACIES

Westward from the Eastern Border Fault the proximal alluvial fan facies is found to be interbedded with, or intertonguing with pebble conglomerates and pebbly, coarse-grained sandstones. The pebbles consist of milky quartz, feldspar, granite, pegmatite and schist. The

sandstones are arkosic, coarse-grained, poorly sorted and contain angular grains. Bedding in the sandstones of the higher formations tends to be planar (Stop 9). A complete gradation from proximal alluvial fan facies to the distal alluvial fan facies can be seen at Stop 9.

The distal alluvial fan facies is also characterized by a moderately regular interbedding of coarse-grained sandstones and mudstones, such as in the New Haven Arkose (Stop 2). Here coarse-grained, arkosic, pebbly sandstones alternate regularly with silty mudstones.

FLOODPLAIN FACIES

The floodplain facies is best developed in the Portland Arkose (Stop 7) and in the New Haven Arkose (Stops 2, 3). This facies is interbedded with and intertongued with the distal alluvial fan facies.

The major rock type in the floodplain facies is coarse-grained, massive-bedded sandstone. The massive bedding ranges in thickness up to 5 meters, with thinner internal sets of 30 cm. These are interbedded with thin (5 cm) siltstone layers. Generally, the basal contact of the sandstone beds is extremely sharp and channelled into the siltstone beds below, whereas the upper contact is characterized by less of a textural distinction or is gradational.

On the upper surfaces of some of the sandstone beds, pebble and cobble trains were observed in the Portland Arkose (Stop 7). These are oriented westerly as shown by a general widening to the west, indicating stream flow from east to west.

The regular bedding, vertical decrease in particle size within beds, channel scour structures, pebble trains and fining-upward cycles suggest an association of features common to the floodplain environment.

MIXED FACIES

The mixed facies contrast with the others because they are dominated by fine-grained, even-bedded lithologies, particularly in the Shuttle Meadow and East Berlin formations. The mixed facies occurs in the center of the Connecticut depositional basin. Although such fine-grained lithologies are present in the Talcott Formation and the Portland Arkose (Sanders, 1968), the discussion here is confined to the East Berlin Formation inasmuch as the principal features of the mixed facies are spectacularly displayed in this unit at two localities: a series of highway exit cuts off Interstate Highway 91, south of Rocky Hill (Stop 5), and in a road cut on Connecticut Highway 72, 0.2 miles east of its intersection with the Berlin Turnpike (Conn. Highway 15) at East Berlin (Stop 6).

Although previous workers such as Krynine (1950) interpreted the mixed facies to represent swamp, floodplain and lake environments, Sanders (1968) interpreted them to be fossil lake deposits from hydrodynamic interpretations of the sedimentary structures, and comparison to other known lake deposits.

The mixed facies appears to be organized into complex cyclic sequences of sedimentary rocks, textures, sedimentary structures and color (fig. 4). A generalized cycle of 12 component members is indicated, although when viewed in detail, variations exist from this generalized scheme (see outcrop description for Stop 5). A total of three major cycles are

exposed at Stop 5. A review of Lehmann's (1959) stratigraphic section at Stop 6 indicates that three major cycles are exposed there too.

The generalized cycle consists of the following 12 members (descending order; see fig. 4):

- (1) Siltstone, red, with dolomitic concretions.
- (2) Siltstone, red, with dolomitic concretions, pull-apart structures and sandstone dikes.
- (3) Siltstones, red, with dolomitic concretions, sandstone dikes and mud cracks.
- (4) Siltstone, red, massive, structureless.
- (5) Sandstones, red in upper half, grading into gray in lower half, locally cross-stratified.
- (6) Siltstones, gray, with dolomite concretions, pull-aparts and sandstone dikes.
- (7) Siltstones, gray, with pull-aparts, and sandstone dikes.
- (8) Siltstones, gray, with graded beds, basal part of graded beds is light-gray siltstone grading upward into dark gray siltstone.
- (9) Siltstone, upper half is gray, lower half is black, thinly-bedded with flaser bedding (smeared).
- (10) Claystone, black, asphaltic, pyritic.
- (11) Siltstone, gray, similar to member (8).
- (12) Siltstone, gray with dolomitic concretions, mud cracks and pull-aparts, grading downward into red siltstone with identical features.

Although more detailed studies, especially of mineralogy, are needed, it is the writer's personal prejudice at this moment that the cycles can be attributed to a combination of continued fault-trough subsidence and variation in the rate of sedimentation. Future work is needed to pinpoint what factors controlled the variations in the rate of sediment supply. Possibly, climatic controls were responsible, as suggested by Van Houten (1962, 1964).

Stop 1 (18.38 N - 53.60 E). 0.25 miles west of Exit 59 of Wilbur Cross Parkway, just west of intersection of June St. and Hazel Terr., behind buildings of the Amity Shopping Center, Woodbridge, Conn.

Outcrop of proximal alluvial fan facies of the New Haven Arkose which unconformably overlies the Milford Chlorite Schist. The New Haven Arkose consists of interlayered and intertonguing cobble- and pebble-conglomerate and green, epidotic, arkosic sandstone of the proximal alluvial fan facies. Both the conglomerate and sandstone are poorly sorted. Bedding is extremely crude, roughly parallel to the basal unconformity.

The conglomerates are pebble and cobble in size. The cobble fraction contains angular and blade-shaped fragments of epidotic phyllite derived from the underlying Milford Chlorite Schist. Accessory cobbles of rounded, milky quartz also occur. The pebble fraction consists almost exclusively of rounded fragments of orthoclase and microcline, milky quartz, and



Fig. 2. Boulder and cobble conglomerate in epidotic, arkosic sandstone matrix, proximal alluvial fan facies, New Haven Arkose, Amity Shopping Center, Woodbridge, Connecticut (Stop 1). Cobble-sized material consists of phyllite (dark) whereas pebbles consist of milky quartz and granite. Scale on hammer is in inches.



Fig. 3. Interbedded pebbly sandstones and mudstones of distal alluvial fan facies and fining-upward sequence of floodplain facies. Hammar is located by a fining-upward sequence of floodplain facies. Remaining sandstones and mudstones are separated by a sharp contact. West Rock Tunnel, New Haven, Connecticut (Stop 2).

granite pegmatite. The pebbles show better rounding than the cobbles; they are disc-shaped and spheroidal (fig. 2).

Sandstone lenses and beds intertongue laterally with the conglomerates. The sandstones are green, medium- to coarse-grained, arkosic and epidotic. The sand grains are angular. Sorting is poor. Petrographic study shows that the sandstones contain quartz (21 percent), polycrystalline quartz (20 percent), recognizable rock fragments (3 percent), orthoclase (16 percent), microcline (4 percent), plagioclase (2 percent) and opaque minerals, epidote and heavy minerals (2 percent). The sandstone is cemented by calcite. About six percent calcite selectively replaces microcline and orthoclase (Badal, 1968).

Interpretation. The basal New Haven Arkose was deposited by fluvial processes and represents the proximal alluvial fan facies. The mixed sorting of the rocks, the sand-grain angularity, the poor stratification, and the mixed population of the conglomerates support this interpretation.

The separation of the conglomerate fraction into two distinct size-composition associations (phyllitic cobbles and quartzo-feldspathic pebbles) suggest two sources for the basal New Haven Arkose. The cobble fraction was probably derived locally from the Milford Chlorite Schist and transported only a short distance, whereas the pebble fraction and the sand fraction were probably derived from a more distant source. The distant source was, most likely, east of the present outcrop belt (Krynine, 1950), although derivation from western pegmatite and granite terrains should not be ruled out entirely.

Stop 2 (18.61 N - 53.88 E) Near Exit 59 of the Wilbur Cross Parkway, 50 yards northwest of south portal of West Rock tunnel, New Haven. Outcrop of the distal alluvial facies and floodplain facies, New Haven Arkose, 50 feet below West Rock Sill.

Outcrop description. The New Haven Arkose is exposed on a rock face 60 ft high by about 140 ft long. Both the distal alluvial fan facies and the floodplain facies are exposed here. The New Haven Arkose consists of seven alternating layers of coarse, purplish pink sandstone and dark red mudstone and siltstone. The sandstone is coarse-grained, pebbly and arkosic. The sand grains are angular to subangular. Sorting is extremely poor. In two sandstone beds, there are fining-upward sequences of the floodplain facies (fig. 3). In the distal alluvial fan facies, the basal and upper contact of each sandstone bed is sharp. The sandstone layers thicken and thin irregularly across the outcrop face, pinching out into siltstone in two cases (fig. 3).

Petrographic analysis of the sandstones shows that they contain quartz (30 percent), polycrystalline quartz (2 percent), orthoclase (15 percent) and plagioclase (21 percent) as major grain components. The sandstone is bound by clay matrix (20 percent) and is cemented by calcite and hematite.

The bedding of the sandstone is defined by sharp basal and upper contacts in the distal alluvial fan facies. Gradational contacts occur only in two beds which have been assigned to the floodplain facies. Although the bedding appears even and laterally-persistent at a distance, closer examination shows that the upper and lower surfaces undulate broadly, and two of the sandstone beds split similar to coal seams. Mudstone occurs

between the split beds, which are of the distal alluvial fan facies.

Two of the beds appear to be graded, even though all particle sizes occur from bottom to top. The median particle size grades upward from coarse-grained sand at the base to fine-grained sand at the top of sandstone beds. The upper contact is gradational with overlying siltstones in both cases. However, isolated pebbles still occur in these siltstones. The sorting is uniformly poor in these fining-upward sequences of the floodplain facies.

The siltstones are dark red, poorly-sorted and micaceous. They contain mixed pebbles and coarse sand (up to 10 percent). The particle size of the siltstones and mudstones grades upward to claystone, where it is in sharp contact with the overlying sandstone. As in the sandstones, the pebbles occur as isolated grains.

Interpretation. These sediments were deposited in a fluvial environment as indicated by the poor sorting, the irregular stratification, the lensing and intertonguing of sandstone beds, and the occurrence of sandstone beds split like coal seams. Two of the sandstone-siltstone interbeds comprise a fining-upward sequence of the floodplain facies.

The remaining beds represent the distal alluvial fan facies. The poor sorting, the scattered pebbles and the sharp contacts suggest deposition by sheet flooding. The sheet flooding involved sediment loads of high concentration, thus accounting for the poor sorting, and the abrupt basal and upper contacts of the sandstone beds. The uniform occurrence of isolated pebbles suggests that the sheet floods occurred spasmodically and the high concentration of sediment load and the poor sorting may have reflected, in part, sedimentation by sieve deposition (Hooke, 1967).

Stop 3 (17.00 N - 56.34 E) Blakeslee Quarry, Russell Street, New Haven. Abandoned quarry in floodplain facies, New Haven Arkose.

Outcrop description. The New Haven Arkose (Floodplain facies) is exposed around the quarry walls. The west side of the quarry is cut by a dolerite dike, three meters thick.

The New Haven Arkose consists of coarse-grained, thick-bedded sandstone and interbedded, thin-bedded siltstone. The sandstones are coarse-grained, arkosic, poorly sorted and pebbly. The sand grains are angular to subangular.

Pebbles of milky quartz, granite, schist and gneiss are scattered throughout the sandstone beds. On the east side of the quarry, the lower sandstone bed was observed to have a concentration of pebbles at the top of the bed.

Krynine (1950, p. 101) reported that the sandstones consisted of quartz (50 percent), microcline (38 percent), plagioclase (2 percent), biotite and muscovite (2 percent) and hematite matrix and calcite cement (6 percent).

Bedding in the New Haven Arkose is expressed by textural changes. The sandstone beds occur in sets ranging from two to 12 meters thick, averaging 4.5 meters. Interbedded siltstones average 35 cm in thickness. Local clay laminae emphasize planar bedding of the massive sandstones.

Local scour-and-fill phenomena occur at the basal contact of most of the sandstones. The relief on the resulting downward channelling ranges from five to 10 cm. The channel axes are oriented west to northwest.

The siltstones are dark red brown, thinly laminated, and clayey. They occur in beds averaging 35 cm in thickness.

Contacts between sandstones and siltstones are sharp, except in one case where sandstone beds were found to grade vertically into a siltstone bed similar to the fining-upward sequences described by Allen (1965).

Interpretation. Krynine (1950) interpreted the New Haven Arkose as of fluvial origin. Evidence for his interpretation included poor sorting, fining-upward sequences, channelling, scour-and-fill structures and concentration of pebbles at the top of sandstone beds.

The one fining-upward sequence confirms a floodplain origin for the beds. However, the concentration of pebbles at the top of the basal bed in the quarry suggests that part of the unit was deposited in a braided system at the distal portion of an alluvial fan. The concentration of pebbles was produced by dispersive stresses (Bagnold, 1956) during high concentration stream flow. Braided stream deposits are characterized by surface concentrations of gravel (Leopold and others, 1964) and by irregular sorting of associated sands. The planar bedding of most of the New Haven Arkose also suggests deposition during the plane-bed phase of the upper flow regime, a condition common to the distal portion of the alluvial fan environment.

The source of the sandstones was east of the present outcrop belt (Krynine, 1950) and is confirmed by the orientation of the channel axes (west and northwest) observed in the quarry. The streams depositing this part of the New Haven Arkose were flowing west to northwest.

Stop 4 (29.83 N - 62.52 E) Dinosaur State Park, on West St. 0.3 miles east of Exit 23 off Interstate Highway 91, Rocky Hill.

Outcrop description. For details about this outcrop, see outcrop description for Trip C-3, Geology of Dinosaur Park, Rocky Hill, Conn.

Stop 5 (28.85 N - 61.45 E to 28.94 N - 61.60 E) 1.8 miles south of Exit 23 and 1.8 miles north of Exit 21 on Interstate Highway 91. Mixed facies of East Berlin Formation in roadcuts in exits off west side of Interstate Highway 91 (proposed Exit 22). Until connecting road is finished, parking is permitted within exit along south-bound lane.

Outcrop description. The East Berlin Formation is exposed in a series of four road cuts and consists of three cyclic units of alternating red and gray siltstone, mudstone, claystone and sandstone (figs. 4, 5) overlain by the Hampden Basalt.

The East Berlin Formation is exposed in a series of four exitways. The contact of the Hampden Basalt and the East Berlin Formation is exposed in all the exitways. The exitways also give an unparalleled three-dimensional exposure of all the units comprising the East Berlin Formation.

Below the basalt is the first (or upper) cycle of the East Berlin Formation. It contains the generalized members shown in fig. 4 except that between members 2 and 3 there is a massive, brown sandstone layer. When this layer is traced from the northernmost exit to the southernmost

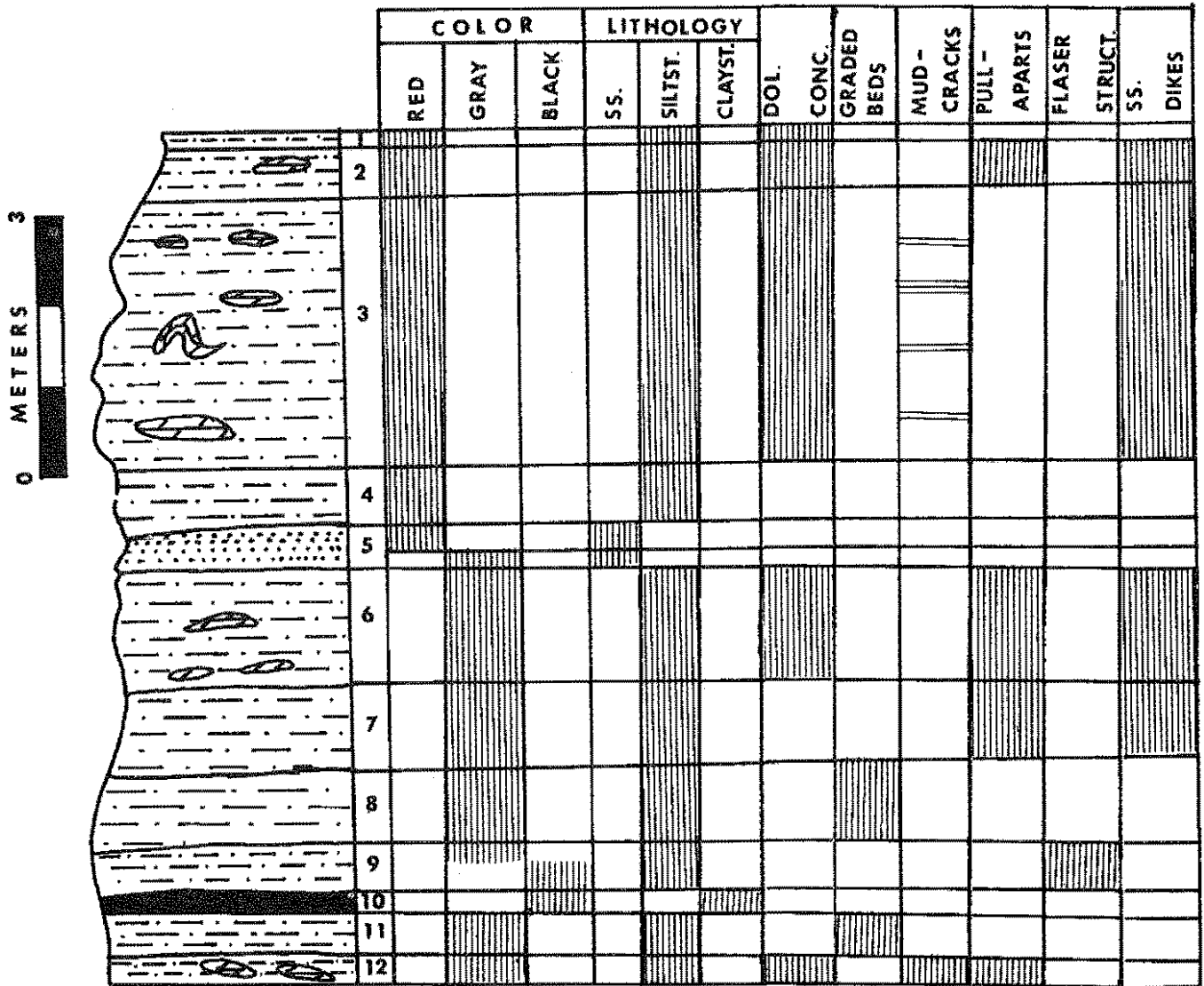

Fig. 4. Generalized cycle in East Berlin Formation, mixed facies. Members shown are (1) siltstone, red, with dolomitic concretions, (2) siltstone, red, with dolomitic concretions, pull-aparts and sandstone dikes, (3) siltstone, red, with dolomitic concretions, sandstone dikes and mud cracks, (4) siltstone, red, structureless, (5) sandstone, red in upper half, grading into gray lower half, locally cross-stratified, (6) siltstone, gray, with dolomite concretions, pull-aparts and sandstone dikes, (7) siltstone, gray, with pull-aparts, and sandstone dikes, (8) siltstone, gray, with graded beds, in which light gray siltstones grade upward into dark gray siltstone, (9) siltstone, upper half gray, lower half black, thinly bedded with flaser structure, (10) claystone, black, asphaltic, pyritic, (11) siltstone, gray, similar to Member 8, (12) siltstone, gray with dolomitic concretions, mud cracks and pull-aparts, grading downward into red siltstone with identical features.

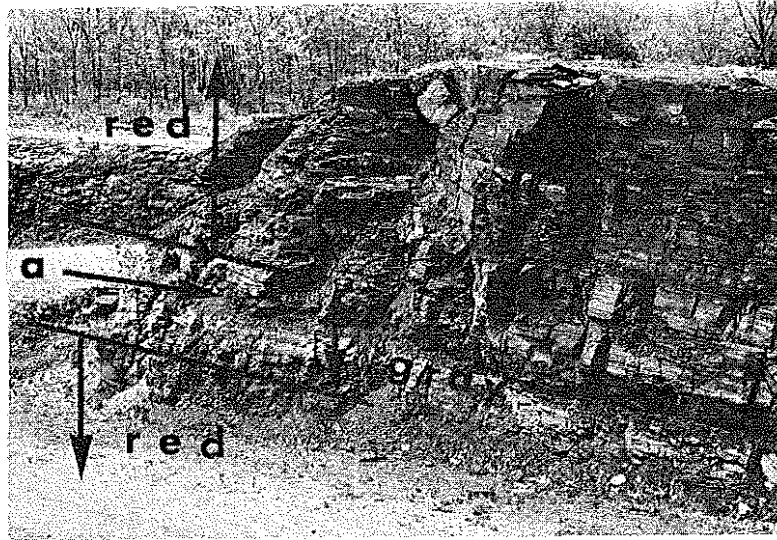

Fig. 5. Cyclic arrangement of red and gray mudstone, siltstone, sandstone and claystone, mixed facies, East Berlin Formation, highway exits off Interstate Highway 91, near Rocky Hill, Connecticut (Stop 5). Middle cycle is shown. "a" marks asphaltic, black claystone, showing symmetrical nature of the cycle.

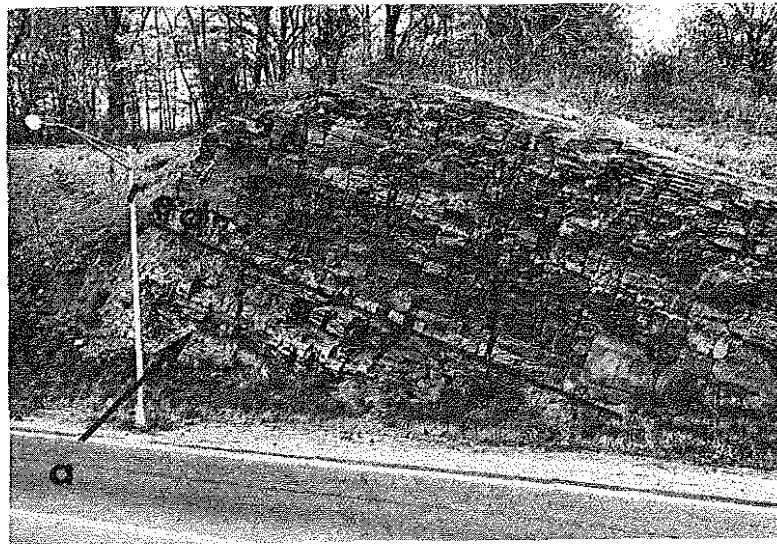

Fig. 6. Mudstones, siltstones and shales of mixed facies, East Berlin Formation, East Berlin, Connecticut (Stop 6), showing middle cyclic unit. "a" refers to asphaltic, black claystone (Member 10; fig. 10). Cycle consists of ordered arrangement of lithologies shown in fig. 10, and alternation of red and gray color.

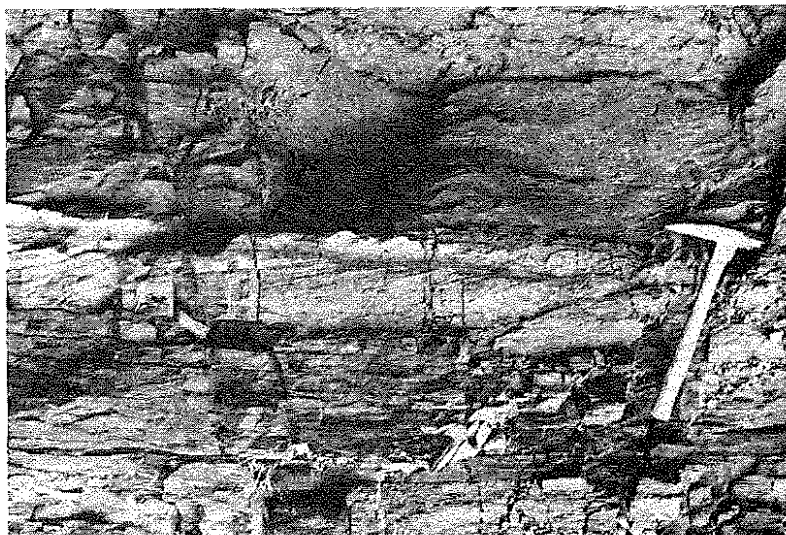

Fig. 7. Lens of cross-stratified sandstone in channel sandstones, mixed facies, East Berlin Formation, East Berlin, Connecticut (Stop 6). Channel bottom is covered by massive sandstone, which is overlain in turn by muddy topsets of overlying cross-stratified sandstone. Scale on hammer handle is in inches.



Fig. 8. Dolomitic concretions in structureless red siltstone, East Berlin Formation, East Berlin, Connecticut (Stop 6). Scale on hammer handle is in inches.

exit, one can observe sharp changes in thickness, indicating a channel geometry. The sandstone is 30 cm thick in the northernmost exit, and increases to 50 cm in thickness in the northcentral exit. In the south-central exit, sharp thickness changes occur. On the north face of this exit, the sandstone is 1 meter thick, but on the south face, the sandstone ranges from 1 meter to 3 meters in thickness. The thickness change on this south face is in the downdip (easterly) direction. In the southernmost exitway, the same sandstone layer thins to 70 cm. The thickening is always at the expense of the underlying beds. Cross-stratification in this channel is oriented to the east.

Within the red siltstones and mudstones of the red phase of the topmost cycle are a series of cross-stratified sandstone lenses. The cross-stratification is oriented east, north, northeast and west in these lenses. The inclination of the cross-stratification changes from low-angle (10 degrees) to high angle (25 degrees) within the same lense.

The siltstones are structureless. Some of the siltstones contain dolomitic concretions, some of which are contorted into "S"-shaped folds, suggesting penecontemporaneous deformation. These are often associated with beds showing pull-apart structures, syneresis cracks and sandstone dikes. Other sedimentary structures include rain prints, mud cracks, current ripple marks and rib-and-furrow structures. The topmost red phase is 16.8 meters thick (Byrnes, 1968).

The contact with the underlying gray beds is gradational, falling within a massive siltstone bed. Siltstones with dolomitic concretions, pull-apart structures, sandstone dikes, and syneresis cracks occur. The apex of the gray cycle is a black, asphaltic claystone with pyrite. This asphaltic layer is bracketed by light gray siltstones with graded bedding. The gray phase of the topmost cycle is 6.3 meters thick (Byrnes, 1968).

The second cycle (fig. 5) fits the 12-member generalized cycle (fig. 4). The top of the cycle is an undulating, gradational contact within a siltstone bed. The red phase of the second cycle totals 5.0 meters in thickness (Byrnes, 1968).

The gray phase of the second cycle (fig. 5) contains a mudstone layer at the top, a brown sandstone below and a gray siltstone with dolomite concretions below the brown sandstone. This gray siltstone grades downward into siltstone with graded bedding below which is a dark gray and black siltstone with flaser bedding. The apex of this gray cycle is another asphaltic black claystone. The gray phase of this middle cycle is 5.7 meters thick (Byrnes, 1968).

The third cycle below is in gradational contact with the second cycle. The red phase fits the generalized cycle shown in fig. 4. It totals 9.0 meters in thickness.

The underlying gray phase (also in gradational contact with the overlying red phase) also fits the generalized cycle (fig. 4). The black asphaltic claystone is cut by thin gypsum veins, however. The lowermost gray phase totals 3.1 meters in thickness.

Below the third cycle are a series of red claystones, mudstones, siltstones and sandstones, the base of which is not exposed. On the south face of the northernmost exitway, there is exposed a sandstone layer 5 cm thick. The surface of this sandstone layer shows asymmetrical and symmetrical

wave-like bedforms, whose wavelength is 25 cm, height 2.5 cm. The steep face of the asymmetrical bedform dips east, as does its internal lamination. The same asymmetrical bedform was found to grade laterally into a symmetrical wave-like bedform which contains internal laminae conformable to the surface wave-like bedform. It is suggested that the asymmetrical bedform possibly may represent a preserved antidune which grades laterally into a preserved standing wave. These bedforms are smaller in size and consist of finer-grained sediment than those reported by Hand and others (1968) in the Triassic of Massachusetts. Indirect line of evidence support for the hypothesis that these bedforms are antidunes and standing waves is that the internal stratification dips opposite to the prevailing westerly orientation of cross-laminae. Perhaps some of the easterly-oriented cross-stratification occurring in the red members of the first and middle cycle may have been so formed and would therefore be an unreliable indicator of transport direction.

Further field work is needed to check this possibility. The standing waves and antidune bedforms occur 43 meters west of the westernmost culvert, on the south face of the northernmost exitway.

Interpretation. The mixed facies probably represents an alternation of lacustrine and alluvial mudflat sedimentation. The asphaltic claystone, the graded siltstone and the siltstones with flaser bedding are interpreted to represent lacustrine deposition, whereas the gray siltstones with concretions, and the transitional gray and red sediments are interpreted to be alternating lacustrine and alluvial mudflat deposition. The higher red beds with channel sandstones are interpreted to represent alluvial mudflat deposition.

Stop 6 (28.74 N - 60.41 E to 28.83 N - 60.29 E) Road cut on Connecticut Highway 72, 0.2 to 0.6 miles east of intersection with Connecticut Highway 15. Mixed facies of East Berlin Formation, East Berlin.

N.B. WATCH THE TRAFFIC AT THIS STOP.

Outcrop description. The East Berlin Formation is overlain by the Hampden Basalt at the east end of the outcrop. The Hampden Basalt is tholeiitic and vesicular and has baked the underlying siltstones of the East Berlin Formation.

The East Berlin Formation consists of an alternating sequence of sandstone, siltstone, mudstone and claystone. These are organized into a complex of lithologic cycles (fig. 6) associated with color changes from red to gray (fig. 4). A measured section of the outcrop appears in Lehmann (1959, p. 16-21). Because of covered intervals between some of the contacts, the repetitive nature of the cycles is not as apparent as at Stop 5.

The thicknesses of the cyclic units are taken from Lehmann (1959) and converted into metric units:

Topmost cyclic unit:	Red phase	- 6.0 meters
	Gray phase	- 2.5 meters
Middle cyclic unit:	Red phase	- 5.7 meters
	Gray phase	- 6.4 meters
Basal cyclic unit:	Red phase	- 5.1 meters
	Gray phase	- 5.2 meters

The organization of the cycles fits the general cycle summarized in fig. 10.

Interbedded with the middle red phase are brown to reddish brown, fine-grained to medium-grained, orthoquartzitic sandstones. These occur as lenses which channel into the underlying beds. The sandstones are cross-stratified (fig. 7). Some mud was transported and incorporated into the cross-stratified sand.

The siltstones show a variety of sedimentary structures including contorted dolomitic concretions (fig. 8), pull-apart structures, mud cracks, raindrop imprints, current ripple marks, rib-and-furrow structures, syneresis cracks, sandstone dikes and micro-cross-laminae. Graded bedding is confined to gray siltstones which bracket asphaltic claystones. No flaser structure was observed at this outcrop.

Although the organization of the cycles at Stops 5 and 6 is generally the same, there are major thickness differences. The topmost cycle at Stop 6 is much thinner than its counterpart at Stop 5. The middle cycle is about the same thickness as its counterpart at Stop 5, whereas the basal cycle shows a thinner red phase and a thicker gray phase at Stop 6. These changes probably indicate lateral differences in the geometry of the depositional basin.

Interpretation. As at Stop 5, the mixed facies of the East Berlin Formation is believed to represent alternating lacustrine and alluvial mudflat sedimentation. The asphaltic black claystone and bracketing graded siltstones represent lacustrine deposition, whereas the upper portion of the gray phase (with concretions) and the lower part of the red phase (also with concretions) probably represent the transition zone of the two environments. The upper portion of the red phase, which contains cross-stratified sandstones, most likely represents the alluvial mudflat environment.

Stop 7 (27.16 N - 62.97 E) Entrance to Brazos Quarry, off Brownstone Ave. 0.5 miles north of intersection with Silver Street, Portland, in the floodplain facies of the Portland Arkose.

Outcrop description. The Brazos Quarry was worked for building stone during the nineteenth century. Most of the stone quarried from it was used for construction in the west side of New York City and other buildings in northeastern U.S.A. The quarry has been flooded since the First World War. A prolific number of fossil dinosaur footprints, many now housed at the Geology Department of Wesleyan University, have given the quarry its geologic fame.

The northwest part of the quarry, the only accessible part, exposes the floodplain facies of the Portland Arkose. The Portland Arkose consists mostly of massive, red-brown, coarse-grained and medium-grained sandstones interbedded with thin sets of mudstone. The sand grains are sub-angular to subrounded and are poorly sorted. The mudstone is dark reddish brown and thinly bedded. It occurs in thin sets averaging 5 cm in thickness.

Bedding in the sandstones is massive, occurring in sets of 3 to 4 meters thick. Within these massive sets are less well developed thinner sets ranging from 1 to 10 cm. The bed thickness was observed to decrease upward within a large massive set. The bedding is essentially planar.

Mud cracks are common on bedding planes. Dinosaur footprints were associated with mud cracks and asymmetrical ripple marks in slabs in the collections at Wesleyan University.

On the surfaces of some of the bedding planes are pebble and cobble conglomerate trains. The pebbles and cobbles consist of fragments of milky quartz, granite, pegmatite, schist, phyllite, amphibolite and gneiss. The conglomerates are openwork and are associated with a matrix of coarse-grained sandstone. The orientations of the cobble and pebble trains are nearly east-west, with the trains widening to the west and thus indicating a flow from east to west.

Petrographic study of the sandstones shows that they consist of quartz (20 percent), microcline (2 percent), orthoclase (14 percent), plagioclase (37 percent) and recognizable metamorphic rock fragments (12 percent). The rock fragments have a diagenetically-altered rim in which biotite is altered to hematite. The sandstones are cemented by calcite (10 percent) and hematite (7 percent).

Interpretation. The Portland Arkose at this locality represents a floodplain. The planar bedding of the sandstones suggests deposition by rivers in the upper flow regime, although the vertical decrease in bed thickness of massive sets also indicates a vertical decrease in stream capacity and competency. These river systems flowed from east to west. The presence of mud cracks and fossil footprints indicates that the fluvial environment was periodically exposed but also rapidly buried. Although this outcrop represents the floodplain facies, some intertonguing elements of the distal alluvial fan facies may be present.

Stop 8 (22.82 N - 61.92 E) On Conn. Highway 77, 0.3 miles south of intersection with Conn. Highway 17. Roadside outcrop in proximal alluvial fan facies, Portland Arkose, Durham.

Outcrop description. The Portland Arkose consists of coarse conglomerate typical of the proximal alluvial fan facies. It is a typical conglomerate. Outcrop size analysis shows that 35 percent of the fragments are cobbles, 15 percent are boulders and 25 percent are pebbles. The remainder of the rock consists of a coarse-grained, arkosic sandstone matrix.

The conglomerate fragments consist of granite, polycrystalline quartz, milky quartz, metamorphic quartzite, schist, gneiss, pegmatite, and amphibolite, all similar to rocks occurring in the Eastern Highlands. Locally, boulders and cobbles of Triassic basalt are present. The fragments are blade-shaped and poorly sorted. Orientation of fragments is mostly random.

Crude imbrication occurs at a few horizons. At the southern end of the outcrop, imbrication is oriented 120 degrees (indicating depositional flow in a direction of 300 degrees). In the center of the outcrop, the imbrication shifts to 70 degrees (flow to 250 degrees), and on the north side of the outcrop, the imbrication again is 120 degrees.

Bedding in the conglomerate is crude to nonexistent. It is indicated locally by zones of pebble, cobble and boulder conglomerate, and planar bedding in sandstone lenses. Bedding in the sandstone is in sets up to 50 cm thick, averaging 3 cm in thickness. The sandstone occurs as lenses, some of which channel into conglomeratic beds. The relief on these channels is 5 to 7 cm.

Interpretation. The Portland Arkose at this locality represents the proximal alluvial fan facies, nearly adjacent to the Eastern Border Fault. The fan sloped to the west, although the slope was irregular as indicated by shifts in pebble imbrication. The presence of crude planar-bedded sandstone suggests that the flow conditions were dominantly of the upper flow regime. The random orientation of most of the pebbles and cobbles indicates that the flow conditions were characterized by high sediment concentrations, accounting also for the lack of sorting. Possibly sieve deposition (Hooke, 1967) accounts for this high concentration.

The source of the conglomerate was east of the present outcrop belt, probably nearby.

Stop 9 (20.43 N - 61.40 E) Outcrops in proximal and distal alluvial fan facies, Portland Arkose, on Conn. Highway 77, on west side of Lake Quonni-paug, 5.2 miles south of intersection of Conn. Highway 17 and 77.

Outcrop description. North of a granite bandstand, a series of outcrops in the East Berlin Formation represents the lateral tonguing of the proximal and distal alluvial fan facies. This facies change can be studied best by starting to examine outcrops 0.2 miles north of the bandstand in the proximal alluvial fan facies, and working back to the bandstand where the distal alluvial facies is exposed.

The predominant rock type at the northern end of the outcrop is a fanglomerate of the proximal alluvial fan facies. The fanglomerate is grayish red, poorly sorted, and contains cobbles and pebbles in a matrix of granule conglomerate (fig. 9). The fanglomerate is open-work, the cobbles and boulders being angular to subangular. Their shape is blade-like. No imbrication occurs. Bedding is indeterminate. The cobbles and boulders consist of schist, gneiss, amphibolites, milky quartz, granite, pegmatite, and Triassic basalt.

The East Berlin Formation changes southward, becoming more of a cobble conglomerate; the amount of interbedded sandstone progressively increases. The sandstone occurs as lenses, and as a conglomerate matrix. The sandstone is also grayish red and is coarse-grained, with accessory granule-size materials. Sandstone bed thickness averages 3 to 4 cm.

By the granite bandstand, cobble conglomerate and sandstone alternates (fig. 10). The cobbles are slightly imbricated with the imbrication oriented 135 degrees, indicating fluvial flow in a direction of 315 degrees.

The sandstone is coarse-grained, arkosic and even bedded, the bed units being 5 mm to 1 cm. Larger order bedding averages 2.5 meters in thickness.

Interpretation. The East Berlin Formation represents an alluvial fan at this locality. The changes in lithologies observed from north to south represent a change in depositional regime from the proximal facies of an alluvial fan to the distal facies of the same alluvial fan. Deposition was by streams flowing under the hydraulic conditions of the upper flow regime, as indicated by the planar bedding. Flow concentration shifted from high (cobble fanglomerates on the north) to low (sandstones and imbricated conglomerates at the bandstand). A braided system of drainage, coupled with sheetflooding is suggested. The flow of these streams was essentially to the northwest and west.



Fig. 9. Boulder- and cobble-conglomerate, proximal alluvial fan facies, East Berlin Formation, Lake Quonnipaug, Connecticut (Stop 9). Scale on hammer handle is in inches. Matrix of conglomerate consists of granule-conglomerate and coarse-grained sandstone.



Fig. 10. Imbricated cobble-conglomerate interbedded with planar-bedded pebbly sandstone, distal alluvial fan facies, East Berlin Formation, Lake Quonnipaug, Connecticut (Stop 9). Scale on hammer handle is in inches.

REFERENCES CITED

- Allen, J. R. L., 1965, Fining-upward cycles in alluvial successions: Geol. Jour., v. 4, p. 229-246.
- Badal, J. C., 1968, An attempt to determine the origin of redbeds: Unpub. class rept., Geology 532, Univ. of Pennsylvania.
- Bagnold, R. A., 1956, The flow of cohesionless grains in fluids: Royal Soc. London Phil. Trans., Ser. A., v. 249, p. 235-297.
- Blissenbach, Erich, 1954, Geology of alluvial fans in semi-arid regions: Geol. Soc. America Bull., v. 65, p. 175-189.
- Byrnes, J. B., 1968, Unpublished MS thesis, Univ. of Connecticut (not seen).
- Hand, B. M., Wessell, J. M., and Hayes, M. O., 1968, Antidunes in the Mount Toby Formation (Triassic), Massachusetts (Abs): Program, 1968 Meeting, Northeastern Section, Geol. Soc. America, p. 31-32.
- Hooke, R. L., 1967, Processes on arid-region alluvial fans: Jour. Geology, v. 75, p. 438-460.
- Krynine, P. D., 1950, Petrology, stratigraphy and origin of the Triassic sedimentary rocks of Connecticut: Connecticut Geol. Nat. History Survey Bull. 73, 247 p.
- Lehmann, E. P., 1959, The bedrock geology of the Middletown quadrangle: Connecticut Geol. Nat. History Survey Quad. Rept. 8, 40 p.
- Leopold, L. B., Wolman, M. G., and Miller, J. P., 1964, Fluvial Processes in Geomorphology: San Francisco, Freeman, 522 p.
- Sanders, J. E., 1968, Stratigraphy and primary sedimentary structures of fine-grained, well-bedded strata, inferred lake deposits, upper Triassic, central and southern Connecticut, in Klein, G. deV., ed., Late Paleozoic and Mesozoic continental sedimentation, northeastern North America: Geol. Soc. America Spec. Paper 106, p. 265-305.
- Simons, D. B., Richardson, E. V., and Nordin, C. F., Jr., 1965, Sedimentary structures generated by flow in alluvial channels, in Middleton, G. V., ed., Primary sedimentary structures and their hydrodynamic interpretation: Soc. Econ. Paleontologists and Mineralogists Spec. Pub. 12, p. 34-52.
- Van Houten, F. B., 1962, Cyclic sedimentation and the origin of analcime-rich upper Triassic Lockatong Formation, west-central New Jersey and adjacent Pennsylvania: Am. Jour. Sci., v. 260, p. 561-576.
- _____ 1964, Cyclic lacustrine sedimentation, Upper Triassic Lockatong Formation, central New Jersey and adjacent Pennsylvania, in Merriam, D. F., ed., Symposium on cyclic sedimentation: Kansas Geol. Survey Bull. 169, p. 497-531.

Trip C-2

GENERAL GEOLOGY OF THE TRIASSIC ROCKS
OF CENTRAL AND SOUTHERN CONNECTICUT

Road Log

by

John Rodgers
 Yale University

This trip visits the following quadrangles, published geologic maps of which are listed:

	Bedrock Geology	Surficial Geology
New Haven*		CG&NHS QR 18 m
Branford		CG&NHS QR 14
Guilford		
Mount Carmel*	USGS GQ 199	CG&NHS QR 12
Wallingford		CG&NHS QR 10
Durham*		
Southington ⁺	USGS GQ 200	USGS GQ 146
Meriden*	USGS GQ 738	USGS GQ 150
Middletown*	CG&NHS QR 8	
Hartford South*		CG&NHS QR 20

* Stops are suggested on this quadrangle.

+ The Southington quadrangle is entered for less than a mile.

Start on New Haven quadrangle. Drive northwest out of New Haven via Whalley Ave. and Amity Road (Rte. 63), to Woodbridge town line, just beyond Amity Shopping Center, which is just north of Wilbur Cross Parkway. Turn left (southwest) on June Street, just north of town line, proceed to end of street and park behind stores of shopping center.

Mile 0.0 Stop A (18.38 N - 53.60 E; New Haven quadrangle) Basal unconformity of New Haven Arkose upon Milford Chlorite Schist. See Stop #1 of Trip C-1 for description.

Return east on June St. to Amity Road (Rte. 63), turn left.

0.2 Traffic light; turn right (east) on Lucy St.

0.4 Stop sign; turn right on Litchfield Turnpike (Rte. 69), then immediately left on Merritt Ave., cross small bridge, turn left on Miles Ave., then right on Manila Ave., and proceed to end of street and park (0.8).

0.8 Stop B (18.61 N - 53.88 E; New Haven quadrangle) Alluvial and flood-plain facies of New Haven Arkose. See Stop #2 of Trip C-1 for description.

0.8 Return to Litchfield Turnpike.

CARS THAT ARE PERMITTED TO TRAVEL ON WILBUR CROSS PARKWAY USE FOLLOWING ITINERARY TO STOP C (15.7) (See next page for alternate itinerary.)

1.2 Turn left (south) on Litchfield Turnpike, proceed under Parkway (New Haven town line) and turn left at once, then bear left onto Parkway (headed northeast).

1.7 West end of tunnel through West Rock sill. Hamden town line at far end.

5.8 Enter Mount Carmel quadrangle. Mount Carmel stock visible to north.

6.7 North Haven town line.

8.0 Enter Wallingford quadrangle.

10.0 Mount Carmel stock visible to northwest.

11.0 Wallingford town line.

11.4 Dike leading northeast from Mount Carmel stock.

12.7 Exit 64; exit from Parkway.

13.0 Turn left under Parkway and bear left (south) onto Old Hartford Turnpike.

13.2 Blinker; turn right (west) up steep hill on Cheshire Road.

13.8 Cross east-west dike; road more or less follows this dike to 16.1.

14.2-14.3 Stop sign; turn left, then bear right, staying on Cheshire Road.

15.3 Cheshire town line; Cheshire Road becomes Boulder Road. The name comes from one of the numerous very large boulders of the Holyoke lava that are strewn over this part of Cheshire, having been plucked off the south-facing escarpment of the Hanging Hills. As we will see there, the characteristic intersection of healed and altered columnar joints and clean parallel systematic joints identifies the rock.

- 15.5 Re-enter Mount Carmel quadrangle.
- 15.7 Stop C (23.22 N - 56.48 E; Mount Carmel quadrangle) Cross Rock dikes intrusive into New Haven Arkose, at yellow house on north side of road (Weber Farm) See Stop #1 of Trip C-5 for description.
- BUSSES NOT PERMITTED TO TRAVEL ON WILBUR CROSS PARKWAY, USE FOLLOWING ITINERARY TO STOP C (14.5)
- 1.2 Turn right (north) on Litchfield Turnpike (Rte. 69). Road follows valley on Triassic sediments between West Rock sill and metamorphic rocks of Western Highlands.
- 3.1 South end of Lake Dawson, which with Lake Watrous to the north lies in the Triassic valley. The road follows the west side of the valley and has numerous good exposures of Wepawaug phyllite. When dam for Lake Dawson was built, excavation uncovered the basal unconformity of the Triassic sediments, already seen at Stop A.
- 3.7 Enter Mount Carmel quadrangle.
- 3.8 On southwest corner of intersection with Dillon Road, half hidden in trees, is old lime kiln, in which was burned impure schistose limestone quarried on hill behind kiln.
- 4.3 Litchfield Turnpike starts to climb hill (excellent exposures of Wepawaug phyllite ahead, showing several rock types and generations of folds). Turn right off Turnpike on Downs Road, continuing along the Triassic valley beside Lake Watrous. In the phyllite exposures along the lake (and also on the Turnpike above) are some bodies of the peculiar tuff-like metarhyolite included by Fritts in his Woodbridge Granite.
- 5.3 Bethany town line. Beyond Lake Watrous, road begins to climb west valley wall, with fine views of West Rock sill to east. The linear valley and ridge topography reminds one forcibly that one is still in the Appalachians.
- 6.2 On hill to west, Wepawaug phyllite shows a large-scale vertical-axis sinistral kink-band, perhaps 20 meters wide. Rodgers interpreted this as a reaction of the vertically foliated Wepawaug phyllite to the forces that produced faulting in the Triassic, for he believed the offsets in the base of the Triassic and in the West Rock sill (the latter to be seen just ahead) were produced by faulting, as had Davis; Fritts however considers the offsets original irregularities in the Triassic floor and the sill.
- 6.9 Turn right (east) on Carmel Road, and descend into valley west of north end of West Rock Ridge.
- 7.2 Turn left (north) with Carmel Road at intersection with Brooks Road.
- 7.4 Bethany Gap; dolerite outcrops connecting offset portions of sill.
- 7.5 Hamden town line; Carmel Road becomes Gaylord Mountain Road.
- 8.0 Turn right (east) on West Woods Road. Mount Carmel stock ahead; north end of West Rock Ridge to south; Bethany Mountain (northern continuation of West Rock sill) behind.
- 8.3 Jog to right; stay on West Woods Road (road ahead will get you lost in suburbia).

- 9.3 Stop sign; turn left (north) on Shepard Ave.
- 10.8 Railroad crossing and stop sign; turn left (north) on Route 10 (Whitney Ave.).
- 12.1 Cheshire town line.
- 12.9 Ives Corner, traffic light. Turn right (east) on Cook Hill Road.
- 13.8 After climbing into arkose hills, turn left (north) on Halfmoon Road.
- 14.2 Stop sign; turn right (east) on Boulder Road (for derivation of name, see 15.3 on car itinerary).
- 14.5 Stop C (23.22 N - 56.48 E; Mount Carmel quadrangle) Cross Rock dikes intrusive into New Haven Arkose. See Stop #1 of Trip C-5 for description. Second yellow house on north side of road (Weber Farm). Busses turn around. (14.5 = 15.7 of car itinerary)
- 15.7 Proceed westward on Boulder Road.
- 16.0 Stop sign; bear right on Coleman Road (intersection with Halfmoon Road).
- 16.4 Bear right (north) on Coleman Road. We are now climbing over Jinny Hill, on which lay the principal mines of the Cheshire barite district (see supplementary notes under Stop #1 of Trip C-2). Over the top of the hill, the Hanging Hills of Meriden are visible to the north.
- 17.6 Jog right on Wallingford Road to Talmadge Road (second left); continue north.
- 18.5 Enter Southington quadrangle (we are on this quadrangle for less than a mile). Stop signs; turn left on Yalesville Road (Rte. 68), then immediately right on Rte. 70 north.
- 19.3 Enter Meriden quadrangle. Fine view of Hanging Hills ahead.
- 20.0 Descend from glacial outwash plain into valley of Quinnipiac River; esker to right.
- 20.8 Meriden town line; road proceeds east through gorge of Quinnipiac River. Strata of New Haven Arkose are very nearly flat, dipping gently north under Hanging Hills.
- 22.1 Turn left (north) across bridge on Oregon Road; Harmony Pond to east. Outcrops on Oregon Road and on Rte. 70 east of intersection show erratic dips (commonly west instead of east) and much minor faulting. Probably the largest of the faults that offset the lava units (as we shall see from the Hanging Hills) passes along the west side of the pond.
- 23.3 Traffic light; continue straight ahead (Oregon Road becomes Centennial Ave.).
- 23.7 Traffic light; turn left (west) on West Main Street (Rte. 66).
- 24.5 Street curves around arkose outcrops; be ready to turn right (north) at blind corner (fortunately, a one-way street our way) just beyond, into Hubbard Park.
- 24.9 Reservoir Ave. on right; continue straight up hill. We will return to this point.
- 25.2 Climb through Talcott lava (quarry on right).

- 25.3 South end of Lake Merimere; dam at this end is built on Talcott lava; Holyoke lava forms cliffs overhanging lake. Island in lake appears to be an uplifted fault block of Talcott lava; lake lies in this fault block.
- 25.8 Road climbs over Holyoke lava.
- 26.2 North end of Lake Merimere; turn left (west) across dam, which is built on Holyoke lava.
- 26.7 Road turns south and starts climbing dip slope of Holyoke lava. Note narrow fault slices expressed in the topography.
- 27.7 Fork in road. Trip takes left fork to stone tower on East Peak of Hanging Hills; right fork leads to steel fire tower on West Peak (1,024 ft above sea level, highest point in Triassic basin south of Mt. Tom in central Massachusetts), looking west over Southington toward Western Highlands.
- 28.1 Parking lot below stone tower.
- Stop D (26.35 N - 57.65 E; Meriden quadrangle) Hanging Hills of Meriden, underlain by Holyoke lava (outstanding view over central Connecticut). See Stop #2 of Trip C-5 for description.
- Return down mountain, retracing itinerary to point 24.9 (will be 31.3).
- 31.3 Turn left (east) on Reservoir Ave., and proceed just south of hills formed by Talcott lava. At each steep pitch, the road crosses a fault.
- 32.2 Stop sign; turn left (north) on Chamberlain Highway.
- 32.9 Climb over Talcott lava, offset from Talcott lava seen in Hubbard Park along fault at east face of mountain to west (South Mountain).
- 33.1 Turn sharp right (east) on Kensington Ave.
- 33.5 Quarries on left are in Holyoke lava on Cathole Mountain block; largest fault runs just east of them. Mountains visible in distance ahead to east are also Holyoke lava, on opposite side of fault.
- 33.7 Stop sign; continue straight on Kensington Ave.
- 34.3 Stop sign; jog right along Colony St. to Britannia St.; continue east on Britannia St. crossing railroad tracks and proceeding through traffic light.
- 34.9 Traffic light; turn right (south) on Rte. 5.
- 35.4 Second traffic light; turn left (east) on Route 66, divided highway leading to Rte. I-91; take left lane.
- 36.6 Take left ramp to I-91 north.
- 37.5 Middletown town line; enter Middletown quadrangle. Outcrops of Talcott lava along road; Higby Mountain to east is formed of Holyoke lava.
- 39.0 Road approaches Higby Mountain where it drops off northward, exposing Holyoke lava. Mountain and lava are cut off by major fault, offsetting Holyoke lava to Lamentation Mountain (visible to west).
- 42.0 Road reaches south end of outcrop belt of Hampden lava north of fault.
- 42.4 Mattabassett River; Cromwell town line. From this point, highway follows dip slope of cuesta of east-dipping Hampden lava.

- 44.0 Future Exit 22, intersection with future divided highway from Middletown. Enter Hartford South quadrangle.
- 44.5 Rocky Hill town line.
- 45.7 Take Exit 23. At this point, Hampden lava changes strike from north-northeast to due east and crosses I-91; base of lava is exposed in road cut somewhat north of this exit ramp, but it will be seen better at Stop F.
- 46.1 Stop sign; turn right (east) on West St. (Rocky Hill).
- 46.8 Stop E (29.83 N - 62.52 E; Hartford South quadrangle) Dinosaur State Park, Rocky Hill, Connecticut. See Stop #1 of Trip C-3 for description. Lunch.
- Return west on West St. to I-91.
- 47.7 On far side of I-91, turn left (south) on entrance ramp.
- 49.2 Cromwell town line.
- 49.5 Stop F (28.9 N - 61.5 E; Hartford South quadrangle) Lacustrine deposits of East Berlin Formation superbly displayed in three dimensions. See Stop #5 of Trip C-1 for description. At future Exit 22. Until exit is opened, one may park in first ramp to right leading into complex of roadways.
- Continue south along I-91; re-enter Middletown quadrangle. (After Exit 22 is completed, take exit for Middletown, rejoining itinerary at 56.2.)
- 51.0 Take Exit 21.
- 51.4 Stop sign; turn left (east) on Rte. 72, crossing Hampden lava.
- 52.4 Low outcrops of Hampden lava; we have crossed fault and are again on same block as Higby Mountain.
- 52.6 Bear left off Rte. 72 onto West St. (Cromwell).
- 54.9 Traffic light in village of Cromwell; turn right (south) on Rte. 9.
- 55.7 Enter divided highway.
- 56.6 Mattabassett River; Middletown town line.
- 57.8 Bear right off divided highway on ramp to Rte. 17. To left, Connecticut River turns east and enters Eastern Highlands, visible downstream.
- 58.3 Turn left on Rte. 17 at traffic circle and proceed south out of city of Middletown. After road reaches upland, Higby and Beseck Mountains are visible to west, back slope of cuesta of Holyoke lava. Occasional outcrops of Portland arkose along road in next several miles.
- 62.3 Enter Durham quadrangle. The well known Durham fish locality is to the west in the first gully leading northward.
- 62.6 Middlefield and Durham town lines.
- 64.8 At south end of village of Durham, first take right fork (Rte. 17, not 79), then left fork (Rte. 77, not 17).
- 65.3 Stop G (22.82 N - 61.92 E; Durham quadrangle) Coarse fanglomerate adjacent to eastern Triassic border fault. See Stop #8 of Trip C-1 for description.

- 65.3 Continue south on Rte. 77. Hills to southeast are across eastern border fault in Eastern Highlands. Road ahead enters valley along fault.
- 65.9 Stop H (22.49 N - 61.82 E; Durham quadrangle) Agglomeratic basaltic rock occurs as cross-cutting vent; so-called "Foye's volcano." See Stop #3 of Trip C-5 for description.
- Continue south on Rte. 77.
- 67.3 Guilford town line. In farmyard on right, north of town line, schist with prominent streaks of mylonite striking north. Across valley to west and southwest, outcrops of Triassic basalt, but unit is uncertain, as structure here is not clear. Holyoke lava is possible.
- Beyond, road bends east away from fault; several outcrops of Brimfield schist on both sides of road in next mile and a half. Totoket Mountain, formed by Holyoke lava dipping south, visible across valley to west.
- 69.1 Road returns to fault exactly at divide (between Coginchaug River, flowing north into Connecticut River at Middletown, and Lake Quonnipaug, flowing south into West River of Guilford). Old quarry on west side of road (20.98 N - 61.46 E) exposes basalt, low cuts on east side expose Brimfield schist. A mass of phyllitic schist is found within basalt in north part of old quarry. Rodgers, following Longwell, interprets this as a block of phyllite from old fault scarp that fell into Holyoke lava; de Boer has suggested that it is a fault block, perhaps in an intrusive mass. CAUTION: That pretty vine climbing all over the outcrop in the quarry is poison ivy.
- 69.3 Sight-line cut (20.87 N - 61.46 E), in which border fault was well exposed when cut was new; see description by Ralph Digman (1950, Am. Jour. Sci., v. 248, p. 37-45; 152). Exposure is much poorer now, as all rocks are crushed and badly weathered. Main part of cut is Triassic basalt, which Rodgers, following Digman, believes to be part of Holyoke lava; de Boer believes paleomagnetic data show it to be an intrusive of Talcott age along fault, but crushing and weathering make determination difficult. Badly crushed schist and pegmatite are still visible in places on floor of cut (and across road to east), and very badly weathered schist forms base of cut at south end.
- 69.6 Outcrop of Brimfield schist on east of road; Lake Quonnipaug ahead.
- 69.9 Stop I (20.59 N - 61.41 E; Durham quadrangle) Outlier of metamorphic rock west of eastern border fault, just beyond bridge over inlet to Lake Quonnipaug. See Stop #4 of Trip C-5 for description.
- Continue south on Rte. 77 along west side of Lake Quonnipaug, which lies along border fault.
- 70.2 Hampden lava makes cliffs on west, dipping south; beneath are sediments at top of East Berlin formation (Stop #9 of Trip C-1; 20.43 N - 61.40 E). Across lake are schist, pegmatite, and mylonitic rocks.
- 70.8 Bend in valley, lake, and road, at minor reentrant in border fault. Here occur highest beds preserved in this fault block (Portland Formation); dip changes from south to east.
- 71.3 South end of Lake Quonnipaug; outcrops of coarse fanglomerate of Portland Formation, dipping east-northeast.

- 71.7 Enter Guilford quadrangle. Hampden lava again on west side of road, dipping east-northeast under beds of Portland Formation.
Beyond, dip in East Berlin Formation becomes east, then southeast, then south, close to minor northwestward projection of border fault that causes bend in valley and road.
- 72.5 Hampden lava, dipping south, on west side of road.
- 72.7 Intersection with Old County Road, exactly on border fault, which makes a reentrant angle here. Outcrop on northwest side of intersection belongs to Portland Formation; note pebbly character and steep dip. Old County Road, to right (west), more or less follows south side of cuesta of Hampden lava, dipping southeast into fault, rejoins itinerary at 75.0.
- Continue south on Rte. 77 into Brimfield schist (outcrops at 73.0).
- 73.3 Road crosses Triassic dike intruded into Brimfield schist.
- 73.45 Intersection with Rte. 80; turn right (west) on Rte. 80. Outcrops on Rte. 80, 1/4 mile east of intersection, show Brimfield schist cut by northwest-dipping normal faults, probably roughly parallel to main border fault.
- 73.7 Road crosses dike again at low diagonal. For a mile beyond, dike forms hills visible south of road. (It can also be seen on Rte. 22, 3/4 mile southeast of North Branford village.)
- 74.85 North Branford town line.
- 75.0 Rte. 80 reaches border fault zone and bears left to follow it to village of North Branford. Intersection with Old County Road.
- 75.3 Enter Branford quadrangle.
- 76.0 Large blocks of coarse conglomerate on north side of road.
- 76.7-76.8 Village of North Branford, intersections with rtes. 22 and 139. Continue on Rte. 80, which swings around south end of cuesta of east-dipping Holyoke lava (south end of Totoket Mountain) where it is cut off by eastern border fault and proceeds northwest at west foot of cuesta (after underpass under trap-rock railroad). Across valley to west is another cuesta of Holyoke lava, dipping southwest; the two face each other across an anticline perpendicular to border fault. To southwest, along fault, are two glacial ponds; the farther one, Linsley Pond, is one of the most intensively studied lakes in the world.
- 77.9 Crusher for trap-rock quarry in Holyoke lava in cuesta east of road. This quarry supplies much of trap-rock ballast for New Haven Railroad.
- 78.1 Intersection with Rte. 22; continue on Rte. 80 to west. Hill ahead on right is Talcott lava in core of anticline.
- 79.3 Traffic light in village of Totoket; continue west on Rte. 80.
- 79.5 Talcott lava in hill on right (north) of road; base visible on east face of hill.
- 79.7 East Haven town line.
- 80.0 Outcrop of Talcott lava on north side of road contains a baked clastic dike; lava flanking dike shows chilled margins. If you decide to visit this outcrop, park to west of cut and be very careful of traffic in road bend. Hills to north of road beyond are also Talcott lava; Holyoke

lava makes cuesta to south; road follows strike valley in Shuttle Meadow Formation; all strike west and dip south.

- 80.6 Village of Foxon; bear right on Rte. 80 (not 100), continuing west and gradually climbing out of strike valley, which turns off to the southwest.
- 81.3 One of flow units in Talcott lava in cuts on both sides of road. Base is visible in new cut on north side.
- 82.3 New Haven town line. Hill ahead is formed by large dike of Fair Haven swarm, now being quarried south of road.
- 82.4 Just past dike, bear left off Rte. 80 onto Foxon St., and then turn left (south) on Eastern St.
- 82.8 Turn right (west) on Hemingway St. Enter New Haven quadrangle.
- 82.9 Turn left (south) on Russell St.
- 83.3 Clifton St.; proceed straight ahead.
- 83.9 Railroad cut on left shows arkose cut by dikes of Fair Haven dike swarm.
- 84.2 Stop J (17.00 N - 56.34 E; New Haven quadrangle) Flood-plain facies of New Haven Arkose exposed in abandoned quarry. See Stop #3 of Trip C-1 for description.

End of trip. To return to Connecticut Turnpike (I-95; connections to I-91), continue on Russell St. to railroad bridge at 85.0, cross bridge and turn left at once on Warwick St. (At bend beyond, note dikes cutting arkose on right; Warwick St. here becomes Burwell St.) At end of Burwell St., bear left on Townsend Ave. and proceed to traffic light. For I-95, I-91, and most parts of New Haven, cross turnpike to traffic light beyond and follow signs to turnpike (west or east).

To return to downtown New Haven by U. S. Rte. 1, turn right at first traffic light.

Trip C-3

THE ROCKY HILL DINOSAURS

by

John H. Ostrom
Yale University

with an Introduction by

Sidney S. Quarrier
Connecticut Geological and Natural History Survey

INTRODUCTION

On August 24, 1966, excavations were under way for the foundation of a Connecticut State Highway Department testing laboratory in the Town of Rocky Hill. Edward McCarthy, a bulldozer operator, noticed that his machine had uncovered a slab of rock bearing oddly shaped tracks; and, thinking that the tracks might hold some significance, he stopped his machine and called the attention of the engineer to his find.

In a rapid succession of events, interested personnel were notified of the discovery; its scientific and educational values were determined; and with a speed rare in government circles, steps were immediately instituted through the direct action of Governor John Dempsey to preserve the tracks in place. The area is now Dinosaur State Park, Rocky Hill, Connecticut.

The tracks at Rocky Hill are in a sequence of gray arkoses and gray shales in the East Berlin Formation. This sequence has been tentatively correlated with the first gray sequence that is exposed below the Hampden Basalt in the roadcuts of Stop 5, Trip C-1. The tracks are best preserved in the arkosic units as the bedding planes are well developed. The trackway strikes N 85 E and dips 7°-10 S. The rocks exposed here are on the south flank of a broad anticlinal structure that gently plunges to the east toward the border fault. This is one of a series of similar structures that occur along the length of the eastern border fault of the Triassic basin. The origin of these structures is not positively known but has been attributed both to differential compaction rates and to differential displacement along the fault to the east.

The Hampden Basalt is exposed on the hill just to the south of the trackway. The arkosic units display excellent ripple marks, raindrop impressions, mud cracks and cross bedding. A small fault that strikes ENE is exposed at the base of the trackway. An apparent vertical displacement of 18 feet was calculated from two core holes that were drilled last summer. The horizontal displacement is not known. The sheared zone of



Figure 1. The footprint horizon at Rocky Hill at an early stage of excavation showing the density and extent of the footprints. (Photo by John Howard, Yale Peabody Museum of Natural History.)

this fault is well exhibited in an outcrop at the park.

John Byrnes of the University of Connecticut is completing a study of the sedimentary rocks.

The largest area of tracks is still covered under a plastic protective blanket. The future of this area is uncertain but some exposure of it is planned for next year. The bubble building exhibits a smaller area of tracks and this is expected to be open for the field trip.

THE ROCKY HILL DINOSAURS

Discovery of dinosaur footprints at Rocky Hill during August of 1966 is the most recent and spectacular event in a long history of fossil footprint discoveries in the Triassic rocks of the Connecticut valley. The earliest known discovery dates back to the year 1800 and was made by a Williams College student named Pliny Moody near South Hadley, Massachusetts. Moody thought his find was a footprint left by some giant ancient bird and believing the rocks in that area to have accumulated as sediments during the biblical flood, he referred to it as "Noah's raven".

Some 35 years later, Edward Hitchcock, Professor of Geology and President of Amherst College (and also State Geologist of Massachusetts) was informed of "turkey tracks" preserved on sandstone slabs in the town of Greenfield. Hitchcock apparently was greatly impressed by these "turkey tracks" for he immediately began what turned out to be a lifelong search for additional examples of ancient bird tracks in the stone quarries up and down the Connecticut River valley. His search produced a surprising variety of fossil footprints which he interpreted as proof of the existence of very ancient birds - a conclusion contrary to the generally held opinion that birds had not existed during such ancient times. This in fact, was the main conclusion of his first report (1836) on bird footmarks from the "New Red sandstone". In his quest for "ornithichnites", Hitchcock amassed a large collection of footprints (now in the Amherst College Museum) and published numerous reports on their occurrence. Best known of these reports is his large volume of lithographs "Ichthyology of New England" published in 1858.

In subsequent years, the Connecticut valley became famous for its fossil footprints (Lull, 1953). More than a hundred sites are now known in Connecticut and Massachusetts and since Moody's initial find literally thousands of footprints have been collected. Most finds have consisted of solitary prints or only short sequences of three or four prints in a single trackway. With a few exceptions (Mt. Holyoke, Turner's Falls, Middlefield) no sites suitable for in situ preservation had been located until the discovery of the Rocky Hill footprints.

The Rocky Hill site is remarkable in that it is perhaps the largest (more than 35,000 square feet) known exposure with abundant fossil footprints preserved on a single bedding plane. There are other impressive

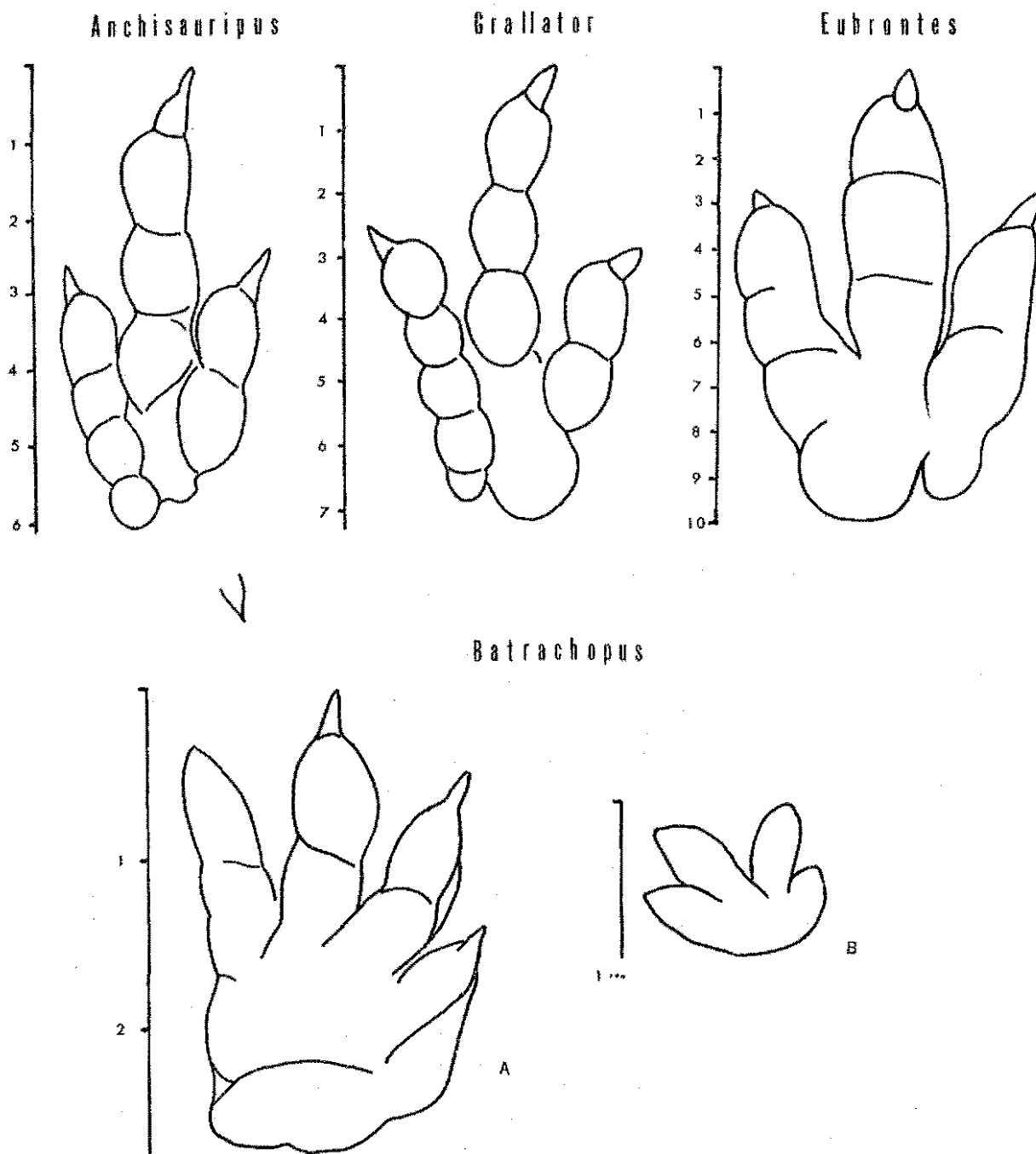

Figure 2. Comparison of the four kinds of fossil footprints so far identified at Rocky Hill. All are drawn to the same unit length to show similarities. Notice the close resemblance between Anchisauripus and Grallator. The Eubrontes print is of the same general type, but is broader and more massive, as well as larger. The vertical scales in inches indicate actual sizes. Batrachopus: A = left hind foot; B = left fore foot.

footprint sites (Arizona, Texas, Basutoland), but all are in remote or wilderness regions and are quite impractical to preserve. To date, more than 1,000 footprints have been studied and identified in less than one fourth of the area presently exposed at Rocky Hill. Aside from the impressive spectacle of so many footprints and such a large expanse, this site contains an unusual record of a "single moment" in Triassic time (fig. 1). It provides documentation of an ancient community of dinosaurs and related reptiles as living creatures approximately 200 million years ago. This record is preserved on a large expanse of a single bedding surface - a bedding surface that could well represent an interval of less than 24 hours duration. Rocky Hill can provide us with new information on animal associations, habits and movement that cannot be obtained from other presently known Triassic fossil sites.

In the absence of detailed knowledge about Triassic dinosaurs and other animals of that time, Moody's and Hitchcock's avian identifications were not unreasonable; many of the Connecticut prints are distinctly bird-like. We now know however, that they are the trails of several different kinds of extinct reptiles - dinosaurs in particular. Because of the extreme rarity of fossil skeletal remains from Connecticut Triassic rocks it is necessary to compare the several kinds of footprints with skeletal evidence from the Triassic of other parts of the world. Such comparisons cannot provide absolute identifications, but they do establish the general kinds of animals that were involved.

To date, three (possibly four) distinct kinds of footprints have been identified at Rocky Hill. In order of decreasing abundance, they are:

Eubrontes giganteus *

Anchisauripus sillimani *

Batrachopus dispar *

The first two kinds are rather similar, differing chiefly in details, proportions and size. Both were made by bipedal animals with feet that were functionally three-toed. Batrachopus dispar is quite different and was made by a quadrupedal animal in which both the hind and fore feet had four functional toes. A few prints have tentatively been identified as Grallator cuneatus *. Other kinds may be recognized as excavation work is continued and detailed studies made.

While our knowledge of Triassic land animals is still incomplete, the only animals presently known with tridactyl feet and bipedal posture are certain kinds of dinosaurs. Currently, dinosaurs are classified in two major groups (Orders) - the Order Saurischia, which includes the great brontosaur-like animals and their relatives, and all carnivorous dinosaurs and, the Order Ornithischia, the horned, plated, armored and duckbilled dinosaurs. Of these, only the carnivorous saurischians (theropods) and the duck-billed ornithischians (ornithopods) had tridactyl feet

* These names refer to the footprints - not to the animals that made them. We can never be certain of that identity.

and were bipedal. Ornithopods may have existed in the Connecticut region during Triassic times. Certain other footprints found elsewhere in Connecticut though not as yet recognized at Rocky Hill, are usually attributed to primitive ornithopods but these animals appear to have been rare prior to Jurassic times. It is only in the last half dozen years that ornithischian remains have been positively identified from Triassic rocks anywhere in the world. The carnivorous dinosaurs are commonly separated into two kinds - small, lightly built and presumably fast-moving predators (coelurosaurs) and large, heavily built and probably slower-moving animals (carnosaurus), (fig. 3). Both kinds were exclusively bipedal and had tri-dactyl feet.

Fragmentary remains of at least one kind of small coelurosaurs have been found in the Connecticut valley. (Colbert and Baird, 1958). The anatomy of this animal, Coelophysis, fortunately, is well known from a number of complete skeletons from the Triassic of New Mexico. The structure of its foot and the size of the animal are perfect matches with Anchisauripus footprints. Figure 5 is an artist's reconstruction of how Coelophysis may have appeared. A Coelophysis-like animal may also have been responsible for those prints identified as Grallator, for the shape and size of Grallator prints are very close to Anchisauripus prints (fig. 2). The principal differences between the two are: the faint impression of the first or "great toe" at the rear of the footprint in Anchisauripus, but not in Grallator; and, the relatively greater length of the stride in the latter. Both differences could easily have resulted from differences in movement (walking vs running). In view of the overall similarities between the two "kinds" of footprints I am inclined to think both were made by a single kind of animal - a Coelophysis-like coelurosaurs.

At present, no skeletal remains of any animal are known that match the much larger and broader footprints (Eubrontes) that dominate the scene at Rocky Hill. However, in view of the general similarity to the prints already described, there is the possibility that they were made by a much larger coelurosaurs. Nevertheless, I am inclined to think they were produced by one of the primitive members of the "carnosaurus" - the larger and more ponderous dinosaurian predators. This interpretation seems quite reasonable, except that no fossil skeletal remains of carnosaurus are known from this region. In fact, Triassic carnosaurus remains are exceedingly rare, although there are several incomplete specimens from the Triassic of western North America (Megalosaurus wetherilli and Poposaurus gracilis) that may be carnosaurian. In view of the apparent absence of Triassic carnosaurus in the Connecticut area, another possible explanation is favored by some paleontologists. They note that the most common kind of dinosaur so far encountered in the Connecticut Triassic is neither coelurosaurs or carnosaurus, but belongs to another very different group of saurischian dinosaurs called prosauropods. The prosauropods included herbivores and carnivores as well as the ancestral stock of the great Brontosaurus-like dinosaurs. Most prosauropods were bipedal - at least part of the time - but the foot structure of all prosauropods was four-toed. It is possible that the short, inner toe did not make contact

¹ (Welles, S. P., 1954)

² (Colbert, E. H., 1961)

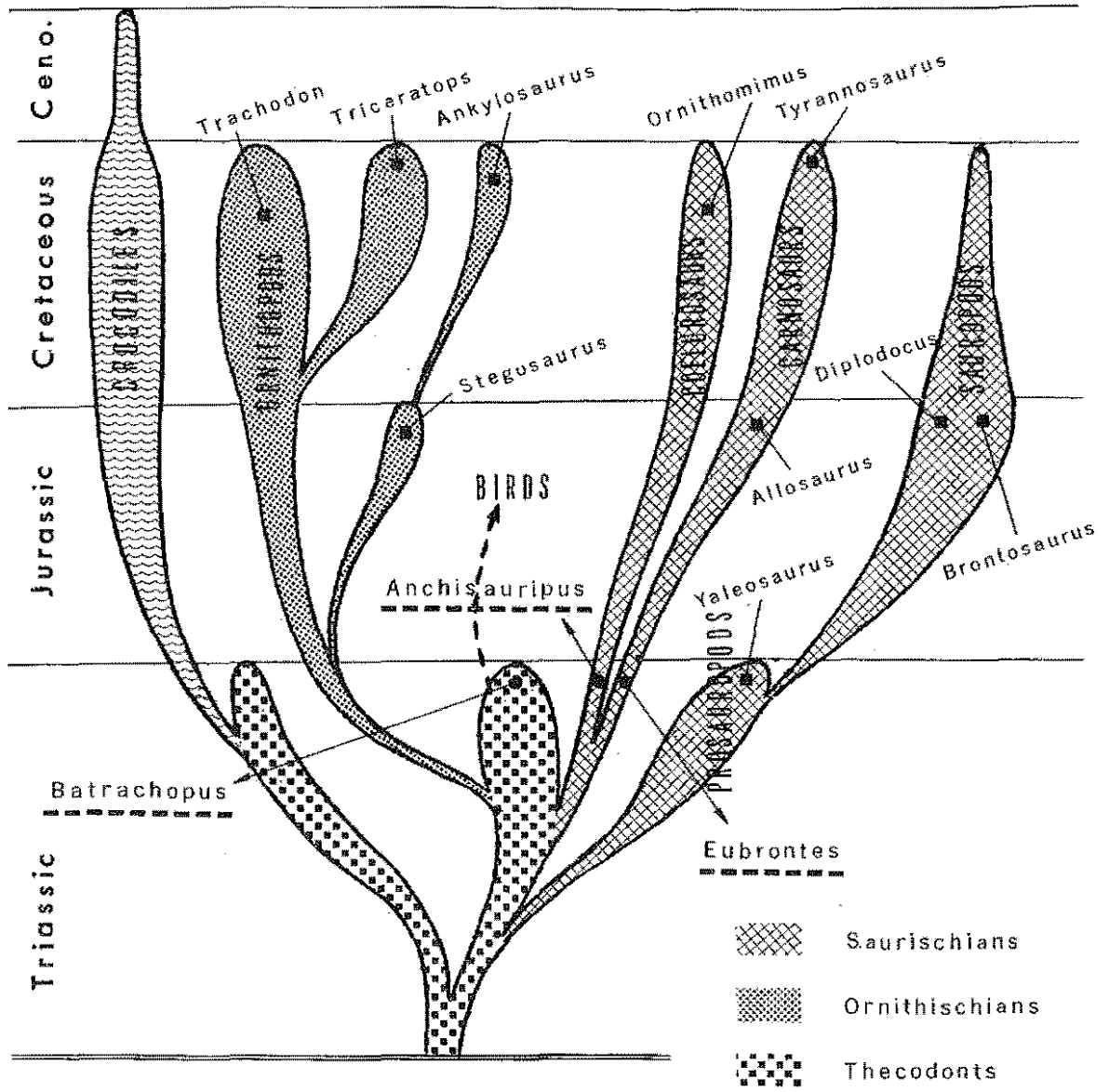

Figure 3. Family tree of dinosaurs and related reptiles of the Mesozoic Era. Several well-known kinds of dinosaurs are identified in each major group and the Rocky Hill footprints are marked.



Figure 4. Anchisauripus sillimani trackway (from left to right) at Rocky Hill, Connecticut. This limited area shows the progression of one animal from relatively firm mud at an ancient shoreline (left) into soft, water-saturated and ripple-marked mud beyond the shoreline. The traverse of a second, smaller animal - apparently another coelurosaur - is preserved trending from the right foreground to the upper left and several faint invertebrate trails are visible. Here is the record of a Triassic "mud hole". (Photo by John Howard, Yale Peabody Museum of Natural History.)

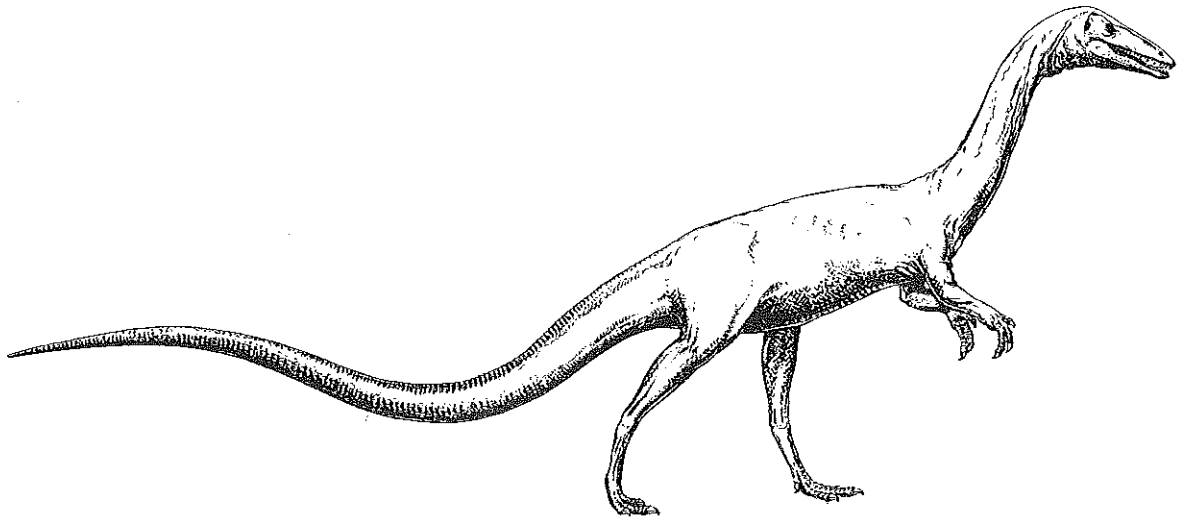

Figure 5. Artist's reconstruction of Coelophysis, a moderate-sized coelurosaurian dinosaur of Late Triassic times - one of the probable perpetrators of the Rocky Hill footprints. Coelophysis was a fleet-footed animal about eight to ten feet long. Restoration by Lois Darling under the direction of Edwin H. Colbert. (Reproduced by permission of the American Museum of Natural History.)

with the ground and thus prosauropods could have left three- rather than four-toed footprints. While correlating the most common footprint kinds with the most frequently found (four specimens) kinds of skeletal evidence is reasonable, in view of the obvious structural discrepancies in this case it does seem highly questionable. Moreover, there are abundant, four-toed footprints of some ancient biped (Otozoum) from many other New England sites that correspond very closely in form and size to prosauropod foot structure. Accordingly, I prefer to believe the Eubrontes type prints were made by some moderate-sized carnivorous dinosaur - possibly carnosauxian - not as yet known from skeletal evidence.

In addition to primitive dinosaurs, the Late Triassic scene was also occupied by a variety of small to medium-sized reptiles called thecodonts. Included in this group were the probable ancestors of crocodilians and both of the dinosaurian orders, as well as numerous other crocodile-like and lizard-like animals. The creatures which made the small, four-toed footprints we have labeled Batrachopus are thought to have been small, crocodile-like thecodonts, perhaps an animal closely related to that represented by the small skeleton (Stegomosuchus) which was found near Longmeadow, Massachusetts in 1897. Again, the evidence is not all in, but of the known Triassic land animals, Stegomosuchus-like thecodonts seem to fill the Batrachopus bill better than any others.

The "single moment" of Triassic time registered at Rocky Hill seems to show that carnivorous dinosaurs dominated the Triassic scene. Eubrontes and Anchisauripus footprints outnumber Batrachopus (which may also have been a carnivore) prints by more than three to one. In fact, there appears to be a total absence of definite herbivores. This is a most unusual community, but until a thorough analysis of the evidence preserved on this bedding plane can be made it would be premature to interpret this seemingly strange association. Nevertheless, the big question to be answered is: where were the herbivores?

I find it particularly interesting that the trackways or trails preserved at Rocky Hill seem to be completely random in orientation. This is in sharp contrast to the trackways preserved at the small park near Mt. Tom in Mt. Holyoke where (again) at least three kinds of footprints are recognizable. The dominant kind, identified as Eubrontes, constitutes 85 percent of the identifiable trackways (as distinct from individual footprints). Of the Eubrontes trackways, 87 percent (21 out of 24) progressed in a westerly direction (trending between N 70° W and N 97° W). The three exceptional Eubrontes traverses bear in almost the opposite direction (N 65° E to N 85° E). Probability suggests that these coincident trackways were not made independently, but were made at one time by a group of animals moving together - as a "herd". Any doubts about this evidence and the "herding" behavior of these animals seems to be eliminated by the evidence of minority groups that strolled across that Mt. Holyoke scene. Two trackways have been identified as Anchisauripus and two others as probably Grallator. None of these followed the Eubrontes crowd - in fact they deviated by more than 100° from the closest Eubrontes traverse. Evidence such as



Figure 6. Eubrontes giganteus, left footprint. Rocky Hill, Connecticut.
(Photo by James F. Chipps, Jr., Conn. State Highway Dept.)

this, revealing what appears to be the herding nature of an extinct animal species, is rare indeed, but it is difficult to avoid the conclusion that at least some Triassic dinosaurs were gregarious. What additional information about the nature and habits of these animals will be revealed by the thousands of footprints at Rocky Hill?

REFERENCES

- Colbert, E. H., 1961. The Triassic reptile Poposaurus. Chicago Natural History Museum, Fieldiana - Geology, v. 14, pp. 59-78.
- _____, 1963. Fossils of the Connecticut Valley. Conn. Geol. and Nat. Hist. Survey, Bull. 96, pp. 1-31.
- _____ and Baird, D., 1958. Coelurosaur bone casts from the Connecticut Valley Triassic. Amer. Mus. Nat. Hist. Novitates No. 1901, pp. 1-11.
- Hitchcock, Edward, 1836. Ornithichnology - description of the footmarks of birds (Ornithichnites) on New Red sandstone in Massachusetts. Amer. Jour. Sci. Arts, v. 29, pp. 307-340.
- _____, 1858. Ichnology of New England - a report on the sandstone of the Connecticut Valley, especially its footmarks. William White (Boston, Mass.), Printer to the State. 220 pp.
- Lull, R. S., 1953. Triassic Life of the Connecticut Valley. Conn. Geol. and Nat. Hist. Survey, Bull. 81., pp. 1-336.
- Welles, S. P., 1954. New Jurassic dinosaur from the Kayenta formation of Arizona. Geol. Soc. Ameri., Bull. v. 65, pp. 591-598.

Trip C-4

STRATIGRAPHY AND STRUCTURE OF THE TRIASSIC STRATA OF THE GAILLARD

GRABEN, SOUTH-CENTRAL CONNECTICUT

by

John E. Sanders
Barnard College

SUMMARY

The Gaillard graben contains an approximately 6,000' thick stratigraphic succession ranging from the upper New Haven Arkose into the basal Portland Formation. The Talcott Formation is especially well displayed; it consists of four volcanic units and three sedimentary units.

The strata have been deformed into two major synclines (Saltonstall and Totoket) separated by a faulted anticline (North Branford). Numerous faults cut the folded strata.

The purpose of the trip will be to demonstrate the stratigraphic succession, particularly of the Talcott Formation, and to study lateral changes in the sedimentary units, both parallel and perpendicular to the Triassic Border Fault.

Special emphasis will be placed on the spectacular pillows and volcanic breccias of the upper Talcott units and on the relationships between the folds and faults.

Trip C-5

LATE TRIASSIC VOLCANISM IN THE CONNECTICUT VALLEY
AND RELATED STRUCTURE

by

Jelle de Boer
Wesleyan University

The volcanic rocks in the Connecticut Valley consist of basalts with typically uniform composition. Because of the general homoclinal eastward dip of the Triassic Newark Formation, the basaltic flows are exposed in a north-trending zone in the center of the rift valley. The trend of this zone is locally interrupted by faulting and changed by folding. Three lava-flow units can be distinguished, from oldest to youngest respectively: the Talcott, the Holyoke, and the Hampden volcanic units. The complexity and thickness of the units increase from the north southward. This is best illustrated by the Talcott volcanic unit, which consists of four flows (total thickness, including intercalated sediments, about 500 feet) in the southern part of the rift valley and only one flow (thickness 50 feet) in the northern part.

As shown by Chapman's (1965) study of the Hampden volcanic flow unit, apparently massive flows have a complex texture. Chapman recognized eight distinctive sheets in the Hampden basalt, which could be correlated over some 20 miles from Berlin to Tariffville. The origin of these sheets is still obscure. They might have been formed by magmatic segregation during laminar flow of the lava.

Chemical analyses indicate that slight differences occur in the distribution of the major oxides. The silica-content of the Hampden flow(s) is less than that of the older volcanic units. The decrease in silica appears to be associated with an increase in total iron. Hanshaw and Barnett (1960) have shown significant differences in the distribution of trace elements. The boron content of the Hampden flow(s) averages much higher than that of the older basalts.

The intrusive masses occur dominantly along the western boundary of the valley and in its southern part. Because of the rather peculiar distribution of the intrusives, the New Haven Arkose (oldest sedimentary member of the Newark Formation) is usually the host rock. The intrusive basalts crop out either as massive dikes and sills, or as normally sized dikes. The latter are relatively rare in the valley. According to Mudge (1968), most larger concordant igneous masses that occur in relatively flat-lying sedimentary formations were intruded at depths ranging from 3000 to 7500 feet. These values are in good accordance with those estimated for the total stratigraphic thickness of the sediments overlying the sills in the Connecticut Valley.

So far it has not been possible to correlate the different lava-flow units and their intrusive counterparts by using petrologic methods. A paleomagnetic analysis of the basalts has shown that it is possible to differentiate and correlate different volcanic units by measuring their remanent magnetization. Four late Triassic-early Jurassic volcanic

events can be distinguished paleomagnetically, from oldest to youngest respectively: the Talcott, the Holyoke, the Hampden, and the Higganum events. By means of their characteristic remanent magnetization it is possible to relate the following intrusive and effusive basalts (de Boer, 1968).

	<u>Talcott event</u>	<u>Holyoke event</u>	<u>Hampden event</u>	<u>Higganum event</u>
effusive	Talcott flow(s)	Holyoke flow(s)	Hampden flow(s)	---
intrusive	---	Mt. Carmel sill West Rock sill Barndoor sill	Cheshire dikes	Higganum dike syst Bridgeport dike system Foxon-Fair Haven dike system

Paleomagnetic correlation of these events with similar volcanic periods in the Appalachians indicates that the late Triassic volcanic activity was close to a one-phase event.

Most of the larger intrusives and the most massive flows were emplaced during the Holyoke volcanic event. The earlier Talcott event was restricted to New England and the later Hampden event was restricted to the Connecticut and Nova Scotia rift valleys. The Higganum volcanic event is represented by intrusive activity only. Dikes emplaced in this period crop out throughout the Appalachians from Georgia to Nova Scotia.

The Talcott, Holyoke, and Hampden volcanic events are separated from the Higganum event by a period of intensive tectonic activity. In this period longitudinal arching along the axis of the Appalachians caused the fracturing and tilting of the late Triassic formations. This period of regional uplift was followed by a period of deep-seated horizontal stress release. The dikes of the Higganum event were emplaced in tensional fractures that were the surficial expressions of these deep-seated movements. The fan-shaped arrangement of the dikes in the Appalachians suggests a south-westward decrease of the rotational component of the shear couple and a sinistral polarity of the shear movements. Both tectogenetic events are possibly related to the initial opening of the Atlantic Ocean.

The source of the basaltic rocks has been discussed many times. Recent gravity data obtained by the U.S.G.S. have indicated that the regional gravity low of the Triassic valley is interrupted by positive anomalies. These anomalies are most probably caused by large dike-shaped masses with high density. Because these anomalies occur in areas with abundant intrusives, there is little doubt that they represent the original feeders. The lack of aeromagnetic anomalies over the feeders suggests that they are only present in the basement. The well defined parting surfaces in the Triassic sediments prevented a normal vertical ascent of the magma. The fluid continued its rise by following the bedding planes and by locally shifting to higher levels, using faults and joints. Locally the magma reached the surface and flowed out to form the Talcott, Holyoke and Hampden flow units (Fig. 1).

Figure 1 is a diagrammatic section of the Triassic rift valley of Connecticut during the Holyoke volcanic event, showing basement feeder, sills like those of West Rock and Mount Carmel, and lava flow. Basement configuration based on interpretation of gravity data by Chang (senior thesis, Wesleyan University).

The discontinuity and complexity of the lava-flow units suggest that several linear feeders may have existed. Not all feeders were simultaneously active. The Talcott flow unit in northern Connecticut, for instance, does not continue northward into Massachusetts despite its proximity to a possible feeder location east of the Barndoor Hills.

Intrusive volcanic activity is especially abundant in the southwestern part of central Connecticut. Most of the larger intrusives occur close to the western boundary of the rift valley and in the New Haven area. No large intrusives crop out in the eastern part of the rift valley. In view of the tectonic significance of the eastern boundary fault, this distribution appears to be anomalous. The eastern boundary fault extends to considerable depth and it must have formed an ideal pathway for ascending magma. Characteristic for the southeastern part of the rift valley is the peculiar distribution of the lava flows, which are folded into broad basins separated by narrow anticlines. These transverse folds have been attributed to differential movement of the Triassic deposits along the fault, caused by differences in the attitude of the fault plane. According to Wheeler (1939) anticlines formed opposite projections, and basins opposite reentrants in the border fault. The transverse folding can also be attributed to strike-slip movements along the boundary fault.

A microtectonic analysis of the fault zones has revealed that the latest movements along the north-trending segments of the fault were transcurrent. The polarity of the movements was sinistral. If the folding was due to sinistral shear along the boundary fault, NE-trending b-axes would be expected; instead, the fold axes of the transverse folds trend NW. A third possibility is that the basins are volcano-tectonic depressions, caused by collapse, following the removal of large quantities of magma from underground reservoirs. This possibility can only be checked by detailed geophysical analysis of the area. Gravity data obtained by the U.S.G.S. have shown the possible presence of a large feeder dike in the fault zone. Detailed geological field work in the Durham quadrangle has shown that many smaller intrusive masses occur in this zone. The most controversial of these is "Foye's volcano" (Stop #3).

Stop #1 (23.22 N - 56.48 E) Cross Rock area, Mount Carmel quadrangle. Bedrock map: USGS GQ 199.

To reach Stop #1, follow Conn. Rte. 10 (Whitney Avenue) to the traffic light at Ives Corner, 0.8 miles N of Cheshire-Hamden town line. Turn east on Cook Hill Road, proceed 0.9 miles, turn left (north) on Halfmoon Road, proceed 0.4 miles, turn right (east) on Boulder Road, proceed 0.3 miles to second yellow house on north side of road.

Stop #1A: outcrop on north side of road close to house.

The volcanic rocks exposed in the Mount Carmel quadrangle are characteristic for the Triassic volcanic activity in the southern part of the Connecticut rift valley. Three types of intrusives can be distinguished: the West Rock sill, the Mount Carmel sill-dike, and the Cross Rock dikes. All igneous masses were emplaced in the New Haven Arkose. Paleomagnetic

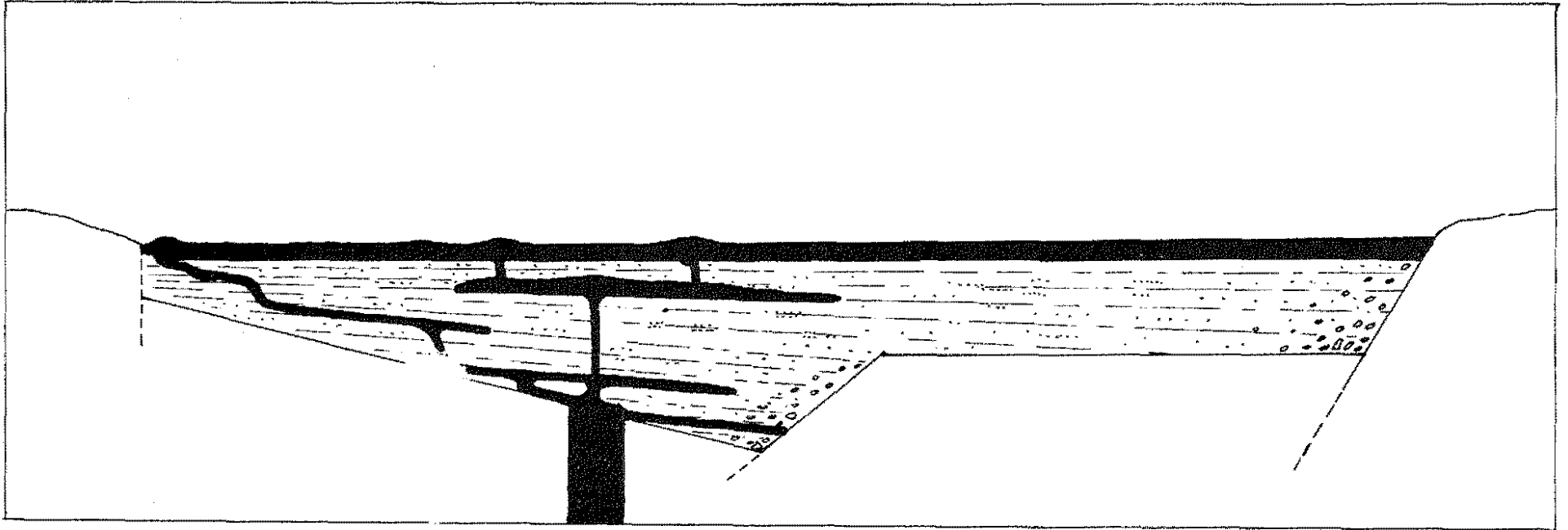

Figure 1. Diagrammatic section of the Triassic rift valley of Connecticut during the Holyoke volcanic event, showing basement feeder, sills like those of West Rock and Mount Carmel, and lava flow. Basement configuration based on interpretation of gravity data by Chang (senior thesis, Wesleyan University).

evidence suggests that the larger intrusives can be correlated with the Holyoke volcanic event. The Cross Rock intrusives consist of a NNE-trending sill (dip 20° to 30° E) and a WNW-trending dike (dip 45° to 60° S). The attitudes of the sill and dike were established by Barringer magnetometer surveys. At Stop #1, it can be observed how the magma, which elsewhere formed a sill, continued upward by using an en echelon set of subvertical faults.

Fritts (1963), who mapped the Mount Carmel quadrangle, assumed that an age difference exists between the Cross Rock sill and the dike. He distinguished the Buttress diabase (NNE-trending sill) from the West Rock diabase (WNW-trending dike). He considered that the latter was intruded contemporaneously with the large West Rock sill to the west and that the former was intruded along a fault that cuts and offsets both the Mount Carmel sill and the WNW dike. Geological evidence supports an age difference between these intrusives, but their paleomagnetic directions indicate that both the younger sill and the older dike intruded contemporaneously with the effusion of the Hampden flow unit.

In the outcrop along the road, an alternating sequence of basaltic breccias, basalts and hornfelses can be seen. Clearly three types of basalt can be distinguished: the basaltic fragments of the breccia, the basaltic matrix of the breccia and the NNE-trending basaltic dikes. The presence of hornfels fragments in the breccia suggests that the metamorphism of the arkose preceded the first two intrusive events.

The following sequence of volcanic events can be deduced from the observations in the Cross Rock area.

Holyoke volcanic event (late Triassic)

- (a) Large-scale intrusive volcanic activity, which resulted in the emplacement of large sills (Mount Carmel, West Rock, etc.) in the New Haven Formation.
- (b) Regional faulting, generally in north-northeast and east-west directions. These directions are respectively parallel and at right angles to the deep-seated intrusive indicated by gravity. The fractures are therefore thought to be tensional and caused by local arching following the intrusive activity.
- (c) General silicification of the wall rock of the fractures by hydrothermal solutions. The quartz influx resulted in relatively extensive hornfelses.
- (d) Explosive volcanic activity. Local formation of coarse breccias composed of fragments of sediments (arkoses, siltstones) and Holyoke-type basalts. The explosive volcanic activity was followed by widespread mineralization of the brecciated zones. The main minerals emplaced were barite and quartz.

Hampden volcanic event (late Triassic)

- (e) Continued faulting along the east-west fractures and subsequent intrusion of basalt. This basalt forms locally the matrix for a volcanic breccia (Stop #1A).
- (f) Continued faulting along the north-northeast fractures and subsequent intrusion of basalt in these fractures. The magma emplaced during this period dominantly followed the bedding planes, but locally it shifted to higher levels by using faults and joints.

Higganum volcanic event (early Jurassic)

- (g) Regional faulting along northeast-southwest fractures. One such fracture cuts the Cross Rock intrusives more or less at their intersection. Dikes were emplaced along these faults in the Eastern and Western Highlands, and in the Gaillard area.

Stop #1B: pits on south side of road about 80 yards west of Stop #1A.

The Cross Rock area is part of the Cheshire barite district, well known for its mineralization. Several attempts have been made to mine the copper and barite minerals. The concentrations, however, were insufficient and the attempts were stopped. Old pits and prospect trenches can be found throughout the area. Behind the rock wall a prospect trench can be seen, which was started for copper in 1710 by John Parker of Wallingford (Fritts, 1962). The trench was recurrently deepened until 1901, the main purpose being stock promotion for the Cheshire barite mines. The arkose mined in the trench contains barite, bornite, chalcocite, malachite, cuprite, and chrysocolla. The copper minerals must have especially attracted investors. A nice piece of arkose with barite and bornite is exposed between the roots on the south side of the large old birch that grows on the north wall of the trench. Smelter marks on this piece suggest that it was brought here from the main plant in Cheshire and that it was probably used to salt the area. The mineralized zone occurs between two east-west dikes. The southern dike is well exposed. One outcrop of basalt in the trench suggests the presence of the northern dike. Magnetometer surveys indicate that the latter intrusion is much smaller and that it pinches out over a distance of a few hundred yards. This dike continues below outcrop 1A.

Supplementary notes on the Jinny Hill barite area (to find the mines, use the bedrock map of the Mount Carmel quadrangle - Fritts, 1963).

The Jinny Hill mines were probably the earliest barite mines in the United States. About 160,000 tons of barite were mined here in the general period from 1838 to 1877. The barite was processed in New Haven and was mainly used by the paint industries of New York City (Fritts, 1962). The mineralization of the Jinny Hill area occurred in three E-W trending zones. This is not the only direction in which mineralization zones occur in the Cheshire area. NNE-trending zones occur east of the West Rock intrusion and parallel to the Cross Rock sill (Tallman mine). The main barite vein in the Jinny Hill zone was about 3 feet wide and extended over 3/4 of a mile (Fritts, 1962). Most barite occurs in lenses which are only a few inches wide. The minerals were emplaced in the cavities of a very coarse breccia, which has been called a fault breccia. Several observations, however, appear to indicate that we may be dealing with a volcanic explosion breccia. The pressure was released along faults which opened up parallel and at right angles to the large deep-seated intrusives.

The sequence of mineral deposition is as follows:

- Primary minerals:
- (a) quartz (silicification of wall rock)
 - (b) granular barite, anhedral barite and chalcocite (often intergrown)
 - (c) euhedral barite (large crystals)
 - (d) euhedral quartz (very clear crystals)

- Secondary minerals:
- (e) hematite, malachite, azurite, chrysocolla
 - (f) limonite, hematite

Three shafts were used to mine the Jinny Hill zone. These shafts were reported to have gone to depths of 500 and 600 feet (Fritts, 1962). The holes have been filled in and only the dumps remain. Most of these are located on privately owned land. Please obtain the permission of the owners before visiting the dumps.

Stop #2 (26.35 N - 57.65 E) East Peak of Hanging Hills of Meriden, Meriden quadrangle. Bedrock map: USGS GQ 738. Description of stop by John Rodgers.

To reach Stop #2, turn north off Connecticut Rte. 66 into Hubbard Park in the western part of Meriden (this is a particularly blind corner coming from the east). Proceed straight north 1.3 miles, through the park, up the hill (through the Talcott flow) to Lake Merimere, and along its east side to its north end, turn left and follow narrow, poorly paved road (up dip slope of Holyoke flow - note great irregularity of upper surface, probably the result of numerous small faults) 1.5 miles to fork near top of hill. Follow left fork to parking place below stone tower on East Peak (right fork leads to steel fire tower and television installation on West Peak). Walk to stone tower.

At the tower, we are standing at about 950 feet above sea level, approximately on the upper surface of the Holyoke lava flow, which holds up all the highest hills in the Connecticut Valley except those on the West Rock, Mount Carmel, and Barndoor sills. The characteristic double jointing in the Holyoke flow is particularly well displayed here. The older columnar joints show narrow altered (silicified?) selvages, which weather in slight relief above both the normal rock and the joint itself; the younger systematic joints cut undeflected across the columnar joints, implying that they had been entirely healed. According to de Boer, the systematic joints here belong to one of two conjugate sets that intersect at a low angle, this one trending about N.35° E, the other about N 5° E. The faults of the region show the same trends; possibly this is an argument for dominant strike slip along many of them. Large boulders of this rock showing the characteristic jointing pattern are scattered over the countryside from here to Long Island Sound. The well known "Judges Cave" on West Rock in New Haven is a group of such boulders so placed as to provide some shelter.

The Talcott flow forms the bench at our feet, between us and the lake in Hubbard Park. The Hampden flow forms low ridges in the country to the northeast, beyond the dip slope on the Holyoke flow, but they are not clearly seen from here. The city of Meriden, spread out before us to the southeast, and all the country to the south is underlain by the New Haven Arkose, drained by the Quinnipiac River to Long Island Sound at New Haven Harbor.

In the Hanging Hills, the Holyoke flow and the beds above and below strike nearly east-west and dip gently north, in strong contrast to their normal north-south strike and moderate east dip; the change is evidently associated with the particularly intense faulting in the Meriden region (see USGS GQ 738, 494; CG&NHS QR 8) and especially with the large sinistral offset in map pattern caused by the largest of these faults (sinistral offset does not prove sinistral strike slip, of course).

To the east across Lake Merimere is South Mountain, Holyoke lava displaced only a little to the left from what we are standing on; half hidden behind it is Cathole Mountain, displaced somewhat more. The largest fault (or group of faults) then offsets the Holyoke flow 8 miles to the northeast, to the north end of Lamentation Mountain, the northernmost of the north-south mountains in the middle distance to the east, in which the Holyoke flow resumes its normal strike and dip. The main Hartford line of the New Haven Railroad and the Berlin Turnpike (visible at the foot of the mountain) go through the gap between, the lowest divide into the Connecticut River drainage (175 feet). Chauncey Peak, the south end of Lamentation Mountain, is slightly offset from the rest. Another fault then displaces the flow another 5 miles to the northeast, to the north end of Higby Mountain; Rte. I-91 goes through this gap. Smaller gaps are visible in the ridge from Higby Mountain south, each caused by a smaller offset along a similar fault; Rte. 66 and the old Air Line of the New Haven follow two of these gaps toward Middletown. From here it is not easy to pick out the larger gaps between Pistapaug Mountain (at the south end of the Higby Mountain ridge) and Totoket Mountain (gap used by Rte. 17) or between Totoket Mountain and Saltonstall Ridge (used by Rte. 80); the latter gap is not caused by faulting within the Triassic but by a transverse anticline that abuts southeastward against the eastern border fault, interrupting the outcrop of the Holyoke flow.

Off to the north of Lamentation Mountain is Cedar Mountain, again upheld by the Holyoke flow brought up along a northern branch of the fault behind Cathole Mountain. The Hampden flow east of Cedar Mountain can be traced onto the Trinity College campus in Hartford. On a good day, the insurance towers of Hartford can be seen behind Cedar Mountain.

Behind Higby and Lamentation mountains and off to the northeast are the Eastern Highlands, metamorphic rocks separated from the Triassic rift valley by the eastern border fault and the chief source of the Triassic sediments. Due east of us, one can make out the break in the Highlands at Middletown, where the Connecticut River turns away from the valley to find its way through the Highlands to the Sound.

In the opposite direction, the Holyoke flow extends west to West Peak (1,024 feet above sea level) and then turns abruptly north, resuming its normal strike and dip. Thence it extends north for many miles, though broken and somewhat offset by faults, forming Talcott Mountain west of Hartford and reaching Mt. Tom and Mt. Holyoke, on the opposite side of the Connecticut River in central Massachusetts - these can be seen from here on a very clear day.

Beyond West Peak is the valley underlain by the New Haven Arkose, and behind that the Western Highlands, underlain by metamorphic rocks; the contact here is mostly a fault. To the south, however, the West Rock sill appears, first as low hills within the valley, then higher and higher in front of the Western Highlands until Mount Sanford reaches the skyline and hides them. Out in the valley southwest of Mount Sanford is the large mass of Mount Carmel or the Sleeping Giant, an irregular sill or stock higher in the New Haven Arkose than the West Rock sill and probably nearly above the main basement feeder dike.

Just to the left of and behind Mount Carmel, on a clear day one can see the Civil War monument on top of East Rock in New Haven and behind

that the waters of Long Island Sound and Long Island. Thus one can see entirely across the 55-mile width of Connecticut, to points in Massachusetts and New York State 95 miles apart.

From the latitude of the Hanging Hills south, the hills upheld by the Holyoke lava and the Mount Carmel and West Rock sills reach to heights that decline steadily southward, reaching sea level around New Haven Harbor; the slope is about 45 feet per mile (8 meters per kilometer). From the Hanging Hills north, however, no peaks on the Holyoke flow reach 1,000 feet until Mt. Tom (1,200 ft.) and the Holyoke Range; the slope from West Peak to Mt. Tom would be only about 4 feet per mile (less than a meter per kilometer). The sloping hill-top surface to the south is continuous with the surface beneath the Cretaceous rocks on Long Island - for this reason, from the Hanging Hills Long Island Sound and Long Island appear higher than any of the hills between - and it therefore represents the Fall Zone surface or facet (Flint, 1963); even the highest hills to the north have been reduced by erosion well below this surface. One can therefore imagine that when that erosion was going on, Cretaceous rocks still reached inland as far as Meriden. As Barrell pointed out long ago, it is probably no coincidence that the Connecticut River deserts the Connecticut Valley just at this latitude.

Stop #3 (22.49 N - 61.82 E) "Foye's Volcano," Durham quadrangle.

To reach Stop #3, follow Conn. Rte. 77 to a point 0.9 miles south of its intersection with Rte. 17 south of Durham, or 1.4 miles north of the Durham-Guilford town line. Walk west across field to old quarry in low hill (north end of group of hills) beyond stream.

Wilbur G. Foye, late Professor of Geology at Wesleyan University, published a paper in 1930 on the possible existence of a late Triassic volcanic vent in the Durham area. The volcano was opened up in a quarry west of Rte. 77. It forms part of a basaltic mass that can be traced westward to a fault contact with the Hampden flow unit. Because of the agglomeratic texture of the basalt in the vent, Davis attributed this intrusion to the Talcott volcanic event. However, paleomagnetic data indicate that the basalt which forms the matrix of this agglomerate cooled during the Hampden volcanic event.

Facing west into the quarry, the following units can be distinguished from north to south:

- (1) unmetamorphosed red sandstones (dip $\pm 30^\circ$ NE)
- (2) contact metamorphosed sandstone (3 to 5 feet thick)
- (3) irregular contact zone containing detached blocks of basalt
- (4) agglomeratic basalt

Magnetite, biotite, muscovite and garnet have grown as new minerals in the contact metamorphosed rock. The formation of the magnetite at the expense of hematite caused a change in the color of the sediments from red to dark gray-green. The biotite and muscovite formed at the expense of the sericite and chlorite. The new micas have grown across the original bedding, resulting in a total loss of fissility for the rock. Locally, recrystallized tourmalines can be found.

Foye was of the opinion that the basalt intruded by stoping and that the eruption occurred quietly without explosive violence. The occurrence of large tuffaceous blocks in certain horizons of the conglomerates exposed to the north, however, appears to indicate that some explosive activity may have taken place in the area.

Stop #4 (20.59 N - 61.41 E) Outcrop of metamorphic rock west of eastern border faults, Durham quadrangle.

To reach Stop #4, follow Conn. Rte. 77 to north end of Lake Quonnipaug, 4 miles south of Stop #3. Park by first houses southwest of bridge over inlet to lake, and walk up private road to west.

This outcrop of metamorphic rock is located on the wrong side of the eastern border fault. The eastern border fault, which separates the basement from the late Triassic deposits, runs through Lake Quonnipaug, more or less parallel to Conn. Rte. 77. The metamorphic rocks are overlain by coarse breccias, which grade upward into arkosic agglomerates and conglomerates. The metamorphic rocks in turn overlie an intrusive mass of basalt, which crops out in the valley north of the exposure. There is no doubt that the basalt is Triassic, so that the metamorphic rocks appear to be completely surrounded by Triassic sediments and igneous rocks.

The metamorphic rocks consist dominantly of cataclastic and mylonitic gneisses, which occasionally contain anthophyllite. This indicates that they belong to the Middletown Formation, which is exposed on the east side of Lake Quonnipaug. Judging by the amphibolite gneisses and schists found on top of the hill at Stop #4, the metamorphic rocks most probably belong to the uppermost part of this formation. Their cataclastic and mylonitic appearance suggests that significant faulting occurred in this area before the metamorphic rocks were emplaced in their present position. The foliation in the gneiss trends from N to NE; the dip varies from 10° W to 70° E. In the exposure in the small road, the foliation dips steeply to the east, whereas on top of the hill the foliation is generally much less steep. These attitudes contrast sharply with those of the metamorphic rocks east of the fault which trend N to NE, but dip about 60° W. It seems therefore that the steeply dipping beds are overturned (cascade folding). A thrust plane (N 50° E - 15° W) is exposed in the cliff on top of the hill. The structure of the mass suggests that we are dealing here with a large landslide (Fig. 2).

Figure 2 is a cross-section at Stop #4, showing interpretation of metamorphic rocks west of eastern border fault as a landslide. Patterns (left to right): sediments grading into fanglomerate, basalt, pegmatite, gneiss of Middletown Formation.

There seems to be little doubt that this landslide was related to movements along the border fault. The sliding occurred after the emplacement of the Holyoke and before the emplacement of the Hampden flow units. It appears as if the mass may have blocked a major stream because it was strongly eroded after emplacement. A walk southward along Rte. 77 shows that the very angular breccias that overlie the metamorphic rocks gradually go over into agglomerates and then into red arkosic sandstones (Stop #9 of Trip C-1).

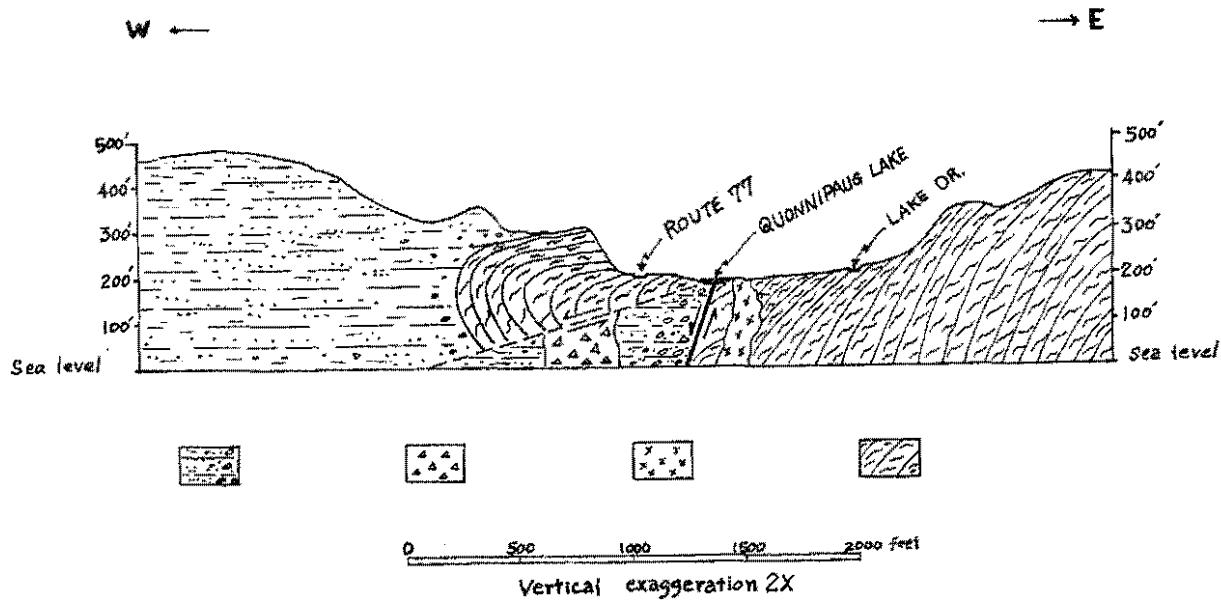

Figure 2. Cross-section at Stop #4, showing interpretation of metamorphic rocks west of eastern border fault as a landslide. Patterns (left to right): sediments grading into fanglomerate, basalt, pegmatite, gneiss of Middletown Formation.

REFERENCES

- Chapman, R. W., 1965, Stratigraphy and petrology of the Hampden Basalt in central Connecticut: Connecticut Geol. Nat. History Survey Rept. Inv. 3, 38 p.
- de Boer, Jelle, 1968, Paleomagnetic differentiation and correlation of the late Triassic volcanic rocks in the central Appalachians: Geol. Soc. America Bull., v. 79, p. 609-626.
- Flint, R. F., 1963, Altitude, lithology, and the Fall Zone in Connecticut: Jour. Geology, v. 71, p. 683-697.
- Foye, W. G., 1930, A basaltic vent of Triassic age at Durham, Connecticut: Am. Jour. Sci., 5th ser., v. 19, p. 151-157.
- Fritts, C. E., 1962, The barite mines of Cheshire: Cheshire, Connecticut, Cheshire Hist. Soc., 36 p.
- _____, 1963, Bedrock geology of the Mount Carmel quadrangle, Connecticut: U. S. Geol. Survey Geol. Quad. GQ-199.
- Hanshaw, P. M., and Barnett, P. R., 1960, Possible use of boron, chromite, and nickel content in correlating Triassic igneous rocks in Connecticut: U. S. Geol. Survey Prof. Paper 400, p. B170-B172.
- Mudge, M. R., 1968, Depth control of some concordant intrusions: Geol. Soc. America Bull., v. 79, p. 315-332.
- Wheeler, Girard, 1939, Triassic fault-line deflections and associated warping: Jour. Geology, v. 47, p. 337-370.

BEDROCK GEOLOGY OF WESTERN CONNECTICUT

by

Rolfe S. Stanley
University of Vermont

Geologically western Connecticut is divided into two major strike belts which extend northward into western Massachusetts and Vermont. The western belt is bordered on the east by "Cameron's line" and consists of metamorphosed Cambrian and Ordovician rocks that represent the miogeosynclinal facies of western New England. Such massifs as the Housatonic and Berkshire Highlands are present in this belt and represent, along with the Fordham Gneiss in the southwestern portion of the state, the Precambrian basement of western Connecticut. The eastern belt between "Cameron's line" and the central Triassic basin of Connecticut contains eugeosynclinal rocks that are stratigraphically equivalent to rocks of Cambrian through Lower Devonian age of eastern Vermont. Rocks of Triassic age are found in the Pomperaug and Cherry Brook valleys and also border the crystalline rocks of western Connecticut on the east.

In the miogeosynclinal belt north of the Housatonic Highlands, Zen (1966, 1967) has shown that the Taconic allochthon is present overlying the characteristic autochthonous sequence of western Vermont and Massachusetts. Recent work by Hall (1965, 1968) in the White Plains area just west of the extreme southwestern portion of Connecticut has correlated subdivisions of the Inwood Marble and Manhattan Schist with the stratigraphy north of the Housatonic Highlands. Hall suggests that the Taconic allochthon may be present in the Manhattan Schist. If his interpretation is correct, then the stratigraphy and structure is similar through the miogeosynclinal belt although the details still must be worked out between the Hudson and Housatonic Highlands.

Detailed mapping since 1956 east of "Cameron's line" has uncovered a variety of major structures whose configuration and sequential history is best understood, at present, along the eastern portion of the eugeosynclinal belt where elliptical domes expose several regionally persistent formations (for example, The Straits Schist). The studies of Crowley (1968) and Dieterich (1968, Trip D-2) in south-central Connecticut, Gates and Martin (1967, Trip D-5) in central Connecticut and Stanley (1964, Trip D-4) in north-central Connecticut, suggest that The Straits Schist and the Collinsville Formation outline a series of east-facing, stacked nappes which have been reformed by the upward movement of the lighter, metavolcanic core in the lowest nappe. This configuration is further complicated by post-metamorphic, high angle faults which are known to be of Upper Triassic age where they border the arkose and basalt in the Pomperaug and Cherry Brook valleys and along the eastern border of the crystalline rocks of western Connecticut.

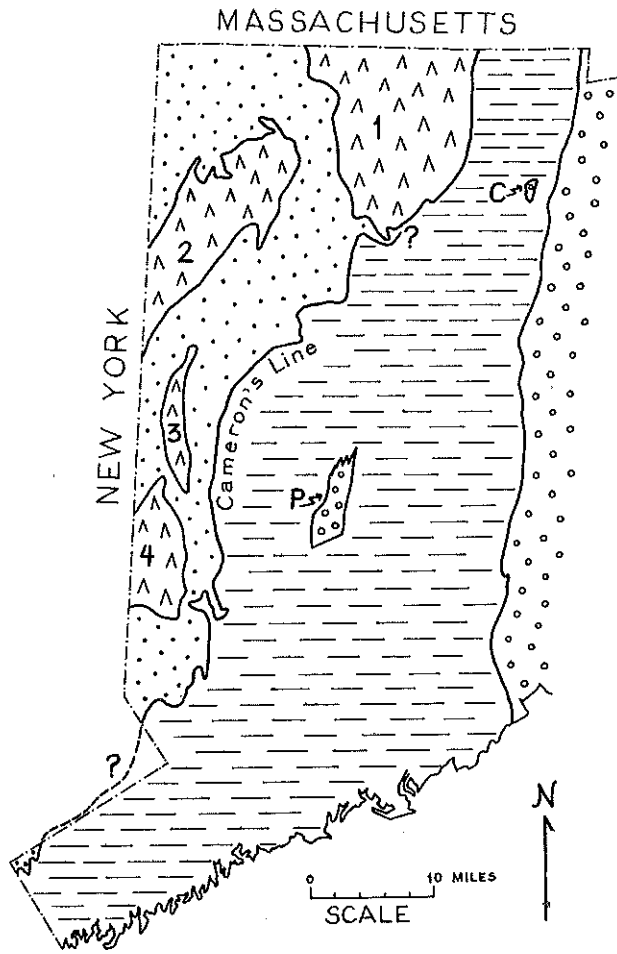

EXPLANATION



Upper Triassic
P = Pomeraug C = Cherry Brook



Miogeosynclinal facies
Cambrian through
Middle Ordovician



Eugeosynclinal facies
Cambrian through
L. Devonian



Precambrian of the
1 Berkshire Highlands
2 Housatonic Highlands
3 New Milford Highlands
4 Hudson Highlands

VSD 1968

Figure 1. Geologic map of western Connecticut.

The origin and significance of "Cameron's line" is unknown, although it has been recognized for some time (Agar, 1927, and Cameron, 1951) as a convenient boundary separating the miogeosyncline facies and the eugeosynclinal facies. Clarke (1958) interpreted "Cameron's line" in the Danbury and Bethel quadrangles as a thrust along which the Manhattan was displaced eastward over the Hartland. Gates and Christensen (1965) in the West Torrington quadrangle showed that some of their units of the Hartland were truncated by Cameron's line and thus support a fault interpretation. Rodgers (1965) suggests that the line may represent a zone of intense downward movement that may have once contained the Taconic slate and, hence, may be the root zone for the allochthon. Whatever interpretation one may favor, "Cameron's line" is a fundamentally important feature of western Connecticut and its significance presents one of the more important problems to be solved in the future.

The post-Precambrian geological history of western Connecticut begins with deposition during the Cambrian and the Lower Ordovician of quartz sandstones, dolostones and limestones in the miogeosyncline west of Cameron's line and shales, graywackes and volcanics in the eugeosyncline to the east. The unconformity at the base of the Walloomsac Formation in northwestern Connecticut (Zen, 1966, 1967) and the Manhattan Schist in the Manhattan Prong (Hall, 1965, 1968) indicates that the miogeosyncline was structurally active during the Middle Ordovician. How far this activity extended eastward into the eugeosyncline is uncertain as convincing evidence for the Middle Ordovician unconformity has not been discovered as yet. The Taconic Orogeny, which is well documented in western New England, certainly affected the eugeosyncline in western Connecticut, but the unconformity that separates the Cambrian - Ordovician rocks from the Silurian - Devonian rocks in Massachusetts, Vermont and New Hampshire has not been demonstrated to date.

In western Connecticut the most intense deformation and metamorphism occurred during the Acadian Orogeny, when the lower and middle Paleozoic rocks were deformed into regionally persistent folds and nappes which, in places, were redeformed into domes. Metamorphism attained the sillimanite and kyanite zones over much of the area except in the southeastern part of western Connecticut where the garnet and biotite zones are present.

The structural history of the area closes with high-angle faulting in the Upper Triassic and broad uplift during the remaining portion of Mesozoic and, possibly, Cenozoic time.

The field trips are designed to sample the diverse geology of western Connecticut. Trip D-6 in the southwesternmost portion of Connecticut will study both the miogeosynclinal and eugeosynclinal sequence adjacent to "Cameron's line", whereas all the other trips will concentrate on the eastern portion of the eugeosynclinal belt. Trip D-1, will cover the progressive metamorphism in the southeastern

part of western Connecticut where rocks of the Wepawaug Schist, supposedly the youngest metasedimentary unit in western Connecticut, are found in a complexly deformed north-plunging synform. Trips D-4 and D-5 will cover the Collinsville, Bristol, and Waterbury domes and include parts of the folds west of the domes. Trip D-2 will cover the area to the south along the strike of the gneiss domes where similar rocks are involved in several generations of folds.

REFERENCES

- Agar, W. M., 1927, The geology of the Shepaug Aqueduct Tunnel, Litchfield County, Connecticut: Connecticut Geol. Nat. History Survey, Bull. 40, 38 p.
- Cameron, E. N., 1951, Preliminary report on the geology of the Mt. Prospect complex: Connecticut Geol. Nat. History Survey, Bull. 76, 44 p.
- Clarke, J. W., 1958, The bedrock geology of the Danbury quadrangle: Connecticut Geol. Nat. History Survey, Quad. Rept. 7, 47 p.
- Crowley, W. P., 1968, The bedrock geology of the Long Hill and Bridgeport quadrangles: Connecticut Geol. Nat. History Survey, Quad. Rept. 24, p.
- Dieterich, J. H., ms., 1968, Sequence and mechanics of folding in the area of New Haven, Westport, and Naugatuck, Connecticut: Ph.D. dissertation, Yale University.
- Gates, R. M. and Christensen, N. I., 1965, The bedrock geology of the West Torrington quadrangle: Connecticut Geol. Nat. History Survey Quad. Rept. 17, 38 p.
- Gates, R. M. and Martin, C. W., 1967, The bedrock geology of the Waterbury quadrangle: Connecticut Geol. Nat. History Survey, Quad. Rept. 22, 36 p.
- Hall, L. M., 1965, Some stratigraphic relationships within the New York City Group in Westchester County, New York (abs.): Geol. Soc. America, Program for the 1965 Annual Meeting, p. 69.
- _____, 1968, Bedrock geology in the vicinity of White Plains, New York: in Guidebook to the 40th New York State Geological Association, p. 7-31.
- Rodgers, John, 1965, Geologic problems on the border between New York and Connecticut: The Empire State Geogram, v. 4, p. 1-4.
- Stanley, R. S., 1964, The bedrock geology of the Collinsville quadrangle: Connecticut Geol. Nat. History Survey, Quad. Rept. 16, 99 p.

Zen, E-an, 1967, Time and space relationships of the Taconic allochthon and autochthon: Geol. Soc. America Special Paper 97, 107 p.

Zen, E-an and Hartshorn, J. H., 1966, Geologic map of the Bashbish quadrangle, Massachusetts, Connecticut and New York: U. S. Geological Survey, Quad. Map GQ-507.

Trip D-1

PROGRESSIVE METAMORPHISM OF PELITIC, CARBONATE, AND BASIC ROCKS
IN SOUTH-CENTRAL CONNECTICUT

by

H. Robert Burger
Smith College

David A. Hewitt
Yale University

With an additional stop description by

Rosemary J. Vidale
State University of New York at Binghamton

INTRODUCTION

Throughout the New England metamorphic province few localities exhibit such a complete example of progressive regional metamorphism within a relatively small area as does south-central Connecticut. The rocks of this immediate area consist of an assortment of metamorphosed shales, graywackes, basic volcanics, and minor amounts of carbonates and sandstones. These metasedimentary and metavolcanic rocks range in age from Cambrian to Devonian and have been metamorphosed from the chlorite to the kyanite zone. Immediately to the east these metamorphic rocks are overlain unconformably by sedimentary rocks of Triassic age. To the northwest lie the Waterbury Dome and the Connecticut Valley synclinorium. The purpose of this trip is to call attention to this area of classic Barrovian metamorphism and to point out problems needing further study.

ACKNOWLEDGMENTS

The authors wish to acknowledge their heavy reliance on the excellent geologic maps of the Milford, Ansonia, and Mount Carmel quadrangles compiled by C. E. Fritts (1963, 1965a, 1965b).

STRATIGRAPHY

The stratigraphy of the metamorphic rocks exposed in the New Haven, Mount Carmel, Ansonia, and Milford quadrangles is straightforward although controversy exists concerning minor interpretations. In order to avoid misunderstandings the stratigraphic relationships as envisaged by Fritts (1962, 1965a, 1965b) and by Burger (1967) are expressed in figure 1. As this trip will avoid most of these complications, the interested reader is referred to Burger (1967) for the reasoning underlying the conflicting interpretations.

The Savin Schist is best exposed in the New Haven quadrangle. It is most likely Ordovician in age and is the oldest rock unit encountered on the field trip. The most outstanding characteristic of the Savin Schist is the pervasive homogeneity of the rocks. Although several minor rock types are present, the overall unit is an albite-muscovite-chlorite-quartz schist containing abundant lenses, pods, and veins of quartz, and thin layers of carbonate and tuffaceous material. This formation is recognized only in the chlorite zone.

The Allingtown Volcanics is considered to be a basic intrusive by Fritts (1965a, 1965b), but Burger (1967) believes this formation represents

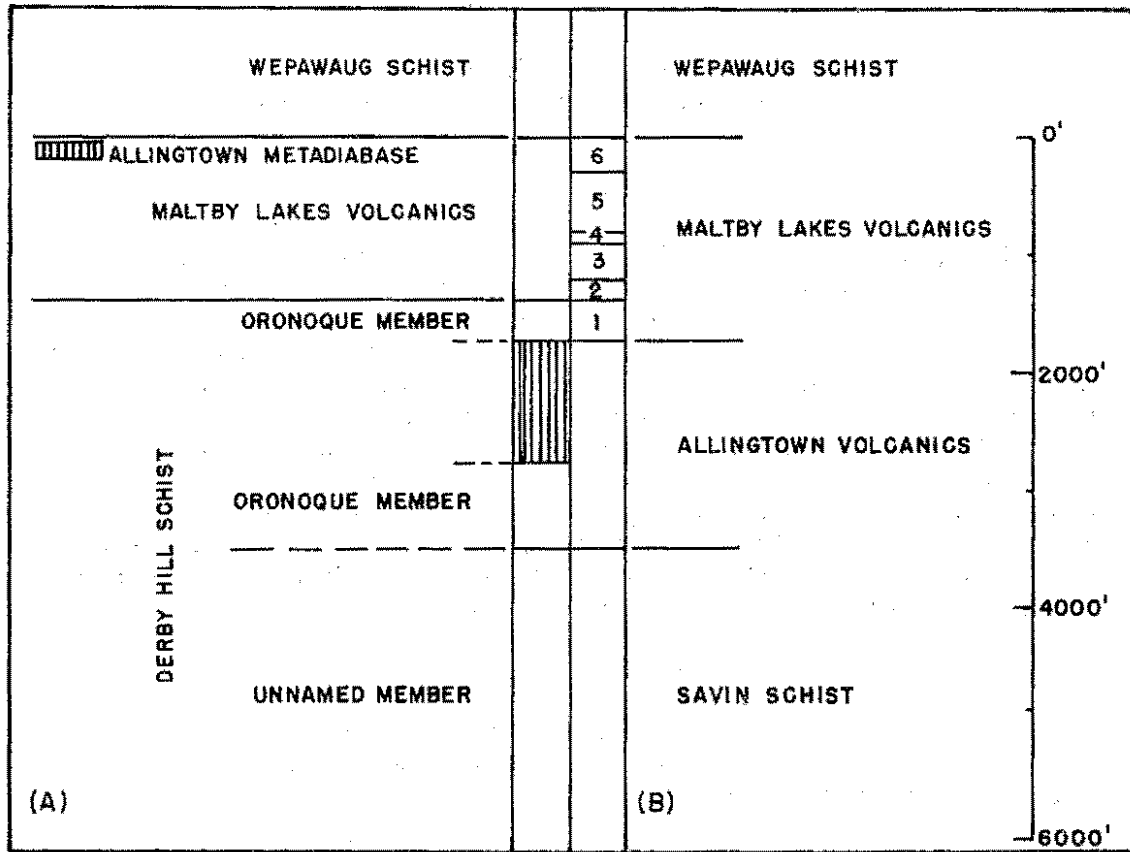

Fig. 1. The stratigraphy encountered in Trip D-1 as interpreted by (A) Fritts (1962, 1965a, 1965b) and by (B) Burger (1967).

a sequence of interbedded basic volcanics and pelitic sediments that is dominated by a thick massive flow. As in the case of the Savin Schist, this formation is recognized only in the chlorite zone. At this grade it is characteristically a porphyroblastic greenstone consisting of epidote porphyroblasts in a matrix of albite, actinolite, epidote, and chlorite.

The Ordovician formation designated as Maltby Lakes Volcanics contains a sequence of volcanic flows, pyroclastics, and tuffs that are interbedded with minor pelitic sediments and carbonates. In the chlorite zone the dominant lithologies are a fine-grained actinolitic greenschist, a quartzo-feldspathic schist, and a massive, epidote-rich actinolitic greenschist. These units can be traced through the kyanite zone.

In the chlorite zone the Wepawaug Schist is mainly a quartz-muscovite-chlorite-albite carbonaceous phyllite. With increasing metamorphic grade the grain size increases and the formation becomes a graphitic muscovite schist with bands of paragneiss (Fritts, 1962). Other lithologies present in this formation are impure limestone layers and minor thin bands of amphibolite. Mineralogic changes associated with increasing grade of metamorphism are best developed in this unit and, therefore, the majority of the stops will be in the Wepawaug Schist. The Wepawaug Schist is correlated with the Waits River and Northfield formations of Vermont and is assigned a Siluro-Devonian age by Fritts (1962, p. 36).

The so-called "Woodbridge Granite" occurs in the Wepawaug Schist as small stocks and as layers conformable to foliation. Often it is in thin layers which may represent tuffaceous acidic volcanic rocks. Whether such tuffs are water-laid or an ash fall or flow is unknown. The assemblage of this trondhjemitic unit is oligoclase, quartz, and muscovite with minor amounts of biotite and K-feldspar.

STRUCTURE

Structural relationships are apparently more complex than formerly recognized in this part of Connecticut. As a separate field trip deals with this problem (Trip D-2), the reader is referred to the portion of the Guidebook dealing with that trip for a detailed interpretation of the regional structural geology.

Structures of specific interest which will be pointed out and discussed on this trip are itemized below:

(1) Wepawaug syncline - The major structure in the New Haven, Mount Carmel, Ansonia, and Milford quadrangles is a regional syncline with a plunge to the northeast. The exact nature of the syncline is unclear due to the difficulty in correlating specific formations (Savin Schist, Allingtown Volcanics) around its hinge. This difficulty is due to structural complexities in the hinge area, lack of critical outcrop, and an increase in metamorphic grade which occurs in the hinge area (refer to fig. 2).

(2) Mixville and other minor faults - Small normal faults of post-Paleozoic age cut the Wepawaug syncline in several places. The largest of these is known as the Mixville Fault and has a displacement of at least several hundred feet (Fritts, 1965a). Fritts has postulated that this fault, which is the Triassic boundary in parts of the Southington and Mount Carmel quadrangles, extends into the Wepawaug formation

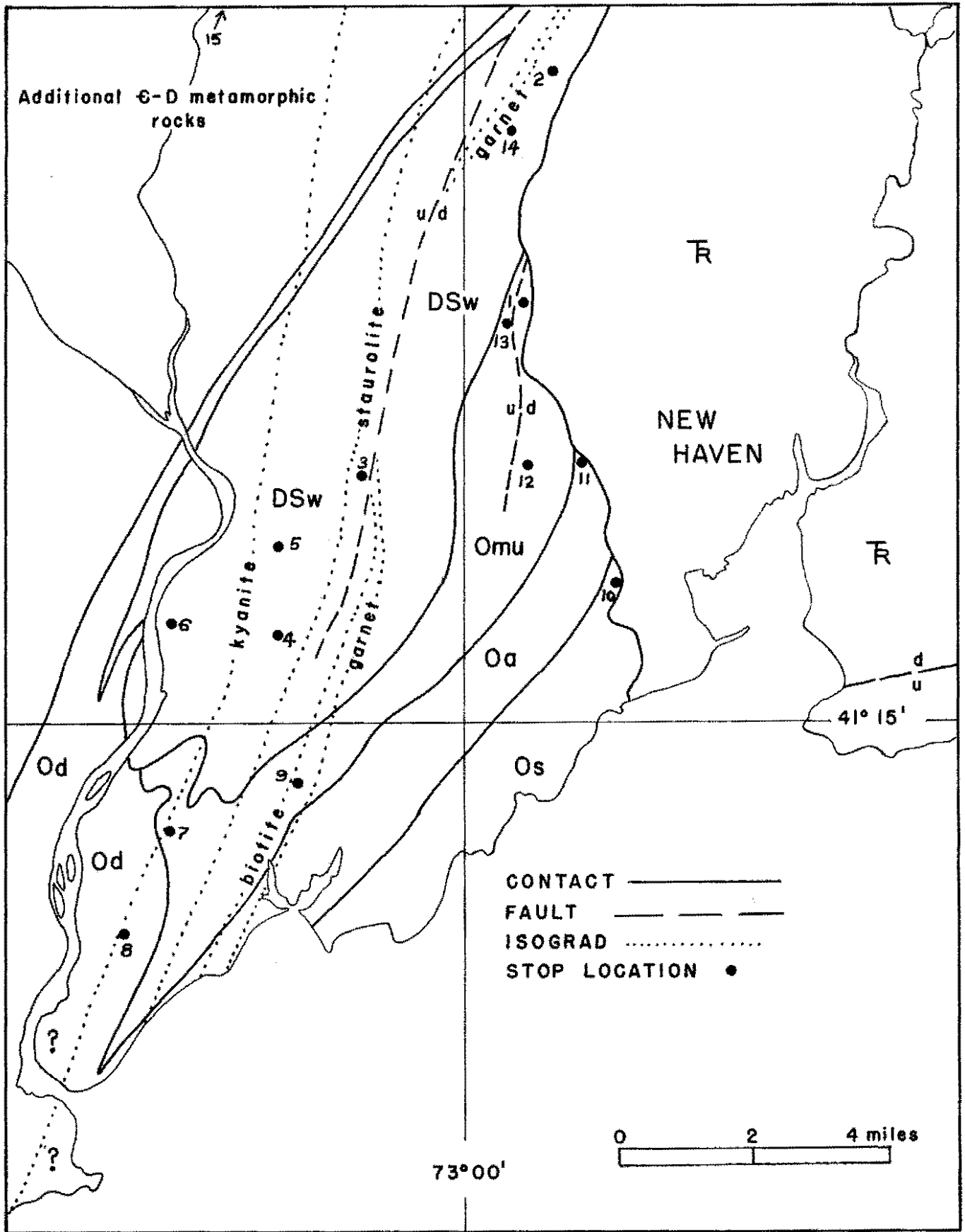

Fig. 2. Generalized geologic map of region after Fritts (1963, 1965a, 1965b) and Burger (1967). Formations shown include Savin Schist (Os), Derby Hill Schist (Od), Allingtown Volcanics (Oa), Maltby Lakes Volcanics (Omu), and Wepawaug Schist (DSw).

as far south as Orange. In the northern portion he sees some discordant foliation attitudes in the schist. In the south, however, the fault is postulated on the occurrence of truncated biotite and garnet isograds. Some evidence of discordant attitudes of foliation will be seen in the Wepawaug River gully. Neither line of evidence is substantial and the actual occurrence of the fault is problematical.

(3) Schistosity and fracture cleavage - The majority of all rock types possess a well-developed schistosity which is parallel or nearly parallel to original bedding throughout much of the area. In many outcrops this schistosity is tightly folded on a small scale and is cut by a well-defined fracture cleavage (strain-slip cleavage in rocks of appropriate composition). At a few localities, all in the Wepawaug Schist, this cleavage is further cut by kink-bands. Such relationships permit identification of at least 3 episodes of structural deformation. Recent detailed work by Dieterich has confirmed 4 distinct stages of structural evolution (see description of Trip D-2).

METAMORPHISM

The regional metamorphism of western Connecticut is similar to the classic Dalradian sequence in the Scottish Highlands, where Barrow (1912) first described metamorphic isograds. In the region of this field trip the rocks are exposed from lower greenschist through the middle amphibolite facies. As previously mentioned, the diversity of rock compositions includes pelitic schists, basic volcanics, and micaceous limestones. Each of these rock types can be seen changing in mineralogy and texture across the isograds.

The age of metamorphism here is controversial. Although throughout most of western Connecticut K-Ar dates of 320-400 m.y. have been obtained, the values from the area between Bridgeport and New Haven are 220-280 m.y. (Clark, 1966; Armstrong et al., 1968). Dieterich (1968) concludes from structural arguments that the isograds are Acadian (360-400 m.y.) and that the lower K-Ar dates are only due to reheating or uplift of warm rocks during the Allegheny orogenic period.

The isograds parallel the major northeast trending structures. Within two miles the grade rises from the chlorite zone to the kyanite zone. Only in the eastern part of the region, near the contact with the Triassic, are the lower grade rocks exposed. Fritts (1962) reports the following order of the isograds: (1) garnet, (2) biotite, (3) staurolite, (4) kyanite. The appearance of garnet before biotite is not typical of a Barrovian sequence unless the garnet is manganiferous. Compositions for the garnets in these rocks have not been determined. However, in at least one locality the reversal of isograds is not substantiated by thin section examination (on Lambert Rd., 1/3 mile north of City Rd.). The pelitic assemblage in this "chlorite zone" outcrop is biotite-chlorite. At a nearby locality in the garnet zone, but below the mapped biotite isograd, garnet occurs with both biotite and chlorite. The biotite in these specimens is fine-grained and a minor constituent, but texturally appears to be in equilibrium. Beyond the mapped biotite isograd, biotite is coarse and plentiful and occurs with garnet \pm chlorite. Whether or not the reversal of isograds actually occurs in this region is an open question needing further investigation.

By taking each rock type and observing it as the metamorphic grade increases several important petrologic phenomena can be shown. Unfortunately no single layer can be followed across the isograds. The schists and volcanics are quite massive and present little problem with correlation. However, the limestone occurs as sparse discontinuous layers which can only be assumed to have had comparable original mineralogy.

At low grade the pelitic rocks in the Wepawaug Schist can be divided into two types: (1) a very mica-rich phyllite, (2) a siltstone. Both rocks have the assemblage quartz-muscovite-chlorite-plagioclase. The phyllite has 40-50% mica whereas the siltstone has 10-20% mica. This results in the phyllite having a strong crinkle texture with very well developed strain-slip cleavage. The siltstone has no crinkles or kink-bands and a relatively poorly developed strain-slip cleavage. Both rocks are fine grained. Veins of quartz and more rarely calcite are common at this grade, suggesting that fluid pressure equaled and perhaps exceeded lithostatic pressure. Texturally the rocks remain fine grained until Fritts' biotite isograd is reached. Grain size increases at this grade so that individual micas can be distinguished in hand specimen. Garnets are easily visible but are less than 1-2 millimeters in diameter. Above the biotite isograd veins are not as common as at lower grades.

In the staurolite zone grain size increases rapidly. Staurolites and garnets several millimeters in diameter are common in a coarse mica-quartz-plagioclase matrix. The differences between the two schist types are much less conspicuous. The siltstone is sandier and has a less aluminous assemblage in general. Garnets at this grade have been more noticeably rolled than at the lower grades. A lineation of included quartz grains at an angle to the foliation of the rock is the criterion used here for rolling. One staurolite from the kyanite zone shows evidence that it too has been rolled. The first staurolites to appear in the schist are anhedral and rare. Just below the kyanite isograd they occur much more commonly and as well-formed euhedral crystals.

The appearance of kyanite is not associated with a distinct textural change. Usually the assemblage in the kyanite-bearing rocks is kyanite-staurolite-garnet-biotite, which raises the question of one or more of the phases being stabilized by an extra component. No analyses of the phases have been performed so that this again is an open question.

There are similar changes in the basic rocks as the grade is increased. In the chlorite zone the assemblage is chlorite-actinolite-epidote-albite. The rocks are heterogeneous. Numerous pods of solid epidote, variations in carbonate content, and veins of calcite and of quartz occur commonly. Homogeneity has increased slightly in the garnet and biotite zones. The assemblage is similar except for an increase in actinolite relative to chlorite. At the kyanite isograd the rock is an amphibolite. Plagioclase, hornblende and quartz dominate the assemblage. Except for some local concentrations, biotite, chlorite and epidote occur as minor phases. The rock is much more homogeneous in appearance and veins are not as common as in the greenschist facies.

As noted previously the carbonates in the Wepawaug Formation are scarce and individual units cannot be traced across the isograds. All indications suggest that they are fairly homogeneous in composition. Modes from material below the staurolite isograd show the following average

mineralogy: calcite 35-45%, dolomite-ankerite 25-35%, quartz 10-20%, muscovite 10-20%, opaque material 2-6%. The ratio of the two carbonates can be quite variable so that rare specimens are nearly all calcite or all dolomite-ankerite. Plagioclase and chlorite can occur in trace amounts in these low grade rocks. No mineral zoning is noticeable in the low grade carbonates. The contacts are slightly gradational with the schist, but very sharp with the tuffaceous material. Grain size increases slightly between the chlorite and biotite zone, but no other changes are evident. In the low grade staurolite zone biotite appears and plagioclase increases to approximately 1% of the rock. Chlorite also seems to increase slightly over lower grades. Muscovite and dolomite diminish rapidly. The ideal proposed reaction is muscovite + dolomite + quartz \rightarrow phlogopite + anorthite + calcite + vapor, although it is difficult to reconcile the large amount of biotite produced with the relatively small amount of plagioclase. Chlorite may be involved, taking up the excess Al_2O_3 .

In the higher grade staurolite zone and in the kyanite zone the reaction biotite + calcite + quartz \rightarrow tremolite-actinolite + K-feldspar + vapor occurs. This reaction and the reaction forming biotite are the only consistent reactions with increasing grade. Two other important reactions occur: (1) $H_2O + anorthite + calcite \rightarrow clinzoisite + CO_2$, (2) tremolite + calcite + quartz \rightarrow vapor + diopside. However, they are commonly found in the same outcrops as the other lower grade assemblages which are in stable textural equilibrium. The explanation lies in the fluid composition. Figure 3 is a plot of several equilibrium curves which seem to be involved in these rocks. The shapes of the curves in this T- X_{CO_2} (fluid) plot, at constant P, are determined by the stoichiometry of the two volatile reactions (Greenwood, 1962). The diagram neither contains all the reactions possible in the system nor does it imply that the reactions shown are the stable ones or in the wholly correct relative positions. With seven components and 12 or more likely phases to occur, the correct reactions are not easily defined. However, these curves do correspond well with the best interpretations of the reactions occurring in the rocks.

The important point to notice is that at constant temperature and pressure a rock could undergo a sequence of reactions by merely changing the fluid composition. For example, take a rock at point (1) (fig. 3) with the assemblage phlogopite-calcite-quartz-plagioclase(an₁₀₀). As X_{CO_2} is decreased the rock will pass (if calcite and quartz are in excess) through the assemblages tremolite-K feldspar-calcite-quartz-plagioclase (which should go to tremolite-muscovite-calcite-quartz-plagioclase if the reactions are reversible), tremolite-muscovite-calcite-quartz-zoisite, tremolite-K feldspar-calcite-quartz-zoisite, diopside-K feldspar-calcite-quartz-zoisite, and wollastonite-K feldspar-diopside-zoisite-(quartz or calcite). One way to see this effect of fluid composition is to look at a gradient in CO_2/H_2O ratio produced at the contact between a limestone and a schist. Reactions in the schist evolve H_2O -rich fluids whereas reactions in a micaceous limestone generally evolve more CO_2 -rich fluids. Therefore since the bulk fluid composition in general will be different, a potential gradient will exist with CO_2 being transported outward. The steepness of this will depend on the rate of diffusive mixing. At Stop #5 a qualitative example of this sequence may be seen. For the large central

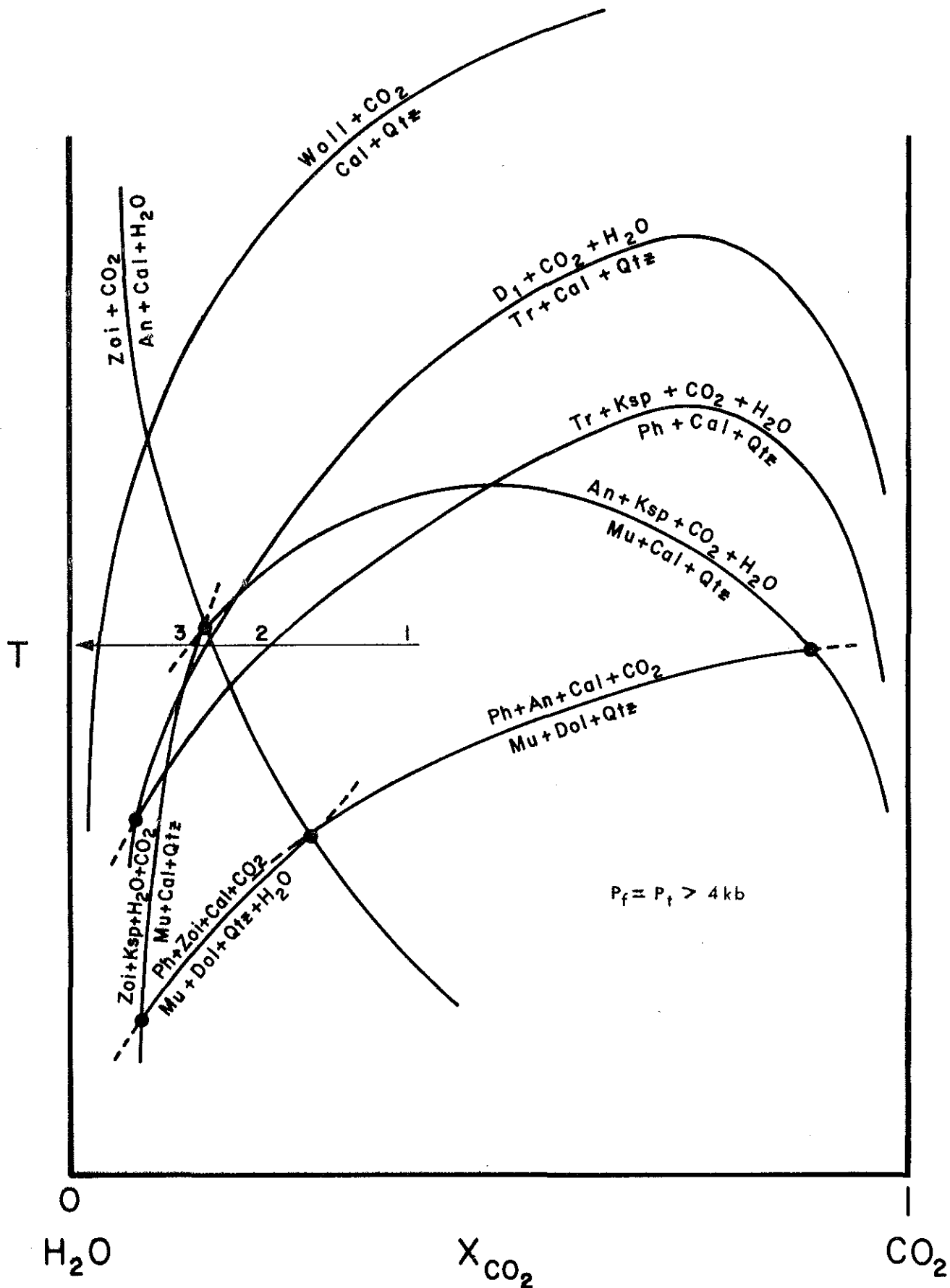

Fig. 3. A constant pressure phase diagram consistent with the available experimental data and the carbonate assemblages seen in western Connecticut. The arrow shows the gradient in X_{CO_2} suggested for the sample Wep-16c.

part of the unit the assemblage is biotite-tremolite-calcite-quartz-plagioclase(an_{43}). At the edges, where large quartz veins occur, the assemblage is diopside-clinzoisite.

Figures 4 and 5 are photographs of a sample from the kyanite zone near Stop #6. The unit is a thin limestone ($\approx 10''$) in the Wepawaug Formation. The sample is of slightly greater than half the limestone plus the schist contact with 1-2 inches of the neighboring schist. The assemblages across the critical part of the sample are listed on figure 6. Some electron microprobe analytical data for the specimen are also shown. The sequence of assemblages corresponds to the path shown on figure 3 between points (2) and \approx (3). Locating point (3) is difficult because of bulk composition effects. The rest of the limestone has the same assemblage as the innermost carbonate zone shown on the diagram. A few millimeters further into the schist the stable assemblage is quartz-plagioclase-(biotite-chlorite)-muscovite with minor K-feldspar which vanishes farther on into the schist. This data implies a sharp gradient in the CO_2/H_2O ratio at the boundary with the values in the limestone and in the schist being relatively constant. If this is true, the rate of diffusive mixing is slow compared to the rates of production of the CO_2 -rich fluid in the limestone and the H_2O -rich fluid in the schist. One further indication that major transport of chemical species has not occurred is that although potassium may have moved a few inches away from the limestone, the plagioclase compositions show that calcium has not been transported, in significant amounts, for more than a few millimeters.

See Figure 8 and the description of Stop #15 by Rosemary Vidale for an example of a layered calc-silicate rock in which movement of major rock components over distances of up to several centimeters can be demonstrated.

DESCRIPTIONS OF INDIVIDUAL STOPS

Refer to figure 7 for the location of all stops and consult figure 2 for their geologic position.

Stop #1 (18.39 N - 53.60 E) Amity Shopping Center, Conn. Rte. 63 at the Wilbur Cross Parkway, New Haven quadrangle.

An exposure of the Triassic unconformity is located at the north end of the outcrop. At this point the basal Triassic conglomerate overlies Ordovician Maltby Lakes Volcanics. The major portion of the outcrop exposes a volcanic unit of the Maltby Lakes Volcanics with a chlorite zone assemblage of epidote-actinolite-chlorite-albite. Numerous quartz and calcite veins are present. Note the abundance of green epidote-rich pods.

Stop #2 (20.16 N - 53.87 E) Lake Watrous on Conn. Rte. 69, Mount Carmel quadrangle.

This chlorite zone outcrop of the Wepawaug Schist exposes the three characteristic rock units of the Wepawaug: (1) a muscovite-chlorite-quartz-plagioclase phyllite with about 40% mica, (2) sandier beds with the same assemblage but with less than 20% mica, (3) brown-weathering micaceous limestone consisting mainly of calcite, dolomite, muscovite, and quartz. There are lenses of "Woodbridge Granite," which consists of plagioclase, quartz, muscovite, and minor K-feldspar. This trondhjemite appears intrusive in other outcrops but was probably tuffaceous material at this locality. Evidence for two periods of folding and a late episode of kink-banding can be seen.

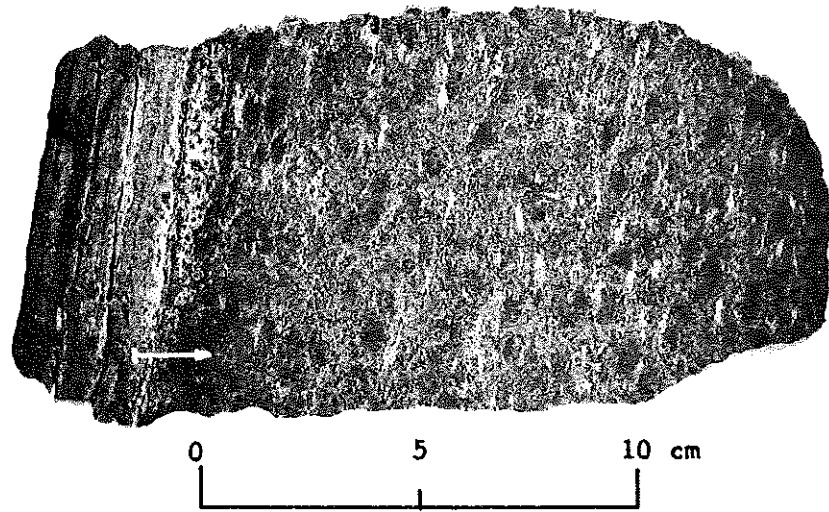

Fig. 4. Kyanite grade schist-micaceous limestone contact (Wep-16c). The arrow represents the path covered by the electron microprobe traverse.

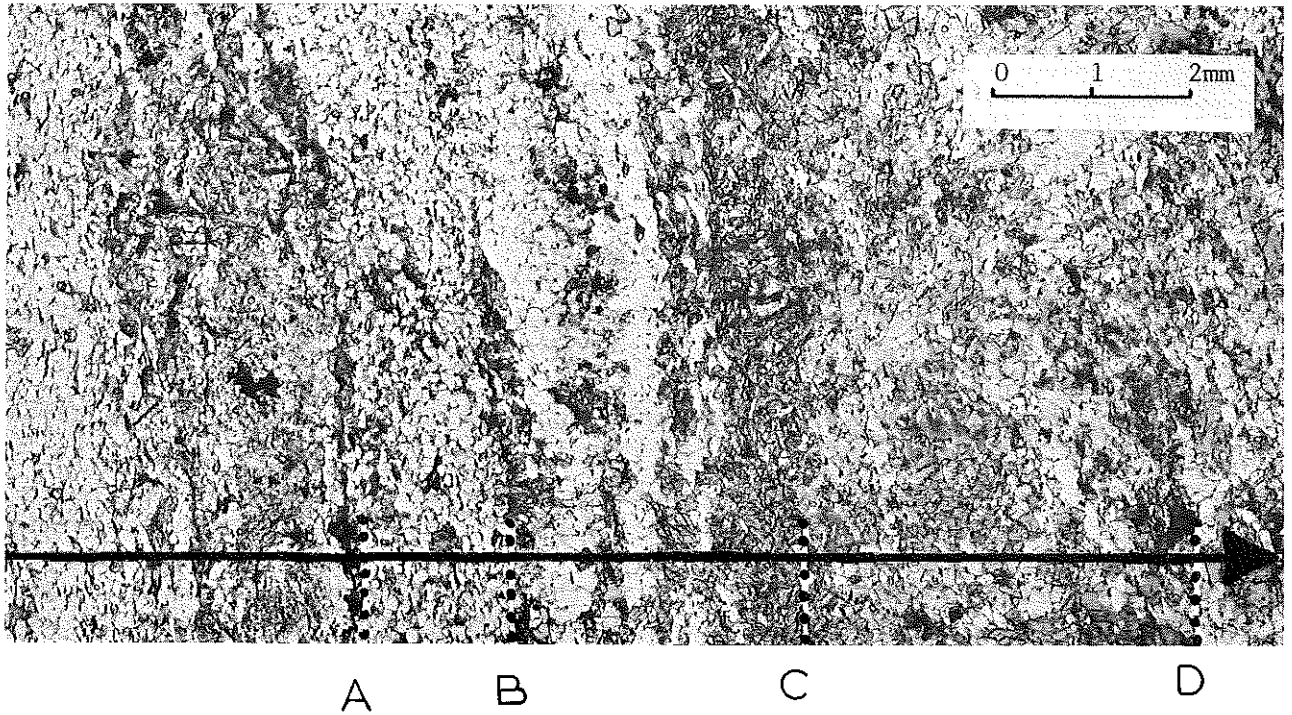

Fig. 5. Microphotograph of the polished electron microprobe section from sample Wep - 16c. The line represents the approximate microprobe traverse. The capital letters correspond to the zone boundaries shown in Fig. 6.

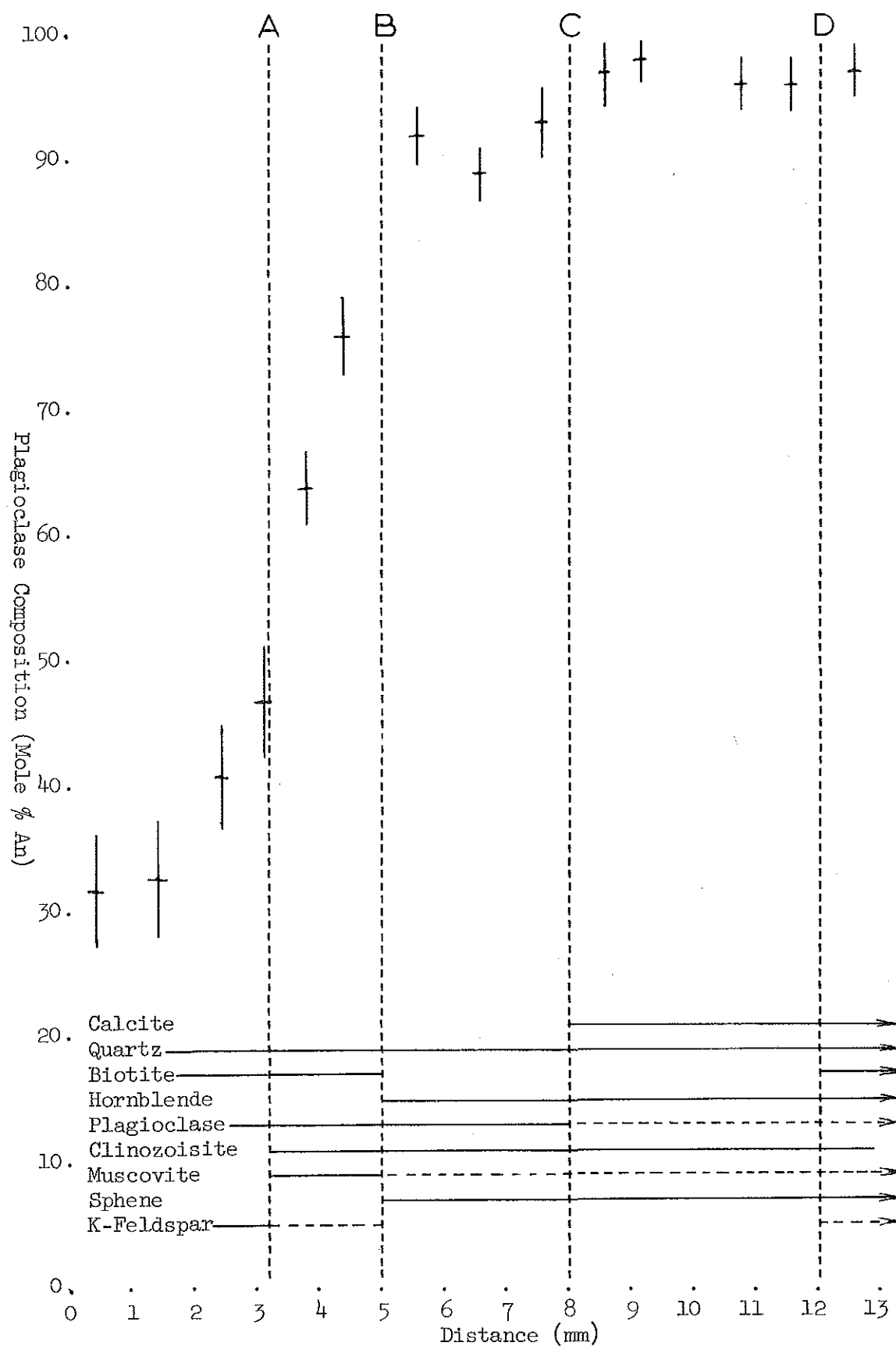

Fig. 6. Assemblages and plagioclase compositions determined in Wep-16c along the electron microprobe traverse shown in Fig. 5.

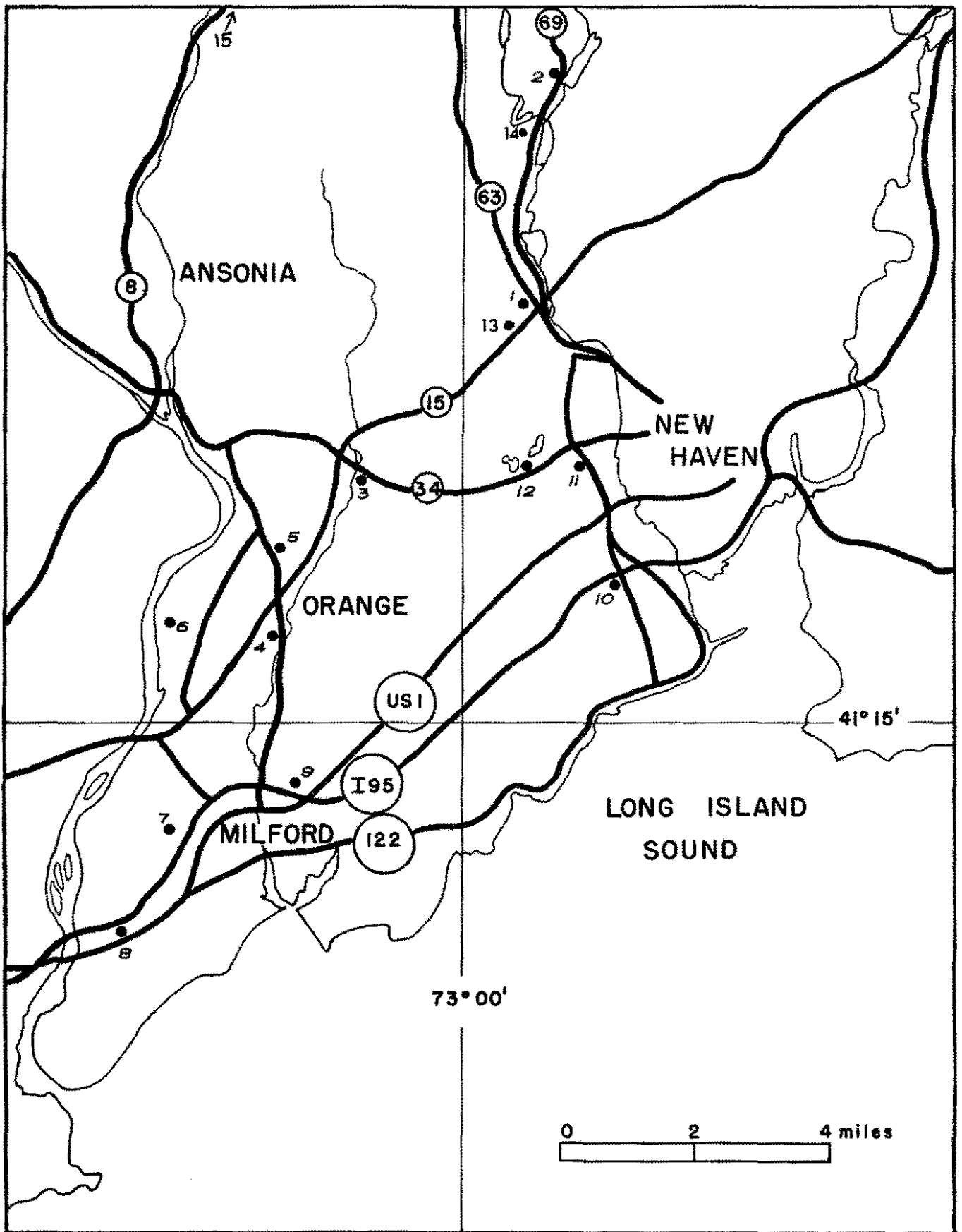

Fig. 7. Map showing location of stops.

Stop #3 (17.14 N - 52.29 E) Wepawaug River gully at the intersection of the Derby Turnpike and Mapledale Avenue, Ansonia quadrangle.

The rock units in the Wepawaug Schist have become slightly more coarsely crystalline at this locality which is located upgrade to the west of the garnet and biotite isograds. The highest grade assemblages are (1) garnet-biotite for the pelitic schist, (2) muscovite-calcite-dolomite-quartz for the limestone, and (3) plagioclase-quartz-muscovite-biotite for the Woodbridge Granite.

Because of the displacement of isograds in the eastern region of the Wepawaug Schist, the Mixville Fault, bordering the Triassic to the north has been extended to pass just east of this outcrop. Some evidence for this is suggested by the change in strike of the schist along the bend in the river just south of the bridge.

Stop #4 (15.92 N - 51.73 E) Derby Milford Road about 300 yards northwest of the intersection with Rte. 121, Ansonia quadrangle.

Coarse-grained Wepawaug Schist (staurolite zone) here contains the assemblage plagioclase-quartz-muscovite-garnet-biotite. Several beds of limestone are exposed and contain the assemblage calcite-phlogopitic biotite-quartz-dolomite-plagioclase. Near either the contacts with the schist or various quartz pods clinozoisite occurs instead of the Ca-plagioclase. This is consistent with a more water-rich fluid stabilizing clinozoisite rather than calcite and anorthite.

Stop #5 (16.52 N - 51.65 E) On Derby Milford Road next to a driveway about 75 yards northwest of intersection with Turkey Hill Road.

The limestone cropping out here is bordered on both sides by thick quartz veins. The assemblage in the center of the limestone is calcite-biotite-(tremolite-actinolite)-quartz-plagioclase(an₄₄). Near the quartz veins the biotite, amphibole, and plagioclase disappear and a quartz-diopside-clinozoisite assemblage takes their place. These relations can be interpreted as constant temperature-total pressure reactions with an increasing H₂O/CO₂ ratio in the fluid. However, potassium must also be lost from the system since no potassium phase occurs in contact with the vein. K-feldspar in the nearby schists is probably a consequence of this.

There are some thin carbonate units in the field to the northwest of this outcrop which have the assemblage calcite-diopside-zoisite (and clinozoisite)-K feldspar. These layers are not noticeably zoned and have no quartz veins at their edges.

Stop #6 (15.97 N - 50.84 E) Along Little Turkey Hill Brook just west of the railroad by Riverview Country Club, Ansonia quadrangle.

The pelitic Wepawaug Schist at this locality is coarse-grained and contains the assemblage kyanite-staurolite-garnet-biotite. Diopside-hornblende-grossularite-calc-silicate bands are exposed in the stream bed. A limestone sample from along the railroad shows a homogeneous assemblage of calcite-quartz-biotite-actinolite-muscovite-(minor K-feldspar and plagioclase) throughout most of the bed. Only within ½ to 1 inch of the sharp contact with the schist is biotite eliminated for actinolite and Ca-plagioclase for clinozoisite. Diopside does not occur. K-feldspar is concentrated in the schists near the contact. These narrow reaction zones

are seen in other samples where veins do not occur at the contact. This can be interpreted as evidence for sharp gradients in the $\text{CO}_2/\text{H}_2\text{O}$ ratio near the contact with the schist and that the rate of transport of CO_2 away from the carbonate is not significantly greater than the rate of production.

Stop #7 (14.38 N - 49.84 E) 400 yards east of the intersection of Rutland Road and Ford Street, Milford quadrangle.

This exposure on the kyanite isograd illustrates the highest-grade Maltby Lakes Volcanics observed on the trip. The dominant assemblage is hornblende-plagioclase-epidote-quartz. Streaks of epidote are common here, as they are at lower grades, but the rock as a whole is apparently much more homogenized and the distinctive and obvious pods of epidote are missing. It is believed, however, that this is the same unit of the Maltby Lakes Volcanics as seen at Stop #1.

Stop #8 (13.57 N - 50.52 E) Interchange 34 of the Connecticut Turnpike, Milford quadrangle.

Because of lack of outcrop around the southern end of the Wepawaug syncline and the change in metamorphic grade in this same general region, it is difficult to correlate the Derby Hill Schist with the Savin Schist as has been proposed. In addition the schist is difficult to differentiate from the Wepawaug Schist in many places. The generally less aluminous nature, the occurrence of quartzitic layers, and the somewhat gneissic pinstripe portions of the Derby Hill Schist are the characteristics used to differentiate it from the Wepawaug. The rock is aluminous enough for kyanite to occur in some places but normally the pelitic assemblage is garnet-biotite \pm chlorite.

Stop #9 (14.69 N - 51.84 E) Burnt Plains Road overpass at the Connecticut Turnpike, Milford quadrangle.

The Maltby Lakes Volcanics are exposed here between the pelitic garnet and biotite isograds. The homogeneity is intermediate between the chlorite and kyanite zone outcrops previously described. The assemblage is chlorite-epidote-actinolite-albite.

Stop #10 (16.31 N - 54.31 E) Intersection of Campbell Avenue with exit ramp of Connecticut Turnpike Interchange 43, New Haven quadrangle.

This exposure of Savin Schist is typical for the formation and includes several of the minor lithologies found in this formation. The most common assemblage is albite-chlorite-muscovite-quartz. Massive greenstones contain albite-chlorite-epidote-calcite and are believed to represent tuffaceous layers. Light tan quartzite layers may represent thin chert beds.

Mesoscopic structures are especially prevalent at this locality. Best developed features include: tight folds of various sizes, strain-slip cleavage, refracted cleavage, and rare complexly refolded folds.

Stop #11 (17.17 N - 54.06 E) 800 yards southeast of the intersection of Derby Avenue (Conn. Rte. 34) and Forest Street, New Haven quadrangle.

This dark green, massive, porphyroblastic rock is representative of the major portion of the Allingtown Volcanics. Its typical chlorite zone assemblage is actinolite-epidote-albite-chlorite.

Stop #12 (17.11 N - 53.60 E) Along the divider strip of Derby Avenue (Conn. Rte. 34) just south of the area between the two southernmost lakes of Maltby Lakes, New Haven quadrangle.

The unit of the Maltby Lakes Volcanics exposed here in the chlorite zone is distinct from the unit seen at Stop #1. The rock type at this stop is a fine-grained, actinolitic greenschist with an assemblage of actinolite-albite-chlorite-epidote. Epidote is much less common in this unit than in the unit at Stop #1. Approximately 3000 feet further to the east along Derby Avenue one encounters a metasedimentary unit within the Maltby Lakes Volcanics. This quartzo-feldspathic schist has an abundance of quartz layers that are broken into individual pods and are parallel to a well-developed schistosity. The most common minerals are albite, quartz, muscovite, chlorite, and epidote.

Stop #13 (18.15 N - 53.51 E) Wilbur Cross Parkway about 1/4 mile west of Amity Center near the Fountain Street overpass, New Haven quadrangle.

The southwest end of the outcrop exposes a late normal fault in the greenschists of the Maltby Lakes Volcanics.

Stop #14 (19.76 N - 53.64 E) Dillon Road off Rte. 69 at Lake Dawson; about 100 yards south on the power line, Mount Carmel quadrangle.

The small lens-shaped body of tuffaceous-looking material is mapped as "Woodbridge Granite." The assemblage here is K-feldspar (50%)-chlorite-quartz-muscovite, whereas there is only minor K-feldspar in the main bodies of the "Woodbridge Granite." The rock contains inclusions of granitic material as well as pieces of phyllite, typical of the country rock.

Stop #15 (20.92 N - 51.18 E) Road cut on east side of Conn. Rte. 8, 0.6 miles north of the Seymour access road, Naugatuck quadrangle.

The calc-silicate band shown in Figure 8 is well exposed for a distance of about 50 feet. This band (Sample #RMV-9-65) is described in detail by Vidale (1968). It lies within a two-mica schist layer in the amphibolite unit between The Straits Schist and the Monroe gneiss. All three units may be seen in this road cut.

The calc-silicate band is symmetrically zoned as can be seen in Fig. 8. A 1600-count mode for each zone is given in Table 1. These modes are approximate because the zones are not homogeneous on the scale of a thin section. Table 2 and Figure 9 give the chemical composition of each zone. Cuts were taken from ground 50 gram slabs in an attempt to obtain representative samples for these analyses. Zone I was sampled several feet along strike from the rest in order to obtain a 50 gram slab. The other analyses are of one continuous sequence.

Plagioclase composition (by the method of Michel Levy) is about an_{25} in the two-mica zone (I); it ranges from about an_{25} to an_{45} going inwards across the biotite zone (II), and reaches an_{88} or higher at the center (zone VI). Garnet compositions determined from the unit cell edge and refractive index show that almandine decreases and grossularite increases from the outside toward the center of the band. Preliminary electron probe work on a kyanite grade calc-silicate band from the Hartland Formation (sample #RMV-7-65) shows similar overall trends in plagioclase and garnet

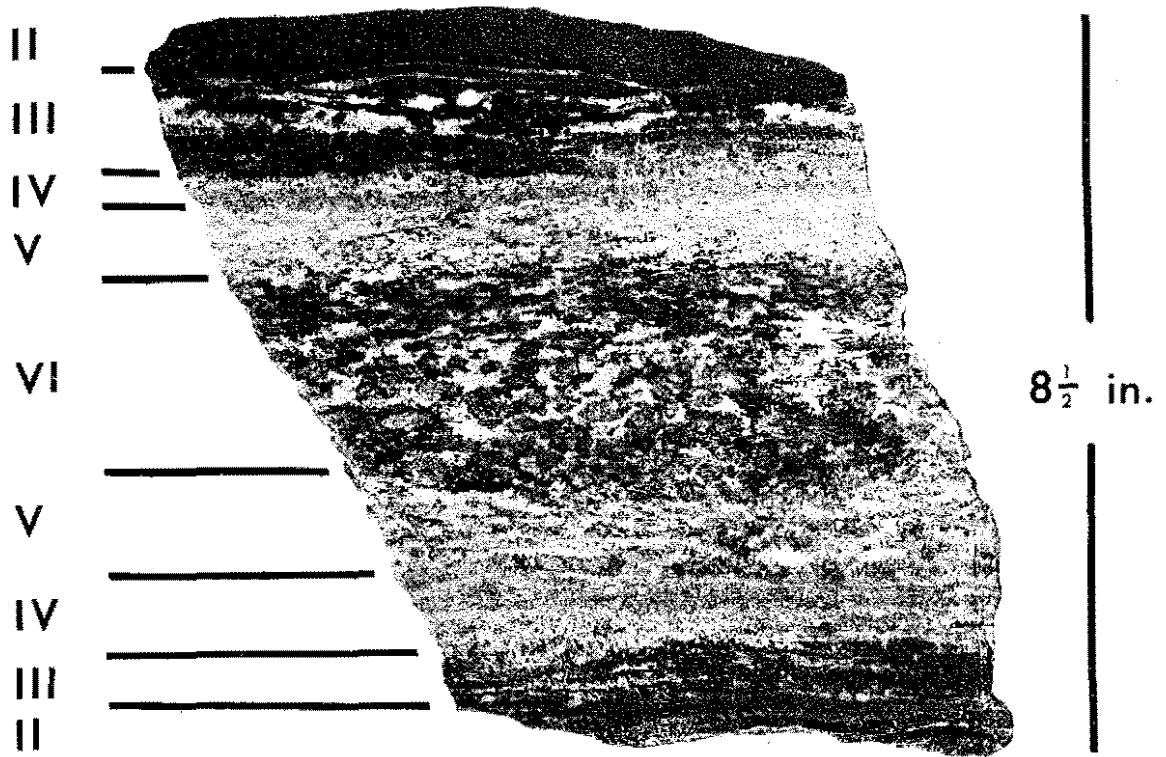

Fig. 8. Symmetrically zoned calc-silicate band at Stop 15 in road cut on Route 8, Seymour, Connecticut.

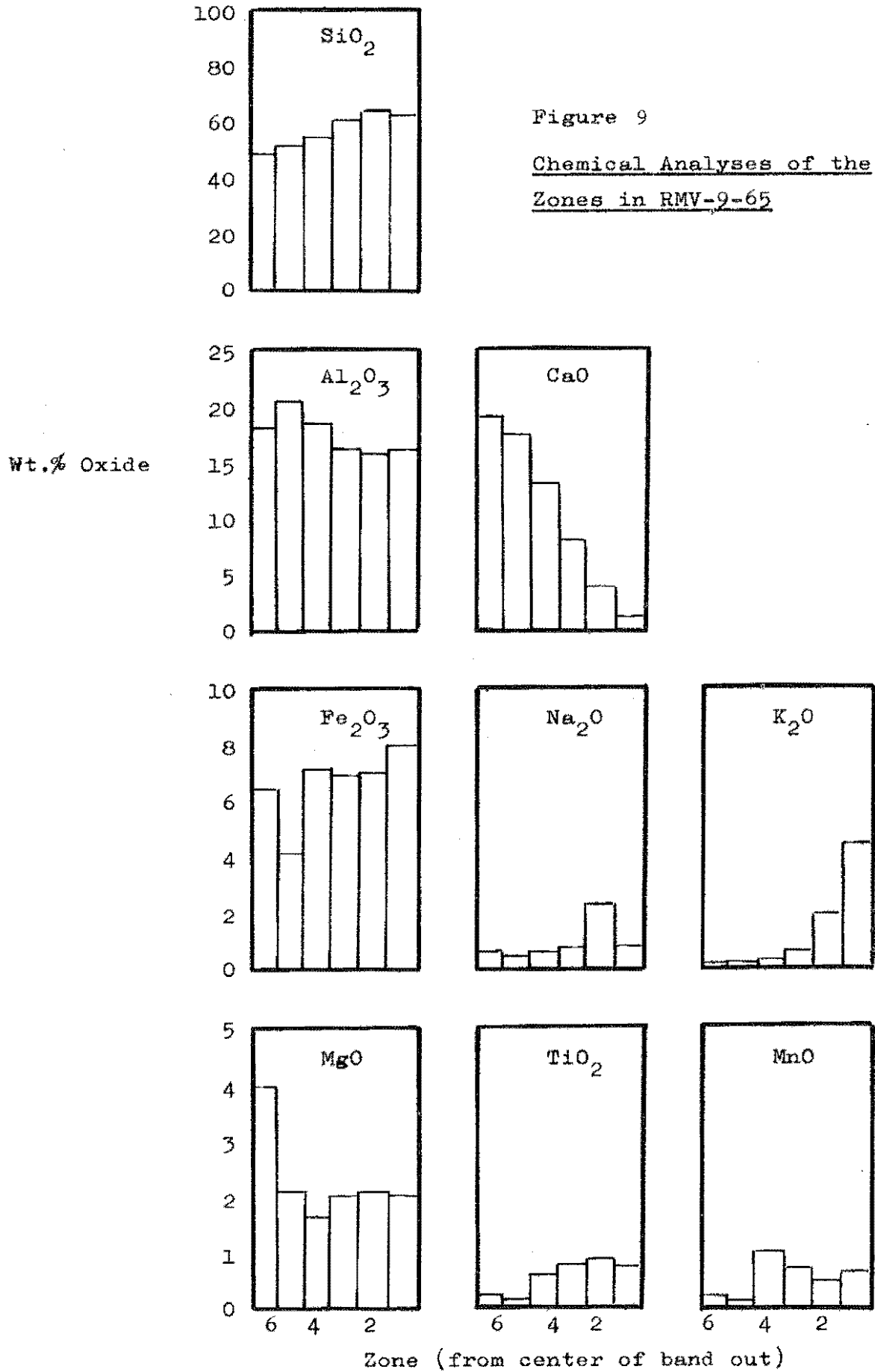

Fig. 9. Chemical analyses of the zones in RMV-9-65.

composition superposed on local variation between grains and zoning within grains. The probe analyses also show a decrease in Fe:Al ratio in the epidote minerals going toward the center of the band.

The chemical compositions of the zones of #RMV-9-65 do not range between the compositions of the center and the outside of the band, as they would in simple gradational contacts. This suggests that there has been differential movement of chemical constituents within this kyanite grade band driven by the chemical composition gradients between the Ca-rich layer and the two-mica schist. Data on sillimanite grade calc-silicate bands and from experimentally produced zonation (Vidale, 1968) provides further evidence for mobility of chemical components and for movement of K and Ca away from the centers of the bands and of Mg, Si, and Al toward the centers.

Table 1. Modes of the Zones in #RMV-9-65 (based on 1600 point counts)

	I	II	III	IV	V	VI
Quartz	33.5	20.0	34.2	27.1	7.3	5.7
Plagioclase	12.3	47.4	10.0			16.8
Muscovite	24.4	0.4				
Biotite	22.0	23.7	0.7			
Pyrrhotite	2.2	0.1				
Apatite	0.2	0.2				
K-feldspar	trace	trace	1.8			
Zoisite + Clinzoisite		0.2	1.2	11.4	65.6	23.3
Amphibole			29.1	7.2	6.2	29.4
Sphene			3.4	2.5	0.5	1.2
Garnet	5.4	8.2	19.6	42.6	8.2	
Diopside				9.2	12.2	11.1
Calcite						12.6

Table 2. Chemical Analyses of the Zones in #RMV-9-65

Zone	SiO ₂ '	Al ₂ O ₃ '	Fe ₂ O ₃ '	CaO'	K ₂ O'	TiO ₂ '	MnO'	MgO*	Na ₂ O*	Total
I	63.4	16.2	8.0	1.24	4.52	0.74	0.69	2.05	0.78	97.6
II	64.1	15.8	7.0	3.81	1.98	0.86	0.51	2.10	2.22	98.4
III	61.2	16.2	6.9	8.06	0.75	0.80	0.73	2.00	0.80	97.5
IV	55.5	18.6	7.1	13.0	0.30	0.63	1.02	1.65	0.68	98.4
V	52.2	20.5	4.1	17.5	0.25	0.19	0.16	2.10	0.58	97.6
VI	48.8	17.9	6.5	19.1	0.20	0.24	0.22	3.95	0.62	97.5

' Determined by x-ray fluorescence using a fusion-heavy absorber method, U.S.G.S. Report #66-WF-30. Analysts: Rosemary Vidale and James Lindsay.

* Determined by atomic absorption. Analyst: Rosemary Vidale.

REFERENCES

- Armstrong, R. L., Barton, J. M., Carmalt, S. W., and Crowley, W., 1968, Geochronologic studies of the Prospect, Ansonia, and Milford formations, southern Connecticut: to be submitted for publication as a Connecticut Geol. Nat. History Survey Rept. Inv.
- Burger, H. R., 1967, Stratigraphy and structure of the western part of the New Haven quadrangle, Connecticut: Connecticut Geol. Nat History Survey Rept. Inv. 4, 15 p.
- Clark, G. S., 1966, Isotopic Age Study of Metamorphism and Intrusion in Western Connecticut and Southeastern New York: Ph.D. thesis, Columbia University.
- Dieterich, J. H., 1968, Sequence and Mechanics of Folding in the Area of New Haven, Naugatuck, and Westport, Connecticut: Ph.D. thesis, Yale University.
- Fritts, C. E., 1962, Age and sequence of metasedimentary and metavolcanic formations northwest of New Haven, Connecticut, in Geological Survey Research 1962: U. S. Geol. Survey Prof. Paper 450-D, p. 32-36.
- _____ 1963, Bedrock geology of the Mount Carmel quadrangle, Connecticut: U. S. Geol. Survey Quad. Map GQ-199.
- _____ 1965a, Bedrock geologic map of the Ansonia quadrangle, Fairfield and New Haven Counties, Connecticut: U. S. Geol. Survey Quad. Map GQ-426.
- _____ 1965b, Bedrock geologic map of the Milford quadrangle, Fairfield and New Haven Counties, Connecticut: U. S. Geol. Survey Quad. Map GQ-427.
- Greenwood, H. J., 1962, Metamorphic reactions involving two volatile components: Carnegie Inst. Washington Year Book 61, p. 82-85.
- Vidale, R. J., 1968, Calc-silicate bands and metasomatism in a chemical gradient: Ph.D. thesis, Yale University.

Trip D-2

MULTIPLE FOLDING IN WESTERN CONNECTICUT: A REINTERPRETATION
OF STRUCTURE IN THE NEW HAVEN-NAUGATUCK-WESTPORT AREA

by

James H. Dieterich
Yale University *

INTRODUCTION

The Paleozoic metamorphic rocks of the New Haven-Naugatuck-Westport area consist predominately of metasediments with lesser amounts of metaigneous (volcanic?) rock. Gates and Rodgers (Rodgers and others, 1959) have referred to this area as "the southeastern belt" (of the Western Connecticut Highlands), a designation that is retained here. This area is to the south and east of the region of Western Connecticut gneiss domes (the "central belt") and in contrast with the irregular structure of that area, the rocks of the southeastern belt have a strongly linear northeast-trending structural pattern. The metamorphism varies from chlorite-grade in the east to sillimanite-grade in the west.

The authors of recent studies (see figure 1) have proposed a number of often conflicting interpretations of the large-scale structure of portions of the southeastern belt. All these interpretations suggest a relatively simple structure for the southeastern belt. However, the map pattern and the minor structures indicate numerous deformational episodes and a rather complex structural configuration. A regional study of the structure has resulted in the reinterpretation outlined here. For the details on which this reinterpretation is based the reader is referred to Dieterich (1968). The main goal of the field trip is to demonstrate the existence of multiple systems of minor structures and to illustrate some features of the large-scale structure.

The State Geological and Natural History Survey of Connecticut provided financial support of the field work during all or parts of the summers of 1964, 1965, 1966, and 1967. This work is from a portion of the author's Ph.D. thesis presented to the Faculty of Yale University. I am indebted to Professor John Rodgers for his advice and encouragement.

STRATIGRAPHY

The stratigraphy illustrated in figure 2 differs from that of previous workers and is based on the author's detailed observations in the Westport quadrangle and more general observations in the remainder of the southeastern belt. The correlations of Fritts (1962, 1965a, 1965b) are followed in the eastern part of the belt in the area of the Wepawaug Schist and the Derby Hill Formation. The principal features of the reinterpretation of the area to the west are the recognition of the Fairfield Formation (name tentative) and the correlation of the Prospect

* Present address: National Center for Earthquake Research, U.S. Geological Survey, Menlo Park, California 94025

SOUTHINGTON	FRITTS, 1963b
SOUTHBURY	SCHOLLE, 1965
NAUGATUCK	CARR, 1960
MOUNT CARMEL	FRITTS, 1963a
LONG HILL & BRIDGEPORT	CROWLEY, 1967
ANSONIA	FRITTS, 1965a
NEW HAVEN	BURGER, 1967
WESTPORT & SHERWOOD PT.	DIETERICH, 1968
MILFORD	FRITTS, 1965b

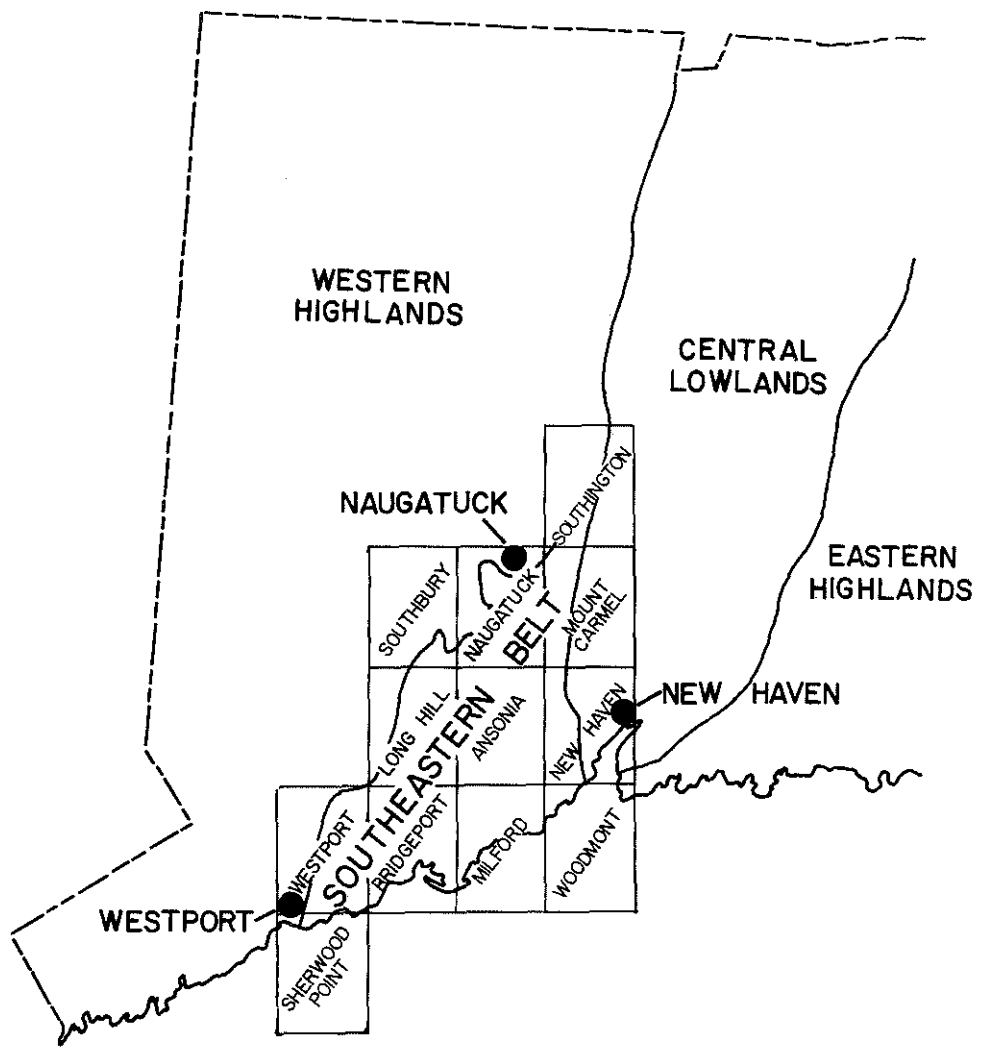

Fig. 1. Index map of the New Haven-Naugatuck-Westport area.

Formation	Member	Brief Description
Wepawaug Schist		Dark gray, graphitic phyllite or phyllitic schist (depending on metamorphic grade).
Maltby Lakes Volcanics		Mainly intermediate to basic metavolcanic rocks with interlayered metasediments.
Allingtown Formation		Dark massive greenstone interlayered with schist. Fritts (1965a, 1965b) considered this formation to be intrusive into the Derby Hill Formation. Burger (1967), however, believes this formation to be volcanics interlayered with the upper portions of Fritts' Derby Hill Formation.
Derby Hill Formation	Oronoque Member	Thinly laminated quartz rich paragneiss. In part interlayered with the Allingtown Formation.
	Unnamed Lower Member	Thinly laminated muscovite-chlorite phyllite or schist with quartz-rich paragneiss.
The Straits Schist		A distinctive coarse quartzose muscovite schist. It is usually graphitic and often contains biotite, garnet, and sillimanite, and/or kyanite.
Fairfield Formation (name tentative)	Upper Member	Interlayered biotite-muscovite schist, biotite gneiss and quartzite with lenses of amphibolite, calc-silicates, marble, and massive quartzite.
	Lower Member	Layered muscovite-biotite schist and biotite gneiss.
Prospect Formation	Upper Member	Porphyroblastic and non-porphyroblastic gneiss, hornblende gneiss, and muscovite-biotite schist.
	Golden Hill Member	Layered muscovite-biotite schist, biotite gneiss with amphibolite, quartz-oligoclase gneiss and calc-silicates.

Fig. 2. Stratigraphy of the New Haven-Naugatuck-Westport area.

Formation with a number of other units.

To the east of the main body of The Straits Schist (see map, figure 3), the Fairfield Formation includes rocks that previously have been correlated with the Southington Mountain Formation by Fritts in the Mount Carmel, Ansonia, and Milford quadrangles (1963a, 1965a, and 1965b respectively), and rocks continuous with these in the Long Hill and Bridgeport quadrangles, variously designated by Crowley (1967) as the upper member of The Straits Schist and the Southington Mountain Formation. Along the west side of the main body of The Straits Schist, the Fairfield Formation is equated with the layered schistose and gneissose portions of the Waterbury and Prospect formations in the Naugatuck quadrangle (Carr, 1960) and portions of the Reynolds Bridge Formation in the Long Hill and Bridgeport quadrangles. North of the southeastern belt, the Fairfield Formation is correlative with the Hitchcock Lake member of the Waterbury Formation in the Waterbury quadrangle (Gates and Martin, 1967) and Southington quadrangle (Fritts, 1963b).

The above correlations are based on the occurrence of a number of distinctive rock types in the upper portion of Fairfield Formation. Occurring as lenses in interlayered biotite-plagioclase-muscovite-quartz schist, biotite gneiss and quartzite are amphibolite, marble, a number of different calc-silicate rocks and massive quartzite. Significantly, these lenses, where present, are in a well-defined sequence. At the bottom of the sequence is a thin amphibolite. Above this is a thicker zone (roughly 200 feet) of the banded schist, gneiss and quartzite which in the upper half is commonly interbedded with calc-silicate rocks. The marble occurs at or near the top of the banded schist and is followed by a massive amphibolite up to 100 feet thick. Above the amphibolite at the top of the Fairfield Formation (i.e., adjacent to The Straits Schist) is a massive quartzite up to 40 feet thick.

On the basis of the control provided by the Fairfield Formation, the Prospect Formation is correlated with similar gneisses of the Waterbury Formation in the Naugatuck quadrangle and with the Reynolds Bridge Formation and perhaps the Newtown Formation in the Long Hill quadrangle.

STRUCTURE

Minor Structures

At many exposures throughout the southeastern belt, it is possible to observe folded folds and in a few places twice-folded folds. A total of four primary minor fold systems are recognized. These are designated from oldest to youngest as F₁, F₂, F₃, and F₄, respectively. Locally along the northwest edge of the belt an additional deformational system has been found which, on the basis of the regional structure and apparent tectonic history, is interpreted as an early phase of F₂. In that part of the area the two F₂ phases are designated F_{2A} and F_{2B}. The first three of the four primary minor fold systems are associated with mappable folds.

The intensity of the deformations associated with each of these minor fold systems is quite variable. With the exception of the youngest fold system, F₄, which consists of kink-type folds, the style of the minor structures is controlled by the lithologies of the layers involved and by the local intensity of the deformations. Fold style is not determined by the fold chronology. As a result, conventional style criteria could

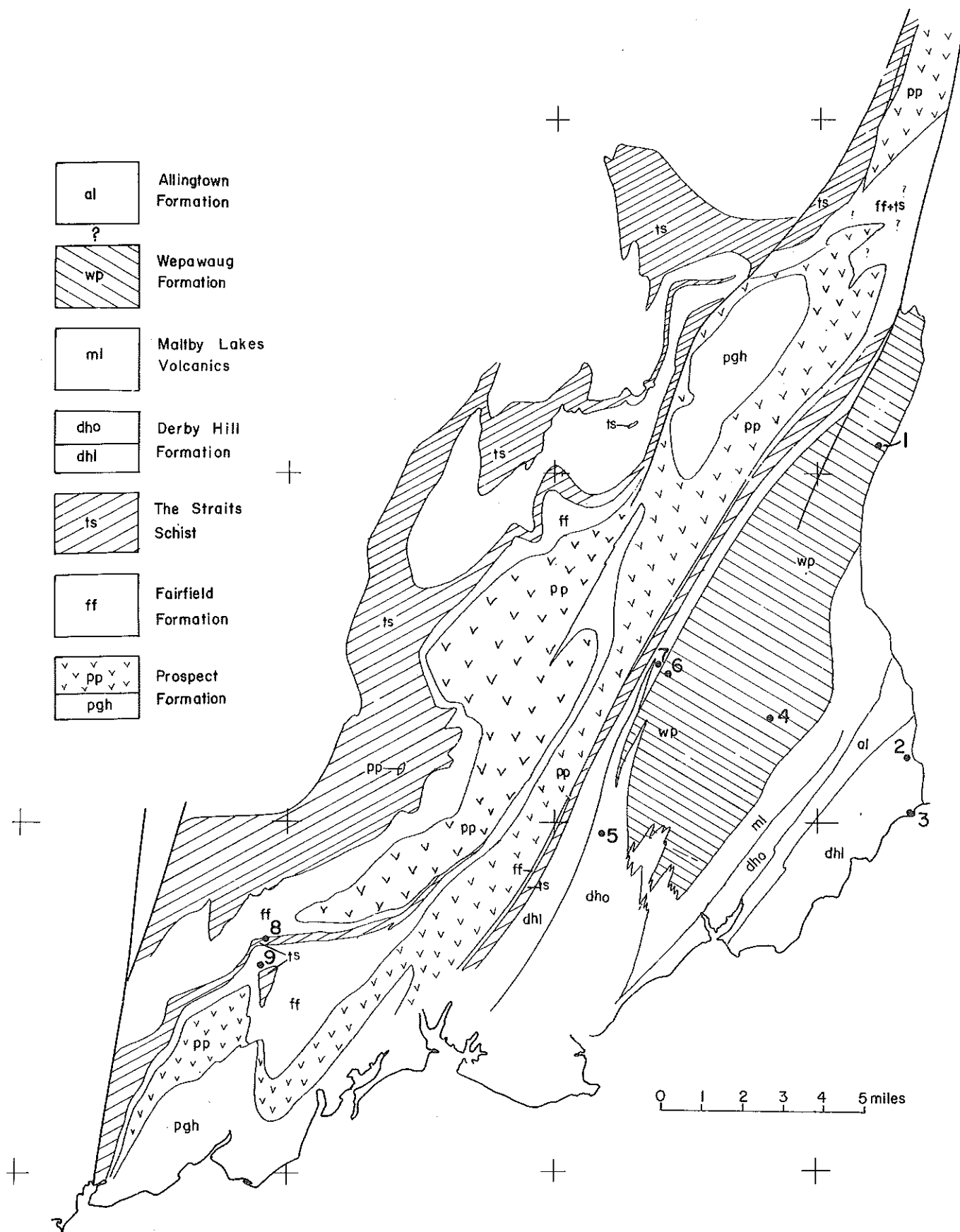

Fig. 3. General geologic map showing stop locations.

not be employed in this area to identify the age of a given minor structure. Only by direct tracing, observing the lateral variations in intensity and orientation, can minor fold systems be correlated.

Axial-plane foliations are associated, at least locally, with each fold system. In every case these foliations seem to have developed from crenulations. The lineations which include crenulations, mineral streaking and preferred mineral orientations, are always parallel to related minor fold axes.

Major Structure

The large-scale structure of the southeastern belt may be expressed in terms of three superimposed major fold systems. The fold axes of these different fold systems are variable, but in general trend northeast to southwest. Three large isoclinal F_1 folds, two synclines with an intervening anticline are recognized in the western part of the southeastern belt. These folds are inferred to extend into the eastern position of the belt. A complex system of F_2 structures has tightly folded and inverted the F_1 folds. Along the western edge of the southeastern belt two systems of recumbent F_2 folds, F_{2A} and F_{2B} , are recognized. In the central and eastern areas of the southeastern belt, F_2 is represented by a single system of tight, nearly upright, major folds. Finally, a series of open F_3 major folds has modified the complex structure resulting from the F_1 and F_2 fold systems.

The overall structure inferred for the southeastern belt is summarized in figure 4.

The main portion of The Straits Schist occupies the axial zone of the Beacon Falls Syncline, which is the westernmost of the F_1 major structures ("C" in figure 4). This syncline has been folded by two systems of F_2 folds. The oldest, F_{2A} , seems to have most affected the northern portion of The Straits Schist and is represented by three large nearly isoclinal folds. The large body of The Straits Schist at the northern apex of the southeastern belt occupies the axial zone of the structurally lowest F_{2A} antiform ("E" in figure 4, section 1). The highest of the F_{2A} folds has isoclinally folded and inverted the Beacon Falls Syncline ("G" in figure 4, section 2). The F_{2B} folds are restricted to the southern end of the area occupied by The Straits Schist. These folds have further folded the Beacon Falls Syncline into a series of gently reclined nearly isoclinal folds ("J" in figure 4, section 3). Upright F_3 folds gently warp the older structure in this portion of the southwestern belt.

Along the east edge of The Straits Schist, the axial zone of the inverted Beacon Falls Syncline extends under the Fairfield and Prospect formations. In the area of these formations the major F_1 structures are the inverted Ox Hill Anticline, "B", and the inverted Fairfield Syncline, "A". Like the Beacon Falls Syncline these F_1 structures have been folded by F_2 major structures, which are at least in part F_{2B} . These F_2 folds are tight, but not isoclinal and, except for the large Bridgeport Synform "H", die out to the north. An interesting feature of the Bridgeport Synform is a nearly complete absence of F_2 minor structures in its vicinity. F_3 structures are less important in this area except in the southern part of the belt where a number of F_3 major folds are recognized. Here the series of F_3 folds in The Straits Schist cuts across the Beacon Falls

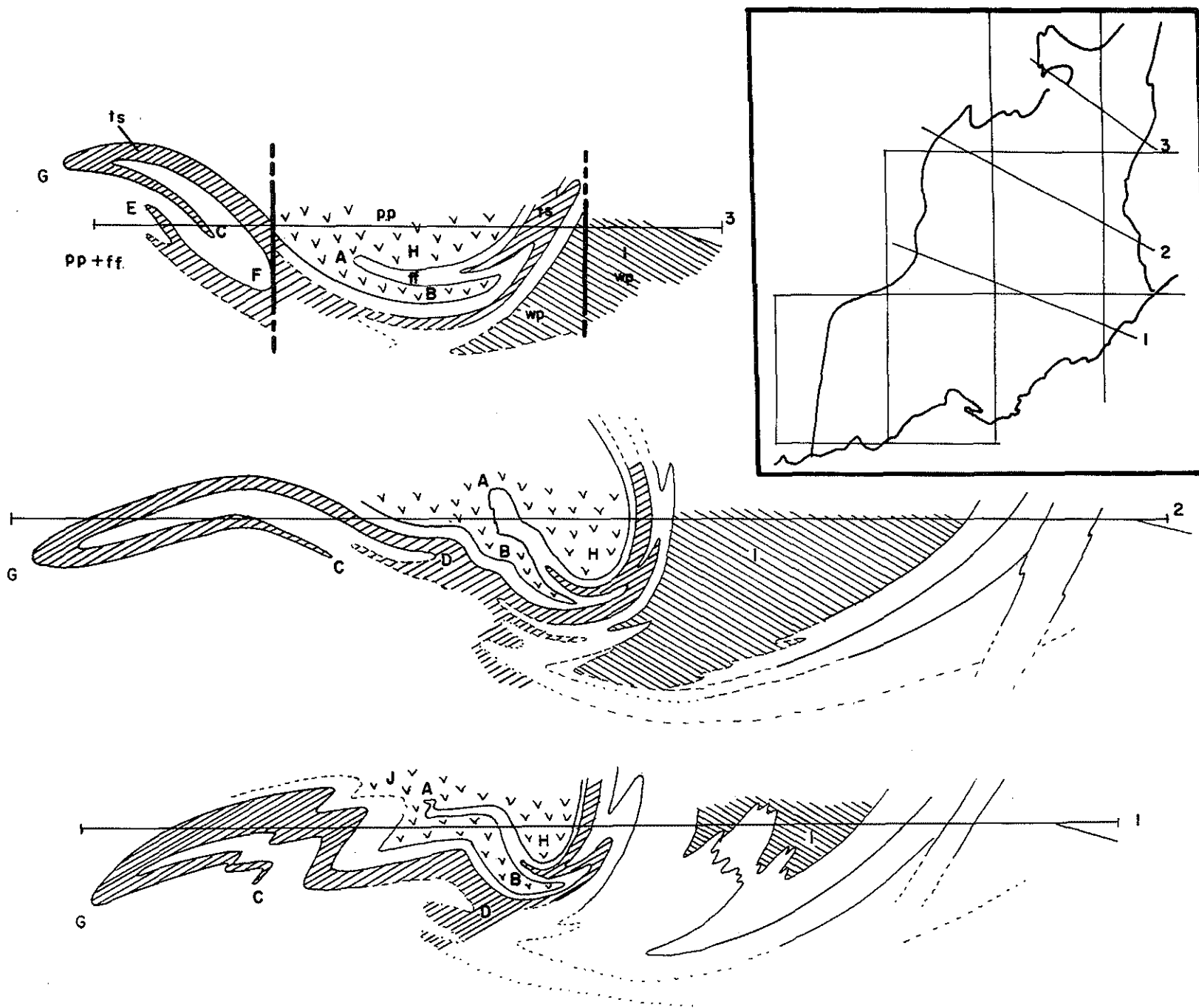

Fig. 4. Geologic cross-sections of the southeastern belt.

Syncline and folds the Ox Hill Anticline and the Fairfield Syncline.

East of the Bridgeport Synform the three inverted F_1 major folds apparently are folded back to the surface (see figure 4). The map pattern here is suggestive of F_1 folding but the detail is insufficient to determine fully the geometry of these folds. The stratigraphic symmetry across the Wepawaug Schist marks the Wepawaug Syncline, "T".

REGIONAL TECTONIC HISTORY

Deformational Stages

A series of four deformational stages corresponding to the deformations that produced the four primary fold systems are inferred to have affected the southeastern belt. The first three stages are of greatest interest because these deformations produced the major fold structures. The similarity of the styles of the F_1 , F_2 , and F_3 minor folds suggests that these folds developed under similar conditions. Furthermore, F_1 , F_2 , and F_3 fabrics associated with critical metamorphic minerals indicate that any given rock was at the same grade of metamorphism during the first three deformational stages. It is suggested therefore that the presently observed pattern of metamorphic isograds is the result of F_2 and F_3 folding of simple pattern of metamorphic isograds established prior to or during the first deformation.

The inferred development of the structure of the southeastern belt is illustrated in figure 5. The composite geologic cross-section in that figure shows the contact between The Straits Schist and the Fairfield Formation. The dashed line represents a schematic isograd.

Stage 1. During the first deformational stage, the large F_1 folds, the Fairfield Syncline, the Ox Hill Anticline, and the Beacon Falls Syncline were formed. These folds are designated "A", "B", and "C", respectively in figures 4 and 5. A fourth anticlinal fold, ("D" in figures 4 and 5) is postulated above the Beacon Falls Syncline. The original trend of the F_1 fold axes is difficult to determine and over an area as large as the southeastern belt was probably somewhat variable. If the folds were initially recumbent as shown in figure 5, the original trend of the F_1 fold axes was probably north or north-northwest.

Stage 2. After the first deformational stage the overall configurations of the central and southeastern belt were probably quite similar. The events of the second deformational stage were most responsible for establishing the differences in the present structure of these areas. The second stage marks a general uplift or doming of the older, higher grade rocks to the west, accompanied by a relative downdropping and compression of the younger rocks to the east. It is inferred that the southeastern belt corresponds to the down-dropped area, with the hinge between this and the domal area marked by the western boundary of the southeastern belt. The axis of the doming was north-northeast parallel to the F_2 folds that developed during this deformation.

The doming and uplift was asymmetric and directed to the east as indicated in figure 5 (b), (c). The effect of this asymmetry was to bring the high-grade rocks that were initially in the domal area above and eventually into the southeastern belt to form the Bridgeport Synform.

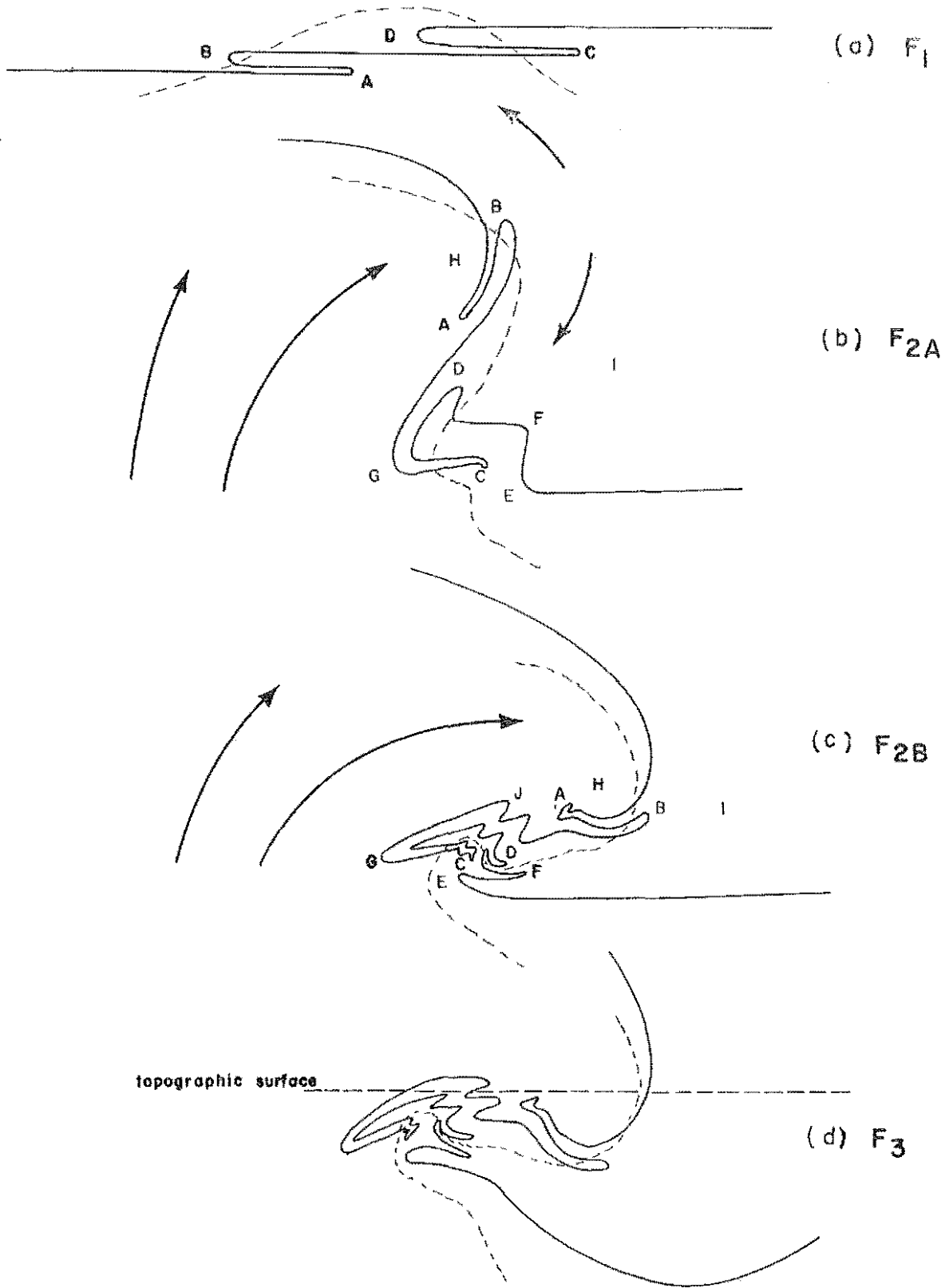

Fig. 5. Evolution of the structure of the southeastern belt. The solid line represents the contact between The Straits Schist and the Fairfield Formation. The dashed line is a schematic isograd.

It is suggested that the deformation in the domal area at this time consisted mainly of extension parallel to the layering as indicated schematically in figure 5 (b). This interpretation, if correct, would explain the absence of the F_2 minor folds in the vicinity of the Bridgeport Synform, "H".

Early in the second deformational stage the three F_{2A} folds ("E", "F", and "G" in figures 4 and 5) formed along the hinge at the edge of the domal area. At the same time the low-grade rocks to the east were downdropped and compressed to form the Wepawaug Syncline ("I" in figure 5). The F_{2B} folds developed late in the second deformation stage as the domal rocks overrode the hinge area (figure 5, "J"). To the east, however, the Wepawaug Syncline continued to be compressed with only a single set of F_2 minor structures being developed.

Stage 3. The large-scale features of the third deformational stage are less pronounced than of the preceding deformations. During the third deformational stage the area was warped by large, open, north-south trending F_3 folds. These folds further deepened the Wepawaug Syncline and arched an area along the west edge of the southeastern belt as illustrated in figure 5 (d). As with the preceding deformations, the F_3 fabrics show that the metamorphism remained in the established patterns.

Stage 4. Regionally the fourth deformational stage is of little importance and seems to be represented only by the minor F_4 kink folds. The marked difference in the style of these folds is taken as an indication that the physical conditions at the time of the fourth deformational stage differed from the conditions during the first three deformational stages. The fabrics associated with the F_4 structure are also quite different. There is little evidence of recrystallization; the mineral grains are commonly strained and bent. The east-west trend of these folds suggests a north-south compression during the fourth deformation stage.

REFERENCES

- Burger, H.W., III, 1967, Stratigraphy and structure of the western part of the New Haven quadrangle, Connecticut: Connecticut Geol. and Nat. History Survey Rept. of Investigations 4, 15 p.
- Carr, M.H., 1960, The bedrock geology of the Naugatuck quadrangle: Connecticut Geol. and Nat. History Survey Quad. Rept. 9, 25 p.
- Crowley, W.P., 1967, Stratigraphic interpretation of metaigneous rocks in south-central Connecticut: bedrock geology of Long Hill and Bridgeport $7\frac{1}{2}'$ quadrangles, Connecticut: Ph.D. thesis, Yale University, 105 p.
- Dieterich, J.H., 1968, Sequence and mechanics of folding in the area of New Haven, Naugatuck, and Westport, Connecticut: Ph.D. thesis, Yale University, 153 p.

Fritts, C.E., 1962, Age and sequence of metasedimentary and metavolcanic formations northwest of New Haven, Connecticut: U.S. Geol. Survey Prof. Paper 450-D, p. D32-36.

-----, 1963a, Bedrock geology of the Mount Carmel quadrangle, Connecticut: U.S. Geol. Survey Quad. Map GQ-199.

-----, 1963b, Bedrock geology of the Southington quadrangle, Connecticut: U.S. Geol. Survey Geol. Quad. Map GQ-200.

-----, 1965a, Bedrock geology of the Ansonia quadrangle, Connecticut: U.S. Geol. Survey Geol. Quad. Map 6Q-426.

-----, 1965b, Bedrock geology of the Milford quadrangle, Connecticut: U.S. Geol. Survey Geol. Quad. Map GQ-427.

Gates, R.M., and Martin, C.W., 1967, The bedrock geology of the Waterbury quadrangle: Connecticut Geol. and Nat. History Survey Quad. Rept. 22, 36 p.

Rodgers, J., Gates, R.M., and Rosenfeld, J.L., 1959, Explanatory text for preliminary geological map of Connecticut, 1956: Connecticut Geol. and Nat. History Survey Bull. 84, 64 p.

Scholle, P., 1965 (unpublished senior essay, Yale University).

STOP DESCRIPTIONS

Stop 1. (20.24N-53.87E) Long roadcut on Route 69 opposite Lake Watrous, 0.9 miles north of intersection of Dillon Road and Route 69.

This stop is in the Wepawaug Schist on the east limb of the F_2 - F_3 Wepawaug Syncline (the Wepawaug Syncline is marked I in the geologic cross-sections of figures 5 and 6). The rocks are of the chlorite grade of metamorphism. Lenses of marble and granite (Woodbridge Granite) are found at the south end of the roadcut.

Evidence for three of the four primary minor fold systems that are found in the New Haven-Naugatuck-Westport area may be seen here. The dominant foliation is a closely spaced F_2 axial-plane crenulation cleavage. In the northern portion of this outcrop F_2 minor folds, associated with this cleavage, may be seen. Streak lineations at an angle to the F_2 fold axes are F_1 lineations parallel to F_1 fold axes. The F_1 folds are difficult to discern on the natural surfaces of the rock, but are easily seen in polished sections. Very prominently displayed here are the F_4 kink-bands which distort the F_2 foliation.

Stop 2. (16.34N-54.29E) Roadcut on eastbound entrance ramp of Connecticut Turnpike, interchange 42, at Campbell Avenue.

This muscovite-chlorite schist belongs to the Lower Member of the Derby Hill Formation (Savin Schist of Burger, 1967). As with stop 1, these rocks are at the chlorite grade of metamorphism and are on the east limb of the Wepawaug Syncline.

The dominant minor structures here are F_2 . The foliation is a crenulation cleavage parallel to the axial planes of F_2 minor folds. These F_2 structures largely obscure the older minor structures. However, there are a few folded F_1 minor folds that can be seen here. In this vicinity rather weakly developed F_3 and F_4 minor folds are sometimes found (e.g., roadcut on Blue Hill Road, 200 feet south of the railroad tracks, 0.6 mile south of here).

Stop 3. (15.35N-54.36E) Outcrop along shore of Long Island Sound adjacent to Ocean Beach Road, 200 feet east of intersection of Savin Avenue and Ocean Beach Road.

As with stop 2, these rocks are of the Lower Member of the Derby Hill Formation and have been metamorphosed to the chlorite grade. Between stops 2 and 3, the F_2 minor structures largely die out and the only evidence for the F_2 deformation here is the presence of scattered, very weak crenulations. The dominant minor structures are F_1 .

Stop 4. (16.45N-52.56E) Small roadcut on Lambert Road, 0.1 mile north of intersection of Tyler City Road and Lambert Road.

This small roadcut in the Wepawaug Schist (chlorite grade of metamorphism) is of interest because all of the four primary minor fold systems are found here or in the immediate vicinity. The most obvious of the minor structures are tight F_2 folds with an axial-plane crenulation cleavage. These F_2 folds largely obscure the older F_1 minor folds, which are generally discernable only in polished sections. However, the streak lineation here is parallel to the F_1 fold axes. Very weakly developed F_3 crenulation cleavage deforms the F_2 cleavage. Please do not

sample the F_3 cleavage; it is quite easily removed and there isn't much of it left. Somewhat questionable F_4 kink-bands are found here. More definite F_4 minor structures are found a short distance away on Tyler City Road, 400 feet west of the intersection with Lambert Road.

Stop 5. (15.07N-50.29E) Long roadcut on westbound entrance ramp to the Merritt Parkway, interchange 53.

Here, the thinly laminated quartzose muscovite schist and paragneiss of the Oronoque Member of the Derby Hill Formation are at the kyanite grade of metamorphism. This stop and stops 6 and 7 are located on the east limb of the Bridgeport Synform and on the west limb of the Wepawaug Syncline "H" and "I", respectively, in figures 4 and 5. The schistosity here is an F_1 axial-plane schistosity. On top of the outcrop minor F_1 similar folds are visible on the glacially polished surfaces. The crenulations are F_3 and the kink-bands are F_4 . In roadcuts on the Merritt Parkway one mile west of here, the F_3 minor structures are more pronounced and locally a coarse F_3 crenulation cleavage is developed.

Stop 6. (17.70N-51.03E) Roadcut on Route 110; 0.9 mile south of intersection of Route 8 and Route 110.

Here we see the Wepawaug Schist at the kyanite grade of metamorphism. As with stops 5 and 7, this stop is situated between the Wepawaug Syncline (to the east) and the Bridgeport Synform (to the west). The dominant minor structures are F_1 . The F_1 axial-plane schistosity is vertical. Axes of the F_1 folds, which may be seen from the top of the exposure, plunge down-dip. The very weak crenulations are believed to be F_2 .

Stop 7. (17.25N-50.96E) Long roadcut on Route 110; 0.7 mile south of intersection of Route 110 and Route 8.

These rocks have been metamorphosed to the kyanite grade and belong to the Lower Member of the Derby Hill Formation (seen at stops 2 and 3 in chlorite zone). The minor structures are F_1 , F_2 (?), and F_4 .

Stop 8. (13.79N-45.90E to 13.59N-45.77E) Series of roadcuts on the Merritt Parkway between the Morehouse Highway overpass and interchange 45.

With this series of roadcuts we begin in the Fairfield Formation on the northwest limb of the inverted F_1 Fairfield Syncline ("A" in figures 5 and 6) and cross into The Straits Schist in the core of this fold and then back into the Fairfield Formation on the southeast limb of the fold. Both contacts between the Fairfield Formation and The Straits Schist are marked here by massive amphibolite and quartzite at the top of the Fairfield Formation. Elsewhere, marble and calc-silicates are also found in the uppermost portion of the Fairfield Formation.

In this area the Fairfield Syncline is folded by a large recumbent F_{2B} fold. The axial-zone of this fold is exposed in this series of roadcuts. The schistosity in this area is in the axial plane of F_{2B} minor folds.

Stop 9. (13.42N-45.76E) Adjacent to Blackrock Turnpike, 0.2 mile southeast of interchange 44-45 of Merritt Parkway.

These recumbent minor folds in the Fairfield Formation are in the axial zone of the major F_{2B} recumbent fold seen at stop 8. These rocks were metamorphosed at the sillimanite grade.

Trip D-4

METAMORPHIC GEOLOGY OF THE COLLINSVILLE AREA

by

Rolfe S. Stanley
University of Vermont

INTRODUCTION

Purpose

Geological work in the southern portion of Massachusetts and the southeastern portion of western Connecticut since 1964 has uncovered a variety of information that requires a new interpretation of the stratigraphy and structure in the Collinsville quadrangle. It is the intent of this trip to study the geology of this area in the light of this new information and to relate the structure and stratigraphy to the geology of the region.

Acknowledgements

Support for the original work in the Collinsville quadrangle was provided by the Connecticut Geological and Natural History Survey. Subsequent work here and other areas to the north and south have been provided by a National Science Foundation Postdoctoral Fellowship and an institutional grant from the University of Vermont. Conferences with Robert Schnabel, Norman Hatch, Edward Simpson, William Crowley, James Dieterich, Leo Hall and many others of the Connecticut Geological and Natural History Survey and the United States Geological Survey have been extremely helpful.

Regional Setting

As shown in figure 1, the Collinsville and Bristol domes are located between the Berkshire Highlands to the west and the central Triassic basin to the east. The rocks in this area represent the western portion of the New England eugeosynclinal sequence and are characterized by metamorphosed derivatives of shale, graywacke, volcanics, and minor amounts of sandstone and carbonates of Cambrian and Ordovician age. Such regionally persistent formations as The Straits Schist and the Collinsville Formation underlie the eastern portion of the Collinsville quadrangle and can be traced northward to southern Massachusetts where they outcrop just west of the Goshen Schist of Emerson. The Hartland Group, which underlies the central and western portion of the quadrangle, is narrow in width from here to southern Massachusetts but widens to four times its width to the south in western Connecticut. Therefore, the area from Collinsville north provides an excellent opportunity to divide the Hartland into mappable units because the belt is narrow, outcrop is abundant and the compositional layering and foliation dip at steep angles to the west.

The rocks in the Collinsville area have been regionally metamorphosed to the kyanite grade in the southern portion of the quadrangle and the sillimanite grade in the northern part. The sillimanite isograds trends

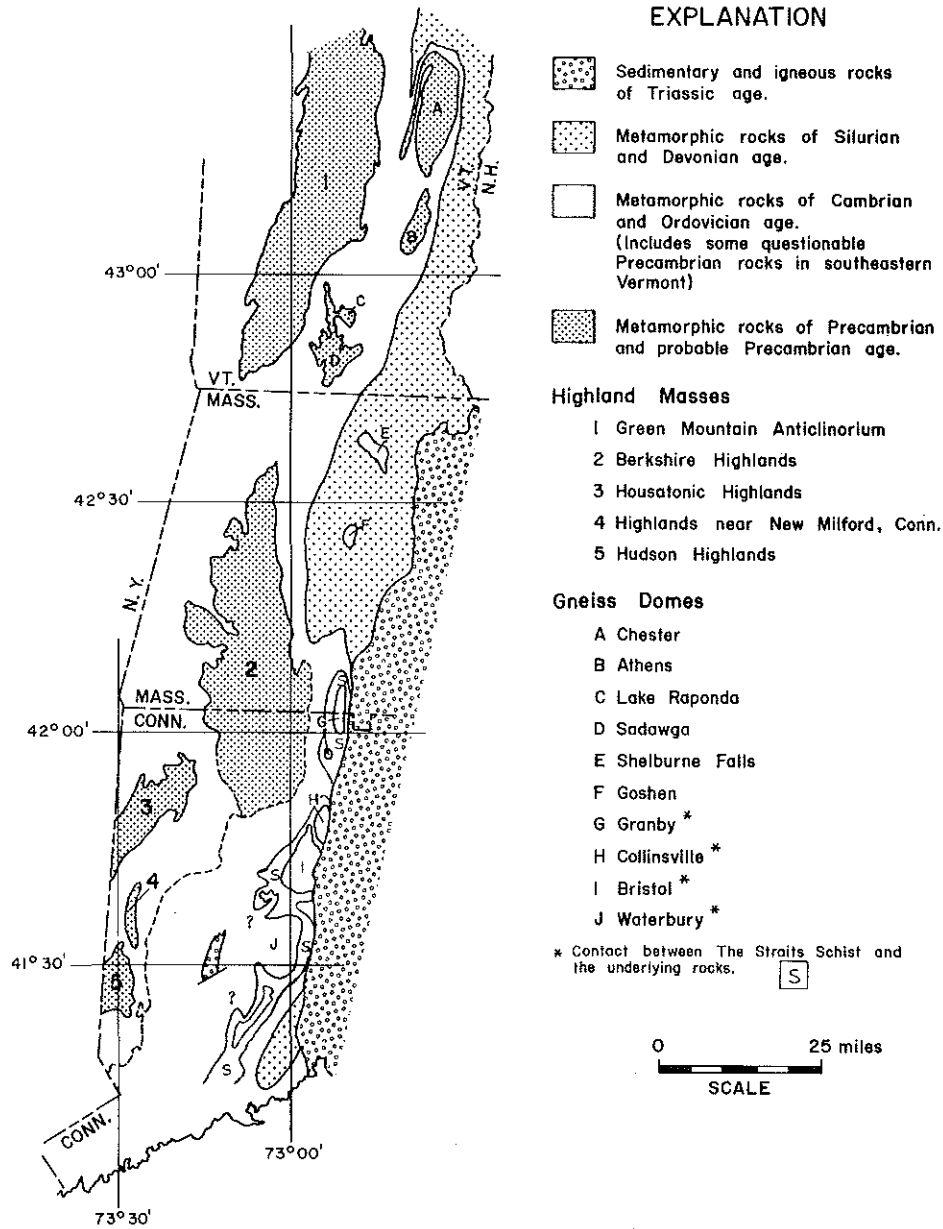

Fig. 1. Geologic Map of Southeastern Vermont, Western Massachusetts, and Western Connecticut

diagonally across the area in a northeastwardly direction.

Geology of the Collinsville Area

Since 1964, many new findings indicate that the stratigraphic column and structure must be modified in order to be incorporated into a regionally coherent framework. Although a unique interpretation that satisfies all the data is still not fully developed, several hypotheses can be suggested at this time which will require modification as current problems are resolved in the Hartland Group. One of the hypotheses represents a fresh approach, particularly in regard to the structure and stratigraphy in the eastern and western parts of the quadrangle. The remaining interpretation incorporates the structural configuration shown in plates 1 and 2 of Quadrangle Report 16 with some modification. Although I believe that recent data support the new interpretation, the other is still considered a possibility as we have much to learn about certain areas in western Connecticut during the next few years of geologic mapping.

Hypothesis I. As I pointed out in 1964, one of the main problems in Collinsville was the stratigraphic and structural relationship of the rocks in the northeastward-trending folds to those found in and around the domes. Three possibilities were suggested, but the hypothesis that placed the rocks of the northeastward-trending folds stratigraphically on top of The Straits Schist, seemed to explain the data most satisfactorily (Stanley, 1964, p. 9-15). Furthermore, I suggested that the major folds of the Hartland Group were created when the domes and the Berkshire Highlands moved upward thus causing the overlying material to slide into the intervening area. The shearing stress generated between the rising rocks and the overlying mantle produced the counterclockwise rotation sense of the Ratlum Mountain-Garrett Mountain fold system and the clockwise rotation sense of the Slashers Ledges-Nepaug fold system (Stanley, 1964, plates 1 and 2). Although I suggested that the stratigraphic units of the Hartland might be part of an older nappe system, the northeastward-trending folds themselves were a direct result of the emplacement of the domes and the Berkshire Highlands.

Recent mapping by Gonthier (1964) and Martin (personal communications) in the Torrington quadrangle and Gates and Christensen (1965) in the West Torrington quadrangle have shown that the upper member of the Rattlesnake Hill Formation (queried on the geologic map) on Jones and Yellow Mountain in the western part of the Collinsville quadrangle grades westward into the pin-striped granulite and schist of unit I of the Hartland which is lithically similar to the Whigville and Wildcat Members of the Taine Mountain Formation in the Bristol dome. The Waramaug Formation, which underlies a large portion of the western part of western Connecticut, is found directly west of Hartland I in both of these quadrangles and appears along with unit I to extend northward into the New Hartford and West Granville quadrangles of northern Connecticut (see geologic map of western Connecticut). The geologic sections shown on plates 1 and 2 (Stanley, 1964) can be modified to incorporate this information by having the Collinsville Formation, The Straits Schist and the lower member of the Rattlesnake Hill Formations pinch out at depth as they extend to the west.

Hypothesis II. Recent mapping in the southern part of Massachusetts and in the southern part of western Connecticut sheds considerable doubt on Hypothesis I. In southern Massachusetts rocks that are identical to the rocks in the northeastward-trending folds in the Collinsville area appear to be stratigraphically older, not younger, than the rocks found in the domes (Stanley, 1967, 1968). The Straits Schist has been traced northward to this area and is found between the rocks of the northeastward-trending folds to the west and the main part of the Goshen Schist and, hence, is presumably younger, not older, than the rocks of the Hartland Group in Collinsville. The mapping that has been completed in this area indicates that the rocks outside of the domes form a large east-facing nappe which is draped over the North Granby dome (fig. 2). In this interpretation The Straits Schist forms the trough of a synclinal nappe and the Collinsville Formation, which is considered to be equivalent, in part, to the Hawley Formation (Hatch, 1967), forms a portion of the anticlinal cores of two stacked nappes; the upper limb of the lower one forms the domes of western Connecticut. Furthermore, west of the North Granby dome the rocks, which are in part continuous with the rocks in the northeastward-trending folds, are stratigraphically older than the rocks in the domes of western Connecticut.

Recent work by Crowley (1968) and Dieterich (personal communications) in the southeastern part of western Connecticut have shown that east-facing nappes cored by rocks belonging in part to the Collinsville Formation dominate much of the geology. Thus, the new interpretation shown in figure 3 for the Collinsville quadrangle is compatible with the regional geology from Massachusetts to Long Island Sound.

The structure in the western part of the Collinsville quadrangle must be reinterpreted in light of the nappe hypothesis and detailed mapping to the north and south and reconnaissance in the western portion of the Hartland Formation. In the first hypothesis the rusty schist member of the Slashers Ledges Formation forms the trough of the complex synform separating the Ratlum Mountain-Garrett Mountain fold system to the east from the Slashers Ledges-Nepaug fold system to the west. Recent mapping by Gonthier (1964), Gates and Christensen (1965) and Martin (personal communications) in the Torrington and West Torrington quadrangles has shown that their unit I of the Hartland forms a continuous belt between the rocks on Jones and Yellow Mountain in the northwestern part of the Collinsville quadrangle and the Waramaug Formation further to the west along the southern and eastern side of the Berkshire Highlands. Inasmuch as unit I of the Hartland in the western part of the eugeosyncline belt is lithically similar to the Taine Mountain Formation of the Bristol and Waterbury domes, the two are considered stratigraphically equivalent and correlative to the Moretown Formation of Massachusetts. Reconnaissance along the western part of the eugeosynclinal belt south of Litchfield and detailed mapping in the Newtown quadrangle have shown that unit I of the Hartland and other units lithically similar to the Moretown extend as far south as Danbury. Because the Satan's Kingdom and Slashers Ledges formations are tentatively correlated to the Rowe Formation of Massachusetts, a major synform containing younger rocks of the Moretown Formation and perhaps even a portion of the Hawley Formation, must be present along the western part of the eugeosynclinal belt just east of Cameron's Line. Thus the stratigraphic evidence to the west and southwest of the Collinsville area warrants reinterpretation of the structure in the western part of the quadrangle.

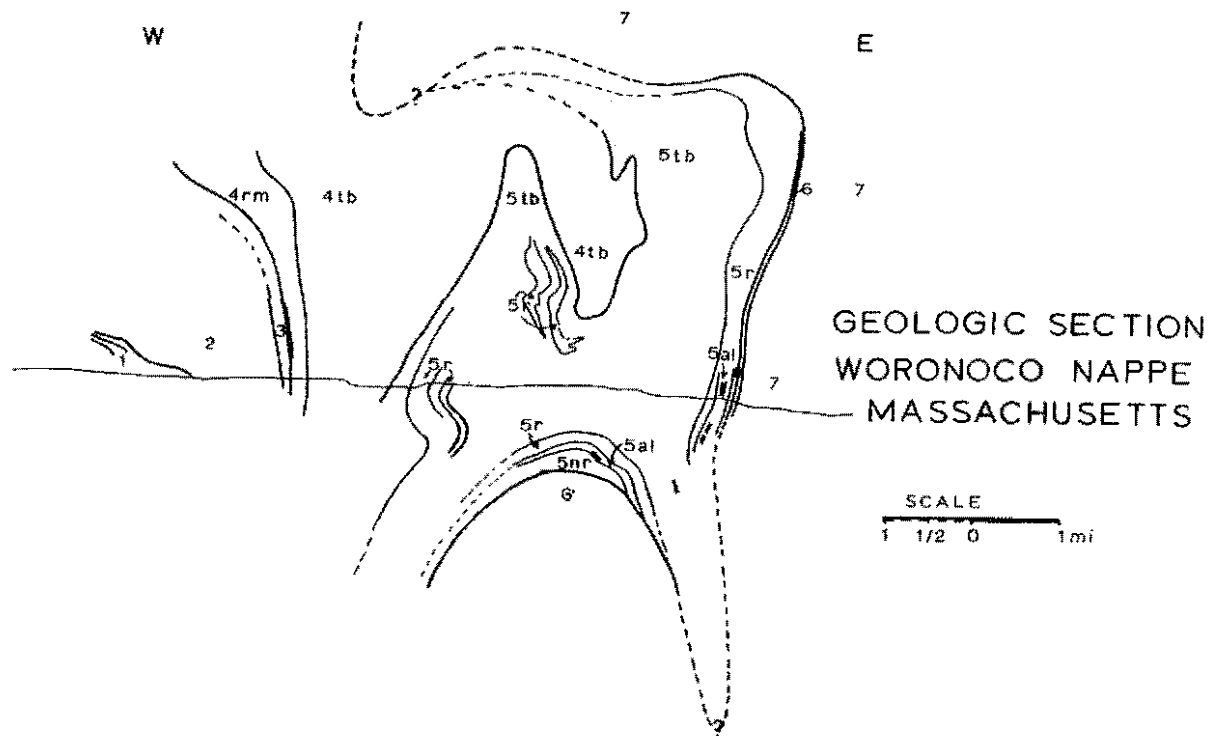

Fig. 2. Numbers refer to map units. Hoosac Formation? (1), Moretown Formation? (4), Hawley Formation? (5), The Straits Schist (6), Goshen Formation (7).

Table I.

Stratigraphic Column for the Collinsville Quadrangle

<u>1964 Version</u>		<u>East-facing Nappe Hypothesis 1968 Version</u>
Slashers Ledges Formation		The Straits Schist
rusty schist member		Collinsville Formation
kyanite schist member		lower member - Sweetheart Mountain Member
Satan's Kingdom Formation	Rattlesnake Hill Formation	upper member
Breezy Hill Member		
Ratlum Mountain Member		Bristol Member
Rattlesnake Hill Formation		*Taine Mountain Formation
upper member		Whigville Member
lower member		Scranton Mountain Member
The Straits Schist		Wildcat Member
The Collinsville Formation		Satan's Kingdom Formation
Sweetheart Mountain Member		Ratlum Mountain Member
Bristol Member		Breezy Hill Member
Taine Mountain Formation		Slashers Ledges Formation
Whigville Member		kyanite schist member
Scranton Mountain Member		rusty schist member
Wildcat Member		

* Unit I of the Hartland Formation (Gates and Christensen, 1965) is considered to be equivalent to the Taine Mountain Formation.

The cross section shown in figure 3 is revised from cross section A - A''' of QR 16. The complex, mushroom-shaped synform separating the two fold systems is reinterpreted here as a major antiform. The rocks to the west of this antiform are involved in a series of folds that enable the Moretown, and possibly younger units in southwestern Connecticut, to reappear between the stratigraphically older formations of the Slashers Ledges-Satan's Kingdom area in the Collinsville quadrangle and the Waramaug Formation in the Torrington quadrangle to the west. These folds are further complicated by a series of imbricated, pre-metamorphic thrusts. These thrusts have been postulated to explain the absence here of key stratigraphic units which are present in the folds of the Ratlum Mountain-Garrett Mountain fold system to the east. The thrust zone shown in figure 3 is interpreted as the northern extension of Cameron's Line and, hence, may well be part of the root zone for the Taconic allochthon of western Connecticut.

A revised stratigraphic column for the Collinsville quadrangle is shown in table 1.

Correlation

Based on the information discussed in the previous paragraphs, a number of the stratigraphic units in the Collinsville quadrangle can be tentatively correlated with units mapped in western Massachusetts (Hatch, 1967). The Straits Schist, the youngest formation in Collinsville according to the east-facing nappe hypothesis, would be physically equivalent to the black schist of the Hawley Formation and the lower part of the Goshen Formation of Massachusetts. The volcanic rocks of the Collinsville Formation are lithically similar and in the correct stratigraphic position to be equivalent to the Hawley Formation but possibly include some of the upper part of the Moretown as mapped in the Blandford and Woronoco quadrangles in southern Massachusetts. The Taine Mountain Formation is physically equivalent to the pin-striped granulite and schist of the Moretown Formation. Although correlation of the individual units in the Satan's Kingdom and Slashers Ledges formations is less clear, they are tentatively correlated with the Rowe Formation and perhaps a portion of the lower part of the Moretown Formation of Massachusetts. The Waramaug Formation in the Torrington and West Torrington quadrangles west of Collinsville appears to be equivalent to the Hoosac Formation to the north.

FIELD TRIP STOPS

Taine Mountain Traverse (34.ON - 55.5E)

Reference. QR 16.

Geologic Map - plate 1, southeastern portion of map west of Unionville, Connecticut.

Cross Section - plate 3.

Stratigraphic Description - pages 17-30.

Descriptions include the Taine Mountain Formation, the Collinsville Formation, and The Straits Schist.

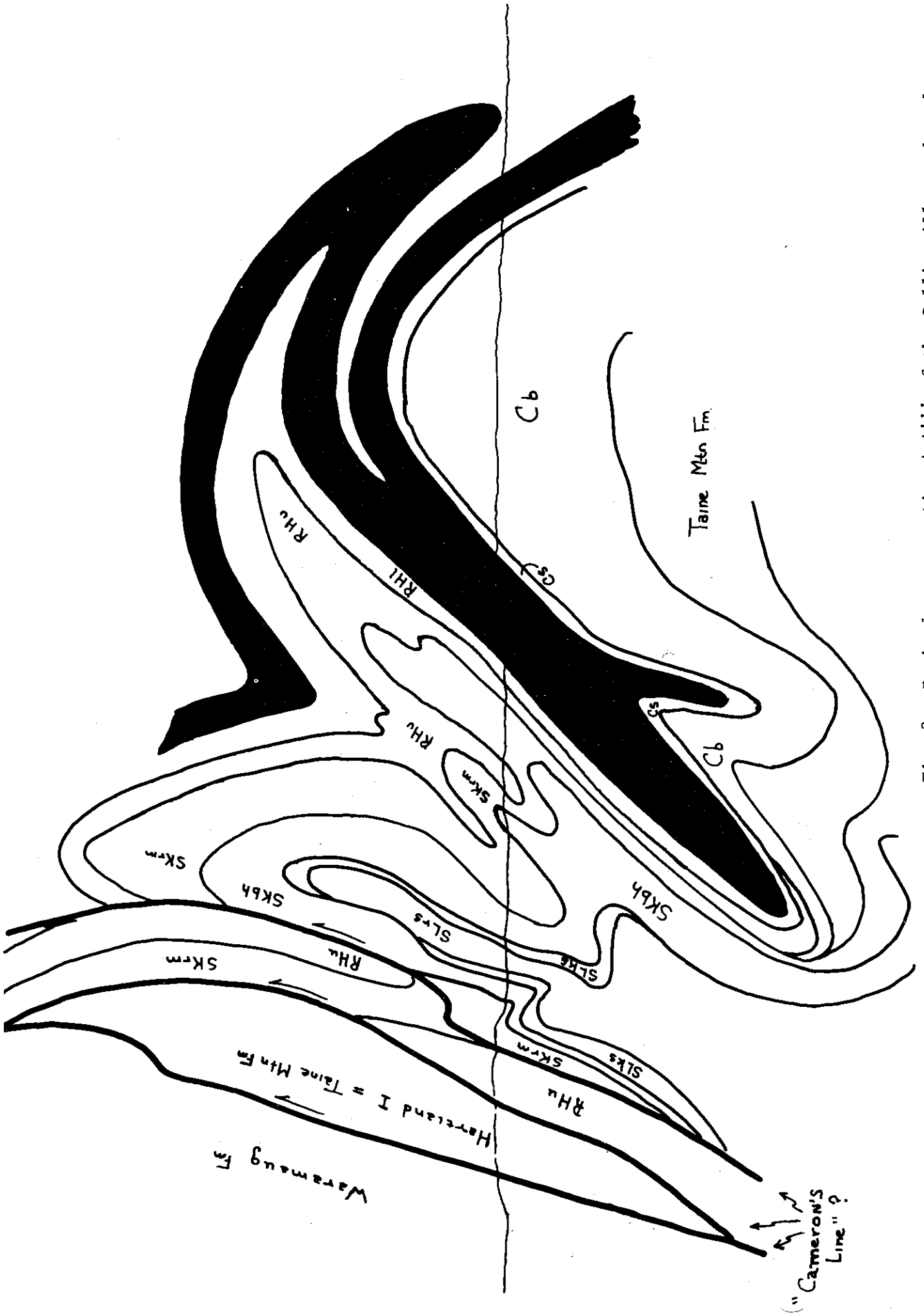

Fig. 3. Revised cross section A-A'' of the Collinsville quadrangle. Black is The Straits Schist, other symbols keyed to geologic map.

Mineral Assemblages - tables 1-7 appearing on pages 18, 19, 21, 22, 24, 28 and 30.

Structural Data - pages 69-76.

Description. Taine Mountain is unique in that five map units are exposed in a tight isoclinal synform whose axial surfaces are curved and dip at moderate angles to the southwest. The traverse will start in the Scranton Mountain Member of the Taine Mountain Formation southwest of Washington Turnpike and proceed northeastward across Taine Mountain to the outcrops of the Bristol Member of the Collinsville Formation located along the west bank of the Farmington River near Unionville, Connecticut. In so doing we will pass through a synform underlain by the Scranton Mountain Member, an antiform cored by the Wildcat Member of the Taine Mountain Formation and the isoclinal synform underlain by The Straits Schist which separates the Bristol from the Collinsville dome (fig. 4). As you will note on the geologic map, the Whigville Member, the highest unit of the Taine Mountain Formation, underlies only two small portions of the Bristol dome in the Collinsville quadrangle. One of these is located just north of our line of traverse. The rocks in this unit are identical to the Wildcat Member.

Minor Structures. Mineral lineation, mullions and a variety of fold styles can be observed along the proposed traverse. Of particular importance are the crenulate folds that are developed in the schists of the Sweetheart Mountain Member of the Collinsville Formation and The Straits Schist in the southern end of the isoclinal synform separating the two domes. In profile these folds vary in style from rather open crenulations to tight chevron folds with slip cleavage along the axial surface. As these structures are traced from the southern end of the synform towards the north, a new foliation develops from the slip cleavage associated with the crenulate folds south of Taine Mountain Road, and dominates the structure north of the road. The statistical parallelism of the axial surfaces of the crenulate folds with the calculated axial surface of the isoclinal synform indicates that they are contemporaneous and formed when the Bristol and Collinsville domes developed. In style and geometry the crenulate folds in the Collinsville quadrangle are identical to similar folds developed in the Woronoco and Blandford quadrangles where four generations of fold structures have been delineated (Stanley, 1968). The geometry of the folds south of Taine Mountain Road is shown in diagram B of figure 15 on page 75 of QR 16.

Sweetheart Mountain Traverse
(35.5N - 55.0E)

Reference. QR 16.

Geologic Map - plate 1, east side of the Nepaug Reservoir.

Cross Section - B-B¹¹¹, plate 2.

Stratigraphic Descriptions - pages 22-30.

Mineral Assemblages - tables 5, 6, and 7.

Structural Data - pages 71-76.

Description. Sweetheart Mountain is situated on the northward-plunging hinge of the Bristol dome and is underlain by the Collinsville Formation and The Straits Schist. The traverse will start at the base of Phelps

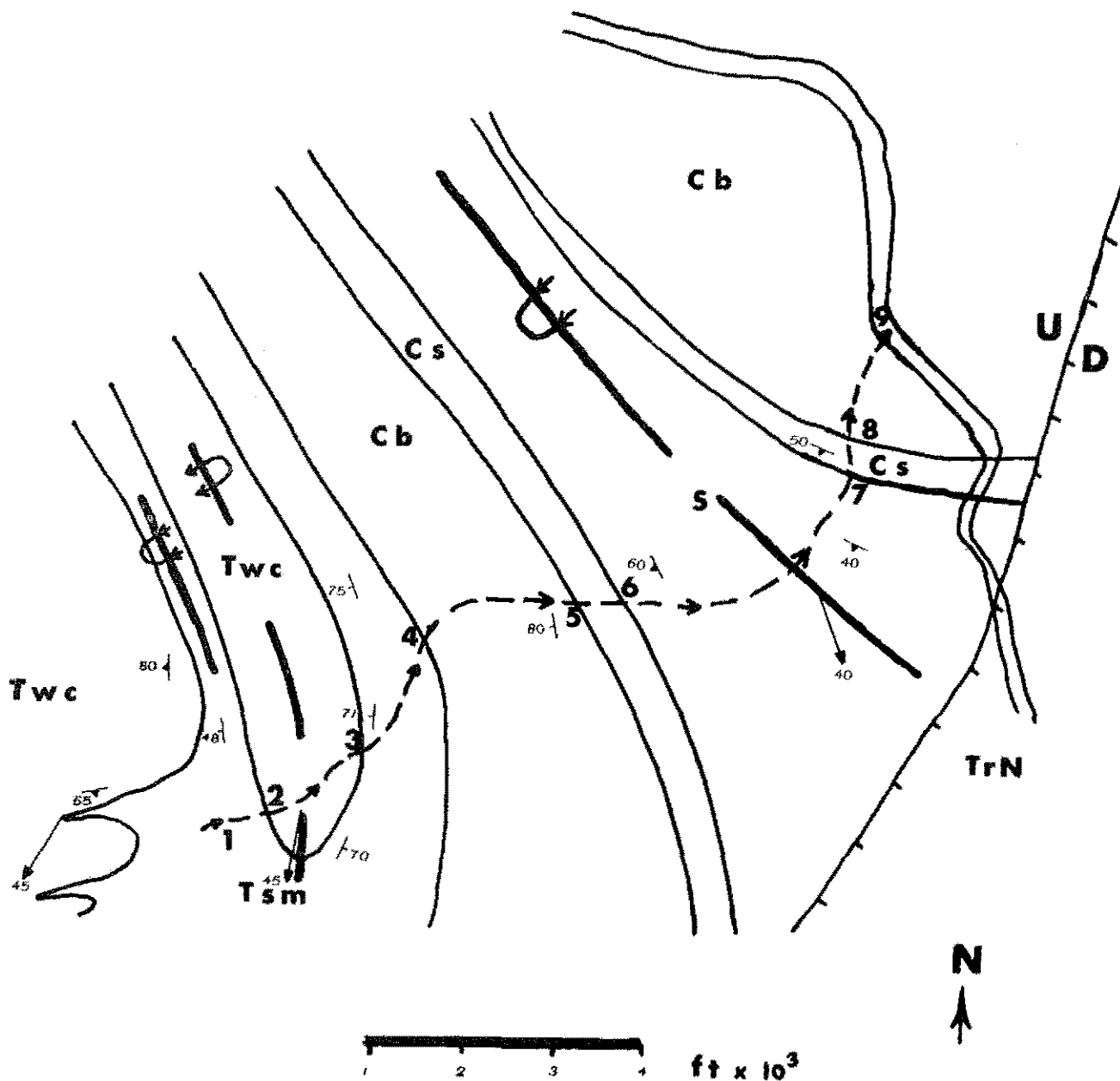

Fig. 4. Traverse map of the Taine Mountain area. Numbers refer to stop locations.

Dam near the intersection of Clear Brook Road and Ford Road on the west side of the isoclinal synform separating the two domes (fig. 5). Typical outcrops of The Straits Schist are located on either side of Ford Road. The contact between the Sweetheart Mountain Member and The Straits Schist is exposed on the north side of Clear Brook Road just west of the intersection with Ford Road. Here the contact is marked by amphibolite and crumbly, deeply-weathered rusty schist. Typical outcrops of the Sweetheart Mountain Member are found along the dirt road north of Phelps Dam and on the southern cliffs of Sweetheart Mountain. Although the contact between the Sweetheart Mountain Member and the Bristol Member is not exposed on the north banks of the Nepaug Reservoir, it can be estimated to within ten feet across strike. Here, the feldspathic binary mica schist typical of the Sweetheart Mountain Member grades into plagioclase gneiss and amphibolite of the Bristol Member. A bed of garnet quartz granulite which is characteristic of the upper part of the Bristol Member is found at several localities along this portion of the Nepaug Reservoir.

Minor Structures. A variety of minor structures are displayed throughout the Sweetheart Mountain area. In the schistose rocks, crenulate folds are well-developed and are characterized by northward-plunging axes and westward-dipping axial surfaces. These structures are identical in style to the crenulate folds south of Taine Mountain Road and are considered contemporaneous in age. In the rocks of the Bristol Member of the Collinsville Formation, folds of different ages, boudinage, and mineral lineation are well exposed. Joints, some of which are curved, and quartz-filled tension fractures are among a variety of brittle structures available for study. The orientation of a sample of these structures is shown by appropriate symbols on the geologic map (QR 16, plate 1).

Rattlesnake Hill Area
(37.0N - 55.5E)

Reference. QR 16.

Geologic Map Plate 1 - This area is located on the northern limb of the Collinsville dome, just west of East Hill along the Bahre-Johnson Road.

Cross Section - Section A-A''', plate 2.

Stratigraphic Description - pages 28-36.

Mineral Assemblages - tables 7, 8, 9.

Structural Data - See Geologic Map and diagram A of figure 15 on page 75.

Description. The western contact of The Straits Schist with the Rattlesnake Hill Formation is well-displayed in the pastures on the east and west side of Bahre-Johnson Road (fig. 6). Outcrops of The Straits Schist are found to the east of the brook whereas the outcrops of the lower member of the Rattlesnake Hill Formation are situated to the west. Between the brook and the road the calc-silicate gneiss and interbedded rusty schist are well-exposed and are typical of the western contact between The Straits Schist and the Rattlesnake Hill Formation north of the Nepaug Reservoir. South of the reservoir calc-silicate gneiss and

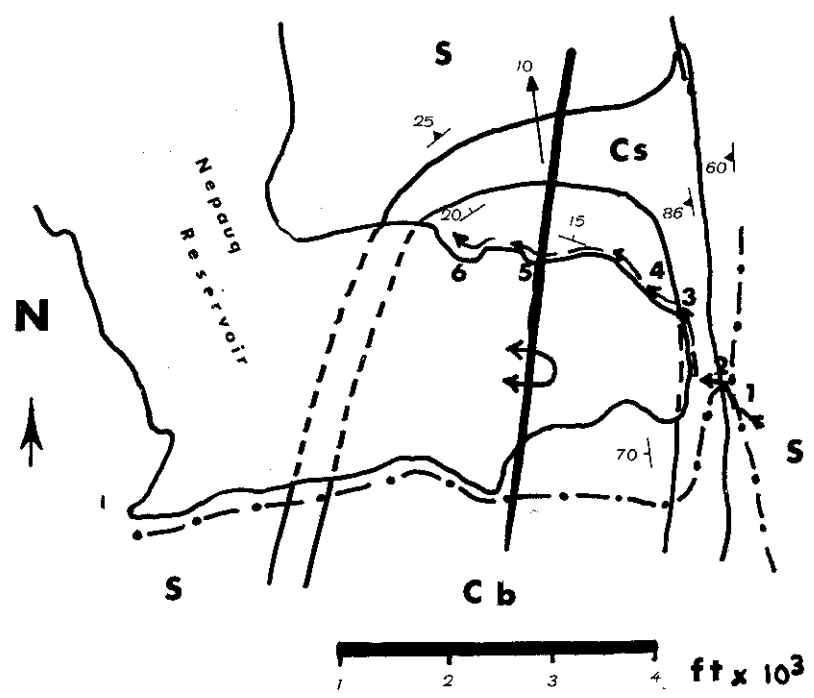

Fig. 5. Traverse map of the Sweetheart Mountain area. Numbers refer to stop locations.

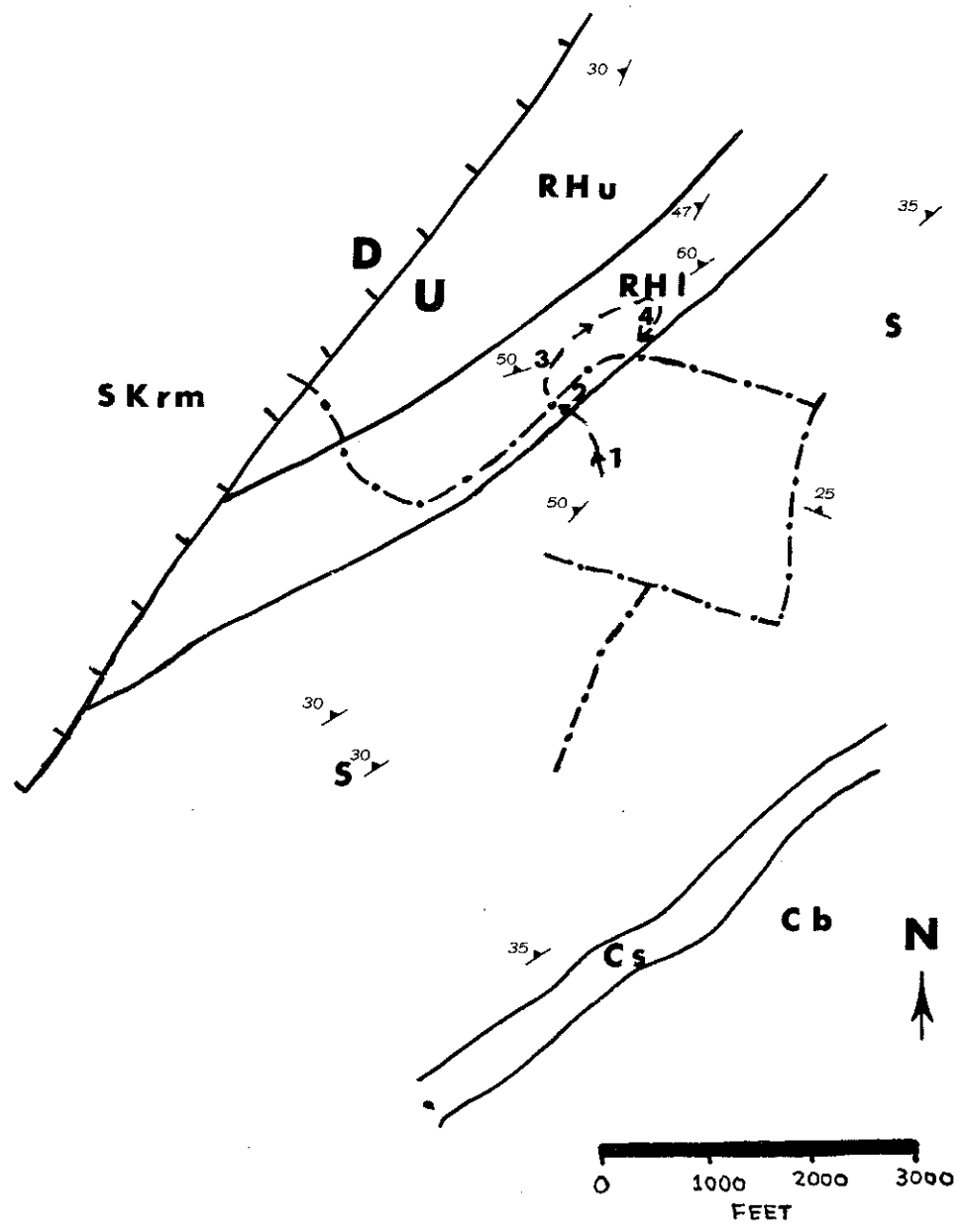

Fig. 6. Traverse map of the Rattlesnake Hill area. Numbers refer to stop locations.

associated rocks have not been found at this same horizon. West of the Bahre-Johnson Road outcrops of the kyanite-garnet-mica-plagioclase-quartz schist with beds of amphibolite are abundant and are typical of most of this map unit.

According to the revised hypothesis on the structure of the Collinsville quadrangle, the lower member of the Rattlesnake Hill Formation is physically equivalent, or a facies of, the Sweetheart Mountain Member of the Collinsville Formation. These two units are similar in the following respects:

(a) Both units are schist, rich in plagioclase and contain kyanite, garnet, muscovite, biotite, and quartz. Staurolite is an additional phase in the Sweetheart Mountain Member and has not as yet been observed in the lower member of the Rattlesnake Hill Formation.

(b) Both units contain beds of amphibolite.

(c) Both schists are somewhat similar in appearance with planar segregations of plagioclase and quartz.

These two units differ, however, in that the eastern portion of the Rattlesnake Hill Formation contains beds of calc-silicate gneiss, whereas similar rocks have not been found between the Sweetheart Mountain Member and The Straits Schist. In central Connecticut, however, Crowley (1968) and Dieterich (personal communications) have found beds of marble, calc-silicate and amphibolite at various localities along the contact between the Collinsville Formation and The Straits Schist. In several of these areas sulphides and other metallic minerals have been concentrated. In the Collinsville quadrangle a similar metalliferous deposit was discovered and mined sometime in the past on the south face of Rattlesnake Hill just north of Route 44 (see geologic map, plate 1). Furthermore, amphibolite is commonly present at the contact of the Sweetheart Mountain Member and The Straits Schist such as found in the outcrops at the junction of Clear Brook Road and Ford Road just east of Nepaug Reservoir. Therefore, the eastern and western contacts of The Straits Schist in the Collinsville area are in part similar to the southeastern part of western Connecticut where beds of amphibolite and calcareous rocks mark either side of The Straits Schist. In conclusion, the data suggest that the lower member of the Rattlesnake Hill Formation is physically equivalent to the Sweetheart Mountain Member of the Collinsville Formation.

Structural Implications. If the correlation suggested in the above paragraphs is accepted, then the outcrop belt of The Straits Schist in the Collinsville quadrangle can be considered an isoclinal synform which is deformed by the Bristol and Collinsville domes. The synform separating the Collinsville and Bristol dome is interpreted as a younger structure that has remolded the lower limb of the earlier isoclinal synform which now envelopes both domes. The upper limb which is here marked by the contact between The Straits Schist and the lower member of the Rattlesnake Hill Formation has apparently not been affected by this latter deformation.

Ratlum Mountain Traverse
(37.5N - 55.0E)

Reference. QR 16.

Geologic Map, plate 1 - The area is located northeast of the Farmington River.

Cross Section - A-A''', plate 1.

Stratigraphic Description - pages 33-40.

Mineral Assemblages - tables 9, 10, and 11.

Structural Data - pages 76-81.

Description. Throughout the Ratlum Mountain area it has been possible to divide a portion of the Hartland Group into three map units, two of which, the upper member of the Rattlesnake Hill Formation and the Ratlum Mountain Member of the Satan's Kingdom Formation are repeated several times across strike and, hence, outline the four major folds of the Ratlum Mountain - Garrett Mountain fold system. The traverse on Ratlum Mountain will cross the best documented antiform in the area. The contact between the two map units, the lithologic details of the Ratlum Mountain Member and a variety of minor structures will be studied in the course of the traverse (fig. 7). Asymmetrical folds with a well-developed axial surface foliation, mineral lineation, fold mullions, and boudinage are the most important and abundant minor structures in the Ratlum Mountain area.

Of interest is a zone of schist containing large porphyroblasts of plagioclase and a bed of amphibolite which have been traced throughout the Ratlum Mountain - Garrett Mountain fold system and conform fairly closely to the contact between the Rattlesnake Hill and Satan's Kingdom formations. Numerous outcrops of these two units are found throughout the Ratlum Mountain area and have been used as key beds within the Ratlum Mountain Member proper. The lens-like bodies of amphibolite are connected by a heavy dotted line on the geologic map (plate 1), and it is likely that they once were continuous. Evidence supporting this belief is found in several large outcrops where the amphibolite is present at the hinges of folds but is pinched off on the limbs. Furthermore, these amphibolite lenses appear to be confined to a rather restricted stratigraphic interval and, therefore, it is likely that they once formed a continuous layer which has subsequently been pulled apart during deformation.

Slashers Ledges - Satan's Kingdom Traverse
(37.0N - 54.0E)

Reference. QR 16.

Geologic Map, plate 1 - Located west of the Farmington River, north of the Nepaug Reservoir, south of Puddletown in the northwestern portion of the Geologic Map.

Cross Section - A-A''', plate 2.

Stratigraphic Descriptions - pages 36-41.

Mineral Assemblages - tables 10, 11, 12, and 13.

Structural Data - pages 81-84.

Description. The Slashers Ledges - Satan's Kingdom area is perhaps one of the most interesting areas in terms of structural geology and

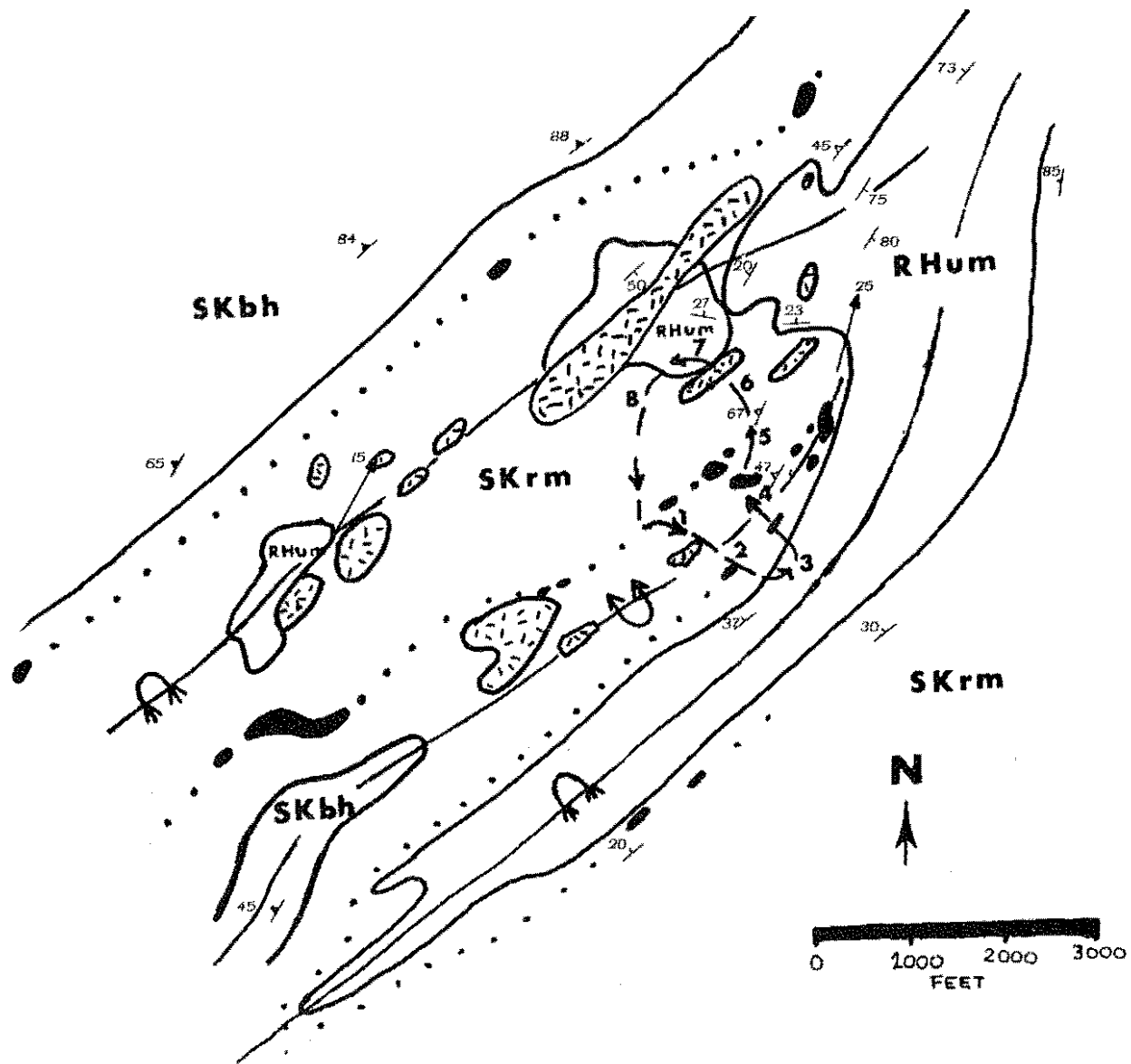

Fig. 7. Traverse map of the Ratlum Mountain area. Numbers refer to stop locations.

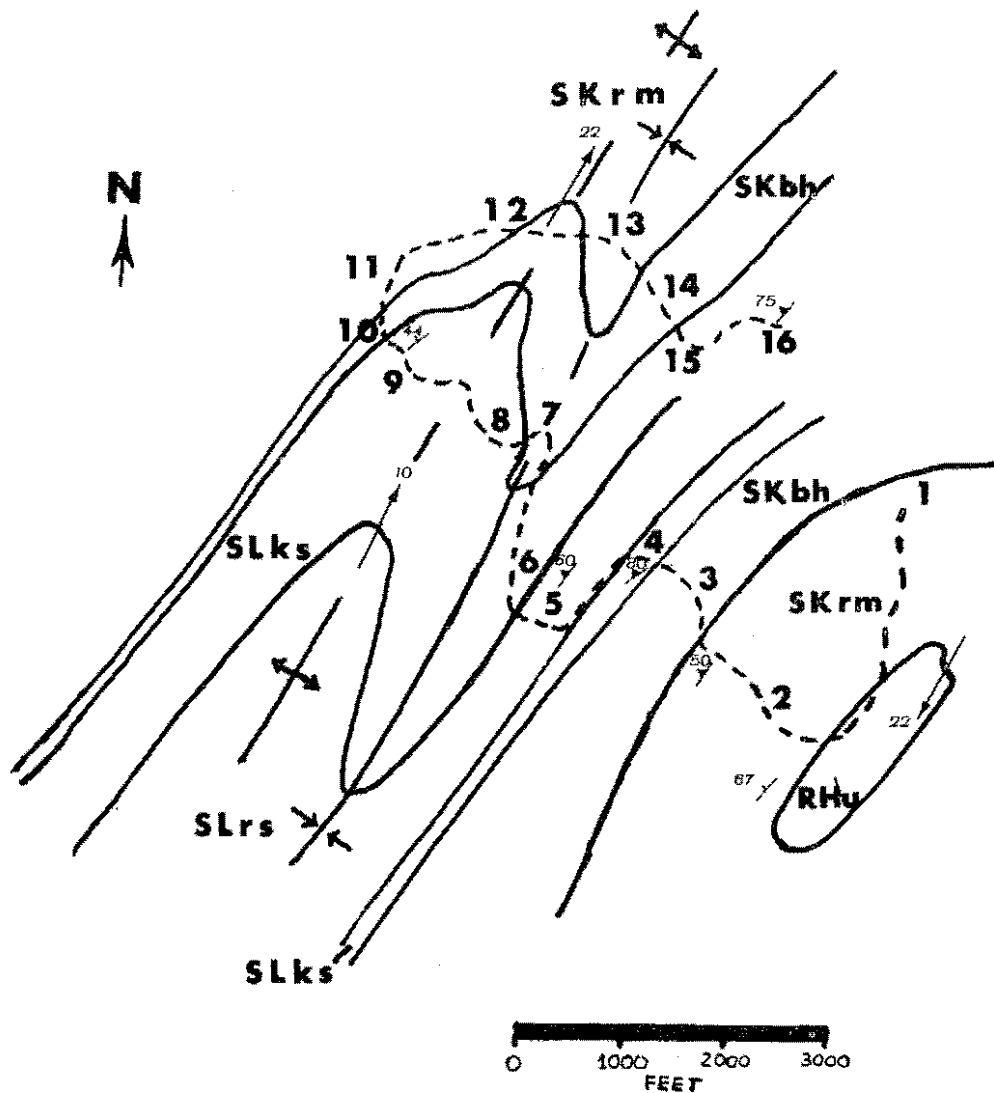

Fig. 8. Traverse map of the Slashers Ledge area. Numbers refer to stop locations.

metamorphic petrology. Both members of the Satan's Kingdom Formation and the Slashers Ledges Formation are well-exposed throughout the area and the traverse is designed to examine the various parts of these map units (fig. 8). The metamorphic stratigraphy in the area outlines a major antiform and synform and is sufficiently diverse in composition to establish the metamorphic facies for this portion of the quadrangle. Furthermore, the minor structures, particularly folds, are abundant and their relationship to the major structures can be shown clearly.

Several important rock types are found in the stratigraphic units and provide valuable key beds in such units as the Ratlum Mountain Member and the kyanite schist member of the Slashers Ledges Formation. For example, the amphibolite and porphyroblastic schist of the Ratlum Mountain Member are present in the Satan's Kingdom area and can be traced northward to Ratlum Mountain. In the kyanite schist member of the Slashers Ledges Formation a distinctive, foliated amphibolite can be traced from a location north of Atwood Swamp around the antiform and synform in Slashers Ledges and northward into the New Hartford quadrangle where it is found in numerous outcrops along Ratlum Brook. Near the contact between the kyanite schist and the rusty schist a serpentine, ranging in composition from a steatite to an epidote-pyroxene-hornblende gneiss, was found at nine localities throughout the Slashers Ledges area. Although the amphibolite in the kyanite schist and the serpentine in the rusty schist are shown as lenses on the geologic map, I believe that they were originally continuous, as they are restricted to a limited stratigraphic interval.

REFERENCES

- Crowley, William P., 1968, Bedrock geology of the Long Hill and Bridgeport quadrangles: Connecticut Geol. Nat. History Survey Quad. Rept. 24, 87 p.
- Gates, R. M., and Christensen, N. I., 1965, The bedrock geology of the West Torrington quadrangle: Connecticut Geol. Nat. Survey Quad. Rept. 17, 38 p.
- Gonthier, J. B., 1964, The bedrock geology of the northern half of the Torrington quadrangle, Connecticut: Unpublished M. S. thesis, University of Massachusetts, 95 p.
- Hatch, N. L., 1967, Redefinition of the Hawley and Goshen Schists in western Massachusetts: U. S. Geol. Survey Bull. 1254-D, p. 1-16.
- Stanley, R. S., 1964, The bedrock geology of the Collinsville quadrangle: Connecticut Geol. Nat. History Survey Quad. Rept. 16, 99 p.
- , 1967, Geometry and age relations of some minor folds and their relation to the Woronoco nappe, Blandford and Woronoco quadrangles, Massachusetts: Guidebook for the 59th New England Intercollegiate Geological Conference, p. 48-60.
- , 1968, Superposed folds associated with the Woronoco nappe, and North Granby domes, Blandford and Woronoco quadrangles, Massachusetts (abs): Geol. Soc. America Program 1968 Northeastern Section Meeting, p. 58.

Trip D-5

THE BEDROCK GEOLOGY OF THE WATERBURY AND THOMASTON QUADRANGLES

by

Robert M. Gates
University of Wisconsin

Charles W. Martin
Earlham College

Robert M. Cassie
State University of New York
College at Brockport

INTRODUCTION

The Waterbury gneiss dome is the southernmost of a series of gneiss domes extending from Chester, Vermont, to Waterbury along the eastern flank of the Green Mountain anticlinorium. Although not strictly a dome, since it is unroofed on its western side, it is mantled on the north, east, and south by a series of three conformable metasedimentary units traceable from the northern border of Connecticut almost to Long Island Sound. Igneous rocks ranging in composition from granitic to ultrabasic are erratically distributed throughout the quadrangle but do not constitute large plutons.

The Waterbury Formation is a metasedimentary gneiss complex that forms the core of the dome and will be seen at stops 1, 2, 3 and 4. The complexly folded metasediments are intermixed in migmatitic fashion with granitic to trondhjemitic rocks that are similar to the biotite-quartz-plagioclase granulitic gneiss of the complex and may merely be recrystallized or mobilized parts of the metasedimentary pile. The structural style of the metasediments and of the migmatitic gneisses clearly separates the core gneiss from the mantling rocks.

The rocks mantling the core constitute the Hartland Formation which has been divided into three distinctive lithologic units. The lowest, seen at stops 5 and 11, is called Unit I (= part of the Waterbury gneiss of Fritts, 1963; = Taine Mountain Formation, Stanley, 1964) and is predominantly a mica-plagioclase quartz granulite and granulitic gneiss. The second unit, seen at stops 6, 7 and 8, is the Hitchcock Lake Member (= Collinsville Formation, Bristol Member of Stanley, 1964; = Reynolds Bridge Formation, Cassie, 1965), a strikingly banded assemblage of quartzofeldspathic granulites and micaceous feldspar-quartz gneisses and schists. The third unit, The Straits Schist Member, is a lustrous medium- to coarse-grained muscovite-plagioclase-quartz schist containing porphyroblasts of garnet and kyanite, and is well displayed at Stop 10. Amphibolites are associated with all members of the Hartland Formation. These may be syntectonic intrusives, in part, and metavolcanics, in part. Discontinuous pods of amphibolite characterize the boundary between the Hitchcock Lake Member and The Straits Schist. This contact will be seen at stops 8, 12, and 16. At Stop 16, small lenses of calcite marble also occur locally at this contact, suggesting a metasedimentary origin for some of the amphibolites associated with these marbles.

In the vicinity of Reynolds Bridge, the position normally occupied by the Hitchcock Lake Member below The Straits is occupied by a large mass of texturally and compositionally heterogeneous quartz-oligoclase-microcline-biotite gneiss with locally abundant amphibolite layers. Small concordant

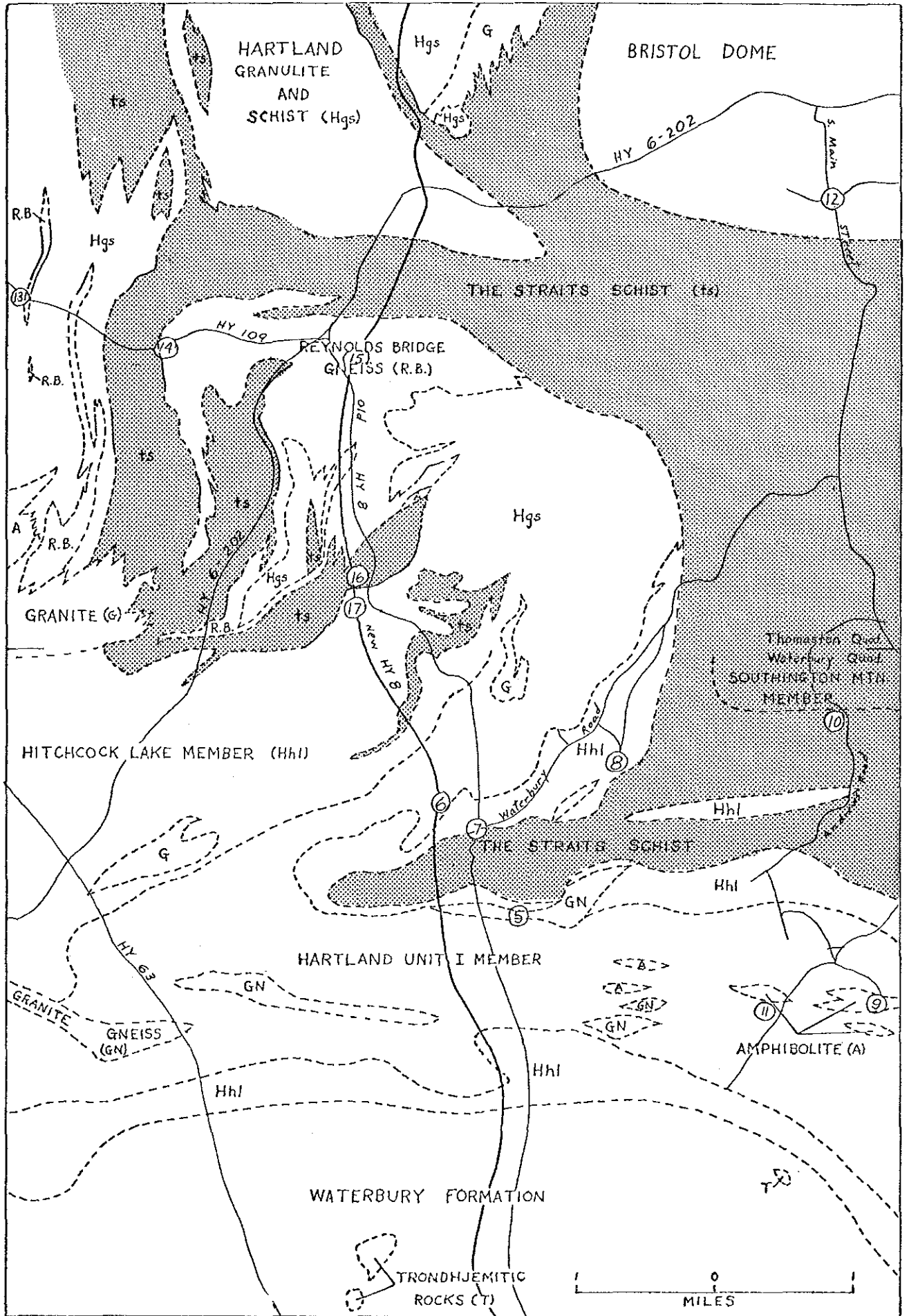

Fig. 1. Index map of the essential parts of the Waterbury Gneiss Dome and the Reynolds Bridge Gneiss.

Granite (G)

Reynolds Bridge Gneiss (R.B.)

Hartland Formation

Southington Mountain Member

The Straits Schist Member (TS)

Hitchcock Lake Member (Hh1)

Unit I Member

Unit I and Hitchcock Lake Member undivided (Hgs)

Amphibolites (A)

Granite gneiss (GN)

Waterbury Formation

(Paragneisses, migmatites, and granites)

Trondhjemite (T) (large masses only)

lenses of this granodioritic gneiss also occur elsewhere in the area, always within the Hitchcock Lake at or near the Straits contact and gradational into the Hitchcock Lake in some exposures. The gneiss, designated the Reynolds Bridge Formation, will be seen at its type locality (Stop 15) and its contact relationships with other rock units can be studied at stops 13, 14, 16 and 17. The Reynolds Bridge Gneiss is most abundant at the crest of a broad anticline which plunges 35° at N 80° W, a crossfold superimposed upon the previously isoclinally folded and foliated Hartland rocks. The development of abundant foliation crenulations and minor folds accompanied the formation of this and other broad superimposed folds in the region; this late tectonic activity occurred at or near the peak of regional metamorphism. The structural localization of the Reynolds Bridge Formation along the axial region of the crossfold, coupled with petrographic data, points to a metasomatic origin for these rocks. The introduction of potash-bearing fluids into the Hitchcock Lake appears to have followed dilatant fold hinge areas, particularly that of the broad anticlinal crossfold, and the contact with the overlying relatively impervious Straits Schist; this metasomatism may have accompanied the emplacement of the stock of Nonewaug Granite less than a mile to the southwest.

Granitic to granodioritic sills and dikes are common in the Hartland Formation, particularly in Unit I and in the Hitchcock Lake Member. Post-tectonic Nonewaug-type granite and pegmatite are common although rarely of mappable extent; one such dike will be seen at Stop 13. Pegmatites are most common in The Straits Schist.

Structurally, the Hartland Formation is an isoclinally folded series of metasediments which have been refolded late in their tectonic and metamorphic history (probably in Acadian time). The late refolding was controlled or influenced by the resistant, buttressing pre-Hartland crystalline Waterbury Formation or by rising, partially melted "domes" in the formation.

Stop 1 (25.25 N - 51.90 E; Waterbury quadrangle) West of new Highway 8, 2000 ft north of Naugatuck River Bridge. Outcrops extend over knob west of highway and north of power line.

Rock: Waterbury Formation. This area represents the many variations in the Waterbury Formation. The paragneisses are thick to thinly inter-layered (1) biotite streaked plagioclase-quartz granulitic gneiss, (2) kyanite bearing biotite-plagioclase quartz gneiss and schist, (3) quartz-plagioclase granulites, with large and small migmatitic streaks and pods of quartz and feldspar. (See Gates and Martin, 1967, Table 1 for modes of these rock types.) Several sill-like and dike-like masses of fine-grained gray trondhjemite are also present. The layering in this area is rather uniform compared to other places where intricate folding and convolutions are common.

Stop 2 (25.30 N - 50.72 E) Road cut on Country Club Road, east of Highway 63, and southeast of Johnson School.

Rock: A major portion of the road cut is small intrusive of trondhjemite in the paragneisses of the Waterbury Formation (fig. 2). The trondhjemite ranges from fine-grained to coarse-grained and from massive to gneissic. Fine-grained cognate inclusions of fine-grained trondhjemite are in the coarser grained varieties (fig. 3). See Gates and Martin



Fig. 2. Trondhjemite in Waterbury Formation paragneiss. 10" hammer shows scale. Location: north side of Highway 64, 500 ft east of intersection with Highway 63.

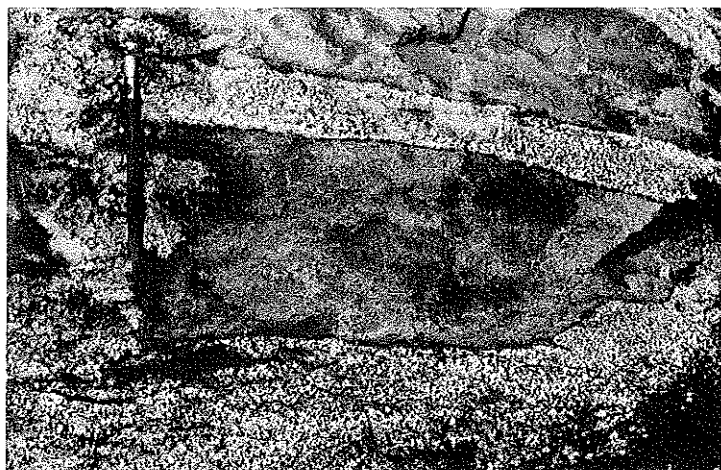

Fig. 3. Trondhjemite "inclusion" in granite. 6" pencil shows scale. Stop 2, 1000 ft east of Highway 63 on Country Club Road.

(1967, Table 2) for modes of trondhjemitic rock types.

Stop 3 (25.65 N - 50.67 E; Waterbury quadrangle) 500 feet south of Interstate 84 on Highway 63, west of highway.

This is an area where rocks excavated in the building of Interstate 84 were dumped. These are blocks representative of the road cuts in Highway 84 east and west of this point.

Rock: The rocks in this dump area are representative of essentially all of the rock types of the Waterbury Formation. Of particular interest are the many varieties of migmatites which clearly reflect the mineralogy and textures of the paragneisses (fig. 4 and Gates and Martin, 1967, fig. 3). These same rock types can be seen in the road cuts on Interstate 84 east and west of Highway 63 and on the east-bound access road from Highway 6A.

Stop 4 (26.00 N - 52.30 E; Waterbury quadrangle) Pine Hill, south of Interstate 84 east of Naugatuck River. This hill is recognized by numerous religious symbols on north side.

Rock: This is a type area for the Waterbury Formation. All of the various paragneisses, migmatites, granites, amphibolites, and trondhjemites of the Waterbury Formation can be seen on this hill.

Stop 5 (27.85 N - 51.70 E; Waterbury quadrangle) East of old Highway 8 near Chase Brass Factory.

Rock: The Straits Schist, Hitchcock Lake Member. Hartland Unit I, and granite gneiss. The south-facing cliff is The Straits Schist Member and the contact between it and the underlying Hitchcock Lake Member can be seen near the base. The Hitchcock Lake Member is very thin here as it is cut off by the granite gneiss which underlies the relatively flat area between the cliff and the knobs of Hartland Unit I a thousand feet south-east.

Stop 6 (28.25 N - 51.42 E; Waterbury quadrangle) 1000 to 1500 feet south of Frost Bridge Road underpass on new Highway 8.

Rock: Hitchcock Lake Member. In the road cuts on both sides of the highway are exposed the major rock types of the Hitchcock Lake Member. The two major rock types to observe here are (1) the hard, finely streaked mica-oligoclase granulite (fig. 5) and (2) coarsely streaked mica-oligoclase quartz gneiss (fig. 6). These two rock types are interlayered on a scale ranging from layers an inch thick to several feet. The small amplitude folding is readily apparent. (See Gates and Martin, 1967, Table 5 for modes of the principal rock types of the Hitchcock Lake Member.)

Stop 7 (28.20 N - 51.57 E; Waterbury quadrangle) Intersection of old Highway 8 and Waterbury Road one-half mile north of Chase Brass Factory.

Rock: South of intersection is The Straits Schist Member, north of intersection is the Hitchcock Lake Member and 1200 feet north is Hartland Unit I.

The heterogeneity of the Hitchcock Lake Member is well exposed in this road cut. Amphibolites, calc-silicates, and pegmatites are seen here as well as the granulite and gneiss seen at Stop 6.

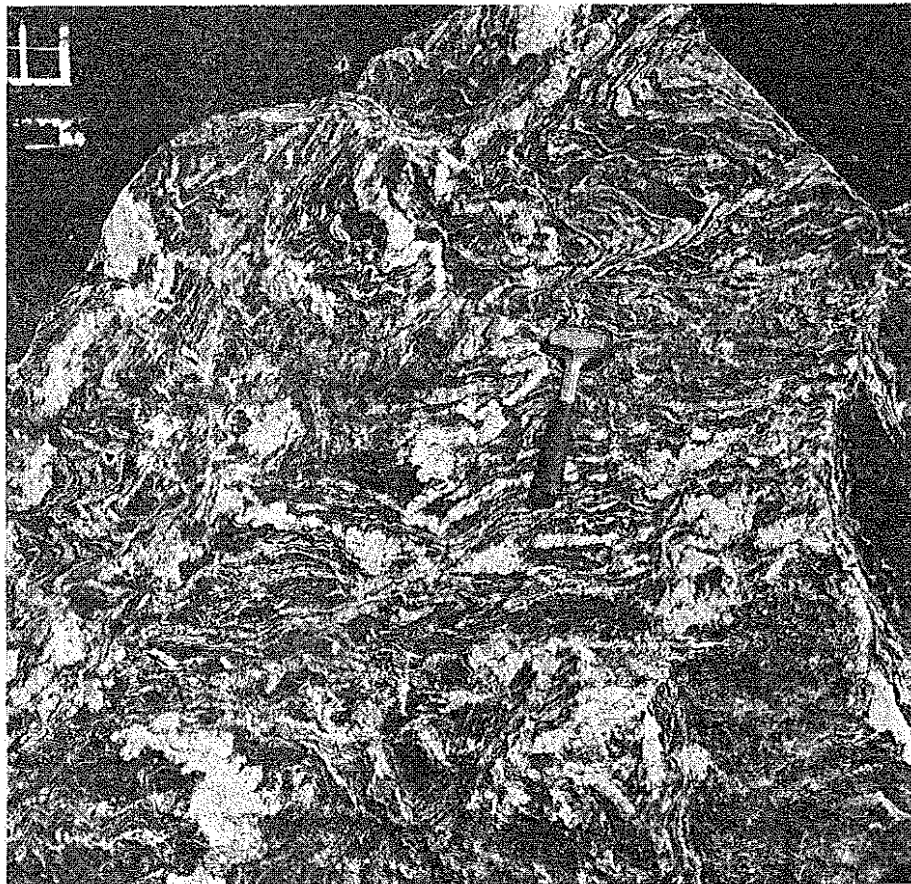

Fig. 4. Waterbury Formation migmatites of thinly layered kyanite-biotite-oligoclase-quartz paragneiss and microcline-quartz-plagioclase material from Interstate Highway 84 near Highway 63 interchange. Scale is shown by 10" hammer. Stop 3.

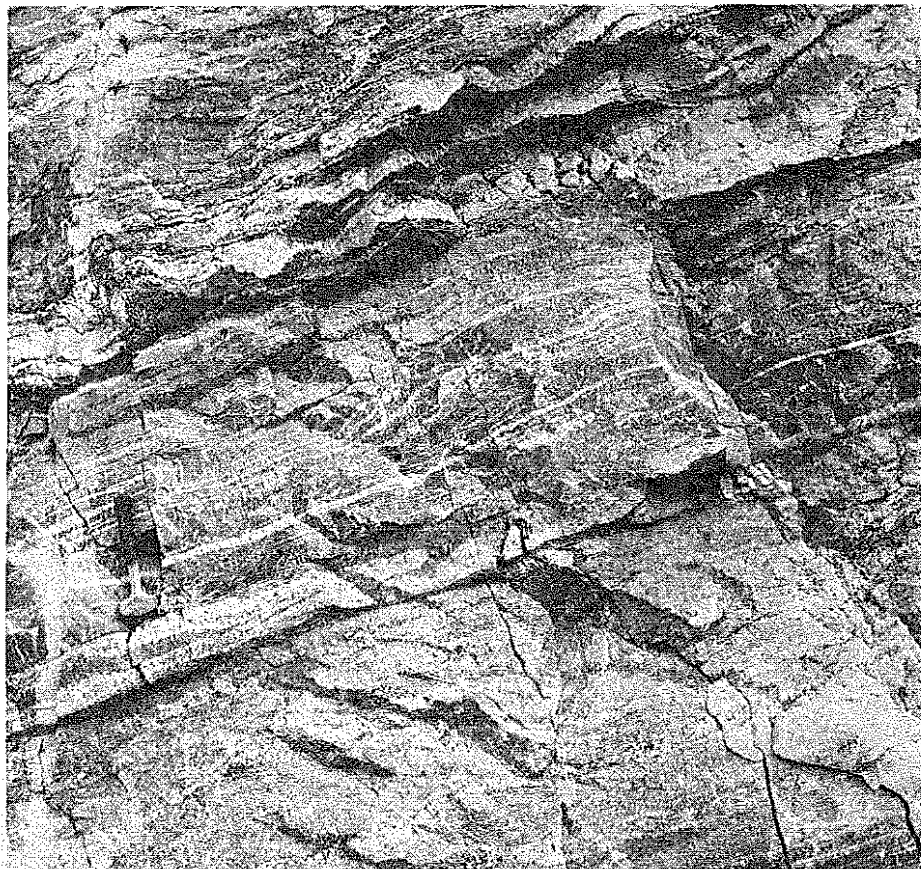

Fig. 5. Finely streaked, mica-oligoclase-quartz granulite of the Hitchcock Lake Member (Hartland Formation). Location: east side of new Highway 8 1/4 mile



Fig. 6. Coarsely streaked mica-oligoclase-quartz gneiss of the Hitchcock Lake Member (Hartland Formation). Scale is given by 6" pencil. Location: east side of new Highway 8, 1/4 mile south of Frost Bridge Road underpass. Stop 6.

Stop 8 (28.50 N - 52.45 E; Waterbury quadrangle) In the stream banks below the dam at the intersection of Greystone Road and the railroad bridge.

Rock: Thin layers of amphibolite are intercalated with the gneisses and granulites of the Hitchcock Lake Member. Amphibolitic rocks are found in discontinuous lenses and pods close to the contact between The Straits Schist and Hitchcock Lake Member.

Stop 9 (27.50 N - 53.11 E; Waterbury quadrangle) 750 feet south of an unnamed road 3000 feet southeast of Chestnut Hill Reservoir.

Rock: Amphibolite and garnet amphibolite. This rock type is characteristic of the amphibolites in the Hartland Unit I Member. The average mode of three garnet amphibolite samples collected near this stop is (in volume percent): 5.6 quartz; 12.2 plagioclase; 67.7 hornblende; 10.1 garnet; 1.6 sphene; 1.8 opaques; 0.9 other.

Stop 10 (28.60 N - 52.90 E; Waterbury quadrangle) Crest of hill on Andrews Road one-half mile south of northern boundary of Waterbury quadrangle.

Rock: The Straits Schist. The rocks in an east-west belt here are exceptionally graphitic. This is a variant of the more common lustrous schist. (See Gates and Martin, 1967, Table 6 for an average mode of The Straits Schist.)

Stop 11 (27.45 N - 52.70 E; Waterbury quadrangle) Intersection of Chestnut Hill Road and power line 3500 ft southwest of Chestnut Hill Reservoir.

Rock: Hartland Unit I. The gray muscovite-biotite-plagioclase-quartz granulite or granulitic gneiss typical of Hartland Unit I is seen in the south-facing cliff on the north side of the power line. In the small knobs 1000 ft northeast is a small body of amphibolite. (See Gates and Martin, 1967, Table 4 for modes of gneisses of Unit I of the Hartland Formation.)

Stop 12 (30.40 N - 52.93 E; Thomaston quadrangle) South of Terryville, intersection of South Main Street and Washington Road. Outcrops along South Main Street extend 1600 ft north from intersection.

Rock: Contact between The Straits Schist and Hitchcock Lake members of the Hartland Formation. Exposures on all four sides of the intersection are Straits Schist, and outcrops 400 ft northwest on the east side of South Main Street show two varieties of the Hitchcock Lake, the well-banded and slabby mica-quartz-oligoclase gneiss and the more schistose mica-oligoclase-quartz granulite. A small exposure of amphibolite, common at this contact, is present on the north side of Washington Road 400 ft east-northeast of the South Main Street intersection.

Stop 13 (30.28 N - 49.86 E; Thomaston quadrangle) North side of new Highway 109, 2200 ft west of Northfield Road intersection. Outcrops extend westward for 500 ft on north side of road.

Rock: Reynolds Bridge Gneiss, Hitchcock Lake Member, and Nonewaug Granite-Pegmatite. This exposure shows one of the "satellite" bodies of the Reynolds Bridge Gneiss which occur conformably within the Hitchcock Lake. The Hitchcock Lake here is a heterogeneous interlayered assemblage of mica-oligoclase-quartz gneiss and schist. A fifty-foot thick body of Nonewaug Granite-Pegmatite displays locally crosscutting contacts and

inclusions; these tabular bodies are generally sill-like overall, being elongate parallel to the country rock foliation in three dimensions.

Stop 14 (30.11 N - 50.36 E; Thomaston quadrangle) New Highway 109 at high voltage power line. Outcrops extend 2000 ft westward on north side of road. See Stop 6 of Trip B-4 for engineering aspects of this roadcut.

Rock: Reynolds Bridge Gneiss and Straits Schist Member. The conformable contact between the gneiss and schist is exposed at the east end of the road cut. The lustrous graphitic Straits here contains ubiquitous garnets and some staurolite and kyanite. The crenulations of the mica folia are typical of the belt of Straits Schist extending south from here.

Stop 15 (29.88 N - 51.05 E; Thomaston quadrangle) Reynolds Bridge Quarry and road cuts on Jackson Street at east end of bridge, new road cuts 200 ft west of bridge on new Highway 8.

Rock: This is the type locality for the Reynolds Bridge Gneiss. The considerable compositional and textural variation within the granitic gneiss is obvious. The composition average and range for 22 specimens of Reynolds Bridge Gneiss in volume percent is: quartz 32.2 (20-56); plagioclase 38.2 (22-51); microcline 16.1 (nil-48); biotite 10.0 (trace-26); muscovite 2.5 (nil-9); garnet tr. (nil-2). Interlayered amphibolitic material (fig. 7) is more abundant here than in the rest of the exposed gneiss mass. The spectacular and extremely attenuated flow folds exposed here have caused this road cut to be branded "obscene" by one scholar of the Connecticut eugeosyncline. Two small dikes of the massive medium-grained Thomaston Granite are exposed at this locality, one in the quarry and one in the road cut. The steep southeastward dip of the 22-foot-thick dike in the quarry parallels the attitude of one locally prominent joint system. The inclusions of Reynolds Bridge Gneiss and amphibolite exposed in the quarry dike are noteworthy.

Stop 16 (29.32 N - 50.97 E; Thomaston quadrangle) New Highway 8, 1.5 miles south of Reynolds Bridge. Extensive new road cuts on west side of highway.

Rock: Straits Schist, Reynolds Bridge Gneiss, marble. The road cut outcrops show The Straits Schist dipping under the Reynolds Bridge Gneiss. A discontinuous 3-foot bed of marble occurs at the contact here and can be seen at the same contact in a cliff 1800 ft due west of the north end of this road cut. That extensive cliff outcrop can be reached by following the old dirt road uphill from the south end of this road cut. In that cliff outcrop, The Straits Schist forms the top of the cliff and is underlain by the Reynolds Bridge Gneiss and amphibolite. The mixture of Reynolds Bridge Gneiss and amphibolite and Hitchcock Lake rocks separating the two Straits belts can be seen along the old road between the new road cut and the cliff to the west. Intense minor folding is readily apparent in the road cut outcrops.

Stop 17 (29.07 N - 51.00 E; Thomaston quadrangle) New Highway 8, 1.4 miles south of Reynolds Bridge. Extensive road cuts on the west side of the highway. See Stop 6 of Trip B-4 for engineering aspects of this cut.

Rock: Straits Schist, Reynolds Bridge Gneiss, Hitchcock Lake. A layer of Reynolds Bridge Gneiss 50 to 100 ft thick is exposed here in contact with and structurally below The Straits. The southern half of the road cut shows Hitchcock Lake rocks structurally below the gneiss and schist.

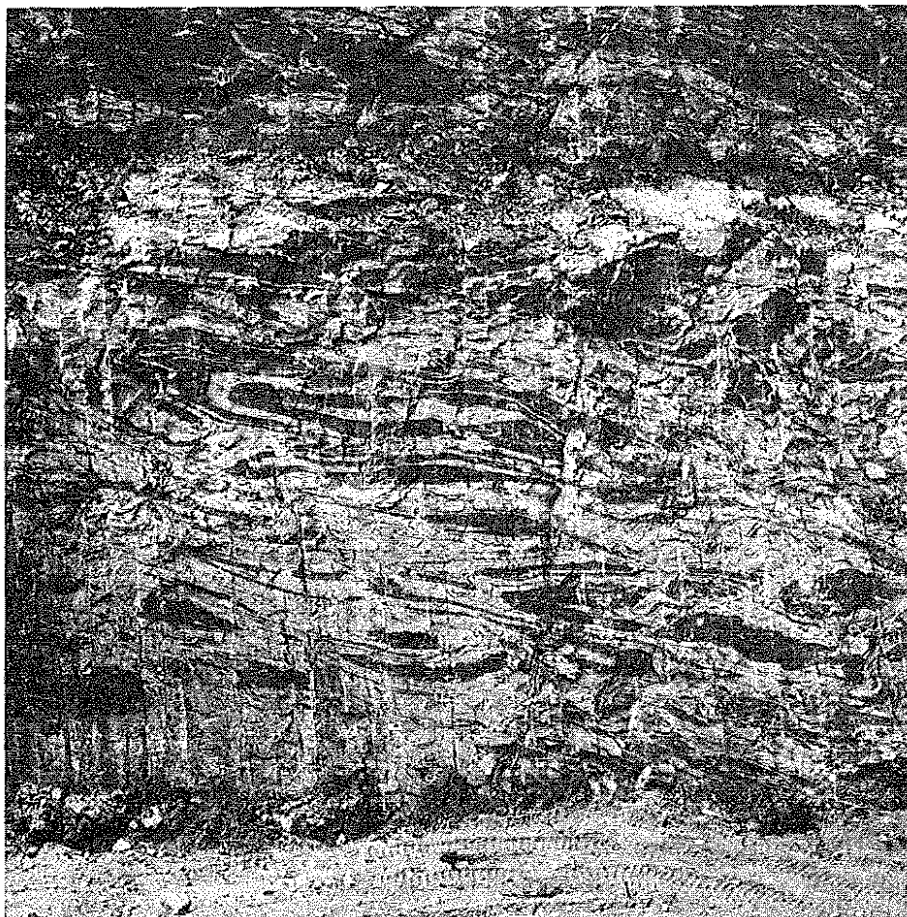

Fig. 7. Amphibolite in Reynolds Bridge Gneiss. Scale: approximately 40 ft from top to bottom. Location: west side of new Highway 8 at Reynolds Bridge. Stop 15.

REFERENCES

- Cassie, R. M., 1965, The evolution of a domal gneiss (granitic) and its relations to the geology of the Thomaston quadrangle, Connecticut: Unpub. Ph.D. dissertation, Univ. of Wisconsin, 109 p.
- Fritts, C. E., 1963, Bedrock geology of the Southington quadrangle, Connecticut: U. S. Geol. Survey Geol. Quad. Map GQ 200.
- Gates, R. M., and Martin, C. W., 1967, The bedrock geology of the Waterbury quadrangle: Connecticut Geol. Nat. History Survey Quad. Rept. 22, 36 p.
- Stanley, R. S., 1964, The bedrock geology of the Collinsville quadrangle: Connecticut Geol. Nat. History Survey Quad. Rept. 16, 99 p.

Trip D-6

GEOLOGY IN THE GLENVILLE AREA,
SOUTHWESTERNMOST CONNECTICUT AND SOUTHEASTERN NEW YORK

by

Leo M. Hall, University of Massachusetts

(Approved for publication by the Assistant Commissioner
for the New York State Museum and Science Service.)

INTRODUCTION

The three major bedrock groupings in the Glenville quadrangle (fig. 1 and table 1) are: 1) Precambrian Yonkers Gneiss - Fordham Gneiss; 2) Cambrian and Ordovician miogeosynclinal Lowerre Quartzite, Inwood Marble, Manhattan Schist; 3) probable Cambrian and Ordovician eugeosynclinal Hartland Formation - Harrison Gneiss. The stratigraphic relations between and within the Precambrian gneisses and the miogeosynclinal sequence are reasonably well understood (Hall, 1968) but the geologic relation of the Hartland Formation and Harrison Gneiss to these rocks is a major problem. At present, the three main working hypotheses related to this problem are:

(1) The Hartland Formation and Harrison Gneiss are successively younger rocks above member C of the Manhattan Schist and thus represent a transition upward from a miogeosynclinal to a eugeosynclinal environment.

(2) Members B and C of the Manhattan Schist (table 1) are Cambrian, and in thrust-fault contact with Manhattan A and rocks underlying it. Under this hypothesis the Hartland Formation and Harrison Gneiss are younger than Manhattan B and C and all of these make up an allochthonous unit of Cambrian and Ordovician eugeosynclinal facies equivalents of the miogeosynclinal Lowerre - Inwood - Manhattan A sequence. This possible eugeosynclinal allochthonous unit would have been thrust westward onto the miogeosynclinal rocks and thus may represent Taconic thrusting.

(3) A major fault separates the Hartland Formation and Harrison Gneiss from the Manhattan Schist and rocks underlying it. This possible fault may also represent Taconic thrusting.

The relative ages of the various subdivisions of the Hartland Formation and their regional correlation are problematical. It is very likely however, that these rocks are Cambrian and/or Ordovician and correlate with the eugeosynclinal sequence on the east side of the Berkshire Mountains in Massachusetts (Hatch and others, 1967). If this correlation is valid, there must be a major thrust fault, as hypothesized above, separating the Hartland Formation from part or all of the Manhattan Schist. Solution of these major stratigraphic and structural problems awaits further study through detailed field mapping.

Evidence for multiple deformation is clearly displayed by major and minor structural features in the Hartland Formation and Harrison Gneiss. The regional map pattern outlined by rock units within the Hartland Formation and the Harrison Gneiss in the Glenville area (fig. 1) is that of a later phase anticlinal fold that refolds an earlier isoclinal fold.

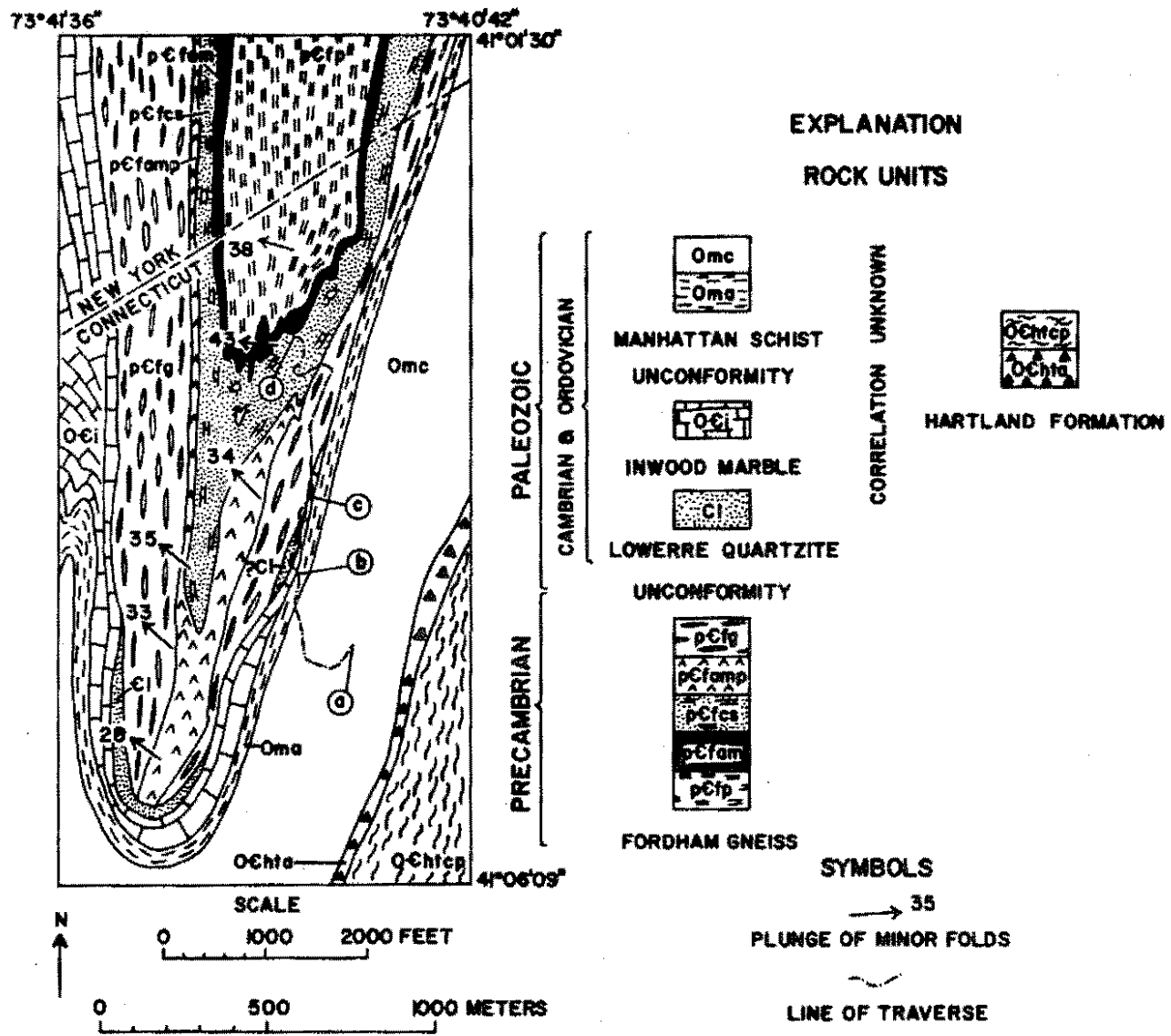

Fig. 1. Preliminary geologic map of the Glenville area.

STRATIGRAPHY OF THE GLENVILLE AREA

AGE	FORMATION	MEMBER	BRIEF DESCRIPTION	REGIONAL CORRELATION
UNCERTAIN	HARRISON		DARK GRAY BIOTITE AND/OR HORNBLLENDE-QUARTZ-FELDSPAR GNEISS WITH SUBORDINATE QUARTZ.	UNCERTAIN. HAWLEY FORMATION (CHIDESTER AND OTHERS, 1967)
UNCERTAIN	HARTLAND FORMATION	S	BROWN OR BROWNISH-TAN WEATHERING GARNET-MUSCOVITE-BIOTITE-QUARTZ-FELDSPAR SCHIST AND MUSCOVITE-BIOTITE-QUARTZ-FELDSPAR GNEISS AND GRANULITE. THE SCHIST COMMONLY CONTAINS SILLIMANITE AND/OR KYANITE.	UNCERTAIN. MORETOWN FORMATION (CHIDESTER AND OTHERS, 1967)
		W	LIGHT GRAY OR WHITE BIOCITE-MUSCOVITE GNEISS WITH LOCAL GARNET	UNCERTAIN
		CP	INTERBEDDED GRAY OR WHITE BIOTITE-MUSCOVITE-GNEISS, BROWN OR RUSTY WEATHERING GARNET-MUSCOVITE-BIOTITE SCHIST WITH LOCAL SILLIMANITE AND/OR KYANITE AND AMPHIBOLITE.	UNCERTAIN
		A	AMPHIBOLITE	UNCERTAIN
UNCERTAIN	MANHATTAN SCHIST	C	PREDOMINANTLY BROWN-WEATHERING FELDSPATHIC SILLIMANITE-GARNET-MUSCOVITE-BIOTITE SCHIST OR SCHISTOSE GNEISS; SILLIMANITE NODULES COMMON. ALTHOUGH SILICEOUS BEDS ARE PROMINENT IN SOME PLACES, BEDDING IS NOT COMMONLY CLEARLY DEFINED.	CORRELATION OF MEMBERS B AND C IS UNCERTAIN BUT THEY MAY BE EQUIVALENT TO THE WARAMAUG FORMATION (GATES AND BRADLEY, 1952), THE HOOSAC FORMATION (CHIDESTER AND OTHERS, 1967), AND LOWER CAMBRIAN AND CAMBRIAN (?) ROCKS OF THE TACONIC SEQUENCE (ZEN, 1967, FIG. 4).
		B	A DISCONTINUOUS UNIT OF AMPHIBOLITE AND MINOR SCHIST; ALTHOUGH THIS UNIT IS COMMONLY AT THE BASE OF MEMBER C, THERE ARE MANY PLACES WHERE IT IS WITHIN MEMBER C.	
MIDDLE ORDOVICIAN		A	GRAY OR DARK GRAY FISSILE SILLIMANITE-GARNET-MUSCOVITE BIOTITE SCHIST WITH INTERBEDDED CALCITE MARBLE LOCALLY AT THE BASE.	BALMVILLE (FISHER, 1962) AND WALLCOMSAC (ZEN AND HARTSHORN, 1966).
			UNCONFORMITY	
LOWER ORDOVICIAN	MARBLE	E	GRAY OR WHITE CALCITE MARBLE, COMMONLY TAN WEATHERING	COPAKE LIMESTONE AND ROCHDALE LIMESTONE (KNOPF, 1962).
		D	INTERBEDDED DOLOMITE MARBLE, CALCITE MARBLE AND SOME CALC-SCHIST.	ROCHDALE LIMESTONE AND HALCYON LAKE FORMATION (KNOPF, 1962).
CAMBRIAN	INWOOD	C	WHITE OR BLUE-GRAY CLEAN DOLOMITE MARBLE.	BRIARCLIFF DOLOMITE (KNOPF, 1962).
		B	INTERBEDDED WHITE, GRAY, BUFF, OR PINKISH DOLOMITE MARBLE, TAN AND REDDISH BROWN CALC-SCHIST, PURPLISH-BROWN OR TAN SILICEOUS CALC-SCHIST AND GRANULITES, TAN QUARTZITE, AND CALCITE-DOLOMITE MARBLE; BEDDING ONE HALF INCH TO FOUR FEET THICK IS PRONOUNCED.	PINE PLAINS FORMATION (KNOPF, 1962).
		A	WELL BEDDED WHITE, GRAY, OR BLUE-GRAY DOLOMITE MARBLE.	STISSING DOLOMITE (KNOPF, 1962).
	LOCERE QUARTZITE		TAN OR BUFF-WEATHERING FELDSPATHIC QUARTZITE AND GRANULITE, MICAREOUS QUARTZITE AND GLASSY QUARTZITE; DARK GRAY, BROWNISH AND LOCALLY RUSTY-WEATHERING GRANULITE AND SCHIST THAT COMMONLY CONTAIN SILLIMANITE ARE LOCALLY PRESENT AT THE BASE.	POUGHQUAC QUARTZITE (KNOPF, 1962).
			UNCONFORMITY	
PRECAMBRIAN	FORDHAM GNEISS	G	INTERBEDDED GRAY GARNET-BIOTITE GNEISS, GRAY BIOTITE-HORNBLLENDE GNEISS AND AMPHIBOLITE.	UNKNOWN.
		AMP	PREDOMINANTLY AMPHIBOLITE WITH SOME GRAY BIOTITE-QUARTZ-FELDSPAR GNEISS.	UNKNOWN.
		CS	LIGHT-GRAY, BROWN, WHITE, OR GREENISH CALC-SILICATE ROCK.	UNKNOWN.
		AM	AMPHIBOLITE.	UNKNOWN.
		P	PINKISH BIOTITE-QUARTZ-FELDSPAR GNEISS.	UNKNOWN.

Table 1. Stratigraphy in the Glenville area.

The early isoclinal fold is defined by the schist and granulite member (O6hts) of the Hartland Formation where it appears on the east and west sides of the Harrison Gneiss in the south central portion and in the southeast portion of the Glenville area (fig. 1). The nose of the early phase isoclinal fold should be exposed south of the Glenville area. The later phase anticline plunges slightly west of north and is particularly well displayed by the Hartland - Harrison contact in the community of Glenville in the south central portion of the area (fig. 1). Refolded minor folds and folded lineation are evidence of multiple deformation at the local outcrop scale. Results of multiple deformation are also abundant in the Precambrian Gneisses and the miogeosynclinal sequence.

The intent of this trip is to illustrate the stratigraphy and structure in the Glenville area as it is currently understood through work now in progress.

FIELD TRIP STOPS

Stop 1. (7.63N - 34.69E) Rock cut in the parking lot of the Grand Union Shopping Center in the community of Glenville.

This rock cut is at the crest of a major later phase anticline (fig. 1) and it exposes the Harrison Gneiss (table 1) as well as several pegmatites. The Harrison Gneiss may correlate with the Hawley Formation (Hatch and others, 1967) and the Beardsley member of the Prospect Formation (Crowley, 1968). At this locality the Harrison Gneiss consists of dark gray biotite-hornblende-feldspar gneiss with quartz generally subordinate, biotite amphibolite and layers or lenses of light gray biotite-quartz-feldspar gneiss. The dark gray quartz-biotite-hornblende gneiss is widespread in the Glenville area and is typical of the Harrison Gneiss. This type of gneiss commonly contains sphene that is megascopically noticeable. The pegmatites are predominantly pink and consist of biotite, quartz, and feldspar; some are bordered by white quartz-feldspar pegmatite. The pegmatites outline a pattern of folds and it is uncertain whether they have been deformed or intruded along folds in previously deformed country rock. Absence of definite secondary foliation in the pegmatites suggests they have not been folded.

The foliation here strikes within 10° of east-west and dips northerly in accord with the shape of the anticlinal crest. A prominent mineral lineation plunges northwesterly parallel to the axis of the anticline. Slickensides occur on many of the fractures and indicate essentially horizontal movement, however this movement has no known regional significance. Minor folds at the southeastern corner of the cut plunge gently S70°E and indicate a reverse drag sense. Small crinkle folds have axial planes parallel the axial planes of the larger minor folds and the mineral lineation is distorted by these minor folds. These relationships indicate that the minor folds are not associated with the major anticline but were developed in another phase of deformation.

Stop 2. (7.22N - 32.88E) A traverse (fig. 1), through the stratigraphic section, beginning 300 feet southeast of the All State office building north of Westchester Avenue in White Plains, New York and ending at the westbound exit ramp from the Hutchinson River Parkway onto route 119.

This traverse begins in member C of the Manhattan Schist exposed in the roadcuts on the Interstate Highway 87 exit ramp 300 feet southeast of the All State building. The rock here is gray garnet-biotite-muscovite schistose gneiss with locally abundant sillimanite and some coarse

plagioclase grains. Proceeding northerly along the rock cuts one finds other rock types typical of member C of the Manhattan. The most common of these are dark gray sillimanite-garnet-muscovite-biotite schist, gray feldspathic, garnet-muscovite-biotite schist and granulite, and brown weathering sillimanite-garnet-muscovite-biotite schist with local large white lenses and pods of sillimanite. Several pegmatites are present, some are boudinaged and some outline well developed folds.

Proceed north and then eastward under the bridge and onto the Interstate Highway 87 exit ramp leading to the Hutchinson River Parkway. Brownish weathering, dark gray, coarse grained garnet-muscovite-biotite schist with elongate white sillimanite knots that plunge very gently southward occurs at the west end of the large rock cuts on the north side of the road. The contact between member C of the Manhattan Schist and the amphibolite member of the Hartland Formation is exposed further east in this continuous rock cut. A pegmatitic gneiss layer is present near the contact. There is no apparent tectonic discontinuity at this contact but the possibility of such a discontinuity being obscured by subsequent deformation and metamorphism does exist. One of the hypotheses presented in the introductory remarks of this field guide proposes that a major fault is present here. Continue eastward through the amphibolite member of the Hartland which here contains white garnet-muscovite-biotite-gneiss and boudinaged pegmatites as well as the typical greenish-black amphibolite.

Proceed eastward across the contact between the amphibolite member and Carringtons Pond member of the Hartland Formation. The Carringtons Pond member consists of rusty weathering to brownish weathering sillimanite-garnet-muscovite-biotite schist, white garnet-muscovite-biotite gneiss and gray garnet-biotite schist. Brownish weathering schist is interbedded with amphibolite near the contact of the Carringtons Pond member with the amphibolite member of the Hartland Formation. The white gneiss layers are parallel to bedding in the schists and for this reason are interpreted to be sedimentary or volcanic in origin and not intrusive.

Proceed southwesterly across the highway and thence through the I. B. M. parking lot to the rock cuts on the north side of route 119 east of the entrance to the parking lot. This dog leg in the traverse crosses diagonally back through the section and the west end of the rock cut here is in member C of the Manhattan Schist. Continue southeasterly along the north side of route 119 successively across the contact between member C of the Manhattan Schist and Hartland amphibolite and then the contact between Hartland amphibolite and Carringtons Pond member of the Hartland Formation. The Carringtons Pond member here is typical inter-layered rusty weathering, locally graphitic, garnet-muscovite-biotite schist and white garnet-muscovite-biotite gneiss. Other rocks are gray garnet-biotite-muscovite schist that weathers brownish, gray feldspathic garnet-biotite schist and amphibolite.

Traverse southeastward across the contact between the Carringtons Pond and white gneiss members of the Hartland Formation. The white gneiss member of the Hartland Formation is light gray or white garnet-biotite-muscovite gneiss. This gneissic rock unit may possibly be a concordant sill-like pluton but at present it is interpreted as a metamorphosed volcanic.

Continue eastward across the contact between the white gneiss member and schist and granulite member of the Hartland Formation. The schist and granulite member consists predominantly of gray feldspathic, muscovite-

biotite schist and schistose gneiss interbedded with brownish-tan weathering, gray biotite-quartz-feldspar granulite. These rocks contain particularly coarse grains of biotite and muscovite. This member of the Hartland Formation may be a correlative of the Moretown Formation in Massachusetts (Hatch and others, 1967) and the Taine Mountain Formation in Connecticut (Stanley, 1964).

The minor folds and lineations in the rocks along this traverse are generally gently plunging. Between the starting point of the traverse and the east side of the amphibolite member of the Hartland on route 119, the plunge is dominantly southwest. From that point eastward along the traverse, the predominant plunge is northeast. The majority of minor folds along the traverse have a reverse movement sense indicating the beds on the east moved upward relative to those on the west. The reverse movement sense indicates that these folds are not related to the major later phase anticline but are related to an earlier phase of deformation.

Stop 3. (6.64N - 33.76E) Rock cut in the Harrison Gneiss on the northeast side of route 119, 1000' southeast of the point where route 120 extends northward from route 119.

The Harrison Gneiss exposed here is on the west limb of the later phase anticline 350 feet northwest of the contact with the schist and granulite member of the Hartland Formation. These rocks are also near the axial region of the earlier phase isoclinal fold. Dark gray biotite-hornblende-feldspar gneiss with subordinate quartz and sparse but noticeable sphene is present here. There are also many irregular shaped white quartz-feldspar segregations of uncertain origin but that appear to be structurally controlled by boudinage and minor folds. The lineation here plunges northwesterly at approximately 40° in accord with the major later phase anticline.

Stop 4. (6.76N - 33.45E) Rock cut on the northwest corner of the intersection of Kenilworth Road and the westbound lanes of route 119.

This exposure of the schist and granulite member of the Hartland Formation consists of interbedded gray garnet-biotite-quartz-feldspar schist and light pinkish-gray to buff muscovite-biotite-quartz-feldspar gneiss and granulite. These rocks are on the west limb of the later phase anticline 300 feet west of the contact with the Harrison Gneiss and also occupy a position northwest of the axial surface of the earlier phase isoclinal fold. Numerous northward plunging minor folds display a shear sense in accord with the major later phase anticline. These folds have an axial plane foliation and refold earlier phase structural elements. An example of refolded isoclinal folds is present on the upper surface of the exposure near the east end of the rock cut.

Stop 5. (10.58N - 32.03E) This traverse is on the property of Mr. F. W. Perry 3/4 miles west of Round Hill Road and the traverse begins 600 feet north of Closes Pond and 2,500 feet west of Buckfield Lane.

The traverse begins in member C of the Manhattan Schist (fig. 2) which consists of brown weathering sillimanite-garnet-muscovite-biotite schist that is intruded by many light gray pegmatites. Proceed westerly into the valley of the east branch of the Byram River across the contact between members A and C of the Manhattan to the exposures in the valley

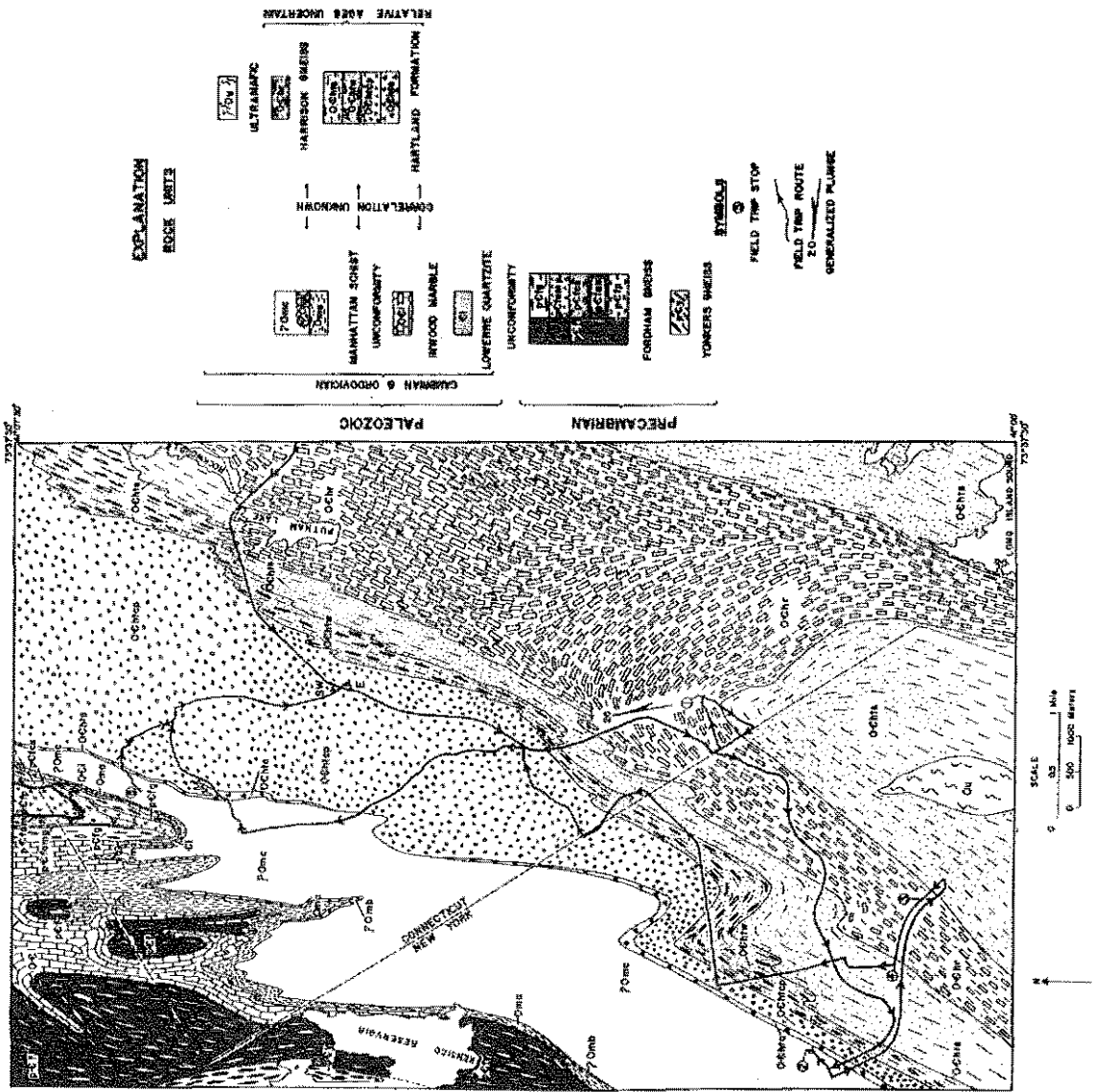

Fig. 2. Geologic map in the vicinity of Stop 5.

bottom. Dark gray garnet-muscovite-biotite schist is interbedded with calcite marble and calc-schist at the base of member A of the Manhattan Schist. Member A of the Manhattan is in contact with white dolomite marble of member A of the Inwood. Coarse tremolite crystals present along contacts between quartz pods and dolomite are displayed in some of the blocks of dolomite marble. Members B, C, D, and E of the Inwood are not present here due to erosion prior to the deposition of member A of the Manhattan. This contact at the base of the Manhattan Schist is a major unconformity that is correlated with the widespread mid-Ordovician unconformity (Hall, 1968). Approximately 100 feet west of the unconformity at the base of the Manhattan Schist there is another major unconformity at the base of the Inwood Marble where it rests on the Precambrian Fordham Gneiss. Typical Lowerre Quartzite is apparently absent here, but a zone of dark gray garnet-biotite schist extends at least 200 feet along the east facing cliff of Fordham Gneiss. This dark aluminous schist may be a facies of the Lowerre Quartzite. The traverse proceeds northward into the Fordham Gneiss to the large cliff east of Sterling Road and 1500 feet south of the New York State line. The traverse crosses the gray biotite gneiss and the gray to white calc-silicate members of the Fordham Gneiss. This large east facing cliff displays a beautiful reclined isoclinal fold that plunges northwest a little too steeply to be referred to as recumbent. The major structure here (fig. 1 and fig. 2) is a northwest plunging reclined fold that has the same geometry as that displayed on this cliff face by the large fold and its subsidiary minor folds. Folding here is clearly visible as a result of the sharp contacts between the calc-silicate, amphibolite, and pinkish-biotite-quartz-feldspar gneiss members of the Fordham Gneiss.

ROAD LOG

The road log begins at the point where the Merritt Parkway crosses the east boundary of the Glenville quadrangle. Refer to figure 1 and/or to the United States Geological Survey topographic map of the Glenville 7½ minute quadrangle.

MILES

- 0.0 Enter the Glenville quadrangle on the Merritt Parkway in an area underlain by the Harrison Gneiss near the nose of a northwesterly plunging later phase anticline. The Harrison Gneiss here and throughout the Glenville quadrangle occupies the core of an earlier phase isoclinal fold that has been refolded by the later phase folding.
- 0.7 Putnam Lake is on the left (south). The contact between the Harrison Gneiss and the schist and granulite member of the Hartland Formation trends essentially east-west across the north end of the lake.
- 1.0 The folded contact between the schist and granulite member and the white gneiss member of the Hartland Formation is on the right (north) side of the parkway.
- 1.3 The contact between the white gneiss and schist and granulite members of the Hartland Formation extends across the Parkway here.

- 1.6 The southwest bound lanes of the Merritt Parkway cross the contact from the white gneiss member into the Carringtons Pond member of the Hartland Formation at the Lake Avenue exit. The parkway extends essentially southwesterly from here and continues along the northwest limb of the later phase anticline in the schists and gneisses of the Carringtons Pond member which are exposed in several highway rock cuts.
- 2.6 Pass the Round Hill Road exit on the southwest bound lanes of the Merritt Parkway.
- 4.5 Proceed across the contact from the Carringtons Pond member into the white gneiss member of the Hartland Formation.
- 4.6 Toll gate on the Merritt Parkway. Cross the contact into the schist and granulite member of the Hartland Formation approximately 200 feet south of the toll gate. Proceed southward through a series of rock cuts in the schist and granulite member.
- 5.0 Cross the contact from the schist and granulite member of the Hartland Formation into the Harrison Gneiss. The Harrison is well exposed in a series of rock cuts along the parkway south of this contact.
- 5.6 Exit from the Merritt Parkway onto King Street at the New York - Connecticut state line.
- 5.7 Turn left (south) on King Street and cross the bridge over the Merritt Parkway.
- 5.8 At the south end of the bridge, turn left (east) onto Glen Ridge Road. Keep to the right, being certain not to turn onto the Merritt Parkway, and proceed down the hill.
- 6.2 Turn left (north) into the Grand Union parking lot. Stop 1.
- 6.2 Leave the parking lot and proceed southwesterly toward King Street.
- 6.3 Cross the contact from the Harrison Gneiss into the schist and granulite member of the Hartland Formation at a point on the nose of the later phase anticline.
- 6.7 Turn right (northwest) onto King Street.
- 6.8 Cross the contact from the schist and granulite member of the Hartland Formation back into the Harrison Gneiss.
- 7.1 Turn left (south) into New York State in order to enter the Hutchinson River Parkway southwest bound. The name of the parkway changes from Merritt to Hutchinson River at the state line.
- 7.2 Enter the Hutchinson River Parkway southwest bound and proceed through the Harrison Gneiss which is exposed along the parkway.
- 7.8 Pass the Ridge Street exit on the southwest bound lanes of the Hutchinson River Parkway.
- 8.5 Pass the Lincoln Avenue exit on the southwest bound lanes of the Hutchinson River Parkway. Continue southwesterly across the Harrison Gneiss in the axial region of the early isoclinal fold.

- 8.9 Cross the contact from the Harrison Gneiss into the schist and granulite member of the Hartland Formation.
- 9.2 Pass the route 120 exit on the southwest bound lanes of the Hutchinson River Parkway.
- 9.9 Exit from the Hutchinson River Parkway onto route 119. The series of rock cuts between this point and the I. B. M. office building at mileage 10.9 will be visited on the traverse to be made at stop 2. The large rock cut here is in the schist and granulite member of the Hartland Formation.
- 10.1 Enter onto route 119 northwest bound. Keep right and do not enter the Cross Westchester Expressway.
- 10.4 Cross the contact from the schist and granulite member into the white gneiss member of the Hartland Formation. Continue northward across the northwest limb of the later phase anticline.
- 10.5 Cross the contact into the Carringtons Pond member of the Hartland Formation.
- 10.7 Cross the contact into the amphibolite member of the Hartland Formation.
- 10.8 Cross the contact into member C of the Manhattan Schist.
- 10.9 Turn right (northeast) into the I. B. M. parking lot and park. Stop 2.
- 10.9 Leave the I. B. M. parking lot and proceed westward directly onto the bridge that overpasses the Cross Westchester Expressway.
- 11.1 Turn left (southeast) onto route 119 (Westchester Avenue) and proceed southeast across the contacts previously described.
- 12.1 Continue on route 119 overpassing the Hutchinson River Parkway.
- 12.4 Proceed southeasterly on route 119 across Kenilworth Road and then across the contact from the schist and granulite member of the Hartland Formation into the Harrison Gneiss.
- 13.2 Cross the contact from the Harrison Gneiss into the schist and granulite member of the Hartland Formation and then bear left (eastward) on route 119 and 120 underpassing the Cross Westchester Expressway.
- 13.3 Turn left (northwest) onto route 119 and 120 northwest bound.
- 13.5 Cross the contact from the schist and granulite member of the Hartland Formation into the Harrison Gneiss.
- 13.6 Stop 3.
- 13.6 Proceed northwest on route 119 and 120 through the axial region of an earlier phase isoclinal fold that is occupied by the Harrison Gneiss.
- 14.2 Cross the contact from the Harrison Gneiss into the schist and granulite member of the Hartland Formation and then turn right onto Kenilworth Road and park. Stop 4.
- 14.2 Proceed north on Kenilworth Road.
- 14.6 Bear right continuing on Kenilworth Road.
- 14.7 Turn left (north) onto route 120.

- 14.8 Underpass the Hutchinson River Parkway continuing north on route 120 across the northwest limb of the later phase anticline.
- 15.8 Turn right (east) onto Anderson Hill Road.
- 16.6 Proceed east on Anderson Hill Road across the intersection with Lincoln Avenue.
- 17.0 Bear left (northeast) continuing on Anderson Hill Road.
- 17.6 Cross the state line into Connecticut and turn left (northwest) onto King Street.
- 18.3 Turn right (northeast) onto Sherwood Avenue. Proceed northeast along the northwest limb of the later phase anticline through an area underlain by the Carringtons Pond member of Hartland Formation.
- 19.3 Turn left (north) onto Riversville Road and proceed across the northwest limb of the later phase anticline through the Carringtons Pond and amphibolite members of the Hartland Formation into member C of the Manhattan Schist.
- 22.0 Turn right (east) onto John Street.
- 22.3 Cross the contact from member C of the Manhattan Schist into the amphibolite member of the Hartland Formation.
- 22.5 Cross the contact from the amphibolite member into the Carringtons Pond member of the Hartland Formation.
- 23.3 Turn left (north) onto Buckfield Lane.
- 23.8 Turn left onto the private road.
- 24.0 Turn left into the driveway.
- 24.1 Turn right and then left onto the dirt road proceeding past a large exposure of white pegmatite.
- 24.2 Turn right and continue on the dirt road across the valley and then bear left.
- 24.5 Stop 5.
- 24.5 Turn around and return to Buckfield Lane using the same route described above but in reverse order.
- 25.2 Turn right (south) onto Buckfield Lane.
- 25.7 Turn left (east) onto John Street.
- 25.8 Turn right (south) onto Round Hill Road.
- 27.2 Turn left to enter the Merritt Parkway southwest bound toward New York City and points south or west.
- 27.4 Turn right to enter the Merritt Parkway northeast bound toward New Haven.

REFERENCES

- Chidester, A. H., Hatch, N. L., Jr., Osberg, P. H., Norton, S. A. and Hartshorn, J. H., 1967, Geologic map of the Rowe quadrangle, Massachusetts-Vermont; U. S. Geol. Survey Geol. Quadrangle Map, GQ-642

- Crowley, W. P., 1968, The bedrock geology of the Long Hill and Bridgeport quadrangles: State Geological and Natural History Survey of Connecticut Quadrangle Rep't. No. 24, 87 p.
- Fisher, D. W., 1962, Correlation of the Ordovician rocks in New York State: New York State Museum Map and Chart Series, No. 3
- Gates, R. M. and Bradley, W. C., 1952, The geology of the New Preston quadrangle: State Geological and Natural History Survey of Connecticut Quadrangle Rep't. No. 11, 35p.
- Hall, L. M., 1968, Trip A: Bedrock geology in the vicinity of White Plains, New York, p. 7-31, in Finks, R. M., Editor, Guidebook to field excursions at the 40th annual meeting of the New York State Geological Ass'n. May 1968, Queens College, Flushing, New York, 253 p.
- Hatch, N. L., Jr., Chidester, A. H., Osberg, P. H., and Norton, S. A., 1966, Redefinition of the Rowe Schist in northwestern Massachusetts, in Cohee, G. V., and West, W. S., Changes in stratigraphic nomenclature by the U. S. Geological Survey, 1965: U. S. Geol. Survey Bull. 1244-A, p. A33-A35
- Knopf, E. B., 1962, Stratigraphy and structure of the Stissing Mountain area Dutchess County, New York: Stanford Univ. Publications, Geol. Sciences, v. 7, No. 1, 55p.
- Stanley, R. S., 1964, The bedrock geology of the Collinsville quadrangle; State Geological and Natural History Survey of Connecticut Quadrangle Rep't. No. 16, 99 p.
- Zen, E-an, 1967, Time and space relationships of the Taconic allochthon and autochthon: Geol. Soc. America Special Paper 97, 107 p.
- Zen, E-an and Hartshorn, J. H., 1966, Geologic map of the Bashbish Falls quadrangle, Massachusetts, Connecticut, and New York: U. S. Geol. Survey Geol. Quadrangle Map, GQ-507, 7 p. explanatory text

Trip E-1

ANIMAL-SEDIMENT RELATIONSHIPS AND EARLY SEDIMENT DIAGENESIS
IN LONG ISLAND SOUND

by

Donald C. Rhoads and Robert A. Berner
Yale University

INTRODUCTION

Research in invertebrate paleontology and sedimentology is becoming increasingly environmental in scope. Problems of environmental reconstruction, early sediment diagenesis, adaptive morphology of fossil organisms, and paleosynecology lean heavily upon the knowledge of Recent marine organisms and geochemical processes. Studies of Long Island Sound provide an insight into biological and sedimentological processes in a boreal terrigenous marine environment. Buzzards Bay, Massachusetts has received more detailed study than Long Island Sound. For this reason, frequent reference will be made to Buzzards Bay data when discussing field observations of L.I. Sound animals and sediments. The purpose of this trip will be to: (1) sample and observe sedimentologic features that are important limiting factors in the distribution of bottom dwelling organisms, (2) present a new hypothesis for explaining the spatial separation of filter feeding and deposit feeding communities, (3) describe how animal-sediment relationships observed in Long Island Sound would be preserved in the fossil record, (4) characterize the chemical environment within the sediments and some of the changes taking place as a result of early diagenesis.

PHYSICAL OCEANOGRAPHY OF L.I. SOUND

The following summary is from Riley's work on the physical oceanography of the Sound (Riley, 1956).

Temperature and Salinity

Long Island Sound is approximately 90 miles long and 15 miles wide, with an area of 930 square miles. Most of the Sound is less than 30 meters in depth. A maximum depth of 100 meters is located near the eastern end of the embayment. Unrestricted passage of water through Block Island Sound permits free exchange of Sound and open shelf water. Seventy-five percent of the fresh water runoff enters the eastern end of the Sound where it is mixed with water of open ocean salinity. More restricted exchange of open ocean and L.I. Sound water at the western end results in water being about 5 ‰ (dissolved solids in parts per thousand) fresher than water at the eastern end. A summary of the temperature-salinity relations for spring and fall conditions 1952-1953 is given in figure 1. Maximum temperature and salinity are recorded in late summer and early fall when fresh water runoff is minimal and solar heating is greatest. The annual temperature range is 23°C (2°-25°C) and seasonal salinity flux about 4 ‰ (25-29‰). A small thermocline is present from February-March until August. Vertical salinity gradients exist throughout the year with

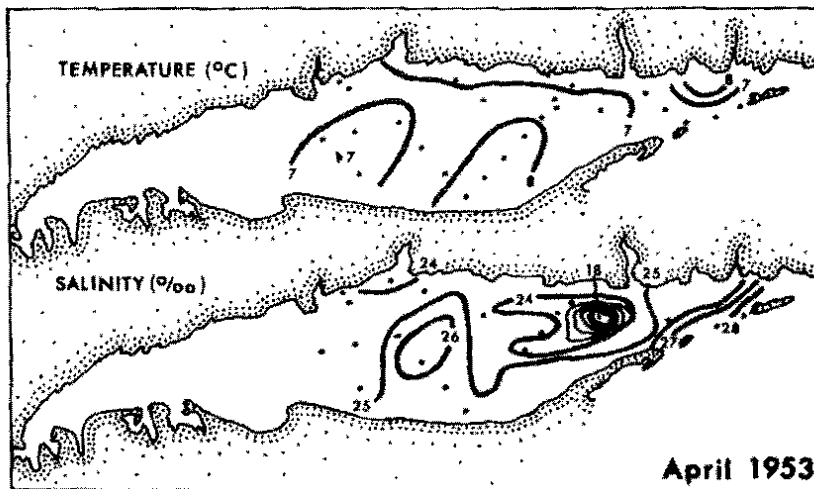
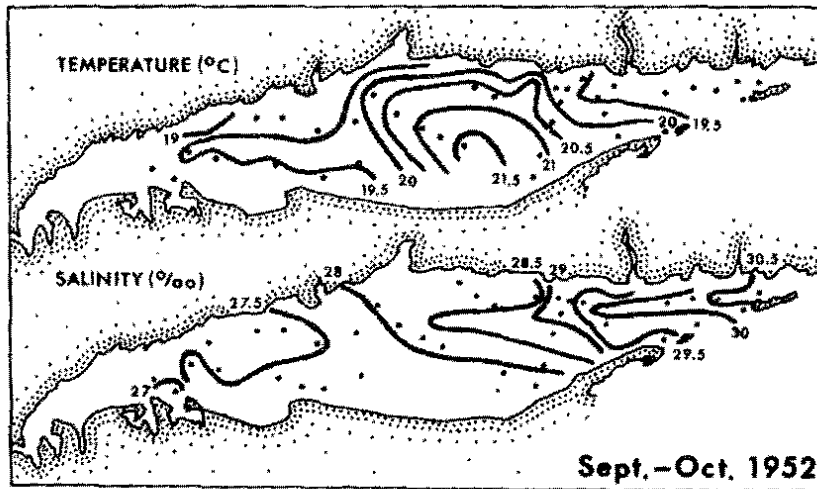
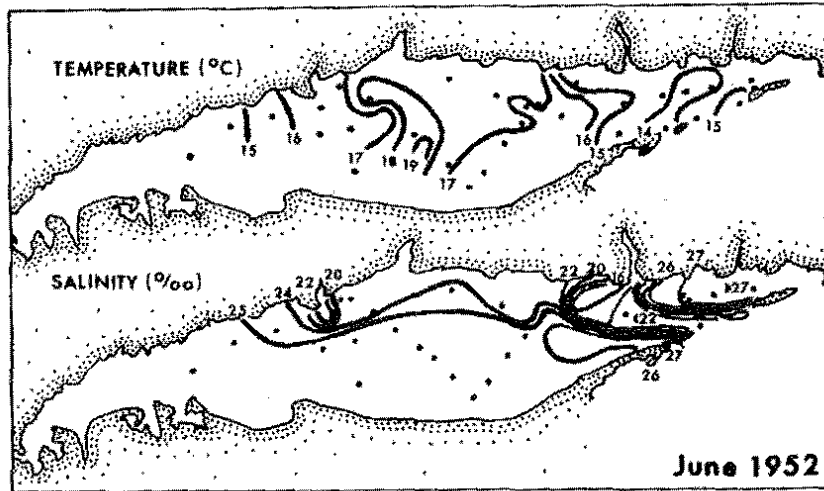

Fig. 1. Seasonal changes in surface temperature and salinity in Long Island Sound. (from Riley, 1956).

surface water being about 1‰ lower than bottom water. Although the salinity regime of L.I. Sound is more brackish than that of Buzzards (35‰), the major macrofaunal benthic associations are the same. It appears that these faunal associations are euryhaline within the range 35‰ - 25‰.

Currents

Mean tidal range in the eastern end of the Sound is 0.75 meters increasing to 2.2 meters at the western end. Strong tidal currents flow between narrow passes scouring the bottom, producing sand, shell, and gravel deposits. Non-tidal currents fit the two layer transport system of other estuaries, i.e. relatively fresh surface water moves eastward from river mouths and is replaced by water of open ocean salinity moving westward along the bottom. Riley (1956) suggests a flushing rate of 30% of the volume of the Sound per month. Figure 2 gives the non-tidal current direction and surface velocity in the area of New Haven Harbor. Current velocities at the sediment-water interface are much lower, especially in the deeper central part of the basin.

Turbidity

Many compounds in the sea contribute to the turbidity of sea water (dissolved solids, colloids, plankton, planktonic detritus, and mineral detritus). Riley (1956) measured the turbidity of L.I. Sound water over a two year period. Much of the periodicity in turbidity was correlated with phytoplankton productivity, but over two thirds of the light extinction was related to the presence of suspended particulate non-living detritus. Riley suggests that resuspension of bottom sediments is important in contributing to decreased water transparency. Patten, Young, and Roberts (1966) found turbidity increasing with depth in the York River due mainly to an increase in inorganic detritus. Morton (1967) also found resuspension of bottom sediments to be locally important in Narragansett Bay and Rhode Island Sound. Recent unpublished work of Dr. David Young, M.B.L., Woods Hole, indicates that mud and small invertebrates are resuspended several meters off the bottom in 20 meters of water in Buzzards Bay.

Lithofacies

The sediment distribution map (fig. 3) is from Buzas (1965). A more detailed look at the major textural types reveals a gradual increase in the silt-clay fraction from the shoreline to the center of the Sound. Depths below 20 meters are especially high (> 50%) in silt-clay. Sands predominate nearshore, on topographic highs like Stratford Shoal, and in the current scoured bottoms in approaches to Block Island Sound. The general textural distribution pattern is also characteristic of Buzzards Bay, Massachusetts. A generalized cross-section of the basin showing the relationship of texture to bathymetry is given in figure 6. Major mineralogic components of the sediments are: quartz, muscovite, biotite, albite, microcline, kyanite, augite, hornblende, chlorite, aragonite, calcite, and dolomite (McCrone, Ellis, and Charmutz, 1961). Moore (1963) described the high percentage silt-clay basinal facies of Buzzards Bay as a protogreywacke and the marginal sand facies as consisting of arkosic sands, feldspathic sands, and quartzose sands (Pettijohn's classification). These compositional terms may also be applied to the major sediment facies found in Long Island Sound. Near-

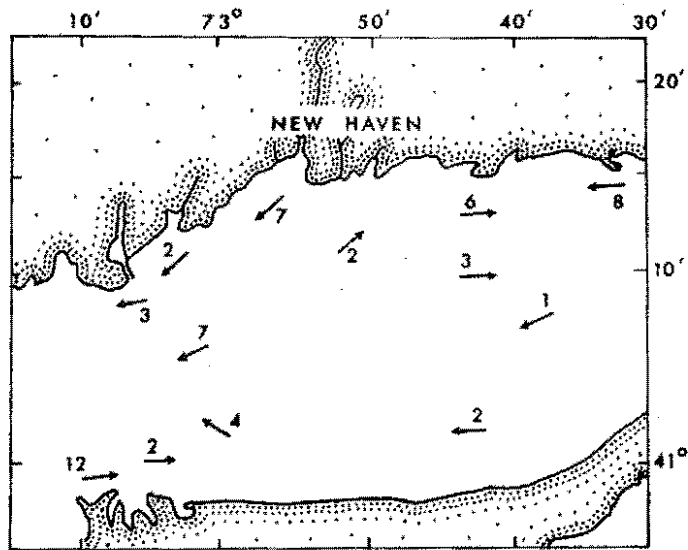

Fig. 2. Current speed and direction of nontidal drift (cm/sec.) in central L. I. Sound (from Riley, 1956).

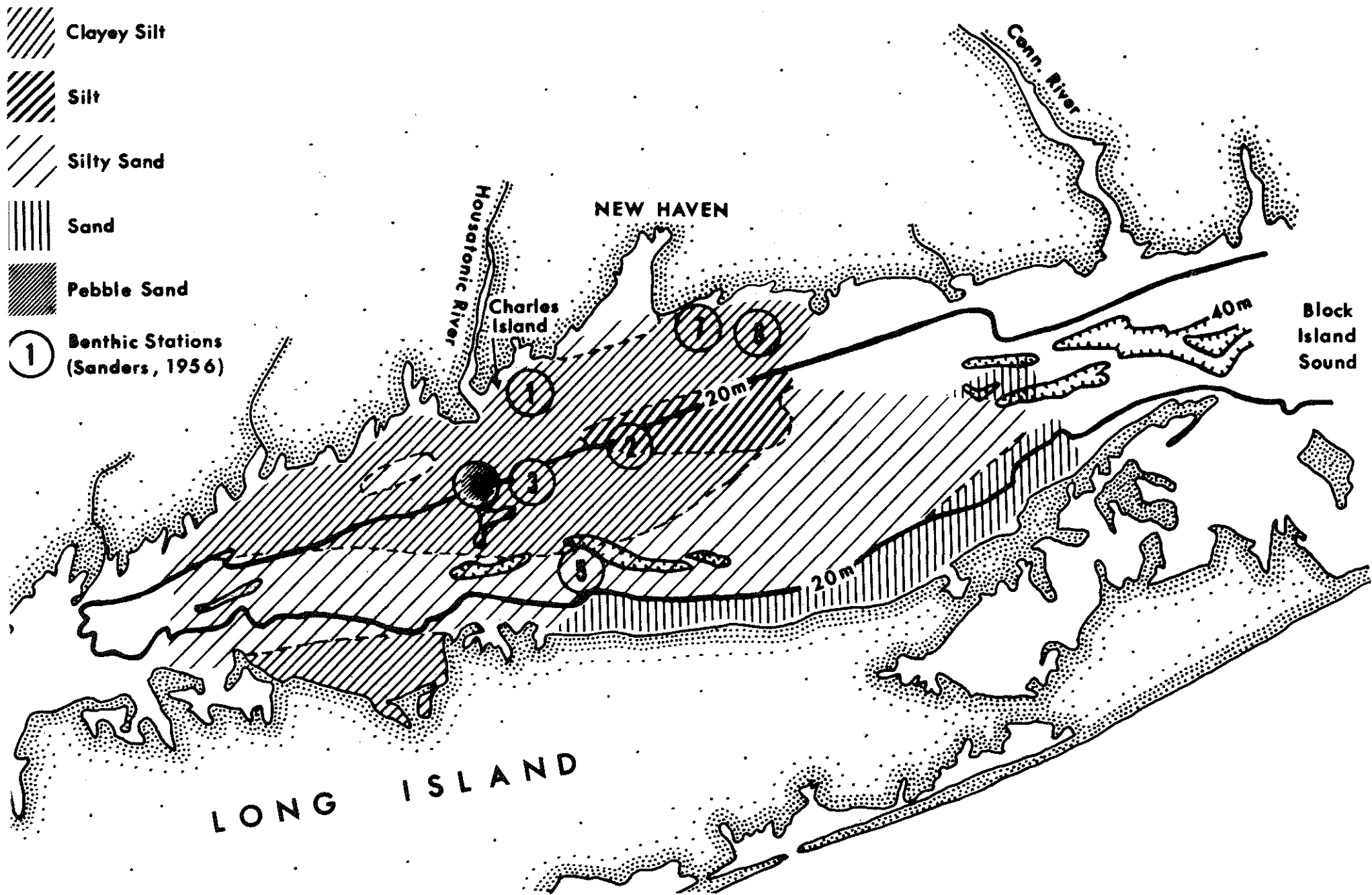

Fig. 3. Sediment distribution map of Long Island Sound (Data from Buzas, 1965).

TABLE 1. Composition of Primary Feeding Types at Each Station.
 Stations Arranged in Order of Increasing Silt-Clay Percentage.
 (data from Sanders, 1956)

<i>Station</i>	<i>Suspension feeder</i>	<i>Deposit-Feeder</i>		<i>% silt-clay</i>
		<i>Selective</i>	<i>Nonselective</i>	
4	95.56%	4.30	0.14	5.4
1	82.94	16.63	0.43	4.7
Charles Is.	76.91	20.19	2.90	11.0
5	43.03	18.93	38.04	18.5
8	10.16	43.52	46.32	28.0
7	5.82	55.82	38.88	31.5
2	6.15	59.84	34.01	56.0
3	5.78	41.68	52.39	65.0

shore sands are crossbedded and contain shell layers. These grade laterally into deeper water muddy sands and silts showing alternating crossbedding and bioturbate structures. The basinal protogreywacke lacks current structures and appears completely reworked by organisms (fig. 6).

BIOFACIES AND ANIMAL-SEDIMENT RELATIONSHIPS

The variables of salinity, temperature, and sedimentary regime are the most important limiting factors controlling the distribution of Recent, and presumably, ancient marine benthos. Within L.I. Sound and Buzzards Bay, sediment type appears to be the major factor controlling benthic distribution patterns (Sanders, 1956, 1958, 1960). It is fortunate for the paleontologist that organisms are so closely tied to preservable aspects of the environment such as grain size and relative organic content.

Feeding Types

Heterotrophic benthic organisms make a living in four ways: (1) by filtering food from the water, (2) by feeding on organic matter in the substratum, (3) by predation, (4) by eating benthic plants. Some organisms feed exclusively by one or another of these four ways while others are facultative. Organisms feeding exclusively by deposit feeding would be expected to reach maximum diversity and biomass on substrata rich in organic matter, i.e. fine grained muds. Filter feeding organisms, in contrast, feed on suspended food. This suggests a greater independence of this trophic group from substratum composition. The distribution of predators and herbivores is controlled by the distribution of prey or plants rather than directly on sediment type. For this reason, we will not consider these trophic groups further. Sanders's work on bottom communities at nine stations in L.I. Sound (Sanders, 1956) and in Buzzards Bay (Sanders, 1958, 1960) are two excellent examples of the separation of trophic groups into different sediment types. Sanders's L.I. Sound stations cut across sediments ranging from coarse sands to silty muds (fig. 3, table 1). Organisms feeding by filtering (suspension or seston feeders) are found in greatest biomass at stations where the bottom is sandy and largely free from silt-clay (fig. 4). These same types of bottoms support the greatest biomass of epifaunal forms (fig. 5). Sanders has named this biofacies the Ampelisca community for the dominance of epifaunal tube dwelling amphipod crustaceans. Deposit feeding benthos, in contrast, attain a high standing crop at stations with a silt-clay content of >50% (fig. 4). Few epifaunal forms are found on these muddy bottoms. Sanders has named this biofacies the Nephtys incisa (polychaete)-Nucula proxima (protobranch bivalve) community. These two major communities are common to L.I. Sound and Buzzard Bay. We will occupy sampling stations off New Haven Harbor similar to Sanders's stations in sediment type and faunal composition. Grab samples will be taken for identification of organisms, feeding types, and sediment texture.

The Filter Feeding Paradox

The absence of deposit feeders from nearshore sands may be attributed to the absence of food in current washed sands. The relative absence of filter feeders from the high silt-clay bottoms presents a problem,

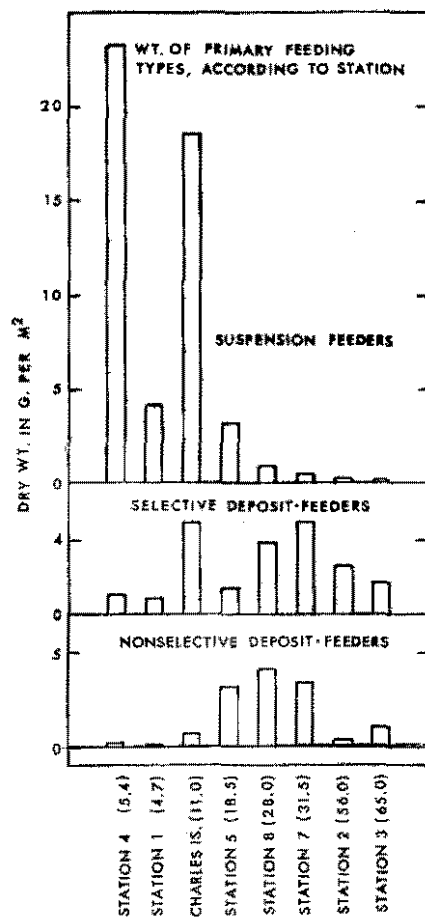

Fig. 4. Wt. of primary feeding types by station. Values following station numbers are percent silt-clay composition. (After Sanders, 1956).

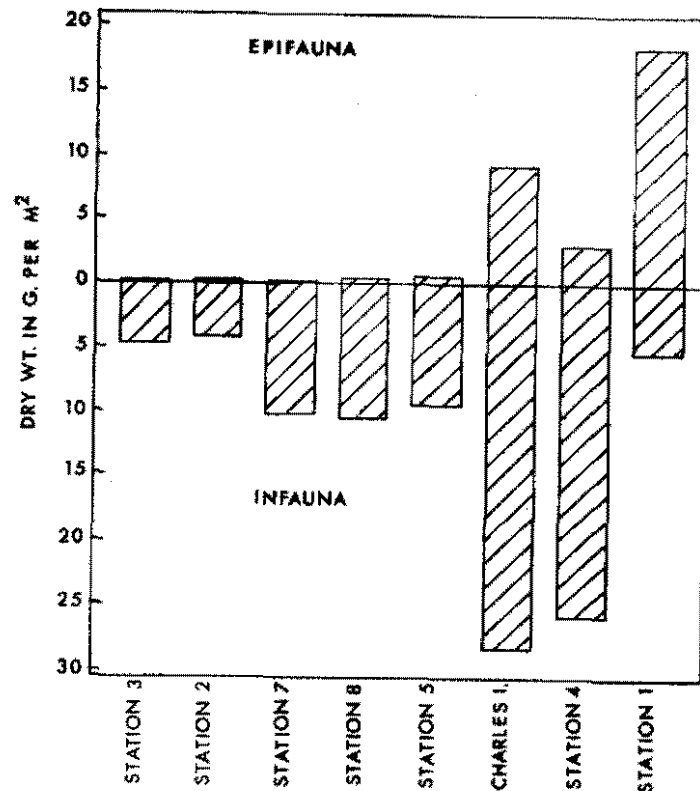
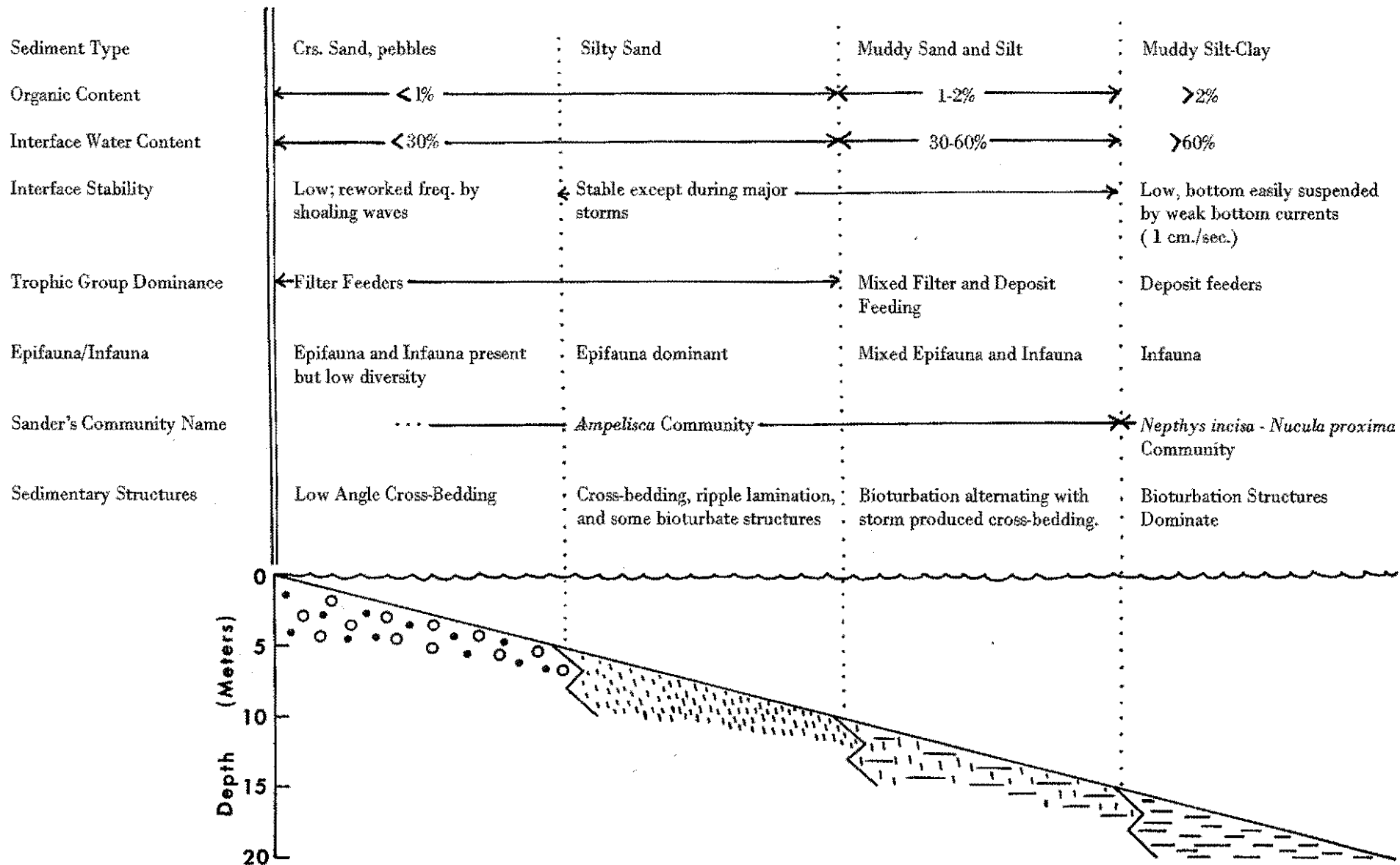

Fig. 5. Mean dry wt. of small infauna and epifauna at each station (after Sanders, 1956).

Fig. 6 Generalized Bathymetric Profile Relating Benthic Community Structure to Sedimentary Parameters.



however. Does this absence reflect a lack of suspended food over the mud bottom or are other limiting factors operating? Visual observation of the high silt-clay facies by diving indicates an abundance of suspended particles over the bottom. We have already cited several studies that indicate resuspension of bottom mud is an important factor in water turbidity. Why, then, are filter feeders rare in the >20 meter silt-clay bottoms when a suspended food source is available?

Interface Stability

This paradox may be resolved by considering the relative stability of the sediment-water interface. Filtering organisms must not only have a source of suspended food but the concentration of particles is also important. Dense concentrations of seston immediately above the bottom will tend to clog ciliary or mucus feeding structures. Little is known about the silting tolerance of early metamorphosed filtering organisms but it is known that adult bivalves feed most efficiently in suspensions containing only a few milligrams of detritus per liter. An hypothesis is presented to suggest that the intensive reworking of the interface of the high silt-clay facies by deposit feeders makes the surface of this bottom type extremely unstable. Resuspension of these bottom muds by weak currents (~1 cm/sec.) creates high turbidity which buries or otherwise clogs the filtering mechanisms of juvenile filter feeders. This interface instability may also explain the absence of epifauna on these bottoms. The granular appearance of the mud surface is largely faecal in origin and the upper 5 mm of mud contains 60-70% water. This upper 5mm zone is suspended by the slightest current action, making the deposit feeder muds much more unstable than bottoms lacking this trophic group. This is perhaps the first evidence that the feeding activities of one type of trophic grouping so change the environment that a second trophic group (filter feeders) is excluded. This kind of biotic relationship is called ammensalism.

PALEOECOLOGIC IMPLICATIONS

Virtually all of the animal-sediment relationships observed on this field trip are capable of being preserved in the fossil record. For this reason our observations may be directly applied to the fossil record when comparing Recent and ancient trophic groupings and their relationships to sediment parameters. If there is an ammensalistic relationship between trophic groupings, then this relationship has perhaps played an important role in shaping the distributions of fossil communities. In what ways did the Paleozoic 'protobranch' facies influence the distribution of the brachiopod-crinoid epifaunal filter feeding associations? To make this type of paleoecologic analysis requires integration of organism and sedimentologic data like that of figure 6. Photomicrographs of thin-sections, radiographs of cores, and bottom photographs will be available on the field trip to show in more detail how the animal-sediment relationships will be preserved.

Early Diagenesis

The effect of bacterial decomposition of organic matter on the chemical composition of sediment pore waters is considerable. Emphasis will be placed during the trip on evidence for anaerobicity in inter-

stitial waters as evidenced by Eh and the presence of H₂S and iron sulfides. Direct electrometric measurement of H₂S, Eh, and pH in muds will be demonstrated. A discussion of the techniques can be found in Berner (1963). Results of pore water and other chemical analyses will be presented to illustrate diagenetic changes and chemical gradients of dissolved species (phosphate, sulfate) between sediments and the overlying water. If time permits, techniques for extracting pore water from fine-grained sediments will also be demonstrated.

REFERENCES

- Berner, R. A., 1963, Electrode studies of hydrogen sulfide in marine sediments: *Geochim. et Cosmochim. Acta*, v. 27, p. 563-575.
- Buzas, M. A., 1965, The distribution and abundance of foraminifera in Long Island Sound: *Smithsonian Misc. Coll.*, v. 149, no. 1, 89 pages, 4 plates.
- McCrone, A., Ellis, B. F., and Charnatz, R., 1961, Preliminary observations on Long Island Sound Sediments: *Trans. New York Acad. Sci.*, v. 24, p. 119-129.
- Moore, J. R., 1963, Bottom sediment studies, Buzzards Bay, Mass.: *Jour. Sed. Petrol.*, v. 33, no. 3, p. 511-558.
- Morton, R. W., 1967, Spatial and temporal observations of suspended sediment: Narragansett Bay and Rhode Island Sound: Naval Underwater Weapons Research Engineering Station, Newport, Rhode Island, Technical Memorandum no. 396, 33 pages.
- Patten, B. C., Young, D. K., and Roberts, M. H. Jr., 1966, Vertical distribution and sinking characteristics of seston in the lower York River, Virginia: *Chesapeake Science*, v. 7, no. 1, p. 20-29.
- Riley, G. A., 1956, Oceanography of Long Island Sound, 1952-1954, II; Physical Oceanography: *Bull. Bingham Oceanogr. Coll.*, v. 15, p. 15-46.
- Sanders, H. L., 1956, Oceanography of Long Island Sound, 1952-1954, X; The biology of marine bottom communities: *Bull. Bingham Oceanogr. Coll.*, v. 15, p. 345-414.
- , 1958, Benthic studies in Buzzards Bay, I; Animal-sediment relationships: *Limn. and Oceanogr.*, v. 3, p. 245-258.
- , 1960, Benthic studies in Buzzard Bay, III; The structure of the soft bottom community: *Limn. and Oceanogr.*, v. 5, p. 138-153.

BEDROCK GEOLOGY OF EASTERN CONNECTICUT^{1/}

by

Richard Goldsmith and H. R. Dixon

Eastern Connecticut is underlain by metasedimentary, metavolcanic and plutonic rocks of Precambrian(?) and early to middle Paleozoic age. Metamorphism of the rocks is medium to high grade over most of the area and structural relationships are complex. The Taconic(?), Acadian, and Alleghenian orogenies have affected the area to a greater or lesser extent.

The age of the rocks is known in only a general way; fossils are lacking. The following section on lithologies will start with the better known rock units. The youngest rocks are dikes of Westerly Granite, which, with the Narragansett Pier Granite in Rhode Island, cut fossiliferous rocks of Late Pennsylvanian age in Rhode Island. Westerly Granite is post-tectonic and clearly is younger than the metamorphic rock it cuts. Radiometric dating indicates the Westerly is Permian or Late Pennsylvanian in age (Quinn and others, 1957; Pinson, 1961). Some pegmatites near Middletown near the western edge of eastern Connecticut are of similar radiometric age. The dikes and pegmatites establish a plutonic-thermal metamorphic event in eastern Connecticut in Permian or Late Pennsylvanian time. K/Ar radiometric dates on biotite from the metamorphic rocks cluster around 250 m.y. (Zartman and others, 1965) and provide further evidence of a metamorphic event at that time. For further discussion of pegmatites in the Middletown district see Trip F-6.

The only age that can be definitely assigned to the metamorphic rocks is pre-Permian or pre-Pennsylvanian. Most rock units, however, are pre-Pennsylvanian, for the Pennsylvanian rocks of the Narragansett Basin rest unconformably on granitic gneisses and other rocks of the "Rhode Island Batholith," which extends into Connecticut along its eastern and southern edge. Furthermore, units along the western edge of eastern Connecticut can be almost directly correlated with the better known Paleozoic sequence of New Hampshire (see table 1). The Bolton Group of Rodgers and others (1959), with some interruptions, can be traced into the Clough, Fitch, and Littleton Formations of Silurian and Devonian age. The Brimfield Schist and Middletown Gneiss, which lie unconformably beneath the Bolton Group, are similar to and can be traced into the Partridge Formation and Ammonoosuc Volcanics of Middle Ordovician age (table 1). Superposition and tenuous correlations suggest that older units -- the Monson Gneiss, New London Gneiss, Mamacoke Formation, and Plainfield Formation -- may be of Ordovician to Cambrian age, though some may be as old as Precambrian.

^{1/} Publication authorized by the Director, U. S. Geological Survey

Table 1. Possible correlations and ages of rocks in eastern Connecticut

	New Hampshire and central Massachusetts	West limb of Monson anticline	East limb of Monson anticline	Willimantic dome	East of Willimantic dome
Lower Devonian and Upper Silurian(?)	Littleton Fm.	Littleton Fm.	Bolton Group of Rodgers and others (1959)		Lower Devonian
Middle Silurian	Fitch Formation	Fitch Formation			Scotland Schist
Lower Silurian	Clough Quartzite	Clough Quartzite			Quartzite
T A C O N I C	U N C O N F O R M I T Y - - - - - ? - - - - -				
Middle Ordovician(?)	Partridge Fm.	Brimfield Schist (390±40 m.y.) <u>1/</u>	Brimfield Schist	Brimfield Schist	Middle Ordovician
Middle Ordovician	Ammonoosuc Volc. (418±15 m.y.) <u>1/</u>	Middletown Gneiss (440±15 m.y.) <u>1/</u> Monson Gneiss (472±15 m.y.) <u>1/</u>	Middletown Gneiss Monson Gneiss	Hebron Fm. Tatnic Hill Fm.	Tatnic Hill Fm.
Cambrian		New London Gneiss Mamacoke Formation Plainfield Formation		Monson Gn. - Quinebaug Fm.	Quinebaug Fm.
				Sterling Plutonic Group	----F a u l t - Plainfield Fm.

1/ Whole-rock Rb/sr ages of Brookins and Hurley (1965); in million years

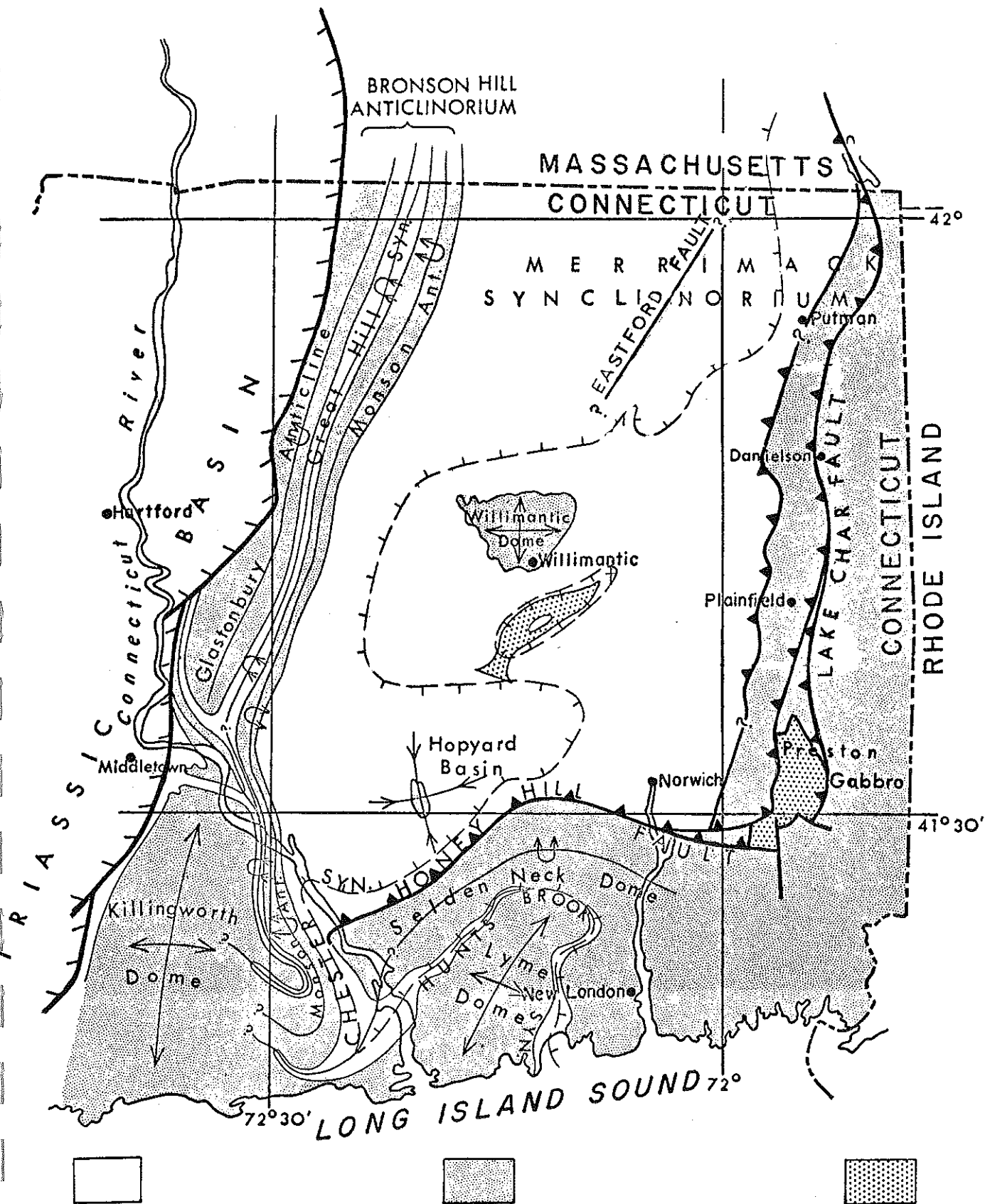

Middle Ordovician and younger metasedimentary rocks and intrusive gneisses

Middle Ordovician and older metavolcanic and metasedimentary rocks and granitic gneisses.

Gabbro

Figure 1. Tectonic map of eastern Connecticut showing the major structural features. The trace of the axial surface of the recumbent syncline is shown by a dashed line; ticks are on the overturned limb.

In the eastern part of eastern Connecticut, the youngest meta-sedimentary rock is Scotland Schist, which is similar to, and may be correlative with the Littleton Formation of Late Silurian(?) and Early Devonian age. Radiometric ages determined by Zartman and others (1965), however, suggest a pre-Silurian age for the Scotland Schist.

The Hebron Formation is older than the Scotland Schist and younger than the Tatnic Hill Formation, which forms the upper part of the Putnam Group (Dixon, 1964), or the Putnam Gneiss of Gregory (in Rice and Gregory, 1906). A quartzite, which locally separates the Scotland Schist from the Hebron Formation, may be equivalent to the Lower Silurian Clough Formation at the base of the Bolton Group. On this basis the Hebron is pre-Silurian and probably Middle to Upper Ordovician. The Hebron may, however, correlate with the generally similar Fitch Formation; in which case it would be Middle Silurian in age (table 1).

The Tatnic Hill Formation is tentatively dated as Middle(?) Ordovician or older by correlation with the Brimfield Schist in the western part of eastern Connecticut. Current mapping has confirmed Percival's observation (1842, p. 289) that the Tatnic Hill Formation is continuous to the southwest with the Brimfield Schist, the two "inclosing" the Hebron. The Quinebaug Formation, which forms the lower unit of the Putnam Group, is in a stratigraphic position similar to that of the Middletown and Monson Gneisses. Although none of these formations are lithologically identical, all are hornblende-biotite and biotite-quartz-plagioclase gneisses of volcanic origin. The Quinebaug is, therefore, also tentatively dated as Middle(?) Ordovician or older (table 1).

The plutonic rocks of the area that are older than the Westerly Granite are gneissic and late tectonic, syntectonic, or pre-tectonic. The Canterbury Gneiss and Eastford Gneiss may correlate with syntectonic granites of the New Hampshire Plutonic Series, which were emplaced during the Acadian orogeny. The whole-rock Rb/Sr radiometric age of the Canterbury Gneiss determined by Zartman and others (1965), however, suggests a pre-tectonic origin (table 1). A Devonian age is indicated for the Glastonbury Gneiss by recent radiometric work (Brookins and Hurley, 1965). The Sterling Plutonic Group is considered to be of Devonian age in Rhode Island (Quinn and others, 1957), but preliminary radiometric ages for contiguous granitic gneisses in southern Connecticut suggest a Cambrian or older age. Some of the Sterling gneisses may represent older granites which were metamorphosed, remobilized, or mixed with younger granites in Acadian time. The granitic gneisses seem to have been emplaced at fairly deep levels in the crust, for they are associated with migmatites and are intimately intermingled with and grade into some associated metasedimentary and metavolcanic gneisses. Sterling

gneisses have not been found stratigraphically above the Quinebaug Formation and Monson Gneiss. The general but not strict concordancy of the Sterling suggests a high confining stress during emplacement. The granitic gneisses increase in volume eastward into Rhode Island at the expense of the metasedimentary and metavolcanic rocks.

Gabbro bodies are among the youngest of the major rock units. The gabbro at Lebanon is younger than the Scotland Schist, and the Preston Gabbro is younger than the regional metamorphism (Sclar, 1958) but older than the thrust faulting and cataclasis.

Most of eastern Connecticut is in the sillimanite grade of metamorphism. Two north-south belts, however, have middle-grade metamorphism; one belt includes the Scotland Schist and Canterbury Gneiss, and the other belt includes the Bolton Group and some of the adjacent Brimfield Schist. Most of the southern part of eastern Connecticut and a belt of Brimfield Schist in the north-central part of the area are in the sillimanite-potassium feldspar grade. A small area within the Tatnic Hill Formation, from the Honey Hill fault north, is also of high metamorphic grade; locally, as in an area southeast of Norwich (Snyder, 1961), the rocks are in the granulite facies. Subsequent to regional metamorphism rocks in the vicinity of thrust faults were cataclastically deformed and converted to mortar gneiss, mylonite gneiss, mylonite, and blastomylonite.

Because the regional metamorphism affected rocks as young as Early Devonian, the main period of metamorphism and probably of granite intrusion was post-Early Devonian and may have been associated with the Acadian orogeny. Post-Pennsylvanian metamorphism has been recognized only in radiometric age work. Cataclastic deformation occurred after regional metamorphism, and its late stages may have been post-Pennsylvanian.

The disposition of map units on the geologic map of eastern Connecticut (Goldsmith, 1963) reflects a complex structural pattern. The western series of north-trending folds -- including the Galstonbury anticline, Great Hill syncline, Monson anticline and possibly the Killingworth dome (Lundgren, 1963, Peper, 1966)-- are a continuation and possibly the termination of the Bronson Hill anticlinorium of New Hampshire (Billings, 1956), an elongate series of gneiss domes. South of the Honey Hill fault (Lundgren and others, 1958), the gneiss domes bend eastward; because of northward tilting of the coastal area here, the domes are exposed in cross section. Although some gneiss domes may have risen because of differences in gravity between light rocks of the core and heavier rocks mantling the dome, it is apparent from the geologic map pattern that some of the domes involve recumbent fold structures of considerable magnitude. These domes apparently represent the

crests or axial areas of folded folds; this is true of the Selden Neck dome (Lundgren, 1963), and the Killingworth and Lyme domes (Lundgren, 1967) are certainly not simple domal structures.

Eastern Connecticut also appears to be the southern terminus of the Merrimack synclinorium (Billings, 1956), a structural and stratigraphic trough that extends through central Maine and New Hampshire into Connecticut. The internal structure of the Merrimack synclinorium in Connecticut is interpreted as a refolded syncline. North of the Honey Hill fault the syncline is isoclinally folded from west to east; the Chester syncline (Lundgren, 1963) west and south of the Honey Hill fault would essentially be the hinge of the re-fold, and the Selden Neck dome (Lundgren, 1966) would represent the axial surface. The Chester syncline and its eastward extension south of the fault, the Hunts Brook syncline (Goldsmith, 1961), would thus appear to be the southern keel of the Merrimack synclinorium. The Killingworth dome is not yet mapped or well understood, but it must involve comparable refolding of folds west of the Chester-Hunts Brook syncline (i.e., the Monson anticline and probably the southern extension of the Great Hill syncline). The folded fold system also probably extends northward underground, and if an east-west vertical section were cut through the Willimantic dome, it possibly would look similar to the surface pattern of the rocks south of the Honey Hill fault. For further discussion of the refolded syncline hypothesis and its stratigraphic implications, see Trip F-4.

The trace of the axial surface of the recumbent syncline follows a sinuous course from Long Island Sound north to the Massachusetts state line. Rocks north and west of this line (and east of the axial surface of the Monson anticline) are interpreted to be overturned. Features interpreted as primary bedding structures in the Brimfield Schist across northern Connecticut would indicate, however, that these rocks are not overturned but are right side up. The Eastford fault of possible major displacement has been mapped in the northern part of the area, and the suggestion made that it may separate the overturned fold sequence from the right side up sequence of Brimfield Schist. By this interpretation, most of the Brimfield would be younger than, rather than correlative with, the Tatnic Hill Formation. For a more detailed review of the evidence favoring this interpretation see Trip F-5.

One of the most obvious structural features in eastern Connecticut is the Honey Hill fault and its northward extension, the Lake Char fault (Dixon, 1965; 1968). The Honey Hill fault, a low-angle thrust fault of regional extent, can be traced from the greatly thinned rocks of the Chester syncline eastward to the Preston Gabbro (Sclar, 1958); the fault bends around the gabbro and can be traced northward into Massachusetts. West and north of the gabbro, the fault splits into two branches, one going beneath the gabbro and the other above it. Rocks adjacent to the fault are crushed; zones of mylonite and blastomylonite are

separated by wider zones of less thoroughly crushed rock. The zone of cataclasis varies in thickness; it is considerably thicker in the upper plate than in the lower plate of the fault. Cataclasis probably started during a late stage of regional metamorphism, when temperatures were low and the rocks more brittle than they had been under sillimanite grade metamorphism but pressures were still high. Lineations along the fault plunge northwest, and indications are that movement was from northwest to southeast. Some features show a conflicting sense of movement but they are interpreted as having formed at different stages of movement. Movement in the fault zone must have persisted over a long period of time. Local areas of coarse fault breccia, in which breccia fragments are mylonite, are suggestive of considerably lower pressures than must have prevailed during the major movement and cataclasis. For a more detailed treatment of the geology of the Honey Hill fault, see Trip F-1.

REFERENCES

- Billings, M. P., 1956, Bedrock geology, Pt. 2 of The geology of New Hampshire: Concord, New Hampshire State Plan. Devel. Comm., 200 p.
- Brookins, D. G., and Hurley P. M., 1965, Rubidium-strontium geochronological investigations in the Middle Haddam and Glastonbury Quadrangles, eastern Connecticut: Am. Jour. Sci., v. 263, p. 1-16.
- Dixon, H. R., 1964, The Putnam Group of eastern Connecticut: U. S. Geol. Survey Bull. 1194-C, p. C1 - C12.
- _____ 1965, Bedrock geologic map of the Plainfield quadrangle, Connecticut: U. S. Geol. Survey Geol. Quad Map GQ-481.
- _____ 1968, Bedrock geologic map of the Danielson quadrangle, Connecticut: U. S. Geol. Survey Geol. Quad. Map GQ-696.
- Goldsmith, Richard, 1961, Axial plane folding in southeastern Connecticut: U. S. Geol. Survey Prof. Paper 424-C, p. C54-C57.
- Lundgren, Lawrence, Jr., 1963, The bedrock geology of the Deep River quadrangle: Connecticut Geol. Nat. History Survey Quad. Rept. 13, 40 p.
- _____ 1966, The bedrock geology of the Hamburg quadrangle: Connecticut Geol. Nat. History Survey Quad. Rept. 19, 41 p.
- _____ 1967, The bedrock geology of the Old Lyme quadrangle: Connecticut Geol. Nat. History Survey Quad. Rept. 21, 30 p.
- Lundgren, Lawrence, Jr., Goldsmith, Richard, and Snyder, G. L., 1958, Major thrust fault in southeastern Connecticut (abs.): Geol. Soc. America Bull., v. 69, p. 1606.
- Quinn, A. W., Jaffe, H. W., Smith, W. L., and Waring, C. L., 1957, Lead-alpha ages of Rhode Island granite rocks compared to their geologic ages: Am. Jour. Sci., v. 255, p. 547-560.
- Peper, John D., 1966, Stratigraphy and structure of the Monson area, Massachusetts-Connecticut: Univ. Rochester, Rochester, N.Y., unpub. Ph.D. thesis, 125 p.
- Percival, J. G., 1842, Report on the geology of the state of Connecticut: New Haven, Conn., Osborn and Baldwin, 495 p.

- Pinson, W. H., Jr., 1961, Some points on the geological time scale from Nova Scotia and New England, in Geochronology of rock systems. New York Acad. Sci. Annals, v. 91, p. 372-377.
- Rice, W. N., and Gregory, H. E., 1906, Manual of the geology of Connecticut: Connecticut Geol. Nat. History Survey Bull. 6, 273 p.
- Rodgers, John, Gates, R. M., and Rosenfeld, J. L., 1959, Explanatory text for the preliminary geological map of Connecticut, 1956: Connecticut Geol. Nat. History Survey Bull. 84, 64 p.
- Sclar, C. B., 1958, The Preston Gabbro and the associated metamorphic gneisses, New London County, Connecticut: Connecticut Geol. Nat. History Survey Bull. 88, 136 p.
- Snyder, G. L., 1961, Bedrock geology of the Norwich quadrangle, Connecticut: U. S. Geol. Survey Geol. Quad. Map GQ-144.
- Zartman, Robert, Snyder, G. L., Stern, T. W., Marvin, R. F., and Bucknam, R. C., 1965, Implications of new radiometric ages in eastern Connecticut and Massachusetts; U. S. Geol. Survey Prof. Paper 525-D, p. D1-D10.

Trip F-1

HONEY HILL AND LAKE CHAR FAULTS

by

Lawrence W. Lundgren, Jr.
University of Rochester

INTRODUCTION

The Honey Hill and Lake Char faults (fig. 1) have been mapped but not yet analyzed in detail. Roberta Dixon (U.S.G.S.) is presently working on part of the Lake Char Fault and I am about to begin detailed work on the Honey Hill Fault. Therefore the guide for this excursion simply describes some areas along the faults, some problems are stated for these areas, and some critical outcrops are located. The exact outcrops for the excursion will be selected during August, 1968. This guide was prepared while I was enjoying the hospitality of the northernmost university in the world (University of Oulu, Finland), far from Honey Hill and from a complete collection of Connecticut maps. Therefore some potential stop areas are described only in general terms, and exact locations of outcrops are not given.

CHESTER AREA

Problems

The Chester area (A in figs. 1 and 2) (southernmost part of the Deep River quadrangle) appears to be the westernmost area in which blastomylonites and ultramylonites can be recognized. Here the NNE-striking segments of all stratigraphic units are blastomylonitic. These blastomylonites terminate in an area in which all units display sinistral minor folds that plunge gently (15-20°) NNW. The basic question raised by these relationships is: How is it possible for the blastomylonite zone to terminate so abruptly here? The following possible answers to this question are not mutually exclusive, but (a) and (b) seem to be most probable.

(a) Movement producing the blastomylonites preceded the formation of the steeply dipping part of the Chester syncline.

(b) The Chester area represents a hinge at which displacement and blastomylonite development were minimal.

(c) The Honey Hill Fault terminates along a tear fault that lies within the east limb of the Chester syncline.

Exposures*

Stop 1. Pattaconck Brook (20.64 N - 67.85 E and surroundings).

Exposures on the north side of Pattaconck Brook east of new highway 9 display sinistral folds in calc-silicate granofels and quartz-

* See figure 2 for locations of exposures.

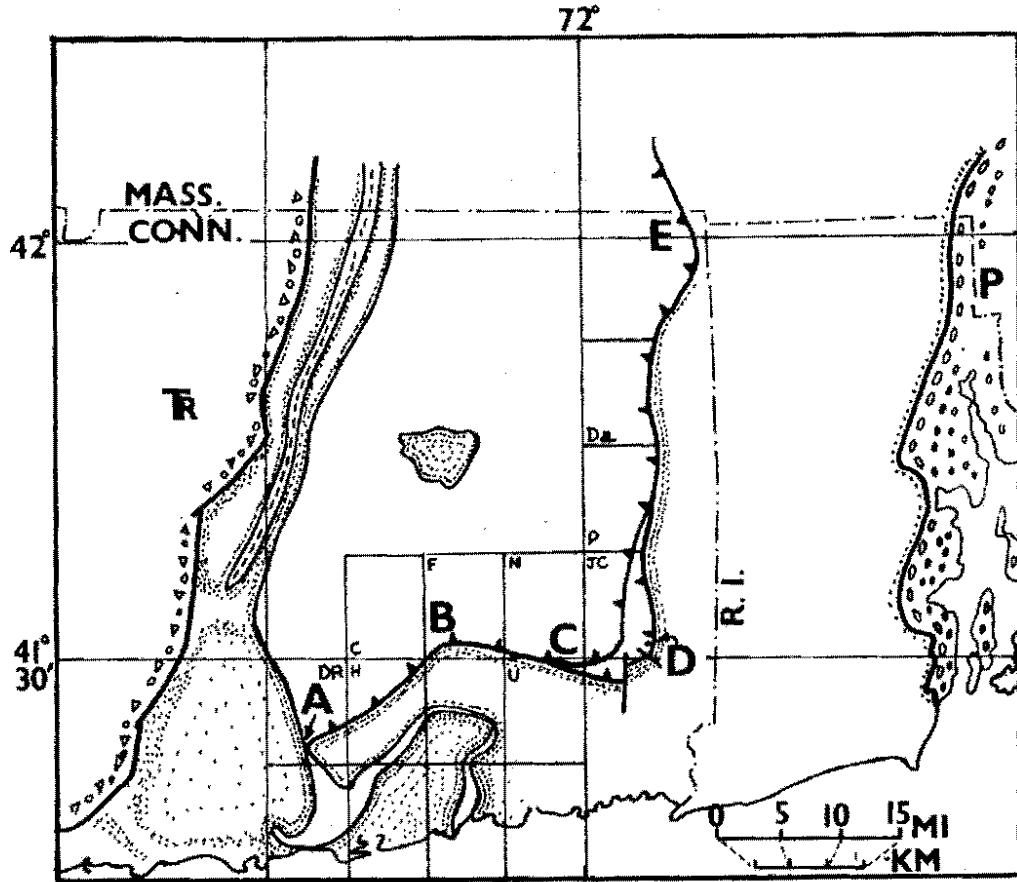

Fig. 1. Index map. Barbed line ABCD = Honey Hill Fault, DE = Lake Char Fault. Stippled areas = borders of anticlinal masses of quartz-feldspar gneiss and intercalated Cambrian (?) metasedimentary rocks. TR = Triassic sedimentary and volcanic rocks bordered on the east by a normal fault. P = metamorphosed Pennsylvanian rocks lying unconformably on rocks to the west. Quadrangle names: Da, Danielson; DR, Deep River; C, Colchester; F, Fitchville; H, Hamburg; JC, Jewett City; N, Norwich; U, Uncasville. Dashed line is trace of synclinal axial plane; syncline contains Silurian and Devonian rocks.

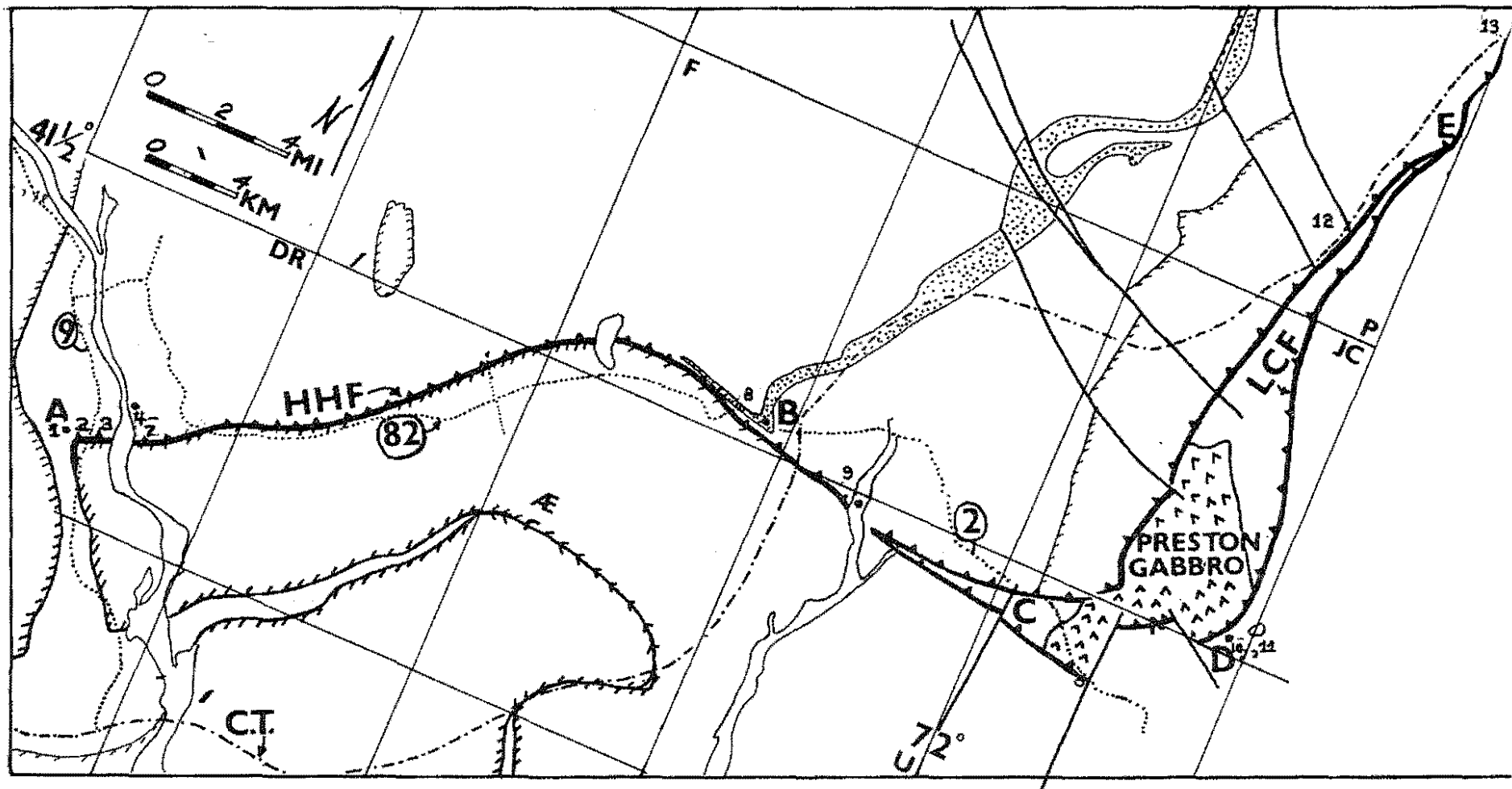

Fig. 2. Position of areas along Honey Hill and Lake Char faults. Numbers refer to trip stops. Circled numbers are Connecticut highway numbers. C.T. (dash-dot line) is Connecticut Turnpike. Letters in corners of $7\frac{1}{2}'$ quadrangles are quadrangle initials. Stippled belt = Fly Pond Member of Tatnic Hill Formation. Hachured line marks contact between quartz-feldspar gneisses (Ivoryton Group and Quinebaug Formation) and schists (Tatnic Hill and Brimfield formations). Hachures on stratigraphically lower side.

biotite schist of the Hebron Formation. Blastomylonite is not conspicuous. Small faults and ultramylonite laminae cut fold structures.

Stop 2. Story Hill (20.94 N - 68.39 E and many other exposures in the vicinity of Hearse Hill and Straits Road and connecting roads)

Sinistral folds in blastomylonitic Canterbury Gneiss (Story Hill) and Tatnic Hill Formation (see Lundgren, 1963) suggest development of folds after development of blastomylonite. Ultramylonite laminae present in Hebron Formation on slope northwest of Story Hill.

Stop 3. St. Josephs Church area (20.80 N - 68.7 E)

Area immediately north of St. Josephs Church along road following the Monson-Tatnic Hill (Putnam) contact. Blastomylonitic garnet-mica schist and calc-silicate granofels in contact with ultramafic "actinolite" rock and Monson Gneiss.

GILLETTE CASTLE AREA

Blastomylonite

Outcrops in Gillette Castle State Park (SE corner of central Deep River quadrangle), particularly those along the Connecticut River, and in the area south of the park, present the best section available through cataclastic rocks developed from the Hebron Formation, the Tatnic Hill Formation (Putnam) and the Canterbury Gneiss, and from pegmatites within these formations.

The first question to be considered here is: What is the physical significance of the blastomylonite and associated ultramylonite? Under what physical conditions are such rocks produced? Is melting a concomitant of faulting? How is the thickness of the blastomylonite zone related to fault displacement?

Exposures

Stop 4. Gillette Castle, and Stop 5. Entire cliff beneath (west of) the Castle (21.45 N - 69.00 E).

Quartz-biotite schist layers are pervasively but not uniformly granulated and calc-silicate gneiss is partially granulated. The blastomylonitic rocks are distinguished by finer than normal grain size, by a distinctive network of fine-grained biotite and fine-grained quartz surrounding ellipsoidal plagioclase grains, and by fractures in plagioclase, diopside, and actinolite. Granulation is more recent than formation of diopside, plagioclase, and major amphibole grains but was accomplished under conditions such that biotite recrystallized and some new amphibole developed.

Ultramylonite laminae present at the base of the cliff are aphanitic greenish black rocks consisting of very fine grained particles in which scattered pieces of blastomylonite occur. Ultramylonite occurs both as structurally concordant laminae parallel to bedding and as discordant laminae along zones of demonstrable offset of bedding. Discordant dikes of ultramylonite radiate from these laminae.

Minor folds

The second question to be considered here is: What are the relationships between the minor folds in calc-silicate granofels layers and the movements associated with the formation of blastomylonites?

Exposures

Stop 6. South side of Gillette Castle Park (22.45 N - 68.26 E)

North side of footpath (once a road) that provides southern access to the castle. Small, asymmetric intrafolial folds occur in calc-silicate granofels within quartz-biotite schist. Such folds are most common in, and possibly restricted to, outcrops in which the quartz-biotite gneiss is blastomylonitic, yet they are not present in all outcrops of blastomylonitic Hebron. They demonstrate movements parallel to layers within the Hebron that were apparently contemporaneous with blastomylonite development. Not all display the same sense of rotation.

Boudinage

A third question raised in this area is: What are the relationships between boudinage development and the formation of blastomylonites?

Exposures

Stop 6a. Outcrops of pegmatite lenses at and west of Stop 6.

Stop 7. Whalebone Creek Quarry (21.35 N - 69.06 E)

Abandoned quarry above east bank of Connecticut River on north side of Whalebone Creek. Three-dimensional exposure of prismatic boudins with rectangular cross-section (perpendicular to long axis) developed from granite pegmatite layer. Boudins are rotated.

TRADING COVE BROOK AREA

Problems

A segment (B-C in figs. 1, 2) of the fault and blastomylonite zone that is exposed along and north of Trading Cove Brook in the Fitchville (Snyder, 1964) and Uncasville (Goldsmith, 1967) quadrangles is of special interest because the fault separates structurally discordant rocks. Units below the fault are essentially concordant with it; units above are truncated by the fault. Here the units on the north side of the fault approach the fault along a generally N-S strike line, and they are either truncated against the fault or warped into partial local conformity with it.

Exposures

Stop 8. Trading Cove West (24.5 N - 76.4 E) Area northwest of Trading Cove in the Fitchville quadrangle (Snyder, 1964).

Here blastomylonitic units of the Tatnic Hill Formation and Canterbury Gneiss are folded on a fairly large scale (see Snyder's map) suggesting drag along the fault during and after development of blastomylonites.

Stop 9. Trading Cove East (24.35 N - 77.93 E) Area north of Trading Cove in the Uncasville quadrangle where Trading Cove Brook enters the Thames River.

Here the blastomylonites developed in the Tatnic Hill Formation are displayed to good advantage. Here too we see the fault-induced reorientation of structures antedating fault development.

BILLINGS LAKE AREA

Problems

The area (D in figs. 1, 2) between Billings Lake (SE Jewett City and SW Voluntown quadrangles) and the Preston Gabbro to the west is a critical area for which detailed recent maps do not exist. The maps of Loughlin (1912) and Sclar (1958) are too small in scale to allow successful reinterpretation. However, reconnaissance mapping by me and the observations of Feininger (1965) suggest the following:

The blastomylonitic and slickensided rocks associated with the Honey Hill and Lake Char faults (see fig. 1) can be traced into one another here. No such rocks occur east of Billings Lake. Therefore we (Dixon and Lundgren) believe that the Honey Hill Fault does not extend east of this area and that the Honey Hill and Lake Char faults are simply segments of a single major fault surface.

The laminar shear parallel to bedding was distributed through all units between the Preston Gabbro and the alaskite (Mag on Feininger's map) that outcrops at Billings Lake. Thus the fault lies at a lower stratigraphic horizon here than in the segment A-B and the Monson Gneiss (or its equivalents) is much more strongly affected here than in segment A-B.

The fault is more recent than the Preston Gabbro, having affected its outer margins rather strongly. Nothing is known about the manner in which the fault cuts beneath the Preston Gabbro, however.

Exposures

Stop 10. Billings Lake (24.45 N - 83.80 E)

Area south and southwest of Billings Lake (SE Jewett City quadrangle) displays blastomylonitic rocks developed from isoclinally folded amphibolite, alaskite, quartz-plagioclase gneiss and other rocks. These apparently represent the position of the Lake Char (or Honey Hill) Fault.

Stop 11. Andersons Pond (24.49 N - 83.46 E)

Excellent outcrops west of Connecticut Highway 201 and south of Andersons Pond in the SE Jewett City quadrangle provide a fine display of conjugate (kink) folds developed in finely laminated mylonite and blastomylonite developed from a unit not yet stratigraphically identified. These folds are of the sort commonly seen in thrust zones, where they develop late in the history of the thrust zone.

PLAINFIELD AREA

Observations

Exposures in the vicinity of the Lake Char Fault in the Plainfield quadrangle (Dixon, 1965) provide excellent illustrations of mylonite and blastomylonite developed from lower Quinebaug and two-feldspar gneisses containing microcline porphyroclasts. They also display cataclastic rocks that are, in general, less recrystallized than those in the Honey Hill Fault zone, and true breccias also are present. Thus there is some evidence that suggests that the segment of the fault exposed here was developed at somewhat different conditions than the segment A-B, for example.

ExposuresStop 12. (31.2 N - 82.9 E)

Connecticut Turnpike Connector cuts at the Plainfield exit (Exit 88) display mylonitic lower Quinebaug, two-feldspar mylonite gneiss, numerous small faults and slickenside surfaces, and cataclastic pegmatites.

Stop 13. (33.6 N - 83.8 E) SE of Roper Rd. overpass, 1000' E of Conn. Turnpike.

Lake Char Fault is exposed in the northeast corner of the Plainfield quadrangle. Above the fault is Quinebaug mylonite and on the fault neomineralized blastomylonite. Below the contact are mylonitic quartzite and alaskite.

OLD LYME AND ESSEX AREAS

Exposures

Stop 14. (16.47 N - 71.55 E) Saltworks Point, Old Lyme quadrangle. Location is designated as "Billow" on the topographic map.

Migmatite consisting of gray, biotitic and hornblende quartz-feldspar gneiss and interleaved pink, garnet-bearing granite is the principal type of rock in the lower Plainfield Formation. It is best exposed at "Billow" (see frontispiece in Lundgren, 1967) where glacially polished surfaces display cross-sections of steeply plunging folds in the migmatite. Originally continuous amphibolite layers occur here in boudins. The individual boudins are now mineralogically zoned; the interior of each boudin is normal black hornblende-plagioclase amphibolite but the outer rim is garnetiferous or biotitic. These rims developed after the original amphibolite layers had been fractured by tension fractures perpendicular to the bedding and after the fragments (boudins) had separated from one another.

The migmatites are cut by a biotite granite (Black Hall type, Lundgren, 1967, p. 22) that is best exposed about 1500 ft east of Billow along the shore south southwest of Little Pond. This biotite granite is discordant, massive, and pegmatitic. It is notable for the common occurrence of large biotite crystals (maximum 1 ft diameter) and graphic granite (intergrowths of K-feldspar and quartz). The same exposures here also display the sillimanite-garnet schists and amphibolites that are an important, although poorly exposed, part of the Plainfield Formation. The beach sands between

Billow and Little Pond reflect the mineralogy of the Plainfield Formation, as garnet sands are conspicuous.

Stop 15. (16.68 N - 73.70 E) Point O'Woods, Old Lyme quadrangle.

The point designated on the topographic map as "Holm" and the entire east shore of Point O'Woods display continuous outcrop of migmatitic gneiss and minor quartzite and amphibolite of the Plainfield Formation. These rocks are isoclinally folded (Lundgren, 1967, p. 24, fig. 6) locally. The most important feature seen here is the set of dikes of Westerly type granite (Lundgren, 1967, p. 21), a rather fine-grained intrusive rock that was intruded into east-west fractures that formed in the rocks of the coastal region between Point O'Woods and southern Rhode Island during the Permian (?). The granite dikes are the youngest rocks in eastern Connecticut; the Plainfield Formation, which they cut, is the oldest rock unit in eastern Connecticut.

Stop 16. (16.8 N - 67.2 E) Exit 64 of the Connecticut Turnpike, Essex quadrangle.

The cuts at Exit 64 are made in garnet-sillimanite-orthoclase migmatitic schist of the Brimfield Formation. The same stratigraphic unit is a garnet-muscovite schist further north in the Deep River quadrangle in the vicinity of Stop 1. The sillimanite and orthoclase present at Stop 16 are the products of a reaction in which muscovite was eliminated. The schists contain abundant pyrite and pyrrhotite, so the exposures have deteriorated rapidly. However, the associated "coticule" (bedded quartz-spessartite rock) is somewhat more resistant to weathering, so it remains in rather fresh state on the north side of the Turnpike. The natural outcrops on the north side of the Turnpike display only the resistant coticule; the schist was completely stripped away by erosion.

REFERENCES

- Dixon, H. R., 1965, Bedrock geology of the Plainfield quadrangle, Connecticut: U. S. Geol. Survey Geol. Quad. Map GQ-481.
- Feininger, Tomas, 1965, Bedrock geology of the Voluntown quadrangle, Connecticut: U. S. Geol. Survey Geol. Quad. Map GQ-436.
- Goldsmith, R. G., 1967, Bedrock geology of the Uncasville quadrangle, Connecticut: U. S. Geol. Survey Geol. Quad. Map GQ-576.
- Loughlin, G. F., 1912, The gabbros and associated rocks at Preston, Connecticut: U. S. Geol. Survey Bull. 492, 158 p.
- Lundgren, L. W., Jr., 1963, The bedrock geology of the Deep River quadrangle, Connecticut: Connecticut Geol. and Nat. History Survey Quad. Rept. 13, 40 p.
- Sclar, C. B., 1958, The Preston gabbro and associated metamorphic gneisses, New London County, Connecticut: Connecticut Geol. and Nat. History Survey Bull. 88, 131 p.
- Snyder, G. L., 1964, Petrochemistry and bedrock geology of the Fitchville quadrangle, Connecticut: U. S. Geol. Survey Bull. 1161-I, 64 p.

Trip F-3

STRATIGRAPHY AND STRUCTURE OF THE METAMORPHIC ROCKS
OF THE STONY CREEK ANTIFORM (A "FOLDED FOLD") AND
RELATED STRUCTURAL FEATURES, SOUTHWESTERN SIDE
OF THE KILLINGWORTH DOME

by

John E. Sanders
Barnard College

SUMMARY

The pre-Triassic metamorphic terrain of the Eastern Highlands province southwest of the Killingworth dome presents many problems. The prominent units of the dome, the Monson and Middletown Formations, evidently do not extend toward the southwest. Instead, what are thought to be older units have been brought up along faults. The structural unit most clearly displayed by these supposedly older rocks is the Stony Creek antiform, whose axial surface resembles a simple anticline plunging eastward. The Stony Creek antiform is clearly delineated by the Plainfield "quartzite." The Stony Creek granite lies within the outcrop belt of the Plainfield.

Other feldspathic gneisses and amphibolites are present north of the Connecticut Turnpike; these are of unknown age, but are thought to be younger than the Plainfield but older than the Monson.

North of Branford Center, intensely sheared and mylonitized rocks dip gently northward and lie north of a recumbent syncline that opens to the south. Although its area of exposure is close to the Triassic Border Fault, the mylonite is clearly unrelated to the Triassic fault and strikes eastward away from this fault. One possible interpretation is that the mylonite marks the Honey Hill fault. If so, then several large younger faults, probably of post-Triassic age, have cut the pre-Triassic rocks to isolate this stretch of the Honey Hill fault from its more continuous belt of exposure on the east side of the Killingworth dome.

Trip F-4

A STRUCTURAL AND STRATIGRAPHIC CROSS-SECTION TRAVERSE
ACROSS EASTERN CONNECTICUT^{1/}

by

H. Roberta Dixon and L. W. Lundgren, Jr.
G. P. Eaton University of Rochester
U. S. Geological Survey

A simplified, but nonetheless fairly accurate, summary of our current interpretation of the structure of eastern Connecticut is given by Percival (1842). Whether Percival has in mind an overturned fold system may be questionable, but his phrasing suggests that he may have.

"...This range [unit F, which is the Putnam Group] presents several analogies to the formation (D,) [Brimfield Schist] in the character and arrangement of its rocks, and the two might indeed be considered as forming a whole, inclosing the range (E) [Hebron Formation] on the East and West; the coarser grained rocks, partly with bucholzite, extending in a narrow band along the borders of the Southwest extremity of the latter, apparently forming a connecting link between them. The formation (D,) like the present range, exhibits a series of rocks along its borders, with a more porphyritic structure than is found in the rocks of its interior. Both ranges present a line of more granitic rocks towards the interposed Micaceous range (E;) but their strongest relations are observed in the affinities of the dark micaceous veined rocks (D epsilon) and (F₂ alpha,) and of the very ferruginous micaceous rocks, with plumbago and seams of bucholzite (D₂ beta 2) and (F₂ delta). The resemblance of these is so obvious that it can hardly escape the attention of the casual observer." (Percival, 1842, p. 289).

The purpose of trip F-4 is to demonstrate at least some of the evidence by which the overturned syncline projected across much of eastern Connecticut has been recognized and to show correlative units within different parts of the structure. The structure, as interpreted from relations shown on the geologic map of eastern Connecticut (Goldsmith, 1963), is not a nappe as it is currently interpreted, but a folded syncline. This is shown in Figure 1, a geologic map, and in Figure 2, a geologic fence diagram. The trace of the axial surface is shown by a dashed line in both figures. Tickmarks have been placed on the overturned limb of the syncline axis trace on the geologic map. The syncline has been mapped in three segments, all

^{1/} Publication authorized by the Director, U. S. Geological Survey.

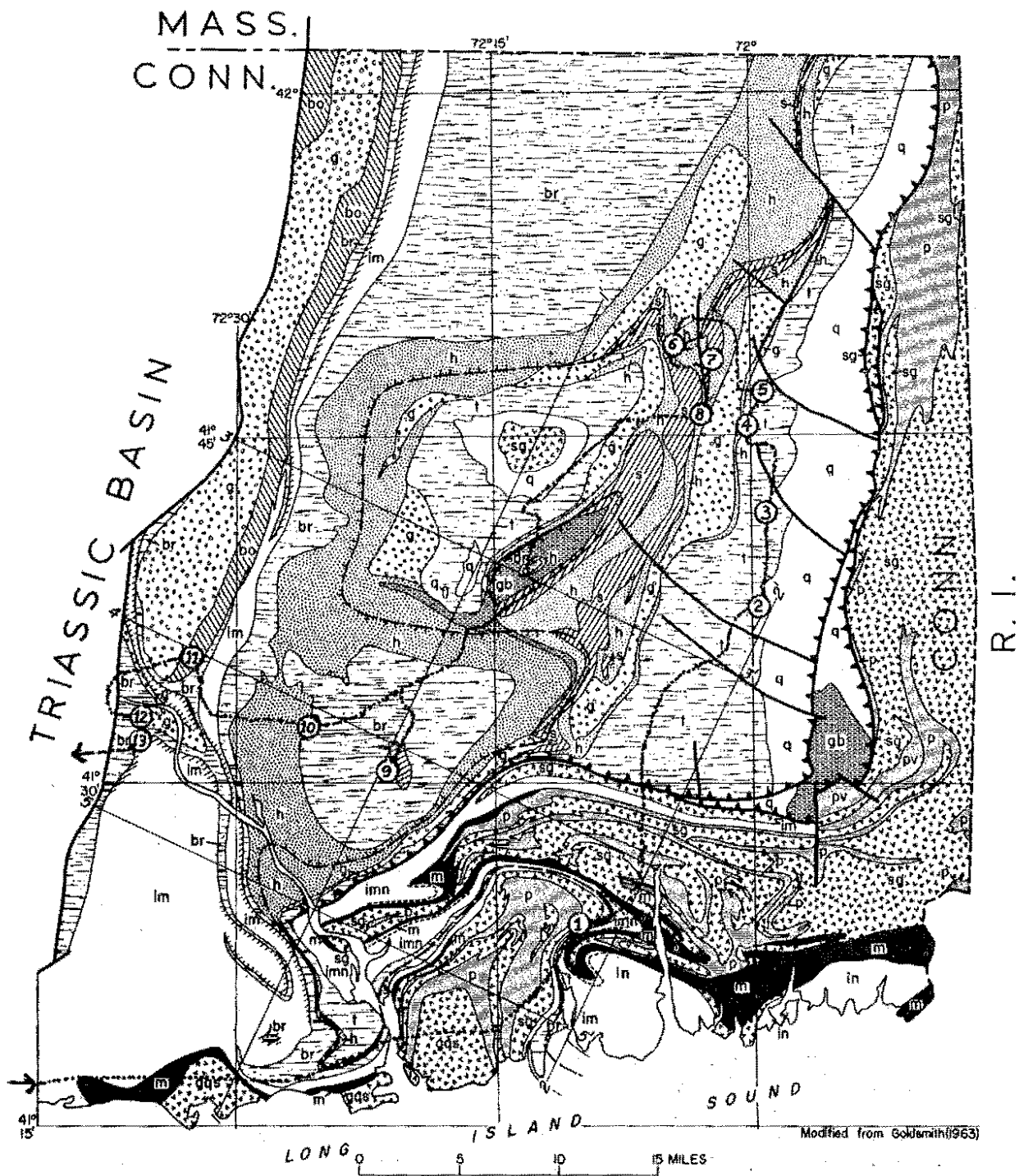

Figure 1. Geologic map of eastern Connecticut showing route and stops for Trip F-4. Explanation of units and symbols given in Fig. 2.

of which are interpreted to be part of the same refolded fold. South of the Honey Hill fault the fold is called the Hunts Brook syncline (Goldsmith, 1961); it contains the Tatnic Hill Formation and Brimfield Schist in the core. West and north of the Honey Hill fault the fold is called the Chester syncline (Lundgren, 1963, 1964). The Hebron Formation forms the core of the Chester syncline and the Tatnic Hill and Brimfield are on the east and west flanks, respectively. North of the Willimantic dome the fold is called the Hampton syncline and Scotland Schist occurs in the core. The axial surface of the Hunts Brook-Chester-Hampton syncline is folded around the Selden Neck "dome," and the "dome" is actually the axial surface of the refolded recumbent syncline. The trace of the synclinal axial surface from the steep part of the Chester syncline, around the Willimantic dome to the Hampton syncline is not well established; it probably is in the Hebron Formation most of the distance, but may be partly in Scotland Schist.

Regional correlations of units within the structure are:

<u>Overtured limb</u>	<u>Normal limb</u>
	Scotland Schist
Hebron Formation	Hebron Formation
Brimfield Schist	Tatnic Hill Formation
Middletown - Monson Gneisses	Quinebaug Formation

The belt of Monson Gneiss west of the Chester syncline is in the core of the Monson anticline. Only the steeply dipping core of the anticline is exposed, but the anticline probably also was refolded and was on top of the Chester syncline before erosion. The Middletown Gneiss in the Hopyard basin (Stop 9) is near the core of the overlying anticline. The Middletown Gneiss and the Brimfield Schist are repeated in the west limb of the Monson anticline and the east limb of the Great Hill syncline. The Clough, Fitch, and Littleton Formations occur in the core of the Great Hill syncline. Correlation of these units with rocks to the east is not well established. The most commonly suggested correlation is the Scotland Schist with the Littleton Formation. If these units are equivalent, the Hebron Formation is either equivalent to the Fitch or is pre-Clough (pre-Silurian). The Great Hill syncline plunges gently north, and the Clough, Fitch, and Littleton Formations are not exposed in the Killingworth dome area. The structure of the dome is complex and is poorly understood because detailed mapping is not complete.

We will make one stop (Stop 1) in the core of the Hunts Brook syncline, and then will cross from the normal limb of the recumbent Chester-Hampton syncline into the overtured limb, westward across

the Monson anticline, and into the core of the Great Hill syncline. We will show what we consider to be correlative units in the normal limb, the overturned limb, and the area west of the Monson anticline.

Quadrangles in which stops will be made and for which there are published geologic quadrangle maps are Montville (Goldsmith, 1967a), Plainfield (Dixon, 1965), Hampton (Dixon and Pessl, 1966), Danielson (Dixon, 1968), and Hamburg (Lundgren, 1966).

STOP DESCRIPTIONS

Stop 1 (20.5 N - 75.96 E) Montville quadrangle. Roadcuts along Interchange 77 of the Connecticut Turnpike (Interstate 95) and along Route 85 southeast of Interchange 77.

The rocks along the interchange are sillimanite-bearing biotite-quartz-feldspar gneisses equivalent to the Brimfield Schist and the Tatnic Hill formation. The rocks are in the sillimanite-potassium feldspar grade of metamorphism. Minor folds plunge steeply northeast. Brimfield and Tatnic Hill gneisses occupy the core of the Hunts Brook syncline (Goldsmith, 1961), which can be traced southwestward into the Chester syncline of the Essex quadrangle (Lundgren, 1964). In the Chester syncline, the Brimfield Schist and the Tatnic Hill Formation are in opposite limbs, separated by the Hebron Formation in the core. Brimfield Schist in the west flank of the Chester syncline can be traced northward and may be continuous with the large area of Brimfield in northern Connecticut and in Massachusetts (Pease and Peper, Trip F-5). Tatnic Hill Formation in the east flank of the Chester syncline can be traced northeast above the Honey Hill fault to the type area of the Tatnic Hill Formation in the Plainfield-Danielson area. Thus, the gneisses exposed in the core of the Hunts Brook syncline, at this stop, are correlated with both the Brimfield and the Tatnic Hill.

The Monson Gneiss on the northwest limb of the Hunts Brook syncline is exposed in the hills north of Interchange 77 and along the turnpike for about $\frac{1}{2}$ mile northeast and southwest of the interchange. Monson Gneiss in the southeastern limb of the syncline is exposed along Connecticut Route 85, southeast of Interchange 77. The rock is well-layered, hornblende-biotite and biotite-quartz-plagioclase gneiss with subordinate amphibolite lenses. A thin, almost horizontal dike of Westerly Granite is also exposed in the roadcuts on Route 85.

Return to Interstate 95 and continue north to Interchange 83A north of Norwich. East of the axis of the Hunts Brook syncline, across the Montville and the Uncasville quadrangles (Goldsmith, 1967b), the rocks traversed by the turnpike are progressively older to the Plainfield Formation, which forms the core of the Montville dome (eastern extension of the Selden Neck dome of Lundgren, 1963,

1966). Continuing northward along the turnpike, the rocks are progressively younger to the Honey Hill fault in the southwestern corner of the Norwich quadrangle (Snyder, 1961). All rocks are extensively intruded by sills of biotite gneiss or alaskite gneiss of the Sterling Plutonic Group. North of the Honey Hill fault the turnpike crosses the lower member of the Tatnic Hill Formation. Putnam Gneiss of the Norwich quadrangle as defined by Snyder (1961), is equivalent to the Tatnic Hill Formation of present usage.

Stop 2 (29.41 N - 80.65 E) Plainfield quadrangle. Exposures along Route 169 south and north of the intersection with an unnamed road in the southwest corner of the quadrangle.

South of the intersection the rock is primarily rusty-weathering gneiss at the base of the Tatnic Hill Formation, though the garnet-biotite gneiss unit is exposed at the southern end of the cuts and along a small fault at the northern end. The garnet-biotite gneiss, which overlies the rusty-weathering gneiss, is also exposed in several small outcrops in the woods east of the road. The rusty-weathering gneiss is typically rich in garnet and sillimanite, and commonly contains some graphite. The rusty-weathering gneiss also contains muscovite, which is probably primary metamorphic, and some potassium feldspar. In some outcrops, however, muscovite is retrograde after sillimanite and feldspar. The garnet-biotite gneiss commonly contains abundant garnet, may contain sillimanite, and characteristically contains a clear pink potassium feldspar which may form coarse megacrysts as much as 2 centimeters in diameter.

North of the intersection with the unnamed road, exposures in the road bank are of the upper member of the Quinebaug Formation. The contact between the Quinebaug and the Tatnic Hill Formations trends northeast; near the road junction, the geologic section is overturned because of a small fold. The Quinebaug Formation here consists of the coarse hornblende gneiss, which is typical of the formation. Hornblende and plagioclase grains as much as a centimeter in diameter are in a finer grained matrix of hornblende, biotite, plagioclase, and minor quartz.

Better exposures of the contact between the Tatnic Hill and the Quinebaug Formations occur in the southwest corner of the Danielson quadrangle, west of the intersection of Route 169 and Beechers Road (33.66 N - 81.57 E) on the east side of Tatnic Hill; these exposures are not included on this trip because of time limitations. Here about 100 to 150 feet of the uppermost Quinebaug Formation is exposed in a series of cliff exposures. The contact with the rusty-weathering gneiss at the base of the Tatnic Hill Formation is exposed at the break in slope at the top of the cliffs; stratigraphically above and west of the rusty-weathering gneiss are several exposures of the garnet-biotite gneiss. Several small

thrust faults occur in the exposures; rotated pods of amphibolite, stacked-up boudins, and a few rotated garnets all indicate a general west to east movement.

Stop 3 (31.54 N - 80.87 to 81.19 E) Plainfield quadrangle. Series of roadcuts along Route 14 in the village of Canterbury, 1000 feet to $\frac{1}{2}$ mile west of the intersection of Routes 14 and 169.

These cuts expose lithologic varieties in the lower member of the Tatnic Hill Formation, except garnet-biotite gneiss. The rusty-weathering gneiss at the eastern end of this series of roadcuts is considerably thicker than the belt of rusty gneiss at the base of the formation (exposed at Stop 2); and this unit may be a lens within the lower member. However, the rocks in this cut are strongly faulted and folded, and much of the rock is cataclastic; perhaps this is the basal unit repeated and thickened tectonically. When Route 14 was widened in 1962, the fresh rock was a dark-gray biotite gneiss, but within a year the rocks acquired the prominent rust stain.

West of the Canterbury School a lens of well-layered, folded calc-silicate gneiss within the lower member can be traced along strike for about 5 miles. This lens, a biotite-hornblende-quartz-plagioclase gneiss, commonly contains diopside and locally has calcite or scapolite. In general it is similar in appearance and mineralogy to the Fly Pond Member of the Tatnic Hill Formation.

The sillimanite gneiss unit at the western end of the cuts that makes up the bulk of the lower member of the Tatnic Hill is exposed. If there is such a thing as a typical rock of the formation, this would probably be it. The rock is primarily a medium-dark-gray, nonrusty or slightly rusty, biotite-quartz-feldspar gneiss containing linear clots or planar mats of sillimanite needles, or sericite after sillimanite, and 1 or 2 percent small red garnet crystal.

Stop 4 (33.94 N - 80.40 E) Hampton Quadrangle (Dixon and Pessl, 1966).

Exposures in the woods about 200 feet northwest of the intersection of Windham Road and North Society Road are of the Fly Pond Member of the Tatnic Hill Formation, a distinctive unit of calc-silicate rock in the middle of the Tatnic Hill. The rock is a medium-gray, well-layered, biotite-hornblende-quartz-plagioclase gneiss that commonly contains diopside. Pegmatites are common in the Fly Pond; the outcrop here is unusual because it contains only a few small pegmatites. Exposures of the unit on the east side of North Society Road about 700 feet south of the intersection with Windham Road are mostly pegmatite and the well-layered nature of the Fly Pond is poorly shown.

Stop 5 (34.86 N - 80.43 E) Danielson quadrangle. Roadcuts on U. S. Route 6 near the western edge of the quadrangle.

The cuts expose the Yantic Member of the Tatnic Hill Formation, which forms the top of the formation. The Yantic is a dark-gray, nonrusty, coarse, two-mica schist interlayered with fine-grained biotite granular schist. Sillimanite-bearing lenses occur on the eastern side of the unit (lower stratigraphically) and kyanite-staurolite-bearing lenses occur on the western side (neither are exposed in the Route 6 cuts). The Yantic is also commonly cut by pegmatites and locally is converted to migmatite. Coarse grains of feldspar, either plagioclase or, near pegmatites, microcline are common in the schist.

Stop 6 (36.46 N - 78.99 E) Hampton quadrangle. A small outcrop is in the woods about 1,500 feet northeast of the northern edge of Hampton Reservoir.

Walk along woods trail to the western edge of the pine woods, then go over the top of the hill to the south-facing slope. The outcrop is about half way down the hill. This exposure is on or near the contact between the Scotland Schist and the Hebron Formation on the hinge of a recumbent syncline. This is the only known exposure of a hinge in the recumbent part of the overturned syncline. Well preserved bedding strikes about N. 10° E. and is almost vertical; axial-plane cleavage dips north at a low angle. Gradational bedding indicates the top is to the east. The Scotland Schist in the eastern edge of the outcrop overlies the Hebron in the western part.

Stop 7 (34.66 N - 78.98 E) Hampton quadrangle. Cliff exposures about 50 feet above Old Route 6 east of Hampton village are of Scotland Schist.

The rock is biotite-muscovite-quartz schist with small red garnet crystals, and staurolite and(or) kyanite; in the Hampton area both staurolite and kyanite commonly are present. Muscovite is in coarse plates and is commonly crinkled to form a strong lineation plunging gently north-northeast. The Scotland in this area is moderately rusty weathering; further south, where a thicker sequence of Scotland Schist is exposed, most rocks of the unit are only slightly rusty weathering.

Scotland Schist is the youngest metasedimentary rock in the eastern side of eastern Connecticut and may be correlative with the Littleton Formation (to be seen at Stop 11). In the Fitchville quadrangle to the south (Snyder, 1964a) and the northern half of the Hampton quadrangle, the Scotland is probably in the core of a recumbent syncline. The axial surface of the syncline has been

warped over the Willimantic dome to the west and wraps around the south, west, and north sides of the dome. The Scotland Schist, in the Scotland quadrangle (Dixon and Shaw, 1965) and southern half of the Hampton quadrangle, is on the east flank of the dome and is in the normal limb of the recumbent syncline.

Stop 8 (34.12 N - 78.98 E), Hampton quadrangle. Roadcuts along U. S. Route 6, 1,000 feet east of its intersection with Route 97, expose well-folded Hebron Formation.

The contact with the Scotland Schist is on the hill north of the cuts and is exposed in Cedar Swamp Brook south of Route 6 and west of Route 97. The Hebron is a well-layered, dark-gray, biotite-quartz-plagioclase, granular schist, commonly containing hornblende, epidote, minor calcite, and, in some layers, diopside, scapolite, and minor garnet. Large exposures of the Hebron commonly show strong internal folding. The folds are overturned to the east, and axes plunge north at a shallow angle.

From Stop 8 continue west on U. S. Route 6 to Willimantic; take Route 89 south to Route 207 across the Willimantic quadrangle (Snyder, 1964b), and Route 207 southwest to Colchester; an alternate is Route 32 south from Willimantic to Route 2, west on Route 2 across the Fitchville quadrangle (Snyder, 1964a). West of Hampton, Route 6 crosses the east side of the Willimantic dome, going through the Tatnic Hill Formation and into the Quinebaug Formation near the core of the dome. South of Willimantic we cross the southern flank of the dome and the body of gabbro at Lebanon, which is near the axial surface of the recumbent syncline. We cross the trace of the axial surface in the northeastern corner of the Colchester quadrangle. On Route 2 the trace of the axial surface is in the belt of Scotland Schist in the center of the Fitchville quadrangle. From there westward we are in the overturned limb of the syncline, and the rocks are progressively older going into the core of the Monson anticline, which we cross between stops 10 and 11.

Stop 9 (24.26 N - 71.20 E) Exposures along Haywardville Road and in the woods north and south of the road near the northern edge of the Hamburg quadrangle.

The rocks here consist of Middletown Gneiss overlying Brimfield Schist in the overturned limb of a recumbent syncline. The overturned contact is exposed on the hill slope between Haywardville Road and Salem Road. The exposures along Haywardville Road are banded biotite-plagioclase-quartz gneiss and amphibolite (Lundgren's unit Omig, 1966) of the Middletown Gneiss. In the woods north and south of the road is the anthophyllite gneiss (Lundgren's unit Omia, 1966) characteristic of the Middletown

Gneiss. Small folds in the outcrops north of the road plunge north-northwest 20° to 30°, parallel to the anthophyllite lineation. The Brimfield Schist beneath the Middletown is a biotite-muscovite-quartz-plagioclase schist that contains garnet and sillimanite; it is typically rust-stained.

Stop 10 (26.07 N - 68.67 to 68.87 E) Moodus quadrangle. Roadcuts along Route 16 about 1 mile west of the intersection with Route 149.

Brimfield Schist overlies the Hebron Formation in the overturned limb of a syncline. Here the Brimfield Schist is a rust-stained, massive, nonlayered, biotite-muscovite schist with garnet and sillimanite; this unit is at the top of the Brimfield and is equivalent to the Yantic Member of the Tatnic Hill Formation seen at Stop 5. Road-cuts about 1/4 mile farther west along Route 16 are in the Hebron Formation. The Hebron here is a layered biotite schist and biotite-hornblende schist with some calc-silicate layers; it is cut by abundant pegmatites, in part folded and boudinaged. The folds are overturned to the east and indicate a general west to east direction of movement.

Stop 11 (27.78 N - 65.84 E) Middle Haddam quadrangle. Exposure on the hilltop about 2,500 feet west-northwest of the intersection of Clark Hill Road and Midwood Farm Road are of the Littleton Formation.

We have crossed the Monson anticline, which forms the core of the anticline west of, and above, the recumbent Chester syncline and are here in the Great Hill syncline. The Littleton Formation (Camp Jenkins Formation of Eaton and Rosenfeld, 1960) exposed here occupies the axial zone of the Great Hill syncline. It is a silvery-gray, muscovite-biotite schist with prominent porphyroblasts of staurolite and garnet. Interbedded with the schist are laminae and thin beds of subordinate "sandy" micaceous quartzite. Two subhorizontal lineations are apparent at this locality -- one formed by the preferred orientation of staurolite, and the other by crinkling of the schistosity. Both are parallel to the axis of the overturned Great Hill syncline.

Approximately 1.6 miles to the southwest, outcrops of Littleton Formation end at the west-plunging nose of the syncline, where they are rimmed by calc-silicate rocks of the Fitch Formation. The Littleton and Fitch Formations and the Clough Quartzite are not seen further to the south within the state of Connecticut. To the north these formations can be traced, via a series of complex structures, across Massachusetts and through western New Hampshire to their type localities. The Littleton Formation may be stratigraphically equivalent to the Scotland Schist seen at Stops 6 and 7. The correlation is based partly on gross lithologic similarity

and partly on the interpretation of an analogous stratigraphic position in the local sequence of stratified rocks.

From Stop 11 continue west along the woods road to Strickland Street. The steep slope left of the road is upheld by Clough Quartzite (Great Hill Quartzite of Eaton and Rosenfeld, 1960), which here defines the west (overturned) limb of the Great Hill syncline. Around a bend in the road to the left the road passes through the only gap in an otherwise continuously exposed, 4-mile-long belt, of Clough within the Middle Haddam quadrangle. To the south and north, the Clough forms a prominent hogback that can be seen for miles from the west.

At the foot of the first downgrade, the road enters the Glastonbury dome, a large, anvil-shaped mass of granitic and dioritic gneiss, with a rounded southern terminus. The outcrop pattern of this terminus is like that of a south-plunging anticline, but, in reality, it plunges north. Several lines of evidence suggest that post-Littleton plastic movement of the Glastonbury Gneiss, primarily upward and southward, carried it differentially along the base of the Clough Quartzite on the west limb of the Great Hill syncline.

Stop 12 (26.44 N - 63.95 to 64.11 E) Middle Haddam quadrangle. Exposures on the south side of River Road about 1 mile east of the intersection with Silvermine Road.

The rocks are of the upper part of the Brimfield Schist and are rusty-weathering, graphitic and pyritic biotite-muscovite schist that locally contains porphyroblasts of kyanite and (or) sillimanite, competent beds of coarse-grained calc-silicate granofels, and abundant beds of biotite-quartz schist. The formational unit is considered correlative with the Tatnic Hill Formation seen at Stops 3, 4, and 5, and with the Brimfield Schist seen at Stop 10. The Brimfield and the Middletown Gneiss (Stop 13) contain most of the pegmatites in the quadrangle. Pegmatites in the Brimfield Schist, are smaller and mineralogically and texturally more varied than those in the Middletown Gneiss.

Stop 13 (25.58 N - 64.30 E) Middle Haddam quadrangle. Outcrops along the powerline between Brooks Road and Bear Hill Road.

The contact between the Middletown Gneiss and the Brimfield Schist is exposed along the power line. The rocks are thought to be stratigraphically equivalent to those at Stop 9 and Stop 2, at the contact of the Quinebaug and Tatnic Hill Formations. We will walk south along the powerline and examine outcrops in the swath and wooded gully to the west.

The powerline swath cuts diagonally across a broad, open, gently plunging syncline in the light-gray gneiss of the basal

member of the Brimfield Schist. The gneiss is a magnetite-bearing, muscovite-biotite-quartz-plagioclase rock with small pebbly-looking masses of quartz, or quartz and sillimanite, that weather in sharp relief. Stratigraphically above the gneiss, at the west edge of the swath part way up the slope of the gully, a rusty-weathering biotite-muscovite schist contains porphyroblasts of kyanite and fibrous sillimanite pseudomorphous after kyanite. Stratigraphically below the gneiss, finely laminated hornblende-epidote-feldspar gneiss and garnetiferous biotite-quartz-feldspar gneiss are exposed in the wooded gully to the west. Below these gneisses exposures on the north-facing slope east of, and below, Bear Hill Road are of typical Middletown Gneiss, a coarse-grained, light-gray, locally rust-stained, anthophyllite-biotite-quartz plagioclase gneiss locally interbedded with subordinate thin beds of hornblende amphibolite.

This stop is at the nose of a north-northwest plunging anticlinorium that marks the north end of the Haddam (Killingworth) dome. The anticlinorial nose is the site of many phacolithic bodies of pegmatite, the largest of which is exposed in the powerline swath on the north-facing slope south of Bear Hill Road.

Trip F-4: Mileage Log

Leave New Haven on the Connecticut Turnpike (Interstate 95), and go east to Interchange 77. Mileage and description of rock units exposed along the turnpike will start at the western edge of the Essex quadrangle. The rocks west of the Essex quadrangle are on the southern flank of the Killingworth dome and are not yet completely mapped.

Mileage

- 00.0 Enter Essex quadrangle (Lundgren, 1964). Cuts near the quadrangle boundary are the Clinton Granite Gneiss of Rodgers and others (1956), which is probably part of the Sterling Plutonic Group. The Clinton here is interleaved with rocks equivalent to the Mamacoke Formation and possibly the New London Gneiss.
- 00.4 Exposures of Monson Gneiss.
- 00.7 Roadcuts from Interchange 64 to 66 are of Brimfield Schist. The roadcuts show the typical rusty-stained, micaceous schist and lenses of amphibolite and calc-silicate gneiss. The Brimfield here is on the west and south limb of the Chester syncline.
- 05.1 Hebron Formation in the core of the Chester syncline near the bend of the axial surface. The exposures should be near the hinge of the re-fold.
- 05.6 Roadcuts from here to the edge of the quadrangle are of the Tatnic Hill Formation in the east and north limb of the Chester syncline.
- 07.2 Old Lyme quadrangle (Lundgren, 1967).
- 08.4 The turnpike again crosses the axis of the folded Chester syncline and goes through progressively older units into the core of the Lyme dome.
- 10.4 - Several roadcuts of the Plainfield Formation in the core of
13.3 the Lyme dome. The rock is primarily biotitic quartz-feldspar gneiss with layers of schist and amphibolite and abundant interleaved younger granite.
- 13.5 Roadcuts in biotite-sillimanite schist and gneiss on the east flank of the Lyme dome. The gneiss commonly contains quartz-sillimanite nodules.

Mileage

- 14.2 Niantic quadrangle (Goldsmith, 1967c).
- 14.3 - Exposures of biotite granite gneiss and alaskite gneiss of
14.8 the Sterling Plutonic Group.
- 15.3 - Several roadcuts in the Plainfield Formation on the east
17.5 flank of the Lyme dome. At the western edge of the roadcuts,
the rocks are quartzite and feldspathic quartzite with thin
seams of sillimanite schist. Roadcuts between Interchanges
73 and 74 are quartz-sillimanite-biotite gneiss, garnet-
biotite gneiss, and minor biotite gneiss.
- 17.5 - Roadcuts of biotite granite gneiss and alaskite gneiss of
18.3 the Sterling Plutonic Group. Minor biotite-quartz-plagio-
clase gneiss of the Mamacoke Formation is exposed at the
northern end of the roadcuts.
- 18.6 Roadcuts in the Mamacoke Formation consisting of interlayered
amphibolite, biotite-quartz-plagioclase gneiss, calc-silicate
gneiss, and biotite-quartz-orthoclase gneiss with quartz-
sillimanite nodules.
- 18.7 Montville quadrangle (Goldsmith, 1967a).
- 18.7 - Exposure of the contact between the Mamacoke Formation and
18.8 the Monson Gneiss.
- 18.8 - Several roadcuts in the Monson Gneiss. Monson is a gray
20.1 layered biotite-quartz-plagioclase gneiss and hornblende-
biotite-quartz-plagioclase gneiss with subordinate amphi-
bolite and microcline-bearing layers. The Monson is on
the east flank of the Lyme dome and the west limb of the
Hunts Brook syncline, which is the eastern extension of the
Chester syncline. The Monson here is continuous around the
dome with the exposures of Monson Gneiss noted at the
western side of the Essex quadrangle at Mile 00.4.
- 20.7 Exit at Interchange 77. Park on the north side of Route 85,
near the turnpike overpass.
- Stop 1.
- Return to the turnpike and continue north.
- 21.4 Roadcuts of Monson Gneiss, in the west limb of the Hunts
Brook syncline.
- 22.3 Cross the axis of the Hunts Brook syncline.

Mileage

- 22.4 Exposure of Brimfield Schist and Tatnic Hill Formation in the synclinal core on the east side of the highway.
- 22.7 - Monson Gneiss and New London Gneiss on the east limb of the
23.0 Hunts Brook syncline. The New London Gneiss consists of a layered granodiorite gneiss and amphibolite. The Joshua Rock Gneiss Member of the New London is exposed and consists of a distinctive aegerine-augite-bearing albite-quartz-microperthite gneiss.
- 23.0 - Roadcuts in the Mamacoke Formation and, in the eastern half,
23.6 in alaskite gneiss and biotite granite gneiss of the Sterling Plutonic Group.
- 24.1 Uncasville quadrangle (Goldsmith, 1967b).
- 24.5 - Exposures of the Plainfield Formation, and alaskite gneiss
27.5 and biotite granite gneiss of the Sterling Plutonic Group. These exposures are in the core of the Montville dome, which is the eastern extension of the Selden Neck dome.
- 28.5 - Roadcuts in alaskite gneiss of the Sterling Plutonic Group
29.2 Norwich quadrangle (Snyder, 1961).
- 29.3 Cross the Honey Hill fault (not exposed). All exposures on the turnpike across the Norwich quadrangle are in the lower member of the Tatnic Hill Formation. The Putnam Gneiss on the geologic map of the Norwich quadrangle (Snyder, 1961) is equivalent to the Tatnic Hill Formation of present usage. The rocks are muscovite-biotite-quartz-plagioclase and biotite-quartz-plagioclase gneisses and schists, many of which contain garnet and sillimanite.
- 38.3 Leave the turnpike at Exit 83A and turn north on Route 169. (Route 93 on Norwich topographic map)
- 39.1 Outcrops in the garnet-biotite gneiss of the lower member of the Tatnic Hill Formation.
- 40.3 Similar garnet-biotite gneiss on the east side of the road.
- 40.7 The sillimanite gneiss unit of the lower member of the Tatnic Hill is exposed at the intersection with Kinsman Hill Road.
- 41.0 Scotland quadrangle (Dixon and Shaw, 1964).
- 41.8 Plainfield quadrangle (Dixon, 1965).

Mileage

42.2 Stop 2.

Continue north on Route 169 to Canterbury village.

47.6 Intersection of Routes 169 and 14; turn west on Route 14 and park on the shoulder beside the roadcuts or in the school parking lot, 0.3 miles west of the intersection.

Stop 3.

Return to Route 169 and continue north. Exposures of the lower member of the Tatnic Hill Formation can be seen in the ridges west of the road. The rocks are mostly the garnet-biotite gneiss unit. Rocks north of the intersection with North Society Road are mylonite and mylonite gneiss.

50.4 Turn west on Buck Hill Road.

51.6 The sillimanite gneiss unit of the lower member of the Tatnic Hill is exposed on both sides of the road.

52.2 Turn north on North Society Road.

52.8 Danielson quadrangle (Dixon, 1968).

53.3 Hampton quadrangle (Dixon and Pessl, 1966).

53.7 Intersection with Windham Road. (Unnamed on Hampton topographic map.)

Stop 4.

Turn east on Windham Road.

53.9 Enter Danielson quadrangle.

54.5 Outcrop in the sillimanite gneiss unit on the west side of the road.

55.5 Intersection with U.S. Route 6; turn west on Route 6.

56.6 Stop 5. A wide parking area west of the exposures is on the south side of Route 6.

Continue west on Route 6.

56.7 Enter Hampton quadrangle.

Mileage

- 57.1 Turn north on Cherry Hill Road.
- 60.9 Turn north on Route 97.
- 61.2 Turn west on Fay Road, which turns into Stetson Road.
- 63.0 Turn west on Kenyon Road.
- 63.2 Stop 6. Park by entrance to a woods road.
Continue south on Kenyon Road.
- 65.6 Turn south on Route 97.
- 67.0 Hampton village; turn east at the center of the village on Old Route 6.
- 67.2 Stop 7.
Continue down the hill.
- 67.7 Turn south on Bigelow Road.
- 68.4 Turn west on Route 6.
- 68.6 Stop 8. Park on the wide shoulder in front of the roadcuts.
Continue west on Route 6.
- 70.3 Lunch stop at Goodwin Woods.
Continue west on Route 6.
- 72.7 Spring Hill quadrangle.
- 74.8 Outcrops on east side of road are in the upper part of the Tatnic Hill Formation on the east side of the Willimantic dome.
- 74.9 Enter Willimantic quadrangle (Snyder, 1964b).
- 79.2 Willimantic; intersection with Route 32; go around the traffic circle and south on 32.
- 79.3 Turn west south of the Willimantic River.
- 79.9 Turn south on Route 289.

Mileage

- 86.2 Lebanon village; turn southwest on Route 207.
- 87.9 Fitchville quadrangle (Snyder, 1964a).
- 88.4 Colchester quadrangle (Lundgren, unpub. data).
- 89.7 Turn south on Route 16.
- 92.6 Exposure of overturned Brimfield Schist on the north side of the road.
- 93.2 Colchester village; turn south on Route 85.
- 95.3 Turn southwest on West Road.
- 98.3 Turn west on Mill Lane Road.
- 99.1 Turn south on Haywardville Road.
- 99.8 Outcrop of overturned Middletown Gneiss on the west side of the road.
- 100.0 Enter Hamburg quadrangle (Lundgren, 1966).
- 100.7 Stop 9.
- Return to Colchester.
- 107.6 Colchester village; turn west on Route 16.
- 108.5 Outcrops of Brimfield Schist on the south side of the road.
- 110.3 Moodus quadrangle (Lundgren, unpub. data).
- 111.3 Brimfield Schist on the south side of the road.
- 113.1 Stop 10.
- Continue west on Route 16.
- 116.2 Outcrops of Brimfield Schist on both sides of the road.
- 117.4 Middle Haddam quadrangle (Eaton, unpub. data).
- 118.5 Outcrop of Brimfield Schist.
- 119.0 Turn north on Chestnut Hill Road.

Mileage

- 119.4 Cross Route 66 and continue north on Cone Road.
- 119.8 Turn west on Abbey Road.
- 120.1 Bear right at Y-intersection and continue north on Clark Hill Road.
- 120.7 Turn northwest on graded woods road.
- 120.9 Park at mouth of secondary woods road entering from the north. Walk about 225 feet north on the secondary road to the intersection of a trail on the right. Follow the trail about 1,600 feet to the top of the hill. About 300 feet northeast of the hilltop, across a low swale, is another broad hill, the top and east slope of which expose Littleton Formation.
- Stop 11.
- Return to the cars and continue northwest on the woods road.
- 122.4 Bear left on Coxs Road at intersection with second woods road.
- 123.1 Continue west on Coxs Road beyond intersection with Great Hill Road.
- 123.8 Bear right at Y-intersection.
- 124.2 Turn south on Rose Hill Road and at foot of the hill opposite the small dammed pond, turn right on Coxs Road.
- 124.8 Turn south on Route 17. In the last half mile we have crossed the contact between Glastonbury Gneiss and Brimfield Schist and, west of an outcrop belt of Brimfield, a belt of Maromas Granite Gneiss and then a large amphibolite of unknown age that was originally correlated with the Middletown or Monson Gneiss. Just before turning onto Route 17, we crossed the Triassic border fault into the Portland Arkose.
- 125.6 On the right of Route 17 is a long roadcut in coarse Triassic conglomerate. Examination of the cobbles and boulders suggests lithologic affinities with rocks of the Eastern Highlands through which we have been traveling, but the metamorphic grade of these clasts is lower than that of rocks in the Highlands. The dip of Triassic

Mileage

strata in this vicinity and in the narrow belt paralleling the fault ranges from 25° to 55° east. These dips are decidedly steeper than those of most Triassic strata in the Connecticut Valley, and this gives the impression that the strata have been subjected to "reverse drag."

- 126.4 Intersection with Route 66. We have crossed back into the crystalline rocks momentarily and are 250 feet east of the border fault. Turn west on Route 66. Follow Route 66 through Portland and across the Connecticut River into Middletown. At the foot of the curving ramp on the far side of the bridge at the head of Main Street, Middletown, bear sharply left around the traffic circle in front of the Catholic Church and proceed east and downhill.
- 129.4 Turn south (right) on Route 9. Once on Route 9, get into the left lane in order not to be shunted off on the main exit into South Middletown.
- 130.6 Leave Route 9 at the Silver Street Exit. At top of exit ramp turn left and proceed east, uphill, past the grounds of the Connecticut State Hospital.
- 131.3 Bear (around) to right on River Road, which skirts the south shore of the Connecticut River.
- 131.7 Ravine on left marks trace of the Triassic border fault. Part way down the ravine toward the river are the old (late 18th century) workings of a mine. Exposures reveal highly brecciated, slickensided, and altered Brimfield Schist, laced with veins of quartz, pyrite, and galena:
- Continue east along road.
- 132.0 Park and walk east along River Road.
- Stop 12.
- Turn around and proceed back along River Road. Bear left at intersection.
- 133.9 Turn left on graded road (Silvermine Road).
- 134.4 Turn left on Bow Lane, proceed for a distance of a little less than 0.10 mile, and turn right on Bartholomew Road.

Mileage

- 135.2 Intersection with cross road. This intersection sits athwart the Triassic border fault. Turn left and proceed less than 0.10 mile to Y-intersection. Bear right at Y.
- 135.8 Intersection in front of farm house. Turn left on Brooks Road and proceed east and uphill.
- 136.5 Stop 13. Park in powerline swath.
Turn around and proceed back along Brooks Road.
- 137.2 Road intersection. Bear left.
- 137.5 Turn north on old Route 9 (Saybrook Road). Proceed northwest to intersection with Route 155, 0.3 mile away. Turn west on Route 155 and proceed approximately 2.25 miles to intersection with Route 17. Turn left on Route 17, proceed 3.5 miles south to Durham. Turn right on Route 68 and proceed west to Interstate Highway 91. Take I-91 back to New Haven.

REFERENCES

- Dixon, H. R., 1965, Bedrock geology of the Plainfield quadrangle, Connecticut: U.S. Geol. Survey Geol. Quad. Map GQ-481.
- _____ 1968, Bedrock geology of the Danielson quadrangle, Connecticut: U.S. Geol. Survey Geol. Quad. Map GQ-696.
- Dixon, H. R., and Pessl, Fred, Jr., 1966, Geologic map of the Hampton quadrangle, Connecticut: U.S. Geol. Survey Geol. Quad. Map GQ-468.
- Dixon, H. R., and Shaw, C. E., 1965, Geologic map of the Scotland quadrangle, Connecticut: U.S. Geol. Survey Geol. Quad. Map GQ-392.
- Eaton, G. P., and Rosenfeld, J. L., 1960, Gravimetric and structural investigations in central Connecticut: Internat. Geol. Congress, 21st, Copenhagen, 1960, Rept., pt.2, p. 168-178.
- Goldsmith, Richard, 1961, Axial plane folding in southeastern Connecticut: U.S. Geol. Survey Prof. Paper 424-C, p. C54-C57.
- _____ 1963, Geologic sketch map of eastern Connecticut: U.S. Geol. Survey open-file map.
- _____ 1967a, Bedrock geologic map of the Montville quadrangle, Connecticut: U.S. Geol. Survey Geol. Quad Map GQ-609.
- _____ 1967b, Bedrock geology of the Uncasville quadrangle, Connecticut: U.S. Geol. Survey Geol. Quad. Map GQ-576.
- _____ 1967c, Bedrock geologic map of the Niantic quadrangle, Connecticut: U.S. Geol. Survey Geol. Quad. Map GQ-575.
- Lundgren, L. W. Jr., 1963, The bedrock geology of the Deep River quadrangle, Connecticut: Connecticut Geol. Nat. History Survey Quad. Rept. 13, 40 p.
- _____ 1964, The bedrock geology of the Essex quadrangle, Connecticut: Connecticut Geol. Nat. History Survey Quad. Rept. 15, 36 p.
- _____ 1966, The bedrock geology of the Hamburg quadrangle, Connecticut: Connecticut Geol. Nat. History Survey Quad. Rept. 19, 41 p.
- _____ 1967, The bedrock geology of the Old Lyme quadrangle, Connecticut: Connecticut Geol. Nat. History Survey Quad. Rept. 21, 30 p.

Percival, J. G., 1842, Report on the geology of the state of Connecticut: New Haven, Conn., Osborn and Baldwin, 495 p.

Rodgers, John and others, 1956, Preliminary geologic map of Connecticut: Connecticut Geol. Nat. History Survey, scale 1:253,440.

Snyder, G. L., 1961, Bedrock geology of the Norwich quadrangle, Connecticut: U.S. Geol. Survey Geol. Quad. Map GQ-144

____ 1964a, Petrochemistry and bedrock geology of the Fitchville quadrangle, Connecticut: U.S. Geol. Survey Bull. 1161-I, 64 p.

____ 1964b, Bedrock geology of the Willimantic quadrangle, Connecticut: U.S. Geol. Survey Geol. Quad. Map GQ-335.

Trip F-5

THE BRIMFIELD(?) AND PAXTON(?) FORMATIONS IN NORTHEASTERN CONNECTICUT^{1/}

by

Maurice H. Pease, Jr.
U. S. Geological Survey
Boston, Mass. 02110

John D. Peper
U. S. Geological Survey
Boston, Mass. 02110

INTRODUCTION

The purpose of this field trip is to examine a sequence of rocks, principally in the Westford and Eastford quadrangles, Connecticut, that are contiguous with strata in Massachusetts mapped by Emerson (1917) as Brimfield Schist and Paxton Quartz Schist. Recent mapping has shown that contacts between the two formations mapped by Emerson are not strictly valid; the rocks exposed northwest of the Eastford fault (Pease, unpub. data) can be divided broadly into a Brimfield(?) Schist and a Paxton(?) Quartz Schist. It has been possible to subdivide the Brimfield(?) Schist; the broad outlines of these subdivisions are shown on the geologic map that accompanies this road log.

LITHOLOGY

In the following description, 11 subdivisions have been made by grouping mapped lithologic units:

The Paxton(?) Quartz Schist (Pease, unpub. data)

px Feldspar-quartz-biotite schist and gneiss-schist layers which are medium to dark gray, rich in black biotite, and locally contain accessory actinolite, diopside, or hornblende; gneiss layers, composed mostly of feldspar and quartz, are lighter gray and mostly coarse grained. Megacrysts of potassium feldspar are characteristic, particularly in the lower part. Garnet and muscovite are present locally, but, along with graphite sulfide layers, are rare.

The Brimfield(?) Schist (Pease, unpub. data)

b
1 Brownish-gray schist containing red-brown biotite, sillimanite (muscovite), and garnet is interlayered with lighter gray granular gneiss composed chiefly of feldspar and quartz. Graphite, pyrite, and pyrrhotite are present but are abundant only in a few mapped lenses of schist. Members and lenticular layers in which calc-silicate minerals are abundant (diopside, hornblende, actinolite, scapolite) have also been mapped; these beds are more common in subdivision b than

¹
1/ Publication authorized by the Director, U. S. Geological Survey

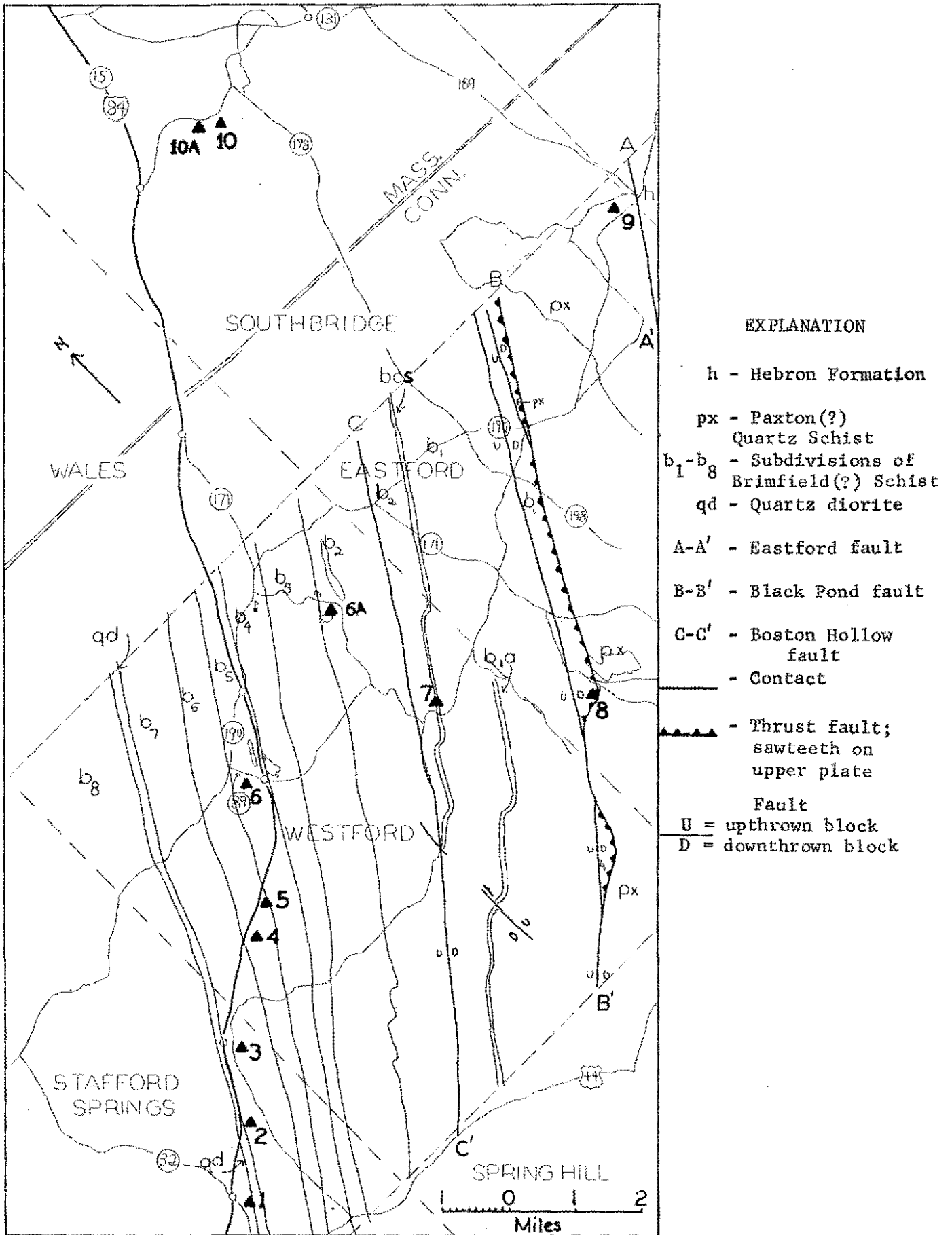

Figure 1. -- Geologic map of the Eastford-Westford area, Connecticut. Thickness of thin units exaggerated. Field-trip localities indicated by triangles.

in any other subdivisions of the Brimfield(?), except the overlying subdivision bcs.

- b₁a Distinctly banded, dark- and light-gray, -- amphibolite and amphibole-bearing gneiss with garnet ore interbedded with gray, garnetiferous sillimanite-poor schist and gneiss.
- bcs This subdivision, which has been mapped as a member of the Brimfield(?) Schist in the Eastford quadrangle, overlies b₁. It is composed almost entirely of lenticular beds of calc-silicate-bearing schist and gneiss similar to those occurring in subdivision b₁, but also includes gray biotite schist.
- b₂ Layers of gray, even-grained, crosslaminated biotite-garnet gneiss, gray biotite-garnet gneiss, and gray biotite-garnet sillimanite-corderite schist form mappable units within biotite-garnet sillimanite-gneiss that characteristically weathers yellowish orange and reddish brown.
- b₃ Coarse-grained, yellowish-orange-weathering, biotite-garnet gneiss contains distinctly less sillimanite than in b₂ and is highly feldspathic.
- b₄ Fine-grained, fissile, sulfidic, graphitic sillimanite-biotite-garnet schist. Thin beds of very fine grained, quartz-rich gneiss with small amounts of biotite and diopside are present in some outcrops.
- b₅ Lenses and layers of distinctly banded, medium- and light-gray, biotite-amphibole-garnet gneiss interlayered with sulfidic and graphitic, sillimanite schist and reddish-brown biotite-garnet gneiss. Layers of compositionally massive, biotite-hypersthene gneiss also occur within this stratigraphic interval.
- b₆ Predominantly rusty-weathering feldspar-quartz-biotite-sillimanite garnet gneiss interlayered with sulfidic and graphitic sillimanite schist. Thick and thin layers and lenses of diopside-bearing gneiss, rare impure marble, and graphite schist occur in the lower 300 feet. Thin layers of even-grained biotite-diopside-garnet gneiss are locally present in the upper 500 feet.
- b₇ Twelve 50- to 400-foot-thick layers of amphibole and calc-silicate-bearing gneisses and sulfidic sillimanite schist can be mapped separately from adjacent intervals of banded, sillimanite-poor, biotite-garnet gneiss.

- b
8 Fine-grained, fissile graphitic and sulfidic sillimanite schist intertongues with and grades into feldspathic gneisses with biotite, garnet, and, rarely, sillimanite. Stratigraphic marker units within the subdivision have not as yet been recognized.

Lenses of gneissoid pegmatite are present. These are inter-layered with and grade into fine-grained, foliated granite. The lenses are as much as 50 feet wide and 100 yards long. They intrude and are concordant with the layered gneiss and schist; they are more abundant in the Brimfield(?) than in the Paxton(?). Foliated biotite-quartz diorite also intrudes the country rock. Contacts are parallel or subparallel to the regional foliation. Most diorite bodies are small isolated lenses less than 100 feet thick, but one body (Stop 2) is as much as 650 feet thick and 15 miles long. The diorite bodies are locally cut by discordant, younger binary granite (Stop 4) and muscovite-bearing pegmatite (Stop 6A). The granite and pegmatite commonly are emplaced along tension joints and high-angle faults.

STRUCTURE

There is no evidence that any part of this homoclinal sequence has been repeated by large-scale folding. None of the mapped units are exposed in reverse image, and most primary sedimentary structures observed (Stops 5 and 9) indicate that the units top westward. This top sense is locally reversed by folds with wavelengths of less than 500 feet, and larger folds appear to be absent. Small-scale folds, however, have thickened the stratigraphic sequence by unknown amounts. The amount of thickening apparently varies with the lithology folded; i.e., biotite-sillimanite schist commonly is tightly folded and most quartzo-feldspathic gneiss is not folded. Most of the small-scale folds observed in outcrop show a west over east sense of movement. Some have axial planes parallel to the regional foliation and plunges parallel to the regional mineral lineation; others, which exhibit a sillimanite lineation down the dip normal to the regional lineation, appear to be drag folds related to low-angle reverse faults that are parallel and subparallel to foliation and bedding.

The stratigraphic sequence is complicated by a system of northeast-trending faults and north-trending cross faults. Most northeast faults are subparallel to the regional foliation and bedding. Thin stratigraphic units are commonly cut out along these faults, and single stratigraphic units are rarely observed on opposite sides of the faults. Thus, direction of movement and amount of stratigraphic displacement are difficult to determine. Most cross faults transect blocks between northeast-trending faults. Displacement

on these cross faults is shown by offset of stratigraphic units, generally on the order of a few hundred feet of apparent lateral dislocation.

High-angle faults of small displacement occur in many outcrops (Stops 1, 3, and 4); strata are offset and dragged along the fault planes. Small-scale, northeast-trending, low-angle thrust faults can be seen in abundance at widely separate localities (Stops 3 and 4). These faults have cataclased sillimanite-orthoclase-grade rock and induced a muscovite foliation along fault traces. Minor drag folds are abundantly associated with the faults; they have west over east sense of movement, and their axes plunge north-northeast at low angles.

STRATIGRAPHIC CORRELATIONS

Emerson (1917) considered the Brimfield to be younger than the Paxton and assigned a Carboniferous age to both on the basis of a rather tenuous correlation with the Worcester Phyllite. The age of these formations is still uncertain, but it is now generally accepted that both were metamorphosed during the Acadian orogeny and consequently are older than Middle Devonian. Because of the absence of fossils and reliable radiometric ages, and because of structural separation from the stratigraphic sequence in southeastern Connecticut by the Eastford fault any correlation of the Brimfield(?) and Paxton(?) with other stratigraphic units can be suggested only on the basis of physical resemblance and long-range stratigraphic projection.

Subdivision b8 of the Brimfield(?) Schist is physically similar to and on strike with the type Brimfield Schist $\frac{1}{2}$ mile east of the town of Brimfield. Subdivisions below b8 are physically distinct from the type Brimfield, although they contain minor amounts of type Brimfield lithology. The lowest two subdivisions of the Brimfield(?) and much of the Paxton(?) are, in general, on strike with and bear a striking physical resemblance to the Berwick, Elliot, and Kittery Formations of Silurian-Devonian age of Billings (1956) exposed in southeastern New Hampshire and northeastern Massachusetts. A structurally complex stratigraphy between these two areas must be resolved, however, before such a correlation can be made with any degree of certainty.

On the basis of reconnaissance mapping in the western part of eastern Connecticut, Dixon (1968) has correlated rocks of the Brimfield(?) Schist with the Partridge Formation of Ordovician age and the Paxton(?) Quartz Schist with the Hebron Formation; she tentatively correlated the Hebron Formation with the Fitch Formation of Silurian age. According to her interpretation, all the rocks in the Eastford and Westford quadrangles lie on the inverted

limb of a recumbent fold and are upside down.

Our recent geologic quadrangle mapping in the Eastford and Westford quadrangles does not support this contention. Instead, we have demonstrated that the Brimfield(?) Schist overlies the Paxton(?) Quartz Schist in a structurally complex but right-side-up homoclinal sequence northwest of the Eastford fault and that the Brimfield(?) rocks have been thrust southeastward over the Paxton(?) on the Black Pond fault (Pease, unpub. data).

The physical character of the rocks of subdivision b8 (equivalent to type Brimfield) does closely resemble the Partridge Formation of Ordovician Age exposed along the Bronson Hill anticline (Peper, 1967), but subdivision b8 is several times as thick as the Partridge and is separated from the Partridge by a large body of Monson gneiss. Perhaps the Partridge Formation exposed along the Bronson Hill anticline represents deposition on the western border of a deep sedimentary basin, and subdivision b8 is a greatly thickened equivalent of the Partridge deposited nearer the center of the basin. If so the Brimfield(?) and Paxton(?) are (1) equivalent to or older than the Partridge, or (2) subdivision b8 has been faulted into juxtaposition with younger rocks along one or more of the northeast-trending thrust faults common to the area. If (1) is true, the tentative correlation of the lower part of the Brimfield(?) and the Paxton(?) with the Berwick, Elliot, and Kittery sequence is invalid. If (2) is true, we have yet to recognize the fault or faults that separate older rocks from younger rocks.

There is also the possibility that none of the rusty-weathering sulfidic graphitic schists and gneisses of the Brimfield(?) are equivalent to the Partridge but that they represent a younger Silurian and Devonian sequence not present in the Bronson Hill anticline. A thick sulfide-bearing sequence of Silurian age has been mapped as the Smalls Falls Formation in the vicinity of Rangeley, Maine (Moench, unpub. data). Also, rocks, observed by road reconnaissance of the poorly exposed sequence above the Berwick in south-central New Hampshire, shown as Littleton Formation on the geologic map of New Hampshire (Billings, 1956), physically resembles the sulfide-bearing gneisses and schists of the Brimfield(?) in the Eastford and Westford quadrangles.

In summary, although the Brimfield(?) and Paxton(?) stratigraphic sequence is westward topping, it is not necessarily younger to the west throughout. Faults of unknown displacement may have caused repetitions or gaps in the stratigraphic section that have not yet been recognized. Rocks of Ordovician age on the west may have been thrust over younger Silurian and Devonian rocks on the east, and a full appreciation of the age relations must await more extensive mapping to the northeast and southwest. The sequence

does not appear to be overturned, and correlation with the stratigraphic sequence of Dixon and others (Trip F-4) southeast of the Eastford fault is still uncertain.

REFERENCES

- Billings, M. P., 1956, The geology of New Hampshire. Part II--
Bedrock geology: Concord, New Hampshire State Planning and
Development Commission, 203 p.
- Emerson, B. K., 1917, Geology of Massachusetts and Rhode Island:
U. S. Geol. Survey Bull. 597, 289 p.
- Peper, J. D., 1967, Stratigraphy and structure of the Monson area,
Massachusetts-Connecticut, in New England Intercollegiate
Geol. Conf., 59th Annual Meeting, Oct. 13-15, 1967, Guidebook
for field trips in the Connecticut Valley of Massachusetts:
Amherst, Mass., p. 105-113.

ROAD LOG

0.0 Trip will assemble at the Intersection of Routes 32 and 15. People heading north on Route 15 should get off at exit 101. Proceed across Route 32 to access road to Route 15 north. Line cars up along east side of access road. See trip leaders for further instructions. (Walk north to the series of outcrops on the east side of Route 15).

Stop 1 (38.88 N - 72.60 E) High-angle fault in rocks of the Brimfield(?) Schist

The 40-foot-wide vegetated area dividing this outcrop marks the trace of a high-angle fault trending about N10 E, 80 W. The drag sense of bedding-foliation implies that this is a normal fault with the foot wall to the east. Rocks on both sides have been dragged against the fault from dips of less than 45° to nearly vertical. The granulated material within the fault zone is cataclased schist and clayey gouge material. The amount of displacement on this fault is not known, but the apparent vertical displacement is greater than the height of the outcrop.

There are at least two other faults in the outcrop west of the principal fault. Displacement on these faults is small and shows offset and drag of lithologic units. A dike of binary granite, about 6 inches wide, has been emplaced along one of these faults. The granite has been offset by later movement on the fault. Cross-bedding and graded bedding west of this fault show tops to the west.

Note the contrast in weathering characteristics on opposite sides of this fault. Rocks on the east side are quartz-feldspar-biotite-garnet schist and gneiss containing very little sulfide. Rocks on the west side are garnetiferous quartz-feldspar-biotite-sillimanite-gneiss containing laminae rich in finely disseminated sulfide and graphite. On weathering, sulfide-bearing layers slake badly and develop the sulfur-yellow and rusty-orange staining that is so prominent.

Return to cars; head north on Route 15.

1.2 Outcrop ahead on right, pull over onto grass.

Stop 2 (39.35 N - 73.08 E) Foliated biotite quartz diorite.

Exposures here and to the north form a nearly complete section of one of the most distinctive map units in this part of northeastern Connecticut. The diorite can be traced for at least 15 miles along strike through the South Coventry, Stafford Springs, and Wales quadrangles and maintains a nearly uniform thickness of about 650

feet. This strongly jointed, coarsely layered, compositionally homogeneous, dark-gray, foliated igneous rock is composed mostly of plagioclase and biotite with quartz and minor amounts of clinopyroxene, amphibole, and garnet. The few thin sections examined show a hypidiomorphic granular texture in which clinopyroxene is intersertal with intermediate plagioclase; the clinopyroxene is altered to blue-green hornblende. Superimposed on the igneous texture is a strong biotite foliation concordant with the regional foliation. The combination of igneous texture and strong biotite foliation indicates that this is an early syntectonic sill. It is probably correlative with the New Hampshire Plutonic Series of Billings (1956).

1.7 Ruby Road exit ahead; park in wide area adjacent to the extensive roadcut on right.

Stop 3 (39.63 N - 73.26 E) Metavolcanic biotite schist and metapelitic rusty sillimanite schist.

In this west-facing dip-slope outcrop, an irregularly shaped body of gray, granular, fine-grained biotite-amphibole schist (metavolcanic rock) overlies quartz-feldspar-biotite-sillimanite-garnet schist and gneiss (metapelitic rock). The latter is characteristic of much of the Brimfield(?) Schist. The contact is extremely uneven, as clearly shown by exposures in the north-central part of the outcrop where the metavolcanic rock forms a bulge about 4 feet wide in the face of the outcrop and the contacts bend sharply into the face. Undulant surfaces in the metavolcanic schist are common. Contacts with the metapelitic schist locally are crenulated. The contacts show no distinct preferred orientation and plunge generally southward, contrary to tectonic trends. In many places, thin layers of metavolcanic schist, as much as 4 inches thick, extend for tens of feet into the metapelitic schist. Most of these layers occur along bedding-foliation planes, but some crosscut at a very low angle.

Along 15 feet near the base of the outcrop is a coarse-grained, foliated, hornblende-pyroxene gabbro exposed in irregularly shaped blobs as much as 3 feet in diameter. Undulant sheets and tongues of brown biotite schist with abundant 1-4-inch feldspar porphyroblasts separate the blobs of diorite on the surface, but they probably are interconnected in third dimension. Locally the gabbro has a thin, fine-grained selvage. Pyrrhotite is disseminated throughout much of the gabbro; pyrite occurs in fractures. The gabbro apparently is a local occurrence, lying stratigraphically between the metapelitic schist and the metavolcanic schist.

The bedrock outcrop further north on the west side of the exit road has a good exposure of the basal contact of the metavolcanic rock overlying the metapelitic rock. The contact, although

irregular and displaced locally by small faults, appears to be conformable. The irregular, west surface of the outcrop shows a bulbous, pillowlike shape which is typical of the metavolcanic schist. Tongues and sheets of brown-biotite schist with feldspar porphyroblasts are prominent along this surface.

About 4 feet beneath the contact is a 2-inch-layer of gray, fine-grained granular schist. Its lithology is identical with the overlying metavolcanic schist. The coarse-grained gabbro is not present in this outcrop.

Cross Ruby Road onto access road onto Route 15, heading north again.

2.7 Outcrops ahead on the left expose layers of sulfidic schist. These occur in a mappable unit of metavolcanic rock extensively exposed in the vicinity of Pinney's Pond, about 4 miles to the northeast.

3.0 A road bridge crosses Route 15 on the horizon ahead. Pull off road into the wide area on the right, just before the bridge.

Stop 4 (40.30 N - 74.25 E) Thrust fault and high-angle faults of small displacement.

The coarse-grained, medium-gray foliated quartz diorite that is extensively exposed here on the east side of Route 15 is also exposed in the lower part of the roadcut on the west side of the highway under the bridge -- where it is overridden by sillimanite-biotite-garnet gneiss and schist along branching thrust faults that dip at low angles to the west. Abundant thin dikes of binary granite fill fractures in the quartz-diorite.

Four high-angle faults of small displacement complicate the schist and gneiss exposed on the west side of the highway, about 150 yards southwest of the bridge. These strike about north-south and dip steeply. A dike of crumbly-weathering granite intrudes the northernmost fault. Primary foliation in the dike and the dike-schist contact are dragged, suggesting that the dike was emplaced during faulting. Varied senses of movement on the other three faults can be inferred from the attitudes at which the schist is dragged into the fault zones. In the sharply defined gouge zones of the faults, the schist is cataclased and retrograded. Structural elements in the cataclased rock include: muscovite foliation parallel to the planes of faulting; induced platiness of quartz and feldspar grains parallel to this foliation and rodding of the grains parallel to transport direction; induced biotite streaking parallel to transport. In addition, a rotation-sense is shown by recrystallized garnets. (See trip leaders for oriented and slabbed samples

of cataclased rock).

4.7 Series of outcrops on left near top of hill ahead. Pull onto shoulder at right across from outcrops.

Stop 5 (40.35 N - 74.30 E) Low-angle thrust faults; styles of drag folding; and late-syntectonic granite pegmatite dikes.

The three large bedrock exposures on the west side of Route 15 have the structural features and lithologies characteristic of the Brimfield(?) Schist in this stratigraphic position. These exposures are about 3/4 of a mile northwest along strike from the thrust-fault at Stop 4, but they are about 300 feet lower in stratigraphic position (trip leaders will explain the stratigraphic significance of the lithologies present).

In the northernmost outcrop, two low-angle thrust faults cut and retrograde the sillimanite-biotite-garnet-cordierite gneiss. The faults branch and splay along foliation planes but trend, in general, N50 E and dip at low angles to the west. Structural elements in the cataclased rock of these faults are similar to those described from the high-angle faults at Stop 4. The pronounced downdip lineations in the cataclased rock are approximately at right angles to the regional N15 E sillimanite lineations in gneiss away from the fault zones. Small purple grains of cordierite are abundant in, and adjacent to, the small and irregular lenses of white, coarse-grained, feldspar-quartz rock in the gneiss.

The second outcrop, about 100 yards to the southwest, exposes a 25-foot-thick lens of calc-silicate gneiss and impure marble. The thin beds outline abundant small drag folds which are characteristic of this lithology. These drag folds have the dominant regional west-over-east sense of movement and have curvilinear axes that plunge at low angles NNE and SSW. The axial planes of the folds dip at moderate angles to the west, parallel and sub-parallel to shearing, regional foliation, and bedding.

The third and largest roadcut, to the southwest, provides an additional exposure of sulfidic, sillimanite-biotite-garnet gneiss and schist interbedded with thin lenses of fine-grained, diopside-bearing granulite. At the southern end of the cut, a late-syntectonic combed dike has been emplaced along a high-angle fault. The walls of the dike consist of fine-grained biotite granite, foliated parallel to the schist-dike contact. Pegmatite in the dike core is quartz rich and contains muscovite. This pegmatite should be compared with older gneissoid pegmatites in the surrounding rocks. The older pegmatites are strongly foliated, concordant, and contain no muscovite. They typically contain small amounts of tiny, pink euhedral garnet. The older pegmatites are found throughout the Brimfield(?) section, regardless of local lithology,

and they appear to have been forcefully injected along foliation and bedding. They also grade into fine-grained, foliated, concordant granite which contains biotite and garnet. In contrast, the irregular lenses of white, cordierite-bearing, quartz-feldspar rock, similar to those in the first exposure at this stop, are more sporadically distributed and apparently are restricted to certain pelitic lithologies. These may have been derived from the crystallization of a local melt fraction, developed during the peak of metamorphism, that remained more or less in place.

5.5 Outcrop of schist and gneiss on left is characteristic of a mappable unit extensively exposed on Snow Hill to the west.

6.3 Exit 104 ahead. Exit, turning left, and head west across Route 15 on Route 89.

6.9 Park in borrow pit just west of Route 15 on the north side of Route 89.

Stop 6 (41.10 N - 75.00 E) Interbedded metavolcanic and meta-sedimentary rocks.

The outcrops scattered along both sides of Route 89 expose the upper two-thirds of a mappable unit of interbedded metavolcanic rock and metashale. At the east end of the series of exposures, thin beds of amphibolite alternate with plagioclase-quartz-biotite-amphibole gneiss. These rocks are overlain by about 40 feet of rusty, red-orange-weathering, layered, plagioclase-quartz-biotite-garnet-sillimanite gneiss. About 100 yards west, on the north side of the road, another outcrop exposes 20 feet of compositionally layered, biotite- and amphibole-bearing gneisses. These are cross-laminated metavolcanic rocks which top west.

Another 10 yards west, on the south side of the road, a homogeneous thick layer of dark-greenish-gray, calcium plagioclase-biotite-hypersthene gneiss overlies platy and fissile, sulfidic, sillimanite-biotite-garnet schist. The compositionally homogeneous rock and physically similar rocks in this unit, are probably metamorphosed and foliated lava.

Continue west on Route 89.

7.4 Intersection with Route 190. Turn right and head northeast on Route 190.

7.6 Outcrops on both sides of road ahead are part of the metavolcanic unit exposed at Stop 5, southwest of Morey Pond.

8.5 Bridge ahead, Route 190 crosses Route 15.

8.8 The outcrop of sulfidic schist, on the right, lies in a thick belt of sulfidic schist, which is extensively exposed at Union School. The contact of this schist with the overlying metavolcanic unit follows the steep gully west of the road.

9.8 Bear right onto road ahead; continue up hill to northeast.

10.1 Union School building to right. Continue east across intersection(downhill). SLOW! ROAD CURVES.

The long east-facing slope we are traversing is covered with thick till. Along Gulf Brook to the north and the mid-reach of Scranton Brook to the south are sulfidic schist and gneiss, which are more quartzofeldspathic than the platy, fissile, sulfidic schist exposed at Union School.

10.8 Walker Mountain ahead, across Bigelow Hollow.

11.0 Unnamed pond on the left, Kinney Pond on right.

Stop 6A (41.84 N - 76.28 E) Northeast Faults.

Although not readily accessible to large groups, outcrops along the valley north of the road show many features of the faults and folds that control prominent topographic lineaments in this area.

About 1,200 feet north of the unnamed pond, the northeast-trending valley branches to either side of a small hill. West of this hill is a rusty-orange weathering, quartzo-feldspathic, sillimanite-garnet-biotite gneiss. Abundant folds are developed in the gneiss by kinking of primary foliation and bedding along later, steeply west-dipping planes. On the south end of the hill, the steeply west-dipping shear cleavages cut across and offset bedding and foliation in quartzo-feldspathic gneiss and layering in foliated pegmatite. Late-syntectonic, quartz-rich, muscovite-bearing pegmatites and quartz veins locally follow the shear cleavages.

The late foliation and cleavage strike consistently 5° - 10° E of the strike of primary foliation and bedding and dip consistently 10° - 20° steeper to the west. Most kink folds have a west-over-east sense of movement; a few have an opposite sense of movement or none at all.

11.1 Outcrops north of the road on the east side of the pond expose layers of gray-weathering, granular, plagioclase-quartz-biotite-garnet gneiss, interbedded with gray, cordierite-bearing, calcium plagioclase-potassium feldspar-quartz-biotite-garnet-sillimanite schist. These rocks make up a mappable unit exposed in the vicinity of Kinney Pond.

11.4 Road turns right and heads south, following Bigelow Hollow, which is a major topographic lineament.

11.5 Scattered outcrops of gray schist and gneiss are on slope to right.

11.7 Outcrop of foliated quartz diorite on right. Additional exposures to northeast display the sill-like nature of the intrusive body.

12.7 You will pass an outcrop of gray gneiss on your right before the road surface changes to dirt. The gneiss is cross laminated and tops to the west.

12.7+ Wood bridge.

12.9 Dirt road enters on right. Bear left across wood bridge.

13.3 Wood bridge crossing Bigelow Brook. Scattered outcrops of gray gneiss and schist north of road east of bridge. The positions of a 10-foot thick layer of gneiss on either side of Bigelow Brook to the south, suggest displacement of 30-feet on a small fault following the bed of the brook.

13.4 Road turns right and crosses another wood bridge.

13.9 Prominent steep-sided valley to southwest is occupied by a fault along Boston Hollow.

14.1 Intersection Boston Hollow Road. Bear left (east) on North Ashford Road. Continue across wood bridge onto paved surface. Pull off to right and park on grass across from first roadcut.

Stop 7 (40.50 N - 76.46 E) Calc-silicate-bearing schist and gneiss.

The two roadcuts along the north side of the road expose calc-silicate-mineral-bearing schist and gneiss characteristic of an important marker unit in this part of the stratigraphic section. The unit is traceable northeastward through the Eastford quadrangle and southwestward across the east slope of Turkey Hill. It separates gray-weathering, garnetiferous, sillimanite-poor schist below, from rusty-weathering, feldspar-quartz-sillimanite-biotite-garnet gneiss and schist above.

Continue east on North Ashford Road.

14.9 Walker Drive enters on right.

15.5 Kozy Road enters on right.

16.7 Note outcrop of foliated, garnet-bearing granite in back yard of the house north of the road, about 200 yards along strike to the southeast. This garnet-bearing granite intertongues and grades into coarser grained, layered, and foliated garnet-bearing pegmatite.

16.8 Intersection Route 171: Turn right and go south on Route 171.

17.7 Turn right on Crystal Pond Road (Floeting Road on topographic map) and continue south.

18.6 French Road enters on right.

18.9 Lake Drive enters on left; bear right through intersection.

19.0 Road forks; bear right.

19.5 Turn right on Buell Road to farmhouse. Park in front of first barn across the road from the house.

Stop 8 (39.65 N - 77.32 E) Black Pond fault.

The Black Pond fault separates the Brimfield(?) Schist from the Paxton(?) Quartz Schist in the Eastford quadrangle. The fault trends in an e. st. direction approximately through the chicken coop and barn north of Buell Road, where the fault appears to be a low-angle thrust fault. A few hundred yards further northeast, along the ridge north of the road, the fault steepens and turns abruptly northward, becoming not quite parallel to the foliation. The fault continues north-northeast beyond the northern border of the quadrangle.

Rocks of the upper plate on the north side of the fault are best exposed behind the chicken coop and barn. These are brownish-gray, rusty-weathering, garnetiferous, quartz-feldspar-biotite-sillimanite schist with abundant deformed quartzo-feldspathic lenses and stringers. The rocks are tightly compressed by shears and drag folds. The low-angle shear surfaces dip gently northwest and cross-cut the contorted axial surfaces of the drag folds. Retrograde muscovite is common on the shear surfaces. A strong downdip lineation is formed by the intersection of quartz and feldspar layers with these shear surfaces.

The exposures that crop out directly east of the barn are assigned to the Paxton(?) Quartz Schist and are in the footwall of the fault. Approximately 6,000 feet of section is cut out along the unexposed fault surface which passes north of these exposures. The dark-gray, biotite-amphibole schists and gneisses of the footwall also show the effect of west-over-east movement by tightly compressed, contorted folds. Shearing is less evident in the rocks of the lower plate.

At the eastern end of the series of outcrops exposed west of Crystal Pond Road, the position of the fault trace can be pinpointed locally to within a foot. It is here that the fault surface appears to have warped abruptly from low angle east trending to nearly vertical northeast trending. Tightly, complexly folded, steeply dipping footwall rocks are best exposed here. The rusty brown schist of the upper plate is present only in a few small outcrops.

Return to Crystal Pond Road (Floeting Road).

19.5 Crystal Pond Road. Turn left and return to the town of North Ashford via Route 171.

21.3 Intersection Route 171: Turn left and head north on Route 171.

22.2 North Ashford. Bear right on Center Pike Road.

23.4 Intersection Union Road, Cross Union Road and continue northeast on Old Turnpike Road.

24.0 Intersection Route 198. Continue northeast across 198 onto dirt road.

24.9 Red and White School Road (Route 197) joins from left. Continue east on Route 197.

26.5 Brickyard Road crosses Route 197.

27.9 Lyon Hill Road crosses Route 197.

29.5 Intersection Route 169. Turn left and head north on Route 169.

29.6 Turn left and head northwest on English Neighborhood Road.

29.8 Pull over to left in branch of driveway.

Stop 9 (42.40 N - 80.35 E) Representative exposure of the Paxton(?) Quartz Schist of the Kenyonville area, the oldest stratigraphic unit exposed in the Eastford quadrangle.

The rock type distinctive of the unit is gray, quartz-feldspar-biotite schist with numerous subhedral megacrysts of potassium feldspar. Interlayered with the biotite schist are light-gray, medium to coarse-grained layers composed almost entirely of feldspar and quartz and grayish-black, fine-grained layers rich in hornblende. The potassium feldspar megacrysts, which commonly show evidence of

secondary growth, appear to be relic sedimentary clasts recrystallized during metamorphism.

Low-angle crossbedding showing tops up is well expressed in this outcrop. Note in one crossbed set the biotite schist layers thin upward and quartz-feldspar septa are cut out against an overlying set of coarser grained beds which show no crossbedding. At the south end of this outcrop small-scale folds are clearly exposed. The sense of these folds is left handed. This sense of folding has been observed in the Westford quadrangle only along very early faults that show a reverse sense to the regional west-over-east sense of movement.

Turn around and return to Route 169.

30.0 Turn left, north, on Route 169.

30.1 Large outcrop just visible on right below the yellow house is also in the Paxton(?) Quartz Schist. A binary granite dike less than a foot in maximum thickness trends at right angles to the foliation and is offset along bedding-plane shears.

Continue on Route 169 for 6 miles to the outskirts of Southbridge.

35.9 Intersection with Route 131. Proceed north on Route 131.

36.5 Bear left around rotary, under railroad bridge, and follow Route 131 through the center of Southbridge.

37.1 West of the center of town, bear left on South Street leaving the main thorough fare. Proceed along South Street through the outskirts of town and continue west along a relatively new macadam highway.

39.2 Sturbridge town line - park the cars wherever possible along the right side of the road.

Stop 10 (44.15 E - 39.20 N) Section of Brimfield(?) Schist - lower part in Massachusetts.

Exposures along this road beginning at Sturbridge town line and continuing to the outcrops just west of the entrance to the large automobile graveyard represent the thickest known well-exposed section of any part of the Brimfield(?) Schist. According to Emerson's map (1917), a tongue of Paxton Quartz Schist is infolded in the Brimfield in these outcrops, but the exposed rock types all are characteristic of the Brimfield(?) Schist, and the contact with the Paxton(?) Quartz Schist should be about 2 miles farther east. Accordingly, this section is tentatively assigned to the lower middle

part of the Brimfield(?) Schist. The section quite possibly is interrupted by faults as yet unmapped.

Most of the rock types characteristic of the Brimfield(?) Schist are present in those exposures. The easternmost exposures consist chiefly of dark-gray, diopsidic, biotite schist and gneiss which characteristically contain greenish-gray lenses of granular schist containing abundant diopside and other calc-silicate minerals. These calc-silicate-rich pods commonly are zoned with light-pinkish-gray garnet and carbonate-rich cores grading outward into greenish-gray, diopside-rich rock. Borders are brown biotite schist. A zone about 50 feet thick contains thin layers rich in sulfide and graphite. Only slight weathering of trace amounts of sulfide causes pervasive staining on the outcrop face.

In the second series of exposures, sulfide- and graphite-bearing layers are more common. Most of the rock is biotite schist and gneiss with few calc-silicate layers. Garnet is appreciably more common in these exposures. The highly fractured, platy pegmatite exposed at the east end of these exposures is rich in sillimanite, but sillimanite is not abundant in the country rock.

The rather small exposures to the west on the south side of the road are divisible into two parts. Rust-stained sulfidic schist and gneiss overlie a zone in which greenish-gray, granular schist layers containing diopside and other calc-silicate minerals are abundant. Such calc-silicate-rich zones, where sufficiently thick and laterally extensive, have been mapped in the Eastford quadrangle. Note the cordierite-bearing pegmatite at the extreme west end of those exposures.

Return to cars and proceed west on highway.

40.0 Park on dirt road opposite entrance to the automobile graveyard.

Stop 10A (44.10 E - 39.21 N) Quartz diorite.

The outcrops are mostly foliated, garnetiferous, biotite quartz diorite similar to the larger mass of foliated quartz diorite at Stop 2. The quartz diorite concordantly intrudes calc-silicate-rich Brimfield(?) rocks. Further west around the corner exposures on the north side of the road consist of garnet-rich, biotite schist alternating with zones in which sillimanite-rich layers are abundant and commonly interleaved with sulfide- and graphite-rich layers. Sillimanite is notably more conspicuous in these rocks than it is lower in the section.

Most pegmatites in exposures at Stops 10 and 10A are concordant, gneissoid, and composed of potassium feldspar and oligoclase with less than 20 percent quartz and minor garnet and biotite. Blue cordierite is prominent in some pegmatites, sillimanite in others.

End of field trip.

Trip F-6

MINERAL DEPOSITS OF THE CENTRAL CONNECTICUT PEGMATITE DISTRICT

by

Harold M. Bannerman
Connecticut Geological
and Natural History
Survey

Sidney S. Quarrier
Connecticut Geological
and Natural History
Survey

Richard Schooner

Pegmatite deposits occur in considerable profusion in various portions of the metamorphic and igneous terranes of the Connecticut Highlands, and, beginning in the early 1800's, scores of these deposits have been tested by prospectors seeking minable quantities of industrial minerals, such as feldspar, mica, quartz, and beryl, and by mineral collectors in search of rare minerals, and/or mineral specimens of unusual form and beauty. A goodly number of these operations were successful. As a consequence, the pegmatites of Connecticut have been a fairly constant source of industrial minerals for the past century and a half. They have also yielded a relatively large number of rare and unusually fine mineral specimens, many of which have found their way into museum and amateur mineral collections the world over. Connecticut pegmatites are discussed in some detail by Cameron and Shainin (1947), Cameron et al. (1954), and Stugard (1958) and this review is largely based upon these sources.

Of the several pegmatite districts in Connecticut, by far the most important is the so-called Middletown district - a 9 x 11 mile stretch of country which straddles the Connecticut River just east of the City of Middletown. This district includes parts of the towns of Haddam, Middletown, Portland, East Hampton, and Glastonbury. Its western boundary is delimited by the Triassic border fault. The east boundary of the district is indefinite and fades rather gradually into the area underlain by Monson Gneiss (fig. 1).

The district has been an important and fairly constant producer of feldspar and, to a lesser extent, of sheet mica since 1865 and it has yielded many rare minerals, some semi-precious gems, and a large number of fine mineral specimens. Well over 400 pegmatites are known to occur within the district and, over the years, a large number of them have been the scene of small mining operations for varying intervals of time. During World War II (1942-1945), under the spur of a national shortage of sheet mica and beryllium, Connecticut produced over 60,000 lbs of sheet and punch mica, and about twenty six tons of beryl. Of this, more than 87% of the mica and practically all of the beryl came from the Middletown district. Currently the district contains the only operating pegmatite plant in the state (the Feldspar Corporation mine at White Rocks, Middletown). Here the Feldspar Corporation maintains an open cut mining operation, which

produces about 6,000 tons of pegmatite per month and a modern mill and flotation plant geared to treat the entire rock and to deliver a three-fold commercial product, feldspar, ground mica, and quartz.

Individual pegmatite deposits in the Middletown district range in size from a few inches in thickness and a few feet in length up to bodies measuring more than a thousand feet in length and 100 feet in thickness. Structurally they take on a variety of forms. In general the deposits are elongate lenses, often warped, sometimes helmet-shaped. Those bounded by schistose rocks are especially prone to swell and pinch both along the strike, and down the dip, conforming in gross detail to the trends in the schistosity of the structural rolls and convolutions in the enclosing rocks. Some of the deposits tend to taper toward the ends but many end abruptly in a bluntly rounded, boudin-shaped nose.

Pegmatites intrude all of the crystalline, schist, and gneiss rock units shown on the geologic map of the Middletown district but about 75% of all the pegmatites thus far discovered, and by far the greater number of those of a size and composition suitable to sustain a profitable mining operation, are in the so-called Bolton Schist - a coarse grained complexly folded metasedimentary unit, made up largely of biotite schist, sparingly interlayered by micaceous quartzite and amphibolitic gneiss. A few pegmatites found in the more massive gneissic rocks have been mined for mica, feldspar and some of them have also yielded a variety of other minerals but their number and their production records are relatively small.

The pegmatites of this district are granitic in composition and consist for the most part of microcline perthite, sodic plagioclase, quartz, and muscovite and commonly some biotite. Some are more or less massive with haphazard arrangement of the mineral components. Others show a consistent and systematic zoning, wherein the major mineral constituents are grouped into mappable structural units of contrasting composition. In such cases the mineral zones tend to bear a concentric relationship to each other in a manner roughly relating to the overall shape of the pegmatite body, hence roughly parallel to the walls. Beryl, black tourmaline, and apatite, magnetite and garnet are common accessory minerals. In some deposits irregularly spaced pockets,miarolitic cavities and crude vein-like structures within the main body of the pegmatite are prone to carry eohedral crystals of quartz and clevelandite, lepidolite, spodumene, amblygonite, and sometimes pollucite, vari-colored tourmaline, beryl, lithiophyllite and a number of relatively rare phosphates and other more or less unusual minerals.

A very wide variety of minerals have been recovered from these deposits. One of us (Richard Schooner) has compiled the following list of 114 mineral species reported from pegmatites in the Middletown district. Most of the quarries from which these minerals came have been idle for many years, however, and in the interim, the waste piles have been rather thoroughly combed by mineral collectors. The chances are, therefore, that most of the rare and more beautiful specimens, once exposed in the walls, or abandoned on the dumps, have long since been picked up.

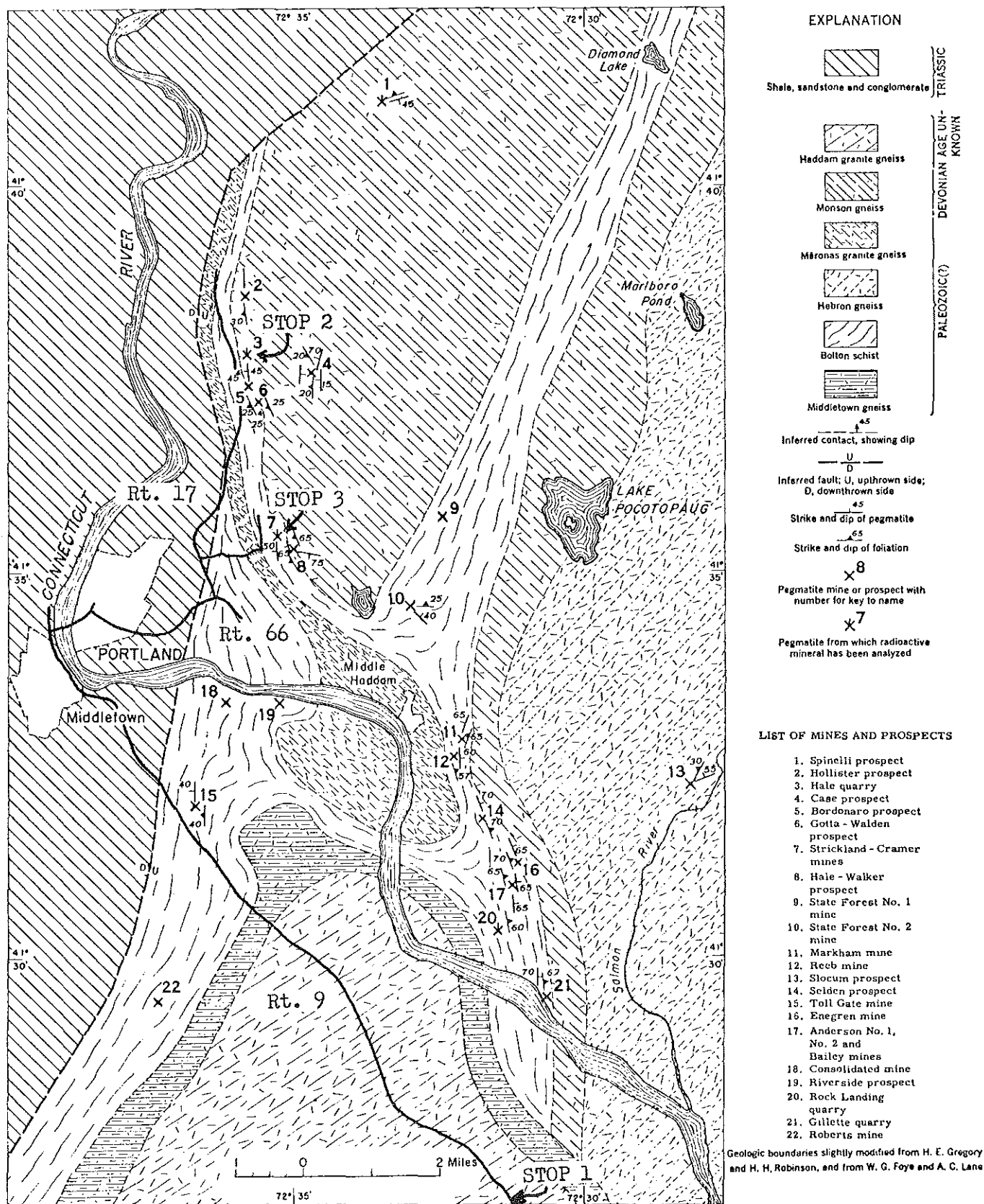

Fig. 1. Generalized Geologic Map of the Middletown Pegmatite District. (after Cameron, 1954).

Note: A modern revision of the stratigraphy and structure of this area can be found in Lundgren (1962).

List of minerals found in pegmatites of the Middletown District, Connecticut. Compiled by Richard Schooner.

<u>Elements</u>	Siderite	<u>Molybdates and Tungstates</u>
Bismuth	Rhodochrosite	Powellite
Sulfur	Bastnaesite	Ferrimolybdite
Graphite	Bismutite	
	<u>Sulfates</u>	<u>Silica and Silicates</u>
<u>Sulfides, Arsenides, etc.</u>	Anglesite	Quartz
Galena	Gypsum	Opal
Sphalerite	Melanterite	Petalite
Chalcopyrite	Pickeringite	Orthoclase
Pyrrhotite	Jarosite	Microcline
Bismuthinite	Copiapite	Albite
Pyrite		Oligoclase
Loellingite	<u>Phosphates and Arsenates</u>	Pollucite
Marcasite	Triphylite	Spodumene
Arsenopyrite	Lithiophilite	Anthophyllite
Molybdenite	Ferri-sicklerite	Beryl
	Heterosite	Cordierite
<u>Oxides</u>	Graftonite	Almandite
Hematite	Xenotime	Spessartite
Pyrolusite	Monazite	Andradite
Cassiterite	Hureaulite	Phenakite
Uraninite	Dickinsonite	Zircon
Becquerelite	Arrojadite	Topaz
Fourmarierite	Messelite	Sillimanite
Vandendriesscheite	Phosphophyllite	Allanite
Goethite	Vivianite	Prehnite
Gahnite	Scorodite	Bertrandite
Magnetite	Herderite	Tourmaline
Chrysoberyl	Amblygonite	Stilbite
Pyrochlore	Montebrasite	Bavenite
Microlite	Brazilianite	Muscovite
Fergusonite	Triplite	Biotite
Columbite	Augelite	Lepidolite
Tantalite	Phosphuranylite	Cookeite
Euxenite	Fluorapatite	Clinochlore
Samarskite	Carbonate-apatite	Ripidolite
	Lazulite	Kaolinite
<u>Halides</u>	Ludlamite	Nacrite
Flourite	Mitridatite	Halloysite
	Xanthoxenite	Montmorillonite
<u>Carbonates</u>	Torbernite	Chrysocolla
Calcite	Autunite	Vermiculite
	Diadochite	Uranophane
	Strunzite	Sphene
	Laueite	

STOP DESCRIPTIONS

Stop 1 (22.73 N - 66.06 E) Interchange on Route 9 at Beaver Meadow Road in Haddam. This is about 9 miles south of Middletown.

The rock at the northern tip of this large series of cuts is the massive, light-gray, Haddam Gneiss. The remainder of the alternating light and dark colored gneiss to the south is in the Middletown Formation. This area is at the southwest corner of the highly pegmatized region that extends several miles to the east and several tens of miles to the north. It is interesting to note that in the well foliated gneisses and schists, the shapes of the pegmatites generally conform to the regional structure. In the more massive Haddam Gneiss the pegmatites often exhibit cross-cutting relationships. The country rock in this area has been metamorphosed to a relatively high degree, and the common metamorphic accessory minerals are particularly well developed.

1-A North side of Beaver Meadow Road. The eastern side of the eastern most road cut. This is actually the newly blasted intersection of Hubbard Road and Beaver Meadow Road. Several small pegmatite lenses have intruded the gneiss in this cut and they contain small pockets of clear blue cordierite. While the blasting was under way last year some museum sized specimens of this mineral were recovered. Cordierite also occurs in lesser amounts in the surrounding gneiss.

1-B North of Beaver Meadow Road. The western side of the cut of the north bound lane of Route 9. This cut is mostly in the Middletown Formation. Extremely coarse prisms of green-brown anthophyllite can be found on the surfaces between the layers of dark and light colored gneiss. This mineral is characteristic of the Middletown Formation in this area.

1-C North of Beaver Meadow Road, on the east side of the cut for the south bound lane of Route 9. A pegmatite at the south end of this cut contains large well developed crystals of magnetite, some nearly an inch across.

1-D South side of Beaver Meadow Road, on the west side of the south end of the southbound entrance ramp for Route 9. The small pegmatite body that is perched on the side of the hill has produced a number of interesting minerals including albite, bismuthinite, monazite, molybdenite, tourmaline and beryl.

Stop 2 (29.02 N - 64.16 E) Hale Quarry.

From the center of Portland, Connecticut, go 2 miles east on Route 66, turn left on Route 17, and go 4.5 miles north to Isinglass Road. Go 0.2 miles to the east and the entrance to the quarry is on the right.

The Hale Quarry was first opened in 1902 and was operated until 1916 when the high cost of labor closed it down. In 1938 the quarry was re-opened and operations have continued almost until the present time. Although there is no active quarrying going on today, material from the remaining dumps is being trucked to the Feldspar Corporation's Mill in Middletown, and a great deal of brush clearing around the quarry indicates that more activity may come in the near future.

The pegmatite has intruded the contact between the Glastonbury Gneiss and the schistose rocks to the west. Its long dimension is generally parallel to the strike of the country rock but it does not conform to the dip of these rocks, and in this sense is crosscutting.

The primary purpose of this stop is to show some of the features of a zoned pegmatite. One of the most striking of these is the mammillary structures which form a wall zone on the west side of the pegmatite body. These are in a medium grained quartz, albite, mica zone with a distinct banding that is partially due to laminar concentrations of pale green mica. There is a quartz core that can be distinctly seen at the south end of the quarry. A large zonolith of schist is exposed in the east wall near the south end. Graphic granite is well developed and good specimens are available. Concentrations of tourmaline also occur in the wall zone. Jelle deBoer, of Wesleyan, is attempting to obtain some paleomagnetic poles from the hematite rich bands that can be seen in the east wall.

In the early 1940's museum specimens of uraninite, autunite, torbernite, and uranophane were removed from the quarry. The yellow stains on the west wall suggest the presence of uranium mineralization. Absolute age determinations have been made by Foye and Lane, and by Knopf (reported in Stugard, 1958), using uraninite and monazite respectively. The samples were taken from the Andrews Quarry which is just at the entrance to the Hale property. The dates calculated were $280 \pm 10\text{my}$ (Foye and Lane) and $300 \pm 10\text{my}$ (Knopf).

Stop 3 (25.85 N - 64.31 E) Strickland Quarry. From the center of Portland, Connecticut go 2 miles east on Route 66, turn left on Route 17 and go 1.1 miles north to Bartlett St., turn right and go 0.8 miles to the intersection of Collins Hill Rd. The entrance to the quarry is just on the other side of the road.

This quarry is owned by the International Minerals and Chemical Corp., Skokie, Ill. and permission must be gotten from them before going on the property.

The Strickland Quarry is one of the most famous mineral collecting localities in the central Connecticut area. The quarry was first opened prior to 1900 and in 1907 was leased to the Eureka Mica and Mining Co. who operated it steadily until 1937. In 1942 the quarry was reactivated

and operations continued until 1950, when all operations ceased. The early mining was primarily for feldspar, but during the 1930's considerable mica was produced. The last phase of activity produced both feldspar and mica and small amounts of beryl.

The main pegmatite body lies roughly parallel to the north - south strike of the crystalline country rock. It is composed essentially of quartz, plagioclase, perthite, and muscovite; with biotite, tourmaline, spodumene, garnet, apatite, and beryl as minor constituents. A comprehensive description of the pegmatite is given in Cameron and others (1954, p. 333-338).

For the mineral collector Strickland's reputation as a first class locality still stands, but today it takes a bit more work to find fresh material in the dumps. An excellent reference for the quarry is Zodac (1937). The various dumps that surround the main pit have been thoroughly picked over on the surface, but a little digging often turns up unexpected finds. These dumps contain enormous quantities of common pegmatite minerals, i.e. feldspars, quartz, and muscovite. Almost all of the minerals on Richard Schooner's list have been found in the Strickland area. A common technique of the local mineral collectors is to dig out a quantity of material on the main dump; let a few rain storms wash it down, then go back in and collect.

There is an excellent example of a glacial striation just away from the northeast corner of the main pit. It is about five feet long and is unusually deep.

A word of caution! The main pit, and the shaft just to the north of it have very steep sides, and it is best to stay well clear of them.

REFERENCES

- Cameron, E. N., and Shainin, V. E., 1947, The beryl resources of Connecticut: *Econ. Geology*, v. 42, p. 353-367.
- Cameron, E. N., and others, 1954, Pegmatite investigations 1942-45 in New England: *U. S. Geol. Survey Prof. Paper 255*, p. 1-56 and p. 296-347.
- Lundgren, L. Jr., 1962, Deep River area, Connecticut: *Stratigraphy and Structure: Am. Jour. Sci.*, v. 260, p. 1-23. (Reprinted as *Connecticut Geol. Nat. Hist. Survey Misc. Ser. 8.*)
- Stugard, Frederick, Jr., 1958, Pegmatites of the Middletown Area, Connecticut: *U. S. Geol. Survey Bull. 1042*, 66 p., map.
- Zodac, Peter, 1937, Minerals of the Strickland quarry: *Rocks and Minerals*, v. 12, no. 5, p. 131-144.

