



STATE OF CONNECTICUT
CONNECTICUT SITING COUNCIL

Ten Franklin Square, New Britain, CT 06051
Phone: (860) 827-2935 Fax: (860) 827-2950
E-Mail: siting.council@po.state.ct.us
Web Site: www.state.ct.us/csc/index.htm

October 8, 2002

Peter W. van Wilgen
Southwestern Bell Mobile Systems, LLC
500 Enterprise Drive
Rocky Hill, CT 06067-3900

RE: **EM-CING-028-077-101-131-137-145-164-020925** - Southwestern Bell Mobile Systems, LLC notice of intent to modify existing telecommunications facility located in Colchester, Manchester, North Haven, Southington, Stonington, Union, and Windsor.

Dear Mr. van Wilgen:

At a public meeting held on October 7, 2002, the Connecticut Siting Council (Council) acknowledged your notice to modify these existing telecommunications facilities, pursuant to Section 16-50j-73 of the Regulations of Connecticut State Agencies with the following conditions: 1) that the tower and foundation in North Haven be reinforced according to the recommendations of SpectraSite Engineering and that a professional engineer certify to the Council the successful completion of these reinforcements; 2) that the tower in Stonington be reinforced according to the recommendations of SpectraSite Engineering and that a professional engineer certify to the Council the successful completion of these reinforcements; 3) that, for the Union tower, a professional engineer prepare a stability analysis of the tower foundation report and that a copy of the results of this analysis be submitted to the Council; and 4) that the wall thickness of the pipe extension on the Windsor tower be verified and replaced if necessary as per the recommendation of URS.

The proposed modifications are to be implemented as specified here and in your notice dated September 25, 2002. The modifications are in compliance with the exception criteria in Section 16-50j-72 (b) of the Regulations of Connecticut State Agencies as changes to an existing facility sites that would not increase tower heights, extend the boundaries of the tower site, increase noise levels at the tower site boundaries by six decibels, and increase the total radio frequencies electromagnetic radiation power density measured at the tower site boundaries to or above the standard adopted by the State Department of Environmental Protection pursuant to General Statutes § 22a-162. These facilities have also been carefully modeled to ensure that radio frequency emissions are conservatively below State and federal standards applicable to the frequencies now used on these towers.

This decision is under the exclusive jurisdiction of the Council. Any additional change to these facilities will require explicit notice to this agency pursuant to Regulations of Connecticut State Agencies Section 16-50j-73. Such notice shall include all relevant information regarding the proposed change with cumulative worst-case modeling of radio frequency exposure at the closest point of uncontrolled access to the tower base, consistent with Federal Communications Commission, Office of Engineering and Technology, Bulletin 65. Any deviation from this format may result in the Council implementing enforcement proceedings pursuant to General Statutes § 16-50u including, without limitation, imposition of expenses resulting from such failure and of civil penalties in an amount not less than one thousand dollars per day for each day of construction or operation in material violation.

Thank you for your attention and cooperation.

Very truly yours,

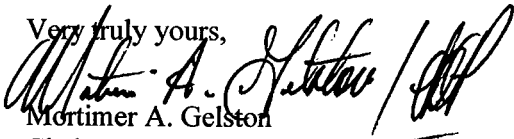
Mortimer A. Gelston
Chairman

MAG/laf

c: See attached list.

List Attachment.

- c: Honorable Jenny Contois, First Selectman, Town of Colchester
- Liz Rasmussen, Zoning Enforcement Officer, Town of Colchester
- Honorable Stephen T. Cassano, Mayor, Town of Manchester
- Thomas R. O'Marra, Zoning Enforcement Officer, Town of Manchester
- Richard J. Sartor, General Manager, Town of Manchester
- Honorable Kevin J. Kopetz, First Selectment, Town of North Haven
- Robert Burns, Zoning Enforcement Officer, Town of North Haven
- Honorable William V. DePaolo, Town Council Chairman, Town of Southington
- John Weichsel, Town Manager, Town of Southington
- Mary Hughes, Town Planner, Town of Southington
- Honorable Peter Dibble, First Selectman, Town of Stonington
- Edward Donnelly, Town Planner, Town of Stonington
- Honorable Albert L. Goodhall, Jr., First Selectman, Town of Union
- Planning and Zoning Official, Town of Union
- Honorable Donald Trinks, Mayor, Town of Windsor
- R. Leon Churchill, Jr., Town Manager, Town of Windsor
- Mario Zavarella, Town Planner, Town of Windsor



STATE OF CONNECTICUT

CONNECTICUT SITING COUNCIL

Ten Franklin Square, New Britain, CT 06051

Phone: (860) 827-2935 Fax: (860) 827-2950

E-Mail: siting.council@po.state.ct.us

Web Site: www.state.ct.us/csc/index.htm

September 25, 2002

Honorable Jenny Contois
First Selectman
Town of Colchester
Town Hall
127 Norwich Avenue
Colchester, CT 06415

RE: **EM-CING-028-077-101-131-137-145-164-020925** – Southwestern Bell Mobile Systems, LLC notice of intent to modify existing telecommunications facility located in Colchester, Manchester, North Haven, Southington, Stonington, Union, and Windsor.

Dear Mr. Contois:

The Connecticut Siting Council (Council) received this request to modify an existing telecommunications facility, pursuant to Regulations of Connecticut State Agencies Section 16-50j-72.

The Council will consider this item at the next meeting tentatively scheduled for October 7, 2002, at 1:30 p.m. in Hearing Room One, Ten Franklin Square, New Britain, Connecticut.

Please call me or inform the Council if you have any questions or comments regarding this proposal.

Thank you for your cooperation and consideration.

Very truly yours,

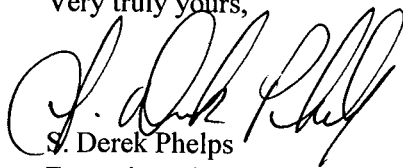

S. Derek Phelps
Executive Director

SDP/slm

Enclosure: Notice of Intent

c: Liz Rasmussen, Zoning Enforcement Officer, Town of Colchester



Southwestern Bell Mobile Systems, LLC
500 Enterprise Drive
Rocky Hill, Connecticut 06067-3900
Phone: (860) 513-7730
Fax: (860) 513-7190

Peter W. van Wilgen
Senior Manager, Construction

RECEIVED

SEP 25 2002

CONNECTICUT
SITING COUNCIL

HAND DELIVERED

September 25, 2002

Mr. Mortimer A. Gelston, Chairman
Connecticut Siting Council
10 Franklin Square
New Britain, Connecticut 06051

Re: Southwestern Bell Mobile Systems, LLC notice of intent to modify existing telecommunications facilities located in Colchester, Manchester, North Haven, Southington, Stonington, Union, and Windsor.

Dear Mr. Gelston:

In order to accommodate technological changes, implement E-911 capability and enhance system performance, Southwestern Bell Mobile Systems, LLC ("SNET" or "Cingular Wireless"; formerly SNET Mobility, LLC) plans to modify the antenna configurations at its existing cell sites. Please accept this letter and attachments as notification, pursuant to R.C.S.A. Section 16-50j-73, of construction which constitutes an exempt modification pursuant to R.C.S.A. Section 16-50j-72(b)(2). In compliance with R.C.S.A. Section 16-50j-73, a copy of this letter and attachments is being sent to the chief elected official of each of the municipalities in which an affected cell site is located.

Attached are summary sheets detailing the planned changes, including power density calculations reflecting the change in the effect of Cingular's operations at each site. Also included is documentation of the structural sufficiency of each tower to accommodate the revised antenna configuration.

The changes to the facilities do not constitute modifications as defined in Connecticut General Statutes ("C.G.S.") Section 16-50i(d) because the general physical characteristics of the facilities will not be significantly changed or altered. Rather, the planned changes to the facilities fall squarely within those activities explicitly provided for in R.C.S.A. Section 16-50j-72(b)(2).

EM-CING-028-077-101-131-137-145-
164-020925

1. The height of the overall structure will be unaffected. At almost all sites, new panel antennas approximately the same size will replace those previously installed. Tower mount amplifiers, approximately 5" x 9" x 13", will be added to the platform on which the panel antennas are mounted to enhance signal reception at the cell site. In addition, the mandated provision of E-911 capability *may* require installation of one LMU ("location measurement unit"), approximately nine inches high, on either the tower, the equipment shelter, or the ice bridge. At this writing, however, it appears that the new panel antennas will serve this purpose as well. One GPS receive-only antenna will be attached to the equipment shelter at each site. None of the modifications will extend the height of the tower.
2. The proposed changes will not extend the site boundaries. There will be no effect on the site compound.
3. The proposed changes will not increase the noise level at the existing facility by six decibels or more.
4. Radio frequency power density will increase due to use of additional channels broadcasting at higher power. However, the changes will not increase the calculated "worst case" power density for the combined operations at the site to a level at or above the applicable standard for uncontrolled environments as calculated for a mixed frequency site.

For the foregoing reasons, Cingular Wireless respectfully submits that the proposed changes at the referenced sites constitute exempt modifications under R.C.S.A. Section 16-50j-72(b)(2).

Please feel free to call me at (860) 513-7730 with questions concerning this matter. Thank you for your consideration.

Sincerely,

A handwritten signature in blue ink that reads "Peter W. Van Wilgen" followed by a large, stylized flourish that appears to be "SLL".

Peter W. van Wilgen
Senior Manager - Construction

Enclosures

**CINGULAR WIRELESS
Antenna Modification**

Site Address: 600 Old Hartford Rd., Colchester
TS-SCLP-028-000406 approved 5/10/00

Tower Owner/Manager: Cordless Data Transfer

Antenna configuration: Antenna center line – 170 ft

Current and/or approved: 9 Allgon 7120.16 panels

Planned: 9 CSS DUO1417-8686-4-0 panels or comparable
6 tower mount amplifiers
3 duplexers

Power Density:

Calculations for Cingular's current operations at the site indicate a radio frequency electromagnetic radiation power density, measured at the tower base, of approximately 4.0% of the standard adopted by the FCC. As depicted in the second table below, the total radio frequency electromagnetic radiation power density for Cingular's planned operations would be approximately 5.7%, or an additional 1.7% of the standard.

Cingular Current

Company	Centerline Ht (feet)	Frequency (MHz)	Number of Channels	Power Per Channel (Watts)	Power Density (mW/cm ²)	Standard Limits (mW/cm ²)	Percent of Limit
Cingular	170	880 - 894	19	100	0.0236	0.5867	4.0

Cingular Planned

Company	Centerline Ht (feet)	Frequency (MHz)	Number of Channels	Power Per Channel (Watts)	Power Density (mW/cm ²)	Standard Limits (mW/cm ²)	Percent of Limit
Cingular TDMA	170	880 - 894	16	100	0.0199	0.5867	3.4
Cingular GSM	170	880 - 894	2	296	0.0074	0.5867	1.3
Cingular GSM	170	1930 - 1935	2	427	0.0106	1.0000	1.1
Total							5.7%

Structural information: Please see attached.

DETAILED STRUCTURAL ANALYSIS AND EVALUATION OF 180' GUYED TOWER FOR REPLACEMENT ANTENNA ARRANGEMENT

600 Old Hartford Road
Colchester, Connecticut
Site No.: 2032

prepared for



Cingular Wireless
500 Enterprise Drive, Suite 3A
Rocky Hill, CT 06067



prepared by



URS CORPORATION
795 BROOK STREET, BUILDING 5
ROCKY HILL, CT 06067
TEL. 860-529-8882

36911722.00000

Revision 2: September 17, 2002

1. EXECUTIVE SUMMARY

This report summarizes the structural analysis of the 180' guyed tower located on 600 Old Hartford Road in Colchester, Connecticut. The analysis was conducted in accordance with the TIA/EIA-222-E standard for wind velocity of 85 mph and 74 mph concurrent with ½" ice design wind load. The antenna loading considered in the analysis consists of all existing and proposed antennas, transmission lines, and ancillary items as outlined in the Analysis Methodology and Loading Condition Section of this report. The proposed Cingular Wireless modification is to add the antennas listed below:

(9) DUO1417-8686 antenna with (3) Cingular @ 170' elevation
Duplexer and (6) TMA mounted on
(3) T-Frame with (9) 1 1/4" coax cables

The results of the analysis indicate that the tower structure is in compliance with the proposed loading conditions. The tower is considered feasible with the TIA/EIA-222-E wind load classification specified above and all the existing and proposed antenna loading. No further analysis was conducted on the tower foundation since the forces calculated were below the original design.

This analysis is based on:

- 1) The tower structure's theoretical capacity not including any assessment of the condition of the tower.
- 2) The tower and foundation report prepared by Fred A. Nudd Corporation project no. 7265 dated November 1999.
- 3) Antenna inventory as specified in section 2 and 6 of this report.
- 4) TIA/EIA-222-E wind load classification.

This report is only valid as per the assumptions and data utilized in this report for antenna inventory, mounts and associated cables. The user of this report shall field verify the assumption of the antenna and mount configuration. Notify the engineer in writing immediately if any of the assumptions in this report are found to be other than specified.

If you should have any questions, please call.

Sincerely,
URS Corporation AES

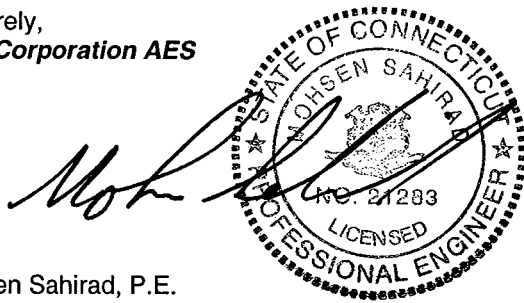

Mohsen Sahirad, P.E.
Senior Structural Engineer

MS/rmn

cc: Richard Johanson – Cingular Wireless
Doug Roberts – URS
N.A. – URS
A.A. – URS
CF/Book

2. INTRODUCTION

The subject tower is located on 600 Old Hartford Road in Colchester, Connecticut. The structure is a self supporting 180' steel guyed tower manufactured by Fred A. Nudd Corporation.

The tower is constructed of pipe legs, diagonal rod braces and horizontal angle braces. The tower members are bolted or welded. The width of the tower is 3'-5". The tower geometry and structural sizes were taken from Fred A. Nudd Corporation project no. 7265 dated November 1999.

The existing structure supports several communication antennas. The antenna and mount configuration as specified below:

Antenna Type	Carrier	Mount	Elev (ft)	Cable
(6) DAPA 58000	Sprint	(3) 12' T-Frame	180'	(6) 1 1/4" coax
(9) DUO1417-8686 antenna with (3) Duplexer and (6) TMA	Cingular (Proposed)	(3) 12' T-Frame	170'	(9) 1 1/4" coax
(6) Allgon 7262.02	AT&T	(3) 8' T-Frame	160'	(6) 1 1/4" coax

Note: The proposed Cingular Wireless modification will utilize the existing mounts, cables and orientation.

This structural analysis of the communications tower was performed by URS Corporation, AES (URS) for Cingular Wireless. The purpose of this analysis was to analyze the existing tower for its existing and proposed antenna loads. This analysis was conducted to evaluate twist (rotation), sway (deflection) and stress on the tower, and the effect of forces to the foundation of the tower resulting from existing and proposed antenna arrangements.

3. ANALYSIS METHODOLOGY AND LOADING CONDITIONS

Methodology:

The structural analysis was done in accordance with the TIA/EIA-222-E, Structural Standard for Steel Antenna Towers and Antenna Supporting Structures, the American Institute of Steel Construction (AISC) and the Manual of Steel Construction; Allowable Stress Design (ASD).

The analysis was conducted using ERI Tower 2.0. The two load conditions were evaluated as shown below which were compared to allowable stresses according to AISC and TIA/EIA. The load combinations were investigated in ERI Tower 2.0 to determine the stress, sway and rotation.

Load Condition 1 = 85 mph Wind Load + Tower Dead Load
Load Condition 2 = 74 mph Wind Load (with 1/2" radial ice) + Tower Dead Load

The TIA/EIA standard permits one-third increase in allowable stresses for towers and monopoles less than 700 feet tall. For purposes of this analysis, allowable stresses of tower members were increased by one-third in computing the load capacity; in addition, the appropriate "k" factors were assigned to each member.

4. FINDINGS AND EVALUATION

The combined axial and bending stresses on the tower structure were evaluated to compare with the allowable stress in accordance with AISC. The analysis indicates that the tower legs, diagonal members and horizontal members have sufficient capacity to carry the loads applied. No further

analysis was conducted on the tower foundation since the forces calculated were below the original design.

The tower reactions are as follows:

Original Reactions	
Horizontal force at anchor block (kips)	63
Uplift force at anchor block (kips)	55.8
Resultant force at anchor block (kips)	84.1
Shear at tower base (kips)	4
Compression at tower base (kips)	95

Proposed Reactions	
Horizontal force at anchor block (kips)	41
Uplift force at anchor block (kips)	38
Resultant force at anchor block (kips)	56
Shear at tower base (kips)	2
Compression at tower base (kips)	85

For detailed proposed tower reactions, see drawing no. E-1 in section 6 of this report.

5. CONCLUSIONS

The results of the analysis indicate that the structure is in compliance with the loading conditions and the materials and member sizes for the tower. The tower is considered feasible with the TIA/EIA-222-E wind load classification specified above and all the existing and proposed antenna loading. The user of this report shall field verify the assumption of the antenna and mount configuration. Notify the engineer in writing immediately if any of the assumptions in this report are found to be other than specified.

Limitations/Assumptions:

This report is based on the following:

- A. Tower is properly installed and maintained.
- B. All members were as specified in the original Construction Documents and are in good condition.
- C. All required members are in place.
- D. All bolts are in place and are properly tightened.
- E. Tower is in plumb condition.
- F. All members protective coating is in good condition.
- G. All tower members were properly designed, detailed, fabricated, installed, and have been properly maintained since erection.

URS is not responsible for any modifications completed prior to or hereafter in which URS is not or was not directly involved. Modifications include but are not limited to:

- A. Removing/Replacing antennas
- B. Adding antennas and amplifiers

URS hereby states that this document represents the entire report and that it assumes no liability for any factual changes that may occur after the date of this report. All representations, recommendations, and conclusions are based upon information contained and set forth herein. If you are aware of any information which conflicts with that which is contained herein, or you are aware of any defects arising from original design, material, fabrication, or erection deficiencies, you should disregard this report and immediately contact URS. URS disclaims all liability for any representation, recommendation, or conclusion not expressly stated herein.

Ongoing and Periodic Inspection and Maintenance by the Owner:

1. After the Contractor has successfully completed the installation and the work has been accepted, the tower owner will be responsible for the ongoing and periodic inspection and maintenance of the tower.
2. The owner shall refer to TIA/EIA-222-E, for recommendations for maintenance and inspection. The frequency of the inspection and maintenance intervals is to be determined by the owner based upon actual site and environmental conditions. It is recommended that a complete and thorough inspection of the entire tower structural system is performed at least yearly and more frequently as conditions warrant. According to TIA/EIA-222-E. It is recommended that the structure be inspected after severe wind and/or ice storms or other extreme loading conditions.



Southwestern Bell Mobile Systems, LLC
500 Enterprise Drive
Rocky Hill, Connecticut 06067-3900
Phone: (860) 513-7730
Fax: (860) 513-7190

Peter W. van Wilgen
Senior Manager - Construction

September 25, 2002

Honorable Jenny Contois
First Selectman, Town of Colchester
Town Hall, 127 Norwich Avenue
Colchester, Connecticut 06415

Re: Telecommunications facility – 600 Old Hartford Rd.

Dear Ms. Contois:

In order to meet the requirements for improved E-911 capability and to implement a more advanced telecommunications system, Southwestern Bell Mobile Systems, LLC, a/k/a Cingular Wireless ("SBMS" or "Cingular"; formerly SNET Mobility, LLC) will be changing its antenna configuration at certain cell sites. Cingular will install panel antennas, small amplifiers and a small locator unit on the tower. As required by Regulations of Connecticut State Agencies ("R.C.S.A.") Section 16-50j-73, the Connecticut Siting Council has been notified of the changes and will review Cingular's proposal. Please accept this letter as notification under Section 16-50j-73 of construction which constitutes an exempt modification pursuant to R.C.S.A. Section 16-50j-72(b)(2).

The accompanying letter fully describes Cingular's proposal. However, if you have any questions or require any further information on our plans or the Siting Council's procedures, please call me at (860) 513-7730 or Mr. Derek Phelps, Executive Director, Connecticut Siting Council at (860) 827-2935.

Sincerely,

Peter W. van Wilgen
Senior Manager – Construction

Enclosure

**CINGULAR WIRELESS
Antenna Modification**

Site Address: 60 Adams Street, Manchester

Tower Owner/Manager: William B. Thornton

Antenna configuration: Antenna center line – 125 ft

Current and/or approved: 9 Allgon ALP 110-11 panels

Planned: 9 CSS DUO1417-8686-4-0 panels or comparable
6 tower mount amplifiers
3 duplexers

Power Density:

Calculations for Cingular's current operations at the site indicate a radio frequency electromagnetic radiation power density, measured at the tower base, of approximately 7.5% of the standard adopted by the FCC. As depicted in the second table below, the total radio frequency electromagnetic radiation power density for Cingular's planned operations would be approximately 10.6%, or an additional 3.1% of the standard.

Cingular Current

Company	Centerline Ht (feet)	Frequency (MHz)	Number of Channels	Power Per Channel (Watts)	Power Density (mW/cm ²)	Standard Limits (mW/cm ²)	Percent of Limit
Cingular	125	880 - 894	19	100	0.0437	0.5867	7.5

Cingular Planned

Company	Centerline Ht (feet)	Frequency (MHz)	Number of Channels	Power Per Channel (Watts)	Power Density (mW/cm ²)	Standard Limits (mW/cm ²)	Percent of Limit
Cingular TDMA	125	880 - 894	16	100	0.0368	0.5867	6.3
Cingular GSM	125	880 - 894	2	296	0.0136	0.5867	2.3
Cingular GSM	125	1930 - 1935	2	427	0.0197	1.0000	2.0
Total							10.6%

Structural information: Please see attached.

DETAILED STRUCTURAL ANALYSIS AND EVALUATION OF 140' MONOPOLE FOR REPLACEMENT ANTENNA ARRANGEMENT

60 Adams Street
Manchester, Connecticut
Site No.: 1080

prepared for



Cingular Wireless
500 Enterprise Drive, Suite 3A
Rocky Hill, CT 06067

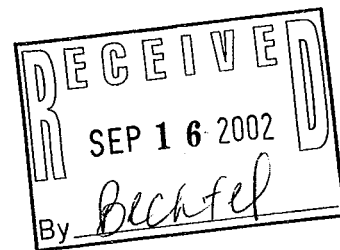

prepared by



URS CORPORATION
795 BROOK STREET, BUILDING 5
ROCKY HILL, CT 06067
TEL. 860-529-8882

36911668.00000

September 16, 2002

1. EXECUTIVE SUMMARY

This report summarizes the structural analysis of the existing 140' monopole located 60 Adams Street in Manchester, Connecticut. The analysis was conducted in accordance with the TIA/EIA-222-E standard for wind velocity of 80 mph bare and 69 mph concurrent with 1/2" ice. The antenna loading considered in the analysis consists of all existing and proposed antennas, transmission lines, and ancillary items as outlined on the following page of this report. The proposed Cingular Wireless modification is to replace the existing Cingular Wireless antennas with the antennas listed below:

(9) DUO1417-8686 antennas with (6) Cingular @ 125' elevation
TMA and (3) Duplexers mounted on the (proposed)
standard platform with (9) 1 1/4" coax
cables within the monopole

The results of the analysis indicate that the structure is in compliance with the proposed loading condition for the monopole. The monopole is considered feasible with the TIA/EIA-222-E wind load classification specified above and all the existing and proposed antenna loading. No further analysis was conducted on the tower foundation since the forces calculated were below the original design.

This analysis is based on:

- 1) The tower structure's theoretical capacity not including any assessment of the condition of the tower.
- 2) Tower and foundation design prepared by Engineered Endeavors Incorporated project no. 4795 approved March 26, 1996.
- 3) Antenna inventory as specified on the following page of this report.
- 4) TIA/EIA-222-E wind load classification.

This report is only valid as per the assumptions and data utilized in this report for antenna inventory, mounts and associated cables. The user of this report shall field verify the assumption of the antenna and mount configuration and that adequate space is available for routing the coaxial cable inside the monopole prior to installation. Notify the engineer in writing immediately if any of the assumptions in this report are found to be other than specified.

If you should have any questions, please call.

Sincerely,

URS Corporation AES

Mohsen Sanirad
Mohsen Sanirad, P.E.
Senior Structural Engineer

MS/rmn

cc: Richard R. Johanson – Bechtel
Doug Roberts – URS
I.A. – URS
A.A. – URS
CF/Book

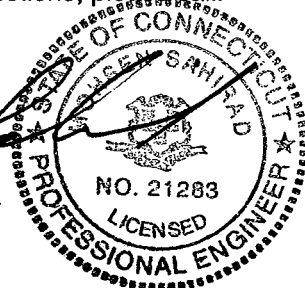

Introduction:

A structural analysis of this 140' communications monopole was performed by URS Corporation AES (URS) for Cingular Wireless. The monopole is located on 60 Adams Street in Manchester, Connecticut.

The structure is self-supporting and was designed by Engineered Endeavors Incorporated project no. 4795 dated March 26, 1999.

This analysis was conducted to evaluate twist (rotation), sway (deflection), and stress on the monopole. The analysis was also used to find the effect of the forces to the foundation resulting from the antenna arrangement listed below.

The antenna inventory obtained:

	<u>Antenna Centerline Elevation</u>
(2) 6' Whip antennas with (2) 4' side arm mounts and (2) 7/8" coax cables within the monopole	@ 142' elevation
(1) 10' Whip antenna with (1) 8' side arm mount and (1) 7/8" coax cable within the monopole	@ 138' elevation
(9) DUO1417-8686 antennas with (6) TMA and (3) Duplexers mounted on the standard platform with (9) 1 1/4" coax cables within the monopole	Cingular (proposed) @ 125' elevation
(9) DB980H90 antennas with low profile platform and (9) 1 1/4" coax cables	Sprint @ 115' elevation
(2) 6' Whip antennas with (2) 4' side arm mounts and (2) 7/8" coax cables within the monopole	@ 110' elevation
(12) DB844H90 antennas with standard platform and (12) 7/8" coax cables	Nextel @ 100' elevation
(12) ALP 9212 antennas with standard platform and (12) 1 5/8" coax cables	Verizon @ 90' elevation

Note: 1. Porthole may be required. Installation of porthole shall be done per manufacturer suggestion.

2. Cingular Wireless shall conduct verification on the assumption of the antenna and mount configuration and that adequate space is available for routing the coaxial cable inside the monopole prior to installation. Notify the engineer immediately if any of the assumptions in this report are found to be other than specified.

Structural Analysis:

Methodology:

The structural analysis was done in accordance with TIA/EIA-222-E, Structural Standard for Steel Antenna Towers and Antenna Supporting Structures, the American Institute of Steel Construction (AISC) and the Manual of Steel Construction; Allowable Stress Design (ASD).

The analysis was conducted using ERI Tower 2.0. Two load conditions were evaluated as shown below which were compared to allowable stresses according to AISC and TIA/EIA. The two load combinations were investigated in ERI Tower 2.0 to determine the stress, sway and rotation.

Load Condition 1 = 80 mph Wind Load (without ice) + Tower Dead Load
Load Condition 2 = 69 mph Wind Load (with ice) + Ice Load + Tower Dead Load

The TIA/EIA standard permits one-third increase in allowable stresses for towers and monopoles less than 700 feet tall. For purposes of this analysis, allowable stresses of the monopole members were increased by one-third in computing the load capacity.

Evaluation of Monopole:

Combined axial and bending stresses on the monopole structure were evaluated to compare with allowable stresses in accordance with AISC. The calculated stresses under the proposed loading were below the allowable stresses.

Analysis Results:

Our analysis determined that the monopole will support the proposed new antenna arrangements under the analysis criteria outlined on the previous page. No further analysis was conducted on the tower foundation since the forces calculated were below the original design.

Our analysis for the proposed new antenna arrangement and load condition is provided in Appendix A.

Limitations/Assumptions:

This report is based on the following:

1. Tower inventory for antennas and mounts as listed in this report.
2. Tower is properly installed and maintained.
3. All members were as specified in the original design Documents and are in good condition.
4. All required members are in place.
5. All bolts are in place and are properly tightened.
6. Tower is in plumb condition.
7. All members are galvanized.
8. All tower members were properly designed, detailed, fabricated, and installed and have been properly maintained since erection.
9. Foundations were properly constructed to support original design loads as specified in the original design Documents.
10. All co-axial cable is installed within or outside the monopole, except as noted.

URS is not responsible for any modifications completed prior to or hereafter, which URS is not or was not directly involved. Modifications include but are not limited to:

1. Removing antennas
2. Adding antennas and amplifiers

URS hereby states that this document represents the entire report and that it assumes no liability for any factual changes that may occur after the date of this report. All representations, recommendations, and

conclusions are based upon information contained and set forth herein. If you are aware of any information which conflicts with that which is contained herein, or you are aware of any defects arising from original design, material, fabrication, or erection deficiencies, you should disregard this report and immediately contact URS. URS disclaims all liability for any representation, recommendation, or conclusion not expressly stated herein.

Ongoing and Periodic Inspection and Maintenance by the Owner:

1. After the Contractor has successfully completed the installation and the work has been accepted, the owner will be responsible for the ongoing and periodic inspection and maintenance of the tower and reinforcing system.
2. The Owner shall refer to TIA/EIA-222-E, for recommendations for maintenance and inspection. The frequency of the inspection and maintenance intervals is to be determined by the Owner based upon actual site and environmental conditions. It is recommended that a complete and thorough inspection of the entire tower structural system is performed at least yearly and more frequently as conditions warrant. According to TIA/EIA-222-E: It is recommended that the structure be inspected after severe wind and/or ice storms or other extreme loading conditions.



Southwestern Bell Mobile Systems, LLC
500 Enterprise Drive
Rocky Hill, Connecticut 06067-3900
Phone: (860) 513-7730
Fax: (860) 513-7190

Peter W. van Wilgen
Senior Manager - Construction

September 25, 2002

Honorable Stephen Cassano, Mayor
Town of Manchester
41 Center Street
Manchester, Connecticut 06040

Re: Telecommunications facility – 60 Adams Street

Dear Mayor Cassano:

In order to meet the requirements for improved E-911 capability and to implement a more advanced telecommunications system, Southwestern Bell Mobile Systems, LLC, a/k/a Cingular Wireless (“SBMS” or “Cingular”; formerly SNET Mobility, LLC) will be changing its antenna configuration at certain cell sites. Cingular will install panel antennas, small amplifiers and a small locator unit on the tower. As required by Regulations of Connecticut State Agencies (“R.C.S.A.”) Section 16-50j-73, the Connecticut Siting Council has been notified of the changes and will review Cingular’s proposal. Please accept this letter as notification under Section 16-50j-73 of construction which constitutes an exempt modification pursuant to R.C.S.A. Section 16-50j-72(b)(2).

The accompanying letter fully describes Cingular’s proposal. However, if you have any questions or require any further information on our plans or the Siting Council’s procedures, please call me at (860) 513-7730 or Mr. Derek Phelps, Executive Director, Connecticut Siting Council at (860) 827-2935.

Sincerely,

Peter W. van Wilgen
Senior Manager – Construction

Enclosure

**CINGULAR WIRELESS
Antenna Modification**

Site Address: 15 Dwight Street, North Haven
Docket 44.4 & Exempt Modif. Approved 9/9/92

Tower Owner/Manager: SpectraSite

Antenna configuration Antenna center line – 153 ft

Current and/or approved: 10 Swedcom ALP 110-11 panels

Planned: 10 CSS DUO1417-8686-4-0 panels or comparable
6 tower mount amplifiers

Power Density:

Calculations for Cingular's current operations at the site indicate a radio frequency electromagnetic radiation power density, measured at the tower base, of approximately 5.0% of the standard adopted by the FCC. As depicted in the second table below, the total radio frequency electromagnetic radiation power density for Cingular's planned operations would be approximately 7.1%, or an additional 2.1% of the standard.

Cingular Current

Company	Centerline Ht (feet)	Frequency (MHz)	Number of Channels	Power Per Channel (Watts)	Power Density (mW/cm ²)	Standard Limits (mW/cm ²)	Percent of Limit
Cingular	153	880 - 894	19	100	0.0292	0.5867	5.0

Cingular Planned

Company	Centerline Ht (feet)	Frequency (MHz)	Number of Channels	Power Per Channel (Watts)	Power Density (mW/cm ²)	Standard Limits (mW/cm ²)	Percent of Limit
Cingular TDMA	153	880 - 894	16	100	0.0246	0.5867	4.2
Cingular GSM	153	880 - 894	2	296	0.0091	0.5867	1.5
Cingular GSM	153	1930 - 1935	2	427	0.0131	1.0000	1.3
Total							7.1%

Structural information: Please see attached.

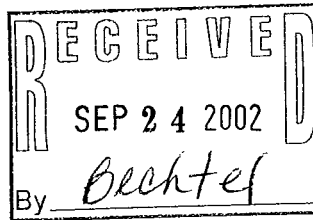

#2012

CT-0018

September 23, 2002

Structural Analysis of 151.42' ITT Meyer Monopole

North Haven, 15 Dwight St., North Haven, CT

1.0 Introduction

A structural analysis was performed on the above noted tower for the addition of proposed antennas as listed below. The analysis consisted of applying the forces caused by the existing and proposed loads, and determining the resulting stresses in the structure and its foundation.

The following criteria were used in the analysis:

- ANSI/TIA/EIA-222-F 85 mph wind [New Haven County], considering two loading cases:

Load Case 1. 100% wind pressure, without radial ice

Load Case 2. 75% wind pressure, with 1/2" radial ice

Information, including geometry and member sizes were obtained from Smith Cullum Steel Data Tower Report dated 6/1/02.

2.0 Antenna and Transmission Line Loading

Table 1. Existing and Proposed Antennas

Elevation (Ft. AGL)	Antenna	Carrier	Transmission Lines*	Notes
153	(10) CSS DUO1417-8686-4-0 (6) ADC TMA's on Platform Mount w/ Handrails	Cingular	(10) 7/8" [I]	Proposed Replacement
153	(10) Swedcom ALP 11011 on Platform Mount w/ Handrails	Cingular	(10) 7/8" [I]	Remove Existing
135	(12) Swedcom ALP 9212-N on Platform Mount w/ Handrails	Verizon	(12) 1-1/4" [O]	Existing
38	(1) Nokia CS72187.01 on Standoff Mount	Cingular	(1) 1/2" [O]	Proposed

* [I]/[O] denotes coax installed inside or outside the monopole respectively.

3.0 Results

Tower Member Stress Levels

Elevation (Ft. A.G.L.)	Monopole
0-33	1.33**
33-71	1.45**
71-110	1.50**
110-151	1.23**

*Maximum Stress Ratio: 1.00=Full Allowable

**Overstressed; requires reinforcing.

Foundation Stress Levels

Base Reactions	Current Analysis	Result*
Moment (kip.ft)	2,164.8	Unsatisfactory
Compression (kips)	16.8	Unsatisfactory
Shear (kips)	21.2	Unsatisfactory

* Based on foundation capacity.

4.0 Conclusions and Recommendations

1. The tower and foundation are not structurally adequate to accommodate the existing and proposed antenna and transmission line loading used in this analysis. The tower and foundation are structurally adequate to accommodate the existing and proposed antenna and transmission line loading used in this analysis with the following modifications:
 - Reinforce tower up to an elevation of 125' as shown conceptually on SCI drawing CT-0018-M2.
 - Reinforce flange and replace bolts at elevation 110' as shown conceptually on SCI drawing CT-0018-M2.
 - Reinforce foundation as shown conceptually on SCI drawing CT-0018-M2. Normal soils were assumed for the analysis of this foundation. Further geotechnical investigation is required.
2. Any future changes in loading must be reviewed by the SpectraSite Engineering Department.

Should any questions arise concerning this report please contact the undersigned

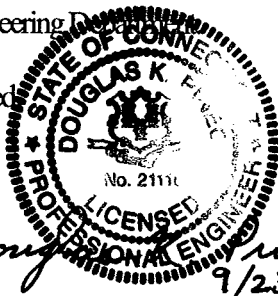

Brenton S. Lockamy, P.E.
Project Engineer
919/466-5536

Douglas K. Pineo
9/23/02
Douglas K. Pineo, P.E.
Senior Design Engineer

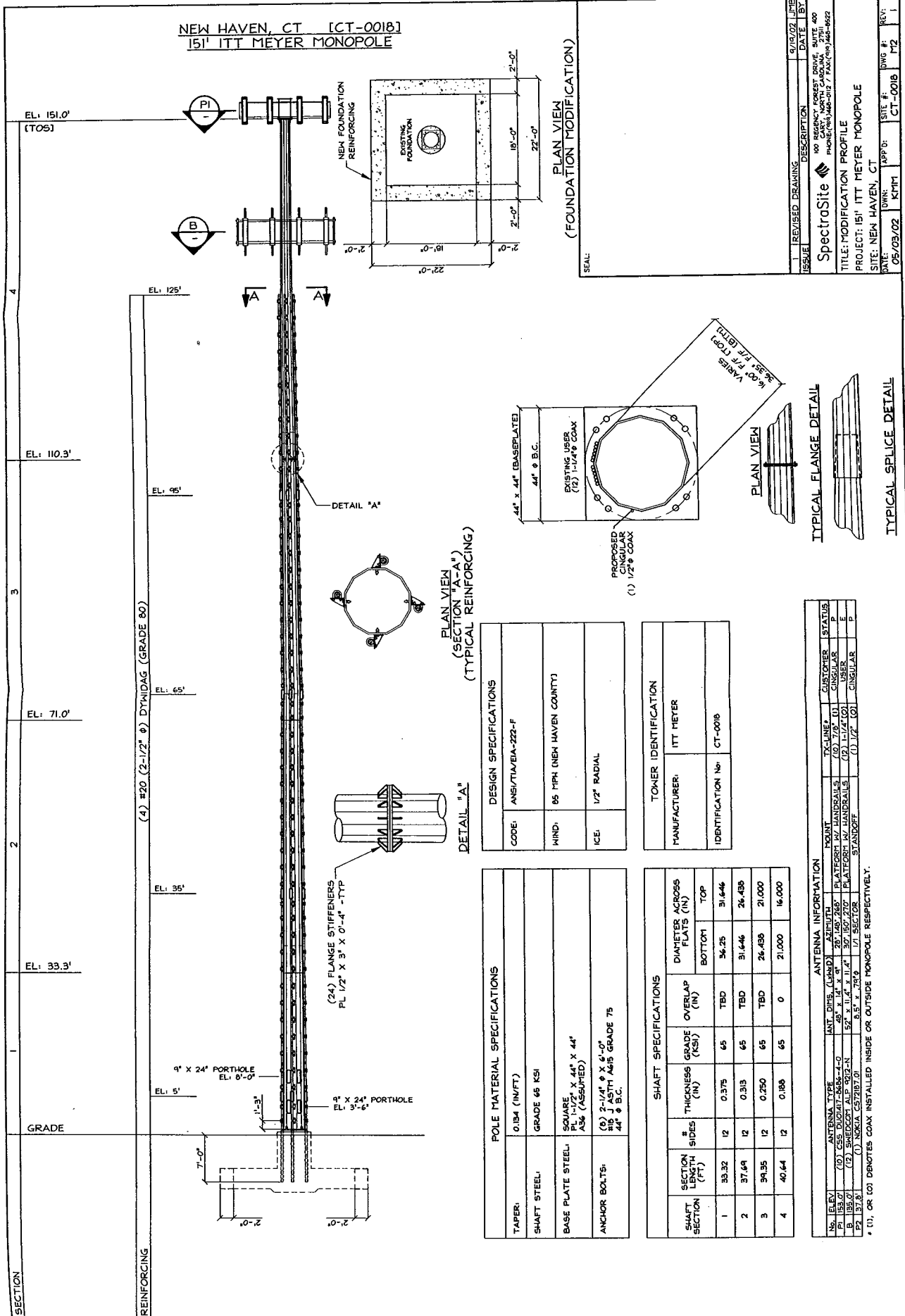
NEW HAVEN, CT [CT-0018]
151' ITT MEYER MONOPOLE

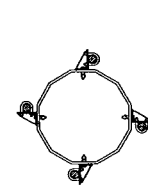
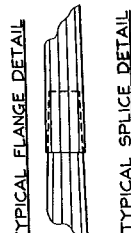
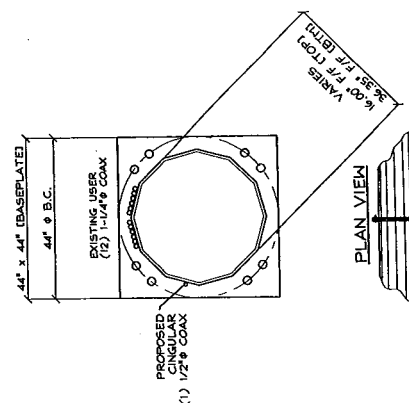

PLAN VIEW
(FOUNDATION MODIFICATION)



DESIGN SPECIFICATIONS	
CODE:	ANSI/AEIA-222-F
KIND:	85 MPH (NEW HAVEN COUNTY)
ICE:	1/2" RADIAL

TOWER IDENTIFICATION	
MANUFACTURER:	ITT MEYER
IDENTIFICATION No.:	CT-0018

POLE MATERIAL SPECIFICATIONS	
TAPER:	0.134 (IN/FT)
SHAFT STEEL:	GRADE 65 KSI
BASE PLATE STEEL:	SQUARE PL 1-1/2" X 44" X 44" A36 (ASSUMED)
ANCHOR BOLTS:	(1) 2-1/4" X 4'-0" 10 J ASTH A415 GRADE 75 44" Ø B.C.

SHAFT SPECIFICATIONS							
SHAFT SECTION	SECTION LENGTH (FT)	# THICKNESS GRADE (KSI)	DIAMETER ACROSS FLATS (IN)				
			OVERLAP (IN)	TOP			
1	33.32	12	0.375	65	TBD	36.25	31.646
2	37.64	12	0.313	65	TBD	31.646	26.436
3	34.35	12	0.250	65	TBD	26.436	21.000
4	40.64	12	0.188	65	0	21.000	16.000

ANTENNA INFORMATION			
No. / ELEV.	ANTENNA TYPE	ANT. DIMS. (LxWxH)	STATUS
P1 158.0'	(1) SPECTRA	30" x 30" x 18"	CIRCULAR
P2 137.8'	(1) SPECTRA	52" x 11.4" x 11.4"	CIRCULAR
P3 137.8'	(1) SPECTRA	52" x 11.4" x 11.4"	CIRCULAR
P4 137.8'	(1) SPECTRA	52" x 11.4" x 11.4"	CIRCULAR
P5 137.8'	(1) SPECTRA	52" x 11.4" x 11.4"	CIRCULAR
P6 137.8'	(1) SPECTRA	52" x 11.4" x 11.4"	CIRCULAR
P7 137.8'	(1) SPECTRA	52" x 11.4" x 11.4"	CIRCULAR
P8 137.8'	(1) SPECTRA	52" x 11.4" x 11.4"	CIRCULAR
P9 137.8'	(1) SPECTRA	52" x 11.4" x 11.4"	CIRCULAR
P10 137.8'	(1) SPECTRA	52" x 11.4" x 11.4"	CIRCULAR
P11 137.8'	(1) SPECTRA	52" x 11.4" x 11.4"	CIRCULAR
P12 137.8'	(1) SPECTRA	52" x 11.4" x 11.4"	CIRCULAR
P13 137.8'	(1) SPECTRA	52" x 11.4" x 11.4"	CIRCULAR
P14 137.8'	(1) SPECTRA	52" x 11.4" x 11.4"	CIRCULAR
P15 137.8'	(1) SPECTRA	52" x 11.4" x 11.4"	CIRCULAR
P16 137.8'	(1) SPECTRA	52" x 11.4" x 11.4"	CIRCULAR
P17 137.8'	(1) SPECTRA	52" x 11.4" x 11.4"	CIRCULAR
P18 137.8'	(1) SPECTRA	52" x 11.4" x 11.4"	CIRCULAR
P19 137.8'	(1) SPECTRA	52" x 11.4" x 11.4"	CIRCULAR
P20 137.8'	(1) SPECTRA	52" x 11.4" x 11.4"	CIRCULAR
P21 137.8'	(1) SPECTRA	52" x 11.4" x 11.4"	CIRCULAR
P22 137.8'	(1) SPECTRA	52" x 11.4" x 11.4"	CIRCULAR
P23 137.8'	(1) SPECTRA	52" x 11.4" x 11.4"	CIRCULAR
P24 137.8'	(1) SPECTRA	52" x 11.4" x 11.4"	CIRCULAR
P25 137.8'	(1) SPECTRA	52" x 11.4" x 11.4"	CIRCULAR
P26 137.8'	(1) SPECTRA	52" x 11.4" x 11.4"	CIRCULAR
P27 137.8'	(1) SPECTRA	52" x 11.4" x 11.4"	CIRCULAR
P28 137.8'	(1) SPECTRA	52" x 11.4" x 11.4"	CIRCULAR
P29 137.8'	(1) SPECTRA	52" x 11.4" x 11.4"	CIRCULAR
P30 137.8'	(1) SPECTRA	52" x 11.4" x 11.4"	CIRCULAR
P31 137.8'	(1) SPECTRA	52" x 11.4" x 11.4"	CIRCULAR
P32 137.8'	(1) SPECTRA	52" x 11.4" x 11.4"	CIRCULAR
P33 137.8'	(1) SPECTRA	52" x 11.4" x 11.4"	CIRCULAR
P34 137.8'	(1) SPECTRA	52" x 11.4" x 11.4"	CIRCULAR
P35 137.8'	(1) SPECTRA	52" x 11.4" x 11.4"	CIRCULAR
P36 137.8'	(1) SPECTRA	52" x 11.4" x 11.4"	CIRCULAR
P37 137.8'	(1) SPECTRA	52" x 11.4" x 11.4"	CIRCULAR
P38 137.8'	(1) SPECTRA	52" x 11.4" x 11.4"	CIRCULAR
P39 137.8'	(1) SPECTRA	52" x 11.4" x 11.4"	CIRCULAR
P40 137.8'	(1) SPECTRA	52" x 11.4" x 11.4"	CIRCULAR
P41 137.8'	(1) SPECTRA	52" x 11.4" x 11.4"	CIRCULAR
P42 137.8'	(1) SPECTRA	52" x 11.4" x 11.4"	CIRCULAR
P43 137.8'	(1) SPECTRA	52" x 11.4" x 11.4"	CIRCULAR
P44 137.8'	(1) SPECTRA	52" x 11.4" x 11.4"	CIRCULAR
P45 137.8'	(1) SPECTRA	52" x 11.4" x 11.4"	CIRCULAR
P46 137.8'	(1) SPECTRA	52" x 11.4" x 11.4"	CIRCULAR
P47 137.8'	(1) SPECTRA	52" x 11.4" x 11.4"	CIRCULAR
P48 137.8'	(1) SPECTRA	52" x 11.4" x 11.4"	CIRCULAR
P49 137.8'	(1) SPECTRA	52" x 11.4" x 11.4"	CIRCULAR
P50 137.8'	(1) SPECTRA	52" x 11.4" x 11.4"	CIRCULAR

* (1), OR (2) DIAPHRAGMS COAX INSTALLED INSIDE OR OUTSIDE MONOPOLE RESPECTIVELY.

ISSUE: 9/19/02
 REVISION: 05/03/02
 DESCRIPTION: MODIFICATION PROFILE
 DATE: 05/03/02
 DRAWN BY: [Signature]
 CHECKED BY: [Signature]
 PROJECT: 151' ITT MEYER MONOPOLE
 SITE: NEW HAVEN, CT
 TOWN: NEW HAVEN, CT
 SHEET: CT-0018
 OF: 12



Southwestern Bell Mobile Systems, LLC
500 Enterprise Drive
Rocky Hill, Connecticut 06067-3900
Phone: (860) 513-7730
Fax: (860) 513-7190

Peter W. van Wilgen
Senior Manager - Construction

September 25, 2002

Hon. Kevin J. Kopetz
1st Selectman, Town of North Haven
Town Hall, 18 Church St.
North Haven, CT 06473

Re: Telecommunications facility – 8 Dwight St. (aka 15 Dwight St.; aka 12 Dwight St.)

Dear Mr. Kopetz:

In order to meet the requirements for improved E-911 capability and to implement a more advanced telecommunications system, Southwestern Bell Mobile Systems, LLC, a/k/a Cingular Wireless (“SBMS” or “Cingular”; formerly SNET Mobility, LLC) will be changing its antenna configuration at certain cell sites. Cingular will install panel antennas, small amplifiers and a small locator unit on the tower. As required by Regulations of Connecticut State Agencies (“R.C.S.A.”) Section 16-50j-73, the Connecticut Siting Council has been notified of the changes and will review Cingular’s proposal. Please accept this letter as notification under Section 16-50j-73 of construction which constitutes an exempt modification pursuant to R.C.S.A. Section 16-50j-72(b)(2).

The accompanying letter fully describes Cingular’s proposal. However, if you have any questions or require any further information on our plans or the Siting Council’s procedures, please call me at (860) 513-7730 or Mr. Derek Phelps, Executive Director, Connecticut Siting Council at (860) 827-2935.

Sincerely,

Peter W. van Wilgen
Senior Manager – Construction

Enclosure

**CINGULAR WIRELESS
Antenna Modification**

Site Address: 250 Meriden Waterbury Turnpike, Southington

Tower Owner/Manager: John Rogus

Antenna configuration: Antenna center line – 77 ft

Current and/or approved: 9 Swedcom SC 9012 DIN panels

Planned: 9 CSS DUO1417-8686-4-0 panels or comparable
6 tower mount amplifiers
3 duplexers

Power Density:

Calculations for Cingular's current operations at the site indicate a radio frequency electromagnetic radiation power density, measured at the tower base, of approximately 19.6% of the standard adopted by the FCC. As depicted in the second table below, the total radio frequency electromagnetic radiation power density for Cingular's planned operations would be approximately 27.8%, or an additional 8.2% of the standard.

Cingular Current

Company	Centerline Ht (feet)	Frequency (MHz)	Number of Channels	Power Per Channel (Watts)	Power Density (mW/cm ²)	Standard Limits (mW/cm ²)	Percent of Limit
Cingular	77	880 - 894	19	100	0.1152	0.5867	19.6

Cingular Planned

Company	Centerline Ht (feet)	Frequency (MHz)	Number of Channels	Power Per Channel (Watts)	Power Density (mW/cm ²)	Standard Limits (mW/cm ²)	Percent of Limit
Cingular TDMA	77	880 - 894	16	100	0.0970	0.5867	16.5
Cingular GSM	77	880 - 894	2	296	0.0359	0.5867	6.1
Cingular GSM	77	1930 - 1935	2	427	0.0518	1.0000	5.2
Total							27.8%

Structural information: Please see attached.

DETAILED STRUCTURAL ANALYSIS AND EVALUATION OF 80' EXISTING SELF SUPPORTING LATTICE TOWER FOR REPLACEMENT ANTENNA ARRANGEMENT

Rogus Electronics
250 Meriden Waterbury Turnpike
Southington, Connecticut
Site No.: 1033

prepared for



Cingular Wireless
500 Enterprise Drive, Suite 3A
Rocky Hill, CT 06067

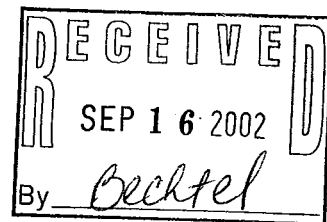

prepared by



URS CORPORATION
795 BROOK STREET, BUILDING 5
ROCKY HILL, CT 06067
TEL. 860-529-8882

36911702.00000

September 16, 2002

1. EXECUTIVE SUMMARY

This report summarizes the structural analysis of the 80' lattice tower located on 23 Meriden Waterbury Turnpike in Southington, Connecticut. The analysis was conducted in accordance with the TIA/EIA-222-E standard for wind velocity of 80 mph and 70 mph concurrent with ½" ice design wind load. The antenna loading considered in the analysis consists of all existing and proposed antennas, transmission lines, and ancillary items as outlined in the Analysis Methodology and Loading Condition Section of this report. The proposed Cingular Wireless modification is to add the antennas listed below:

(9) DUO1417-8686 antenna with (3) Duplexer and (6) TMA mounted on (3) T-Frame with existing (9) 7/8" coax cables Cingular @ 77' elevation

The results of the analysis indicate that the tower structure is in compliance with the proposed loading conditions. The tower is considered feasible with the TIA/EIA-222-E wind load classification specified above and all the existing and proposed antenna loading. No further analysis was conducted on the tower foundation since the forces calculated were below the original design.

This analysis is based on:

- 1) The tower structure's theoretical capacity not including any assessment of the condition of the tower.
- 2) The tower report prepared by Pirod Incorporated engineering file no. A-115911 approved July 27, 1999.
- 3) The foundation was prepared by Maguire Group Incorporated for SNET dated August 14, 1999.
- 4) Antenna inventory as specified in section 2 and 6 of this report. The tower antenna inventory was obtained by CSB Communication dated 8/21/2002.
- 5) TIA/EIA-222-E wind load classification.

This report is only valid as per the assumptions and data utilized in this report for antenna inventory, mounts and associated cables. The user of this report shall field verify the assumption of the antenna and mount configuration. Notify the engineer in writing immediately if any of the assumptions in this report are found to be other than specified.

If you should have any questions, please call.

Sincerely,
URS Corporation AES

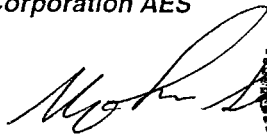

Mohsen Sahirad, P.E.
Senior Structural Engineer

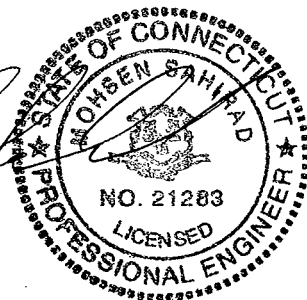

MS/rmn

- cc: Richard Johanson – Cingular Wireless
Doug Roberts – URS
N.A. – URS
A.A. – URS
CF/Book

2. **INTRODUCTION**

The subject tower is located on 250 Meriden Waterbury Turnpike in Southington, Connecticut. The structure is a self supporting 80' steel tapered lattice tower manufactured by Pirod Incorporated.

The tower is constructed of pipe legs, diagonal rod braces and horizontal rod braces. The tower members are all bolted. The width of the tower face is 3'-0" at the top and 5'-0" at the bottom. The tower geometry and structural sizes were taken from Pirod Incorporated engineering file no. A-115911 dated July 27, 1999.

The existing structure supports several communication antennas. The antenna and mount configuration as specified below:

Antenna Type	Carrier	Mount	Elev. (ft)	Cable
(1) ASP-682		Pipe to pipe kit	80'	(1) 7/8" coax
(1) 6' Whip		Pipe to pipe kit	80'	(1) 7/8" coax
PD201		Pipe to pipe kit	80'	(1) 7/8" coax
(9) DUO1417-8686 antenna with (3) Duplexer and (6) TMA	Cingular (Proposed)	(3) T-Frame	77'	(9) 7/8" coax
(1) ASP-680		(1) 3' Side arm mount	68'	(1) 7/8" coax
(1) 8' Whip		(1) 3' Side arm mount	66'	(1) 7/8" coax
(1) PD220		(3) Side arm mount	59'	(1) 1/2" coax
(1) SPF-701		(1) 3' Side arm mount	58'	(1) 7/8" coax
(1) 16' Whip		(1) 3' Side arm mount	46'	(1) 1/2" coax
-----		(1) Side arm mount	36'	-----

Note: All antenna elevations are based upon their centerlines except for the whip antennas which are based upon their bottom elevations. The proposed Cingular Wireless modification will utilize the existing mounts, cables and orientation.

This structural analysis of the communications tower was performed by URS Corporation, AES (URS) for Cingular Wireless. The purpose of this analysis was to analyze the existing tower for its existing and proposed antenna loads. This analysis was conducted to evaluate twist (rotation), sway (deflection) and stress on the tower, and the effect of forces to the foundation of the tower resulting from existing and proposed antenna arrangements.

3. **ANALYSIS METHODOLOGY AND LOADING CONDITIONS**

Methodology:

The structural analysis was done in accordance with the TIA/EIA-222-E, Structural Standard for Steel Antenna Towers and Antenna Supporting Structures, the American Institute of Steel Construction (AISC) and the Manual of Steel Construction; Allowable Stress Design (ASD).

The analysis was conducted using ERI Tower 2.0. The two load conditions were evaluated as shown below which were compared to allowable stresses according to AISC and TIA/EIA. The load combinations were investigated in ERI Tower 2.0 to determine the stress, sway and rotation.

Load Condition 1 = 80 mph Wind Load + Tower Dead Load
Load Condition 2 = 70 mph Wind Load (with ½" radial ice) + Tower Dead Load

The TIA/EIA standard permits one-third increase in allowable stresses for towers and monopoles less than 700 feet tall. For purposes of this analysis, allowable stresses of tower members were increased by one-third in computing the load capacity; in addition, the appropriate "k" factors were assigned to each member.

4. FINDINGS AND EVALUATION

The combined axial and bending stresses on the tower structure were evaluated to compare with the allowable stress in accordance with AISC. The analysis indicates that the tower legs, diagonal members and horizontal members have sufficient capacity to carry the loads applied. No further analysis was conducted on the tower foundation since the forces calculated were below the original design.

The tower base reactions are as follows:

Proposed Tower Reactions	
Compression (kips)	114
Uplift (kips)	107
Total Shear (kips)	9
Moment (kips-ft)	479

For detailed proposed tower reactions, see drawing no. E-1 in section 6 of this report.

5. CONCLUSIONS

The results of the analysis indicate that the structure is in compliance with the loading conditions and the materials and member sizes for the tower. The tower is considered feasible with the TIA/EIA-222-E wind load classification specified above and all the existing and proposed antenna loading. The user of this report shall field verify the assumption of the antenna and mount configuration. Notify the engineer in writing immediately if any of the assumptions in this report are found to be other than specified.

Limitations/Assumptions:

This report is based on the following:

- A. Tower is properly installed and maintained.
- B. All members were as specified in the original Construction Documents and are in good condition.
- C. All required members are in place.
- D. All bolts are in place and are properly tightened.
- E. Tower is in plumb condition.
- F. All members protective coating is in good condition.
- G. All tower members were properly designed, detailed, fabricated, installed, and have been properly maintained since erection.

URS is not responsible for any modifications completed prior to or hereafter in which URS is not or was not directly involved. Modifications include but are not limited to:

- A. Removing/Replacing antennas
- B. Adding antennas and amplifiers

URS hereby states that this document represents the entire report and that it assumes no liability for any factual changes that may occur after the date of this report. All representations, recommendations, and conclusions are based upon information contained and set forth herein. If you are aware of any information which conflicts with that which is contained herein, or you are aware of any defects arising from original design, material, fabrication, or erection deficiencies, you should disregard this report and immediately contact URS. URS disclaims all liability for any representation, recommendation, or conclusion not expressly stated herein.

Ongoing and Periodic Inspection and Maintenance by the Owner:

1. After the Contractor has successfully completed the installation and the work has been accepted, the tower owner will be responsible for the ongoing and periodic inspection and maintenance of the tower and reinforcing system.
2. The owner shall refer to TIA/EIA-222-E, for recommendations for maintenance and inspection. The frequency of the inspection and maintenance intervals is to be determined by the owner based upon actual site and environmental conditions. It is recommended that a complete and thorough inspection of the entire tower structural system is performed at least yearly and more frequently as conditions warrant. According to TIA/EIA-222-E. It is recommended that the structure be inspected after severe wind and/or ice storms or other extreme loading conditions.



Southwestern Bell Mobile Systems, LLC
500 Enterprise Drive
Rocky Hill, Connecticut 06067-3900
Phone: (860) 513-7730
Fax: (860) 513-7190

Peter W. van Wilgen
Senior Manager - Construction

September 25, 2002

Hon. John Weichsel
Town Manager, Town of Southington
Town Office Building, 75 Main Street
Southington, Connecticut 06489

Re: Telecommunications facility – 250 Meriden Waterbury Turnpike

Dear Mr. Weichsel:

In order to meet the requirements for improved E-911 capability and to implement a more advanced telecommunications system, Southwestern Bell Mobile Systems, LLC, a/k/a Cingular Wireless (“SBMS” or “Cingular”; formerly SNET Mobility, LLC) will be changing its antenna configuration at certain cell sites. Cingular will install panel antennas, small amplifiers and a small locator unit on the tower. As required by Regulations of Connecticut State Agencies (“R.C.S.A.”) Section 16-50j-73, the Connecticut Siting Council has been notified of the changes and will review Cingular’s proposal. Please accept this letter as notification under Section 16-50j-73 of construction which constitutes an exempt modification pursuant to R.C.S.A. Section 16-50j-72(b)(2).

The accompanying letter fully describes Cingular’s proposal. However, if you have any questions or require any further information on our plans or the Siting Council’s procedures, please call me at (860) 513-7730 or Mr. Derek Phelps, Executive Director, Connecticut Siting Council at (860) 827-2935.

Sincerely,

Peter W. van Wilgen
Senior Manager – Construction

Enclosure

**CINGULAR WIRELESS
Antenna Modification**

Site Address: 40 Taugwonk Rd., Stonington
Docket 121

Tower Owner/Manager: SpectraSite

Antenna configuration Antenna center line – 152 ft

Current and/or approved: 9 Swedcom ALP 110-11 panels

Planned: 9 CSS DUO1417-8686-4-0 panels or comparable
9 tower mount amplifiers

Power Density:

Calculations for Cingular's current operations at the site indicate a radio frequency electromagnetic radiation power density, measured at the tower base, of approximately 4.9% of the standard adopted by the FCC. As depicted in the second table below, the total radio frequency electromagnetic radiation power density for Cingular's planned operations would be approximately 7.1%, or an additional 2.2% of the standard.

Cingular Current

Company	Centerline Ht (feet)	Frequency (MHz)	Number of Channels	Power Per Channel (Watts)	Power Density (mW/cm ²)	Standard Limits (mW/cm ²)	Percent of Limit
Cingular	154	880 - 894	19	100	0.0288	0.5867	4.9

Cingular Planned

Company	Centerline Ht (feet)	Frequency (MHz)	Number of Channels	Power Per Channel (Watts)	Power Density (mW/cm ²)	Standard Limits (mW/cm ²)	Percent of Limit
Cingular TDMA	152	880 - 894	16	100	0.0249	0.5867	4.2
Cingular GSM	152	880 - 894	2	296	0.0092	0.5867	1.6
Cingular GSM	152	1930 - 1935	2	427	0.0133	1.0000	1.3
Total							7.1%

Structural information: Please see attached.

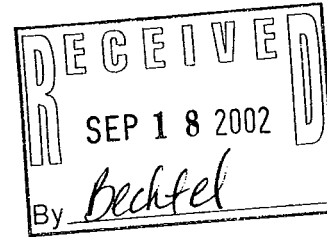

Structural Analysis of 150' ITT Meyer Monopole
 Sgtn-Stonington, 40 Taugwonk Road, Stonington, CT 06378

CT-0035
 9/17/2002

1.0 Introduction

A structural analysis was performed on the above noted tower for the addition of proposed antennas as listed below. The analysis consisted of applying the forces caused by the existing and proposed loads, and determining the resulting stresses in the structure and its foundation.

The following criteria were used in the analysis:

1. ANSI/TIA/EIA-222-F, **85 mph** wind [New London County], considering two loading cases:
 - Load Case 1. 100% wind pressure, without radial ice
 - Load Case 2. 75% wind pressure, with 1/2" radial ice

Tower information, including geometry and member sizes was obtained from Smith-Cullum Report Number CT-0035, dated 06/01/02. Foundation information was obtained from Girard and Co. Engineers Report No. 3C230, dated 03/08/90.

2.0 Antenna and Transmission Line Loading

Table 1. Existing and Proposed Antennas

Elevation (Ft. A.G.L.)	Antenna	Carrier	Transmission Lines*	Notes
154	(9) Swedcom ALP11011 on Platform Mount with Handrails	Cingular	(9) 7/8"	Remove Existing
152	(9) CSS DUO-14178686-4-0 (9) ADC TMA on Platform Mount with Handrails	Cingular	(9) 7/8"	Proposed Replacement
114	(9) Decibel DB844H80E-XY on T-Arm Mounts	Verizon	(9) 1-1/4"	Remove Existing
114	(12) Swedcom ALP-E 9011-DIN on Existing T-Arm Mounts	Verizon	(12) 1-1/4"	Proposed Replacement
39	(1) Nokia CS72187.01 on Standoff Mount	Cingular	(1) 1/2"	Proposed

*Coax installed inside monopole.

3.0 Results

Monopole Stress Levels

Elevation (Ft. A.G.L.)	Combined Stress Index*
0 to 31.5	0.96
31.5 to 70	1.05**
70 to 110	1.03**
110 to 150	0.78

*Maximum Stress Ratio: 1.00=Full Allowable.

**Overstressed; Considered acceptable.

Foundation Stress Levels

Base Reactions	Current Analysis	Result*
Moment (kip.ft)	1666.9	Satisfactory
Compression (kips)	15.9	Satisfactory
Shear (kips)	17.8	Satisfactory

*Based on foundation analysis

Conclusions and Recommendations

1. The tower, foundation and base plate are structurally adequate to accommodate the proposed antenna and transmission line loading used in this analysis.
2. The anchor bolts and flange plate at 110' are not structurally adequate to accommodate the existing and proposed antenna and transmission line loading used in this analysis. They are structurally adequate after reinforcing per the attached Drawing CT-0035-M1.
3. Any future changes in loading must be reviewed by the SpectraSite Engineering Department.

Should any questions arise concerning this report please contact the undersigned.

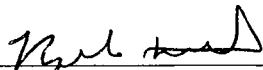

Raphael Mohamed, P.Eng.
Project Engineer
919-465-6629

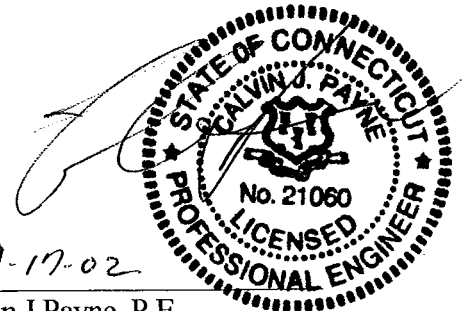

Calvin J Payne, P.E.
Chief Engineer

STONINGTON, CT [CT-0035]
150.0' ITT MEYER MONOPOLE

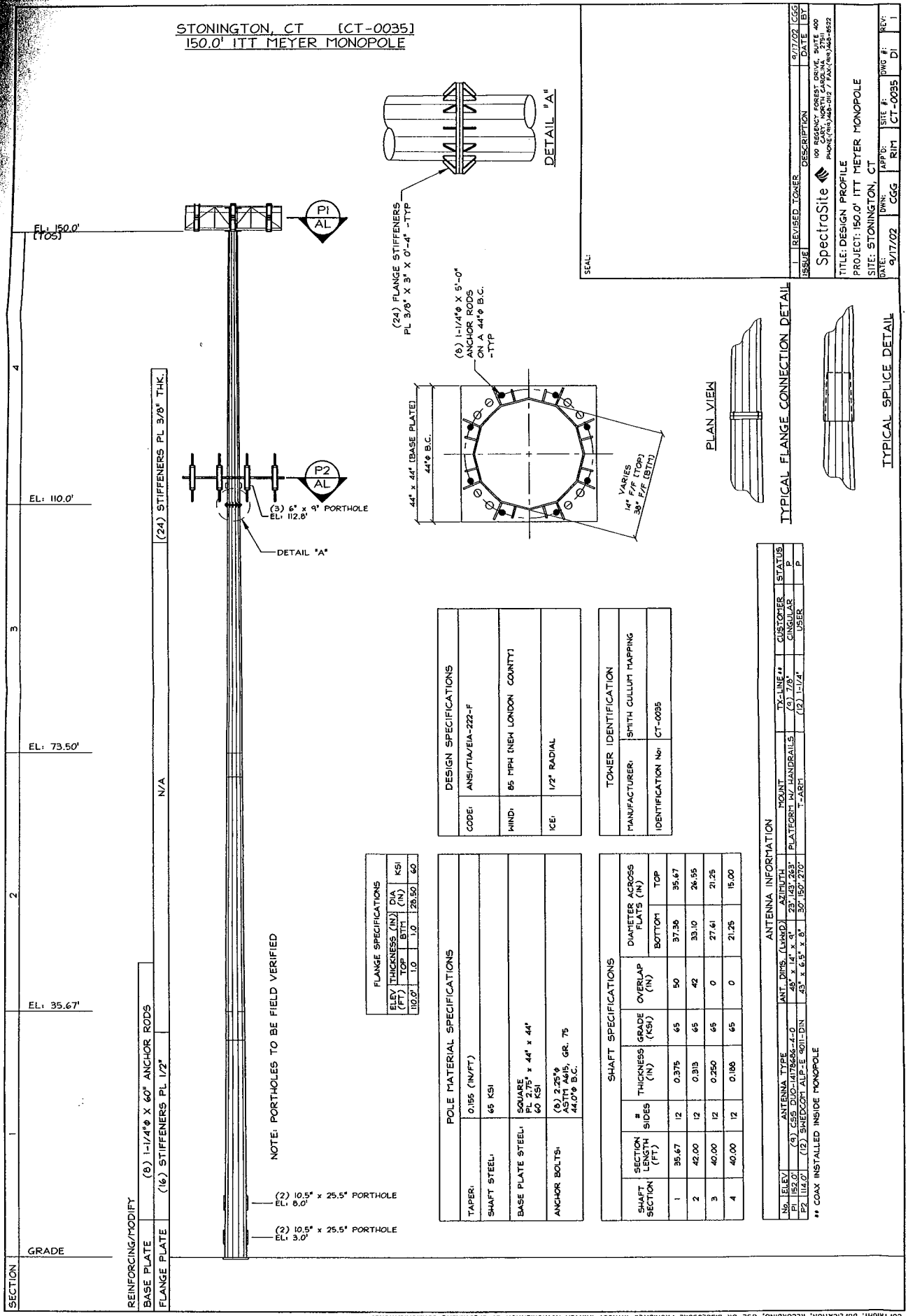

FLANGE SPECIFICATIONS

ELEV. (FT)	THICKNESS (IN)	DIA (IN)	DIA (IN)	KS
TOP	BTH			
110.0'	1.0	1.0	26.50	60

POLE MATERIAL SPECIFICATIONS

TAPER:	0.185 (IN/FT)
SHAFT STEEL:	65 KSI
BASE PLATE STEEL:	SQUARE PL 2.75" x 44" x 44" 60 KSI
ANCHOR BOLTS:	(8) 2.25" ASTM A490, GR. 75 44.0" B.C.

SHAFT SPECIFICATIONS

SECTION LENGTH (FT)	# SIDES	THICKNESS (IN)	GRADE (KSI)	DIAMETER ACROSS FLATS (IN)	
				BOTTOM	TOP
1	36.67	12	0.375	65	37.36 / 35.67
2	42.00	12	0.313	65	33.10 / 26.55
3	40.00	12	0.250	65	27.61 / 21.25
4	40.00	12	0.180	65	21.25 / 15.00

ANTENNA INFORMATION

No.	ELEV. (FT)	ANT. TYPE	ANT. DIMS. (LxWxH)	HEIGHT (FT)	PLACEMENT	MOUNT	TY-CLINE #	CUSTOMER	STATUS
P1	150.0	(1) GSE DDD-1410666-1.0	45" x 45" x 6"	30'	PLATFORM	T-4881	(2) 1-1/4"	CUNGLAR	P
P2	114.0	(2) SREDDTALU-E-8011-DIN	45" x 45" x 6"	30'	PLATFORM	T-4881	(2) 1-1/4"	USER	P

** COAX INSTALLED INSIDE MONOPOLE

NOTE: PORTHOLES TO BE FIELD VERIFIED

DESIGN SPECIFICATIONS

CODE:	ANSI/TIA/EIA-222-F
WIND:	65 MPH (NEK LONDON COUNTY)
ICE:	1/2" RADIAL

TOWER IDENTIFICATION

MANUFACTURER:	SMITH CULLUM MAPPING
IDENTIFICATION No.:	CT-0035

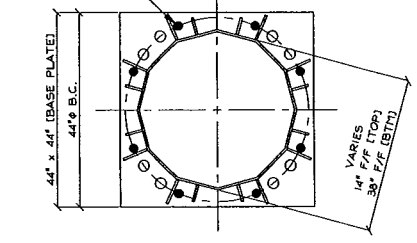

PLAN VIEW

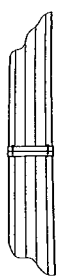

TYPICAL FLANGE CONNECTION DETAIL

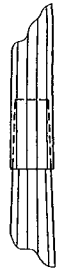

TYPICAL SPLICE DETAIL

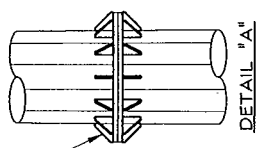

DETAIL "A"

SEAL:

ISSUE	REVISION	DATE	BY
1	REVISED TOWER	9/17/02	CGG

SpecroSite
100 CANTONVILLE AVENUE, SUITE 400
STONINGTON, CT 06424
PHONE: (860) 445-0112 / FAX: (860) 445-0522

TITLE: DESIGN PROFILE
PROJECT: 150.0' ITT MEYER MONOPOLE
SITE: STONINGTON, CT

DATE:	9/17/02	DWN:	CGG	APP'D:	RHM	REV:	DI



Southwestern Bell Mobile Systems, LLC
500 Enterprise Drive
Rocky Hill, Connecticut 06067-3900
Phone: (860) 513-7730
Fax: (860) 513-7190

Peter W. van Wilgen
Senior Manager - Construction

September 25, 2002

Hon. Peter N. Dibble
1st Selectman, Town of Stonington
Town Hall, 152 Elm St.
Stonington, CT 06378

Re: Telecommunications facility – Taugwonk Rd.

Dear Mr. Dibble:

In order to meet the requirements for improved E-911 capability and to implement a more advanced telecommunications system, Southwestern Bell Mobile Systems, LLC, a/k/a Cingular Wireless (“SBMS” or “Cingular”; formerly SNET Mobility, LLC) will be changing its antenna configuration at certain cell sites. Cingular will install panel antennas, small amplifiers and a small locator unit on the tower. As required by Regulations of Connecticut State Agencies (“R.C.S.A.”) Section 16-50j-73, the Connecticut Siting Council has been notified of the changes and will review Cingular’s proposal. Please accept this letter as notification under Section 16-50j-73 of construction which constitutes an exempt modification pursuant to R.C.S.A. Section 16-50j-72(b)(2).

The accompanying letter fully describes Cingular’s proposal. However, if you have any questions or require any further information on our plans or the Siting Council’s procedures, please call me at (860) 513-7730 or Mr. Derek Phelps, Executive Director, Connecticut Siting Council at (860) 827-2935.

Sincerely,

Peter W. van Wilgen
Senior Manager – Construction

Enclosure

**CINGULAR WIRELESS
Antenna Modification**

Site Address: 107 Stickney Hill Road, Union
Docket 36.3 and Exempt Mod. approved 2/26/90

Tower Owner/Manager: Continental Cablevision

Antenna configuration Antenna center line – 113 ft to 121 ft

Current and/or approved: 6 Swedcom ALP 110-11 panels @ 121 ft
3 Swedcom ALP 110-11 panels @ 115 ft

Planned: 6 CSS DUO1417-8686-4-0 panels or comp. @ 119'
4 tower mount amplifiers @ 119 ft
2 duplexer @ 119 ft

3 CSS DUO1417-8686-4-0 panels or comp. @ 113'
2 tower mount amplifiers @ 113 ft
1 duplexer @ 113 ft

Power Density:

Calculations for Cingular's current operations at the site indicate a radio frequency electromagnetic radiation power density, measured at the tower base, of approximately 8.3% of the standard adopted by the FCC. As depicted in the second table below, the total radio frequency electromagnetic radiation power density for Cingular's planned operations would be approximately 12.2%, or an additional 3.9% of the standard.

Cingular Current

Company	Centerline Ht (feet)	Frequency (MHz)	Number of Channels	Power Per Channel (Watts)	Power Density (mW/cm ²)	Standard Limits (mW/cm ²)	Percent of Limit
Cingular TDMA	121	880 - 894	12	100	0.0295	0.5867	5.0
Cingular TDMA	115	880 - 894	7	100	0.0190	0.5867	3.2
Total							8.3%

Cingular Planned

Company	Centerline Ht (feet)	Frequency (MHz)	Number of Channels	Power Per Channel (Watts)	Power Density (mW/cm ²)	Standard Limits (mW/cm ²)	Percent of Limit
Cingular TDMA	119	880 - 894	10	100	0.0254	0.5867	4.3
Cingular GSM	119	880 - 894	1	296	0.0075	0.5867	1.3
Cingular GSM	119	1930 - 1935	1	427	0.0108	1.0000	1.1
Cingular TDMA	113	880 - 894	6	100	0.0169	0.5867	2.9
Cingular GSM	113	880 - 894	1	296	0.0083	0.5867	1.4
Cingular GSM	113	1930 - 1935	1	427	0.0120	1.0000	1.2
Total							12.2%

Structural information: Please see attached. Cingular has taken note of the requirement in the structural analysis for further study of the foundation. We will not proceed with construction until this condition has been satisfied, including structural modification if required.

DETAILED STRUCTURAL ANALYSIS AND EVALUATION OF 110' SELF SUPPORTING LATTICE TOWER FOR REPLACEMENT ANTENNA ARRANGEMENT

107 Stickney Hill Road
Union, Connecticut
Site No.: 1048

prepared for



Cingular Wireless
500 Enterprise Drive, Suite 3A
Rocky Hill, CT 06067

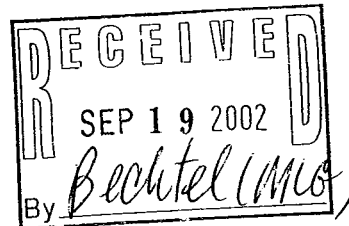

prepared by



URS CORPORATION
795 BROOK STREET, BUILDING 5
ROCKY HILL, CT 06067
TEL. 860-529-8882

36911789.00012

September 18, 2002

2. INTRODUCTION

The subject tower is located on 107 Stickney Hill Road, Union, Connecticut. The structure is a self supporting 110' steel tapered lattice tower. The tower manufacturer was identified as ROHN.

The tower is constructed of pipe legs, and angle member diagonal and horizontal braces. The tower members are all bolted. The width of the tower face is 8' 6 3/4" at the top and 18' 9 1/4" at the bottom. The tower geometry and structural sizes were taken from a climb inspection report performed by URS Corporation, dated September 2002.

The existing structure supports several communication antennas. The antenna and mount configuration are as specified below:

<i>Antenna Type</i>	<i>Carrier</i>	<i>Mount</i>	<i>Elev.(ft)</i>	<i>Cable</i>
4' DiPole	Cox Communications	To leg extension	122'	(1) 7/8" coax
(9) DUO1417-8686 antenna with (3) Duplexer and(6) TMA's	Cingular (Proposed)	(3) T-Frame	113' 119'	(9) 7/8" coax
4' Grid Dish	Cox Communications	To tower leg	106.5'	(1) 1/2" coax
8' Dish	Cox Communications	To tower leg	106'	(1) EW52
8' Wire Grid Dish in Sq. Frame	Cox Communications	To tower leg with Stabilizing arm	104	(1) 1/2" coax
6' Yagi	Cox Communications	To tower leg	103	(1) 1/2" coax
10' Yagi	Cox Communications	To tower leg	95	(1) 1/2" coax
4' Grid Dish	Cox Communications	To tower leg	89	(1) 1/2" coax
20' Omni	Cox Communications	12" stand-off mount	81	(1) 7/8" coax
12' Yagi	Cox Communications	12" stand-off mount	78	(1) 1/2" coax

Note: All elevations are based upon the antenna centerlines except for the whip antennas which are based upon the centerline of the antenna mount. The proposed Cingular Wireless modification will utilize the existing mounts and orientations.

This structural analysis of the communications tower was performed by URS Corporation, AES (URS) for Cingular Wireless. The purpose of this analysis was to analyze the existing tower for its existing and proposed antenna loads. This analysis was conducted to evaluate twist (rotation), sway (deflection) and stress on the tower, and the effect of forces to the foundation of the tower resulting from existing and proposed antenna arrangements.

3. ANALYSIS METHODOLOGY AND LOADING CONDITIONS

Methodology:

The structural analysis was completed in accordance with the TIA/EIA-222-F, Structural Standard for Steel Antenna Towers and Antenna Supporting Structures, the American Institute of Steel Construction (AISC) and the Manual of Steel Construction; Allowable Stress Design (ASD).

rotation. Calculated loads were compared to allowable stresses according to AISC and TIA/EIA. The load combinations investigated are as follows:

- Load Condition 1 = 85 mph Wind Load + Tower Dead Load
- Load Condition 2 = 74 mph Wind Load (with 1/2" radial ice) + Tower Dead Load

The TIA/EIA standard permits one-third increase in allowable stresses for towers and monopoles less than 700 feet tall. For purposes of this analysis, load capacity was determined by increasing allowable stresses of tower members by one-third; in addition, the appropriate "k" factors were assigned to each member.

4. FINDINGS AND EVALUATION

The combined axial and bending stresses on the tower structure were evaluated to compare with the allowable stress in accordance with AISC. The analysis indicates that the tower legs, diagonal members and horizontal members have sufficient capacity to carry the loads applied. No analysis was conducted on the tower foundation since original design drawings and calculations were not available. It should be noted that the tower base leg members are loaded to approximately 70% of full capacity under the configuration analyzed. It is probable that the existing foundations are adequate for the predicted tower reactions.

The tower base reactions per footing are as follows:

Proposed Tower Reactions	
Compression (kips)	91.81
Uplift (kips)	87.43
Total Shear (kips)	12.13
Overall Overturning Moment (kips-ft)	1523.90

For detailed proposed tower reactions, see drawings and data.

5. CONCLUSIONS

The results of the analysis indicate that the tower steel structure is in compliance with the loading conditions and the materials and member sizes for the tower. The tower steel structure is considered feasible with the TIA/EIA-222-F wind load classification specified above and all the existing and proposed antenna loading. The user of this report shall field verify the assumption of the antenna and mount configuration. Notify the engineer in writing immediately if any of the assumptions in this report are other than specified. This report shall not be implemented unless an investigation and stability analysis of the foundation has been completed by a professional engineer licensed in the State of Connecticut stating that the foundation is acceptable to support the new reactions resulting from the proposed antenna arrangements. The foundation evaluation must comply with the Connecticut State Building Code.

Limitations/Assumptions:

This report is based on the following:

- A. Tower is properly installed and maintained.
- B. All members were as specified in the climb report and are in good condition.

- C. All required members are in place.
- D. All bolts are in place and are properly tightened.
- E. Tower is plumb.
- F. All protective coating of the structural members is in good condition.
- G. All tower members were properly designed, detailed, fabricated, installed, and have been properly maintained since erection.
- H. Based on experience from previous Rohn towers, the steel yield stresses were assumed to be 50 ksi for all leg and diagonal pipe members and angle bracing equal to and greater than L3x3x1/4 and 36 ksi for all diagonal and horizontal angle bracing L3x3x3/16 and smaller. All bolted connections were assumed to have been made with A325N bolts. Anchor bolts were assumed to have a minimum tensile strength equal to that of an A325 bolt.

URS is not responsible for any modifications completed prior to or hereafter in which URS is not or was not directly involved. Modifications include but are not limited to:

- A. Removing/Replacing antennas
- B. Adding antennas and amplifiers

URS hereby states that this document represents the entire report and that it assumes no liability for any factual changes that may occur after the date of this report. All representations, recommendations, and conclusions are based upon information contained and set forth herein. If you are aware of any information which conflicts with that which is contained herein, or you are aware of any defects arising from original design, material, fabrication, or erection deficiencies, you should disregard this report and immediately contact URS. URS disclaims all liability for any representation, recommendation, or conclusion not expressly stated herein.

Ongoing and Periodic Inspection and Maintenance by the Owner:

1. After the Contractor has successfully completed the installation and the work has been accepted, the tower owner will be responsible for the ongoing and periodic inspection and maintenance of the tower.
2. The owner shall refer to TIA/EIA-222-F, for recommendations for maintenance and inspection. The frequency of the inspection and maintenance intervals is to be determined by the owner based upon actual site and environmental conditions. It is recommended that a complete and thorough inspection of the entire tower structural system be performed at least yearly and more frequently as conditions warrant. According to TIA/EIA-222-F it is recommended that the structure be inspected after severe wind and/or ice storms or other extreme loading conditions.



Southwestern Bell Mobile Systems, LLC
500 Enterprise Drive
Rocky Hill, Connecticut 06067-3900
Phone: (860) 513-7730
Fax: (860) 513-7190

Peter W. van Wilgen
Senior Manager - Construction

September 25, 2002

Honorable Joseph L. Kratochvil
First Selectman, Town of Union
Route 171, 1043 Buckley Highway
Union, Connecticut 06076

Re: Telecommunications facility – Stickney Hill Rd.

Dear Mr. Kratochvil:

In order to meet the requirements for improved E-911 capability and to implement a more advanced telecommunications system, Southwestern Bell Mobile Systems, LLC, a/k/a Cingular Wireless (“SBMS” or “Cingular”; formerly SNET Mobility, LLC) will be changing its antenna configuration at certain cell sites. Cingular will install panel antennas, small amplifiers and a small locator unit on the tower. As required by Regulations of Connecticut State Agencies (“R.C.S.A.”) Section 16-50j-73, the Connecticut Siting Council has been notified of the changes and will review Cingular’s proposal. Please accept this letter as notification under Section 16-50j-73 of construction which constitutes an exempt modification pursuant to R.C.S.A. Section 16-50j-72(b)(2).

The accompanying letter fully describes Cingular’s proposal. However, if you have any questions or require any further information on our plans or the Siting Council’s procedures, please call me at (860) 513-7730 or Mr. Derek Phelps, Executive Director, Connecticut Siting Council at (860) 827-2935.

Sincerely,

Peter W. van Wilgen
Senior Manager – Construction

Enclosure

**CINGULAR WIRELESS
Antenna Modification**

Site Address: 482 Pigeon Hill Road, Windsor
Docket 58 and EM-SCLP-164-001206 Approved 12/14/00

Tower Owner/Manager: Verizon / Crown Castle

Antenna configuration Antenna center line – 169 ft

Current and/or approved: 3 EMS RS90-12 panels on pipe mount

Planned: 3 EMS MB96RR900200 panels or comparable
3 tower mount amplifiers
3 duplexers
Note: Pipe mount wall thickness issue in structural report has been noted, and Cingular will comply therewith.

Power Density:

Calculations for Cingular's current operations at the site indicate a radio frequency electromagnetic radiation power density, measured at the tower base, of approximately 4.1% of the standard adopted by the FCC. As depicted in the second table below, the total radio frequency electromagnetic radiation power density for Cingular's planned operations would be approximately 5.8%, or an additional 1.7% of the standard.

Cingular Current

Company	Centerline Ht (feet)	Frequency (MHz)	Number of Channels	Power Per Channel (Watts)	Power Density (mW/cm ²)	Standard Limits (mW/cm ²)	Percent of Limit
Cingular	169	880 - 894	19	100	0.0239	0.5867	4.1

Cingular Planned

Company	Centerline Ht (feet)	Frequency (MHz)	Number of Channels	Power Per Channel (Watts)	Power Density (mW/cm ²)	Standard Limits (mW/cm ²)	Percent of Limit
Cingular TDMA	169	880 - 894	16	100	0.0201	0.5867	3.4
Cingular GSM	169	880 - 894	2	296	0.0075	0.5867	1.3
Cingular GSM	169	1930 - 1935	2	427	0.0108	1.0000	1.1
Total							5.8%

Structural information: Please see attached.

DETAILED STRUCTURAL ANALYSIS AND EVALUATION OF 160' EXISTING SELF SUPPORTING LATTICE TOWER WITH PIPE EXTENSION FOR REPLACEMENT ANTENNA ARRANGEMENT

482 Pigeon Hill Road
Windsor, Connecticut
Site No.: 1144

prepared for



Cingular Wireless
500 Enterprise Drive, Suite 3A
Rocky Hill, CT 06067



prepared by



URS CORPORATION
795 BROOK STREET, BUILDING 5
ROCKY HILL, CT 06067
TEL. 860-529-8882

36911672.00000

September 19, 2002

1. EXECUTIVE SUMMARY

This report summarizes the structural analysis of the 160' lattice tower with pipe extension located on 482 Pigeon Hill Road in Windsor, Connecticut. The analysis was conducted in accordance with the TIA/EIA-222-E standard for wind velocity of 80 mph and 70 mph concurrent with ½" ice design wind loads. The antenna loading considered in the analysis consists of all existing and proposed antennas, transmission lines, and ancillary items as outlined in the Analysis Methodology and Loading Condition Section of this report. The proposed Cingular Wireless modification is to replace the existing Cingular Wireless antennas with the antennas listed below:

(3) MB96RR900200_PBL antennas with (3) Cingular @ 169' elevation
TMA and (3) Duplexers flush mounted to
pipe extension and (9) 1 5/8" coax cables

The results of the analysis indicate the steel structure to be in compliance with the proposed loading condition for the tower. The tower is considered feasible with the TIA/EIA-222-E wind load classification specified above with an exception of the 4" diameter pipe extension which shall be verified for the pipe wall thickness. **If the pipe extension is found to have a wall thickness of less than 0.674", the extension will need to be replaced with a 4" diameter double extra strong pipe or equivalent.**

This analysis is based on:

- 1) The tower structure's theoretical capacity not including any assessment of the condition of the tower.
- 2) Tower manufactured by Rohn Industries.
- 3) Antenna inventory as specified in section 2 and 6 of this report.
- 4) TIA/EIA-222-E wind load classification.

This report is only valid as per the assumptions and data utilized in this report for antenna inventory, mounts and associated cables. The user of this report shall field verify the assumption of the antenna and mount configuration. Notify the engineer in writing immediately if any of the assumptions in this report are found to be other than specified.

If you should have any questions, please call.

Sincerely,
URS Corporation AES

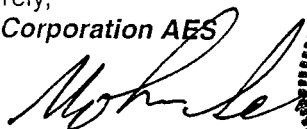

Mohsen Sahirad, P.E.
Senior Structural Engineer

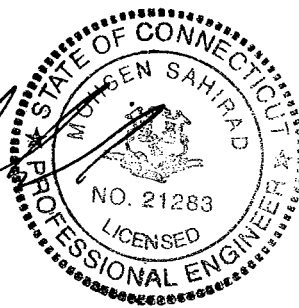

MS/rmn

cc: Richard R. Johanson – Bechtel
Doug Roberts – URS
N.A. – URS
A.A. – URS
CF/Book

2. INTRODUCTION

The subject tower is located on 482 Pigeon Hill Road in Windsor, Connecticut. The structure is a self supporting 160' steel triangular tapered lattice tower with pipe extension manufactured by Rohn Industries.

The tower is constructed of pipe legs, diagonal angle braces and horizontal angle braces. The tower sections are all bolted together. The width of the face is 8'-6 3/4" at the top and 22'-10" at the bottom. The tower geometry and structural member sizes were taken from Begeron analysis dated April 16, 2001.

The existing structure supports several communication antennas. The antenna and mount configuration as specified below:

Antenna model	Mount	Associated cable	Elevation (ft)
(3) MBRR900200_PBL with (3) TMA and (3) Duplexer	Flush mounted	(9) 1 5/8" coax	169
14' Whip	Mounted to leg	(1) 5/8" coax	160
(15) Allgon 7130.16	(3) T-Frame	(15) 7/8" coax	155
---	Mount	---	151
(6) RR90-17-DP	(3) T-Frame	(12) 1 5/8"	145
(1) 14' Whip	4' side arm	(1) 7/8"	116
(1) 8' HP Dish	Mounted to leg	(1) EW52	110
(1) 6' Dish w/ Radome	Mounted to leg	(1) 7/8"	101
(1) 14' Whip	4' side arm	(1) 7/8" coax	97
(1) 6' HP Dish	Mounted to leg	(1) EW52	93
(1) 10' HP Dish	Mounted to leg	(1) EW52	71
(1) GPS	Side arm	(1) 1/2"	47
(1) 8' Whip	Side arm	(1) 5/8"	37

The structural analysis of this communications tower was performed by URS Corporation, AES (URS) for Cingular Wireless. The purpose of this analysis was to analyze the existing tower for its existing and proposed antenna loads. This analysis was conducted to evaluate twist (rotation), sway (deflection) and stress on the tower, and the effect of forces to the foundation of the tower resulting from existing and proposed antenna arrangements.

3. ANALYSIS METHODOLOGY AND LOADING CONDITIONS

Methodology:

The structural analysis was done in accordance with the TIA/EIA-222-E, Structural Standard for Steel Antenna Towers and Antenna Supporting Structures, the American Institute of Steel Construction (AISC) and the Manual of Steel Construction; Allowable Stress Design (ASD).

The analysis was conducted using ERI Tower 2.0. The load condition was evaluated as shown below which was compared to allowable stresses according to AISC and TIA/EIA. The load combination was investigated in ERI Tower 2.0 to determine the stress, sway and rotation.

Load Condition 1 = 80 mph Wind Load + Tower Dead Load
 Load Condition 2 = 70 mph Wind Load (with 1/2" radial ice) + Tower Dead Load

The TIA/EIA standard permits one-third increase in allowable stresses for towers and monopoles less than 700 feet tall. For purposes of this analysis, allowable stresses of tower members were increased

by one-third in computing the load capacity; in addition, the appropriate "k" factors were assigned to each member.

4. FINDINGS AND EVALUATION

The combined axial and bending stresses on the tower structure were evaluated to compare with the allowable stress in accordance with AISC. The analysis indicates that the tower legs, diagonal members, horizontal members and foundation have sufficient capacity to carry the loads applied.

The tower base reactions are as follows:

Previous Analysis Reactions	
Compression (kips)	186
Uplift (kips)	160.3
Total Shear (kips)	38.2
Moment (kips-ft)	3517.3

Proposed Tower Reactions	
Compression (kips)	178
Uplift (kips)	151
Total Shear (kips)	34
Moment (kips-ft)	3308

For detailed proposed tower reactions, see drawing no. E-1 in section 6 of this report.

5. CONCLUSIONS

The results of the analysis indicate the structure to be in compliance with the loading conditions and the materials and member sizes for the tower. The tower is considered feasible with the Connecticut State Police requirements and the TIA/EIA-222-E wind load classification specified above and all the existing and proposed antenna loading. The user of this report shall field verify the assumption of the antenna and mount configuration. Notify the engineer in writing immediately if any of the assumptions in this report are found to be other than specified.

Limitations/Assumptions:

This report is based on the following:

- A. Tower is properly installed and maintained.
- B. All members were as specified in the previous analysis by Bergeron dated April 16, 2001 are in good condition.
- C. All required members are in place.
- D. All bolts are in place and are properly tightened.
- E. Tower is in plumb condition.
- F. All members are galvanized.

- G. All tower members were properly designed, detailed, fabricated, installed, and have been properly maintained since erection.

URS is not responsible for any modifications completed prior to or hereafter in which URS is not or was not directly involved. Modifications include but are not limited to:

- A. Replacing/Removing antennas
- B. Adding antennas and amplifiers

URS hereby states that this document represents the entire report and that it assumes no liability for any factual changes that may occur after the date of this report. All representations, recommendations, and conclusions are based upon information contained and set forth herein. If you are aware of any information which conflicts with that which is contained herein, or you are aware of any defects arising from original design, material, fabrication, or erection deficiencies, you should disregard this report and immediately contact URS. URS disclaims all liability for any representation, recommendation, or conclusion not expressly stated herein.

Ongoing and Periodic Inspection and Maintenance by the Owner:

1. After the Contractor has successfully completed the installation and the work has been accepted, the owner will be responsible for the ongoing and periodic inspection and maintenance of the tower.
2. The Owner shall refer to TIA/EIA-222-E for recommendations for maintenance and inspection. The frequency of the inspection and maintenance intervals is to be determined by the Owner based upon actual site and environmental conditions. It is recommended that a complete and thorough inspection of the entire tower structural system is performed at least yearly and more frequently as conditions warrant. According to TIA/EIA-222-E: It is recommended that the structure be inspected after severe wind and/or ice storms or other extreme loading conditions.

**CINGULAR WIRELESS
Antenna Modification**

Site Address: 482 Pigeon Hill Road, Windsor
Docket 58 and EM-SCLP-164-001206 Approved 12/14/00

Tower Owner/Manager: Verizon / Crown Castle

Antenna configuration Antenna center line – 169 ft

Current and/or approved: 3 EMS RS90-12 panels on pipe mount

Planned: 3 EMS MB96RR900200 panels or comparable
3 tower mount amplifiers
3 duplexers

Note: Pipe mount wall thickness issue in structural report has been noted, and Cingular will comply therewith.

Power Density:

Calculations for Cingular's current operations at the site indicate a radio frequency electromagnetic radiation power density, measured at the tower base, of approximately 4.1% of the standard adopted by the FCC. As depicted in the second table below, the total radio frequency electromagnetic radiation power density for Cingular's planned operations would be approximately 5.8%, or an additional 1.7% of the standard.

Cingular Current

Company	Centerline Ht (feet)	Frequency (MHz)	Number of Channels	Power Per Channel (Watts)	Power Density (mW/cm ²)	Standard Limits (mW/cm ²)	Percent of Limit
Cingular	169	880 - 894	19	100	0.0239	0.5867	4.1

Cingular Planned

Company	Centerline Ht (feet)	Frequency (MHz)	Number of Channels	Power Per Channel (Watts)	Power Density (mW/cm ²)	Standard Limits (mW/cm ²)	Percent of Limit
Cingular TDMA	169	880 - 894	16	100	0.0201	0.5867	3.4
Cingular GSM	169	880 - 894	2	296	0.0075	0.5867	1.3
Cingular GSM	169	1930 - 1935	2	427	0.0108	1.0000	1.1
Total							5.8%

Structural information: Please see attached.