



STATE OF CONNECTICUT

CONNECTICUT SITING COUNCIL

Ten Franklin Square, New Britain, CT 06051

Phone: (860) 827-2935 Fax: (860) 827-2950

E-Mail: siting.council@ct.gov

www.ct.gov/csc

VIA ELECTRONIC MAIL

November 9, 2018

Denise Sabo
Northeast Site Solutions
420 Main Street, Unit 2
Sturbridge, MA 01566

RE: **EM-T-MOBILE-159-181023** – T-Mobile notice of intent to modify an existing telecommunications facility located at 23 Kelleher Court, Wethersfield, Connecticut.

Dear Ms. Sabo:

The Connecticut Siting Council (Council) is in receipt of your correspondence of November 7, 2018, 2018 submitted in response to the Council's October 24, 2018 notification of an incomplete request for exempt modification with regard to the above-referenced matter.

The submission renders the request for exempt modification complete and the Council will process the request in accordance with the Federal Communications Commission 60-day timeframe.

Thank you for your attention and cooperation.

Sincerely,

Melanie A. Bachman
Executive Director

MAB/FC



Robidoux, Evan

From: Deborah Chase <deborah@northeastsitesolutions.com>
Sent: Wednesday, November 07, 2018 10:07 AM
To: CSC-DL Siting Council; Bachman, Melanie; Mathews, Lisa A
Cc: Sheldon Freinckle; Denise Sabo; victoria@northeastsitesolutions.com
Subject: RE: 23 Kelleher Court, Wethersfield CT - T-Mobile EM application - CTHA014A L700 4x2 - NHP18- REVISED STRUCTURAL APPLICATION (
Attachments: em-t-mobile-159-181023_incompleteltr_kellehercourt.pdf; 23 Kelleher Court Wethersfield CT 06109 T-Mobile EM Application (CTHA014A_L700 4x2 NHP18).pdf

Siting Council,

Please see attached corrected EM Application for 23 Kelleher Court, Wethersfield CT.

Per the incomplete letter, the Structural has been updated to include AT&T proposed and approved equipment.

The CD has been updated to reference and correspond with the Structural.

Please let us know if you have any questions.

Thank you

Deborah Chase

Senior Project Coordinator & Analyst

Mobile: 860-490-8839



 Save a tree. Refuse. Reduce. Reuse. Recycle.



NORTHEAST
SITE SOLUTIONS

Turnkey Wireless Development

Northeast Site Solutions
Denise Sabo
4 Angela's Way, Burlington CT 06013
860-209-4690
denise@northeastsitesolutions.com

October 18, 2018

Members of the Siting Council
Connecticut Siting Council
Ten Franklin Square
New Britain, CT 06051

RE: Notice of Exempt Modification
23 Kelleher Court, Wethersfield CT 06109
Latitude: 41.715275
Longitude: -72.690275
T-Mobile Site#: CTHA014A_L700 4x2

Dear Ms. Bachman:

T-Mobile currently maintains nine (9) antennas at the 151-foot level of the existing 179-foot monopole tower at 23 Kelleher Court, Wethersfield CT. The 179-foot tower and property are both owned by the Town of Wethersfield. T-Mobile now intends to replace six (6) of its existing antennas with three (3) new 1900/2100 MHz antenna and three (3) new 600/700 MHz antenna. The new antennas would be installed at the 151-foot level of the tower.

Planned Modifications:

Remove:

(3) Twin TMA

Remove and Replace:

(3) LNX6515 Antenna **(Remove)** - (3) APXVAARR24_43U-NA20 Antenna 600/700 MHz **(Replace)**

(3) AIR21B2P B4A **(Remove)** – AIR32 KRD901146-1 B66A_B2A **(Replace)**

(3)RRUS11 B12 **(Remove)** - (3) RRU 4449 B12/B71 **(Replace)**

Install New:

(2) Fiber Hybrid Line

Existing to Remain:

(12) 1-5/8" Coax

(2) Fiber Hybrid Line

(3) Twin TMA

(3)AIR21 B2A/B4P 1900/2100 MHz

Ground:

Install New:

- (1) Delta 25KW DC Generator – 220 gallon double walled self-contained tank with fuel sensor.
Requires two (2) 20 minute run cycles annually.

- (1) 5'x6' Concrete pad extension

This facility was approved by the Wethersfield ZBA--on April 17, 2002 Town of Wethersfield was approved to erect two (2) tower shelters and a tower in the side yard of 23 Kelleher CT. Please see attached minutes provided by the Town of Wethersfield Zoning Department.

Please accept this letter as notification pursuant to Regulations of Connecticut State Agencies § 16-50j-73, for construction that constitutes an exempt modification pursuant to R.C.S.A. § 16-50j-72(b)(2). In accordance with R.C.S.A. § 16-50j-73, a copy of this letter is being sent to Mayor Amy Morrin Bello, Elected Official and Peter Gillespie, Zoning Director for the Town of Wethersfield, as well as the property owner and the tower owner.

The planned modifications to the facility fall squarely within those activities explicitly provided for in R.C.S.A. § 16-50j-72(b)(2).

1. The proposed modifications will not result in an increase in the height of the existing structure.
2. The proposed modifications will not require the extension of the site boundary.
3. The proposed modifications will not increase noise levels at the facility by six decibels or more, or to levels that exceed state and local criteria.
4. The operation of the replacement antennas will not increase radio frequency emissions at the facility to a level at or above the Federal Communications Commission safety standard.
5. The proposed modifications will not cause a change or alteration in the physical or environmental characteristics of the site.
6. The existing structure and its foundation can support the proposed loading.

For the foregoing reasons, T-Mobile respectfully submits that the proposed modifications to the above referenced telecommunications facility constitute an exempt modification under R.C.S.A. § 16-50j-72(b)(2).

Sincerely,

Denise Sabo

Mobile: 860-209-4690

Fax: 413-521-0558

Office: 4 Angela's Way Burlington, CT 06013

Email: denise@northeastsitesolutions.com

Attachments

- cc: Amy Morrin Bello- Mayor -Wethersfield elected official
- Peter Gillespie – Director of Planning and Zoning
- Town of Wethersfield - as property and tower owner

NORTHEAST SITE SOLUTIONS, LLC
420 MAIN ST. BUILDING #4, 2nd FLOOR
STURBRIDGE, MA 01566

WEBSTER BANK
FARMINGTON, CT 06032
51-7010/2111

3633

08/22/2018

PAY TO THE ORDER OF Connecticut Siting Council

\$ *625.00

EXACTLY SIX HUNDRED TWENTY-FIVE DOLLARS

DOLLARS

Connecticut Siting Council
10 Franklin Square
New Britain CT 06051

Lisa Lisa Allen
AUTHORIZED SIGNATURE

MEMO

⑈003633⑈ ⑆211170101⑆ 0010608887⑈

NORTHEAST SITE SOLUTIONS, LLC

3633

Check#: 3633 Date: 08/22/2018 Vendor#: 10023 Connecticut Siting Co Check Total: *625.00

Invoice#	Job/Description	Balance	Retain	Discount	This Check
CTHA014A CSC	7 TMO L700 4x2	625.00			625.00

NORTHEAST SITE SOLUTIONS, LLC

3633

Check#: 3633 Date: 08/22/2018 Vendor#: 10023 Connecticut Siting Co Check Total: *625.00

Invoice#	Job/Description	Balance	Retain	Discount	This Check
CTHA014A CSC	7 TMO L700 4x2	625.00			625.00

Exhibit A

Town of Wethersfield
505 SILAS DEANE HIGHWAY
WETHERSFIELD, CONNECTICUT 06109



17 April 2002

Mr. Michael J. Turner
Town Engineer
Town of Wethersfield
505 Silas Deane Highway
Wethersfield, Connecticut 06109

Dear Mr. Turner:

Re: Application No. 5694-2002

At a meeting of the Zoning Board of Appeals held on Monday, April 15, 2002, it was unanimously voted that the application seeking variance to erect two equipment shelters and tower in the side yard at 23 Kelleher Court, east side, A-1 Residence Zone, **BE APPROVED AS SUBMITTED.**

A building permit must be obtained from, and all construction is done under the supervision of the Building Inspection Division, Town of Wethersfield.

The effective date of this permission is April 19, 2002. This variance must be recorded with the Town Clerk, Town of Wethersfield immediately after the 15 days from the effective date of this permission. Please come to the Building Department first to pick up the form to be recorded in the Town Clerk's Office.

Very truly yours,

TOWN OF WETHERSFIELD
ZONING BOARD OF APPEALS
MORRIS R. BOREA, CHAIRMAN

Nancy Azeredo
Nancy Azeredo, Duly Authorized for
Bruce T. Bockstael, Clerk

na
Enc.

Cc: Lee C. Erdmann, Town Manager

**WETHERSFIELD ZONING BOARD OF APPEALS
PUBLIC HEARING**

April 15, 2002

The Wethersfield Zoning Board of Appeals held a public hearing on April 15, 2002 at 7:30 PM in the Town Hall, 505 Silas Deane Highway, Wethersfield, Connecticut.

PRESENT: Morris R. Borea, Chairman
Bruce T. Bockstael, Clerk
Frank A. Falvo, Jr.
Thomas J. Vaughan, Jr.
Cynthia Clancy, Alternate

ABSENT: J. Edward Brymer, Jr., Vice Chairman

Also Present: Brian O'Connor, Assistant Building & Zoning Official

Chairman Borea opened the meeting. Before the meeting started, the public was welcomed to speak regarding anything except specific cases in the past or on the night's agenda. There was no one present who wished to speak.

Mr. O'Connor requested that the agenda be taken out of order as the last applicant, (Application No. 5694-2002), has to be at the Town Council Meeting being held in the Council Chambers at the same time as this meeting. Commissioner Bockstael stated that at the end of the meeting the public would again be asked if they would like to speak regarding Application No. 5694-2002 in case there were any late arrivals.

Commissioner Bockstael read the legal notice into the record.

APPLICATION NO. 5694-2002. Town of Wethersfield seeking variance to erect two equipment shelters and tower in the side yard at 23 Kelleher Court, east side, A-1 Residence Zone. (Section 167-75)

Mike Turner, Town Engineer appeared before the Board of behalf of the Town of Wethersfield, seeking variance for the location of the two equipment shelters and antenna tower that they would like to locate at Fire House #3 at 23 Kelleher Court. He stated that this is one of three tower sites that the Town is pursuing as part of the new town wide radio system that they are constructing. Mr. Turner stated that this tower site would be the main tower site where most of the radio equipment would be located.

April 15, 2002

Mr. Turner stated that the regulations require that any tower be located in the rear yard. He stated that the upper portion of the site by the parking lot is around elevation 130 to 131, the site drops off in the rear to about elevation 102. Therefore the rear portion of the property would require an antenna tower to be built around 29 to 30 feet taller. He stated that this tower site needs to have a clear line of site to the Newington tower, around 30 to 40 feet above of the tree line. Therefore what they are proposing is that the construction of the tower be in the south west corner of the property, with the equipment shelter adjacent to the tower, generally around 10 feet from the tower.

Chairman Borea questioned how high the tower is going to be. Mr. Turner stated 190 feet. Chairman Borea verified that if it were to be put in the rear yard the tower would have to be around 220 feet. Mr. Turner stated that this was correct, adding that anything over 199 feet needs flashing lights, strobe lights, etc.

There were no further questions or comments from the Board.

There was no one in the audience who wished to speak in favor of this application.

The following audience member wished to speak in opposition to this application:

1. Mr. Robert Young, 20 Coppermill Road, Wethersfield, CT – Stated that he feels this location is a bad site and feels that it will bring down the property value of homes in this area, which will in turn bring down his property value. He stated that he also feels that not all the facts were presented to the public.

APPLICATION NO. 5689-2002. Jeannine Steucek seeking variance to erect a 24'X26' detached garage over the building line at 931 Prospect Street, north side, A-1 Residence Zone. (Section 167-114)

Jeannine Steucek, 931 Prospect Street, Wethersfield, CT, appeared before the Board seeking variance to erect a detached garage over the building line. She stated that she has never had a garage but would like a garage for the protection of her car.

April 15, 2002

APPLICATION NO. 5693-2002. Sebastian A. Panioto seeking variance to construct a single car garage and attached entry having less than the required side yard at 95 Mohawk Lane, north side, A Residence Zone. (Section 167-172)

Upon motion made by Commissioner Falvo, Jr., seconded by Chairman Borea and a poll of the Board it was unanimously voted that the above application **BE APPROVED** as submitted.

APPLICATION NO. 5694-2002. Town of Wethersfield seeking variance to erect two equipment shelters and tower in the side yard at 23 Kelleher Court, east side, A-1 Residence Zone. (Section 167-75)

Upon motion made Chairman Borea, seconded by Commissioner Falvo, Jr., and a poll of the Board it was unanimously voted that the above application **BE APPROVED** as submitted.

APPROVAL OF MINUTES

Tabled until next meeting.

ADJOURNMENT

The meeting was adjourned at 8:30PM.

Exhibit B

CURRENT OWNER		TOPO.	UTILITIES	STRT./ROAD	LOCATION	CURRENT ASSESSMENT			
WETHERSFIELD TOWN OF FIREHOUSE #3 23 KELLEHER CT		1 Level	1 All Public			Description	Code	Appraised Value	Assessed Value
WETHERSFIELD, CT 06109 Additional Owners:		SUPPLEMENTAL DATA Other ID: LOT NO 7-18 CALLBACK CENSUS 4923 SECTION 1 GIS ID: 073060				EXEMPT	BAAX	642,900	450,000
						EXEMPT	BAAX	117,400	82,200
						EXEMPT	BAAX	1,371,600	960,100
						Total		2,131,900	1,492,300

6159
WETHERSFIELD, CT
VISION

RECORD OF OWNERSHIP		BK-VOL/PAGE	SALE DATE	q/u	v/i	SALE PRICE	V.C.	PREVIOUS ASSESSMENTS (HISTORY)								
WETHERSFIELD TOWN OF		0169/0075	06/25/1956	U		0		Yr.	Code	Assessed Value	Yr.	Code	Assessed Value	Yr.	Code	Assessed Value
								2012	100	1,629,500	2010	BAAX	467,300	2008	BAAX	467,300
								2012	100	84,700	2010	BAAX	84,700	2008	BAAX	84,700
											2010	BAAX	1,162,200	2008	BAAX	1,162,200
								Total:		1,714,200	Total:		1,714,200	Total:		1,714,200

EXEMPTIONS				OTHER ASSESSMENTS			
Year	Type	Description	Amount	Code	Description	Number	Amount
<i>Total:</i>							

This signature acknowledges a visit by a Data Collector or Assessor

ASSESSING NEIGHBORHOOD				
NBHD/ SUB	NBHD NAME	STREET INDEX NAME	TRACING	BATCH
0001/A				

APPRAISED VALUE SUMMARY	
Appraised Bldg. Value (Card)	642,900
Appraised XF (B) Value (Bldg)	0
Appraised OB (L) Value (Bldg)	1,371,600
Appraised Land Value (Bldg)	117,400
Special Land Value	0
Total Appraised Parcel Value	2,131,900
Valuation Method:	C
Adjustment:	0
Net Total Appraised Parcel Value	2,131,900

NOTES				
CELL TOWER + EQUIP ON SITE				
2000 GAL DIESEL TANK		METRO PCS LEASE		
CELL TOWER VALUE= 5 SITES@ 3000/MONTH				
5 X 3000 X 12= 180,000		FIREHOUSE 3		
LESS 25% EXP= 135,000/.11= 1,227,250				

BUILDING PERMIT RECORD								VISIT/ CHANGE HISTORY							
Permit ID	Issue Date	Type	Description	Amount	Insp. Date	% Comp.	Date Comp.	Comments	Date	Type	IS	ID	Cd.	Purpose/Result	
M-13-170	08/14/2013	HA	HVAC	21,165	10/07/2013	100	10/01/2013	REPL ONE ROOFTOP A	10/7/2013			CR	49	No Change After Inspe	
B-13-46	03/26/2013	CM	Commercial	20,000	05/01/2013	100	10/01/2013	LEASE AREA EXPANDI	5/1/2013			CR	49	No Change After Inspe	
B-10-152	08/12/2010	BP		15,000	05/11/2012	100	03/02/2012	Install 3 antnmas, 3 dishes	5/11/2012			CR	49	No Change After Inspe	
BP0097	05/11/2009	BP		5,000	10/05/2009	100		Add antenna's and cabine	10/5/2009			CR	49	No Change After Inspe	
BP-0093	04/29/2009	BP		15,000	10/05/2009	100		Install antennas and radi	7/25/2008			JL	51	Field review	
EP-0320	11/25/2008	CM	Commercial	15,000	10/05/2009	100		100 amp service & shutof							
EP07225	07/27/2007	EL	Electric	6,400		100		200 amp svce for T-Mobil							

LAND LINE VALUATION SECTION																		
B #	Use Code	Use Description	Zone	D	Frontage	Depth	Units	Unit Price	I. Factor	S.A.		C. Factor	ST. Idx	Adj.	Notes- Adj	Special Pricing	Adj. Unit Price	Land Value
1	901C	Municipal MDL-94	A1				1.00	AC	118,800.00	1.00	F	1.00	010	0.90			106,920.00	106,900
1	901C	Municipal MDL-94	A1				1.30	AC	9,000.00	1.00	0	1.00	010	0.90			8,100.00	10,500
Total Card Land Units:							2.30	AC	Parcel Total Land Area:			2.3 AC			Total Land Value:			117,400

CONSTRUCTION DETAIL				CONSTRUCTION DETAIL (CONTINUED)			
Element	Cd.	Ch.	Description	Element	Cd.	Ch.	Description
Style	59		Fire Station				
Model	96		Ind/Comm				
Grade	06		Good				
Occupancy	1			MIXED USE			
Exterior Wall 1	20		Brick	<i>Code</i>	<i>Description</i>		<i>Percentage</i>
Exterior Wall 2				901C	Municipal MDL-94		100
Roof Structure	03		Gable/Hip	COST/MARKET VALUATION			
Roof Cover	03		Asphalt Shingl	Adj. Base Rate:			85.19
Interior Wall 1	05		Drywall				
Interior Wall 2	03		Plaster				
Interior Floor 1	05		Vinyl/Asphalt	AYB			1969
Interior Floor 2	03		Concr-Finished	Dep Code			G
Heating Fuel	03		Oil/Gas	Remodel Rating			
Heating Type	05		Hot Water	Year Remodeled			
AC Type	03		Central	Dep %			22
Bldg Use	907		Fire-Vol	Functional Obslnc			0
Total Rooms				External Obslnc			0
Total Bedrms	00			Cost Trend Factor			
Total Baths	0			Condition			
Heat/AC	02		HEAT/AC SPLIT	% Complete			
Frame Type	03		MASONRY	Overall % Cond			78
Baths/Plumbing	02		AVERAGE	Apprais Val			642,900
Ceiling/Wall	06		CEIL & WALLS	Dep % Ovr			0
Rooms/Prtns	02		AVERAGE	Dep Ovr Comment			
Wall Height	12			Misc Imp Ovr			0
% Conn Wall	0			Misc Imp Ovr Comment			
				Cost to Cure Ovr			0
				Cost to Cure Ovr Comment			

OB-OUTBUILDING & YARD ITEMS(L) / XF-BUILDING EXTRA FEATURES(B)												
Code	Description	Sub	Sub Descript	L/B	Units	Unit Price	Yr	Gde	Dp Rt	Cnd	%Cnd	Apr Value
PAV1	Asphalt Paving			L	3,600	1.60	1999			G	75	4,300
CB3	PreCastConCel			L	200	350.00	2008			A	50	35,000
CB3	PreCastConCel			L	240	350.00	2008			A	50	42,000
CB3	PreCastConCel			L	360	350.00	2008			A	50	63,000
	CELL SITES			L	5	245,450.00	2008					1,227,300

BUILDING SUB-AREA SUMMARY SECTION							
Code	Description	Living Area	Gross Area	Eff. Area	Unit Cost	Undeprec. Value	
BAS	First Floor	4,938	4,938				
FUS	Finished Upper Story	4,718	4,718				
UST	Unfinished Storage	0	60				
Ttl. Gross Liv/Lease Area:		9,656	9,716				

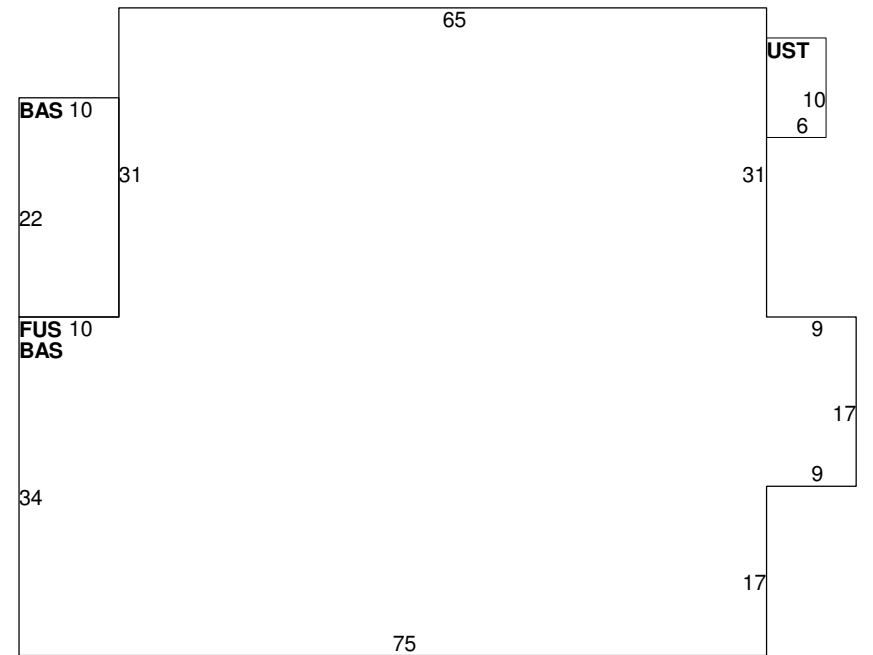

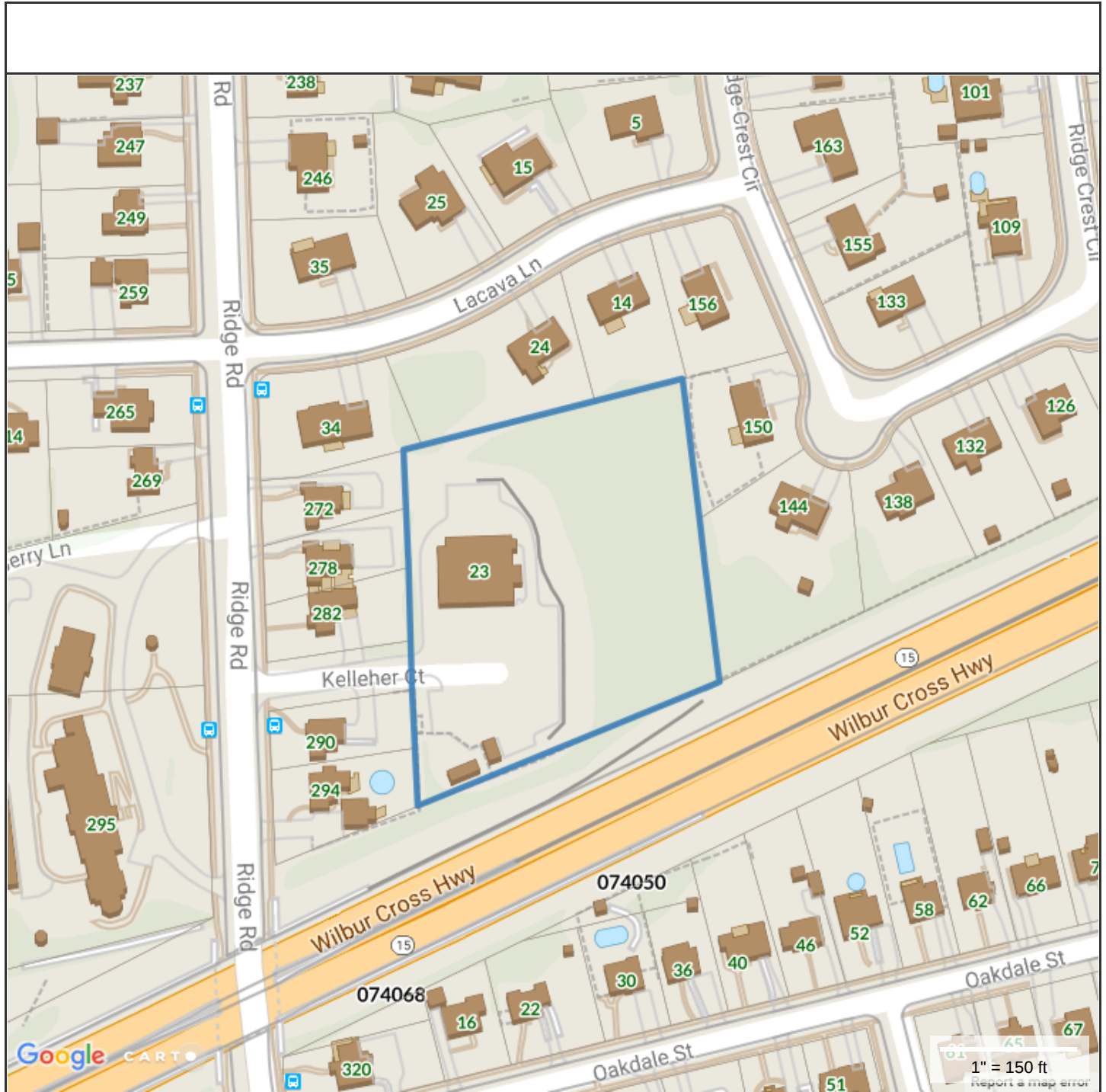

Property Information

Property ID 073060
 Location 23 KELLEHER CT
 Owner WETHERSFIELD TOWN OF



**MAP FOR REFERENCE ONLY
NOT A LEGAL DOCUMENT**

Town of Wethersfield, CT makes no claims and no warranties, expressed or implied, concerning the validity or accuracy of the GIS data presented on this map.

Parcels updated 11/14/17
 Properties updated daily

Exhibit C

Copyright © 2018 Foresite LLC all rights reserved. The details, templates, drawing formats or any portion of this document generated by Foresite LLC may not be duplicated, traced or used otherwise for any profit-driven enterprise.

ANTENNA UPGRADES BY

T-MOBILE NORTHEAST LLC

PROJECT: L700 4X2
SITE NUMBER: CTHA014A
SITE NAME: HA014/T OF WETHERSFIELD_MP
SITE ADDRESS: 23 KELLEHER COURT
WETHERSFIELD, CT 06109
(RF CONFIGURATION 67D92DB)

APPLICANT:

T-MOBILE NORTHEAST LLC
 35 GRIFFIN ROAD SOUTH
 BLOOMFIELD, CT 06002
 860-692-7100

PROJECT MANAGER

NSS NORTHEAST
 SITE SOLUTIONS
Turnkey Wireless Development
 420 MAIN STREET, BLDG 4
 STURBRIDGE, MA 01566
 203-275-6669

CONSULTANT:

FORESITE LLC
 Architects . Engineers . Surveyors
 462 WALNUT STREET
 NEWTON, MA 02460
 617-212-3123

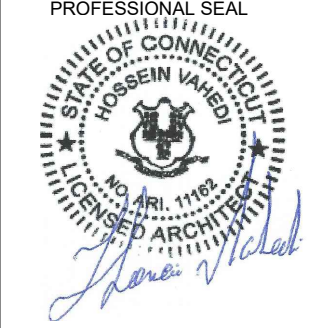
PROFESSIONAL SEAL



THIS DOCUMENT IS THE DESIGN PROPERTY AND COPYRIGHT OF FORESITE, LLC. AND FOR THE EXCLUSIVE USE BY THE TITLE CLIENT. DUPLICATION OR USE WITHOUT THE EXPRESS WRITTEN CONSENT OF THE CREATOR IS STRICTLY PROHIBITED. DRAWING SCALES ARE INTENDED FOR 11"x17" SIZE PRINTED MEDIA ONLY. ALL OTHER PRINTED SIZES ARE DEEMED "NOT TO SCALE".

REV	DESCRIPTION	DATE
A	PRELIMINARY	07/20/18
B	REVISED CABLE COUNT	07/27/18
C	REVISED PER NEW RFDS	08/07/18
0	SIGNED AND SEALED	08/14/18
1	REVISED STRUCTURAL REF.	11/06/18

SITE NUMBER: CTHA014A
 SITE NAME: HA014/T OF WETHERSFIELD_MP
 SITE ADDRESS: 23 KELLEHER COURT
 WETHERSFIELD, CT 06109

SHEET TITLE:
 T-1: TITLE SHEET

PROJECT SCOPE:
 UPGRADE OF EXISTING WIRELESS FACILITY AS FOLLOWS:
 REPLACE (6) EXISTING ANTENNAS,
 REPLACE (3) EXISTING REMOTE RADIO UNITS AT ANTENNAS,
 REMOVE (3) EXISTING TOWER MOUNTED AMPLIFIER (TMA),
 REPLACE (2) 9X18 HCS WITH (2) 6X12 HCS CABLES.

PROJECT NOTES:

1. THIS IS AN UNMANNED TELECOMMUNICATION FACILITY AND NOT FOR HUMAN HABITATION. HANDICAPPED ACCESS IS NOT REQUIRED. POTABLE WATER OR SANITARY SERVICE IS NOT REQUIRED. NO OUTDOOR STORAGE OR ANY SOLID WASTE RECEPTACLES REQUIRED.
2. CONTRACTOR SHALL VERIFY ALL PLANS, EXISTING DIMENSIONS, AND CONDITIONS ON THE JOB SITE. CONTRACTOR SHALL IMMEDIATELY NOTIFY THE ARCHITECT/ENGINEER IN WRITING OF ANY DISCREPANCIES BEFORE PROCEEDING WITH THE WORK. FAILURE TO NOTIFY THE ARCHITECT/ENGINEER PLACES THE RESPONSIBILITY ON THE CONTRACTOR TO CORRECT THE DISCREPANCIES AT THE CONTRACTOR'S EXPENSE.
3. DEVELOPMENT AND USE OF THE SITE WILL CONFORM TO ALL APPLICABLE CODES, ORDINANCES AND SPECIFICATIONS.
4. REFER TO STRUCTURAL ANALYSIS REPORT TITLED " STRUCTURAL ANALYSIS REPORT-REV. 1 - MONOPOLE " SITE ID: CTHA014A, DATED NOVEMBER 5, 2018, PREPARED BY DESTEK.

APPLICABLE STATE ADOPTION CODES:

2016 CONNECTICUT STATE BUILDING CODE (CSBC).
 ANSITIA-222-G-2005 STRUCTURAL STANDARD FOR ANTENNA SUPPORTING STRUCTURES AND ANTENNAS.
 2014 NATIONAL ELECTRICAL CODE (NFPA 70) FOR POWER AND GROUNDING REQUIREMENTS.

APPROVALS:

FSA CM	DATE
RF ENGINEER	DATE
FOPS	DATE
T-MOBILE ENGINEERING AND DEVELOPMENT	DATE
	DATE
	DATE

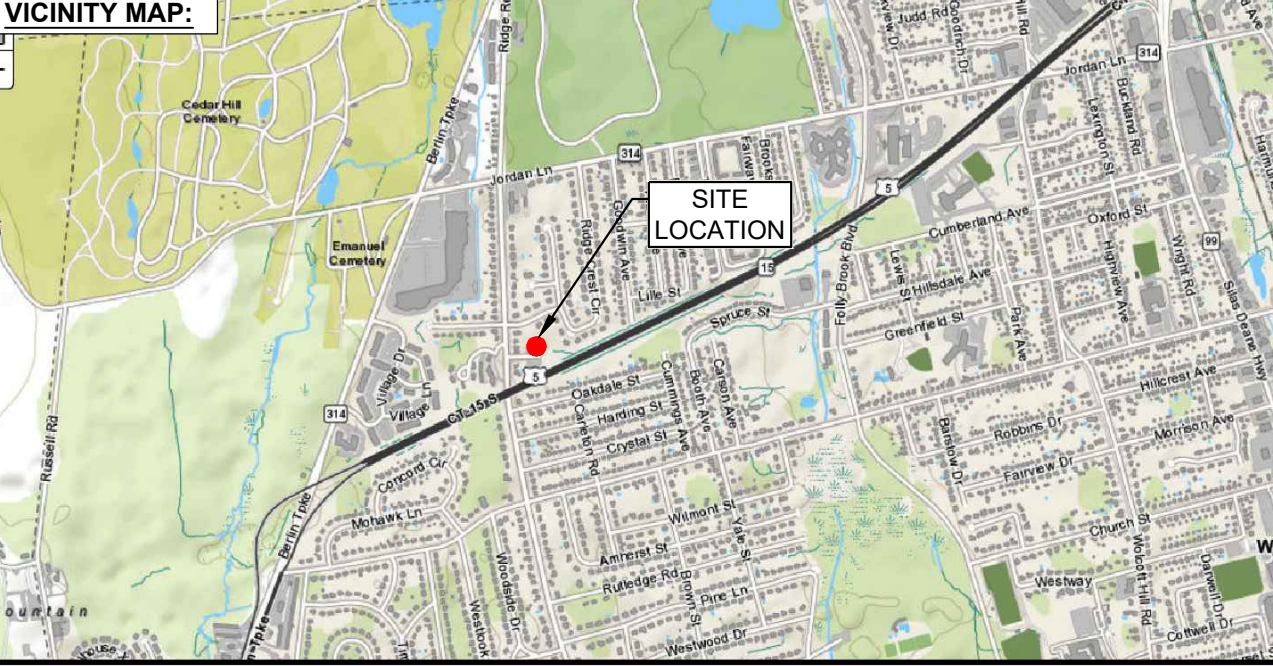

PROJECT INFORMATION:

ADDRESS: 23 KELLEHER COURT
 WETHERSFIELD, CT 06109

STRUCTURE TYPE: MONOPOLE TOWER

COORDINATES: 41.715275 N, -72.690275W

TOWER HEIGHT: 179'-0" AGL

TOP OF T-MOBILE ANTENNAS ELEV: 155'-0" AGL

PROJECT TEAM:

APPLICANT: T-MOBILE NORTHEAST, LLC.
 35 GRIFFIN ROAD SOUTH
 BLOOMFIELD, CT 06002
 860-692-7100

LANDLORD: TOWN OF WETHERSFIELD
 505 SILAS DEANE HIGHWAY
 WETHERSFIELD, CT 06109
 PHONE: (860) 721-2801
 FAX: (860) 721-2994

PROJECT MANAGER: NORTHEAST SITE SOLUTIONS
 420 MAIN STREET, BLDG 4
 STURBRIDGE, MA 01566
 SHELDON FREINCLE
 SHELDON@NORTHEASTSITE
 SOLUTIONS.COM
 201-776-8521

CONSULTANTS: FORESITE LLC
 462 WALNUT ST
 NEWTON, MA 02460
 SAEED MOSSAVAT
 SMOSSAVAT@FORESITELLC.COM
 617-212-3123

SHEET INDEX:

T-1:	TITLE SHEET
N-1:	GENERAL NOTES
A-1:	PLAN
A-2:	ELEVATION
A-3:	ANTENNA PLAN
A-4:	ANTENNA DETAILS
E-1:	GROUNDING DETAILS

Copyright © 2018 Foresite LLC all rights reserved. The details, templates, drawing formats or any portion of this document generated by Foresite LLC may not be duplicated, traced or used otherwise for any profit-driven enterprise.

GENERAL NOTES:

1. THE CONTRACTOR SHALL GIVE ALL NOTICES AND COMPLY WITH ALL LAWS, ORDINANCES, RULES, REGULATIONS AND LAWFUL ORDERS OF ANY PUBLIC AUTHORITY, MUNICIPAL AND UTILITY COMPANY SPECIFICATIONS, AND LOCAL AND STATE JURISDICTIONAL CODES BEARING ON THE PERFORMANCE OF THE WORK. THE WORK PERFORMED ON THE PROJECT AND THE MATERIALS INSTALLED SHALL BE IN STRICT ACCORDANCE WITH ALL APPLICABLE CODES, REGULATIONS, AND ORDINANCES.
2. THE ARCHITECT/ENGINEER HAS MADE EVERY EFFORT TO SET FORTH IN THE CONSTRUCTION AND CONTRACT DOCUMENTS THE COMPLETE SCOPE OF WORK. THE CONTRACTOR BIDDING THE JOB IS NEVERTHELESS CAUTIONED THAT MINOR OMISSIONS OR ERRORS IN THE DRAWINGS AND OR SPECIFICATIONS SHALL NOT EXCUSE SAID CONTRACTOR FROM COMPLETING THE PROJECT AND IMPROVEMENTS IN ACCORDANCE WITH THE INTENT OF THESE DOCUMENTS.
3. THE CONTRACTOR OR BIDDER SHALL BEAR THE RESPONSIBILITY OF NOTIFYING (IN WRITING) THE CLIENT'S REPRESENTATIVE OF ANY CONFLICTS, ERRORS, OR OMISSIONS PRIOR TO THE SUBMISSION OF CONTRACTOR'S PROPOSAL OR PERFORMANCE OF WORK.
5. THE CONTRACTOR SHALL VISIT THE JOB SITE PRIOR TO THE SUBMISSION OF BIDS OR PERFORMING WORK TO FAMILIARIZE HIMSELF WITH THE FIELD CONDITIONS AND TO VERIFY THAT THE PROJECT CAN BE CONSTRUCTED IN ACCORDANCE WITH THE CONSTRUCTION DOCUMENTS.
6. THE CONTRACTOR SHALL INSTALL ALL EQUIPMENT AND MATERIALS ACCORDING TO THE MANUFACTURER'S / VENDOR'S SPECIFICATIONS UNLESS NOTED OTHERWISE OR WHERE LOCAL CODES OR ORDINANCES TAKE PRECEDENCE.
7. THE CONTRACTOR SHALL MAKE NECESSARY PROVISIONS TO PROTECT EXISTING IMPROVEMENTS DURING CONSTRUCTION.
8. THE CONTRACTOR SHALL COMPLY WITH ALL PERTINENT SECTIONS OF THE BASIC STATE BUILDING CODE, LATEST EDITION, AND ALL OSHA REQUIREMENTS AS THEY APPLY TO THIS PROJEC
9. THE CONTRACTOR SHALL NOTIFY THE CLIENT'S REPRESENTATIVE IN WRITING WHERE A CONFLICT OCCURS ON ANY OF THE CONTRACT DOCUMENTS. THE CONTRACTOR IS NOT TO ORDER MATERIAL OR CONSTRUCT ANY PORTION OF THE WORK THAT IS IN CONFLICT UNTIL CONFLICT IS RESOLVED BY THE CLIENT'S REPRESENTATIVE.
10. THE WORK SHALL CONFORM TO THE CODES AND STANDARDS OF THE FOLLOWING AGENCIES AS FURTHER CITED HEREIN:
 - A. ASTM: AMERICAN SOCIETY FOR TESTING AND MATERIALS, AS PUBLISHED IN "COMPILATION OF ASTM STANDARDS BUILDING CODES" OR LATEST EDITION.
 - B. AWS: AMERICAN WELDING SOCIETY INC. AS PUBLISHED IN "STANDARD D1.1-08, STRUCTURAL WELDING CODE" OR LATEST EDITION.
 - C. AISC: AMERICAN INSTITUTE FOR STEEL CONSTRUCTION AS PUBLISHED IN "CODE FOR STANDARD PRACTICE FOR STEEL BUILDINGS AND BRIDGES"; "SPECIFICATIONS FOR THE DESIGN, FABRICATION AND ERECTION OF STRUCTURAL STEEL FOR BUILDINGS" (LATEST EDITION).
11. BOLTING:
 - A. BOLTS SHALL BE CONFORMING TO ASTM A325 HIGH STRENGTH, HOT DIP GALVANIZED WITH ASTM A153 HEAVY HEX TYPE NUTS.
 - B. BOLTS SHALL BE 3/4"Ø MINIMUM (UNLESS OTHERWISE NOTED)
 - C. ALL CONNECTIONS SHALL BE 2 BOLTS MINIMUM.
12. FABRICATION:
 - A. FABRICATION OF STEEL SHALL CONFORM TO THE AISC AND AWS STANDARDS AND CODES (LATEST EDITION).
 - B. ALL STRUCTURAL STEEL SHALL BE HOT-DIP GALVANIZED AFTER FABRICATION IN ACCORDANCE WITH ASTM A123 (LATEST EDITION), UNLESS OTHERWISE NOTED.
13. ERECTION OF STEEL:
 - A. PROVIDE ALL ERECTION EQUIPMENT, BRACING, PLANKING, FIELD BOLTS, NUTS, WASHERS, DRIFT PINS, AND SIMILAR MATERIALS WHICH DO NOT FORM A PART OF THE COMPLETED CONSTRUCTION BUT ARE NECESSARY FOR ITS PROPER ERECTION.
 - B. ERECT AND ANCHOR ALL STRUCTURAL STEEL IN ACCORDANCE WITH AISC REFERENCE STANDARDS. ALL WORK SHALL BE ACCURATELY SET TO ESTABLISHED LINES AND ELEVATIONS AND RIGIDLY FASTENED IN PLACE WITH SUITABLE ATTACHMENTS TO THE CONSTRUCTION OF THE BUILDING.
 - C. TEMPORARY BRACING, GUYING AND SUPPORT SHALL BE PROVIDED TO KEEP THE STRUCTURE SAFE AND ALIGNED AT ALL TIMES DURING CONSTRUCTION, AND TO PREVENT DANGER TO PERSONS AND PROPERTY. CHECK ALL TEMPORARY LOADS AND STAY WITHIN SAFE CAPACITY OF ALL BUILDING COMPONENTS.

14. ANTENNA INSTALLATION:
 - A. INSTALL ANTENNAS AS INDICATED ON DRAWINGS AND CLIENT'S REPRESENTATIVE SPECIFICATIONS.
 - B. INSTALL GALVANIZED STEEL ANTENNA MOUNTS AS INDICATED ON DRAWINGS.
 - C. INSTALL COAXIAL / FIBER CABLES AND TERMINATIONS BETWEEN ANTENNAS AND EQUIPMENT PER MANUFACTURER'S RECOMMENDATIONS. WEATHERPROOF ALL CONNECTORS BETWEEN THE ANTENNA AND EQUIPMENT PER MANUFACTURER'S REQUIREMENTS.
15. ANTENNA AND COAXIAL / FIBER CABLE GROUNDING:
 - A. ALL EXTERIOR #6 GREEN GROUND WIRE "DAISY CHAIN" CONNECTIONS ARE TO BE WEATHER SEALED WITH ANDREWS CONNECTOR/SPLICE WEATHERPROOFING KIT TYPE #221213 OR EQUAL.
 - B. ALL COAXIAL / FIBER CABLE GROUNDING KITS ARE TO BE INSTALLED ON STRAIGHT RUNS OF COAXIAL / FIBER CABLE (NOT WITHIN BENDS).
16. RELATED WORK, FURNISH THE FOLLOWING WORK AS SPECIFIED UNDER CONSTRUCTION DOCUMENTS, BUT COORDINATE WITH OTHER TRADES PRIOR TO BID:
 - A. FLASHING OF OPENING INTO OUTSIDE WALLS
 - B. SEALING AND CAULKING ALL OPENINGS
 - C. PAINTING
 - D. CUTTING AND PATCHING
17. REQUIREMENTS OF REGULATORY AGENCIES:
 - A. FURNISH U.L. LISTED EQUIPMENT WHERE SUCH LABEL IS AVAILABLE. INSTALL IN CONFORMANCE WITH U.L. STANDARDS WHERE APPLICABLE.
 - B. INSTALL ANTENNA, ANTENNA CABLES, GROUNDING SYSTEM IN ACCORDANCE WITH DRAWINGS AND SPECIFICATION IN EFFECT AT PROJECT LOCATION AND RECOMMENDATIONS OF STATE AND LOCAL BUILDING CODES, AND SPECIAL CODES HAVING JURISDICTION OVER SPECIFIC PORTIONS OF WORK. THIS WORK INCLUDES BUT IS NOT LIMITED TO THE FOLLOWING:
 - C. TIA-EIA - 222 (LATEST EDITION). STRUCTURAL STANDARDS FOR STEEL ANTENNA TOWERS AND ANTENNA SUPPORTING STRUCTURES.
 - D. FAA - FEDERAL AVIATION ADMINISTRATION ADVISORY CIRCULAR AC 70/7460-IH, OBSTRUCTION MARKING AND LIGHTING.
 - E. FCC - FEDERAL COMMUNICATIONS COMMISSION RULES AND REGULATIONS FORM 715, OBSTRUCTION MARKING AND LIGHTING SPECIFICATION FOR ANTENNA STRUCTURES AND FORM 715A, HIGH INTENSITY OBSTRUCTION LIGHTING SPECIFICATIONS FOR ANTENNA STRUCTURES.
 - F. AISC - AMERICAN INSTITUTE OF STEEL CONSTRUCTION SPECIFICATION FOR STRUCTURAL JOINTS USING ASTM A325 BOLTS (LATEST EDITION).
 - G. NEC - NATIONAL ELECTRICAL CODE - ON TOWER LIGHTING KITS.
 - H. UL - UNDERWRITER'S LABORATORIES APPROVED ELECTRICAL PRODUCTS.
 - I. IN ALL CASES, PART 77 OF THE FAA RULES AND PARTS 17 AND 22 OF THE FCC RULES ARE APPLICABLE AND IN THE EVENT OF CONFLICT, SUPERSEDE ANY OTHER STANDARDS OR SPECIFICATIONS.
 - J. 2009 LIFE SAFETY CODE NFPA - 101.

APPLICANT:

T-MOBILE NORTHEAST LLC
 35 GRIFFIN ROAD SOUTH
 BLOOMFIELD, CT 06002
 860-692-7100

PROJECT MANAGER

NSS NORTHEAST
Turnkey Wireless Development
 420 MAIN STREET, BLDG 4
 STURBRIDGE, MA 01566
 203-275-6669

CONSULTANT:

Architects . Engineers . Surveyors
 462 WALNUT STREET
 NEWTON, MA 02460
 617-212-3123

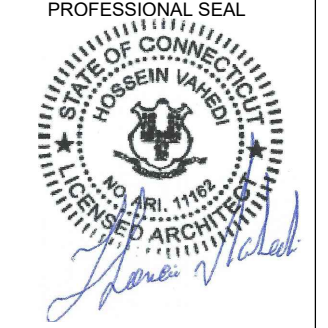
PROFESSIONAL SEAL



THIS DOCUMENT IS THE DESIGN PROPERTY AND COPYRIGHT OF FORESITE, LLC. AND FOR THE EXCLUSIVE USE BY THE TITLE CLIENT. DUPLICATION OR USE WITHOUT THE EXPRESS WRITTEN CONSENT OF THE CREATOR IS STRICTLY PROHIBITED. DRAWING SCALES ARE INTENDED FOR 11"x17" SIZE PRINTED MEDIA ONLY. ALL OTHER PRINTED SIZES ARE DEEMED "NOT TO SCALE".

REV	DESCRIPTION	DATE
A	PRELIMINARY	07/20/18
B	REVISED CABLE COUNT	07/27/18
C	REVISED PER NEW RFDS	08/07/18
0	SIGNED AND SEALED	08/14/18
1	REVISED STRUCTURAL REF.	11/06/18

SITE NUMBER: CTHA014A
 SITE NAME: HA014/T OF WETHERSFIELD_MP
 SITE ADDRESS: 23 KELLEHER COURT
 WETHERSFIELD, CT 06109

SHEET TITLE:
N-1: NOTES AND DISCLAIMERS

Copyright © 2018 Foresite LLC all rights reserved. The details, templates, drawing formats or any portion of this document generated by Foresite LLC may not be duplicated, traced or used otherwise for any profit-driven enterprise.

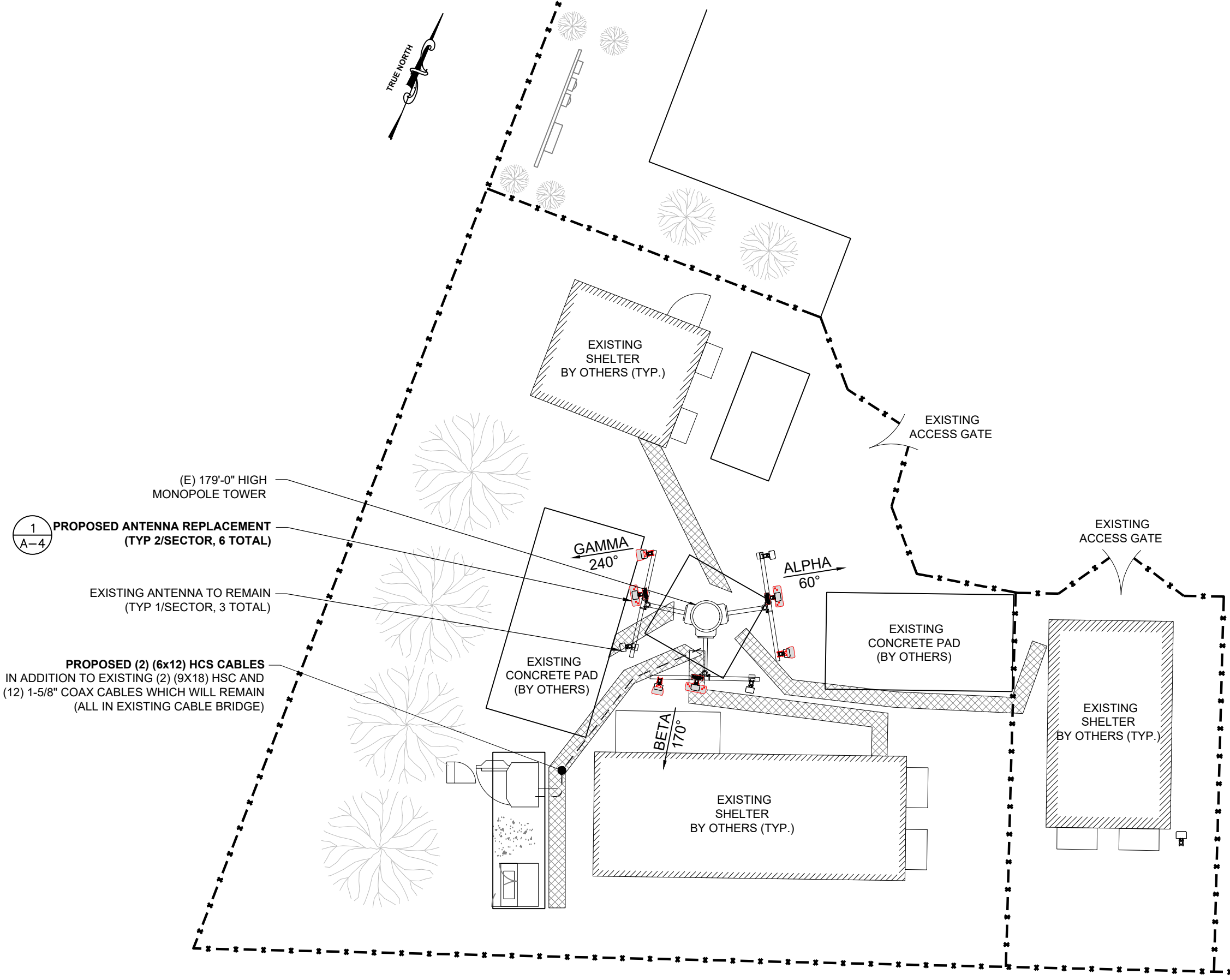

1
A-4

PROPOSED ANTENNA REPLACEMENT
(TYP 2/SECTOR, 6 TOTAL)

EXISTING ANTENNA TO REMAIN
(TYP 1/SECTOR, 3 TOTAL)

PROPOSED (2) (6x12) HCS CABLES
IN ADDITION TO EXISTING (2) (9X18) HSC AND
(12) 1-5/8" COAX CABLES WHICH WILL REMAIN
(ALL IN EXISTING CABLE BRIDGE)

SITE PLAN
SCALE: 1" = 10'-0"

1
A-1

APPLICANT:
T-Mobile
T-MOBILE NORTHEAST LLC
35 GRIFFIN ROAD SOUTH
BLOOMFIELD, CT 06002
860-692-7100

PROJECT MANAGER
NSS NORTHEAST
SITE SOLUTIONS
Turnkey Wireless Development
420 MAIN STREET, BLDG 4
STURBRIDGE, MA 01566
203-275-6669

CONSULTANT:
FORESITE LLC
Architects . Engineers . Surveyors
462 WALNUT STREET
NEWTON, MA 02460
617-212-3123

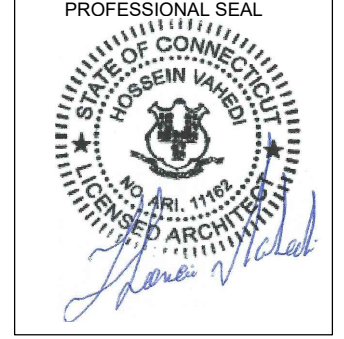

THIS DOCUMENT IS THE DESIGN PROPERTY AND COPYRIGHT OF FORESITE, LLC. AND FOR THE EXCLUSIVE USE BY THE TITLE CLIENT. DUPLICATION OR USE WITHOUT THE EXPRESS WRITTEN CONSENT OF THE CREATOR IS STRICTLY PROHIBITED. DRAWING SCALES ARE INTENDED FOR 11"x17" SIZE PRINTED MEDIA ONLY. ALL OTHER PRINTED SIZES ARE DEEMED "NOT TO SCALE".

REV	DESCRIPTION	DATE
A	PRELIMINARY	07/20/18
B	REVISED CABLE COUNT	07/27/18
C	REVISED PER NEW RFDS	08/07/18
0	SIGNED AND SEALED	08/14/18
1	REVISED STRUCTURAL REF.	11/06/18

SITE NUMBER: CTHA014A
SITE NAME: HA014/T OF WETHERSFIELD_MP
SITE ADDRESS: 23 KELLEHER COURT
WETHERSFIELD, CT 06109

SHEET TITLE:
A-1: PLAN

Copyright © 2018 Foresite LLC all rights reserved. The details, templates, drawing formats or any portion of this document generated by Foresite LLC may not be duplicated, traced or used otherwise for any profit-driven enterprise.

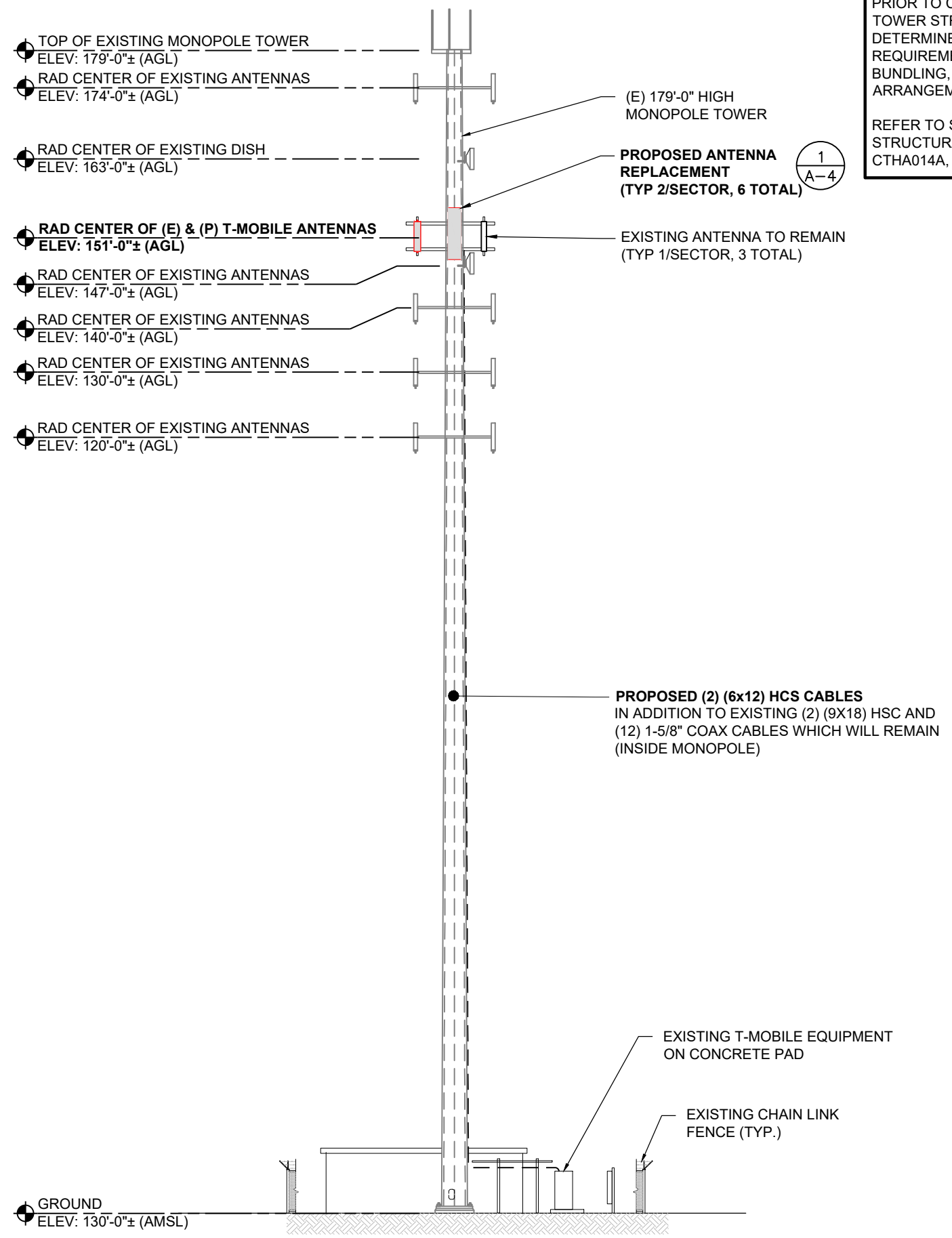

STRUCTURAL NOTES:
 PRIOR TO COMMENCING CONSTRUCTION, GC SHALL REFER TO TOWER STRUCTURAL ANALYSIS PROVIDED BY DESTEK TO DETERMINE IF THERE ARE ANY SUPPLEMENTAL OR SPECIAL REQUIREMENTS FOR TOWER TOP EQUIPMENT AND FOR CABLE BUNDLING, SHIELDING, MOUNTING OR RELOCATION ARRANGEMENTS.

REFER TO STRUCTURAL ANALYSIS REPORT TITLED "STRUCTURAL ANALYSIS REPORT-REV. 1 - MONOPOLE " SITE ID: CTHA014A, DATED NOVEMBER 5, 2018, PREPARED BY DESTEK.

APPLICANT:
T-Mobile
T-MOBILE NORTHEAST LLC
 35 GRIFFIN ROAD SOUTH
 BLOOMFIELD, CT 06002
 860-692-7100

PROJECT MANAGER
NSS NORTHEAST
 SITE SOLUTIONS
Turnkey Wireless Development
 420 MAIN STREET, BLDG 4
 STURBRIDGE, MA 01566
 203-275-6669

CONSULTANT:
FORESITE LLC
 Architects . Engineers . Surveyors
 462 WALNUT STREET
 NEWTON, MA 02460
 617-212-3123

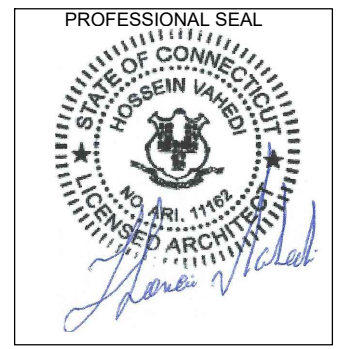

THIS DOCUMENT IS THE DESIGN PROPERTY AND COPYRIGHT OF FORESITE, LLC. AND FOR THE EXCLUSIVE USE BY THE TITLE CLIENT. DUPLICATION OR USE WITHOUT THE EXPRESS WRITTEN CONSENT OF THE CREATOR IS STRICTLY PROHIBITED. DRAWING SCALES ARE INTENDED FOR 11"x17" SIZE PRINTED MEDIA ONLY. ALL OTHER PRINTED SIZES ARE DEEMED "NOT TO SCALE".

REV	DESCRIPTION	DATE
A	PRELIMINARY	07/20/18
B	REVISED CABLE COUNT	07/27/18
C	REVISED PER NEW RFDS	08/07/18
0	SIGNED AND SEALED	08/14/18
1	REVISED STRUCTURAL REF.	11/06/18

SITE NUMBER: CTHA014A
 SITE NAME: HA014/T OF WETHERSFIELD_MP
 SITE ADDRESS: 23 KELLEHER COURT
 WETHERSFIELD, CT 06109

SHEET TITLE:
 A-2: ELEVATION

Copyright © 2018 Foresite LLC all rights reserved. The details, templates, drawing formats or any portion of this document generated by Foresite LLC may not be duplicated, traced or used otherwise for any profit-driven enterprise.

STRUCTURAL NOTES:
 PRIOR TO COMMENCING CONSTRUCTION, GC SHALL REFER TO TOWER STRUCTURAL ANALYSIS PROVIDED BY DESTEK TO DETERMINE IF THERE ARE ANY SUPPLEMENTAL OR SPECIAL REQUIREMENTS FOR TOWER TOP EQUIPMENT AND FOR CABLE BUNDLING, SHIELDING, MOUNTING OR RELOCATION ARRANGEMENTS.

REFER TO STRUCTURAL ANALYSIS REPORT TITLED "STRUCTURAL ANALYSIS REPORT-REV. 1 - MONOPOLE" SITE ID: CTHA014A, DATED NOVEMBER 5, 2018, PREPARED BY DESTEK.

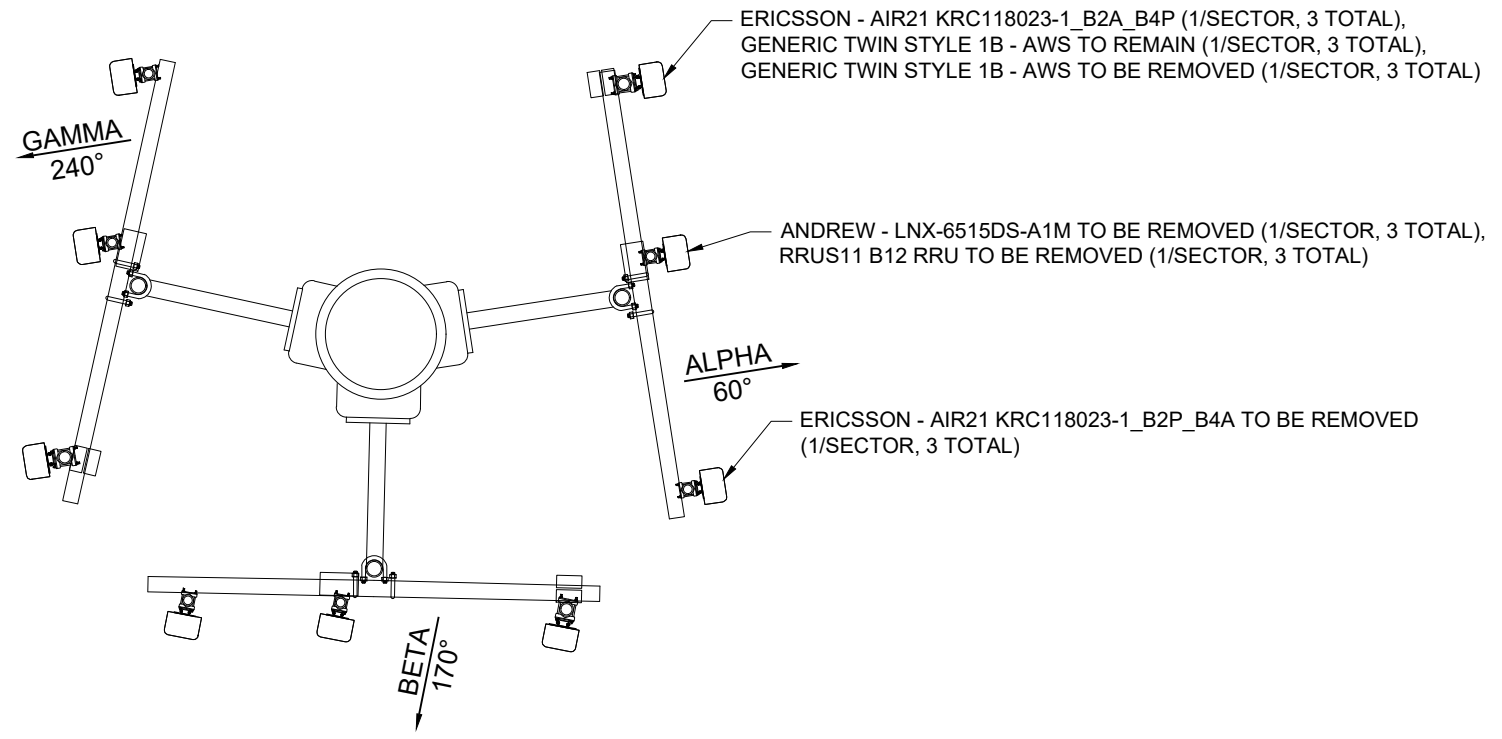

EXISTING ANTENNA PLAN

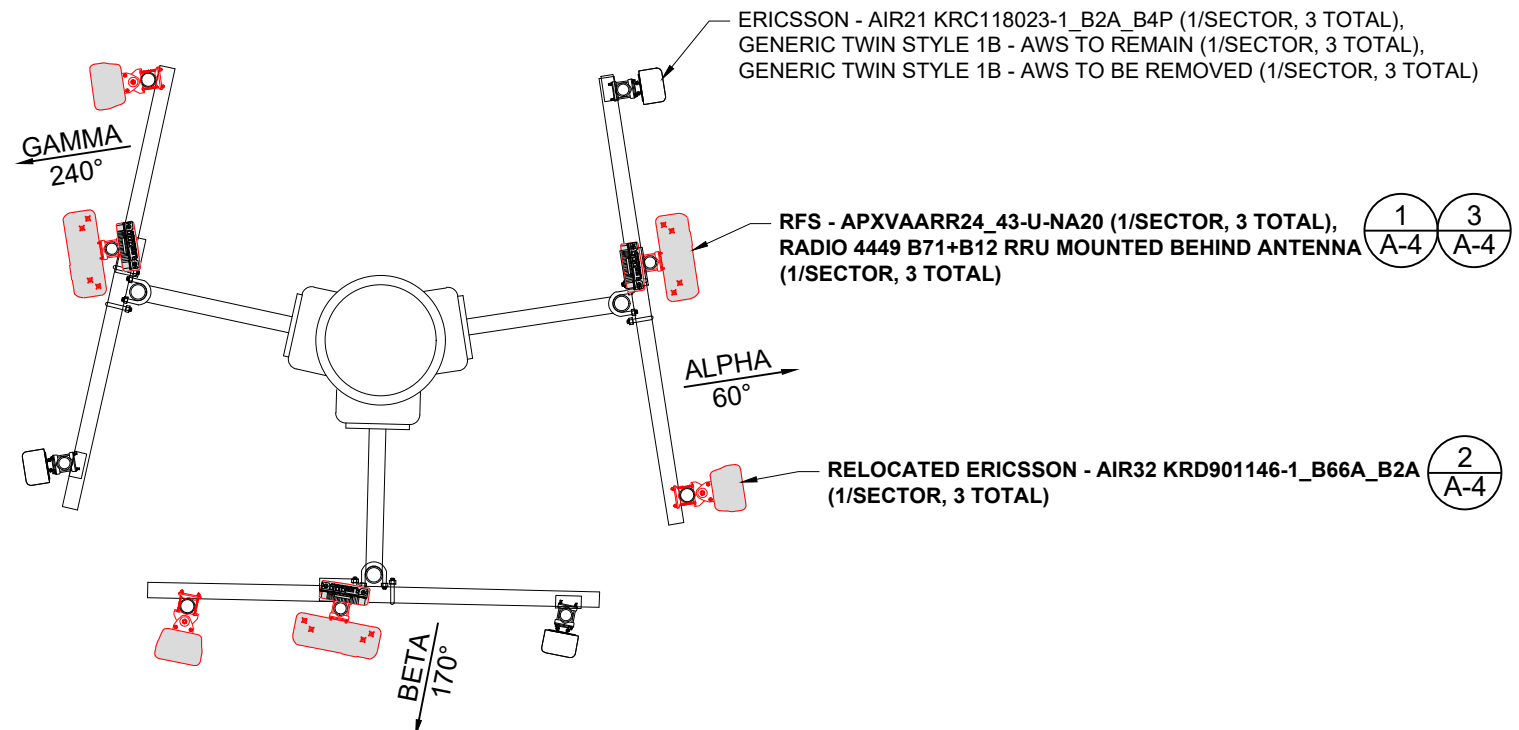

FINAL ANTENNA PLAN

ANTENNA PLAN
 SCALE: NTS

1
A-3

APPLICANT:
T-Mobile
T-MOBILE NORTHEAST LLC
 35 GRIFFIN ROAD SOUTH
 BLOOMFIELD, CT 06002
 860-692-7100

PROJECT MANAGER
NSS NORTHEAST
 SITE SOLUTIONS
Turnkey Wireless Development
 420 MAIN STREET, BLDG 4
 STURBRIDGE, MA 01566
 203-275-6669

CONSULTANT:
FORESITE LLC
 Architects . Engineers . Surveyors
 462 WALNUT STREET
 NEWTON, MA 02460
 617-212-3123

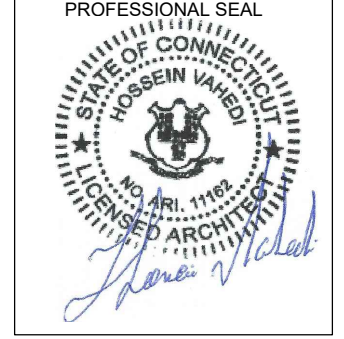

THIS DOCUMENT IS THE DESIGN PROPERTY AND COPYRIGHT OF FORESITE, LLC. AND FOR THE EXCLUSIVE USE BY THE TITLE CLIENT. DUPLICATION OR USE WITHOUT THE EXPRESS WRITTEN CONSENT OF THE CREATOR IS STRICTLY PROHIBITED. DRAWING SCALES ARE INTENDED FOR 11"x17" SIZE PRINTED MEDIA ONLY. ALL OTHER PRINTED SIZES ARE DEEMED "NOT TO SCALE".

REV	DESCRIPTION	DATE
A	PRELIMINARY	07/20/18
B	REVISED CABLE COUNT	07/27/18
C	REVISED PER NEW RFDS	08/07/18
0	SIGNED AND SEALED	08/14/18
1	REVISED STRUCTURAL REF.	11/06/18

SITE NUMBER: CTHA014A
 SITE NAME: HA014/T OF WETHERSFIELD_MP
 SITE ADDRESS: 23 KELLEHER COURT
 WETHERSFIELD, CT 06109

SHEET TITLE:
 A-3: ANTENNA PLAN AND DETAILS

Copyright © 2018 Foresite LLC all rights reserved. The details, templates, drawing formats or any portion of this document generated by Foresite LLC may not be duplicated, traced or used otherwise for any profit-driven enterprise.

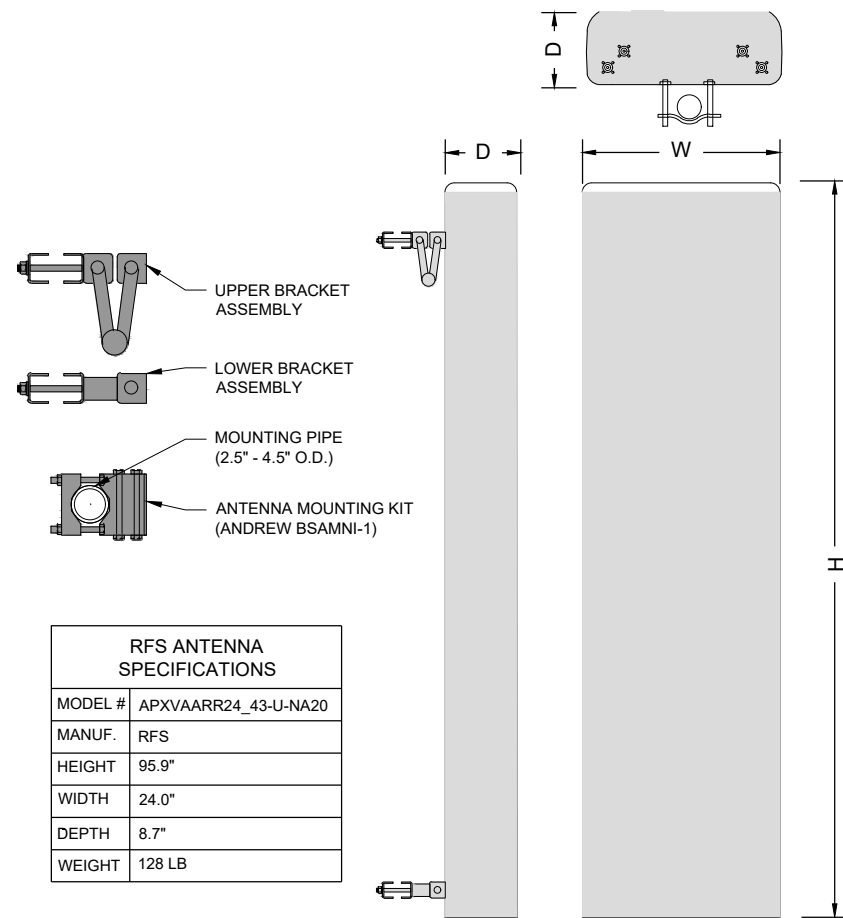

RFS ANTENNA SPECIFICATIONS	
MODEL #	APXVAARR24_43-U-NA20
MANUF.	RFS
HEIGHT	95.9"
WIDTH	24.0"
DEPTH	8.7"
WEIGHT	128 LB

RFS ANTENNA
N.T.S

1
A-4

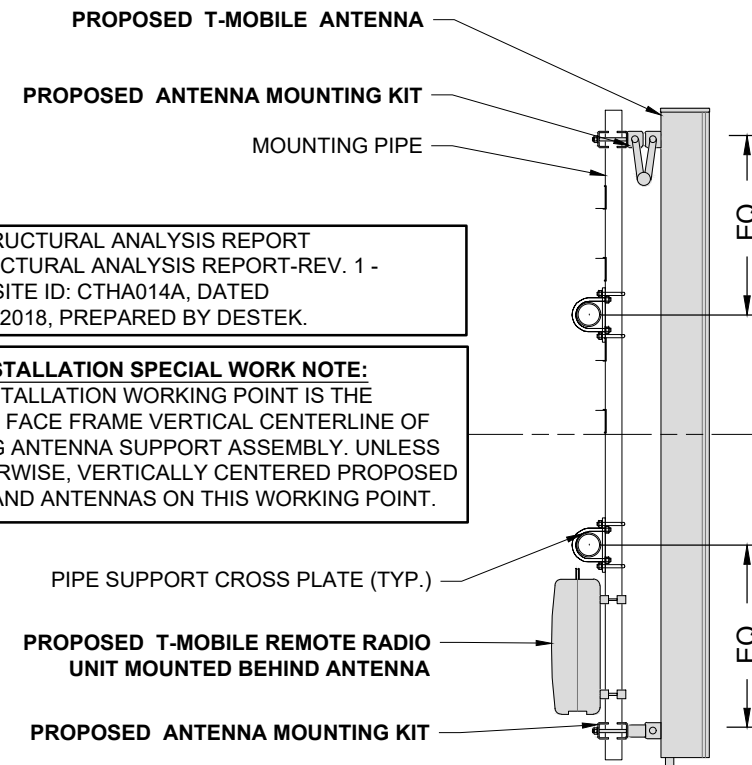

REFER TO STRUCTURAL ANALYSIS REPORT TITLED " STRUCTURAL ANALYSIS REPORT-REV. 1 - MONOPOLE " SITE ID: CTHA014A, DATED NOVEMBER 5, 2018, PREPARED BY DESTEK.

ANTENNA INSTALLATION SPECIAL WORK NOTE:
ANTENNA INSTALLATION WORKING POINT IS THE STRUCTURAL FACE FRAME VERTICAL CENTERLINE OF THE EXISTING ANTENNA SUPPORT ASSEMBLY. UNLESS NOTED OTHERWISE, VERTICALLY CENTERED PROPOSED PIPE MASTS AND ANTENNAS ON THIS WORKING POINT.

ANTENNA MOUNTING DETAIL
N.T.S

4
A-4

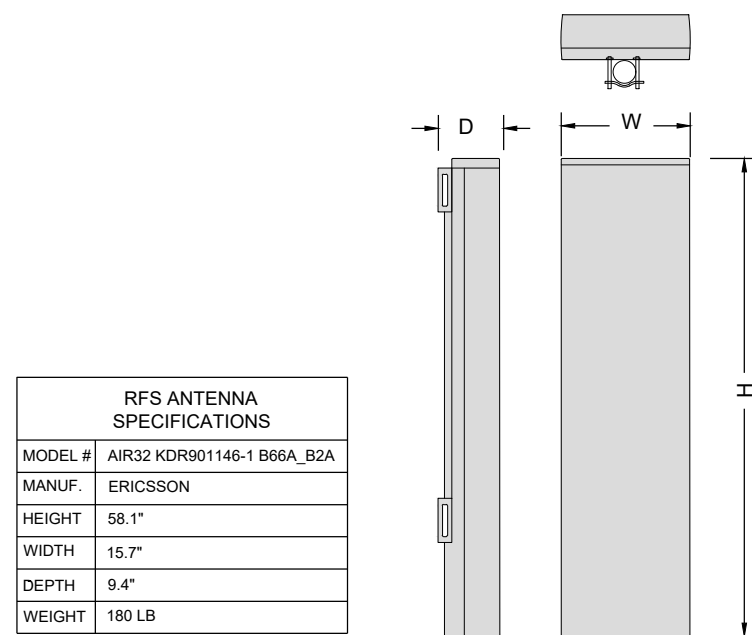

RFS ANTENNA SPECIFICATIONS	
MODEL #	AIR32 KDR901146-1 B66A_B2A
MANUF.	ERICSSON
HEIGHT	58.1"
WIDTH	15.7"
DEPTH	9.4"
WEIGHT	180 LB

ERICSSON ANTENNA
N.T.S

2
A-4

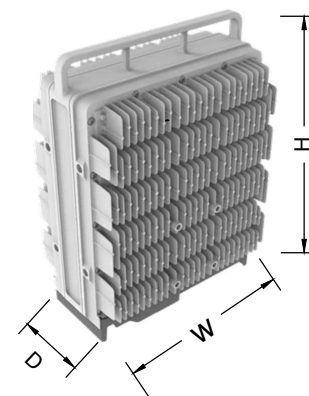

REMOTE RADIO UNIT SPECIFICATIONS	
MODEL #	RADIO 4449 B71+B12
MANUF.	ERICSSON
HEIGHT	14.9"
WIDTH	13.2"
DEPTH	10.4"
WEIGHT	74 LB

RADIO 4449 B71+B12 REMOTE RADIO UNIT
N.T.S

3
A-4

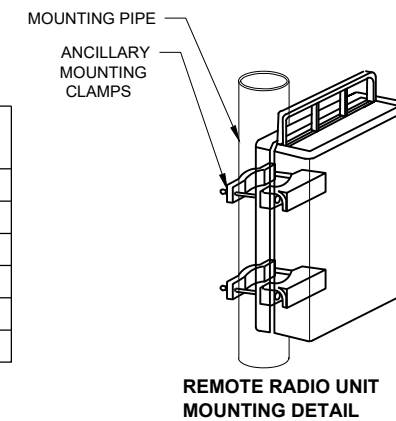

REMOTE RADIO UNIT MOUNTING DETAIL

APPLICANT:
T-Mobile
T-MOBILE NORTHEAST LLC

35 GRIFFIN ROAD SOUTH
BLOOMFIELD, CT 06002
860-692-7100

PROJECT MANAGER
NSS NORTHEAST
SITE SOLUTIONS
Turnkey Wireless Development
420 MAIN STREET, BLDG 4
STURBRIDGE, MA 01566
203-275-6669

CONSULTANT:
FORESITE LLC
Architects . Engineers . Surveyors
462 WALNUT STREET
NEWTON, MA 02460
617-212-3123

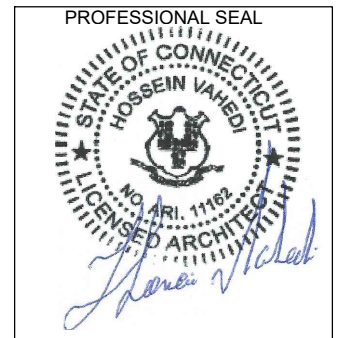

THIS DOCUMENT IS THE DESIGN PROPERTY AND COPYRIGHT OF FORESITE, LLC. AND FOR THE EXCLUSIVE USE BY THE TITLE CLIENT. DUPLICATION OR USE WITHOUT THE EXPRESS WRITTEN CONSENT OF THE CREATOR IS STRICTLY PROHIBITED. DRAWING SCALES ARE INTENDED FOR 11"x17" SIZE PRINTED MEDIA ONLY. ALL OTHER PRINTED SIZES ARE DEEMED "NOT TO SCALE".

REV	DESCRIPTION	DATE
A	PRELIMINARY	07/20/18
B	REVISED CABLE COUNT	07/27/18
C	REVISED PER NEW RFDS	08/07/18
0	SIGNED AND SEALED	08/14/18
1	REVISED STRUCTURAL REF.	11/06/18

SITE NUMBER: CTHA014A
SITE NAME: HA014/T OF WETHERSFIELD_MP
SITE ADDRESS: 23 KELLEHER COURT
WETHERSFIELD, CT 06109

SHEET TITLE:
A-4: ANTENNA DETAILS

Copyright © 2018 Foresite LLC all rights reserved. The details, templates, drawing formats or any portion of this document generated by Foresite LLC may not be duplicated, traced or used otherwise for any profit-driven enterprise.

ELECTRICAL & GROUNDING NOTES

1. ALL ELECTRICAL WORK SHALL CONFORM TO THE REQUIREMENTS OF THE NATIONAL ELECTRICAL CODE (NEC) AS WELL AS APPLICABLE STATE AND LOCAL CODES.
2. ALL ELECTRICAL ITEMS SHALL BE U.L. APPROVED OR LISTED AND PRODUCED PER SPECIFICATION REQUIREMENTS.
3. THE ELECTRICAL WORK INCLUDES ALL LABOR AND MATERIAL DESCRIBED BY DRAWINGS AND SPECIFICATION INCLUDING INCIDENTAL WORK TO PROVIDE COMPLETE OPERATING AND APPROVED ELECTRICAL SYSTEM.
4. GENERAL CONTRACTOR SHALL PAY FEES FOR PERMITS, AND RESPONSIBLE FOR OBTAINING SAID PERMITS AND COORDINATION OF INSPECTIONS.
5. ELECTRICAL AND TELCO WIRING OUTSIDE A BUILDING AND EXPOSED TO WEATHER SHALL BE IN WATER TIGHT GALVANIZED RIGID STEEL CONDUITS OR SCHEDULE 80 PVC (AS PERMITTED BY CODE) AND WHERE REQUIRED IN LIQUID TIGHT FLEXIBLE METAL OR NONMETALLIC CONDUITS.
6. RIGID STEEL CONDUITS SHALL BE GROUNDED AT BOTH ENDS.
7. ELECTRICAL WIRING SHALL BE COPPER WITH TYPE XHHW, THWN, OR THIN INSULATION.
8. RUN ELECTRICAL CONDUIT OR CABLING BETWEEN ELECTRICAL ROOM AND PROPOSED CELL SITE ARE PEDESTAL AS INDICATED ON THIS DRAWING. PROVIDE FULL LENGTH PULL ROPE. COORDINATE INSTALLATION WITH UTILITY COMPANY.
9. RUN TELCO CONDUIT OR CABLE BETWEEN TELEPHONE UTILITY DEMARCATION POINT AND PROPOSED CELL SITE TELECOM CABINET AND RBS CABINET AS INDICATED ON DRAWING A -1. PROVIDE FULL LENGTH PULL ROPE INSTALLED TELCO CONDUIT. PROVIDE GREENLEE CONDUIT MEASURING TAPE AT EACH END.
10. ALL EQUIPMENT LOCATED OUTSIDE SHALL HAVE NAME 3R ENCLOSURE.
11. GROUNDING SHALL COMPLY WITH NEC ART. 250.
12. GROUNDING COAX CABLE SHIELDS MINIMUM AT BOTH ENDS USING MANUFACTURES COAX CABLE GROUNDING KITS SUPPLIED BY PROJECT OWNER.
13. USE #6 COPPER STRANDED WIRE WITH GREEN COLOR INSTALLATION FOR ABOVE GRADE GROUNDING (UNLESS OTHERWISE SPECIFIED) AND #2 SOLID TINNED BARE COPPER WIRE FOR BELOW GRADE GROUNDING AS INDICATED ON THE GROUND.
14. ALL GROUND CONNECTION TO BE BURNDY HYGROUND COMPRESSION TYPE CONNECTORS OR CADWELD EXOTHERMIC WELD. DO NOT ALLOW BARE COPPER WIRE TO BE IN CONTACT WITH GALVANIZED STEEL.
15. ROUTE GROUNDING CONDUCTORS ALONG THE SHORTEST AND STRAIGHTEST PATH POSSIBLE, EXCEPT AS OTHERWISE INDICATED. GROUNDING LEADS SHOULD NEVER BE BENT AS RIGHT ANGLE. ALWAYS MAKE AT LEAST 12" RADIUS BENDS. #6 WIRE CAN BE BENT AT 6" RADIUS WHEN NECESSARY BOND ANY METER OBJECTS WITHIN 7 FEET OF PROPOSED EQUIPMENT OR CABINET TO MASTER GROUND BAR.
16. CONNECTIONS TO MGB SHALL BE ARRANGED IN THREE MAIN GROUPS: SURGE PROCEDURES (COAXIAL CABLE GROUND KITS, TELCO AND POWER PANEL GROUND); (GROUNDING ELECTRODE RING OR BUILDING STEEL); NON-SURGING OBJECTS (EGB GROUND IN RBS UNIT).
17. CONNECTIONS TO GROUND BARS SHALL BE MADE WITH TWO HOLE COMPRESSION TYPE COPPER LUGS. APPLY OXIDE INHIBITING COMPOUND TO ALL LOCATIONS.
18. APPLY OXIDE INHIBITING COMPOUND TO ALL COMPRESSION TYPE GROUND CONNECTION.
19. BOND ANTENNA MOUNTING BRACKETS, COAXIAL CABLE GROUND KITS, AND ALNA TO EGB PLACED NEAR THE ANTENNA LOCATION.
20. BOND ANTENNA EGB'S AND MGB TO WATER MAIN.
21. TEST COMPLETED GROUND SYSTEM AND RECORD RESULTS FOR PROJECT CLOSE-OUT DOCUMENTATION.
22. BOND ANY METAL OBJECTS WITHIN 7 FEET OF PROPOSED EQUIPMENT OR CABINET TO MASTER GROUND BAR.
23. VERIFY PROPOSED SERVICE UPGRADE WITH LOCAL UTILITY COMPANY PRIOR TO CONSTRUCTION.

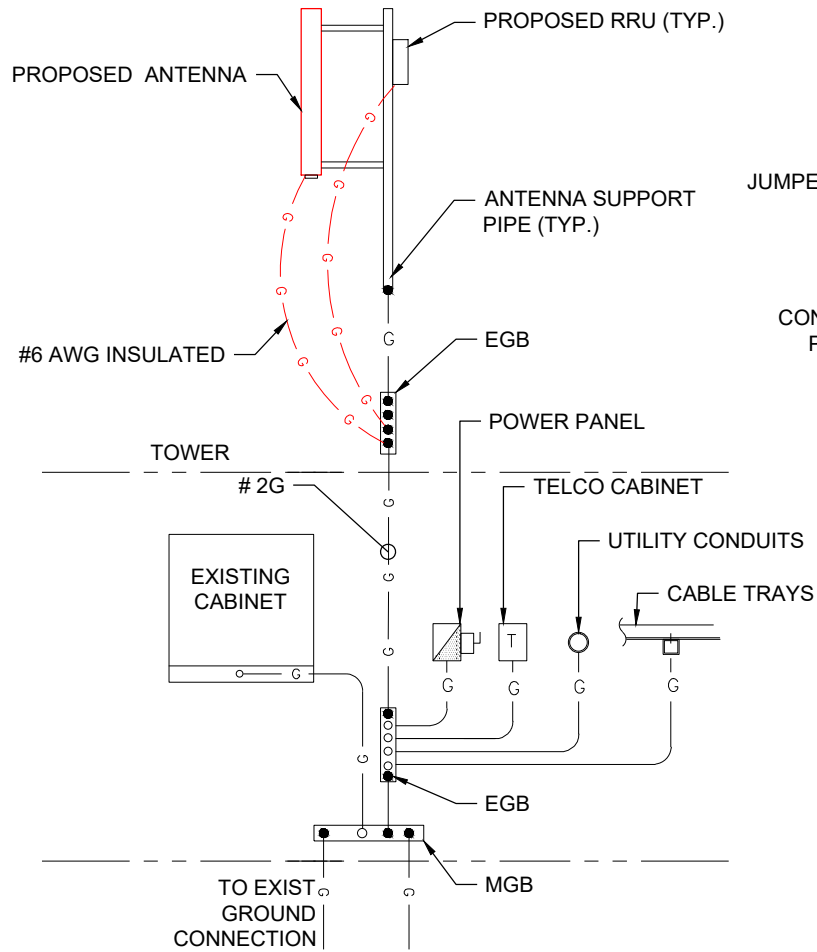

GROUNDING RISER DIAGRAM 1
SCALE: N.T.S. E-1

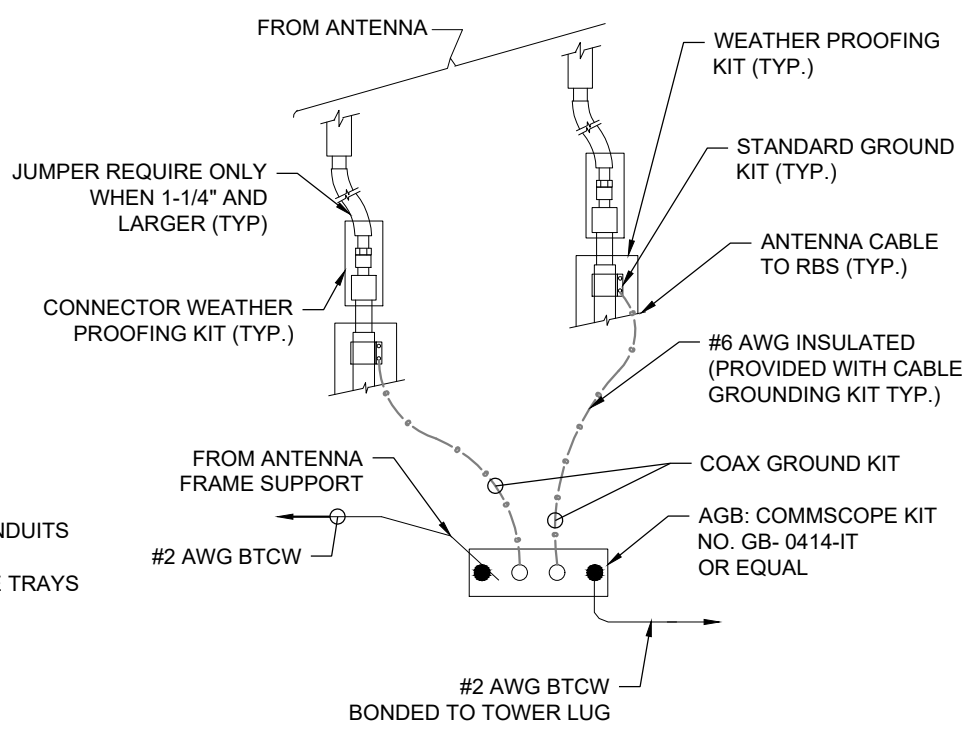

NOTES:
INSTALL CABLE GROUND KIT ABOVE HORIZONTAL BEND AND ALWAYS DIRECT GROUND WIRE DOWN TO AGB/EGB

TOWER TOP CABLE GROUNDING DETAIL 2
SCALE: N.T.S. E-1

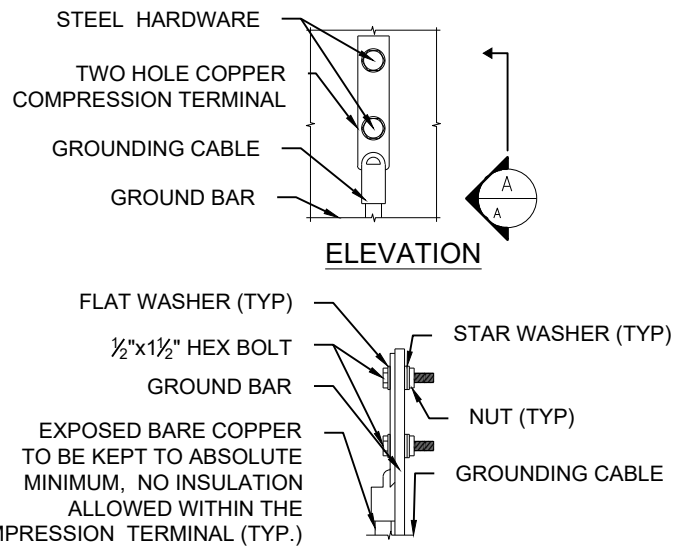

NOTES:
1. "DOUBLING UP" OR "STACKING " OF CONNECTIONS IS NOT PERMITTED.
2. OXIDE INHIBITING COMPOUND TO BE USED AT ALL LOCATIONS.

TYPICAL GROUND BAR CONNECTIONS DETAIL 3
SCALE: N.T.S. E-1

APPLICANT:
T-Mobile
T-MOBILE NORTHEAST LLC
35 GRIFFIN ROAD SOUTH
BLOOMFIELD, CT 06002
860-692-7100

PROJECT MANAGER
NSS NORTHEAST
SITE SOLUTIONS
Turnkey Wireless Development
420 MAIN STREET, BLDG 4
STURBRIDGE, MA 01566
203-275-6669

CONSULTANT:
FORESITE LLC
Architects . Engineers . Surveyors
462 WALNUT STREET
NEWTON, MA 02460
617-212-3123

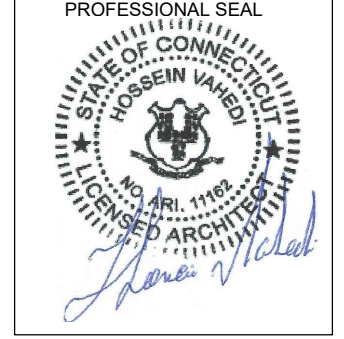

THIS DOCUMENT IS THE DESIGN PROPERTY AND COPYRIGHT OF FORESITE, LLC. AND FOR THE EXCLUSIVE USE BY THE TITLE CLIENT. DUPLICATION OR USE WITHOUT THE EXPRESS WRITTEN CONSENT OF THE CREATOR IS STRICTLY PROHIBITED. DRAWING SCALES ARE INTENDED FOR 11"x17" SIZE PRINTED MEDIA ONLY. ALL OTHER PRINTED SIZES ARE DEEMED "NOT TO SCALE".

REV	DESCRIPTION	DATE
A	PRELIMINARY	07/20/18
B	REVISED CABLE COUNT	07/27/18
C	REVISED PER NEW RFDS	08/07/18
0	SIGNED AND SEALED	08/14/18
1	REVISED STRUCTURAL REF.	11/06/18

SITE NUMBER: CTHA014A
SITE NAME: HA014/T OF WETHERSFIELD_MP
SITE ADDRESS: 23 KELLEHER COURT
WETHERSFIELD, CT 06109

SHEET TITLE:
E-1: GROUNDING AND ELECTRICAL DETAILS

Exhibit D

**STRUCTURAL ANALYSIS REPORT - REV. 1
MONOPOLE**



Prepared For:



**T-Mobile Northeast, LLC
35 Griffin Road South
Bloomfield, CT 06002**



Structure Rating

Monopole:	Pass (76.4%)
Anchor Rods:	Pass (81.4%)
Base Plate:	Pass (82.6%)
Foundation:	Pass (65.4%)

Sincerely,
Destek Engineering, LLC
License No: PEC0001429

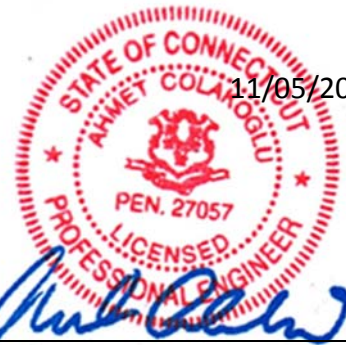

Ahmet Colakoglu, PE
Connecticut Professional Engineer
License No: 27057

**Site ID: CTHA014A
Site Name: HA014/TofWethersfield_MP
23 Kelleher Court
Wethersfield, CT 06109**

CONTENTS

1.0 – SUBJECT AND REFERENCES

1.1 – STRUCTURE

2.0 – EXISTING AND PROPOSED APPURTENANCES

3.0 - CODES AND LOADING

4.0 - STANDARD CONDITIONS FOR ENGINEERING SERVICES ON EXISTING
STRUCTURES

5.0 - ANALYSIS AND ASSUMPTIONS

6.0 – RESULTS AND CONCLUSION

APPENDIX

A – CALCULATIONS

1.0 SUBJECT AND REFERENCES

The purpose of this analysis is to evaluate the structural capacity of the existing 179 feet tall monopole tower, located at 23 Kelleher Court, Wethersfield, CT 06109 for the additions and alterations proposed by T-Mobile.

The structural analysis of the site is based on the following documents provided to Destek Engineering, LLC (Destek):

- Structural Analysis Report prepared by Destek Engineering, LLC, dated 11/29/2016.
- Construction Drawings prepared by Clough Harbour & Associates LLP, dated 08/01/2006.
- RFDS prepared by T-Mobile, dated 05/08/2018.
- Site Audit pictures, dated 04/23/2018.
- Monopole Feasibility Study prepared by Maser Consulting Connecticut, dated 03/02/2018.

1.1 STRUCTURE

The structure is a 179'-0" tall, (18) sided monopole, which is attached to the foundation with anchor bolts and a base plate. Please refer to the software output in Appendix A, for tower geometry, member sizes, and other details.

ELEVATION (FEET)	SECTION LENGTH (FEET)	LAP SPLICE (FT)	SHAFT THICKNESS (IN)	TOP DIAMETER (IN)	BOTTOM DIAMETER (IN)	YIELD STRENGTH (KSI)
179.00-141.25	37.75	4.33	0.250	23.100	33.249	65
141.25-92.58	53.00	5.92	0.375	31.585	45.834	65
92.58-45.50	53.00	7.50	0.375	43.492	57.742	65
45.50-0.0	53.00	-	0.375	54.976	69.225	65

*Does not include description of existing monopole modifications.

2.0 EXISTING AND PROPOSED APPURTENANCES

This analysis was based on the following existing and proposed appurtenances:

Existing Configuration of T-MOBILE Appurtenances:

RAD CENTER (FT)	ANTENNA & TMA	COAX	MOUNT
151	(3) AIR21 KRC118023-1_B2A_B4P (3) LNX-6515DS-A1M (3) AIR21 KRC118023-1_B2P_B4A (3) RRUS11_B12 (6) Generic Twin Style 1B-AWS TMA	(12) 1-5/8" + (2) 9x18 Hybrid Cables	(3) Sector Mounts

Proposed and Final Configuration of T-MOBILE Appurtenances:

RAD CENTER (FT)	ANTENNA & TMA	COAX	MOUNT
151	(3) APXVAARR24_43-U-NA20 (3) AIR32 KRD901146-1_B66A_B2A (3) AIR21 KRC118023-1_B2A_B4P (3) Radio 4449 B12/B71 (3) Generic Twin Style 1B-AWS TMA	(12) 1-5/8" + (2) 9x18 + (2) 6x12 Hybrid Cables	(3) Sector Mounts

Existing and Remaining Appurtenances by Others:

Rad. Center (ft)	Antenna & TMA	Mount	Feedlines
188	(1) 10' Omni	(1) Pipe Mount	(1) 1-1/4"
186	(2) 6' Omni	(2) Pipe Mounts	(2) 7/8"
185	(2) 4' Omni (1) 4' Dipole	(3) Pipe Mounts	(4) 1-5/8"
181	(1) Distribution Box	-	(2) 1/2"
174	(2) APXVSP18-C w/Mount Pipe (1) ET-X-TU-42-15 w/Mount Pipe (3) APXV9TM14 w/Mount Pipe (3) RRH 8X20-25	(3) Sector Mounts	(4) 1-1/4"
170	(3) RRH 800 (3) RRH 1900	(1) Ring Mount	-
159	(1) 2' Dish	(1) Pipe Mount	(1) 1/4"

Existing and Remaining Appurtenances by Others (Continued):

Rad. Center (ft)	Antenna & TMA	Mount	Feedlines
142	(3) Ericsson RRUS 11 (3) Ericsson RRUS 32 B2	(1) Ring Mount	
140	(3) 7770.00 w/Mount Pipe (2) SBNHH-1D65A w/Mount Pipe (2) HPA-65R-BUU-H8 w/Mount Pipe (2) TPA-65R-LCUUUU-H8 w/Mount Pipe (2) Kathrein 80010966 w/Mount Pipe (1) Kathrein 80010964 w/Mount Pipe (3) Ericsson RRUS 4478 B14 (3) Ericsson RRUS 32 B66 (3) Ericsson RRUS 32 (6) Powerwave LGP 21401 (3) Raycap DC6-48-60-0-8C	(3) Sector Mounts	(12) 1-5/8" (2) DC Cable (1) Fiber Cable
130	(3) BXA-171063-12CF w/Mount Pipe (3) BXA-70063-4CF w/Mount Pipe (3) BXA-70063-6CF w/Mount Pipe (3) MGD3-900 w/Mount Pipe (3) RRH2X40 AWS (1) RXXDC-3315-PF-48	(1) Platform Mount	(18) 1-5/8" (1) 1/4"
126	(1) 2' Dish	(1) Pipe Mount	(1) 1/4"

3.0 **CODES AND LOADING**

The tower was analyzed per *TIA/EIA-222-G* as referenced by the *2018 Connecticut State Building Code* with all of the adopted Addendums and Supplements. The following wind loading was used in compliance with the standard for Hartford, CT:

- Basic wind speed 97 mph without ice (W_0)
- Basic wind speed 50 mph with 1" escalating ice (W_i)
- Exposure Category C
- Topographic Category 1
- Structure Class II

The following load combinations were used with wind blowing at 0°, 30°, 45°, 60°, and 90° measured from a line normal to the face of the monopole tower.

- $1.2 D + 1.6 W_0$
- $0.9 D + 1.6 W_0$
- $1.2 D + 1.0 D_i + 1.0 W_i$

D: Dead Load of structure and appurtenances

W_0 : Wind Load, without ice

W_i : Wind Load, with ice

D_i : Weight of Ice

4.0 **STANDARD CONDITIONS FOR ENGINEERING SERVICES ON EXISTING STRUCTURES**

The analysis is based on the information provided to Destek and is assumed to be current and correct. Unless otherwise noted, the structure and the foundation system are assumed to be in good condition, free of defects and can achieve theoretical strength.

It is assumed that the structure has been maintained and shall be maintained during its service. The superstructure and the foundation system are assumed to be designed with proper engineering practice and fabricated, constructed and erected in accordance with the design documents. Destek will accept no liability which may arise due to any existing deficiency in design, material, fabrication, erection, construction, etc. or lack of maintenance.

The analysis results presented in this report are only applicable for the previously mentioned existing and proposed additions and alterations. Any deviation of the proposed equipment and placement, etc., will require Destek to generate an additional structural analysis.

5.0 ANALYSIS AND ASSUMPTIONS

The tower was analyzed by utilizing tnxTower, a non-linear, three-dimensional, finite element-analysis software package, a product of Tower Numerics, Inc. Software output for this analysis is provided in Appendix A of this report.

This analysis assumes that the modifications detailed in the Structural Modification Drawings prepared by Hudson Design Group, dated 08/23/2016, have been installed.

6.0 RESULTS AND CONCLUSION

The structural modifications detailed in the Structural Modification Drawings prepared by Hudson Design Group, dated 8/23/2016, have been incorporated into our analysis. After analyzing the upgraded structure, Destek has deemed the modifications to be **ineffective** due to the inadequate thickness of the reinforcement plates. The added wind area of the reinforcement has been considered in this analysis.

Based on a structural analysis per ANSI/TIA-222-G, the existing monopole tower **has adequate** structural capacity for the proposed changes by T-Mobile. For the aforementioned load combinations and as a maximum, the monopole shaft between the elevation 0' and 45.5' is stressed to **76.4%** of capacity. The anchor rods and base plate are stressed to **81.4%** and **82.6%** of capacity. The existing foundation is found to have **adequate** capacity to support the proposed installation by T-Mobile. As a maximum, the foundation is stressed to **65.4%** of its structural capacity.

Therefore, the proposed additions and alterations by T-Mobile **can** be implemented as intended with the conditions outlined in this report.

Should you have any questions about this report, please contact us at (770) 693-0835.

**APPENDIX A
CALCULATIONS**

Section	1	2	3	4
Length (ft)	37.75	53.00	53.00	53.00
Number of Sides	18	18	18	18
Thickness (in)	0.2500	0.3750	0.3750	0.3750
Socket Length (ft)	4.33	5.92	7.50	
Top Dia (in)	23.1000	31.5849	43.4924	54.9755
Bot Dia (in)	33.2490	45.8340	57.7420	69.2250
Grade			A572-65	
Weight (lb)	2846.3	8228.8	10784.9	13249.9

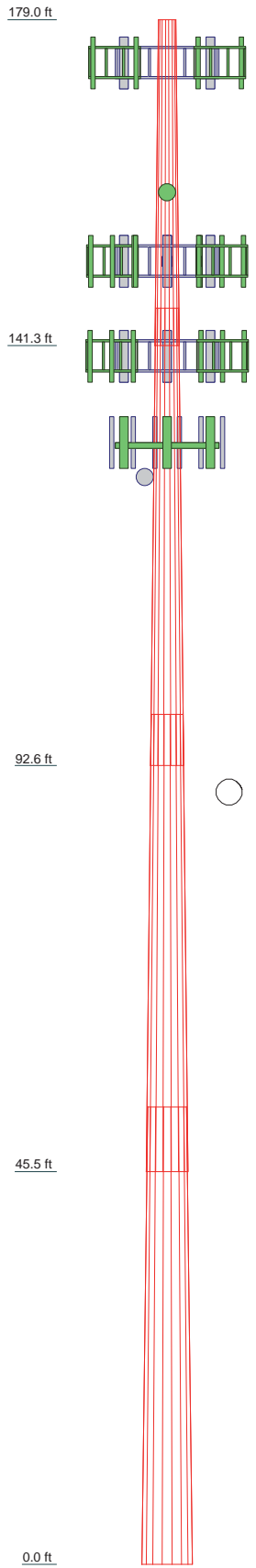

DESIGNED APPURTENANCE LOADING

TYPE	ELEVATION	TYPE	ELEVATION
(3) 6' x 2" Mount Pipe	181	RRUS 32 B2	142
(3) 6' x 2" Mount Pipe	181	RRUS 32 B2	142
(3) 6' x 2" Mount Pipe	181	RRUS 32 B2	142
Omni 4"x6'	181	RRUS-11	142
Omni 2"x6'	181	7770.00 w/ Mount Pipe	140
Distribution Box	181	7770.00 w/ Mount Pipe	140
Omni 3"x4'	181	TPA-65R-LCUUUU-H8 w/ Mount Pipe	140
Omni 3"x10'	181	TPA-65R-LCUUUU-H8 w/ Mount Pipe	140
Distribution Box	181	CCI HPA-65R-BUUU-H8 with pipe	140
Omni 3" x 4'	181	CCI HPA-65R-BUUU-H8 with pipe	140
4' Dipole	181	(2) SBNHH-1D65A w/ Mount Pipe	140
TA 702-3	181	RRUS 32	140
ET-X-TU-42-15-37-18-iR-ST w/ Mount Pipe	174	RRUS 32	140
APXVSPP18-C w/ Mount Pipe	174	RRUS 32	140
APXVSPP18-C w/ Mount Pipe	174	(2) LGP21401	140
APXV9TM14 w/ Mount Pipe	174	(2) LGP21401	140
APXV9TM14 w/ Mount Pipe	174	(2) LGP21401	140
APXV9TM14 w/ Mount Pipe	174	800 10966 w/mount pipe	140
APXV9TM14 w/ Mount Pipe	174	800 10966 w/mount pipe	140
TA 602-3	174	800 10964 w/ Mount Pipe	140
RRH8x20-25	174	RRUS 4478 B14	140
RRH8x20-25	174	RRUS 4478 B14	140
RRH8x20-25	174	RRUS 4478 B14	140
RRH800MHz	170	RRUS 32 B66	140
RRH800MHz	170	RRUS 32 B66	140
RRH800MHz	170	RRUS 32 B66	140
RRH1900MHz	170	DC6-48-60-0-8C	140
RRH1900MHz	170	DC6-48-60-0-8C	140
RRH1900MHz	170	DC6-48-60-0-8C	140
Ring Mount	170	TA 602-3	140
HP2-102	159	7770.00 w/ Mount Pipe	140
AIR 21 B4A/B2P w/ Mount Pipe	151	BXA-70080-4CF-EDIN w/ Mount Pipe	130
AIR 21 B4A/B2P w/ Mount Pipe	151	BXA-70080-6CF-EDIN w/ Mount Pipe	130
Gen TMA	151	Rymsa MGD3-900	130
Gen TMA	151	RRH2x40-AWS	130
Gen TMA	151	BXA-171063-12CF-EDIN w/ Mount Pipe	130
AIR -32 B2A/B66AA w/ Mount Pipe	151	BXA-70080-4CF-EDIN w/ Mount Pipe	130
AIR -32 B2A/B66AA w/ Mount Pipe	151	BXA-70080-6CF-EDIN w/ Mount Pipe	130
AIR -32 B2A/B66AA w/ Mount Pipe	151	BXA-70080-6CF-EDIN w/ Mount Pipe	130
APXVAARR24_43-U-NA20 w/ Mount Pipe	151	Rymsa MGD3-900	130
APXVAARR24_43-U-NA20 w/ Mount Pipe	151	RRH2x40-AWS	130
APXVAARR24_43-U-NA20 w/ Mount Pipe	151	BXA-171063-12CF-EDIN w/ Mount Pipe	130
APXVAARR24_43-U-NA20 w/ Mount Pipe	151	BXA-70080-4CF-EDIN w/ Mount Pipe	130
RADIO 4449 B12/B71	151	BXA-70080-6CF-EDIN w/ Mount Pipe	130
RADIO 4449 B12/B71	151	Rymsa MGD3-900	130
RADIO 4449 B12/B71	151	RRH2x40-AWS	130
RADIO 4449 B12/B71	151	RxxDC-3315-PF-48	130
TA 602-3	151	Piroad 13' Low Profile Platform	130
AIR 21 B4A/B2P w/ Mount Pipe	151	BXA-171063-12CF-EDIN w/ Mount Pipe	130
RRUS-11	142	HP2-102	126
RRUS-11	142		

Destek Engineering, LLC		Job: CTHA014A	
1281 Kennestone Circle, Ste. 100		Project: 1875043	
Marietta, GA 30066		Client: T-Mobile	Drawn by: Ahmet Colakoglu
Phone: (770) 693-0835		Code: TIA-222-G	Date: 11/05/18
FAX:		Path:	App'd: _____
		Scale: NTS	
		Dwg No. E-1	

Section	1	2	3	4
Length (ft)	37.75	53.00	53.00	53.00
Number of Sides	18	18	18	18
Thickness (in)	0.2500	0.3750	0.3750	0.3750
Socket Length (ft)	4.33	5.92	7.50	54.9755
Top Dia (in)	23.1000	31.5849	43.4924	69.2250
Bot Dia (in)	33.2490	45.8340	57.7420	132.49.9
Grade		A572-65		
Weight (lb)	2846.3	8228.8	10784.9	13249.9

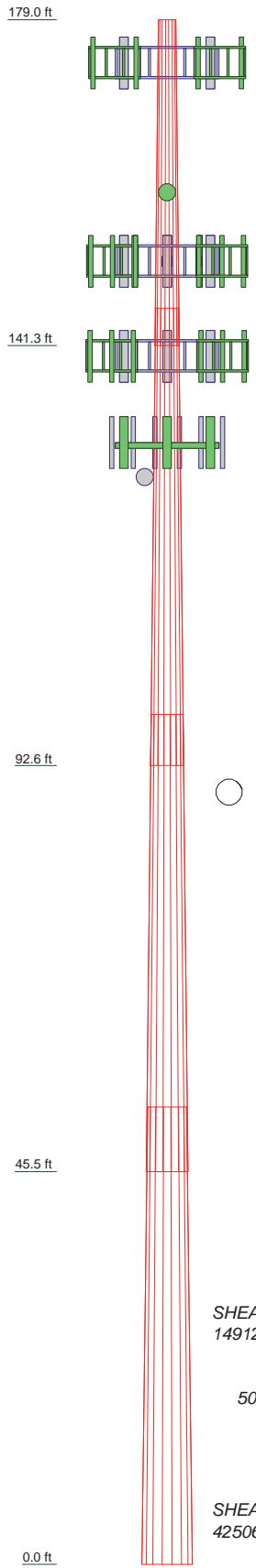

MATERIAL STRENGTH

GRADE	Fy	Fu	GRADE	Fy	Fu
A572-65	65 ksi	80 ksi			

TOWER DESIGN NOTES

1. Tower designed for Exposure C to the TIA-222-G Standard.
2. Tower designed for a 97 mph basic wind in accordance with the TIA-222-G Standard.
3. Tower is also designed for a 50 mph basic wind with 1.00 in ice. Ice is considered to increase in thickness with height.
4. Deflections are based upon a 60 mph wind.
5. Tower Structure Class II.
6. Topographic Category 1 with Crest Height of 0.00 ft
7. TOWER RATING: 76.4%

179.0 ft

141.3 ft

92.6 ft

45.5 ft

0.0 ft

ALL REACTIONS
ARE FACTORED

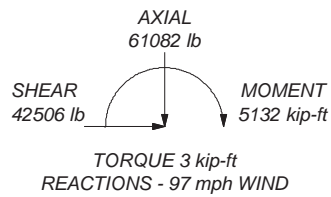
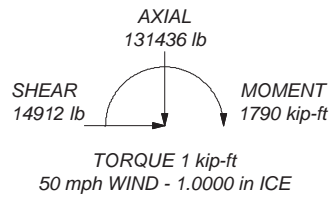

Destek Engineering, LLC
1281 Kennestone Circle, Ste. 100
Marietta, GA 30066
Phone: (770) 693-0835
FAX:

Job:	CTHA014A		
Project:	1875043		
Client:	T-Mobile	Drawn by:	Ahmet Colakoglu
Code:	TIA-222-G	Date:	11/05/18
Path:		App'd:	
		Scale:	NTS
		Dwg No.	E-1

tnxTower Destek Engineering, LLC 1281 Kennestone Circle, Ste. 100 Marietta, GA 30066 Phone: (770) 693-0835 FAX:	Job	CTHA014A	Page	1 of 19
	Project	1875043	Date	12:17:37 11/05/18
	Client	T-Mobile	Designed by	Ahmet Colakoglu

Tower Input Data

The tower is a monopole.

This tower is designed using the TIA-222-G standard.

The following design criteria apply:

Basic wind speed of 97 mph.

Structure Class II.

Exposure Category C.

Topographic Category 1.

Crest Height 0.00 ft.

Nominal ice thickness of 1.0000 in.

Ice thickness is considered to increase with height.

Ice density of 56 pcf.

A wind speed of 50 mph is used in combination with ice.

Temperature drop of 50 °F.

Deflections calculated using a wind speed of 60 mph.

A non-linear (P-delta) analysis was used.

Pressures are calculated at each section.

Stress ratio used in pole design is 1.

Local bending stresses due to climbing loads, feed line supports, and appurtenance mounts are not considered.

Options

<ul style="list-style-type: none"> Consider Moments - Legs Consider Moments - Horizontals Consider Moments - Diagonals Use Moment Magnification √ Use Code Stress Ratios √ Use Code Safety Factors - Guys Escalate Ice Always Use Max Kz Use Special Wind Profile Include Bolts In Member Capacity Leg Bolts Are At Top Of Section Secondary Horizontal Braces Leg Use Diamond Inner Bracing (4 Sided) SR Members Have Cut Ends SR Members Are Concentric 	<ul style="list-style-type: none"> Distribute Leg Loads As Uniform Assume Legs Pinned √ Assume Rigid Index Plate √ Use Clear Spans For Wind Area Use Clear Spans For KL/r Retention Guys To Initial Tension √ Bypass Mast Stability Checks √ Use Azimuth Dish Coefficients √ Project Wind Area of Appurt. Autocalc Torque Arm Areas Add IBC .6D+W Combination √ Sort Capacity Reports By Component Triangulate Diamond Inner Bracing Treat Feed Line Bundles As Cylinder Ignore KL/ry For 60 Deg. Angle Legs 	<ul style="list-style-type: none"> Use ASCE 10 X-Brace Ly Rules Calculate Redundant Bracing Forces Ignore Redundant Members in FEA SR Leg Bolts Resist Compression All Leg Panels Have Same Allowable Offset Girt At Foundation √ Consider Feed Line Torque Include Angle Block Shear Check Use TIA-222-G Bracing Resist. Exemption Use TIA-222-G Tension Splice Exemption <li style="text-align: center;">Poles √ Include Shear-Torsion Interaction Always Use Sub-Critical Flow Use Top Mounted Sockets Pole Without Linear Attachments Pole With Shroud Or No Appurtenances Outside and Inside Corner Radii Are Known
--	---	---

Tapered Pole Section Geometry

Section	Elevation	Section Length	Splice Length	Number of Sides	Top Diameter	Bottom Diameter	Wall Thickness	Bend Radius	Pole Grade
	ft	ft	ft		in	in	in	in	
L1	179.00-141.25	37.75	4.33	18	23.1000	33.2490	0.2500	1.0000	A572-65 (65 ksi)

tnxTower Destek Engineering, LLC 1281 Kennestone Circle, Ste. 100 Marietta, GA 30066 Phone: (770) 693-0835 FAX:	Job CTHA014A	Page 2 of 19
	Project 1875043	Date 12:17:37 11/05/18
	Client T-Mobile	Designed by Ahmet Colakoglu

Section	Elevation ft	Section Length ft	Splice Length ft	Number of Sides	Top Diameter in	Bottom Diameter in	Wall Thickness in	Bend Radius in	Pole Grade
L2	141.25-92.58	53.00	5.92	18	31.5849	45.8340	0.3750	1.5000	A572-65 (65 ksi)
L3	92.58-45.50	53.00	7.50	18	43.4924	57.7420	0.3750	1.5000	A572-65 (65 ksi)
L4	45.50-0.00	53.00		18	54.9755	69.2250	0.3750	1.5000	A572-65 (65 ksi)

Tapered Pole Properties

Section	Tip Dia. in	Area in ²	I in ⁴	r in	C in	I/C in ³	J in ⁴	I/Q in ²	w in	w/t
L1	23.4178	18.1315	1196.0325	8.1118	11.7348	101.9219	2393.6388	9.0675	3.6256	14.502
	33.7234	26.1847	3602.3567	11.7146	16.8905	213.2772	7209.4536	13.0948	5.4118	21.647
L2	33.1964	37.1476	4571.4330	11.0795	16.0451	284.9110	9148.8811	18.5773	4.8989	13.064
	46.4832	54.1076	14126.5228	16.1379	23.2837	606.7137	28271.6336	27.0589	7.4068	19.751
L3	45.7217	51.3205	12054.0604	15.3067	22.0941	545.5773	24123.9819	25.6651	6.9947	18.652
	58.5749	68.2811	28389.7820	20.3653	29.3329	967.8466	56816.9200	34.1470	9.5026	25.34
L4	57.8133	64.9883	24477.4753	19.3832	27.9276	876.4625	48987.1587	32.5003	9.0157	24.042
	70.2351	81.9487	49078.0698	24.4417	35.1663	1395.5995	98220.7178	40.9821	11.5236	30.73

Tower Elevation ft	Gusset Area (per face) ft ²	Gusset Thickness in	Gusset Grade	Adjust. Factor A _f	Adjust. Factor A _r	Weight Mult.	Double Angle Stitch Bolt Spacing Diagonals in	Double Angle Stitch Bolt Spacing Horizontals in	Double Angle Stitch Bolt Spacing Redundants in
L1 179.00-141.25				1	1	1			
L2 141.25-92.58				1	1	1			
L3 92.58-45.50				1	1	1			
L4 45.50-0.00				1	1	1			

Feed Line/Linear Appurtenances - Entered As Round Or Flat

Description	Sector	Exclude From Torque Calculation	Component Type	Placement ft	Total Number	Number Per Row	Start/End Position	Width or Diameter in	Perimeter in	Weight plf
AVA6-50(1-1/4)	B	No	Surface Ar (CaAa)	6.00 - 174.00	1	1	0.000 0.000	1.5600		0.46
AL7-50(1-5/8")	C	No	Surface Ar (CaAa)	6.00 - 151.00	6	6	-0.100 -0.100	1.9600		0.52
AVA6-50(1-1/4)	C	No	Surface Af (CaAa)	6.00 - 151.00	2	2	-0.125 -0.125	1.5600	4.9009	0.46
HB114-13U6-S12F18(1-1/4")	C	No	Surface Af (CaAa)	6.00 - 151.00	2	2	-0.123 -0.123	1.5400	4.8381	1.51
AL7-50(1-5/8")	C	No	Surface Ar (CaAa)	6.00 - 130.00	6	6	0.100 0.300	1.9600		0.52
ATCB-B01(1/4")	C	No	Surface Ar (CaAa)	6.00 - 130.00	1	1	0.313 0.313	0.3150		0.07
***** Step Pegs (Surface Ar)	C	No	Surface Ar	6.00 -	1	1	0.000	0.8000		2.72

tnxTower Destek Engineering, LLC 1281 Kennestone Circle, Ste. 100 Marietta, GA 30066 Phone: (770) 693-0835 FAX:	Job	CTHA014A	Page	3 of 19
	Project	1875043	Date	12:17:37 11/05/18
	Client	T-Mobile	Designed by	Ahmet Colakoglu

Description	Sector	Exclude From Torque Calculation	Component Type	Placement ft	Total Number	Number Per Row	Start/End Position	Width or Diameter in	Perimeter in	Weight plf
****			(CaAa)	179.00			0.000			
8x0.5	A	No	Surface Af (CaAa)	30.00 - 0.00	1	1	0.000 0.000	8.0000	17.0000	13.61
8x0.5	B	No	Surface Af (CaAa)	30.00 - 0.00	1	1	0.000 0.000	8.0000	17.0000	13.61
8x0.5	C	No	Surface Af (CaAa)	30.00 - 0.00	1	1	0.000 0.000	8.0000	17.0000	13.61

Feed Line/Linear Appurtenances - Entered As Area

Description	Face or Leg	Allow Shield	Exclude From Torque Calculation	Component Type	Placement ft	Total Number		C _A A _A ft ² /ft	Weight plf
AL7-50(1-5/8")	B	No	No	Inside Pole	6.00 - 179.00	4	No Ice 1/2" Ice 1" Ice	0.00 0.00 0.00	0.52 0.52 0.52
AVA6-50(1-1/4)	B	No	No	Inside Pole	6.00 - 179.00	1	No Ice 1/2" Ice 1" Ice	0.00 0.00 0.00	0.46 0.46 0.46
AL5-50(7/8")	B	No	No	Inside Pole	6.00 - 179.00	2	No Ice 1/2" Ice 1" Ice	0.00 0.00 0.00	0.26 0.26 0.26
HJ4-50(1/2")	B	No	No	Inside Pole	6.00 - 179.00	2	No Ice 1/2" Ice 1" Ice	0.00 0.00 0.00	0.25 0.25 0.25

AVA6-50(1-1/4)	B	No	No	Inside Pole	6.00 - 174.00	3	No Ice 1/2" Ice 1" Ice	0.00 0.00 0.00	0.46 0.46 0.46

ATCB-B01(1/4")	B	No	No	Inside Pole	6.00 - 159.00	1	No Ice 1/2" Ice 1" Ice	0.00 0.00 0.00	0.07 0.07 0.07

AL7-50(1-5/8")	C	No	No	Inside Pole	6.00 - 151.00	6	No Ice 1/2" Ice 1" Ice	0.00 0.00 0.00	0.52 0.52 0.52

AL7-50(1-5/8")	A	No	No	Inside Pole	6.00 - 140.00	12	No Ice 1/2" Ice 1" Ice	0.00 0.00 0.00	0.52 0.52 0.52
FB-L98-002-XXX(3/8")	A	No	No	Inside Pole	6.00 - 140.00	1	No Ice 1/2" Ice 1" Ice	0.00 0.00 0.00	0.06 0.06 0.06
WR-VG122ST-BRD A(7/16")	A	No	No	Inside Pole	6.00 - 140.00	2	No Ice 1/2" Ice 1" Ice	0.00 0.00 0.00	0.25 0.25 0.25

AL7-50(1-5/8")	C	No	No	Inside Pole	6.00 - 130.00	12	No Ice 1/2" Ice 1" Ice	0.00 0.00 0.00	0.52 0.52 0.52

ATCB-B01(1/4")	B	No	No	Inside Pole	6.00 - 126.00	1	No Ice 1/2" Ice 1" Ice	0.00 0.00 0.00	0.07 0.07 0.07

tnxTower Destek Engineering, LLC 1281 Kennestone Circle, Ste. 100 Marietta, GA 30066 Phone: (770) 693-0835 FAX:	Job	CTHA014A	Page	4 of 19
	Project	1875043	Date	12:17:37 11/05/18
	Client	T-Mobile	Designed by	Ahmet Colakoglu

Feed Line/Linear Appurtenances Section Areas

Tower Section	Tower Elevation ft	Face	A _R ft ²	A _F ft ²	C _{AA} In Face ft ²	C _{AA} Out Face ft ²	Weight lb
L1	179.00-141.25	A	0.000	0.000	0.000	0.000	0.00
		B	0.000	0.000	5.109	0.000	195.98
		C	0.000	0.000	24.561	0.000	201.93
L2	141.25-92.58	A	0.000	0.000	0.000	0.000	322.67
		B	0.000	0.000	7.593	0.000	268.97
		C	0.000	0.000	156.607	0.000	980.90
L3	92.58-45.50	A	0.000	0.000	0.000	0.000	320.36
		B	0.000	0.000	7.344	0.000	261.29
		C	0.000	0.000	164.631	0.000	1051.53
L4	45.50-0.00	A	0.000	0.000	40.000	0.000	677.08
		B	0.000	0.000	46.162	0.000	627.52
		C	0.000	0.000	178.125	0.000	1290.53

Feed Line/Linear Appurtenances Section Areas - With Ice

Tower Section	Tower Elevation ft	Face or Leg	Ice Thickness in	A _R ft ²	A _F ft ²	C _{AA} In Face ft ²	C _{AA} Out Face ft ²	Weight lb
L1	179.00-141.25	A	2.341	0.000	0.000	0.000	0.000	0.00
		B		0.000	0.000	20.441	0.000	561.30
		C		0.000	0.000	40.730	0.000	1149.22
L2	141.25-92.58	A	2.268	0.000	0.000	0.000	0.000	322.67
		B		0.000	0.000	30.377	0.000	811.88
		C		0.000	0.000	222.305	0.000	5926.24
L3	92.58-45.50	A	2.152	0.000	0.000	0.000	0.000	320.36
		B		0.000	0.000	28.696	0.000	760.52
		C		0.000	0.000	239.746	0.000	6044.11
L4	45.50-0.00	A	1.929	0.000	0.000	52.909	0.000	1308.23
		B		0.000	0.000	76.068	0.000	1644.04
		C		0.000	0.000	249.930	0.000	5825.35

Feed Line Center of Pressure

Section	Elevation ft	CP _x in	CP _z in	CP _x Ice in	CP _z Ice in
L1	179.00-141.25	2.1421	3.9114	1.5894	2.2296
L2	141.25-92.58	1.7775	10.9480	0.0999	6.3723
L3	92.58-45.50	1.5668	13.0387	-0.2995	7.9607
L4	45.50-0.00	1.1511	9.5266	-0.2594	6.7172

Note: For pole sections, center of pressure calculations do not consider feed line shielding.

tnxTower Destek Engineering, LLC 1281 Kennestone Circle, Ste. 100 Marietta, GA 30066 Phone: (770) 693-0835 FAX:	Job CTHA014A	Page 5 of 19
	Project 1875043	Date 12:17:37 11/05/18
	Client T-Mobile	Designed by Ahmet Colakoglu

Shielding Factor Ka

Tower Section	Feed Line Record No.	Description	Feed Line Segment Elev.	K_a No Ice	K_a Ice
L1	7	AVA6-50(1-1/4)	141.25 - 174.00	1.0000	1.0000
L1	12	AL7-50(1-5/8")	141.25 - 151.00	1.0000	1.0000
L1	13	AVA6-50(1-1/4)	141.25 - 151.00	1.0000	1.0000
L1	14	HB114-13U6-S12F18(1-1/4")	141.25 - 151.00	1.0000	1.0000
L1	28	Step Pegs (Surface Ar)	141.25 - 179.00	1.0000	1.0000
L1	23	AL7-50(1-5/8")	141.25 - 130.00	1.0000	1.0000
L1	24	ATCB-B01(1/4")	141.25 - 130.00	1.0000	1.0000
L2	7	AVA6-50(1-1/4)	92.58 - 141.25	1.0000	1.0000
L2	12	AL7-50(1-5/8")	92.58 - 141.25	1.0000	1.0000
L2	13	AVA6-50(1-1/4)	92.58 - 141.25	1.0000	1.0000
L2	14	HB114-13U6-S12F18(1-1/4")	92.58 - 141.25	1.0000	1.0000
L2	23	AL7-50(1-5/8")	92.58 - 130.00	1.0000	1.0000
L2	24	ATCB-B01(1/4")	92.58 - 130.00	1.0000	1.0000
L2	28	Step Pegs (Surface Ar)	92.58 - 141.25	1.0000	1.0000
L3	7	AVA6-50(1-1/4)	45.50 - 92.58	1.0000	1.0000
L3	12	AL7-50(1-5/8")	45.50 - 92.58	1.0000	1.0000
L3	13	AVA6-50(1-1/4)	45.50 - 92.58	1.0000	1.0000
L3	14	HB114-13U6-S12F18(1-1/4")	45.50 - 92.58	1.0000	1.0000
L3	23	AL7-50(1-5/8")	45.50 - 92.58	1.0000	1.0000
L3	24	ATCB-B01(1/4")	45.50 - 92.58	1.0000	1.0000
L3	28	Step Pegs (Surface Ar)	45.50 - 92.58	1.0000	1.0000
L3	30	8x0.5	45.50 - 30.00	1.0000	1.0000
L3	31	8x0.5	45.50 - 30.00	1.0000	1.0000
L3	32	8x0.5	45.50 - 30.00	1.0000	1.0000

Discrete Tower Loads

Description	Face or Leg	Offset Type	Offsets: Horz Lateral Vert ft ft ft	Azimuth Adjustment °	Placement ft	C_{AA} Front ft ²	C_{AA} Side ft ²	Weight lb	
(3) 6' x 2" Mount Pipe	A	From Face	2.00	0.0000	181.00	No Ice	1.43	1.43	22.00
			0.00			1/2" Ice	1.92	1.92	32.83
			0.00			1" Ice	2.29	2.29	47.71
(3) 6' x 2" Mount Pipe	B	From Face	2.00	0.0000	181.00	No Ice	1.43	1.43	22.00
			0.00			1/2" Ice	1.92	1.92	32.83
			0.00			1" Ice	2.29	2.29	47.71
(3) 6' x 2" Mount Pipe	C	From Face	2.00	0.0000	181.00	No Ice	1.43	1.43	22.00

tnxTower Destek Engineering, LLC 1281 Kennestone Circle, Ste. 100 Marietta, GA 30066 Phone: (770) 693-0835 FAX:	Job	CTHA014A	Page	6 of 19
	Project	1875043	Date	12:17:37 11/05/18
	Client	T-Mobile	Designed by	Ahmet Colakoglu

Description	Face or Leg	Offset Type	Offsets:		Azimuth Adjustment	Placement	C _{AA} Front	C _{AA} Side	Weight
			Horz	Lateral					
			0.00						32.83
			0.00			1/2" Ice	1.92	1.92	47.71
			0.00			1" Ice	2.29	2.29	20.00
Omni 4"x6'	A	From Face	2.00	0.0000	181.00	No Ice	2.09	2.09	37.13
			0.00			1/2" Ice	2.46	2.46	54.26
			0.00			1" Ice	2.83	2.83	25.00
Omni 2"x6'	A	From Face	2.00	0.0000	181.00	No Ice	1.20	1.20	34.39
			0.00			1/2" Ice	1.80	1.80	43.78
			0.00			1" Ice	2.40	2.40	10.00
Distribution Box	A	From Face	2.00	0.0000	181.00	No Ice	2.33	1.36	26.33
			0.00			1/2" Ice	2.55	1.54	42.66
			0.00			1" Ice	2.77	1.50	15.00
Omni 3"x4'	B	From Face	2.00	0.0000	181.00	No Ice	1.00	1.00	23.96
			0.00			1/2" Ice	1.25	1.25	32.92
			0.00			1" Ice	1.50	5.06	20.00
Omni 3"x10'	B	From Face	2.00	0.0000	181.00	No Ice	3.00	3.00	41.79
			0.00			1/2" Ice	4.03	4.03	63.58
			0.00			1" Ice	5.06	1.72	10.00
Distribution Box	B	From Face	2.00	0.0000	181.00	No Ice	2.33	1.36	26.33
			0.00			1/2" Ice	2.55	1.54	42.66
			0.00			1" Ice	2.77	1.50	15.00
Omni 3" x 4'	C	From Face	2.00	0.0000	181.00	No Ice	1.00	1.00	23.96
			0.00			1/2" Ice	1.25	1.25	32.92
			0.00			1" Ice	1.50	2.18	15.00
4' Dipole	C	From Face	2.00	0.0000	181.00	No Ice	1.64	1.64	32.13
			0.00			1/2" Ice	1.91	1.91	49.26
			0.00			1" Ice	2.18	2.18	339.00
TA 702-3	A	None		0.0000	181.00	No Ice	5.64	5.64	429.00
						1/2" Ice	6.55	6.55	519.00
						1" Ice	7.46	7.46	

ET-X-TU-42-15-37-18-iR-ST w/ Mount Pipe	A	From Face	3.00	0.0000	174.00	No Ice	8.68	4.50	68.25
			0.00			1/2" Ice	9.18	5.17	127.30
			0.00			1" Ice	9.68	5.84	192.77
APXVSPP18-C w/ Mount Pipe	B	From Face	3.00	0.0000	174.00	No Ice	8.26	6.95	82.55
			0.00			1/2" Ice	8.82	8.13	150.56
			0.00			1" Ice	9.35	9.02	226.53
APXVSPP18-C w/ Mount Pipe	C	From Face	3.00	0.0000	174.00	No Ice	8.26	6.95	82.55
			0.00			1/2" Ice	8.82	8.13	150.56
			0.00			1" Ice	9.35	9.02	226.53
APXV9TM14 w/ Mount Pipe	A	From Face	3.00	0.0000	174.00	No Ice	7.21	5.03	91.90
			0.00			1/2" Ice	7.77	5.89	147.31
			0.00			1" Ice	8.33	6.75	202.72
APXV9TM14 w/ Mount Pipe	B	From Face	3.00	0.0000	174.00	No Ice	7.21	5.03	91.90
			0.00			1/2" Ice	7.77	5.89	147.31
			0.00			1" Ice	8.33	6.75	202.72
APXV9TM14 w/ Mount Pipe	C	From Face	3.00	0.0000	174.00	No Ice	7.21	5.03	91.90
			0.00			1/2" Ice	7.77	5.89	147.31
			0.00			1" Ice	8.33	6.75	202.72
TA 602-3	C	None		0.0000	174.00	No Ice	11.59	11.59	774.00
						1/2" Ice	15.44	15.44	990.00
						1" Ice	19.29	19.29	1206.00

RRH1900MHz	A	From Face	1.50	0.0000	170.00	No Ice	2.60	3.72	59.13
			0.00			1/2" Ice	2.84	4.10	97.16
			0.00			1" Ice	3.09	4.50	139.81
RRH1900MHz	B	From Face	1.50	0.0000	170.00	No Ice	2.60	3.72	59.13
			0.00			1/2" Ice	2.84	4.10	97.16

tnxTower Destek Engineering, LLC 1281 Kennestone Circle, Ste. 100 Marietta, GA 30066 Phone: (770) 693-0835 FAX:	Job	CTHA014A	Page	7 of 19
	Project	1875043	Date	12:17:37 11/05/18
	Client	T-Mobile	Designed by	Ahmet Colakoglu

Description	Face or Leg	Offset Type	Offsets:		Azimuth Adjustment	Placement	C _{AA} Front	C _{AA} Side	Weight	
			Horz	Vert						
			ft	ft	°	ft	ft ²	ft ²	lb	
RRH1900MHz	C	From Face	0.00		0.0000	170.00	1" Ice	3.09	4.50	139.81
			1.50				No Ice	2.60	3.72	59.13
			0.00				1/2" Ice	2.84	4.10	97.16
RRH800MHz	A	From Face	0.00		0.0000	170.00	1" Ice	3.09	4.50	139.81
			1.50				No Ice	2.24	2.41	49.43
			0.00				1/2" Ice	2.49	2.75	78.53
RRH800MHz	B	From Face	0.00		0.0000	170.00	1" Ice	2.74	3.11	111.69
			1.50				No Ice	2.24	2.41	49.43
			0.00				1/2" Ice	2.49	2.75	78.53
RRH800MHz	C	From Face	0.00		0.0000	170.00	1" Ice	2.74	3.11	111.69
			1.50				No Ice	2.24	2.41	49.43
			0.00				1/2" Ice	2.49	2.75	78.53
RRH8x20-25	A	From Face	0.00		0.0000	174.00	1" Ice	2.74	3.11	111.69
			1.50				No Ice	4.72	1.70	70.00
			0.00				1/2" Ice	5.01	1.92	97.14
RRH8x20-25	B	From Face	0.00		0.0000	174.00	1" Ice	5.30	2.14	124.28
			1.50				No Ice	4.72	1.70	70.00
			0.00				1/2" Ice	5.01	1.92	97.14
RRH8x20-25	C	From Face	0.00		0.0000	174.00	1" Ice	5.30	2.14	124.28
			1.50				No Ice	4.72	1.70	70.00
			0.00				1/2" Ice	5.01	1.92	97.14
Ring Mount	C	None	0.00		0.0000	170.00	1" Ice	5.30	2.14	124.28
							No Ice	1.40	1.40	90.00
							1/2" Ice	2.40	2.40	130.00
						1" Ice	3.40	3.40	170.00	
** 151ft T Mobile**										
AIR 21 B4A/B2P w/ Mount Pipe	A	From Face	3.00		0.0000	151.00	No Ice	6.16	5.55	103.38
			0.00				1/2" Ice	6.60	6.30	159.18
			1.00				1" Ice	7.03	7.00	221.63
AIR 21 B4A/B2P w/ Mount Pipe	B	From Face	3.00		0.0000	151.00	No Ice	6.16	5.55	103.38
			0.00				1/2" Ice	6.60	6.30	159.18
			1.00				1" Ice	7.03	7.00	221.63
AIR 21 B4A/B2P w/ Mount Pipe	C	From Face	3.00		0.0000	151.00	No Ice	6.16	5.55	103.38
			0.00				1/2" Ice	6.60	6.30	159.18
			1.00				1" Ice	7.03	7.00	221.63
Gen TMA	A	From Face	2.00		0.0000	151.00	No Ice	0.68	0.45	13.20
			0.00				1/2" Ice	0.80	0.56	18.38
			0.00				1" Ice	0.92	0.67	23.56
Gen TMA	B	From Face	2.00		0.0000	151.00	No Ice	0.68	0.45	13.20
			0.00				1/2" Ice	0.80	0.56	18.38
			0.00				1" Ice	0.92	0.67	23.56
Gen TMA	C	From Face	2.00		0.0000	151.00	No Ice	0.68	0.45	13.20
			0.00				1/2" Ice	0.80	0.56	18.38
			0.00				1" Ice	0.92	0.67	23.56
AIR -32 B2A/B66AA w/ Mount Pipe	A	From Leg	3.00		0.0000	151.00	No Ice	6.75	6.07	153.07
			0.00				1/2" Ice	7.20	6.87	214.04
			0.00				1" Ice	7.65	7.58	281.89
AIR -32 B2A/B66AA w/ Mount Pipe	B	From Leg	3.00		0.0000	151.00	No Ice	6.75	6.07	153.07
			0.00				1/2" Ice	7.20	6.87	214.04
			0.00				1" Ice	7.65	7.58	281.89
AIR -32 B2A/B66AA w/ Mount Pipe	C	From Leg	3.00		0.0000	151.00	No Ice	6.75	6.07	153.07
			0.00				1/2" Ice	7.20	6.87	214.04
			0.00				1" Ice	7.65	7.58	281.89
APXVAARR24_43-U-NA20 w/ Mount Pipe	A	From Leg	3.00		0.0000	151.00	No Ice	20.48	11.02	160.82
			0.00				1/2" Ice	21.23	12.55	297.10
			0.00				1" Ice	21.99	14.10	444.18
APXVAARR24_43-U-NA20	B	From Leg	3.00		0.0000	151.00	No Ice	20.48	11.02	160.82

tnxTower Destek Engineering, LLC 1281 Kennestone Circle, Ste. 100 Marietta, GA 30066 Phone: (770) 693-0835 FAX:	Job		CTHA014A					Page	
	Project		1875043					Date	
	Client		T-Mobile					Designed by	
							8 of 19		
							12:17:37 11/05/18		
							Ahmet Colakoglu		

Description	Face or Leg	Offset Type	Offsets:		Azimuth Adjustment	Placement	C _{AA} Front	C _{AA} Side	Weight
			Horz	Lateral					
			ft	ft	°	ft	ft ²	ft ²	lb
w/ Mount Pipe			0.00			1/2" Ice	21.23	12.55	297.10
			0.00			1" Ice	21.99	14.10	444.18
APXVAARR24_43-U-NA20	C	From Leg	3.00		0.0000	No Ice	20.48	11.02	160.82
w/ Mount Pipe			0.00			1/2" Ice	21.23	12.55	297.10
			0.00			1" Ice	21.99	14.10	444.18
RADIO 4449 B12/B71	A	From Leg	3.00		0.0000	No Ice	1.64	1.15	75.00
			0.00			1/2" Ice	1.80	1.29	91.07
			0.00			1" Ice	1.97	1.44	109.76
RADIO 4449 B12/B71	B	From Leg	3.00		0.0000	No Ice	1.64	1.15	75.00
			0.00			1/2" Ice	1.80	1.29	91.07
			0.00			1" Ice	1.97	1.44	109.76
RADIO 4449 B12/B71	C	From Leg	3.00		0.0000	No Ice	1.64	1.15	75.00
			0.00			1/2" Ice	1.80	1.29	91.07
			0.00			1" Ice	1.97	1.44	109.76
TA 602-3	C	None			0.0000	No Ice	11.59	11.59	774.00
						1/2" Ice	15.44	15.44	990.00
						1" Ice	19.29	19.29	1206.00

RRUS-11	A	From Face	1.00		0.0000	No Ice	2.78	1.19	47.62
			0.00			1/2" Ice	2.99	1.33	68.42
			0.00			1" Ice	3.21	1.49	92.25
RRUS-11	B	From Face	1.00		0.0000	No Ice	2.78	1.19	47.62
			0.00			1/2" Ice	2.99	1.33	68.42
			0.00			1" Ice	3.21	1.49	92.25
RRUS-11	C	From Face	1.00		0.0000	No Ice	2.78	1.19	47.62
			0.00			1/2" Ice	2.99	1.33	68.42
			0.00			1" Ice	3.21	1.49	92.25
RRUS 32 B2	A	From Face	1.00		0.0000	No Ice	2.73	1.67	52.90
			0.00			1/2" Ice	2.95	1.86	73.96
			0.00			1" Ice	3.18	2.05	98.21
RRUS 32 B2	B	From Face	1.00		0.0000	No Ice	2.73	1.67	52.90
			0.00			1/2" Ice	2.95	1.86	73.96
			0.00			1" Ice	3.18	2.05	98.21
RRUS 32 B2	C	From Face	1.00		0.0000	No Ice	2.73	1.67	52.90
			0.00			1/2" Ice	2.95	1.86	73.96
			0.00			1" Ice	3.18	2.05	98.21

7770.00 w/ Mount Pipe	A	From Face	3.00		0.0000	No Ice	5.75	4.25	55.38
			0.00			1/2" Ice	6.18	5.01	102.81
			0.00			1" Ice	6.61	5.71	156.64
7770.00 w/ Mount Pipe	B	From Face	3.00		0.0000	No Ice	5.75	4.25	55.38
			0.00			1/2" Ice	6.18	5.01	102.81
			0.00			1" Ice	6.61	5.71	156.64
7770.00 w/ Mount Pipe	C	From Face	3.00		0.0000	No Ice	5.75	4.25	55.38
			0.00			1/2" Ice	6.18	5.01	102.81
			0.00			1" Ice	6.61	5.71	156.64
TPA-65R-LCUUUU-H8 w/ Mount Pipe	A	From Face	3.00		0.0000	No Ice	13.54	10.96	114.45
			0.00			1/2" Ice	14.24	12.49	217.61
			0.00			1" Ice	14.95	14.04	330.97
TPA-65R-LCUUUU-H8 w/ Mount Pipe	B	From Face	3.00		0.0000	No Ice	13.54	10.96	114.45
			0.00			1/2" Ice	14.24	12.49	217.61
			0.00			1" Ice	14.95	14.04	330.97
CCI HPA-65R-BUU-H8 with pipe	A	From Face	3.00		0.0000	No Ice	13.28	9.65	122.85
			0.00			1/2" Ice	14.00	11.15	220.33
			0.00			1" Ice	14.73	12.68	327.71
CCI HPA-65R-BUU-H8 with pipe	B	From Face	3.00		0.0000	No Ice	13.28	9.65	122.85
			0.00			1/2" Ice	14.00	11.15	220.33

tnxTower Destek Engineering, LLC 1281 Kennestone Circle, Ste. 100 Marietta, GA 30066 Phone: (770) 693-0835 FAX:	Job	CTHA014A	Page	9 of 19
	Project	1875043	Date	12:17:37 11/05/18
	Client	T-Mobile	Designed by	Ahmet Colakoglu

Description	Face or Leg	Offset Type	Offsets:		Azimuth Adjustment	Placement	C _{AA} Front	C _{AA} Side	Weight	
			Horz	Lateral						
			ft	ft	°	ft	ft ²	ft ²	lb	
(2) SBNHH-1D65A w/ Mount Pipe	C	From Face	0.00		0.0000	140.00	1" Ice	14.73	12.68	327.71
			3.00				No Ice	5.95	5.19	61.30
			0.00				1/2" Ice	6.39	5.96	114.32
RRUS 32	A	From Face	0.00		0.0000	140.00	1" Ice	6.82	6.66	173.89
			1.00				No Ice	2.86	1.78	55.12
			0.00				1/2" Ice	3.08	1.97	77.39
RRUS 32	B	From Face	0.00		0.0000	140.00	1" Ice	3.32	2.17	102.93
			1.00				No Ice	2.86	1.78	55.12
			0.00				1/2" Ice	3.08	1.97	77.39
RRUS 32	C	From Face	0.00		0.0000	140.00	1" Ice	3.32	2.17	102.93
			1.00				No Ice	2.86	1.78	55.12
			0.00				1/2" Ice	3.08	1.97	77.39
(2) LGP21401	A	From Face	0.00		0.0000	140.00	1" Ice	3.32	2.17	102.93
			2.00				No Ice	1.10	0.21	14.10
			0.00				1/2" Ice	1.24	0.27	21.26
(2) LGP21401	B	From Face	0.00		0.0000	140.00	1" Ice	1.38	0.35	30.32
			2.00				No Ice	1.10	0.21	14.10
			0.00				1/2" Ice	1.24	0.27	21.26
(2) LGP21401	C	From Face	0.00		0.0000	140.00	1" Ice	1.38	0.35	30.32
			2.00				No Ice	1.10	0.21	14.10
			0.00				1/2" Ice	1.24	0.27	21.26
800 10966 w/mount pipe	A	From Leg	0.00		0.0000	140.00	1" Ice	1.38	0.35	30.32
			3.00				No Ice	17.36	9.40	154.90
			0.00				1/2" Ice	17.99	10.82	268.18
800 10966 w/mount pipe	B	From Leg	0.00		0.0000	140.00	1" Ice	18.63	12.09	391.69
			3.00				No Ice	17.36	9.40	154.90
			0.00				1/2" Ice	17.99	10.82	268.18
800 10964 w/ Mount Pipe	C	From Leg	0.00		0.0000	140.00	1" Ice	18.63	12.09	391.69
			3.00				No Ice	7.14	3.68	35.00
			0.00				1/2" Ice	7.52	4.03	79.18
RRUS 4478 B14	A	From Leg	0.00		0.0000	140.00	1" Ice	7.90	4.38	123.36
			3.00				No Ice	1.84	1.06	59.90
			0.00				1/2" Ice	2.01	1.20	75.78
RRUS 4478 B14	B	From Leg	0.00		0.0000	140.00	1" Ice	2.19	1.34	94.29
			3.00				No Ice	1.84	1.06	59.90
			0.00				1/2" Ice	2.01	1.20	75.78
RRUS 4478 B14	C	From Leg	0.00		0.0000	140.00	1" Ice	2.19	1.34	94.29
			3.00				No Ice	1.84	1.06	59.90
			0.00				1/2" Ice	2.01	1.20	75.78
RRUS 32 B66	A	From Leg	0.00		0.0000	140.00	1" Ice	2.19	1.34	94.29
			3.00				No Ice	2.74	1.67	53.00
			0.00				1/2" Ice	2.96	1.86	74.11
RRUS 32 B66	B	From Leg	0.00		0.0000	140.00	1" Ice	3.19	2.05	98.42
			3.00				No Ice	2.74	1.67	53.00
			0.00				1/2" Ice	2.96	1.86	74.11
RRUS 32 B66	C	From Leg	0.00		0.0000	140.00	1" Ice	3.19	2.05	98.42
			3.00				No Ice	2.74	1.67	53.00
			0.00				1/2" Ice	2.96	1.86	74.11
DC6-48-60-0-8C	A	From Face	0.00		0.0000	140.00	1" Ice	3.19	2.05	98.42
			1.00				No Ice	0.85	0.85	18.90
			0.00				1/2" Ice	1.36	1.36	35.59
DC6-48-60-0-8C	B	From Face	0.00		0.0000	140.00	1" Ice	1.53	1.53	54.69
			1.00				No Ice	0.85	0.85	18.90
			0.00				1/2" Ice	1.36	1.36	35.59
DC6-48-60-0-8C	C	From Face	0.00		0.0000	140.00	1" Ice	1.53	1.53	54.69
			1.00				No Ice	0.85	0.85	18.90
			0.00				1/2" Ice	1.36	1.36	35.59

tnxTower Destek Engineering, LLC 1281 Kennestone Circle, Ste. 100 Marietta, GA 30066 Phone: (770) 693-0835 FAX:	Job	CTHA014A	Page	11 of 19
	Project	1875043	Date	12:17:37 11/05/18
	Client	T-Mobile	Designed by	Ahmet Colakoglu

Dishes

Description	Face or Leg	Dish Type	Offset Type	Offsets:		Azimuth Adjustment	3 dB Beam Width	Elevation	Outside Diameter	Aperture Area	Weight	
				Horz Lateral	Vert							
				ft	°	°	ft	ft	ft ²	lb		
HP2-102	C	Paraboloid w/Shroud (HP)	From Face	1.50	0.0000	0.0000		159.00	2.00	No Ice	3.14	25.00
				0.00						1/2" Ice	3.41	42.49
				0.00						1" Ice	3.68	59.98
HP2-102	A	Paraboloid w/Shroud (HP)	From Face	1.50	0.0000	0.0000		126.00	2.00	No Ice	3.14	25.00
				0.00						1/2" Ice	3.41	42.49
				0.00						1" Ice	3.68	59.98

Load Combinations

Comb. No.	Description
1	Dead Only
2	1.2 Dead+1.6 Wind 0 deg - No Ice
3	0.9 Dead+1.6 Wind 0 deg - No Ice
4	1.2 Dead+1.6 Wind 30 deg - No Ice
5	0.9 Dead+1.6 Wind 30 deg - No Ice
6	1.2 Dead+1.6 Wind 60 deg - No Ice
7	0.9 Dead+1.6 Wind 60 deg - No Ice
8	1.2 Dead+1.6 Wind 90 deg - No Ice
9	0.9 Dead+1.6 Wind 90 deg - No Ice
10	1.2 Dead+1.6 Wind 120 deg - No Ice
11	0.9 Dead+1.6 Wind 120 deg - No Ice
12	1.2 Dead+1.6 Wind 150 deg - No Ice
13	0.9 Dead+1.6 Wind 150 deg - No Ice
14	1.2 Dead+1.6 Wind 180 deg - No Ice
15	0.9 Dead+1.6 Wind 180 deg - No Ice
16	1.2 Dead+1.6 Wind 210 deg - No Ice
17	0.9 Dead+1.6 Wind 210 deg - No Ice
18	1.2 Dead+1.6 Wind 240 deg - No Ice
19	0.9 Dead+1.6 Wind 240 deg - No Ice
20	1.2 Dead+1.6 Wind 270 deg - No Ice
21	0.9 Dead+1.6 Wind 270 deg - No Ice
22	1.2 Dead+1.6 Wind 300 deg - No Ice
23	0.9 Dead+1.6 Wind 300 deg - No Ice
24	1.2 Dead+1.6 Wind 330 deg - No Ice
25	0.9 Dead+1.6 Wind 330 deg - No Ice
26	1.2 Dead+1.0 Ice+1.0 Temp
27	1.2 Dead+1.0 Wind 0 deg+1.0 Ice+1.0 Temp
28	1.2 Dead+1.0 Wind 30 deg+1.0 Ice+1.0 Temp
29	1.2 Dead+1.0 Wind 60 deg+1.0 Ice+1.0 Temp
30	1.2 Dead+1.0 Wind 90 deg+1.0 Ice+1.0 Temp
31	1.2 Dead+1.0 Wind 120 deg+1.0 Ice+1.0 Temp
32	1.2 Dead+1.0 Wind 150 deg+1.0 Ice+1.0 Temp
33	1.2 Dead+1.0 Wind 180 deg+1.0 Ice+1.0 Temp
34	1.2 Dead+1.0 Wind 210 deg+1.0 Ice+1.0 Temp
35	1.2 Dead+1.0 Wind 240 deg+1.0 Ice+1.0 Temp
36	1.2 Dead+1.0 Wind 270 deg+1.0 Ice+1.0 Temp

tnxTower Destek Engineering, LLC 1281 Kennestone Circle, Ste. 100 Marietta, GA 30066 Phone: (770) 693-0835 FAX:	Job	CTHA014A	Page	12 of 19
	Project	1875043	Date	12:17:37 11/05/18
	Client	T-Mobile	Designed by	Ahmet Colakoglu

<i>Comb. No.</i>	<i>Description</i>
37	1.2 Dead+1.0 Wind 300 deg+1.0 Ice+1.0 Temp
38	1.2 Dead+1.0 Wind 330 deg+1.0 Ice+1.0 Temp
39	Dead+Wind 0 deg - Service
40	Dead+Wind 30 deg - Service
41	Dead+Wind 60 deg - Service
42	Dead+Wind 90 deg - Service
43	Dead+Wind 120 deg - Service
44	Dead+Wind 150 deg - Service
45	Dead+Wind 180 deg - Service
46	Dead+Wind 210 deg - Service
47	Dead+Wind 240 deg - Service
48	Dead+Wind 270 deg - Service
49	Dead+Wind 300 deg - Service
50	Dead+Wind 330 deg - Service

Maximum Member Forces

<i>Section No.</i>	<i>Elevation ft</i>	<i>Component Type</i>	<i>Condition</i>	<i>Gov. Load Comb.</i>	<i>Axial lb</i>	<i>Major Axis Moment kip-ft</i>	<i>Minor Axis Moment kip-ft</i>
L1	179 - 141.25	Pole	Max Tension	1	0.00	0.00	0.00
			Max. Compression	26	-25819.83	-0.87	-1.43
			Max. Mx	8	-8229.97	-259.00	-2.19
			Max. My	2	-8236.83	1.65	256.27
			Max. Vy	8	13955.20	-259.00	-2.19
			Max. Vx	2	-13942.31	1.65	256.27
			Max. Torque	12			0.52
L2	141.25 - 92.58	Pole	Max Tension	1	0.00	0.00	0.00
			Max. Compression	26	-67228.84	-4.57	-7.00
			Max. Mx	8	-24018.41	-1474.95	-11.90
			Max. My	2	-24034.80	9.46	1466.07
			Max. Vy	8	30868.79	-1474.95	-11.90
			Max. Vx	2	-30729.82	9.46	1466.07
			Max. Torque	23			-2.84
L3	92.58 - 45.5	Pole	Max Tension	1	0.00	0.00	0.00
			Max. Compression	26	-93724.21	-6.62	-19.18
			Max. Mx	8	-38683.15	-3010.24	-24.24
			Max. My	2	-38692.39	19.16	2993.42
			Max. Vy	8	36568.25	-3010.24	-24.24
			Max. Vx	2	-36430.54	19.16	2993.42
			Max. Torque	23			-2.55
L4	45.5 - 0	Pole	Max Tension	1	0.00	0.00	0.00
			Max. Compression	26	-131436.17	-8.77	-32.95
			Max. Mx	8	-61055.09	-5112.65	-38.51
			Max. My	14	-61055.32	-37.53	-5088.49
			Max. Vy	8	42428.86	-5112.65	-38.51
			Max. Vx	2	-42296.74	30.25	5086.59
			Max. Torque	23			-2.55

Maximum Reactions

<i>Location</i>	<i>Condition</i>	<i>Gov. Load Comb.</i>	<i>Vertical lb</i>	<i>Horizontal, X lb</i>	<i>Horizontal, Z lb</i>
Pole	Max. Vert	30	131436.17	-14911.68	-39.01

<p style="text-align: center;">tnxTower</p> <p style="text-align: center;">Destek Engineering, LLC 1281 Kennestone Circle, Ste. 100 Marietta, GA 30066 Phone: (770) 693-0835 FAX:</p>	Job	CTHA014A	Page	13 of 19
	Project	1875043	Date	12:17:37 11/05/18
	Client	T-Mobile	Designed by	Ahmet Colakoglu

Location	Condition	Gov. Load Comb.	Vertical lb	Horizontal, X lb	Horizontal, Z lb
	Max. H _x	20	61081.55	42348.89	177.69
	Max. H _z	2	61081.55	208.86	42258.83
	Max. M _x	2	5086.59	208.86	42258.83
	Max. M _z	8	5112.65	-42390.76	-229.10
	Max. Torsion	11	2.49	-36778.18	-21310.97
	Min. Vert	5	45811.16	-20997.11	36540.27
	Min. H _x	8	61081.55	-42390.76	-229.10
	Min. H _z	14	61081.55	-248.88	-42224.87
	Min. M _x	14	-5088.49	-248.88	-42224.87
	Min. M _z	20	-5105.13	42348.89	177.69
	Min. Torsion	23	-2.55	36729.96	21331.65

Tower Mast Reaction Summary

Load Combination	Vertical lb	Shear _x lb	Shear _z lb	Overturning Moment, M _x kip-ft	Overturning Moment, M _z kip-ft	Torque kip-ft
Dead Only	50901.29	0.00	0.00	3.17	-0.83	0.00
1.2 Dead+1.6 Wind 0 deg - No Ice	61081.55	-208.86	-42258.83	-5086.59	30.25	1.16
0.9 Dead+1.6 Wind 0 deg - No Ice	45811.16	-208.86	-42258.82	-5044.96	30.24	1.17
1.2 Dead+1.6 Wind 30 deg - No Ice	61081.55	20997.11	-36540.27	-4395.89	-2527.06	-0.18
0.9 Dead+1.6 Wind 30 deg - No Ice	45811.16	20997.11	-36540.27	-4360.04	-2505.64	-0.18
1.2 Dead+1.6 Wind 60 deg - No Ice	61081.55	36608.41	-20974.10	-2519.51	-4411.36	-1.31
0.9 Dead+1.6 Wind 60 deg - No Ice	45811.16	36608.41	-20974.10	-2499.38	-4374.14	-1.32
1.2 Dead+1.6 Wind 90 deg - No Ice	61081.55	42390.76	229.10	38.51	-5112.65	-2.10
0.9 Dead+1.6 Wind 90 deg - No Ice	45811.16	42390.75	229.10	37.20	-5069.55	-2.10
1.2 Dead+1.6 Wind 120 deg - No Ice	61081.55	36778.18	21310.97	2576.81	-4437.90	-2.48
0.9 Dead+1.6 Wind 120 deg - No Ice	45811.16	36778.18	21310.97	2554.24	-4400.44	-2.49
1.2 Dead+1.6 Wind 150 deg - No Ice	61081.55	21352.94	36673.34	4423.50	-2580.06	-2.18
0.9 Dead+1.6 Wind 150 deg - No Ice	45811.16	21352.94	36673.34	4385.48	-2558.17	-2.19
1.2 Dead+1.6 Wind 180 deg - No Ice	61081.55	248.88	42224.87	5088.49	-37.53	-1.23
0.9 Dead+1.6 Wind 180 deg - No Ice	45811.16	248.88	42224.86	5044.92	-36.94	-1.23
1.2 Dead+1.6 Wind 210 deg - No Ice	61081.55	-21018.60	36477.09	4393.94	2527.40	0.18
0.9 Dead+1.6 Wind 210 deg - No Ice	45811.16	-21018.60	36477.09	4356.19	2506.50	0.18
1.2 Dead+1.6 Wind 240 deg - No Ice	61081.55	-36592.62	20962.66	2524.42	4407.64	1.32
0.9 Dead+1.6 Wind 240 deg - No Ice	45811.16	-36592.62	20962.66	2502.32	4370.98	1.32
1.2 Dead+1.6 Wind 270 deg - No Ice	61081.55	-42348.89	-177.69	-22.64	5105.13	2.10
0.9 Dead+1.6 Wind 270 deg - No Ice	45811.16	-42348.88	-177.69	-23.41	5062.62	2.10

tnxTower Destek Engineering, LLC 1281 Kennestone Circle, Ste. 100 Marietta, GA 30066 Phone: (770) 693-0835 FAX:	Job	CTHA014A	Page	14 of 19
	Project	1875043	Date	12:17:37 11/05/18
	Client	T-Mobile	Designed by	Ahmet Colakoglu

Load Combination	Vertical lb	Shear _x lb	Shear _z lb	Overturning Moment, M _x kip-ft	Overturning Moment, M _z kip-ft	Torque kip-ft
No Ice						
1.2 Dead+1.6 Wind 300 deg - No Ice	61081.55	-36729.96	-21331.65	-2573.10	4429.14	2.54
0.9 Dead+1.6 Wind 300 deg - No Ice	45811.16	-36729.96	-21331.65	-2552.50	4392.27	2.55
1.2 Dead+1.6 Wind 330 deg - No Ice	61081.55	-21331.25	-36688.28	-4419.18	2575.54	2.18
0.9 Dead+1.6 Wind 330 deg - No Ice	45811.16	-21331.25	-36688.28	-4383.12	2554.20	2.19
1.2 Dead+1.0 Ice+1.0 Temp	131436.17	0.02	0.05	32.95	-8.77	0.00
1.2 Dead+1.0 Wind 0 deg+1.0 Ice+1.0 Temp	131436.17	-34.29	-12972.50	-1589.27	-3.35	0.35
1.2 Dead+1.0 Wind 30 deg+1.0 Ice+1.0 Temp	131436.17	6462.05	-11228.39	-1370.88	-816.50	-0.02
1.2 Dead+1.0 Wind 60 deg+1.0 Ice+1.0 Temp	131436.17	11234.17	-6462.55	-774.68	-1414.17	-0.35
1.2 Dead+1.0 Wind 90 deg+1.0 Ice+1.0 Temp	131436.17	14911.68	39.01	39.38	-1789.31	-0.58
1.2 Dead+1.0 Wind 120 deg+1.0 Ice+1.0 Temp	131436.17	11259.43	6516.13	849.15	-1418.50	-0.70
1.2 Dead+1.0 Wind 150 deg+1.0 Ice+1.0 Temp	131436.17	6520.06	11245.08	1439.70	-825.67	-0.62
1.2 Dead+1.0 Wind 180 deg+1.0 Ice+1.0 Temp	131436.17	43.55	12964.58	1653.97	-15.54	-0.36
1.2 Dead+1.0 Wind 210 deg+1.0 Ice+1.0 Temp	131436.17	-6467.00	11213.71	1434.64	799.46	0.03
1.2 Dead+1.0 Wind 240 deg+1.0 Ice+1.0 Temp	131436.17	-11230.53	6459.85	840.12	1396.16	0.35
1.2 Dead+1.0 Wind 270 deg+1.0 Ice+1.0 Temp	131436.17	-14901.99	-27.05	28.80	1770.37	0.58
1.2 Dead+1.0 Wind 300 deg+1.0 Ice+1.0 Temp	131436.17	-11248.25	-6520.97	-784.00	1399.25	0.71
1.2 Dead+1.0 Wind 330 deg+1.0 Ice+1.0 Temp	131436.17	-6515.05	-11248.60	-1374.41	807.47	0.62
Dead+Wind 0 deg - Service	50901.29	-44.69	-9041.74	-1080.81	5.79	0.25
Dead+Wind 30 deg - Service	50901.29	4492.56	-7818.19	-933.71	-538.79	-0.04
Dead+Wind 60 deg - Service	50901.29	7832.77	-4487.64	-534.13	-940.06	-0.28
Dead+Wind 90 deg - Service	50901.29	9069.96	49.02	10.61	-1089.42	-0.45
Dead+Wind 120 deg - Service	50901.29	7869.09	4559.71	551.16	-945.73	-0.53
Dead+Wind 150 deg - Service	50901.29	4568.69	7846.66	944.43	-550.09	-0.47
Dead+Wind 180 deg - Service	50901.29	53.25	9034.47	1086.03	-8.64	-0.27
Dead+Wind 210 deg - Service	50901.29	-4497.16	7804.67	938.12	537.58	0.04
Dead+Wind 240 deg - Service	50901.29	-7829.39	4485.19	540.00	937.98	0.28
Dead+Wind 270 deg - Service	50901.29	-9061.00	-38.02	-2.41	1086.53	0.45
Dead+Wind 300 deg - Service	50901.29	-7858.78	-4564.14	-545.55	942.57	0.55
Dead+Wind 330 deg - Service	50901.29	-4564.05	-7849.86	-938.69	547.83	0.47

Solution Summary

Load Comb.	Sum of Applied Forces			Sum of Reactions			% Error
	PX lb	PY lb	PZ lb	PX lb	PY lb	PZ lb	
1	0.00	-50901.29	0.00	0.00	50901.29	0.00	0.000%
2	-208.86	-61081.55	-42258.82	208.86	61081.55	42258.83	0.000%
3	-208.86	-45811.16	-42258.82	208.86	45811.16	42258.82	0.000%
4	20997.11	-61081.55	-36540.27	-20997.11	61081.55	36540.27	0.000%
5	20997.11	-45811.16	-36540.27	-20997.11	45811.16	36540.27	0.000%
6	36608.41	-61081.55	-20974.10	-36608.41	61081.55	20974.10	0.000%

tnxTower Destek Engineering, LLC 1281 Kennestone Circle, Ste. 100 Marietta, GA 30066 Phone: (770) 693-0835 FAX:	Job	CTHA014A	Page	15 of 19
	Project	1875043	Date	12:17:37 11/05/18
	Client	T-Mobile	Designed by	Ahmet Colakoglu

Load Comb.	Sum of Applied Forces			Sum of Reactions			% Error
	PX lb	PY lb	PZ lb	PX lb	PY lb	PZ lb	
7	36608.41	-45811.16	-20974.10	-36608.41	45811.16	20974.10	0.000%
8	42390.75	-61081.55	229.10	-42390.75	61081.55	-229.10	0.000%
9	42390.75	-45811.16	229.10	-42390.75	45811.16	-229.10	0.000%
10	36778.18	-61081.55	21310.97	-36778.18	61081.55	-21310.97	0.000%
11	36778.18	-45811.16	21310.97	-36778.18	45811.16	-21310.97	0.000%
12	21352.94	-61081.55	36673.34	-21352.94	61081.55	-36673.34	0.000%
13	21352.94	-45811.16	36673.34	-21352.94	45811.16	-36673.34	0.000%
14	248.88	-61081.55	42224.85	-248.88	61081.55	-42224.87	0.000%
15	248.88	-45811.16	42224.85	-248.88	45811.16	-42224.86	0.000%
16	-21018.60	-61081.55	36477.09	21018.60	61081.55	-36477.09	0.000%
17	-21018.60	-45811.16	36477.09	21018.60	45811.16	-36477.09	0.000%
18	-36592.62	-61081.55	20962.66	36592.62	61081.55	-20962.66	0.000%
19	-36592.62	-45811.16	20962.66	36592.62	45811.16	-20962.66	0.000%
20	-42348.88	-61081.55	-177.69	42348.88	61081.55	177.69	0.000%
21	-42348.88	-45811.16	-177.69	42348.88	45811.16	177.69	0.000%
22	-36729.96	-61081.55	-21331.65	36729.96	61081.55	21331.65	0.000%
23	-36729.96	-45811.16	-21331.65	36729.96	45811.16	21331.65	0.000%
24	-21331.25	-61081.55	-36688.28	21331.25	61081.55	36688.28	0.000%
25	-21331.25	-45811.16	-36688.28	21331.25	45811.16	36688.28	0.000%
26	0.00	-131436.17	0.00	-0.02	131436.17	-0.05	0.000%
27	-34.29	-131436.17	-12972.35	34.29	131436.17	12972.50	0.000%
28	6461.97	-131436.17	-11228.26	-6462.05	131436.17	11228.39	0.000%
29	11234.03	-131436.17	-6462.48	-11234.17	131436.17	6462.55	0.000%
30	14911.52	-131436.17	39.00	-14911.68	131436.17	-39.01	0.000%
31	11259.30	-131436.17	6516.05	-11259.43	131436.17	-6516.13	0.000%
32	6519.98	-131436.17	11244.95	-6520.06	131436.17	-11245.08	0.000%
33	43.55	-131436.17	12964.43	-43.55	131436.17	-12964.58	0.000%
34	-6466.93	-131436.17	11213.57	6467.00	131436.17	-11213.71	0.000%
35	-11230.40	-131436.17	6459.77	11230.53	131436.17	-6459.85	0.000%
36	-14901.83	-131436.17	-27.05	14901.99	131436.17	27.05	0.000%
37	-11248.12	-131436.17	-6520.90	11248.25	131436.17	6520.97	0.000%
38	-6514.98	-131436.17	-11248.47	6515.05	131436.17	11248.60	0.000%
39	-44.69	-50901.29	-9041.73	44.69	50901.29	9041.74	0.000%
40	4492.56	-50901.29	-7818.19	-4492.56	50901.29	7818.19	0.000%
41	7832.77	-50901.29	-4487.64	-7832.77	50901.29	4487.64	0.000%
42	9069.96	-50901.29	49.02	-9069.96	50901.29	-49.02	0.000%
43	7869.09	-50901.29	4559.71	-7869.09	50901.29	-4559.71	0.000%
44	4568.69	-50901.29	7846.66	-4568.69	50901.29	-7846.66	0.000%
45	53.25	-50901.29	9034.47	-53.25	50901.29	-9034.47	0.000%
46	-4497.16	-50901.29	7804.67	4497.16	50901.29	-7804.67	0.000%
47	-7829.39	-50901.29	4485.19	7829.39	50901.29	-4485.19	0.000%
48	-9061.00	-50901.29	-38.02	9061.00	50901.29	38.02	0.000%
49	-7858.78	-50901.29	-4564.14	7858.78	50901.29	4564.14	0.000%
50	-4564.05	-50901.29	-7849.86	4564.05	50901.29	7849.86	0.000%

Non-Linear Convergence Results

Load Combination	Converged?	Number of Cycles	Displacement Tolerance	Force Tolerance
1	Yes	4	0.00000001	0.00000001
2	Yes	4	0.00000001	0.00020161
3	Yes	4	0.00000001	0.00011277
4	Yes	5	0.00000001	0.00036249
5	Yes	5	0.00000001	0.00016039
6	Yes	5	0.00000001	0.00036960
7	Yes	5	0.00000001	0.00016375

tnxTower Destek Engineering, LLC 1281 Kennestone Circle, Ste. 100 Marietta, GA 30066 Phone: (770) 693-0835 FAX:	Job	CTHA014A	Page	16 of 19
	Project	1875043	Date	12:17:37 11/05/18
	Client	T-Mobile	Designed by	Ahmet Colakoglu

8	Yes	4	0.00000001	0.00030852
9	Yes	4	0.00000001	0.00019102
10	Yes	5	0.00000001	0.00036320
11	Yes	5	0.00000001	0.00015951
12	Yes	5	0.00000001	0.00038404
13	Yes	5	0.00000001	0.00016973
14	Yes	4	0.00000001	0.00050299
15	Yes	4	0.00000001	0.00031102
16	Yes	5	0.00000001	0.00036249
17	Yes	5	0.00000001	0.00016045
18	Yes	5	0.00000001	0.00035782
19	Yes	5	0.00000001	0.00015803
20	Yes	4	0.00000001	0.00059205
21	Yes	4	0.00000001	0.00037297
22	Yes	5	0.00000001	0.00038581
23	Yes	5	0.00000001	0.00017067
24	Yes	5	0.00000001	0.00036210
25	Yes	5	0.00000001	0.00015930
26	Yes	4	0.00000001	0.00006279
27	Yes	5	0.00000001	0.00036311
28	Yes	5	0.00000001	0.00047413
29	Yes	5	0.00000001	0.00047525
30	Yes	5	0.00000001	0.00039706
31	Yes	5	0.00000001	0.00049553
32	Yes	5	0.00000001	0.00050013
33	Yes	5	0.00000001	0.00037621
34	Yes	5	0.00000001	0.00048318
35	Yes	5	0.00000001	0.00048407
36	Yes	5	0.00000001	0.00039118
37	Yes	5	0.00000001	0.00047408
38	Yes	5	0.00000001	0.00046784
39	Yes	4	0.00000001	0.00002797
40	Yes	4	0.00000001	0.00012796
41	Yes	4	0.00000001	0.00013601
42	Yes	4	0.00000001	0.00003309
43	Yes	4	0.00000001	0.00012387
44	Yes	4	0.00000001	0.00014805
45	Yes	4	0.00000001	0.00003060
46	Yes	4	0.00000001	0.00012841
47	Yes	4	0.00000001	0.00012299
48	Yes	4	0.00000001	0.00003544
49	Yes	4	0.00000001	0.00014912
50	Yes	4	0.00000001	0.00012232

Maximum Tower Deflections - Service Wind

Section No.	Elevation ft	Horz. Deflection in	Gov. Load Comb.	Tilt °	Twist °
L1	179 - 141.25	21.487	43	1.0024	0.0023
L2	145.58 - 92.58	14.686	43	0.9152	0.0018
L3	98.5 - 45.5	6.771	43	0.6541	0.0008
L4	53 - 0	1.958	43	0.3385	0.0003

Critical Deflections and Radius of Curvature - Service Wind

tnxTower Destek Engineering, LLC 1281 Kennestone Circle, Ste. 100 Marietta, GA 30066 Phone: (770) 693-0835 FAX:	Job CTHA014A	Page 17 of 19
	Project 1875043	Date 12:17:37 11/05/18
	Client T-Mobile	Designed by Ahmet Colakoglu

Elevation	Appurtenance	Gov. Load Comb.	Deflection in	Tilt °	Twist °	Radius of Curvature ft
181.00	(3) 6' x 2" Mount Pipe	43	21.487	1.0024	0.0023	86676
174.00	ET-X-TU-42-15-37-18-iR-ST w/ Mount Pipe	43	20.445	0.9921	0.0023	86676
170.00	RRH1900MHz	43	19.613	0.9837	0.0022	48153
159.00	HP2-102	43	17.351	0.9575	0.0021	21668
151.00	AIR 21 B4A/B2P w/ Mount Pipe	43	15.746	0.9341	0.0019	15477
142.00	RRUS-11	43	14.000	0.9012	0.0018	12539
140.00	7770.00 w/ Mount Pipe	43	13.623	0.8928	0.0017	12305
130.00	BXA-171063-12CF-EDIN w/ Mount Pipe	43	11.794	0.8454	0.0015	11273
126.00	HP2-102	43	11.092	0.8243	0.0014	10907

Maximum Tower Deflections - Design Wind

Section No.	Elevation ft	Horz. Deflection in	Gov. Load Comb.	Tilt °	Twist °
L1	179 - 141.25	100.717	10	4.7035	0.0109
L2	145.58 - 92.58	68.857	10	4.2952	0.0085
L3	98.5 - 45.5	31.757	10	3.0697	0.0035
L4	53 - 0	9.185	10	1.5880	0.0013

Critical Deflections and Radius of Curvature - Design Wind

Elevation	Appurtenance	Gov. Load Comb.	Deflection in	Tilt °	Twist °	Radius of Curvature ft
181.00	(3) 6' x 2" Mount Pipe	10	100.717	4.7035	0.0109	18759
174.00	ET-X-TU-42-15-37-18-iR-ST w/ Mount Pipe	10	95.833	4.6555	0.0106	18759
170.00	RRH1900MHz	10	91.936	4.6159	0.0104	10421
159.00	HP2-102	10	81.342	4.4935	0.0096	4687
151.00	AIR 21 B4A/B2P w/ Mount Pipe	10	73.823	4.3837	0.0090	3347
142.00	RRUS-11	10	65.644	4.2292	0.0082	2708
140.00	7770.00 w/ Mount Pipe	10	63.874	4.1898	0.0080	2657
130.00	BXA-171063-12CF-EDIN w/ Mount Pipe	10	55.304	3.9678	0.0069	2430
126.00	HP2-102	10	52.013	3.8685	0.0064	2349

Compression Checks

Pole Design Data

Section No.	Elevation ft	Size	L ft	L _u ft	Kl/r	A in ²	P _u lb	φP _n lb	Ratio $\frac{P_u}{\phi P_n}$
-------------	--------------	------	------	-------------------	------	-------------------	-------------------	--------------------	------------------------------

tnxTower Destek Engineering, LLC 1281 Kennestone Circle, Ste. 100 Marietta, GA 30066 Phone: (770) 693-0835 FAX:	Job CTHA014A	Page 18 of 19
	Project 1875043	Date 12:17:37 11/05/18
	Client T-Mobile	Designed by Ahmet Colakoglu

Section No.	Elevation ft	Size	L ft	L _u ft	Kl/r	A in ²	P _u lb	φP _n lb	Ratio $\frac{P_u}{\phi P_n}$
L1	179 - 141.25 (1)	TP33.249x23.1x0.25	37.75	0.00	0.0	25.2610	-8223.17	1748390.00	0.005
L2	141.25 - 92.58 (2)	TP45.834x31.5849x0.375	53.00	0.00	0.0	52.2132	-24005.60	3714610.00	0.006
L3	92.58 - 45.5 (3)	TP57.742x43.4924x0.375	53.00	0.00	0.0	65.8810	-38675.90	4311140.00	0.009
L4	45.5 - 0 (4)	TP69.225x54.9755x0.375	53.00	0.00	0.0	81.9487	-61054.90	4812990.00	0.013

Pole Bending Design Data

Section No.	Elevation ft	Size	M _{ux} kip-ft	φM _{ux} kip-ft	Ratio $\frac{M_{ux}}{\phi M_{ux}}$	M _{uy} kip-ft	φM _{uy} kip-ft	Ratio $\frac{M_{uy}}{\phi M_{uy}}$
L1	179 - 141.25 (1)	TP33.249x23.1x0.25	259.86	1144.56	0.227	0.00	1144.56	0.000
L2	141.25 - 92.58 (2)	TP45.834x31.5849x0.375	1480.68	3348.51	0.442	0.00	3348.51	0.000
L3	92.58 - 45.5 (3)	TP57.742x43.4924x0.375	3022.18	4912.18	0.615	0.00	4912.18	0.000
L4	45.5 - 0 (4)	TP69.225x54.9755x0.375	5131.75	6830.50	0.751	0.00	6830.50	0.000

Pole Shear Design Data

Section No.	Elevation ft	Size	Actual V _u lb	φV _n lb	Ratio $\frac{V_u}{\phi V_n}$	Actual T _u kip-ft	φT _n kip-ft	Ratio $\frac{T_u}{\phi T_n}$
L1	179 - 141.25 (1)	TP33.249x23.1x0.25	13996.30	874196.00	0.016	0.17	2294.63	0.000
L2	141.25 - 92.58 (2)	TP45.834x31.5849x0.375	30989.80	1857310.00	0.017	2.49	6713.85	0.000
L3	92.58 - 45.5 (3)	TP57.742x43.4924x0.375	36687.90	2155570.00	0.017	2.48	9846.42	0.000
L4	45.5 - 0 (4)	TP69.225x54.9755x0.375	42544.60	2406490.00	0.018	2.48	13689.00	0.000

Pole Interaction Design Data

Section No.	Elevation ft	Ratio $\frac{P_u}{\phi P_n}$	Ratio $\frac{M_{ux}}{\phi M_{ux}}$	Ratio $\frac{M_{uy}}{\phi M_{uy}}$	Ratio $\frac{V_u}{\phi V_n}$	Ratio $\frac{T_u}{\phi T_n}$	Comb. Stress Ratio	Allow. Stress Ratio	Criteria
L1	179 - 141.25 (1)	0.005	0.227	0.000	0.016	0.000	0.232	1.000	4.8.2
L2	141.25 - 92.58 (2)	0.006	0.442	0.000	0.017	0.000	0.449	1.000	4.8.2
L3	92.58 - 45.5 (3)	0.009	0.615	0.000	0.017	0.000	0.625	1.000	4.8.2
L4	45.5 - 0 (4)	0.013	0.751	0.000	0.018	0.000	0.764	1.000	4.8.2

<i>tnxTower</i> <i>Destek Engineering, LLC</i> <i>1281 Kennestone Circle, Ste. 100</i> <i>Marietta, GA 30066</i> <i>Phone: (770) 693-0835</i> <i>FAX:</i>	Job	CTHA014A	Page	19 of 19
	Project	1875043	Date	12:17:37 11/05/18
	Client	T-Mobile	Designed by	Ahmet Colakoglu

Section Capacity Table

Section No.	Elevation ft	Component Type	Size	Critical Element	P lb	ϕP_{allow} lb	% Capacity	Pass Fail	
L1	179 - 141.25	Pole	TP33.249x23.1x0.25	1	-8223.17	1748390.00	23.2	Pass	
L2	141.25 - 92.58	Pole	TP45.834x31.5849x0.375	2	-24005.60	3714610.00	44.9	Pass	
L3	92.58 - 45.5	Pole	TP57.742x43.4924x0.375	3	-38675.90	4311140.00	62.5	Pass	
L4	45.5 - 0	Pole	TP69.225x54.9755x0.375	4	-61054.90	4812990.00	76.4	Pass	
							Summary		
							Pole (L4)	76.4	Pass
							RATING =	76.4	Pass

Monopole Base Plate Connection



Site Info	
BU #	
Site Name	CTHA014A
Order #	

Analysis Considerations	
TIA-222 Revision	G
Grout Considered:	No
I_{ar} (in)	0
Eta Factor, η	0.5

Applied Loads	
Moment (kip-ft)	5131.75
Axial Force (kips)	61.05
Shear Force (kips)	42.54

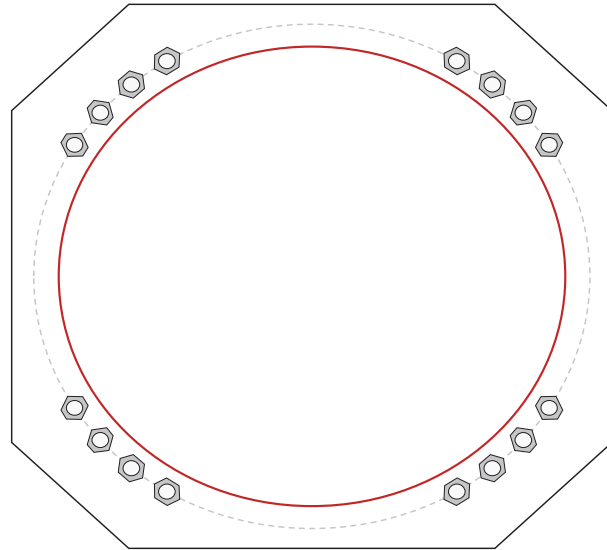

Connection Properties	Analysis Results
-----------------------	------------------

Anchor Rod Data	
(16) 2-1/4" ϕ bolts (A615-75 N; $F_y=75$ ksi, $F_u=100$ ksi) on 76" BC	

Base Plate Data	
82" OD x 2.25" Plate (A572-60; $F_y=60$ ksi, $F_u=75$ ksi)	

Stiffener Data	
N/A	

Pole Data	
69.225" x 0.375" 18-sided pole (A572-65; $F_y=65$ ksi, $F_u=80$ ksi)	

Anchor Rod Summary		<i>(units of kips, kip-in)</i>
$Pu_c = 206.31$	$\phi Pn_t = 260$	Stress Rating
$Vu = 2.66$	$\phi Vn = n/a$	81.4%
$Mu = n/a$	$\phi Mn = n/a$	Pass

Base Plate Summary		
Max Stress (ksi):	44.6	(Flexural)
Allowable Stress (ksi):	54	
Stress Rating:	82.6%	Pass

Pier and Pad Foundation

BU # :
 Site Name: CTHA014A
 App. Number:

TIA-222 Revision:
 Tower Type:

Block Foundation?:

Superstructure Analysis Reactions		
Compression, P_{comp} :	61.1	kips
Base Shear, V_{u_comp} :	42.5	kips
Moment, M_u :	5132	ft-kips
Tower Height, H :	179	ft
BP Dist. Above Fdn, bp_{dist} :	3	in

Foundation Analysis Checks				
	Capacity	Demand	Rating	Check
<i>Lateral (Sliding) (kips)</i>	299.58	42.50	14.2%	Pass
<i>Bearing Pressure (ksf)</i>	4.99	1.89	37.9%	Pass
<i>Overturning (kip*ft)</i>	9403.09	5440.13	57.9%	Pass
<i>Pier Flexure (Comp.) (kip*ft)</i>	8138.89	5323.25	65.4%	Pass
<i>Pier Compression (kip)</i>	27087.80	107.06	0.4%	Pass
<i>Pad Flexure (kip*ft)</i>	3598.09	1898.00	52.8%	Pass
<i>Pad Shear - 1-way (kips)</i>	748.54	264.47	35.3%	Pass
<i>Pad Shear - 2-way (Comp) (ksi)</i>	0.164	0.055	33.6%	Pass

Pier Properties		
Pier Shape:	Circular	
Pier Diameter, $dpier$:	8.5	ft
Ext. Above Grade, E :	0.5	ft
Pier Rebar Size, S_c :	9	
Pier Rebar Quantity, mc :	41	
Pier Tie/Spiral Size, S_t :	4	
Pier Tie/Spiral Quantity, mt :	14	
Pier Reinforcement Type:	Tie	
Pier Clear Cover, cc_{pier} :	3	in

Soil Rating:	57.9%
Structural Rating:	65.4%

Pad Properties		
Depth, D :	6.5	ft
Pad Width, W :	30	ft
Pad Thickness, T :	2.5	ft
Pad Rebar Size, S_p :	9	
Pad Rebar Quantity, mp :	33	
Pad Clear Cover, cc_{pad} :	3	in

Material Properties		
Rebar Grade, F_y :	60000	psi
Concrete Compressive Strength, F'_c :	3000	psi
Dry Concrete Density, δ_c :	150	pcf

Soil Properties		
Total Soil Unit Weight, γ :	100	pcf
Ultimate Net Bearing, Q_{net} :	6.000	ksf
Cohesion, C_u :	0.000	ksf
Friction Angle, ϕ :	30	degrees
SPT Blow Count, N_{blows} :		
Base Friction, μ :	0.4	
Neglected Depth, N :	3.33	ft
Foundation Bearing on Rock?	No	
Groundwater Depth, gw :	N/A	ft

<--Toggle between Gross and Net

Exhibit E

June 25, 2018

To: T-Mobile Northeast, LLC
35 Griffin Road South
Bloomfield, CT 06002

Subject: Mount Assessment – CTHA014 (Destek Job #: 1875043)

Per your request, Destek Engineering, LLC (Destek) has performed a structural assessment of the antenna mounting system which supports the T-Mobile Equipment at the referenced site. We have evaluated the subject mount for the additions and alterations specified in the RFDS, which is referenced in Table 1. This assessment is based on the documents and information listed in Table 1 and is in accordance with the mount loading and evaluation criteria stated in Table 2.

Based on our experience with similar mount structures and with respect to the changes in applied loads, Destek opines that the mount **WILL BE ADEQUATE**.

This assessment is only valid for the loading scenario described herein. Variations between this document and actual field conditions will void this assessment. It is assumed that all structural members and connections of the subject mount are in good condition and the mount has been properly designed, constructed and assembled. Discrepancies between this document and field conditions should be immediately brought to our attention. It is assumed that the tower and other components of the site have been analyzed and qualified by others.

We at *Destek Engineering, LLC* appreciate the opportunity of providing our continuing professional services to you. If you have any questions or need further assistance on this or any other project, please do not hesitate to contact us.

Sincerely,
Destek Engineering, LLC
License No: PEC00001429



Ahmet Colakoglu, PE
Connecticut Professional Engineer
License No: 27057

References and Loading

Table 1: Documents and Information Provided

DOCUMENT	PREPARED BY	DATE
Structural Analysis Report	Destek Engineering, LLC	11/29/2016
RFDS	T-Mobile	05/08/2018
Site Photos	ForeSite LLC	04/23/2018

Table 2: Mount Loading and Evaluation Criteria

LOCATION	Wethersfield, Hartford County, CT
BUILDING CODE AND TOWER STANDARD	2016 Connecticut State Building Code and TIA-222-G
RAD CENTER	151 ft
STRUCTURE TYPE	Monopole
EXPOSURE CATEGORY	C
WIND LOADING	125 mph ultimate basic wind (97 mph nominal wind speed)
ICE LOADING	1.00 inch ice with 50 mph basic wind. Ice is considered to increase in thickness with height
CLASS	II
TOPOGRAPHIC CATEGORY	1

Table 2.1 – Existing Appurtenance Configuration

QTY	MODEL
3	AIR21 KRC118023-1 B2A B4P – Antennas
3	AIR21 KRC118023-1 B4A B2P – Antennas
3	LNx-6515DS-A1M – Antennas
6	Generic Twin Style 1B AWS - TMAs
3	RRUS 11 B12

Table 2.2 – Proposed and Final Appurtenance Configuration

QTY	MODEL
3	AIR21 KRC118023-1 B2A B4P – Antennas
3	APXVAARR24-43-U-NA20 – Antennas
3	AIR32 KRD901146-1 B66A B2A – Antennas
3	Generic Twin Style 1B AWS - TMAs
3	Radio 4449 B71 + B12 – RRUs

Mount Photos

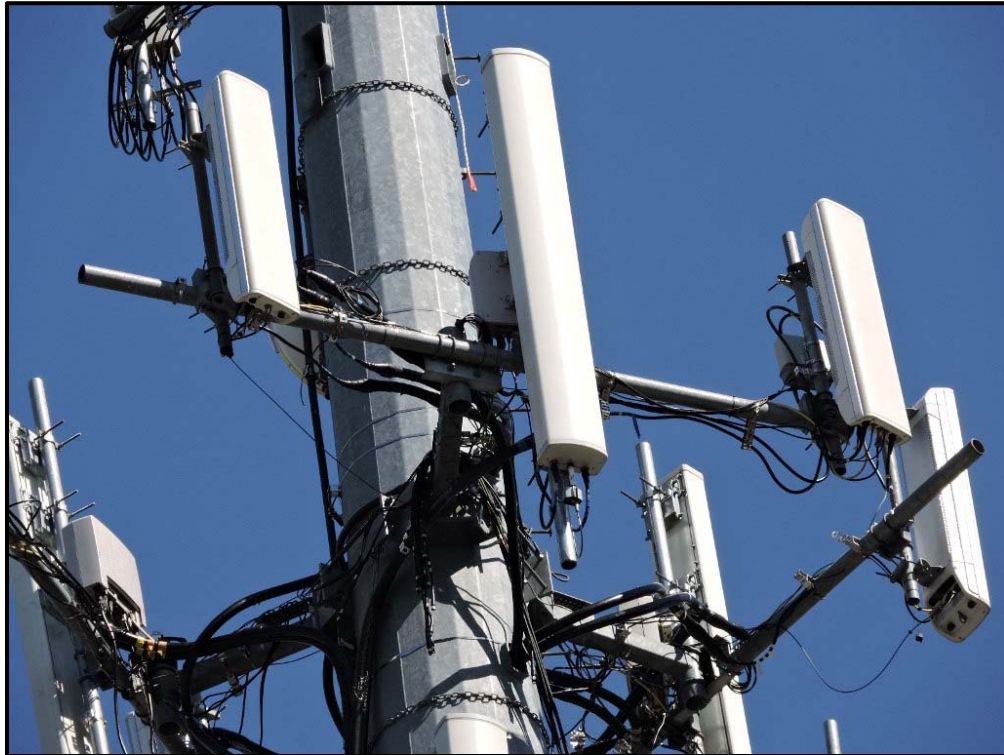

Exhibit F



RADIO FREQUENCY EMISSIONS ANALYSIS REPORT EVALUATION OF HUMAN EXPOSURE POTENTIAL TO NON-IONIZING EMISSIONS

T-Mobile Existing Facility

Site ID: CTHA014A

HA014/Town of Wethersfield_MP
23 Kelleher Court
Wethersfield, CT 06109

July 23, 2018

EBI Project Number: 6218005203

Site Compliance Summary	
Compliance Status:	COMPLIANT
Site total MPE% of FCC general population allowable limit:	15.71 %



July 23, 2018

T-Mobile USA
Attn: Jason Overbey, RF Manager
35 Griffin Road South
Bloomfield, CT 06002

Emissions Analysis for Site: **CTHA014A – HA014/Town of Wethersfield_MP**

EBI Consulting was directed to analyze the proposed T-Mobile facility located at **23 Kelleher Court, Wethersfield, CT**, for the purpose of determining whether the emissions from the Proposed T-Mobile Antenna Installation located on this property are within specified federal limits.

All information used in this report was analyzed as a percentage of current Maximum Permissible Exposure (% MPE) as listed in the FCC OET Bulletin 65 Edition 97-01 and ANSI/IEEE Std C95.1. The FCC regulates Maximum Permissible Exposure in units of microwatts per square centimeter ($\mu\text{W}/\text{cm}^2$). The number of $\mu\text{W}/\text{cm}^2$ calculated at each sample point is called the power density. The exposure limit for power density varies depending upon the frequencies being utilized. Wireless Carriers and Paging Services use different frequency bands each with different exposure limits, therefore it is necessary to report results and limits in terms of percent MPE rather than power density.

All results were compared to the FCC (Federal Communications Commission) radio frequency exposure rules, 47 CFR 1.1307(b)(1) – (b)(3), to determine compliance with the Maximum Permissible Exposure (MPE) limits for General Population/Uncontrolled environments as defined below.

General population/uncontrolled exposure limits apply to situations in which the general population may be exposed or in which persons who are exposed as a consequence of their employment may not be made fully aware of the potential for exposure or cannot exercise control over their exposure. Therefore, members of the general population would always be considered under this category when exposure is not employment related, for example, in the case of a telecommunications tower that exposes persons in a nearby residential area.

Public exposure to radio frequencies is regulated and enforced in units of microwatts per square centimeter ($\mu\text{W}/\text{cm}^2$). The general population exposure limits for the 600 MHz and 700 MHz Band are approximately $400 \mu\text{W}/\text{cm}^2$ and $467 \mu\text{W}/\text{cm}^2$ respectively. The general population exposure limit for the 1900 MHz (PCS) and 2100 MHz (AWS) bands is $1000 \mu\text{W}/\text{cm}^2$. Because each carrier will be using different frequency bands, and each frequency band has different exposure limits, it is necessary to report percent of MPE rather than power density.



Occupational/controlled exposure limits apply to situations in which persons are exposed as a consequence of their employment and in which those persons who are exposed have been made fully aware of the potential for exposure and can exercise control over their exposure. Occupational/controlled exposure limits also apply where exposure is of a transient nature as a result of incidental passage through a location where exposure levels may be above general population/uncontrolled limits (see below), as long as the exposed person has been made fully aware of the potential for exposure and can exercise control over his or her exposure by leaving the area or by some other appropriate means.

Additional details can be found in FCC OET 65.

CALCULATIONS

Calculations were done for the proposed T-Mobile Wireless antenna facility located at **23 Kelleher Court, Wethersfield, CT**, using the equipment information listed below. All calculations were performed per the specifications under FCC OET 65. Since T-Mobile is proposing highly focused directional panel antennas, which project most of the emitted energy out toward the horizon, all calculations were performed assuming a lobe representing the maximum gain of the antenna per the antenna manufactures supplied specifications, minus 10 dB for directional panel antennas, was focused at the base of the tower. For this report the sample point is the top of a 6-foot person standing at the base of the tower.

For all calculations, all equipment was calculated using the following assumptions:

- 1) 2 GSM channels (PCS Band - 1900 MHz) were considered for each sector of the proposed installation. These Channels have a transmit power of 30 Watts per Channel.
- 2) 2 UMTS channels (AWS Band – 2100 MHz) were considered for each sector of the proposed installation. These Channels have a transmit power of 30 Watts per Channel.
- 3) 2 LTE channels (PCS Band - 1900 MHz) were considered for each sector of the proposed installation. These Channels have a transmit power of 60 Watts per Channel.
- 4) 2 LTE channels (AWS Band – 2100 MHz) were considered for each sector of the proposed installation. These Channels have a transmit power of 60 Watts per Channel
- 5) 2 LTE channels (600 MHz Band) were considered for each sector of the proposed installation. These channels have a transmit power of 30 Watts.
- 6) 2 LTE channels (700 MHz Band) were considered for each sector of the proposed installation. These channels have a transmit power of 30 Watts.



- 7) All radios at the proposed installation were considered to be running at full power and were uncombined in their RF transmissions paths per carrier prescribed configuration. Per FCC OET Bulletin No. 65 - Edition 97-01 recommendations to achieve the maximum anticipated value at each sample point, all power levels emitting from the proposed antenna installation are increased by a factor of 2.56 to account for possible in-phase reflections from the surrounding environment. This is rarely the case, and if so, is never continuous.
- 8) For the following calculations the sample point was the top of a 6-foot person standing at the base of the tower. The maximum gain of the antenna per the antenna manufactures supplied specifications, minus 10 dB for directional panel antennas, was used in this direction. This value is a very conservative estimate as gain reductions for these particular antennas are typically much higher in this direction.
- 9) The antennas used in this modeling are the **Ericsson AIR32 B66A/B2A & Ericsson AIR21 B2A/B4P** for 1900 MHz (PCS) and 2100 MHz (AWS) channels and the **RFS APXVAARR24_43-U-NA20** for 600 MHz and 700 MHz channels. This is based on feedback from the carrier with regard to anticipated antenna selection. All Antenna gain values and associated transmit power levels are shown in the Site Inventory and Power Data table below. The maximum gain of the antenna per the antenna manufactures supplied specifications, minus 10 dB for directional panel antennas, was used for all calculations. This value is a very conservative estimate as gain reductions for these particular antennas are typically much higher in this direction.
- 10) The antenna mounting height centerline of the proposed antennas is **151 feet** above ground level (AGL).
- 11) Emissions values for additional carriers were taken from the Connecticut Siting Council active database. Values in this database are provided by the individual carriers themselves.
- 12) All calculations were done with respect to uncontrolled / general population threshold limits.



T-Mobile Site Inventory and Power Data

Sector:	A	Sector:	B	Sector:	C
Antenna #:	1	Antenna #:	1	Antenna #:	1
Make / Model:	Ericsson AIR32 B66A/B2A	Make / Model:	Ericsson AIR32 B66A/B2A	Make / Model:	Ericsson AIR32 B66A/B2A
Gain:	15.9 dBd	Gain:	15.9 dBd	Gain:	15.9 dBd
Height (AGL):	151	Height (AGL):	151	Height (AGL):	151
Frequency Bands	1900 MHz (PCS) / 2100 MHz (AWS)	Frequency Bands	1900 MHz (PCS) / 2100 MHz (AWS)	Frequency Bands	1900 MHz (PCS) / 2100 MHz (AWS)
Channel Count	4	Channel Count	4	Channel Count	4
Total TX Power(W):	240	Total TX Power(W):	240	Total TX Power(W):	240
ERP (W):	9,337.08	ERP (W):	9,337.08	ERP (W):	9,337.08
Antenna A1 MPE%	1.60	Antenna B1 MPE%	1.60	Antenna C1 MPE%	1.60
Antenna #:	2	Antenna #:	2	Antenna #:	2
Make / Model:	Ericsson AIR21 B2A/B4P	Make / Model:	Ericsson AIR21 B2A/B4P	Make / Model:	Ericsson AIR21 B2A/B4P
Gain:	15.9 dBd	Gain:	15.9 dBd	Gain:	15.9 dBd
Height (AGL):	151	Height (AGL):	151	Height (AGL):	151
Frequency Bands	1900 MHz (PCS) / 2100 MHz (AWS)	Frequency Bands	1900 MHz (PCS) / 2100 MHz (AWS)	Frequency Bands	1900 MHz (PCS) / 2100 MHz (AWS)
Channel Count	4	Channel Count	4	Channel Count	4
Total TX Power(W):	120	Total TX Power(W):	120	Total TX Power(W):	120
ERP (W):	4,668.54	ERP (W):	4,668.54	ERP (W):	4,668.54
Antenna A2 MPE%	0.80	Antenna B2 MPE%	0.80	Antenna C2 MPE%	0.80
Antenna #:	3	Antenna #:	3	Antenna #:	3
Make / Model:	RFS APXVAARR24_43-U-NA20	Make / Model:	RFS APXVAARR24_43-U-NA20	Make / Model:	RFS APXVAARR24_43-U-NA20
Gain:	12.95 / 13.35 dBd	Gain:	12.95 / 13.35 dBd	Gain:	12.95 / 13.35 dBd
Height (AGL):	151	Height (AGL):	151	Height (AGL):	151
Frequency Bands	600 MHz / 700 MHz	Frequency Bands	600 MHz / 700 MHz	Frequency Bands	600 MHz / 700 MHz
Channel Count	4	Channel Count	4	Channel Count	4
Total TX Power(W):	120	Total TX Power(W):	120	Total TX Power(W):	120
ERP (W):	2,481.08	ERP (W):	2,481.08	ERP (W):	2,481.08
Antenna A3 MPE%	0.98	Antenna B3 MPE%	0.98	Antenna C3 MPE%	0.98

Site Composite MPE%	
Carrier	MPE%
T-Mobile (Per Sector Max)	3.38 %
Town of Wethersfield	0.17%
Clearwire	0.07%
AT&T	3.79%
Verizon Wireless	5.38%
Sprint	1.27%
Nextel	1.65%
Site Total MPE%:	15.71 %

T-Mobile Sector A Total:	3.38 %
T-Mobile Sector B Total:	3.38 %
T-Mobile Sector C Total:	3.38 %
Site Total:	15.71 %



T-Mobile Max Power Values (Per Sector)

T-Mobile_Max Power Values (per sector)	# Channels	Watts ERP (Per Channel)	Height (feet)	Total Power Density ($\mu\text{W}/\text{cm}^2$)	Frequency (MHz)	Allowable MPE ($\mu\text{W}/\text{cm}^2$)	Calculated % MPE
T-Mobile AWS - 2100 MHz LTE	2	2,334.27	151	7.98	AWS - 2100 MHz	1000	0.80%
T-Mobile PCS - 1900 MHz LTE	2	2,334.27	151	7.98	PCS - 1900 MHz	1000	0.80%
T-Mobile PCS - 1900 MHz GSM	2	1,167.14	151	3.99	PCS - 1900 MHz	1000	0.40%
T-Mobile AWS - 2100 MHz UMTS	2	1,167.14	151	3.99	AWS - 2100 MHz	1000	0.40%
T-Mobile 600 MHz LTE	2	591.73	151	2.02	600 MHz	400	0.50%
T-Mobile 700 MHz LTE	2	648.82	151	2.22	700 MHz	467	0.48%
						Total:	3.38%



Summary

All calculations performed for this analysis yielded results that were **within** the allowable limits for general population exposure to RF Emissions.

The anticipated maximum composite contributions from the T-Mobile facility as well as the site composite emissions value with regards to compliance with FCC's allowable limits for general population exposure to RF Emissions are shown here:

T-Mobile Sector	Power Density Value (%)
Sector A:	3.38 %
Sector B:	3.38 %
Sector C:	3.38 %
T-Mobile Maximum MPE % (Per Sector):	3.38 %
Site Total:	15.71 %
Site Compliance Status:	COMPLIANT

The anticipated composite MPE value for this site assuming all carriers present is **15.71%** of the allowable FCC established general population limit sampled at the ground level. This is based upon values listed in the Connecticut Siting Council database for existing carrier emissions.

FCC guidelines state that if a site is found to be out of compliance (over allowable thresholds), that carriers over a 5% contribution to the composite value will require measures to bring the site into compliance. For this facility, the composite values calculated were well within the allowable 100% threshold standard per the federal government.

Exhibit G

T-Mobile DC Diesel Generators 15kW and 25kW





Contents

1

Overview & General Specifications

2

Block Diagrams

3

Dimensions & Layouts



Features

- Intelligent and Friendly Monitoring by Remote Control (via SNMP)
- Longer Service Interval: >500hrs
- Low Acoustic Noise: <75dBA @ 7 meters
 - Optional Upgrades: <65dBA @ 7 meters

Longer Backup Time:	Tank	15kW @ 75% Load	25kW @ 75% Load
Standard	130 gallon	94 hours	72 hours
Upgraded	220 gallon	155 hours	120 hours

- Output Ripple < 250mV
- Battery Management – Temperature compensation,
Life management,
Precise Battery Current Limitation
- Corrosion Resistant
- Rodent Resistant

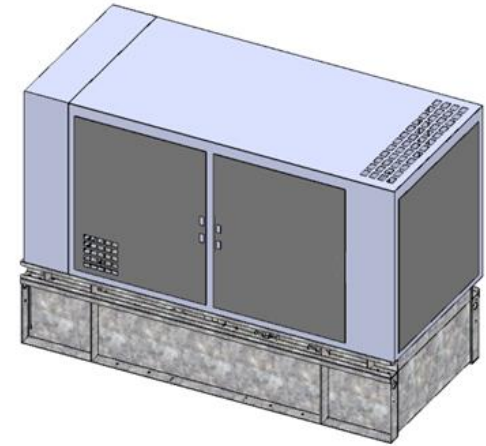



General Specification

Model	15kW DC	25kW DC
DC Output	52Vdc at 100% load	
Engine Model	Perkins Tier 4 Interim	
Engine Speed	1800rpm	
Weight (estimated)	1120kg (2470lb)	1320kg (2910lb)
Operating Temperature	-25°C to +45°C	
Safety	UL2200 / UL142	

Block Diagram

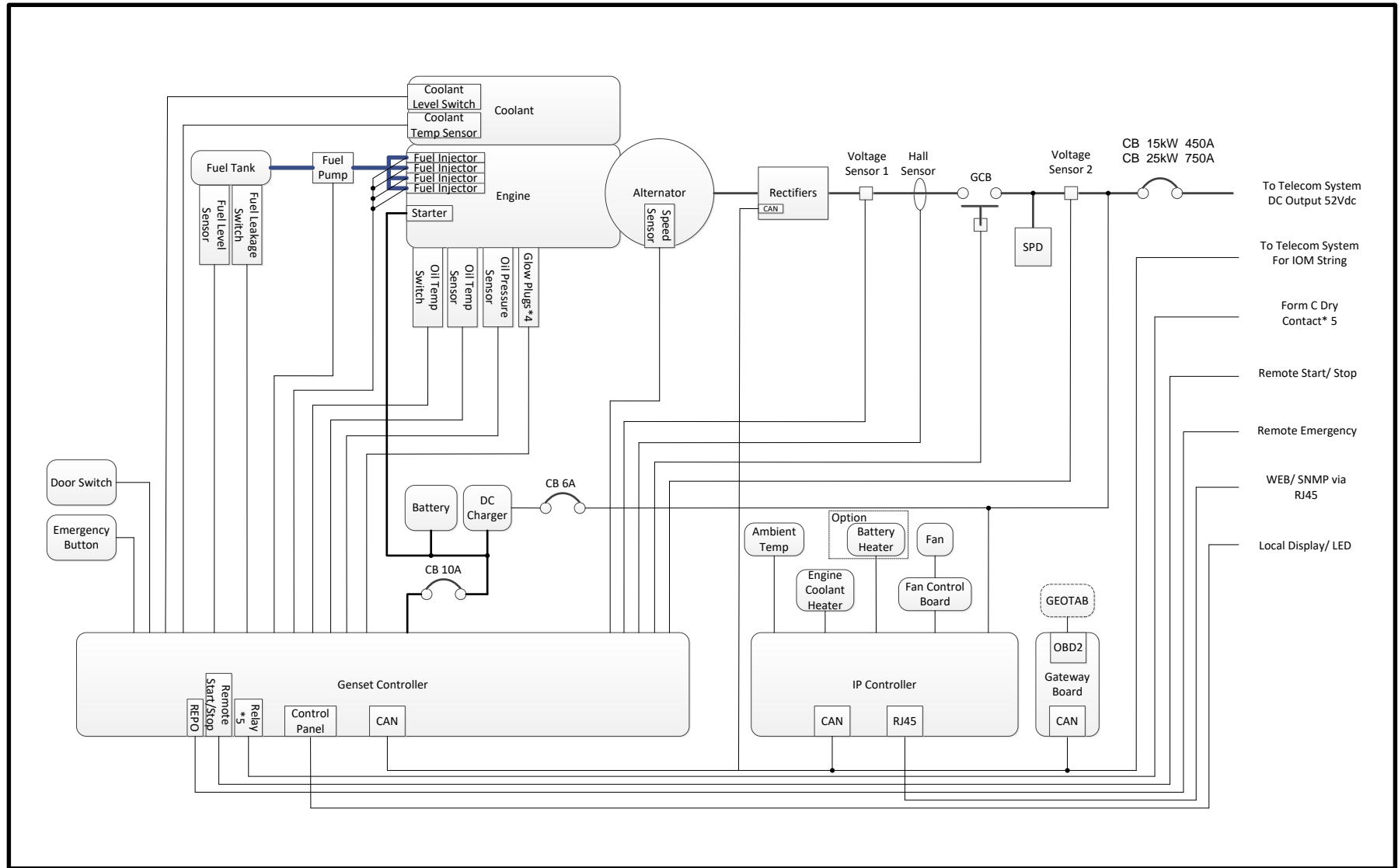



130 Gallon Tank Dimensions 15kW or 25kW DC Genset

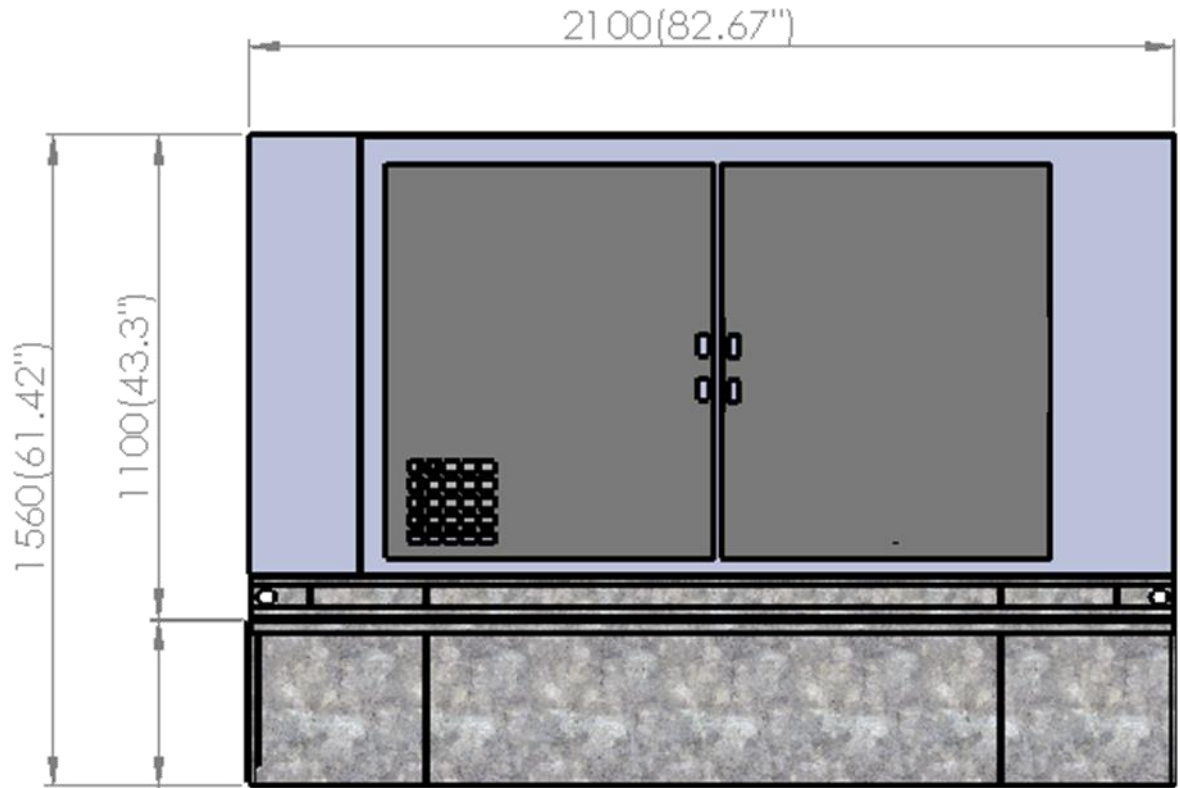
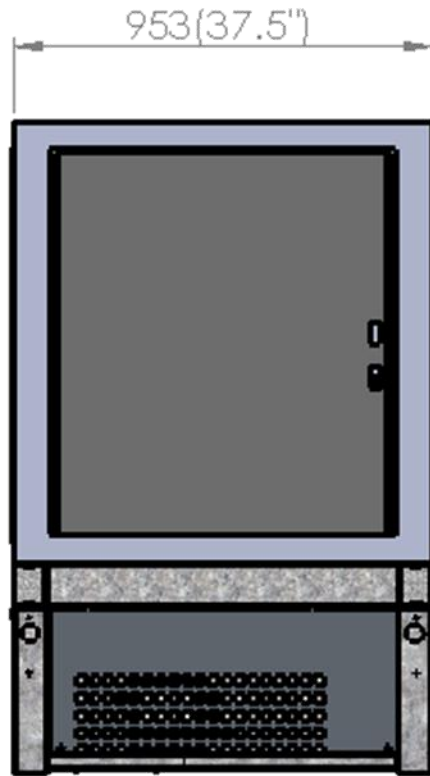

130 gallon fuel tank

Standard Tank	15kW @ 75% Load	25kW @ 75% Load
130 gallon	94 hours	72 hours



220 Gallon Tank Dimensions 15kW or 25kW DC Genset

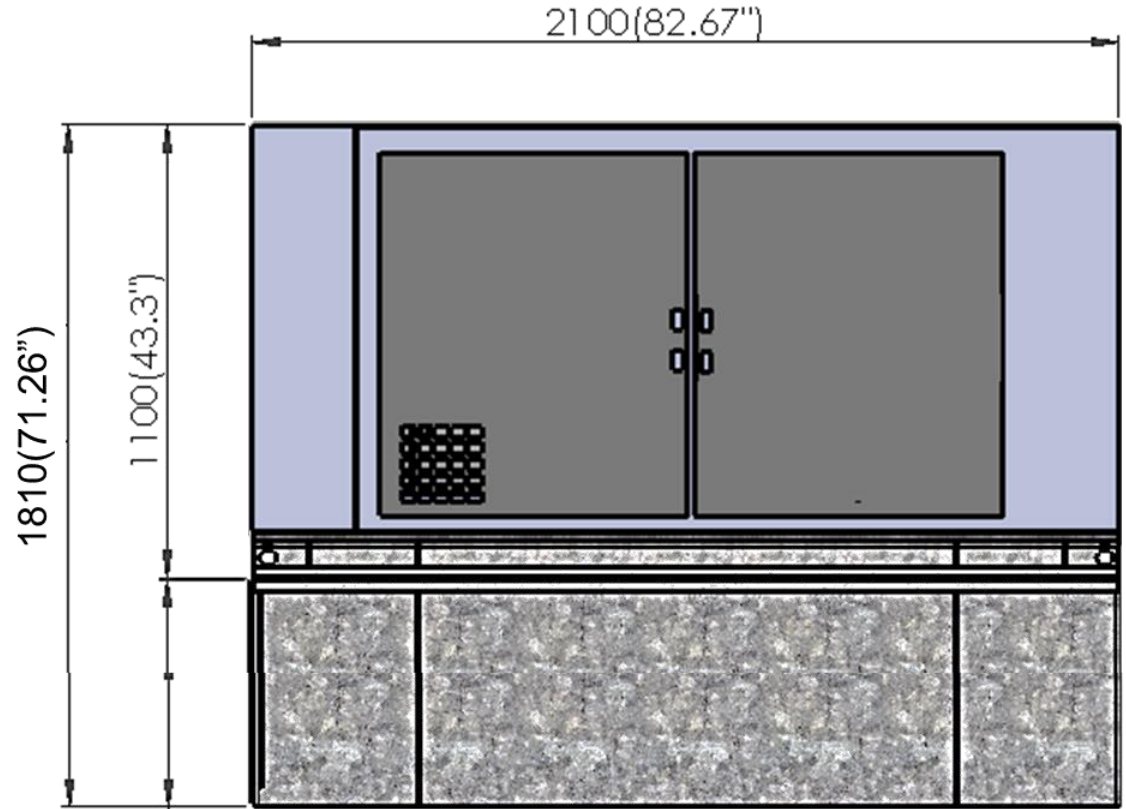
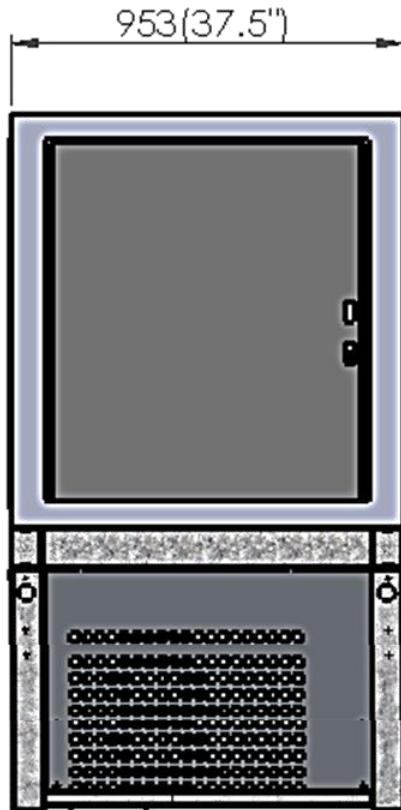

220 gallon fuel tank

Upgraded Tank	15kW @ 75% Load	25kW @ 75% Load
220 gallon	155 hours	120 hours

Generator Layout Front View

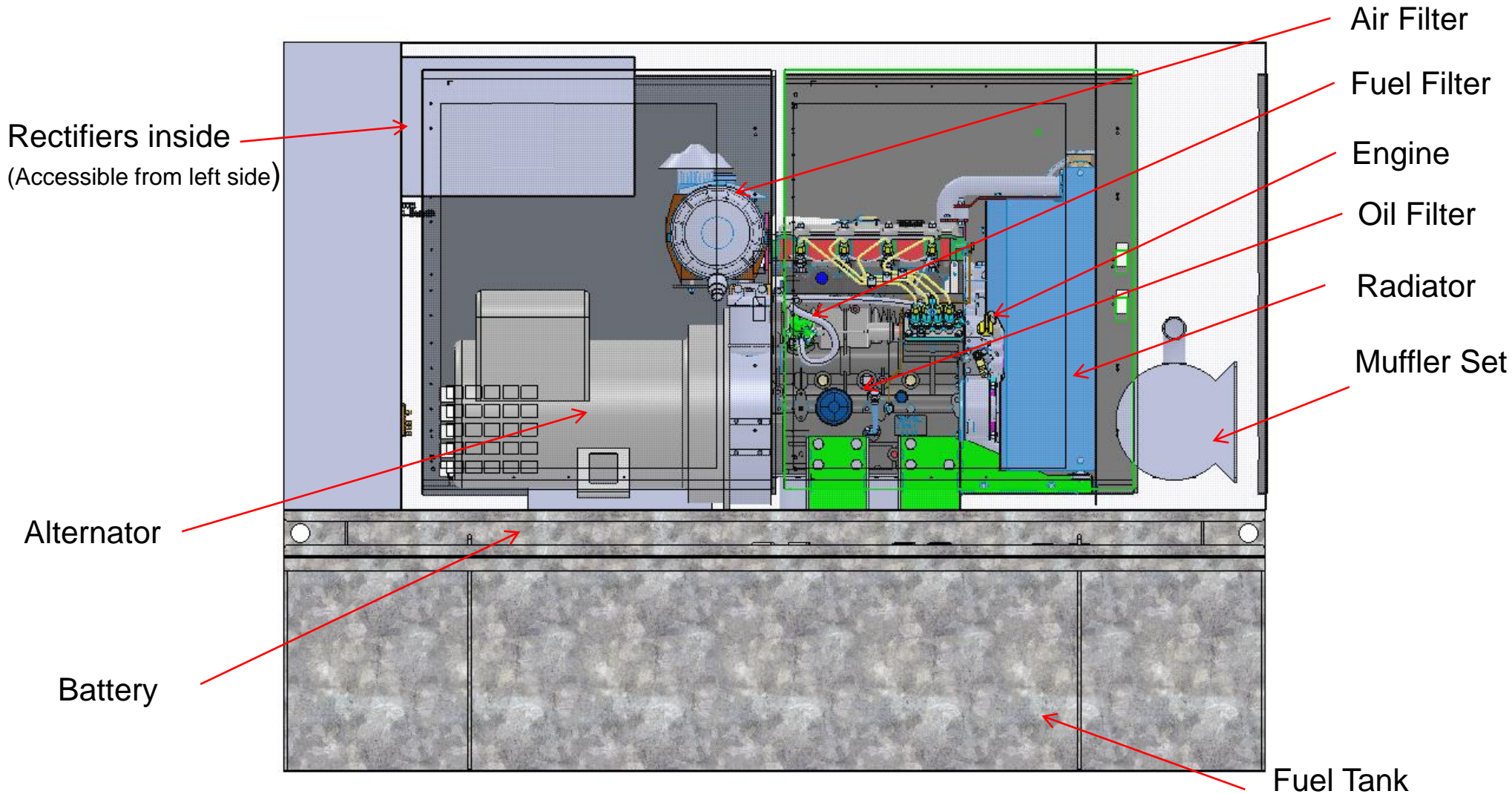

Left Side View

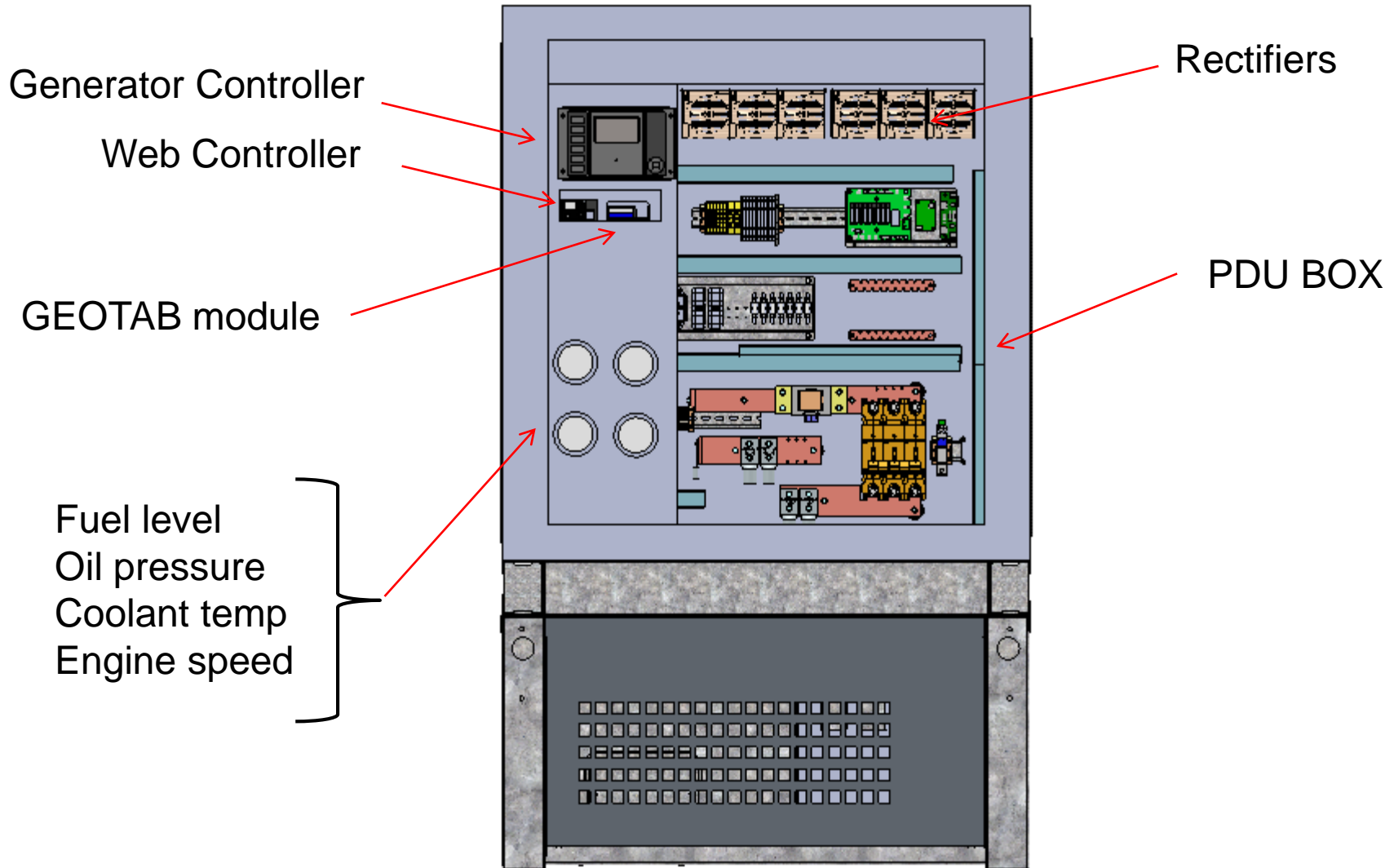

Cable Connections

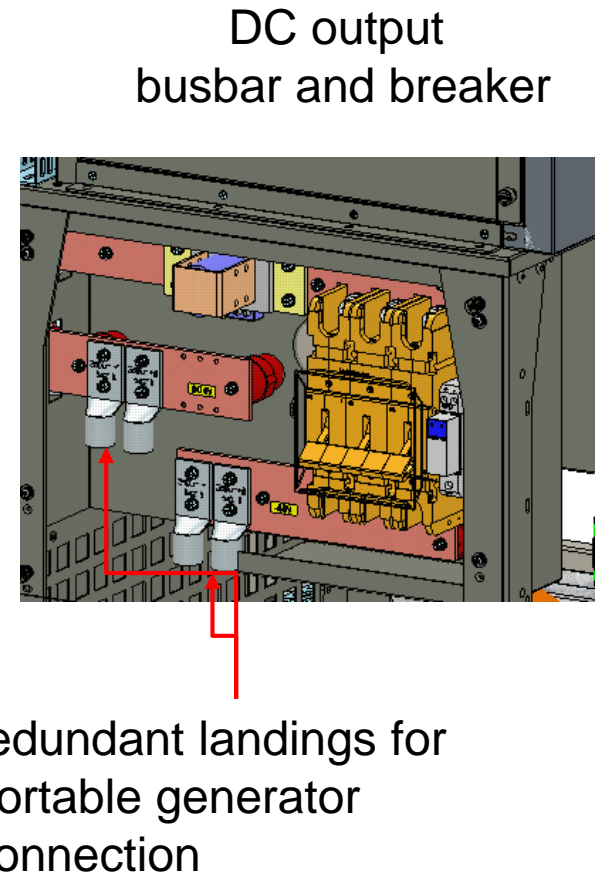
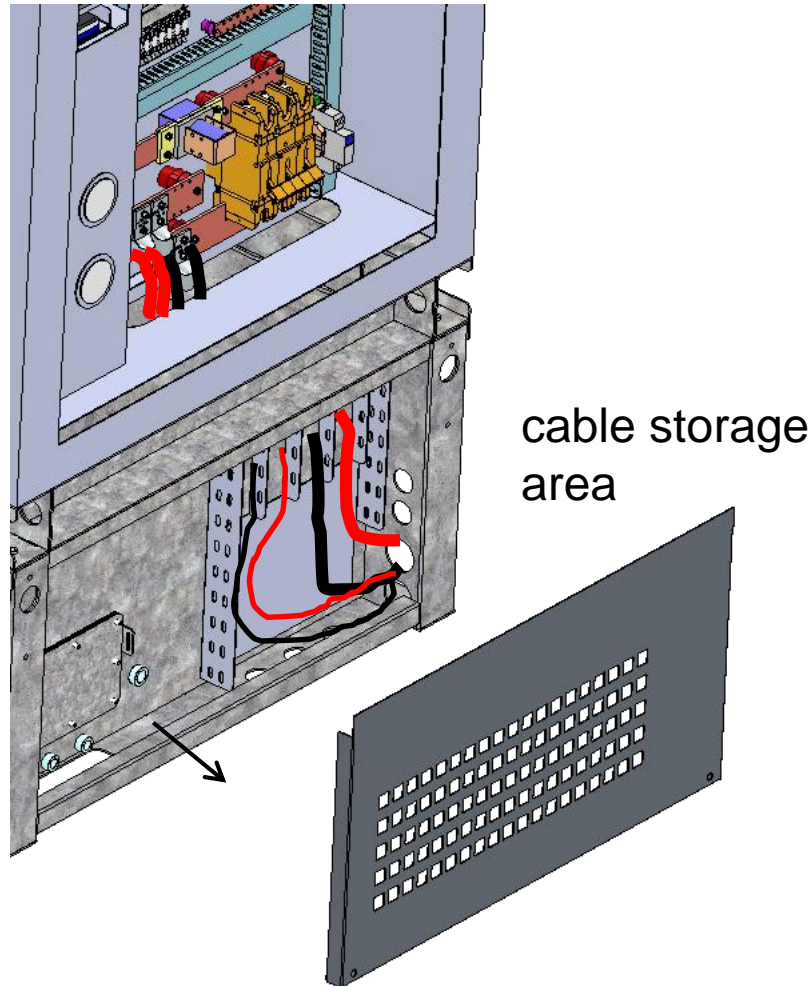

External Detail

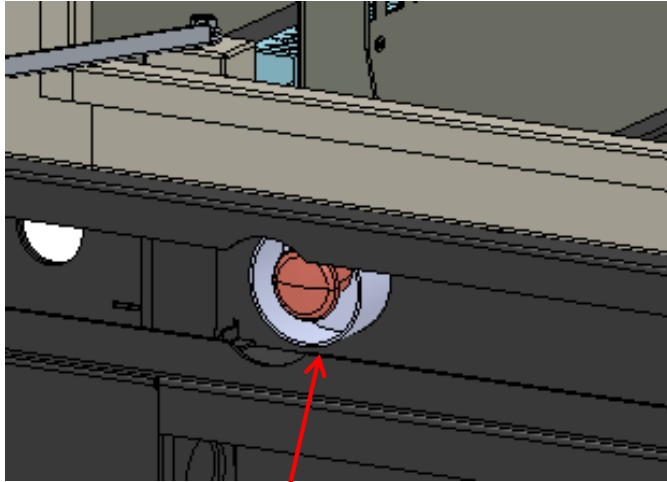

Front Bottom Left Side:
Emergency shutdown
switch externally mounted

Front Bottom Right Side:
External coolant, and
oil drains with plugs

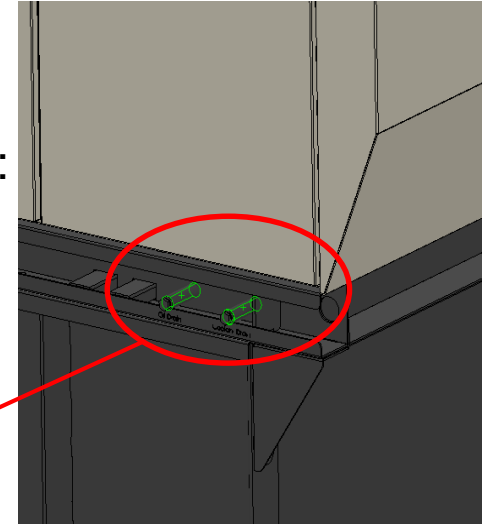
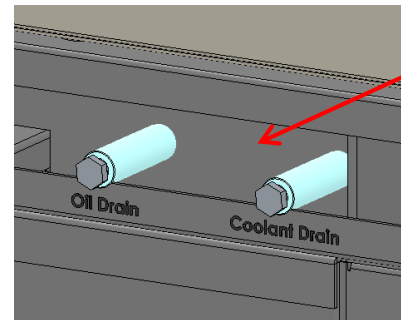

Right Side Panel:
Ball valve drain switch
inside with a padlock

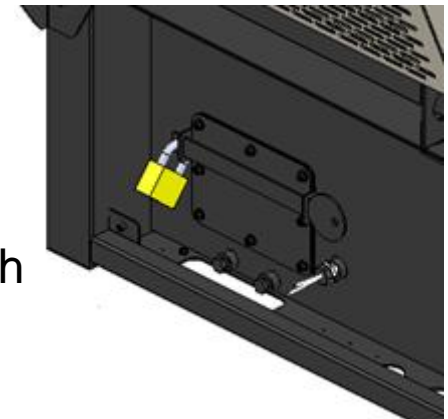

Higher Locking Method

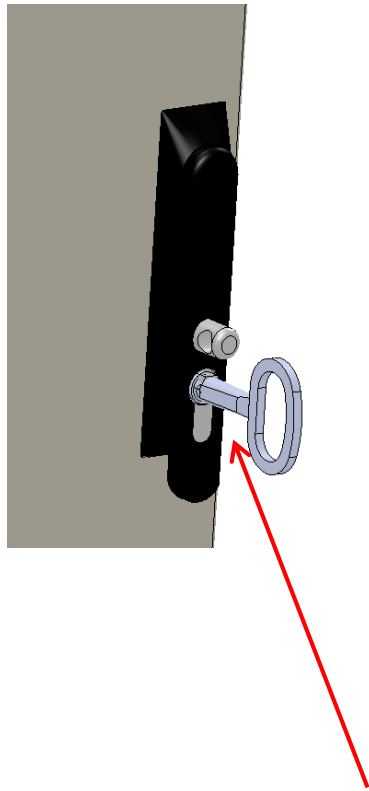

twist key to release handle

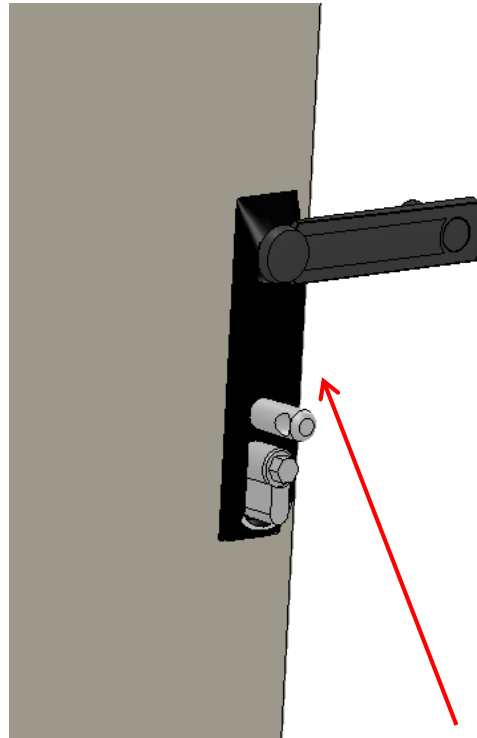

twist handle to release connecting bar

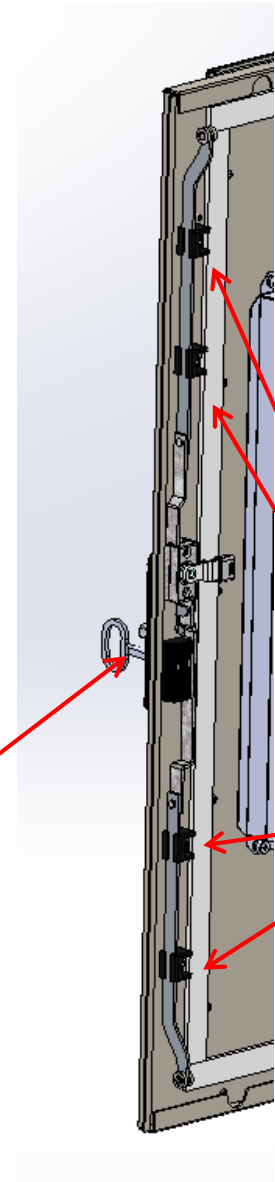

4 positions to lock the door

Fuel Tank Detail

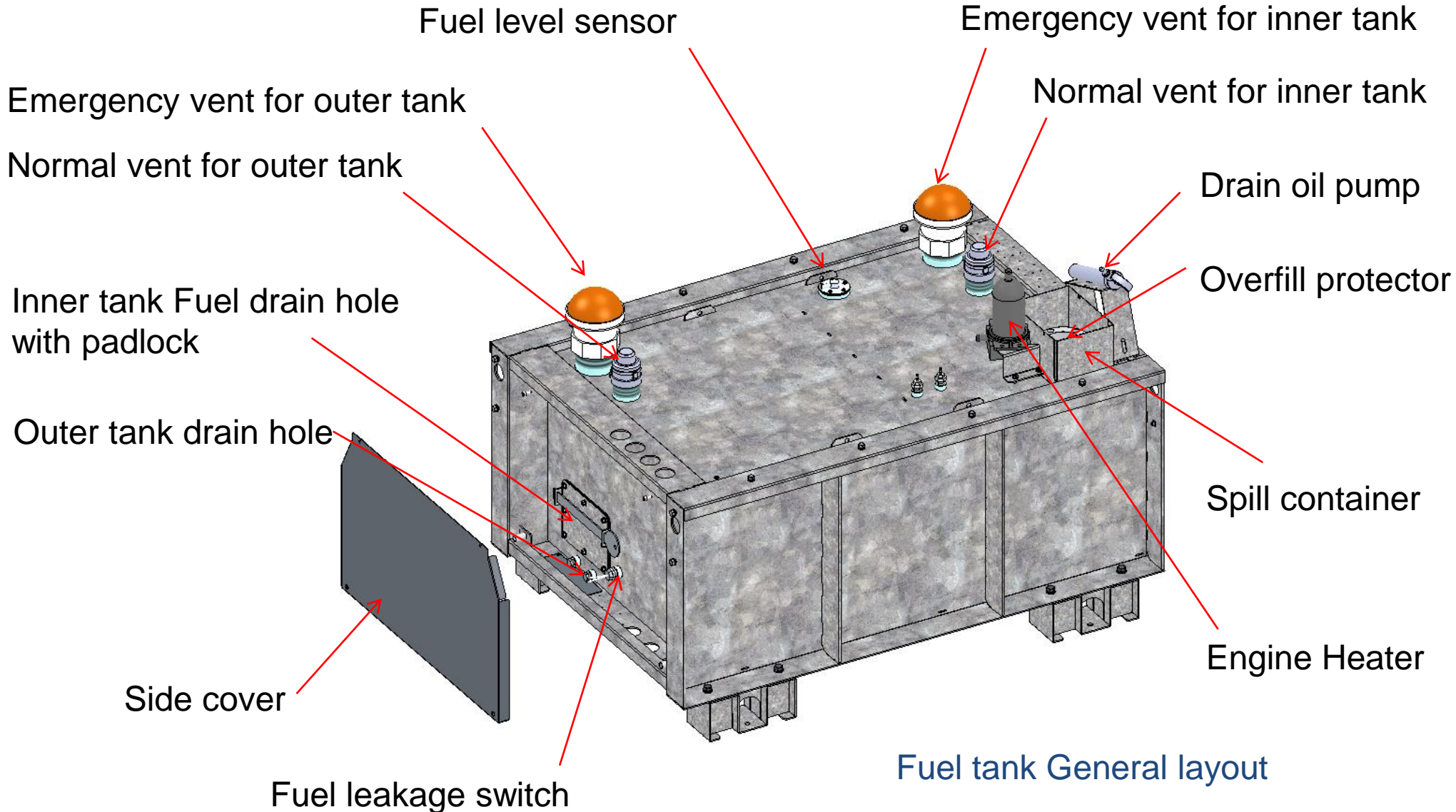



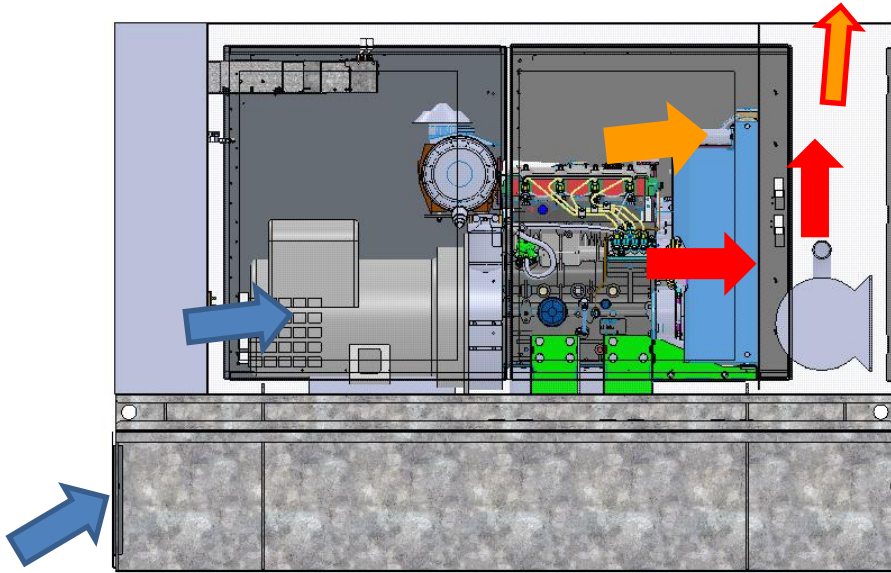

Air Flow

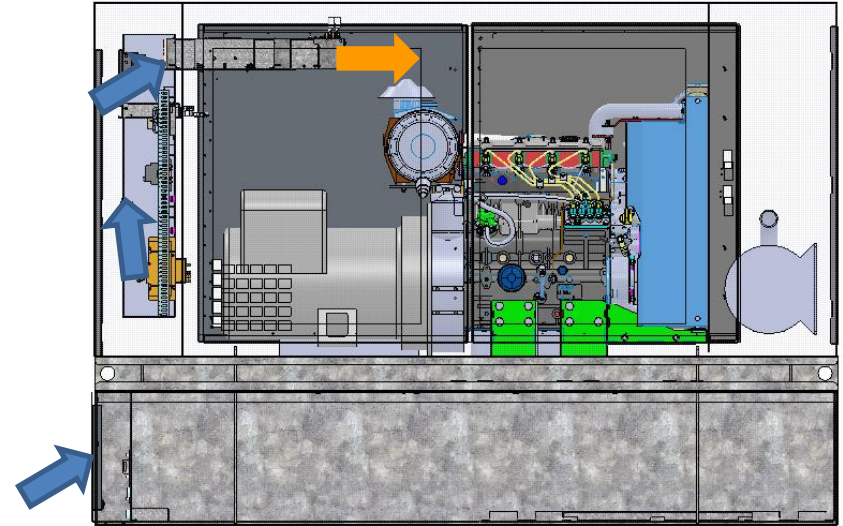

**Front View
Air flow for engine**



**Front View
Air flow for Rectifier**

-  Cool air intake
-  Warm air exhaust
-  Hot air exhaust
-  Mixed cooler exhaust air

Controllers

Generator controller provides local user interface



IP controller provides WEB and SNMP via RJ45



Local User Interface

① See next page for Screen shot



1. Controller LCD Display
2. Stop Button
3. Start Button
4. Manual Button ON/OFF DC Output Contactor
LED Indication – Run and Output connected.
5. Alarm reset
6. Skip Buzzer Button
7. Menu Button
8. Up/Down and Left/Right Direct Button
9. Enter Button

Local User Interface Screen



The screenshot displays a green LCD screen with the following information:

- 1. Generator output power: 0.0kW
- 2. Generator output voltage: 0.0V
- 3. Generator output current: 0.0A
- 4. Alternator output voltage: 0.0V
- 5. Operative mode: MANUAL
- 6. Running status: Brks Off, Not ready
- 7. Counter: Timer 0s
- 8. Speed: RPM 0

1. Generator output power
2. Generator output voltage
3. Generator output current
4. Alternator output voltage
5. Operative mode
6. Running status
7. Counter
8. Speed

WEB Interface

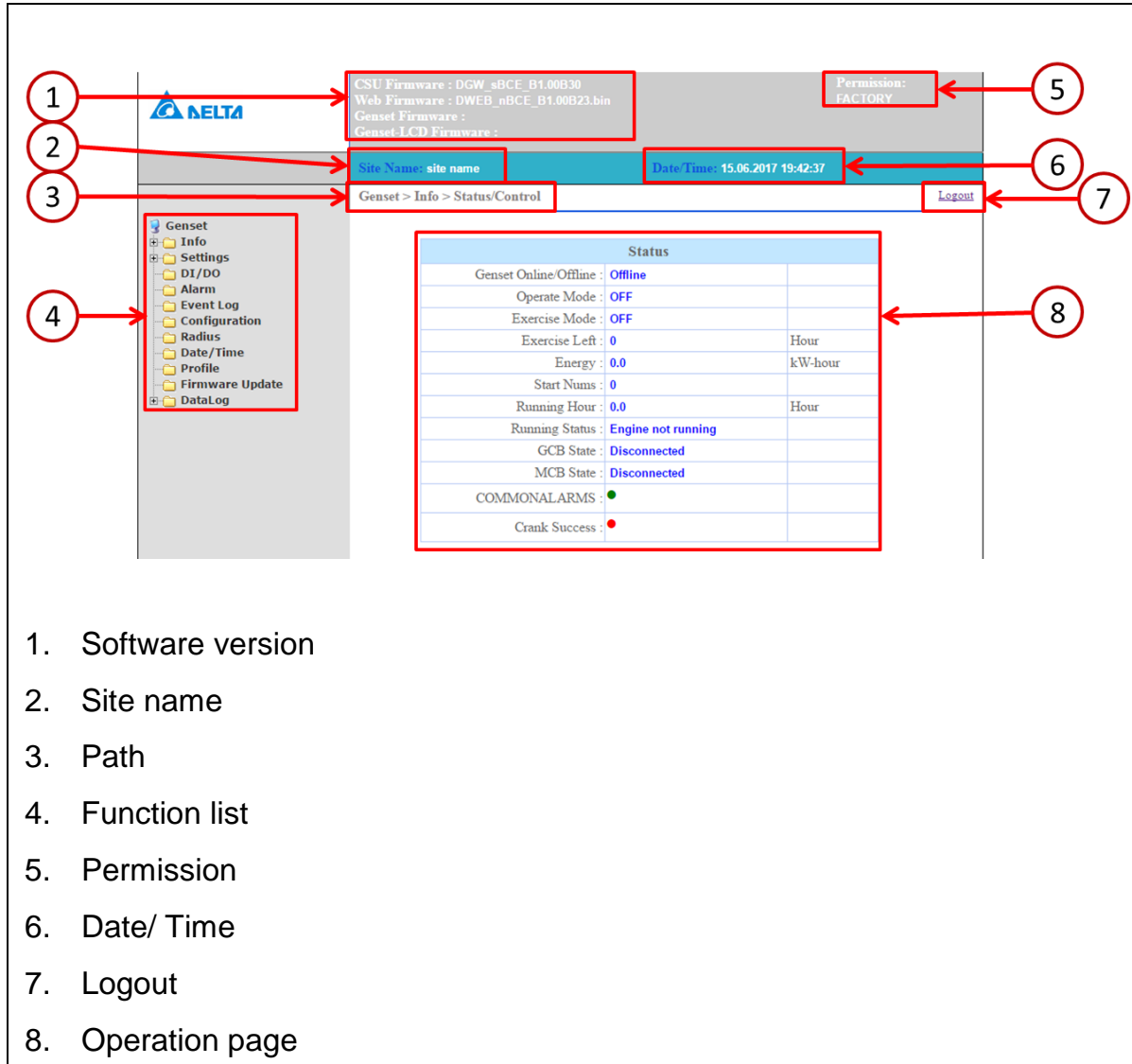

The screenshot shows the DELTA web interface with the following elements highlighted by numbered callouts:

- 1. Software version (CSU Firmware, Web Firmware, Genset Firmware, Genset-LCD Firmware)
- 2. Site name (Site Name: site name)
- 3. Path (Genset > Info > Status/Control)
- 4. Function list (Genset menu: Info, Settings, DI/DO, Alarm, Event Log, Configuration, Radius, Date/Time, Profile, Firmware Update, DataLog)
- 5. Permission (Permission: FACTORY)
- 6. Date/ Time (Date-Time: 15.06.2017 19:42:37)
- 7. Logout (Logout button)
- 8. Operation page (Status table)

Status	
Genset Online/Offline :	Offline
Operate Mode :	OFF
Exercise Mode :	OFF
Exercise Left :	0 Hour
Energy :	0.0 kW-hour
Start Num :	0
Running Hour :	0.0 Hour
Running Status :	Engine not running
GCB State :	Disconnected
MCB State :	Disconnected
COMMONALARMS :	●
Crank Success :	●

- Software version
- Site name
- Path
- Function list
- Permission
- Date/ Time
- Logout
- Operation page

Smarter. Greener. Together.

To learn more about Delta, please visit www.deltaww.com



Exhibit I



**UNITED STATES
POSTAL SERVICE®**

Click-N-Ship®

P

usps.com
US POSTAGE
 Flat Rate Env
 10/22/2018



Mailed from 06002 062S0000001307

PRIORITY MAIL 1-DAY™

DEBORAH CHASE
 T-MOBILE USA- NSS
 35 GRIFFIN RD S
 BLOOMFIELD CT 06002-1351

Expected Delivery Date: 10/23/18
 Ref#: HA014L74X2
0024

Carrier -- Leave if No Response

C027

SHIP TO: PETER GILLESPIE
 DIR. PLANNING & ZONING
 505 SILAS DEANE HWY
 WETHERSFIELD CT 06109-2216

USPS TRACKING #

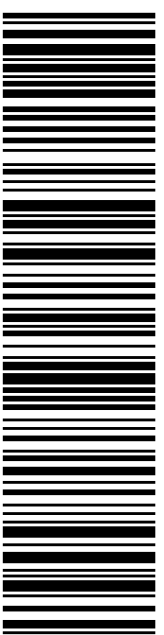

9405 5036 9930 0312 0781 85

Electronic Rate Approved #038555749



Cut on dotted line.

Instructions

1. Each Click-N-Ship® label is unique. Labels are to be used as printed and used only once. DO NOT PHOTO COPY OR ALTER LABEL.
2. Place your label so it does not wrap around the edge of the package.
3. Adhere your label to the package. A self-adhesive label is recommended. If tape or glue is used, DO NOT TAPE OVER BARCODE. Be sure all edges are secure.
4. To mail your package with PC Postage®, you may schedule a Package Pickup online, hand to your letter carrier, take to a Post Office™, or drop in a USPS collection box.
5. Mail your package on the "Ship Date" you selected when creating this label.

Click-N-Ship® Label Record

USPS TRACKING # :
9405 5036 9930 0312 0781 85

Trans. #: 446757642	Priority Mail® Postage: \$6.70
Print Date: 10/19/2018	Total: \$6.70
Ship Date: 10/22/2018	
Expected Delivery Date: 10/23/2018	

From: DEBORAH CHASE
 T-MOBILE USA- NSS
 35 GRIFFIN RD S
 BLOOMFIELD CT 06002-1351

Ref#: HA014L74X2

To: PETER GILLESPIE
 DIR. PLANNING & ZONING
 505 SILAS DEANE HWY
 WETHERSFIELD CT 06109-2216

* Retail Pricing Priority Mail rates apply. There is no fee for USPS Tracking® service on Priority Mail service with use of this electronic rate shipping label. Refunds for unused postage paid labels can be requested online 30 days from the print date.



Thank you for shipping with the United States Postal Service!
 Check the status of your shipment on the USPS Tracking® page at usps.com



**UNITED STATES
POSTAL SERVICE®**

Click-N-Ship®

P

usps.com
US POSTAGE
 Flat Rate Env
 \$6.70

9405 5036 9930 0312 0781 78 0067 0000 0010 6109



Mailed from 06002 062S00000001307

PRIORITY MAIL 1-DAY™

DEBORAH CHASE
 T-MOBILE USA- NSS
 35 GRIFFIN RD S
 BLOOMFIELD CT 06002-1351

Expected Delivery Date: 10/23/18
 Ref#: HA014L74X2
0024

Carrier -- Leave if No Response

C027

SHIP TO: AMY MORIN BELLO
 MAYOR OF WETHERSFIELD CT
 505 SILAS DEANE HWY
 WETHERSFIELD CT 06109-2216

USPS TRACKING #



9405 5036 9930 0312 0781 78

Electronic Rate Approved #038555749



Cut on dotted line.

Instructions

1. Each Click-N-Ship® label is unique. Labels are to be used as printed and used only once. DO NOT PHOTO COPY OR ALTER LABEL.
2. Place your label so it does not wrap around the edge of the package.
3. Adhere your label to the package. A self-adhesive label is recommended. If tape or glue is used, DO NOT TAPE OVER BARCODE. Be sure all edges are secure.
4. To mail your package with PC Postage®, you may schedule a Package Pickup online, hand to your letter carrier, take to a Post Office™, or drop in a USPS collection box.
5. Mail your package on the "Ship Date" you selected when creating this label.

Click-N-Ship® Label Record

USPS TRACKING # :
9405 5036 9930 0312 0781 78

Trans. #: 446757642	Priority Mail® Postage: \$6.70
Print Date: 10/19/2018	Total: \$6.70
Ship Date: 10/22/2018	
Expected Delivery Date: 10/23/2018	

From: DEBORAH CHASE
 T-MOBILE USA- NSS
 35 GRIFFIN RD S
 BLOOMFIELD CT 06002-1351

Ref#: HA014L74X2

To: AMY MORIN BELLO
 MAYOR OF WETHERSFIELD CT
 505 SILAS DEANE HWY
 WETHERSFIELD CT 06109-2216

* Retail Pricing Priority Mail rates apply. There is no fee for USPS Tracking® service on Priority Mail service with use of this electronic rate shipping label. Refunds for unused postage paid labels can be requested online 30 days from the print date.



Thank you for shipping with the United States Postal Service!
 Check the status of your shipment on the USPS Tracking® page at usps.com



**UNITED STATES
POSTAL SERVICE®**

Click-N-Ship®

P

usps.com
US POSTAGE
 Flat Rate Env
 10/22/2018



Mailed from 06002 062S0000001307

9405 5036 9930 0312 0781 92

9405 5036 9930 0312 0781 92 0067 0000 0010 6109

PRIORITY MAIL 1-DAY™

Expected Delivery Date: 10/23/18

DEBORAH CHASE
 T-MOBILE USA- NSS
 35 GRIFFIN RD S
 BLOOMFIELD CT 06002-1351

0024

Carrier -- Leave if No Response

C027

SHIP
 TO: TOWN CLERK
 TOWN OF WETHERSFIELD
 505 SILAS DEANE HWY
 WETHERSFIELD CT 06109-2216

USPS TRACKING #

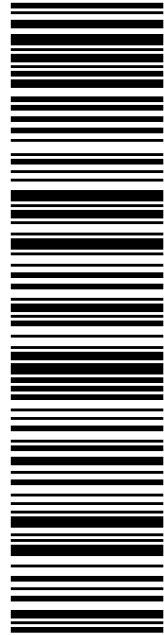

9405 5036 9930 0312 0781 92

Electronic Rate Approved #038555749



Cut on dotted line.

Instructions

1. Each Click-N-Ship® label is unique. Labels are to be used as printed and used only once. DO NOT PHOTO COPY OR ALTER LABEL.
2. Place your label so it does not wrap around the edge of the package.
3. Adhere your label to the package. A self-adhesive label is recommended. If tape or glue is used, DO NOT TAPE OVER BARCODE. Be sure all edges are secure.
4. To mail your package with PC Postage®, you may schedule a Package Pickup online, hand to your letter carrier, take to a Post Office™, or drop in a USPS collection box.
5. Mail your package on the "Ship Date" you selected when creating this label.

Click-N-Ship® Label Record

USPS TRACKING # :
9405 5036 9930 0312 0781 92

Trans. #: 446757642	Priority Mail® Postage: \$6.70
Print Date: 10/19/2018	Total: \$6.70
Ship Date: 10/22/2018	
Expected Delivery Date: 10/23/2018	

From: DEBORAH CHASE
 T-MOBILE USA- NSS
 35 GRIFFIN RD S
 BLOOMFIELD CT 06002-1351

To: TOWN CLERK
 TOWN OF WETHERSFIELD
 505 SILAS DEANE HWY
 WETHERSFIELD CT 06109-2216

* Retail Pricing Priority Mail rates apply. There is no fee for USPS Tracking® service on Priority Mail service with use of this electronic rate shipping label. Refunds for unused postage paid labels can be requested online 30 days from the print date.



Thank you for shipping with the United States Postal Service!
 Check the status of your shipment on the USPS Tracking® page at usps.com



STATE OF CONNECTICUT

CONNECTICUT SITING COUNCIL

Ten Franklin Square, New Britain, CT 06051

Phone: (860) 827-2935 Fax: (860) 827-2950

E-Mail: siting.council@ct.gov

www.ct.gov/csc

Denise Sabo
Northeast Site Solutions
420 Main Street, Unit 2
Sturbridge, MA 01566

RE: **EM-T-MOBILE-159-181023** – T-Mobile notice of intent to modify an existing telecommunications facility located at 23 Kelleher Court, Wethersfield, Connecticut.

Dear Ms. Sabo:

The Connecticut Siting Council (Council) received a notice of intent to modify the above-referenced facility on October 23, 2018.

According to Section 16-50j-71 of the Regulations of Connecticut State Agencies, "...any modification, as defined in Section 16-50j-2a of the Regulations of Connecticut State Agencies, to an existing tower site, except as specified in Sections 16-50j-72 and 16-50j-88 of the Regulations of Connecticut State Agencies, may have a substantial adverse environmental effect."

Staff has reviewed this exempt modification request for completeness and has identified a deficiency in the Structural Analysis Report provided with the filing. The Structural Analysis Report provided is dated August 8, 2018. The Council had received a request for exempt modification from AT&T for the same facility in May of 2018. The above-referenced request for exempt modification does not include AT&T's approved equipment; Please see AT&T's exempt modification filing for this facility, which may be found on the Council's website under the Decisions page in Wethersfield under the filing number EM-AT&T-159-180509 or by following the link:

https://www.ct.gov/csc/lib/csc/ems/wethersfield/kelleherct/att_cing/em-at&t-159-180509_filing_kellehercourt.pdf

Also the Construction Drawings submitted with the request prepared by Foresite and signed and sealed on October 18, 2018 includes a structural note on sheets A-3 and A-4 which refers to a Structural Analysis Report prepared by Destek and dated June 25, 2018. This is inconsistent with the Structural Analysis Report provided with the request.

Therefore, the exempt modification request is incomplete at this time. The Council recommends that Northeast Site Solutions provide an updated Structural Analysis Report for the facility that includes proposed and approved equipment by AT&T and other entities that are located at this facility and an updated Construction Drawing consistent with the Structural Analysis Report provided, on or before November 30, 2018. If additional time is needed to gather the requested information, please submit a written request for an extension of time prior to November 30, 2018.

This notice of incompleteness shall have the effect of tolling the Federal Communications Commission (FCC) 60-day timeframe in accordance with Paragraph 217 of the FCC Wireless Infrastructure Report and Order issued on October 21, 2014 (FCC 14-153).

Thank you for your attention to this matter. Should you have any questions, please feel free to contact me at 860-827-2951.

Sincerely,

Melanie Bachman
Executive Director

MAB/FOC/IN

c: The Honorable Amy Morin Bello, Mayor, Town of Wethersfield
Kathleen A. Bagley, Interim Town Manager, Town of Wethersfield
Peter Gillespie, Director of Planning & Economic Development, Town of Wethersfield

S:\EMS_TS\1_BYTOWN\Wethersfield\KelleherCourt\T_MOBILE\em-t-mobile-159-181023_incomplete\tr_kellehercourt.docx

CONNECTICUT SITING COUNCIL

Affirmative Action / Equal Opportunity Employer