



Daniel F. Caruso
Chairman

STATE OF CONNECTICUT

CONNECTICUT SITING COUNCIL

Ten Franklin Square, New Britain, CT 06051

Phone: (860) 827-2935 Fax: (860) 827-2950

E-Mail: siting.council@ct.gov

Internet: ct.gov/csc

October 10, 2008

Carrie L. Larson, Esq.
Pullman and Comley, LLC
90 State House Square
Hartford, CT 06103-3702

RE: **EM-POCKET-155-080922** – Youghioghny Communications-Northeast, LLC d/b/a Pocket Communications notice of intent to modify an existing telecommunications facility located at 1030 New Britain Avenue, West Hartford, Connecticut.

Dear Attorney Larson:

The Connecticut Siting Council (Council) hereby acknowledges your notice to modify this existing telecommunications facility, pursuant to Section 16-50j-73 of the Regulations of Connecticut State Agencies.

The proposed modifications are to be implemented as specified here and in your notice dated September 19, 2008, including the placement of all necessary equipment and shelters within the tower compound. The modifications are in compliance with the exception criteria in Section 16-50j-72 (b) of the Regulations of Connecticut State Agencies as changes to an existing facility site that would not increase tower height, extend the boundaries of the tower site, increase noise levels at the tower site boundary by six decibels, and increase the total radio frequencies electromagnetic radiation power density measured at the tower site boundary to or above the standard adopted by the State Department of Environmental Protection pursuant to General Statutes § 22a-162. This facility has also been carefully modeled to ensure that radio frequency emissions are conservatively below State and federal standards applicable to the frequencies now used on this tower.

This decision is under the exclusive jurisdiction of the Council. Please be advised that the validity of this action shall expire one year from the date of this letter. Any additional change to this facility will require explicit notice to this agency pursuant to Regulations of Connecticut State Agencies Section 16-50j-73. Such notice shall include all relevant information regarding the proposed change with cumulative worst-case modeling of radio frequency exposure at the closest point of uncontrolled access to the tower base, consistent with Federal Communications Commission, Office of Engineering and Technology, Bulletin 65. Any deviation from this format may result in the Council implementing enforcement proceedings pursuant to General Statutes § 16-50u including, without limitation, imposition of expenses resulting from such failure and of civil penalties in an amount not less than one thousand dollars per day for each day of construction or operation in material violation.

Thank you for your attention and cooperation.

Very truly yours,

S. Derek Phelps
Executive Director

SDP/CML/cm

c: The Honorable Scott Slifka, Mayor, Town of West Hartford
Mila Limson, Town Planner, Town of West Hartford
Hirschfeld Communications

EM-POCKET-155-080922

CARRIE L. LARSON
90 State House Square
Hartford, CT 06103-3702
p (860) 424-4312
f (860) 424-4370

www.pullcom.com

September 19, 2008

Via Federal Express

S. Derek Phelps, Executive Director
Connecticut Siting Council
Ten Franklin Square
New Britain, CT 06051

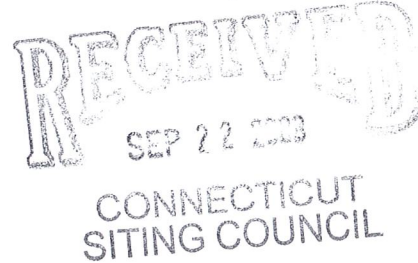

Re: Notice of Exempt Modification
Hirschfeld Communications Telecommunications Facility
1030 New Britain, Avenue, West Hartford, Connecticut

Dear Mr. Phelps:

Youghiogheny Communications-Northeast, LLC, doing business as Pocket Communications ("Pocket"), intends to install antennas and appurtenant equipment at the existing 180-foot lattice tower facility owned by Hirschfeld Communications and located at 1030 New Britain, Avenue, West Hartford, Connecticut ("Facility"). Pocket Communications provides prepaid, flat rate wireless voice and data services to more than a quarter of a million subscribers. Pocket is licensed by the Federal Communications Commission (FCC) to provide PCS wireless telecommunications service in the State of Connecticut, which includes the area to be served by the proposed installation. This installation constitutes an exempt modification pursuant to the Public Utility Environmental Standards Act, Connecticut General Statutes Section 16-50g et. seq. (PUESA), and Section 16-50j-72(b)(2) of the Regulations of the Connecticut State Agencies adopted pursuant to PUESA. In accordance with R.C.S.A. Section 16-50j-73, a copy of this notice has been sent to Scott Slifka, Mayor, Town of West Hartford.

The existing Facility consists of a 180-foot self-supporting lattice tower capable of supporting multiple carriers within a fenced compound. The coordinates for the Facility are **Lat: 41°-43'-50" and Long: 72°-43'-27"**. The tower is approximately 230 feet north of New Britain Avenue, near its intersection with South Street. The Facility is in the Elmwood section of West Hartford, in the southern portion of town, roughly 2,800 feet north of the Newington town line (see Site Map, attached as Exhibit A). The tower currently supports Sprint antennas at the one hundred fifty five foot (155') level centerline AGL (above ground level), T-Mobile antennas at the one hundred sixty five foot level (165') AGL, and AT&T antennas at the one hundred eighty foot level (180') AGL. Pocket proposes to install three Kathrein 742-213 flush mount antennas on the tower at the one hundred forty five foot centerline (145') AGL, and a Nortel CDMA Micro BTS 3231 cabinet, mounted on an "H-Frame," contained within a six foot by six foot (6'-0" x 6'-0") lease area. A small GPS antenna will be mounted to an ice bridge which will run

Page 2

from the lease area to the tower. Utilities will be run via a proposed underground conduit from an existing utility backboard, within the northwest corner of the compound (See Design Drawings and Equipment Specifications, attached as Exhibits B and C respectively).

For the following reasons, the proposed modifications to the New Britain Facility meet the exempt modification criteria set forth in R.C.S.A. Section 16-50j-72(b)(2):

1. The proposed modification will not increase the height of the tower as Pocket's antennas will be installed at a center line height of approximately 145 feet.
2. The installation of Pocket's equipment and shelter will not require an extension of the site boundaries.
3. The proposed modifications will not increase the noise levels at the existing Facility by six decibels or more.
4. The operation of the additional antennas will not increase the total radio frequency (RF) power density, measured at the site boundary, to a level at or above the standard adopted by the Connecticut Department of Environmental Protection as set forth in Section 22a-162 of the Connecticut General Statutes and MPE limits established by the Federal Communications Commission. The worst-case RF power density calculations for the proposed Pocket antennas would be 4.74% of the FCC standard (see general power density calculations table, attached as Exhibit D).

Also attached, Exhibit E, is a structural analysis confirming that the tower can support the existing and proposed antennas and associated equipment.

For the foregoing reasons, Pocket respectfully submits that the proposed antenna installation and equipment at the West Hartford Facility constitutes an exempt modification under R.C.S.A. Section 16-50j-72(b)(2)

Respectfully Submitted,



Carrie L. Larson

cc: Scott Slifka, Mayor
Ten Thirty Building Company c/o Hirschfeld Management, underlying property owner

Exhibit A

Site Map

**Pocket Site HFCT1338A
1030 New Britain Avenue
West Hartford, Connecticut**

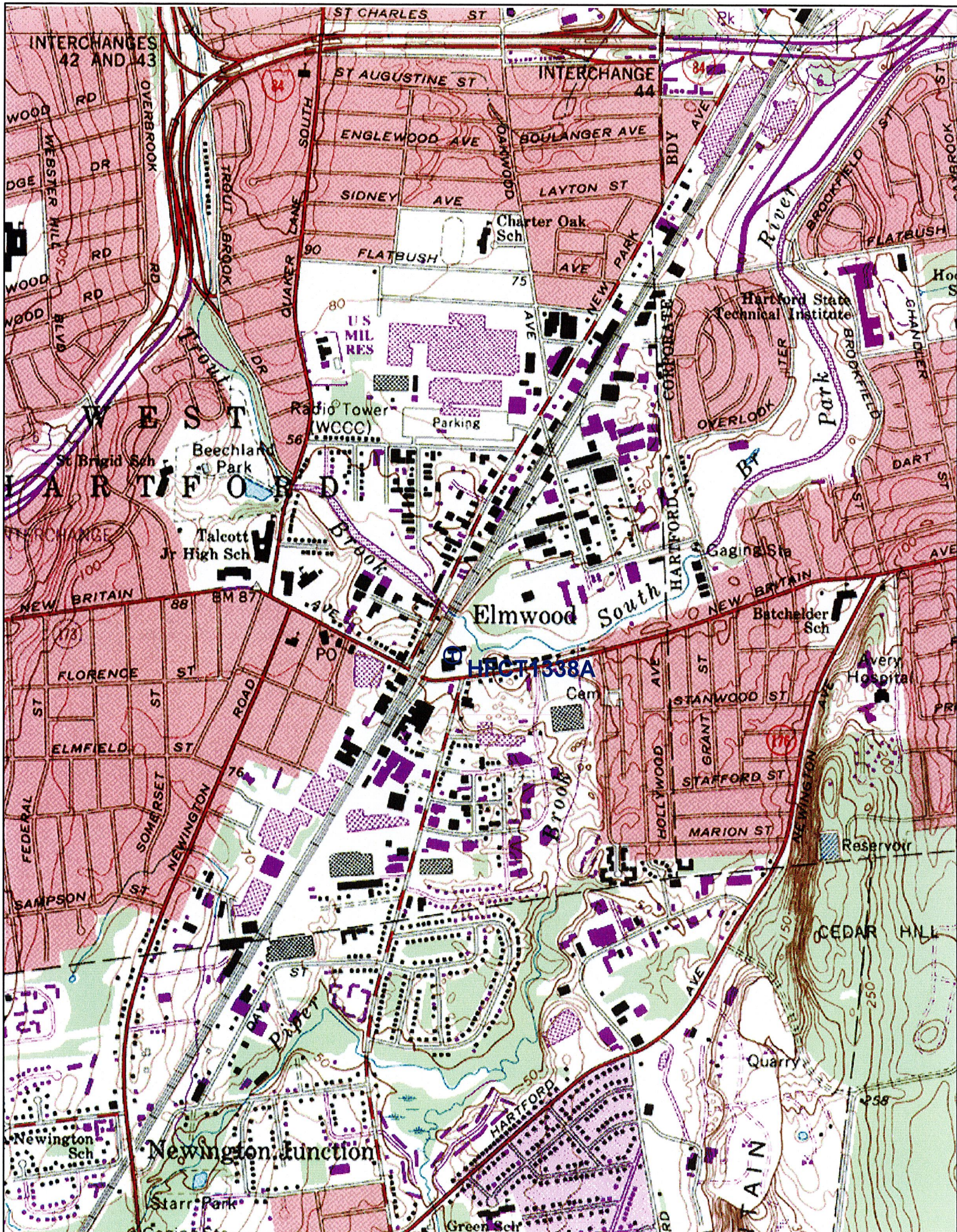

Exhibit B

Design Drawings

**Pocket Site HFCT1338A
1030 New Britain Avenue
West Hartford, Connecticut**

POCKET COMMUNICATIONS

HFCT1338A
HIRSCHFELD COMMUNICATIONS, LLC
CT-0001
180' SELF-SUPPORTING TOWER

SITE INFORMATION

OWNER: HIRSCHFELD COMMUNICATIONS
 CONTACT: IAN ORMESHER
 1030 NEW BRITAIN AVENUE
 WEST HARTFORD, CT 06110
 (763) 862-0714

OWNER SITE ID#: CT-0001

APPLICANT: YOLCHOSCHERY COMMUNICATIONS-
 NORTHEAST LLC
 2819 NW LOOP 410
 SAN ANTONIO, TX 78230

SITE ADDRESS: 1030 NEW BRITAIN AVENUE
 WEST HARTFORD, CT 06110

COUNTY: HARTFORD

LATITUDE: 41° 43' 50.16" N

LONGITUDE: 72° 43' 27.12" W

ZONING CLASSIFICATION: N/A

ZONING JURISDICTION: CONNECTICUT SITING COUNCIL

POWER COMPANY: CL&P
 (860) 379-5582

TELEPHONE COMPANY: AT&T
 (860) 521-6601

DESIGN FIRM: TRIVIS
 180 CHANDALAR PLACE DRIVE
 PELHAM, AL 35124
 PHONE: (205) 621-0106

DRAWING INDEX

1	TITLE SHEET
2	SITE PLAN
3	TOWER, ANTENNA, GPS, & EQUIPMENT SUPPORT DESIGN
4	GROUNDING PLAN & DETAILS
5	COAX SUPPORT STRUCTURE DETAIL & GROUNDING DETAILS
6	ELECTRICAL SITE PLAN & DETAILS

APPROVALS

REAL ESTATE _____
 RF _____
 OPS/CONSTRUCTION _____
 LEGAL/COMPLIANCE _____
 NET DESIGN _____

SITE INFORMATION

CONTRACTOR'S WORK SHALL COMPLY WITH ALL APPLICABLE NATIONAL, STATE, AND LOCAL CODES AS ADOPTED BY THE LOCAL AUTHORITY HAVING JURISDICTION (AHJ) FOR THE LOCATION. THE EDITION OF THE AHJ ADOPTED CODES AND STANDARDS IN EFFECT ON THE DATE OF CONTRACT AWARD SHALL GOVERN THE DESIGN.

SECTION 107.1, 2000 IECC CODES AND THE 2004 CITY PUBLIC SERVICE ELECTRICAL SERVICE STANDARDS.

BUILDING CODE: INTERNATIONAL BUILDING CODE (IBC), 2006

ELECTRICAL CODE: NATIONAL FIRE PROTECTION ASSOCIATION (NFPA) 70 - 2005, NATIONAL ELECTRICAL CODE LIGHTNING PROTECTION CODE: [NFPA 780 - 2005, LIGHTNING PROTECTION CODE]

CONTRACTOR'S WORK SHALL COMPLY WITH THE LATEST EDITION OF THE FOLLOWING STANDARDS:

AMERICAN CONCRETE INSTITUTE (ACI) 318, BUILDING CODE REQUIREMENTS FOR STRUCTURAL CONCRETE

AMERICAN INSTITUTE OF STEEL CONSTRUCTION (AISC), MANUAL OF STEEL CONSTRUCTION, 13TH EDITION

TELECOMMUNICATIONS INDUSTRY ASSOCIATION (TIA) 222-F, STRUCTURAL STANDARDS FOR STEEL ANTENNA TOWER AND ANTENNA SUPPORTING STRUCTURES;

TIA 607, COMMERCIAL BUILDING GROUNDING AND BONDING REQUIREMENTS FOR TELECOMMUNICATIONS

INSTITUTE FOR ELECTRICAL AND ELECTRONICS ENGINEERS (IEEE) 81, GUIDE FOR MEASURING EARTH RESISTIVITY, GROUND IMPEDANCE, AND EARTH SURFACE POTENTIALS OF A GROUND SYSTEM

IEEE 1100 (1998) RECOMMENDED PRACTICE FOR POWERING AND GROUNDING OF ELECTRONIC EQUIPMENT

IEEE 662.41, RECOMMENDED PRACTICES ON SURGE VOLTAGES IN LOW VOLTAGE AC POWER CIRCUITS (FOR LOCATION CATEGORY "C3" AND "HIGH SYSTEM EXPOSURE")

TELECORDIA GR-1275, GENERAL INSTALLATION REQUIREMENTS

ANSI T1-311, FOR TELECOM - DC POWER SYSTEMS - TELECOM, ENVIRONMENTAL PROTECTION

FOR ANY CONFLICTS BETWEEN SECTIONS OF LISTED CODES AND STANDARDS REGARDING MATERIAL METHODS OF CONSTRUCTION, OR OTHER REQUIREMENTS, THE MOST RESTRICTIVE MATERIAL METHOD SHALL GOVERN. WHERE CONFLICT BETWEEN A GENERAL REQUIREMENT AND A SPECIFIC REQUIREMENT, THE SPECIFIC REQUIREMENT SHALL GOVERN

SITE INFORMATION

1. THIS SITE IS UNMANNED AND IS RESTRICTED TO OUTDOOR EQUIPMENT. IT WILL BE USED FOR THE TRANSMISSION OR RADIO SIGNALS FOR THE PURPOSE OF PROVIDING PUBLIC CELLULAR SERVICE.
2. POCKET COMMUNICATIONS CERTIFIES THAT THIS TELEPHONE EQUIPMENT FACILITY WILL BE SERVICED ONLY BY PERSONNEL WHO ARE TRAINED AND LICENSED TO SERVICED WITH ANY EQUIPMENT CANNOT BE PERFORMED BY HANDICAPPED PERSONS. THIS FACILITY WILL BE EXEMPT FROM THE REQUIREMENTS OF THE AMERICANS WITH DISABILITIES ACT (ADA), APPENDIX B, SECTION 4.11.(5)(B).
3. NO POTABLE WATER SUPPLY IS TO BE PROVIDED AT THIS LOCATION.
4. NO WASTE WATER WILL BE GENERATED AT THIS LOCATION.
5. NO SOLID WASTE WILL BE GENERATED AT THIS LOCATION.
6. POCKET COMMUNICATIONS MAINTENANCE CREW (TYPICALLY ONE PERSON) WILL MAKE AN AVERAGE OF ONE TRIP PER MONTH AT ONE HOUR PER VISIT.

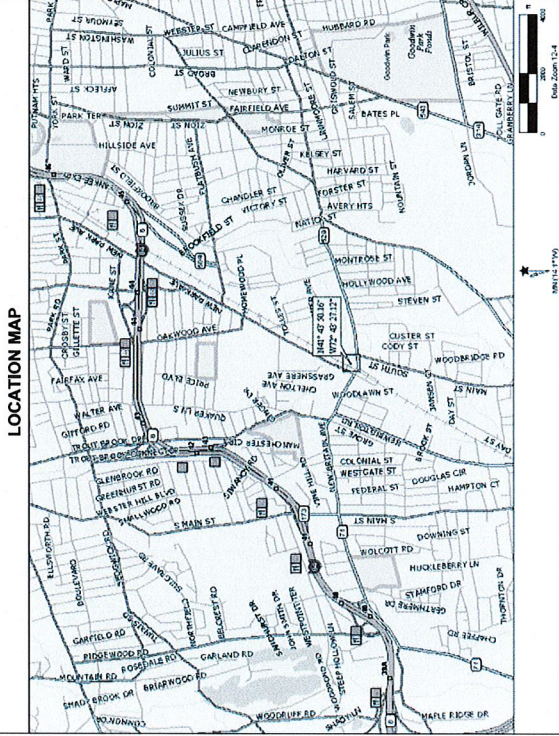

DRIVING DIRECTIONS

FROM HARTFORD I-84 WEST TO EXIT 45 (LEFT). SR-504 0.7 MILE TO RIGHT ON FLATBUSH AVENUE. 0.3 MILES TO LEFT ON NEW PARK AVENUE. 1.0 MILE TO LEFT ON NEW BRITAIN AVENUE. CROSS UNDER RAILROAD TRACKS TO STRIP MALL ON LEFT. TOWER IS BEHIND BUILDING.

NO.	DATE	ISSUED FOR REVIEW & COMMENT	REVISIONS
A	8-20-08		
B	8/4/08		REVISED COORDINATES
SSB			
JSW			

PROJECT: HIRSCHFELD COMM., CT-0001
SHEET TITLE SHEET

THE INFORMATION CONTAINED HEREIN IS THE PROPERTY OF TRIVIS INC. THIS DOCUMENT IS NOT TO BE REPRODUCED OR TRANSMITTED IN ANY FORM OR BY ANY MEANS, WITHOUT WRITTEN PERMISSION OF TRIVIS INC.



DESIGNED BY: JSW
CHECKED BY: SSB
DATE: 8/20/08
JOB NO.: 08456
DWG. NO.:

01



CONSTRUCTION NOTES

1. FIELD VERIFICATION: CONTRACTOR SHALL FIELD VERIFY SCOPE OF WORK, POCKET COMMUNICATIONS ANTENNA MOUNT LOCATION AND ANTENNAS TO BE INSTALLED.
2. COORDINATION OF WORK: CONTRACTOR SHOULD COORDINATE RF WORK AND COMMUNICATIONS.
3. GRAVEL SURFACE IN AREAS OF COMPOUND THAT ARE DISTURBED DURING CONSTRUCTION SHALL BE BUILT TO ORIGINAL CONDITION BY CONTRACTOR.

GENERAL NOTES

1. FOR THE PURPOSE OF CONSTRUCTION DRAWING, THE FOLLOWING DEFINITIONS SHALL APPLY:
(CONSTRUCTION) - POCKET COMMUNICATIONS OEM - ORIGINAL EQUIPMENT MANUFACTURER
2. PRIOR TO THE SUBMISSION OF BIDS, THE BIDDING CONTRACTOR SHALL BE MADE FULLY FAMILIAR WITH THE EXISTING CONDITIONS AND TO CONFIRM THAT THE WORK CAN BE ACCOMPLISHED AS SHOWN ON THE CONSTRUCTION DRAWINGS. ANY DISCREPANCY FOUND SHALL BE BROUGHT TO THE ATTENTION OF CONTRACTOR.
3. ALL MATERIALS FURNISHED AND INSTALLED SHALL BE IN STRICT ACCORDANCE WITH ALL APPLICABLE

- CODES, REGULATIONS, AND ORDINANCES. CONTRACTOR SHALL ISSUE ALL APPROPRIATE NOTICES AND COMPLY WITH ALL LAWS, ORDINANCES, AND REGULATIONS. CONTRACTOR SHALL OBTAIN ALL NECESSARY PERMITS AND APPROVALS FROM ALL APPLICABLE MUNICIPAL AND UTILITY COMPANY SPECIFICATIONS AND APPLICABLE REGULATIONS.
4. UNLESS NOTED OTHERWISE, THE WORK SHALL INCLUDE FURNISHING MATERIALS, AFFURTENANCES, INSTALLATIONS AS INDICATED EQUIPMENT, ON THE DRAWINGS.
 5. THE CONTRACTOR SHALL INSTALL ALL EQUIPMENT AND MATERIALS IN ACCORDANCE WITH

- MANUFACTURER'S RECOMMENDATIONS UNLESS SPECIFICALLY STATED OTHERWISE.
6. IF THE SPECIFIED EQUIPMENT CANNOT BE INSTALLED AS SHOWN, THE CONTRACTOR SHALL PROPOSE AN ALTERNATIVE INSTALLATION FOR APPROVAL.
 7. CONTRACTOR SHALL DETERMINE ACTUAL ROUTING OF ALL CABLES AS SHOWN ON THE POWER, GROUNDING AND TELCO PLAN DRAWING.
 8. THE CONTRACTOR SHALL PROTECT EXISTING IMPROVEMENTS, PAVEMENT, UTILITY LINES, AND CABLES AS SHOWN ON THE ELECTRICAL PLAN.
 9. CONTRACTOR SHALL LEGALLY AND PROPERLY DISPOSE OF ALL SCRAP MATERIALS SUCH AS

- COAXIAL CABLES AND OTHER ITEMS REMOVED FROM THE EXISTING FACILITY. ANTENNAS REMOVED SHALL BE RETURNED TO THE OWNER'S DESIGNATED LOCATION.
10. CONTRACTOR TO OBTAIN REQUIRED NOTICE TO PROCEED DOCUMENTS FROM THE TOWER OWNER BEFORE COMMENCING CONSTRUCTION.

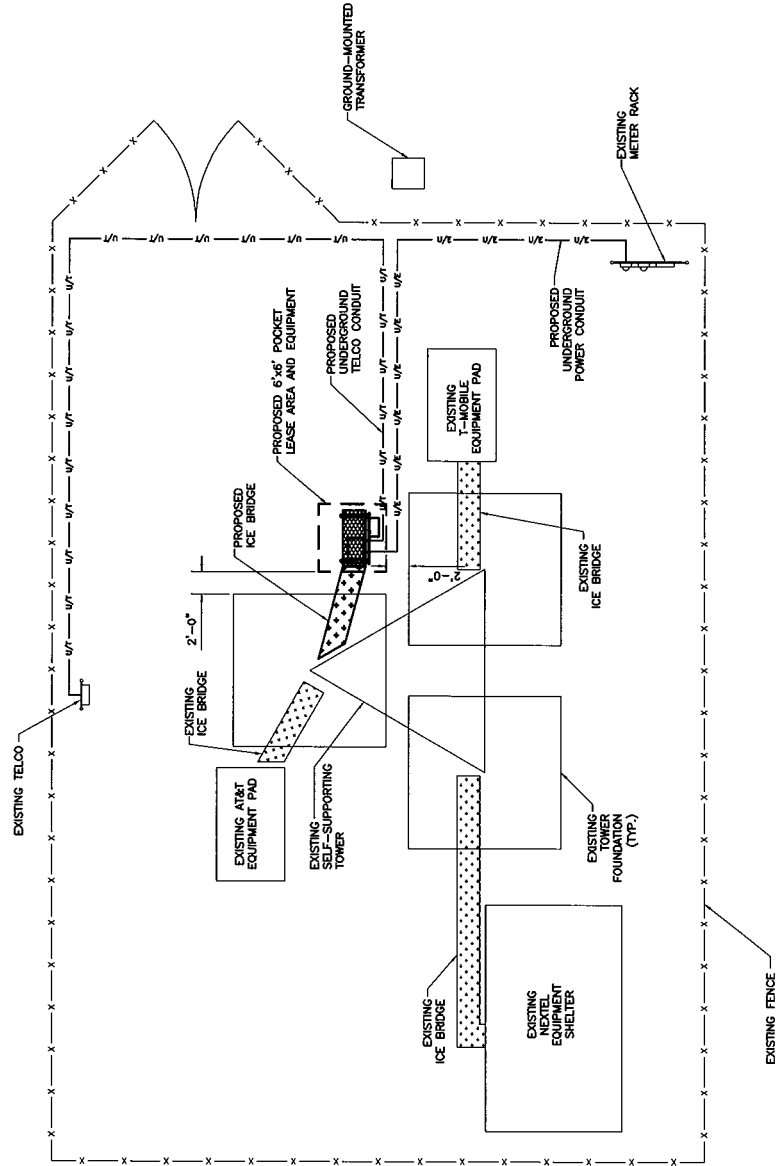

SITE PLAN
11x17 SCALE: 3/32" = 1'
22x34 SCALE: 3/16" = 1'



NO.	DATE	ISSUED FOR REVIEW & COMMENT	REVISIONS
A	8-20-08		
B			
C			
D			
E			
F			
G			
H			
I			
J			
K			
L			
M			
N			
O			
P			
Q			
R			
S			
T			
U			
V			
W			
X			
Y			
Z			

POCKET COMMUNICATIONS

HIRSCHFELD COMM., CT-0001

SHEET NO. 02

SITE PLAN

THE INFORMATION CONTAINED HEREIN IS THE PROPERTY OF TRIVIS INC. THIS DOCUMENT IS NOT TO BE REPRODUCED OR TRANSMITTED IN ANY FORM OR BY ANY MEANS, WITHOUT THE WRITTEN PERMISSION OF TRIVIS INC.



CHECKED BY:	USW
DRAWN BY:	SSD
DATE:	8/20/08
ISS. NO.:	08456
SCALE:	AS SHOWN

02

NO.	DATE	ISSUED FOR REVIEW & COMMENT	REVISIONS
1	8-20-08		
2			
3			
4			
5			
6			
7			
8			
9			
10			
11			
12			
13			
14			
15			
16			
17			
18			
19			
20			
21			
22			
23			
24			
25			
26			
27			
28			
29			
30			
31			
32			
33			
34			
35			
36			
37			
38			
39			
40			
41			
42			
43			
44			
45			
46			
47			
48			
49			
50			
51			
52			
53			
54			
55			
56			
57			
58			
59			
60			
61			
62			
63			
64			
65			
66			
67			
68			
69			
70			
71			
72			
73			
74			
75			
76			
77			
78			
79			
80			
81			
82			
83			
84			
85			
86			
87			
88			
89			
90			
91			
92			
93			
94			
95			
96			
97			
98			
99			
100			

POCKET COMMUNICATIONS
 HIRSCHFELD COMM., CT-0001
 TELEV., ANTENNA, GPS, H-FRAME

THE INFORMATION CONTAINED IN THIS DOCUMENT IS NOT TO BE REPRODUCED OR TRANSMITTED IN ANY FORM OR BY ANY MEANS, ELECTRONIC OR MECHANICAL, INCLUDING PHOTOCOPYING, RECORDING, OR BY ANY INFORMATION STORAGE AND RETRIEVAL SYSTEM, WITHOUT WRITTEN PERMISSION OF TRIVIS INC.



DRAWING NO. 08456
 DATE: 08/20/08
 DRAWN BY: SSB
 CHECKED BY: JSW

03

ANTENNA KEY

ALPHA FACE	BETA FACE	GAMMA FACE	# ANTENNAS PER SECTOR	ANTENNA NUMBER	COAX COLOR CODE	ANTENNA VENDOR	MODEL NUMBER	AZIMUTH	C/L HEIGHT	MECHANICAL DOWNTILT	COAX SIZE	# COAX PER ANTENNA	COAX MODEL NUMBER	COMMSCOPE
			1	A-1	(1)-RED BAND	KATHREIN	742-213	30°	145'-0"	0°	1 5/8"	2	COMMSCOPE	
			1	B-1	(1)-GREEN BAND	KATHREIN	742-213	150°	145'-0"	0°	1 5/8"	2	COMMSCOPE	
			1	C-1	(1)-BROWN BAND	KATHREIN	742-213	270°	145'-0"	0°	1 5/8"	2	COMMSCOPE	

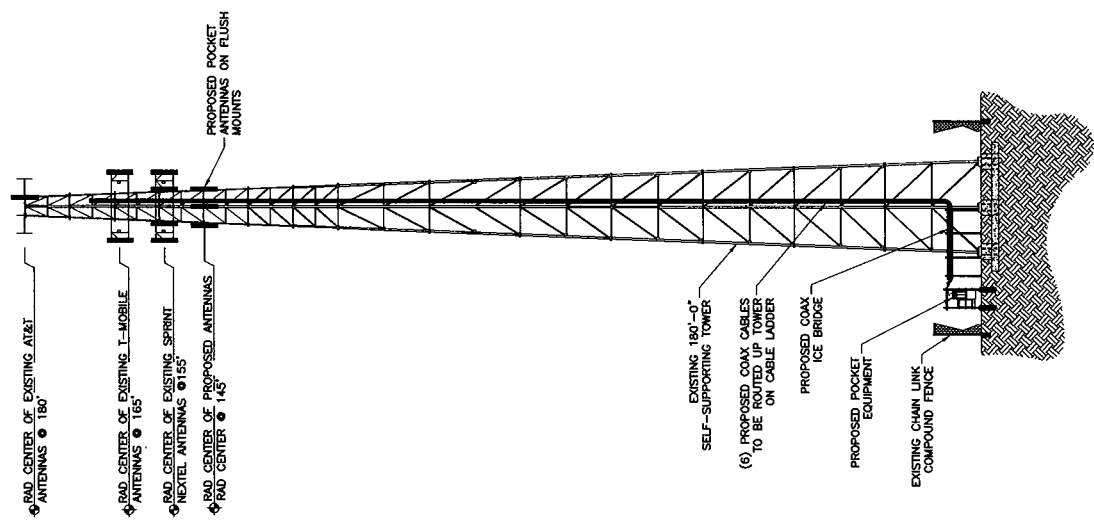
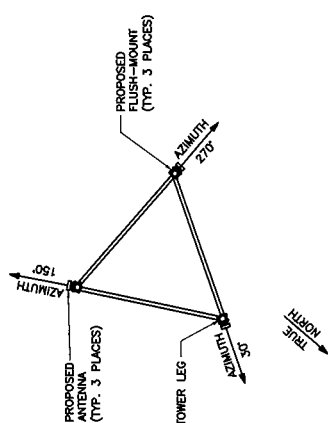

TOWER ELEVATION
N.T.S.

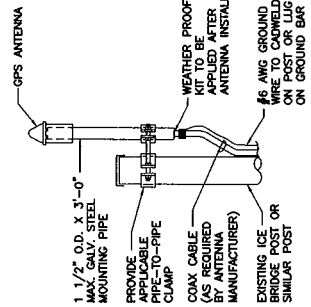

NOTES:
 1. LOCATION OF ANTENNA MUST HAVE CLEAR VIEW OF SOUTHERN SKY AND GAINING HAVE NO BLOCKAGES EXCEEDING 25% OF THE SURFACE AREA OF A HEMISPHERE AROUND THE GPS ANTENNA.
 2. ALL GPS ANTENNA LOCATIONS MUST BE ABLE TO RECEIVE CLEAR SIGNALS FROM A MINIMUM OF FOUR (4) SATELLITES. VERIFY WITH HANDHELD GPS BEFORE FINAL LOCATION OF GPS ANTENNA.

GPS ANTENNA PIPE MOUNT
SCALE: N.T.S.

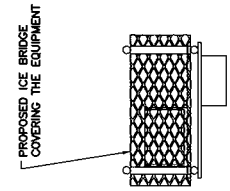

PROPOSED ICE BRIDGE COVERING THE EQUIPMENT

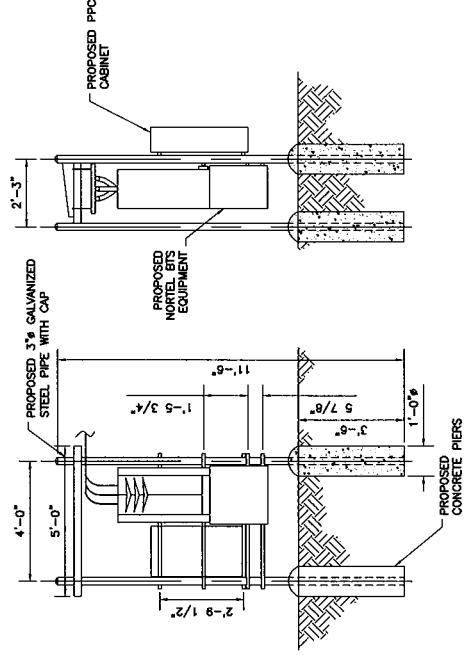

PROPOSED EQUIPMENT SUPPORT
SCALE: N.T.S.

NO.	DATE	ISSUED FOR REVIEW & COMMENT	REVISIONS
A	8-20-08		
B			
C			
D			
E			
F			
G			
H			
I			
J			
K			
L			
M			
N			
O			
P			
Q			
R			
S			
T			
U			
V			
W			
X			
Y			
Z			

HIRSCHELD COMM., CT-0001
 pocket COMMUNICATIONS
 COAX SUPPORT STRUCTURE

THE INFORMATION CONTAINED HEREIN IS THE PROPERTY OF HIRSCHELD COMMUNICATIONS AND IS LOANED TO TRAVIS INC. THIS DOCUMENT IS NOT TO BE REPRODUCED OR TRANSMITTED IN ANY FORM OR BY ANY MEANS WITHOUT WRITTEN PERMISSION OF TRAVIS INC.



Drawn By:	LSW
Checked By:	SSB
Date:	8/20/08
Doc. No.:	08456
Rev. No.:	05

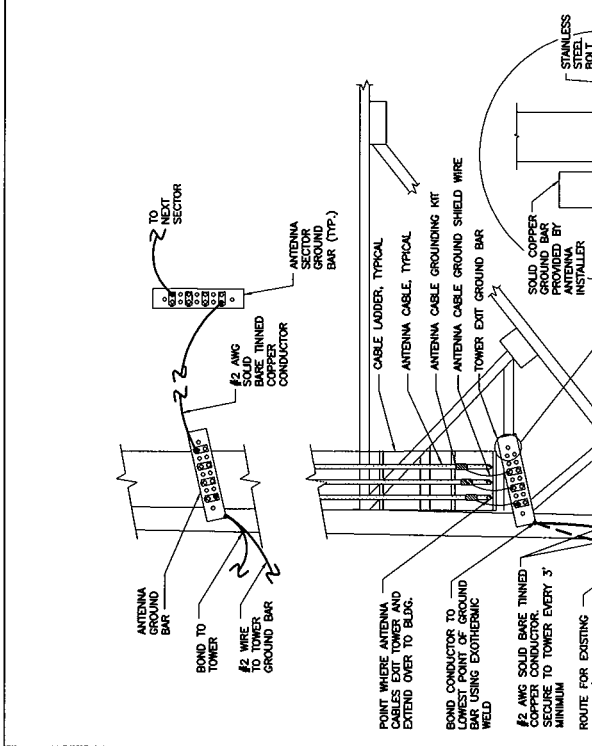

SELF-SUPPORTING TOWER GROUNDING DETAIL

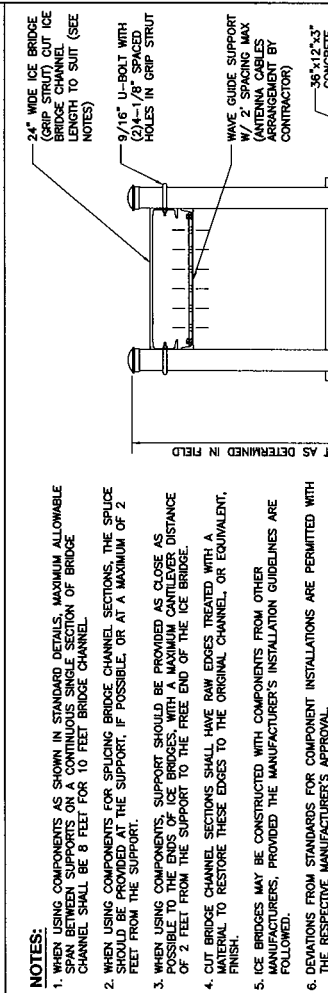
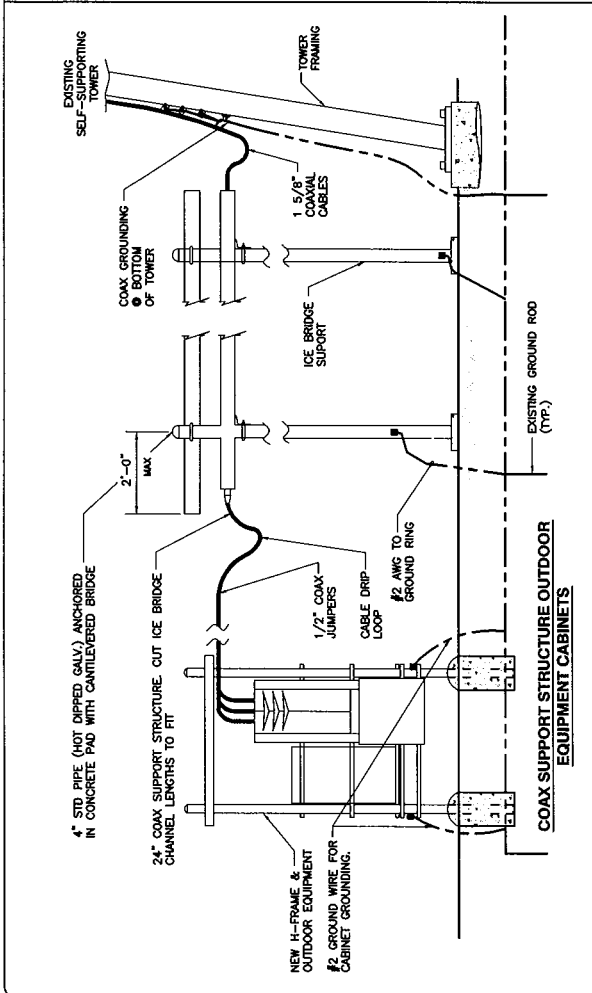

NOTES:
 1. WHEN USING COMPONENTS AS SHOWN IN STANDARD DETAILS, MAXIMUM ALLOWABLE SPAN BETWEEN SUPPORTS ON A CONTINUOUS SINGLE SECTION OF BRIDGE CHANNEL SHALL BE 8 FEET FOR 10 FEET BRIDGE CHANNEL.
 2. WHEN USING COMPONENTS FOR SPlicing BRIDGE CHANNEL SECTIONS, THE SPlice SHOULD BE PROVIDED AT THE SUPPORT, IF POSSIBLE, OR AT A MAXIMUM OF 2 FEET FROM THE SUPPORT.
 3. WHEN USING COMPONENTS, SUPPORT SHOULD BE PROVIDED AS CLOSE AS POSSIBLE TO THE ENDS OF ICE BRIDGES, WITH A MAXIMUM CANTILEVER DISTANCE OF 2 FEET FROM THE SUPPORT TO THE FREE END OF THE ICE BRIDGE.
 4. CUT BRIDGE CHANNEL SECTIONS SHALL HAVE RAW EDGES TREATED WITH A FINISH.
 5. ICE BRIDGES MAY BE CONSTRUCTED WITH COMPONENTS FROM OTHER MANUFACTURERS, PROVIDED THE MANUFACTURER'S INSTALLATION GUIDELINES ARE FOLLOWED.
 6. DEVIATIONS FROM STANDARDS FOR COMPONENT INSTALLATIONS ARE PERMITTED WITH THE RESPECTIVE MANUFACTURER'S APPROVAL.
 7. DEVIATIONS FROM ICE BRIDGE FOUNDATIONS REQUIRE ENGINEERING APPROVAL.
 8. THE DESIGN IS BASED ON ASCE 7-98, 3 SECOND GUST WIND SPEED OF 110 MPH, EXPOSURE C, ELEVATION AT GRADE.
 9. THIS DESIGN IS BASED ON 24" WIDE ICE BRIDGE AND (12) 1 5/8" DIA COAX CABLES AND MAX. POST SUPPORT SPACING OF 10'-0".

DETAIL NOTES

PANEL 'SSC'				
LOAD DESCRIPTION	LOAD (KVA)	PHASE	CT BRKR	LOAD DESCRIPTION
BTS CABINET	2.5	30/2	1	2.2 TVSS
LIGHTING	.9	10/1	5	SPACE
SPACE	-	-	7	SPACE
SPACE	-	-	9	SPACE
SPACE	-	-	11	SPACE
SPACE	-	-	13	SPACE
SPACE	-	-	15	SPACE
SPACE	-	-	17	SPACE
SPACE	-	-	19	SPACE
SPACE	-	-	21	SPACE
SPACE	-	-	23	SPACE
LOAD SUB-TOTAL	5.6	LOAD TOTAL	10.3 kVA	4.4
LOAD SUB-TOTAL				

PANEL SCHEDULE	
TOTAL CONNECTED LOAD	10.3 KW
25% OF LARGEST CONT. LOAD	1.250 W
TOTAL LOADS	11.5 KW
	47.9 AMPS

NOTE: ALL NON-OPTIONAL BREAKERS PROVIDED BY SSC MFR

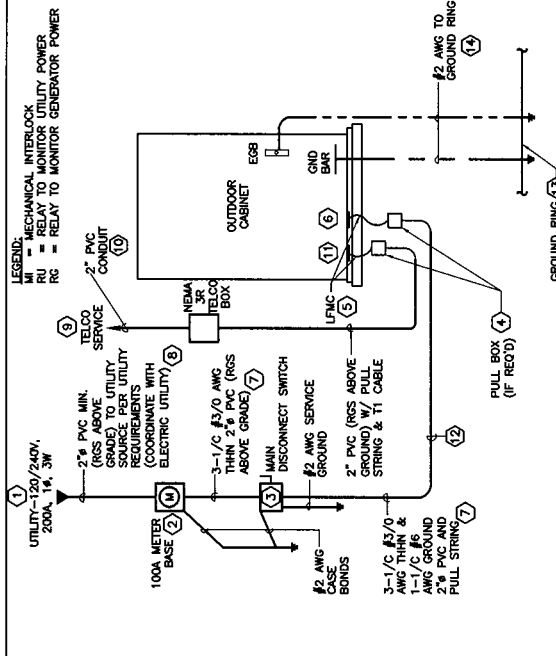

- REFERENCE NOTES**
- ELECTRICAL DEMARCATION POINT. ELECTRICAL CONTRACTOR TO COORDINATE WITH LOCAL POWER FOR SERVICE TO METER.
 - CONTRACTOR TO SUPPLY AND INSTALL A 100A, 120/208/240V 1ϕ, 3W METER BASE. METER BASE TO BE NEMA 3R RATED AND ACCEPTABLE TO LOCAL UTILITY. PROVIDE WITH MECHANICALLY ATTACHED ENGRAVED IDENTIFICATION LABEL INDICATING 'POCKET COMMUNICATIONS'.
 - CONTRACTOR TO SUPPLY AND INSTALL NEMA 3R 100A FUSIBLE DISCONNECT SWITCH WITH LOCKABLE HANDLE. PROVIDE WITH 100A FUSES. AC RATING TO COORDINATE WITH LOCAL UTILITY REQUIREMENTS. PROVIDE WITH MECHANICALLY ATTACHED ENGRAVED IDENTIFICATION LABEL INDICATING 'POCKET COMMUNICATIONS SERVICE DISCONNECT'.
 - WEATHER TIGHT JUNCTION BOX (IF REQUIRED). SIZE TO NEC CODE FOR APPLICATION.
 - ACQUIRE FLEXIBLE METALLIC CONDUIT W/IN WEATHER TIGHT FITTINGS AND TIGHTEN SET SCREWS AND CONTENTS TO MATCH ASSOCIATED USE (POWER OR TELCO).
 - UTILITY POWER ENTRY INTO CABINET. COORDINATE TERMINATION WITH CABINET MANUFACTURER.
 - CONTRACTOR SUPPLY AND INSTALL 2" GRC AFG AND PVC 24" BFG C/W #3/0 AWG THIN & (1) #6 GRND FOR UTILITY SERVICE.
 - CONTRACTOR SUPPLY AND INSTALL 4" GRC AFG AND PVC 24" BFG C/W #3/0 AWG THIN FOR UTILITY SERVICE.
 - ELECTRICAL CONTRACTOR TO COORDINATE WITH LOCAL TELCO FOR SERVICE TO TELEBOX OR CABINET.
 - CONTRACTOR TO SUPPLY AND INSTALL (1) 2" GRC AFG AND PVC 24" BFG C/W PULL CORDS FOR TELCO SERVICE TO CABINET TERMINATION POINT.
 - TELCO SERVICE ENTRY INTO CABINET. COORDINATE TERMINATION IN WITH CABINET MANUFACTURER.
 - CONTRACTOR TO SUPPLY AND INSTALL 2" GRC AFG AND PVC 24" BFG C/W PULL CORDS FOR ALL UNDERGROUND UTILITY LOCATION SERVICES. FOR ALL TRENCHING, REUSE EXISTING BUCKLE AND RE-INSTALL TO ORIGINAL CONDITION. INSTALL 8" WIDE METALLIC LINED RED PLASTIC MARKER TAPE 8" ABOVE ALL BURIED CONDUIT.
 - PART OF CABINET BURIED GROUND RING.
 - (1) #2 SOLID BARE FINISHED CU GEC BONDED TO 5/8"x10" COPPER ANODE. (2) #2 SOLID BARE FINISHED CU ANODE. (3) #2 SOLID BARE FINISHED CU ANODE. (4) #2 SOLID BARE FINISHED CU ANODE. (5) #2 SOLID BARE FINISHED CU ANODE. (6) #2 SOLID BARE FINISHED CU ANODE. (7) #2 SOLID BARE FINISHED CU ANODE. (8) #2 SOLID BARE FINISHED CU ANODE. (9) #2 SOLID BARE FINISHED CU ANODE. (10) #2 SOLID BARE FINISHED CU ANODE. (11) #2 SOLID BARE FINISHED CU ANODE. (12) #2 SOLID BARE FINISHED CU ANODE. (13) #2 SOLID BARE FINISHED CU ANODE. (14) #2 SOLID BARE FINISHED CU ANODE.

- NOTES**
- CONTRACTOR SHALL PROVIDE 100AMP, SINGLE PHASE, 120/240 VAC, 60HZ SERVICE FOR SITE.
 - CONTRACTOR SHALL COORDINATE WITH UTILITY COMPANY BEFORE THE START OF CONSTRUCTION. POWER AND TELCO CONDUIT SHALL BE PROVIDED AND INSTALLED PER UTILITY REQUIREMENTS.
 - FOR COMPLETE INTERNAL WIRING AND ARRANGEMENT REFER TO DRAWINGS PROVIDED BY AC OR TELCO PANEL MANUFACTURER.
 - ALL SERVICE EQUIPMENT AND INSTALLATIONS SHALL COMPLY WITH THE N.E.C. AND UTILITY COMPANY AND LOCAL CODE REQUIREMENTS.
 - CONTRACTOR SHALL INSTALL SUFFICIENT LENGTHS OF LFMC INCLUDING ALL CONDUIT FITTINGS (NUTS, REDUCING BUSHINGS, ELBOWS, COUPLINGS, ETC) NECESSARY FOR CONNECTION FROM IMC CONDUIT TO THE PORELL POWER CABINET.
 - CONTRACTOR SHALL PROVIDE ELECTRICAL SERVICE EQUIPMENT WITH FAULT CURRENT RATINGS GREATER THAN THE AVAILABLE FAULT CURRENT FROM THE POWER UTILITY.
 - CONTRACTOR SHALL VERIFY THAT THE MAIN BONDING JUMPER AND GROUNDING ELECTRODE CONDUCTOR IS INSTALLED PROPERLY IN MAIN DISCONNECT SWITCH.

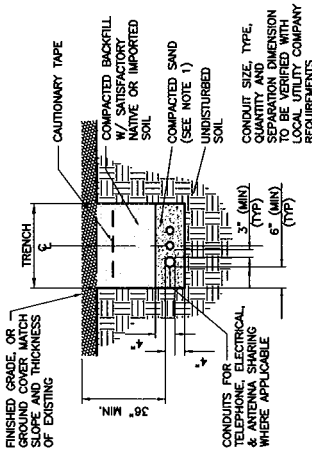

NOTE: LEAN CONCRETE, RED-COLORED TOP, MAY BE USED IN PLACE OF COMPACTED SAND.

DIRECT BURIED CONDUIT

NTS

- GENERAL ELECTRICAL NOTES**
- ALL ELECTRICAL AND GROUNDING WORK SHALL BE PERFORMED IN ACCORDANCE WITH THE PROJECT SPECIFICATIONS, NEC AND ALL APPLICABLE LOCAL CODES.
 - CONDUIT ROUTINGS ARE SUBJECTIVE. CONTRACTOR SHALL VERIFY ROUTING AND LENGTHS PRIOR TO CONSTRUCTION.
 - WIRING, RACEWAY AND SUPPORT METHODS AND MATERIALS SHALL COMPLY WITH THE REQUIREMENTS OF THE NEC AND TELCORDIA.
 - THE CONTRACTOR SHALL NOTIFY AND OBTAIN NECESSARY AUTHORIZATION BEFORE COMMENCING WORK ON THE AC POWER DISTRIBUTION PANELS.
 - THE CONTRACTOR SHALL PROVIDE NECESSARY TAGGING ON THE BREAKERS, CABLES AND DISTRIBUTION PANELS IN ACCORDANCE WITH THE APPLICABLE CODES AND STANDARDS TO SAFEGUARD AGAINST LIFE AND PROPERTY.

NO.	DATE	ISSUED FOR REVIEW & COMMENT	REVISIONS
1	8/20/08		

POCKET COMMUNICATIONS

HIRSCHELD COMM., CT-0001

ELECTRICAL PLAN & DETAILS

THIS INFORMATION IS NOT TO BE REPRODUCED OR TRANSMITTED IN ANY FORM OR BY ANY MEANS, WITHOUT WRITTEN PERMISSION OF TRIVIS INC.



DESIGNED BY: JSW
 DRAWN BY: SSB
 DATE: 8/20/08
 JOB NO: 08456
 PLOT NO:

06

Exhibit C

Equipment Specifications

Pocket Site HFCT1338A

1030 New Britain Avenue

West Hartford, Connecticut

Kathrein's X-polarized adjustable electrical downtilt antennas offer the wireless carrier the ability to tailor polarization diversity sites for optimum performance. Using variable downtilt, only a few models need be procured to accommodate the needs of widely varying conditions. Remotely controlled downtilt is available as a retrofitable option.

- 0-6° downtilt range.
- UV resistant pultruded fiberglass radome.
- DC Grounded metallic parts for impulse suppression.
- No moving electrical connections.
- Wideband vector dipole technology.
- Optional remote downtilt Control.
- Will accommodate future 3G / UMTS applications.

General specifications:

Frequency range	1710–2170 MHz	
VSWR	< 1.5:1	
Impedance	50 ohms	
Intermodulation (2x20w)	IM3: <-150 dBc	
Polarization	+45° and -45°	
Front-to-back ratio (180°±30°)	>30 dB (co-polar) >25 dB (total power)	
Maximum input power	300 watts per input (at 50°C)	
Electrical downtilt continuously adjustable	0–6 degrees	
Connector	2 x 7/16 DIN female	
Isolation	>30 dB	
Cross polar ratio		
Main direction 0°	25 dB (typical)	
Sector ±60°	>10 dB	
Weight	22 lb (10 kg)	
Dimensions	76.5 x 6.1 x 2.7 inches (1942 x 155 x 69 mm)	
Equivalent flat plate area	4.62 ft ² (0.429 m ²)	
Wind survival rating*	120 mph (200 kph)	
Shipping dimensions	87.2 x 6.8 x 3.6 inches (2214 x 172 x 92 mm)	
Shipping weight	24.3 lb (11 kg)	
Mounting	Fixed and tilt mount options are available for 2 to 4.6 inch (50 to 115 mm) OD masts.	

See reverse for order information.

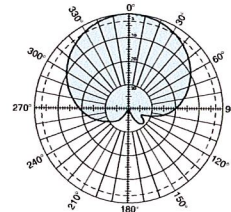

Horizontal pattern
±45°- polarization

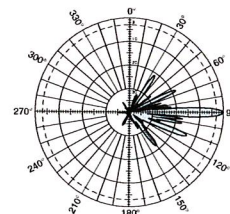

Vertical pattern
±45°- polarization



Specifications:	1710–1880 MHz	1850–1990 MHz	1920–2170 MHz
Gain	19 dBi	19.2 dBi	19.5 dBi
+45° and -45° polarization horizontal beamwidth	67° (half-power)	65° (half-power)	63° (half-power)
+45° and -45° polarization vertical beamwidth	4.7° (half-power)	4.5° (half-power)	4.3° (half-power)
Vertical Pattern—sidelobe suppression for first side-lobe above main beam	0° 2° 4° 6° T 18 17 15 15 dB	0° 2° 4° 6° T 18 18 17 15 dB	0° 2° 4° 6° T 18 18 17 15 dB



10642-H
936.2074/h



* Mechanical design is based on environmental conditions as stipulated in EIA-222-F (June 1996) and/or ETS 300 019-1-4 which include the static mechanical load imposed on an antenna by wind at maximum velocity. See the Engineering Section of the catalog for further details.

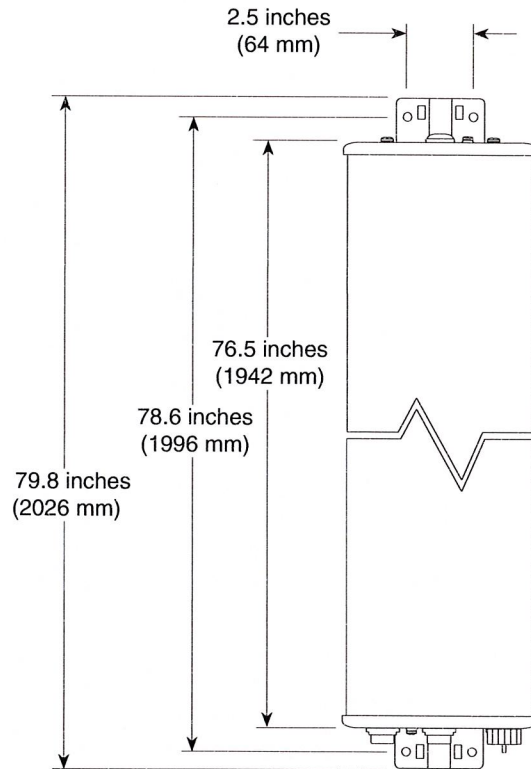
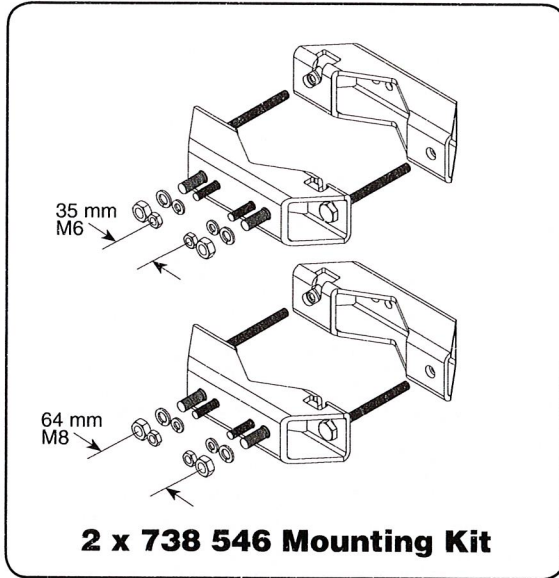

Mounting Options:

Model	Description
2 x 738 546	Mounting Kit for 2 to 4.6 inch (50 to 115 mm) OD mast.
737 978	Tilt Kit for use with the above mounting kit, 0–11 degrees downtilt angle. (requires 2 x 738 546 Mounting Kit)
742 263	Three-panel Sector Mounting Kit (120 deg. ea.) for 3.5 inch (89 mm) OD mast.

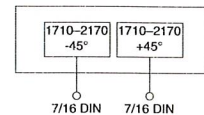
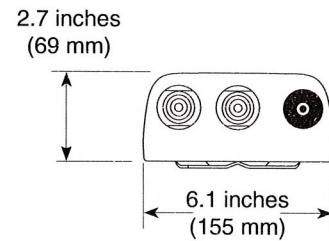

Order Information:

Model	Description
742 213	Antenna with 7/16 DIN connectors 0°–6° adjustable electrical downtilt

All specifications are subject to change without notice. The latest specifications are available at www.kathrein-scala.com.

Kathrein Inc., Scala Division Post Office Box 4580 Medford, OR 97501 (USA) Phone: (541) 779-6500 Fax: (541) 779-3991
Email: communications@kathrein.com Internet: www.kathrein-scala.com

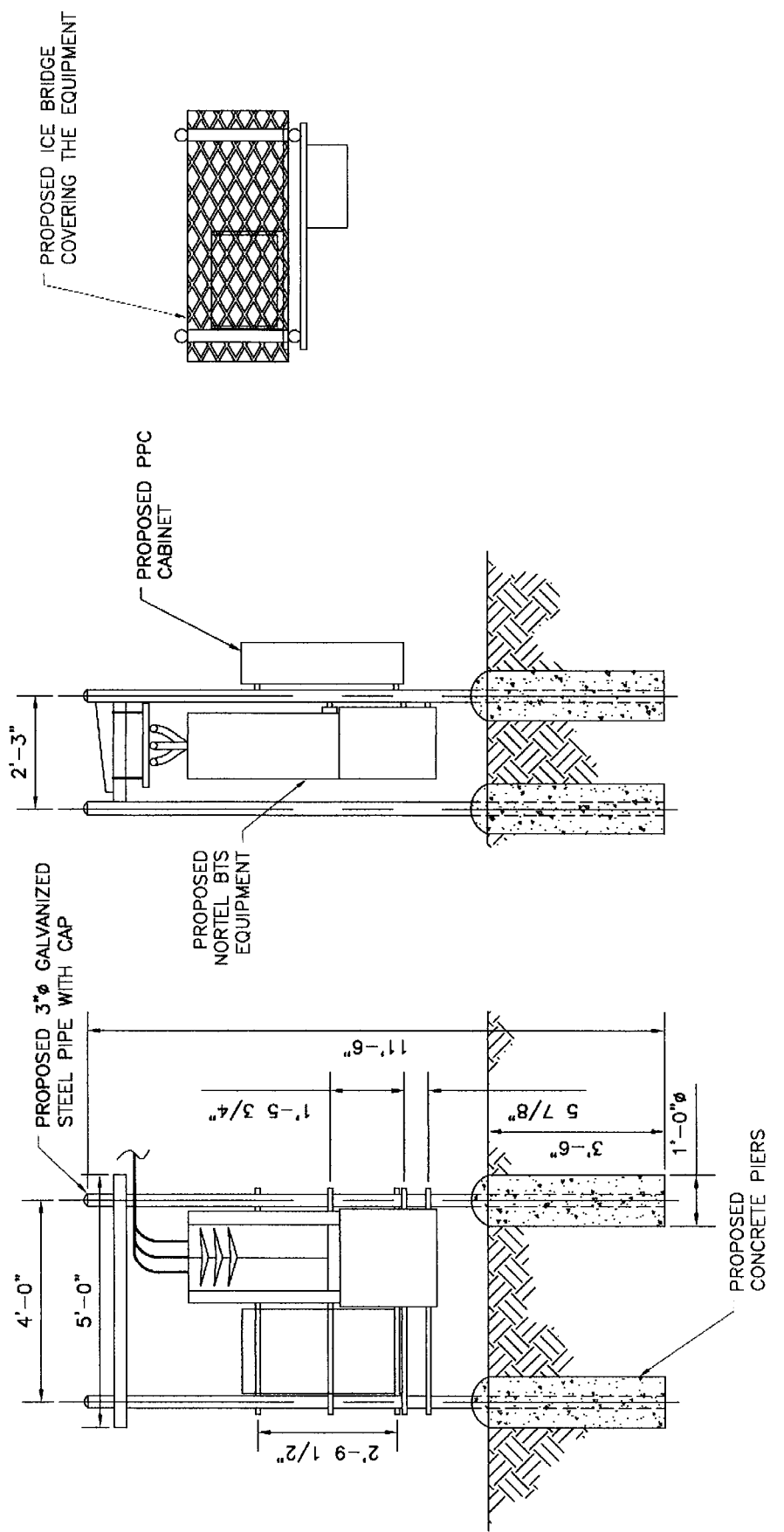

Pocket/Youghiogheny Communications - Northeast, LLC
 Rack Detail



CDMA BTS 3231 AWS 1.7/2.1 GHz (Outdoor/Indoor)

to transport to hard to reach locations such as the top of a high rise building.

CDMA BTS 3231

Industry's Highest Capacity AWS Micro BTS

The CDMA BTS 3231 is the latest extension to Nortel Networks BTS (Base Transceiver Station) portfolio providing the ideal solution for urban, sub-urban and rural deployments. The CDMA BTS 3231 is a 3-carrier, 3-sector outdoor/indoor BTS operating at the AWS band of 1.7/2.1 GHz supporting IS-95, 1XRTT and 1xEV-DO simultaneously. BTS 3231 provides flexible deployments solutions including floor, rack, and wall mount options. The power consumption of BTS3231 is industry leading consuming only 630W for 3C3S. The BTS 3231 is also very light at 240lbs making it easy

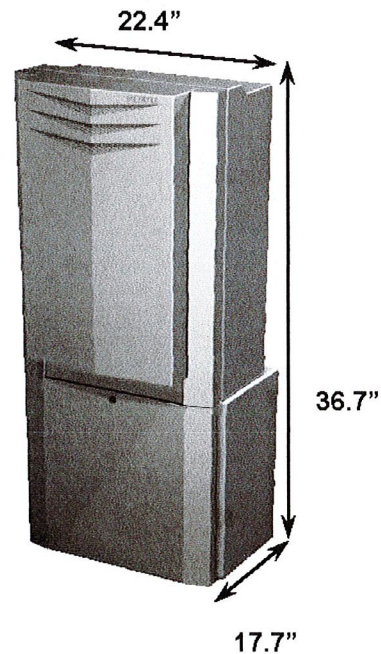

Exhibit D

Power Density Calculations

Pocket Site HFCT1338A

1030 New Britain Avenue

West Hartford, Connecticut



C Squared Systems, LLC
920 Candia Road
Manchester, NH 03109
Phone: (603) 657 9702
E-mail:

support@csquaredsystems.com

Calculated Radio Frequency Emissions

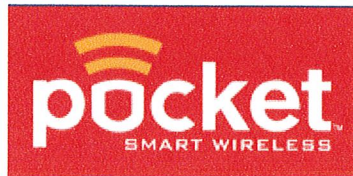

CT-1338

1030 New Britain Ave, West Hartford, CT

Table of Contents

1. Introduction.....	1
2. FCC Guidelines for Evaluating RF Radiation Exposure Limits.....	2
3. RF Exposure Prediction Methods.....	2
4. Calculation Results.....	3
5. Conclusion.....	4
6. Statement of Certification.....	5
Attachment A: References.....	6
Attachment B: FCC Limits For Maximum Permissible Exposure (MPE).....	7

List of Tables

Table 1: Proposed Carrier Information.....	3
--	---

1. Introduction

The purpose of this report is to investigate compliance with applicable FCC regulations for the proposed Pocket antennas installed on the existing tower at 1030 New Britain Ave, West Hartford, CT.

These calculations assume that the antennas are operating at 100 percent capacity, that all antenna channels are transmitting simultaneously, and that the radio transmitters are operating at full power. Obstructions (trees, buildings etc.) that would normally attenuate the signal are not taken into account. As a result, the predicted signal levels are much more conservative (higher) than the actual signal levels will be from the finished installation.

Public exposure to radio frequencies is regulated and enforced in units of microwatts per square centimeter (mW/cm^2). The number of mW/cm^2 emitted is called the power density. The general population exposure limit for the cellular band is 0.567-0.593 mW/cm^2 , and the general population exposure limit for the PCS/AWS band is 1.0 mW/cm^2 . Because each carrier will be using different frequency bands, and each frequency band has different exposure limits, it is necessary to report percent of MPE rather than power density.

The FCC general population / uncontrolled limits set the maximum exposure to which most people may be subjected. General population / uncontrolled exposures apply in situations in which the general public may be exposed, or in which persons that are exposed as a consequence of their employment may not be fully aware of the potential for exposure or cannot exercise control over their exposure.

Higher exposure limits are permitted under the occupational / controlled exposure category, but only for persons who are exposed as a consequence of their employment and who have been made fully aware of the potential for exposure (through training), and they must be able to exercise control over their exposure. General population / uncontrolled limits are five times more stringent than the levels that are acceptable for occupational, or radio frequency trained individuals.”

The FCC describes exposure to radio frequency (RF) energy in terms of percentage of maximum permissible exposure (MPE) with 100% being the maximum allowed. Rather than the FCC presenting the user specification in terms of complex power density figures over a specified surface area, this MPE measure is particularly useful, and even more so when considering that power density limits actually vary by frequency because of the different absorptive properties of the human body at different frequencies.

MPE limits are specified as time-averaged exposure limits. This means that exposure can be averaged over 30 minutes for general population / uncontrolled exposure (or 6 minutes for occupational / controlled exposure). However, for the case of exposure of the general public, time averaging is usually not applied because of uncertainties over exact exposure conditions and difficulty in controlling time of exposure. Therefore, the typical conservative approach is to assume that any RF exposure to the general public will be continuous.

Finally, it should be noted that the MPE limits adopted by the FCC for both general population / uncontrolled exposure and for occupational / controlled exposure incorporate a substantial margin of safety and have been established to be well below levels generally accepted as having the potential to cause adverse health effects.

2. FCC Guidelines for Evaluating RF Radiation Exposure Limits

In 1985, the FCC established rules to regulate radio frequency (RF) exposure from FCC licensed antenna facilities. In 1996, the FCC updated these rules, which were further amended in August 1997 by OET Bulletin 65 Edition 97-01. These new rules include limits for Maximum Permissible Exposure (MPE) for transmitters operating between 300 kHz and 100 GHz. The FCC MPE limits are based on exposure limits recommended by the National Council on Radiation Protection and Measurements (NCRP), the exposure limits developed by the Institute of Electrical and Electronics Engineers, Inc., (IEEE) and adopted by the American National Standards Institute (ANSI).

Attachment B contains excerpts from OET Bulletin 65 and defines the Maximum Exposure Limit. As shown in these excerpts, each frequency band has different exposure limits, requiring power density to be reported as a percent of Maximum Permissible Exposure (MPE) when dealing with carriers transmitting in different frequency bands.

3. RF Exposure Prediction Methods

The emission field calculation results displayed in the following figures were generated using the following formula as outlined in FCC bulletin OET 65:

$$\text{Power Density} = \left(\frac{EIRP}{\pi \times R^2} \right) \times \text{Off Beam Loss}$$

Where:

EIRP = Effective Isotropic Radiated Power

R = Radial Distance = $\sqrt{(H^2 + V^2)}$

H = Horizontal Distance from antenna

V = Vertical Distance from bottom of antenna

Off Beam Loss is determined by the selected antenna patterns

4. Calculation Results

Table 1 below outlines the power assumptions used to compute the power density.

Carrier	Operating Frequency (MHz)	Antenna Height (Feet)	Number of Trans.	Effective Radiated Power (ERP) Per Transmitter (Watts)	Total ERP (Watts)
AT&T UMTS	1962.5	180	1	500	500
T-Mobil	1945	165	4	250	1,000
Sprint-Nextel CDMA	1935	155	9	100	900
Pocket	2130-2133.75	145	3	631	1,893

Table 1: Proposed Carrier Information

The calculated result for the cumulative %MPE is 4.74%.

Please note that for distances of 100 feet or less, a nominal 10 dB of attenuation due to antenna pattern is assumed. Also, as noted in the introduction, obstructions (trees, buildings etc.) that would normally attenuate the signal are not taken into account. As a result, the predicted signal levels are more conservative (higher) than the actual signal levels will be from the finished installation.

5. Conclusion

The above analysis verifies that emissions from the proposed site will be well below the maximum power density levels as outlined by the FCC in the OET Bulletin 65 Ed. 97-01. Even when using conservative methods, the cumulative power density from the transmit antennas at the proposed facility is well below the limits for the general public. The highest expected percent of Maximum Permissible Exposure at the base of the tower is 4.74% of the FCC limit.

Please note that for distances of 100 feet or less, a nominal 10 dB of attenuation due to antenna pattern is assumed. Also, as noted in the introduction, obstructions (trees, buildings etc.) that would normally attenuate the signal are not taken into account. As a result, the predicted signal levels are more conservative (higher) than the actual signal levels will be from the finished installation.

6. Statement of Certification

I certify to the best of my knowledge that the statements in this report are true and accurate. The calculations follow guidelines set forth in ANSI/IEEE Std. C95.3, ANSI/IEE Std. C95.1 and FCC OET Bulletin 65 Edition 97-01.

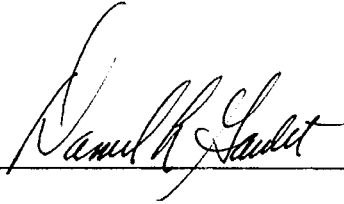

Daniel I. Goulet
C Squared Systems, LLC

August 11, 2008
Date

Attachment A: References

OET Bulletin 65 - Edition 97-01 - August 1997 Federal Communications Commission Office of Engineering & Technology

ANSI C95.1-1982, American National Standard Safety Levels With Respect to Human Exposure to Radio Frequency Electromagnetic Fields, 300 kHz to 100 GHz. IEEE-SA Standards Board

IEEE Std C95.3-1991 (Reaff 1997), IEEE Recommended Practice for the Measurement of Potentially Hazardous Electromagnetic Fields - RF and Microwave. IEEE-SA Standards Board

Attachment B: FCC Limits For Maximum Permissible Exposure (MPE)

(A) Limits for Occupational/Controlled Exposure

Frequency Range (MHz)	Electric Field Strength (E) (V/m)	Magnetic Field Strength (E) (A/m)	Power Density (S) (mW/cm ²)	Averaging Time E ² , H ² or S (minutes)
0.3-3.0	614	1.63	(100)*	6
3.0-30	1842/f	4.89/f	(900/f ²)*	6
30-300	61.4	0.163	1.0	6
300-1500	-	-	f/300	6
1500-100,000	-	-	5	6

(B) Limits for General Population/Uncontrolled Exposure

Frequency Range (MHz)	Electric Field Strength (E) (V/m)	Magnetic Field Strength (E) (A/m)	Power Density (S) (mW/cm ²)	Averaging Time E ² , H ² or S (minutes)
0.3-1.34	614	1.63	(100)*	30
1.34-30	824/f	2.19/f	(180/f ²)*	30
30-300	27.5	0.073	0.2	30
300-1500	-	-	f/1500	30
1500-100,000	-	-	1.0	30

f = frequency in MHz * Plane-wave equivalent power density

NOTE 1: Occupational/controlled limits apply in situations in which persons are exposed as a consequence of their employment provided those persons are fully aware of the potential for exposure and can exercise control over their exposure. Limits for occupational/controlled exposure also apply in situations when an individual is transient through a location where occupational/controlled limits apply provided he or she is made aware of the potential for exposure.

NOTE 2: General population/uncontrolled exposures apply in situations in which the general public may be exposed, or in which persons that are exposed as a consequence of their employment may not be fully aware of the potential for exposure or can not exercise control over their exposure.

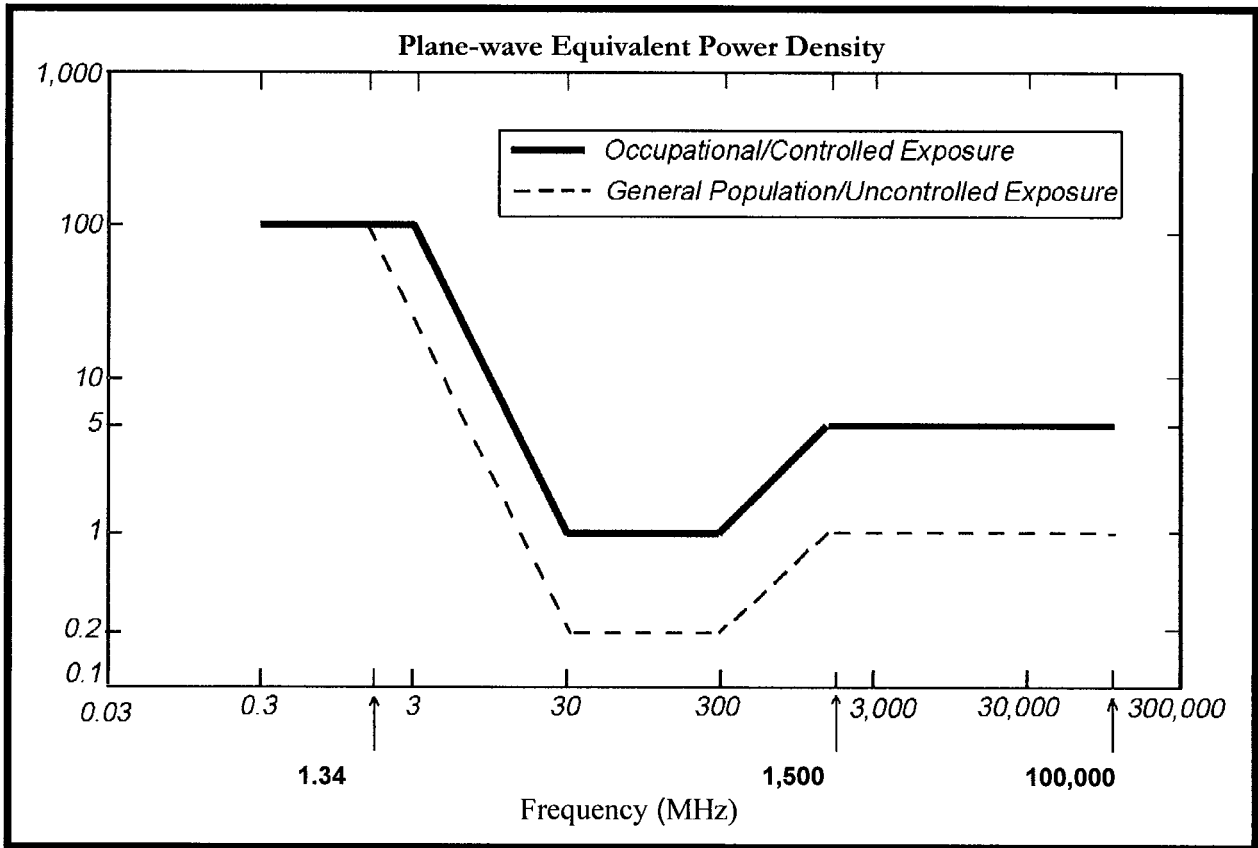

• FCC Limits for Maximum Permissible Exposure (MPE)

Exhibit E

Structural Analysis

Pocket Site HFCT1338A

1030 New Britain Avenue

West Hartford, Connecticut



**STRUCTURAL NARRATIVE AND CALCULATIONS
FOR 180' LATTICE TOWER
1030 NEW BRITAIN AVENUE
WEST HARTFORD, CT 06110**

**Site Name: WEST HARTFORD-NEW BRITAIN AVE
Pocket Site ID: HFCT1338A**

**Prepared For:
Pocket Communications**

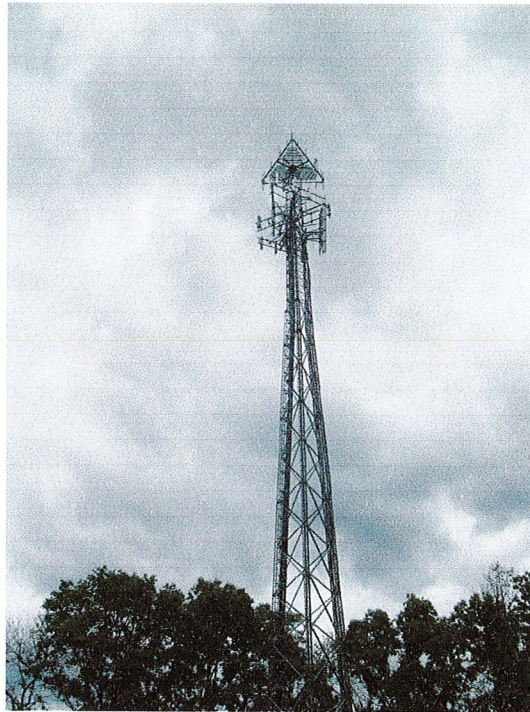

**Prepared by:
CMX Telecommunications
1101 Laurel Oak Road, Suite 100, Voorhees, NJ 08043 - (856) 772-0313
27 August 2008 - CMX Project #080282301**

TABLE OF CONTENTS

<u>Section</u>	<u>Page Number</u>
1.0 OBJECTIVE	1
2.0 EXISTING AND PROPOSED APPURTENANCES	1
3.0 TOWER MEMBERS	1
4.0 ANALYSIS STANDARDS AND LOADING	2
5.0 ANALYSIS APPROACH	2
5.1 ANALYSIS ASSUMPTIONS	2
6.0 CALCULATIONS	2
7.0 CONCLUSIONS	2
APPENDIX A PLS -TOWER OUTPUT	

1.0 OBJECTIVE

The objective of this report is to evaluate the structural capacity of the existing 180' lattice tower located at 1030 New Britain Ave, West Hartford, CT 06110 for existing appurtenances as well as additional gravity, wind, and ice loads imparted by proposed Sprint/Nextel discrete and linear appurtenances.

CMX Telecommunications (CMX) obtained a previous Structural report for the tower prepared by Atlantic Design Engineers, LLC, Project #2387.00, dated October 22, 2004. CMX also conducted a site visit to determine the existing appurtenances from the ground. This analysis is based on this information.

2.0 EXISTING AND PROPOSED APPURTENANCES

Below is a list of the existing and proposed discrete and linear appurtenances located on the lattice tower:

Existing Appurtenances

Height (ft A.G.L.)	Appurtenance Type	Mount Type	Coax Size
180 - AT&T	(3) Allgon 7250.0 (3) Allgon 7250.0 ¹	Low Profile	(6) 1-5/8" (6) 1-5/8" ¹
167 - T-Mobile	(8) EMS RR90-17-02D	Sector Mounts	(16) 1-5/8"
154 - Sprint/Nextel	(12) Andrew Corporation DB844H90T6-XY	Sector Mounts	(12) 1-5/8"
145 ¹	(6) DAPA 48010 ¹ (3) 2' Diameter Dishes ¹	Sector Mounts ¹	(9) 1- 5/8" ¹

¹ denotes secured for future expansion in the original design

Proposed Appurtenances

Height (ft A.G.L.)	Appurtenance Type	Mount Type	Coax Size
145- Pocket	(3) Kathrein Scala 742 213	Sector Mounts	(6) 1-5/8"

3.0 TOWER MEMBERS

Height (ft)	Legs (50 ksi)	Diagonal Bracing (36 ksi)
0-20	2" SR Truss	L3x3x5/16
20-40	2" SR Truss	L3x3x5/16
40-60	1.75" SR Truss	L3x3x3/16
60-80	1.75" SR Truss	L3x3x3/16
80-100	1.5" SR Truss	L2.5x2.5x3/16
100-120	1.5" SR Truss	L2.5x2.5x3/16
120-130	1.25" SR Truss	L2.5x2.5x3/16
130-150	2.25" SR	1" SR
150-170	2" SR	7/8" SR
170-180	1.5" SR	3/4" SR

Note: "SR" denotes solid round members

4.0 ANALYSIS STANDARDS AND LOADING

The following codes, standards, and analysis data were considered in the analysis:

- a. *2003 International Building Code*, International Code Council
- b. *Structural Standards for Steel Antenna Towers and Antenna Supporting Structures TIA/EIA-222-F*, Telecommunications Industry Association
- c. 80 mph Basic Wind Speed for Hartford County, CT per TIA/EIA-222-F
- d. 69.3 mph operational wind speed with 1/2" ice accumulation

Calculations for this analysis are provided in Appendix A of this report

5.0 ANALYSIS APPROACH AND ASSUMPTIONS

The analysis approach used in this report is founded on the premise that if the existing **Structure** can support the additional gravity, wind, and ice loads from the proposed appurtenances, per TIA/EIA-222-F requirements, along with the existing appurtenances then the existing **Structure** is structurally adequate. Tower by Power Line Systems, a 3-D, non-linear, finite element analysis program, was used to perform the structural analysis.

For this analysis, the following has been assumed:

- a. The **Structure** has been properly installed and maintained.
- b. All members are in good condition.
- c. All structural elements are in place.
- d. All bolts are tightened and the **Structure** is plumb.
- e. All antennas are assumed to have full exposure to wind.

6.0 CALCULATIONS

Calculations for this analysis are provided in Appendix A of this report.

7.0 CONCLUSIONS

The existing lattice tower **can** structurally support the existing and proposed linear and discrete appurtenances per the aforementioned standards without structural modifications. The diagonals between 80'-100' are stressed to a maximum of 78.8% of capacity.

The structural report by Atlantic Design Engineers listed the design reactions for the existing tower. The calculated tower reactions from the proposed loadings are less than the listed design reactions. Therefore, the foundation is found to have adequate capacity to support the proposed and existing loads based on the provided report.

TOWER REACTIONS:

	CMX Analysis (80 mph Basic Wind Speed)	Atlantic Design Engineers (Listed Structural Capacity)
Maximum Compression Per Leg (kips)	243.8	295.5
Maximum Uplift Per Leg (kips)	212.1	263.4
Maximum Shear Per Tower Leg (kips)	19.5	27.7

CMX reserves the right to add to or modify this report as more information becomes available. The conclusions reached by CMX in this report are applicable only for the previously listed existing and proposed discrete and linear appurtenances.

For CMX Telecommunications:



Charles Utschig, P.E.
Connecticut License No. PEN.0019262