

280 Trumbull Street  
Hartford, CT 06103-3597  
Main (860) 275-8200  
Fax (860) 275-8299  
kbaldwin@rc.com  
Direct (860) 275-8345

Also admitted in Massachusetts

ORIGINAL

December 26, 2013

Melanie A. Bachman  
Acting Executive Director  
Connecticut Siting Council  
10 Franklin Square  
New Britain, CT 06051

Re: **TS-VER-102-130717B – 31F Clark Falls Road, North Stonington, Connecticut**  
**TS-VER-152-130802 – 15 Miner Lane, Waterford, Connecticut**  
**TS-VER-134-130520 – 33 South Road, Stafford, Connecticut**  
**TS-VER-088-130620 – 880 Andrews Mountain Road, Naugatuck, Connecticut**  
**EM-VER-147-130220 – 422 Rockville Road, Voluntown, Connecticut**

**Completion of Construction Activity**

Dear Ms. Bachman:

The purpose of this letter is to notify the Siting Council that construction activity associated with the above-referenced Cellco Partnership d/b/a Verizon Wireless telecommunications facilities has been completed.

If you have any questions or need any additional information regarding these facilities please do not hesitate to contact me.

Sincerely,



Kenneth C. Baldwin

Copy to:  
Sandy M. Carter



Law Offices

BOSTON

PROVIDENCE

HARTFORD

NEW LONDON

STAMFORD

WHITE PLAINS

NEW YORK CITY

ALBANY

SARASOTA

www.rc.com

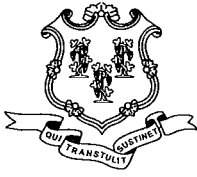

STATE OF CONNECTICUT  
CONNECTICUT SITING COUNCIL

Ten Franklin Square, New Britain, CT 06051

Phone: (860) 827-2935 Fax: (860) 827-2950

E-Mail: [siting.council@ct.gov](mailto:siting.council@ct.gov)

[www.ct.gov/csc](http://www.ct.gov/csc)

August 23, 2013

Kenneth C. Baldwin, Esq.  
Robinson & Cole  
280 Trumbull Street  
Hartford, CT 06103-3597

RE: **TS-VER-152-130802** – Cellco Partnership d/b/a Verizon Wireless request for an order to approve the shared use of an existing telecommunications facility located at 15 Miner Lane, Waterford, Connecticut.

Dear Attorney Baldwin:

At a public meeting held August 22, 2013, the Connecticut Siting Council (Council) ruled that the shared use of this existing tower site is technically, legally, environmentally, and economically feasible and meets public safety concerns, and therefore, in compliance with General Statutes § 16-50aa, the Council has ordered the shared use of this facility to avoid the unnecessary proliferation of tower structures with the following conditions:

- Any deviation from the proposed installation as specified in the original tower share request and supporting materials with the Council shall render this decision invalid;
- Any material changes to the proposed installation as specified in the original tower share request and supporting materials filed with the Council shall require an explicit request for modification to the Council pursuant to Connecticut General Statutes § 16-50aa, including all relevant information regarding the proposed change with cumulative worst-case modeling of radio frequency exposure at the closest point of uncontrolled access to the tower base, consistent with Federal Communications Commission, Office of Engineering and Technology, Bulletin 65;
- Not less than 45 days after completion of the proposed installation, the Council shall be notified in writing that the installation has been completed;
- The validity of this action shall expire one year from the date of this letter; and
- The applicant may file a request for an extension of time beyond the one year deadline provided that such request is submitted to the Council not less than 60 days prior to the expiration.

This decision is under the exclusive jurisdiction of the Council. This facility has been carefully modeled to ensure that radio frequency emissions are conservatively below State and federal standards applicable to the frequencies now used on this tower. Any deviation from this format may result in the Council implementing enforcement proceedings pursuant to General Statutes § 16-50u including, without limitation, imposition of expenses resulting from such failure and of civil penalties in an amount not less than one thousand dollars per day for each day of construction or operation in material violation.

This decision applies only to this request for tower sharing and is not applicable to any other request or construction. Please be advised that the validity of this action shall expire one year from the date of this letter.

The proposed shared use is to be implemented as specified in your letter dated July 31, 2013, including the placement of all necessary equipment and shelters within the tower compound.

Thank you for your attention and cooperation.

Very truly yours,

Robert Stein  
Chairman

RS/CDM/jb

c: The Honorable Daniel M. Steward, First Selectman, Town of Waterford  
Dennis G. Goderre, AICP, Planning Director, Town of Waterford  
American Tower Corporation



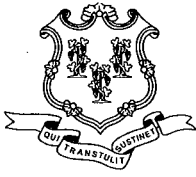

# STATE OF CONNECTICUT

## CONNECTICUT SITING COUNCIL

Ten Franklin Square, New Britain, CT 06051

Phone: (860) 827-2935 Fax: (860) 827-2950

E-Mail: [siting.council@ct.gov](mailto:siting.council@ct.gov)

[www.ct.gov/csc](http://www.ct.gov/csc)

August 7, 2013

The Honorable Daniel M. Steward  
First Selectman  
Town of Waterford  
Town Hall  
15 Rope Ferry Road  
Waterford, CT 06385

RE: **TS-VER-152-130802** – Cellco Partnership d/b/a Verizon Wireless request for an order to approve the shared use of an existing telecommunications facility located at 15 Miner Lane, Waterford, Connecticut.

Dear First Selectman Steward:

The Connecticut Siting Council (Council) received a request for tower sharing, pursuant to Connecticut General Statutes § 16-50aa, a copy of which has already been provided to you.

The Council will consider this item at a future public meeting. A copy of the agenda will be forwarded to you.

If you have any questions or comments regarding the proposal, please call me or inform the council by August 21, 2013.

Thank you for your cooperation and consideration.

Very truly yours,

Melanie Bachman  
Acting Executive Director

MB/jb

c: Dennis G. Goderre, AICP, Planning Director, Town of Waterford

280 Trumbull Street  
Hartford, CT 06103-3597  
Main (860) 275-8200  
Fax (860) 275-8299  
kbaldwin@rc.com  
Direct (860) 275-8345

Also admitted in Massachusetts

July 31, 2013

ORIGINAL

RECEIVED  
AUG - 2 2013  
CONNECTICUT  
SITING COUNCIL

Melanie A. Bachman  
Acting Executive Director  
Connecticut Siting Council  
10 Franklin Square  
New Britain, CT 06051

Re: **Request of Cellco Partnership d/b/a Verizon Wireless for an Order to Approve the Shared Use of an Existing Tower at 15 Miner Lane in Waterford, Connecticut**

Dear Ms. Bachman:

Pursuant to Connecticut General Statutes §16-50aa, as amended, Cellco Partnership d/b/a Verizon Wireless (“Cellco”) hereby requests an order from the Connecticut Siting Council (“Council”) to approve the shared use by Cellco of an existing telecommunications tower, owned by American Tower Corporation (“ATC”), at 15 Miner Lane in Waterford, Connecticut. Cellco requests that the Council find that the proposed shared use of the ATC tower satisfies the criteria of Connecticut General Statutes § 16-50aa and issue an order approving the proposed shared use. A copy of this letter is being sent to Waterford First Selectman, Daniel M. Steward. The Town of Waterford is the owner of the property on which the tower is located.

**Background**

The existing ATC facility consists of a 180-foot monopole tower within a fenced compound. The tower is currently being shared by the Town of Waterford at the 180-foot level; Clearwire at the 170-foot level; U.S. Mobility at the 153-foot level; AT&T at the 150-foot level; and T-Mobil at the 128-foot level on the tower.



Law Offices

BOSTON

PROVIDENCE

HARTFORD

NEW LONDON

STAMFORD

WHITE PLAINS

NEW YORK CITY

ALBANY

SARASOTA

www.rc.com

Melanie A. Bachman  
July 31, 2013  
Page 2

Cellco is licensed by the Federal Communications Commission (“FCC”) to provide wireless services throughout the State of Connecticut. Cellco and ATC have agreed to the proposed shared use of the Miner Lane tower pursuant to mutually acceptable terms and conditions, and ATC has authorized Cellco to apply for all necessary permits and approvals that may be required for the shared use of this tower. (See Owner’s authorization letter attached behind Tab 1).

Cellco proposes to install twelve (12) panel-type antennas at the 160-foot level on the ATC tower. Cellco will also install six (6) remote radio heads (RRHs), two (2) RRHs per sector, behind its AWS and LTE antennas and one (1) main distribution box on its antenna platform and two (2) HYBRIFLEX™ antenna cables inside the monopole tower. Equipment associated with Cellco’s antennas will be located inside a 12’ x 20’ shelter within the fenced compound. Cellco intends to share an ATC generator located inside the facility compound. Included behind Tab 2 are Cellco’s project plans showing the location of all site improvements and specifications for Cellco’s antennas, RRHs and antenna cables.

C.G.S. § 16-50aa(c)(1) provides that, upon written request for approval of a proposed shared use, “if the council finds that the proposed shared use of the facility is technically, legally, environmentally and economically feasible and meets public safety concerns, the council shall issue an order approving such shared use.” Cellco respectfully submits that the shared use of the tower satisfies these criteria.

**A. Technical Feasibility.** The existing tower is structurally capable of supporting Cellco’s antennas. The proposed shared use of this tower therefore is technically feasible. According to the Structural Analysis Report, attached to this filing behind Tab 3, the tower and foundation can support Cellco’s antennas and related equipment.

**B. Legal Feasibility.** Under C.G.S. § 16-50aa, the Council has been authorized to issue orders approving the proposed shared use of an existing tower facility such as the ATC facility in Waterford. This authority complements the Council’s prior-existing authority under C.G.S. § 16-50p to issue orders approving the construction of new towers that are subject to the Council’s jurisdiction. In addition, § 16-50x(a) directs the Council to “give such consideration to other state laws and municipal regulations as it shall deem appropriate” in ruling on requests for the shared use of existing tower facilities. Under the statutory authority vested in the



Melanie A. Bachman

July 31, 2013

Page 3

Council, an order by the Council approving the requested shared use would permit the Applicant to obtain a building permit for the proposed installations.

**C. Environmental Feasibility.** The proposed shared use of the ATC tower would have a minimal environmental effect, for the following reasons:

1. The proposed installations would have an insignificant incremental visual impact and would not cause any significant change or alteration in the physical or environmental characteristics of the existing site. The proposed installation of Cellco's shelter would not require expansion of the existing fenced compound.
2. The proposed installations would not increase the noise levels at the existing facility by six decibels or more.
3. Operation of the existing and Cellco's proposed antennas would not exceed the RF emissions standards adopted by the Federal Communications Commission. The cumulative "worst-case" RF emissions for the operation of the existing antennas and Cellco's proposed antennas would be 36.26% of the FCC standard. *See* the cumulative General Power Density table included behind Tab 4.
4. Under ordinary operating conditions, the proposed installation would not require the use of any water or sanitary facilities and would not generate air emissions or discharges to water bodies or sanitary facilities. After construction is complete the proposed installations would not generate any increased traffic to the ATC property other than periodic (monthly) maintenance visits.

The proposed shared use of this Miner Lane facility would, therefore, have a minimal environmental effect, and is environmentally feasible.

**D. Economic Feasibility.** As previously mentioned, ATC and Cellco have entered into a lease to share the existing tower on mutually agreeable terms. The proposed tower sharing is therefore economically feasible. (*See* Tab 1).



Melanie A. Bachman

July 31, 2013

Page 4

**E. Public Safety Concerns.** As stated above, the tower is structurally capable of supporting all existing antennas, as well as Cellco's proposed antennas and related equipment. Cellco is not aware of any public safety concerns relative to the proposed shared use of the existing ATC tower. In fact, the provision of new or improved wireless service through shared use of the existing tower is expected to enhance the safety and welfare of area residents.

**Conclusion**

For the reasons discussed above, the proposed shared use of the existing ATC tower at 15 Miner Lane in Waterford satisfies the criteria stated in C.G.S. § 16-50aa and advances the General Assembly's and the Siting Council's goal of preventing the unnecessary proliferation of towers in Connecticut. The Applicant, therefore, requests that the Council issue an order approving the proposed shared use of the ATC tower.

Thank you for your consideration of this matter.

Very truly yours,



Kenneth C. Baldwin

Enclosures

Copy to:

Daniel M. Steward, First Selectman

Sandy M. Carter



LETTER OF AUTHORIZATION

SITE NO: 310972

SITE NAME: WATERFORD REBUILD CT

ADDRESS: 15 Miner Lane  
Waterford, CT 06385-3106

I, Richard Rossi, Vice President, Contract Management of American Tower\*, owner of the tower facility located at the address identified above (the "Tower Facility"), do hereby authorize CELLCO PARTNERSHIP D/B/A VERIZON WIRELESS, its successors and assigns, ("Verizon Wireless") and/or its agent, to act as American Tower's non-exclusive agent for the sole purpose of filing and consummating any land-use or building permit application(s) necessary to obtain approval of the applicable jurisdiction for VERIZON WIRELESS's installation of its antennas and related telecommunications equipment on the existing tower and Tower Facility. This installation shall not affect adjoining lands and will occur only within the area leased by American Tower.

We understand that this application may be denied, modified or approved with conditions. The above authorization is limited to the acceptance by VERIZON WIRELESS only of conditions related to VERIZON WIRELESS's installation, provided that any such conditions of approval or modifications will be the sole responsibility of VERIZON WIRELESS.

The above authorization does not permit VERIZON WIRELESS to modify or alter any existing permit(s) and/or zoning or land-use conditions or impose any additional conditions unrelated to VERIZON WIRELESS's installation of telecommunications equipment without the prior written approval of American Tower.

Signature: \_\_\_\_\_  
Print Name: Richard Rossi  
Vice President, Contract Management  
American Tower\*

**NOTARY BLOCK**

Commonwealth of MASSACHUSETTS  
County of Middlesex

This instrument was acknowledged before me by Richard Rossi, Vice President, Contract Management of American Tower (Tower Facility owner), personally known to me (or proved to me on the basis of satisfactory evidence) to be the person whose name is subscribed to the within instrument and acknowledged to me that he/she executed the same.

WITNESS my hand and official seal, this 11<sup>th</sup> day of June, 2013

NOTARY SEAL



Notary Public \_\_\_\_\_  
My Commission Expires 5/27/14

\* American Tower as used herein is defined as American Towers LLC and any of its affiliates or subsidiaries.



# Cellco Partnership

d.b.a. **verizon** wireless

## WIRELESS COMMUNICATIONS FACILITY

WATERFORD SE  
15 MINER LANE  
WATERFORD, CT 06385

SITE DIRECTIONS	
<b>FROM:</b> 99 EAST RIVER DRIVE EAST HARTFORD, CT	<b>TO:</b> 15 MINER LANE WATERFORD, CT 06385
1. Start out going Southwest on E. River Drive toward Pitkin St.	0.9 mi
2. Turn right to merge onto CT-2 E toward Norwich.	23.2 mi
3. Keep right to continue on CT-11 S, follow signs for Connecticut 11S/New London	7.4 mi
4. Take exit 4 for CT-82 toward Salem/Hadlyme	7.4 mi
5. Turn left onto CT-82 E/E Haddam Rd.	1.2 mi
6. At the traffic circle, take the 1st exit onto CT-85 S/New London Rd.	8.6 mi
7. Turn Right onto Cross Rd	2.2 mi
8. Turn Left onto U.S. 1 N/Boston Post Rd	2.3 mi
9. Turn Right onto Miner Ln.	

**GENERAL NOTES**

1. PROPOSED ANTENNA LOCATIONS AND HEIGHTS PROVIDED BY CELLCO PARTNERSHIP.

**PROJECT SCOPE**

1. THE SCOPE OF WORK GENERALLY INCLUDES THE INSTALLATION OF (12) PANEL ANTENNAS TO THE EXISTING MONOPOLE TOWER AND A EQUIPMENT SHELTER AT GRADE. PROPOSED CELLCO PARTNERSHIP EQUIPMENT SHELTER TO UTILIZES THE APPROVED AMERICAN TOWER CORP. BACKUP POWER GENERATOR.

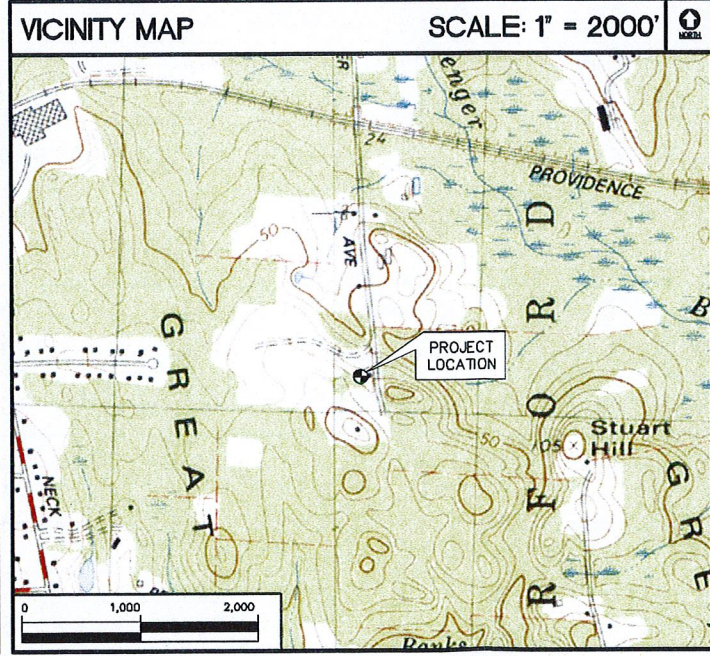

PROJECT SUMMARY	
SITE NAME:	WATERFORD SE
SITE ADDRESS:	15 MINER LANE WATERFORD, CT 06385
LESSEE/TENANT:	CELLCO PARTNERSHIP d.b.a. CELLCO PARTNERSHIP WIRELESS 99 EAST RIVER DRIVE EAST HARTFORD, CT 06108
CONTACT PERSON:	SANDY CARTER CELLCO PARTNERSHIP (860) 803-8219
ENGINEER:	CEN TEK ENGINEERING, INC. 63-2 NORTH BRANFORD ROAD BRANFORD, CT 06405 (203) 488-0580
TOWER COORDINATES:	LATITUDE: 41°-19'-44.85" LONGITUDE: 72°-07'-28.75" GROUND ELEVATION: ±94' A.M.S.L. (REFERENCED FROM CSC DATABASE)

SHEET INDEX		
SHT. NO.	DESCRIPTION	REV. NO.
T-1	TITLE SHEET	0
C-1	ELEVATION, PLAN AND ANTENNA CONFIG.	0

REV.	DATE	CLT DRAWN BY	DMD CHK'D BY	ISSUED FOR CSC - CLIENT REVIEW	DESCRIPTION
0	07/30/13				

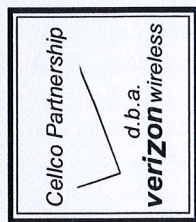

**CEN TEK engineering**  
Centered on Solutions™  
www.CentekEng.com  
(203) 488-0580  
(203) 488-8887 Fax  
63-2 North Branford Road, Branford, CT 06405

Cellco Partnership d/b/a Verizon Wireless  
**WATERFORD SE**  
15 MINER LANE  
WATERFORD, CT 06385  
DATE: 07/29/13  
SCALE: AS NOTED  
JOB NO. 13163.000

**TITLE SHEET**

**T-1**  
DWG. 1 OF 2

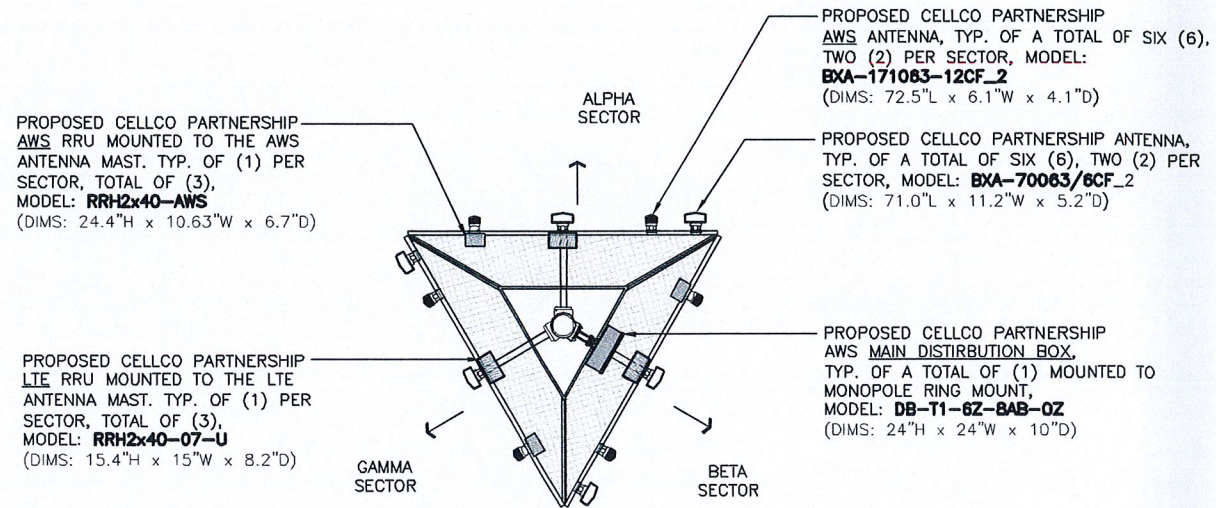

**3 ANTENNA CONFIGURATION - PLAN**  
 C-1 SCALE: 3/32" = 1'-0" (PROPOSED)

TRUE NORTH

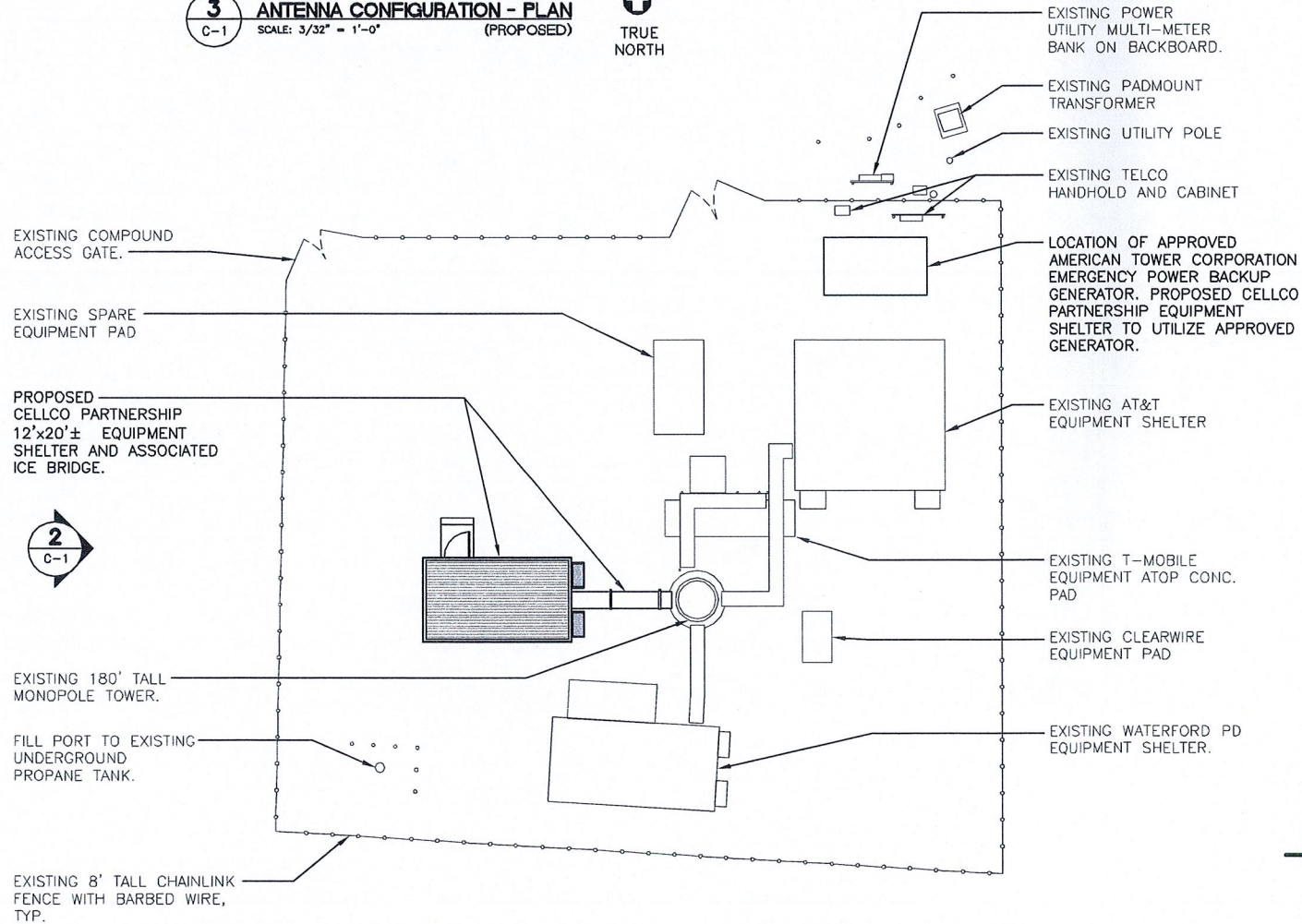

**1 COMPOUND PLAN - PROPOSED**  
 C-1 SCALE: 1" = 30'-0" (PROPOSED)

TRUE NORTH

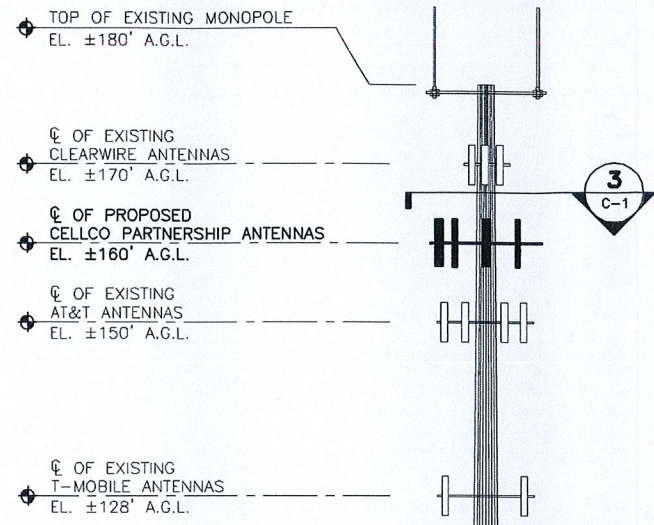
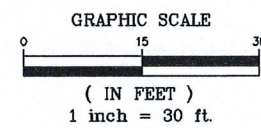

**TOWER NOTES:**

- EXISTING 180' TALL MONOPOLE TOWER.
- REFER TO STRUCTURAL ANALYSIS REPORT AS PREPARED BY AMERICAN TOWER CORP. DATED MAY 13, 2013 ATC E/N: 43755127

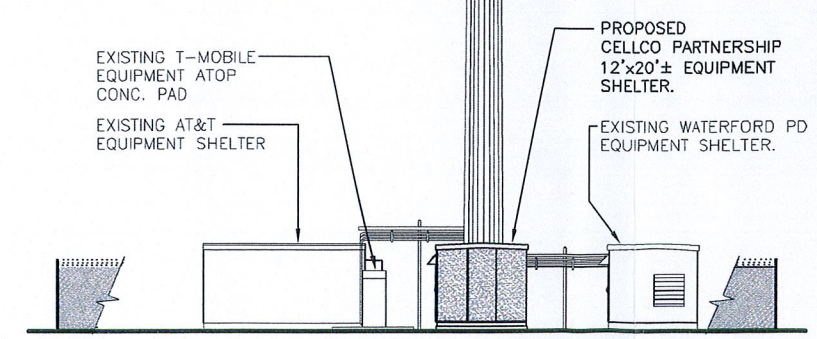

**2 WEST ELEVATION - PROPOSED**  
 C-1 SCALE: 1" = 30'-0" (PROPOSED)

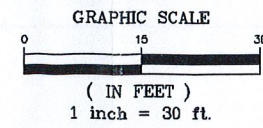

REV.	DATE	CLT DRAWN BY	DMD CHK'D BY	ISSUED FOR CSC - CLIENT REVIEW	DESCRIPTION
0	07/30/13				

Cellco Partnership  
 d.b.a.  
**verizon wireless**

**CENTEK engineering**  
 Centered on Solutions™  
 www.CentekEng.com  
 (203) 488-0580  
 (203) 488-8387 Fax  
 63-2 North Branford Road, Branford, CT 06405

Cellco Partnership d/b/a Verizon Wireless  
**WATERFORD SE**  
 15 MINER LANE  
 WATERFORD, CT 06385

DATE: 07/29/13  
 SCALE: AS NOTED  
 JOB NO. 13163.000

**ELEVATION, PLAN AND ANTENNA CONFIG.**

**C-1**  
 DWG. 2 OF 2

## BXA-70063-6CF-EDIN-X

X-Pol | FET Panel | 63° | 14.5 dBd

Replace "X" with desired electrical downtilt.

Antenna is also available with NE connector(s). Replace "EDIN" with "NE" in the model number when ordering.

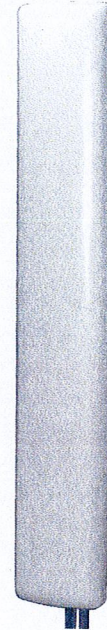

Electrical Characteristics	696-900 MHz		
Frequency bands	696-806 MHz	806-900 MHz	
Polarization	±45°		
Horizontal beamwidth	65°	63°	
Vertical beamwidth	13°	11°	
Gain	14.0 dBd (16.1 dBi)	14.5 dBd (16.6 dBi)	
Electrical downtilt (X)	0, 2, 3, 4, 5, 6, 8, 10		
Impedance	50Ω		
VSWR	≤1.35:1		
Upper sidelobe suppression (0°)	-18.3 dB	-18.2 dB	
Front-to-back ratio (+/-30°)	-33.4 dB	-36.3 dB	
Null fill	5% (-26.02 dB)		
Isolation between ports	< -25 dB		
Input power with EDIN connectors	500 W		
Input power with NE connectors	300 W		
Lightning protection	Direct Ground		
Connector(s)	2 Ports / EDIN or NE / Female / Center (Back)		
Mechanical Characteristics			
Dimensions Length x Width x Depth	1804 x 285 x 132 mm	71.0 x 11.2 x 5.2 in	
Depth with z-brackets	172 mm	6.8 in	
Weight without mounting brackets	7.9 kg	17 lbs	
Survival wind speed	> 201 km/hr	> 125 mph	
Wind area	Front: 0.51 m <sup>2</sup> Side: 0.24 m <sup>2</sup>	Front: 5.5 ft <sup>2</sup> Side: 2.6 ft <sup>2</sup>	
Wind load @ 161 km/hr (100 mph)	Front: 759 N Side: 391 N	Front: 169 lbf Side: 89 lbf	
Mounting Options	Part Number	Fits Pipe Diameter	Weight
3-Point Mounting & Downtilt Bracket Kit	36210008	40-115 mm 1.57-4.5 in	6.9 kg 15.2 lbs
Concealment Configurations	For concealment configurations, order BXA-70063-6CF-EDIN-X-FP		

BXA-70063-6CF-EDIN-X

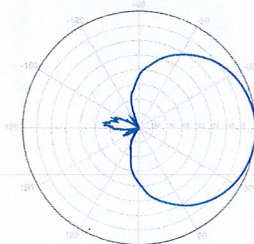

Horizontal | 750 MHz

BXA-70063-6CF-EDIN-0

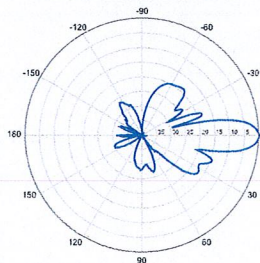

0° | Vertical | 750 MHz

BXA-70063-6CF-EDIN-2

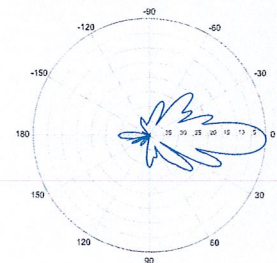

2° | Vertical | 750 MHz

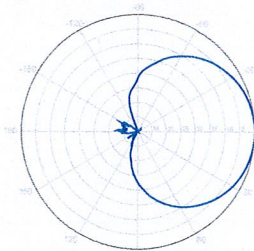

Horizontal | 850 MHz

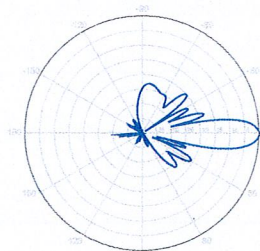

0° | Vertical | 850 MHz

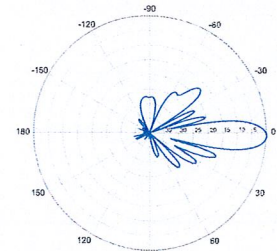

2° | Vertical | 850 MHz

Quoted performance parameters are provided to offer typical or range values only and may vary as a result of normal manufacturing and operational conditions. Extreme operational conditions and/or stress on structural supports is beyond our control. Such conditions may result in damage to this product. Improvements to product may be made without notice.

**BXA-70063-6CF-EDIN-X**

X-Pol | FET Panel | 63° | 14.5 dBd

**BXA-70063-6CF-EDIN-3**

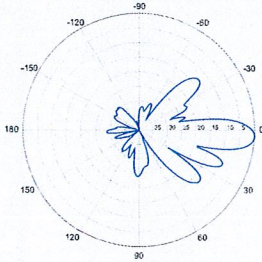

3° | Vertical | 750 MHz

**BXA-70063-6CF-EDIN-4**

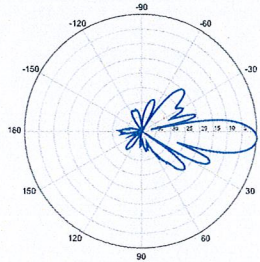

4° | Vertical | 750 MHz

**BXA-70063-6CF-EDIN-5**

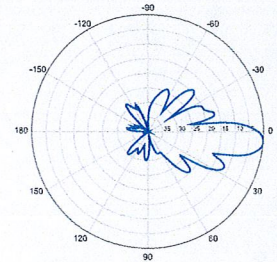

5° | Vertical | 750 MHz

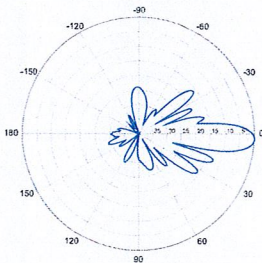

3° | Vertical | 850 MHz

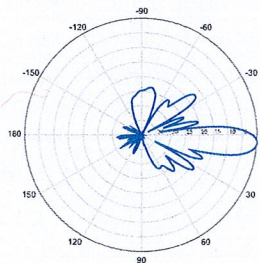

4° | Vertical | 850 MHz

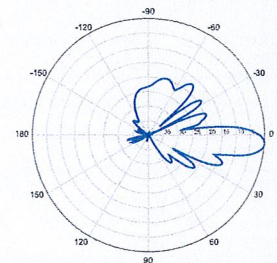

5° | Vertical | 850 MHz

**BXA-70063-6CF-EDIN-6**

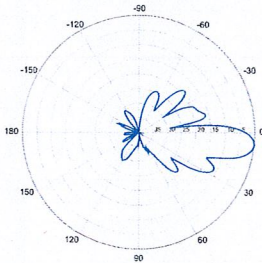

6° | Vertical | 750 MHz

**BXA-70063-6CF-EDIN-8**

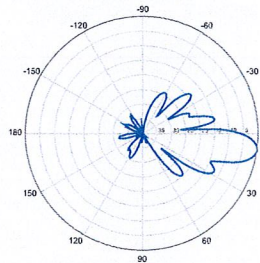

8° | Vertical | 750 MHz

**BXA-70063-6CF-EDIN-10**

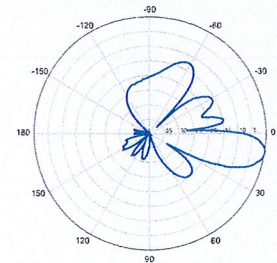

10° | Vertical | 750 MHz

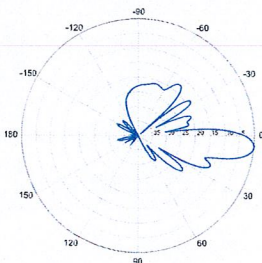

6° | Vertical | 850 MHz

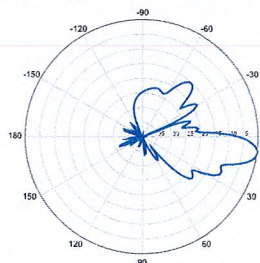

8° | Vertical | 850 MHz

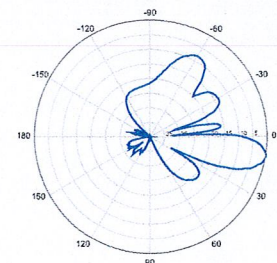

10° | Vertical | 850 MHz

Quoted performance parameters are provided to offer typical or range values only and may vary as a result of normal manufacturing and operational conditions. Extreme operational conditions and/or stress on structural supports is beyond our control. Such conditions may result in damage to this product. Improvements to product may be made without notice.

## BXA-171063-12CF-EDIN-X

X-Pol | FET Panel | 63° | 19.0 dBi

Replace "X" with desired electrical downtilt.

Antenna is also available with NE connector(s). Replace "EDIN" with "NE" in the model number when ordering.



Electrical Characteristics	1710-2170 MHz			
Frequency bands	1710-1880 MHz	1850-1990 MHz	1920-2170 MHz	
Polarization	±45°	±45°	±45°	
Horizontal beamwidth	68°	65°	60°	
Vertical beamwidth	4.5°	4.5°	4.5°	
Gain	16.1 dBd / 18.2 dBi	16.5 dBd / 18.6 dBi	16.9 dBd / 19.0 dBi	
Electrical downtilt (X)	0, 2, 5			
Impedance	50Ω			
VSWR	≤1.5:1			
First upper sidelobe	< -17 dB			
Front-to-back ratio	> 30 dB			
In-band isolation	> 28 dB			
IM3 (20W carrier)	< -150 dBc			
Input power	300 W			
Lightning protection	Direct Ground			
Connector(s)	2 Ports / EDIN or NE / Female / Center (Back)			
Operating temperature	-40° to +60° C / -40° to +140° F			
Mechanical Characteristics				
Dimensions Length x Width x Depth	1842 x 154 x 105 mm	72.5 x 6.1 x 4.1 in		
Depth with z-brackets	133 mm	5.2 in		
Weight without mounting brackets	5.8 kg	12.8 lbs		
Survival wind speed	> 201 km/hr		> 125 mph	
Wind area	Front: 0.28 m <sup>2</sup> Side: 0.19 m <sup>2</sup>	Front: 3.1 ft <sup>2</sup>	Side: 2.1 ft <sup>2</sup>	
Wind load @ 161 km/hr (100 mph)	Front: 460 N Side: 304 N	Front: 103 lbf	Side: 68 lbf	
Mounting Options	Part Number	Fits Pipe Diameter		Weight
2-Point Mounting Bracket Kit	26799997	50-102 mm	2.0-4.0 in	2.3 kg 5 lbs
2-Point Mounting & Downtilt Bracket Kit	26799999	50-102 mm	2.0-4.0 in	3.6 kg 8 lbs
Concealment Configurations	For concealment configurations, order BXA-171063-12CF-EDIN-X-FP			

BXA-171063-12CF-EDIN-X

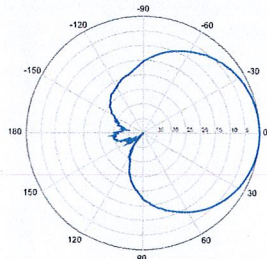

Horizontal | 1710-1880 MHz  
BXA-171063-12CF-EDIN-0

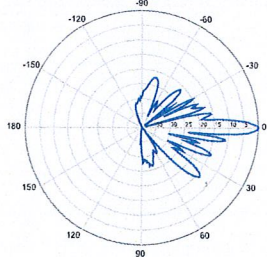

0° | Vertical | 1710-1880 MHz

BXA-171063-12CF-EDIN-X

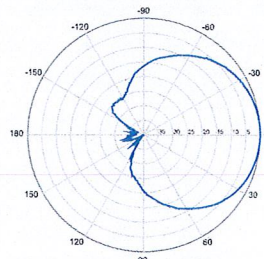

Horizontal | 1850-1990 MHz  
BXA-171063-12CF-EDIN-0

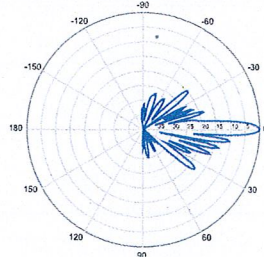

0° | Vertical | 1850-1990 MHz

BXA-171063-12CF-EDIN-X

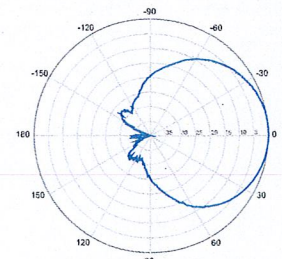

Horizontal | 1920-2170 MHz  
BXA-171063-12CF-EDIN-0

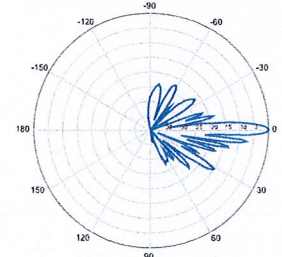

0° | Vertical | 1920-2170 MHz

Quoted performance parameters are provided to offer typical or range values only and may vary as a result of normal manufacturing and operational conditions. Extreme operational conditions and/or stress on structural supports is beyond our control. Such conditions may result in damage to this product. Improvements to product may be made without notice.

# BXA-171063-12CF-EDIN-X

X-Pol | FET Panel | 63° | 19.0 dBi

**BXA-171063-12CF-EDIN-2**

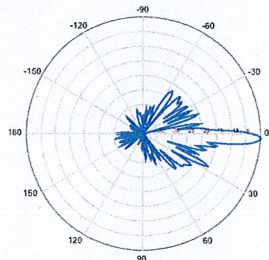

2° | Vertical | 1710-1880 MHz

**BXA-171063-12CF-EDIN-5**

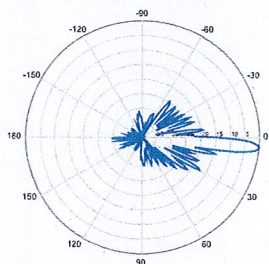

5° | Vertical | 1710-1880 MHz

**BXA-171063-12CF-EDIN-2**

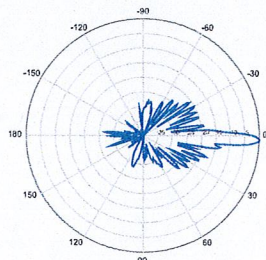

2° | Vertical | 1850-1990 MHz

**BXA-171063-12CF-EDIN-5**

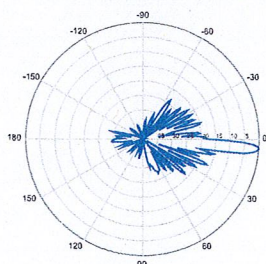

5° | Vertical | 1850-1990 MHz

**BXA-171063-12CF-EDIN-2**

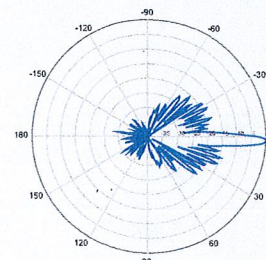

2° | Vertical | 1920-2170 MHz

**BXA-171063-12CF-EDIN-5**

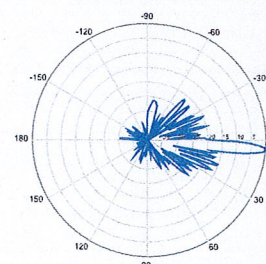

5° | Vertical | 1920-2170 MHz

Quoted performance parameters are provided to offer typical or range values only and may vary as a result of normal manufacturing and operational conditions. Extreme operational conditions and/or stress on structural supports is beyond our control. Such conditions may result in damage to this product. Improvements to product may be made without notice.

## Alcatel-Lucent RRH2x40-07-U REMOTE RADIO HEAD

The Alcatel-Lucent RRH2x40-07-U is a high-power, small form-factor Remote Radio Head (RRH) operating in the North American Digital Dividend / 700MHz frequency band (3GPP Band 13). The Alcatel-Lucent RRH2x40-07-U is designed with an eco-efficient approach, providing operators with the means to achieve high quality and capacity coverage with minimum site requirements.



A distributed eNodeB expands deployment options by using two components, a Base Band Unit (BBU) containing the digital assets and a separate RRH containing the radio-frequency (RF) elements. This modular design optimizes available space and allows the main components of an eNodeB to be installed separately, within the same site or several kilometres apart.

The Alcatel-Lucent RRH2x40-07-U is linked to the BBU by an optical-fiber connection carrying downlink and uplink digital radio signals along with operations, administration and maintenance (OA&M) information. The Alcatel-Lucent RRH2x40-07-U has two transmit RF paths, 40 W RF output power per transmit path, and is designed to manage up to two-way receive diversity. The device is ideally suited to support macro coverage, with multiple-input multiple-output (MIMO) 2x2 operation in up to 10 MHz of bandwidth.

The Alcatel-Lucent RRH2x40-07-U is designed to make available all the benefits of a distributed eNodeB, with excellent RF characteristics, with low

capital expenditures (CAPEX) and low operating expenditures (OPEX). The limited space available in some sites may prevent the installation of traditional single-cabinet BTS equipment or require costly cranes to be employed, leaving coverage holes. However, many of these sites can host an Alcatel-Lucent RRH2x40-07-U installation, providing more flexible site selection and improved network quality along with greatly reduced installation time and costs.

### Fast, low-cost installation and deployment

The Alcatel-Lucent RRH2x40-07-U is a zero-footprint solution and operates noise-free, simplifying negotiations with site property owners and minimizing environmental impacts. Installation can easily be done by a single person because the Alcatel-Lucent RRH2x40-07-U is compact and weighs less than 23 kg (50 lb), eliminating the need for a crane to hoist the BTS cabinet to the rooftop. A site can be in operation in less than one day — a fraction of the time required for a traditional BTS.

## Excellent RF performance

Because of its small size and weight, the Alcatel-Lucent RRH2x40-07-U can be installed close to the antenna. Operators can therefore locate the Alcatel-Lucent RRH2x40-07-U where RF engineering is deemed ideal, minimizing trade-offs between available sites and RF optimum sites. The RF feeder cost and installation costs are reduced or eliminated, and there is no need for a Tower Mounted Amplifier (TMA) because losses introduced by the RF feeder are greatly reduced. The Alcatel-Lucent RRH2x40-07-U provides more RF power while at the same time consuming less electricity.

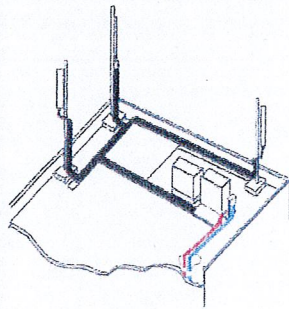

Macro

## Features

- Zero-footprint deployment
- Easy installation, with a lightweight unit can be carried and set up by one person
- Optimized RF power, with flexible site selection and elimination of a TMA
- Convection-cooled (fanless), noise-free, and heaterless unit
- Best-in-class power efficiency, with significantly reduced energy consumption

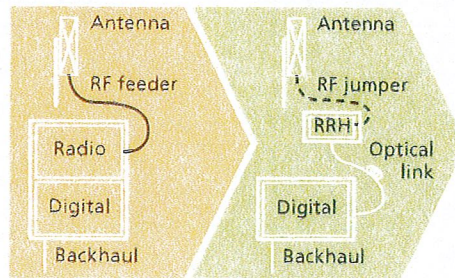

RRH for space-constrained cell sites

## Benefits

- Leverages existing real estate with lower site costs
- Reduces installation costs, with fewer installation materials and simplified logistics
- Decreases power costs and minimizes environmental impacts, with the potential for eco-sustainable power options
- Improves RF performance and adds flexibility to network planning

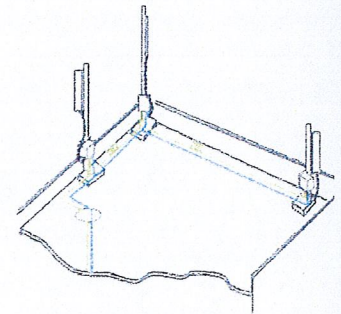

Distributed

## Technical specifications

### Physical dimensions

- Height: 390 mm (15.4 in.)
- Width: 380 mm (15 in.)
- Depth: 210 mm (8.2 in.)
- Weight (without mounting kit): less than 23 kg (50 lb)

### Power

- Power supply: -48V

### Operating environment

- Outdoor temperature range:
  - With solar load: -40°C to +50°C (-40°F to +122°F)
  - Without solar load: -40°C to +55°C (-40°F to +131°F)
- Passive convection cooling (no fans)

- Enclosure protection
  - IP65 (International Protection rating)

### RF characteristics

- Frequency band: 700 MHz; 3GPP Band 13
- Bandwidth: up to 10 MHz
- RF output power at antenna port:
  - 40 W nominal RF power for each Tx port
- Rx diversity: 2-way or 4-way
- Noise figure: below 2.5 dB typical
- ALD features
  - TMA
  - Remote electrical tilt (RET) support (AISG v2.0)

### Optical characteristics

#### Type/number of fibers

- Up to 3.12 Gb/s line bit rate
- Single-mode variant
  - One SM fiber (9/125 μm) per RRH2x, carrying UL and DL using CWDM (at 1550/1310 nm)
- Multi-mode variant
  - Two MM fibers (50/125 μm) per RRH2x: one carrying UL, the other carrying DL (at 850 nm)

### Optical fiber length

- Up to 500 m (0.31 mi), using MM fiber
- Up to 20 km (12.43 mi), using SM fiber

### Alarms and ports

- Six external alarms
- Two optical ports to support daisy-chaining

[www.alcatel-lucent.com](http://www.alcatel-lucent.com) Alcatel, Lucent, Alcatel-Lucent and the Alcatel-Lucent logo are trademarks of Alcatel-Lucent. All other trademarks are the property of their respective owners. The information presented is subject to change without notice. Alcatel-Lucent assumes no responsibility for inaccuracies contained herein. Copyright © 2010 Alcatel-Lucent. All rights reserved. CPG2809100913 (09)



## Alcatel-Lucent RRH2x40-AWS

### REMOTE RADIO HEAD

The Alcatel-Lucent RRH2x40-AWS is a high-power, small form-factor Remote Radio Head (RRH) operating in the AWS frequency band (1700/2100MHz - 3GPP Band 4). The Alcatel-Lucent RRH2x40-AWS is designed with an eco-efficient approach, providing operators with the means to achieve high quality and capacity coverage with minimum site requirements.

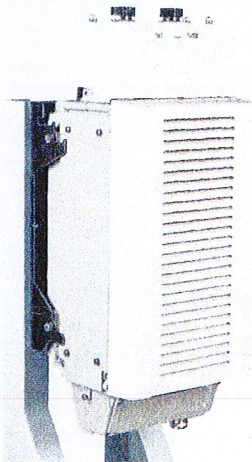

A distributed eNodeB expands deployment options by using two components, a Base Band Unit (BBU) containing the digital assets and a separate RRH containing the radio-frequency (RF) elements. This modular design optimizes available space and allows the main components of an eNodeB to be installed separately, within the same site or several kilometres apart.

The Alcatel-Lucent RRH2x40-AWS is linked to the BBU by an optical-fiber connection carrying downlink and uplink digital radio signals along with operations, administration and maintenance (OA&M) information. The Alcatel-Lucent RRH2x40-AWS has two transmit RF paths, 40 W RF output power per transmit path, and is designed to manage up to four-way receive diversity. The device is ideally suited to support macro coverage, with multiple-input multiple-output (MIMO) 2x2 operation in up to 20 MHz of bandwidth.

The Alcatel-Lucent RRH2x40-AWS is designed to make available all the benefits of a distributed eNodeB, with excellent RF characteristics, with low

capital expenditures (CAPEX) and low operating expenditures (OPEX). The limited space available in some sites may prevent the installation of traditional single-cabinet BTS equipment or require costly cranes to be employed, leaving coverage holes. However, many of these sites can host an Alcatel-Lucent RRH2x40-AWS installation, providing more flexible site selection and improved network quality along with greatly reduced installation time and costs.

#### Fast, low-cost installation and deployment

The Alcatel-Lucent RRH2x40-AWS is a zero-footprint solution and operates noise-free, simplifying negotiations with site property owners and minimizing environmental impacts. Installation can easily be done by a single person because the Alcatel-Lucent RRH2x40-AWS is compact and weighs less than 20 kg (44 lb), eliminating the need for a crane to hoist the BTS cabinet to the rooftop. A site can be in operation in less than one day — a fraction of the time required for a traditional BTS.

## Excellent RF performance

Because of its small size and weight, the Alcatel-Lucent RRH2x40-AWS can be installed close to the antenna. Operators can therefore locate the Alcatel-Lucent RRH2x40-AWS where RF engineering is deemed ideal, minimizing trade-offs between available sites and RF optimum sites. The RF feeder cost and installation costs are reduced or eliminated, and there is no need for a Tower Mounted Amplifier (TMA) because losses introduced by the RF feeder are greatly reduced. The Alcatel-Lucent RRH2x40-AWS provides more RF power while at the same time consuming less electricity.

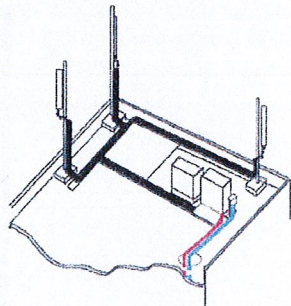

Macro

## Features

- Zero-footprint deployment
- Easy installation, with a lightweight unit can be carried and set up by one person
- Optimized RF power, with flexible site selection and elimination of a TMA
- Convection-cooled (fanless)
- Noise-free
- Best-in-class power efficiency, with significantly reduced energy consumption

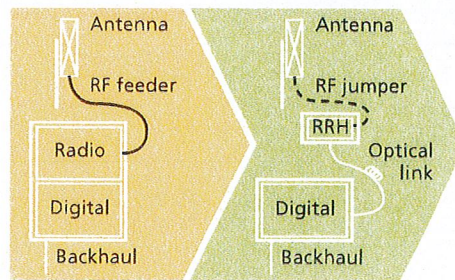

RRH for space-constrained cell sites

## Benefits

- Leverages existing real estate with lower site costs
- Reduces installation costs, with fewer installation materials and simplified logistics
- Decreases power costs and minimizes environmental impacts, with the potential for eco-sustainable power options
- Improves RF performance and adds flexibility to network planning

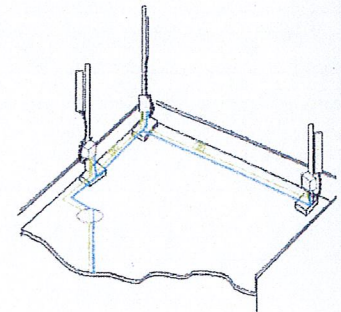

Distributed

## Technical specifications

### Physical dimensions

- Height: 620 mm (24.4 in.)
- Width: 270 mm (10.63 in.)
- Depth: 170mm (6.7 in.)
- Weight (without mounting kit): less than 20 kg (44 lb)

### Power

- Power supply: -48VDC

### Operating environment

- Outdoor temperature range:
  - With solar load: -40°C to +50°C (-40°F to +122°F)
  - Without solar load: -40°C to +55°C (-40°F to +131°F)

- Passive convection cooling (no fans)
- Enclosure protection
  - IP65 (International Protection rating)

### RF characteristics

- Frequency band: 1700/2100 MHz (AWS); 3GPP Band 4
- Bandwidth: up to 20 MHz
- RF output power at antenna port: 40 W nominal RF power for each Tx port
- Rx diversity: 2-way or 4-way with optional Rx Diversity module
- Noise figure: below 2.0 dB typical
- Antenna Line Device features
  - TMA and Remote electrical tilt (RET) support via AISG v2.0

### Optical characteristics

#### Type/number of fibers

- Single-mode variant
  - One Single Mode Single Fiber per RRH2x, carrying UL and DL using CWDM
  - Single mode dual fiber (SM/DF)
- Multi-mode variant
  - Two Multi-mode fibers per RRH2x: one carrying UL, the other carrying DL

### Optical fiber length

- Up to 500 m (0.31 mi), using MM fiber
- Up to 20 km (12.43 mi), using SM fiber

### Digital Ports and Alarms

- Two optical ports to support daisy-chaining
- Six external alarms

[www.alcatel-lucent.com](http://www.alcatel-lucent.com) Alcatel, Lucent, Alcatel-Lucent and the Alcatel-Lucent logo are trademarks of Alcatel-Lucent. All other trademarks are the property of their respective owners. The information presented is subject to change without notice. Alcatel-Lucent assumes no responsibility for inaccuracies contained herein. Copyright © 2010 Alcatel-Lucent. All rights reserved. CPG2809100912 (09)



**HYBRIFLEX™ RRH Hybrid Feeder Cabling Solution, 1-5/8", Single-Mode Fiber**

**Product Description**

RFS' HYBRIFLEX Remote Radio Head (RRH) hybrid feeder cabling solution combines optical fiber and DC power for RRHs in a single lightweight aluminum corrugated cable, making it the world's most innovative solution for RRH deployments.

It was developed to reduce installation complexity and costs at Cellular sites. HYBRIFLEX allows mobile operators deploying an RRH architecture to standardize the RRH installation process and eliminate the need for and cost of cable grounding. HYBRIFLEX combines optical fiber (multi-mode or single-mode) and power in a single corrugated cable. It eliminates the need for junction boxes and can connect multiple RRHs with a single feeder. Standard RFS CELLFLEX® accessories can be used with HYBRIFLEX cable. Both pre-connectorized and on-site options are available.

**Features/Benefits**

- Aluminum corrugated armor with outstanding bending characteristics - minimizes installation time and enables mechanical protection and shielding
- Same accessories as 1 5/8" coaxial cable
- Outer conductor grounding - Eliminates typical grounding requirements and saves on installation costs
- Lightweight solution and compact design - Decreases tower loading
- Robust cabling - Eliminates need for expensive cable trays and ducts
- Installation of tight bundled fiber optic cable pairs directly to the RRH - Reduces CAPEX and wind load by eliminating need for interconnection
- Optical fiber and power cables housed in single corrugated cable - Saves CAPEX by standardizing RRH cable installation and reducing installation requirements
- Outdoor polyethylene jacket - Ensures long-lasting cable protection

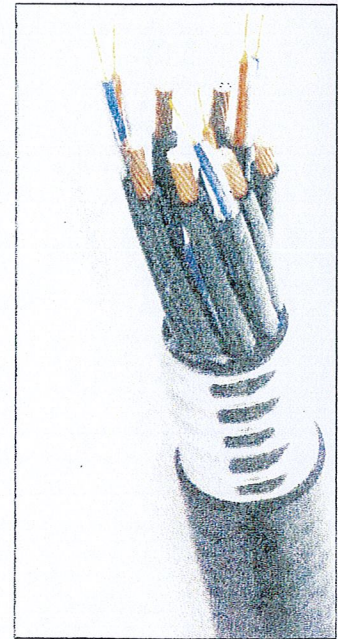

Figure 1: HYBRIFLEX Series

**Technical Specifications**

<b>Structure</b>			
Outer Conductor Armor:	Corrugated Aluminum	[mm (in.)]	46.5 (1.83)
Jacket:	Polyethylene, PE	[mm (in.)]	50.3 (1.98)
UV-Protection:	Individual and External Jacket		Yes
<b>Mechanical Properties</b>			
Weight, Approximate		[kg/m (lb/ft)]	1.9 (1.30)
Minimum Bending Radius, Single Bending		[mm (in.)]	200 (8)
Minimum Bending Radius, Repeated Bending		[mm (in.)]	500 (20)
Recommended/Maximum Clamp Spacing		[m (ft)]	1.0 / 1.2 (3.25 / 4.0)
<b>Electrical Properties</b>			
DC-Resistance Outer Conductor Armor		[Ω/km (Ω/1000ft)]	0.68 (0.205)
DC-Resistance Power Cable, 8.4mm <sup>2</sup> (8AWG)		[Ω/km (Ω/1000ft)]	2.1 (0.307)
<b>Fiber Optic Properties</b>			
Version			Single-mode OM3
Quantity, Fiber Count			16 (8 pairs)
Core/Clad		[μm]	50/125
Primary Coating (Acrylate)		[μm]	245
Buffer Diameter, Nominal		[μm]	900
Secondary Protection, Jacket, Nominal		[mm (in.)]	2.0 (0.08)
Minimum Bending Radius		[mm (in.)]	104 (4.1)
Insertion Loss @ wavelength 850nm		dB/km	3.0
Insertion Loss @ wavelength 1310nm		dB/km	1.0
Standards (Meets or exceeds)			UL94-V0, UL1666 RoHS Compliant
<b>DC Power Cable Properties</b>			
Size (Power)		[mm (AWG)]	8.4 (8)
Quantity, Wire Count (Power)			16 (8 pairs)
Size (Alarm)		[mm (AWG)]	0.8 (18)
Quantity, Wire Count (Alarm)			4 (2 pairs)
Type			UV protected
Strands			19
Primary Jacket Diameter, Nominal		[mm (in.)]	6.8 (0.27)
Standards (Meets or exceeds)			NFPA 130, ICEA S-95-658 UL Type XHHW-2, UL 44 UL-LS Limited Smoke, UL VW-1 IEEE-383 (1974), IEEE1202/FT4 RoHS Compliant
<b>Environment</b>			
Installation Temperature		[°C (°F)]	-40 to +65 (-40 to 149)
Operation Temperature		[°C (°F)]	-40 to +65 (-40 to 149)

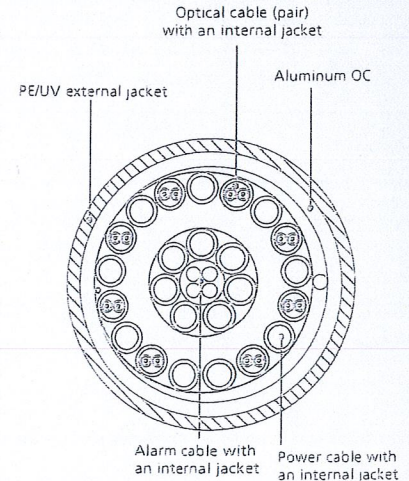

Figure 2: Construction Detail

All information contained in the present datasheet is subject to confirmation at time of ordering.



**AMERICAN TOWER®**  
CORPORATION

---

## Structural Analysis Report

**Structure** : 180 ft Monopole  
**ATC Site Name** : Waterford Rebuild CT, CT  
**ATC Site Number** : 310972  
**Engineering Number** : 43755127  
**Proposed Carrier** : Verizon Wireless  
**Carrier Site Name** : Waterford SE  
**Carrier Site Number** : N/A  
**Site Location** : 15 Miner Lane  
Waterford, CT 06385-3016  
41.329069,-72.124592  
**County** : New London  
**Date** : May 13, 2013  
**Max Usage** : 90%  
**Result** : Pass

Jyoti Ojha, E.I.  
Design Engineer

*Jyoti*

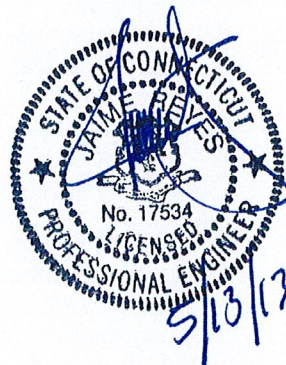



**Table of Contents**

Introduction .....	1
Supporting Documents .....	1
Analysis .....	1
Conclusion.....	1
Existing and Reserved Equipment.....	2
Proposed Equipment .....	2
Structure Usages .....	3
Foundations .....	3
Deflection, Twist, and Sway.....	3
Standard Conditions .....	4
Calculations .....	Attached



## Introduction

The purpose of this report is to summarize results of a structural analysis performed on the 180 ft monopole to reflect the change in loading by Verizon Wireless.

## Supporting Documents

<b>Tower Drawings</b>	FWT, Job# 23766000 dated July 18, 2001
<b>Foundation Drawing</b>	ATC, Job# 42693971 dated December 8, 2008
<b>Geotechnical Report</b>	Tower Engineering Professionals, Project# 082973.01 dated November 7, 2008

## Analysis

The tower was analyzed using American Tower Corporation's tower analysis software. This program considers an elastic three-dimensional model and second-order effects per ANSI/EIA-222.

<b>Basic Wind Speed:</b>	100 mph (Fastest Mile)
<b>Basic Wind Speed w/ Ice:</b>	87 mph (Fastest Mile)w/ 1/2" radial ice concurrent
<b>Code:</b>	ANSI/TIA/EIA-222-F / 2003 IBC , Sec. 1609.1.1, Exception (4) & Sec. 3108.4 w/ 2005 CT Supplement & 2009 CT Amendment

## Conclusion

Based on the analysis results, the structure meets the requirements per the applicable codes listed above. The tower and foundation can support the equipment as described in this report.

If you have any questions or require additional information, please contact me via email at [jyoti.ojha@americantower.com](mailto:jyoti.ojha@americantower.com) or call 972-999-8949.



**Existing and Reserved Equipment**

Mount Elev. <sup>1</sup> (ft)	Qty.	Antenna	Mount Type	Lines	Carrier
180.0	1	dbSpectra ATS8TMA10	Low Profile Platform	(2) 1 5/8" Coax	Town of Waterford
	2	Sinclair SC488-SF1SNF(D04)			
170.0	3	KMW HB-X-WM-17-65-00T	Flush Mounts	(6) 1 5/8" Coax	Clearwire Corporation
	3	KMW HB-X-WM-17-65-00T-TTLNA			
153.0	1	12' Omni	Flush	(1) 1 1/4" Coax	USA Mobility
150.0	6	Allgon 7770.00	Low Profile Platform	(12) 1 1/4" Coax (2) 8 AWG 7 (1) RG6	AT&T Mobility
	6	Ericsson RRUS 11 (Band 12)			
	3	KMW AM-X-CD-14-65-00T-RET			
	6	Powerwave LGP21401			
	6	Powerwave LGP21903			
	1	Raycap DC6-48-60-18-8F			
128.0	6	EMS DR85-17-02DPL2Q	T-Arms	(12) 1 5/8" Coax (1) LMR-400	T-Mobile
	6	RFS ATMAA1412D-1A20			

**Proposed Equipment**

Elevation <sup>1</sup> (ft)		Qty.	Antenna	Mount Type	Lines	Carrier
Mount	RAD					
160.0	160.0	3	Alcatel-Lucent RRH2x40 (700)	Low Profile Platform	(14) 1 5/8" Coax	Verizon Wireless
		3	Alcatel-Lucent RRH2x40-AWS			
		6	Antel BXA-171063/12CF_2FP			
		6	Antel BXA-70063/6CF			
		1	RFS DB-T1-6Z-8AB-OZ			

<sup>1</sup>Mount elevation is defined as height above bottom of steel structure to the bottom of mount, RAD elevation is defined as center of antenna above ground level (AGL).

Install proposed coax inside the pole shaft.



**Structure Usages**

Structural Component	Controlling Usage	Pass/Fail
Anchor Bolts	90%	Pass
Shaft	88%	Pass
Base Plate	62%	Pass

**Foundations**

Reaction Component	Original Design Reactions	Analysis Reactions	% of Design
Moment (Kips-Ft)	5,552.0	4983.1	90%
Shear (Kips)	45.6	41.3	91%

The structure base reactions resulting from this analysis are acceptable when compared to those shown on the original structure drawings, therefore no modification or reinforcement of the foundation will be required.

**Deflection and Sway\***

Antenna Elevation (ft)	Deflection (ft)	Sway (Rotation) (°)
160.0	1.949	1.301

\*Deflection and Sway was evaluated considering a design wind speed of 50 mph (Fastest Mile) per ANSI/TIA/EIA-222-F.





### Standard Conditions

All engineering services are performed on the basis that the information used is current and correct. This information may consist of, but is not necessary limited, to:

- Information supplied by the client regarding the structure itself, antenna, mounts and feed line loading on the structure and its components, or other relevant information.
- Information from drawings in the possession of American Tower Corporation, or generated by field inspections or measurements of the structure.

It is the responsibility of the client to ensure that the information provided to ATC Tower Services and used in the performance of our engineering services is correct and complete. In the absence of information to the contrary, we assume that all structures were constructed in accordance with the drawings and specifications and that their capacity has not significantly changed from the "as new" condition.

Unless explicitly agreed by both the client and American Tower Corporation, all services will be performed in accordance with the current revision of ANSI/TIA -222. The design basic wind speed will be determined based on the minimum basic wind speed as prescribed in ANSI/TIA-222. Although every effort is taken to ensure that the loading considered is adequate to meet the requirements of all applicable regulatory entities, we can provide no assurance to meet any other local and state codes or requirements. If wind and ice loads or other relevant parameters are to be different from the minimum values recommended by the codes, the client shall specify the exact requirement.

All services are performed, results obtained, and recommendations made in accordance with generally accepted engineering principles and practices. ATC Tower Services is not responsible for the conclusions, opinions and recommendations made by others based on the information we supply.

Copyright © 2007 - 2011 by American Tower Corporation. All rights reserved.

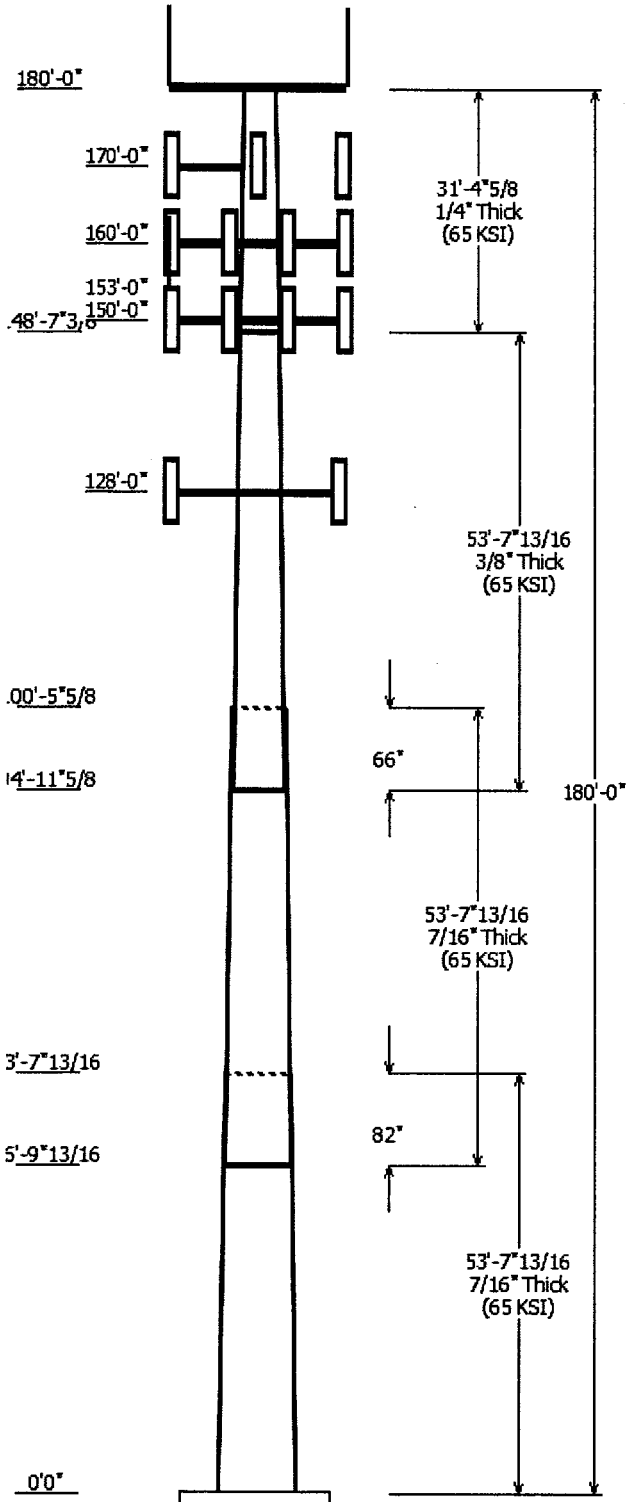

Job Information	
Pole :	310972
Code:	TIA/EIA-222 Rev F
Description :	180' FWT monopole
Client :	Verizon Wireless
Location :	Waterford Rebuild CT, CT
Shape :	18 Sides
Height :	180.00 (ft)
Base Elev (ft):	0.00
Taper:	0.22874(in/ft)

Sections Properties								
Shaft Section	Length (ft)	Diameter (in)		Thick Joint (in)	Type	Overlap Length (in)	Steel Taper (in/ft)	Steel Grade (ksi)
		Across Top	Flats Bottom					
1	53.650	50.17	62.45	0.438		0.000	0.228740	65
2	53.650	40.34	52.61	0.438	Slip Joint	82.000	0.228740	65
3	53.650	30.08	42.35	0.375	Slip Joint	66.000	0.228740	65
4	31.384	22.90	30.08	0.250	Butt Joint	0.000	0.228740	65

Discrete Appurtenance				
Attach Elev (ft)	Force Elev (ft)	Qty	Description	
180.000	180.000	1	dbSpectra ATS8TMA10	
180.000	180.000	1	Round Low Profile Platform	
180.000	187.625	2	Sinclair SC488-SF1SNF(D04)	
170.000	170.000	1	Flush Mounts	
170.000	170.000	3	KMW HB-X-WM-17-65-00T-	
170.000	170.000	3	KMW HB-X-WM-17-65-00T	
160.000	160.000	1	RFS DB-T1-6Z-8AB-0Z	
160.000	160.000	6	Antel BXA-171063/12CF_2FP	
160.000	160.000	1	Round Low Profile Platform	
160.000	160.000	3	Alcatel-Lucent RRH2x40-AWS	
160.000	160.000	3	Alcatel-Lucent RRH2x40 (700)	
160.000	160.000	6	Antel BXA-70063/6CF	
153.000	159.000	1	12' Omni	
150.000	150.000	6	RCU	
150.000	150.000	1	Raycap DC6-48-60-18-8F	
150.000	150.000	3	KMW AM-X-CD-14-65-00T-RET	
150.000	150.000	6	Ericsson RRUS 11 (Band 12)	
150.000	150.000	6	Powerwave LGP21903	
150.000	150.000	6	Powerwave LGP21401	
150.000	150.000	6	Allgon 7770.00	
150.000	150.000	1	Round Low Profile Platform	
128.000	128.000	6	RFS ATMAA1412D-1A20	
128.000	128.000	6	EMS DR85-17-02DPL2Q	
128.000	128.000	3	Round T-Arm	

Linear Appurtenance			
Elev (ft)		Description	Exposed To Wind
From	To		
0.000	128.0	1 5/8" Coax	No
0.000	128.0	LMR-400	No
0.000	150.0	1 1/4" Coax	No
0.000	150.0	8 AWG 7	No
0.000	150.0	RG6	No
0.000	153.0	1 1/4" Coax	No
0.000	160.0	1 5/8" Coax	No
0.000	160.0	1 5/8" Coax	No
0.000	170.0	1 5/8" Coax	No
0.000	180.0	1 5/8" Coax	No

Load Cases	

No Ice	100.00 mph Wind with No Ice
Ice	86.60 mph Wind with Ice
Twist/Sway	50.00 mph Wind with No Ice

Reactions			
Load Case	Moment (kip-ft)	Shear (kip)	Axial (kip)
No Ice	4983.09	41.33	48.56
Ice	4201.37	33.85	55.62
Twist/Sway	1247.22	10.33	48.61

Dish Deflections			
Load Case	Attach Elev (ft)	Deflection (in)	Rotation (deg)
	0.00	0.000	0.000

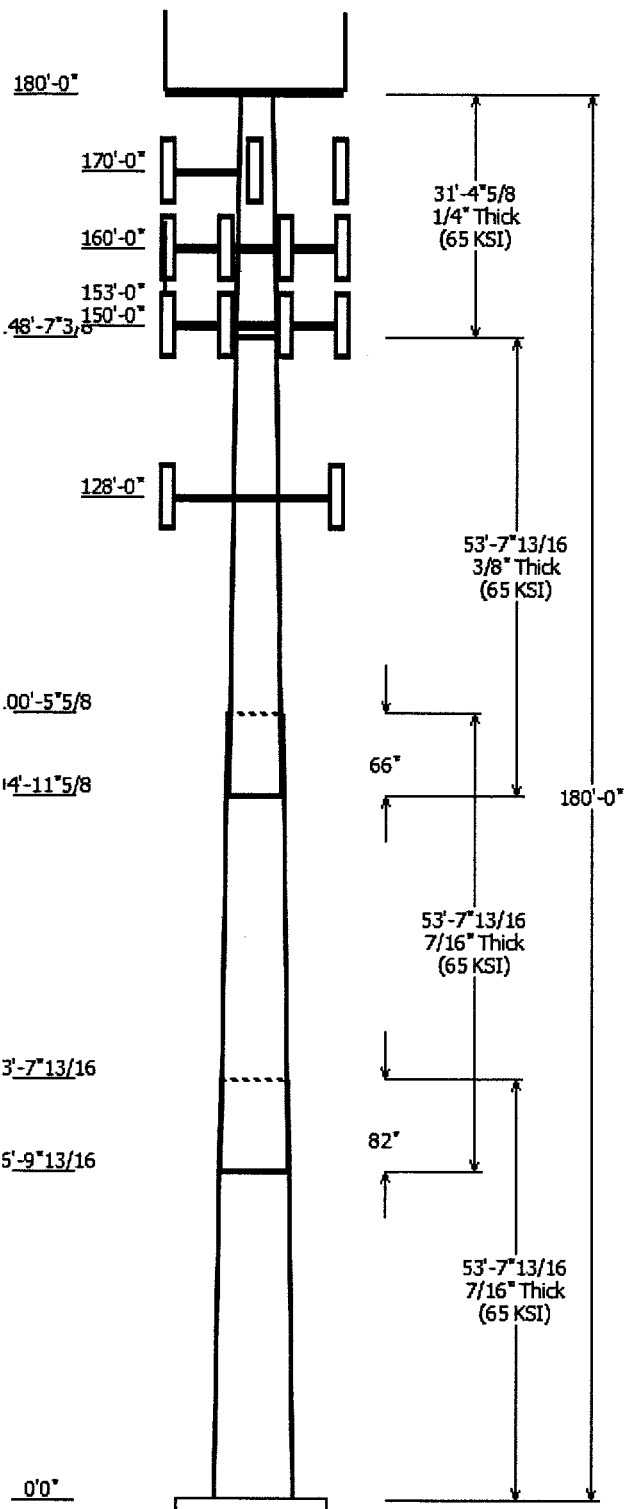

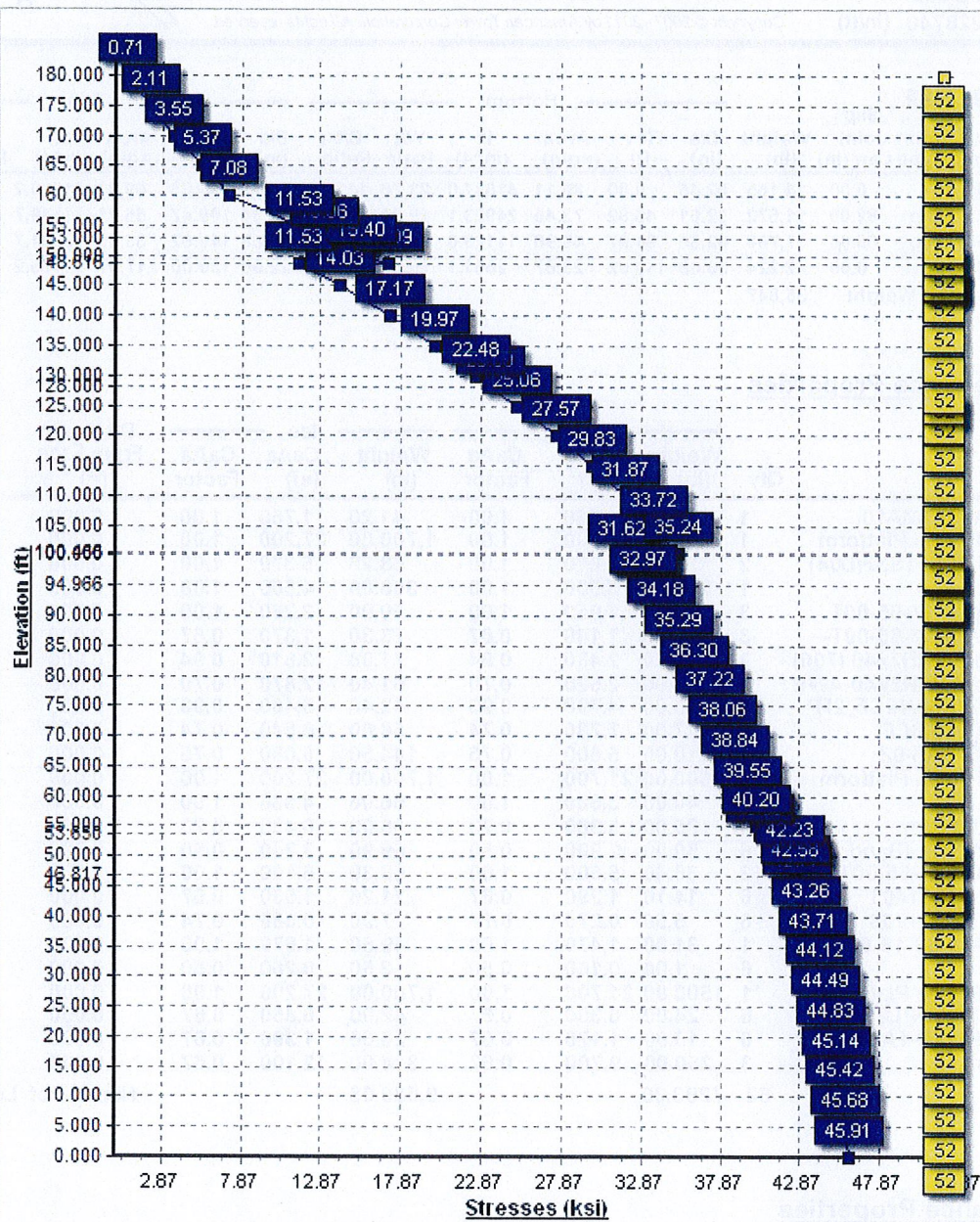

Item	Qty	Unit	Weight (lb)	Volume (cu ft)	Value (\$)	Notes
1	1	EA	100	0.00	100	
2	1	EA	200	0.00	200	
3	1	EA	300	0.00	300	
4	1	EA	400	0.00	400	
5	1	EA	500	0.00	500	
6	1	EA	600	0.00	600	
7	1	EA	700	0.00	700	
8	1	EA	800	0.00	800	
9	1	EA	900	0.00	900	
10	1	EA	1000	0.00	1000	

Pole : 310972  
 Location : Waterford Rebuild CT, CT  
 Height : 180.0 (ft)  
 Base Dia : 62.45 (in)  
 Top Dia : 22.90 (in)  
 Shape : 18 Sides  
 Taper : 0.228740 (in/ft)

Code: TIA/EIA-222 Rev F

5/13/2013 2:41:06 PM  
 Page: 1

Base Elev : 0.000 (ft)

Copyright © 2007 - 2011 by American Tower Corporation. All rights reserved.

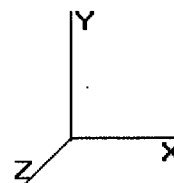

### Shaft Section Properties

Sect Info	Length (ft)	Thick (in)	Fy (ksi)	Slip		Weight (lb)	Bottom				Top				Taper (in/ft)				
				Joint Type	Joint Len (in)		Dia (in)	Elev (ft)	Area (sqin)	Ix (in^4)	W/t Ratio	D/t Ratio	Dia (in)	Elev (ft)		Area (sqin)	Ix (in^4)	W/t Ratio	D/t Ratio
1-18	53.650	0.4375	65	0.00		14,165	62.45	0.00	86.11	41837.0	23.76	142.74	50.17	53.65	69.07	21590.2	18.81	114.69	0.228740
2-18	53.650	0.4375	65	Slip	82.00	11,672	52.61	46.82	72.45	24923.1	19.80	120.27	40.34	100.47	55.41	11149.7	14.85	92.22	0.228740
3-18	53.650	0.3750	65	Slip	66.00	7,788	42.35	94.97	49.96	11123.0	18.50	112.94	30.08	148.62	35.36	3941.7	12.73	80.21	0.228740
4-18	31.384	0.2500	65	Butt	0.00	2,224	30.08	148.62	23.67	2661.1	19.81	120.32	22.90	180.00	17.97	1165.2	14.74	91.61	0.228740
Shaft Weight						35,847													

### Discrete Appurtenance Properties

Attach Elev (ft)	Description	Qty	No Ice			Ice			Distance From Face (ft)	Vert Ecc (ft)
			Weight (lb)	CaAa (sf)	CaAa Factor	Weight (lb)	CaAa (sf)	CaAa Factor		
180.00	dbSpectra ATS8TMA10	1	25.00	1.560	1.00	41.20	1.760	1.00	0.000	0.000
180.00	Round Low Profile Platform	1	1500.00	21.700	1.00	1,700.00	27.200	1.00	0.000	0.000
180.00	Sinclair SC488-SF1SNF(D04)	2	30.00	3.810	1.00	58.26	5.370	1.00	0.000	7.625
170.00	Flush Mounts	1	200.00	3.500	1.00	300.00	4.500	1.00	0.000	0.000
170.00	KMW HB-X-WM-17-65-00T	3	30.00	1.950	1.00	50.90	2.260	1.00	0.000	0.000
170.00	KMW HB-X-WM-17-65-00T-	3	15.90	1.140	0.67	23.30	1.370	0.67	0.000	0.000
160.00	Alcatel-Lucent RRH2x40 (700)	3	50.00	2.480	0.94	71.08	2.810	0.94	0.000	0.000
160.00	Alcatel-Lucent RRH2x40-AWS	3	44.00	2.520	0.70	61.40	2.870	0.70	0.000	0.000
160.00	Antel BXA-171063/12CF_2FP	6	15.00	4.790	0.93	42.40	5.460	0.93	0.000	0.000
160.00	Antel BXA-70063/6CF	6	17.00	7.730	0.74	58.00	8.540	0.74	0.000	0.000
160.00	RFS DB-T1-6Z-8AB-0Z	1	110.00	5.600	0.75	144.50	6.080	0.75	0.000	0.000
160.00	Round Low Profile Platform	1	1500.00	21.700	1.00	1,700.00	27.200	1.00	0.000	0.000
153.00	12' Omni	1	40.00	3.600	1.00	66.06	4.830	1.00	0.000	6.000
150.00	Allgon 7770.00	6	35.00	5.880	0.73	68.00	6.430	0.73	0.000	0.000
150.00	Ericsson RRUS 11 (Band 12)	6	50.00	2.990	0.50	69.90	3.340	0.50	0.000	0.000
150.00	KMW AM-X-CD-14-65-00T-	3	36.40	5.500	1.00	68.30	6.100	1.00	0.000	0.000
150.00	Powerwave LGP21401	6	14.10	1.290	0.67	21.26	1.530	0.67	0.000	0.000
150.00	Powerwave LGP21903	6	5.50	0.270	0.74	7.90	0.380	0.74	0.000	0.000
150.00	Raycap DC6-48-60-18-8F	1	31.80	1.470	1.00	49.50	1.670	1.00	0.000	0.000
150.00	RCU	6	1.00	0.160	0.50	2.50	0.260	0.50	0.000	0.000
150.00	Round Low Profile Platform	1	1500.00	21.700	1.00	1,700.00	27.200	1.00	0.000	0.000
128.00	EMS DR85-17-02DPL2Q	6	24.00	6.300	0.67	42.00	6.850	0.67	0.000	0.000
128.00	RFS ATMAA1412D-1A20	6	13.00	1.170	0.67	20.60	1.390	0.67	0.000	0.000
128.00	Round T-Arm	3	250.00	9.700	0.67	314.00	12.100	0.67	0.000	0.000
Totals		82	7293.30			9,580.08			Number of Loadings : 24	

### Linear Appurtenance Properties

Elev From (ft)	Elev To (ft)	Description	No Ice		Ice		Exposed To Wind
			Weight (lb/ft)	CaAa (sf/ft)	Weight (lb/ft)	CaAa (sf/ft)	
0.00	180.00	(2) 1 5/8" Coax	1.64	0.00	0.00	0.00	N
0.00	170.00	(6) 1 5/8" Coax	4.92	0.00	0.00	0.00	N
0.00	160.00	(12) 1 5/8" Coax	9.84	0.00	0.00	0.00	N
0.00	160.00	(2) 1 5/8" Coax	0.82	0.00	0.00	0.00	N
0.00	153.00	(1) 1 1/4" Coax	0.63	0.00	0.00	0.00	N
0.00	150.00	(12) 1 1/4" Coax	0.63	0.00	0.00	0.00	N
0.00	150.00	(2) 8 AWG7	3.65	0.00	0.00	0.00	N
0.00	150.00	(1) RG6	0.03	0.00	0.00	0.00	N
0.00	128.00	(12) 1 5/8" Coax	14.76	0.00	0.00	0.00	N
0.00	128.00	(1) LMR-400	0.07	0.00	0.00	0.00	N

Pole : 310972  
Location : Waterford Rebuild CT, CT  
Height : 180.0 (ft)  
Base Dia : 62.45 (in)  
Top Dia : 22.90 (in)  
Shape : 18 Sides  
Taper : 0.228740 (in/ft)

Code: TIA/EIA-222 Rev F

Base Elev : 0.000 (ft)

Copyright © 2007 - 2011 by American Tower Corporation. All rights reserved.

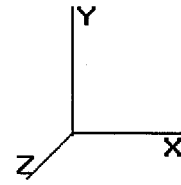

5/13/2013 2:41:06 PM  
Page: 2

Total Weight 5,477.89 (lb) 0.00 (lb)



Pole : 310972  
 Location : Waterford Rebuild CT, CT  
 Height : 180.0 (ft)  
 Base Dia : 62.45 (in)  
 Top Dia : 22.90 (in)  
 Shape : 18 Sides  
 Taper : 0.228740 (in/ft)

Code: TIA/EIA-222 Rev F

Base Elev : 0.000 (ft)

Copyright © 2007 - 2011 by American Tower Corporation. All rights reserved.

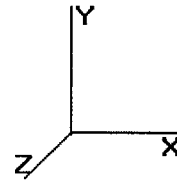

5/13/2013 2:41:06 PM  
 Page: 4

<b>Load Case:</b> No Ice	100.00 mph Wind with No Ice	24 Iterations
Gust Response Factor : 1.69		
Dead Load Factor : 1.00		
Wind Load Factor : 1.00		

**Shaft Segment Forces**

Seg Top Elev (ft)	Description	Kz	qz (psf)	qzGh (psf)	C (mph-ft)	Cf	Ice Thick (in)	Tributary (ft)	Aa (sf)	CfAa (sf)	Wind Force X (lb)	Dead Load Ice (lb)	Tot Dead Load (lb)
0.00		0.00	1.00 25.600	43.26 520.41	0.650		0.000	0.00	0.000	0.00	0.0	0.0	0.0
5.00		0.00	1.00 25.600	43.26 510.88	0.650		0.000	5.00 25.783	16.76	725.0	0.0	0.0	1,451.5
10.00		0.00	1.00 25.600	43.26 501.35	0.650		0.000	5.00 25.306	16.45	711.6	0.0	0.0	1,424.5
15.00		0.00	1.00 25.600	43.26 491.82	0.650		0.000	5.00 24.829	16.14	698.2	0.0	0.0	1,397.5
20.00		0.00	1.00 25.600	43.26 482.29	0.650		0.000	5.00 24.353	15.83	684.8	0.0	0.0	1,370.5
25.00		0.00	1.00 25.600	43.26 472.76	0.650		0.000	5.00 23.876	15.52	671.4	0.0	0.0	1,343.5
30.00		0.00	1.00 25.600	43.26 463.23	0.650		0.000	5.00 23.400	15.21	658.0	0.0	0.0	1,316.4
35.00		0.00	1.01 26.034	43.99 457.53	0.650		0.000	5.00 22.923	14.90	655.6	0.0	0.0	1,289.4
40.00		0.00	1.05 27.046	45.70 456.54	0.650		0.000	5.00 22.447	14.59	666.9	0.0	0.0	1,262.4
45.00		0.00	1.09 27.972	47.27 454.33	0.650		0.000	5.00 21.970	14.28	675.1	0.0	0.0	1,235.4
46.82	Bot - Section 2	0.00	1.10 28.290	47.81 453.26	0.650		0.000	1.82 7.864	5.11	244.4	0.0	0.0	442.1
50.00		0.00	1.12 28.827	48.71 451.10	0.650		0.000	3.18 13.862	9.01	439.0	0.0	0.0	1,545.6
53.65	Top - Section 1	0.00	1.14 29.413	49.70 448.21	0.650		0.000	3.65 15.655	10.18	505.8	0.0	0.0	1,745.1
55.00		0.00	1.15 29.623	50.06 454.88	0.650		0.000	1.35 5.727	3.72	186.3	0.0	0.0	321.9
60.00		0.00	1.18 30.368	51.32 450.19	0.650		0.000	5.00 20.905	13.59	697.4	0.0	0.0	1,175.0
65.00		0.00	1.21 31.071	52.51 444.86	0.650		0.000	5.00 20.429	13.28	697.3	0.0	0.0	1,148.0
70.00		0.00	1.24 31.736	53.63 438.99	0.650		0.000	5.00 19.952	12.97	695.6	0.0	0.0	1,121.0
75.00		0.00	1.26 32.368	54.70 432.62	0.650		0.000	5.00 19.476	12.66	692.5	0.0	0.0	1,093.9
80.00		0.00	1.28 32.970	55.71 425.81	0.650		0.000	5.00 18.999	12.35	688.1	0.0	0.0	1,066.9
85.00		0.00	1.31 33.546	56.69 418.60	0.650		0.000	5.00 18.522	12.04	682.6	0.0	0.0	1,039.9
90.00		0.00	1.33 34.098	57.62 411.04	0.650		0.000	5.00 18.046	11.73	675.9	0.0	0.0	1,012.9
94.97	Bot - Section 3	0.00	1.35 34.626	58.51 403.19	0.650		0.000	4.97 17.453	11.34	663.9	0.0	0.0	979.3
95.00		0.00	1.35 34.629	58.52 403.14	0.650		0.000	0.03 0.118	0.08	4.5	0.0	0.0	12.2
100.0		0.00	1.37 35.140	59.38 394.94	0.650		0.000	5.00 17.405	11.31	671.9	0.0	0.0	1,797.1
100.4	Top - Section 2	0.00	1.37 35.187	59.46 394.16	0.650		0.000	0.47 1.599	1.04	61.8	0.0	0.0	165.1
105.0		0.00	1.39 35.634	60.22 393.83	0.650		0.000	4.53 15.329	9.96	600.0	0.0	0.0	738.1
110.0		0.00	1.41 36.111	61.02 385.13	0.650		0.000	5.00 16.452	10.69	652.6	0.0	0.0	792.0
115.0		0.00	1.42 36.572	61.80 376.20	0.650		0.000	5.00 15.976	10.38	641.8	0.0	0.0	768.8
120.0		0.00	1.44 37.020	62.56 367.03	0.650		0.000	5.00 15.499	10.07	630.3	0.0	0.0	745.7
125.0		0.00	1.46 37.454	63.29 357.65	0.650		0.000	5.00 15.023	9.76	618.1	0.0	0.0	722.5
128.0	Appertunance(s)	0.00	1.47 37.708	63.72 351.92	0.650		0.000	3.00 8.785	5.71	363.9	0.0	0.0	422.4
130.0		0.00	1.48 37.876	64.01 348.06	0.650		0.000	2.00 5.761	3.74	239.7	0.0	0.0	277.0
135.0		0.00	1.49 38.286	64.70 338.29	0.650		0.000	5.00 14.070	9.15	591.7	0.0	0.0	676.2
140.0		0.00	1.51 38.686	65.38 328.34	0.650		0.000	5.00 13.593	8.84	577.7	0.0	0.0	653.0
145.0		0.00	1.52 39.076	66.03 318.21	0.650		0.000	5.00 13.116	8.53	563.0	0.0	0.0	629.9
148.6	Top - Section 3	0.00	1.53 39.352	66.50 310.79	0.650		0.000	3.62 9.190	5.97	397.3	0.0	0.0	441.1
150.0	Appertunance(s)	0.00	1.54 39.457	66.68 307.92	0.650		0.000	1.38 3.450	2.24	149.5	0.0	0.0	110.9
153.0	Appertunance(s)	0.00	1.55 39.680	67.06 301.68	0.650		0.000	3.00 7.355	4.78	320.6	0.0	0.0	236.3
155.0		0.00	1.55 39.828	67.30 297.48	0.650		0.000	2.00 4.808	3.13	210.4	0.0	0.0	154.4
160.0	Appertunance(s)	0.00	1.57 40.191	67.92 286.89	0.650		0.000	5.00 11.687	7.60	516.0	0.0	0.0	375.3
165.0		0.00	1.58 40.546	68.52 276.16	0.650		0.000	5.00 11.210	7.29	499.3	0.0	0.0	359.8
170.0	Appertunance(s)	0.00	1.59 40.893	69.10 265.30	0.650		0.000	5.00 10.734	6.98	482.2	0.0	0.0	344.4
175.0		0.00	1.61 41.233	69.68 254.30	0.650		0.000	5.00 10.257	6.67	464.6	0.0	0.0	329.0
180.0	Appertunance(s)	0.00	1.62 41.566	70.24 243.18	0.650		0.000	5.00 9.781	6.36	446.6	0.0	0.0	313.5
<b>Totals:</b>								180.00			22,719.0	0.0	35,847.5



Pole : 310972  
 Location : Waterford Rebuild CT, CT  
 Height : 180.0 (ft)  
 Base Dia : 62.45 (in)  
 Top Dia : 22.90 (in)  
 Shape : 18 Sides  
 Taper : 0.228740 (in/ft)

Code: TIA/EIA-222 Rev F

Base Elev : 0.000 (ft)

Copyright © 2007 - 2011 by American Tower Corporation. All rights reserved.

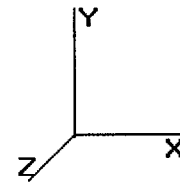

5/13/2013 2:41:06 PM  
 Page: 5

<b>Load Case:</b> No Ice	100.00 mph Wind with No Ice	24 Iterations
Gust Response Factor : 1.69		
Dead Load Factor : 1.00		
Wind Load Factor : 1.00		

**Discrete Appurtenance Segment Forces**

Elev (ft)	Description	Qty	qz (psf)	qzGh (psf)	CaAa Factor	Total CaAa (sf)	Horiz Ecc (ft)	Vert Ecc (ft)	Wind FX (lb)	Mom Y (lb-ft)	Mom Z (lb-ft)	Dead Load (lb)
128.0	EMS DR85-17-	6	37.708	63.727	0.67	25.33	0.000	0.000	1,613.96	0.00	0.00	144.00
128.0	RFS ATMAA1412D-	6	37.708	63.727	0.67	4.70	0.000	0.000	299.73	0.00	0.00	78.00
128.0	Round T-Arm	3	37.708	63.727	0.67	19.50	0.000	0.000	1,242.48	0.00	0.00	750.00
150.0	Allgon 7770.00	6	39.457	66.682	0.73	25.75	0.000	0.000	1,717.34	0.00	0.00	210.00
150.0	Ericsson RRUS 11 (Ba	6	39.457	66.682	0.50	8.97	0.000	0.000	598.13	0.00	0.00	300.00
150.0	KMW AM-X-CD-14-65-	3	39.457	66.682	1.00	16.50	0.000	0.000	1,100.25	0.00	0.00	109.20
150.0	Powerwave LGP21401	6	39.457	66.682	0.67	5.19	0.000	0.000	345.80	0.00	0.00	84.60
150.0	Powerwave LGP21903	6	39.457	66.682	0.74	1.20	0.000	0.000	79.94	0.00	0.00	33.00
150.0	Raycap DC6-48-60-18-	1	39.457	66.682	1.00	1.47	0.000	0.000	98.02	0.00	0.00	31.80
150.0	RCU	6	39.457	66.682	0.50	0.48	0.000	0.000	32.01	0.00	0.00	6.00
150.0	Round Low Profile PI	1	39.457	66.682	1.00	21.70	0.000	0.000	1,446.98	0.00	0.00	1,500.00
153.0	12' Omni	1	40.119	67.801	1.00	3.60	0.000	6.000	244.08	0.00	1,464.50	40.00
160.0	Alcatel-Lucent RRH2x	3	40.191	67.923	0.94	6.99	0.000	0.000	475.02	0.00	0.00	150.00
160.0	Alcatel-Lucent RRH2x	3	40.191	67.923	0.70	5.29	0.000	0.000	359.45	0.00	0.00	132.00
160.0	Antel BXA-171063/12C	6	40.191	67.923	0.93	26.73	0.000	0.000	1,815.45	0.00	0.00	90.00
160.0	Antel BXA-70063/6CF	6	40.191	67.923	0.74	34.32	0.000	0.000	2,331.18	0.00	0.00	102.00
160.0	RFS DB-T1-6Z-8AB-0Z	1	40.191	67.923	0.75	4.20	0.000	0.000	285.27	0.00	0.00	110.00
160.0	Round Low Profile PI	1	40.191	67.923	1.00	21.70	0.000	0.000	1,473.91	0.00	0.00	1,500.00
170.0	Flush Mounts	1	40.893	69.109	1.00	3.50	0.000	0.000	241.88	0.00	0.00	200.00
170.0	KMW HB-X-WM-17-65-	3	40.893	69.109	1.00	5.85	0.000	0.000	404.29	0.00	0.00	90.00
170.0	KMW HB-X-WM-17-65-	3	40.893	69.109	0.67	2.29	0.000	0.000	158.36	0.00	0.00	47.70
180.0	dbSpectra	1	41.566	70.247	1.00	1.56	0.000	0.000	109.59	0.00	0.00	25.00
180.0	Round Low Profile PI	1	41.566	70.247	1.00	21.70	0.000	0.000	1,524.36	0.00	0.00	1,500.00
180.0	Sinclair SC488-SF1SN	2	42.062	71.085	1.00	7.62	0.000	7.625	541.67	0.00	4,130.21	60.00
									18,539.15			7,293.30

Pole : 310972  
 Location : Waterford Rebuild CT, CT  
 Height : 180.0 (ft)  
 Base Dia : 62.45 (in)  
 Top Dia : 22.90 (in)  
 Shape : 18 Sides  
 Taper : 0.228740 (in/ft)

Code: TIA/EIA-222 Rev F

Base Elev : 0.000 (ft)

Copyright © 2007 - 2011 by American Tower Corporation. All rights reserved.

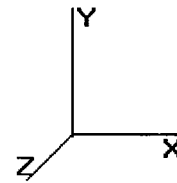

5/13/2013 2:41:06 PM

Page: 6

**Load Case:** No Ice                      100.00 mph Wind with No Ice

24 Iterations

Gust Response Factor : 1.69  
 Dead Load Factor : 1.00  
 Wind Load Factor : 1.00

### Applied Segment Forces Summary

Seg Elev (ft)	Lateral FX (-) (lb)	Axial FY (-) (lb)	Torsion MY (lb-ft)	Moment MZ (lb-ft)
0.00	0.00	0.00	0.00	0.00
5.00	725.05	1,636.47	0.00	0.00
10.00	711.65	1,609.45	0.00	0.00
15.00	698.24	1,582.43	0.00	0.00
20.00	684.84	1,555.41	0.00	0.00
25.00	671.44	1,528.39	0.00	0.00
30.00	658.04	1,501.37	0.00	0.00
35.00	655.57	1,474.35	0.00	0.00
40.00	666.91	1,447.33	0.00	0.00
45.00	675.09	1,420.31	0.00	0.00
46.82	244.39	509.33	0.00	0.00
50.00	438.95	1,663.35	0.00	0.00
53.65	505.82	1,880.12	0.00	0.00
55.00	186.34	371.84	0.00	0.00
60.00	697.39	1,359.93	0.00	0.00
65.00	697.26	1,332.91	0.00	0.00
70.00	695.57	1,305.89	0.00	0.00
75.00	692.47	1,278.87	0.00	0.00
80.00	688.10	1,251.85	0.00	0.00
85.00	682.56	1,224.83	0.00	0.00
90.00	675.95	1,197.81	0.00	0.00
94.97	663.85	1,163.02	0.00	0.00
95.00	4.50	13.46	0.00	0.00
100.0	671.88	1,982.07	0.00	0.00
100.4	61.83	182.35	0.00	0.00
105.0	600.05	905.80	0.00	0.00
110.0	652.62	976.92	0.00	0.00
115.0	641.82	953.76	0.00	0.00
120.0	630.29	930.60	0.00	0.00
125.0	618.08	907.44	0.00	0.00
128.0	3,520.06	1,505.35	0.00	0.00
130.0	239.71	321.28	0.00	0.00
135.0	591.73	786.98	0.00	0.00
140.0	577.66	763.82	0.00	0.00
145.0	563.03	740.66	0.00	0.00
148.6	397.26	521.27	0.00	0.00
150.0	5,568.00	2,416.11	0.00	0.00
153.0	564.69	329.83	0.00	1,464.50
155.0	210.36	188.88	0.00	0.00
160.0	7,256.26	2,545.38	0.00	0.00
165.0	499.30	392.64	0.00	0.00
170.0	1,286.70	714.90	0.00	0.00
175.0	464.60	337.16	0.00	0.00
180.0	2,622.20	1,906.72	0.00	4,130.21
<b>Totals:</b>	<b>41,258.11</b>	<b>48,618.66</b>	<b>0.00</b>	<b>5,594.71</b>

Pole : 310972  
 Location : Waterford Rebuild CT, CT  
 Height : 180.0 (ft)  
 Base Dia : 62.45 (in)  
 Top Dia : 22.90 (in)  
 Shape : 18 Sides  
 Taper : 0.228740 (in/ft)

Code: TIA/EIA-222 Rev F

5/13/2013 2:41:06 PM  
 Page: 7

Base Elev: 0.000 (ft)

Copyright © 2007-2011 by American Tower Corporation. All rights reserved.

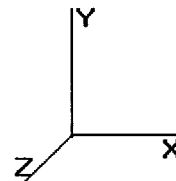

**Load Case:** No Ice      100.00 mph Wind with No Ice      24 Iterations

Gust Response Factor : 1.69  
 Dead Load Factor : 1.00  
 Wind Load Factor : 1.00

**Calculated Shaft Forces and Deflections**

Seg Elev (ft)	Lateral FX (-) (kips)	Axial FY (-) (kips)	Lateral FZ (kips)	Moment MX (ft-kips)	Torsion MY (ft-kips)	Moment MZ (ft-kips)	X Deflect (in)	Z Deflect (in)	Total Deflect (in)	Rotation (deg)
0.00	-41.330	-48.557	0.000	0.000	0.000	-4,983.089	0.000	0.000	0.000	0.000
5.00	-40.739	-46.803	0.000	0.000	0.000	-4,776.444	-0.089	0.000	0.089	-0.166
10.00	-40.153	-45.078	0.000	0.000	0.000	-4,572.754	-0.354	0.000	0.354	-0.334
15.00	-39.573	-43.383	0.000	0.000	0.000	-4,371.991	-0.795	0.000	0.795	-0.504
20.00	-38.999	-41.717	0.000	0.000	0.000	-4,174.128	-1.416	0.000	1.416	-0.677
25.00	-38.430	-40.080	0.000	0.000	0.000	-3,979.136	-2.219	0.000	2.219	-0.851
30.00	-37.867	-38.473	0.000	0.000	0.000	-3,786.989	-3.205	0.000	3.205	-1.027
35.00	-37.298	-36.895	0.000	0.000	0.000	-3,597.659	-4.377	0.000	4.377	-1.206
40.00	-36.711	-35.347	0.000	0.000	0.000	-3,411.170	-5.737	0.000	5.737	-1.386
45.00	-36.073	-33.866	0.000	0.000	0.000	-3,227.619	-7.287	0.000	7.287	-1.569
46.82	-35.869	-33.305	0.000	0.000	0.000	-3,162.091	-7.898	0.000	7.898	-1.637
50.00	-35.451	-31.577	0.000	0.000	0.000	-3,047.907	-9.030	0.000	9.030	-1.755
53.65	-34.934	-29.657	0.000	0.000	0.000	-2,918.515	-10.426	0.000	10.426	-1.892
55.00	-34.794	-29.221	0.000	0.000	0.000	-2,871.351	-10.968	0.000	10.968	-1.943
60.00	-34.136	-27.781	0.000	0.000	0.000	-2,697.381	-13.099	0.000	13.099	-2.121
65.00	-33.470	-26.372	0.000	0.000	0.000	-2,526.706	-15.415	0.000	15.415	-2.299
70.00	-32.799	-24.994	0.000	0.000	0.000	-2,359.359	-17.919	0.000	17.919	-2.478
75.00	-32.124	-23.647	0.000	0.000	0.000	-2,195.368	-20.609	0.000	20.609	-2.657
80.00	-31.446	-22.331	0.000	0.000	0.000	-2,034.751	-23.488	0.000	23.488	-2.836
85.00	-30.768	-21.047	0.000	0.000	0.000	-1,877.521	-26.554	0.000	26.554	-3.015
90.00	-30.089	-19.795	0.000	0.000	0.000	-1,723.684	-29.806	0.000	29.806	-3.193
94.97	-29.388	-18.627	0.000	0.000	0.000	-1,574.248	-33.221	0.000	33.221	-3.369
95.00	-29.412	-18.568	0.000	0.000	0.000	-1,573.263	-33.244	0.000	33.244	-3.370
100.0	-28.649	-16.583	0.000	0.000	0.000	-1,426.205	-36.866	0.000	36.866	-3.544
100.4	-28.601	-16.362	0.000	0.000	0.000	-1,412.842	-37.213	0.000	37.213	-3.561
105.0	-27.991	-15.412	0.000	0.000	0.000	-1,283.179	-40.669	0.000	40.669	-3.717
110.0	-27.320	-14.395	0.000	0.000	0.000	-1,143.228	-44.659	0.000	44.659	-3.901
115.0	-26.654	-13.407	0.000	0.000	0.000	-1,006.629	-48.838	0.000	48.838	-4.078
120.0	-25.994	-12.450	0.000	0.000	0.000	-873.360	-53.199	0.000	53.199	-4.248
125.0	-25.334	-11.537	0.000	0.000	0.000	-743.391	-57.732	0.000	57.732	-4.409
128.0	-21.722	-10.281	0.000	0.000	0.000	-667.388	-60.531	0.000	60.531	-4.502
130.0	-21.475	-9.942	0.000	0.000	0.000	-623.945	-62.428	0.000	62.428	-4.561
135.0	-20.842	-9.157	0.000	0.000	0.000	-516.572	-67.276	0.000	67.276	-4.699
140.0	-20.220	-8.403	0.000	0.000	0.000	-412.361	-72.261	0.000	72.261	-4.823
145.0	-19.608	-7.684	0.000	0.000	0.000	-311.260	-77.367	0.000	77.367	-4.931
148.6	-19.173	-7.184	0.000	0.000	0.000	-240.351	-81.125	0.000	81.125	-4.997
150.0	-13.419	-5.254	0.000	0.000	0.000	-213.823	-82.575	0.000	82.575	-5.020
153.0	-12.832	-4.963	0.000	0.000	0.000	-172.102	-85.747	0.000	85.747	-5.084
155.0	-12.610	-4.781	0.000	0.000	0.000	-146.439	-87.883	0.000	87.883	-5.122
160.0	-5.157	-2.894	0.000	0.000	0.000	-83.388	-93.283	0.000	93.283	-5.193
165.0	-4.626	-2.545	0.000	0.000	0.000	-57.601	-98.742	0.000	98.742	-5.243
170.0	-3.281	-1.950	0.000	0.000	0.000	-34.470	-104.247	0.000	104.247	-5.280
175.0	-2.787	-1.656	0.000	0.000	0.000	-18.067	-109.782	0.000	109.782	-5.304
180.0	-2.622	0.000	0.000	0.000	0.000	-4.130	-115.336	0.000	115.336	-5.315

Pole : 310972  
 Location : Waterford Rebuild CT, CT  
 Height : 180.0 (ft)  
 Base Dia : 62.45 (in)  
 Top Dia : 22.90 (in)  
 Shape : 18 Sides  
 Taper : 0.228740 (in/ft)

Code: TIA/EIA-222 Rev F

5/13/2013 2:41:06 PM  
 Page: 8

Base Elev : 0.000 (ft)

Copyright © 2007 - 2011 by American Tower Corporation. All rights reserved.

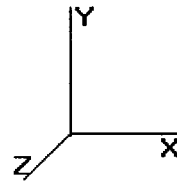

**Load Case:** No Ice                      100.00 mph Wind with No Ice                      24 Iterations

Gust Response Factor : 1.69  
 Dead Load Factor : 1.00  
 Wind Load Factor : 1.00

**Calculated Stresses**

Seg Elev (ft)	Applied Stresses							Allowable Stress (Fb) (ksi)	Stress Ratio	
	Axial (Y) (ksi)	Shear (X) (ksi)	Shear (Z) (ksi)	Torsion (ksi)	Bending (X) (ksi)	Bending (Z) (ksi)	Combined (ksi)			
0.00	0.56	0.97	0.00	0.00	0.00	45.32	45.91	52.0	0.0	0.883
5.00	0.55	0.97	0.00	0.00	0.00	45.09	45.68	52.0	0.0	0.879
10.00	0.54	0.98	0.00	0.00	0.00	44.84	45.42	52.0	0.0	0.874
15.00	0.53	0.98	0.00	0.00	0.00	44.57	45.14	52.0	0.0	0.868
20.00	0.52	0.99	0.00	0.00	0.00	44.27	44.83	52.0	0.0	0.862
25.00	0.51	0.99	0.00	0.00	0.00	43.94	44.49	52.0	0.0	0.856
30.00	0.50	1.00	0.00	0.00	0.00	43.58	44.12	52.0	0.0	0.849
35.00	0.49	1.00	0.00	0.00	0.00	43.18	43.71	52.0	0.0	0.841
40.00	0.48	1.01	0.00	0.00	0.00	42.74	43.26	52.0	0.0	0.832
45.00	0.47	1.01	0.00	0.00	0.00	42.26	42.77	52.0	0.0	0.823
46.82	0.47	1.01	0.00	0.00	0.00	42.08	42.58	52.0	0.0	0.819
50.00	0.45	1.02	0.00	0.00	0.00	41.74	42.23	52.0	0.0	0.812
53.65	0.42	1.00	0.00	0.00	0.00	39.90	40.36	52.0	0.0	0.777
55.00	0.42	1.00	0.00	0.00	0.00	39.74	40.20	52.0	0.0	0.773
60.00	0.41	1.01	0.00	0.00	0.00	39.10	39.55	52.0	0.0	0.761
65.00	0.40	1.01	0.00	0.00	0.00	38.40	38.84	52.0	0.0	0.747
70.00	0.38	1.02	0.00	0.00	0.00	37.64	38.06	52.0	0.0	0.732
75.00	0.37	1.02	0.00	0.00	0.00	36.80	37.22	52.0	0.0	0.716
80.00	0.36	1.02	0.00	0.00	0.00	35.89	36.30	52.0	0.0	0.698
85.00	0.35	1.03	0.00	0.00	0.00	34.89	35.29	52.0	0.0	0.679
90.00	0.34	1.03	0.00	0.00	0.00	33.80	34.18	52.0	0.0	0.658
94.97	0.33	1.04	0.00	0.00	0.00	32.61	32.98	52.0	0.0	0.635
95.00	0.32	1.04	0.00	0.00	0.00	32.60	32.97	52.0	0.0	0.634
100.00	0.30	1.04	0.00	0.00	0.00	31.27	31.62	52.0	0.0	0.608
100.47	0.34	1.19	0.00	0.00	0.00	34.84	35.24	52.0	0.0	0.678
105.00	0.33	1.19	0.00	0.00	0.00	33.33	33.72	52.0	0.0	0.649
110.00	0.31	1.20	0.00	0.00	0.00	31.49	31.87	52.0	0.0	0.613
115.00	0.30	1.21	0.00	0.00	0.00	29.46	29.83	52.0	0.0	0.574
120.00	0.29	1.21	0.00	0.00	0.00	27.20	27.57	52.0	0.0	0.530
125.00	0.28	1.22	0.00	0.00	0.00	24.70	25.06	52.0	0.0	0.482
128.00	0.25	1.07	0.00	0.00	0.00	23.07	23.39	52.0	0.0	0.450
130.00	0.25	1.07	0.00	0.00	0.00	22.16	22.48	52.0	0.0	0.432
135.00	0.23	1.08	0.00	0.00	0.00	19.65	19.97	52.0	0.0	0.384
140.00	0.22	1.08	0.00	0.00	0.00	16.85	17.17	52.0	0.0	0.330
145.00	0.21	1.09	0.00	0.00	0.00	13.69	14.03	52.0	0.0	0.270
148.62	0.20	1.09	0.00	0.00	0.00	11.17	11.53	52.0	0.0	0.222
148.62	0.30	1.63	0.00	0.00	0.00	16.55	17.09	52.0	0.0	0.329
150.00	0.22	1.15	0.00	0.00	0.00	15.04	15.40	52.0	0.0	0.296
153.00	0.22	1.13	0.00	0.00	0.00	12.69	13.06	52.0	0.0	0.251
155.00	0.21	1.13	0.00	0.00	0.00	11.15	11.53	52.0	0.0	0.222
160.00	0.13	0.48	0.00	0.00	0.00	6.90	7.08	52.0	0.0	0.136
165.00	0.12	0.45	0.00	0.00	0.00	5.19	5.37	52.0	0.0	0.103
170.00	0.10	0.33	0.00	0.00	0.00	3.40	3.55	52.0	0.0	0.068
175.00	0.09	0.30	0.00	0.00	0.00	1.96	2.11	52.0	0.0	0.041
180.00	0.00	0.29	0.00	0.00	0.00	0.49	0.71	52.0	0.0	0.014

Pole : 310972  
 Location : Waterford Rebuild CT, CT  
 Height : 180.0 (ft)  
 Base Dia : 62.45 (in)  
 Top Dia : 22.90 (in)  
 Shape : 18 Sides  
 Taper : 0.228740 (in/ft)

Code : TIA/EIA-222 Rev F

Base Elev : 0.000 (ft)

Copyright © 2007 - 2011 by American Tower Corporation. All rights reserved.

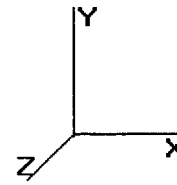

5/13/2013 2:41:06 PM

Page : 9

<b>Load Case:</b> Ice	86.60 mph Wind with Ice	24 Iterations
Gust Response Factor : 1.69		
Dead Load Factor : 1.00		
Wind Load Factor : 1.00		

**Shaft Segment Forces**

Seg Top Elev (ft)	Description	Kz	qz (psf)	qzGh (psf)	C (mph-ft)	Cf	Ice Thick (in)	Tributary (ft)	Aa (sf)	CfAa (sf)	Wind Force X (lb)	Dead Load Ice (lb)	Tot Dead Load (lb)	
0.00		0.00	1.00	19.199	32.44	450.68	0.650	0.500	0.00	0.000	0.00	0.0	0.0	
5.00		0.00	1.00	19.199	32.44	442.42	0.650	0.500	5.00	26.199	17.03	552.5	190.7	1,642.3
10.00		0.00	1.00	19.199	32.44	434.17	0.650	0.500	5.00	25.723	16.72	542.5	187.2	1,611.7
15.00		0.00	1.00	19.199	32.44	425.91	0.650	0.500	5.00	25.246	16.41	532.4	183.7	1,581.2
20.00		0.00	1.00	19.199	32.44	417.66	0.650	0.500	5.00	24.770	16.10	522.4	180.1	1,550.6
25.00		0.00	1.00	19.199	32.44	409.41	0.650	0.500	5.00	24.293	15.79	512.3	176.6	1,520.1
30.00		0.00	1.00	19.199	32.44	401.15	0.650	0.500	5.00	23.817	15.48	502.3	173.1	1,489.5
35.00		0.00	1.01	19.524	32.99	396.22	0.650	0.500	5.00	23.340	15.17	500.6	169.5	1,459.0
40.00		0.00	1.05	20.284	34.27	395.36	0.650	0.500	5.00	22.863	14.86	509.4	166.0	1,428.4
45.00		0.00	1.09	20.978	35.45	393.44	0.650	0.500	5.00	22.387	14.55	515.9	162.5	1,397.9
46.82	Bot - Section 2	0.00	1.10	21.216	35.85	392.52	0.650	0.500	1.82	8.015	5.21	186.8	58.6	500.7
50.00		0.00	1.12	21.619	36.53	390.65	0.650	0.500	3.18	14.127	9.18	335.5	102.9	1,648.5
53.65	Top - Section 1	0.00	1.14	22.059	37.27	388.15	0.650	0.500	3.65	15.959	10.37	386.7	116.1	1,861.2
55.00		0.00	1.15	22.216	37.54	393.92	0.650	0.500	1.35	5.839	3.80	142.5	42.7	364.6
60.00		0.00	1.18	22.775	38.49	389.86	0.650	0.500	5.00	21.322	13.86	533.4	154.6	1,329.6
65.00		0.00	1.21	23.302	39.38	385.25	0.650	0.500	5.00	20.845	13.55	533.6	151.1	1,299.0
70.00		0.00	1.24	23.800	40.22	380.16	0.650	0.500	5.00	20.369	13.24	532.5	147.5	1,268.5
75.00		0.00	1.26	24.274	41.02	374.65	0.650	0.500	5.00	19.892	12.93	530.4	144.0	1,237.9
80.00		0.00	1.28	24.726	41.78	368.75	0.650	0.500	5.00	19.416	12.62	527.4	140.5	1,207.4
85.00		0.00	1.31	25.158	42.51	362.51	0.650	0.500	5.00	18.939	12.31	523.4	137.0	1,176.8
90.00		0.00	1.33	25.572	43.21	355.96	0.650	0.500	5.00	18.463	12.00	518.6	133.4	1,146.3
94.97	Bot - Section 3	0.00	1.35	25.968	43.88	349.16	0.650	0.500	4.97	17.867	11.61	509.7	129.0	1,108.4
95.00		0.00	1.35	25.970	43.89	349.12	0.650	0.500	0.03	0.121	0.08	3.5	0.9	13.1
100.0		0.00	1.37	26.354	44.53	342.01	0.650	0.500	5.00	17.822	11.58	515.9	128.7	1,925.8
100.4	Top - Section 2	0.00	1.37	26.389	44.59	341.34	0.650	0.500	0.47	1.638	1.06	47.5	12.0	177.1
105.0		0.00	1.39	26.724	45.16	341.05	0.650	0.500	4.53	15.707	10.21	461.1	113.5	851.6
110.0		0.00	1.41	27.081	45.76	333.53	0.650	0.500	5.00	16.869	10.96	501.8	121.6	913.6
115.0		0.00	1.42	27.427	46.35	325.78	0.650	0.500	5.00	16.392	10.66	493.9	118.1	886.9
120.0		0.00	1.44	27.763	46.91	317.85	0.650	0.500	5.00	15.916	10.35	485.4	114.6	860.2
125.0		0.00	1.46	28.089	47.47	309.72	0.650	0.500	5.00	15.439	10.04	476.4	111.0	833.5
128.0	Appertunance(s)	0.00	1.47	28.280	47.79	304.76	0.650	0.500	3.00	9.035	5.87	280.7	65.3	487.7
130.0		0.00	1.48	28.405	48.00	301.42	0.650	0.500	2.00	5.928	3.85	185.0	43.0	320.0
135.0		0.00	1.49	28.713	48.52	292.96	0.650	0.500	5.00	14.486	9.42	456.9	104.0	780.2
140.0		0.00	1.51	29.013	49.03	284.34	0.650	0.500	5.00	14.010	9.11	446.5	100.4	753.5
145.0		0.00	1.52	29.305	49.52	275.57	0.650	0.500	5.00	13.533	8.80	435.7	96.9	726.8
148.6	Top - Section 3	0.00	1.53	29.512	49.87	269.14	0.650	0.500	3.62	9.491	6.17	307.7	68.3	509.4
150.0	Appertunance(s)	0.00	1.54	29.591	50.00	266.66	0.650	0.500	1.38	3.565	2.32	115.9	25.8	136.7
153.0	Appertunance(s)	0.00	1.55	29.759	50.29	261.25	0.650	0.500	3.00	7.605	4.94	248.6	54.8	291.0
155.0		0.00	1.55	29.869	50.47	257.62	0.650	0.500	2.00	4.975	3.23	163.2	35.9	190.4
160.0	Appertunance(s)	0.00	1.57	30.141	50.93	248.45	0.650	0.500	5.00	12.104	7.87	400.8	86.3	461.6
165.0		0.00	1.58	30.407	51.38	239.16	0.650	0.500	5.00	11.627	7.56	388.4	82.8	442.6
170.0	Appertunance(s)	0.00	1.59	30.668	51.82	229.75	0.650	0.500	5.00	11.150	7.25	375.6	79.3	423.7
175.0		0.00	1.61	30.923	52.26	220.22	0.650	0.500	5.00	10.674	6.94	362.6	75.7	404.7
180.0	Appertunance(s)	0.00	1.62	31.173	52.68	210.59	0.650	0.500	5.00	10.197	6.63	349.2	72.2	385.7
<b>Totals:</b>								180.00				17,453.1	4,758.0	40,605.4

Pole : 310972  
 Location : Waterford Rebuild CT, CT  
 Height : 180.0 (ft)  
 Base Dia : 62.45 (in)  
 Top Dia : 22.90 (in)  
 Shape : 18 Sides  
 Taper : 0.228740 (in/ft)

Code: TIA/EIA-222 Rev F

Base Elev : 0.000 (ft)

Copyright © 2007 - 2011 by American Tower Corporation. All rights reserved.

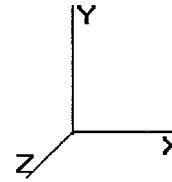

5/13/2013 2:41:06 PM  
 Page: 10

<b>Load Case:</b> Ice	86.60 mph Wind with Ice	24 Iterations
Gust Response Factor : 1.69		
Dead Load Factor : 1.00		
Wind Load Factor : 1.00		

**Discrete Appurtenance Segment Forces**

Elev (ft)	Description	Qty	qz (psf)	qzGh (psf)	CaAa Factor	Total CaAa (sf)	Horiz Ecc (ft)	Vert Ecc (ft)	Wind FX (lb)	Mom Y (lb-ft)	Mom Z (lb-ft)	Dead Load (lb)
128.0	EMS DR85-17-	6	28.280	47.793	0.67	27.54	0.000	0.000	1,316.06	0.00	0.00	252.00
128.0	RFS ATMAA1412D-	6	28.280	47.793	0.67	5.59	0.000	0.000	267.06	0.00	0.00	123.60
128.0	Round T-Arm	3	28.280	47.793	0.67	24.32	0.000	0.000	1,162.36	0.00	0.00	942.00
150.0	Allgon 7770.00	6	29.591	50.008	0.73	28.16	0.000	0.000	1,408.40	0.00	0.00	408.00
150.0	Ericsson RRUS 11 (Ba	6	29.591	50.008	0.50	10.02	0.000	0.000	501.08	0.00	0.00	419.40
150.0	KMW AM-X-CD-14-65-	3	29.591	50.008	1.00	18.30	0.000	0.000	915.15	0.00	0.00	204.90
150.0	Powerwave LGP21401	6	29.591	50.008	0.67	6.15	0.000	0.000	307.58	0.00	0.00	127.56
150.0	Powerwave LGP21903	6	29.591	50.008	0.74	1.69	0.000	0.000	84.37	0.00	0.00	47.40
150.0	Raycap DC6-48-60-18-	1	29.591	50.008	1.00	1.67	0.000	0.000	83.51	0.00	0.00	49.50
150.0	RCU	6	29.591	50.008	0.50	0.78	0.000	0.000	39.01	0.00	0.00	15.00
150.0	Round Low Profile PI	1	29.591	50.008	1.00	27.20	0.000	0.000	1,360.21	0.00	0.00	1,700.00
153.0	12' Omni	1	30.087	50.848	1.00	4.83	0.000	6.000	245.59	0.00	1,473.57	66.06
160.0	Alcatel-Lucent RRH2x	3	30.141	50.939	0.94	7.92	0.000	0.000	403.65	0.00	0.00	213.24
160.0	Alcatel-Lucent RRH2x	3	30.141	50.939	0.70	6.03	0.000	0.000	307.01	0.00	0.00	184.20
160.0	Antel BXA-171063/12C	6	30.141	50.939	0.93	30.47	0.000	0.000	1,551.94	0.00	0.00	254.40
160.0	Antel BXA-70063/6CF	6	30.141	50.939	0.74	37.92	0.000	0.000	1,931.43	0.00	0.00	348.00
160.0	RFS DB-T1-6Z-8AB-0Z	1	30.141	50.939	0.75	4.56	0.000	0.000	232.28	0.00	0.00	144.50
160.0	Round Low Profile PI	1	30.141	50.939	1.00	27.20	0.000	0.000	1,385.53	0.00	0.00	1,700.00
170.0	Flush Mounts	1	30.668	51.829	1.00	4.50	0.000	0.000	233.23	0.00	0.00	300.00
170.0	KMW HB-X-WM-17-65-	3	30.668	51.829	1.00	6.78	0.000	0.000	351.40	0.00	0.00	152.70
170.0	KMW HB-X-WM-17-65-	3	30.668	51.829	0.67	2.75	0.000	0.000	142.72	0.00	0.00	69.90
180.0	dbSpectra	1	31.173	52.682	1.00	1.76	0.000	0.000	92.72	0.00	0.00	41.20
180.0	Round Low Profile PI	1	31.173	52.682	1.00	27.20	0.000	0.000	1,432.95	0.00	0.00	1,700.00
180.0	Sinclair SC488-SF1SN	2	31.545	53.310	1.00	10.74	0.000	7.625	572.55	0.00	4,365.72	116.52
									16,327.81			9,580.08

Pole : 310972  
 Location : Waterford Rebuild CT, CT  
 Height : 180.0 (ft)  
 Base Dia : 62.45 (in)  
 Top Dia : 22.90 (in)  
 Shape : 18 Sides  
 Taper : 0.228740 (in/ft)

Code: TIA/EIA-222 Rev F

5/13/2013 2:41:06 PM  
 Page: 11

Base Elev : 0.000 (ft)

Copyright © 2007 - 2011 by American Tower Corporation. All rights reserved.

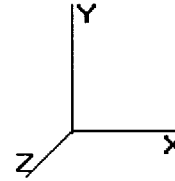

**Load Case:** Ice                      86.60 mph Wind with Ice                      24 Iterations

Gust Response Factor : 1.69  
 Dead Load Factor : 1.00  
 Wind Load Factor : 1.00

**Applied Segment Forces Summary**

Seg Elev (ft)	Lateral FX (-) (lb)	Axial FY (-) (lb)	Torsion MY (lb-ft)	Moment MZ (lb-ft)
0.00	0.00	0.00	0.00	0.00
5.00	552.54	1,827.19	0.00	0.00
10.00	542.49	1,796.64	0.00	0.00
15.00	532.44	1,766.09	0.00	0.00
20.00	522.39	1,735.54	0.00	0.00
25.00	512.34	1,704.99	0.00	0.00
30.00	502.29	1,674.44	0.00	0.00
35.00	500.58	1,643.90	0.00	0.00
40.00	509.43	1,613.35	0.00	0.00
45.00	515.89	1,582.80	0.00	0.00
46.82	186.81	567.89	0.00	0.00
50.00	335.49	1,766.27	0.00	0.00
53.65	386.72	1,996.25	0.00	0.00
55.00	142.50	414.54	0.00	0.00
60.00	533.44	1,514.52	0.00	0.00
65.00	533.58	1,483.97	0.00	0.00
70.00	532.54	1,453.42	0.00	0.00
75.00	530.43	1,422.87	0.00	0.00
80.00	527.36	1,392.33	0.00	0.00
85.00	523.40	1,361.78	0.00	0.00
90.00	518.63	1,331.23	0.00	0.00
94.97	509.67	1,292.07	0.00	0.00
95.00	3.46	14.35	0.00	0.00
100.0	515.94	2,110.75	0.00	0.00
100.4	47.49	194.33	0.00	0.00
105.0	461.10	1,019.28	0.00	0.00
110.0	501.83	1,098.54	0.00	0.00
115.0	493.89	1,071.85	0.00	0.00
120.0	485.40	1,045.16	0.00	0.00
125.0	476.39	1,018.47	0.00	0.00
128.0	3,026.15	1,916.30	0.00	0.00
130.0	184.97	364.28	0.00	0.00
135.0	456.92	890.96	0.00	0.00
140.0	446.50	864.27	0.00	0.00
145.0	435.66	837.58	0.00	0.00
148.6	307.70	589.52	0.00	0.00
150.0	4,815.21	3,139.11	0.00	0.00
153.0	494.21	410.66	0.00	1,473.57
155.0	163.23	224.82	0.00	0.00
160.0	6,212.60	3,392.05	0.00	0.00
165.0	388.37	475.44	0.00	0.00
170.0	1,102.99	979.07	0.00	0.00
175.0	362.58	412.90	0.00	0.00
180.0	2,447.42	2,251.65	0.00	4,365.72
<b>Totals:</b>	<b>33,780.93</b>	<b>55,663.41</b>	<b>0.00</b>	<b>5,839.29</b>

Pole : 310972  
Location : Waterford Rebuild CT, CT  
Height : 180.0 (ft)  
Base Dia : 62.45 (in)  
Top Dia : 22.90 (in)  
Shape : 18 Sides  
Taper : 0.228740 (in/ft)

Code : TIA/EIA-222 Rev F

5/13/2013 2:41:06 PM  
Page : 12

Base Elev : 0.000 (ft)

Copyright © 2007 - 2011 by American Tower Corporation. All rights reserved.

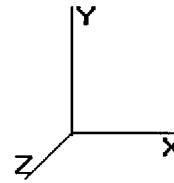

**Load Case:** Ice

86.60 mph Wind with Ice

24 Iterations

Gust Response Factor : 1.69  
Dead Load Factor : 1.00  
Wind Load Factor : 1.00

**Calculated Shaft Forces and Deflections**

Seg Elev (ft)	Lateral FX (-) (kips)	Axial FY (-) (kips)	Lateral FZ (kips)	Moment MX (ft-kips)	Torsion MY (ft-kips)	Moment MZ (ft-kips)	X Deflect (in)	Z Deflect (in)	Total Deflect (in)	Rotation (deg)
0.00	-33.850	-55.621	0.000	0.000	0.000	-4,201.366	0.000	0.000	0.000	0.000
5.00	-33.428	-53.712	0.000	0.000	0.000	-4,032.119	-0.075	0.000	0.075	-0.140
10.00	-33.008	-51.835	0.000	0.000	0.000	-3,864.985	-0.298	0.000	0.298	-0.282
15.00	-32.591	-49.990	0.000	0.000	0.000	-3,699.949	-0.671	0.000	0.671	-0.426
20.00	-32.177	-48.177	0.000	0.000	0.000	-3,536.997	-1.196	0.000	1.196	-0.572
25.00	-31.766	-46.396	0.000	0.000	0.000	-3,376.114	-1.874	0.000	1.874	-0.720
30.00	-31.358	-44.646	0.000	0.000	0.000	-3,217.286	-2.709	0.000	2.709	-0.870
35.00	-30.945	-42.928	0.000	0.000	0.000	-3,060.497	-3.701	0.000	3.701	-1.021
40.00	-30.516	-41.243	0.000	0.000	0.000	-2,905.773	-4.853	0.000	4.853	-1.175
45.00	-30.039	-39.616	0.000	0.000	0.000	-2,753.195	-6.167	0.000	6.167	-1.330
46.82	-29.893	-39.011	0.000	0.000	0.000	-2,698.628	-6.685	0.000	6.685	-1.388
50.00	-29.585	-37.198	0.000	0.000	0.000	-2,603.466	-7.646	0.000	7.646	-1.490
53.65	-29.193	-35.172	0.000	0.000	0.000	-2,495.488	-8.830	0.000	8.830	-1.606
55.00	-29.099	-34.712	0.000	0.000	0.000	-2,456.075	-9.291	0.000	9.291	-1.650
60.00	-28.608	-33.138	0.000	0.000	0.000	-2,310.584	-11.101	0.000	11.101	-1.802
65.00	-28.111	-31.597	0.000	0.000	0.000	-2,167.546	-13.070	0.000	13.070	-1.955
70.00	-27.608	-30.090	0.000	0.000	0.000	-2,026.996	-15.200	0.000	15.200	-2.108
75.00	-27.101	-28.615	0.000	0.000	0.000	-1,888.959	-17.491	0.000	17.491	-2.263
80.00	-26.590	-27.174	0.000	0.000	0.000	-1,753.459	-19.943	0.000	19.943	-2.417
85.00	-26.077	-25.766	0.000	0.000	0.000	-1,620.511	-22.557	0.000	22.557	-2.571
90.00	-25.563	-24.392	0.000	0.000	0.000	-1,490.126	-25.332	0.000	25.332	-2.725
94.97	-25.021	-23.094	0.000	0.000	0.000	-1,363.172	-28.247	0.000	28.247	-2.877
95.00	-25.048	-23.046	0.000	0.000	0.000	-1,362.332	-28.267	0.000	28.267	-2.878
100.0	-24.454	-20.930	0.000	0.000	0.000	-1,237.095	-31.362	0.000	31.362	-3.029
100.4	-24.423	-20.706	0.000	0.000	0.000	-1,225.688	-31.659	0.000	31.659	-3.044
105.0	-23.959	-19.651	0.000	0.000	0.000	-1,114.965	-34.614	0.000	34.614	-3.179
110.0	-23.446	-18.519	0.000	0.000	0.000	-995.174	-38.029	0.000	38.029	-3.339
115.0	-22.935	-17.417	0.000	0.000	0.000	-877.946	-41.608	0.000	41.608	-3.494
120.0	-22.427	-16.348	0.000	0.000	0.000	-763.271	-45.345	0.000	45.345	-3.642
125.0	-21.915	-15.321	0.000	0.000	0.000	-651.137	-49.234	0.000	49.234	-3.782
128.0	-18.784	-13.589	0.000	0.000	0.000	-585.393	-51.636	0.000	51.636	-3.864
130.0	-18.595	-13.209	0.000	0.000	0.000	-547.826	-53.265	0.000	53.265	-3.916
135.0	-18.102	-12.316	0.000	0.000	0.000	-454.854	-57.430	0.000	57.430	-4.037
140.0	-17.615	-11.454	0.000	0.000	0.000	-364.345	-61.715	0.000	61.715	-4.147
145.0	-17.134	-10.628	0.000	0.000	0.000	-276.269	-66.107	0.000	66.107	-4.242
148.6	-16.790	-10.051	0.000	0.000	0.000	-214.308	-69.342	0.000	69.342	-4.301
150.0	-11.757	-7.275	0.000	0.000	0.000	-191.077	-70.591	0.000	70.591	-4.321
153.0	-11.239	-6.894	0.000	0.000	0.000	-154.332	-73.323	0.000	73.323	-4.379
155.0	-11.065	-6.673	0.000	0.000	0.000	-131.855	-75.164	0.000	75.164	-4.413
160.0	-4.611	-3.769	0.000	0.000	0.000	-76.532	-79.819	0.000	79.819	-4.477
165.0	-4.189	-3.322	0.000	0.000	0.000	-53.476	-84.529	0.000	84.529	-4.523
170.0	-3.013	-2.432	0.000	0.000	0.000	-32.530	-89.281	0.000	89.281	-4.557
175.0	-2.620	-2.049	0.000	0.000	0.000	-17.464	-94.062	0.000	94.062	-4.580
180.0	-2.447	0.000	0.000	0.000	0.000	-4.366	-98.861	0.000	98.861	-4.592



Pole : 310972  
 Location : Waterford Rebuild CT, CT  
 Height : 180.0 (ft)  
 Base Dia : 62.45 (in)  
 Top Dia : 22.90 (in)  
 Shape : 18 Sides  
 Taper : 0.228740 (in/ft)

Code: TIA/EIA-222 Rev F

5/13/2013 2:41:06 PM  
 Page: 13

Base Elev: 0.000 (ft)

Copyright © 2007 - 2011 by American Tower Corporation. All rights reserved.

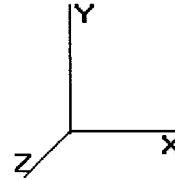

**Load Case:** Ice

86.60 mph Wind with Ice

24 Iterations

Gust Response Factor : 1.69  
 Dead Load Factor : 1.00  
 Wind Load Factor : 1.00

**Calculated Stresses**

Seg Elev (ft)	Applied Stresses							Allowable Stress (Fb) (ksi)	Stress Ratio	
	Axial (Y) (ksi)	Shear (X) (ksi)	Shear (Z) (ksi)	Torsion (ksi)	Bending (X) (ksi)	Bending (Z) (ksi)	Combined (ksi)			
0.00	0.65	0.79	0.00	0.00	0.00	38.21	38.88	52.0	0.0	0.748
5.00	0.64	0.80	0.00	0.00	0.00	38.07	38.73	52.0	0.0	0.745
10.00	0.63	0.80	0.00	0.00	0.00	37.90	38.55	52.0	0.0	0.742
15.00	0.61	0.81	0.00	0.00	0.00	37.72	38.36	52.0	0.0	0.738
20.00	0.60	0.81	0.00	0.00	0.00	37.52	38.15	52.0	0.0	0.734
25.00	0.59	0.82	0.00	0.00	0.00	37.28	37.90	52.0	0.0	0.729
30.00	0.58	0.83	0.00	0.00	0.00	37.03	37.64	52.0	0.0	0.724
35.00	0.57	0.83	0.00	0.00	0.00	36.73	37.34	52.0	0.0	0.718
40.00	0.56	0.84	0.00	0.00	0.00	36.41	37.00	52.0	0.0	0.712
45.00	0.55	0.84	0.00	0.00	0.00	36.05	36.63	52.0	0.0	0.705
46.82	0.55	0.85	0.00	0.00	0.00	35.91	36.49	52.0	0.0	0.702
50.00	0.53	0.85	0.00	0.00	0.00	35.65	36.21	52.0	0.0	0.697
53.65	0.50	0.84	0.00	0.00	0.00	34.12	34.65	52.0	0.0	0.667
55.00	0.50	0.84	0.00	0.00	0.00	34.00	34.52	52.0	0.0	0.664
60.00	0.49	0.84	0.00	0.00	0.00	33.49	34.01	52.0	0.0	0.654
65.00	0.47	0.85	0.00	0.00	0.00	32.94	33.45	52.0	0.0	0.644
70.00	0.46	0.85	0.00	0.00	0.00	32.33	32.83	52.0	0.0	0.632
75.00	0.45	0.86	0.00	0.00	0.00	31.67	32.15	52.0	0.0	0.619
80.00	0.44	0.87	0.00	0.00	0.00	30.93	31.40	52.0	0.0	0.604
85.00	0.43	0.87	0.00	0.00	0.00	30.12	30.58	52.0	0.0	0.588
90.00	0.42	0.88	0.00	0.00	0.00	29.22	29.67	52.0	0.0	0.571
94.97	0.40	0.88	0.00	0.00	0.00	28.23	28.68	52.0	0.0	0.552
95.00	0.40	0.88	0.00	0.00	0.00	28.23	28.67	52.0	0.0	0.552
100.00	0.38	0.89	0.00	0.00	0.00	27.13	27.55	52.0	0.0	0.530
100.47	0.43	1.02	0.00	0.00	0.00	30.23	30.70	52.0	0.0	0.591
105.00	0.42	1.02	0.00	0.00	0.00	28.96	29.43	52.0	0.0	0.566
110.00	0.40	1.03	0.00	0.00	0.00	27.41	27.87	52.0	0.0	0.536
115.00	0.39	1.04	0.00	0.00	0.00	25.69	26.15	52.0	0.0	0.503
120.00	0.38	1.05	0.00	0.00	0.00	23.78	24.22	52.0	0.0	0.466
125.00	0.37	1.06	0.00	0.00	0.00	21.63	22.08	52.0	0.0	0.425
128.00	0.33	0.92	0.00	0.00	0.00	20.24	20.63	52.0	0.0	0.397
130.00	0.33	0.93	0.00	0.00	0.00	19.45	19.85	52.0	0.0	0.382
135.00	0.32	0.93	0.00	0.00	0.00	17.30	17.69	52.0	0.0	0.340
140.00	0.30	0.94	0.00	0.00	0.00	14.89	15.28	52.0	0.0	0.294
145.00	0.29	0.95	0.00	0.00	0.00	12.15	12.56	52.0	0.0	0.242
148.62	0.28	0.96	0.00	0.00	0.00	9.96	10.38	52.0	0.0	0.200
148.62	0.42	1.43	0.00	0.00	0.00	14.76	15.38	52.0	0.0	0.296
150.00	0.31	1.01	0.00	0.00	0.00	13.44	13.87	52.0	0.0	0.267
153.00	0.30	0.99	0.00	0.00	0.00	11.38	11.81	52.0	0.0	0.227
155.00	0.30	0.99	0.00	0.00	0.00	10.04	10.48	52.0	0.0	0.202
160.00	0.17	0.43	0.00	0.00	0.00	6.33	6.55	52.0	0.0	0.126
165.00	0.16	0.41	0.00	0.00	0.00	4.82	5.03	52.0	0.0	0.097
170.00	0.12	0.31	0.00	0.00	0.00	3.21	3.38	52.0	0.0	0.065
175.00	0.11	0.28	0.00	0.00	0.00	1.89	2.06	52.0	0.0	0.040
180.00	0.00	0.27	0.00	0.00	0.00	0.52	0.71	52.0	0.0	0.014

Pole : 310972  
 Location : Waterford Rebuild CT, CT  
 Height : 180.0 (ft)  
 Base Dia : 62.45 (in)  
 Top Dia : 22.90 (in)  
 Shape : 18 Sides  
 Taper : 0.228740 (in/ft)

Code: TIA/EIA-222 Rev F

Base Elev : 0.000 (ft)

Copyright © 2007 - 2011 by American Tower Corporation. All rights reserved.

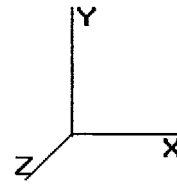

5/13/2013 2:41:06 PM  
 Page: 14

**Load Case:** Twist/Sway      50.00 mph Wind with No Ice      23 Iterations

Gust Response Factor : 1.69  
 Dead Load Factor : 1.00  
 Wind Load Factor : 1.00

**Shaft Segment Forces**

Seg Top Elev (ft)	Description	Kz	qz (psf)	qzGh (psf)	C (mph-ft)	Cf	Ice Thick (in)	Tributary (ft)	Aa (sf)	CfAa (sf)	Wind Force X (lb)	Dead Load Ice (lb)	Tot Dead Load (lb)	
0.00		0.00	1.00	6.400	10.81	260.20	0.650	0.000	0.00	0.000	0.00	0.0	0.0	
5.00		0.00	1.00	6.400	10.81	255.44	0.650	0.000	5.00	25.783	16.76	181.3	0.0	1,451.5
10.00		0.00	1.00	6.400	10.81	250.67	0.650	0.000	5.00	25.306	16.45	177.9	0.0	1,424.5
15.00		0.00	1.00	6.400	10.81	245.91	0.650	0.000	5.00	24.829	16.14	174.6	0.0	1,397.5
20.00		0.00	1.00	6.400	10.81	241.14	0.650	0.000	5.00	24.353	15.83	171.2	0.0	1,370.5
25.00		0.00	1.00	6.400	10.81	236.38	0.650	0.000	5.00	23.876	15.52	167.9	0.0	1,343.5
30.00		0.00	1.00	6.400	10.81	231.61	0.650	0.000	5.00	23.400	15.21	164.5	0.0	1,316.4
35.00		0.00	1.01	6.509	10.99	228.76	0.650	0.000	5.00	22.923	14.90	163.9	0.0	1,289.4
40.00		0.00	1.05	6.762	11.42	228.27	0.650	0.000	5.00	22.447	14.59	166.7	0.0	1,262.4
45.00		0.00	1.09	6.993	11.81	227.16	0.650	0.000	5.00	21.970	14.28	168.8	0.0	1,235.4
46.82	Bot - Section 2	0.00	1.10	7.073	11.95	226.63	0.650	0.000	1.82	7.864	5.11	61.1	0.0	442.1
50.00		0.00	1.12	7.207	12.17	225.55	0.650	0.000	3.18	13.862	9.01	109.7	0.0	1,545.6
53.65	Top - Section 1	0.00	1.14	7.353	12.42	224.10	0.650	0.000	3.65	15.655	10.18	126.5	0.0	1,745.1
55.00		0.00	1.15	7.406	12.51	227.44	0.650	0.000	1.35	5.727	3.72	46.6	0.0	321.9
60.00		0.00	1.18	7.592	12.83	225.09	0.650	0.000	5.00	20.905	13.59	174.3	0.0	1,175.0
65.00		0.00	1.21	7.768	13.12	222.43	0.650	0.000	5.00	20.429	13.28	174.3	0.0	1,148.0
70.00		0.00	1.24	7.934	13.40	219.49	0.650	0.000	5.00	19.952	12.97	173.9	0.0	1,121.0
75.00		0.00	1.26	8.092	13.67	216.31	0.650	0.000	5.00	19.476	12.66	173.1	0.0	1,093.9
80.00		0.00	1.28	8.242	13.93	212.90	0.650	0.000	5.00	18.999	12.35	172.0	0.0	1,066.9
85.00		0.00	1.31	8.387	14.17	209.30	0.650	0.000	5.00	18.522	12.04	170.6	0.0	1,039.9
90.00		0.00	1.33	8.525	14.40	205.52	0.650	0.000	5.00	18.046	11.73	169.0	0.0	1,012.9
94.97	Bot - Section 3	0.00	1.35	8.656	14.62	201.59	0.650	0.000	4.97	17.453	11.34	166.0	0.0	979.3
95.00		0.00	1.35	8.657	14.63	201.57	0.650	0.000	0.03	0.118	0.08	1.1	0.0	12.2
100.0		0.00	1.37	8.785	14.84	197.47	0.650	0.000	5.00	17.405	11.31	168.0	0.0	1,797.1
100.4	Top - Section 2	0.00	1.37	8.797	14.86	197.08	0.650	0.000	0.47	1.599	1.04	15.5	0.0	165.1
105.0		0.00	1.39	8.908	15.05	196.91	0.650	0.000	4.53	15.329	9.96	150.0	0.0	738.1
110.0		0.00	1.41	9.028	15.25	192.56	0.650	0.000	5.00	16.452	10.69	163.2	0.0	792.0
115.0		0.00	1.42	9.143	15.45	188.10	0.650	0.000	5.00	15.976	10.38	160.5	0.0	768.8
120.0		0.00	1.44	9.255	15.64	183.51	0.650	0.000	5.00	15.499	10.07	157.6	0.0	745.7
125.0		0.00	1.46	9.363	15.82	178.82	0.650	0.000	5.00	15.023	9.76	154.5	0.0	722.5
128.0	Appertunance(s)	0.00	1.47	9.427	15.93	175.96	0.650	0.000	3.00	8.785	5.71	91.0	0.0	422.4
130.0		0.00	1.48	9.469	16.00	174.03	0.650	0.000	2.00	5.761	3.74	59.9	0.0	277.0
135.0		0.00	1.49	9.572	16.17	169.14	0.650	0.000	5.00	14.070	9.15	147.9	0.0	676.2
140.0		0.00	1.51	9.672	16.34	164.17	0.650	0.000	5.00	13.593	8.84	144.4	0.0	653.0
145.0		0.00	1.52	9.769	16.51	159.10	0.650	0.000	5.00	13.116	8.53	140.8	0.0	629.9
148.6	Top - Section 3	0.00	1.53	9.838	16.62	155.39	0.650	0.000	3.62	9.190	5.97	99.3	0.0	441.1
150.0	Appertunance(s)	0.00	1.54	9.864	16.67	153.96	0.650	0.000	1.38	3.450	2.24	37.4	0.0	110.9
153.0	Appertunance(s)	0.00	1.55	9.920	16.76	150.84	0.650	0.000	3.00	7.355	4.78	80.2	0.0	236.3
155.0		0.00	1.55	9.957	16.82	148.74	0.650	0.000	2.00	4.808	3.13	52.6	0.0	154.4
160.0	Appertunance(s)	0.00	1.57	10.048	16.98	143.44	0.650	0.000	5.00	11.687	7.60	129.0	0.0	375.3
165.0		0.00	1.58	10.136	17.13	138.08	0.650	0.000	5.00	11.210	7.29	124.8	0.0	359.8
170.0	Appertunance(s)	0.00	1.59	10.223	17.27	132.65	0.650	0.000	5.00	10.734	6.98	120.5	0.0	344.4
175.0		0.00	1.61	10.308	17.42	127.15	0.650	0.000	5.00	10.257	6.67	116.1	0.0	329.0
180.0	Appertunance(s)	0.00	1.62	10.392	17.56	121.59	0.650	0.000	5.00	9.781	6.36	111.6	0.0	313.5
<b>Totals:</b>								<b>180.00</b>			<b>5,679.7</b>	<b>0.0</b>	<b>35,847.5</b>	

Pole : 310972  
 Location : Waterford Rebuild CT, CT  
 Height : 180.0 (ft)  
 Base Dia : 62.45 (in)  
 Top Dia : 22.90 (in)  
 Shape : 18 Sides  
 Taper : 0.228740 (in/ft)

Code: TIA/EIA-222 Rev F

Base Elev : 0.000 (ft)

Copyright © 2007 - 2011 by American Tower Corporation. All rights reserved.

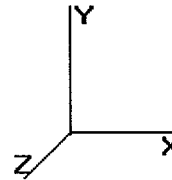

5/13/2013 2:41:07 PM  
 Page: 15

**Load Case:** Twist/Sway      50.00 mph Wind with No Ice      23 Iterations

Gust Response Factor : 1.69  
 Dead Load Factor : 1.00  
 Wind Load Factor : 1.00

**Discrete Appurtenance Segment Forces**

Elev (ft)	Description	Qty	qz (psf)	qzGh (psf)	CaAa Factor	Total CaAa (sf)	Horiz Ecc (ft)	Vert Ecc (ft)	Wind FX (lb)	Mom Y (lb-ft)	Mom Z (lb-ft)	Dead Load (lb)
128.0	EMS DR85-17-	6	9.427	15.932	0.67	25.33	0.000	0.000	403.49	0.00	0.00	144.00
128.0	RFS ATMAA1412D-	6	9.427	15.932	0.67	4.70	0.000	0.000	74.93	0.00	0.00	78.00
128.0	Round T-Arm	3	9.427	15.932	0.67	19.50	0.000	0.000	310.62	0.00	0.00	750.00
150.0	Allgon 7770.00	6	9.864	16.670	0.73	25.75	0.000	0.000	429.34	0.00	0.00	210.00
150.0	Ericsson RRUS 11 (Ba	6	9.864	16.670	0.50	8.97	0.000	0.000	149.53	0.00	0.00	300.00
150.0	KMW AM-X-CD-14-65-	3	9.864	16.670	1.00	16.50	0.000	0.000	275.06	0.00	0.00	109.20
150.0	Powerwave LGP21401	6	9.864	16.670	0.67	5.19	0.000	0.000	86.45	0.00	0.00	84.60
150.0	Powerwave LGP21903	6	9.864	16.670	0.74	1.20	0.000	0.000	19.98	0.00	0.00	33.00
150.0	Raycap DC6-48-60-18-	1	9.864	16.670	1.00	1.47	0.000	0.000	24.51	0.00	0.00	31.80
150.0	RCU	6	9.864	16.670	0.50	0.48	0.000	0.000	8.00	0.00	0.00	6.00
150.0	Round Low Profile PI	1	9.864	16.670	1.00	21.70	0.000	0.000	361.74	0.00	0.00	1,500.00
153.0	12' Omni	1	10.030	16.950	1.00	3.60	0.000	6.000	61.02	0.00	366.13	40.00
160.0	Alcatel-Lucent RRH2x	3	10.048	16.981	0.94	6.99	0.000	0.000	118.76	0.00	0.00	150.00
160.0	Alcatel-Lucent RRH2x	3	10.048	16.981	0.70	5.29	0.000	0.000	89.86	0.00	0.00	132.00
160.0	Antel BXA-171063/12C	6	10.048	16.981	0.93	26.73	0.000	0.000	453.86	0.00	0.00	90.00
160.0	Antel BXA-70063/6CF	6	10.048	16.981	0.74	34.32	0.000	0.000	582.80	0.00	0.00	102.00
160.0	RFS DB-T1-6Z-8AB-0Z	1	10.048	16.981	0.75	4.20	0.000	0.000	71.32	0.00	0.00	110.00
160.0	Round Low Profile PI	1	10.048	16.981	1.00	21.70	0.000	0.000	368.48	0.00	0.00	1,500.00
170.0	Flush Mounts	1	10.223	17.277	1.00	3.50	0.000	0.000	60.47	0.00	0.00	200.00
170.0	KMW HB-X-WM-17-65-	3	10.223	17.277	1.00	5.85	0.000	0.000	101.07	0.00	0.00	90.00
170.0	KMW HB-X-WM-17-65-	3	10.223	17.277	0.67	2.29	0.000	0.000	39.59	0.00	0.00	47.70
180.0	dbSpectra	1	10.392	17.562	1.00	1.56	0.000	0.000	27.40	0.00	0.00	25.00
180.0	Round Low Profile PI	1	10.392	17.562	1.00	21.70	0.000	0.000	381.09	0.00	0.00	1,500.00
180.0	Sinclair SC488-SF1SN	2	10.516	17.771	1.00	7.62	0.000	7.625	135.42	0.00	1,032.55	60.00
									4,634.79			7,293.30

Pole : 310972  
 Location : Waterford Rebuild CT, CT  
 Height : 180.0 (ft)  
 Base Dia : 62.45 (in)  
 Top Dia : 22.90 (in)  
 Shape : 18 Sides  
 Taper : 0.228740 (in/ft)

Code: TIA/EIA-222 Rev F

Base Elev : 0.000 (ft)

Copyright © 2007 - 2011 by American Tower Corporation. All rights reserved.

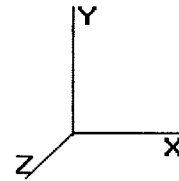

5/13/2013 2:41:07 PM  
 Page: 16

<b>Load Case:</b> Twist/Sway	50.00 mph Wind with No Ice	23 Iterations
Gust Response Factor : 1.69		
Dead Load Factor : 1.00		
Wind Load Factor : 1.00		

**Applied Segment Forces Summary**

Seg Elev (ft)	Lateral FX (-) (lb)	Axial FY (-) (lb)	Torsion MY (lb-ft)	Moment MZ (lb-ft)
0.00	0.00	0.00	0.00	0.00
5.00	181.26	1,636.47	0.00	0.00
10.00	177.91	1,609.45	0.00	0.00
15.00	174.56	1,582.43	0.00	0.00
20.00	171.21	1,555.41	0.00	0.00
25.00	167.86	1,528.39	0.00	0.00
30.00	164.51	1,501.37	0.00	0.00
35.00	163.89	1,474.35	0.00	0.00
40.00	166.73	1,447.33	0.00	0.00
45.00	168.77	1,420.31	0.00	0.00
46.82	61.10	509.33	0.00	0.00
50.00	109.74	1,663.35	0.00	0.00
53.65	126.46	1,880.12	0.00	0.00
55.00	46.59	371.84	0.00	0.00
60.00	174.35	1,359.93	0.00	0.00
65.00	174.31	1,332.91	0.00	0.00
70.00	173.89	1,305.89	0.00	0.00
75.00	173.12	1,278.87	0.00	0.00
80.00	172.02	1,251.85	0.00	0.00
85.00	170.64	1,224.83	0.00	0.00
90.00	168.99	1,197.81	0.00	0.00
94.97	165.96	1,163.02	0.00	0.00
95.00	1.13	13.46	0.00	0.00
100.0	167.97	1,982.07	0.00	0.00
100.4	15.46	182.35	0.00	0.00
105.0	150.01	905.80	0.00	0.00
110.0	163.15	976.92	0.00	0.00
115.0	160.45	953.76	0.00	0.00
120.0	157.57	930.60	0.00	0.00
125.0	154.52	907.44	0.00	0.00
128.0	880.02	1,505.35	0.00	0.00
130.0	59.93	321.28	0.00	0.00
135.0	147.93	786.98	0.00	0.00
140.0	144.42	763.82	0.00	0.00
145.0	140.76	740.66	0.00	0.00
148.6	99.32	521.27	0.00	0.00
150.0	1,392.00	2,416.11	0.00	0.00
153.0	141.17	329.83	0.00	366.13
155.0	52.59	188.88	0.00	0.00
160.0	1,814.07	2,545.38	0.00	0.00
165.0	124.83	392.64	0.00	0.00
170.0	321.68	714.90	0.00	0.00
175.0	116.15	337.16	0.00	0.00
180.0	655.55	1,906.72	0.00	1,032.55
<b>Totals:</b>	<b>10,314.53</b>	<b>48,618.66</b>	<b>0.00</b>	<b>1,398.68</b>

Pole : 310972  
 Location : Waterford Rebuild CT, CT  
 Height : 180.0 (ft)  
 Base Dia : 62.45 (in)  
 Top Dia : 22.90 (in)  
 Shape : 18 Sides  
 Taper : 0.228740 (in/ft)

Code: TIA/EIA-222 Rev F

5/13/2013 2:41:07 PM  
 Page: 17

Base Elev: 0.000 (ft)

Copyright © 2007 - 2011 by American Tower Corporation. All rights reserved.

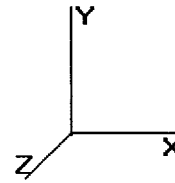

**Load Case:** Twist/Sway      50.00 mph Wind with No Ice      23 Iterations

Gust Response Factor : 1.69  
 Dead Load Factor : 1.00  
 Wind Load Factor : 1.00

**Calculated Shaft Forces and Deflections**

Seg Elev (ft)	Lateral FX (-) (kips)	Axial FY (-) (kips)	Lateral FZ (kips)	Moment MX (ft-kips)	Torsion MY (ft-kips)	Moment MZ (ft-kips)	X Deflect (in)	Z Deflect (in)	Total Deflect (in)	Rotation (deg)
0.00	-10.332	-48.615	0.000	0.000	0.000	-1,247.225	0.000	0.000	0.000	0.000
5.00	-10.184	-46.971	0.000	0.000	0.000	-1,195.566	-0.022	0.000	0.022	-0.042
10.00	-10.038	-45.354	0.000	0.000	0.000	-1,144.645	-0.089	0.000	0.089	-0.084
15.00	-9.893	-43.765	0.000	0.000	0.000	-1,094.455	-0.199	0.000	0.199	-0.126
20.00	-9.750	-42.202	0.000	0.000	0.000	-1,044.989	-0.355	0.000	0.355	-0.169
25.00	-9.608	-40.667	0.000	0.000	0.000	-996.239	-0.555	0.000	0.555	-0.213
30.00	-9.468	-39.159	0.000	0.000	0.000	-948.197	-0.802	0.000	0.802	-0.257
35.00	-9.327	-37.678	0.000	0.000	0.000	-900.857	-1.096	0.000	1.096	-0.302
40.00	-9.180	-36.225	0.000	0.000	0.000	-854.225	-1.436	0.000	1.436	-0.347
45.00	-9.021	-34.801	0.000	0.000	0.000	-808.324	-1.824	0.000	1.824	-0.393
46.82	-8.971	-34.288	0.000	0.000	0.000	-791.937	-1.977	0.000	1.977	-0.410
50.00	-8.867	-32.621	0.000	0.000	0.000	-763.380	-2.261	0.000	2.261	-0.439
53.65	-8.738	-30.738	0.000	0.000	0.000	-731.017	-2.610	0.000	2.610	-0.474
55.00	-8.704	-30.362	0.000	0.000	0.000	-719.220	-2.746	0.000	2.746	-0.487
60.00	-8.540	-28.997	0.000	0.000	0.000	-675.703	-3.280	0.000	3.280	-0.531
65.00	-8.374	-27.660	0.000	0.000	0.000	-633.005	-3.860	0.000	3.860	-0.576
70.00	-8.207	-26.349	0.000	0.000	0.000	-591.135	-4.487	0.000	4.487	-0.620
75.00	-8.039	-25.066	0.000	0.000	0.000	-550.099	-5.161	0.000	5.161	-0.665
80.00	-7.871	-23.810	0.000	0.000	0.000	-509.903	-5.882	0.000	5.882	-0.710
85.00	-7.702	-22.582	0.000	0.000	0.000	-470.548	-6.650	0.000	6.650	-0.755
90.00	-7.534	-21.380	0.000	0.000	0.000	-432.037	-7.465	0.000	7.465	-0.800
94.97	-7.359	-20.217	0.000	0.000	0.000	-394.621	-8.321	0.000	8.321	-0.844
95.00	-7.365	-20.201	0.000	0.000	0.000	-394.375	-8.327	0.000	8.327	-0.844
100.0	-7.175	-18.219	0.000	0.000	0.000	-357.548	-9.234	0.000	9.234	-0.888
100.4	-7.164	-18.034	0.000	0.000	0.000	-354.201	-9.321	0.000	9.321	-0.892
105.0	-7.012	-17.125	0.000	0.000	0.000	-321.725	-10.187	0.000	10.187	-0.931
110.0	-6.845	-16.146	0.000	0.000	0.000	-286.666	-11.188	0.000	11.188	-0.977
115.0	-6.680	-15.190	0.000	0.000	0.000	-252.440	-12.235	0.000	12.235	-1.022
120.0	-6.516	-14.258	0.000	0.000	0.000	-219.041	-13.329	0.000	13.329	-1.064
125.0	-6.351	-13.350	0.000	0.000	0.000	-186.463	-14.465	0.000	14.465	-1.105
128.0	-5.446	-11.860	0.000	0.000	0.000	-167.409	-15.167	0.000	15.167	-1.128
130.0	-5.385	-11.538	0.000	0.000	0.000	-156.517	-15.643	0.000	15.643	-1.143
135.0	-5.227	-10.751	0.000	0.000	0.000	-129.592	-16.859	0.000	16.859	-1.177
140.0	-5.072	-9.988	0.000	0.000	0.000	-103.456	-18.109	0.000	18.109	-1.209
145.0	-4.919	-9.248	0.000	0.000	0.000	-78.096	-19.390	0.000	19.390	-1.236
148.6	-4.810	-8.728	0.000	0.000	0.000	-60.307	-20.333	0.000	20.333	-1.252
150.0	-3.367	-6.343	0.000	0.000	0.000	-53.651	-20.696	0.000	20.696	-1.258
153.0	-3.220	-6.015	0.000	0.000	0.000	-43.185	-21.492	0.000	21.492	-1.274
155.0	-3.164	-5.827	0.000	0.000	0.000	-36.746	-22.028	0.000	22.028	-1.283
160.0	-1.294	-3.323	0.000	0.000	0.000	-20.924	-23.383	0.000	23.383	-1.301
165.0	-1.161	-2.933	0.000	0.000	0.000	-14.453	-24.753	0.000	24.753	-1.314
170.0	-0.823	-2.225	0.000	0.000	0.000	-8.647	-26.134	0.000	26.134	-1.323
175.0	-0.700	-1.891	0.000	0.000	0.000	-4.531	-27.523	0.000	27.523	-1.329
180.0	-0.656	0.000	0.000	0.000	0.000	-1.033	-28.917	0.000	28.917	-1.332

Pole : 310972  
 Location : Waterford Rebuild CT, CT  
 Height : 180.0 (ft)  
 Base Dia : 62.45 (in)  
 Top Dia : 22.90 (in)  
 Shape : 18 Sides  
 Taper : 0.228740 (in/ft)

Code: TIA/EIA-222 Rev F

Base Elev : 0.000 (ft)

Copyright © 2007 - 2011 by American Tower Corporation. All rights reserved.

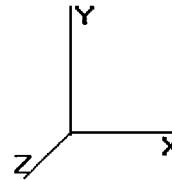

5/13/2013 2:41:07 PM  
 Page: 18

**Load Case: Twist/Sway**      50.00 mph Wind with No Ice      23 Iterations

Gust Response Factor : 1.69  
 Dead Load Factor : 1.00  
 Wind Load Factor : 1.00

**Calculated Stresses**

Seg Elev (ft)	Applied Stresses							Allowable Stress (Fb) (ksi)	Stress Ratio	
	Axial (Y) (ksi)	Shear (X) (ksi)	Shear (Z) (ksi)	Torsion (ksi)	Bending (X) (ksi)	Bending (Z) (ksi)	Combined (ksi)			
0.00	0.56	0.24	0.00	0.00	0.00	11.34	11.91	52.0	0.0	0.229
5.00	0.56	0.24	0.00	0.00	0.00	11.29	11.85	52.0	0.0	0.228
10.00	0.55	0.24	0.00	0.00	0.00	11.23	11.78	52.0	0.0	0.227
15.00	0.54	0.25	0.00	0.00	0.00	11.16	11.70	52.0	0.0	0.225
20.00	0.53	0.25	0.00	0.00	0.00	11.08	11.62	52.0	0.0	0.224
25.00	0.52	0.25	0.00	0.00	0.00	11.00	11.53	52.0	0.0	0.222
30.00	0.51	0.25	0.00	0.00	0.00	10.91	11.43	52.0	0.0	0.220
35.00	0.50	0.25	0.00	0.00	0.00	10.81	11.32	52.0	0.0	0.218
40.00	0.49	0.25	0.00	0.00	0.00	10.70	11.21	52.0	0.0	0.216
45.00	0.48	0.25	0.00	0.00	0.00	10.58	11.08	52.0	0.0	0.213
46.82	0.48	0.25	0.00	0.00	0.00	10.54	11.03	52.0	0.0	0.212
50.00	0.46	0.25	0.00	0.00	0.00	10.45	10.93	52.0	0.0	0.210
53.65	0.44	0.25	0.00	0.00	0.00	9.99	10.44	52.0	0.0	0.201
55.00	0.43	0.25	0.00	0.00	0.00	9.96	10.40	52.0	0.0	0.200
60.00	0.42	0.25	0.00	0.00	0.00	9.79	10.23	52.0	0.0	0.197
65.00	0.41	0.25	0.00	0.00	0.00	9.62	10.04	52.0	0.0	0.193
70.00	0.40	0.25	0.00	0.00	0.00	9.43	9.84	52.0	0.0	0.189
75.00	0.39	0.26	0.00	0.00	0.00	9.22	9.63	52.0	0.0	0.185
80.00	0.38	0.26	0.00	0.00	0.00	8.99	9.39	52.0	0.0	0.181
85.00	0.37	0.26	0.00	0.00	0.00	8.75	9.13	52.0	0.0	0.176
90.00	0.36	0.26	0.00	0.00	0.00	8.47	8.85	52.0	0.0	0.170
94.97	0.35	0.26	0.00	0.00	0.00	8.17	8.54	52.0	0.0	0.164
95.00	0.35	0.26	0.00	0.00	0.00	8.17	8.54	52.0	0.0	0.164
100.00	0.33	0.26	0.00	0.00	0.00	7.84	8.18	52.0	0.0	0.157
100.47	0.37	0.30	0.00	0.00	0.00	8.73	9.12	52.0	0.0	0.175
105.00	0.36	0.30	0.00	0.00	0.00	8.36	8.73	52.0	0.0	0.168
110.00	0.35	0.30	0.00	0.00	0.00	7.90	8.26	52.0	0.0	0.159
115.00	0.34	0.30	0.00	0.00	0.00	7.39	7.75	52.0	0.0	0.149
120.00	0.33	0.30	0.00	0.00	0.00	6.82	7.17	52.0	0.0	0.138
125.00	0.32	0.31	0.00	0.00	0.00	6.19	6.54	52.0	0.0	0.126
128.00	0.29	0.27	0.00	0.00	0.00	5.79	6.09	52.0	0.0	0.117
130.00	0.29	0.27	0.00	0.00	0.00	5.56	5.86	52.0	0.0	0.113
135.00	0.28	0.27	0.00	0.00	0.00	4.93	5.23	52.0	0.0	0.101
140.00	0.26	0.27	0.00	0.00	0.00	4.23	4.52	52.0	0.0	0.087
145.00	0.25	0.27	0.00	0.00	0.00	3.44	3.72	52.0	0.0	0.072
148.62	0.25	0.27	0.00	0.00	0.00	2.80	3.09	52.0	0.0	0.059
148.62	0.37	0.41	0.00	0.00	0.00	4.15	4.58	52.0	0.0	0.088
150.00	0.27	0.29	0.00	0.00	0.00	3.77	4.08	52.0	0.0	0.078
153.00	0.26	0.28	0.00	0.00	0.00	3.19	3.48	52.0	0.0	0.067
155.00	0.26	0.28	0.00	0.00	0.00	2.80	3.10	52.0	0.0	0.060
160.00	0.15	0.12	0.00	0.00	0.00	1.73	1.90	52.0	0.0	0.036
165.00	0.14	0.11	0.00	0.00	0.00	1.30	1.46	52.0	0.0	0.028
170.00	0.11	0.08	0.00	0.00	0.00	0.85	0.98	52.0	0.0	0.019
175.00	0.10	0.07	0.00	0.00	0.00	0.49	0.61	52.0	0.0	0.012
180.00	0.00	0.07	0.00	0.00	0.00	0.12	0.18	52.0	0.0	0.003

Pole : 310972  
 Location : Waterford Rebuild CT, CT  
 Height : 180.0 (ft)  
 Base Dia : 62.45 (in)  
 Top Dia : 22.90 (in)  
 Shape : 18 Sides  
 Taper : 0.228740 (in/ft)

Code: TIA/EIA-222 Rev F

5/13/2013 2:41:07 PM  
 Page: 19

Base Elev : 0.000 (ft)

Copyright © 2007 - 2011 by American Tower Corporation. All rights reserved.

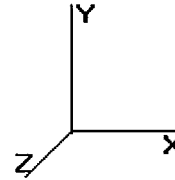

### Analysis Summary

Load Case	Reactions						Max Stresses			
	Shear FX (kips)	Shear FZ (kips)	Axial FY (kips)	Moment MX (ft-kips)	Moment MY (ft-kips)	Moment MZ (ft-kips)	Combined Stress (ksi)	Allowable Stress (ksi)	Elev (ft)	Stress Ratio
No Ice	41.3	0.00	48.56	0.00	0.00	4983.09	45.91	52.0	0.00	0.883
Ice	33.9	0.00	55.62	0.00	0.00	4201.37	38.88	52.0	0.00	0.748
Twist/Sway	10.3	0.00	48.61	0.00	0.00	1247.22	11.91	52.0	0.00	0.229

Site Name: Waterford SE Tower Height: Verizon @ 160ft		General	Power	Density				
CARRIER	# OF CHAN.	WATTS ERP	HEIGHT	CALC. POWER DENS	FREQ.	MAX. PERMISS. EXP.	FRACTION MPE	Total
*AT&T GSM	11	427	153	0.0721	1900	1.0000	7.21%	
*AT&T LTE	1	500	153	0.0077	740	0.4933	1.56%	
*Clearwire	6	153.46	170	0.0115	2500	1.0000	1.15%	
*Town of Waterford	1	100	180	0.0011	851	0.5673	0.20%	
*Town of Waterford	1	100	180	0.0011	851	0.5673	0.20%	
*USA Mobility	1	100	153	0.0015	929.6	0.6197	0.25%	
*Springwich Paging	1	1000	158.5	0.0143	928	0.6187	2.31%	
*Cingular Yagi	2	500	156	0.0148	809	0.5393	2.74%	
*T-Mobile	8	178	130	0.0303	1945	1.0000	3.03%	
*T-Mobile	2	711	130	0.0303	2100	1.0000	3.03%	
Verizon PCS	11	233	160	0.0360	1970	1.0000	3.60%	
Verizon Cellular	9	246	160	0.0311	869	0.5793	5.37%	
Verizon AWS	1	1750	160	0.0246	2145	1.0000	2.46%	
Verizon 700	1	1050	160	0.0147	698	0.4653	3.17%	36.26%
* Source: Siting Council								