



March 31, 2015

Members of the Siting Council
Connecticut Siting Council
Ten Franklin Square
New Britain, CT 06051

RE: Notice of Exempt Modification
208 Reed Road, Tolland, CT 06084
N 41° 51' 11.77"
W 72° 24' 21.89"
T-Mobile Site #: CT11413D_L700

Members of the Siting Council:

On behalf of T-Mobile, SBA Communications is submitting an exempt modification application to the Connecticut Siting council for modification of existing equipment at a tower facility located at 208 Reed Road, Tolland, CT 06084.

The 208 Reed Road, Tolland, CT facility consists of a 150' Monopole Tower owned and operated by SBA 2012 TC Assets, LLC. In order to accommodate technological changes and enhance system performance in the State of Connecticut, T-Mobile plans to modify the equipment configurations at many of its existing cell sites. Please accept this letter and attachments as notification, pursuant to R.C.S.A. Section 16-50j-73, of construction which constitutes an exempt modification pursuant to R.C.S.A. Section 16-50j-72(b)(2). In compliance with R.C.S.A. Section 16-50j-73, a copy of this letter and attachments is being sent to the chief elected official of the municipality in which the affected cell site is located.

As part of T-Mobile's L700 project, T-Mobile desires to upgrade their equipment to meet the new standards of 4G technology. The new equipment will allow customers to download files and browse the internet at a high rate of speed while also allowing their phones to be compatible with the latest 4G technology.

Attached is a summary of the planned modifications, including power density calculations reflecting the change in T-Mobile's operations at the site along with the required fee of \$625.

The changes to the facility do not constitute modifications as defined in Connecticut General Statutes ("C.G.S.") Section 16-50i(d) because the general physical characteristics of the facility will not be

significantly changed or altered. Rather, the planned changes to the facility fall squarely within those activities explicitly provided for in R.C.S.A. Section 16-50j-72(b)(2).

1. The overall height of the structure will be unaffected.
2. The proposed changes will not extend the site boundaries. There will be no effect on the site compound other than the new equipment cabinets.
3. The proposed changes will not increase the noise level at the existing facility by six decibels or more.
4. The changes in radio frequency power density will not increase the calculated "worst case" power density for the combined operations at the site to a level at or above the applicable standard for uncontrolled environments as calculated for a mixed frequency site.

For the foregoing reasons, SBA Communications on behalf of T-Mobile, respectfully submits that the proposed changes at the referenced site constitute exempt modifications under R.C.S.A. Section 16-50j-72(b)(2).

Please feel free to call me at 508.251.0720 x 3804 with any questions you may have concerning this matter.

Thank you,

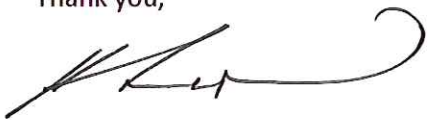

Kri Pelletier
SBA Communications Corporation
33 Boston Post Road West Suite 320
Marlborough, MA 01752
508-251-0720 x 3804 + T
508-251-1755 + F
203-446-7700 + C
kpelletier@sbsite.com



T-Mobile Equipment Modification

208 Reed Road, Tolland, CT 06084
Site number CT11413D_L700

Tower Owner: SBA 2012 TC Assets, LLC

Equipment Configuration: Monopole

Current and/or approved:

- (3) EMS RR90-17-00DP (at 140.5')
- (6) 1-5/8" feed lines

Planned Modifications:

- (3) EMS RR90-17-00DP (at 140.5')
- (3) Commscope LNX-6515DS (at 139.25')
- (3) Kathrein 782 11056 (at 139.25')
- (12) 1-5/8" feed lines

Structural Information:

The attached structural analysis demonstrates that the tower and foundation will have adequate structural capacity to accommodate the proposed modifications.

Power Density:

The anticipated Maximum Composite contributions from the T-Mobile facility are 5.07% of the allowable FCC established general public limit. The anticipated composite MPE value for this site assuming all carriers present is 40.99% of the allowable FCC established general public limit sampled at the ground level.

Site Composite MPE%	
Carrier	MPE%
T-Mobile	5.07
Nextel	2.60 %
Verizon Wireless	33.32 %
Site Total MPE %:	40.99 %

March 31, 2015

Mr. Steven R. Werbner
Town Manager
Town of Tolland
21 Tolland Green
Tolland, CT 06084

RE: Telecommunications Facility @ 208 Reed Road, Tolland, CT 06084

Dear Mr. Werbner,

In order to accommodate technological changes and enhance system performance in the State of Connecticut, T-Mobile will be changing its equipment configuration at certain cell sites.

As required by Regulations of Connecticut State Agencies (R.C.S.A.) Section 16-50j-73, the Connecticut Siting Council has been notified of the changes and will review T-Mobile's proposal. Please accept this letter as notification under Section 16-50j-73 of construction which constitutes an exempt modification pursuant to R.C.S.A. Section 16-50j-72(b)(2).

The accompanying letter to the Siting Council fully describes T-Mobile's proposal for the referenced cell site. However, if you have any questions or require any further information on our plans or the Siting Council's procedures, please call me at 508.251.0720 x 3804.

Thank you,



Kri Pelletier
SBA Communications Company
33 Boston Post Road West Suite 320
Marlborough, MA 01752
508-251-0720 x 3804 + T
508-251-1755 + F
203-446-7700 + C
kpelletier@sbsite.com



March 31, 2015

Reed Road Realty, LLC
70 Slater Road
Tolland, CT 06084

RE: Telecommunications Facility @ 208 Reed Road, Tolland, CT 06084

To Whom It May Concern:

In order to accommodate technological changes and enhance system performance in the State of Connecticut, T-Mobile will be changing its equipment configuration at certain cell sites.

As required by Regulations of Connecticut State Agencies (R.C.S.A.) Section 16-50j-73, the Connecticut Siting Council has been notified of the changes and will review T-Mobile's proposal. Please accept this letter as notification under Section 16-50j-73 of construction which constitutes an exempt modification pursuant to R.C.S.A. Section 16-50j-72(b)(2).

The accompanying letter to the Siting Council fully describes T-Mobile's proposal for the referenced cell site. However, if you have any questions or require any further information on our plans or the Siting Council's procedures, please call me at 508.251.0720 x 3804.

Thank you,

A handwritten signature in black ink, appearing to read "Kri Pelletier", is written over a horizontal line.

Kri Pelletier
SBA Communications Company
33 Boston Post Road West Suite 320
Marlborough, MA 01752
508-251-0720 x 3804 + T
508-251-1755 + F
203-446-7700 + C
kpelletier@sbsite.com



FDH Engineering, Inc., 6521 Meriden Drive Raleigh, NC 27616, Ph. 919.755.1012

**Structural Analysis for
SBA Network Services, Inc.**

150' Monopole Tower

**SBA Site Name: Tolland Reed Rd
SBA Site ID: CT46129-A-01
T-Mobile Site ID: CT11413D**

FDH Project Number 15BHDQ1400

Analysis Results

Tower Components	75.0%	Sufficient
Foundation	71.7%	Sufficient

Prepared By:

Tyler Ferguson
Project Engineer I

Reviewed By:

Dennis D. Abel, PE
Director of Structural Engineering
CT PE License No. 23247

FDH Engineering, Inc.
6521 Meriden Drive
Raleigh, NC 27616
(919) 755-1012
info@fdh-inc.com

March 23, 2015



03-23-2015

Prepared pursuant to TIA/EIA-222-F Structural Standards for Steel Antenna Towers and Antenna Supporting Structures and the 2005 Connecticut Building Code (CBC)

TABLE OF CONTENTS

EXECUTIVE SUMMARY3

 Conclusions.....3

 Recommendation.....3

APPURTENANCE LISTING4

RESULTS.....5

GENERAL COMMENTS6

LIMITATIONS.....6

APPENDIX7

EXECUTIVE SUMMARY

At the request of SBA Network Services, Inc., FDH Engineering, Inc. performed a structural analysis of the monopole located in Tolland, CT to determine whether the tower is structurally adequate to support both the existing and proposed loads pursuant to the *Structural Standards for Steel Antenna Towers and Antenna Supporting Structures, TIA/EIA-222-F* and the *2005 Connecticut Building Code (CBC)*. Information pertaining to the existing/proposed antenna loading, current tower geometry, geotechnical data, and member sizes was obtained from:

- Engineered Endeavors Inc. (Job No. 3238) Structure & Foundation Design Calculations dated November 26, 1997
- Applied Earth Technologies (Site No. CT0718) Subsurface Investigation dated December 10, 1997
- Vertical Structures, Inc. (Project No. 100157.04, Rev0) Rigorous Structural Analysis dated September 22, 2010
- SBA Network Services, Inc.

The *basic design wind speed* per the *TIA/EIA-222-F* standards and the *2005 Connecticut Building Code* is 85 mph without ice and 38 mph with 1" radial ice. Ice is considered to increase in thickness with height.

Conclusions

With the existing and proposed antennas from T-Mobile in place at 138 ft, the tower meets the requirements of the *TIA/EIA-222-F* standards and *2005 CBC* provided the **Recommendation** listed below is satisfied. Furthermore, provided the foundation was designed and constructed to support the original design reactions (see Engineered Endeavors Inc. Job No. 3238), the foundation should have the necessary capacity to support both the proposed and existing loading. For a more detailed description of the analysis of the tower, see the **Results** section of this report.

Our structural analysis has been performed assuming all information provided to FDH Engineering, Inc. is accurate (i.e., the steel data, tower layout, existing antenna loading, and proposed antenna loading) and that the tower has been properly erected and maintained per the original design drawings.

Recommendation

To ensure the requirements of the *TIA/EIA-222-F* standards and *2005 CBC* are met with the existing and proposed loading in place, we have the following recommendation:

1. The proposed coax should be installed inside the pole's shaft.

APPURTENANCE LISTING

The proposed and existing antennas with their corresponding cables/coax lines are shown in **Table 1**. *If the actual layout determined in the field deviates from the layout, FDH Engineering, Inc. should be contacted to perform a revised analysis.*

Table 1 - Appurtenance Loading

Existing Loading:

Antenna Elevation (ft)	Description	Feedlines	Carrier	Mount Elevation (ft)	Mount Type
149.08	(9) Decibel DB844H90E-XY (3) Kathrein AP11-880/090/XP	(15) 1-1/4"	Sprint	149.08	(1) Low Profile Platform
140.5	(3) EMS RR90-17-00DP	(6) 1-5/8"	T-Mobile	140.5	(3) Side Arms
127	(3) Antel BXA-70063-6CF-EDIN (4) Antel LPA-80080-6CF (2) Antel 80063/6 (6) RFS FD9R6004/2C-3L Diplexers (6) Kathrein 742213_2110 (3) Alcatel Lucent RRH 2x40 AWS (1) RFS DB-T1-6Z-8AB-0Z	(1) 1-5/8" Fiber (12) 1-5/8"	Verizon	127	(1) Low Profile Platform

1. Coax installed inside pole's shaft unless otherwise noted.

Proposed Loading:

Antenna Elevation (ft)	Description	Feedlines	Carrier	Mount Elevation (ft)	Mount Type
140.5	(3) EMS RR90-17-00DP	(12) 1-5/8"	T-Mobile	140.5	(3) Side Arms
139.25	(3) Commscope LNX-6515DS (3) Kathrein 782 11056			139.25	(3) Side Arms

RESULTS

The following yield strength of steel for individual members was used for analysis:

Table 2 - Material Strength

Member Type	Yield Strength
Tower Shaft Sections	65 ksi
Base Plate	60 ksi
Anchor Bolts	75 ksi

Table 3 displays the summary of the ratio (as a percentage) of force in the member to their capacities. Values greater than 100% indicate locations where the maximum force in the member exceeds its capacity. *Note: Capacities up to 100% are considered acceptable.* **Table 4** displays the maximum foundation reactions.

If the assumptions outlined in this report differ from actual field conditions, FDH Engineering, Inc. should be contacted to perform a revised analysis. Furthermore, as no information pertaining to the allowable twist and sway requirements for the existing or proposed appurtenances was provided, deflection and rotation were not taken into consideration when performing this analysis.

See the **Appendix** for detailed modeling information

Table 3 - Summary of Working Percentage of Structural Components

Section No.	Elevation ft	Component Type	Size	% Capacity*	Pass Fail
L1	150 - 120.96	Pole	TP31.99x24.74x0.3125	18.6	Pass
L2	120.96 - 81.21	Pole	TP39.99x30.2416x0.375	49.3	Pass
L3	81.21 - 39.67	Pole	TP48.26x38.0283x0.4375	60.2	Pass
L4	39.67 - 0	Pole	TP56x45.9531x0.5	63.9	Pass
	0	Anchor Bolts	(24) 2.25" Ø on a 65" BC	51.2	Pass
	0	Base Plate	71" Ø PL x 2.25" Thick	75.0	Pass

*Capacities include 1/3 allowable stress increase for wind per TIA-222-F standards.

Table 4 - Maximum Base Reactions

Base Reactions	Current Analysis* (TIA/EIA-222-F)	Original Design (TIA/EIA-222-F)
Axial	42 k	39 k
Shear	33 k	39 k
Moment	3,304 k-ft	4,611 k-ft

* Per our experience with foundations of similar type, the axial loading should not control the foundation analysis.

GENERAL COMMENTS

This engineering analysis is based upon the theoretical capacity of the structure. It is not a condition assessment of the tower and its foundation. It is the responsibility of SBA Network Services, Inc. to verify that the tower modeled and analyzed is the correct structure (with accurate antenna loading information) modeled. If there are substantial modifications to be made or the assumptions made in this analysis are not accurate, FDH Engineering, Inc. should be notified immediately to perform a revised analysis.

LIMITATIONS

All opinions and conclusions are considered accurate to a reasonable degree of engineering certainty based upon the evidence available at the time of this report. All opinions and conclusions are subject to revision based upon receipt of new or additional/updated information. All services are provided exercising a level of care and diligence equivalent to the standard and care of our profession. No other warranty or guarantee, expressed or implied, is offered. Our services are confidential in nature and we will not release this report to any other party without the client's consent. The use of this engineering work is limited to the express purpose for which it was commissioned and it may not be reused, copied, or distributed for any other purpose without the written consent of FDH Engineering, Inc.

APPENDIX

DESIGNED APPURTENANCE LOADING

TYPE	ELEVATION	TYPE	ELEVATION
Lightning Rod	150	(2) FD9R6004/2C-3L Diplexer	127
(3) DB844H90E-XY w/ Mount Pipe	149.08	Low Profile Platform	127
(3) DB844H90E-XY w/ Mount Pipe	149.08	(2) 742213_2110 w/ Mount Pipe	127
(3) DB844H90E-XY w/ Mount Pipe	149.08	(2) 742213_2110 w/ Mount Pipe	127
AP11-880/090/XP w/Mount Pipe	149.08	(2) 742213_2110 w/ Mount Pipe	127
AP11-880/090/XP w/Mount Pipe	149.08	DB-T1-6Z-8AB-0Z	127
AP11-880/090/XP w/Mount Pipe	149.08	BXA-70063-6CF-EDIN w/ Mount Pipe	127
Low Profile Platform	149.08	BXA-70063-6CF-EDIN w/ Mount Pipe	127
(3) Side Arms	140.5	BXA-70063-6CF-EDIN w/ Mount Pipe	127
RR90-17-00DP w/Mount Pipe	140.5	LPA-80080-6CF w/ Mount Pipe	127
RR90-17-00DP w/Mount Pipe	140.5	(2) LPA-80080-6CF w/ Mount Pipe	127
RR90-17-00DP w/Mount Pipe	140.5	LPA-80080-6CF w/ Mount Pipe	127
LNX-6515DS w/ Mount Pipe	139.25	80063/6 w/ Mount Pipe	127
LNX-6515DS w/ Mount Pipe	139.25	80063/6 w/ Mount Pipe	127
LNX-6515DS w/ Mount Pipe	139.25	(2) FD9R6004/2C-3L Diplexer	127
782 11056	139.25	(2) FD9R6004/2C-3L Diplexer	127
782 11056	139.25	RRH 2x40 AWS	127
782 11056	139.25	RRH 2x40 AWS	127
(3) Side Arms	139.25	RRH 2x40 AWS	127

MATERIAL STRENGTH

GRADE	Fy	Fu	GRADE	Fy	Fu
A572-65	65 ksi	80 ksi			

TOWER DESIGN NOTES

1. Tower is located in Tolland County, Connecticut.
2. Tower designed for a 85 mph basic wind in accordance with the TIA/EIA-222-F Standard.
3. Tower is also designed for a 38 mph basic wind with 1.00 in ice. Ice is considered to increase in thickness with height.
4. Deflections are based upon a 60 mph wind.

Section	1	2	3	4
Length (ft)	28.04	44.25	47.04	46.25
Number of Sides	12	12	12	12
Thickness (in)	0.3125	0.3750	0.4375	0.5000
Socket Length (ft)	4.50	5.50	6.58	45.9531
Top Dia (in)	24.7400	30.2416	38.0283	56.0000
Bot Dia (in)	31.9900	39.9900	48.2600	12.8
Grade			A572-65	
Weight (K)	2.8	6.3	9.6	12.8

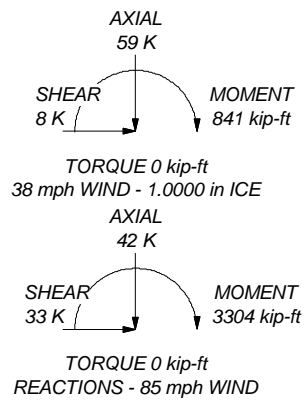
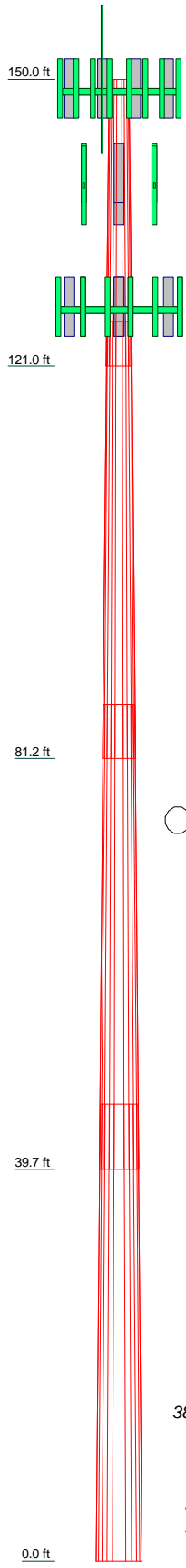

 FDH Engineering, Inc. 6521 Meridian Drive, Suite 107 Raleigh, North Carolina 27616 Phone: 9197551012 FAX: 9197551031	Job: Tolland-Reed Rd, CT46129-A-01 Project: 15BHDQ1400
	Client: SBA Network Services, Inc. Code: TIA/EIA-222-F Path:

RADIO FREQUENCY EMISSIONS ANALYSIS REPORT
EVALUATION OF HUMAN EXPOSURE POTENTIAL
TO NON-IONIZING EMISSIONS

T-Mobile Existing Facility

Site ID: CT11413D

Tolland/ Rt-84/X66_1
208 Reed Road
Tolland, CT 06084

March 26, 2015

EBI Project Number: 6215001895

Site Compliance Summary	
Compliance Status:	COMPLIANT
Site total MPE% of FCC general public allowable limit:	40.99 %

March 26, 2015

T-Mobile USA
Attn: Jason Overbey, RF Manager
35 Griffin Road South
Bloomfield, CT 06002

Emissions Analysis for Site: **CT11413D – Tolland/ Rt-84/X66_1**

EBI Consulting was directed to analyze the proposed T-Mobile facility located at **208 Reed Road, Tolland, CT**, for the purpose of determining whether the emissions from the Proposed T-Mobile Antenna Installation located on this property are within specified federal limits.

All information used in this report was analyzed as a percentage of current Maximum Permissible Exposure (% MPE) as listed in the FCC OET Bulletin 65 Edition 97-01 and ANSI/IEEE Std C95.1. The FCC regulates Maximum Permissible Exposure in units of microwatts per square centimeter ($\mu\text{W}/\text{cm}^2$). The number of $\mu\text{W}/\text{cm}^2$ calculated at each sample point is called the power density. The exposure limit for power density varies depending upon the frequencies being utilized. Wireless Carriers and Paging Services use different frequency bands each with different exposure limits, therefore it is necessary to report results and limits in terms of percent MPE rather than power density.

All results were compared to the FCC (Federal Communications Commission) radio frequency exposure rules, 47 CFR 1.1307(b)(1) – (b)(3), to determine compliance with the Maximum Permissible Exposure (MPE) limits for General Population/Uncontrolled environments as defined below.

General population/uncontrolled exposure limits apply to situations in which the general public may be exposed or in which persons who are exposed as a consequence of their employment may not be made fully aware of the potential for exposure or cannot exercise control over their exposure. Therefore, members of the general public would always be considered under this category when exposure is not employment related, for example, in the case of a telecommunications tower that exposes persons in a nearby residential area.

Public exposure to radio frequencies is regulated and enforced in units of microwatts per square centimeter ($\mu\text{W}/\text{cm}^2$). The general population exposure limit for the 700 MHz Band is $467 \mu\text{W}/\text{cm}^2$, and the general population exposure limit for the PCS band is $1000 \mu\text{W}/\text{cm}^2$. Because each carrier will be using different frequency bands, and each frequency band has different exposure limits, it is necessary to report percent of MPE rather than power density.

Occupational/controlled exposure limits apply to situations in which persons are exposed as a consequence of their employment and in which those persons who are exposed have been made fully aware of the potential for exposure and can exercise control over their exposure. Occupational/controlled exposure limits also apply where exposure is of a transient nature as a result of incidental passage through a location where exposure levels may be above general population/uncontrolled limits (see below), as long as the exposed person has been made fully aware of the potential for exposure and can exercise control over his or her exposure by leaving the area or by some other appropriate means.

Additional details can be found in FCC OET 65.

CALCULATIONS

Calculations were done for the proposed T-Mobile Wireless antenna facility located at **208 Reed Road, Tolland, CT**, using the equipment information listed below. All calculations were performed per the specifications under FCC OET 65. Since T-Mobile is proposing highly focused directional panel antennas, which project most of the emitted energy out toward the horizon, all calculations were performed assuming a lobe representing the maximum gain of the antenna per the antenna manufactures supplied specifications, minus 10 dB, was focused at the base of the tower. For this report the sample point is the top of a 6 foot person standing at the base of the tower.

For all calculations, all equipment was calculated using the following assumptions:

- 1) 2 GSM channels (PCS Band - 1900 MHz) were considered for each sector of the proposed installation. These Channels have a transmit power of 30 Watts per Channel
- 2) 2 UMTS channels (AWS Band – 2100 MHz) were considered for each sector of the proposed installation. These Channels have a transmit power of 30 Watts per Channel.
- 3) 2 LTE channels (AWS Band – 2100 MHz) were considered for each sector of the proposed installation. These Channels have a transmit power of 60 Watts per Channel.
- 4) 1 LTE channel (700 MHz Band) was considered for each sector of the proposed installation. This channel has a transmit power of 30 Watts.
- 5) All radios at the proposed installation were considered to be running at full power and were uncombined in their RF transmissions paths per carrier prescribed configuration. Per FCC OET Bulletin No. 65 - Edition 97-01 recommendations to achieve the maximum anticipated value at each sample point, all power levels emitting from the proposed antenna installation are increased by a factor of 2.56 to account for possible in-phase reflections from the surrounding environment. This is rarely the case, and if so, is never continuous.

- 6) For the following calculations the sample point was the top of a six foot person standing at the base of the tower. The maximum gain of the antenna per the antenna manufactures supplied specifications minus 10 dB was used in this direction. This value is a very conservative estimate as gain reductions for these particular antennas are typically much higher in this direction.
- 7) The antennas used in this modeling are the **EMS RR90_17_00DP** for 1900 MHz (PCS) channels and the **Commscope LNX-6515DS-VTM** for 700 MHz channels. This is based on feedback from the carrier with regards to anticipated antenna selection. The **EMS RR90_17_00DP** has a maximum gain of **14.4 dBd** at its main lobe. The **Commscope LNX-6515DS-VTM** has a maximum gain of **14.6 dBd** at its main lobe. The maximum gain of the antenna per the antenna manufactures supplied specifications, minus 10 dB, was used for all calculations. This value is a very conservative estimate as gain reductions for these particular antennas are typically much higher in this direction.
- 8) The antenna mounting height centerlines of the proposed antennas are **140.5 feet and 139.25 feet** above ground level (AGL).
- 9) Emissions values for additional carriers were taken from the Connecticut Siting Council active database. Values in this database are provided by the individual carriers themselves.

All calculations were done with respect to uncontrolled / general public threshold limits.

T-Mobile Site Inventory and Power Data

Sector:	A	Sector:	B	Sector:	C
Antenna #:	1	Antenna #:	1	Antenna #:	1
Make / Model:	EMS RR90_17_00DP	Make / Model:	EMS RR90_17_00DP	Make / Model:	EMS RR90_17_00DP
Gain:	14.4 dBd	Gain:	14.4 dBd	Gain:	14.4 dBd
Height (AGL):	140.5	Height (AGL):	140.5	Height (AGL):	140.5
Frequency Bands	1900 MHz(PCS)	Frequency Bands	1900 MHz(PCS)	Frequency Bands	1900 MHz(PCS)
Channel Count	6	Channel Count	6	# PCS Channels:	6
Total TX Power:	240	Total TX Power:	240	# AWS Channels:	240
ERP (W):	6,610.15	ERP (W):	6,610.15	ERP (W):	6,610.15
Antenna A1 MPE%	1.31	Antenna B1 MPE%	1.31	Antenna C1 MPE%	1.31
Antenna #:	2	Antenna #:	2	Antenna #:	2
Make / Model:	Commscope LNX- 6515DS-VTM	Make / Model:	Commscope LNX- 6515DS-VTM	Make / Model:	Commscope LNX- 6515DS-VTM
Gain:	14.6 dBd	Gain:	14.6 dBd	Gain:	14.6 dBd
Height (AGL):	139.25	Height (AGL):	139.25	Height (AGL):	139.25
Frequency Bands	700 MHz	Frequency Bands	700 MHz	Frequency Bands	700 MHz
Channel Count	1	Channel Count	1	Channel Count	1
Total TX Power:	30	Total TX Power:	30	Total TX Power:	30
ERP (W):	865.21	ERP (W):	865.21	ERP (W):	865.21
Antenna A2 MPE%	0.38	Antenna B2 MPE%	0.38	Antenna C2 MPE%	0.38

Site Composite MPE%	
Carrier	MPE%
T-Mobile	5.07
Nextel	2.60 %
Verizon Wireless	33.32 %
Site Total MPE %:	40.99 %

T-Mobile Sector 1 Total:	1.69 %
T-Mobile Sector 2 Total:	1.69 %
T-Mobile Sector 3 Total:	1.69 %
Site Total:	40.99 %

Summary

All calculations performed for this analysis yielded results that were **within** the allowable limits for general public exposure to RF Emissions.

The anticipated maximum composite contributions from the T-Mobile facility as well as the site composite emissions value with regards to compliance with FCC's allowable limits for general public exposure to RF Emissions are shown here:

T-Mobile Sector	Power Density Value (%)
Sector 1:	1.69 %
Sector 2:	1.69 %
Sector 3 :	1.69 %
T-Mobile Total:	5.07 %
Site Total:	40.99 %
Site Compliance Status:	COMPLIANT

The anticipated composite MPE value for this site assuming all carriers present is **40.99%** of the allowable FCC established general public limit sampled at the ground level. This is based upon values listed in the Connecticut Siting Council database for existing carrier emissions.

FCC guidelines state that if a site is found to be out of compliance (over allowable thresholds), that carriers over a 5% contribution to the composite value will require measures to bring the site into compliance. For this facility, the composite values calculated were well within the allowable 100% threshold standard per the federal government.



Scott Heffernan
RF Engineering Director

EBI Consulting
21 B Street
Burlington, MA 01803

**T-MOBILE
NORTHEAST LLC**

35 GRIFFIN ROAD SOUTH
BLOOMFIELD, CT 06002
OFFICE: (860) 448-1116



SBA COMMUNICATIONS CORP.
33 BOSTON POST ROAD WEST, SUITE 320 TEL: (508) 251-0720
MARLBOROUGH, MA 01752 FAX: (508) 251-1755



1600 OSGOOD STREET
BUILDING 20 NORTH, SUITE 3090 TEL: (978) 557-5553
N. ANDOVER, MA 01845 FAX: (978) 336-5586

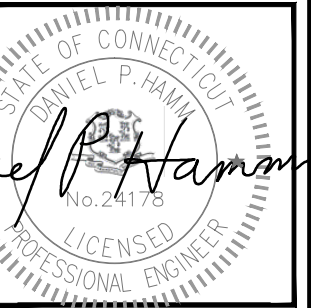

Daniel P. Hamm

CHECKED BY: KB

APPROVED BY: DPH

SUBMITTALS

REV.	DATE	DESCRIPTION	BY
0	02/25/15	ISSUED FOR CONSTRUCTION	JA

SITE NUMBER:
CT11413D
SITE NAME:
TOLLAND/
RT-84/X66_1
SITE ADDRESS:
208 REED ROAD
TOLLAND, CT 06084
TOLLAND COUNTY

SHEET TITLE
**COMPOUND &
ELEVATION PLAN**

SHEET NUMBER
A-1

STRUCTURAL NOTES:
1. ADDITIONAL TOWER MAPPING AND STRUCTURAL ANALYSIS ARE REQUIRED PRIOR TO CONSTRUCTION. DRAWINGS ARE SUBJECT TO CHANGE PENDING OUTCOME OF STRUCTURAL ANALYSIS.
2. MOUNT ALL ANTENNAS, COAX, ETC. IN ACCORDANCE WITH STRUCTURAL ANALYSIS.

ANTENNA MOUNT STRUCTURAL ASSESSMENT REQUIREMENT:
ENGINEER OF RECORD HAS MADE A VISUAL ASSESSMENT ONLY AND DETERMINED THAT THE EXISTING ANTENNA MOUNT SHALL BE REPLACED OR MODIFIED TO ACCOMMODATE ANY ADDITIONAL EQUIPMENT LOADS. STRUCTURAL DESIGNS AND DETAILS AS SHOWN HEREIN FOR STRUCTURAL MODIFICATIONS OF THE EXISTING ANTENNA MOUNT ARE PRELIMINARY ONLY AND FINAL CONSTRUCTION DETAILS ARE SUBJECT TO CHANGE PENDING THE COMPLETION OF AN ANTENNA MOUNT STRUCTURAL ASSESSMENT.

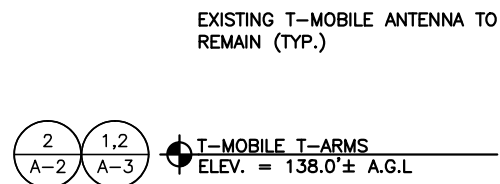
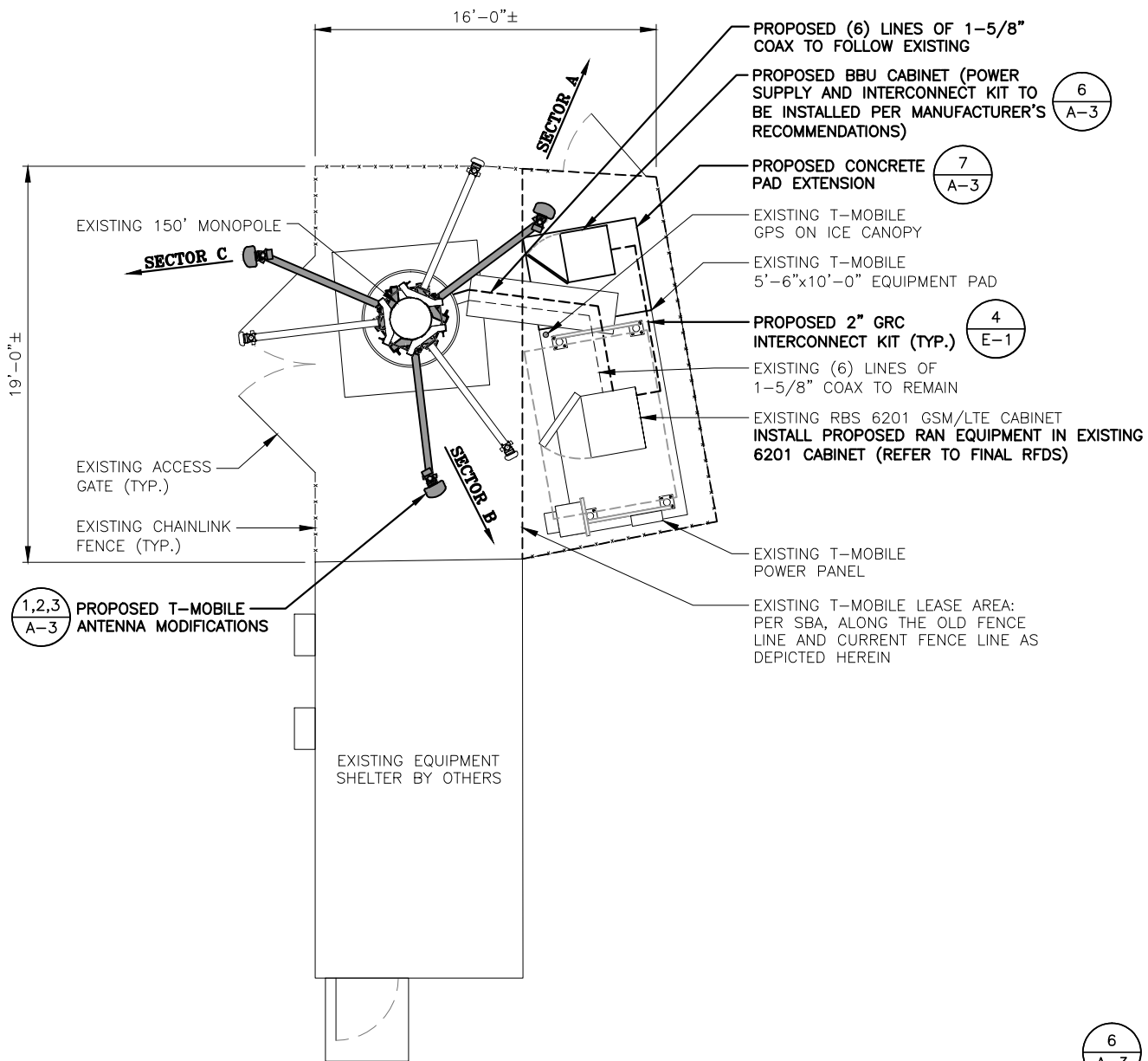

SOURCE: HDG 01-29-2015
PARTIAL ELEVATION PHOTO DETAIL
SCALE: N.T.S.

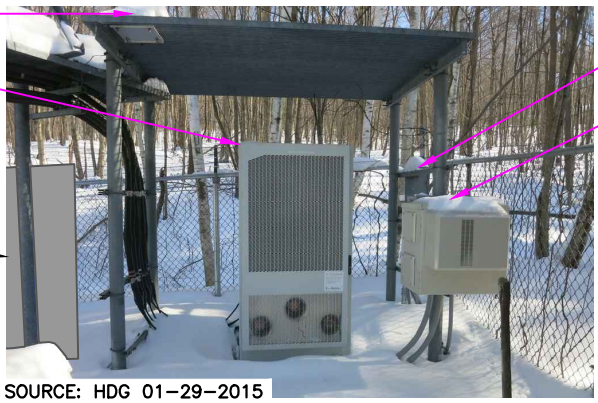
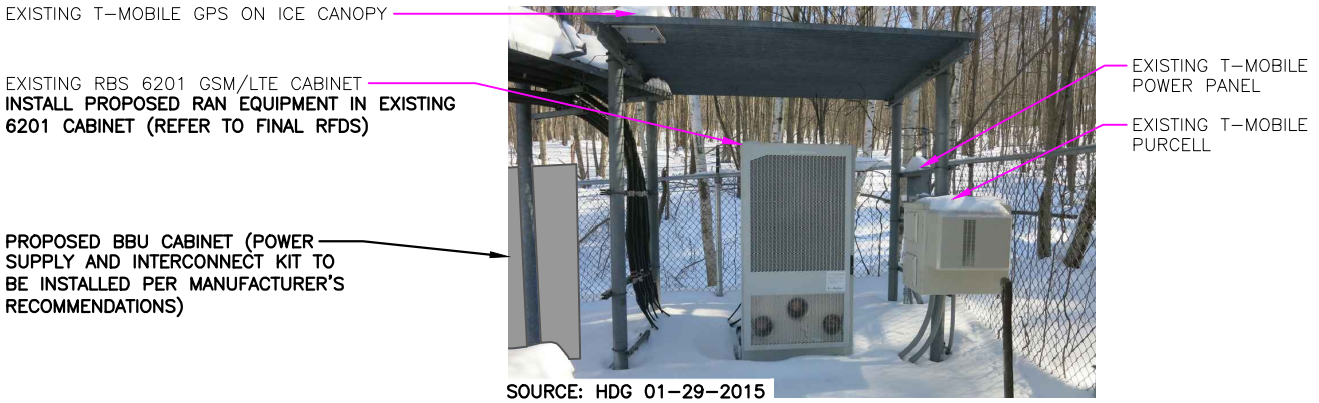

SOURCE: HDG 01-29-2015
EQUIPMENT PHOTO DETAIL
SCALE: N.T.S.

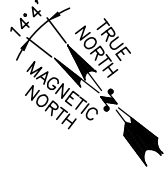

COMPOUND PLAN
22x34 SCALE: 1/4"=1'-0"
11x17 SCALE: 1/8"=1'-0"

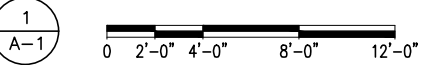

**T-MOBILE
NORTHEAST LLC**

35 GRIFFIN ROAD SOUTH
BLOOMFIELD, CT 06002
OFFICE: (860) 448-1116



SBA COMMUNICATIONS CORP.
33 BOSTON POST ROAD WEST, SUITE 320 TEL: (508) 251-0720
MARLBOROUGH, MA 01752 FAX: (508) 251-1755



1600 OSGOOD STREET
BUILDING 20 NORTH, SUITE 3090 TEL: (978) 557-5553
N. ANDOVER, MA 01845 FAX: (978) 336-5586



Daniel P. Hamm

CHECKED BY: KB

APPROVED BY: DPH

SUBMITTALS

REV.	DATE	DESCRIPTION	BY
0	02/25/15	ISSUED FOR CONSTRUCTION	JA

SITE NUMBER:
CT11413D
SITE NAME:
TOLLAND/
RT-84/X66_1
SITE ADDRESS:
208 REED ROAD
TOLLAND, CT 06084
TOLLAND COUNTY

SHEET TITLE
**EXISTING &
PROPOSED ANTENNA
PLANS**

SHEET NUMBER
A-2

STRUCTURAL NOTES:
1. ADDITIONAL TOWER MAPPING AND STRUCTURAL ANALYSIS ARE REQUIRED PRIOR TO CONSTRUCTION. DRAWINGS ARE SUBJECT TO CHANGE PENDING OUTCOME OF STRUCTURAL ANALYSIS.
2. MOUNT ALL ANTENNAS, COAX, ETC. IN ACCORDANCE WITH STRUCTURAL ANALYSIS.

ANTENNA MOUNT STRUCTURAL ASSESSMENT REQUIREMENT:
ENGINEER OF RECORD HAS MADE A VISUAL ASSESSMENT ONLY AND DETERMINED THAT THE EXISTING ANTENNA MOUNT SHALL BE REPLACED OR MODIFIED TO ACCOMMODATE ANY ADDITIONAL EQUIPMENT LOADS. STRUCTURAL DESIGNS AND DETAILS AS SHOWN HEREIN FOR STRUCTURAL MODIFICATIONS OF THE EXISTING ANTENNA MOUNT ARE PRELIMINARY ONLY AND FINAL CONSTRUCTION DETAILS ARE SUBJECT TO CHANGE PENDING THE COMPLETION OF AN ANTENNA MOUNT STRUCTURAL ASSESSMENT.

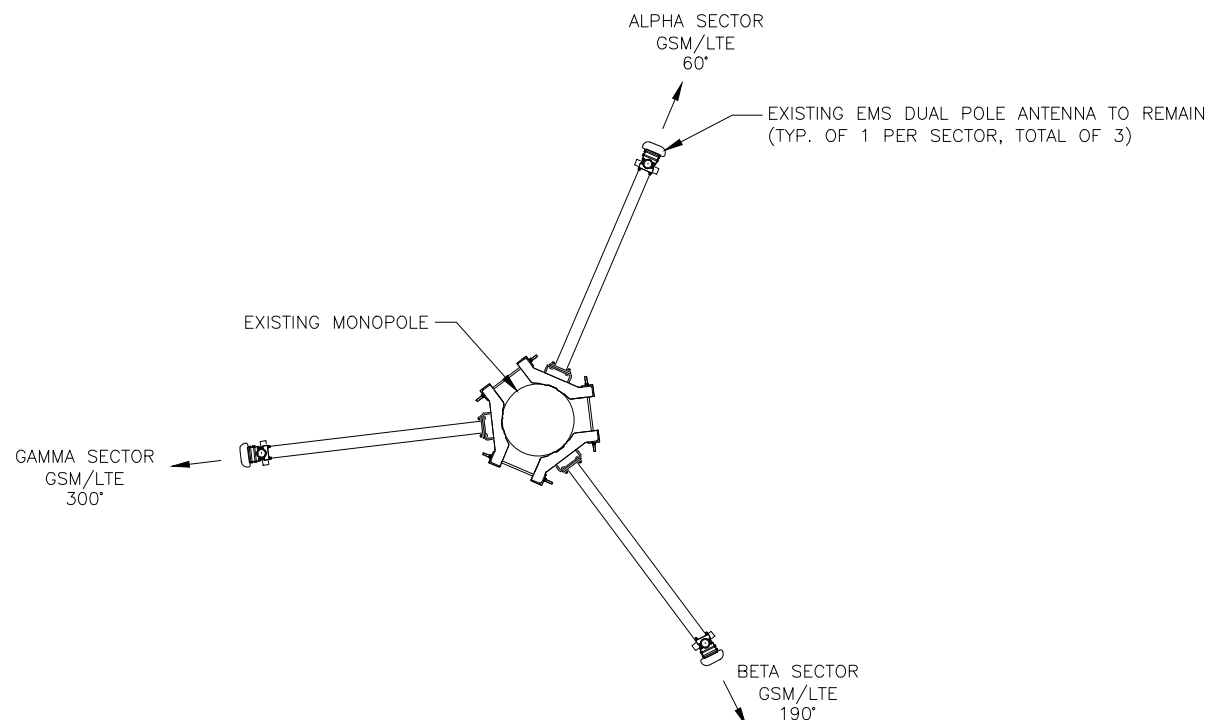

EXISTING ANTENNA PLAN
SCALE: N.T.S.

1
A-2

EXISTING EMS DUAL POLE ANTENNA TO REMAIN
(TYP. OF 1 PER SECTOR, TOTAL OF 3)

PROPOSED T-MOBILE ANTENNA ON PROPOSED PIPE
(TYP. OF 1 PER SECTOR, TOTAL OF 3)

1
A-3

PROPOSED T-MOBILE SMART BIAS TEE
(TYP. OF 1 PER SECTOR, TOTAL OF 3)

4
A-3

PROPOSED L700 RAD
ELEV. = 138.0'± A.G.L.

PROPOSED 4"x1/4" TS (6'-0" LONG)
(TYP. OF 1 PER SECTOR, TOTAL OF 3)

PROPOSED UNIVERSAL RING MOUNT
(SITE PRO1 PART # LWRM)

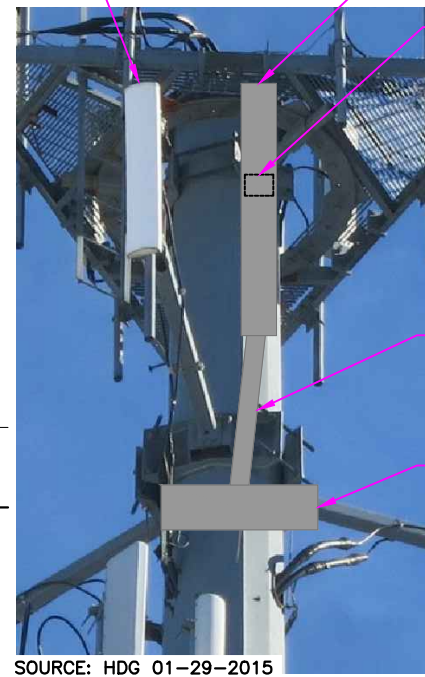

SOURCE: HDG 01-29-2015

PROPOSED ANTENNA PHOTO DETAIL
SCALE: N.T.S.

3
A-2

EXISTING STANDOFFS
ELEV. = 138.0'± A.G.L.

PROPOSED STANDOFFS
ELEV. = 137.0'± A.G.L.

1
A-3

2
A-3

5
A-3

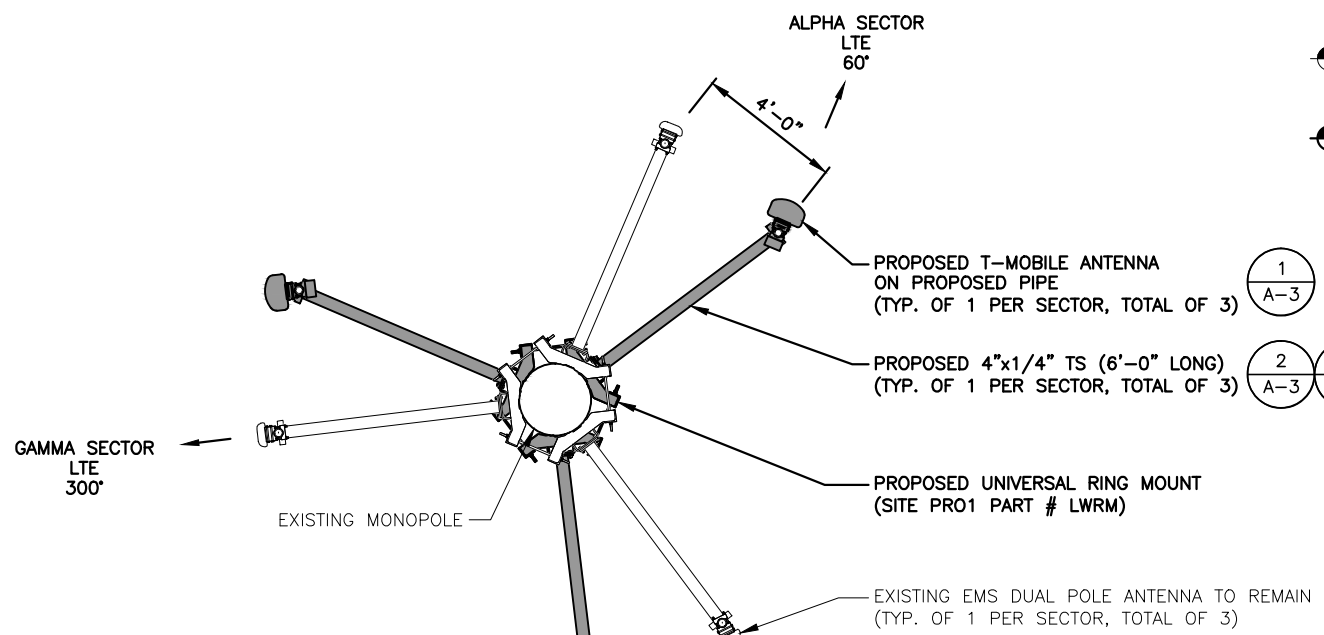

PROPOSED ANTENNA PLAN
SCALE: N.T.S.

2
A-2

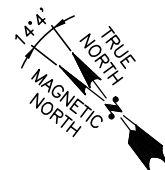
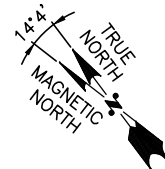

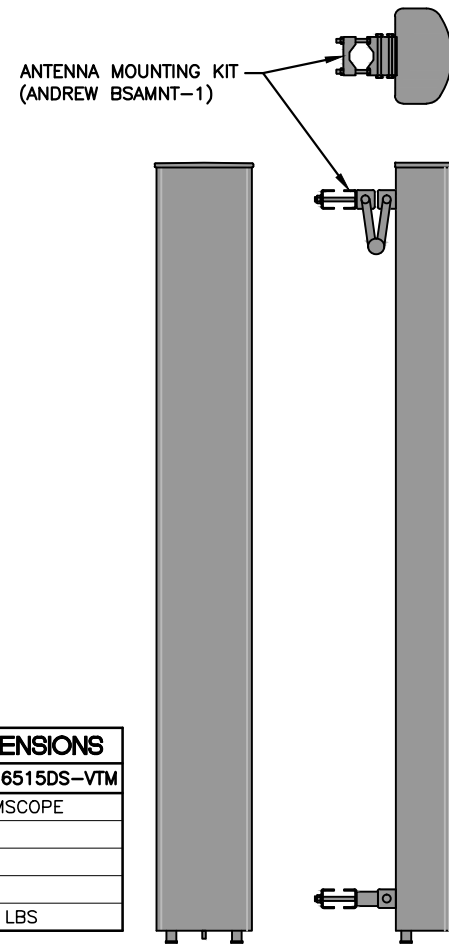

ANTENNA DIMENSIONS	
MODEL #	LNX-6515DS-VTM
MANUF.	COMMSCOPE
WIDTH	11.9"
DEPTH	7.1"
HEIGHT	96"
WEIGHT	43.7 LBS

LNX ANTENNA DETAIL 1
SCALE: N.T.S. A-3

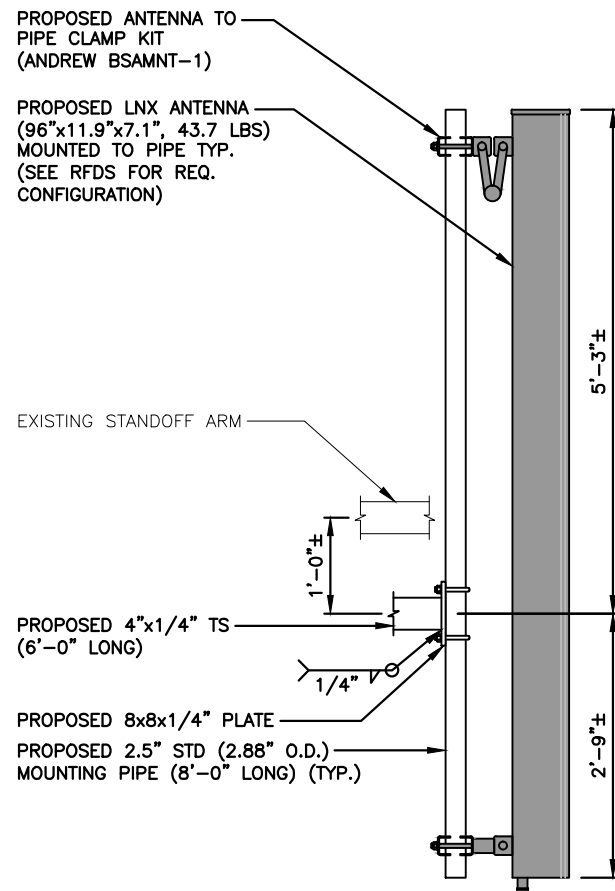

PROPOSED ANTENNA MOUNTING DETAIL 2
SCALE: N.T.S. A-3

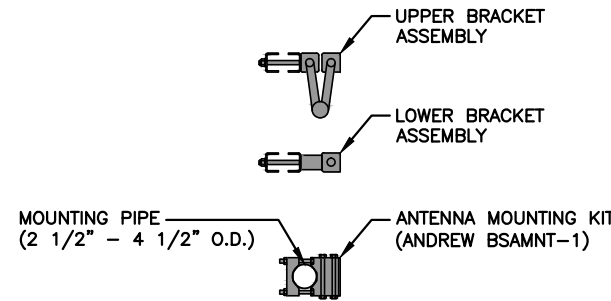

ANTENNA MOUNTING BRACKET 3
SCALE: N.T.S. A-3

SBIAST DIMENSIONS	
MODEL #	75211054
MANUF.	KATHREIN
LENGTH	5.5"
WIDTH	3.2"
DEPTH	1.8"

SMART BIAS TEE (SBT) 4
SCALE: N.T.S. A-3

ANTENNA MOUNT STRUCTURAL ASSESSMENT REQUIREMENT:
ENGINEER OF RECORD HAS MADE A VISUAL ASSESSMENT ONLY AND DETERMINED THAT THE EXISTING ANTENNA MOUNT SHALL BE REPLACED OR MODIFIED TO ACCOMMODATE ANY ADDITIONAL EQUIPMENT LOADS. STRUCTURAL DESIGNS AND DETAILS AS SHOWN HEREIN FOR STRUCTURAL MODIFICATIONS OF THE EXISTING ANTENNA MOUNT ARE PRELIMINARY ONLY AND FINAL CONSTRUCTION DETAILS ARE SUBJECT TO CHANGE PENDING THE COMPLETION OF AN ANTENNA MOUNT STRUCTURAL ASSESSMENT.

STRUCTURAL NOTES:
1. ADDITIONAL TOWER MAPPING AND STRUCTURAL ANALYSIS ARE REQUIRED PRIOR TO CONSTRUCTION. DRAWINGS ARE SUBJECT TO CHANGE PENDING OUTCOME OF STRUCTURAL ANALYSIS.
2. MOUNT ALL ANTENNAS, COAX, ETC. IN ACCORDANCE WITH STRUCTURAL ANALYSIS.

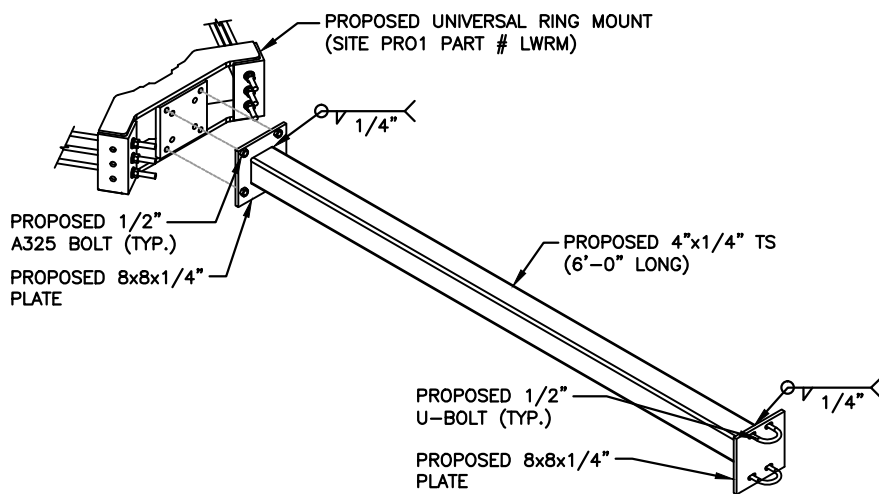

STANDOFF ARM DETAIL 5
SCALE: N.T.S. A-3

BBU DIMENSIONS	
MODEL #	DVBMM-2ALM
MANUF.	MSF DATA SERVICES
WIDTH	28.45"
DEPTH	28.45"
HEIGHT	29.67"
WEIGHT	1,264 LBS
MOUNT BASE WITH (4) 1/2" DROP IN ANCHOR'S WITH 2" MINIMUM EMBEDMENT (INSTALL PER MANUFACTURER'S INSTALLATION GUIDELINES)	

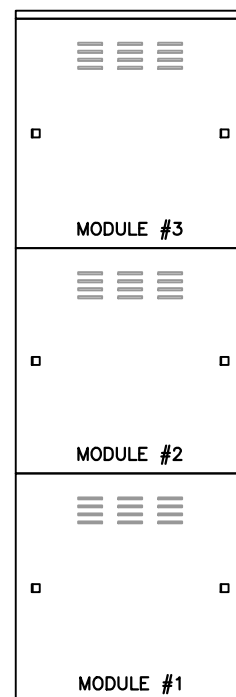

BATTERY CABINET (BBU) 6
SCALE: N.T.S. A-3

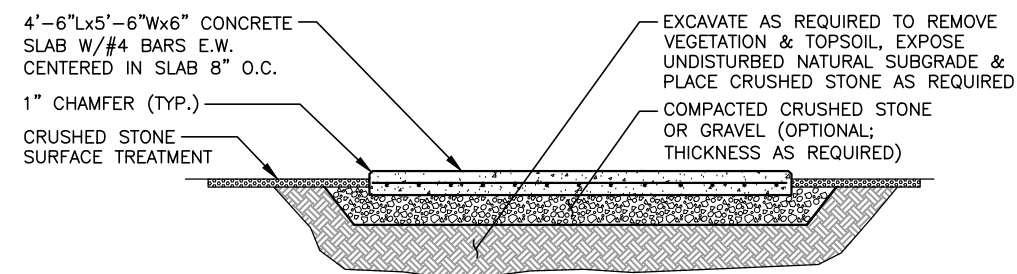

NEW CONC. PAD NOTES:
- REINF. W/ #4's @ 8" O.C. EA. WAY (MID-DEPTH).
- DOWEL NEW CONC. TO EXIST. W/ #4's @ 8" O.C. x 4" LONG. DRILL & EPOXY GROUT 4" INTO EXIST. CONC.
- REINF. SHALL BE ASTM A615-GRADE 60. SECURE IN PLACE.
- REINFORCEMENT IN EQUIPMENT SLAB TO BE WELDED AND BONDED TO GROUND RING

CONCRETE PAD DETAIL 7
SCALE: N.T.S. A-3

T-MOBILE NORTHEAST LLC
35 GRIFFIN ROAD SOUTH
BLOOMFIELD, CT 06002
OFFICE: (860) 448-1116

SBA

SBA COMMUNICATIONS CORP.
33 BOSTON POST ROAD WEST, SUITE 320 TEL: (508) 251-0720
MARLBOROUGH, MA 01752 FAX: (508) 251-1755

Hudson Design Group

1600 OSGOOD STREET
BUILDING 20 NORTH, SUITE 3090 TEL: (978) 557-5553
N. ANDOVER, MA 01845 FAX: (978) 336-5586

STATE OF CONNECTICUT
DANIEL P. HAMM
No. 24178
LICENSED PROFESSIONAL ENGINEER

Daniel P. Hamm

CHECKED BY: KB

APPROVED BY: DPH

SUBMITTALS			
REV.	DATE	DESCRIPTION	BY
0	02/25/15	ISSUED FOR CONSTRUCTION	JA

SITE NUMBER:
CT11413D
SITE NAME:
TOLLAND/
RT-84/X66_1
SITE ADDRESS:
208 REED ROAD
TOLLAND, CT 06084
TOLLAND COUNTY

SHEET TITLE
EQUIPMENT DETAILS

SHEET NUMBER
A-3