



NSS **NORTHEAST**
SITE SOLUTIONS
Turnkey Wireless Development

Northeast Site Solutions
Denise Sabo
4 Angela's Way, Burlington CT 06013
203-435-3640
denise@northeastsitesolutions.com

January 19, 2023

Members of the Siting Council
Connecticut Siting Council
Ten Franklin Square
New Britain, CT 06051

RE: Tower Share Application
419 Ekonk Hill Road, Sterling, CT 06377
Latitude: 41.662286
Longitude: -71.847125
Site #: CT20001-A_BOBOS00062A_SBA_DISH

Dear Ms. Bachman:

This letter and attachments are submitted on behalf of Dish Wireless LLC. Dish Wireless LLC plans to install antennas and related equipment to the tower site located at 419 (aka 421) Ekonk Hill Road, Sterling, Connecticut.

Dish Wireless LLC proposes to install three (3) 600/1900 MHz 5G antennas and six (6) RRUs, at the 150-foot level of the existing 200-foot guyed lattice tower, one (1) Fiber cable will also be installed. Dish Wireless LLC equipment cabinets will be placed within a 7' x 5' lease area. Included are plans by B+T, dated January 5, 2023, Exhibit C. Also included is a structural analysis prepared by TES, dated January 3, 2023, confirming that the existing tower is structurally capable of supporting the proposed equipment. Attached as Exhibit D. The facility was approved by the Town of Sterling, on or before January 1, 1998, but a copy of the decision was not available.

Please accept this letter as notification pursuant to Regulations of Connecticut State Agencies 16-50aa, of Dish Wireless LLC intent to share a telecommunications facility pursuant to R.C.S.A. 16-50j-88. In accordance with R.C.S.A., a copy of this letter is being sent to Lincoln A. Cooper, First Selectman and Melissa Gil, Zoning Enforcement Officer for the Town of Sterling, as well as the tower owner (SBA) and property owner (SBA Structures Inc.).

The planned modifications of the facility fall squarely within those activities explicitly provided for in R.C.S.A. 16-50j-89.

1. The proposed modification will not result in an increase in the height of the existing structure. The top of the existing tower is 200-feet and the Dish Wireless LLC antennas will be located at a center line height of 150-feet.
2. The proposed modifications will not result in an increase of the site boundary as depicted on the attached site plan.
3. The proposed modifications will not increase noise levels at the facility by six decibels or more, or to levels that exceed local and state criteria. The incremental effect of the proposed changes will be negligible.



NSS **NORTHEAST**
SITE SOLUTIONS

Turnkey Wireless Development

4. The operation of the proposed antennas will not increase radio frequency emissions at the facility to a level at or above the Federal Communications Commission safety standard. The combined site operations will result in a total power density of 3.99% as evidenced by Exhibit F.

Connecticut General Statutes 16-50aa indicates that the Council must approve the shared use of a telecommunications facility provided it finds the shared use is technically, legally, environmentally, and economically feasible and meets public safety concerns. As demonstrated in this letter, Dish Wireless LLC respectfully submits that the shared use of this facility satisfies these criteria.

A. Technical Feasibility. The existing tower has been deemed structurally capable of supporting Dish Wireless LLC proposed loading. The structural analysis is included as Exhibit D.

B. Legal Feasibility. As referenced above, C.G.S. 16-50aa has been authorized to issue orders approving the shared use of an existing tower such as this tower in Sterling. Under the authority granted to the Council, an order of the Council approving the requested shared use would permit Dish Wireless LLC to obtain a building permit for the proposed installation. Further, a Letter of Authorization is included as Exhibit G, authorizing Dish Wireless LLC to file this application for shared use.

C. Environmental Feasibility. The proposed shared use of this facility would have a minimal environmental impact. The installation of Dish Wireless LLC equipment at the 150-foot level of the existing 200-foot tower would have an insignificant visual impact on the area around the tower. Dish Wireless LLC ground equipment would be installed within the existing facility compound. Dish Wireless LLC shared use would therefore not cause any significant alteration in the physical or environmental characteristics of the existing site. Additionally, as evidenced by Exhibit F, the proposed antennas would not increase radio frequency emissions to a level at or above the Federal Communications Commission safety standard.

D. Economic Feasibility. Dish Wireless LLC will be entering into an agreement with the owner of this facility to mutually agreeable terms. As previously mentioned, the Letter of Authorization has been provided by the owner to assist Dish Wireless LLC with this tower sharing application.

E. Public Safety Concerns. As discussed above, the tower is structurally capable of supporting Dish Wireless LLC proposed loading. Dish Wireless LLC is not aware of any public safety concerns relative to the proposed sharing of the existing tower. Dish Wireless LLC intentions of providing new and improved wireless service through the shared use of this facility is expected to enhance the safety and welfare of local residents and individuals traveling through Sterling.

Sincerely,

Denise Sabo

Denise Sabo
Mobile: 203-435-3640
Fax: 413-521-0558
Office: 4 Angela's Way, Burlington CT 06013
Email: denise@northeastitesolutions.com



NSS **NORTHEAST**
SITE SOLUTIONS
Turnkey Wireless Development

Attachments

Cc: Lincoln A. Cooper, First Selectman
Town of Sterling
1183 Plainfield Pike
P.O. Box 157
Oneco, CT 06373-0157

Melissa Gil, Zoning Enforcement Officer
Town of Sterling
1183 Plainfield Pike
P.O. Box 157
Oneco, CT 06373-0157

SBA Structures Inc. – Property & Tower Owner
8051 Congress Ave
Boca Raton, FL 33487

Exhibit A

Original Facility Approval

The facility was approved by the Town of Sterling, on or before January 1, 1998, but a copy of the decision was not available.

Exhibit B

Property Card

Situs : 421 EKONK HILL RD

Map ID: 10017200

Class: Land w/ OBYS

Card: 1 of 1

Printed: March 9, 2016

CURRENT OWNER
SBA STRUCTURES INC
ATTN TAX DEPT - CT20001-A
8051 CONGRESS AVE
BOCA RATON FL 33487 1307

GENERAL INFORMATION
Living Units 0
Neighborhood 200
Alternate Id 03633-034-009A
Vol / Pg 73/1100
District
Zoning
Class 500

Property Notes
TOWER IS DECLARED AS PP
POWERSCOURT DRIVE
"SBA SITE ID# 20001-A; FCC# 1060082;
LEASING: 800-487-SITE EMERGENCY: 800-

Land Information

Type	Size	Influence Factors	Influence %	Value
Primary	AC 1.4000			35,200

Total Acres: 1.4
Spot: Location:

Assessment Information

	Assessed	Appraised	Cost	Income	
Land	24,640	35,200	35,200	0	35,200
Building	0	0	0	0	0
Total	24,640	35,200	35,200	0	35,200

Manual Override Reason
Base Date of Value 10-01-2012
Effective Date of Value 10-01-2016

Value Flag COST APPROACH
Gross Building:

Entrance Information

Date	ID	Entry Code	Source
02/28/07	AS	Exterior	Other

Permit Information

Date Issued	Number	Price	Purpose	% Complet
01/30/13	13-09	750	CFX Disconnect Existing Bts (Base Tra	

Sales/Ownership History

Transfer Date	Price	Type	Validity	Deed Reference	Deed Type	Grantee

Situs : 421 EKONK HILL RD

Parcel Id: 10017200

Class: Land w/ OBYs

Card: 1 of 1

Printed: March 9, 2016

Dwelling Information

Style	Year Built
Story height	Eff Year Built
Attic	Year Remodeled
Exterior Walls	Amenities
Masonry Trim x	
Color	In-law Apt No

Basement

Basement	# Car Bsmt Gar
FBLA Size x	FBLA Type
Rec Rm Size x	Rec Rm Type

Heating & Cooling

Fireplaces

Heat Type	Stacks
Fuel Type	Openings
System Type	Pre-Fab

Room Detail

Bedrooms	Full Baths
Family Rooms	Half Baths
Kitchens	Extra Fixtures
Total Rooms	
Kitchen Type	Bath Type
Kitchen Remod	Bath Remod

Adjustments

Int vs Ext	Unfinished Area
Cathedral Ceiling x	Unheated Area

Grade & Depreciation

Grade C	Market Adj
Condition	Functional
CDU AVERAGE	Economic
Cost & Design 0	% Good Ovr
% Complete	

Dwelling Computations

Base Price	% Good
Plumbing	% Good Override
Basement	Functional
Heating	Economic
Attic	% Complete
Other Features 0	C&D Factor
	Adj Factor
Subtotal	Additions

Ground Floor Area	Dwelling Value
Total Living Area	

Building Notes

Outbuilding Data

Type	Size 1	Size 2	Area	Qty	Yr Blt	Grade	Condition	Value
Frame Shed	x			1	1998	C	A	
Frame Shed	x			1	1998	C	A	

Condominium / Mobile Home Information

Complex Name	
Condo Model	
Unit Number	
Unit Level	Unit Location
Unit Parking	Unit View
Model (MH)	Model Make (MH)

Addition Details

Line #	Low	1st	2nd	3rd	Value

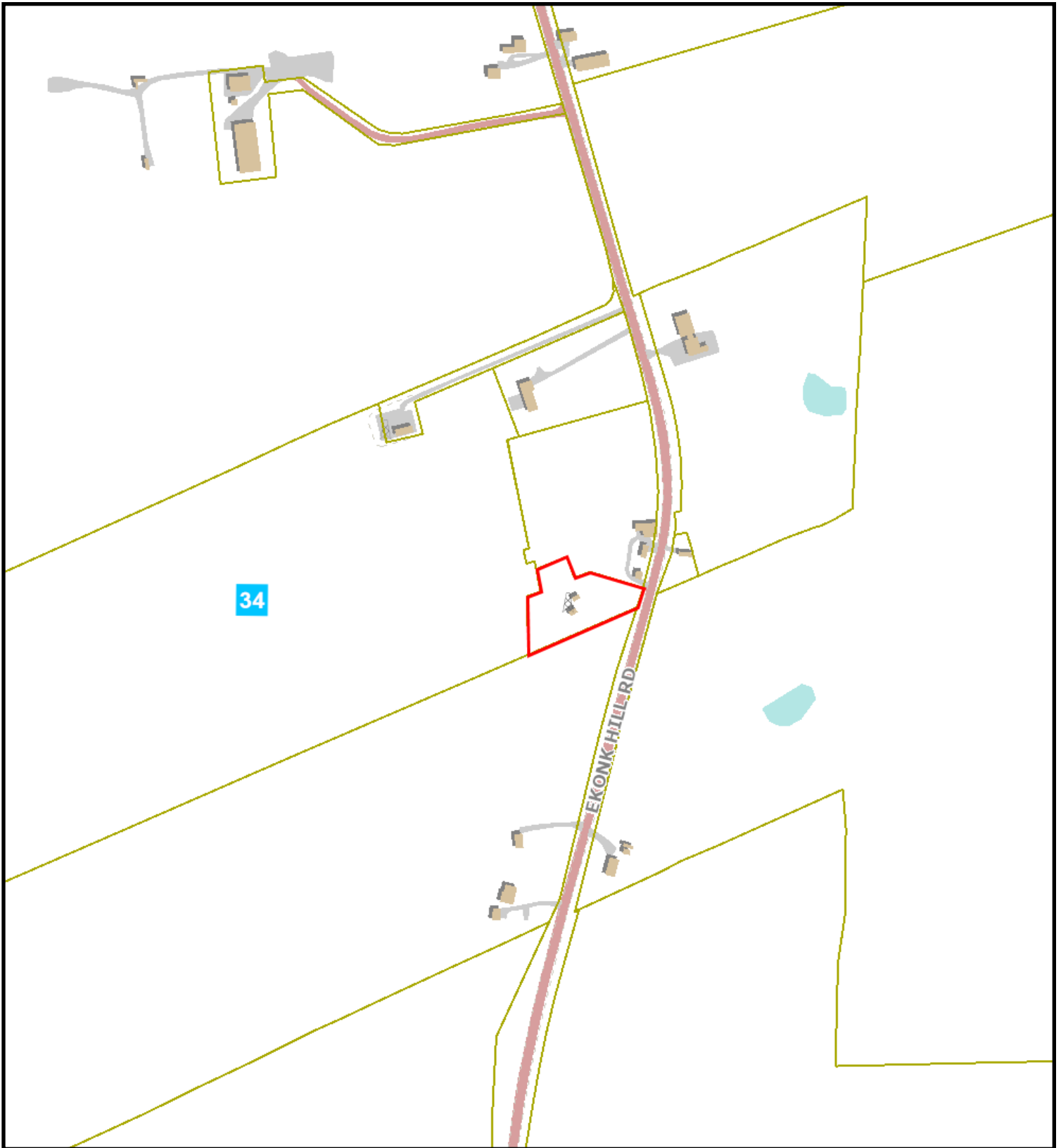

421 EKONK HILL ROAD

6/29/2022 12:57:34 PM

Scale: 1"=400'

Scale is approximate

The information depicted on this map is for planning purposes only.
It is not adequate for legal boundary definition, regulatory
interpretation, or parcel-level analyses.



Exhibit C

Construction Drawings



DISH Wireless L.L.C. SITE ID:

BOBOS00062A

DISH Wireless L.L.C. SITE ADDRESS:

**419 EKONK HILL ROAD (RT-49)
STERLING, CT 06377**



By sroth at 6:42:16 PM, 1/5/2023

SCOPE OF WORK

THIS IS NOT AN ALL INCLUSIVE LIST. CONTRACTOR SHALL UTILIZE SPECIFIED EQUIPMENT PART OR ENGINEER APPROVED EQUIVALENT. CONTRACTOR SHALL VERIFY ALL NEEDED EQUIPMENT TO PROVIDE A FUNCTIONAL SITE. THE PROJECT GENERALLY CONSISTS OF THE FOLLOWING:

- TOWER SCOPE OF WORK:**
- INSTALL (3) PROPOSED PANEL ANTENNAS (1 PER SECTOR)
 - INSTALL (3) PROPOSED ANTENNA SECTOR FRAMES
 - INSTALL PROPOSED JUMPERS
 - INSTALL (6) PROPOSED RRUs (2 PER SECTOR)
 - INSTALL (1) PROPOSED OVER VOLTAGE PROTECTION DEVICE (OVP)
 - INSTALL (1) PROPOSED HYBRID CABLE

- GROUND SCOPE OF WORK:**
- INSTALL (1) PROPOSED METAL PLATFORM
 - INSTALL (1) PROPOSED ICE BRIDGE
 - INSTALL (1) PROPOSED PPC CABINET
 - INSTALL (1) PROPOSED EQUIPMENT CABINET
 - INSTALL (1) PROPOSED POWER CONDUIT
 - INSTALL (1) PROPOSED TELCO CONDUIT
 - INSTALL (1) PROPOSED TELCO-FIBER BOX
 - INSTALL (1) PROPOSED GPS UNIT
 - INSTALL (1) PROPOSED FIBER NID (IF REQUIRED)
 - INSTALL (1) PROPOSED SIX-GANG METER BANK
 - INSTALL (1) PROPOSED TRANSFORMER

SITE INFORMATION

PROPERTY OWNER: SBA STRUCTURES INC
ADDRESS: ATTN TAX DEPT - CT20001-A
BOCA RATON FL 33487

TOWER TYPE: GUYED TOWER

TOWER CO SITE ID: CT20001-A

TOWER APP NUMBER: 167078

COUNTY: WINDHAM

LATITUDE (NAD 83): 41° 39' 44.2656" N
41.662296 N

LONGITUDE (NAD 83): 71° 50' 49.578" W
71.847105 W

ZONING JURISDICTION: WINDHAM COUNTY

ZONING DISTRICT: AG

PARCEL NUMBER: 03633-034-009A

OCCUPANCY GROUP: U

CONSTRUCTION TYPE: II-B

POWER COMPANY: EVERSOURCE (CT)

TELEPHONE COMPANY: XFINITY

PROJECT DIRECTORY

APPLICANT: DISH Wireless L.L.C.
5701 SOUTH SANTA FE DRIVE
LITTLETON, CO 80120

TOWER OWNER: SBA COMMUNICATAIONS CORP.
8051 CONGRESS AVENUE
BOCA RATON, FL 33487
(800) 487-7483

SITE DESIGNER: B+T GROUP
1717 S. BOULDER AVE, SUITE 300
TULSA, OK 74119
(918) 587-4630

SITE ACQUISITION: RYAN LYNCH
RYAN.LYNCH@DISH.COM

CONST. MANAGER: AARON CHANDLER
AARON.CHANDLER@DISH.COM

RF ENGINEER: DIPESH PARIKH
DIPESH.PARIKH@DISH.COM



5701 SOUTH SANTA FE DRIVE
LITTLETON, CO 80120



8051 CONGRESS AVENUE
BOCA RATON, FL 33487



1717 S. BOULDER
SUITE 300
TULSA, OK 74119
PH: (918) 587-4630
www.btgrp.com

1/5/23



MTS ENGINEERING P.L.L.C.
BER:2386985
Expires 3/31/23

IT IS A VIOLATION OF LAW FOR ANY PERSON, UNLESS THEY ARE ACTING UNDER THE DIRECTION OF A LICENSED PROFESSIONAL ENGINEER, TO ALTER THIS DOCUMENT.

DRAWN BY: CHECKED BY: APPROVED BY:

BLJ BEH BEH

RFDS REV #: 0

CONSTRUCTION DOCUMENTS

SUBMITTALS		
REV	DATE	DESCRIPTION
A	9/10/21	ISSUED FOR REVIEW
B	01/05/22	ISSUED FOR REVIEW
0	3/8/22	ISSUED FOR CONSTRUCTION
1	5/13/22	ISSUED FOR CONSTRUCTION
2	6/27/22	ISSUED FOR CONSTRUCTION
3	8/23/22	ISSUED FOR CONSTRUCTION
4	01/05/23	ISSUED FOR CONSTRUCTION

A&E PROJECT NUMBER
149477.001.01

DISH Wireless L.L.C.
PROJECT INFORMATION
BOBOS00062A
419 EKONK HILL ROAD (RT-49)
STERLING CT 06377

SHEET TITLE
TITLE SHEET

SHEET NUMBER
T-1

CONNECTICUT CODE OF COMPLIANCE

ALL WORK SHALL BE PERFORMED AND MATERIALS INSTALLED IN ACCORDANCE WITH THE CURRENT EDITIONS OF THE FOLLOWING CODES AS ADOPTED BY THE LOCAL GOVERNING AUTHORITIES. NOTHING IN THESE PLANS IS TO BE CONSTRUED TO PERMIT WORK NOT CONFORMING TO THESE CODES

CODE TYPE	CODE
BUILDING	2021 IBC
MECHANICAL	2021 IMC
ELECTRICAL	2020 NEC

SITE PHOTO



DIRECTIONS

DIRECTIONS FROM SOUTHBRIDGE MUNICIPAL AIRPORT:

TAKE CLEMENCE HILL RD TO CENTRAL ST HEAD SOUTH ON CLEMENCE HILL RD TOWARD AIRPORT ACCESS RD CONTINUE ONTO PAIGE HILL RD SLIGHT LEFT ONTO TWINE HURST PL TAKE MA-131, CT-131 E/QUINEBAUG RD, CT-12 S/RIVERSIDE DR AND I-395 S TO CT-49 S IN STERLING TURN RIGHT ONTO CENTRAL ST CONTINUE STRAIGHT ONTO FOSTER ST TURN LEFT ONTO NORTH ST TURN RIGHT ONTO CRYSTAL ST AT THE ROUNDABOUT, TAKE THE 2ND EXIT ONTO MA-131/E MAIN ST CONTINUE TO FOLLOW MA-131 ENTERING CONNECTICUT CONTINUE ONTO CT-131 E/QUINEBAUG RD CONTINUE STRAIGHT ONTO CT-12 S/RIVERSIDE DR MERGE WITH I-395 S TAKE EXIT 29 FOR CT-14A TOWARD PLAIN FIELD/ONECO TURN LEFT ONTO CT-14A E TURN RIGHT ONTO NEW RD NEW RD TURNS SLIGHTLY RIGHT AND BECOMES CT-49 S DESTINATION WILL BE ON THE RIGHT ARRIVE AT BOBOS00062A

VICINITY MAP

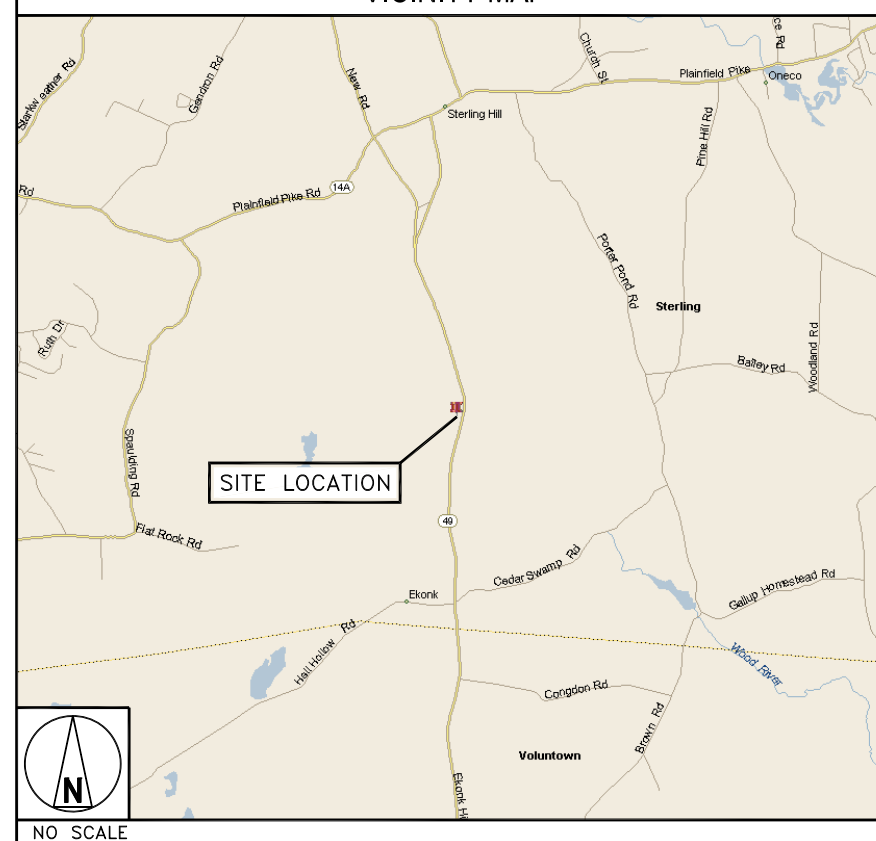

UNDERGROUND SERVICE ALERT CBYD 811
UTILITY NOTIFICATION CENTER OF CONNECTICUT
(800) 922-4455
WWW.CBYD.COM



CALL 2 WORKING DAYS UTILITY NOTIFICATION PRIOR TO CONSTRUCTION

GENERAL NOTES

THE FACILITY IS UNMANNED AND NOT FOR HUMAN HABITATION. A TECHNICIAN WILL VISIT THE SITE AS REQUIRED FOR ROUTINE MAINTENANCE. THE PROJECT WILL NOT RESULT IN ANY SIGNIFICANT DISTURBANCE OR EFFECT ON DRAINAGE. NO SANITARY SEWER SERVICE, POTABLE WATER, OR TRASH DISPOSAL IS REQUIRED AND NO COMMERCIAL SIGNAGE IS PROPOSED.

11"x17" PLOT WILL BE HALF SCALE UNLESS OTHERWISE NOTED

CONTRACTOR SHALL VERIFY ALL PLANS, EXISTING DIMENSIONS, AND CONDITIONS ON THE JOB SITE, AND SHALL IMMEDIATELY NOTIFY THE ENGINEER IN WRITING OF ANY DISCREPANCIES BEFORE PROCEEDING WITH THE WORK.

SHEET INDEX

SHEET NO.	SHEET TITLE
T-1	TITLE SHEET
LS1	SITE SURVEY
A-1	OVERALL AND ENLARGED SITE PLAN
A-2	ELEVATION, ANTENNA LAYOUT AND SCHEDULE
A-3	EQUIPMENT PLATFORM AND H-FRAME DETAILS
A-4	EQUIPMENT DETAILS
A-5	EQUIPMENT DETAILS
A-6	EQUIPMENT DETAILS
E-1	ELECTRICAL/FIBER ROUTE PLAN AND NOTES
E-2	ELECTRICAL DETAILS
E-3	ELECTRICAL ONE-LINE, FAULT CALCS & PANEL SCHEDULE
G-1	GROUNDING PLANS AND NOTES
G-2	GROUNDING DETAILS
G-3	GROUNDING DETAILS
RF-1	RF CABLE COLOR CODE
GN-1	LEGEND AND ABBREVIATIONS
GN-2	GENERAL NOTES
GN-3	GENERAL NOTES
GN-4	GENERAL NOTES

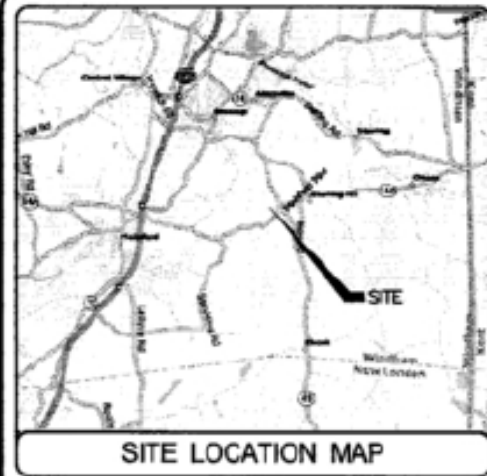

SITE LOCATION MAP

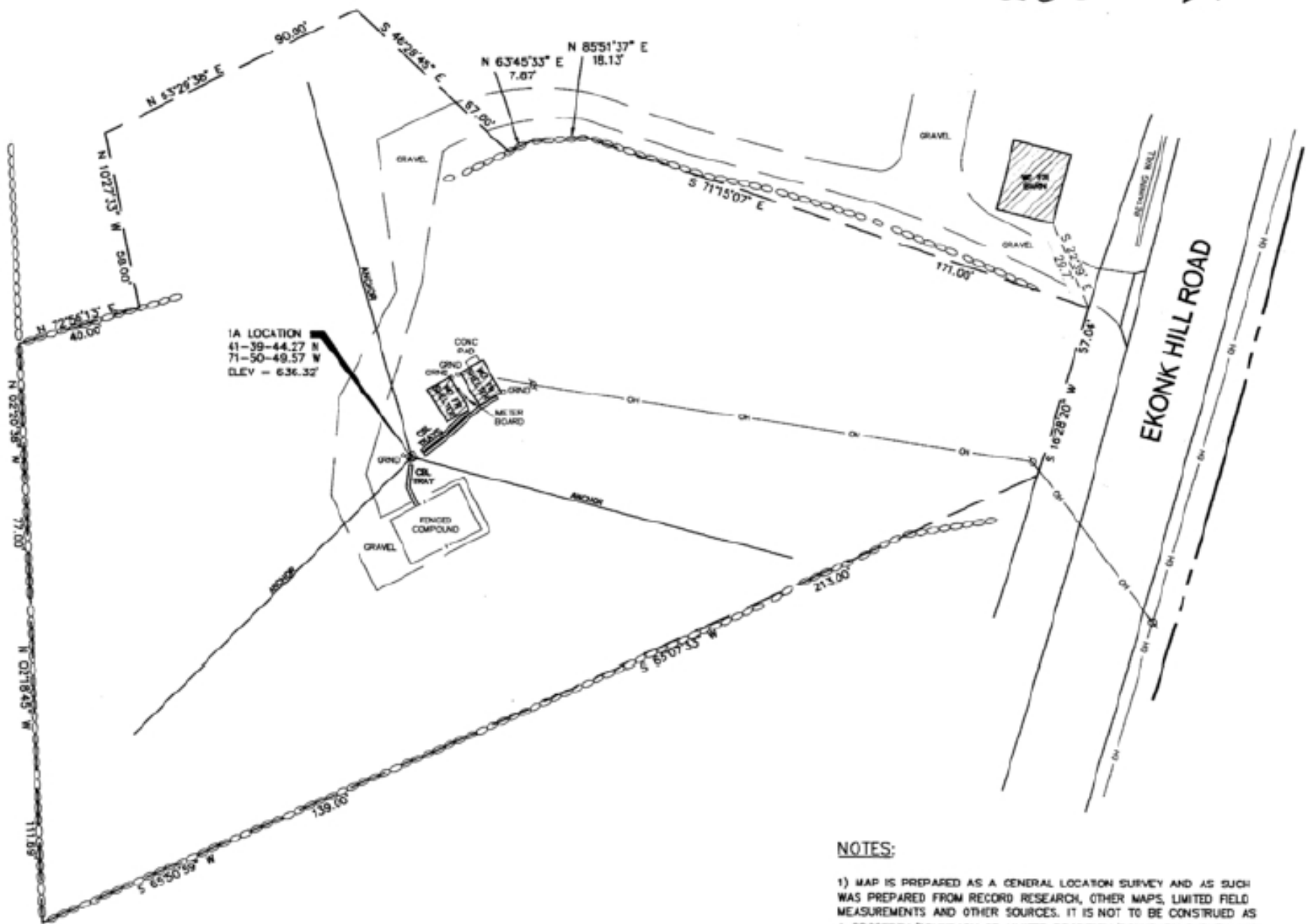

CT 20001-A

1A LOCATION
41-39-44.27 N
71-50-49.57 W
ELEV = 636.32'

SUGGESTED DESCRIPTION
LEASE PARCEL
SITUATE ON THE WESTERLY SIDE OF EKONK HILL ROAD
STERLING CONNECTICUT

COMMENCING AT THE SOUTHEASTERLY CORNER OF AN EXISTING 1 STORY WOOD FRAME BARN, THENCE: SOUTH 22°39' EAST, A DISTANCE OF 29.7 FEET TO THE WESTERLY SIDE OF EKONK HILL ROAD AND THE POINT OF BEGINNING, THENCE FROM SAID POINT OF BEGINNING: SOUTH 18°28'20" WEST, A DISTANCE OF 57.04' TO A POINT, THENCE: SOUTH 60°07'33" WEST, GENERALLY ALONG A STONE WALL IN PART, A DISTANCE OF 213.00 FEET, THENCE SOUTH 65°50'59" WEST, GENERALLY ALONG A STONE WALL, 139.00 FEET TO A POINT, THENCE NORTH 02°18'45" WEST, GENERALLY ALONG A STONE WALL, 111.60' TO A POINT, THENCE NORTH 02°29'38" WEST, GENERALLY ALONG A STONE WALL, A DISTANCE OF 77.00 FEET TO A POINT, THENCE NORTH 72°56'13" EAST, GENERALLY ALONG A STONE WALL IN PART, A DISTANCE OF 40.00 FEET TO A POINT, THENCE NORTH 10°27'33" WEST, A DISTANCE OF 58.00 FEET TO A POINT, THENCE: NORTH 63°29'38" EAST, A DISTANCE OF 90.00 FEET TO A POINT, THENCE: SOUTH 48°28'45" EAST, A DISTANCE OF 67.00 FEET TO A POINT ALONG AN EXISTING STONEWALL, THENCE: NORTH 63°45'33" EAST, GENERALLY ALONG A STONEWALL, A DISTANCE OF 7.87 FEET TO A POINT, THENCE: NORTH 85°51'37" EAST, GENERALLY ALONG A STONEWALL, A DISTANCE OF 18.13 FEET TO A POINT, THENCE: SOUTH 71°15'07" EAST, GENERALLY ALONG A STONEWALL IN PART, A DISTANCE OF 171.00 FEET TO THE POINT OR PLACE OF BEGINNING AND CONTAINING 1.32+/- ACRES OF LAND MORE OR LESS.

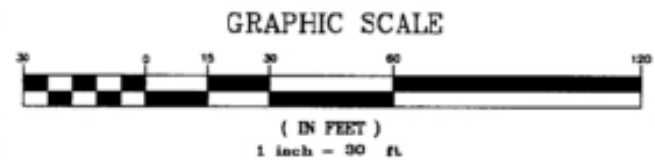

NOTES:

- 1) MAP IS PREPARED AS A GENERAL LOCATION SURVEY AND AS SUCH WAS PREPARED FROM RECORD RESEARCH, OTHER MAPS, LIMITED FIELD MEASUREMENTS AND OTHER SOURCES. IT IS NOT TO BE CONSTRUED AS A PROPERTY/BOUNDARY OR LIMITED PROPERTY/BOUNDARY SURVEY AND IS SUBJECT TO SUCH FACTS AS SAID SURVEYS MAY DISCLOSE.
- 2) SURVEY PREPARED BY INFINGY ENGINEERING & SURVEYING, PLLC, FROM AN ACTUAL FIELD SURVEY COMPLETED IN MAY 2008.
- 3) NORTH IS REFERENCED TO NAD 83 CONNECTICUT STATE PLANE. ELEVATION - TOPOGRAPHIC DATUM IS REFERENCED TO NAVD 1988.
- 4) SUBJECT TO ANY AND ALL RIGHTS, EASEMENTS, COVENANTS OR RESTRICTIONS; RECORDED OR UNRECORDED.
- 5) SUBJECT TO ANY STATEMENT OF FACT CONTAINED IN RECORD REVIEW PREPARED BY NATIONAL SEARCH & RETRIEVAL HAVING AN EFFECTIVE DATE OF OCTOBER 19, 2001.
- 6) SUBJECT TO ANY STATEMENT OF FACT CONTAINED IN AN UP-TO-DATE ABSTRACT OF TITLE WOULD DISCLOSE.
- 7) UNDERGROUND UTILITIES IF SHOWN HEREON ARE BASED ON VISIBLE PHYSICAL EVIDENCE. THEY SHOULD BE CONSIDERED SCHEMATIC ONLY AND ARE SHOWN TO DEPICT GENERAL UTILITY CONNECTIONS RATHER THAN EXACT UNDERGROUND LOCATIONS. INFINGY ENGINEERING & SURVEYING, PLLC MAKES NO CERTIFICATION AS TO THE ACCURACY OF THE UNDERGROUND UTILITY LOCATIONS AND OTHER UTILITIES MAY EXIST THAT ARE NOT SHOWN ON THIS MAP. CALL DCSAFE FOR FURTHER VERIFICATION.
- 8) SURVEY IS PREPARED IN ACCORDANCE WITH CURRENT STANDARDS OF PRACTICE FOR LAND SURVEYS.

infingy
engineering
& surveying
300 Great Oaks Blvd., Suite 312
Albany, NY 12203
(518) 690-0790

Charles E. Lort CTPLS 70226



5900 Broken Sound PKW NW
Boca Raton, Florida 33487

No.	Submital / Revision	App'd	Date

Project Title
Tower Location
421 Ekonk Hill Road
Sterling
Connecticut 06377

Drawing Title
General Location Survey

Project Number
218-003

Drawing Scale:
1" = 30'
Date:
05/20/08
Sheet No:
1



File: N:\INFINGY\ SURVEY\218-003\STERLING\218-003\STERLING.DWG Saved: 6/25/2008 3:48:33 PM Plotted: 6/25/2008 8:14:06 AM User: Gerry Gray

NOTES

- 1. CONTRACTOR SHALL FIELD VERIFY ALL PROPOSED UNDERGROUND UTILITY CONDUIT ROUTE.
- 2. ANTENNAS AND MOUNTS OMITTED FOR CLARITY.

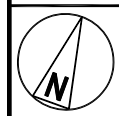
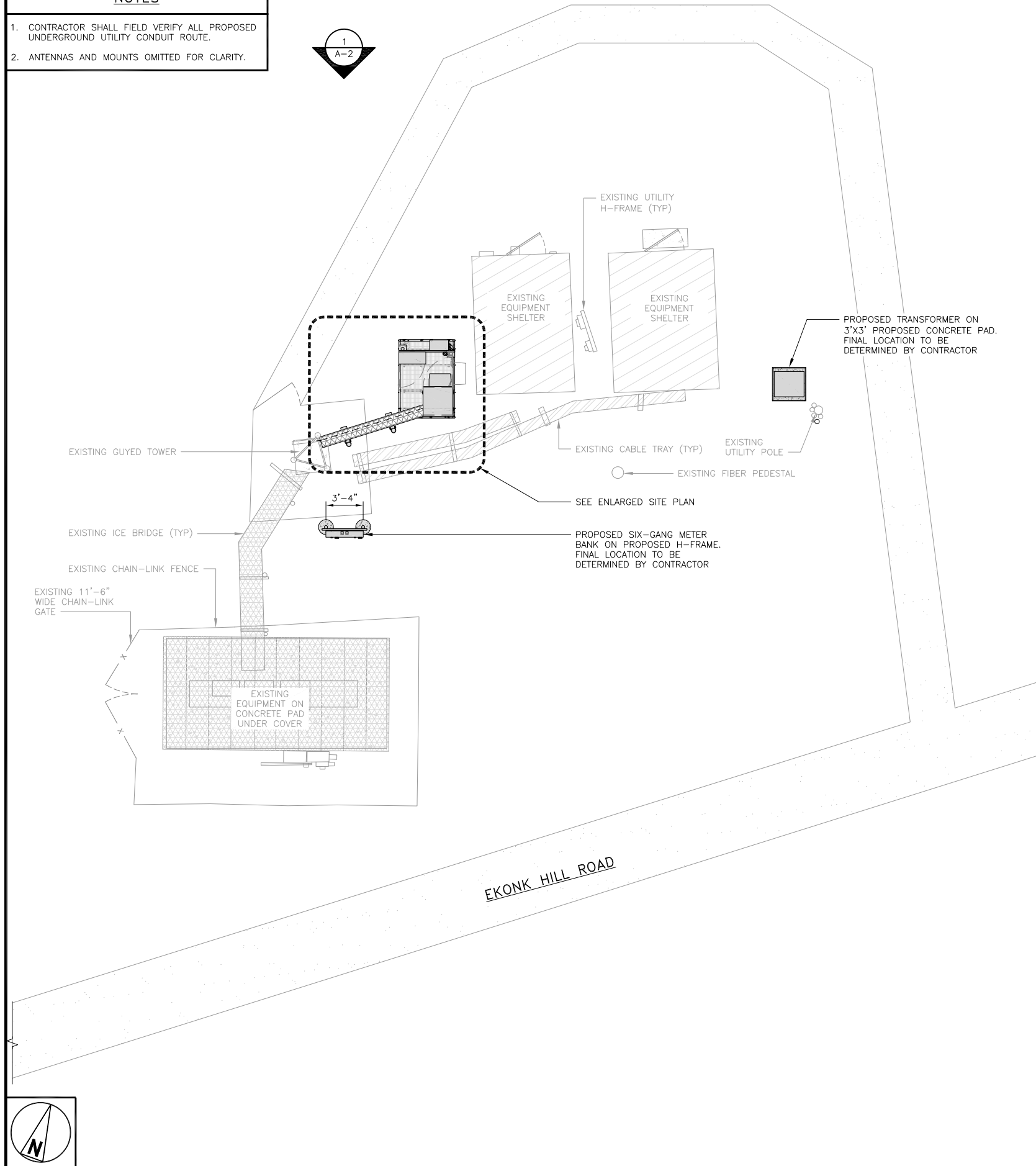
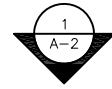

OVERALL SITE PLAN

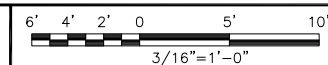

1

NOTES

- 1. CONTRACTOR SHALL FIELD VERIFY ALL DIMENSIONS.
- 2. CONTRACTOR SHALL MAINTAIN A 10'-0\"/>
- 3. ANTENNAS AND MOUNTS OMITTED FOR CLARITY.

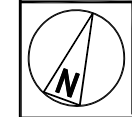
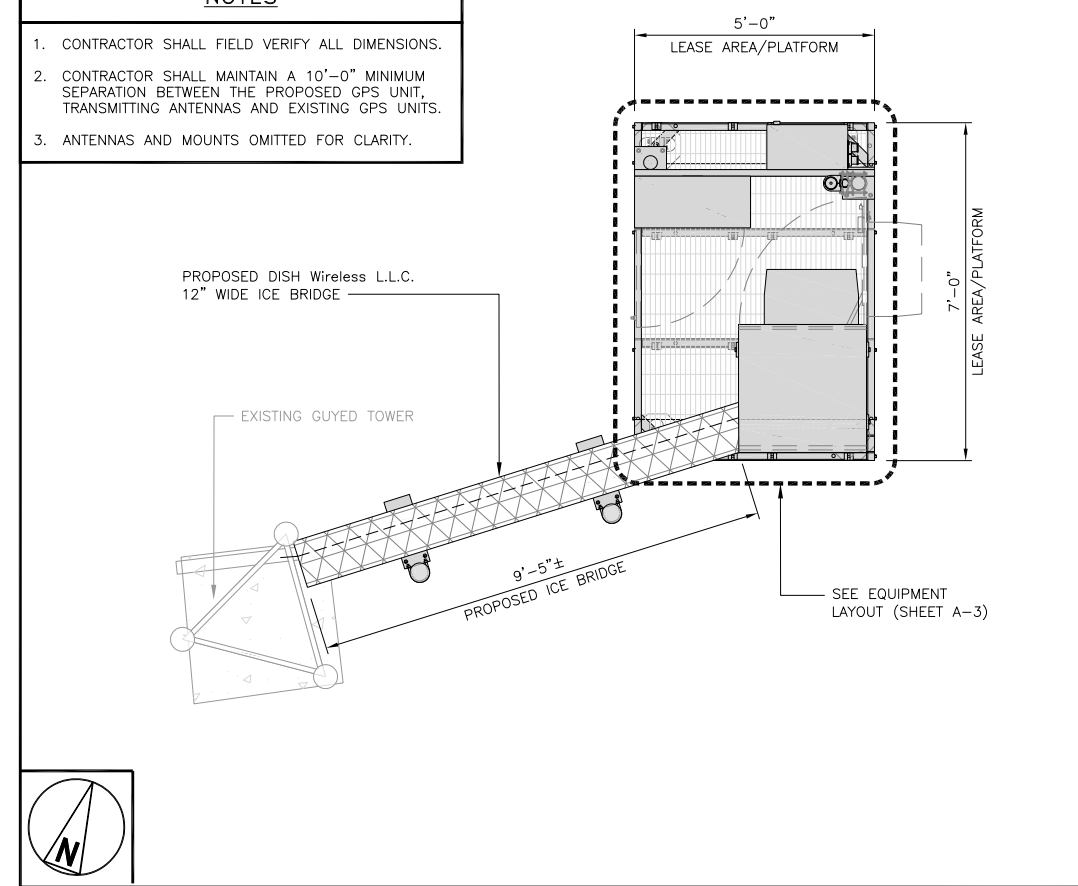

ENLARGED SITE PLAN

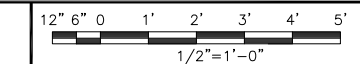

2

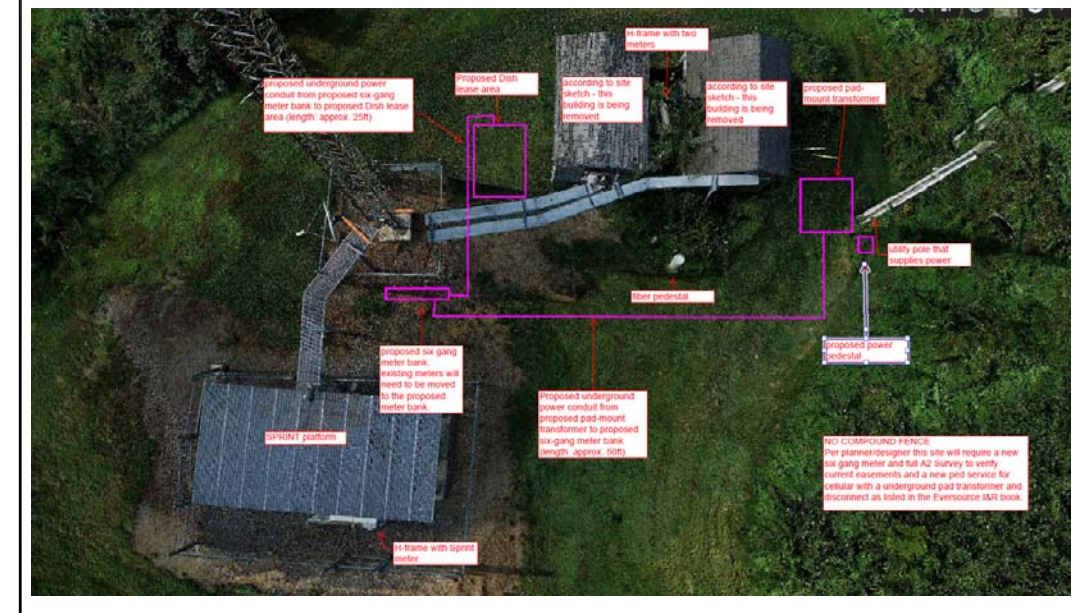

AERIAL PLAN

NO SCALE

3



5701 SOUTH SANTA FE DRIVE
LITTLETON, CO 80120



8051 CONGRESS AVENUE
BOCA RATON, FL 33487



1/5/23



MTS ENGINEERING P.L.L.C.
BER:2386985
Expires 3/31/23

IT IS A VIOLATION OF LAW FOR ANY PERSON, UNLESS THEY ARE ACTING UNDER THE DIRECTION OF A LICENSED PROFESSIONAL ENGINEER, TO ALTER THIS DOCUMENT.

DRAWN BY: CHECKED BY: APPROVED BY:
BLJ BEH BEH

RFDS REV #: 0

CONSTRUCTION DOCUMENTS

SUBMITTALS

REV	DATE	DESCRIPTION
A	9/10/21	ISSUED FOR REVIEW
B	01/05/22	ISSUED FOR REVIEW
0	3/8/22	ISSUED FOR CONSTRUCTION
1	5/13/22	ISSUED FOR CONSTRUCTION
2	6/27/22	ISSUED FOR CONSTRUCTION
3	8/23/22	ISSUED FOR CONSTRUCTION
4	01/05/23	ISSUED FOR CONSTRUCTION

A&E PROJECT NUMBER
149477.001.01

DISH Wireless L.L.C.
PROJECT INFORMATION
BOBOS00062A
419 EKONK HILL ROAD (RT-49)
STERLING CT 06377

SHEET TITLE
OVERALL AND ENLARGED SITE PLAN

SHEET NUMBER

A-1

NOTES

1. CONTRACTOR SHALL FIELD VERIFY ALL DIMENSIONS.
2. ANTENNA AND MW DISH SPECIFICATIONS REFER TO ANTENNA SCHEDULE AND TO FINAL CONSTRUCTION RFDS FOR ALL RF DETAILS
3. EXISTING EQUIPMENT AND FENCE OMITTED FOR CLARITY.

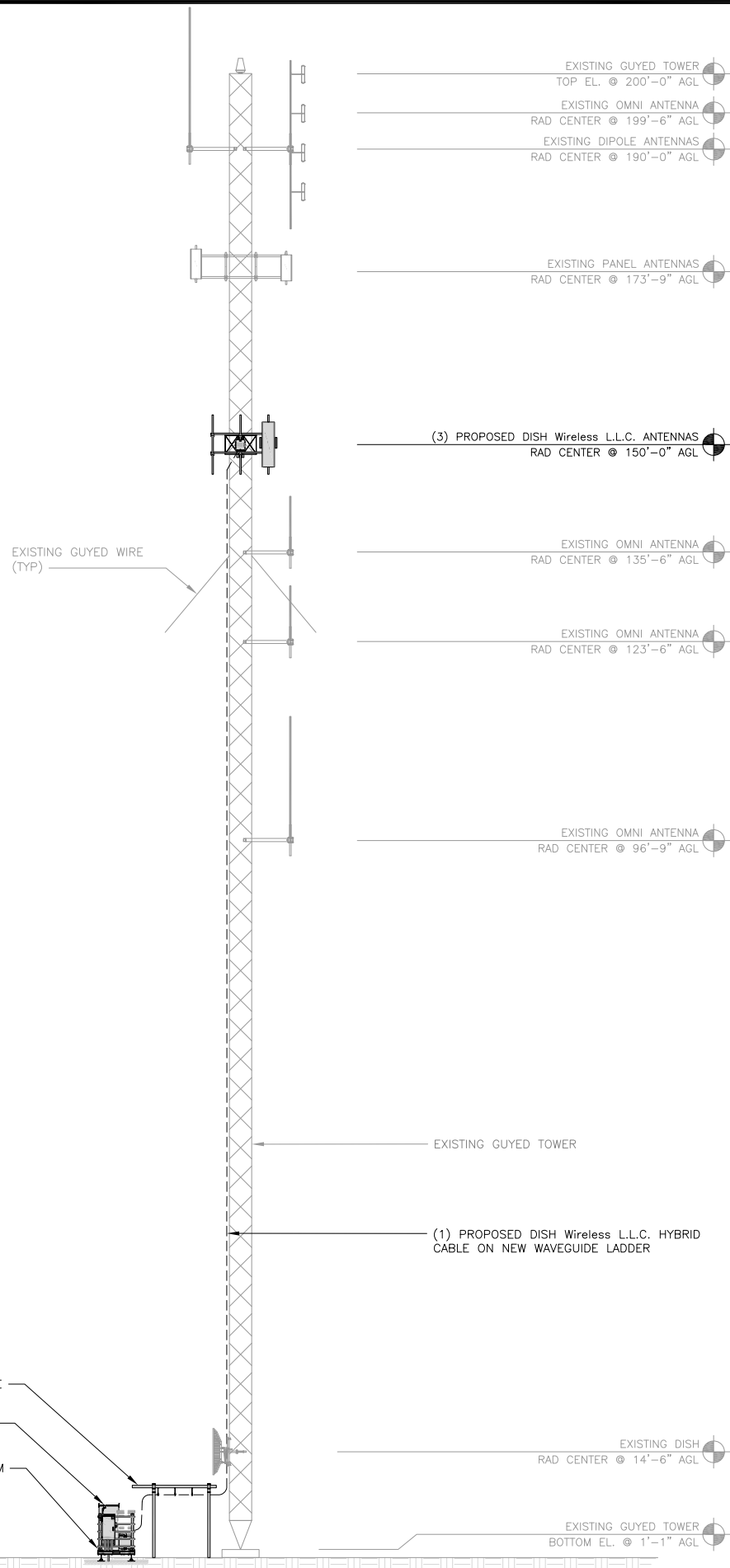

PROPOSED NORTH ELEVATION

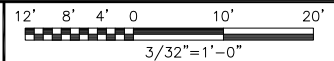

1

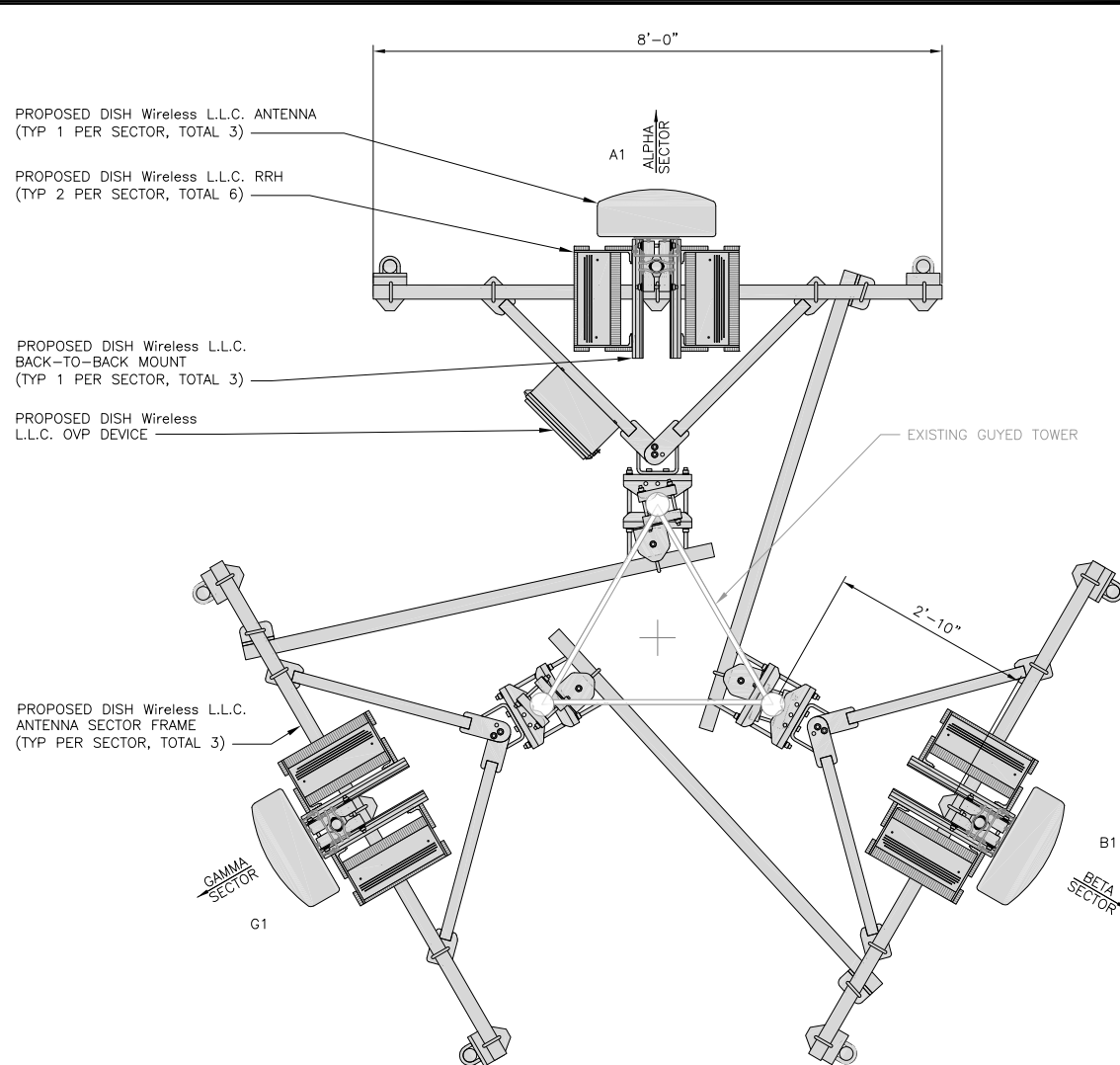

ANTENNA LAYOUT

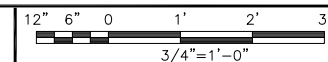

2

SECTOR	POSITION	ANTENNA					RAD CENTER	TRANSMISSION CABLE
		EXISTING OR PROPOSED	MANUFACTURER - MODEL NUMBER	TECHNOLOGY	SIZE (HxW)	AZIMUTH		
ALPHA	A1	PROPOSED	JMA - MX08FR0665-21	5G	72.0" x 20.0"	0°	150'-0"	(1) HIGH-CAPACITY HYBRID CABLE (185' LONG)
BETA	B1	PROPOSED	JMA - MX08FR0665-21	5G	72.0" x 20.0"	120°	150'-0"	
GAMMA	G1	PROPOSED	JMA - MX08FR0665-21	5G	72.0" x 20.0"	240°	150'-0"	

SECTOR	POSITION	RRH		NOTES
		MANUFACTURER - MODEL NUMBER	TECHNOLOGY	
ALPHA	A1	FUJITSU-TA08025-B605	5G	1. CONTRACTOR TO REFER TO FINAL CONSTRUCTION RFDS FOR ALL RF DETAILS. 2. ANTENNA AND RRH MODELS MAY CHANGE DUE TO EQUIPMENT AVAILABILITY. ALL EQUIPMENT CHANGES MUST BE APPROVED AND REMAIN IN COMPLIANCE WITH THE PROPOSED DESIGN AND STRUCTURAL ANALYSES.
	A1	FUJITSU-TA08025-B604	5G	
BETA	B1	FUJITSU-TA08025-B605	5G	
	B1	FUJITSU-TA08025-B604	5G	
GAMMA	G1	FUJITSU-TA08025-B605	5G	
	G1	FUJITSU-TA08025-B604	5G	

ANTENNA SCHEDULE

NO SCALE

3



5701 SOUTH SANTA FE DRIVE
LITTLETON, CO 80120



8051 CONGRESS AVENUE
BOCA RATON, FL 33487



1/5/23

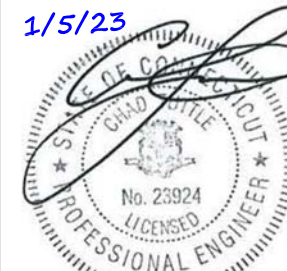

MTS ENGINEERING P.L.L.C.
BER:2386985
Expires 3/31/23

IT IS A VIOLATION OF LAW FOR ANY PERSON, UNLESS THEY ARE ACTING UNDER THE DIRECTION OF A LICENSED PROFESSIONAL ENGINEER, TO ALTER THIS DOCUMENT.

DRAWN BY: CHECKED BY: APPROVED BY:

BLJ BEH BEH

RFDS REV #: 0

CONSTRUCTION DOCUMENTS

SUBMITTALS		
REV	DATE	DESCRIPTION
A	9/10/21	ISSUED FOR REVIEW
B	01/05/22	ISSUED FOR REVIEW
0	3/8/22	ISSUED FOR CONSTRUCTION
1	5/13/22	ISSUED FOR CONSTRUCTION
2	6/27/22	ISSUED FOR CONSTRUCTION
3	8/23/22	ISSUED FOR CONSTRUCTION
4	01/05/23	ISSUED FOR CONSTRUCTION

A&E PROJECT NUMBER
149477.001.01

DISH Wireless L.L.C.
PROJECT INFORMATION
BOBOS00062A
419 EKONK HILL ROAD
(RT-49)
STERLING CT 06377

SHEET TITLE
ELEVATION, ANTENNA LAYOUT AND SCHEDULE

SHEET NUMBER

A-2



5701 SOUTH SANTA FE DRIVE
LITTLETON, CO 80120



8051 CONGRESS AVENUE
BOCA RATON, FL 33487



1717 S. BOULDER
SUITE 300
TULSA, OK 74119
PH: (918) 587-4630
www.btgrp.com

1/5/23



MTS ENGINEERING P.L.L.C.
BER:2386985
Expires 3/31/23

IT IS A VIOLATION OF LAW FOR ANY PERSON, UNLESS THEY ARE ACTING UNDER THE DIRECTION OF A LICENSED PROFESSIONAL ENGINEER, TO ALTER THIS DOCUMENT.

DRAWN BY: BLJ
CHECKED BY: BEH
APPROVED BY: BEH

RFDS REV #: 0

CONSTRUCTION DOCUMENTS

SUBMITTALS		
REV	DATE	DESCRIPTION
A	9/10/21	ISSUED FOR REVIEW
B	01/05/22	ISSUED FOR REVIEW
0	3/8/22	ISSUED FOR CONSTRUCTION
1	5/13/22	ISSUED FOR CONSTRUCTION
2	6/27/22	ISSUED FOR CONSTRUCTION
3	8/23/22	ISSUED FOR CONSTRUCTION
4	01/05/23	ISSUED FOR CONSTRUCTION

A&E PROJECT NUMBER
149477.001.01

DISH Wireless L.L.C.
PROJECT INFORMATION
BOBOS00062A
419 EKONK HILL ROAD
(RT-49)
STERLING CT 06377

SHEET TITLE
EQUIPMENT PLATFORM AND
H-FRAME DETAILS

SHEET NUMBER
A-3

NOTES

1. CONTRACTOR TO BURY PLATFORM FEET WITH A MINIMUM OF 2" OF FILL PER EXISTING SITE SURFACE
2. WEED BARRIER FABRIC TO BE ADDED AT DISCRETION OF DISH Wireless L.L.C. CONSTRUCTION MANAGER AT TIME OF CONSTRUCTION. ONE SHEET 8'x8' INSTALLED UNDER ALL FOUR FEET OF THE PLATFORM (4 MIL BLACK PLASTIC)
3. EQUIPMENT CABINET OMITTED FOR CLARITY

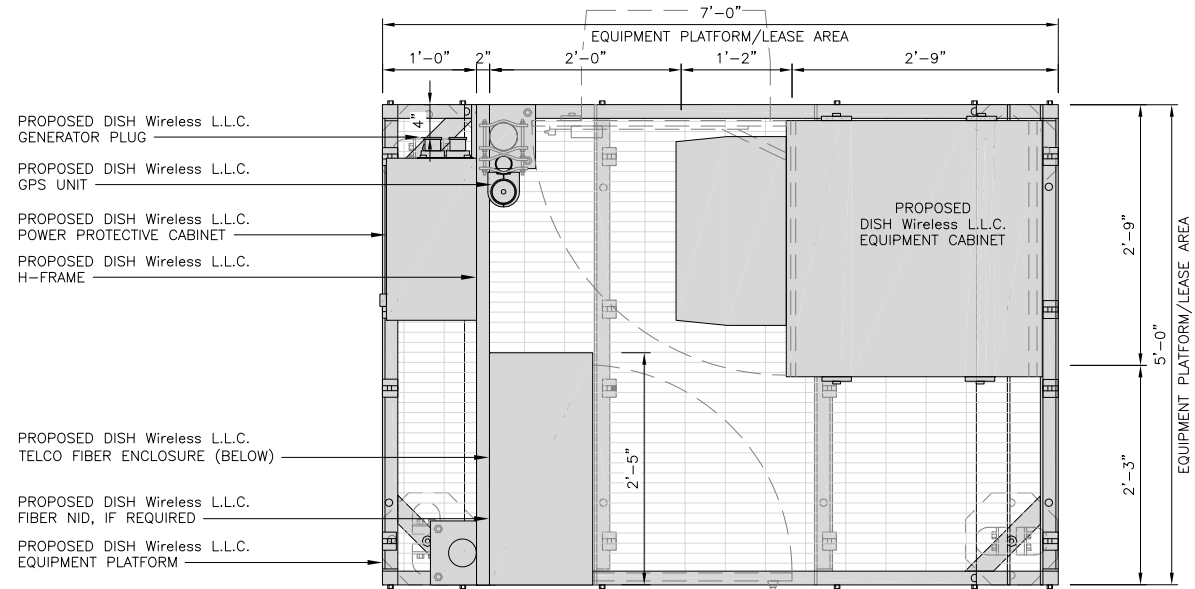

PLATFORM EQUIPMENT PLAN

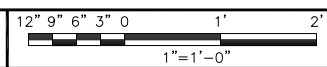

1

COMMSCOPE MTC4045LP
5X7 PLATFORM

DIMENSIONS (HxWxD)	16"x84"x60"
TOTAL WEIGHT	423 LBS

NOTE:
GC TO PROVIDE EXTENDED
THREAD FOR PLATFORM IF
REQUIRED HEIGHT EXCEEDS 17"

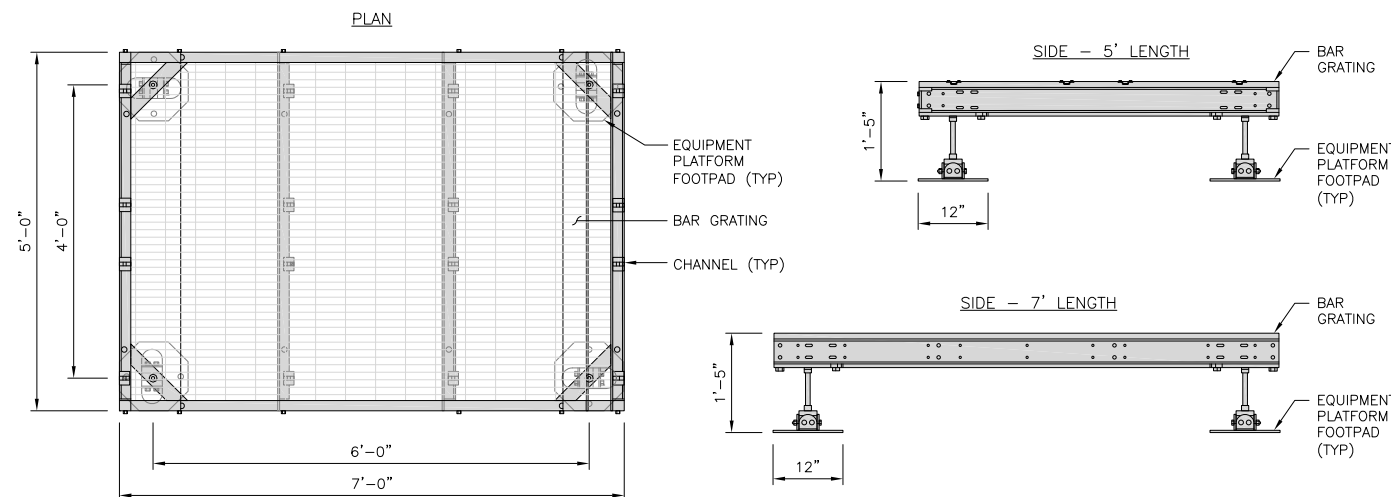

PLATFORM DETAIL

NO SCALE 2

COMMSCOPE MTC4045HFLD
H-FRAME

UNISTRUT/SUPPORT RAILS QTY	5
WEIGHT	59.74 lbs

NOTE:
OR DISH Wireless L.L.C.
APPROVED EQUIVALENT

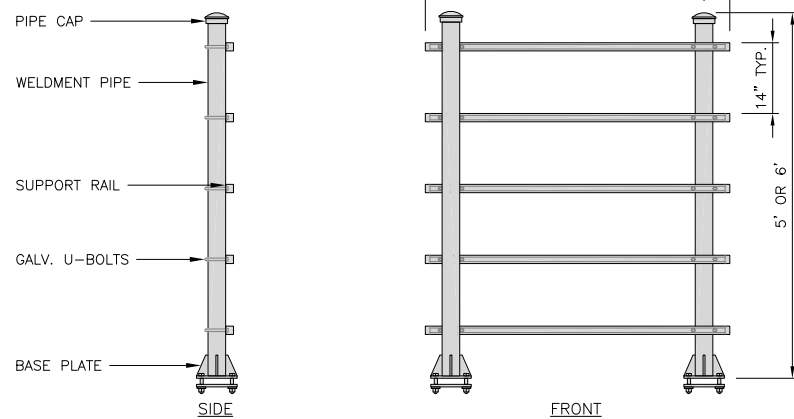

H-FRAME DETAIL

NO SCALE 3

NOT USED

NO SCALE 4

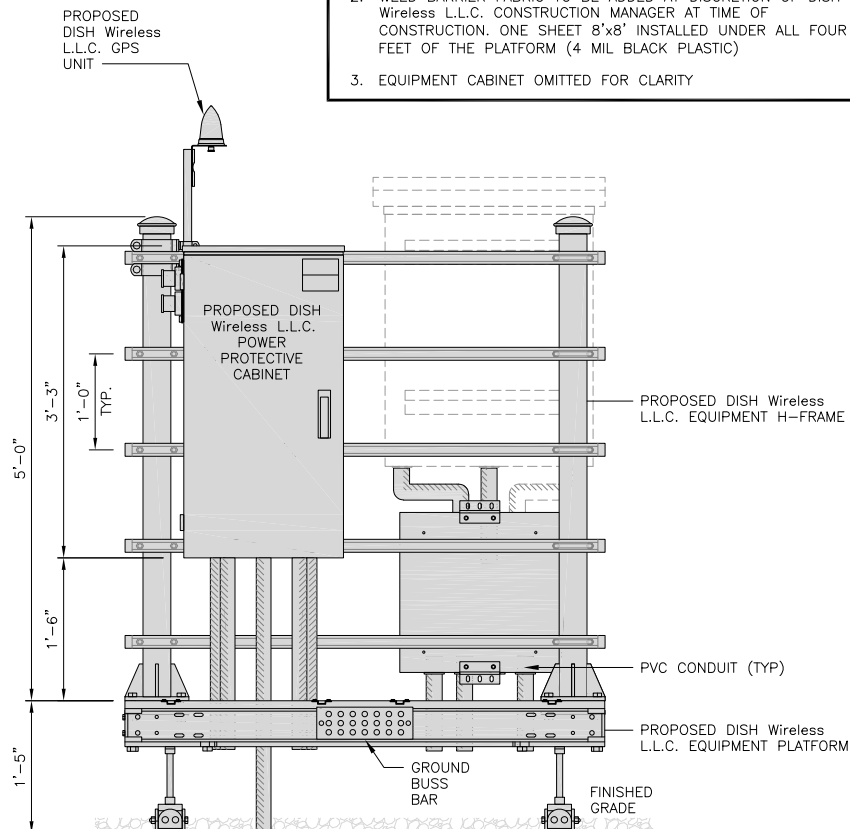

FRONT ELEVATION

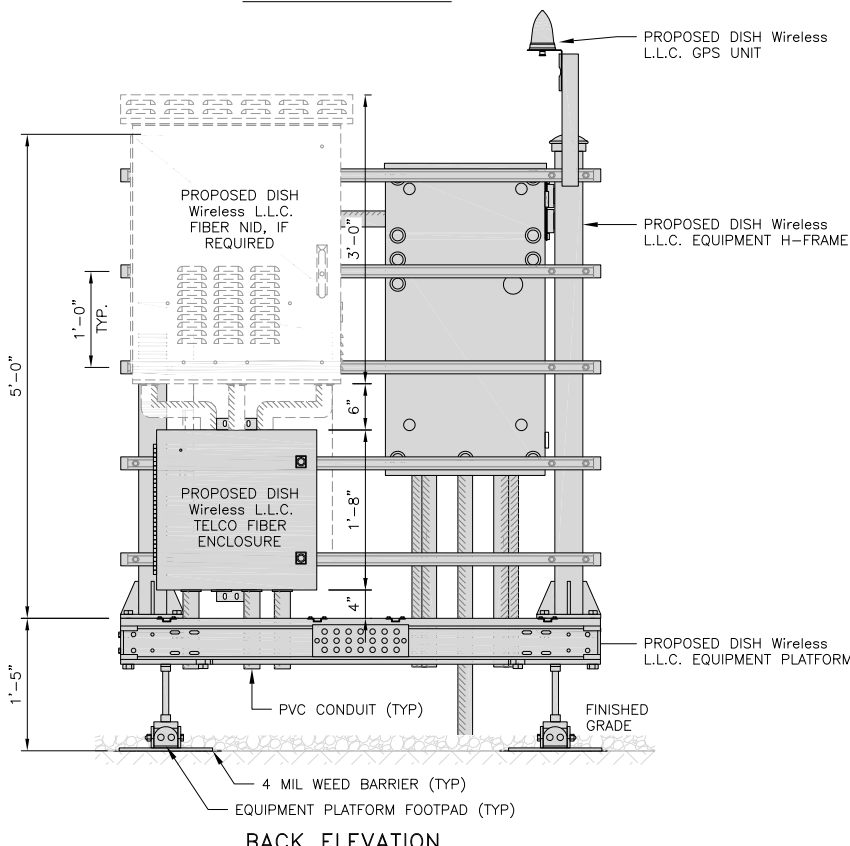

BACK ELEVATION

H-FRAME EQUIPMENT ELEVATION

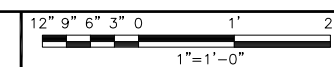

5

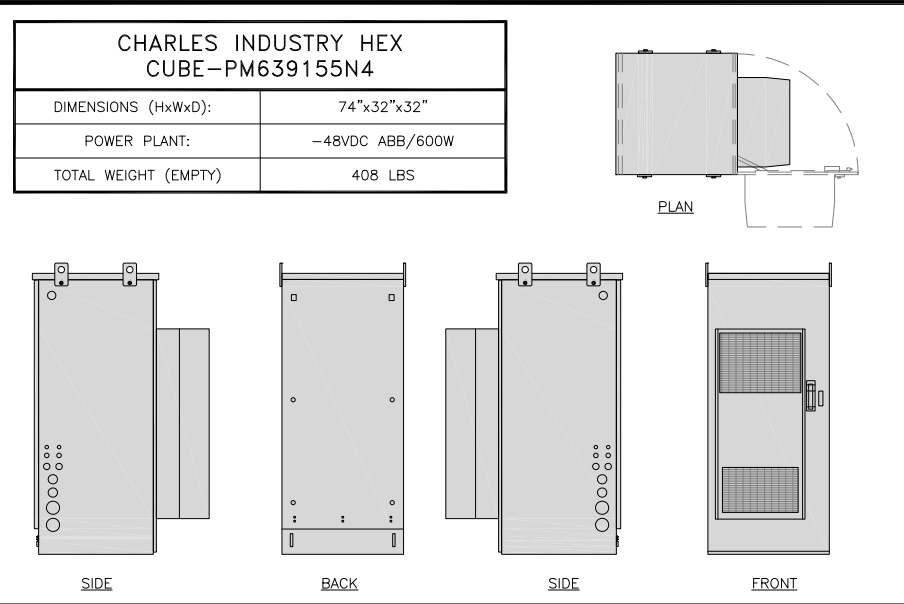

CABINET DETAIL

NO SCALE 1

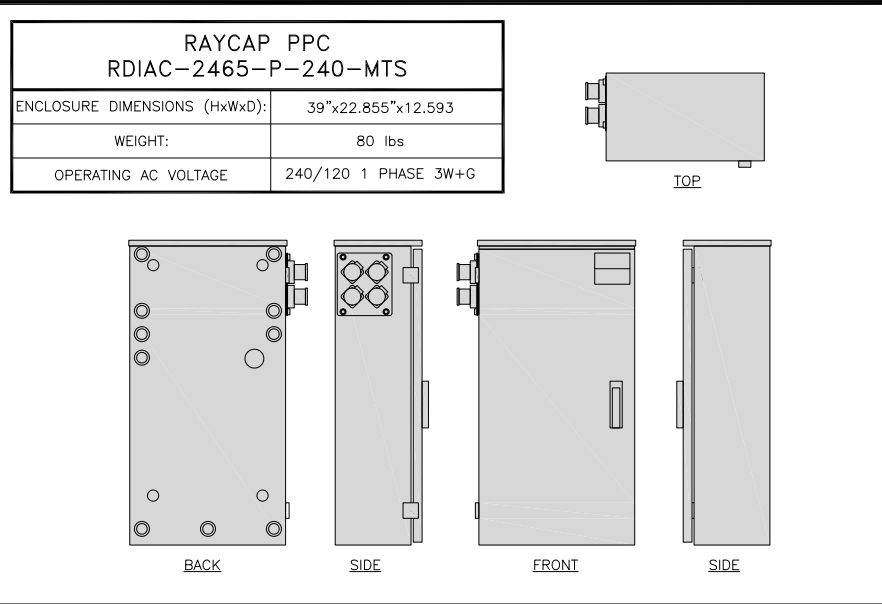

POWER PROTECTION CABINET (PPC) DETAIL

NO SCALE 2

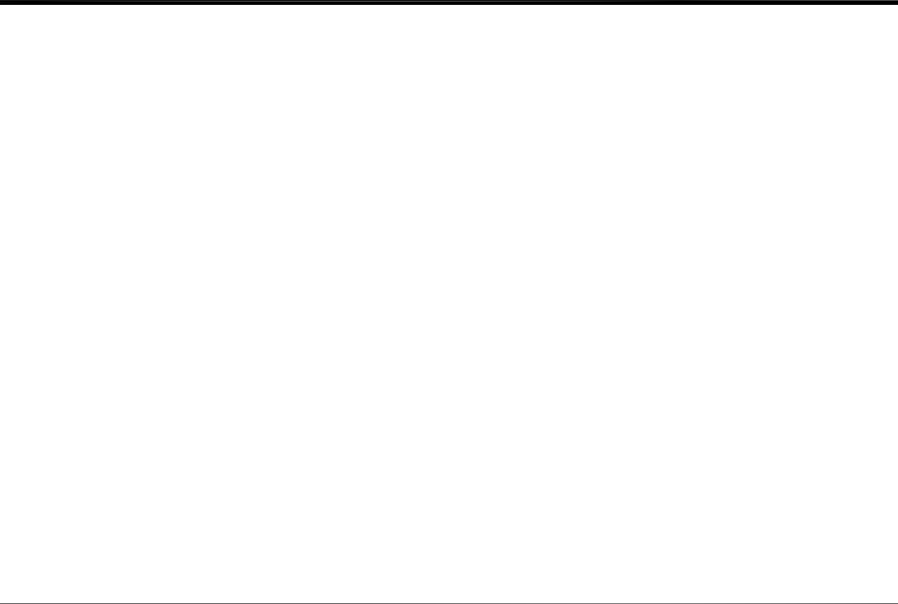

NOT USED

NO SCALE 3

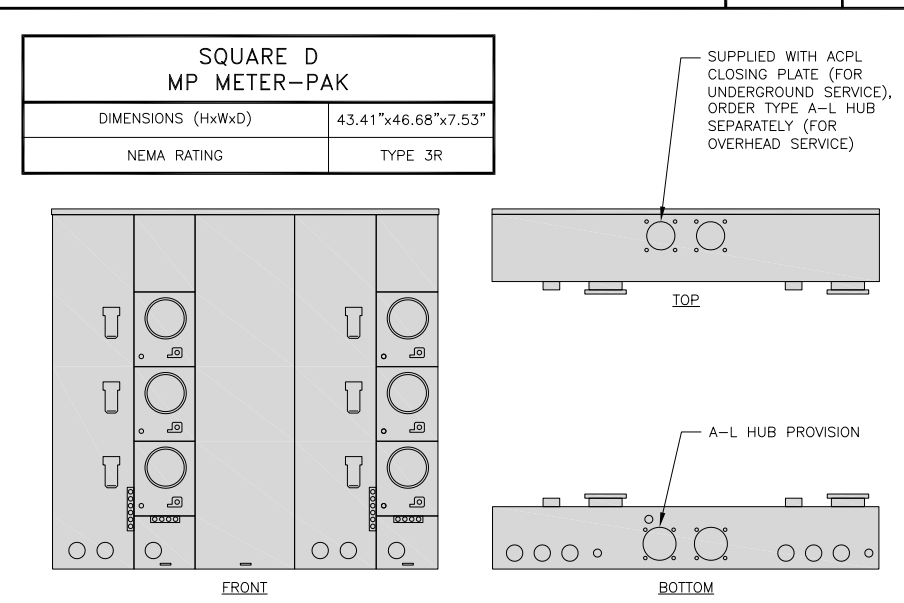

METER BANK DETAIL

NO SCALE 4

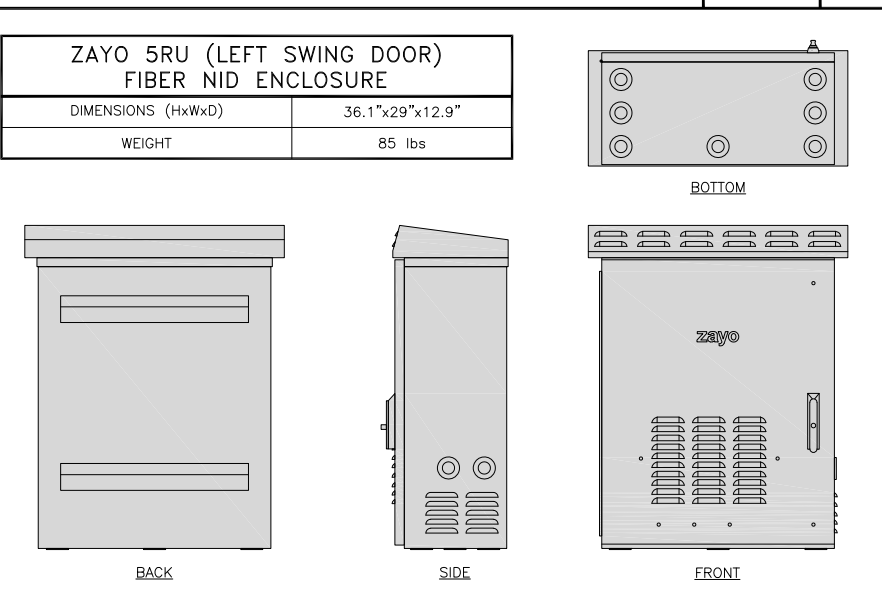

FIBER NID ENCLOSURE DETAIL

NO SCALE 5

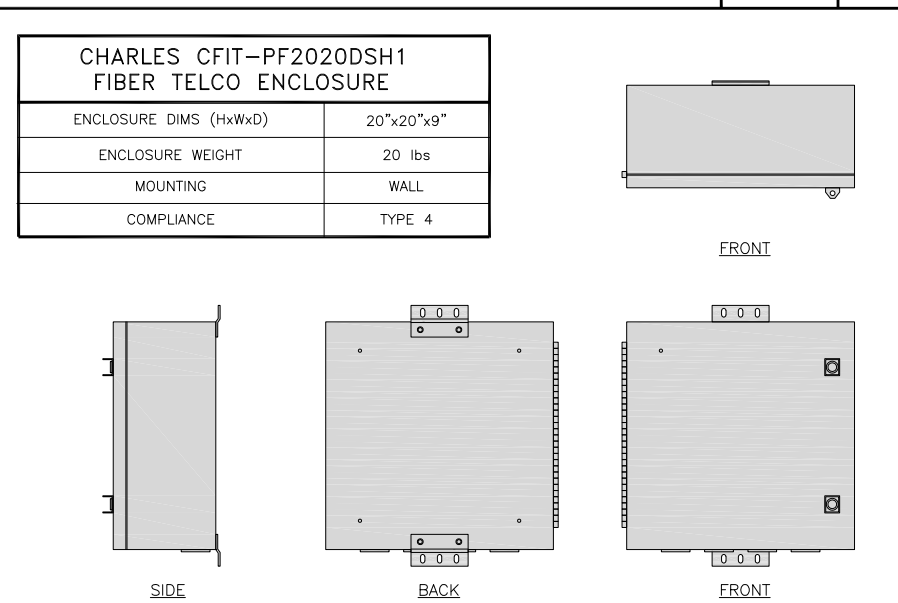

FIBER TELCO ENCLOSURE DETAIL

NO SCALE 6

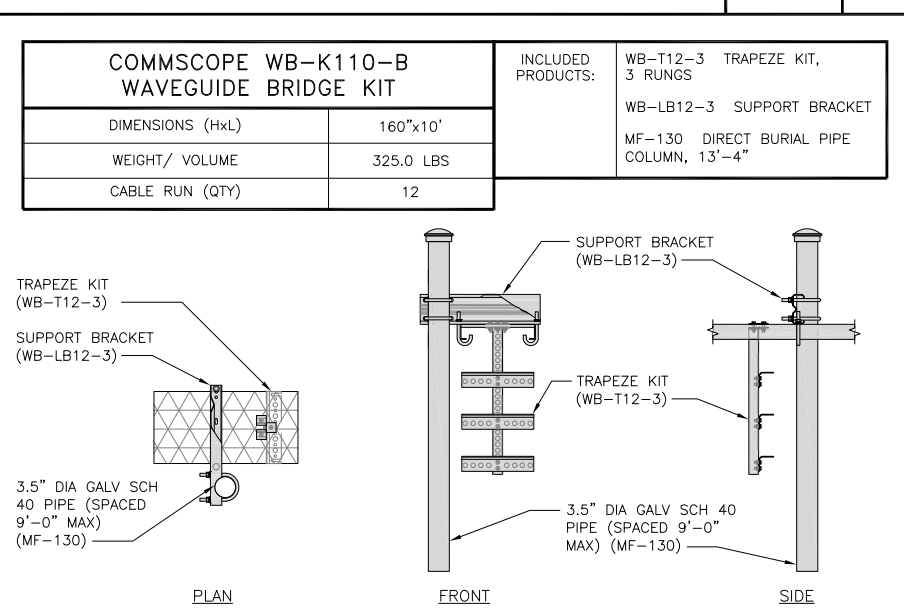

ICE BRIDGE DETAIL

NO SCALE 7

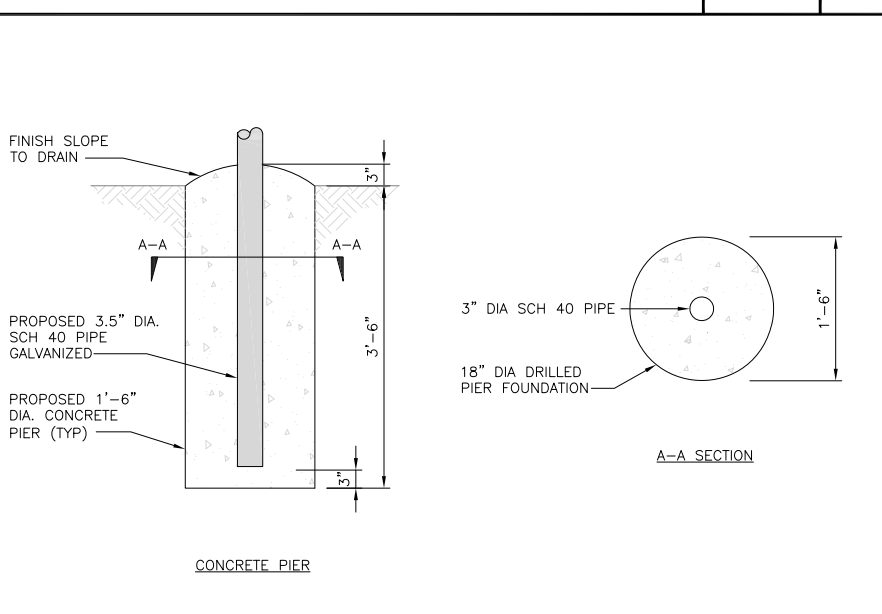

TYPICAL ICE BRIDGE CONCRETE PIER DETAIL

NO SCALE 8

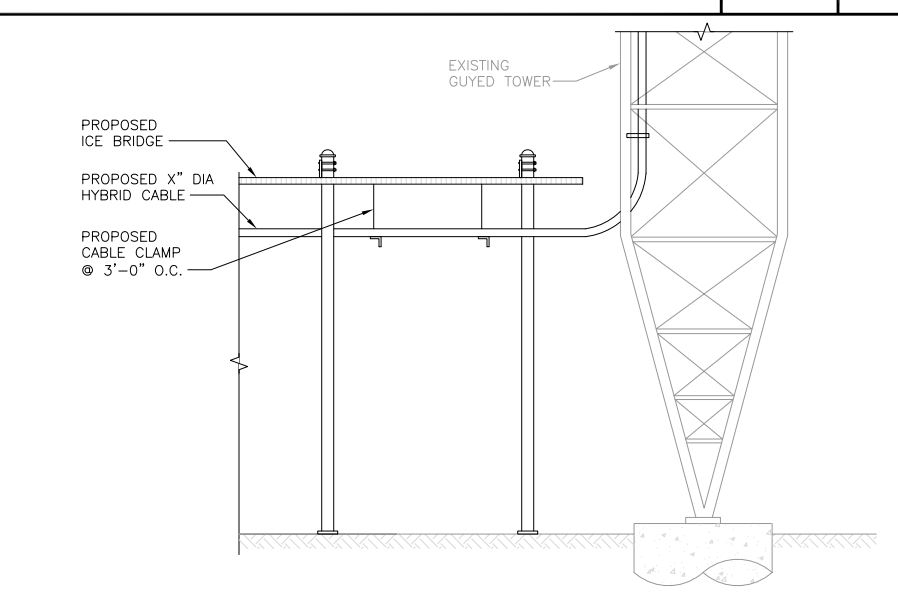

HYBRID CABLE RUN

NO SCALE 9

5701 SOUTH SANTA FE DRIVE
LITTLETON, CO 80120

8051 CONGRESS AVENUE
BOCA RATON, FL 33487

1717 S. BOULDER SUITE 300
TULSA, OK 74119
PH: (918) 587-4630
www.btgrp.com

1/5/23

MTS ENGINEERING P.L.L.C.
BER:2386985
Expires 3/31/23

IT IS A VIOLATION OF LAW FOR ANY PERSON, UNLESS THEY ARE ACTING UNDER THE DIRECTION OF A LICENSED PROFESSIONAL ENGINEER, TO ALTER THIS DOCUMENT.

DRAWN BY:	CHECKED BY:	APPROVED BY:
BLJ	BEH	BEH

RFDS REV #: 0

CONSTRUCTION DOCUMENTS

SUBMITTALS		
REV	DATE	DESCRIPTION
A	9/10/21	ISSUED FOR REVIEW
B	01/05/22	ISSUED FOR REVIEW
0	3/8/22	ISSUED FOR CONSTRUCTION
1	5/13/22	ISSUED FOR CONSTRUCTION
2	6/27/22	ISSUED FOR CONSTRUCTION
3	8/23/22	ISSUED FOR CONSTRUCTION
4	01/05/23	ISSUED FOR CONSTRUCTION

A&E PROJECT NUMBER
149477.001.01

DISH Wireless L.L.C.
PROJECT INFORMATION
BOBOS00062A
419 EKONK HILL ROAD (RT-49)
STERLING CT 06377

SHEET TITLE
EQUIPMENT DETAILS

SHEET NUMBER
A-4

PCTEL GPSGL-TMG-SPI-40NCB	
DIMENSIONS (DIAxH) MM/INCH	81x184mm 3.2"x7.25"
WEIGHT W/ACCESSORIES	075 lbs
CONNECTOR	N-FEMALE
FREQUENCY RANGE	1590 ± 30MHz

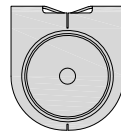

TOP

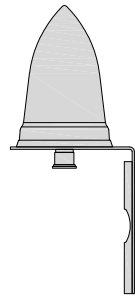

BACK

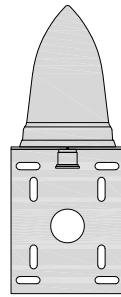

SIDE

GPS DETAIL

NO SCALE

1

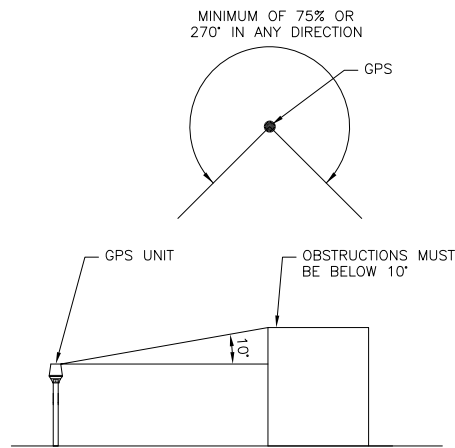

GPS MINIMUM SKY VIEW REQUIREMENTS

NO SCALE

2

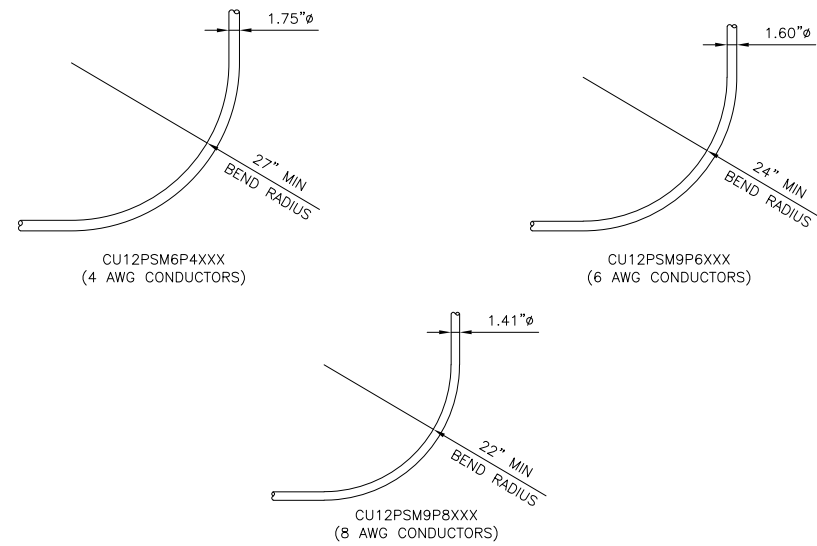

CABLES UNLIMITED HYBRID CABLE
MINIMUM BEND RADIUSES

NO SCALE

3

SQUARE D 75T6HNV TRANSFORMER DRY	
DIMENSIONS (HxWxD)	43.75"x32"x27"
WEIGHT	1025 lbs
PRODUCT	NON-VENTILATED
ENCLOSURE CODE	22E
INSULATION TEMP	428°F
PHASE	3 PHASE
PRIMARY VOLTAGE	480 V DELTA
POWER RATING	75KVA
SECONDARY VOLTAGE	240 V DELTA
FULL CAPACITY TAPS	6 2.5 % 2+ 4-
TEMPERATURE RISE	150°C
WINDING MATERIAL	ALUMINIUM



PLAN

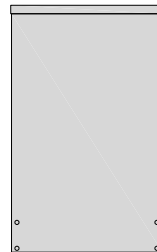

SIDE

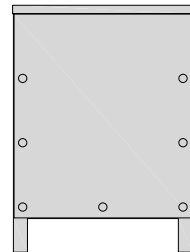

FRONT

TRANSFORMER DETAIL

NO SCALE

4

NOT USED

NO SCALE

5

NOT USED

NO SCALE

6

NOT USED

NO SCALE

7

NOT USED

NO SCALE

8

NOT USED

NO SCALE

9



5701 SOUTH SANTA FE DRIVE
LITTLETON, CO 80120



8051 CONGRESS AVENUE
BOCA RATON, FL 33487



1717 S. BOULDER
SUITE 300
TULSA, OK 74119
PH: (918) 587-4630
www.blgrp.com

1/5/23

MTS ENGINEERING P.L.L.C.
BER:2386985
Expires 3/31/23

IT IS A VIOLATION OF LAW FOR ANY PERSON, UNLESS THEY ARE ACTING UNDER THE DIRECTION OF A LICENSED PROFESSIONAL ENGINEER, TO ALTER THIS DOCUMENT.

DRAWN BY:	CHECKED BY:	APPROVED BY:
BLJ	BEH	BEH

RFDS REV #: 0

CONSTRUCTION DOCUMENTS

SUBMITTALS		
REV	DATE	DESCRIPTION
A	9/10/21	ISSUED FOR REVIEW
B	01/05/22	ISSUED FOR REVIEW
0	3/8/22	ISSUED FOR CONSTRUCTION
1	5/13/22	ISSUED FOR CONSTRUCTION
2	6/27/22	ISSUED FOR CONSTRUCTION
3	8/23/22	ISSUED FOR CONSTRUCTION
4	01/05/23	ISSUED FOR CONSTRUCTION

A&E PROJECT NUMBER
149477.001.01

DISH Wireless L.L.C.
PROJECT INFORMATION
BOBOS00062A
419 EKONK HILL ROAD
(RT-49)
STERLING CT 06377

SHEET TITLE
EQUIPMENT DETAILS

SHEET NUMBER
A-5

FUJITSU TRIPLE BAND TA08025-B605	
DIMENSIONS (HxWxD)	14.9"x15.7"x9"
WEIGHT	74.95 lbs
CONNECTOR TYPE	4.3-10 RF CONNECTOR
POWER SUPPLY	DC -58~-36V

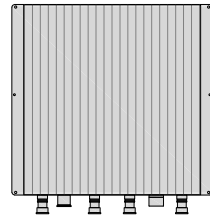
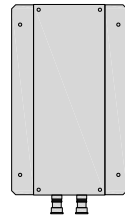
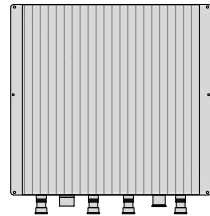
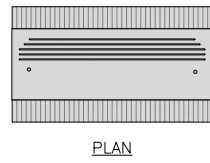

BACK

SIDE

FRONT

RRH DETAIL

NO SCALE

1

FUJITSU DUAL BAND TA08025-B604	
DIMENSIONS (HxWxD)	14.9"x15.7"x7.8"
WEIGHT	63.9 lbs
CONNECTOR TYPE	4.3-10 RF CONNECTOR
POWER SUPPLY	DC -58~-36V

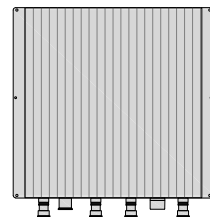
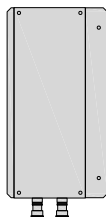
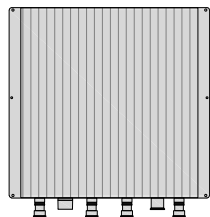
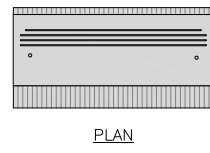

BACK

SIDE

FRONT

RRH DETAIL

NO SCALE

2

COMMSCOPE RR-FA2 LARGE STABILIZER	
DIMENSIONS (HxWxD)	16.4"x8.5"x18"
WEIGHT	39.2 lbs

DESIGN NOTES:
MOUNT WILL FIT LEGS UP TO:
- 5.6" ROUND
- 6.0" 60° ANGLE
- 4.5" 90° ANGLE



PLAN

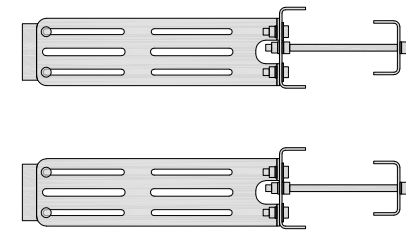

SIDE

NOTE:
OR DISH Wireless L.L.C.
APPROVED EQUIVALENT

RRH MOUNT DETAIL

NO SCALE

3

JMA MX08FRO665-21	
DIMENSIONS (HxWxD)	72"x20.0"x8.0"
RF PORTS, CONNECTOR TYPE	8 x 4.3-10 FEMALE
WEIGHT	64.5 lbs
WEIGHT WITH BRACKETS	82.5 lbs

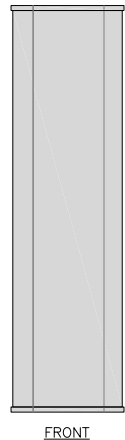
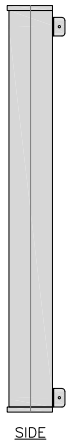
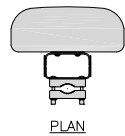

SIDE

FRONT

ANTENNA DETAIL

NO SCALE

4

RAYCAP RDIDC-9181-PF-48 DC SURGE PROTECTION (OVP)	
DIMENSIONS (HxWxD)	18.98"x14.39"x8.15"
WEIGHT	21.82 LBS

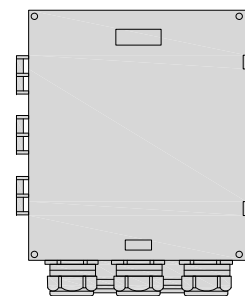
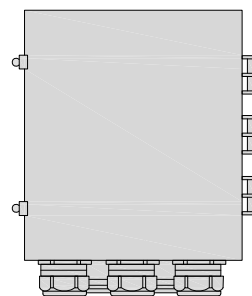
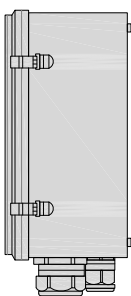
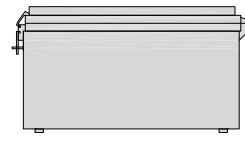

SIDE

BACK

FRONT

SURGE SUPPRESSION DETAIL (OVP)

NO SCALE

7

COMMSCOPE 20' CABLE LADDER 6 HOLE RUNGS	
DIMENSIONS (WxL)	20.5"x240"
WEIGHT	84.94 lbs

ITEM#	DESCRIPTION
1	20' ANGLE SIDE RAIL
2	20" LADDER RUNG
3	BACKING PLATE
4	3/8"x1-1/2" GALV BOLT KIT
5	8" GALV J-BOLT KIT
6	3/8" GALV FLAT WASHER
7	3/8" GALV LOCK WASHER
8	3/8" GALV HEX NUT

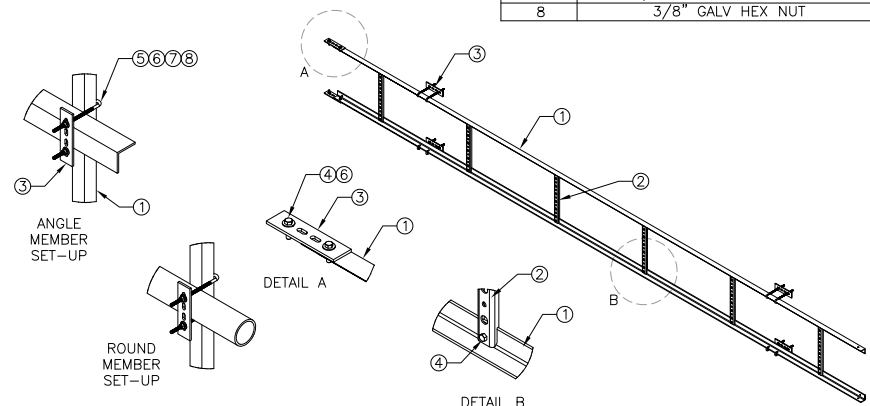

ANGLE MEMBER SET-UP

ROUND MEMBER SET-UP

DETAIL A

DETAIL B

NOT USED

NO SCALE

5

COMMSCOPE V-FRAME MTC3975083	
FACE SIZE	8'-0"
WEIGHT	352.136 lbs

NOTE:
OR DISH Wireless L.L.C.
APPROVED EQUIVALENT

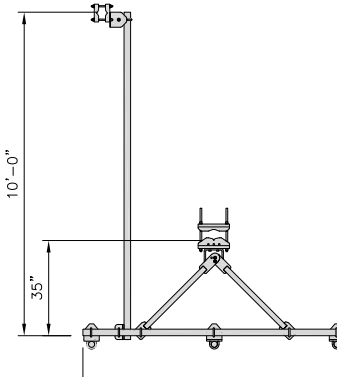

PLAN

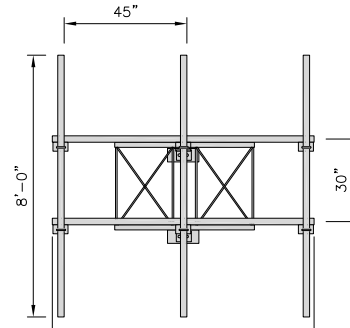

FRONT

ANTENNA FRAME DETAIL

NO SCALE

9

JMA ANTENNA MOUNT BRACKET #91900318	
TOTAL WEIGHT (WITH BRACKETS)	18 lbs (8.18 Kg)
POLE DIAMETER RANGE	2.5" TO 4.5"

NOTE:
KIT #91900318: TOP AND BOTTOM BRACKETS
FOR 4-, 6-, AND 8-FOOT ANTENNAS
ANTENNA BRACKET NOT PART OF KIT

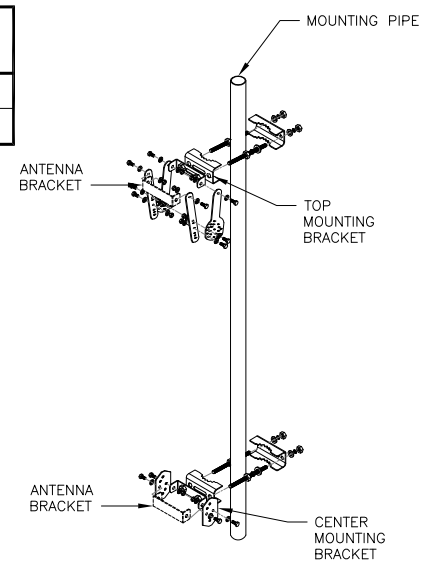

ANTENNA BRACKET

ANTENNA BRACKET

MOUNTING PIPE

TOP MOUNTING BRACKET

CENTER MOUNTING BRACKET

NOTE:
OR DISH Wireless L.L.C.
APPROVED EQUIVALENT

ANTENNA BRACKET DETAIL

NO SCALE

6



5701 SOUTH SANTA FE DRIVE
LITTLETON, CO 80120



8051 CONGRESS AVENUE
BOCA RATON, FL 33487



1/5/23



MTS ENGINEERING P.L.L.C.
BER:2386985
Expires 3/31/23

IT IS A VIOLATION OF LAW FOR ANY PERSON,
UNLESS THEY ARE ACTING UNDER THE DIRECTION
OF A LICENSED PROFESSIONAL ENGINEER,
TO ALTER THIS DOCUMENT.

DRAWN BY: CHECKED BY: APPROVED BY:
BLJ BEH BEH

RFDS REV #: 0

CONSTRUCTION DOCUMENTS

SUBMITTALS		
REV	DATE	DESCRIPTION
A	9/10/21	ISSUED FOR REVIEW
B	01/05/22	ISSUED FOR REVIEW
0	3/8/22	ISSUED FOR CONSTRUCTION
1	5/13/22	ISSUED FOR CONSTRUCTION
2	6/27/22	ISSUED FOR CONSTRUCTION
3	8/23/22	ISSUED FOR CONSTRUCTION
4	01/05/23	ISSUED FOR CONSTRUCTION

A&E PROJECT NUMBER
149477.001.01

DISH Wireless L.L.C.
PROJECT INFORMATION
BOBOS00062A
419 EKONK HILL ROAD
(RT-49)
STERLING CT 06377

SHEET TITLE
EQUIPMENT DETAILS

SHEET NUMBER
A-6

NOTES

1. CONTRACTOR SHALL FIELD VERIFY ALL PROPOSED UNDERGROUND UTILITY CONDUIT ROUTE.
2. ANTENNAS AND MOUNTS OMITTED FOR CLARITY.

DC POWER WIRING SHALL BE COLOR CODED AT EACH END FOR IDENTIFYING +24V AND -48V CONDUCTORS. RED MARKINGS SHALL IDENTIFY +24V AND BLUE MARKINGS SHALL IDENTIFY -48V.

1. CONTRACTOR SHALL INSPECT THE EXISTING CONDITIONS PRIOR TO SUBMITTING A BID. ANY QUESTIONS ARISING DURING THE BID PERIOD IN REGARDS TO THE CONTRACTOR'S FUNCTIONS, THE SCOPE OF WORK, OR ANY OTHER ISSUE RELATED TO THIS PROJECT SHALL BE BROUGHT UP DURING THE BID PERIOD WITH THE PROJECT MANAGER FOR CLARIFICATION, NOT AFTER THE CONTRACT HAS BEEN AWARDED.
2. ALL ELECTRICAL WORK SHALL BE DONE IN ACCORDANCE WITH CURRENT NATIONAL ELECTRICAL CODES AND ALL STATE AND LOCAL CODES, LAWS, AND ORDINANCES. PROVIDE ALL COMPONENTS AND WIRING SIZES AS REQUIRED TO MEET NEC STANDARDS.
3. LOCATION OF EQUIPMENT, CONDUIT AND DEVICES SHOWN ON THE DRAWINGS ARE APPROXIMATE AND SHALL BE COORDINATED WITH FIELD CONDITIONS PRIOR TO CONSTRUCTION.
4. CONDUIT ROUGH-IN SHALL BE COORDINATED WITH THE MECHANICAL EQUIPMENT TO AVOID LOCATION CONFLICTS. VERIFY WITH THE MECHANICAL EQUIPMENT CONTRACTOR AND COMPLY AS REQUIRED.
5. CONTRACTOR SHALL PROVIDE ALL BREAKERS, CONDUITS AND CIRCUITS AS REQUIRED FOR A COMPLETE SYSTEM.
6. CONTRACTOR SHALL PROVIDE PULL BOXES AND JUNCTION BOXES AS REQUIRED BY THE NEC ARTICLE 314.
7. CONTRACTOR SHALL PROVIDE ALL STRAIN RELIEF AND CABLE SUPPORTS FOR ALL CABLE ASSEMBLIES. INSTALLATION SHALL BE IN ACCORDANCE WITH MANUFACTURER'S SPECIFICATIONS AND RECOMMENDATIONS.
8. ALL DISCONNECTS AND CONTROLLING DEVICES SHALL BE PROVIDED WITH ENGRAVED PHENOLIC NAMEPLATES INDICATING EQUIPMENT CONTROLLED, BRANCH CIRCUITS INSTALLED ON, AND PANEL FIELD LOCATIONS FED FROM.
9. INSTALL AN EQUIPMENT GROUNDING CONDUCTOR IN ALL CONDUITS PER THE SPECIFICATIONS AND NEC 250. THE EQUIPMENT GROUNDING CONDUCTORS SHALL BE BONDED AT ALL JUNCTION BOXES, PULL BOXES, AND ALL DISCONNECT SWITCHES, AND EQUIPMENT CABINETS.
10. ALL NEW MATERIAL SHALL HAVE A U.L. LABEL.
11. PANEL SCHEDULE LOADING AND CIRCUIT ARRANGEMENTS REFLECT POST-CONSTRUCTION EQUIPMENT.
12. CONTRACTOR SHALL BE RESPONSIBLE FOR AS-BUILT PANEL SCHEDULE AND SITE DRAWINGS.
13. ALL TRENCHES IN COMPOUND TO BE HAND DUG.

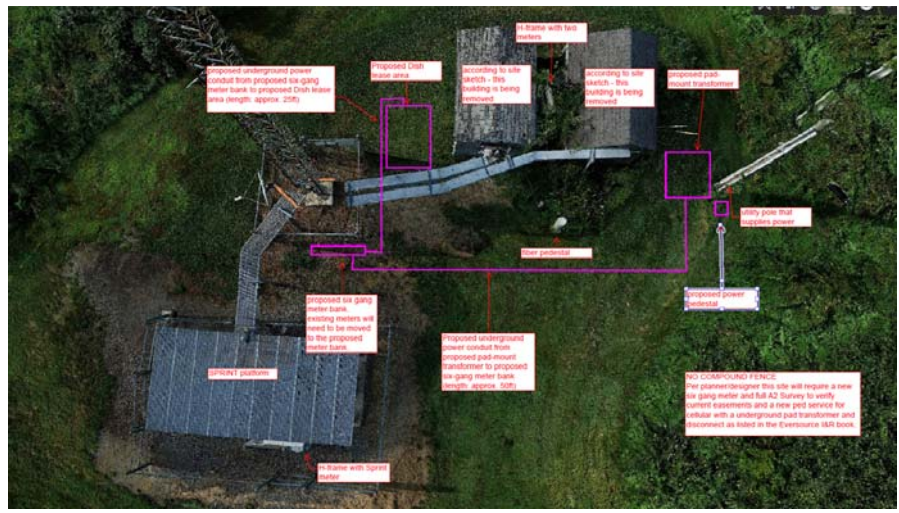
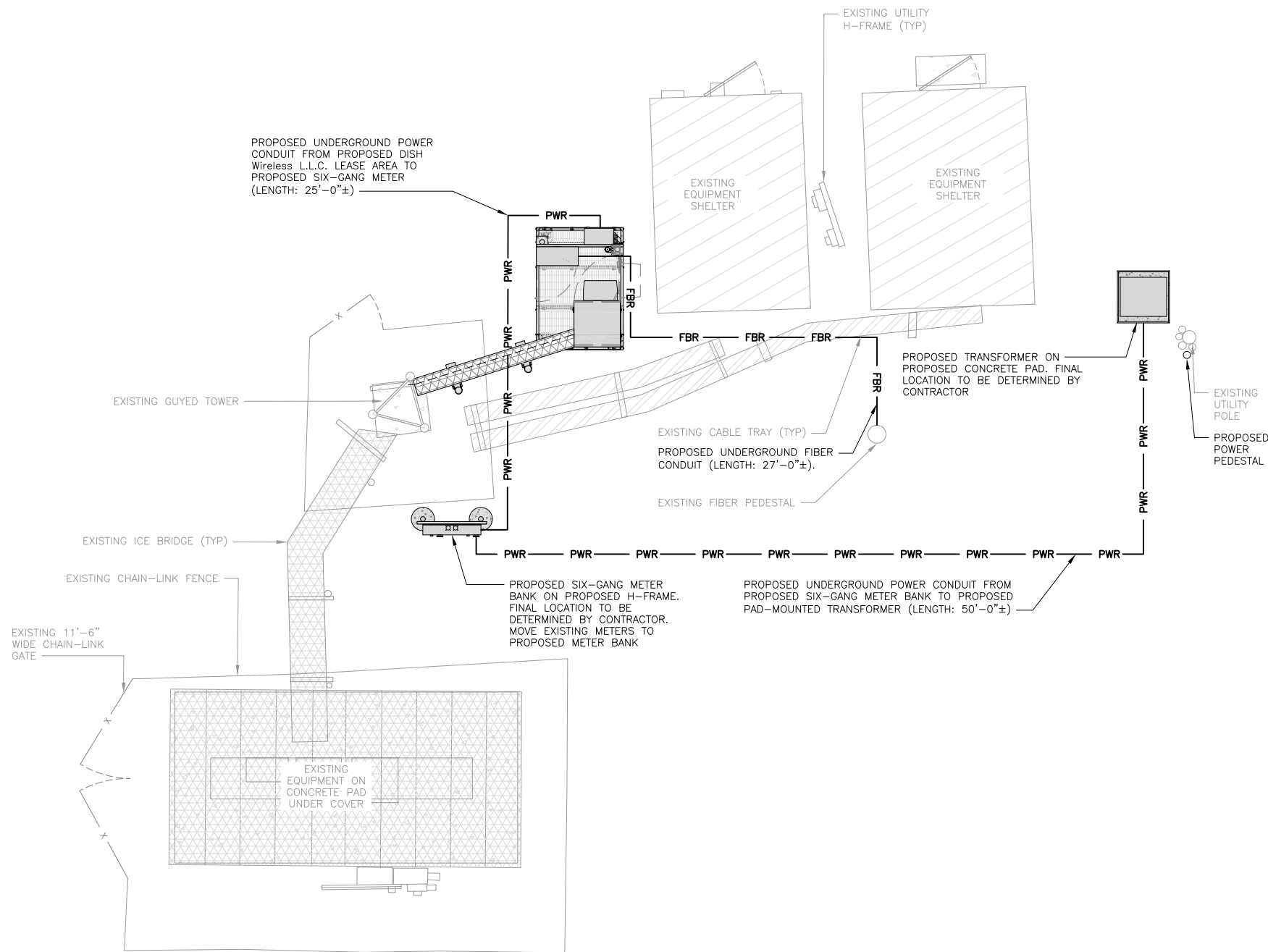

UTILITY ROUTE PLAN

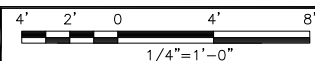

1

ELECTRICAL NOTES

NO SCALE

2

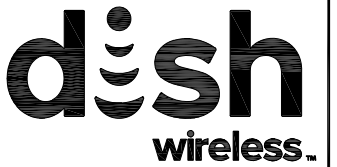

5701 SOUTH SANTA FE DRIVE
LITTLETON, CO 80120



8051 CONGRESS AVENUE
BOCA RATON, FL 33487



1717 S. BOULDER
SUITE 300
TULSA, OK 74119
PH: (918) 587-4630
www.btgrp.com

1/5/23



MTS ENGINEERING P.L.L.C.
BER:2386985
Expires 3/31/23

IT IS A VIOLATION OF LAW FOR ANY PERSON, UNLESS THEY ARE ACTING UNDER THE DIRECTION OF A LICENSED PROFESSIONAL ENGINEER, TO ALTER THIS DOCUMENT.

DRAWN BY: CHECKED BY: APPROVED BY:

BLJ BEH BEH

RFDS REV #: 0

CONSTRUCTION DOCUMENTS

SUBMITTALS		
REV	DATE	DESCRIPTION
A	9/10/21	ISSUED FOR REVIEW
B	01/05/22	ISSUED FOR REVIEW
0	3/8/22	ISSUED FOR CONSTRUCTION
1	5/13/22	ISSUED FOR CONSTRUCTION
2	6/27/22	ISSUED FOR CONSTRUCTION
3	8/23/22	ISSUED FOR CONSTRUCTION
4	01/05/23	ISSUED FOR CONSTRUCTION

A&E PROJECT NUMBER
149477.001.01

DISH Wireless L.L.C.
PROJECT INFORMATION
BOBOS00062A
419 EKONK HILL ROAD
(RT-49)
STERLING CT 06377

SHEET TITLE
ELECTRICAL/FIBER ROUTE
PLAN AND NOTES

SHEET NUMBER
E-1

CARLON EXPANSION FITTINGS

COUPLING END PART#	MALE TERMINAL ADAPTER END PART#	SIZE	STD CTN QTY.	TRAVEL LENGTH
E945D	E945DX	1/2"	20	4"
E945E	E945EX	3/4"	15	4"
E945F	E945FX	1"	10	4"
E945G	E945GX	1 1/4"	5	4"
E945H	E945HX	1 1/2"	5	4"
E945J	E945JX	2"	15	8"
E945K	E945KX	2 1/2"	10	8"
E945L	E945LX	3"	10	8"
E945M	E945MX	3 1/2"	5	8"
E945N	E945NX	4"	5	8"
E945P	E945PX	5"	1	8"
E945R	E945RX	6"	1	8"

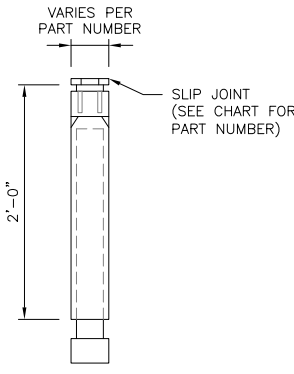

NOTE: CONTRACTOR TO INSTALL EXPANSION FITTING SLIP JOINT AT METER CENTER CONDUIT TERMINATION, AS PER LOCAL UTILITY POLICY, ORDINANCE AND/OR SPECIFIED REQUIREMENT.

TRENCHING NOTES

- CONTRACTOR SHALL RESTORE THE TRENCH TO ITS ORIGINAL CONDITIONS BY EITHER SEEDING OR SODDING GRASS AREAS, OR REPLACING ASPHALT OR CONCRETE AREAS TO ITS ORIGINAL CROSS SECTION.
- TRENCHING SAFETY; INCLUDING, BUT NOT LIMITED TO SOIL CLASSIFICATION, SLOPING, AND SHORING, SHALL BE GOVERNED BY THE CURRENT OSHA TRENCHING AND EXCAVATION SAFETY STANDARDS.
- ALL CONDUITS SHALL BE INSTALLED IN COMPLIANCE WITH THE CURRENT NATIONAL ELECTRIC CODE (NEC) OR AS REQUIRED BY THE LOCAL JURISDICTION, WHICHEVER IS THE MOST STRINGENT.

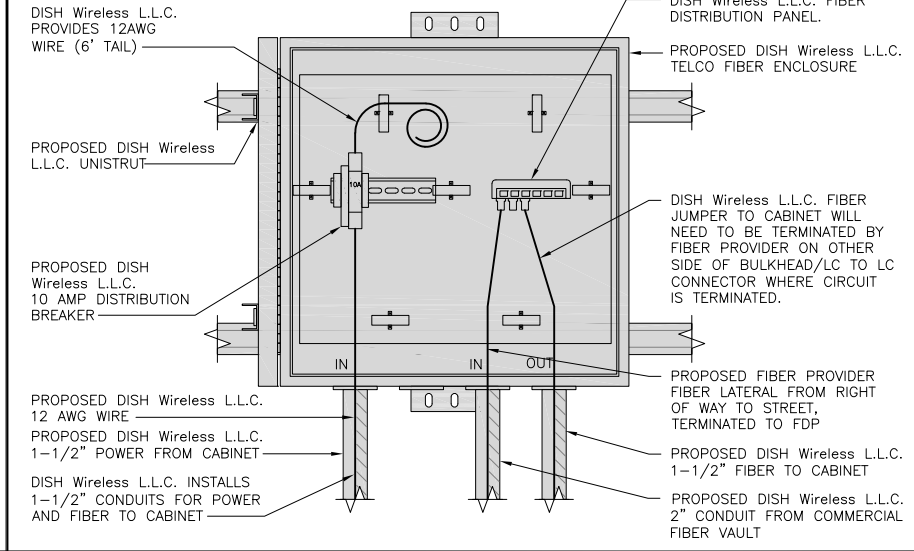
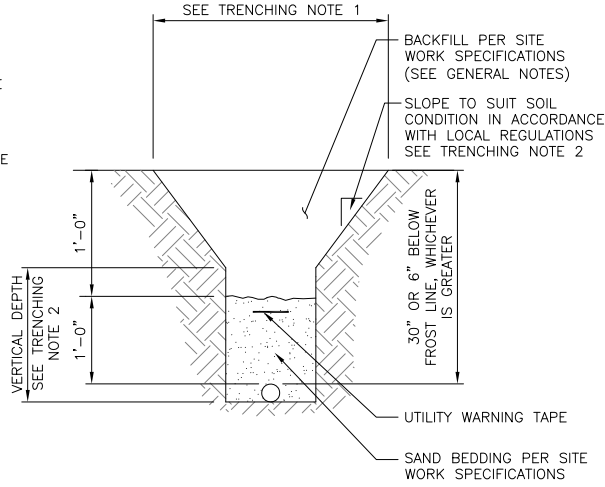

EXPANSION JOINT DETAIL

NO SCALE 1

TYPICAL UNDERGROUND TRENCH DETAIL

NO SCALE 2

DARK TELCO BOX – INTERIOR WIRING LAYOUT

NO SCALE 3

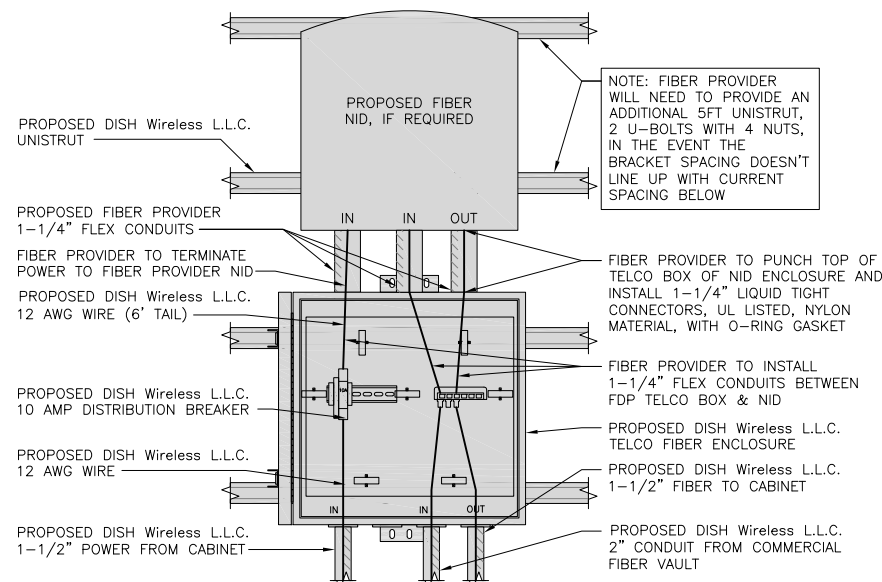

LIT TELCO BOX – INTERIOR WIRING LAYOUT (OPTIONAL)

NO SCALE 4

NOT USED

NO SCALE 5

NOT USED

NO SCALE 6

NOT USED

NO SCALE 7

NOT USED

NO SCALE 8

NOT USED

NO SCALE 9



5701 SOUTH SANTA FE DRIVE
LITTLETON, CO 80120



8051 CONGRESS AVENUE
BOCA RATON, FL 33487



1/5/23

MTS ENGINEERING P.L.L.C.
BER:2386985
Expires 3/31/23

IT IS A VIOLATION OF LAW FOR ANY PERSON, UNLESS THEY ARE ACTING UNDER THE DIRECTION OF A LICENSED PROFESSIONAL ENGINEER, TO ALTER THIS DOCUMENT.

DRAWN BY:	CHECKED BY:	APPROVED BY:
BLJ	BEH	BEH

RFDS REV #: 0

CONSTRUCTION DOCUMENTS

SUBMITTALS		
REV	DATE	DESCRIPTION
A	9/10/21	ISSUED FOR REVIEW
B	01/05/22	ISSUED FOR REVIEW
0	3/8/22	ISSUED FOR CONSTRUCTION
1	5/13/22	ISSUED FOR CONSTRUCTION
2	6/27/22	ISSUED FOR CONSTRUCTION
3	8/23/22	ISSUED FOR CONSTRUCTION
4	01/05/23	ISSUED FOR CONSTRUCTION

A&E PROJECT NUMBER
149477.001.01

DISH Wireless L.L.C.
PROJECT INFORMATION
BOBOS00062A
419 EKONK HILL ROAD
(RT-49)
STERLING CT 06377

SHEET TITLE
ELECTRICAL DETAILS

SHEET NUMBER
E-2

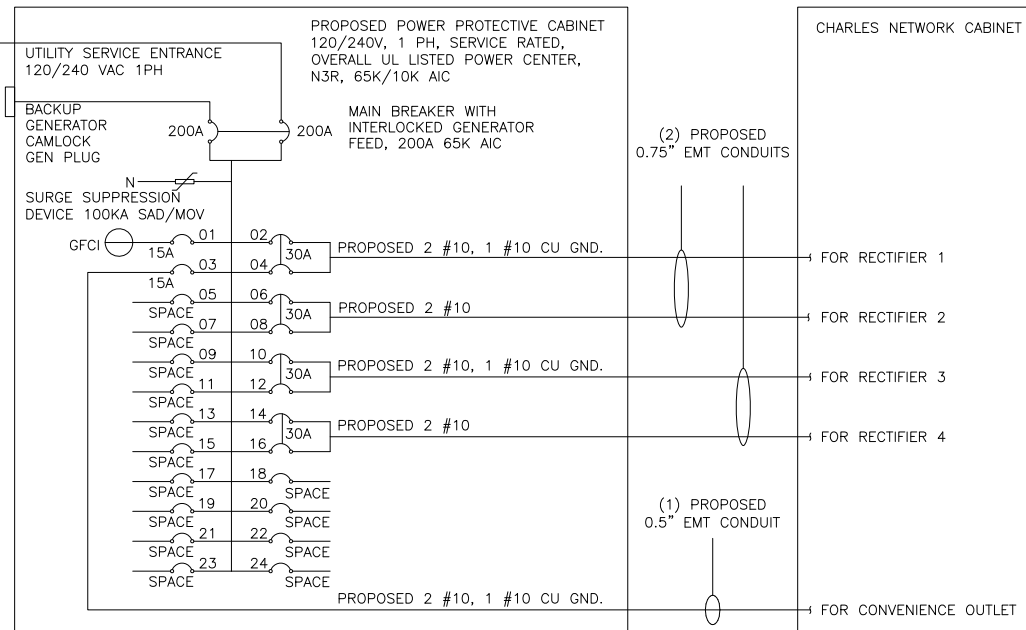
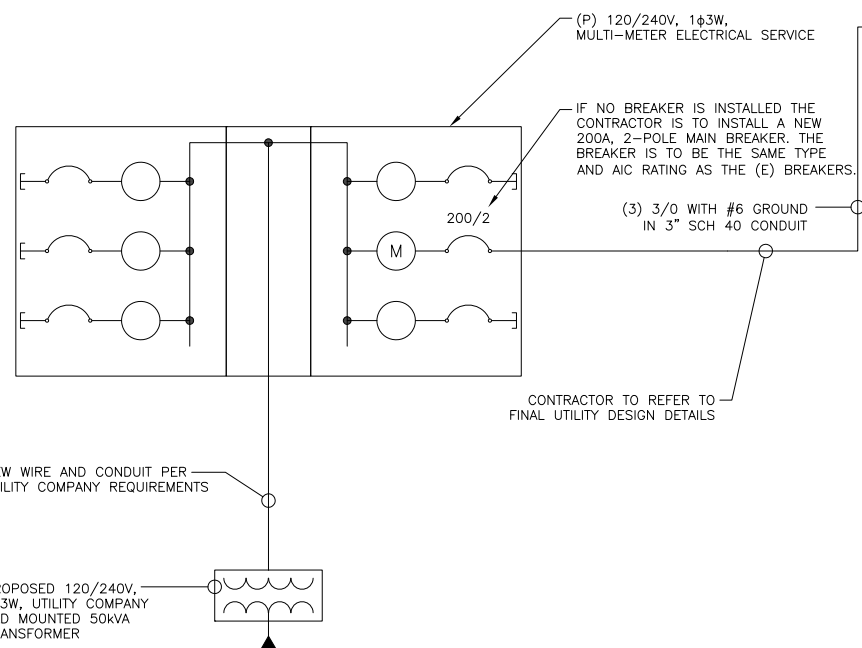

NOTE:
BRANCH CIRCUIT WIRING SUPPLYING RECTIFIERS ARE TO BE RATED UL1015, 105°C, 600V, AND PVC INSULATED, IN THE SIZES SHOWN IN THE ONE-LINE DIAGRAM. CONTRACTOR MAY SUBSTITUTE UL1015 WIRE FOR THWN-2 FOR CONVENIENCE OUTLET BRANCH CIRCUIT.

BREAKERS REQUIRED:
(4) 30A, 2P BREAKER - SQUARE D P/N:Q0230
(1) 15A, 1P BREAKER - SQUARE D P/N:Q0115

NOTES

THE (2) CONDUITS WITH (4) CURRENT CARRYING CONDUCTORS EACH, SHALL APPLY THE ADJUSTMENT FACTOR OF 80% PER 2014/17 NEC TABLE 310.15(B)(3)(g) OR 2020 NEC TABLE 310.15(C)(1) FOR UL1015 WIRE.

#12 FOR 15A-20A/1P BREAKER: 0.8 x 30A = 24.0A
#10 FOR 25A-30A/2P BREAKER: 0.8 x 40A = 32.0A
#8 FOR 35A-40A/2P BREAKER: 0.8 x 55A = 44.0A
#6 FOR 45A-60A/2P BREAKER: 0.8 x 75A = 60.0A

CONDUIT SIZING: AT 40% FILL PER NEC CHAPTER 9, TABLE 4, ARTICLE 358.
0.5" CONDUIT - 0.122 SQ. IN AREA
0.75" CONDUIT - 0.213 SQ. IN AREA
2.0" CONDUIT - 1.316 SQ. IN AREA
3.0" CONDUIT - 2.907 SQ. IN AREA

CABINET CONVENIENCE OUTLET CONDUCTORS (1 CONDUIT): USING THWN-2, CU.
#10 - 0.0211 SQ. IN X 2 = 0.0422 SQ. IN
#10 - 0.0211 SQ. IN X 1 = 0.0211 SQ. IN <GROUND
TOTAL = 0.0633 SQ. IN

0.5" EMT CONDUIT IS ADEQUATE TO HANDLE THE TOTAL OF (3) WIRES, INCLUDING GROUND WIRE, AS INDICATED ABOVE.

RECTIFIER CONDUCTORS (2 CONDUITS): USING UL1015, CU.
#10 - 0.0266 SQ. IN X 4 = 0.1064 SQ. IN
#10 - 0.0082 SQ. IN X 1 = 0.0082 SQ. IN <BARE GROUND
TOTAL = 0.1146 SQ. IN

0.75" EMT CONDUIT IS ADEQUATE TO HANDLE THE TOTAL OF (5) WIRES, INCLUDING GROUND WIRE, AS INDICATED ABOVE.

PPC FEED CONDUCTORS (1 CONDUIT): USING THWN, CU.
3/0 - 0.2679 SQ. IN X 3 = 0.8037 SQ. IN
#6 - 0.0507 SQ. IN X 1 = 0.0507 SQ. IN <GROUND
TOTAL = 0.8544 SQ. IN

3.0" SCH 40 PVC CONDUIT IS ADEQUATE TO HANDLE THE TOTAL OF (4) WIRES, INCLUDING GROUND WIRE, AS INDICATED ABOVE.

PPC ONE-LINE DIAGRAM

NO SCALE 1

PROPOSED CHARLES PANEL SCHEDULE										
LOAD SERVED	VOLT AMPS (WATTS)		TRIP	CKT #	PHASE	CKT #	TRIP	VOLT AMPS (WATTS)		LOAD SERVED
	L1	L2						L1	L2	
PPC GFCI OUTLET	180	180	15A	1	A	2	30A	2880	2880	ABB/GE INFINITY RECTIFIER 1
CHARLES GFCI OUTLET			15A	3	B	4	30A	2880	2880	ABB/GE INFINITY RECTIFIER 1
-SPACE-				5	A	6	30A	2880	2880	ABB/GE INFINITY RECTIFIER 2
-SPACE-				7	B	8	30A	2880	2880	ABB/GE INFINITY RECTIFIER 2
-SPACE-				9	A	10	30A	2880	2880	ABB/GE INFINITY RECTIFIER 3
-SPACE-				11	B	12	30A	2880	2880	ABB/GE INFINITY RECTIFIER 3
-SPACE-				13	A	14	30A	2880	2880	ABB/GE INFINITY RECTIFIER 4
-SPACE-				15	B	16	30A	2880	2880	ABB/GE INFINITY RECTIFIER 4
-SPACE-				17	A	18				-SPACE-
-SPACE-				19	B	20				-SPACE-
-SPACE-				21	A	22				-SPACE-
-SPACE-				23	B	24				-SPACE-
VOLTAGE AMPS			180	180				11520	11520	
200A MCB, 1φ, 24 SPACE, 120/240V			L1		L2					
MB RATING: 65,000 AIC			11700	11700	VOLTAGE AMPS					
			98	98	AMPS					
			98		MAX AMPS					
			123		MAX 125%					

PANEL SCHEDULE

NO SCALE 2

NOT USED

NO SCALE 3



5701 SOUTH SANTA FE DRIVE
LITTLETON, CO 80120



8051 CONGRESS AVENUE
BOCA RATON, FL 33487



1/5/23



MTS ENGINEERING P.L.L.C.
BER:2386985
Expires 3/31/23

IT IS A VIOLATION OF LAW FOR ANY PERSON, UNLESS THEY ARE ACTING UNDER THE DIRECTION OF A LICENSED PROFESSIONAL ENGINEER, TO ALTER THIS DOCUMENT.

DRAWN BY: BLJ
CHECKED BY: BEH
APPROVED BY: BEH

RFDS REV #: 0

CONSTRUCTION DOCUMENTS

SUBMITTALS		
REV	DATE	DESCRIPTION
A	9/10/21	ISSUED FOR REVIEW
B	01/05/22	ISSUED FOR REVIEW
0	3/8/22	ISSUED FOR CONSTRUCTION
1	5/13/22	ISSUED FOR CONSTRUCTION
2	6/27/22	ISSUED FOR CONSTRUCTION
3	8/23/22	ISSUED FOR CONSTRUCTION
4	01/05/23	ISSUED FOR CONSTRUCTION

A&E PROJECT NUMBER
149477.001.01

DISH Wireless L.L.C.
PROJECT INFORMATION
BOBOS00062A
419 EKONK HILL ROAD
(RT-49)
STERLING CT 06377

SHEET TITLE
ELECTRICAL ONE-LINE, FAULT
CALCS & PANEL SCHEDULE

SHEET NUMBER
E-3

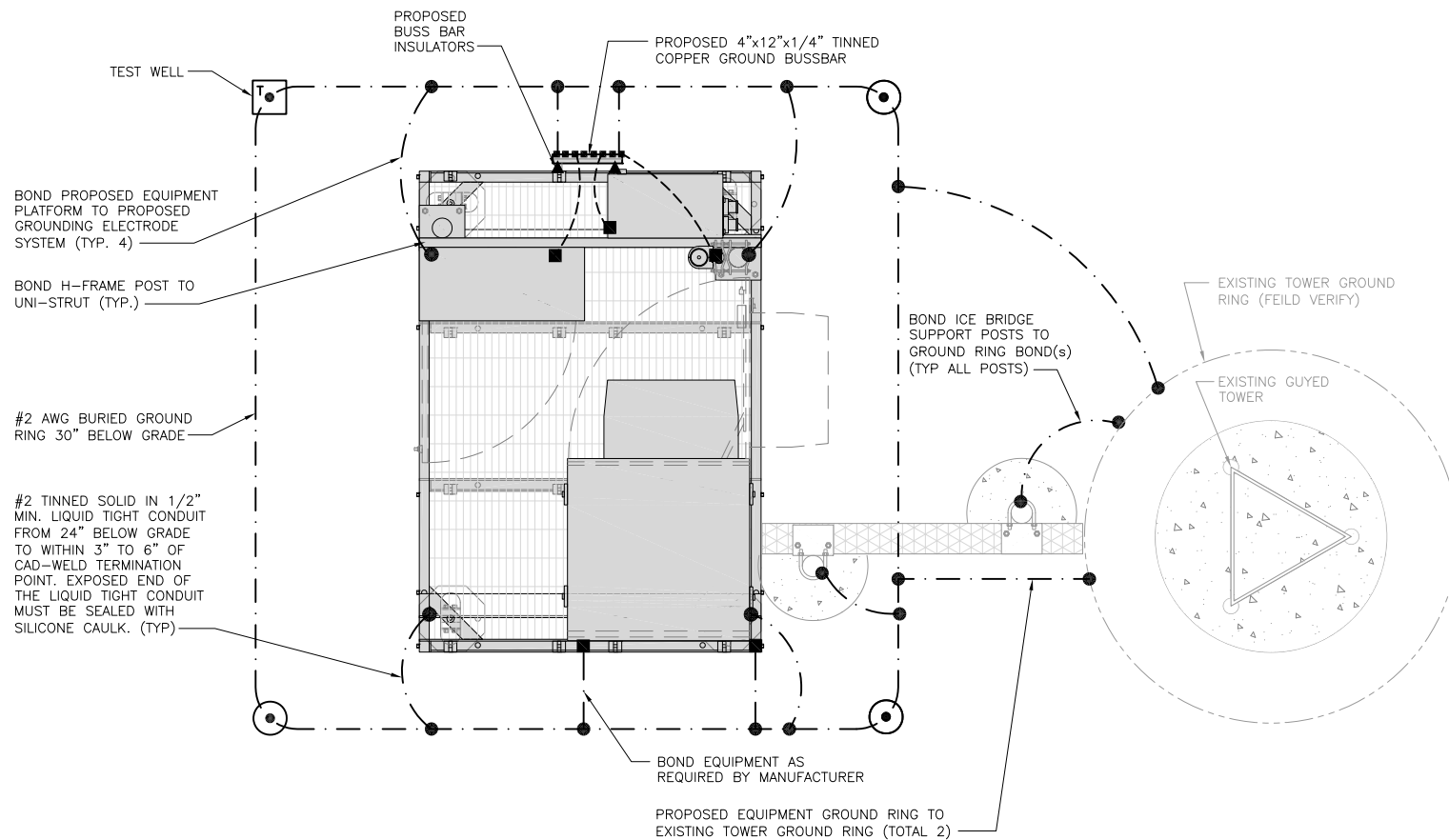

TYPICAL EQUIPMENT GROUNDING PLAN

NO SCALE 1

NOTES

ANTENNAS AND OVP SHOWN ARE GENERIC AND NOT REFERENCING TO A SPECIFIC MANUFACTURER. THIS LAYOUT IS FOR REFERENCE PURPOSES ONLY

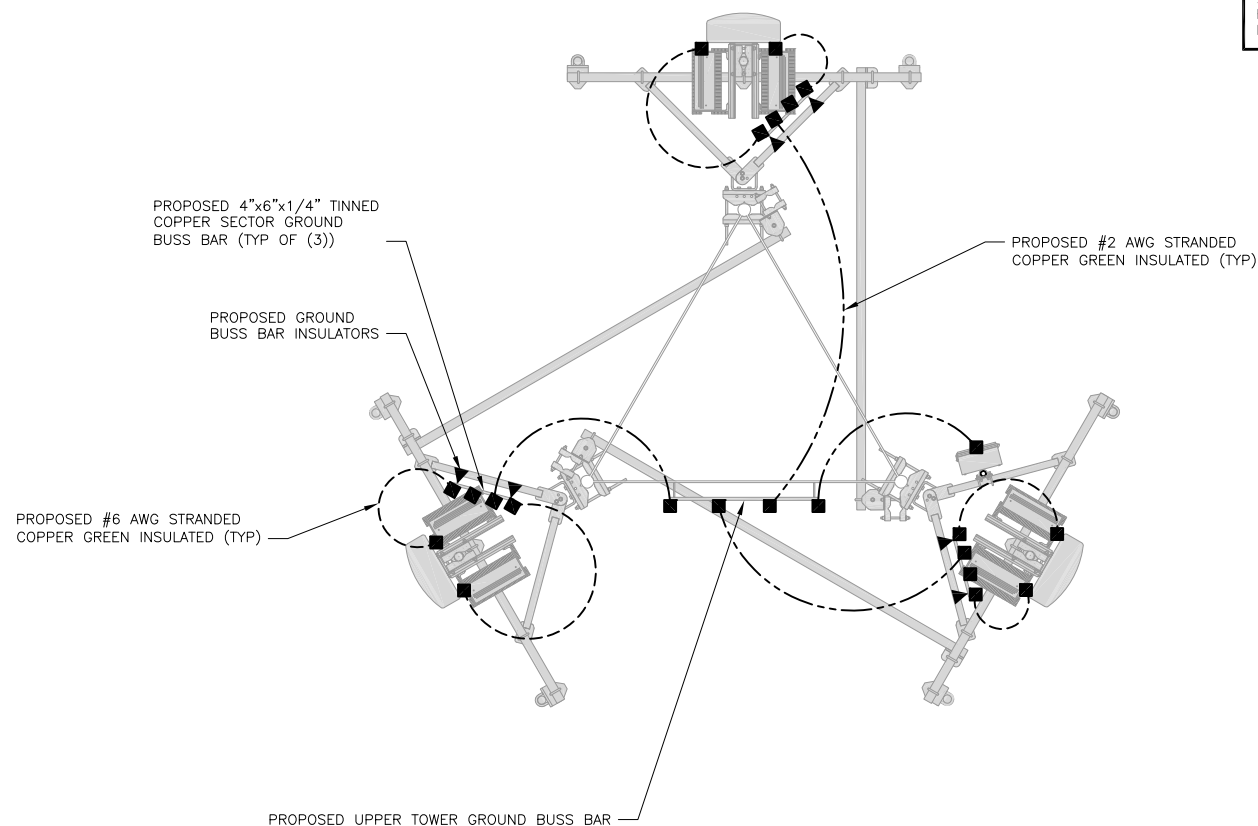

TYPICAL ANTENNA GROUNDING PLAN

NO SCALE 2

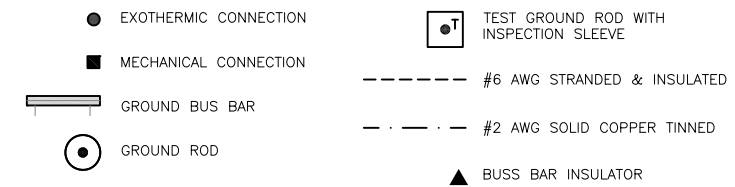

GROUNDING LEGEND

- GROUNDING IS SHOWN DIAGRAMMATICALLY ONLY.
- CONTRACTOR SHALL GROUND ALL EQUIPMENT AS A COMPLETE SYSTEM. GROUNDING SHALL BE IN COMPLIANCE WITH NEC SECTION 250 AND DISH Wireless L.L.C. GROUNDING AND BONDING REQUIREMENTS AND MANUFACTURER'S SPECIFICATIONS.
- ALL GROUND CONDUCTORS SHALL BE COPPER; NO ALUMINUM CONDUCTORS SHALL BE USED.

GROUNDING KEY NOTES

- (A) EXTERIOR GROUND RING: #2 AWG SOLID COPPER, BURIED AT A DEPTH OF AT LEAST 30 INCHES BELOW GRADE, OR 6 INCHES BELOW THE FROST LINE AND APPROXIMATELY 24 INCHES FROM THE EXTERIOR WALL OR FOOTING.
- (B) TOWER GROUND RING: THE GROUND RING SYSTEM SHALL BE INSTALLED AROUND AN ANTENNA TOWER'S LEGS, AND/OR GUY ANCHORS. WHERE SEPARATE SYSTEMS HAVE BEEN PROVIDED FOR THE TOWER AND THE BUILDING, AT LEAST TWO BONDS SHALL BE MADE BETWEEN THE TOWER RING GROUND SYSTEM AND THE BUILDING RING GROUND SYSTEM USING MINIMUM #2 AWG SOLID COPPER CONDUCTORS.
- (C) INTERIOR GROUND RING: #2 AWG STRANDED GREEN INSULATED COPPER CONDUCTOR EXTENDED AROUND THE PERIMETER OF THE EQUIPMENT AREA. ALL NON-TELECOMMUNICATIONS RELATED METALLIC OBJECTS FOUND WITHIN A SITE SHALL BE GROUND TO THE INTERIOR GROUND RING WITH #6 AWG STRANDED GREEN INSULATED CONDUCTOR.
- (D) BOND TO INTERIOR GROUND RING: #2 AWG SOLID TINNED COPPER WIRE PRIMARY BONDS SHALL BE PROVIDED AT LEAST AT FOUR POINTS ON THE INTERIOR GROUND RING, LOCATED AT THE CORNERS OF THE BUILDING.
- (E) GROUND ROD: UL LISTED COPPER CLAD STEEL. MINIMUM 1/2" DIAMETER BY EIGHT FEET LONG. GROUND RODS SHALL BE INSTALLED WITH INSPECTION SLEEVES. GROUND RODS SHALL BE DRIVEN TO THE DEPTH OF GROUND RING CONDUCTOR.
- (F) CELL REFERENCE GROUND BAR: POINT OF GROUND REFERENCE FOR ALL COMMUNICATIONS EQUIPMENT FRAMES. ALL BONDS ARE MADE WITH #2 AWG UNLESS NOTED OTHERWISE STRANDED GREEN INSULATED COPPER CONDUCTORS. BOND TO GROUND RING WITH (2) #2 SOLID TINNED COPPER CONDUCTORS.
- (G) HATCH PLATE GROUND BAR: BOND TO THE INTERIOR GROUND RING WITH TWO #2 AWG STRANDED GREEN INSULATED COPPER CONDUCTORS. WHEN A HATCH-PLATE AND A CELL REFERENCE GROUND BAR ARE BOTH PRESENT, THE CRGB MUST BE CONNECTED TO THE HATCH-PLATE AND TO THE INTERIOR GROUND RING USING (2) TWO #2 AWG STRANDED GREEN INSULATED COPPER CONDUCTORS EACH.
- (H) EXTERIOR CABLE ENTRY PORT GROUND BARS: LOCATED AT THE ENTRANCE TO THE CELL SITE BUILDING. BOND TO GROUND RING WITH A #2 AWG SOLID TINNED COPPER CONDUCTORS WITH AN EXOTHERMIC WELD AND INSPECTION SLEEVE.
- (I) TELCO GROUND BAR: BOND TO BOTH CELL REFERENCE GROUND BAR OR EXTERIOR GROUND RING.
- (J) FRAME BONDING: THE BONDING POINT FOR TELECOM EQUIPMENT FRAMES SHALL BE THE GROUND BUS THAT IS NOT ISOLATED FROM THE EQUIPMENTS METAL FRAMEWORK.
- (K) INTERIOR UNIT BONDS: METAL FRAMES, CABINETS AND INDIVIDUAL METALLIC UNITS LOCATED WITH THE AREA OF THE INTERIOR GROUND RING REQUIRE A #6 AWG STRANDED GREEN INSULATED COPPER BOND TO THE INTERIOR GROUND RING.
- (L) FENCE AND GATE GROUNDING: METAL FENCES WITHIN 7 FEET OF THE EXTERIOR GROUND RING OR OBJECTS BONDED TO THE EXTERIOR GROUND RING SHALL BE BONDED TO THE GROUND RING WITH A #2 AWG SOLID TINNED COPPER CONDUCTOR AT AN INTERVAL NOT EXCEEDING 25 FEET. BONDS SHALL BE MADE AT EACH GATE POST AND ACROSS GATE OPENINGS.
- (M) EXTERIOR UNIT BONDS: METALLIC OBJECTS, EXTERNAL TO OR MOUNTED TO THE BUILDING, SHALL BE BONDED TO THE EXTERIOR GROUND RING. USING #2 TINNED SOLID COPPER WIRE
- (N) ICE BRIDGE SUPPORTS: EACH ICE BRIDGE LEG SHALL BE BONDED TO THE GROUND RING WITH #2 AWG BARE TINNED COPPER CONDUCTOR. PROVIDE EXOTHERMIC WELDS AT BOTH THE ICE BRIDGE LEG AND BURIED GROUND RING.
- (O) DURING ALL DC POWER SYSTEM CHANGES INCLUDING DC SYSTEM CHANGE OUTS, RECTIFIER REPLACEMENTS OR ADDITIONS, BREAKER DISTRIBUTION CHANGES, BATTERY ADDITIONS, BATTERY REPLACEMENTS AND INSTALLATIONS OR CHANGES TO DC CONVERTER SYSTEMS IT SHALL BE REQUIRED THAT SERVICE CONTRACTORS VERIFY ALL DC POWER SYSTEMS ARE EQUIPPED WITH A MASTER DC SYSTEM RETURN GROUND CONDUCTOR FROM THE DC POWER SYSTEM COMMON RETURN BUS DIRECTLY CONNECTED TO THE CELL SITE REFERENCE GROUND BAR
- (P) TOWER TOP COLLECTOR BUSS BAR IS TO BE MECHANICALLY BONDED TO TOWER STEEL.

REFER TO DISH Wireless L.L.C. GROUNDING NOTES.

GROUNDING KEY NOTES

NO SCALE 3



5701 SOUTH SANTA FE DRIVE
LITTLETON, CO 80120



8051 CONGRESS AVENUE
BOCA RATON, FL 33487



1717 S. BOULDER
SUITE 300
TULSA, OK 74119
PH: (918) 587-4630
www.btgrp.com

1/5/23



MTS ENGINEERING P.L.L.C.
BER:2386985
Expires 3/31/23

IT IS A VIOLATION OF LAW FOR ANY PERSON, UNLESS THEY ARE ACTING UNDER THE DIRECTION OF A LICENSED PROFESSIONAL ENGINEER, TO ALTER THIS DOCUMENT.

DRAWN BY: CHECKED BY: APPROVED BY:

BLJ BEH BEH

RFDS REV #: 0

CONSTRUCTION DOCUMENTS

SUBMITTALS		
REV	DATE	DESCRIPTION
A	9/10/21	ISSUED FOR REVIEW
B	01/05/22	ISSUED FOR REVIEW
0	3/8/22	ISSUED FOR CONSTRUCTION
1	5/13/22	ISSUED FOR CONSTRUCTION
2	6/27/22	ISSUED FOR CONSTRUCTION
3	8/23/22	ISSUED FOR CONSTRUCTION
4	01/05/23	ISSUED FOR CONSTRUCTION

A&E PROJECT NUMBER
149477.001.01

DISH Wireless L.L.C.
PROJECT INFORMATION
BOBOS00062A
419 EKON HILL ROAD
(RT-49)
STERLING CT 06377

SHEET TITLE
GROUNDING PLANS
AND NOTES

SHEET NUMBER

G-1

NOTES
EQUIPMENT CABINET OMITTED FOR CLARITY

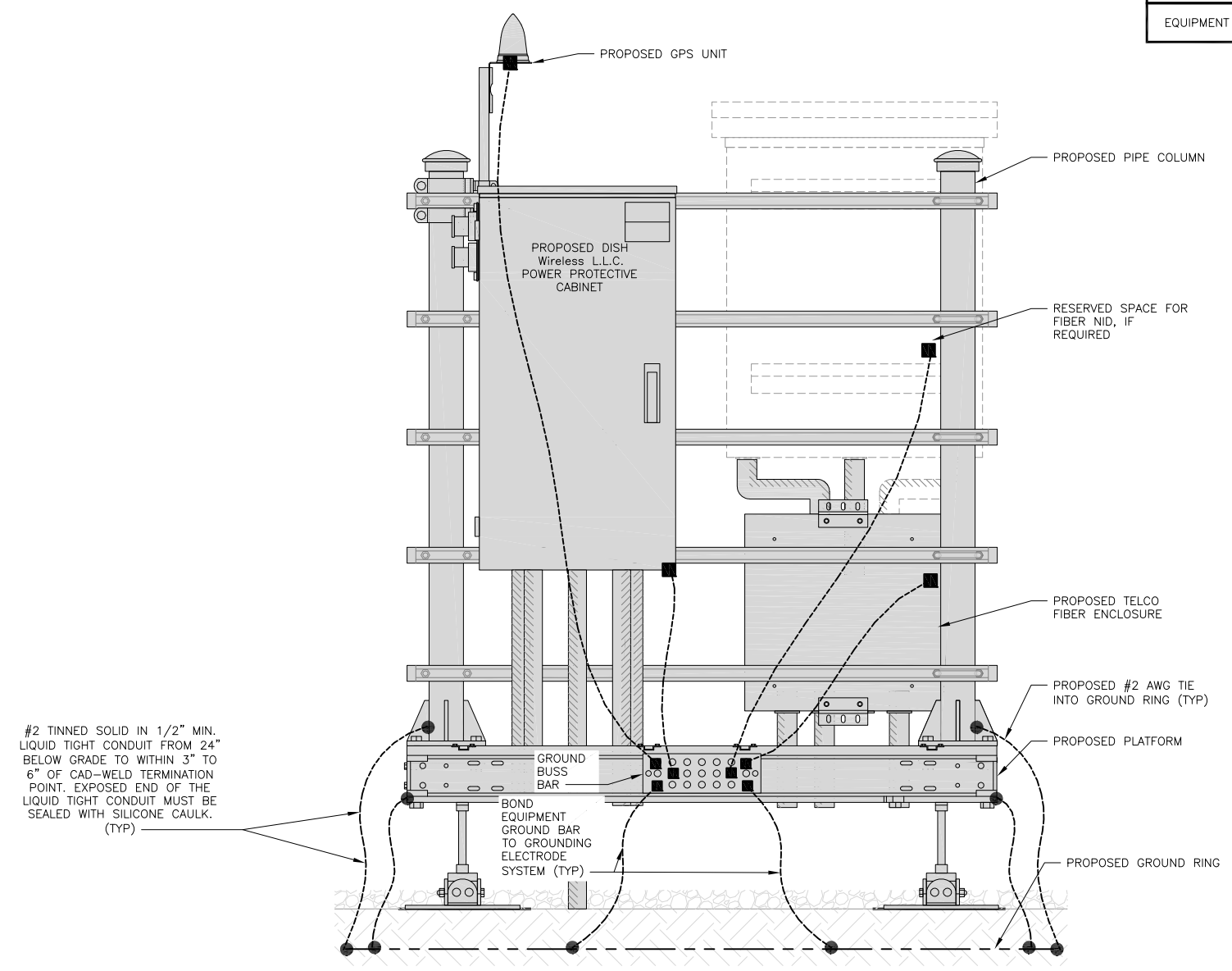

H-FRAME GROUNDING DETAIL

NO SCALE 1

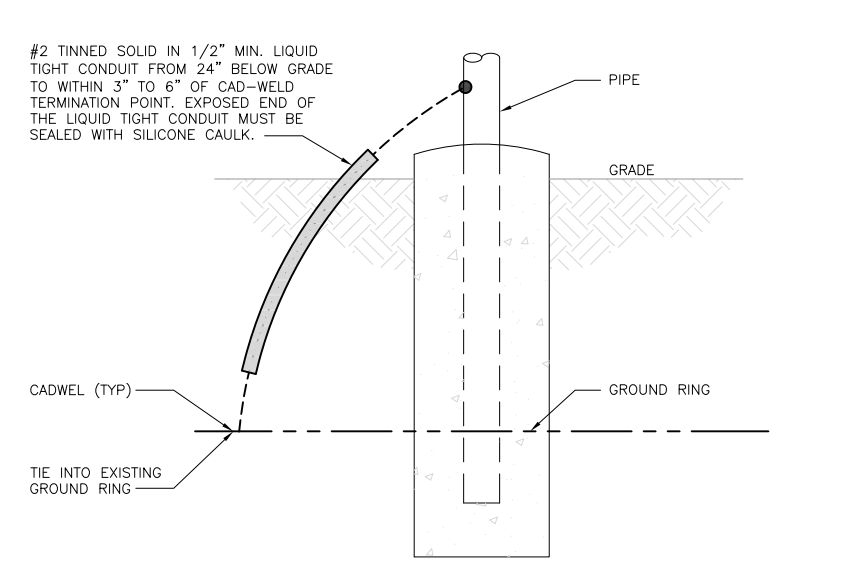

TRANSITIONING GROUND DETAIL

NO SCALE 4

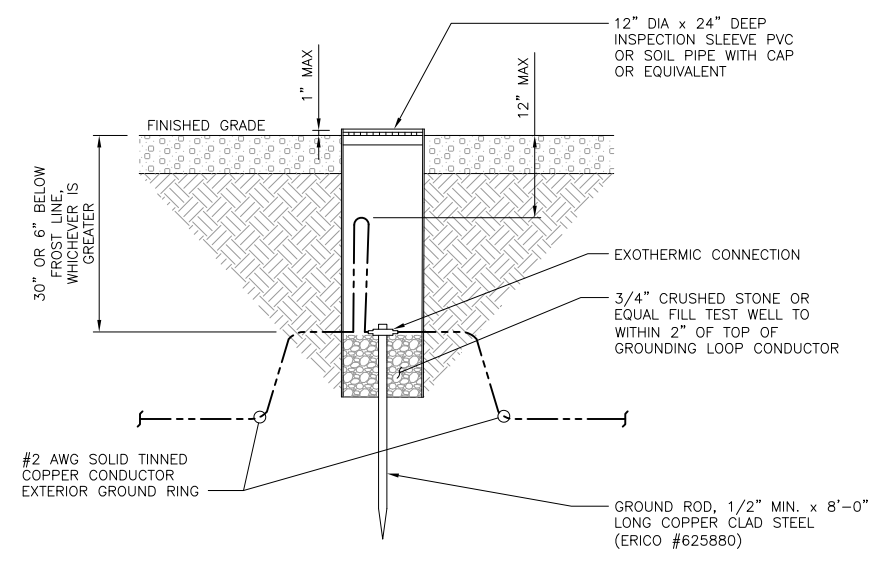

TYPICAL TEST GROUND ROD WITH INSPECTION SLEEVE

NO SCALE 5

NOTES
CABLE GROUNDING NOT REQUIRED WHEN ANTENNA IS LESS THAN 10' FROM CABINET

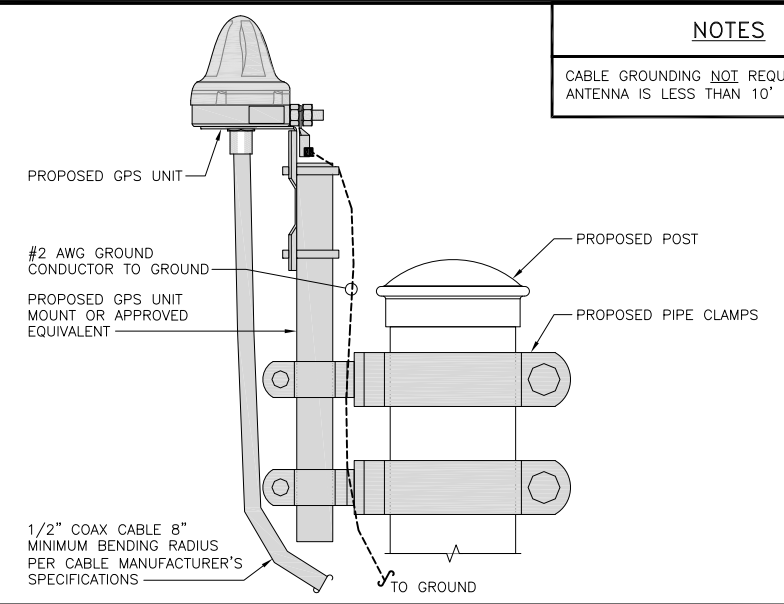

TYPICAL GPS UNIT GROUNDING

NO SCALE 2

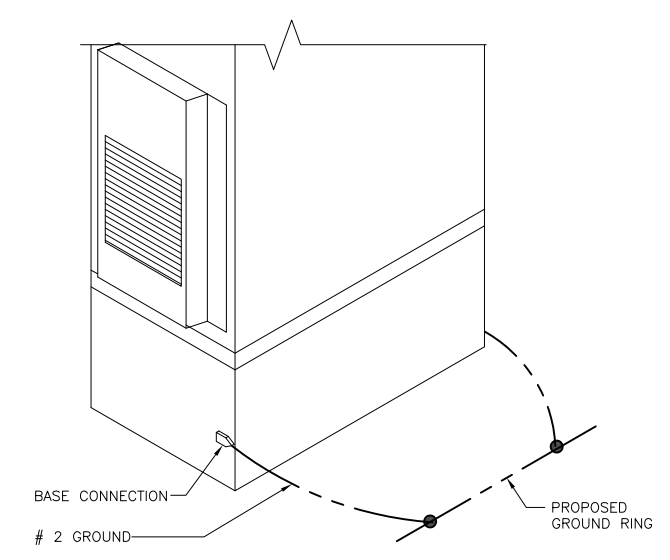

OUTDOOR CABINET GROUNDING

NO SCALE 3

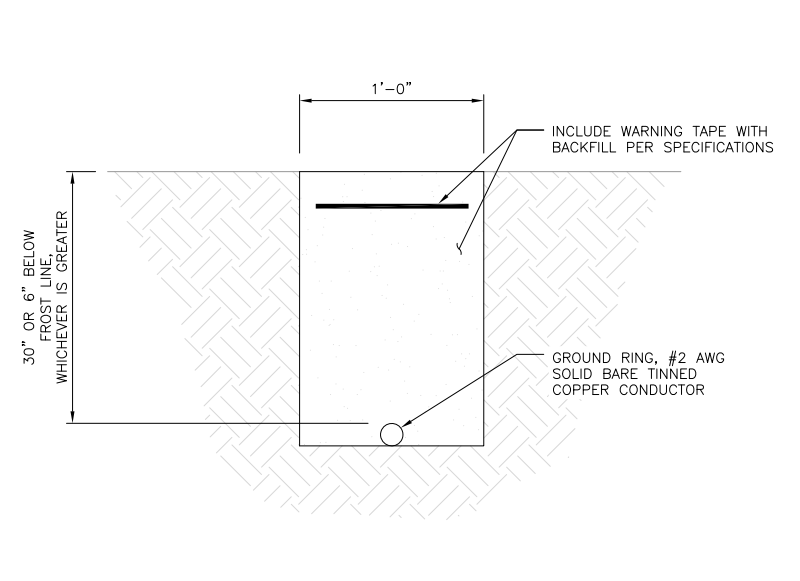

TYPICAL GROUND RING TRENCH

NO SCALE 6



5701 SOUTH SANTA FE DRIVE
LITTLETON, CO 80120



8051 CONGRESS AVENUE
BOCA RATON, FL 33487



1/5/23



IT IS A VIOLATION OF LAW FOR ANY PERSON, UNLESS THEY ARE ACTING UNDER THE DIRECTION OF A LICENSED PROFESSIONAL ENGINEER, TO ALTER THIS DOCUMENT.

DRAWN BY: BLJ CHECKED BY: BEH APPROVED BY: BEH

RFDS REV #: 0

CONSTRUCTION DOCUMENTS

SUBMITTALS		
REV	DATE	DESCRIPTION
A	9/10/21	ISSUED FOR REVIEW
B	01/05/22	ISSUED FOR REVIEW
0	3/8/22	ISSUED FOR CONSTRUCTION
1	5/13/22	ISSUED FOR CONSTRUCTION
2	6/27/22	ISSUED FOR CONSTRUCTION
3	8/23/22	ISSUED FOR CONSTRUCTION
4	01/05/23	ISSUED FOR CONSTRUCTION

A&E PROJECT NUMBER
149477.001.01

DISH Wireless L.L.C.
PROJECT INFORMATION
BOBOS00062A
419 EKONK HILL ROAD
(RT-49)
STERLING CT 06377

SHEET TITLE
GROUNDING DETAILS

SHEET NUMBER

G-2

1. EXOTHERMIC WELD (2) TWO, #2 AWG BARE TINNED SOLID COPPER CONDUCTORS TO GROUND BAR. ROUTE CONDUCTORS TO BURIED GROUND RING AND PROVIDE PARALLEL EXOTHERMIC WELD.
2. ALL EXTERIOR GROUNDING HARDWARE SHALL BE STAINLESS STEEL 3/8" DIAMETER OR LARGER. ALL HARDWARE 18-8 STAINLESS STEEL INCLUDING LOCK WASHERS, COAT ALL SURFACES WITH AN ANTI-OXIDANT COMPOUND BEFORE MATING.
3. FOR GROUND BOND TO STEEL ONLY: COAT ALL SURFACES WITH AN ANTI-OXIDANT COMPOUND BEFORE MATING.
4. DO NOT INSTALL CABLE GROUNDING KIT AT A BEND AND ALWAYS DIRECT GROUND CONDUCTOR DOWN TO GROUNDING BUS.
5. NUT & WASHER SHALL BE PLACED ON THE FRONT SIDE OF THE GROUND BAR AND BOLTED ON THE BACK SIDE.
6. ALL GROUNDING PARTS AND EQUIPMENT TO BE SUPPLIED AND INSTALLED BY CONTRACTOR.
7. THE CONTRACTOR SHALL BE RESPONSIBLE FOR INSTALLING ADDITIONAL GROUND BAR AS REQUIRED.
8. ENSURE THE WIRE INSULATION TERMINATION IS WITHIN 1/8" OF THE BARREL (NO SHINERS).

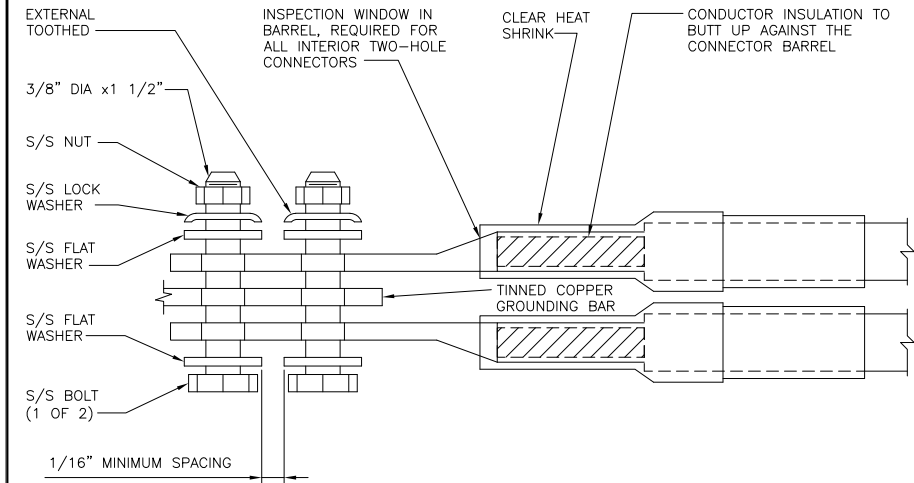
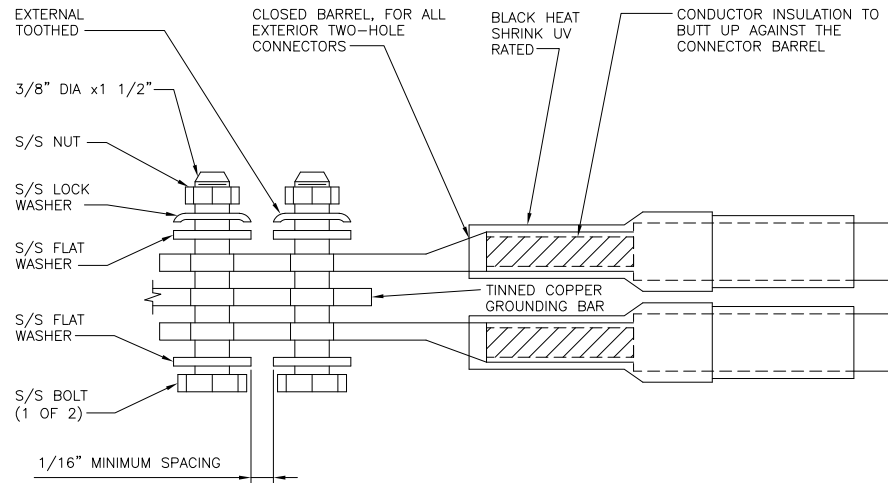

TYPICAL GROUNDING NOTES

NO SCALE

1

TYPICAL EXTERIOR TWO HOLE LUG

NO SCALE

2

TYPICAL INTERIOR TWO HOLE LUG

NO SCALE

3

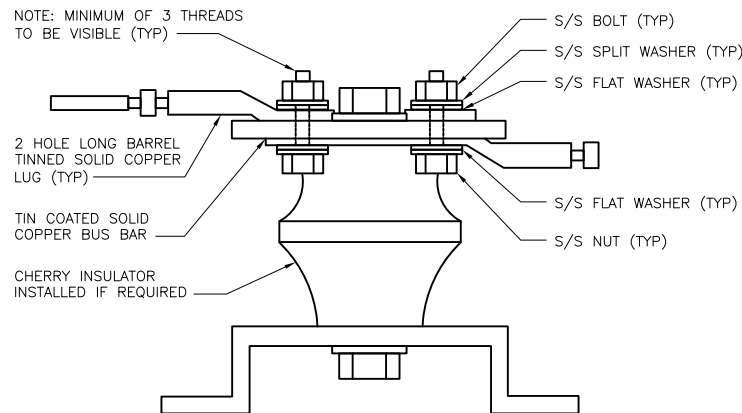

LUG DETAIL

NO SCALE

4

NOT USED

NO SCALE

5

NOT USED

NO SCALE

6

NOT USED

NO SCALE

7

NOT USED

NO SCALE

8

NOT USED

NO SCALE

9

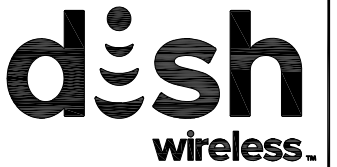

5701 SOUTH SANTA FE DRIVE
LITTLETON, CO 80120



8051 CONGRESS AVENUE
BOCA RATON, FL 33487



1717 S. BOULDER
SUITE 300
TULSA, OK 74119
PH: (918) 587-4630
www.blgrp.com

1/5/23



MTS ENGINEERING P.L.L.C.
BER:2386985
Expires 3/31/23

IT IS A VIOLATION OF LAW FOR ANY PERSON, UNLESS THEY ARE ACTING UNDER THE DIRECTION OF A LICENSED PROFESSIONAL ENGINEER, TO ALTER THIS DOCUMENT.

DRAWN BY: CHECKED BY: APPROVED BY:

BLJ BEH BEH

RFDS REV #: 0

CONSTRUCTION DOCUMENTS

SUBMITTALS		
REV	DATE	DESCRIPTION
A	9/10/21	ISSUED FOR REVIEW
B	01/05/22	ISSUED FOR REVIEW
0	3/8/22	ISSUED FOR CONSTRUCTION
1	5/13/22	ISSUED FOR CONSTRUCTION
2	6/27/22	ISSUED FOR CONSTRUCTION
3	8/23/22	ISSUED FOR CONSTRUCTION
4	01/05/23	ISSUED FOR CONSTRUCTION

A&E PROJECT NUMBER
149477.001.01

DISH Wireless L.L.C.
PROJECT INFORMATION
BOBOS00062A
419 EKONK HILL ROAD
(RT-49)
STERLING CT 06377

SHEET TITLE
GROUNDING DETAILS

SHEET NUMBER
G-3

RF JUMPER COLOR CODING

3/4" TAPE WIDTHS WITH 3/4" SPACING

LOW-BAND RRH -
(600MHz N71 BASEBAND) +
(850MHz N26 BAND) +
(700MHz N29 BAND) - OPTIONAL PER MARKET

ADD FREQUENCY COLOR TO SECTOR BAND
(CBRS WILL USE YELLOW BANDS)

ALPHA RRH				BETA RRH				GAMMA RRH			
PORT 1 + SLANT	PORT 2 - SLANT	PORT 3 + SLANT	PORT 4 - SLANT	PORT 1 + SLANT	PORT 2 - SLANT	PORT 3 + SLANT	PORT 4 - SLANT	PORT 1 + SLANT	PORT 2 - SLANT	PORT 3 + SLANT	PORT 4 - SLANT
RED	RED	RED	RED	BLUE	BLUE	BLUE	BLUE	GREEN	GREEN	GREEN	GREEN
ORANGE	ORANGE	RED	RED	ORANGE	ORANGE	BLUE	BLUE	ORANGE	ORANGE	GREEN	GREEN
	WHITE (-) PORT	ORANGE	ORANGE		WHITE (-) PORT	ORANGE	ORANGE		WHITE (-) PORT	ORANGE	ORANGE
			WHITE (-) PORT				WHITE (-) PORT				WHITE (-) PORT

MID-BAND RRH -
(AWS BANDS N66+N70)

ADD FREQUENCY COLOR TO SECTOR BAND
(CBRS WILL USE YELLOW BANDS)

RED	RED	RED	RED	BLUE	BLUE	BLUE	BLUE	GREEN	GREEN	GREEN	GREEN
PURPLE	PURPLE	RED	RED	PURPLE	PURPLE	BLUE	BLUE	PURPLE	PURPLE	GREEN	GREEN
	WHITE (-) PORT	PURPLE	PURPLE		WHITE (-) PORT	PURPLE	PURPLE		WHITE (-) PORT	PURPLE	PURPLE
			WHITE (-) PORT				WHITE (-) PORT				WHITE (-) PORT

HYBRID/DISCREET CABLES

INCLUDE SECTOR BANDS BEING SUPPORTED
ALONG WITH FREQUENCY BANDS

EXAMPLE 1 - HYBRID, OR DISCREET, SUPPORTS
ALL SECTORS, BOTH LOW-BANDS AND MID-BANDS

EXAMPLE 2 - HYBRID, OR DISCREET, SUPPORTS
CBRS ONLY, ALL SECTORS

EXAMPLE 1	EXAMPLE 2	EXAMPLE 3
RED	RED	RED
BLUE	BLUE	
GREEN	GREEN	ORANGE
ORANGE	YELLOW	PURPLE
PURPLE		

CONTRACTOR TO REFER TO FINAL
CONSTRUCTION RFDS FOR ALL RD DETAILS.
FINAL RFDS IS IN NEXSYSONE.

FIBER JUMPERS TO RRHs

LOW-BAND RRH FIBER CABLES HAVE SECTOR
STRIPE ONLY

LOW BAND RRH	HIGH BAND RRH	LOW BAND RRH	HIGH BAND RRH	LOW BAND RRH	HIGH BAND RRH
RED	RED	BLUE	BLUE	GREEN	GREEN
	PURPLE		PURPLE		PURPLE

POWER CABLES TO RRHs

LOW-BAND RRH POWER CABLES HAVE SECTOR
STRIPE ONLY

LOW BAND RRH	HIGH BAND RRH	LOW BAND RRH	HIGH BAND RRH	LOW BAND RRH	HIGH BAND RRH
RED	RED	BLUE	BLUE	GREEN	GREEN
	PURPLE		PURPLE		PURPLE

RET MOTORS AT ANTENNAS

ANTENNA 1 LOW BAND/ "IN"	ANTENNA 1 HIGH BAND/ "IN"	ANTENNA 1 LOW BAND/ "IN"	ANTENNA 1 HIGH BAND/ "IN"	ANTENNA 1 LOW BAND/ "IN"	ANTENNA 1 HIGH BAND/ "IN"
RED	RED	BLUE	BLUE	GREEN	GREEN
	PURPLE		PURPLE		PURPLE

MICROWAVE RADIO LINKS

LINKS WILL HAVE A 1.5-2 INCH WHITE WRAP WITH
THE AZIMUTH COLOR OVERLAPPING IN THE MIDDLE.
ADD ADDITIONAL SECTOR COLOR BANDS FOR EACH
ADDITIONAL MW RADIO.

MICROWAVE CABLES WILL REQUIRE P-TOUCH
LABELS INSIDE THE CABINET TO IDENTIFY THE
LOCAL AND REMOTE SITE ID'S

FORWARD AZIMUTH OF 0-120 DEGREES		FORWARD AZIMUTH OF 120-240 DEGREES		FORWARD AZIMUTH OF 240-360 DEGREES	
PRIMARY	SECONDARY	PRIMARY	SECONDARY	PRIMARY	SECONDARY
WHITE	WHITE	WHITE	WHITE	WHITE	WHITE
RED	RED	BLUE	BLUE	GREEN	GREEN
WHITE	WHITE	WHITE	WHITE	WHITE	WHITE
	RED		BLUE		GREEN
	WHITE		WHITE		WHITE

RF CABLE COLOR CODES

NO SCALE

1

LOW BANDS (N71+N26)
OPTIONAL - (N29)



AWS
(N66+N70+H-BLOCK)



CBRS TECH
(3 GHz)



NEGATIVE SLANT PORT
ON ANT/RRH



ALPHA SECTOR



BETA SECTOR



GAMMA SECTOR



COLOR IDENTIFIER

NO SCALE

2

NOT USED

NO SCALE

3

NOT USED

NO SCALE

4



5701 SOUTH SANTA FE DRIVE
LITTLETON, CO 80120



8051 CONGRESS AVENUE
BOCA RATON, FL 33487



1717 S. BOULDER
SUITE 300
TULSA, OK 74119
PH: (918) 587-4630
www.btgrp.com

1/5/23



MTS ENGINEERING P.L.L.C.
BER:2386985
Expires 3/31/23

IT IS A VIOLATION OF LAW FOR ANY PERSON,
UNLESS THEY ARE ACTING UNDER THE DIRECTION
OF A LICENSED PROFESSIONAL ENGINEER,
TO ALTER THIS DOCUMENT.

DRAWN BY: CHECKED BY: APPROVED BY:

BLJ BEH BEH

RFDS REV #: 0

CONSTRUCTION DOCUMENTS

SUBMITTALS		
REV	DATE	DESCRIPTION
A	9/10/21	ISSUED FOR REVIEW
B	01/05/22	ISSUED FOR REVIEW
0	3/8/22	ISSUED FOR CONSTRUCTION
1	5/13/22	ISSUED FOR CONSTRUCTION
2	6/27/22	ISSUED FOR CONSTRUCTION
3	8/23/22	ISSUED FOR CONSTRUCTION
4	01/05/23	ISSUED FOR CONSTRUCTION

A&E PROJECT NUMBER
149477.001.01

DISH Wireless L.L.C.
PROJECT INFORMATION
BOBOS00062A
419 EKONK HILL ROAD
(RT-49)
STERLING CT 06377

SHEET TITLE
RF
CABLE COLOR CODE

SHEET NUMBER
RF-1

EXOTHERMIC CONNECTION
 MECHANICAL CONNECTION
 BUSS BAR INSULATOR
 CHEMICAL ELECTROLYTIC GROUNDING SYSTEM
 TEST CHEMICAL ELECTROLYTIC GROUNDING SYSTEM
 EXOTHERMIC WITH INSPECTION SLEEVE
 GROUNDING BAR
 GROUND ROD
 TEST GROUND ROD WITH INSPECTION SLEEVE
 SINGLE POLE SWITCH
 DUPLEX RECEPTACLE
 DUPLEX GFCI RECEPTACLE
 FLUORESCENT LIGHTING FIXTURE (2) TWO LAMPS 48-T8
 SMOKE DETECTION (DC)
 EMERGENCY LIGHTING (DC)
 SECURITY LIGHT W/PHOTOCELL LITHONIA ALXW
 LED-1-25A400/51K-SR4-120-PE-DDBTXD
 CHAIN LINK FENCE
 WOOD/WROUGHT IRON FENCE
 WALL STRUCTURE
 LEASE AREA
 PROPERTY LINE (PL)
 SETBACKS
 ICE BRIDGE
 CABLE TRAY
 WATER LINE
 UNDERGROUND POWER
 UNDERGROUND TELCO
 OVERHEAD POWER
 OVERHEAD TELCO
 UNDERGROUND TELCO/POWER
 ABOVE GROUND POWER
 ABOVE GROUND TELCO
 ABOVE GROUND TELCO/POWER
 WORKPOINT

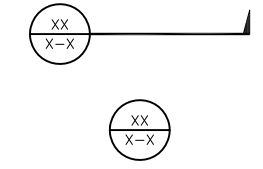
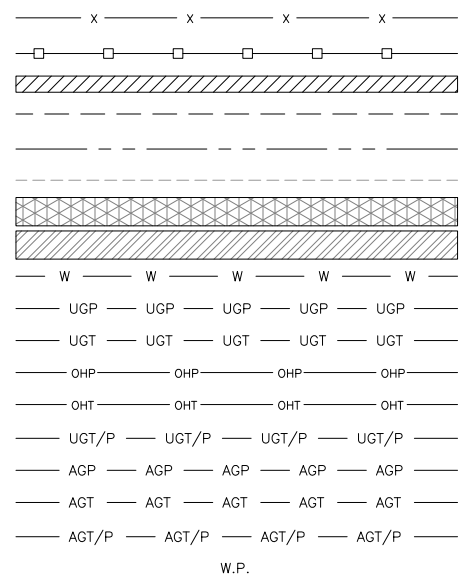
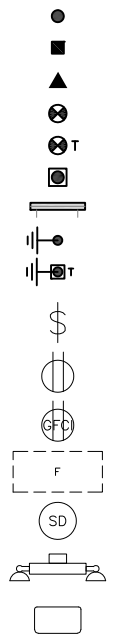

SECTION REFERENCE
 DETAIL REFERENCE

LEGEND

AB ANCHOR BOLT	IN INCH
ABV ABOVE	INT INTERIOR
AC ALTERNATING CURRENT	LB(S) POUND(S)
ADDL ADDITIONAL	LF LINEAR FEET
AFF ABOVE FINISHED FLOOR	LTE LONG TERM EVOLUTION
AFG ABOVE FINISHED GRADE	MAS MASONRY
AGL ABOVE GROUND LEVEL	MAX MAXIMUM
AIC AMPERAGE INTERRUPTION CAPACITY	MB MACHINE BOLT
ALUM ALUMINUM	MECH MECHANICAL
ALT ALTERNATE	MFR MANUFACTURER
ANT ANTENNA	MGB MASTER GROUND BAR
APPROX APPROXIMATE	MIN MINIMUM
ARCH ARCHITECTURAL	MISC MISCELLANEOUS
ATS AUTOMATIC TRANSFER SWITCH	MTL METAL
AWG AMERICAN WIRE GAUGE	MTS MANUAL TRANSFER SWITCH
BATT BATTERY	MW MICROWAVE
BLDG BUILDING	NEC NATIONAL ELECTRIC CODE
BLK BLOCK	NM NEWTON METERS
BLKG BLOCKING	NO. NUMBER
BM BEAM	# NUMBER
BTC BARE TINNED COPPER CONDUCTOR	NTS NOT TO SCALE
BOF BOTTOM OF FOOTING	OC ON-CENTER
CAB CABINET	OSHA OCCUPATIONAL SAFETY AND HEALTH ADMINISTRATION
CANT CANTILEVERED	OPNG OPENING
CHG CHARGING	P/C PRECAST CONCRETE
CLG CEILING	PCS PERSONAL COMMUNICATION SERVICES
CLR CLEAR	PCU PRIMARY CONTROL UNIT
COL COLUMN	PRC PRIMARY RADIO CABINET
COMM COMMON	PP POLARIZING PRESERVING
CONC CONCRETE	PSF POUNDS PER SQUARE FOOT
CONSTR CONSTRUCTION	PSI POUNDS PER SQUARE INCH
DBL DOUBLE	PT PRESSURE TREATED
DC DIRECT CURRENT	PWR POWER CABINET
DEPT DEPARTMENT	QTY QUANTITY
DF DOUGLAS FIR	RAD RADIUS
DIA DIAMETER	RECT RECTIFIER
DIAG DIAGONAL	REF REFERENCE
DIM DIMENSION	REINF REINFORCEMENT
DWG DRAWING	REQ'D REQUIRED
DWL DOWEL	RET REMOTE ELECTRIC TILT
EA EACH	RF RADIO FREQUENCY
EC ELECTRICAL CONDUCTOR	RMC RIGID METALLIC CONDUIT
EL ELEVATION	RRH REMOTE RADIO HEAD
ELEC ELECTRICAL	RRU REMOTE RADIO UNIT
EMT ELECTRICAL METALLIC TUBING	RWY RACEWAY
ENG ENGINEER	SCH SCHEDULE
EQ EQUAL	SHT SHEET
EXP EXPANSION	SIAD SMART INTEGRATED ACCESS DEVICE
EXT EXTERIOR	SIM SIMILAR
EW EACH WAY	SPEC SPECIFICATION
FAB FABRICATION	SQ SQUARE
FF FINISH FLOOR	SS STAINLESS STEEL
FG FINISH GRADE	STD STANDARD
FIF FACILITY INTERFACE FRAME	STL STEEL
FIN FINISH(ED)	TEMP TEMPORARY
FLR FLOOR	THK THICKNESS
FDN FOUNDATION	TMA TOWER MOUNTED AMPLIFIER
FOC FACE OF CONCRETE	TN TOE NAIL
FOM FACE OF MASONRY	TOA TOP OF ANTENNA
FOS FACE OF STUD	TOC TOP OF CURB
FOW FACE OF WALL	TOF TOP OF FOUNDATION
FS FINISH SURFACE	TOP TOP OF PLATE (PARAPET)
FT FOOT	TOS TOP OF STEEL
FTG FOOTING	TOW TOP OF WALL
GA GAUGE	TVSS TRANSIENT VOLTAGE SURGE SUPPRESSION
GEN GENERATOR	TYP TYPICAL
GFCI GROUND FAULT CIRCUIT INTERRUPTER	UG UNDERGROUND
GLB GLUE LAMINATED BEAM	UL UNDERWRITERS LABORATORY
GLV GALVANIZED	UNO UNLESS NOTED OTHERWISE
GPS GLOBAL POSITIONING SYSTEM	UMTS UNIVERSAL MOBILE TELECOMMUNICATIONS SYSTEM
GND GROUND	UPS UNINTERRUPTIBLE POWER SYSTEM (DC POWER PLANT)
GSM GLOBAL SYSTEM FOR MOBILE	VIF VERIFIED IN FIELD
HDG HOT DIPPED GALVANIZED	W WIDE
HDR HEADER	W/ WITH
HGR HANGER	WD WOOD
HVAC HEAT/VENTILATION/AIR CONDITIONING	WP WEATHERPROOF
HT HEIGHT	WT WEIGHT
IGR INTERIOR GROUND RING	

ABBREVIATIONS



5701 SOUTH SANTA FE DRIVE
 LITTLETON, CO 80120



8051 CONGRESS AVENUE
 BOCA RATON, FL 33487



1/5/23



MTS ENGINEERING P.L.L.C.
 BER:2386985
 Expires 3/31/23

IT IS A VIOLATION OF LAW FOR ANY PERSON, UNLESS THEY ARE ACTING UNDER THE DIRECTION OF A LICENSED PROFESSIONAL ENGINEER, TO ALTER THIS DOCUMENT.

DRAWN BY:	CHECKED BY:	APPROVED BY:
BLJ	BEH	BEH

RFDS REV #: 0

CONSTRUCTION DOCUMENTS

SUBMITTALS		
REV	DATE	DESCRIPTION
A	9/10/21	ISSUED FOR REVIEW
B	01/05/22	ISSUED FOR REVIEW
0	3/8/22	ISSUED FOR CONSTRUCTION
1	5/13/22	ISSUED FOR CONSTRUCTION
2	6/27/22	ISSUED FOR CONSTRUCTION
3	8/23/22	ISSUED FOR CONSTRUCTION
4	01/05/23	ISSUED FOR CONSTRUCTION

A&E PROJECT NUMBER
149477.001.01

DISH Wireless L.L.C.
 PROJECT INFORMATION
BOBOS00062A
419 EKONK HILL ROAD
(RT-49)
STERLING CT 06377

SHEET TITLE
LEGEND AND ABBREVIATIONS

SHEET NUMBER
GN-1

SITE ACTIVITY REQUIREMENTS:

1. NOTICE TO PROCEED – NO WORK SHALL COMMENCE PRIOR TO CONTRACTOR RECEIVING A WRITTEN NOTICE TO PROCEED (NTP) AND THE ISSUANCE OF A PURCHASE ORDER. PRIOR TO ACCESSING/ENTERING THE SITE YOU MUST CONTACT THE DISH Wireless L.L.C. AND TOWER OWNER NOC & THE DISH Wireless L.L.C. AND TOWER OWNER CONSTRUCTION MANAGER.
2. "LOOK UP" – DISH Wireless L.L.C. AND TOWER OWNER SAFETY CLIMB REQUIREMENT:
THE INTEGRITY OF THE SAFETY CLIMB AND ALL COMPONENTS OF THE CLIMBING FACILITY SHALL BE CONSIDERED DURING ALL STAGES OF DESIGN, INSTALLATION, AND INSPECTION. TOWER MODIFICATION, MOUNT REINFORCEMENTS, AND/OR EQUIPMENT INSTALLATIONS SHALL NOT COMPROMISE THE INTEGRITY OR FUNCTIONAL USE OF THE SAFETY CLIMB OR ANY COMPONENTS OF THE CLIMBING FACILITY ON THE STRUCTURE. THIS SHALL INCLUDE, BUT NOT BE LIMITED TO: PINCHING OF THE WIRE ROPE, BENDING OF THE WIRE ROPE FROM ITS SUPPORTS, DIRECT CONTACT OR CLOSE PROXIMITY TO THE WIRE ROPE WHICH MAY CAUSE FRICTIONAL WEAR, IMPACT TO THE ANCHORAGE POINTS IN ANY WAY, OR TO IMPEDE/BLOCK ITS INTENDED USE. ANY COMPROMISED SAFETY CLIMB, INCLUDING EXISTING CONDITIONS MUST BE TAGGED OUT AND REPORTED TO YOUR DISH Wireless L.L.C. AND DISH Wireless L.L.C. AND TOWER OWNER POC OR CALL THE NOC TO GENERATE A SAFETY CLIMB MAINTENANCE AND CONTRACTOR NOTICE TICKET.
3. PRIOR TO THE START OF CONSTRUCTION, ALL REQUIRED JURISDICTIONAL PERMITS SHALL BE OBTAINED. THIS INCLUDES, BUT IS NOT LIMITED TO, BUILDING, ELECTRICAL, MECHANICAL, FIRE, FLOOD ZONE, ENVIRONMENTAL, AND ZONING. AFTER ONSITE ACTIVITIES AND CONSTRUCTION ARE COMPLETED, ALL REQUIRED PERMITS SHALL BE SATISFIED AND CLOSED OUT ACCORDING TO LOCAL JURISDICTIONAL REQUIREMENTS.
4. ALL CONSTRUCTION MEANS AND METHODS; INCLUDING BUT NOT LIMITED TO, ERECTION PLANS, RIGGING PLANS, CLIMBING PLANS, AND RESCUE PLANS SHALL BE THE RESPONSIBILITY OF THE GENERAL CONTRACTOR RESPONSIBLE FOR THE EXECUTION OF THE WORK CONTAINED HEREIN, AND SHALL MEET ANSI/ASSE A10.48 (LATEST EDITION); FEDERAL, STATE, AND LOCAL REGULATIONS; AND ANY APPLICABLE INDUSTRY CONSENSUS STANDARDS RELATED TO THE CONSTRUCTION ACTIVITIES BEING PERFORMED. ALL RIGGING PLANS SHALL ADHERE TO ANSI/ASSE A10.48 (LATEST EDITION) AND DISH Wireless L.L.C. AND TOWER OWNER STANDARDS, INCLUDING THE REQUIRED INVOLVEMENT OF A QUALIFIED ENGINEER FOR CLASS IV CONSTRUCTION, TO CERTIFY THE SUPPORTING STRUCTURE(S) IN ACCORDANCE WITH ANSI/TIA-322 (LATEST EDITION).
5. ALL SITE WORK TO COMPLY WITH DISH Wireless L.L.C. AND TOWER OWNER INSTALLATION STANDARDS FOR CONSTRUCTION ACTIVITIES ON DISH Wireless L.L.C. AND TOWER OWNER TOWER SITE AND LATEST VERSION OF ANSI/TIA-1019-A-2012 "STANDARD FOR INSTALLATION, ALTERATION, AND MAINTENANCE OF ANTENNA SUPPORTING STRUCTURES AND ANTENNAS."
6. IF THE SPECIFIED EQUIPMENT CAN NOT BE INSTALLED AS SHOWN ON THESE DRAWINGS, THE CONTRACTOR SHALL PROPOSE AN ALTERNATIVE INSTALLATION FOR APPROVAL BY DISH Wireless L.L.C. AND TOWER OWNER PRIOR TO PROCEEDING WITH ANY SUCH CHANGE OF INSTALLATION.
7. ALL MATERIALS FURNISHED AND INSTALLED SHALL BE IN STRICT ACCORDANCE WITH ALL APPLICABLE CODES, REGULATIONS AND ORDINANCES. CONTRACTOR SHALL ISSUE ALL APPROPRIATE NOTICES AND COMPLY WITH ALL LAWS, ORDINANCES, RULES, REGULATIONS AND LAWFUL ORDERS OF ANY PUBLIC AUTHORITY REGARDING THE PERFORMANCE OF THE WORK. ALL WORK CARRIED OUT SHALL COMPLY WITH ALL APPLICABLE MUNICIPAL AND UTILITY COMPANY SPECIFICATIONS AND LOCAL JURISDICTIONAL CODES, ORDINANCES AND APPLICABLE REGULATIONS.
8. THE CONTRACTOR SHALL INSTALL ALL EQUIPMENT AND MATERIALS IN ACCORDANCE WITH MANUFACTURER'S RECOMMENDATIONS UNLESS SPECIFICALLY STATED OTHERWISE.
9. THE CONTRACTOR SHALL CONTACT UTILITY LOCATING SERVICES INCLUDING PRIVATE LOCATES SERVICES PRIOR TO THE START OF CONSTRUCTION.
10. ALL EXISTING ACTIVE SEWER, WATER, GAS, ELECTRIC AND OTHER UTILITIES WHERE ENCOUNTERED IN THE WORK, SHALL BE PROTECTED AT ALL TIMES AND WHERE REQUIRED FOR THE PROPER EXECUTION OF THE WORK, SHALL BE RELOCATED AS DIRECTED BY CONTRACTOR. EXTREME CAUTION SHOULD BE USED BY THE CONTRACTOR WHEN EXCAVATING OR DRILLING PIERS AROUND OR NEAR UTILITIES. CONTRACTOR SHALL PROVIDE SAFETY TRAINING FOR THE WORKING CREW. THIS WILL INCLUDE BUT NOT BE LIMITED TO A) FALL PROTECTION B) CONFINED SPACE C) ELECTRICAL SAFETY D) TRENCHING AND EXCAVATION E) CONSTRUCTION SAFETY PROCEDURES.
11. ALL SITE WORK SHALL BE AS INDICATED ON THE STAMPED CONSTRUCTION DRAWINGS AND DISH PROJECT SPECIFICATIONS, LATEST APPROVED REVISION.
12. CONTRACTOR SHALL KEEP THE SITE FREE FROM ACCUMULATING WASTE MATERIAL, DEBRIS, AND TRASH AT THE COMPLETION OF THE WORK. IF NECESSARY, RUBBISH, STUMPS, DEBRIS, STICKS, STONES AND OTHER REFUSE SHALL BE REMOVED FROM THE SITE AND DISPOSED OF LEGALLY.
13. ALL EXISTING INACTIVE SEWER, WATER, GAS, ELECTRIC AND OTHER UTILITIES, WHICH INTERFERE WITH THE EXECUTION OF THE WORK, SHALL BE REMOVED AND/OR CAPPED, PLUGGED OR OTHERWISE DISCONTINUED AT POINTS WHICH WILL NOT INTERFERE WITH THE EXECUTION OF THE WORK, SUBJECT TO THE APPROVAL OF DISH Wireless L.L.C. AND TOWER OWNER, AND/OR LOCAL UTILITIES.
14. THE CONTRACTOR SHALL PROVIDE SITE SIGNAGE IN ACCORDANCE WITH THE TECHNICAL SPECIFICATION FOR SITE SIGNAGE REQUIRED BY LOCAL JURISDICTION AND SIGNAGE REQUIRED ON INDIVIDUAL PIECES OF EQUIPMENT, ROOMS, AND SHELTERS.
15. THE SITE SHALL BE GRADED TO CAUSE SURFACE WATER TO FLOW AWAY FROM THE CARRIER'S EQUIPMENT AND TOWER AREAS.
16. THE SUB GRADE SHALL BE COMPACTED AND BROUGHT TO A SMOOTH UNIFORM GRADE PRIOR TO FINISHED SURFACE APPLICATION.
17. THE AREAS OF THE OWNERS PROPERTY DISTURBED BY THE WORK AND NOT COVERED BY THE TOWER, EQUIPMENT OR DRIVEWAY, SHALL BE GRADED TO A UNIFORM SLOPE, AND STABILIZED TO PREVENT EROSION AS SPECIFIED ON THE CONSTRUCTION DRAWINGS AND/OR PROJECT SPECIFICATIONS.
18. CONTRACTOR SHALL MINIMIZE DISTURBANCE TO EXISTING SITE DURING CONSTRUCTION. EROSION CONTROL MEASURES, IF REQUIRED DURING CONSTRUCTION, SHALL BE IN CONFORMANCE WITH THE LOCAL GUIDELINES FOR EROSION AND SEDIMENT CONTROL.
19. THE CONTRACTOR SHALL PROTECT EXISTING IMPROVEMENTS, PAVEMENTS, CURBS, LANDSCAPING AND STRUCTURES. ANY DAMAGED PART SHALL BE REPAIRED AT CONTRACTOR'S EXPENSE TO THE SATISFACTION OF OWNER.
20. CONTRACTOR SHALL LEGALLY AND PROPERLY DISPOSE OF ALL SCRAP MATERIALS SUCH AS COAXIAL CABLES AND OTHER ITEMS REMOVED FROM THE EXISTING FACILITY. ANTENNAS AND RADIOS REMOVED SHALL BE RETURNED TO THE OWNER'S DESIGNATED LOCATION.
21. CONTRACTOR SHALL LEAVE PREMISES IN CLEAN CONDITION. TRASH AND DEBRIS SHOULD BE REMOVED FROM SITE ON A DAILY BASIS.
22. NO FILL OR EMBANKMENT MATERIAL SHALL BE PLACED ON FROZEN GROUND. FROZEN MATERIALS, SNOW OR ICE SHALL NOT BE PLACED IN ANY FILL OR EMBANKMENT.

GENERAL NOTES:

1. FOR THE PURPOSE OF CONSTRUCTION DRAWING, THE FOLLOWING DEFINITIONS SHALL APPLY:
CONTRACTOR: GENERAL CONTRACTOR RESPONSIBLE FOR CONSTRUCTION
CARRIER: DISH Wireless L.L.C.
TOWER OWNER: TOWER OWNER
2. THESE DRAWINGS HAVE BEEN PREPARED USING STANDARDS OF PROFESSIONAL CARE AND COMPLETENESS NORMALLY EXERCISED UNDER SIMILAR CIRCUMSTANCES BY REPUTABLE ENGINEERS IN THIS OR SIMILAR LOCALITIES. IT IS ASSUMED THAT THE WORK DEPICTED WILL BE PERFORMED BY AN EXPERIENCED CONTRACTOR AND/OR WORKPEOPLE WHO HAVE A WORKING KNOWLEDGE OF THE APPLICABLE CODE STANDARDS AND REQUIREMENTS AND OF INDUSTRY ACCEPTED STANDARD GOOD PRACTICE. AS NOT EVERY CONDITION OR ELEMENT IS (OR CAN BE) EXPLICITLY SHOWN ON THESE DRAWINGS, THE CONTRACTOR SHALL USE INDUSTRY ACCEPTED STANDARD GOOD PRACTICE FOR MISCELLANEOUS WORK NOT EXPLICITLY SHOWN.
3. THESE DRAWINGS REPRESENT THE FINISHED STRUCTURE. THEY DO NOT INDICATE THE MEANS OR METHODS OF CONSTRUCTION. THE CONTRACTOR SHALL BE SOLELY RESPONSIBLE FOR THE CONSTRUCTION MEANS, METHODS, TECHNIQUES, SEQUENCES, AND PROCEDURES. THE CONTRACTOR SHALL PROVIDE ALL MEASURES NECESSARY FOR PROTECTION OF LIFE AND PROPERTY DURING CONSTRUCTION. SUCH MEASURES SHALL INCLUDE, BUT NOT BE LIMITED TO, BRACING, FORMWORK, SHORING, ETC. SITE VISITS BY THE ENGINEER OR HIS REPRESENTATIVE WILL NOT INCLUDE INSPECTION OF THESE ITEMS AND IS FOR STRUCTURAL OBSERVATION OF THE FINISHED STRUCTURE ONLY.
4. NOTES AND DETAILS IN THE CONSTRUCTION DRAWINGS SHALL TAKE PRECEDENCE OVER GENERAL NOTES AND TYPICAL DETAILS. WHERE NO DETAILS ARE SHOWN, CONSTRUCTION SHALL CONFORM TO SIMILAR WORK ON THE PROJECT, AND/OR AS PROVIDED FOR IN THE CONTRACT DOCUMENTS. WHERE DISCREPANCIES OCCUR BETWEEN PLANS, DETAILS, GENERAL NOTES, AND SPECIFICATIONS, THE GREATER, MORE STRICT REQUIREMENTS, SHALL GOVERN. IF FURTHER CLARIFICATION IS REQUIRED CONTACT THE ENGINEER OF RECORD.
5. SUBSTANTIAL EFFORT HAS BEEN MADE TO PROVIDE ACCURATE DIMENSIONS AND MEASUREMENTS ON THE DRAWINGS TO ASSIST IN THE FABRICATION AND/OR PLACEMENT OF CONSTRUCTION ELEMENTS BUT IT IS THE SOLE RESPONSIBILITY OF THE CONTRACTOR TO FIELD VERIFY THE DIMENSIONS, MEASUREMENTS, AND/OR CLEARANCES SHOWN IN THE CONSTRUCTION DRAWINGS PRIOR TO FABRICATION OR CUTTING OF ANY NEW OR EXISTING CONSTRUCTION ELEMENTS. IF IT IS DETERMINED THAT THERE ARE DISCREPANCIES AND/OR CONFLICTS WITH THE CONSTRUCTION DRAWINGS THE ENGINEER OF RECORD IS TO BE NOTIFIED AS SOON AS POSSIBLE.
6. PRIOR TO THE SUBMISSION OF BIDS, THE BIDDING CONTRACTOR SHALL VISIT THE CELL SITE TO FAMILIARIZE WITH THE EXISTING CONDITIONS AND TO CONFIRM THAT THE WORK CAN BE ACCOMPLISHED AS SHOWN ON THE CONSTRUCTION DRAWINGS. ANY DISCREPANCY FOUND SHALL BE BROUGHT TO THE ATTENTION OF CARRIER POC AND TOWER OWNER.
7. ALL MATERIALS FURNISHED AND INSTALLED SHALL BE IN STRICT ACCORDANCE WITH ALL APPLICABLE CODES, REGULATIONS AND ORDINANCES. CONTRACTOR SHALL ISSUE ALL APPROPRIATE NOTICES AND COMPLY WITH ALL LAWS, ORDINANCES, RULES, REGULATIONS AND LAWFUL ORDERS OF ANY PUBLIC AUTHORITY REGARDING THE PERFORMANCE OF THE WORK. ALL WORK CARRIED OUT SHALL COMPLY WITH ALL APPLICABLE MUNICIPAL AND UTILITY COMPANY SPECIFICATIONS AND LOCAL JURISDICTIONAL CODES, ORDINANCES AND APPLICABLE REGULATIONS.
8. UNLESS NOTED OTHERWISE, THE WORK SHALL INCLUDE FURNISHING MATERIALS, EQUIPMENT, APPURTENANCES AND LABOR NECESSARY TO COMPLETE ALL INSTALLATIONS AS INDICATED ON THE DRAWINGS.
9. THE CONTRACTOR SHALL INSTALL ALL EQUIPMENT AND MATERIALS IN ACCORDANCE WITH MANUFACTURER'S RECOMMENDATIONS UNLESS SPECIFICALLY STATED OTHERWISE.
10. IF THE SPECIFIED EQUIPMENT CAN NOT BE INSTALLED AS SHOWN ON THESE DRAWINGS, THE CONTRACTOR SHALL PROPOSE AN ALTERNATIVE INSTALLATION FOR APPROVAL BY THE CARRIER AND TOWER OWNER PRIOR TO PROCEEDING WITH ANY SUCH CHANGE OF INSTALLATION.
11. CONTRACTOR IS TO PERFORM A SITE INVESTIGATION, BEFORE SUBMITTING BIDS, TO DETERMINE THE BEST ROUTING OF ALL CONDUITS FOR POWER, AND TELCO AND FOR GROUNDING CABLES AS SHOWN IN THE POWER, TELCO, AND GROUNDING PLAN DRAWINGS.
12. THE CONTRACTOR SHALL PROTECT EXISTING IMPROVEMENTS, PAVEMENTS, CURBS, LANDSCAPING AND STRUCTURES. ANY DAMAGED PART SHALL BE REPAIRED AT CONTRACTOR'S EXPENSE TO THE SATISFACTION OF DISH Wireless L.L.C. AND TOWER OWNER
13. CONTRACTOR SHALL LEGALLY AND PROPERLY DISPOSE OF ALL SCRAP MATERIALS SUCH AS COAXIAL CABLES AND OTHER ITEMS REMOVED FROM THE EXISTING FACILITY. ANTENNAS REMOVED SHALL BE RETURNED TO THE OWNER'S DESIGNATED LOCATION.
14. CONTRACTOR SHALL LEAVE PREMISES IN CLEAN CONDITION. TRASH AND DEBRIS SHOULD BE REMOVED FROM SITE ON A DAILY BASIS.

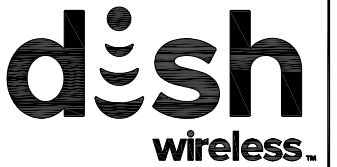

5701 SOUTH SANTA FE DRIVE
LITTLETON, CO 80120



8051 CONGRESS AVENUE
BOCA RATON, FL 33487



1/5/23

MTS ENGINEERING P.L.L.C.
BER: 2386985
Expires 3/31/23

IT IS A VIOLATION OF LAW FOR ANY PERSON, UNLESS THEY ARE ACTING UNDER THE DIRECTION OF A LICENSED PROFESSIONAL ENGINEER, TO ALTER THIS DOCUMENT.

DRAWN BY:	CHECKED BY:	APPROVED BY:
BLJ	BEH	BEH

RFDS REV #: 0

CONSTRUCTION DOCUMENTS

SUBMITTALS		
REV	DATE	DESCRIPTION
A	9/10/21	ISSUED FOR REVIEW
B	01/05/22	ISSUED FOR REVIEW
0	3/8/22	ISSUED FOR CONSTRUCTION
1	5/13/22	ISSUED FOR CONSTRUCTION
2	6/27/22	ISSUED FOR CONSTRUCTION
3	8/23/22	ISSUED FOR CONSTRUCTION
4	01/05/23	ISSUED FOR CONSTRUCTION

A&E PROJECT NUMBER
149477.001.01

DISH Wireless L.L.C.
PROJECT INFORMATION
BOBOS00062A
419 EKONK HILL ROAD
(RT-49)
STERLING CT 06377

SHEET TITLE
GENERAL NOTES

SHEET NUMBER
GN-2

CONCRETE, FOUNDATIONS, AND REINFORCING STEEL:

1. ALL CONCRETE WORK SHALL BE IN ACCORDANCE WITH THE ACI 301, ACI 318, ACI 336, ASTM A184, ASTM A185 AND THE DESIGN AND CONSTRUCTION SPECIFICATION FOR CAST-IN-PLACE CONCRETE.
2. UNLESS NOTED OTHERWISE, SOIL BEARING PRESSURE USED FOR DESIGN OF SLABS AND FOUNDATIONS IS ASSUMED TO BE 1000 psf.
3. ALL CONCRETE SHALL HAVE A MINIMUM COMPRESSIVE STRENGTH (f'c) OF 3000 psi AT 28 DAYS, UNLESS NOTED OTHERWISE. NO MORE THAN 90 MINUTES SHALL ELAPSE FROM BATCH TIME TO TIME OF PLACEMENT UNLESS APPROVED BY THE ENGINEER OF RECORD. TEMPERATURE OF CONCRETE SHALL NOT EXCEED 90°f AT TIME OF PLACEMENT.
4. CONCRETE EXPOSED TO FREEZE-THAW CYCLES SHALL CONTAIN AIR ENTRAINING ADMIXTURES. AMOUNT OF AIR ENTRAINMENT TO BE BASED ON SIZE OF AGGREGATE AND F3 CLASS EXPOSURE (VERY SEVERE). CEMENT USED TO BE TYPE II PORTLAND CEMENT WITH A MAXIMUM WATER-TO-CEMENT RATIO (W/C) OF 0.45.
5. ALL STEEL REINFORCING SHALL CONFORM TO ASTM A615. ALL WELDED WIRE FABRIC (WWF) SHALL CONFORM TO ASTM A185. ALL SPLICES SHALL BE CLASS "B" TENSION SPLICES, UNLESS NOTED OTHERWISE. ALL HOOKS SHALL BE STANDARD 90 DEGREE HOOKS, UNLESS NOTED OTHERWISE. YIELD STRENGTH (Fy) OF STANDARD DEFORMED BARS ARE AS FOLLOWS:
 #4 BARS AND SMALLER 40 ksi
 #5 BARS AND LARGER 60 ksi
6. THE FOLLOWING MINIMUM CONCRETE COVER SHALL BE PROVIDED FOR REINFORCING STEEL UNLESS SHOWN OTHERWISE ON DRAWINGS:
 - CONCRETE CAST AGAINST AND PERMANENTLY EXPOSED TO EARTH 3"
 - CONCRETE EXPOSED TO EARTH OR WEATHER:
 - #6 BARS AND LARGER 2"
 - #5 BARS AND SMALLER 1-1/2"
 - CONCRETE NOT EXPOSED TO EARTH OR WEATHER:
 - SLAB AND WALLS 3/4"
 - BEAMS AND COLUMNS 1-1/2"
7. A TOOLED EDGE OR A 3/4" CHAMFER SHALL BE PROVIDED AT ALL EXPOSED EDGES OF CONCRETE, UNLESS NOTED OTHERWISE, IN ACCORDANCE WITH ACI 301 SECTION 4.2.4.

ELECTRICAL INSTALLATION NOTES:

1. ALL ELECTRICAL WORK SHALL BE PERFORMED IN ACCORDANCE WITH THE PROJECT SPECIFICATIONS, NEC AND ALL APPLICABLE FEDERAL, STATE, AND LOCAL CODES/ORDINANCES.
2. CONDUIT ROUTINGS ARE SCHEMATIC. CONTRACTOR SHALL INSTALL CONDUITS SO THAT ACCESS TO EQUIPMENT IS NOT BLOCKED AND TRIP HAZARDS ARE ELIMINATED.
3. WIRING, RACEWAY AND SUPPORT METHODS AND MATERIALS SHALL COMPLY WITH THE REQUIREMENTS OF THE NEC.
4. ALL CIRCUITS SHALL BE SEGREGATED AND MAINTAIN MINIMUM CABLE SEPARATION AS REQUIRED BY THE NEC.
- 4.1. ALL EQUIPMENT SHALL BEAR THE UNDERWRITERS LABORATORIES LABEL OF APPROVAL, AND SHALL CONFORM TO REQUIREMENT OF THE NATIONAL ELECTRICAL CODE.
- 4.2. ALL OVERCURRENT DEVICES SHALL HAVE AN INTERRUPTING CURRENT RATING THAT SHALL BE GREATER THAN THE SHORT CIRCUIT CURRENT TO WHICH THEY ARE SUBJECTED, 22,000 AIC MINIMUM. VERIFY AVAILABLE SHORT CIRCUIT CURRENT DOES NOT EXCEED THE RATING OF ELECTRICAL EQUIPMENT IN ACCORDANCE WITH ARTICLE 110.24 NEC OR THE MOST CURRENT ADOPTED CODE PRE THE GOVERNING JURISDICTION.
5. EACH END OF EVERY POWER PHASE CONDUCTOR, GROUNDING CONDUCTOR, AND TELCO CONDUCTOR OR CABLE SHALL BE LABELED WITH COLOR-CODED INSULATION OR ELECTRICAL TAPE (3M BRAND, 1/2" PLASTIC ELECTRICAL TAPE WITH UV PROTECTION, OR EQUAL). THE IDENTIFICATION METHOD SHALL CONFORM WITH NEC AND OSHA.
6. ALL ELECTRICAL COMPONENTS SHALL BE CLEARLY LABELED WITH LAMICOID TAGS SHOWING THEIR RATED VOLTAGE, PHASE CONFIGURATION, WIRE CONFIGURATION, POWER OR AMPACITY RATING AND BRANCH CIRCUIT ID NUMBERS (i.e. PANEL BOARD AND CIRCUIT ID'S).
7. PANEL BOARDS (ID NUMBERS) SHALL BE CLEARLY LABELED WITH PLASTIC LABELS.
8. TIE WRAPS ARE NOT ALLOWED.
9. ALL POWER AND EQUIPMENT GROUND WIRING IN TUBING OR CONDUIT SHALL BE SINGLE COPPER CONDUCTOR (#14 OR LARGER) WITH TYPE THHW, THWN, THWN-2, XHHW, XHHW-2, THW, THW-2, RHW, OR RHW-2 INSULATION UNLESS OTHERWISE SPECIFIED.
10. SUPPLEMENTAL EQUIPMENT GROUND WIRING LOCATED INDOORS SHALL BE SINGLE COPPER CONDUCTOR (#6 OR LARGER) WITH TYPE THHW, THWN, THWN-2, XHHW, XHHW-2, THW, THW-2, RHW, OR RHW-2 INSULATION UNLESS OTHERWISE SPECIFIED.
11. POWER AND CONTROL WIRING IN FLEXIBLE CORD SHALL BE MULTI-CONDUCTOR, TYPE SOOW CORD (#14 OR LARGER) UNLESS OTHERWISE SPECIFIED.
12. POWER AND CONTROL WIRING FOR USE IN CABLE TRAY SHALL BE MULTI-CONDUCTOR, TYPE TC CABLE (#14 OR LARGER), WITH TYPE THHW, THWN, THWN-2, XHHW, XHHW-2, THW, THW-2, RHW, OR RHW-2 INSULATION UNLESS OTHERWISE SPECIFIED.
13. ALL POWER AND GROUNDING CONNECTIONS SHALL BE CRIMP-STYLE, COMPRESSION WIRE LUGS AND WIRE NUTS BY THOMAS AND BETTS (OR EQUAL). LUGS AND WIRE NUTS SHALL BE RATED FOR OPERATION NOT LESS THAN 75° C (90° C IF AVAILABLE).
14. RACEWAY AND CABLE TRAY SHALL BE LISTED OR LABELED FOR ELECTRICAL USE IN ACCORDANCE WITH NEMA, UL, ANSI/IEEE AND NEC.
15. ELECTRICAL METALLIC TUBING (EMT), INTERMEDIATE METAL CONDUIT (IMC), OR RIGID METAL CONDUIT (RMC) SHALL BE USED FOR EXPOSED INDOOR LOCATIONS.

16. ELECTRICAL METALLIC TUBING (EMT) OR METAL-CLAD CABLE (MC) SHALL BE USED FOR CONCEALED INDOOR LOCATIONS.
17. SCHEDULE 40 PVC UNDERGROUND ON STRAIGHTS AND SCHEDULE 80 PVC FOR ALL ELBOWS/90s AND ALL APPROVED ABOVE GRADE PVC CONDUIT.
18. LIQUID-TIGHT FLEXIBLE METALLIC CONDUIT (LIQUID-TITE FLEX) SHALL BE USED INDOORS AND OUTDOORS, WHERE VIBRATION OCCURS OR FLEXIBILITY IS NEEDED.
19. CONDUIT AND TUBING FITTINGS SHALL BE THREADED OR COMPRESSION-TYPE AND APPROVED FOR THE LOCATION USED. SET SCREW FITTINGS ARE NOT ACCEPTABLE.
20. CABINETS, BOXES AND WIRE WAYS SHALL BE LABELED FOR ELECTRICAL USE IN ACCORDANCE WITH NEMA, UL, ANSI/IEEE AND THE NEC.
21. WIREWAYS SHALL BE METAL WITH AN ENAMEL FINISH AND INCLUDE A HINGED COVER, DESIGNED TO SWING OPEN DOWNWARDS (WIREMOLD SPECMATE WIREWAY).
22. SLOTTED WIRING DUCT SHALL BE PVC AND INCLUDE COVER (PANDUIT TYPE E OR EQUAL).
23. CONDUITS SHALL BE FASTENED SECURELY IN PLACE WITH APPROVED NON-PERFORATED STRAPS AND HANGERS. EXPLOSIVE DEVICES (i.e. POWDER-ACTUATED) FOR ATTACHING HANGERS TO STRUCTURE WILL NOT BE PERMITTED. CLOSELY FOLLOW THE LINES OF THE STRUCTURE, MAINTAIN CLOSE PROXIMITY TO THE STRUCTURE AND KEEP CONDUITS IN TIGHT ENVELOPES. CHANGES IN DIRECTION TO ROUTE AROUND OBSTACLES SHALL BE MADE WITH CONDUIT OUTLET BODIES. CONDUIT SHALL BE INSTALLED IN A NEAT AND WORKMANLIKE MANNER. PARALLEL AND PERPENDICULAR TO STRUCTURE WALL AND CEILING LINES. ALL CONDUIT SHALL BE FISHED TO CLEAR OBSTRUCTIONS. ENDS OF CONDUITS SHALL BE TEMPORARILY CAPPED FLUSH TO FINISH GRADE TO PREVENT CONCRETE, PLASTER OR DIRT FROM ENTERING. CONDUITS SHALL BE RIGIDLY CLAMPED TO BOXES BY GALVANIZED MALLEABLE IRON BUSHING ON INSIDE AND GALVANIZED MALLEABLE IRON LOCKNUT ON OUTSIDE AND INSIDE.
24. EQUIPMENT CABINETS, TERMINAL BOXES, JUNCTION BOXES AND PULL BOXES SHALL BE GALVANIZED OR EPOXY-COATED SHEET STEEL. SHALL MEET OR EXCEED UL 50 AND BE RATED NEMA 1 (OR BETTER) FOR INTERIOR LOCATIONS AND NEMA 3 (OR BETTER) FOR EXTERIOR LOCATIONS.
25. METAL RECEPTACLE, SWITCH AND DEVICE BOXES SHALL BE GALVANIZED, EPOXY-COATED OR NON-CORRODING; SHALL MEET OR EXCEED UL 514A AND NEMA OS 1 AND BE RATED NEMA 1 (OR BETTER) FOR INTERIOR LOCATIONS AND WEATHER PROTECTED (WP OR BETTER) FOR EXTERIOR LOCATIONS.
26. NONMETALLIC RECEPTACLE, SWITCH AND DEVICE BOXES SHALL MEET OR EXCEED NEMA OS 2 (NEWEST REVISION) AND BE RATED NEMA 1 (OR BETTER) FOR INTERIOR LOCATIONS AND WEATHER PROTECTED (WP OR BETTER) FOR EXTERIOR LOCATIONS.
27. THE CONTRACTOR SHALL NOTIFY AND OBTAIN NECESSARY AUTHORIZATION FROM THE CARRIER AND/OR DISH Wireless L.L.C. AND TOWER OWNER BEFORE COMMENCING WORK ON THE AC POWER DISTRIBUTION PANELS.
28. THE CONTRACTOR SHALL PROVIDE NECESSARY TAGGING ON THE BREAKERS, CABLES AND DISTRIBUTION PANELS IN ACCORDANCE WITH THE APPLICABLE CODES AND STANDARDS TO SAFEGUARD LIFE AND PROPERTY.
29. INSTALL LAMICOID LABEL ON THE METER CENTER TO SHOW "DISH Wireless L.L.C.".
30. ALL EMPTY/SPARE CONDUITS THAT ARE INSTALLED ARE TO HAVE A METERED MULE TAPE PULL CORD INSTALLED.



5701 SOUTH SANTA FE DRIVE
LITTLETON, CO 80120



8051 CONGRESS AVENUE
BOCA RATON, FL 33487



1717 S. BOULDER
SUITE 300
TULSA, OK 74119
PH: (918) 587-4630
www.btgrp.com



MTS ENGINEERING P.L.L.C.
BER:2386985
Expires 3/31/23

IT IS A VIOLATION OF LAW FOR ANY PERSON, UNLESS THEY ARE ACTING UNDER THE DIRECTION OF A LICENSED PROFESSIONAL ENGINEER, TO ALTER THIS DOCUMENT.

DRAWN BY:	CHECKED BY:	APPROVED BY:
BLJ	BEH	BEH

RFDS REV #: 0

CONSTRUCTION DOCUMENTS

SUBMITTALS		
REV	DATE	DESCRIPTION
A	9/10/21	ISSUED FOR REVIEW
B	01/05/22	ISSUED FOR REVIEW
0	3/8/22	ISSUED FOR CONSTRUCTION
1	5/13/22	ISSUED FOR CONSTRUCTION
2	6/27/22	ISSUED FOR CONSTRUCTION
3	8/23/22	ISSUED FOR CONSTRUCTION
4	01/05/23	ISSUED FOR CONSTRUCTION

A&E PROJECT NUMBER
149477.001.01

DISH Wireless L.L.C.
PROJECT INFORMATION
BOBOS00062A
419 EKONK HILL ROAD
(RT-49)
STERLING CT 06377

SHEET TITLE
GENERAL NOTES

SHEET NUMBER
GN-3

GROUNDING NOTES:

1. ALL GROUND ELECTRODE SYSTEMS (INCLUDING TELECOMMUNICATION, RADIO, LIGHTNING PROTECTION AND AC POWER GES'S) SHALL BE BONDED TOGETHER AT OR BELOW GRADE, BY TWO OR MORE COPPER BONDING CONDUCTORS IN ACCORDANCE WITH THE NEC.
2. THE CONTRACTOR SHALL PERFORM IEEE FALL-OF-POTENTIAL RESISTANCE TO EARTH TESTING (PER IEEE 1100 AND 81) FOR GROUND ELECTRODE SYSTEMS, THE CONTRACTOR SHALL FURNISH AND INSTALL SUPPLEMENTAL GROUND ELECTRODES AS NEEDED TO ACHIEVE A TEST RESULT OF 5 OHMS OR LESS.
3. THE CONTRACTOR IS RESPONSIBLE FOR PROPERLY SEQUENCING GROUNDING AND UNDERGROUND CONDUIT INSTALLATION AS TO PREVENT ANY LOSS OF CONTINUITY IN THE GROUNDING SYSTEM OR DAMAGE TO THE CONDUIT AND PROVIDE TESTING RESULTS.
4. METAL CONDUIT AND TRAY SHALL BE GROUNDED AND MADE ELECTRICALLY CONTINUOUS WITH LISTED BONDING FITTINGS OR BY BONDING ACROSS THE DISCONTINUITY WITH #6 COPPER WIRE UL APPROVED GROUNDING TYPE CONDUIT CLAMPS.
5. METAL RACEWAY SHALL NOT BE USED AS THE NEC REQUIRED EQUIPMENT GROUND CONDUCTOR. STRANDED COPPER CONDUCTORS WITH GREEN INSULATION, SIZED IN ACCORDANCE WITH THE NEC, SHALL BE FURNISHED AND INSTALLED WITH THE POWER CIRCUITS TO BTS EQUIPMENT.
6. EACH CABINET FRAME SHALL BE DIRECTLY CONNECTED TO THE MASTER GROUND BAR WITH GREEN INSULATED SUPPLEMENTAL EQUIPMENT GROUND WIRES, #6 STRANDED COPPER OR LARGER FOR INDOOR BTS; #2 BARE SOLID TINNED COPPER FOR OUTDOOR BTS.
7. CONNECTIONS TO THE GROUND BUS SHALL NOT BE DOUBLED UP OR STACKED BACK TO BACK CONNECTIONS ON OPPOSITE SIDE OF THE GROUND BUS ARE PERMITTED.
8. ALL EXTERIOR GROUND CONDUCTORS BETWEEN EQUIPMENT/GROUND BARS AND THE GROUND RING SHALL BE #2 SOLID TINNED COPPER UNLESS OTHERWISE INDICATED.
9. ALUMINUM CONDUCTOR OR COPPER CLAD STEEL CONDUCTOR SHALL NOT BE USED FOR GROUNDING CONNECTIONS.
10. USE OF 90° BENDS IN THE PROTECTION GROUNDING CONDUCTORS SHALL BE AVOIDED WHEN 45° BENDS CAN BE ADEQUATELY SUPPORTED.
11. EXOTHERMIC WELDS SHALL BE USED FOR ALL GROUNDING CONNECTIONS BELOW GRADE.
12. ALL GROUND CONNECTIONS ABOVE GRADE (INTERIOR AND EXTERIOR) SHALL BE FORMED USING HIGH PRESS CRIMPS.
13. COMPRESSION GROUND CONNECTIONS MAY BE REPLACED BY EXOTHERMIC WELD CONNECTIONS.
14. ICE BRIDGE BONDING CONDUCTORS SHALL BE EXOTHERMICALLY BONDED OR BOLTED TO THE BRIDGE AND THE TOWER GROUND BAR.
15. APPROVED ANTIOXIDANT COATINGS (i.e. CONDUCTIVE GEL OR PASTE) SHALL BE USED ON ALL COMPRESSION AND BOLTED GROUND CONNECTIONS.
16. ALL EXTERIOR GROUND CONNECTIONS SHALL BE COATED WITH A CORROSION RESISTANT MATERIAL.
17. MISCELLANEOUS ELECTRICAL AND NON-ELECTRICAL METAL BOXES, FRAMES AND SUPPORTS SHALL BE BONDED TO THE GROUND RING, IN ACCORDANCE WITH THE NEC.
18. BOND ALL METALLIC OBJECTS WITHIN 6 ft OF MAIN GROUND RING WITH (1) #2 BARE SOLID TINNED COPPER GROUND CONDUCTOR.
19. GROUND CONDUCTORS USED FOR THE FACILITY GROUNDING AND LIGHTNING PROTECTION SYSTEMS SHALL NOT BE ROUTED THROUGH METALLIC OBJECTS THAT FORM A RING AROUND THE CONDUCTOR, SUCH AS METALLIC CONDUITS, METAL SUPPORT CLIPS OR SLEEVES THROUGH WALLS OR FLOORS. WHEN IT IS REQUIRED TO BE HOUSED IN CONDUIT TO MEET CODE REQUIREMENTS OR LOCAL CONDITIONS, NON-METALLIC MATERIAL SUCH AS PVC CONDUIT SHALL BE USED. WHERE USE OF METAL CONDUIT IS UNAVOIDABLE (i.e., NONMETALLIC CONDUIT PROHIBITED BY LOCAL CODE) THE GROUND CONDUCTOR SHALL BE BONDED TO EACH END OF THE METAL CONDUIT.
20. ALL GROUNDS THAT TRANSITION FROM BELOW GRADE TO ABOVE GRADE MUST BE #2 BARE SOLID TINNED COPPER IN 3/4" NON-METALLIC, FLEXIBLE CONDUIT FROM 24" BELOW GRADE TO WITHIN 3" TO 6" OF CAD-WELD TERMINATION POINT. THE EXPOSED END OF THE CONDUIT MUST BE SEALED WITH SILICONE CAULK. (ADD TRANSITIONING GROUND STANDARD DETAIL AS WELL).
21. BUILDINGS WHERE THE MAIN GROUNDING CONDUCTORS ARE REQUIRED TO BE ROUTED TO GRADE, THE CONTRACTOR SHALL ROUTE TWO GROUNDING CONDUCTORS FROM THE ROOFTOP, TOWERS, AND WATER TOWERS GROUNDING RING, TO THE EXISTING GROUNDING SYSTEM, THE GROUNDING CONDUCTORS SHALL NOT BE SMALLER THAN 2/0 COPPER. ROOFTOP GROUNDING RING SHALL BE BONDED TO THE EXISTING GROUNDING SYSTEM, THE BUILDING STEEL COLUMNS, LIGHTNING PROTECTION SYSTEM, AND BUILDING MAIN WATER LINE (FERROUS OR NONFERROUS METAL PIPING ONLY). DO NOT ATTACH GROUNDING TO FIRE SPRINKLER SYSTEM PIPES.



5701 SOUTH SANTA FE DRIVE
LITTLETON, CO 80120



8051 CONGRESS AVENUE
BOCA RATON, FL 33487



1717 S. BOULDER
SUITE 300
TULSA, OK 74119
PH: (918) 587-4630
www.blgrp.com

1/5/23



MTS ENGINEERING P.L.L.C.
BER:2386985
Expires 3/31/23

IT IS A VIOLATION OF LAW FOR ANY PERSON, UNLESS THEY ARE ACTING UNDER THE DIRECTION OF A LICENSED PROFESSIONAL ENGINEER, TO ALTER THIS DOCUMENT.

DRAWN BY: CHECKED BY: APPROVED BY:

BLJ BEH BEH

RFDS REV #: 0

CONSTRUCTION DOCUMENTS

SUBMITTALS		
REV	DATE	DESCRIPTION
A	9/10/21	ISSUED FOR REVIEW
B	01/05/22	ISSUED FOR REVIEW
0	3/8/22	ISSUED FOR CONSTRUCTION
1	5/13/22	ISSUED FOR CONSTRUCTION
2	6/27/22	ISSUED FOR CONSTRUCTION
3	8/23/22	ISSUED FOR CONSTRUCTION
4	01/05/23	ISSUED FOR CONSTRUCTION

A&E PROJECT NUMBER
149477.001.01

DISH Wireless L.L.C.
PROJECT INFORMATION
BOBOS00062A
419 EKONK HILL ROAD
(RT-49)
STERLING CT 06377

SHEET TITLE
GENERAL NOTES

SHEET NUMBER
GN-4

Exhibit D

Structural Analysis Report



Tower Engineering Solutions

Phone (972) 483-0607, Fax (972) 975-9615
1320 Greenway Drive, Suite 600, Irving, Texas 75038

Structural Analysis Report

Existing 200 ft Pirod Guyed Tower

Customer Name: SBA Communications Corp

Customer Site Number: CT20001-A

Customer Site Name: STERLING CT TOWER

Carrier Name: Dish Wireless (App#: 167078-1)

Carrier Site ID / Name: BOBOS00062A / 0

Site Location: 419 Ekonk Hill Road (Rt-49)

Sterling, Connecticut

WINDHAM County

Latitude: 41.662222

Longitude: -71.846944

Exp. 01/31/2024

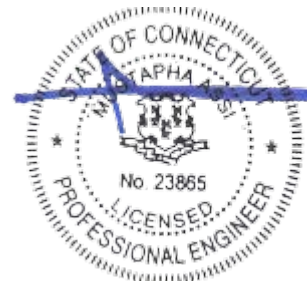

Analysis Result:

Max Structural Usage: 62.4% [Pass]

Max Foundation Usage: 42.3% [Pass]

Additional Usage Caused by New Mount/Mount Modification: N/A

01/03/2023

Report Prepared By : Tawfeeq Alajaj



Tower Engineering Solutions

Phone (972) 483-0607, Fax (972) 975-9615
1320 Greenway Drive, Suite 600, Irving, Texas 75038

Structural Analysis Report

Existing 200 ft Pirod Guyed Tower

Customer Name: SBA Communications Corp

Customer Site Number: CT20001-A

Customer Site Name: STERLING CT TOWER

Carrier Name: Dish Wireless (App#: 167078-1)

Carrier Site ID / Name: BOBOS00062A / 0

Site Location: 419 Ekonk Hill Road (Rt-49)

Sterling, Connecticut

WINDHAM County

Latitude: 41.662222

Longitude: -71.846944

Analysis Result:

Max Structural Usage: 62.4% [Pass]

Max Foundation Usage: 42.3% [Pass]

Additional Usage Caused by New Mount/Mount Modification: N/A

Report Prepared By : Tawfeeq Alajaj

Introduction

The purpose of this report is to summarize the analysis results on the 200 ft Pirod Guyed Tower to support the proposed antennas and transmission lines in addition to those currently installed. Any modification listed under Sources of Information was assumed completed and was included in this analysis.

Sources of Information

Tower Drawings	Original design drawings prepared by PiROD. Inc. Dated 11-04-1988. Drawing No 112268-B. Job No A-106,708.
Foundation Drawing	Original foundation drawings prepared by PiROD. Inc. Dated 11-04-1988. Drawing No 112268-B. Job No A-106,708.
Geotechnical Report	Geotechnical report prepared by FDH Engineering, Inc. Dated 08-09-2012. Project No 1207123EG1.
Modification Drawings	N/A
Mount Analysis	TES, Job# 120130, Dated 11/06/21

Analysis Criteria

The comprehensive analysis was performed in accordance with the requirements and stipulations of the TIA-222-H. In accordance with this standard, the structure was analyzed using **TESTowers**, a proprietary analysis software. The program considers the structure as an elastic 3-D model with second-order effects and temperature effects incorporated in the analysis. The analysis was performed using multiple wind directions.

Wind Speed Used in the Analysis:	125.0 mph (3-Sec. Gust) (Ultimate wind speed)
Wind Speed with Ice:	50 mph (3-Sec. Gust) with 1" radial ice concurrent
Service Load Wind Speed:	60 mph + 0" Radial ice
Standard/Codes:	TIA-222-H / 2021 IBC / 2022 Connecticut State Building Code
Exposure Category:	C
Risk Category:	II
Topographic Category:	1
Crest Height:	0 ft
Seismic Parameters:	$S_S = 0.187$, $S_1 = 0.054$

This structural analysis is based upon the tower being classified as a Risk Category II; however, if a different classification is required subsequent to the date hereof, the tower classification will be changed to meet such requirement and a new structural analysis will be run.

Existing Antennas, Mounts and Transmission Lines

The table below summarizes the antennas, mounts and transmission lines that were considered in the analysis as existing on the tower.

Items	Elevation (ft)	Qty.	Antenna Descriptions	Mount Type & Qty.	Transmission Lines	Owner
1	195.0	1	120" Omni	(1) Side Arm	(1) 7/8"	Marc Dodge
2	178.0	1	Decibel DB809 Omni	(1) Side Arm	(1) 7/8"	American Messaging
3	170.0	3	RFS APXVAALL24_43-U-NA20 - Panel	(3) SitePro VFA12-HD Sector Frames	(3) 1.9" Hybrid	T-Mobile Sprint
4		3	Ericsson AIR6449 B41 - Panel			
5		3	Ericsson 4480 B71 + B85 RRU			
6		6	ALU 800 MHz RRUs			
7		3	Ericsson 4460 B25 + B66 RRU			
12	140.0	1	Decibel DB809 Omni	(1) Side Arm	(2) 1/4"	Arch Wireless
13	99.0	1	ASPC680 (96") Omni	(1) Side Arm	(1) 1/2"	Plainfield Municipal
14	41.0	1	Larsen YA2-540 (36") - Yagi	Direct	(1) 7/8"	
15	39.0	1	Larsen YA2-540 (36") - Yagi	Direct	(1) 3/8"	
16	25.0	1	36" - Dish	(1) Pipe Mount	(2) 1/4"	American Messaging
17	14.0	1	36" - Dish	(1) Pipe Mount	(1) 7/8"	Arch Wireless

Proposed Carrier’s Final Configuration of Antennas, Mounts and Transmission Lines

Information pertaining to the proposed carrier’s final configuration of antennas and transmission lines was provided by SBA Communications Corp. The proposed antennas and lines are listed below.

Items	Elevation (ft)	Qty.	Antenna Descriptions	Mount Type & Qty.	Transmission Lines	Owner
8	150.0	3	JMA Wireless MX08FRO665-21 - Panel	(1) Commscope MTC3975083	(1) 1.6" Hybrid	Dish Wireless
9		3	Fujitsu TA08025-B604 RRU			
10		3	Fujitsu TA08025-B605 RRU			
11		1	Raycap RDIDC-9181-PF-48 - OVP			

See the attached coax layout for the line placement considered in the analysis.

Analysis Results

The results of the structural analysis, performed for the wind and ice loading and antenna equipment as defined above, are summarized as the following:

Tower Component	Legs	Diagonals	Horizontals	Guy Wires
Max. Usage:	48.2%	44.4%	24.6%	62.4%
Pass/Fail	Pass	Pass	Pass	Pass

Foundations

Reactions (kips)	Base Reactions		Inner Anchors	
	Axial	Shear	Uplift	Shear
Analysis Reactions	73.3	1.1	25.2	23.6

The foundation has been investigated using the supplied documents and soils report and was found adequate. Therefore, no modification to the foundation will be required.

Service Load Condition (Rigidity):

Operational characteristics of the tower are found to be within the limits prescribed by TIA-222 for the installed antennas. The maximum twist/sway at the elevation of the proposed equipment is 0.0522 degrees under the operational wind speed as specified in the Analysis Criteria.

Conclusions

Based on the analysis results, the existing structure and its foundation were found to be adequate to safely support the existing and proposed equipment and meet the minimum requirements per the TIA-222 Standard under the design basic wind speed as specified in the Analysis Criteria.

Standard Conditions

1. This analysis was performed based on the information supplied to **(TES) Tower Engineering Solutions, LLC**. Verification of the information provided was not included in the Scope of Work for **TES**. The accuracy of the analysis is dependent on the accuracy of the information provided.
2. The structural analysis was performance based upon the evidence available at the time of this report. All information provided by the client is considered to be accurate.
3. The analyses will be performed based on the codes as specified by the client or based on the best knowledge of the engineering staff of **TES**. In the absence of information to the contrary, all work will be performed in accordance with the latest relevant revision of ANSI/TIA-222. If wind speed and/or ice loads are different from the minimum values recommended by the ANSI/TIA-222 standard or other codes, **TES** should be notified in writing and the applicable minimum values provided by the client.
4. The configuration of the existing mounts, antennas, coax and other appurtenances were supplied by the customer for the current structural analysis. **TES** has not visited the tower site to verify the adequacy of the information provided. If there is any discrepancy found in the report regarding the existing conditions, **TES** should be notified immediately to evaluate the effect of the discrepancy on the analysis results.
5. The client will assume responsibility for rework associated with the differences in initially provided information, including tower and foundation information, existing and/or proposed equipment and transmission lines.
6. If a feasibility analysis was performed, final acceptance of changed conditions shall be based upon a rigorous structural analysis.

Structure: CT20001-A-SBA

Site Name: STERLING CT TOWER

Code: TIA-222-H

1/3/2023

Type: Guyed

Base Shape: Triangle

Basic WS: 125.00

Height: 200.00 (ft)

Base Width: 0.00

Basic Ice WS: 50.00

Base Elev: 0.00 (ft)

Top Width: 3.00

Operational WS: 60.00

Page: 1



Section Properties

Sect	Leg Members	Diagonal Members	Horizontal Members
1-11	SOL 1 3/4" SOLID	SOL 3/4" SOLID	SOL 3/4" SOLID

Discrete Appurtenances

Attach Elev (ft)	Force Elev (ft)	Qty	Description
200.00	200.00	1	Beacon
190.00	190.00	1	Torque Arms
185.00	190.00	1	120" Omni
185.00	185.00	1	Side Arm
170.00	170.00	1	(3) SitePro VFA12-HD Sector Frames
170.00	170.00	3	RFS APXVAALL24_43-U-NA20
170.00	170.00	3	Ericsson AIR6449 B41
170.00	170.00	3	Ericsson 4480 B71 + B85 RRU
170.00	170.00	6	ALU 800 MHz RRUs
170.00	170.00	3	Ericsson 4460 B25 + B66 RRU
168.00	173.00	1	Decibel DB809
168.00	168.00	1	Side Arm
150.00	150.00	3	JMA Wireless MX08FRO665-21
150.00	150.00	3	Fujitsu TA08025-B604
150.00	150.00	3	Fujitsu TA08025-B605
150.00	150.00	1	Raycap RDIDC-9181-PF-48
150.00	150.00	1	Commscope MTC3975083
135.00	135.00	1	Torque Arms
130.00	135.00	1	Decibel DB809
130.00	130.00	1	Side Arm
95.00	99.00	1	ASPC680 (96")
95.00	95.00	1	Side Arm
41.00	41.00	1	Larsen YA2-540 (36")
39.00	39.00	1	Larsen YA2-540 (36")
25.00	25.00	1	36" Dish
25.00	25.00	1	Pipe Mount
14.00	14.00	1	36" Dish
14.00	14.00	1	Pipe Mount

Linear Appurtenances

Elev From (ft)	Elev To (ft)	Qty	Description
3.00	185.00	1	7/8" Coax
3.00	170.00	3	1.9" Hybrid
3.00	168.00	1	7/8" Coax
3.00	150.00	1	1.6" Hybrid
3.00	130.00	2	1/4" Coax
3.00	95.00	1	1/2" Coax
3.00	41.00	1	7/8" Coax
3.00	39.00	1	3/8" Coax
3.00	25.00	2	1/4" Coax
3.00	14.00	1	7/8" Coax

Max Guy Wire

62.42% @ 134.6665 ft - 7/16 EHS

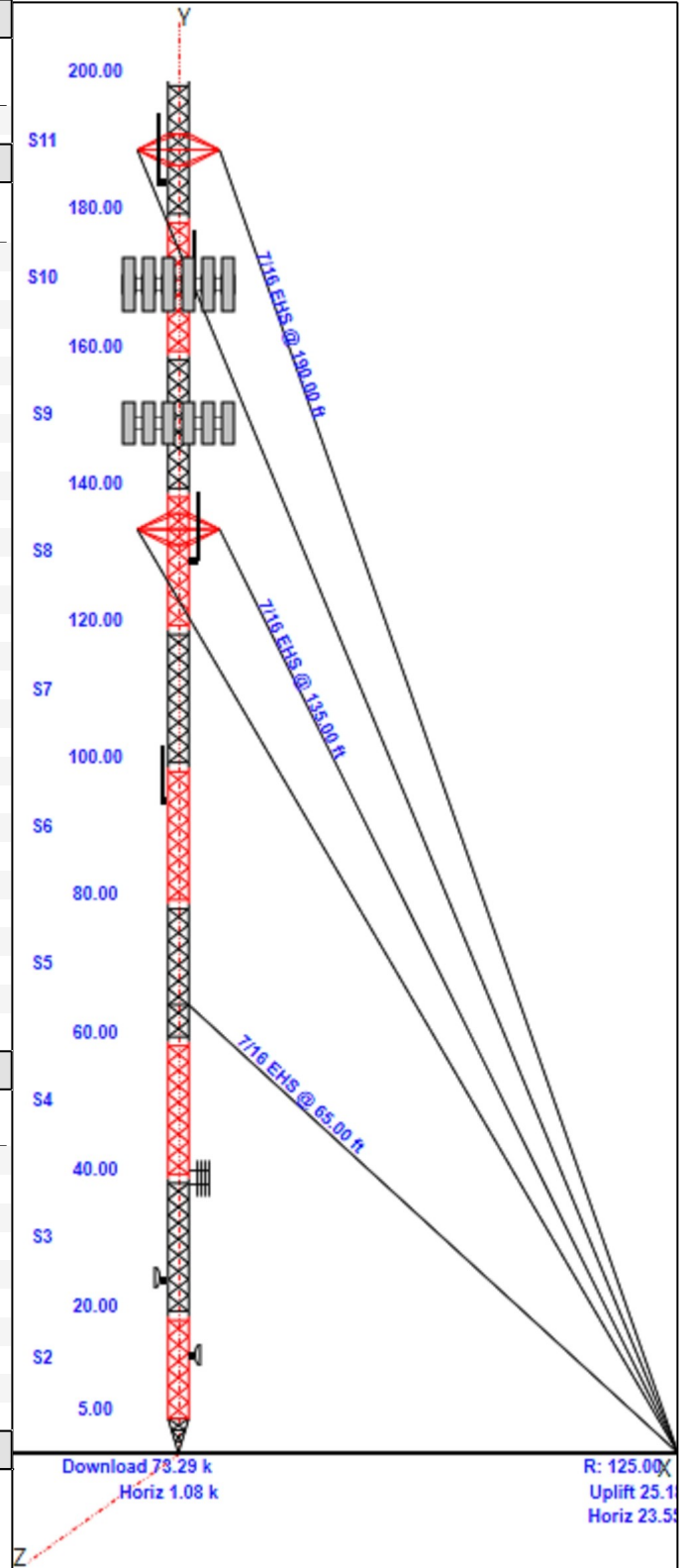

Structure: CT20001-A-SBA

Site Name: STERLING CT TOWER

Code: TIA-222-H

1/3/2023

Type: Guyed

Base Shape: Triangle

Basic WS: 125.00

Height: 200.00 (ft)

Base Width: 0.00

Basic Ice WS: 50.00

Base Elev: 0.00 (ft)

Top Width: 3.00

Operational WS: 60.00

Page: 2

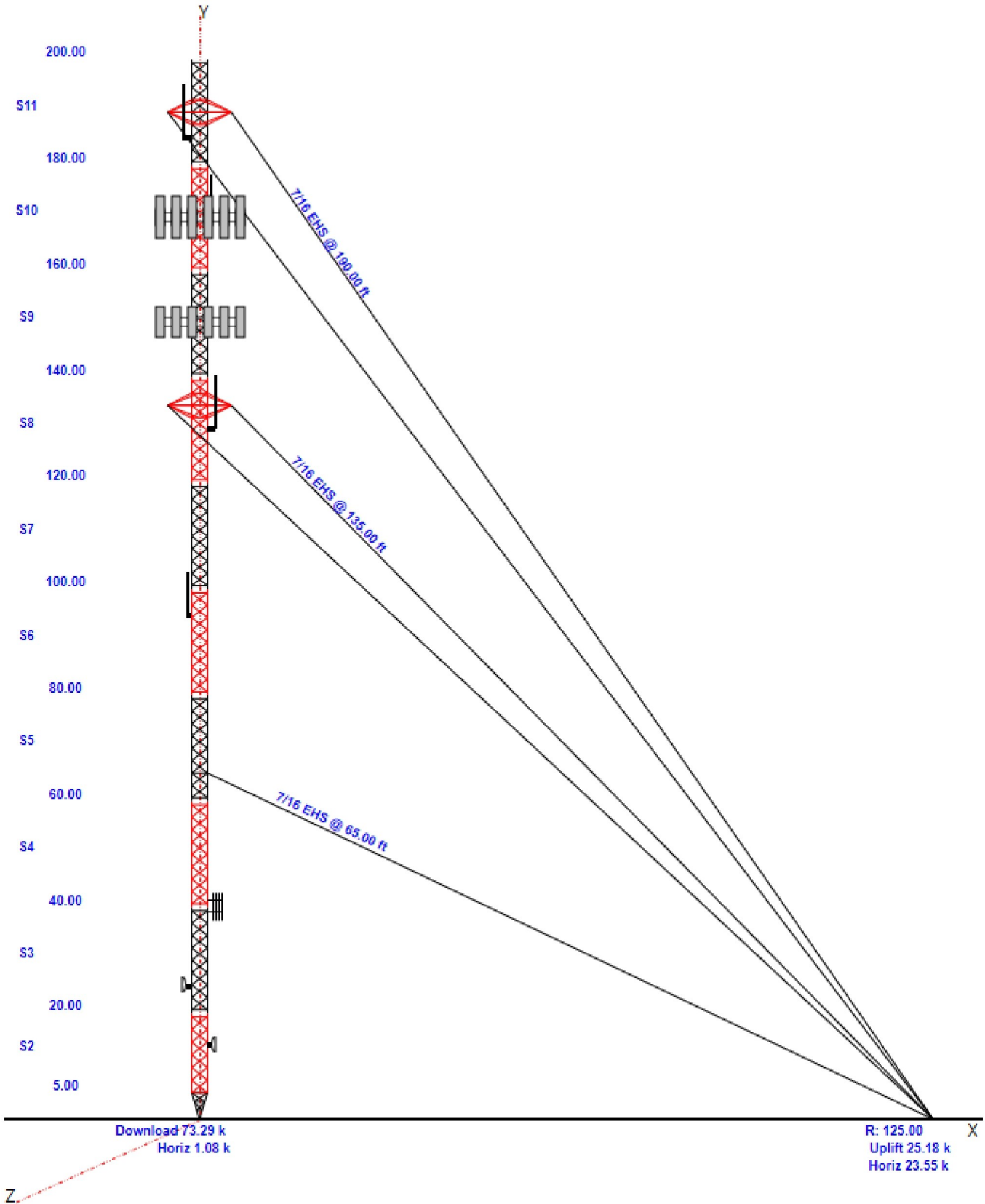

Anchor Drops with Guy Radius - Structure: CT20001-A-SBA

Site Name: STERLING CT TOWER

Code: EIA_H

1/3/2023

Type: Guyed

Base Shape: Triangle

Basic WS: 125.00

Height: 200.00 (ft)

Base Width: 0.00

Basic Ice WS: 50.00

Base Elev: 0.00 (ft)

Top Width: 3.00

Operational WS: 60.00

Page: 3

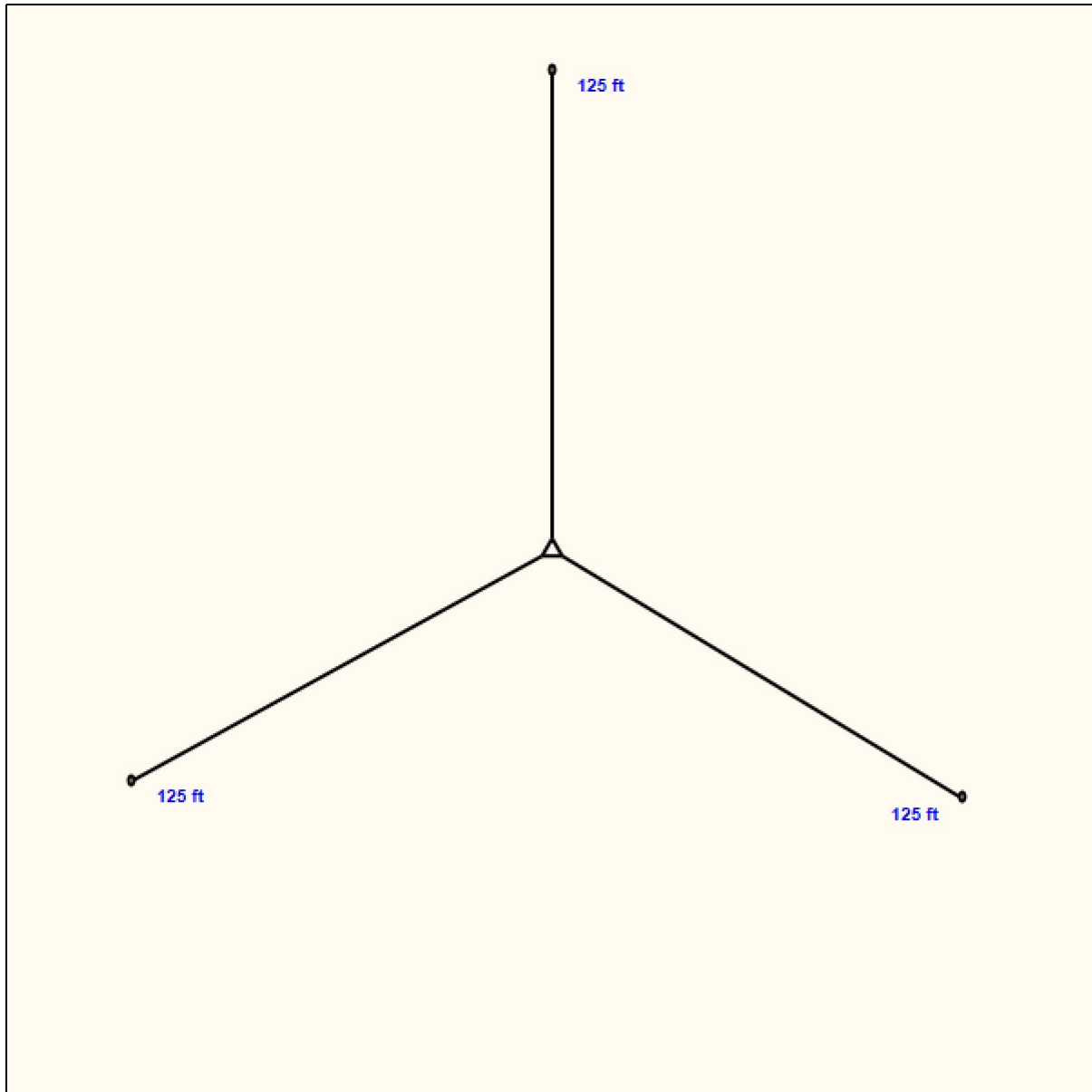

Structure: CT20001-A-SBA - Coax Line Placement

Type: Guyed
Site Name: STERLING CT TOWER
Height: 200.00 (ft)

1/3/2023

Page: 4

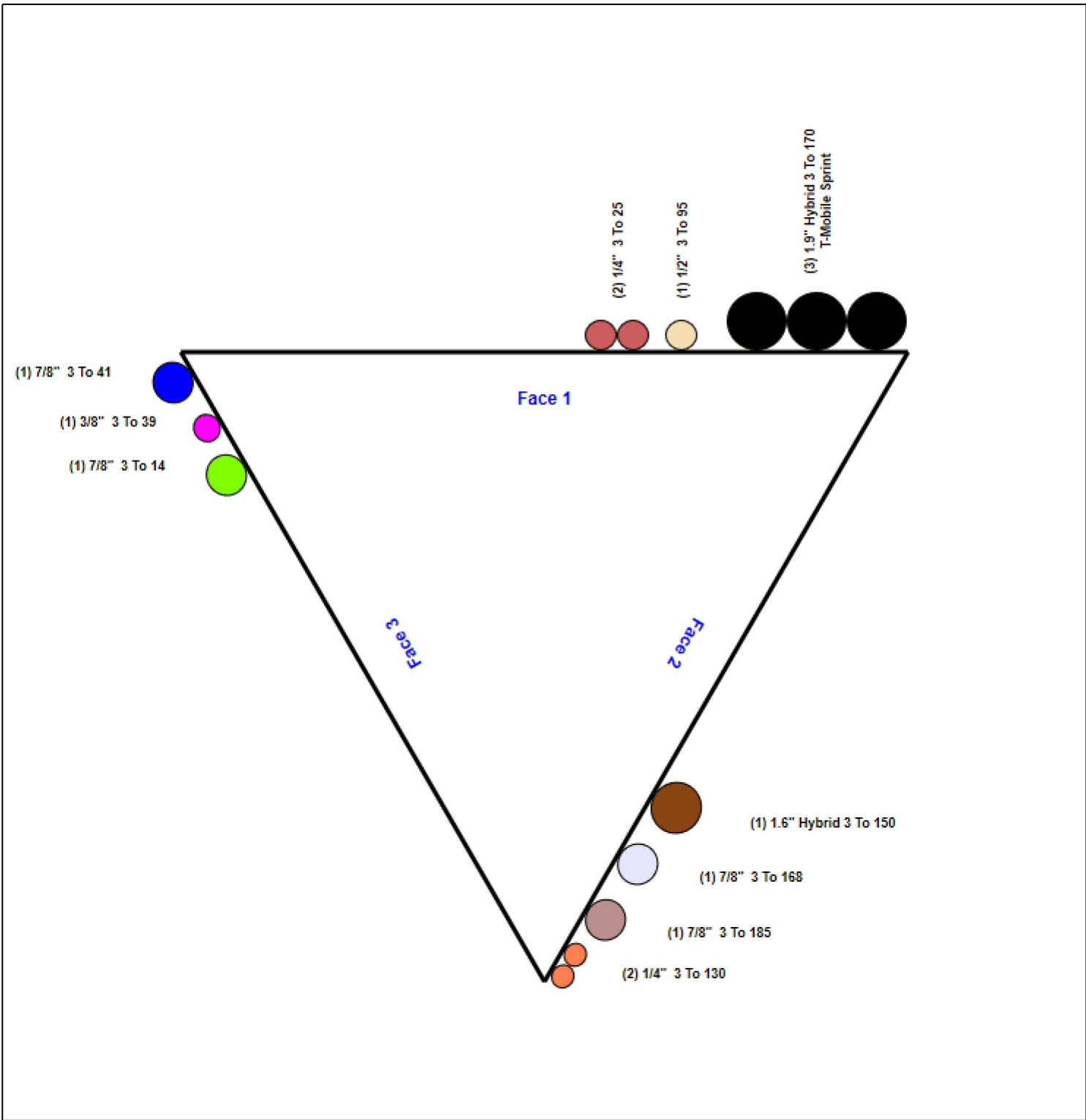

Loading Summary

Structure: CT20001-A-SBA	Code: TIA-222-H	1/3/2023
Site Name: STERLING CT TOWER	Exposure: C	
Height: 200.00 (ft)	Crest Height: 0.00	
Base Elev: 0.000 (ft)	Site Class: D - Stiff Soil	
Gh: 0.85	Topography: 1	Struct Class: II



Page: 5

Discrete Appurtenances Properties

Attach Elev (ft)	Description	Qty	No Ice		Ice		Len (in)	Width (in)	Depth (in)	Ka	Orientation Factor	Vert Ecc (ft)
			Weight (lb)	CaAa (sf)	Weight (lb)	CaAa (sf)						
200.00	Beacon	1	15.00	2.400	26.91	2.400	0.000	0.000	0.000	1.00	1.00	0.000
190.00	Torque Arms	1	300.00	5.000	471.55	7.859	0.000	0.000	0.000	1.00	1.00	0.000
185.00	120" Omni	1	30.00	3.000	106.17	6.268	120.000	3.000	3.000	1.00	1.00	5.000
185.00	Side Arm	1	40.00	2.630	94.80	6.704	20.000	0.000	0.000	1.00	1.00	0.000
170.00	(3) SitePro VFA12-HD Sector	1	2322.0	50.700	3853.95	93.707	0.000	0.000	0.000	0.75	1.00	0.000
170.00	RFS APXVAALL24_43-U-NA20	3	128.00	20.240	405.10	21.507	95.900	24.000	8.500	0.80	0.72	0.000
170.00	Ericsson AIR6449 B41	3	103.00	5.650	195.56	6.292	33.100	20.500	8.300	0.80	0.71	0.000
170.00	Ericsson 4480 B71 + B85 RRU	3	93.00	2.850	141.56	3.305	21.800	15.700	7.500	0.80	0.67	0.000
170.00	ALU 800 MHz RRUs	6	61.80	2.910	123.05	3.731	19.700	13.000	15.200	0.80	0.67	0.000
170.00	Ericsson 4460 B25 + B66 RRU	3	109.00	2.850	157.54	3.305	21.800	15.700	7.500	0.80	0.67	0.000
168.00	Decibel DB809	1	30.00	3.000	91.61	5.434	120.000	3.000	3.000	1.00	1.00	5.000
168.00	Side Arm	1	40.00	2.630	94.19	6.659	10.000	0.000	0.000	1.00	1.00	0.000
150.00	JMA Wireless MX08FRO665-21	3	64.50	12.490	258.41	13.466	72.000	20.000	8.000	0.80	0.74	0.000
150.00	Fujitsu TA08025-B604	3	63.90	1.960	97.65	2.334	15.800	15.000	7.900	0.80	0.67	0.000
150.00	Fujitsu TA08025-B605	3	75.00	1.960	109.87	2.334	15.800	15.000	9.100	0.80	0.67	0.000
150.00	Raycap RDIDC-9181-PF-48	1	21.90	2.010	57.40	2.389	16.600	14.600	8.500	1.00	1.00	0.000
150.00	Commscope MTC3975083	1	1242.0	28.050	2051.22	51.548	0.000	0.000	0.000	0.75	1.00	0.000
135.00	Torque Arms	1	300.00	5.000	465.16	7.753	0.000	0.000	0.000	1.00	1.00	0.000
130.00	Decibel DB809	1	25.00	3.000	74.98	5.370	120.000	3.000	3.000	1.00	1.00	5.000
130.00	Side Arm	1	40.00	2.630	92.76	6.553	20.000	0.000	0.000	1.00	1.00	0.000
95.00	ASPC680 (96")	1	25.00	2.400	63.72	4.144	96.000	3.000	3.000	1.00	1.00	4.000
95.00	Side Arm	1	40.00	2.630	90.85	6.411	10.000	0.000	0.000	1.00	1.00	0.000
41.00	Larsen YA2-540 (36")	1	10.00	2.980	63.77	6.730	36.000	36.000	3.000	1.00	1.00	0.000
39.00	Larsen YA2-540 (36")	1	10.00	2.980	61.09	6.543	36.000	36.000	3.000	1.00	1.00	0.000
25.00	36" Dish	1	100.00	11.760	199.05	13.158	0.000	0.000	0.000	1.00	1.00	0.000
25.00	Pipe Mount	1	50.00	1.600	106.95	3.661	10.000	0.000	0.000	1.00	1.00	0.000
14.00	36" Dish	1	100.00	11.760	190.75	13.041	0.000	0.000	0.000	1.00	1.00	0.000
14.00	Pipe Mount	1	50.00	1.600	102.18	3.488	10.000	0.000	0.000	1.00	1.00	0.000
Totals:		47	7,070.90		13,194.45						Number of Appurtenances :	28

Loading Summary

Structure: CT20001-A-SBA	Code: TIA-222-H	1/3/2023
Site Name: STERLING CT TOWER	Exposure: C	
Height: 200.00 (ft)	Crest Height: 0.00	
Base Elev: 0.000 (ft)	Site Class: D - Stiff Soil	
Gh: 0.85	Topography: 1	Struct Class: II



Page: 6

Linear Appurtenances Properties

Elev. From (ft)	Elev. To (ft)	Description	Qty	Width (in)	Weight (lb/ft)	Pct In Block	Spread On Faces	Bundling Arrangement	Cluster Dia (in)	Out of Zone	Spacing (in)	Orientation Factor	Ka Override
3.00	185.00	7/8" Coax	1	1.11	0.52	100.00	2	Individual NR		N	1.00	1.00	
3.00	170.00	1.9" Hybrid	3	1.99	1.10	100.00	1	Individual IR		N	0.50	1.00	
3.00	168.00	7/8" Coax	1	1.11	0.52	100.00	2	Individual NR		N	1.00	1.00	
3.00	150.00	1.6" Hybrid	1	1.60	1.00	100.00	2	Individual NR		N	1.00	1.00	
3.00	130.00	1/4" Coax	2	0.25	0.04	100.00	2	Individual IR		N	0.25	1.00	
3.00	95.00	1/2" Coax	1	0.65	0.16	100.00	1	Individual NR		N	1.00	1.00	
3.00	41.00	7/8" Coax	1	1.11	0.52	100.00	3	Individual NR		N	1.00	1.00	
3.00	39.00	3/8" Coax	1	0.44	0.08	100.00	3	Individual NR		N	1.00	1.00	
3.00	25.00	1/4" Coax	2	0.65	0.16	100.00	1	Individual IR		N	0.25	1.00	
3.00	14.00	7/8" Coax	1	1.11	0.52	100.00	3	Individual NR		N	1.00	1.00	

Section Forces

Structure: CT20001-A-SBA	Code: TIA-222-H	1/3/2023
Site Name: STERLING CT TOWER	Exposure: C	
Height: 200.00 (ft)	Crest Height: 0.00	
Base Elev: 0.000 (ft)	Site Class: D - Stiff Soil	
Gh: 0.85	Topography: 1	Struct Class: II

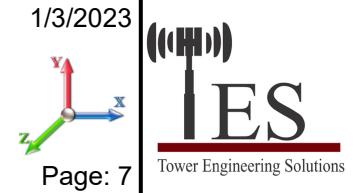

Page: 7

Load Case: 1.2D + 1.0W Normal Wind	1.2D + 1.0W 125 mph Wind at Normal To Face
Wind Load Factor: 1.00	Wind Importance Factor: 1.00
Dead Load Factor: 1.20	
Ice Dead Load Factor: 0.00	Ice Importance Factor: 1.00

Sect Seq	Wind Height (ft)	Wind qz (psf)	Total Flat Area (sqft)	Total Round Area (sqft)	Ice Round Area (sqft)	Sol Ratio	Cf	Df	Dr	Ice Thick (in)	Eff Area (sqft)	Ice		Total Weight (lb)	Weight Ice (lb)	Struct Force (lb)	Linear Force (lb)	Total Force (lb)	
												Linear Area (sqft)	Linear Area (sqft)						
1	2.5	28.25	0.000	2.51	0.00	0.31	2.28	1.00	1.00	0.00	1.55	2.48	0.00	262.4	0.0	84.84	42.94	127.78	
2	12.5	28.25	0.000	7.50	0.00	0.16	2.74	1.00	1.00	0.00	4.34	18.07	0.00	846.2	0.0	285.17	312.44	597.61	
3	30.0	32.65	0.000	9.84	0.00	0.16	2.75	1.00	1.00	0.00	5.69	21.32	0.00	1,101.2	0.0	433.69	426.02	859.71	
4	50.0	36.36	0.000	9.84	0.00	0.16	2.75	1.00	1.00	0.00	5.69	18.33	0.00	1,085.6	0.0	482.93	407.74	890.67	
5	70.0	39.02	0.000	10.06	0.00	0.16	2.74	1.00	1.00	0.00	5.82	18.23	0.00	1,107.1	0.0	527.65	435.46	963.11	
6	90.0	41.14	0.000	9.84	0.00	0.16	2.75	1.00	1.00	0.00	5.69	17.96	0.00	1,084.0	0.0	546.54	452.30	998.84	
7	110.0	42.92	0.000	9.84	0.00	0.16	2.75	1.00	1.00	0.00	5.69	17.15	0.00	1,081.1	0.0	570.13	450.48	1,020.60	
8	130.0	44.46	0.000	9.84	0.00	0.16	2.75	1.00	1.00	0.00	5.69	16.73	0.00	1,080.0	0.0	590.54	455.26	1,045.80	
9	150.0	45.82	0.000	9.84	0.00	0.16	2.75	1.00	1.00	0.00	5.69	14.98	0.00	1,067.0	0.0	608.60	420.12	1,028.72	
10	170.0	47.04	0.000	9.84	0.00	0.16	2.75	1.00	1.00	0.00	5.69	7.56	0.00	1,007.9	0.0	624.85	217.78	842.63	
11	190.0	48.15	0.000	9.84	0.00	0.16	2.75	1.00	1.00	0.00	5.69	0.46	0.00	953.9	0.0	639.65	13.63	653.28	
														10,676.4	0.0				9,028.75

Load Case: 1.2D + 1.0W 60° Wind	1.2D + 1.0W 125 mph Wind at 60° From Face
Wind Load Factor: 1.00	Wind Importance Factor: 1.00
Dead Load Factor: 1.20	
Ice Dead Load Factor: 0.00	Ice Importance Factor: 1.00

Sect Seq	Wind Height (ft)	Wind qz (psf)	Total Flat Area (sqft)	Total Round Area (sqft)	Ice Round Area (sqft)	Sol Ratio	Cf	Df	Dr	Ice Thick (in)	Eff Area (sqft)	Ice		Total Weight (lb)	Weight Ice (lb)	Struct Force (lb)	Linear Force (lb)	Total Force (lb)	
												Linear Area (sqft)	Linear Area (sqft)						
1	2.5	28.25	0.000	2.51	0.00	0.31	2.28	0.80	1.00	0.00	1.55	2.48	0.00	262.4	0.0	84.84	42.94	127.78	
2	12.5	28.25	0.000	7.50	0.00	0.16	2.74	0.80	1.00	0.00	4.34	18.07	0.00	846.2	0.0	285.17	312.44	597.61	
3	30.0	32.65	0.000	9.84	0.00	0.16	2.75	0.80	1.00	0.00	5.69	21.32	0.00	1,101.2	0.0	433.69	426.02	859.71	
4	50.0	36.36	0.000	9.84	0.00	0.16	2.75	0.80	1.00	0.00	5.69	18.33	0.00	1,085.6	0.0	482.93	407.74	890.67	
5	70.0	39.02	0.000	10.06	0.00	0.16	2.74	0.80	1.00	0.00	5.82	18.23	0.00	1,107.1	0.0	527.65	435.46	963.11	
6	90.0	41.14	0.000	9.84	0.00	0.16	2.75	0.80	1.00	0.00	5.69	17.96	0.00	1,084.0	0.0	546.54	452.30	998.84	
7	110.0	42.92	0.000	9.84	0.00	0.16	2.75	0.80	1.00	0.00	5.69	17.15	0.00	1,081.1	0.0	570.13	450.48	1,020.60	
8	130.0	44.46	0.000	9.84	0.00	0.16	2.75	0.80	1.00	0.00	5.69	16.73	0.00	1,080.0	0.0	590.54	455.26	1,045.80	
9	150.0	45.82	0.000	9.84	0.00	0.16	2.75	0.80	1.00	0.00	5.69	14.98	0.00	1,067.0	0.0	608.60	420.12	1,028.72	
10	170.0	47.04	0.000	9.84	0.00	0.16	2.75	0.80	1.00	0.00	5.69	7.56	0.00	1,007.9	0.0	624.85	217.78	842.63	
11	190.0	48.15	0.000	9.84	0.00	0.16	2.75	0.80	1.00	0.00	5.69	0.46	0.00	953.9	0.0	639.65	13.63	653.28	
														10,676.4	0.0				9,028.75

Section Forces

Structure: CT20001-A-SBA	Code: TIA-222-H	1/3/2023
Site Name: STERLING CT TOWER	Exposure: C	
Height: 200.00 (ft)	Crest Height: 0.00	
Base Elev: 0.000 (ft)	Site Class: D - Stiff Soil	
Gh: 0.85	Topography: 1	Struct Class: II



Page: 8

Load Case: 1.2D + 1.0W 90° Wind	1.2D + 1.0W 125 mph Wind at 90° From Face
Wind Load Factor: 1.00	Wind Importance Factor: 1.00
Dead Load Factor: 1.20	
Ice Dead Load Factor: 0.00	Ice Importance Factor: 1.00

Sect Seq	Wind Height (ft)	Wind qz (psf)	Total Flat Area (sqft)	Total Round Area (sqft)	Ice Round Area (sqft)	Sol Ratio	Cf	Df	Dr	Ice Thick (in)	Eff Area (sqft)	Ice		Total Weight (lb)	Weight Ice (lb)	Struct Force (lb)	Linear Force (lb)	Total Force (lb)	
												Linear Area (sqft)	Linear Area (sqft)						
1	2.5	28.25	0.000	2.51	0.00	0.31	2.28	0.85	1.00	0.00	1.55	2.48	0.00	262.4	0.0	84.84	42.94	127.78	
2	12.5	28.25	0.000	7.50	0.00	0.16	2.74	0.85	1.00	0.00	4.34	18.07	0.00	846.2	0.0	285.17	312.44	597.61	
3	30.0	32.65	0.000	9.84	0.00	0.16	2.75	0.85	1.00	0.00	5.69	21.32	0.00	1,101.2	0.0	433.69	426.02	859.71	
4	50.0	36.36	0.000	9.84	0.00	0.16	2.75	0.85	1.00	0.00	5.69	18.33	0.00	1,085.6	0.0	482.93	407.74	890.67	
5	70.0	39.02	0.000	10.06	0.00	0.16	2.74	0.85	1.00	0.00	5.82	18.23	0.00	1,107.1	0.0	527.65	435.46	963.11	
6	90.0	41.14	0.000	9.84	0.00	0.16	2.75	0.85	1.00	0.00	5.69	17.96	0.00	1,084.0	0.0	546.54	452.30	998.84	
7	110.0	42.92	0.000	9.84	0.00	0.16	2.75	0.85	1.00	0.00	5.69	17.15	0.00	1,081.1	0.0	570.13	450.48	1,020.60	
8	130.0	44.46	0.000	9.84	0.00	0.16	2.75	0.85	1.00	0.00	5.69	16.73	0.00	1,080.0	0.0	590.54	455.26	1,045.80	
9	150.0	45.82	0.000	9.84	0.00	0.16	2.75	0.85	1.00	0.00	5.69	14.98	0.00	1,067.0	0.0	608.60	420.12	1,028.72	
10	170.0	47.04	0.000	9.84	0.00	0.16	2.75	0.85	1.00	0.00	5.69	7.56	0.00	1,007.9	0.0	624.85	217.78	842.63	
11	190.0	48.15	0.000	9.84	0.00	0.16	2.75	0.85	1.00	0.00	5.69	0.46	0.00	953.9	0.0	639.65	13.63	653.28	
														10,676.4	0.0				9,028.75

Load Case: 0.9D + 1.0W Normal Wind	0.9D + 1.0W 125 mph Wind at Normal To Face
Wind Load Factor: 1.00	Wind Importance Factor: 1.00
Dead Load Factor: 0.90	
Ice Dead Load Factor: 0.00	Ice Importance Factor: 1.00

Sect Seq	Wind Height (ft)	Wind qz (psf)	Total Flat Area (sqft)	Total Round Area (sqft)	Ice Round Area (sqft)	Sol Ratio	Cf	Df	Dr	Ice Thick (in)	Eff Area (sqft)	Ice		Total Weight (lb)	Weight Ice (lb)	Struct Force (lb)	Linear Force (lb)	Total Force (lb)	
												Linear Area (sqft)	Linear Area (sqft)						
1	2.5	28.25	0.000	2.51	0.00	0.31	2.28	1.00	1.00	0.00	1.55	2.48	0.00	196.8	0.0	84.84	42.94	127.78	
2	12.5	28.25	0.000	7.50	0.00	0.16	2.74	1.00	1.00	0.00	4.34	18.07	0.00	634.7	0.0	285.17	312.44	597.61	
3	30.0	32.65	0.000	9.84	0.00	0.16	2.75	1.00	1.00	0.00	5.69	21.32	0.00	825.9	0.0	433.69	426.02	859.71	
4	50.0	36.36	0.000	9.84	0.00	0.16	2.75	1.00	1.00	0.00	5.69	18.33	0.00	814.2	0.0	482.93	407.74	890.67	
5	70.0	39.02	0.000	10.06	0.00	0.16	2.74	1.00	1.00	0.00	5.82	18.23	0.00	830.3	0.0	527.65	435.46	963.11	
6	90.0	41.14	0.000	9.84	0.00	0.16	2.75	1.00	1.00	0.00	5.69	17.96	0.00	813.0	0.0	546.54	452.30	998.84	
7	110.0	42.92	0.000	9.84	0.00	0.16	2.75	1.00	1.00	0.00	5.69	17.15	0.00	810.8	0.0	570.13	450.48	1,020.60	
8	130.0	44.46	0.000	9.84	0.00	0.16	2.75	1.00	1.00	0.00	5.69	16.73	0.00	810.0	0.0	590.54	455.26	1,045.80	
9	150.0	45.82	0.000	9.84	0.00	0.16	2.75	1.00	1.00	0.00	5.69	14.98	0.00	800.2	0.0	608.60	420.12	1,028.72	
10	170.0	47.04	0.000	9.84	0.00	0.16	2.75	1.00	1.00	0.00	5.69	7.56	0.00	755.9	0.0	624.85	217.78	842.63	
11	190.0	48.15	0.000	9.84	0.00	0.16	2.75	1.00	1.00	0.00	5.69	0.46	0.00	715.4	0.0	639.65	13.63	653.28	
														8,007.3	0.0				9,028.75

Section Forces

Structure: CT20001-A-SBA	Code: TIA-222-H	1/3/2023
Site Name: STERLING CT TOWER	Exposure: C	
Height: 200.00 (ft)	Crest Height: 0.00	
Base Elev: 0.000 (ft)	Site Class: D - Stiff Soil	
Gh: 0.85	Topography: 1	Struct Class: II

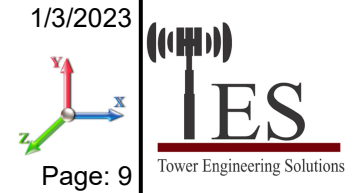

Load Case: 0.9D + 1.0W 60° Wind	0.9D + 1.0W 125 mph Wind at 60° From Face
Wind Load Factor: 1.00	Wind Importance Factor: 1.00
Dead Load Factor: 0.90	
Ice Dead Load Factor: 0.00	Ice Importance Factor: 1.00

Sect Seq	Wind Height (ft)	Wind qz (psf)	Total Flat Area (sqft)	Total Round Area (sqft)	Ice Round Area (sqft)	Sol Ratio	Cf	Df	Dr	Ice Thick (in)	Eff Area (sqft)	Ice		Total Weight (lb)	Weight Ice (lb)	Struct Force (lb)	Linear Force (lb)	Total Force (lb)	
												Linear Area (sqft)	Linear Area (sqft)						
1	2.5	28.25	0.000	2.51	0.00	0.31	2.28	0.80	1.00	0.00	1.55	2.48	0.00	196.8	0.0	84.84	42.94	127.78	
2	12.5	28.25	0.000	7.50	0.00	0.16	2.74	0.80	1.00	0.00	4.34	18.07	0.00	634.7	0.0	285.17	312.44	597.61	
3	30.0	32.65	0.000	9.84	0.00	0.16	2.75	0.80	1.00	0.00	5.69	21.32	0.00	825.9	0.0	433.69	426.02	859.71	
4	50.0	36.36	0.000	9.84	0.00	0.16	2.75	0.80	1.00	0.00	5.69	18.33	0.00	814.2	0.0	482.93	407.74	890.67	
5	70.0	39.02	0.000	10.06	0.00	0.16	2.74	0.80	1.00	0.00	5.82	18.23	0.00	830.3	0.0	527.65	435.46	963.11	
6	90.0	41.14	0.000	9.84	0.00	0.16	2.75	0.80	1.00	0.00	5.69	17.96	0.00	813.0	0.0	546.54	452.30	998.84	
7	110.0	42.92	0.000	9.84	0.00	0.16	2.75	0.80	1.00	0.00	5.69	17.15	0.00	810.8	0.0	570.13	450.48	1,020.60	
8	130.0	44.46	0.000	9.84	0.00	0.16	2.75	0.80	1.00	0.00	5.69	16.73	0.00	810.0	0.0	590.54	455.26	1,045.80	
9	150.0	45.82	0.000	9.84	0.00	0.16	2.75	0.80	1.00	0.00	5.69	14.98	0.00	800.2	0.0	608.60	420.12	1,028.72	
10	170.0	47.04	0.000	9.84	0.00	0.16	2.75	0.80	1.00	0.00	5.69	7.56	0.00	755.9	0.0	624.85	217.78	842.63	
11	190.0	48.15	0.000	9.84	0.00	0.16	2.75	0.80	1.00	0.00	5.69	0.46	0.00	715.4	0.0	639.65	13.63	653.28	
														8,007.3	0.0				9,028.75

Load Case: 0.9D + 1.0W 90° Wind	0.9D + 1.0W 125 mph Wind at 90° From Face
Wind Load Factor: 1.00	Wind Importance Factor: 1.00
Dead Load Factor: 0.90	
Ice Dead Load Factor: 0.00	Ice Importance Factor: 1.00

Sect Seq	Wind Height (ft)	Wind qz (psf)	Total Flat Area (sqft)	Total Round Area (sqft)	Ice Round Area (sqft)	Sol Ratio	Cf	Df	Dr	Ice Thick (in)	Eff Area (sqft)	Ice		Total Weight (lb)	Weight Ice (lb)	Struct Force (lb)	Linear Force (lb)	Total Force (lb)	
												Linear Area (sqft)	Linear Area (sqft)						
1	2.5	28.25	0.000	2.51	0.00	0.31	2.28	0.85	1.00	0.00	1.55	2.48	0.00	196.8	0.0	84.84	42.94	127.78	
2	12.5	28.25	0.000	7.50	0.00	0.16	2.74	0.85	1.00	0.00	4.34	18.07	0.00	634.7	0.0	285.17	312.44	597.61	
3	30.0	32.65	0.000	9.84	0.00	0.16	2.75	0.85	1.00	0.00	5.69	21.32	0.00	825.9	0.0	433.69	426.02	859.71	
4	50.0	36.36	0.000	9.84	0.00	0.16	2.75	0.85	1.00	0.00	5.69	18.33	0.00	814.2	0.0	482.93	407.74	890.67	
5	70.0	39.02	0.000	10.06	0.00	0.16	2.74	0.85	1.00	0.00	5.82	18.23	0.00	830.3	0.0	527.65	435.46	963.11	
6	90.0	41.14	0.000	9.84	0.00	0.16	2.75	0.85	1.00	0.00	5.69	17.96	0.00	813.0	0.0	546.54	452.30	998.84	
7	110.0	42.92	0.000	9.84	0.00	0.16	2.75	0.85	1.00	0.00	5.69	17.15	0.00	810.8	0.0	570.13	450.48	1,020.60	
8	130.0	44.46	0.000	9.84	0.00	0.16	2.75	0.85	1.00	0.00	5.69	16.73	0.00	810.0	0.0	590.54	455.26	1,045.80	
9	150.0	45.82	0.000	9.84	0.00	0.16	2.75	0.85	1.00	0.00	5.69	14.98	0.00	800.2	0.0	608.60	420.12	1,028.72	
10	170.0	47.04	0.000	9.84	0.00	0.16	2.75	0.85	1.00	0.00	5.69	7.56	0.00	755.9	0.0	624.85	217.78	842.63	
11	190.0	48.15	0.000	9.84	0.00	0.16	2.75	0.85	1.00	0.00	5.69	0.46	0.00	715.4	0.0	639.65	13.63	653.28	
														8,007.3	0.0				9,028.75

Section Forces

Structure: CT20001-A-SBA	Code: TIA-222-H	1/3/2023
Site Name: STERLING CT TOWER	Exposure: C	
Height: 200.00 (ft)	Crest Height: 0.00	
Base Elev: 0.000 (ft)	Site Class: D - Stiff Soil	
Gh: 0.85	Topography: 1	Struct Class: II
		Page: 10

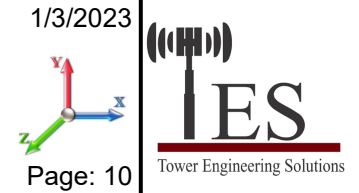

Load Case: 1.2D + 1.0Di + 1.0Wi Normal Wind	1.2D + 1.0Di + 1.0Wi 50 mph Wind at Normal From Face
Wind Load Factor: 1.00	Wind Importance Factor: 1.00
Dead Load Factor: 1.20	
Ice Dead Load Factor: 1.00	Ice Importance Factor: 1.00

Sect Seq	Wind Height (ft)	Wind qz (psf)	Total Flat Area (sqft)	Total Round Area (sqft)	Ice Round Area (sqft)	Sol Ratio	Cf	Df	Dr	Ice Thick (in)	Eff Area (sqft)	Ice		Total Weight (lb)	Weight Ice (lb)	Struct Force (lb)	Linear Force (lb)	Total Force (lb)
												Linear Area (sqft)	Linear Area (sqft)					
1	2.5	4.52	0.000	6.01	3.49	0.68	1.78	1.00	1.00	0.77	4.83	3.08	2.58	419.3	156.9	32.96	8.75	41.71
2	12.5	4.52	0.000	19.90	12.41	0.40	2.06	1.00	1.00	0.91	12.77	26.75	14.97	1,691.8	845.6	101.01	127.63	228.63
3	30.0	5.22	0.000	27.48	17.63	0.41	2.04	1.00	1.00	0.99	17.77	30.94	19.65	2,277.4	1176.2	160.57	174.00	334.57
4	50.0	5.82	0.000	28.40	18.56	0.43	2.01	1.00	1.00	1.04	18.53	27.36	14.07	2,244.4	1158.8	184.30	157.48	341.78
5	70.0	6.24	0.000	29.79	19.73	0.45	1.98	1.00	1.00	1.08	19.72	27.50	14.37	2,343.0	1236.0	206.91	164.86	371.77
6	90.0	6.58	0.000	29.52	19.68	0.44	1.98	1.00	1.00	1.11	19.48	27.42	13.82	2,329.4	1245.4	216.30	173.05	389.35
7	110.0	6.87	0.000	29.92	20.08	0.45	1.98	1.00	1.00	1.13	19.82	26.75	11.28	2,326.2	1245.1	228.53	166.52	395.05
8	130.0	7.11	0.000	30.26	20.42	0.45	1.97	1.00	1.00	1.15	20.11	24.34	11.47	2,325.7	1245.6	239.27	159.83	399.11
9	150.0	7.33	0.000	30.56	20.71	0.46	1.96	1.00	1.00	1.16	20.37	20.53	9.70	2,268.7	1201.8	248.91	138.32	387.23
10	170.0	7.53	0.000	30.82	20.97	0.46	1.96	1.00	1.00	1.18	20.59	10.36	5.50	2,030.6	1022.7	257.67	73.66	331.33
11	190.0	7.70	0.000	31.05	21.21	0.46	1.95	1.00	1.00	1.19	20.80	0.46	0.99	1,793.8	839.9	265.74	6.13	271.87
														22,050.4	11374.0			3,492.40

Load Case: 1.2D + 1.0Di + 1.0Wi 60° Wind	1.2D + 1.0Di + 1.0Wi 50 mph Wind at 60° From Face
Wind Load Factor: 1.00	Wind Importance Factor: 1.00
Dead Load Factor: 1.20	
Ice Dead Load Factor: 1.00	Ice Importance Factor: 1.00

Sect Seq	Wind Height (ft)	Wind qz (psf)	Total Flat Area (sqft)	Total Round Area (sqft)	Ice Round Area (sqft)	Sol Ratio	Cf	Df	Dr	Ice Thick (in)	Eff Area (sqft)	Ice		Total Weight (lb)	Weight Ice (lb)	Struct Force (lb)	Linear Force (lb)	Total Force (lb)
												Linear Area (sqft)	Linear Area (sqft)					
1	2.5	4.52	0.000	6.01	3.49	0.68	1.78	0.80	1.00	0.77	4.83	3.08	2.58	419.3	156.9	32.96	8.75	41.71
2	12.5	4.52	0.000	19.90	12.41	0.40	2.06	0.80	1.00	0.91	12.77	26.75	14.97	1,691.8	845.6	101.01	127.63	228.63
3	30.0	5.22	0.000	27.48	17.63	0.41	2.04	0.80	1.00	0.99	17.77	30.94	19.65	2,277.4	1176.2	160.57	174.00	334.57
4	50.0	5.82	0.000	28.40	18.56	0.43	2.01	0.80	1.00	1.04	18.53	27.36	14.07	2,244.4	1158.8	184.30	157.48	341.78
5	70.0	6.24	0.000	29.79	19.73	0.45	1.98	0.80	1.00	1.08	19.72	27.50	14.37	2,343.0	1236.0	206.91	164.86	371.77
6	90.0	6.58	0.000	29.52	19.68	0.44	1.98	0.80	1.00	1.11	19.48	27.42	13.82	2,329.4	1245.4	216.30	173.05	389.35
7	110.0	6.87	0.000	29.92	20.08	0.45	1.98	0.80	1.00	1.13	19.82	26.75	11.28	2,326.2	1245.1	228.53	166.52	395.05
8	130.0	7.11	0.000	30.26	20.42	0.45	1.97	0.80	1.00	1.15	20.11	24.34	11.47	2,325.7	1245.6	239.27	159.83	399.11
9	150.0	7.33	0.000	30.56	20.71	0.46	1.96	0.80	1.00	1.16	20.37	20.53	9.70	2,268.7	1201.8	248.91	138.32	387.23
10	170.0	7.53	0.000	30.82	20.97	0.46	1.96	0.80	1.00	1.18	20.59	10.36	5.50	2,030.6	1022.7	257.67	73.66	331.33
11	190.0	7.70	0.000	31.05	21.21	0.46	1.95	0.80	1.00	1.19	20.80	0.46	0.99	1,793.8	839.9	265.74	6.13	271.87
														22,050.4	11374.0			3,492.40

Section Forces

Structure: CT20001-A-SBA	Code: TIA-222-H	1/3/2023
Site Name: STERLING CT TOWER	Exposure: C	
Height: 200.00 (ft)	Crest Height: 0.00	
Base Elev: 0.000 (ft)	Site Class: D - Stiff Soil	
Gh: 0.85	Topography: 1	Struct Class: II

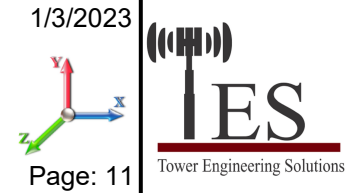

Page: 11

Load Case: 1.2D + 1.0Di + 1.0Wi 90° Wind	1.2D + 1.0Di + 1.0Wi 50 mph Wind at 90° From Face
Wind Load Factor: 1.00	Wind Importance Factor: 1.00
Dead Load Factor: 1.20	
Ice Dead Load Factor: 1.00	Ice Importance Factor: 1.00

Sect Seq	Wind Height (ft)	Wind qz (psf)	Total Flat Area (sqft)	Total Round Area (sqft)	Ice Round Area (sqft)	Sol Ratio	Cf	Df	Dr	Ice Thick (in)	Eff Area (sqft)	Ice		Total Weight (lb)	Weight Ice (lb)	Struct Force (lb)	Linear Force (lb)	Total Force (lb)
												Linear Area (sqft)	Linear Area (sqft)					
1	2.5	4.52	0.000	6.01	3.49	0.68	1.78	0.85	1.00	0.77	4.83	3.08	2.58	419.3	156.9	32.96	8.75	41.71
2	12.5	4.52	0.000	19.90	12.41	0.40	2.06	0.85	1.00	0.91	12.77	26.75	14.97	1,691.8	845.6	101.01	127.63	228.63
3	30.0	5.22	0.000	27.48	17.63	0.41	2.04	0.85	1.00	0.99	17.77	30.94	19.65	2,277.4	1176.2	160.57	174.00	334.57
4	50.0	5.82	0.000	28.40	18.56	0.43	2.01	0.85	1.00	1.04	18.53	27.36	14.07	2,244.4	1158.8	184.30	157.48	341.78
5	70.0	6.24	0.000	29.79	19.73	0.45	1.98	0.85	1.00	1.08	19.72	27.50	14.37	2,343.0	1236.0	206.91	164.86	371.77
6	90.0	6.58	0.000	29.52	19.68	0.44	1.98	0.85	1.00	1.11	19.48	27.42	13.82	2,329.4	1245.4	216.30	173.05	389.35
7	110.0	6.87	0.000	29.92	20.08	0.45	1.98	0.85	1.00	1.13	19.82	26.75	11.28	2,326.2	1245.1	228.53	166.52	395.05
8	130.0	7.11	0.000	30.26	20.42	0.45	1.97	0.85	1.00	1.15	20.11	24.34	11.47	2,325.7	1245.6	239.27	159.83	399.11
9	150.0	7.33	0.000	30.56	20.71	0.46	1.96	0.85	1.00	1.16	20.37	20.53	9.70	2,268.7	1201.8	248.91	138.32	387.23
10	170.0	7.53	0.000	30.82	20.97	0.46	1.96	0.85	1.00	1.18	20.59	10.36	5.50	2,030.6	1022.7	257.67	73.66	331.33
11	190.0	7.70	0.000	31.05	21.21	0.46	1.95	0.85	1.00	1.19	20.80	0.46	0.99	1,793.8	839.9	265.74	6.13	271.87
														22,050.4	11374.0			3,492.40

Load Case: 1.0D + 1.0W Normal Wind	1.0D + 1.0W 60 mph Wind at Normal To Face
Wind Load Factor: 1.00	Wind Importance Factor: 1.00
Dead Load Factor: 1.00	
Ice Dead Load Factor: 0.00	Ice Importance Factor: 1.00

Sect Seq	Wind Height (ft)	Wind qz (psf)	Total Flat Area (sqft)	Total Round Area (sqft)	Ice Round Area (sqft)	Sol Ratio	Cf	Df	Dr	Ice Thick (in)	Eff Area (sqft)	Ice		Total Weight (lb)	Weight Ice (lb)	Struct Force (lb)	Linear Force (lb)	Total Force (lb)
												Linear Area (sqft)	Linear Area (sqft)					
1	2.5	6.51	0.000	2.51	0.00	0.31	2.28	1.00	1.00	0.00	1.55	2.48	0.00	218.7	0.0	19.55	9.89	29.44
2	12.5	6.51	0.000	7.50	0.00	0.16	2.74	1.00	1.00	0.00	4.34	18.07	0.00	705.2	0.0	65.70	71.99	137.69
3	30.0	7.52	0.000	9.84	0.00	0.16	2.75	1.00	1.00	0.00	5.69	21.32	0.00	917.7	0.0	99.92	98.16	198.08
4	50.0	8.38	0.000	9.84	0.00	0.16	2.75	1.00	1.00	0.00	5.69	18.33	0.00	904.7	0.0	111.27	93.94	205.21
5	70.0	8.99	0.000	10.06	0.00	0.16	2.74	1.00	1.00	0.00	5.82	18.23	0.00	922.6	0.0	121.57	100.33	221.90
6	90.0	9.48	0.000	9.84	0.00	0.16	2.75	1.00	1.00	0.00	5.69	17.96	0.00	903.3	0.0	125.92	104.21	230.13
7	110.0	9.89	0.000	9.84	0.00	0.16	2.75	1.00	1.00	0.00	5.69	17.15	0.00	900.9	0.0	131.36	103.79	235.15
8	130.0	10.24	0.000	9.84	0.00	0.16	2.75	1.00	1.00	0.00	5.69	16.73	0.00	900.0	0.0	136.06	104.89	240.95
9	150.0	10.56	0.000	9.84	0.00	0.16	2.75	1.00	1.00	0.00	5.69	14.98	0.00	889.1	0.0	140.22	96.80	237.02
10	170.0	10.84	0.000	9.84	0.00	0.16	2.75	1.00	1.00	0.00	5.69	7.56	0.00	839.9	0.0	143.96	50.18	194.14
11	190.0	11.09	0.000	9.84	0.00	0.16	2.75	1.00	1.00	0.00	5.69	0.46	0.00	794.9	0.0	147.38	3.14	150.52
														8,897.0	0.0			2,080.22

Section Forces

Structure: CT20001-A-SBA	Code: TIA-222-H	1/3/2023
Site Name: STERLING CT TOWER	Exposure: C	
Height: 200.00 (ft)	Crest Height: 0.00	
Base Elev: 0.000 (ft)	Site Class: D - Stiff Soil	
Gh: 0.85	Topography: 1	Struct Class: II
		Page: 12



Load Case: 1.0D + 1.0W 60° Wind	1.0D + 1.0W 60 mph Wind at 60° From Face
Wind Load Factor: 1.00	Wind Importance Factor: 1.00
Dead Load Factor: 1.00	
Ice Dead Load Factor: 0.00	Ice Importance Factor: 1.00

Sect Seq	Wind Height (ft)	Wind qz (psf)	Total Flat Area (sqft)	Total Round Area (sqft)	Ice Round Area (sqft)	Sol Ratio	Cf	Df	Dr	Ice Thick (in)	Eff Area (sqft)	Ice		Total Weight (lb)	Weight Ice (lb)	Struct Force (lb)	Linear Force (lb)	Total Force (lb)	
												Linear Area (sqft)	Linear Area (sqft)						
1	2.5	6.51	0.000	2.51	0.00	0.31	2.28	0.80	1.00	0.00	1.55	2.48	0.00	218.7	0.0	19.55	9.89	29.44	
2	12.5	6.51	0.000	7.50	0.00	0.16	2.74	0.80	1.00	0.00	4.34	18.07	0.00	705.2	0.0	65.70	71.99	137.69	
3	30.0	7.52	0.000	9.84	0.00	0.16	2.75	0.80	1.00	0.00	5.69	21.32	0.00	917.7	0.0	99.92	98.16	198.08	
4	50.0	8.38	0.000	9.84	0.00	0.16	2.75	0.80	1.00	0.00	5.69	18.33	0.00	904.7	0.0	111.27	93.94	205.21	
5	70.0	8.99	0.000	10.06	0.00	0.16	2.74	0.80	1.00	0.00	5.82	18.23	0.00	922.6	0.0	121.57	100.33	221.90	
6	90.0	9.48	0.000	9.84	0.00	0.16	2.75	0.80	1.00	0.00	5.69	17.96	0.00	903.3	0.0	125.92	104.21	230.13	
7	110.0	9.89	0.000	9.84	0.00	0.16	2.75	0.80	1.00	0.00	5.69	17.15	0.00	900.9	0.0	131.36	103.79	235.15	
8	130.0	10.24	0.000	9.84	0.00	0.16	2.75	0.80	1.00	0.00	5.69	16.73	0.00	900.0	0.0	136.06	104.89	240.95	
9	150.0	10.56	0.000	9.84	0.00	0.16	2.75	0.80	1.00	0.00	5.69	14.98	0.00	889.1	0.0	140.22	96.80	237.02	
10	170.0	10.84	0.000	9.84	0.00	0.16	2.75	0.80	1.00	0.00	5.69	7.56	0.00	839.9	0.0	143.96	50.18	194.14	
11	190.0	11.09	0.000	9.84	0.00	0.16	2.75	0.80	1.00	0.00	5.69	0.46	0.00	794.9	0.0	147.38	3.14	150.52	
														8,897.0	0.0				2,080.22

Load Case: 1.0D + 1.0W 90° Wind	1.0D + 1.0W 60 mph Wind at 90° From Face
Wind Load Factor: 1.00	Wind Importance Factor: 1.00
Dead Load Factor: 1.00	
Ice Dead Load Factor: 0.00	Ice Importance Factor: 1.00

Sect Seq	Wind Height (ft)	Wind qz (psf)	Total Flat Area (sqft)	Total Round Area (sqft)	Ice Round Area (sqft)	Sol Ratio	Cf	Df	Dr	Ice Thick (in)	Eff Area (sqft)	Ice		Total Weight (lb)	Weight Ice (lb)	Struct Force (lb)	Linear Force (lb)	Total Force (lb)	
												Linear Area (sqft)	Linear Area (sqft)						
1	2.5	6.51	0.000	2.51	0.00	0.31	2.28	0.85	1.00	0.00	1.55	2.48	0.00	218.7	0.0	19.55	9.89	29.44	
2	12.5	6.51	0.000	7.50	0.00	0.16	2.74	0.85	1.00	0.00	4.34	18.07	0.00	705.2	0.0	65.70	71.99	137.69	
3	30.0	7.52	0.000	9.84	0.00	0.16	2.75	0.85	1.00	0.00	5.69	21.32	0.00	917.7	0.0	99.92	98.16	198.08	
4	50.0	8.38	0.000	9.84	0.00	0.16	2.75	0.85	1.00	0.00	5.69	18.33	0.00	904.7	0.0	111.27	93.94	205.21	
5	70.0	8.99	0.000	10.06	0.00	0.16	2.74	0.85	1.00	0.00	5.82	18.23	0.00	922.6	0.0	121.57	100.33	221.90	
6	90.0	9.48	0.000	9.84	0.00	0.16	2.75	0.85	1.00	0.00	5.69	17.96	0.00	903.3	0.0	125.92	104.21	230.13	
7	110.0	9.89	0.000	9.84	0.00	0.16	2.75	0.85	1.00	0.00	5.69	17.15	0.00	900.9	0.0	131.36	103.79	235.15	
8	130.0	10.24	0.000	9.84	0.00	0.16	2.75	0.85	1.00	0.00	5.69	16.73	0.00	900.0	0.0	136.06	104.89	240.95	
9	150.0	10.56	0.000	9.84	0.00	0.16	2.75	0.85	1.00	0.00	5.69	14.98	0.00	889.1	0.0	140.22	96.80	237.02	
10	170.0	10.84	0.000	9.84	0.00	0.16	2.75	0.85	1.00	0.00	5.69	7.56	0.00	839.9	0.0	143.96	50.18	194.14	
11	190.0	11.09	0.000	9.84	0.00	0.16	2.75	0.85	1.00	0.00	5.69	0.46	0.00	794.9	0.0	147.38	3.14	150.52	
														8,897.0	0.0				2,080.22

Force/Stress Compression Summary

Structure: CT20001-A-SBA	Code: EIA/TIA-222-H	1/3/2023
Site Name: STERLING CT TOWER	Exposure: C	
Height: 200.00 (ft)	Crest Height: 0.00	
Base Elev: 0.000 (ft)	Site Class: D - Stiff Soil	
Gh: 0.85	Topography: 1	Struct Class: II

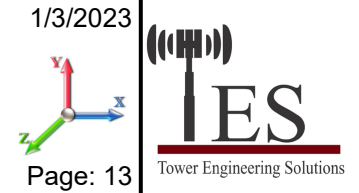

LEG MEMBERS

Sect	Top Elev	Member	Force (kips)		Load Case	Len (ft)	Bracing %			Fy (ksi)	Mem Cap (kips)	Leg Use %	Controls
							X	Y	Z				
1	5	SOL - 1 3/4" SOLID	-26.88	1.2D + 1.0Di + 1.0Wi	60° Wind	1.76	100	100	100	48.38	91.21	29.5	Member X
2	20	SOL - 1 3/4" SOLID	-26.82	1.2D + 1.0W	90° Wind	2.39	100	100	100	65.52	79.08	33.9	Member X
3	40	SOL - 1 3/4" SOLID	-27.58	1.2D + 1.0W	90° Wind	2.33	100	100	100	64.00	80.23	34.4	Member X
4	60	SOL - 1 3/4" SOLID	-28.12	1.2D + 1.0W	Normal Wind	2.33	100	100	100	64.00	80.23	35.0	Member X
5	80	SOL - 1 3/4" SOLID	-33.40	1.2D + 1.0W	Normal Wind	2.33	100	100	100	64.00	80.23	41.6	Member X
6	100	SOL - 1 3/4" SOLID	-21.61	1.2D + 1.0Di + 1.0Wi	60° Wind	2.33	100	100	100	64.00	80.23	26.9	Member X
7	120	SOL - 1 3/4" SOLID	-21.45	1.2D + 1.0Di + 1.0Wi	60° Wind	2.33	100	100	100	64.00	80.23	26.7	Member X
8	140	SOL - 1 3/4" SOLID	-21.87	1.2D + 1.0W	Normal Wind	2.33	100	100	100	64.00	80.23	27.3	Member X
9	160	SOL - 1 3/4" SOLID	-29.81	1.2D + 1.0W	60° Wind	2.33	100	100	100	64.00	80.23	37.2	Member X
10	180	SOL - 1 3/4" SOLID	-38.70	1.2D + 1.0W	60° Wind	2.33	100	100	100	64.00	80.23	48.2	Member X
11	200	SOL - 1 3/4" SOLID	-25.23	1.2D + 1.0W	60° Wind	2.33	100	100	100	64.00	80.23	31.4	Member X

HORIZONTAL MEMBERS

Sect	Top Elev	Member	Force (kips)		Load Case	Len (ft)	Bracing %			Fy (ksi)	Mem Cap (kips)	Num Bolts	Num Holes	Shear Cap (kips)	Bear Cap (kips)	Use %	Controls
							X	Y	Z								
1	5									0.00	0	0					
2	20	SOL - 3/4" SOLID	-0.06	0.9D + 1.0W	60° Wind	3.00	100	100	100	134.40	5.53	0	0			1.1	Member X
3	40	SOL - 3/4" SOLID	-0.14	0.9D + 1.0W	Normal Wind	3.00	100	100	100	134.40	5.53	0	0			2.5	Member X
4	60	SOL - 3/4" SOLID	-0.50	0.9D + 1.0W	Normal Wind	3.00	100	100	100	134.40	5.53	0	0			9.1	Member X
5	80	SOL - 3/4" SOLID	-0.45	1.2D + 1.0W	60° Wind	3.00	100	100	100	134.40	5.53	0	0			8.2	Member X
6	100	SOL - 3/4" SOLID	-0.35	0.9D + 1.0W	Normal Wind	3.00	100	100	100	134.40	5.53	0	0			6.3	Member X
7	120	SOL - 3/4" SOLID	-0.04	0.9D + 1.0W	Normal Wind	3.00	100	100	100	134.40	5.53	0	0			0.8	Member X
8	140	SOL - 3/4" SOLID	-0.74	0.9D + 1.0W	60° Wind	3.00	100	100	100	134.40	5.53	0	0			13.4	Member X
9	160	SOL - 3/4" SOLID	-1.36	1.2D + 1.0W	Normal Wind	3.00	100	100	100	134.40	5.53	0	0			24.6	Member X
10	180	SOL - 3/4" SOLID	-0.57	1.2D + 1.0W	Normal Wind	3.00	100	100	100	134.40	5.53	0	0			10.3	Member X
11	200	SOL - 3/4" SOLID	-0.77	1.2D + 1.0W	60° Wind	3.00	100	100	100	134.40	5.53	0	0			13.9	Member X

DIAGONAL MEMBERS

Sect	Top Elev	Member	Force (kips)		Load Case	Len (ft)	Bracing %			Fy (ksi)	Mem Cap (kips)	Num Bolts	Num Holes	Shear Cap (kips)	Bear Cap (kips)	Use %	Controls
							X	Y	Z								
1	5	SOL - 3/4" SOLID	-2.00	1.2D + 1.0Di + 1.0Wi	90° Wind	2.26	50	50	50	65.11	14.58	0	0			13.7	Member X
2	20	SOL - 3/4" SOLID	-0.57	1.2D + 1.0W	60° Wind	3.83	50	50	50	110.45	8.15	0	0			7.0	Member X
3	40	SOL - 3/4" SOLID	-0.82	1.2D + 1.0W	Normal Wind	3.80	50	50	50	109.46	8.28	0	0			9.9	Member X
4	60	SOL - 3/4" SOLID	-1.33	1.2D + 1.0W	Normal Wind	3.80	50	50	50	109.46	8.28	0	0			16.0	Member X
5	80	SOL - 3/4" SOLID	-1.39	1.2D + 1.0W	90° Wind	3.80	50	50	50	109.46	8.28	0	0			16.8	Member X
6	100	SOL - 3/4" SOLID	-1.04	1.2D + 1.0W	90° Wind	3.80	50	50	50	109.46	8.28	0	0			12.6	Member X
7	120	SOL - 3/4" SOLID	-0.55	1.2D + 1.0W	60° Wind	3.80	50	50	50	109.46	8.28	0	0			6.6	Member X
8	140	SOL - 3/4" SOLID	-3.67	1.2D + 1.0W	90° Wind	3.80	50	50	50	109.46	8.28	0	0			44.4	Member X
9	160	SOL - 3/4" SOLID	-3.11	1.2D + 1.0W	90° Wind	3.80	50	50	50	109.46	8.28	0	0			37.6	Member X
10	180	SOL - 3/4" SOLID	-1.85	1.2D + 1.0W	90° Wind	3.80	50	50	50	109.46	8.28	0	0			22.3	Member X
11	200	SOL - 3/4" SOLID	-2.49	1.2D + 1.0W	90° Wind	3.80	50	50	50	109.46	8.28	0	0			30.1	Member X

Force/Stress Tension Summary

Structure: CT20001-A-SBA	Code: EIA/TIA-222-H	1/3/2023
Site Name: STERLING CT TOWER	Exposure: C	
Height: 200.00 (ft)	Crest Height: 0.00	
Base Elev: 0.000 (ft)	Site Class: D - Stiff Soil	
Gh: 0.85	Topography: 1	Struct Class: II



Page: 14

LEG MEMBERS

Sect	Top Elev	Member	Force (kips)	Load Case	Fy (ksi)	Mem Cap (kips)	Leg Use %	Controls
1	5				0	0.00		
2	20				0	0.00		
3	40				0	0.00		
4	60				0	0.00		
5	80				0	0.00		
6	100				0	0.00		
7	120				0	0.00		
8	140	SOL - 1 3/4" SOLID	2.53	0.9D + 1.0W 60° Wind	50	108.24	2.3	Member
9	160	SOL - 1 3/4" SOLID	15.67	0.9D + 1.0W Normal Wind	50	108.24	14.5	Member
10	180	SOL - 1 3/4" SOLID	23.32	0.9D + 1.0W Normal Wind	50	108.24	21.5	Member
11	200	SOL - 1 3/4" SOLID	13.37	0.9D + 1.0W Normal Wind	50	108.24	12.4	Member

HORIZONTAL MEMBERS

Sect	Top Elev	Member	Force (kips)	Load Case	Fy (ksi)	Mem Cap (kips)	Num Bolts	Num Holes	Shear Cap (kips)	Bear Cap (kips)	B.S. Cap (kips)	Use %	Controls
1	5	SOL - 3/4" SOLID	2.55	1.2D + 1.0Di + 1.0Wi 9C	50	19.88	0	0				12.8	Member
2	20	SOL - 3/4" SOLID	2.55	1.2D + 1.0Di + 1.0Wi 9C	50	19.88	0	0				12.8	Member
3	40	SOL - 3/4" SOLID	0.37	1.2D + 1.0W 60° Wind	50	19.88	0	0				1.9	Member
4	60	SOL - 3/4" SOLID	0.69	1.2D + 1.0W 60° Wind	50	19.88	0	0				3.5	Member
5	80	SOL - 3/4" SOLID	0.77	1.2D + 1.0W Normal Wi	50	19.88	0	0				3.9	Member
6	100	SOL - 3/4" SOLID	0.49	1.2D + 1.0W 60° Wind	50	19.88	0	0				2.5	Member
7	120	SOL - 3/4" SOLID	0.31	1.2D + 1.0W 60° Wind	50	19.88	0	0				1.5	Member
8	140	SOL - 3/4" SOLID	1.43	1.2D + 1.0W Normal Wi	50	19.88	0	0				7.2	Member
9	160	SOL - 3/4" SOLID	1.56	1.2D + 1.0W 60° Wind	50	19.88	0	0				7.8	Member
10	180	SOL - 3/4" SOLID	0.66	1.2D + 1.0W 60° Wind	50	19.88	0	0				3.3	Member
11	200	SOL - 3/4" SOLID	1.09	1.2D + 1.0W Normal Wi	50	19.88	0	0				5.5	Member

DIAGONAL MEMBERS

Sect	Top Elev	Member	Force (kips)	Load Case	Fy (ksi)	Mem Cap (kips)	Num Bolts	Num Holes	Shear Cap (kips)	Bear Cap (kips)	B.S. Cap (kips)	Use %	Controls
1	5	SOL - 3/4" SOLID	0.00		50	0.00	0	0					
2	20	SOL - 3/4" SOLID	0.54	1.2D + 1.0W 90° Wind	50	19.88	0	0				2.7	Member
3	40	SOL - 3/4" SOLID	0.46	0.9D + 1.0W Normal Wi	50	19.88	0	0				2.3	Member
4	60	SOL - 3/4" SOLID	0.98	1.2D + 1.0W 60° Wind	50	19.88	0	0				4.9	Member
5	80	SOL - 3/4" SOLID	1.07	1.2D + 1.0W Normal Wi	50	19.88	0	0				5.4	Member
6	100	SOL - 3/4" SOLID	0.79	0.9D + 1.0W 90° Wind	50	19.88	0	0				4.0	Member
7	120	SOL - 3/4" SOLID	0.40	0.9D + 1.0W 60° Wind	50	19.88	0	0				2.0	Member
8	140	SOL - 3/4" SOLID	2.92	0.9D + 1.0W 90° Wind	50	19.88	0	0				14.7	Member
9	160	SOL - 3/4" SOLID	3.02	1.2D + 1.0W 90° Wind	50	19.88	0	0				15.2	Member
10	180	SOL - 3/4" SOLID	1.61	1.2D + 1.0W 90° Wind	50	19.88	0	0				8.1	Member
11	200	SOL - 3/4" SOLID	1.97	0.9D + 1.0W 90° Wind	50	19.88	0	0				9.9	Member

Seismic Section Forces

Structure: CT20001-A-SBA	Code: TIA-222-H	1/3/2023
Site Name: STERLING CT TOWER	Exposure: C	
Height: 200.00 (ft)	Crest Height: 0.00	
Base Elev: 0.000 (ft)	Site Class: D - Stiff Soil	
Gh: 0.85	Topography: 1	Struct Class: II

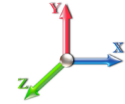

Page: 15

Load Case: 1.2D + 1.0Ev + 1.0Eh

Dead Load Factor	1.20	Sds	0.199	Ss	0.1870	Fa	1.6000	Ke	1.0000	TL	6.0000
Seismic Load Factor	1.00	Sd1	0.086	S1	0.0540	Fv	2.4000	Kg	0.0040	Cs	0.0661
Seismic Importance Factor	1.00	W1	0.000	R	3.0000	Vs	1.2870	T	0.4359	f1	2.2940

Sect #	Elev (ft)	Wz (lb)	Lateral Fsz (lbs)	Vertical Ev (lbs)
1	2.50	218.66	0.35	8.73
2	12.50	855.21	6.77	34.13
3	30.00	1077.6	20.46	43.01
4	50.00	914.66	28.94	36.51
5	70.00	1005.7	44.56	40.14
6	90.00	968.34	55.16	38.65
7	110.00	900.94	62.72	35.96
8	130.00	1265.0	104.08	50.49
9	150.00	2763.2	262.33	110.29
10	170.00	4901.7	527.39	195.64
11	190.00	1449.2	174.28	57.84

Load Case: 0.9D + 1.0Ev + 1.0Eh

Dead Load Factor	0.90	Sds	0.199	Ss	0.1870	Fa	1.6000	Ke	1.0000	TL	6.0000
Seismic Load Factor	1.00	Sd1	0.086	S1	0.0540	Fv	2.4000	Kg	0.0040	Cs	0.0661
Seismic Importance Factor	1.00	W1	0.000	R	3.0000	Vs	1.2870	T	0.4359	f1	2.2940

Sect #	Elev (ft)	Wz (lb)	Lateral Fsz (lbs)	Vertical Ev (lbs)
1	2.50	218.66	0.35	8.73
2	12.50	855.21	6.77	34.13
3	30.00	1077.6	20.46	43.01
4	50.00	914.66	28.94	36.51
5	70.00	1005.7	44.56	40.14
6	90.00	968.34	55.16	38.65
7	110.00	900.94	62.72	35.96
8	130.00	1265.0	104.08	50.49
9	150.00	2763.2	262.33	110.29
10	170.00	4901.7	527.39	195.64
11	190.00	1449.2	174.28	57.84

Support Forces Summary

Structure: CT20001-A-SBA

Code: TIA-222-H

1/3/2023

Site Name: STERLING CT TOWER

Exposure: C

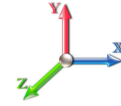

Height: 200.00 (ft)

Crest Height: 0.00

Base Elev: 0.000 (ft)

Site Class: D - Stiff Soil

Gh: 0.85

Topography: 1

Struct Class: II

Page: 16

Load Case	Node	FX (kips)	FY (kips)	FZ (kips)	(-) = Uplift (+) = Down
1.2D + 1.0W Normal Wind	1	0.00	65.04	-0.83	
	A1	0.00	-2.28	1.22	
	A1b	16.64	-21.17	-10.49	
	A1a	-16.65	-21.17	-10.49	
1.2D + 1.0W 60° Wind	1	-0.92	57.98	-0.53	
	A1	-0.66	-6.32	5.15	
	A1b	4.13	-6.34	-3.14	
	A1a	-20.39	-25.17	-11.78	
1.2D + 1.0W 90° Wind	1	-0.93	62.34	-0.11	
	A1	-0.87	-14.03	12.72	
	A1b	1.61	-3.14	-1.31	
	A1a	-20.41	-24.89	-11.30	
0.9D + 1.0W Normal Wind	1	0.00	60.23	-0.87	
	A1	0.00	-2.29	1.23	
	A1b	16.63	-21.15	-10.48	
	A1a	-16.63	-21.15	-10.48	
0.9D + 1.0W 60° Wind	1	-0.94	53.27	-0.54	
	A1	-0.66	-6.36	5.17	
	A1b	4.15	-6.37	-3.16	
	A1a	-20.40	-25.18	-11.78	
0.9D + 1.0W 90° Wind	1	-0.96	57.57	-0.11	
	A1	-0.86	-14.03	12.71	
	A1b	1.62	-3.16	-1.31	
	A1a	-20.40	-24.88	-11.29	
1.2D + 1.0Di + 1.0Wi Normal Wind	1	0.00	72.15	-0.44	
	A1	0.00	-5.93	5.85	
	A1b	10.81	-12.63	-6.94	
	A1a	-10.81	-12.63	-6.94	
1.2D + 1.0Di + 1.0Wi 60° Wind	1	-0.30	73.29	-0.17	
	A1	-0.61	-8.62	8.38	
	A1b	6.95	-8.62	-4.72	
	A1a	-13.41	-15.35	-7.74	
1.2D + 1.0Di + 1.0Wi 90° Wind	1	-0.40	72.76	0.05	
	A1	-0.74	-10.64	10.61	
	A1b	5.48	-6.71	-3.52	
	A1a	-12.96	-14.58	-7.13	
1.2D + 1.0Ev + 1.0Eh	1	0.00	45.89	0.01	
	A1	0.00	-7.23	7.12	
	A1b	7.18	-8.65	-4.15	
	A1a	-7.18	-8.65	-4.15	
0.9D + 1.0Ev + 1.0Eh	1	0.00	41.25	0.01	
	A1	0.00	-7.32	7.19	
	A1b	7.24	-8.74	-4.18	
	A1a	-7.24	-8.74	-4.18	

1.0D + 1.0W Normal Wind	1	0.00	37.65	-0.30
	A1	0.00	-4.05	3.73
	A1b	6.65	-8.24	-4.02
	A1a	-6.65	-8.24	-4.02

1.0D + 1.0W 60° Wind	1	-0.24	37.96	-0.14
	A1	-0.15	-5.59	5.16
	A1b	4.39	-5.59	-2.71
	A1a	-7.94	-9.72	-4.59

1.0D + 1.0W 90° Wind	1	-0.29	37.80	0.01
	A1	-0.19	-6.92	6.47
	A1b	3.54	-4.50	-2.13
	A1a	-7.64	-9.30	-4.32

Max Reactions (kips)	Base	Anchor 1
Vertical	73.29	25.18
Horizontal	1.08	23.55

Cable Forces Summary

Structure: CT20001-A-SBA	Code: TIA-222-H	1/3/2023
Site Name: STERLING CT TOWER	Exposure: C	
Height: 200.00 (ft)	Crest Height: 0.00	
Base Elev: 0.000 (ft)	Site Class: D - Stiff Soil	
Gh: 0.85	Topography: 1	Struct Class: II



Page: 18

Load Case	Elevation (ft)	Cable	Node 1	Node 2	Allow Tension (kips)	Applied Tension (kips)	Use %
1.2D + 1.0W Normal Wind	65.33	7/16 EHS	A1	34	12.48	0.05	0
			A1b	34a	12.48	5.36	43
			A1a	34b	12.48	5.36	43
	134.67		A1	T2	12.48	0.45	4
			A1a	T2b	12.48	6.38	51
			A1b	T2a	12.48	6.40	51
			A1b	T2	12.48	6.42	51
			A1a	T2a	12.48	6.44	52
			A1	T2b	12.48	0.45	4
	190.00		A1	T3	12.48	0.97	8
			A1a	T3b	12.48	6.04	48
			A1b	T3a	12.48	5.46	44
			A1b	T3	12.48	6.02	48
			A1a	T3a	12.48	5.44	44
			A1	T3b	12.48	0.97	8
1.2D + 1.0W 60° Wind	65.33	A1	34	12.48	1.27	10	
		A1b	34a	12.48	1.24	10	
		A1a	34b	12.48	6.31	51	
	134.67	A1	T2	12.48	1.57	13	
		A1a	T2b	12.48	7.79	62	
		A1b	T2a	12.48	1.50	12	
		A1b	T2	12.48	1.56	12	
		A1a	T2a	12.48	7.77	62	
		A1	T2b	12.48	1.50	12	
	190.00	A1	T3	12.48	2.26	18	
		A1a	T3b	12.48	6.73	54	
		A1b	T3a	12.48	2.06	16	
		A1b	T3	12.48	2.26	18	
		A1a	T3a	12.48	6.68	54	
		A1	T3b	12.48	2.02	16	
1.2D + 1.0W 90° Wind	65.33	A1	34	12.48	3.53	28	
		A1b	34a	12.48	0.33	3	
		A1a	34b	12.48	6.35	51	
	134.67	A1	T2	12.48	4.04	32	
		A1a	T2b	12.48	7.72	62	
		A1b	T2a	12.48	0.64	5	
		A1b	T2	12.48	0.69	6	
		A1a	T2a	12.48	7.65	61	
		A1	T2b	12.48	3.96	32	
	190.00	A1	T3	12.48	4.31	35	
		A1a	T3b	12.48	6.43	52	
		A1b	T3a	12.48	1.18	9	
		A1b	T3	12.48	1.26	10	
		A1a	T3a	12.48	6.78	54	
		A1	T3b	12.48	3.73	30	
0.9D + 1.0W Normal Wind	65.33	A1	34	12.48	0.05	0	
		A1b	34a	12.48	5.35	43	
		A1a	34b	12.48	5.35	43	
	134.67	A1	T2	12.48	0.45	4	
		A1a	T2b	12.48	6.38	51	
		A1b	T2a	12.48	6.39	51	
		A1b	T2	12.48	6.41	51	
		A1a	T2a	12.48	6.43	52	

0.9D + 1.0W Normal Wind	134.67	7/16 EHS	A1	T2b	12.48	0.45	4
	190.00		A1	T3	12.48	0.98	8
			A1a	T3b	12.48	6.04	48
			A1b	T3a	12.48	5.45	44
			A1b	T3	12.48	6.02	48
			A1a	T3a	12.48	5.44	44
0.9D + 1.0W 60° Wind	65.33	A1	T3b	12.48	0.97	8	
	134.67	A1	34	12.48	1.27	10	
		A1b	34a	12.48	1.25	10	
		A1a	34b	12.48	6.30	51	
		A1	T2	12.48	1.58	13	
		A1a	T2b	12.48	7.79	62	
		A1b	T2a	12.48	1.51	12	
		A1b	T2	12.48	1.57	13	
		A1a	T2a	12.48	7.77	62	
		A1	T2b	12.48	1.51	12	
		A1	T3	12.48	2.27	18	
	190.00	A1a	T3b	12.48	6.74	54	
0.9D + 1.0W 90° Wind	65.33	A1b	T3a	12.48	2.07	17	
	134.67	A1b	T3	12.48	2.27	18	
		A1a	T3a	12.48	6.69	54	
		A1	T3b	12.48	2.03	16	
		A1	34	12.48	3.53	28	
		A1b	34a	12.48	0.33	3	
		A1a	34b	12.48	6.34	51	
		A1	T2	12.48	4.04	32	
		A1a	T2b	12.48	7.72	62	
		A1b	T2a	12.48	0.65	5	
		A1b	T2	12.48	0.70	6	
	A1a	T2a	12.48	7.65	61		
190.00	A1	T2b	12.48	3.95	32		
1.2D + 1.0Di + 1.0Wi Normal Wind	65.33	A1	T3	12.48	4.31	35	
	134.67	A1a	T3b	12.48	6.43	52	
		A1b	T3a	12.48	1.19	10	
		A1b	T3	12.48	1.26	10	
		A1a	T3a	12.48	6.78	54	
		A1	T3b	12.48	3.73	30	
		A1	34	12.48	2.10	17	
		A1b	34a	12.48	3.91	31	
		A1a	34b	12.48	3.92	31	
		A1	T2	12.48	1.86	15	
		A1a	T2b	12.48	4.01	32	
	A1b	T2a	12.48	3.89	31		
190.00	A1b	T2	12.48	4.02	32		
1.2D + 1.0Di + 1.0Wi 60° Wind	65.33	A1a	T2a	12.48	3.89	31	
	134.67	A1	T2b	12.48	1.87	15	
		A1	T3	12.48	2.22	18	
		A1a	T3b	12.48	4.21	34	
		A1b	T3a	12.48	4.02	32	
		A1b	T3	12.48	4.21	34	
		A1a	T3a	12.48	4.02	32	
		A1	T3b	12.48	2.21	18	
		A1	34	12.48	2.63	21	
		A1b	34a	12.48	2.62	21	
		A1a	34b	12.48	4.54	36	
	190.00	A1	T2	12.48	2.71	22	
	65.33	A1a	T2b	12.48	4.81	39	
	134.67	A1b	T2a	12.48	2.57	21	
		A1b	T2	12.48	2.71	22	
		A1a	T2a	12.48	4.81	39	
		A1	T2b	12.48	2.57	21	
		A1	T3	12.48	3.17	25	
		A1a	T3b	12.48	4.87	39	
		A1b	T3a	12.48	2.94	24	
		A1b	T3	12.48	3.17	25	
		A1a	T3a	12.48	4.86	39	

1.2D + 1.0Di + 1.0Wi 60° Wind	190.00	7/16 EHS	A1	T3b	12.48	2.92	23
1.2D + 1.0Di + 1.0Wi 90° Wind	65.33		A1	34	12.48	3.27	26
			A1b	34a	12.48	2.18	17
			A1a	34b	12.48	4.40	35
	134.67		A1	T2	12.48	3.38	27
			A1a	T2b	12.48	4.56	37
			A1b	T2a	12.48	2.03	16
			A1b	T2	12.48	2.09	17
			A1a	T2a	12.48	4.59	37
			A1	T2b	12.48	3.21	26
	190.00		A1	T3	12.48	3.72	30
			A1a	T3b	12.48	4.61	37
			A1b	T3a	12.48	2.42	19
			A1b	T3	12.48	2.58	21
			A1a	T3a	12.48	4.68	37
1.2D + 1.0Ev + 1.0Eh	65.33		A1	T3b	12.48	3.46	28
			A1	34	12.48	2.71	22
			A1b	34a	12.48	2.87	23
			A1a	34b	12.48	2.87	23
	134.67		A1	T2	12.48	2.06	16
			A1a	T2b	12.48	2.49	20
			A1b	T2a	12.48	2.51	20
			A1b	T2	12.48	2.49	20
			A1a	T2a	12.48	2.51	20
			A1	T2b	12.48	2.06	16
	190.00		A1	T3	12.48	1.91	15
			A1a	T3b	12.48	2.34	19
			A1b	T3a	12.48	2.30	18
			A1b	T3	12.48	2.34	19
			A1a	T3a	12.48	2.30	18
			A1	T3b	12.48	1.91	15
0.9D + 1.0Ev + 1.0Eh	65.33		A1	34	12.48	2.72	22
			A1b	34a	12.48	2.89	23
			A1a	34b	12.48	2.89	23
	134.67		A1	T2	12.48	2.08	17
			A1a	T2b	12.48	2.51	20
			A1b	T2a	12.48	2.53	20
			A1b	T2	12.48	2.51	20
			A1a	T2a	12.48	2.53	20
			A1	T2b	12.48	2.08	17
	190.00		A1	T3	12.48	1.93	15
			A1a	T3b	12.48	2.36	19
			A1b	T3a	12.48	2.33	19
			A1b	T3	12.48	2.36	19
			A1a	T3a	12.48	2.33	19
			A1	T3b	12.48	1.93	15
1.0D + 1.0W Normal Wind	65.33		A1	34	12.48	1.32	11
			A1b	34a	12.48	2.38	19
			A1a	34b	12.48	2.38	19
	134.67		A1	T2	12.48	1.00	8
			A1a	T2b	12.48	2.39	19
			A1b	T2a	12.48	2.38	19
			A1b	T2	12.48	2.39	19
			A1a	T2a	12.48	2.38	19
			A1	T2b	12.48	1.01	8
	190.00		A1	T3	12.48	1.30	10
			A1a	T3b	12.48	2.40	19
			A1b	T3a	12.48	2.27	18
			A1b	T3	12.48	2.39	19
			A1a	T3a	12.48	2.27	18
			A1	T3b	12.48	1.29	10
1.0D + 1.0W 60° Wind	65.33		A1	34	12.48	1.66	13
			A1b	34a	12.48	1.66	13
			A1a	34b	12.48	2.74	22
	134.67		A1	T2	12.48	1.52	12
			A1a	T2b	12.48	2.87	23

1.0D + 1.0W 60° Wind	134.67	7/16 EHS	A1b	T2a	12.48	1.50	12	
			A1b	T2	12.48	1.52	12	
			A1a	T2a	12.48	2.87	23	
			A1	T2b	12.48	1.50	12	
			190.00	A1	T3	12.48	1.75	14
				A1a	T3b	12.48	2.70	22
				A1b	T3a	12.48	1.62	13
				A1b	T3	12.48	1.75	14
				A1a	T3a	12.48	2.69	22
				A1	T3b	12.48	1.61	13
1.0D + 1.0W 90° Wind	65.33		A1	34	12.48	2.02	16	
			A1b	34a	12.48	1.40	11	
			A1a	34b	12.48	2.64	21	
			134.67	A1	T2	12.48	1.96	16
				A1a	T2b	12.48	2.74	22
				A1b	T2a	12.48	1.15	9
			190.00	A1b	T2	12.48	1.16	9
				A1a	T2a	12.48	2.73	22
				A1	T2b	12.48	1.93	15
				A1	T3	12.48	2.09	17
				A1a	T3b	12.48	2.56	21
				A1b	T3a	12.48	1.38	11
				A1b	T3	12.48	1.45	12
				A1a	T3a	12.48	2.62	21
				A1	T3b	12.48	1.93	15

Analysis Summary

Structure: CT20001-A-SBA	Code: TIA-222-H	1/3/2023
Site Name: STERLING CT TOWER	Exposure: C	
Height: 200.00 (ft)	Crest Height: 0.00	
Base Elev: 0.000 (ft)	Site Class: D - Stiff Soil	
Gh: 0.85	Topography: 1	Struct Class: II
		Page: 22



Max Reactions

Base:	73.29 (Vertical)	1.08 (Horizontal)
Anchor 1:	25.18 (Vertical)	23.55 (Horizontal)

Max Usages

Max Leg: 48.2% (1.2D + 1.0W 60° Wind - Sect 10)
 Max Diag: 44.4% (1.2D + 1.0W 90° Wind - Sect 8)
 Max Horiz: 24.6% (1.2D + 1.0W Normal Wind - Sect 9)
 Max Cable: 62.4% (0.9D + 1.0W 60° Wind) - Elev: 135 ft

Max Deflection, Twist and Sway

Load Case	Elevation (ft)	Deflection (ft)	Twist (deg)	Sway (deg)
0.9D + 1.0Ev + 1.0Eh - Normal To Face	14.56	0.0013	0.0000	0.0033
	25.33	0.0011	0.0000	0.0032
	39.33	0.0033	0.0000	0.0078
	40.67	0.0033	0.0000	0.0057
	94.67	0.0143	0.0000	0.0200
	130.00	0.0281	0.0002	0.0256
	134.67	0.0302	-0.0002	0.0275
	150.00	0.0396	-0.0002	0.0298
	167.67	0.0473	-0.0001	0.0128
	170.00	0.0478	-0.0001	0.0104
	185.33	0.0464	0.0000	0.0091
0.9D + 1.0W 125 mph Wind at 60° From Face	14.56	0.0764	0.0578	0.2895
	25.33	0.1317	0.0563	0.2481
	39.33	0.1823	0.0643	0.0923
	40.67	0.1833	0.0649	0.0681
	94.67	0.4123	0.0671	0.2668
	130.00	0.5762	0.0211	0.2347
	134.67	0.5987	0.0154	0.2875
	150.00	0.7050	0.0281	0.3257
	167.67	0.7845	0.0492	0.1383
	170.00	0.7911	0.0501	0.1094
	185.33	0.7788	0.0483	0.2084
190.00	0.7698	0.0555	0.1135	
200.00	0.7530	0.0536	0.0431	

0.9D + 1.0W 125 mph Wind at 90° From Face	14.56	0.0955	0.2096	0.3709
	25.33	0.1712	0.1974	0.3280
	39.33	0.2328	0.1962	0.1887
	40.67	0.2360	0.1955	0.1732
	94.67	0.5593	0.1144	0.3155
	130.00	0.7723	0.0524	0.2150
	134.67	0.8008	0.0487	0.3464
	150.00	0.9187	0.0522	0.3631
	167.67	1.0058	0.0528	0.0427
	170.00	1.0148	0.0561	0.1504
	185.33	1.0091	0.0549	0.2139
	190.00	1.0024	0.0593	0.0945
	200.00	0.9909	0.0577	0.0300

0.9D + 1.0W 125 mph Wind at Normal To Face	14.56	0.1117	-0.1757	0.4001
	25.33	0.1791	-0.1576	0.3618
	39.33	0.2577	-0.1347	0.2225
	40.67	0.2619	-0.1323	0.2096
	94.67	0.6230	-0.0556	0.5217
	130.00	0.8748	-0.0179	0.5049
	134.67	0.9061	-0.0200	0.3989
	150.00	1.0366	-0.0141	0.4088
	167.67	1.1402	-0.0028	0.3400
	170.00	1.1482	0.0070	0.1587
	185.33	1.1514	0.0129	0.0799
	190.00	1.1486	0.0159	0.0458
	200.00	1.1433	0.0145	0.0220

1.0D + 1.0W 60 mph Wind at 60° From Face	14.56	0.0148	0.0039	0.0558
	25.33	0.0252	0.0020	0.0448
	39.33	0.0338	0.0027	0.0150
	40.67	0.0338	0.0029	0.0014
	94.67	0.0691	0.0022	0.0405
	130.00	0.0932	0.0013	0.0358
	134.67	0.0964	0.0014	0.0441
	150.00	0.1144	0.0016	0.0522
	167.67	0.1258	0.0030	0.0281
	170.00	0.1265	0.0036	0.0078
	185.33	0.1187	0.0065	0.0624
	190.00	0.1153	0.0080	0.0425
	200.00	0.1085	0.0075	0.0268

1.0D + 1.0W 60 mph Wind at 90° From Face	14.56	0.0144	0.0190	0.0560
	25.33	0.0258	0.0097	0.0440
	39.33	0.0327	0.0073	0.0151
	40.67	0.0327	0.0076	0.0062
	94.67	0.0667	0.0043	0.0243
	130.00	0.0872	0.0069	0.0080
	134.67	0.0901	0.0076	0.0382
	150.00	0.1065	0.0052	0.0456
	167.67	0.1155	0.0067	0.0287
	170.00	0.1162	0.0074	0.0108
	185.33	0.1067	0.0144	0.0790
	190.00	0.1027	0.0166	0.0519
	200.00	0.0948	0.0158	0.0353

1.0D + 1.0W 60 mph Wind at Normal To Face	14.56	0.0157	-0.0194	0.0528
	25.33	0.0241	-0.0100	0.0425
	39.33	0.0321	-0.0049	0.0153
	40.67	0.0322	-0.0048	0.0117
	94.67	0.0626	-0.0017	0.0549
	130.00	0.0803	-0.0020	0.0556
	134.67	0.0827	-0.0033	0.0323
	150.00	0.0972	-0.0018	0.0385
	167.67	0.1048	0.0003	0.0283
	170.00	0.1047	0.0012	0.0208
	185.33	0.0930	0.0025	0.0282
	190.00	0.0886	0.0031	0.0566
	200.00	0.0793	0.0028	0.0415

1.2D + 1.0Di + 1.0Wi 50 mph Wind at 60° From Face	14.56	0.0309	0.0113	0.1193
	25.33	0.0530	0.0076	0.1006
	39.33	0.0743	0.0086	0.0553
	40.67	0.0750	0.0088	0.0288
	94.67	0.1483	0.0064	0.0713
	130.00	0.1818	0.0029	0.0409
	134.67	0.1854	0.0028	0.0465
	150.00	0.2057	0.0046	0.0574
	167.67	0.2176	0.0075	0.0397
	170.00	0.2178	0.0089	0.0099
	185.33	0.2060	0.0128	0.0942
	190.00	0.2006	0.0151	0.0693
	200.00	0.1894	0.0144	0.0526

1.2D + 1.0Di + 1.0Wi 50 mph Wind at 90° From Face	14.56	0.0310	0.0563	0.1239
	25.33	0.0563	0.0451	0.1020
	39.33	0.0743	0.0433	0.0565
	40.67	0.0751	0.0436	0.0339
	94.67	0.1381	0.0331	0.0427
	130.00	0.1499	0.0380	0.0659
	134.67	0.1523	0.0392	0.0510
	150.00	0.1630	0.0434	0.0566
	167.67	0.1635	0.0556	0.1144
	170.00	0.1640	0.0577	0.0948
	185.33	0.1497	0.0736	0.1822
	190.00	0.1451	0.0776	0.1514
	200.00	0.1389	0.0768	0.1338

1.2D + 1.0Di + 1.0Wi 50 mph Wind at Normal From Face	14.56	0.0328	-0.0095	0.1192
	25.33	0.0536	-0.0058	0.0997
	39.33	0.0745	-0.0025	0.0550
	40.67	0.0754	-0.0023	0.0430
	94.67	0.1157	-0.0006	0.0362
	130.00	0.0986	-0.0019	0.0240
	134.67	0.0936	-0.0035	0.0622
	150.00	0.0831	-0.0019	0.0656
	167.67	0.0560	0.0010	0.0889
	170.00	0.0507	0.0028	0.1500
	185.33	0.0018	0.0049	0.1613
	190.00	0.0148	0.0059	0.2068
	200.00	0.0498	0.0054	0.1903

1.2D + 1.0Ev + 1.0Eh - Normal To Face	14.56	0.0013	0.0000	0.0033
	25.33	0.0011	0.0000	0.0030
	39.33	0.0032	0.0000	0.0085
	40.67	0.0033	0.0000	0.0064
	94.67	0.0143	0.0000	0.0202
	130.00	0.0281	0.0002	0.0258
	134.67	0.0303	0.0002	0.0276
	150.00	0.0397	-0.0002	0.0298
	167.67	0.0474	-0.0001	0.0128
	170.00	0.0479	0.0001	0.0105
	185.33	0.0466	0.0000	0.0091
	190.00	0.0469	-0.0001	0.0076
	200.00	0.0449	0.0000	0.0039

1.2D + 1.0W 125 mph Wind at 60° From Face	14.56	0.0767	0.0580	0.2908
	25.33	0.1323	0.0565	0.2490
	39.33	0.1830	0.0646	0.0916
	40.67	0.1839	0.0652	0.0660
	94.67	0.4137	0.0675	0.2682
	130.00	0.5785	0.0212	0.2361
	134.67	0.6011	0.0156	0.2891
	150.00	0.7080	0.0284	0.3272
	167.67	0.7878	0.0496	0.1388
	170.00	0.7945	0.0505	0.1103
	185.33	0.7823	0.0487	0.2083
	190.00	0.7733	0.0559	0.1132
	200.00	0.7566	0.0540	0.0428

1.2D + 1.0W 125 mph Wind at 90° From Face	14.56	0.0962	0.2104	0.3736
	25.33	0.1723	0.1981	0.3302
	39.33	0.2343	0.1969	0.1894
	40.67	0.2375	0.1962	0.1732
	94.67	0.5632	0.1146	0.3186
	130.00	0.7780	0.0524	0.2177
	134.67	0.8066	0.0486	0.3493
	150.00	0.9255	0.0522	0.3657
	167.67	1.0132	0.0528	0.0444
	170.00	1.0223	0.0561	0.1522
	185.33	1.0170	0.0549	0.2129
	190.00	1.0104	0.0594	0.0935
	200.00	0.9991	0.0577	0.0299

1.2D + 1.0W 125 mph Wind at Normal To Face	14.56	0.1124	-0.1769	0.4025
	25.33	0.1803	-0.1587	0.3641
	39.33	0.2593	-0.1356	0.2232
	40.67	0.2636	-0.1332	0.2097
	94.67	0.6274	-0.0559	0.5255
	130.00	0.8814	-0.0179	0.5085
	134.67	0.9129	-0.0200	0.4024
	150.00	1.0445	-0.0141	0.4120
	167.67	1.1491	-0.0029	0.3426
	170.00	1.1572	0.0071	0.1614
	185.33	1.1610	0.0130	0.0820
	190.00	1.1584	0.0160	0.0437
	200.00	1.1534	0.0145	0.0242

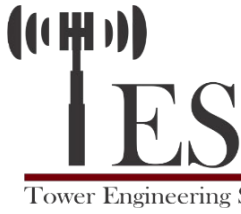

Guyed Tower Base Design

Date

1/3/2023

Customer Name:	SBA Communications Corp	TIA Standard:	TIA-222-H
Site Name:		Structure Height (Ft.):	200
Site Nmber:	CT20001-A-SBA	Engineer Name:	H. You
Engr. Number:	137372	Engineer Login ID:	

Foundation Info Obtained from:

Drawings/Calculations

Structure Type:

Guyed Tower

Analysis or Design?

Analysis

Base Reactions (Factored):

Axial Load (Kips):	73.3	Shear Force (Kips):	1.1
Uplift Force (Kips):	0.0	Moment (Kips-ft):	
Allowable overstress %:	5.0%		

Foundation Geometries:

		Mods required -Yes/No ?:	No
Diameter of Pier (ft.):	2.5	Depth of Base BG (ft.):	4.0
Pier Height A. G. (ft.):	0.50	Thickness of Pad (ft):	1.00
Length of Pad (ft.):	7	Width of Pad (ft.):	7
Final Length of pad (ft)	7.0	Final width of pad (ft):	7.0

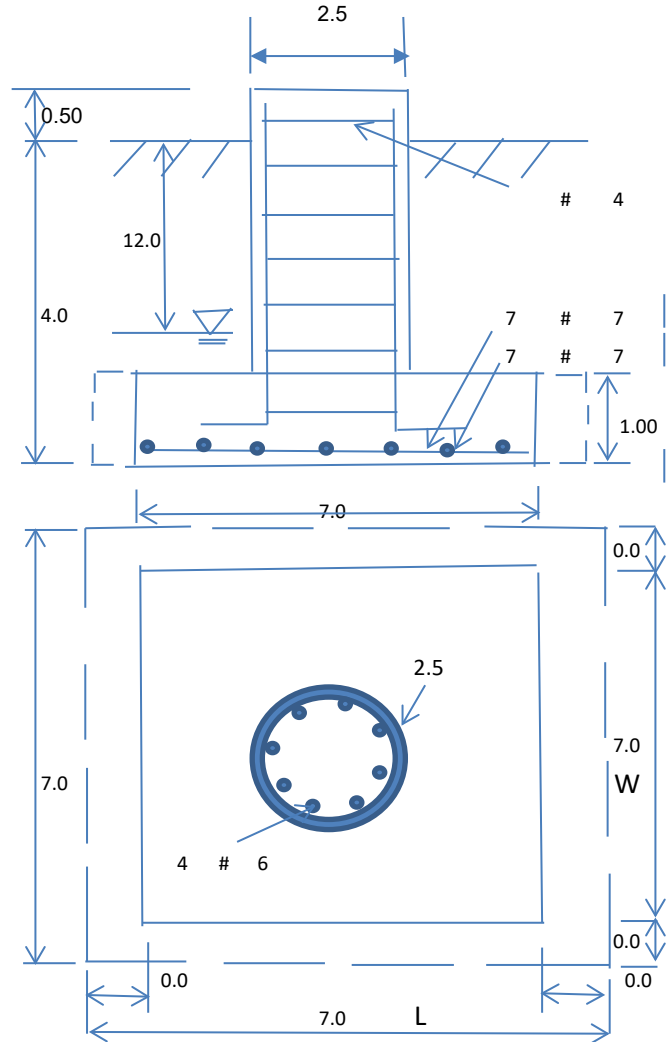

Material Properties and Reabr Info:

Concrete Strength (psi):	4000	Steel Elastic Modulus:	29000	ksi
Vertical bar yield (ksi)	60	Tie steel yield (ksi):	60	
Vertical Rebar Size #:	6	Tie / Stirrup Size #:	4	
Qty. of Vertical Rebars:	4	Tie Spacing (in):	16.0	
Pad Rebar Yield (Ksi):	60	Pad Steel Rebar Size (#):	7	
Concrete Cover (in.):	3	Unit Weight of Concrete:	150.0	pcf
Rebar at the bottom of the concrete pad:				
Qty. of Rebar in Pad (L):	7	Qty. of Rebar in Pad (W):	7	

Soil Design Parameters:

Soil Unit Weight (pcf):	125.0	Soil Buoyant Weight:	62.6	Pcf
Water Table B.G.S. (ft):	12.0	Unit Weight of Water:	62.4	pcf
Ultimate Bearing Pressure (psf):	30000	Ultimate Skin Friction:	0	Psf
		Angle from Top of Pad:	30	
		Angle from Bottm of Pad:	25	
		Angle from Bottm of Pad:	25	

Foundation Analysis and Design:

Uplift Strength Reduction Factor:	0.75	Compression Strength Reduction Factor:	0.6
Total Dry Soil Volume (cu. Ft.):	132.27	Total Dry Soil Weight (Kips):	16.53
Total Buoyant Soil Volume (cu. Ft.):	0.00	Total Buoyant Soil Weight (Kips):	0.00
Total Effective Soil Weight (Kips):	16.53	Weight from the Concrete Block at Top (K):	0.00
Total Dry Concrete Volume (cu. Ft.):	66.18	Total Dry Concrete Weight (Kips):	9.93
Total Buoyant Concrete Volume (cu. Ft.):	0.00	Total Buoyant Concrete Weight (Kips):	0.00
Total Effective Concrete Weight (Kips):	9.93	Total Vertical Load on Base (Kips):	99.76

Check Soil Capacities:

Calculated Maxium Net Soil Pressure under the base (psf):	1576.1	<	Allowable Factored Soil Bearing (psf):	18000	0.09	OK!
Calculated Foundation Allowable Axail Capacity (Kips):	882.0	>	Design Factored Axial Load (Kips):	76	0.09	OK!

Load/
Capacity
Ratio

Check the capacities of Reinforcing Concrete:

Strength reduction factor (Flexure and axial tension):	0.90	Strength reduction factor (Shear):	0.75
Strength reduction factor (Axial compression):	0.65	Wind Load Factor on Concrete Design:	1.00

Load/
Capacity
Ratio

(1) Concrete Pier:

Vertical Steel Rebar Area (sq. in./each):	0.44	Tie / Stirrup Area (sq. in./each):	0.20		
Calculated Moment Capacity (Mn,Kips-Ft):	92.1	> Design Factored Moment (Mu, Kips-Ft)	3.8	0.04	OK!
Calculated Shear Capacity (Kips):	103.1	> Design Factored Shear (Kips):	1.1	0.01	OK!
Calculated Tension Capacity (Tn, Kips):	95.0	> Design Factored Tension (Tu Kips):	0.0	0.00	OK!
Calculated Compression Capacity (Pn, Kips):	1246.6	> Design Factored Axial Load (Pu Kips):	73.3	0.06	OK!
Moment & Axial Strength Combination(Pu/Pn+Mu/Mn):	0.10	OK!			
Pier Reinforcement Ratio:	0.002				

(2).Concrete Pad:

One-Way Design Shear Capacity (L-Dir. Kips);	68.2	> One-Way Factored Shear (L-Dir Kips):	16.5	0.24	OK!
One-Way Design Shear Capacity (W-Dir. Kips):	68.2	> One-Way Factored Shear (W-Dir Kips)	16.5	0.24	OK!
Two-Way Design Shear Capacity (Kips):	196.8	> Two-Way Factored Shear (Kips):	61.1	0.31	OK!
Lower Steel Pad Reinforcement Ratio (L-Direct.):	0.0058	OK!	Lower Steel Pad Reinf. Ratio (W-Direc	0.0058	OK!
Lower Steel Pad Moment Capacity (L-Direction. Kips-ft):	153.5	> Moment at Bottom (L-Direct. K-Ft):	27.2	0.18	OK!
Lower Steel Pad Moment Capacity (W-Dir. Kips-ft):	153.5	> Moment at Bottom (W-Dir. Kips-Ft):	27.2	0.18	OK!

Exhibit E

Mount Analysis



January 9, 2023

Sherri Knapik
SBA Network Services, LLC.
134 Flanders Road, Suite 125
Westborough, MA 01581
(508) 251-0720 x 3805

B+T Group
1717 S. Boulder, Suite 300
Tulsa, OK 74119
(918) 587-4630
btwo@btgrp.com

Subject: Appurtenance Mount Analysis Report

Carrier Designation: *Dish Wireless Co-Locate*
Site Number: BOBOS00062A
Site Name: N/A

SBA Network Services Designation: **Site Number:** CT20001-A
Site Name: Sterling CT Tower
Application Number: 167078, v1

Engineering Firm Designation: **B+T Group Project Number:** 149477.003.01 Rev 1

Site Data: 419 Ekonk Hill Road (Rt-49), Sterling, CT, 06377, Windham County
Latitude 41.66222°, Longitude -71.84694°
Guyed Tower
(3) 8 ft. Sector Mount

Dear Ms. Knapik,

B+T Group is pleased to submit this “**Appurtenance Mount Analysis Report**” to determine the structural integrity of the antenna mount on the above-mentioned structure.

The purpose of the analysis is to determine acceptability of the mount’s stress level. Based on our analysis we have determined the stress level for the mount under the following load case to be:

Proposed Equipment
Note: See Table 1 for the final loading configuration

**Sufficient Capacity
(Passing at 52.0%)**

This analysis utilizes an ultimate 3-second gust wind speed of 124 mph as required by the 2022 Connecticut State Building Code. Applicable Standard references and design criteria are listed in Section 2 - Analysis Criteria.

All the equipment proposed in this report shall be installed in accordance with the drawings for the determined available structural capacity to be effective.

We at B+T Group appreciate the opportunity of providing our continuing professional services to you and SBA Network Services, LLC. If you have any questions or need further assistance on this or any other projects, please give us a call.

Mount structural analysis prepared by: Erik Perez

Respectfully submitted by: B&T Engineering, Inc.
COA: PEC.0001564 Expires: 2/1/2023

Chad E. Tuttle, P.E.

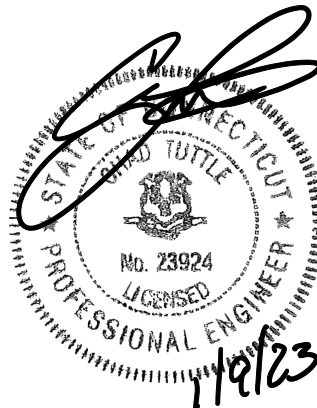

TABLE OF CONTENTS

1) INTRODUCTION

2) ANALYSIS CRITERIA

Table 1 - Proposed Equipment Information

Table 2 - Documents Provided

3) ANALYSIS PROCEDURE

3.1) Analysis Method

3.2) Assumptions

4) ANALYSIS RESULTS

Table 3 – Mount Component Stresses vs. Capacity

5) RECOMMENDATIONS

6) APPENDIX A

RISA-3D Output

7) APPENDIX B

Additional Calculations

1) INTRODUCTION

The appurtenance mount consists of Commscope sector mount (Part #MTC3975083) at 150 ft., attached to guyed tower at 419 Ekonk Hill Road (Rt-49), Sterling, CT, 06377, Windham County. The proposed antenna loading information was obtained from SBA Network Services, LLC. All information provided to B+T Group was assumed accurate and complete.

2) ANALYSIS CRITERIA

The structural analysis was performed for this mount in accordance with the ANSI/TIA-222-H-2017 Structural Standard for Antenna Supporting Structures and Antennas – Addendum 2 using a 3-second gust wind speed of 124 mph with no ice and 50 mph with 1 inch escalated ice thickness Exposure category C & Topographic Category 1 and Risk Category II were used in the analysis. In addition, the sector mount has been analyzed for various live loading conditions consisting of a 250-lb man live load applied individually at the midpoint and cantilevered ends of horizontal members as well as a 500-pound man live load applied individually at mount pipe locations using a 3-second gust of 30mph. The mount was analyzed under 30° increments in the wind direction. The analyzed loading is detailed in Table 1.

Table 1 – Proposed Equipment Information

Loading	RAD Center Elev. (ft.)	Position	Qty.	Description	Note
Proposed	150	1	3	JMA Wireless MX08FRO665-21	1
			3	Fujitsu TA08025-B605	2
			3	Fujitsu TA08025-B604	
		-	1	Raycap RDIDC-9181-PF-48	3

Note:

- 1) Proposed Antenna to be installed on the Proposed Mount Pipe.
- 2) Proposed Equipment to be installed directly behind the Antenna
- 3) Proposed Equipment to be installed on Mount.

Table 2 - Documents Provided

Documents	Remarks	Reference	Source
SBA Application	Proposed Loading	Date: 07/27/2021	SBA Network Services, LLC.
RFDS		Date: 07/22/2021	

3) ANALYSIS PROCEDURE

3.1) Analysis Method

RISA-3D (Version 19.0.4), a commercially available analysis software package, was used to create a three-dimensional model of the mount and calculate member stresses and deflections for various loading cases. Selected output from the analysis is included in Appendix A.

Manufacturer’s drawings were used to create the model.

3.2) Assumptions

1. The mount was built in accordance with the manufacturer’s specifications.
2. The mount has been maintained in accordance with the manufacturer’s specifications and is free of damage.
3. The configuration of antennas and other appurtenances are as specified in Table 1.
4. All mount components have been assumed to be in sufficient condition to carry their full design capacity for the analysis.
5. Mount areas and weights are determined from field measurements, standard material properties, and/or manufacturer product data.

6. Serviceability with respect to antenna twist, tilt, roll or lateral translation is not checked and is left to the carrier or tower owner to ensure conformance.
7. All prior structural modifications, if any are assumed to be correctly installed and fully effective.
8. All member connections are assumed to have been designed to meet or exceed the load carrying capacity of the connected member unless otherwise specified in this report.
9. The following material grades were assumed (Unless Noted Otherwise):
 - a) Connection Bolts : ASTM A325
 - b) Steel Pipe : ASTM A53 (GR. 35)
 - c) HSS (Round) : ASTM 500 (GR. B-42)
 - d) HSS (Rectangular) : ASTM 500 (GR. B-46)
 - e) Channel : ASTM A36 (GR. 36)
 - f) Steel Solid Rod : ASTM A36 (GR. 36)
 - g) Steel Plate : ASTM A36 (GR. 36)
 - h) Steel Angle : ASTM A36 (GR. 36)
 - i) UNISTRUT : ASTM A570 (GR. 33)

This analysis may be affected if any assumptions are not valid or have been made in error. B+T Group should be notified to determine the effect on the structural integrity of the antenna mounting system.

4) ANALYSIS RESULTS

Table 3 – Mount Component Stresses vs. Capacity

Notes	Component	Elevation (ft.)	% Capacity	Pass / Fail
-	Face Horizontals	150	15.2	Pass
-	Support Arms	150	29.4	Pass
-	Diagonals	150	32.1	Pass
-	Connection Plates	150	24.2	Pass
-	Verticals	150	52.0	Pass
-	Tiebacks	150	6.8	Pass
-	Mount Pipes	150	16.4	Pass

5) RECOMMENDATIONS

The Commscope sector mount, Part #MTC3975083 has sufficient capacity to carry the proposed loads and is in compliance with the ANSI/TIA-222-H standard for the proposed loading. (Refer to the RISA output for the specific members).

APPENDIX A

(RISA-3D Output)

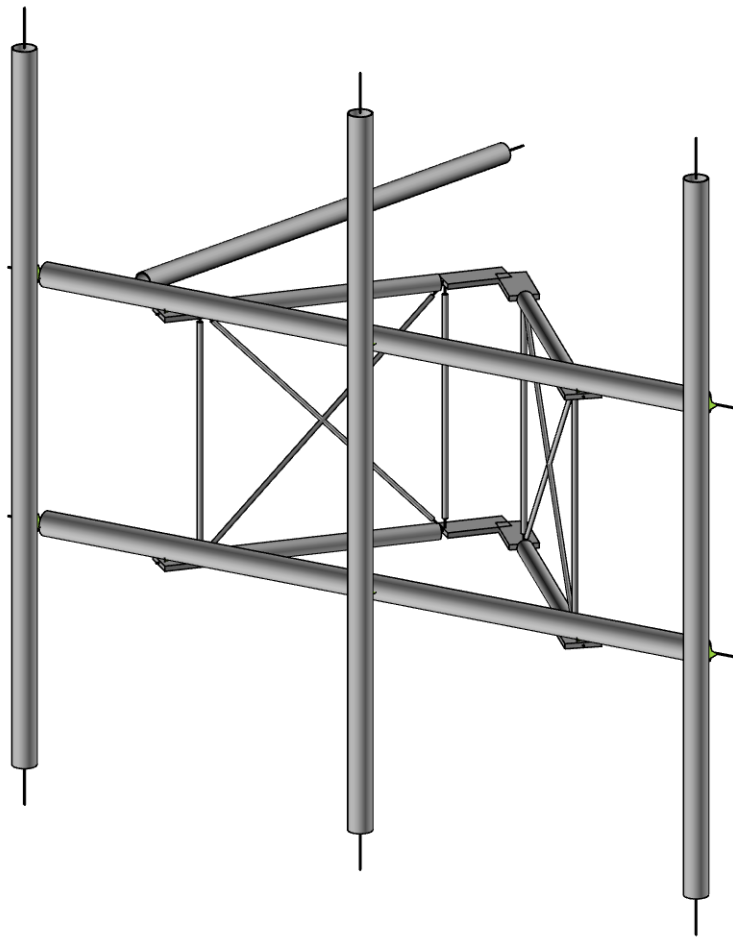
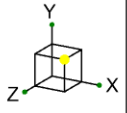

Loads: BLC 21, Maint LL 7
Envelope Only Solution

B+T Group

AS

149477.003.01

CT20001-A - Sterling CT Tower

SK-1

Jan 09, 2023

149477_003_01_Sterling CT Towe...

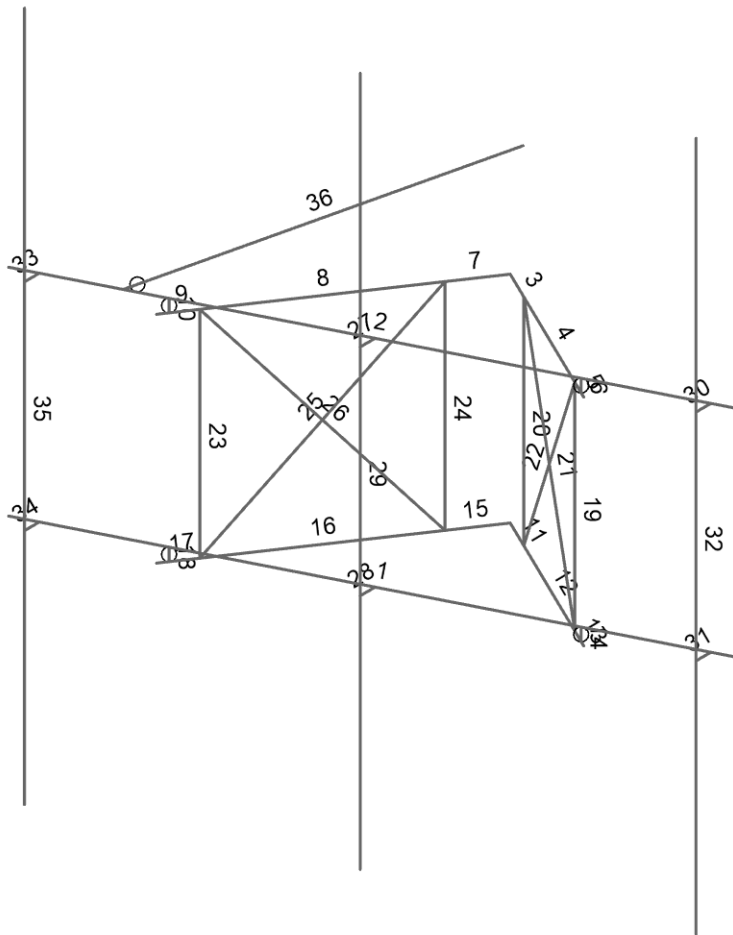
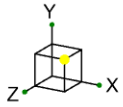

Loads: BLC 21, Maint LL 7
Envelope Only Solution

B+T Group	CT20001-A - Sterling CT Tower	SK-2
AS		Jan 09, 2023
149477.003.01		149477_003_01_Sterling CT Towe...

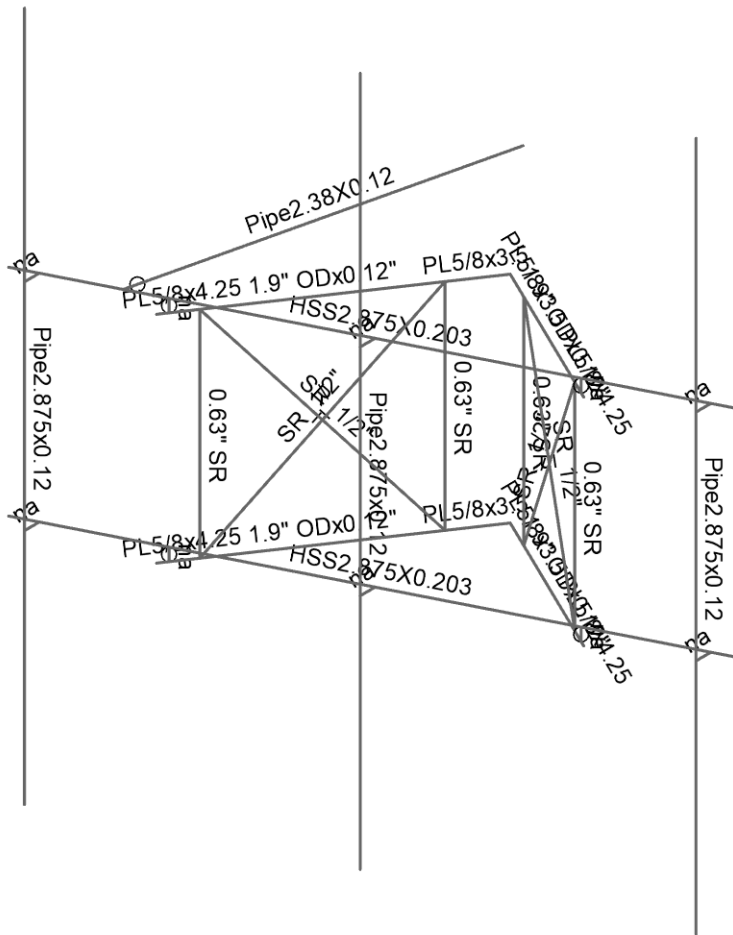
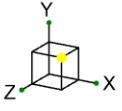

Loads: BLC 21, Maint LL 7
Envelope Only Solution

B+T Group

AS

149477.003.01

CT20001-A - Sterling CT Tower

SK-3

Jan 09, 2023

149477_003_01_Sterling CT Towe...

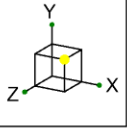

Code Check
(Env)

- No Calc
- > 1.0
- .90-1.0
- .75-.90
- .50-.75
- 0.-.50

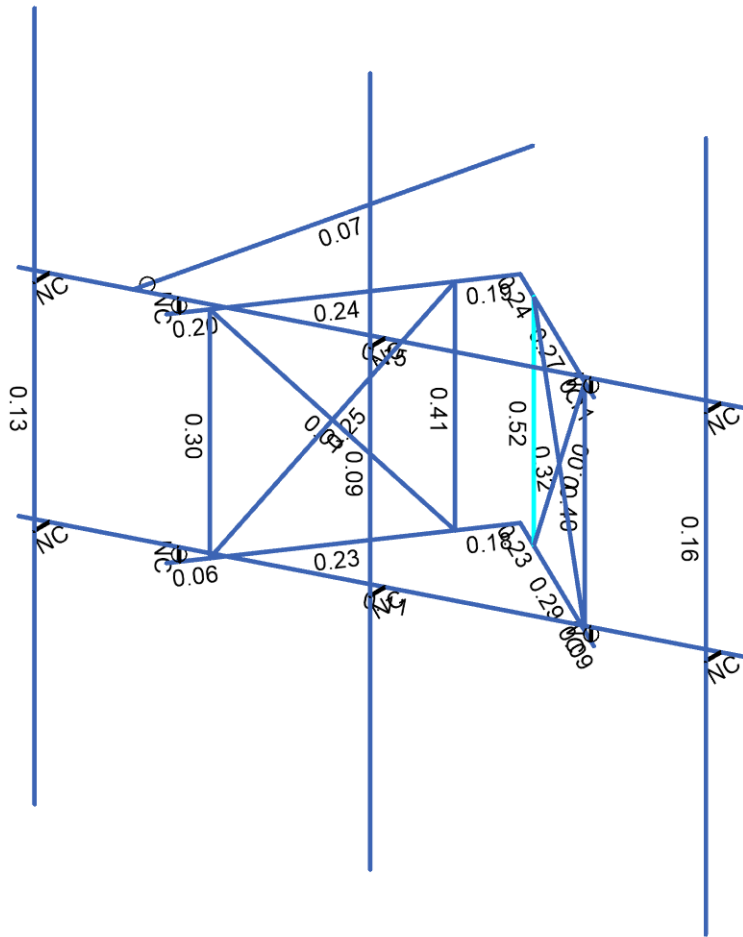

Member Code Checks Displayed (Enveloped)
Envelope Only Solution

B+T Group

AS

149477.003.01

CT20001-A - Sterling CT Tower

SK-4

Jan 09, 2023

149477_003_01_Sterling CT Towe...

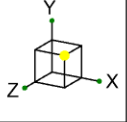

Shear Check (Env)

- No Calc
- > 1.0
- .90-1.0
- .75-.90
- .50-.75
- 0-.50

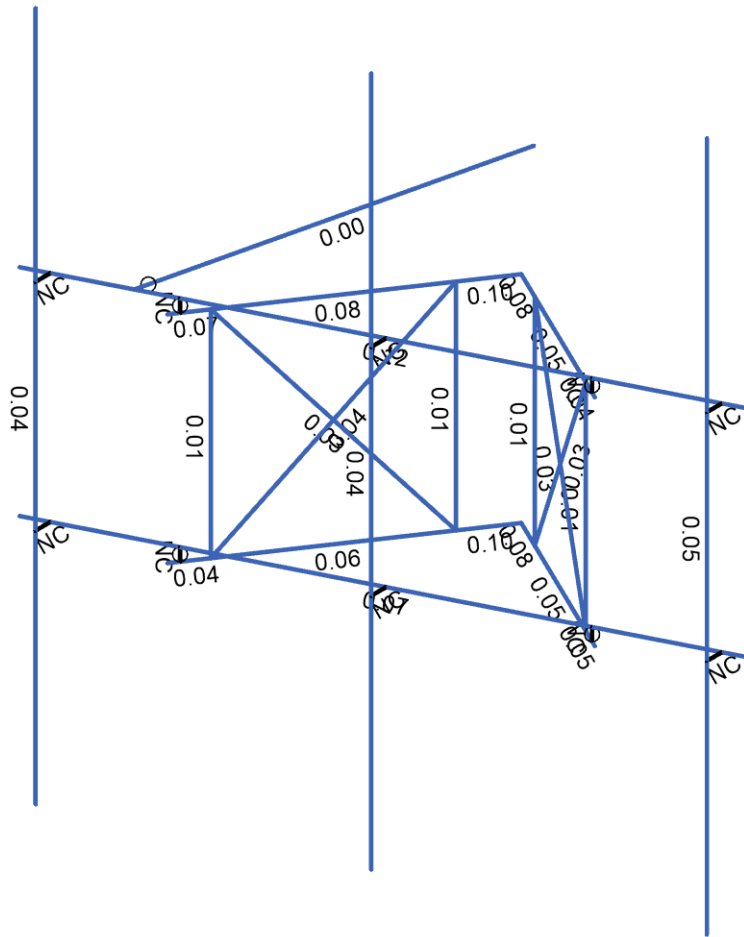

Member Shear Checks Displayed (Enveloped)
Envelope Only Solution

B+T Group
AS
149477.003.01

CT20001-A - Sterling CT Tower

SK-5
Jan 09, 2023
149477_003_01_Sterling CT Towe...



Node Coordinates

	Label	X [ft]	Y [ft]	Z [ft]	Detach From Diaphragm
1	1	-4	-2.354167	2.796875	
2	2	4	-2.354167	2.796875	
3	3	-4	0.145833	2.796875	
4	4	4	0.145833	2.796875	
5	5	0.467947	0	0.771833	
6	6	0.385368	0	0.677994	
7	7	2.091999	0	2.61733	
8	8	2.00942	0	2.523491	
9	9	2.332579	0	2.890714	
10	10	2.25	0.145833	2.796875	
11	11	2.25	0	2.796875	
12	12	0	0	0.24008	
13	13	-0.467947	0	0.771833	
14	14	-0.385368	0	0.677994	
15	15	-2.091999	0	2.61733	
16	16	-2.00942	0	2.523491	
17	17	-2.332579	0	2.890714	
18	18	-2.25	0.145833	2.796875	
19	19	-2.25	0	2.796875	
20	20	0.467947	-2.5	0.771833	
21	21	0.385368	-2.5	0.677994	
22	22	2.091999	-2.5	2.61733	
23	23	2.00942	-2.5	2.523491	
24	24	2.332579	-2.5	2.890714	
25	25	2.25	-2.354167	2.796875	
26	26	2.25	-2.5	2.796875	
27	27	0	-2.5	0.24008	
28	28	-0.467947	-2.5	0.771833	
29	29	-0.385368	-2.5	0.677994	
30	30	-2.091999	-2.5	2.61733	
31	31	-2.00942	-2.5	2.523491	
32	32	-2.332579	-2.5	2.890714	
33	33	-2.25	-2.354167	2.796875	
34	34	-2.25	-2.5	2.796875	
35	35	0.430236	0	0.72898	
36	36	2.047131	-2.5	2.566344	
37	37	2.047131	0	2.566344	
38	38	0.430236	-2.5	0.72898	
39	39	-0.430236	0	0.72898	
40	40	-2.047131	-2.5	2.566344	
41	41	-2.047131	0	2.566344	
42	42	-0.430236	-2.5	0.72898	
43	43	0	0.145833	2.796875	
44	44	0	0.145833	3.078125	
45	45	0	-2.354167	2.796875	
46	46	0	-2.354167	3.078125	
47	47	0	2.895833	3.078125	
48	48	0	-5.104167	3.078125	
49	49	3.666667	0.145833	2.796875	
50	50	3.666667	0.145833	3.078125	
51	51	3.666667	-2.354167	2.796875	
52	52	3.666667	-2.354167	3.078125	
53	53	3.666667	2.895833	3.078125	
54	54	3.666667	-5.104167	3.078125	
55	55	-3.666667	0.145833	2.796875	

Node Coordinates (Continued)

	Label	X [ft]	Y [ft]	Z [ft]	Detach From Diaphragm
56	56	-3.666667	0.145833	3.078125	
57	57	-3.666667	-2.354167	2.796875	
58	58	-3.666667	-2.354167	3.078125	
59	59	-3.666667	2.895833	3.078125	
60	60	-3.666667	-5.104167	3.078125	
61	61	0	0	0	
62	62	-2.75	0.145833	2.796875	
63	63	-1.5	0.145833	-2.598076	
64	66	1.5	0	-2.598076	
65	67	-1.5	0	-2.598076	
66	68	1.238684	-1.25	1.647662	
67	69	-1.238684	-1.25	1.647662	

Node Boundary Conditions

	Node Label	X [k/in]	Y [k/in]	Z [k/in]
1	12	Reaction	Reaction	Reaction
2	27	Reaction	Reaction	Reaction
3	63	Reaction	Reaction	Reaction

Hot Rolled Steel Properties

	Label	E [ksi]	G [ksi]	Nu	Therm. Coeff. [1e ⁵ F ⁻¹]	Density [k/ft ³]	Yield [ksi]	Ry	Fu [ksi]	Rt
1	A992	29000	11154	0.3	0.65	0.49	50	1.1	65	1.1
2	A36 Gr.36	29000	11154	0.3	0.65	0.49	36	1.5	58	1.2
3	A572 Gr.50	29000	11154	0.3	0.65	0.49	50	1.1	65	1.1
4	A500 Gr.B RND	29000	11154	0.3	0.65	0.527	42	1.4	58	1.3
5	A500 Gr.B Rect	29000	11154	0.3	0.65	0.527	46	1.4	58	1.3
6	A53 Gr.B	29000	11154	0.3	0.65	0.49	35	1.6	60	1.2
7	A1085	29000	11154	0.3	0.65	0.49	50	1.4	65	1.3
8	A529 Gr.50	29000	11154	0.3	0.65	0.49	50	1.1	65	1.1
9	A500 Gr.42	29000	11154	0.3	0.65	0.49	42	1.4	58	1.3
10	A500 Gr.46	29000	11154	0.3	0.65	0.49	46	1.4	58	1.3
11	A500 Gr.C	29000	11154	0.3	0.65	0.49	46	1.4	62	1.3

Cold Formed Steel Properties

	Label	E [ksi]	G [ksi]	Nu	Therm. Coeff. [1e ⁵ F ⁻¹]	Density [k/ft ³]	Yield [ksi]	Fu [ksi]
1	A653 SS Gr33	29500	11346	0.3	0.65	0.49	33	45
2	A653 SS Gr50/1	29500	11346	0.3	0.65	0.49	50	65

Hot Rolled Steel Section Sets

	Label	Shape	Type	Design List	Material	Design Rule	Area [in ²]	Iyy [in ⁴]	Izz [in ⁴]	J [in ⁴]
1	MF-H1	HSS2.875X0.203	Beam	HSS Pipe	A500 Gr.C	Typical	1.59	1.45	1.45	2.89
2	MF-SA1	1.9" ODx0.12"	Beam	Pipe	A500 Gr.B RND	Typical	0.671	0.267	0.267	0.534
3	MF-D1	SR 1/2"	VBrace	BAR	A529 Gr.50	Typical	0.196	0.003	0.003	0.006
4	MF-CP1	PL5/8x3.5	Beam	RECT	A572 Gr.50	Typical	2.205	0.073	2.251	0.259
5	MF-V1	0.63" SR	Column	BAR	A529 Gr.50	Typical	0.312	0.008	0.008	0.015
6	MF-CP2	PL5/8x4.25	Beam	RECT	A572 Gr.50	Typical	2.656	0.086	3.998	0.314
7	Tieback	Pipe2.38X0.12	Beam	Pipe	A500 Gr.C	Typical	0.852	0.545	0.545	1.091
8	MF-P1	Pipe2.875x0.12	Column	Pipe	A500 Gr.C	Typical	1.039	0.987	0.987	1.975



Cold Formed Steel Section Sets

	Label	Shape	Type	Design List	Material	Design Rule	Area [in ²]	Iyy [in ⁴]	Izz [in ⁴]	J [in ⁴]
1	CF1	8CU1.25X057	Beam	None	A653 SS Gr33	Typical	0.581	0.057	4.41	0.00063

Member Primary Data

	Label	I Node	J Node	Rotate(deg)	Section/Shape	Type	Design List	Material	Design Rule
1	1	1	2		MF-H1	Beam	HSS Pipe	A500 Gr.C	Typical
2	2	3	4		MF-H1	Beam	HSS Pipe	A500 Gr.C	Typical
3	3	12	5	90	MF-CP1	Beam	RECT	A572 Gr.50	Typical
4	4	6	7		MF- SA1	Beam	Pipe	A500 Gr.B RND	Typical
5	5	8	9	90	MF-CP2	Beam	RECT	A572 Gr.50	Typical
6	6	10	11	90	RIGID	None	None	RIGID	Typical
7	7	12	13	90	MF-CP1	Beam	RECT	A572 Gr.50	Typical
8	8	14	15		MF- SA1	Beam	Pipe	A500 Gr.B RND	Typical
9	9	16	17	90	MF-CP2	Beam	RECT	A572 Gr.50	Typical
10	10	18	19	90	RIGID	None	None	RIGID	Typical
11	11	27	20	90	MF-CP1	Beam	RECT	A572 Gr.50	Typical
12	12	21	22		MF- SA1	Beam	Pipe	A500 Gr.B RND	Typical
13	13	23	24	90	MF-CP2	Beam	RECT	A572 Gr.50	Typical
14	14	25	26	90	RIGID	None	None	RIGID	Typical
15	15	27	28	90	MF-CP1	Beam	RECT	A572 Gr.50	Typical
16	16	29	30		MF- SA1	Beam	Pipe	A500 Gr.B RND	Typical
17	17	31	32	90	MF-CP2	Beam	RECT	A572 Gr.50	Typical
18	18	33	34	90	RIGID	None	None	RIGID	Typical
19	19	37	36		MF-V1	Column	BAR	A529 Gr.50	Typical
20	20	35	38		MF-V1	Column	BAR	A529 Gr.50	Typical
21	21	35	36		MF-D1	VBrace	BAR	A529 Gr.50	Typical
22	22	37	38		MF-D1	VBrace	BAR	A529 Gr.50	Typical
23	23	41	40		MF-V1	Column	BAR	A529 Gr.50	Typical
24	24	39	42		MF-V1	Column	BAR	A529 Gr.50	Typical
25	25	39	40		MF-D1	VBrace	BAR	A529 Gr.50	Typical
26	26	41	42		MF-D1	VBrace	BAR	A529 Gr.50	Typical
27	27	43	44	90	RIGID	None	None	RIGID	Typical
28	28	45	46	90	RIGID	None	None	RIGID	Typical
29	29	47	48		MF-P1	Column	Pipe	A500 Gr.C	Typical
30	30	49	50	90	RIGID	None	None	RIGID	Typical
31	31	51	52	90	RIGID	None	None	RIGID	Typical
32	32	53	54		MF-P1	Column	Pipe	A500 Gr.C	Typical
33	33	55	56	90	RIGID	None	None	RIGID	Typical
34	34	57	58	90	RIGID	None	None	RIGID	Typical
35	35	59	60		MF-P1	Column	Pipe	A500 Gr.C	Typical
36	36	62	63		Tieback	Beam	Pipe	A500 Gr.C	Typical

Member Advanced Data

	Label	I Release	T/C Only	Physical	Deflection Ratio Options	Seismic DR
1	1			Yes	N/A	None
2	2			Yes	N/A	None
3	3			Yes	N/A	None
4	4			Yes	N/A	None
5	5			Yes	N/A	None
6	6	OOOOXO		Yes	** NA **	None
7	7			Yes	N/A	None
8	8			Yes	N/A	None
9	9			Yes	N/A	None



Member Advanced Data (Continued)

	Label	I Release	T/C Only	Physical	Deflection Ratio Options	Seismic DR
10	10	OOOOXO		Yes	** NA **	None
11	11			Yes	N/A	None
12	12			Yes	N/A	None
13	13			Yes	N/A	None
14	14	OOOOXO		Yes	** NA **	None
15	15			Yes	N/A	None
16	16			Yes	N/A	None
17	17			Yes	N/A	None
18	18	OOOOXO		Yes	** NA **	None
19	19			Yes	** NA **	None
20	20			Yes	** NA **	None
21	21			Yes	** NA **	None
22	22		Euler Buckling	Yes	** NA **	None
23	23			Yes	** NA **	None
24	24			Yes	** NA **	None
25	25			Yes	** NA **	None
26	26		Euler Buckling	Yes	** NA **	None
27	27			Yes	** NA **	None
28	28			Yes	** NA **	None
29	29			Yes	** NA **	None
30	30			Yes	** NA **	None
31	31			Yes	** NA **	None
32	32			Yes	** NA **	None
33	33			Yes	** NA **	None
34	34			Yes	** NA **	None
35	35			Yes	** NA **	None
36	36	BenPIN		Yes	Default	None

Hot Rolled Steel Design Parameters

	Label	Shape	Length [ft]	Lcomp top [ft]	Function
1	1	MF-H1	8	Lbyy	Lateral
2	2	MF-H1	8	Lbyy	Lateral
3	3	MF-CP1	0.708	Lbyy	Lateral
4	4	MF- SA1	2.583	Lbyy	Lateral
5	5	MF-CP2	0.489	Lbyy	Lateral
6	7	MF-CP1	0.708	Lbyy	Lateral
7	8	MF- SA1	2.583	Lbyy	Lateral
8	9	MF-CP2	0.489	Lbyy	Lateral
9	11	MF-CP1	0.708	Lbyy	Lateral
10	12	MF- SA1	2.583	Lbyy	Lateral
11	13	MF-CP2	0.489	Lbyy	Lateral
12	15	MF-CP1	0.708	Lbyy	Lateral
13	16	MF- SA1	2.583	Lbyy	Lateral
14	17	MF-CP2	0.489	Lbyy	Lateral
15	19	MF-V1	2.5	Lbyy	Lateral
16	20	MF-V1	2.5	Lbyy	Lateral
17	21	MF-D1	3.499	Lbyy	Lateral
18	22	MF-D1	3.499	Lbyy	Lateral
19	23	MF-V1	2.5	Lbyy	Lateral
20	24	MF-V1	2.5	Lbyy	Lateral
21	25	MF-D1	3.499	Lbyy	Lateral
22	26	MF-D1	3.499	Lbyy	Lateral
23	29	MF-P1	8	Lbyy	Lateral
24	32	MF-P1	8	Lbyy	Lateral
25	35	MF-P1	8	Lbyy	Lateral

Hot Rolled Steel Design Parameters (Continued)

	Label	Shape	Length [ft]	Lcomp top [ft]	Function
26	36	Tieback	5.538	Lbyy	Lateral

Member Point Loads (BLC 1 : Dead)

	Member Label	Direction	Magnitude [k, k-ft]	Location [(ft, %)]
1	32	Y	-0.032	%15
2	32	Y	-0.032	%85
3	32	Y	-0.075	%20
4	32	Y	-0.064	%50
5	32	Y	0	0
6	8	Y	-0.022	%50
7	8	Y	0	0
8	8	Y	0	0
9	8	Y	0	0
10	8	Y	0	0

Member Point Loads (BLC 2 : 0 Wind - No Ice)

	Member Label	Direction	Magnitude [k, k-ft]	Location [(ft, %)]
1	32	Z	-0.202	%15
2	32	Z	-0.202	%85
3	32	Z	-0.089	%20
4	32	Z	-0.089	%50
5	32	Z	0	0
6	8	Z	-0.091	%50
7	8	Z	0	0
8	8	Z	0	0
9	8	Z	0	0
10	8	Z	0	0

Member Point Loads (BLC 3 : 90 Wind - No Ice)

	Member Label	Direction	Magnitude [k, k-ft]	Location [(ft, %)]
1	32	X	-0.081	%15
2	32	X	-0.081	%85
3	32	X	-0.054	%20
4	32	X	-0.047	%50
5	32	X	0	0
6	8	X	-0.051	%50
7	8	X	0	0
8	8	X	0	0
9	8	X	0	0
10	8	X	0	0

Member Point Loads (BLC 4 : 0 Wind - Ice)

	Member Label	Direction	Magnitude [k, k-ft]	Location [(ft, %)]
1	32	Z	-0.037	%15
2	32	Z	-0.037	%85
3	32	Z	-0.015	%20
4	32	Z	-0.015	%50
5	32	Z	0	0
6	8	Z	-0.015	%50
7	8	Z	0	0

Member Point Loads (BLC 4 : 0 Wind - Ice) (Continued)

	Member Label	Direction	Magnitude [k, k-ft]	Location [(ft, %)]
8	8	Z	0	0
9	8	Z	0	0
10	8	Z	0	0

Member Point Loads (BLC 5 : 90 Wind - Ice)

	Member Label	Direction	Magnitude [k, k-ft]	Location [(ft, %)]
1	32	X	-0.017	%15
2	32	X	-0.017	%85
3	32	X	-0.009	%20
4	32	X	-0.008	%50
5	32	X	0	0
6	8	X	-0.008	%50
7	8	X	0	0
8	8	X	0	0
9	8	X	0	0
10	8	X	0	0

Member Point Loads (BLC 6 : 0 Wind - Service)

	Member Label	Direction	Magnitude [k, k-ft]	Location [(ft, %)]
1	32	Z	-0.012	%15
2	32	Z	-0.012	%85
3	32	Z	-0.005	%20
4	32	Z	-0.005	%50
5	32	Z	0	0
6	8	Z	-0.005	%50
7	8	Z	0	0
8	8	Z	0	0
9	8	Z	0	0
10	8	Z	0	0

Member Point Loads (BLC 7 : 90 Wind - Service)

	Member Label	Direction	Magnitude [k, k-ft]	Location [(ft, %)]
1	32	X	-0.005	%15
2	32	X	-0.005	%85
3	32	X	-0.003	%20
4	32	X	-0.003	%50
5	32	X	0	0
6	8	X	-0.003	%50
7	8	X	0	0
8	8	X	0	0
9	8	X	0	0
10	8	X	0	0

Member Point Loads (BLC 8 : Ice)

	Member Label	Direction	Magnitude [k, k-ft]	Location [(ft, %)]
1	32	Y	-0.118	%15
2	32	Y	-0.118	%85
3	32	Y	-0.035	%20
4	32	Y	-0.034	%50
5	32	Y	0	0



Member Point Loads (BLC 8 : Ice) (Continued)

	Member Label	Direction	Magnitude [k, k-ft]	Location [(ft, %)]
6	8	Y	-0.035	%50
7	8	Y	0	0
8	8	Y	0	0
9	8	Y	0	0
10	8	Y	0	0

Member Point Loads (BLC 9 : 0 Seismic)

	Member Label	Direction	Magnitude [k, k-ft]	Location [(ft, %)]
1	32	Z	-0.013	%15
2	32	Z	-0.013	%85
3	32	Z	-0.015	%20
4	32	Z	-0.013	%50
5	32	Z	0	0
6	8	Z	-0.004	%50
7	8	Z	0	0
8	8	Z	0	0
9	8	Z	0	0
10	8	Z	0	0

Member Point Loads (BLC 10 : 90 Seismic)

	Member Label	Direction	Magnitude [k, k-ft]	Location [(ft, %)]
1	32	X	-0.013	%15
2	32	X	-0.013	%85
3	32	X	-0.015	%20
4	32	X	-0.013	%50
5	32	X	0	0
6	8	X	-0.004	%50
7	8	X	0	0
8	8	X	0	0
9	8	X	0	0
10	8	X	0	0

Member Point Loads (BLC 15 : Maint LL 1)

	Member Label	Direction	Magnitude [k, k-ft]	Location [(ft, %)]
1	1	Y	-0.25	%5

Member Point Loads (BLC 16 : Maint LL 2)

	Member Label	Direction	Magnitude [k, k-ft]	Location [(ft, %)]
1	2	Y	-0.25	%5

Member Point Loads (BLC 17 : Maint LL 3)

	Member Label	Direction	Magnitude [k, k-ft]	Location [(ft, %)]
1	8	Y	-0.25	%50



Member Point Loads (BLC 18 : Maint LL 4)

	Member Label	Direction	Magnitude [k, k-ft]	Location [(ft, %)]
1	16	Y	-0.25	%50

Member Point Loads (BLC 19 : Maint LL 5)

	Member Label	Direction	Magnitude [k, k-ft]	Location [(ft, %)]
1	4	Y	-0.25	%50

Member Point Loads (BLC 20 : Maint LL 6)

	Member Label	Direction	Magnitude [k, k-ft]	Location [(ft, %)]
1	12	Y	-0.25	%50

Member Distributed Loads (BLC 2 : 0 Wind - No Ice)

	Member Label	Direction	Start Magnitude [k/ft, F, ksf, k-ft/ft]	End Magnitude [k/ft, F, ksf, k-ft/ft]	Start Location [(ft, %)]	End Location [(ft, %)]
1	1	Z	-0.013	-0.013	0	%100
2	2	Z	-0.013	-0.013	0	%100
3	3	Z	-0.004	-0.004	0	%100
4	4	Z	-0.007	-0.007	0	%100
5	5	Z	-0.003	-0.003	0	%100
6	7	Z	-0.004	-0.004	0	%100
7	8	Z	-0.007	-0.007	0	%100
8	9	Z	-0.003	-0.003	0	%100
9	11	Z	-0.004	-0.004	0	%100
10	12	Z	-0.007	-0.007	0	%100
11	13	Z	-0.003	-0.003	0	%100
12	15	Z	-0.004	-0.004	0	%100
13	16	Z	-0.007	-0.007	0	%100
14	17	Z	-0.003	-0.003	0	%100
15	19	Z	-0.003	-0.003	0	%100
16	20	Z	-0.003	-0.003	0	%100
17	21	Z	-0.002	-0.002	0	%100
18	22	Z	-0.002	-0.002	0	%100
19	23	Z	-0.003	-0.003	0	%100
20	24	Z	-0.003	-0.003	0	%100
21	25	Z	-0.002	-0.002	0	%100
22	26	Z	-0.002	-0.002	0	%100
23	29	Z	-0.013	-0.013	0	%100
24	32	Z	-0.013	-0.013	0	%100
25	35	Z	-0.013	-0.013	0	%100
26	36	Z	-0.011	-0.011	0	%100

Member Distributed Loads (BLC 3 : 90 Wind - No Ice)

	Member Label	Direction	Start Magnitude [k/ft, F, ksf, k-ft/ft]	End Magnitude [k/ft, F, ksf, k-ft/ft]	Start Location [(ft, %)]	End Location [(ft, %)]
1	1	X	-0.013	-0.013	0	%100
2	2	X	-0.013	-0.013	0	%100
3	3	X	-0.004	-0.004	0	%100
4	4	X	-0.007	-0.007	0	%100
5	5	X	-0.003	-0.003	0	%100
6	7	X	-0.004	-0.004	0	%100
7	8	X	-0.007	-0.007	0	%100
8	9	X	-0.003	-0.003	0	%100



Member Distributed Loads (BLC 3 : 90 Wind - No Ice) (Continued)

Member	Label	Direction	Start Magnitude [k/ft, F, ksf, k-ft/ft]	End Magnitude [k/ft, F, ksf, k-ft/ft]	Start Location [(ft, %)]	End Location [(ft, %)]
9	11	X	-0.004	-0.004	0	%100
10	12	X	-0.007	-0.007	0	%100
11	13	X	-0.003	-0.003	0	%100
12	15	X	-0.004	-0.004	0	%100
13	16	X	-0.007	-0.007	0	%100
14	17	X	-0.003	-0.003	0	%100
15	19	X	-0.003	-0.003	0	%100
16	20	X	-0.003	-0.003	0	%100
17	21	X	-0.002	-0.002	0	%100
18	22	X	-0.002	-0.002	0	%100
19	23	X	-0.003	-0.003	0	%100
20	24	X	-0.003	-0.003	0	%100
21	25	X	-0.002	-0.002	0	%100
22	26	X	-0.002	-0.002	0	%100
23	29	X	-0.013	-0.013	0	%100
24	32	X	-0.013	-0.013	0	%100
25	35	X	-0.013	-0.013	0	%100
26	36	X	-0.011	-0.011	0	%100

Member Distributed Loads (BLC 4 : 0 Wind - Ice)

Member	Label	Direction	Start Magnitude [k/ft, F, ksf, k-ft/ft]	End Magnitude [k/ft, F, ksf, k-ft/ft]	Start Location [(ft, %)]	End Location [(ft, %)]
1	1	Z	-0.002	-0.002	0	%100
2	2	Z	-0.002	-0.002	0	%100
3	3	Z	-0.004	-0.004	0	%100
4	4	Z	-0.002	-0.002	0	%100
5	5	Z	-0.004	-0.004	0	%100
6	7	Z	-0.004	-0.004	0	%100
7	8	Z	-0.002	-0.002	0	%100
8	9	Z	-0.004	-0.004	0	%100
9	11	Z	-0.004	-0.004	0	%100
10	12	Z	-0.002	-0.002	0	%100
11	13	Z	-0.004	-0.004	0	%100
12	15	Z	-0.004	-0.004	0	%100
13	16	Z	-0.002	-0.002	0	%100
14	17	Z	-0.004	-0.004	0	%100
15	19	Z	-0.002	-0.002	0	%100
16	20	Z	-0.002	-0.002	0	%100
17	21	Z	-0.002	-0.002	0	%100
18	22	Z	-0.002	-0.002	0	%100
19	23	Z	-0.002	-0.002	0	%100
20	24	Z	-0.002	-0.002	0	%100
21	25	Z	-0.002	-0.002	0	%100
22	26	Z	-0.002	-0.002	0	%100
23	29	Z	-0.002	-0.002	0	%100
24	32	Z	-0.002	-0.002	0	%100
25	35	Z	-0.002	-0.002	0	%100
26	36	Z	-0.002	-0.002	0	%100

Member Distributed Loads (BLC 5 : 90 Wind - Ice)

Member	Label	Direction	Start Magnitude [k/ft, F, ksf, k-ft/ft]	End Magnitude [k/ft, F, ksf, k-ft/ft]	Start Location [(ft, %)]	End Location [(ft, %)]
1	1	X	-0.002	-0.002	0	%100
2	2	X	-0.002	-0.002	0	%100
3	3	X	-0.004	-0.004	0	%100



Member Distributed Loads (BLC 5 : 90 Wind - Ice) (Continued)

Member	Label	Direction	Start Magnitude [k/ft, F, ksf, k-ft/ft]	End Magnitude [k/ft, F, ksf, k-ft/ft]	Start Location [(ft, %)]	End Location [(ft, %)]
4	4	X	-0.002	-0.002	0	%100
5	5	X	-0.004	-0.004	0	%100
6	7	X	-0.004	-0.004	0	%100
7	8	X	-0.002	-0.002	0	%100
8	9	X	-0.004	-0.004	0	%100
9	11	X	-0.004	-0.004	0	%100
10	12	X	-0.002	-0.002	0	%100
11	13	X	-0.004	-0.004	0	%100
12	15	X	-0.004	-0.004	0	%100
13	16	X	-0.002	-0.002	0	%100
14	17	X	-0.004	-0.004	0	%100
15	19	X	-0.002	-0.002	0	%100
16	20	X	-0.002	-0.002	0	%100
17	21	X	-0.002	-0.002	0	%100
18	22	X	-0.002	-0.002	0	%100
19	23	X	-0.002	-0.002	0	%100
20	24	X	-0.002	-0.002	0	%100
21	25	X	-0.002	-0.002	0	%100
22	26	X	-0.002	-0.002	0	%100
23	29	X	-0.002	-0.002	0	%100
24	32	X	-0.002	-0.002	0	%100
25	35	X	-0.002	-0.002	0	%100
26	36	X	-0.002	-0.002	0	%100

Member Distributed Loads (BLC 6 : 0 Wind - Service)

Member	Label	Direction	Start Magnitude [k/ft, F, ksf, k-ft/ft]	End Magnitude [k/ft, F, ksf, k-ft/ft]	Start Location [(ft, %)]	End Location [(ft, %)]
1	1	Z	-0.0004	-0.0004	0	%100
2	2	Z	-0.0004	-0.0004	0	%100
3	3	Z	-0.0002	-0.0002	0	%100
4	4	Z	-0.0003	-0.0003	0	%100
5	5	Z	-0.0002	-0.0002	0	%100
6	7	Z	-0.0002	-0.0002	0	%100
7	8	Z	-0.0003	-0.0003	0	%100
8	9	Z	-0.0002	-0.0002	0	%100
9	11	Z	-0.0002	-0.0002	0	%100
10	12	Z	-0.0003	-0.0003	0	%100
11	13	Z	-0.0002	-0.0002	0	%100
12	15	Z	-0.0002	-0.0002	0	%100
13	16	Z	-0.0003	-0.0003	0	%100
14	17	Z	-0.0002	-0.0002	0	%100
15	19	Z	-1e-04	-1e-04	0	%100
16	20	Z	-1e-04	-1e-04	0	%100
17	21	Z	-1e-04	-1e-04	0	%100
18	22	Z	-1e-04	-1e-04	0	%100
19	23	Z	-1e-04	-1e-04	0	%100
20	24	Z	-1e-04	-1e-04	0	%100
21	25	Z	-1e-04	-1e-04	0	%100
22	26	Z	-1e-04	-1e-04	0	%100
23	29	Z	-0.0004	-0.0004	0	%100
24	32	Z	-0.0004	-0.0004	0	%100
25	35	Z	-0.0004	-0.0004	0	%100
26	36	Z	-0.0003	-0.0003	0	%100



Member Distributed Loads (BLC 7 : 90 Wind - Service)

Member	Label	Direction	Start Magnitude [k/ft, F, ksf, k-ft/ft]	End Magnitude [k/ft, F, ksf, k-ft/ft]	Start Location [(ft, %)]	End Location [(ft, %)]
1	1	X	-0.0004	-0.0004	0	%100
2	2	X	-0.0004	-0.0004	0	%100
3	3	X	-0.0002	-0.0002	0	%100
4	4	X	-0.0003	-0.0003	0	%100
5	5	X	-0.0002	-0.0002	0	%100
6	7	X	-0.0002	-0.0002	0	%100
7	8	X	-0.0003	-0.0003	0	%100
8	9	X	-0.0002	-0.0002	0	%100
9	11	X	-0.0002	-0.0002	0	%100
10	12	X	-0.0003	-0.0003	0	%100
11	13	X	-0.0002	-0.0002	0	%100
12	15	X	-0.0002	-0.0002	0	%100
13	16	X	-0.0003	-0.0003	0	%100
14	17	X	-0.0002	-0.0002	0	%100
15	19	X	-1e-04	-1e-04	0	%100
16	20	X	-1e-04	-1e-04	0	%100
17	21	X	-1e-04	-1e-04	0	%100
18	22	X	-1e-04	-1e-04	0	%100
19	23	X	-1e-04	-1e-04	0	%100
20	24	X	-1e-04	-1e-04	0	%100
21	25	X	-1e-04	-1e-04	0	%100
22	26	X	-1e-04	-1e-04	0	%100
23	29	X	-0.0004	-0.0004	0	%100
24	32	X	-0.0004	-0.0004	0	%100
25	35	X	-0.0004	-0.0004	0	%100
26	36	X	-0.0003	-0.0003	0	%100

Member Distributed Loads (BLC 8 : Ice)

Member	Label	Direction	Start Magnitude [k/ft, F, ksf, k-ft/ft]	End Magnitude [k/ft, F, ksf, k-ft/ft]	Start Location [(ft, %)]	End Location [(ft, %)]
1	1	Y	-0.006	-0.006	0	%100
2	2	Y	-0.006	-0.006	0	%100
3	3	Y	-0.012	-0.012	0	%100
4	4	Y	-0.004	-0.004	0	%100
5	5	Y	-0.014	-0.014	0	%100
6	7	Y	-0.012	-0.012	0	%100
7	8	Y	-0.004	-0.004	0	%100
8	9	Y	-0.014	-0.014	0	%100
9	11	Y	-0.012	-0.012	0	%100
10	12	Y	-0.004	-0.004	0	%100
11	13	Y	-0.014	-0.014	0	%100
12	15	Y	-0.012	-0.012	0	%100
13	16	Y	-0.004	-0.004	0	%100
14	17	Y	-0.014	-0.014	0	%100
15	19	Y	-0.003	-0.003	0	%100
16	20	Y	-0.003	-0.003	0	%100
17	21	Y	-0.002	-0.002	0	%100
18	22	Y	-0.002	-0.002	0	%100
19	23	Y	-0.003	-0.003	0	%100
20	24	Y	-0.003	-0.003	0	%100
21	25	Y	-0.002	-0.002	0	%100
22	26	Y	-0.002	-0.002	0	%100
23	29	Y	-0.006	-0.006	0	%100
24	32	Y	-0.006	-0.006	0	%100
25	35	Y	-0.006	-0.006	0	%100



Member Distributed Loads (BLC 8 : Ice) (Continued)

Member	Label	Direction	Start Magnitude [k/ft, F, ksf, k-ft/ft]	End Magnitude [k/ft, F, ksf, k-ft/ft]	Start Location [(ft, %)]	End Location [(ft, %)]
26	36	Y	-0.005	-0.005	0	%100

Member Distributed Loads (BLC 9 : 0 Seismic)

Member	Label	Direction	Start Magnitude [k/ft, F, ksf, k-ft/ft]	End Magnitude [k/ft, F, ksf, k-ft/ft]	Start Location [(ft, %)]	End Location [(ft, %)]
1	1	Z	-0.001	-0.001	0	%100
2	2	Z	-0.001	-0.001	0	%100
3	3	Z	-0.001	-0.001	0	%100
4	4	Z	-0.0005	-0.0005	0	%100
5	5	Z	-0.002	-0.002	0	%100
6	7	Z	-0.001	-0.001	0	%100
7	8	Z	-0.0005	-0.0005	0	%100
8	9	Z	-0.002	-0.002	0	%100
9	11	Z	-0.001	-0.001	0	%100
10	12	Z	-0.0005	-0.0005	0	%100
11	13	Z	-0.002	-0.002	0	%100
12	15	Z	-0.001	-0.001	0	%100
13	16	Z	-0.0005	-0.0005	0	%100
14	17	Z	-0.002	-0.002	0	%100
15	19	Z	-0.0004	-0.0004	0	%100
16	20	Z	-0.0004	-0.0004	0	%100
17	21	Z	-0.0003	-0.0003	0	%100
18	22	Z	-0.0003	-0.0003	0	%100
19	23	Z	-0.0004	-0.0004	0	%100
20	24	Z	-0.0004	-0.0004	0	%100
21	25	Z	-0.0003	-0.0003	0	%100
22	26	Z	-0.0003	-0.0003	0	%100
23	29	Z	-0.0007	-0.0007	0	%100
24	32	Z	-0.0007	-0.0007	0	%100
25	35	Z	-0.0007	-0.0007	0	%100
26	36	Z	-0.0006	-0.0006	0	%100

Member Distributed Loads (BLC 10 : 90 Seismic)

Member	Label	Direction	Start Magnitude [k/ft, F, ksf, k-ft/ft]	End Magnitude [k/ft, F, ksf, k-ft/ft]	Start Location [(ft, %)]	End Location [(ft, %)]
1	1	X	-0.001	-0.001	0	%100
2	2	X	-0.001	-0.001	0	%100
3	3	X	-0.001	-0.001	0	%100
4	4	X	-0.0005	-0.0005	0	%100
5	5	X	-0.002	-0.002	0	%100
6	7	X	-0.001	-0.001	0	%100
7	8	X	-0.0005	-0.0005	0	%100
8	9	X	-0.002	-0.002	0	%100
9	11	X	-0.001	-0.001	0	%100
10	12	X	-0.0005	-0.0005	0	%100
11	13	X	-0.002	-0.002	0	%100
12	15	X	-0.001	-0.001	0	%100
13	16	X	-0.0005	-0.0005	0	%100
14	17	X	-0.002	-0.002	0	%100
15	19	X	-0.0004	-0.0004	0	%100
16	20	X	-0.0004	-0.0004	0	%100
17	21	X	-0.0003	-0.0003	0	%100
18	22	X	-0.0003	-0.0003	0	%100
19	23	X	-0.0004	-0.0004	0	%100
20	24	X	-0.0004	-0.0004	0	%100



Member Distributed Loads (BLC 10 : 90 Seismic) (Continued)

Member	Label	Direction	Start Magnitude [k/ft, F, ksf, k-ft/ft]	End Magnitude [k/ft, F, ksf, k-ft/ft]	Start Location [(ft, %)]	End Location [(ft, %)]
21	25	X	-0.0003	-0.0003	0	%100
22	26	X	-0.0003	-0.0003	0	%100
23	29	X	-0.0007	-0.0007	0	%100
24	32	X	-0.0007	-0.0007	0	%100
25	35	X	-0.0007	-0.0007	0	%100
26	36	X	-0.0006	-0.0006	0	%100

Basic Load Cases

	BLC Description	Category	Y Gravity	Nodal	Point	Distributed
1	Dead	DL	-1		10	
2	0 Wind - No Ice	WLZ			10	26
3	90 Wind - No Ice	WLX			10	26
4	0 Wind - Ice	WLZ			10	26
5	90 Wind - Ice	WLX			10	26
6	0 Wind - Service	WLZ			10	26
7	90 Wind - Service	WLX			10	26
8	Ice	OL1			10	26
9	0 Seismic	ELZ			10	26
10	90 Seismic	ELX			10	26
11	Live Load a	LL		1		
12	Live Load b	LL		1		
13	Live Load c	LL		1		
14	Live Load d	LL				
15	Maint LL 1	LL			1	
16	Maint LL 2	LL			1	
17	Maint LL 3	LL			1	
18	Maint LL 4	LL			1	
19	Maint LL 5	LL			1	
20	Maint LL 6	LL			1	
21	Maint LL 7	LL				
22	Maint LL 8	LL				
23	Maint LL 9	LL				
24	Maint LL 10	LL				
25	Maint LL 11	LL				
26	Maint LL 12	LL				
27	Maint LL 13	LL				
28	Maint LL 14	LL				
29	Maint LL 15	LL				

Load Combinations

	Description	Solve	P-Delta	BLC	Factor	BLC	Factor	BLC	Factor	BLC	Factor
1	1.4 Dead	Yes	Y	1	1.4						
2	1.2 D + 1.0 - 0 W	Yes	Y	1	1.2	2	1				
3	1.2 D + 1.0 - 30 W	Yes	Y	1	1.2	2	0.866	3	0.5		
4	1.2 D + 1.0 - 60 W	Yes	Y	1	1.2	3	0.866	2	0.5		
5	1.2 D + 1.0 - 90 W	Yes	Y	1	1.2	3	1				
6	1.2 D + 1.0 - 120 W	Yes	Y	1	1.2	3	0.866	2	-0.5		
7	1.2 D + 1.0 - 150 W	Yes	Y	1	1.2	2	-0.866	3	0.5		
8	1.2 D + 1.0 - 180 W	Yes	Y	1	1.2	2	-1				
9	1.2 D + 1.0 - 210 W	Yes	Y	1	1.2	2	-0.866	3	-0.5		
10	1.2 D + 1.0 - 240 W	Yes	Y	1	1.2	3	-0.866	2	-0.5		
11	1.2 D + 1.0 - 270 W	Yes	Y	1	1.2	3	-1				
12	1.2 D + 1.0 - 300 W	Yes	Y	1	1.2	3	-0.866	2	0.5		



Load Combinations (Continued)

	Description	Solve	P-Delta	BLC	Factor	BLC	Factor	BLC	Factor	BLC	Factor
13	1.2 D + 1.0 - 330 W	Yes	Y	1	1.2	2	0.866	3	-0.5		
14	1.2 D + 1.0 - 0 W/Ice	Yes	Y	1	1.2	4	1			8	1
15	1.2 D + 1.0 - 30 W/Ice	Yes	Y	1	1.2	4	0.866	5	0.5	8	1
16	1.2 D + 1.0 - 60 W/Ice	Yes	Y	1	1.2	5	0.866	4	0.5	8	1
17	1.2 D + 1.0 - 90 W/Ice	Yes	Y	1	1.2	5	1			8	1
18	1.2 D + 1.0 - 120 W/Ice	Yes	Y	1	1.2	5	0.866	4	-0.5	8	1
19	1.2 D + 1.0 - 150 W/Ice	Yes	Y	1	1.2	4	-0.866	5	0.5	8	1
20	1.2 D + 1.0 - 180 W/Ice	Yes	Y	1	1.2	4	-1			8	1
21	1.2 D + 1.0 - 210 W/Ice	Yes	Y	1	1.2	4	-0.866	5	-0.5	8	1
22	1.2 D + 1.0 - 240 W/Ice	Yes	Y	1	1.2	5	-0.866	4	-0.5	8	1
23	1.2 D + 1.0 - 270 W/Ice	Yes	Y	1	1.2	5	-1			8	1
24	1.2 D + 1.0 - 300 W/Ice	Yes	Y	1	1.2	5	-0.866	4	0.5	8	1
25	1.2 D + 1.0 - 330 W/Ice	Yes	Y	1	1.2	4	0.866	5	-0.5	8	1
26	1.2 D + 1.0 E - 0	Yes	Y	1	1.2	9	1				
27	1.2 D + 1.0 E - 30	Yes	Y	1	1.2	9	0.866	10	0.5		
28	1.2 D + 1.0 E - 60	Yes	Y	1	1.2	10	0.866	9	0.5		
29	1.2 D + 1.0 E - 90	Yes	Y	1	1.2	10	1				
30	1.2 D + 1.0 E - 120	Yes	Y	1	1.2	10	0.866	9	-0.5		
31	1.2 D + 1.0 E - 150	Yes	Y	1	1.2	9	-0.866	10	0.5		
32	1.2 D + 1.0 E - 180	Yes	Y	1	1.2	9	-1				
33	1.2 D + 1.0 E - 210	Yes	Y	1	1.2	9	-0.866	10	-0.5		
34	1.2 D + 1.0 E - 240	Yes	Y	1	1.2	10	-0.866	9	-0.5		
35	1.2 D + 1.0 E - 270	Yes	Y	1	1.2	10	-1				
36	1.2 D + 1.0 E - 300	Yes	Y	1	1.2	10	-0.866	9	0.5		
37	1.2 D + 1.0 E - 330	Yes	Y	1	1.2	9	0.866	10	-0.5		
38	1.2 D + 1.5 LL a + Service - 0 W	Yes	Y	1	1.2	6	1			11	1.5
39	1.2 D + 1.5 LL a + Service - 30 W	Yes	Y	1	1.2	6	0.866	7	0.5	11	1.5
40	1.2 D + 1.5 LL a + Service - 60 W	Yes	Y	1	1.2	7	0.866	6	0.5	11	1.5
41	1.2 D + 1.5 LL a + Service - 90 W	Yes	Y	1	1.2	7	1			11	1.5
42	1.2 D + 1.5 LL a + Service - 120 W	Yes	Y	1	1.2	7	0.866	6	-0.5	11	1.5
43	1.2 D + 1.5 LL a + Service - 150 W	Yes	Y	1	1.2	6	-0.866	7	0.5	11	1.5
44	1.2 D + 1.5 LL a + Service - 180 W	Yes	Y	1	1.2	6	-1			11	1.5
45	1.2 D + 1.5 LL a + Service - 210 W	Yes	Y	1	1.2	6	-0.866	7	-0.5	11	1.5
46	1.2 D + 1.5 LL a + Service - 240 W	Yes	Y	1	1.2	7	-0.866	6	-0.5	11	1.5
47	1.2 D + 1.5 LL a + Service - 270 W	Yes	Y	1	1.2	7	-1			11	1.5
48	1.2 D + 1.5 LL a + Service - 300 W	Yes	Y	1	1.2	7	-0.866	6	0.5	11	1.5
49	1.2 D + 1.5 LL a + Service - 330 W	Yes	Y	1	1.2	6	0.866	7	-0.5	11	1.5
50	1.2 D + 1.5 LL b + Service - 0 W	Yes	Y	1	1.2	6	1			12	1.5
51	1.2 D + 1.5 LL b + Service - 30 W	Yes	Y	1	1.2	6	0.866	7	0.5	12	1.5
52	1.2 D + 1.5 LL b + Service - 60 W	Yes	Y	1	1.2	7	0.866	6	0.5	12	1.5
53	1.2 D + 1.5 LL b + Service - 90 W	Yes	Y	1	1.2	7	1			12	1.5
54	1.2 D + 1.5 LL b + Service - 120 W	Yes	Y	1	1.2	7	0.866	6	-0.5	12	1.5
55	1.2 D + 1.5 LL b + Service - 150 W	Yes	Y	1	1.2	6	-0.866	7	0.5	12	1.5
56	1.2 D + 1.5 LL b + Service - 180 W	Yes	Y	1	1.2	6	-1			12	1.5
57	1.2 D + 1.5 LL b + Service - 210 W	Yes	Y	1	1.2	6	-0.866	7	-0.5	12	1.5
58	1.2 D + 1.5 LL b + Service - 240 W	Yes	Y	1	1.2	7	-0.866	6	-0.5	12	1.5
59	1.2 D + 1.5 LL b + Service - 270 W	Yes	Y	1	1.2	7	-1			12	1.5
60	1.2 D + 1.5 LL b + Service - 300 W	Yes	Y	1	1.2	7	-0.866	6	0.5	12	1.5
61	1.2 D + 1.5 LL b + Service - 330 W	Yes	Y	1	1.2	6	0.866	7	-0.5	12	1.5
62	1.2 D + 1.5 LL c + Service - 0 W	Yes	Y	1	1.2	6	1			13	1.5
63	1.2 D + 1.5 LL c + Service - 30 W	Yes	Y	1	1.2	6	0.866	7	0.5	13	1.5
64	1.2 D + 1.5 LL c + Service - 60 W	Yes	Y	1	1.2	7	0.866	6	0.5	13	1.5
65	1.2 D + 1.5 LL c + Service - 90 W	Yes	Y	1	1.2	7	1			13	1.5
66	1.2 D + 1.5 LL c + Service - 120 W	Yes	Y	1	1.2	7	0.866	6	-0.5	13	1.5
67	1.2 D + 1.5 LL c + Service - 150 W	Yes	Y	1	1.2	6	-0.866	7	0.5	13	1.5

Load Combinations (Continued)

	Description	Solve	P-Delta	BLC	Factor	BLC	Factor	BLC	Factor	BLC	Factor
68	1.2 D + 1.5 LL c + Service - 180 W	Yes	Y	1	1.2	6	-1			13	1.5
69	1.2 D + 1.5 LL c + Service - 210 W	Yes	Y	1	1.2	6	-0.866	7	-0.5	13	1.5
70	1.2 D + 1.5 LL c + Service - 240 W	Yes	Y	1	1.2	7	-0.866	6	-0.5	13	1.5
71	1.2 D + 1.5 LL c + Service - 270 W	Yes	Y	1	1.2	7	-1			13	1.5
72	1.2 D + 1.5 LL c + Service - 300 W	Yes	Y	1	1.2	7	-0.866	6	0.5	13	1.5
73	1.2 D + 1.5 LL c + Service - 330 W	Yes	Y	1	1.2	6	0.866	7	-0.5	13	1.5
74	1.2 D + 1.5 LL d + Service - 0 W	Yes	Y	1	1.2	6	1			14	1.5
75	1.2 D + 1.5 LL d + Service - 30 W	Yes	Y	1	1.2	6	0.866	7	0.5	14	1.5
76	1.2 D + 1.5 LL d + Service - 60 W	Yes	Y	1	1.2	7	0.866	6	0.5	14	1.5
77	1.2 D + 1.5 LL d + Service - 90 W	Yes	Y	1	1.2	7	1			14	1.5
78	1.2 D + 1.5 LL d + Service - 120 W	Yes	Y	1	1.2	7	0.866	6	-0.5	14	1.5
79	1.2 D + 1.5 LL d + Service - 150 W	Yes	Y	1	1.2	6	-0.866	7	0.5	14	1.5
80	1.2 D + 1.5 LL d + Service - 180 W	Yes	Y	1	1.2	6	-1			14	1.5
81	1.2 D + 1.5 LL d + Service - 210 W	Yes	Y	1	1.2	6	-0.866	7	-0.5	14	1.5
82	1.2 D + 1.5 LL d + Service - 240 W	Yes	Y	1	1.2	7	-0.866	6	-0.5	14	1.5
83	1.2 D + 1.5 LL d + Service - 270 W	Yes	Y	1	1.2	7	-1			14	1.5
84	1.2 D + 1.5 LL d + Service - 300 W	Yes	Y	1	1.2	7	-0.866	6	0.5	14	1.5
85	1.2 D + 1.5 LL d + Service - 330 W	Yes	Y	1	1.2	6	0.866	7	-0.5	14	1.5
86	1.2 D + 1.5 LL Maint (1)	Yes	Y	1	1.2					15	1.5
87	1.2 D + 1.5 LL Maint (2)	Yes	Y	1	1.2					16	1.5
88	1.2 D + 1.5 LL Maint (3)	Yes	Y	1	1.2					17	1.5
89	1.2 D + 1.5 LL Maint (4)	Yes	Y	1	1.2					18	1.5
90	1.2 D + 1.5 LL Maint (5)	Yes	Y	1	1.2					19	1.5
91	1.2 D + 1.5 LL Maint (6)	Yes	Y	1	1.2					20	1.5
92	1.2 D + 1.5 LL Maint (7)	Yes	Y	1	1.2					21	1.5
93	1.2 D + 1.5 LL Maint (8)	Yes	Y	1	1.2					22	1.5
94	1.2 D + 1.5 LL Maint (9)	Yes	Y	1	1.2					23	1.5
95	1.2 D + 1.5 LL Maint (10)	Yes	Y	1	1.2					24	1.5
96	1.2 D + 1.5 LL Maint (11)	Yes	Y	1	1.2					25	1.5
97	1.2 D + 1.5 LL Maint (12)	Yes	Y	1	1.2					26	1.5
98	1.2 D + 1.5 LL Maint (13)	Yes	Y	1	1.2					27	1.5
99	1.2 D + 1.5 LL Maint (14)	Yes	Y	1	1.2					28	1.5
100	1.2 D + 1.5 LL Maint (15)	Yes	Y	1	1.2					29	1.5

Envelope Node Reactions

Node Label	X [k]	LC	Y [k]	LC	Z [k]	LC	MX [k-ft]	LC	MY [k-ft]	LC	MZ [k-ft]	LC
1	12	max	0.805	42	0.708	18	1.644	13	0	100	0	100
2		min	-1.474	72	0.241	12	-2.794	7	0	1	0	1
3	27	max	1.447	65	0.659	24	1.407	14	0	100	0	100
4		min	-0.778	47	0.228	5	0.154	8	0	1	0	1
5	63	max	0.311	12	0.024	24	1.444	6	0	100	0	100
6		min	-0.313	6	0.01	43	-1.446	12	0	1	0	1
7	Totals:	max	1.045	5	1.365	17	1.405	2				
8		min	-1.045	11	0.597	11	-1.405	8				

Envelope AISC 13TH (360-05): LRFD Member Steel Code Checks

Member	Shape	Code Check	Loc [ft]	LC	Shear	Check	Loc [ft]	LC	DirLcphi*Pnc [k]	phi*Pnt [k]	phi*Mn y-y [k-ft]	phi*Mn z-z [k-ft]	Cb	Eqn		
1	1	HSS2.875X0.203	0.109	7	667	71	0.071	6	25	68	33.355	65.826	4.727	4.727	2.279	H1-1b
2	2	HSS2.875X0.203	0.152	6	25	8	0.116	1	75	6	33.355	65.826	4.727	4.727	1.494	H1-1b
3	3	PL5/8x3.5	0.242	0	583	67	0.08	0	583	38	84.578	99.225	1.302	7.235	1.59	H1-1b
4	4	1.9" ODX0.12"	0.267	0	135	67	0.055	2	449	18	21.867	25.364	1.2	1.2	2.071	H1-1b
5	5	PL5/8x4.25	0.114	0	127	7	0.037	0	362	43	110.629	119.531	1.556	10.583	1.434	H1-1b
6	7	PL5/8x3.5	0.186	0	583	38	0.096	0	007	67	84.578	99.225	1.302	7.235	1.198	H1-1b



Company : B+T Group
 Designer : AS
 Job Number : 149477.003.01
 Model Name : CT20001-A - Sterling CT Tower

1/9/2023
 10:39:13 AM
 Checked By : _____

Envelope AISC 13TH (360-05): LRFD Member Steel Code Checks (Continued)

Member	Shape	Code	Check	Loc[ft]	LC	Shear	Check	Loc[ft]	Dir	Cphi*Pnc [k]	phi*Pnt [k]	phi*Mn y-y [k-ft]	phi*Mn z-z [k-ft]	Cb	Eqn
7	8	1.9" ODx0.12"	0.239	2.449	13	0.077	2.449	7		21.867	25.364	1.2	1.2	1.189	H1-1b
8	9	PL5/8x4.25	0.199	0.362	13	0.07	0.127	y	6	110.629	119.531	1.556	10.583	1.422	H1-1b
9	11	PL5/8x3.5	0.233	0.583	67	0.08	0.583	y	45	84.578	99.225	1.302	7.201	1.006	H1-1b
10	12	1.9" ODx0.12"	0.294	0.135	66	0.053	2.449		8	21.867	25.364	1.2	1.2	2.068	H1-1b
11	13	PL5/8x4.25	0.087	0.127	8	0.047	0.362	y	8	110.629	119.531	1.556	10.583	1.447	H1-1b
12	15	PL5/8x3.5	0.184	0.583	49	0.098	0.583	y	67	84.578	99.225	1.302	7.235	1.053	H1-1b
13	16	1.9" ODx0.12"	0.232	0.135	49	0.06	0.135		67	21.867	25.364	1.2	1.2	2.056	H1-1b
14	17	PL5/8x4.25	0.056	0.127	13	0.045	0.362	y	68	110.629	119.531	1.556	10.583	1.449	H1-1b
15	19	0.63" SR	0.398	2.5	65	0.006	2.5		66	1.941	14.028	0.147	0.147	2.231	H1-1a
16	20	0.63" SR	0.52	2.5	67	0.013	0		67	1.941	14.028	0.147	0.147	2.266	H1-1a
17	21	SR 1/2"	0.321	0	68	0.028	1.749		49	0.393	8.836	0.074	0.074	2.693	H1-1a
18	22	SR 1/2"	0	3.499	100	0.026	1.749		49	0.393	8.836	0.074	0.074	1	H1-1a
19	23	0.63" SR	0.302	2.5	49	0.014	0		6	1.941	14.028	0.147	0.147	1.111	H1-1a
20	24	0.63" SR	0.412	2.5	48	0.014	0		68	1.941	14.028	0.147	0.147	2.263	H1-1a
21	25	SR 1/2"	0.248	0	49	0.037	1.749		73	0.393	8.836	0.074	0.074	2.605	H1-1a
22	26	SR 1/2"	0.011	3.499	6	0.034	3.499		63	0.393	8.836	0.074	0.074	3	H1-1b*
23	29	Pipe2.875x0.12	0.091	2.75	7	0.043	2.75		67	22.398	42.998	3.144	3.144	3	H1-1b
24	32	Pipe2.875x0.12	0.164	2.75	2	0.047	5.25		62	22.398	42.998	3.144	3.144	3	H1-1b
25	35	Pipe2.875x0.12	0.125	5.25	43	0.041	2.75		6	22.398	42.998	3.144	3.144	3	H1-1b
26	36	Pipe2.38X0.12	0.068	0	6	0.003	5.538		5	22.169	35.273	2.115	2.115	1.136	H1-1b*

APPENDIX B

(Additional Calculations)

PROJECT	149477.003.01 - STERLING CT TOWER KSC	
SUBJECT	Sector Mount Analysis	
DATE	01/09/23	



B+T Group
 1717 S. Boulder, Suite 300
 Tulsa, OK 74119
 (918) 587-4630

B+T GRP

Tower Type	:	Guyed	
Ground Elevation	z_s :	626	ft [ASCE7 Hazard Tool]
Tower Height	:	200.00	ft
Mount Elevation	:	150.00	ft
Antenna Elevation	:	150.00	ft
Crest Height	:	0	ft
Risk Category	:	II	[Table 2-1]
Exposure Category	:	C	[Sec. 2.6.5.1.2]
Topography Category	:	1.00	[Sec. 2.6.6.2]
Wind Velocity	V :	124	mph [ASCE7 Hazard Tool]
Ice wind Velocity	V_i :	50	mph [ASCE7 Hazard Tool]
Service Velocity	V_s :	30	mph [ASCE7 Hazard Tool]
Base Ice thickness	t_i :	1.00	in [ASCE7 Hazard Tool]
Seismic Design Cat.	:	B	[ASCE7 Hazard Tool]
	S_s :	0.19	
	S_1 :	0.05	
	S_{DS} :	0.20	
	S_{D1} :	0.09	
Gust Factor	G_h :	1.00	[Sec. 16.6]
Pressure Coefficient	K_z :	1.38	[Sec. 2.6.5.2]
Topography Factor	K_{zt} :	1.00	[Sec. 2.6.6]
Elevation Factor	K_e :	0.98	[Sec. 2.6.8]
Directionality Factor	K_d :	0.95	[Sec. 16.6]
Shielding Factor	K_a :	0.90	[Sec. 16.6]
Design Ice Thickness	t_{iz} :	1.16	in [Sec. 2.6.10]
Importance Factor	I_e :	1	[Table 2-3]
Response Coefficient	C_s :	0.100	[Sec. 2.7.7.1]
Amplification	A_s :	2	[Sec. 16.7]
	q_z :	50.39	psf

ASCE 7 Hazards Report

Address:
No Address at This Location

Standard: ASCE/SEI 7-16
Risk Category: II
Soil Class: D - Stiff Soil

Latitude: 41.66222
Longitude: -71.84694
Elevation: 626.9 ft (NAVD 88)

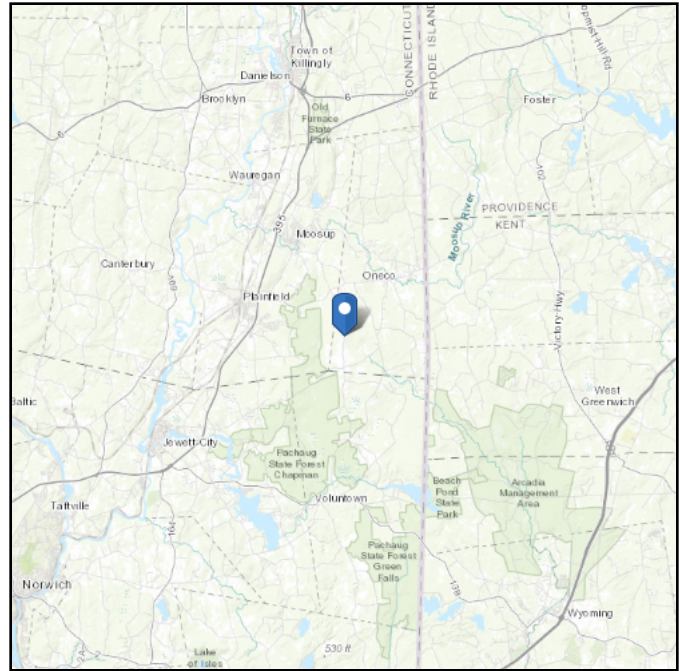
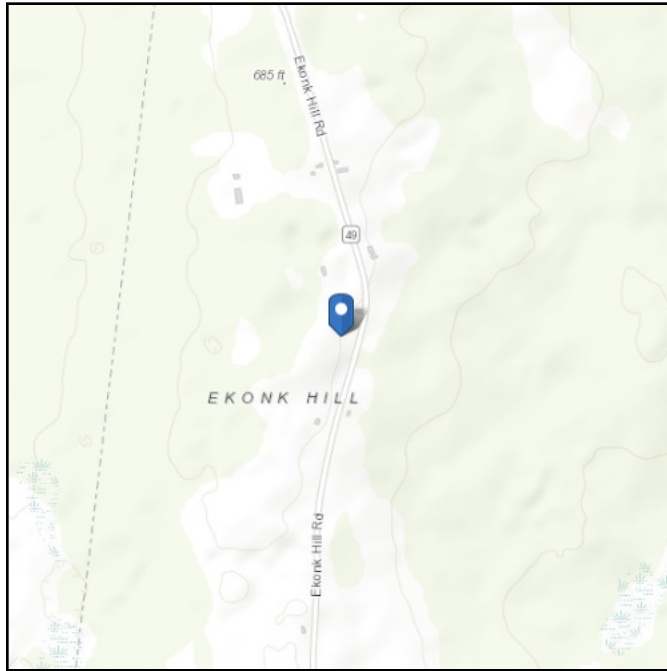

Wind

Results:

Wind Speed	124 Vmph
10-year MRI	75 Vmph
25-year MRI	85 Vmph
50-year MRI	97 Vmph
100-year MRI	102 Vmph

Data Source: ASCE/SEI 7-16, Fig. 26.5-1B and Figs. CC.2-1–CC.2-4, and Section 26.5.2

Date Accessed: Mon Jan 09 2023

Value provided is 3-second gust wind speeds at 33 ft above ground for Exposure C Category, based on linear interpolation between contours. Wind speeds are interpolated in accordance with the 7-16 Standard. Wind speeds correspond to approximately a 7% probability of exceedance in 50 years (annual exceedance probability = 0.00143, MRI = 700 years).

Site is in a hurricane-prone region as defined in ASCE/SEI 7-16 Section 26.2. Glazed openings need not be protected against wind-borne debris.

Site Soil Class:

Results:

S_s :	0.187	S_{D1} :	0.086
S_1 :	0.054	T_L :	6
F_a :	1.6	PGA :	0.102
F_v :	2.4	PGA _M :	0.163
S_{MS} :	0.3	F_{PGA} :	1.596
S_{M1} :	0.129	I_e :	1
S_{DS} :	0.2	C_v :	0.7

Seismic Design Category: B

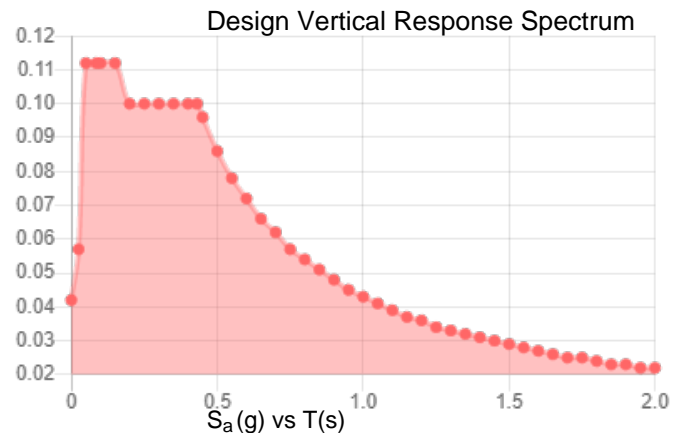
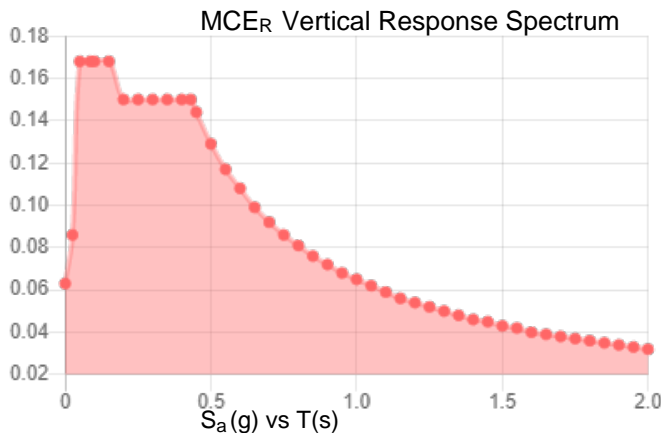
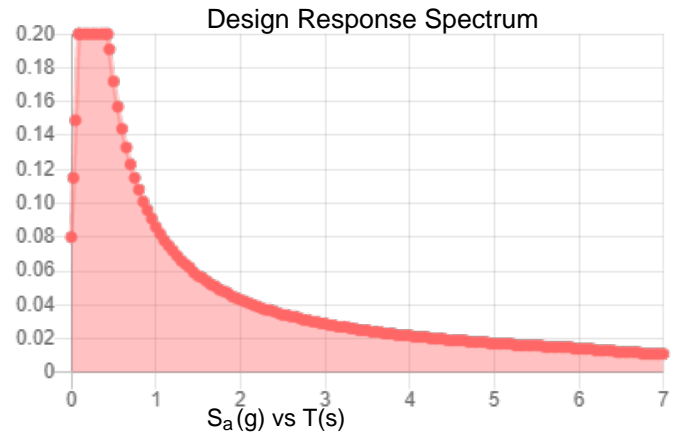
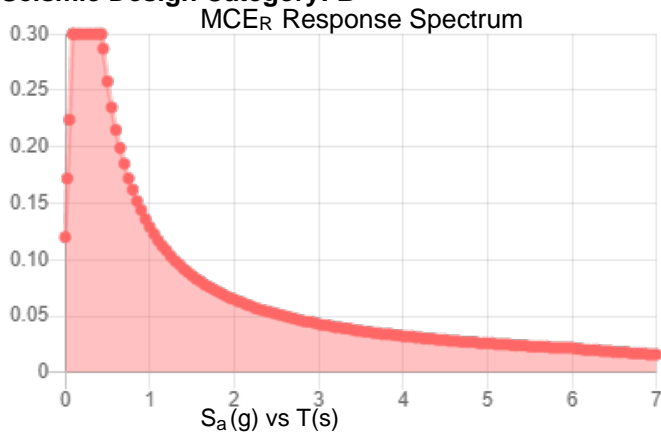

Data Accessed: Mon Jan 09 2023

Date Source:

USGS Seismic Design Maps based on ASCE/SEI 7-16 and ASCE/SEI 7-16 Table 1.5-2. Additional data for site-specific ground motion procedures in accordance with ASCE/SEI 7-16 Ch. 21 are available from USGS.

Ice

Results:

Ice Thickness: 1.00 in.
Concurrent Temperature: 15 F
Gust Speed 50 mph

Data Source: Standard ASCE/SEI 7-16, Figs. 10-2 through 10-8

Date Accessed: Mon Jan 09 2023

Ice thicknesses on structures in exposed locations at elevations higher than the surrounding terrain and in valleys and gorges may exceed the mapped values.

Values provided are equivalent radial ice thicknesses due to freezing rain with concurrent 3-second gust speeds, for a 500-year mean recurrence interval, and temperatures concurrent with ice thicknesses due to freezing rain. Thicknesses for ice accretions caused by other sources shall be obtained from local meteorological studies. Ice thicknesses in exposed locations at elevations higher than the surrounding terrain and in valleys and gorges may exceed the mapped values.

The ASCE 7 Hazard Tool is provided for your convenience, for informational purposes only, and is provided “as is” and without warranties of any kind. The location data included herein has been obtained from information developed, produced, and maintained by third party providers; or has been extrapolated from maps incorporated in the ASCE 7 standard. While ASCE has made every effort to use data obtained from reliable sources or methodologies, ASCE does not make any representations or warranties as to the accuracy, completeness, reliability, currency, or quality of any data provided herein. Any third-party links provided by this Tool should not be construed as an endorsement, affiliation, relationship, or sponsorship of such third-party content by or from ASCE.

ASCE does not intend, nor should anyone interpret, the results provided by this Tool to replace the sound judgment of a competent professional, having knowledge and experience in the appropriate field(s) of practice, nor to substitute for the standard of care required of such professionals in interpreting and applying the contents of this Tool or the ASCE 7 standard.

In using this Tool, you expressly assume all risks associated with your use. Under no circumstances shall ASCE or its officers, directors, employees, members, affiliates, or agents be liable to you or any other person for any direct, indirect, special, incidental, or consequential damages arising from or related to your use of, or reliance on, the Tool or any information obtained therein. To the fullest extent permitted by law, you agree to release and hold harmless ASCE from any and all liability of any nature arising out of or resulting from any use of data provided by the ASCE 7 Hazard Tool.

Exhibit F

Power Density/RF Emissions Report



Radio Frequency Emissions Analysis Report



Site ID: BOBOS00062A

SBA - Ekonk Hill Road (Rt-49)
419 Ekonk Hill Road (Rt-49)
Sterling, CT 06377

December 13, 2022

Fox Hill Telecom Project Number: 222027

Site Compliance Summary	
Compliance Status:	COMPLIANT
Site total MPE% of FCC general population allowable limit:	3.99 %

December 13, 2022

Dish Wireless
5701 South Santa Fe Drive
Littleton, CO 80120

Emissions Analysis for Site: **BOBOS00062A – SBA - Ekonk Hill Road (Rt-49)**

Fox Hill Telecom, Inc (“Fox Hill”) was directed to analyze the proposed radio installation for Dish Wireless, LLC (Dish) facility located at **419 Ekonk Hill Road (Rt-49), Sterling, CT**, for the purpose of determining whether the emissions from the Proposed Dish radio and antenna installation located on this property are within specified federal limits.

All information used in this report was analyzed as a percentage of current Maximum Permissible Exposure (% MPE) as listed in the FCC OET Bulletin 65 Edition 97-01 and ANSI/IEEE Std C95.1. The FCC regulates Maximum Permissible Exposure in units of microwatts per square centimeter ($\mu\text{W}/\text{cm}^2$). The number of $\mu\text{W}/\text{cm}^2$ calculated at each sample point is called the power density. The exposure limit for power density varies depending upon the frequencies being utilized. Wireless Carriers and Paging Services use different frequency bands each with different exposure limits, therefore it is necessary to report results and limits in terms of percent MPE rather than power density.

All results were compared to the FCC (Federal Communications Commission) radio frequency exposure rules, 47 CFR 1.1307(b)(1) – (b)(3), to determine compliance with the Maximum Permissible Exposure (MPE) limits for General Population/Uncontrolled environments as defined below.

General population/uncontrolled exposure limits apply to situations in which the general population may be exposed or in which persons who are exposed as a consequence of their employment may not be made fully aware of the potential for exposure or cannot exercise control over their exposure. Therefore, members of the general population would always be considered under this category when exposure is not employment related, for example, in the case of a telecommunications tower that exposes persons in a nearby residential area.

Population exposure to radio frequencies is regulated and enforced in units of microwatts per square centimeter ($\mu\text{W}/\text{cm}^2$). The general population exposure limit for the 600 MHz band is approximately $400 \mu\text{W}/\text{cm}^2$. The general population exposure limit for the 1900 MHz (PCS) and 2100 MHz (AWS / AWS-4) bands is $1000 \mu\text{W}/\text{cm}^2$. Because each carrier will be using different frequency bands, and each frequency band has different exposure limits, it is necessary to report percent of MPE rather than power density.



Occupational/controlled exposure limits apply to situations in which persons are exposed as a consequence of their employment and in which those persons who are exposed have been made fully aware of the potential for exposure and can exercise control over their exposure. Occupational/controlled exposure limits also apply where exposure is of a transient nature as a result of incidental passage through a location where exposure levels may be above general population/uncontrolled limits (see below), as long as the exposed person has been made fully aware of the potential for exposure and can exercise control over his or her exposure by leaving the area or by some other appropriate means.

Additional details can be found in FCC OET 65.



CALCULATIONS

Calculations were performed for the proposed upgrades to the T-MOBILE antenna facility located at **419 Ekonk Hill Road (Rt-49), Sterling, CT**, using the equipment information listed below. All calculations were performed per the specifications under FCC OET 65 for far field modeling calculations.

In OET-65, plane wave power densities in the Far Field of an antenna are calculated by considering antenna gain and reflective waves that would contribute to exposure.

Since the radiation pattern of an antenna has developed in the **Far Field** region the power gain in specific directions needs to be considered in exposure predictions to yield an Effective Radiated Power (ERP) in each specific direction from the antenna. Also, since the vertical radiation pattern of the antenna is considered, the exposure calculations would most likely be reduced significantly at ground level, resulting in a more realistic estimate of the actual exposure levels. To determine a worst-case scenario at each point along the calculation radials, each point was calculated using the antenna gain value at each angle of incident and compared against the result using an isotropic radiator at the antenna height with the greater of the two used to yield the more pessimistic far field value for each point along the calculation radial.

Additionally, to model a truly "worst case" prediction of exposure levels at or near a surface, such as at ground-level or on a rooftop, reflection off the surface of antenna radiation power can be assumed, resulting in a potential 1.6 times increase in power density in calculating far field power density values.

With these factors Considered, the worst case **Far Field prediction model** utilized in this analysis is determined by the following equation:

Equation 9 per FCC OET65 for Far Field Modeling

$$S = \frac{33.4 \text{ ERP}}{R^2}$$

S = Power Density (in $\mu\text{w}/\text{cm}^2$)

ERP = Effective Radiated Power from antenna (watts)

R = Distance from the antenna (meters)

Predicted far field power density values for all carriers identified in this report were calculated 6 feet above the ground level and are displayed as a percentage of the applicable FCC standards. All emissions values for other carriers were calculated using the same Far Field model outlined above, using industry standard radio configurations and frequency band selection based upon available licenses in this geographic area for emissions contribution estimates.



For each Dish sector the following channel counts, frequency bands and power levels were utilized as shown in *Table 1*:

Technology	Frequency Band	Channel Count	Transmit Power per Channel (W)
5G	n71 (600 MHz)	4	61.5
5G	n70 (AWS-4 / 1995-2020)	4	40
5G	n66 (AWS-4 / 2180-2200)	4	40

Table 1: Channel Data Table



The following **Dish** antennas listed in *Table 2* were used in the modeling for transmission in the 600 MHz (n71) frequency band and the 2100 MHz (AWS 4) frequency bands at 1995-2020 MHz (n70) and 2180-2200 MHz (n66). This is based on feedback from Dish regarding anticipated antenna selection. Maximum gain values for all antennas are listed in the Inventory and Power Data table below.

Sector	Antenna Number	Antenna Make / Model	Antenna Centerline (ft)
A	1	JMA MX08FRO665-21	150
B	1	JMA MX08FRO665-21	150
C	1	JMA MX08FRO665-21	150

Table 2: Antenna Data

All calculations were done with respect to uncontrolled / general population threshold limits.



RESULTS

Per the calculations completed for the proposed **Dish** configurations *Table 3* shows resulting emissions power levels and percentages of the FCC’s allowable general population limit.

Antenna ID	Antenna Make / Model	Frequency Bands	Antenna Gain (dBd)	Channel Count	Total TX Power (W)	ERP (W)	MPE %
Antenna A1	JMA MX08FRO665-21	71 (600 MHz) / n70 (AWS-4 / 1995-2020) / n66 (AWS-4 / 2180-2200)	12.15 / 15.95 / 16.25	12	566	17,079.80	1.64
Sector A Composite MPE%							1.64
Antenna B1	JMA MX08FRO665-21	71 (600 MHz) / n70 (AWS-4 / 1995-2020) / n66 (AWS-4 / 2180-2200)	12.15 / 15.95 / 16.25	12	566	17,079.80	1.64
Sector B Composite MPE%							1.64
Antenna C1	JMA MX08FRO665-21	71 (600 MHz) / n70 (AWS-4 / 1995-2020) / n66 (AWS-4 / 2180-2200)	12.15 / 15.95 / 16.25	12	566	17,079.80	1.64
Sector C Composite MPE%							1.64

Table 3: Dish Emissions Levels



The Following table (Table 4) shows all additional carriers on site and their emissions contribution estimates, along with the newly calculated **Dish** far field emissions contributions per this report. FCC OET 65 specifies that for carriers utilizing directional antennas that the highest recorded sector value be used for composite site emissions values due to their greatly reduced emissions contributions in the directions of the adjacent sectors. Table 5 below shows a summary for each **Dish** Sector as well as the composite emissions value for the site.

Site Composite MPE%	
Carrier	MPE%
Dish – Max Per Sector Value	1.64 %
EVERSOURCE	0.17 %
T-Mobile	1.10 %
CSP	0.18 %
DEP	0.34 %
HAM	0.07 %
WTR	0.15 %
NEU	0.23 %
QVC	0.10 %
FBI	0.01 %
Site Total MPE %:	3.99 %

Table 4: All Carrier MPE Contributions

Dish Sector A Total:	1.64 %
Dish Sector B Total:	1.64 %
Dish Sector C Total:	1.64 %
Site Total:	3.99 %

Table 5: Site MPE Summary

Table 6 below details a breakdown by frequency band and technology for the MPE power values for the maximum calculated **Dish** sector(s). For this site, all three sectors have the same configuration yielding the same results on all three sectors.

Dish _ Frequency Band / Technology Max Power Values (Per Sector)	# Channels	Watts ERP (Per Channel)	Height (feet)	Total Power Density ($\mu\text{W}/\text{cm}^2$)	Frequency (MHz)	Allowable MPE ($\mu\text{W}/\text{cm}^2$)	Calculated % MPE
Dish n71 (600 MHz) 5G	4	1,008.96	150	1.12	n71 (600 MHz)	400	0.28%
Dish n70 (AWS-4 / 1995-2020) 5G	4	1,574.20	150	2.80	n70 (AWS-4 / 1995-2020)	1000	0.28%
Dish n66 (AWS-4 / 2180-2200) 5G	4	1,686.79	150	10.80	n66 (AWS-4 / 2180-2200)	1000	1.08%
						Total:	1.64%

Table 6: Dish Maximum Sector MPE Power Values



Summary

All calculations performed for this analysis yielded results that were **within** the allowable limits for general population exposure to RF Emissions.

The anticipated maximum composite contributions from the Dish facility as well as the site composite emissions value with regards to compliance with FCC's allowable limits for general population exposure to RF Emissions are shown here:

Dish Sector	Power Density Value (%)
Sector A:	1.64 %
Sector B:	1.64 %
Sector C:	1.64 %
Dish Maximum Total (per sector):	1.64 %
Site Total:	3.99 %
Site Compliance Status:	COMPLIANT

The anticipated composite emissions value for this site, assuming all carriers present, is **3.99 %** of the allowable FCC established general population limit sampled at the ground level. This is based upon the far field calculations performed for all carriers identified in this report.

FCC guidelines state that if a site is found to be out of compliance (over allowable thresholds), that carriers over a 5% contribution to the composite value will require measures to bring the site into compliance. For this facility, the composite values calculated were well within the allowable 100% threshold standard per the federal government.

Scott Heffernan
Principal RF Engineer
Fox Hill Telecom, Inc
Worcester, MA 01609
(978)660-3998

Exhibit G

Letter of Authorization

SBA Letter of Authorization

CT - CONNECTICUT SITING COUNCIL

Melanie A. Bachman

Executive Director

Connecticut Siting Council

10 Franklin Square

New Britain, CT 06051

Re: Tower Share Application

SBA COMMUNICATIONS CORPORATION hereby authorizes DISH Wireless LLC, including their Agent, to act as our Agent in the processing of all zoning applications, building permits and approvals through the CONNECTICUT SITING COUNCIL for existing wireless communications towers.

SBA COMMUNICATIONS CORPORATION

134 Flanders Road, Suite 125

Westboro, MA 01581

Exhibit H

Recipient Mailings



SBA STRUCTURES INC.
8051 CONGRESS AVE
BOCA RATON FL 33487-1307

USPS TRACKING #

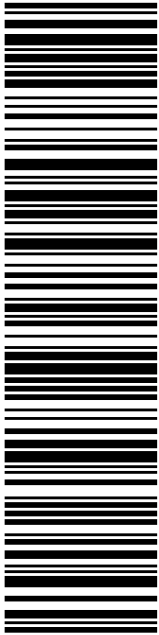

9405 5036 9930 0460 7230 12

P

USPS.com 9405 5036 9930 0460 7230 12 0099 0000 0063 3487
US POSTAGE
 Flat Rate Env
U.S. POSTAGE PAID
 Click-N-Ship®

01/20/2023 Mailed from 01566 986768400423434

PRIORITY MAIL®

DEBORAH CHASE
NORTHEAST SITE SOLUTIONS
STE 1
420 MAIN ST
STURBRIDGE MA 01566-1359

Expected Delivery Date: 01/23/23
Ref#: SBDS-00062
0000

C036

Electronic Rate Approved #038555749





Cut on dotted line.

Instructions

1. Each Click-N-Ship® label is unique. Labels are to be used as printed and used only once. DO NOT PHOTO COPY OR ALTER LABEL.
2. Place your label so it does not wrap around the edge of the package.
3. Adhere your label to the package. A self-adhesive label is recommended. If tape or glue is used, DO NOT TAPE OVER BARCODE. Be sure all edges are secure.
4. To mail your package with PC Postage®, you may schedule a Package Pickup online, hand to your letter carrier, take to a Post Office™, or drop in a USPS collection box.
5. Mail your package on the "Ship Date" you selected when creating this label.

Click-N-Ship® Label Record

USPS TRACKING # :
9405 5036 9930 0460 7230 12

Trans. #: 580924669	Priority Mail® Postage: \$9.90
Print Date: 01/20/2023	Total: \$9.90
Ship Date: 01/20/2023	
Expected Delivery Date: 01/23/2023	

From: DEBORAH CHASE Ref#: SBDS-00062
 NORTHEAST SITE SOLUTIONS
 STE 1
 420 MAIN ST
 STURBRIDGE MA 01566-1359

To: SBA STRUCTURES INC.
 8051 CONGRESS AVE
 BOCA RATON FL 33487-1307

* Retail Pricing Priority Mail rates apply. There is no fee for USPS Tracking® service on Priority Mail service with use of this electronic rate shipping label. Refunds for unused postage paid labels can be requested online 30 days from the print date.



Thank you for shipping with the United States Postal Service!
 Check the status of your shipment on the USPS Tracking® page at usps.com



LINCOLN A COOPER
FIRST SELECTMAN-TOWN OF STERLING
PO BOX 157
ONECO CT 06373-0157

USPS TRACKING #

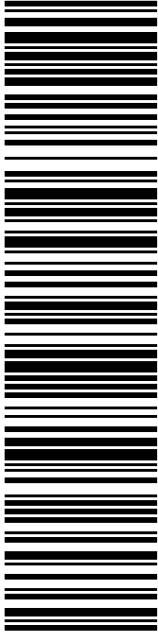

9405 5036 9930 0460 7230 43

DEBORAH CHASE
NORTHEAST SITE SOLUTIONS
STE 1
420 MAIN ST
STURBRIDGE MA 01566-1359

PRIORITY MAIL®

Expected Delivery Date: 01/23/23
Ref#: SBDS-00062
0000

B003

P

USPS.com 9405 5036 9930 0460 7230 43 0099 0000 0010 6373
US POSTAGE
Flat Rate Envoy

U.S. POSTAGE PAID
Click-N-Ship®

Mailed from 01566 986768400422436

01/20/2023

Click-N-Ship®

UNITED STATES POSTAL SERVICE®

Click-N-Ship®

Electronic Rate Approved #038555749





Cut on dotted line.

Instructions

1. Each Click-N-Ship® label is unique. Labels are to be used as printed and used only once. DO NOT PHOTO COPY OR ALTER LABEL.
2. Place your label so it does not wrap around the edge of the package.
3. Adhere your label to the package. A self-adhesive label is recommended. If tape or glue is used, DO NOT TAPE OVER BARCODE. Be sure all edges are secure.
4. To mail your package with PC Postage®, you may schedule a Package Pickup online, hand to your letter carrier, take to a Post Office™, or drop in a USPS collection box.
5. Mail your package on the "Ship Date" you selected when creating this label.

Click-N-Ship® Label Record

USPS TRACKING # :
9405 5036 9930 0460 7230 43

Trans. #: 580924669	Priority Mail® Postage: \$9.90
Print Date: 01/20/2023	Total: \$9.90
Ship Date: 01/20/2023	
Expected Delivery Date: 01/23/2023	

From: DEBORAH CHASE Ref#: SBDS-00062
NORTHEAST SITE SOLUTIONS
STE 1
420 MAIN ST
STURBRIDGE MA 01566-1359

To: LINCOLN A COOPER
FIRST SELECTMAN-TOWN OF STERLING
PO BOX 157
ONECO CT 06373-0157

* Retail Pricing Priority Mail rates apply. There is no fee for USPS Tracking® service on Priority Mail service with use of this electronic rate shipping label. Refunds for unused postage paid labels can be requested online 30 days from the print date.



Thank you for shipping with the United States Postal Service!
Check the status of your shipment on the USPS Tracking® page at usps.com



MELISSA GIL
ZONING ENFORCEMENT OFFICER-TOWN OF
PO BOX 157
ONECO CT 06373-0157

USPS TRACKING #

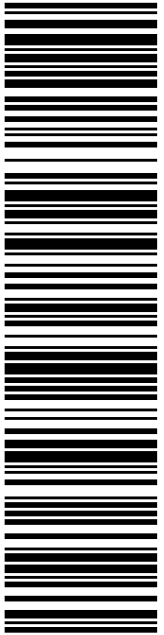

9405 5036 9930 0460 7230 50

P

USPS.com 9405 5036 9930 0460 7230 50 0099 0000 0010 6373
US POSTAGE
 Flat Rate Env
U.S. POSTAGE PAID
 Click-N-Ship®

01/20/2023 Mailed from 01566 986768400420867

DEBORAH CHASE
NORTHEAST SITE SOLUTIONS
STE 1
420 MAIN ST
STURBRIDGE MA 01566-1359

PRIORITY MAIL®

Expected Delivery Date: 01/23/23
 Ref#: SBDS-00062
0000

B003

Electronic Rate Approved #038555749



✂ ————— Cut on dotted line. —————

Instructions

1. Each Click-N-Ship® label is unique. Labels are to be used as printed and used only once. DO NOT PHOTO COPY OR ALTER LABEL.
2. Place your label so it does not wrap around the edge of the package.
3. Adhere your label to the package. A self-adhesive label is recommended. If tape or glue is used, DO NOT TAPE OVER BARCODE. Be sure all edges are secure.
4. To mail your package with PC Postage®, you may schedule a Package Pickup online, hand to your letter carrier, take to a Post Office™, or drop in a USPS collection box.
5. Mail your package on the "Ship Date" you selected when creating this label.

Click-N-Ship® Label Record

USPS TRACKING # :
9405 5036 9930 0460 7230 50

Trans. #: 580924669	Priority Mail® Postage: \$9.90
Print Date: 01/20/2023	Total: \$9.90
Ship Date: 01/20/2023	
Expected Delivery Date: 01/23/2023	

From: DEBORAH CHASE Ref#: SBDS-00062
 NORTHEAST SITE SOLUTIONS
 STE 1
 420 MAIN ST
 STURBRIDGE MA 01566-1359

To: MELISSA GIL
 ZONING ENFORCEMENT OFFICER-TOWN OF STERLING
 PO BOX 157
 ONECO CT 06373-0157

* Retail Pricing Priority Mail rates apply. There is no fee for USPS Tracking® service on Priority Mail service with use of this electronic rate shipping label. Refunds for unused postage paid labels can be requested online 30 days from the print date.

 Thank you for shipping with the United States Postal Service!
 Check the status of your shipment on the USPS Tracking® page at usps.com

POBOS0062A



FARMINGTON
210 MAIN ST
FARMINGTON, CT 06032-9998
(800)275-8777

01/20/2023 04:35 PM

Product	Qty	Unit Price	Price
Prepaid Mail Boca Raton, FL 33487 Weight: 0 lb 1.90 oz Acceptance Date: Fri 01/20/2023 Tracking #: 9405 5036 9930 0460 7230 12	1		\$0.00
Prepaid Mail Oneco, CT 06373 Weight: 0 lb 10.70 oz Acceptance Date: Fri 01/20/2023 Tracking #: 9405 5036 9930 0460 7230 43	1		\$0.00
Prepaid Mail Oneco, CT 06373 Weight: 0 lb 10.60 oz Acceptance Date: Fri 01/20/2023 Tracking #: 9405 5036 9930 0460 7230 50	1		\$0.00
Grand Total:			\$0.00

Text your tracking number to 28777 (2USPS) to get the latest status. Standard Message and Data rates may apply. You may also visit www.usps.com USPS Tracking or call 1-800-222-1811.

Preview your Mail
Track your Packages
Sign up for FREE @
<https://informedelivery.usps.com>

All sales final on stamps and postage.
Refunds for guaranteed services only.
Thank you for your business.

Tell us about your experience.
Go to: <https://postalexperience.com/Pos>
or scan this code with your mobile device,



or call 1-800-410-7420.

UFN: 082618-0132
Receipt #: 840-50600020-2-6046893-1
Clerk: 13