



Crown Castle
3 Corporate Park Drive, Suite 101
Clifton Park, NY 12065

November 19, 2020

Melanie A. Bachman
Executive Director
Connecticut Siting Council
10 Franklin Square
New Britain, CT 06051

RE: **Notice of Exempt Modification for T-Mobile:
806378 - T-Mobile Site ID: CTHA534A
126 Pioneer Heights Road, Somers, CT 06071
Latitude: 41° 56' 55.98"/ Longitude: -72° 29' 31.55"**

Dear Ms. Bachman:

T-Mobile currently maintains nine (9) antennas at the 113-foot mount on the existing 161-foot self support tower, located at 126 Pioneer Heights Road, Somers, CT. The tower is owned by Crown Castle and the property is owned by The Clarence and Lena Farnham Living Trust. T-Mobile now intends to replace three (3) existing antennas with (3) new 1900/2100 MHz antennas and three (3) new 600/700 MHz antennas. The new antennas will be installed at the 113-ft level of the tower on a replacement mount.

Planned Modifications:

Tower:

Remove:

- (9) Coax
- (3) Hybrid Cables

Remove and Replace:

(3) AIR21 KRC118023-1_B2P_B4A Antenna (**REMOVE**) – (3) AIR32_B66A_B2A Antenna 1900/2100 MHz (**REPLACE**) & (3) RFS-APXVAARR24_43-U-NA20 Antenna 600/700 MHz (**REPLACE**)

Install New:

- (3) 1 5/8" Hybrid Fiber Line
- (3) RADIO 4449 B12/B71 RRUs

Existing to Remain:

(3) AIR21 KRC118023-1_B2P_B4A Antenna 2100 MHz

Ground:

- Replacement of existing ground cabinet.
- Upgrade to existing ground cabinet. (Internally)

This facility was approved by the by the Connecticut Siting Council in Docket No. 58 on July 11, 1986. This approval included conditions which this exempt modification application comply with.

Please accept this letter as notification pursuant to Regulations of Connecticut State Agencies §16-50j-73, for construction that constitutes an exempt modification pursuant to R.C.S.A. § 16-50j-72(b)(2). In accordance with R.C.S.A. § 16-50j-73, a copy of this letter is being sent to C.G. Knorr, First Selectman for the Town of Somers, Jennifer Roy, ZEO for the Town of Somers, Crown Castle as the tower owner, and The Farnham Living Trust, the property owner.

1. The proposed modifications will not result in an increase in the height of the existing tower.
2. The proposed modifications will not require the extension of the site boundary.
3. The proposed modification will not increase noise levels at the facility by six decibels or more, or to levels that exceed state and local criteria.
4. The operation of the replacement antennas will not increase radio frequency emissions at the facility to a level at or above the Federal Communication Commission safety standard.
5. The proposed modifications will not cause a change or alteration in the physical or environmental characteristics of the site.
6. The existing structure and its foundation can support the proposed loading.

For the foregoing reasons, T-Mobile respectfully submits that the proposed modifications to the above-reference telecommunications facility constitutes an exempt modification under R.C.S.A. § 16-50j-72(b)(2). Please send approval/rejection letter to Attn: Anne Marie Zsamba.

Sincerely,

Anne Marie Zsamba
Site Acquisition Specialist
3 Corporate Park Drive, Suite 101
Clifton Park, NY 12065
(201) 236-9224
AnneMarie.Zsamba@crowncastle.com

Attachments

cc:

C.G. Knorr, Jr., First Selectman (*via email only to selectman@somersct.gov*)
Town of Somers
Town Hall – Selectman’s Office

Melanie A. Bachman

Page 3

600 Main Street
Somers, CT 06071
860-763-8201

Jennifer Roy, ZEO (*via email only to jroy@somersct.gov*)
Town of Somers
Town Hall – Planning Department
600 Main Street
Somers, CT 06071
860-763-8201

The Farnham Living Trust
C/O Clarence & Lena Farnham
126 Pioneer Heights Road
Somers, CT 06071
860.749.3870

Crown Castle, Tower Owner

ORIGIN ID: SCHA (518) 350-3639
ANNE MARIE ZSAMBRA
CROWN CASTLE
21 HEATHER DRIVE

SHIP DATE: 19NOV20
ACT WGT: 1.00 LB
CAD: 104924194/INET4280

GANSEVOORT, NY 12831
UNITED STATES US

BILL SENDER

TO C/O CLARENCE & LENA FARNHAM
FARNHAM LIVING TRUST
126 PIONEER HEIGHTS RD

SOMERS CT 06071

REF: 1734 7880

(860) 749-3870
INV/ PO/ DEPT:

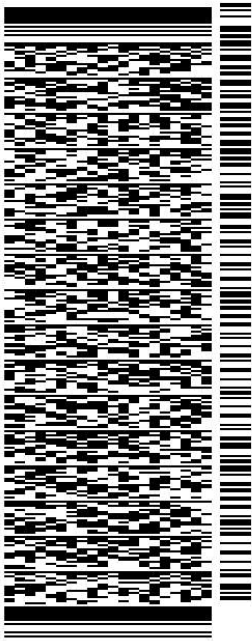

56BJ5/BAB9/B766

TRK# 7721 3062 6905
0201

FRI - 20 NOV 10:30A
PRIORITY OVERNIGHT

EB QCWA

06071
CT-US BDL

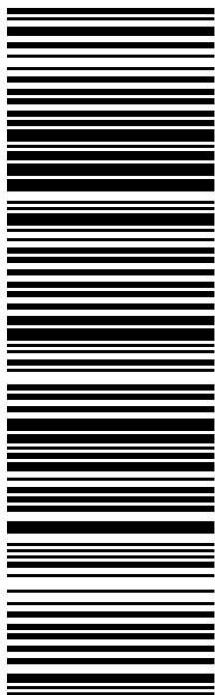

After printing this label:

1. Use the 'Print' button on this page to print your label to your laser or inkjet printer.
2. Fold the printed page along the horizontal line.
3. Place label in shipping pouch and affix it to your shipment so that the barcode portion of the label can be read and scanned.

Warning: Use only the printed original label for shipping. Using a photocopy of this label for shipping purposes is fraudulent and could result in additional billing charges, along with the cancellation of your FedEx account number.

Use of this system constitutes your agreement to the service conditions in the current FedEx Service Guide, available on fedex.com. FedEx will not be responsible for any claim in excess of \$100 per package, whether the result of loss, damage, delay, non-delivery, misdelivery, or misinformation, unless you declare a higher value, pay an additional charge, document your actual loss and file a timely claim. Limitations found in the current FedEx Service Guide apply. Your right to recover from FedEx for any loss, including intrinsic value of the package, loss of sales, income interest, profit, attorney's fees, costs, and other forms of damage whether direct, incidental, consequential, or special is limited to the greater of \$100 or the authorized declared value. Recovery cannot exceed actual documented loss. Maximum for items of extraordinary value is \$1,000, e.g. jewelry, precious metals, negotiable instruments and other items listed in our Service Guide. Written claims must be filed within strict time limits, see current FedEx Service Guide.

From: [Zsamba, Anne Marie](#)
To: selectman@somersct.gov
Subject: Notice of Exempt Modification - 126 Pioneer Heights Rd, Somers - T-Mobile - 806378
Date: Thursday, November 19, 2020 12:15:00 PM
Attachments: [EM-T-MOBILE-CTHA534A-806378-126 PIONEER HEIGHTS RD SOMERS-REFILE 11.19.2020-NOTICE.pdf](#)

Dear First Selectman Knorr:

Attached please find T-Mobile's exempt modification application that is being submitted to the Connecticut Siting Council today, November 19, 2020.

In light of the present circumstances with Covid-19, The Council has advised that electronic notification of this filing is acceptable. If you could kindly confirm receipt. Thank you.

Best,
Anne Marie Zsamba

ANNE MARIE ZSAMBA
Site Acquisition Specialist
T: (201) 236-9224
M: (518) 350-3639
F: (724) 416-6112

CROWN CASTLE
3 Corporate Park Drive, Suite 101
Clifton Park, NY 12065
CrownCastle.com

From: [Zsamba, Anne Marie](#)
To: jroy@somersct.gov
Subject: Notice of Exempt Modification - 126 Pioneer Heights Rd, Somers - T-Mobile - 806378
Date: Thursday, November 19, 2020 12:15:00 PM
Attachments: [EM-T-MOBILE-CTHA534A-806378-126 PIONEER HEIGHTS RD SOMERS-REFILE 11.19.2020-NOTICE.pdf](#)

Dear ZEO Roy:

Attached please find T-Mobile's exempt modification application that is being submitted to the Connecticut Siting Council today, November 19, 2020.

In light of the present circumstances with Covid-19, The Council has advised that electronic notification of this filing is acceptable. If you could kindly confirm receipt. Thank you.

Best,
Anne Marie Zsamba

ANNE MARIE ZSAMBA
Site Acquisition Specialist
T: (201) 236-9224
M: (518) 350-3639
F: (724) 416-6112

CROWN CASTLE
3 Corporate Park Drive, Suite 101
Clifton Park, NY 12065
CrownCastle.com

Exhibit A

Original Facility Approval

DOCKET NO. 58

AN APPLICATION OF HARTFORD CELLULAR
COPANY FOR A CERTIFICATE OF
ENVIRONMENTAL COMPATIBILITY AND PUBLIC
NEED FOR THE CONSTRUCTION, MAINTENANCE,
AND OPERATION OF FACILITIES TO PROVIDE
CELLULAR SERVICE IN HARTFORD, TOLLAND AND
MIDDLESEX COUNTIES.

CONNECTICUT SITING
COUNCIL

July 11, 1986.

D E C I S I O N A N D O R D E R

Pursuant to the foregoing opinion, the Connecticut Siting Council (Council) hereby directs that a Certificate of Environmental Compatibility and Public Need as provided by Section 16-50k of the General Statutes of Connecticut (CGS) be issued to the Hartford Cellular Company for the construction, maintenance, and operation of cellular mobile phone telecommunication towers and associated equipment in the towns of Glastonbury, Haddam, Hartford, Portland, Rocky Hill, Somers, Vernon, Windsor, and Willington subject to the conditions below.

- 1) The proposed Bloomfield and Middlefield sites are rejected without prejudice.
- 2) The antennas on the Glastonbury tower shall be mounted no higher than the 180' level of this existing tower.
- 3) The Portland and Rocky Hill towers shall be monopoles.
- 4) The towers shall be no taller than necessary to provide the proposed service, and in no event shall exceed total heights, including antennas, of
 - a) 193' at the Haddam site;
 - b) 173' at the Portland site;

- c) 153' at the Rocky Hill site;
- d) 173' at the Somers site;
- e) 173' at the Vernon site;
- f) 153' at the Willington site;
- g) 173' at the Windsor site.

5) The Hartford site receive antennas shall be mounted below the top of the high point of the building to preclude visibility.

6) Any future actions requiring the removal of the existing Glastonbury tower to be shared by the certificate holder shall also apply to the equipment mounted on that tower by the certificate holder, regardless of that equipment's status under Chapter 277a of the CGS.

7) The certificate holder shall submit a development and management (D&M) plan for the Haddam, Portland, Rocky Hill, Somers, Vernon and Windsor sites pursuant to Sections 16-50j-75 through 16-50j-77 of the Regulations of State Agencies (RSA), except that irrelevant items in Section 16-50j-76 need only be identified as such. In addition to the requirements of Section 16-50j-76, the D&M plan shall provide plans for evergreen screening around the fenced perimeter at the Haddam, Somers, Vernon, and Windsor sites. The D&M plan shall include a proposal for painting the approved monopole structures to blend with the sky. The D&M plan must be approved prior to facility construction. Any changes to specifications in the D&M plan must be approved by the Council prior to facility operation.

8) All certified facilities shall be constructed, operated, and maintained as specified in the Council's record and in the

site plan required by order number 7.

9) The certificate holder shall comply with any future radiofrequency (RF) standards promulgated by state or federal regulatory agencies. Upon the establishment of any new governmental RF standards, the facilities granted in this decision shall continue to be in compliance with such standards.

10) The certificate holder shall permit public or private entities to share space on the towers approved herein, for due consideration received, or shall provide any requesting entity with specific legal, technical, environmental, or economic reasons precluding such tower sharing. In addition to complying with Section 16-50j-73 of the RSA, the certificate holder shall notify the Council of the addition of any equipment to any approved tower.

11) A fence not lower than 8' shall surround each tower and associated equipment.

12) Unless necessary to comply with order 13, no lights shall be installed on any of these towers.

13) The facilities' construction and any future tower sharing shall be in accordance with all applicable federal, state, and municipal laws and regulations. Shared uses by entities not subject to jurisdiction pursuant to Section 16-50k of the CGS shall be subject to all applicable federal, state, and municipal laws and regulations.

14) Construction activities shall take place during daylight working hours.

15) This decision and order shall be void and the towers and associate equipment shall be dismantled and removed, or reapplication for any new use shall be made to the Council before any such new use is made, if the towers do not provide or permanently cease to provide cellular service following completion of construction.

16) This decision and order shall be void if all construction authorized herein is not completed within three years of the issuance of this decision, or within three years of the completion of any appeal if appeal of this decision is taken, unless otherwise approved by the Council.

Pursuant to CGS Section 16-50p, we hereby direct that a copy of the decision and order shall be served on each person listed below. A notice of the issuance shall be published in the Hartford Courant, Middletown Press, Manchester Journal Inquirer, and the Willimantic Chronicle.

The parties to the proceeding are:

Metro Mobile (applicant)
5 Eversley Avenue
Norwalk, Connecticut 06855
ATTN: Armand Mascioli
General Manager

Howard L. Slater, Esq. (its attorneys)
Scott A. Gursky, Esq.
Byrne, Slater, Sandler,
Shulman & Rouse, P.C.
111 Pearl Street
Hartford, Connecticut 06103

Richard Rubin, Esq.
Fleischman and Walsh, P.C.
1725 N Street, N.W.
Washington, D. C. 20036

Mr. William Wamester
1225 Randolph Road
Middletown, Connecticut 06457

The Southern New England Telephone Company
227 Church Street
New Haven, Connecticut 06506
ATTN: Peter J. Tyrrell, Esq.

Mr. James W. Tilney

represented by:
Patricia A. Ayars
Samuel Baily, Jr.
Robinson & Cole
One Commercial Plaza
Hartford, CT. 06103-3597

Mr. Samuel DuBosar, Chairman
Bessie Bennett, Esq.
Town Plan & Zoning Commission
P.O. Box 337
Bloomfield, Connecticut 06002

Town of Somers

represented by:

Mr. Robert F. Peters
Town Counsel
Tatoian, Devline, Peters
& Davis
11 South Road
P.O. Box 415
Somers, CT. 06071

Town of Haddam
represented by:

Lucy R. Petrella
Chairperson
Town Office Building
Route 9A
P.O. Box 87
Haddam, CT. 06438

Midstate Regional Planning Agency

represented by:

Thomas M. Gilligan
Regional Planner
P.O. Box 139
Middletown, CT. 06457

Dr. Donald P. LaSalle
Director
Talcott Mountain Science Center
Montevideo Road
Avon, Connecticut 06001

Barnard Tilson (service waived)
Secretary
Avon Planning and Zoning
60 West Main Street
Avon, Connecticut 06001

Alden Giddings
33 Privelege Road
Bloomfield, Connecticut 06002

Town of Bloomfield

represented by:

Joseph M. Suggs, Jr.
Deputy Mayor
Town Hall
880 Bloomfield Avenue
P.O. Box 337
Bloomfield, CT. 06002
(service waived)

Town of Middlefield

represented by:

David Silverstone, Esq.
Silverstone & Koontz
37 Lewis Street
Hartford, CT. 06103

with a copy to:

Geoffrey Colegrove
Midstate Regional Planning Agency
100 DeKoven Drive
Middletown, CT. 06457

Zoning Commission
Town of Somers

represented by:

Joseph A. Paradis
Chairman
Town Hall
600 Main Street
P.O. Box 803
Somers, CT. 06071

Barbara Sirwilo, Secretary (service waived)
Planning & Zoning Commission
Town of Rocky Hill
600 Old Main Street
P.O. Box 657
Rocky Hill, Connecticut 06067

H. Robert Goodrich (service waived)
Goodrich Lane
Portland, Connecticut 06480

The Honorable Richard P. Antonetti
State Representative (service waived)
5 Sachem Circle
Meriden, Connecticut 06450

John Hevrin
R.D. #1 - Plains Road
Haddam, Connecticut 06438







Norman and Darlene Manning (represented by)

Elizabeth Allen, Esq.
P.O. Box 467
Higganum, CT. 06441
(service waived)

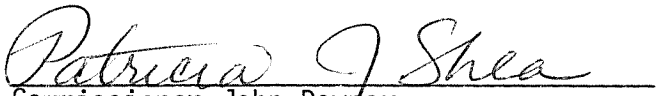
C E R T I F I C A T I O N

The undersigned members of the Connecticut Siting Council hereby certify that they have heard this case or read the record thereof, and that we voted as follows:

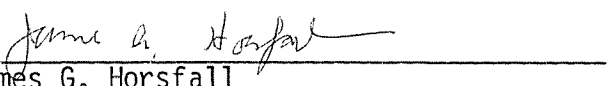
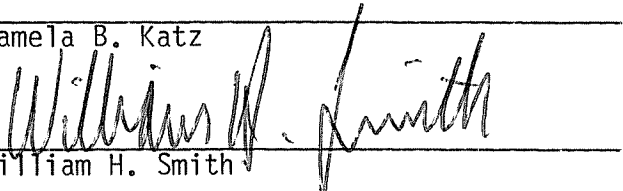
Dated at New Britain, Connecticut, this 11th day of July, 1986.

<u>Council Members</u>	<u>Vote Cast</u>
_____) Gloria Dibble Pond Chairperson	Absent
 _____) Commissioner John Downey Designee: Patricia Shea	Yes
 _____) Commissioner Stanley Pac Designee: Christopher Cooper	Yes
 _____) Owen L. Clark	Yes
 _____) Mortimer A. Gelston	Yes
 _____) James G. Horsfall	Yes
_____) Pamela B. Katz	Absent
 _____) William H. Smith	Yes
 _____) Colin C. Tait	Yes

STATE OF CONNECTICUT)
 :
COUNTY OF HARTFORD) ss. New Britain, July 11, 1986

I hereby certify that the foregoing is a true and correct copy of the decision and order issued by the Connecticut Siting Council, State of Connecticut.

ATTEST:



Christopher S. Wood, Executive Director
Connecticut Siting Council

Exhibit B

Property card



Property Information

Property Location	126 PIONEER HEIGHTS
Owner	FARNHAM LENA G & FAYE F GATELY
Co-Owner	C/O CROWN ATLANTIC CO LLC
Mailing Address	PMB 353 4017 WASHINGTON R MCMURRAY PA 15317
Land Use	299 Vac Comm Lnd
Land Class	C
Zoning Code	A-1
Census Tract	5382.01

Neighborhood	C
Acreage	0.5
Utilities	
Lot Setting/Desc	
Book / Page	0280/0125
Additional Info	

Primary Construction Details

Year Built	0
Building Desc.	Vac Comm Lnd
Building Style	UNKNOWN
Building Grade	
Stories	
Occupancy	
Exterior Walls	
Exterior Walls 2	NA
Roof Style	
Roof Cover	
Interior Walls	
Interior Walls 2	NA
Interior Floors 1	
Interior Floors 2	NA

Heating Fuel	
Heating Type	
AC Type	
Bedrooms	0
Full Bathrooms	0
Half Bathrooms	0
Extra Fixtures	0
Total Rooms	0
Bath Style	NA
Kitchen Style	NA
Fin Bsmt Area	0
Fin Bsmt Quality	0
Bsmt Gar	0
Fireplaces	0

(*Industrial / Commercial Details)

Building Use	Vacant
Building Condition	
Sprinkler %	NA
Heat / AC	NA
Frame Type	NA
Baths / Plumbing	NA
Ceiling / Wall	NA
Rooms / Prtns	NA
Wall Height	NA
First Floor Use	NA
Foundation	NA

Photo



Sketch



Town of Somers, Connecticut - Assessment Parcel Map



Parcel: 01-13-A

Address: 126 PIONEER HEIGHTS

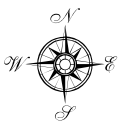
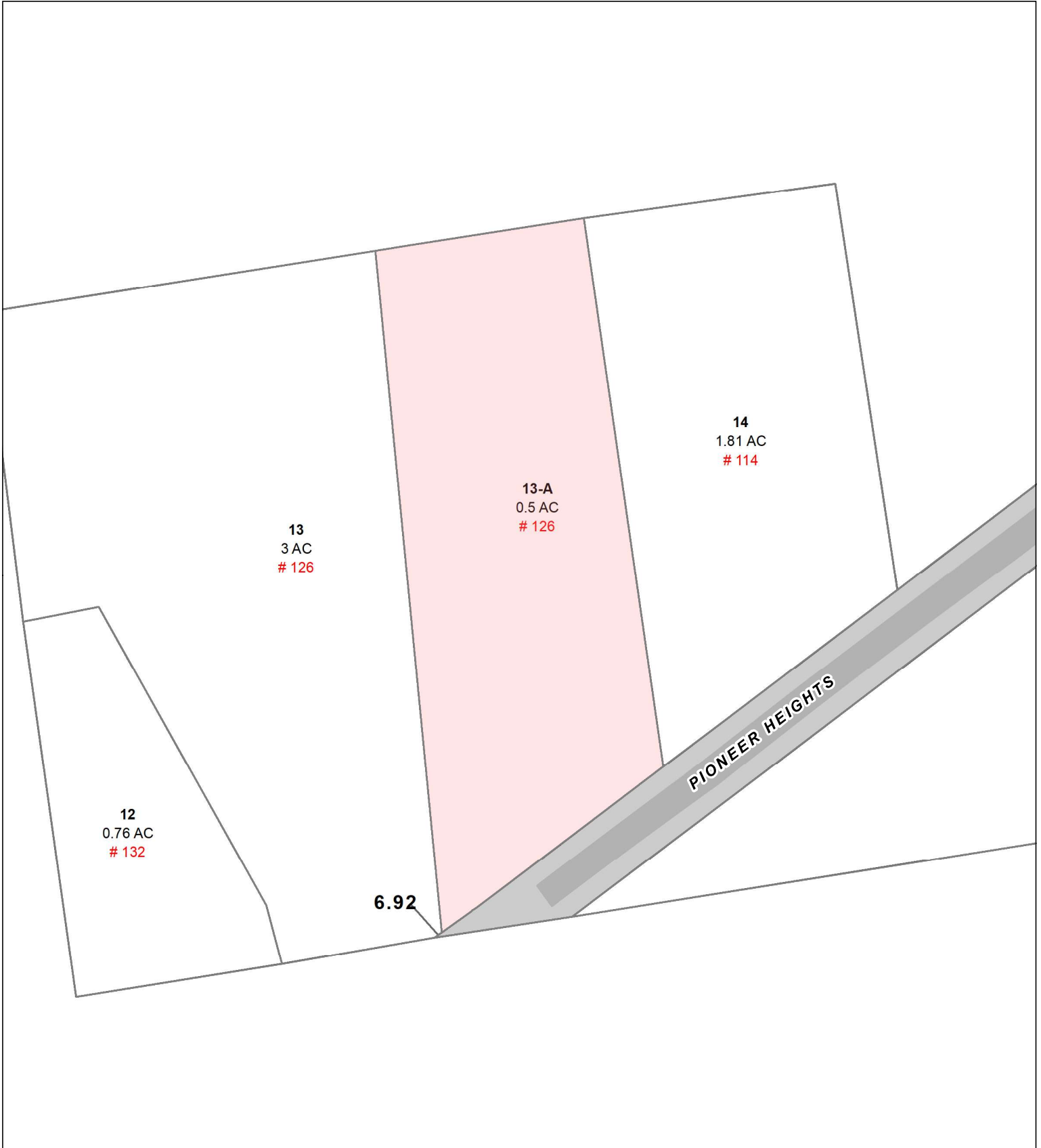

Approximate Scale: 1 inch = 100 feet

Map Produced June 2020

Disclaimer: This map is for informational purposes only. All information is subject to verification by any user. The Town of Somers and its mapping contractors assume no legal responsibility for the information contained herein.

Exhibit C

Construction Drawings

T-Mobile

T-MOBILE SITE NAME:
CROWN SOMERS LATTICE TOWER

T-MOBILE SITE NUMBER:
CTHA534A

CROWN BU: 806378 / APP#: 482056
67D95ADB CONFIGURATION

126 PIONEER HEIGHTS RD
SOMERS, CT 06071

EXISTING 160'-0" SELF-SUPPORT TOWER

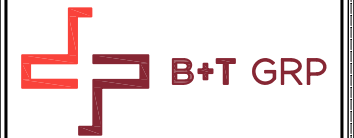

PROJECT SUMMARY

SITE TYPE: EXISTING EQUIPMENT UPGRADE
SITE ADDRESS: 126 PIONEER HEIGHTS RD
SOMERS, CT 06071
JURISDICTION: TOLLAND COUNTY

NAD83
LATITUDE: 41.948700° N
LONGITUDE: 72.492400° W
TOWER OWNER: CROWN CASTLE
3200 HORIZON DRIVE, SUITE 150
KING OF PRUSSIA, PA 19406
JASON SMITH
(610) 635-3225

CUSTOMER/APPLICANT: T-MOBILE
4 SYLVAN WAY
PARSIPPANY, NJ 07054
(973) 397-4800

OCCUPANCY TYPE: UNMANNED
A.D.A. COMPLIANCE: FACILITY IS UNMANNED AND NOT
FOR HUMAN HABITATION

LOCATION MAP

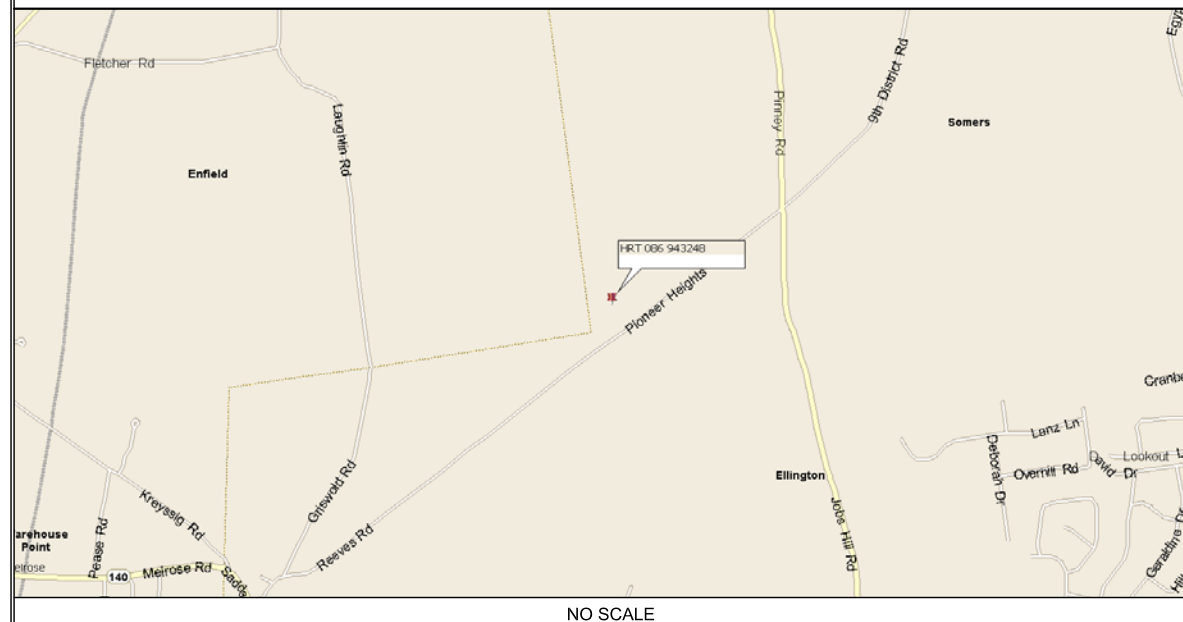

NO SCALE

DRAWING INDEX

SHEET #	SHEET DESCRIPTION	REV. #
T-1	TITLE SHEET	1
A-1	OVERALL SITE PLAN	1
A-2	ANTENNA/CABLE SCHEDULE AND AZIMUTH PLANS	1
A-3	TOWER ELEVATION	1
A-4	ANTENNA AND RRU DETAILS	1
E-1	PANEL SCHEDULE AND ONE-LINE DIAGRAM	1

CTHA534A
BU #: 806378
CROWN SOMERS LATTICE TOWER
126 PIONEER HEIGHTS RD
SOMERS, CT 06071
EXISTING 160'-0" SELF-SUPPORT TOWER

PROJECT NO: 136290.001.01
CHECKED BY: GEH

ISSUED FOR:			
REV	DATE	DRWN	DESCRIPTION
0	6/17/19	RFC	CONSTRUCTION
1	7/17/19	JJD	CONSTRUCTION

CONTACT INFORMATION

A&E FIRM: B+T GROUP
1717 S. BOULDER, STE. 300
TULSA, OK 74119
CONTACT: MIKE OAKES
PHONE: (918) 587-4630
ELECTRIC PROVIDER: N/A
TELCO PROVIDER: AT&T
855-637-9527

DRIVING DIRECTIONS

DEPART FROM BRADLEY INTERNATIONAL AIRPORT ON TERMINAL RD. ROAD NAME CHANGES TO BRADLEY FIELD CONNECTOR. ROAD NAME CHANGES TO CT-20 [BRADLEY FIELD CONNECTOR]. TAKE RAMP (LEFT) ONTO I-91. AT EXIT 45, TURN RIGHT ONTO RAMP. TURN RIGHT ONTO CT-140 [BRIDGE ST]. KEEP STRAIGHT ONTO CT-140 [NORTH RD]. BEAR LEFT ONTO CT-140 [CT-191]. TURN RIGHT ONTO CT-140 [MELROSE RD]. KEEP STRAIGHT ONTO CT-140 [SADDS MILL RD]. TURN LEFT ONTO REEVES RD. TURN LEFT ONTO LOCAL ROAD(S) AND ARRIVE AT CROWN SOMERS LATTICE TOWER.

A/E DOCUMENT REVIEW STATUS

TITLE	SIGNATURE	DATE
T-MOBILE PROP:		
T-MOBILE R.F. MGR.:		
T-MOBILE NetOps:		
T-MOBILE CONST. MGR.:		
INTERCONNECT:		
T-MOBILE SITE DEV. MGR.:		
PROPERTY OWNER:		
PLANNING:		

THE FOLLOWING PARTIES HEREBY APPROVE AND ACCEPT THESE DOCUMENTS AND AUTHORIZE THE CONTRACTOR TO PROCEED WITH THE CONSTRUCTION DESCRIBED HEREIN. ALL DOCUMENTS ARE SUBJECT TO REVIEW BY THE LOCAL BUILDING DEPARTMENT AND MAY IMPOSE CHANGES OR MODIFICATIONS.

CODE COMPLIANCE

ALL WORK SHALL BE PERFORMED AND MATERIALS INSTALLED IN ACCORDANCE WITH THE CURRENT EDITIONS OF THE FOLLOWING CODES AS ADOPTED BY THE LOCAL GOVERNING AUTHORITIES. NOTHING IN THESE PLANS IS TO BE CONSTRUED TO PERMIT WORK NOT CONFORMING TO THESE CODES:

CODE TYPE	CODE
BUILDING/DWELLING	IBC 2015
STRUCTURAL	IBC 2015
MECHANICAL	IMC 2015
ELECTRICAL	NEC 2017

PROJECT DESCRIPTION

- THE PROPOSED PROJECT INCLUDES:
- REMOVE (3) EXISTING ANTENNAS AT 114'-0".
 - REMOVE (9) EXISTING COAXIAL LINES.
 - REMOVE AND REPLACE (3) EXISTING SECTOR MOUNTS.
 - REPLACE (3) EXISTING HYBRIDS.
 - REPLACE EXISTING CABINET WITH (1) NEW RBS 6102 CABINET.
 - INSTALL (6) NEW ANTENNAS AT 114'-0".
 - INSTALL (3) NEW RRUS AT 114'-0".
 - INSTALL (3) NEW 6x12 HYBRID CABLE FOR NEW ANTENNAS.
 - REPLACE (1) DUS41 WITH (2) BB 6630

DO NOT SCALE DRAWINGS

ALL DRAWINGS CONTAINED HEREIN ARE FORMATTED FOR 11X17. CONTRACTOR SHALL VERIFY ALL PLANS AND EXISTING DIMENSIONS AND CONDITIONS ON THE JOB SITE AND SHALL IMMEDIATELY NOTIFY THE ENGINEER IN WRITING OF ANY DISCREPANCIES BEFORE PROCEEDING WITH THE WORK OR BE RESPONSIBLE FOR SAME.



CALL CONNECTICUT ONE CALL
(800) 922-4455
CALL 3 WORKING DAYS
BEFORE YOU DIG!



B&T ENGINEERING, INC.
PEC.0001564
Expires 2/10/20



IT IS A VIOLATION OF LAW FOR ANY PERSON, UNLESS THEY ARE ACTING UNDER THE DIRECTION OF A LICENSED PROFESSIONAL ENGINEER, TO ALTER THIS DOCUMENT.

SHEET NUMBER: **T-1** REVISION: **1**

136290_806378_HRT 086 943248.dwg - Sheet:A-1 - User: ghoyes - Jul 18, 2019 - 8:54am

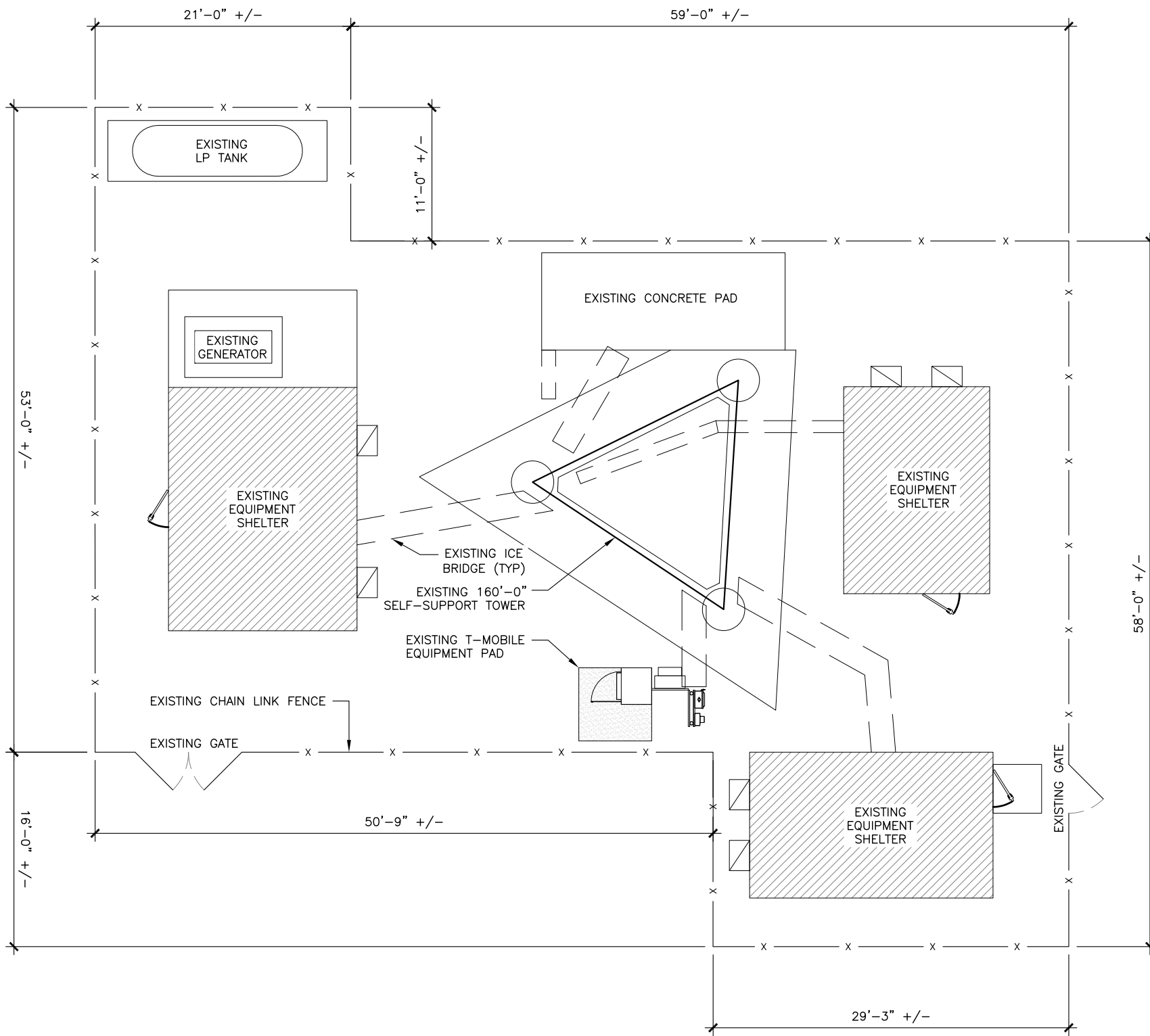

1 OVERALL SITE PLAN
 SCALE: 0' 4' 8' 16' 32'



- GENERAL NOTES:**
- SUBJECT PROPERTY IS KNOWN AS BLOCK TBD LOT TBD AS SHOWN ON THE SOMERS TOWNSHIP TAX MAP AND IS SITUATED AT 126 PIONEER HEIGHTS RD, SOMERS, CT 06071.
 - APPLICANT: T-MOBILE
 A DELAWARE LIMITED LIABILITY COMPANY
 4 SYLVAN WAY
 PARSIPPANY, NEW JERSEY 07054
 (973) 397-4800

 TOWER OWNER: CROWN CASTLE INTERNATIONAL
 - THE APPLICANT IS TO UPDATE THEIR NETWORK BY INSTALLING SIX (6) NEW PANEL ANTENNAS, THREE (3) RRUS, AND REPLACING THREE (3) HYBRID CABLES MOUNTED ON AN EXISTING SELF-SUPPORT TOWER.
 - THIS FACILITY SHALL BE VISITED ON THE AVERAGE OF ONCE A MONTH FOR MAINTENANCE AND SHALL BE MONITORED FROM A REMOTE FACILITY.
 - THE EXISTING SITE IS LOCATED AT LATITUDE OF 41.948700' N± AND LONGITUDE OF 72.492400' W±. THE HORIZONTAL DATUM ARE IN TERMS OF NORTH AMERICAN DATUM OF 1983 (NAD 83).
 - THIS SET OF PLANS HAS BEEN PREPARED FOR THE PURPOSES OF MUNICIPAL AND AGENCY REVIEW AND APPROVAL. THIS SET OF PLANS SHALL NOT BE UTILIZED AS CONSTRUCTION DOCUMENTS UNTIL ALL CONDITIONS OF APPROVAL HAVE BEEN SATISFIED AND EACH OF THE DRAWINGS HAVE BEEN REVISED TO INDICATED "ISSUED FOR CONSTRUCTION"
 - ALL MATERIALS, WORKMANSHIP, AND CONSTRUCTION FOR THE SITE IMPROVEMENTS SHOWN HEREON SHALL BE IN ACCORDANCE WITH:
 - CURRENT PREVAILING MUNICIPAL AND/OR COUNTY SPECIFICATIONS, STANDARDS, AND REQUIREMENTS.
 - CURRENT PREVAILING UTILITY COMPANY AUTHORITY SPECIFICATIONS, STANDARDS AND REQUIREMENTS.
 - THE CONTRACTOR SHALL NOTIFY B+T GROUP, P.A. IMMEDIATELY IF ANY FIELD-CONDITIONS ENCOUNTERED DIFFER FROM THOSE REPRESENTED HEREON, AND/OR IF SUCH CONDITIONS WOULD OR COULD RENDER THE DESIGNS SHOWN HEREON INAPPROPRIATE AND/OR INEFFECTIVE.
 - THE CONTRACTOR IS RESPONSIBLE TO PROTECT, REPAIR AND/OR REPLACE ANY DAMAGED STRUCTURES, UTILITIES OR LANDSCAPED AREA WHICH MAY BE DISTURBED DURING THE CONSTRUCTION OF THIS FACILITY.
 - THE CONSTRUCTION CONTRACTOR IS SOLELY RESPONSIBLE FOR DETERMINING ALL CONSTRUCTION MEANS AND METHODS. THE CONSTRUCTION CONTRACTOR IS ALSO RESPONSIBLE FOR ALL JOB SITE SAFETY.
 - SITE INFORMATION SHOWN TAKEN FROM CROWN CASTLE SITE PLANS AND FROM CROWN CASTLE INSPECTION PHOTOS.
 - NO GUARANTEE IS MADE NOR SHOULD BE ASSUMED AS TO THE COMPLETENESS OR ACCURACY OF THE HORIZONTAL OR VERTICAL LOCATIONS. ALL PARTIES UTILIZING THIS INFORMATION SHALL FIELD VERIFY THE ACCURACY AND COMPLETENESS OF THE INFORMATION SHOWN PRIOR TO CONSTRUCTION ACTIVITIES.
 - ALL IMPROVEMENTS SHALL BE SUBJECT TO INSPECTION AND APPROVAL BY THE TOWNSHIP ENGINEER WHO WILL BE GIVEN PROPER NOTIFICATION PRIOR TO THE START OF ANY CONSTRUCTION.

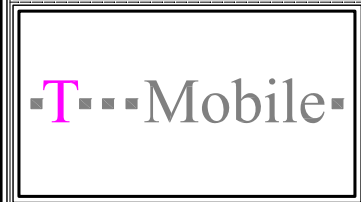

CTHA534A
 BU #: 806378
 CROWN SOMERS LATTICE TOWER
 126 PIONEER HEIGHTS RD
 SOMERS, CT 06071
 EXISTING 160'-0" SELF-SUPPORT TOWER

PROJECT NO: 136290.001.01
 CHECKED BY: GEH

ISSUED FOR:

REV	DATE	DRWN	DESCRIPTION
0	6/17/19	RFC	CONSTRUCTION
1	7/17/19	JJD	CONSTRUCTION

B&T ENGINEERING, INC.
 PEC.0001564
 Expires 2/10/20



IT IS A VIOLATION OF LAW FOR ANY PERSON, UNLESS THEY ARE ACTING UNDER THE DIRECTION OF A LICENSED PROFESSIONAL ENGINEER, TO ALTER THIS DOCUMENT.

SHEET NUMBER: **A-1** REVISION: **1**



CTHA534A
 BU #: 806378
 CROWN SOMERS LATTICE TOWER
 126 PIONEER HEIGHTS RD
 SOMERS, CT 06071
 EXISTING 160'-0" SELF-SUPPORT TOWER

PROJECT NO: 136290.001.01
 CHECKED BY: GEH

ISSUED FOR:			
REV	DATE	DRWN	DESCRIPTION
0	6/17/19	RFC	CONSTRUCTION
1	7/17/19	JJD	CONSTRUCTION

B&T ENGINEERING, INC.
 PEC.0001564
 Expires 2/10/20



IT IS A VIOLATION OF LAW FOR ANY PERSON, UNLESS THEY ARE ACTING UNDER THE DIRECTION OF A LICENSED PROFESSIONAL ENGINEER, TO ALTER THIS DOCUMENT.

SHEET NUMBER: **A-2** REVISION: **1**

ANTENNA AND CABLE SCHEDULE											
SECTOR	POSITION	EXISTING ANTENNAS	PROPOSED ANTENNA CONFIGURATION		E-TILT	M-TILT	ANTENNA CENTERLINE	TMA/RRU	CABLES	JUMPER TYPE	CABLE LENGTH
90° - ALPHA	A1	ERICSSON-AIR21 KRC118023-1_B2P_B4A	U2100	-	2'	0'	114'-0"	0/0	-	1/2" COAX	-
	A2	RFS APXVAARR24_43-U-NA20	L600 L700	B71 + B12	2'	0'		0/1	(1) 1 5/8" HYBRID FIBER TRUNK	DC/FIBER & 1/2" COAX	190'-0"
	A3	ERICSSON - AIR32 KRD901146-1_B66A_B2A	L1900 L2100	-	2'	0'		0/0	-	DC/FIBER	-
210° - BETA	B1	ERICSSON-AIR21 KRC118023-1_B2P_B4A	U2100	-	2'	0'	114'-0"	0/0	-	1/2" COAX	-
	B2	RFS APXVAARR24_43-U-NA20	L600 L700	B71 + B12	2'	0'		0/1	(1) 1 5/8" HYBRID FIBER TRUNK	DC/FIBER & 1/2" COAX	190'-0"
	B3	ERICSSON - AIR32 KRD901146-1_B66A_B2A	L1900 L2100	-	2'	0'		0/0	-	DC/FIBER	-
330° - GAMMA	G1	ERICSSON-AIR21 KRC118023-1_B2P_B4A	U2100	-	2'	0'	114'-0"	0/0	-	1/2" COAX	-
	G2	RFS APXVAARR24_43-U-NA20	L600 L700	B71 + B12	2'	0'		0/1	(1) 1 5/8" HYBRID FIBER TRUNK	DC/FIBER & 1/2" COAX	190'-0"
	G3	ERICSSON - AIR32 KRD901146-1_B66A_B2A	L1900 L2100	-	2'	0'		0/0	-	DC/FIBER	-

LEGEND	
EXISTING/DEMOLITION NOTES	INSTALLATION NOTES
(A) EXISTING ERICSSON - AIR21 KRC118023-1_B2PB4A ANTENNA TO REMAIN (TOTAL OF 3)	(1) INSTALL RFS APXVAARR24_43-U-NA20 (8 FT) ANTENNAS. PROVIDE NEW 2 7/8" OD SCH.40 PIPE MAST (LENGTH TO BE V.I.F) (TYP. OF 1 PER SECTOR, TOTAL OF 3)
(B) EXISTING ERICSSON - AIR21 KRC118023-1_B2PB4A ANTENNA TO BE REMOVED (TOTAL OF 3)	(2) INSTALL ERICSSON - AIR32 KRD901146-1_B66A_B2A ANTENNAS ON EXISTING MOUNT. (TYP. OF 1 PER SECTOR, TOTAL OF 3)
(C) EXISTING COAX CABLES TO BE REMOVED (TOTAL OF 9)	(3) INSTALL RADIO 4449 B12/B71 (TYP. OF 1 PER SECTOR, TOTAL OF 3)
(D) EXISTING 3x6 HYBRID CABLES TO BE REMOVED (TOTAL OF 3)	(4) INSTALL (3) 1 5/8" 6x12 HCS HYBRID FIBER TRUNK. FROM EQUIPMENT TO ANTENNAS FOLLOWING EXISTING ROUTING
(E) EXISTING (1) DUS41 TO BE REMOVED	(5) INSTALL (2) NEW BB6630
(F) EXISTING RBS 6201 CABINET TO BE REMOVED	(6) INSTALL (1) NEW RBS 6102 CABINET
(G) EXISTING (3) SECTOR MOUNTS TO BE REMOVED	(7) INSTALL (3) NEW VFA12-HD SECTOR MOUNTS

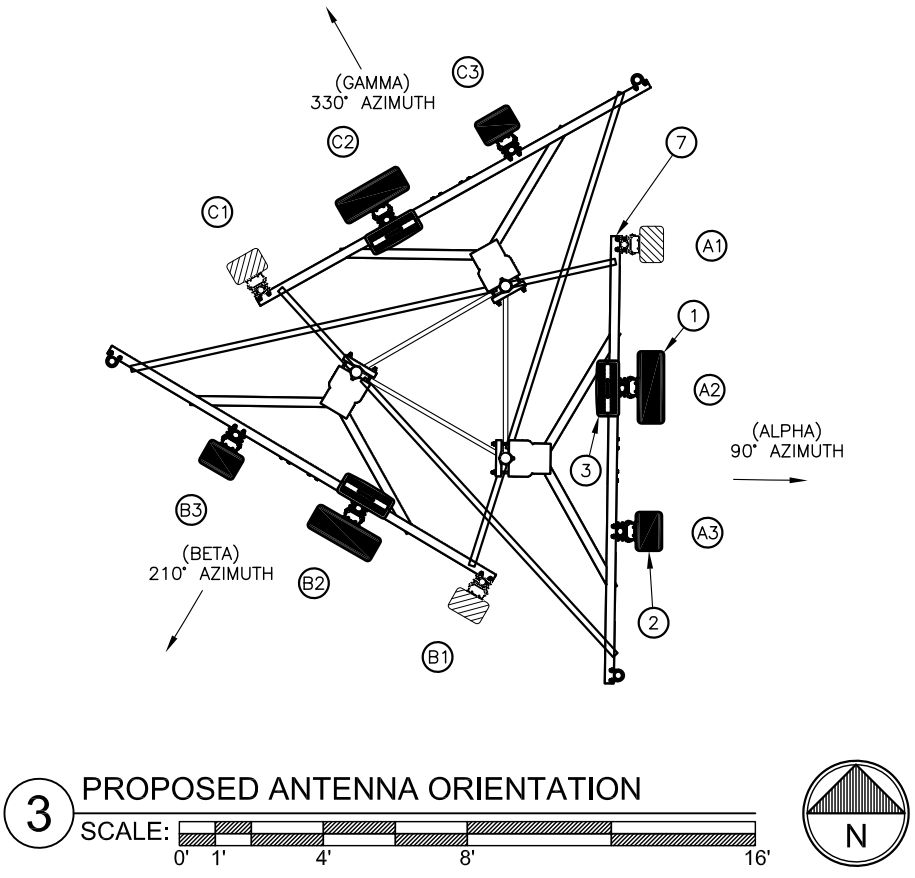
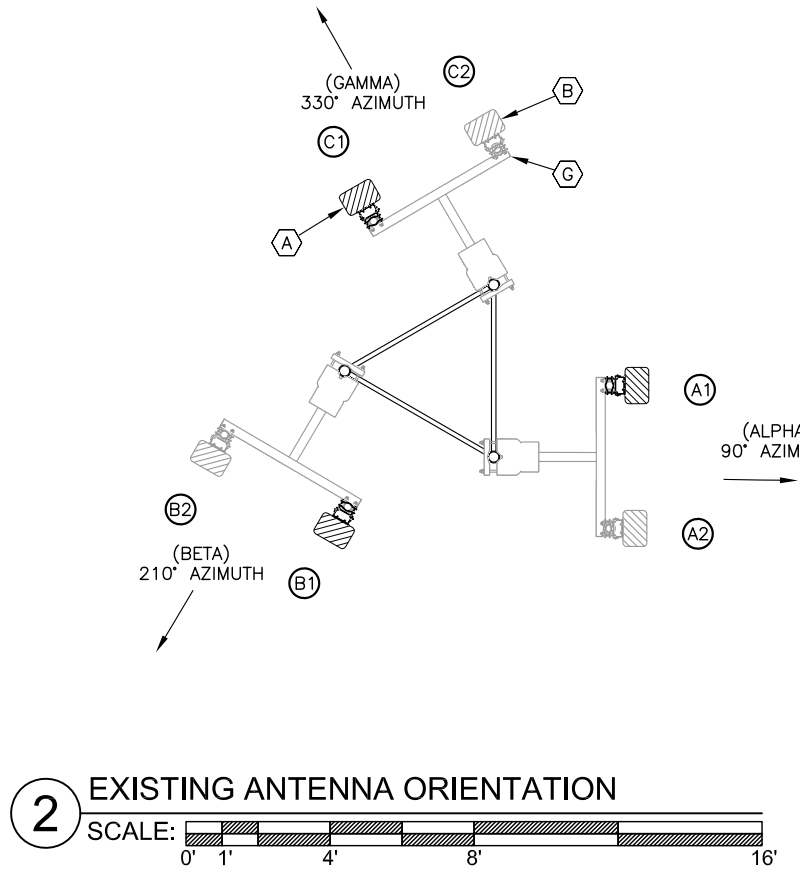
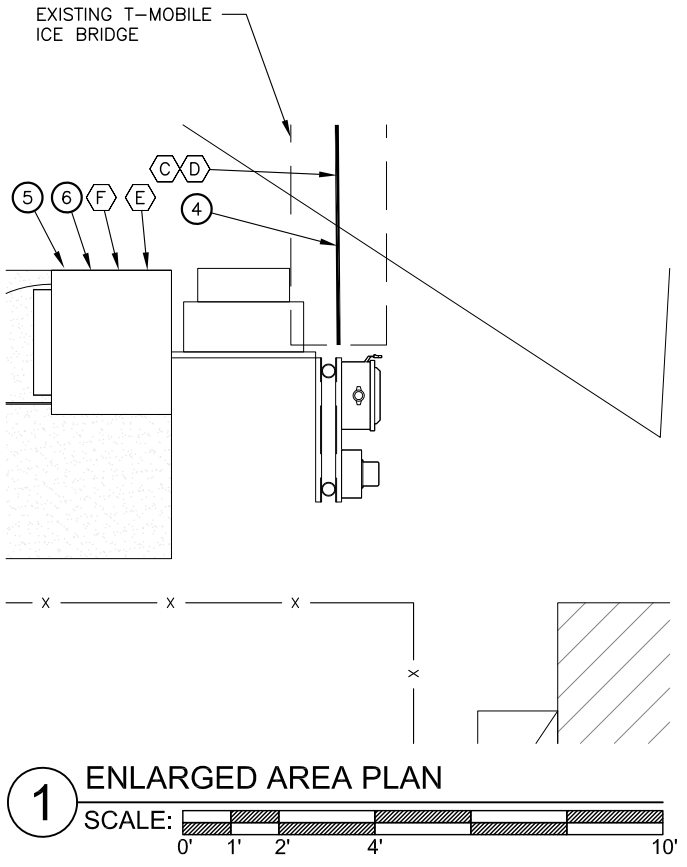

136290_806378_HRT 086 943248.dwg - Sheet-A-2 - User: ghoyes - Jul 18, 2019 - 8:54am

136290_806378_HRT 086 943248.dwg - Sheet:A-3 - User: ghoyes - Jul 18, 2019 - 8:54am

LEGEND	
EXISTING/DEMOLITION NOTES	INSTALLATION NOTES
(A) EXISTING ERICSSON - AIR21 KRC118023-1_B2PB4A ANTENNA TO REMAIN (TOTAL OF 3)	(1) INSTALL RFS APXVAARR24_43-U-NA20 (8 FT) ANTENNAS. PROVIDE NEW 2 7/8" OD SCH.40 PIPE MAST (LENGTH TO BE V.I.F) (TYP. OF 1 PER SECTOR, TOTAL OF 3)
(B) EXISTING ERICSSON - AIR21 KRC118023-1_B2PB4A ANTENNA TO BE REMOVED (TOTAL OF 3)	(2) INSTALL ERICSSON - AIR32 KRD901146-1_B66A_B2A ANTENNAS ON EXISTING MOUNT. (TYP. OF 1 PER SECTOR, TOTAL OF 3)
(C) EXISTING COAX CABLES TO BE REMOVED (TOTAL OF 9)	(3) INSTALL RADIO 4449 B12/B71 (TYP. OF 1 PER SECTOR, TOTAL OF 3)
(D) EXISTING 3x6 HYBRID CABLES TO BE REMOVED (TOTAL OF 3)	(4) INSTALL (3) 1 5/8" 6x12 HCS HYBRID FIBER TRUNK. FROM EQUIPMENT TO ANTENNAS FOLLOWING EXISTING ROUTING
(E) EXISTING (1) DUS41 TO BE REMOVED	(5) INSTALL (2) NEW BB6630
(F) EXISTING RBS 6201 CABINET TO BE REMOVED	(6) INSTALL (1) NEW RBS 6102 CABINET
(G) EXISTING (3) SECTOR MOUNTS TO BE REMOVED	(7) INSTALL (3) NEW VFA12-HD SECTOR MOUNTS

PROPOSED MOUNT IS SUFFICIENT PER MOUNT ANALYSIS BY MASTEC NETWORK SOLUTIONS DATED 6/6/19.

EXISTING TOWER IS SUFFICIENT PER STRUCTURAL ANALYSIS BY PAUL J. FORD DATED 5/20/19.

LEGEND:

-  NEW
-  EXISTING
-  FUTURE

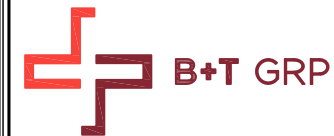
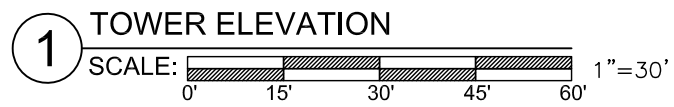
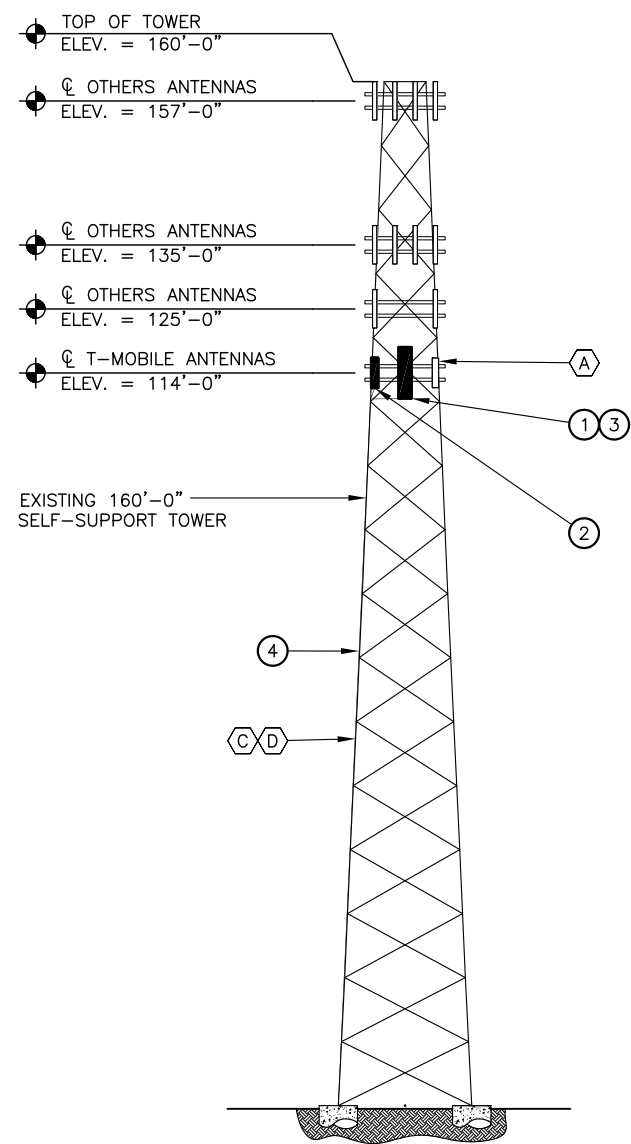

CTHA534A
 BU #: 806378
 CROWN SOMERS LATTICE TOWER
 126 PIONEER HEIGHTS RD
 SOMERS, CT 06071
 EXISTING 160'-0" SELF-SUPPORT TOWER

PROJECT NO: 136290.001.01
 CHECKED BY: GEH

ISSUED FOR:			
REV	DATE	DRWN	DESCRIPTION
0	6/17/19	RFC	CONSTRUCTION
1	7/17/19	JJD	CONSTRUCTION

B&T ENGINEERING, INC.
 PEC.0001564
 Expires 2/10/20



IT IS A VIOLATION OF LAW FOR ANY PERSON, UNLESS THEY ARE ACTING UNDER THE DIRECTION OF A LICENSED PROFESSIONAL ENGINEER, TO ALTER THIS DOCUMENT.

SHEET NUMBER: **A-3** REVISION: **1**



CTHA534A
 BU #: 806378
 CROWN SOMERS LATTICE TOWER
 126 PIONEER HEIGHTS RD
 SOMERS, CT 06071
 EXISTING 160'-0" SELF-SUPPORT TOWER

PROJECT NO: 136290.001.01
 CHECKED BY: GEH

ISSUED FOR:

REV	DATE	DRWN	DESCRIPTION
0	6/17/19	RFK	CONSTRUCTION
1	7/17/19	JJD	CONSTRUCTION

B&T ENGINEERING, INC.
 PEC.0001564
 Expires 2/10/20



IT IS A VIOLATION OF LAW FOR ANY PERSON, UNLESS THEY ARE ACTING UNDER THE DIRECTION OF A LICENSED PROFESSIONAL ENGINEER, TO ALTER THIS DOCUMENT.

SHEET NUMBER: **A-4** REVISION: **1**

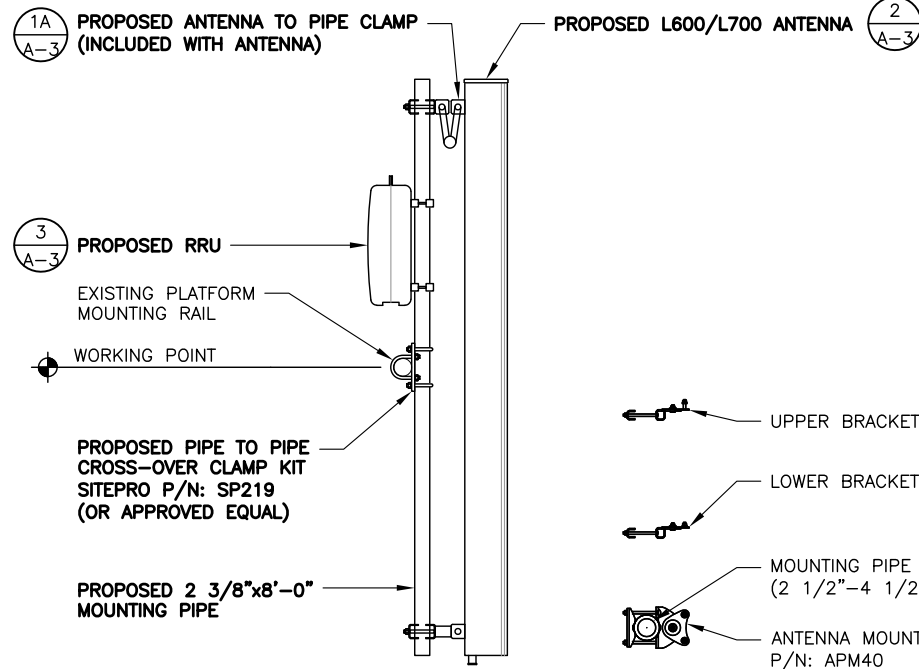

1 PROPOSED ANTENNA & RRU MOUNTING DETAIL
 SCALE: N.T.S.

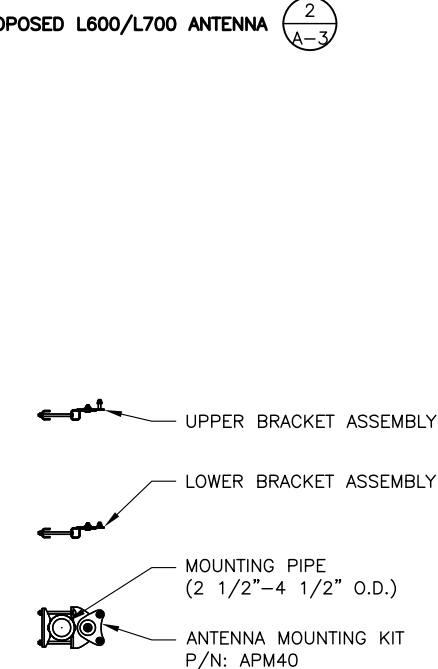

1A ANTENNA MOUNTING BRACKET
 SCALE: N.T.S.

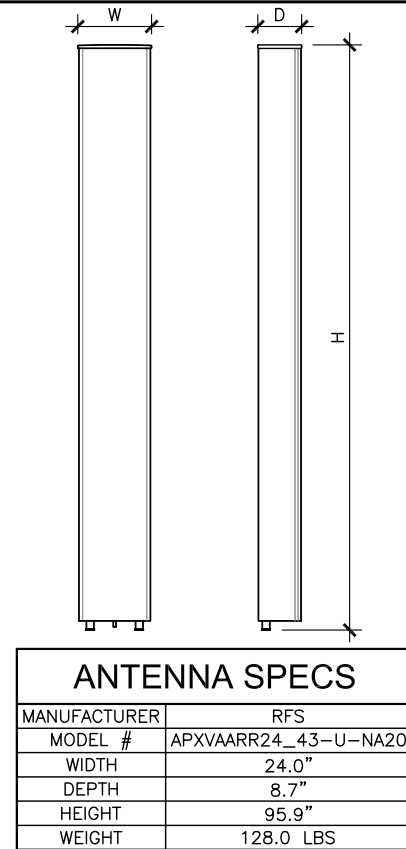

2 L700/L600 ANTENNA DETAIL
 SCALE: N.T.S.

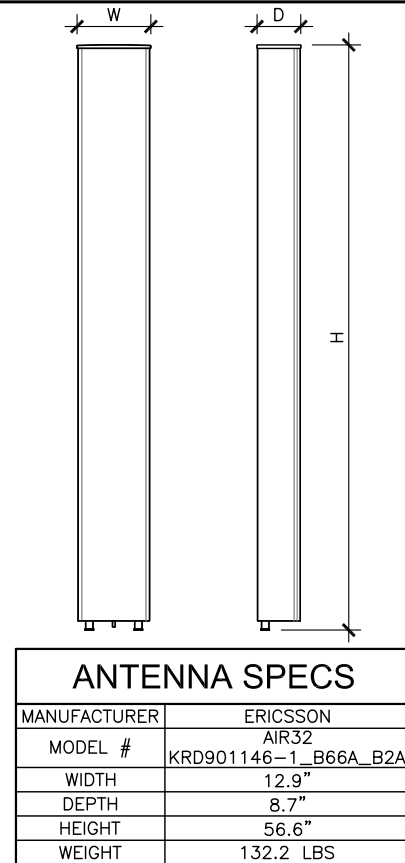

3 L2100/L1900 ANTENNA DETAIL
 SCALE: N.T.S.

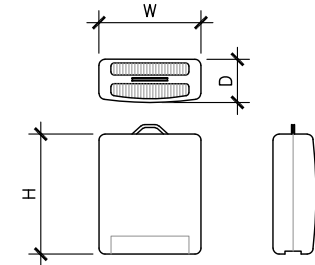

RRU SPECIFICATIONS

MANUFACTURER	ERICSSON
MODEL #	4449
WIDTH	13.2"
DEPTH	9.3"
HEIGHT	14.9"
WEIGHT	75 LBS

4 REMOTE RADIO UNIT (RRU)
 SCALE: N.T.S.

- NOTES:
- TAG ALL EXISTING AND PROPOSED CABLES/JUMPERS PER T-MOBILE SPECIFICATIONS.
 - SEE RF SCHEDULE FOR CABLE AND JUMPER LENGTHS.
 - REFER TO ANTENNA ORIENTATION ON SHEET C-3 FOR EXACT ANTENNA POSITIONING.

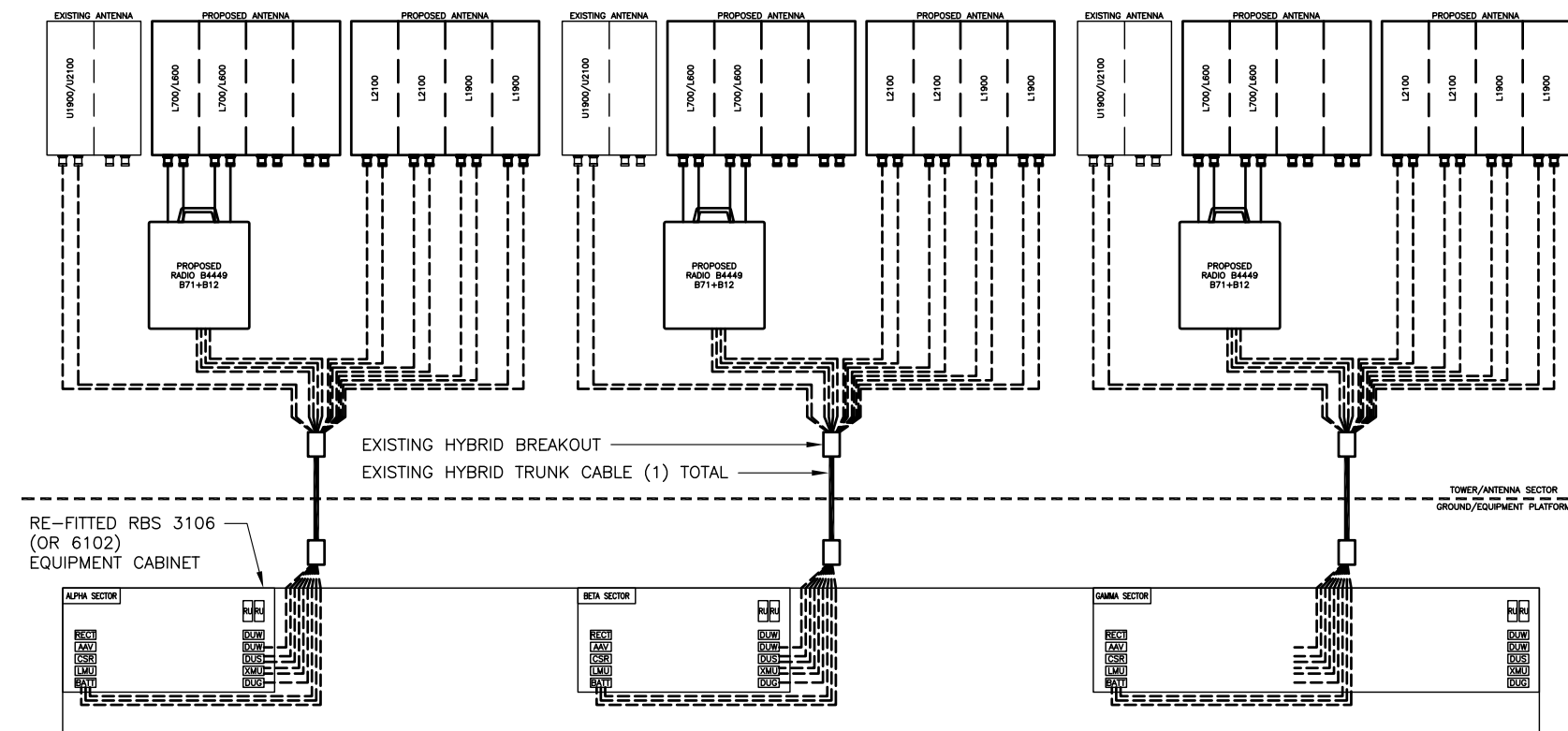

5 ANTENNA & CABLING SCHEMATIC
 SCALE: N.T.S.

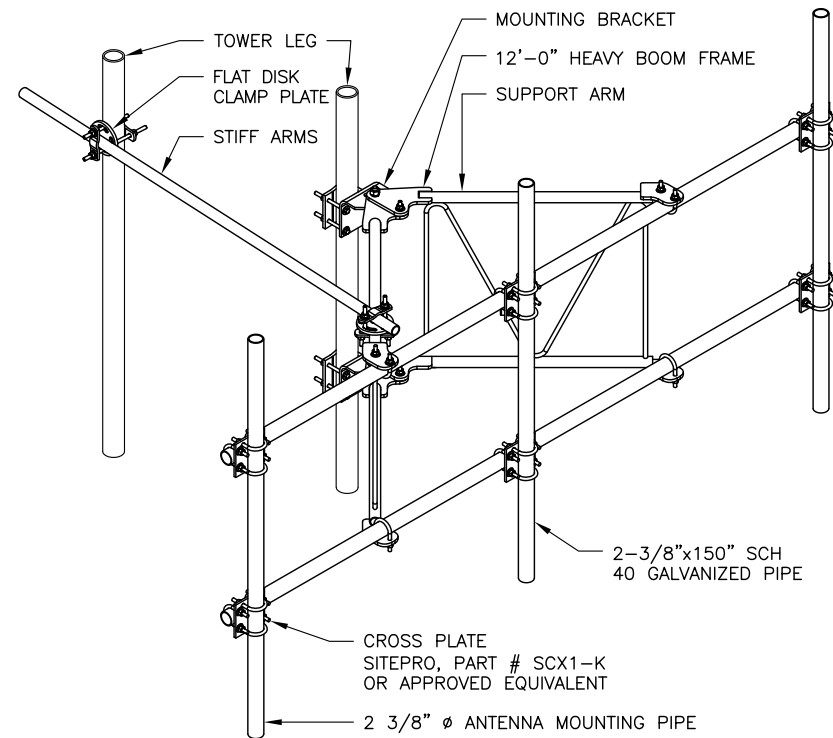

6 SECTOR MOUNT DETAIL
 SCALE: N.T.S.



FINAL PANEL SCHEDULE								
LOAD	POLES	AMPS	BUS			AMPS	POLES	LOAD
			L1	L2	L3			
TVSS	2	30	1	2		100	2	BTS1
			3	4				GFCI BELOW
			5	6		20	1	FIBER CAB
			7	8		20	1	

RATED VOLTAGE: 120/240 _____ 3 PHASE, 4 WIRE
 BRANCH POLES: 12 24 30 42 APPROVED MF'RS
 RATED AMPS: 100 225 400 _____ CABINET: SURFACE FLUSH NEMA 1 3R 4X
 MAIN LUGS ONLY MAIN 225 AMPS BREAKER FUSED SWITCH HINGED DOOR KEYPED DOOR LATCH
 FUSED CIRCUIT BREAKER BRANCH DEVICES _____ TO BE GFCI BREAKERS FULL NEUTRAL BUS GROUND BAR
 ALL BREAKERS MUST BE RATED TO INTERRUPT A SHORT CIRCUIT ISC OF 10,000 AMPS SYMMETRICAL

REPLACE EXISTING 60A BREAKER WITH NEW 100A BREAKER
 REPLACE EXISTING WIRES FOR EXISTING 6102 CABINET WITH (3) 2/0 AWG THWN (COPPER) AND (1) #6G AWG. MINIMUM CONDUIT SIZE TO BE 2"
 FINAL PANEL DESIGN AND CALCULATIONS FOR WIRE SIZE WERE BASED OFF OF EXISTING PHOTOS

1 FINAL T-MOBILE PANEL DETAIL
SCALE: N.T.S.

CTHA534A
 BU #: 806378
 CROWN SOMERS LATTICE TOWER
 126 PIONEER HEIGHTS RD
 SOMERS, CT 06071
 EXISTING 160'-0" SELF-SUPPORT TOWER

PROJECT NO: 136290.001.01
 CHECKED BY: GEH

ISSUED FOR:			
REV	DATE	DRWN	DESCRIPTION
0	6/17/19	RFC	CONSTRUCTION
1	7/17/19	JJD	CONSTRUCTION

B&T ENGINEERING, INC.
 PEC.0001564
 Expires 2/10/20



IT IS A VIOLATION OF LAW FOR ANY PERSON,
 UNLESS THEY ARE ACTING UNDER THE DIRECTION
 OF A LICENSED PROFESSIONAL ENGINEER,
 TO ALTER THIS DOCUMENT.

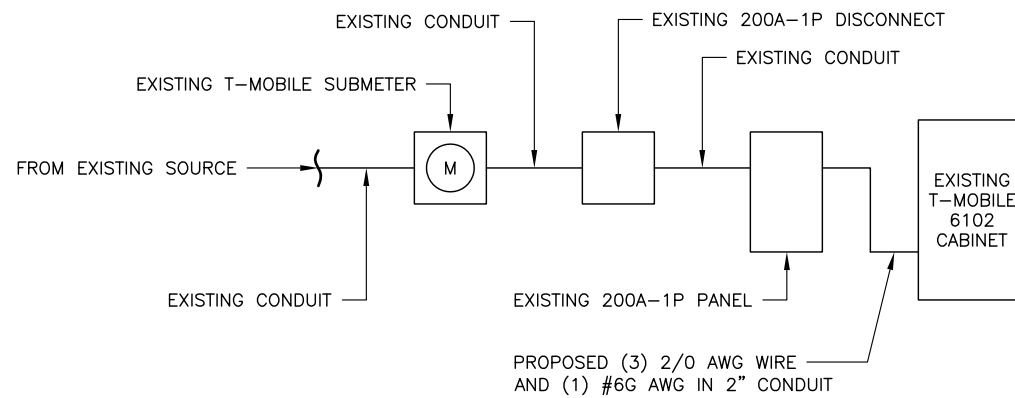

2 ONE-LINE DIAGRAM
SCALE: N.T.S.

SHEET NUMBER: E-1
 REVISION: 1

Exhibit D

Structural Analysis Report

Date: **May 20, 2019**

Amanda D Brown
Crown Castle
3530 Toringdon Way
Charlotte, NC 28277

Paul J. Ford and Company
250 East Broad St., Suite 600
Columbus, OH 43215
(614) 221-6679

Subject: Structural Analysis Report

Carrier Designation: Metro PCS Co-Locate
Carrier Site Number: CTHA534A
Carrier Site Name: Crown Somers Lattice Tower

Crown Castle Designation: Crown Castle BU Number: 806378
Crown Castle Site Name: HRT 086 943248
Crown Castle JDE Job Number: 560995
Crown Castle Work Order Number: 1740509
Crown Castle Order Number: 482056 Rev. 1

Engineering Firm Designation: Paul J. Ford and Company Project Number: 37519-1552.002.8700

Site Data: 126 PIONEER HEIGHTS RD, SOMERS, Tolland County, CT
Latitude 41° 56' 55.98", Longitude -72° 29' 31.55"
160 Foot - Self Support Tower

Dear Amanda D Brown,

Paul J. Ford and Company is pleased to submit this "Structural Analysis Report" to determine the structural integrity of the above mentioned tower.

The purpose of the analysis is to determine acceptability of the tower stress level. Based on our analysis we have determined the tower stress level for the structure and foundation, under the following load case, to be:

LC5: Proposed Equipment Configuration

Sufficient Capacity – 94.3%

This analysis utilizes an ultimate 3-second gust wind speed of 125 mph as required by the 2018 Connecticut State Building Code and Appendix N. Applicable Standard references and design criteria are listed in Section 2 - Analysis Criteria.

Respectfully submitted by:

Michael T Bange

Michael Bange, EI
Structural Designer
mbange@pauljford.com JPJ



Joseph Pachicaran Jacobs

MAY 21 2019

TABLE OF CONTENTS

1) INTRODUCTION

2) ANALYSIS CRITERIA

Table 1 - Proposed Equipment Configuration

Table 2 - Other Considered Equipment

3) ANALYSIS PROCEDURE

Table 3 - Documents Provided

3.1) Analysis Method

3.2) Assumptions

4) ANALYSIS RESULTS

Table 4 - Section Capacity (Summary)

Table 5 – Tower Component Stresses vs. Capacity

4.1) Recommendations

5) APPENDIX A

tnxTower Output

6) APPENDIX B

Base Level Drawing

7) APPENDIX C

Additional Calculations

1) INTRODUCTION

This tower is a 160 ft Self Support tower designed by ROHN in December of 1986. The tower has been modified multiple times to accommodate additional loading.

2) ANALYSIS CRITERIA

TIA-222 Revision:	TIA-222-H
Risk Category:	II
Wind Speed:	125 mph
Exposure Category:	C
Topographic Factor:	1
Ice Thickness:	2 in
Wind Speed with Ice:	50 mph
Service Wind Speed:	60 mph

Table 1 - Proposed Equipment Configuration

Mounting Level (ft)	Center Line Elevation (ft)	Number of Antennas	Antenna Manufacturer	Antenna Model	Number of Feed Lines	Feed Line Size (in)
113.0	114.0	2	ericsson	AIR 32 B2A/B66AA w/ Mount Pipe	3	1-5/8
		1	ericsson	AIR 32 B2A/B66AA w/ Mount Pipe		
		3	ericsson	ERICSSON AIR 21 B4A B2P w/ Mount Pipe		
		2	ericsson	RADIO 4449 B12/B71		
	3	rfs celwave	APXVAARR24_43-U-NA20 w/ Mount Pipe			
	113.0	1	tower mounts	Sector Mount [SM 502-3]		

Table 2 - Other Considered Equipment

Mounting Level (ft)	Center Line Elevation (ft)	Number of Antennas	Antenna Manufacturer	Antenna Model	Number of Feed Lines	Feed Line Size (in)
157.0	157.0	3	alcatel lucent	RRH2X60-PCS	20 1	1-5/8 1/2
		3	alcatel lucent	RRH2x60-AWS		
		3	andrew	LNx-6514DS-VTM w/ Mount Pipe		
		2	antel	LPA-80063/4CF w/ Mount Pipe		
		2	antel	LPA-80063/4CFx5 w/ Mount Pipe		
		6	commscope	HBXX-6517DS-VTM w/ Mount Pipe		
		2	rfs celwave	APL866513-42T6 w/ Mount Pipe		
		1	rfs celwave	DB-T1-6Z-8AB-0Z		
		1	tower mounts	Sector Mount [SM 504-3]		

Mounting Level (ft)	Center Line Elevation (ft)	Number of Antennas	Antenna Manufacturer	Antenna Model	Number of Feed Lines	Feed Line Size (in)
135.0	137.0	3	cci antennas	HPA-65R-BUU-H8 w/ Mount Pipe	2 4 12	3/8 3/4 1-1/4
		3	cci antennas	TPA-65R-LCUUUU-H8 w/ Mount Pipe		
		3	ericsson	RRUS 11		
		3	ericsson	RRUS 4415 B25		
		3	ericsson	RRUS 4426 B66		
		3	ericsson	WCS RRUS-32-B30		
		3	kaelus	DBC0062F1V51-1		
		6	powerwave technologies	7020.00		
		3	powerwave technologies	7770.00 w/ Mount Pipe		
	3	powerwave technologies	TT19-08BP111-001			
	135.0	2	raycap	DC6-48-60-18-8F		
		1	tower mounts	Sector Mount [SM 504-3]		
125.0	126.0	3	alcatel lucent	1900MHz RRH (65MHz)	1 3	5/8 1-1/4
		3	alcatel lucent	800MHz 2X50W RRH W/FILTER		
		3	alcatel lucent	TD-RRH8x20-25		
		1	rfs celwave	APXV9ERR18-C-A20 w/ Mount Pipe		
		2	rfs celwave	APXVSP18-C-A20 w/ Mount Pipe		
	3	rfs celwave	APXVTM14-C-120 w/ Mount Pipe			
	125.0	1	tower mounts	Sector Mount [SM 402-3]		
57.0	60.0	1	gps	GPS_A	1	1/2
	57.0	1	tower mounts	Side Arm Mount [SO 202-1]		
48.0	50.0	1	empty	EMPTY_MOUNT w/ Mount Pipe	1	1/2
	48.0	1	tower mounts	Side Arm Mount [SO 202-1]		

3) ANALYSIS PROCEDURE

Table 3 - Documents Provided

Document	Remarks	Reference	Source
4-GEOTECHNICAL REPORTS	FDH, 11/6/2006	1275233	CCISITES
4-TOWER MANUFACTURER DRAWINGS	Rohn 12/16/1986	7175605	CCISITES
4-TOWER REINFORCEMENT DESIGN/DRAWINGS/DATA	VSI, 11/8/2006 (PMI Included)	1278690	CCISITES
4-TOWER REINFORCEMENT DESIGN/DRAWINGS/DATA	VSI, 2/17/2011	2961397	CCISITES
4-POST-MODIFICATION INSPECTION	VSI, 9/16/2011	2961404	CCISITES
4-TOWER REINFORCEMENT DESIGN/DRAWINGS/DATA	VSI, 6/15/2012	3265393	CCISITES
4-POST-MODIFICATION INSPECTION	TEP, 2/19/2013	3684249	CCISITES
4-TOWER REINFORCEMENT DESIGN/DRAWINGS/DATA	VSI, 2/26/2015	5615504	CCISITES
4-POST-MODIFICATION INSPECTION	TEP, 8/20/2015	5852475	CCISITES
4-TOWER REINFORCEMENT DESIGN/DRAWINGS/DATA	PJF, 4/19/2018	7498454	CCISITES
4-POST-MODIFICATION INSPECTION	TEP, 11/19/2018	8011021	CCISITES

3.1) Analysis Method

tnxTower (version 8.0.5.0), a commercially available analysis software package, was used to create a three-dimensional model of the tower and calculate member stresses for various loading cases. Selected output from the analysis is included in Appendix A.

tnxTower was used to determine the loads on the modified structure. Additional calculations were performed to determine the stresses in the reinforced leg sections. These calculations are presented in Appendix C.

3.2) Assumptions

- 1) Tower and structures were built in accordance with the manufacturer's specifications.
- 2) The tower and structures have been maintained in accordance with the manufacturer's specification.
- 3) The configuration of antennas, transmission cables, mounts and other appurtenances are as specified in Tables 1 and 2 and the referenced drawings.
- 4) The existing base plate grout was considered in this analysis. Grout must be maintained and inspected periodically and must be replaced if damaged or cracked. Refer to Crown Castle document ENG-PRC-10012, Base Plate Grout Repair.

This analysis may be affected if any assumptions are not valid or have been made in error. Paul J. Ford and Company should be notified to determine the effect on the structural integrity of the tower.

4) ANALYSIS RESULTS

Table 4 - Section Capacity (Summary)

Section No.	Elevation (ft)	Component Type	Size	Critical Element	P (K)	SF*P_allow (K)	% Capacity	Pass / Fail
T1	160 - 140	Leg	Pipe 2.375" x 0.154" (2 STD)	2	-18.44	38.68	47.7	Pass
T2	140 - 135	Leg	Pipe 2.875" x 0.276" (2.5 EH)	38	-23.04	78.15	29.5	Pass
T3	135 - 130	Leg	Pipe 2.875" x 0.276" (2.5 EH)	50	-33.27	78.15	42.6	Pass
T4	130 - 125	Leg	Pipe 2.875" x 0.276" (2.5 EH)	59	-41.75	78.15	53.4	Pass
T5	125 - 120	Leg	Pipe 2.875" x 0.276" (2.5 EH)	68	-51.84	78.15	66.3	Pass
T6	120 - 113.333	Leg	Pipe 3.5" x 0.300" (3 EH)	77	-62.82	99.06	63.4	Pass
T7	113.333 - 106.667	Leg	Pipe 3.5" x 0.300" (3 EH)	86	-77.60	99.07	78.3	Pass
T8	106.667 - 100	Leg	Pipe 3.5" x 0.300" (3 EH)	95	-92.42	129.33	71.5	Pass
T9	100 - 93.333	Leg	Pipe 4" x 0.318" (3.5 EH)	107	-106.32	132.01	80.5	Pass
T10	93.333 - 86.667	Leg	Pipe 4" x 0.318" (3.5 EH)	116	-120.09	132.02	91.0	Pass
T11	86.667 - 80	Leg	Pipe 4" x 0.318" (3.5 EH)	125	-133.06	161.63	82.3	Pass
T12	80 - 73.333	Leg	Pipe 4.5" x 0.337" (4 XS)	137	-146.65	167.89	87.3	Pass
T13	73.333 - 66.667	Leg	Pipe 4.5" x 0.337" (4 XS)	146	-158.95	196.79	80.8	Pass
T14	66.667 - 60	Leg	Pipe 4.5" x 0.337" (4 XS)	158	-171.89	196.81	87.3	Pass
T15	60 - 50	Leg	Pipe 5.563" x 0.375" (5 EH)	170	-187.98	211.31	89.0	Pass
T16	50 - 40	Leg	Pipe 5.563" x 0.375" (5 EH)	179	-206.47	265.80	77.7 79.7 (b)	Pass
T17	40 - 30	Leg	Pipe 5.563" x 0.375" (5 XS)	191	-225.15	265.82	84.7	Pass
T18	30 - 20	Leg	Pipe 5.563" x 0.375" (5 XS)	203	-243.13	283.21	85.8	Pass
T19	20 - 0	Leg	BU 806378 (PJF) - 6.625"x0.34" pipe w/ 2" SR- (modified with 19.5" spacing)	245	-279.95	306.71	91.3	Pass
T1	160 - 140	Diagonal	L 1.75 x 1.75 x 3/16	10	-2.79	11.65	23.9 45.8 (b)	Pass
T2	140 - 135	Diagonal	L 1.75 x 1.75 x 3/16	45	-3.11	8.95	34.7 47.9 (b)	Pass
T3	135 - 130	Diagonal	L 1.75 x 1.75 x 3/16	54	-4.28	8.11	52.7 71.5 (b)	Pass
T4	130 - 125	Diagonal	L 1.75 x 1.75 x 3/16	63	-4.45	7.37	60.3 72.7 (b)	Pass
T5	125 - 120	Diagonal	L 2 x 2 x 3/16	72	-5.25	10.18	51.6 80.1 (b)	Pass
T6	120 - 113.333	Diagonal	L 2.5 x 2.5 x 1/4	81	-5.88	19.77	29.7 73.5 (b)	Pass
T7	113.333 - 106.667	Diagonal	L 2.5 x 2.5 x 1/4	90	-7.66	17.94	42.7 93.1 (b)	Pass
T8	106.667 - 100	Diagonal	L 2.5 x 2.5 x 1/4	99	-7.59	15.77	48.2 94.3 (b)	Pass
T9	100 - 93.333	Diagonal	L 2.5 x 2.5 x 3/16	111	-7.70	11.17	68.9	Pass
T10	93.333 - 86.667	Diagonal	L 2.5 x 2.5 x 1/4	120	-7.76	13.26	58.5	Pass
T11	86.667 - 80	Diagonal	2L 2.5 x 2.5 x 3/16 (1/4)	129	-8.52	39.79	21.4 28.9 (b)	Pass
T12	80 - 73.333	Diagonal	L 3 x 3 x 3/16	141	-8.04	15.17	53.0	Pass

Section No.	Elevation (ft)	Component Type	Size	Critical Element	P (K)	SF*P_allow (K)	% Capacity	Pass / Fail
							54.7 (b)	
T13	73.333 - 66.667	Diagonal	L 3 x 3 x 3/16	150	-9.01	13.95	64.6	Pass
T14	66.667 - 60	Diagonal	L 3 x 3 x 3/16	162	-8.84	12.86	68.7	Pass
T15	60 - 50	Diagonal	2L 3 x 3 x 3/16 (1/4)	174	-10.23	41.93	24.4 64.7 (b)	Pass
T16	50 - 40	Diagonal	2L 3 x 3 x 3/16 (1/4)	183	-11.23	37.65	29.8 65.8 (b)	Pass
T17	40 - 30	Diagonal	2L 3 x 3 x 1/4 (1/4)	195	-11.41	46.26	24.7 66.1 (b)	Pass
T18	30 - 20	Diagonal	2L 3 x 3 x 1/4 (1/4)	213	-12.29	75.60	16.3 71.0 (b)	Pass
T19	20 - 0	Diagonal	2L 3.5 x 3.5 x 1/4 (1/4)	249	-12.50	59.08	21.2 75.1 (b)	Pass
T18	30 - 20	Horizontal	L 3 x 3 x 3/16	205	-4.22	10.41	40.5 47.3 (b)	Pass
T8	106.667 - 100	Secondary Horizontal	L 1.75 x 1.75 x 1/4	103	-1.60	7.91	20.3 22.3 (b)	Pass
T11	86.667 - 80	Secondary Horizontal	L 2 x 2 x 3/16	133	-2.31	6.44	35.8	Pass
T13	73.333 - 66.667	Secondary Horizontal	L 1.75 x 1.75 x 1/4	154	-2.76	4.44	62.1	Pass
T14	66.667 - 60	Secondary Horizontal	L 2 x 2 x 3/16	166	-2.98	4.70	63.4	Pass
T16	50 - 40	Secondary Horizontal	L 2.5 x 2.5 x 3/16	187	-3.58	7.40	48.4	Pass
T17	40 - 30	Secondary Horizontal	L 3 x 3 x 1/4	200	-3.91	14.90	26.2 32.9 (b)	Pass
T1	160 - 140	Top Girt	L 2 x 2 x 1/8	5	-0.56	4.27	13.0	Pass
T2	140 - 135	Top Girt	L 2 x 2 x 1/8	40	-0.46	4.22	10.8 11.4 (b)	Pass
T18	30 - 20	Redund Horz 1 Bracing	L 2 x 2 x 3/16	230	-4.22	12.23	34.5	Pass
T18	30 - 20	Redund Diag 1 Bracing	L 2 x 2 x 3/16	234	-2.53	9.01	28.1	Pass
							Summary	
						Leg (T19)	91.3	Pass
						Diagonal (T8)	94.3	Pass
						Horizontal (T18)	47.3	Pass
						Secondary Horizontal (T14)	63.4	Pass
						Top Girt (T1)	13.0	Pass
						Redund Horz 1 Bracing (T18)	34.5	Pass
						Redund Diag 1 Bracing (T18)	28.1	Pass
						Bolt Checks	94.3	Pass
						Rating =	94.3	Pass

Table 5 - Tower Component Stresses vs. Capacity – LC5

Notes	Component	Elevation (ft)	% Capacity	Pass / Fail
1	Anchor Rods	0	58.3	Pass
1	Base Foundation Structural	0	46.0	Pass
1	Base Foundation Soil Interaction	0	81.5	Pass

Structure Rating (max from all components) =	94.3%
-----------------------------------------------------	--------------

Notes:

- All structural ratings are per TIA-222-H Section 15.5.
- 1) See additional documentation in "Appendix C – Additional Calculations" for calculations supporting the % capacity.

4.1) Recommendations

The tower and its foundation(s) have sufficient capacity to carry the proposed load configuration. No modifications are required at this time.

APPENDIX A
TNXTOWER OUTPUT

Section	T19	T18	T17	T16	T15	T14	T13	T12	T11	T10	T9	T8	T7	T6	T5	T4	T3	T2	T1
Legs	A	Pipe 5.563" x 0.375" (5 XS)	Pipe 5.563" x 0.375" (5 XS)	Pipe 5.563" x 0.375" (5 XS)	Pipe 5.563" x 0.375" (5 XS)	Pipe 4.5" x 0.337" (4 XS)	Pipe 4.5" x 0.337" (4 XS)	Pipe 4" x 0.318" (3.5 EH)	Pipe 4" x 0.318" (3.5 EH)	Pipe 3.5" x 0.300" (3 EH)	Pipe 2.875" x 0.276" (2.5 EH)	Pipe 2.875" x 0.276" (2.5 EH)	Pipe 2.375" x 0.154" (2 STD)						
Leg Grade		2L 3.5 x 3.5 x 1/4 (1/4)	2L 3 x 3 x 1/4 (1/4)	2L 3 x 3 x 3/16 (1/4)	2L 3 x 3 x 3/16 (1/4)	L 3 x 3 x 3/16	L 3 x 3 x 3/16	L 2.5 x 2.5 x 1/4	L 2.5 x 2.5 x 1/4	L 1.75 x 1.75 x 3/16									
Diagonal Grade		A572-50	A572-50	A572-50	A572-50	A36	A36												
Top Girts						N.A.	N.A.												
Horizontals		L 3 x 3 x 3/16	L 3 x 3 x 1/4	C	N.A.	B	F	N.A.	B	N.A.	F	N.A.							
Sec. Horizontals		N.A.	N.A.	N.A.	N.A.	N.A.	N.A.	N.A.	N.A.	N.A.	N.A.	N.A.							
Red. Horizontals		N.A.	N.A.	N.A.	N.A.	N.A.	N.A.	N.A.	N.A.	N.A.	N.A.	N.A.							
Red. Diagonals		N.A.	N.A.	N.A.	N.A.	N.A.	N.A.	N.A.	N.A.	N.A.	N.A.	N.A.							
Face Width (ft)	20.8646	18.8542	17.8125	16.7708	15.7708	14.7708	14.0729	13.375	12.6771	11.9974	11.3151	10.6354	9.95833	9.28125	8.604176	8.039375	7.583337	7.07292	6.5625
# Panels @ (ft)	2 @ 10	2 @ 5	2 @ 5	3 @ 10	3 @ 10	1 @ 6.667	1 @ 6.667	1 @ 6.666	2 @ 6.667	2 @ 6.667	1 @ 6.666	1 @ 6.667	1 @ 6.667	4 @ 5	4 @ 5	5 @ 4			
Weight (K)	21.6	5.3	2.5	2.2	1.7	1.5	0.9	0.9	0.8	0.8	0.6	0.6	0.5	0.5	0.3	0.2	0.2	0.3	0.8

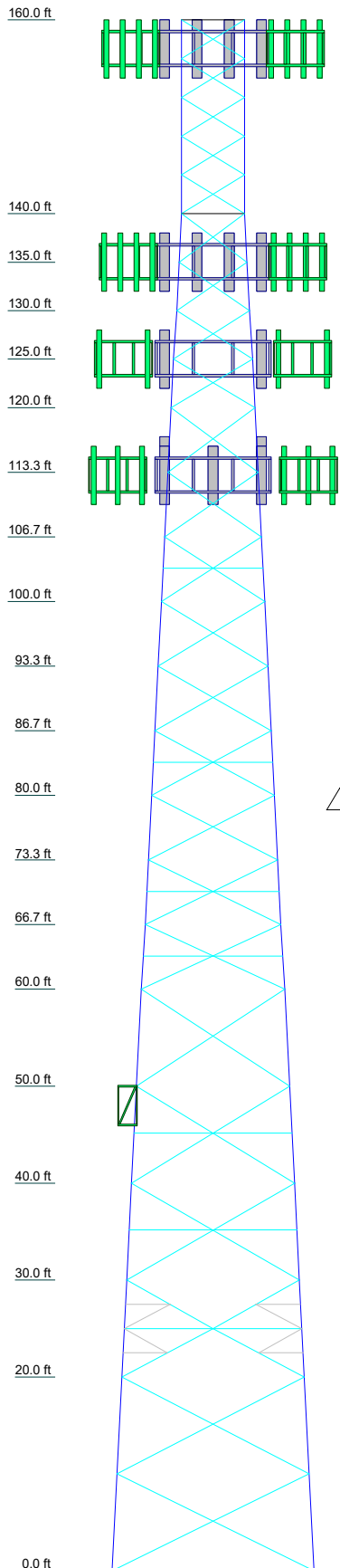

SYMBOL LIST

MARK	SIZE	MARK	SIZE
A	BU 806378 (PJF) - 6.625"x0.34" pipe w/ 2" SR- (modified with 19.5" spacing)	D	L 2.5 x 2.5 x 1/4
B	L 2 x 2 x 3/16	E	2L 2.5 x 2.5 x 3/16 (1/4)
C	L 2.5 x 2.5 x 3/16	F	L 1.75 x 1.75 x 1/4

MATERIAL STRENGTH

GRADE	Fy	Fu	GRADE	Fy	Fu
A572-50	50 ksi	65 ksi	A36	36 ksi	58 ksi

- ### TOWER DESIGN NOTES
1. Tower is located in Tolland County, Connecticut.
 2. Tower designed for Exposure C to the TIA-222-H Standard.
 3. Tower designed for a 125 mph basic wind in accordance with the TIA-222-H Standard.
 4. Tower is also designed for a 50 mph basic wind with 2.00 in ice. Ice is considered to increase in thickness with height.
 5. Deflections are based upon a 60 mph wind.
 6. Tower Risk Category II.
 7. Topographic Category 1 with Crest Height of 0.00 ft
 8. TIA-222-H Annex S
 9. TOWER RATING: 94.3%

ALL REACTIONS ARE FACTORED

MAX. CORNER REACTIONS AT BASE:

DOWN: 289 K
SHEAR: 33 K

UPLIFT: -252 K
SHEAR: 29 K

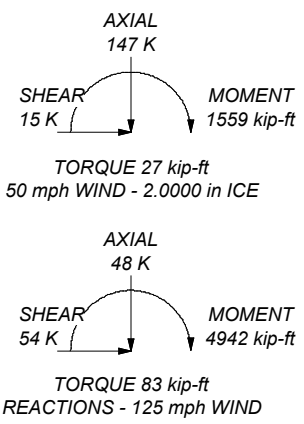

 Paul J. Ford and Company 250 East Broad st., Suite 600 Columbus, OH 43215 Phone: (614) 221-6679 FAX:	Job: 160-ft SST / Somers, CT Project: BU 806378 / PJF 37519-1552		
	Client: Crown Castle Code: TIA-222-H Path:	Drawn by: mbange Date: 05/21/19	App'd: Scale: NTS Dwg No. E-1

Tower Input Data

The main tower is a 3x free standing tower with an overall height of 160.00 ft above the ground line.
 The base of the tower is set at an elevation of 0.00 ft above the ground line.
 The face width of the tower is 6.52 ft at the top and 20.86 ft at the base.
 This tower is designed using the TIA-222-H standard.

The following design criteria apply:

- 1) Tower is located in Tolland County, Connecticut.
- 2) Tower base elevation above sea level: 396.00 ft.
- 3) Basic wind speed of 125 mph.
- 4) Risk Category II.
- 5) Exposure Category C.
- 6) Simplified Topographic Factor Procedure for wind speed-up calculations is used.
- 7) Topographic Category: 1.
- 8) Crest Height: 0.00 ft.
- 9) Nominal ice thickness of 2.0000 in.
- 10) Ice thickness is considered to increase with height.
- 11) Ice density of 56 pcf.
- 12) A wind speed of 50 mph is used in combination with ice.
- 13) Deflections calculated using a wind speed of 60 mph.
- 14) TIA-222-H Annex S.
- 15) Pressures are calculated at each section.
- 16) Tower analysis based on target reliabilities in accordance with Annex S.
- 17) Load Modification Factors used: $K_{es}(F_w) = 0.95$, $K_{es}(t_i) = 0.85$.
- 18) Stress ratio used in tower member design is 1.05.
- 19) Local bending stresses due to climbing loads, feed line supports, and appurtenance mounts are not considered.

Options

<ul style="list-style-type: none"> Consider Moments - Legs Consider Moments - Horizontals Consider Moments - Diagonals Use Moment Magnification Use Code Stress Ratios √ Use Code Safety Factors - Guys Escalate Ice Always Use Max Kz Use Special Wind Profile √ Include Bolts In Member Capacity Leg Bolts Are At Top Of Section √ Secondary Horizontal Braces Leg Use Diamond Inner Bracing (4 Sided) √ SR Members Have Cut Ends SR Members Are Concentric 	<ul style="list-style-type: none"> Distribute Leg Loads As Uniform Assume Legs Pinned Assume Rigid Index Plate √ Use Clear Spans For Wind Area √ Use Clear Spans For KL/r Retension Guys To Initial Tension √ Bypass Mast Stability Checks √ Use Azimuth Dish Coefficients √ Project Wind Area of Appurt. Autocalc Torque Arm Areas Add IBC .6D+W Combination √ Sort Capacity Reports By Component Triangulate Diamond Inner Bracing Treat Feed Line Bundles As Cylinder Ignore KL/ry For 60 Deg. Angle Legs 	<ul style="list-style-type: none"> Use ASCE 10 X-Brace Ly Rules √ Calculate Redundant Bracing Forces Ignore Redundant Members in FEA √ SR Leg Bolts Resist Compression All Leg Panels Have Same Allowable Offset Girt At Foundation √ Consider Feed Line Torque √ Include Angle Block Shear Check Use TIA-222-H Bracing Resist. Exemption Use TIA-222-H Tension Splice Exemption <li style="text-align: center;">Poles Include Shear-Torsion Interaction Always Use Sub-Critical Flow Use Top Mounted Sockets Pole Without Linear Attachments Pole With Shroud Or No Appurtenances Outside and Inside Corner Radii Are Known
------------------------------------------------------------------------------------------------------------------------------------------------------------------------------------------------------------------------------------------------------------------------------------------------------------------------------------------------------------------------------------------------------------------------------------------------------------------------------------------------------------------------------------------------------------------------------------------------------------------------	-----------------------------------------------------------------------------------------------------------------------------------------------------------------------------------------------------------------------------------------------------------------------------------------------------------------------------------------------------------------------------------------------------------------------------------------------------------------------------------------------------------------------------------------------------------------------------------------------------------------------------------------------------------------------	------------------------------------------------------------------------------------------------------------------------------------------------------------------------------------------------------------------------------------------------------------------------------------------------------------------------------------------------------------------------------------------------------------------------------------------------------------------------------------------------------------------------------------------------------------------------------------------------------------------------------------------------------------------------------------------------------------------------------------------------------------------------------------------------------------------------------------------

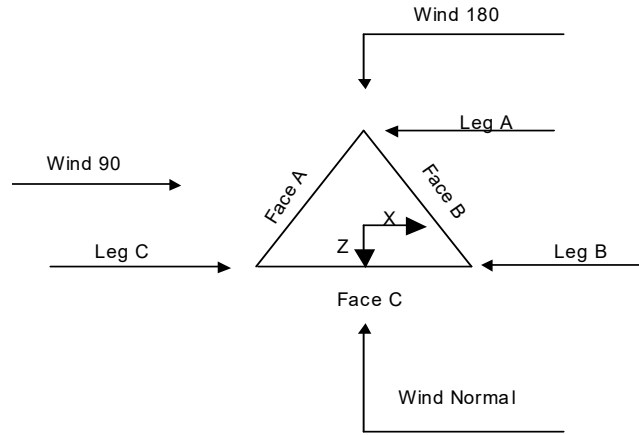

Triangular Tower

Tower Section Geometry

Tower Section	Tower Elevation	Assembly Database	Description	Section Width	Number of Sections	Section Length
	ft			ft		ft
T1	160.00-140.00			6.52	1	20.00
T2	140.00-135.00			6.56	1	5.00
T3	135.00-130.00			7.07	1	5.00
T4	130.00-125.00			7.58	1	5.00
T5	125.00-120.00			8.09	1	5.00
T6	120.00-113.33			8.60	1	6.67
T7	113.33-106.67			9.28	1	6.67
T8	106.67-100.00			9.96	1	6.67
T9	100.00-93.33			10.64	1	6.67
T10	93.33-86.67			11.32	1	6.67
T11	86.67-80.00			12.00	1	6.67
T12	80.00-73.33			12.68	1	6.67
T13	73.33-66.67			13.38	1	6.67
T14	66.67-60.00			14.07	1	6.67
T15	60.00-50.00			14.77	1	10.00
T16	50.00-40.00			15.77	1	10.00
T17	40.00-30.00			16.77	1	10.00
T18	30.00-20.00			17.81	1	10.00
T19	20.00-0.00			18.85	1	20.00

Tower Section Geometry (cont'd)

Tower Section	Tower Elevation	Diagonal Spacing	Bracing Type	Has K Brace End Panels	Has Horizontals	Top Girt Offset	Bottom Girt Offset
	ft	ft				in	in
T1	160.00-140.00	4.00	X Brace	No	No	0.0000	0.0000
T2	140.00-135.00	5.00	X Brace	No	No	0.0000	0.0000
T3	135.00-130.00	5.00	X Brace	No	No	0.0000	0.0000
T4	130.00-125.00	5.00	X Brace	No	No	0.0000	0.0000

Tower Section	Tower Elevation ft	Diagonal Spacing ft	Bracing Type	Has K Brace End Panels	Has Horizontals	Top Girt Offset in	Bottom Girt Offset in
T5	125.00-120.00	5.00	X Brace	No	No	0.0000	0.0000
T6	120.00-113.33	6.67	X Brace	No	No	0.0000	0.0000
T7	113.33-106.67	6.67	X Brace	No	No	0.0000	0.0000
T8	106.67-100.00	6.67	X Brace	No	Yes	0.0000	0.0000
T9	100.00-93.33	6.67	X Brace	No	No	0.0000	0.0000
T10	93.33-86.67	6.67	X Brace	No	No	0.0000	0.0000
T11	86.67-80.00	6.67	X Brace	No	Yes	0.0000	0.0000
T12	80.00-73.33	6.67	X Brace	No	No	0.0000	0.0000
T13	73.33-66.67	6.67	X Brace	No	Yes	0.0000	0.0000
T14	66.67-60.00	6.67	X Brace	No	Yes	0.0000	0.0000
T15	60.00-50.00	10.00	X Brace	No	No	0.0000	0.0000
T16	50.00-40.00	10.00	X Brace	No	Yes	0.0000	0.0000
T17	40.00-30.00	10.00	X Brace	No	Yes	0.0000	0.0000
T18	30.00-20.00	5.00	Double K1	No	Yes	0.0000	0.0000
T19	20.00-0.00	10.00	X Brace	No	No	0.0000	0.0000

Tower Section Geometry (cont'd)

Tower Elevation ft	Leg Type	Leg Size	Leg Grade	Diagonal Type	Diagonal Size	Diagonal Grade
T1 160.00-140.00	Pipe	Pipe 2.375" x 0.154" (2 STD)	A572-50 (50 ksi)	Single Angle	L 1.75 x 1.75 x 3/16	A36 (36 ksi)
T2 140.00-135.00	Pipe	Pipe 2.875" x 0.276" (2.5 EH)	A572-50 (50 ksi)	Single Angle	L 1.75 x 1.75 x 3/16	A36 (36 ksi)
T3 135.00-130.00	Pipe	Pipe 2.875" x 0.276" (2.5 EH)	A572-50 (50 ksi)	Single Angle	L 1.75 x 1.75 x 3/16	A36 (36 ksi)
T4 130.00-125.00	Pipe	Pipe 2.875" x 0.276" (2.5 EH)	A572-50 (50 ksi)	Single Angle	L 1.75 x 1.75 x 3/16	A36 (36 ksi)
T5 125.00-120.00	Pipe	Pipe 2.875" x 0.276" (2.5 EH)	A572-50 (50 ksi)	Single Angle	L 2 x 2 x 3/16	A36 (36 ksi)
T6 120.00-113.33	Pipe	Pipe 3.5" x 0.300" (3 EH)	A572-50 (50 ksi)	Single Angle	L 2.5 x 2.5 x 1/4	A36 (36 ksi)
T7 113.33-106.67	Pipe	Pipe 3.5" x 0.300" (3 EH)	A572-50 (50 ksi)	Single Angle	L 2.5 x 2.5 x 1/4	A36 (36 ksi)
T8 106.67-100.00	Pipe	Pipe 3.5" x 0.300" (3 EH)	A572-50 (50 ksi)	Single Angle	L 2.5 x 2.5 x 1/4	A36 (36 ksi)
T9 100.00-93.33	Pipe	Pipe 4" x 0.318" (3.5 EH)	A572-50 (50 ksi)	Single Angle	L 2.5 x 2.5 x 3/16	A36 (36 ksi)
T10 93.33-86.67	Pipe	Pipe 4" x 0.318" (3.5 EH)	A572-50 (50 ksi)	Single Angle	L 2.5 x 2.5 x 1/4	A36 (36 ksi)
T11 86.67-80.00	Pipe	Pipe 4" x 0.318" (3.5 EH)	A572-50 (50 ksi)	Double Angle	2L 2.5 x 2.5 x 3/16 (1/4)	A36 (36 ksi)
T12 80.00-73.33	Pipe	Pipe 4.5" x 0.337" (4 XS)	A572-50 (50 ksi)	Single Angle	L 3 x 3 x 3/16	A36 (36 ksi)
T13 73.33-66.67	Pipe	Pipe 4.5" x 0.337" (4 XS)	A572-50 (50 ksi)	Single Angle	L 3 x 3 x 3/16	A36 (36 ksi)
T14 66.67-60.00	Pipe	Pipe 4.5" x 0.337" (4 XS)	A572-50 (50 ksi)	Single Angle	L 3 x 3 x 3/16	A36 (36 ksi)
T15 60.00-50.00	Pipe	Pipe 5.563" x 0.375" (5 EH)	A572-50 (50 ksi)	Double Angle	2L 3 x 3 x 3/16 (1/4)	A36 (36 ksi)
T16 50.00-40.00	Pipe	Pipe 5.563" x 0.375" (5 EH)	A572-50 (50 ksi)	Double Angle	2L 3 x 3 x 3/16 (1/4)	A36 (36 ksi)
T17 40.00-30.00	Pipe	Pipe 5.563" x 0.375" (5 XS)	A572-50 (50 ksi)	Double Angle	2L 3 x 3 x 1/4 (1/4)	A572-50 (50 ksi)
T18 30.00-20.00	Pipe	Pipe 5.563" x 0.375" (5 XS)	A572-50 (50 ksi)	Double Angle	2L 3 x 3 x 1/4 (1/4)	A572-50 (50 ksi)
T19 20.00-0.00	Arbitrary Shape	BU 806378 (PJF) - 6.625"x0.34" pipe w/ 2" SR- (modified with 19.5" spacing)	A572-50 (50 ksi)	Double Angle	2L 3.5 x 3.5 x 1/4 (1/4)	A572-50 (50 ksi)

Tower Section Geometry (cont'd)

Tower Elevation ft	Top Girt Type	Top Girt Size	Top Girt Grade	Bottom Girt Type	Bottom Girt Size	Bottom Girt Grade
T1 160.00-140.00	Equal Angle	L 2 x 2 x 1/8	A36 (36 ksi)	Single Angle		A36 (36 ksi)
T2 140.00-135.00	Equal Angle	L 2 x 2 x 1/8	A36 (36 ksi)	Single Angle		A36 (36 ksi)

Tower Section Geometry (cont'd)

Tower Elevation ft	No. of Mid Girts	Mid Girt Type	Mid Girt Size	Mid Girt Grade	Horizontal Type	Horizontal Size	Horizontal Grade
T18 30.00-20.00	None	Single Angle		A36 (36 ksi)	Equal Angle	L 3 x 3 x 3/16	A36 (36 ksi)

Tower Section Geometry (cont'd)

Tower Elevation ft	Secondary Horizontal Type	Secondary Horizontal Size	Secondary Horizontal Grade	Inner Bracing Type	Inner Bracing Size	Inner Bracing Grade
T8 106.67-100.00	Equal Angle	L 1.75 x 1.75 x 1/4	A36 (36 ksi)	Single Angle		A36 (36 ksi)
T11 86.67-80.00	Equal Angle	L 2 x 2 x 3/16	A36 (36 ksi)	Single Angle		A36 (36 ksi)
T13 73.33-66.67	Equal Angle	L 1.75 x 1.75 x 1/4	A36 (36 ksi)	Single Angle		A36 (36 ksi)
T14 66.67-60.00	Equal Angle	L 2 x 2 x 3/16	A36 (36 ksi)	Single Angle		A36 (36 ksi)
T16 50.00-40.00	Equal Angle	L 2.5 x 2.5 x 3/16	A36 (36 ksi)	Single Angle		A36 (36 ksi)
T17 40.00-30.00	Equal Angle	L 3 x 3 x 1/4	A36 (36 ksi)	Single Angle		A36 (36 ksi)

Tower Section Geometry (cont'd)

Tower Elevation ft	Redundant Bracing Grade	Redundant Type	Redundant Size	K Factor
T18 30.00-20.00	A36 (36 ksi)	Horizontal (1) Diagonal (1)	Equal Angle Equal Angle	1 1

Tower Section Geometry (cont'd)

Tower Elevation	Gusset Area (per face)	Gusset Thickness	Gusset Grade	Adjust. Factor A_r	Adjust. Factor A_r	Weight Mult.	Double Angle Stitch Bolt Spacing Diagonals in	Double Angle Stitch Bolt Spacing Horizontals in	Double Angle Stitch Bolt Spacing Redundants in
ft	ft ²	in							
T1 160.00-140.00	0.00	0.1875	A36 (36 ksi)	1.03	1	1.05	Mid-Pt	Mid-Pt	Mid-Pt
T2 140.00-135.00	0.00	0.1875	A36 (36 ksi)	1.03	1	1.05	Mid-Pt	Mid-Pt	Mid-Pt
T3 135.00-130.00	0.00	0.1875	A36 (36 ksi)	1.03	1	1.05	Mid-Pt	Mid-Pt	Mid-Pt
T4 130.00-125.00	0.00	0.1875	A36 (36 ksi)	1.03	1	1.05	Mid-Pt	Mid-Pt	Mid-Pt
T5 125.00-120.00	0.00	0.1875	A36 (36 ksi)	1.03	1	1.05	Mid-Pt	Mid-Pt	Mid-Pt
T6 120.00-113.33	0.00	0.1875	A36 (36 ksi)	1.03	1	1.05	Mid-Pt	Mid-Pt	Mid-Pt
T7 113.33-106.67	0.00	0.1875	A36 (36 ksi)	1.03	1	1.05	Mid-Pt	Mid-Pt	Mid-Pt
T8 106.67-100.00	0.00	0.1875	A36 (36 ksi)	1.03	1	1.05	Mid-Pt	Mid-Pt	Mid-Pt
T9 100.00-93.33	1.99	0.5000	A572-50 (50 ksi)	1	1	1.05	Mid-Pt	Mid-Pt	Mid-Pt
T10 93.33-86.67	2.36	0.5000	A572-50 (50 ksi)	1	1	1.05	Mid-Pt	Mid-Pt	Mid-Pt
T11 86.67-80.00	2.13	0.5000	A572-50 (50 ksi)	1	1	1.05	Mid-Pt	Mid-Pt	Mid-Pt
T12 80.00-73.33	1.99	0.5000	A572-50 (50 ksi)	1	1	1.05	Mid-Pt	Mid-Pt	Mid-Pt
T13 73.33-66.67	2.36	0.5000	A572-50 (50 ksi)	1	1	1.05	Mid-Pt	Mid-Pt	Mid-Pt
T14 66.67-60.00	1.99	0.5000	A572-50 (50 ksi)	1	1	1.05	Mid-Pt	Mid-Pt	Mid-Pt
T15 60.00-50.00	0.00	0.2500	A36 (36 ksi)	1.03	1	1.05	Mid-Pt	Mid-Pt	Mid-Pt
T16 50.00-40.00	0.00	0.2500	A36 (36 ksi)	1.03	1	1.05	Mid-Pt	Mid-Pt	Mid-Pt
T17 40.00-30.00	0.00	0.2500	A36 (36 ksi)	1.03	1	1.05	Mid-Pt	Mid-Pt	Mid-Pt
T18 30.00-20.00	0.00	0.2500	A36 (36 ksi)	1.03	1	1.05	Mid-Pt	Mid-Pt	Mid-Pt
T19 20.00-0.00	0.00	0.2500	A36 (36 ksi)	1.03	1	1.05	Mid-Pt	Mid-Pt	Mid-Pt

Tower Section Geometry (cont'd)

Tower Elevation	Calc K Single Angles	Calc K Solid Rounds	K Factors ¹									
			Legs	X Brace Diags		K Brace Diags		Single Diags	Girts	Horiz.	Sec. Horiz.	Inner Brace
				X	Y	X	Y					
T1 160.00-140.00	Yes	No	1	1	1	1	1	1	1	1	1	1
T2 140.00-135.00	Yes	No	1	1	1	1	1	1	1	1	1	1
T3 135.00-130.00	Yes	No	1	1	1	1	1	1	1	1	1	1
T4 130.00-125.00	Yes	No	1	1	1	1	1	1	1	1	1	1
T5 125.00-120.00	Yes	No	1	1	1	1	1	1	1	1	1	1
T6 120.00-113.33	Yes	No	1	1	1	1	1	1	1	1	1	1
T7 113.33-106.67	Yes	No	1	1	1	1	1	1	1	1	1	1
T8 106.67-100.00	No	No	1	1	1	1	1	1	1	0.5	1	1

Tower Elevation ft	Calc K Single Angles	Calc K Solid Rounds	Legs	K Factors ¹								
				X Brace Diags X Y	K Brace Diags X Y	Single Diags X Y	Girts X Y	Horiz. X Y	Sec. Horiz. X Y	Inner Brace X Y		
T9 100.00-93.33	No	No	1	1	1	1	1	1	1	1	1	1
T10 93.33-86.67	No	No	1	1	1	1	1	1	1	1	1	1
T11 86.67-80.00	No	No	1	1	1	1	1	1	1	1	1	1
T12 80.00-73.33	No	No	1	1	1	1	1	1	1	0.5	1	1
T13 73.33-66.67	No	No	1	1	1	1	1	1	1	1	1	1
T14 66.67-60.00	No	No	1	1	1	1	1	1	1	0.5	1	1
T15 60.00-50.00	Yes	No	1	1	1	1	1	1	1	1	1	1
T16 50.00-40.00	No	No	1	1	1	1	1	1	1	1	0.5	1
T17 40.00-30.00	No	No	1	1	1	1	1	1	1	1	1	1
T18 30.00-20.00	Yes	No	1	1	1	1	1	1	1	1	0.5	1
T19 20.00-0.00	Yes	No	1	1	1	1	1	1	1	1	1	1

¹Note: K factors are applied to member segment lengths. K-braces without inner supporting members will have the K factor in the out-of-plane direction applied to the overall length.

Tower Section Geometry (cont'd)

Tower Elevation ft	Leg		Diagonal		Top Girt		Bottom Girt		Mid Girt		Long Horizontal		Short Horizontal	
	Net Width Deduct in	U	Net Width Deduct in	U	Net Width Deduct in	U	Net Width Deduct in	U	Net Width Deduct in	U	Net Width Deduct in	U	Net Width Deduct in	U
T1 160.00-140.00	0.0000	1	0.0000	0.75	0.0000	0.75	0.0000	0.75	0.0000	0.75	0.0000	0.75	0.0000	0.75
T2 140.00-135.00	0.0000	1	0.0000	0.75	0.0000	0.75	0.0000	0.75	0.0000	0.75	0.0000	0.75	0.0000	0.75
T3 135.00-130.00	0.0000	1	0.0000	0.75	0.0000	0.75	0.0000	0.75	0.0000	0.75	0.0000	0.75	0.0000	0.75
T4 130.00-125.00	0.0000	1	0.0000	0.75	0.0000	0.75	0.0000	0.75	0.0000	0.75	0.0000	0.75	0.0000	0.75
T5 125.00-120.00	0.0000	1	0.0000	0.75	0.0000	0.75	0.0000	0.75	0.0000	0.75	0.0000	0.75	0.0000	0.75
T6 120.00-113.33	0.0000	1	0.0000	0.75	0.0000	0.75	0.0000	0.75	0.0000	0.75	0.0000	0.75	0.0000	0.75
T7 113.33-106.67	0.0000	1	0.0000	0.75	0.0000	0.75	0.0000	0.75	0.0000	0.75	0.0000	0.75	0.0000	0.75
T8 106.67-100.00	0.0000	1	0.0000	0.75	0.0000	0.75	0.0000	0.75	0.0000	0.75	0.0000	0.75	0.0000	0.75
T9 100.00-93.33	0.0000	1	0.0000	0.75	0.0000	0.75	0.0000	0.75	0.0000	0.75	0.0000	0.75	0.0000	0.75
T10 93.33-86.67	0.0000	1	0.0000	0.75	0.0000	0.75	0.0000	0.75	0.0000	0.75	0.0000	0.75	0.0000	0.75
T11 86.67-80.00	0.0000	1	0.0000	0.75	0.0000	0.75	0.0000	0.75	0.0000	0.75	0.0000	0.75	0.0000	0.75
T12 80.00-73.33	0.0000	1	0.0000	0.75	0.0000	0.75	0.0000	0.75	0.0000	0.75	0.0000	0.75	0.0000	0.75
T13 73.33-66.67	0.0000	1	0.0000	0.75	0.0000	0.75	0.0000	0.75	0.0000	0.75	0.0000	0.75	0.0000	0.75
T14 66.67-60.00	0.0000	1	0.0000	0.75	0.0000	0.75	0.0000	0.75	0.0000	0.75	0.0000	0.75	0.0000	0.75

Tower Elevation ft	Leg		Diagonal		Top Girt		Bottom Girt		Mid Girt		Long Horizontal		Short Horizontal	
	Net Width Deduct in	U	Net Width Deduct in	U	Net Width Deduct in	U	Net Width Deduct in	U	Net Width Deduct in	U	Net Width Deduct in	U	Net Width Deduct in	U
T15 60.00-50.00	0.0000	1	0.0000	0.75	0.0000	0.75	0.0000	0.75	0.0000	0.75	0.0000	0.75	0.0000	0.75
T16 50.00-40.00	0.0000	1	0.0000	0.75	0.0000	0.75	0.0000	0.75	0.0000	0.75	0.0000	0.75	0.0000	0.75
T17 40.00-30.00	0.0000	1	0.0000	0.75	0.0000	0.75	0.0000	0.75	0.0000	0.75	0.0000	0.75	0.0000	0.75
T18 30.00-20.00	0.0000	1	0.0000	0.75	0.0000	0.75	0.0000	0.75	0.0000	0.75	0.0000	0.75	0.0000	0.75
T19 20.00-0.00	0.0000	1	0.0000	0.75	0.0000	0.75	0.0000	0.75	0.0000	0.75	0.0000	0.75	0.0000	0.75

Tower Section Geometry (cont'd)

Tower Elevation ft	Leg Connection Type	Leg		Diagonal		Top Girt		Bottom Girt		Mid Girt		Long Horizontal		Short Horizontal							
		Bolt Size in	No.	Bolt Size in	No.	Bolt Size in	No.	Bolt Size in	No.	Bolt Size in	No.	Bolt Size in	No.	Bolt Size in	No.						
T1 160.00-140.00	Flange	0.6250	4	A325N		0.5000	1	A325N		0.5000	1	0.0000	0	A325N		0.6250	0	A325N		0.6250	0
T2 140.00-135.00	Flange	0.7500	0	A325N		0.5000	1	A325N		0.5000	1	0.0000	0	A325N		0.6250	0	A325N		0.6250	0
T3 135.00-130.00	Flange	0.7500	0	A325N		0.5000	1	A325N		0.6250	0	0.0000	0	A325N		0.6250	0	A325N		0.6250	0
T4 130.00-125.00	Flange	0.7500	0	A325N		0.5000	1	A325N		0.6250	0	0.0000	0	A325N		0.6250	0	A325N		0.6250	0
T5 125.00-120.00	Flange	0.7500	4	A325N		0.5000	1	A325N		0.6250	0	0.0000	0	A325N		0.6250	0	A325N		0.6250	0
T6 120.00-113.33	Flange	0.8750	0	A325N		0.5000	1	A325X		0.6250	0	0.0000	0	A325N		0.6250	0	A325N		0.6250	0
T7 113.33-106.67	Flange	0.8750	0	A325N		0.5000	1	A325X		0.6250	0	0.0000	0	A325N		0.6250	0	A325N		0.6250	0
T8 106.67-100.00	Flange	0.8750	4	A325N		0.5000	1	A325X		0.6250	0	0.0000	0	A325N		0.6250	0	A325N		0.6250	1
T9 100.00-93.33	Flange	0.8750	0	A325N		0.5000	2	A325N		0.6250	0	0.0000	0	A325N		0.6250	0	A325N		0.6250	0
T10 93.33-86.67	Flange	0.8750	0	A325N		0.5000	2	A325N		0.6250	0	0.0000	0	A325N		0.6250	0	A325N		0.6250	0
T11 86.67-80.00	Flange	0.8750	4	A325N		0.5000	2	A325N		0.6250	0	0.0000	0	A325N		0.6250	0	A325N		0.6250	1
T12 80.00-73.33	Flange	1.0000	0	A325N		0.5000	2	A325N		0.6250	0	0.0000	0	A325N		0.6250	0	A325N		0.6250	0
T13 73.33-66.67	Flange	1.0000	0	A325N		0.5000	2	A325N		0.6250	0	0.0000	0	A325N		0.6250	0	A325N		0.6250	1
T14 66.67-60.00	Flange	1.0000	4	A325N		0.5000	2	A325N		0.6250	0	0.0000	0	A325N		0.6250	0	A325N		0.6250	1
T15 60.00-50.00	Flange	1.0000	0	A325N		0.6250	1	A325N		0.6250	0	0.0000	0	A325N		0.6250	0	A325N		0.6250	0
T16 50.00-40.00	Flange	1.0000	4	A325N		0.6250	1	A325N		0.6250	0	0.0000	0	A325N		0.6250	0	A325N		0.6250	1
T17 40.00-30.00	Flange	1.0000	0	A325N		0.6250	1	A325N		0.6250	0	0.0000	0	A325N		0.6250	0	A325N		0.6250	1
T18 30.00-20.00	Flange	1.0000	6	A325N		0.6250	1	A325N		0.6250	0	0.0000	0	A325N		0.6250	0	A325N		0.6250	0
T19 20.00-0.00	Flange	1.0000	0	A449		0.6250	1	A325N		0.6250	0	0.0000	0	A325N		0.6250	0	A325N		0.6250	0

Feed Line/Linear Appurtenances - Entered As Round Or Flat

Description	Face or Leg	Allow Shield	Exclude From Torque Calculation	Component Type	Placement ft	Face Offset in	Lateral Offset (Frac FW)	#	# Per Row	Clear Spacing in	Width or Diameter in	Perimeter in	Weight plf
Face A													
HCS 6X12 4AWG(1-5/8)	A	No	No	Ar (CaAa)	113.00 - 0.00	0.0000	-0.35	3	3	1.0000 0.5000	1.6600		2.40
1.5" flat Cable Ladder Rail *****	A	No	No	Af (CaAa)	113.00 - 0.00	0.0000	-0.35	2	2	30.0000 0 1.5000	1.5000		1.80
LDF4-50A(1/2)	A	No	No	Ar (CaAa)	57.00 - 0.00	0.0000	0.35	1	1	0.6250 0.5000	0.6250		0.15
LDF7-50A(1-5/8)	A	No	No	Ar (CaAa)	157.00 - 0.00	0.0000	0.35	20	7	1.0000 0.5000	1.9800		0.82
1.5" flat Cable Ladder Rail *****	A	No	No	Af (CaAa)	157.00 - 0.00	0.0000	0.35	2	2	30.0000 0 1.5000	1.5000		1.80
Face B													
FB-L98B-002-75000(3/8)	B	No	No	Ar (CaAa)	135.00 - 0.00	0.0000	-0.4	1	1	0.3937 0.5000	0.3937		0.06
WR-VG86ST-BRD(3/4)	B	No	No	Ar (CaAa)	135.00 - 0.00	0.0000	-0.4	2	2	0.7950 0.5000	0.7950		0.58
FB-L98B-002-75000(3/8)	B	No	No	Ar (CaAa)	135.00 - 0.00	0.0000	-0.4	1	1	0.3937 0.5000	0.3937		0.06
WR-VG86ST-BRD(3/4)	B	No	No	Ar (CaAa)	135.00 - 0.00	0.0000	-0.4	2	2	0.7950 0.5000	0.7950		0.58
LDF6-50A(1-1/4)	B	No	No	Ar (CaAa)	135.00 - 0.00	0.0000	-0.42	6	3	1.0000 0.5000	1.5500		0.60
LCF114-50J(1-1/4)	B	No	No	Ar (CaAa)	135.00 - 0.00	0.0000	-0.37	6	3	1.0000 0.5000	1.5800		0.70
1.5" flat Cable Ladder Rail *****	B	No	No	Af (CaAa)	135.00 - 0.00	0.0000	-0.4	1	1	1.5000 1.5000	1.5000		1.80
LDF4-50A(1/2)	B	No	No	Ar (CaAa)	48.00 - 0.00	0.0000	-0.35	1	1	0.6250 0.5000	0.6250		0.15
HB058-M12-XXXF(5/8)	B	No	No	Ar (CaAa)	125.00 - 0.00	0.0000	-0.35	1	1	0.8400 0.5000	0.8400		0.24
HB114-1-08U4-M5J(1-1/4)	B	No	No	Ar (CaAa)	125.00 - 0.00	0.0000	-0.35	3	3	0.7500 0.5000	1.5400		1.08
1.5" flat Cable Ladder Rail *****	B	No	No	Af (CaAa)	135.00 - 0.00	0.0000	-0.35	1	1	1.5000 1.5000	1.5000		1.80
Face C													
1.5" flat Cable Ladder Rail *****	C	No	No	Af (CaAa)	143.00 - 0.00	0.0000	0.35	2	2	30.0000 0 1.5000	1.5000		1.80

Discrete Tower Loads

Description	Face or Leg	Offset Type	Offsets: Horz Lateral Vert ft ft ft	Azimuth Adjustment	Placement ft	C _A A _A Front ft ²	C _A A _A Side ft ²	Weight K	
(2) APL866513-42T6 w/ Mount Pipe	A	From Leg	4.00 0.00	0.0000	157.00	No Ice	4.29 4.66	4.80 5.42	0.03 0.08

Description	Face or Leg	Offset Type	Offsets: Horz Lateral Vert ft ft ft	Azimuth Adjustment t °	Placement ft	C _{AA} Front ft ²	C _{AA} Side ft ²	Weight K
			0.00			1/2" Ice 5.04 5.83	6.04 7.34	0.13 0.25
(2) LPA-80063/4CF w/ Mount Pipe	B	From Leg	4.00 0.00 0.00	0.0000	157.00	No Ice 1/2" Ice 7.19 8.04	6.60 7.23 7.88 9.21	0.04 0.10 0.18 0.34
(2) LPA-80063/4CFx5 w/ Mount Pipe	C	From Leg	4.00 0.00 0.00	0.0000	157.00	No Ice 1/2" Ice 7.19 8.04	6.60 7.23 7.88 9.21	0.04 0.10 0.18 0.34
(2) HBXX-6517DS-VTM w/ Mount Pipe	A	From Leg	4.00 0.00 0.00	0.0000	157.00	No Ice 1/2" Ice 9.89 10.99	6.96 8.18 9.14 11.02	0.07 0.14 0.22 0.40
(2) HBXX-6517DS-VTM w/ Mount Pipe	B	From Leg	4.00 0.00 0.00	0.0000	157.00	No Ice 1/2" Ice 9.89 10.99	6.96 8.18 9.14 11.02	0.07 0.14 0.22 0.40
(2) HBXX-6517DS-VTM w/ Mount Pipe	C	From Leg	4.00 0.00 0.00	0.0000	157.00	No Ice 1/2" Ice 9.89 10.99	6.96 8.18 9.14 11.02	0.07 0.14 0.22 0.40
LNx-6514DS-VTM w/ Mount Pipe	A	From Leg	4.00 0.00 0.00	0.0000	157.00	No Ice 1/2" Ice 9.48 10.55	7.07 8.25 9.15 10.98	0.06 0.13 0.21 0.39
LNx-6514DS-VTM w/ Mount Pipe	B	From Leg	4.00 0.00 0.00	0.0000	157.00	No Ice 1/2" Ice 9.48 10.55	7.07 8.25 9.15 10.98	0.06 0.13 0.21 0.39
LNx-6514DS-VTM w/ Mount Pipe	C	From Leg	4.00 0.00 0.00	0.0000	157.00	No Ice 1/2" Ice 9.48 10.55	7.07 8.25 9.15 10.98	0.06 0.13 0.21 0.39
RRH2x60-AWS	A	From Leg	4.00 0.00 0.00	0.0000	157.00	No Ice 1/2" Ice 2.24 2.63	1.24 1.39 1.54 1.89	0.04 0.06 0.08 0.13
RRH2x60-AWS	B	From Leg	4.00 0.00 0.00	0.0000	157.00	No Ice 1/2" Ice 2.24 2.63	1.24 1.39 1.54 1.89	0.04 0.06 0.08 0.13
RRH2x60-AWS	C	From Leg	4.00 0.00 0.00	0.0000	157.00	No Ice 1/2" Ice 2.24 2.63	1.24 1.39 1.54 1.89	0.04 0.06 0.08 0.13
RRH2x60-PCS	A	From Leg	4.00 0.00 0.00	0.0000	157.00	No Ice 1/2" Ice 2.59 3.01	1.72 1.90 2.09 2.48	0.06 0.08 0.10 0.16
RRH2x60-PCS	B	From Leg	4.00	0.0000	157.00	No Ice	1.72	0.06

Description	Face or Leg	Offset Type	Offsets: Horz Lateral Vert ft ft ft	Azimuth Adjustment °	Placement ft	C _{AA} Front ft ²	C _{AA} Side ft ²	Weight K	
			0.00			1/2"	2.39	1.90	0.08
			0.00			Ice	2.59	2.09	0.10
						1" Ice	3.01	2.48	0.16
						2" Ice			
RRH2X60-PCS	C	From Leg	4.00	0.0000	157.00	No Ice	2.20	1.72	0.06
			0.00			1/2"	2.39	1.90	0.08
			0.00			Ice	2.59	2.09	0.10
						1" Ice	3.01	2.48	0.16
						2" Ice			
DB-T1-6Z-8AB-0Z	C	From Leg	4.00	0.0000	157.00	No Ice	4.80	2.00	0.04
			0.00			1/2"	5.07	2.19	0.08
			0.00			Ice	5.35	2.39	0.12
						1" Ice	5.93	2.81	0.21
						2" Ice			
Sector Mount [SM 504-3]	C	None		0.0000	157.00	No Ice	34.25	34.25	1.71
						1/2"	48.98	48.98	2.29
						Ice	63.71	63.71	2.86
						1" Ice	93.17	93.17	4.02
						2" Ice			

7770.00 w/ Mount Pipe	A	From Leg	4.00	0.0000	135.00	No Ice	5.75	4.25	0.06
			0.00			1/2"	6.18	5.01	0.10
			2.00			Ice	6.61	5.71	0.16
						1" Ice	7.49	7.16	0.29
						2" Ice			
7770.00 w/ Mount Pipe	B	From Leg	4.00	0.0000	135.00	No Ice	5.75	4.25	0.06
			0.00			1/2"	6.18	5.01	0.10
			2.00			Ice	6.61	5.71	0.16
						1" Ice	7.49	7.16	0.29
						2" Ice			
7770.00 w/ Mount Pipe	C	From Leg	4.00	0.0000	135.00	No Ice	5.75	4.25	0.06
			0.00			1/2"	6.18	5.01	0.10
			2.00			Ice	6.61	5.71	0.16
						1" Ice	7.49	7.16	0.29
						2" Ice			
HPA-65R-BUU-H8 w/ Mount Pipe	A	From Leg	4.00	0.0000	135.00	No Ice	13.21	9.58	0.10
			0.00			1/2"	13.90	11.05	0.20
			2.00			Ice	14.59	12.50	0.30
						1" Ice	15.91	14.75	0.55
						2" Ice			
HPA-65R-BUU-H8 w/ Mount Pipe	B	From Leg	4.00	0.0000	135.00	No Ice	13.21	9.58	0.10
			0.00			1/2"	13.90	11.05	0.20
			2.00			Ice	14.59	12.50	0.30
						1" Ice	15.91	14.75	0.55
						2" Ice			
HPA-65R-BUU-H8 w/ Mount Pipe	C	From Leg	4.00	0.0000	135.00	No Ice	13.21	9.58	0.10
			0.00			1/2"	13.90	11.05	0.20
			2.00			Ice	14.59	12.50	0.30
						1" Ice	15.91	14.75	0.55
						2" Ice			
TPA-65R-LCUUUU-H8 w/ Mount Pipe	A	From Leg	4.00	0.0000	135.00	No Ice	13.54	10.96	0.11
			0.00			1/2"	14.24	12.49	0.22
			2.00			Ice	14.95	14.04	0.33
						1" Ice	16.31	16.39	0.59
						2" Ice			
TPA-65R-LCUUUU-H8 w/ Mount Pipe	B	From Leg	4.00	0.0000	135.00	No Ice	13.54	10.96	0.11
			0.00			1/2"	14.24	12.49	0.22
			2.00			Ice	14.95	14.04	0.33
						1" Ice	16.31	16.39	0.59
						2" Ice			
TPA-65R-LCUUUU-H8 w/ Mount Pipe	C	From Leg	4.00	0.0000	135.00	No Ice	13.54	10.96	0.11
			0.00			1/2"	14.24	12.49	0.22
			2.00			Ice	14.95	14.04	0.33
						1" Ice	16.31	16.39	0.59
						2" Ice			

Description	Face or Leg	Offset Type	Offsets:		Azimuth Adjustment	Placement	C _{AA} _{Front}	C _{AA} _{Side}	Weight
			Horz	Lateral					
			ft	ft	°	ft	ft ²	ft ²	K
TT19-08BP111-001	A	From Leg	4.00	0.0000	135.00	No Ice	0.55	0.45	0.02
			0.00			1/2"	0.65	0.53	0.02
			2.00			Ice	0.75	0.63	0.03
						1" Ice	0.98	0.84	0.05
						2" Ice			
TT19-08BP111-001	B	From Leg	4.00	0.0000	135.00	No Ice	0.55	0.45	0.02
			0.00			1/2"	0.65	0.53	0.02
			2.00			Ice	0.75	0.63	0.03
						1" Ice	0.98	0.84	0.05
						2" Ice			
TT19-08BP111-001	C	From Leg	4.00	0.0000	135.00	No Ice	0.55	0.45	0.02
			0.00			1/2"	0.65	0.53	0.02
			2.00			Ice	0.75	0.63	0.03
						1" Ice	0.98	0.84	0.05
						2" Ice			
(2) 7020.00	A	From Leg	4.00	0.0000	135.00	No Ice	0.10	0.17	0.00
			0.00			1/2"	0.15	0.24	0.01
			2.00			Ice	0.20	0.31	0.01
						1" Ice	0.33	0.48	0.02
						2" Ice			
(2) 7020.00	B	From Leg	4.00	0.0000	135.00	No Ice	0.10	0.17	0.00
			0.00			1/2"	0.15	0.24	0.01
			2.00			Ice	0.20	0.31	0.01
						1" Ice	0.33	0.48	0.02
						2" Ice			
(2) 7020.00	C	From Leg	4.00	0.0000	135.00	No Ice	0.10	0.17	0.00
			0.00			1/2"	0.15	0.24	0.01
			2.00			Ice	0.20	0.31	0.01
						1" Ice	0.33	0.48	0.02
						2" Ice			
DC6-48-60-18-8F	A	From Leg	4.00	0.0000	135.00	No Ice	1.21	1.21	0.03
			0.00			1/2"	1.89	1.89	0.05
			2.00			Ice	2.11	2.11	0.08
						1" Ice	2.57	2.57	0.14
						2" Ice			
DC6-48-60-18-8F	C	From Leg	4.00	0.0000	135.00	No Ice	1.21	1.21	0.03
			0.00			1/2"	1.89	1.89	0.05
			2.00			Ice	2.11	2.11	0.08
						1" Ice	2.57	2.57	0.14
						2" Ice			
RRUS 11	A	From Leg	4.00	0.0000	135.00	No Ice	2.79	1.19	0.05
			0.00			1/2"	3.00	1.34	0.07
			2.00			Ice	3.21	1.50	0.10
						1" Ice	3.67	1.84	0.15
						2" Ice			
RRUS 11	B	From Leg	4.00	0.0000	135.00	No Ice	2.79	1.19	0.05
			0.00			1/2"	3.00	1.34	0.07
			2.00			Ice	3.21	1.50	0.10
						1" Ice	3.67	1.84	0.15
						2" Ice			
RRUS 11	C	From Leg	4.00	0.0000	135.00	No Ice	2.79	1.19	0.05
			0.00			1/2"	3.00	1.34	0.07
			2.00			Ice	3.21	1.50	0.10
						1" Ice	3.67	1.84	0.15
						2" Ice			
RRUS 4415 B25	A	From Leg	4.00	0.0000	135.00	No Ice	1.64	0.68	0.04
			0.00			1/2"	1.80	0.79	0.06
			2.00			Ice	1.97	0.91	0.07
						1" Ice	2.33	1.18	0.11
						2" Ice			
RRUS 4415 B25	B	From Leg	4.00	0.0000	135.00	No Ice	1.64	0.68	0.04
			0.00			1/2"	1.80	0.79	0.06
			2.00			Ice	1.97	0.91	0.07
						1" Ice	2.33	1.18	0.11
						2" Ice			

Description	Face or Leg	Offset Type	Offsets:			Azimuth Adjustment	Placement	C _{AA} _{Front}	C _{AA} _{Side}	Weight
			Horz	Lateral	Vert					
			ft	ft	ft	°	ft	ft ²	ft ²	K
RRUS 4415 B25	C	From Leg	4.00	0.0000	135.00		No Ice	1.64	0.68	0.04
			0.00				1/2"	1.80	0.79	0.06
			2.00				Ice	1.97	0.91	0.07
							1" Ice	2.33	1.18	0.11
							2" Ice			
DBC0062F1V51-1	A	From Leg	4.00	0.0000	135.00		No Ice	0.22	0.71	0.01
			0.00				1/2"	0.29	0.82	0.01
			2.00				Ice	0.37	0.93	0.02
							1" Ice	0.54	1.18	0.04
							2" Ice			
DBC0062F1V51-1	B	From Leg	4.00	0.0000	135.00		No Ice	0.22	0.71	0.01
			0.00				1/2"	0.29	0.82	0.01
			2.00				Ice	0.37	0.93	0.02
							1" Ice	0.54	1.18	0.04
							2" Ice			
DBC0062F1V51-1	C	From Leg	4.00	0.0000	135.00		No Ice	0.22	0.71	0.01
			0.00				1/2"	0.29	0.82	0.01
			2.00				Ice	0.37	0.93	0.02
							1" Ice	0.54	1.18	0.04
							2" Ice			
RRUS 4426 B66	A	From Leg	4.00	0.0000	135.00		No Ice	1.64	0.73	0.05
			0.00				1/2"	1.80	0.84	0.06
			2.00				Ice	1.97	0.97	0.08
							1" Ice	2.33	1.24	0.11
							2" Ice			
RRUS 4426 B66	B	From Leg	4.00	0.0000	135.00		No Ice	1.64	0.73	0.05
			0.00				1/2"	1.80	0.84	0.06
			2.00				Ice	1.97	0.97	0.08
							1" Ice	2.33	1.24	0.11
							2" Ice			
RRUS 4426 B66	C	From Leg	4.00	0.0000	135.00		No Ice	1.64	0.73	0.05
			0.00				1/2"	1.80	0.84	0.06
			2.00				Ice	1.97	0.97	0.08
							1" Ice	2.33	1.24	0.11
							2" Ice			
WCS RRUS-32-B30	A	From Leg	4.00	0.0000	135.00		No Ice	3.31	2.42	0.08
			0.00				1/2"	3.56	2.64	0.10
			2.00				Ice	3.81	2.86	0.14
							1" Ice	4.33	3.32	0.21
							2" Ice			
WCS RRUS-32-B30	B	From Leg	4.00	0.0000	135.00		No Ice	3.31	2.42	0.08
			0.00				1/2"	3.56	2.64	0.10
			2.00				Ice	3.81	2.86	0.14
							1" Ice	4.33	3.32	0.21
							2" Ice			
WCS RRUS-32-B30	C	From Leg	4.00	0.0000	135.00		No Ice	3.31	2.42	0.08
			0.00				1/2"	3.56	2.64	0.10
			2.00				Ice	3.81	2.86	0.14
							1" Ice	4.33	3.32	0.21
							2" Ice			
Sector Mount [SM 504-3]	C	None		0.0000	135.00		No Ice	34.25	34.25	1.71
							1/2"	48.98	48.98	2.29
							Ice	63.71	63.71	2.86
							1" Ice	93.17	93.17	4.02
							2" Ice			
***** APXVSPP18-C-A20 w/ Mount Pipe	A	From Leg	4.00	0.0000	125.00		No Ice	4.60	4.01	0.09
			0.00				1/2"	5.05	4.45	0.15
			1.00				Ice	5.50	4.89	0.23
							1" Ice	6.44	5.82	0.41
							2" Ice			
APXV9ERR18-C-A20 w/ Mount Pipe	B	From Leg	4.00	0.0000	125.00		No Ice	8.26	7.47	0.09
			0.00				1/2"	8.82	8.66	0.16
			1.00				Ice	9.35	9.56	0.24
							1" Ice	10.42	11.39	0.42
							2" Ice			

Description	Face or Leg	Offset Type	Offsets: Horz Lateral Vert ft ft ft	Azimuth Adjustment t °	Placement ft	C _{AA} Front ft ²	C _{AA} Side ft ²	Weight K	
APXVSPP18-C-A20 w/ Mount Pipe	C	From Leg	4.00 0.00 1.00	0.0000	125.00	2" Ice			
						No Ice	4.60	4.01	0.09
						1/2"	5.05	4.45	0.15
						Ice	5.50	4.89	0.23
APXVTM14-C-120 w/ Mount Pipe	A	From Leg	4.00 0.00 1.00	0.0000	125.00	1" Ice	6.44	5.82	0.41
						2" Ice			
						No Ice	6.58	4.96	0.08
						1/2"	7.03	5.75	0.13
APXVTM14-C-120 w/ Mount Pipe	B	From Leg	4.00 0.00 1.00	0.0000	125.00	Ice	7.47	6.47	0.19
						1" Ice	8.38	7.94	0.34
						2" Ice			
						No Ice	6.58	4.96	0.08
APXVTM14-C-120 w/ Mount Pipe	C	From Leg	4.00 0.00 1.00	0.0000	125.00	1/2"	7.03	5.75	0.13
						Ice	7.47	6.47	0.19
						1" Ice	8.38	7.94	0.34
						2" Ice			
TD-RRH8x20-25	A	From Leg	4.00 0.00 1.00	0.0000	125.00	No Ice	4.05	1.53	0.07
						1/2"	4.30	1.71	0.10
						Ice	4.56	1.90	0.13
						1" Ice	5.10	2.30	0.20
TD-RRH8x20-25	B	From Leg	4.00 0.00 1.00	0.0000	125.00	2" Ice			
						No Ice	4.05	1.53	0.07
						1/2"	4.30	1.71	0.10
						Ice	4.56	1.90	0.13
TD-RRH8x20-25	C	From Leg	4.00 0.00 1.00	0.0000	125.00	1" Ice	5.10	2.30	0.20
						2" Ice			
						No Ice	4.05	1.53	0.07
						1/2"	4.30	1.71	0.10
800MHz 2X50W RRH W/FILTER	A	From Leg	4.00 0.00 1.00	0.0000	125.00	Ice	4.56	1.90	0.13
						1" Ice	5.10	2.30	0.20
						2" Ice			
						No Ice	2.06	1.93	0.06
800MHz 2X50W RRH W/FILTER	B	From Leg	4.00 0.00 1.00	0.0000	125.00	1/2"	2.24	2.11	0.09
						Ice	2.43	2.29	0.11
						1" Ice	2.83	2.68	0.17
						2" Ice			
800MHz 2X50W RRH W/FILTER	C	From Leg	4.00 0.00 1.00	0.0000	125.00	No Ice	2.06	1.93	0.06
						1/2"	2.24	2.11	0.09
						Ice	2.43	2.29	0.11
						1" Ice	2.83	2.68	0.17
1900MHz RRH (65MHz)	A	From Leg	4.00 0.00 1.00	0.0000	125.00	2" Ice			
						No Ice	2.32	2.24	0.06
						1/2"	2.53	2.44	0.08
						Ice	2.74	2.65	0.11
1900MHz RRH (65MHz)	B	From Leg	4.00 0.00 1.00	0.0000	125.00	1" Ice	3.19	3.09	0.17
						2" Ice			
						No Ice	2.32	2.24	0.06
						1/2"	2.53	2.44	0.08
1900MHz RRH (65MHz)	C	From Leg	4.00 0.00 1.00	0.0000	125.00	Ice	2.74	2.65	0.11
						1" Ice	3.19	3.09	0.17
						2" Ice			
						No Ice	2.32	2.24	0.06
1900MHz RRH (65MHz)	C	From Leg	4.00 0.00 1.00	0.0000	125.00	1/2"	2.53	2.44	0.08
						Ice	2.74	2.65	0.11
						1" Ice	3.19	3.09	0.17
						2" Ice			

Description	Face or Leg	Offset Type	Offsets: Horz Lateral Vert ft ft ft	Azimuth Adjustment t °	Placement ft	C _{AA} Front ft ²	C _{AA} Side ft ²	Weight K	
Sector Mount [SM 402-3]	C	None		0.0000	125.00	2" Ice No Ice 1/2" Ice 1" Ice 2" Ice	18.91 18.91 26.78 34.65 50.39 50.39	0.85 1.23 1.62 2.38	

(2) ERICSSON AIR 21 B4A B2P w/ Mount Pipe	A	From Leg	2.00 0.00 1.00	0.0000	113.00	No Ice 1/2" Ice 1" Ice 2" Ice	6.32 6.42 7.12 8.58 8.58	5.63 6.42 7.12 8.58	0.11 0.17 0.23 0.38
ERICSSON AIR 21 B4A B2P w/ Mount Pipe	B	From Leg	2.00 0.00 1.00	0.0000	113.00	No Ice 1/2" Ice 1" Ice 2" Ice	6.32 6.42 7.12 8.58 8.58	5.63 6.42 7.12 8.58	0.11 0.17 0.23 0.38
AIR 32 B2A/B66AA w/ Mount Pipe	A	From Leg	4.00 0.00 1.00	0.0000	113.00	No Ice 1/2" Ice 1" Ice 2" Ice	6.75 7.20 7.58 8.57 9.06	6.07 6.87 7.58 9.06	0.15 0.21 0.28 0.44
AIR 32 B2A/B66AA w/ Mount Pipe	B	From Leg	4.00 0.00 1.00	0.0000	113.00	No Ice 1/2" Ice 1" Ice 2" Ice	6.75 7.20 7.58 8.57 9.06	6.07 6.87 7.58 9.06	0.15 0.21 0.28 0.44
AIR 32 B2A/B66AA w/ Mount Pipe	C	From Leg	4.00 0.00 1.00	0.0000	113.00	No Ice 1/2" Ice 1" Ice 2" Ice	6.75 7.20 7.58 8.57 9.06	6.07 6.87 7.58 9.06	0.15 0.21 0.28 0.44
APXVAARR24_43-U-NA20 w/ Mount Pipe	A	From Leg	4.00 0.00 1.00	0.0000	113.00	No Ice 1/2" Ice 1" Ice 2" Ice	20.48 21.23 21.99 23.44 23.44	11.02 12.55 14.10 16.45	0.16 0.30 0.44 0.78
APXVAARR24_43-U-NA20 w/ Mount Pipe	B	From Leg	4.00 0.00 1.00	0.0000	113.00	No Ice 1/2" Ice 1" Ice 2" Ice	20.48 21.23 21.99 23.44 23.44	11.02 12.55 14.10 16.45	0.16 0.30 0.44 0.78
APXVAARR24_43-U-NA20 w/ Mount Pipe	C	From Leg	4.00 0.00 1.00	0.0000	113.00	No Ice 1/2" Ice 1" Ice 2" Ice	20.48 21.23 21.99 23.44 23.44	11.02 12.55 14.10 16.45	0.16 0.30 0.44 0.78
RADIO 4449 B12/B71	A	From Leg	4.00 0.00 1.00	0.0000	113.00	No Ice 1/2" Ice 1" Ice 2" Ice	1.65 1.81 1.98 2.34 2.34	1.16 1.30 1.45 1.76	0.07 0.09 0.11 0.16
RADIO 4449 B12/B71	B	From Leg	4.00 0.00 1.00	0.0000	113.00	No Ice 1/2" Ice 1" Ice 2" Ice	1.65 1.81 1.98 2.34 2.34	1.16 1.30 1.45 1.76	0.07 0.09 0.11 0.16
Sector Mount [SM 502-3]	C	None		0.0000	113.00	No Ice 1/2" Ice 1" Ice 2" Ice	33.02 47.36 61.70 90.38 90.38	33.02 47.36 61.70 90.38	1.67 2.22 2.77 3.88

GPS_A	A	From Leg	2.00 0.00	0.0000	57.00	No Ice	0.26 0.32	0.26 0.32	0.00 0.00

Description	Face or Leg	Offset Type	Offsets: Horz Lateral Vert ft ft ft	Azimuth Adjustment °	Placement ft	C _{AA} _{Front} ft ²	C _{AA} _{Side} ft ²	Weight K	
			3.00			1/2" Ice 0.39 0.56	0.39 0.56	0.01 0.02	
Side Arm Mount [SO 202-1]	A	From Leg	1.00 0.00 0.00	0.0000	57.00	No Ice 1" Ice 2" Ice 1/2" Ice Ice 1" Ice 2" Ice	2.96 2.53 4.10 3.51 5.24 4.49 7.52 6.45	0.11 0.13 0.16 0.20	

EMPTY_MOUNT w/ Mount Pipe	C	From Leg	2.00 0.00 2.00	0.0000	48.00	No Ice 1/2" Ice Ice 1" Ice 2" Ice	0.15 0.23 0.32 0.56 0.56	0.15 0.23 0.32 0.56 0.56	0.00 0.00 0.00 0.00
Side Arm Mount [SO 202-1]	C	From Leg	1.00 0.00 0.00	0.0000	48.00	No Ice 1/2" Ice Ice 1" Ice 2" Ice	2.96 2.53 4.10 3.51 5.24 4.49 7.52 6.45	0.11 0.13 0.16 0.20	

Load Combinations

Comb. No.	Description
1	Dead Only
2	1.2 Dead+1.0 Wind 0 deg - No Ice
3	0.9 Dead+1.0 Wind 0 deg - No Ice
4	1.2 Dead+1.0 Wind 30 deg - No Ice
5	0.9 Dead+1.0 Wind 30 deg - No Ice
6	1.2 Dead+1.0 Wind 60 deg - No Ice
7	0.9 Dead+1.0 Wind 60 deg - No Ice
8	1.2 Dead+1.0 Wind 90 deg - No Ice
9	0.9 Dead+1.0 Wind 90 deg - No Ice
10	1.2 Dead+1.0 Wind 120 deg - No Ice
11	0.9 Dead+1.0 Wind 120 deg - No Ice
12	1.2 Dead+1.0 Wind 150 deg - No Ice
13	0.9 Dead+1.0 Wind 150 deg - No Ice
14	1.2 Dead+1.0 Wind 180 deg - No Ice
15	0.9 Dead+1.0 Wind 180 deg - No Ice
16	1.2 Dead+1.0 Wind 210 deg - No Ice
17	0.9 Dead+1.0 Wind 210 deg - No Ice
18	1.2 Dead+1.0 Wind 240 deg - No Ice
19	0.9 Dead+1.0 Wind 240 deg - No Ice
20	1.2 Dead+1.0 Wind 270 deg - No Ice
21	0.9 Dead+1.0 Wind 270 deg - No Ice
22	1.2 Dead+1.0 Wind 300 deg - No Ice
23	0.9 Dead+1.0 Wind 300 deg - No Ice
24	1.2 Dead+1.0 Wind 330 deg - No Ice
25	0.9 Dead+1.0 Wind 330 deg - No Ice
26	1.2 Dead+1.0 Ice
27	1.2 Dead+1.0 Wind 0 deg+1.0 Ice
28	1.2 Dead+1.0 Wind 30 deg+1.0 Ice
29	1.2 Dead+1.0 Wind 60 deg+1.0 Ice
30	1.2 Dead+1.0 Wind 90 deg+1.0 Ice
31	1.2 Dead+1.0 Wind 120 deg+1.0 Ice
32	1.2 Dead+1.0 Wind 150 deg+1.0 Ice
33	1.2 Dead+1.0 Wind 180 deg+1.0 Ice

Comb. No.	Description
34	1.2 Dead+1.0 Wind 210 deg+1.0 Ice
35	1.2 Dead+1.0 Wind 240 deg+1.0 Ice
36	1.2 Dead+1.0 Wind 270 deg+1.0 Ice
37	1.2 Dead+1.0 Wind 300 deg+1.0 Ice
38	1.2 Dead+1.0 Wind 330 deg+1.0 Ice
39	Dead+Wind 0 deg - Service
40	Dead+Wind 30 deg - Service
41	Dead+Wind 60 deg - Service
42	Dead+Wind 90 deg - Service
43	Dead+Wind 120 deg - Service
44	Dead+Wind 150 deg - Service
45	Dead+Wind 180 deg - Service
46	Dead+Wind 210 deg - Service
47	Dead+Wind 240 deg - Service
48	Dead+Wind 270 deg - Service
49	Dead+Wind 300 deg - Service
50	Dead+Wind 330 deg - Service

Maximum Tower Deflections - Service Wind

Section No.	Elevation ft	Horz. Deflection in	Gov. Load Comb.	Tilt °	Twist °
T1	160 - 140	4.532	49	0.2586	0.0421
T2	140 - 135	3.455	49	0.2398	0.0411
T3	135 - 130	3.203	49	0.2342	0.0401
T4	130 - 125	2.953	49	0.2269	0.0387
T5	125 - 120	2.714	49	0.2183	0.0368
T6	120 - 113.333	2.480	49	0.2080	0.0350
T7	113.333 - 106.667	2.193	49	0.1964	0.0333
T8	106.667 - 100	1.918	49	0.1830	0.0310
T9	100 - 93.333	1.666	49	0.1681	0.0286
T10	93.333 - 86.667	1.428	49	0.1549	0.0253
T11	86.667 - 80	1.213	43	0.1407	0.0226
T12	80 - 73.333	1.022	43	0.1256	0.0208
T13	73.333 - 66.667	0.846	43	0.1127	0.0177
T14	66.667 - 60	0.686	43	0.0994	0.0145
T15	60 - 50	0.544	43	0.0857	0.0112
T16	50 - 40	0.370	43	0.0701	0.0089
T17	40 - 30	0.233	43	0.0542	0.0066
T18	30 - 20	0.126	43	0.0377	0.0048
T19	20 - 0	0.059	43	0.0211	0.0031

Critical Deflections and Radius of Curvature - Service Wind

Elevation ft	Appurtenance	Gov. Load Comb.	Deflection in	Tilt °	Twist °	Radius of Curvature ft
157.00	(2) APL866513-42T6 w/ Mount Pipe	49	4.366	0.2559	0.0421	108165
135.00	7770.00 w/ Mount Pipe	49	3.203	0.2342	0.0401	320395
125.00	APXVSPP18-C-A20 w/ Mount Pipe	49	2.714	0.2183	0.0368	66250
113.00	(2) ERICSSON AIR 21 B4A B2P w/ Mount Pipe	49	2.179	0.1958	0.0332	66295
57.00	GPS_A	43	0.487	0.0805	0.0103	24450
48.00	EMPTY_MOUNT w/ Mount Pipe	43	0.340	0.0671	0.0085	36732

Maximum Tower Deflections - Design Wind

Section No.	Elevation ft	Horz. Deflection in	Gov. Load Comb.	Tilt °	Twist °
T1	160 - 140	18.836	11	1.0667	0.1737
T2	140 - 135	14.389	11	0.9914	0.1694
T3	135 - 130	13.347	11	0.9689	0.1653
T4	130 - 125	12.309	11	0.9388	0.1596
T5	125 - 120	11.320	11	0.9043	0.1519
T6	120 - 113.333	10.349	11	0.8618	0.1444
T7	113.333 - 106.667	9.159	11	0.8144	0.1373
T8	106.667 - 100	8.016	11	0.7590	0.1280
T9	100 - 93.333	6.968	11	0.6977	0.1180
T10	93.333 - 86.667	5.978	11	0.6433	0.1043
T11	86.667 - 80	5.081	11	0.5847	0.0934
T12	80 - 73.333	4.280	11	0.5225	0.0858
T13	73.333 - 66.667	3.539	11	0.4691	0.0730
T14	66.667 - 60	2.872	11	0.4142	0.0596
T15	60 - 50	2.275	11	0.3573	0.0462
T16	50 - 40	1.548	11	0.2926	0.0367
T17	40 - 30	0.972	11	0.2265	0.0271
T18	30 - 20	0.527	11	0.1576	0.0198
T19	20 - 0	0.246	11	0.0885	0.0126

Critical Deflections and Radius of Curvature - Design Wind

Elevation ft	Appurtenance	Gov. Load Comb.	Deflection in	Tilt °	Twist °	Radius of Curvature ft
157.00	(2) APL866513-42T6 w/ Mount Pipe	11	18.151	1.0558	0.1737	26838
135.00	7770.00 w/ Mount Pipe	11	13.347	0.9689	0.1653	95509
125.00	APXVSPP18-C-A20 w/ Mount Pipe	11	11.320	0.9043	0.1519	16423
113.00	(2) ERICSSON AIR 21 B4A B2P w/ Mount Pipe	11	9.101	0.8120	0.1369	16360
57.00	GPS_A	11	2.037	0.3358	0.0424	5869
48.00	EMPTY_MOUNT w/ Mount Pipe	11	1.423	0.2800	0.0350	8901

Bolt Design Data

Section No.	Elevation ft	Component Type	Bolt Grade	Bolt Size in	Number Of Bolts	Maximum Load per Bolt K	Allowable Load per Bolt K	Ratio Load Allowable	Allowable Ratio	Criteria
T1	160	Leg	A325N	0.6250	4	3.92	20.34	0.193	1.05	Bolt Tension
		Diagonal	A325N	0.5000	1	2.75	5.71	0.481	1.05	Member Block Shear
		Top Girt	A325N	0.5000	1	0.55	4.13	0.133	1.05	Member Bearing
T2	140	Diagonal	A325N	0.5000	1	2.87	5.71	0.503	1.05	Member Block Shear
		Top Girt	A325N	0.5000	1	0.49	4.13	0.119	1.05	Member Bearing
T3	135	Diagonal	A325N	0.5000	1	4.28	5.71	0.750	1.05	Member Block Shear
T4	130	Diagonal	A325N	0.5000	1	4.36	5.71	0.763	1.05	Member Block Shear
T5	125	Leg	A325N	0.7500	4	11.02	30.10	0.366	1.05	Bolt Tension
		Diagonal	A325N	0.5000	1	5.21	6.20	0.841	1.05	Member Bearing

Section No.	Elevation ft	Component Type	Bolt Grade	Bolt Size in	Number Of Bolts	Maximum Load per Bolt K	Allowable Load per Bolt K	Ratio Load Allowable	Allowable Ratio	Criteria
T6	120	Diagonal	A325X	0.5000	1	5.79	7.50	0.772	1.05	Gusset Bearing
T7	113.333	Diagonal	A325X	0.5000	1	7.34	7.50	0.978	1.05	Gusset Bearing
T8	106.667	Leg	A325N	0.8750	4	19.95	41.56	0.480	1.05	Bolt Tension
		Diagonal	A325X	0.5000	1	7.43	7.50	0.991	1.05	Gusset Bearing
		Secondary Horizontal	A325N	0.6250	1	1.60	6.85	0.234	1.05	Member Block Shear
T9	100	Diagonal	A325N	0.5000	2	3.70	6.53	0.567	1.05	Member Block Shear
T10	93.333	Diagonal	A325N	0.5000	2	3.87	8.70	0.445	1.05	Member Block Shear
T11	86.667	Leg	A325N	0.8750	4	29.30	41.56	0.705	1.05	Bolt Tension
		Diagonal	A325N	0.5000	2	3.96	13.05	0.304	1.05	Member Block Shear
		Secondary Horizontal	A325N	0.6250	1	2.31	7.12	0.324	1.05	Member Block Shear
T12	80	Diagonal	A325N	0.5000	2	4.04	7.03	0.575	1.05	Member Block Shear
T13	73.333	Diagonal	A325N	0.5000	2	4.16	7.03	0.591	1.05	Member Block Shear
		Secondary Horizontal	A325N	0.6250	1	2.76	8.13	0.339	1.05	Member Block Shear
T14	66.667	Leg	A325N	1.0000	4	38.00	54.52	0.697	1.05	Bolt Tension
		Diagonal	A325N	0.5000	2	4.13	7.03	0.587	1.05	Member Block Shear
		Secondary Horizontal	A325N	0.6250	1	2.98	7.12	0.419	1.05	Member Block Shear
T15	60	Diagonal	A325N	0.6250	1	10.05	14.79	0.680	1.05	Gusset Bearing
T16	50	Leg	A325N	1.0000	4	45.63	54.52	0.837	1.05	Bolt Tension
		Diagonal	A325N	0.6250	1	10.21	14.79	0.690	1.05	Gusset Bearing
		Secondary Horizontal	A325N	0.6250	1	3.58	8.48	0.422	1.05	Member Bearing
T17	40	Diagonal	A325N	0.6250	1	10.27	14.79	0.694	1.05	Gusset Bearing
		Secondary Horizontal	A325N	0.6250	1	3.91	11.31	0.345	1.05	Member Bearing
T18	30	Leg	A325N	1.0000	6	35.56	54.52	0.652	1.05	Bolt Tension
		Diagonal	A325N	0.6250	1	11.03	14.79	0.746	1.05	Gusset Bearing
		Horizontal	A325N	0.6250	1	4.22	8.48	0.497	1.05	Member Bearing
T19	20	Diagonal	A325N	0.6250	1	11.67	14.79	0.789	1.05	Gusset Bearing

Compression Checks

Leg Design Data (Compression)

Section No.	Elevation ft	Size	L ft	L_u ft	Kl/r	A in ²	P_u K	ϕP_n K	Ratio $\frac{P_u}{\phi P_n}$
T1	160 - 140	Pipe 2.375" x 0.154" (2 STD)	20.00	4.00	61.0 K=1.00	1.0745	-18.44	36.84	0.500 ¹
T2	140 - 135	Pipe 2.875" x 0.276" (2.5 EH)	5.01	5.01	65.0 K=1.00	2.2535	-23.04	74.43	0.310 ¹
T3	135 - 130	Pipe 2.875" x 0.276" (2.5 EH)	5.01	5.01	65.0 K=1.00	2.2535	-33.27	74.43	0.447 ¹
T4	130 - 125	Pipe 2.875" x 0.276" (2.5 EH)	5.01	5.01	65.0 K=1.00	2.2535	-41.75	74.43	0.561 ¹
T5	125 - 120	Pipe 2.875" x 0.276" (2.5 EH)	5.01	5.01	65.0 K=1.00	2.2535	-51.84	74.43	0.697 ¹
T6	120 - 113.333	Pipe 3.5" x 0.300" (3 EH)	6.68	6.68	70.5 K=1.00	3.0159	-62.82	94.34	0.666 ¹

Section No.	Elevation ft	Size	L ft	L _u ft	Kl/r	A in ²	P _u K	φP _n K	Ratio $\frac{P_u}{\phi P_n}$
T7	113.333 - 106.667	Pipe 3.5" x 0.300" (3 EH)	6.68	6.68	70.5 K=1.00	3.0159	-77.60	94.35	0.822 ¹
T8	106.667 - 100	Pipe 3.5" x 0.300" (3 EH)	6.68	3.45	36.4 K=1.00	3.0159	-92.42	123.17	0.750 ¹
T9	100 - 93.333	Pipe 4" x 0.318" (3.5 EH)	6.68	6.68	61.3 K=1.00	3.6784	-106.32	125.72	0.846 ¹
T10	93.333 - 86.667	Pipe 4" x 0.318" (3.5 EH)	6.68	6.68	61.3 K=1.00	3.6784	-120.09	125.73	0.955 ¹
T11	86.667 - 80	Pipe 4" x 0.318" (3.5 EH)	6.68	3.43	31.5 K=1.00	3.6784	-133.06	153.94	0.864 ¹
T12	80 - 73.333	Pipe 4.5" x 0.337" (4 XS)	6.68	6.68	54.3 K=1.00	4.4074	-146.65	159.90	0.917 ¹
T13	73.333 - 66.667	Pipe 4.5" x 0.337" (4 XS)	6.68	3.42	27.8 K=1.00	4.4074	-158.95	187.42	0.848 ¹
T14	66.667 - 60	Pipe 4.5" x 0.337" (4 XS)	6.68	3.42	27.8 K=1.00	4.4074	-171.89	187.44	0.917 ¹
T15	60 - 50	Pipe 5.563" x 0.375" (5 EH)	10.02	10.02	65.4 K=1.00	6.1120	-187.98	201.25	0.934 ¹
T16	50 - 40	Pipe 5.563" x 0.375" (5 EH)	10.02	5.16	33.7 K=1.00	6.1120	-206.47	253.14	0.816 ¹
T17	40 - 30	Pipe 5.563" x 0.375" (5 XS)	10.02	5.16	33.7 K=1.00	6.1120	-225.15	253.16	0.889 ¹
T18	30 - 20	Pipe 5.563" x 0.375" (5 XS)	10.02	2.50	16.3 K=1.00	6.1120	-243.13	269.72	0.901 ¹
T19	20 - 0	BU 806378 (PJF) - 6.625"x0.34" pipe w/ 2" SR- (modified with 19.5" spacing)	20.03	10.02	75.6 K=1.00	9.8549	-279.95	292.10	0.958 ¹

¹ P_u / φP_n controls

Diagonal Design Data (Compression)

Section No.	Elevation ft	Size	L ft	L _u ft	Kl/r	A in ²	P _u K	φP _n K	Ratio $\frac{P_u}{\phi P_n}$
T1	160 - 140	L 1.75 x 1.75 x 3/16	7.68	3.62	126.6 K=1.00	0.6211	-2.79	11.09	0.251 ¹
T2	140 - 135	L 1.75 x 1.75 x 3/16	8.46	4.13	144.4 K=1.00	0.6211	-3.11	8.52	0.364 ¹
T3	135 - 130	L 1.75 x 1.75 x 3/16	8.87	4.34	151.7 K=1.00	0.6211	-4.28	7.73	0.554 ¹
T4	130 - 125	L 1.75 x 1.75 x 3/16	9.30	4.55	159.1 K=1.00	0.6211	-4.45	7.02	0.634 ¹
T5	125 - 120	L 2 x 2 x 3/16	9.73	4.77	145.3 K=1.00	0.7150	-5.25	9.69	0.542 ¹
T6	120 - 113.333	L 2.5 x 2.5 x 1/4	11.16	5.50	134.5 K=1.00	1.1900	-5.88	18.83	0.312 ¹
T7	113.333 - 106.667	L 2.5 x 2.5 x 1/4	11.71	5.78	141.2 K=1.00	1.1900	-7.66	17.09	0.448 ¹
T8	106.667 - 100	L 2.5 x 2.5 x 1/4	12.27	6.16	150.6 K=1.00	1.1900	-7.59	15.02	0.506 ¹
T9	100 - 93.333	L 2.5 x 2.5 x 3/16	12.84	6.43	155.8 K=1.00	0.9020	-7.70	10.64	0.723 ¹
T10	93.333 - 86.667	L 2.5 x 2.5 x 1/4	13.43	6.72	164.2 K=1.00	1.1900	-7.76	12.63	0.615 ¹
T11	86.667 - 80	2L 2.5 x 2.5 x 3/16 (1/4)	14.02	7.02	113.1 K=1.00	1.8047	-8.52	37.90	0.225 ¹
T12	80 - 73.333	2L 'a' > 40.1531 in - 129 L 3 x 3 x 3/16	14.63	7.30	147.0 K=1.00	1.0898	-8.04	14.44	0.556 ¹
T13	73.333 - 66.667	L 3 x 3 x 3/16	15.26	7.61	153.2 K=1.00	1.0898	-9.01	13.28	0.678 ¹
T14	66.667 - 60	L 3 x 3 x 3/16	15.89	7.93	159.6 K=1.00	1.0898	-8.84	12.25	0.722 ¹

Section No.	Elevation ft	Size	L ft	L _u ft	Kl/r	A in ²	P _u K	φP _n K	Ratio $\frac{P_u}{\phi P_n}$
T15	60 - 50	2L 3 x 3 x 3/16 (1/4)	18.26	9.03	K=1.00 122.0	2.1797	-10.23	39.93	0.256 ¹
T16	50 - 40	2L 'a' > 51.5914 in - 174 2L 3 x 3 x 3/16 (1/4)	19.10	9.57	K=1.00 129.3	2.1797	-11.23	35.86	0.313 ¹
T17	40 - 30	2L 'a' > 54.6855 in - 183 2L 3 x 3 x 1/4 (1/4)	19.98	10.02	K=1.00 135.4	2.8750	-11.41	44.05	0.259 ¹
T18	30 - 20	2L 'a' > 57.4295 in - 195 2L 3 x 3 x 1/4 (1/4)	10.67	10.17	K=1.00 105.2	2.8750	-12.29	72.00	0.171 ¹
T19	20 - 0	2L 3.5 x 3.5 x 1/4 (1/4) 2L 'a' > 63.5109 in - 249	22.69	11.10	K=1.00 129.1	3.3750	-12.50	56.27	0.222 ¹

¹ P_u / φP_n controls

Horizontal Design Data (Compression)

Section No.	Elevation ft	Size	L ft	L _u ft	Kl/r	A in ²	P _u K	φP _n K	Ratio $\frac{P_u}{\phi P_n}$
T18	30 - 20	L 3 x 3 x 3/16	18.33	8.81	K=1.00 177.4	1.0900	-4.22	9.92	0.425 ¹

¹ P_u / φP_n controls

Secondary Horizontal Design Data (Compression)

Section No.	Elevation ft	Size	L ft	L _u ft	Kl/r	A in ²	P _u K	φP _n K	Ratio $\frac{P_u}{\phi P_n}$
T8	106.667 - 100	L 1.75 x 1.75 x 1/4	10.29	5.00	K=1.00 175.7	0.8125	-1.60	7.54	0.213 ¹
T11	86.667 - 80	L 2 x 2 x 3/16	12.33	6.00	K=1.00 182.7	0.7150	-2.31	6.13	0.376 ¹
T13	73.333 - 66.667	L 1.75 x 1.75 x 1/4	13.72	6.67	K=1.00 234.5	0.8125	-2.76	4.23	0.652 ¹
T14	66.667 - 60	L 2 x 2 x 3/16	14.41	7.02	K=1.00 213.8	0.7150	-2.98	4.48	0.666 ¹
T16	50 - 40	L 2.5 x 2.5 x 3/16	16.26	7.90	K=1.00 191.4	0.9020	-3.58	7.05	0.508 ¹
T17	40 - 30	L 3 x 3 x 1/4	17.28	8.41	K=1.00 170.4	1.4400	-3.91	14.20	0.275 ¹

¹ P_u / φP_n controls

Top Girt Design Data (Compression)

Section No.	Elevation ft	Size	L ft	L _u ft	Kl/r	A in ²	P _u K	φP _n K	Ratio $\frac{P_u}{\phi P_n}$
T1	160 - 140	L 2 x 2 x 1/8	6.52	6.11	K=1.00 184.6	0.4844	-0.56	4.07	0.137 ¹

Section No.	Elevation ft	Size	L ft	L_u ft	Kl/r	A in ²	P_u K	ϕP_n K	Ratio $\frac{P_u}{\phi P_n}$
T2	140 - 135	L 2 x 2 x 1/8	6.56	6.16	185.8 K=1.00	0.4844	-0.46	4.01	0.113 ¹

¹ $P_u / \phi P_n$ controls

Redundant Horizontal (1) Design Data (Compression)

Section No.	Elevation ft	Size	L ft	L_u ft	Kl/r	A in ²	P_u K	ϕP_n K	Ratio $\frac{P_u}{\phi P_n}$
T18	30 - 20	L 2 x 2 x 3/16	4.58	4.35	132.5 K=1.00	0.7150	-4.22	11.65	0.362 ¹

¹ $P_u / \phi P_n$ controls

Redundant Diagonal (1) Design Data (Compression)

Section No.	Elevation ft	Size	L ft	L_u ft	Kl/r	A in ²	P_u K	ϕP_n K	Ratio $\frac{P_u}{\phi P_n}$
T18	30 - 20	L 2 x 2 x 3/16	5.34	5.07	154.4 K=1.00	0.7150	-2.53	8.58	0.295 ¹

¹ $P_u / \phi P_n$ controls

Tension Checks

Leg Design Data (Tension)

Section No.	Elevation ft	Size	L ft	L_u ft	Kl/r	A in ²	P_u K	ϕP_n K	Ratio $\frac{P_u}{\phi P_n}$
T1	160 - 140	Pipe 2.375" x 0.154" (2 STD)	20.00	4.00	61.0	1.0745	15.67	48.35	0.324 ¹
T2	140 - 135	Pipe 2.875" x 0.276" (2.5 EH)	5.01	5.01	65.0	2.2535	20.03	101.41	0.198 ¹
T3	135 - 130	Pipe 2.875" x 0.276" (2.5 EH)	5.01	5.01	65.0	2.2535	27.44	101.41	0.271 ¹
T4	130 - 125	Pipe 2.875" x 0.276" (2.5 EH)	5.01	5.01	65.0	2.2535	35.51	101.41	0.350 ¹
T5	125 - 120	Pipe 2.875" x 0.276" (2.5 EH)	5.01	5.01	65.0	2.2535	44.08	101.41	0.435 ¹
T6	120 - 113.333	Pipe 3.5" x 0.300" (3 EH)	6.68	6.68	70.5	3.0159	54.09	135.72	0.399 ¹
T7	113.333 - 106.667	Pipe 3.5" x 0.300" (3 EH)	6.68	6.68	70.5	3.0159	66.48	135.72	0.490 ¹
T8	106.667 - 100	Pipe 3.5" x 0.300" (3 EH)	6.68	3.23	34.1	3.0159	79.80	135.72	0.588 ¹
T9	100 - 93.333	Pipe 4" x 0.318" (3.5 EH)	6.68	6.68	61.3	3.6784	92.69	165.53	0.560 ¹
T10	93.333 - 86.667	Pipe 4" x 0.318" (3.5 EH)	6.68	6.68	61.3	3.6784	105.45	165.53	0.637 ¹
T11	86.667 - 80	Pipe 4" x 0.318" (3.5 EH)	6.68	3.25	29.8	3.6784	117.25	165.53	0.708 ¹
T12	80 - 73.333	Pipe 4.5" x 0.337" (4 XS)	6.68	6.68	54.3	4.4074	129.38	198.34	0.652 ¹
T13	73.333 - 66.667	Pipe 4.5" x 0.337" (4 XS)	6.68	3.25	26.4	4.4074	140.58	198.34	0.709 ¹

Section No.	Elevation ft	Size	L ft	L _u ft	Kl/r	A in ²	P _u K	φP _n K	Ratio $\frac{P_u}{\phi P_n}$
T14	66.667 - 60	Pipe 4.5" x 0.337" (4 XS)	6.68	3.26	26.5	4.4074	152.04	198.34	0.767 ¹
T15	60 - 50	Pipe 5.563" x 0.375" (5 EH)	10.02	10.02	65.4	6.1120	166.21	275.04	0.604 ¹
T16	50 - 40	Pipe 5.563" x 0.375" (5 EH)	10.02	4.85	31.7	6.1120	182.62	275.04	0.664 ¹
T17	40 - 30	Pipe 5.563" x 0.375" (5 XS)	10.02	4.86	31.7	6.1120	198.74	275.04	0.723 ¹
T18	30 - 20	Pipe 5.563" x 0.375" (5 XS)	10.02	2.50	16.3	6.1120	213.53	275.04	0.776 ¹
T19	20 - 0	BU 806378 (PJF) - 6.625"x0.34" pipe w/ 2" SR- (modified with 19.5" spacing)	20.03	10.02	75.6	9.8549	244.22	443.47	0.551 ¹

¹ P_u / φP_n controls

Diagonal Design Data (Tension)

Section No.	Elevation ft	Size	L ft	L _u ft	Kl/r	A in ²	P _u K	φP _n K	Ratio $\frac{P_u}{\phi P_n}$
T1	160 - 140	L 1.75 x 1.75 x 3/16	7.68	3.62	83.3	0.3779	2.75	16.44	0.167 ¹
T2	140 - 135	L 1.75 x 1.75 x 3/16	8.46	4.13	94.7	0.3779	2.87	16.44	0.175 ¹
T3	135 - 130	L 1.75 x 1.75 x 3/16	8.87	4.34	99.4	0.3779	4.28	16.44	0.261 ¹
T4	130 - 125	L 1.75 x 1.75 x 3/16	9.30	4.55	104.1	0.3779	4.36	16.44	0.265 ¹
T5	125 - 120	L 2 x 2 x 3/16	9.73	4.77	94.8	0.4484	5.21	19.50	0.267 ¹
T6	120 - 113.333	L 2.5 x 2.5 x 1/4	11.16	5.50	87.5	0.7753	5.79	33.73	0.172 ¹
T7	113.333 - 106.667	L 2.5 x 2.5 x 1/4	11.71	5.78	91.8	0.7753	7.34	33.73	0.218 ¹
T8	106.667 - 100	L 2.5 x 2.5 x 1/4	12.27	6.16	96.2	0.7753	7.43	33.73	0.220 ¹
T9	100 - 93.333	L 2.5 x 2.5 x 3/16	12.84	6.43	99.0	0.5886	7.40	25.60	0.289 ¹
T10	93.333 - 86.667	L 2.5 x 2.5 x 1/4	13.43	6.72	104.9	0.7753	7.73	33.73	0.229 ¹
T11	86.667 - 80	2L 2.5 x 2.5 x 3/16 (1/4) 2L 'a' > 40.1531 in - 129	14.02	7.02	108.2	1.1777	7.93	51.23	0.155 ¹
T12	80 - 73.333	L 3 x 3 x 3/16	14.63	7.30	93.3	0.7295	8.08	31.73	0.255 ¹
T13	73.333 - 66.667	L 3 x 3 x 3/16	15.26	7.61	97.3	0.7295	8.32	31.73	0.262 ¹
T14	66.667 - 60	L 3 x 3 x 3/16	15.89	7.93	101.3	0.7295	8.25	31.73	0.260 ¹
T15	60 - 50	2L 3 x 3 x 3/16 (1/4) 2L 'a' > 51.5914 in - 175	18.26	9.03	116.9	1.4238	10.05	61.94	0.162 ¹
T16	50 - 40	2L 3 x 3 x 3/16 (1/4) 2L 'a' > 54.6855 in - 183	19.10	9.57	122.3	1.4238	10.21	61.94	0.165 ¹
T17	40 - 30	2L 3 x 3 x 1/4 (1/4) 2L 'a' > 57.4295 in - 195	19.98	10.02	129.3	1.8750	10.27	91.41	0.112 ¹
T18	30 - 20	2L 3 x 3 x 1/4 (1/4)	10.67	10.17	93.1	1.8750	11.03	91.41	0.121 ¹
T19	20 - 0	2L 3.5 x 3.5 x 1/4 (1/4) 2L 'a' > 60.9601 in - 256	21.79	10.66	118.5	2.2500	11.67	109.69	0.106 ¹

¹ P_u / φP_n controls

Horizontal Design Data (Tension)

Section No.	Elevation ft	Size	L ft	L _u ft	Kl/r	A in ²	P _u K	φP _n K	Ratio $\frac{P_u}{\phi P_n}$
T18	30 - 20	L 3 x 3 x 3/16	18.33	8.81	171.3	0.7120	4.22	30.97	0.136 ¹

¹ $P_u / \phi P_n$ controls

Secondary Horizontal Design Data (Tension)

Section No.	Elevation ft	Size	L ft	L_u ft	Kl/r	A in ²	P_u K	ϕP_n K	Ratio $\frac{P_u}{\phi P_n}$
T8	106.667 - 100	L 1.75 x 1.75 x 1/4	10.29	5.00	226.8	0.4688	1.60	20.39	0.079 ¹
T11	86.667 - 80	L 2 x 2 x 3/16	12.33	6.00	233.3	0.4308	2.31	18.74	0.123 ¹
T13	73.333 - 66.667	L 1.75 x 1.75 x 1/4	13.72	6.67	302.7	0.4688	2.76	20.39	0.135 ¹
T14	66.667 - 60	L 2 x 2 x 3/16	14.41	7.02	273.0	0.4308	2.98	18.74	0.159 ¹
T16	50 - 40	L 2.5 x 2.5 x 3/16	16.26	7.90	243.6	0.5710	3.58	24.84	0.144 ¹
T17	40 - 30	L 3 x 3 x 1/4	17.28	8.41	216.9	0.9394	3.91	40.86	0.096 ¹

¹ $P_u / \phi P_n$ controls

Top Girt Design Data (Tension)

Section No.	Elevation ft	Size	L ft	L_u ft	Kl/r	A in ²	P_u K	ϕP_n K	Ratio $\frac{P_u}{\phi P_n}$
T1	160 - 140	L 2 x 2 x 1/8	6.52	6.11	121.2	0.3047	0.55	13.25	0.042 ¹
T2	140 - 135	L 2 x 2 x 1/8	6.56	6.16	122.0	0.3047	0.49	13.25	0.037 ¹

¹ $P_u / \phi P_n$ controls

Redundant Horizontal (1) Design Data (Tension)

Section No.	Elevation ft	Size	L ft	L_u ft	Kl/r	A in ²	P_u K	ϕP_n K	Ratio $\frac{P_u}{\phi P_n}$
T18	30 - 20	L 2 x 2 x 3/16	4.58	4.35	84.6	0.7150	4.22	23.17	0.182 ¹

¹ $P_u / \phi P_n$ controls

Redundant Diagonal (1) Design Data (Tension)

Section No.	Elevation ft	Size	L ft	L_u ft	Kl/r	A in ²	P_u K	ϕP_n K	Ratio $\frac{P_u}{\phi P_n}$
T18	30 - 20	L 2 x 2 x 3/16	5.34	5.07	98.6	0.7150	2.45	23.17	0.106 ¹

¹ $P_u / \phi P_n$ controls

Section Capacity Table

Section No.	Elevation ft	Component Type	Size	Critical Element	P K	ϕP_{allow} K	% Capacity	Pass Fail
T1	160 - 140	Leg	Pipe 2.375" x 0.154" (2 STD)	2	-18.44	38.68	47.7	Pass
T2	140 - 135	Leg	Pipe 2.875" x 0.276" (2.5 EH)	38	-23.04	78.15	29.5	Pass

Section No.	Elevation ft	Component Type	Size	Critical Element	P K	ϕP_{allow} K	% Capacity	Pass Fail
T3	135 - 130	Leg	Pipe 2.875" x 0.276" (2.5 EH)	50	-33.27	78.15	42.6	Pass
T4	130 - 125	Leg	Pipe 2.875" x 0.276" (2.5 EH)	59	-41.75	78.15	53.4	Pass
T5	125 - 120	Leg	Pipe 2.875" x 0.276" (2.5 EH)	68	-51.84	78.15	66.3	Pass
T6	120 - 113.333	Leg	Pipe 3.5" x 0.300" (3 EH)	77	-62.82	99.06	63.4	Pass
T7	113.333 - 106.667	Leg	Pipe 3.5" x 0.300" (3 EH)	86	-77.60	99.07	78.3	Pass
T8	106.667 - 100	Leg	Pipe 3.5" x 0.300" (3 EH)	95	-92.42	129.33	71.5	Pass
T9	100 - 93.333	Leg	Pipe 4" x 0.318" (3.5 EH)	107	-106.32	132.01	80.5	Pass
T10	93.333 - 86.667	Leg	Pipe 4" x 0.318" (3.5 EH)	116	-120.09	132.02	91.0	Pass
T11	86.667 - 80	Leg	Pipe 4" x 0.318" (3.5 EH)	125	-133.06	161.63	82.3	Pass
T12	80 - 73.333	Leg	Pipe 4.5" x 0.337" (4 XS)	137	-146.65	167.89	87.3	Pass
T13	73.333 - 66.667	Leg	Pipe 4.5" x 0.337" (4 XS)	146	-158.95	196.79	80.8	Pass
T14	66.667 - 60	Leg	Pipe 4.5" x 0.337" (4 XS)	158	-171.89	196.81	87.3	Pass
T15	60 - 50	Leg	Pipe 5.563" x 0.375" (5 EH)	170	-187.98	211.31	89.0	Pass
T16	50 - 40	Leg	Pipe 5.563" x 0.375" (5 EH)	179	-206.47	265.80	77.7	Pass
							79.7 (b)	
T17	40 - 30	Leg	Pipe 5.563" x 0.375" (5 XS)	191	-225.15	265.82	84.7	Pass
T18	30 - 20	Leg	Pipe 5.563" x 0.375" (5 XS)	203	-243.13	283.21	85.8	Pass
T19	20 - 0	Leg	BU 806378 (PJF) - 6.625"x0.34" pipe w/ 2" SR-(modified with 19.5" spacing)	245	-279.95	306.71	91.3	Pass
T1	160 - 140	Diagonal	L 1.75 x 1.75 x 3/16	10	-2.79	11.65	23.9	Pass
							45.8 (b)	
T2	140 - 135	Diagonal	L 1.75 x 1.75 x 3/16	45	-3.11	8.95	34.7	Pass
							47.9 (b)	
T3	135 - 130	Diagonal	L 1.75 x 1.75 x 3/16	54	-4.28	8.11	52.7	Pass
							71.5 (b)	
T4	130 - 125	Diagonal	L 1.75 x 1.75 x 3/16	63	-4.45	7.37	60.3	Pass
							72.7 (b)	
T5	125 - 120	Diagonal	L 2 x 2 x 3/16	72	-5.25	10.18	51.6	Pass
							80.1 (b)	
T6	120 - 113.333	Diagonal	L 2.5 x 2.5 x 1/4	81	-5.88	19.77	29.7	Pass
							73.5 (b)	
T7	113.333 - 106.667	Diagonal	L 2.5 x 2.5 x 1/4	90	-7.66	17.94	42.7	Pass
							93.1 (b)	
T8	106.667 - 100	Diagonal	L 2.5 x 2.5 x 1/4	99	-7.59	15.77	48.2	Pass
							94.3 (b)	
T9	100 - 93.333	Diagonal	L 2.5 x 2.5 x 3/16	111	-7.70	11.17	68.9	Pass
T10	93.333 - 86.667	Diagonal	L 2.5 x 2.5 x 1/4	120	-7.76	13.26	58.5	Pass
T11	86.667 - 80	Diagonal	2L 2.5 x 2.5 x 3/16 (1/4)	129	-8.52	39.79	21.4	Pass
							28.9 (b)	
T12	80 - 73.333	Diagonal	L 3 x 3 x 3/16	141	-8.04	15.17	53.0	Pass
							54.7 (b)	
T13	73.333 - 66.667	Diagonal	L 3 x 3 x 3/16	150	-9.01	13.95	64.6	Pass
T14	66.667 - 60	Diagonal	L 3 x 3 x 3/16	162	-8.84	12.86	68.7	Pass
T15	60 - 50	Diagonal	2L 3 x 3 x 3/16 (1/4)	174	-10.23	41.93	24.4	Pass
							64.7 (b)	
T16	50 - 40	Diagonal	2L 3 x 3 x 3/16 (1/4)	183	-11.23	37.65	29.8	Pass
							65.8 (b)	
T17	40 - 30	Diagonal	2L 3 x 3 x 1/4 (1/4)	195	-11.41	46.26	24.7	Pass
							66.1 (b)	
T18	30 - 20	Diagonal	2L 3 x 3 x 1/4 (1/4)	213	-12.29	75.60	16.3	Pass
							71.0 (b)	
T19	20 - 0	Diagonal	2L 3.5 x 3.5 x 1/4 (1/4)	249	-12.50	59.08	21.2	Pass
							75.1 (b)	
T18	30 - 20	Horizontal	L 3 x 3 x 3/16	205	-4.22	10.41	40.5	Pass
							47.3 (b)	
T8	106.667 - 100	Secondary Horizontal	L 1.75 x 1.75 x 1/4	103	-1.60	7.91	20.3	Pass
							22.3 (b)	
T11	86.667 - 80	Secondary Horizontal	L 2 x 2 x 3/16	133	-2.31	6.44	35.8	Pass
T13	73.333 - 66.667	Secondary Horizontal	L 1.75 x 1.75 x 1/4	154	-2.76	4.44	62.1	Pass
T14	66.667 - 60	Secondary Horizontal	L 2 x 2 x 3/16	166	-2.98	4.70	63.4	Pass
T16	50 - 40	Secondary Horizontal	L 2.5 x 2.5 x 3/16	187	-3.58	7.40	48.4	Pass
T17	40 - 30	Secondary Horizontal	L 3 x 3 x 1/4	200	-3.91	14.90	26.2	Pass
							32.9 (b)	
T1	160 - 140	Top Girt	L 2 x 2 x 1/8	5	-0.56	4.27	13.0	Pass

Section No.	Elevation ft	Component Type	Size	Critical Element	P K	ϕP_{allow} K	% Capacity	Pass Fail	
T2	140 - 135	Top Girt	L 2 x 2 x 1/8	40	-0.46	4.22	10.8 11.4 (b)	Pass	
T18	30 - 20	Redund Horz 1 Bracing	L 2 x 2 x 3/16	230	-4.22	12.23	34.5	Pass	
T18	30 - 20	Redund Diag 1 Bracing	L 2 x 2 x 3/16	234	-2.53	9.01	28.1	Pass	
							Summary		
							Leg (T19)	91.3	Pass
							Diagonal (T8)	94.3	Pass
							Horizontal (T18)	47.3	Pass
							Secondary Horizontal (T14)	63.4	Pass
							Top Girt (T1)	13.0	Pass
							Redund Horz 1 Bracing (T18)	34.5	Pass
							Redund Diag 1 Bracing (T18)	28.1	Pass
							Bolt Checks	94.3	Pass
							RATING =	94.3	Pass

APPENDIX B
BASE LEVEL DRAWING

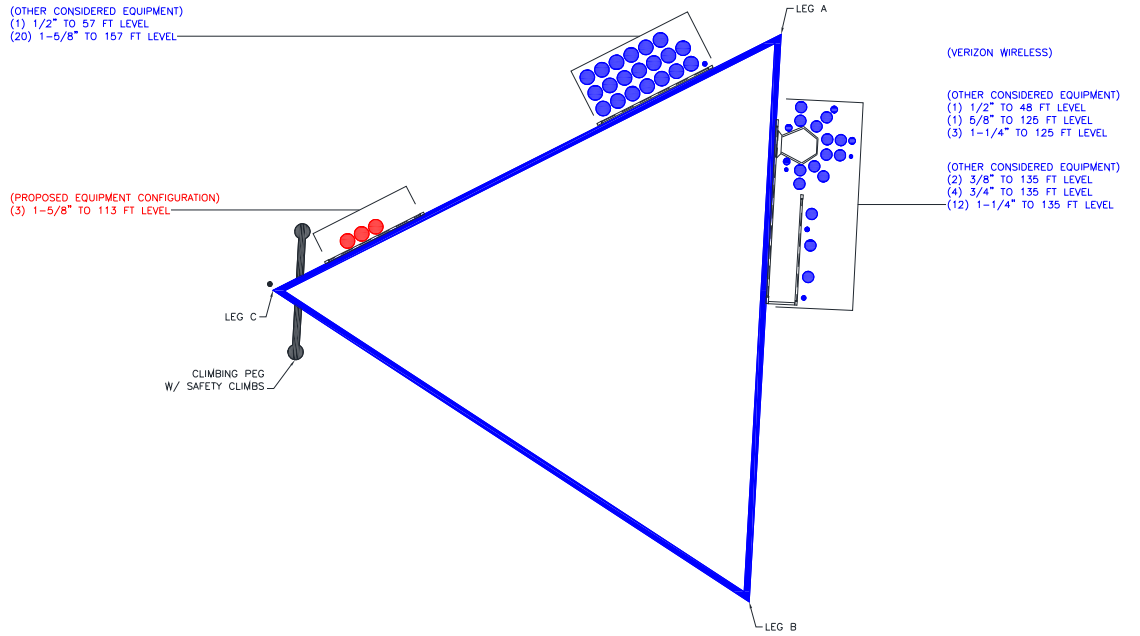

BUSINESS UNIT: 806378 TOWER ID: C_BASELEVEL

APPENDIX C
ADDITIONAL CALCULATIONS

Max ratio: **1.05**
 Rating includes max ratio? **Y**

Job #: **37519-1552.002.8700**
 Site #: **806378**
 Site: **HRT 086 943248**
 By: **MTB**

Date: 5/21/2019
 Version: 1.1
 Effective: 3/19/2019

Modified Leg Calculation Summary - TIA-222-H

Elevations		Existing Member			Reinforcement			Built-up Member						Capacity: ϕP_n			Loads		Rating	
Bottom	Top	Type	L_u	Area	Type	a_i	Area	Connection Type	a_i/r_i	$(KL/r)_o$	$(KL/r)_m$	F_y	F_{cr}	Comp.	Cope	Crushing	Comp.			
ft	ft		in	in ²		in	in ²		ksi			ksi	kip	kip	kip	kip				
0	20	P 6.625 x 0.34	120.0	6.71	2" SR	19.5	3.14	Bolted	39.00	64.58	75.44	50.00	32.98	292.51	N/A	N/A	279.95	91.1%	PASS	

CCIplate

Project Information	
BU #	806378
Site Name	
Order #	

Tower Information	
Tower Type	Self Support
TIA-222 Rev	H

Apply TIA-222-H Section 15.5

Applied Loads		
	Comp.	Uplift
Axial (k)	0.00	252.00
Shear (k)	0.00	29.00

Anchor Rod Data	
Quantity:	6
Diameter (in):	1
Material Grade:	A449
Grout Considered:	Yes
l_{ar} (in):	0
Eta Factor, η :	
Thread Type:	N-Included
Configuration:	Symmetrical

Fy=92 ksi Fu=120 ksi
Not Considered, $l_{ar} \leq 1(d)$

Anchor Rod Results	
Axial, P_u (kips)	42.00
Shear, V_u (kips)	4.83
Moment, M_u (kip-in)	-
Axial Cap., ϕP_n (kips)	54.54
Shear Cap., ϕV_n (kips)	35.34
Moment Cap., ϕM_n (kip-in)	-
Stress Rating	58.3%

Pass

Pier and Pad Foundation



BU #: 806378
 Site Name:
 App. Number:

TIA-222 Revision: H
 Tower Type: Self Support

Top & Bot. Pad Rein. Different?:
 Block Foundation?:

Superstructure Analysis Reactions		
Compression, P_{comp} :	289	kips
Compression Shear, V_{u_comp} :	33	kips
Uplift, P_{uplift} :	252	kips
Uplift Shear, V_{u_uplift} :	29	kips
Tower Height, H :	160	ft
Base Face Width, BW :	20.8646	ft
BP Dist. Above Fdn, bp_{dist} :	3	in

Pier Properties		
Pier Shape:	Circular	
Pier Diameter, $dpier$:	3.5	ft
Ext. Above Grade, E :	0.5	ft
Pier Rebar Size, Sc :	9	
Pier Rebar Quantity, mc :	16	
Pier Tie/Spiral Size, St :	3	
Pier Tie/Spiral Quantity, mt :	12	
Pier Reinforcement Type:	Tie	
Pier Clear Cover, cc_{pier} :	3	in

Pad Properties		
Depth, D :	12	ft
Pad Width, W :	10	ft
Pad Thickness, T :	2	ft
Pad Rebar Size (Bottom), Sp :	7	
Pad Rebar Quantity (Bottom), mp :	11	
Pad Clear Cover, cc_{pad} :	3	in

Material Properties		
Rebar Grade, Fy :	60	ksi
Concrete Compressive Strength, $F'c$:	3	ksi
Dry Concrete Density, δc :	150	pcf

Soil Properties		
Total Soil Unit Weight, γ :	115	pcf
Ultimate Net Bearing, Q_{net} :	16.500	ksf
Cohesion, Cu :	0.000	ksf
Friction Angle, ϕ :	34	degrees
SPT Blow Count, N_{blows} :		
Base Friction, μ :		
Neglected Depth, N :	3.30	ft
Foundation Bearing on Rock?	No	
Groundwater Depth, gw :	10.5	ft

Foundation Analysis Checks				
	Capacity	Demand	Rating*	Check
<i>Uplift (kips)</i>	294.43	252.00	81.5%	Pass
<i>Lateral (Sliding) (kips)</i>	112.83	29.00	24.5%	Pass
<i>Bearing Pressure (ksf)</i>	13.34	4.57	32.6%	Pass
<i>Pier Flexure (Comp.) (kip*ft)</i>	1334.74	346.50	24.7%	Pass
<i>Pier Flexure (Tension) (kip*ft)</i>	855.79	304.50	33.9%	Pass
<i>Pier Compression (kip)</i>	2315.08	307.18	12.6%	Pass
<i>Pad Flexure (kip*ft)</i>	565.50	155.22	26.1%	Pass
<i>Pad Shear - 1-way (kips)</i>	194.10	47.30	23.2%	Pass
<i>Pad Shear - 2-way (Comp) (ksi)</i>	0.164	0.063	36.8%	Pass
<i>Flexural 2-way (Comp) (kip*ft)</i>	1037.39	207.90	19.1%	Pass
<i>Pad Shear - 2-way (Uplift) (ksi)</i>	0.164	0.079	46.0%	Pass
<i>Flexural 2-way (Tension) (kip*ft)</i>	1037.39	182.70	16.8%	Pass

*Rating per TIA-222-H Section 15.5

Soil Rating*:	81.5%
Structural Rating*:	46.0%

<--Toggle between Gross and Net

ASCE 7 Hazards Report

Address:
No Address at This Location

Standard: ASCE/SEI 7-10
Risk Category: II
Soil Class: D - Stiff Soil

Elevation: 396.21 ft (NAVD 88)
Latitude: 41.948883
Longitude: -72.492097

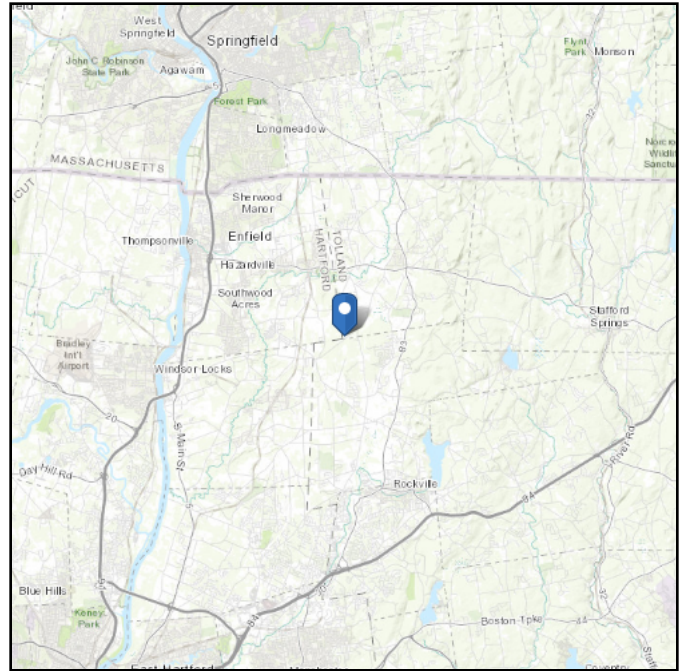

Wind

Results:

Wind Speed:	122 Vmph
10-year MRI	76 Vmph
25-year MRI	86 Vmph
50-year MRI	93 Vmph
100-year MRI	100 Vmph

← 125 mph per jurisdiction requirements

Data Source: ASCE/SEI 7-10, Fig. 26.5-1A and Figs. CC-1–CC-4, incorporating errata of March 12, 2014

Date Accessed: Mon May 20 2019

Value provided is 3-second gust wind speeds at 33 ft above ground for Exposure C Category, based on linear interpolation between contours. Wind speeds are interpolated in accordance with the 7-10 Standard. Wind speeds correspond to approximately a 7% probability of exceedance in 50 years (annual exceedance probability = 0.00143, MRI = 700 years).

Site is in a hurricane-prone region as defined in ASCE/SEI 7-10 Section 26.2. Glazed openings need not be protected against wind-borne debris.

Mountainous terrain, gorges, ocean promontories, and special wind regions should be examined for unusual wind conditions.

Site Soil Class: D - Stiff Soil

Results:

S_S :	0.176	S_{DS} :	0.187
S_1 :	0.064	S_{D1} :	0.103
F_a :	1.6	T_L :	6
F_v :	2.4	PGA :	0.086
S_{MS} :	0.281	PGA _M :	0.138
S_{M1} :	0.154	F _{PGA} :	1.6
		I_e :	1

Seismic Design Category B

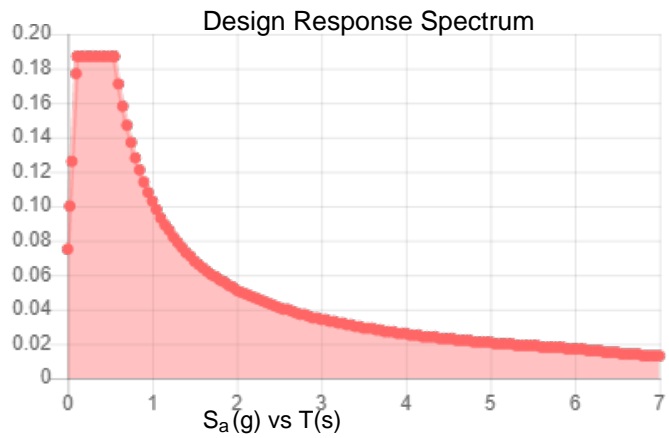
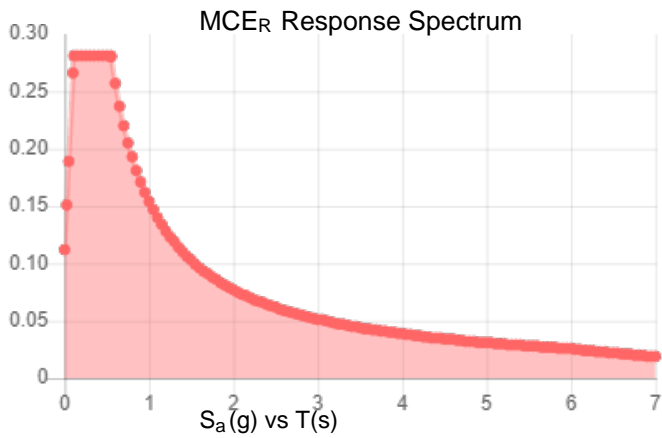

Data Accessed:

Mon May 20 2019

Date Source:

USGS Seismic Design Maps based on ASCE/SEI 7-10, incorporating Supplement 1 and errata of March 31, 2013, and ASCE/SEI 7-10 Table 1.5-2. Additional data for site-specific ground motion procedures in accordance with ASCE/SEI 7-10 Ch. 21 are available from USGS.

Ice

Results:

Ice Thickness: 1.00 in.

Concurrent Temperature: 5 F

Gust Speed: 50 mph

Data Source: Standard ASCE/SEI 7-10, Figs. 10-2 through 10-8

Date Accessed: Mon May 20 2019

Ice thicknesses on structures in exposed locations at elevations higher than the surrounding terrain and in valleys and gorges may exceed the mapped values.

Values provided are equivalent radial ice thicknesses due to freezing rain with concurrent 3-second gust speeds, for a 50-year mean recurrence interval, and temperatures concurrent with ice thicknesses due to freezing rain. Thicknesses for ice accretions caused by other sources shall be obtained from local meteorological studies. Ice thicknesses in exposed locations at elevations higher than the surrounding terrain and in valleys and gorges may exceed the mapped values.

The ASCE 7 Hazard Tool is provided for your convenience, for informational purposes only, and is provided "as is" and without warranties of any kind. The location data included herein has been obtained from information developed, produced, and maintained by third party providers; or has been extrapolated from maps incorporated in the ASCE 7 standard. While ASCE has made every effort to use data obtained from reliable sources or methodologies, ASCE does not make any representations or warranties as to the accuracy, completeness, reliability, currency, or quality of any data provided herein. Any third-party links provided by this Tool should not be construed as an endorsement, affiliation, relationship, or sponsorship of such third-party content by or from ASCE.

ASCE does not intend, nor should anyone interpret, the results provided by this Tool to replace the sound judgment of a competent professional, having knowledge and experience in the appropriate field(s) of practice, nor to substitute for the standard of care required of such professionals in interpreting and applying the contents of this Tool or the ASCE 7 standard.

In using this Tool, you expressly assume all risks associated with your use. Under no circumstances shall ASCE or its officers, directors, employees, members, affiliates, or agents be liable to you or any other person for any direct, indirect, special, incidental, or consequential damages arising from or related to your use of, or reliance on, the Tool or any information obtained therein. To the fullest extent permitted by law, you agree to release and hold harmless ASCE from any and all liability of any nature arising out of or resulting from any use of data provided by the ASCE 7 Hazard Tool.

Exhibit E

Mount Analysis



Date: **June 6, 2019**

Charles McGuirt
Crown Castle
3530 Toringdon Way Suite 300
Charlotte, NC 28277

MasTec Network Solutions
507 Airport Blvd, Suite 111
Morrisville, NC 27560
(919) 244-5207

Subject: **Mount Analysis**

Carrier Designation: **MetroPCS Equipment Change-Out**
Carrier Site Number: CTHA534A
Carrier Site Name: Crown Somers Lattice Tower

Crown Castle Designation: **Crown Castle BU Number:** 806378
Crown Castle Site Name: HRT 086 943248
Crown Castle JDE Number: 560995
Crown Castle Order Number: 482056 Revision Rev 1

Engineering Firm Designation: **MasTec Network Solutions**
Project Number: 18753-MNT2

Site Data: **126 Pioneer Heights Rd, Somers, Tolland County, CT 06071**
Latitude: 41° 56' 55.96" Longitude: -72° 29' 32"

Structure Information **Tower Height & Type:** 160 ft Self Support
Mount Elevation: 113 ft
Mount Width & Type: 12.5 ft Sector Mount

Dear Charles McGuirt,

MasTec Network Solutions is pleased to submit this "**Mount Analysis Report**" to determine the structural integrity of MetroPCS's antenna mounting system with the proposed appurtenance and equipment addition on the above mentioned supporting tower structure. Analysis of the existing supporting tower structure is to be completed by others and therefore is not part of this analysis. Analysis of the antenna mounting system as a tie-off point for fall protection or rigging is not part of this document.

The purpose of the analysis is to determine acceptability of the mount stress level. Based on our analysis we have determined the mount stress level to be:

VFA12-HD

Sufficient

This analysis utilizes an ultimate 3-second gust wind speed of 125 mph as required by the 2018 Connecticut Building Code. Applicable Standard references and design criteria are listed in Section 2 - Analysis Criteria.

Mount analysis prepared by: Vladimir Blanchard

Respectfully Submitted by:

Raphael Mohamed, PE, Peng
Senior Director of Engineering
CT PE License No. 25112

Raphael Mohamed

Digitally signed by Raphael Mohamed
DN:
E=Raphael.Mohamed@mastec.com,
CN=Raphael Mohamed, OU=Users,
OU=MasTec Network Solutions,
OU=Service Lines, DC=mastec,
DC=local
Date: 2019.06.06 14:09:13-04'00'



TABLE OF CONTENTS

1) INTRODUCTION

2) ANALYSIS CRITERIA

Table 1 - Proposed Equipment Configuration Information

3) ANALYSIS PROCEDURE

Table 2 - Documents Provided

3.1) Analysis Method

3.2) Assumptions

4) ANALYSIS RESULTS

Table 3 - Mount Component Stresses vs. Capacity

Table 4 - Tieback Resultant End Reactions

4.1) Recommendations

5) APPENDIX A

Wire Frame and Rendered Models

6) APPENDIX B

Software Input Calculations

7) APPENDIX C

Software Analysis Output

8) APPENDIX D

Additional Calculations

1) INTRODUCTION

This is a 12.5 ft VFA12-HD Sector Mount designed by Site Pro 1.

2) ANALYSIS CRITERIA

TIA-222 Revision:	TIA-222-H
Risk Category	II
Ultimate Wind Speed:	125 mph
Exposure Category:	C
Ice Thickness:	2 in
Wind Speed with Ice:	50 mph
Seismic Ss:	0.176
Seismic S1:	0.064
Live Loading Wind Speed:	30 mph
Live Loading at Mid/End-Points:	250 lb
Man Live Loading at Mount Pipes	500 lb

Table 1 - Proposed Loading Configuration

Mount Centerline (ft)	Antenna Centerline (ft)	Number of Antennas	Antenna Manufacturer	Antenna Model	Mount / Modification Details
113.0	114.0	3	ericsson	AIR 21 B4A B2P	(3) 12.5' Sector Frame [VFA12-HD]
		3	rfs/celwave	APXVAARR24_43-U-NA20	
		3	ericsson	AIR 32 B2A/B66AA	
		3	ericsson	RADIO 4449 B12/B71	

3) ANALYSIS PROCEDURE

Table 3 - Documents Provided

Document	Remarks	Reference	Source
4-ORDER INFORMATION	CROWN CASTLE	Order No. 482056, Rev. 1	CCIsites
4-MOUNT DRAWING	Site Pro 1	Part No. VFA12-HD	On File
4-STRUCTURAL ANALYSIS REPORT	Paul J. Ford & Company	Project No. 37518-1565.001.8800	CCIsites

3.1) Analysis Method

RISA-3D (Version No. 17.0.0), a commercially available analysis software package, was used to create a three-dimensional model of the antenna mounting system and calculate member stresses for various loading cases.

This analysis was performed in accordance with Crown Castle's ENG-SOW-10208 *Tower Mount Analysis* (Revision C).

3.2) Assumptions

- 1) The antenna mounting system was properly fabricated, installed and maintained in good condition in accordance with its original design and manufacturer's specifications.
- 2) The configuration of antennas, mounts, and other appurtenances are as specified in Tables 1 and the referenced drawings.

- 3) All member connections are assumed to have been designed to meet or exceed the load carrying capacity of the connected member unless otherwise specified in this report.
- 4) Steel grades have been assumed as follows, unless noted otherwise:

Channel, Solid Round, Angle, Plate	ASTM A36 (GR 36)
HSS (Rectangular)	ASTM 500 (GR B-46)
Pipe	ASTM A53 (GR B-35)
Connection Bolts	ASTM A325

This analysis may be affected if any assumptions are not valid or have been made in error. Mastec should be notified to determine the effect on the structural integrity of the antenna mounting system.

4) ANALYSIS RESULTS

Table 4 - Mount Component Stresses vs. Capacity (Sector Mount)

Notes	Component	Beam No.	Centerline (ft)	% Capacity	Pass / Fail
1	Pipe Mounts	--	113	58.5	Pass
1	Horizontals	--	113	33.8	Pass
1	Standoffs	--	113	32.9	Pass
1	Diagonal Bracing	--	113	20.7	Pass
1	Vertical Bracing	--	113	25.9	Pass
1	Standoff Gusset Plate	--	113	66.6	Pass
1	Standoff Connection Plate	--	113	83.8	Pass
1	Stiff-Arm	--	113	14.7	Pass
1	Bolt Connection	--	113	9.4	Pass

Structure Rating (max from all components) =	83.8%
-----------------------------------------------------	--------------

Notes:

- 1) See additional documentation in "Appendix C - Software Analysis Output" for calculations supporting the % capacity consumed.
- 2) All sectors are typical

Table 4 - Tieback Connection Data Table

Tower Connection Node No.	Existing / Proposed	Resultant End Reaction (lb)	Connected Member Type	Connected Member Size	Member Compressive Capacity (lb) ³	Notes
N65B	Proposed	116	Leg	Pipe 3.5 x 0.300	77170	1
N66	Proposed	115	Leg	Pipe 3.5 x 0.300	77170	1

Notes:

- 1) Tieback connection point is within 25% of either end of the connected tower member
- 2) Tieback connection point is NOT within 25% of either end of the connected tower member
- 3) Reduced member compressive capacity according to CED-STD-10294 *Standard for Installation of Mounts and Appurtenances*

4.1) Recommendations

The proposed mount has sufficient capacity to support the existing and proposed loading configuration.

APPENDIX A
WIRE FRAME AND RENDERED MODELS

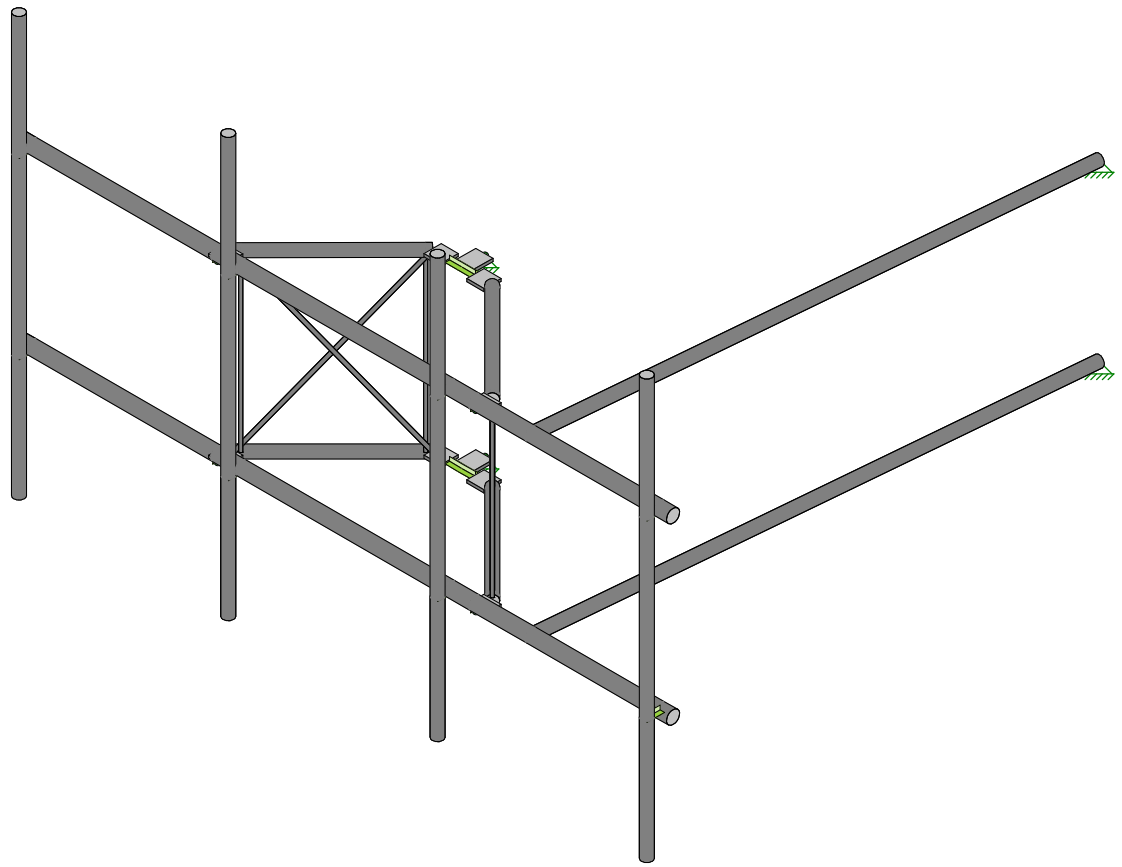
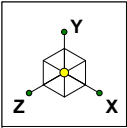

Envelope Only Solution

Mastec Network Solutions	HRT 086 943248, App 482056	Rendered View
VB		May 16, 2019 at 10:13 AM
18753-MNT1		18753-MNT1_HRT 086 943248.r3d

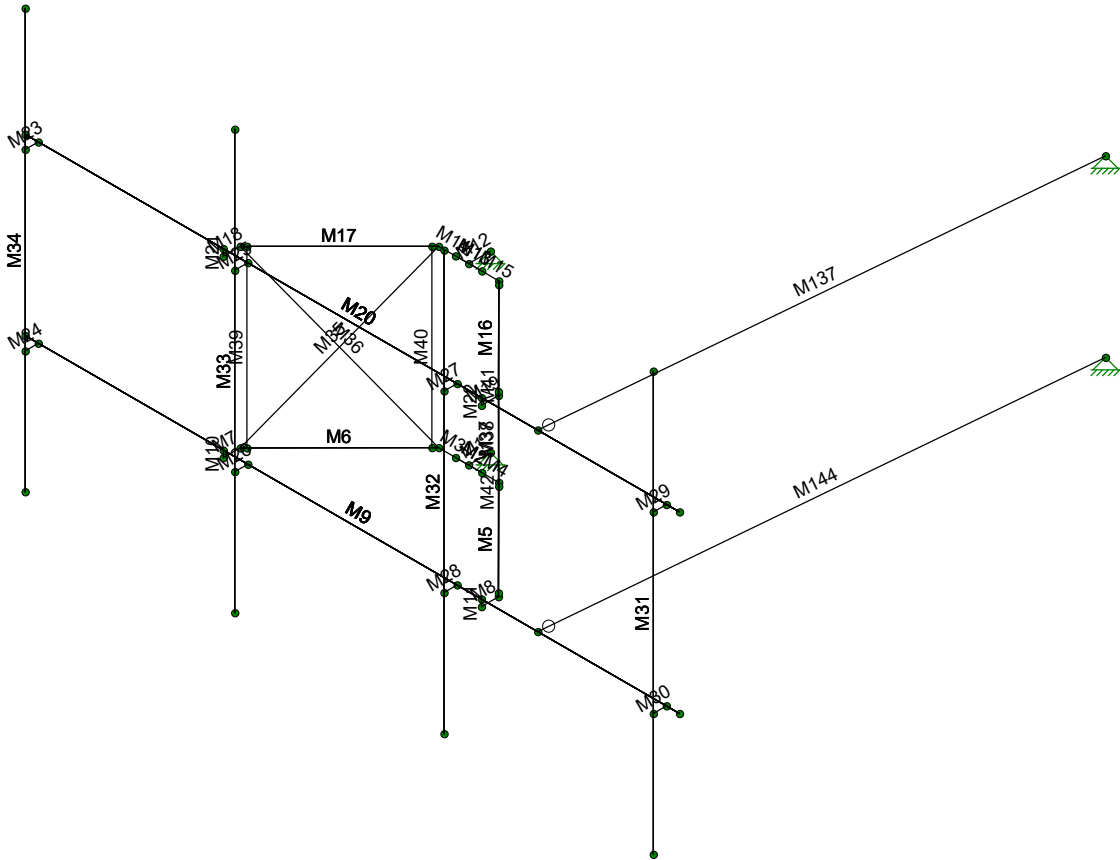
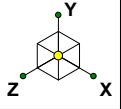

Envelope Only Solution

Mastec Network Solutions

VB

18753-MNT1

HRT 086 943248, App 482056

Member Labels

May 16, 2019 at 10:14 AM

18753-MNT1_HRT 086 943248.r3d

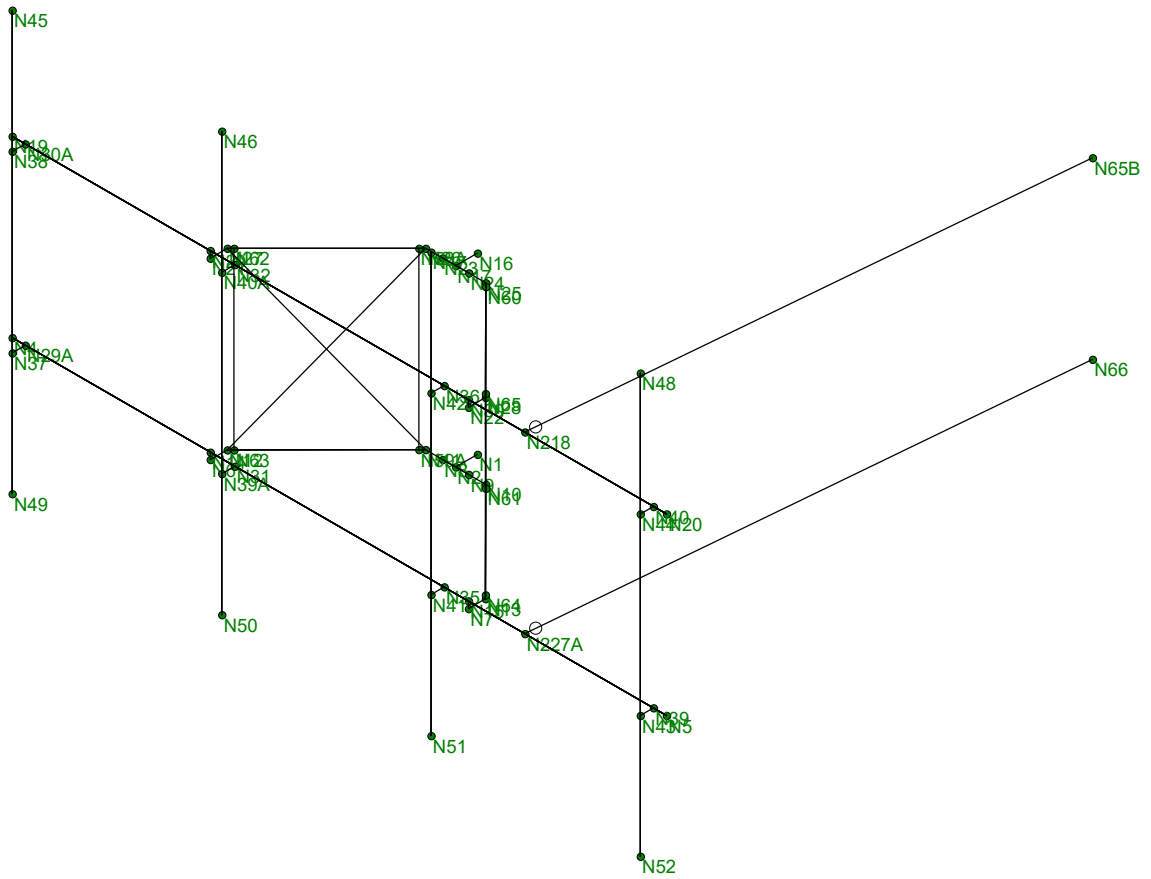
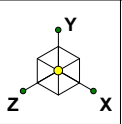

Envelope Only Solution

Mastec Network Solutions

VB

18753-MNT1

HRT 086 943248, App 482056

Node Labels

May 16, 2019 at 10:14 AM

18753-MNT1_HRT 086 943248.r3d

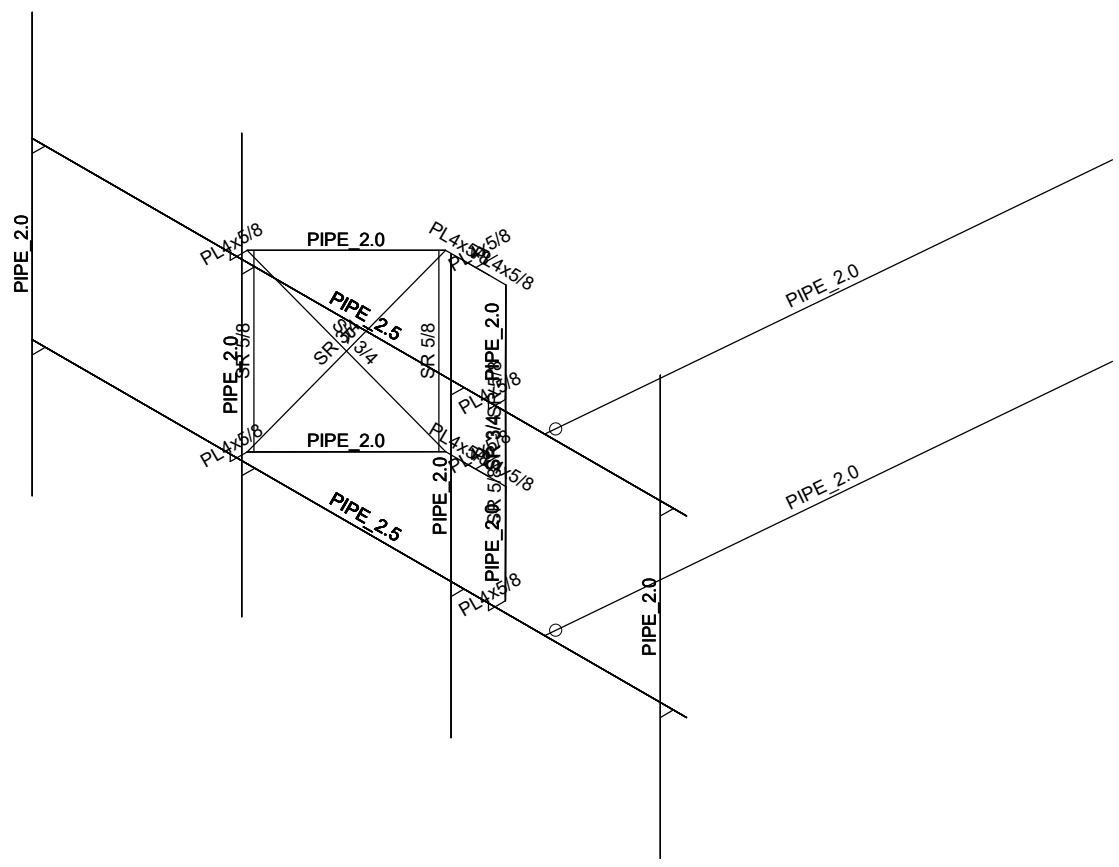
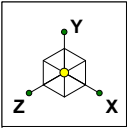

Envelope Only Solution

Mastec Network Solutions	HRT 086 943248, App 482056	Member Shapes
VB		May 16, 2019 at 10:14 AM
18753-MNT1		18753-MNT1_HRT 086 943248.r3d

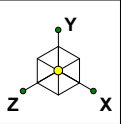

Section Sets	
■	Pipe Mounts
■	Horizontals
■	Standoffs
■	Diagonal Bracing
■	Vertical Bracing
■	Standoff Gusset Plate
■	Standoff Connection Plate
■	Stiff-Arm
■	RIGID

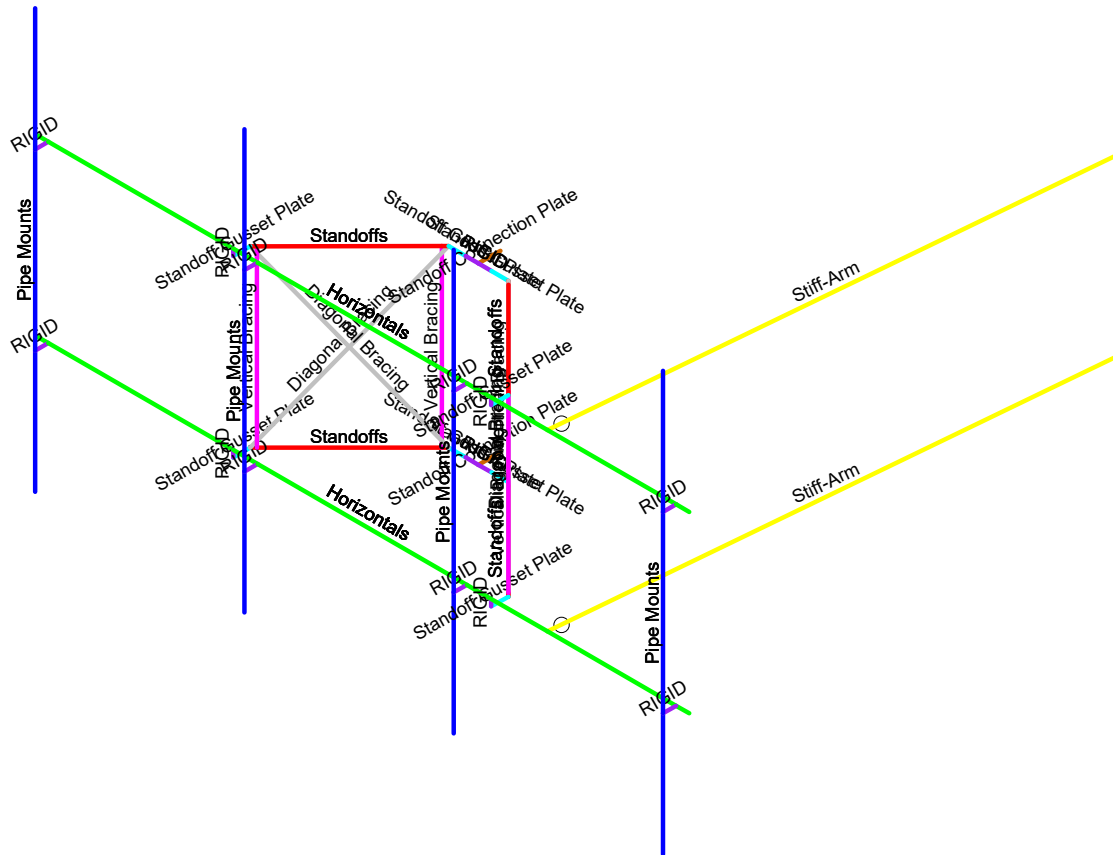

Envelope Only Solution

Mastec Network Solutions

VB

18753-MNT1

HRT 086 943248, App 482056

Section Sets

May 16, 2019 at 10:15 AM

18753-MNT1_HRT 086 943248.r3d

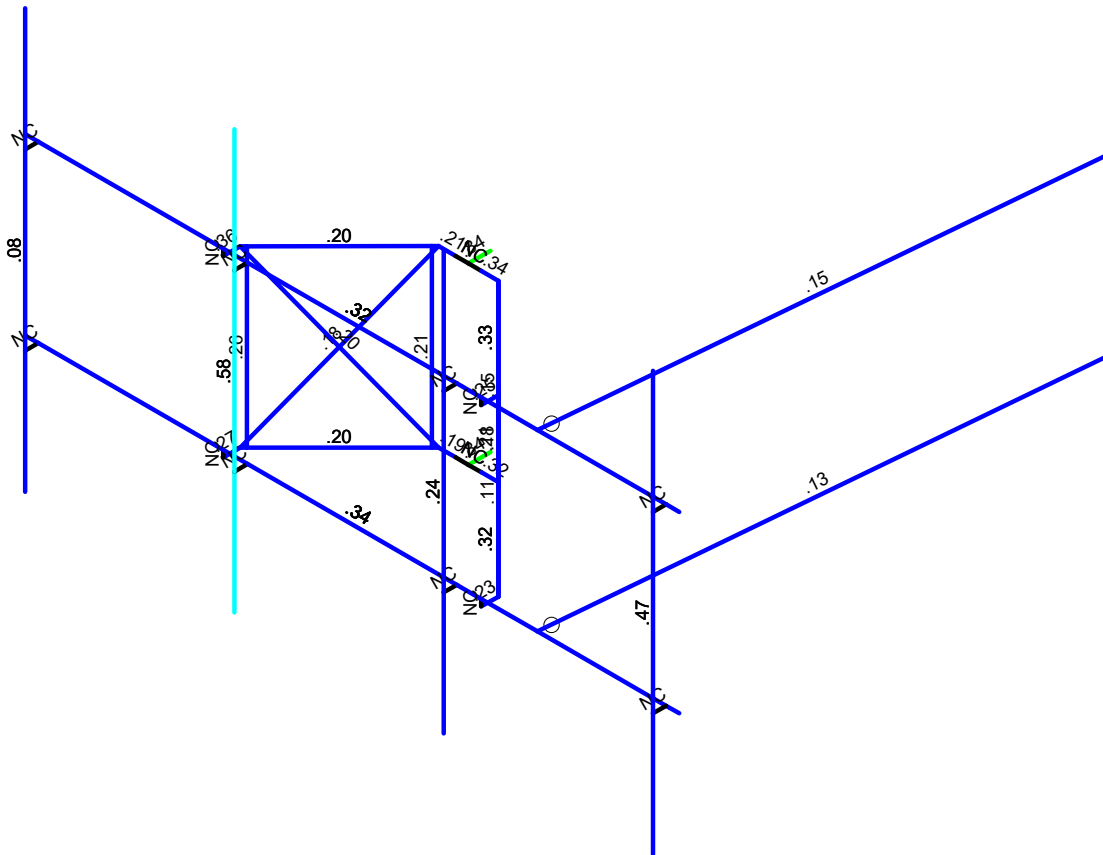
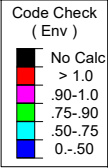
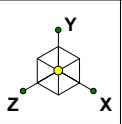

Member Code Checks Displayed (Enveloped)
Envelope Only Solution

Mastec	HRT 086 943248, App 482056	Unity Check
VB		May 16, 2019 at 1:44 PM
18753-MNT1		18753-MNT1_HRT 086 943248.r3d

APPENDIX B
SOFTWARE INPUT CALCULATIONS

Pipe Mount	Antenna	Elevation (ft)	Quantity	Orientation (deg)	Front Exposed (%)	Side Exposed (%)	Type	Height (in)	Width (in)	Depth (in)	Weight (lbs)	Front CaAa (ft ²)	Side CaAa (ft ²)	Front F _x (kips)	Side F _x (kips)	Top %	Bottom %
M31	Ericsson AIR 32 B2A/B66AA	114	1	0	100.0%	100.0%	Antenna	56.600	12.900	8.700	132.200	6.510	4.712	0.286	0.207	0.0%	74.7%
M31	Ericsson Radio 4449 B12/B71	114	1	0	0.0%	100.0%	RRU, TMA, Etc.	14.950	13.190	9.250	75.000	1.643	1.152	0.000	0.051	20.5%	43.1%
M31																	
M31																	
M31																	
M32	Ericsson AIR 21 B4A B2P	114	1	0	100.0%	100.0%	Antenna	55.900	12.100	7.870	91.500	6.079	4.288	0.267	0.188	0.0%	74.2%
M32	Ericsson Radio 4449 B12/B71	114	1	0	0.0%	100.0%	RRU, TMA, Etc.	14.950	13.190	9.250	75.000	1.643	1.152	0.000	0.051	20.5%	43.1%
M32																	
M32																	
M32																	
M32																	
M33	Celwave APXVAARR24_43-U-H	114	1	0	100.0%	100.0%	Antenna	95.900	24.000	8.700	128.000	20.243	8.889	0.889	0.390	0.0%	80.0%
M33	Ericsson Radio 4449 B12/B71	114	1	0	0.0%	100.0%	RRU, TMA, Etc.	14.950	13.190	9.250	75.000	1.643	1.152	0.000	0.051	33.8%	46.2%
M33																	
M33																	
M33																	
M33																	

Pipe Mount	Antenna	Elevation (ft)	Quantity	Orientation (deg)	Front Exposed (%)	Side Exposed (%)	Type	Height (in)	Width (in)	Depth (in)	Ice Weight (lb)	Front CaAa (ft ²)	Side CaAa (ft ²)	Front F _A (kips)	Side F _A (kips)	Top %	Bottom %
M31	Ericsson AIR 32 B2A/B66AA	114	1	0	100.0%	100.0%	Antenna	56.600	12.900	8.700	232.296	9.207	7.265	0.065	0.051	0.0%	74.7%
M31	Ericsson Radio 4449 B12/B71	114	1	0	0.0%	100.0%	RRU, TMA, Etc.	14.950	13.190	9.250	63.253	2.875	2.235	0.000	0.016	20.5%	43.1%
M31																	
M31																	
M31																	
M32	Ericsson AIR 21 B4A B2P	114	1	0	100.0%	100.0%	Antenna	55.900	12.100	7.870	214.936	8.723	6.790	0.061	0.048	0.0%	74.2%
M32	Ericsson Radio 4449 B12/B71	114	1	0	0.0%	100.0%	RRU, TMA, Etc.	14.950	13.190	9.250	63.253	2.875	2.235	0.000	0.016	20.5%	43.1%
M32																	
M32																	
M32																	
M33	Celwave APXVAARR24_43-U-N	114	1	0	100.0%	100.0%	Antenna	95.900	24.000	8.700	613.749	24.773	13.094	0.174	0.092	0.0%	80.0%
M33	Ericsson Radio 4449 B12/B71	114	1	0	0.0%	100.0%	RRU, TMA, Etc.	14.950	13.190	9.250	63.253	2.875	2.235	0.000	0.016	33.8%	46.2%
M33																	
M33																	
M33																	
M33																	

APPENDIX C
SOFTWARE ANALYSIS OUTPUT



Hot Rolled Steel Properties

	Label	E [ksi]	G [ksi]	Nu	Therm (1E...	Density[k/ft...	Yield[ksi]	Ry	Fu[ksi]	Rt
1	A992	29000	11154	.3	.65	.49	50	1.1	65	1.1
2	A36 Gr.36	29000	11154	.3	.65	.49	36	1.5	58	1.2
3	A572 Gr.50	29000	11154	.3	.65	.49	50	1.1	65	1.1
4	A500 Gr.B RND	29000	11154	.3	.65	.527	42	1.4	58	1.3
5	A500 Gr.B Rect	29000	11154	.3	.65	.527	46	1.4	58	1.3
6	A53 Gr.B	29000	11154	.3	.65	.49	35	1.6	60	1.2
7	A1085	29000	11154	.3	.65	.49	50	1.4	65	1.3

Hot Rolled Steel Section Sets

	Label	Shape	Type	Design List	Material	Design ...	A [in2]	Iyy [in4]	Izz [in4]	J [in4]
1	Pipe Mounts	PIPE_2.0	Beam	Pipe	A53 Gr.B	Typical	1.02	.627	.627	1.25
2	Horizontals	PIPE_2.5	Beam	Pipe	A53 Gr.B	Typical	1.61	1.45	1.45	2.89
3	Standoffs	PIPE_2.0	Beam	Pipe	A53 Gr.B	Typical	1.02	.627	.627	1.25
4	Diagonal Bracing	SR 3/4	Beam	BAR	A36 Gr.36	Typical	.442	.016	.016	.031
5	Vertical Bracing	SR 5/8	Beam	RECT	A36 Gr.36	Typical	.307	.007	.007	.015
6	Standoff Gusset Plate	PL4x5/8	Beam	RECT	A36 Gr.36	Typical	2.5	.081	3.333	.293
7	Standoff Connection...	PL4x5/8	Beam	RECT	A36 Gr.36	Typical	2.5	.081	3.333	.293
8	Stiff-Arm	PIPE_2.0	Beam	Pipe	A53 Gr.B	Typical	1.02	.627	.627	1.25
9	Pipe Frame	PIPE_2.0	Beam	Pipe	A53 Gr.B	Typical	1.02	.627	.627	1.25

Joint Coordinates and Temperatures

	Label	X [ft]	Y [ft]	Z [ft]	Temp [F]	Detach From Diap...
1	N1	0.	0	1.940383	0	
2	N2	0.	0	2.35705	0	
3	N4	-6.25	.125	4.578683	0	
4	N5	6.25	.125	4.578683	0	
5	N6	-2.466425	0	4.578683	0	
6	N7	2.466425	0	4.578683	0	
7	N8	-.25	0	2.35705	0	
8	N9	.25	0	2.35705	0	
9	N10	0.574242	0	2.35705	0	
10	N11	-0.574242	0	2.35705	0	
11	N12	-2.466425	0	4.254442	0	
12	N13	2.466425	0	4.254442	0	
13	N14	-2.466425	.125	4.578683	0	
14	N15	2.466425	.125	4.578683	0	
15	N16	0.	3.333333	1.940383	0	
16	N17	0.	3.333333	2.35705	0	
17	N19	-6.25	3.458333	4.578683	0	
18	N20	6.25	3.458333	4.578683	0	
19	N21	-2.466425	3.333333	4.578683	0	
20	N22	2.466425	3.333333	4.578683	0	
21	N23	-.25	3.333333	2.35705	0	
22	N24	.25	3.333333	2.35705	0	
23	N25	0.574242	3.333333	2.35705	0	
24	N26	-0.574242	3.333333	2.35705	0	
25	N27	-2.466425	3.333333	4.254442	0	
26	N28	2.466425	3.333333	4.254442	0	
27	N29	-2.466425	3.458333	4.578683	0	
28	N30	2.466425	3.458333	4.578683	0	
29	N29A	-6	.125	4.578683	0	
30	N30A	-6	3.458333	4.578683	0	
31	N31	-2	.125	4.578683	0	



Company : Mastec
 Designer : VB
 Job Number : 18753-MNT1
 Model Name : HRT 086 943248, App 482056

May 16, 2019
 1:44 PM
 Checked By: _____

Joint Coordinates and Temperatures (Continued)

	Label	X [ft]	Y [ft]	Z [ft]	Temp [F]	Detach From Diap...
32	N32	-2	3.458333	4.578683	0	
33	N35	2	.125	4.578683	0	
34	N36	2	3.458333	4.578683	0	
35	N39	6	.125	4.578683	0	
36	N40	6	3.458333	4.578683	0	
37	N37	-6	.125	4.828683	0	
38	N38	-6	3.458333	4.828683	0	
39	N39A	-2	.125	4.828683	0	
40	N40A	-2	3.458333	4.828683	0	
41	N41	2	.125	4.828683	0	
42	N42	2	3.458333	4.828683	0	
43	N43	6	.125	4.828683	0	
44	N44	6	3.458333	4.828683	0	
45	N45	-6	5.791667	4.828683	0	
46	N46	-2	5.791667	4.828683	0	
47	N47	2	5.791667	4.828683	0	
48	N48	6	5.791667	4.828683	0	
49	N49	-6	-2.208333	4.828683	0	
50	N50	-2	-2.208333	4.828683	0	
51	N51	2	-2.208333	4.828683	0	
52	N52	6	-2.208333	4.828683	0	
53	N58A	-0.637676	3.333333	2.420659	0	
54	N59A	-0.637676	0	2.420659	0	
55	N60	0.637676	3.333333	2.420659	0	
56	N61	0.637676	0	2.420659	0	
57	N62	-2.403012	3.333333	4.190854	0	
58	N63	-2.403012	0	4.190854	0	
59	N64	2.403012	0	4.190854	0	
60	N65	2.403012	3.333333	4.190854	0	
61	N218	3.541667	3.458333	4.578683	0	
62	N227A	3.541667	0.125	4.578683	0	
63	N65B	4.30209	3.333333	-5.511047	0	
64	N66	4.30209	-0.	-5.511047	0	

Joint Boundary Conditions

	Joint Label	X [k/in]	Y [k/in]	Z [k/in]	X Rot.[k-ft/rad]	Y Rot.[k-ft/rad]	Z Rot.[k-ft/rad]
1	N1	Reaction	Reaction	Reaction			
2	N16	Reaction	Reaction	Reaction			
3	N65B	Reaction	Reaction	Reaction			
4	N66	Reaction	Reaction	Reaction			

Member Primary Data

	Label	I Joint	J Joint	K Joint	Rotate(de...)	Section/Shape	Type	Design List	Material	Design Rules
1	M1	N1	N2		90	Standoff Connection P..	Beam	RECT	A36 Gr.36	Typical
2	M2	N8	N9			RIGID	None	None	RIGID	Typical
3	M3	N8	N11		90	Standoff Gusset Plate	Beam	RECT	A36 Gr.36	Typical
4	M4	N9	N10		90	Standoff Gusset Plate	Beam	RECT	A36 Gr.36	Typical
5	M5	N10	N13			Standoffs	Beam	Pipe	A53 Gr.B	Typical
6	M6	N11	N12			Standoffs	Beam	Pipe	A53 Gr.B	Typical
7	M7	N12	N6		90	Standoff Gusset Plate	Beam	RECT	A36 Gr.36	Typical
8	M8	N13	N7		90	Standoff Gusset Plate	Beam	RECT	A36 Gr.36	Typical
9	M9	N4	N5			Horizontals	Beam	Pipe	A53 Gr.B	Typical
10	M10	N14	N6			RIGID	None	None	RIGID	Typical
11	M11	N15	N7			RIGID	None	None	RIGID	Typical



Company : Mastec
 Designer : VB
 Job Number : 18753-MNT1
 Model Name : HRT 086 943248, App 482056

May 16, 2019
 1:44 PM
 Checked By: _____

Member Primary Data (Continued)

	Label	I Joint	J Joint	K Joint	Rotate(de...)	Section/Shape	Type	Design List	Material	Design Rules
12	M12	N16	N17		90	Standoff Connection P..	Beam	RECT	A36 Gr.36	Typical
13	M13	N23	N24			RIGID	None	None	RIGID	Typical
14	M14	N23	N26		90	Standoff Gusset Plate	Beam	RECT	A36 Gr.36	Typical
15	M15	N24	N25		90	Standoff Gusset Plate	Beam	RECT	A36 Gr.36	Typical
16	M16	N25	N28			Standoffs	Beam	Pipe	A53 Gr.B	Typical
17	M17	N26	N27			Standoffs	Beam	Pipe	A53 Gr.B	Typical
18	M18	N27	N21		90	Standoff Gusset Plate	Beam	RECT	A36 Gr.36	Typical
19	M19	N28	N22		90	Standoff Gusset Plate	Beam	RECT	A36 Gr.36	Typical
20	M20	N19	N20			Horizontals	Beam	Pipe	A53 Gr.B	Typical
21	M21	N29	N21			RIGID	None	None	RIGID	Typical
22	M22	N30	N22			RIGID	None	None	RIGID	Typical
23	M23	N30A	N38			RIGID	None	None	RIGID	Typical
24	M24	N29A	N37			RIGID	None	None	RIGID	Typical
25	M25	N32	N40A			RIGID	None	None	RIGID	Typical
26	M26	N31	N39A			RIGID	None	None	RIGID	Typical
27	M27	N36	N42			RIGID	None	None	RIGID	Typical
28	M28	N35	N41			RIGID	None	None	RIGID	Typical
29	M29	N40	N44			RIGID	None	None	RIGID	Typical
30	M30	N39	N43			RIGID	None	None	RIGID	Typical
31	M31	N48	N52			Pipe Mounts	Beam	Pipe	A53 Gr.B	Typical
32	M32	N47	N51			Pipe Mounts	Beam	Pipe	A53 Gr.B	Typical
33	M33	N46	N50			Pipe Mounts	Beam	Pipe	A53 Gr.B	Typical
34	M34	N45	N49			Pipe Mounts	Beam	Pipe	A53 Gr.B	Typical
35	M35	N26	N12			Diagonal Bracing	Beam	BAR	A36 Gr.36	Typical
36	M36	N27	N11			Diagonal Bracing	Beam	BAR	A36 Gr.36	Typical
37	M37	N28	N10			Diagonal Bracing	Beam	BAR	A36 Gr.36	Typical
38	M38	N25	N13			Diagonal Bracing	Beam	BAR	A36 Gr.36	Typical
39	M39	N62	N63			Vertical Bracing	Beam	RECT	A36 Gr.36	Typical
40	M40	N58A	N59A			Vertical Bracing	Beam	RECT	A36 Gr.36	Typical
41	M41	N60	N61			Vertical Bracing	Beam	RECT	A36 Gr.36	Typical
42	M42	N65	N64			Vertical Bracing	Beam	RECT	A36 Gr.36	Typical
43	M137	N218	N65B			Stiff-Arm	Beam	Pipe	A53 Gr.B	Typical
44	M144	N227A	N66			Stiff-Arm	Beam	Pipe	A53 Gr.B	Typical

Joint Loads and Enforced Displacements (BLC 42 : Man 1 (500 lbs))

	Joint Label	L,D,M	Direction	Magnitude((k.k-ft), (in.rad), (k*s^2/ft...
1				0

Joint Loads and Enforced Displacements (BLC 43 : Man 2 (500 lbs))

	Joint Label	L,D,M	Direction	Magnitude((k.k-ft), (in.rad), (k*s^2/ft...
1	N39	L	Y	-.5

Joint Loads and Enforced Displacements (BLC 44 : Man 3 (500 lbs))

	Joint Label	L,D,M	Direction	Magnitude((k.k-ft), (in.rad), (k*s^2/ft...
1				0

Joint Loads and Enforced Displacements (BLC 45 : Man 4 (250 lbs))

	Joint Label	L,D,M	Direction	Magnitude((k.k-ft), (in.rad), (k*s^2/ft...
1				0

Joint Loads and Enforced Displacements (BLC 46 : Man 5 (250 lbs))

	Joint Label	L,D,M	Direction	Magnitude((k.k-ft), (in.rad), (k*s^2/ft...
1				0



Joint Loads and Enforced Displacements (BLC 47 : Man 6 (250 lbs))

	Joint Label	L,D,M	Direction	Magnitude[(k,k-ft), (in.rad), (k*s^2/ft...
1	N5	L	Y	-.25

Member Point Loads (BLC 1 : Dead)

	Member Label	Direction	Magnitude[k,k-ft]	Location[ft,%]
1	M31	Y	-.132	%37.3
2	M31	Y	-.075	%31.8
3	M32	Y	-.092	%37.1
4	M32	Y	-.075	%31.8
5	M33	Y	-.128	%40
6	M33	Y	-.075	%40

Member Point Loads (BLC 2 : Ice Dead)

	Member Label	Direction	Magnitude[k,k-ft]	Location[ft,%]
1	M31	Y	-.232	%37.3
2	M31	Y	-.063	%31.8
3	M32	Y	-.215	%37.1
4	M32	Y	-.063	%31.8
5	M33	Y	-.614	%40
6	M33	Y	-.063	%40

Member Point Loads (BLC 3 : Full Wind Antenna (0 Deg))

	Member Label	Direction	Magnitude[k,k-ft]	Location[ft,%]
1	M31	Z	-.143	0
2	M32	Z	-.133	0
3	M33	Z	-.444	0
4	M31	Z	-.143	%74.7
5	M32	Z	-.133	%74.2
6	M33	Z	-.444	%80

Member Point Loads (BLC 4 : Full Wind Antenna (30 Deg))

	Member Label	Direction	Magnitude[k,k-ft]	Location[ft,%]
1	M31	Z	-.115	0
2	M32	Z	-.107	0
3	M33	Z	-.331	0
4	M31	Z	-.115	%74.7
5	M32	Z	-.107	%74.2
6	M33	Z	-.331	%80
7	M31	X	.067	0
8	M31	X	.006	%31.8
9	M32	X	.062	0
10	M32	X	.006	%31.8
11	M33	X	.191	0
12	M33	X	.006	%40
13	M31	X	.067	%74.7
14	M32	X	.062	%74.2
15	M33	X	.191	%80

Member Point Loads (BLC 5 : Full Wind Antenna (60 Deg))

	Member Label	Direction	Magnitude[k,k-ft]	Location[ft,%]
1	M31	Z	-.057	0
2	M32	Z	-.052	0
3	M33	Z	-.129	0
4	M31	Z	-.057	%74.7



Member Point Loads (BLC 5 : Full Wind Antenna (60 Deg)) (Continued)

	Member Label	Direction	Magnitude[k,k-ft]	Location[ft, %]
5	M32	Z	-.052	%74.2
6	M33	Z	-.129	%80
7	M31	X	.098	0
8	M31	X	.033	%31.8
9	M32	X	.09	0
10	M32	X	.033	%31.8
11	M33	X	.223	0
12	M33	X	.033	%40
13	M31	X	.098	%74.7
14	M32	X	.09	%74.2
15	M33	X	.223	%80

Member Point Loads (BLC 6 : Full Wind Antenna (90 Deg))

	Member Label	Direction	Magnitude[k,k-ft]	Location[ft, %]
1	M31	Z	0	0
2	M32	Z	0	0
3	M33	Z	0	0
4	M31	Z	0	%74.7
5	M32	Z	0	%74.2
6	M33	Z	0	%80
7	M31	X	.103	0
8	M31	X	.051	%31.8
9	M32	X	.094	0
10	M32	X	.051	%31.8
11	M33	X	.195	0
12	M33	X	.051	%40
13	M31	X	.103	%74.7
14	M32	X	.094	%74.2
15	M33	X	.195	%80

Member Point Loads (BLC 7 : Full Wind Antenna (120 Deg))

	Member Label	Direction	Magnitude[k,k-ft]	Location[ft, %]
1	M31	Z	.057	0
2	M32	Z	.052	0
3	M33	Z	.129	0
4	M31	Z	.057	%74.7
5	M32	Z	.052	%74.2
6	M33	Z	.129	%80
7	M31	X	.098	0
8	M31	X	.033	%31.8
9	M32	X	.09	0
10	M32	X	.033	%31.8
11	M33	X	.223	0
12	M33	X	.033	%40
13	M31	X	.098	%74.7
14	M32	X	.09	%74.2
15	M33	X	.223	%80

Member Point Loads (BLC 8 : Full Wind Antenna (150 Deg))

	Member Label	Direction	Magnitude[k,k-ft]	Location[ft, %]
1	M31	Z	.115	0
2	M32	Z	.107	0
3	M33	Z	.331	0
4	M31	Z	.115	%74.7
5	M32	Z	.107	%74.2



Member Point Loads (BLC 8 : Full Wind Antenna (150 Deg)) (Continued)

	Member Label	Direction	Magnitude[k,k-ft]	Location[ft,%]
6	M33	Z	.331	%80
7	M31	X	.067	0
8	M31	X	.006	%31.8
9	M32	X	.062	0
10	M32	X	.006	%31.8
11	M33	X	.191	0
12	M33	X	.006	%40
13	M31	X	.067	%74.7
14	M32	X	.062	%74.2
15	M33	X	.191	%80

Member Point Loads (BLC 15 : Ice Wind Antenna (0 Deg))

	Member Label	Direction	Magnitude[k,k-ft]	Location[ft,%]
1	M31	Z	-.032	0
2	M32	Z	-.031	0
3	M33	Z	-.087	0
4	M31	Z	-.032	%74.7
5	M32	Z	-.031	%74.2
6	M33	Z	-.087	%80

Member Point Loads (BLC 16 : Ice Wind Antenna (30 Deg))

	Member Label	Direction	Magnitude[k,k-ft]	Location[ft,%]
1	M31	Z	-.027	0
2	M32	Z	-.025	0
3	M33	Z	-.066	0
4	M31	Z	-.027	%74.7
5	M32	Z	-.025	%74.2
6	M33	Z	-.066	%80
7	M31	X	.015	0
8	M31	X	.002	%31.8
9	M32	X	.014	0
10	M32	X	.002	%31.8
11	M33	X	.038	0
12	M33	X	.002	%40
13	M31	X	.015	%74.7
14	M32	X	.014	%74.2
15	M33	X	.038	%80

Member Point Loads (BLC 17 : Ice Wind Antenna (60 Deg))

	Member Label	Direction	Magnitude[k,k-ft]	Location[ft,%]
1	M31	Z	-.014	0
2	M32	Z	-.013	0
3	M33	Z	-.028	0
4	M31	Z	-.014	%74.7
5	M32	Z	-.013	%74.2
6	M33	Z	-.028	%80
7	M31	X	.024	0
8	M31	X	.01	%31.8
9	M32	X	.022	0
10	M32	X	.01	%31.8
11	M33	X	.049	0
12	M33	X	.01	%40
13	M31	X	.024	%74.7
14	M32	X	.022	%74.2
15	M33	X	.049	%80



Member Point Loads (BLC 18 : Ice Wind Antenna (90 Deg))

	Member Label	Direction	Magnitude[k,k-ft]	Location[ft, %]
1	M31	Z	0	0
2	M32	Z	0	0
3	M33	Z	0	0
4	M31	Z	0	%74.7
5	M32	Z	0	%74.2
6	M33	Z	0	%80
7	M31	X	.026	0
8	M31	X	.016	%31.8
9	M32	X	.024	0
10	M32	X	.016	%31.8
11	M33	X	.046	0
12	M33	X	.016	%40
13	M31	X	.026	%74.7
14	M32	X	.024	%74.2
15	M33	X	.046	%80

Member Point Loads (BLC 19 : Ice Wind Antenna (120 Deg))

	Member Label	Direction	Magnitude[k,k-ft]	Location[ft, %]
1	M31	Z	.014	0
2	M32	Z	.013	0
3	M33	Z	.028	0
4	M31	Z	.014	%74.7
5	M32	Z	.013	%74.2
6	M33	Z	.028	%80
7	M31	X	.024	0
8	M31	X	.01	%31.8
9	M32	X	.022	0
10	M32	X	.01	%31.8
11	M33	X	.049	0
12	M33	X	.01	%40
13	M31	X	.024	%74.7
14	M32	X	.022	%74.2
15	M33	X	.049	%80

Member Point Loads (BLC 20 : Ice Wind Antenna (150 Deg))

	Member Label	Direction	Magnitude[k,k-ft]	Location[ft, %]
1	M31	Z	.027	0
2	M32	Z	.013	0
3	M33	Z	.028	0
4	M31	Z	.027	%74.7
5	M32	Z	.013	%74.2
6	M33	Z	.028	%80
7	M31	X	.015	0
8	M31	X	.01	%31.8
9	M32	X	.022	0
10	M32	X	.01	%31.8
11	M33	X	.049	0
12	M33	X	.01	%40
13	M31	X	.015	%74.7
14	M32	X	.022	%74.2
15	M33	X	.049	%80

Member Point Loads (BLC 27 : Seismic Antenna (0 Deg))

	Member Label	Direction	Magnitude[k,k-ft]	Location[ft, %]
1	M31	Z	-.012	%37.3



Member Point Loads (BLC 27 : Seismic Antenna (0 Deg)) (Continued)

	Member Label	Direction	Magnitude[k,k-ft]	Location[ft,%]
2	M31	Z	-.007	%31.8
3	M32	Z	-.009	%37.1
4	M32	Z	-.007	%31.8
5	M33	Z	-.012	%40
6	M33	Z	-.007	%40

Member Point Loads (BLC 28 : Seismic Antenna (90 Deg))

	Member Label	Direction	Magnitude[k,k-ft]	Location[ft,%]
1	M31	X	.012	%37.3
2	M31	X	.007	%31.8
3	M32	X	.009	%37.1
4	M32	X	.007	%31.8
5	M33	X	.012	%40
6	M33	X	.007	%40

Member Point Loads (BLC 41 : Seismic Vertical Antennas)

	Member Label	Direction	Magnitude[k,k-ft]	Location[ft,%]
1	M31	Y	-.026	%37.3
2	M31	Y	-.015	%31.8
3	M32	Y	-.018	%37.1
4	M32	Y	-.015	%31.8
5	M33	Y	-.026	%40
6	M33	Y	-.015	%40

Member Distributed Loads (BLC 2 : Ice Dead)

	Member Label	Direction	Start Magnitude[k/ft,...	End Magnitude[k/ft,F,...	Start Location[ft,%]	End Location[ft,%]
1	M1	Y	-.008	-.008	0	%100
2	M2	Y	-.006	-.006	0	%100
3	M3	Y	-.008	-.008	0	%100
4	M4	Y	-.008	-.008	0	%100
5	M5	Y	-.013	-.013	0	%100
6	M6	Y	-.013	-.013	0	%100
7	M7	Y	-.008	-.008	0	%100
8	M8	Y	-.008	-.008	0	%100
9	M9	Y	-.014	-.014	0	%100
10	M10	Y	-.006	-.006	0	%100
11	M11	Y	-.006	-.006	0	%100
12	M12	Y	-.008	-.008	0	%100
13	M13	Y	-.006	-.006	0	%100
14	M14	Y	-.008	-.008	0	%100
15	M15	Y	-.008	-.008	0	%100
16	M16	Y	-.013	-.013	0	%100
17	M17	Y	-.013	-.013	0	%100
18	M18	Y	-.008	-.008	0	%100
19	M19	Y	-.008	-.008	0	%100
20	M20	Y	-.014	-.014	0	%100
21	M21	Y	-.006	-.006	0	%100
22	M22	Y	-.006	-.006	0	%100
23	M23	Y	-.006	-.006	0	%100
24	M24	Y	-.006	-.006	0	%100
25	M25	Y	-.006	-.006	0	%100
26	M26	Y	-.006	-.006	0	%100
27	M27	Y	-.006	-.006	0	%100
28	M28	Y	-.006	-.006	0	%100



Member Distributed Loads (BLC 2 : Ice Dead) (Continued)

	Member Label	Direction	Start Magnitude[k/ft....	End Magnitude[k/ft.F....	Start Location[ft.%]	End Location[ft.%]
29	M29	Y	-0.006	-0.006	0	%100
30	M30	Y	-0.006	-0.006	0	%100
31	M31	Y	-0.013	-0.013	0	%100
32	M32	Y	-0.013	-0.013	0	%100
33	M33	Y	-0.013	-0.013	0	%100
34	M34	Y	-0.013	-0.013	0	%100
35	M35	Y	-0.008	-0.008	0	%100
36	M36	Y	-0.008	-0.008	0	%100
37	M37	Y	-0.008	-0.008	0	%100
38	M38	Y	-0.008	-0.008	0	%100
39	M39	Y	-0.008	-0.008	0	%100
40	M40	Y	-0.008	-0.008	0	%100
41	M41	Y	-0.008	-0.008	0	%100
42	M42	Y	-0.008	-0.008	0	%100
43	M137	Y	-0.013	-0.013	0	%100
44	M144	Y	-0.013	-0.013	0	%100

Member Distributed Loads (BLC 9 : Full Wind Members (0 Deg))

	Member Label	Direction	Start Magnitude[k/ft....	End Magnitude[k/ft.F....	Start Location[ft.%]	End Location[ft.%]
1	M1	Z	0	0	0	%100
2	M3	Z	-0.005	-0.005	0	%100
3	M4	Z	-0.005	-0.005	0	%100
4	M5	Z	-0.005	-0.005	0	%100
5	M6	Z	-0.005	-0.005	0	%100
6	M7	Z	0	0	0	%100
7	M8	Z	0	0	0	%100
8	M9	Z	-0.013	-0.013	0	%100
9	M12	Z	0	0	0	%100
10	M14	Z	-0.005	-0.005	0	%100
11	M15	Z	-0.005	-0.005	0	%100
12	M16	Z	-0.005	-0.005	0	%100
13	M17	Z	-0.005	-0.005	0	%100
14	M18	Z	0	0	0	%100
15	M19	Z	0	0	0	%100
16	M20	Z	-0.013	-0.013	0	%100
17	M33	Z	-0.01	-0.01	0	0
18	M34	Z	-0.01	-0.01	0	%100
19	M35	Z	-0.003	-0.003	0	%100
20	M36	Z	-0.003	-0.003	0	%100
21	M37	Z	-0.003	-0.003	0	%100
22	M38	Z	-0.003	-0.003	0	%100
23	M39	Z	-0.003	-0.003	0	%100
24	M40	Z	-0.003	-0.003	0	%100
25	M41	Z	-0.003	-0.003	0	%100
26	M42	Z	-0.003	-0.003	0	%100
27	M137	Z	0	0	0	%100
28	M144	Z	0	0	0	%100
29	M31	Z	-0.01	-0.01	%74.7	%100
30	M32	Z	-0.01	-0.01	%74.2	%100
31	M33	Z	-0.01	-0.01	%80	%100
32	M1	X	0	0	0	%100
33	M3	X	0	0	0	%100
34	M4	X	0	0	0	%100
35	M5	X	0	0	0	%100
36	M6	X	0	0	0	%100
37	M7	X	0	0	0	%100



Company : Mastec
 Designer : VB
 Job Number : 18753-MNT1
 Model Name : HRT 086 943248, App 482056

May 16, 2019
 1:44 PM
 Checked By: _____

Member Distributed Loads (BLC 9 : Full Wind Members (0 Deg)) (Continued)

	Member Label	Direction	Start Magnitude[k/ft,...	End Magnitude[k/ft.F,...	Start Location[ft.%]	End Location[ft.%]
38	M8	X	0	0	0	%100
39	M9	X	0	0	0	%100
40	M12	X	0	0	0	%100
41	M14	X	0	0	0	%100
42	M15	X	0	0	0	%100
43	M16	X	0	0	0	%100
44	M17	X	0	0	0	%100
45	M18	X	0	0	0	%100
46	M19	X	0	0	0	%100
47	M20	X	0	0	0	%100
48	M31	X	0	0	0	%100
49	M32	X	0	0	0	%100
50	M33	X	0	0	0	%100
51	M34	X	0	0	0	%100
52	M35	X	0	0	0	%100
53	M36	X	0	0	0	%100
54	M37	X	0	0	0	%100
55	M38	X	0	0	0	%100
56	M39	X	0	0	0	%100
57	M40	X	0	0	0	%100
58	M41	X	0	0	0	%100
59	M42	X	0	0	0	%100
60	M137	X	0	0	0	%100
61	M144	X	0	0	0	%100

Member Distributed Loads (BLC 10 : Full Wind Members (30 Deg))

	Member Label	Direction	Start Magnitude[k/ft,...	End Magnitude[k/ft.F,...	Start Location[ft.%]	End Location[ft.%]
1	M1	Z	-.001	-.001	0	%100
2	M3	Z	-.003	-.003	0	%100
3	M4	Z	-.003	-.003	0	%100
4	M5	Z	-.008	-.008	0	%100
5	M6	Z	-.001	-.001	0	%100
6	M7	Z	-.001	-.001	0	%100
7	M8	Z	-.001	-.001	0	%100
8	M9	Z	-.008	-.008	0	%100
9	M12	Z	-.001	-.001	0	%100
10	M14	Z	-.003	-.003	0	%100
11	M15	Z	-.003	-.003	0	%100
12	M16	Z	-.008	-.008	0	%100
13	M17	Z	-.001	-.001	0	%100
14	M18	Z	-.001	-.001	0	%100
15	M19	Z	-.001	-.001	0	%100
16	M20	Z	-.008	-.008	0	%100
17	M33	Z	-.009	-.009	0	0
18	M34	Z	-.009	-.009	0	%100
19	M35	Z	-.002	-.002	0	%100
20	M36	Z	-.002	-.002	0	%100
21	M37	Z	-.003	-.003	0	%100
22	M38	Z	-.003	-.003	0	%100
23	M39	Z	-.002	-.002	0	%100
24	M40	Z	-.002	-.002	0	%100
25	M41	Z	-.002	-.002	0	%100
26	M42	Z	-.002	-.002	0	%100
27	M137	Z	-.002	-.002	0	%100
28	M144	Z	-.002	-.002	0	%100
29	M31	Z	-.009	-.009	%74.7	%100



Member Distributed Loads (BLC 10 : Full Wind Members (30 Deg)) (Continued)

	Member Label	Direction	Start Magnitude[k/ft,...	End Magnitude[k/ft.F,...	Start Location[ft, %]	End Location[ft, %]
30	M32	Z	-.009	-.009	%74.2	%100
31	M33	Z	-.009	-.009	%80	%100
32	M1	X	.001	.001	0	%100
33	M3	X	.002	.002	0	%100
34	M4	X	.002	.002	0	%100
35	M5	X	.005	.005	0	%100
36	M6	X	0	0	0	%100
37	M7	X	.001	.001	0	%100
38	M8	X	.001	.001	0	%100
39	M9	X	.005	.005	0	%100
40	M12	X	.001	.001	0	%100
41	M14	X	.002	.002	0	%100
42	M15	X	.002	.002	0	%100
43	M16	X	.005	.005	0	%100
44	M17	X	0	0	0	%100
45	M18	X	.001	.001	0	%100
46	M19	X	.001	.001	0	%100
47	M20	X	.005	.005	0	%100
48	M31	X	.005	.005	0	%100
49	M32	X	.005	.005	0	%100
50	M33	X	.005	.005	0	%100
51	M34	X	.005	.005	0	%100
52	M35	X	.001	.001	0	%100
53	M36	X	.001	.001	0	%100
54	M37	X	.002	.002	0	%100
55	M38	X	.002	.002	0	%100
56	M39	X	.001	.001	0	%100
57	M40	X	.001	.001	0	%100
58	M41	X	.001	.001	0	%100
59	M42	X	.001	.001	0	%100
60	M137	X	.001	.001	0	%100
61	M144	X	.001	.001	0	%100

Member Distributed Loads (BLC 11 : Full Wind Members (60 Deg))

	Member Label	Direction	Start Magnitude[k/ft,...	End Magnitude[k/ft.F,...	Start Location[ft, %]	End Location[ft, %]
1	M1	Z	-.002	-.002	0	%100
2	M3	Z	-.001	-.001	0	%100
3	M4	Z	-.001	-.001	0	%100
4	M5	Z	-.005	-.005	0	%100
5	M6	Z	0	0	0	%100
6	M7	Z	-.002	-.002	0	%100
7	M8	Z	-.002	-.002	0	%100
8	M9	Z	-.002	-.002	0	%100
9	M12	Z	-.002	-.002	0	%100
10	M14	Z	-.001	-.001	0	%100
11	M15	Z	-.001	-.001	0	%100
12	M16	Z	-.005	-.005	0	%100
13	M17	Z	0	0	0	%100
14	M18	Z	-.002	-.002	0	%100
15	M19	Z	-.002	-.002	0	%100
16	M20	Z	-.002	-.002	0	%100
17	M33	Z	-.005	-.005	0	0
18	M34	Z	-.005	-.005	0	%100
19	M35	Z	-.001	-.001	0	%100
20	M36	Z	-.001	-.001	0	%100
21	M37	Z	-.002	-.002	0	%100



Member Distributed Loads (BLC 11 : Full Wind Members (60 Deg)) (Continued)

	Member Label	Direction	Start Magnitude[k/ft....	End Magnitude[k/ft.F....	Start Location[ft.%]	End Location[ft.%]
22	M38	Z	-.002	-.002	0	%100
23	M39	Z	-.001	-.001	0	%100
24	M40	Z	-.001	-.001	0	%100
25	M41	Z	-.001	-.001	0	%100
26	M42	Z	-.001	-.001	0	%100
27	M137	Z	-.004	-.004	0	%100
28	M144	Z	-.004	-.004	0	%100
29	M31	Z	-.005	-.005	%74.7	%100
30	M32	Z	-.005	-.005	%74.2	%100
31	M33	Z	-.005	-.005	%80	%100
32	M1	X	.003	.003	0	%100
33	M3	X	.001	.001	0	%100
34	M4	X	.001	.001	0	%100
35	M5	X	.008	.008	0	%100
36	M6	X	.001	.001	0	%100
37	M7	X	.003	.003	0	%100
38	M8	X	.003	.003	0	%100
39	M9	X	.003	.003	0	%100
40	M12	X	.003	.003	0	%100
41	M14	X	.001	.001	0	%100
42	M15	X	.001	.001	0	%100
43	M16	X	.008	.008	0	%100
44	M17	X	.001	.001	0	%100
45	M18	X	.003	.003	0	%100
46	M19	X	.003	.003	0	%100
47	M20	X	.003	.003	0	%100
48	M31	X	.009	.009	0	%100
49	M32	X	.009	.009	0	%100
50	M33	X	.009	.009	0	%100
51	M34	X	.009	.009	0	%100
52	M35	X	.002	.002	0	%100
53	M36	X	.002	.002	0	%100
54	M37	X	.003	.003	0	%100
55	M38	X	.003	.003	0	%100
56	M39	X	.002	.002	0	%100
57	M40	X	.002	.002	0	%100
58	M41	X	.002	.002	0	%100
59	M42	X	.002	.002	0	%100
60	M137	X	.006	.006	0	%100
61	M144	X	.006	.006	0	%100

Member Distributed Loads (BLC 12 : Full Wind Members (90 Deg))

	Member Label	Direction	Start Magnitude[k/ft....	End Magnitude[k/ft.F....	Start Location[ft.%]	End Location[ft.%]
1	M1	Z	0	0	0	%100
2	M3	Z	0	0	0	%100
3	M4	Z	0	0	0	%100
4	M5	Z	0	0	0	%100
5	M6	Z	0	0	0	%100
6	M7	Z	0	0	0	%100
7	M8	Z	0	0	0	%100
8	M9	Z	0	0	0	%100
9	M12	Z	0	0	0	%100
10	M14	Z	0	0	0	%100
11	M15	Z	0	0	0	%100
12	M16	Z	0	0	0	%100
13	M17	Z	0	0	0	%100



Member Distributed Loads (BLC 12 : Full Wind Members (90 Deg)) (Continued)

	Member Label	Direction	Start Magnitude[k/ft,...	End Magnitude[k/ft.F,...	Start Location[ft, %]	End Location[ft, %]
14	M18	Z	0	0	0	%100
15	M19	Z	0	0	0	%100
16	M20	Z	0	0	0	%100
17	M33	Z	0	0	0	0
18	M34	Z	0	0	0	%100
19	M35	Z	0	0	0	%100
20	M36	Z	0	0	0	%100
21	M37	Z	0	0	0	%100
22	M38	Z	0	0	0	%100
23	M39	Z	0	0	0	%100
24	M40	Z	0	0	0	%100
25	M41	Z	0	0	0	%100
26	M42	Z	0	0	0	%100
27	M137	Z	0	0	0	%100
28	M144	Z	0	0	0	%100
29	M31	Z	0	0	%74.7	%100
30	M32	Z	0	0	%74.2	%100
31	M33	Z	0	0	%80	%100
32	M1	X	.005	.005	0	%100
33	M3	X	0	0	0	%100
34	M4	X	0	0	0	%100
35	M5	X	.005	.005	0	%100
36	M6	X	.005	.005	0	%100
37	M7	X	.005	.005	0	%100
38	M8	X	.005	.005	0	%100
39	M9	X	0	0	0	%100
40	M12	X	.005	.005	0	%100
41	M14	X	0	0	0	%100
42	M15	X	0	0	0	%100
43	M16	X	.005	.005	0	%100
44	M17	X	.005	.005	0	%100
45	M18	X	.005	.005	0	%100
46	M19	X	.005	.005	0	%100
47	M20	X	0	0	0	%100
48	M31	X	.01	.01	0	%100
49	M32	X	.01	.01	0	%100
50	M33	X	.01	.01	0	%100
51	M34	X	.01	.01	0	%100
52	M35	X	.003	.003	0	%100
53	M36	X	.003	.003	0	%100
54	M37	X	.003	.003	0	%100
55	M38	X	.003	.003	0	%100
56	M39	X	.003	.003	0	%100
57	M40	X	.003	.003	0	%100
58	M41	X	.003	.003	0	%100
59	M42	X	.003	.003	0	%100
60	M137	X	.01	.01	0	%100
61	M144	X	.01	.01	0	%100

Member Distributed Loads (BLC 13 : Full Wind Members (120 Deg))

	Member Label	Direction	Start Magnitude[k/ft,...	End Magnitude[k/ft.F,...	Start Location[ft, %]	End Location[ft, %]
1	M1	Z	.002	.002	0	%100
2	M3	Z	.001	.001	0	%100
3	M4	Z	.001	.001	0	%100
4	M5	Z	0	0	0	%100
5	M6	Z	.005	.005	0	%100



Member Distributed Loads (BLC 13 : Full Wind Members (120 Deg)) (Continued)

	Member Label	Direction	Start Magnitude[k/ft....	End Magnitude[k/ft.F....	Start Location[ft.%]	End Location[ft.%]
6	M7	Z	.002	.002	0	%100
7	M8	Z	.002	.002	0	%100
8	M9	Z	.002	.002	0	%100
9	M12	Z	.002	.002	0	%100
10	M14	Z	.001	.001	0	%100
11	M15	Z	.001	.001	0	%100
12	M16	Z	0	0	0	%100
13	M17	Z	.005	.005	0	%100
14	M18	Z	.002	.002	0	%100
15	M19	Z	.002	.002	0	%100
16	M20	Z	.002	.002	0	%100
17	M33	Z	.005	.005	0	0
18	M34	Z	.005	.005	0	%100
19	M35	Z	.002	.002	0	%100
20	M36	Z	.002	.002	0	%100
21	M37	Z	.001	.001	0	%100
22	M38	Z	.001	.001	0	%100
23	M39	Z	.001	.001	0	%100
24	M40	Z	.001	.001	0	%100
25	M41	Z	.001	.001	0	%100
26	M42	Z	.001	.001	0	%100
27	M137	Z	.004	.004	0	%100
28	M144	Z	.004	.004	0	%100
29	M31	Z	.005	.005	%74.7	%100
30	M32	Z	.005	.005	%74.2	%100
31	M33	Z	.005	.005	%80	%100
32	M1	X	.003	.003	0	%100
33	M3	X	.001	.001	0	%100
34	M4	X	.001	.001	0	%100
35	M5	X	.001	.001	0	%100
36	M6	X	.008	.008	0	%100
37	M7	X	.003	.003	0	%100
38	M8	X	.003	.003	0	%100
39	M9	X	.003	.003	0	%100
40	M12	X	.003	.003	0	%100
41	M14	X	.001	.001	0	%100
42	M15	X	.001	.001	0	%100
43	M16	X	.001	.001	0	%100
44	M17	X	.008	.008	0	%100
45	M18	X	.003	.003	0	%100
46	M19	X	.003	.003	0	%100
47	M20	X	.003	.003	0	%100
48	M31	X	.009	.009	0	%100
49	M32	X	.009	.009	0	%100
50	M33	X	.009	.009	0	%100
51	M34	X	.009	.009	0	%100
52	M35	X	.003	.003	0	%100
53	M36	X	.003	.003	0	%100
54	M37	X	.002	.002	0	%100
55	M38	X	.002	.002	0	%100
56	M39	X	.002	.002	0	%100
57	M40	X	.002	.002	0	%100
58	M41	X	.002	.002	0	%100
59	M42	X	.002	.002	0	%100
60	M137	X	.007	.007	0	%100
61	M144	X	.007	.007	0	%100



Company : Mastec
 Designer : VB
 Job Number : 18753-MNT1
 Model Name : HRT 086 943248, App 482056

May 16, 2019
 1:44 PM
 Checked By: _____

Member Distributed Loads (BLC 14 : Full Wind Members (150 Deg))

	Member Label	Direction	Start Magnitude[k/ft....	End Magnitude[k/ft.F....	Start Location[ft.%]	End Location[ft.%]
1	M1	Z	.001	.001	0	%100
2	M3	Z	.003	.003	0	%100
3	M4	Z	.003	.003	0	%100
4	M5	Z	.001	.001	0	%100
5	M6	Z	.008	.008	0	%100
6	M7	Z	.001	.001	0	%100
7	M8	Z	.001	.001	0	%100
8	M9	Z	.008	.008	0	%100
9	M12	Z	.001	.001	0	%100
10	M14	Z	.003	.003	0	%100
11	M15	Z	.003	.003	0	%100
12	M16	Z	.001	.001	0	%100
13	M17	Z	.008	.008	0	%100
14	M18	Z	.001	.001	0	%100
15	M19	Z	.001	.001	0	%100
16	M20	Z	.008	.008	0	%100
17	M33	Z	.009	.009	0	0
18	M34	Z	.009	.009	0	%100
19	M35	Z	.003	.003	0	%100
20	M36	Z	.003	.003	0	%100
21	M37	Z	.002	.002	0	%100
22	M38	Z	.002	.002	0	%100
23	M39	Z	.002	.002	0	%100
24	M40	Z	.002	.002	0	%100
25	M41	Z	.002	.002	0	%100
26	M42	Z	.002	.002	0	%100
27	M137	Z	.003	.003	0	%100
28	M144	Z	.003	.003	0	%100
29	M31	Z	.009	.009	%74.7	%100
30	M32	Z	.009	.009	%74.2	%100
31	M33	Z	.009	.009	%80	%100
32	M1	X	.001	.001	0	%100
33	M3	X	.002	.002	0	%100
34	M4	X	.002	.002	0	%100
35	M5	X	0	0	0	%100
36	M6	X	.005	.005	0	%100
37	M7	X	.001	.001	0	%100
38	M8	X	.001	.001	0	%100
39	M9	X	.005	.005	0	%100
40	M12	X	.001	.001	0	%100
41	M14	X	.002	.002	0	%100
42	M15	X	.002	.002	0	%100
43	M16	X	0	0	0	%100
44	M17	X	.005	.005	0	%100
45	M18	X	.001	.001	0	%100
46	M19	X	.001	.001	0	%100
47	M20	X	.005	.005	0	%100
48	M31	X	.005	.005	0	%100
49	M32	X	.005	.005	0	%100
50	M33	X	.005	.005	0	%100
51	M34	X	.005	.005	0	%100
52	M35	X	.002	.002	0	%100
53	M36	X	.002	.002	0	%100
54	M37	X	.001	.001	0	%100
55	M38	X	.001	.001	0	%100
56	M39	X	.001	.001	0	%100
57	M40	X	.001	.001	0	%100



Company : Mastec
 Designer : VB
 Job Number : 18753-MNT1
 Model Name : HRT 086 943248, App 482056

May 16, 2019
 1:44 PM
 Checked By: _____

Member Distributed Loads (BLC 14 : Full Wind Members (150 Deg)) (Continued)

	Member Label	Direction	Start Magnitude[k/ft,...	End Magnitude[k/ft.F,...	Start Location[ft, %]	End Location[ft, %]
58	M41	X	.001	.001	0	%100
59	M42	X	.001	.001	0	%100
60	M137	X	.002	.002	0	%100
61	M144	X	.002	.002	0	%100

Member Distributed Loads (BLC 21 : Ice Wind Members (0 Deg))

	Member Label	Direction	Start Magnitude[k/ft,...	End Magnitude[k/ft.F,...	Start Location[ft, %]	End Location[ft, %]
1	M1	Z	0	0	0	%100
2	M2	Z	-.006	-.006	0	%100
3	M3	Z	-.008	-.008	0	%100
4	M4	Z	-.008	-.008	0	%100
5	M5	Z	-.003	-.003	0	%100
6	M6	Z	-.003	-.003	0	%100
7	M7	Z	0	0	0	%100
8	M8	Z	0	0	0	%100
9	M9	Z	-.005	-.005	0	%100
10	M10	Z	-.022	-.022	0	%100
11	M11	Z	-.022	-.022	0	%100
12	M12	Z	0	0	0	%100
13	M13	Z	-.006	-.006	0	%100
14	M14	Z	-.008	-.008	0	%100
15	M15	Z	-.008	-.008	0	%100
16	M16	Z	-.003	-.003	0	%100
17	M17	Z	-.003	-.003	0	%100
18	M18	Z	0	0	0	%100
19	M19	Z	0	0	0	%100
20	M20	Z	-.005	-.005	0	%100
21	M21	Z	-.022	-.022	0	%100
22	M22	Z	-.022	-.022	0	%100
23	M23	Z	0	0	0	%100
24	M24	Z	0	0	0	%100
25	M25	Z	0	0	0	%100
26	M26	Z	0	0	0	%100
27	M27	Z	0	0	0	%100
28	M28	Z	0	0	0	%100
29	M29	Z	0	0	0	%100
30	M30	Z	0	0	0	%100
31	M33	Z	-.005	-.005	0	0
32	M34	Z	-.005	-.005	0	%100
33	M35	Z	-.004	-.004	0	%100
34	M36	Z	-.004	-.004	0	%100
35	M37	Z	-.004	-.004	0	%100
36	M38	Z	-.004	-.004	0	%100
37	M39	Z	-.004	-.004	0	%100
38	M40	Z	-.004	-.004	0	%100
39	M41	Z	-.004	-.004	0	%100
40	M42	Z	-.004	-.004	0	%100
41	M137	Z	0	0	0	%100
42	M144	Z	0	0	0	%100
43	M31	Z	-.005	-.005	%74.7	%100
44	M32	Z	-.005	-.005	%74.2	%100
45	M33	Z	-.005	-.005	%80	%100
46	M1	X	0	0	0	%100
47	M2	X	0	0	0	%100
48	M3	X	0	0	0	%100
49	M4	X	0	0	0	%100



Member Distributed Loads (BLC 21 : Ice Wind Members (0 Deg)) (Continued)

	Member Label	Direction	Start Magnitude[k/ft,...	End Magnitude[k/ft.F,...	Start Location[ft, %]	End Location[ft, %]
50	M5	X	0	0	0	%100
51	M6	X	0	0	0	%100
52	M7	X	0	0	0	%100
53	M8	X	0	0	0	%100
54	M9	X	0	0	0	%100
55	M10	X	0	0	0	%100
56	M11	X	0	0	0	%100
57	M12	X	0	0	0	%100
58	M13	X	0	0	0	%100
59	M14	X	0	0	0	%100
60	M15	X	0	0	0	%100
61	M16	X	0	0	0	%100
62	M17	X	0	0	0	%100
63	M18	X	0	0	0	%100
64	M19	X	0	0	0	%100
65	M20	X	0	0	0	%100
66	M21	X	0	0	0	%100
67	M22	X	0	0	0	%100
68	M23	X	0	0	0	%100
69	M24	X	0	0	0	%100
70	M25	X	0	0	0	%100
71	M26	X	0	0	0	%100
72	M27	X	0	0	0	%100
73	M28	X	0	0	0	%100
74	M29	X	0	0	0	%100
75	M30	X	0	0	0	%100
76	M31	X	0	0	0	%100
77	M32	X	0	0	0	%100
78	M33	X	0	0	0	%100
79	M34	X	0	0	0	%100
80	M35	X	0	0	0	%100
81	M36	X	0	0	0	%100
82	M37	X	0	0	0	%100
83	M38	X	0	0	0	%100
84	M39	X	0	0	0	%100
85	M40	X	0	0	0	%100
86	M41	X	0	0	0	%100
87	M42	X	0	0	0	%100
88	M137	X	0	0	0	%100
89	M144	X	0	0	0	%100

Member Distributed Loads (BLC 22 : Ice Wind Members (30 Deg))

	Member Label	Direction	Start Magnitude[k/ft,...	End Magnitude[k/ft.F,...	Start Location[ft, %]	End Location[ft, %]
1	M1	Z	0	0	0	%100
2	M2	Z	-0.005	-0.005	0	%100
3	M3	Z	-0.007	-0.007	0	%100
4	M4	Z	-0.007	-0.007	0	%100
5	M5	Z	-0.003	-0.003	0	%100
6	M6	Z	-0.002	-0.002	0	%100
7	M7	Z	0	0	0	%100
8	M8	Z	0	0	0	%100
9	M9	Z	-0.004	-0.004	0	%100
10	M10	Z	-0.019	-0.019	0	%100
11	M11	Z	-0.019	-0.019	0	%100
12	M12	Z	0	0	0	%100
13	M13	Z	-0.005	-0.005	0	%100



Company : Mastec
 Designer : VB
 Job Number : 18753-MNT1
 Model Name : HRT 086 943248, App 482056

May 16, 2019
 1:44 PM
 Checked By: _____

Member Distributed Loads (BLC 22 : Ice Wind Members (30 Deg)) (Continued)

	Member Label	Direction	Start Magnitude[k/ft....	End Magnitude[k/ft.F....	Start Location[ft.%]	End Location[ft.%]
14	M14	Z	-0.07	-0.07	0	%100
15	M15	Z	-0.07	-0.07	0	%100
16	M16	Z	-0.03	-0.03	0	%100
17	M17	Z	-0.02	-0.02	0	%100
18	M18	Z	0	0	0	%100
19	M19	Z	0	0	0	%100
20	M20	Z	-0.04	-0.04	0	%100
21	M21	Z	-0.19	-0.19	0	%100
22	M22	Z	-0.19	-0.19	0	%100
23	M23	Z	0	0	0	%100
24	M24	Z	0	0	0	%100
25	M25	Z	0	0	0	%100
26	M26	Z	0	0	0	%100
27	M27	Z	0	0	0	%100
28	M28	Z	0	0	0	%100
29	M29	Z	0	0	0	%100
30	M30	Z	0	0	0	%100
31	M33	Z	-0.05	-0.05	0	0
32	M34	Z	-0.05	-0.05	0	%100
33	M35	Z	-0.03	-0.03	0	%100
34	M36	Z	-0.03	-0.03	0	%100
35	M37	Z	-0.04	-0.04	0	%100
36	M38	Z	-0.04	-0.04	0	%100
37	M39	Z	-0.04	-0.04	0	%100
38	M40	Z	-0.04	-0.04	0	%100
39	M41	Z	-0.04	-0.04	0	%100
40	M42	Z	-0.04	-0.04	0	%100
41	M137	Z	-0.01	-0.01	0	%100
42	M144	Z	-0.01	-0.01	0	%100
43	M31	Z	-0.05	-0.05	%74.7	%100
44	M32	Z	-0.05	-0.05	%74.2	%100
45	M33	Z	-0.05	-0.05	%80	%100
46	M1	X	0	0	0	%100
47	M2	X	.003	.003	0	%100
48	M3	X	.004	.004	0	%100
49	M4	X	.004	.004	0	%100
50	M5	X	.002	.002	0	%100
51	M6	X	.001	.001	0	%100
52	M7	X	0	0	0	%100
53	M8	X	0	0	0	%100
54	M9	X	.002	.002	0	%100
55	M10	X	.011	.011	0	%100
56	M11	X	.011	.011	0	%100
57	M12	X	0	0	0	%100
58	M13	X	.003	.003	0	%100
59	M14	X	.004	.004	0	%100
60	M15	X	.004	.004	0	%100
61	M16	X	.002	.002	0	%100
62	M17	X	.001	.001	0	%100
63	M18	X	0	0	0	%100
64	M19	X	0	0	0	%100
65	M20	X	.002	.002	0	%100
66	M21	X	.011	.011	0	%100
67	M22	X	.011	.011	0	%100
68	M23	X	0	0	0	%100
69	M24	X	0	0	0	%100
70	M25	X	0	0	0	%100



Company : Mastec
 Designer : VB
 Job Number : 18753-MNT1
 Model Name : HRT 086 943248, App 482056

May 16, 2019
 1:44 PM
 Checked By: _____

Member Distributed Loads (BLC 22 : Ice Wind Members (30 Deg)) (Continued)

	Member Label	Direction	Start Magnitude[k/ft....	End Magnitude[k/ft.F....	Start Location[ft.%]	End Location[ft.%]
71	M26	X	0	0	0	%100
72	M27	X	0	0	0	%100
73	M28	X	0	0	0	%100
74	M29	X	0	0	0	%100
75	M30	X	0	0	0	%100
76	M31	X	.003	.003	0	%100
77	M32	X	.003	.003	0	%100
78	M33	X	.003	.003	0	%100
79	M34	X	.003	.003	0	%100
80	M35	X	.002	.002	0	%100
81	M36	X	.002	.002	0	%100
82	M37	X	.002	.002	0	%100
83	M38	X	.002	.002	0	%100
84	M39	X	.002	.002	0	%100
85	M40	X	.002	.002	0	%100
86	M41	X	.002	.002	0	%100
87	M42	X	.002	.002	0	%100
88	M137	X	.001	.001	0	%100
89	M144	X	.001	.001	0	%100

Member Distributed Loads (BLC 23 : Ice Wind Members (60 Deg))

	Member Label	Direction	Start Magnitude[k/ft....	End Magnitude[k/ft.F....	Start Location[ft.%]	End Location[ft.%]
1	M1	Z	0	0	0	%100
2	M2	Z	-.003	-.003	0	%100
3	M3	Z	-.004	-.004	0	%100
4	M4	Z	-.004	-.004	0	%100
5	M5	Z	-.002	-.002	0	%100
6	M6	Z	-.001	-.001	0	%100
7	M7	Z	0	0	0	%100
8	M8	Z	0	0	0	%100
9	M9	Z	-.002	-.002	0	%100
10	M10	Z	-.011	-.011	0	%100
11	M11	Z	-.011	-.011	0	%100
12	M12	Z	0	0	0	%100
13	M13	Z	-.003	-.003	0	%100
14	M14	Z	-.004	-.004	0	%100
15	M15	Z	-.004	-.004	0	%100
16	M16	Z	-.002	-.002	0	%100
17	M17	Z	-.001	-.001	0	%100
18	M18	Z	0	0	0	%100
19	M19	Z	0	0	0	%100
20	M20	Z	-.002	-.002	0	%100
21	M21	Z	-.011	-.011	0	%100
22	M22	Z	-.011	-.011	0	%100
23	M23	Z	0	0	0	%100
24	M24	Z	0	0	0	%100
25	M25	Z	0	0	0	%100
26	M26	Z	0	0	0	%100
27	M27	Z	0	0	0	%100
28	M28	Z	0	0	0	%100
29	M29	Z	0	0	0	%100
30	M30	Z	0	0	0	%100
31	M33	Z	-.003	-.003	0	0
32	M34	Z	-.003	-.003	0	%100
33	M35	Z	-.002	-.002	0	%100
34	M36	Z	-.002	-.002	0	%100



Member Distributed Loads (BLC 23 : Ice Wind Members (60 Deg)) (Continued)

	Member Label	Direction	Start Magnitude[k/ft....	End Magnitude[k/ft.F....	Start Location[ft.%,]	End Location[ft.%,]
35	M37	Z	-.002	-.002	0	%100
36	M38	Z	-.002	-.002	0	%100
37	M39	Z	-.002	-.002	0	%100
38	M40	Z	-.002	-.002	0	%100
39	M41	Z	-.002	-.002	0	%100
40	M42	Z	-.002	-.002	0	%100
41	M137	Z	-.002	-.002	0	%100
42	M144	Z	-.002	-.002	0	%100
43	M31	Z	-.003	-.003	%74.7	%100
44	M32	Z	-.003	-.003	%74.2	%100
45	M33	Z	-.003	-.003	%80	%100
46	M1	X	0	0	0	%100
47	M2	X	.005	.005	0	%100
48	M3	X	.007	.007	0	%100
49	M4	X	.007	.007	0	%100
50	M5	X	.003	.003	0	%100
51	M6	X	.002	.002	0	%100
52	M7	X	0	0	0	%100
53	M8	X	0	0	0	%100
54	M9	X	.003	.003	0	%100
55	M10	X	.019	.019	0	%100
56	M11	X	.019	.019	0	%100
57	M12	X	0	0	0	%100
58	M13	X	.005	.005	0	%100
59	M14	X	.007	.007	0	%100
60	M15	X	.007	.007	0	%100
61	M16	X	.003	.003	0	%100
62	M17	X	.002	.002	0	%100
63	M18	X	0	0	0	%100
64	M19	X	0	0	0	%100
65	M20	X	.003	.003	0	%100
66	M21	X	.019	.019	0	%100
67	M22	X	.019	.019	0	%100
68	M23	X	0	0	0	%100
69	M24	X	0	0	0	%100
70	M25	X	0	0	0	%100
71	M26	X	0	0	0	%100
72	M27	X	0	0	0	%100
73	M28	X	0	0	0	%100
74	M29	X	0	0	0	%100
75	M30	X	0	0	0	%100
76	M31	X	.005	.005	0	%100
77	M32	X	.005	.005	0	%100
78	M33	X	.005	.005	0	%100
79	M34	X	.005	.005	0	%100
80	M35	X	.003	.003	0	%100
81	M36	X	.003	.003	0	%100
82	M37	X	.004	.004	0	%100
83	M38	X	.004	.004	0	%100
84	M39	X	.004	.004	0	%100
85	M40	X	.004	.004	0	%100
86	M41	X	.004	.004	0	%100
87	M42	X	.004	.004	0	%100
88	M137	X	.003	.003	0	%100
89	M144	X	.003	.003	0	%100



Company : Mastec
 Designer : VB
 Job Number : 18753-MNT1
 Model Name : HRT 086 943248, App 482056

May 16, 2019
 1:44 PM
 Checked By: _____

Member Distributed Loads (BLC 24 : Ice Wind Members (90 Deg))

	Member Label	Direction	Start Magnitude[k/ft....	End Magnitude[k/ft.F....	Start Location[ft.%,]	End Location[ft.%,]
1	M1	Z	0	0	0	%100
2	M2	Z	0	0	0	%100
3	M3	Z	0	0	0	%100
4	M4	Z	0	0	0	%100
5	M5	Z	0	0	0	%100
6	M6	Z	0	0	0	%100
7	M7	Z	0	0	0	%100
8	M8	Z	0	0	0	%100
9	M9	Z	0	0	0	%100
10	M10	Z	0	0	0	%100
11	M11	Z	0	0	0	%100
12	M12	Z	0	0	0	%100
13	M13	Z	0	0	0	%100
14	M14	Z	0	0	0	%100
15	M15	Z	0	0	0	%100
16	M16	Z	0	0	0	%100
17	M17	Z	0	0	0	%100
18	M18	Z	0	0	0	%100
19	M19	Z	0	0	0	%100
20	M20	Z	0	0	0	%100
21	M21	Z	0	0	0	%100
22	M22	Z	0	0	0	%100
23	M23	Z	0	0	0	%100
24	M24	Z	0	0	0	%100
25	M25	Z	0	0	0	%100
26	M26	Z	0	0	0	%100
27	M27	Z	0	0	0	%100
28	M28	Z	0	0	0	%100
29	M29	Z	0	0	0	%100
30	M30	Z	0	0	0	%100
31	M33	Z	0	0	0	0
32	M34	Z	0	0	0	%100
33	M35	Z	0	0	0	%100
34	M36	Z	0	0	0	%100
35	M37	Z	0	0	0	%100
36	M38	Z	0	0	0	%100
37	M39	Z	0	0	0	%100
38	M40	Z	0	0	0	%100
39	M41	Z	0	0	0	%100
40	M42	Z	0	0	0	%100
41	M137	Z	0	0	0	%100
42	M144	Z	0	0	0	%100
43	M31	Z	0	0	%74.7	%100
44	M32	Z	0	0	%74.2	%100
45	M33	Z	0	0	%80	%100
46	M1	X	.001	.001	0	%100
47	M2	X	.006	.006	0	%100
48	M3	X	.007	.007	0	%100
49	M4	X	.007	.007	0	%100
50	M5	X	.003	.003	0	%100
51	M6	X	.003	.003	0	%100
52	M7	X	.001	.001	0	%100
53	M8	X	.001	.001	0	%100
54	M9	X	.003	.003	0	%100
55	M10	X	.022	.022	0	%100
56	M11	X	.022	.022	0	%100
57	M12	X	.001	.001	0	%100



Company : Mastec
 Designer : VB
 Job Number : 18753-MNT1
 Model Name : HRT 086 943248, App 482056

May 16, 2019
 1:44 PM
 Checked By: _____

Member Distributed Loads (BLC 24 : Ice Wind Members (90 Deg)) (Continued)

	Member Label	Direction	Start Magnitude[k/ft,...	End Magnitude[k/ft.F,...	Start Location[ft, %]	End Location[ft, %]
58	M13	X	.006	.006	0	%100
59	M14	X	.007	.007	0	%100
60	M15	X	.007	.007	0	%100
61	M16	X	.003	.003	0	%100
62	M17	X	.003	.003	0	%100
63	M18	X	.001	.001	0	%100
64	M19	X	.001	.001	0	%100
65	M20	X	.003	.003	0	%100
66	M21	X	.022	.022	0	%100
67	M22	X	.022	.022	0	%100
68	M23	X	0	0	0	%100
69	M24	X	0	0	0	%100
70	M25	X	0	0	0	%100
71	M26	X	0	0	0	%100
72	M27	X	0	0	0	%100
73	M28	X	0	0	0	%100
74	M29	X	0	0	0	%100
75	M30	X	0	0	0	%100
76	M31	X	.005	.005	0	%100
77	M32	X	.005	.005	0	%100
78	M33	X	.005	.005	0	%100
79	M34	X	.005	.005	0	%100
80	M35	X	.004	.004	0	%100
81	M36	X	.004	.004	0	%100
82	M37	X	.004	.004	0	%100
83	M38	X	.004	.004	0	%100
84	M39	X	.004	.004	0	%100
85	M40	X	.004	.004	0	%100
86	M41	X	.004	.004	0	%100
87	M42	X	.004	.004	0	%100
88	M137	X	.005	.005	0	%100
89	M144	X	.005	.005	0	%100

Member Distributed Loads (BLC 25 : Ice Wind Members (120 Deg))

	Member Label	Direction	Start Magnitude[k/ft,...	End Magnitude[k/ft.F,...	Start Location[ft, %]	End Location[ft, %]
1	M1	Z	0	0	0	%100
2	M2	Z	.003	.003	0	%100
3	M3	Z	.004	.004	0	%100
4	M4	Z	.004	.004	0	%100
5	M5	Z	.001	.001	0	%100
6	M6	Z	.002	.002	0	%100
7	M7	Z	0	0	0	%100
8	M8	Z	0	0	0	%100
9	M9	Z	.002	.002	0	%100
10	M10	Z	.011	.011	0	%100
11	M11	Z	.011	.011	0	%100
12	M12	Z	0	0	0	%100
13	M13	Z	.003	.003	0	%100
14	M14	Z	.004	.004	0	%100
15	M15	Z	.004	.004	0	%100
16	M16	Z	.001	.001	0	%100
17	M17	Z	.002	.002	0	%100
18	M18	Z	0	0	0	%100
19	M19	Z	0	0	0	%100
20	M20	Z	.002	.002	0	%100
21	M21	Z	.011	.011	0	%100



Company : Mastec
 Designer : VB
 Job Number : 18753-MNT1
 Model Name : HRT 086 943248, App 482056

May 16, 2019
 1:44 PM
 Checked By: _____

Member Distributed Loads (BLC 25 : Ice Wind Members (120 Deg)) (Continued)

	Member Label	Direction	Start Magnitude[k/ft....	End Magnitude[k/ft.F....	Start Location[ft.%]	End Location[ft.%]
22	M22	Z	.011	.011	0	%100
23	M23	Z	0	0	0	%100
24	M24	Z	0	0	0	%100
25	M25	Z	0	0	0	%100
26	M26	Z	0	0	0	%100
27	M27	Z	0	0	0	%100
28	M28	Z	0	0	0	%100
29	M29	Z	0	0	0	%100
30	M30	Z	0	0	0	%100
31	M33	Z	.003	.003	0	0
32	M34	Z	.003	.003	0	%100
33	M35	Z	.002	.002	0	%100
34	M36	Z	.002	.002	0	%100
35	M37	Z	.002	.002	0	%100
36	M38	Z	.002	.002	0	%100
37	M39	Z	.002	.002	0	%100
38	M40	Z	.002	.002	0	%100
39	M41	Z	.002	.002	0	%100
40	M42	Z	.002	.002	0	%100
41	M137	Z	.002	.002	0	%100
42	M144	Z	.002	.002	0	%100
43	M31	Z	.003	.003	%74.7	%100
44	M32	Z	.003	.003	%74.2	%100
45	M33	Z	.003	.003	%80	%100
46	M1	X	0	0	0	%100
47	M2	X	.005	.005	0	%100
48	M3	X	.007	.007	0	%100
49	M4	X	.007	.007	0	%100
50	M5	X	.002	.002	0	%100
51	M6	X	.003	.003	0	%100
52	M7	X	0	0	0	%100
53	M8	X	0	0	0	%100
54	M9	X	.003	.003	0	%100
55	M10	X	.019	.019	0	%100
56	M11	X	.019	.019	0	%100
57	M12	X	0	0	0	%100
58	M13	X	.005	.005	0	%100
59	M14	X	.007	.007	0	%100
60	M15	X	.007	.007	0	%100
61	M16	X	.002	.002	0	%100
62	M17	X	.003	.003	0	%100
63	M18	X	0	0	0	%100
64	M19	X	0	0	0	%100
65	M20	X	.003	.003	0	%100
66	M21	X	.019	.019	0	%100
67	M22	X	.019	.019	0	%100
68	M23	X	0	0	0	%100
69	M24	X	0	0	0	%100
70	M25	X	0	0	0	%100
71	M26	X	0	0	0	%100
72	M27	X	0	0	0	%100
73	M28	X	0	0	0	%100
74	M29	X	0	0	0	%100
75	M30	X	0	0	0	%100
76	M31	X	.005	.005	0	%100
77	M32	X	.005	.005	0	%100
78	M33	X	.005	.005	0	%100



Company : Mastec
 Designer : VB
 Job Number : 18753-MNT1
 Model Name : HRT 086 943248, App 482056

May 16, 2019
 1:44 PM
 Checked By: _____

Member Distributed Loads (BLC 25 : Ice Wind Members (120 Deg)) (Continued)

	Member Label	Direction	Start Magnitude[k/ft,...	End Magnitude[k/ft,F,...	Start Location[ft, %]	End Location[ft, %]
79	M34	X	.005	.005	0	%100
80	M35	X	.004	.004	0	%100
81	M36	X	.004	.004	0	%100
82	M37	X	.003	.003	0	%100
83	M38	X	.003	.003	0	%100
84	M39	X	.004	.004	0	%100
85	M40	X	.004	.004	0	%100
86	M41	X	.004	.004	0	%100
87	M42	X	.004	.004	0	%100
88	M137	X	.004	.004	0	%100
89	M144	X	.004	.004	0	%100

Member Distributed Loads (BLC 26 : Ice Wind Members (150 Deg))

	Member Label	Direction	Start Magnitude[k/ft,...	End Magnitude[k/ft,F,...	Start Location[ft, %]	End Location[ft, %]
1	M1	Z	0	0	0	%100
2	M2	Z	.005	.005	0	%100
3	M3	Z	.007	.007	0	%100
4	M4	Z	.007	.007	0	%100
5	M5	Z	.002	.002	0	%100
6	M6	Z	.003	.003	0	%100
7	M7	Z	0	0	0	%100
8	M8	Z	0	0	0	%100
9	M9	Z	.004	.004	0	%100
10	M10	Z	.019	.019	0	%100
11	M11	Z	.019	.019	0	%100
12	M12	Z	0	0	0	%100
13	M13	Z	.005	.005	0	%100
14	M14	Z	.007	.007	0	%100
15	M15	Z	.007	.007	0	%100
16	M16	Z	.002	.002	0	%100
17	M17	Z	.003	.003	0	%100
18	M18	Z	0	0	0	%100
19	M19	Z	0	0	0	%100
20	M20	Z	.004	.004	0	%100
21	M21	Z	.019	.019	0	%100
22	M22	Z	.019	.019	0	%100
23	M23	Z	0	0	0	%100
24	M24	Z	0	0	0	%100
25	M25	Z	0	0	0	%100
26	M26	Z	0	0	0	%100
27	M27	Z	0	0	0	%100
28	M28	Z	0	0	0	%100
29	M29	Z	0	0	0	%100
30	M30	Z	0	0	0	%100
31	M33	Z	.005	.005	0	0
32	M34	Z	.005	.005	0	%100
33	M35	Z	.004	.004	0	%100
34	M36	Z	.004	.004	0	%100
35	M37	Z	.003	.003	0	%100
36	M38	Z	.003	.003	0	%100
37	M39	Z	.004	.004	0	%100
38	M40	Z	.004	.004	0	%100
39	M41	Z	.004	.004	0	%100
40	M42	Z	.004	.004	0	%100
41	M137	Z	.002	.002	0	%100
42	M144	Z	.002	.002	0	%100



Member Distributed Loads (BLC 26 : Ice Wind Members (150 Deg)) (Continued)

	Member Label	Direction	Start Magnitude[k/ft....	End Magnitude[k/ft.F....	Start Location[ft.%]	End Location[ft.%]
43	M31	Z	.005	.005	%74.7	%100
44	M32	Z	.005	.005	%74.2	%100
45	M33	Z	.005	.005	%80	%100
46	M1	X	0	0	0	%100
47	M2	X	.003	.003	0	%100
48	M3	X	.004	.004	0	%100
49	M4	X	.004	.004	0	%100
50	M5	X	.001	.001	0	%100
51	M6	X	.002	.002	0	%100
52	M7	X	0	0	0	%100
53	M8	X	0	0	0	%100
54	M9	X	.002	.002	0	%100
55	M10	X	.011	.011	0	%100
56	M11	X	.011	.011	0	%100
57	M12	X	0	0	0	%100
58	M13	X	.003	.003	0	%100
59	M14	X	.004	.004	0	%100
60	M15	X	.004	.004	0	%100
61	M16	X	.001	.001	0	%100
62	M17	X	.002	.002	0	%100
63	M18	X	0	0	0	%100
64	M19	X	0	0	0	%100
65	M20	X	.002	.002	0	%100
66	M21	X	.011	.011	0	%100
67	M22	X	.011	.011	0	%100
68	M23	X	0	0	0	%100
69	M24	X	0	0	0	%100
70	M25	X	0	0	0	%100
71	M26	X	0	0	0	%100
72	M27	X	0	0	0	%100
73	M28	X	0	0	0	%100
74	M29	X	0	0	0	%100
75	M30	X	0	0	0	%100
76	M31	X	.003	.003	0	%100
77	M32	X	.003	.003	0	%100
78	M33	X	.003	.003	0	%100
79	M34	X	.003	.003	0	%100
80	M35	X	.002	.002	0	%100
81	M36	X	.002	.002	0	%100
82	M37	X	.002	.002	0	%100
83	M38	X	.002	.002	0	%100
84	M39	X	.002	.002	0	%100
85	M40	X	.002	.002	0	%100
86	M41	X	.002	.002	0	%100
87	M42	X	.002	.002	0	%100
88	M137	X	.001	.001	0	%100
89	M144	X	.001	.001	0	%100

Member Area Loads

Joint A	Joint B	Joint C	Joint D	Direction	Distribution	Magnitude[ksf]
No Data to Print ...						



Load Combinations (Continued)

Description	Solve	PDelta	S...	B...	Fa...	B...	Fa...	B...	Fa...	B...	Fa...	B...	Fa...	B...	Fa...	B...	Fa...	B...	Fa...	B...	Fa...
5	1.2D + 1.0W 90°	Yes	Y		1	1.2	6	1	12	1											
6	1.2D + 1.0W 120°	Yes	Y		1	1.2	7	1	13	1											
7	1.2D + 1.0W 150°	Yes	Y		1	1.2	8	1	14	1											
8	1.2D + 1.0W 180°	Yes	Y		1	1.2	3	-1	9	-1											
9	1.2D + 1.0W 210°	Yes	Y		1	1.2	4	-1	10	-1											
10	1.2D + 1.0W 240°	Yes	Y		1	1.2	5	-1	11	-1											
11	1.2D + 1.0W 270°	Yes	Y		1	1.2	6	-1	12	-1											
12	1.2D + 1.0W 300°	Yes	Y		1	1.2	7	-1	13	-1											
13	1.2D + 1.0W 330°	Yes	Y		1	1.2	8	-1	14	-1											
14	1.2D + 1.0Di + 1....	Yes	Y		1	1.2	2	1	15	1	21	1									
15	1.2D + 1.0Di + 1....	Yes	Y		1	1.2	2	1	16	1	22	1									
16	1.2D + 1.0Di + 1....	Yes	Y		1	1.2	2	1	17	1	23	1									
17	1.2D + 1.0Di + 1....	Yes	Y		1	1.2	2	1	18	1	24	1									
18	1.2D + 1.0Di + 1....	Yes	Y		1	1.2	2	1	19	1	25	1									
19	1.2D + 1.0Di + 1....	Yes	Y		1	1.2	2	1	20	1	26	1									
20	1.2D + 1.0Di + 1....	Yes	Y		1	1.2	2	1	15	-1	21	-1									
21	1.2D + 1.0Di + 1....	Yes	Y		1	1.2	2	1	16	-1	22	-1									
22	1.2D + 1.0Di + 1....	Yes	Y		1	1.2	2	1	17	-1	23	-1									
23	1.2D + 1.0Di + 1....	Yes	Y		1	1.2	2	1	18	-1	24	-1									
24	1.2D + 1.0Di + 1....	Yes	Y		1	1.2	2	1	19	-1	25	-1									
25	1.2D + 1.0Di + 1....	Yes	Y		1	1.2	2	1	20	-1	26	-1									
26	1.2D + 1.5Lm_1 +...	Yes	Y		1	1.2	3	.061	9	.061	42	1.5									
27	1.2D + 1.5Lm_1 +...	Yes	Y		1	1.2	4	.061	10	.061	42	1.5									
28	1.2D + 1.5Lm_1 +...	Yes	Y		1	1.2	5	.061	11	.061	42	1.5									
29	1.2D + 1.5Lm_1 +...	Yes	Y		1	1.2	6	.061	12	.061	42	1.5									
30	1.2D + 1.5Lm_1 +...	Yes	Y		1	1.2	7	.061	13	.061	42	1.5									
31	1.2D + 1.5Lm_1 +...	Yes	Y		1	1.2	8	.061	14	.061	42	1.5									
32	1.2D + 1.5Lm_1 +...	Yes	Y		1	1.2	3	-0...	9	-0...	42	1.5									
33	1.2D + 1.5Lm_1 +...	Yes	Y		1	1.2	4	-0...	10	-0...	42	1.5									
34	1.2D + 1.5Lm_1 +...	Yes	Y		1	1.2	5	-0...	11	-0...	42	1.5									
35	1.2D + 1.5Lm_1 +...	Yes	Y		1	1.2	6	-0...	12	-0...	42	1.5									
36	1.2D + 1.5Lm_1 +...	Yes	Y		1	1.2	7	-0...	13	-0...	42	1.5									
37	1.2D + 1.5Lm_1 +...	Yes	Y		1	1.2	8	-0...	14	-0...	42	1.5									
38	1.2D + 1.5Lm_2 +...	Yes	Y		1	1.2	3	.061	9	.061	43	1.5									
39	1.2D + 1.5Lm_2 +...	Yes	Y		1	1.2	4	.061	10	.061	43	1.5									
40	1.2D + 1.5Lm_2 +...	Yes	Y		1	1.2	5	.061	11	.061	43	1.5									
41	1.2D + 1.5Lm_2 +...	Yes	Y		1	1.2	6	.061	12	.061	43	1.5									
42	1.2D + 1.5Lm_2 +...	Yes	Y		1	1.2	7	.061	13	.061	43	1.5									
43	1.2D + 1.5Lm_2 +...	Yes	Y		1	1.2	8	.061	14	.061	43	1.5									
44	1.2D + 1.5Lm_2 +...	Yes	Y		1	1.2	3	-0...	9	-0...	43	1.5									
45	1.2D + 1.5Lm_2 +...	Yes	Y		1	1.2	4	-0...	10	-0...	43	1.5									
46	1.2D + 1.5Lm_2 +...	Yes	Y		1	1.2	5	-0...	11	-0...	43	1.5									
47	1.2D + 1.5Lm_2 +...	Yes	Y		1	1.2	6	-0...	12	-0...	43	1.5									
48	1.2D + 1.5Lm_2 +...	Yes	Y		1	1.2	7	-0...	13	-0...	43	1.5									
49	1.2D + 1.5Lm_2 +...	Yes	Y		1	1.2	8	-0...	14	-0...	43	1.5									
50	1.2D + 1.5Lm_3 +...	Yes	Y		1	1.2	3	.061	9	.061	44	1.5									
51	1.2D + 1.5Lm_3 +...	Yes	Y		1	1.2	4	.061	10	.061	44	1.5									
52	1.2D + 1.5Lm_3 +...	Yes	Y		1	1.2	5	.061	11	.061	44	1.5									
53	1.2D + 1.5Lm_3 +...	Yes	Y		1	1.2	6	.061	12	.061	44	1.5									
54	1.2D + 1.5Lm_3 +...	Yes	Y		1	1.2	7	.061	13	.061	44	1.5									
55	1.2D + 1.5Lm_3 +...	Yes	Y		1	1.2	8	.061	14	.061	44	1.5									
56	1.2D + 1.5Lm_3 +...	Yes	Y		1	1.2	3	-0...	9	-0...	44	1.5									
57	1.2D + 1.5Lm_3 +...	Yes	Y		1	1.2	4	-0...	10	-0...	44	1.5									
58	1.2D + 1.5Lm_3 +...	Yes	Y		1	1.2	5	-0...	11	-0...	44	1.5									
59	1.2D + 1.5Lm_3 +...	Yes	Y		1	1.2	6	-0...	12	-0...	44	1.5									
60	1.2D + 1.5Lm_3 +...	Yes	Y		1	1.2	7	-0...	13	-0...	44	1.5									
61	1.2D + 1.5Lm_3 +...	Yes	Y		1	1.2	8	-0...	14	-0...	44	1.5									



Load Combinations (Continued)

Description	Solve	PDelta	S...	B...	Fa...	B...	Fa...	B...	Fa...	B...	Fa...	B...	Fa...	B...	Fa...	B...	Fa...	B...	Fa...	B...	Fa...	
62	1.2D + 1.5Lv_1 0°	Yes	Y		1	1.2	45	1.5														
63	1.2D + 1.5Lv_1 3..	Yes	Y		1	1.2	45	1.5														
64	1.2D + 1.5Lv_1 6..	Yes	Y		1	1.2	45	1.5														
65	1.2D + 1.5Lv_1 9..	Yes	Y		1	1.2	45	1.5														
66	1.2D + 1.5Lv_1 1..	Yes	Y		1	1.2	45	1.5														
67	1.2D + 1.5Lv_1 1..	Yes	Y		1	1.2	45	1.5														
68	1.2D + 1.5Lv_1 1..	Yes	Y		1	1.2	45	1.5														
69	1.2D + 1.5Lv_1 2..	Yes	Y		1	1.2	45	1.5														
70	1.2D + 1.5Lv_1 2..	Yes	Y		1	1.2	45	1.5														
71	1.2D + 1.5Lv_1 2..	Yes	Y		1	1.2	45	1.5														
72	1.2D + 1.5Lv_1 3..	Yes	Y		1	1.2	45	1.5														
73	1.2D + 1.5Lv_1 3..	Yes	Y		1	1.2	45	1.5														
74	1.2D + 1.5Lv_2 0°	Yes	Y		1	1.2	46	1.5														
75	1.2D + 1.5Lv_2 3..	Yes	Y		1	1.2	46	1.5														
76	1.2D + 1.5Lv_2 6..	Yes	Y		1	1.2	46	1.5														
77	1.2D + 1.5Lv_2 9..	Yes	Y		1	1.2	46	1.5														
78	1.2D + 1.5Lv_2 1..	Yes	Y		1	1.2	46	1.5														
79	1.2D + 1.5Lv_2 1..	Yes	Y		1	1.2	46	1.5														
80	1.2D + 1.5Lv_2 1..	Yes	Y		1	1.2	46	1.5														
81	1.2D + 1.5Lv_2 2..	Yes	Y		1	1.2	46	1.5														
82	1.2D + 1.5Lv_2 2..	Yes	Y		1	1.2	46	1.5														
83	1.2D + 1.5Lv_2 2..	Yes	Y		1	1.2	46	1.5														
84	1.2D + 1.5Lv_2 3..	Yes	Y		1	1.2	46	1.5														
85	1.2D + 1.5Lv_2 3..	Yes	Y		1	1.2	46	1.5														
86	1.2D + 1.5Lv_3 0°	Yes	Y		1	1.2	47	1.5														
87	1.2D + 1.5Lv_3 3..	Yes	Y		1	1.2	47	1.5														
88	1.2D + 1.5Lv_3 6..	Yes	Y		1	1.2	47	1.5														
89	1.2D + 1.5Lv_3 9..	Yes	Y		1	1.2	47	1.5														
90	1.2D + 1.5Lv_3 1..	Yes	Y		1	1.2	47	1.5														
91	1.2D + 1.5Lv_3 1..	Yes	Y		1	1.2	47	1.5														
92	1.2D + 1.5Lv_3 1..	Yes	Y		1	1.2	47	1.5														
93	1.2D + 1.5Lv_3 2..	Yes	Y		1	1.2	47	1.5														
94	1.2D + 1.5Lv_3 2..	Yes	Y		1	1.2	47	1.5														
95	1.2D + 1.5Lv_3 2..	Yes	Y		1	1.2	47	1.5														
96	1.2D + 1.5Lv_3 3..	Yes	Y		1	1.2	47	1.5														
97	1.2D + 1.5Lv_3 3..	Yes	Y		1	1.2	47	1.5														
98	1.2D + 1.0EV +1....	Yes	Y		1	1.2	27	1	28		29	1	40	1								
99	1.2D + 1.0EV +1....	Yes	Y		1	1.2	27	.866	28	.5	30	1	40	1								
100	1.2D + 1.0EV +1....	Yes	Y		1	1.2	27	.5	28	.866	31	1	40	1								
101	1.2D + 1.0EV +1....	Yes	Y		1	1.2	27		28	1	32	1	40	1								
102	1.2D + 1.0EV +1....	Yes	Y		1	1.2	27	-.5	28	.866	33	1	40	1								
103	1.2D + 1.0EV +1....	Yes	Y		1	1.2	27	-.8...	28	.5	34	1	40	1								
104	1.2D + 1.0EV +1....	Yes	Y		1	1.2	27	-1	28		35	1	40	1								
105	1.2D + 1.0EV +1....	Yes	Y		1	1.2	27	-.8...	28	-.5	36	1	40	1								
106	1.2D + 1.0EV +1....	Yes	Y		1	1.2	27	-.5	28	-.8...	37	1	40	1								
107	1.2D + 1.0EV +1....	Yes	Y		1	1.2	27		28	-1	38	1	40	1								
108	1.2D + 1.0EV +1....	Yes	Y		1	1.2	27	.5	28	-.8...	39	1	40	1								
109	1.2D + 1.0EV +1....	Yes	Y		1	1.2	27	.866	28	-.5	40	1	40	1								

Envelope Joint Reactions

Joint		X [k]	LC	Y [k]	LC	Z [k]	LC	MX [k-ft]	LC	MY [k-ft]	LC	MZ [k-ft]	LC
1	N1	max	1.806	47	1.83	14	3.512	25	0	109	0	109	0
2		min	.04	5	.512	8	.158	7	0	1	0	1	0
3	N16	max	.554	11	1.958	20	.503	13	0	109	0	109	0
4		min	-1.843	41	.527	2	-3.597	19	0	1	0	1	0



Company : Mastec
 Designer : VB
 Job Number : 18753-MNT1
 Model Name : HRT 086 943248, App 482056

May 16, 2019
 1:44 PM
 Checked By: _____

Envelope Joint Reactions (Continued)

Joint	X [k]	LC	Y [k]	LC	Z [k]	LC	MX [k-ft]	LC	MY [k-ft]	LC	MZ [k-ft]	LC		
5	N65B	max	.092	11	.092	17	.817	4	0	109	0	109	0	109
6		min	-.107	5	.014	10	-.62	10	0	1	0	1	0	1
7	N66	max	.092	11	.087	17	.383	4	0	109	0	109	0	109
8		min	-.077	5	.014	10	-.581	10	0	1	0	1	0	1
9	Totals:	max	1.615	11	3.912	16	2.133	2						
10		min	-1.615	5	1.202	9	-2.133	8						

Envelope AISC 14th(360-10): LRFD Steel Code Checks

Member	Shape	Code ...	Loc[ft]	LC	Shear Check	Loc[ft]	Dir	LC	phi*Pnc [k]	phi*Pnt [k]	phi*Mn y...	phi*Mn ...	Cb	Eqn	
1	M1	PL4x5/8	.838	.417	24	.056	0	y	47	76.419	81	1.055	6.75	1.667	H1-1b
2	M3	PL4x5/8	.188	0	14	.490	0	y	25	79.041	81	1.055	6.75	1.619	H1-1b
3	M4	PL4x5/8	.323	.324	22	.660	0	y	14	79.041	81	1.055	6.75	1.807	H1-1b
4	M5	PIPE_...	.323	0	24	.086	.084		14	29.48	32.13	1.872	1.872	2.161	H1-1b
5	M6	PIPE_...	.197	0	24	.102	.084		14	29.48	32.13	1.872	1.872	2.119	H1-1b
6	M7	PL4x5/8	.269	.324	8	.248	0	y	18	79.041	81	1.055	6.75	1.471	H1-1b
7	M8	PL4x5/8	.229	.324	22	.343	0	y	22	79.041	81	1.055	6.75	1.408	H1-1b
8	M9	PIPE_...	.338	8.724	49	.158	3.906		8	38.92	50.715	3.596	3.596	2.486	H1-1b
9	M12	PL4x5/8	.838	.417	18	.057	0	y	41	76.419	81	1.055	6.75	1.667	H1-1b
10	M14	PL4x5/8	.207	0	20	.481	0	y	21	79.041	81	1.055	6.75	1.583	H1-1b
11	M15	PL4x5/8	.336	.324	17	.666	0	y	19	79.041	81	1.055	6.75	1.804	H1-1b
12	M16	PIPE_...	.329	0	18	.084	2.68		20	29.48	32.13	1.872	1.872	2.162	H1-1b
13	M17	PIPE_...	.197	0	25	.094	.084		20	29.48	32.13	1.872	1.872	2.095	H1-1b
14	M18	PL4x5/8	.362	.324	2	.260	0	y	21	79.041	81	1.055	6.75	1.749	H1-1b
15	M19	PL4x5/8	.254	.324	13	.373	0	y	18	79.041	81	1.055	6.75	1.322	H1-1b
16	M20	PIPE_...	.325	8.724	7	.180	3.906		2	38.92	50.715	3.596	3.596	2.775	H1-1b
17	M31	PIPE_...	.473	5.667	42	.062	2.333		38	24.093	32.13	1.872	1.872	4.815	H1-1b
18	M32	PIPE_...	.243	2.333	43	.036	2.333		42	24.093	32.13	1.872	1.872	4.663	H1-1b
19	M33	PIPE_...	.585	2.333	2	.055	5.667		8	24.093	32.13	1.872	1.872	2.955	H1-1b
20	M34	PIPE_...	.077	2.333	21	.023	2.333		20	24.093	32.13	1.872	1.872	4.135	H1-1b
21	M35	SR 3/4	.179	4.277	25	.015	4.277		25	9.437	14.314	.179	.179	2.098	H1-1b
22	M36	SR 3/4	.198	0	19	.016	0		19	9.437	14.314	.179	.179	2.153	H1-1b
23	M37	SR 3/4	.207	0	20	.011	0		19	9.437	14.314	.179	.179	2.201	H1-1b
24	M38	SR 3/4	.176	4.277	15	.011	4.277		13	9.437	14.314	.179	.179	2.129	H1-1b
25	M39	SR 5/8	.259	3.333	2	.006	0		19	2.503	9.94	.104	.104	2.211	H1-1a
26	M40	SR 5/8	.207	3.333	25	.008	0		19	2.503	9.94	.104	.104	2.334	H1-1b
27	M41	SR 5/8	.153	3.333	25	.004	0		21	2.503	9.94	.104	.104	2.599	H1-1b
28	M42	SR 5/8	.114	3.333	2	.005	0		21	2.503	9.94	.104	.104	2.006	H1-1b*
29	M137	PIPE_...	.147	5.06	17	.009	10.119		23	9.606	32.13	1.872	1.872	1.136	H1-1b
30	M144	PIPE_...	.129	5.06	23	.009	10.119		23	9.606	32.13	1.872	1.872	1.136	H1-1b

APPENDIX D
ADDITIONAL CALCUATIONS

ASCE 7 Hazards Report

Address:
No Address at This Location

Standard: ASCE/SEI 7-10
Risk Category: II
Soil Class: D - Stiff Soil

Elevation: 396.55 ft (NAVD 88)
Latitude: 41.9489
Longitude: -72.4921

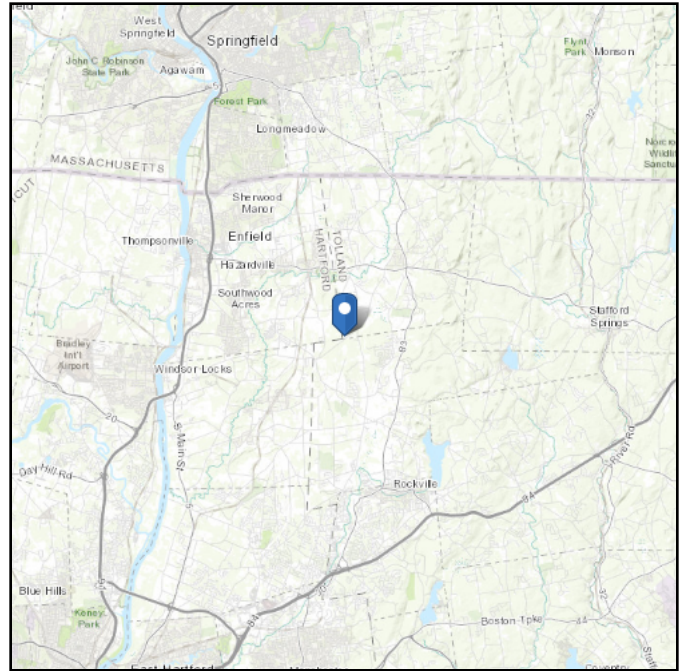
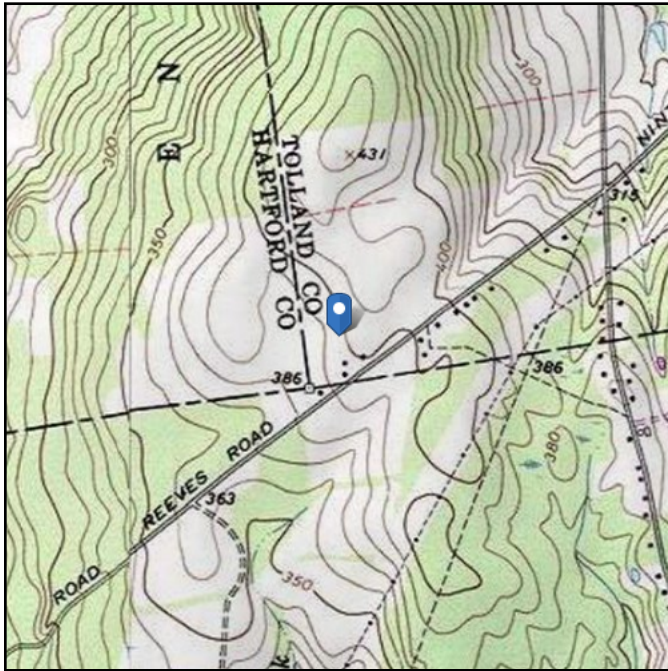

Wind

Results:

Wind Speed:	122 Vmph
10-year MRI	76 Vmph
25-year MRI	86 Vmph
50-year MRI	93 Vmph
100-year MRI	100 Vmph

Used 125 mph per 2018 Connecticut Building Code

Data Source: ASCE/SEI 7-10, Fig. 26.5-1A and Figs. CC-1–CC-4, incorporating errata of March 12, 2014

Date Accessed: Wed May 15 2019

Value provided is 3-second gust wind speeds at 33 ft above ground for Exposure C Category, based on linear interpolation between contours. Wind speeds are interpolated in accordance with the 7-10 Standard. Wind speeds correspond to approximately a 7% probability of exceedance in 50 years (annual exceedance probability = 0.00143, MRI = 700 years).

Site is in a hurricane-prone region as defined in ASCE/SEI 7-10 Section 26.2. Glazed openings need not be protected against wind-borne debris.

Mountainous terrain, gorges, ocean promontories, and special wind regions should be examined for unusual wind conditions.

Site Soil Class: D - Stiff Soil

Results:

S_S :	0.176	S_{DS} :	0.187
S_1 :	0.064	S_{D1} :	0.103
F_a :	1.6	T_L :	6
F_v :	2.4	PGA :	0.086
S_{MS} :	0.281	PGA _M :	0.138
S_{M1} :	0.154	F _{PGA} :	1.6
		I_e :	1

Seismic Design Category B

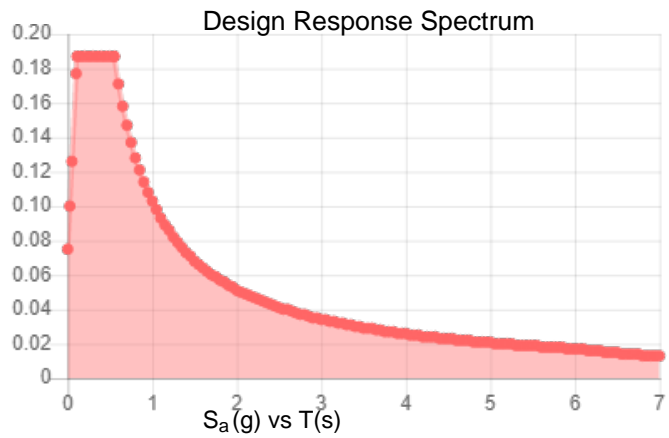
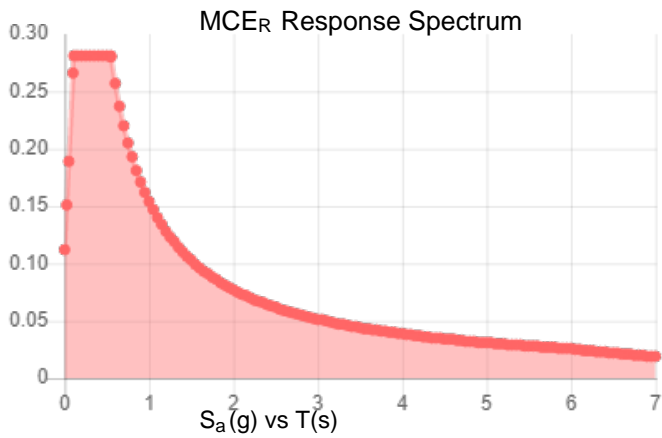

Data Accessed:

Wed May 15 2019

Date Source:

USGS Seismic Design Maps based on ASCE/SEI 7-10, incorporating Supplement 1 and errata of March 31, 2013, and ASCE/SEI 7-10 Table 1.5-2. Additional data for site-specific ground motion procedures in accordance with ASCE/SEI 7-10 Ch. 21 are available from USGS.

Ice

Results:

Ice Thickness: 1.00 in.

Concurrent Temperature: 5 F

Gust Speed: 50 mph

Data Source: Standard ASCE/SEI 7-10, Figs. 10-2 through 10-8

Date Accessed: Wed May 15 2019

Ice thicknesses on structures in exposed locations at elevations higher than the surrounding terrain and in valleys and gorges may exceed the mapped values.

Values provided are equivalent radial ice thicknesses due to freezing rain with concurrent 3-second gust speeds, for a 50-year mean recurrence interval, and temperatures concurrent with ice thicknesses due to freezing rain. Thicknesses for ice accretions caused by other sources shall be obtained from local meteorological studies. Ice thicknesses in exposed locations at elevations higher than the surrounding terrain and in valleys and gorges may exceed the mapped values.

The ASCE 7 Hazard Tool is provided for your convenience, for informational purposes only, and is provided “as is” and without warranties of any kind. The location data included herein has been obtained from information developed, produced, and maintained by third party providers; or has been extrapolated from maps incorporated in the ASCE 7 standard. While ASCE has made every effort to use data obtained from reliable sources or methodologies, ASCE does not make any representations or warranties as to the accuracy, completeness, reliability, currency, or quality of any data provided herein. Any third-party links provided by this Tool should not be construed as an endorsement, affiliation, relationship, or sponsorship of such third-party content by or from ASCE.

ASCE does not intend, nor should anyone interpret, the results provided by this Tool to replace the sound judgment of a competent professional, having knowledge and experience in the appropriate field(s) of practice, nor to substitute for the standard of care required of such professionals in interpreting and applying the contents of this Tool or the ASCE 7 standard.

In using this Tool, you expressly assume all risks associated with your use. Under no circumstances shall ASCE or its officers, directors, employees, members, affiliates, or agents be liable to you or any other person for any direct, indirect, special, incidental, or consequential damages arising from or related to your use of, or reliance on, the Tool or any information obtained therein. To the fullest extent permitted by law, you agree to release and hold harmless ASCE from any and all liability of any nature arising out of or resulting from any use of data provided by the ASCE 7 Hazard Tool.

Exhibit F

Power Density/RF Emissions Report

Transcom Engineering, Inc.

Wireless Network Design and Deployment

Radio Frequency Emissions Analysis Report

T-MOBILE Existing Facility

Site ID: CTHA534A

Crown Somers Lattice Tower
196 Pioneer Hts
Somers, CT 06071

May 24, 2019

Transcom Engineering Project Number: 737001-0041

Site Compliance Summary	
Compliance Status:	COMPLIANT
Site total MPE% of FCC general population allowable limit:	11.77 %

Transcom Engineering, Inc.

Wireless Network Design and Deployment

May 24, 2019

T-MOBILE

Attn: Jason Overbey, RF Manager
35 Griffin Road South
Bloomfield, CT 6009

Emissions Analysis for Site: **CTHA534A – Crown Somers Lattice Tower**

Transcom Engineering, Inc (“Transcom”) was directed to analyze the proposed upgrades to the T-MOBILE facility located at **196 Pioneer Hts, Somers, CT**, for the purpose of determining whether the emissions from the Proposed T-MOBILE Antenna Installation located on this property are within specified federal limits.

All information used in this report was analyzed as a percentage of current Maximum Permissible Exposure (% MPE) as listed in the FCC OET Bulletin 65 Edition 97-01 and ANSI/IEEE Std C95.1. The FCC regulates Maximum Permissible Exposure in units of microwatts per square centimeter ($\mu\text{W}/\text{cm}^2$). The number of $\mu\text{W}/\text{cm}^2$ calculated at each sample point is called the power density. The exposure limit for power density varies depending upon the frequencies being utilized. Wireless Carriers and Paging Services use different frequency bands each with different exposure limits, therefore it is necessary to report results and limits in terms of percent MPE rather than power density.

All results were compared to the FCC (Federal Communications Commission) radio frequency exposure rules, 47 CFR 1.1307(b)(1) – (b)(3), to determine compliance with the Maximum Permissible Exposure (MPE) limits for General Population/Uncontrolled environments as defined below.

General population/uncontrolled exposure limits apply to situations in which the general population may be exposed or in which persons who are exposed as a consequence of their employment may not be made fully aware of the potential for exposure or cannot exercise control over their exposure. Therefore, members of the general population would always be considered under this category when exposure is not employment related, for example, in the case of a telecommunications tower that exposes persons in a nearby residential area.

Population exposure to radio frequencies is regulated and enforced in units of microwatts per square centimeter ($\mu\text{W}/\text{cm}^2$). The general population exposure limits for the 600 & 700 MHz bands are approximately $400 \mu\text{W}/\text{cm}^2$ and $467 \mu\text{W}/\text{cm}^2$ respectively. The general population exposure limit for the 1900 MHz (PCS) and 2100 MHz (AWS) bands is $1000 \mu\text{W}/\text{cm}^2$. Because each carrier will be using different frequency bands, and each frequency band has different exposure limits, it is necessary to report percent of MPE rather than power density.

Transcom Engineering, Inc.

Wireless Network Design and Deployment

Occupational/controlled exposure limits apply to situations in which persons are exposed as a consequence of their employment and in which those persons who are exposed have been made fully aware of the potential for exposure and can exercise control over their exposure. Occupational/controlled exposure limits also apply where exposure is of a transient nature as a result of incidental passage through a location where exposure levels may be above general population/uncontrolled limits (see below), as long as the exposed person has been made fully aware of the potential for exposure and can exercise control over his or her exposure by leaving the area or by some other appropriate means.

Additional details can be found in FCC OET 65.

Transcom Engineering, Inc.

Wireless Network Design and Deployment

CALCULATIONS

Calculations were performed for the proposed upgrades to the T-MOBILE antenna facility located at **196 Pioneer Hts, Somers, CT**, using the equipment information listed below. All calculations were performed per the specifications under FCC OET 65. Since T-MOBILE is proposing highly focused directional panel antennas, which project most of the emitted energy out toward the horizon, all calculations were performed assuming a lobe representing the maximum gain of the antenna per the antenna manufactures supplied specifications, minus 10 dB for directional panel antennas, was focused at the base of the tower. For this report the sample point is the top of a 6-foot person standing at the base of the tower.

Per FCC OET Bulletin No. 65 - Edition 97-01 recommendations to achieve the maximum anticipated value at each sample point, all power levels emitting from the proposed antenna installation are increased by a factor of 2.56 to account for possible in-phase reflections from the surrounding environment. All power values expressed and analyzed are maximum power levels expected to be used on all radios.

All emissions values for additional carriers were taken from the Connecticut Siting Council (CSC) active MPE database. Values in this database are provided by the individual carriers themselves

For each sector the following channel counts, frequency bands and power levels were utilized as shown in *Table 1*:

Technology	Frequency Band	Channel Count	Transmit Power per Channel (W)
LTE	1900 MHz (PCS)	4	40
LTE	2100 MHz (AWS)	2	60
UMTS	2100 MHz (AWS)	1	40
LTE / 5G NR	600 MHz	2	40
LTE	700 MHz	2	20

Table 1: Channel Data Table

Transcom Engineering, Inc.

Wireless Network Design and Deployment

The following antennas listed in *Table 2* were used in the modeling for transmission in the 600, 700 MHz, 1900 MHz (PCS) and 2100 MHz (AWS) frequency bands. This is based on feedback from the carrier with regards to anticipated antenna selection. Maximum gain values for all antennas are listed in the Inventory and Power Data table below. The maximum gain of the antenna per the antenna manufactures supplied specifications, minus 10 dB for directional panel antennas, was used for all calculations. This value is a very conservative estimate as gain reductions for these particular antennas are typically much higher in this direction.

Sector	Antenna Number	Antenna Make / Model	Antenna Centerline (ft)
A	1	Ericsson AIR32 B66A / B2A	115
A	2	Ericsson AIR21 B4A/B2P	115
A	3	RFS APXVAARR24_43-U-NA20	115
B	1	Ericsson AIR32 B66A / B2A	115
B	2	Ericsson AIR21 B4A/B2P	115
B	3	RFS APXVAARR24_43-U-NA20	115
C	1	Ericsson AIR32 B66A / B2A	115
C	2	Ericsson AIR21 B4A/B2P	115
C	3	RFS APXVAARR24_43-U-NA20	115

Table 2: Antenna Data

All calculations were done with respect to uncontrolled / general population threshold limits.

Transcom Engineering, Inc.

Wireless Network Design and Deployment

RESULTS

Per the calculations completed for the proposed T-MOBILE configurations *Table 3* shows resulting emissions power levels and percentages of the FCC's allowable general population limit.

Antenna ID	Antenna Make / Model	Frequency Bands	Antenna Gain (dBd)	Channel Count	Total TX Power (W)	ERP (W)	MPE %
Antenna A1	Ericsson AIR32 B66A / B2A	1900 MHz (PCS) / 2100 MHz (AWS)	15.85	6	280	10,768.57	3.26
Antenna A2	Ericsson AIR21 B4A/B2P	2100 MHz (AWS)	15.9	1	40	1,556.18	0.47
Antenna A3	RFS APXVAARR24_43-U-NA20	600 MHz / 700 MHz	12.95 / 13.35	4	120	2,443.03	1.75
Sector A Composite MPE%							5.48
Antenna B1	Ericsson AIR32 B66A / B2A	1900 MHz (PCS) / 2100 MHz (AWS)	15.85	6	280	10,768.57	3.26
Antenna B2	Ericsson AIR21 B4A/B2P	2100 MHz (AWS)	15.9	1	40	1,556.18	0.47
Antenna B3	RFS APXVAARR24_43-U-NA20	600 MHz / 700 MHz	12.95 / 13.35	4	120	2,443.03	1.75
Sector B Composite MPE%							5.48
Antenna C1	Ericsson AIR32 B66A / B2A	1900 MHz (PCS) / 2100 MHz (AWS)	15.85	6	280	10,768.57	3.26
Antenna C2	Ericsson AIR21 B4A/B2P	2100 MHz (AWS)	15.9	1	40	1,556.18	0.47
Antenna C3	RFS APXVAARR24_43-U-NA20	600 MHz / 700 MHz	12.95 / 13.35	4	120	2,443.03	1.75
Sector C Composite MPE%							5.48

Table 3: T-MOBILE Emissions Levels

Transcom Engineering, Inc.

Wireless Network Design and Deployment

The Following table (*table 4*) shows all additional carriers on site and their MPE% as recorded in the CSC active MPE database for this facility along with the newly calculated maximum T-MOBILE MPE contributions per this report. FCC OET 65 specifies that for carriers utilizing directional antennas that the highest recorded sector value be used for composite site MPE values due to their greatly reduced emissions contributions in the directions of the adjacent sectors. For this site, all three sectors have the same configuration yielding the same results on all three sectors. *Table 5* below shows a summary for each T-MOBILE Sector as well as the composite MPE value for the site.

Site Composite MPE%	
Carrier	MPE%
T-MOBILE – Max Per Sector Value	5.48 %
AT&T	3.06 %
MetroPCS	0.03 %
Nextel	0.26 %
Verizon Wireless	2.23 %
Sprint	0.71 %
Site Total MPE %:	11.77 %

Table 4: All Carrier MPE Contributions

T-MOBILE Sector A Total:	5.48 %
T-MOBILE Sector B Total:	5.48 %
T-MOBILE Sector C Total:	5.48 %
Site Total:	11.77 %

Table 5: Site MPE Summary

Transcom Engineering, Inc.

Wireless Network Design and Deployment

FCC OET 65 specifies that for carriers utilizing directional antennas that the highest recorded sector value be used for composite site MPE values due to their greatly reduced emissions contributions in the directions of the adjacent sectors. *Table 6* below details a breakdown by frequency band and technology for the MPE power values for the maximum calculated T-MOBILE sector(s). For this site, all three sectors have the same configuration yielding the same results on all three sectors.

T-MOBILE _ Frequency Band / Technology Max Power Values (Per Sector)	# Channels	Watts ERP (Per Channel)	Height (feet)	Total Power Density ($\mu\text{W}/\text{cm}^2$)	Frequency (MHz)	Allowable MPE ($\mu\text{W}/\text{cm}^2$)	Calculated % MPE
T-Mobile 1900 MHz (PCS) LTE	4	1,538.37	115	18.62	1900 MHz (PCS)	1000	1.86%
T-Mobile 2100 MHz (AWS) LTE	2	2,307.55	115	13.96	2100 MHz (AWS)	1000	1.40%
T-Mobile 2100 MHz (AWS) UMTS	1	1,556.18	115	4.71	2100 MHz (AWS)	1000	0.47%
T-Mobile 600 MHz LTE / 5G NR	2	788.97	115	4.77	600 MHz	400	1.19%
T-Mobile 700 MHz LTE	2	432.54	115	2.62	700 MHz	467	0.56%
						Total:	5.48%

Table 6: T-MOBILE Maximum Sector MPE Power Values

Transcom Engineering, Inc.

Wireless Network Design and Deployment

Summary

All calculations performed for this analysis yielded results that were **within** the allowable limits for general population exposure to RF Emissions.

The anticipated maximum composite contributions from the T-MOBILE facility as well as the site composite emissions value with regards to compliance with FCC's allowable limits for general population exposure to RF Emissions are shown here:

T-MOBILE Sector	Power Density Value (%)
Sector A:	5.48 %
Sector B:	5.48 %
Sector C:	5.48 %
T-MOBILE Maximum Total (per sector):	5.48 %
Site Total:	11.77 %
Site Compliance Status:	COMPLIANT

The anticipated composite MPE value for this site assuming all carriers present is **11.77 %** of the allowable FCC established general population limit sampled at the ground level. This is based upon values listed in the Connecticut Siting Council database for existing carrier emissions.

FCC guidelines state that if a site is found to be out of compliance (over allowable thresholds), that carriers over a 5% contribution to the composite value will require measures to bring the site into compliance. For this facility, the composite values calculated were well within the allowable 100% threshold standard per the federal government.



Scott Heffernan
RF Engineering Director
Transcom Engineering, Inc
PO Box 1048
Sterling, MA 01564