



Northeast Site Solutions
Denise Sabo
199 Brickyard Rd Farmington, CT 06032
860-209-4690
denise@northeastsitesolutions.com

November 22, 2016

Members of the Siting Council
Connecticut Siting Council
Ten Franklin Square
New Britain, CT 06051

RE: Notice of Exempt Modification
52 LIBRARY STREET, SALISBURY, CT 06068
Latitude: 41.980846
Longitude: -73.418423
T-Mobile Site#: CTNH547A-NSD-ROB

Dear Ms. Bachman:

This letter and attachments are submitted on behalf of T-Mobile Northeast LLC ("T-Mobile"). T-Mobile plans to install antennas and related equipment at the tower site located at 52 Library Street in Salisbury, Connecticut.

T-Mobile will install three (3) 700MHz antenna, three (3) 1900/2100 MHz antennas and nine (9) RRUs at the 123-foot level of the existing 149.7-foot monopole. Two (2) hybrid cables will also be installed. T-Mobile's equipment cabinets will be placed on a new 6x8 equipment pad within 10x12 lease area. Included are plans by SMW Engineering, dated November 3, 2016. **Exhibit C**. Also included is a structural analysis prepared by American Tower Corporation, dated October 5, 2016, confirming that the existing tower is structurally capable of supporting the proposed equipment. Attached as **Exhibit D**.

Please accept this letter as notification pursuant to Regulations of Connecticut State Agencies 16-50aa, of T-Mobile's intent to share a telecommunications facility pursuant to R.C.S.A. 16-50j-88. In accordance with R.C.S.A., a copy of this letter is being sent to Curtis Rand, First Selectman of the Town of Salisbury, as well as the tower owner (ATC) and property owner (Town of Salisbury).

The planned modifications of the facility fall squarely within those activities explicitly provided for in R.C.S.A. 16-50j-89.

1. The proposed modification will not result in an increase in the height of the existing structure. The top of the monopole is 149.7-feet; T-Mobile's proposed antennas will be located at a center line height of 123-feet.
2. The proposed modifications will not result in the increase of the site boundary as depicted on the attached site plan.
3. The proposed modifications will not increase noise levels at the facility by six decibels or more, or to levels that exceed local and state criteria. The incremental effect of the proposed changes will be negligible.
4. The operation of the proposed antennas will not increase radio frequency emissions at the facility to a level at or above the Federal Communications Commission safety standard. As indicated in the attached power density calculations, the combined site operations will result in a total power density of 6.97% as evidenced by **Exhibit E**.



NSS **NORTHEAST**
SITE SOLUTIONS

Turnkey Wireless Development

Connecticut General Statutes 16-50aa indicates that the Council must approve the shared use of a telecommunications facility provided it finds the shared use is technically, legally, environmentally, and economically feasible and meets public safety concerns. As demonstrated in this letter, T-Mobile respectfully indicates that the shared use of this facility satisfies these criteria.

A. Technical Feasibility. The existing monopole has been deemed structurally capable of supporting T-Mobile's proposed loading. The structural analysis is included as Exhibit D.

B. Legal Feasibility. As referenced above, C.G.S. 16-50aa has been authorized to issue orders approving the shared use of an existing tower such as this monopole in Salisbury. Under the authority granted to the Council, an order of the Council approving the requested shared use would permit T-Mobile to obtain a building permit for the proposed installation. Further, a Letter of Authorization is included as Exhibit F, authorizing T-Mobile to file this application for shared use.

C. Environmental Feasibility. The proposed shared use of this facility would have a minimal environmental impact. The installation of T-Mobile equipment at the 123-foot level of the existing 149.7-foot tower would have an insignificant visual impact on the area around the tower. T-Mobile's ground equipment would be installed within the existing facility compound. T-Mobile's shared use would therefore not cause any significant alteration in the physical or environmental characteristics of the existing site. Additionally, as evidenced by Exhibit E, the proposed antennas would not increase radio frequency emissions to a level at or above the Federal Communications Commission safety standard.

D. Economic Feasibility. T-Mobile will be entering into an agreement with the owner of this facility to mutually agreeable terms. As previously mentioned, the Letter of Authorization has been provided by the owner to assist T-Mobile with this tower sharing application.

E. Public Safety Concerns. As discussed above, the guyed tower is structurally capable of supporting T-Mobile's proposed loading. T-Mobile is not aware of any public safety concerns relative to the proposed sharing of the existing guyed tower. T-Mobile's intentions of providing new and improved wireless service through the shared use of this facility is expected to enhance the safety and welfare of local residents and individuals traveling through Salisbury.

Sincerely,

Denise Sabo
Mobile: 860-209-4690
Fax: 413-521-0558
Office: 199 Brickyard Rd, Farmington, CT 06032
Email: denise@northeastsitesolutions.com

Attachments

cc: Curtis Rand-First Selectman, as elected official
American Tower Company - as tower owner
Town of Salisbury - as property owner

Exhibit A

DOCKET NO. 306 – Wireless <i>EDGE</i> Fairfield Group LLC } application for a Certificate of Environmental Compatibility and } Public Need for the construction, maintenance, and operation of a } cellular telecommunications facility located at 52 Library Street, } Salisbury, Connecticut. }	Connecticut Siting Council
--	--

November 17, 2005

Decision and Order

Pursuant to the foregoing Findings of Fact and Opinion, the Connecticut Siting Council (Council) finds that the effects associated with the construction, operation, and maintenance of a telecommunications facility including effects on the natural environment; ecological integrity and balance; public health and safety; scenic, historic, and recreational values; forests and parks; air and water purity; and fish and wildlife are not disproportionate either alone or cumulatively with other effects when compared to need, are not in conflict with the policies of the State concerning such effects, and are not sufficient reason to deny the application and therefore directs that a Certificate of Environmental Compatibility and Pubic Need, as provided by General Statutes § 16-50k, be issued to Wireless *EDGE* Fairfield Group LLC for the construction, maintenance and operation of a wireless telecommunications facility to be located at 52 Library Street in Salisbury, Connecticut.

The facility shall be constructed, operated, and maintained substantially as specified in the Council’s record in this matter, and subject to the following conditions:

1. The tower shall be designed as a monopole and shall be constructed no taller than 150 feet above ground level to provide telecommunications services to both public and private entities. Cingular’s antennas to be mounted on the monopole shall be installed using a T-arm configuration.

2. The tower shall be designed and constructed in such a manner as to be able to accommodate a future extension. Any such extension must be approved by the Council as a petition for declaratory ruling, or other administrative procedure as deemed appropriate by the Council.

3. The Certificate Holder shall prepare a Development and Management (D&M) Plan for this site in compliance with Sections 16-50j-75 through 16-50j-77 of the Regulations of Connecticut State Agencies. The D&M Plan shall be served on the Town of Salisbury and all parties and intervenors, as listed in the service list, and submitted to and approved by the Council prior to the commencement of facility construction and shall include:
 - a) a final site plan(s) of site development to include specifications for the tower, tower foundation, antennas mountings, equipment building, access road, utility line, and landscaping; and

- b) construction plans for site clearing, water drainage, and erosion and sedimentation control consistent with the 2002 Connecticut Guidelines for Soil Erosion and Sediment Control, as amended.
4. The Certificate Holder shall, prior to the commencement of operation, provide the Council worst-case modeling of electromagnetic radio frequency power density of all proposed entities' antennas at the closest point of uncontrolled access to the tower base, consistent with Federal Communications Commission, Office of Engineering and Technology, Bulletin No. 65, August 1997. The Certificate Holder shall ensure a recalculated report of electromagnetic radio frequency power density is submitted to the Council in the event other carriers locate at this facility or if circumstances in operation cause a change in power density above the levels calculated and provided pursuant to this Decision and Order.
5. Upon the establishment of any new State or federal radio frequency standards applicable to frequencies of this facility, the facility granted herein shall be brought into compliance with such standards.
6. The Certificate Holder shall permit public or private entities to share space on the proposed tower for fair consideration, or shall provide any requesting entity with specific legal, technical, environmental, or economic reasons precluding such tower sharing.
7. The Certificate Holder shall provide reasonable space on the tower for no compensation for any municipal antennas, provided such antennas are compatible with the structural integrity of the tower.
8. If the facility authorized herein is not fully constructed and providing wireless services within eighteen months from the date of the mailing of the Council's Findings of Fact, Opinion, and Decision and Order (collectively called "Final Decision"), this Decision and Order shall be void, and the Certificate Holder shall dismantle the tower and remove all associated equipment or reapply for any continued or new use to the Council before any such use is made. The time between the filing and resolution of any appeals of the Council's Final Decision shall not be counted in calculating this deadline.
9. If the facility ceases to provide wireless services for a period of one year, this Decision and Order shall be void, and the Certificate Holder shall dismantle the tower and remove all associated equipment or reapply for any continued or new use to the Council before any such use is made.
10. Any antenna that becomes obsolete and ceases to function shall be removed within 60 days after such antennas become obsolete and cease to function.
11. Any request for extension of the time periods referred to in Conditions 8 and 9 shall be filed with the Council not later than sixty days prior to the expiration date of this Certificate and shall be served on all parties and intervenors and the Town of Salisbury, as listed in the service list. Any proposed modifications to this Decision and Order shall likewise be so served.

12. In accordance with Section 16-50j-77 of the Regulations of Connecticut State Agencies, the Certificate Holder shall provide the Council with written notice two weeks prior to the commencement of construction activities. In addition, the Certificate Holder shall provide the Council with written notice of the completion of site construction and the commencement of site operation.

Pursuant to General Statutes § 16-50p, we hereby direct that a copy of the Findings of Fact, Opinion, and Decision and Order be served on each person listed below, and notice of issuance shall be published in the Litchfield County Times and in the Lakeville Journal.

By this Decision and Order, the Council disposes of the legal rights, duties, and privileges of each party named or admitted to the proceeding in accordance with Section 16-50j-17 of the Regulations of Connecticut State Agencies.

The parties and intervenors to this proceeding are:

Status Granted	Status Holder (name, address & phone number)	Representative (name, address & phone number)
Applicant	Wireless Edge Fairfield Group, LLC 270 North Avenue New Rochelle, NY 10801	Julie Donaldson Kohler, Esq. Cohen & Wolf, P.C. 1115 Broad Street Bridgeport, CT 06604 (203) 368-0211 (203) 394-9901 - fax jkohler@cohenandwolf.com
Intervenor (approved 7/20/05)	New Cingular Wireless PCS, LLC	Christopher B. Fisher, Esq. Cuddy & Feder LLP 90 Maple Avenue White Plains, NY 10601 (914) 761-1300 (914) 761-6405 Fax
Intervenor (approved 8/24/05)	Berkshire-Litchfield Environmental Council (BLEC) P.O. Box 552 Lakeville, CT 06039	Send correspondence to: B. Blake Levitt, Trustee 355 Lake Road New Preston, CT 06777 (860) 868-7437 (860) 868-6010 blakelevit.com

Exhibit B



PROPERTY MAP
 TOWN OF SALISBURY
 LITCHFIELD COUNTY, CONNECTICUT
 JAMES W. BEWALL COMPANY
 OLD TOWN, MAINE
 SCALE 1 INCH = 100 FEET

REVISED MARCH 2016
 NOT TO BE USED FOR CONVEYANCES
 FOR ASSESSMENT PURPOSES ONLY
 NOT A TRUE SURVEY

LEGEND
 PARCEL NUMBERS
 ADJACENT MAPS
 MATCH LINE

For Assessment Purposes
 Not to be used for Conveyances

CURRENT OWNER					TOPO.	UTILITIES	STRT./ROAD	LOCATION	CURRENT ASSESSMENT				
SALISBURY TOWN OF									Description	Code	Appraised Value	Assessed Value	6122 SALISBURY, CT
27 MAIN ST									COMM	2-1	205,900	144,100	
SALISBURY, CT 06068									2-5	360,300	252,100		
Additional Owners:					SUPPLEMENTAL DATA				VACANT	5-2	186,800	130,800	VISION
Other ID: CENSUS TR ACCTNUM 98103071 SURVEY 854 Hist. Distr.					ASSOC PID#				Total		753,000	527,000	

RECORD OF OWNERSHIP								PREVIOUS ASSESSMENTS (HISTORY)															
SALISBURY TOWN OF								BK-VOL/PAGE	84/ 121	SALE DATE	10/31/1961	q/u	U	v/i	V	SALE PRICE	0	V.C.	1N				
Yr.		Code		Assessed Value		Yr.		Code		Assessed Value		Yr.		Code		Assessed Value							
2015		2-1		144,100		2014		2-1		186,300		2010		2-1		186,300							
2015		2-5		252,100		2014		2-5		275,900		2010		2-5		275,900							
2015		5-2		130,800		2014		5-2		65,400		2010		5-2		65,400							
Total:				527,000				Total:				527,600				Total:				527,600			

EXEMPTIONS				OTHER ASSESSMENTS				
Year	Type	Description	Amount	Code	Description	Number	Amount	Comm. Int.
Total:								

This signature acknowledges a visit by a Data Collector or Assessor

ASSESSING NEIGHBORHOOD			
NBHD/ SUB	NBHD NAME	STREET INDEX NAME	BATCH
10/A			

APPRAISED VALUE SUMMARY

Appraised Bldg. Value (Card)	0
Appraised XF (B) Value (Bldg)	0
Appraised OB (L) Value (Bldg)	360,300
Appraised Land Value (Bldg)	392,700
Special Land Value	0
Total Appraised Parcel Value	753,000
Valuation Method:	C
Adjustment:	0
Net Total Appraised Parcel Value	753,000

NOTES

TOWN GARAGE
2006 REVIEW BUILDINGS

BUILDING PERMIT RECORD								VISIT/ CHANGE HISTORY							
Permit ID	Issue Date	Type	Description	Amount	Insp. Date	% Comp.	Date Comp.	Comments	Date	Type	IS	ID	Cd.	Purpose/Result	
	07/06/2006		REROOF	11,000		0			07/10/2006			BB	03	MEAS/PART INT	

LAND LINE VALUATION SECTION																				
B #	Use Code	Use Description	Zone	Frontage	Depth	Units	Unit Price	I. Factor	S A	Acre Disc	C. Factor	ST. Idx	S.I. Adj.	Notes- Adj	Rec Y/N	CU Cond	Special Pricing	Adj. Unit Price	Land Value	
1	5-2	VACANT COM	C20			0.46 AC	139,040.00	1.7887	6	1.0000	1.00	7	1.80	in use	N	1.000			205,900	
1	5-2	VACANT COM				4.67 AC	20,000.00	1.0000	0	1.0000	2.00		0.00		N	1.000			186,800	
Total Card Land Units:						5.13 AC	Parcel Total Land Area:						5.13 AC	Total Land Value:						392,700

CONSTRUCTION DETAIL				CONSTRUCTION DETAIL (CONTINUED)			
Element	Cd.	Ch.	Description	Element	Cd.	Ch.	Description
Model	00		Vacant				
MIXED USE							
Code	Description			Percentage			
5-2	VACANT COM			100			
COST/MARKET VALUATION							
Adj. Base Rate:				0.00			
Replace Cost				0			
AYB							
Dep Code							
Remodel Rating							
Year Remodeled							
Dep %							
Functional ObsInc							
External ObsInc							
Cost Trend Factor							
Condition							
% Complete							
Overall % Cond							
Apprais Val							
Dep % Ovr				0			
Dep Ovr Comment							
Misc Imp Ovr				0			
Misc Imp Ovr Comment							
Cost to Cure Ovr				0			
Cost to Cure Ovr Comment							

OB-OUTBUILDING & YARD ITEMS(L) / XF-BUILDING EXTRA FEATURES(B)												
Code	Description	Sub	Sub Descript	L/B	Units	Unit Price	Yr	Gde	Dp Rt	Cnd	%Cnd	Apr Value
FGRI	Garage			L	7,260	25.00	1982		1		50	30,900
SHP2	Work Shop Gd			L	400	20.00	1982		1		100	5,400
FGRI	Garage			L	8,400	25.00	2001		1		70	117,600
SHD2	Shed aver			L	2,960	16.00	1975		1		75	16,600
SHD2	Shed aver			L	12,421	16.00	2000		1		100	168,900
FGRI	Garage			L	1,160	25.00	1987		1		100	20,900
SHD1	Shed fair			L	600	10.00	1940		1		75	0

BUILDING SUB-AREA SUMMARY SECTION						
Code	Description	Living Area	Gross Area	Eff. Area	Unit Cost	Undeprec. Value
Ttl. Gross Liv/Lease Area:		0	0			



Exhibit C

GENERAL NOTES

- ALL MATERIALS FURNISHED AND INSTALLED SHALL BE IN STRICT ACCORDANCE WITH ALL APPLICABLE CODES, REGULATIONS, AND ORDINANCES. SUBCONTRACTORS SHALL ISSUE ALL APPROPRIATE NOTICES AND COMPLY WITH ALL LAWS, ORDINANCES, RULES, REGULATIONS, AND LAWFUL ORDERS OF ANY PUBLIC AUTHORITY REGARDING THE PERFORMANCE OF THE WORK.
- ALL WORK CARRIED OUT SHALL COMPLY WITH ALL APPLICABLE MUNICIPAL AND UTILITY COMPANY SPECIFICATIONS AND LOCAL JURISDICTIONAL CODES, ORDINANCES AND APPLICABLE REGULATIONS.
- UNLESS NOTED OTHERWISE, THE WORK SHALL INCLUDE FURNISHING MATERIALS, EQUIPMENT, APPURTENANCES, AND LABOR NECESSARY TO COMPLETE ALL INSTALLATIONS AS INDICATED ON THE DRAWINGS.
- THE SUBCONTRACTOR SHALL INSTALL ALL EQUIPMENT AND MATERIALS IN ACCORDANCE WITH MANUFACTURER'S RECOMMENDATIONS UNLESS SPECIFICALLY STATED OTHERWISE.
- IF THE SPECIFIED EQUIPMENT CANNOT BE INSTALLED AS SHOWN ON THESE DRAWINGS, THE SUBCONTRACTOR SHALL PROPOSE AN ALTERNATIVE INSTALLATION SPACE FOR APPROVAL BY THE CONTRACTOR.
- THE SUBCONTRACTOR SHALL LEGALLY AND PROPERLY DISPOSE OF ALL SCRAP MATERIALS SUCH AS COAXIAL CABLES AND OTHER ITEMS REMOVED FROM THE EXISTING FACILITY. ANTENNAS REMOVED SHALL BE RETURNED TO THE OWNER'S DESIGNATED LOCATION.
- THE SUBCONTRACTOR SHALL LEAVE PREMISES IN CLEAN CONDITION.
- SUBCONTRACTOR SHALL VERIFY ALL EXISTING DIMENSIONS AND CONDITIONS PRIOR TO COMMENCING ANY WORK. ALL DIMENSIONS OF EXISTING CONSTRUCTION SHOWN ON THE DRAWING MUST BE VERIFIED. SUBCONTRACTOR SHALL NOTIFY THE CONTRACTOR OF ANY DISCREPANCIES PRIOR TO ORDERING MATERIAL OR PROCEEDING WITH CONSTRUCTION.
- ALL SAFETY PRECAUTIONS MUCH BE TAKEN WHEN WORKING AROUND HIGH LEVELS OF ELECTROMAGNETIC RADIATION. EQUIPMENT SHOULD BE SHUTDOWN PRIOR TO PERFORMING ANY WORK THAT COULD EXPOSE THE WORKERS TO DANGER. PERSONAL RF EXPOSURE MONITORS ARE ADVISED TO BE WORN TO ALERT OF ANY DANGEROUS EXPOSURE LEVELS.

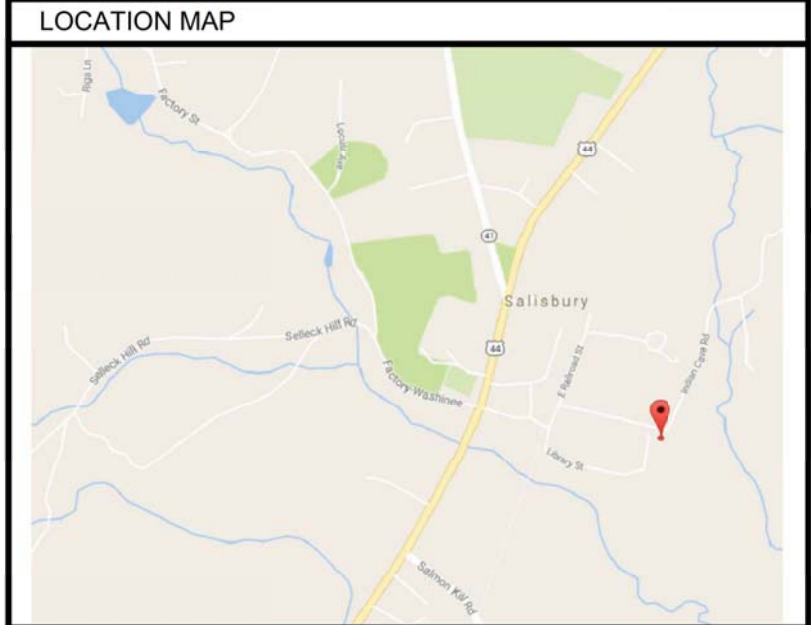

HANDICAP REQUIREMENTS

FACILITY IS UNMANNED AND NOT FOR HUMAN HABITATION. HANDICAP ACCESS IS NOT REQUIRED.

PLUMBING REQUIREMENTS

FACILITY HAS NO SANITARY OR POTABLE WATER

T-Mobile

2016 INFILL/ROB/GREENFIELD
T-MOBILE SITE NUMBER
CTNH547A
150' MONOPOLE
ATC SITE NUMBER
370630
SITE ADDRESS
52 LIBRARY ST.
SALISBURY, CT 06068
CONFIGURATION 707C

SITE SUMMARY

SITE TYPE: PROPOSED EQUIPMENT INSTALLATION
TECHNOLOGY TYPE: U1900/L2100/L700

SITE ADDRESS: 52 LIBRARY ST. SALISBURY, CT 06068

SITE LATITUDE: 41° 58' 51.044"
SITE LONGITUDE: -73° 25' 6.324"

JURISDICTION: TOWN OF SALISBURY

POWER COMPANY: EVERSOURCE
TELEPHONE COMPANY: AT&T

TOWER OWNER: AMERICAN TOWER
116 HUNTINGTON AVE, 11TH FLOOR
BOSTON, MA 02116
CONTACT: CUSTOMER SERVICE
PHONE: 877-518-6937

TOWER MANAGER: NORTHEAST SITE SOLUTIONS, LLC
199 BRICKYARD ROAD
FARMINGTON, CT 06032
SHELDON FREINCLE
(201) 776-8521

WIRELESS CARRIER: T-MOBILE
35 GRIFFIN RD S
BLOOMFIELD, CT 06002
OFFICE: 860-692-7100
FAX: 860-692-7159

ENGINEER: SMW ENGINEERING
158 BUSINESS CENTER DRIVE
BIRMINGHAM, AL 35244
PHONE: 205-252-6985
ALVIN A. KRAFT, PE

BUILDING CODES

ALL CONSTRUCTION SHALL COMPLY WITH THE LATEST EDITION OF THE (AS ADOPTED BY LOCAL JURISDICTION):

- 2016 CONNECTICUT BUILDING CODE
- 2012 INTERNATIONAL BUILDING CODE W/AMENDMENTS
- 2009 ICC/ANSI A117.1 W/AMENDMENTS
- 2012 INTERNATIONAL EXISTING BUILDING CODE W/AMENDMENTS
- 2012 INTERNATIONAL PLUMBING CODE WITH AMENDMENTS
- 2012 INTERNATIONAL MECHANICAL CODE W/AMENDMENTS
- 2012 INTERNATIONAL ENERGY CONSERVATION CODE W/AMENDMENTS
- 2014 NFPA 70, NATIONAL ELECTRICAL CODE W/AMENDMENTS
- 2012 INTERNATIONAL RESIDENTIAL CODE W/AMENDMENTS

APPROVALS

DEPARTMENT	NAME/SIGNATURE	DATE
DEVELOPMENT MANAGER		
PROPERTY/TOWER OWNER		
SITE ACQUISITION MANAGER		
CONSTRUCTION MANAGER		
RF ENGINEER		
OPERATIONS MANAGER		

PROJECT SCOPE

THE PROPOSED PROJECT SCOPE WILL CONSIST OF CONSTRUCTING A NEW TELECOMMUNICATIONS BASE STATION INSTALLATION ON AN EXISTING TOWER SITE. THE PROPOSED CONSTRUCTION WILL INCLUDE THE INSTALLATION OF ANTENNA, RADIOS, CABLES AND RELATED EQUIPMENT ON THE TOWER AS WELL AS THE RADIOS, CABINETS, UTILITIES AND ANCILLARY EQUIPMENT ON THE GROUND.

SHEET INDEX

#	TITLE
T-1	TITLE SHEET
C-1	OVERALL SITE PLAN
C-2	TOWER ELEVATION & ANTENNA PLAN
C-3	TOWER TOP EQUIPMENT SCHEDULE
C-4	GROUND EQUIPMENT DETAIL
C-5	ICE BRIDGE DETAILS
C-6	FOUNDATION DETAILS & NOTES
E-1	ONE-LINE DIAGRAM
E-2	ELECTRICAL UTILITY PLAN
E-3	GROUNDING PLAN
E-4	EQUIPMENT SCHEMATIC
E-5	ELECTRICAL & GROUNDING DETAILS
--	ATTACHMENTS

CALL BEFORE YOU DIG

CONNECTICUT CALL BEFORE YOU DIG
STATE WIDE
1-800-922-4455 OR 811
HTTP://WWW.CBYD.COM/#

**Know what's below.
Call before you dig.**

T-Mobile

35 GRIFFIN RD S
BLOOMFIELD, CT 06002
OFFICE: 860-692-7100
FAX: 860-692-7159

PLANS PREPARED BY:

NSS NORTHEAST
SITE SOLUTIONS
Turnkey Wireless Development

NORTHEAST SITE SOLUTIONS, LLC
199 BRICKYARD ROAD
FARMINGTON CT 06032
(860) 677-1999

SMW
ENGINEERING GROUP, INC.
TOGETHER PLANNING A BETTER TOMORROW

11/03/16

SITE INFORMATION:

CTNH547A
52 LIBRARY ST.
SALISBURY, CT 06068

#	DATE	DESCRIPTION
0	10/21/16	ISSUED FOR CLIENT REV.
1	11/03/16	ISSUED FOR CONSTRUCTION

T-MOBILE SITE ID: CTNH547A
ATC SITE ID: 370630

SHEET NAME:
TITLE SHEET

SMW #: 16-2561	SHEET NUMBER: T-1
DESIGNER: BMD	CHECKED BY: RTB
ENGINEER: JDS	

SUBJECT PROPERTY IS LOCATED IN PANEL # 0900520016B, DATED (JANUARY 5, 1989) AND IS IN THE BASE FLOOD ZONE "X" AND IS NOT IN A SPECIAL FLOOD HAZARD AREA.

UTILITY NOTE:
THERE ARE NOT ANY EXISTING STORM OR SANITARY SEWER LINES OR BURIED UTILITIES ON THE PARENT TRACK WITHIN THE VICINITY OF THE PROPOSED CONSTRUCTION.

NOTE TO CONTRACTORS:
DIGGING AND/OR TRENCHING INSIDE COMPOUND, MUST BE DONE BY HAND.

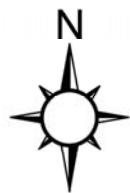
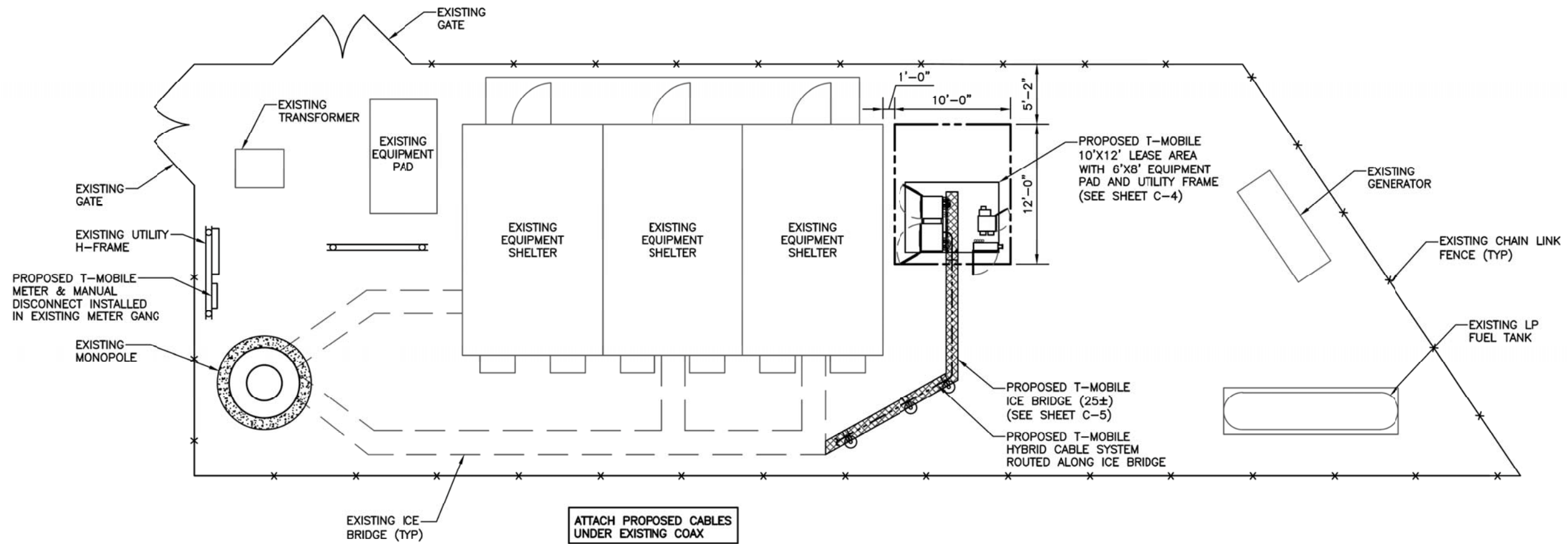

1 OVERALL SITE PLAN
C-1

T-Mobile

35 GRIFFIN RD S
BLOOMFIELD, CT 06002
OFFICE: 860-692-7100
FAX: 860-692-7159

PLANS PREPARED BY:

NSS NORTHEAST
SITE SOLUTIONS
Tuesday Winslow Development
NORTHEAST SITE SOLUTIONS, LLC
199 BRICKYARD ROAD
FARMINGTON CT 06032
(860) 677-1999

SMW
ENGINEERING GROUP, INC.
TOGETHER PLANNING A BETTER TOMORROW



11/03/16

SITE INFORMATION:
CTNH547A
52 LIBRARY ST.
SALISBURY, CT 06068

#	DATE	DESCRIPTION
0	10/21/16	ISSUED FOR CLIENT REV.
1	11/03/16	ISSUED FOR CONSTRUCTION

T-MOBILE SITE ID: **CTNH547A** ATC SITE ID: **370630**

SHEET NAME:
OVERALL SITE PLAN

SMW #: **16-2561** SHEET NUMBER:
C-1
DESIGNER: **BMD**
CHECKED BY: **RTB**
ENGINEER: **JDS**

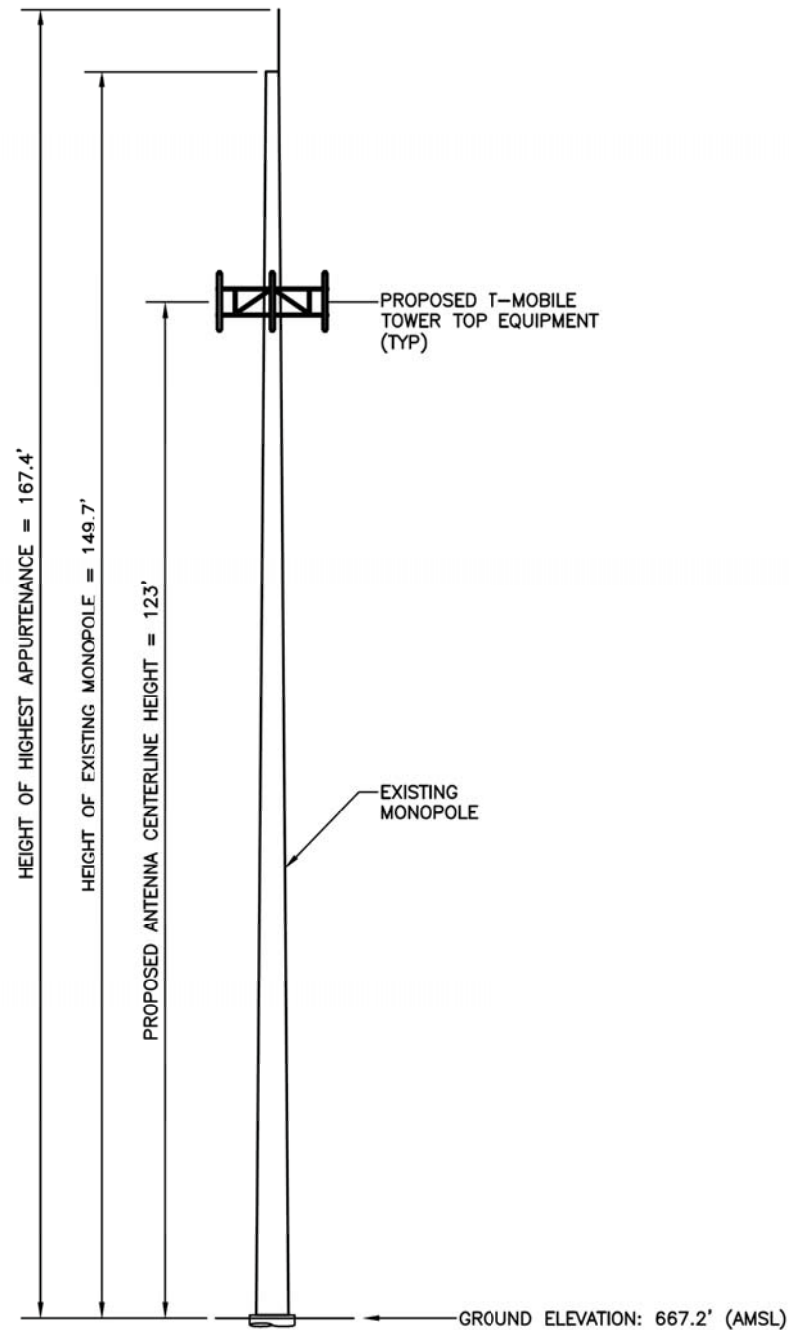

NOTES:

- SMW HAS NOT PERFORMED A STRUCTURAL ANALYSIS OF THE EXISTING TOWER OR PROPOSED ANTENNA MOUNT. REFER TO STRUCTURAL ANALYSIS OR STRUCTURAL LETTER BY OTHERS FOR ADDITIONAL INFORMATION.
- IF THE TOWER STRUCTURAL ANALYSIS SHOWS THE NEED FOR TOWER REINFORCEMENT REFER TO TOWER REINFORCEMENT DESIGN PRIOR TO THE INSTALLATION OF ANY PROPOSED EQUIPMENT.
- REFER TO TOWER STRUCTURAL ANALYSIS FOR PROPOSED CABLE ROUTING AND ATTACHMENT DETAILS.
- TOWER ELEVATION SHOWN IS NOT DRAWN TO SCALE AND IS INTENDED ONLY FOR REFERENCE PURPOSES. REFER TO ORIGINAL TOWER DESIGN FOR ADDITIONAL INFORMATION.

1 TOWER ELEVATION
C-2 NOT TO SCALE

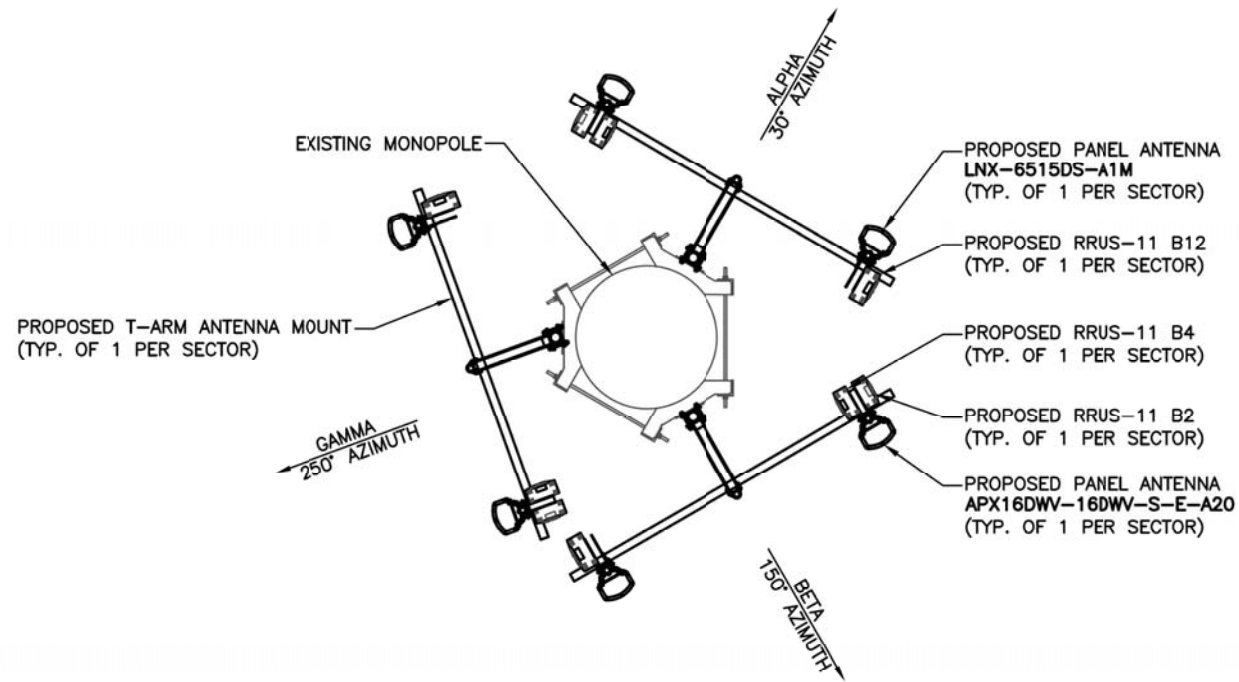

2 PROPOSED ANTENNA ORIENTATION PLAN
C-2 NOT TO SCALE

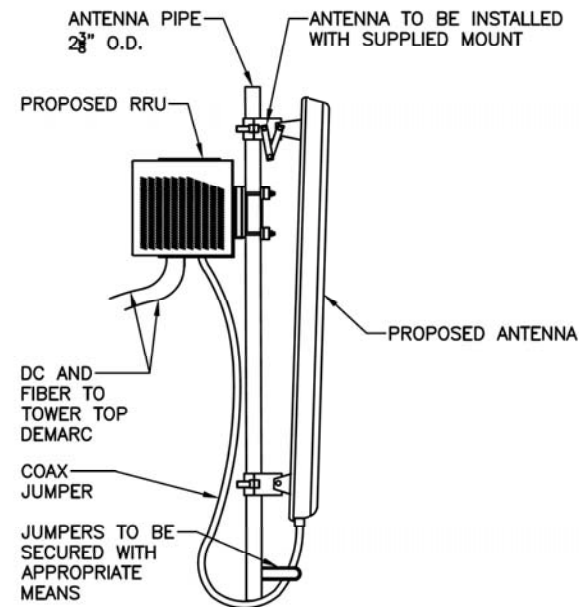

3 ANTENNA MOUNT DETAIL
C-2 NOT TO SCALE



T-Mobile

35 GRIFFIN RD S
BLOOMFIELD, CT 06002
OFFICE: 860-692-7100
FAX: 860-692-7159

PLANS PREPARED BY:

NSS NORTHEAST
SITE SOLUTIONS
Turnkey Wireless Development
NORTHEAST SITE SOLUTIONS, LLC
199 BRICKYARD ROAD
FARMINGTON CT 06032
(860) 677-1999

SMW
ENGINEERING GROUP, INC.
TOGETHER PLANNING A BETTER TOMORROW



11/03/16

SITE INFORMATION:

CTNH547A
52 LIBRARY ST.
SALISBURY, CT 06068

#	DATE	DESCRIPTION
0	10/21/16	ISSUED FOR CLIENT REV.
1	11/03/16	ISSUED FOR CONSTRUCTION

T-MOBILE SITE ID: CTNH547A ATC SITE ID: 370630

SHEET NAME:
TOWER ELEVATION & ANTENNA PLAN

SMW #:
16-2561
DESIGNER: BMD
CHECKED BY: RTB
ENGINEER: JDS

SHEET NUMBER:
C-2

707C_TOWER_1QP_1DP / U1900/L2100/L700 - TOWER TOP EQUIPMENT SCHEDULE							
ANTENNA SECTOR	ANTENNA MARK	ANTENNA AZIMUTH	ANTENNA MODEL	RRU MODEL	TMA MODEL	TOWER TOP COVP MODEL	ANTENNA CABLE DESCRIPTION
ALPHA	A1	30°	APX16DWV-16DWV-S-E-A20 (QUAD)	(1) RRUS-11 B2 (P) (1) RRUS-11 B4 (P)	--	--	(1) 1 5/8" HYBRID CABLE SYSTEM (P)
	A2	30°	--	--	--	--	--
	A3	30°	LNx-6515DS-A1M (DUAL)	(1) RRUS-11 B12 (P)	--	--	--
BETA	B1	150°	APX16DWV-16DWV-S-E-A20 (QUAD)	(1) RRUS-11 B2 (P) (1) RRUS-11 B4 (P)	--	--	(1) 1 5/8" HYBRID CABLE SYSTEM (R)
	B2	150°	--	--	--	--	--
	B3	150°	LNx-6515DS-A1M (DUAL)	(1) RRUS-11 B12 (P)	--	--	--
GAMMA	C1	250°	APX16DWV-16DWV-S-E-A20 (QUAD)	(1) RRUS-11 B2 (P) (1) RRUS-11 B4 (P)	--	--	--
	C2	250°	--	--	--	--	--
	C3	250°	LNx-6515DS-A1M (DUAL)	(1) RRUS-11 B12 (P)	--	--	--

NOTE:

- (P) DENOTES PROPOSED EQUIPMENT
- (R) DENOTES RESERVED EQUIPMENT
- (E) DENOTES EXISTING EQUIPMENT

NOTE:

1. THE HYBRID CABLE LENGTH SHOWN IS ONLY AN ESTIMATE AND SHOULD NOT BE USED FOR ORDERING MATERIALS. CONFIRM THE REQUIRED HYBRID CABLE LENGTH WITH T-MOBILE PRIOR TO ORDERING OR INSTALLATION.
2. THE CONTRACTOR SHALL TEST THE OPTICAL FIBER AFTER INSTALLATION IN ACCORDANCE WITH T-MOBILE STANDARDS AND SUPPLY THE RESULTS TO T-MOBILE.
3. THE CONTRACTOR SHALL CONFIRM THE TOWER TOP EQUIPMENT LIST ABOVE WITH THE FINAL T-MOBILE RFDS PRIOR TO INSTALLATION.
4. ALL EXISTING AND PROPOSED ANTENNA CABLES SHALL BE COLOR CODED PER T-MOBILE MARKET STANDARDS.
5. REFER MANUFACTURERS INSTALLATION STANDARDS FOR ADDITIONAL INFORMATION.
6. REFER TO EQUIPMENT MANUFACTURER'S SPECIFICATION SHEETS FOR ADDITIONAL INFORMATION NOT LISTED ABOVE.

TOWER LOADING SUMMARY		
EQUIPMENT TYPE	ADD QUANTITY	TOTAL QUANTITY
PANEL ANTENNA	6	6
COAX CABLE	0	0
RRUS	9	9
HYBRID CABLE	2	2
COVP	0	0

T-Mobile

35 GRIFFIN RD S
BLOOMFIELD, CT 06002
OFFICE: 860-692-7100
FAX: 860-692-7159

PLANS PREPARED BY:



NSS NORTHEAST
SITE SOLUTIONS
Turnkey Wireless Development
NORTHEAST SITE SOLUTIONS, LLC
199 BRICKYARD ROAD
FARMINGTON CT 06032
(860) 677-1999



SMW
ENGINEERING GROUP, INC.
TOGETHER PLANNING A BETTER TOMORROW



11/03/16

SITE INFORMATION:
CTNH547A
52 LIBRARY ST.
SALISBURY, CT 06068

#	DATE	DESCRIPTION
0	10/21/16	ISSUED FOR CLIENT REV.
1	11/03/16	ISSUED FOR CONSTRUCTION

T-MOBILE SITE ID: **CTNH547A** ATC SITE ID: **370630**

SHEET NAME:
**TOWER TOP
EQUIPMENT SCHEDULE**

SMW #: **16-2561** SHEET NUMBER: **C-3**

DESIGNER:	BMD
CHECKED BY:	RTB
ENGINEER:	JDS

- ① 2"Ø CONDUIT (ABOVE SLAB)
- ② 2"Ø U/G CONDUIT (UNDER CONCRETE) FROM PROPOSED PPC TO PROPOSED PBC CABINETS
- ③ 2"Ø U/G CONDUIT (UNDER CONCRETE) FROM PROPOSED PPC DAISY-CHAINING SSC CAGINETS
- ④ 2"Ø PVC CONDUIT WITH (3) 3/0 + #4G FROM PROPOSED METER TO PPC CABINET. COORDINATE WITH THE LOCAL UTILITY COMPANY REGARDING FINAL SERVICE CONNECTION.
- ⑤ 2"Ø PVC CONDUIT WITH PULLSTRING FOR TELCO FROM PROPOSED AAV CABINET TO EXISTING TELCO SERVICE. COORDINATE WITH THE LOCAL UTILITY COMPANY REGARDING FINAL SERVICE CONNECTION.

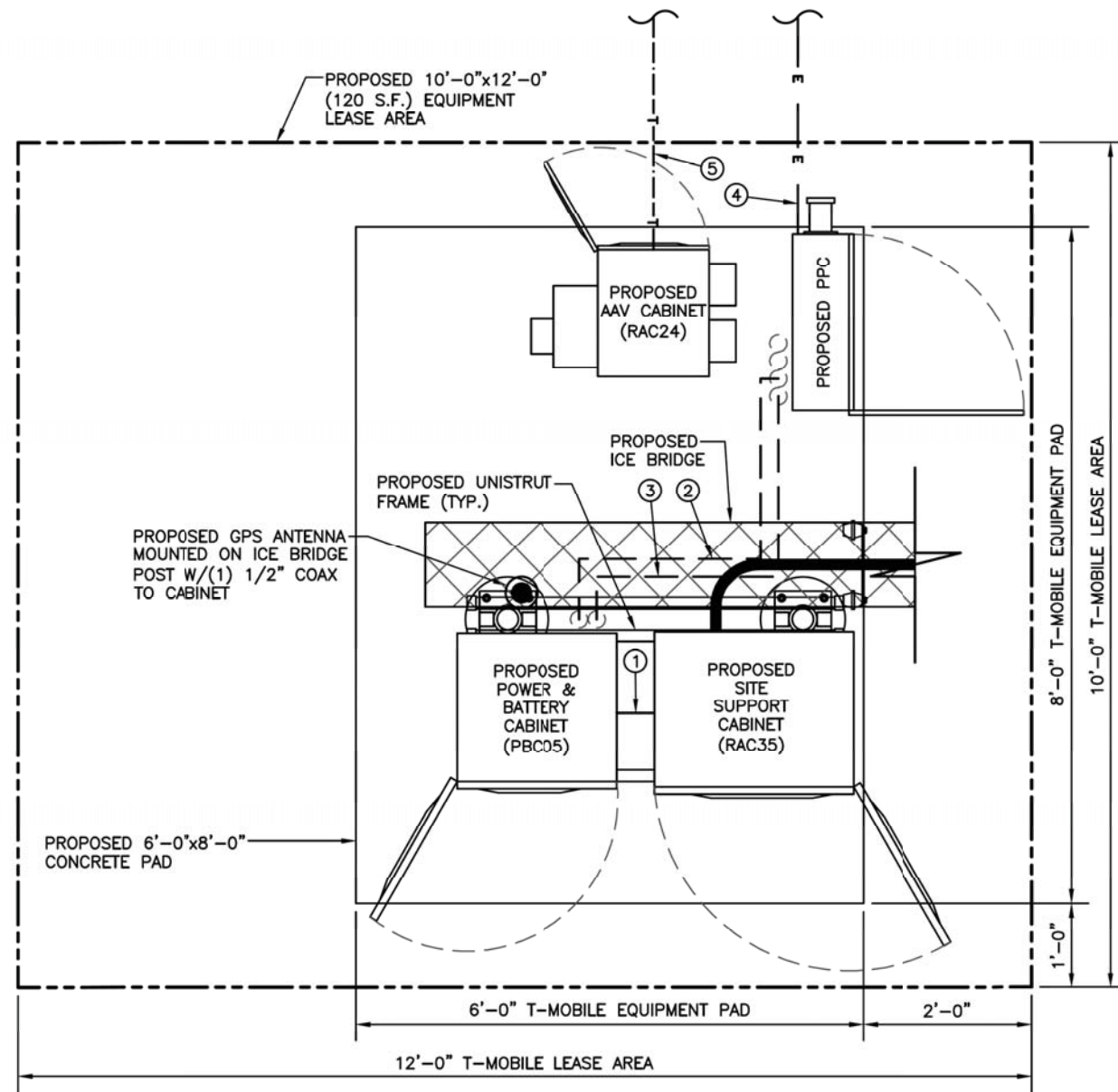

① GROUND EQUIPMENT DETAIL
C-4



T-Mobile

35 GRIFFIN RD S
BLOOMFIELD, CT 06002
OFFICE: 860-692-7100
FAX: 860-692-7159

PLANS PREPARED BY:

NSS NORTHEAST
SITE SOLUTIONS
Tuesday Winslow Development
NORTHEAST SITE SOLUTIONS, LLC
199 BRICKYARD ROAD
FARMINGTON CT 06032
(860) 677-1999

SMW
ENGINEERING GROUP, INC.
TOGETHER PLANNING A BETTER TOMORROW



11/03/16

SITE INFORMATION:

CTNH547A
52 LIBRARY ST.
SALISBURY, CT 06068

#	DATE	DESCRIPTION
0	10/21/16	ISSUED FOR CLIENT REV.
1	11/03/16	ISSUED FOR CONSTRUCTION

T-MOBILE SITE ID: **CTNH547A** ATC SITE ID: **370630**

SHEET NAME:
GROUND EQUIPMENT DETAIL

SMW #: **16-2561** SHEET NUMBER:
C-4

DESIGNER: **BMD**
CHECKED BY: **RTB**
ENGINEER: **JDS**

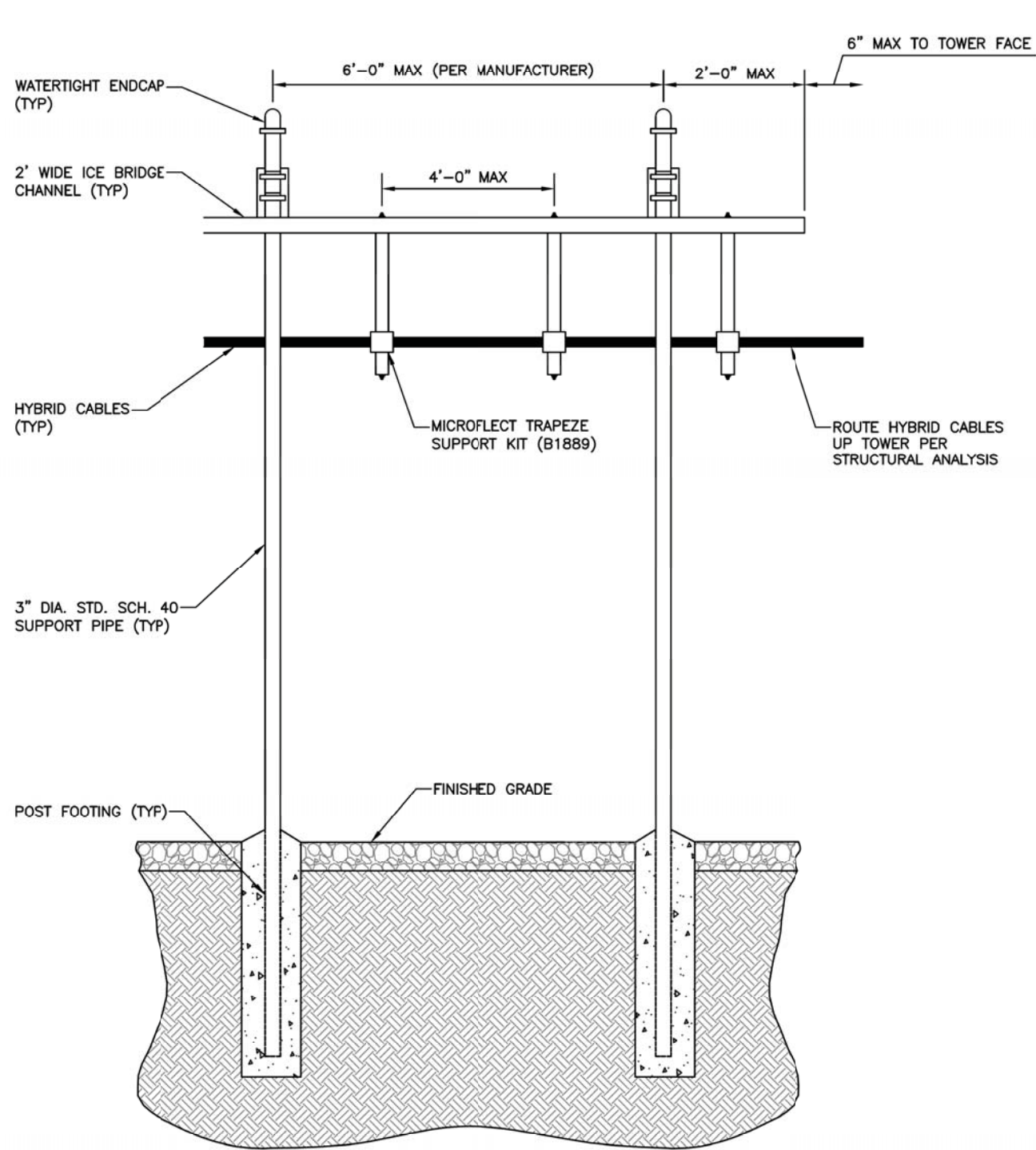

1 ICE BRIDGE ELEVATION
C-5 NOT TO SCALE

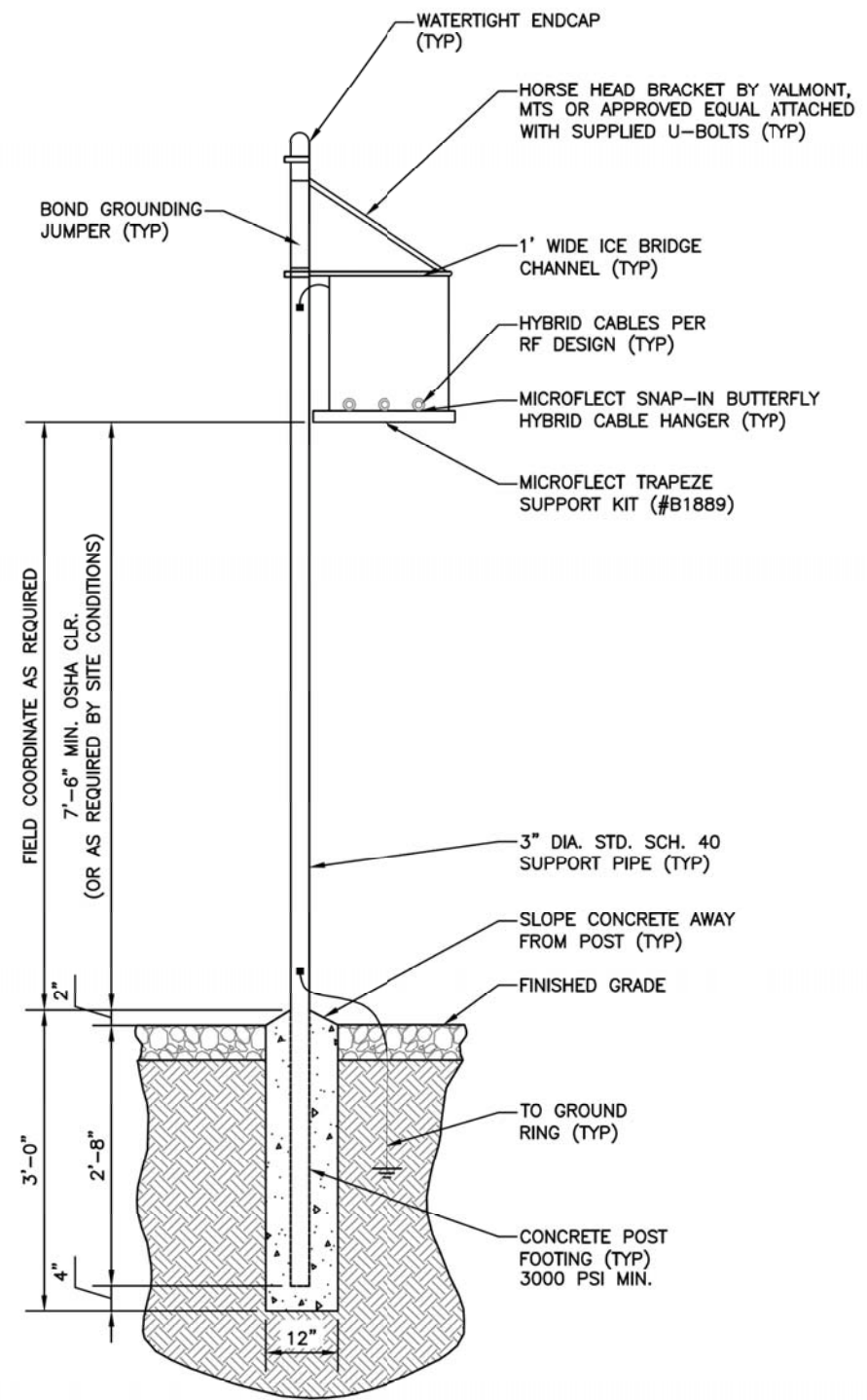

2 ICE BRIDGE SECTION (WITH 1 SUPPORT POST)
C-5 NOT TO SCALE

T-Mobile

35 GRIFFIN RD S
BLOOMFIELD, CT 06002
OFFICE: 860-692-7100
FAX: 860-692-7159

PLANS PREPARED BY:

NSS NORTHEAST
 SITE SOLUTIONS
Turnkey Wireless Development
 NORTHEAST SITE SOLUTIONS, LLC
 199 BRICKYARD ROAD
 FARMINGTON CT 06032
 (860) 677-1999

SMW
 ENGINEERING GROUP, INC.
 TOGETHER PLANNING A BETTER TOMORROW



11/03/16

SITE INFORMATION:
CTNH547A
 52 LIBRARY ST.
 SALISBURY, CT 06068

#	DATE	DESCRIPTION
0	10/21/16	ISSUED FOR CLIENT REV.
1	11/03/16	ISSUED FOR CONSTRUCTION

T-MOBILE SITE ID: **CTNH547A** ATC SITE ID: **370630**

SHEET NAME:
ICE BRIDGE DETAILS

SMW #:
16-2561

DESIGNER:	BMD
CHECKED BY:	RTB
ENGINEER:	JDS

SHEET NUMBER:
C-5

PLANS PREPARED BY:
NSS NORTHEAST
SITE SOLUTIONS
Turnkey Wireless Development
NORTHEAST SITE SOLUTIONS, LLC
199 BRICKYARD ROAD
FARMINGTON CT 06032
(860) 677-1999

SMW
ENGINEERING GROUP, INC.
TOGETHER PLANNING A BETTER TOMORROW



11/03/16

SITE INFORMATION:
CTNH547A
52 LIBRARY ST.
SALISBURY, CT 06068

#	DATE	DESCRIPTION
0	10/21/16	ISSUED FOR CLIENT REV.
1	11/03/16	ISSUED FOR CONSTRUCTION

T-MOBILE SITE ID: **CTNH547A** ATC SITE ID: **370630**

SHEET NAME:
**FOUNDATION
DETAILS & NOTES**

SMW #:
16-2561

DESIGNER:	BMD
CHECKED BY:	RTB
ENGINEER:	JDS

SHEET NUMBER:
C-6

REINFORCED CONCRETE NOTES:

- ALL CONCRETE WORK SHALL BE IN ACCORDANCE WITH THE ACI SPECIFICATIONS FOR THE DESIGN & CONSTRUCTION OF CAST-IN-PLACE CONCRETE, AND WHERE CODES CONFLICT THE MORE STRINGENT NATIONAL OR LOCAL CODE SHALL GOVERN.
- SITECAST CONCRETE FOR SLABS AND POST FOOTINGS SHALL HAVE A MINIMUM COMPRESSIVE STRENGTH OF 3000 PSI AT 28 DAYS. CONCRETE TESTING IS NOT REQUIRED FOR SLABS AND POST FOOTINGS UNLESS NOTED OTHERWISE.

SLUMP - 4" MIN. / 6" MAX.
AIR ENTRAINMENT - 2% TO 3% BY VOLUME

CLASSES OF CONCRETE				
CLASS	28 DAY STRENGTH (PSI)	MAX WATER/CEMENT RATIO	PLACEMENT LOCATION	NOTES
TYPE I	3000	0.55	SLABS & POST FOOTINGS	NORMAL WEIGHT
TYPE II*	5000	0.45	SLABS & POST FOOTINGS	HIGH EARLY STRENGTH

*IF REQUIRED BY THE CONSTRUCTION SCHEDULE THE CONTRACTOR MAY SUBSTITUTE TYPE III HIGH EARLY STRENGTH CONCRETE WITH THE APPROVAL OF THE CONSTRUCTION MANAGER.

- REINFORCING STEEL SHALL CONFORM TO ASTM A 615, GRADE 60, DEFORMED UNLESS NOTED OTHERWISE. WELDED WIRE FABRIC SHALL CONFORM TO ASTM A185 WELDED STEEL WIRE FABRIC UNLESS NOTED OTHERWISE. SPLICES FOR REBAR SHALL BE CLASS "B" AND ALL HOOKS SHALL BE STANDARD, UNO. LAPS FOR WELDED WIRE FABRIC SHALL BE AT LEAST 8", UNO.
- THE FOLLOWING MINIMUM CONCRETE COVER SHALL BE PROVIDED FOR REINFORCING STEEL UNLESS SHOWN OTHERWISE ON DRAWINGS:
CONCRETE CAST AGAINST EARTH.....3"
CONCRETE EXPOSED TO EARTH OR WEATHER
#6 AND LARGER.....2"
#5 AND SMALLER & W.W.F.....1-1/2"
- MAXIMUM COARSE AGGREGATE SIZE SHALL BE 3/4"
- INSTALLATION OF CONCRETE ANCHORS SHALL BE IN ACCORDANCE WITH THE MANUFACTURER'S WRITTEN SPECIFICATIONS. THE ANCHOR BOLT, DOWEL, OR ROD SHALL CONFORM TO THE ANCHOR MANUFACTURER'S SPECIFICATIONS FOR MATERIAL STRENGTH, EMBEDMENT DEPTH, SPACING, AND EDGE DISTANCE OR AS DETAILED ON THE DRAWINGS. NO REBAR SHALL BE CUT WITHOUT PRIOR ENGINEERING APPROVAL WHEN DRILLING HOLES IN CONCRETE. EXPANSION BOLTS SHALL BE PROVIDED BY RAMSET/REDHEAD, HILTI, OR APPROVED EQUAL IF THE MANUFACTURER'S SPECIFICATIONS AND DETAILS ARE FOUND TO CONFLICT WITH THAT SHOWN HEREIN, THE ENGINEER SHALL BE NOTIFIED IMMEDIATELY.
- THE CONTRACTOR SHALL VERIFY FROST LINE AND FOOTING DEPTH REQUIREMENTS WITH THE JURISDICTION HAVING AUTHORITY PRIOR TO CONSTRUCTION AND CONSULT THE ENGINEER ACCORDINGLY.
- THE CONTRACTOR SHALL VERIFY ALL ELECTRICAL CONDUIT SIZES AND PENETRATION LOCATIONS PRIOR TO POURING THE SLAB.

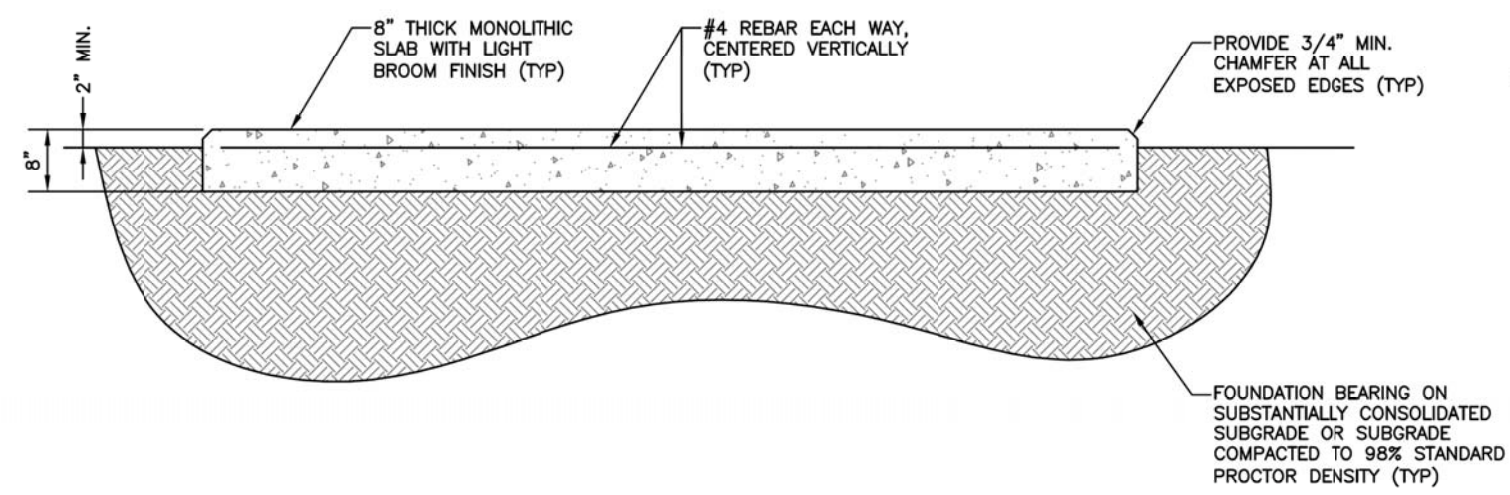
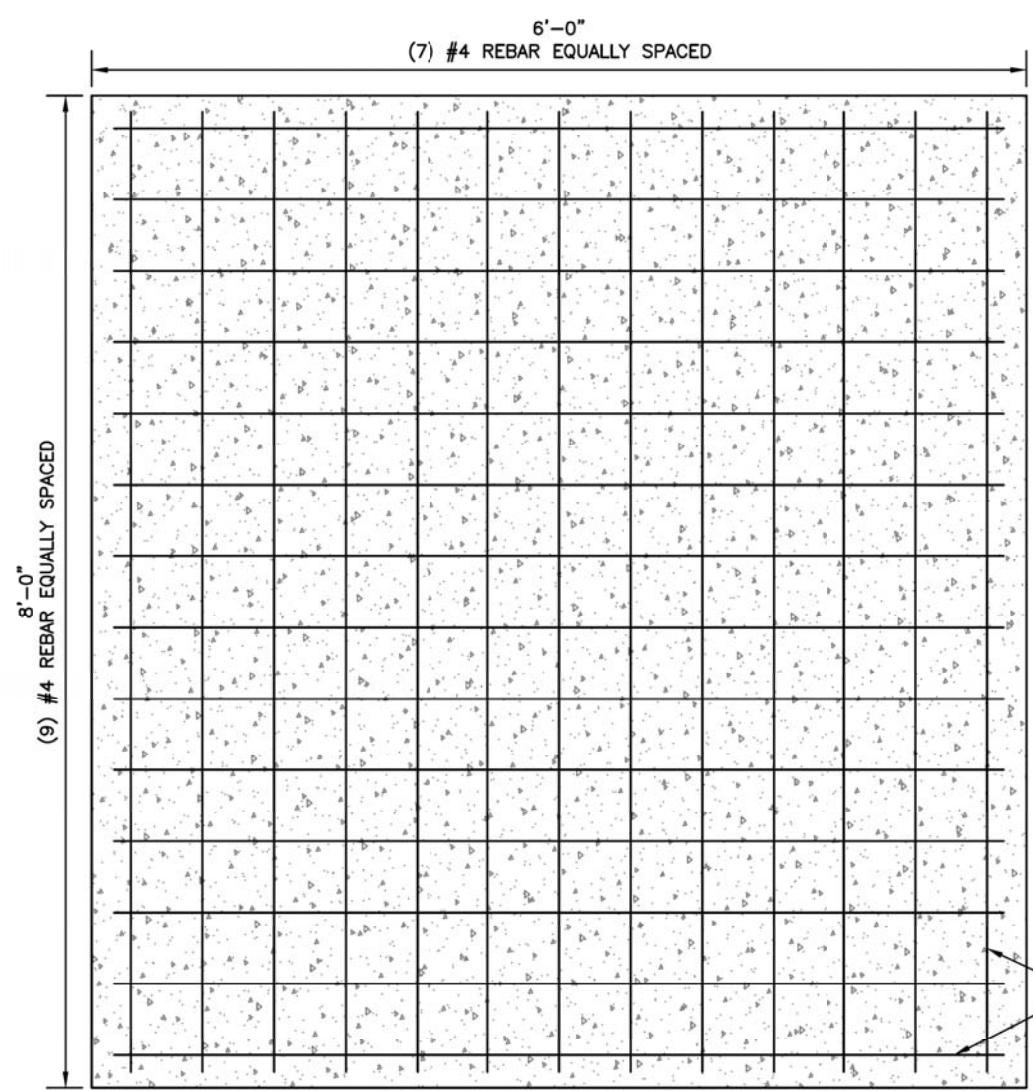

1 MONOLITHIC EQUIPMENT SLAB DETAIL
C-6 NOT TO SCALE

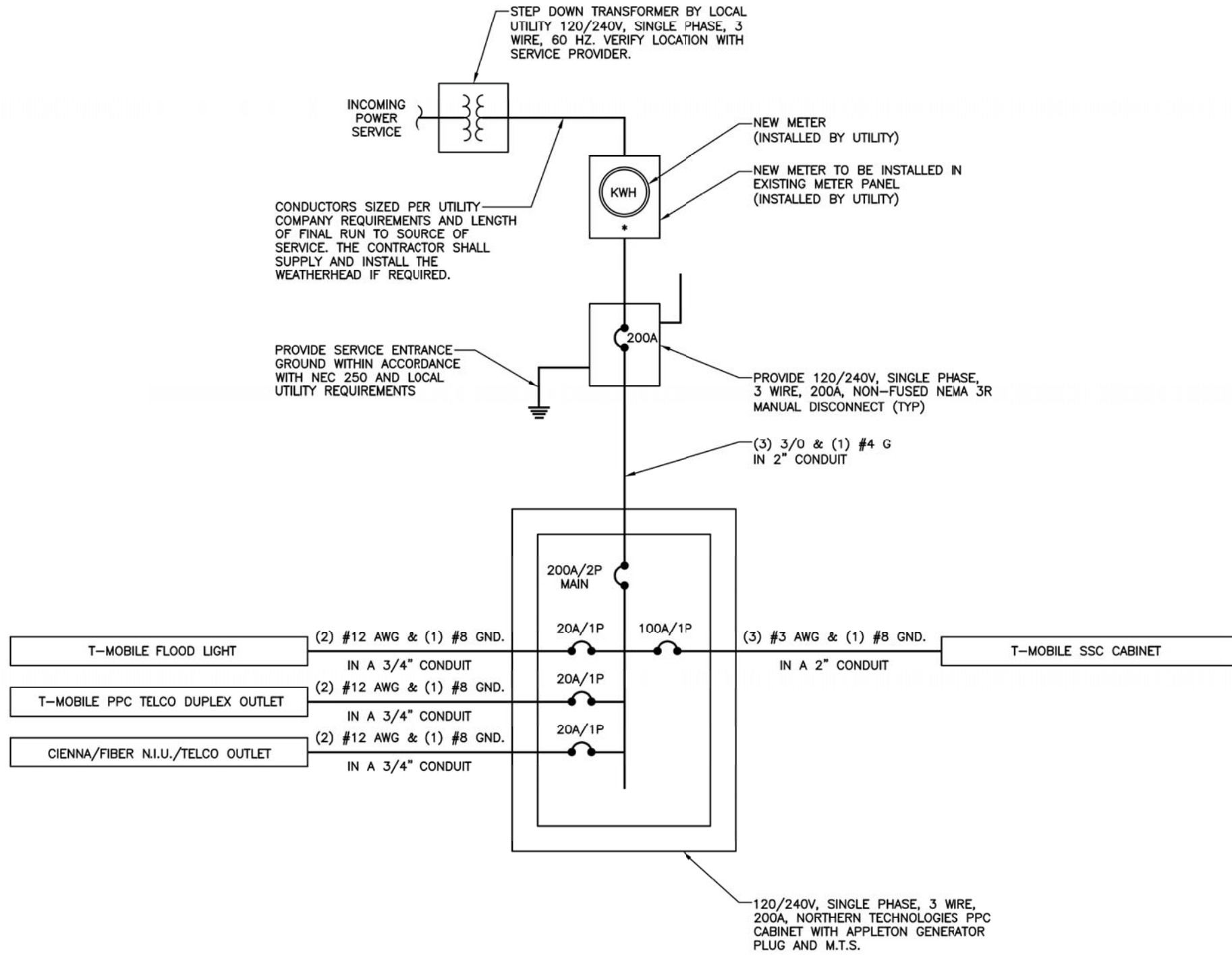

1 ONE-LINE DIAGRAM
E-1 NOT TO SCALE

T-Mobile

35 GRIFFIN RD S
BLOOMFIELD, CT 06002
OFFICE: 860-692-7100
FAX: 860-692-7159

PLANS PREPARED BY:

NSS NORTHEAST SITE SOLUTIONS
Turnkey Wireless Development
NORTHEAST SITE SOLUTIONS, LLC
199 BRICKYARD ROAD
FARMINGTON CT 06032
(860) 677-1999

SMW
ENGINEERING GROUP, INC.
TOGETHER PLANNING A BETTER TOMORROW



11/03/16

SITE INFORMATION:
CTNH547A
52 LIBRARY ST.
SALISBURY, CT 06068

#	DATE	DESCRIPTION
0	10/21/16	ISSUED FOR CLIENT REV.
1	11/03/16	ISSUED FOR CONSTRUCTION

T-MOBILE SITE ID: **CTNH547A** ATC SITE ID: **370630**

SHEET NAME:
ONE-LINE DIAGRAM

SMW #:
16-2561

DESIGNER: **BMD**
CHECKED BY: **RTB**
ENGINEER: **JDS**

SHEET NUMBER:
E-1

ELECTRICAL KEY NOTES:

- ① PROPOSED 2" PVC CONDUIT WITH (3) 3/0 + #4G FROM PROPOSED METER TO PPC CABINET. COORDINATE WITH THE LOCAL UTILITY COMPANY REGARDING FINAL SERVICE CONNECTION.
- ② PROPOSED METER & 200A MANUAL DISCONNECT. COORDINATE WITH LOCAL UTILITY COMPANY REGARDING FINAL SERVICE CONNECTION.
- ③ PROPOSED 200A NORTHERN TECHNOLOGIES PPC CABINET WITH INTEGRATED 200A APPLETON GENERATOR BACKUP PLUG.
- ④ PROPOSED 2" PVC CONDUIT WITH PULLSTRING FOR TELCO FROM PROPOSED AAV CABINET TO EXISTING TELCO SERVICE. COORDINATE WITH THE LOCAL UTILITY COMPANY REGARDING FINAL SERVICE CONNECTION.

REFER TO C-4 FOR EQUIPMENT UTILITY PLAN

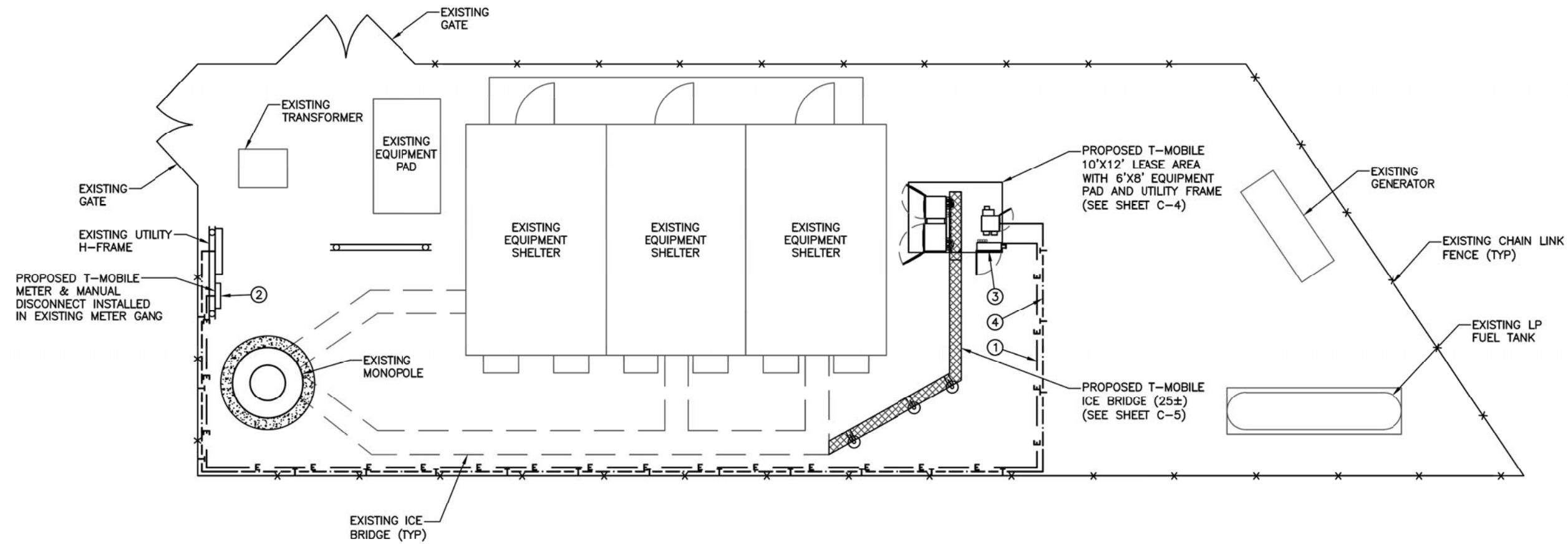

① ELECTRICAL UTILITY PLAN
E-2

T-Mobile

35 GRIFFIN RD S
BLOOMFIELD, CT 06002
OFFICE: 860-692-7100
FAX: 860-692-7159

PLANS PREPARED BY:

NSS NORTHEAST
SITE SOLUTIONS
Turnkey Wireless Development
NORTHEAST SITE SOLUTIONS, LLC
199 BRICKYARD ROAD
FARMINGTON CT 06032
(860) 677-1999

SMW
ENGINEERING GROUP, INC.
TOGETHER PLANNING A BETTER TOMORROW



11/03/16

SITE INFORMATION:
CTNH547A
52 LIBRARY ST.
SALISBURY, CT 06068

#	DATE	DESCRIPTION
0	10/21/16	ISSUED FOR CLIENT REV.
1	11/03/16	ISSUED FOR CONSTRUCTION

T-MOBILE SITE ID: **CTNH547A** ATC SITE ID: **370630**

SHEET NAME:
ELECTRICAL UTILITY PLAN

SMW #:
16-2561

DESIGNER: **BMD**
CHECKED BY: **RTB**
ENGINEER: **JDS**

SHEET NUMBER:
E-2

GROUNDING KEY NOTES:

- ① PROPOSED #2 BARE TINNED SOLID COPPER GROUND RING (TYP)
- ② PROPOSED 5/8" DIA. X 8' LONG STEEL SHAFT COPPER CLAD GROUND ROD (TYP)
- ③ PROPOSED GROUND ROD WITH COVERED PVC TEST WELL (TYP)
- ④ GROUND PROPOSED UTILITY FRAME POST WITH CADWELD CONNECTION TO BASE PLATE (TYP)
- ⑤ GROUND PROPOSED ICE BRIDGE POST WITH CADWELD CONNECTION TO BASE (TYP)
- ⑥ GROUND PROPOSED PPC POWER PANEL PER NEC 250 AND LOCAL UTILITY REQUIREMENTS (TYP)
- ⑦ GROUND PROPOSED SSC CABINET MAIN GROUND BAR WITH 2-HOLE LUG CONNECTION (TYP)
- ⑧ PROVIDE 12 POSITION MAIN EQUIPMENT COLLECTOR GROUND BAR ATTACHED TO UNISTRUT FRAME WITH STANDOFF INSULATORS, GROUND WITH (2) CADWELDED CONNECTIONS, 1 PER SITE (TYP)
- ⑨ GROUND ICE BRIDGE CHANNEL SECTIONS WITH 2-HOLE LUG CONNECTION. BOND ADJOINING CHANNEL SECTIONS TOGETHER WITH 2-HOLE LUG JUMPERS (TYP)
- ⑩ GROUND TO ALL METALLIC OBJECTS WITHIN 6' OF THE PROPOSED EQUIPMENT AND BURIED GROUND RING (TYP)
- ⑪ GROUND PROPOSED T-MOBILE BURIED EQUIPMENT GROUND RING TO EXISTING SITE GROUND RING. CONDUCT GROUNDING SYSTEM TEST AND INCLUDE IN THE CLOSEOUT PACKAGE TO T-MOBILE. ADDITIONAL GROUNDING MAY BE REQUIRED PENDING THE RESULTS OF THE GROUNDING SYSTEM TEST (TYP x2)
- ⑫ CADWELD CONNECTION (SEE SHEET E-6)

NOTE TO CONTRACTORS:
DIGGING AND/OR TRENCHING INSIDE
COMPOUND, MUST BE DONE BY HAND.

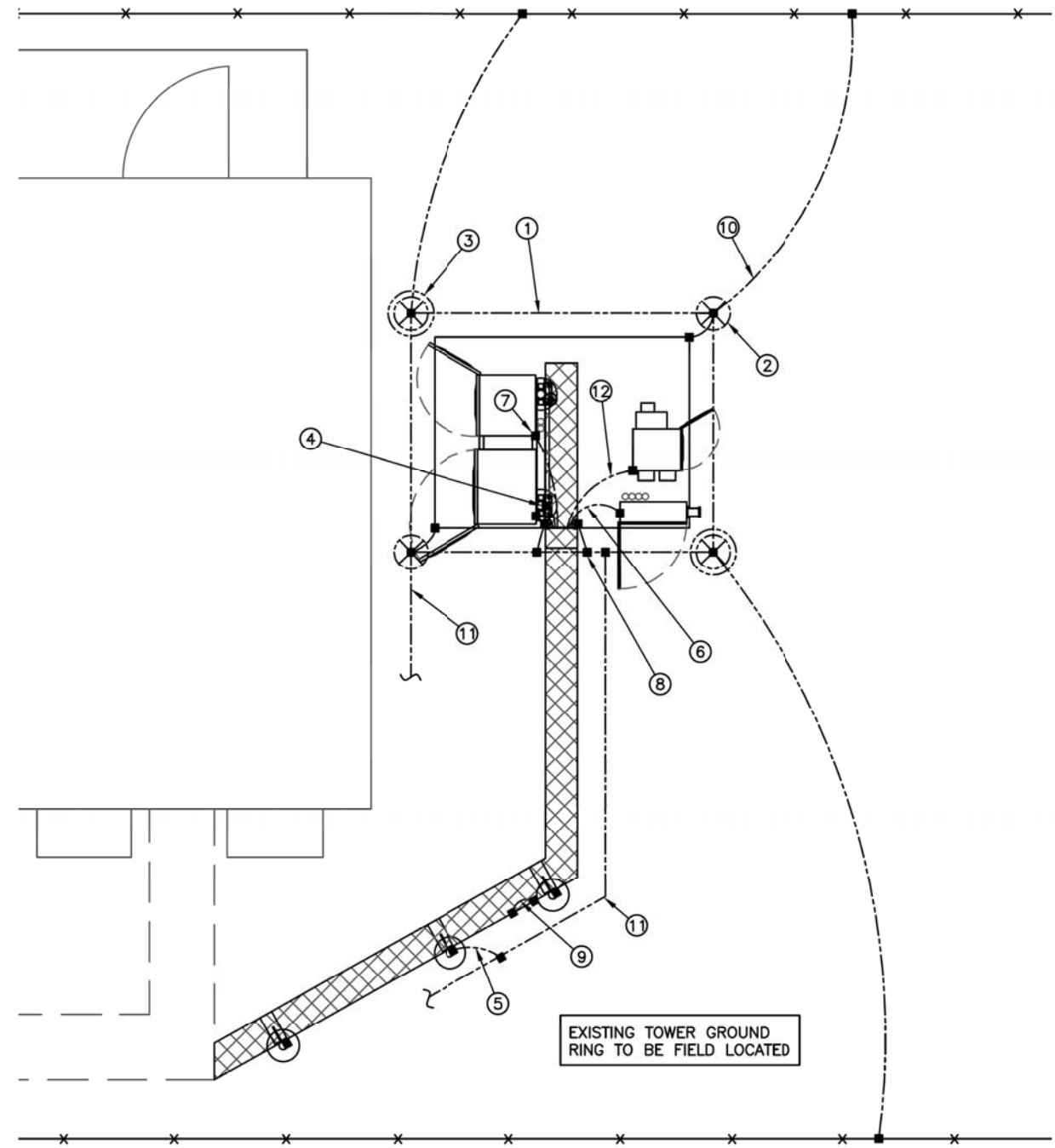

T-Mobile

35 GRIFFIN RD S
BLOOMFIELD, CT 06002
OFFICE: 860-692-7100
FAX: 860-692-7159

PLANS PREPARED BY:
NSS NORTHEAST
SITE SOLUTIONS
Turnkey Wireless Development
NORTHEAST SITE SOLUTIONS, LLC
199 BRICKYARD ROAD
FARMINGTON CT 06032
(860) 677-1999

SMW
ENGINEERING GROUP, INC.
TOGETHER PLANNING A BETTER TOMORROW



11/03/16

SITE INFORMATION:
CTNH547A
52 LIBRARY ST.
SALISBURY, CT 06068

#	DATE	DESCRIPTION
0	10/21/16	ISSUED FOR CLIENT REV.
1	11/03/16	ISSUED FOR CONSTRUCTION

T-MOBILE SITE ID: **CTNH547A** ATC SITE ID: **370630**

SHEET NAME:
GROUNDING PLAN

SMW #:
16-2561

DESIGNER:	BMD
CHECKED BY:	RTB
ENGINEER:	JDS

SHEET NUMBER:
E-3

① **GROUNDING PLAN**
E-3 NOT TO SCALE

T-MOBILE ANTENNA CABLE COLOR CODES SHALL BE PROVIDED BY THE LOCAL T-MOBILE MARKET PRIOR TO CONSTRUCTION.

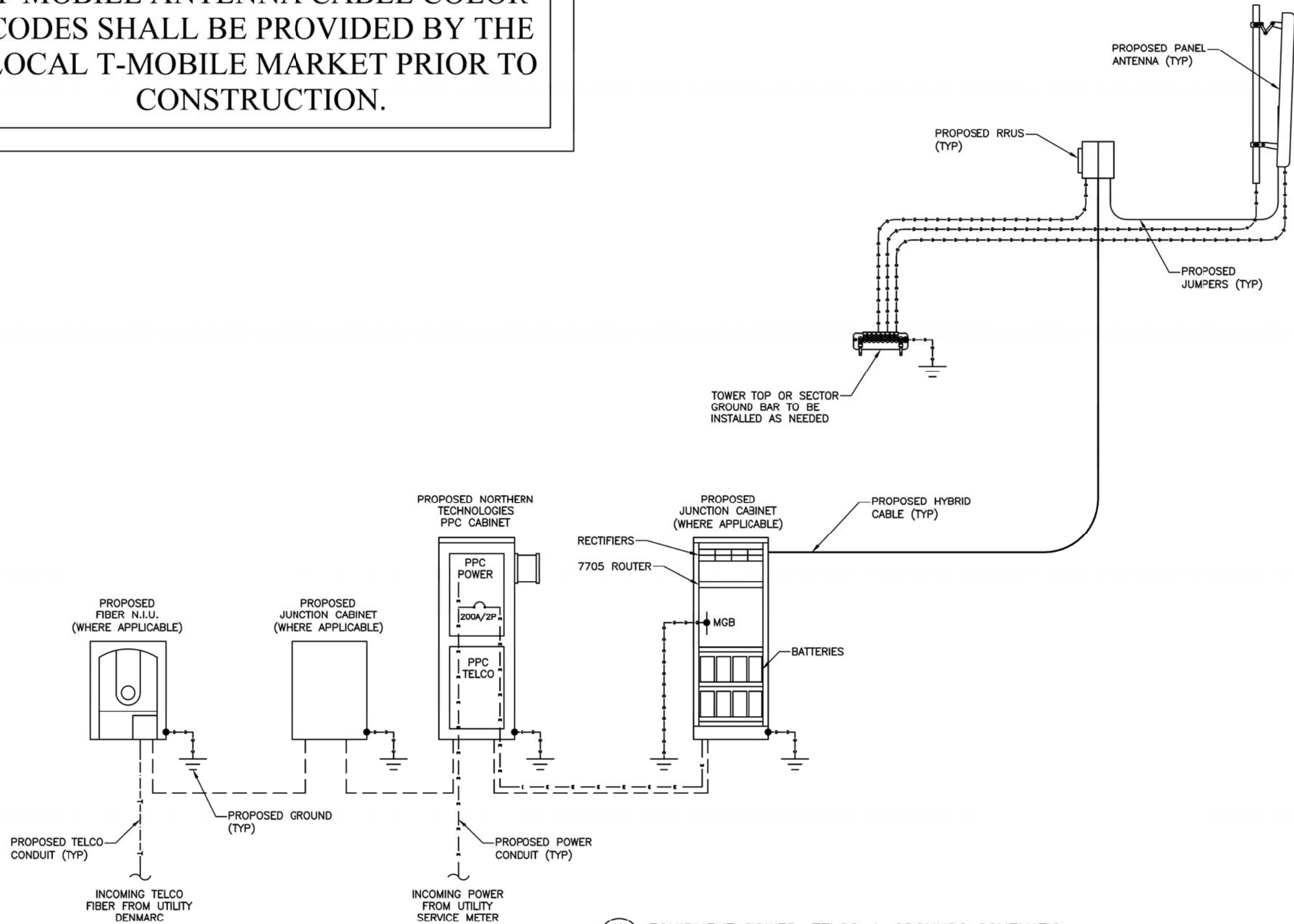

1 EQUIPMENT POWER, TELCO & GROUNDS SCHEMATIC
E-4 NOT TO SCALE

T-Mobile

35 GRIFFIN RD S
BLOOMFIELD, CT 06002
OFFICE: 860-692-7100
FAX: 860-692-7159

PLANS PREPARED BY:

NSS NORTHEAST
SITE SOLUTIONS
Turnkey Wireless Development
NORTHEAST SITE SOLUTIONS, LLC
199 BRICKYARD ROAD
FARMINGTON CT 06032
(860) 677-1999

SMW
ENGINEERING GROUP, INC.
TOGETHER PLANNING A BETTER TOMORROW



11/03/16

SITE INFORMATION:
CTNH547A
52 LIBRARY ST.
SALISBURY, CT 06068

#	DATE	DESCRIPTION
0	10/21/16	ISSUED FOR CLIENT REV.
1	11/03/16	ISSUED FOR CONSTRUCTION

T-MOBILE SITE ID: **CTNH547A** ATC SITE ID: **370630**







SHEET NAME:
EQUIPMENT SCHEMATIC

SMW #:
16-2561
DESIGNER: BMD
CHECKED BY: RTB
ENGINEER: JDS

SHEET NUMBER:
E-4

- ALL WORK IS TO COMPLY WITH THE LATEST EDITION OF THE NATIONAL ELECTRIC CODE (NEC) AND ANY LOCAL ORDINANCES, CODES, AND ALL OTHER ADMINISTRATIVE AUTHORITIES HAVING JURISDICTION. THE CONTRACTOR SHALL FURNISH AND PAY FOR ALL PERMITS AND RELATED FEES.
- ALL EQUIPMENT AND MATERIAL FURNISHED AND INSTALLED UNDER THIS CONTRACT SHALL BE UNDERWRITERS LABORATORIES (U.L.) LISTED, NEW, FREE FROM DEFECTS, AND SHALL BE GUARANTEED FOR A PERIOD OF ONE YEAR FROM DATE OF FINAL ACCEPTANCE BY OWNER OR HIS REPRESENTATIVE. SHOULD ANY TROUBLE DEVELOP DURING THIS PERIOD DUE TO FAULTY WORKMANSHIP, MATERIAL, OR EQUIPMENT, THE CONTRACTOR SHALL FURNISH ALL NECESSARY MATERIALS AND LABOR TO CORRECT THE TROUBLE WITHOUT COST TO THE OWNER.
- ALL WORK SHALL BE EXECUTED IN A WORKMAN LIKE MANNER AND SHALL PRESENT A NEAT MECHANICAL APPEARANCE WHEN COMPLETED. CONTRACTOR SHOULD AVOID DAMAGE TO EXISTING UTILITIES WHEREVER POSSIBLE. THE CONTRACTOR SHALL BE RESPONSIBLE FOR ALL CUTTING AND PATCHING RELATED TO ELECTRICAL WORK, AND SHALL RESTORE ALL EXISTING LANDSCAPING, SPRINKLER SYSTEMS, CONDUITS, WIRING, PIPING, ETC. DAMAGED BY THE ELECTRICAL WORK TO MATCH EXISTING CONDITIONS.
- ELECTRICAL WORK SHALL INCLUDE, BUT NOT BE LIMITED TO, ALL LABOR, MATERIALS AND EQUIPMENT REQUIRED TO COMPLETE ELECTRICAL POWER AND LIGHTING SYSTEMS, TELEPHONE AND COMMUNICATION SYSTEMS, PANELBOARDS, CONDUIT, CONTROL WIRING, GROUNDING, ETC. AS INDICATED ON ELECTRICAL DRAWINGS AND/OR AS REQUIRED BY GOVERNING CODES.
- PRIOR TO INSTALLING ANY ELECTRICAL WORK, THE CONTRACTOR SHALL VISIT THE JOB SITE AND VERIFY EXISTING SITE LOCATIONS AND CONDITIONS AND UTILITY SERVICE REQUIREMENTS OF THE JOB, AND BY REFERENCE TO ENGINEERING AND EQUIPMENT SUPPLIERS' DRAWINGS. SHOULD THERE BE ANY QUESTION OR PROBLEM CONCERNING THE NECESSARY PROVISIONS TO BE MADE. PROPER DIRECTIONS SHALL BE OBTAINED BEFORE PROCEEDING WITH ANY WORK.
- PROVIDE POWER AND TELEPHONE TO SERVICE POINTS PER UTILITY COMPANY REQUIREMENTS. CONTRACTOR SHALL CONTACT UTILITY SERVICE PLANNERS AND OBTAIN ALL SERVICE REQUIREMENTS AND INCLUDE COSTS FOR SUCH IN THEIR BID.
- SERVICE EQUIPMENT SHALL HAVE A SHORT CIRCUIT WITHSTAND RATING EXCEEDING THE MAXIMUM AVAILABLE FAULT CURRENT AT THE SUPPLY TERMINAL ON THE UTILITY TRANSFORMER SECONDARY, THE INSULATION SHALL BE FREE FROM ANY SHORT CIRCUITS AND GROUNDS. CONTRACTOR TO OBTAIN THE AVAILABLE SHORT CIRCUIT CURRENT FROM THE ELECTRICAL SERVICE PROVIDER.
- ALL WIRES SHALL BE STRANDED COPPER WITH THHN/THWN AND 600 VOLTS INSULATION. ALL GROUND CONDUCTORS TO BE PROPERLY SIZED COPPER. (STRANDED OR SOLID)
- IN THE EVENT OF ANY CONFLICT OR INCONSISTENCY BETWEEN ITEMS SHOWN ON THE PLANS AND/OR SPECIFICATIONS, THE NOTE, SPECIFICATION OR CODE WHICH PRESCRIBES AND ESTABLISHES THE HIGHEST STANDARD OF PERFORMANCE SHALL PREVAIL.
- SERVICE CONDUITS SHALL HAVE NO MORE THAN (4) -50° BENDS IN ANY SINGLE RUN. THE CONTRACTOR SHALL PROVIDE PULL BOXES AS NEEDED WHERE CONDUIT REQUIREMENTS EXCEED THESE CONDITIONS. PULL WIRES AND CAPS SHALL BE PROVIDED AT ALL SPARE CONDUITS FOR FUTURE USE.
- ALL ELECTRICAL EQUIPMENT SHALL BE ANCHORED TO WITHSTAND LOCAL WIND SPEED REQUIREMENTS AND DESIGNED FOR OUTDOOR EXPOSURE.
- ALL COAX, POWER AND TELEPHONE SYSTEM CONDUITS SHALL HAVE A MINIMUM 24" SCH. 80 PVC RADIUS SWEEPS TO EQUIPMENT, PULLBOXES, GUY, ETC., UNLESS OTHERWISE NOTED, OR AS REQUIRED BY UTILITY COMPANIES.
- FUSE TYPE SHALL BE BUSSMAN RKI LOW PEAK FUSE (LPN-RK-140).
- UPON COMPLETION OF THE JOB, THE CONTRACTOR SHALL FURNISH AS-BUILT DRAWINGS TO THE OWNER.
- GENERAL GROUNDING CRITERIA
1ST STEP: GROUND TO EXISTING BUILDING STRUCTURAL STEEL AND TO THE EXISTING COLD WATER METAL PIPE LINE. (WHERE APPLICABLE) THEN TEST GROUNDING RESISTANCE FOR 5 OHMS OR LESS OVERALL GROUND RESISTANCE. WHERE THE EFFECTIVE RESISTANCE DOES NOT MEET THIS CRITERIA, PROVIDE SUPPLEMENTAL GROUNDING AND RE-TEST UNTIL GROUND RESISTANCE FALLS BELOW THIS LEVEL.
- SUPPLEMENTAL GROUND MAY CONSIST OF ONE OR MORE OF THE FOLLOWING:
COUNTERPOISE, USER GROUND, GROUND ROD AND/OR GROUND WELL IN EXTREMELY ADVERSE SOIL CONDITIONS. WHERE THE EXISTING BUILDING STEEL DOES NOT PROVIDE AN EFFECTIVE GROUND RESISTANCE, THEN THE CONTRACTOR SHALL PROVIDE A SEPARATE GROUND CONDUCTOR FROM ROOF MOUNTED BTS EQUIPMENT LOCATIONS EITHER DOWN THROUGH THE INSIDE OF THE BUILDING OR DOWN THE OUTSIDE OF THE BUILDING, DEPENDING UPON OWNER PREFERENCE. WHERE THE GROUND CONDUCTOR FROM THE ROOF MOUNTED EQUIPMENT IS ROUTED IN CONDUIT, THE CONDUIT SHALL BE EFFECTIVELY GROUNDED TO THE GROUND CONDUCTOR AT BOTH ENDS OF THE CONDUIT. (GUY INSTALLATIONS):

FOR INSTALLATIONS WHERE WOODEN STRUCTURES, TOWERS, CONCRETE SILOS ETC. ARE ENCOUNTERED A PARATE DOWNLEAD SHALL BE PROVIDED FROM THE 3 ANTENNAS SEPARATED BY A MINIMUM OF 12 INCHES FROM THE COAXIAL CABLES. THE GROUND CONDUCTOR SHALL BE SECURELY FASTENED TO THE EXTERIOR OF OUTSIDE STRUCTURES WITH NONMETALLIC GROUND STRAPS EVERY 10 FEET. AGAIN, AS FOR TENANT IMPROVEMENT PROJECTS, TEST THE GROUND RESISTANCE FOR GUY INSTALLATIONS AND PROCEED PER THE ABOVE STEPS.
- CONTRACTOR TO COLOR PHASE CONDUCTORS BLACK (B PHASE), RED (A PHASE), WHITE (NEUTRAL), AND GREEN (GROUND).
- CONTRACTOR TO PROVIDE GUTTER TAP.
- THERE SHALL BE A MINIMUM CLEARANCE OF 48" BETWEEN FRONT OF ELECTRICAL EQUIPMENT AND ANY WALL OR OBSTRUCTION.

CADWELD CONNECTIONS OR APPROVED EQUAL		BURNDY CONNECTIONS OR APPROVED EQUAL	
 PARALLEL HORIZONTAL CONDUCTORS PARALLEL THROUGH CONNECTION OF HORIZONTAL CABLES TYPE PT	 HORIZONTAL STEEL SURFACE TO FLAT STEEL SURFACE OR HORIZONTAL PIPE TYPE HS	 VERTICAL PIPE CABLE DOWN AT 45° TO RANGE OF VERTICAL PIPES TYPE VS	 BOND JUMPER FIELD FABRICATED GREEN STRANDED INSULATED TYPE 2-YA-2
 THROUGH CABLE TO GROUND ROD THROUGH CABLE TO TOP OF GROUND ROD TYPE GT	 VERTICAL STEEL SURFACE CABLE DOWN AT 45° TO VERTICAL STEEL SURFACE INCLUDING PIPE TYPE VS	 COPPER LUGS TWO HOLE - LONG BARREL LENGTH TYPE YA-2	

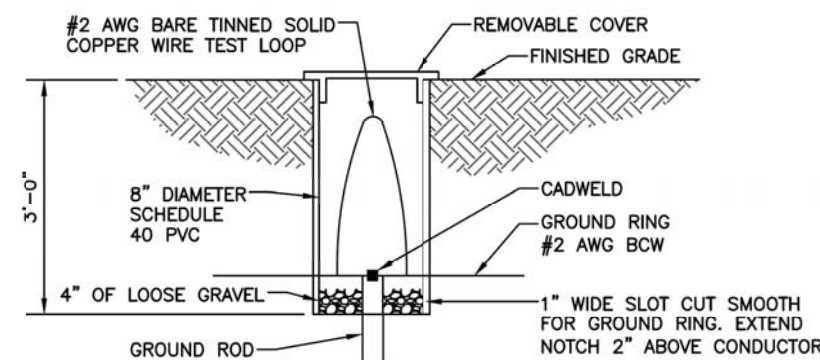
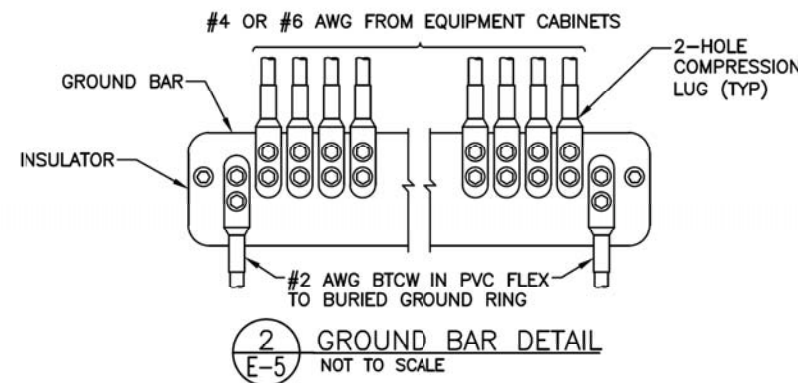
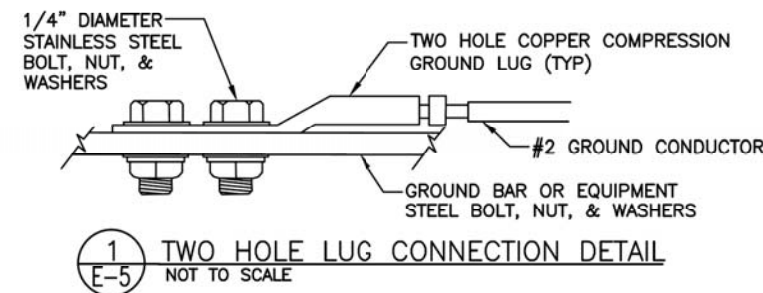

T-Mobile

35 GRIFFIN RD S
BLOOMFIELD, CT 06002
OFFICE: 860-692-7100
FAX: 860-692-7159

PLANS PREPARED BY:

NSS NORTHEAST
 SITE SOLUTIONS
Turnkey Wireless Development
 NORTHEAST SITE SOLUTIONS, LLC
 199 BRICKYARD ROAD
 FARMINGTON CT 06032
 (860) 677-1999

SMW
 ENGINEERING GROUP, INC.
 TOGETHER PLANNING A BETTER TOMORROW



11/03/16

SITE INFORMATION:
CTNH547A
 52 LIBRARY ST.
 SALISBURY, CT 06068

#	DATE	DESCRIPTION
0	10/21/16	ISSUED FOR CLIENT REV.
1	11/03/16	ISSUED FOR CONSTRUCTION

T-MOBILE SITE ID: **CTNH547A** ATC SITE ID: **370630**

SHEET NAME:
ELECTRICAL & GROUNDING DETAILS

SMW #:
 16-2561
 DESIGNER: **BMD**
 CHECKED BY: **RTB**
 ENGINEER: **JDS**

SHEET NUMBER:
E-5

Exhibit D



AMERICAN TOWER®
CORPORATION

This report was prepared for American Tower Corporation by



Structural Analysis Report

Structure : 148.5 ft Monopole
ATC Site Name : Salisbury CT, CT
ATC Site Number : 370630
Engineering Number : OAA686579_C3_03
Proposed Carrier : T-Mobile
Carrier Site Name : ROB9
Carrier Site Number : CTNH547A
Site Location : 52 Library St.
Salisbury, CT 06068-0000
41.980528,-73.418056
County : Litchfield
Date : October 5, 2016
Max Usage : 22%
Result : Pass

Prepared By:
Spencer Collins
CLS

Reviewed By:

COA: PEC.0001553



Table of Contents

Introduction	1
Supporting Documents	1
Analysis	1
Conclusion.....	1
Existing and Reserved Equipment.....	2
Equipment to be Removed.....	2
Proposed Equipment	2
Structure Usages	3
Foundations	3
Deflection, Twist, and Sway.....	3
Standard Conditions	4
Calculations	Attached



Introduction

The purpose of this report is to summarize results of a structural analysis performed on the 148.5 ft monopole to reflect the change in loading by T-Mobile.

Supporting Documents

Tower Drawings	Paul J. Ford Job #29206-0003, dated January 9, 2006
Foundation Drawing	Paul J. Ford Job #29206-0003, dated January 9, 2006
Geotechnical Report	JGI Eastern, Inc. Project #05463G, dated August 11, 2005

Analysis

The tower was analyzed using American Tower Corporation's tower analysis software. This program considers an elastic three-dimensional model and second-order effects per ANSI/TIA-222.

Basic Wind Speed:	90 mph (3-Second Gust, V_{asd}) / 115 mph (3-Second Gust, V_{ult})
Basic Wind Speed w/ Ice:	40 mph (3-Second Gust) w/ 1" radial ice concurrent
Code:	ANSI/TIA-222-G / 2012 IBC / 2016 Connecticut State Building Code
Structure Class:	II
Exposure Category:	B
Topographic Category:	1
Crest Height:	0 ft
Spectral Response:	$S_s = 0.17$, $S_1 = 0.06$
Site Class:	D - Stiff Soil

Conclusion

Based on the analysis results, the structure meets the requirements per the applicable codes listed above. The tower and foundation can support the equipment as described in this report.

If you have any questions or require additional information, please contact American Tower via email at Engineering@americantower.com. Please include the American Tower site name, site number, and engineering number in the subject line for any questions.



Existing and Reserved Equipment

Elevation ¹ (ft)		Qty	Antenna	Mount Type	Lines	Carrier
Mount	RAD					
146.0	150.0	1	RFS Celwave PD220	T-Arms	(1) 1/2" Coax	Salisbury Volunteer Ambulance
	146.0	1	RFS Celwave PD220			Town Of Salisbury
141.0	141.0	6	Powerwave LGP21401	T-Arms	(6) 1/2" Coax (12) 1 5/8" Coax (2) 0.78" 8 AWG 6 (1) 0.39" Fiber Trunk	AT&T Mobility
		1	Raycap DC6-48-60-18-8F			
		6	Ericsson RRUS 11 (Band 12) (55 lb)			
		9	Powerwave 7770.00			
		3	KMW AM-X-CD-16-65-00T-RET			
134.0	134.0	3	Antel BXA-185085/12CF	T-Arms	(18) 1 5/8" Coax	Verizon
		3	Antel BXA-70063/6CF			
		6	Antel LPA-80080/6CF			

Equipment to be Removed

Elevation ¹ (ft)		Qty	Antenna	Mount Type	Lines	Carrier
Mount	RAD					
No loading considered as to be removed						

Proposed Equipment

Elevation ¹ (ft)		Qty	Antenna	Mount Type	Lines	Carrier
Mount	RAD					
123.0	123.0	1	Symmetricom 58532A	T-Arms	(2) 1 5/8" Hybriflex (1) 1/2" Coax	T-Mobile
		3	Ericsson RRUS 11 B12			
		3	Ericsson RRUS 11 B2			
		3	Ericsson RRUS 11 B4			
		3	RFS APX16DWV-16DWVS-E-A20			
		3	Commscope LNX-6515DS-A1M			

¹Mount elevation is defined as height above bottom of steel structure to the bottom of mount, RAD elevation is defined as center of antenna above ground level (AGL).

Install proposed coax inside the pole shaft.



Structure Usages

Structural Component	Controlling Usage	Pass/Fail
Anchor Bolts	18%	Pass
Shaft	22%	Pass
Base Plate	19%	Pass

Foundations

Reaction Component	Original Design Reactions	Factored Design Reactions*	Analysis Reactions	% of Design
Moment (Kips-Ft)	7,150.0	9,652.5	2,042.3	21%
Shear (Kips)	62.0	83.7	20.5	25%

* The design reactions are factored by 1.35 per ANSI/TIA-222-G, Sec. 15.5.1

The structure base reactions resulting from this analysis are acceptable when compared to those shown on the original structure drawings, therefore no modification or reinforcement of the foundation will be required.

Deflection and Sway*

Antenna Elevation (ft)	Antenna	Carrier	Deflection (ft)	Sway (Rotation) (°)
123.0	Symmetricom 58532A	T-Mobile	0.324	0.333
	Ericsson RRUS 11 B12			
	Ericsson RRUS 11 B4			
	Ericsson RRUS 11 B2			
	RFS APX16DWV-16DWVS-E-A20			
	Commscope LNX-6515DS-A1M			

*Deflection and Sway was evaluated considering a design wind speed of 60 mph (3-Second Gust) per ANSI/TIA-222-G



Standard Conditions

All engineering services are performed on the basis that the information used is current and correct. This information may consist of, but is not necessary limited, to:

- Information supplied by the client regarding the structure itself, antenna, mounts and feed line loading on the structure and its components, or other relevant information.
- Information from drawings in the possession of American Tower Corporation, or generated by field inspections or measurements of the structure.

It is the responsibility of the client to ensure that the information provided to A.T. Engineering Service, PLLC and used in the performance of our engineering services is correct and complete. In the absence of information to the contrary, we assume that all structures were constructed in accordance with the drawings and specifications and that their capacity has not significantly changed from the "as new" condition.

Unless explicitly agreed by both the client and American Tower Corporation, all services will be performed in accordance with the current revision of ANSI/TIA -222. The design basic wind speed will be determined based on the minimum basic wind speed as prescribed in ANSI/TIA-222. Although every effort is taken to ensure that the loading considered is adequate to meet the requirements of all applicable regulatory entities, we can provide no assurance to meet any other local and state codes or requirements. If wind and ice loads or other relevant parameters are to be different from the minimum values recommended by the codes, the client shall specify the exact requirement.

All services are performed, results obtained, and recommendations made in accordance with generally accepted engineering principles and practices. A.T. Engineering Service, PLLC is not responsible for the conclusions, opinions and recommendations made by others based on the information we supply.

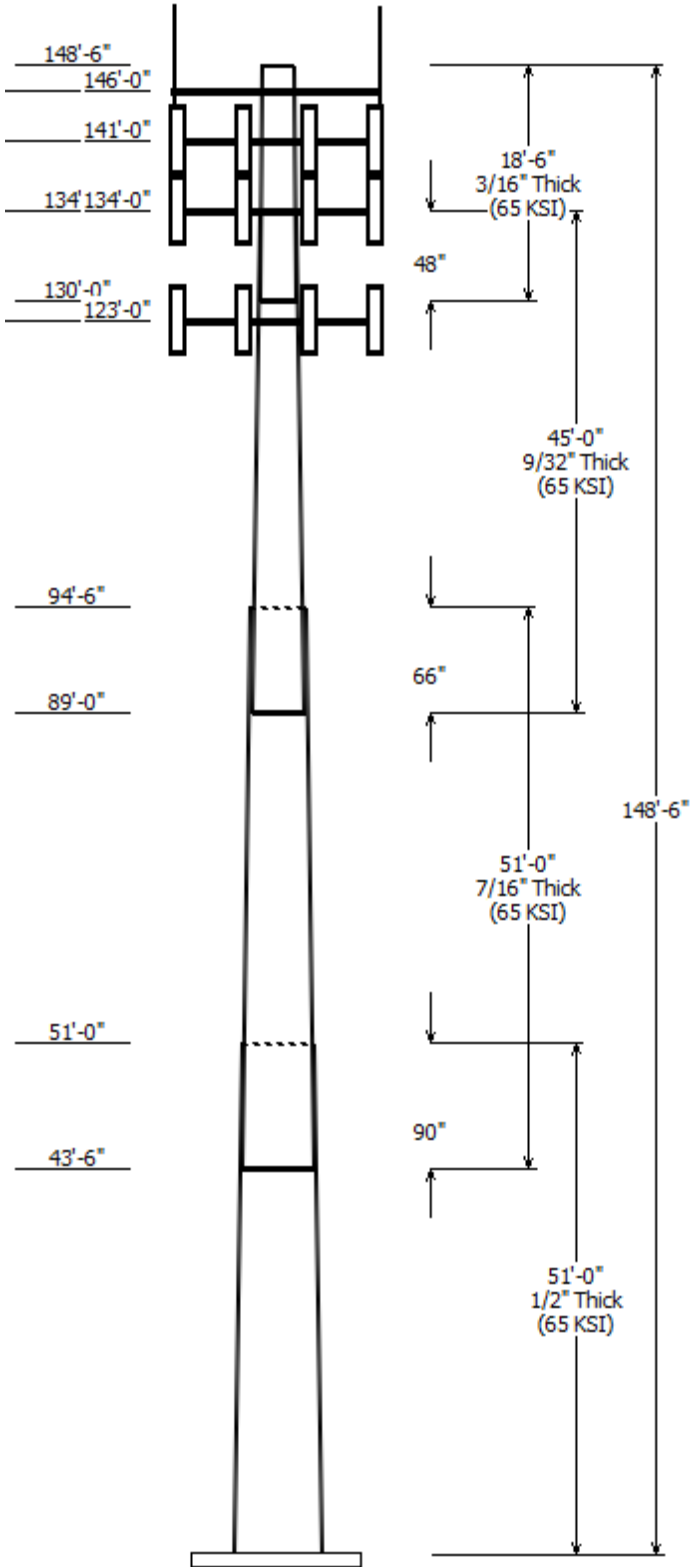

Job Information	
Pole :	370630
Code:	ANSI/TIA-222-G
Description :	149 ft Monopole
Client :	T- Mobile
Struct Class :	II
Location :	Salisbury CT, CT
Shape :	18 Sides
Exposure :	B
Height :	148.50 (ft)
Topo :	1
Base Elev (ft):	0.00
Taper:	0.34001 in/ft

Sections Properties								
Shaft Section	Length (ft)	Diameter (in)		Thick (in)	Joint Type	Overlap Length (in)	Taper (in/ft)	Steel Grade (ksi)
		Across Top	Across Bottom					
1	51.000	55.73	73.08	0.500		0.000	0.340000	65
2	51.000	41.82	59.16	0.438	Slip Joint	90.000	0.340000	65
3	45.000	28.95	44.25	0.281	Slip Joint	66.000	0.340000	65
4	18.500	24.40	30.69	0.188	Slip Joint	48.000	0.340000	65

Discrete Appurtenance			
Attach Elev (ft)	Force Elev (ft)	Qty	Description
146.000	146.000	3	Flat T-Arm
146.000	146.000	1	RFS Celwave PD220
146.000	150.000	1	RFS Celwave PD220
141.000	141.000	3	Flat T-Arm
141.000	141.000	3	KMW AM-X-CD-16-65-00T-RET
141.000	141.000	9	Powerwave 7770.00
141.000	141.000	6	Ericsson RRUS 11 (Band 12) (55
141.000	141.000	1	Raycap DC6-48-60-18-8F
141.000	141.000	6	Powerwave Allgon LGP21401
134.000	134.750	3	Round T-Arm
134.000	134.000	6	Antel LPA-80080/6CF
134.000	134.000	3	Antel BXA-70063/6CF
134.000	134.000	3	Antel BXA-185085/12CF
123.000	123.000	3	Flat T-Arm
123.000	123.000	3	Commscope LNX-6515DS-A1M
123.000	123.000	3	RFS APX16DWV-16DWVS-E-A20
123.000	123.000	3	Ericsson RRUS 11 B2
123.000	123.000	3	Ericsson RRUS 11 B4
123.000	123.000	3	Ericsson RRUS 11 B12
123.000	123.000	1	Symmetricon 58532A

Linear Appurtenance				
Elev (ft)	From	To	Description	Exposed To Wind
0.000	123.0	146.0	1 5/8" Hybriflex	No
0.000	123.0	123.0	1/2" Coax	No
0.000	134.0	134.0	1 5/8" Coax	No
0.000	141.0	141.0	0.39" Fiber Trunk	No
0.000	141.0	141.0	0.78" 8 AWG 6	No
0.000	141.0	141.0	1 5/8" Coax	No
0.000	141.0	141.0	1/2" Coax	No
0.000	146.0	146.0	1/2" Coax	No

Load Cases	
1.2D + 1.6W	90 mph with No Ice
0.9D + 1.6W	90 mph with No Ice (Reduced DL)
1.2D + 1.0Di + 1.0Wi	40 mph with 1.00 in Radial Ice
(1.2 + 0.2Sds) * DL + E	Seismic Equivalent Lateral Forces Method
(1.2 + 0.2Sds) * DL + E	Seismic Equivalent Modal Analysis Method

(0.9 - 0.2Sds) * DL + E Seismic (Reduced DL) Equivalent Lateral
 (0.9 - 0.2Sds) * DL + E Seismic (Reduced DL) Equivalent Modal
 1.0D + 1.0W Serviceability 60 mph

Reactions

Load Case	Moment (kip-ft)	Shear (kip)	Axial (kip)
1.2D + 1.6W	2042.30	20.53	53.50
0.9D + 1.6W	2035.98	20.53	40.12
1.2D + 1.0Di + 1.0Wi	431.54	4.47	85.34
(1.2 + 0.2Sds) * DL + E ELFM	341.18	3.45	52.58
(1.2 + 0.2Sds) * DL + E EMAM	246.77	2.40	52.58
(0.9 - 0.2Sds) * DL + E ELFM	340.02	3.45	36.67
(0.9 - 0.2Sds) * DL + E EMAM	245.87	2.40	36.67
1.0D + 1.0W	566.10	5.70	44.59

Dish Deflections

Load Case	Attach Elev (ft)	Deflection (in)	Rotation (deg)
	0.00	0.000	0.000

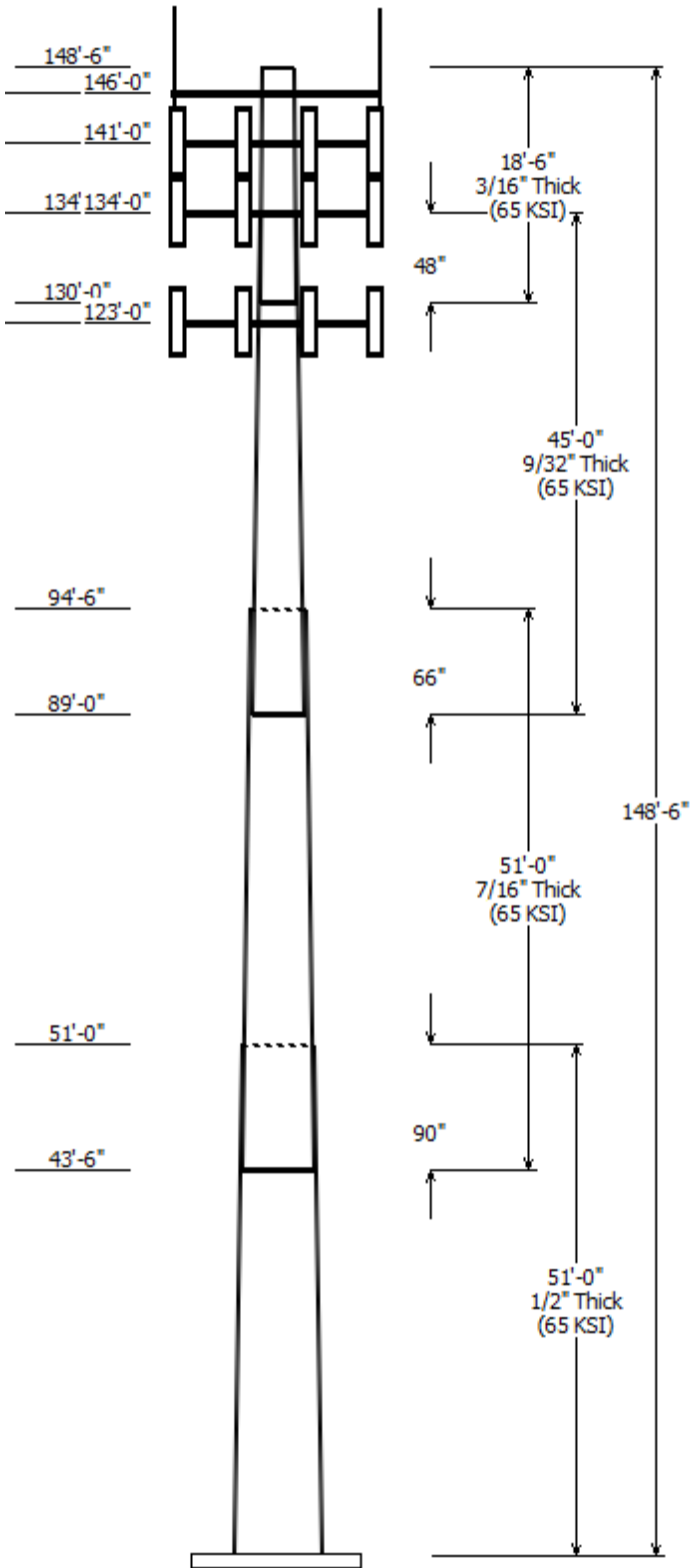

Load Case : 1.2D + 1.6W
Max Ratio 22.43% at 94.5 ft

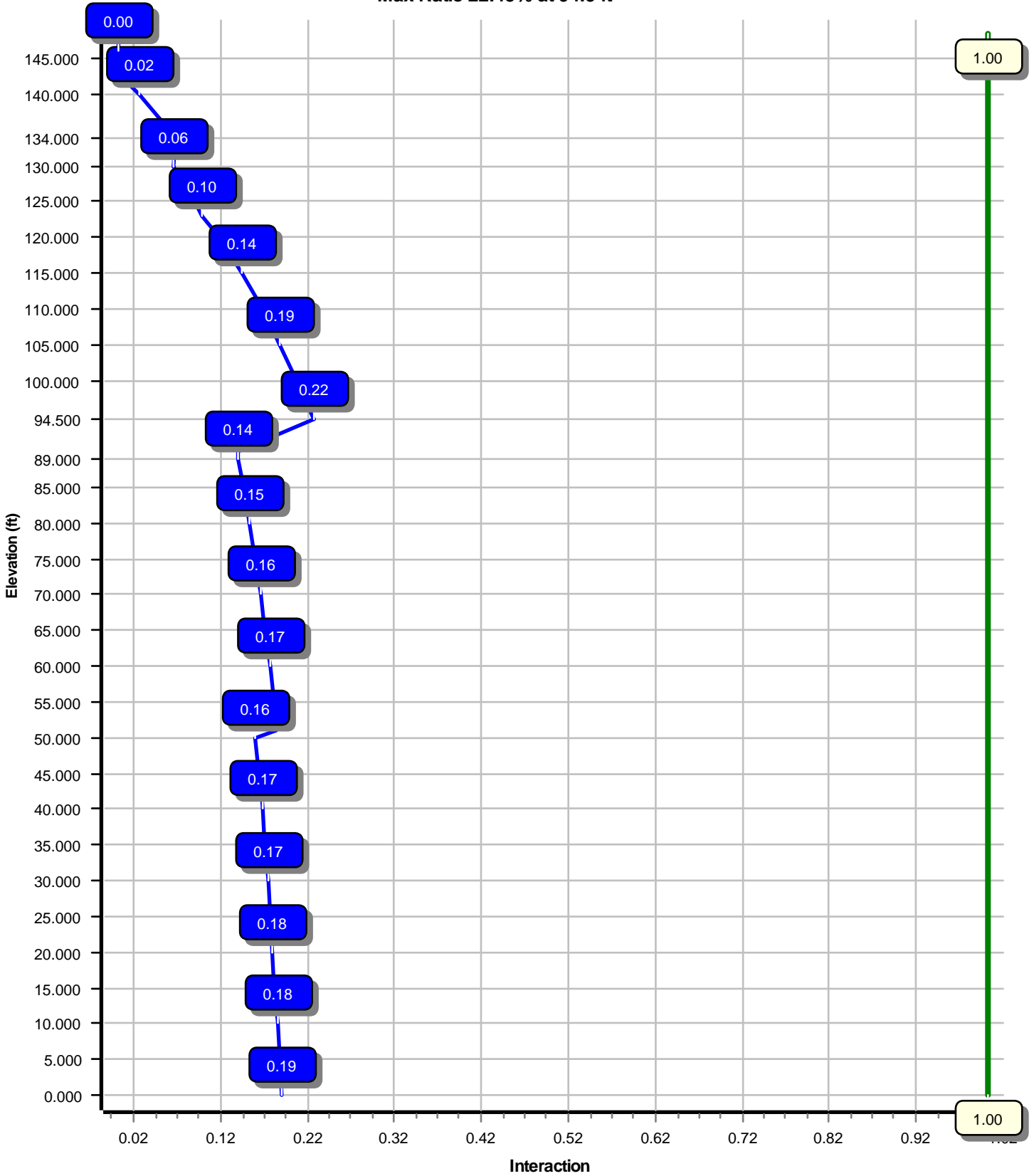

Site Number: 370630

Code: ANSI/TIA-222-G

© 2007 - 2016 by ATC IP LLC. All rights reserved.

Site Name: Salisbury CT, CT

Engineering Number: OAA686579_C3_03

10/5/2016 8:39:16 PM

Customer: T- Mobile

Analysis Parameters

Location:	Litchfield County, CT		
Code:	ANSI/TIA-222-G	Height (ft):	148.
Shape:	18 Sides	Base Diameter (in):	73.08
Pole Type:	Taper	Top Diameter (in):	24.40
Pole Manufacturer:	PennSummit Tub	Taper (in/ft) :	0.340

Ice & Wind Parameters

Structure Class:	II	Design Wind Speed Without Ice:	90 mph
Exposure Category:	B	Design Wind Speed With Ice:	40 mph
Topographic Category:	1	Operational Wind Speed:	60 mph
Crest Height:	0.0 ft	Design Ice Thickness:	0.50 in

Seismic Parameters

Analysis Method:	Equivalent Modal Analysis & Equivalent Lateral Force Methods		
Site Class:	D - Stiff Soil		
Period Based on Rayleigh Method (sec):	1.17		
T _L (sec):	6	p:	1.3
S _s :	0.174	S ₁ :	0.065
F _a :	1.600	F _v :	2.400
S _{ds} :	0.186	S _{d1} :	0.104
		C _s :	0.059
		C _s Max:	0.059
		C _s Min:	0.030

Load Cases

1.2D + 1.6W	90 mph with No Ice
0.9D + 1.6W	90 mph with No Ice (Reduced DL)
1.2D + 1.0Di + 1.0Wi	40 mph with 1.00 in Radial Ice
(1.2 + 0.2S _{ds}) * DL + E ELFM	Seismic Equivalent Lateral Forces Method
(1.2 + 0.2S _{ds}) * DL + E EMAM	Seismic Equivalent Modal Analysis Method
(0.9 - 0.2S _{ds}) * DL + E ELFM	Seismic (Reduced DL) Equivalent Lateral Forces Method
(0.9 - 0.2S _{ds}) * DL + E EMAM	Seismic (Reduced DL) Equivalent Modal Analysis Method
1.0D + 1.0W	Serviceability 60 mph

Site Number: 370630

Code: ANSI/TIA-222-G

© 2007 - 2016 by ATC IP LLC. All rights reserved.

Site Name: Salisbury CT, CT

Engineering Number: OAA686579_C3_03

10/5/2016 8:39:16 PM

Customer: T-Mobile

Shaft Section Properties

Sect Info	Length (ft)	Thick (in)	Fy (ksi)	Joint Type	Joint Len (in)	Weight (lb)	Bottom						Top						
							Dia (in)	Elev (ft)	Area (in ²)	Ix (in ⁴)	W/t Ratio	D/t Ratio	Dia (in)	Elev (ft)	Area (in ²)	Ix (in ⁴)	W/t Ratio	D/t Ratio	Taper (in/ft)
1-18	51.000	0.5000	65		0.00	17,601	73.08	0.00	115.18	76659.4	24.36	146.16	55.73	51.00	87.66	33795.1	18.25	111.48	0.340018
2-18	51.000	0.4375	65	Slip	90.00	12,062	59.16	43.50	81.55	35532.9	22.43	135.23	41.82	94.50	57.47	12435.9	15.45	95.60	0.340018
3-18	45.000	0.2813	65	Slip	66.00	4,966	44.25	89.00	39.26	9592.3	26.33	157.33	28.95	134.00	25.60	2659.4	16.74	102.93	0.340018
4-18	18.500	0.1875	65	Slip	48.00	1,025	30.69	130.00	18.15	2133.9	27.45	163.68	24.40	148.50	14.41	1067.2	21.54	130.13	0.340018
Shaft Weight						35,654													

Discrete Appurtenance Properties

Attach Elev (ft)	Description	Qty	Weight (lb)	No Ice EPAa (sf)	Orientation Factor	Weight (lb)	Ice EPAa (sf)	Orientation Factor	Distance From Face (ft)	Vert Ecc (ft)
146.00	Flat T-Arm	3	250.00	12.900	0.67	528.39	23.793	0.67	0.000	0.000
146.00	RFS Celwave PD220	1	25.00	5.500	1.00	395.40	14.963	1.00	0.000	4.000
146.00	RFS Celwave PD220	1	25.00	5.500	1.00	395.40	14.963	1.00	0.000	0.000
141.00	Ericsson RRUS 11 (Band 12)	6	55.00	2.520	0.67	170.01	3.401	0.67	0.000	0.000
141.00	Flat T-Arm	3	250.00	12.900	0.67	527.41	23.755	0.67	0.000	0.000
141.00	KMW AM-X-CD-16-65-00T-	3	48.50	8.020	0.79	315.23	9.772	0.79	0.000	0.000
141.00	Powerwave 7770.00	9	35.00	5.510	0.77	227.49	6.941	0.77	0.000	0.000
141.00	Powerwave Allgon LGP21401	6	14.10	1.100	0.50	64.50	1.738	0.50	0.000	0.000
141.00	Raycap DC6-48-60-18-8F	1	32.80	1.280	1.00	165.12	3.091	1.00	0.000	0.000
134.00	Antel BXA-185085/12CF	3	13.00	4.790	0.88	186.15	6.418	0.88	0.000	0.000
134.00	Antel BXA-70063/6CF	3	17.00	7.570	0.75	253.07	9.273	0.75	0.000	0.000
134.00	Antel LPA-80080/6CF	6	21.00	8.630	0.75	293.75	5.931	0.75	0.000	0.000
134.00	Round T-Arm	3	250.00	9.700	0.67	525.69	20.575	0.67	0.000	0.750
123.00	Commscope LNX-6515DS-	3	50.30	11.450	0.84	413.85	13.628	0.84	0.000	0.000
123.00	Ericsson RRUS 11 B12	3	50.70	2.790	0.67	171.70	3.701	0.67	0.000	0.000
123.00	Ericsson RRUS 11 B2	3	50.70	2.790	0.67	171.70	3.701	0.67	0.000	0.000
123.00	Ericsson RRUS 11 B4	3	50.70	2.790	0.67	171.70	3.701	0.67	0.000	0.000
123.00	Flat T-Arm	3	250.00	12.900	0.67	523.41	23.599	0.67	0.000	0.000
123.00	RFS APX16DWV-16DWVS-E-	3	40.70	6.590	0.66	233.95	8.082	0.66	0.000	0.000
123.00	Symmetricom 58532A	1	0.40	0.220	0.50	10.84	0.703	0.50	0.000	0.000
Totals		67	4903.60			18,250.47			Number of Loadings : 20	

Linear Appurtenance Properties

Elev From (ft)	Elev To (ft)	Qty	Description	Coax Diameter (in)	Coax Weight (lb/ft)	Projected Flat	Width (in)	Exposed To Wind	Carrier
0.00	146.00	1	1/2" Coax	0.63	0.15	N	0.00	N	Town of Salisbury
0.00	141.00	1	0.39" Fiber Trunk	0.39	0.07	N	0.00	N	AT&T Mobility
0.00	141.00	2	0.78" 8 AWG 6	0.78	0.59	N	0.00	N	AT&T Mobility
0.00	141.00	12	1 5/8" Coax	1.98	0.82	N	0.00	N	AT&T Mobility
0.00	141.00	6	1/2" Coax	0.63	0.15	N	0.00	N	AT&T Mobility
0.00	134.00	18	1 5/8" Coax	1.98	0.82	N	0.00	N	Verizon
0.00	123.00	2	1 5/8" Hybriflex	1.98	1.30	N	0.00	N	T-Mobile
0.00	123.00	1	1/2" Coax	0.63	0.15	N	0.00	N	T-Mobile

Site Number: 370630

Code: ANSI/TIA-222-G

© 2007 - 2016 by ATC IP LLC. All rights reserved.

Site Name: Salisbury CT, CT

Engineering Number: OAA686579_C3_03

10/5/2016 8:39:17 PM

Customer: T- Mobile

Segment Properties (Max Len : 5. ft)

Seg Top Elev (ft)	Description	Thick (in)	Flat Dia (in)	Area (in ²)	Ix (in ⁴)	W/t Ratio	D/t Ratio	F'y (ksi)	S (in ³)	Z (in ³)	Weight (lb)
0.00		0.5000	73.080	115.180	76,659.4	24.36	146.16	72.7	2066.	0.0	0.0
5.00		0.5000	71.380	112.482	71,397.6	23.76	142.76	73.5	1970.	0.0	1,936.7
10.00		0.5000	69.680	109.784	66,382.4	23.16	139.36	74.2	1876.	0.0	1,890.8
15.00		0.5000	67.980	107.086	61,607.6	22.56	135.96	74.9	1785.	0.0	1,844.9
20.00		0.5000	66.280	104.389	57,067.5	21.96	132.56	75.6	1695.	0.0	1,799.0
25.00		0.5000	64.580	101.691	52,756.1	21.36	129.16	76.3	1609.	0.0	1,753.1
30.00		0.5000	62.879	98.993	48,667.6	20.76	125.76	77.0	1524.	0.0	1,707.2
35.00		0.5000	61.179	96.295	44,795.9	20.16	122.36	77.7	1442.	0.0	1,661.3
40.00		0.5000	59.479	93.597	41,135.2	19.56	118.96	78.4	1362.	0.0	1,615.4
43.50	Bot - Section 2	0.5000	58.289	91.708	38,695.0	19.15	116.58	78.9	1307.	0.0	1,103.5
45.00		0.5000	57.779	90.899	37,679.5	18.97	115.56	79.1	1284.	0.0	880.4
50.00		0.5000	56.079	88.201	34,423.1	18.37	112.16	79.8	1209.	0.0	2,878.9
51.00	Top - Section 1	0.4375	56.614	78.005	31,102.0	21.41	129.40	76.2	1082.	0.0	565.4
55.00		0.4375	55.254	76.117	28,897.3	20.86	126.29	76.9	1030.	0.0	1,048.9
60.00		0.4375	53.554	73.756	26,291.2	20.17	122.41	77.7	966.9	0.0	1,275.0
65.00		0.4375	51.854	71.395	23,846.6	19.49	118.52	78.5	905.8	0.0	1,234.8
70.00		0.4375	50.154	69.035	21,558.5	18.80	114.64	79.3	846.6	0.0	1,194.6
75.00		0.4375	48.454	66.674	19,421.6	18.12	110.75	80.1	789.5	0.0	1,154.5
80.00		0.4375	46.754	64.313	17,430.8	17.43	106.87	80.9	734.3	0.0	1,114.3
85.00		0.4375	45.054	61.953	15,581.0	16.75	102.98	81.7	681.2	0.0	1,074.1
89.00	Bot - Section 3	0.4375	43.693	60.064	14,199.1	16.20	99.87	82.3	640.1	0.0	830.4
90.00		0.4375	43.353	59.592	13,866.9	16.06	99.09	82.5	630.0	0.0	336.7
94.50	Top - Section 2	0.2813	42.386	37.592	8,419.8	25.16	150.68	71.8	391.3	0.0	1,482.3
95.00		0.2813	42.216	37.440	8,318.3	25.05	150.07	71.9	388.1	0.0	63.8
100.0		0.2813	40.516	35.922	7,347.0	23.99	144.03	73.2	357.2	0.0	624.1
105.0		0.2813	38.816	34.404	6,454.5	22.92	137.99	74.4	327.5	0.0	598.3
110.0		0.2813	37.116	32.886	5,637.3	21.85	131.94	75.7	299.2	0.0	572.4
115.0		0.2813	35.416	31.368	4,892.2	20.79	125.90	76.9	272.1	0.0	546.6
120.0		0.2813	33.716	29.851	4,215.9	19.72	119.86	78.2	246.3	0.0	520.8
123.0		0.2813	32.695	28.940	3,841.7	19.08	116.23	79.0	231.4	0.0	300.1
125.0		0.2813	32.015	28.333	3,604.9	18.66	113.81	79.5	221.8	0.0	194.9
130.0	Bot - Section 4	0.2813	30.315	26.815	3,056.0	17.59	107.77	80.7	198.6	0.0	469.1
134.0	Top - Section 3	0.1875	29.330	17.343	1,861.0	26.17	156.43	70.6	125.0	0.0	598.3
135.0		0.1875	28.990	17.141	1,796.6	25.85	154.61	71.0	122.1	0.0	58.7
140.0		0.1875	27.290	16.129	1,496.9	24.25	145.55	72.9	108.0	0.0	283.0
141.0		0.1875	26.950	15.927	1,441.2	23.93	143.73	73.3	105.3	0.0	54.5
145.0		0.1875	25.590	15.117	1,232.5	22.65	136.48	74.8	94.9	0.0	211.3
146.0		0.1875	25.250	14.915	1,183.6	22.33	134.67	75.1	92.3	0.0	51.1
148.5		0.1875	24.400	14.409	1,067.2	21.54	130.13	76.1	86.2	0.0	124.7
35,654.0											

Load Case: 1.2D + 1.6W	90 mph with No Ice	19 Iterations
Gust Response Factor :1.10		Wind Importance Factor :1.00
Dead Load Factor :1.20		
Wind Load Factor :1.60		

Applied Segment Forces Summary

Seg Elev (ft)	Description	Shaft Forces		Discrete Forces			Linear Forces		Sum of Forces				
		Wind FX (lb)	Dead Load (lb)	Wind FX (lb)	Torsion MY (lb-ft)	Moment MZ (lb-ft)	Dead Load (lb)	Wind FX (lb)	Dead Load (lb)	Wind FX (lb)	Dead Load (lb)	Torsion MY (lb-ft)	Moment MZ (lb)
0.00		241.0	0.0					0.0	0.0	241.0	0.0	0.0	0.0
5.00		476.4	2,324.1					0.0	177.9	476.4	2,502.0	0.0	0.0
10.00		465.1	2,269.0					0.0	177.9	465.1	2,446.9	0.0	0.0
15.00		453.7	2,213.9					0.0	177.9	453.7	2,391.8	0.0	0.0
20.00		442.4	2,158.8					0.0	177.9	442.4	2,336.7	0.0	0.0
25.00		431.0	2,103.7					0.0	177.9	431.0	2,281.6	0.0	0.0
30.00		424.6	2,048.6					0.0	177.9	424.6	2,226.5	0.0	0.0
35.00		426.7	1,993.6					0.0	177.9	426.7	2,171.5	0.0	0.0
40.00		366.1	1,938.5					0.0	177.9	366.1	2,116.4	0.0	0.0
43.50	Bot - Section 2	217.3	1,324.2					0.0	124.5	217.3	1,448.7	0.0	0.0
45.00		286.1	1,056.5					0.0	53.4	286.1	1,109.9	0.0	0.0
50.00		264.2	3,454.7					0.0	177.9	264.2	3,632.6	0.0	0.0
51.00	Top - Section 1	219.9	678.5					0.0	35.6	219.9	714.1	0.0	0.0
55.00		394.7	1,258.7					0.0	142.3	394.7	1,401.0	0.0	0.0
60.00		435.9	1,530.0					0.0	177.9	435.9	1,707.9	0.0	0.0
65.00		431.9	1,481.8					0.0	177.9	431.9	1,659.7	0.0	0.0
70.00		426.7	1,433.6					0.0	177.9	426.7	1,611.5	0.0	0.0
75.00		420.4	1,385.4					0.0	177.9	420.4	1,563.3	0.0	0.0
80.00		413.2	1,337.2					0.0	177.9	413.2	1,515.1	0.0	0.0
85.00		365.4	1,289.0					0.0	177.9	365.4	1,466.9	0.0	0.0
89.00	Bot - Section 3	201.0	996.5					0.0	142.3	201.0	1,138.8	0.0	0.0
90.00		219.0	404.0					0.0	35.6	219.0	439.6	0.0	0.0
94.50	Top - Section 2	198.4	1,778.8					0.0	160.1	198.4	1,938.9	0.0	0.0
95.00		213.1	76.6					0.0	17.8	213.1	94.4	0.0	0.0
100.00		381.7	748.9					0.0	177.9	381.7	926.8	0.0	0.0
105.00		370.8	717.9					0.0	177.9	370.8	895.8	0.0	0.0
110.00		359.3	686.9					0.0	177.9	359.3	864.8	0.0	0.0
115.00		347.2	655.9					0.0	177.9	347.2	833.8	0.0	0.0
120.00		269.8	624.9					0.0	177.9	269.8	802.8	0.0	0.0
123.00	Appertunance(s)	164.1	360.1	2,417.9	0.0	0.0	1,775.6	0.0	106.7	2,581.9	2,242.5	0.0	0.0
125.00		222.2	233.9					0.0	64.6	222.2	298.4	0.0	0.0
130.00	Bot - Section 4	279.8	563.0					0.0	161.4	279.8	724.4	0.0	0.0
134.00	Top - Section 3	152.4	717.9	2,587.3	0.0	409.2	1,159.2	0.0	129.1	2,739.7	2,006.3	0.0	0.0
135.00		175.1	70.4					0.0	14.6	175.1	85.0	0.0	0.0
140.00		173.4	339.6					0.0	72.8	173.4	412.5	0.0	0.0
141.00	Appertunance(s)	137.8	65.4	2,909.2	0.0	0.0	1,989.5	0.0	14.6	3,047.0	2,069.5	0.0	0.0
145.00		136.3	253.5					0.0	0.7	136.3	254.2	0.0	0.0
146.00	Appertunance(s)	92.0	61.3	1,079.6	0.0	677.1	960.0	0.0	0.2	1,171.6	1,021.5	0.0	0.0
148.50		65.3	149.7					0.0	0.0	65.3	149.7	0.0	0.0
								Totals:		20,755.3	53,503.3	0.00	0.00

Site Number: 370630

Code: ANSI/TIA-222-G

© 2007 - 2016 by ATC IP LLC. All rights reserved.

Site Name: Salisbury CT, CT

Engineering Number: OAA686579_C3_03

10/5/2016 8:39:18 PM

Customer: T-Mobile

Load Case: 1.2D + 1.6W

90 mph with No Ice

19 Iterations

Gust Response Factor :1.10

Wind Importance Factor :1.00

Dead Load Factor :1.20

Wind Load Factor :1.60

Calculated Forces

Seg Elev (ft)	Pu FY (-) (kips)	Vu FX (-) (kips)	Tu MY (ft-kips)	Mu MZ (ft-kips)	Mu MX (ft-kips)	Resultant Moment (ft-kips)	phi Pn (kips)	phi Vn (kips)	phi Tn (ft-kips)	phi Mn (ft-kips)	Total Deflect (in)	Rotation (deg)	Ratio
0.00	-53.50	-20.53	0.00	-2,042.30	0.00	2,042.30	7,541.17	3,770.58	22,511.9	11,272.6	0.00	0.00	0.188
5.00	-50.98	-20.09	0.00	-1,939.65	0.00	1,939.65	7,435.91	3,717.96	21,674.1	10,853.2	0.02	-0.04	0.186
10.00	-48.52	-19.65	0.00	-1,839.21	0.00	1,839.21	7,327.23	3,663.62	20,841.5	10,436.2	0.08	-0.07	0.183
15.00	-46.12	-19.23	0.00	-1,740.95	0.00	1,740.95	7,215.13	3,607.56	20,014.7	10,022.2	0.18	-0.11	0.180
20.00	-43.77	-18.81	0.00	-1,644.82	0.00	1,644.82	7,099.60	3,549.80	19,194.4	9,611.47	0.32	-0.15	0.177
25.00	-41.48	-18.40	0.00	-1,550.78	0.00	1,550.78	6,980.64	3,490.32	18,381.3	9,204.34	0.50	-0.19	0.174
30.00	-39.24	-17.99	0.00	-1,458.78	0.00	1,458.78	6,858.27	3,429.13	17,576.2	8,801.21	0.72	-0.23	0.171
35.00	-37.06	-17.59	0.00	-1,368.81	0.00	1,368.81	6,732.46	3,366.23	16,779.9	8,402.42	0.99	-0.27	0.168
40.00	-34.93	-17.23	0.00	-1,280.89	0.00	1,280.89	6,603.24	3,301.62	15,992.9	8,008.36	1.30	-0.32	0.165
43.50	-33.48	-17.02	0.00	-1,220.58	0.00	1,220.58	6,510.74	3,255.37	15,448.0	7,735.51	1.54	-0.35	0.163
45.00	-32.36	-16.74	0.00	-1,195.05	0.00	1,195.05	6,470.58	3,235.29	15,216.1	7,619.37	1.65	-0.36	0.162
50.00	-28.72	-16.47	0.00	-1,111.35	0.00	1,111.35	6,334.51	3,167.25	14,450.1	7,235.83	2.05	-0.40	0.158
51.00	-28.00	-16.25	0.00	-1,094.89	0.00	1,094.89	5,351.19	2,675.60	12,353.0	6,185.72	2.14	-0.41	0.182
55.00	-26.59	-15.87	0.00	-1,029.88	0.00	1,029.88	5,265.80	2,632.90	11,859.3	5,938.51	2.50	-0.45	0.179
60.00	-24.88	-15.44	0.00	-950.55	0.00	950.55	5,155.98	2,577.99	11,249.0	5,632.89	2.99	-0.50	0.174
65.00	-23.21	-15.01	0.00	-873.37	0.00	873.37	5,042.74	2,521.37	10,646.9	5,331.40	3.54	-0.55	0.168
70.00	-21.59	-14.59	0.00	-798.32	0.00	798.32	4,926.07	2,463.04	10,053.8	5,034.40	4.14	-0.60	0.163
75.00	-20.02	-14.17	0.00	-725.39	0.00	725.39	4,805.98	2,402.99	9,470.41	4,742.24	4.79	-0.65	0.157
80.00	-18.49	-13.75	0.00	-654.55	0.00	654.55	4,682.46	2,341.23	8,897.37	4,455.30	5.50	-0.70	0.151
85.00	-17.02	-13.38	0.00	-585.79	0.00	585.79	4,555.52	2,277.76	8,335.45	4,173.92	6.25	-0.75	0.144
89.00	-15.88	-13.17	0.00	-532.27	0.00	532.27	4,451.50	2,225.75	7,894.42	3,953.08	6.90	-0.79	0.138
90.00	-15.44	-12.96	0.00	-519.10	0.00	519.10	4,425.16	2,212.58	7,785.39	3,898.48	7.06	-0.80	0.137
94.50	-13.50	-12.73	0.00	-460.80	0.00	460.80	2,429.52	1,214.76	4,208.21	2,107.23	7.84	-0.84	0.224
95.00	-13.40	-12.53	0.00	-454.43	0.00	454.43	2,423.93	1,211.97	4,181.46	2,093.84	7.93	-0.85	0.223
100.00	-12.46	-12.15	0.00	-391.78	0.00	391.78	2,366.19	1,183.09	3,915.26	1,960.54	8.86	-0.92	0.205
105.00	-11.56	-11.78	0.00	-331.04	0.00	331.04	2,305.01	1,152.51	3,651.76	1,828.59	9.86	-0.99	0.186
110.00	-10.69	-11.41	0.00	-272.15	0.00	272.15	2,240.42	1,120.21	3,391.69	1,698.37	10.94	-1.06	0.165
115.00	-9.85	-11.06	0.00	-215.08	0.00	215.08	2,172.39	1,086.20	3,135.78	1,570.22	12.08	-1.12	0.142
120.00	-9.04	-10.78	0.00	-159.77	0.00	159.77	2,100.95	1,050.47	2,884.74	1,444.51	13.28	-1.17	0.115
123.00	-6.85	-8.16	0.00	-127.43	0.00	127.43	2,056.44	1,028.22	2,736.75	1,370.41	14.03	-1.20	0.096
125.00	-6.55	-7.93	0.00	-111.11	0.00	111.11	2,026.08	1,013.04	2,639.30	1,321.61	14.54	-1.22	0.087
130.00	-5.83	-7.64	0.00	-71.46	0.00	71.46	1,947.78	973.89	2,400.18	1,201.87	15.84	-1.26	0.063
134.00	-3.88	-4.86	0.00	-40.49	0.00	40.49	1,102.25	551.13	1,321.80	661.88	16.90	-1.28	0.065
135.00	-3.80	-4.68	0.00	-35.63	0.00	35.63	1,095.19	547.60	1,297.91	649.92	17.17	-1.28	0.058
140.00	-3.39	-4.50	0.00	-12.23	0.00	12.23	1,057.85	528.92	1,179.18	590.46	18.52	-1.30	0.024
141.00	-1.39	-1.41	0.00	-7.73	0.00	7.73	1,049.97	524.98	1,155.61	578.66	18.80	-1.30	0.015
145.00	-1.14	-1.26	0.00	-2.11	0.00	2.11	1,017.07	508.54	1,062.12	531.85	19.89	-1.31	0.005
146.00	-0.15	-0.07	0.00	-0.17	0.00	0.17	1,008.51	504.25	1,038.98	520.26	20.16	-1.31	0.000
148.50	0.00	-0.07	0.00	0.00	0.00	0.00	986.50	493.25	981.57	491.52	20.85	-1.31	0.000

Site Number: 370630

Code: ANSI/TIA-222-G

© 2007 - 2016 by ATC IP LLC. All rights reserved.

Site Name: Salisbury CT, CT

Engineering Number: OAA686579_C3_03

10/5/2016 8:39:18 PM

Customer: T- Mobile

Load Case: 0.9D + 1.6W

90 mph with No Ice (Reduced DL)

19 Iterations

Gust Response Factor :1.10

Wind Importance Factor :1.00

Dead Load Factor :0.90

Wind Load Factor :1.60

Applied Segment Forces Summary

Seg Elev (ft)	Description	Shaft Forces		Discrete Forces			Linear Forces		Sum of Forces				
		Wind FX (lb)	Dead Load (lb)	Wind FX (lb)	Torsion MY (lb-ft)	Moment MZ (lb-ft)	Dead Load (lb)	Wind FX (lb)	Dead Load (lb)	Wind FX (lb)	Dead Load (lb)	Torsion MY (lb-ft)	Moment MZ (lb)
0.00		241.0	0.0					0.0	0.0	241.0	0.0	0.0	0.0
5.00		476.4	1,743.0					0.0	133.4	476.4	1,876.5	0.0	0.0
10.00		465.1	1,701.7					0.0	133.4	465.1	1,835.2	0.0	0.0
15.00		453.7	1,660.4					0.0	133.4	453.7	1,793.8	0.0	0.0
20.00		442.4	1,619.1					0.0	133.4	442.4	1,752.5	0.0	0.0
25.00		431.0	1,577.8					0.0	133.4	431.0	1,711.2	0.0	0.0
30.00		424.6	1,536.5					0.0	133.4	424.6	1,669.9	0.0	0.0
35.00		426.7	1,495.2					0.0	133.4	426.7	1,628.6	0.0	0.0
40.00		366.1	1,453.9					0.0	133.4	366.1	1,587.3	0.0	0.0
43.50	Bot - Section 2	217.3	993.1					0.0	93.4	217.3	1,086.5	0.0	0.0
45.00		286.1	792.4					0.0	40.0	286.1	832.4	0.0	0.0
50.00		264.2	2,591.0					0.0	133.4	264.2	2,724.4	0.0	0.0
51.00	Top - Section 1	219.9	508.9					0.0	26.7	219.9	535.6	0.0	0.0
55.00		394.7	944.0					0.0	106.7	394.7	1,050.7	0.0	0.0
60.00		435.9	1,147.5					0.0	133.4	435.9	1,280.9	0.0	0.0
65.00		431.9	1,111.3					0.0	133.4	431.9	1,244.7	0.0	0.0
70.00		426.7	1,075.2					0.0	133.4	426.7	1,208.6	0.0	0.0
75.00		420.4	1,039.0					0.0	133.4	420.4	1,172.4	0.0	0.0
80.00		413.2	1,002.9					0.0	133.4	413.2	1,136.3	0.0	0.0
85.00		365.4	966.7					0.0	133.4	365.4	1,100.1	0.0	0.0
89.00	Bot - Section 3	201.0	747.4					0.0	106.7	201.0	854.1	0.0	0.0
90.00		219.0	303.0					0.0	26.7	219.0	329.7	0.0	0.0
94.50	Top - Section 2	198.4	1,334.1					0.0	120.1	198.4	1,454.2	0.0	0.0
95.00		213.1	57.4					0.0	13.3	213.1	70.8	0.0	0.0
100.00		381.7	561.7					0.0	133.4	381.7	695.1	0.0	0.0
105.00		370.8	538.4					0.0	133.4	370.8	671.9	0.0	0.0
110.00		359.3	515.2					0.0	133.4	359.3	648.6	0.0	0.0
115.00		347.2	491.9					0.0	133.4	347.2	625.4	0.0	0.0
120.00		269.8	468.7					0.0	133.4	269.8	602.1	0.0	0.0
123.00	Appertunance(s)	164.1	270.1	2,417.9	0.0	0.0	1,331.7	0.0	80.1	2,581.9	1,681.9	0.0	0.0
125.00		222.2	175.4					0.0	48.4	222.2	223.8	0.0	0.0
130.00	Bot - Section 4	279.8	422.2					0.0	121.0	279.8	543.3	0.0	0.0
134.00	Top - Section 3	152.4	538.5	2,587.3	0.0	409.2	869.4	0.0	96.8	2,739.7	1,504.7	0.0	0.0
135.00		175.1	52.8					0.0	10.9	175.1	63.7	0.0	0.0
140.00		173.4	254.7					0.0	54.6	173.4	309.3	0.0	0.0
141.00	Appertunance(s)	137.8	49.1	2,909.2	0.0	0.0	1,492.1	0.0	10.9	3,047.0	1,552.1	0.0	0.0
145.00		136.3	190.1					0.0	0.5	136.3	190.7	0.0	0.0
146.00	Appertunance(s)	92.0	46.0	1,079.6	0.0	677.1	720.0	0.0	0.1	1,171.6	766.1	0.0	0.0
148.50		65.3	112.3					0.0	0.0	65.3	112.3	0.0	0.0
Totals:										20,755.3	40,127.5	0.00	0.00

Site Number: 370630

Code: ANSI/TIA-222-G

© 2007 - 2016 by ATC IP LLC. All rights reserved.

Site Name: Salisbury CT, CT

Engineering Number: OAA686579_C3_03

10/5/2016 8:39:20 PM

Customer: T-Mobile

Load Case: 0.9D + 1.6W

90 mph with No Ice (Reduced DL)

19 Iterations

Gust Response Factor :1.10

Wind Importance Factor :1.00

Dead Load Factor :0.90

Wind Load Factor :1.60

Calculated Forces

Seg Elev (ft)	Pu FY (-) (kips)	Vu FX (-) (kips)	Tu MY (ft-kips)	Mu MZ (ft-kips)	Mu MX (ft-kips)	Resultant Moment (ft-kips)	phi Pn (kips)	phi Vn (kips)	phi Tn (ft-kips)	phi Mn (ft-kips)	Total Deflect (in)	Rotation (deg)	Ratio
0.00	-40.12	-20.53	0.00	-2,035.98	0.00	2,035.98	7,541.17	3,770.58	22,511.9	11,272.6	0.00	0.00	0.186
5.00	-38.23	-20.08	0.00	-1,933.35	0.00	1,933.35	7,435.91	3,717.96	21,674.1	10,853.2	0.02	-0.04	0.183
10.00	-36.38	-19.63	0.00	-1,832.97	0.00	1,832.97	7,327.23	3,663.62	20,841.5	10,436.2	0.08	-0.07	0.181
15.00	-34.58	-19.20	0.00	-1,734.81	0.00	1,734.81	7,215.13	3,607.56	20,014.7	10,022.2	0.18	-0.11	0.178
20.00	-32.81	-18.77	0.00	-1,638.82	0.00	1,638.82	7,099.60	3,549.80	19,194.4	9,611.47	0.32	-0.15	0.175
25.00	-31.09	-18.36	0.00	-1,544.94	0.00	1,544.94	6,980.64	3,490.32	18,381.3	9,204.34	0.50	-0.19	0.172
30.00	-29.41	-17.95	0.00	-1,453.14	0.00	1,453.14	6,858.27	3,429.13	17,576.2	8,801.21	0.72	-0.23	0.169
35.00	-27.77	-17.54	0.00	-1,363.39	0.00	1,363.39	6,732.46	3,366.23	16,779.9	8,402.42	0.99	-0.27	0.166
40.00	-26.17	-17.18	0.00	-1,275.71	0.00	1,275.71	6,603.24	3,301.62	15,992.9	8,008.36	1.29	-0.31	0.163
43.50	-25.08	-16.96	0.00	-1,215.58	0.00	1,215.58	6,510.74	3,255.37	15,448.0	7,735.51	1.54	-0.34	0.161
45.00	-24.24	-16.69	0.00	-1,190.13	0.00	1,190.13	6,470.58	3,235.29	15,216.1	7,619.37	1.65	-0.36	0.160
50.00	-21.51	-16.41	0.00	-1,106.71	0.00	1,106.71	6,334.51	3,167.25	14,450.1	7,235.83	2.05	-0.40	0.156
51.00	-20.97	-16.20	0.00	-1,090.29	0.00	1,090.29	5,351.19	2,675.60	12,353.0	6,185.72	2.13	-0.41	0.180
55.00	-19.91	-15.81	0.00	-1,025.50	0.00	1,025.50	5,265.80	2,632.90	11,859.3	5,938.51	2.49	-0.45	0.177
60.00	-18.62	-15.38	0.00	-946.45	0.00	946.45	5,155.98	2,577.99	11,249.0	5,632.89	2.98	-0.49	0.172
65.00	-17.37	-14.95	0.00	-869.56	0.00	869.56	5,042.74	2,521.37	10,646.9	5,331.40	3.53	-0.54	0.167
70.00	-16.15	-14.53	0.00	-794.80	0.00	794.80	4,926.07	2,463.04	10,053.8	5,034.40	4.13	-0.59	0.161
75.00	-14.97	-14.11	0.00	-722.17	0.00	722.17	4,805.98	2,402.99	9,470.41	4,742.24	4.77	-0.64	0.155
80.00	-13.83	-13.69	0.00	-651.63	0.00	651.63	4,682.46	2,341.23	8,897.37	4,455.30	5.48	-0.69	0.149
85.00	-12.72	-13.32	0.00	-583.17	0.00	583.17	4,555.52	2,277.76	8,335.45	4,173.92	6.23	-0.74	0.143
89.00	-11.87	-13.12	0.00	-529.88	0.00	529.88	4,451.50	2,225.75	7,894.42	3,953.08	6.87	-0.78	0.137
90.00	-11.53	-12.90	0.00	-516.76	0.00	516.76	4,425.16	2,212.58	7,785.39	3,898.48	7.04	-0.80	0.135
94.50	-10.08	-12.68	0.00	-458.72	0.00	458.72	2,429.52	1,214.76	4,208.21	2,107.23	7.81	-0.84	0.222
95.00	-10.00	-12.48	0.00	-452.38	0.00	452.38	2,423.93	1,211.97	4,181.46	2,093.84	7.90	-0.85	0.220
100.00	-9.30	-12.10	0.00	-390.00	0.00	390.00	2,366.19	1,183.09	3,915.26	1,960.54	8.82	-0.92	0.203
105.00	-8.62	-11.72	0.00	-329.52	0.00	329.52	2,305.01	1,152.51	3,651.76	1,828.59	9.82	-0.99	0.184
110.00	-7.96	-11.36	0.00	-270.90	0.00	270.90	2,240.42	1,120.21	3,391.69	1,698.37	10.89	-1.05	0.163
115.00	-7.33	-11.01	0.00	-214.09	0.00	214.09	2,172.39	1,086.20	3,135.78	1,570.22	12.03	-1.11	0.140
120.00	-6.73	-10.73	0.00	-159.04	0.00	159.04	2,100.95	1,050.47	2,884.74	1,444.51	13.23	-1.17	0.113
123.00	-5.10	-8.12	0.00	-126.84	0.00	126.84	2,056.44	1,028.22	2,736.75	1,370.41	13.98	-1.20	0.095
125.00	-4.87	-7.89	0.00	-110.60	0.00	110.60	2,026.08	1,013.04	2,639.30	1,321.61	14.48	-1.22	0.086
130.00	-4.33	-7.61	0.00	-71.12	0.00	71.12	1,947.78	973.89	2,400.18	1,201.87	15.78	-1.25	0.061
134.00	-2.89	-4.83	0.00	-40.29	0.00	40.29	1,102.25	551.13	1,321.80	661.88	16.83	-1.27	0.064
135.00	-2.83	-4.66	0.00	-35.46	0.00	35.46	1,095.19	547.60	1,297.91	649.92	17.10	-1.28	0.057
140.00	-2.52	-4.48	0.00	-12.17	0.00	12.17	1,057.85	528.92	1,179.18	590.46	18.45	-1.29	0.023
141.00	-1.04	-1.40	0.00	-7.69	0.00	7.69	1,049.97	524.98	1,155.61	578.66	18.72	-1.30	0.014
145.00	-0.85	-1.26	0.00	-2.10	0.00	2.10	1,017.07	508.54	1,062.12	531.85	19.81	-1.30	0.005
146.00	-0.11	-0.07	0.00	-0.17	0.00	0.17	1,008.51	504.25	1,038.98	520.26	20.08	-1.30	0.000
148.50	0.00	-0.07	0.00	0.00	0.00	0.00	986.50	493.25	981.57	491.52	20.76	-1.30	0.000

Load Case: 1.2D + 1.0Di + 1.0Wi	40 mph with 1.00 in Radial Ice	18 Iterations
Gust Response Factor :1.10	Ice Dead Load Factor :1.00	Wind Importance Factor :1.00
Dead Load Factor :1.20		Ice Importance Factor :1.00
Wind Load Factor :1.00		

Applied Segment Forces Summary

Seg Elev (ft)	Description	Shaft Forces		Discrete Forces			Linear Forces		Sum of Forces				
		Wind FX (lb)	Dead Load (lb)	Wind FX (lb)	Torsion MY (lb-ft)	Moment MZ (lb-ft)	Dead Load (lb)	Wind FX (lb)	Dead Load (lb)	Wind FX (lb)	Dead Load (lb)	Torsion MY (lb-ft)	Moment MZ (lb)
0.00		57.3	0.0					0.0	0.0	57.3	0.0	0.0	0.0
5.00		113.5	3,030.0					0.0	177.9	113.5	3,207.9	0.0	0.0
10.00		111.3	3,040.4					0.0	177.9	111.3	3,218.3	0.0	0.0
15.00		108.9	3,007.4					0.0	177.9	108.9	3,185.3	0.0	0.0
20.00		106.5	2,960.2					0.0	177.9	106.5	3,138.1	0.0	0.0
25.00		104.1	2,905.6					0.0	177.9	104.1	3,083.5	0.0	0.0
30.00		102.8	2,846.3					0.0	177.9	102.8	3,024.2	0.0	0.0
35.00		103.6	2,783.8					0.0	177.9	103.6	2,961.7	0.0	0.0
40.00		89.0	2,718.9					0.0	177.9	89.0	2,896.8	0.0	0.0
43.50	Bot - Section 2	52.9	1,865.8					0.0	124.5	52.9	1,990.4	0.0	0.0
45.00		69.8	1,291.5					0.0	53.4	69.8	1,344.9	0.0	0.0
50.00		64.5	4,221.5					0.0	177.9	64.5	4,399.4	0.0	0.0
51.00	Top - Section 1	53.8	832.0					0.0	35.6	53.8	867.6	0.0	0.0
55.00		96.7	1,861.3					0.0	142.3	96.7	2,003.6	0.0	0.0
60.00		107.1	2,267.1					0.0	177.9	107.1	2,445.0	0.0	0.0
65.00		106.4	2,202.6					0.0	177.9	106.4	2,380.5	0.0	0.0
70.00		105.5	2,137.3					0.0	177.9	105.5	2,315.2	0.0	0.0
75.00		104.3	2,071.3					0.0	177.9	104.3	2,249.2	0.0	0.0
80.00		102.9	2,004.6					0.0	177.9	102.9	2,182.5	0.0	0.0
85.00		91.3	1,937.5					0.0	177.9	91.3	2,115.4	0.0	0.0
89.00	Bot - Section 3	50.3	1,503.1					0.0	142.3	50.3	1,645.5	0.0	0.0
90.00		55.0	531.7					0.0	35.6	55.0	567.2	0.0	0.0
94.50	Top - Section 2	49.8	2,335.9					0.0	160.1	49.8	2,496.1	0.0	0.0
95.00		53.7	138.4					0.0	17.8	53.7	156.2	0.0	0.0
100.00		96.4	1,345.5					0.0	177.9	96.4	1,523.4	0.0	0.0
105.00		94.1	1,293.8					0.0	177.9	94.1	1,471.7	0.0	0.0
110.00		91.7	1,241.7					0.0	177.9	91.7	1,419.6	0.0	0.0
115.00		89.1	1,189.3					0.0	177.9	89.1	1,367.2	0.0	0.0
120.00		69.6	1,136.6					0.0	177.9	69.6	1,314.5	0.0	0.0
123.00	Appertunance(s)	42.5	659.4	421.8	0.0	0.0	5,171.3	0.0	106.7	464.3	5,937.5	0.0	0.0
125.00		57.9	430.0					0.0	64.6	57.9	494.5	0.0	0.0
130.00	Bot - Section 4	73.2	1,030.2					0.0	161.4	73.2	1,191.6	0.0	0.0
134.00	Top - Section 3	40.0	1,081.8	380.2	0.0	107.2	4,658.4	0.0	129.1	420.2	5,869.3	0.0	0.0
135.00		46.3	160.6					0.0	14.6	46.3	175.1	0.0	0.0
140.00		45.9	767.0					0.0	72.8	45.9	839.8	0.0	0.0
141.00	Appertunance(s)	36.8	150.1	515.2	0.0	0.0	6,287.1	0.0	14.6	552.0	6,451.8	0.0	0.0
145.00		36.5	577.1					0.0	0.7	36.5	577.8	0.0	0.0
146.00	Appertunance(s)	24.8	141.4	282.3	0.0	227.4	2,344.0	0.0	0.2	307.1	2,485.5	0.0	0.0
148.50		17.6	343.9					0.0	0.0	17.6	343.9	0.0	0.0
								Totals:		4,522.86	85,337.3	0.00	0.00

Site Number: 370630

Code: ANSI/TIA-222-G

© 2007 - 2016 by ATC IP LLC. All rights reserved.

Site Name: Salisbury CT, CT

Engineering Number: OAA686579_C3_03

10/5/2016 8:39:21 PM

Customer: T-Mobile

Load Case: 1.2D + 1.0Di + 1.0Wi

40 mph with 1.00 in Radial Ice

18 Iterations

Gust Response Factor :1.10

Ice Dead Load Factor :1.00

Wind Importance Factor :1.00

Dead Load Factor :1.20

Ice Importance Factor :1.00

Wind Load Factor :1.00

Calculated Forces

Seg Elev (ft)	Pu FY (-) (kips)	Vu FX (-) (kips)	Tu MY (ft-kips)	Mu MZ (ft-kips)	Mu MX (ft-kips)	Resultant Moment (ft-kips)	phi Pn (kips)	phi Vn (kips)	phi Tn (ft-kips)	phi Mn (ft-kips)	Total Deflect (in)	Rotation (deg)	Ratio
0.00	-85.34	-4.47	0.00	-431.54	0.00	431.54	7,541.17	3,770.58	22,511.9	11,272.6	0.00	0.00	0.050
5.00	-82.13	-4.37	0.00	-409.18	0.00	409.18	7,435.91	3,717.96	21,674.1	10,853.2	0.00	-0.01	0.049
10.00	-78.91	-4.27	0.00	-387.34	0.00	387.34	7,327.23	3,663.62	20,841.5	10,436.2	0.02	-0.02	0.048
15.00	-75.72	-4.17	0.00	-366.00	0.00	366.00	7,215.13	3,607.56	20,014.7	10,022.2	0.04	-0.02	0.047
20.00	-72.59	-4.07	0.00	-345.16	0.00	345.16	7,099.60	3,549.80	19,194.4	9,611.47	0.07	-0.03	0.046
25.00	-69.50	-3.98	0.00	-324.81	0.00	324.81	6,980.64	3,490.32	18,381.3	9,204.34	0.11	-0.04	0.045
30.00	-66.48	-3.88	0.00	-304.93	0.00	304.93	6,858.27	3,429.13	17,576.2	8,801.21	0.15	-0.05	0.044
35.00	-63.51	-3.78	0.00	-285.53	0.00	285.53	6,732.46	3,366.23	16,779.9	8,402.42	0.21	-0.06	0.043
40.00	-60.62	-3.70	0.00	-266.62	0.00	266.62	6,603.24	3,301.62	15,992.9	8,008.36	0.27	-0.07	0.042
43.50	-58.63	-3.65	0.00	-253.67	0.00	253.67	6,510.74	3,255.37	15,448.0	7,735.51	0.32	-0.07	0.042
45.00	-57.28	-3.58	0.00	-248.20	0.00	248.20	6,470.58	3,235.29	15,216.1	7,619.37	0.35	-0.08	0.041
50.00	-52.88	-3.52	0.00	-230.29	0.00	230.29	6,334.51	3,167.25	14,450.1	7,235.83	0.43	-0.08	0.040
51.00	-52.01	-3.47	0.00	-226.77	0.00	226.77	5,351.19	2,675.60	12,353.0	6,185.72	0.45	-0.09	0.046
55.00	-50.01	-3.37	0.00	-212.91	0.00	212.91	5,265.80	2,632.90	11,859.3	5,938.51	0.52	-0.09	0.045
60.00	-47.56	-3.27	0.00	-196.04	0.00	196.04	5,155.98	2,577.99	11,249.0	5,632.89	0.63	-0.10	0.044
65.00	-45.18	-3.17	0.00	-179.68	0.00	179.68	5,042.74	2,521.37	10,646.9	5,331.40	0.74	-0.11	0.043
70.00	-42.87	-3.07	0.00	-163.84	0.00	163.84	4,926.07	2,463.04	10,053.8	5,034.40	0.87	-0.12	0.041
75.00	-40.62	-2.96	0.00	-148.52	0.00	148.52	4,805.98	2,402.99	9,470.41	4,742.24	1.00	-0.13	0.040
80.00	-38.44	-2.86	0.00	-133.70	0.00	133.70	4,682.46	2,341.23	8,897.37	4,455.30	1.15	-0.14	0.038
85.00	-36.32	-2.77	0.00	-119.39	0.00	119.39	4,555.52	2,277.76	8,335.45	4,173.92	1.31	-0.16	0.037
89.00	-34.68	-2.72	0.00	-108.30	0.00	108.30	4,451.50	2,225.75	7,894.42	3,953.08	1.44	-0.16	0.035
90.00	-34.11	-2.67	0.00	-105.58	0.00	105.58	4,425.16	2,212.58	7,785.39	3,898.48	1.47	-0.17	0.035
94.50	-31.61	-2.61	0.00	-93.59	0.00	93.59	2,429.52	1,214.76	4,208.21	2,107.23	1.64	-0.17	0.057
95.00	-31.46	-2.56	0.00	-92.28	0.00	92.28	2,423.93	1,211.97	4,181.46	2,093.84	1.65	-0.18	0.057
100.00	-29.93	-2.47	0.00	-79.47	0.00	79.47	2,366.19	1,183.09	3,915.26	1,960.54	1.85	-0.19	0.053
105.00	-28.46	-2.38	0.00	-67.13	0.00	67.13	2,305.01	1,152.51	3,651.76	1,828.59	2.05	-0.20	0.049
110.00	-27.04	-2.29	0.00	-55.24	0.00	55.24	2,240.42	1,120.21	3,391.69	1,698.37	2.28	-0.22	0.045
115.00	-25.67	-2.20	0.00	-43.82	0.00	43.82	2,172.39	1,086.20	3,135.78	1,570.22	2.51	-0.23	0.040
120.00	-24.36	-2.12	0.00	-32.84	0.00	32.84	2,100.95	1,050.47	2,884.74	1,444.51	2.76	-0.24	0.034
123.00	-18.42	-1.64	0.00	-26.46	0.00	26.46	2,056.44	1,028.22	2,736.75	1,370.41	2.91	-0.25	0.028
125.00	-17.93	-1.58	0.00	-23.19	0.00	23.19	2,026.08	1,013.04	2,639.30	1,321.61	3.02	-0.25	0.026
130.00	-16.74	-1.50	0.00	-15.30	0.00	15.30	1,947.78	973.89	2,400.18	1,201.87	3.29	-0.26	0.021
134.00	-10.87	-1.06	0.00	-9.18	0.00	9.18	1,102.25	551.13	1,321.80	661.88	3.50	-0.26	0.024
135.00	-10.69	-1.01	0.00	-8.13	0.00	8.13	1,095.19	547.60	1,297.91	649.92	3.56	-0.26	0.022
140.00	-9.85	-0.96	0.00	-3.08	0.00	3.08	1,057.85	528.92	1,179.18	590.46	3.84	-0.27	0.015
141.00	-3.41	-0.38	0.00	-2.12	0.00	2.12	1,049.97	524.98	1,155.61	578.66	3.90	-0.27	0.007
145.00	-2.83	-0.34	0.00	-0.61	0.00	0.61	1,017.07	508.54	1,062.12	531.85	4.12	-0.27	0.004
146.00	-0.34	-0.02	0.00	-0.05	0.00	0.05	1,008.51	504.25	1,038.98	520.26	4.18	-0.27	0.000
148.50	0.00	-0.02	0.00	0.00	0.00	0.00	986.50	493.25	981.57	491.52	4.32	-0.27	0.000

Site Number: 370630

Code: ANSI/TIA-222-G

© 2007 - 2016 by ATC IP LLC. All rights reserved.

Site Name: Salisbury CT, CT

Engineering Number: OAA686579_C3_03

10/5/2016 8:39:22 PM

Customer: T-Mobile

Load Case: 1.0D + 1.0W

Serviceability 60 mph

18 Iterations

Gust Response Factor :1.10

Wind Importance Factor :1.00

Dead Load Factor :1.00

Wind Load Factor :1.00

Applied Segment Forces Summary

Seg Elev (ft)	Description	Shaft Forces		Discrete Forces			Linear Forces		Sum of Forces				
		Wind FX (lb)	Dead Load (lb)	Wind FX (lb)	Torsion MY (lb-ft)	Moment MZ (lb-ft)	Dead Load (lb)	Wind FX (lb)	Dead Load (lb)	Wind FX (lb)	Dead Load (lb)	Torsion MY (lb-ft)	Moment MZ (lb)
0.00		67.0	0.0					0.0	0.0	67.0	0.0	0.0	0.0
5.00		132.3	1,936.7					0.0	148.3	132.3	2,085.0	0.0	0.0
10.00		129.2	1,890.8					0.0	148.3	129.2	2,039.1	0.0	0.0
15.00		126.0	1,844.9					0.0	148.3	126.0	1,993.2	0.0	0.0
20.00		122.9	1,799.0					0.0	148.3	122.9	1,947.3	0.0	0.0
25.00		119.7	1,753.1					0.0	148.3	119.7	1,901.4	0.0	0.0
30.00		118.0	1,707.2					0.0	148.3	118.0	1,855.5	0.0	0.0
35.00		118.5	1,661.3					0.0	148.3	118.5	1,809.5	0.0	0.0
40.00		101.7	1,615.4					0.0	148.3	101.7	1,763.6	0.0	0.0
43.50	Bot - Section 2	60.4	1,103.5					0.0	103.8	60.4	1,207.2	0.0	0.0
45.00		79.5	880.4					0.0	44.5	79.5	924.9	0.0	0.0
50.00		73.4	2,878.9					0.0	148.3	73.4	3,027.1	0.0	0.0
51.00	Top - Section 1	61.1	565.4					0.0	29.7	61.1	595.1	0.0	0.0
55.00		109.6	1,048.9					0.0	118.6	109.6	1,167.5	0.0	0.0
60.00		121.1	1,275.0					0.0	148.3	121.1	1,423.2	0.0	0.0
65.00		120.0	1,234.8					0.0	148.3	120.0	1,383.0	0.0	0.0
70.00		118.5	1,194.6					0.0	148.3	118.5	1,342.9	0.0	0.0
75.00		116.8	1,154.5					0.0	148.3	116.8	1,302.7	0.0	0.0
80.00		114.8	1,114.3					0.0	148.3	114.8	1,262.6	0.0	0.0
85.00		101.5	1,074.1					0.0	148.3	101.5	1,222.4	0.0	0.0
89.00	Bot - Section 3	55.8	830.4					0.0	118.6	55.8	949.0	0.0	0.0
90.00		60.8	336.7					0.0	29.7	60.8	366.3	0.0	0.0
94.50	Top - Section 2	55.1	1,482.3					0.0	133.4	55.1	1,615.7	0.0	0.0
95.00		59.2	63.8					0.0	14.8	59.2	78.7	0.0	0.0
100.00		106.0	624.1					0.0	148.3	106.0	772.3	0.0	0.0
105.00		103.0	598.3					0.0	148.3	103.0	746.5	0.0	0.0
110.00		99.8	572.4					0.0	148.3	99.8	720.7	0.0	0.0
115.00		96.5	546.6					0.0	148.3	96.5	694.9	0.0	0.0
120.00		74.9	520.8					0.0	148.3	74.9	669.0	0.0	0.0
123.00	Appertunance(s)	45.6	300.1	671.6	0.0	0.0	1,479.7	0.0	88.9	717.2	1,868.7	0.0	0.0
125.00		61.7	194.9					0.0	53.8	61.7	248.7	0.0	0.0
130.00	Bot - Section 4	77.7	469.1					0.0	134.5	77.7	603.6	0.0	0.0
134.00	Top - Section 3	42.3	598.3	718.7	0.0	113.7	966.0	0.0	107.6	761.0	1,671.9	0.0	0.0
135.00		48.6	58.7					0.0	12.1	48.6	70.8	0.0	0.0
140.00		48.2	283.0					0.0	60.7	48.2	343.7	0.0	0.0
141.00	Appertunance(s)	38.3	54.5	808.1	0.0	0.0	1,657.9	0.0	12.1	846.4	1,724.6	0.0	0.0
145.00		37.9	211.3					0.0	0.6	37.9	211.9	0.0	0.0
146.00	Appertunance(s)	25.5	51.1	299.9	0.0	188.1	800.0	0.0	0.2	325.4	851.2	0.0	0.0
148.50		18.1	124.7					0.0	0.0	18.1	124.7	0.0	0.0
								Totals:		5,765.38	44,586.1	0.00	0.00

Site Number: 370630

Code: ANSI/TIA-222-G

© 2007 - 2016 by ATC IP LLC. All rights reserved.

Site Name: Salisbury CT, CT

Engineering Number: OAA686579_C3_03

10/5/2016 8:39:23 PM

Customer: T-Mobile

Load Case: 1.0D + 1.0W

Serviceability 60 mph

18 Iterations

Gust Response Factor :1.10

Wind Importance Factor :1.00

Dead Load Factor :1.00

Wind Load Factor :1.00

Calculated Forces

Seg Elev (ft)	Pu FY (-) (kips)	Vu FX (-) (kips)	Tu MY (ft-kips)	Mu MZ (ft-kips)	Mu MX (ft-kips)	Resultant Moment (ft-kips)	phi Pn (kips)	phi Vn (kips)	phi Tn (ft-kips)	phi Mn (ft-kips)	Total Deflect (in)	Rotation (deg)	Ratio
0.00	-44.59	-5.70	0.00	-566.10	0.00	566.10	7,541.17	3,770.58	22,511.9	11,272.6	0.00	0.00	0.056
5.00	-42.50	-5.58	0.00	-537.59	0.00	537.59	7,435.91	3,717.96	21,674.1	10,853.2	0.01	-0.01	0.055
10.00	-40.46	-5.45	0.00	-509.70	0.00	509.70	7,327.23	3,663.62	20,841.5	10,436.2	0.02	-0.02	0.054
15.00	-38.47	-5.33	0.00	-482.43	0.00	482.43	7,215.13	3,607.56	20,014.7	10,022.2	0.05	-0.03	0.053
20.00	-36.52	-5.22	0.00	-455.76	0.00	455.76	7,099.60	3,549.80	19,194.4	9,611.47	0.09	-0.04	0.053
25.00	-34.62	-5.10	0.00	-429.67	0.00	429.67	6,980.64	3,490.32	18,381.3	9,204.34	0.14	-0.05	0.052
30.00	-32.76	-4.99	0.00	-404.15	0.00	404.15	6,858.27	3,429.13	17,576.2	8,801.21	0.20	-0.06	0.051
35.00	-30.95	-4.88	0.00	-379.20	0.00	379.20	6,732.46	3,366.23	16,779.9	8,402.42	0.27	-0.08	0.050
40.00	-29.18	-4.78	0.00	-354.83	0.00	354.83	6,603.24	3,301.62	15,992.9	8,008.36	0.36	-0.09	0.049
43.50	-27.98	-4.72	0.00	-338.11	0.00	338.11	6,510.74	3,255.37	15,448.0	7,735.51	0.43	-0.10	0.048
45.00	-27.05	-4.64	0.00	-331.04	0.00	331.04	6,470.58	3,235.29	15,216.1	7,619.37	0.46	-0.10	0.048
50.00	-24.02	-4.56	0.00	-307.84	0.00	307.84	6,334.51	3,167.25	14,450.1	7,235.83	0.57	-0.11	0.046
51.00	-23.43	-4.50	0.00	-303.27	0.00	303.27	5,351.19	2,675.60	12,353.0	6,185.72	0.59	-0.11	0.053
55.00	-22.26	-4.40	0.00	-285.26	0.00	285.26	5,265.80	2,632.90	11,859.3	5,938.51	0.69	-0.12	0.052
60.00	-20.84	-4.28	0.00	-263.28	0.00	263.28	5,155.98	2,577.99	11,249.0	5,632.89	0.83	-0.14	0.051
65.00	-19.45	-4.16	0.00	-241.89	0.00	241.89	5,042.74	2,521.37	10,646.9	5,331.40	0.98	-0.15	0.049
70.00	-18.11	-4.04	0.00	-221.10	0.00	221.10	4,926.07	2,463.04	10,053.8	5,034.40	1.15	-0.17	0.048
75.00	-16.81	-3.92	0.00	-200.90	0.00	200.90	4,805.98	2,402.99	9,470.41	4,742.24	1.33	-0.18	0.046
80.00	-15.54	-3.81	0.00	-181.28	0.00	181.28	4,682.46	2,341.23	8,897.37	4,455.30	1.52	-0.19	0.044
85.00	-14.32	-3.71	0.00	-162.24	0.00	162.24	4,555.52	2,277.76	8,335.45	4,173.92	1.73	-0.21	0.042
89.00	-13.37	-3.65	0.00	-147.41	0.00	147.41	4,451.50	2,225.75	7,894.42	3,953.08	1.91	-0.22	0.040
90.00	-13.00	-3.59	0.00	-143.76	0.00	143.76	4,425.16	2,212.58	7,785.39	3,898.48	1.96	-0.22	0.040
94.50	-11.39	-3.53	0.00	-127.62	0.00	127.62	2,429.52	1,214.76	4,208.21	2,107.23	2.17	-0.23	0.065
95.00	-11.31	-3.47	0.00	-125.85	0.00	125.85	2,423.93	1,211.97	4,181.46	2,093.84	2.20	-0.24	0.065
100.00	-10.54	-3.36	0.00	-108.50	0.00	108.50	2,366.19	1,183.09	3,915.26	1,960.54	2.45	-0.26	0.060
105.00	-9.79	-3.26	0.00	-91.68	0.00	91.68	2,305.01	1,152.51	3,651.76	1,828.59	2.73	-0.27	0.054
110.00	-9.07	-3.16	0.00	-75.37	0.00	75.37	2,240.42	1,120.21	3,391.69	1,698.37	3.03	-0.29	0.048
115.00	-8.37	-3.06	0.00	-59.56	0.00	59.56	2,172.39	1,086.20	3,135.78	1,570.22	3.35	-0.31	0.042
120.00	-7.70	-2.99	0.00	-44.25	0.00	44.25	2,100.95	1,050.47	2,884.74	1,444.51	3.68	-0.33	0.034
123.00	-5.84	-2.26	0.00	-35.29	0.00	35.29	2,056.44	1,028.22	2,736.75	1,370.41	3.89	-0.33	0.029
125.00	-5.59	-2.20	0.00	-30.77	0.00	30.77	2,026.08	1,013.04	2,639.30	1,321.61	4.03	-0.34	0.026
130.00	-4.99	-2.12	0.00	-19.79	0.00	19.79	1,947.78	973.89	2,400.18	1,201.87	4.39	-0.35	0.019
134.00	-3.32	-1.34	0.00	-11.21	0.00	11.21	1,102.25	551.13	1,321.80	661.88	4.68	-0.35	0.020
135.00	-3.25	-1.30	0.00	-9.87	0.00	9.87	1,095.19	547.60	1,297.91	649.92	4.76	-0.35	0.018
140.00	-2.90	-1.25	0.00	-3.39	0.00	3.39	1,057.85	528.92	1,179.18	590.46	5.13	-0.36	0.008
141.00	-1.19	-0.39	0.00	-2.14	0.00	2.14	1,049.97	524.98	1,155.61	578.66	5.21	-0.36	0.005
145.00	-0.97	-0.35	0.00	-0.58	0.00	0.58	1,017.07	508.54	1,062.12	531.85	5.51	-0.36	0.002
146.00	-0.12	-0.02	0.00	-0.05	0.00	0.05	1,008.51	504.25	1,038.98	520.26	5.59	-0.36	0.000
148.50	0.00	-0.02	0.00	0.00	0.00	0.00	986.50	493.25	981.57	491.52	5.78	-0.36	0.000

Equivalent Lateral Forces Method Analysis

(Based on ASCE7-10 Chapters 11, 12, 15)

Spectral Response Acceleration for Short Period (S_{s1}):	0.17
Spectral Response Acceleration at 1.0 Second Period (S_{s1}):	0.06
Long-Period Transition Period (T_{L1}):	6
Importance Factor (I_E):	1.00
Site Coefficient F_a :	1.60
Site Coefficient F_v :	2.40
Response Modification Coefficient (R):	1.50
Design Spectral Response Acceleration at Short Period (S_{ds1}):	0.19
Design Spectral Response Acceleration at 1.0 Second Period (S_{d1}):	0.10
Seismic Response Coefficient (C_s):	0.06
Upper Limit C_s	0.06
Lower Limit C_s	0.03
Period based on Rayleigh Method (sec):	1.17
Redundancy Factor (ρ):	1.30
Seismic Force Distribution Exponent (k):	1.33
Total Unfactored Dead Load:	44.59 k
Seismic Base Shear (E):	3.45 k

Load Case (1.2 + 0.2Sds) * DL + E ELFM

Seismic Equivalent Lateral Forces Method

Segment	Height Above Base (ft)	Weight (lb)	W_z (lb-ft)	C_{vx}	Horizontal Force (lb)	Vertical Force (lb)
38	147.25	125	97	0.008	26	154
37	145.50	51	39	0.003	11	63
36	143.00	212	158	0.013	43	262
35	140.50	67	49	0.004	13	82
34	137.50	344	243	0.019	66	425
33	134.50	71	49	0.004	13	88
32	132.00	706	473	0.037	129	873
31	127.50	604	386	0.031	105	747
30	124.00	249	153	0.012	42	308
29	121.50	389	233	0.018	64	481
28	117.50	669	384	0.030	105	828
27	112.50	695	376	0.030	103	860
26	107.50	721	367	0.029	100	892
25	102.50	747	357	0.028	97	924
24	97.50	772	346	0.027	94	955
23	94.75	79	34	0.003	9	97
22	92.25	1,616	672	0.053	183	1,999
21	89.50	366	146	0.012	40	453
20	87.00	949	365	0.029	100	1,174
19	82.50	1,222	438	0.035	119	1,512
18	77.50	1,263	416	0.033	114	1,562
17	72.50	1,303	393	0.031	107	1,612
16	67.50	1,343	368	0.029	100	1,661

Site Number: 370630

Code: ANSI/TIA-222-G

© 2007 - 2016 by ATC IP LLC. All rights reserved.

Site Name: Salisbury CT, CT

Engineering Number: OAA686579_C3_03

10/5/2016 8:39:23 PM

Customer: T- Mobile

15	62.50	1,383	342	0.027	93	1,711
14	57.50	1,423	315	0.025	86	1,761
13	53.00	1,167	232	0.018	63	1,444
12	50.50	595	111	0.009	30	736
11	47.50	3,027	520	0.041	142	3,745
10	44.25	925	144	0.011	39	1,144
9	41.75	1,207	174	0.014	48	1,494
8	37.50	1,764	221	0.017	60	2,182
7	32.50	1,810	187	0.015	51	2,239
6	27.50	1,855	154	0.012	42	2,295
5	22.50	1,901	121	0.010	33	2,352
4	17.50	1,947	88	0.007	24	2,409
3	12.50	1,993	58	0.005	16	2,466
2	7.50	2,039	30	0.002	8	2,523
1	2.50	2,085	7	0.001	2	2,579
RFS Celwave PD220	146.00	25	19	0.002	5	31
RFS Celwave PD220	146.00	25	19	0.002	5	31
Flat T-Arm	146.00	750	575	0.045	157	928
Powerwave Allgon LGP	141.00	85	62	0.005	17	105
Raycap DC6-48-60-18-	141.00	33	24	0.002	7	41
Ericsson RRUS 11 (Ba	141.00	330	241	0.019	66	408
Powerwave 7770.00	141.00	315	230	0.018	63	390
KMW AM-X-CD-16-65-00	141.00	146	106	0.008	29	180
Flat T-Arm	141.00	750	549	0.043	150	928
Antel BXA-185085/12C	134.00	39	27	0.002	7	48
Antel BXA-70063/6CF	134.00	51	35	0.003	10	63
Antel LPA-80080/6CF	134.00	126	86	0.007	24	156
Round T-Arm	134.00	750	513	0.041	140	928
Symmetricon 58532A	123.00	0	0	0.000	0	0
Ericsson RRUS 11 B12	123.00	152	93	0.007	25	188
Ericsson RRUS 11 B4	123.00	152	93	0.007	25	188
Ericsson RRUS 11 B2	123.00	152	93	0.007	25	188
RFS APX16DWV-16DWVS-	123.00	122	74	0.006	20	151
Commscope LNX-6515DS	123.00	151	92	0.007	25	187
Flat T-Arm	123.00	750	457	0.036	125	928
		44,586	12,634	1.000	3,448	55,158

Load Case (0.9 - 0.2Sds) * DL + E ELMF

Seismic (Reduced DL) Equivalent Lateral Forces Method

Segment	Height Above Base (ft)	Weight (lb)	W _z (lb-ft)	C _{vx}	Horizontal Force (lb)	Vertical Force (lb)
38	147.25	125	97	0.008	26	108
37	145.50	51	39	0.003	11	44
36	143.00	212	158	0.013	43	183
35	140.50	67	49	0.004	13	58
34	137.50	344	243	0.019	66	297
33	134.50	71	49	0.004	13	61
32	132.00	706	473	0.037	129	609
31	127.50	604	386	0.031	105	521
30	124.00	249	153	0.012	42	215
29	121.50	389	233	0.018	64	336
28	117.50	669	384	0.030	105	577
27	112.50	695	376	0.030	103	600
26	107.50	721	367	0.029	100	622
25	102.50	747	357	0.028	97	644
24	97.50	772	346	0.027	94	666
23	94.75	79	34	0.003	9	68
22	92.25	1,616	672	0.053	183	1,394
21	89.50	366	146	0.012	40	316
20	87.00	949	365	0.029	100	819

Site Number: 370630

Code: ANSI/TIA-222-G

© 2007 - 2016 by ATC IP LLC. All rights reserved.

Site Name: Salisbury CT, CT

Engineering Number: OAA686579_C3_03

10/5/2016 8:39:23 PM

Customer: T- Mobile

19	82.50	1,222	438	0.035	119	1,055
18	77.50	1,263	416	0.033	114	1,089
17	72.50	1,303	393	0.031	107	1,124
16	67.50	1,343	368	0.029	100	1,159
15	62.50	1,383	342	0.027	93	1,193
14	57.50	1,423	315	0.025	86	1,228
13	53.00	1,167	232	0.018	63	1,007
12	50.50	595	111	0.009	30	513
11	47.50	3,027	520	0.041	142	2,612
10	44.25	925	144	0.011	39	798
9	41.75	1,207	174	0.014	48	1,042
8	37.50	1,764	221	0.017	60	1,522
7	32.50	1,810	187	0.015	51	1,561
6	27.50	1,855	154	0.012	42	1,601
5	22.50	1,901	121	0.010	33	1,641
4	17.50	1,947	88	0.007	24	1,680
3	12.50	1,993	58	0.005	16	1,720
2	7.50	2,039	30	0.002	8	1,759
1	2.50	2,085	7	0.001	2	1,799
RFS Celwave PD220	146.00	25	19	0.002	5	22
RFS Celwave PD220	146.00	25	19	0.002	5	22
Flat T-Arm	146.00	750	575	0.045	157	647
Powerwave Allgon LGP	141.00	85	62	0.005	17	73
Raycap DC6-48-60-18-	141.00	33	24	0.002	7	28
Ericsson RRUS 11 (Ba	141.00	330	241	0.019	66	285
Powerwave 7770.00	141.00	315	230	0.018	63	272
KMW AM-X-CD-16-65-00	141.00	146	106	0.008	29	126
Flat T-Arm	141.00	750	549	0.043	150	647
Antel BXA-185085/12C	134.00	39	27	0.002	7	34
Antel BXA-70063/6CF	134.00	51	35	0.003	10	44
Antel LPA-80080/6CF	134.00	126	86	0.007	24	109
Round T-Arm	134.00	750	513	0.041	140	647
Symmetricom 58532A	123.00	0	0	0.000	0	0
Ericsson RRUS 11 B12	123.00	152	93	0.007	25	131
Ericsson RRUS 11 B4	123.00	152	93	0.007	25	131
Ericsson RRUS 11 B2	123.00	152	93	0.007	25	131
RFS APX16DWV-16DWVS-	123.00	122	74	0.006	20	105
Commscope LNX-6515DS	123.00	151	92	0.007	25	130
Flat T-Arm	123.00	750	457	0.036	125	647
		44,586	12,634	1.000	3,448	38,472

Load Case (1.2 + 0.2Sds) * DL + E ELFM

Seismic Equivalent Lateral Forces Method

Calculated Forces

Seg Elev (ft)	Pu FY (-) (kips)	Vu FX (-) (kips)	Tu MY (ft-kips)	Mu MZ (ft-kips)	Mu MX (ft-kips)	Resultant Moment (ft-kips)	phi Pn (kips)	phi Vn (kips)	phi Tn (ft-kips)	phi Mn (ft-kips)	Total Deflect (in)	Rotation (deg)	Ratio
0.00	-52.58	-3.45	0.00	-341.18	0.00	341.18	7,541.17	3,770.58	22,511.9	11,272.6	0.00	0.00	0.037
5.00	-50.06	-3.45	0.00	-323.93	0.00	323.93	7,435.91	3,717.96	21,674.1	10,853.2	0.00	-0.01	0.037
10.00	-47.59	-3.44	0.00	-306.70	0.00	306.70	7,327.23	3,663.62	20,841.5	10,436.2	0.01	-0.01	0.036
15.00	-45.18	-3.42	0.00	-289.53	0.00	289.53	7,215.13	3,607.56	20,014.7	10,022.2	0.03	-0.02	0.035
20.00	-42.83	-3.39	0.00	-272.45	0.00	272.45	7,099.60	3,549.80	19,194.4	9,611.47	0.05	-0.03	0.034
25.00	-40.53	-3.35	0.00	-255.52	0.00	255.52	6,980.64	3,490.32	18,381.3	9,204.34	0.08	-0.03	0.034
30.00	-38.29	-3.30	0.00	-238.78	0.00	238.78	6,858.27	3,429.13	17,576.2	8,801.21	0.12	-0.04	0.033
35.00	-36.11	-3.24	0.00	-222.28	0.00	222.28	6,732.46	3,366.23	16,779.9	8,402.42	0.16	-0.05	0.032
40.00	-34.62	-3.20	0.00	-206.07	0.00	206.07	6,603.24	3,301.62	15,992.9	8,008.36	0.22	-0.05	0.031
43.50	-33.47	-3.16	0.00	-194.88	0.00	194.88	6,510.74	3,255.37	15,448.0	7,735.51	0.26	-0.06	0.030
45.00	-29.73	-3.02	0.00	-190.14	0.00	190.14	6,470.58	3,235.29	15,216.1	7,619.37	0.27	-0.06	0.030
50.00	-28.99	-2.99	0.00	-175.06	0.00	175.06	6,334.51	3,167.25	14,450.1	7,235.83	0.34	-0.07	0.029
51.00	-27.55	-2.92	0.00	-172.08	0.00	172.08	5,351.19	2,675.60	12,353.0	6,185.72	0.35	-0.07	0.033
55.00	-25.79	-2.84	0.00	-160.38	0.00	160.38	5,265.80	2,632.90	11,859.3	5,938.51	0.41	-0.07	0.032
60.00	-24.07	-2.75	0.00	-146.20	0.00	146.20	5,155.98	2,577.99	11,249.0	5,632.89	0.49	-0.08	0.031
65.00	-22.41	-2.65	0.00	-132.47	0.00	132.47	5,042.74	2,521.37	10,646.9	5,331.40	0.58	-0.09	0.029
70.00	-20.80	-2.54	0.00	-119.24	0.00	119.24	4,926.07	2,463.04	10,053.8	5,034.40	0.68	-0.10	0.028
75.00	-19.24	-2.42	0.00	-106.55	0.00	106.55	4,805.98	2,402.99	9,470.41	4,742.24	0.78	-0.10	0.026
80.00	-17.73	-2.30	0.00	-94.43	0.00	94.43	4,682.46	2,341.23	8,897.37	4,455.30	0.89	-0.11	0.025
85.00	-16.55	-2.20	0.00	-82.90	0.00	82.90	4,555.52	2,277.76	8,335.45	4,173.92	1.01	-0.12	0.023
89.00	-16.10	-2.16	0.00	-74.08	0.00	74.08	4,451.50	2,225.75	7,894.42	3,953.08	1.12	-0.12	0.022
90.00	-14.10	-1.98	0.00	-71.92	0.00	71.92	4,425.16	2,212.58	7,785.39	3,898.48	1.14	-0.12	0.022
94.50	-14.00	-1.97	0.00	-63.02	0.00	63.02	2,429.52	1,214.76	4,208.21	2,107.23	1.26	-0.13	0.036
95.00	-13.05	-1.87	0.00	-62.03	0.00	62.03	2,423.93	1,211.97	4,181.46	2,093.84	1.28	-0.13	0.035
100.00	-12.12	-1.78	0.00	-52.66	0.00	52.66	2,366.19	1,183.09	3,915.26	1,960.54	1.42	-0.14	0.032
105.00	-11.23	-1.68	0.00	-43.78	0.00	43.78	2,305.01	1,152.51	3,651.76	1,828.59	1.57	-0.15	0.029
110.00	-10.37	-1.57	0.00	-35.40	0.00	35.40	2,240.42	1,120.21	3,391.69	1,698.37	1.74	-0.16	0.025
115.00	-9.55	-1.47	0.00	-27.54	0.00	27.54	2,172.39	1,086.20	3,135.78	1,570.22	1.91	-0.17	0.022
120.00	-9.06	-1.40	0.00	-20.21	0.00	20.21	2,100.95	1,050.47	2,884.74	1,444.51	2.09	-0.17	0.018
123.00	-6.93	-1.11	0.00	-16.00	0.00	16.00	2,056.44	1,028.22	2,736.75	1,370.41	2.20	-0.18	0.015
125.00	-6.18	-1.00	0.00	-13.79	0.00	13.79	2,026.08	1,013.04	2,639.30	1,321.61	2.27	-0.18	0.013
130.00	-5.31	-0.87	0.00	-8.79	0.00	8.79	1,947.78	973.89	2,400.18	1,201.87	2.46	-0.18	0.010
134.00	-4.03	-0.67	0.00	-5.31	0.00	5.31	1,102.25	551.13	1,321.80	661.88	2.62	-0.19	0.012
135.00	-3.60	-0.60	0.00	-4.64	0.00	4.64	1,095.19	547.60	1,297.91	649.92	2.66	-0.19	0.010
140.00	-3.52	-0.59	0.00	-1.62	0.00	1.62	1,057.85	528.92	1,179.18	590.46	2.86	-0.19	0.006
141.00	-1.21	-0.21	0.00	-1.03	0.00	1.03	1,049.97	524.98	1,155.61	578.66	2.90	-0.19	0.003
145.00	-1.14	-0.20	0.00	-0.20	0.00	0.20	1,017.07	508.54	1,062.12	531.85	3.06	-0.19	0.001
146.00	0.00	0.00	0.00	0.00	0.00	0.00	1,008.51	504.25	1,038.98	520.26	3.10	-0.19	0.000
148.50	0.00	0.00	0.00	0.00	0.00	0.00	986.50	493.25	981.57	491.52	3.20	-0.19	0.000

Load Case (0.9 - 0.2Sds) * DL + E ELMF

Seismic (Reduced DL) Equivalent Lateral Forces Method

Calculated Forces

Seg Elev (ft)	Pu FY (-) (kips)	Vu FX (-) (kips)	Tu MY (ft-kips)	Mu MZ (ft-kips)	Mu MX (ft-kips)	Resultant Moment (ft-kips)	phi Pn (kips)	phi Vn (kips)	phi Tn (ft-kips)	phi Mn (ft-kips)	Total Deflect (in)	Rotation (deg)	Ratio
0.00	-36.67	-3.45	0.00	-340.02	0.00	340.02	7,541.17	3,770.58	22,511.9	11,272.6	0.00	0.00	0.035
5.00	-34.91	-3.44	0.00	-322.78	0.00	322.78	7,435.91	3,717.96	21,674.1	10,853.2	0.00	-0.01	0.034
10.00	-33.19	-3.43	0.00	-305.57	0.00	305.57	7,327.23	3,663.62	20,841.5	10,436.2	0.01	-0.01	0.034
15.00	-31.51	-3.41	0.00	-288.41	0.00	288.41	7,215.13	3,607.56	20,014.7	10,022.2	0.03	-0.02	0.033
20.00	-29.87	-3.38	0.00	-271.36	0.00	271.36	7,099.60	3,549.80	19,194.4	9,611.47	0.05	-0.03	0.032
25.00	-28.27	-3.34	0.00	-254.46	0.00	254.46	6,980.64	3,490.32	18,381.3	9,204.34	0.08	-0.03	0.032
30.00	-26.71	-3.29	0.00	-237.76	0.00	237.76	6,858.27	3,429.13	17,576.2	8,801.21	0.12	-0.04	0.031
35.00	-25.19	-3.23	0.00	-221.30	0.00	221.30	6,732.46	3,366.23	16,779.9	8,402.42	0.16	-0.05	0.030
40.00	-24.14	-3.19	0.00	-205.14	0.00	205.14	6,603.24	3,301.62	15,992.9	8,008.36	0.21	-0.05	0.029
43.50	-23.35	-3.15	0.00	-193.98	0.00	193.98	6,510.74	3,255.37	15,448.0	7,735.51	0.25	-0.06	0.029
45.00	-20.73	-3.01	0.00	-189.26	0.00	189.26	6,470.58	3,235.29	15,216.1	7,619.37	0.27	-0.06	0.028
50.00	-20.22	-2.98	0.00	-174.23	0.00	174.23	6,334.51	3,167.25	14,450.1	7,235.83	0.34	-0.07	0.027
51.00	-19.21	-2.91	0.00	-171.26	0.00	171.26	5,351.19	2,675.60	12,353.0	6,185.72	0.35	-0.07	0.031
55.00	-17.98	-2.83	0.00	-159.60	0.00	159.60	5,265.80	2,632.90	11,859.3	5,938.51	0.41	-0.07	0.030
60.00	-16.79	-2.73	0.00	-145.47	0.00	145.47	5,155.98	2,577.99	11,249.0	5,632.89	0.49	-0.08	0.029
65.00	-15.63	-2.63	0.00	-131.79	0.00	131.79	5,042.74	2,521.37	10,646.9	5,331.40	0.58	-0.09	0.028
70.00	-14.51	-2.53	0.00	-118.62	0.00	118.62	4,926.07	2,463.04	10,053.8	5,034.40	0.68	-0.10	0.027
75.00	-13.42	-2.41	0.00	-105.99	0.00	105.99	4,805.98	2,402.99	9,470.41	4,742.24	0.78	-0.10	0.025
80.00	-12.36	-2.29	0.00	-93.92	0.00	93.92	4,682.46	2,341.23	8,897.37	4,455.30	0.89	-0.11	0.024
85.00	-11.54	-2.19	0.00	-82.45	0.00	82.45	4,555.52	2,277.76	8,335.45	4,173.92	1.01	-0.12	0.022
89.00	-11.23	-2.15	0.00	-73.67	0.00	73.67	4,451.50	2,225.75	7,894.42	3,953.08	1.11	-0.12	0.021
90.00	-9.83	-1.97	0.00	-71.52	0.00	71.52	4,425.16	2,212.58	7,785.39	3,898.48	1.14	-0.12	0.021
94.50	-9.77	-1.96	0.00	-62.66	0.00	62.66	2,429.52	1,214.76	4,208.21	2,107.23	1.26	-0.13	0.034
95.00	-9.10	-1.86	0.00	-61.68	0.00	61.68	2,423.93	1,211.97	4,181.46	2,093.84	1.27	-0.13	0.033
100.00	-8.46	-1.77	0.00	-52.36	0.00	52.36	2,366.19	1,183.09	3,915.26	1,960.54	1.41	-0.14	0.030
105.00	-7.83	-1.67	0.00	-43.52	0.00	43.52	2,305.01	1,152.51	3,651.76	1,828.59	1.57	-0.15	0.027
110.00	-7.23	-1.56	0.00	-35.19	0.00	35.19	2,240.42	1,120.21	3,391.69	1,698.37	1.73	-0.16	0.024
115.00	-6.66	-1.46	0.00	-27.37	0.00	27.37	2,172.39	1,086.20	3,135.78	1,570.22	1.90	-0.17	0.020
120.00	-6.32	-1.39	0.00	-20.09	0.00	20.09	2,100.95	1,050.47	2,884.74	1,444.51	2.08	-0.17	0.017
123.00	-4.83	-1.10	0.00	-15.91	0.00	15.91	2,056.44	1,028.22	2,736.75	1,370.41	2.19	-0.18	0.014
125.00	-4.31	-0.99	0.00	-13.70	0.00	13.70	2,026.08	1,013.04	2,639.30	1,321.61	2.26	-0.18	0.012
130.00	-3.70	-0.86	0.00	-8.73	0.00	8.73	1,947.78	973.89	2,400.18	1,201.87	2.45	-0.18	0.009
134.00	-2.81	-0.67	0.00	-5.28	0.00	5.28	1,102.25	551.13	1,321.80	661.88	2.61	-0.19	0.011
135.00	-2.51	-0.60	0.00	-4.61	0.00	4.61	1,095.19	547.60	1,297.91	649.92	2.65	-0.19	0.009
140.00	-2.45	-0.59	0.00	-1.61	0.00	1.61	1,057.85	528.92	1,179.18	590.46	2.85	-0.19	0.005
141.00	-0.84	-0.21	0.00	-1.02	0.00	1.02	1,049.97	524.98	1,155.61	578.66	2.89	-0.19	0.003
145.00	-0.80	-0.20	0.00	-0.20	0.00	0.20	1,017.07	508.54	1,062.12	531.85	3.04	-0.19	0.001
146.00	0.00	0.00	0.00	0.00	0.00	0.00	1,008.51	504.25	1,038.98	520.26	3.08	-0.19	0.000
148.50	0.00	0.00	0.00	0.00	0.00	0.00	986.50	493.25	981.57	491.52	3.18	-0.19	0.000

Equivalent Modal Forces Analysis

(Based on ASCE7-10 Chapters 11, 12 & 15 and ANSI/TIA-G, section 2.7)

Spectral Response Acceleration for Short Period (S_s):	0.17
Spectral Response Acceleration at 1.0 Second Period (S_1):	0.06
Importance Factor (I_E):	1.00
Site Coefficient F_a :	1.60
Site Coefficient F_v :	2.40
Response Modification Coefficient (R):	1.50
Design Spectral Response Acceleration at Short Period (S_{ds}):	0.19
Design Spectral Response Acceleration at 1.0 Second Period (S_{d1}):	0.10
Period Based on Rayleigh Method (sec):	1.17
Redundancy Factor (ρ):	1.30

Load Case (1.2 + 0.2Sds) * DL + E EMAM

Seismic Equivalent Modal Analysis Method

Segment	Height Above Base (ft)	Weight (lb)	a	b	c	Saz	Horizontal Force (lb)	Vertical Force (lb)
38	147.25	125	1.858	1.817	1.081	0.364	39	154
37	145.50	51	1.814	1.605	1.002	0.338	15	63
36	143.00	212	1.753	1.332	0.898	0.303	56	262
35	140.50	67	1.692	1.092	0.802	0.271	16	82
34	137.50	344	1.620	0.843	0.698	0.234	70	425
33	134.50	71	1.550	0.633	0.605	0.201	12	88
32	132.00	706	1.493	0.485	0.535	0.176	108	873
31	127.50	604	1.393	0.271	0.425	0.136	71	747
30	124.00	249	1.318	0.146	0.352	0.110	24	308
29	121.50	389	1.265	0.075	0.306	0.093	31	481
28	117.50	669	1.183	-0.010	0.243	0.071	41	828
27	112.50	695	1.085	-0.078	0.178	0.050	30	860
26	107.50	721	0.990	-0.112	0.127	0.036	23	892
25	102.50	747	0.900	-0.122	0.087	0.028	18	924
24	97.50	772	0.815	-0.114	0.058	0.025	17	955
23	94.75	79	0.769	-0.106	0.045	0.026	2	97
22	92.25	1,616	0.729	-0.095	0.036	0.026	37	1,999
21	89.50	366	0.687	-0.083	0.027	0.028	9	453
20	87.00	949	0.649	-0.070	0.021	0.029	24	1,174
19	82.50	1,222	0.583	-0.047	0.013	0.033	35	1,512
18	77.50	1,263	0.515	-0.022	0.008	0.037	41	1,562
17	72.50	1,303	0.450	0.001	0.006	0.040	45	1,612
16	67.50	1,343	0.390	0.021	0.007	0.042	49	1,661
15	62.50	1,383	0.335	0.037	0.010	0.043	52	1,711
14	57.50	1,423	0.283	0.049	0.014	0.043	53	1,761
13	53.00	1,167	0.241	0.057	0.018	0.042	42	1,444
12	50.50	595	0.219	0.060	0.021	0.041	21	736
11	47.50	3,027	0.193	0.064	0.024	0.040	104	3,745
10	44.25	925	0.168	0.066	0.028	0.038	31	1,144
9	41.75	1,207	0.149	0.068	0.030	0.037	39	1,494
8	37.50	1,764	0.121	0.070	0.034	0.035	54	2,182
7	32.50	1,810	0.091	0.071	0.038	0.033	52	2,239
6	27.50	1,855	0.065	0.072	0.041	0.031	50	2,295
5	22.50	1,901	0.043	0.071	0.042	0.029	47	2,352

Site Number: 370630

Code: ANSI/TIA-222-G

© 2007 - 2016 by ATC IP LLC. All rights reserved.

Site Name: Salisbury CT, CT

Engineering Number: OAA686579_C3_03

10/5/2016 8:39:23 PM

Customer: T- Mobile

4	17.50	1,947	0.026	0.067	0.040	0.026	44	2,409
3	12.50	1,993	0.013	0.059	0.034	0.022	39	2,466
2	7.50	2,039	0.005	0.044	0.025	0.017	29	2,523
1	2.50	2,085	0.001	0.018	0.010	0.007	13	2,579
RFS Celwave PD220	146.00	25	1.827	1.664	1.024	0.346	7	31
RFS Celwave PD220	146.00	25	1.827	1.664	1.024	0.346	7	31
Flat T-Arm	146.00	750	1.827	1.664	1.024	0.346	225	928
Powerwave Allgon LGP	141.00	85	1.704	1.137	0.821	0.277	20	105
Raycap DC6-48-60-18-	141.00	33	1.704	1.137	0.821	0.277	8	41
Ericsson RRUS 11 (Ba	141.00	330	1.704	1.137	0.821	0.277	79	408
Powerwave 7770.00	141.00	315	1.704	1.137	0.821	0.277	76	390
KMW AM-X-CD-16-65-00	141.00	146	1.704	1.137	0.821	0.277	35	180
Flat T-Arm	141.00	750	1.704	1.137	0.821	0.277	180	928
Antel BXA-185085/12C	134.00	39	1.539	0.602	0.590	0.196	7	48
Antel BXA-70063/6CF	134.00	51	1.539	0.602	0.590	0.196	9	63
Antel LPA-80080/6CF	134.00	126	1.539	0.602	0.590	0.196	21	156
Round T-Arm	134.00	750	1.539	0.602	0.590	0.196	127	928
Symmetricom 58532A	123.00	0	1.297	0.116	0.333	0.103	0	0
Ericsson RRUS 11 B12	123.00	152	1.297	0.116	0.333	0.103	14	188
Ericsson RRUS 11 B4	123.00	152	1.297	0.116	0.333	0.103	14	188
Ericsson RRUS 11 B2	123.00	152	1.297	0.116	0.333	0.103	14	188
RFS APX16DWV-	123.00	122	1.297	0.116	0.333	0.103	11	151
Commscope LNX-	123.00	151	1.297	0.116	0.333	0.103	13	187
Flat T-Arm	123.00	750	1.297	0.116	0.333	0.103	67	928
		44,586	58.393	23.365	20.657	7.385	2,415	55,158

Load Case (0.9 - 0.2Sds) * DL + E EMAM

Seismic (Reduced DL) Equivalent Modal Analysis Method

Segment	Height Above Base (ft)	Weight (lb)	a	b	c	Saz	Horizontal Force (lb)	Vertical Force (lb)
38	147.25	125	1.858	1.817	1.081	0.364	39	108
37	145.50	51	1.814	1.605	1.002	0.338	15	44
36	143.00	212	1.753	1.332	0.898	0.303	56	183
35	140.50	67	1.692	1.092	0.802	0.271	16	58
34	137.50	344	1.620	0.843	0.698	0.234	70	297
33	134.50	71	1.550	0.633	0.605	0.201	12	61
32	132.00	706	1.493	0.485	0.535	0.176	108	609
31	127.50	604	1.393	0.271	0.425	0.136	71	521
30	124.00	249	1.318	0.146	0.352	0.110	24	215
29	121.50	389	1.265	0.075	0.306	0.093	31	336
28	117.50	669	1.183	-0.010	0.243	0.071	41	577
27	112.50	695	1.085	-0.078	0.178	0.050	30	600
26	107.50	721	0.990	-0.112	0.127	0.036	23	622
25	102.50	747	0.900	-0.122	0.087	0.028	18	644
24	97.50	772	0.815	-0.114	0.058	0.025	17	666
23	94.75	79	0.769	-0.106	0.045	0.026	2	68
22	92.25	1,616	0.729	-0.095	0.036	0.026	37	1,394
21	89.50	366	0.687	-0.083	0.027	0.028	9	316
20	87.00	949	0.649	-0.070	0.021	0.029	24	819
19	82.50	1,222	0.583	-0.047	0.013	0.033	35	1,055
18	77.50	1,263	0.515	-0.022	0.008	0.037	41	1,089
17	72.50	1,303	0.450	0.001	0.006	0.040	45	1,124
16	67.50	1,343	0.390	0.021	0.007	0.042	49	1,159
15	62.50	1,383	0.335	0.037	0.010	0.043	52	1,193
14	57.50	1,423	0.283	0.049	0.014	0.043	53	1,228
13	53.00	1,167	0.241	0.057	0.018	0.042	42	1,007
12	50.50	595	0.219	0.060	0.021	0.041	21	513
11	47.50	3,027	0.193	0.064	0.024	0.040	104	2,612
10	44.25	925	0.168	0.066	0.028	0.038	31	798

Site Number: 370630

Code: ANSI/TIA-222-G

© 2007 - 2016 by ATC IP LLC. All rights reserved.

Site Name: Salisbury CT, CT

Engineering Number: OAA686579_C3_03

10/5/2016 8:39:23 PM

Customer: T- Mobile

9	41.75	1,207	0.149	0.068	0.030	0.037	39	1,042
8	37.50	1,764	0.121	0.070	0.034	0.035	54	1,522
7	32.50	1,810	0.091	0.071	0.038	0.033	52	1,561
6	27.50	1,855	0.065	0.072	0.041	0.031	50	1,601
5	22.50	1,901	0.043	0.071	0.042	0.029	47	1,641
4	17.50	1,947	0.026	0.067	0.040	0.026	44	1,680
3	12.50	1,993	0.013	0.059	0.034	0.022	39	1,720
2	7.50	2,039	0.005	0.044	0.025	0.017	29	1,759
1	2.50	2,085	0.001	0.018	0.010	0.007	13	1,799
RFS Celwave PD220	146.00	25	1.827	1.664	1.024	0.346	7	22
RFS Celwave PD220	146.00	25	1.827	1.664	1.024	0.346	7	22
Flat T-Arm	146.00	750	1.827	1.664	1.024	0.346	225	647
Powerwave Allgon LGP	141.00	85	1.704	1.137	0.821	0.277	20	73
Raycap DC6-48-60-18-	141.00	33	1.704	1.137	0.821	0.277	8	28
Ericsson RRUS 11 (Ba	141.00	330	1.704	1.137	0.821	0.277	79	285
Powerwave 7770.00	141.00	315	1.704	1.137	0.821	0.277	76	272
KMW AM-X-CD-16-65-00	141.00	146	1.704	1.137	0.821	0.277	35	126
Flat T-Arm	141.00	750	1.704	1.137	0.821	0.277	180	647
Antel BXA-185085/12C	134.00	39	1.539	0.602	0.590	0.196	7	34
Antel BXA-70063/6CF	134.00	51	1.539	0.602	0.590	0.196	9	44
Antel LPA-80080/6CF	134.00	126	1.539	0.602	0.590	0.196	21	109
Round T-Arm	134.00	750	1.539	0.602	0.590	0.196	127	647
Symmetricom 58532A	123.00	0	1.297	0.116	0.333	0.103	0	0
Ericsson RRUS 11 B12	123.00	152	1.297	0.116	0.333	0.103	14	131
Ericsson RRUS 11 B4	123.00	152	1.297	0.116	0.333	0.103	14	131
Ericsson RRUS 11 B2	123.00	152	1.297	0.116	0.333	0.103	14	131
RFS APX16DWV-	123.00	122	1.297	0.116	0.333	0.103	11	105
Commscope LNX-	123.00	151	1.297	0.116	0.333	0.103	13	130
Flat T-Arm	123.00	750	1.297	0.116	0.333	0.103	67	647
		44,586	58.393	23.365	20.657	7.385	2,415	38,472

Load Case (1.2 + 0.2Sds) * DL + E EMAM

Seismic Equivalent Modal Analysis Method

Calculated Forces

Seg Elev (ft)	Pu FY (-) (kips)	Vu FX (-) (kips)	Tu MY (ft-kips)	Mu MZ (ft-kips)	Mu MX (ft-kips)	Resultant Moment (ft-kips)	phi Pn (kips)	phi Vn (kips)	phi Tn (ft-kips)	phi Mn (ft-kips)	Total Deflect (in)	Rotation (deg)	Ratio
0.00	-52.58	-2.40	0.00	-246.77	0.00	246.77	7,541.17	3,770.58	22,511.9	11,272.6	0.00	0.00	0.029
5.00	-50.06	-2.38	0.00	-234.75	0.00	234.75	7,435.91	3,717.96	21,674.1	10,853.2	0.00	0.00	0.028
10.00	-47.59	-2.34	0.00	-222.86	0.00	222.86	7,327.23	3,663.62	20,841.5	10,436.2	0.01	-0.01	0.028
15.00	-45.18	-2.30	0.00	-211.14	0.00	211.14	7,215.13	3,607.56	20,014.7	10,022.2	0.02	-0.01	0.027
20.00	-42.83	-2.26	0.00	-199.63	0.00	199.63	7,099.60	3,549.80	19,194.4	9,611.47	0.04	-0.02	0.027
25.00	-40.53	-2.21	0.00	-188.34	0.00	188.34	6,980.64	3,490.32	18,381.3	9,204.34	0.06	-0.02	0.026
30.00	-38.29	-2.16	0.00	-177.29	0.00	177.29	6,858.27	3,429.13	17,576.2	8,801.21	0.09	-0.03	0.026
35.00	-36.11	-2.11	0.00	-166.48	0.00	166.48	6,732.46	3,366.23	16,779.9	8,402.42	0.12	-0.03	0.025
40.00	-34.62	-2.07	0.00	-155.93	0.00	155.93	6,603.24	3,301.62	15,992.9	8,008.36	0.16	-0.04	0.025
43.50	-33.47	-2.04	0.00	-148.68	0.00	148.68	6,510.74	3,255.37	15,448.0	7,735.51	0.19	-0.04	0.024
45.00	-29.73	-1.94	0.00	-145.61	0.00	145.61	6,470.58	3,235.29	15,216.1	7,619.37	0.20	-0.04	0.024
50.00	-28.99	-1.92	0.00	-135.92	0.00	135.92	6,334.51	3,167.25	14,450.1	7,235.83	0.25	-0.05	0.023
51.00	-27.55	-1.88	0.00	-134.01	0.00	134.01	5,351.19	2,675.60	12,353.0	6,185.72	0.26	-0.05	0.027
55.00	-25.79	-1.82	0.00	-126.51	0.00	126.51	5,265.80	2,632.90	11,859.3	5,938.51	0.30	-0.05	0.026
60.00	-24.08	-1.77	0.00	-117.39	0.00	117.39	5,155.98	2,577.99	11,249.0	5,632.89	0.36	-0.06	0.026
65.00	-22.42	-1.72	0.00	-108.53	0.00	108.53	5,042.74	2,521.37	10,646.9	5,331.40	0.43	-0.07	0.025
70.00	-20.80	-1.68	0.00	-99.92	0.00	99.92	4,926.07	2,463.04	10,053.8	5,034.40	0.50	-0.07	0.024
75.00	-19.24	-1.64	0.00	-91.53	0.00	91.53	4,805.98	2,402.99	9,470.41	4,742.24	0.58	-0.08	0.023
80.00	-17.73	-1.60	0.00	-83.34	0.00	83.34	4,682.46	2,341.23	8,897.37	4,455.30	0.67	-0.09	0.022
85.00	-16.56	-1.58	0.00	-75.33	0.00	75.33	4,555.52	2,277.76	8,335.45	4,173.92	0.76	-0.09	0.022
89.00	-16.10	-1.57	0.00	-69.02	0.00	69.02	4,451.50	2,225.75	7,894.42	3,953.08	0.84	-0.10	0.021
90.00	-14.10	-1.53	0.00	-67.45	0.00	67.45	4,425.16	2,212.58	7,785.39	3,898.48	0.86	-0.10	0.020
94.50	-14.01	-1.53	0.00	-60.56	0.00	60.56	2,429.52	1,214.76	4,208.21	2,107.23	0.96	-0.10	0.035
95.00	-13.05	-1.51	0.00	-59.80	0.00	59.80	2,423.93	1,211.97	4,181.46	2,093.84	0.97	-0.11	0.034
100.00	-12.13	-1.49	0.00	-52.24	0.00	52.24	2,366.19	1,183.09	3,915.26	1,960.54	1.08	-0.11	0.032
105.00	-11.23	-1.47	0.00	-44.77	0.00	44.77	2,305.01	1,152.51	3,651.76	1,828.59	1.21	-0.12	0.029
110.00	-10.37	-1.44	0.00	-37.42	0.00	37.42	2,240.42	1,120.21	3,391.69	1,698.37	1.35	-0.13	0.027
115.00	-9.55	-1.40	0.00	-30.21	0.00	30.21	2,172.39	1,086.20	3,135.78	1,570.22	1.49	-0.14	0.024
120.00	-9.07	-1.37	0.00	-23.22	0.00	23.22	2,100.95	1,050.47	2,884.74	1,444.51	1.64	-0.15	0.020
123.00	-6.93	-1.21	0.00	-19.12	0.00	19.12	2,056.44	1,028.22	2,736.75	1,370.41	1.74	-0.15	0.017
125.00	-6.18	-1.13	0.00	-16.71	0.00	16.71	2,026.08	1,013.04	2,639.30	1,321.61	1.80	-0.16	0.016
130.00	-5.31	-1.02	0.00	-11.04	0.00	11.04	1,947.78	973.89	2,400.18	1,201.87	1.97	-0.16	0.012
134.00	-4.03	-0.84	0.00	-6.94	0.00	6.94	1,102.25	551.13	1,321.80	661.88	2.11	-0.17	0.014
135.00	-3.60	-0.77	0.00	-6.10	0.00	6.10	1,095.19	547.60	1,297.91	649.92	2.14	-0.17	0.013
140.00	-3.52	-0.76	0.00	-2.23	0.00	2.23	1,057.85	528.92	1,179.18	590.46	2.32	-0.17	0.007
141.00	-1.21	-0.30	0.00	-1.47	0.00	1.47	1,049.97	524.98	1,155.61	578.66	2.35	-0.17	0.004
145.00	-1.14	-0.28	0.00	-0.28	0.00	0.28	1,017.07	508.54	1,062.12	531.85	2.50	-0.17	0.002
146.00	0.00	0.00	0.00	0.00	0.00	0.00	1,008.51	504.25	1,038.98	520.26	2.53	-0.17	0.000
148.50	0.00	0.00	0.00	0.00	0.00	0.00	986.50	493.25	981.57	491.52	2.62	-0.17	0.000

Load Case (0.9 - 0.2Sds) * DL + E EMAM

Seismic (Reduced DL) Equivalent Modal Analysis Method

Calculated Forces

Seg Elev (ft)	Pu FY (-) (kips)	Vu FX (-) (kips)	Tu MY (ft-kips)	Mu MZ (ft-kips)	Mu MX (ft-kips)	Resultant Moment (ft-kips)	phi Pn (kips)	phi Vn (kips)	phi Tn (ft-kips)	phi Mn (ft-kips)	Total Deflect (in)	Rotation (deg)	Ratio
0.00	-36.67	-2.40	0.00	-245.87	0.00	245.87	7,541.17	3,770.58	22,511.9	11,272.6	0.00	0.00	0.027
5.00	-34.91	-2.38	0.00	-233.85	0.00	233.85	7,435.91	3,717.96	21,674.1	10,853.2	0.00	0.00	0.026
10.00	-33.19	-2.34	0.00	-221.97	0.00	221.97	7,327.23	3,663.62	20,841.5	10,436.2	0.01	-0.01	0.026
15.00	-31.51	-2.30	0.00	-210.27	0.00	210.27	7,215.13	3,607.56	20,014.7	10,022.2	0.02	-0.01	0.025
20.00	-29.87	-2.25	0.00	-198.78	0.00	198.78	7,099.60	3,549.80	19,194.4	9,611.47	0.04	-0.02	0.025
25.00	-28.27	-2.21	0.00	-187.51	0.00	187.51	6,980.64	3,490.32	18,381.3	9,204.34	0.06	-0.02	0.024
30.00	-26.71	-2.16	0.00	-176.48	0.00	176.48	6,858.27	3,429.13	17,576.2	8,801.21	0.09	-0.03	0.024
35.00	-25.19	-2.10	0.00	-165.71	0.00	165.71	6,732.46	3,366.23	16,779.9	8,402.42	0.12	-0.03	0.023
40.00	-24.15	-2.07	0.00	-155.19	0.00	155.19	6,603.24	3,301.62	15,992.9	8,008.36	0.16	-0.04	0.023
43.50	-23.35	-2.04	0.00	-147.96	0.00	147.96	6,510.74	3,255.37	15,448.0	7,735.51	0.19	-0.04	0.023
45.00	-20.74	-1.93	0.00	-144.91	0.00	144.91	6,470.58	3,235.29	15,216.1	7,619.37	0.20	-0.04	0.022
50.00	-20.22	-1.91	0.00	-135.26	0.00	135.26	6,334.51	3,167.25	14,450.1	7,235.83	0.25	-0.05	0.022
51.00	-19.21	-1.87	0.00	-133.35	0.00	133.35	5,351.19	2,675.60	12,353.0	6,185.72	0.26	-0.05	0.025
55.00	-17.99	-1.81	0.00	-125.88	0.00	125.88	5,265.80	2,632.90	11,859.3	5,938.51	0.30	-0.05	0.025
60.00	-16.79	-1.76	0.00	-116.81	0.00	116.81	5,155.98	2,577.99	11,249.0	5,632.89	0.36	-0.06	0.024
65.00	-15.63	-1.71	0.00	-107.99	0.00	107.99	5,042.74	2,521.37	10,646.9	5,331.40	0.43	-0.07	0.023
70.00	-14.51	-1.67	0.00	-99.42	0.00	99.42	4,926.07	2,463.04	10,053.8	5,034.40	0.50	-0.07	0.023
75.00	-13.42	-1.63	0.00	-91.07	0.00	91.07	4,805.98	2,402.99	9,470.41	4,742.24	0.58	-0.08	0.022
80.00	-12.37	-1.59	0.00	-82.92	0.00	82.92	4,682.46	2,341.23	8,897.37	4,455.30	0.67	-0.09	0.021
85.00	-11.55	-1.57	0.00	-74.95	0.00	74.95	4,555.52	2,277.76	8,335.45	4,173.92	0.76	-0.09	0.020
89.00	-11.23	-1.56	0.00	-68.67	0.00	68.67	4,451.50	2,225.75	7,894.42	3,953.08	0.84	-0.10	0.020
90.00	-9.84	-1.52	0.00	-67.11	0.00	67.11	4,425.16	2,212.58	7,785.39	3,898.48	0.86	-0.10	0.019
94.50	-9.77	-1.52	0.00	-60.26	0.00	60.26	2,429.52	1,214.76	4,208.21	2,107.23	0.95	-0.10	0.033
95.00	-9.10	-1.50	0.00	-59.50	0.00	59.50	2,423.93	1,211.97	4,181.46	2,093.84	0.96	-0.10	0.032
100.00	-8.46	-1.49	0.00	-51.98	0.00	51.98	2,366.19	1,183.09	3,915.26	1,960.54	1.08	-0.11	0.030
105.00	-7.83	-1.46	0.00	-44.55	0.00	44.55	2,305.01	1,152.51	3,651.76	1,828.59	1.20	-0.12	0.028
110.00	-7.24	-1.43	0.00	-37.23	0.00	37.23	2,240.42	1,120.21	3,391.69	1,698.37	1.34	-0.13	0.025
115.00	-6.66	-1.39	0.00	-30.07	0.00	30.07	2,172.39	1,086.20	3,135.78	1,570.22	1.48	-0.14	0.022
120.00	-6.32	-1.36	0.00	-23.11	0.00	23.11	2,100.95	1,050.47	2,884.74	1,444.51	1.63	-0.15	0.019
123.00	-4.83	-1.20	0.00	-19.04	0.00	19.04	2,056.44	1,028.22	2,736.75	1,370.41	1.73	-0.15	0.016
125.00	-4.31	-1.13	0.00	-16.63	0.00	16.63	2,026.08	1,013.04	2,639.30	1,321.61	1.79	-0.16	0.015
130.00	-3.70	-1.02	0.00	-10.99	0.00	10.99	1,947.78	973.89	2,400.18	1,201.87	1.96	-0.16	0.011
134.00	-2.81	-0.84	0.00	-6.91	0.00	6.91	1,102.25	551.13	1,321.80	661.88	2.10	-0.16	0.013
135.00	-2.51	-0.77	0.00	-6.07	0.00	6.07	1,095.19	547.60	1,297.91	649.92	2.13	-0.17	0.012
140.00	-2.45	-0.75	0.00	-2.22	0.00	2.22	1,057.85	528.92	1,179.18	590.46	2.31	-0.17	0.006
141.00	-0.84	-0.30	0.00	-1.47	0.00	1.47	1,049.97	524.98	1,155.61	578.66	2.34	-0.17	0.003
145.00	-0.80	-0.28	0.00	-0.28	0.00	0.28	1,017.07	508.54	1,062.12	531.85	2.48	-0.17	0.001
146.00	0.00	0.00	0.00	0.00	0.00	0.00	1,008.51	504.25	1,038.98	520.26	2.52	-0.17	0.000
148.50	0.00	0.00	0.00	0.00	0.00	0.00	986.50	493.25	981.57	491.52	2.61	-0.17	0.000

Site Number: 370630

Code: ANSI/TIA-222-G

© 2007 - 2016 by ATC IP LLC. All rights reserved.

Site Name: Salisbury CT, CT

Engineering Number: OAA686579_C3_03

10/5/2016 8:39:23 PM

Customer: T-Mobile

Analysis Summary

Load Case	Reactions						Max Usage	
	Shear FX (kips)	Shear FZ (kips)	Axial FY (kips)	Moment MX (ft-kips)	Moment MY (ft-kips)	Moment MZ (ft-kips)	Elev (ft)	Interaction Ratio
1.2D + 1.6W	20.53	0.00	53.50	0.00	0.00	2042.30	94.50	0.22
0.9D + 1.6W	20.53	0.00	40.12	0.00	0.00	2035.98	94.50	0.22
1.2D + 1.0Di + 1.0Wi	4.47	0.00	85.34	0.00	0.00	431.54	94.50	0.06
(1.2 + 0.2Sds) * DL + E ELFM	3.45	0.00	52.58	0.00	0.00	341.18	0.00	0.04
(1.2 + 0.2Sds) * DL + E EMAM	2.40	0.00	52.58	0.00	0.00	246.77	94.50	0.03
(0.9 - 0.2Sds) * DL + E ELFM	3.45	0.00	36.67	0.00	0.00	340.02	0.00	0.04
(0.9 - 0.2Sds) * DL + E EMAM	2.40	0.00	36.67	0.00	0.00	245.87	94.50	0.03
1.0D + 1.0W	5.70	0.00	44.59	0.00	0.00	566.10	94.50	0.07

Site Number: 370630

Code: ANSI/TIA-222-G

© 2007 - 2016 by ATC IP LLC. All rights reserved.

Site Name: Salisbury CT, CT

Engineering Number: OAA686579_C3_03

10/5/2016 8:39:23 PM

Customer: T-Mobile

Base Summary

Reactions

Original Design			Analysis			Moment Design %
Moment (kip-ft)	Axial (kip)	Shear (kip)	Moment (kip-ft)	Axial (kip)	Shear (kip)	
7,150.00	53.00	62.00	2,042.30	85.34	20.53	21.16

Base Plate

Yield (ksi)	Thick (in)	Width (in)	Style	Poly Sides	Clip Len (in)	Effective Len (in)	Mu (kip-in)	Phi Mn (kip-in)	Ratio
50.0	3.250	81.000	Clipped	8	18.00	8.284	183.23	984.35	0.19

Anchor Bolts

Bolt Circle	Num Bolts	Bolt Type	Bolt Dia (in)	Yield (ksi)	Ultimate (ksi)	Arrange	Cluster Dist (in)	Start Angle (deg)	Compression			Tension		
									Force (kip)	Allow (kip)	Ratio	Force (kip)	Allow (kip)	Ratio
81.00	28	2.25" 18J	2.25	75.00	100.00	Clustered	6.00	45.0	46.27	260.00	0.18	40.18	260.00	0.16

Exhibit E

RADIO FREQUENCY EMISSIONS ANALYSIS REPORT
EVALUATION OF HUMAN EXPOSURE POTENTIAL
TO NON-IONIZING EMISSIONS

T-Mobile Existing Facility

Site ID: CTNH547A

Salisbury
52 Library Street
Salisbury, CT 06068

October 14, 2016

EBI Project Number: 6216004604

Site Compliance Summary	
Compliance Status:	COMPLIANT
Site total MPE% of FCC general public allowable limit:	6.97 %

October 14, 2016

T-Mobile USA
Attn: Jason Overbey, RF Manager
35 Griffin Road South
Bloomfield, CT 06002

Emissions Analysis for Site: **CTNH547A – Salisbury**

EBI Consulting was directed to analyze the proposed T-Mobile facility located at **52 Library Street, Salisbury, CT**, for the purpose of determining whether the emissions from the Proposed T-Mobile Antenna Installation located on this property are within specified federal limits.

All information used in this report was analyzed as a percentage of current Maximum Permissible Exposure (% MPE) as listed in the FCC OET Bulletin 65 Edition 97-01 and ANSI/IEEE Std C95.1. The FCC regulates Maximum Permissible Exposure in units of microwatts per square centimeter ($\mu\text{W}/\text{cm}^2$). The number of $\mu\text{W}/\text{cm}^2$ calculated at each sample point is called the power density. The exposure limit for power density varies depending upon the frequencies being utilized. Wireless Carriers and Paging Services use different frequency bands each with different exposure limits, therefore it is necessary to report results and limits in terms of percent MPE rather than power density.

All results were compared to the FCC (Federal Communications Commission) radio frequency exposure rules, 47 CFR 1.1307(b)(1) – (b)(3), to determine compliance with the Maximum Permissible Exposure (MPE) limits for General Population/Uncontrolled environments as defined below.

General population/uncontrolled exposure limits apply to situations in which the general public may be exposed or in which persons who are exposed as a consequence of their employment may not be made fully aware of the potential for exposure or cannot exercise control over their exposure. Therefore, members of the general public would always be considered under this category when exposure is not employment related, for example, in the case of a telecommunications tower that exposes persons in a nearby residential area.

Public exposure to radio frequencies is regulated and enforced in units of microwatts per square centimeter ($\mu\text{W}/\text{cm}^2$). The general population exposure limit for the 700 MHz Band is approximately 467 $\mu\text{W}/\text{cm}^2$, and the general population exposure limit for the 1900 MHz (PCS) and 2100 MHz (AWS) bands is 1000 $\mu\text{W}/\text{cm}^2$. Because each carrier will be using different frequency bands, and each frequency band has different exposure limits, it is necessary to report percent of MPE rather than power density.

Occupational/controlled exposure limits apply to situations in which persons are exposed as a consequence of their employment and in which those persons who are exposed have been made fully aware of the potential for exposure and can exercise control over their exposure. Occupational/controlled exposure limits also apply where exposure is of a transient nature as a result of incidental passage through a location where exposure levels may be above general population/uncontrolled limits (see below), as long as the exposed person has been made fully aware of the potential for exposure and can exercise control over his or her exposure by leaving the area or by some other appropriate means.

Additional details can be found in FCC OET 65.

CALCULATIONS

Calculations were done for the proposed T-Mobile Wireless antenna facility located at **52 Library Street, Salisbury, CT**, using the equipment information listed below. All calculations were performed per the specifications under FCC OET 65. Since T-Mobile is proposing highly focused directional panel antennas, which project most of the emitted energy out toward the horizon, all calculations were performed assuming a lobe representing the maximum gain of the antenna per the antenna manufactures supplied specifications, minus 10 dB, was focused at the base of the tower. For this report the sample point is the top of a 6-foot person standing at the base of the tower.

For all calculations, all equipment was calculated using the following assumptions:

- 1) 2 UMTS channels (PCS Band - 1900 MHz) were considered for each sector of the proposed installation. These Channels have a transmit power of 30 Watts per Channel.
- 2) 2 LTE channels (AWS Band – 2100 MHz) were considered for each sector of the proposed installation. These Channels have a transmit power of 60 Watts per Channel
- 3) 1 LTE channel (700 MHz Band) was considered for each sector of the proposed installation. This channel has a transmit power of 30 Watts.
- 4) All radios at the proposed installation were considered to be running at full power and were uncombined in their RF transmissions paths per carrier prescribed configuration. Per FCC OET Bulletin No. 65 - Edition 97-01 recommendations to achieve the maximum anticipated value at each sample point, all power levels emitting from the proposed antenna installation are increased by a factor of 2.56 to account for possible in-phase reflections from the surrounding environment. This is rarely the case, and if so, is never continuous.

- 5) For the following calculations the sample point was the top of a 6-foot person standing at the base of the tower. The maximum gain of the antenna per the antenna manufactures supplied specifications minus 10 dB was used in this direction. This value is a very conservative estimate as gain reductions for these particular antennas are typically much higher in this direction.
- 6) The antennas used in this modeling are the **RFS APX16DWV-16DWVS-E-A20** for 1900 MHz (PCS) and 2100 MHz (AWS) channels and the **Commscope LNX-6515DS-VTM** for 700 MHz channels. This is based on feedback from the carrier with regards to anticipated antenna selection. The **RFS APX16DWV-16DWVS-E-A20** has a maximum gain of **16.3 dBd** at its main lobe at 1900 MHz and 2100 MHz. The **Commscope LNX-6515DS-VTM** has a maximum gain of **14.6 dBd** at its main lobe at 700 MHz. The maximum gain of the antenna per the antenna manufactures supplied specifications, minus 10 dB, was used for all calculations. This value is a very conservative estimate as gain reductions for these particular antennas are typically much higher in this direction.
- 7) The antenna mounting height centerline of the proposed antennas is **123 feet** above ground level (AGL).
- 8) Emissions values for additional carriers were taken from the Connecticut Siting Council active database. Values in this database are provided by the individual carriers themselves.
- 9) All calculations were done with respect to uncontrolled / general public threshold limits.

T-Mobile Site Inventory and Power Data

Sector:	A	Sector:	B	Sector:	C
Antenna #:	1	Antenna #:	1	Antenna #:	1
Make / Model:	RFS APX16DWV-16DWVS-E-A20	Make / Model:	RFS APX16DWV-16DWVS-E-A20	Make / Model:	RFS APX16DWV-16DWVS-E-A20
Gain:	16.3 dBd	Gain:	16.3 dBd	Gain:	16.3 dBd
Height (AGL):	123	Height (AGL):	123	Height (AGL):	123
Frequency Bands	1900 MHz (PCS) / 2100 MHz (AWS)	Frequency Bands	1900 MHz (PCS) / 2100 MHz (AWS)	Frequency Bands	1900 MHz (PCS) / 2100 MHz (AWS)
Channel Count	4	Channel Count	4	Channel Count	4
Total TX Power(W):	180	Total TX Power(W):	180	Total TX Power(W):	180
ERP (W):	7,678.43	ERP (W):	7,678.43	ERP (W):	7,678.43
Antenna A1 MPE%	2.02	Antenna B1 MPE%	2.02	Antenna C1 MPE%	2.02
Antenna #:	2	Antenna #:	2	Antenna #:	2
Make / Model:	Commscope LNX-6515DS-VTM	Make / Model:	Commscope LNX-6515DS-VTM	Make / Model:	Commscope LNX-6515DS-VTM
Gain:	14.6 dBd	Gain:	14.6 dBd	Gain:	14.6 dBd
Height (AGL):	123	Height (AGL):	123	Height (AGL):	123
Frequency Bands	700 MHz	Frequency Bands	700 MHz	Frequency Bands	700 MHz
Channel Count	1	Channel Count	1	Channel Count	1
Total TX Power(W):	30	Total TX Power(W):	30	Total TX Power(W):	30
ERP (W):	865.21	ERP (W):	865.21	ERP (W):	865.21
Antenna A2 MPE%	0.49	Antenna B2 MPE%	0.49	Antenna C2 MPE%	0.49

Site Composite MPE%	
Carrier	MPE%
T-Mobile (Per Sector Max)	2.50 %
Litchfield County Dispatch	0.64 %
EMS	0.32 %
AT&T	1.69 %
Verizon Wireless	1.82 %
Site Total MPE %:	6.97 %

T-Mobile Sector A Total:	2.50 %
T-Mobile Sector B Total:	2.50 %
T-Mobile Sector C Total:	2.50 %
Site Total:	6.97 %

T-Mobile _per sector	# Channels	Watts ERP (Per Channel)	Height (feet)	Total Power Density ($\mu\text{W}/\text{cm}^2$)	Frequency (MHz)	Allowable MPE ($\mu\text{W}/\text{cm}^2$)	Calculated % MPE
T-Mobile AWS - 2100 MHz LTE	2	2,559.48	123	13.44	AWS - 2100 MHz	1000	1.34%
T-Mobile PCS - 1950 MHz UMTS	2	1,279.74	123	6.72	PCS - 1950 MHz	1000	0.67%
T-Mobile 700 MHz LTE	1	865.21	123	2.27	700 MHz	467	0.49%
						Total, :	2.50%

* NOTE: Totals may vary by 0.01% due to summing of remainders

Summary

All calculations performed for this analysis yielded results that were **within** the allowable limits for general public exposure to RF Emissions.

The anticipated maximum composite contributions from the T-Mobile facility as well as the site composite emissions value with regards to compliance with FCC's allowable limits for general public exposure to RF Emissions are shown here:

T-Mobile Sector	Power Density Value (%)
Sector A:	2.50 %
Sector B:	2.50 %
Sector C:	2.50 %
T-Mobile Per Sector Maximum:	2.50 %
Site Total:	6.97 %
Site Compliance Status:	COMPLIANT

The anticipated composite MPE value for this site assuming all carriers present is **6.97%** of the allowable FCC established general public limit sampled at the ground level. This is based upon values listed in the Connecticut Siting Council database for existing carrier emissions.

FCC guidelines state that if a site is found to be out of compliance (over allowable thresholds), that carriers over a 5% contribution to the composite value will require measures to bring the site into compliance. For this facility, the composite values calculated were well within the allowable 100% threshold standard per the federal government.

Exhibit F



AMERICAN TOWER®
CORPORATION

LETTER OF AUTHORIZATION

ATC SITE # / NAME: 370630 / Salisbury CT
SITE ADDRESS: 52 Liberty Street, Salisbury, CT
LICENSEE: T-Mobile Northeast LLC d/b/a T-Mobile

I, Margaret Robinson, Senior Counsel for American Tower*, owner of the tower facility located at the address identified above (the "Tower Facility"), do hereby authorize **T-Mobile Northeast LLC d/b/a T-Mobile**, its successors and assigns, and/or its agent, (collectively, the "Licensee") to act as American Tower's non-exclusive agent for the sole purpose of filing and consummating any land-use or building permit application(s) as may be required by the applicable permitting authorities for Licensee's telecommunications' installation.

We understand that this application may be denied, modified or approved with conditions. The above authorization is limited to the acceptance by Licensee only of conditions related to Licensee's installation and any such conditions of approval or modifications will be Licensee's sole responsibility.

Signature:

Print Name: Margaret Robinson
Senior Counsel
American Tower*

NOTARY BLOCK

Commonwealth of MASSACHUSETTS
County of Middlesex

This instrument was acknowledged before me by Margaret Robinson, Senior Counsel for American Tower*, personally known to me (or proved to me on the basis of satisfactory evidence) to be the person whose name is subscribed to the within instrument and acknowledged to me that he executed the same.

WITNESS my hand and official seal, this 9 day of November, 2016.

NOTARY SEAL

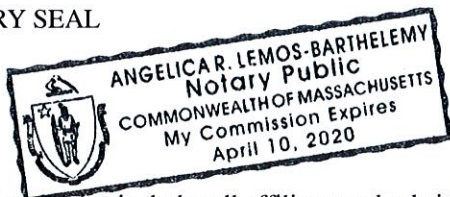

Notary Public
My Commission Expires: April 10, 2020

*American Tower includes all affiliates and subsidiaries of American Tower Corporation.

Exhibit G

2-C CERTIFICATION

Date: November 14, 2016

RE: Site Name: CTNH547
Address: 52 Library St.
Salisbury, CT 06068
Ground Elevation: 667.2' (AMSL)
Top of Tower: 149.7' (AGL)
Highest Appurtenance: 167.4 (AGL)
(Lightning Rod)

City Name: Salisbury County: Litchfield State: Connecticut

I certify that the Latitude of 41 Degrees 58 Min. 51.044 Sec. North and the longitude of 73 Degrees 25 Min. 06.324 Sec. West is accurate to within +/- 50 feet horizontally; and is accurate to within +/- 20 feet vertically. The horizontal datum (coordinates) is in terms of the North America Datum of 1983 (NAD83) and is expressed in degrees, minutes and seconds. The vertical datum (heights) is in terms of the North American Vertical Datum of 1988 (NAVD88).

Decimal Format

41.980846 Latitude
-73.418423 Longitude

State of Connecticut

Date: 11/14/16



Alvin A. Kraft
Connecticut Registered No. 20787
SMW Job No. 16-2561
Prepared By: JP