



STATE OF CONNECTICUT

CONNECTICUT SITING COUNCIL

Ten Franklin Square, New Britain, CT 06051

Phone: (860) 827-2935 Fax: (860) 827-2950

E-Mail: siting.council@po.state.ct.us

Web Site: www.ct.gov/csc

March 23, 2004

Stephen J. Humes, Esq.
LeBoeuf, Lamb, Greene & MacRae LLP
Goodwin Square
225 Asylum Street
Hartford, CT 06103

RE: **EM-T-MOBILE-111-040303** – Omnipoint Communications, Inc. notice of intent to modify an existing telecommunications facility located at 171 Town Hill Road, Plymouth, Connecticut.

Dear Attorney Humes:

At a public meeting held on March 17, 2004, the Connecticut Siting Council (Council) acknowledged your notice to modify this existing telecommunications facility, pursuant to Section 16-50j-73 of the Regulations of Connecticut State Agencies.

The proposed modifications are to be implemented as specified here and in your notice dated March 3, 2004. The modifications are in compliance with the exception criteria in Section 16-50j-72 (b) of the Regulations of Connecticut State Agencies as changes to an existing facility site that would not increase tower height, extend the boundaries of the tower site, increase noise levels at the tower site boundary by six decibels, and increase the total radio frequencies electromagnetic radiation power density measured at the tower site boundary to or above the standard adopted by the State Department of Environmental Protection pursuant to General Statutes § 22a-162. This facility has also been carefully modeled to ensure that radio frequency emissions are conservatively below State and federal standards applicable to the frequencies now used on this tower.

This decision is under the exclusive jurisdiction of the Council. Any additional change to this facility will require explicit notice to this agency pursuant to Regulations of Connecticut State Agencies Section 16-50j-73. Such notice shall include all relevant information regarding the proposed change with cumulative worst-case modeling of radio frequency exposure at the closest point of uncontrolled access to the tower base, consistent with Federal Communications Commission, Office of Engineering and Technology, Bulletin 65. Any deviation from this format may result in the Council implementing enforcement proceedings pursuant to General Statutes § 16-50u including, without limitation, imposition of expenses resulting from such failure and of civil penalties in an amount not less than one thousand dollars per day for each day of construction or operation in material violation.

Thank you for your attention and cooperation.

Very truly yours,

Pamela B. Katz, P.E.
Chairman

PBK/mp

c: Honorable Richard G. Covello, Mayor, Town of Plymouth
William Kuehn, Town Planner, Town of Plymouth
Christopher B. Fisher, Esq., Cuddy & Feder LLP
Thomas J. Regan, Esq., Brown Rudnick Berlack Israels LLP
Kenneth C. Baldwin, Esq., Robinson & Cole LLP

LEBOEUF
LAMB.
GREENE &
MACRAE LLP*

Goodwin Square
225 Asylum Street, 13th Floor
Hartford, CT 06103
Tel: (860) 293-3500
Fax: (860) 293-3555

FAX

TRANSMISSION

TRANSMISSION PROBLEMS: (860) 293-3722

FROM: Roger J. Cirella	ID#: 5344	DATE: March 23, 2004
TEL: (860) 293-3722	PAGES: 1 of 2	CLIENT/MATTER NO.: 07687-00005

TO:	COMPANY:	FAX NO.:	CONFIRMING TELEPHONE NO.:
Mike Perrone	Connecticut Siting Council	(860) 827-2950	(860) 827-2943

Comments/Message:

Mike,

Enclosed please find the Tower Elevation for Plymouth. Please let me know if you need anything else. Thanks.

Roger

RECEIVED
MAR 23 2004
CONNECTICUT
SITING COUNCIL

***A LIMITED LIABILITY PARTNERSHIP INCLUDING PROFESSIONAL CORPORATIONS**

THIS FACSIMILE TRANSMISSION CONTAINS CONFIDENTIAL AND/OR LEGALLY PRIVILEGED INFORMATION INTENDED ONLY FOR THE USE OF THE INDIVIDUAL(S) NAMED ON THE TRANSMISSION SHEET. IF YOU ARE NOT THE INTENDED RECIPIENT, YOU ARE HEREBY NOTIFIED THAT ANY DISCLOSURE, COPYING, DISTRIBUTION OR THE TAKING OF ANY ACTION IN RELIANCE ON THE CONTENTS OF THIS FACSIMILE TRANSMISSION IS STRICTLY PROHIBITED. IF YOU HAVE RECEIVED THIS COMMUNICATION IN ERROR, PLEASE CALL US IMMEDIATELY SO THAT WE CAN ARRANGE FOR RETURN OF THE DOCUMENTS TO US AT NO COST TO YOU. THANK YOU.

EM-T-MOBILE-111-040303

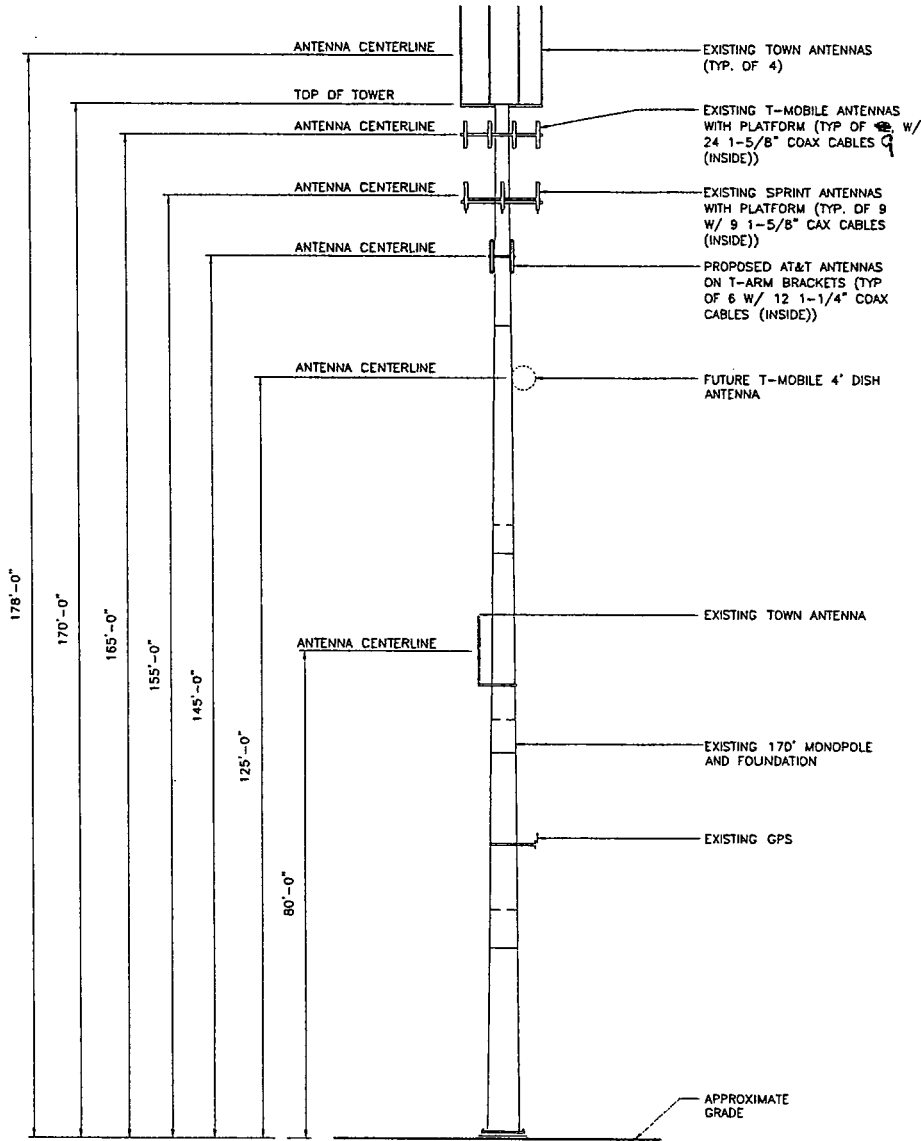

1 TOWER ELEVATION
SC-2 SCALE: 1" = 30'-0"

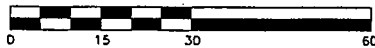

SITING COUNCIL REVIEW

T-MOBILE SITE NUMBER: CT11417C SITE NAME: TERRYVILLE

LATITUDE: 41.6883 (NAD 83)
LONGITUDE: 73.0200 (NAD 83)

URS
URS CORPORATION-AES
795 BROOK STREET, BLDG 5
ROCKY HILL, CT. 06067
1-(860)-529-8882
1-(860)-529-5566 (FAX)

AT&T
AT&T WIRELESS PCS LLC
12 OMEGA DRIVE
STAMFORD, CONNECTICUT 06902

DRAWING TITLE TOWER ELEVATION
PROJECT INFORMATION TERRYVILLE-LIONS CLUB PARK
CT-832
171 TOWN HILL ROAD
PLYMOUTH, CT
TOWER OWNER T-MOBILE
16 WING DRIVE
CEDAR KNOLLS, NEW JERSEY

DRAWING TITLE	
907-007-832B-SC2	
REVISION NO. A	DRAWN BY: RB
DATE ISSUED: 05/08/03	CHECKED BY: JCF
SCALE: AS NOTED	APPROVED BY:
	SHEET NO. 2 OF 2
URS JOB NO.: BA1048 (369152D3)	

LEBOEUF, LAMB, GREENE
L.L.P.

A LIMITED LIABILITY PARTNERSHIP INCLUDING PROFESSIONAL CORPORATIONS

NEW YORK
WASHINGTON, DC.
ALBANY
BOSTON
DENVER
HARRISBURG
HARTFORD
HOUSTON
JACKSONVILLE
LOS ANGELES
NEWARK
PITTSBURGH
SALT LAKE CITY
SAN FRANCISCO

GOODWIN SQUARE
225 ASYLUM STREET, 13TH FLOOR
HARTFORD, CT 06103

(860) 293-3500

FACSIMILE: (860) 293-3555

E-MAIL ADDRESS: STEPHEN.HUMES@LLGM.COM

WRITER'S DIRECT DIAL: (860) 293-3744

WRITER'S DIRECT FACSIMILE: (860) 241-1344

LONDON
(A LONDON-BASED
MULTINATIONAL PARTNERSHIP)

PARIS

BRUSSELS

JOHANNESBURG
(PTY) LTD.

MOSCOW

RIYADH
(AFFILIATED OFFICE)

TASHKENT

BISHKEK

ALMATY

BEIJING

March 3, 2004

Pamela Katz, Chairman
Connecticut Siting Council
Ten Franklin Square
New Britain, CT 06051

RECEIVED
MAR - 3 2004

CONNECTICUT
SITING COUNCIL

Re: Notice of Exempt Modification
171 Town Hill Road Plymouth, Connecticut

Dear Chairman Katz and Members of the Council:

Please be advised that LeBoeuf, Lamb, Greene & MacRae, L.L.P. represents Omnipoint Communications, Inc., a subsidiary of T-Mobile USA, Inc. (hereinafter T-Mobile) in the above-referenced matter. T-Mobile intends to replace one (1) S8000 cabinet with two (2) S12000 cabinets. Also, six (6) antennas will be added to the existing three (3) antennas for a total of nine (9) EMS FR90-16-XXXP antennas mounted on an existing platform on the existing monopole tower facility at 171 Town Hill Road in Plymouth. Please accept this letter as notification, pursuant to R.C.S.A. § 16-50j-73, of construction that constitutes an exempt modification pursuant to R.C.S.A. § 16-50j-72(b)(2). In accordance with R.C.S.A. § 16-50j-73, a copy of this letter is being sent to the Mayor of Plymouth, David C. Mischke.

Background

T-Mobile holds the "A block" "Wideband PCS" license for the 2-GHz PCS frequencies for the greater New York City area, including the entire State of Connecticut. T-Mobile is licensed by the Federal Communications Commission (FCC) to provide PCS wireless telecommunications service in the State of Connecticut, which includes the area to be served by the proposed installation.

Discussion

The existing facility consists of a one hundred seventy foot (170') monopole tower (see drawing attached as Exhibit B) and surrounding compound. The coordinates for the site are **Lat: 41°-40-05** and **Long: 73°-1-14**. The tower is in the northeast corner of Plymouth. The tower is approximately six hundred thirty-two feet (632') south of Washington Road and roughly one thousand three hundred ninety-six (1,396') west of Eagle Street.

T-Mobile's proposal calls for the addition of six (6) antennas to its existing three (3) antenna array, creating a total of nine (9) antennas. The proposed configuration is a cluster of three sectors with two (2) antennas per sector mounted on an existing low profile platform at the one hundred sixty-five foot (165') centerline above ground level ("AGL"). The model number for the new antennas are FR90-16-XXXP. A new structural analysis of the tower has been completed and is attached as Exhibit D. As stated in the structural analysis, the existing tower structure is capable of supporting the proposed T-Mobile installation. Two new S12000 cabinets will replace the existing S8000 equipment cabinet. Utilities will be run via underground conduit from those currently in place.

The planned modifications to the Plymouth facility fall squarely within those activities explicitly provided for in R.C.S.A. § 16-50j-72(b)(2).

1. The proposed modification will not increase the height of T-Mobile's approved antennas on the tower and will not extend the boundaries of the existing compound area. The enclosed tower drawings confirm that the planned changes will not increase the overall height of the tower.
2. The installation of T-Mobile equipment, as reflected on the attached site plan, will not require an extension of the site boundaries.
3. The proposed modification to the facility will not increase the noise levels at the existing facility by six decibels or more. T-Mobile's equipment is self-contained and requires no additional heating, ventilation or cooling equipment.
4. The operation of the additional antennas will not increase the total radio frequency (RF) power density, measured at the site boundary, to a level at or above the applicable standard. The "worst-case" RF power density calculations, for a point at the site boundary, are attached hereto as Exhibit E.

For the foregoing reasons, T-Mobile respectfully submits that the proposed addition of antennas and equipment at the Plymouth facility constitutes an exempt modification under R.C.S.A. § 16-50j-72(b)(2).

Thank you for your consideration of this matter.

Respectfully submitted,

OMNIPOINT COMMUNICATIONS, INC.

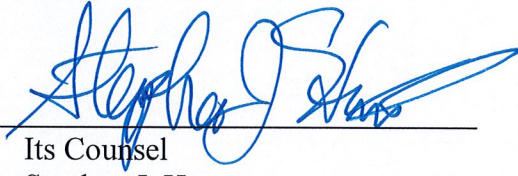
By: 
Its Counsel
Stephen J. Humes

cc: Plymouth Mayor, David C. Mischke

Exhibit A
Site Map

171 Town Hill Road
Plymouth, Connecticut



Exhibit B
Design Drawings

171 Town Hill Road
Plymouth, Connecticut

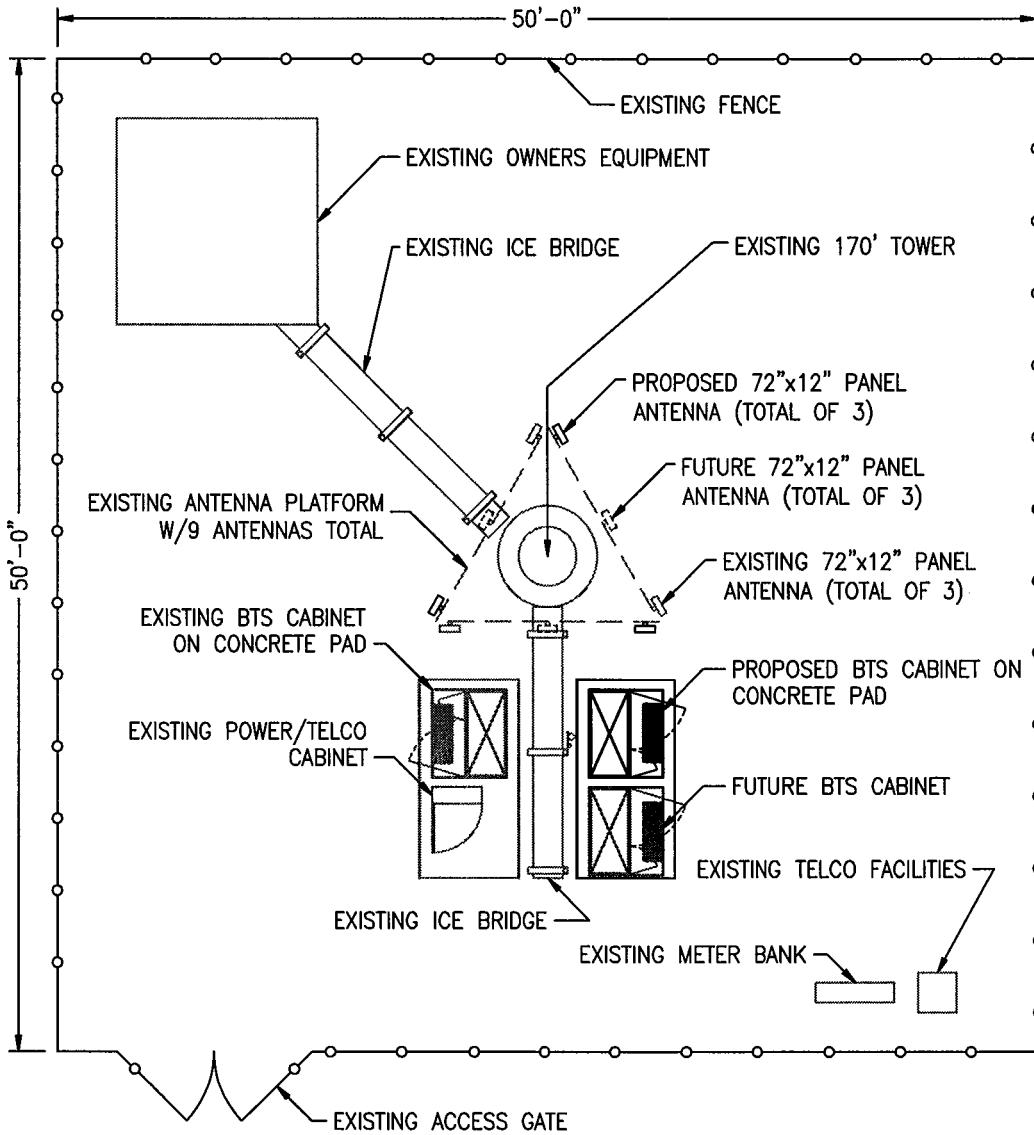

RF APPROVED: *[Signature]*

ANTENNA AZIMUTHS:
 SECTOR A=
 SECTOR B=
 SECTOR C=



SPECIAL LANDLORD NOTE:
 T-MOBILE "FUTURE" PANEL ANTENNAS ARE DEPICTED FOR THE PURPOSES OF DETERMINING TOWER/MONOPOLE STRUCTURAL CAPACITY, OBTAINING ZONING APPROVALS AND BUILDING PERMITS. SUBSEQUENT ENDORSEMENT OR ACCEPTANCE OF THIS DRAWING BY THE TOWER OWNER IS NOT TO BE CONSTRUED AS PERMISSION OR APPROVAL TO INSTALL "FUTURE" ANTENNAS THAT EXCEED "PROPOSED" OR ACTUAL EQUIPMENT LISTED IN THE T-MOBILE LEASE AGREEMENT.

SITE NO: CT-11-417
 SITE NAME: TERRYVILLE LIONS CLUB
 ADDRESS: TOWN HILL ROAD
 PLYMOUTH, CT

OMNIPPOINT COMMUNICATIONS, INC.
 100 FILLEY STREET
 BLOOMFIELD, CT 06002

SITE MODIFICATION PLAN	DATE: 2/20/04
DRAWN BY: M. GRANESE	SCALE: NTS

Exhibit C
Equipment Specifications

171 Town Hill Road
Plymouth, Connecticut

1850 MHz - 1990 MHz (P)

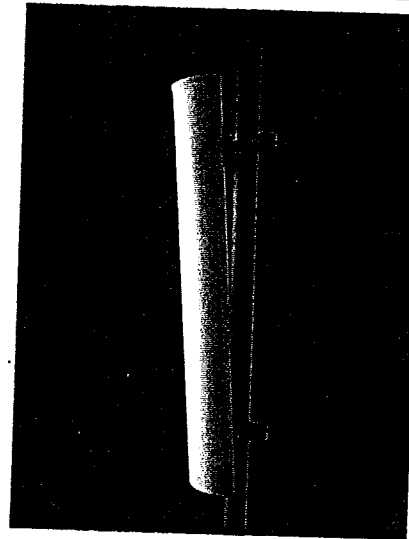
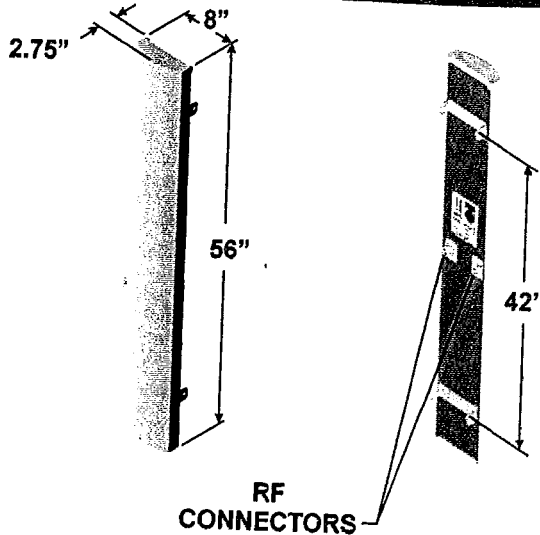

- 90° beamwidth
- 15.5 dBi gain
- ±45° DualPol™
- 56 inch

SPECIFICATIONS

Electrical		Mechanical	
Azimuth Beamwidth	90°	Dimensions (L x W x D)	56in x 8in x 2.75in (142 cm x 20.3 cm x 7.0 cm)
Elevation Beamwidth	7°	Rated Wind Velocity	150 mph (241 km/hr)
Gain	15.5 dBi (13.4 dBd)	Equivalent Flat Plate Area	3.1ft ² (.29 m ²)
Polarization	Slant, ±45°	Front Wind Load @ 100 mph (161 kph)	90 lbs (400 N)
Port-to-Port Isolation	≥ 30 dB	Side Wind Load @ 100 mph (161 kph)	31 lbs (139 N)
Front-to-Back Ratio	≥ 25 dB (≥ 30 dB Typ.)	Weight	18 lbs (8.2 kg)
Electrical Downtilt Options	0°, 2°, 4°	<p>Note: Patent Pending and US Patent number 5, 757, 246.</p> <p>Values and patterns are representative and variations may occur. Specifications may change without notice due to continuous product enhancements. Digitized pattern data is available from the factory or via the web site www.emswireless.com and reflect all updates.</p>	
VSWR	1.35:1 Max		
Connectors	2; Type N or 7-16 DIN (female)		
Power Handling	250 Watts CW		
Passive Intermodulation	<-147 dBc (2 tone @ +43 dBm (20W) ea.)		
Lightning Protection	Chassis Ground		

MOUNTING OPTIONS

Model Number	Description	Comments
MTG-P00-10	Standard Mount (Supplied with antenna)	Mounts to Wall or 1.5 inch to 5.0 inch O.D. Pole (3.8 cm to 12.7 cm)
MTG-S02-10	Swivel Mount	Mounting kit providing azimuth adjustment.
MTG-DXX-20*	Mechanical Downtilt Kits	0° - 10° or 0° - 15° Mechanical Downtilt
MTG-CXX-10*	Cluster Mount Kits	3 antennas 120° apart or 2 antennas 180° apart
MTG-C02-10	U-Bolt Cluster Mount Kit	3 antennas 120° apart, 4.5" O.D. pole.
MTG-TXX-10*	Steel Band Mount	Pole diameters 7.5" - 45"

* Model number shown represents a series of products. See mounting options section for specific model number.

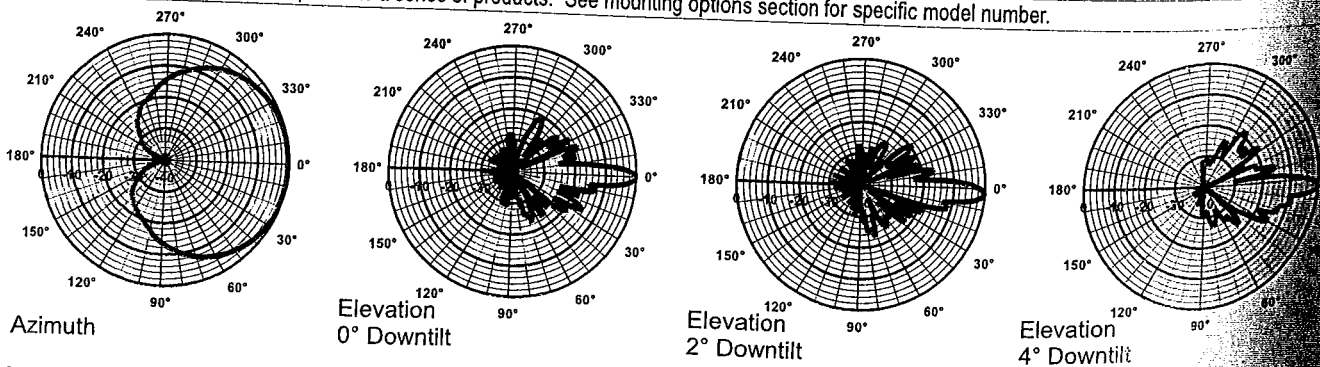

3.2.12 S12000 Outdoor BTS

3.2.12.1 Hardware description

The base cabinet and the extension cabinet have the same physical structure.

The cabinets are a compact metallic structure. Equipment is accessed from the front of the cabinets and all the cables enter through the base of the cabinet (cabinets can be installed on a plinth for ease of cabling).

The cabinet is divided into separate compartments (see *Figure 3-49*):

- The top compartment contains the Direct Ambient Cooling System (DACCS) and the batteries.
- The main compartment accommodates the plug-in radio, digital processing and power supply units. The number of units varies according to the configuration.
- In a fully loaded configuration the left compartment contains the following elements:
 - two DRX interconnection (DRX-ICOA and DRX-ICOB) modules
 - two DRX shelves that contain up to 12 DRXs
 - two RX splitter shelves that contain four RX splitters
 - RF combiner shelf that contains four RF combiner
- In a fully loaded configuration the right compartment contains the following elements:
 - The user rack and its interconnection module
 - The RECAL board
 - two F-type converters
 - The CBCF module
 - the rectifier rack that contains up to eight rectifiers
 - The PA interconnection (PA-ICO) module
 - The PA shelf that contains up to 12 PAs
 - The RF combiner shelf that contains eight RF combiners
 - The combiners interconnection (COM-ICO) module
 - The ac box

3.2.12.2 Physical characteristics

Base cabinet dimensions

- height: 191 cm (75.2 in.)
- width: 135 cm (53.1 in.)
- depth: 65 cm (25.6 in.)

Plinth dimensions

- height: 191 cm (75.2 in.)
- width: 80 cm (31.5 in.)
- depth: 65 cm (25.6 in.)

Weight

A fully equipped cabinet can weigh up to 180 kg (396 lb).

3.3 Power supplies

The two following tables give the BTSs input voltages.

	GSM 850	GSM 900	GSM 1800	GSM 1900	GSM -R 900
S2000				120 V ac	
S2000E Indoor		220 – 240 V ac			
S2000E Outdoor				120 V ac	
S2000H "FP" and "EP"		220–240 V ac		216–254 V ac	
S2000L "FP" and "EP"		220–240 V ac or 120 V ac		216–254 V ac or 120 V ac	
e-cell		–48 V dc (*)			
S4000 Indoor		–48 V dc (*)			
S4000C Indoor		–48 V dc (*)			
S4000 Outdoor		220–240 V ac		240 V ac	
S4000 Smart				240 V ac	
S8000 Indoor	–48 V dc	–48 V dc		–48 V dc	–48 V dc
S8000 Outdoor	120 V ac	220–240 V ac		240 V ac	220–240 V ac
S8002 Outdoor					220–240 V ac
S8006			230 V ac ± 10%		
S12000 Indoor				–48 V dc	
S12000 Outdoor				220–240 V ac	

 Product unavailable

(*) rated voltage: –48 V dc
minimum voltage: –40.5 V dc
maximum voltage: –57 V dc

■ Table 3-3 BTS input voltages

Exhibit D

Structural Analysis

171 Town Hill Road

Plymouth, Connecticut

March 14, 2001

Tower Reanalysis Report Proposal PR-2001-02-080

TP63 x 170' Tower
Terryville/Plymouth, CT
PiRod Engineering File A-117464

Contact Person:



Dennis D. Abel, P.E.
Manager of Reanalysis Services
e-mail: dabel@pirod.com
telephone extension: 5257

Completed under the Supervision and Approval by
John R. Erichsen, P.E.
Vice President of Operations
e-mail: jerichsen@pirod.com
telephone extension: 5221

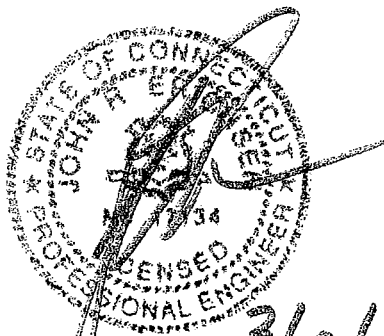

3/15/01

1545 Pidco Drive, Plymouth, Indiana 46563

Phone: 219-936-4221

www.pirod.com

Fax: 219-936-6458

TABLE OF CONTENTS

Description	Page No.
1.0 EXECUTIVE SUMMARY	1
2.0 ASSUMPTIONS	1
3.0 TOWER HISTORY	2
4.0 CURRENT WIND LOAD REQUIREMENT	2
5.0 ANTENNA LOADING	3
6.0 RESULTS.....	4
6.1 Tower Modifications	4
6.2 Foundation Modifications	4
7.0 LIST OF APPENDICES	4

1.0 EXECUTIVE SUMMARY

This reanalysis was performed by PiRod to determine if the structure is capable of accommodating loading that is different than previous design specifications. This engineering report gives the tower history, details how the loading changes affect the tower, specifies feasible modifications, and proposes modification materials. PiRod's engineering study concludes that the tower complies without modifications. See section 6.0 for details.

2.0 ASSUMPTIONS

This engineering study is based on the theoretical capacity of the structure. It is not a condition assessment of the tower. This report is being provided by PiRod without the benefit of an inspection by PiRod personnel and is based on information supplied by the customer to PiRod. PiRod has made no independent determination, nor is required to, of the accuracy of the information provided. Therefore, unless specifically informed to the contrary by the customer in writing, PiRod assumes the following:

1. The subsoil characteristics exist as stated on the tower drawing or stated elsewhere in this report;
2. The tower is erected and maintained in accordance with the manufacturer's plans and specifications and is plumb;
3. There is no damage, natural or manmade, to the structure, either gradual or sudden;
4. All connections and guy cables are properly installed;
5. The information concerning the components, existing and proposed, is accurate; and
6. There are no modifications to the tower itself, except as may be disclosed elsewhere in this report.

PiRod recommends that a condition assessment be performed by qualified personnel, preferably a structural engineer. Following is a list of the general areas that PiRod recommends to be inspected. Contact PiRod for a complete checklist.

<u>Tower Structure</u>	<u>Guyed Towers</u>	<u>Foundations</u>	<u>Appurtenances</u>
Tower Sections	Guy Cables	Cracking	Antennas
Bolted Connections	Turnbuckles	Drainage	Mounts
Welded Connections	Preforms	Spalling	Transmission Lines
Plumbness	Guy Lugs	Anchor Bolts	Line Brackets
Corrosion	Thimbles	Settling	Cable Hangers
Linearity	Torque Arms	Grounding	Lighting
Galvanization	Ice Clips	Grout	
Paint	Guy Tensions	Subsoil	
	Anchor Rods	Characteristics	
	Shackles	Erosion	
	Insulators		

3.0 TOWER HISTORY

Date of Origination: September 1, 2000
 PiRod Model: TP63 x 170' Tower
 Sold to: Voicestream Wireless
 Original Wind Load Requirement: 80 mph per EIA/TIA-222-F
 Original Ice Load Design: No ice and ½" ice with 25% load reduction

The original design is based on the following antenna loading. This may not truly represent the antennas that have actually been placed on the tower.

HEIGHT (FT)	ANTENNAS		ASSUMED CAAC (SQ.FT.)	MOUNTS		LINES	
	QTY.	MODEL		QTY.	MODEL	QTY.	SIZE
Top	1	15' Lightning Rod Ext.					
170'	12	EMS RR65-19		1 12	13' Low Profile Platform 2" x 50" Antenna Pipe	12	1-5/8"
160'	12	EMS RR65-19		1 12	13' Low Profile Platform 2" x 50" Antenna Pipe	12	1-5/8"
150'	12	EMS RR65-19		1 12	13' Low Profile Platform 2" x 50" Antenna Pipe	12	1-5/8"
140'	12	EMS RR65-19		1 12	13' Low Profile Platform 2" x 50" Antenna Pipe	12	1-5/8"
130'	12	EMS RR65-19		1 12	13' Low Profile Platform 2" x 50" Antenna Pipe	12	1-5/8"
120'	12	EMS RR65-19		1 12	13' Low Profile Platform 2" x 50" Antenna Pipe	12	1-5/8"

For the structural analysis, the tower and foundation are assumed to exist as shown on the enclosed tower drawing, which is PiRod's latest revision.

4.0 CURRENT WIND LOAD REQUIREMENT

The TIA/EIA Standard is currently at version F. Litchfield County is designated as an 80 mph basic wind speed zone by the current TIA/EIA Standard. We have taken the opportunity to reanalyze this structure using the following wind speed and ice load condition.

<u>Wind Speed</u>	<u>Ice Load</u>	<u>EIA Standard</u>
80 mph	no ice	TIA/EIA-222-F
80 mph	½" ice with 25% wind load reduction	TIA/EIA-222-F

5.0 ANTENNA LOADING

The tower analysis uses the following antenna loading, which was supplied on February 28, 2001.

HEIGHT (FT)	ANTENNAS		ASSUMED CAAC (SQ-FT.)	MOUNTS		LINES	
	QTY.	MODEL		QTY.	MODEL	QTY.	SIZE
Existing Loading							
170'	1	ACP-305	6.30*	4	10' Summit 4-Omni Mnt	1	1-5/8"
	1	PD455		4	2 x 84" Antenna Pipe	1	1-5/8"
	1	PD220			(25.6* assumed CaAc for all mounts at this level)	1	1-5/8"
	1	SRL229				1	1-5/8"
165	12	FR90-16		1	13' Low Profile Platform	24	1-5/8"
				12	2" x 50" Antenna Pipe		
145'	12	RR65-19-00XP <i>future</i>		1	13' Low Profile Platform	12	1-5/8"
				12	2" x 50" Antenna Pipe		
135'	12	RR65-19-00XP <i>future</i>		1	13' Low Profile Platform	12	1-5/8"
				12	2" x 50" Antenna Pipe		
Proposed Additional Loading							
155'	9	DB980H		1	13' Low Profile Platform	12	1-5/8"
				12	2" x 72" Antenna Pipe		

These antennas, mounts, and lines represent PiRod's understanding of the antenna loading required. Please contact PiRod if any discrepancies are evident. If different antennas, mounts, or lines are installed on this structure, this analysis is invalid. In the event it becomes necessary for the customer to supplement the information previously provided to PiRod for this analysis, the information must be supplied in writing.

* Items marked with an asterisk were not supplied to PiRod with specific projected areas (CAAC). Based on the information provided, the listed projected areas were assumed and used for the analysis. The actual projected area for each antenna or mount must be confirmed to be equal to the assumed area listed above. If it is determined that the area is different than that stated for any of the above items, this analysis is invalid. Additional engineering fees may be incurred if the tower needs to be analyzed again.

6.0 RESULTS

With the antennas listed in section 5.0, the following modifications are required for the tower to comply with the indicated code and TIA/EIA Standard listed in section 4.0.

6.1 Tower Modifications

The tower complies without modifications.

6.2 Foundation Modifications

The foundation complies without modifications.

7.0 LIST OF APPENDICES

Reanalysis Parts Pricing Proposal	
Main Tower Drawing, latest revision	150737-B
13' Low Profile Platform	140575

Note: The tower drawing included with this report is PiRod's latest revision and depicts the tower as we understand it to currently exist. It has not been updated to show the existing or proposed antenna loading or any modifications required as a result of this analysis.

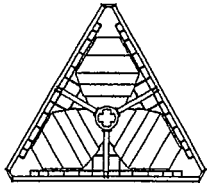

ROTATABLE TOP - TOP VIEW

TAPERED POLE SECTION DATA

LENGTH	PART#	SECTION			BOLT @ BOT **	
		SIZE	WALL	WT. *	DIAM	LENGTH #
1'	801458	18"	N/A		1"	4-1/2" 8
4' -9"	134325	26"	.2500"	351#		
37' -6"	131508	34"	.3125"	3900#		
37' -6"	131509	42"	.3750"	5875#		
37' -6"	131510	49"	.3750"	7040#		
37' -6"	131511	56"	.3750"	8155#		
37' -6"	131517	63"	.3750"	9220#		

*THE WEIGHTS LISTED ARE THEORETICAL. THE ACTUAL WEIGHTS WILL VARY. ALL WEIGHTS SHOULD BE CONFIRMED IN THE FIELD PRIOR TO ERECTION.
 **ALL CONNECTION BOLTS ARE A-325.

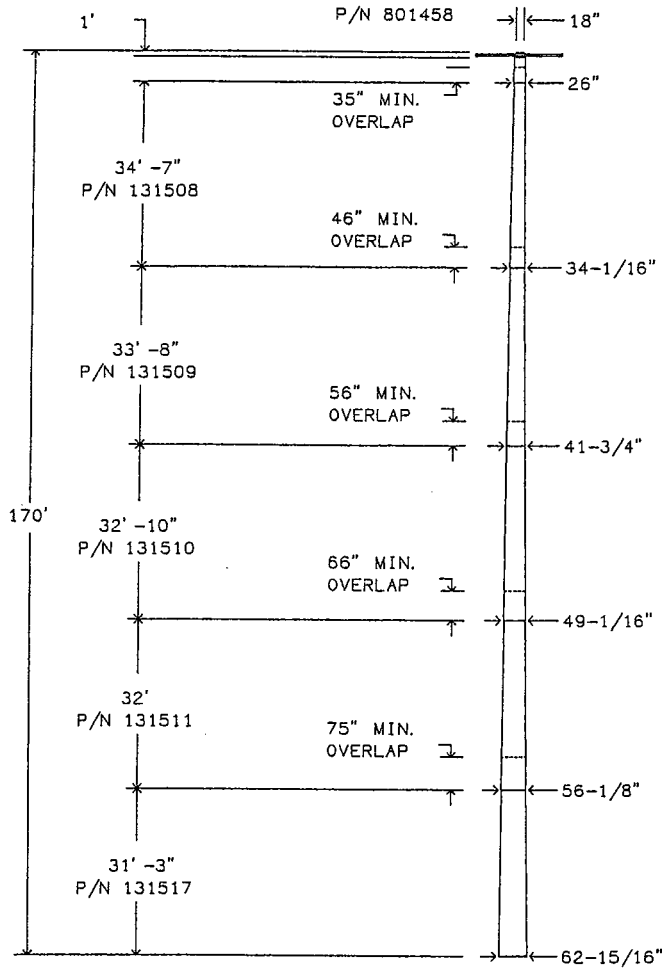

TOP 1' CONSISTS OF ROTATABLE TOP ASSEMBLY. SEE DWG # 130555-B FOR INSTALLATION DETAILS. JAM NUTS NOT REQUIRED.

SEE PAGE 2 OF THIS DRAWING FOR OPENING INFORMATION.

SEE PAGE 4 OF THIS DRAWING FOR CONNECTION BOLT TIGHTENING SPECIFICATIONS.

SEE PAGE 7 OF THIS DRAWING FOR BASE SECTION INSTALL.

REMOVABLE CLIMBING RUNGS

VOICESTREAM WIRELESS
 TERRYVILLE CT-11-417C, CT
 TP63 X 170' ASSEMBLY DRAWING

B	ADDED FOUNDATIONS PER SOIL REPORT	ACP	09/01/2000
A	HEIGHT CHANGE	TSD	08/28/2000
REV	DESCRIPTION OF REVISIONS	INI	DATE

APPROVED/ENG.	WBR	09/01/2000
APPROVED/FOUND.	N/A	
DRAWN BY	TSD	



OPENINGS & BRACKETS (CONTINUED ON NEXT PAGE)

NOMINAL HT AGL	HEIGHT *H	TYP	DESCRIPTION	ANGL	ASSEMBLY DRAWING#
169' -1"	4' -9"	20	FLANGE PART NUMBER 133316		
162'	32' -3"	22	4" X 16" RECT TUBULAR PORTHOLE	60°	
162'	32' -3"	22	4" X 16" RECT TUBULAR PORTHOLE	180°	
162'	32' -3"	22	4" X 16" RECT TUBULAR PORTHOLE	300°	
161' -9"	32'	19	PAD EYES FOR FUTURE PLATFORM	SEE>	121975-B
157' -9"	28'	22	4" X 16" RECT TUBULAR PORTHOLE	60°	
157' -9"	28'	22	4" X 16" RECT TUBULAR PORTHOLE	180°	
157' -9"	28'	22	4" X 16" RECT TUBULAR PORTHOLE	300°	
155' -9"	26'	19	PAD EYES FOR FUTURE PLATFORM	SEE>	121975-B
147' -9"	18'	22	4" X 16" RECT TUBULAR PORTHOLE	60°	
147' -9"	18'	22	4" X 16" RECT TUBULAR PORTHOLE	180°	
147' -9"	18'	22	4" X 16" RECT TUBULAR PORTHOLE	300°	
145' -9"	16'	19	PAD EYES FOR FUTURE PLATFORM	SEE>	121975-B
137' -9"	8'	22	4" X 16" RECT TUBULAR PORTHOLE	60°	
137' -9"	8'	22	4" X 16" RECT TUBULAR PORTHOLE	180°	
137' -9"	8'	22	4" X 16" RECT TUBULAR PORTHOLE	300°	
135' -9"	6'	19	PAD EYES FOR FUTURE PLATFORM	SEE>	121975-B
125' -9"	29' -8"	22	4" X 16" RECT TUBULAR PORTHOLE	60°	
125' -9"	29' -8"	22	4" X 16" RECT TUBULAR PORTHOLE	180°	
125' -9"	29' -8"	22	4" X 16" RECT TUBULAR PORTHOLE	300°	
123' -9"	27' -8"	19	PAD EYES FOR FUTURE PLATFORM	SEE>	121975-B
117' -9"	21' -8"	22	4" X 16" RECT TUBULAR PORTHOLE	60°	
117' -9"	21' -8"	22	4" X 16" RECT TUBULAR PORTHOLE	180°	
117' -9"	21' -8"	22	4" X 16" RECT TUBULAR PORTHOLE	300°	
115' -9"	19' -8"	19	PAD EYES FOR FUTURE PLATFORM	SEE>	121975-B
9' -10"	9' -10"	8	TRANS. LINE BRIDGE ATTACH BRACKET	90°	
9' -10"	9' -10"	8	TRANS. LINE BRIDGE ATTACH BRACKET	180°	
9' -10"	9' -10"	8	TRANS. LINE BRIDGE ATTACH BRACKET	270°	
9' -6"	9' -6"	13	SAFETY CLIMB BRACKET	0°	
7' -4"	7' -4"	2	10" X 25" OVAL PORTHOLE	90°	
7' -4"	7' -4"	2	10" X 25" OVAL PORTHOLE	180°	
7' -4"	7' -4"	2	10" X 25" OVAL PORTHOLE	270°	
6' -9"	6' -9"	7	GROUNDING PLATE	90°	
6' -9"	6' -9"	7	GROUNDING PLATE	180°	
6' -9"	6' -9"	7	GROUNDING PLATE	270°	
4'	4'	8	TRANS. LINE BRIDGE ATTACH BRACKET	90°	
4'	4'	8	TRANS. LINE BRIDGE ATTACH BRACKET	270°	
1' -6"	1' -6"	2	10" X 25" OVAL PORTHOLE	90°	132512-B
1' -6"	1' -6"	2	10" X 25" OVAL PORTHOLE	180°	
1' -6"	1' -6"	2	10" X 25" OVAL PORTHOLE	270°	132512-B
1' -3"	1' -3"	18	GROUNDING ANGLES (3)	SEE>	131093-B
1'	1'	7	GROUNDING PLATE	90°	

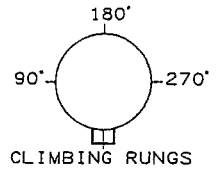

THE ANGLE TO THE OPENING IS MEASURED CLOCKWISE FROM THE CENTER-LINE OF THE CLIMBING RUNGS WHEN LOOKING DOWN.

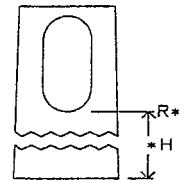

* THE HEIGHT IN THE TABLE IS THE DISTANCE FROM THE BASE OF THE CURRENT POLE SECTION TO THE OPENING REFERENCE (R*) AS SHOWN ON PAGES 2 - 3 OF THIS DRAWING.

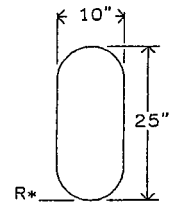

TYPE 2 OPENING

VOICESTREAM WIRELESS
TERRYVILLE CT-11-417C, CT
TP63 X 170' OPENINGS

APPROVED/ENG.	WBR 09/01/2000
APPROVED/FOUND.	N/A
DRAWN BY	TSD



From: F1000825.OFT - 08/28/2000 13:20

Printed from: 1507372A.DWG - 08/28/2000 13:22 @ 03/07/2001 15:38

ENG. FILE NO. A-117464-
ARCHIVE F-1000825

DRAWING NO. 150737-B
PAGE 2 OF 9

OPENINGS & BRACKETS (CONTINUED FROM PREVIOUS PAGE)

NOMINAL HT. AGL	HEIGHT *H	TYP	DESCRIPTION	ANGL	ASSEMBLY DRAWING#
1'	1'	7	GROUNDING PLATE	270°	

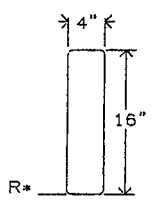
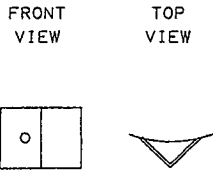
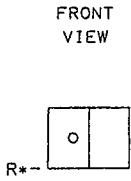
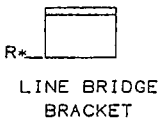
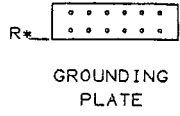

GROUNDING ANGLE

TYPE 22 OPENING

VOICESTREAM WIRELESS
TERRYVILLE CT-11-417C, CT
TP63 X 170' OPENINGS

APPROVED/ENG.	WBR 09/01/2000
APPROVED/FOUND.	N/A
DRAWN BY	TSD



From: F1000825.DFT - 08/28/2000 13:20
Printed from: 1507373A.DWG - 08/28/2000 13:22 @ 03/07/2001 15:38

ENG. FILE NO. A-117464- ARCHIVE F-1000825
DRAWING NO. 150737-B
PAGE 3 OF 9

GENERAL NOTES

1. TOWER DESIGN CONFORMS TO STANDARD EIA/TIA-222-F FOR 80 MPH BASIC WIND SPEED WITH NO ICE.
TOWER DESIGN CONFORMS TO STANDARD EIA/TIA-222-F FOR 80 MPH BASIC WIND SPEED WITH .5" RADIAL ICE WITH LOAD DUE TO WIND REDUCED BY 25% WHEN CONSIDERED SIMULTANEOUSLY WITH ICE.
2. NO TWIST AND SWAY LIMITATIONS SPECIFIED OR USED FOR THIS TOWER.
3. MATERIAL: (A) SOLID RODS CONFORM TO ASTM A-572 GRADE 50 REQUIREMENTS.
(B) ANGLES CONFORM TO ASTM A-36 REQUIREMENTS.
(C) PIPE CONFORMS TO ASTM A-53 TYPE E, GRADE B REQUIREMENTS. (MIN YIELD STRENGTH=42 KSI)
(D) BASE FLANGE AND GUSSETS CONFORM TO ASTM A-572 GRADE 50 REQUIREMENTS. ALL OTHER PLATE CONFORMS TO ASTM A-36 REQUIREMENTS.
(E) TAPERED POLES CONFORM TO ASTM A-572 GRADE 65 REQUIREMENTS.
(F) ANCHOR BOLTS CONFORM TO ASTM A-687 REQUIREMENTS.
4. BASE REACTIONS PER EIA/TIA-222-F FOR 80 MPH BASIC WIND SPEED WITH NO ICE.
TOTAL WEIGHT= 43.9 KIPS.
MOMENT= 4181.3 KIP-FT.
MAXIMUM SHEAR= 34.2 KIPS TOTAL.
5. BASE REACTIONS PER EIA/TIA-222-F FOR 80 MPH BASIC WIND SPEED WITH 0.50" RADIAL ICE:
TOTAL WEIGHT= 56.2 KIPS.
MOMENT= 3315.7 KIP-FT.
MAXIMUM SHEAR= 27.0 KIPS TOTAL.
6. FINISH: HOT DIPPED GALVANIZED AFTER FABRICATION.
7. ANTENNAS: TOP (12) RR65-19-00XP ANTENNAS MOUNTED ON A LOW PROFILE PLATFORM USING 1-5/8" LINES.
160' (12) RR65-19-00XP ANTENNAS MOUNTED ON A LOW PROFILE PLATFORM USING 1-5/8" LINES.
150' (12) RR65-19-00XP ANTENNAS MOUNTED ON A LOW PROFILE PLATFORM USING 1-5/8" LINES.
140' (12) RR65-19-00XP ANTENNAS MOUNTED ON A LOW PROFILE PLATFORM USING 1-5/8" LINES.
130' (12) RR65-19-00XP ANTENNAS MOUNTED ON A LOW PROFILE PLATFORM USING 1-5/8" LINES.
120' (12) RR65-19-00XP ANTENNAS MOUNTED ON A LOW PROFILE PLATFORM USING 1-5/8" LINES.
8. INSTALL BASE SECTION WITH MINIMUM OF 2" CLEARANCE ABOVE CONCRETE. SEE BASE SECTION PLACEMENT PAGE OF THIS DRAWING FOR MORE INFORMATION.
9. MIN. WELDS 5/16" UNLESS OTHERWISE SPECIFIED. ALL WELDING TO CONFORM TO AWS SPECIFICATIONS.
10. ALL BOLTS MUST BE IN PLACE WITH JAM NUTS PRIOR TO ERECTION OF THE STRUCTURE. ALL BOLTS AND NUTS MUST BE IN PLACE AND TIGHTENED BEFORE THE ADJOINING SECTION(S) ARE PLACED.
11. ALL A-325 BOLTS ARE TO BE TIGHTENED TO A SNUG TIGHT CONDITION AS DEFINED BY AISC SPECIFICATION UNLESS OTHERWISE NOTED. A MORE QUANTITATIVE ALTERNATIVE APPROACH TO ACHIEVING A SNUG TIGHT CONDITION IS TO TIGHTEN USING THE TORQUE VALUES FROM DRAWING 123107-A.
12. EIA GROUNDING FOR TOWER.
13. OUTSIDE CLIMB RUNGS WITH SAFETY CLIMB.
14. MONOPOLE TO BE PAINTED SLATE GRAY.

		VOICESTREAM WIRELESS TERRYVILLE CT-11-417C, CT TP63 X 170' NOTES	
APPROVED/ENG.	WBR	09/01/2000	 1545 Pidco Dr. Plymouth, IN 46563-0128 219-936-4221
APPROVED/FOUND.	N/A		
DRAWN BY	TSD		
From: F1000825.DFT - 08/28/2000 13:20 Printed from: 1507374A.DWG - 08/28/2000 13:22 @ 03/07/2001 15:38		ENG. FILE NO. A-117464- ARCHIVE F-1000825	DRAWING NO. 150737-8 PAGE 4 OF 9

FOUNDATION NOTES

1. SOIL AS PER REPORT BY: CLARENCE WALTI ASSOCIATES, DATED: 8/14/00
2. CONCRETE TO BE 4000 PSI @ 28 DAYS. REINFORCING BAR TO CONFORM TO ASTM A615 GRADE 60 SPECIFICATIONS. CONCRETE INSTALLATION TO CONFORM TO ACI-318 BUILDING REQUIREMENTS FOR REINFORCED CONCRETE. ALL CONCRETE TO BE PLACED AGAINST UNDISTURBED EARTH FREE OF WATER AND ALL FOREIGN OBJECTS AND MATERIALS. A MINIMUM OF THREE INCHES OF CONCRETE SHALL COVER ALL REINFORCEMENT. WELDING OF REBAR NOT PERMITTED.
3. A COLD JOINT IS PERMISSIBLE UPON CONSULTATION WITH PIROD. ALL COLD JOINTS SHALL BE COATED WITH BONDING AGENTS PRIOR TO SECOND POUR.
4. ALL FILL SHOULD BE PLACED IN LOOSE LEVEL LIFTS OF NO MORE THAN 9" THICK. FILL MATERIALS SHOULD BE CLEAN AND FREE OF ORGANIC AND FROZEN MATERIALS OR ANY OTHER DELETERIOUS MATERIALS. COMPACT FILL TO 95% OF MODIFIED PROCTOR MAXIMUM DRY DENSITY IN ACCORDANCE WITH ASTM D1557.
5. GROUTING OF POLE BASE IS OPTIONAL. IF GROUT IS USED, DRAINAGE MUST BE PROVIDED FROM THE INTERIOR OF THE POLE. REFER TO DRAWING # 118492-B FOR BASE SECTION INSTALLATION.
6. BENDING, STRAIGHTENING OR REALIGNING (HOT OR COLD) OF THE ANCHOR BOLTS BY ANY METHOD IS PROHIBITED.
7. CROWN TOP OF FOUNDATION FOR PROPER DRAINAGE.
8. INSTALL BASE SECTION WITH MINIMUM OF 2" CLEARANCE ABOVE CONCRETE. SEE PAGE 9 OF THIS DRAWING FOR MORE INFORMATION.
9. A WELL POINT OR OTHER DEWATERING SYSTEM MAY BE REQUIRED TO LOWER THE WATER TABLE TO FACILITATE THE INSTALLATION OF THE FOUNDATION.
10. SOFT OR UNSTABLE SUBGRADE SOILS SHOULD BE REMOVED AND REPLACED WITH COMPACTED FILL.

VOICESTREAM WIRELESS TERRYVILLE CT-11-417C, CT TP63 X 170' NOTES		 1545 Pidea Dr. Plymouth, IN 46563-0128 219-936-4221
APPROVED/ENG.	WBR 09/01/2000	
APPROVED/FOUND.	WBR 09/01/2000	
DRAWN BY	TSD	
From: F1000825.DFT - 09/01/2000 12:59	ENG. FILE NO. A-117464-	DRAWING NO. 150737-B
Printed from: 1507375B.DWG - 09/01/2000 13:01 @ 03/07/2001 15:38	ARCHIVE F-1000825	PAGE 5 OF 9

7' -6" ROUND PIER,
CENTERED AROUND THE CIR-
CULAR REBAR CAGE.

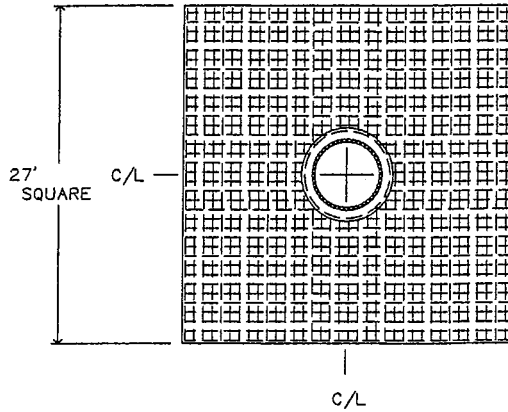

BASE FLANGE MUST BE CENTERED IN PIER
WITHIN +/- 10% OF PIER DIAMETER.

ALL REBAR REQUIRES MINIMUM OF
3" CONCRETE COVERAGE.

FOR ANCHOR STEEL IDENTIFICATION AND
PLACEMENT INFORMATION, SEE PAGE 8.

FOR BASE SECTION INSTALLATION, SEE
PAGE 9 OF THIS DRAWING

GROUTING OF POLE BASE IS OPTIONAL.
IF GROUT IS USED, DRAINAGE MUST BE
PROVIDED FROM THE INTERIOR OF POLE.
CROWN TOP OF FOUNDATION TO
FACILITATE DRAINAGE.

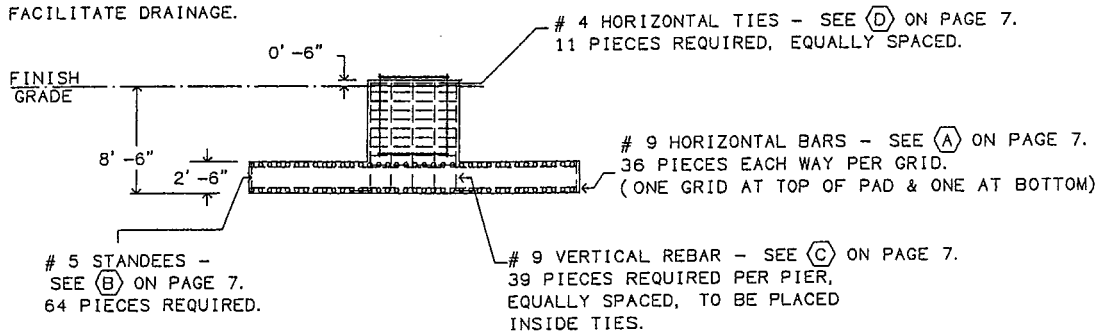

TOWER FOUNDATION

78.1 CUBIC YARDS CONCRETE REQUIRED
FOR INSTALLATION SPECIFICATIONS AND
ADDITIONAL INFORMATION, SEE PAGE 5
OF THIS DRAWING.

VOICESTREAM WIRELESS
TERRYVILLE CT-11-417C, CT
TP63 X 170' BASE FOUNDATION

APPROVED/ENG. WBR 09/01/2000

APPROVED/FOUND. WBR 09/01/2000

DRAWN BY TSD



1545 Pideo Dr.
Plymouth, IN 46563-0128
219-936-4221

From F1000825.DFT - 09/01/2000 12:59

Printed from: 1507376B.DWG - 09/01/2000 13:01 @ 03/07/2001 15:38

ENG. FILE NO. A-117464-

ARCHIVE F-1000825

DRAWING NO.

PAGE

150737-B

6 OF 9

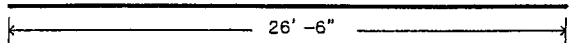
(A)  # 9 REBAR - 144 PIECES REQ. TOTAL
APPROX WT = 90.1# EACH, 12974# TOTAL

REBAR SUPPORTS MAY CONSIST OF ANY ACCEPTABLE MEANS OF SECURELY SUPPORTING THE TOP REINFORCEMENT GRID ABOVE THE BOTTOM REINFORCEMENT GRID WHILE MAINTAINING A SEPARATION OF 2' (OUTSIDE REBAR TO OUTSIDE REBAR).

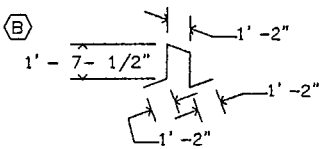

5 REBAR - 64 PIECES REQUIRED TOTAL
TYPE 26 STANDEE PLACED BETWEEN REBAR GRIDS ON NOMINAL 4' SPACING THROUGHOUT
APPROX UNBENT LENGTH = 6'-9-3/8"
APPROX WT = 7.1# EACH, 454# TOTAL

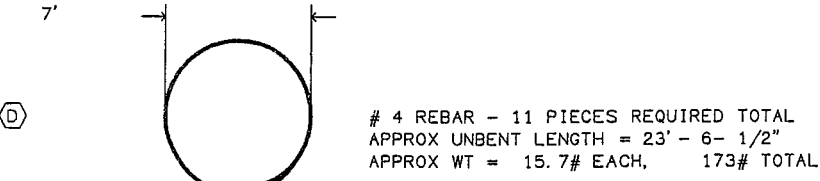
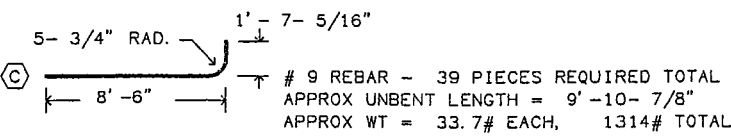

LAP DIMENSION: 1'-6-1/2"
PLACE REBAR RINGS SO THAT LAPS ON ADJACENT RINGS ARE 180 DEGREES APART.
PLACE ONE RING AT TOP OF PAD AND TWO RINGS AT TOP OF PIER REBAR. EQUALLY SPACE REMAINING RINGS ALONG PIER.

REBAR DETAIL

TOTAL APPROX REBAR WEIGHT = 14915#
REINFORCING BAR TO CONFORM TO
ASTM A615 GRADE 60 SPECIFICATIONS.

		VOICESTREAM WIRELESS TERRYVILLE CT-11-417C, CT TP63 X 170' REBAR DETAIL	
		APPROVED/ENG.	WBR 09/01/2000
		APPROVED/FOUND.	WBR 09/01/2000
		DRAWN BY	TSD
From F1000825.DFT - 09/01/2000 12:59 Printed from: 1507377B.DWG - 09/01/2000 13:01 @ 03/07/2001 15:38		ENG. FILE NO. A-117464- ARCHIVE F-1000825	DRAWING NO. 150737-B PAGE 7 OF 9

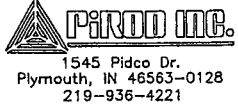

BASE FLANGE MUST BE CENTERED IN PIER
WITHIN +/- 10% OF PIER DIAMETER.

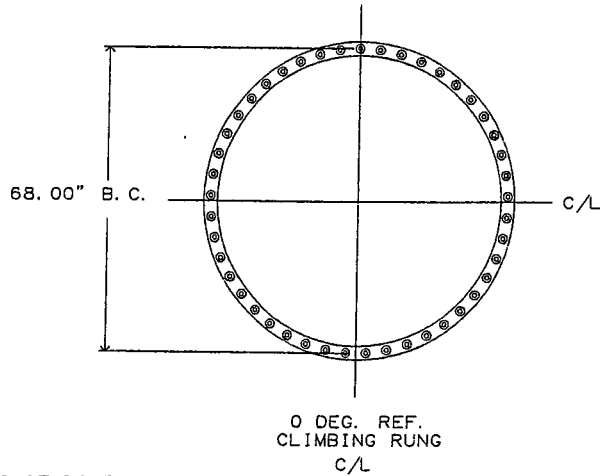

GROUTING OF POLE BASE IS OPTIONAL.
IF GROUT IS USED, DRAINAGE MUST BE
PROVIDED FROM THE INTERIOR OF POLE.

FOUNDATION PLATE P/N 133120 MUST BE SECURELY
DOUBLE-NUTTED TO ANCHOR BOLTS DURING CONCRETE
INSTALLATION AND MUST BE LEVEL +/- 1/8\"/>

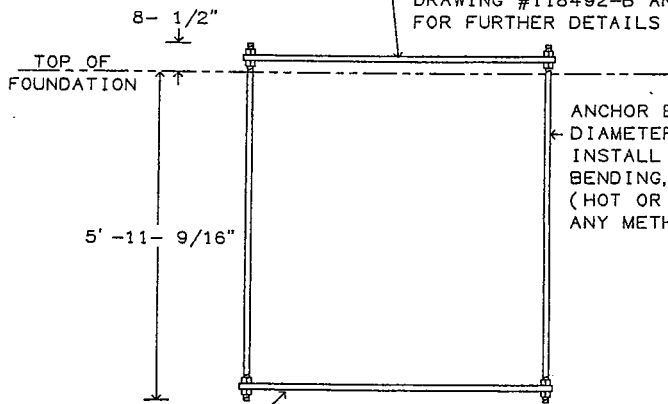

ANCHOR BOLT P/N 109881 - 45 REQUIRED
← DIAMETER= 1.25" COLOR CODE= PINK/WHITE
INSTALL WITH 8.5" OF THREADS EXPOSED.
BENDING, STRAIGHTENING OR REALIGNING
(HOT OR COLD) OF THE ANCHOR BOLTS BY
ANY METHOD IS PROHIBITED.

PLATE P/N 133120 SECURELY DOUBLE-NUTTED TO ANCHOR
BOLTS USED AS EMBEDMENT PLATE IN CONCRETE.

TOWER ANCHOR STEEL PLACEMENT

		VOICESTREAM WIRELESS TERRYVILLE CT-11-417C, CT TP63 X 170' ANCHOR STEEL	
		APPROVED/ENG.	WBR 09/01/2000
		APPROVED/FOUND.	WBR 09/01/2000
		DRAWN BY	TSD
From: F1000825.DFT - 09/01/2000 12:59 Printed from: 1507378B.DWG - 09/01/2000 13:01 @ 03/07/2001 15:38		ENG. FILE NO. A-117464- F-1000825	DRAWING NO. 150737-B PAGE 8 OF 9



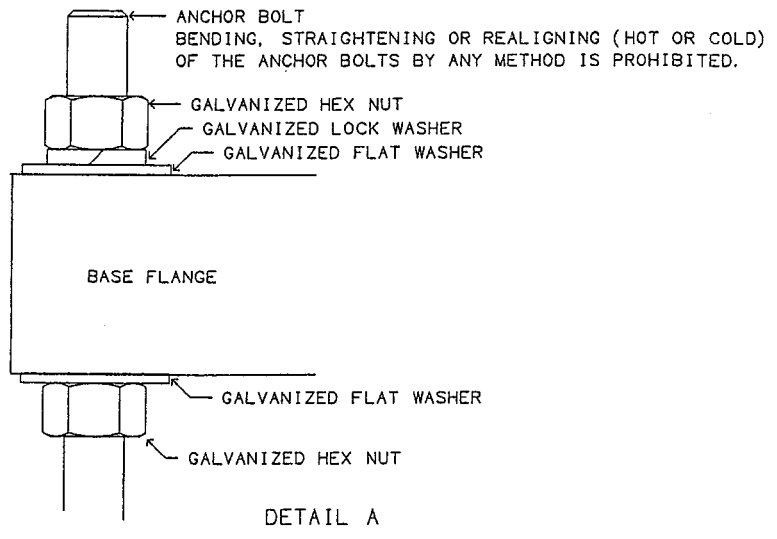
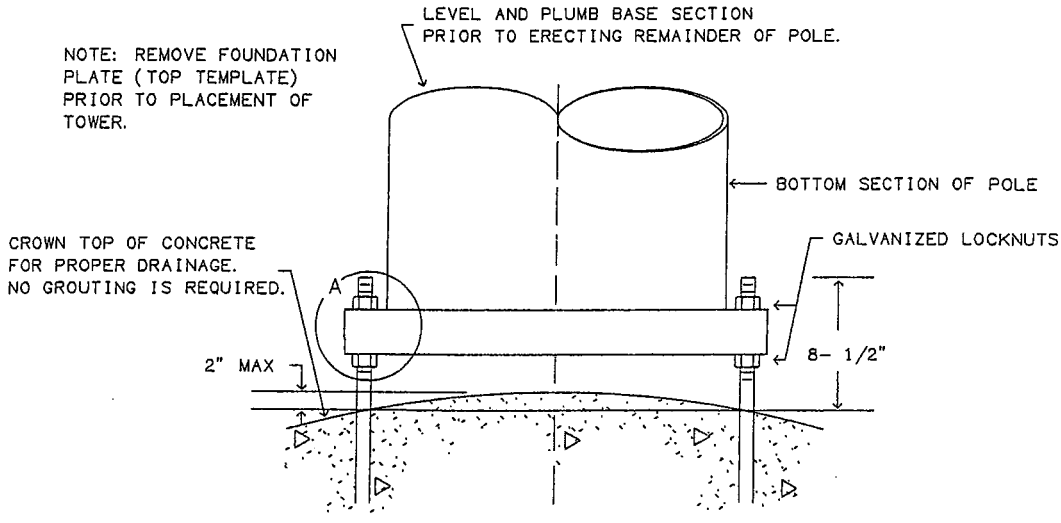

TOWER BASE SECTION PLACEMENT

		VOICESTREAM WIRELESS TERRYVILLE CT-11-417C, CT TP63 X 170' BASE SECTION PLACEMENT	
		APPROVED/ENG.	WBR 09/01/2000
		APPROVED/FOUND.	WBR 09/01/2000
		DRAWN BY	TSD
From: F1000825.DFT - 09/01/2000 12:59 Printed from: 1507379B.DWG - 09/01/2000 13:01 @ 03/07/2001 15:38		ENG. FILE NO. A-117464- ARCHIVE F-1000825	DRAWING NO. 150737-B PAGE 9 OF 9



13' LOW PROFILE PLATFORM

(Dwg. # 140575 Rev. C / 10/09/2000)

Add antenna mounting to new or existing towers

Low Profile Platforms fit on a wide range of Monopole/Tapered Pole diameters

NOTE: Platforms cannot rotate on lattice tower sections

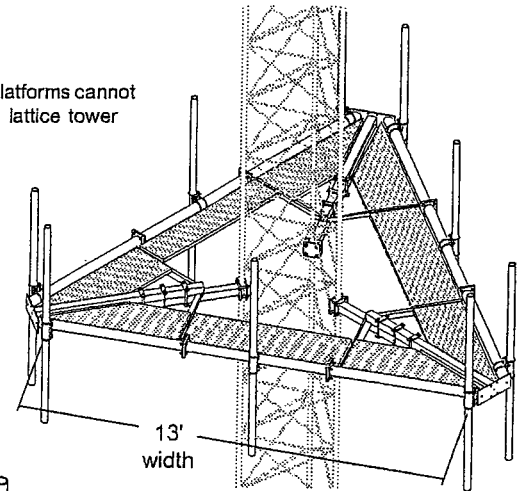
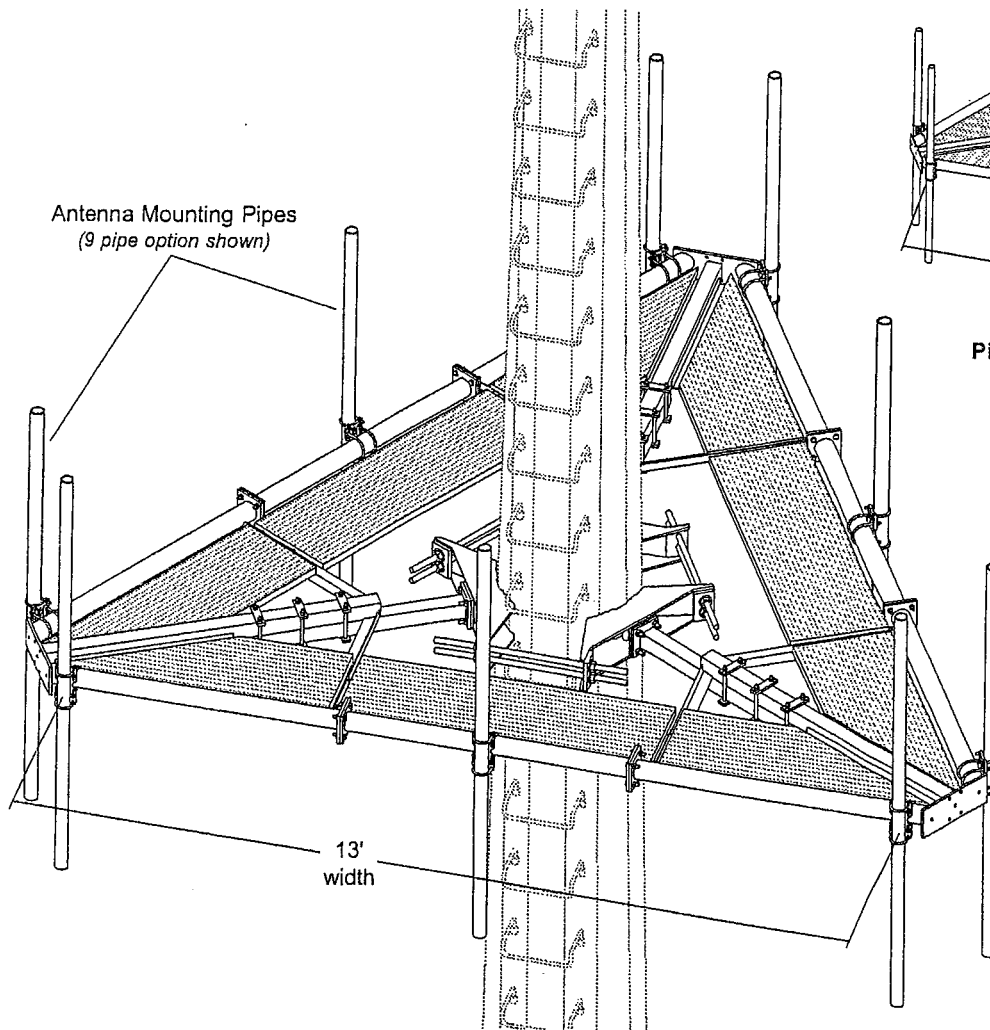

PiRod Low Profile Platforms work well with various tower types and sizes (Maximum Leg Size = 3 1/4" O.D.)

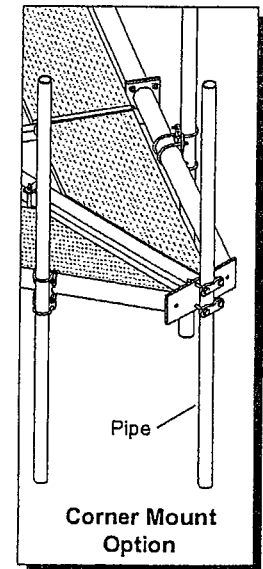

13' Low Profile Platform Ordering Numbers

Catalog List Price

13' Low Profile Platform to fit 12" to 54" monopoles (no antenna mounting pipes included)	P/N 852206	\$3200.00
13' Low Profile Platform to fit 12" to 54" monopoles (includes 9 - 84" antenna mounting pipes)	P/N 852207	\$3800.00
13' Low Profile Platform to fit 12" to 54" monopoles (includes 12 - 84" antenna mounting pipes)	P/N 852208	\$4000.00
13' Low Profile Platform to fit 24" to 54" sections (no antenna mounting pipes included)	P/N 852209	\$2700.00
13' Low Profile Platform to fit 24" to 54" sections (includes 9 - 84" antenna mounting pipes)	P/N 852210	\$3300.00
13' Low Profile Platform to fit 24" to 54" sections (includes 12 - 84" antenna mounting pipes)	P/N 852211	\$3500.00
Corner Mount Option - Lightweight (includes 3 - 84" antenna mounting pipes - 2 3/8" O.D.)	P/N 852215	\$ 200.00
Corner Mount Option - Heavy Duty (includes 3 - 36" antenna mounting pipes - 3 1/2" O.D.)	P/N 852216	\$ 250.00

*For antenna mounting pipe options call a PiRod parts sales representative or see our latest catalog

13' Low Profile Platform	Weight (lbs.)	Area 0" Ice* (CaAc)	Area with 1/2" Ice* (CaAc)
13' Low Profile Platform	1,340 no ice / 2,080 with 1/2" ice	15.3 ft ²	17.0 ft ²

*All areas presented are computed in accordance with ANSI/TIA/EIA-222-F 1996.

**All areas do not include cross arms, pipemounts or antenna mounting pipes.

***All of the above information, including but not limited to: prices, areas, dimensions, is subject to change without notice.



1545 Pidco Drive, P.O. Box 128, Plymouth, IN 46563 • Phone (877) GO PIROD • Fax (219) 936-6796 • www.pirod.com

Printed: 03/07/2001 15:38

Exhibit E

Power Density Calculations

171 Town Hill Road

Plymouth, Connecticut

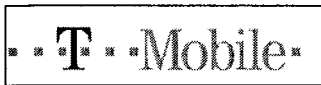

T-Mobile USA Inc.
100 Filley St, Bloomfield, CT 06002-1853
Phone: (860) 692-7100
Fax: (860) 692-7159

Technical Memo

To: Marie Burbanks
From: Hassan Syed - Radio Frequency Engineer
cc: Jason Overbey
Subject: Power Density Report for CT11417
Date: February 18, 2004

1. Introduction:

This report is the result of an Electromagnetic Field Intensities (EMF - Power Densities) study for the T-Mobile PCS antenna installation on a Monopole at 171 Town Hill Road, Plymouth, CT. This study incorporates the most conservative consideration for determining the practical combined worst case power density levels that would be theoretically encountered from locations surrounding the transmitting location.

2. Discussion:

The following assumptions were used in the calculations:

- 1) The emissions from T-Mobile transmitters are in the 1935-1945 MHz frequency band.
- 2) The antenna array consists of three sectors, with 3 antennas per sector.
- 3) The model number for each antenna is FR90-16-02DP.
- 4) The antenna center line height is 165 ft.
- 5) The maximum transmit power from any sector is 1245.43 Watts Effective Radiated Power (EIRP) assuming 8 channels per sector.
- 6) All the antennas are simultaneously transmitting and receiving, 24 hours a day.
- 7) Power levels emitting from the antennas are increased by a factor of 2.56 to account for possible in-phase reflections from the surrounding environment. This is rarely the case, and if so, is never continuous.
- 8) The average ground level of the studied area does not change significantly with respect to the transmitting location

Equations given in "FCC OET Bulletin 65, Edition 97-01" were then used with the above information to perform the calculations.

3. Conclusion:

Based on the above worst case assumptions, the power density calculation from the T-Mobile PCS antenna installation on a Monopole at 171 Town Hill Road, Plymouth, CT, is 0.01081 mW/cm². This value represents 1.081% of the Maximum Permissible Emission (MPE) standard of 1 milliwatt per square centimeter (mW/cm²) set forth in the FCC/ANSI/IEEE C95.1-1991. Furthermore, the proposed antenna location for T-Mobile will not interfere with existing public safety communications, AM or FM radio broadcasts, TV, Police Communications, HAM Radio communications or any other signals in the area.

The combined Power Density from other carriers is 25.09%. The combined Power Density for the site is 26.171% of the M.P.E. standard.

New England Market



Connecticut

Worst Case Power Density

Site:	CT11417
Site Address:	171 Town Hill Road
Town:	Plymouth
Tower Height:	170 ft.
Tower Style:	Monopole
Base Station TX output	20 W
Number of channels	8
Antenna Model	FR90-16-02DP
Cable Size	1 5/8 in.
Cable Length	180 ft.
Antenna Height	165.0 ft.
Ground Reflection	1.6
Frequency	1935.0 MHz
Jumper & Connector loss	4.50 dB
Antenna Gain	15.5 dBi
Cable Loss per foot	0.0116 dB
Total Cable Loss	2.0880 dB
Total Attenuation	6.5880 dB
Total EIRP per Channel	51.92 dBm
(In Watts)	155.68 W
Total EIRP per Sector	60.95 dBm
(In Watts)	1245.43 W
nsg	8.9120
Power Density (S) =	0.010808 mW/cm²
T-Mobile Worst Case % MPE =	1.0808%
Equation Used :	$S = \frac{(1000)(grf)^2 (Power)^{nsg} 10^{(nsg/10)}}{4 \pi (R)^2}$
	Office of Engineering and Technology (OET) Bulletin 65, Edition 97-01, August 1997

Co-Location Total	
Carrier	% of Standard
Verizon	2.9200 %
Cingular	
Sprint PCS	8.9800 %
AT&T Wireless	5.1300 %
Nextel	
Town	8.0600 %
Total Excluding T-Mobile	25.0900 %
T-Mobile	1.0808
Total % MPE for Site	26.1708%