

280 Trumbull Street
Hartford, CT 06103-3597
Main (860) 275-8200
Fax (860) 275-8299
kbaldwin@rc.com
Direct (860) 275-8345

Also admitted in Massachusetts

June 19, 2014

Melanie A. Bachman
Acting Executive Director
Connecticut Siting Council
10 Franklin Square
New Britain, CT 06051

Re: **Notice of Exempt Modification – Facility Modification
548 Green Hollow Road, Plainfield, Connecticut**

Dear Ms. Bachman:

Cellco Partnership d/b/a Verizon Wireless (“Cellco”) currently maintains twelve (12) wireless telecommunications antennas at the 125-foot level on an existing 178-foot tower at 548 Green Hollow Road in Plainfield, Connecticut (the “Property”). The tower is owned by SBA. Cellco’s use of the tower was approved by the Council in 2000. Cellco now intends to modify its facility by removing six (6) 850 MHz antennas and replacing them with three (3) model BXA-70080-4CF, 850 MHz antennas and three (3) model WBX065X19R050, 2100 MHz antennas. Cellco also intends to install three (3) remote radio heads (“RRHs”) behind its new 2100 MHz antennas and one (1) HYBRIFLEX™ antenna cable inside of the monopole. Included in Attachment 1 are specifications for Cellco’s replacement antennas, RRHs and HYBRIFLEX™ cable.

Please accept this letter as notification pursuant to R.C.S.A. § 16-50j-73, for construction that constitutes an exempt modification pursuant to R.C.S.A. § 16-50j-72(b)(2). In accordance with R.C.S.A. § 16-50j-73, a copy of this notice is being sent to Paul E. Sweet, First Selectman for the Town of Plainfield. A copy of this letter is also being sent to Quikrete Companies Inc., the owner of the Property.

The planned modifications to the facility fall squarely within those activities explicitly provided for in R.C.S.A. § 16-50j-72(b)(2).



Law Offices

BOSTON

HARTFORD

NEW YORK

PROVIDENCE

STAMFORD

ALBANY

LOS ANGELES

NEW LONDON

SARASOTA

www.rc.com

12979418-v1

ROBINSON & COLE^{LLP}

Melanie A. Bachman
June 19, 2014
Page 2

1. The proposed modifications will not result in an increase in the height of the existing tower. Cellco's replacement antennas and RRHs will be installed at the 125-foot level on the existing 178-foot tower.
2. The proposed modifications will not involve any change to ground-mounted equipment and, therefore, will not require the extension of the site boundary.
3. The proposed modifications will not increase noise levels at the facility by six decibels or more, or to levels that exceed state and local criteria.
4. The operation of the replacement antennas will not increase radio frequency (RF) emissions at the facility to a level at or above the Federal Communications Commission (FCC) safety standard. A cumulative General Power Density table for Cellco's modified facility is included in Attachment 2.
5. The proposed modifications will not cause a change or alteration in the physical or environmental characteristics of the site.
6. The tower and its foundation can support Cellco's proposed modifications. (See Structural Analysis included in Attachment 3).

For the foregoing reasons, Cellco respectfully submits that the proposed modifications to the above-referenced telecommunications facility constitutes an exempt modification under R.C.S.A. § 16-50j-72(b)(2).

Sincerely,

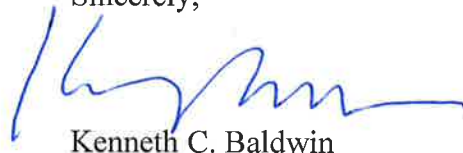

Kenneth C. Baldwin

Enclosures
Copy to:

Paul E. Sweet, Plainfield First Selectman
Quikrete Companies Inc.
Sandy M. Carter



ATTACHMENT 1

BXA-70080-4CF-EDIN-X

X-Pol | FET Panel | 80° | 12.0 dBd

Replace 'X' with desired electrical downtilt.

Antenna is also available with NE connector(s). Replace 'EDIN' with 'NE' in the model number when ordering.



Electrical Characteristics	696-900 MHz		
Frequency bands	696-806 MHz	806-900 MHz	
Polarization	±45°		
Horizontal beamwidth	82°	80°	
Vertical beamwidth	17°	15°	
Gain	11.5 dBd (13.6 dBi)	12.0 dBd (14.1 dBi)	
Electrical downtilt (X)	0, 2, 4, 6, 8, 10, 12, 14		
Impedance	50Ω		
VSWR	≤1.35:1		
Upper sidelobe suppression (0°)	-11.8 dB	-13.1 dB	
Front-to-back ratio (+/-30°)	-30.3 dB	-36.7 dB	
Null fill	5% (-26.02 dB)		
Isolation between ports	< -25 dB		
Input power with EDIN connectors	500 W		
Input power with NE connectors	300 W		
Lightning protection	Direct Ground		
Connector(s)	2 Ports / EDIN or NE / Female / Center (Back)		
Mechanical Characteristics			
Dimensions Length x Width x Depth	1206 x 204 x 151 mm	47.5 x 8.0 x 5.9 in	
Depth with z-brackets	196 mm	7.7 in	
Weight without mounting brackets	5.4 kg	12 lbs	
Survival wind speed	> 201 km/hr	> 125 mph	
Wind area	Front: 0.25 m ² Side: 0.18 m ²	Front: 2.6 ft ² Side: 1.9 ft ²	
Wind load @ 161 km/hr (100 mph)	Front: 351 N Side: 280 N	Front: 79 lbf Side: 61 lbf	
Mounting Options	Part Number	Fits Pipe Diameter	Weight
2-Point Mounting & Downtilt Bracket Kit	36210006	40-115 mm 1.57-4.5 in	4.1 kg 9 lbs
Concealment Configurations	For concealment configurations, order BXA-70080-4CF-EDIN-X-FP		

BXA-70080-4CF-EDIN-X

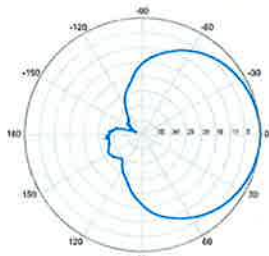

Horizontal | 750 MHz

BXA-70080-4CF-EDIN-0

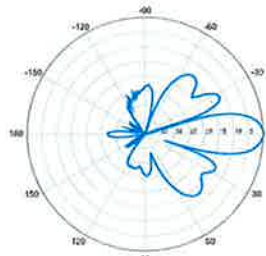

0° | Vertical | 750 MHz

BXA-70080-4CF-EDIN-2

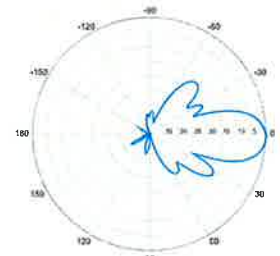

2° | Vertical | 750 MHz

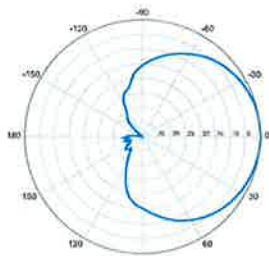

Horizontal | 850 MHz

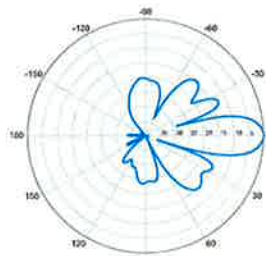

0° | Vertical | 850 MHz

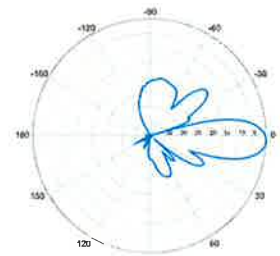

2° | Vertical | 850 MHz

Quoted performance parameters are provided to offer typical or range values only and may vary as a result of normal manufacturing and operational conditions. Extreme operational conditions and/or stress on structural supports is beyond our control. Such conditions may result in damage to this product. Improvements to product may be made without notice.

BXA-70080-4CF-EDIN-X

X-Pol | FET Panel | 80° | 12.0 dBd

BXA-70080-4CF-EDIN-4

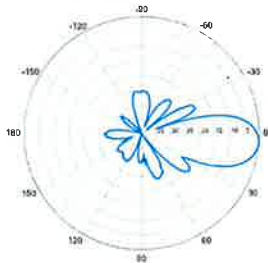

4° | Vertical | 750 MHz

BXA-70080-4CF-EDIN-6

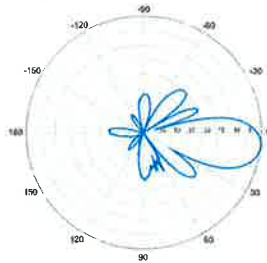

6° | Vertical | 750 MHz

BXA-70080-4CF-EDIN-8

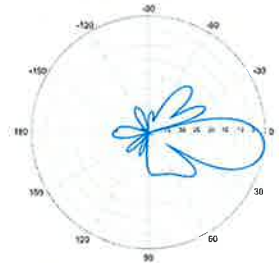

8° | Vertical | 750 MHz

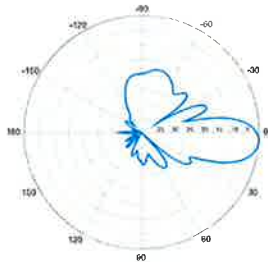

4° | Vertical | 850 MHz

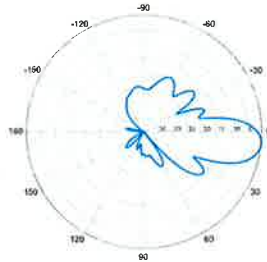

6° | Vertical | 850 MHz

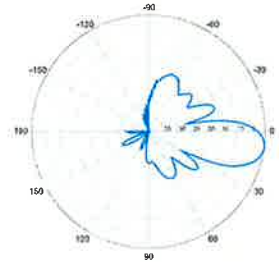

8° | Vertical | 850 MHz

BXA-70080-4CF-EDIN-10

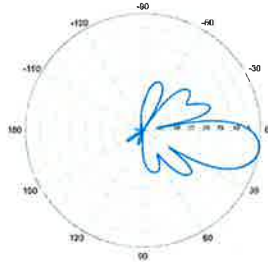

10° | Vertical | 750 MHz

BXA-70080-4CF-EDIN-12

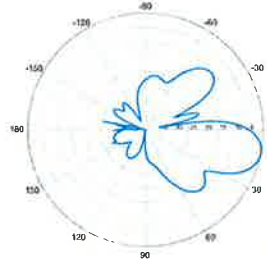

12° | Vertical | 750 MHz

BXA-70080-4CF-EDIN-14

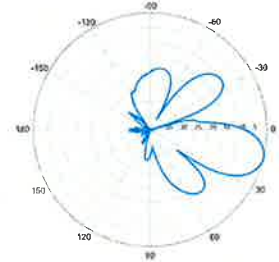

14° | Vertical | 750 MHz

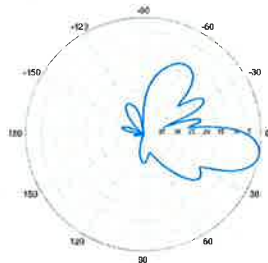

10° | Vertical | 850 MHz

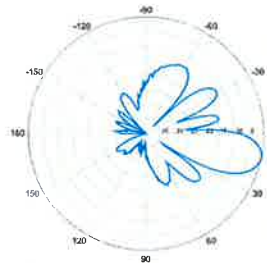

12° | Vertical | 850 MHz

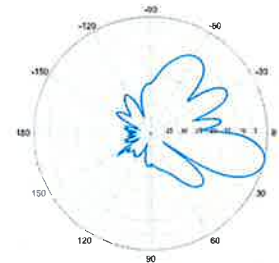

14° | Vertical | 850 MHz

Quoted performance parameters are provided to offer typical or range values only and may vary as a result of normal manufacturing and operational conditions. Extreme operational conditions and/or stress on structural supports is beyond our control. Such conditions may result in damage to this product. Improvements to product may be made without notice.

WBX065X19x050

X-Pol | VET Panel | 65° | 19.0 dBi



Model Number Options

WBX065X19M150 - Manual Electrical Tilt Antenna (aka 5142100)
 WBX065X19R150 - Remote Electrical Tilt Antenna (aka 5142000)

Electrical Characteristics	1710-2170 MHz		
	1710-1880 MHz	1850-1990 MHz	1900-2170 MHz
Frequency bands	1710-1880 MHz	1850-1990 MHz	1900-2170 MHz
Polarization	± 45°	± 45°	± 45°
Horizontal beamwidth	69°	66°	63°
Vertical beamwidth	4.9°	4.6°	4.3°
Gain	15.9 dBi / 18.0 dBi	16.4 dBi / 18.5 dBi	16.9 dBi / 19.0 dBi
Electrical downtilt	2°-10° Variable Electrical Tilt		
Impedance	50Ω		
VSWR	< 1.4:1		
Upper sidelobe suppression	< -18 dB		
Front-to-Back ratio	> 25 dB		
First null	> -20 dB typical		
Inter-port isolation	> 30 dB		
IM3 (2x20W carrier)	< -153 dBc		
Input power	2 x 160 W		
Connector(s)	2 Ports / 7/16 DIN / Female / Bottom		
Operating temperature	-40° to +60° C (-40° to +140° F)		
Mechanical Characteristics			
Dimensions HxWxD	1950 x 157 x 69 mm		76.8 x 6.2 x 2.7 in
Weight without brackets	9.5 kg		20.9 lbs
Survival wind speed	241 km/hr		150 mph
Wind load @ 161 km/hr (100 mph)	Front: 405 N	Side: 176 N	Front: 91 lbf Side: 40 lbf
RET type / Part number	Internal / RETU-CA01		
Mounting Options			
	Part Number	Fits Pipe Diameter	Weight
Pole mounting bracket kit	MKS05P01	40-115 mm 1.6-4.5 in	2.9 kg 6.5 lbs
Scissor tilt bracket kit	MKS05T03	40-115 mm 1.6-4.5 in	4.1 kg 9.1 lbs
Bar tilt bracket kit	MKS05T04	40-115 mm 1.6-4.5 in	4.0 kg 8.8 lbs
Concealment Options			
UNICELL module	UNX14-19	UNX20-19	
Azimuth swivel	± 30°	± 30°	
Elevation tilt	Fixed	Fixed	
Required mounting kit	UNX14-WBX-AZ	UNX20-WBX-AZ	
FP mounting configuration	None		

1710-1880 MHz

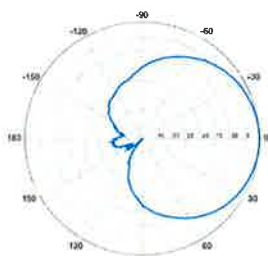

Horizontal

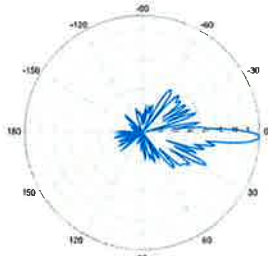

2° | Vertical

1850-1990 MHz

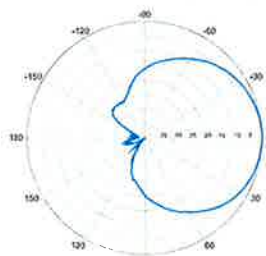

Horizontal

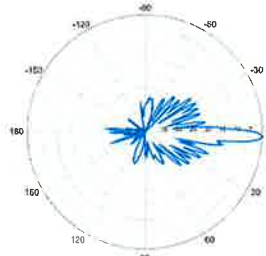

2° | Vertical

1900-2170 MHz

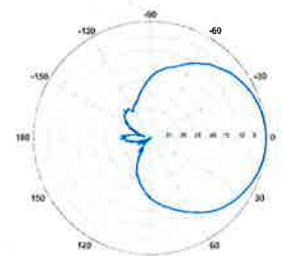

Horizontal

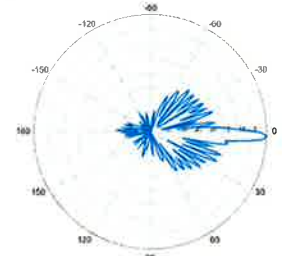

2° | Vertical

Quoted performance parameters are provided to offer typical or range values only and may vary as a result of normal manufacturing and operational conditions. Extreme operational conditions and/or stress on structural supports is beyond our control. Such conditions may result in damage to this product. Improvements to product may be made without notice.

WBX065X19x050

X-Pol | VET Panel | 65° | 19.0 dBi

1710-1880 MHz

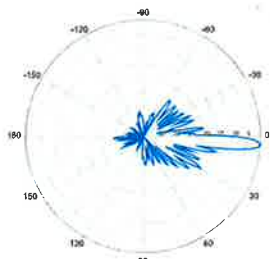

4° | Vertical

1850-1990 MHz

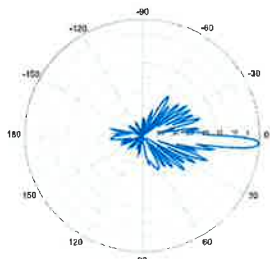

4° | Vertical

1900-2170 MHz

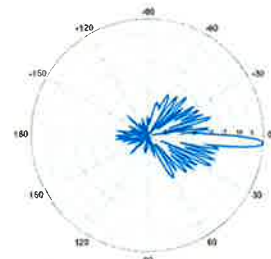

4° | Vertical

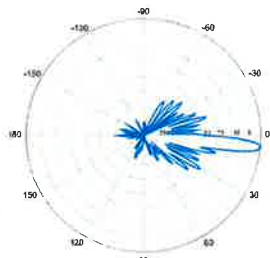

6° | Vertical

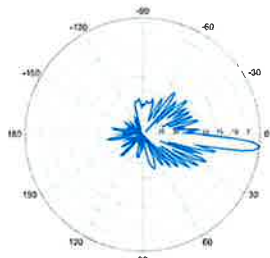

6° | Vertical

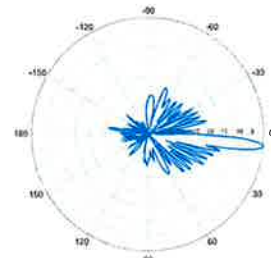

6° | Vertical

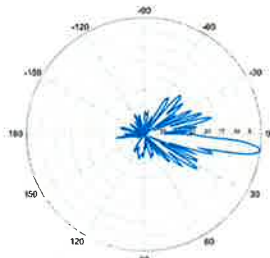

8° | Vertical

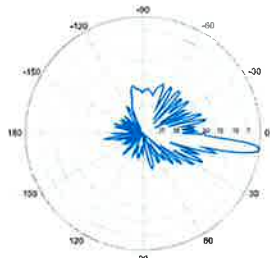

8° | Vertical

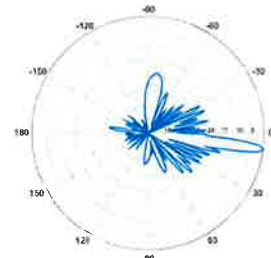

8° | Vertical

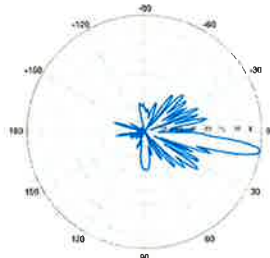

10° | Vertical

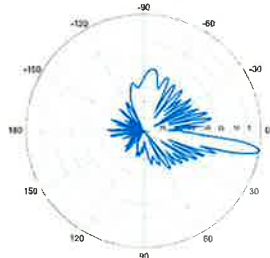

10° | Vertical

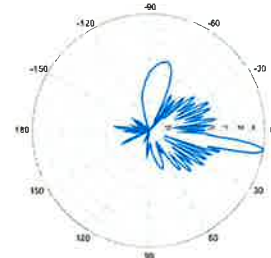

10° | Vertical

Quoted performance parameters are provided to offer typical or range values only and may vary as a result of normal manufacturing and operational conditions. Extreme operational conditions and/or stress on structural supports is beyond our control. Such conditions may result in damage to this product. Improvements to product may be made without notice.

Alcatel-Lucent RRH2x40-AWS

REMOTE RADIO HEAD

The Alcatel-Lucent RRH2x40-AWS is a high-power, small form-factor Remote Radio Head (RRH) operating in the AWS frequency band (1700/2100MHz - 3GPP Band 4). The Alcatel-Lucent RRH2x40-AWS is designed with an eco-efficient approach, providing operators with the means to achieve high quality and capacity coverage with minimum site requirements.

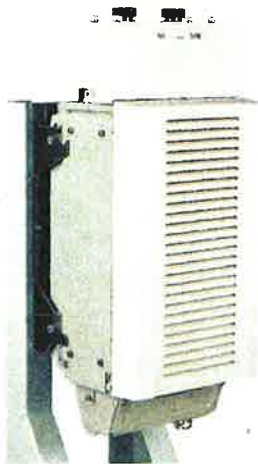

A distributed eNodeB expands deployment options by using two components, a Base Band Unit (BBU) containing the digital assets and a separate RRH containing the radio-frequency (RF) elements. This modular design optimizes available space and allows the main components of an eNodeB to be installed separately, within the same site or several kilometres apart.

The Alcatel-Lucent RRH2x40-AWS is linked to the BBU by an optical-fiber connection carrying downlink and uplink digital radio signals along with operations, administration and maintenance (OA&M) information. The Alcatel-Lucent RRH2x40-AWS has two transmit RF paths, 40 W RF output power per transmit path, and is designed to manage up to four-way receive diversity. The device is ideally suited to support macro coverage, with multiple-input multiple-output (MIMO) 2x2 operation in up to 20 MHz of bandwidth.

The Alcatel-Lucent RRH2x40-AWS is designed to make available all the benefits of a distributed eNodeB, with excellent RF characteristics, with low

capital expenditures (CAPEX) and low operating expenditures (OPEX). The limited space available in some sites may prevent the installation of traditional single-cabinet BTS equipment or require costly cranes to be employed, leaving coverage holes. However, many of these sites can host an Alcatel-Lucent RRH2x40-AWS installation, providing more flexible site selection and improved network quality along with greatly reduced installation time and costs.

Fast, low-cost installation and deployment

The Alcatel-Lucent RRH2x40-AWS is a zero-footprint solution and operates noise-free, simplifying negotiations with site property owners and minimizing environmental impacts. Installation can easily be done by a single person because the Alcatel-Lucent RRH2x40-AWS is compact and weighs less than 20 kg (44 lb), eliminating the need for a crane to hoist the BTS cabinet to the rooftop. A site can be in operation in less than one day — a fraction of the time required for a traditional BTS.

Excellent RF performance

Because of its small size and weight, the Alcatel-Lucent RRH2x40-AWS can be installed close to the antenna. Operators can therefore locate the Alcatel-Lucent RRH2x40-AWS where RF engineering is deemed ideal, minimizing trade-offs between available sites and RF optimum sites. The RF feeder cost and installation costs are reduced or eliminated, and there is no need for a Tower Mounted Amplifier (TMA) because losses introduced by the RF feeder are greatly reduced. The Alcatel-Lucent RRH2x40-AWS provides more RF power while at the same time consuming less electricity.

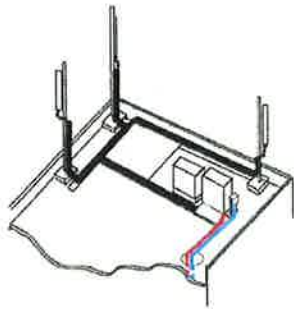

Macro

Features

- Zero-footprint deployment
- Easy installation, with a lightweight unit can be carried and set up by one person
- Optimized RF power, with flexible site selection and elimination of a TMA
- Convection-cooled (fanless)
- Noise-free
- Best-in-class power efficiency, with significantly reduced energy consumption

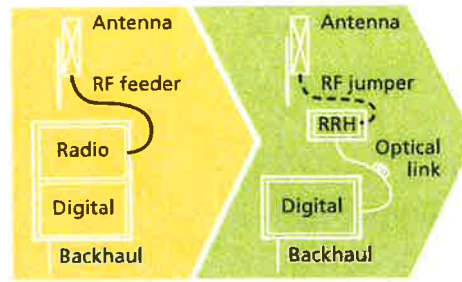

RRH for space-constrained cell sites

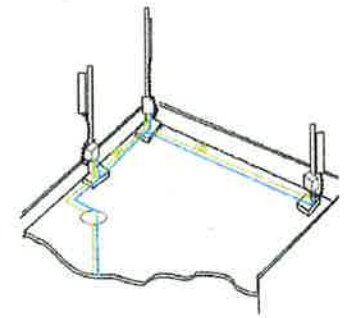

Distributed

Benefits

- Leverages existing real estate with lower site costs
- Reduces installation costs, with fewer installation materials and simplified logistics
- Decreases power costs and minimizes environmental impacts, with the potential for eco-sustainable power options
- Improves RF performance and adds flexibility to network planning

Technical specifications

Physical dimensions

- Height: 620 mm (24.4 in.)
- Width: 270 mm (10.63 in.)
- Depth: 170mm (6.7 in.)
- Weight (without mounting kit): less than 20 kg (44 lb)

Power

- Power supply: -48VDC

Operating environment

- Outdoor temperature range:
 - With solar load: -40°C to +50°C (-40°F to +122°F)
 - Without solar load: -40°C to +55°C (-40°F to +131°F)

- Passive convection cooling (no fans)
- Enclosure protection
 - IP65 (International Protection rating)

RF characteristics

- Frequency band: 1700/2100 MHz (AWS); 3GPP Band 4
- Bandwidth: up to 20 MHz
- RF output power at antenna port: 40 W nominal RF power for each Tx port
- Rx diversity: 2-way or 4-way with optional Rx Diversity module
- Noise figure: below 2.0 dB typical
- Antenna Line Device features
 - TMA and Remote electrical tilt (RET) support via AISG v2.0

Optical characteristics

Type/number of fibers

- Single-mode variant
 - One Single Mode Single Fiber per RRH2x, carrying UL and DL using CWDM
 - Single mode dual fiber (SM/DF)
- Multi-mode variant
 - Two Multi-mode fibers per RRH2x: one carrying UL, the other carrying DL

Optical fiber length

- Up to 500 m (0.31 mi), using MM fiber
- Up to 20 km (12.43 mi), using SM fiber

Digital Ports and Alarms

- Two optical ports to support daisy-chaining
- Six external alarms

www.alcatel-lucent.com Alcatel, Lucent, Alcatel-Lucent and the Alcatel-Lucent logo are trademarks of Alcatel-Lucent. All other trademarks are the property of their respective owners. The information presented is subject to change without notice. Alcatel-Lucent assumes no responsibility for inaccuracies contained herein. Copyright © 2010 Alcatel-Lucent. All rights reserved. CPG2809100912 (09)



HYBRIFLEX™ RRH Hybrid Feeder Cabling Solution, 1-5/8", Single-Mode Fiber

Product Description

RFS' HYBRIFLEX Remote Radio Head (RRH) hybrid feeder cabling solution combines optical fiber and DC power for RRHs in a single lightweight aluminum corrugated cable, making it the world's most innovative solution for RRH deployments.

It was developed to reduce installation complexity and costs at Cellular sites. HYBRIFLEX allows mobile operators deploying an RRH architecture to standardize the RRH installation process and eliminate the need for and cost of cable grounding. HYBRIFLEX combines optical fiber (multi-mode or single-mode) and power in a single corrugated cable. It eliminates the need for junction boxes and can connect multiple RRHs with a single feeder. Standard RFS CELLFLEX® accessories can be used with HYBRIFLEX cable. Both pre-connectorized and on-site options are available.

Features/Benefits

- Aluminum corrugated armor with outstanding bending characteristics - minimizes installation time and enables mechanical protection and shielding
- Same accessories as 1 5/8" coaxial cable
- Outer conductor grounding - eliminates typical grounding requirements and saves on installation costs
- Lightweight solution and compact design - Decreases tower loading
- Robust cabling - Eliminates need for expensive cable trays and ducts
- Installation of tight bundled fiber optic cable pairs directly to the RRH - Reduces CAPEX and wind load by eliminating need for interconnection
- Optical fiber and power cables housed in single corrugated cable - Saves CAPEX by standardizing RRH cable installation and reducing installation requirements
- Outdoor polyethylene jacket - Ensures long-lasting cable protection



Figure 1: HYBRIFLEX Series

Technical Specifications

Outer Conductor Armor	Corrugated Aluminum	[mm (in.)]	46.5 (1.83)
Jacket	Polyethylene, PE	[mm (in.)]	50.3 (1.98)
UV-Protection	Individual and External Jacket		Yes
Mechanical Properties			
Weight, Approximate		[kg/m (lb/ft)]	1.9 (1.30)
Minimum Bending Radius, Single Bending		[mm (in.)]	200 (8)
Minimum Bending Radius, Repeated Bending		[mm (in.)]	500 (20)
Recommended/Maximum Clamp Spacing		[m (ft)]	1.0 / 1.2 (3.25 / 4.0)
Electrical Properties			
DC-Resistance Outer Conductor Armor		[Ω/km (Ω/1000ft)]	0.68 (0.205)
DC-Resistance Power Cable, 8 4mm²(8AWG)		[Ω/km (Ω/1000ft)]	2.1 (0.307)
Optical Properties			
Version			Single-mode OM3
Quantity, Fiber Count			16 (8 pairs)
Core/Clad		[μm]	50/125
Primary Coating (Acrylate)		[μm]	245
Buffer Diameter, Nominal		[μm]	900
Secondary Protection, Jacket, Nominal		[mm (in.)]	2.0 (0.08)
Minimum Bending Radius		[mm (in.)]	104 (4.1)
Insertion Loss @ wavelength 850nm		dB/km	3.0
Insertion Loss @ wavelength 1310nm		dB/km	1.0
Standards (Meets or exceeds)			UL94-V0, UL1666 RoHS Compliant
DC Power Cable Properties			
Size (Power)		[mm (AWG)]	8 4 (8)
Quantity, Wire Count (Power)			16 (8 pairs)
Size (Alarm)		[mm (AWG)]	0 8 (18)
Quantity, Wire Count (Alarm)			4 (2 pairs)
Type			UV protected
Strands			19
Primary Jacket Diameter, Nominal		[mm (in.)]	6.8 (0.27)
Standards (Meets or exceeds)			NFPA 130, ICEA S-95-658 UL Type XHHW-2, UL 44 UL-LS Limited Smoke, UL VW-1 IEEE-383 (1974), IEEE1202/FT4 RoHS Compliant
Operating Range			
Installation Temperature		[°C (°F)]	-40 to +65 (-40 to 149)
Operation Temperature		[°C (°F)]	-40 to +65 (-40 to 149)

* This data is provisional and subject to change

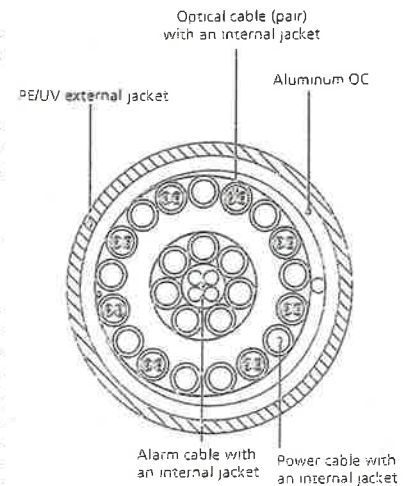

Figure 2: Construction Detail

All information contained in the present datasheet is subject to confirmation at time of ordering

ATTACHMENT 2

		General		Power	Density				
Site Name: Plainfield N Tower Height: 178Ft									
CARRIER	# OF CHAN.	WATTS ERP	HEIGHT	CALC. POWER DENS	FREQ.	MAX. PERMISS. EXP.	FRACTION MPE	Total	
*AT&T UMTS	2	565	155	0.0169	880	0.5867	2.88%		
*AT&T UMTS	2	875	155	0.0262	1900	1.0000	2.62%		
*AT&T GSM	1	283	155	0.0042	880	0.5867	0.72%		
*AT&T GSM	4	525	155	0.0314	1900	1.0000	3.14%		
*AT&T LTE	1	1771	155	0.0265	734	0.4893	5.42%		
*MetroPCS	3	443.61	135	0.0263	2140	1.0000	2.63%		
*Sprint CDMA/LTE	2	625.5	145.4	0.0213	1900	1.0000	2.13%		
*T-Mobile	16	250	165	0.0528	1945	1.0000	5.28%		
*Nextel	9	100	175	0.0106	806	0.5373	1.97%		
Verizon	11	433	125	0.1096	1970	1.0000	10.96%		
Verizon	9	400	125	0.0828	869	0.5793	14.30%		
Verizon	1	1750	125	0.0403	2145	1.0000	4.03%		
Verizon	1	1050	125	0.0242	698	0.4653	5.19%		
								61.27%	
* Source: Siting Council									

ATTACHMENT 3



FDH Engineering, Inc., 6521 Meridien Drive Raleigh, NC 27616, Ph. 919.755.1012

**Structural Analysis for
SBA Network Services, Inc.**

178' Monopole Tower

**SBA Site Name: Plainfield North
SBA Site ID: CT00594-S-06
Verizon Site ID: 118616
Verizon Site Name: Plainfield North CT**

FDH Project Number 1425021400

Analysis Results

Tower Components	93.8 %	Sufficient
Foundation	94.0 %	Sufficient

Prepared By:

Cary J. Webb, PE
Project Engineer

Reviewed By:

Bradley R. Newman, PE
Senior Project Engineer
CT PE License No. 29630

FDH Engineering, Inc.
6521 Meridien Drive
Raleigh, NC 27616
(919) 755-1012
info@fdh-inc.com



March 28, 2014

Prepared pursuant to TIA/EIA-222-F Structural Standards for Steel Antenna Towers and Antenna Supporting Structures and the 2005 Connecticut Building Code

TABLE OF CONTENTS

EXECUTIVE SUMMARY 3
 Conclusions 3
 Recommendations 3
APPURTENANCE LISTING 4
RESULTS 5
GENERAL COMMENTS 6
LIMITATIONS 6
APPENDIX 7

EXECUTIVE SUMMARY

At the request of SBA Network Services, Inc., FDH Engineering, Inc. performed a structural analysis of the monopole located in Plainfield, CT to determine whether the tower is structurally adequate to support both the existing and proposed loads pursuant to the *Structural Standards for Steel Antenna Towers and Antenna Supporting Structures, TIA/EIA-222-F and the 2005 Connecticut Building Code (CBC)*. Information pertaining to the existing/proposed antenna loading, current tower geometry, geotechnical data, and member sizes was obtained from:

- Valmont Industries, Inc. (Order No. 17665-98) original design drawings dated September 11, 1998
- JGI (Project No. C98326G) geotechnical report dated July 23, 1998
- SBA Network Services, Inc.

The *basic design wind speed* per the *TIA/EIA-222-F* standards and *2005 CBC* is 85 mph without ice and 28 mph with 1" radial ice. Ice is considered to increase in thickness with height.

Conclusions

With the existing and proposed antennas from Verizon in place at 125 ft, the tower meets the requirements of the *TIA/EIA-222-F* standards and *2005 CBC* provided the **Recommendations** listed below are satisfied. Furthermore, provided the foundation was designed and constructed to support the original design reactions (see Valmont Order No. 17665-98), the foundation should have the necessary capacity to support the existing and proposed loading. For a more detailed description of the analysis of the tower, see the **Results** section of this report.

Our structural analysis has been performed assuming all information provided to FDH Engineering, Inc. is accurate (i.e., the steel data, tower layout, existing antenna loading, and proposed antenna loading) and that the tower has been properly erected and maintained per the original design drawings.

Recommendations

To ensure the requirements of the *TIA/EIA-222-F* standards and *2005 CBC* are met with the existing and proposed loading in place, we have the following recommendations:

1. The proposed coax should be installed inside the pole's shaft, but may be installed outside the pole shaft beside the existing coax.
2. RRU/RRH Stipulation: The equipment may be installed in any arrangement as determined by the client.
3. The proposed diplexers should be installed directly behind the existing and proposed panel antennas.

APPURTENANCE LISTING

The proposed and existing antennas with their corresponding cables/coax lines are shown in **Table 1**. *If the actual layout determined in the field deviates from the layout, FDH Engineering, Inc. should be contacted to perform a revised analysis.*

Table 1 - Appurtenance Loading

Existing Loading:

Antenna Elevation (ft)	Description	Coax and Lines ¹	Carrier	Mount Elevation (ft)	Mount Type
175	(9) Allgon 7130.16	(9) 1-5/8"	Nextel	175	(1) Low Profile Platform
165	(3) EMS RR90-18-02DP (3) TMAs	(6) 1-5/8"	T-Mobile	165	(1) Platform w/ Handrails
155	(6) Powerwave 7770 (1) KMW AM-X-CD-17-65-00T (1) Powerwave P65-17-XLH-RR (1) Kathrein 800 10764 (1) Nokia CS72188.01 (6) Powerwave LGP21401 TMAs (6) Powerwave LGP21903 Diplexers	(12) 1-5/8" (2) 3/4" DC Power (1) 7/16" Fiber (1) 1/2"	AT&T	155	(1) Platform w/ Handrails
152.5	(6) Ericsson RRUS11 RRUs (1) Raycap DC2-48-60-18-8F Surge Arrestor			152.5	(1) Universal Ring Mount (Part No. LWRM)
145	(6) Decibel DB908H90E-M	(6) 1-5/8"	Sprint	145	(1) Platform w/ Handrails
135 ²	(6) Kathrein 742-351	(12) 1-5/8" (1) 3/8"	Metro PCS	135	(3) 12.5' T-Arms
125 ³	(3) Antel BXA-70063/6CF (6) Antel LPA-80080/4CF (3) Antel BXA-185090/8CF (6) RFS FD9R6004/2C-3L Diplexers	(12) 1-5/8"	Verizon	125	(1) Low Profile Platform

1. Coax installed inside the pole's shaft unless otherwise noted.
2. The future coax for Metro PCS to 135 ft can be installed outside the monopole's shaft in a single row.
3. The coax for Verizon to 125 ft is installed outside the monopole's shaft in a single row.

Proposed Loading:

Antenna Elevation (ft)	Description	Coax and Lines	Carrier	Mount Elevation (ft)	Mount Type
125	(3) Antel BXA-70063/6CF (3) Antel BXA-185090/8CF (3) Antel WBX065X19R050 (3) Antel BXA-70080/4CF (3) Alcatel Lucent RRH 2x40-AWS RRHs (6) RFS FD9R6004/2C-3L Diplexers (1) RFS DB-T1-6Z-8AB-0Z Distribution Box	(12) 1-5/8" (1) 1-5/8" Fiber	Verizon	125	(1) Low Profile Platform

RESULTS

The following yield strength of steel for individual members was used for analysis:

Table 2 - Material Strength

Member Type	Yield Strength
Tower Shaft Sections	65 ksi
Base Plate	60 ksi
Anchor Bolts	75 ksi

Table 3 displays the summary of the ratio (as a percentage) of force in the member to their capacities. Values greater than 100% indicate locations where the maximum force in the member exceeds its capacity. *Note: Capacities up to 105% are considered acceptable.* **Table 4** displays the maximum foundation reactions.

If the assumptions outlined in this report differ from actual field conditions, FDH Engineering, Inc. should be contacted to perform a revised analysis. Furthermore, as no information pertaining to the allowable twist and sway requirements for the existing or proposed appurtenances was provided, deflection and rotation were not taken into consideration when performing this analysis.

See the **Appendix** for detailed modeling information

Table 3 - Summary of Working Percentage of Structural Components

Section No.	Elevation ft	Component Type	Size	% Capacity*	Pass Fail
L1	178 - 124.083	Pole	TP32.09x19.69x0.281	69.4	Pass
L2	124.083 - 77.9167	Pole	TP42.14x30.3972x0.438	81.5	Pass
L3	77.9167 - 32.8333	Pole	TP51.63x39.8656x0.469	92.1	Pass
L4	32.8333 - 0	Pole	TP58.25x49.0442x0.5	93.8	Pass
		Anchor Bolts	(24) 2-1/4" \emptyset on a 66.81" BC	79.6	Pass
		Base Plate	3" thick x 72.81" round PL	60.5	Pass

*Capacities include 1/3 allowable stress increase for wind per TIA/EIA-222-F standards.

Table 4 - Maximum Base Reactions

Base Reactions	Current Analysis (TIA/EIA-222-F)	Original Design (TIA/EIA-222-F)
Axial	57 k	51 k
Shear	45 k	45 k
Moment	5,261 k-ft	5,596 k-ft

GENERAL COMMENTS

This engineering analysis is based upon the theoretical capacity of the structure. It is not a condition assessment of the tower and its foundation. It is the responsibility of SBA Network Services, Inc. to verify that the tower modeled and analyzed is the correct structure (with accurate antenna loading information) modeled. If there are substantial modifications to be made or the assumptions made in this analysis are not accurate, FDH Engineering, Inc. should be notified immediately to perform a revised analysis.

LIMITATIONS

All opinions and conclusions are considered accurate to a reasonable degree of engineering certainty based upon the evidence available at the time of this report. All opinions and conclusions are subject to revision based upon receipt of new or additional/updated information. All services are provided exercising a level of care and diligence equivalent to the standard and care of our profession. No other warranty or guarantee, expressed or implied, is offered. Our services are confidential in nature and we will not release this report to any other party without the client's consent. The use of this engineering work is limited to the express purpose for which it was commissioned and it may not be reused, copied, or distributed for any other purpose without the written consent of FDH Engineering, Inc.

APPENDIX

Section	1	2	3	4
Length (ft)	53.92	51.08	51.17	40.00
Number of Sides	12	12	12	12
Thickness (in)	0.2810	0.4380	0.4650	0.5000
Socket Length (ft)	4.92	6.08	7.17	49.0442
Top Dia (in)	19.6900	30.3972	39.8656	58.2500
Bot Dia (in)	32.0900	42.1400	51.6300	58.2500
Grade	A572-65			
Weight (K)	4.3	8.8	11.9	11.6

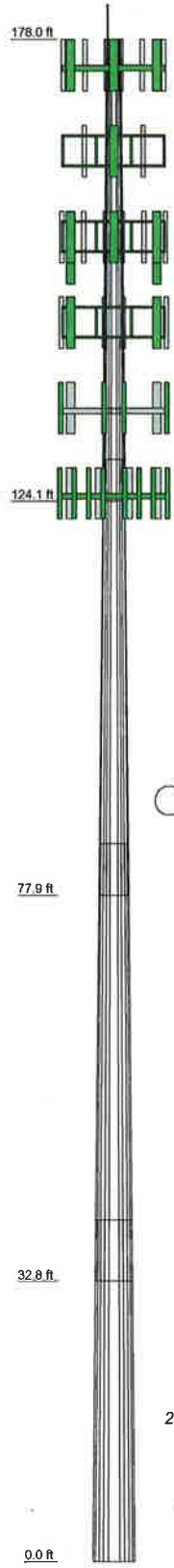

DESIGNED APPURTENANCE LOADING

TYPE	ELEVATION	TYPE	ELEVATION
Lighting Rod	178	Universal Ring Mount	152.5
(3) 7130.16 w/Mount Pipe	175	(2) RRUS 11	152.5
(3) 7130.16 w/Mount Pipe	175	(2) RRUS 11	152.5
Low Profile Platform	175	(2) DB908H90E-M w/ Mount Pipe	145
(3) 7130.16 w/Mount Pipe	175	(2) DB908H90E-M w/ Mount Pipe	145
RR90-17-02DP w/Mount Pipe	165	Platform w/handrail	145
RR90-17-02DP w/Mount Pipe	165	(2) DB908H90E-M w/ Mount Pipe	145
TMA	165	(2) Kalhrein 742-351 w/ Mount Pipe	135
TMA	165	(2) Kalhrein 742-351 w/ Mount Pipe	135
TMA	165	(2) Kalhrein 742-351 w/ Mount Pipe	135
Platform w/handrail	165	(3) 12.5' T-Arms	135
RR90-17-02DP w/Mount Pipe	165	BXA-185090-8CF w/Mount Pipe	125
(2) Powerwave 7770 w/ Mount Pipe	155	WBX065X19R050 w/ Mount Pipe	125
(2) Powerwave 7770 w/ Mount Pipe	155	WBX065X19R050 w/ Mount Pipe	125
AM-X-CD-14-65-00T w/ Mount Pipe	155	WBX065X19R050 w/ Mount Pipe	125
P65-17-XLH-RR w/Mount Pipe	155	BXA-70080/4CF w/ Mount Pipe	125
800 10764 w/ Mount Pipe	155	BXA-70080/4CF w/ Mount Pipe	125
CS72188.01 LMU	155	BXA-70080/4CF w/ Mount Pipe	125
(2) TMA - Powerwave LGP21401	155	RRH2X40-AWS	125
(2) TMA - Powerwave LGP21401	155	RRH2X40-AWS	125
(2) TMA - Powerwave LGP21401	155	RRH2X40-AWS	125
(2) LGP21903 Diplexer	155	DB-T1-6Z-8AB-0Z	125
(2) LGP21903 Diplexer	155	(2) FD9R6004/2C-3L Diplexer	125
(2) LGP21903 Diplexer	155	(2) FD9R6004/2C-3L Diplexer	125
Platform w/handrail	155	(2) FD9R6004/2C-3L Diplexer	125
(2) Powerwave 7770 w/ Mount Pipe	155	Low Profile Platform	125
(2) RRUS 11	152.5	BXA-70063/6CF w/ Mount Pipe	125
DC6-48-60-18-8F Surge Arrestor	152.5	BXA-70063/6CF w/ Mount Pipe	125
5x2.43" Pipe Mount	152.5	BXA-185090-8CF w/Mount Pipe	125
(2) Empty Mount Pipe	152.5	BXA-185090-8CF w/Mount Pipe	125
(2) Empty Mount Pipe	152.5	BXA-70063/6CF w/ Mount Pipe	125
(2) Empty Mount Pipe	152.5	BXA-70063/6CF w/ Mount Pipe	125

MATERIAL STRENGTH

GRADE	Fy	Fu	GRADE	Fy	Fu
A572-65	65 ksi	80 ksi			

TOWER DESIGN NOTES

1. Tower is located in Windham County, Connecticut.
2. Tower designed for a 85 mph basic wind in accordance with the TIA/EIA-222-F Standard.
3. Tower is also designed for a 28 mph basic wind with 1.00 in ice. Ice is considered to increase in thickness with height.
4. Deflections are based upon a 50 mph wind.
5. TOWER RATING: 93.8%

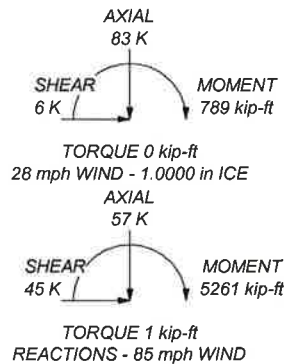

 FDH Engineering, Inc. 6521 Meriden Drive, Suite 107 Raleigh, NC 27616 Phone: 9197551012 FAX: 9197551031	Job: Plainfield North, CT00594-S		
	Project: 1425021400		
	Client: SBA	Drawn by: Cary Webb	App'd:
	Code: TIA/EIA-222-F	Date: 03/28/14	Scale: NTS
Tower Analysis		Path:	Dwg No. E-1