



10 INDUSTRIAL AVE,
SUITE 3
MAHWAH NJ 07430

PHONE: 201.684.0055
FAX: 201.684.0066

December 22, 2020

Members of the Siting Council
Connecticut Siting Council
Ten Franklin Square
New Britain, CT 06051

RE: Notice of Exempt Modification
59 Youngs Apple Orchard Road, North Branford, CT 06472
Latitude: 41.4210130000
Longitude: -72.7494530000
T-Mobile Site#: CT11224A – L600

Dear Ms. Bachman:

T-Mobile currently maintains six (6) antennas at the 97-foot level of the existing 130-foot lattice tower at 59 Youngs Apple Orchard Road, North Branford, CT. The 130-foot lattice tower is owned and operated by Everest Infrastructure Partners. The property is owned by Southern New England Telephone Company. T-Mobile now intends to remove the six (6) existing antennas and add three (3) new 600/700/1900/2100 MHz antennas. The new antennas will be installed at the same 97-foot level of the tower.

Planned Modifications:

Tower:

Remove

- (3) RR90-17-02DP Antenna 1900 MHz
- (3) TMA
- (12) 7/8" coax cables

Remove and Replace:

- (3) LNX-6515DS (Remove) – (3) APXVAARR24_43-U-NA20 (Replace) 600/700/1900/2100 MHz

Install New:

- (3) Radio 4449 B71+B12
- (3) Radio 4415 B25
- (3) Radio 4415 B66A
- (3) 1-3/8" Hybrid Cables

Existing to Remain:

N/A

Ground:

Replace existing 6201 cabinet with 6102 cabinet

There is no record of an original approval from the Siting Council for this facility. The Town of North Branford Zoning Enforcement Officer, Tom Hogarty, confirmed the town does not maintain a record of the original approval of the facility. This correspondence is enclosed.

Please accept this letter as notification pursuant to Regulations of Connecticut State Agencies § 16-50j-73, for construction that constitutes an exempt modification pursuant to R.C.S.A. § 16-50j-72(b)(2). In accordance with R.C.S.A. § 16-50j-73, a copy of this letter is being sent to Town Manager- Michael Paulhus, Elected Official, and Cary Duques, Town Planner for the Town of North Branford, as well as the tower owner and property owner.

The planned modifications to the facility fall squarely within those activities explicitly provided for in R.C.S.A. § 16-50j-72(b)(2).

1. The proposed modifications will not result in an increase in the height of the existing structure.
2. The proposed modifications will not require the extension of the site boundary.
3. The proposed modifications will not increase noise levels at the facility by six decibels or more, or to levels that exceed state and local criteria.
4. The operation of the replacement antennas will not increase radio frequency emissions at the facility to a level at or above the Federal Communications Commission safety standard.
5. The proposed modifications will not cause a change or alteration in the physical or environmental characteristics of the site.
6. The existing structure and its foundation can support the proposed loading.

For the foregoing reasons, T-Mobile respectfully submits that the proposed modifications to the above referenced telecommunications facility constitute an exempt modification under R.C.S.A. § 16-50j-72(b)(2).

Sincerely,

Kyle Richers

Transcend Wireless

Cell: 908-447-4716

Email: krichers@transcendwireless.com

Attachments

cc: Michael Paulhus – Town of North Branford Town Manager

Cary Duques – Town of North Branford Town Planner

Everest Infrastructure Partners – Tower Owner

Southern New England Telephone Company- Property Owner

View/Print Label

1. **Ensure there are no other shipping or tracking labels attached to your package.** Select the Print button on the print dialogue box that appears. Note: If your browser does not support this function, select Print from the File menu to print the label.

2. **Fold the printed label at the solid line below.** Place the label in a UPS Shipping Pouch. If you do not have a pouch, affix the folded label using clear plastic shipping tape over the entire label.

3. GETTING YOUR SHIPMENT TO UPS

Customers with a scheduled Pickup

- Your driver will pickup your shipment(s) as usual.

Customers without a scheduled Pickup

- Schedule a Pickup on ups.com to have a UPS driver pickup all of your packages.
- Take your package to any location of The UPS Store®, UPS Access Point(TM) location, UPS Drop Box, UPS Customer Center, Staples® or Authorized Shipping Outlet near you. To find the location nearest you, please visit the 'Locations' Quick link at ups.com.

UPS Access Point™
 MICHAELS STORE # 7773
 75 INTERSTATE SHOP CTR
 RAMSEY NJ 07446-1130

UPS Access Point™
 THE UPS STORE
 115 FRANKLIN TPKE
 MAHWAH NJ 07430-1325

UPS Access Point™
 THE UPS STORE
 120 E MAIN ST
 RAMSEY NJ 07446-1925

FOLD HERE

<p>NEIL GUERRIERO 3473040176 TRANSCEND WIRELESS 10 INDUSTRIAL AVE MAHWAH NJ 07430</p> <p>SHIP TO: CARY DUQUES TOWN OF NORTH BRANFORD 909 FOXON ROAD NORTH BRANFORD CT 06471</p>	<p>1 LBS</p> <p style="text-align: right;">1 OF 1</p>	<p>CT 065 2-01</p> 	<p>UPS GROUND</p> <p>TRACKING #: 1Z V25 742 42 9298 9181</p> 	<p>BILLING: P/P SIGNATURE REQUIRED UPS CARBON NEUTRAL SHIPMENT</p> <p>Reference #1: CT11224A CSC ZO</p> <p style="font-size: small;">XOL 20.10.23 NV45 39.0A 11/2020*</p> 
---	---	---	--	--

View/Print Label

1. **Ensure there are no other shipping or tracking labels attached to your package.** Select the Print button on the print dialogue box that appears. Note: If your browser does not support this function, select Print from the File menu to print the label.

2. **Fold the printed label at the solid line below.** Place the label in a UPS Shipping Pouch. If you do not have a pouch, affix the folded label using clear plastic shipping tape over the entire label.

3. GETTING YOUR SHIPMENT TO UPS

Customers with a scheduled Pickup

- o Your driver will pickup your shipment(s) as usual.

Customers without a scheduled Pickup



- o Schedule a Pickup on ups.com to have a UPS driver pickup all of your packages.
- o Take your package to any location of The UPS Store®, UPS Access Point(TM) location, UPS Drop Box, UPS Customer Center, Staples® or Authorized Shipping Outlet near you. To find the location nearest you, please visit the 'Locations' Quick link at ups.com.

UPS Access Point™
 MICHAELS STORE # 7773
 75 INTERSTATE SHOP CTR
 RAMSEY NJ 07446-1130

UPS Access Point™
 THE UPS STORE
 115 FRANKLIN TPKE
 MAHWAH NJ 07430-1325

UPS Access Point™
 THE UPS STORE
 120 E MAIN ST
 RAMSEY NJ 07446-1925

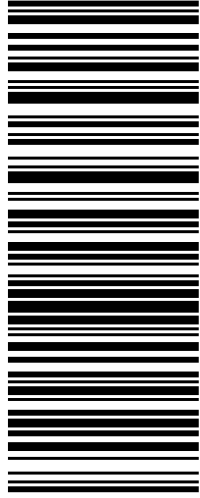
FOLD HERE

<p>NEIL GUERRIERO 3473040176 TRANSCEND WIRELESS 10 INDUSTRIAL AVE MAHWAH NJ 07430</p> <p>SHIP TO: MICHAEL PAULHUS TOWN OF NORTH BRANFORD 909 FOXON ROAD NORTH BRANFORD CT 06471</p>	<p style="text-align: right;">1 LBS</p> <p style="text-align: right;">1 OF 1</p> <p style="text-align: center;">CT 065 2-01</p> 	<p style="text-align: center;">UPS GROUND</p> <p>TRACKING #: 1Z V25 742 42 9366 7197</p> 	<p>BILLING: P/P SIGNATURE REQUIRED UPS CARBON NEUTRAL SHIPMENT</p> <p>Reference #1: CT11224A CSC EO</p> <p style="font-size: small;">XOL 20.10.23 NV45 39.0A 11/2020*</p> 
---	--	--	---

View/Print Label

1. **Ensure there are no other shipping or tracking labels attached to your package.** Select the Print button on the print dialogue box that appears. Note: If your browser does not support this function, select Print from the File menu to print the label.

2. **Fold the printed label at the solid line below.** Place the label in a UPS Shipping Pouch. If you do not have a pouch, affix the folded label using clear plastic shipping tape over the entire label.

3. GETTING YOUR SHIPMENT TO UPS

Customers with a scheduled Pickup

- o Your driver will pickup your shipment(s) as usual.

Customers without a scheduled Pickup



- o Schedule a Pickup on ups.com to have a UPS driver pickup all of your packages.
- o Take your package to any location of The UPS Store®, UPS Access Point(TM) location, UPS Drop Box, UPS Customer Center, Staples® or Authorized Shipping Outlet near you. To find the location nearest you, please visit the 'Locations' Quick link at ups.com.

UPS Access Point™
 MICHAELS STORE # 7773
 75 INTERSTATE SHOP CTR
 RAMSEY NJ 07446-1130

UPS Access Point™
 THE UPS STORE
 115 FRANKLIN TPKE
 MAHWAH NJ 07430-1325

UPS Access Point™
 THE UPS STORE
 120 E MAIN ST
 RAMSEY NJ 07446-1925

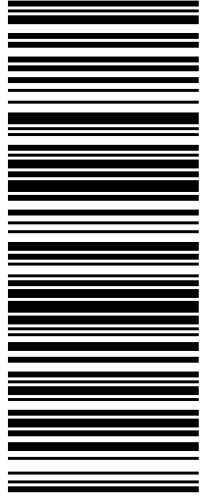
FOLD HERE

<p>NEIL GUERRIERO 3473040176 TRANSCEND WIRELESS 10 INDUSTRIAL AVE MAHWAH NJ 07430</p> <p>SHIP TO: SOUTHERN NEW ENGLAND TELEPHONE CO 401 MERRITT 7 NORWALK CT 06851</p>	<p>1 LBS</p> <p>1 OF 1</p>	<p>CT 069 9-04</p> 	<p>UPS GROUND</p> <p>TRACKING #: 1Z V25 742 03 9054 9205</p> 	<p>BILLING: P/P UPS CARBON NEUTRAL SHIPMENT</p> <p>Reference #1: CT11224A CSC PO</p> <p>XOL 20.10.23 NV45 39.0A 11/2020* </p>
--	--	---	--	---

View/Print Label

1. **Ensure there are no other shipping or tracking labels attached to your package.** Select the Print button on the print dialogue box that appears. Note: If your browser does not support this function, select Print from the File menu to print the label.

2. **Fold the printed label at the solid line below.** Place the label in a UPS Shipping Pouch. If you do not have a pouch, affix the folded label using clear plastic shipping tape over the entire label.

3. GETTING YOUR SHIPMENT TO UPS

Customers with a scheduled Pickup

- o Your driver will pickup your shipment(s) as usual.

Customers without a scheduled Pickup



- o Schedule a Pickup on ups.com to have a UPS driver pickup all of your packages.
- o Take your package to any location of The UPS Store®, UPS Access Point(TM) location, UPS Drop Box, UPS Customer Center, Staples® or Authorized Shipping Outlet near you. To find the location nearest you, please visit the 'Locations' Quick link at ups.com.

UPS Access Point™
 MICHAELS STORE # 7773
 75 INTERSTATE SHOP CTR
 RAMSEY NJ 07446-1130

UPS Access Point™
 THE UPS STORE
 115 FRANKLIN TPKE
 MAHWAH NJ 07430-1325

UPS Access Point™
 THE UPS STORE
 120 E MAIN ST
 RAMSEY NJ 07446-1925

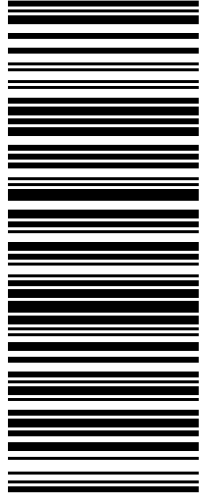
FOLD HERE

<p>NEIL GUERRIERO 3473040176 TRANSCEND WIRELESS 10 INDUSTRIAL AVE MAHWAH NJ 07430</p> <p>SHIP TO: EVEREST INFRASTRUCTURE PARTNERS SUITE 703 NOVA TOWER 2 TWO ALLEGHENY CENTER PITTSBURGH PA 15212</p>	<p style="text-align: right;">1 LBS</p> <p style="text-align: right;">1 OF 1</p> <p style="text-align: center;">PA 152 9-42</p> 	<p style="text-align: center;">UPS GROUND</p> <p>TRACKING #: 1Z V25 742 42 9730 2340</p> 	<p>BILLING: P/P SIGNATURE REQUIRED UPS CARBON NEUTRAL SHIPMENT</p> <p>Reference #1: CT11224A CSC TO</p> <p style="font-size: small;">XOL 20.10.23 NV45 39.0A 11/2020*</p> 
--	--	--	---

59 YOUNGS APPLE ORCH

Location 59 YOUNGS APPLE ORCH

Mblu 81/ 23/ / /

Acct# 003797

Owner SOUTHERN NEW ENGLAND
TEL CO

Assessment \$82,000

Appraisal \$117,200

PID 5034

Building Count 1

Current Value

Appraisal			
Valuation Year	Improvements	Land	Total
2015	\$0	\$117,200	\$117,200

Assessment			
Valuation Year	Improvements	Land	Total
2015	\$0	\$82,000	\$82,000

Owner of Record

Owner SOUTHERN NEW ENGLAND TEL CO
Co-Owner C/O FRONTIER COMM ATT: TAX DEPT
Address 401 MERRITT 7
 NORWALK, CT 06851

Sale Price \$0
Certificate
Book & Page 0035/0296
Sale Date 02/21/1958

Ownership History

Ownership History				
Owner	Sale Price	Certificate	Book & Page	Sale Date
SOUTHERN NEW ENGLAND TEL CO	\$0		0035/0296	02/21/1958

Building Information

Building 1 : Section 1

Year Built:
Living Area: 0
Replacement Cost: \$0
Building Percent Good:
Replacement Cost
Less Depreciation: \$0

Building Attributes

Field	Description
Style	Outbuildings
Model	
Grade:	
Stories:	
Occupancy	
Exterior Wall 1	
Exterior Wall 2	
Roof Structure:	
Roof Cover	
Interior Wall 1	
Interior Wall 2	
Interior Flr 1	
Interior Flr 2	
Heat Fuel	
Heat Type:	
AC Type:	
Total Bedrooms:	
Total Bthrms:	
Total Half Baths:	
Total Xtra Fixtrs:	
Total Rooms:	
Bath Style:	
Kitchen Style:	
Num Kitchens	
Cndtn	
Usrflid 103	
Usrflid 104	
Usrflid 105	
Usrflid 106	
Usrflid 107	
Num Park	
Fireplaces	
Usrflid 108	
Usrflid 101	
Usrflid 102	
Usrflid 100	
Usrflid 300	
Usrflid 301	

Building Photo



(<http://images.vgsi.com/photos/NorthBranfordCTPhotos//default.jpg>)

Building Layout

 Building Layout

(http://images.vgsi.com/photos/NorthBranfordCTPhotos//Sketches/5034_5)

Building Sub-Areas (sq ft)	Legend
No Data for Building Sub-Areas	

Extra Features

Extra Features	<u>Legend</u>
No Data for Extra Features	

Land

Land Use	Land Line Valuation
Use Code 504V	Size (Acres) 0.36
Description PUB UTIL MDL-00	Frontage 0
Zone R40	Depth 0
Neighborhood	Assessed Value \$82,000
Alt Land Appr No	Appraised Value \$117,200
Category	

Outbuildings

Outbuildings	<u>Legend</u>
No Data for Outbuildings	

Valuation History

Appraisal			
Valuation Year	Improvements	Land	Total
2019	\$0	\$117,200	\$117,200
2018	\$0	\$117,200	\$117,200
2017	\$0	\$117,200	\$117,200

Assessment			
Valuation Year	Improvements	Land	Total
2019	\$0	\$82,000	\$82,000
2018	\$0	\$82,000	\$82,000
2017	\$0	\$82,000	\$82,000

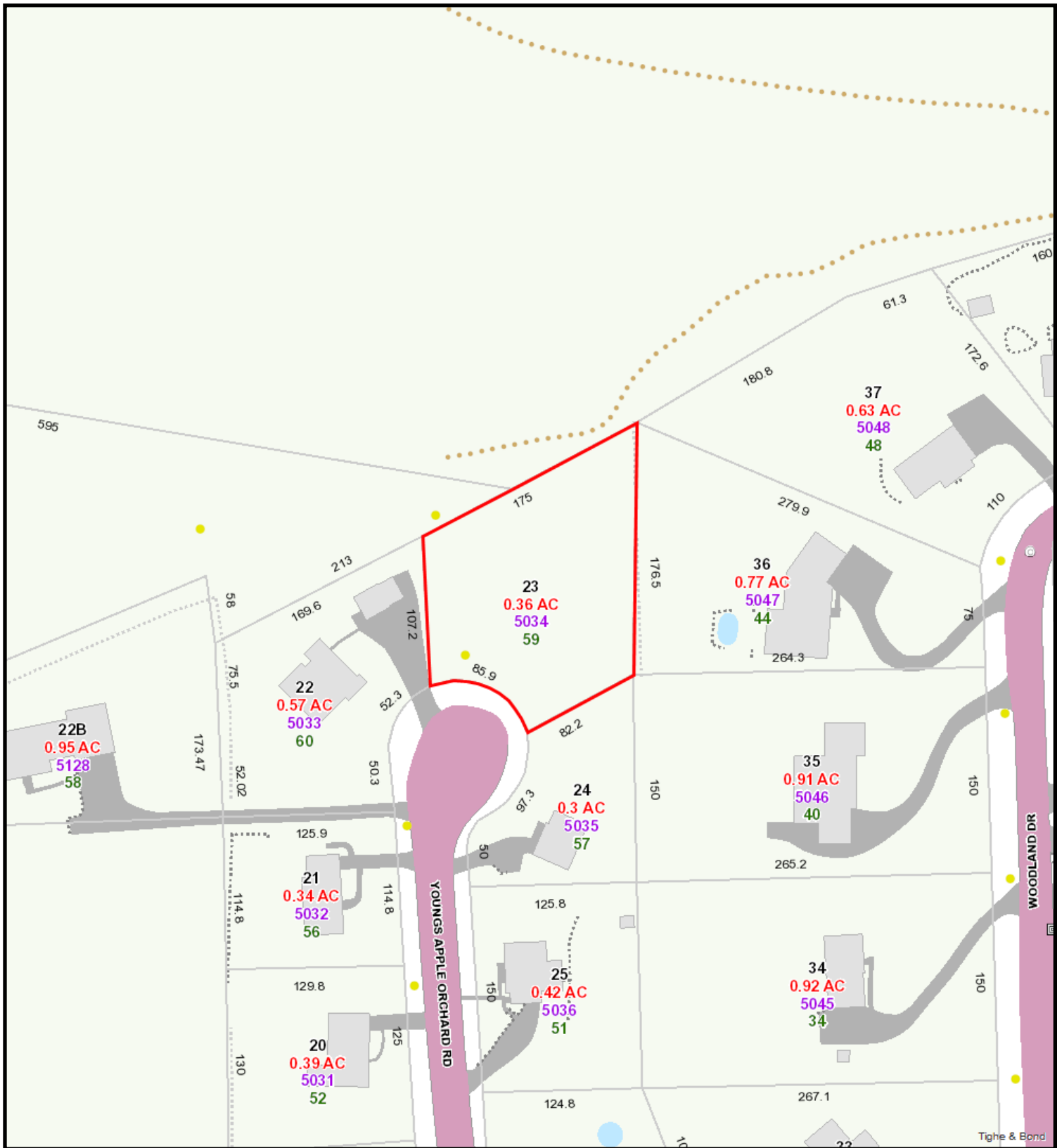

6/10/2019 12:09:40 PM

Scale: 1"=100'

Scale is approximate

The information depicted on this map is for planning purposes only. It is not adequate for legal boundary definition, regulatory interpretation, or parcel-level analyses.



Kyle Richers

From: Tom Hogarty <zeo@townofnorthbranfordct.com>
Sent: Thursday, June 13, 2019 1:25 PM
To: 'Kyle Richers'
Subject: RE: T-Mobile Site at 59 Youngs Apple Orchard Road -- Original Zoning Approval -- CT11224A

Kyle, I am not finding any documentation for zoning approval for 59 Youngs Apple Orchard cell tower location.

Tom Hogarty, CZEO
Zoning Enforcement Officer
909 Foxon Road
North Branford, CT 06471-1290

203-484-6010

zeo@townofnorthbranfordct.com

From: Kyle Richers [<mailto:krichters@transcendwireless.com>]
Sent: Monday, June 10, 2019 1:20 PM
To: 'Tom Hogarty' <zeo@townofnorthbranfordct.com>; townplanner@townofnorthbranfordct.com
Subject: RE: T-Mobile Site at 59 Youngs Apple Orchard Road -- Original Zoning Approval -- CT11224A

Tom,

Ideally an approval for the initial installation for T-Mobile or when the tower was originally built. I believe the T-Mobile facility was installed around 1997/1998 and the tower was built prior to that (T-Mobile was "Omnipoint Communications" back then). I know that dates back quite some time, if you have anything let me know. Thanks for looking.

Kyle

From: Tom Hogarty <zeo@townofnorthbranfordct.com>
Sent: Monday, June 10, 2019 12:52 PM
To: 'Kyle Richers' <krichters@transcendwireless.com>; townplanner@townofnorthbranfordct.com
Subject: RE: T-Mobile Site at 59 Youngs Apple Orchard Road -- Original Zoning Approval -- CT11224A

Kyle: There are quite a few documents on micro film. Attached are a few examples of what we have. Is there anything specific you need?

Tom Hogarty, CZEO
Zoning Enforcement Officer
909 Foxon Road
North Branford, CT 06471-1290

203-484-6010

zeo@townofnorthbranfordct.com

From: Kyle Richers [<mailto:krichers@transcendwireless.com>]

Sent: Monday, June 10, 2019 12:11 PM

To: townplanner@townofnorthbranfordct.com; zeo@townofnorthbranfordct.com

Subject: T-Mobile Site at 59 Youngs Apple Orchard Road -- Original Zoning Approval -- CT11224A

Carey/Tom,

I am reaching out on behalf of T-Mobile regarding their site located at 59 Youngs Apple Orchard Road (cell tower). I am wondering if by any chance you had any record of the original planning/zoning approval by the town for this facility. We are gearing up for a filing with the Connecticut Siting Council for an antenna modification. We typically include some information on the original zoning approval, whether it was from the Council or the jurisdiction. In this case it does not appear the Council was involved with approving this facility originally, so I am wondering if the town had something on record about this. Let me know either way if possible. If you do not show any records, please just confirm that in an email and that would be sufficient. Thank you for your help.

Property card is attached for reference.

Kyle Richers
Transcend Wireless
10 Industrial Ave., Suite 3
Mahwah, New Jersey 07430
908-447-4716
krichers@transcendwireless.com



WIRELESS COMMUNICATIONS FACILITY

GUILFORD-1_1

SITE ID: CT11224A

59 YOUNGS APPLE ORCHARD ROAD
NORTH BRANFORD, CT 06472

GENERAL NOTES

- ALL WORK SHALL BE IN ACCORDANCE WITH THE 2015 INTERNATIONAL BUILDING CODE AS MODIFIED BY THE 2018 CONNECTICUT SUPPLEMENT, INCLUDING THE TIA/EIA-222 REVISION "G" "STRUCTURAL STANDARDS FOR STEEL ANTENNA TOWERS AND SUPPORTING STRUCTURES." 2017 CONNECTICUT FIRE SAFETY CODE, NATIONAL ELECTRICAL CODE AND LOCAL CODES.
- CONTRACTOR SHALL REVIEW ALL DRAWINGS AND SPECIFICATIONS IN THE CONTRACT DOCUMENT SET. CONTRACTOR SHALL COORDINATE ALL WORK SHOWN IN THE SET OF DRAWINGS. THE CONTRACTOR SHALL PROVIDE A COMPLETE SET OF DRAWINGS TO ALL SUBCONTRACTORS AND ALL RELATED PARTIES. THE SUBCONTRACTORS SHALL EXAMINE ALL THE DRAWINGS AND SPECIFICATIONS FOR THE INFORMATION THAT AFFECTS THEIR WORK.
- CONTRACTOR SHALL PROVIDE A COMPLETE BUILD-OUT WITH ALL FINISHES, STRUCTURAL, MECHANICAL, AND ELECTRICAL COMPONENTS AND PROVIDE ALL ITEMS AS SHOWN OR INDICATED ON THE DRAWINGS OR IN THE WRITTEN SPECIFICATIONS.
- CONTRACTOR SHALL FURNISH ALL MATERIAL, LABOR AND EQUIPMENT TO COMPLETE THE WORK AND FURNISH A COMPLETED JOB ALL IN ACCORDANCE WITH LOCAL AND STATE GOVERNING AUTHORITIES AND OTHER AUTHORITIES HAVING LAWFUL JURISDICTION OVER THE WORK.
- CONTRACTOR SHALL SECURE AND PAY FOR ALL PERMITS AND ALL INSPECTIONS REQUIRED AND SHALL ALSO PAY FEES REQUIRED FOR THE GENERAL CONSTRUCTION, PLUMBING, ELECTRICAL AND HVAC. PERMITS SHALL BE PAID FOR BY THE RESPECTIVE SUBCONTRACTORS.
- CONTRACTOR SHALL MAINTAIN A CURRENT SET OF DRAWINGS AND SPECIFICATIONS ON SITE AT ALL TIMES AND INSURE DISTRIBUTION OF NEW DRAWINGS TO SUBCONTRACTORS AND OTHER RELEVANT PARTIES AS SOON AS THEY ARE MADE AVAILABLE. ALL OLD DRAWINGS SHALL BE MARKED VOID AND REMOVED FROM THE CONTRACT AREA. THE CONTRACTOR SHALL FURNISH AN "AS-BUILT" SET OF DRAWINGS TO OWNER UPON COMPLETION OF PROJECT.
- LOCATION OF EQUIPMENT, AND WORK SUPPLIED BY OTHERS THAT IS DIAGRAMMATICALLY INDICATED ON THE DRAWINGS SHALL BE DETERMINED BY THE CONTRACTOR. THE CONTRACTOR SHALL DETERMINE LOCATIONS AND DIMENSIONS SUBJECT TO STRUCTURAL CONDITIONS AND WORK OF THE SUBCONTRACTORS.
- THE CONTRACTOR IS SOLELY RESPONSIBLE TO DETERMINE CONSTRUCTION PROCEDURE AND SEQUENCE, AND TO ENSURE THE SAFETY OF THE EXISTING STRUCTURES AND ITS COMPONENT PARTS DURING CONSTRUCTION. THIS INCLUDES THE ADDITION OF WHATEVER SHORING, BRACING, UNDERPINNING, ETC. THAT MAY BE NECESSARY.
- DRAWINGS INDICATE THE MINIMUM STANDARDS, BUT IF ANY WORK SHOULD BE INDICATED TO BE SUBSTANDARD TO ANY ORDINANCES, LAWS, CODES, RULES, OR REGULATIONS BEARING ON THE WORK, THE CONTRACTOR SHALL INCLUDE IN HIS WORK AND SHALL EXECUTE THE WORK CORRECTLY IN ACCORDANCE WITH SUCH ORDINANCES, LAWS, CODES, RULES OR REGULATIONS WITH NO INCREASE IN COSTS.
- ALL UTILITY WORK SHALL BE IN ACCORDANCE WITH LOCAL UTILITY COMPANY REQUIREMENTS AND SPECIFICATIONS.
- ALL EQUIPMENT AND PRODUCTS PURCHASED ARE TO BE REVIEWED BY CONTRACTOR AND ALL APPLICABLE SUBCONTRACTORS FOR ANY CONDITION PER MFR.'S RECOMMENDATIONS. CONTRACTOR TO SUPPLY THESE ITEMS AT NO COST TO OWNER OR CONSTRUCTION MANAGER.
- ANY AND ALL ERRORS, DISCREPANCIES, AND "MISSED" ITEMS ARE TO BE BROUGHT TO THE ATTENTION OF THE T-MOBILE CONSTRUCTION MANAGER DURING THE BIDDING PROCESS BY THE CONTRACTOR. ALL THESE ITEMS ARE TO BE INCLUDED IN THE BID. NO "EXTRA" WILL BE ALLOWED FOR MISSED ITEMS.
- CONTRACTOR SHALL BE RESPONSIBLE FOR ALL ON-SITE SAFETY FROM THE TIME THE JOB IS AWARDED UNTIL ALL WORK IS COMPLETE AND ACCEPTED BY THE OWNER.
- CONTRACTOR TO REVIEW ALL SHOP DRAWINGS AND SUBMIT COPY TO ENGINEER FOR APPROVAL. DRAWINGS MUST BEAR THE CHECKER'S INITIALS BEFORE SUBMITTING TO THE CONSTRUCTION MANAGER FOR REVIEW.
- THE CONTRACTOR SHALL FIELD VERIFY ALL DIMENSIONS, ELEVATIONS, ANGLES, AND EXISTING CONDITIONS AT THE SITE, PRIOR TO FABRICATION AND/OR INSTALLATION OF ANY WORK IN THE CONTRACT AREA.
- COORDINATION, LAYOUT, FURNISHING AND INSTALLATION OF CONDUIT AND ALL APPURTENANCES REQUIRED FOR PROPER INSTALLATION OF ELECTRICAL AND TELECOMMUNICATION SERVICE SHALL BE THE SOLE RESPONSIBILITY OF THE CONTRACTOR.
- ALL DAMAGE CAUSED TO ANY EXISTING STRUCTURE SHALL BE THE SOLE RESPONSIBILITY OF THE CONTRACTOR. THE CONTRACTOR WILL BE HELD LIABLE FOR ALL REPAIRS REQUIRED FOR EXISTING STRUCTURES IF DAMAGED DURING CONSTRUCTION ACTIVITIES.
- THE CONTRACTOR SHALL CONTACT "CALL BEFORE YOU DIG" AT LEAST 48 HOURS PRIOR TO ANY EXCAVATIONS AT 1-800-922-4455. ALL UTILITIES SHALL BE IDENTIFIED AND CLEARLY MARKED. CONTRACTOR SHALL MAINTAIN AND PROTECT MARKED UTILITIES THROUGHOUT PROJECT COMPLETION.
- CONTRACTOR SHALL COMPLY WITH OWNERS ENVIRONMENTAL ENGINEER ON ALL METHODS AND PROVISIONS FOR ALL EXCAVATION ACTIVITIES INCLUDING SOIL DISPOSAL. ALL BACKFILL MATERIALS TO BE PROVIDED BY THE CONTRACTOR.

SITE DIRECTIONS

FROM:	TO:
35 GRIFFIN ROAD SOUTH BLOOMFIELD, CT 06002	59 YOUNGS APPLE ORCHARD RD NORTH BRANFORD, CT 06472
1. HEAD SOUTHEAST ON W NEWBERRY RD TOWARD GRIFFIN RD S.	0.01 MI.
2. TURN LEFT ONTO GRIFFIN RD S.	0.60 MI.
3. TURN RIGHT ONTO DAY HILL RD.	3.60 MI.
4. USE THE RIGHT LANE TO MERGE ONTO I-91 S VIA THE RAMP TO HARTFORD.	0.40 MI.
5. MERGE ONTO I-91 S.	32.30 MI.
6. TAKE EXIT 14 FOR E CENTER ST TOWARD CT-150/WALLINGFORD.	0.20 MI.
7. TURN LEFT ONTO E CENTER ST.	0.70 MI.
8. TURN RIGHT ONTO NORTHFORD RD.	1.90 MI.
9. CONTINUE ONTO WOODS HILL RD.	0.40 MI.
10. TURN LEFT ONTO CT-17 N.	1.60 MI.
11. TURN LEFT ONTO YOUNGS APPLE ORCHARD RD.	0.30 MI.

VICINITY MAP

SCALE: 1" = 1000'

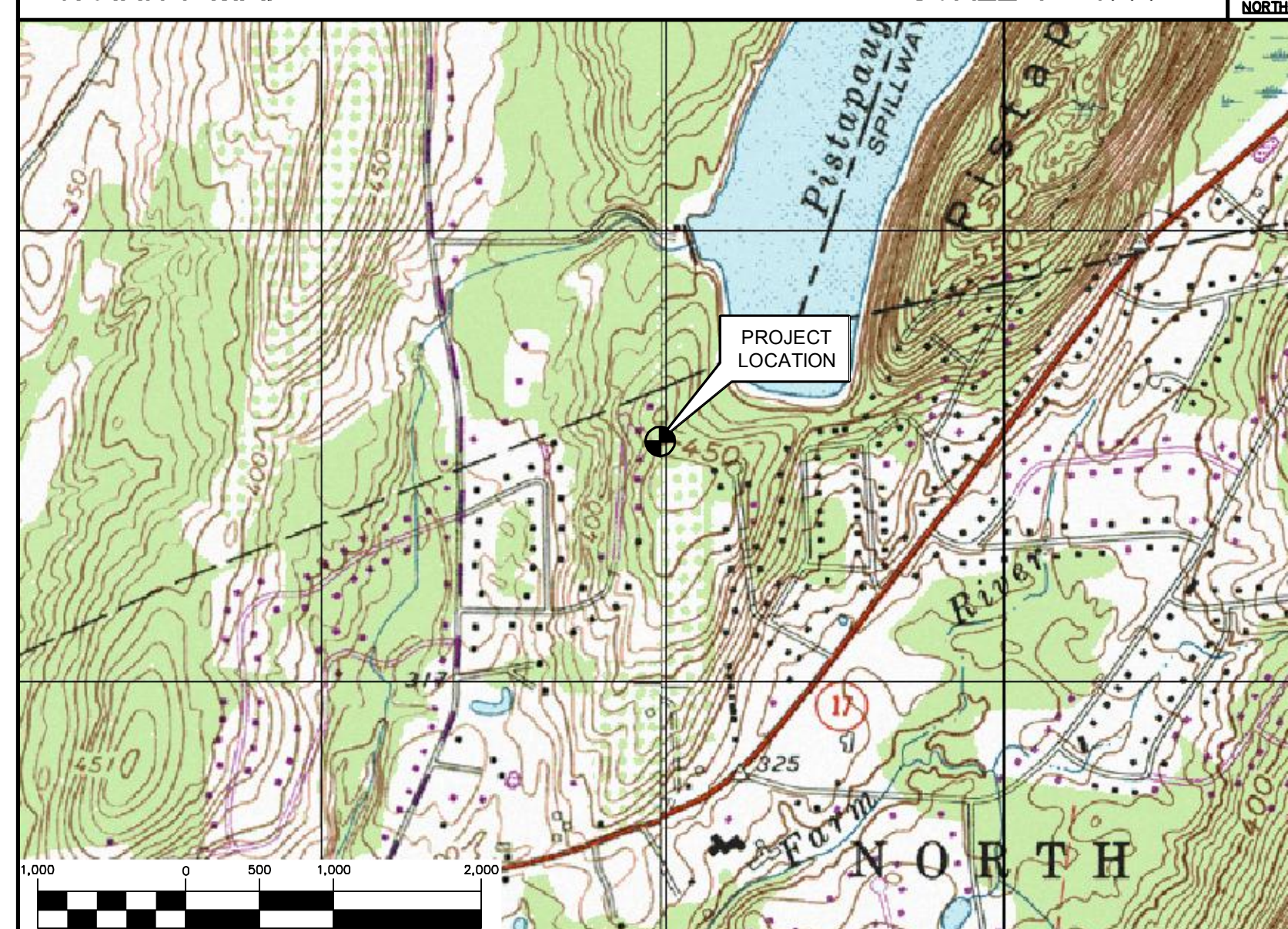

T-MOBILE RF CONFIGURATION

67D97C

PROJECT SUMMARY

1. THE PROPOSED SCOPE OF WORK CONSISTS OF A MODIFICATION TO THE EXISTING UNMANNED TELECOMMUNICATIONS FACILITY INCLUDING THE FOLLOWING:
- REMOVE (6) PANEL ANTENNAS.
 - INSTALL (3) PANEL ANTENNAS.
 - REMOVE (3) TMAs.
 - INSTALL (9) REMOTE RADIO UNITS.
 - REMOVE (12) EXISTING 7/8" COAX CABLES.
 - INSTALL (3) 6X12 HYBRID CABLES.
 - REMOVE AND REPLACE RBS 6201 CABINET WITH NEW ODE 6102 MU AC.
 - REMOVE AND REPLACE (1) 100 AMP MAIN BREAKER WITH (1) 200 AMP MAIN BREAKER.
 - INSTALL (1) 125 AMP CABINET BREAKER.

PROJECT INFORMATION

SITE NAME:	GUILFORD-1_1
SITE ID:	CT11224A
SITE ADDRESS:	59 YOUNGS APPLE ORCHARD RD NORTH BRANFORD, CT 06472
APPLICANT:	T-MOBILE NORTHEAST, LLC 35 GRIFFIN ROAD SOUTH BLOOMFIELD, CT 06002
CONTACT PERSON:	DAN REID (PROJECT MANAGER) TRANSCEND WIRELESS, LLC (203) 592-8291
ENGINEER:	CEN TEK ENGINEERING, INC. 63-2 NORTH BRANFORD RD. BRANFORD, CT 06405
PROJECT COORDINATES:	LATITUDE: 41°-25'-15.80" N LONGITUDE: 72°-44'-57.61" W GROUND ELEVATION: 516'± AMSL
	SITE COORDINATES AND GROUND ELEVATION REFERENCED FROM GOOGLE EARTH.

SHEET INDEX

SHT. NO.	DESCRIPTION	REV.
T-1	TITLE SHEET	2
N-1	DESIGN BASIS AND SITE NOTES	2
C-1	SITE LOCATION PLAN	2
C-2	COMPOUND PLAN AND ELEVATION	2
C-3	ANTENNA MOUNTING CONFIGURATION	2
E-1	TYPICAL ELECTRICAL DETAILS	2
E-2	TYPICAL ELECTRICAL DETAILS	2

DATE: 04/24/19

SCALE: AS NOTED

JOB NO. 19027.20

TITLE SHEET

T-1

Sheet No. 1 of 7

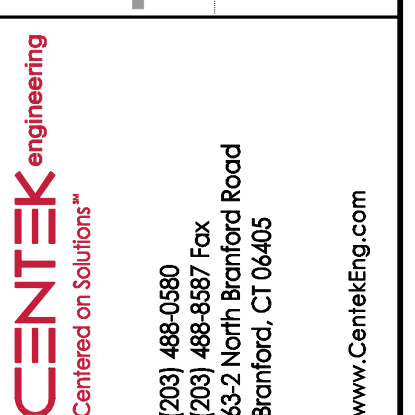
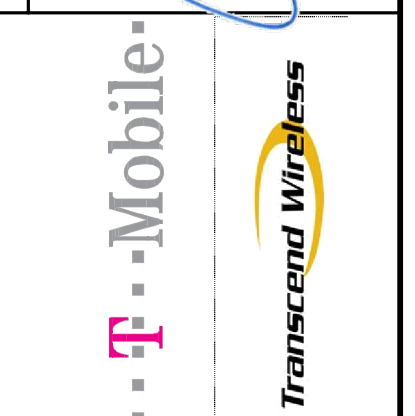
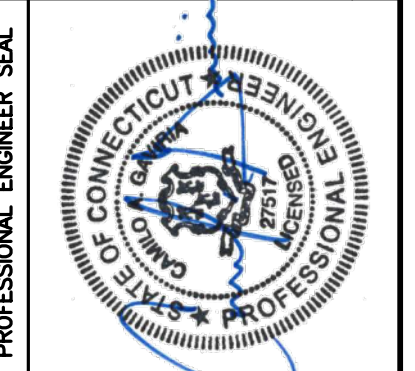

T-MOBILE NORTHEAST LLC
WIRELESS COMMUNICATIONS FACILITY
GUILFORD-1_1
SITE ID: CT11224A
59 YOUNGS APPLE ORCHARD RD
NORTH BRANFORD, CT 06472

REV.	DATE	BY	CHK'D BY	DESCRIPTION
2	04/18/19	RTS		CONSTRUCTION DRAWINGS - ISSUED FOR CONSTRUCTION
1	04/17/19	LAA		CONSTRUCTION DRAWINGS - ISSUED FOR CONSTRUCTION
0	05/07/19	LAA		CONSTRUCTION DRAWINGS - ISSUED FOR CONSTRUCTION

DESIGN BASIS:

GOVERNING CODE: 2015 INTERNATIONAL BUILDING (IBC) AS MODIFIED BY THE 2018 CT STATE BUILDING CODE AND AMENDMENTS.

- 1. DESIGN CRITERIA:
• RISK CATEGORY: II (BASED ON IBC TABLE 1604.5)
• ULTIMATE DESIGN SPEED (OTHER STRUCTURE): 130 MPH (Vasd) (EXPOSURE B)/IMPORTANCE FACTOR 1.0 BASED ON ASCE 7-10 PER 2015 INTERNATIONAL BUILDING CODE (IBC) AS MODIFIED BY THE 2018 CONNECTICUT STATE BUILDING CODE.
• SEISMIC LOAD (DOES NOT CONTROL): PER ASCE 7-10 MINIMUM DESIGN LOADS FOR BUILDING AND OTHER STRUCTURES.

GENERAL NOTES:

- 1. ALL CONSTRUCTION SHALL BE IN COMPLIANCE WITH THE GOVERNING BUILDING CODE.
2. DRAWINGS INDICATE THE MINIMUM STANDARDS, BUT IF ANY WORK SHOULD BE INDICATED TO BE SUBSTANDARD TO ANY ORDINANCES, LAWS, CODES, RULES, OR REGULATIONS BEARING ON THE WORK, THE CONTRACTOR SHALL INCLUDE IN HIS WORK AND SHALL EXECUTE THE WORK CORRECTLY IN ACCORDANCE WITH SUCH ORDINANCES, LAWS, CODES, RULES OR REGULATIONS WITH NO INCREASE IN COSTS.
3. BEFORE BEGINNING THE WORK, THE CONTRACTOR IS RESPONSIBLE FOR MAKING SUCH INVESTIGATIONS CONCERNING PHYSICAL CONDITIONS (SURFACE AND SUBSURFACE) AT OR CONTIGUOUS TO THE SITE WHICH MAY AFFECT PERFORMANCE AND COST OF THE WORK.
4. DIMENSIONS AND DETAILS SHALL BE CHECKED AGAINST EXISTING FIELD CONDITIONS.
5. THE CONTRACTOR SHALL VERIFY AND COORDINATE THE SIZE AND LOCATION OF ALL OPENINGS, SLEEVES AND ANCHOR BOLTS AS REQUIRED BY ALL TRADES.
6. ALL DIMENSIONS, ELEVATIONS, AND OTHER REFERENCES TO EXISTING STRUCTURES, SURFACE, AND SUBSURFACE CONDITIONS ARE APPROXIMATE. NO GUARANTEE IS MADE FOR THE ACCURACY OR COMPLETENESS OF THE INFORMATION SHOWN. THE CONTRACTOR SHALL VERIFY AND COORDINATE ALL DIMENSIONS, ELEVATIONS, ANGLES WITH EXISTING CONDITIONS AND WITH ARCHITECTURAL AND SITE DRAWINGS BEFORE PROCEEDING WITH ANY WORK.
7. AS THE WORK PROGRESSES, THE CONTRACTOR SHALL NOTIFY THE OWNER OF ANY CONDITIONS WHICH ARE IN CONFLICT OR OTHERWISE NOT CONSISTENT WITH THE CONSTRUCTION DOCUMENTS AND SHALL NOT PROCEED WITH SUCH WORK UNTIL THE CONFLICT IS SATISFACTORILY RESOLVED.
8. THE CONTRACTOR SHALL COMPLY WITH ALL APPLICABLE SAFETY CODES AND REGULATIONS DURING ALL PHASES OF CONSTRUCTION. THE CONTRACTOR IS SOLELY RESPONSIBLE FOR PROVIDING AND MAINTAINING ADEQUATE SHORING, BRACING, AND BARRICADES AS MAY BE REQUIRED FOR THE PROTECTION OF EXISTING PROPERTY, CONSTRUCTION WORKERS, AND FOR PUBLIC SAFETY.
9. THE CONTRACTOR IS SOLELY RESPONSIBLE TO DETERMINE CONSTRUCTION PROCEDURE AND SEQUENCE, AND TO ENSURE THE SAFETY OF THE EXISTING STRUCTURES AND ITS COMPONENT PARTS DURING CONSTRUCTION. THIS INCLUDES THE ADDITION OF WHATEVER SHORING, BRACING, UNDERPINNING, ETC. THAT MAY BE NECESSARY. MAINTAIN EXISTING SITE OPERATIONS, COORDINATE WORK WITH NORTHEAST UTILITIES
10. THE STRUCTURE IS DESIGNED TO BE SELF-SUPPORTING AND STABLE AFTER FOUNDATION REMEDIATION WORK IS COMPLETE. IT IS THE CONTRACTOR'S SOLE RESPONSIBILITY TO DETERMINE ERECTION PROCEDURE AND SEQUENCE AND TO ENSURE THE SAFETY OF THE STRUCTURE AND ITS COMPONENT PARTS DURING ERECTION. THIS INCLUDES THE ADDITION OF WHATEVER SHORING, TEMPORARY BRACING, GUYS OR TIEDOWNS, WHICH MIGHT BE NECESSARY.
11. ALL DAMAGE CAUSED TO ANY EXISTING STRUCTURE SHALL BE THE SOLE RESPONSIBILITY OF THE CONTRACTOR. THE CONTRACTOR WILL BE HELD LIABLE FOR ALL REPAIRS REQUIRED FOR EXISTING STRUCTURES IF DAMAGED DURING CONSTRUCTION ACTIVITIES.
12. SHOP DRAWINGS, CONCRETE MIX DESIGNS, TEST REPORTS, AND OTHER SUBMITTALS PERTAINING TO STRUCTURAL WORK SHALL BE FORWARDED TO THE OWNER FOR REVIEW BEFORE FABRICATION AND/OR INSTALLATION IS MADE. SHOP DRAWINGS SHALL INCLUDE ERECTION DRAWINGS AND COMPLETE DETAILS OF CONNECTIONS AS WELL AS MANUFACTURER'S SPECIFICATION DATA WHERE APPROPRIATE. SHOP DRAWINGS SHALL BE CHECKED BY THE CONTRACTOR AND BEAR THE CHECKER'S INITIALS BEFORE BEING SUBMITTED FOR REVIEW.
13. NO DRILLING WELDING OR TAPING ON EVERSOURCE OWNED EQUIPMENT.
14. REFER TO DRAWING T1 FOR ADDITIONAL NOTES AND REQUIREMENTS.

STRUCTURAL STEEL

- 1. ALL STRUCTURAL STEEL IS DESIGNED BY ALLOWABLE STRESS DESIGN (ASD)
A. STRUCTURAL STEEL (W SHAPES)---ASTM A992 (FY = 50 KSI)
B. STRUCTURAL STEEL (OTHER SHAPES)---ASTM A36 (FY = 36 KSI)
C. STRUCTURAL HSS (RECTANGULAR SHAPES)---ASTM A500 GRADE B, (FY = 46 KSI)
D. STRUCTURAL HSS (ROUND SHAPES)---ASTM A500 GRADE B, (FY = 42 KSI)
E. PIPE---ASTM A53 (FY = 35 KSI)
F. CONNECTION BOLTS---ASTM A325-N
G. U-BOLTS---ASTM A36
H. ANCHOR RODS---ASTM F 1554
I. WELDING ELECTRODE---ASTM E 70XX
2. CONTRACTOR TO REVIEW ALL SHOP DRAWINGS AND SUBMIT COPY TO ENGINEER FOR APPROVAL. DRAWINGS MUST BEAR THE CHECKER'S INITIALS BEFORE SUBMITTING TO THE ENGINEER FOR REVIEW. SHOP DRAWINGS SHALL INCLUDE THE FOLLOWING: SECTION PROFILES, SIZES, CONNECTION ATTACHMENTS, REINFORCING, ANCHORAGE, SIZE AND TYPE OF FASTENERS AND ACCESSORIES. INCLUDE ERECTION DRAWINGS, ELEVATIONS AND DETAILS.
3. STRUCTURAL STEEL SHALL BE DETAILED, FABRICATED AND ERECTED IN ACCORDANCE WITH THE LATEST PROVISIONS OF AISC MANUAL OF STEEL CONSTRUCTION.
4. PROVIDE ALL PLATES, CLIP ANGLES, CLOSURE PIECES, STRAP ANCHORS, MISCELLANEOUS PIECES AND HOLES REQUIRED TO COMPLETE THE STRUCTURE.
5. FIT AND SHOP ASSEMBLE FABRICATIONS IN THE LARGEST PRACTICAL SECTIONS FOR DELIVERY TO SITE.
6. INSTALL FABRICATIONS PLUMB AND LEVEL, ACCURATELY FITTED, AND FREE FROM DISTORTIONS OR DEFECTS.
7. AFTER ERECTION OF STRUCTURES, TOUCHUP ALL WELDS, ABRASIONS AND NON-GALVANIZED SURFACES WITH A 95% ORGANIC ZINC RICH PAINT IN ACCORDANCE WITH ASTM 780.
8. ALL STEEL MATERIAL (EXPOSED TO WEATHER) SHALL BE GALVANIZED AFTER FABRICATION IN ACCORDANCE WITH ASTM A123 "ZINC (HOT DIPPED GALVANIZED) COATINGS" ON IRONS AND STEEL PRODUCTS.
9. ALL BOLTS, ANCHORS AND MISCELLANEOUS HARDWARE SHALL BE GALVANIZED IN ACCORDANCE WITH ASTM A153 "ZINC COATING (HOT-DIP) ON IRON AND STEEL HARDWARE".
10. THE ENGINEER SHALL BE NOTIFIED OF ANY INCORRECTLY FABRICATED, DAMAGED OR OTHERWISE MISFITTING OR NON CONFORMING MATERIALS OR CONDITIONS TO REMEDIAL OR CORRECTIVE ACTION. ANY SUCH ACTION SHALL REQUIRE ENGINEER REVIEW.
11. CONNECTION ANGLES SHALL HAVE A MINIMUM THICKNESS OF 1/4 INCHES.
12. STRUCTURAL CONNECTION BOLTS SHALL CONFORM TO ASTM A325. ALL BOLTS SHALL BE 3/4" DIAMETER MINIMUM AND SHALL HAVE A MINIMUM OF TWO BOLTS, UNLESS OTHERWISE ON THE DRAWINGS.
13. LOCK WASHER ARE NOT PERMITTED FOR A325 STEEL ASSEMBLIES.
14. SHOP CONNECTIONS SHALL BE WELDED OR HIGH STRENGTH BOLTED.
15. MILL BEARING ENDS OF COLUMNS, STIFFENERS, AND OTHER BEARING SURFACES TO TRANSFER LOAD OVER ENTIRE CROSS SECTION.
16. FABRICATE BEAMS WITH MILL CAMBER UP.
17. LEVEL AND PLUMB INDIVIDUAL MEMBERS OF THE STRUCTURE TO AN ACCURACY OF 1:500, BUT NOT TO EXCEED 1/4" IN THE FULL HEIGHT OF THE COLUMN.
18. COMMENCEMENT OF STRUCTURAL STEEL WORK WITHOUT NOTIFYING THE ENGINEER OF ANY DISCREPANCIES WILL BE CONSIDERED ACCEPTANCE OF PRECEDING WORK.
19. INSPECTION AND TESTING OF ALL WELDING AND HIGH STRENGTH BOLTING SHALL BE PERFORMED BY AN INDEPENDENT TESTING LABORATORY.
20. FOUR COPIES OF ALL INSPECTION TEST REPORTS SHALL BE SUBMITTED TO THE ENGINEER WITHIN TEN (10) WORKING DAYS OF THE DATE OF INSPECTION.

Table with columns for CONSTRUCTION DRAWINGS - ISSUED FOR CONSTRUCTION, CAG, DATE, and DESCRIPTION.

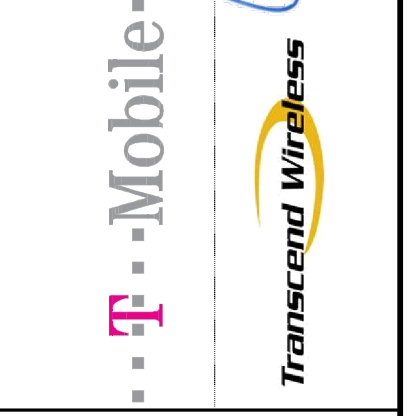
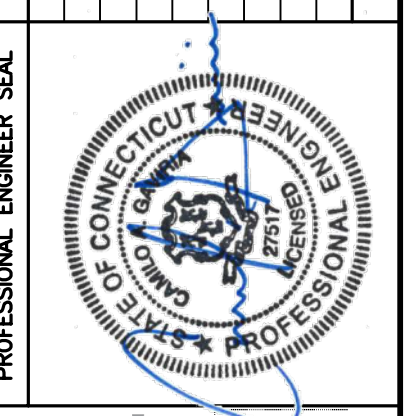

CENTEK engineering
Centered on Solutions
(203) 498-0380
(203) 498-3897 Fax
632 North Branford Road
Branford, CT 06405
www.CentekEng.com

T-MOBILE NORTHEAST LLC
WIRELESS COMMUNICATIONS FACILITY
GUILFORD-1_1
SITE ID: CT11224A
59 YOUNGS APPLE ORCHARD RD
NORTH BRANFORD, CT 06472

DATE: 04/24/19
SCALE: AS NOTED
JOB NO. 19027.20

DESIGN BASIS AND SITE NOTES

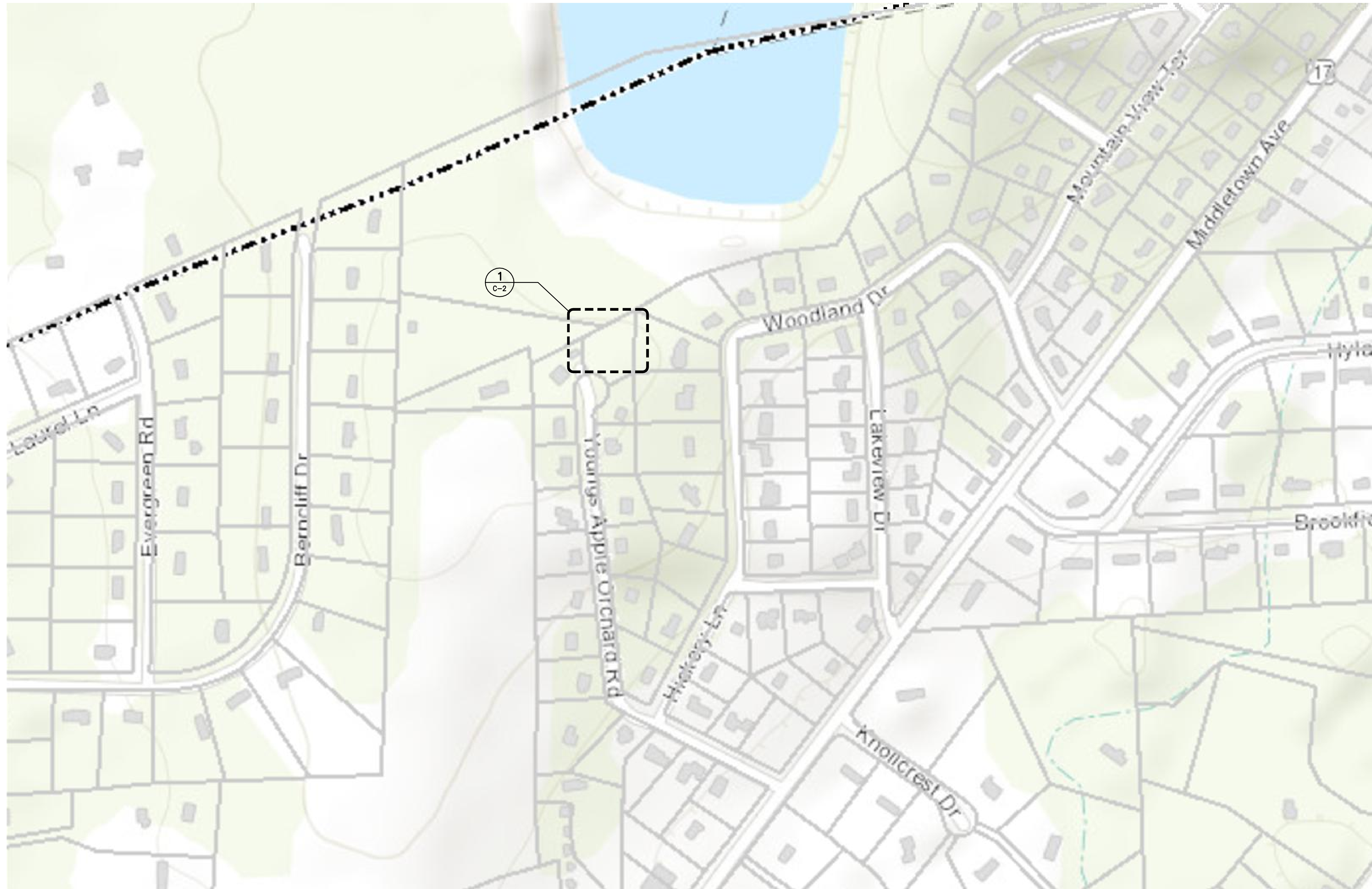

1 SITE LOCATION PLAN
C-1

SCALE: 1" = 50'

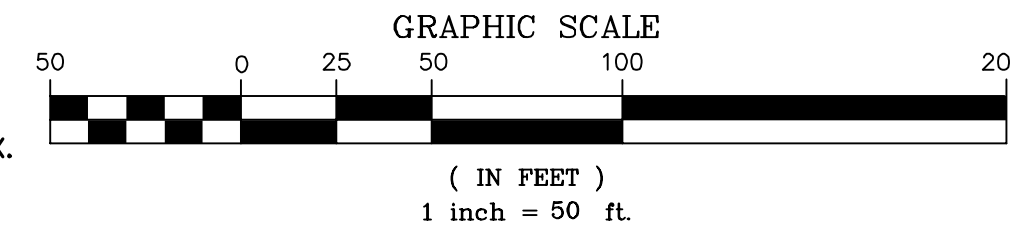

REV.	DATE	BY	CHK'D BY	DESCRIPTION
2	06/18/19	RTS	CAG	CONSTRUCTION DRAWINGS - ISSUED FOR CONSTRUCTION
1	06/17/19	LAA	CAG	CONSTRUCTION DRAWINGS - ISSUED FOR CONSTRUCTION
0	05/07/19	LAA	CAG	CONSTRUCTION DRAWINGS - ISSUED FOR CONSTRUCTION

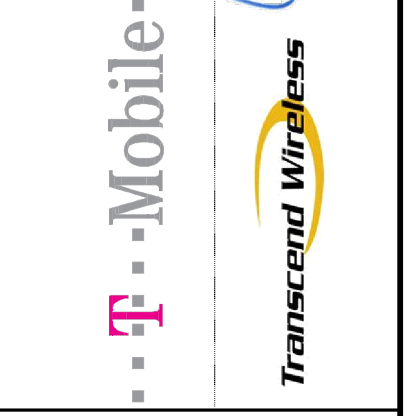
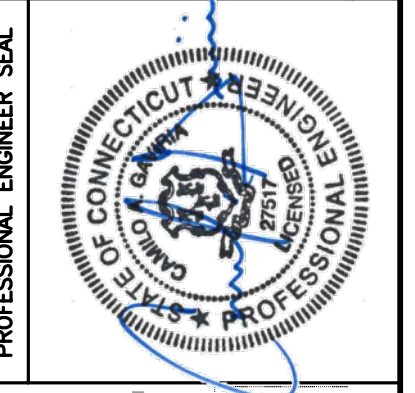

CEN TEK engineering
Centered on Solutions
(203) 488-0390
(203) 488-3397 Fax
632 North Branford Road
Branford, CT 06405
www.CenTekEng.com

T-MOBILE NORTHEAST LLC
WIRELESS COMMUNICATIONS FACILITY
GUILFORD-1_1
SITE ID: CT11224A
59 YOUNGS APPLE ORCHARD RD
NORTH BRANFORD, CT 06472

DATE: 04/24/19
SCALE: AS NOTED
JOB NO. 19027.20

SITE LOCATION PLAN

C-1
Sheet No. 3 of 7

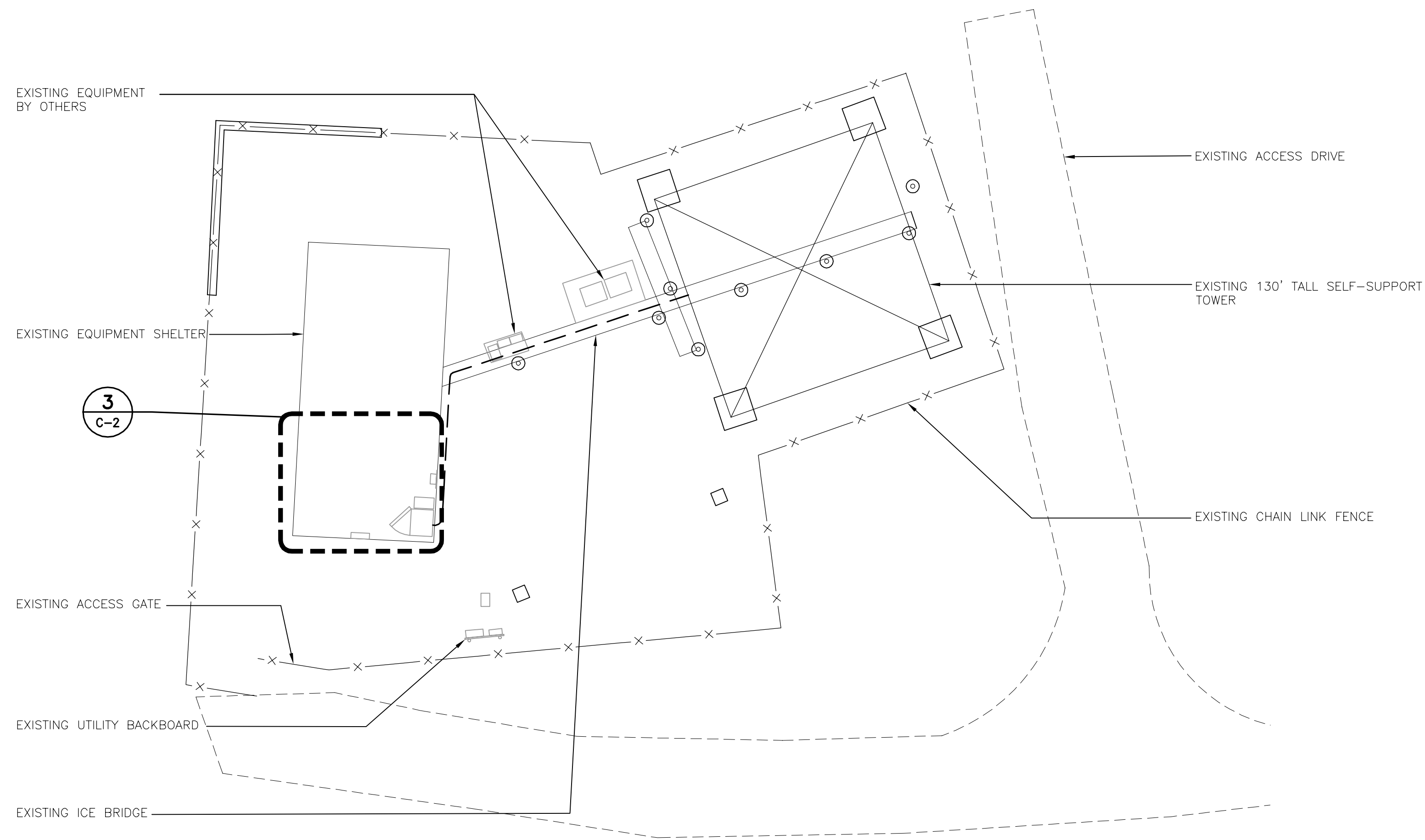

1 COMPOUND PLAN
C-2 SCALE: 1" = 10'

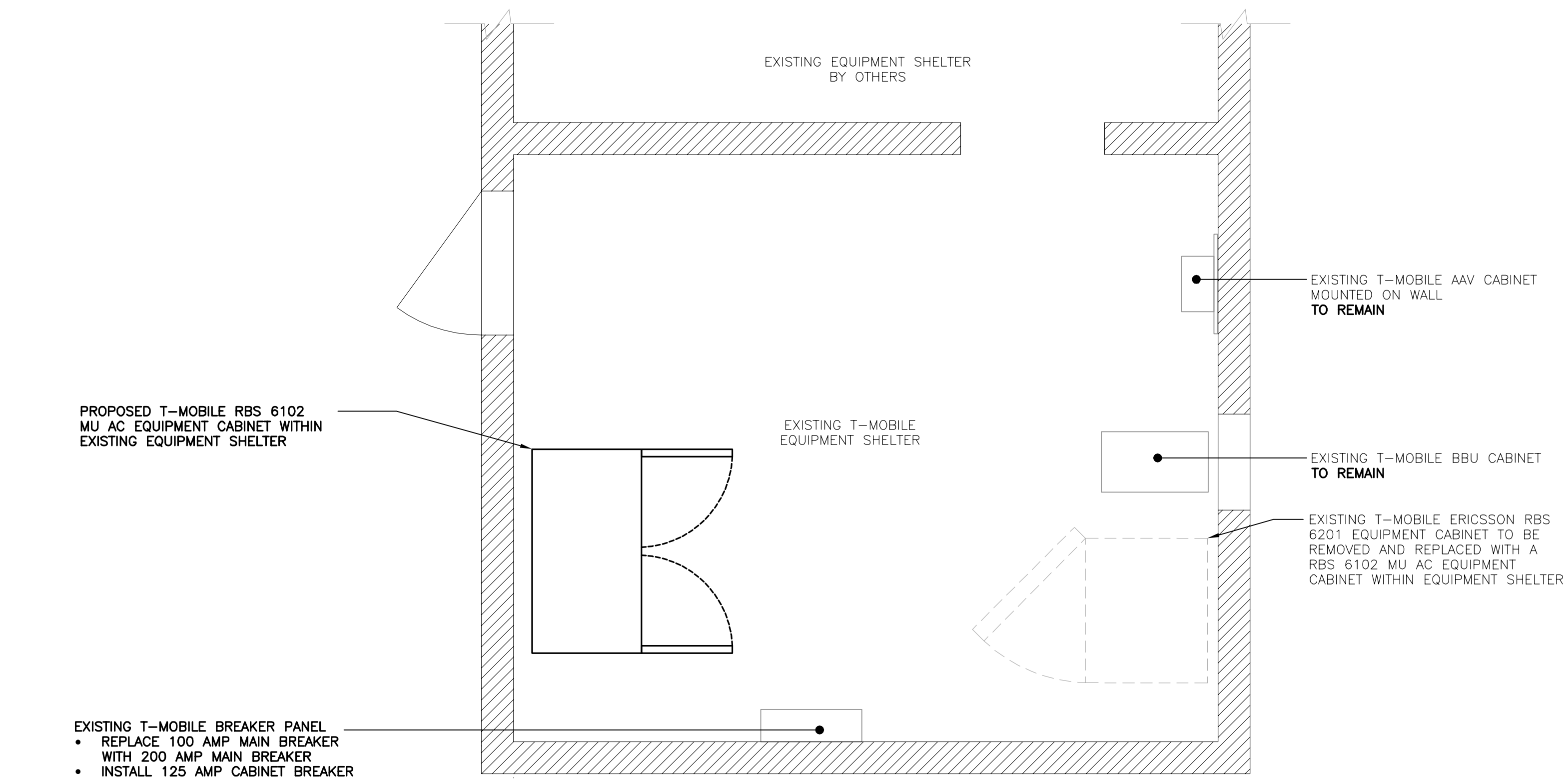
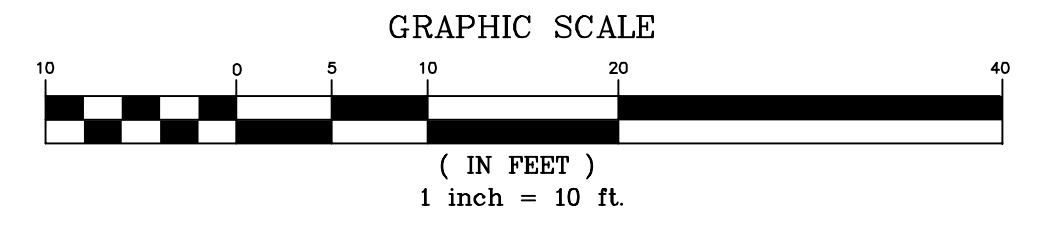

3 EQUIPMENT PLAN
C-2 SCALE: 1/2" = 1'
TRUE NORTH

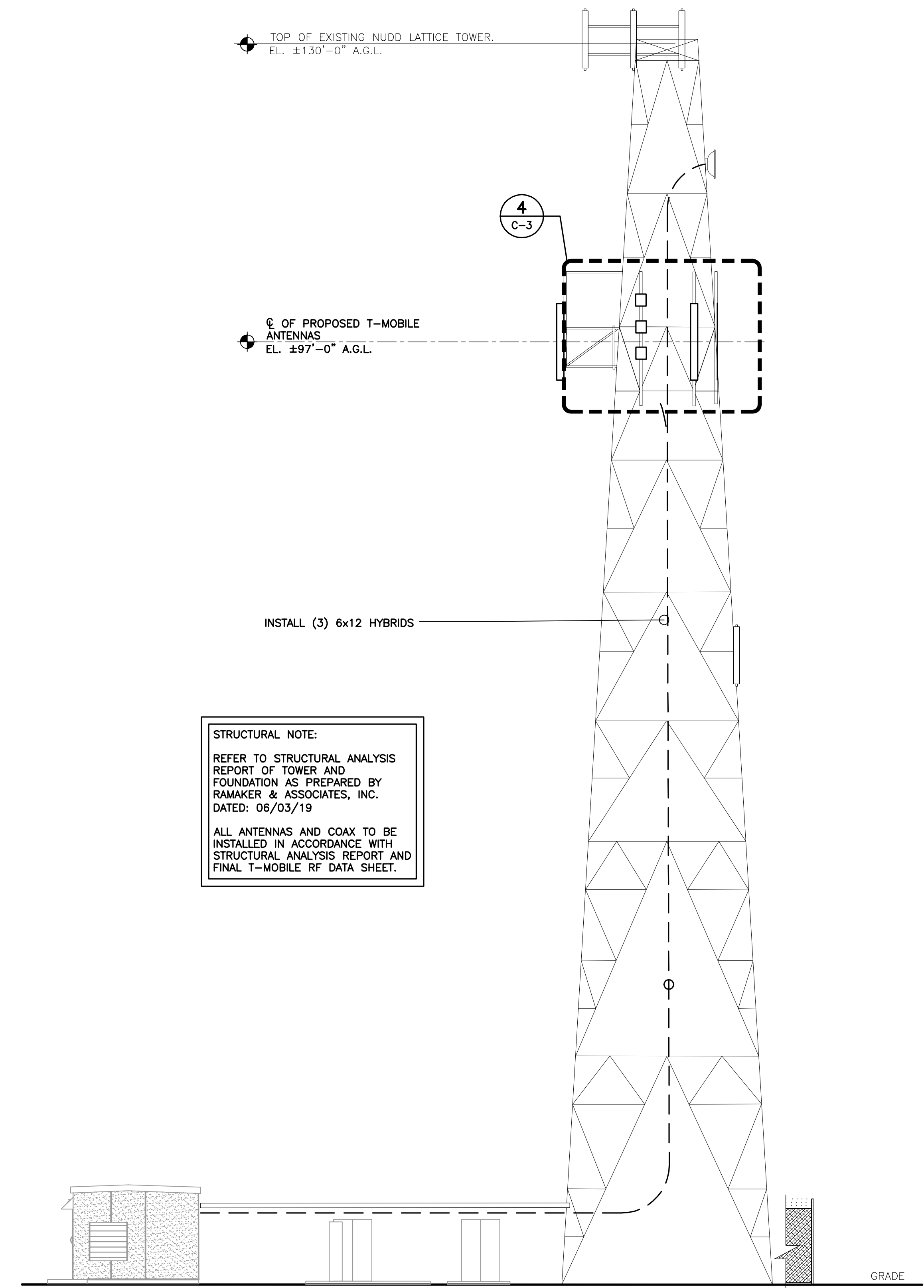

STRUCTURAL NOTE:
REFER TO STRUCTURAL ANALYSIS REPORT OF TOWER AND FOUNDATION AS PREPARED BY RAMAKER & ASSOCIATES, INC. DATED: 06/03/19
ALL ANTENNAS AND COAX TO BE INSTALLED IN ACCORDANCE WITH STRUCTURAL ANALYSIS REPORT AND FINAL T-MOBILE RF DATA SHEET.

2 SOUTH TOWER ELEVATION
C-2 SCALE: 1/8" = 1'

REV.	DATE	BY	CHK'D BY	DESCRIPTION
2	06/18/19	RTS	CAG	CONSTRUCTION DRAWINGS - ISSUED FOR CONSTRUCTION
1	06/12/19	LAA	CAG	CONSTRUCTION DRAWINGS - ISSUED FOR CONSTRUCTION
0	05/07/19	LAA	CAG	CONSTRUCTION DRAWINGS - ISSUED FOR CONSTRUCTION

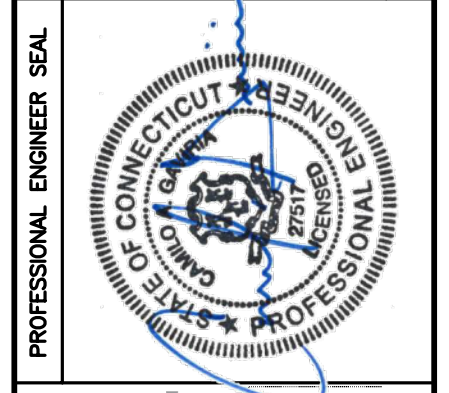

CENTEK engineering
Centered on Solutions
(203) 488-0380
(203) 488-3887 Fax
622 North Branford Road
Branford, CT 06405
www.CentekEng.com

T-MOBILE NORTHEAST LLC
WIRELESS COMMUNICATIONS FACILITY
GUILFORD-1_L1
SITE ID: CT11224A
59 YOUNGS APPLE ORCHARD RD
NORTH BRANFORD, CT 06472

DATE: 04/24/19
SCALE: AS NOTED
JOB NO. 19027.20

COMPOUND PLAN,
AND ELEVATION

EXISTING T-MOBILE ANTENNA, TYP. (1)
PER SECTOR, TOTAL OF (3)
TO BE REMOVED
(P/N: EMS-RR90-17-02DP)

EXISTING T-MOBILE TMA, TYP. (1) PER
SECTOR, TOTAL OF (3)
TO BE REMOVED

EXISTING T-MOBILE ANTENNA, TYP. (1)
PER SECTOR, TOTAL OF (3)
TO BE REMOVED
(P/N: ANDREW LNX-6515DS)

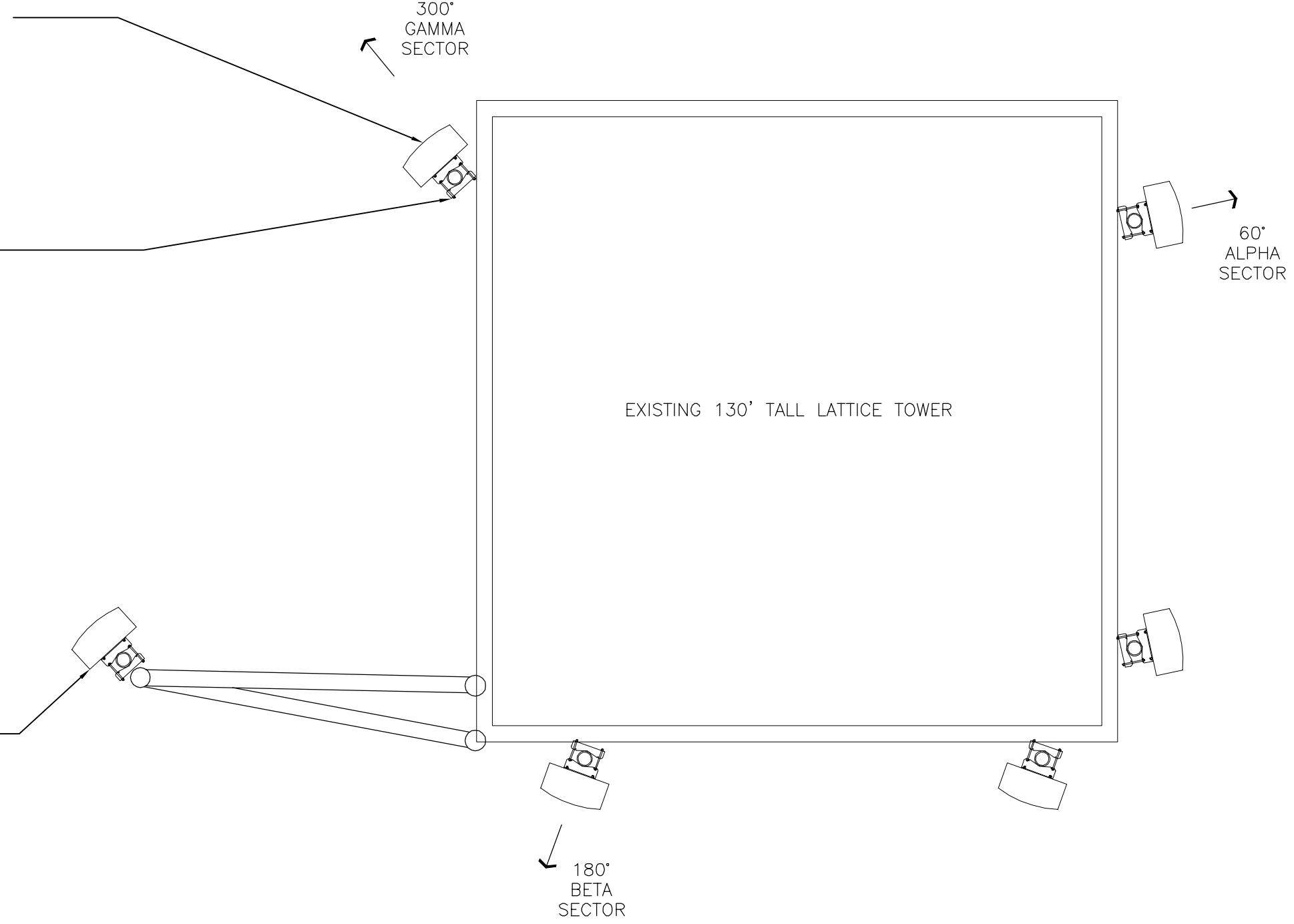

1
C-3 **EXISTING ANTENNA MOUNTING CONFIGURATION**
SCALE: 1/2" = 1'
97' ELEVATION APPROXIMATE NORTH

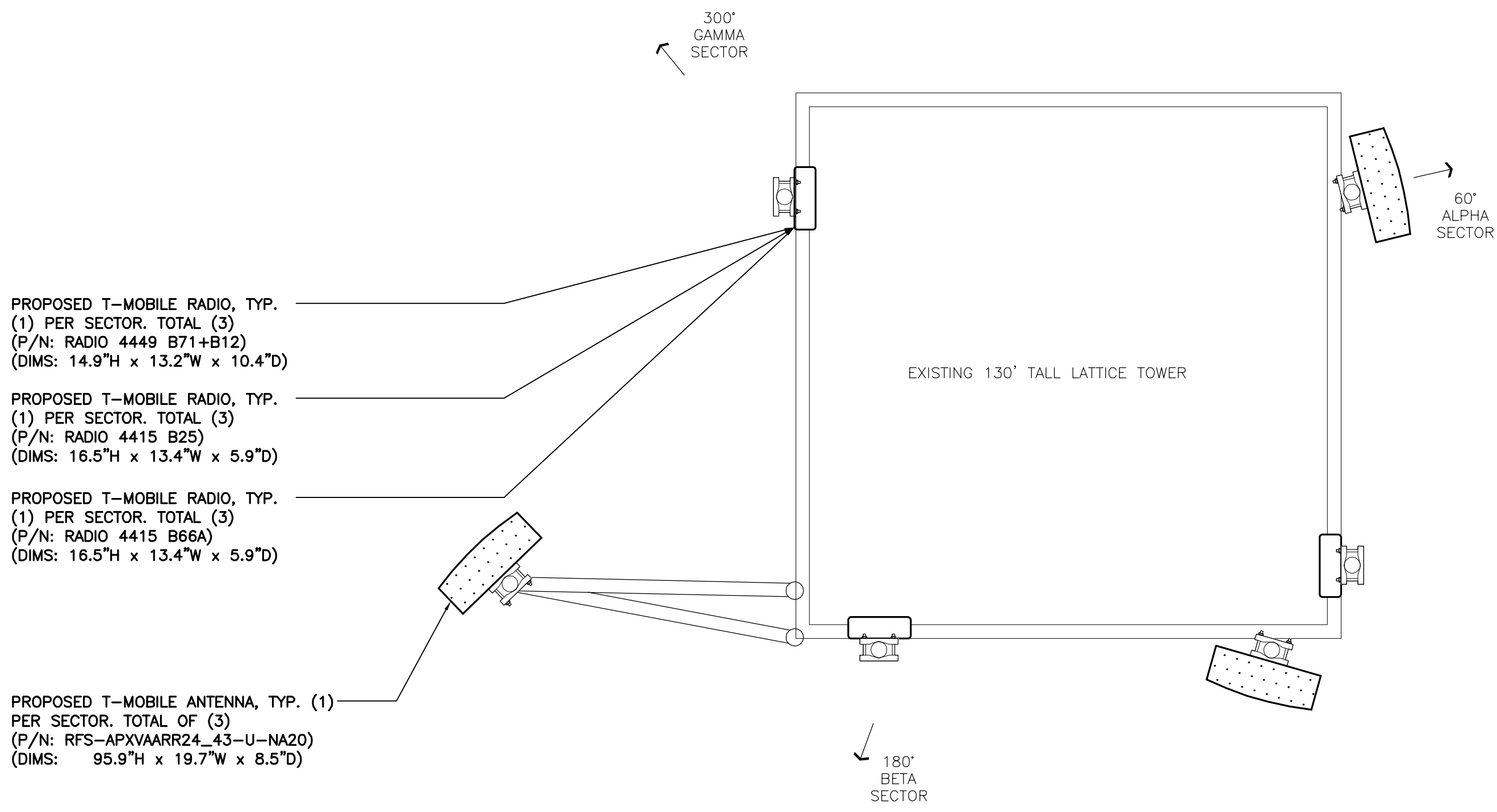

PROPOSED T-MOBILE RADIO, TYP. (1)
PER SECTOR, TOTAL (3)
(P/N: RADIO 4449 B71+B12)
(DIMS: 14.9"H x 13.2"W x 10.4"D)

PROPOSED T-MOBILE RADIO, TYP. (1)
PER SECTOR, TOTAL (3)
(P/N: RADIO 4415 B25)
(DIMS: 16.5"H x 13.4"W x 5.9"D)

PROPOSED T-MOBILE RADIO, TYP. (1)
PER SECTOR, TOTAL (3)
(P/N: RADIO 4415 B66A)
(DIMS: 16.5"H x 13.4"W x 5.9"D)

PROPOSED T-MOBILE ANTENNA, TYP. (1)
PER SECTOR, TOTAL OF (3)
(P/N: RFS-APXVAARR24_43-U-NA20)
(DIMS: 95.9"H x 19.7"W x 8.5"D)

2
C-3 **PROPOSED ANTENNA MOUNTING CONFIGURATION**
SCALE: 1/2" = 1'
97' ELEVATION APPROXIMATE NORTH

RRU NOTES:
PROPOSED RRUS TO BE MOUNTED TO
EXISTING VERTICAL PIPE MASTS OF THE
REMOVED POS.2 ANTENNAS

PROPOSED T-MOBILE RADIO, TYP. (1)
PER SECTOR, TOTAL (3)
(P/N: RADIO 4449 B71+B12)
(DIMS: 14.9"H x 13.2"W x 10.4"D)
MOUNTED ON EXISTING ANTENNA MOUNT

PROPOSED T-MOBILE ANTENNA, TYP. (1)
PER SECTOR, TOTAL (3)
(P/N: RFS-APXVAARR24_43-U-NA20)
(DIMS: 95.9"H x 19.7"W x 8.5"D) ON
EXISTING ANTENNA MOUNT

PROPOSED T-MOBILE RADIO, TYP. (1)
PER SECTOR, TOTAL (3)
(P/N: RADIO 4415 B25)
(DIMS: 16.5"H x 13.4"W x 5.9"D)
MOUNTED ON BACK OF EXISTING
ANTENNA MOUNT

PROPOSED T-MOBILE RADIO, TYP. (1)
PER SECTOR, TOTAL (3)
(P/N: RADIO 4415 B66A)
(DIMS: 16.5"H x 13.4"W x 5.9"D)
MOUNTED ON EXISTING ANTENNA MOUNT

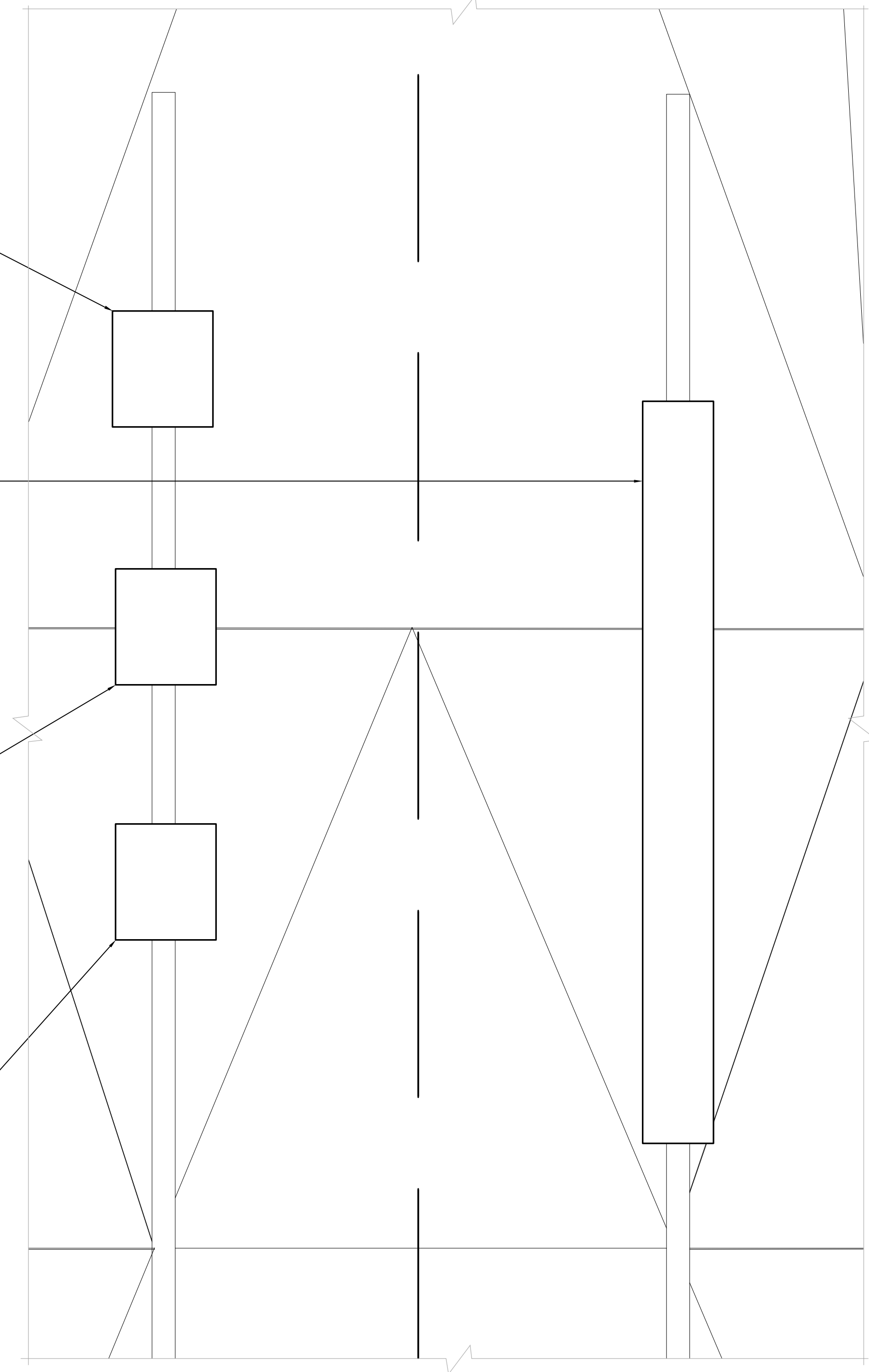

3
C-3 **PROPOSED MOUNTING ELEVATION**
SCALE: 1" = 1'

REV.	DATE	BY	CHK'D BY	DESCRIPTION
2	06/18/19	RIS	CAG	CONSTRUCTION DRAWINGS - ISSUED FOR CONSTRUCTION
1	06/17/19	LAA	CAG	CONSTRUCTION DRAWINGS - ISSUED FOR CONSTRUCTION
0	05/07/19	LAA	CAG	CONSTRUCTION DRAWINGS - ISSUED FOR CONSTRUCTION

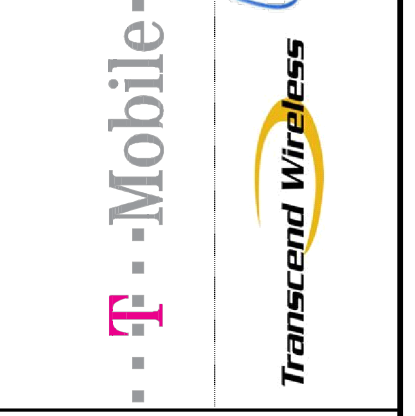
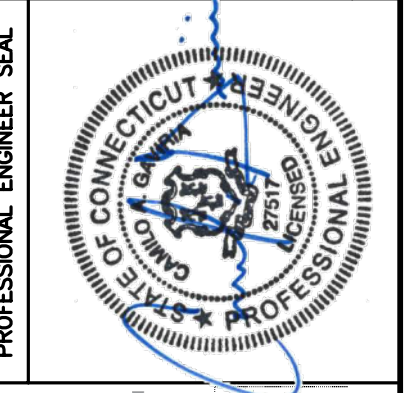

CENTEK engineering
Central on Solutions
(203) 488-0380
(203) 488-3897 Fax
632 North Branford Road
Branford, CT 06405
www.CentekEng.com

T-MOBILE NORTHEAST LLC
WIRELESS COMMUNICATIONS FACILITY
GUILFORD-1_L1
SITE ID: CT11224A
59 YOUNGS APPLE ORCHARD RD
NORTH BRANFORD, CT 06472

DATE: 04/24/19
SCALE: AS NOTED
JOB NO. 19027.20

ANTENNA MOUNTING CONFIGURATION

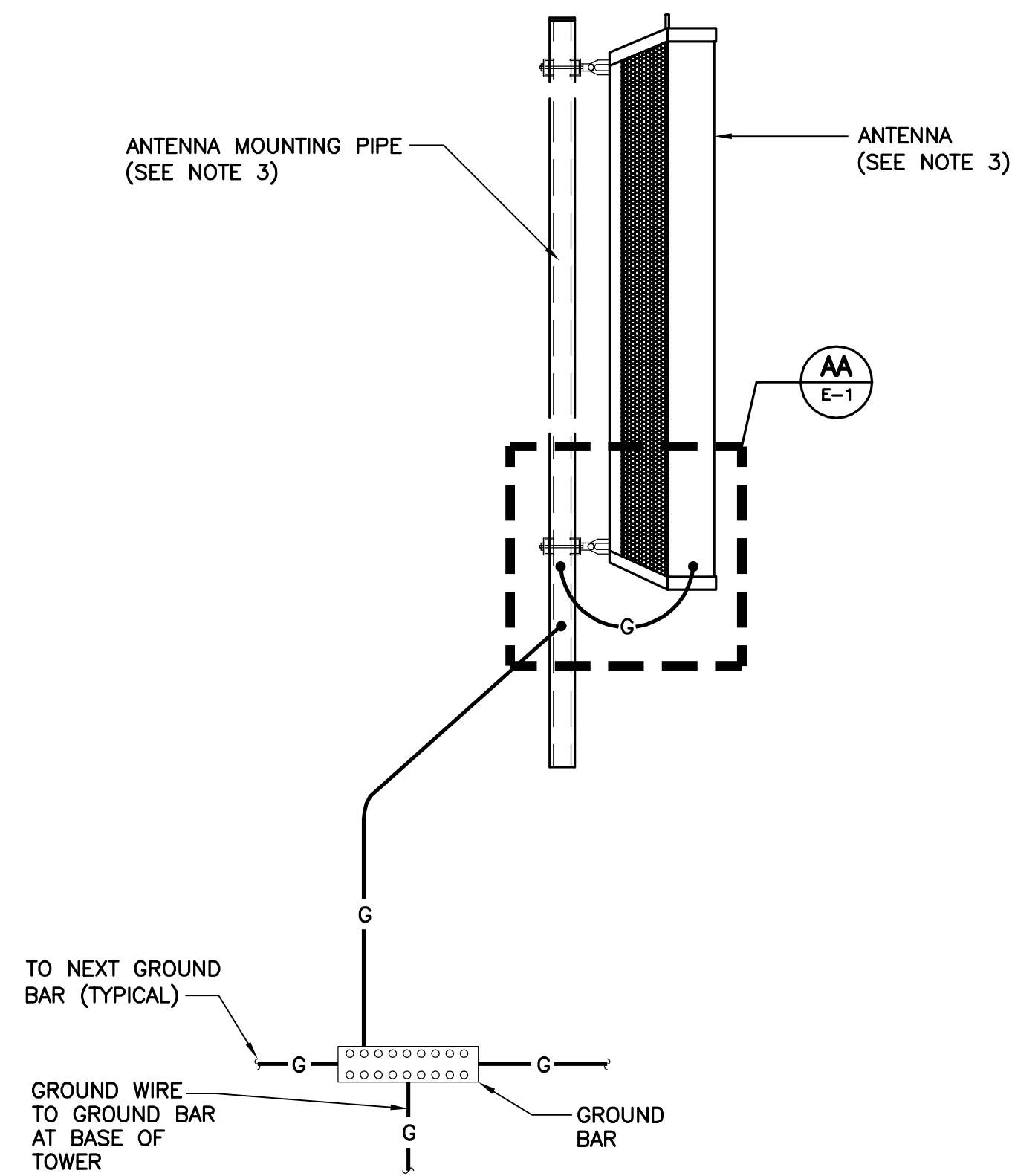

NOTES:

1. BOND COAXIAL CABLE GROUND KITS TO EACH OWNER'S GROUND BAR ALONG ENTIRE COAX RUN FROM ANTENNA TO SHELTER.
2. BOND ALL EQUIPMENT TO GROUND PER NEC AND MANUFACTURERS SPECIFICATIONS.
3. DETAIL IS TYPICAL FOR ALL ANTENNA SECTORS, INCLUDING GPS ANTENNA.

1 TYPICAL ANTENNA GROUNDING DETAIL
SCALE: NONE

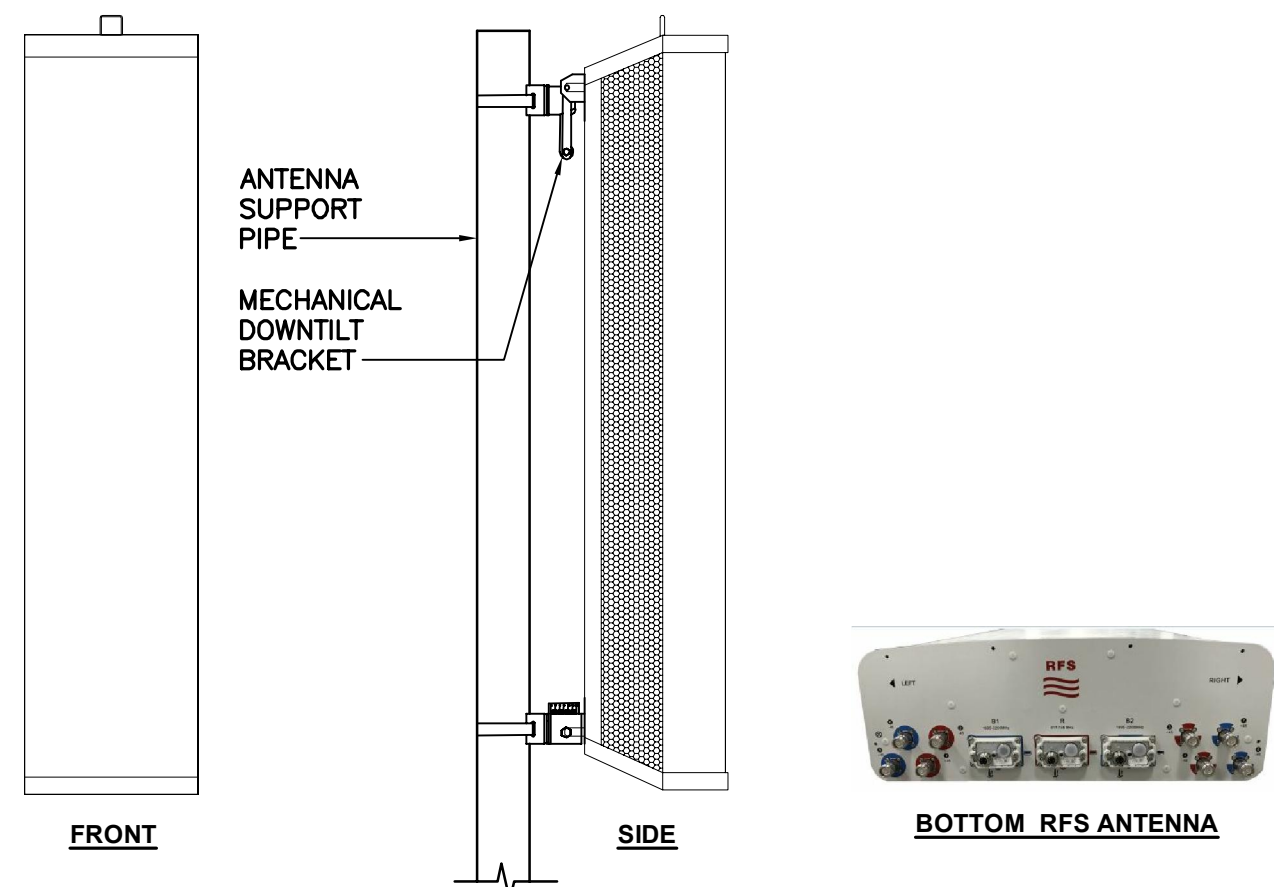

ALPHA/BETA/GAMMA ANTENNA		
EQUIPMENT	DIMENSIONS	WEIGHT
MAKE: RFS MODEL: APXVAARR24_43-U-NA20	95.9"L x 24"W x 8.7"D	153 LBS.

2 PROPOSED ANTENNA DETAIL
SCALE: NOT TO SCALE

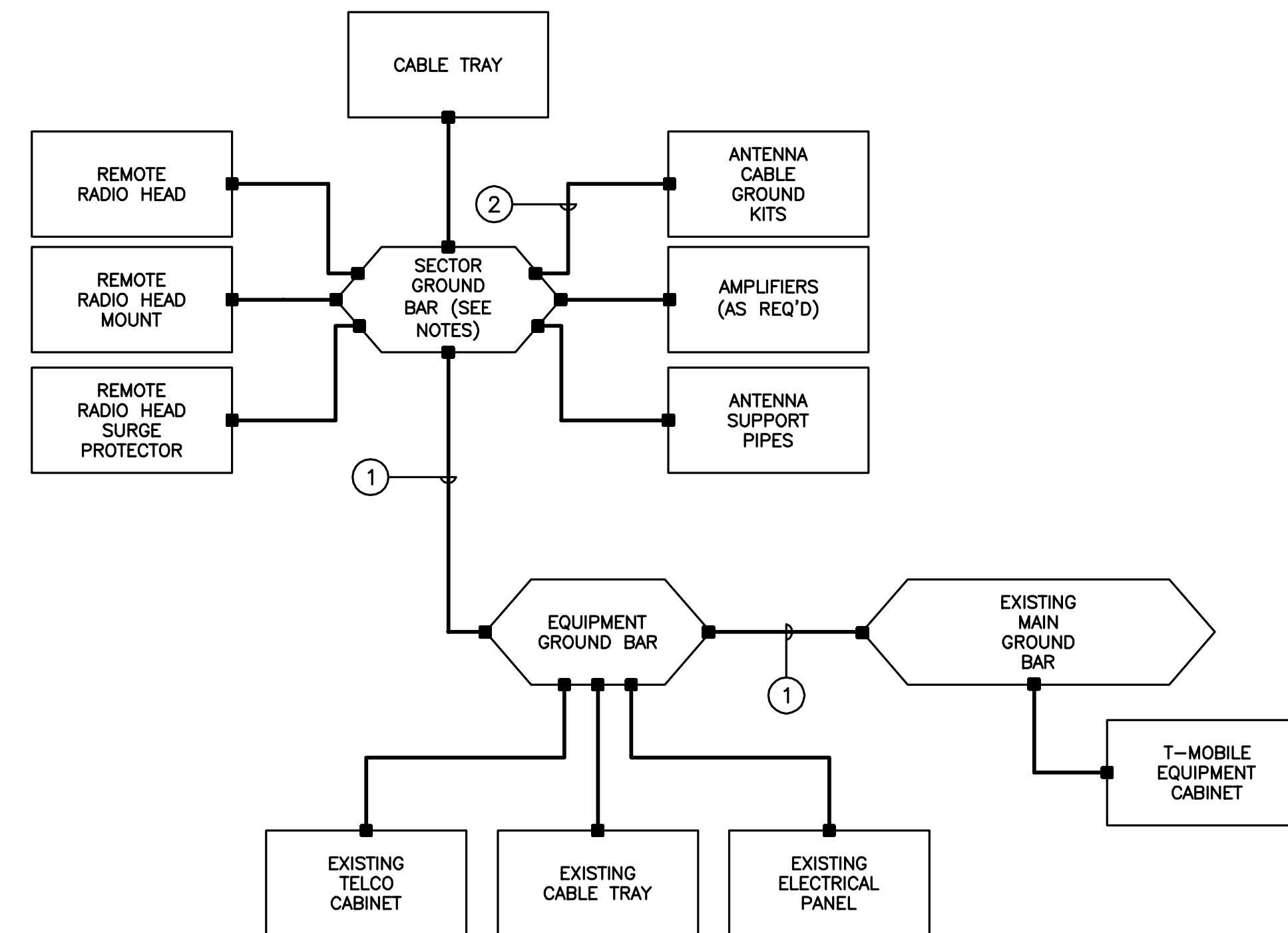

GROUNDING SCHEMATIC NOTES

- ① #2 AWG
- ② #6 AWG

GENERAL NOTES:

1. ALL SURGE SUPPRESSION EQUIPMENT SHALL BE BONDED TO GROUND PER MANUFACTURER'S SPECIFICATIONS
2. UNLESS OTHERWISE NOTED OR REQUIRED BY CODE, GROUND CONDUCTORS SHOWN SHALL BE #2 AWG (SOLID TINNED BCW - EXTERIOR; STRANDED GREEN INSULATED - INTERIOR).
3. ALL SECTOR GROUND BARS SHALL BE BONDED TOGETHER WITH #2 AWG SOLID TINNED BCW.
4. BOND ALL EQUIPMENT CABINETS AND BATTERY CABINETS TO GROUND PER MANUFACTURER'S SPECIFICATIONS.
5. COORDINATE ALL ROOF MOUNTED EQUIPMENT WITH OWNER.
6. ALL ROOF MOUNTED AMPLIFIERS AND ASSOCIATED EQUIPMENT SHALL BE BONDED TO THE SECTOR GROUND BAR PER MANUFACTURER'S SPECIFICATIONS.
7. ALL GROUNDING SHALL BE IN ACCORDANCE WITH NEC AND OWNER'S REQUIREMENTS.

3 TYPICAL GROUNDING SCHEMATIC DETAIL
SCALE: NOT TO SCALE

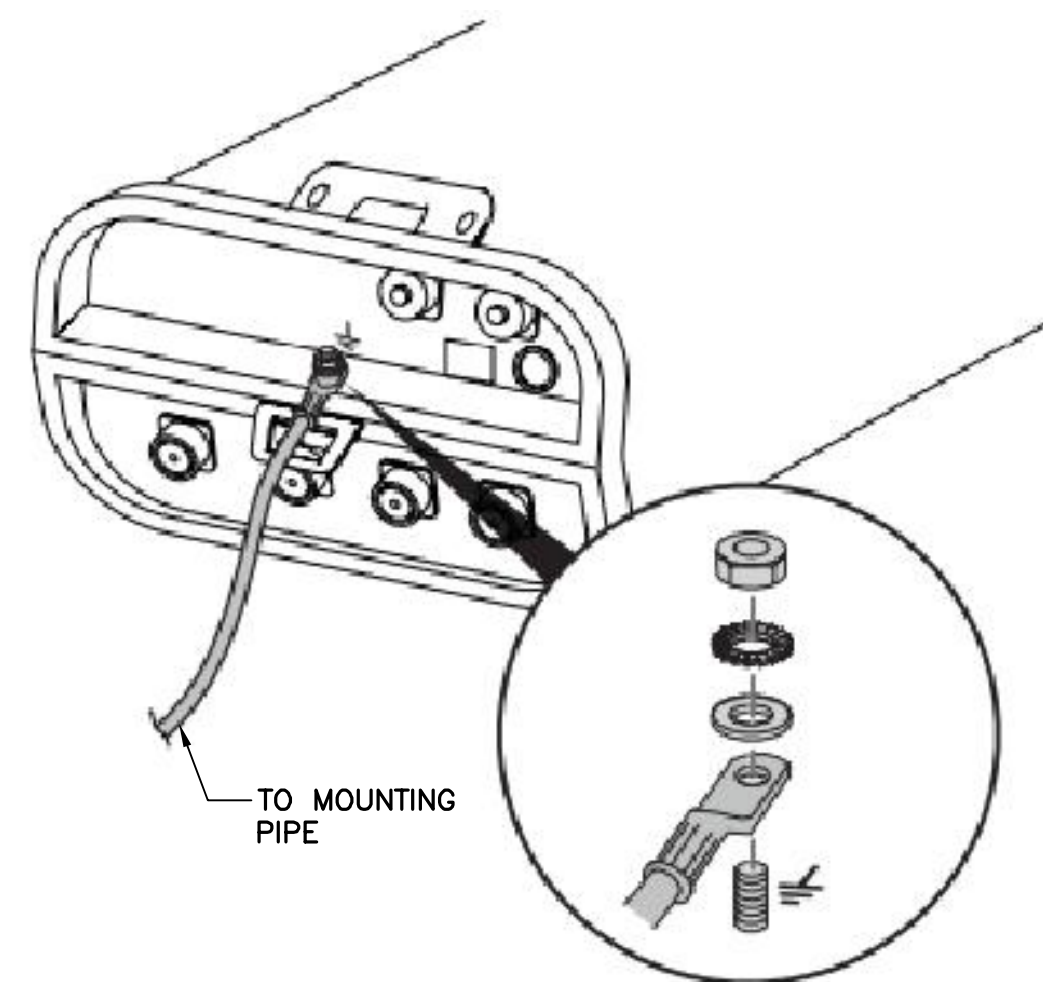

4 TYPICAL ANTENNA GROUNDING DETAIL
SCALE: NONE

REV.	DATE	BY	CHK'D BY	DESCRIPTION
2	06/18/19	RTS	CAG	CONSTRUCTION DRAWINGS - ISSUED FOR CONSTRUCTION
1	06/17/19	LAA	CAG	CONSTRUCTION DRAWINGS - ISSUED FOR CONSTRUCTION
0	05/07/19	LAA	CAG	CONSTRUCTION DRAWINGS - ISSUED FOR CONSTRUCTION

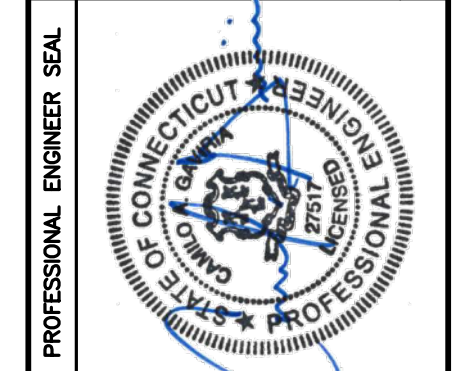

CENTEK engineering
Centered on Solutions
 (203) 498-0390
 (203) 498-3897 Fax
 622 North Branford Road
 Branford, CT 06405
 www.CentekEng.com

T-MOBILE NORTHEAST LLC
 WIRELESS COMMUNICATIONS FACILITY
GUILFORD-1_L1
SITE ID: CT11224A
 59 YOUNGS APPLE ORCHARD RD
 NORTH BRANFORD, CT 06472

DATE: 04/24/19
 SCALE: AS NOTED
 JOB NO. 19027.20

TYPICAL ELECTRICAL DETAILS
E-1
 Sheet No. 6 of 7

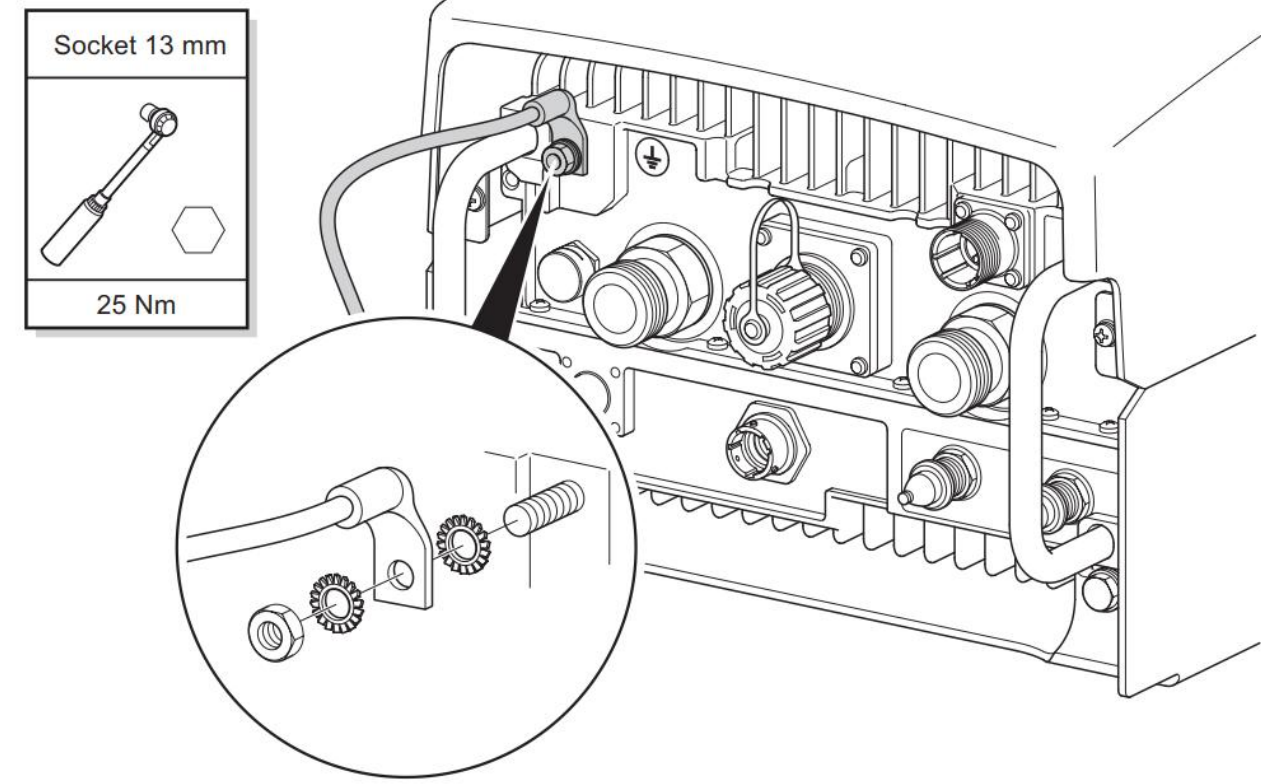

1 TYPICAL RRU GROUNDING DETAIL
E-2 SCALE: NOT TO SCALE

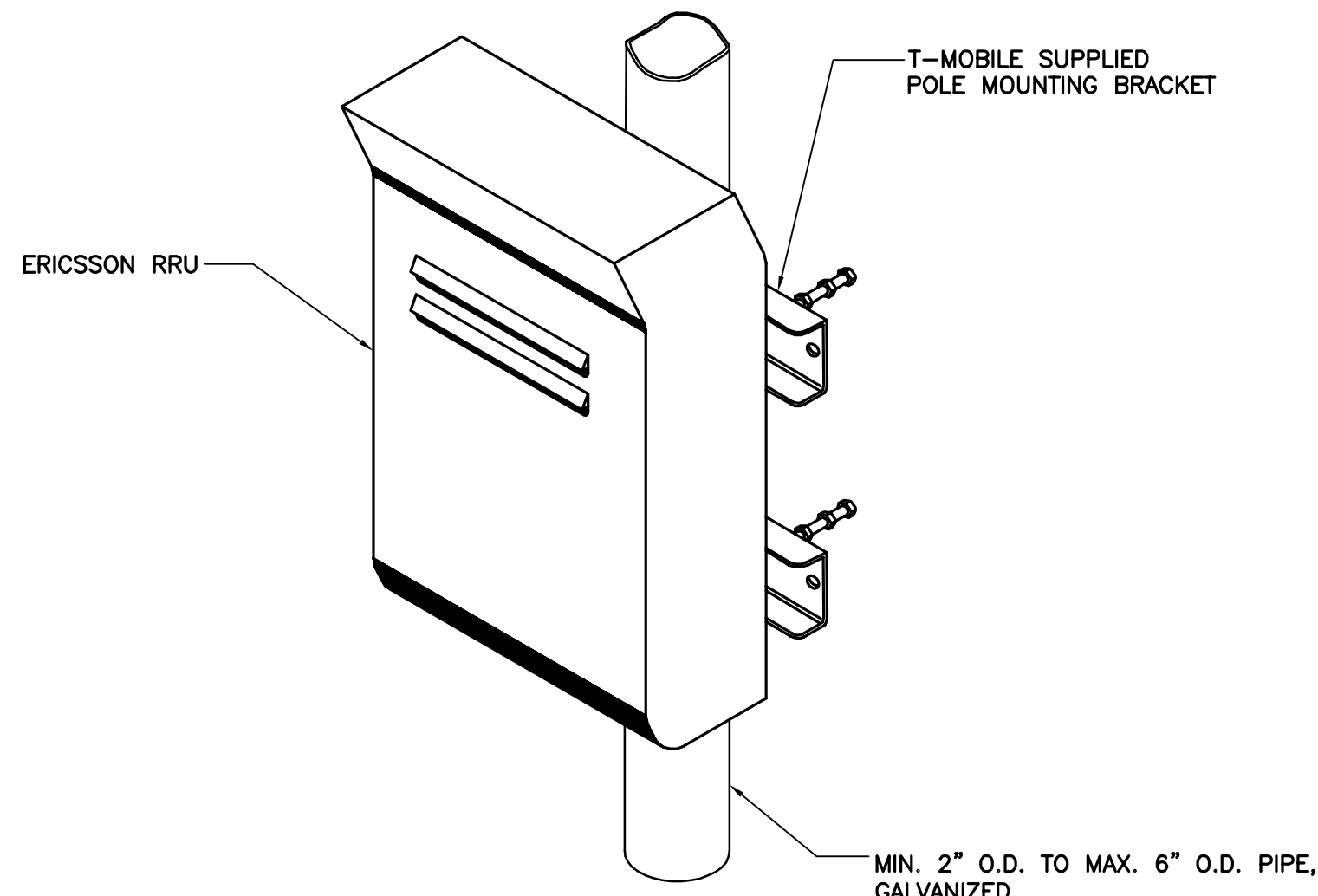

2 TYPICAL RRUS MOUNTING DETAILS
E-2 SCALE: NOT TO SCALE

- RISER DIAGRAM NOTES**
- EXISTING T-MOBILE 100A DISTRIBUTION PANEL TO BE REMOVED AND REPLACED.
 - CONDUITS AND CONDUCTORS SERVING EXISTING RADIO EQUIPMENT CABINETS TO BE REMOVED.
 - CONDUITS AND CONDUCTORS FEEDING EXISTING 100A PANEL TO BE REMOVED.
 - (3) #3/0 AWG, (1) #6 AWG GROUND, 2 1/2" CONDUIT CONNECTED TO SOURCE PREVIOUSLY FEEDING REMOVED 100A PANEL. MAXIMUM CIRCUIT LENGTH OF 200FT. VERIFY LOCATION IN FIELD. COORDINATE ANY REQUIRED UPGRADES WITH BUILDING OWNER AND LOCAL UTILITY COMPANY.
 - NEW 200A, 240V, SINGLE PHASE, 30 POSITION, NEMA 3R PANEL WITH COPPER BUS, BOLT ON CIRCUIT BREAKERS AND 200A/2P MAIN CIRCUIT BREAKER.
 - (3) #1/0 AWG, (1) #6 AWG GROUND, 2" CONDUIT CONNECTED TO NEW 125A/2P CIRCUIT BREAKER AND ROUTED TO EXISTING T-MOBILE RADIO CABINET.
 - EXISTING T-MOBILE RADIO CABINET TO REMAIN.

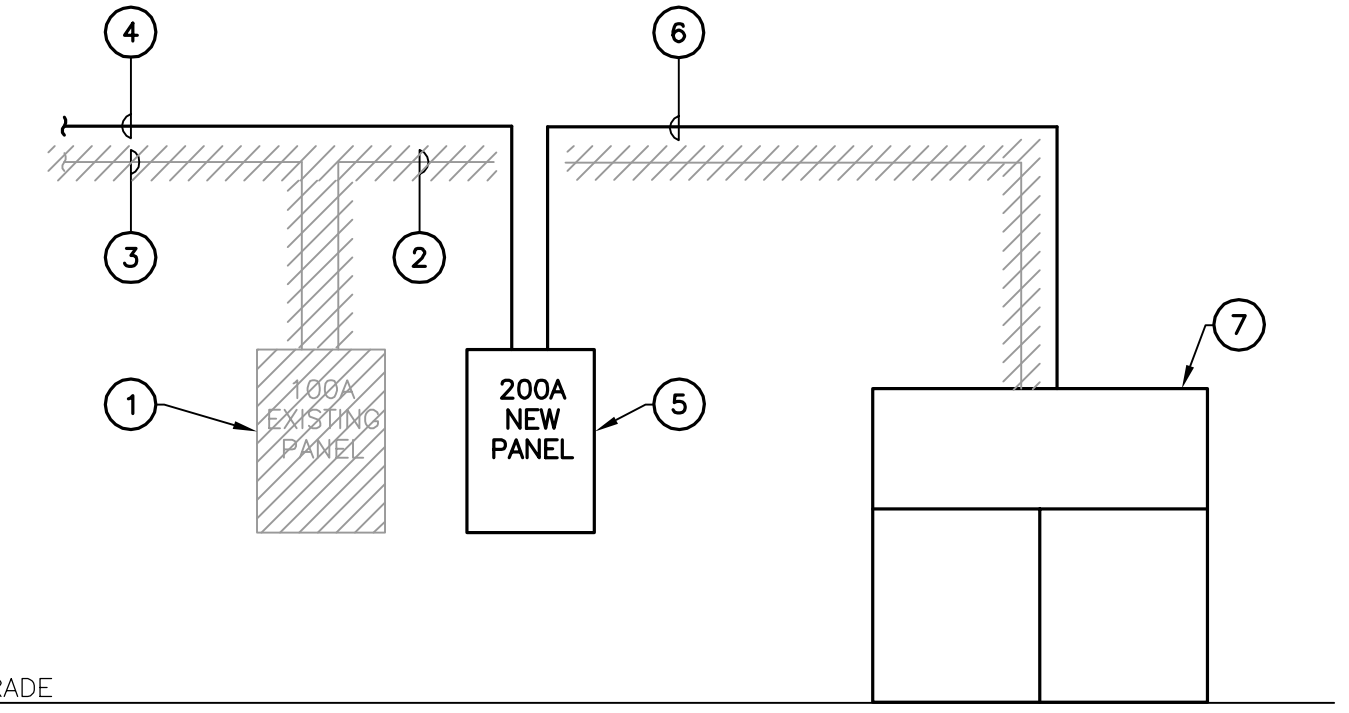

3 ELECTRICAL POWER RISER DIAGRAM
E-2 NOT TO SCALE



RRU (REMOTE RADIO UNIT)			
EQUIPMENT	DIMENSIONS	WEIGHT	CLEARANCES
MAKE: ERICSSON MODEL: RADIO 4449 B71B12	14.9"L x 13.2"W x 10.4"D	74 LBS.	ABOVE: 16" MIN. BELOW: 12" MIN. FRONT: 36" MIN.

4 PROPOSED RRU DETAIL
E-2 SCALE: NOT TO SCALE



RRU (REMOTE RADIO UNIT)			
EQUIPMENT	DIMENSIONS	WEIGHT	CLEARANCES
MAKE: ERICSSON MODEL: RADIO 4415 B25	16.5"L x 13.4"W x 5.9"D	46 LBS.	ABOVE: 16" MIN. BELOW: 12" MIN. FRONT: 36" MIN.
MAKE: ERICSSON MODEL: RADIO 4415 B66A	16.5"L x 13.4"W x 5.9"D	46 LBS.	ABOVE: 16" MIN. BELOW: 12" MIN. FRONT: 36" MIN.

5 PROPOSED RRU DETAIL
E-2 SCALE: NOT TO SCALE



EQUIPMENT	DIMENSIONS	WEIGHT
MAKE: ERICSSON MODEL: 6102 MU AC CABINET	57.09"H x 51.18"W x 27.56"D	727.53 LBS

6 ERICSSON RADIO CABINET DETAIL
E-2 SCALE: NOT TO SCALE

REV.	DATE	BY	CHK'D BY	DESCRIPTION
2	08/18/19	RTS	CAG	CONSTRUCTION DRAWINGS - ISSUED FOR CONSTRUCTION
1	08/14/19	LAA	CAG	CONSTRUCTION DRAWINGS - ISSUED FOR CONSTRUCTION
0	05/07/19	LAA	CAG	CONSTRUCTION DRAWINGS - ISSUED FOR CONSTRUCTION

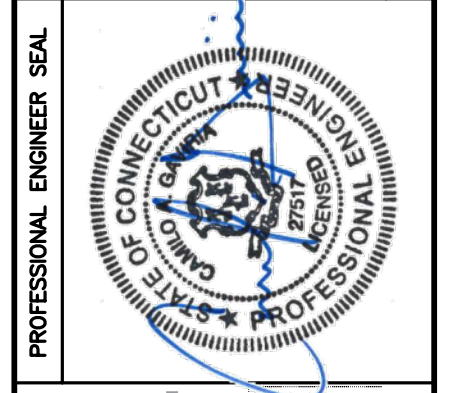

CEN TEK engineering
Centered on Solutions
(203) 488-0390
(203) 488-3397 Fax
632 North Branford Road
Branford, CT 06405
www.CenTekEng.com

T-MOBILE NORTHEAST LLC
WIRELESS COMMUNICATIONS FACILITY
GUILFORD-1_L1
SITE ID: CT11224A
59 YOUNGS APPLE ORCHARD RD
NORTH BRANFORD, CT 06472

DATE: 04/24/19
SCALE: AS NOTED
JOB NO. 19027.20

TYPICAL ELECTRICAL DETAILS



June 3, 2019

Mike Kithcart
Transcend Wireless
10 Industrial Avenue, Suite 3
Mahwah, NJ 07430

Ramaker & Associates, Inc.
855 Community Drive
Sauk City, WI 53583

**SUBJECT: STRUCTURAL ASSESSMENT
129-FOOT SELF-SUPPORT TOWER**

CARRIER: T-MOBILE

**SITE: YOUNGS APPLE ORCHARD
59 YOUNGS APPLE ORCHARD ROAD
NORTH BRANFORD, NEW HAVEN COUNTY, CONNECTICUT 06472
RAMAKER & ASSOCIATES PROJECT NUMBER: 30775**

**RESULTS: TOWER: 80.7% PASS
FOUNDATION: 21.9% PASS**

Dear Mike Kithcart:

Ramaker & Associates, Inc. (RAMAKER) respectfully submits this structural assessment for the above-mentioned site. The purpose of this report is to determine the structural integrity of the existing structure with the existing and proposed loading. Engineering recommendations regarding the analysis results are provided in the following pages.

RAMAKER developed a finite element model of the tower using tnxTower analysis software. All information contained herein is valid only for the described structure configuration and loading conditions. RAMAKER reserves the right to modify our recommendations should alterations to the tower loading occur.

If you have any questions or comments, please do not hesitate to contact our office.

Sincerely,

RAMAKER & ASSOCIATES, INC.

Thomas E Moore
Thomas E. Moore
Project Engineer

James R. Skowronski
James R. Skowronski, P.E.
Supervising Engineer



ANALYSIS CRITERIA

Adopted Building Code	2018 CT State Building Code
Referenced Standard 1	2015 IBC
Referenced Standard 2	TIA-222-G
Risk Category	II
Ultimate Design Wind Speed, V_{ult}	130 mph (3 sec. gust)
Nominal Design Wind Speed, V_{asd}	101 mph (3 sec. gust)
Design Wind Speed w/ Ice	50 mph (3 sec. gust)
Ice Thickness	3/4 inch
Exposure Category	C
Topographic Feature	None

SUPPORTING DOCUMENTATION

- Structural analysis by RAMAKER, project number 30775, dated June 9, 2015
- Foundation mapping by Tower Engineering Professionals, job 144567.1-177569, dated September 11, 2018
- Geotechnical report by Tower Engineering Professionals, job 144567.177660, dated September 13, 2018
- Construction drawings by RAMAKER, project number 30775
- Site visit(s) conducted by RAMAKER
- Other pertinent data procured or assumed by RAMAKER during site due diligence activities

TOWER LOADING

RAMAKER understands that the loading to be used for this analysis will consist of the antenna equipment, mount, and cable configurations as shown in the following chart:

Elevation	Appurtenance	Mount	Coax	Owner	Status
132	(1) RFI CC807-08	(1) Pipe Mount	(1) 7/8	Others	Future
125	(3) RFS APXVSP18-C-A20	(3) Sector Frame	(4) 1-1/4	Sprint	Existing
	(3) ALU 1900MHz 4x45W RRH				
	(3) ALU 800MHz 2x50W RRH				
	(3) ALU External Notch Filter				
	(3) Commscope DT465B-2XR-V2				
	(3) ALU TD-RRH8x20-25				
117.5	(1) RFS SC3-W100A	(1) Pipe Mount	(1) EU 90	Others	Future
100	(1) RFI CC807-08	(1) 6' Standoff	(1) 7/8	Others	Future
94	(3) EMS RR90-17-02DP	(6) Pipe Mount (1) 6' Standoff	(12) 1-5/8 (1) RET (3) Hybrid	T-Mobile	Remove
	(3) Commscope LNX-6515DS-VTM				Proposed
	(3) RFS APXVAARR24_43-U-NA20				
	(3) Ericsson Radio 4449 B71 B12				
	(3) Ericsson Radio 4415 B25				
	(3) Ericsson Radio 4415 B66A				
(3) Ericsson KRY 112 89/4	Existing				
76.5	(1) GPS	Leg Mounted	(1) 1/2	--	Existing

TOWER RESULTS

The maximum tower member stress capacities under the loading conditions previously described are as follows:

Component Type	Percent Capacity	Pass/Fail
Leg	57.3	Pass
Diagonal	70.8	Pass
Horizontal	80.7	Pass
Redundant Bracing	51.2	Pass
Inner Bracing	33.4	Pass
Bolt	83.8	Pass
Anchor Rod	36.8	Pass
RATING	80.7	PASS

Note: A rating of 105% or less is within engineering tolerances and considered acceptable.

Results of the analysis show that the existing tower will be stressed to a maximum of 80.7 percent of capacity. Therefore, the existing tower will pass the TIA-222-G analysis requirements under proposed loading conditions.

FOUNDATION RESULTS

The maximum foundation stress capacities are as follows:

Component Type	Percent Capacity	Pass/Fail
Pad & Pier - Soil Interaction	21.9	Pass
Pad & Pier - Structural	17.8	Pass
RATING	21.9	PASS

Note: A rating of 105% or less is within engineering tolerances and considered acceptable.

The foundations were analyzed utilizing the foundation mapping and geotechnical report referenced above. Reinforcing Results of the analysis show that the existing foundation will be stressed to a maximum of 21.9 percent of capacity. Therefore, the existing foundation will pass the TIA-222-G analysis requirements under proposed loading conditions.

LIMITATIONS

The recommendations contained within this report were developed using the supporting documentation as previously described. All recommendations pertain only to the proposed antenna installation activities as described in this report. RAMAKER assumes no responsibility for failures caused by factors beyond our control. These include but are not limited to the following:

- Missing, corroding, and/or deteriorating members
- Improper manufacturing and/or construction
- Improper maintenance

RAMAKER assumes no responsibility for modifications completed prior to or hereafter in which RAMAKER was not directly involved. These modifications include but are not limited to the following:

- Replacing or strengthening bracing members
- Reinforcing or extending vertical members
- Installing or removing antenna mounting gates or side arms
- Changing loading configurations

The tower owner is responsible for verifying that the existing loading on the structure is consistent with the loading applied to the structure within this report. If there is any information contrary to that contained herein, or if there are any defects arising from the original design, material, fabrication and erection deficiencies, this report should be disregarded and RAMAKER should be contacted immediately. RAMAKER is not liable for any representation, recommendation, or conclusion not expressly stated herein.

This analysis pertains only to the tower structure, and no analyses or conclusions were made regarding the antenna and equipment mounting structure(s). Analysis and certification of the antenna and equipment mounting structure(s) is performed and submitted separately.

ATTACHMENTS

- Analysis Figures
- Analysis Calculations

Section	T8	T7	T6	T5	T4	T3	T2	T1
Legs	L6x6x1/2	L6x6x5/8	L6x6x1/2	L5x5x1/2	L5x5x1/2	L4x4x3/8	L4x4x3/8	
Leg Grade			A36					
Diagonals		2L2 1/2x3x3/8x3/8		2L2 1/2x2x1/4x3/8		2L2 1/2x2x3/8x3/8		N.A.
Diagonal Grade			A36					N.A.
Top Girts			N.A.					SR 1
Horizontals			2L2 1/2x2x1/4x3/8					N.A.
Red. Horizontals	L2 1/2x2x1/4	L2 1/2x2x3/16	L2 1/2x2x3/16	L2 1/2x2x3/16	L2 1/2x2x3/16	L2 1/2x2x3/16	L2 1/2x2x3/16	N.A.
Red. Diagonals	L2x2 1/2x1/4							N.A.
Red. Hips		N.A.						N.A.
Inner Bracing	L2 1/2x2 1/2x3/16							N.A.
Face Width (ft)	24.3333	21.4234	18.494	14.0459	12.5566	11.1115	9.666348	16667
# Panels @ (ft)	1 @ 24.75	1 @ 24.9167	1 @ 25.1667	2 @ 12.6667	2 @ 12.2917	2 @ 12.2917	1 @ 4.25	
Weight (lb)	8660.5	7676.7	6735.8	2604.5	2410.8	2305.1	2465.0	2093

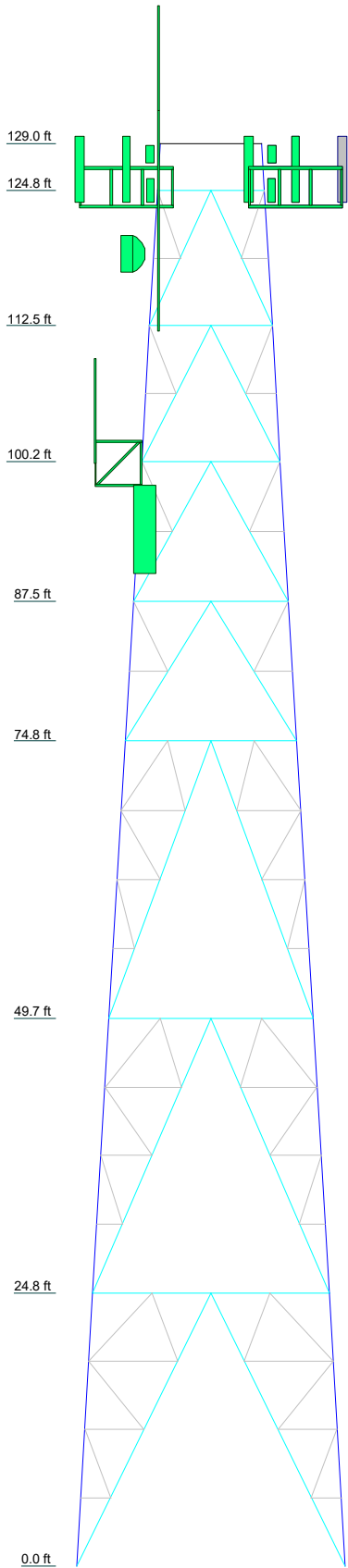

DESIGNED APPURTENANCE LOADING

TYPE	ELEVATION	TYPE	ELEVATION
CC807-08	132	4"x4" Pipe Mount (Others)	117.5
20"x2 1/2" Pipe Mount (Others)	132	SC3-W100 (Others)	117.5
APXVSP18-C-A20 w/Mount Pipe	125	TMA	100
APXVSP18-C-A20 w/Mount Pipe	125	Side Arm Mount [SO 601-1] (Others)	100
APXVSP18-C-A20 w/Mount Pipe	125	CC807-08	100
800MHz 2x50W RRH	125	APXVAARR24_43-U-NA20	94
800MHz 2x50W RRH	125	APXVAARR24_43-U-NA20	94
800MHz 2x50W RRH	125	KRY 112 89/4	94
800 External Notch Filter	125	KRY 112 89/4	94
800 External Notch Filter	125	KRY 112 89/4	94
800 External Notch Filter	125	Radio 4449 - B12 + B71	94
1900MHz 4x45W RRH	125	Radio 4449 - B12 + B71	94
1900MHz 4x45W RRH	125	Radio 4449 - B12 + B71	94
1900MHz 4x45W RRH	125	Radio 4415 B25	94
DT465B-2XR w/Mount Pipe	125	Radio 4415 B25	94
DT465B-2XR w/Mount Pipe	125	Radio 4415 B66A	94
800MHz 2x50W RRH	125	Radio 4415 B66A	94
800MHz 2x50W RRH	125	Radio 4415 B66A	94
800MHz 2x50W RRH	125	(2) 14.5"x2-1/2" Pipe Mount (TMobile)	94
TD-RRH8x20-25	125	(2) 14.5"x2-1/2" Pipe Mount (TMobile)	94
TD-RRH8x20-25	125	(2) 14.5"x2-1/2" Pipe Mount (TMobile)	94
TD-RRH8x20-25	125	6' Standoff - Flat (TMobile)	94
Sector Mount [SM 702-1] (Sprint)	125	APXVAARR24_43-U-NA20	94
Sector Mount [SM 702-1] (Sprint)	125	GPS	76.5
Sector Mount [SM 702-1] (Sprint)	125	Catwalk	75

MATERIAL STRENGTH

GRADE	Fy	Fu	GRADE	Fy	Fu
A36	36 ksi	58 ksi			

TOWER DESIGN NOTES

1. Tower is located in New Haven County, Connecticut.
2. Tower designed for Exposure C to the TIA-222-G Standard.
3. Tower designed for a 101 mph basic wind in accordance with the TIA-222-G Standard.
4. Tower is also designed for a 50 mph basic wind with 0.75 in ice. Ice is considered to increase in thickness with height.
5. Deflections are based upon a 60 mph wind.
6. Tower Structure Class II.
7. Topographic Category 1 with Crest Height of 0.00 ft

 Ramaker & Associates, Inc 855 Community Drive Sauk City, WI 53583 Phone: (608) 643-4100 FAX: (608) 643-7999	Job: Youngs Apple Orchard		
	Project: 30775		
	Client: T-Mobile	Drawn by: TEM	App'd:
	Code: TIA-222-G	Date: 06/03/19	Scale: NTS
Path: I:\30700\30775\Structural\TNX30775 rev4a.et			Dwg No. E-1

tnxTower Ramaker & Associates, Inc 855 Community Drive Sauk City, WI 53583 Phone: (608) 643-4100 FAX: (608) 643-7999	Job Youngs Apple Orchard	Page 1 of 27
	Project 30775	Date 12:56:32 06/03/19
	Client T-Mobile	Designed by TEM

Tower Input Data

The main tower is a 4x free standing tower with an overall height of 129.00 ft above the ground line.

The base of the tower is set at an elevation of 0.00 ft above the ground line.

The face width of the tower is 9.17 ft at the top and 24.33 ft at the base.

This tower is designed using the TIA-222-G standard.

The following design criteria apply:

Tower is located in New Haven County, Connecticut.

ASCE 7-10 Wind Data is used (wind speeds converted to nominal values).

Basic wind speed of 101 mph.

Structure Class II.

Exposure Category C.

Topographic Category 1.

Crest Height 0.00 ft.

Nominal ice thickness of 0.7500 in.

Ice thickness is considered to increase with height.

Ice density of 56 pcf.

A wind speed of 50 mph is used in combination with ice.

Temperature drop of 50 °F.

Deflections calculated using a wind speed of 60 mph.

A non-linear (P-delta) analysis was used.

Pressures are calculated at each section.

Stress ratio used in tower member design is 1.

Local bending stresses due to climbing loads, feed line supports, and appurtenance mounts are not considered.

Options

<ul style="list-style-type: none"> Consider Moments - Legs Consider Moments - Horizontals Consider Moments - Diagonals Use Moment Magnification √ Use Code Stress Ratios √ Use Code Safety Factors - Guys Escalate Ice Always Use Max Kz Use Special Wind Profile Include Bolts In Member Capacity Leg Bolts Are At Top Of Section √ Secondary Horizontal Braces Leg Use Diamond Inner Bracing (4 Sided) SR Members Have Cut Ends SR Members Are Concentric 	<ul style="list-style-type: none"> Distribute Leg Loads As Uniform Assume Legs Pinned √ Assume Rigid Index Plate √ Use Clear Spans For Wind Area Use Clear Spans For KL/r Retension Guys To Initial Tension √ Bypass Mast Stability Checks √ Use Azimuth Dish Coefficients √ Project Wind Area of Appurt. Autocalc Torque Arm Areas Add IBC .6D+W Combination Sort Capacity Reports By Component Triangulate Diamond Inner Bracing Treat Feed Line Bundles As Cylinder Ignore KL/ry For 60 Deg. Angle Legs 	<ul style="list-style-type: none"> Use ASCE 10 X-Brace Ly Rules √ Calculate Redundant Bracing Forces Ignore Redundant Members in FEA SR Leg Bolts Resist Compression √ All Leg Panels Have Same Allowable Offset Girt At Foundation √ Consider Feed Line Torque √ Include Angle Block Shear Check Use TIA-222-G Bracing Resist. Exemption Use TIA-222-G Tension Splice Exemption <li style="text-align: center;">Poles Include Shear-Torsion Interaction Always Use Sub-Critical Flow Use Top Mounted Sockets Pole Without Linear Attachments Pole With Shroud Or No Appurtenances Outside and Inside Corner Radii Are Known
--	---	---

tnxTower Ramaker & Associates, Inc 855 Community Drive Sauk City, WI 53583 Phone: (608) 643-4100 FAX: (608) 643-7999	Job Youngs Apple Orchard	Page 2 of 27
	Project 30775	Date 12:56:32 06/03/19
	Client T-Mobile	Designed by TEM

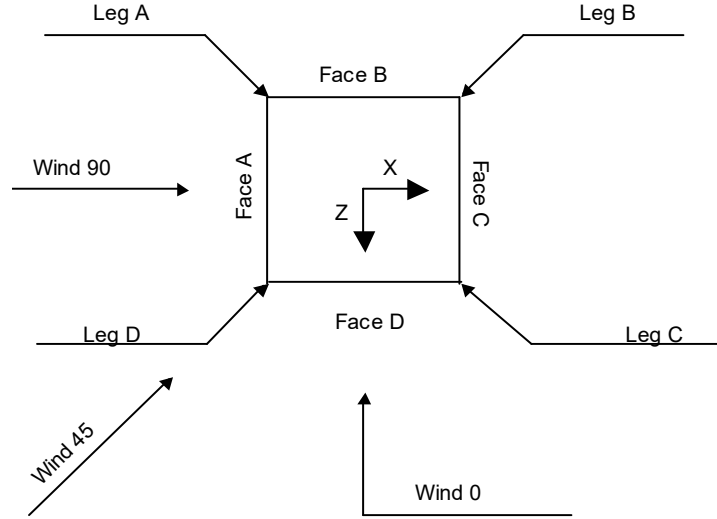

Square Tower

Tower Section Geometry

Tower Section	Tower Elevation	Assembly Database	Description	Section Width	Number of Sections	Section Length
	<i>ft</i>			<i>ft</i>		<i>ft</i>
T1	129.00-124.75			9.17	1	4.25
T2	124.75-112.46			9.67	1	12.29
T3	112.46-100.17			11.11	1	12.29
T4	100.17-87.50			12.56	1	12.67
T5	87.50-74.83			14.05	1	12.67
T6	74.83-49.67			15.54	1	25.17
T7	49.67-24.75			18.49	1	24.92
T8	24.75-0.00			21.42	1	24.75

Tower Section Geometry (cont'd)

Tower Section	Tower Elevation	Diagonal Spacing	Bracing Type	Has K Brace End Panels	Has Horizontals	Top Girt Offset	Bottom Girt Offset
	<i>ft</i>	<i>ft</i>				<i>in</i>	<i>in</i>
T1	129.00-124.75	4.25	X Brace	No	Yes	0.0000	0.0000
T2	124.75-112.46	12.29	K1 Down	No	Yes	0.0000	0.0000
T3	112.46-100.17	12.29	K1 Down	No	Yes	0.0000	0.0000
T4	100.17-87.50	12.67	K1 Down	No	Yes	0.0000	0.0000
T5	87.50-74.83	12.67	K1 Down	No	Yes	0.0000	0.0000
T6	74.83-49.67	25.17	K3A Down	No	Yes	0.0000	0.0000
T7	49.67-24.75	24.92	K3A Down	No	Yes	0.0000	0.0000
T8	24.75-0.00	24.75	K3A Down	No	Yes	0.0000	0.0000

tnxTower Ramaker & Associates, Inc 855 Community Drive Sauk City, WI 53583 Phone: (608) 643-4100 FAX: (608) 643-7999	Job	Youngs Apple Orchard	Page	3 of 27
	Project	30775	Date	12:56:32 06/03/19
	Client	T-Mobile	Designed by	TEM

Tower Section Geometry (cont'd)

Tower Elevation ft	Leg Type	Leg Size	Leg Grade	Diagonal Type	Diagonal Size	Diagonal Grade
T1 129.00-124.75	Single Angle	L4x4x3/8	A36 (36 ksi)	Double Angle		A36 (36 ksi)
T2 124.75-112.46	Single Angle	L4x4x3/8	A36 (36 ksi)	Double Angle	2L2 1/2x2x3/8x3/8	A36 (36 ksi)
T3 112.46-100.17	Single Angle	L4x4x3/8	A36 (36 ksi)	Double Angle	2L2 1/2x2x3/8x3/8	A36 (36 ksi)
T4 100.17-87.50	Single Angle	L5x5x1/2	A36 (36 ksi)	Double Angle	2L2 1/2x2x1/4x3/8	A36 (36 ksi)
T5 87.50-74.83	Single Angle	L5x5x1/2	A36 (36 ksi)	Double Angle	2L2 1/2x2x1/4x3/8	A36 (36 ksi)
T6 74.83-49.67	Single Angle	L6x6x1/2	A36 (36 ksi)	Double Angle	2L2 1/2x3x3/8x3/8	A36 (36 ksi)
T7 49.67-24.75	Single Angle	L6x6x5/8	A36 (36 ksi)	Double Angle	2L2 1/2x3x3/8x3/8	A36 (36 ksi)
T8 24.75-0.00	Single Angle	L8x8x1/2	A36 (36 ksi)	Double Angle	2L2 1/2x3x3/8x3/8	A36 (36 ksi)

Tower Section Geometry (cont'd)

Tower Elevation ft	Top Girt Type	Top Girt Size	Top Girt Grade	Bottom Girt Type	Bottom Girt Size	Bottom Girt Grade
T1 129.00-124.75	Solid Round	1	A36 (36 ksi)	Single Angle		A36 (36 ksi)

Tower Section Geometry (cont'd)

Tower Elevation ft	No. of Mid Girts	Mid Girt Type	Mid Girt Size	Mid Girt Grade	Horizontal Type	Horizontal Size	Horizontal Grade
T2 124.75-112.46	None	Flat Bar		A36 (36 ksi)	Channel	C9x13.4	A36 (36 ksi)
T3 112.46-100.17	None	Flat Bar		A36 (36 ksi)	Double Angle	2L2 1/2x2x1/4x3/8	A36 (36 ksi)
T4 100.17-87.50	None	Flat Bar		A36 (36 ksi)	Double Angle	2L2 1/2x2x1/4x3/8	A36 (36 ksi)
T5 87.50-74.83	None	Flat Bar		A36 (36 ksi)	Double Angle	2L2 1/2x2x1/4x3/8	A36 (36 ksi)
T6 74.83-49.67	None	Flat Bar		A36 (36 ksi)	Double Angle	2L2 1/2x2x1/4x3/8	A36 (36 ksi)
T7 49.67-24.75	None	Flat Bar		A36 (36 ksi)	Double Angle	2L2 1/2x2x1/4x3/8	A36 (36 ksi)
T8 24.75-0.00	None	Flat Bar		A36 (36 ksi)	Double Angle	2L2 1/2x2x1/4x3/8	A36 (36 ksi)

tnxTower Ramaker & Associates, Inc 855 Community Drive Sauk City, WI 53583 Phone: (608) 643-4100 FAX: (608) 643-7999	Job Youngs Apple Orchard	Page 4 of 27
	Project 30775	Date 12:56:32 06/03/19
	Client T-Mobile	Designed by TEM

Tower Section Geometry (cont'd)

Tower Elevation <i>ft</i>	Secondary Horizontal Type	Secondary Horizontal Size	Secondary Horizontal Grade	Inner Bracing Type	Inner Bracing Size	Inner Bracing Grade
T2 124.75-112.46	Equal Angle		A36 (36 ksi)	Single Angle	L2 1/2x2x3/16	A36 (36 ksi)
T3 112.46-100.17	Equal Angle		A36 (36 ksi)	Single Angle	L2 1/2x2x3/16	A36 (36 ksi)
T4 100.17-87.50	Equal Angle		A36 (36 ksi)	Single Angle	L2 1/2x2x3/16	A36 (36 ksi)
T5 87.50-74.83	Equal Angle		A36 (36 ksi)	Single Angle	L2 1/2x2x3/16	A36 (36 ksi)
T6 74.83-49.67	Equal Angle		A36 (36 ksi)	Single Angle	L2 1/2x2x3/16	A36 (36 ksi)
T7 49.67-24.75	Equal Angle		A36 (36 ksi)	Single Angle	L2 1/2x2x3/16	A36 (36 ksi)
T8 24.75-0.00	Equal Angle		A36 (36 ksi)	Single Angle	L2 1/2x2 1/2x3/16	A36 (36 ksi)

Tower Section Geometry (cont'd)

Tower Elevation <i>ft</i>	Redundant Bracing Grade	Redundant Type	Redundant Size	K Factor
T2 124.75-112.46	A36 (36 ksi)	Horizontal (1)	Single Angle	1
		Diagonal (1)	Single Angle	1
		Hip (1)	Single Angle	1
T3 112.46-100.17	A36 (36 ksi)	Horizontal (1)	Single Angle	1
		Diagonal (1)	Single Angle	1
		Hip (1)	Single Angle	1
T4 100.17-87.50	A36 (36 ksi)	Horizontal (1)	Single Angle	1
		Diagonal (1)	Single Angle	1
		Hip (1)	Single Angle	1
T5 87.50-74.83	A36 (36 ksi)	Horizontal (1)	Single Angle	1
		Diagonal (1)	Single Angle	1
		Hip (1)	Single Angle	1
T6 74.83-49.67	A36 (36 ksi)	Horizontal (1)	Single Angle	1
		Horizontal (2)	Single Angle	1
		Horizontal (3)	Single Angle	1
T7 49.67-24.75	A36 (36 ksi)	Diagonal (1)	Single Angle	1
		Diagonal (2)	Single Angle	1
		Diagonal (3)	Single Angle	1
T8 24.75-0.00	A36 (36 ksi)	Horizontal (1)	Single Angle	1
		Horizontal (2)	Single Angle	1
		Horizontal (3)	Single Angle	1
		Diagonal (1)	Single Angle	1
		Diagonal (2)	Single Angle	1
		Diagonal (3)	Single Angle	1

tnxTower Ramaker & Associates, Inc 855 Community Drive Sauk City, WI 53583 Phone: (608) 643-4100 FAX: (608) 643-7999	Job	Youngs Apple Orchard	Page	5 of 27
	Project	30775	Date	12:56:32 06/03/19
	Client	T-Mobile	Designed by	TEM

Tower Section Geometry (cont'd)

Tower Elevation	Gusset Area (per face)	Gusset Thickness	Gusset Grade	Adjust. Factor A_f	Adjust. Factor A_r	Weight Mult.	Double Angle Stitch Bolt Spacing Diagonals in	Double Angle Stitch Bolt Spacing Horizontals in	Double Angle Stitch Bolt Spacing Redundants in
ft	ft ²	in							
T1 129.00-124.75	0.00	0.0000	A36 (36 ksi)	1.03	1	1.02	36.0000	36.0000	36.0000
T2 124.75-112.46	0.00	0.0000	A36 (36 ksi)	1.03	1	1.02	21.0000	58.0000	36.0000
T3 112.46-100.17	0.00	0.0000	A36 (36 ksi)	1.03	1	1.02	24.0000	19.0000	36.0000
T4 100.17-87.50	0.00	0.0000	A36 (36 ksi)	1.03	1	1.02	21.0000	28.0000	36.0000
T5 87.50-74.83	0.00	0.0000	A36 (36 ksi)	1.03	1	1.02	24.0000	28.0000	36.0000
T6 74.83-49.67	0.00	0.0000	A36 (36 ksi)	1.03	1	1.02	19.0000	21.0000	36.0000
T7 49.67-24.75	0.00	0.0000	A36 (36 ksi)	1.03	1	1.02	19.0000	20.0000	22.0000
T8 24.75-0.00	0.00	0.0000	A36 (36 ksi)	1.03	1	1.02	20.0000	21.0000	24.0000

Tower Section Geometry (cont'd)

Tower Elevation	Calc K Single Angles	Calc K Solid Rounds	Legs	K Factors ¹							
				X Brace Diags	K Brace Diags	Single Diags	Girts	Horiz.	Sec. Horiz.	Inner Brace	
											X Y
ft											
T1 129.00-124.75	Yes	No	1	1	1	1	1	1	1	1	1
T2 124.75-112.46	Yes	No	1	1	1	1	1	1	1	1	1
T3 112.46-100.17	Yes	No	1	1	1	1	1	1	1	1	1
T4 100.17-87.50	Yes	No	1	1	1	1	1	1	1	1	1
T5 87.50-74.83	Yes	No	1	1	1	1	1	1	1	1	1
T6 74.83-49.67	Yes	No	1	1	1	1	1	1	1	1	1
T7 49.67-24.75	Yes	No	1	1	1	1	1	1	1	1	1
T8 24.75-0.00	Yes	No	1	1	1	1	1	1	1	1	1

¹Note: K factors are applied to member segment lengths. K-braces without inner supporting members will have the K factor in the out-of-plane direction applied to the overall length.

Tower Section Geometry (cont'd)

tnxTower Ramaker & Associates, Inc 855 Community Drive Sauk City, WI 53583 Phone: (608) 643-4100 FAX: (608) 643-7999	Job	Youngs Apple Orchard	Page	6 of 27
	Project	30775	Date	12:56:32 06/03/19
	Client	T-Mobile	Designed by	TEM

Tower Elevation ft	Leg		Diagonal		Top Girt		Bottom Girt		Mid Girt		Long Horizontal		Short Horizontal	
	Net Width Deduct in	U	Net Width Deduct in	U	Net Width Deduct in	U	Net Width Deduct in	U	Net Width Deduct in	U	Net Width Deduct in	U	Net Width Deduct in	U
T1 129.00-124.75	0.0000	1	0.0000	0.75	0.0000	0.75	0.0000	0.75	0.0000	0.75	0.0000	0.75	0.0000	0.75
T2 124.75-112.46	0.0000	1	0.0000	0.75	0.0000	0.75	0.0000	0.75	0.0000	0.75	0.0000	0.75	0.0000	0.75
T3 112.46-100.17	0.0000	1	0.0000	0.75	0.0000	0.75	0.0000	0.75	0.0000	0.75	0.0000	0.75	0.0000	0.75
T4 100.17-87.50	0.0000	1	0.0000	0.75	0.0000	0.75	0.0000	0.75	0.0000	0.75	0.0000	0.75	0.0000	0.75
T5 87.50-74.83	0.0000	1	0.0000	0.75	0.0000	0.75	0.0000	0.75	0.0000	0.75	0.0000	0.75	0.0000	0.75
T6 74.83-49.67	0.0000	1	0.0000	0.75	0.0000	0.75	0.0000	0.75	0.0000	0.75	0.0000	0.75	0.0000	0.75
T7 49.67-24.75	0.0000	1	0.0000	0.75	0.0000	0.75	0.0000	0.75	0.0000	0.75	0.0000	0.75	0.0000	0.75
T8 24.75-0.00	0.0000	1	0.0000	0.75	0.0000	0.75	0.0000	0.75	0.0000	0.75	0.0000	0.75	0.0000	0.75

Tower Section Geometry (cont'd)

Tower Elevation ft	Leg Connection Type	Leg		Diagonal		Top Girt		Bottom Girt		Mid Girt		Long Horizontal		Short Horizontal	
		Bolt Size in	No.	Bolt Size in	No.	Bolt Size in	No.	Bolt Size in	No.	Bolt Size in	No.	Bolt Size in	No.	Bolt Size in	No.
T1 129.00-124.75	Sleeve SS	0.6250	0	0.6250	0	0.6250	0	0.0000	0	0.6250	0	0.6250	0	0.6250	0
		A307		A307		A325N		A325N		A325N		A307		A325N	
T2 124.75-112.46	Sleeve SS	0.6250	0	0.6250	2	0.6250	0	0.0000	0	0.6250	0	0.6250	3	0.6250	0
		A307		A307		A325N		A325N		A325N		A307		A325N	
T3 112.46-100.17	Sleeve SS	0.6250	24	0.6250	2	0.6250	0	0.6250	0	0.6250	0	0.6250	2	0.6250	0
		A307		A307		A325N		A325N		A325N		A307		A325N	
T4 100.17-87.50	Sleeve SS	0.6250	0	0.6250	2	0.6250	0	0.0000	0	0.6250	0	0.6250	2	0.6250	0
		A307		A307		A325N		A325N		A325N		A307		A325N	
T5 87.50-74.83	Sleeve SS	0.6250	24	0.6250	2	0.6250	0	0.6250	0	0.6250	0	0.6250	2	0.6250	0
		A307		A307		A325N		A325N		A325N		A307		A325N	
T6 74.83-49.67	Sleeve SS	0.6250	32	0.6250	2	0.6250	0	0.6250	0	0.6250	0	0.6250	2	0.6250	0
		A307		A307		A325N		A325N		A325N		A307		A325N	
T7 49.67-24.75	Sleeve SS	0.6250	40	0.6250	2	0.6250	0	0.6250	0	0.6250	0	0.6250	2	0.6250	0
		A307		A307		A325N		A325N		A325N		A307		A325N	
T8 24.75-0.00	Sleeve SS	0.6250	48	0.6250	2	0.6250	0	0.6250	0	0.6250	0	0.6250	2	0.6250	0
		A307		A307		A325N		A325N		A325N		A307		A325N	

Feed Line/Linear Appurtenances - Entered As Round Or Flat

Description	Face or Leg	Allow Shield	Exclude From Torque Calculation	Component Type	Placement ft	Face Offset in	Lateral Offset (Frac FW)	#	# Per Row	Clear Spacing in	Width or Diameter in	Perimeter in	Weight plf

L4x4x1/4 Climbing Pegs	D	No	No	Ar (CaAa)	129.00 - 75.00	0.0000	0	1	1	4.0000	4.0000		6.60
Safety Line 3/8	D	No	No	Ar (CaAa)	129.00 - 75.00	0.0000	0	1	1	0.8800	0.8800		0.00

1/2 (129)	B	No	No	Ar (CaAa)	129.00 - 0.00	0.0000	0.1	1	1	0.5800	0.5800		0.25

7/8 (129)	A	No	No	Ar (CaAa)	129.00 - 0.00	-2.0000	0.35	1	1	1.1100	1.1100		0.54

tnxTower Ramaker & Associates, Inc 855 Community Drive Sauk City, WI 53583 Phone: (608) 643-4100 FAX: (608) 643-7999	Job Youngs Apple Orchard	Page 7 of 27
	Project 30775	Date 12:56:32 06/03/19
	Client T-Mobile	Designed by TEM

Description	Face or Leg	Allow Shield	Exclude From Torque Calculation	Component Type	Placement ft	Face Offset in	Lateral Offset (Frac FW)	#	# Per Row	Clear Spacing in	Width or Diameter in	Perimeter in	Weight plf
***** 1 1/4 (125)	A	No	No	Ar (CaAa)	125.00 - 0.00	-2.0000	0.41	3	3	1.5500	1.5500		0.66
1 1/4 (125)	A	No	No	Ar (CaAa)	125.00 - 0.00	-2.0000	0.43	1	1	1.5500	1.5500		0.66
Feedline Ladder (Af) (125)	A	No	No	Af (CaAa)	125.00 - 0.00	-2.0000	0.37	1	1	3.0000	3.0000		8.40
***** EU 90 (117.5)	A	No	No	Ar (CaAa)	117.50 - 0.00	-2.0000	0.33	1	1	1.2900	1.2900		0.34
***** 3/8 (102)	B	No	No	Ar (CaAa)	102.00 - 0.00	0.0000	0.5	1	1	0.4400	0.4400		0.08
***** 7/8 (100)	A	No	No	Ar (CaAa)	100.00 - 0.00	-2.0000	0.31	1	1	1.1100	1.1100		0.54
1/2 (100)	A	No	No	Ar (CaAa)	100.00 - 0.00	-2.0000	0.29	1	1	0.5800	0.5800		0.25
***** 1 5/8 (94)	A	No	No	Ar (CaAa)	94.00 - 0.00	8.0000	0.5	12	2	1.9800	1.9800		1.04
RET Cable (94)	A	No	No	Ar (CaAa)	94.00 - 0.00	3.0000	0.47	1	1	0.4400	0.4400		0.08
MLCH Hybrid 6X12 (1-3/8") (94)	A	No	No	Ar (CaAa)	94.00 - 0.00	3.0000	0.45	3	3	1.4300	1.4300		1.72
T-Bracket (94)	A	No	No	Ar (CaAa)	94.00 - 0.00	3.0000	0.5	1	1	0.7500	1.0000		1.50
***** L4x4x1/4 Climbing Pegs	B	No	No	Ar (CaAa)	79.00 - 0.00	0.0000	0	1	1	4.0000	4.0000		6.60
Safety Line 3/8	B	No	No	Ar (CaAa)	79.00 - 0.00	0.0000	0.04	1	1	0.8800	0.8800		0.00
***** 1/2 (74)	B	No	No	Ar (CaAa)	79.00 - 0.00	0.0000	0.04	1	1	0.3750	0.3750		0.22
***** 1/2 (74)	A	No	No	Ar (CaAa)	74.00 - 0.00	-2.0000	0.39	1	1	0.5800	0.5800		0.25

Feed Line/Linear Appurtenances Section Areas

Tower Section	Tower Elevation ft	Face	A _R ft ²	A _F ft ²	C _A A _A In Face ft ²	C _A A _A Out Face ft ²	Weight lb
T1	129.00-124.75	A	0.000	0.000	0.752	0.000	5.05
		B	0.000	0.000	0.247	0.000	1.06
		C	0.000	0.000	0.000	0.000	0.00
		D	0.000	0.000	1.938	0.000	28.98
T2	124.75-112.46	A	0.000	0.000	15.781	0.000	144.05
		B	0.000	0.000	0.713	0.000	3.07
		C	0.000	0.000	0.000	0.000	0.00
		D	0.000	0.000	5.635	0.000	83.83
T3	112.46-100.17	A	0.000	0.000	16.717	0.000	146.52
		B	0.000	0.000	0.794	0.000	3.22
		C	0.000	0.000	0.000	0.000	0.00
		D	0.000	0.000	5.682	0.000	83.83
T4	100.17-87.50	A	0.000	0.000	38.508	0.000	285.69

tnxTower Ramaker & Associates, Inc 855 Community Drive Sauk City, WI 53583 Phone: (608) 643-4100 FAX: (608) 643-7999	Job	Youngs Apple Orchard	Page	8 of 27
	Project	30775	Date	12:56:32 06/03/19
	Client	T-Mobile	Designed by	TEM

Tower Section	Tower Elevation ft	Face	A_R ft ²	A_F ft ²	C_{AA} In Face ft ²	C_{AA} Out Face ft ²	Weight lb
T5	87.50-74.83	B	0.000	0.000	1.292	0.000	4.18
		C	0.000	0.000	0.000	0.000	0.00
		D	0.000	0.000	5.912	0.000	86.39
		A	0.000	0.000	56.721	0.000	404.26
T6	74.83-49.67	B	0.000	0.000	3.267	0.000	32.60
		C	0.000	0.000	0.000	0.000	0.00
		D	0.000	0.000	5.899	0.000	85.25
		A	0.000	0.000	114.108	0.000	809.28
T7	49.67-24.75	B	0.000	0.000	14.693	0.000	179.94
		C	0.000	0.000	0.000	0.000	0.00
		D	0.000	0.000	0.000	0.000	0.00
		A	0.000	0.000	113.022	0.000	801.44
T8	24.75-0.00	B	0.000	0.000	15.041	0.000	178.15
		C	0.000	0.000	0.000	0.000	0.00
		D	0.000	0.000	0.000	0.000	0.00
		A	0.000	0.000	112.266	0.000	796.08
		B	0.000	0.000	15.531	0.000	176.96
		C	0.000	0.000	0.000	0.000	0.00
		D	0.000	0.000	0.000	0.000	0.00
		A	0.000	0.000	0.000	0.000	0.00

Feed Line/Linear Appurtenances Section Areas - With Ice

Tower Section	Tower Elevation ft	Face or Leg	Ice Thickness in	A_R ft ²	A_F ft ²	C_{AA} In Face ft ²	C_{AA} Out Face ft ²	Weight lb
T1	129.00-124.75	A	1.716	0.000	0.000	2.648	0.000	39.39
		B		0.000	0.000	1.705	0.000	21.52
		C		0.000	0.000	0.000	0.000	0.00
		D		0.000	0.000	6.610	0.000	121.70
T2	124.75-112.46	A	1.705	0.000	0.000	43.120	0.000	693.50
		B		0.000	0.000	4.904	0.000	61.56
		C		0.000	0.000	0.000	0.000	0.00
		D		0.000	0.000	19.031	0.000	349.28
T3	112.46-100.17	A	1.686	0.000	0.000	46.269	0.000	732.57
		B		0.000	0.000	5.557	0.000	68.63
		C		0.000	0.000	0.000	0.000	0.00
		D		0.000	0.000	18.895	0.000	344.98
T4	100.17-87.50	A	1.665	0.000	0.000	94.187	0.000	1651.82
		B		0.000	0.000	9.729	0.000	116.29
		C		0.000	0.000	0.000	0.000	0.00
		D		0.000	0.000	19.312	0.000	350.55
T5	87.50-74.83	A	1.641	0.000	0.000	128.044	0.000	2355.44
		B		0.000	0.000	15.900	0.000	226.92
		C		0.000	0.000	0.000	0.000	0.00
		D		0.000	0.000	18.878	0.000	340.38
T6	74.83-49.67	A	1.598	0.000	0.000	260.801	0.000	4690.54
		B		0.000	0.000	56.016	0.000	881.03
		C		0.000	0.000	0.000	0.000	0.00
		D		0.000	0.000	0.000	0.000	0.00
T7	49.67-24.75	A	1.518	0.000	0.000	252.972	0.000	4459.28
		B		0.000	0.000	53.462	0.000	818.93
		C		0.000	0.000	0.000	0.000	0.00
		D		0.000	0.000	0.000	0.000	0.00
T8	24.75-0.00	A	1.360	0.000	0.000	240.411	0.000	4074.01
		B		0.000	0.000	49.187	0.000	714.57
		C		0.000	0.000	0.000	0.000	0.00
		D		0.000	0.000	0.000	0.000	0.00

tnxTower Ramaker & Associates, Inc 855 Community Drive Sauk City, WI 53583 Phone: (608) 643-4100 FAX: (608) 643-7999	Job Youngs Apple Orchard	Page 9 of 27
	Project 30775	Date 12:56:32 06/03/19
	Client T-Mobile	Designed by TEM

Feed Line Center of Pressure

Section	Elevation	CP _x	CP _z	CP _x Ice	CP _z Ice
	ft	in	in	in	in
T1	129.00-124.75	-2.0983	4.6777	-4.2394	2.9281
T2	124.75-112.46	-5.0178	-1.7798	-9.9994	-5.9642
T3	112.46-100.17	-7.0887	-2.7778	-12.9208	-8.1790
T4	100.17-87.50	-17.8932	-7.9443	-24.6895	-17.1562
T5	87.50-74.83	-26.0053	-13.3015	-32.2370	-24.0141
T6	74.83-49.67	-26.8902	-21.5887	-35.1891	-35.8662
T7	49.67-24.75	-29.1273	-23.8198	-38.4914	-39.2995
T8	24.75-0.00	-29.6229	-22.6587	-39.6598	-40.2866

Shielding Factor Ka

Tower Section	Feed Line Record No.	Description	Feed Line Segment Elev.	K _a No Ice	K _a Ice
T1	2	L4x4x1/4	124.75 - 129.00	1.0000	0.6000
T1	3	Climbing Pegs	124.75 - 129.00	0.6000	0.6000
T1	4	Safety Line 3/8	124.75 - 129.00	0.6000	0.6000
T1	6	1/2	124.75 - 129.00	0.6000	0.6000
T1	8	7/8	124.75 - 129.00	1.0000	1.0000
T1	10	1 1/4	124.75 - 125.00	0.6000	0.6000
T1	11	1 1/4	124.75 - 125.00	0.6000	0.6000
T1	12	Feedline Ladder (Af)	124.75 - 125.00	0.6000	0.6000
T2	2	L4x4x1/4	112.46 - 124.75	1.0000	0.6000
T2	3	Climbing Pegs	112.46 - 124.75	0.6000	0.6000
T2	4	Safety Line 3/8	112.46 - 124.75	0.6000	0.6000
T2	6	1/2	112.46 - 124.75	0.6000	0.6000
T2	8	7/8	112.46 - 124.75	1.0000	1.0000
T2	10	1 1/4	112.46 - 124.75	0.6000	0.6000
T2	11	1 1/4	112.46 - 124.75	0.6000	0.6000
T2	12	Feedline Ladder (Af)	112.46 - 124.75	0.6000	0.6000
T2	14	EU 90	112.46 - 117.50	1.0000	1.0000
T3	2	L4x4x1/4	100.17 - 112.46	1.0000	0.6000
T3	3	Climbing Pegs	100.17 - 112.46	0.6000	0.6000
T3	4	Safety Line 3/8	100.17 - 112.46	0.6000	0.6000
T3	6	1/2	100.17 - 112.46	0.6000	0.6000
T3	8	7/8	100.17 - 112.46	1.0000	1.0000
T3	10	1 1/4	100.17 - 112.46	0.6000	0.6000
T3	11	1 1/4	100.17 - 112.46	0.6000	0.6000
T3	12	Feedline Ladder (Af)	100.17 - 112.46	0.6000	0.6000
T3	14	EU 90	100.17 - 112.46	1.0000	1.0000
T3	16	3/8	100.17 - 102.00	0.6000	0.6000
T4	2	L4x4x1/4	87.50 - 100.17	1.0000	0.6000
T4	3	Climbing Pegs	87.50 - 100.17	0.6000	0.6000
T4	4	Safety Line 3/8	87.50 - 100.17	0.6000	0.6000
T4	6	1/2	87.50 - 100.17	0.6000	0.6000
T4	8	7/8	87.50 - 100.17	1.0000	1.0000
T4	10	1 1/4	87.50 - 100.17	0.6000	0.6000
T4	11	1 1/4	87.50 - 100.17	0.6000	0.6000
T4	12	Feedline Ladder (Af)	87.50 - 100.17	0.6000	0.6000

Job	Youngs Apple Orchard	Page	10 of 27
Project	30775	Date	12:56:32 06/03/19
Client	T-Mobile	Designed by	TEM

Tower Section	Feed Line Record No.	Description	Feed Line Segment Elev.	K _a No Ice	K _a Ice
T4	14	EU 90	87.50 - 100.17	1.0000	1.0000
T4	16	3/8	87.50 - 100.17	0.6000	0.6000
T4	18	7/8	87.50 - 100.00	1.0000	1.0000
T4	19	1/2	87.50 - 100.00	1.0000	1.0000
T4	21	1 5/8	87.50 - 94.00	0.6000	0.6000
T4	22	RET Cable	87.50 - 94.00	0.6000	0.6000
T4	23	MLCH Hybrid 6X12 (1-3/8")	87.50 - 94.00	0.6000	0.6000
T4	24	T-Bracket	87.50 - 94.00	0.6000	0.6000
T5	2	L4x4x1/4	75.00 - 87.50	1.0000	0.6000
T5	3	Climbing Pegs	75.00 - 87.50	0.6000	0.6000
T5	4	Safety Line 3/8	75.00 - 87.50	0.6000	0.6000
T5	6	1/2	74.83 - 87.50	0.6000	0.6000
T5	8	7/8	74.83 - 87.50	1.0000	1.0000
T5	10	1 1/4	74.83 - 87.50	0.6000	0.6000
T5	11	1 1/4	74.83 - 87.50	0.6000	0.6000
T5	12	Feedline Ladder (Af)	74.83 - 87.50	0.6000	0.6000
T5	14	EU 90	74.83 - 87.50	1.0000	1.0000
T5	16	3/8	74.83 - 87.50	0.6000	0.6000
T5	18	7/8	74.83 - 87.50	1.0000	1.0000
T5	19	1/2	74.83 - 87.50	1.0000	1.0000
T5	21	1 5/8	74.83 - 87.50	0.6000	0.6000
T5	22	RET Cable	74.83 - 87.50	0.6000	0.6000
T5	23	MLCH Hybrid 6X12 (1-3/8")	74.83 - 87.50	0.6000	0.6000
T5	24	T-Bracket	74.83 - 87.50	0.6000	0.6000
T5	26	L4x4x1/4	74.83 - 79.00	1.0000	0.6000
T5	27	Climbing Pegs	74.83 - 79.00	0.6000	0.6000
T5	28	Safety Line 3/8	74.83 - 79.00	0.6000	0.6000
T6	6	1/2	49.67 - 74.83	0.6000	0.6000
T6	8	7/8	49.67 - 74.83	1.0000	1.0000
T6	10	1 1/4	49.67 - 74.83	0.6000	0.6000
T6	11	1 1/4	49.67 - 74.83	0.6000	0.6000
T6	12	Feedline Ladder (Af)	49.67 - 74.83	0.6000	0.6000
T6	14	EU 90	49.67 - 74.83	1.0000	1.0000
T6	16	3/8	49.67 - 74.83	0.6000	0.6000
T6	18	7/8	49.67 - 74.83	1.0000	1.0000
T6	19	1/2	49.67 - 74.83	1.0000	1.0000
T6	21	1 5/8	49.67 - 74.83	0.6000	0.6000
T6	22	RET Cable	49.67 - 74.83	0.6000	0.6000
T6	23	MLCH Hybrid 6X12 (1-3/8")	49.67 - 74.83	0.6000	0.6000
T6	24	T-Bracket	49.67 - 74.83	0.6000	0.6000
T6	26	L4x4x1/4	49.67 - 74.83	1.0000	0.6000
T6	27	Climbing Pegs	49.67 - 74.83	0.6000	0.6000
T6	28	Safety Line 3/8	49.67 - 74.83	0.6000	0.6000
T6	30	1/2	49.67 - 74.00	0.6000	0.6000
T7	6	1/2	24.75 - 49.67	0.6000	0.6000
T7	8	7/8	24.75 - 49.67	1.0000	1.0000
T7	10	1 1/4	24.75 - 49.67	0.6000	0.6000
T7	11	1 1/4	24.75 - 49.67	0.6000	0.6000
T7	12	Feedline Ladder (Af)	24.75 - 49.67	0.6000	0.6000
T7	14	EU 90	24.75 - 49.67	1.0000	1.0000
T7	16	3/8	24.75 - 49.67	0.6000	0.6000
T7	18	7/8	24.75 - 49.67	1.0000	1.0000
T7	19	1/2	24.75 - 49.67	1.0000	1.0000
T7	21	1 5/8	24.75 - 49.67	0.6000	0.6000
T7	22	RET Cable	24.75 - 49.67	0.6000	0.6000
T7	23	MLCH Hybrid 6X12 (1-3/8")	24.75 - 49.67	0.6000	0.6000
T7	24	T-Bracket	24.75 - 49.67	0.6000	0.6000
T7	26	L4x4x1/4	24.75 - 49.67	1.0000	0.6000
T7	27	Climbing Pegs	24.75 - 49.67	0.6000	0.6000
T7	28	Safety Line 3/8	24.75 - 49.67	0.6000	0.6000
T7	30	1/2	24.75 - 49.67	0.6000	0.6000
T8	6	1/2	0.00 - 24.75	0.6000	0.6000

tnxTower Ramaker & Associates, Inc 855 Community Drive Sauk City, WI 53583 Phone: (608) 643-4100 FAX: (608) 643-7999	Job Youngs Apple Orchard	Page 11 of 27
	Project 30775	Date 12:56:32 06/03/19
	Client T-Mobile	Designed by TEM

Tower Section	Feed Line Record No.	Description	Feed Line Segment Elev.	K _a No Ice	K _a Ice
T8	8	7/8	0.00 - 24.75	1.0000	1.0000
T8	10	1 1/4	0.00 - 24.75	0.6000	0.6000
T8	11	1 1/4	0.00 - 24.75	0.6000	0.6000
T8	12	Feedline Ladder (Af)	0.00 - 24.75	0.6000	0.6000
T8	14	EU 90	0.00 - 24.75	1.0000	1.0000
T8	16	3/8	0.00 - 24.75	0.6000	0.6000
T8	18	7/8	0.00 - 24.75	1.0000	1.0000
T8	19	1/2	0.00 - 24.75	1.0000	1.0000
T8	21	1 5/8	0.00 - 24.75	0.6000	0.6000
T8	22	RET Cable	0.00 - 24.75	0.6000	0.6000
T8	23	MLCH Hybrid 6X12 (1-3/8")	0.00 - 24.75	0.6000	0.6000
T8	24	T-Bracket	0.00 - 24.75	0.6000	0.6000
T8	26	L4x4x1/4	0.00 - 24.75	0.6000	0.6000
T8	27	Climbing Pegs	0.00 - 24.75	0.6000	0.6000
T8	28	Safety Line 3/8	0.00 - 24.75	0.6000	0.6000
T8	30	1/2	0.00 - 24.75	0.6000	0.6000

Discrete Tower Loads

Description	Face or Leg	Offset Type	Offsets: Horz Lateral Vert	Azimuth Adjustment	Placement	C _{AA} Front	C _{AA} Side	Weight
			ft ft ft	°	ft	ft ²	ft ²	lb
***** CC807-08	D	From Leg	0.50 0.00	0.0000	132.00	No Ice 1/2" Ice	2.85 3.83	27.00 47.72
			4.75			1" Ice	4.67	74.70
20'x2 1/2" Pipe Mount (Others)	D	From Leg	0.50 0.00	0.0000	132.00	No Ice 1/2" Ice	5.75 7.78	116.00 157.62
			-10.00			1" Ice	9.83	211.89

APXVSPP18-C-A20 w/Mount Pipe	B	From Leg	4.00 0.00	0.0000	125.00	No Ice 1/2" Ice	8.31 8.87	82.55 150.82
			1.66			1" Ice	9.40	227.06
APXVSPP18-C-A20 w/Mount Pipe	C	From Leg	4.00 0.00	0.0000	125.00	No Ice 1/2" Ice	8.31 8.87	82.55 150.82
			1.66			1" Ice	9.40	227.06
APXVSPP18-C-A20 w/Mount Pipe	D	From Leg	4.00 0.00	0.0000	125.00	No Ice 1/2" Ice	8.31 8.87	82.55 150.82
			1.66			1" Ice	9.40	227.06
800MHz 2x50W RRH	B	From Leg	1.00 0.00	0.0000	125.00	No Ice 1/2" Ice	2.06 2.24	64.00 86.12
			3.00			1" Ice	2.43	111.30
800MHz 2x50W RRH	C	From Leg	1.00 0.00	0.0000	125.00	No Ice 1/2" Ice	2.06 2.24	64.00 86.12
			3.00			1" Ice	2.43	111.30
800MHz 2x50W RRH	D	From Leg	1.00 0.00	0.0000	125.00	No Ice 1/2" Ice	2.06 2.24	64.00 86.12
			3.00			1" Ice	2.43	111.30
800 External Notch Filter	B	From Leg	1.00 0.00	0.0000	125.00	No Ice 1/2" Ice	0.65 0.76	11.00 16.54
			3.00			1" Ice	0.87	23.67

tnxTower Ramaker & Associates, Inc 855 Community Drive Sauk City, WI 53583 Phone: (608) 643-4100 FAX: (608) 643-7999	Job	Youngs Apple Orchard	Page	12 of 27
	Project	30775	Date	12:56:32 06/03/19
	Client	T-Mobile	Designed by	TEM

Description	Face or Leg	Offset Type	Offsets:		Azimuth Adjustment	Placement	CAA Front	CAA Side	Weight	
			Horz	Vert						ft
			Lateral		°	ft	ft ²	ft ²	lb	
			ft	ft						
800 External Notch Filter	C	From Leg	1.00	0.00	0.0000	125.00	No Ice	0.65	0.29	11.00
			0.00				1/2" Ice	0.76	0.37	16.54
			3.00				1" Ice	0.87	0.45	23.67
800 External Notch Filter	D	From Leg	1.00	0.00	0.0000	125.00	No Ice	0.65	0.29	11.00
			0.00				1/2" Ice	0.76	0.37	16.54
			3.00				1" Ice	0.87	0.45	23.67
1900MHz 4x45W RRH	B	From Leg	1.00	0.00	0.0000	125.00	No Ice	2.32	2.24	59.50
			0.00				1/2" Ice	2.53	2.44	82.62
			-0.25				1" Ice	2.74	2.65	108.98
1900MHz 4x45W RRH	C	From Leg	1.00	0.00	0.0000	125.00	No Ice	2.32	2.24	59.50
			0.00				1/2" Ice	2.53	2.44	82.62
			-0.25				1" Ice	2.74	2.65	108.98
1900MHz 4x45W RRH	D	From Leg	1.00	0.00	0.0000	125.00	No Ice	2.32	2.24	59.50
			0.00				1/2" Ice	2.53	2.44	82.62
			-0.25				1" Ice	2.74	2.65	108.98
DT465B-2XR w/Mount Pipe	B	From Leg	4.00	6.00	0.0000	125.00	No Ice	9.34	7.64	83.55
			1.66				1/2" Ice	9.91	8.82	160.05
			6.00				1" Ice	10.44	9.72	244.71
DT465B-2XR w/Mount Pipe	C	From Leg	4.00	6.00	0.0000	125.00	No Ice	9.34	7.64	83.55
			1.66				1/2" Ice	9.91	8.82	160.05
			6.00				1" Ice	10.44	9.72	244.71
DT465B-2XR w/Mount Pipe	D	From Leg	4.00	6.00	0.0000	125.00	No Ice	9.34	7.64	83.55
			1.66				1/2" Ice	9.91	8.82	160.05
			6.00				1" Ice	10.44	9.72	244.71
800MHz 2x50W RRH	B	From Leg	4.00	6.00	0.0000	125.00	No Ice	2.06	1.93	64.00
			4.66				1/2" Ice	2.24	2.11	86.12
			6.00				1" Ice	2.43	2.29	111.30
800MHz 2x50W RRH	C	From Leg	4.00	6.00	0.0000	125.00	No Ice	2.06	1.93	64.00
			4.66				1/2" Ice	2.24	2.11	86.12
			6.00				1" Ice	2.43	2.29	111.30
800MHz 2x50W RRH	D	From Leg	4.00	6.00	0.0000	125.00	No Ice	2.06	1.93	64.00
			4.66				1/2" Ice	2.24	2.11	86.12
			6.00				1" Ice	2.43	2.29	111.30
TD-RRH8x20-25	B	From Leg	4.00	6.00	0.0000	125.00	No Ice	4.05	1.53	70.00
			1.66				1/2" Ice	4.30	1.71	97.14
			6.00				1" Ice	4.56	1.90	127.80
TD-RRH8x20-25	C	From Leg	4.00	6.00	0.0000	125.00	No Ice	4.05	1.53	70.00
			1.66				1/2" Ice	4.30	1.71	97.14
			6.00				1" Ice	4.56	1.90	127.80
TD-RRH8x20-25	D	From Leg	4.00	6.00	0.0000	125.00	No Ice	4.05	1.53	70.00
			1.66				1/2" Ice	4.30	1.71	97.14
			6.00				1" Ice	4.56	1.90	127.80
Sector Mount [SM 702-1] (Sprint)	B	From Leg	4.00	0.00	0.0000	125.00	No Ice	20.60	12.90	517.00
			0.00				1/2" Ice	28.80	19.40	784.00
			0.00				1" Ice	37.00	25.90	1051.00
Sector Mount [SM 702-1] (Sprint)	C	From Leg	4.00	0.00	0.0000	125.00	No Ice	20.60	12.90	517.00
			0.00				1/2" Ice	28.80	19.40	784.00
			0.00				1" Ice	37.00	25.90	1051.00
Sector Mount [SM 702-1] (Sprint)	D	From Leg	4.00	0.00	0.0000	125.00	No Ice	20.60	12.90	517.00
			0.00				1/2" Ice	28.80	19.40	784.00
			0.00				1" Ice	37.00	25.90	1051.00

4'x4" Pipe Mount (Others)	D	From Leg	1.00	0.00	0.0000	117.50	No Ice	1.11	1.11	44.00
			0.00				1/2" Ice	1.58	1.58	56.99
			0.00				1" Ice	1.84	1.84	73.03

CC807-08	D	From Leg	6.00	0.00	0.0000	100.00	No Ice	2.85	2.85	27.00

Job	Youngs Apple Orchard	Page	13 of 27
Project	30775	Date	12:56:32 06/03/19
Client	T-Mobile	Designed by	TEM

Description	Face or Leg	Offset Type	Offsets:		Azimuth Adjustment	Placement	CAA _A Front	CAA _A Side	Weight	
			Horz	Vert						
			ft	ft	°	ft	ft ²	ft ²	lb	
			0.00							
			4.75							
TMA	D	From Leg	2.00		0.0000	100.00	1/2" Ice	3.83	3.83	47.72
			0.00				1" Ice	4.67	4.67	74.70
			0.00				No Ice	1.20	0.60	5.00
			0.00				1/2" Ice	1.34	0.70	15.34
			0.00				1" Ice	1.48	0.81	27.81
Side Arm Mount [SO 601-1] (Others)	D	From Leg	3.00		0.0000	100.00	No Ice	1.22	6.30	158.70
			0.00				1/2" Ice	1.85	8.61	196.52
			0.00				1" Ice	2.48	10.92	234.34

APXVAARR24_43-U-NA20	A	From Face	1.00		0.0000	94.00	No Ice	20.24	8.89	69.50
			6.00				1/2" Ice	20.89	9.49	182.09
			0.00				1" Ice	21.54	10.09	303.22
APXVAARR24_43-U-NA20	C	From Face	1.00		0.0000	94.00	No Ice	20.24	8.89	69.50
			6.00				1/2" Ice	20.89	9.49	182.09
			0.00				1" Ice	21.54	10.09	303.22
APXVAARR24_43-U-NA20	D	From Face	1.00		0.0000	94.00	No Ice	20.24	8.89	69.50
			6.00				1/2" Ice	20.89	9.49	182.09
			0.00				1" Ice	21.54	10.09	303.22
KRY 112 89/4	A	From Face	1.00		0.0000	94.00	No Ice	0.56	0.37	15.43
			6.00				1/2" Ice	0.66	0.45	20.51
			0.00				1" Ice	0.77	0.54	27.15
KRY 112 89/4	C	From Face	1.00		0.0000	94.00	No Ice	0.56	0.37	15.43
			6.00				1/2" Ice	0.66	0.45	20.51
			0.00				1" Ice	0.77	0.54	27.15
KRY 112 89/4	D	From Face	1.00		0.0000	94.00	No Ice	0.56	0.37	15.43
			6.00				1/2" Ice	0.66	0.45	20.51
			0.00				1" Ice	0.77	0.54	27.15
Radio 4449 - B12 + B71	A	From Face	1.00		0.0000	94.00	No Ice	1.64	1.15	74.00
			6.00				1/2" Ice	1.80	1.29	90.08
			0.00				1" Ice	1.97	1.44	108.77
Radio 4449 - B12 + B71	C	From Face	1.00		0.0000	94.00	No Ice	1.64	1.15	74.00
			6.00				1/2" Ice	1.80	1.29	90.08
			0.00				1" Ice	1.97	1.44	108.77
Radio 4449 - B12 + B71	D	From Face	1.00		0.0000	94.00	No Ice	1.64	1.15	74.00
			6.00				1/2" Ice	1.80	1.29	90.08
			0.00				1" Ice	1.97	1.44	108.77
Radio 4415 B25	A	From Face	1.00		0.0000	94.00	No Ice	1.84	0.82	46.00
			6.00				1/2" Ice	2.01	0.94	60.07
			0.00				1" Ice	2.19	1.07	76.66
Radio 4415 B25	C	From Face	1.00		0.0000	94.00	No Ice	1.84	0.82	46.00
			6.00				1/2" Ice	2.01	0.94	60.07
			0.00				1" Ice	2.19	1.07	76.66
Radio 4415 B25	D	From Face	1.00		0.0000	94.00	No Ice	1.84	0.82	46.00
			6.00				1/2" Ice	2.01	0.94	60.07
			0.00				1" Ice	2.19	1.07	76.66
Radio 4415 B66A	A	From Face	1.00		0.0000	94.00	No Ice	1.86	0.82	44.09
			6.00				1/2" Ice	2.03	0.94	58.21
			0.00				1" Ice	2.20	1.07	74.84
Radio 4415 B66A	C	From Face	1.00		0.0000	94.00	No Ice	1.86	0.82	44.09
			6.00				1/2" Ice	2.03	0.94	58.21
			0.00				1" Ice	2.20	1.07	74.84
Radio 4415 B66A	D	From Face	1.00		0.0000	94.00	No Ice	1.86	0.82	44.09
			6.00				1/2" Ice	2.03	0.94	58.21
			0.00				1" Ice	2.20	1.07	74.84
(2) 14.5"x2-1/2" Pipe Mount (TMobile)	A	From Face	1.00		0.0000	94.00	No Ice	4.17	4.17	84.10
			0.00				1/2" Ice	5.65	5.65	114.38
			0.00				1" Ice	7.15	7.15	153.96

tnxTower Ramaker & Associates, Inc 855 Community Drive Sauk City, WI 53583 Phone: (608) 643-4100 FAX: (608) 643-7999	Job	Youngs Apple Orchard	Page	14 of 27
	Project	30775	Date	12:56:32 06/03/19
	Client	T-Mobile	Designed by	TEM

Description	Face or Leg	Offset Type	Offsets: Horz Lateral Vert ft ft ft	Azimuth Adjustment °	Placement ft		C _{AA} Front ft ²	C _{AA} Side ft ²	Weight lb
(2) 14.5'x2-1/2" Pipe Mount (TMobile)	C	From Face	1.00 0.00 0.00	0.0000	94.00	No Ice 1/2" Ice 1" Ice	4.17 5.65 7.15	4.17 5.65 7.15	84.10 114.38 153.96
(2) 14.5'x2-1/2" Pipe Mount (TMobile)	D	From Face	1.00 0.00 0.00	0.0000	94.00	No Ice 1/2" Ice 1" Ice	4.17 5.65 7.15	4.17 5.65 7.15	84.10 114.38 153.96
6' Standoff - Flat (TMobile)	D	From Leg	3.00 0.00 0.00	0.0000	94.00	No Ice 1/2" Ice 1" Ice	1.96 3.08 4.20	8.31 11.83 15.35	97.06 138.19 179.32
***** GPS	C	None		0.0000	76.50	No Ice 1/2" Ice 1" Ice	1.00 1.50 2.00	1.00 1.50 2.00	10.00 15.00 20.00
***** Catwalk	C	None		0.0000	75.00	No Ice 1/2" Ice 1" Ice	18.00 23.00 28.00	4.00 6.00 8.00	1000.00 1200.00 1400.00

Dishes

Description	Face or Leg	Dish Type	Offset Type	Offsets: Horz Lateral Vert ft ft ft	Azimuth Adjustment °	3 dB Beam Width °	Elevation ft	Outside Diameter ft	Aperture Area ft ²	Weight lb
***** SC3-W100 (Others)	D	Paraboloid w/Shroud (HP)	From Leg	1.00 0.00 1.50	0.0000		117.50	3.29	No Ice 1/2" Ice 1" Ice	40.00 85.94 131.88

Force Totals

Load Case	Vertical Forces lb	Sum of Forces X lb	Sum of Forces Z lb	Sum of Overturning Moments, M _x lb-ft	Sum of Overturning Moments, M _z lb-ft	Sum of Torques lb-ft
Leg Weight	9981.38					
Bracing Weight	22968.33					
Total Member Self-Weight	32949.71					
Total Weight	42920.78					
Wind 0 deg - No Ice		130.42	-30266.50	-2124685.65	11817.45	-53515.02
Wind 45 deg - No Ice		22908.63	-22720.63	-1603467.30	-1574731.57	-56610.57
Wind 90 deg - No Ice		29409.53	-130.42	-34590.36	-2053509.27	-18043.99
Wind 135 deg - No Ice		22787.55	22632.15	1557030.41	-1554931.22	17140.55
Wind 180 deg - No Ice		-100.14	30229.82	2089804.00	46878.67	53564.64
Wind 225 deg - No Ice		-22871.95	22683.95	1568585.65	1632665.54	56610.57

Job	Youngs Apple Orchard	Page	15 of 27
Project	30775	Date	12:56:32 06/03/19
Client	T-Mobile	Designed by	TEM

Load Case	Vertical Forces lb	Sum of Forces X lb	Sum of Forces Z lb	Sum of Overturning Moments, M _x lb-ft	Sum of Overturning Moments, M _z lb-ft	Sum of Torques lb-ft
Wind 270 deg - No Ice		-29372.85	100.14	470.86	2111443.24	17994.36
Wind 315 deg - No Ice		-22820.15	-22599.55	-1583666.95	1621110.30	-17140.55
Member Ice	49514.57					
Total Weight Ice	121215.19					
Wind 0 deg - Ice		4.93	-11934.30	-121926.89	171181.16	-27012.27
Wind 45 deg - Ice		9201.74	-9153.78	-772462.77	-483862.83	-30673.30
Wind 90 deg - Ice		11953.45	-4.93	-124363.17	-686806.59	-16487.57
Wind 135 deg - Ice		9213.03	9174.47	528455.66	-482590.92	6526.63
Wind 180 deg - Ice		3.80	11923.72	725885.22	172578.76	27026.58
Wind 225 deg - Ice		-9191.17	9143.21	527350.59	824966.76	30673.30
Wind 270 deg - Ice		-11942.88	-3.80	-120529.29	1027910.51	16473.27
Wind 315 deg - Ice		-9222.43	-9165.07	-771190.86	826071.83	-6526.63
Total Weight	42920.78			-15258.30	31149.51	
Wind 0 deg - Service		46.02	-10681.25	-729616.92	-7685.28	-18885.80
Wind 45 deg - Service		8084.61	-8018.26	-545675.53	-567588.86	-19978.24
Wind 90 deg - Service		10378.82	-46.02	7991.46	-736552.66	-6367.84
Wind 135 deg - Service		8041.87	7987.03	569684.90	-560601.19	6049.01
Wind 180 deg - Service		-35.34	10668.30	757704.20	4688.06	18903.32
Wind 225 deg - Service		-8071.66	8005.31	573762.82	564322.68	19978.24
Wind 270 deg - Service		-10365.87	35.34	20364.79	733286.47	6350.33
Wind 315 deg - Service		-8053.38	-7975.53	-538687.86	560244.76	-6049.01

Load Combinations

Comb. No.	Description
1	Dead Only
2	1.2 Dead+1.6 Wind 0 deg - No Ice
3	0.9 Dead+1.6 Wind 0 deg - No Ice
4	1.2 Dead+1.6 Wind 45 deg - No Ice
5	0.9 Dead+1.6 Wind 45 deg - No Ice
6	1.2 Dead+1.6 Wind 90 deg - No Ice
7	0.9 Dead+1.6 Wind 90 deg - No Ice
8	1.2 Dead+1.6 Wind 135 deg - No Ice
9	0.9 Dead+1.6 Wind 135 deg - No Ice
10	1.2 Dead+1.6 Wind 180 deg - No Ice
11	0.9 Dead+1.6 Wind 180 deg - No Ice
12	1.2 Dead+1.6 Wind 225 deg - No Ice
13	0.9 Dead+1.6 Wind 225 deg - No Ice
14	1.2 Dead+1.6 Wind 270 deg - No Ice
15	0.9 Dead+1.6 Wind 270 deg - No Ice
16	1.2 Dead+1.6 Wind 315 deg - No Ice
17	0.9 Dead+1.6 Wind 315 deg - No Ice
18	1.2 Dead+1.0 Ice+1.0 Temp
19	1.2 Dead+1.0 Wind 0 deg+1.0 Ice+1.0 Temp
20	1.2 Dead+1.0 Wind 45 deg+1.0 Ice+1.0 Temp
21	1.2 Dead+1.0 Wind 90 deg+1.0 Ice+1.0 Temp
22	1.2 Dead+1.0 Wind 135 deg+1.0 Ice+1.0 Temp
23	1.2 Dead+1.0 Wind 180 deg+1.0 Ice+1.0 Temp
24	1.2 Dead+1.0 Wind 225 deg+1.0 Ice+1.0 Temp
25	1.2 Dead+1.0 Wind 270 deg+1.0 Ice+1.0 Temp
26	1.2 Dead+1.0 Wind 315 deg+1.0 Ice+1.0 Temp
27	Dead+Wind 0 deg - Service
28	Dead+Wind 45 deg - Service
29	Dead+Wind 90 deg - Service
30	Dead+Wind 135 deg - Service

tnxTower Ramaker & Associates, Inc 855 Community Drive Sauk City, WI 53583 Phone: (608) 643-4100 FAX: (608) 643-7999	Job	Youngs Apple Orchard	Page	16 of 27
	Project	30775	Date	12:56:32 06/03/19
	Client	T-Mobile	Designed by	TEM

Comb. No.	Description
31	Dead+Wind 180 deg - Service
32	Dead+Wind 225 deg - Service
33	Dead+Wind 270 deg - Service
34	Dead+Wind 315 deg - Service

Maximum Member Forces

Section No.	Elevation ft	Component Type	Condition	Gov. Load Comb.	Axial lb	Major Axis Moment lb-ft	Minor Axis Moment lb-ft			
T1	129 - 124.75	Leg	Max Tension	9	283.62	39.48	626.08			
			Max. Compression	22	-5029.37	-193.98	99.56			
			Max. Mx	16	-1191.99	1281.76	-1250.09			
			Max. My	8	-1191.97	-1242.65	1275.78			
			Max. Vy	14	-1605.06	1186.58	-685.96			
			Max. Vx	6	-1560.52	-675.90	1193.06			
		Top Girt	Max Tension	3	98.51	-13.27	0.09			
			Max. Compression	2	-120.95	-20.09	-0.10			
			Max. Mx	19	-43.22	-71.32	-0.65			
			Max. My	6	-17.82	2.99	2.22			
			Max. Vy	19	43.07	-71.32	-0.65			
			Max. Vx	8	-0.43	-3.08	1.53			
			T2	124.75 - 112.458	Leg	Max Tension	1	0.00	0.00	0.00
						Max. Compression	22	-5488.72	37.34	56.56
Max. Mx	16	-1333.73				1282.29	-1249.42			
Max. My	8	-1333.23				-1242.10	1276.19			
Max. Vy	16	319.59				1282.29	-1249.42			
Max. Vx	8	318.26				-1242.10	1276.19			
Diagonal	Max Tension	15			4270.49	0.00	0.00			
	Max. Compression	14			-4600.48	-33.54	1.58			
	Max. Mx	26			-1466.61	-59.85	1.95			
	Max. My	26			279.18	-35.43	-34.14			
	Max. Vy	26			-47.13	-59.85	1.97			
	Max. Vx	26			-10.56	0.00	0.00			
	Horizontal	Max Tension			15	1713.08	-241.63	2.50		
		Max. Compression			14	-1908.23	-324.57	3.33		
Max. Mx		21	65.35	-872.72	8.70					
Max. My		19	-240.49	-871.73	9.87					
Max. Vy		21	-275.56	-872.72	8.70					
Max. Vx		19	-7.70	-871.73	9.87					
Redund Horz 1 Bracing		Max Tension	14	216.74	0.00	0.00				
		Max. Compression	7	-228.10	0.00	0.00				
		Max. Mx	18	82.01	-9.05	0.00				
		Max. My	23	40.87	0.00	0.53				
	Max. Vy	18	14.98	0.00	0.00					
	Max. Vx	23	-0.88	0.00	0.00					
Redund Diag 1 Bracing	Max Tension	6	389.08	0.00	0.00					
	Max. Compression	15	-233.91	0.00	0.00					
	Max. Mx	25	308.01	-20.71	0.00					
	Max. My	25	253.59	0.00	3.86					
	Max. Vy	25	12.76	0.00	0.00					
	Max. Vx	25	-2.38	0.00	0.00					
Redund Hip 1 Bracing	Max Tension	17	2.22	0.00	0.00					
	Max. Compression	26	-22.65	0.00	0.00					
	Max. Mx	18	-17.71	-18.13	0.00					
	Max. My	16	-5.89	0.00	0.00					
	Max. Vy	18	21.22	0.00	0.00					
	Max. Vx	16	-0.00	0.00	0.00					
	Inner Bracing	Max Tension	1	0.00	0.00	0.00				

Job	Youngs Apple Orchard	Page	17 of 27
Project	30775	Date	12:56:32 06/03/19
Client	T-Mobile	Designed by	TEM

Section No.	Elevation ft	Component Type	Condition	Gov. Load Comb.	Axial lb	Major Axis Moment lb-ft	Minor Axis Moment lb-ft
T3	112.458 - 100.167	Leg	Max. Compression	26	-29.65	0.00	0.00
			Max. Mx	18	-24.03	-79.35	0.00
			Max. My	26	-20.24	0.00	-0.07
			Max. Vy	18	46.44	0.00	0.00
			Max. Vx	26	0.04	0.00	0.00
		Diagonal	Max Tension	13	3543.16	88.32	78.37
			Max. Compression	22	-8452.37	70.11	79.80
			Max. Mx	16	-2490.66	302.21	-235.46
			Max. My	8	-2488.86	-235.29	307.62
			Max. Vy	16	-123.92	302.21	-235.46
			Max. Vx	8	-125.03	-235.29	307.62
			Max Tension	15	5250.95	-13.81	1.17
			Max. Compression	14	-5554.51	0.00	0.00
			Max. Mx	21	-396.28	-60.50	-12.91
			Max. My	21	-1601.42	-43.54	38.92
		Horizontal	Max. Vy	21	-51.72	-60.50	-12.92
			Max. Vx	23	-11.19	0.00	0.00
			Max Tension	14	2425.98	-44.08	2.47
			Max. Compression	15	-2384.65	-33.24	1.78
			Max. Mx	23	-121.58	-117.91	5.73
		Redund Horz 1 Bracing	Max. My	19	-96.40	-111.38	8.71
			Max. Vy	23	86.16	-117.91	5.73
			Max. Vx	19	-5.41	-111.38	8.71
			Max Tension	12	136.85	0.00	0.00
			Max. Compression	22	-127.24	0.00	0.00
		Redund Diag 1 Bracing	Max. Mx	18	109.00	-11.82	0.00
			Max. My	19	96.40	0.00	0.70
			Max. Vy	18	17.02	0.00	0.00
			Max. Vx	19	-1.00	0.00	0.00
			Max Tension	22	264.01	0.00	0.00
		Redund Hip 1 Bracing	Max. Compression	22	-151.47	0.00	0.00
			Max. Mx	25	203.55	-26.85	0.00
			Max. My	25	224.51	0.00	4.34
Max. Vy	25		16.24	0.00	0.00		
Max. Vx	25		-2.62	0.00	0.00		
Inner Bracing	Max Tension	9	0.64	0.00	0.00		
	Max. Compression	22	-18.06	0.00	0.00		
	Max. Mx	18	-8.51	-23.69	0.00		
	Max. My	16	-4.94	0.00	0.00		
	Max. Vy	18	24.12	0.00	0.00		
T4	100.167 - 87.5	Leg	Max. Vx	16	-0.00	0.00	0.00
			Max Tension	1	0.00	0.00	0.00
			Max. Compression	26	-27.47	0.00	0.00
			Max. Mx	18	-26.79	-103.70	0.00
			Max. My	24	-25.60	0.00	-0.06
		Diagonal	Max. Vy	18	52.79	0.00	0.00
			Max. Vx	24	0.03	0.00	0.00
			Max Tension	13	8432.99	70.15	112.63
			Max. Compression	12	-14614.11	-11.99	64.70
			Max. Mx	16	-4288.55	672.15	-563.21
			Max. My	8	-4433.70	-559.80	675.27
			Max. Vy	14	-851.11	-239.07	297.70
Horizontal	Max. Vx	6	-869.75	302.48	-228.30		
	Max Tension	7	8028.75	-0.69	-4.60		
	Max. Compression	6	-8235.01	0.00	0.00		
	Max. Mx	26	-1473.67	-65.99	6.08		
	Max. My	26	-1797.04	-61.53	-18.47		
	Max. Vy	26	-49.74	-65.99	6.12		
	Max. Vx	26	-7.11	0.00	0.00		
	Max Tension	7	3446.98	0.00	0.00		
	Max. Compression	6	-3477.45	-49.39	2.94		

Job	Youngs Apple Orchard	Page	18 of 27
Project	30775	Date	12:56:32 06/03/19
Client	T-Mobile	Designed by	TEM

Section No.	Elevation ft	Component Type	Condition	Gov. Load Comb.	Axial lb	Major Axis Moment lb-ft	Minor Axis Moment lb-ft
			Max. Mx	23	-177.92	-133.89	6.33
			Max. My	6	236.64	-37.16	11.31
			Max. Vy	23	94.01	-133.89	6.33
			Max. Vx	19	-5.92	-127.65	10.22
		Redund Horz 1 Bracing	Max Tension	9	822.97	0.00	0.00
			Max. Compression	6	-835.30	0.00	0.00
			Max. Mx	18	152.83	-14.90	0.00
			Max. My	19	127.70	0.00	0.88
			Max. Vy	18	-18.99	0.00	0.00
			Max. Vx	19	-1.12	0.00	0.00
		Redund Diag 1 Bracing	Max Tension	6	984.19	0.00	0.00
			Max. Compression	9	-862.37	0.00	0.00
			Max. Mx	25	218.95	-29.01	0.00
			Max. My	25	270.11	0.00	4.28
			Max. Vy	25	16.76	0.00	0.00
			Max. Vx	25	-2.48	0.00	0.00
		Redund Hip 1 Bracing	Max Tension	1	0.00	0.00	0.00
			Max. Compression	20	-19.82	0.00	0.00
			Max. Mx	18	-16.89	-29.86	0.00
			Max. My	16	-6.03	0.00	0.00
			Max. Vy	18	26.90	0.00	0.00
			Max. Vx	16	-0.00	0.00	0.00
		Inner Bracing	Max Tension	1	0.00	0.00	0.00
			Max. Compression	26	-23.92	0.00	0.00
			Max. Mx	18	-22.18	-130.77	0.00
			Max. My	26	-20.18	0.00	-0.07
			Max. Vy	18	58.92	0.00	0.00
			Max. Vx	26	0.03	0.00	0.00
T5	87.5 - 74.8333	Leg	Max Tension	13	17026.78	5.53	114.00
			Max. Compression	12	-24870.34	-28.56	121.14
			Max. Mx	4	-4347.00	936.34	-797.98
			Max. My	12	-4489.37	-805.11	941.07
			Max. Vy	4	-460.02	936.34	-797.98
			Max. Vx	12	-460.31	-805.11	941.07
		Diagonal	Max Tension	7	8369.55	0.00	0.00
			Max. Compression	6	-8563.91	-29.61	17.07
			Max. Mx	25	-370.74	-74.11	4.85
			Max. My	25	-2342.71	-64.50	-20.63
			Max. Vy	25	-54.44	-74.11	4.87
			Max. Vx	25	-7.47	0.00	0.00
		Horizontal	Max Tension	7	4381.59	0.00	0.00
			Max. Compression	6	-4421.48	-60.38	3.75
			Max. Mx	25	-261.25	-162.54	7.44
			Max. My	6	241.28	-41.75	12.82
			Max. Vy	25	103.56	-162.54	7.44
			Max. Vx	19	-6.47	-152.97	12.04
		Redund Horz 1 Bracing	Max Tension	12	373.70	0.00	0.00
			Max. Compression	12	-373.70	0.00	0.00
			Max. Mx	18	210.56	-18.37	0.00
			Max. My	19	199.65	0.00	1.08
			Max. Vy	18	20.93	0.00	0.00
			Max. Vx	19	-1.23	0.00	0.00
		Redund Diag 1 Bracing	Max Tension	12	376.65	0.00	0.00
			Max. Compression	12	-376.65	0.00	0.00
			Max. Mx	25	263.32	-33.15	0.00
			Max. My	25	227.01	0.00	4.41
			Max. Vy	25	18.73	0.00	0.00
			Max. Vx	25	2.49	0.00	0.00
		Redund Hip 1 Bracing	Max Tension	1	0.00	0.00	0.00
			Max. Compression	24	-20.64	0.00	0.00
			Max. Mx	18	-18.23	-36.81	0.00

tnxTower Ramaker & Associates, Inc 855 Community Drive Sauk City, WI 53583 Phone: (608) 643-4100 FAX: (608) 643-7999	Job	Youngs Apple Orchard	Page	19 of 27
	Project	30775	Date	12:56:32 06/03/19
	Client	T-Mobile	Designed by	TEM

Section No.	Elevation ft	Component Type	Condition	Gov. Load Comb.	Axial lb	Major Axis Moment lb-ft	Minor Axis Moment lb-ft
			Max. My	12	-6.50	0.00	-0.00
			Max. Vy	18	29.65	0.00	0.00
			Max. Vx	12	0.00	0.00	0.00
		Inner Bracing	Max Tension	1	0.00	0.00	0.00
			Max. Compression	21	-24.34	0.00	0.00
			Max. Mx	18	-23.18	-161.28	0.00
			Max. My	26	-23.02	0.00	-0.08
			Max. Vy	18	64.96	0.00	0.00
			Max. Vx	26	0.03	0.00	0.00
T6	74.8333 - 49.6667	Leg	Max Tension	13	26373.75	-21.66	166.21
			Max. Compression	12	-35596.10	-100.87	-46.95
			Max. Mx	4	-6503.27	2135.28	-1767.42
			Max. My	12	-6871.96	-1758.65	2132.56
			Max. Vy	4	-608.18	2135.28	-1767.42
			Max. Vx	12	-607.31	-1758.65	2132.56
		Diagonal	Max Tension	3	16681.73	-0.83	-8.80
			Max. Compression	2	-17188.08	0.00	0.00
			Max. Mx	26	-3219.53	74.25	100.27
			Max. My	19	-4721.98	-34.82	-124.59
			Max. Vy	26	-43.55	-31.70	92.37
			Max. Vx	22	-24.89	-52.00	-44.89
		Horizontal	Max Tension	3	5497.78	-20.43	5.68
			Max. Compression	2	-5712.20	-27.62	7.69
			Max. Mx	25	-279.66	-90.39	21.59
			Max. My	21	-249.78	-64.47	26.49
			Max. Vy	24	-59.24	-87.15	22.15
			Max. Vx	19	12.79	-56.36	26.01
		Redund Horz 1 Bracing	Max Tension	12	534.86	0.00	0.00
			Max. Compression	12	-534.86	0.00	0.00
			Max. Mx	23	340.34	-6.00	0.00
			Max. My	25	342.10	0.00	0.35
			Max. Vy	23	12.35	0.00	0.00
			Max. Vx	25	-0.73	0.00	0.00
		Redund Horz 2 Bracing	Max Tension	12	534.86	0.00	0.00
			Max. Compression	12	-534.86	0.00	0.00
			Max. Mx	22	268.85	-25.94	0.00
			Max. My	23	282.52	0.00	1.52
			Max. Vy	22	-26.72	0.00	0.00
			Max. Vx	23	1.57	0.00	0.00
		Redund Horz 3 Bracing	Max Tension	12	534.86	0.00	0.00
			Max. Compression	12	-534.86	0.00	0.00
			Max. Mx	23	223.15	-53.96	0.00
			Max. My	24	377.00	0.00	3.17
			Max. Vy	23	-37.05	0.00	0.00
			Max. Vx	24	-2.18	0.00	0.00
		Redund Diag 1 Bracing	Max Tension	12	894.56	0.00	0.00
			Max. Compression	12	-894.56	0.00	0.00
			Max. Mx	25	609.04	-16.27	0.00
			Max. My	19	330.42	0.00	-3.97
			Max. Vy	25	10.02	0.00	0.00
			Max. Vx	19	2.45	0.00	0.00
		Redund Diag 2 Bracing	Max Tension	12	565.51	0.00	0.00
			Max. Compression	12	-496.88	0.00	0.00
			Max. Mx	25	338.29	-40.36	0.00
			Max. My	19	231.03	0.00	-4.88
			Max. Vy	25	22.37	0.00	0.00
			Max. Vx	19	2.70	0.00	0.00
		Redund Diag 3 Bracing	Max Tension	12	523.57	0.00	0.00
			Max. Compression	12	-644.18	0.00	0.00
			Max. Mx	25	134.85	-55.64	0.00
			Max. My	19	136.47	0.00	-5.86

Job	Youngs Apple Orchard	Page	20 of 27
Project	30775	Date	12:56:32 06/03/19
Client	T-Mobile	Designed by	TEM

Section No.	Elevation ft	Component Type	Condition	Gov. Load Comb.	Axial lb	Major Axis Moment lb-ft	Minor Axis Moment lb-ft
T7	49.6667 - 24.75	Redund Hip 3 Bracing	Max. Vy	25	-29.27	0.00	0.00
			Max. Vx	19	-3.08	0.00	0.00
			Max Tension	1	0.00	0.00	0.00
			Max. Compression	20	-65.31	0.00	0.00
			Max. Mx	18	-62.14	-116.93	0.00
			Max. My	12	-20.13	0.00	0.00
		Redund Hip Diagonal 3 Bracing	Max. Vy	18	56.77	0.00	0.00
			Max. Vx	12	-0.00	0.00	0.00
			Max Tension	10	61.46	0.00	0.00
			Max. Compression	22	-64.67	0.00	0.00
			Max. Mx	26	46.15	-227.40	0.00
			Max. My	26	38.24	0.00	-0.07
		Inner Bracing	Max. Vy	26	-78.12	0.00	0.00
			Max. Vx	26	0.02	0.00	0.00
			Max Tension	17	9.68	0.00	0.00
			Max. Compression	23	-31.41	0.00	0.00
			Max. Mx	18	-23.26	-192.20	0.00
			Max. My	26	-0.01	0.00	54.78
		Leg	Max. Vy	18	69.99	0.00	0.00
			Max. Vx	26	-37.44	0.00	0.00
			Max Tension	13	45288.10	-343.12	163.17
			Max. Compression	12	-58562.86	-156.17	-174.48
			Max. Mx	4	-9296.71	3000.94	-2472.34
			Max. My	12	-10005.58	-2454.68	3005.12
		Diagonal	Max. Vy	4	-784.33	3000.94	-2472.34
			Max. Vx	12	-785.62	-2454.68	3005.12
			Max Tension	3	18314.68	-5.27	-12.43
			Max. Compression	10	-18858.95	0.00	0.00
			Max. Mx	12	10463.60	-91.39	35.09
			Max. My	2	-18731.48	-31.15	-126.97
		Horizontal	Max. Vy	26	-47.67	-36.34	95.42
			Max. Vx	22	-25.30	-58.77	-51.98
			Max Tension	3	7056.77	-59.29	-4.09
			Max. Compression	2	-7329.59	-28.24	10.90
			Max. Mx	25	-534.61	-87.59	28.70
			Max. My	21	-347.38	-62.24	34.05
		Redund Horz 1 Bracing	Max. Vy	19	-63.05	-60.45	-18.75
			Max. Vx	23	-14.19	-60.31	33.74
			Max Tension	12	879.95	0.00	0.00
			Max. Compression	12	-879.95	0.00	0.00
			Max. Mx	23	392.60	-8.08	0.00
			Max. My	25	482.21	0.00	0.48
Redund Horz 2 Bracing	Max. Vy	23	13.99	0.00	0.00		
	Max. Vx	25	-0.82	0.00	0.00		
	Max Tension	12	879.95	0.00	0.00		
	Max. Compression	12	-879.95	0.00	0.00		
	Max. Mx	21	232.11	-35.02	0.00		
	Max. My	23	392.60	0.00	2.06		
Redund Horz 3 Bracing	Max. Vy	21	30.30	0.00	0.00		
	Max. Vx	23	-1.78	0.00	0.00		
	Max Tension	12	879.95	0.00	0.00		
	Max. Compression	12	-879.95	0.00	0.00		
	Max. Mx	21	232.11	-72.76	0.00		
	Max. My	24	543.92	0.00	4.28		
Redund Diag 1 Bracing	Max. Vy	21	-41.97	0.00	0.00		
	Max. Vx	24	-2.47	0.00	0.00		
	Max Tension	12	1243.98	0.00	0.00		
	Max. Compression	12	-1243.98	0.00	0.00		
	Max. Mx	19	759.92	-19.26	0.00		
	Max. My	24	590.17	0.00	3.82		
			Max. Vy	19	11.79	0.00	0.00

tnxTower Ramaker & Associates, Inc 855 Community Drive Sauk City, WI 53583 Phone: (608) 643-4100 FAX: (608) 643-7999	Job Youngs Apple Orchard	Page 21 of 27
	Project 30775	Date 12:56:32 06/03/19
	Client T-Mobile	Designed by TEM

Section No.	Elevation ft	Component Type	Condition	Gov. Load Comb.	Axial lb	Major Axis Moment lb-ft	Minor Axis Moment lb-ft
			Max. Vx	24	-2.34	0.00	0.00
		Redund Diag 2 Bracing	Max Tension	12	718.84	0.00	0.00
			Max. Compression	12	-718.84	0.00	0.00
			Max. Mx	25	441.26	-52.73	0.00
			Max. My	19	262.90	0.00	-5.50
			Max. Vy	25	-27.92	0.00	0.00
			Max. Vx	19	-2.91	0.00	0.00
		Redund Diag 3 Bracing	Max Tension	12	760.30	0.00	0.00
			Max. Compression	12	-760.30	0.00	0.00
			Max. Mx	26	68.93	-75.75	0.00
			Max. My	19	126.20	0.00	-7.14
			Max. Vy	26	37.92	0.00	0.00
			Max. Vx	19	3.58	0.00	0.00
		Redund Hip 3 Bracing	Max Tension	1	0.00	0.00	0.00
			Max. Compression	19	-69.43	0.00	0.00
			Max. Mx	18	-66.50	-183.06	0.00
			Max. My	12	-25.14	0.00	0.00
			Max. Vy	18	74.66	0.00	0.00
			Max. Vx	12	-0.00	0.00	0.00
		Redund Hip Diagonal 3 Bracing	Max Tension	10	57.20	0.00	0.00
			Max. Compression	22	-60.88	0.00	0.00
			Max. Mx	26	41.92	-292.61	0.00
			Max. My	26	36.22	0.00	-0.05
			Max. Vy	26	-88.64	0.00	0.00
			Max. Vx	26	0.02	0.00	0.00
		Inner Bracing	Max Tension	5	12.91	0.00	0.00
			Max. Compression	23	-32.71	0.00	0.00
			Max. Mx	21	-23.48	-259.15	0.00
			Max. My	26	-0.01	0.00	69.33
			Max. Vy	21	-79.27	0.00	0.00
			Max. Vx	26	-41.06	0.00	0.00
T8	24.75 - 0	Leg	Max Tension	13	65872.73	-720.43	-35.61
			Max. Compression	12	-83957.53	66.38	-3.21
			Max. Mx	4	-10408.64	3000.43	-2472.94
			Max. My	12	-11386.18	-2455.29	3004.59
			Max. Vy	4	681.48	3000.43	-2472.94
			Max. Vx	12	681.47	-2455.29	3004.59
		Diagonal	Max Tension	11	19996.13	-47.14	-7.55
			Max. Compression	10	-20822.03	0.00	0.00
			Max. Mx	12	11048.65	-115.16	34.22
			Max. My	2	-20243.40	-29.88	-138.74
			Max. Vy	26	-51.73	-42.04	101.30
			Max. Vx	22	-25.05	-62.97	-50.25
		Horizontal	Max Tension	10	8500.16	0.00	0.00
			Max. Compression	10	-8839.79	-32.98	12.97
			Max. Mx	14	-544.71	-82.25	5.65
			Max. My	21	-320.52	-38.69	38.50
			Max. Vy	19	-68.25	-78.33	-22.14
			Max. Vx	22	-14.38	-40.57	37.58
		Redund Horz 1 Bracing	Max Tension	12	1261.53	0.00	0.00
			Max. Compression	12	-1261.53	0.00	0.00
			Max. Mx	25	156.67	-10.73	0.00
			Max. My	26	817.32	0.00	0.63
			Max. Vy	25	16.03	0.00	0.00
			Max. Vx	26	-0.94	0.00	0.00
		Redund Horz 2 Bracing	Max Tension	12	1261.53	0.00	0.00
			Max. Compression	12	-1261.53	0.00	0.00
			Max. Mx	26	817.32	-46.85	0.00
			Max. My	24	729.06	0.00	2.75
			Max. Vy	26	34.99	0.00	0.00
			Max. Vx	24	-2.06	0.00	0.00

tnxTower Ramaker & Associates, Inc 855 Community Drive Sauk City, WI 53583 Phone: (608) 643-4100 FAX: (608) 643-7999	Job Youngs Apple Orchard	Page 22 of 27
	Project 30775	Date 12:56:32 06/03/19
	Client T-Mobile	Designed by TEM

Section No.	Elevation ft	Component Type	Condition	Gov. Load Comb.	Axial lb	Major Axis Moment lb-ft	Minor Axis Moment lb-ft
		Redund Horz 3 Bracing	Max Tension	12	1261.53	0.00	0.00
			Max. Compression	12	-1261.53	0.00	0.00
			Max. Mx	18	454.98	-95.76	0.00
			Max. My	24	729.06	0.00	5.63
			Max. Vy	18	-47.68	0.00	0.00
			Max. Vx	24	2.80	0.00	0.00
		Redund Diag 1 Bracing	Max Tension	12	1558.37	0.00	0.00
			Max. Compression	12	-1558.37	0.00	0.00
			Max. Mx	23	782.91	-22.92	0.00
			Max. My	20	669.61	0.00	-3.87
			Max. Vy	23	13.86	0.00	0.00
			Max. Vx	20	2.34	0.00	0.00
		Redund Diag 2 Bracing	Max Tension	12	937.29	0.00	0.00
			Max. Compression	12	-937.29	0.00	0.00
			Max. Mx	26	607.25	-64.92	0.00
			Max. My	20	285.49	0.00	-6.08
			Max. Vy	26	32.63	0.00	0.00
			Max. Vx	20	3.06	0.00	0.00
		Redund Diag 3 Bracing	Max Tension	12	993.27	0.00	0.00
			Max. Compression	12	-993.27	0.00	0.00
			Max. Mx	26	50.22	-83.37	0.00
			Max. My	26	50.22	0.00	-7.24
			Max. Vy	26	-39.54	0.00	0.00
			Max. Vx	26	-3.43	0.00	0.00
		Redund Hip 3 Bracing	Max Tension	1	0.00	0.00	0.00
			Max. Compression	19	-71.36	0.00	0.00
			Max. Mx	18	-68.35	289.41	0.00
			Max. Vy	18	-101.89	0.00	0.00
			Max. Vx	4	-0.00	0.00	0.00
			Redund Hip Diagonal 3 Bracing	Max Tension	10	66.25	0.00
		Max. Compression		22	-81.23	0.00	0.00
		Max. Mx		18	52.04	526.82	0.00
		Max. My		4	23.55	0.00	0.05
		Max. Vy		18	-142.14	0.00	0.00
		Max. Vx		4	-0.01	0.00	0.00
		Inner Bracing	Max Tension	5	24.96	0.00	0.00
			Max. Compression	13	-38.63	0.00	0.00
			Max. Mx	18	-25.28	-341.07	0.00
			Max. My	23	-0.00	0.00	86.05
			Max. Vy	18	90.06	0.00	0.00
			Max. Vx	20	-45.34	0.00	0.00

Maximum Reactions

Location	Condition	Gov. Load Comb.	Vertical lb	Horizontal, X lb	Horizontal, Z lb
Leg D	Max. Vert	12	109704.05	11948.93	-13819.32
	Max. H _x	14	77070.40	12335.07	-5067.00
	Max. H _z	3	-54485.72	-2348.36	12358.98
	Min. Vert	5	-86828.10	-10488.18	12273.95
	Min. H _x	7	-54099.31	-10873.30	3460.52
	Min. H _z	10	77452.57	3858.14	-13901.42
Leg C	Max. Vert	8	107284.53	-13102.17	-12481.12
	Max. H _x	17	-86805.70	11629.21	11035.87
	Max. H _z	17	-86805.70	11629.21	11035.87
	Min. Vert	17	-86805.70	11629.21	11035.87

tnxTower Ramaker & Associates, Inc 855 Community Drive Sauk City, WI 53583 Phone: (608) 643-4100 FAX: (608) 643-7999	Job	Youngs Apple Orchard	Page	23 of 27
	Project	30775	Date	12:56:32 06/03/19
	Client	T-Mobile	Designed by	TEM

Location	Condition	Gov. Load Comb.	Vertical lb	Horizontal, X lb	Horizontal, Z lb
Leg B	Min. H _x	8	107284.53	-13102.17	-12481.12
	Min. H _z	8	107284.53	-13102.17	-12481.12
	Max. Vert	4	109208.86	-13858.35	11908.29
	Max. H _x	13	-87130.56	12309.18	-10442.48
	Max. H _z	2	76934.67	-5669.08	12091.31
	Min. Vert	13	-87130.56	12309.18	-10442.48
Leg A	Min. H _x	4	109208.86	-13858.35	11908.29
	Min. H _z	11	-54817.32	4066.16	-10628.67
	Max. Vert	16	109568.66	12574.75	13115.66
	Max. H _x	14	76786.08	12890.85	4394.06
	Max. H _z	2	77200.17	3806.65	13847.27
	Min. Vert	9	-85085.05	-11036.30	-11548.44
	Min. H _x	7	-52260.30	-11370.91	-2764.00
	Min. H _z	11	-52618.61	-2223.00	-12273.87

Tower Mast Reaction Summary

Load Combination	Vertical lb	Shear _x lb	Shear _z lb	Overturning Moment, M _x lb-ft	Overturning Moment, M _z lb-ft	Torque lb-ft
Dead Only	42920.78	0.01	0.00	-15259.66	31180.23	-0.07
1.2 Dead+1.6 Wind 0 deg - No Ice	51504.91	208.56	-48425.96	-3123971.39	6465.06	-85638.30
0.9 Dead+1.6 Wind 0 deg - No Ice	38628.68	208.57	-48426.06	-3118712.71	-2879.73	-85633.49
1.2 Dead+1.6 Wind 45 deg - No Ice	51504.92	36653.45	-36352.74	-2358744.67	-2331285.83	-90589.37
0.9 Dead+1.6 Wind 45 deg - No Ice	38628.69	36653.53	-36352.81	-2353651.20	-2340120.61	-90585.70
1.2 Dead+1.6 Wind 90 deg - No Ice	51504.92	47054.81	-208.69	-49276.54	-3049392.89	-28871.11
0.9 Dead+1.6 Wind 90 deg - No Ice	38628.69	47054.91	-208.69	-44691.63	-3058066.20	-28871.78
1.2 Dead+1.6 Wind 135 deg - No Ice	51504.92	36459.76	36211.15	2296609.42	-2299587.54	27434.31
0.9 Dead+1.6 Wind 135 deg - No Ice	38628.69	36459.84	36211.22	2300681.49	-2308428.06	27430.71
1.2 Dead+1.6 Wind 180 deg - No Ice	51504.92	-160.29	48367.27	3080359.46	62626.39	85719.02
0.9 Dead+1.6 Wind 180 deg - No Ice	38628.68	-160.28	48367.38	3084256.67	53265.61	85714.23
1.2 Dead+1.6 Wind 225 deg - No Ice	51504.92	-36594.82	36293.97	2315084.59	2399138.48	90588.64
0.9 Dead+1.6 Wind 225 deg - No Ice	38628.69	-36594.90	36294.06	2319158.47	2389264.73	90581.53
1.2 Dead+1.6 Wind 270 deg - No Ice	51504.92	-46996.11	160.22	6879.77	3117197.77	28791.88
0.9 Dead+1.6 Wind 270 deg - No Ice	38628.69	-46996.21	160.22	11450.24	3107166.16	28792.48
1.2 Dead+1.6 Wind 315 deg - No Ice	51504.92	-36511.95	-36158.94	-2326989.87	2380619.10	-27437.97
0.9 Dead+1.6 Wind 315 deg - No Ice	38628.69	-36512.03	-36159.02	-2321909.21	2370751.62	-27432.92
1.2 Dead+1.0 Ice+1.0 Temp	129799.35	0.08	0.05	-125055.54	177606.26	2.64
1.2 Dead+1.0 Wind 0 deg+1.0 Ice+1.0 Temp	129799.35	5.01	-11933.99	-899565.61	175176.13	-26986.43
1.2 Dead+1.0 Wind 45 deg+1.0 Ice+1.0 Temp	129799.35	9201.63	-9153.55	-718708.35	-420534.68	-30648.95
1.2 Dead+1.0 Wind 90 deg+1.0 Ice+1.0 Temp	129799.35	11953.27	-4.89	-127503.21	-606777.78	-16476.68
1.2 Dead+1.0 Wind 135 deg+1.0 Ice+1.0 Temp	129799.35	9212.92	9174.32	468442.72	-419268.74	6522.91
1.2 Dead+1.0 Wind 180 deg+1.0 Ice+1.0 Temp	129799.35	3.88	11923.51	648198.27	179036.49	27002.80
1.2 Dead+1.0 Wind 225 deg+1.0 Ice+1.0 Temp	129799.35	-9190.88	9143.05	467326.44	774538.47	30650.89
1.2 Dead+1.0 Wind 270 deg+1.0 Ice+1.0 Temp	129799.35	-11942.53	-3.76	-123645.43	960764.21	16461.28
1.2 Dead+1.0 Wind 315 deg+1.0 Ice+1.0 Temp	129799.35	-9222.15	-9164.83	-717416.32	775626.19	-6520.42
Dead+Wind 0 deg - Service	42920.78	46.03	-10681.17	-700172.56	24336.64	-18887.18
Dead+Wind 45 deg - Service	42920.78	8084.55	-8018.20	-531414.74	-491226.34	-19980.12
Dead+Wind 90 deg - Service	42920.78	10378.75	-46.02	-22088.52	-649589.86	-6367.31
Dead+Wind 135 deg - Service	42920.78	8041.82	7986.98	495274.18	-484239.49	6050.10
Dead+Wind 180 deg - Service	42920.78	-35.33	10668.23	668114.38	36719.08	18906.04
Dead+Wind 225 deg - Service	42920.78	-8071.60	8005.26	499344.32	552013.70	19981.30
Dead+Wind 270 deg - Service	42920.78	-10365.79	35.34	-9702.34	710376.31	6350.55
Dead+Wind 315 deg - Service	42920.78	-8053.32	-7975.47	-524411.56	547928.99	-6050.75

tnxTower Ramaker & Associates, Inc 855 Community Drive Sauk City, WI 53583 Phone: (608) 643-4100 FAX: (608) 643-7999	Job Youngs Apple Orchard	Page 24 of 27
	Project 30775	Date 12:56:32 06/03/19
	Client T-Mobile	Designed by TEM

Solution Summary

Load Comb.	PX lb	Sum of Applied Forces			Sum of Reactions			% Error
		PY lb	PZ lb	PX lb	PY lb	PZ lb		
1	0.00	-42920.78	0.00	-0.01	42920.78	-0.00	0.000%	
2	208.67	-51504.94	-48426.40	-208.56	51504.91	48425.96	0.001%	
3	208.67	-38628.70	-48426.40	-208.57	38628.68	48426.06	0.001%	
4	36653.80	-51504.94	-36353.00	-36653.45	51504.92	36352.74	0.001%	
5	36653.80	-38628.70	-36353.00	-36653.53	38628.69	36352.81	0.001%	
6	47055.24	-51504.94	-208.67	-47054.81	51504.92	208.69	0.001%	
7	47055.24	-38628.70	-208.67	-47054.91	38628.69	208.69	0.001%	
8	36460.07	-51504.94	36211.44	-36459.76	51504.92	-36211.15	0.001%	
9	36460.07	-38628.70	36211.44	-36459.84	38628.69	-36211.22	0.001%	
10	-160.22	-51504.94	48367.71	160.29	51504.92	-48367.27	0.001%	
11	-160.22	-38628.70	48367.71	160.28	38628.68	-48367.38	0.001%	
12	-36595.11	-51504.94	36294.31	36594.82	51504.92	-36293.97	0.001%	
13	-36595.11	-38628.70	36294.31	36594.90	38628.69	-36294.06	0.001%	
14	-46996.55	-51504.94	160.22	46996.11	51504.92	-160.22	0.001%	
15	-46996.55	-38628.70	160.22	46996.21	38628.69	-160.22	0.001%	
16	-36512.24	-51504.94	-36159.27	36511.95	51504.92	36158.94	0.001%	
17	-36512.24	-38628.70	-36159.27	36512.03	38628.69	36159.02	0.001%	
18	0.00	-129799.35	0.00	-0.08	129799.35	-0.05	0.000%	
19	4.93	-129799.35	-11934.30	-5.01	129799.35	11933.99	0.000%	
20	9201.74	-129799.35	-9153.78	-9201.63	129799.35	9153.55	0.000%	
21	11953.45	-129799.35	-4.93	-11953.27	129799.35	4.89	0.000%	
22	9213.03	-129799.35	9174.47	-9212.92	129799.35	-9174.32	0.000%	
23	3.80	-129799.35	11923.72	-3.88	129799.35	-11923.51	0.000%	
24	-9191.17	-129799.35	9143.21	9190.88	129799.35	-9143.05	0.000%	
25	-11942.88	-129799.35	-3.80	11942.53	129799.35	3.76	0.000%	
26	-9222.43	-129799.35	-9165.07	9222.15	129799.35	9164.83	0.000%	
27	46.02	-42920.78	-10681.25	-46.03	42920.78	10681.17	0.000%	
28	8084.61	-42920.78	-8018.26	-8084.55	42920.78	8018.20	0.000%	
29	10378.82	-42920.78	-46.02	-10378.75	42920.78	46.02	0.000%	
30	8041.87	-42920.78	7987.03	-8041.82	42920.78	-7986.98	0.000%	
31	-35.34	-42920.78	10668.30	35.33	42920.78	-10668.23	0.000%	
32	-8071.66	-42920.78	8005.31	8071.60	42920.78	-8005.26	0.000%	
33	-10365.87	-42920.78	35.34	10365.79	42920.78	-35.34	0.000%	
34	-8053.38	-42920.78	-7975.53	8053.32	42920.78	7975.47	0.000%	

Non-Linear Convergence Results

Load Combination	Converged?	Number of Cycles	Displacement Tolerance	Force Tolerance
1	Yes	6	0.00000001	0.00000001
2	Yes	6	0.00000001	0.00009258
3	Yes	6	0.00000001	0.00007088
4	Yes	6	0.00000001	0.00009183
5	Yes	6	0.00000001	0.00007012
6	Yes	6	0.00000001	0.00009257
7	Yes	6	0.00000001	0.00007090
8	Yes	6	0.00000001	0.00009077
9	Yes	6	0.00000001	0.00006924
10	Yes	6	0.00000001	0.00009209
11	Yes	6	0.00000001	0.00007044
12	Yes	6	0.00000001	0.00009175
13	Yes	6	0.00000001	0.00006984
14	Yes	6	0.00000001	0.00009348

tnxTower Ramaker & Associates, Inc 855 Community Drive Sauk City, WI 53583 Phone: (608) 643-4100 FAX: (608) 643-7999	Job	Youngs Apple Orchard	Page	25 of 27
	Project	30775	Date	12:56:32 06/03/19
	Client	T-Mobile	Designed by	TEM

15	Yes	6	0.00000001	0.00007138
16	Yes	6	0.00000001	0.00009186
17	Yes	6	0.00000001	0.00006997
18	Yes	6	0.00000001	0.00003775
19	Yes	6	0.00000001	0.00010767
20	Yes	6	0.00000001	0.00009314
21	Yes	6	0.00000001	0.00006695
22	Yes	6	0.00000001	0.00006918
23	Yes	6	0.00000001	0.00008356
24	Yes	6	0.00000001	0.00011140
25	Yes	6	0.00000001	0.00011858
26	Yes	6	0.00000001	0.00012305
27	Yes	6	0.00000001	0.00005727
28	Yes	6	0.00000001	0.00005753
29	Yes	6	0.00000001	0.00005546
30	Yes	6	0.00000001	0.00005717
31	Yes	6	0.00000001	0.00005677
32	Yes	6	0.00000001	0.00005985
33	Yes	6	0.00000001	0.00006029
34	Yes	6	0.00000001	0.00005954

Maximum Tower Deflections - Service Wind

Section No.	Elevation ft	Horz. Deflection in	Gov. Load Comb.	Tilt °	Twist °
T1	129 - 124.75	0.446	32	0.0183	0.0136
T2	124.75 - 112.458	0.399	32	0.0201	0.0065
T3	112.458 - 100.167	0.344	32	0.0200	0.0067
T4	100.167 - 87.5	0.291	32	0.0188	0.0067
T5	87.5 - 74.8333	0.235	34	0.0176	0.0062
T6	74.8333 - 49.6667	0.184	34	0.0154	0.0055
T7	49.6667 - 24.75	0.094	34	0.0111	0.0034
T8	24.75 - 0	0.033	30	0.0061	0.0016

Critical Deflections and Radius of Curvature - Service Wind

Elevation ft	Appurtenance	Gov. Load Comb.	Deflection in	Tilt °	Twist °	Radius of Curvature ft
132.00	CC807-08	32	0.446	0.0183	0.0136	10370
125.00	APXVSP18-C-A20 w/Mount Pipe	32	0.402	0.0200	0.0067	10370
119.00	SC3-W100	32	0.364	0.0207	0.0050	18921
117.50	4"x4" Pipe Mount	32	0.359	0.0206	0.0053	30200
100.00	CC807-08	32	0.290	0.0188	0.0067	316498
94.00	APXVAARR24 43-U-NA20	32	0.263	0.0183	0.0064	284785
76.50	GPS	34	0.190	0.0157	0.0056	456867
75.00	Catwalk	34	0.184	0.0154	0.0055	442538

Maximum Tower Deflections - Design Wind

tnxTower Ramaker & Associates, Inc 855 Community Drive Sauk City, WI 53583 Phone: (608) 643-4100 FAX: (608) 643-7999	Job Youngs Apple Orchard	Page 26 of 27
	Project 30775	Date 12:56:32 06/03/19
	Client T-Mobile	Designed by TEM

Section No.	Elevation ft	Horz. Deflection in	Gov. Load Comb.	Tilt °	Twist °
T1	129 - 124.75	1.976	12	0.0755	0.0618
T2	124.75 - 112.458	1.761	12	0.0841	0.0294
T3	112.458 - 100.167	1.526	12	0.0846	0.0301
T4	100.167 - 87.5	1.296	12	0.0802	0.0303
T5	87.5 - 74.8333	1.050	12	0.0757	0.0280
T6	74.8333 - 49.6667	0.822	12	0.0669	0.0249
T7	49.6667 - 24.75	0.425	4	0.0489	0.0153
T8	24.75 - 0	0.146	8	0.0266	0.0074

Critical Deflections and Radius of Curvature - Design Wind

Elevation ft	Appurtenance	Gov. Load Comb.	Deflection in	Tilt °	Twist °	Radius of Curvature ft
132.00	CC807-08	12	1.976	0.0755	0.0618	2425
125.00	APXVSPPI8-C-A20 w/Mount Pipe	12	1.771	0.0837	0.0303	2425
119.00	SC3-W100	12	1.605	0.0875	0.0227	4410
117.50	4"x4" Pipe Mount	12	1.583	0.0872	0.0239	7014
100.00	CC807-08	12	1.293	0.0802	0.0302	74773
94.00	APXVAARR24_43-U-NA20	12	1.173	0.0784	0.0289	65977
76.50	GPS	12	0.852	0.0681	0.0254	121286
75.00	Catwalk	12	0.825	0.0670	0.0249	116146

Bolt Design Data

Section No.	Elevation ft	Component Type	Bolt Grade	Bolt Size in	Number Of Bolts	Maximum Load per Bolt lb	Allowable Load per Bolt lb	Ratio Load Allowable	Allowable Ratio	Criteria	
T2	124.75	Diagonal	A307	0.6250	2	2300.24	12425.20	0.185	✓	1	Bolt Shear
		Horizontal	A307	0.6250	3	636.08	6212.62	0.102	✓	1	Bolt Shear
T3	112.458	Leg	A307	0.6250	24	704.36	6212.62	0.113	✓	1	Bolt SS
		Diagonal	A307	0.6250	2	2777.25	12425.20	0.224	✓	1	Bolt Shear
T4	100.167	Horizontal	A307	0.6250	2	1212.99	12425.20	0.098	✓	1	Bolt Shear
		Diagonal	A307	0.6250	2	4117.51	12425.20	0.331	✓	1	Bolt Shear
T5	87.5	Horizontal	A307	0.6250	2	1738.72	12425.20	0.140	✓	1	Bolt Shear
		Leg	A307	0.6250	24	2072.53	6212.62	0.334	✓	1	Bolt SS
		Diagonal	A307	0.6250	2	4281.95	12425.20	0.345	✓	1	Bolt Shear
T6	74.8333	Horizontal	A307	0.6250	2	2210.74	12425.20	0.178	✓	1	Bolt Shear
		Leg	A307	0.6250	32	2171.04	6212.62	0.349	✓	1	Bolt SS
		Diagonal	A307	0.6250	2	8594.04	12425.20	0.692	✓	1	Bolt Shear
T7	49.6667	Horizontal	A307	0.6250	2	2679.78	12425.20	0.216	✓	1	Bolt Shear
		Leg	A307	0.6250	40	2891.94	6212.62	0.465	✓	1	Bolt SS
		Diagonal	A307	0.6250	2	9429.48	12425.20	0.759	✓	1	Bolt Shear
		Horizontal	A307	0.6250	2	3551.87	12425.20	0.286	✓	1	Bolt Shear

tnxTower Ramaker & Associates, Inc 855 Community Drive Sauk City, WI 53583 Phone: (608) 643-4100 FAX: (608) 643-7999	Job	Youngs Apple Orchard	Page	27 of 27
	Project	30775	Date	12:56:32 06/03/19
	Client	T-Mobile	Designed by	TEM

Section No.	Elevation ft	Component Type	Bolt Grade	Bolt Size in	Number Of Bolts	Maximum Load per Bolt lb	Allowable Load per Bolt lb	Ratio Load Allowable	Allowable Ratio	Criteria
T8	24.75	Leg	A307	0.6250	48	3478.55	6212.62	0.560 ✓	1	Bolt SS
		Diagonal	A307	0.6250	2	10411.00	12425.20	0.838 ✓	1	Bolt Shear
		Horizontal	A307	0.6250	2	4272.29	12425.20	0.344 ✓	1	Bolt Shear

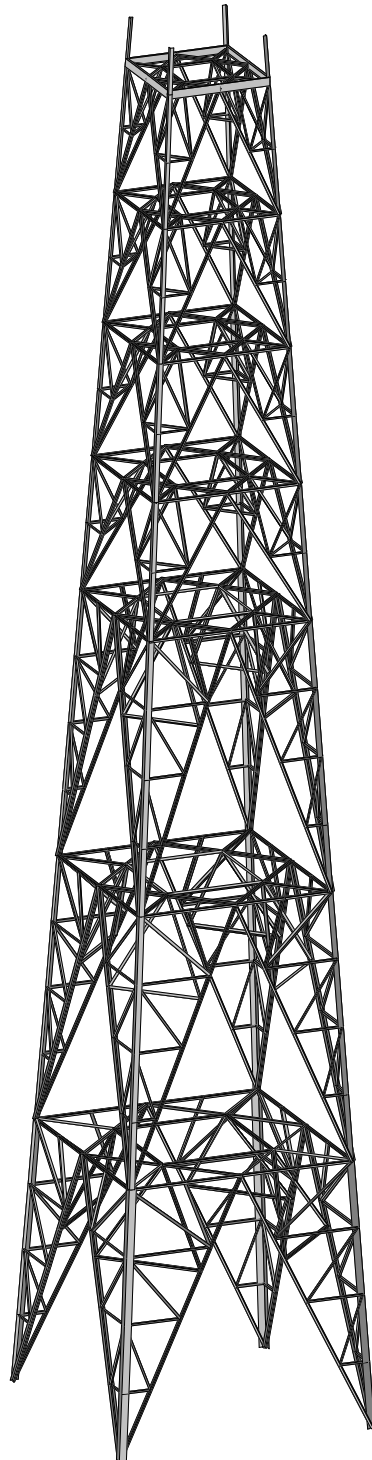

Ramaker & Associates, Inc
TEM
30775

Youngs Apple Orchard

SK - 1
June 3, 2019 at 12:25 PM
30775 rev4a.rt3

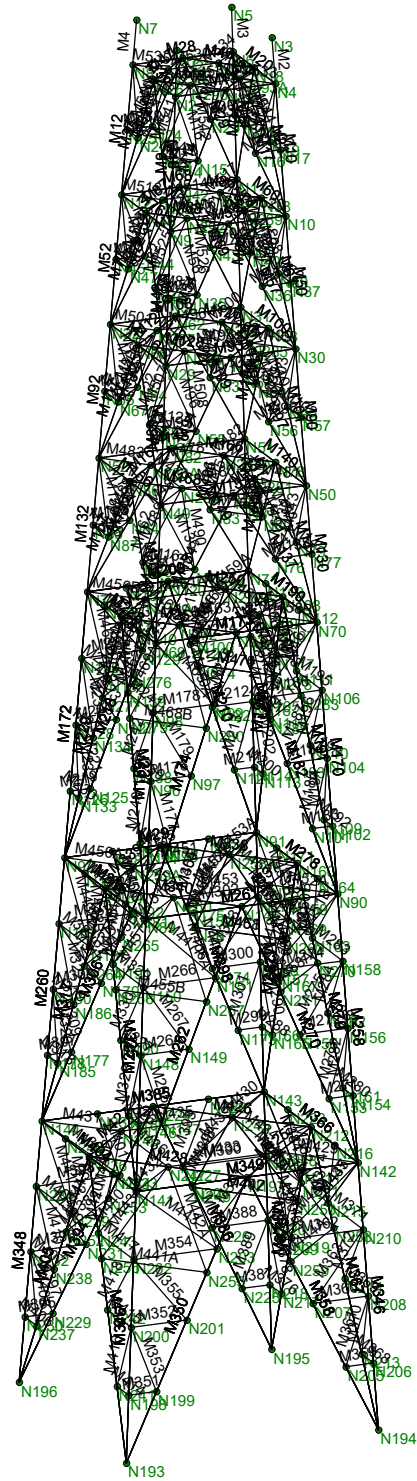

Ramaker & Associates, Inc

TEM

30775

Youngs Apple Orchard

SK - 2

June 3, 2019 at 12:26 PM

30775 rev4a.rt3

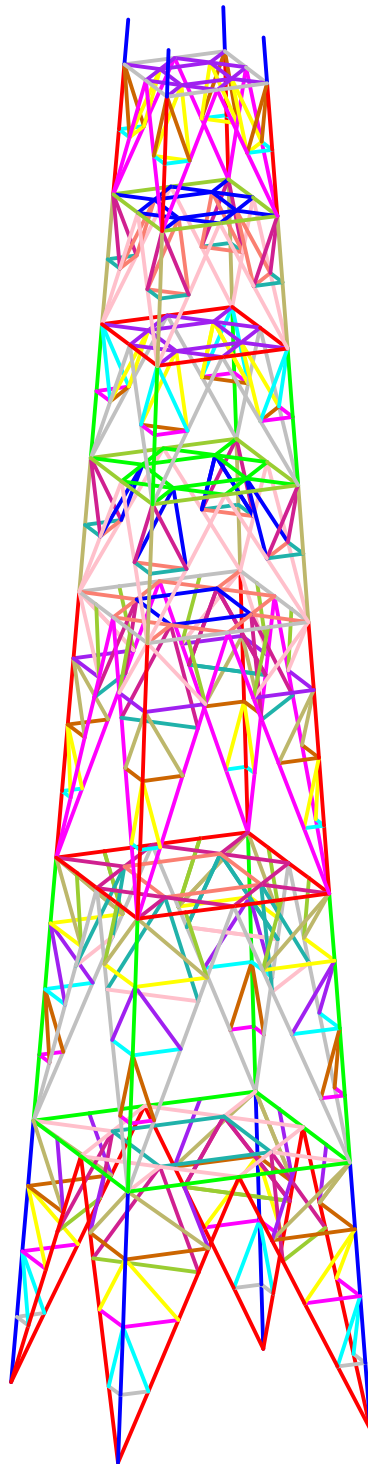

- Section Sets
- LEG_T1
 - TOP_GIRT_T1
 - LEG_T2
 - HORZ_T2
 - DIAG_T2
 - RED_HORZ_T2
 - RED_DIAG_T2
 - RED_HIP_T2
 - INNER_SUPP_T2
 - LEG_T3
 - HORZ_T3
 - DIAG_T3
 - RED_HORZ_T3
 - RED_DIAG_T3
 - RED_HIP_T3
 - INNER_SUPP_T3
 - LEG_T4
 - HORZ_T4
 - DIAG_T4
 - RED_HORZ_T4
 - RED_DIAG_T4
 - RED_HIP_T4
 - RED_HIP_DIAG_T4
 - INNER_SUPP_T4
 - LEG_T5
 - HORZ_T5
 - DIAG_T5
 - RED_HORZ_T5
 - RED_DIAG_T5
 - RED_HIP_T5
 - RED_HIP_DIAG_T5
 - INNER_SUPP_T5
 - LEG_T6
 - HORZ_T6
 - DIAG_T6
 - RED_HORZ_T6
 - RED_HORZ_2_T6
 - RED_DIAG_T6
 - RED_HORZ_3_T6
 - RED_DIAG_2_T6
 - RED_DIAG_3_T6
 - RED_DIAG_4_T6
 - RED_HIP_3_T6
 - RED_HIPDIA_3_T6
 - INNER_SUPP_T6
 - INNER_SUPP_1_T6
 - LEG_T7
 - HORZ_T7
 - DIAG_T7
 - RED_HORZ_T7
 - RED_HORZ_2_T7
 - RED_DIAG_T7
 - RED_HORZ_3_T7
 - RED_DIAG_2_T7
 - RED_DIAG_3_T7
 - RED_DIAG_4_T7
 - RED_HIP_3_T7
 - RED_HIPDIA_3_T7
 - INNER_SUPP_T7
 - INNER_SUPP_1_T7
 - LEG_T8
 - HORZ_T8
 - DIAG_T8
 - RED_HORZ_T8
 - RED_HORZ_2_T8
 - RED_DIAG_T8
 - RED_HORZ_3_T8
 - RED_DIAG_2_T8
 - RED_DIAG_3_T8
 - RED_DIAG_4_T8
 - RED_HIP_3_T8
 - INNER_SUPP_T8
 - INNER_SUPP_1_T8
 - INNER_SUPP_2_T8

Ramaker & Associates, Inc

TEM

30775

Youngs Apple Orchard

SK - 3

June 3, 2019 at 12:26 PM

30775 rev4a.rt3

(Global) Model Settings

Display Sections for Member Calcs	5
Max Internal Sections for Member Calcs	97
Include Shear Deformation?	Yes
Increase Nailing Capacity for Wind?	Yes
Include Warping?	Yes
Trans Load Btwn Intersecting Wood Wall?	Yes
Area Load Mesh (in^2)	144
Merge Tolerance (in)	.12
P-Delta Analysis Tolerance	0.50%
Include P-Delta for Walls?	Yes
Automatically Iterate Stiffness for Walls?	No
Max Iterations for Wall Stiffness	3
Gravity Acceleration (ft/sec^2)	32.2
Wall Mesh Size (in)	24
Eigensolution Convergence Tol. (1.E-)	4
Vertical Axis	Y
Global Member Orientation Plane	XZ
Static Solver	Sparse Accelerated
Dynamic Solver	Standard Solver

Hot Rolled Steel Code	AISC 14th(360-10): LRFD
Adjust Stiffness?	No
RISACONNECTION Code	None
Cold Formed Steel Code	None
Wood Code	None
Wood Temperature	< 100F
Concrete Code	None
Masonry Code	None
Aluminum Code	None - Building
Stainless Steel Code	None

Number of Shear Regions	4
Region Spacing Increment (in)	4
Biaxial Column Method	Exact Integration
Parame Beta Factor (PCA)	.65
Concrete Stress Block	Rectangular
Use Cracked Sections?	Yes
Use Cracked Sections Slab?	Yes
Bad Framing Warnings?	No
Unused Force Warnings?	Yes
Min 1 Bar Diam. Spacing?	No
Concrete Rebar Set	REBAR SET ASTMA615
Min % Steel for Column	1
Max % Steel for Column	8

(Global) Model Settings, Continued

Seismic Code	ASCE 7-10
Seismic Base Elevation (ft)	Not Entered
Add Base Weight?	Yes
Ct X	.02
Ct Z	.02
T X (sec)	Not Entered
T Z (sec)	Not Entered
R X	3
R Z	3
Ct Exp. X	.75
Ct Exp. Z	.75
SD1	1
SDS	1
S1	1
TL (sec)	5
Risk Cat	I or II
Drift Cat	Other
Om Z	1
Om X	1
Cd Z	1
Cd X	1
Rho Z	1
Rho X	1

Hot Rolled Steel Properties

	Label	E [ksi]	G [ksi]	Nu	Therm (1...	Density[k/ft^3]	Yield[ksi]	Ry	Fu[ksi]	Rt
1	A36	29000	11200	.2946	.65	.49	36	1.5	58	1.2

General Material Properties

	Label	E [ksi]	G [ksi]	Nu	Therm (1E5 F)	Density[k/ft^3]
1	gen Conc3NW	3155	1372	.15	.6	.145
2	gen Conc4NW	3644	1584	.15	.6	.145
3	gen Conc3LW	2085	906	.15	.6	.11
4	gen Conc4LW	2408	1047	.15	.6	.11
5	gen Alum	10600	4077	.3	1.29	.173
6	gen Steel	29000	11154	.3	.65	.49
7	RIGID	1e+6		.3	0	0

Hot Rolled Steel Section Sets

	Label	Shape	Type	Design List	Material	Design Ru...	A [in2]	Iyy [in4]	Izz [in4]	J [in4]
1	LEG T1	L4x4x3/8	Column	Single Angle	A36	Typical	2.86	4.36	4.36	.141
2	TOP_GIRT_T1	SR 1	Beam	None	A36	Typical	.7854	.0491	.0491	.0982
3	LEG T2	L4x4x3/8	Column	Single Angle	A36	Typical	2.86	4.36	4.36	.141
4	HORZ_T2	C9X13.4	Beam	Channel	A36	Typical	3.94	1.75	47.8	.168
5	DIAG_T2	2L2 1/2x2x3/8x3/8	Column	None	A36	Typical	3.09	2.8592	1.82	.145
6	RED_HORZ_T2	L2x2x3/16	Beam	Single Angle	A36	Typical	.715	.272	.272	.0088
7	RED_DIAG_T2	L2x2x3/16	Column	Single Angle	A36	Typical	.715	.272	.272	.0088
8	RED_HIP_T2	L2x2x3/16	Beam	Single Angle	A36	Typical	.715	.272	.272	.0088
9	INNER_SUPP_T2	LL2.5x2x3x3	Beam	Single Angle	A36	Typical	1.64	1.38	1.02	.0206
10	LEG T3	L4x4x3/8	Column	Single Angle	A36	Typical	2.86	4.36	4.36	.141
11	HORZ_T3	2L2 1/2x2x1/4x3/8	Beam	None	A36	Typical	2.13	1.858	1.31	.0443
12	DIAG_T3	2L2 1/2x2x3/8x3/8	Column	None	A36	Typical	3.09	2.8592	1.82	.145
13	RED_HORZ_T3	L2x2x3/16	Beam	Single Angle	A36	Typical	.715	.272	.272	.0088

Hot Rolled Steel Section Sets (Continued)

	Label	Shape	Type	Design List	Material	Design Ru...	A [in ²]	I _{yy} [in ⁴]	I _{zz} [in ⁴]	J [in ⁴]
14	RED DIAG T3	L2x2 1/2x3/16	Column	Single Angle	A36	Typical	.809	.509	.291	.0099
15	RED HIP T3	L2x2x3/16	Beam	Single Angle	A36	Typical	.715	.272	.272	.0088
16	INNER SUPP T3	LL2.5x2x3x3	Beam	Single Angle	A36	Typical	1.64	1.38	1.02	.0206
17	LEG T4	L5x5x1/2	Column	Single Angle	A36	Typical	4.75	11.3	11.3	.417
18	HORZ T4	2L2 1/2x2x1/4x3/8	Beam	None	A36	Typical	2.13	1.858	1.31	.0443
19	DIAG T4	2L2 1/2x2x1/4x3/8	Column	None	A36	Typical	2.13	1.858	1.31	.0443
20	RED HORZ T4	L2x2x3/16	Beam	Single Angle	A36	Typical	.715	.272	.272	.0088
21	RED DIAG T4	L2x2x3/16	Column	Single Angle	A36	Typical	.715	.272	.272	.0088
22	RED HIP T4	L2x2x3/16	Beam	Single Angle	A36	Typical	.715	.272	.272	.0088
23	RED HIP DIAG T4	L2 1/2x2 1/2x3/16	Beam	Single Angle	A36	Typical	.902	.547	.547	.011
24	INNER SUPP T4	LL2.5x2x3x3	Beam	Single Angle	A36	Typical	1.64	1.38	1.02	.0206
25	LEG T5	L5x5x1/2	Column	Single Angle	A36	Typical	4.75	11.3	11.3	.417
26	HORZ T5	2L2 1/2x2x1/4x3/8	Beam	None	A36	Typical	2.13	1.858	1.31	.0443
27	DIAG T5	2L2 1/2x2x1/4x3/8	Column	None	A36	Typical	2.13	1.858	1.31	.0443
28	RED HORZ T5	L2x2x3/16	Beam	Single Angle	A36	Typical	.715	.272	.272	.0088
29	RED DIAG T5	L2x2x3/16	Column	Single Angle	A36	Typical	.715	.272	.272	.0088
30	RED HIP T5	L2x2x3/16	Beam	Single Angle	A36	Typical	.715	.272	.272	.0088
31	RED HIP DIAG T5	L2.5x2.5x3	Beam	Single Angle	A36	Typical	.901	.535	.535	.0114
32	INNER SUPP T5	LL2.5x2x3x3	Beam	Single Angle	A36	Typical	1.64	1.38	1.02	.0206
33	LEG T6	L6x6x1/2	Column	Single Angle	A36	Typical	5.75	19.9	19.9	.501
34	HORZ T6	2L2 1/2x2x1/4x3/8	Beam	None	A36	Typical	2.13	1.858	1.31	.0443
35	DIAG T6	2L2 1/2x3x3/8x3/8	Column	None	A36	Typical	3.84	8.3408	2.08	.1802
36	RED HORZ T6	L2 1/2x2x3/16	Beam	Single Angle	A36	Typical	.809	.291	.509	.0099
37	RED HORZ 2 T6	L2 1/2x2 1/2x3/16	Beam	Single Angle	A36	Typical	.902	.547	.547	.011
38	RED DIAG T6	L2x2 1/2x3/16	Column	Single Angle	A36	Typical	.809	.509	.291	.0099
39	RED HORZ 3 T6	L2 1/2x2x3/16	Beam	Single Angle	A36	Typical	.809	.291	.509	.0099
40	RED DIAG 2 T6	L2x2 1/2x3/16	Column	Single Angle	A36	Typical	.809	.509	.291	.0099
41	RED DIAG 3 T6	LL2.5x2x3x3	Column	Single Angle	A36	Typical	1.64	1.38	1.02	.0206
42	RED DIAG 4 T6	L2 1/2x2 1/2x3/16	Column	Single Angle	A36	Typical	.902	.547	.547	.011
43	RED HIP 3 T6	L2 1/2x2 1/2x3/16	Beam	Single Angle	A36	Typical	.902	.547	.547	.011
44	RED HIPDIA 3 T6	L3x3x3/16	Column	Single Angle	A36	Typical	1.09	.96	.96	.0142
45	INNER SUPP T6	LL2.5x2x3x3	Beam	Single Angle	A36	Typical	1.64	1.38	1.02	.0206
46	INNER SUPP 1 T6	L2.5x2.5x3	Beam	Single Angle	A36	Typical	.901	.535	.535	.0114
47	LEG T7	L6x6x5/8	Column	Single Angle	A36	Typical	7.11	24.2	24.2	.954
48	HORZ T7	2L2 1/2x2x1/4x3/8	Beam	None	A36	Typical	2.13	1.858	1.31	.0443
49	DIAG T7	2L2 1/2x3x3/8x3/8	Column	None	A36	Typical	3.84	8.3408	2.08	.1802
50	RED HORZ T7	L2 1/2x2x3/16	Beam	Single Angle	A36	Typical	.809	.291	.509	.0099
51	RED HORZ 2 T7	L2 1/2x2 1/2x3/16	Beam	Single Angle	A36	Typical	.902	.547	.547	.011
52	RED DIAG T7	L2x2 1/2x3/16	Column	Single Angle	A36	Typical	.809	.509	.291	.0099
53	RED HORZ 3 T7	L2 1/2x2x3/16	Beam	Single Angle	A36	Typical	.809	.291	.509	.0099
54	RED DIAG 2 T7	L2 1/2x2 1/2x3/16	Column	Single Angle	A36	Typical	.902	.547	.547	.011
55	RED DIAG 3 T7	L3x3x3/16	Column	Single Angle	A36	Typical	1.09	.96	.96	.0142
56	RED DIAG 4 T7	LL2.5x2x3x3	Column	Single Angle	A36	Typical	1.64	1.38	1.02	.0206
57	RED HIP 3 T7	L3x3x3/16	Beam	Single Angle	A36	Typical	1.09	.96	.96	.0142
58	RED HIPDIA 3 T7	L3x3x3/16	Column	Single Angle	A36	Typical	1.09	.96	.96	.0142
59	INNER SUPP T7	LL2.5x2x3x3	Beam	Single Angle	A36	Typical	1.64	1.38	1.02	.0206
60	INNER SUPP 1 T7	L3x3x1/4	Beam	Single Angle	A36	Typical	1.44	1.24	1.24	.0322
61	LEG T8	L8x8x1/2	Column	Single Angle	A36	Typical	7.75	48.6	48.6	.682
62	HORZ T8	2L2 1/2x2x1/4x3/8	Beam	None	A36	Typical	2.13	1.858	1.31	.0443
63	DIAG T8	2L2 1/2x3x3/8x3/8	Column	None	A36	Typical	3.84	8.3408	2.08	.1802
64	RED HORZ T8	L2 1/2x2x1/4	Beam	Single Angle	A36	Typical	1.06	.372	.654	.0227
65	RED HORZ 2 T8	L2 1/2x2 1/2x1/4	Beam	Single Angle	A36	Typical	1.19	.703	.703	.0253
66	RED DIAG T8	L2x2 1/2x1/4	Column	Single Angle	A36	Typical	1.06	.654	.372	.0227
67	RED HORZ 3 T8	L2 1/2x2 1/2x3/16	Beam	Single Angle	A36	Typical	.902	.547	.547	.011
68	RED DIAG 2 T8	L2 1/2x2 1/2x1/4	Column	Single Angle	A36	Typical	1.19	.703	.703	.0253
69	RED DIAG 3 T8	L3x3x3/16	Column	Single Angle	A36	Typical	1.09	.96	.96	.0142
70	RED DIAG 4 T8	L3x3x3/16	Column	Single Angle	A36	Typical	1.09	.96	.96	.0142

Hot Rolled Steel Section Sets (Continued)

	Label	Shape	Type	Design List	Material	Design Ru...	A [in2]	Iyy [in4]	Izz [in4]	J [in4]
71	RED HIP 3 T8	2L2 1/2x2x3/16x3/8	Beam	None	A36	Typical	1.62	1.3781	1.02	.019
72	RED_HIPDIA_3_T8	2L2 1/2x2 1/2x1/4x...	Column	None	A36	Typical	2.38	3.3474	1.41	.0495
73	INNER_SUPP_T8	L2 1/2x2 1/2x3/16	Beam	Single Angle	A36	Typical	.902	.547	.547	.011
74	INNER_SUPP_1_T8	LL2.5x2x4x3	Beam	Single Angle	A36	Typical	2.14	1.85	1.31	.047
75	INNER_SUPP_2_T8	LL2.5x2x4x3	Beam	Single Angle	A36	Typical	2.14	1.85	1.31	.047

General Section Sets

	Label	Shape	Type	Material	A [in2]	Iyy [in4]	Izz [in4]	J [in4]
1	GEN1	RE4X4	Beam	gen_Conc3NW	16	21.3333	21.3333	31.5733

Member Primary Data

	Label	I Joint	J Joint	K Joint	Rotate(de...	Section/Shape	Type	Design List	Material	Design Rules
1	M1	N2	N1		135	LEG T1	Column	Single An...	A36	Typical
2	M2	N4	N3		135	LEG T1	Column	Single An...	A36	Typical
3	M3	N6	N5		135	LEG T1	Column	Single An...	A36	Typical
4	M4	N8	N7		135	LEG T1	Column	Single An...	A36	Typical
5	M5	N1	N3			TOP GIRT T1	Beam	None	A36	Typical
6	M6	N3	N5			TOP GIRT T1	Beam	None	A36	Typical
7	M7	N5	N7			TOP GIRT T1	Beam	None	A36	Typical
8	M8	N7	N1			TOP GIRT T1	Beam	None	A36	Typical
9	M9	N9	N2		135	LEG T2	Column	Single An...	A36	Typical
10	M10	N10	N4		135	LEG T2	Column	Single An...	A36	Typical
11	M11	N11	N6		135	LEG T2	Column	Single An...	A36	Typical
12	M12	N12	N8		135	LEG T2	Column	Single An...	A36	Typical
13	M13	N2	N4		176.6357	HORZ T2	Beam	Channel	A36	Typical
14	M14	N9	N13		351.8657	DIAG T2	Column	None	A36	Typical
15	M15	N14	N15		86.6357	RED HORZ T2	Beam	Single An...	A36	Typical
16	M16	N15	N2		100.5166	RED DIAG T2	Column	Single An...	A36	Typical
17	M17	N10	N13		8.1343	DIAG T2	Column	None	A36	Typical
18	M18	N16	N17		86.6357	RED HORZ T2	Beam	Single An...	A36	Typical
19	M19	N16	N4		79.4834	RED DIAG T2	Column	Single An...	A36	Typical
20	M20	N4	N6		176.6357	HORZ T2	Beam	Channel	A36	Typical
21	M21	N10	N18		351.8657	DIAG T2	Column	None	A36	Typical
22	M22	N17	N19		86.6357	RED HORZ T2	Beam	Single An...	A36	Typical
23	M23	N19	N4		100.5166	RED DIAG T2	Column	Single An...	A36	Typical
24	M24	N11	N18		8.1343	DIAG T2	Column	None	A36	Typical
25	M25	N20	N21		86.6357	RED HORZ T2	Beam	Single An...	A36	Typical
26	M26	N20	N6		79.4834	RED DIAG T2	Column	Single An...	A36	Typical
27	M27	N16	N19		90	RED HIP T2	Beam	Single An...	A36	Typical
28	M28	N6	N8		176.6357	HORZ T2	Beam	Channel	A36	Typical
29	M29	N11	N22		351.8657	DIAG T2	Column	None	A36	Typical
30	M30	N21	N23		86.6357	RED HORZ T2	Beam	Single An...	A36	Typical
31	M31	N23	N6		100.5166	RED DIAG T2	Column	Single An...	A36	Typical
32	M32	N12	N22		8.1343	DIAG T2	Column	None	A36	Typical
33	M33	N24	N25		86.6357	RED HORZ T2	Beam	Single An...	A36	Typical
34	M34	N24	N8		79.4834	RED DIAG T2	Column	Single An...	A36	Typical
35	M35	N20	N23		90	RED HIP T2	Beam	Single An...	A36	Typical
36	M36	N8	N2		176.6357	HORZ T2	Beam	Channel	A36	Typical
37	M37	N12	N26		351.8657	DIAG T2	Column	None	A36	Typical
38	M38	N25	N27		86.6357	RED HORZ T2	Beam	Single An...	A36	Typical
39	M39	N27	N8		100.5166	RED DIAG T2	Column	Single An...	A36	Typical
40	M40	N9	N26		8.1343	DIAG T2	Column	None	A36	Typical
41	M41	N28	N14		86.6357	RED HORZ T2	Beam	Single An...	A36	Typical
42	M42	N28	N2		79.4834	RED DIAG T2	Column	Single An...	A36	Typical

Member Primary Data (Continued)

	Label	I Joint	J Joint	K Joint	Rotate(de...	Section/Shape	Type	Design List	Material	Design Rules
43	M43	N24	N27		90	RED HIP T2	Beam	Single An...	A36	Typical
44	M44	N15	N28		90	RED HIP T2	Beam	Single An...	A36	Typical
45	M45	N13	N18		90	INNER SUPP T2	Beam	Single An...	A36	Typical
46	M46	N18	N22		90	INNER SUPP T2	Beam	Single An...	A36	Typical
47	M47	N22	N26		90	INNER SUPP T2	Beam	Single An...	A36	Typical
48	M48	N26	N13		90	INNER SUPP T2	Beam	Single An...	A36	Typical
49	M49	N29	N9		135	LEG T3	Column	Single An...	A36	Typical
50	M50	N30	N10		135	LEG T3	Column	Single An...	A36	Typical
51	M51	N31	N11		135	LEG T3	Column	Single An...	A36	Typical
52	M52	N32	N12		135	LEG T3	Column	Single An...	A36	Typical
53	M53	N9	N10		356.6357	HORZ T3	Beam	None	A36	Typical
54	M54	N29	N33		352.6263	DIAG T3	Column	None	A36	Typical
55	M55	N34	N35		86.6357	RED HORZ T3	Beam	Single An...	A36	Typical
56	M56	N35	N9		99.1397	RED DIAG T3	Column	Single An...	A36	Typical
57	M57	N30	N33		7.3737	DIAG T3	Column	None	A36	Typical
58	M58	N36	N37		86.6357	RED HORZ T3	Beam	Single An...	A36	Typical
59	M59	N36	N10		80.8603	RED DIAG T3	Column	Single An...	A36	Typical
60	M60	N10	N11		356.6357	HORZ T3	Beam	None	A36	Typical
61	M61	N30	N38		352.6263	DIAG T3	Column	None	A36	Typical
62	M62	N37	N39		86.6357	RED HORZ T3	Beam	Single An...	A36	Typical
63	M63	N39	N10		99.1397	RED DIAG T3	Column	Single An...	A36	Typical
64	M64	N31	N38		7.3737	DIAG T3	Column	None	A36	Typical
65	M65	N40	N41		86.6357	RED HORZ T3	Beam	Single An...	A36	Typical
66	M66	N40	N11		80.8603	RED DIAG T3	Column	Single An...	A36	Typical
67	M67	N36	N39		90	RED HIP T3	Beam	Single An...	A36	Typical
68	M68	N11	N12		356.6357	HORZ T3	Beam	None	A36	Typical
69	M69	N31	N42		352.6263	DIAG T3	Column	None	A36	Typical
70	M70	N41	N43		86.6357	RED HORZ T3	Beam	Single An...	A36	Typical
71	M71	N43	N11		99.1397	RED DIAG T3	Column	Single An...	A36	Typical
72	M72	N32	N42		7.3737	DIAG T3	Column	None	A36	Typical
73	M73	N44	N45		86.6357	RED HORZ T3	Beam	Single An...	A36	Typical
74	M74	N44	N12		80.8603	RED DIAG T3	Column	Single An...	A36	Typical
75	M75	N40	N43		90	RED HIP T3	Beam	Single An...	A36	Typical
76	M76	N12	N9		356.6357	HORZ T3	Beam	None	A36	Typical
77	M77	N32	N46		352.6263	DIAG T3	Column	None	A36	Typical
78	M78	N45	N47		86.6357	RED HORZ T3	Beam	Single An...	A36	Typical
79	M79	N47	N12		99.1397	RED DIAG T3	Column	Single An...	A36	Typical
80	M80	N29	N46		7.3737	DIAG T3	Column	None	A36	Typical
81	M81	N48	N34		86.6357	RED HORZ T3	Beam	Single An...	A36	Typical
82	M82	N48	N9		80.8603	RED DIAG T3	Column	Single An...	A36	Typical
83	M83	N44	N47		90	RED HIP T3	Beam	Single An...	A36	Typical
84	M84	N35	N48		90	RED HIP T3	Beam	Single An...	A36	Typical
85	M85	N33	N38		90	INNER SUPP T3	Beam	Single An...	A36	Typical
86	M86	N38	N42		90	INNER SUPP T3	Beam	Single An...	A36	Typical
87	M87	N42	N46		90	INNER SUPP T3	Beam	Single An...	A36	Typical
88	M88	N46	N33		90	INNER SUPP T3	Beam	Single An...	A36	Typical
89	M89	N49	N29		135	LEG T4	Column	Single An...	A36	Typical
90	M90	N50	N30		135	LEG T4	Column	Single An...	A36	Typical
91	M91	N51	N31		135	LEG T4	Column	Single An...	A36	Typical
92	M92	N52	N32		135	LEG T4	Column	Single An...	A36	Typical
93	M93	N29	N30		356.6357	HORZ T4	Beam	None	A36	Typical
94	M94	N49	N53		353.0786	DIAG T4	Column	None	A36	Typical
95	M95	N54	N55		86.6357	RED HORZ T4	Beam	Single An...	A36	Typical
96	M96	N55	N29		98.3656	RED DIAG T4	Column	Single An...	A36	Typical
97	M97	N50	N53		6.9214	DIAG T4	Column	None	A36	Typical
98	M98	N56	N57		86.6357	RED HORZ T4	Beam	Single An...	A36	Typical
99	M99	N56	N30		81.6344	RED DIAG T4	Column	Single An...	A36	Typical

Member Primary Data (Continued)

	Label	I Joint	J Joint	K Joint	Rotate(de...	Section/Shape	Type	Design List	Material	Design Rules
100	M100	N30	N31		356.6357	HORZ T4	Beam	None	A36	Typical
101	M101	N50	N58		353.0786	DIAG T4	Column	None	A36	Typical
102	M102	N57	N59		86.6357	RED HORZ T4	Beam	Single An...	A36	Typical
103	M103	N59	N30		98.3656	RED DIAG T4	Column	Single An...	A36	Typical
104	M104	N51	N58		6.9214	DIAG T4	Column	None	A36	Typical
105	M105	N60	N61		86.6357	RED HORZ T4	Beam	Single An...	A36	Typical
106	M106	N60	N31		81.6344	RED DIAG T4	Column	Single An...	A36	Typical
107	M107	N56	N59		90	RED HIP T4	Beam	Single An...	A36	Typical
108	M108	N31	N32		356.6357	HORZ T4	Beam	None	A36	Typical
109	M109	N51	N62		353.0786	DIAG T4	Column	None	A36	Typical
110	M110	N61	N63		86.6357	RED HORZ T4	Beam	Single An...	A36	Typical
111	M111	N63	N31		98.3656	RED DIAG T4	Column	Single An...	A36	Typical
112	M112	N52	N62		6.9214	DIAG T4	Column	None	A36	Typical
113	M113	N64	N65		86.6357	RED HORZ T4	Beam	Single An...	A36	Typical
114	M114	N64	N32		81.6344	RED DIAG T4	Column	Single An...	A36	Typical
115	M115	N60	N63		90	RED HIP T4	Beam	Single An...	A36	Typical
116	M116	N32	N29		356.6357	HORZ T4	Beam	None	A36	Typical
117	M117	N52	N66		353.0786	DIAG T4	Column	None	A36	Typical
118	M118	N65	N67		86.6357	RED HORZ T4	Beam	Single An...	A36	Typical
119	M119	N67	N32		98.3656	RED DIAG T4	Column	Single An...	A36	Typical
120	M120	N49	N66		6.9214	DIAG T4	Column	None	A36	Typical
121	M121	N68	N54		86.6357	RED HORZ T4	Beam	Single An...	A36	Typical
122	M122	N68	N29		81.6344	RED DIAG T4	Column	Single An...	A36	Typical
123	M123	N64	N67		90	RED HIP T4	Beam	Single An...	A36	Typical
124	M124	N55	N68		90	RED HIP T4	Beam	Single An...	A36	Typical
125	M125	N53	N58		90	INNER SUPP T4	Beam	Single An...	A36	Typical
126	M126	N58	N62		90	INNER SUPP T4	Beam	Single An...	A36	Typical
127	M127	N62	N66		90	INNER SUPP T4	Beam	Single An...	A36	Typical
128	M128	N66	N53		90	INNER SUPP T4	Beam	Single An...	A36	Typical
129	M129	N69	N49		135	LEG T5	Column	Single An...	A36	Typical
130	M130	N70	N50		135	LEG T5	Column	Single An...	A36	Typical
131	M131	N71	N51		135	LEG T5	Column	Single An...	A36	Typical
132	M132	N72	N52		135	LEG T5	Column	Single An...	A36	Typical
133	M133	N49	N50		356.6357	HORZ T5	Beam	None	A36	Typical
134	M134	N69	N73		353.576	DIAG T5	Column	None	A36	Typical
135	M135	N74	N75		86.6357	RED HORZ T5	Beam	Single An...	A36	Typical
136	M136	N75	N49		97.5508	RED DIAG T5	Column	Single An...	A36	Typical
137	M137	N70	N73		6.424	DIAG T5	Column	None	A36	Typical
138	M138	N76	N77		86.6357	RED HORZ T5	Beam	Single An...	A36	Typical
139	M139	N76	N50		82.4492	RED DIAG T5	Column	Single An...	A36	Typical
140	M140	N50	N51		356.6357	HORZ T5	Beam	None	A36	Typical
141	M141	N70	N78		353.576	DIAG T5	Column	None	A36	Typical
142	M142	N77	N79		86.6357	RED HORZ T5	Beam	Single An...	A36	Typical
143	M143	N79	N50		97.5508	RED DIAG T5	Column	Single An...	A36	Typical
144	M144	N71	N78		6.424	DIAG T5	Column	None	A36	Typical
145	M145	N80	N81		86.6357	RED HORZ T5	Beam	Single An...	A36	Typical
146	M146	N80	N51		82.4492	RED DIAG T5	Column	Single An...	A36	Typical
147	M147	N76	N79		90	RED HIP T5	Beam	Single An...	A36	Typical
148	M148	N51	N52		356.6357	HORZ T5	Beam	None	A36	Typical
149	M149	N71	N82		353.576	DIAG T5	Column	None	A36	Typical
150	M150	N81	N83		86.6357	RED HORZ T5	Beam	Single An...	A36	Typical
151	M151	N83	N51		97.5508	RED DIAG T5	Column	Single An...	A36	Typical
152	M152	N72	N82		6.424	DIAG T5	Column	None	A36	Typical
153	M153	N84	N85		86.6357	RED HORZ T5	Beam	Single An...	A36	Typical
154	M154	N84	N52		82.4492	RED DIAG T5	Column	Single An...	A36	Typical
155	M155	N80	N83		90	RED HIP T5	Beam	Single An...	A36	Typical
156	M156	N52	N49		356.6357	HORZ T5	Beam	None	A36	Typical

Member Primary Data (Continued)

	Label	I Joint	J Joint	K Joint	Rotate(de...	Section/Shape	Type	Design List	Material	Design Rules
157	M157	N72	N86		353.576	DIAG T5	Column	None	A36	Typical
158	M158	N85	N87		86.6357	RED_HORZ_T5	Beam	Single An...	A36	Typical
159	M159	N87	N52		97.5508	RED_DIAG_T5	Column	Single An...	A36	Typical
160	M160	N69	N86		6.424	DIAG T5	Column	None	A36	Typical
161	M161	N88	N74		86.6357	RED_HORZ_T5	Beam	Single An...	A36	Typical
162	M162	N88	N49		82.4492	RED_DIAG_T5	Column	Single An...	A36	Typical
163	M163	N84	N87		90	RED_HIP_T5	Beam	Single An...	A36	Typical
164	M164	N75	N88		90	RED_HIP_T5	Beam	Single An...	A36	Typical
165	M165	N73	N78		90	INNER_SUPP_T5	Beam	Single An...	A36	Typical
166	M166	N78	N82		90	INNER_SUPP_T5	Beam	Single An...	A36	Typical
167	M167	N82	N86		90	INNER_SUPP_T5	Beam	Single An...	A36	Typical
168	M168	N86	N73		90	INNER_SUPP_T5	Beam	Single An...	A36	Typical
169	M169	N89	N69		135	LEG_T6	Column	Single An...	A36	Typical
170	M170	N90	N70		135	LEG_T6	Column	Single An...	A36	Typical
171	M171	N91	N71		135	LEG_T6	Column	Single An...	A36	Typical
172	M172	N92	N72		135	LEG_T6	Column	Single An...	A36	Typical
173	M173	N69	N70		356.6357	HORZ_T6	Beam	None	A36	Typical
174	M174	N89	N93		350.3125	DIAG_T6	Column	None	A36	Typical
175	M175	N94	N95		86.6357	RED_HORZ_T6	Beam	Single An...	A36	Typical
176	M176	N96	N97		86.6357	RED_HORZ_2_T6	Beam	Single An...	A36	Typical
177	M177	N95	N96		103.6528	RED_DIAG_T6	Column	Single An...	A36	Typical
178	M178	N98	N99		86.6357	RED_HORZ_3_T6	Beam	Single An...	A36	Typical
179	M179	N97	N98		96.8833	RED_DIAG_2_T6	Column	Single An...	A36	Typical
180	M181	N99	N100		103.6528	RED_DIAG_3_T6	Column	Single An...	A36	Typical
181	M182	N90	N93		9.6875	DIAG_T6	Column	None	A36	Typical
182	M183	N101	N102		86.6357	RED_HORZ_T6	Beam	Single An...	A36	Typical
183	M184	N103	N104		86.6357	RED_HORZ_2_T6	Beam	Single An...	A36	Typical
184	M185	N101	N104		76.3472	RED_DIAG_T6	Column	Single An...	A36	Typical
185	M186	N105	N106		86.6357	RED_HORZ_3_T6	Beam	Single An...	A36	Typical
186	M187	N103	N106		83.1167	RED_DIAG_2_T6	Column	Single An...	A36	Typical
187	M189	N105	N107		76.3472	RED_DIAG_3_T6	Column	Single An...	A36	Typical
188	M190	N70	N71		356.6357	HORZ_T6	Beam	None	A36	Typical
189	M191	N90	N108		350.3125	DIAG_T6	Column	None	A36	Typical
190	M192	N102	N109		86.6357	RED_HORZ_T6	Beam	Single An...	A36	Typical
191	M193	N104	N110		86.6357	RED_HORZ_2_T6	Beam	Single An...	A36	Typical
192	M194	N109	N104		103.6528	RED_DIAG_T6	Column	Single An...	A36	Typical
193	M195	N106	N111		86.6357	RED_HORZ_3_T6	Beam	Single An...	A36	Typical
194	M196	N110	N106		96.8833	RED_DIAG_2_T6	Column	Single An...	A36	Typical
195	M198	N111	N112		103.6528	RED_DIAG_3_T6	Column	Single An...	A36	Typical
196	M199	N91	N108		9.6875	DIAG_T6	Column	None	A36	Typical
197	M200	N113	N114		86.6357	RED_HORZ_T6	Beam	Single An...	A36	Typical
198	M201	N115	N116		86.6357	RED_HORZ_2_T6	Beam	Single An...	A36	Typical
199	M202	N113	N116		76.3472	RED_DIAG_T6	Column	Single An...	A36	Typical
200	M203	N117	N118		86.6357	RED_HORZ_3_T6	Beam	Single An...	A36	Typical
201	M204	N115	N118		83.1167	RED_DIAG_2_T6	Column	Single An...	A36	Typical
202	M206	N117	N119		76.3472	RED_DIAG_3_T6	Column	Single An...	A36	Typical
203	M209	N71	N72		356.6357	HORZ_T6	Beam	None	A36	Typical
204	M210	N91	N120		350.3125	DIAG_T6	Column	None	A36	Typical
205	M211	N114	N121		86.6357	RED_HORZ_T6	Beam	Single An...	A36	Typical
206	M212	N116	N122		86.6357	RED_HORZ_2_T6	Beam	Single An...	A36	Typical
207	M213	N121	N116		103.6528	RED_DIAG_T6	Column	Single An...	A36	Typical
208	M214	N118	N123		86.6357	RED_HORZ_3_T6	Beam	Single An...	A36	Typical
209	M215	N122	N118		96.8833	RED_DIAG_2_T6	Column	Single An...	A36	Typical
210	M217	N123	N124		103.6528	RED_DIAG_3_T6	Column	Single An...	A36	Typical
211	M218	N92	N120		9.6875	DIAG_T6	Column	None	A36	Typical
212	M219	N125	N126		86.6357	RED_HORZ_T6	Beam	Single An...	A36	Typical
213	M220	N127	N128		86.6357	RED_HORZ_2_T6	Beam	Single An...	A36	Typical

Member Primary Data (Continued)

	Label	I Joint	J Joint	K Joint	Rotate(de...	Section/Shape	Type	Design List	Material	Design Rules
214	M221	N125	N128		76.3472	RED DIAG 3 T6	Column	Single An...	A36	Typical
215	M222	N129	N130		86.6357	RED HORZ 3 T6	Beam	Single An...	A36	Typical
216	M223	N127	N130		83.1167	RED DIAG 2 T6	Column	Single An...	A36	Typical
217	M225	N129	N131		76.3472	RED DIAG 3 T6	Column	Single An...	A36	Typical
218	M228	N72	N69		356.6357	HORZ T6	Beam	None	A36	Typical
219	M229	N92	N132		350.3125	DIAG T6	Column	None	A36	Typical
220	M230	N126	N133		86.6357	RED HORZ T6	Beam	Single An...	A36	Typical
221	M231	N128	N134		86.6357	RED HORZ 2 T6	Beam	Single An...	A36	Typical
222	M232	N133	N128		103.6528	RED DIAG T6	Column	Single An...	A36	Typical
223	M233	N130	N135		86.6357	RED HORZ 3 T6	Beam	Single An...	A36	Typical
224	M234	N134	N130		96.8833	RED DIAG 2 T6	Column	Single An...	A36	Typical
225	M236	N135	N136		103.6528	RED DIAG 3 T6	Column	Single An...	A36	Typical
226	M237	N89	N132		9.6875	DIAG T6	Column	None	A36	Typical
227	M238	N137	N94		86.6357	RED HORZ T6	Beam	Single An...	A36	Typical
228	M239	N138	N96		86.6357	RED HORZ 2 T6	Beam	Single An...	A36	Typical
229	M240	N137	N96		76.3472	RED DIAG T6	Column	Single An...	A36	Typical
230	M241	N139	N98		86.6357	RED HORZ 3 T6	Beam	Single An...	A36	Typical
231	M242	N138	N98		83.1167	RED DIAG 2 T6	Column	Single An...	A36	Typical
232	M244	N139	N140		76.3472	RED DIAG 3 T6	Column	Single An...	A36	Typical
233	M249	N93	N108		90	INNER SUPP T6	Beam	Single An...	A36	Typical
234	M250	N108	N120		90	INNER SUPP T6	Beam	Single An...	A36	Typical
235	M251	N120	N132		90	INNER SUPP T6	Beam	Single An...	A36	Typical
236	M252	N132	N93		90	INNER SUPP T6	Beam	Single An...	A36	Typical
237	M257	N141	N89		135	LEG T7	Column	Single An...	A36	Typical
238	M258	N142	N90		135	LEG T7	Column	Single An...	A36	Typical
239	M259	N143	N91		135	LEG T7	Column	Single An...	A36	Typical
240	M260	N144	N92		135	LEG T7	Column	Single An...	A36	Typical
241	M261	N89	N90		356.6357	HORZ T7	Beam	None	A36	Typical
242	M262	N141	N145		351.522	DIAG T7	Column	None	A36	Typical
243	M263	N146	N147		86.6357	RED HORZ T7	Beam	Single An...	A36	Typical
244	M264	N148	N149		86.6357	RED HORZ 2 T7	Beam	Single An...	A36	Typical
245	M265	N147	N148		101.1717	RED DIAG T7	Column	Single An...	A36	Typical
246	M266	N150	N151		86.6357	RED HORZ 3 T7	Beam	Single An...	A36	Typical
247	M267	N149	N150		95.9547	RED DIAG 2 T7	Column	Single An...	A36	Typical
248	M270	N142	N145		8.478	DIAG T7	Column	None	A36	Typical
249	M271	N153	N154		86.6357	RED HORZ T7	Beam	Single An...	A36	Typical
250	M272	N155	N156		86.6357	RED HORZ 2 T7	Beam	Single An...	A36	Typical
251	M273	N153	N156		78.8283	RED DIAG T7	Column	Single An...	A36	Typical
252	M274	N157	N158		86.6357	RED HORZ 3 T7	Beam	Single An...	A36	Typical
253	M275	N155	N158		84.0453	RED DIAG 2 T7	Column	Single An...	A36	Typical
254	M278	N90	N91		356.6357	HORZ T7	Beam	None	A36	Typical
255	M279	N142	N160		351.522	DIAG T7	Column	None	A36	Typical
256	M280	N154	N161		86.6357	RED HORZ T7	Beam	Single An...	A36	Typical
257	M281	N156	N162		86.6357	RED HORZ 2 T7	Beam	Single An...	A36	Typical
258	M282	N161	N156		101.1717	RED DIAG T7	Column	Single An...	A36	Typical
259	M283	N158	N163		86.6357	RED HORZ 3 T7	Beam	Single An...	A36	Typical
260	M284	N162	N158		95.9547	RED DIAG 2 T7	Column	Single An...	A36	Typical
261	M287	N143	N160		8.478	DIAG T7	Column	None	A36	Typical
262	M288	N165	N166		86.6357	RED HORZ T7	Beam	Single An...	A36	Typical
263	M289	N167	N168		86.6357	RED HORZ 2 T7	Beam	Single An...	A36	Typical
264	M290	N165	N168		78.8283	RED DIAG T7	Column	Single An...	A36	Typical
265	M291	N169	N170		86.6357	RED HORZ 3 T7	Beam	Single An...	A36	Typical
266	M292	N167	N170		84.0453	RED DIAG 2 T7	Column	Single An...	A36	Typical
267	M297	N91	N92		356.6357	HORZ T7	Beam	None	A36	Typical
268	M298	N143	N172		351.522	DIAG T7	Column	None	A36	Typical
269	M299	N166	N173		86.6357	RED HORZ T7	Beam	Single An...	A36	Typical
270	M300	N168	N174		86.6357	RED HORZ 2 T7	Beam	Single An...	A36	Typical

Member Primary Data (Continued)

	Label	I Joint	J Joint	K Joint	Rotate(de...	Section/Shape	Type	Design List	Material	Design Rules
271	M301	N173	N168		101.1717	RED DIAG T7	Column	Single An...	A36	Typical
272	M302	N170	N175		86.6357	RED_HORZ_3_T7	Beam	Single An...	A36	Typical
273	M303	N174	N170		95.9547	RED DIAG 2 T7	Column	Single An...	A36	Typical
274	M305	N175	N176		101.1717	RED DIAG 4 T7	Column	Single An...	A36	Typical
275	M306	N144	N172		8.478	DIAG T7	Column	None	A36	Typical
276	M307	N177	N178		86.6357	RED_HORZ_T7	Beam	Single An...	A36	Typical
277	M308	N179	N180		86.6357	RED_HORZ_2_T7	Beam	Single An...	A36	Typical
278	M309	N177	N180		78.8283	RED DIAG T7	Column	Single An...	A36	Typical
279	M310	N181	N182		86.6357	RED_HORZ_3_T7	Beam	Single An...	A36	Typical
280	M311	N179	N182		84.0453	RED DIAG 2 T7	Column	Single An...	A36	Typical
281	M316	N92	N89		356.6357	HORIZ T7	Beam	None	A36	Typical
282	M317	N144	N184		351.522	DIAG T7	Column	None	A36	Typical
283	M318	N178	N185		86.6357	RED_HORZ_T7	Beam	Single An...	A36	Typical
284	M319	N180	N186		86.6357	RED_HORZ_2_T7	Beam	Single An...	A36	Typical
285	M320	N185	N180		101.1717	RED DIAG T7	Column	Single An...	A36	Typical
286	M321	N182	N187		86.6357	RED_HORZ_3_T7	Beam	Single An...	A36	Typical
287	M322	N186	N182		95.9547	RED DIAG 2 T7	Column	Single An...	A36	Typical
288	M325	N141	N184		8.478	DIAG T7	Column	None	A36	Typical
289	M326	N189	N146		86.6357	RED_HORZ_T7	Beam	Single An...	A36	Typical
290	M327	N190	N148		86.6357	RED_HORZ_2_T7	Beam	Single An...	A36	Typical
291	M328	N189	N148		78.8283	RED DIAG T7	Column	Single An...	A36	Typical
292	M329	N191	N150		86.6357	RED_HORZ_3_T7	Beam	Single An...	A36	Typical
293	M330	N190	N150		84.0453	RED DIAG 2 T7	Column	Single An...	A36	Typical
294	M337	N145	N160		90	INNER_SUPP_T7	Beam	Single An...	A36	Typical
295	M338	N160	N172		90	INNER_SUPP_T7	Beam	Single An...	A36	Typical
296	M339	N172	N184		90	INNER_SUPP_T7	Beam	Single An...	A36	Typical
297	M340	N184	N145		90	INNER_SUPP_T7	Beam	Single An...	A36	Typical
298	M345	N193	N141		135	LEG T8	Column	Single An...	A36	Typical
299	M346	N194	N142		135	LEG T8	Column	Single An...	A36	Typical
300	M347	N195	N143		135	LEG T8	Column	Single An...	A36	Typical
301	M348	N196	N144		135	LEG T8	Column	Single An...	A36	Typical
302	M349	N141	N142		356.6357	HORIZ T8	Beam	None	A36	Typical
303	M350	N193	N197		352.3995	DIAG T8	Column	None	A36	Typical
304	M351	N198	N199		86.6357	RED_HORZ_T8	Beam	Single An...	A36	Typical
305	M352	N200	N201		86.6357	RED_HORZ_2_T8	Beam	Single An...	A36	Typical
306	M353	N199	N200		99.5402	RED DIAG T8	Column	Single An...	A36	Typical
307	M354	N202	N203		86.6357	RED_HORZ_3_T8	Beam	Single An...	A36	Typical
308	M355	N201	N202		95.354	RED DIAG 2 T8	Column	Single An...	A36	Typical
309	M357	N203	N204		99.5402	RED DIAG 3 T8	Column	Single An...	A36	Typical
310	M358	N194	N197		7.6005	DIAG T8	Column	None	A36	Typical
311	M359	N205	N206		86.6357	RED_HORZ_T8	Beam	Single An...	A36	Typical
312	M360	N207	N208		86.6357	RED_HORZ_2_T8	Beam	Single An...	A36	Typical
313	M361	N205	N208		80.4598	RED DIAG T8	Column	Single An...	A36	Typical
314	M362	N209	N210		86.6357	RED_HORZ_3_T8	Beam	Single An...	A36	Typical
315	M363	N207	N210		84.646	RED DIAG 2 T8	Column	Single An...	A36	Typical
316	M365	N209	N211		80.4598	RED DIAG 3 T8	Column	Single An...	A36	Typical
317	M366	N142	N143		356.6357	HORIZ T8	Beam	None	A36	Typical
318	M367	N194	N212		352.3995	DIAG T8	Column	None	A36	Typical
319	M368	N206	N213		86.6357	RED_HORZ_T8	Beam	Single An...	A36	Typical
320	M369	N208	N214		86.6357	RED_HORZ_2_T8	Beam	Single An...	A36	Typical
321	M370	N213	N208		99.5402	RED DIAG T8	Column	Single An...	A36	Typical
322	M371	N210	N215		86.6357	RED_HORZ_3_T8	Beam	Single An...	A36	Typical
323	M372	N214	N210		95.354	RED DIAG 2 T8	Column	Single An...	A36	Typical
324	M374	N215	N216		99.5402	RED DIAG 3 T8	Column	Single An...	A36	Typical
325	M375	N195	N212		7.6005	DIAG T8	Column	None	A36	Typical
326	M376	N217	N218		86.6357	RED_HORZ_T8	Beam	Single An...	A36	Typical
327	M377	N219	N220		86.6357	RED_HORZ_2_T8	Beam	Single An...	A36	Typical

Member Primary Data (Continued)

	Label	I Joint	J Joint	K Joint	Rotate(de...	Section/Shape	Type	Design List	Material	Design Rules
328	M378	N217	N220		80.4598	RED DIAG 3 T8	Column	Single An...	A36	Typical
329	M379	N221	N222		86.6357	RED HORZ 3 T8	Beam	Single An...	A36	Typical
330	M380	N219	N222		84.646	RED DIAG 2 T8	Column	Single An...	A36	Typical
331	M381	N221	N143		94.9542	RED DIAG 4 T8	Column	Single An...	A36	Typical
332	M382	N221	N223		80.4598	RED DIAG 3 T8	Column	Single An...	A36	Typical
333	M385	N143	N144		356.6357	HORZ T8	Beam	None	A36	Typical
334	M386	N195	N224		352.3995	DIAG T8	Column	None	A36	Typical
335	M387	N218	N225		86.6357	RED HORZ T8	Beam	Single An...	A36	Typical
336	M388	N220	N226		86.6357	RED HORZ 2 T8	Beam	Single An...	A36	Typical
337	M389	N225	N220		99.5402	RED DIAG T8	Column	Single An...	A36	Typical
338	M390	N222	N227		86.6357	RED HORZ 3 T8	Beam	Single An...	A36	Typical
339	M391	N226	N222		95.354	RED DIAG 2 T8	Column	Single An...	A36	Typical
340	M393	N227	N228		99.5402	RED DIAG 3 T8	Column	Single An...	A36	Typical
341	M394	N196	N224		7.6005	DIAG T8	Column	None	A36	Typical
342	M395	N229	N230		86.6357	RED HORZ T8	Beam	Single An...	A36	Typical
343	M396	N231	N232		86.6357	RED HORZ 2 T8	Beam	Single An...	A36	Typical
344	M397	N229	N232		80.4598	RED DIAG T8	Column	Single An...	A36	Typical
345	M398	N233	N234		86.6357	RED HORZ 3 T8	Beam	Single An...	A36	Typical
346	M399	N231	N234		84.646	RED DIAG 2 T8	Column	Single An...	A36	Typical
347	M401	N233	N235		80.4598	RED DIAG 3 T8	Column	Single An...	A36	Typical
348	M402	N250	N249			RED HIP 3 T8	Beam	None	A36	Typical
349	M404	N144	N141		356.6357	HORZ T8	Beam	None	A36	Typical
350	M405	N196	N236		352.3995	DIAG T8	Column	None	A36	Typical
351	M406	N230	N237		86.6357	RED HORZ T8	Beam	Single An...	A36	Typical
352	M407	N232	N238		86.6357	RED HORZ 2 T8	Beam	Single An...	A36	Typical
353	M408	N237	N232		99.5402	RED DIAG T8	Column	Single An...	A36	Typical
354	M409	N234	N239		86.6357	RED HORZ 3 T8	Beam	Single An...	A36	Typical
355	M410	N238	N234		95.354	RED DIAG 2 T8	Column	Single An...	A36	Typical
356	M412	N239	N240		99.5402	RED DIAG 3 T8	Column	Single An...	A36	Typical
357	M413	N193	N236		7.6005	DIAG T8	Column	None	A36	Typical
358	M414	N241	N198		86.6357	RED HORZ T8	Beam	Single An...	A36	Typical
359	M415	N242	N200		86.6357	RED HORZ 2 T8	Beam	Single An...	A36	Typical
360	M416	N241	N200		80.4598	RED DIAG T8	Column	Single An...	A36	Typical
361	M417	N243	N202		86.6357	RED HORZ 3 T8	Beam	Single An...	A36	Typical
362	M418	N242	N202		84.646	RED DIAG 2 T8	Column	Single An...	A36	Typical
363	M420	N243	N244		80.4598	RED DIAG 3 T8	Column	Single An...	A36	Typical
364	M425	N197	N212		90	INNER SUPP T8	Beam	Single An...	A36	Typical
365	M426	N212	N224		90	INNER SUPP T8	Beam	Single An...	A36	Typical
366	M427	N224	N236		90	INNER SUPP T8	Beam	Single An...	A36	Typical
367	M428	N236	N197		90	INNER SUPP T8	Beam	Single An...	A36	Typical
368	M429	N142	N248			INNER SUPP T8	Beam	Single An...	A36	Typical
369	M430	N245	N143			INNER SUPP T8	Beam	Single An...	A36	Typical
370	M431	N246	N144			INNER SUPP T8	Beam	Single An...	A36	Typical
371	M432	N247	N141			INNER SUPP T8	Beam	Single An...	A36	Typical
372	M433	N247	N248			INNER SUPP 1 T8	Beam	Single An...	A36	Typical
373	M434	N248	N245			INNER SUPP 1 T8	Beam	Single An...	A36	Typical
374	M435	N245	N246			INNER SUPP 1 T8	Beam	Single An...	A36	Typical
375	M436	N246	N247			INNER SUPP 1 T8	Beam	Single An...	A36	Typical
376	M437	N215	N142		94.9542	RED DIAG 4 T8	Column	Single An...	A36	Typical
377	M438	N233	N144		94.9542	RED DIAG 4 T8	Column	Single An...	A36	Typical
378	M439	N227	N143		94.9542	RED DIAG 4 T8	Column	Single An...	A36	Typical
379	M440	N243	N141		94.9542	RED DIAG 4 T8	Column	Single An...	A36	Typical
380	M441	N239	N144		94.9542	RED DIAG 4 T8	Column	Single An...	A36	Typical
381	M442	N209	N142		94.9542	RED DIAG 4 T8	Column	Single An...	A36	Typical
382	M443	N203	N141		94.9542	RED DIAG 4 T8	Column	Single An...	A36	Typical
383	M444	N221	N143		94.9542	RED DIAG 4 T8	Column	Single An...	A36	Typical
384	M445	N215	N142		94.9542	RED DIAG 4 T8	Column	Single An...	A36	Typical

Member Primary Data (Continued)

	Label	I Joint	J Joint	K Joint	Rotate(de...	Section/Shape	Type	Design List	Material	Design Rules
385	M439A	N249	N245			INNER SUPP 2 T8	Beam	Single An...	A36	Typical
386	M440A	N245	N250			INNER SUPP 2 T8	Beam	Single An...	A36	Typical
387	M438A	N253	N252			RED HIP 3 T8	Beam	None	A36	Typical
388	M439B	N252	N246			INNER SUPP 2 T8	Beam	Single An...	A36	Typical
389	M440B	N246	N253			INNER SUPP 2 T8	Beam	Single An...	A36	Typical
390	M441A	N256	N255			RED HIP 3 T8	Beam	None	A36	Typical
391	M442A	N255	N247			INNER SUPP 2 T8	Beam	Single An...	A36	Typical
392	M443A	N247	N256			INNER SUPP 2 T8	Beam	Single An...	A36	Typical
393	M444A	N259	N258			RED HIP 3 T8	Beam	None	A36	Typical
394	M445A	N258	N248			INNER SUPP 2 T8	Beam	Single An...	A36	Typical
395	M446	N248	N259			INNER SUPP 2 T8	Beam	Single An...	A36	Typical
396	M447	N250	N249			RED HIP 3 T8	Beam	None	A36	Typical
397	M448	N249	N245			INNER SUPP 2 T8	Beam	Single An...	A36	Typical
398	M449	N245	N250			INNER SUPP 2 T8	Beam	Single An...	A36	Typical
399	M450	N257	N258A			INNER SUPP 1 T7	Beam	Single An...	A36	Typical
400	M451	N258A	N259A			INNER SUPP 1 T7	Beam	Single An...	A36	Typical
401	M452	N259A	N260			INNER SUPP 1 T7	Beam	Single An...	A36	Typical
402	M453	N260	N257			INNER SUPP 1 T7	Beam	Single An...	A36	Typical
403	M450A	N92	N259A			INNER SUPP T7	Beam	Single An...	A36	Typical
404	M451A	N89	N260			INNER SUPP T7	Beam	Single An...	A36	Typical
405	M452A	N90	N257			INNER SUPP T7	Beam	Single An...	A36	Typical
406	M453A	N91	N258A			INNER SUPP T7	Beam	Single An...	A36	Typical
407	M452B	N175	N91			RED DIAG 3 T7	Column	Single An...	A36	Typical
408	M440C	N181	N183		101.1717	RED DIAG 4 T7	Column	Single An...	A36	Typical
409	M441B	N181	N92			RED DIAG 3 T7	Column	Single An...	A36	Typical
410	M442B	N187	N188		101.1717	RED DIAG 4 T7	Column	Single An...	A36	Typical
411	M443B	N187	N92			RED DIAG 3 T7	Column	Single An...	A36	Typical
412	M444B	N191	N192		101.1717	RED DIAG 4 T7	Column	Single An...	A36	Typical
413	M445B	N191	N89			RED DIAG 3 T7	Column	Single An...	A36	Typical
414	M446A	N151	N152		101.1717	RED DIAG 4 T7	Column	Single An...	A36	Typical
415	M447A	N151	N89			RED DIAG 3 T7	Column	Single An...	A36	Typical
416	M448A	N157	N159		101.1717	RED DIAG 4 T7	Column	Single An...	A36	Typical
417	M449A	N157	N90			RED DIAG 3 T7	Column	Single An...	A36	Typical
418	M450B	N163	N164		101.1717	RED DIAG 4 T7	Column	Single An...	A36	Typical
419	M451B	N163	N90			RED DIAG 3 T7	Column	Single An...	A36	Typical
420	M452C	N169	N171		101.1717	RED DIAG 4 T7	Column	Single An...	A36	Typical
421	M453B	N169	N91			RED DIAG 3 T7	Column	Single An...	A36	Typical
422	M454	N175	N176		101.1717	RED DIAG 4 T7	Column	Single An...	A36	Typical
423	M455	N175	N91			RED DIAG 3 T7	Column	Single An...	A36	Typical
424	M456	N181	N183		101.1717	RED DIAG 4 T7	Column	Single An...	A36	Typical
425	M457	N181	N92			RED DIAG 3 T7	Column	Single An...	A36	Typical
426	M458	N261	N262			RED HIP 3 T7	Beam	Single An...	A36	Typical
427	M454A	N261	N258A			RED HIPDIA 3 T7	Column	Single An...	A36	Typical
428	M455A	N258A	N262			RED HIPDIA 3 T7	Column	Single An...	A36	Typical
429	M452D	N264	N265			RED HIP 3 T7	Beam	Single An...	A36	Typical
430	M453C	N264	N259A			RED HIPDIA 3 T7	Column	Single An...	A36	Typical
431	M454B	N259A	N265			RED HIPDIA 3 T7	Column	Single An...	A36	Typical
432	M455B	N267	N268			RED HIP 3 T7	Beam	Single An...	A36	Typical
433	M456A	N267	N260			RED HIPDIA 3 T7	Column	Single An...	A36	Typical
434	M457A	N260	N268			RED HIPDIA 3 T7	Column	Single An...	A36	Typical
435	M458A	N270	N271			RED HIP 3 T7	Beam	Single An...	A36	Typical
436	M459	N270	N257			RED HIPDIA 3 T7	Column	Single An...	A36	Typical
437	M460	N257	N271			RED HIPDIA 3 T7	Column	Single An...	A36	Typical
438	M461	N261	N262			RED HIP 3 T7	Beam	Single An...	A36	Typical
439	M462	N261	N258A			RED HIPDIA 3 T7	Column	Single An...	A36	Typical
440	M463	N258A	N262			RED HIPDIA 3 T7	Column	Single An...	A36	Typical
441	M460A	N269	N270A			INNER_SUPP 1 T6	Beam	Single An...	A36	Typical

Member Primary Data (Continued)

	Label	I Joint	J Joint	K Joint	Rotate(de...	Section/Shape	Type	Design List	Material	Design Rules
442	M461A	N270A	N271A			INNER SUPP 1 T6	Beam	Single An...	A36	Typical
443	M462A	N271A	N272			INNER SUPP 1 T6	Beam	Single An...	A36	Typical
444	M463A	N272	N269			INNER SUPP 1 T6	Beam	Single An...	A36	Typical
445	M456B	N72	N271A			INNER SUPP T6	Beam	Single An...	A36	Typical
446	M457B	N69	N272			INNER SUPP T6	Beam	Single An...	A36	Typical
447	M458B	N70	N269			INNER SUPP T6	Beam	Single An...	A36	Typical
448	M459A	N71	N270A			INNER SUPP T6	Beam	Single An...	A36	Typical
449	M460B	N129	N72			RED DIAG 4 T6	Column	Single An...	A36	Typical
450	M461B	N123	N71			RED DIAG 4 T6	Column	Single An...	A36	Typical
451	M462B	N139	N69			RED DIAG 4 T6	Column	Single An...	A36	Typical
452	M463B	N135	N72			RED DIAG 4 T6	Column	Single An...	A36	Typical
453	M464	N105	N70			RED DIAG 4 T6	Column	Single An...	A36	Typical
454	M465	N99	N69			RED DIAG 4 T6	Column	Single An...	A36	Typical
455	M466	N117	N71			RED DIAG 4 T6	Column	Single An...	A36	Typical
456	M467	N111	N70			RED DIAG 4 T6	Column	Single An...	A36	Typical
457	M468	N129	N72			RED DIAG 4 T6	Column	Single An...	A36	Typical
458	M469	N123	N71			RED DIAG 4 T6	Column	Single An...	A36	Typical
459	M470	N273	N274			RED HIP 3 T6	Beam	Single An...	A36	Typical
460	M467A	N273	N270A			RED HIPDIA 3 T6	Column	Single An...	A36	Typical
461	M468A	N270A	N274			RED HIPDIA 3 T6	Column	Single An...	A36	Typical
462	M465A	N276	N277			RED HIP 3 T6	Beam	Single An...	A36	Typical
463	M466A	N276	N271A			RED HIPDIA 3 T6	Column	Single An...	A36	Typical
464	M467B	N271A	N277			RED HIPDIA 3 T6	Column	Single An...	A36	Typical
465	M468B	N279	N280			RED HIP 3 T6	Beam	Single An...	A36	Typical
466	M469A	N279	N272			RED HIPDIA 3 T6	Column	Single An...	A36	Typical
467	M470A	N272	N280			RED HIPDIA 3 T6	Column	Single An...	A36	Typical
468	M471	N282	N283			RED HIP 3 T6	Beam	Single An...	A36	Typical
469	M472	N282	N269			RED HIPDIA 3 T6	Column	Single An...	A36	Typical
470	M473	N269	N283			RED HIPDIA 3 T6	Column	Single An...	A36	Typical
471	M474	N273	N274			RED HIP 3 T6	Beam	Single An...	A36	Typical
472	M475	N273	N270A			RED HIPDIA 3 T6	Column	Single An...	A36	Typical
473	M476	N270A	N274			RED HIPDIA 3 T6	Column	Single An...	A36	Typical
474	M477	N281	N282A			INNER SUPP T5	Beam	Single An...	A36	Typical
475	M478	N282A	N283A			INNER SUPP T5	Beam	Single An...	A36	Typical
476	M479	N283A	N284			INNER SUPP T5	Beam	Single An...	A36	Typical
477	M480	N284	N281			INNER SUPP T5	Beam	Single An...	A36	Typical
478	M481	N281	N50			INNER SUPP T5	Beam	Single An...	A36	Typical
479	M482	N51	N282A			INNER SUPP T5	Beam	Single An...	A36	Typical
480	M483	N52	N283A			INNER SUPP T5	Beam	Single An...	A36	Typical
481	M484	N284	N49			INNER SUPP T5	Beam	Single An...	A36	Typical
482	M485	N80	N282A			RED HIP DIAG T5	Beam	Single An...	A36	Typical
483	M486	N282A	N83			RED HIP DIAG T5	Beam	Single An...	A36	Typical
484	M487	N84	N283A			RED HIP DIAG T5	Beam	Single An...	A36	Typical
485	M488	N283A	N87			RED HIP DIAG T5	Beam	Single An...	A36	Typical
486	M489	N88	N284			RED HIP DIAG T5	Beam	Single An...	A36	Typical
487	M490	N284	N75			RED HIP DIAG T5	Beam	Single An...	A36	Typical
488	M491	N76	N281			RED HIP DIAG T5	Beam	Single An...	A36	Typical
489	M492	N281	N79			RED HIP DIAG T5	Beam	Single An...	A36	Typical
490	M493	N80	N282A			RED HIP DIAG T5	Beam	Single An...	A36	Typical
491	M494	N282A	N83			RED HIP DIAG T5	Beam	Single An...	A36	Typical
492	M495	N285	N286			INNER SUPP T4	Beam	Single An...	A36	Typical
493	M496	N286	N287			INNER SUPP T4	Beam	Single An...	A36	Typical
494	M497	N287	N288			INNER SUPP T4	Beam	Single An...	A36	Typical
495	M498	N288	N285			INNER SUPP T4	Beam	Single An...	A36	Typical
496	M499	N30	N285			INNER SUPP T4	Beam	Single An...	A36	Typical
497	M500	N31	N286			INNER SUPP T4	Beam	Single An...	A36	Typical
498	M501	N32	N287			INNER SUPP T4	Beam	Single An...	A36	Typical

Member Primary Data (Continued)

Label	I Joint	J Joint	K Joint	Rotate(de...	Section/Shape	Type	Design List	Material	Design Rules
499	M502	N288	N29		INNER SUPP T4	Beam	Single An...	A36	Typical
500	M503	N60	N286		RED HIP DIAG T4	Beam	Single An...	A36	Typical
501	M504	N286	N63		RED HIP DIAG T4	Beam	Single An...	A36	Typical
502	M505	N64	N287		RED HIP DIAG T4	Beam	Single An...	A36	Typical
503	M506	N287	N67		RED HIP DIAG T4	Beam	Single An...	A36	Typical
504	M507	N68	N288		RED HIP DIAG T4	Beam	Single An...	A36	Typical
505	M508	N288	N55		RED HIP DIAG T4	Beam	Single An...	A36	Typical
506	M509	N56	N285		RED HIP DIAG T4	Beam	Single An...	A36	Typical
507	M510	N285	N59		RED HIP DIAG T4	Beam	Single An...	A36	Typical
508	M511	N60	N286		RED HIP DIAG T4	Beam	Single An...	A36	Typical
509	M512	N286	N63		RED HIP DIAG T4	Beam	Single An...	A36	Typical
510	M513	N289	N290		INNER SUPP T3	Beam	Single An...	A36	Typical
511	M514	N290	N293		INNER SUPP T3	Beam	Single An...	A36	Typical
512	M515	N293	N292		INNER SUPP T3	Beam	Single An...	A36	Typical
513	M516	N292	N289		INNER SUPP T3	Beam	Single An...	A36	Typical
514	M517	N11	N290		INNER SUPP T3	Beam	Single An...	A36	Typical
515	M518	N12	N293		INNER SUPP T3	Beam	Single An...	A36	Typical
516	M519	N9	N292		INNER SUPP T3	Beam	Single An...	A36	Typical
517	M520	N10	N289		INNER SUPP T3	Beam	Single An...	A36	Typical
518	M521	N40	N290		RED HIP T3	Beam	Single An...	A36	Typical
519	M522	N290	N43		RED HIP T3	Beam	Single An...	A36	Typical
520	M523	N44	N293		RED HIP T3	Beam	Single An...	A36	Typical
521	M524	N293	N47		RED HIP T3	Beam	Single An...	A36	Typical
522	M525	N48	N292		RED HIP T3	Beam	Single An...	A36	Typical
523	M526	N292	N35		RED HIP T3	Beam	Single An...	A36	Typical
524	M527	N36	N289		RED HIP T3	Beam	Single An...	A36	Typical
525	M528	N289	N39		RED HIP T3	Beam	Single An...	A36	Typical
526	M529	N293A	N294		INNER SUPP T2	Beam	Single An...	A36	Typical
527	M530	N294	N295		INNER SUPP T2	Beam	Single An...	A36	Typical
528	M531	N295	N296		INNER SUPP T2	Beam	Single An...	A36	Typical
529	M532	N296	N293A		INNER SUPP T2	Beam	Single An...	A36	Typical
530	M533	N4	N293A		INNER SUPP T2	Beam	Single An...	A36	Typical
531	M534	N6	N294		INNER SUPP T2	Beam	Single An...	A36	Typical
532	M535	N8	N295		INNER SUPP T2	Beam	Single An...	A36	Typical
533	M536	N2	N296		INNER SUPP T2	Beam	Single An...	A36	Typical
534	M537	N20	N294		RED HIP T2	Beam	Single An...	A36	Typical
535	M538	N294	N23		RED HIP T2	Beam	Single An...	A36	Typical
536	M539	N24	N295		RED HIP T2	Beam	Single An...	A36	Typical
537	M540	N295	N27		RED HIP T2	Beam	Single An...	A36	Typical
538	M541	N28	N296		RED HIP T2	Beam	Single An...	A36	Typical
539	M542	N296	N15		RED HIP T2	Beam	Single An...	A36	Typical
540	M543	N16	N293A		RED HIP T2	Beam	Single An...	A36	Typical
541	M544	N293A	N19		RED HIP T2	Beam	Single An...	A36	Typical

Basic Load Cases

	BLC Description	Category	X Gravity	Y Gravity	Z Gravity	Joint	Point	Distributed Area(Me...	Surface(...
1	Dead	None		-1		44	208	32	
2	No Ice Wind 0 deg	None				44	494	96	
3	No Ice Wind 45 deg	None				88	464	128	
4	No Ice Wind 90 deg	None				44	490	96	
5	No Ice Wind 135 deg	None				88	464	120	
6	No Ice Wind 180 deg	None				44	494	96	
7	No Ice Wind 225 deg	None				88	464	128	
8	No Ice Wind 270 deg	None				44	490	96	
9	No Ice Wind 315 deg	None				88	464	120	

Basic Load Cases (Continued)

BLC Description	Category	X Gravity	Y Gravity	Z Gravity	Joint	Point	Distributed Area(Me...Surface(...
10 Ice	None				44	208	407
11 Temperature Drop	None						375
12 Ice Wind 0 deg	None				44	500	96
13 Ice Wind 45 deg	None				88	456	120
14 Ice Wind 90 deg	None				44	496	96
15 Ice Wind 135 deg	None				88	454	128
16 Ice Wind 180 deg	None				44	500	96
17 Ice Wind 225 deg	None				88	456	120
18 Ice Wind 270 deg	None				44	496	96
19 Ice Wind 315 deg	None				88	454	128
20 Service Wind 0 deg	None				44	494	96
21 Service Wind 45 deg	None				88	460	128
22 Service Wind 90 deg	None				44	490	96
23 Service Wind 135 deg	None				88	456	104
24 Service Wind 180 deg	None				44	494	96
25 Service Wind 225 deg	None				88	460	128
26 Service Wind 270 deg	None				44	490	96
27 Service Wind 315 deg	None				88	456	104
28 Superimposed Self Weight	None						117

Load Combinations

Description	Solve PD...	SR...	B...	Fa...	BLC Fac...	BLC Fa...	BLC Fa...	BLC Fa...	BLC Fa...	B...	Fa...	B...	Fa...	B...	Fa...	B...	Fa...
1 Dead Only	Yes	Y	1	1	28	1	29	1	0	0	0	0	0	0	0	0	0
2 1.2 Dead+1.6 Wind 0 deg...	Yes	Y	1	1.2	2	1.6	28	1.2	29	1	0	0	0	0	0	0	0
3 0.9 Dead+1.6 Wind 0 deg...	Yes	Y	1	.9	2	1.6	28	.9	29	1	0	0	0	0	0	0	0
4 1.2 Dead+1.6 Wind 45 de...	Yes	Y	1	1.2	3	1.6	28	1.2	29	1	0	0	0	0	0	0	0
5 0.9 Dead+1.6 Wind 45 de...	Yes	Y	1	.9	3	1.6	28	.9	29	1	0	0	0	0	0	0	0
6 1.2 Dead+1.6 Wind 90 de...	Yes	Y	1	1.2	4	1.6	28	1.2	29	1	0	0	0	0	0	0	0
7 0.9 Dead+1.6 Wind 90 de...	Yes	Y	1	.9	4	1.6	28	.9	29	1	0	0	0	0	0	0	0
8 1.2 Dead+1.6 Wind 135 d...	Yes	Y	1	1.2	5	1.6	28	1.2	29	1	0	0	0	0	0	0	0
9 0.9 Dead+1.6 Wind 135 d...	Yes	Y	1	.9	5	1.6	28	.9	29	1	0	0	0	0	0	0	0
10 1.2 Dead+1.6 Wind 180 d...	Yes	Y	1	1.2	6	1.6	28	1.2	29	1	0	0	0	0	0	0	0
11 0.9 Dead+1.6 Wind 180 d...	Yes	Y	1	.9	6	1.6	28	.9	29	1	0	0	0	0	0	0	0
12 1.2 Dead+1.6 Wind 225 d...	Yes	Y	1	1.2	7	1.6	28	1.2	29	1	0	0	0	0	0	0	0
13 0.9 Dead+1.6 Wind 225 d...	Yes	Y	1	.9	7	1.6	28	.9	29	1	0	0	0	0	0	0	0
14 1.2 Dead+1.6 Wind 270 d...	Yes	Y	1	1.2	8	1.6	28	1.2	29	1	0	0	0	0	0	0	0
15 0.9 Dead+1.6 Wind 270 d...	Yes	Y	1	.9	8	1.6	28	.9	29	1	0	0	0	0	0	0	0
16 1.2 Dead+1.6 Wind 315 d...	Yes	Y	1	1.2	9	1.6	28	1.2	29	1	0	0	0	0	0	0	0
17 0.9 Dead+1.6 Wind 315 d...	Yes	Y	1	.9	9	1.6	28	.9	29	1	0	0	0	0	0	0	0
18 1.2 Dead+1.0 Ice+1.0 Te...	Yes	Y	1	1.2	10	1	11	1	28	1.2	29	1	0	0	0	0	0
19 1.2 Dead+1.0 Wind 0 deg...	Yes	Y	1	1.2	12	1	10	1	11	1	28	1.2	29	1	0	0	0
20 1.2 Dead+1.0 Wind 45 de...	Yes	Y	1	1.2	13	1	10	1	11	1	28	1.2	29	1	0	0	0
21 1.2 Dead+1.0 Wind 90 de...	Yes	Y	1	1.2	14	1	10	1	11	1	28	1.2	29	1	0	0	0
22 1.2 Dead+1.0 Wind 135 d...	Yes	Y	1	1.2	15	1	10	1	11	1	28	1.2	29	1	0	0	0
23 1.2 Dead+1.0 Wind 180 d...	Yes	Y	1	1.2	16	1	10	1	11	1	28	1.2	29	1	0	0	0
24 1.2 Dead+1.0 Wind 225 d...	Yes	Y	1	1.2	17	1	10	1	11	1	28	1.2	29	1	0	0	0
25 1.2 Dead+1.0 Wind 270 d...	Yes	Y	1	1.2	18	1	10	1	11	1	28	1.2	29	1	0	0	0
26 1.2 Dead+1.0 Wind 315 d...	Yes	Y	1	1.2	19	1	10	1	11	1	28	1.2	29	1	0	0	0
27 Dead+Wind 0 deg - Servi...	Yes	Y	1	1	20	1	28	1	29	1	0	0	0	0	0	0	0
28 Dead+Wind 45 deg - Ser...	Yes	Y	1	1	21	1	28	1	29	1	0	0	0	0	0	0	0
29 Dead+Wind 90 deg - Ser...	Yes	Y	1	1	22	1	28	1	29	1	0	0	0	0	0	0	0
30 Dead+Wind 135 deg - Se...	Yes	Y	1	1	23	1	28	1	29	1	0	0	0	0	0	0	0
31 Dead+Wind 180 deg - Se...	Yes	Y	1	1	24	1	28	1	29	1	0	0	0	0	0	0	0
32 Dead+Wind 225 deg - Se...	Yes	Y	1	1	25	1	28	1	29	1	0	0	0	0	0	0	0
33 Dead+Wind 270 deg - Se...	Yes	Y	1	1	26	1	28	1	29	1	0	0	0	0	0	0	0

Load Combinations (Continued)

	Description	Solve	PD	SR	B	
34	Dead+Wind 315 deg - Se...	Yes	Y		1	1	27	1	28	1	29	1	0		0		0		0		

Envelope Joint Reactions

	Joint		X [k]	LC	Y [k]	LC	Z [k]	LC	MX [k-ft]	LC	MY [k-ft]	LC	MZ [k-ft]	LC
1	N193	max	15.1419	14	120.175	12	15.2044	3	0	34	.0002	8	0	34
2		min	-13.4582	7	-94.4077	5	-16.9699	10	0	1	0	17	0	1
3	N194	max	13.968	17	117.8716	8	13.3977	3	0	34	.0003	4	0	34
4		min	-15.6504	8	-94.2928	17	-15.102	10	0	1	-.0002	13	0	1
5	N195	max	14.6134	13	120.0858	4	15.1865	2	0	34	.0005	2	0	34
6		min	-16.4433	4	-94.4019	13	-13.4385	11	0	1	-.0004	11	0	1
7	N196	max	15.7203	14	120.207	16	16.8979	2	0	34	.0002	16	0	34
8		min	-13.9363	7	-92.5417	9	-15.1175	11	0	1	-.0001	9	0	1
9	Totals:	max	57.7025	15	140.064	26	60.1639	3						
10		min	-57.7611	6	44.0028	3	-60.1053	10						

Envelope AISC 14th(360-10): LRFD Steel Code Checks

Member	Shape	Code C...	Loc[ft]	LC	She...	Loc[ft]	Dir	LC	phi*Pnc [k]	phi*Pnt ...	phi*Mn y-y...	phi*Mn z-z...	Cb	Eqn	
1	M1	L4x4x3/8	.530	0	16	.054	0	y	6	74.213	92.664	2.5074	9.6019	1	H2-1
2	M2	L4x4x3/8	.560	0	14	.056	0	z	14	74.213	92.664	2.5074	9.6019	1	H2-1
3	M3	L4x4x3/8	.385	0	4	.046	0	z	10	74.213	92.664	2.5074	9.6019	1	H2-1
4	M4	L4x4x3/8	.305	0	4	.037	0	y	10	74.213	92.664	2.5074	9.6019	1	H2-1
5	M9	L4x4x3/8	.542	12.3341	16	.011	12.33...	y	6	58.2452	92.664	2.5074	9.0048	1	H2-1
6	M10	L4x4x3/8	.569	12.3341	14	.011	12.33...	z	14	58.2452	92.664	2.5074	9.0048	1	H2-1
7	M11	L4x4x3/8	.393	12.3341	4	.007	12.33...	z	10	58.2452	92.664	2.5074	9.0048	1	H2-1
8	M12	L4x4x3/8	.313	12.3341	4	.010	12.33...	y	10	58.2452	92.664	2.5074	9.0048	1	H2-1
9	M13	C9X13.4	.057	4.8332	25	.005	4.8332	y	23	85.6824	127.656	4.1334	30.4062	1	H1-1b
10	M14	2L2 1/2x2x3/8x3/8	.083	6.7541	14	.001	6.7541	y	24	55.656	100.116	5.6465	2.9468	1	H1-1b*
11	M15	L2x2x3/16	.006	0	21	.002	0	z	26	17.4179	23.166	.222	1.188	1	H2-1
12	M16	L2x2x3/16	.022	0	7	.002	6.4905	z	26	4.1336	23.166	.222	.9329	1	H2-1
13	M17	2L2 1/2x2x3/8x3/8	.082	6.7541	6	.001	6.7541	y	21	55.656	100.116	5.6465	2.9468	1	H1-1b*
14	M18	L2x2x3/16	.005	0	25	.002	0	z	26	17.4179	23.166	.222	1.188	1	H2-1
15	M19	L2x2x3/16	.020	0	15	.002	0	z	26	4.1336	23.166	.222	.9329	1	H2-1
16	M20	C9X13.4	.053	4.8332	20	.004	4.8332	y	21	85.6824	127.656	4.1334	30.4062	1	H1-1b
17	M21	2L2 1/2x2x3/8x3/8	.070	0	10	.001	6.7541	y	22	55.656	100.116	5.6465	4.7149	1	H1-1b*
18	M22	L2x2x3/16	.006	0	20	.002	0	z	26	17.4179	23.166	.222	1.188	1	H2-1
19	M23	L2x2x3/16	.013	0	5	.002	0	z	26	4.1336	23.166	.222	.9329	1	H2-1
20	M24	2L2 1/2x2x3/8x3/8	.072	0	2	.001	6.7541	y	19	55.656	100.116	5.6465	4.7149	1	H1-1b*
21	M25	L2x2x3/16	.002	0	24	.002	0	z	26	17.4179	23.166	.222	1.188	1	H2-1
22	M26	L2x2x3/16	.012	6.4905	20	.002	6.4905	z	26	4.1336	23.166	.222	.9329	1	H2-1
23	M27	L2x2x3/16	.002	0	26	.003	3.4176	z	26	13.0961	23.166	.222	1.1124	1	H2-1
24	M28	C9X13.4	.044	7.0484	25	.003	4.8332	y	19	85.6824	127.656	4.1334	30.4062	1	H1-1b
25	M29	2L2 1/2x2x3/8x3/8	.053	0	6	.001	6.7541	y	19	55.656	100.116	5.6465	4.7149	1	H1-1b*
26	M30	L2x2x3/16	.003	0	4	.002	0	z	26	17.4179	23.166	.222	1.188	1	H2-1
27	M31	L2x2x3/16	.009	6.4905	22	.002	6.4905	z	26	4.1336	23.166	.222	.9329	1	H2-1
28	M32	2L2 1/2x2x3/8x3/8	.054	0	14	.001	6.7541	y	24	55.656	100.116	5.6465	4.7149	1	H1-1b*
29	M33	L2x2x3/16	.003	0	4	.002	0	z	26	17.4179	23.166	.222	1.188	1	H2-1
30	M34	L2x2x3/16	.012	6.4905	26	.002	6.4905	z	26	4.1336	23.166	.222	.9329	1	H2-1
31	M35	L2x2x3/16	.002	0	24	.003	3.4176	z	26	13.0961	23.166	.222	1.1124	1	H2-1
32	M36	C9X13.4	.046	4.8332	26	.003	4.8332	y	25	85.6824	127.656	4.1334	30.4062	1	H1-1b
33	M37	2L2 1/2x2x3/8x3/8	.066	0	2	.001	6.7541	y	26	55.656	100.116	5.6465	4.7149	1	H1-1b*
34	M38	L2x2x3/16	.004	0	6	.002	0	z	26	17.4179	23.166	.222	1.188	1	H2-1
35	M39	L2x2x3/16	.016	0	7	.002	0	z	26	4.1336	23.166	.222	.9329	1	H2-1
36	M40	2L2 1/2x2x3/8x3/8	.063	0	10	.001	6.7541	y	23	55.656	100.116	5.6465	4.7149	1	H1-1b*
37	M41	L2x2x3/16	.006	0	7	.002	0	z	26	17.4179	23.166	.222	1.188	1	H2-1

Envelope AISC 14th(360-10): LRFD Steel Code Checks (Continued)

Member	Shape	Code C...	Loc[ft]	LC	She...	Loc[ft]	Dir	LC	phi*Pnc [k]	phi*Pnt	phi*Mn y-v	phi*Mn z-...	Cb	Egn	
38	M42	L2x2x3/16	.017	0	15	.002	6.4905	z	26	4.1336	23.166	.222	.9329	1	H2-1
39	M43	L2x2x3/16	.002	0	19	.003	3.4176	z	26	13.0961	23.166	.222	1.1124	1	H2-1
40	M44	L2x2x3/16	.002	0	20	.003	3.4176	z	26	13.0961	23.166	.222	1.1124	1	H2-1
41	M45	LL2.5x2x3x3	.090	3.4176	22	.006	3.4176	z	20	29.8424	53.136	2.7253	1.5773	1	H1-1b
42	M46	LL2.5x2x3x3	.091	3.4176	20	.006	3.4176	z	21	29.8424	53.136	2.7253	1.5773	1	H1-1b
43	M47	LL2.5x2x3x3	.091	3.4176	26	.007	3.4176	z	20	29.8424	53.136	2.7253	1.5773	1	H1-1b
44	M48	LL2.5x2x3x3	.091	3.4176	24	.006	3.4176	z	23	29.8424	53.136	2.7253	1.5773	1	H1-1b
45	M49	L4x4x3/8	.199	0	24	.005	0	y	8	58.2452	92.664	2.5074	9.0048	1	H2-1
46	M50	L4x4x3/8	.205	0	22	.004	0	y	4	58.2452	92.664	2.5074	9.0048	1	H2-1
47	M51	L4x4x3/8	.159	6.167	4	.004	0	y	16	58.2452	92.664	2.5074	9.0048	1	H2-1
48	M52	L4x4x3/8	.144	6.167	16	.005	0	y	12	58.2452	92.664	2.5074	9.0048	1	H2-1
49	M53	2L2 1/2x2x1/4x3/8	.117	5.5557	24	.004	5.5557	y	23	47.173	69.012	3.6692	2.0623	1	H1-1b
50	M54	2L2 1/2x2x3/8x3/8	.105	0	14	.001	6.9106	y	19	54.1455	100.116	5.6465	4.7149	1	H1-1b*
51	M55	L2x2x3/16	.006	0	24	.002	2.7779	z	26	15.8926	23.166	.222	1.1592	1	H2-1
52	M56	L2x2 1/2x3/16	.020	0	13	.002	0	z	26	5.2904	26.2116	.4733	1.4297	1	H2-1
53	M57	2L2 1/2x2x3/8x3/8	.104	0	6	.001	6.9106	y	19	54.1455	100.116	5.6465	4.7149	1	H1-1b*
54	M58	L2x2x3/16	.005	0	17	.002	2.7779	z	26	15.8926	23.166	.222	1.1592	1	H2-1
55	M59	L2x2 1/2x3/16	.014	0	9	.002	0	z	26	5.2904	26.2116	.4733	1.4297	1	H2-1
56	M60	2L2 1/2x2x1/4x3/8	.115	5.5557	20	.003	5.5557	y	21	47.173	69.012	3.6692	2.0623	1	H1-1b
57	M61	2L2 1/2x2x3/8x3/8	.092	0	10	.001	6.9106	y	25	54.1455	100.116	5.6465	4.7149	1	H1-1b*
58	M62	L2x2x3/16	.008	0	21	.002	0	z	26	15.8926	23.166	.222	1.1592	1	H2-1
59	M63	L2x2 1/2x3/16	.027	0	9	.002	0	z	26	5.2904	26.2116	.4733	1.4297	1	H2-1
60	M64	2L2 1/2x2x3/8x3/8	.094	0	2	.001	6.9106	y	25	54.1455	100.116	5.6465	4.7149	1	H1-1b*
61	M65	L2x2x3/16	.005	0	11	.002	0	z	26	15.8926	23.166	.222	1.1592	1	H2-1
62	M66	L2x2 1/2x3/16	.012	0	3	.002	6.6137	z	26	5.2904	26.2116	.4733	1.4297	1	H2-1
63	M67	L2x2x3/16	.002	0	22	.003	0	z	26	10.9028	23.166	.222	1.0782	1	H2-1
64	M68	2L2 1/2x2x1/4x3/8	.111	5.5557	26	.003	5.5557	y	19	47.173	69.012	3.6692	2.0623	1	H1-1b
65	M69	2L2 1/2x2x3/8x3/8	.082	0	6	.001	6.9106	y	23	54.1455	100.116	5.6465	4.7149	1	H1-1b*
66	M70	L2x2x3/16	.008	0	4	.002	0	z	26	15.8926	23.166	.222	1.1592	1	H2-1
67	M71	L2x2 1/2x3/16	.029	0	5	.002	0	z	26	5.2904	26.2116	.4733	1.4297	1	H2-1
68	M72	2L2 1/2x2x3/8x3/8	.082	0	14	.001	6.9106	y	23	54.1455	100.116	5.6465	4.7149	1	H1-1b*
69	M73	L2x2x3/16	.007	0	7	.002	0	z	26	15.8926	23.166	.222	1.1592	1	H2-1
70	M74	L2x2 1/2x3/16	.016	0	15	.002	0	z	26	5.2904	26.2116	.4733	1.4297	1	H2-1
71	M75	L2x2x3/16	.002	0	20	.003	0	z	26	10.9028	23.166	.222	1.0782	1	H2-1
72	M76	2L2 1/2x2x1/4x3/8	.114	5.5557	26	.003	5.5557	y	25	47.173	69.012	3.6692	2.0623	1	H1-1b
73	M77	2L2 1/2x2x3/8x3/8	.093	0	2	.001	6.9106	y	21	54.1455	100.116	5.6465	4.7149	1	H1-1b*
74	M78	L2x2x3/16	.006	0	16	.002	0	z	26	15.8926	23.166	.222	1.1592	1	H2-1
75	M79	L2x2 1/2x3/16	.019	0	17	.002	0	z	26	5.2904	26.2116	.4733	1.4297	1	H2-1
76	M80	2L2 1/2x2x3/8x3/8	.090	0	10	.001	6.9106	y	22	54.1455	100.116	5.6465	4.7149	1	H1-1b*
77	M81	L2x2x3/16	.007	0	5	.002	2.7779	z	26	15.8926	23.166	.222	1.1592	1	H2-1
78	M82	L2x2 1/2x3/16	.019	0	13	.002	6.6137	z	26	5.2904	26.2116	.4733	1.4297	1	H2-1
79	M83	L2x2x3/16	.002	0	26	.003	0	z	26	10.9028	23.166	.222	1.0782	1	H2-1
80	M84	L2x2x3/16	.002	0	24	.003	0	z	26	10.9028	23.166	.222	1.0782	1	H2-1
81	M85	LL2.5x2x3x3	.084	3.9285	22	.006	3.9285	z	22	24.9295	53.136	2.7253	1.5773	1	H1-1b
82	M86	LL2.5x2x3x3	.085	3.9285	20	.006	3.9285	z	20	24.9295	53.136	2.7253	1.5773	1	H1-1b
83	M87	LL2.5x2x3x3	.085	3.9285	26	.006	3.9285	z	26	24.9295	53.136	2.7253	1.5773	1	H1-1b
84	M88	LL2.5x2x3x3	.084	3.9285	24	.006	3.9285	z	24	24.9295	53.136	2.7253	1.5773	1	H1-1b
85	M89	L5x5x1/2	.186	0	24	.018	6.3552	z	2	112.1061	153.9	5.1983	19.6297	1	H2-1
86	M90	L5x5x1/2	.166	6.3552	8	.019	6.3552	z	14	112.1061	153.9	5.1983	19.6297	1	H2-1
87	M91	L5x5x1/2	.152	6.3552	4	.013	6.3552	y	6	112.1061	153.9	5.1983	19.6297	1	H2-1
88	M92	L5x5x1/2	.154	0	26	.016	6.3552	y	2	112.1061	153.9	5.1983	19.6297	1	H2-1
89	M93	2L2 1/2x2x1/4x3/8	.125	6.2783	25	.004	6.2783	y	23	42.454	69.012	3.6692	2.0623	1	H1-1b
90	M94	2L2 1/2x2x1/4x3/8	.249	7.2512	14	.002	7.2512	y	26	36.0958	69.012	3.6692	2.0623	1	H1-1a
91	M95	L2x2x3/16	.056	0	7	.003	0	z	26	14.3172	23.166	.222	1.1322	1	H2-1
92	M96	L2x2x3/16	.248	0	15	.002	0	z	26	3.6349	23.166	.222	.9116	1	H2-1
93	M97	2L2 1/2x2x1/4x3/8	.252	7.2512	6	.002	7.2512	y	20	36.0958	69.012	3.6692	2.0623	1	H1-1a
94	M98	L2x2x3/16	.066	0	14	.003	0	z	26	14.3172	23.166	.222	1.1322	1	H2-1

Envelope AISC 14th(360-10): LRFD Steel Code Checks (Continued)

Member	Shape	Code C...	Loc[ft]	LC	She...	Loc[ft]	Dir	LC	phi*Pnc [k]	phi*Pnt	phi*Mn y-y	phi*Mn z...	Cb	Eqn	
95	M99	L2x2x3/16	.271	0	7	.002	0	z	26	3.6349	23.166	.222	.9116	1	H2-1
96	M100	2L2 1/2x2x1/4x3/8	.123	6.2783	20	.004	6.2783	y	21	42.454	69.012	3.6692	2.0623	1	H1-1b
97	M101	2L2 1/2x2x1/4x3/8	.183	0	10	.002	7.2512	y	25	36.0958	69.012	3.6692	3.2997	1	H1-1b*
98	M102	L2x2x3/16	.030	0	3	.003	0	z	26	14.3172	23.166	.222	1.1322	1	H2-1
99	M103	L2x2x3/16	.143	0	10	.002	6.9214	z	26	3.6349	23.166	.222	.9116	1	H2-1
100	M104	2L2 1/2x2x1/4x3/8	.188	0	2	.002	7.2512	y	26	36.0958	69.012	3.6692	3.2997	1	H1-1b*
101	M105	L2x2x3/16	.038	0	11	.003	0	z	26	14.3172	23.166	.222	1.1322	1	H2-1
102	M106	L2x2x3/16	.152	0	3	.002	0	z	26	3.6349	23.166	.222	.9116	1	H2-1
103	M107	L2x2x3/16	.002	0	22	.004	4.4394	z	26	8.8353	23.166	.222	1.0461	1	H2-1
104	M108	2L2 1/2x2x1/4x3/8	.121	6.2783	20	.004	6.2783	y	26	42.454	69.012	3.6692	2.0623	1	H1-1b
105	M109	2L2 1/2x2x1/4x3/8	.187	0	6	.002	7.2512	y	23	36.0958	69.012	3.6692	3.2997	1	H1-1b*
106	M110	L2x2x3/16	.046	0	13	.003	0	z	26	14.3172	23.166	.222	1.1322	1	H2-1
107	M111	L2x2x3/16	.208	0	5	.002	0	z	26	3.6349	23.166	.222	.9116	1	H2-1
108	M112	2L2 1/2x2x1/4x3/8	.187	0	14	.002	7.2512	y	24	36.0958	69.012	3.6692	3.2997	1	H1-1b*
109	M113	L2x2x3/16	.052	0	6	.003	0	z	26	14.3172	23.166	.222	1.1322	1	H2-1
110	M114	L2x2x3/16	.205	0	15	.002	6.9214	z	26	3.6349	23.166	.222	.9116	1	H2-1
111	M115	L2x2x3/16	.003	0	20	.004	4.4394	z	26	8.8353	23.166	.222	1.0461	1	H2-1
112	M116	2L2 1/2x2x1/4x3/8	.124	6.2783	26	.004	6.2783	y	24	42.454	69.012	3.6692	2.0623	1	H1-1b
113	M117	2L2 1/2x2x1/4x3/8	.236	7.2512	2	.002	7.2512	y	20	36.0958	69.012	3.6692	2.0623	1	H1-1a
114	M118	L2x2x3/16	.054	0	11	.003	0	z	26	14.3172	23.166	.222	1.1322	1	H2-1
115	M119	L2x2x3/16	.240	0	3	.002	0	z	26	3.6349	23.166	.222	.9116	1	H2-1
116	M120	2L2 1/2x2x1/4x3/8	.233	7.2512	10	.002	7.2512	y	22	36.0958	69.012	3.6692	2.0623	1	H1-1a
117	M121	L2x2x3/16	.066	0	2	.003	0	z	26	14.3172	23.166	.222	1.1322	1	H2-1
118	M122	L2x2x3/16	.263	0	11	.002	6.9214	z	26	3.6349	23.166	.222	.9116	1	H2-1
119	M123	L2x2x3/16	.002	0	26	.004	4.4394	z	26	8.8353	23.166	.222	1.0461	1	H2-1
120	M124	L2x2x3/16	.002	0	24	.004	4.4394	z	26	8.8353	23.166	.222	1.0461	1	H2-1
121	M125	LL2.5x2x3x3	.079	4.4394	22	.005	4.4394	z	22	20.2984	53.136	2.7253	1.5773	1	H1-1b
122	M126	LL2.5x2x3x3	.080	4.4394	20	.005	4.4394	z	20	20.2984	53.136	2.7253	1.5773	1	H1-1b
123	M127	LL2.5x2x3x3	.080	4.4394	26	.005	4.4394	z	26	20.2984	53.136	2.7253	1.5773	1	H1-1b
124	M128	LL2.5x2x3x3	.079	4.4394	24	.005	4.4394	z	24	20.2984	53.136	2.7253	1.5773	1	H1-1b
125	M129	L5x5x1/2	.310	0	24	.010	0	y	8	112.1061	153.9	5.1983	19.6297	1	H2-1
126	M130	L5x5x1/2	.276	6.3552	8	.008	0	y	4	112.1061	153.9	5.1983	19.6297	1	H2-1
127	M131	L5x5x1/2	.267	6.3552	4	.009	0	y	16	112.1061	153.9	5.1983	19.6297	1	H2-1
128	M132	L5x5x1/2	.298	0	26	.010	0	y	12	112.1061	153.9	5.1983	19.6297	1	H2-1
129	M133	2L2 1/2x2x1/4x3/8	.143	7.0229	22	.004	7.0229	y	23	37.5751	69.012	3.6692	2.0623	1	H1-1b
130	M134	2L2 1/2x2x1/4x3/8	.268	7.4386	14	.002	7.4386	y	19	34.8913	69.012	3.6692	2.0623	1	H1-1a
131	M135	L2x2x3/16	.023	0	23	.003	3.5115	z	26	12.6866	23.166	.222	1.106	1	H2-1
132	M136	L2x2x3/16	.103	0	23	.003	7.0784	z	26	3.4754	23.166	.222	.9039	1	H2-1
133	M137	2L2 1/2x2x1/4x3/8	.270	7.4386	6	.002	7.4386	y	20	34.8913	69.012	3.6692	2.0623	1	H1-1a
134	M138	L2x2x3/16	.012	0	17	.003	3.5115	z	26	12.6866	23.166	.222	1.106	1	H2-1
135	M139	L2x2x3/16	.043	0	9	.003	0	z	26	3.4754	23.166	.222	.9039	1	H2-1
136	M140	2L2 1/2x2x1/4x3/8	.140	7.0229	20	.004	7.0229	y	21	37.5751	69.012	3.6692	2.0623	1	H1-1b
137	M141	2L2 1/2x2x1/4x3/8	.221	7.4386	10	.002	7.4386	y	26	34.8913	69.012	3.6692	2.0623	1	H1-1a
138	M142	L2x2x3/16	.024	0	21	.003	3.5115	z	26	12.6866	23.166	.222	1.106	1	H2-1
139	M143	L2x2x3/16	.124	0	6	.003	0	z	26	3.4754	23.166	.222	.9039	1	H2-1
140	M144	2L2 1/2x2x1/4x3/8	.224	7.4386	2	.002	7.4386	y	24	34.8913	69.012	3.6692	2.0623	1	H1-1a
141	M145	L2x2x3/16	.006	0	13	.003	3.5115	z	26	12.6866	23.166	.222	1.106	1	H2-1
142	M146	L2x2x3/16	.014	0	5	.003	7.0784	z	26	3.4754	23.166	.222	.9039	1	H2-1
143	M147	L2x2x3/16	.003	0	22	.004	0	z	26	7.061	23.166	.222	1.0149	1	H2-1
144	M148	2L2 1/2x2x1/4x3/8	.141	7.0229	20	.004	7.0229	y	19	37.5751	69.012	3.6692	2.0623	1	H1-1b
145	M149	2L2 1/2x2x1/4x3/8	.236	7.4386	6	.002	7.4386	y	24	34.8913	69.012	3.6692	2.0623	1	H1-1a
146	M150	L2x2x3/16	.023	0	13	.003	3.5115	z	26	12.6866	23.166	.222	1.106	1	H2-1
147	M151	L2x2x3/16	.113	0	2	.003	7.0784	z	26	3.4754	23.166	.222	.9039	1	H2-1
148	M152	2L2 1/2x2x1/4x3/8	.233	7.4386	14	.002	7.4386	y	23	34.8913	69.012	3.6692	2.0623	1	H1-1a
149	M153	L2x2x3/16	.013	0	7	.003	3.5115	z	26	12.6866	23.166	.222	1.106	1	H2-1
150	M154	L2x2x3/16	.040	0	15	.003	7.0784	z	26	3.4754	23.166	.222	.9039	1	H2-1
151	M155	L2x2x3/16	.003	0	20	.004	0	z	26	7.061	23.166	.222	1.0149	1	H2-1

Envelope AISC 14th(360-10): LRFD Steel Code Checks (Continued)

Member	Shape	Code C...	Loc[ft]	LC	She...	Loc[ft]	Dir	LC	phi*Pnc [k]	phi*Pnt ...	phi*Mn y-v...	phi*Mn z-...	Cb	Eqn	
152	M156	2L2 1/2x2x1/4x3/8	.143	7.0229	26	.004	7.0229	y	25	37.5751	69.012	3.6692	2.0623	1	H1-1b
153	M157	2L2 1/2x2x1/4x3/8	.271	7.4386	2	.002	7.4386	y	20	34.8913	69.012	3.6692	2.0623	1	H1-1a
154	M158	L2x2x3/16	.020	0	25	.003	3.5115	z	26	12.6866	23.166	.222	1.106	1	H2-1
155	M159	L2x2x3/16	.083	0	14	.003	7.0784	z	26	3.4754	23.166	.222	.9039	1	H2-1
156	M160	2L2 1/2x2x1/4x3/8	.267	7.4386	10	.002	7.4386	y	22	34.8913	69.012	3.6692	2.0623	1	H1-1a
157	M161	L2x2x3/16	.019	0	5	.003	3.5115	z	26	12.6866	23.166	.222	1.106	1	H2-1
158	M162	L2x2x3/16	.068	0	13	.003	0	z	26	3.4754	23.166	.222	.9039	1	H2-1
159	M163	L2x2x3/16	.003	0	26	.004	0	z	26	7.061	23.166	.222	1.0149	1	H2-1
160	M164	L2x2x3/16	.003	0	24	.004	0	z	26	7.061	23.166	.222	1.0149	1	H2-1
161	M165	LL2.5x2x3x3	.076	4.966	22	.005	4.966	z	22	16.2222	53.136	2.7253	1.5773	1	H1-1b
162	M166	LL2.5x2x3x3	.076	4.966	20	.005	4.966	z	20	16.2222	53.136	2.7253	1.5773	1	H1-1b
163	M167	LL2.5x2x3x3	.076	4.966	26	.005	4.966	z	26	16.2222	53.136	2.7253	1.5773	1	H1-1b
164	M168	LL2.5x2x3x3	.075	4.966	24	.005	4.966	z	24	16.2222	53.136	2.7253	1.5773	1	H1-1b
165	M169	L6x6x1/2	.385	0	24	.013	0	y	23	149.9574	186.3	7.5116	28.6644	1	H2-1
166	M170	L6x6x1/2	.332	6.3134	8	.011	6.3134	y	21	149.9574	186.3	7.5116	28.6644	1	H2-1
167	M171	L6x6x1/2	.350	0	4	.011	6.3134	y	19	149.9574	186.3	7.5116	28.6644	1	H2-1
168	M172	L6x6x1/2	.409	0	26	.014	0	y	25	149.9574	186.3	7.5116	28.6644	1	H2-1
169	M173	2L2 1/2x2x1/4x3/8	.138	7.7675	22	.006	7.7675	y	22	56.4222	69.012	3.6692	2.0623	1	H1-1b
170	M174	2L2 1/2x3x3/8x3/8	.261	4.4754	14	.001	20.13...	y	25	66.2157	124.416	11.3043	5.01	1	H1-1a
171	M175	L2 1/2x2x3/16	.055	.9709	23	.001	0	z	26	22.0852	26.2116	.3439	1.6083	1	H2-1
172	M176	L2 1/2x2 1/2x3/16	.060	1.9419	23	.003	3.8838	z	26	18.1581	29.2248	.4958	1.7031	1	H2-1
173	M177	L2x2 1/2x3/16	.278	0	23	.001	6.4956	z	26	5.4845	26.2116	.4733	1.4438	1	H2-1
174	M178	L2 1/2x2x3/16	.176	2.9128	22	.004	0	z	26	6.8185	26.2116	.3439	1.2214	1	H2-1
175	M179	L2x2 1/2x3/16	.030	0	15	.003	0	z	26	4.4442	26.2116	.4733	1.3601	1	H2-1
176	M181	LL2.5x2x3x3	.012	3.1125	26	.001	6.4956	z	26	31.5053	53.136	2.7253	1.5773	1	H1-1b
177	M182	2L2 1/2x3x3/8x3/8	.257	13.4262	6	.002	13.42...	y	21	66.2157	124.416	11.3043	3.1313	1	H1-1a
178	M183	L2 1/2x2x3/16	.030	.9709	23	.001	1.9419	z	26	22.0852	26.2116	.3439	1.6083	1	H2-1
179	M184	L2 1/2x2 1/2x3/16	.058	1.9419	19	.003	3.8838	z	26	18.1581	29.2248	.4958	1.7031	1	H2-1
180	M185	L2x2 1/2x3/16	.093	0	8	.001	6.4956	z	26	5.4845	26.2116	.4733	1.4438	1	H2-1
181	M186	L2 1/2x2x3/16	.164	2.9128	23	.004	0	z	26	6.8185	26.2116	.3439	1.2214	1	H2-1
182	M187	L2x2 1/2x3/16	.039	0	9	.003	0	z	26	4.4442	26.2116	.4733	1.3601	1	H2-1
183	M189	LL2.5x2x3x3	.010	3.1125	20	.001	6.4956	z	26	31.5053	53.136	2.7253	2.5237	1	H1-1b
184	M190	2L2 1/2x2x1/4x3/8	.133	7.7675	22	.006	7.7675	y	21	56.4222	69.012	3.6692	2.0623	1	H1-1b
185	M191	2L2 1/2x3x3/8x3/8	.228	4.4754	10	.002	20.13...	y	23	66.2157	124.416	11.3043	5.01	1	H1-1a
186	M192	L2 1/2x2x3/16	.051	.9709	21	.001	0	z	26	22.0852	26.2116	.3439	1.6083	1	H2-1
187	M193	L2 1/2x2 1/2x3/16	.061	1.9419	25	.003	3.8838	z	26	18.1581	29.2248	.4958	1.7031	1	H2-1
188	M194	L2x2 1/2x3/16	.259	0	6	.001	6.4956	z	26	5.4845	26.2116	.4733	1.4438	1	H2-1
189	M195	L2 1/2x2x3/16	.181	2.9128	21	.004	0	z	26	6.8185	26.2116	.3439	1.2214	1	H2-1
190	M196	L2x2 1/2x3/16	.059	0	9	.003	7.2159	z	26	4.4442	26.2116	.4733	1.3601	1	H2-1
191	M198	LL2.5x2x3x3	.012	3.1125	24	.001	0	z	26	31.5053	53.136	2.7253	1.5773	1	H1-1b
192	M199	2L2 1/2x3x3/8x3/8	.225	13.4262	2	.002	20.13...	y	26	66.2157	124.416	11.3043	3.1313	1	H1-1a
193	M200	L2 1/2x2x3/16	.028	.9709	20	.001	0	z	26	22.0852	26.2116	.3439	1.6083	1	H2-1
194	M201	L2 1/2x2 1/2x3/16	.061	1.9419	22	.003	3.8838	z	26	18.1581	29.2248	.4958	1.7031	1	H2-1
195	M202	L2x2 1/2x3/16	.076	0	4	.001	0	z	26	5.4845	26.2116	.4733	1.4438	1	H2-1
196	M203	L2 1/2x2x3/16	.165	2.9128	22	.004	0	z	26	6.8185	26.2116	.3439	1.2214	1	H2-1
197	M204	L2x2 1/2x3/16	.036	0	17	.003	0	z	26	4.4442	26.2116	.4733	1.3601	1	H2-1
198	M206	LL2.5x2x3x3	.010	3.1125	26	.001	0	z	26	31.5053	53.136	2.7253	2.5237	1	H1-1b
199	M209	2L2 1/2x2x1/4x3/8	.142	7.7675	20	.006	7.7675	y	19	56.4222	69.012	3.6692	2.0623	1	H1-1b
200	M210	2L2 1/2x3x3/8x3/8	.257	4.4754	6	.002	20.13...	y	21	66.2157	124.416	11.3043	5.01	1	H1-1a
201	M211	L2 1/2x2x3/16	.051	.9709	20	.001	0	z	26	22.0852	26.2116	.3439	1.6083	1	H2-1
202	M212	L2 1/2x2 1/2x3/16	.065	1.9419	24	.003	3.8838	z	26	18.1581	29.2248	.4958	1.7031	1	H2-1
203	M213	L2x2 1/2x3/16	.251	0	4	.001	0	z	26	5.4845	26.2116	.4733	1.4438	1	H2-1
204	M214	L2 1/2x2x3/16	.179	2.9128	20	.004	0	z	26	6.8185	26.2116	.3439	1.2214	1	H2-1
205	M215	L2x2 1/2x3/16	.090	0	5	.003	0	z	26	4.4442	26.2116	.4733	1.3601	1	H2-1
206	M217	LL2.5x2x3x3	.012	3.1125	22	.001	0	z	26	31.5053	53.136	2.7253	1.5773	1	H1-1b
207	M218	2L2 1/2x3x3/8x3/8	.249	4.4754	14	.002	13.42...	y	25	66.2157	124.416	11.3043	5.01	1	H1-1a
208	M219	L2 1/2x2x3/16	.030	.9709	26	.001	1.9419	z	26	22.0852	26.2116	.3439	1.6083	1	H2-1

Envelope AISC 14th(360-10): LRFD Steel Code Checks (Continued)

Member	Shape	Code C...	Loc[ft]	LC	She...	Loc[ft]	Dir	LC	phi*Pnc [k]	phi*Pnt ...	phi*Mn y-y...	phi*Mn z-...	Cb	Eqn	
209	M220	L2 1/2x2 1/2x3/16	.066	1.9419	20	.003	3.8838	z	26	18.1581	29.2248	.4958	1.7031	1	H2-1
210	M221	L2x2 1/2x3/16	.101	0	16	.001	6.4956	z	26	5.4845	26.2116	.4733	1.4438	1	H2-1
211	M222	L2 1/2x2x3/16	.183	2.9128	21	.004	0	z	26	6.8185	26.2116	.3439	1.2214	1	H2-1
212	M223	L2x2 1/2x3/16	.076	0	13	.003	0	z	26	4.4442	26.2116	.4733	1.3601	1	H2-1
213	M225	LL2.5x2x3x3	.010	3.1125	24	.001	6.4956	z	26	31.5053	53.136	2.7253	2.5237	1	H1-1b
214	M228	2L2 1/2x2x1/4x3/8	.145	7.7675	26	.006	7.7675	y	26	56.4222	69.012	3.6692	2.0623	1	H1-1b
215	M229	2L2 1/2x3x3/8x3/8	.284	4.1957	2	.002	20.13...	y	19	66.2157	124.416	11.3043	5.01	1	H1-1a
216	M230	L2 1/2x2x3/16	.054	.9709	25	.001	0	z	26	22.0852	26.2116	.3439	1.6083	1	H2-1
217	M231	L2 1/2x2 1/2x3/16	.066	1.9419	23	.003	3.8838	z	26	18.1581	29.2248	.4958	1.7031	1	H2-1
218	M232	L2x2 1/2x3/16	.276	0	25	.001	6.4956	z	26	5.4845	26.2116	.4733	1.4438	1	H2-1
219	M233	L2 1/2x2x3/16	.175	2.9128	19	.004	0	z	26	6.8185	26.2116	.3439	1.2214	1	H2-1
220	M234	L2x2 1/2x3/16	.076	0	3	.003	7.2159	z	26	4.4442	26.2116	.4733	1.3601	1	H2-1
221	M236	LL2.5x2x3x3	.012	3.1125	20	.001	6.4956	z	26	31.5053	53.136	2.7253	1.5773	1	H1-1b
222	M237	2L2 1/2x3x3/8x3/8	.281	4.4754	10	.002	13.42...	y	23	66.2157	124.416	11.3043	5.01	1	H1-1a
223	M238	L2 1/2x2x3/16	.031	.9709	24	.001	1.9419	z	26	22.0852	26.2116	.3439	1.6083	1	H2-1
224	M239	L2 1/2x2 1/2x3/16	.063	1.9419	20	.003	3.8838	z	26	18.1581	29.2248	.4958	1.7031	1	H2-1
225	M240	L2x2 1/2x3/16	.125	0	12	.001	6.4956	z	26	5.4845	26.2116	.4733	1.4438	1	H2-1
226	M241	L2 1/2x2x3/16	.174	2.9128	20	.004	0	z	26	6.8185	26.2116	.3439	1.2214	1	H2-1
227	M242	L2x2 1/2x3/16	.085	0	11	.003	0	z	26	4.4442	26.2116	.4733	1.3601	1	H2-1
228	M244	LL2.5x2x3x3	.010	3.1125	22	.001	0	z	26	31.5053	53.136	2.7253	2.5237	1	H1-1b
229	M249	LL2.5x2x3x3	.062	5.4925	22	.005	5.4925	z	22	13.2611	53.136	2.7253	2.5237	1	H1-1b
230	M250	LL2.5x2x3x3	.062	5.4925	20	.005	5.4925	z	20	13.2611	53.136	2.7253	2.5237	1	H1-1b
231	M251	LL2.5x2x3x3	.062	5.4925	26	.005	5.4925	z	19	13.2611	53.136	2.7253	2.5237	1	H1-1b
232	M252	LL2.5x2x3x3	.062	5.4925	24	.005	5.4925	z	25	13.2611	53.136	2.7253	2.5237	1	H1-1b
233	M257	L6x6x5/8	.496	0	12	.015	0	y	10	186.2228	230.364	9.3776	36.4387	1	H2-1
234	M258	L6x6x5/8	.480	0	8	.013	6.2507	y	6	186.2228	230.364	9.3776	36.4387	1	H2-1
235	M259	L6x6x5/8	.504	0	4	.013	6.2507	y	2	186.2228	230.364	9.3776	36.4387	1	H2-1
236	M260	L6x6x5/8	.501	0	16	.015	0	y	25	186.2228	230.364	9.3776	36.4387	1	H2-1
237	M261	2L2 1/2x2x1/4x3/8	.125	0	6	.003	13.87...	y	20	53.0264	69.012	3.6692	3.2997	1	H1-1b*
238	M262	2L2 1/2x3x3/8x3/8	.281	4.5269	14	.002	20.37...	y	25	65.2571	124.416	11.3043	5.01	1	H1-1a
239	M263	L2 1/2x2x3/16	.073	1.1559	23	.002	0	z	26	20.7099	26.2116	.3439	1.5633	1	H2-1
240	M264	L2 1/2x2 1/2x3/16	.085	2.3117	20	.003	0	z	26	14.9952	29.2248	.4958	1.6299	1	H2-1
241	M265	L2x2 1/2x3/16	.344	0	10	.002	6.5362	z	26	5.4167	26.2116	.4733	1.439	1	H2-1
242	M266	L2 1/2x2x3/16	.249	3.4676	23	.005	6.9352	z	26	4.8113	26.2116	.3439	1.1338	1	H2-1
243	M267	L2 1/2x2 1/2x3/16	.122	3.7769	20	.003	7.5539	z	26	6.0765	29.2248	.4958	1.386	1	H2-1
244	M270	2L2 1/2x3x3/8x3/8	.273	4.5269	6	.002	13.58...	y	22	65.2571	124.416	11.3043	5.01	1	H1-1a
245	M271	L2 1/2x2x3/16	.036	1.1559	23	.002	0	z	26	20.7099	26.2116	.3439	1.5633	1	H2-1
246	M272	L2 1/2x2 1/2x3/16	.081	2.3117	19	.003	0	z	26	14.9952	29.2248	.4958	1.6299	1	H2-1
247	M273	L2x2 1/2x3/16	.115	0	8	.002	0	z	26	5.4167	26.2116	.4733	1.439	1	H2-1
248	M274	L2 1/2x2x3/16	.222	3.4676	23	.005	6.9352	z	26	4.8113	26.2116	.3439	1.1338	1	H2-1
249	M275	L2 1/2x2 1/2x3/16	.121	3.7769	19	.003	0	z	26	6.0765	29.2248	.4958	1.386	1	H2-1
250	M278	2L2 1/2x2x1/4x3/8	.114	13.8705	10	.003	13.87...	y	26	53.0264	69.012	3.6692	3.2997	1	H1-1b*
251	M279	2L2 1/2x3x3/8x3/8	.261	4.5269	10	.002	20.37...	y	23	65.2571	124.416	11.3043	5.01	1	H1-1a
252	M280	L2 1/2x2x3/16	.067	1.1559	22	.002	0	z	26	20.7099	26.2116	.3439	1.5633	1	H2-1
253	M281	L2 1/2x2 1/2x3/16	.085	2.3117	25	.003	0	z	26	14.9952	29.2248	.4958	1.6299	1	H2-1
254	M282	L2x2 1/2x3/16	.334	0	8	.002	0	z	26	5.4167	26.2116	.4733	1.439	1	H2-1
255	M283	L2 1/2x2x3/16	.250	3.4676	21	.005	6.9352	z	26	4.8113	26.2116	.3439	1.1338	1	H2-1
256	M284	L2 1/2x2 1/2x3/16	.123	3.7769	25	.003	0	z	26	6.0765	29.2248	.4958	1.386	1	H2-1
257	M287	2L2 1/2x3x3/8x3/8	.252	4.8098	2	.002	20.37...	y	26	65.2571	124.416	11.3043	5.01	1	H1-1a
258	M288	L2 1/2x2x3/16	.035	1.1559	20	.002	0	z	26	20.7099	26.2116	.3439	1.5633	1	H2-1
259	M289	L2 1/2x2 1/2x3/16	.085	2.3117	21	.003	0	z	26	14.9952	29.2248	.4958	1.6299	1	H2-1
260	M290	L2x2 1/2x3/16	.108	0	4	.002	6.5362	z	26	5.4167	26.2116	.4733	1.439	1	H2-1
261	M291	L2 1/2x2x3/16	.217	3.4676	20	.005	6.9352	z	26	4.8113	26.2116	.3439	1.1338	1	H2-1
262	M292	L2 1/2x2 1/2x3/16	.123	3.7769	21	.003	7.5539	z	26	6.0765	29.2248	.4958	1.386	1	H2-1
263	M297	2L2 1/2x2x1/4x3/8	.128	13.8705	6	.003	9.247	y	26	53.0264	69.012	3.6692	3.2997	1	H1-1b*
264	M298	2L2 1/2x3x3/8x3/8	.296	4.5269	6	.002	20.37...	y	21	65.2571	124.416	11.3043	5.01	1	H1-1a
265	M299	L2 1/2x2x3/16	.070	1.1559	20	.002	0	z	26	20.7099	26.2116	.3439	1.5633	1	H2-1

Envelope AISC 14th(360-10): LRFD Steel Code Checks (Continued)

Member	Shape	Code C...	Loc[ft]	LC	She...	Loc[ft]	Dir	LC	phi*Pnc [k]	phi*Pnt ...	phi*Mn y-v...	phi*Mn z-...	Cb	Egn	
266	M300	L2 1/2x2 1/2x3/16	.090	2.3117	24	.003	0	z	26	14.9952	29.2248	.4958	1.6299	1	H2-1
267	M301	L2x2 1/2x3/16	.330	0	4	.002	6.5362	z	26	5.4167	26.2116	.4733	1.439	1	H2-1
268	M302	L2 1/2x2x3/16	.249	3.4676	20	.005	6.9352	z	26	4.8113	26.2116	.3439	1.1338	1	H2-1
269	M303	L2 1/2x2 1/2x3/16	.126	3.7769	24	.003	7.5539	z	26	6.0765	29.2248	.4958	1.386	1	H2-1
270	M305	LL2.5x2x3x3	.086	3.3362	26	.001	0	z	26	31.3064	53.136	2.7253	1.5773	1	H1-1b
271	M306	2L2 1/2x3x3/8x3/8	.284	4.5269	14	.002	13.58...	y	25	65.2571	124.416	11.3043	5.01	1	H1-1a
272	M307	L2 1/2x2x3/16	.037	1.1559	26	.002	0	z	26	20.7099	26.2116	.3439	1.5633	1	H2-1
273	M308	L2 1/2x2 1/2x3/16	.091	2.3117	20	.003	0	z	26	14.9952	29.2248	.4958	1.6299	1	H2-1
274	M309	L2x2 1/2x3/16	.123	0	16	.002	6.5362	z	26	5.4167	26.2116	.4733	1.439	1	H2-1
275	M310	L2 1/2x2x3/16	.224	3.4676	21	.005	6.9352	z	26	4.8113	26.2116	.3439	1.1338	1	H2-1
276	M311	L2 1/2x2 1/2x3/16	.126	3.7769	20	.003	7.5539	z	26	6.0765	29.2248	.4958	1.386	1	H2-1
277	M316	2L2 1/2x2x1/4x3/8	.143	0	10	.003	9.247	y	26	53.0264	69.012	3.6692	3.2997	1	H1-1b*
278	M317	2L2 1/2x3x3/8x3/8	.322	4.5269	2	.002	20.37...	y	19	65.2571	124.416	11.3043	5.01	1	H1-1a
279	M318	L2 1/2x2x3/16	.075	1.1559	25	.002	0	z	26	20.7099	26.2116	.3439	1.5633	1	H2-1
280	M319	L2 1/2x2 1/2x3/16	.090	2.3117	23	.003	0	z	26	14.9952	29.2248	.4958	1.6299	1	H2-1
281	M320	L2x2 1/2x3/16	.334	0	25	.002	0	z	26	5.4167	26.2116	.4733	1.439	1	H2-1
282	M321	L2 1/2x2x3/16	.248	3.4676	26	.005	6.9352	z	26	4.8113	26.2116	.3439	1.1338	1	H2-1
283	M322	L2 1/2x2 1/2x3/16	.125	3.7769	23	.003	0	z	26	6.0765	29.2248	.4958	1.386	1	H2-1
284	M325	2L2 1/2x3x3/8x3/8	.316	4.5269	10	.002	13.58...	y	23	65.2571	124.416	11.3043	5.01	1	H1-1a
285	M326	L2 1/2x2x3/16	.038	1.1559	24	.002	0	z	26	20.7099	26.2116	.3439	1.5633	1	H2-1
286	M327	L2 1/2x2 1/2x3/16	.088	2.3117	20	.003	0	z	26	14.9952	29.2248	.4958	1.6299	1	H2-1
287	M328	L2x2 1/2x3/16	.137	0	12	.002	0	z	26	5.4167	26.2116	.4733	1.439	1	H2-1
288	M329	L2 1/2x2x3/16	.222	3.4676	24	.005	6.9352	z	26	4.8113	26.2116	.3439	1.1338	1	H2-1
289	M330	L2 1/2x2 1/2x3/16	.124	3.7769	20	.003	0	z	26	6.0765	29.2248	.4958	1.386	1	H2-1
290	M337	LL2.5x2x3x3	.059	6.5386	22	.005	6.5386	z	21	9.3572	53.136	2.7253	2.5237	1	H1-1b
291	M338	LL2.5x2x3x3	.059	6.5386	20	.005	6.5386	z	19	9.3572	53.136	2.7253	2.5237	1	H1-1b
292	M339	LL2.5x2x3x3	.060	6.5386	26	.005	6.5386	z	25	9.3572	53.136	2.7253	2.5237	1	H1-1b
293	M340	LL2.5x2x3x3	.059	6.5386	24	.005	6.5386	z	23	9.3572	53.136	2.7253	2.5237	1	H1-1b
294	M345	L8x8x1/2	.573	6.2088	12	.016	24.83...	y	23	206.0018	251.1	13.6496	51.932	1	H2-1
295	M346	L8x8x1/2	.554	6.2088	8	.014	18.62...	y	21	206.0018	251.1	13.6496	51.932	1	H2-1
296	M347	L8x8x1/2	.568	6.2088	4	.015	24.83...	y	19	206.0018	251.1	13.6496	51.932	1	H2-1
297	M348	L8x8x1/2	.572	6.2088	16	.017	24.83...	y	25	206.0018	251.1	13.6496	51.932	1	H2-1
298	M349	2L2 1/2x2x1/4x3/8	.228	10.7117	6	.004	10.71...	y	22	48.4584	69.012	3.6692	2.0623	1	H1-1a
299	M350	2L2 1/2x3x3/8x3/8	.394	4.6029	14	.002	20.71...	y	26	63.8467	124.416	11.3043	5.01	1	H1-1a
300	M351	L2 1/2x2x1/4	.050	1.339	24	.001	2.6779	z	26	25.3817	34.344	.4496	2.146	1	H2-1
301	M352	L2 1/2x2 1/2x1/4	.116	2.6779	23	.003	0	z	26	15.6442	38.556	.6512	2.2059	1	H2-1
302	M353	L2x2 1/2x1/4	.232	3.1013	12	.001	0	z	26	6.8298	34.344	.527	1.5947	1	H2-1
303	M354	L2 1/2x2 1/2x3/16	.233	4.0169	23	.005	8.0338	z	26	5.3722	29.2248	.4958	1.3509	1	H2-1
304	M355	L2 1/2x2 1/2x1/4	.124	3.9793	23	.003	0	z	26	7.1059	38.556	.6512	1.9769	1	H2-1
305	M357	L3x3x3/16	.048	3.1702	26	.001	6.6161	z	26	13.7382	35.316	.7203	2.1143	1	H2-1
306	M358	2L2 1/2x3x3/8x3/8	.389	13.8086	6	.003	20.71...	y	21	63.8467	124.416	11.3043	3.1313	1	H1-1a
307	M359	L2 1/2x2x1/4	.031	1.339	22	.001	2.6779	z	26	25.3817	34.344	.4496	2.146	1	H2-1
308	M360	L2 1/2x2 1/2x1/4	.079	2.6779	26	.003	0	z	26	15.6442	38.556	.6512	2.2059	1	H2-1
309	M361	L2x2 1/2x1/4	.086	3.1013	8	.001	6.6161	z	26	6.8298	34.344	.527	1.5502	1	H2-1
310	M362	L2 1/2x2 1/2x3/16	.214	4.0169	26	.005	8.0338	z	26	5.3722	29.2248	.4958	1.3509	1	H2-1
311	M363	L2 1/2x2 1/2x1/4	.109	3.9793	24	.003	7.9586	z	26	7.1059	38.556	.6512	1.9769	1	H2-1
312	M365	L3x3x3/16	.050	3.1702	20	.001	0	z	26	13.7382	35.316	.7203	2.1143	1	H2-1
313	M366	2L2 1/2x2x1/4x3/8	.224	10.7117	10	.004	10.71...	y	20	48.4584	69.012	3.6692	2.0623	1	H1-1a
314	M367	2L2 1/2x3x3/8x3/8	.391	4.6029	10	.002	20.71...	y	23	63.8467	124.416	11.3043	5.01	1	H1-1a
315	M368	L2 1/2x2x1/4	.047	1.339	22	.001	2.6779	z	26	25.3817	34.344	.4496	2.146	1	H2-1
316	M369	L2 1/2x2 1/2x1/4	.110	2.6779	22	.003	0	z	26	15.6442	38.556	.6512	2.2059	1	H2-1
317	M370	L2x2 1/2x1/4	.233	3.1013	8	.001	0	z	26	6.8298	34.344	.527	1.5947	1	H2-1
318	M371	L2 1/2x2 1/2x3/16	.234	4.0169	21	.005	8.0338	z	26	5.3722	29.2248	.4958	1.3509	1	H2-1
319	M372	L2 1/2x2 1/2x1/4	.122	3.9793	22	.003	0	z	26	7.1059	38.556	.6512	1.9769	1	H2-1
320	M374	L3x3x3/16	.048	3.1702	24	.001	6.6161	z	26	13.7382	35.316	.7203	2.1143	1	H2-1
321	M375	2L2 1/2x3x3/8x3/8	.387	13.8086	2	.004	20.71...	y	19	63.8467	124.416	11.3043	3.1313	1	H1-1a
322	M376	L2 1/2x2x1/4	.030	1.339	20	.001	2.6779	z	26	25.3817	34.344	.4496	2.146	1	H2-1

Envelope AISC 14th(360-10): LRFD Steel Code Checks (Continued)

Member	Shape	Code C...	Loc[ft]	LC	She...	Loc[ft]	Dir	LC	phi*Pnc [k]	phi*Pnt	phi*Mn y-y	phi*Mn z...	Cb	Eqn	
323	M377	L2 1/2x2 1/2x1/4	.086	2.6779	21	.003	0	z	26	15.6442	38.556	.6512	2.2059	1	H2-1
324	M378	L2x2 1/2x1/4	.076	3.1013	4	.001	0	z	26	6.8298	34.344	.527	1.5502	1	H2-1
325	M379	L2 1/2x2 1/2x3/16	.220	4.0169	24	.005	8.0338	z	26	5.3722	29.2248	.4958	1.3509	1	H2-1
326	M380	L2 1/2x2 1/2x1/4	.113	3.9793	21	.003	0	z	26	7.1059	38.556	.6512	1.9769	1	H2-1
327	M381	L3x3x3/16	.194	4.9307	24	.005	0	z	26	6.2462	35.316	.7203	1.8912	1.13...	H2-1
328	M382	L3x3x3/16	.050	3.1702	26	.001	0	z	26	13.7382	35.316	.7203	2.1143	1	H2-1
329	M385	2L2 1/2x2x1/4x3/8	.240	10.7117	6	.004	10.71...	y	26	48.4584	69.012	3.6692	2.0623	1	H1-1a
330	M386	2L2 1/2x3x3/8x3/8	.420	4.8905	6	.003	20.71...	y	21	63.8467	124.416	11.3043	5.01	1	H1-1a
331	M387	L2 1/2x2x1/4	.049	1.339	20	.001	2.6779	z	26	25.3817	34.344	.4496	2.146	1	H2-1
332	M388	L2 1/2x2 1/2x1/4	.115	2.6779	25	.003	0	z	26	15.6442	38.556	.6512	2.2059	1	H2-1
333	M389	L2x2 1/2x1/4	.240	3.1013	4	.001	6.6161	z	26	6.8298	34.344	.527	1.5947	1	H2-1
334	M390	L2 1/2x2 1/2x3/16	.232	4.0169	20	.005	8.0338	z	26	5.3722	29.2248	.4958	1.3509	1	H2-1
335	M391	L2 1/2x2 1/2x1/4	.124	3.9793	25	.003	0	z	26	7.1059	38.556	.6512	1.9769	1	H2-1
336	M393	L3x3x3/16	.048	3.1702	22	.001	0	z	26	13.7382	35.316	.7203	2.1143	1	H2-1
337	M394	2L2 1/2x3x3/8x3/8	.408	13.8086	14	.003	20.71...	y	24	63.8467	124.416	11.3043	3.1313	1	H1-1a
338	M395	L2 1/2x2x1/4	.031	1.339	26	.001	2.6779	z	26	25.3817	34.344	.4496	2.146	1	H2-1
339	M396	L2 1/2x2 1/2x1/4	.092	2.6779	20	.003	0	z	26	15.6442	38.556	.6512	2.2059	1	H2-1
340	M397	L2x2 1/2x1/4	.086	3.1013	16	.001	6.6161	z	26	6.8298	34.344	.527	1.5502	1	H2-1
341	M398	L2 1/2x2 1/2x3/16	.228	4.0169	22	.005	8.0338	z	26	5.3722	29.2248	.4958	1.3509	1	H2-1
342	M399	L2 1/2x2 1/2x1/4	.114	3.9793	20	.003	7.9586	z	26	7.1059	38.556	.6512	1.9769	1	H2-1
343	M401	L3x3x3/16	.050	3.1702	24	.001	0	z	26	13.7382	35.316	.7203	2.1143	1	H2-1
344	M402	2L2 1/2x2x3/16x3/8	.164	5.0496	25	.005	10.09...	y	26	15.6896	52.488	2.7216	2.5364	1	H1-1b
345	M404	2L2 1/2x2x1/4x3/8	.263	10.7117	10	.004	10.71...	y	24	48.4584	69.012	3.6692	2.0623	1	H1-1a
346	M405	2L2 1/2x3x3/8x3/8	.456	4.6029	2	.002	20.71...	y	19	63.8467	124.416	11.3043	5.01	1	H1-1a
347	M406	L2 1/2x2x1/4	.052	1.339	26	.001	2.6779	z	26	25.3817	34.344	.4496	2.146	1	H2-1
348	M407	L2 1/2x2 1/2x1/4	.122	2.6779	24	.003	0	z	26	15.6442	38.556	.6512	2.2059	1	H2-1
349	M408	L2x2 1/2x1/4	.234	3.1013	16	.001	6.6161	z	26	6.8298	34.344	.527	1.5947	1	H2-1
350	M409	L2 1/2x2 1/2x3/16	.233	4.0169	26	.005	8.0338	z	26	5.3722	29.2248	.4958	1.3509	1	H2-1
351	M410	L2 1/2x2 1/2x1/4	.126	3.9793	24	.003	7.9586	z	26	7.1059	38.556	.6512	1.9769	1	H2-1
352	M412	L3x3x3/16	.048	3.1702	20	.001	6.6161	z	26	13.7382	35.316	.7203	2.1143	1	H2-1
353	M413	2L2 1/2x3x3/8x3/8	.452	13.8086	10	.003	20.71...	y	23	63.8467	124.416	11.3043	3.1313	1	H1-1a
354	M414	L2 1/2x2x1/4	.031	1.339	24	.001	2.6779	z	26	25.3817	34.344	.4496	2.146	1	H2-1
355	M415	L2 1/2x2 1/2x1/4	.087	2.6779	19	.003	0	z	26	15.6442	38.556	.6512	2.2059	1	H2-1
356	M416	L2x2 1/2x1/4	.098	3.1013	12	.001	6.6161	z	26	6.8298	34.344	.527	1.5502	1	H2-1
357	M417	L2 1/2x2 1/2x3/16	.226	4.0169	20	.005	8.0338	z	26	5.3722	29.2248	.4958	1.3509	1	H2-1
358	M418	L2 1/2x2 1/2x1/4	.112	3.9793	19	.003	0	z	26	7.1059	38.556	.6512	1.9769	1	H2-1
359	M420	L3x3x3/16	.050	3.1702	22	.001	0	z	26	13.7382	35.316	.7203	2.1143	1	H2-1
360	M425	L2 1/2x2 1/2x3/16	.278	7.5743	22	.007	7.5743	z	20	1.5109	29.2248	.4958	.9222	1	H2-1
361	M426	L2 1/2x2 1/2x3/16	.226	7.5743	26	.007	7.5743	z	26	1.5109	29.2248	.4958	.9222	1	H2-1
362	M427	L2 1/2x2 1/2x3/16	.290	7.5743	24	.007	7.5743	z	24	1.5109	29.2248	.4958	.9222	1	H2-1
363	M428	L2 1/2x2 1/2x3/16	.204	7.5743	22	.007	7.5743	z	22	1.5109	29.2248	.4958	.9222	1	H2-1
364	M429	L2 1/2x2 1/2x3/16	.061	3.7872	26	.005	0	y	24	6.0437	29.2248	.4958	1.3845	1	H2-1
365	M430	L2 1/2x2 1/2x3/16	.061	3.7872	26	.005	0	y	22	6.0437	29.2248	.4958	1.3845	1	H2-1
366	M431	L2 1/2x2 1/2x3/16	.061	3.7872	26	.005	0	y	20	6.0437	29.2248	.4958	1.3845	1	H2-1
367	M432	L2 1/2x2 1/2x3/16	.061	3.7872	26	.005	0	y	26	6.0437	29.2248	.4958	1.3845	1	H2-1
368	M433	LL2.5x2x4x3	.041	5.3559	19	.002	0	y	14	17.9114	69.336	3.6535	3.2883	1	H1-1b
369	M434	LL2.5x2x4x3	.041	5.3559	21	.002	0	y	2	17.9114	69.336	3.6535	3.2883	1	H1-1b
370	M435	LL2.5x2x4x3	.041	5.3559	26	.002	0	y	6	17.9114	69.336	3.6535	3.2883	1	H1-1b
371	M436	LL2.5x2x4x3	.041	5.3559	21	.002	0	y	2	17.9114	69.336	3.6535	3.2883	1	H1-1b
372	M437	L3x3x3/16	.118	4.828	21	.002	0	z	26	6.2462	35.316	.7203	1.8912	1.13...	H2-1
373	M438	L3x3x3/16	.200	4.9307	22	.005	9.8614	z	26	6.2462	35.316	.7203	1.8912	1.13...	H2-1
374	M439	L3x3x3/16	.166	4.828	19	.002	9.8614	z	26	6.2462	35.316	.7203	1.8912	1.13...	H2-1
375	M440	L3x3x3/16	.200	4.9307	20	.005	9.8614	z	26	6.2462	35.316	.7203	1.8912	1.13...	H2-1
376	M441	L3x3x3/16	.178	4.828	25	.002	0	z	26	6.2462	35.316	.7203	1.8912	1.13...	H2-1
377	M442	L3x3x3/16	.198	4.9307	19	.005	0	z	26	6.2462	35.316	.7203	1.8912	1.13...	H2-1
378	M443	L3x3x3/16	.177	4.828	23	.002	9.8614	z	26	6.2462	35.316	.7203	1.8912	1.13...	H2-1
379	M444	L3x3x3/16	.194	4.9307	24	.005	0	z	26	8.5396	35.316	.7203	1.9161	1	H2-1

Envelope AISC 14th(360-10): LRFD Steel Code Checks (Continued)

Member	Shape	Code C...	Loc[ft]	LC	She...	Loc[ft]	Dir	LC	phi*Pnc [k]	phi*Pnt ...	phi*Mn y-v...	phi*Mn z-...	Cb	Egn
380	M445	L3x3x3/16	.103	4.828	21	.002	0	z	26	8.5396	35.316	.7203	1.9161	1 H2-1
381	M439A	LL2.5x2x4x3	.023	4.9896	21	.001	10.19...	y	6	19.7863	69.336	3.6535	3.2883	1 H1-1b
382	M440A	LL2.5x2x4x3	.024	5.202	26	.002	10.19...	y	2	19.7863	69.336	3.6535	3.2883	1 H1-1b
383	M438A	2L2 1/2x2x3/16x3/8	.034	5.0496	23	.002	10.09...	y	26	15.6896	52.488	2.7216	2.5364	1 H1-1b
384	M439B	LL2.5x2x4x3	.025	4.9896	19	.001	0	y	16	19.7863	69.336	3.6535	3.2883	1 H1-1b
385	M440B	LL2.5x2x4x3	.026	5.202	24	.002	0	y	14	19.7863	69.336	3.6535	3.2883	1 H1-1b
386	M441A	2L2 1/2x2x3/16x3/8	.034	5.0496	22	.002	10.09...	y	26	15.6896	52.488	2.7216	2.5364	1 H1-1b
387	M442A	LL2.5x2x4x3	.025	4.9896	25	.001	10.19...	y	12	19.7863	69.336	3.6535	3.2883	1 H1-1b
388	M443A	LL2.5x2x4x3	.026	5.202	20	.002	0	y	10	19.7863	69.336	3.6535	3.2883	1 H1-1b
389	M444A	2L2 1/2x2x3/16x3/8	.034	5.0496	20	.002	10.09...	y	26	15.6896	52.488	2.7216	2.5364	1 H1-1b
390	M445A	LL2.5x2x4x3	.025	4.9896	23	.001	0	y	10	19.7863	69.336	3.6535	3.2883	1 H1-1b
391	M446	LL2.5x2x4x3	.026	5.202	26	.002	0	y	6	19.7863	69.336	3.6535	3.2883	1 H1-1b
392	M447	2L2 1/2x2x3/16x3/8	.512	5.0496	21	.002	10.09...	y	26	15.6896	52.488	2.7216	2.5364	1 H1-1a
393	M448	LL2.5x2x4x3	.023	4.9896	21	.001	10.19...	y	6	19.7863	69.336	3.6535	3.2883	1 H1-1b
394	M449	LL2.5x2x4x3	.024	5.202	26	.002	10.19...	y	2	19.7863	69.336	3.6535	3.2883	1 H1-1b
395	M450	L3x3x1/4	.020	0	9	.002	9.247	y	2	9.2594	46.656	.6725	2.8844	1.13... H2-1*
396	M451	L3x3x1/4	.020	0	5	.002	9.247	y	6	9.2594	46.656	.6725	2.8844	1.13... H2-1*
397	M452	L3x3x1/4	.020	0	13	.002	9.247	y	10	9.2594	46.656	.6725	2.8844	1.13... H2-1*
398	M453	L3x3x1/4	.020	0	9	.002	9.247	y	6	9.2594	46.656	.6725	2.8844	1.13... H2-1*
399	M450A	LL2.5x2x3x3	.027	3.2693	16	.002	6.5386	y	4	31.2945	53.136	2.7253	2.5237	1 H1-1b
400	M451A	LL2.5x2x3x3	.027	3.2693	12	.002	6.5386	y	16	31.2945	53.136	2.7253	2.5237	1 H1-1b
401	M452A	LL2.5x2x3x3	.027	3.2693	8	.002	6.5386	y	12	31.2945	53.136	2.7253	2.5237	1 H1-1b
402	M453A	LL2.5x2x3x3	.027	3.2693	4	.002	6.5386	y	8	31.2945	53.136	2.7253	2.5237	1 H1-1b
403	M452B	L3x3x3/16	.057	4.247	4	.002	9.0603	y	6	7.3996	35.316	.7203	1.9641	1.13... H2-1
404	M440C	LL2.5x2x3x3	.006	3.1319	24	.000	0	z	26	31.3064	53.136	2.7253	1.5773	1 H1-1b
405	M441B	L3x3x3/16	.027	4.247	14	.002	0	y	12	7.3996	35.316	.7203	1.9641	1.13... H2-1
406	M442B	LL2.5x2x3x3	.007	3.1319	20	.000	0	z	26	31.3064	53.136	2.7253	1.5773	1 H1-1b
407	M443B	L3x3x3/16	.102	4.247	26	.002	0	y	4	7.3996	35.316	.7203	1.9641	1.13... H2-1
408	M444B	LL2.5x2x3x3	.007	3.1319	22	.000	6.5362	z	26	31.3064	53.136	2.7253	1.5773	1 H1-1b
409	M445B	L3x3x3/16	.063	4.247	13	.002	9.0603	y	10	7.3996	35.316	.7203	1.9641	1.13... H2-1
410	M446A	LL2.5x2x3x3	.007	3.1319	26	.000	6.5362	z	26	31.3064	53.136	2.7253	1.5773	1 H1-1b
411	M447A	L3x3x3/16	.106	4.247	23	.002	0	y	16	7.3996	35.316	.7203	1.9641	1.13... H2-1
412	M448A	LL2.5x2x3x3	.007	3.1319	20	.000	6.5362	z	26	31.3064	53.136	2.7253	1.5773	1 H1-1b
413	M449A	L3x3x3/16	.040	4.247	9	.002	9.0603	y	6	7.3996	35.316	.7203	1.9641	1.13... H2-1
414	M450B	LL2.5x2x3x3	.007	3.1319	24	.000	6.5362	z	26	31.3064	53.136	2.7253	1.5773	1 H1-1b
415	M451B	L3x3x3/16	.108	4.247	21	.002	0	y	12	7.3996	35.316	.7203	1.9641	1.13... H2-1
416	M452C	LL2.5x2x3x3	.007	3.1319	26	.000	6.5362	z	26	31.3064	53.136	2.7253	1.5773	1 H1-1b
417	M453B	L3x3x3/16	.030	4.6245	12	.002	9.0603	y	2	7.3996	35.316	.7203	1.9641	1.13... H2-1
418	M454	LL2.5x2x3x3	.254	3.0638	22	.000	0	z	26	31.3064	53.136	2.7253	1.5773	1 H1-1a
419	M455	L3x3x3/16	.057	4.247	4	.002	9.0603	y	6	7.3996	35.316	.7203	1.9641	1.13... H2-1
420	M456	LL2.5x2x3x3	.006	3.1319	24	.000	0	z	26	31.3064	53.136	2.7253	1.5773	1 H1-1b
421	M457	L3x3x3/16	.027	4.247	14	.002	0	y	12	7.3996	35.316	.7203	1.9641	1.13... H2-1
422	M458	L3x3x3/16	.022	4.3591	20	.002	8.7181	y	8	7.9919	35.316	.7203	1.9963	1.13... H2-1
423	M454A	L3x3x3/16	.030	4.3937	21	.001	9.8092	y	6	6.3129	35.316	.7203	1.8958	1.13... H2-1
424	M455A	L3x3x3/16	.029	5.4155	26	.001	0	y	4	6.3129	35.316	.7203	1.8958	1.13... H2-1
425	M452D	L3x3x3/16	.023	4.3591	19	.002	8.7181	y	4	7.9919	35.316	.7203	1.9963	1.13... H2-1
426	M453C	L3x3x3/16	.040	4.3937	19	.001	0	y	16	6.3129	35.316	.7203	1.8958	1.13... H2-1
427	M454B	L3x3x3/16	.040	5.4155	25	.001	9.8092	y	16	6.3129	35.316	.7203	1.8958	1.13... H2-1
428	M455B	L3x3x3/16	.023	4.3591	25	.002	8.7181	y	16	7.9919	35.316	.7203	1.9963	1.13... H2-1
429	M456A	L3x3x3/16	.040	4.3937	25	.001	0	y	12	6.3129	35.316	.7203	1.8958	1.13... H2-1
430	M457A	L3x3x3/16	.040	5.4155	23	.001	9.8092	y	12	6.3129	35.316	.7203	1.8958	1.13... H2-1
431	M458A	L3x3x3/16	.023	4.3591	22	.002	8.7181	y	12	7.9919	35.316	.7203	1.9963	1.13... H2-1
432	M459	L3x3x3/16	.040	4.3937	23	.001	9.8092	y	10	6.3129	35.316	.7203	1.8958	1.13... H2-1
433	M460	L3x3x3/16	.039	5.4155	21	.001	9.8092	y	6	6.3129	35.316	.7203	1.8958	1.13... H2-1
434	M461	L3x3x3/16	.022	4.3591	20	.002	8.7181	y	8	7.9919	35.316	.7203	1.9963	1.13... H2-1
435	M462	L3x3x3/16	.030	4.3937	21	.001	9.8092	y	6	6.3129	35.316	.7203	1.8958	1.13... H2-1
436	M463	L3x3x3/16	.029	5.4155	26	.001	0	y	4	6.3129	35.316	.7203	1.8958	1.13... H2-1

Envelope AISC 14th(360-10): LRFD Steel Code Checks (Continued)

Member	Shape	Code C...	Loc[ft]	LC	She...	Loc[ft]	Dir	LC	phi*Pnc [k]	phi*Pnt ...	phi*Mn y-y...	phi*Mn z-...	Cb	Eqn
437	M460A	L2.5x2.5x3	.022	0	5	.002	0	y	2	5.4429	29.1924	.8726	1.4497	1.13... H2-1*
438	M461A	L2.5x2.5x3	.022	0	5	.002	0	y	6	5.4429	29.1924	.8726	1.4497	1.13... H2-1*
439	M462A	L2.5x2.5x3	.022	0	13	.002	0	y	2	5.4429	29.1924	.8726	1.4497	1.13... H2-1*
440	M463A	L2.5x2.5x3	.022	0	9	.002	0	y	14	5.4429	29.1924	.8726	1.4497	1.13... H2-1*
441	M456B	LL2.5x2x3x3	.019	2.7462	16	.002	0	y	4	36.3879	53.136	2.7253	2.5237	1 H1-1b
442	M457B	LL2.5x2x3x3	.019	2.7462	12	.002	0	y	16	36.3879	53.136	2.7253	2.5237	1 H1-1b
443	M458B	LL2.5x2x3x3	.019	2.7462	8	.002	0	y	12	36.3879	53.136	2.7253	2.5237	1 H1-1b
444	M459A	LL2.5x2x3x3	.019	2.7462	4	.002	0	y	16	36.3879	53.136	2.7253	2.5237	1 H1-1b
445	M460B	L2 1/2x2 1/2x3/16	.043	3.8206	15	.001	0	y	12	4.9898	29.2248	.4958	1.4023	1.13... H2-1
446	M461B	L2 1/2x2 1/2x3/16	.066	3.8206	4	.001	0	y	4	4.9898	29.2248	.4958	1.4023	1.13... H2-1
447	M462B	L2 1/2x2 1/2x3/16	.095	3.8206	13	.001	8.3359	y	10	4.9898	29.2248	.4958	1.4023	1.13... H2-1
448	M463B	L2 1/2x2 1/2x3/16	.076	3.8206	26	.001	0	y	4	4.9898	29.2248	.4958	1.4023	1.13... H2-1
449	M464	L2 1/2x2 1/2x3/16	.052	3.8206	9	.001	8.3359	y	6	4.9898	29.2248	.4958	1.4023	1.13... H2-1
450	M465	L2 1/2x2 1/2x3/16	.085	3.8206	22	.001	0	y	2	4.9898	29.2248	.4958	1.4023	1.13... H2-1
451	M466	L2 1/2x2 1/2x3/16	.029	4.2548	10	.001	8.3359	y	16	4.9898	29.2248	.4958	1.4023	1.13... H2-1
452	M467	L2 1/2x2 1/2x3/16	.108	3.8206	21	.001	0	y	14	4.9898	29.2248	.4958	1.4023	1.13... H2-1
453	M468	L2 1/2x2 1/2x3/16	.043	3.8206	15	.001	0	y	12	4.9898	29.2248	.4958	1.4023	1.13... H2-1
454	M469	L2 1/2x2 1/2x3/16	.066	3.8206	4	.001	0	y	4	4.9898	29.2248	.4958	1.4023	1.13... H2-1
455	M470	L2 1/2x2 1/2x3/16	.018	3.6617	21	.002	0	y	16	6.4652	29.2248	.4958	1.4716	1.13... H2-1
456	M467A	L3x3x3/16	.023	4.2534	19	.001	0	y	4	6.7363	35.316	.7203	1.9241	1.13... H2-1
457	M468A	L3x3x3/16	.024	5.2426	21	.001	9.496	y	6	6.7363	35.316	.7203	1.9241	1.13... H2-1
458	M465A	L2 1/2x2 1/2x3/16	.018	3.6617	18	.002	0	y	12	6.4652	29.2248	.4958	1.4716	1.13... H2-1
459	M466A	L3x3x3/16	.031	4.2534	25	.001	9.496	y	2	6.7363	35.316	.7203	1.9241	1.13... H2-1
460	M467B	L3x3x3/16	.032	5.2426	19	.001	0	y	2	6.7363	35.316	.7203	1.9241	1.13... H2-1
461	M468B	L2 1/2x2 1/2x3/16	.018	3.6617	25	.002	0	y	8	6.4652	29.2248	.4958	1.4716	1.13... H2-1
462	M469A	L3x3x3/16	.031	4.2534	23	.001	9.496	y	2	6.7363	35.316	.7203	1.9241	1.13... H2-1
463	M470A	L3x3x3/16	.032	5.2426	25	.001	0	y	12	6.7363	35.316	.7203	1.9241	1.13... H2-1
464	M471	L2 1/2x2 1/2x3/16	.018	3.6617	23	.002	0	y	4	6.4652	29.2248	.4958	1.4716	1.13... H2-1
465	M472	L3x3x3/16	.031	4.2534	21	.001	0	y	4	6.7363	35.316	.7203	1.9241	1.13... H2-1
466	M473	L3x3x3/16	.031	5.2426	23	.001	0	y	10	6.7363	35.316	.7203	1.9241	1.13... H2-1
467	M474	L2 1/2x2 1/2x3/16	.018	3.6617	21	.002	0	y	16	6.4652	29.2248	.4958	1.4716	1.13... H2-1
468	M475	L3x3x3/16	.023	4.2534	19	.001	0	y	4	6.7363	35.316	.7203	1.9241	1.13... H2-1
469	M476	L3x3x3/16	.024	5.2426	21	.001	9.496	y	6	6.7363	35.316	.7203	1.9241	1.13... H2-1
470	M477	LL2.5x2x3x3	.295	3.5115	25	.001	0	y	10	28.9262	53.136	2.7253	2.5237	1 H1-1a
471	M478	LL2.5x2x3x3	.295	3.5115	23	.001	0	y	14	28.9262	53.136	2.7253	2.5237	1 H1-1a
472	M479	LL2.5x2x3x3	.296	3.5115	21	.001	0	y	10	28.9262	53.136	2.7253	2.5237	1 H1-1a
473	M480	LL2.5x2x3x3	.296	3.5115	19	.001	0	y	14	28.9262	53.136	2.7253	2.5237	1 H1-1a
474	M481	LL2.5x2x3x3	.302	2.483	26	.002	4.966	y	4	38.3105	53.136	2.7253	2.5237	1 H1-1a
475	M482	LL2.5x2x3x3	.301	2.483	24	.001	4.966	y	16	38.3105	53.136	2.7253	2.5237	1 H1-1a
476	M483	LL2.5x2x3x3	.302	2.483	22	.001	4.966	y	12	38.3105	53.136	2.7253	2.5237	1 H1-1a
477	M484	LL2.5x2x3x3	.303	2.483	20	.002	4.966	y	8	38.3105	53.136	2.7253	2.5237	1 H1-1a
478	M485	L2.5x2.5x3	.030	3.4869	21	.001	7.4386	y	23	5.9348	29.1924	.8726	1.4726	1.13... H2-1
479	M486	L2.5x2.5x3	.030	3.9518	19	.001	7.4386	y	16	5.9348	29.1924	.8726	1.4726	1.13... H2-1
480	M487	L2.5x2.5x3	.040	3.4869	19	.001	7.4386	y	10	5.9348	29.1924	.8726	1.4726	1.13... H2-1
481	M488	L2.5x2.5x3	.040	3.9518	25	.001	0	y	12	5.9348	29.1924	.8726	1.4726	1.13... H2-1
482	M489	L2.5x2.5x3	.040	3.4869	25	.001	7.4386	y	10	5.9348	29.1924	.8726	1.4726	1.13... H2-1
483	M490	L2.5x2.5x3	.040	3.9518	22	.001	0	y	8	5.9348	29.1924	.8726	1.4726	1.13... H2-1
484	M491	L2.5x2.5x3	.040	3.4869	24	.001	7.4386	y	10	5.9348	29.1924	.8726	1.4726	1.13... H2-1
485	M492	L2.5x2.5x3	.040	3.9518	21	.001	7.4386	y	4	5.9348	29.1924	.8726	1.4726	1.13... H2-1
486	M493	L2.5x2.5x3	.030	3.4869	21	.001	7.4386	y	23	5.9348	29.1924	.8726	1.4726	1.13... H2-1
487	M494	L2.5x2.5x3	.030	3.9518	19	.001	7.4386	y	16	5.9348	29.1924	.8726	1.4726	1.13... H2-1
488	M495	LL2.5x2x3x3	.259	3.1392	25	.001	6.2783	y	10	32.5707	53.136	2.7253	2.5237	1 H1-1a
489	M496	LL2.5x2x3x3	.259	3.1392	23	.001	6.2783	y	14	32.5707	53.136	2.7253	2.5237	1 H1-1a
490	M497	LL2.5x2x3x3	.260	3.1392	21	.001	6.2783	y	10	32.5707	53.136	2.7253	2.5237	1 H1-1a
491	M498	LL2.5x2x3x3	.260	3.1392	19	.001	6.2783	y	14	32.5707	53.136	2.7253	2.5237	1 H1-1a
492	M499	LL2.5x2x3x3	.290	2.2197	26	.001	0	y	2	39.5564	53.136	2.7253	2.5237	1 H1-1a
493	M500	LL2.5x2x3x3	.289	2.2197	24	.001	4.4394	y	2	39.5564	53.136	2.7253	2.5237	1 H1-1a

Envelope AISC 14th(360-10): LRFD Steel Code Checks (Continued)

Member	Shape	Code C...	Loc[ft]	LC	She...	Loc[ft]	Dir	LC	phi*Pnc [k]	phi*Pnt ...	phi*Mn y-v...	phi*Mn z-...	Cb	Eqn	
494	M501	LL2.5x2x3x3	.290	2.2197	22	.001	4.4394	y	2	39.5564	53.136	2.7253	2.5237	1	H1-1a
495	M502	LL2.5x2x3x3	.291	2.2197	20	.001	4.4394	y	2	39.5564	53.136	2.7253	2.5237	1	H1-1a
496	M503	L2 1/2x2 1/2x3/16	.019	3.2479	21	.001	7.2512	y	10	6.5944	29.2248	.4958	1.4767	1.13...	H2-1
497	M504	L2 1/2x2 1/2x3/16	.019	4.0033	19	.001	0	y	12	6.5944	29.2248	.4958	1.4767	1.13...	H2-1
498	M505	L2 1/2x2 1/2x3/16	.028	3.2479	19	.001	7.2512	y	10	6.5944	29.2248	.4958	1.4767	1.13...	H2-1
499	M506	L2 1/2x2 1/2x3/16	.028	4.0033	25	.001	7.2512	y	10	6.5944	29.2248	.4958	1.4767	1.13...	H2-1
500	M507	L2 1/2x2 1/2x3/16	.028	3.2479	24	.001	7.2512	y	10	6.5944	29.2248	.4958	1.4767	1.13...	H2-1
501	M508	L2 1/2x2 1/2x3/16	.028	4.0033	24	.001	0	y	6	6.5944	29.2248	.4958	1.4767	1.13...	H2-1
502	M509	L2 1/2x2 1/2x3/16	.028	3.2479	23	.001	7.2512	y	2	6.5944	29.2248	.4958	1.4767	1.13...	H2-1
503	M510	L2 1/2x2 1/2x3/16	.028	4.0033	21	.001	7.2512	y	2	6.5944	29.2248	.4958	1.4767	1.13...	H2-1
504	M511	L2 1/2x2 1/2x3/16	.019	3.2479	21	.001	7.2512	y	10	6.5944	29.2248	.4958	1.4767	1.13...	H2-1
505	M512	L2 1/2x2 1/2x3/16	.019	4.0033	19	.001	0	y	12	6.5944	29.2248	.4958	1.4767	1.13...	H2-1
506	M513	LL2.5x2x3x3	.231	2.7779	25	.001	0	y	10	36.0845	53.136	2.7253	2.5237	1	H1-1a
507	M514	LL2.5x2x3x3	.230	2.7779	23	.001	0	y	6	36.0845	53.136	2.7253	2.5237	1	H1-1a
508	M515	LL2.5x2x3x3	.231	2.7779	21	.001	0	y	10	36.0845	53.136	2.7253	2.5237	1	H1-1a
509	M516	LL2.5x2x3x3	.231	2.7779	19	.001	0	y	6	36.0845	53.136	2.7253	2.5237	1	H1-1a
510	M517	LL2.5x2x3x3	.280	1.9643	24	.001	0	y	10	40.5164	53.136	2.7253	2.5237	1	H1-1a
511	M518	LL2.5x2x3x3	.280	1.9643	22	.001	0	y	12	40.5164	53.136	2.7253	2.5237	1	H1-1a
512	M519	LL2.5x2x3x3	.280	1.9643	20	.001	0	y	16	40.5164	53.136	2.7253	2.5237	1	H1-1a
513	M520	LL2.5x2x3x3	.280	1.9643	26	.001	0	y	14	40.5164	53.136	2.7253	2.5237	1	H1-1a
514	M521	L2x2x3/16	.036	0	21	.001	0	y	10	3.6463	23.166	.222	.9539	1.13...	H2-1
515	M522	L2x2x3/16	.037	6.9106	19	.001	6.9106	y	16	3.6463	23.166	.222	.9539	1.13...	H2-1
516	M523	L2x2x3/16	.037	0	19	.001	0	y	10	3.6463	23.166	.222	.9539	1.13...	H2-1
517	M524	L2x2x3/16	.037	6.9106	25	.001	0	y	12	3.6463	23.166	.222	.9539	1.13...	H2-1
518	M525	L2x2x3/16	.036	0	25	.001	0	y	10	3.6463	23.166	.222	.9539	1.13...	H2-1
519	M526	L2x2x3/16	.037	6.9106	22	.001	0	y	8	3.6463	23.166	.222	.9539	1.13...	H2-1
520	M527	L2x2x3/16	.036	0	23	.001	0	y	8	3.6463	23.166	.222	.9539	1.13...	H2-1
521	M528	L2x2x3/16	.037	6.9106	21	.001	0	y	4	3.6463	23.166	.222	.9539	1.13...	H2-1
522	M529	LL2.5x2x3x3	.258	2.4166	25	.001	0	y	10	38.6485	53.136	2.7253	2.5237	1	H1-1a
523	M530	LL2.5x2x3x3	.257	2.4166	23	.001	0	y	6	38.6485	53.136	2.7253	2.5237	1	H1-1a
524	M531	LL2.5x2x3x3	.257	2.4166	21	.001	4.8332	y	10	38.6485	53.136	2.7253	2.5237	1	H1-1a
525	M532	LL2.5x2x3x3	.258	2.4166	19	.001	4.8332	y	6	38.6485	53.136	2.7253	2.5237	1	H1-1a
526	M533	LL2.5x2x3x3	.334	1.7088	26	.010	3.4176	y	14	41.2412	53.136	2.7253	2.5237	1	H1-1a
527	M534	LL2.5x2x3x3	.333	1.7088	24	.006	0	y	2	41.2412	53.136	2.7253	2.5237	1	H1-1a
528	M535	LL2.5x2x3x3	.332	1.7088	22	.006	3.4176	y	4	41.2412	53.136	2.7253	2.5237	1	H1-1a
529	M536	LL2.5x2x3x3	.333	1.7088	20	.010	3.4176	y	16	41.2412	53.136	2.7253	2.5237	1	H1-1a
530	M537	L2x2x3/16	.036	0	22	.001	6.7541	y	4	3.8171	23.166	.222	.9611	1.13...	H2-1
531	M538	L2x2x3/16	.036	6.7541	19	.001	6.7541	y	2	3.8171	23.166	.222	.9611	1.13...	H2-1
532	M539	L2x2x3/16	.036	0	19	.001	0	y	4	3.8171	23.166	.222	.9611	1.13...	H2-1
533	M540	L2x2x3/16	.036	6.7541	24	.001	6.7541	y	14	3.8171	23.166	.222	.9611	1.13...	H2-1
534	M541	L2x2x3/16	.036	0	25	.001	0	y	10	3.8171	23.166	.222	.9611	1.13...	H2-1
535	M542	L2x2x3/16	.036	6.7541	22	.001	6.7541	y	12	3.8171	23.166	.222	.9611	1.13...	H2-1
536	M543	L2x2x3/16	.036	0	24	.001	6.7541	y	16	3.8171	23.166	.222	.9611	1.13...	H2-1
537	M544	L2x2x3/16	.036	6.7541	21	.001	6.7541	y	4	3.8171	23.166	.222	.9611	1.13...	H2-1

Material Takeoff

	Material	Size	Pieces	Length[ft]	Weight[K]
1	Hot Rolled Steel				
2	A36	2L2 1/2x2x1/4x3/8	40	607.7	4.4
3	A36	2L2 1/2x2x3/16x3/8	5	50.5	.3
4	A36	2L2 1/2x2x3/8x3/8	16	218.6	2.3
5	A36	2L2 1/2x3x3/8x3/8	24	653	8.5
6	A36	C9X13.4	4	38.7	.5
7	A36	L2 1/2x2 1/2x1/4	16	106.5	.4
8	A36	L2 1/2x2 1/2x3/16	65	476.1	1.5

Company : Ramaker & Associates, Inc
 Designer : TEM
 Job Number : 30775
 Model Name : Youngs Apple Orchard

June 3, 2019
 12:27 PM
 Checked By: _____

Material Takeoff (Continued)

	Material	Size	Pieces	Length[ft]	Weight[K]
9	A36	L2 1/2x2x1/4	8	21.4	0
10	A36	L2 1/2x2x3/16	32	136.1	.4
11	A36	L2.5x2.5x3	14	105.5	.3
12	A36	L2x2 1/2x1/4	8	52.9	.2
13	A36	L2x2 1/2x3/16	32	214.9	.6
14	A36	L2x2x3/16	88	435	1.1
15	A36	L3x3x1/4	4	37	.2
16	A36	L3x3x3/16	53	478.8	1.8
17	A36	L4x4x3/8	12	115.7	1.1
18	A36	L5x5x1/2	8	101.7	1.6
19	A36	L6x6x1/2	4	101	2
20	A36	L6x6x5/8	4	100	2.4
21	A36	L8x8x1/2	4	99.3	2.6
22	A36	LL2.5x2x3x3	82	557.5	3.1
23	A36	LL2.5x2x4x3	14	144.8	1.1
24	A36	SR 1	4	36.7	0
25	Total HR Steel		541	4889.5	36.5

Project Information	
Project #	30775
Site Name	Youngs Apple Orchard

Tower Information	
Tower Type	Self Support
TIA-222 Rev	G

Load Z Normalization

Applied Loads		
	Comp.	Uplift
Axial (k)	120.21	94.41
Shear (k)	21.79	19.44

Anchor Rod Data	
Quantity:	4
Diameter (in):	1.75
Material Grade:	A36
Grout Considered:	Yes
l_{ar} (in):	1.75
Eta Factor, η :	0.55
Thread Type:	N-Included
Configuration:	Symmetrical

Fy=36 ksi Fu=58 ksi
 Grout Considered
 Bending Interaction Not Considered

Anchor Rod Results	
Axial, P_u (kips)	23.60
Shear, V_u (kips)	4.86
Moment, M_u (kip-in)	-
Axial Cap., ϕP_n (kips)	88.16
Shear Cap., ϕV_n (kips)	-
Moment Cap., ϕM_n (kip-in)	-
Stress Rating	36.8%

Pass

Pier and Pad Foundation

Project #: 30775
 Site Name: Youngs Apple Or.

TIA-222 Revision: G
 Tower Type: Self Support

Top & Bot. Pad Rein. Different?:
 Block Foundation?:

Superstructure Analysis Reactions		
Compression, P_{comp} :	120.207	kips
Compression Shear, V_{u_comp} :	21.795	kips
Uplift, P_{uplift} :	94.408	kips
Uplift Shear, V_{u_uplift} :	19.439	kips
Tower Height, H :	129	ft
Base Face Width, BW :	24.333	ft
BP Dist. Above Fdn, bp_{dist} :	3	in

Foundation Analysis Checks				
	Capacity	Demand	Rating	Check
<i>Uplift (kips)</i>	430.23	94.41	21.9%	Pass
<i>Lateral (Sliding) (kips)</i>	144.51	19.44	13.5%	Pass
<i>Bearing Pressure (ksf)</i>	36.36	2.43	6.7%	Pass
<i>Pier Flexure (Comp.) (kip*ft)</i>	1343.58	217.95	16.2%	Pass
<i>Pier Flexure (Tension) (kip*ft)</i>	1094.39	194.39	17.8%	Pass
<i>Pier Compression (kip)</i>	7637.76	149.01	2.0%	Pass
<i>Pad Flexure (kip*ft)</i>	568.70	86.93	15.3%	Pass
<i>Pad Shear - 1-way (kips)</i>	232.92	25.64	11.0%	Pass
<i>Pad Shear - 2-way (Comp) (ksi)</i>	0.164	0.028	17.2%	Pass

Pier Properties		
Pier Shape:	Square	
Pier Diameter, dpier :	4	ft
Ext. Above Grade, E :	1.5	ft
Pier Rebar Size, Sc :	7	
Pier Rebar Quantity, mc :	24	
Pier Tie/Spiral Size, St :	3	
Pier Tie/Spiral Quantity, mt :	12	
Pier Reinforcement Type:	Tie	
Pier Clear Cover, cc_{pier} :	3	in

Soil Rating:	21.9%
Structural Rating:	17.8%

Pad Properties		
Depth, D :	10.5	ft
Pad Width, W :	12	ft
Pad Thickness, T :	2	ft
Pad Rebar Size (Bottom), Sp :	7	
Pad Rebar Quantity (Bottom), mp :	11	
Pad Clear Cover, cc_{pad} :	3	in

Material Properties		
Rebar Grade, Fy :	60	ksi
Concrete Compressive Strength, F'c :	3	ksi
Dry Concrete Density, δc :	150	pcf

Soil Properties		
Total Soil Unit Weight, γ :	114	pcf
Ultimate Gross Bearing, Qult :	48.475	ksf
Cohesion, Cu :		ksf
Friction Angle, φ :	36	degrees
SPT Blow Count, N_{blows} :	31	
Base Friction, μ :	0.5	
Neglected Depth, N :	3.33	ft
Foundation Bearing on Rock?	No	
Groundwater Depth, gw :	None	ft

<--Toggle between Gross and Net

Structural Analysis Report

Antenna Mount Analysis

T-Mobile Site #: CT11224A

*59 Youngs Apple Orchard Road
North Branford, CT*

Centek Project No. 19027.20

Date: April 29, 2019

Max Stress Ratio = 55.6%

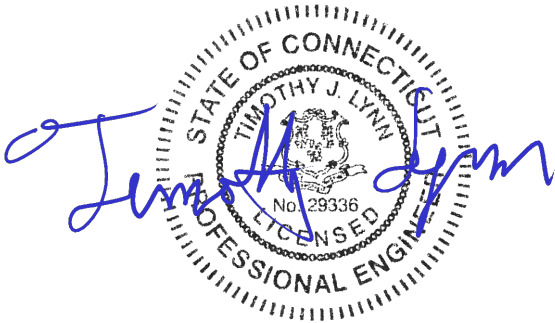

Prepared for:

*T-Mobile USA
35 Griffin Road
Bloomfield, CT 06002*

CENTEK Engineering, Inc.
Structural Analysis – Mount Analysis
T-Mobile Site Ref. ~ CT11224A
North Branford, CT
April 29, 2019

Table of Contents

SECTION 1 – REPORT

- ANTENNA AND APPURTENANCE SUMMARY
- STRUCTURE LOADING
- CONCLUSION

SECTION 2 – CALCULATIONS

- WIND LOAD ON APPURTENANCES
- RISA3D OUTPUT REPORT

SECTION 3 – REFERENCE MATERIALS (NOT INCLUDED WITHIN REPORT)

- RF DATA SHEET, DATED 04/17/2019

April 29, 2019

Mr. Dan Reid
Transcend Wireless
10 Industrial Ave
Mahwah, NJ 07430

Re: *Structural Letter ~ Antenna Mount
T-Mobile – Site Ref: CT11224A
59 Youngs Apple Orchard Road
North Branford, CT 06472*

Centek Project No. 19027.20

Dear Mr. Reid,

Centek Engineering, Inc. has reviewed the T-Mobile antenna installation at the above referenced site. The purpose of the review is to determine the structural adequacy of the existing antenna pipe masts, Pipe 2.5 STD X ±14-ft, to support the proposed equipment configuration. The review considered the effects of wind load, dead load and ice load in accordance with the 2015 International Building Code as modified by the 2018 Connecticut State Building Code (CTBC) including ASCE 7-10 and ANSI/TIA-222-G *Structural Standards for Steel Antenna Towers and Supporting Structures*.

The loads considered in this analysis consist of the following:

- T-Mobile:
Pipe Masts: Three (3) RFS APXVAARR24-43-NA20 panel antennas, three (3) Ericsson 4449 B71_B12, three (3) Ericsson 4415 B25 and three (3) Ericsson 4415 B66A remote radio units mounted to three (3) pipe masts with a RAD center elevation of 97-ft +/- AGL.

The antenna mount was analyzed per the requirements of the 2015 International Building Code as modified by the 2018 Connecticut State Building Code considering a nominal design wind speed of 101 mph for North Branford as required in Appendix N of the 2018 Connecticut State Building Code.

A structural analysis of tower and foundation needs to be completed prior to any work.

Based on our review of the installation, it is our opinion that the subject antenna mount is structurally adequate to support the aforementioned antenna configuration. If there are any questions regarding this matter, please feel free to call.

Respectfully Submitted by:

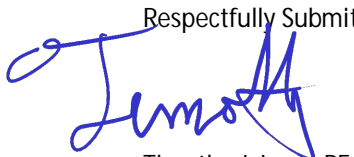
Timothy J. Lynn, PE
Structural Engineer



Prepared by:

Fernando J. Palacios
Engineer

CEN TEK Engineering, Inc.
Structural Analysis – Mount Analysis
T-Mobile Site Ref. ~ CT11224A
North Branford, CT
April 29, 2019

Section 2 - Calculations

Development of Wind & Ice Load on Antennas

Antenna Data:

Antenna Model =	RFS APXVAARR24_43	
Antenna Shape =	Flat	(User Input)
Antenna Height =	$L_{ant} := 95.9$	in (User Input)
Antenna Width =	$W_{ant} := 19.7$	in (User Input)
Antenna Thickness =	$T_{ant} := 8.7$	in (User Input)
Antenna Weight =	$WT_{ant} := 133.4$	lbs (User Input)
Number of Antennas =	$N_{ant} := 1$	(User Input)
Antenna Aspect Ratio =	$AR_{ant} := \frac{L_{ant}}{W_{ant}} = 4.9$	

Antenna Force Coefficient = $Ca_{ant} = 1.31$

Wind Load (without ice)

Surface Area for One Antenna = $SA_{antF} := \frac{L_{ant} \cdot W_{ant}}{144} = 13.1$ sf

Total Antenna Wind Force Front = $F_{ant} := qz \cdot G_H \cdot Ca_{ant} \cdot K_a \cdot SA_{antF} = 634$ lbs

Surface Area for One Antenna = $SA_{antS} := \frac{L_{ant} \cdot T_{ant}}{144} = 5.8$ sf

Total Antenna Wind Force Side = $F_{ant} := qz \cdot G_H \cdot Ca_{ant} \cdot K_a \cdot SA_{antS} = 280$ lbs

Wind Load (with ice)

Surface Area for One Antenna w/ Ice = $SA_{ICEantF} := \frac{(L_{ant} + 2 \cdot t_{iz}) \cdot (W_{ant} + 2 \cdot t_{iz})}{144} = 15.9$ sf

Total Antenna Wind Force w/ Ice Front = $Fi_{ant} := qz_{ice} \cdot G_H \cdot Ca_{ant} \cdot K_a \cdot SA_{ICEantF} = 188$ lbs

Surface Area for One Antenna w/ Ice = $SA_{ICEantS} := \frac{(L_{ant} + 2 \cdot t_{iz}) \cdot (T_{ant} + 2 \cdot t_{iz})}{144} = 8.3$ sf

Total Antenna Wind Force w/ Ice Side = $Fi_{ant} := qz_{ice} \cdot G_H \cdot Ca_{ant} \cdot K_a \cdot SA_{ICEantS} = 98$ lbs

Gravity Load (without ice)

Weight of All Antennas = $WT_{ant} \cdot N_{ant} = 133$ lbs

Gravity Loads (ice only)

Volume of Each Antenna = $V_{ant} := L_{ant} \cdot W_{ant} \cdot T_{ant} = 2 \cdot 10^4$ cu in

Volume of Ice on Each Antenna = $V_{ice} := (L_{ant} + 2 \cdot t_{iz}) \cdot (W_{ant} + 2 \cdot t_{iz}) \cdot (T_{ant} + 2 \cdot t_{iz}) - V_{ant} = 1 \cdot 10^4$ cu in

Weight of Ice on Each Antenna = $W_{ICEant} := \frac{V_{ice}}{1728} \cdot Id = 360$ lbs

Weight of Ice on All Antennas = $W_{ICEant} \cdot N_{ant} = 360$ lbs

Development of Wind & Ice Load on RRUS's

RRUS Data:

RRUS Model =	Ericsson 4449 B71B12	
RRUS Shape =	Flat	(User Input)
RRUS Height =	$L_{RRUS} := 14.9$	in (User Input)
RRUS Width =	$W_{RRUS} := 13.2$	in (User Input)
RRUS Thickness =	$T_{RRUS} := 10.4$	in (User Input)
RRUS Weight =	$WT_{RRUS} := 74$	lbs (User Input)
Number of RRUS's =	$N_{RRUS} := 1$	
RRUS Aspect Ratio =	$Ar_{RRUS} := \frac{L_{RRUS}}{W_{RRUS}} = 1.1$	
RRUS Force Coefficient =	$Ca_{RRUS} = 1.2$	

Wind Load (without ice)

Surface Area for One RRUS = $SA_{RRUSF} := \frac{L_{RRUS} \cdot W_{RRUS}}{144} = 1.4$ sf

Total RRUS Wind Force = $F_{RRUS} := qz \cdot G_H \cdot Ca_{RRUS} \cdot K_a \cdot SA_{RRUSF} = 61$ lbs

Surface Area for One RRUS = $SA_{RRUS} := \frac{L_{RRUS} \cdot T_{RRUS}}{144} = 1.1$ sf

Total RRUS Wind Force = $F_{RRUS} := qz \cdot G_H \cdot Ca_{RRUS} \cdot K_a \cdot SA_{RRUS} = 48$ lbs

Wind Load (with ice)

Surface Area for One RRUS w/ Ice = $SA_{ICERRUSF} := \frac{(L_{RRUS} + 2 \cdot t_{iz}) \cdot (W_{RRUS} + 2 \cdot t_{iz})}{144} = 2.1$ sf

Total RRUS Wind Force w/ Ice = $F_{IRRUS} := qz_{ice} \cdot G_H \cdot Ca_{RRUS} \cdot K_a \cdot SA_{ICERRUSF} = 23$ lbs

Surface Area for One RRUS w/ Ice = $SA_{ICERRUS} := \frac{(L_{RRUS} + 2 \cdot t_{iz}) \cdot (T_{RRUS} + 2 \cdot t_{iz})}{144} = 1.7$ sf

Total RRUS Wind Force w/ Ice = $F_{IRRUS} := qz_{ice} \cdot G_H \cdot Ca_{RRUS} \cdot K_a \cdot SA_{ICERRUS} = 19$ lbs

Gravity Load (without ice)

Weight of All RRUSs = $WT_{RRUS} \cdot N_{RRUS} = 74$ lbs

Gravity Loads (ice only)

Volume of Each RRUS = $V_{RRUS} := L_{RRUS} \cdot W_{RRUS} \cdot T_{RRUS} = 2045$ cu in

Volume of Ice on Each RRUS = $V_{ice} := (L_{RRUS} + 2 \cdot t_{iz}) \cdot (W_{RRUS} + 2 \cdot t_{iz}) \cdot (T_{RRUS} + 2 \cdot t_{iz}) - V_{RRUS} = 2101$ cu in

Weight of Ice on Each RRUS = $W_{ICERRUS} := \frac{V_{ice}}{1728} \cdot Id = 68$ lbs

Weight of Ice on All RRUSs = $W_{ICERRUS} \cdot N_{RRUS} = 68$ lbs

Development of Wind & Ice Load on RRUS's

RRUS Data:

RRUS Model =	Ericsson 4415 B25	
RRUS Shape =	Flat	(User Input)
RRUS Height =	$L_{RRUS} := 16.5$	in (User Input)
RRUS Width =	$W_{RRUS} := 13.4$	in (User Input)
RRUS Thickness =	$T_{RRUS} := 5.9$	in (User Input)
RRUS Weight =	$WT_{RRUS} := 46$	lbs (User Input)
Number of RRUS's =	$N_{RRUS} := 1$	
RRUS Aspect Ratio =	$Ar_{RRUS} := \frac{L_{RRUS}}{W_{RRUS}} = 1.2$	
RRUS Force Coefficient =	$Ca_{RRUS} = 1.2$	

Wind Load (without ice)

Surface Area for One RRUS = $SA_{RRUSF} := \frac{L_{RRUS} \cdot W_{RRUS}}{144} = 1.5$ sf

Total RRUS Wind Force = $F_{RRUS} := qz \cdot G_H \cdot Ca_{RRUS} \cdot K_a \cdot SA_{RRUSF} = 68$ lbs

Surface Area for One RRUS = $SA_{RRUSS} := \frac{L_{RRUS} \cdot T_{RRUS}}{144} = 0.7$ sf

Total RRUS Wind Force = $F_{RRUS} := qz \cdot G_H \cdot Ca_{RRUS} \cdot K_a \cdot SA_{RRUSS} = 30$ lbs

Wind Load (with ice)

Surface Area for One RRUS w/ Ice = $SA_{ICERRUSF} := \frac{(L_{RRUS} + 2 \cdot t_{iz}) \cdot (W_{RRUS} + 2 \cdot t_{iz})}{144} = 2.3$ sf

Total RRUS Wind Force w/ Ice = $F_{IRRUS} := qz_{ice} \cdot G_H \cdot Ca_{RRUS} \cdot K_a \cdot SA_{ICERRUSF} = 25$ lbs

Surface Area for One RRUS w/ Ice = $SA_{ICERRUSS} := \frac{(L_{RRUS} + 2 \cdot t_{iz}) \cdot (T_{RRUS} + 2 \cdot t_{iz})}{144} = 1.3$ sf

Total RRUS Wind Force w/ Ice = $F_{IRRUS} := qz_{ice} \cdot G_H \cdot Ca_{RRUS} \cdot K_a \cdot SA_{ICERRUSS} = 14$ lbs

Gravity Load (without ice)

Weight of All RRUSs = $WT_{RRUS} \cdot N_{RRUS} = 46$ lbs

Gravity Loads (ice only)

Volume of Each RRUS = $V_{RRUS} := L_{RRUS} \cdot W_{RRUS} \cdot T_{RRUS} = 1304$ cu in

Volume of Ice on Each RRUS = $V_{ice} := (L_{RRUS} + 2 \cdot t_{iz}) \cdot (W_{RRUS} + 2 \cdot t_{iz}) \cdot (T_{RRUS} + 2 \cdot t_{iz}) - V_{RRUS} = 1765$ cu in

Weight of Ice on Each RRUS = $W_{ICERRUS} := \frac{V_{ice}}{1728} \cdot Id = 57$ lbs

Weight of Ice on All RRUSs = $W_{ICERRUS} \cdot N_{RRUS} = 57$ lbs

Development of Wind & Ice Load on RRUS's

RRUS Data:

RRUS Model =	Ericsson 4415 B66A	
RRUS Shape =	Flat	(User Input)
RRUS Height =	$L_{RRUS} := 16.5$	in (User Input)
RRUS Width =	$W_{RRUS} := 13.4$	in (User Input)
RRUS Thickness =	$T_{RRUS} := 5.9$	in (User Input)
RRUS Weight =	$WT_{RRUS} := 47.40$	lbs (User Input)
Number of RRUS's =	$N_{RRUS} := 1$	
RRUS Aspect Ratio =	$Ar_{RRUS} := \frac{L_{RRUS}}{W_{RRUS}} = 1.2$	
RRUS Force Coefficient =	$Ca_{RRUS} = 1.2$	

Wind Load (without ice)

Surface Area for One RRUS = $SA_{RRUSF} := \frac{L_{RRUS} \cdot W_{RRUS}}{144} = 1.5$ sf

Total RRUS Wind Force = $F_{RRUS} := qz \cdot G_H \cdot Ca_{RRUS} \cdot K_a \cdot SA_{RRUSF} = 68$ lbs

Surface Area for One RRUS = $SA_{RRUSS} := \frac{L_{RRUS} \cdot T_{RRUS}}{144} = 0.7$ sf

Total RRUS Wind Force = $F_{RRUS} := qz \cdot G_H \cdot Ca_{RRUS} \cdot K_a \cdot SA_{RRUSS} = 30$ lbs

Wind Load (with ice)

Surface Area for One RRUS w/ Ice = $SA_{ICERRUSF} := \frac{(L_{RRUS} + 2 \cdot t_{iz}) \cdot (W_{RRUS} + 2 \cdot t_{iz})}{144} = 2.3$ sf

Total RRUS Wind Force w/ Ice = $F_{IRRUS} := qz_{ice} \cdot G_H \cdot Ca_{RRUS} \cdot K_a \cdot SA_{ICERRUSF} = 25$ lbs

Surface Area for One RRUS w/ Ice = $SA_{ICERRUSS} := \frac{(L_{RRUS} + 2 \cdot t_{iz}) \cdot (T_{RRUS} + 2 \cdot t_{iz})}{144} = 1.3$ sf

Total RRUS Wind Force w/ Ice = $F_{IRRUS} := qz_{ice} \cdot G_H \cdot Ca_{RRUS} \cdot K_a \cdot SA_{ICERRUSS} = 14$ lbs

Gravity Load (without ice)

Weight of All RRUSs = $WT_{RRUS} \cdot N_{RRUS} = 47$ lbs

Gravity Loads (ice only)

Volume of Each RRUS = $V_{RRUS} := L_{RRUS} \cdot W_{RRUS} \cdot T_{RRUS} = 1304$ cu in

Volume of Ice on Each RRUS = $V_{ice} := (L_{RRUS} + 2 \cdot t_{iz}) \cdot (W_{RRUS} + 2 \cdot t_{iz}) \cdot (T_{RRUS} + 2 \cdot t_{iz}) - V_{RRUS} = 1765$ cu in

Weight of Ice on Each RRUS = $W_{ICERRUS} := \frac{V_{ice}}{1728} \cdot Id = 57$ lbs

Weight of Ice on All RRUSs = $W_{ICERRUS} \cdot N_{RRUS} = 57$ lbs

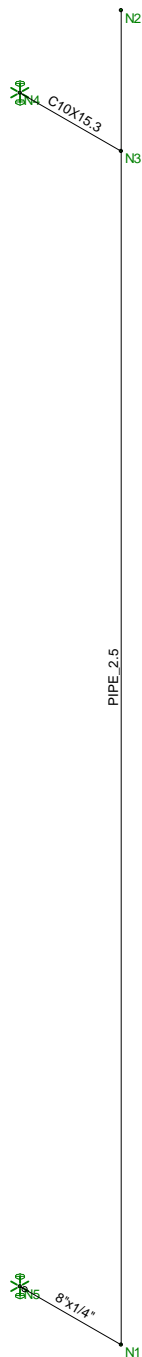

Loads: BLC 1, Self Weight
Envelope Only Solution

Centek	CT11224A_AMA Member Framing	Apr 29, 2019 at 5:26 PM
THC		CT11224A_AMA Pipe Mount.r3d
19027.20		



Code Check (Env)	
Black	No Calc
Red	> 1.0
Yellow	50-1.0
Green	75-90
Cyan	50-75
Blue	0-50

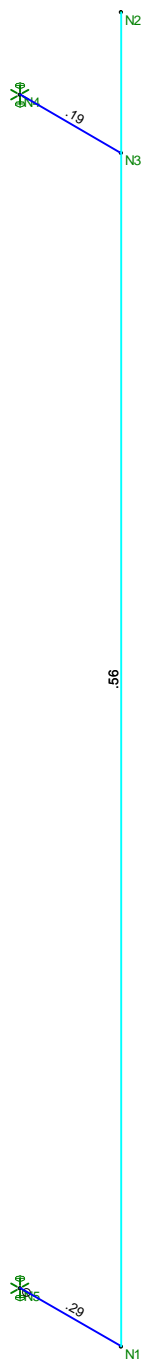

Member Code Checks Displayed (Enveloped)
Loads: BLC 1, Self Weight
Envelope Only Solution

Centek	CT11224A_AMA Member Unity Check	
THC		Apr 29, 2019 at 5:27 PM
19027.20		CT11224A_AMA Pipe Mount.r3d



RADIO FREQUENCY EMISSIONS ANALYSIS REPORT EVALUATION OF HUMAN EXPOSURE POTENTIAL TO NON-IONIZING EMISSIONS

T-Mobile Existing Facility

Site ID: CT11224A

Guilford-I_I

59 Youngs Apple Orchard Road
North Branford, Connecticut 06472

May 17, 2019

EBI Project Number: 6219001676

Site Compliance Summary	
Compliance Status:	COMPLIANT
Site total MPE% of FCC general population allowable limit:	8.12%

May 17, 2019

T-Mobile

Attn: Jason Overbey, RF Manager
35 Griffin Road South
Bloomfield, Connecticut 06002

Emissions Analysis for Site: CT11224A - Guilford-1_1

EBI Consulting was directed to analyze the proposed T-Mobile facility located at **59 Youngs Apple Orchard Road in North Branford, Connecticut** for the purpose of determining whether the emissions from the Proposed T-Mobile Antenna Installation located on this property are within specified federal limits.

All information used in this report was analyzed as a percentage of current Maximum Permissible Exposure (% MPE) as listed in the FCC OET Bulletin 65 Edition 97-01 and ANSI/IEEE Std C95.1. The FCC regulates Maximum Permissible Exposure in units of microwatts per square centimeter ($\mu\text{W}/\text{cm}^2$). The number of $\mu\text{W}/\text{cm}^2$ calculated at each sample point is called the power density. The exposure limit for power density varies depending upon the frequencies being utilized. Wireless Carriers and Paging Services use different frequency bands each with different exposure limits; therefore, it is necessary to report results and limits in terms of percent MPE rather than power density.

All results were compared to the FCC (Federal Communications Commission) radio frequency exposure rules, 47 CFR 1.1307(b)(1) – (b)(3), to determine compliance with the Maximum Permissible Exposure (MPE) limits for General Population/Uncontrolled environments as defined below.

General population/uncontrolled exposure limits apply to situations in which the general population may be exposed or in which persons who are exposed as a consequence of their employment may not be made fully aware of the potential for exposure or cannot exercise control over their exposure. Therefore, members of the general population would always be considered under this category when exposure is not employment related, for example, in the case of a telecommunications tower that exposes persons in a nearby residential area.

Public exposure to radio frequencies is regulated and enforced in units of microwatts per square centimeter ($\mu\text{W}/\text{cm}^2$). The general population exposure limits for the 600 MHz and 700 MHz frequency bands are approximately $400 \mu\text{W}/\text{cm}^2$ and $467 \mu\text{W}/\text{cm}^2$, respectively. The general population exposure limit for the 1900 MHz (PCS), 2100 MHz (AWS) and 11 GHz frequency bands is $1000 \mu\text{W}/\text{cm}^2$. Because

each carrier will be using different frequency bands, and each frequency band has different exposure limits, it is necessary to report percent of MPE rather than power density.

Occupational/controlled exposure limits apply to situations in which persons are exposed as a consequence of their employment and in which those persons who are exposed have been made fully aware of the potential for exposure and can exercise control over their exposure. Occupational/controlled exposure limits also apply where exposure is of a transient nature as a result of incidental passage through a location where exposure levels may be above general population/uncontrolled limits (see below), as long as the exposed person has been made fully aware of the potential for exposure and can exercise control over his or her exposure by leaving the area or by some other appropriate means.

Additional details can be found in FCC OET 65.

CALCULATIONS

Calculations were done for the proposed T-Mobile Wireless antenna facility located at 59 Youngs Apple Orchard Road in North Branford, Connecticut using the equipment information listed below. All calculations were performed per the specifications under FCC OET 65. Since T-Mobile is proposing highly focused directional panel antennas, which project most of the emitted energy out toward the horizon, all calculations were performed assuming a lobe representing the maximum gain of the antenna per the antenna manufacturer's supplied specifications, minus 10 dB for directional panel antennas and 20 dB for highly focused parabolic microwave dishes, was focused at the base of the tower. For this report, the sample point is the top of a 6-foot person standing at the base of the tower.

For all calculations, all equipment was calculated using the following assumptions:

- 1) 2 LTE channels (600 MHz Band) were considered for each sector of the proposed installation. These Channels have a transmit power of 30 Watts per Channel.
- 2) 2 LTE channels (700 MHz Band) were considered for each sector of the proposed installation. These Channels have a transmit power of 30 Watts per Channel.
- 3) 4 GSM channels (PCS Band - 1900 MHz) were considered for each sector of the proposed installation. These Channels have a transmit power of 30 Watts per Channel.
- 4) 2 LTE channels (PCS Band - 1900 MHz) were considered for each sector of the proposed installation. These Channels have a transmit power of 60 Watts per Channel.

- 5) 2 LTE channels (AWS Band – 2100 MHz) were considered for each sector of the proposed installation. These Channels have a transmit power of 60 Watts per Channel.
- 6) All radios at the proposed installation were considered to be running at full power and were uncombined in their RF transmissions paths per carrier prescribed configuration. Per FCC OET Bulletin No. 65 - Edition 97-01 recommendations to achieve the maximum anticipated value at each sample point, all power levels emitting from the proposed antenna installation are increased by a factor of 2.56 to account for possible in-phase reflections from the surrounding environment. This is rarely the case, and if so, is never continuous.
- 7) For the following calculations, the sample point was the top of a 6-foot person standing at the base of the tower. The maximum gain of the antenna per the antenna manufacturer's supplied specifications, minus 10 dB for directional panel antennas and 20 dB for highly focused parabolic microwave dishes, was used in this direction. This value is a very conservative estimate as gain reductions for these particular antennas are typically much higher in this direction.
- 8) The antennas used in this modeling are the RFS APXVAARR24_43-U-NA20 for the 600 MHz / 700 MHz / 1900 MHz / 1900 MHz / 2100 MHz channel(s) in Sector A, the RFS APXVAARR24_43-U-NA20 for the 600 MHz / 700 MHz / 1900 MHz / 1900 MHz / 2100 MHz channel(s) in Sector B, the RFS APXVAARR24_43-U-NA20 for the 600 MHz / 700 MHz / 1900 MHz / 1900 MHz / 2100 MHz channel(s) in Sector C. This is based on feedback from the carrier with regard to anticipated antenna selection. All Antenna gain values and associated transmit power levels are shown in the Site Inventory and Power Data table below. The maximum gain of the antenna per the antenna manufacturer's supplied specifications, minus 10 dB for directional panel antennas and 20 dB for highly focused parabolic microwave dishes, was used for all calculations. This value is a very conservative estimate as gain reductions for these particular antennas are typically much higher in this direction.
- 9) The antenna mounting height centerline of the proposed antennas is 97 feet above ground level (AGL).
- 10) Emissions values for additional carriers were taken from the Connecticut Siting Council active database. Values in this database are provided by the individual carriers themselves.
- 11) All calculations were done with respect to uncontrolled / general population threshold limits.

T-Mobile Site Inventory and Power Data

Sector:	A	Sector:	B	Sector:	C
Antenna #:	I	Antenna #:	I	Antenna #:	I
Make / Model:	RFS APXVAARR24_43-U-NA20	Make / Model:	RFS APXVAARR24_43-U-NA20	Make / Model:	RFS APXVAARR24_43-U-NA20
Frequency Bands:	600 MHz / 700 MHz / 1900 MHz / 1900 MHz / 2100 MHz	Frequency Bands:	600 MHz / 700 MHz / 1900 MHz / 1900 MHz / 2100 MHz	Frequency Bands:	600 MHz / 700 MHz / 1900 MHz / 1900 MHz / 2100 MHz
Gain:	12.95 dBd / 13.35 dBd / 15.65 dBd / 15.65 dBd / 16.35 dBd	Gain:	12.95 dBd / 13.35 dBd / 15.65 dBd / 15.65 dBd / 16.35 dBd	Gain:	12.95 dBd / 13.35 dBd / 15.65 dBd / 15.65 dBd / 16.35 dBd
Height (AGL):	97 feet	Height (AGL):	97 feet	Height (AGL):	97 feet
Channel Count:	12	Channel Count:	12	Channel Count:	12
Total TX Power (W):	480 Watts	Total TX Power (W):	480 Watts	Total TX Power (W):	480 Watts
ERP (W):	16,474.09	ERP (W):	16,474.09	ERP (W):	16,474.09
Antenna A1 MPE %:	7.54%	Antenna B1 MPE %:	7.54%	Antenna C1 MPE %:	7.54%
Antenna A4 MPE %:	0.00%	Antenna B4 MPE %:	0.00%	Antenna C4 MPE %:	0.00%



Site Composite MPE %	
Carrier	MPE %
T-Mobile (Max at Sector A):	7.54%
Sprint	0.58%
Site Total MPE % :	8.12%

T-Mobile Sector A Total:	7.54%
T-Mobile Sector B Total:	7.54%
T-Mobile Sector C Total:	7.54%
Site Total:	8.12%

T-Mobile Maximum MPE Power Values (Sector A)

T-Mobile Frequency Band / Technology (Sector A)	# Channels	Watts ERP (Per Channel)	Height (feet)	Total Power Density ($\mu\text{W}/\text{cm}^2$)	Frequency (MHz)	Allowable MPE ($\mu\text{W}/\text{cm}^2$)	Calculated % MPE
T-Mobile 600 MHz LTE	2	591.73	97.0	4.52	600 MHz LTE	400	1.13%
T-Mobile 700 MHz LTE	2	648.82	97.0	4.96	700 MHz LTE	467	1.06%
T-Mobile 1900 MHz GSM	4	1101.85	97.0	16.84	1900 MHz GSM	1000	1.68%
T-Mobile 1900 MHz LTE PCS	2	2203.69	97.0	16.84	1900 MHz LTE PCS	1000	1.68%
T-Mobile 2100 MHz LTE AWS	2	2589.11	97.0	19.79	2100 MHz LTE AWS	1000	1.98%
						Total:	7.54%

Summary

All calculations performed for this analysis yielded results that were **within** the allowable limits for general population exposure to RF Emissions.

The anticipated maximum composite contributions from the T-Mobile facility as well as the site composite emissions value with regards to compliance with FCC's allowable limits for general population exposure to RF Emissions are shown here:

T-Mobile Sector	Power Density Value (%)
Sector A:	7.54%
Sector B:	7.54%
Sector C:	7.54%
T-Mobile Maximum MPE % (Sector A):	7.54%
Site Total:	8.12%
Site Compliance Status:	COMPLIANT

The anticipated composite MPE value for this site assuming all carriers present is **8.12%** of the allowable FCC established general population limit sampled at the ground level. This is based upon values listed in the Connecticut Siting Council database for existing carrier emissions.

FCC guidelines state that if a site is found to be out of compliance (over allowable thresholds), that carriers over a 5% contribution to the composite value will require measures to bring the site into compliance. For this facility, the composite values calculated were well within the allowable 100% threshold standard per the federal government.