

STATE OF CONNECTICUT
CONNECTICUT SITING COUNCIL

Ten Franklin Square, New Britain, CT 06051

Phone: (860) 827-2935 Fax: (860) 827-2950

E-Mail: siting.council@ct.gov

www.ct.gov/csc

July 11, 2011

Douglas L. Culp, Real Estate Consultant
New Cingular Wireless PCS, LLC
500 Enterprise Drive
Rocky Hill, CT 06067-3900

RE: **EM-CING-085-110624A** - New Cingular Wireless PCS, LLC notice of intent to modify an existing telecommunications facility located at 500 Moose Hill Road, Monroe, Connecticut.

Dear Mr. Culp:

The Connecticut Siting Council (Council) hereby acknowledges your notice to modify this existing telecommunications facility, pursuant to Section 16-50j-73 of the Regulations of Connecticut State Agencies with the following conditions:

- The proposed coax and remote radio heads be installed in accordance with recommendations made in the Structural Analysis prepared by FDH Engineering dated June 16, 2011 and stamped by Christopher Murphy; and
- Following the installation of the proposed equipment, a signed letter from a Professional Engineer duly licensed in the State of Connecticut shall be submitted to the Council to certify that the installation complied with the engineer's recommendations. Any deviation from the proposed modification as specified in this notice and supporting materials with Council shall render this acknowledgement invalid;
- Any material changes to this modification as proposed shall require the filing of a new notice with the Council;
- Not less than 45 days after completion of construction, the Council shall be notified in writing that construction has been completed;
- The validity of this action shall expire one year from the date of this letter; and
- The applicant may file a request for an extension of time beyond the one year deadline provided that such request is submitted to the Council not less than 60 days prior to the expiration;

The proposed modifications including the placement of all necessary equipment and shelters within the tower compound are to be implemented as specified here and in your notice dated June 21, 2011. The modifications are in compliance with the exception criteria in Section 16-50j-72 (b) of the Regulations of Connecticut State Agencies as changes to an existing facility site that would not increase tower height, extend the boundaries of the tower site, increase noise levels at the tower site boundary by six decibels, and increase the total radio frequencies electromagnetic radiation power density measured at the tower site boundary to or above the standard adopted by the State Department of Environmental Protection pursuant to General Statutes § 22a-162. This facility has also been carefully modeled to ensure that radio frequency emissions are conservatively below State and federal standards applicable to the frequencies now used on this tower.



This decision is under the exclusive jurisdiction of the Council. Please be advised that the validity of this action shall expire one year from the date of this letter. Any additional change to this facility will require explicit notice to this agency pursuant to Regulations of Connecticut State Agencies Section 16-50j-73. Such notice shall include all relevant information regarding the proposed change with cumulative worst-case modeling of radio frequency exposure at the closest point of uncontrolled access to the tower base, consistent with Federal Communications Commission, Office of Engineering and Technology, Bulletin 65. Thank you for your attention and cooperation.

Very truly yours,

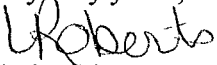

Linda Roberts
Executive Director

LR/CDM/laf

c: The Honorable Stephen Vavrek, First Selectman, Town of Monroe
SBA, Inc.



New Cingular Wireless PCS, LLC
500 Enterprise Drive
Rocky Hill, Connecticut 06067-3900
Phone: (860) 463-5511
Fax: (860) 513-7190

Douglas L. Culp
Real Estate Consultant

HAND DELIVERED

June 21, 2011

Ms. Linda Roberts
Executive Director
Connecticut Siting Council
10 Franklin Square
New Britain, Connecticut 06051

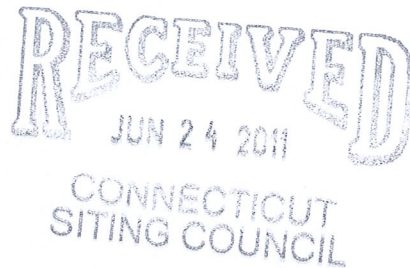

Re: New Cingular Wireless PCS, LLC notice of intent to modify an existing tele-communications facility located at 500 Moose Hill Road Monroe, CT (owner SBA).

Dear Ms. Roberts:

In order to accommodate technological changes, implement Uniform Mobile Telecommunications System (“UMTS”) and/or Long Term Evolution (“LTE”) capabilities, and enhance system performance in the State of Connecticut, New Cingular Wireless PCS, LLC (“AT&T”) plans to modify the equipment configurations at many of its existing cell sites. Please accept this letter and attachments as notification, pursuant to R.C.S.A. Section 16-50j-73, of construction which constitutes an exempt modification pursuant to R.C.S.A. Section 16-50j-72(b)(2). In compliance with R.C.S.A. Section 16-50j-73, a copy of this letter and attachments is being sent to the chief elected official of the municipality in which the affected cell site is located.

UMTS technology offers services to mobile computer and phone users anywhere in the world. Based on the Global System for Mobile (“GSM”) communication standard, UMTS is the planned worldwide standard for mobile users. UMTS, fully implemented, gives computer and phone users high-speed access to the Internet as they travel. They have the same capabilities even when they roam, through both terrestrial wireless and satellite transmissions.

LTE is a new high-performance air interface for cellular mobile communications. It is designed to increase the capacity and speed of mobile telephone networks.

Attached is a summary of the planned modifications, including power density calculations reflecting the change in AT&T’s operations at the site. Also included is documentation of the structural sufficiency of the tower to accommodate the revised antenna configuration.

The changes to the facility do not constitute modifications as defined in Connecticut General Statutes ("C.G.S.") Section 16-50i(d) because the general physical characteristics of the facility will not be significantly changed or altered. Rather, the planned changes to the facility fall squarely within those activities explicitly provided for in R.C.S.A. Section 16-50j-72(b)(2).

1. The height of the overall structure will be unaffected.
2. The proposed changes will not extend the site boundaries. There will be no effect on the site compound other than some enlarged equipment pads as may be noted in the attachments.
3. The proposed changes will not increase the noise level at the existing facility by six decibels or more.
4. Radio frequency power density may increase due to use of one or more GSM channel for UMTS transmissions. Moreover, LTE will utilize additional radio frequencies newly-licensed by the FCC for cellular mobile communications. However, the changes will not increase the calculated "worst case" power density for the combined operations at the site to a level at or above the applicable standard for uncontrolled environments as calculated for a mixed frequency site.

For the foregoing reasons, New Cingular Wireless respectfully submits that the proposed changes at the referenced site constitute exempt modifications under R.C.S.A. Section 16-50j-72(b)(2).

Please feel free to call me at (860) 463-5511 with questions concerning this matter. Thank you for your consideration.

Sincerely,

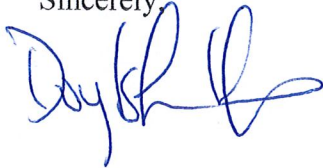
A handwritten signature in blue ink, appearing to read "Douglas L. Culp". The signature is fluid and cursive, with a large initial "D" and "C".

Douglas L. Culp
Real Estate Consultant

Attachments

**NEW CINGULAR WIRELESS PCS, LLC
Equipment Modification**

500 Moose Hill Road Monroe, CT
Site Number CT2203
Exempt Mod

Tower Owner/Manager: SBA

Equipment configuration: Monopole

Current and/or approved: Six PowerWave P7770 antennas @ 138 ft
Six PowerWave TMA's and Six PowerWave Diplexers @ 138 ft
Twelve runs 1 1/4 inch coax to 138 ft
Equipment Shelter

Planned Modifications: Retain existing PowerWave P7770 Antenna's, TMA's and Diplexers @ 138 ft
Retain all Coax Cabling
Install three PowerWave P65-16 antennas or equivalent @ 138 ft
Install six remote radio heads Ericsson RRUS-11 @ 138 ft
Install one Raycap Fiber Power Connector/ Surge Suppressor – DC6-48-60-18-8F @ 138 ft
Install one fiber and two DC power cables @ 138 ft

Power Density:

Worst-case calculations for existing wireless operations at the site, using standard parameters for other carriers, indicate a radio frequency electromagnetic radiation power density, measured at ground level beside the Tower, of approximately 57 % of the standard adopted by the FCC. As depicted in the second table below, the total radio frequency electromagnetic radiation power density following proposed modifications would be approximately 58.9 % of the standard.

Existing

Other Users							49.06
AT&T UMTS	138	1900 Band	1	500	0.0094	1.0000	0.94
AT&T UMTS	138	800 Band	1	500	0.0094	0.5867	1.61
AT&T GSM	138	800Band	4	296	0.0224	0.5867	3.81
AT&T GSM	138	1900 Band	2	427	0.0161	1.0000	1.61
Total							57.0%

* Data for other users are from Siting Council records.

Proposed

Company	Centerline Ht (feet)	Frequency (MHz)	Number of Channels	Power Per Channel (Watts)	Power Density (mW/cm ²)	Standard Limits (mW/cm ²)	Percent of Limit
Other Users							49.06
AT&T UMTS	138	800 Band	1	500	0.0094	0.5867	1.61
AT&T UMTS	138	1900 Band	1	500	0.0094	1.0000	0.94
AT&T GSM	138	1900 Band	2	427	0.0161	1.0000	1.61
AT&T GSM	138	880 - 894	4	296	0.0224	0.5867	3.81
AT&T LTE	138	740 - 746	1	500	0.0094	0.4933	1.91
Total							58.9%

* Data for other users are from Siting Council records.

Structural information:

The attached structural analysis demonstrates that the monopole and foundation have adequate structural capacity to accommodate the proposed modifications. (FDH Engineering dated 6-16-11).

NEW CINGULAR WIRELESS PCS, LLC WIRELESS COMMUNICATIONS FACILITY CT2203 MONROE - MOOSE HILL ROAD

500 MOOSE HILL ROAD MONROE, CONNECTICUT



NEW CINGULAR WIRELESS PCS, LLC
500 ENTERPRISE DRIVE
ROCKY HILL, CT 06867

Circle 6, Copyright © 2011



2139 Silas Beane Highway, Suite 213, Rocky Hill, CT 06867-2298
Phone: (860) 257-4657 • www.cha-engineer.com

CHA PROFESSIONAL ENGINEER
27702 - 1014 - 43000

NO.	DATE	ISSUED FOR REVIEW	ISSUED FOR CONSTRUCTION	DATE	BY	CHK.	APP.
0	02/17/11						
1	04/08/11						

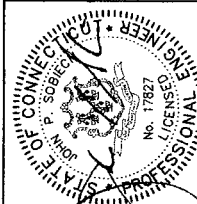

IT IS A VIOLATION OF LAW FOR ANY PERSON, WITHOUT THE WRITTEN PERMISSION OF A LICENSED PROFESSIONAL ENGINEER, TO ALTER THIS DOCUMENT.

SITE ID: CT2203
SITE NAME: MONROE - MOOSE HILL RD
SITE ADDRESS: 500 MOOSE HILL ROAD
MONROE, CT 06468
FAIRFIELD COUNTY

SHEET TITLE
TITILE SHEET

SHEET NUMBER
T01

SHEET NO.	SHEET TITLE	REVISION HISTORY	
		NO.	DATE
T01	TITILE SHEET	1	04 / 08 / 11
	COMPOUND PLAN	1	04 / 08 / 11
	SHELTER PLAN	1	04 / 08 / 11
	ELEVATION AND ANTENNA PLAN	1	04 / 08 / 11
	STRUCTURAL DETAILS	1	04 / 08 / 11
	GROUNDING DETAILS & PLUMBING DIAGRAM	1	04 / 08 / 11
	GENERAL NOTES	1	04 / 08 / 11

DO NOT SCALE DRAWINGS

CONTRACTOR SHALL VERIFY DIMENSIONS & CONDITIONS ON THE JOB SITE & SHALL BE RESPONSIBLE FOR ANY DISCREPANCIES BEFORE PROCEEDING WITH THE WORK OR BE RESPONSIBLE FOR SAME.

CALL before you DIG
860-238-4657
PAUL LUSTRANI, P.E.

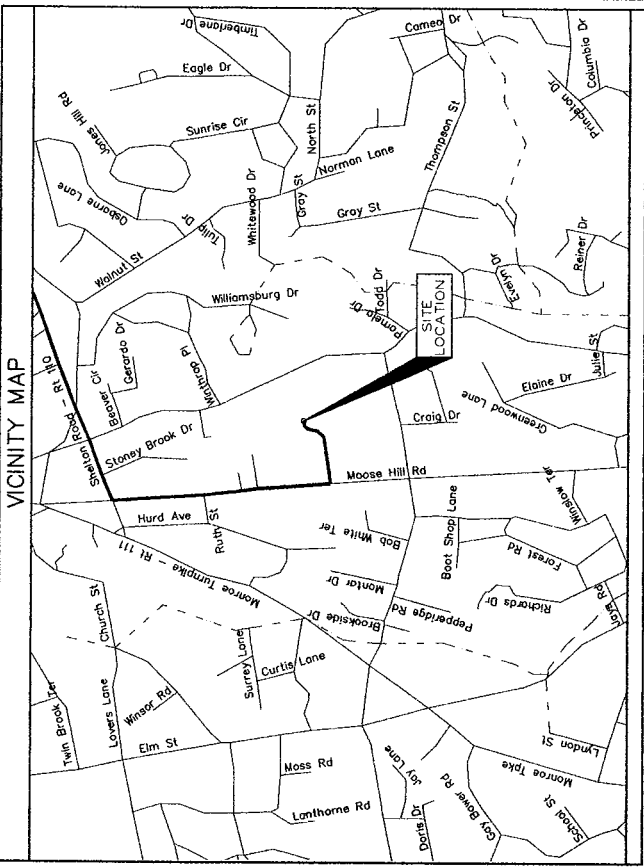

APRIL 08, 2011

PROJECT SUMMARY

SITE NUMBER: CT2203
SITE NAME: MONROE - MOOSE HILL ROAD
SITE ADDRESS: 500 MOOSE HILL ROAD, MONROE, CT 06468
STRUCTURE OWNER: SBA
APPLICANT: NEW CINGULAR WIRELESS PCS, LLC
CONTACT: MICHAEL D. FOLEY, (203) 414-1184
COORDINATES: 41°19' 15.44"N, 73°12' 51.5"W
HORIZONTAL DATUM: NAD 83
ENGINEER: CHA, INC., 2139 SILAS BEANE HIGHWAY, ROCKY HILL, CT 06867
CONTACT: PAUL LUSTRANI, (860) 257-4657

DRIVING DIRECTIONS

FROM HARTFORD:

1. MERGE ONTO CT-15 S
2. TURN LEFT ON DERBY AVE / DERBY TURNPIKE
3. TURN RIGHT AT DERBY AVE / DERBY TURNPIKE
4. CONTINUE ONTO NEW HAVEN AVE
5. CONTINUE ONTO OLD NEW HAVEN AVE
6. CONTINUE ONTO NEW HAVEN AVE
7. TURN LEFT AT MAIN ST
8. TURN LEFT AT BRIDGE ST
9. TURN LEFT AT HOWE AVE
10. CONTINUE ONTO CT-110 N / LEAVENWORTH RD
11. TURN LEFT AT LEAVENWORTH RD
12. AT 0.4 MILES MAKE LEFT INTO 472 BNAH ISREAL
13. AT 0.4 MILES MAKE LEFT INTO 472 BNAH ISREAL
14. CONTINUE STRAIGHT TO MONSPOLE

PROJECT DESCRIPTION

THIS PROJECT ADDS THREE ANTENNAS, SIX RRH, SURGE ARRESTORS, AND A RADIO CABINET TO AN EXISTING TELECOMMUNICATIONS SITE





NEW CONSUMER WIRELESS PCS, LLC
500 ENTERPRISE DRIVE
ROCKY HILL, CT 06867

2118 Main Street Highway, Suite 212, Rocky Hill, CT 06867-0218
Tel: 860.399.4667 Fax: 860.399.4667



CHA PROJECT NO.
22702 - 1014 - 43000

SUBMITTALS	
0	EXISTING SITE
1	EXISTING MONOPOLE
2	EXISTING ANTENNA MOUNTED TO CABLE BRIDGE
3	EXISTING VERIZON EQUIPMENT SHELTER AND GENERATOR
4	EXISTING SPRINT EQUIPMENT PAD
5	EXISTING T-MOBILE EQUIPMENT PAD
6	PROPOSED DC POWER AND FIBER CABLES
7	PROPOSED ANTENNA MOUNTED TO CABLE BRIDGE
8	PROPOSED 1/2" COAX FOR AT&T LTE GPS
9	PROPOSED 1/2" COAX FOR VERIZON LTE GPS
10	PROPOSED ANTENNA MOUNTED TO CABLE BRIDGE
11	PROPOSED DC POWER AND FIBER CABLES
12	PROPOSED ANTENNA MOUNTED TO CABLE BRIDGE
13	PROPOSED ANTENNA MOUNTED TO CABLE BRIDGE
14	PROPOSED ANTENNA MOUNTED TO CABLE BRIDGE
15	PROPOSED ANTENNA MOUNTED TO CABLE BRIDGE
16	PROPOSED ANTENNA MOUNTED TO CABLE BRIDGE
17	PROPOSED ANTENNA MOUNTED TO CABLE BRIDGE
18	PROPOSED ANTENNA MOUNTED TO CABLE BRIDGE
19	PROPOSED ANTENNA MOUNTED TO CABLE BRIDGE
20	PROPOSED ANTENNA MOUNTED TO CABLE BRIDGE
21	PROPOSED ANTENNA MOUNTED TO CABLE BRIDGE
22	PROPOSED ANTENNA MOUNTED TO CABLE BRIDGE
23	PROPOSED ANTENNA MOUNTED TO CABLE BRIDGE
24	PROPOSED ANTENNA MOUNTED TO CABLE BRIDGE
25	PROPOSED ANTENNA MOUNTED TO CABLE BRIDGE
26	PROPOSED ANTENNA MOUNTED TO CABLE BRIDGE
27	PROPOSED ANTENNA MOUNTED TO CABLE BRIDGE
28	PROPOSED ANTENNA MOUNTED TO CABLE BRIDGE
29	PROPOSED ANTENNA MOUNTED TO CABLE BRIDGE
30	PROPOSED ANTENNA MOUNTED TO CABLE BRIDGE
31	PROPOSED ANTENNA MOUNTED TO CABLE BRIDGE
32	PROPOSED ANTENNA MOUNTED TO CABLE BRIDGE
33	PROPOSED ANTENNA MOUNTED TO CABLE BRIDGE
34	PROPOSED ANTENNA MOUNTED TO CABLE BRIDGE
35	PROPOSED ANTENNA MOUNTED TO CABLE BRIDGE
36	PROPOSED ANTENNA MOUNTED TO CABLE BRIDGE
37	PROPOSED ANTENNA MOUNTED TO CABLE BRIDGE
38	PROPOSED ANTENNA MOUNTED TO CABLE BRIDGE
39	PROPOSED ANTENNA MOUNTED TO CABLE BRIDGE
40	PROPOSED ANTENNA MOUNTED TO CABLE BRIDGE
41	PROPOSED ANTENNA MOUNTED TO CABLE BRIDGE
42	PROPOSED ANTENNA MOUNTED TO CABLE BRIDGE
43	PROPOSED ANTENNA MOUNTED TO CABLE BRIDGE
44	PROPOSED ANTENNA MOUNTED TO CABLE BRIDGE
45	PROPOSED ANTENNA MOUNTED TO CABLE BRIDGE
46	PROPOSED ANTENNA MOUNTED TO CABLE BRIDGE
47	PROPOSED ANTENNA MOUNTED TO CABLE BRIDGE
48	PROPOSED ANTENNA MOUNTED TO CABLE BRIDGE
49	PROPOSED ANTENNA MOUNTED TO CABLE BRIDGE
50	PROPOSED ANTENNA MOUNTED TO CABLE BRIDGE
51	PROPOSED ANTENNA MOUNTED TO CABLE BRIDGE
52	PROPOSED ANTENNA MOUNTED TO CABLE BRIDGE
53	PROPOSED ANTENNA MOUNTED TO CABLE BRIDGE
54	PROPOSED ANTENNA MOUNTED TO CABLE BRIDGE
55	PROPOSED ANTENNA MOUNTED TO CABLE BRIDGE
56	PROPOSED ANTENNA MOUNTED TO CABLE BRIDGE
57	PROPOSED ANTENNA MOUNTED TO CABLE BRIDGE
58	PROPOSED ANTENNA MOUNTED TO CABLE BRIDGE
59	PROPOSED ANTENNA MOUNTED TO CABLE BRIDGE
60	PROPOSED ANTENNA MOUNTED TO CABLE BRIDGE
61	PROPOSED ANTENNA MOUNTED TO CABLE BRIDGE
62	PROPOSED ANTENNA MOUNTED TO CABLE BRIDGE
63	PROPOSED ANTENNA MOUNTED TO CABLE BRIDGE
64	PROPOSED ANTENNA MOUNTED TO CABLE BRIDGE
65	PROPOSED ANTENNA MOUNTED TO CABLE BRIDGE
66	PROPOSED ANTENNA MOUNTED TO CABLE BRIDGE
67	PROPOSED ANTENNA MOUNTED TO CABLE BRIDGE
68	PROPOSED ANTENNA MOUNTED TO CABLE BRIDGE
69	PROPOSED ANTENNA MOUNTED TO CABLE BRIDGE
70	PROPOSED ANTENNA MOUNTED TO CABLE BRIDGE
71	PROPOSED ANTENNA MOUNTED TO CABLE BRIDGE
72	PROPOSED ANTENNA MOUNTED TO CABLE BRIDGE
73	PROPOSED ANTENNA MOUNTED TO CABLE BRIDGE
74	PROPOSED ANTENNA MOUNTED TO CABLE BRIDGE
75	PROPOSED ANTENNA MOUNTED TO CABLE BRIDGE
76	PROPOSED ANTENNA MOUNTED TO CABLE BRIDGE
77	PROPOSED ANTENNA MOUNTED TO CABLE BRIDGE
78	PROPOSED ANTENNA MOUNTED TO CABLE BRIDGE
79	PROPOSED ANTENNA MOUNTED TO CABLE BRIDGE
80	PROPOSED ANTENNA MOUNTED TO CABLE BRIDGE
81	PROPOSED ANTENNA MOUNTED TO CABLE BRIDGE
82	PROPOSED ANTENNA MOUNTED TO CABLE BRIDGE
83	PROPOSED ANTENNA MOUNTED TO CABLE BRIDGE
84	PROPOSED ANTENNA MOUNTED TO CABLE BRIDGE
85	PROPOSED ANTENNA MOUNTED TO CABLE BRIDGE
86	PROPOSED ANTENNA MOUNTED TO CABLE BRIDGE
87	PROPOSED ANTENNA MOUNTED TO CABLE BRIDGE
88	PROPOSED ANTENNA MOUNTED TO CABLE BRIDGE
89	PROPOSED ANTENNA MOUNTED TO CABLE BRIDGE
90	PROPOSED ANTENNA MOUNTED TO CABLE BRIDGE
91	PROPOSED ANTENNA MOUNTED TO CABLE BRIDGE
92	PROPOSED ANTENNA MOUNTED TO CABLE BRIDGE
93	PROPOSED ANTENNA MOUNTED TO CABLE BRIDGE
94	PROPOSED ANTENNA MOUNTED TO CABLE BRIDGE
95	PROPOSED ANTENNA MOUNTED TO CABLE BRIDGE
96	PROPOSED ANTENNA MOUNTED TO CABLE BRIDGE
97	PROPOSED ANTENNA MOUNTED TO CABLE BRIDGE
98	PROPOSED ANTENNA MOUNTED TO CABLE BRIDGE
99	PROPOSED ANTENNA MOUNTED TO CABLE BRIDGE
100	PROPOSED ANTENNA MOUNTED TO CABLE BRIDGE

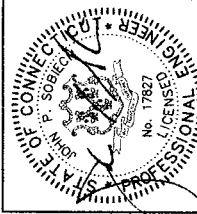

STATE OF CONNECTICUT
JOHN P. SOBCHAK
No. 17827
LICENSED PROFESSIONAL ENGINEER
I AM NOT PROVIDING ANY WARRANTY OR GUARANTEE
UNLESS THEY ARE ACTING UNDER THE DIRECTION
OF A LICENSED PROFESSIONAL ENGINEER.
TO ALTER THIS DOCUMENT

SITE ID: C12203
SITE NAME: MONROE - MOOSE HILL RD
SITE ADDRESS: 500 MOOSE HILL ROAD, MONROE, CT 06468
FAIRFIELD COUNTY

SHEET TITLE: COMPOUND PLAN

SHEET NUMBER: C01

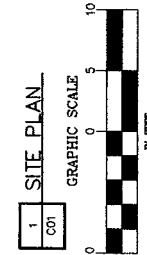
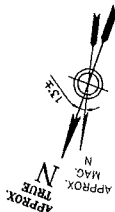
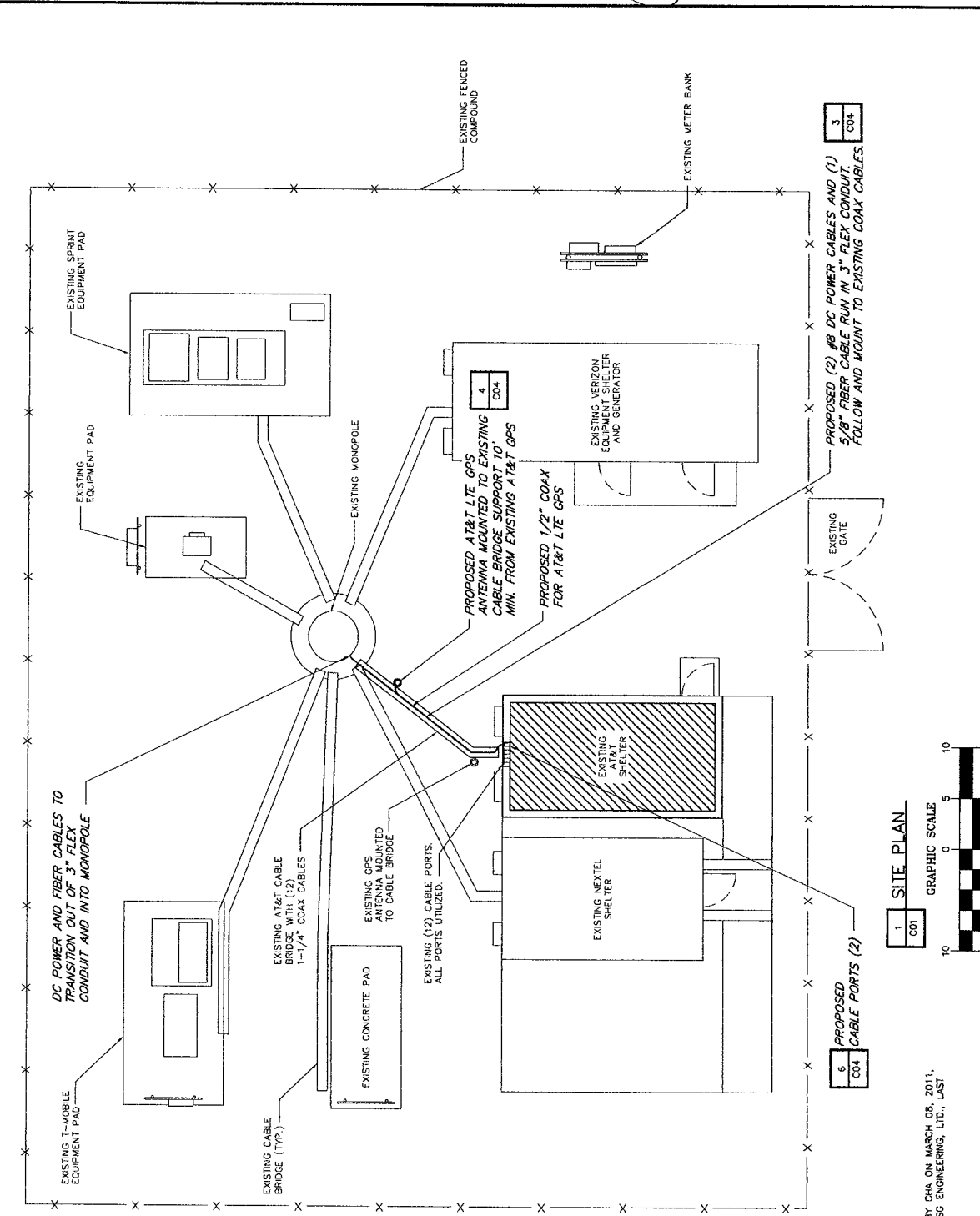

NOTE:
1. PLANS BASED ON A SITE VISIT BY CHA ON MARCH 08, 2011,
AND DRAWINGS PREPARED BY PSG ENGINEERING, LTD., LAST
DATED 08/19/05.



NEW CONULAR WIRELESS COS, LLC
500 ENTERPRISE DRIVE
ROCKY HILL, CT 06867



CHA PROJECT NO.
22702 - 1014 - 0090

NO.	DATE	DESCRIPTION
0	03/25/11	ISSUED FOR PERMIT
1	04/28/11	ISSUED FOR CONSTRUCTION
2	07/10/11	ISSUED FOR CONSTRUCTION
3	07/10/11	ISSUED FOR CONSTRUCTION
4	07/10/11	ISSUED FOR CONSTRUCTION
5	07/10/11	ISSUED FOR CONSTRUCTION
6	07/10/11	ISSUED FOR CONSTRUCTION

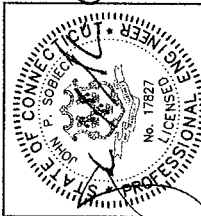

IT IS A VIOLATION OF LAW FOR ANY PERSON TO REPRODUCE OR TRANSMIT THIS DOCUMENT WITHOUT THE WRITTEN PERMISSION OF A LICENSED PROFESSIONAL ENGINEER TO ALTER THIS DOCUMENT.

SITE ID:
CT2203
SITE NAME:
MONROE-MOOSE HILL RD
SITE ADDRESS:
500 MOOSE HILL ROAD
MONROE, CT
06468
FAIRFIELD COUNTY

SHEET TITLE
SHELTER PLAN

SHEET NUMBER
C02

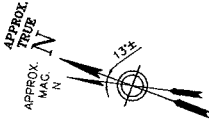

PROPOSED 1/2" COAX FOR AT&T LTE GPS

PROPOSED (2) #8 DC POWER CABLES AND (1) 5/8" FIBER CABLE RUN IN EXISTING CABLE TRAY

PROPOSED RBS 6601 IN 23" EQUIPMENT RACK WITH DC TO DC CONVERTER FOR LTE EQUIPMENT

EXISTING (12) POWERWAVE DUPLEXERS MOUNTED ON OVERHEAD CABLE TRAY

DC POWER, FIBER, AND COAX CABLES TO EXIT ROOF THROUGH NEW CABLE PORTS. TRANSITION POWER AND FIBER INTO 3" FLEX CONDUIT

PROPOSED CABLE PORTS (2)

EXISTING (12) CABLE PORTS ALL PORTS UTILIZED.

EXISTING HVAC UNIT

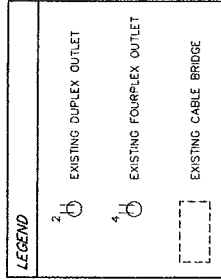
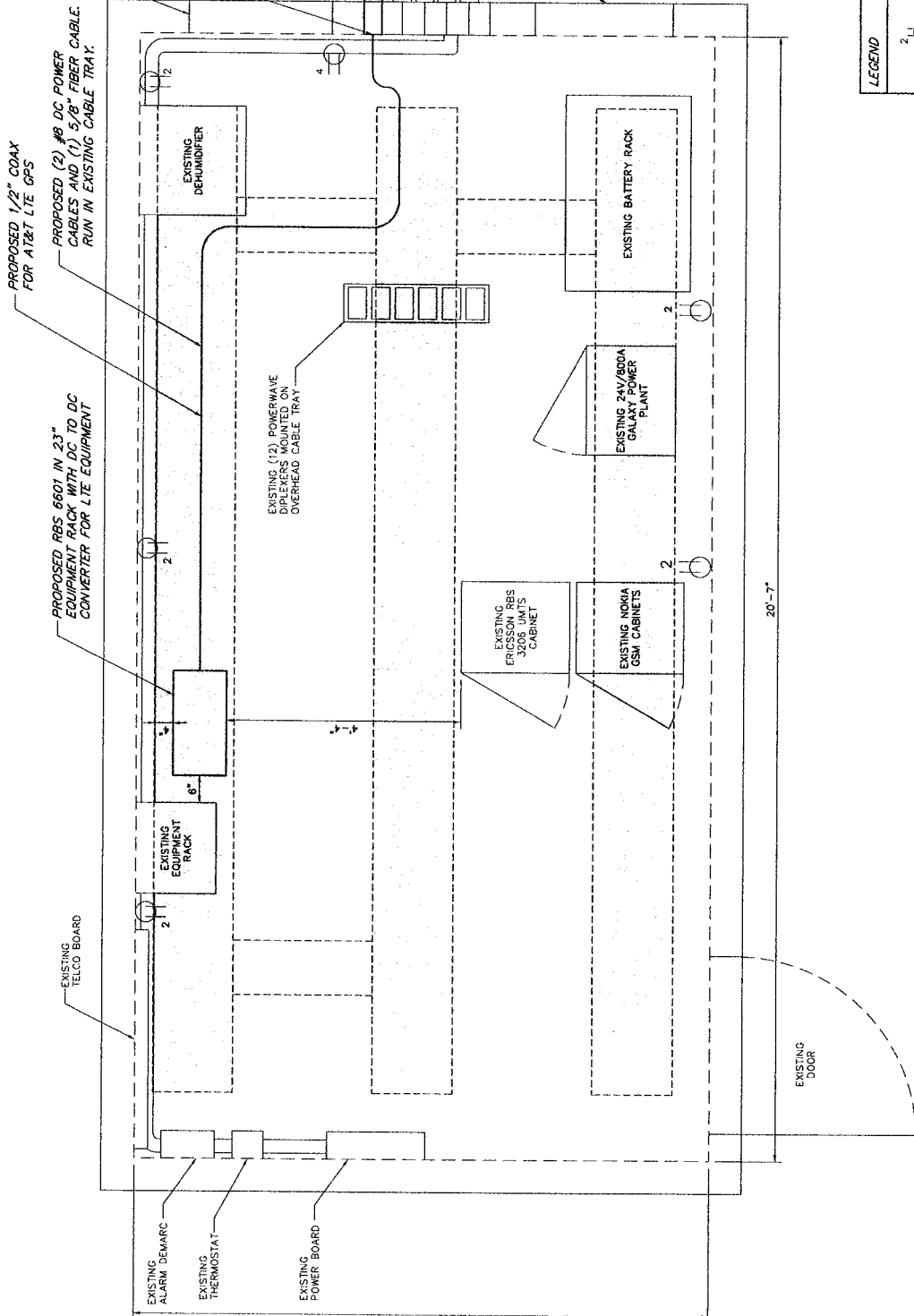



at&t
Your world. Delivered.

NEW CIRCULAR WIRELESS PCS, LLC
500 ENTERPRISE DRIVE
ROCKY HILL, CT 06867



218 Elm Street, Suite 212, Rocky Hill, CT 06867-2206
Tel: (860) 261-4007 Fax: (860) 261-4008

CONTRACT NO.
27702 - 1014 - 43000

NO.	DATE	DESCRIPTION
1	08/11/11	ISSUED FOR CONSTRUCTION
2	08/11/11	ISSUED FOR CONSTRUCTION
3	08/11/11	ISSUED FOR CONSTRUCTION
4	08/11/11	ISSUED FOR CONSTRUCTION
5	08/11/11	ISSUED FOR CONSTRUCTION
6	08/11/11	ISSUED FOR CONSTRUCTION
7	08/11/11	ISSUED FOR CONSTRUCTION

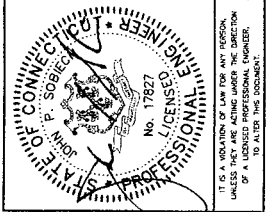

IT IS A VIOLATION OF LAW FOR ANY PERSON, UNLESS HE OR SHE IS A LICENSED PROFESSIONAL ENGINEER, TO ALTER THIS DOCUMENT.

SITE ID: CT2203
SITE NAME: MONROE-MOOSE HILL RD
SITE ADDRESS: 500 MOOSE HILL ROAD, MONROE, CT 06468
FAIRFIELD COUNTY

SHEET TITLE: ELEVATION AND ANTENNA PLAN
SHEET NUMBER: C03

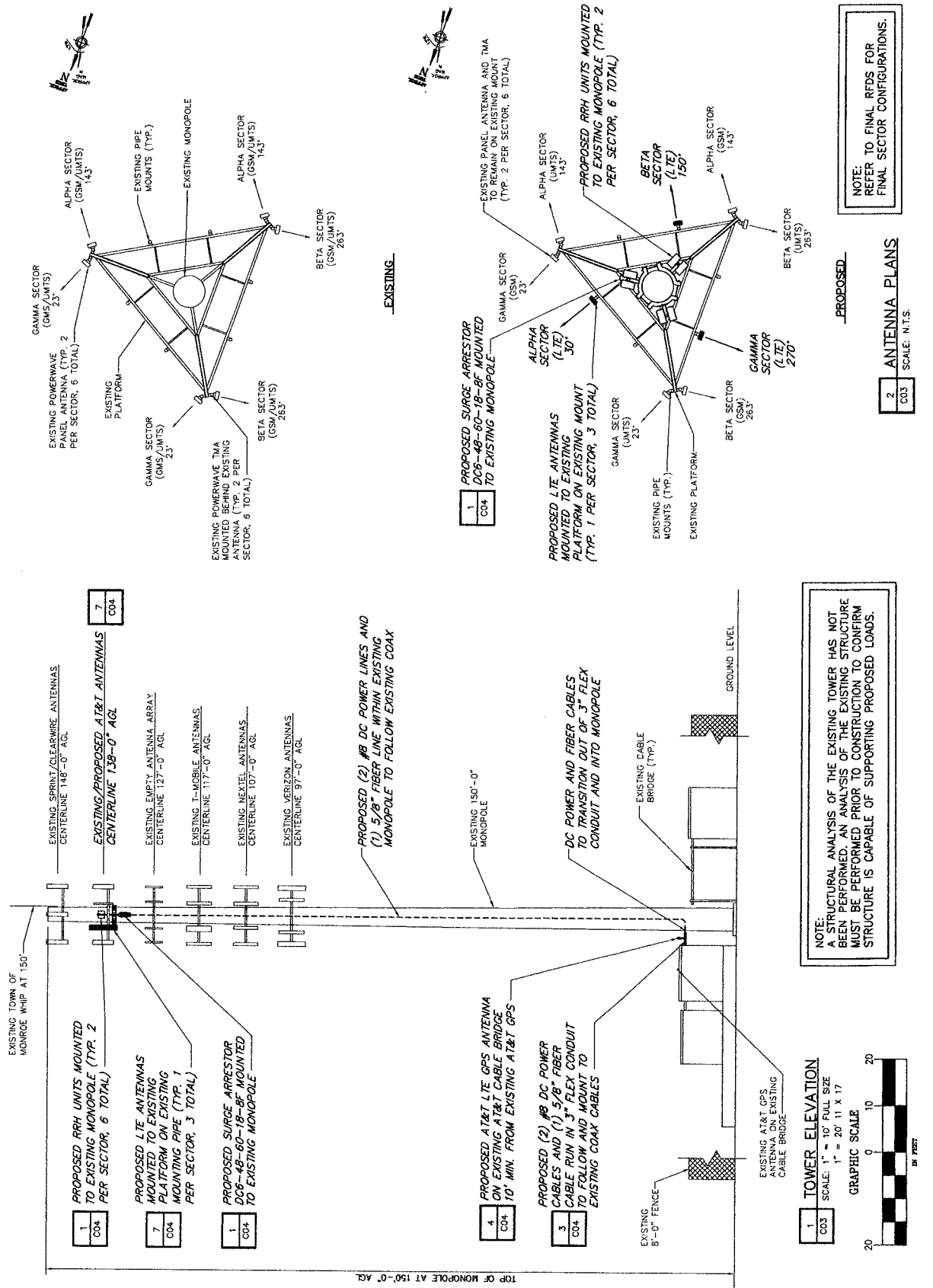

NOTE: REFER TO FINAL RFDS FOR FINAL SECTOR CONFIGURATIONS.

2 ANTENNA PLANS
C03

NOTE: STRUCTURAL ANALYSIS OF THE EXISTING TOWER HAS NOT BEEN PERFORMED. AN ANALYSIS OF THE EXISTING STRUCTURE MUST BE PERFORMED PRIOR TO CONSTRUCTION TO CONFIRM STRUCTURE IS CAPABLE OF SUPPORTING PROPOSED LOADS.

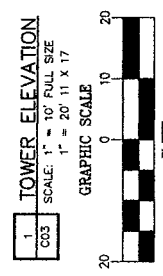

TOP OF MONOPOLE AT 150'-0" AGL



Your world. Delivered.
 NEW CINGULAR WIRELESS PCS, LLC
 500 ENTERPRISE DRIVE
 ROCKY HILL, CT 06067



CHA PROJECT NO.
 22702 - 1014 - 43000

NO.	SUBMITTAL	DATE	ISSUED FOR REVIEW	BY	CHK'D BY	APPROVED
1	ISSUED FOR CONSTRUCTION	07/25/11				
2	ISSUED FOR CONSTRUCTION	08/11/11				

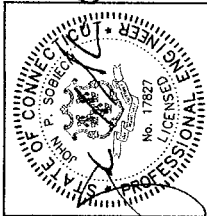

IT IS A VIOLATION OF LAW FOR ANY PERSON UNLESS THEY ARE ACTING UNDER THE DIRECTION OF A LICENSED PROFESSIONAL ENGINEER TO ALTER THIS DOCUMENT.

SITE NO.
 C12203
 SITE NAME
 MONROE - MOOSE HILL RD
 SITE ADDRESS
 500 MOOSE HILL ROAD
 MONROE, CT
 06468
 FAIRFIELD COUNTY

SHEET TITLE
 STRUCTURAL DETAILS

SHEET NUMBER
 C04

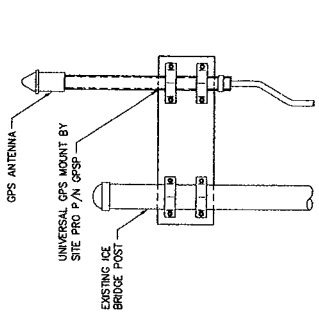

NOTE:
 1. THE WEIGHT OF THE ANTENNA MOUNT IS 6.5 LBS.

4 GPS MOUNTING DETAIL
 CO4 SCALE: NTS

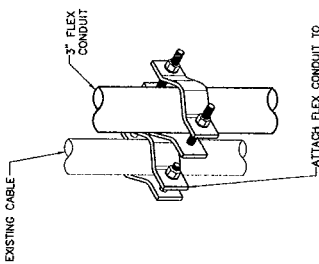

NOTE:
 ATTACH FLEX CONDUIT TO EXISTING CABLE WITH SINGULAR CLAMP ONLY

3 FLEX CONDUIT DETAIL
 CO4 SCALE: NTS

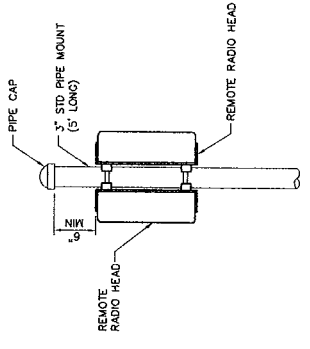

NOTE:
 REMOTE RADIO HEAD MOUNTING BRACKET AND HARDWARE TO BE PROVIDED BY MANUFACTURER.

2 RRR MOUNTING DETAIL
 CO4 SCALE: NTS

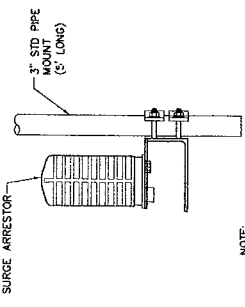

NOTE:
 SURGE ARRESTOR MOUNTING BRACKET AND HARDWARE TO BE PROVIDED BY MANUFACTURER.

5 SURGE ARRESTOR MOUNTING DETAIL
 CO4 SCALE: NTS

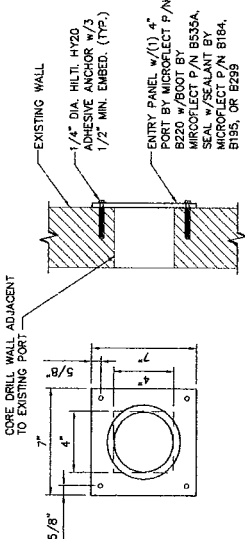

6 PORT PANEL DETAIL
 CO4 SCALE: NTS

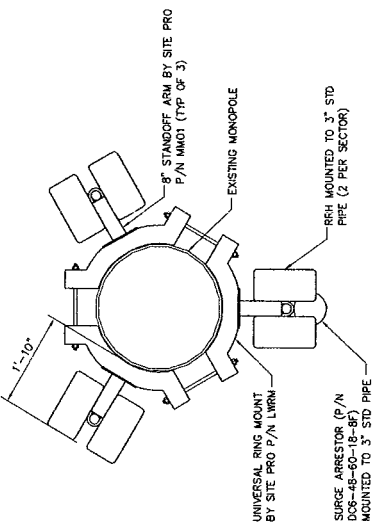

PLAN

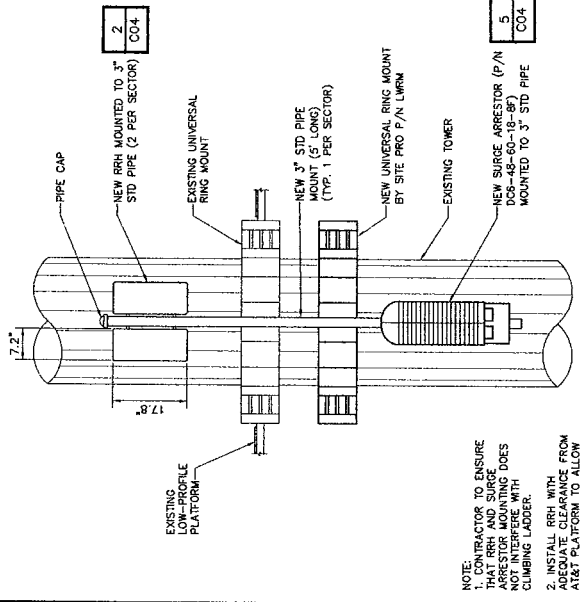

ELEVATION

NOTE:
 1. CONTRACTOR TO ENSURE THAT RRR AND SURGE ARRESTOR MOUNTING DOES NOT INTERFERE WITH CLIMBING LADDER.
 2. INSTALL RRR WITH 18 INCH FROM EXISTING TOWER AND AT&T PLATFORM TO ALLOW ROOM FOR ACCESS.

1 RRR/SURGE ARRESTOR MOUNTING DETAIL
 CO4 SCALE: NTS

7 TYPICAL ANTENNA MOUNTING DETAIL
 CO4 SCALE: NTS

NOTE:
 1. MOUNT ANTENNA IN ACCORDANCE WITH MANUFACTURER'S RECOMMENDED PROCEDURE.
 2. USE EXISTING PIPE MOUNT IF AVAILABLE.

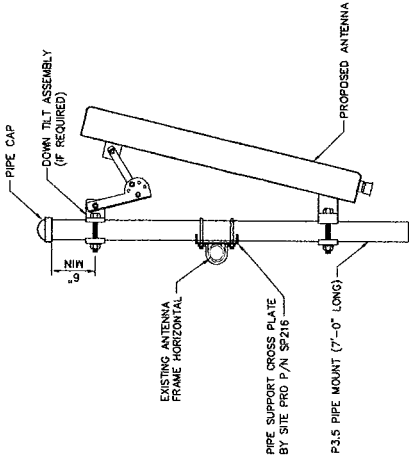



NEW CIRCULAR WIRELESS PCS, LLC
ROCKY HILL, CT 06067



2100 Main Street, Rocky Hill, CT 06067
Tel: (860) 397-1111

CONTRACT NO. 22702 - 1074 - 05000

NO.	DATE	DESCRIPTION
1	02/17/13	ISSUED FOR REVIEW
2	04/02/13	ISSUED FOR CONSTRUCTION
3	07/10/13	REVISED PER COMMENTS
4	08/14/13	REVISED PER COMMENTS
5	09/10/13	REVISED PER COMMENTS

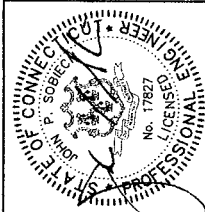

IT IS A VIOLATION OF LAW FOR ANY PERSON, UNLESS HE OR SHE IS A LICENSED PROFESSIONAL ENGINEER, TO ALTER THIS DOCUMENT.

SITE ID: CT2203
SITE NAME: MONROE - MOOSE HILL RD
SITE ADDRESS: 500 MOOSE HILL ROAD
MONROE, CT 06468
FAIRFIELD COUNTY

SHEET TITLE: GROUNDING DETAILS & PLUMBING DIAGRAM

SHEET NUMBER: E01

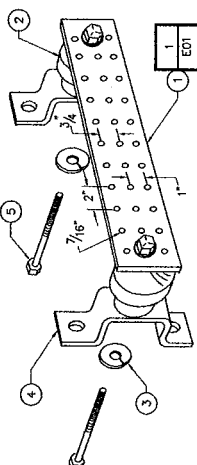

- LEGEND**
- 1 - COPPER GROUND BAR - HOLE CENTERS TO MATCH NEMA DOUBLE LUG CONFIGURATION.
 - 2 - INSULATORS, NEWTON INSTRUMENT CAT. NO. 3061-4. (NOT TO BE USED ON BARS PHYSICALLY ATTACHED TO TOWER.)
 - 3 - 5/8" LOCKWASHERS, NEWTON INSTRUMENT CO. CAT. NO. 3015-B
 - 4 - WALL MOUNTING BRACKET, NEWTON INSTRUMENT CO. CAT. NO. A-6056
 - 5 - 5/8-11 X 1" H.H.C.S. BOLTS, NEWTON INSTRUMENT CO. CAT. NO. 3012-1

2 GROUND BAR
E01 NO SCALE

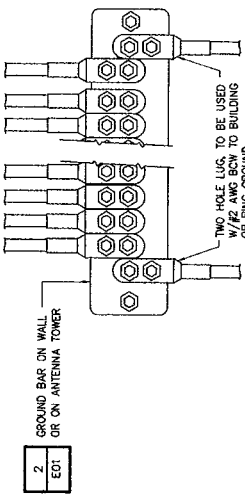

1 GROUND WIRE INSTALLATION TO GROUND BAR
E01 NO SCALE

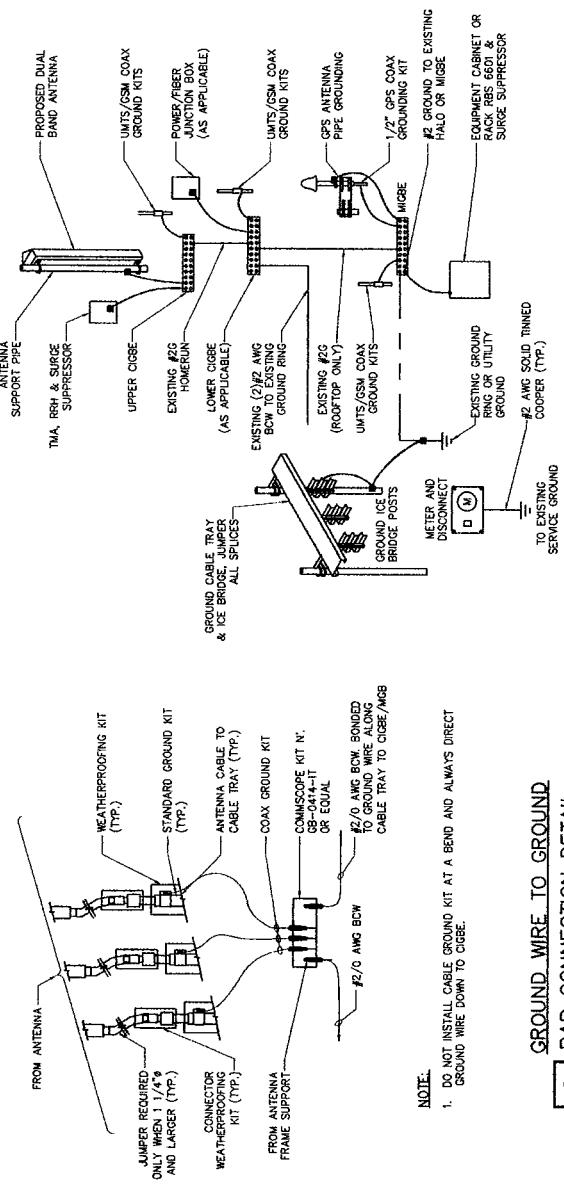

3 GROUND WIRE TO GROUND BAR CONNECTION DETAIL
E01 NO SCALE

4 GROUNDING RISER DIAGRAM
E01 NO SCALE

5 PLUMBING DIAGRAM
E01 NO SCALE

- NOTES:**
- CONTRACTOR TO CONFIRM ALL PARTS.
 - INSTALL ALL EQUIPMENT TO MANUFACTURER'S RECOMMENDATIONS.



FDH Engineering, Inc., 2730 Rowland Rd. Raleigh, NC 27615, Ph. 919.755.1012, Fax 919.755.1031

**Structural Analysis for
SBA Network Services, Inc.**

149 ft Monopole

**SBA Site Name: Moosehill
SBA Site ID: CT13056-A**

FDH Project Number 11-06183E S1

Prepared By:

Taylor LaForge
Project Engineer

Reviewed By:

Christopher M. Murphy, P.E.
President
CT PE License No. 25842

FDH Engineering, Inc.

2730 Rowland Rd.
Raleigh, NC 27615
(919) 755-1012
info@fdh-inc.com

June 16, 2011

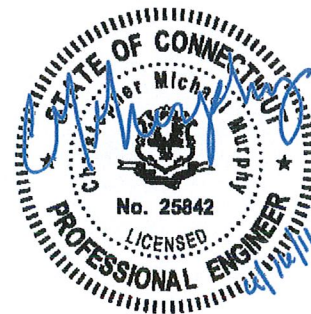

Prepared pursuant to TIA/EIA-222-F June 1996 Structural Standards for Steel Antenna Towers and Antenna Supporting Structures

TABLE OF CONTENTS

EXECUTIVE SUMMARY.....	3
Conclusions	
Recommendations	
APPURTENANCE LISTING.....	4
RESULTS.....	5
GENERAL COMMENTS.....	6
LIMITATIONS.....	6
APPENDIX.....	7

EXECUTIVE SUMMARY

At the request of SBA Network Services, Inc., FDH Engineering, Inc. performed a structural analysis of the monopole located in Monroe, CT to determine whether the tower is structurally adequate to support both the existing and proposed loads, pursuant to the *Structural Standards for Steel Antenna Towers and Antenna Supporting Structures, TIA/EIA-222-F*. Information pertaining to the existing/proposed antenna loading, current tower geometry, and member sizes was obtained from Sabre Communications Corporation (Job No. 02-03107 Revision A) Structural Design Report dated April 3, 2002, FDH, Inc. (Job No. 08-07121T Revised) TIA Inspection Report dated November 10, 2008, and SBA Network Services, Inc.

The *basic design wind speed* per the *TIA/EIA-222-F* standard is 85 mph without ice and 38 mph with 3/4" radial ice. Ice is considered to increase in thickness with height.

Conclusions

With the current and proposed antennas from AT&T at 139 ft, the tower meets the requirements of the *TIA/EIA-222-F* standards provided the **Recommendations** listed below are satisfied. Furthermore, provided the foundations were designed and constructed to support the original design reactions (see Sabre Job No. 02-03107 Revision A), the foundation should have the necessary capacity to support both the existing and proposed loading. For a more detailed description of the analysis of the tower, see the **Results** section of this report.

Our structural analysis has been performed assuming all information provided to FDH Engineering, Inc. is accurate (i.e. the steel data, tower layout, existing antenna loading, and proposed antenna loading) and that the tower has been properly erected and maintained per the original design drawings.

Recommendations

To ensure the requirements of the *TIA/EIA-222-F* standards are met with the existing and proposed loading in place, we have the following recommendations:

1. The proposed coax should be installed inside the pole's shaft.
2. The proposed RRHs should be installed behind the proposed panel antennas.

APPURTENANCE LISTING

The proposed and existing antennas with their corresponding cables/coax lines are shown in **Table 1**. If the actual layout determined in the field deviates from this layout, FDH Engineering, Inc. should be contacted to perform a revised analysis.

Table 1 – Appurtenance Loading

Existing Loading:

Antenna No.	Antenna Elevation (ft)	Description	Coax and Lines ¹	Carrier	Mount Elevation (ft)	Mount Type
1	152.5	(1) Decibel DB404-B Dipole	(1) 7/8"	Town of Monroe	149	(1) Pipe Mount
2-12	147 ²	(6) Decibel 948F85T2E-M (3) Argus LLPX310R (1) Andrew VHLP2-11 Dish (1) Andrew VHLP800-11-DW1 Dish (3) Samsung U-RAS Flexible RRHs	(6) 1-5/8" (6) 5/16" (2) 1/2"	Sprint/ Clearwire	147	(1) 12.5' Low Profile Platform
13-18	139 ³	(6) Powerwave 7770 (6) Powerwave LGP13514 Diplexers (6) Powerwave LGP21401 TMAs	(12) 1-1/4"	AT&T	139	(1) 13' Low Profile Platform
---	---	---	---	---	128	(1) 12.5' Low Profile Platform
19-30	121	(9) EMS RR90-17-02DP (3) RFS APX16DWV-16DWVS-A20 (6) Powerwave LGP13901 TMAs (3) RFS ATMAA1412D-1A20 TMAs	(18) 1-5/8" (6) 7/8"	T-Mobile	121	(1) 13' Low Profile Platform
31-42	109	(12) Decibel DB844H90E-XY	(12) 7/8"	Nextel	109	(1) 14' Low Profile Platform
43-54	99 ⁴	(6) Antel LPA-80090/4CF (6) Antel LPA-185090/8CF	(12) 1-5/8"	Verizon	99	(1) 12.5' Low Profile Platform
55	64 ⁵	(1) Decibel 260B GPS	(1) 1/2"	Sprint	64	(1) 3' Standoff

1. Coax installed inside the pole's shaft unless otherwise noted.
2. The (6) 1-5/8" coax for Sprint/Clearwire is installed on the outside of the pole's shaft in a single row.
3. The loading for AT&T at 139 ft will be altered. See the proposed loading below.
4. The coax for Verizon at 99 ft is installed on the outside of the pole's shaft double stacked.
5. The coax for Sprint at 64 ft is installed on the outside of the pole's shaft.

Proposed Loading:

Antenna No.	Antenna Elevation (ft)	Description	Coax and Lines	Carrier	Mount Elevation (ft)	Mount Type
1-9	139 ¹	(6) Powerwave 7770 (3) Powerwave P65-16 (6) Powerwave LGP 21401 TMAs (6) Powerwave LGP 13519 Diplexers (6) Ericsson RRUS-11 RRHs (1) Raycap DC6-48-60-18-8F Surge Suppressor	(12) 1-1/4" (1) 0.393" (2) 0.645"	AT&T	139	(1) 13' Low Profile Platform

1. This represents the final configuration for AT&T at 139 ft. According to information provided by SBA, AT&T will add (3) Powerwave P65-16 antennas, (6) Ericsson RRUS-11 RRHs, (1) Raycap DC6-48-60-18-8F Surge Suppressor, (1) 0.393" Fiber Cable, and (2) 0.645" DC Cables at 139 ft.

RESULTS

Based on information obtained from the original design drawings, the yield strength of steel for individual members was as follows:

Table 2 - Material Strength

Member Type	Yield Strength
Tower Shaft Sections	65 ksi
Flange Plate	60 ksi
Flange Bolts	F _u = 120 ksi
Base Plate	60 ksi
Anchor Bolts	75 ksi

Table 3 displays the summary of the ratio (as a percentage) of force in the member to their capacities. Values greater than 100% indicate locations where the maximum force in the member exceeds its capacity. **Table 4** displays the maximum foundation reactions.

If the assumptions outlined in this report differ from actual field conditions, FDH Engineering, Inc. should be contacted to perform a revised analysis. Furthermore, as no information pertaining to the allowable twist and sway requirements for the existing or proposed appurtenances was provided, deflection and rotation were not taken into consideration when performing this analysis.

See the **Appendix** for detailed modeling information.

Table 3 – Summary of Working Percentage of Structural Components

Section No.	Elevation ft	Component Type	Size	% Capacity	Pass Fail
L1	149 - 129	Pole	TP28.82x24x0.1875	25.6	Pass
		Flange Bolts	(8) 1" \varnothing w/ BC = 32.5"	50.1	Pass
		Flange Plate	36.25" \varnothing PL x 1" thk.	45.2	Pass
L2	129 - 96	Pole	TP36.9x28.82x0.25	57.5	Pass
L3	96 - 47.25	Pole	TP48.15x35.237x0.3125	82.7	Pass
L4	47.25 - 0	Pole	TP58.91x46.0768x0.375	84.6	Pass
		Anchor Bolts	(16) 2.25" \varnothing w/ BC = 66"	81.5	Pass
		Base Plate	64" Square PL x 3" thk.	65.1	Pass

Table 4 – Maximum Base Reactions

Base Reactions	Current Analysis (TIA/EIA-222-F)	Original Design (TIA/EIA-222-F)
Axial	43 k	45 k
Shear	34 k	39 k
Moment	3,556 k-ft	4,184 k-ft

GENERAL COMMENTS

This engineering analysis is based upon the theoretical capacity of the structure. It is not a condition assessment of the tower and its foundation. It is the responsibility of SBA Network Services, Inc. to verify that the tower modeled and analyzed is the correct structure (with accurate antenna loading information) modeled. If there are substantial modifications to be made or the assumptions made in this analysis are not accurate, FDH Engineering, Inc. should be notified immediately to perform a revised analysis.

LIMITATIONS

All opinions and conclusions are considered accurate to a reasonable degree of engineering certainty based upon the evidence available at the time of this report. All opinions and conclusion are subject to revision based upon receipt of new or additional/updated information. All services are provided exercising a level of care and diligence equivalent to the standard and care of our profession. No other warranty or guarantee, expressed or implied, is offered. Our services are confidential in nature and we will not release this report to any other party without the client's consent. The use of this engineering work is limited to the express purpose for which it was commissioned and it may not be reused, copied, or distributed for any other purpose without the written consent of FDH Engineering, Inc.

APPENDIX

DESIGNED APPURTENANCE LOADING

TYPE	ELEVATION	TYPE	ELEVATION
Lightning Rod 1/2"x4" on 15' Pole	149	(2) Powerwave - 7770 w/ mount pipe (ATI)	139
Pipe Mount	149	(2) Powerwave - 7770 w/ mount pipe (ATI)	139
Decibel - DB404-B Dipole (Town of Monroe)	149	(4) Pipe Mount	128
Pipe Mount (Town of Monroe)	149	(4) Pipe Mount	128
(2) Decibel - 948F85T2E-M w/ mount pipe (Sprint)	147	(4) Pipe Mount	128
(2) Decibel - 948F85T2E-M w/ mount pipe (Sprint)	147	12.5' Low Profile Platform	128
(2) Decibel - 948F85T2E-M w/ mount pipe (Sprint)	147	RFS - APX16DWW-16DWS-A20 w/ mount pipe (T-Mobile)	121
Argus LLPX310R w/ Mount Pipe (Sprint)	147	RFS - APX16DWW-16DWS-A20 w/ mount pipe (T-Mobile)	121
Argus LLPX310R w/ Mount Pipe (Sprint)	147	RFS - APX16DWW-16DWS-A20 w/ mount pipe (T-Mobile)	121
Argus LLPX310R w/ Mount Pipe (Sprint)	147	RFS - ATMAA1412D-1A20 TMA (T-Mobile)	121
U-RAS Flexible RRH ODU (Sprint)	147	RFS - ATMAA1412D-1A20 TMA (T-Mobile)	121
U-RAS Flexible RRH ODU (Sprint)	147	RFS - ATMAA1412D-1A20 TMA (T-Mobile)	121
U-RAS Flexible RRH ODU (Sprint)	147	RFS - ATMAA1412D-1A20 TMA (T-Mobile)	121
12.5' Low Profile Platform (Sprint)	147	(2) LGP13901 TMA (T-Mobile)	121
VHLP2-11 (Clearwire)	147	13' Low Profile Platform (T-Mobile)	121
VHLP800-11-DW1 (Clearwire)	147	(3) RR90-17-02DP w/Mount Pipe (T-Mobile)	121
(2) Powerwave - 7770 w/ mount pipe (ATI)	139	(3) RR90-17-02DP w/Mount Pipe (T-Mobile)	121
(2) Powerwave - LGP21401 TMA (ATI)	139	(3) RR90-17-02DP w/Mount Pipe (T-Mobile)	121
(2) Powerwave - LGP21401 TMA (ATI)	139	(2) LGP13901 TMA (T-Mobile)	121
(2) Powerwave - LGP21401 TMA (ATI)	139	(2) LGP13901 TMA (T-Mobile)	121
(2) Powerwave - LGP13514 Diplexers (ATI)	139	(4) DB844H90E-XY w/Mount Pipe (Nextel)	109
(2) Powerwave - LGP13514 Diplexers (ATI)	139	(4) DB844H90E-XY w/Mount Pipe (Nextel)	109
(2) Powerwave - LGP13514 Diplexers (ATI)	139	(4) DB844H90E-XY w/Mount Pipe (Nextel)	109
Pipe Mount (ATI)	139	14' Low Profile Platform (Nextel)	109
Pipe Mount (ATI)	139	(2) LPA-185090/8CF w/Mount Pipe (Verizon)	99
Pipe Mount (ATI)	139	(2) LPA-185090/8CF w/Mount Pipe (Verizon)	99
13' Low Profile Platform (ATI)	139	(2) LPA-80090/4CF w/Mount Pipe (Verizon)	99
Powerwave - P65-16 w/ mount pipe (ATI)	139	(2) LPA-80090/4CF w/Mount Pipe (Verizon)	99
Powerwave - P65-16 w/ mount pipe (ATI)	139	12.5' Low Profile Platform (Verizon)	99
Powerwave - P65-16 w/ mount pipe (ATI)	139	(2) LPA-80090/4CF w/Mount Pipe (Verizon)	99
(2) Ericsson RRUS-11 RRH (ATI)	139	(2) LPA-185090/8CF w/Mount Pipe (Verizon)	99
(2) Ericsson RRUS-11 (ATI)	139	(2) LPA-185090/8CF w/Mount Pipe (Verizon)	99
(2) Ericsson RRUS-11 (ATI)	139	Decibel - 26OB GPS	64
Raycap - DC6-48-60-18-8F Surge Protection (ATI)	139	3' Standoff	64

Section	Length (ft)	Number of Sides	Thickness (in)	Socket Length (ft)	Top Dia (in)	Bot Dia (in)	Grade	Weight (K)
1	20.00	18	0.1875	24.0000	28.8200			1.1
2	33.00	18	0.2500	4.75	28.8200	36.9000	A572-85	2.9
3	53.50	18	0.3125	6.00	35.2370	48.1500	A572-85	7.5
4	53.25	18	0.3750	46.0768	58.9100			11.2
								22.7

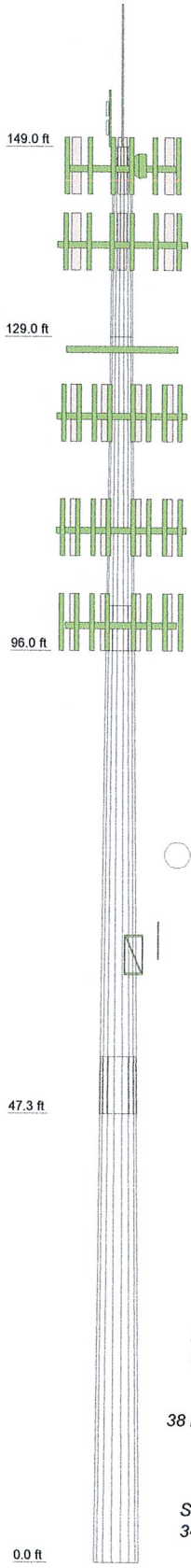

MATERIAL STRENGTH

GRADE	Fy	Fu	GRADE	Fy	Fu
A572-85	65 ksi	80 ksi			

TOWER DESIGN NOTES

1. Tower is located in Fairfield County, Connecticut.
 2. Tower designed for a 85 mph basic wind in accordance with the TIA/EIA-222-F Standard.
 3. Tower is also designed for a 38 mph basic wind with 0.75 in ice. Ice is considered to increase in thickness with height.
- Deflections are based upon a 50 mph wind.
TOWER RATING: 84.6%

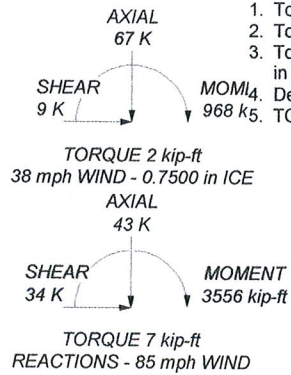

FDH Engineering, PC.
2730 Rowland Road, Suite 100
Raleigh, NC 27615
Phone: (919) 755-1012
FAX: (919) 755-1031

Job: **Moosehill - CT13056-A**
Project: **11-06183E S1**
Client: **SBA Network Services, Inc.** Drawn by: **Sean O'Sullivan** App'd:
Code: **TIA/EIA-222-F** Date: **06/16/11** Scale: **NTS**
Path: **\\FDH-3\proj\krs\2011\Pages\11-06183E\WSP\06_CFD1-BA_ATT\DWG\WSP\Moosehill CT Tower.rvt**
Dwg No. **E-1**

P65-16-XLH-RR Dual Broadband Antennas

POLARIZATION: Dual linear ±45°
 FREQUENCY (MHz): 698-894, 1710-2170
 HORIZONTAL BEAM WIDTH (°): 65, 65
 GAIN (dBi/dBd): 15.5/13.4 17.5/15.4
 TILT: 1-12, 0-8
 LENGTH: 72"

ELECTRICAL SPECIFICATIONS*

	698-894		1710-2170		
	698-806	806-894	1710-1880	1850-1990	1900-2170
Frequency range (MHz)					
Frequency band (MHz)	698-806	806-894	1710-1880	1850-1990	1900-2170
Gain (dBi/dBd)	14.8/12.7	15.5/13.4	16.9/14.8	17.2/15.1	17.5/15.4
Polarization	Dual Linear +/- 45		Dual Linear +/- 45		
Nominal Impedance (Ω)	50		50		
VSWR	< 1.5:1		< 1.5:1		
Horizontal beam width, -3 dB (°)	66	65	60	63	63
Vertical beam width, -3 dB (°)	14.7	12.5	6.8	6.4	5.7
Electrical down tilt (°)	1 to 12		0 to 8		
Side lobe suppression, vertical 1st upper (dB)	> 16	>16	> 16		
	>16	>16			
Isolation between inputs (dB)	> 30	> 30	> 30	> 30	
Inter band Isolation (dB)	> 40		> 40		
Tracking, horizontal plane ±60° (dB)	< 2		< 2	< 2	< 2
First null fill (dB)			>-20	>-20	>-20
Vertical beam squint (°)	< 0.8	< 0.8	< 0.5	< 0.5	< 0.5
Front to back ratio (dB) 180°±30° copolar	>24	>24	> 30	>30	>28
Front to back ratio (dB) 180°±30° total power					
Cross polar discrimination (XPD) 0° (dB)	> 15	> 15	> 15	> 15	> 15
Cross polar discrimination (XPD) ±60° (dB)	> 10	> 10	> 10	> 10	> 10
Far field coupling					
IM3, 2xTx@43dBm (dBc)	<-153		<-153		
IM7, 2xTx@43dBm (dBc)					
Power handling, average per input (W)	500		250		
Power handling, average total (W)	1000		500		

MECHANICAL SPECIFICATIONS*

Connector	4 X 7/16 DIN Female, IP67
Connector position	Bottom
Dimensions, HxWxD, mm (ft)	72" x 12" x 6" (1829 x 305 x 152)
Mounting	Pre-mounted Tilt Brackets
Weight, with brackets, kg (lbs)	29 (64)
Weight, without brackets, kg (lbs)	24 (53)
Wind load, frontal/lateral/rear side 42 m/s Cd=1.6 (N)	1380
Maximum operational wind speed, m/s (mph)	100 (45)
Survival wind speed, m/s (mph)	150 (67)
Lightning protection	DC Ground
Operating Temperature	-40C to +60C
Radome material	PVC, IP55
Packet size, HxWxD, mm (ft)	87" x 16" x 10" (2225 x 400 x 225)
Radome colour	Light Grey
Shipping weight, kg (lbs)	34 (75)
RET	iRET AISGv1.1, MET and AISGv2.0
Brackets	7256.00, 7454.00A



*All specifications subject to change without notice. Please contact your Powerwave representative for complete performance data.

ANTENNA PATTERNS*

For detailed patterns visit <http://www.powerwave.com/rpa/>.

RRUS 11 – Dual PA RRU.

Technical Data

- > Multi standard
- > RF: 2x30 Watts
- > Carrier BW: 1.4 – 20 MHz
- > Alarms: 2
- > Dimensions (with sunshield):
 - Width: 17.0 in
 - Height: 17.8 in
 - Depth: 7.2 in
 - Weight: 55 lbs (Band 12)
 - Weight: 50 lbs (Band 4)
- > Temperature: -40 to +131 F
- > Cooling: Self convection
- > Power: -48 VDC
- > Rec. fuse size 20 Amp
 - Rec. DC cable:
 - > 6 mm² up to 60 meters
 - > 10 mm² over 60 meters
 - > Shielded
- > Power Cons: 200 Watts typ.



RRUS-11 I/F



RBS6000

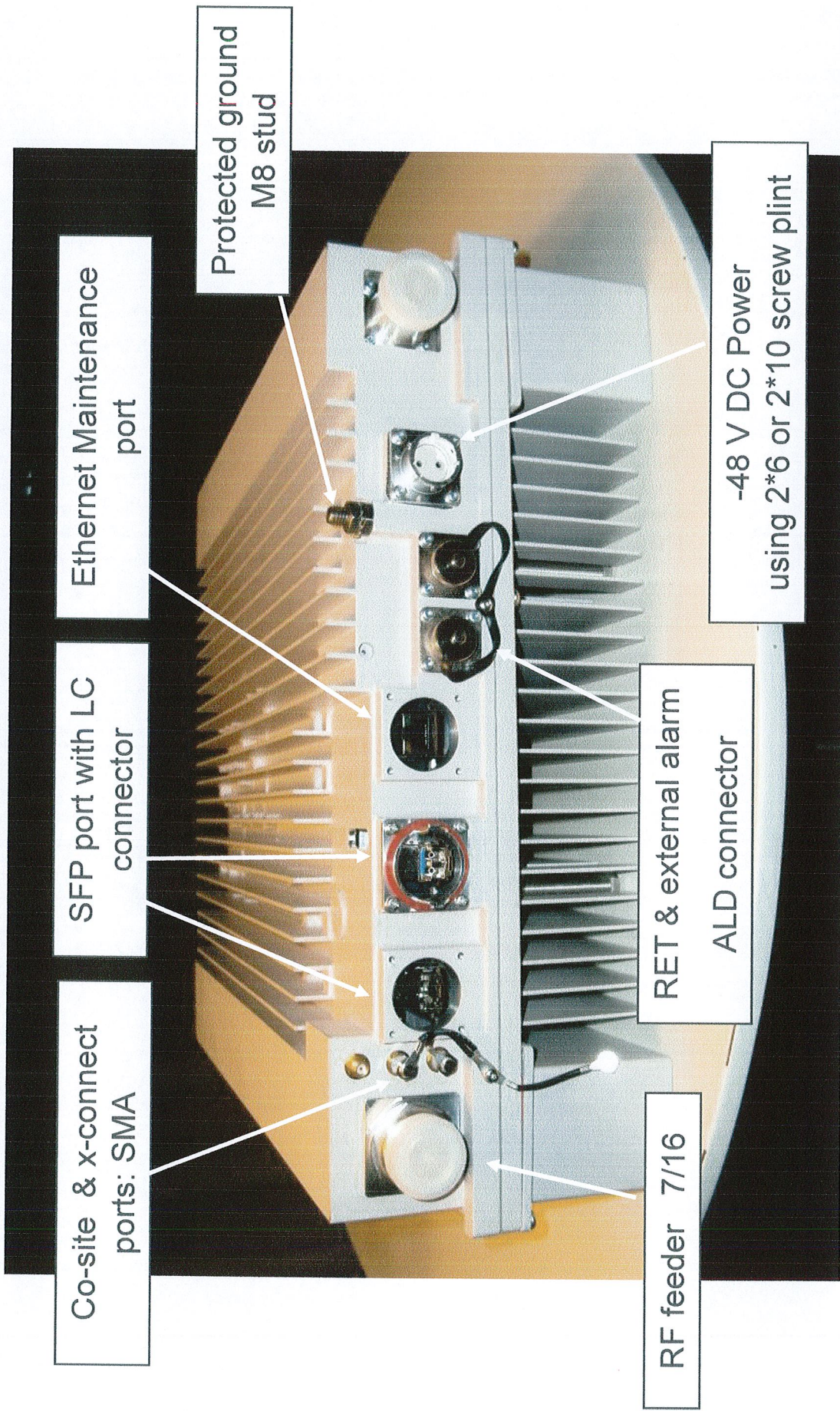

POWER

DC6-48-60-18-8F

DC Surge Suppression Solution

The DC6-48-60-18 is a dual chambered, DC surge suppression system for use in multi-circuit, Distributed Antenna Systems. The system will protect up to 6 Remote Radio Heads from voltage surges and lightning, and connect up to 18 fiber pairs. The system is enclosed in a NEMA 4 rated, waterproof enclosure.

FEATURES

- Protects up to 6 Remote Radio Heads, each with its own protection circuit.
- Flexible design allows for installation at the top of a tower for Remote Radio Head protection.
- Includes fiber connections for up to 18 pairs of fiber.
- LED indicators on individual circuits provide visual indication of suppressor status.
- Form 'C' relays allow for remote monitoring of the suppressor status.
- Patented Strikesorb technology provides over 60 kA of surge current capacity per circuit.
- Strikesorb suppression modules are fully recognized to UL 1449-3rd Edition Safety Standard, meeting all intermediate and high current fault requirements to facilitate use in OEM applications.
- Raycap recommends that DC protection system be installed within 2 meters or 6 feet of the radio.
- Dome design is lightweight and aerodynamic providing maximum flexibility for installation on top of towers.

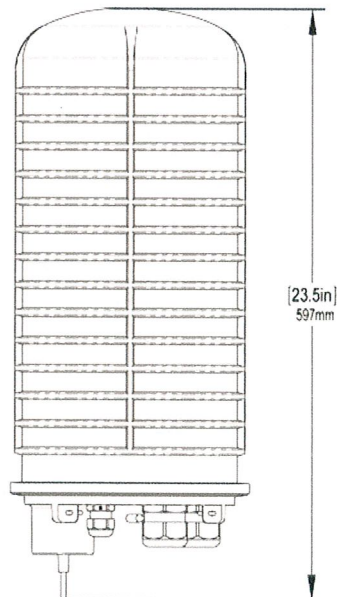
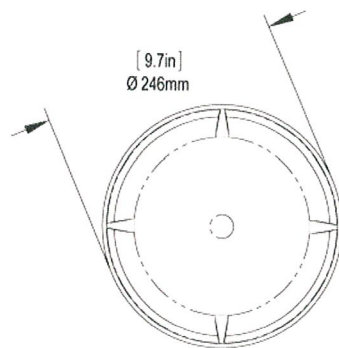
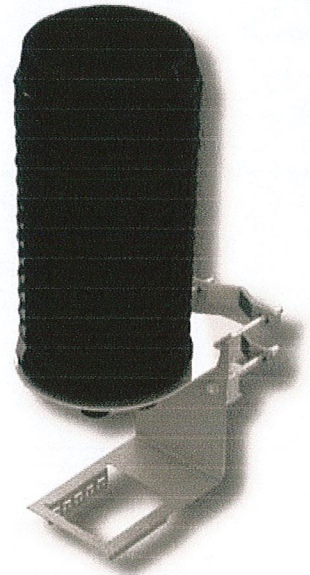

Raycap

DC6-48-60-18-8F

DC Power Surge Protection

Electrical Specifications	
Model Number	DC6-48-60-18-8F
Nominal Operating Voltage	48 VDC
Nominal Discharge Current (I_n)	20 kA 8/20 μ s
Maximum Discharge Current (I_{max}) per NEMA LS-1	60 kA 8/20 μ s
Maximum Continuous Operating Voltage (U_c)	75 VDC
Voltage Protection Rating	400 V

Mechanical Specifications	
Suppression Connection Method	Compression lug, #2-#14 AWG Copper, #2-#12 Aluminum
Fiber Connection Method	LC-LC Single mode duplex
Environmental Rating	IP 68, 7m 72hrs
Operating Temperature	-40° C to + 80° C
Storage Temperature	-70° C to + 80° C
Cold Temperature Cycling	IEC 61300-2-22e -30° C to + 60° C 200 hrs @ 5 psi
Resistance to Aggressive Materials	CEI IEC 61073-2 including acids and bases
UV Protection	ISO 4892-2 Method A Xenon-Arc 2160 hrs
Weight	20 lbs without Mounting Bracket

STANDARDS

Strikesorb modules are compliant to the following Surge Protection Device (SPD) Standards:

- ANSI/UL 1449 - 3rd Edition
- IEEE C62.41
- NEMA LS-1, IEC 61643-1:2005 2nd Edition:2005
- IEC 61643-12
- EN 61643-11:2002 (including A11:2007)



Raycap

G02-00-068 REV 050610



GS-07F-0435V



Certified to
ISO 9001:2000



TUV Rheinland
of North America

Raycap, Inc. 806 W. Clearwater Loop • Post Falls • Idaho • 83854 • USA
Phone 208.777.1166 • Toll Free 800.890.2569 • Fax 208.777.4466 • www.raycapsurgeprotection.com



New Cingular Wireless PCS, LLC
500 Enterprise Drive
Rocky Hill, Connecticut 06067-3900
Phone: (860) 463-5511
Fax: (860) 513-7190

Douglas L. Culp
Real Estate Consultant

June 22, 2011

Honorable Steve Vavrek
1st Selectman, Monroe
Monroe Town Hall
7 Fan Hill Road
Monroe, CT 06468

Re: Telecommunications Facility – 500 Moose Hill Road Monroe, CT

Dear First Selectman Vavrek:

In order to accommodate technological changes, implement Uniform Mobile Telecommunications System (“UMTS”) and Long Term Evolution (“LTE”) capabilities, and enhance system performance in the State of Connecticut, New Cingular Wireless PCS, LLC (“AT&T”) will be changing its equipment configuration at certain cell sites.

As required by Regulations of Connecticut State Agencies (“R.C.S.A.”) Section 16-50j-73, the Connecticut Siting Council has been notified of the changes and will review AT&T’s proposal. Please accept this letter as notification under Section 16-50j-73 of construction which constitutes an exempt modification pursuant to R.C.S.A. Section 16-50j-72(b)(2).

The accompanying letter to the Siting Council fully describes Cingular’s proposal for the referenced cell site. However, if you have any questions or require any further information on our plans or the Siting Council’s procedures; please call me at (860) 463-5511 or Ms. Linda Roberts, Executive Director, Connecticut Siting Council at (860) 827-2935.

Sincerely,

Douglas L. Culp
Real Estate Consultant

Enclosure