



Michael Gentile, Site Acquisition
c/o New Cingular Wireless, PCS LLC (AT&T)
Centerline Communications, LLC
95 Ryan Drive, Suite 1
Raynham, MA 02767
Mobile: (508) 844-9813
MGentile@clinellc.com

January 19, 2016

Melanie A. Bachman
Acting Executive Director
Connecticut Siting Council
10 Franklin Square
New Britain, CT 06051

**RE: Notice of Exempt Modification // Site Number: CT1142
290 Preston Avenue, Middletown, CT 06457 (Name: Middletown SW)
N 41.5573531 // W -072.7432769**

Dear Ms. Bachman:

New Cingular Wireless, PCS, LLC (“AT&T”) currently maintains nine (9) antennas at the 150-foot level of the existing 150-foot monopole tower at 290 Preston Avenue, Middletown, CT. The tower is owned by New Cingular Wireless PCS, LLC (“AT&T”). The property is owned by Brenda & Ernie Trumpold. AT&T now intends to replace three (3) of its existing antennas with 3 new LTE (700/1900 band) antennas for its LTE upgrade. These antennas would be installed at the 150-foot level of the tower. AT&T also intends to install three (3) remote radio units and three (3) remote radio unit modules.

The current proposal involves an antenna swap only (three for three); no antennas will be added. Prior conditions do not pertain.

Please accept this letter as notification pursuant to Regulations of Connecticut State Agencies § 16-50j-73, for construction that constitutes an exempt modification pursuant to R.C.S.A. § 16-50j-72(b)(2). In accordance with R.C.S.A. § 16-50j-73, a copy of this letter is being sent to Daniel Drew, Mayor for the Town of Middletown, as well as the property owner, Brenda & Ernie Trumpold and the tower owner.

The planned modifications to the facility fall squarely within those activities explicitly provided for in R.C.S.A. § 16-50j-72(b)(2).

Attached to accommodate this filing are construction drawings dated December 12, 2015 by ComEx Consultants, a structural analysis dated December 29, 2015 by B&T Group and an Emissions Analysis Report dated January 10, 2016 by EBI Consulting.

1. The proposed modifications will not result in an increase in the height of the existing structure.

2. The proposed modifications will not require the extension of the site boundary.
3. The proposed modifications will not increase noise levels at the facility by six decibels or more, or to levels that exceed state and local criteria.
4. The operation of the replacement antennas will not increase radio frequency emissions at the facility to a level at or above the Federal Communications Commission safety standard.
5. The proposed modifications will not cause a change or alteration in the physical or environmental characteristics of the site.
6. The existing structure and its foundation can support the proposed loading as shown in the attached structural analysis by B&T Group, dated December 29, 2015.

For the foregoing reasons, AT&T respectfully submits that the proposed modifications to the above referenced telecommunications facility constitute an exempt modification under R.C.S.A. § 16-50j-72(b)(2).

Sincerely,

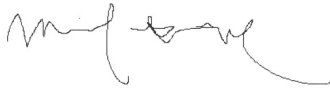

Michael Gentile, Site Acquisition
c/o New Cingular Wireless, PCS LLC (AT&T)
Centerline Communications, LLC
95 Ryan Drive, Suite 1
Raynham, MA 02767
Mobile: (508) 844-9813
MGentile@centerlincommunications.com

Attachments

cc: Daniel Drew, Mayor, Town of Middletown - as elected official
New Cingular Wireless PCS, LLC - as tower owner
Brenda & Ernie Trumpold, individuals - as property owner

RADIO FREQUENCY EMISSIONS ANALYSIS REPORT
EVALUATION OF HUMAN EXPOSURE POTENTIAL
TO NON-IONIZING EMISSIONS

AT&T Existing Facility

Site ID: CT1142

Middletown SW
290 Preston Avenue
Middletown, CT 06457

January 10, 2016

EBI Project Number: 6216000141

Site Compliance Summary	
Compliance Status:	COMPLIANT
Site total MPE% of FCC general public allowable limit:	10.14 %

January 10, 2016

AT&T Mobility – New England
Attn: Cameron Syme, RF Manager
550 Cochituate Road
Suite 550 – 13&14
Framingham, MA 06040

Emissions Analysis for Site: **CT1142 – Middletown SW**

EBI Consulting was directed to analyze the proposed AT&T facility located at **290 Preston Avenue, Middletown, CT**, for the purpose of determining whether the emissions from the Proposed AT&T Antenna Installation located on this property are within specified federal limits.

All information used in this report was analyzed as a percentage of current Maximum Permissible Exposure (% MPE) as listed in the FCC OET Bulletin 65 Edition 97-01 and ANSI/IEEE Std C95.1. The FCC regulates Maximum Permissible Exposure in units of microwatts per square centimeter ($\mu\text{W}/\text{cm}^2$). The number of $\mu\text{W}/\text{cm}^2$ calculated at each sample point is called the power density. The exposure limit for power density varies depending upon the frequencies being utilized. Wireless Carriers and Paging Services use different frequency bands each with different exposure limits, therefore it is necessary to report results and limits in terms of percent MPE rather than power density.

All results were compared to the FCC (Federal Communications Commission) radio frequency exposure rules, 47 CFR 1.1307(b)(1) – (b)(3), to determine compliance with the Maximum Permissible Exposure (MPE) limits for General Population/Uncontrolled environments as defined below.

General population/uncontrolled exposure limits apply to situations in which the general public may be exposed or in which persons who are exposed as a consequence of their employment may not be made fully aware of the potential for exposure or cannot exercise control over their exposure. Therefore, members of the general public would always be considered under this category when exposure is not employment related, for example, in the case of a telecommunications tower that exposes persons in a nearby residential area.

Public exposure to radio frequencies is regulated and enforced in units of microwatts per square centimeter ($\mu\text{W}/\text{cm}^2$). The general population exposure limits for the 700 and 850 MHz Bands are approximately $467 \mu\text{W}/\text{cm}^2$ and $567 \mu\text{W}/\text{cm}^2$ respectively. The general population exposure limit for the 1900 MHz (PCS), 2100 MHz (AWS) and 2300 MHz (WCS) bands is $1000 \mu\text{W}/\text{cm}^2$. Because each carrier will be using different frequency bands, and each frequency band has different exposure limits, it is necessary to report percent of MPE rather than power density.

Occupational/controlled exposure limits apply to situations in which persons are exposed as a consequence of their employment and in which those persons who are exposed have been made fully aware of the potential for exposure and can exercise control over their exposure. Occupational/controlled exposure limits also apply where exposure is of a transient nature as a result of incidental passage through a location where exposure levels may be above general population/uncontrolled limits (see below), as long as the exposed person has been made fully aware of the potential for exposure and can exercise control over his or her exposure by leaving the area or by some other appropriate means.

Additional details can be found in FCC OET 65.

CALCULATIONS

Calculations were done for the proposed AT&T Wireless antenna facility located at **290 Preston Avenue, Middletown, CT**, using the equipment information listed below. All calculations were performed per the specifications under FCC OET 65. Since AT&T is proposing highly focused directional panel antennas, which project most of the emitted energy out toward the horizon, all calculations were performed assuming a lobe representing the maximum gain of the antenna per the antenna manufactures supplied specifications, minus 10 dB, was focused at the base of the tower. For this report the sample point is the top of a 6 foot person standing at the base of the tower.

For all calculations, all equipment was calculated using the following assumptions:

- 1) 2 UMTS channels (850 MHz) were considered for each sector of the proposed installation. These Channels have a transmit power of 30 Watts per Channel.
- 2) 2 UMTS channels (PCS Band – 1900 MHz) were considered for each sector of the proposed installation. These Channels have a transmit power of 30 Watts per Channel.
- 3) 2 LTE channels (700 MHz) were considered for each sector of the proposed installation. These Channels have a transmit power of 60 Watts per Channel.
- 4) 2 LTE channels (PCS Band – 1900 MHz) were considered for each sector of the proposed installation. These Channels have a transmit power of 60 Watts per Channel.
- 5) 2 GSM channels (850 MHz) were considered for each sector of the proposed installation. These Channels have a transmit power of 30 Watts per Channel.
- 6) 2 GSM channels (PCS Band – 1900 MHz) were considered for each sector of the proposed installation. These Channels have a transmit power of 30 Watts per Channel.

- 7) All radios at the proposed installation were considered to be running at full power and were uncombined in their RF transmissions paths per carrier prescribed configuration. Per FCC OET Bulletin No. 65 - Edition 97-01 recommendations to achieve the maximum anticipated value at each sample point, all power levels emitting from the proposed antenna installation are increased by a factor of 2.56 to account for possible in-phase reflections from the surrounding environment. This is rarely the case, and if so, is never continuous.
- 8) For the following calculations the sample point was the top of a six foot person standing at the base of the tower. The maximum gain of the antenna per the antenna manufactures supplied specifications minus 10 dB was used in this direction. This value is a very conservative estimate as gain reductions for these particular antennas are typically much higher in this direction.
- 9) The antennas used in this modeling are the **CCI HPA-65R-BUU-H6, Commscope SBNHH-1D65A, Commscope SBNHH-1D65C and the Powerwave 7770.00** for transmission in the 700 MHz, 850 MHz and 1900 MHz (PCS) frequency bands. This is based on feedback from the carrier with regards to anticipated antenna selection. Maximum gain values for all antennas are listed in the Inventory and Power Data table below. The maximum gain of the antenna per the antenna manufactures supplied specifications, minus 10 dB, was used for all calculations. This value is a very conservative estimate as gain reductions for these particular antennas are typically much higher in this direction.
- 10) The antenna mounting height centerline of the proposed antennas is **150 feet** above ground level (AGL).
- 11) Emissions values for additional carriers were taken from the Connecticut Siting Council active database. Values in this database are provided by the individual carriers themselves.

All calculations were done with respect to uncontrolled / general public threshold limits.

AT&T Site Inventory and Power Data

Sector:	A	Sector:	B	Sector:	C
Antenna #:	1	Antenna #:	1	Antenna #:	1
Make / Model:	Powerwave 7770.00	Make / Model:	Powerwave 7770.00	Make / Model:	Powerwave 7770.00
Gain:	11.4 / 13.4 dBd	Gain:	11.4 / 13.4 dBd	Gain:	11.4 / 13.4 dBd
Height (AGL):	150 feet	Height (AGL):	150 feet	Height (AGL):	150 feet
Frequency Bands	850 MHz / 1900 MHz (PCS)	Frequency Bands	850 MHz / 1900 MHz (PCS)	Frequency Bands	850 MHz / 1900 MHz (PCS)
Channel Count	4	Channel Count	4	Channel Count	4
Total TX Power(W):	120	Total TX Power(W):	120	Total TX Power(W):	120
ERP (W):	2,140.89	ERP (W):	2,140.89	ERP (W):	2,140.89
Antenna A1 MPE%	0.48	Antenna B1 MPE%	0.48	Antenna C1 MPE%	0.48
Antenna #:	2	Antenna #:	2	Antenna #:	2
Make / Model:	CCI HPA-65R-BUU-H6	Make / Model:	Commscope SBNHH-1D65C	Make / Model:	Commscope SBNHH-1D65A
Gain:	11.95 / 14.75 dBd	Gain:	13.55 / 15.05 dBd	Gain:	10.85 / 14.55 dBd
Height (AGL):	150 feet	Height (AGL):	150 feet	Height (AGL):	150 feet
Frequency Bands	700 MHz / 1900 MHz (PCS)	Frequency Bands	700 MHz / 1900 MHz (PCS)	Frequency Bands	700 MHz / 1900 MHz (PCS)
Channel Count	4	Channel Count	4	Channel Count	4
Total TX Power(W):	240	Total TX Power(W):	240	Total TX Power(W):	240
ERP (W):	5,462.56	ERP (W):	6,556.25	ERP (W):	5,462.56
Antenna A2 MPE%	1.32	Antenna B2 MPE%	1.67	Antenna C2 MPE%	1.52
Antenna #:	3	Antenna #:	3	Antenna #:	3
Make / Model:	Powerwave 7770.00	Make / Model:	Powerwave 7770.00	Make / Model:	Powerwave 7770.00
Gain:	11.4 / 13.4 dBd	Gain:	11.4 / 13.4 dBd	Gain:	11.4 / 13.4 dBd
Height (AGL):	150 feet	Height (AGL):	150 feet	Height (AGL):	150 feet
Frequency Bands	850 MHz / 1900 MHz (PCS)	Frequency Bands	850 MHz / 1900 MHz (PCS)	Frequency Bands	850 MHz / 1900 MHz (PCS)
Channel Count	4	Channel Count	4	Channel Count	4
Total TX Power(W):	120	Total TX Power(W):	120	Total TX Power(W):	120
ERP (W):	2,140.89	ERP (W):	2,140.89	ERP (W):	4,880.65
Antenna A3 MPE%	0.48	Antenna B3 MPE%	0.48	Antenna C3 MPE%	0.48

Site Composite MPE%	
Carrier	MPE%
AT&T – Max per sector	2.64 %
MetroPCS	1.72 %
Sprint	0.53 %
Nextel	0.46 %
Verizon Wireless	3.84 %
T-Mobile	0.95 %
Site Total MPE %:	10.14 %

AT&T Sector 1 Total:	2.28 %
AT&T Sector 2 Total:	2.64 %
AT&T Sector 3 Total:	2.10 %
Site Total:	10.14 %

AT&T _ Per Sector	# Channels	Watts ERP (Per Channel)	Height (feet)	Total Power Density ($\mu\text{W}/\text{cm}^2$)	Frequency (MHz)	Allowable MPE ($\mu\text{W}/\text{cm}^2$)	Calculated % MPE
AT&T 850 MHz UMTS	2	414.12	150	1.44	850	567	0.25 %
AT&T 1900 MHz (PCS) UMTS	2	656.33	150	2.28	1900	1000	0.23 %
AT&T 850 MHz LTE	2	1358.79	150	4.71	700	467	1.01 %
AT&T 1900 MHz (PCS) LTE	2	1919.34	150	6.66	1900	1000	0.67 %
AT&T 700 MHz GSM	2	414.12	150	1.44	850	567	0.25 %
AT&T 1900 MHz (PCS) GSM	2	656.33	150	2.28	1900	1000	0.23 %
						Total:	2.64 %

Summary

All calculations performed for this analysis yielded results that were **within** the allowable limits for general public exposure to RF Emissions.

The anticipated maximum composite contributions from the AT&T facility as well as the site composite emissions value with regards to compliance with FCC's allowable limits for general public exposure to RF Emissions are shown here:

AT&T Sector	Power Density Value (%)
Sector 1:	2.28 %
Sector 2:	2.64 %
Sector 3 :	2.10 %
AT&T Maximum Total (per sector):	2.64 %
Site Total:	10.14 %
Site Compliance Status:	COMPLIANT

The anticipated composite MPE value for this site assuming all carriers present is **10.14%** of the allowable FCC established general public limit sampled at the ground level. This is based upon values listed in the Connecticut Siting Council database for existing carrier emissions.

FCC guidelines state that if a site is found to be out of compliance (over allowable thresholds), that carriers over a 5% contribution to the composite value will require measures to bring the site into compliance. For this facility, the composite values calculated were well within the allowable 100% threshold standard per the federal government.



Scott Heffernan
RF Engineering Director

EBI Consulting
21 B Street
Burlington, MA 01803

PROJECT INFORMATION

SCOPE OF WORK:

- AT&T ANTENNAS: (1) NEW ANTENNA PER SECTOR, FOR A TOTAL (3) NEW ANTENNAS. (1) EXISTING ANTENNAS PER SECTOR FOR 3 SECTORS, FOR A TOTAL OF (3) EXISTING ANTENNAS TO REMAIN. (1) EXISTING ANTENNA PER SECTOR FOR 3 SECTORS, FOR A TOTAL OF (3) EXISTING ANTENNAS TO BE RELOCATED. (1) EXISTING ANTENNA PER SECTOR FOR (3) SECTORS, FOR A TOTAL OF (3) EXISTING ANTENNAS TO BE REMOVED.
- AT&T RRUS: (1) NEW RRUS PER SECTOR WITH (3) SECTORS, FOR A TOTAL OF (3) NEW RRUS; (1) EXISTING RRU PER SECTOR TO BE REUSED, FOR A TOTAL OF (3) EXISTING RRUS.
- AT&T SQUID: (1) EXISTING DC-6 SQUID TO REMAIN.

SITE ADDRESS: 290 PRESTON AVENUE
MIDDLETOWN, CT 06457

LATITUDE: 41.5573531 41° 33' 26.47116"N
LONGITUDE: -72.7432769 -72° 44' 35.79684"W

USID: 14635

TOWER OWNER: AT&T MOBILITY

TYPE OF SITE: MONOPOLE/INDOOR EQUIPMENT

MONOPOLE HEIGHT: 150'-0"±

RAD CENTER: 150'-0"±

CURRENT USE: UNMANNED WIRELESS TELECOMMUNICATIONS FACILITY

PROPOSED USE: UNMANNED WIRELESS TELECOMMUNICATIONS FACILITY

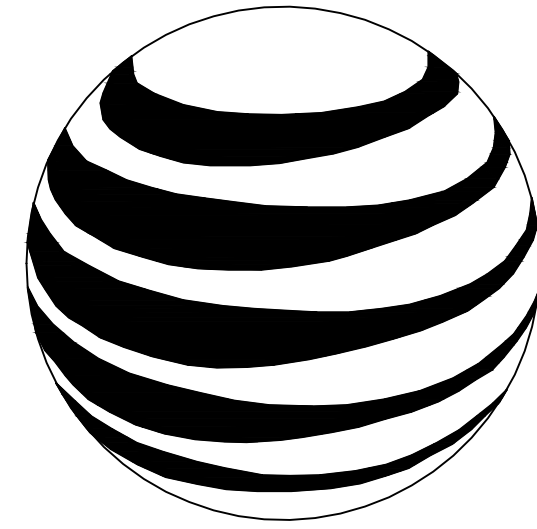

at&t
MOBILITY

FA CODE: 10035088
SITE NUMBER: CT1142
SITE NAME: MIDDLETOWN SW

PROJECT TEAM

CLIENT REPRESENTATIVE

COMPANY: EMPIRE TELECOM
ADDRESS: 16 ESQUIRE ROAD
BILLERICA, MA 01821
CONTACT: DAVID COOPER
PHONE: 617-639-4908
EMAIL: dcooper@empiretelecomm.com

SITE ACQUISITION:

COMPANY: EMPIRE TELECOM
ADDRESS: 16 ESQUIRE ROAD
BILLERICA, MA 01821
CONTACT: DAVID COOPER
PHONE: 617-639-4908
EMAIL: dcooper@empiretelecomm.com

COMPANY: EMPIRE TELECOM
ADDRESS: 16 ESQUIRE ROAD
BILLERICA, MA 01821
CONTACT: DAVID COOPER
PHONE: 617-639-4908
EMAIL: dcooper@empiretelecomm.com

COMPANY: COM-EX CONSULTANTS, LLC
ADDRESS: 115 ROUTE 46
SUITE E39
MOUNTAIN LAKES, NJ 07046
CONTACT: NICHOLAS D. BARILE, P.E.
PHONE: 862-209-4300
EMAIL: nbarile@comexconsultants.com

RF ENGINEER:

COMPANY: AT&T MOBILITY – NEW ENGLAND
ADDRESS: 550 COCHITUATE ROAD
SUITE 550 13 & 14
FRAMINGHAM, MA 01701
CONTACT: CAMERON SYME
PHONE: 508-596-7146
EMAIL: cs6970@att.com

CONSTRUCTION MANAGEMENT:

COMPANY: EMPIRE TELECOM
ADDRESS: 16 ESQUIRE ROAD
BILLERICA, MA 01821
CONTACT: GRZEGORZ "GREG" DORMAN
PHONE: 484-683-1750
EMAIL: gdorman@empiretelecomm.com

DRAWING INDEX

REV.

T-1	TITLE SHEET	0
GN-1	GROUNDING & GENERAL NOTES	0
A-1	COMPOUND LAYOUT	0
A-2	EQUIPMENT LAYOUTS	0
A-3	ANTENNA LAYOUTS & ELEVATIONS	0
A-4	DETAILS	0
G-1	GROUNDING, ONE-LINE DIAGRAM & DETAILS	0

VICINITY MAP

FROM ROCKY HILL, CT: HEAD NORTH ON ENTERPRISE DRIVE TOWARD CAPITOL BLVD, TURN LEFT ON CAPITOL BLVD, TURN LEFT ONTO WEST STREET, TURN LEFT TO MERGE ONTO I-91 S TOWARD NEW HAVEN, TAKE EXIT 20 FOR MIDDLE STREET TOWARD COUNTY CLUB ROAD, TURN LEFT ONTO PRESTON AVENUE, DESTINATION WILL BE ON THE LEFT.



GENERAL NOTES

- THIS DOCUMENT IS THE CREATION, DESIGN, PROPERTY, AND COPYRIGHTED WORK OF AT&T. ANY DUPLICATION OR USE WITHOUT EXPRESS WRITTEN CONSENT IS STRICTLY PROHIBITED. DUPLICATION AND USE BY GOVERNMENT AGENCIES FOR THE PURPOSES OF CONDUCTING THEIR LAWFULLY AUTHORIZED REGULATORY AND ADMINISTRATIVE FUNCTIONS IS SPECIFICALLY ALLOWED.
- THE FACILITY IS AN UNMANNED PRIVATE AND SECURED EQUIPMENT INSTALLATION. IT IS ONLY ACCESSED BY TRAINED TECHNICIANS FOR PERIODIC ROUTINE MAINTENANCE AND THEREFORE DOES NOT REQUIRE ANY WATER OR SANITARY SEWER SERVICE. THE FACILITY IS NOT GOVERNED BY REGULATIONS REQUIRING PUBLIC ACCESS PER ADA REQUIREMENTS.
- CONTRACTOR SHALL VERIFY ALL PLANS AND EXISTING DIMENSIONS AND CONDITIONS ON THE JOB SITE AND SHALL IMMEDIATELY NOTIFY THE AT&T REPRESENTATIVE IN WRITING OF DISCREPANCIES BEFORE PROCEEDING WITH THE WORK OR BE RESPONSIBLE FOR SAME.

APPROVALS

THE FOLLOWING PARTIES HEREBY APPROVE AND ACCEPT THESE DOCUMENTS AND AUTHORIZE THE SUBCONTRACTOR TO PROCEED WITH THE CONSTRUCTION DESCRIBED HEREIN, ALL DOCUMENTS ARE SUBJECT TO REVIEW BY THE LOCAL BUILDING DEPARTMENT AND MAY IMPOSE CHANGES OR SITE MODIFICATIONS.

DISCIPLINE:	NAME:	
SITE ACQUISITION:		
CONSTRUCTION MANAGER:		
AT&T PROJECT MANAGER:		



CONNECTICUT LAW REQUIRES TWO WORKING DAYS NOTICE PRIOR TO ANY EARTH MOVING ACTIVITIES BY CALLING 800-922-4455 OR DIAL 811



SITE NUMBER: CT1142
SITE NAME: MIDDLETOWN SW
290 PRESTON AVENUE
MIDDLETOWN, CT 06457
MIDDLESEX COUNTY



0	12/10/15	ISSUED AS FINAL	NJM	NDB	NDB
NO.	DATE	REVISIONS	BY	CHK	APP'D
SCALE: AS SHOWN		DESIGNED BY: NJM	DRAWN BY: NJM		

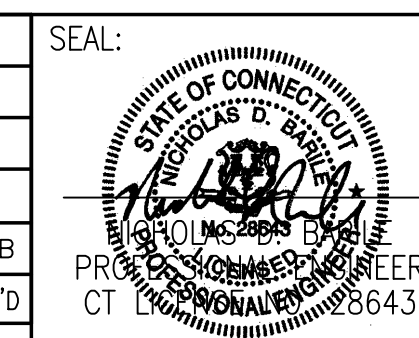

AT&T		
DRAWING TITLE: TITLE SHEET		
JOB NUMBER 15109-EMP	DRAWING NUMBER T-1	REV 0

GROUNDING NOTES:

1. THE SUBCONTRACTOR SHALL REVIEW AND INSPECT THE EXISTING FACILITY GROUNDING SYSTEM AND LIGHTNING PROTECTION SYSTEM (AS DESIGNED AND INSTALLED) FOR STRICT COMPLIANCE WITH THE NEC (AS ADOPTED BY THE AHJ), THE SITE-SPECIFIC (UL, LPI, OR NFPA) LIGHTING PROTECTION CODE, AND GENERAL COMPLIANCE WITH TELCORDIA AND TIA GROUNDING STANDARDS. THE SUBCONTRACTOR SHALL REPORT ANY VIOLATIONS OR ADVERSE FINDINGS TO THE CONTRACTOR FOR RESOLUTION.
2. ALL GROUND ELECTRODE SYSTEMS (INCLUDING TELECOMMUNICATION, RADIO, LIGHTNING PROTECTION, AND AC POWER GES'S) SHALL BE BONDED TOGETHER, AT OR BELOW GRADE, BY TWO OR MORE COPPER BONDING CONDUCTORS IN ACCORDANCE WITH THE NEC.
3. THE SUBCONTRACTOR SHALL PERFORM IEEE FALL-OF-POTENTIAL RESISTANCE TO EARTH TESTING (PER IEEE 1100 AND 81) FOR NEW GROUND ELECTRODE SYSTEMS. THE SUBCONTRACTOR SHALL FURNISH AND INSTALL SUPPLEMENTAL GROUND ELECTRODES AS NEEDED TO ACHIEVE A TEST RESULT OF 5 OHMS OR LESS. TESTS SHALL BE PERFORMED IN ACCORDANCE WITH 25471-000-3PS-EG00-0001, DESIGN & TESTING OF FACILITY GROUNDING FOR CELL SITES.
4. METAL RACEWAY SHALL NOT BE USED AS THE NEC REQUIRED EQUIPMENT GROUND CONDUCTOR. STRANDED COPPER CONDUCTORS WITH GREEN INSULATION, SIZED IN ACCORDANCE WITH THE NEC, SHALL BE FURNISHED AND INSTALLED WITH THE POWER CIRCUITS TO BTS EQUIPMENT.
5. EACH BTS CABINET FRAME SHALL BE DIRECTLY CONNECTED TO THE MASTER GROUND BAR WITH GREEN INSULATED SUPPLEMENTAL EQUIPMENT GROUND WIRES, 6 AWG STRANDED COPPER OR LARGER FOR INDOOR BTS; 2 AWG STRANDED COPPER FOR OUTDOOR BTS.
6. EXOTHERMIC WELDS SHALL BE USED FOR ALL GROUNDING CONNECTIONS BELOW GRADE.
7. APPROVED ANTIOXIDANT COATINGS (I.E., CONDUCTIVE GEL OR PASTE) SHALL BE USED ON ALL COMPRESSION AND BOLTED GROUND CONNECTIONS.
8. ICE BRIDGE BONDING CONDUCTORS SHALL BE EXOTHERMICALLY BONDED OR BOLTED WITH STAINLESS STEEL HARDWARE TO THE BRIDGE AND THE TOWER GROUND BAR.
9. ALUMINUM CONDUCTOR OR COPPER CLAD STEEL CONDUCTOR SHALL NOT BE USED FOR GROUNDING CONNECTIONS.
10. MISCELLANEOUS ELECTRICAL AND NON-ELECTRICAL METAL BOXES, FRAMES AND SUPPORTS SHALL BE BONDED TO THE GROUND RING, IN ACCORDANCE WITH THE NEC.
11. METAL CONDUIT AND TRAY SHALL BE GROUNDED AND MADE ELECTRICALLY CONTINUOUS WITH LISTED BONDING FITTINGS OR BY BONDING ACROSS THE DISCONTINUITY WITH 6 AWG COPPER WIRE UL APPROVED GROUNDING TYPE CONDUIT CLAMPS.
12. GROUND CONDUCTORS USED IN THE FACILITY GROUND AND LIGHTNING PROTECTION SYSTEMS SHALL NOT BE ROUTED THROUGH METALLIC OBJECTS THAT FORM A RING AROUND THE CONDUCTOR, SUCH AS METALLIC CONDUITS, METAL SUPPORT CLIPS OR SLEEVES THROUGH WALLS OR FLOORS. WHEN IT IS REQUIRED TO BE HOUSED IN CONDUIT TO MEET CODE REQUIREMENTS OR LOCAL CONDITIONS, NON-METALLIC MATERIAL SUCH AS PVC PLASTIC CONDUIT SHALL BE USED. WHERE USE OF METAL CONDUIT IS UNAVOIDABLE (E.G., NON-METALLIC CONDUIT PROHIBITED BY LOCAL CODE) THE GROUND CONDUCTOR SHALL BE BONDED TO EACH END OF THE METAL CONDUIT.
13. ALL TOWER GROUNDING SYSTEMS SHALL COMPLY WITH THE REQUIREMENTS OF ANSI/TIA 222. FOR TOWERS BEING BUILT TO REV-G OF THE STANDARD, THE WIRE SIZE OF THE BURIED GROUND RING AND CONNECTIONS BETWEEN THE TOWER AND THE BURIED GROUND RING SHALL BE CHANGED FROM 2 AWG TO 2/0 AWG. IN ADDITION, THE MINIMUM LENGTH OF THE GROUND RODS SHALL BE INCREASED FROM EIGHT FEET (8') TO TEN FEET (10').
14. ALL NEW STRUCTURES WITH A FOUNDATION AND/OR FOOTING HAVING 20 FT. OR MORE 1/2" OR GREATER ELECTRICALLY CONDUCTIVE REINFORCING STEEL MUST HAVE IT BONDED TO THE GROUND RING USING AN EXOTHERMIC WELD CONNECTION USING #2 AWG SOLID TINNED COPPER GROUND WIRE, PER NEC 250.50.

GENERAL NOTES:

1. FOR THE PURPOSE OF CONSTRUCTION DRAWING, THE FOLLOWING DEFINITIONS SHALL APPLY:
 CONTRACTOR - EMPIRE TELECOM
 SUBCONTRACTOR - GENERAL CONTRACTOR (CONSTRUCTION)
 OWNER - AT&T MOBILITY
 OEM - ORIGINAL EQUIPMENT MANUFACTURER
2. PRIOR TO THE SUBMISSION OF BIDS, THE BIDDING SUBCONTRACTOR SHALL VISIT THE CELL SITE TO FAMILIARIZE WITH THE EXISTING CONDITIONS AND TO CONFIRM THAT THE WORK CAN BE ACCOMPLISHED AS SHOWN ON THE CONSTRUCTION DRAWINGS. ANY DISCREPANCY FOUND SHALL BE BROUGHT TO THE ATTENTION OF CONTRACTOR (EMPIRE TELECOM).
3. ALL MATERIALS FURNISHED AND INSTALLED SHALL BE IN STRICT ACCORDANCE WITH ALL APPLICABLE CODES, REGULATIONS, AND ORDINANCES. SUBCONTRACTOR SHALL ISSUE ALL APPROPRIATE NOTICES AND COMPLY WITH ALL LAWS, ORDINANCES, RULES, REGULATIONS, AND LAWFUL ORDERS OF ANY PUBLIC AUTHORITY REGARDING THE PERFORMANCE OF THE WORK. ALL WORK CARRIED OUT SHALL COMPLY WITH ALL APPLICABLE MUNICIPAL AND UTILITY COMPANY SPECIFICATIONS AND LOCAL JURISDICTIONAL CODES, ORDINANCES AND APPLICABLE REGULATIONS.
4. DRAWINGS PROVIDED HERE ARE NOT TO BE SCALED AND ARE INTENDED TO SHOW OUTLINE ONLY.
5. UNLESS NOTED OTHERWISE, THE WORK SHALL INCLUDE FURNISHING MATERIALS, EQUIPMENT, APPURTENANCES, AND LABOR NECESSARY TO COMPLETE ALL INSTALLATIONS AS INDICATED ON THE DRAWINGS.
6. THE SUBCONTRACTOR SHALL INSTALL ALL EQUIPMENT AND MATERIALS IN ACCORDANCE WITH MANUFACTURER'S RECOMMENDATIONS UNLESS SPECIFICALLY STATED OTHERWISE.
7. IF THE SPECIFIED EQUIPMENT CANNOT BE INSTALLED AS SHOWN ON THESE DRAWINGS, THE SUBCONTRACTOR SHALL PROPOSE AN ALTERNATIVE INSTALLATION SPACE FOR APPROVAL BY THE CONTRACTOR.
8. SUBCONTRACTOR SHALL DETERMINE ACTUAL ROUTING OF CONDUIT, POWER AND T1 CABLES, GROUNDING CABLES AS SHOWN ON THE POWER, GROUNDING AND TELCO PLAN DRAWING. SUBCONTRACTOR SHALL UTILIZE EXISTING TRAYS AND/OR SHALL ADD NEW TRAYS AS NECESSARY. SUBCONTRACTOR SHALL CONFIRM THE ACTUAL ROUTING WITH THE CONTRACTOR. ROUTING OF TRENCHING SHALL BE APPROVED BY CONTRACTOR
9. THE SUBCONTRACTOR SHALL PROTECT EXISTING IMPROVEMENTS, PAVEMENTS, CURBS, LANDSCAPING AND STRUCTURES. ANY DAMAGED PART SHALL BE REPAIRED AT SUBCONTRACTOR'S EXPENSE TO THE SATISFACTION OF OWNER.
10. SUBCONTRACTOR SHALL LEGALLY AND PROPERLY DISPOSE OFF ALL SCRAP MATERIALS SUCH AS COAXIAL CABLES AND OTHER ITEMS REMOVED FROM THE EXISTING FACILITY. ANTENNAS REMOVED SHALL BE RETURNED TO THE OWNER'S DESIGNATED LOCATION.
11. SUBCONTRACTOR SHALL LEAVE PREMISES IN CLEAN CONDITION.
12. ALL CONCRETE REPAIR WORK SHALL BE DONE IN ACCORDANCE WITH AMERICAN CONCRETE INSTITUTE (ACI) 301.
13. ANY NEW CONCRETE NEEDED FOR THE CONSTRUCTION SHALL HAVE 4000 PSI STRENGTH AT 28 DAYS UNLESS OTHERWISE SPECIFIED. ALL CONCRETING WORK SHALL BE DONE IN ACCORDANCE WITH ACI 318 CODE REQUIREMENTS.
14. ALL STRUCTURAL STEEL WORK SHALL BE DETAILED, FABRICATED AND ERECTED IN ACCORDANCE WITH AISC SPECIFICATIONS. ALL STRUCTURAL STEEL SHALL BE ASTM A36 (Fy=36 ksi). ALL STEEL EXPOSED TO WEATHER SHALL BE HOT DIPPED GALVANIZED. TOUCH UP ALL SCRATCHES AND OTHER MARKS IN THE FIELD AFTER STEEL IS ERECTED USING A COMPATIBLE ZINC RICH PAINT.
15. CONSTRUCTION SHALL COMPLY WITH SPECIFICATION 25741-000-3APS-A00Z-00002, "GENERAL CONSTRUCTION SERVICES FOR CONSTRUCTION OF AT&T MOBILITY SITES."
16. SUBCONTRACTOR SHALL VERIFY ALL EXISTING DIMENSIONS AND CONDITIONS PRIOR TO COMMENCING ANY WORK. ALL DIMENSIONS OF EXISTING CONSTRUCTION SHOWN ON THE DRAWINGS MUST BE VERIFIED. SUBCONTRACTOR SHALL NOTIFY THE CONTRACTOR OF ANY DISCREPANCIES PRIOR TO ORDERING MATERIAL OR PROCEEDING WITH CONSTRUCTION.
17. THE EXISTING CELL SITE IS IN FULL COMMERCIAL OPERATION. ANY CONSTRUCTION WORK BY SUBCONTRACTOR SHALL NOT DISRUPT THE EXISTING NORMAL OPERATION. ANY WORK ON EXISTING EQUIPMENT MUST BE COORDINATED WITH CONTRACTOR. ALSO, WORK MAY NEED TO BE SCHEDULED FOR AN APPROPRIATE MAINTENANCE WINDOW USUALLY IN LOW TRAFFIC PERIODS AFTER MIDNIGHT.
18. SINCE THE CELL SITE MAY BE ACTIVE, ALL SAFETY PRECAUTIONS MUST BE TAKEN WHEN WORKING AROUND HIGH LEVELS OF ELECTROMAGNETIC RADIATION. EQUIPMENT SHOULD BE SHUTDOWN PRIOR TO PERFORMING ANY WORK THAT COULD EXPOSE THE WORKERS TO DANGER. PERSONAL RF EXPOSURE MONITORS ARE REQUIRED TO BE WORN TO ALERT OF ANY DANGEROUS EXPOSURE LEVELS.

19. SUBCONTRACTOR'S WORK SHALL COMPLY WITH ALL APPLICABLE NATIONAL, STATE, AND LOCAL CODES AS ADOPTED BY THE LOCAL AUTHORITY HAVING JURISDICTION (AHJ) FOR THE LOCATION. THE EDITION OF THE AHJ ADOPTED CODES AND STANDARDS IN EFFECT ON THE DATE OF CONTRACT AWARD SHALL GOVERN THE DESIGN.
 - INTERNATIONAL BUILDING CODE: IBC 2009 WITH LOCAL & COUNTY AMENDMENTS
 - NATIONAL ELECTRICAL CODE: NEC 2011 WITH LOCAL & COUNTY AMENDMENTS
 - FIRE/LIFE SAFETY CODE: NFPA-101 2009 WITH LOCAL & COUNTY AMENDMENTS
20. SUBCONTRACTOR'S WORK SHALL COMPLY WITH THE LATEST EDITION OF THE FOLLOWING STANDARDS:
 - AMERICAN CONCRETE INSTITUTE (ACI) 318, BUILDING CODE REQUIREMENTS FOR STRUCTURAL CONCRETE
 - AMERICAN INSTITUTE OF STEEL CONSTRUCTION (AISC), MANUAL OF STEEL CONSTRUCTION, THIRTEENTH EDITION
 - AMERICAN SOCIETY OF TESTING OF MATERIALS, ASTM
 - TELECOMMUNICATIONS INDUSTRY ASSOCIATION (ANSI/TIA-222-G-1), STRUCTURAL STANDARDS FOR STEEL ANTENNA TOWER AND ANTENNA SUPPORTING STRUCTURES:
 - TIA 607, COMMERCIAL BUILDING GROUNDING AND BONDING REQUIREMENTS FOR TELECOMMUNICATIONS
 - OCCUPATIONAL SAFETY AND HEALTH ADMINISTRATION, OSHA
 - INSTITUTE FOR ELECTRICAL AND ELECTRONICS ENGINEERS (IEEE) 81, GUIDE FOR MEASURING EARTH RESISTIVELY, GROUND IMPEDANCE, AND EARTH SURFACE POTENTIALS OF A GROUND SYSTEM IEEE 1100 (1999) RECOMMENDED PRACTICE FOR POWERING AND GROUNDING OF ELECTRONIC EQUIPMENT
 - TELCORDIA GR-1503, COAXIAL CABLE CONNECTIONS
21. FOR ANY CONFLICTS BETWEEN SECTIONS OF LISTED CODES AND STANDARDS REGARDING MATERIAL, METHODS OF CONSTRUCTION, OR OTHER REQUIREMENTS, THE MOST RESTRICTIVE REQUIREMENT SHALL GOVERN. WHERE THERE IS CONFLICT BETWEEN A GENERAL REQUIREMENT AND A SPECIFIC REQUIREMENT, THE SPECIFIC REQUIREMENT SHALL GOVERN.
22. CONTRACTOR SHALL FIELD VERIFY ALL DIMENSIONS, ELEVATIONS, ANGLES AND EXISTING CONDITIONS AT THE SITE PRIOR TO FABRICATION AND/OR INSTALLATION OF ANY WORK IN THE CONTRACT AREA AND SUBMIT TO THE ENGINEER ANY DISCREPANCIES FROM THE DRAWINGS.
23. INFORMATION SHOWN ON THIS SET OF PLANS TAKEN FROM DRAWINGS PREPARED BY CENTEK ENGINEERING FOR A RECENT UPGRADE DATED 01/25/2012. CONTRACTOR TO NOTIFY DESIGN ENGINEER OF ANY DISCREPANCIES PRIOR TO COMMENCEMENT OF CONSTRUCTION.



SITE NUMBER: CT1142
SITE NAME: MIDDLETOWN SW
 290 PRESTON AVENUE
 MIDDLETOWN, CT 06457
 MIDDLESEX COUNTY



0	12/10/15	ISSUED AS FINAL	NJM	NDB	NDB
NO.	DATE	REVISIONS	BY	CHK	APP'D
SCALE: AS SHOWN		DESIGNED BY: NJM	DRAWN BY: NJM		

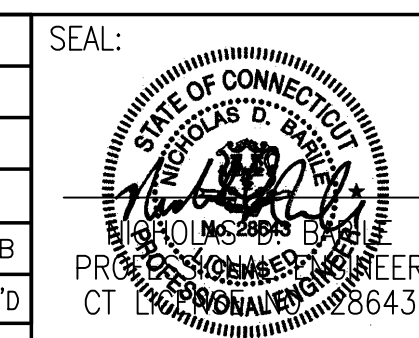

AT&T		
DRAWING TITLE: GROUNDING & GENERAL NOTES		
JOB NUMBER 15109-EMP	DRAWING NUMBER GN-1	REV 0

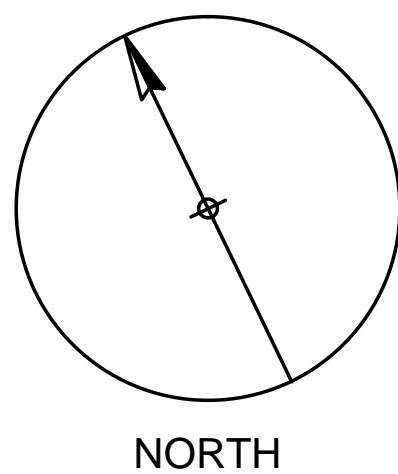
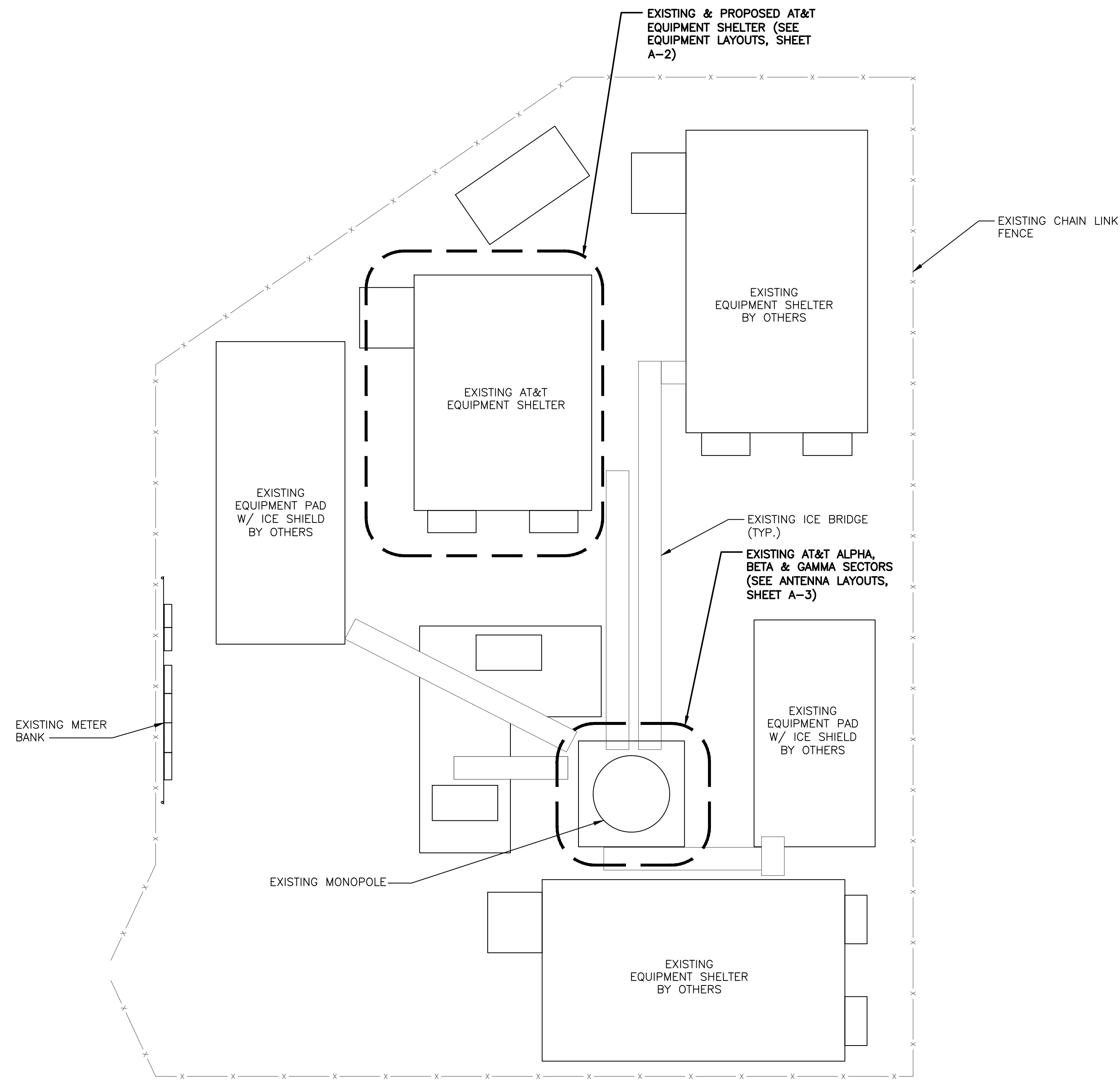

COMPOUND LAYOUT

SCALE: 3/32" = 1'-0"

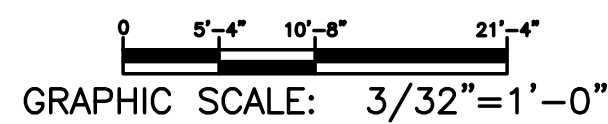

NOTE:
CONTRACTOR SHALL FIELD VERIFY ALL DIMENSIONS, ELEVATIONS, ANGLES, AND EXISTING CONDITIONS AT THE SITE PRIOR TO FABRICATION AND/OR INSTALLATION OF ANY WORK IN THE CONTRACT AREA AND SUBMIT TO THE ENGINEER ANY DISCREPANCIES FROM THE DRAWINGS.

COM-EX
Consultants
115 ROUTE 46
SUITE E39
MOUNTAIN LAKES, NJ 07046
PHONE: 862.209.4300
FAX: 862.209.4301

EMPIRE
telecom
16 ESQUIRE ROAD
BILLERICA, MA 01821

SITE NUMBER: CT1142
SITE NAME: MIDDLETOWN SW
290 PRESTON AVENUE
MIDDLETOWN, CT 06457
MIDDLESEX COUNTY

 **at&t**
MOBILITY
550 COCHITUATE ROAD
FRAMINGHAM, MA 01701

0	12/10/15	ISSUED AS FINAL	NJM	NDB	NDB
NO.	DATE	REVISIONS	BY	CHK	APP'D
SCALE: AS SHOWN		DESIGNED BY: NJM	DRAWN BY: NJM		

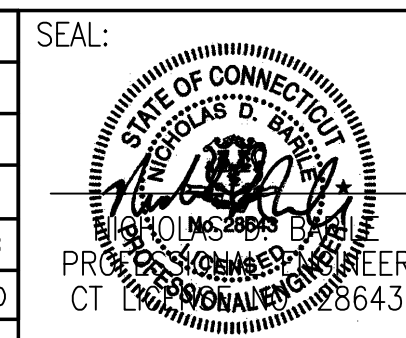

AT&T		
DRAWING TITLE: COMPOUND LAYOUT		
JOB NUMBER 15109-EMP	DRAWING NUMBER A-1	REV 0

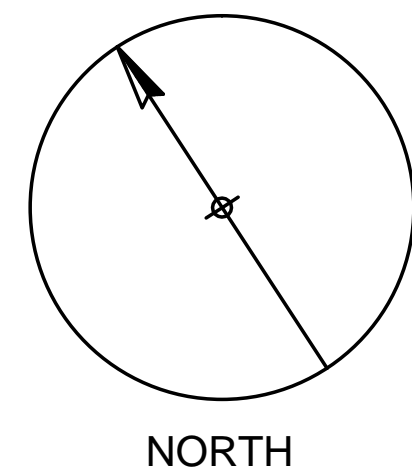
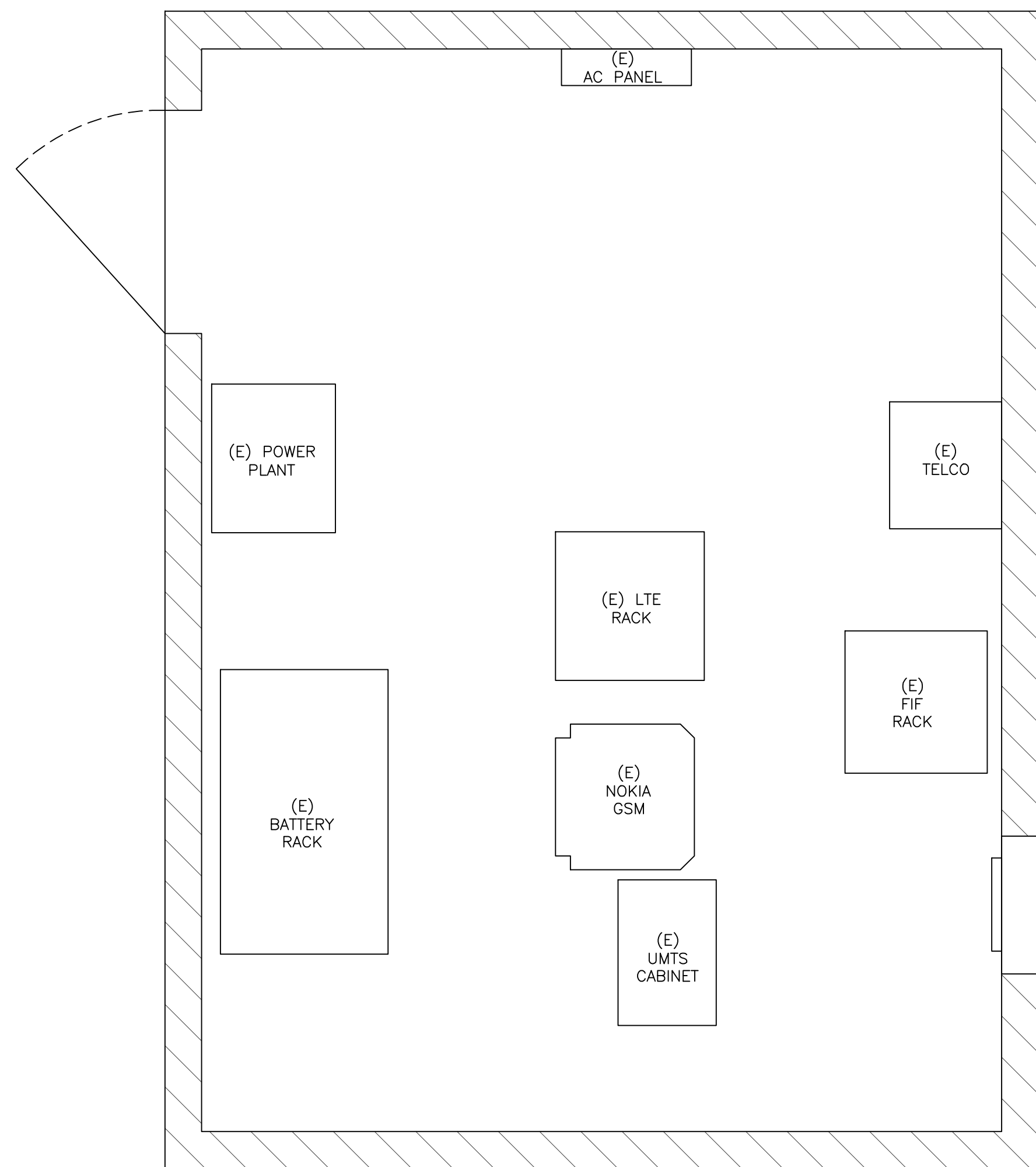

EXISTING EQUIPMENT LAYOUT
SCALE: 1/2" = 1'-0"

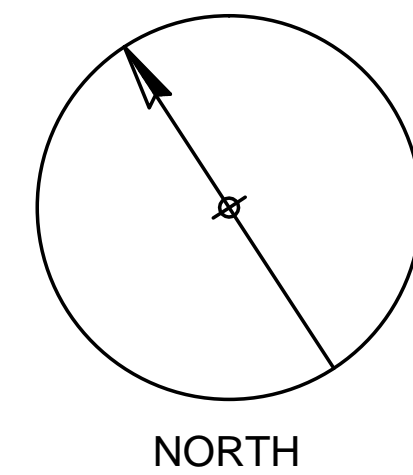
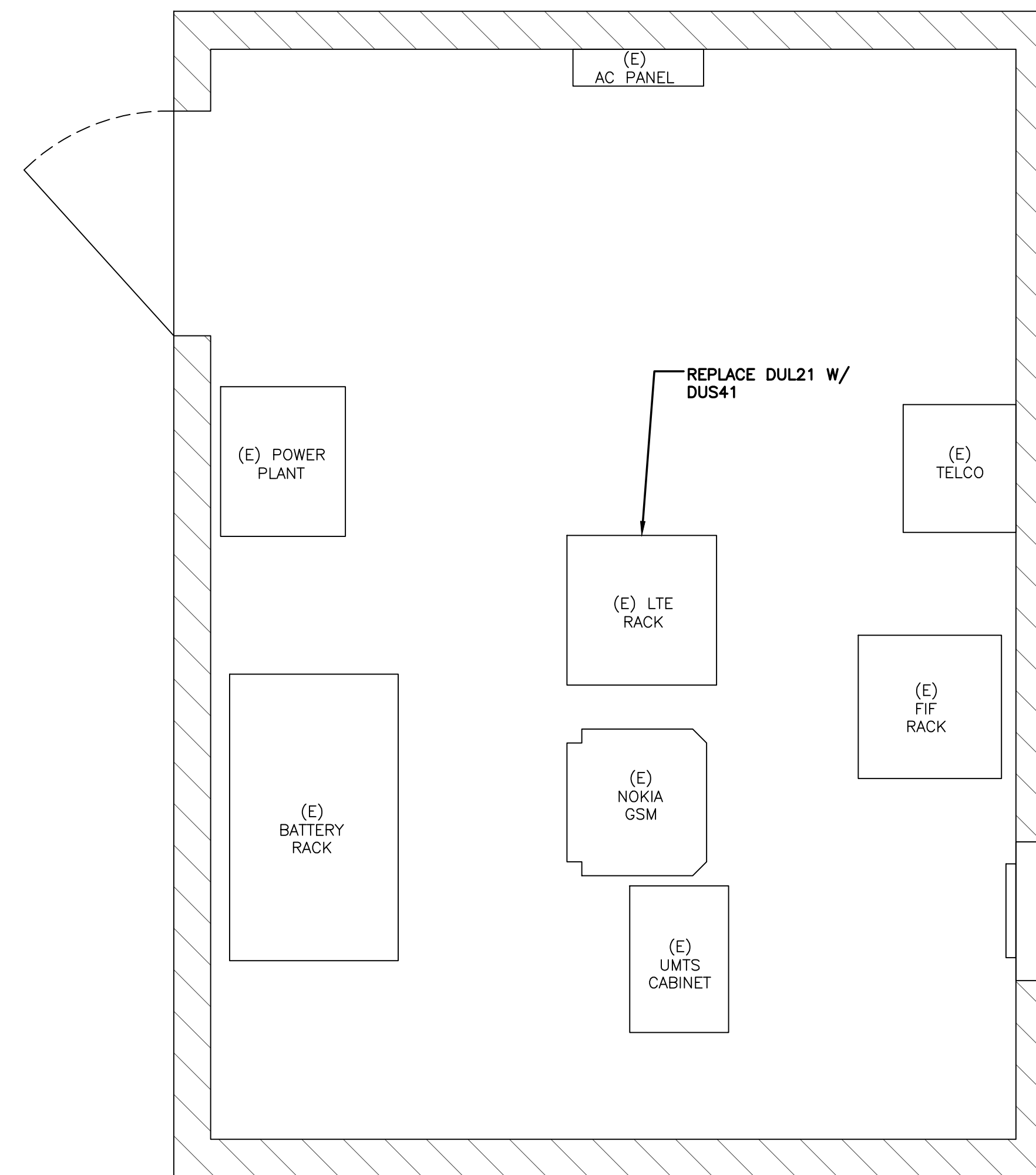
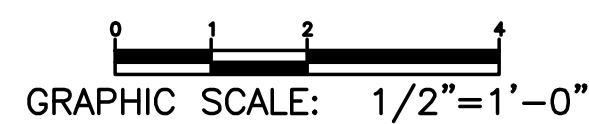

PROPOSED EQUIPMENT LAYOUT
SCALE: 1/2" = 1'-0"

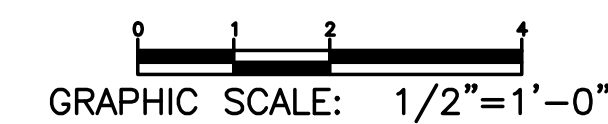

COM-EX
Consultants
115 ROUTE 46
SUITE E39
MOUNTAIN LAKES, NJ 07046
PHONE: 862.209.4300
FAX: 862.209.4301

EMPIRE
telecom
16 ESQUIRE ROAD
BILLERICA, MA 01821

SITE NUMBER: CT1142
SITE NAME: MIDDLETOWN SW
290 PRESTON AVENUE
MIDDLETOWN, CT 06457
MIDDLESEX COUNTY

 **at&t**
MOBILITY
550 COCHITUATE ROAD
FRAMINGHAM, MA 01701

0	12/10/15	ISSUED AS FINAL	NJM	NDB	NDB
NO.	DATE	REVISIONS	BY	CHK	APP'D
SCALE: AS SHOWN		DESIGNED BY: NJM	DRAWN BY: NJM		

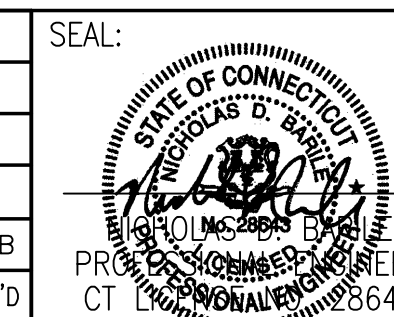

AT&T		
DRAWING TITLE: EQUIPMENT LAYOUT		
JOB NUMBER 15109-EMP	DRAWING NUMBER A-2	REV 0

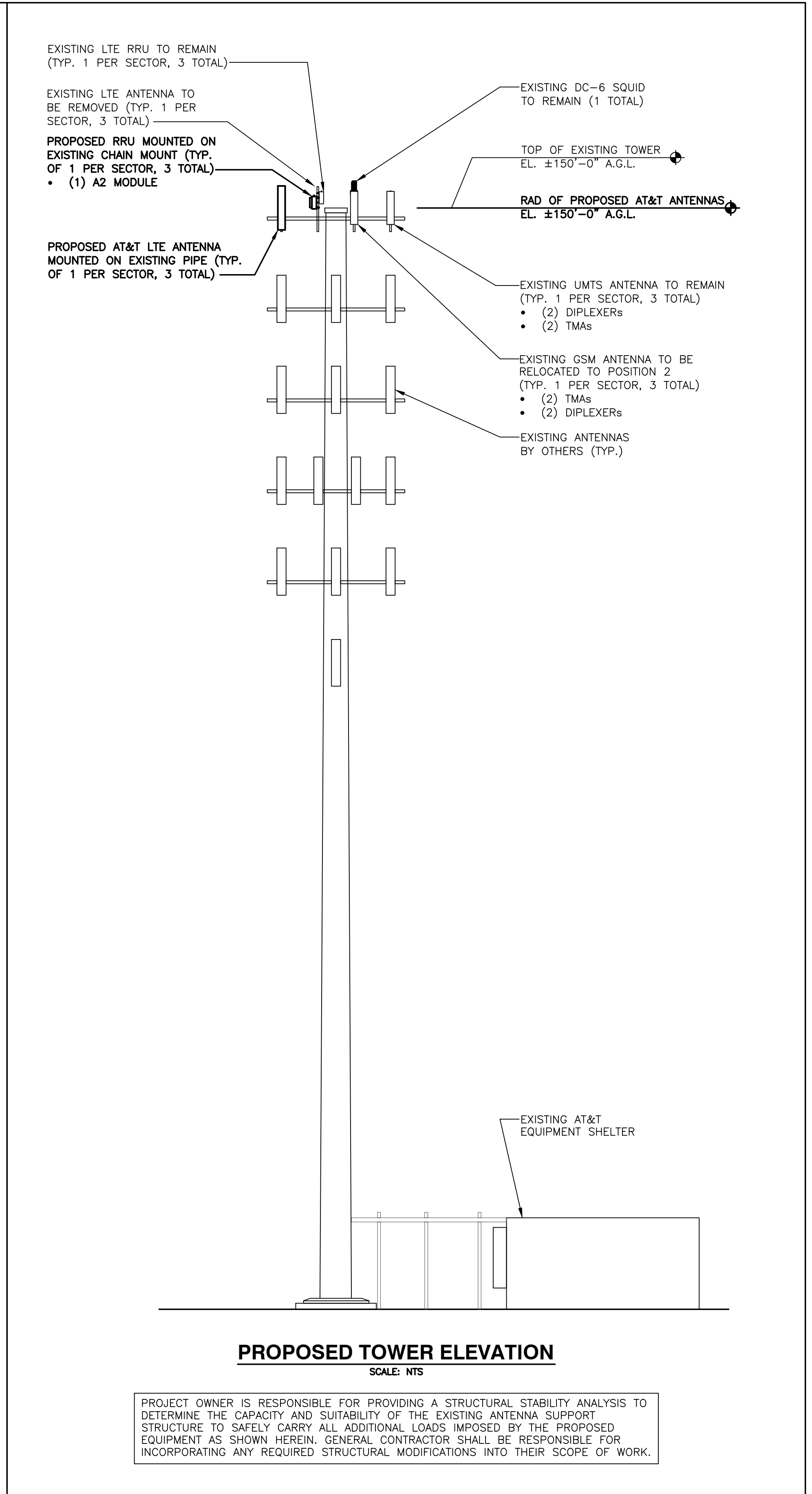
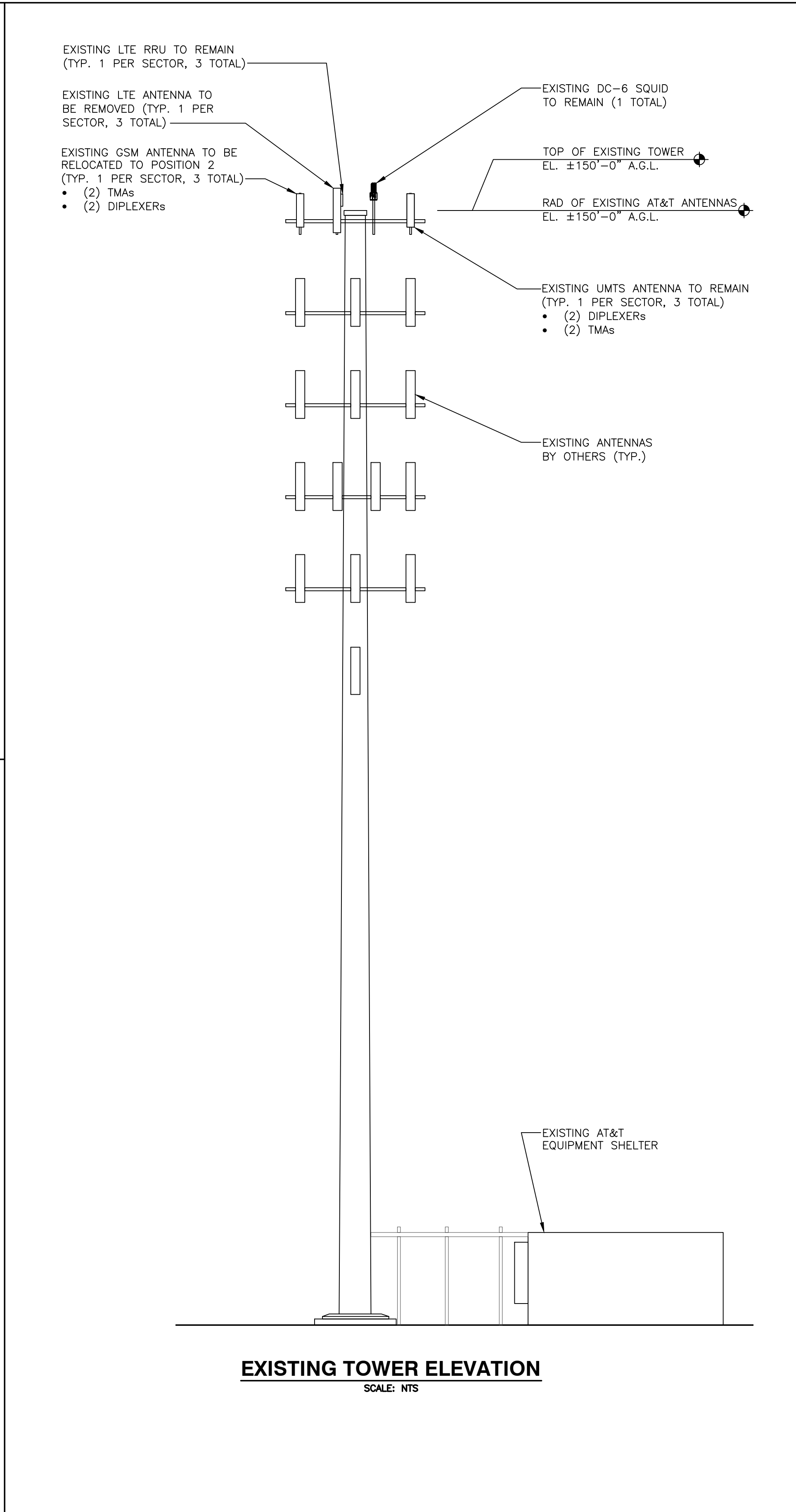
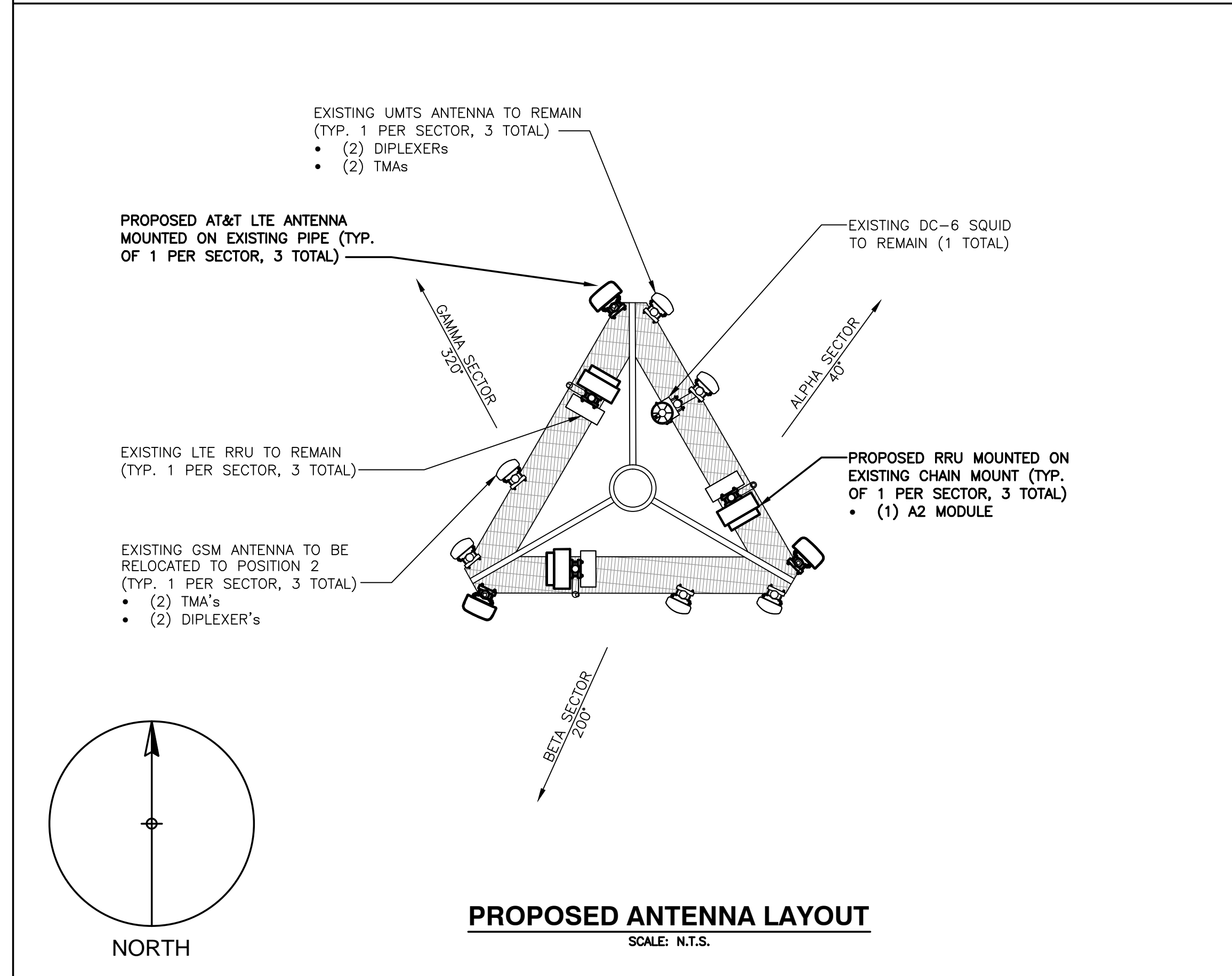
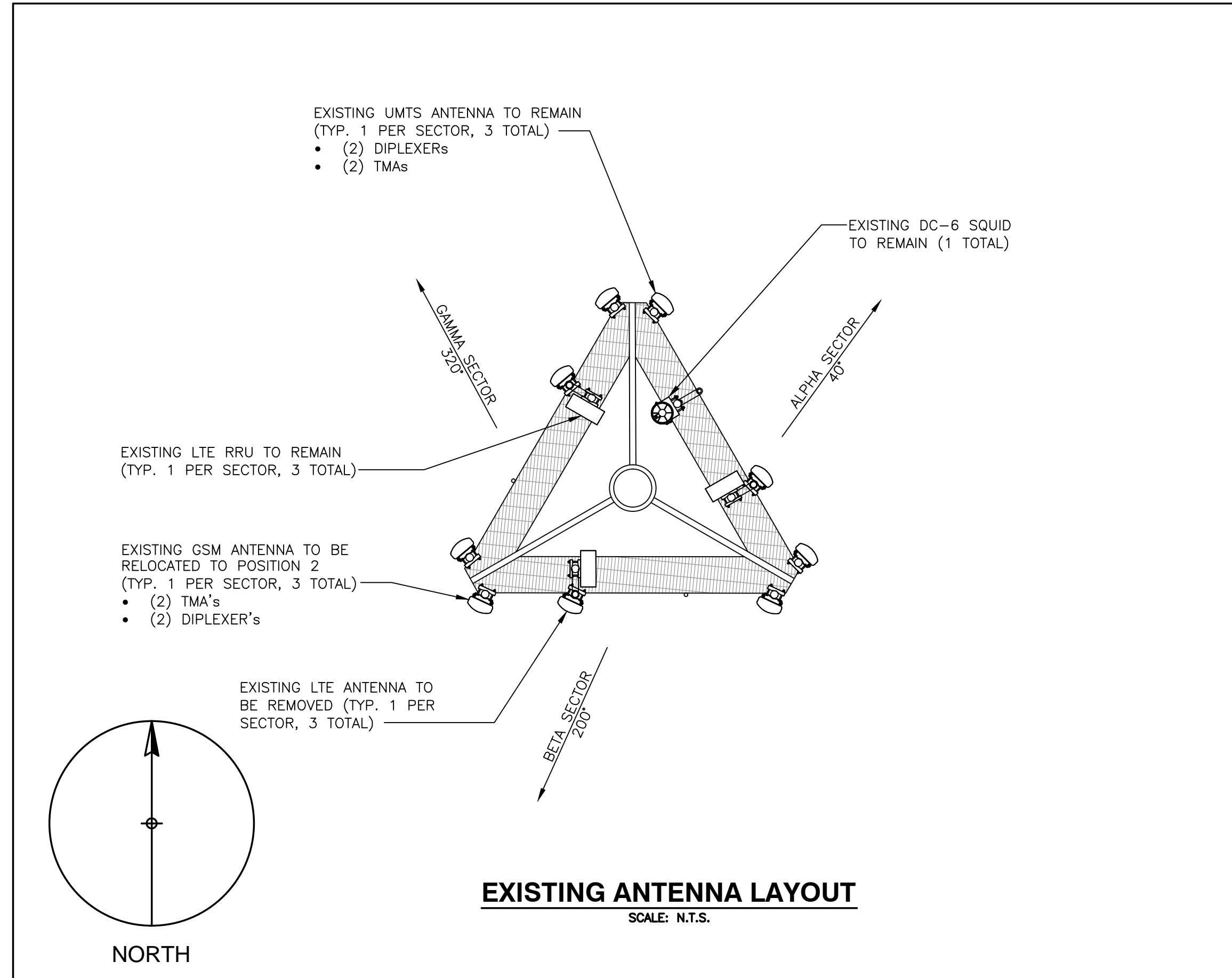

COM-EX
Consultants
115 ROUTE 46
SUITE E39
MOUNTAIN LAKES, NJ 07046
PHONE: 862.209.4300
FAX: 862.209.4301

EMPIRE
telecom
16 ESQUIRE ROAD
BILLERICA, MA 01821

SITE NUMBER: CT1142
SITE NAME: MIDDLETOWN SW
290 PRESTON AVENUE
MIDDLETOWN, CT 06457
MIDDLESEX COUNTY

at&t
MOBILITY
550 COCHITUATE ROAD
FRAMINGHAM, MA 01701

0	12/10/15	ISSUED AS FINAL	NJM	NDB	NDB
NO.	DATE	REVISIONS	BY	CHK	APP'D
SCALE: AS SHOWN		DESIGNED BY: NJM	DRAWN BY: NJM		

SEAL:
STATE OF CONNECTICUT
PROFESSIONAL ENGINEER
CT LICENSE NO. 28643

AT&T
DRAWING TITLE:
ANTENNA LAYOUTS & ELEVATIONS
JOB NUMBER: 15109-EMP
DRAWING NUMBER: A-3
REV: 0

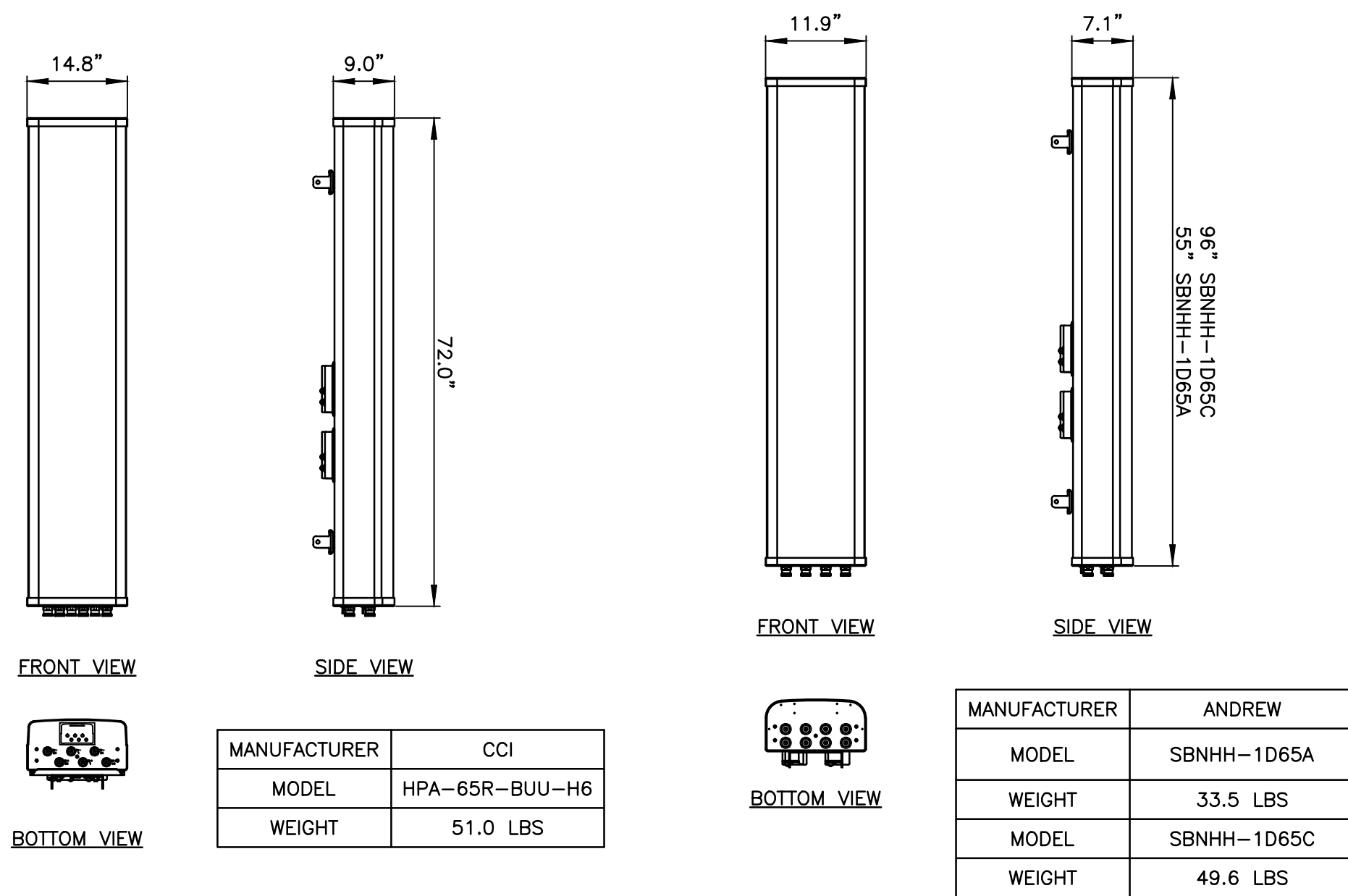

LTE ANTENNA DETAIL
SCALE: N.T.S.

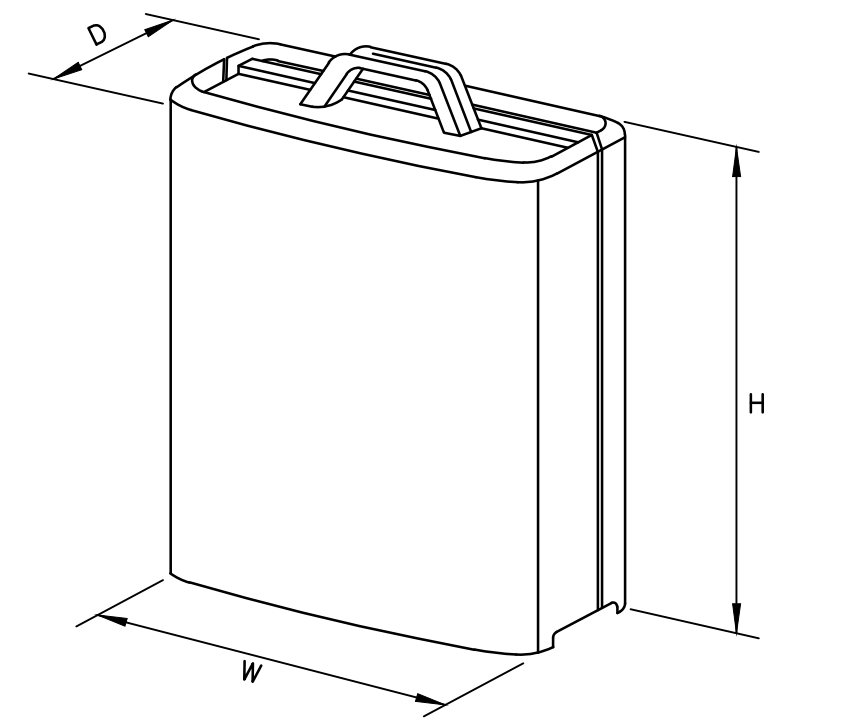

MODEL	L x W x H	WEIGHT
*RRUS-11	19.69" x 16.97" x 7.17"	50.7 LBS
RRUS-12	20.4"x18.5"x7.5"	58 LBS

*DENOTES EXISTING.

RRUS DETAIL
SCALE: N.T.S.

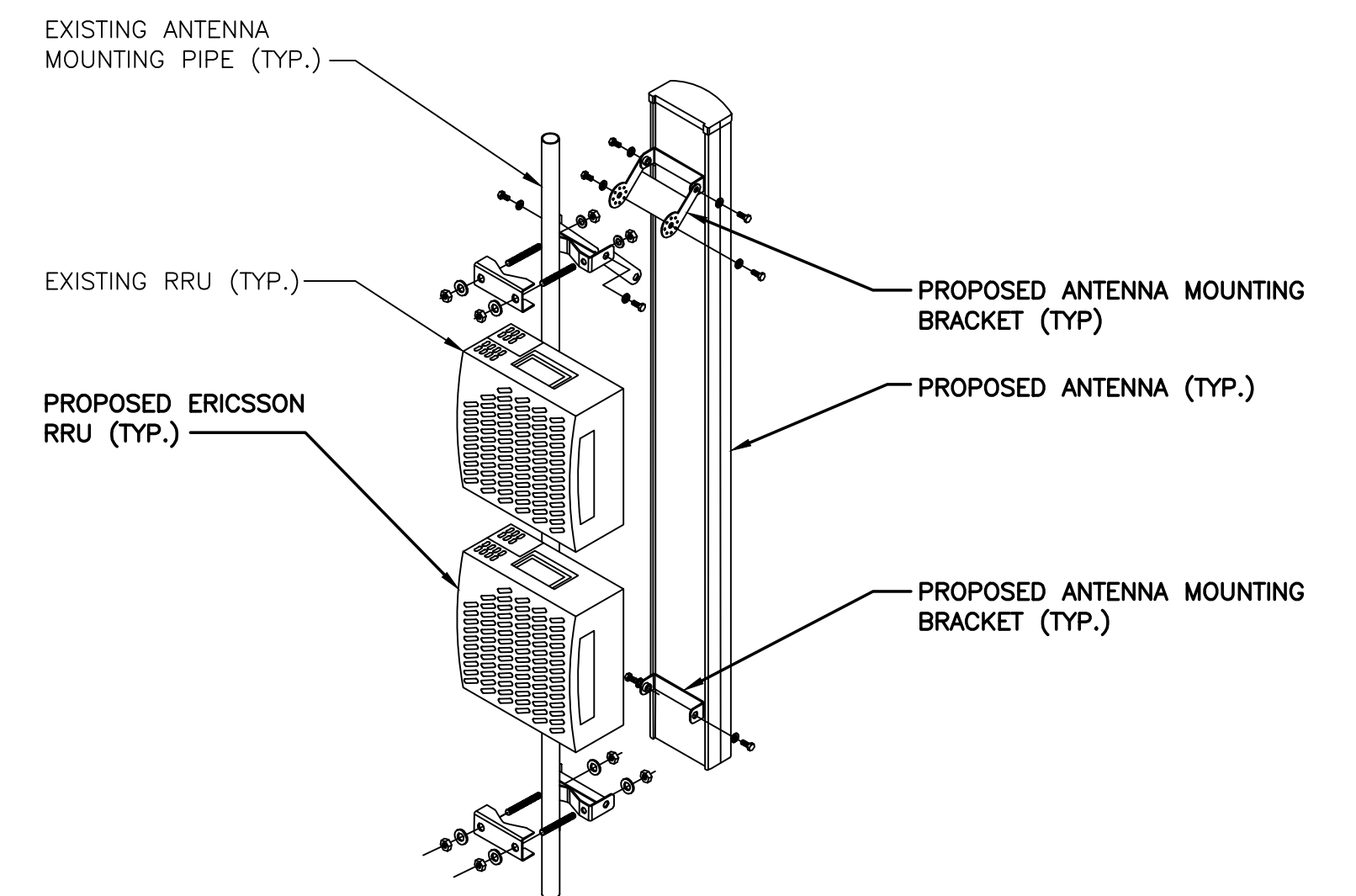

ANTENNA AND RRU MOUNTING DETAIL
SCALE: N.T.S.

EXISTING ANTENNA SCHEDULE

SECTOR	POSITION	MAKE	MODEL	SIZE (INCHES)
ALPHA	A1	POWERWAVE	7770.00.850.10	55"x11"x5"
	A2	-	-	-
	A3	KMW	AM-X-CD-16-65-00T-RET	72"x11.8"x5.9"
	A4	POWERWAVE	7770.00.850.10	55"x11"x5"
BETA	B1	POWERWAVE	7770.00.850.10	55"x11"x5"
	B2	-	-	-
	B3	KMW	AM-X-CD-14-65-00T-RET	48"x11.8"x5.9"
	B4	POWERWAVE	7770.00.850.10	55"x11"x5"
GAMMA	G1	POWERWAVE	7770.00.850.10	55"x11"x5"
	G2	-	-	-
	G3	KMW	AM-X-CD-14-65-00T-RET	48"x11.8"x5.9"
	G4	POWERWAVE	7770.00.850.10	55"x11"x5"

FINAL ANTENNA SCHEDULE

SECTOR	POSITION	MAKE	MODEL	SIZE (INCHES)
ALPHA	A1	POWERWAVE	7770.00.850.10	55"x11"x5"
	A2	POWERWAVE	7770.00.850.10	55"x11"x5"
	A3	-	-	-
	A4	CCI	HPA-65R-BUU-H6	72"x14.8"x9"
BETA	B1	POWERWAVE	7770.00.850.10	55"x11"x5"
	B2	POWERWAVE	7770.00.850.10	55"x11"x5"
	B3	-	-	-
	B4	ANDREW	SBNHH-1D65C	96"x11.9"x7.1"
GAMMA	G1	POWERWAVE	7770.00.850.10	55"x11"x5"
	G2	POWERWAVE	7770.00.850.10	55"x11"x5"
	G3	-	-	-
	G4	ANDREW	SBNHH-1D65A	55"x11.9"x7.1"

PROPOSED RRU SCHEDULE

SECTOR	MAKE	MODEL	SIZE (INCHES)	ADDITIONAL COMPONENT	SIZE (INCHES)
ALPHA	ERICSSON	RRUS-12	20.4"x18.5"x9.5"	A2 MODULE	-
	ERICSSON	RRUS-11 (EXISTING)	19.7"x16.9"x7.2"	-	-
	-	-	-	-	-
BETA	ERICSSON	RRUS-12	20.4"x18.5"x9.5"	A2 MODULE	-
	ERICSSON	RRUS-11 (EXISTING)	19.7"x16.9"x7.2"	-	-
	-	-	-	-	-
GAMMA	ERICSSON	RRUS-12	20.4"x18.5"x9.5"	A2 MODULE	-
	ERICSSON	RRUS-11 (EXISTING)	19.7"x16.9"x7.2"	-	-
	-	-	-	-	-

PROJECT OWNER IS RESPONSIBLE FOR PROVIDING A STRUCTURAL STABILITY ANALYSIS TO DETERMINE THE CAPACITY AND SUITABILITY OF THE EXISTING ANTENNA SUPPORT STRUCTURE TO SAFELY CARRY ALL ADDITIONAL LOADS IMPOSED BY THE PROPOSED EQUIPMENT AS SHOWN HEREIN. GENERAL CONTRACTOR SHALL BE RESPONSIBLE FOR INCORPORATING ANY REQUIRED STRUCTURAL MODIFICATIONS INTO THEIR SCOPE OF WORK.

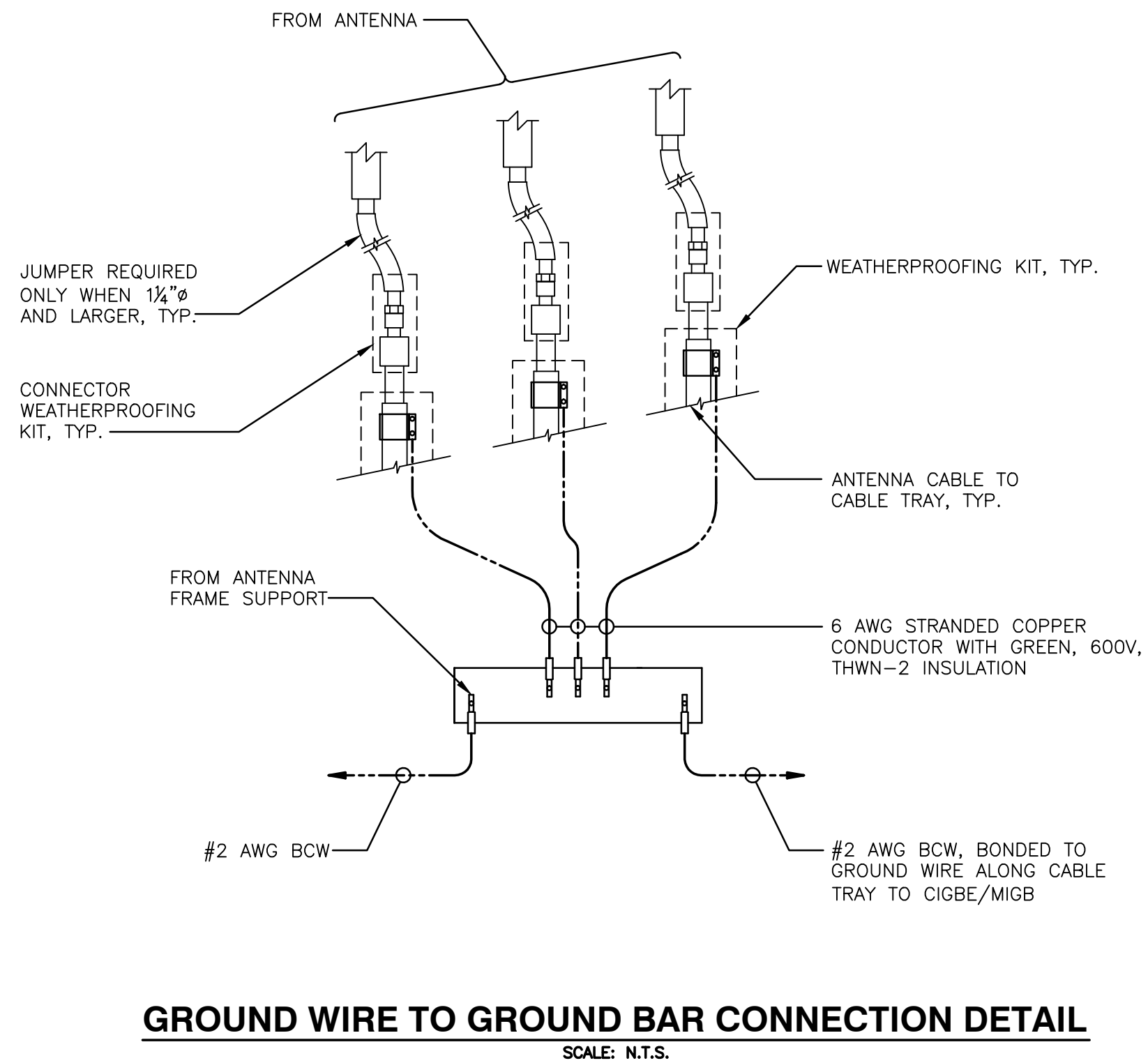

GROUND WIRE TO GROUND BAR CONNECTION DETAIL
SCALE: N.T.S.

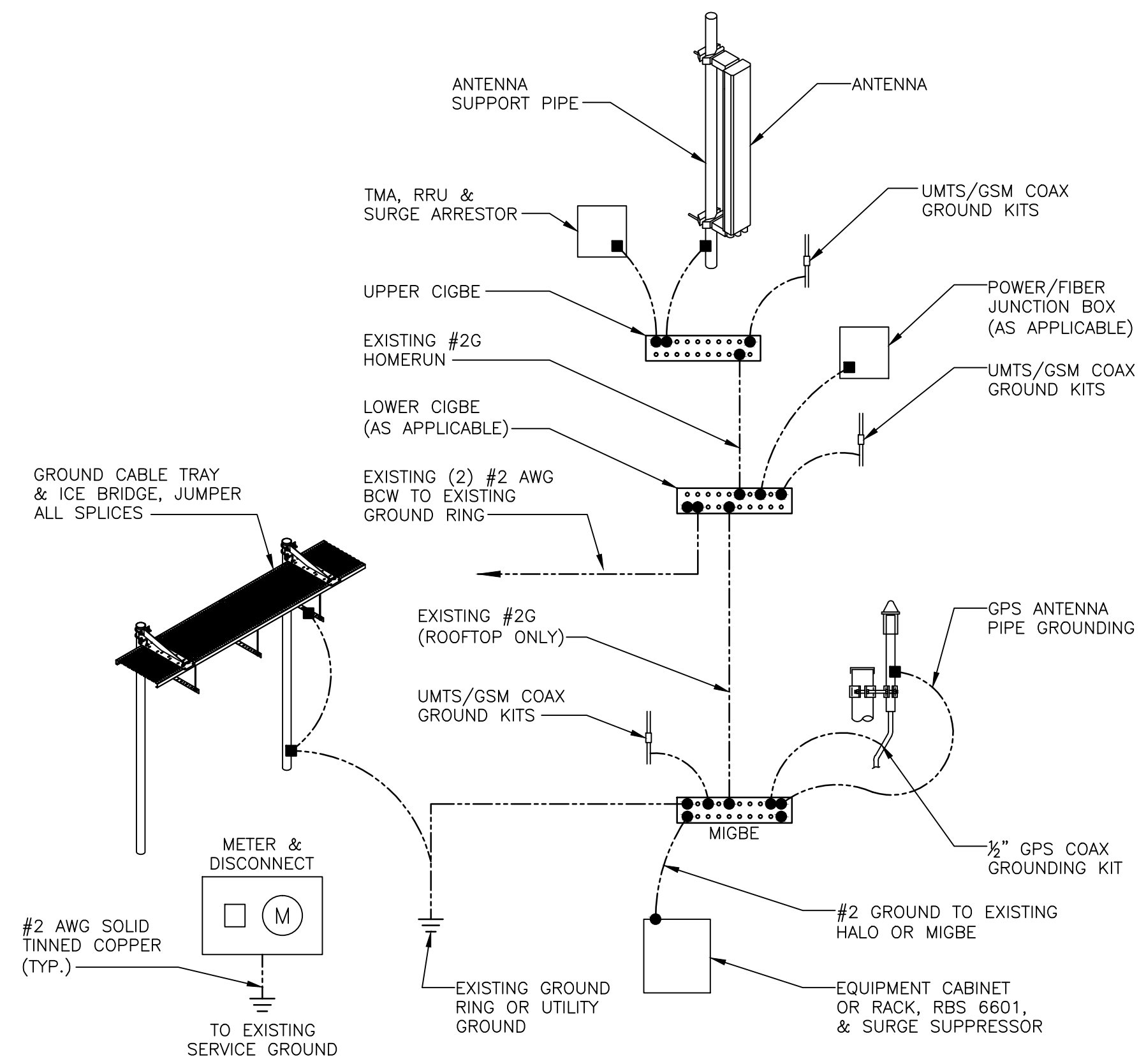

GROUNDING RISER DIAGRAM
SCALE: N.T.S.

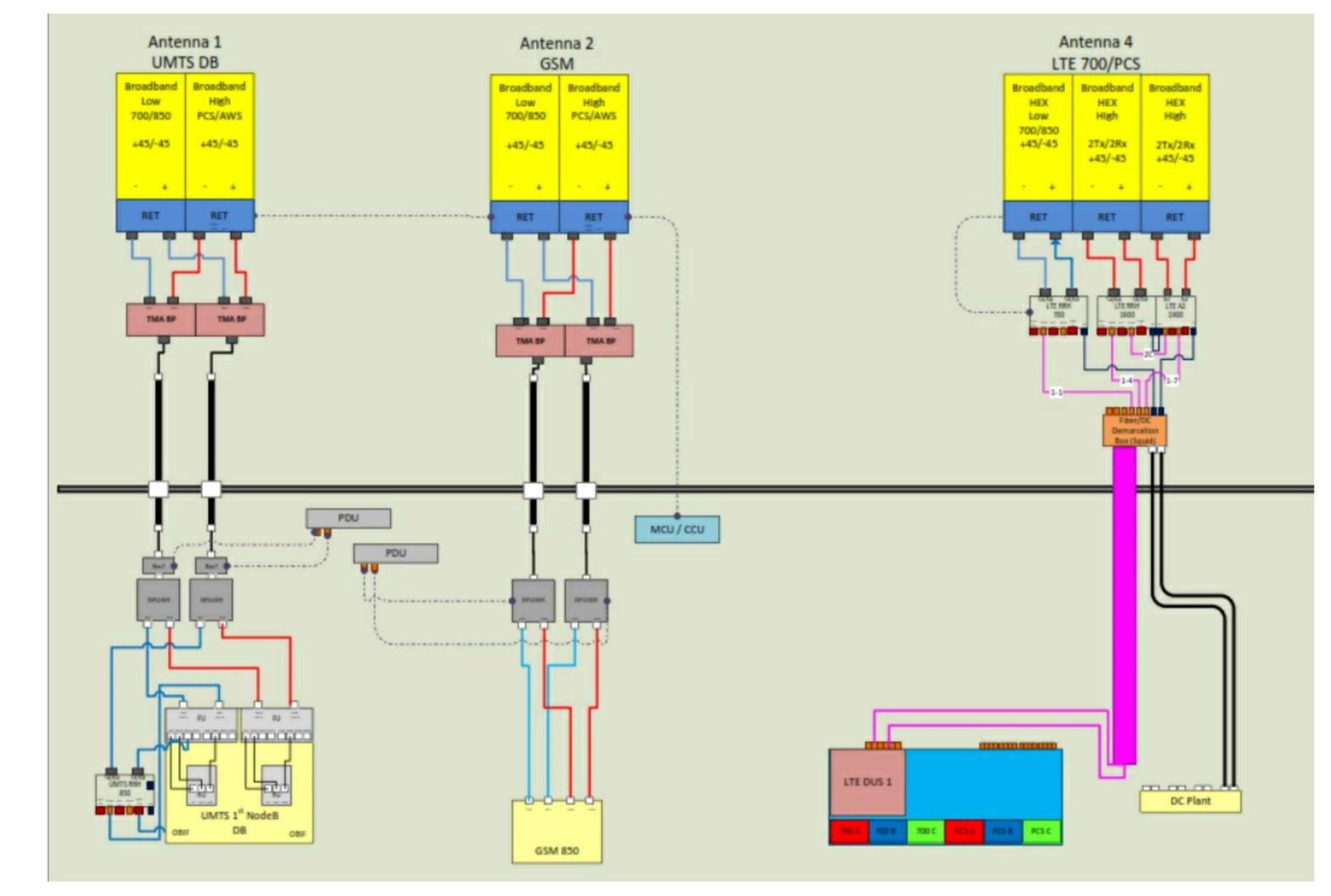

TYPICAL PLUMBING DIAGRAM (PER SECTOR)
SCALE: N.T.S.

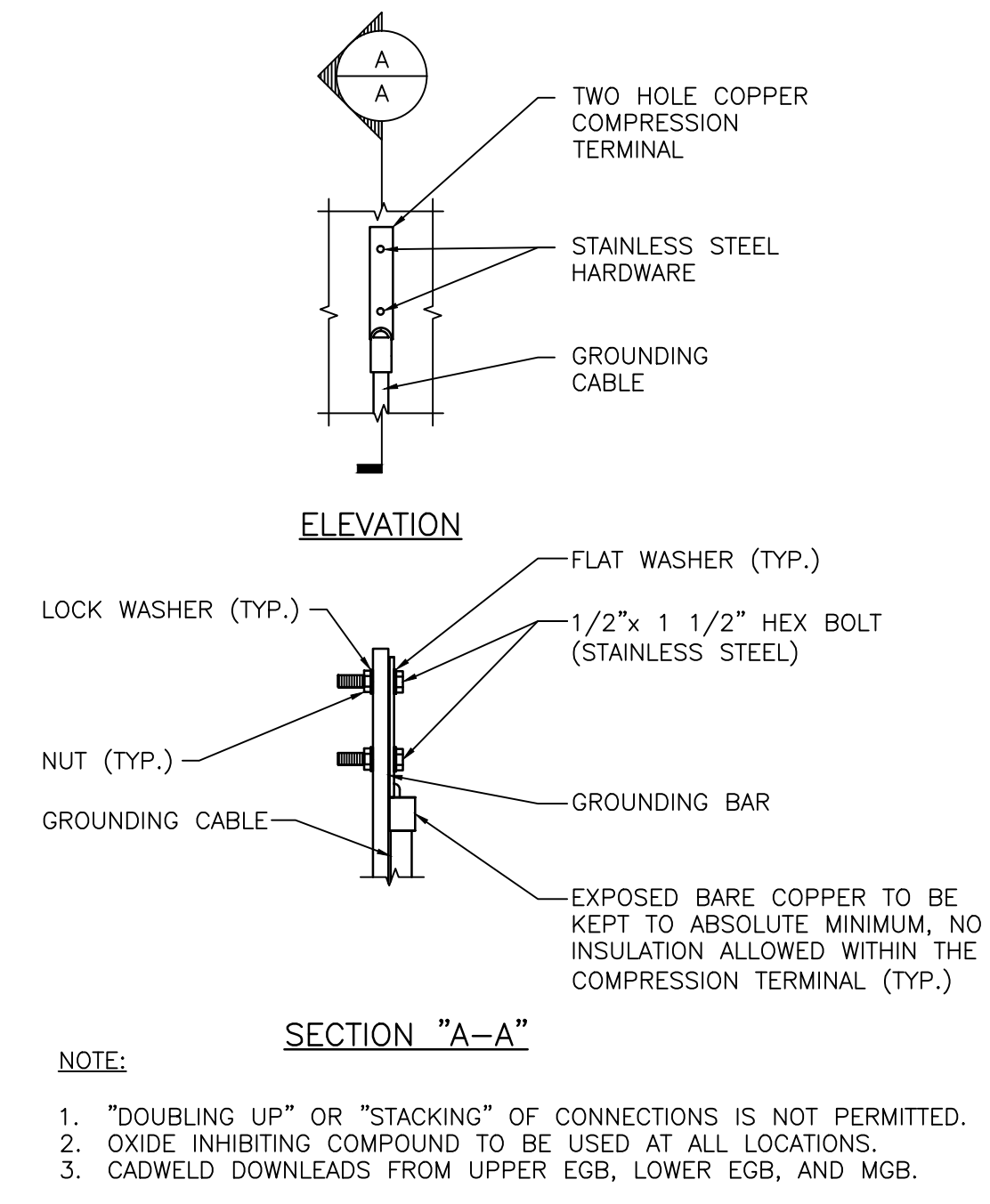

TYPICAL GROUND BAR CONNECTION DETAIL
SCALE: N.T.S.

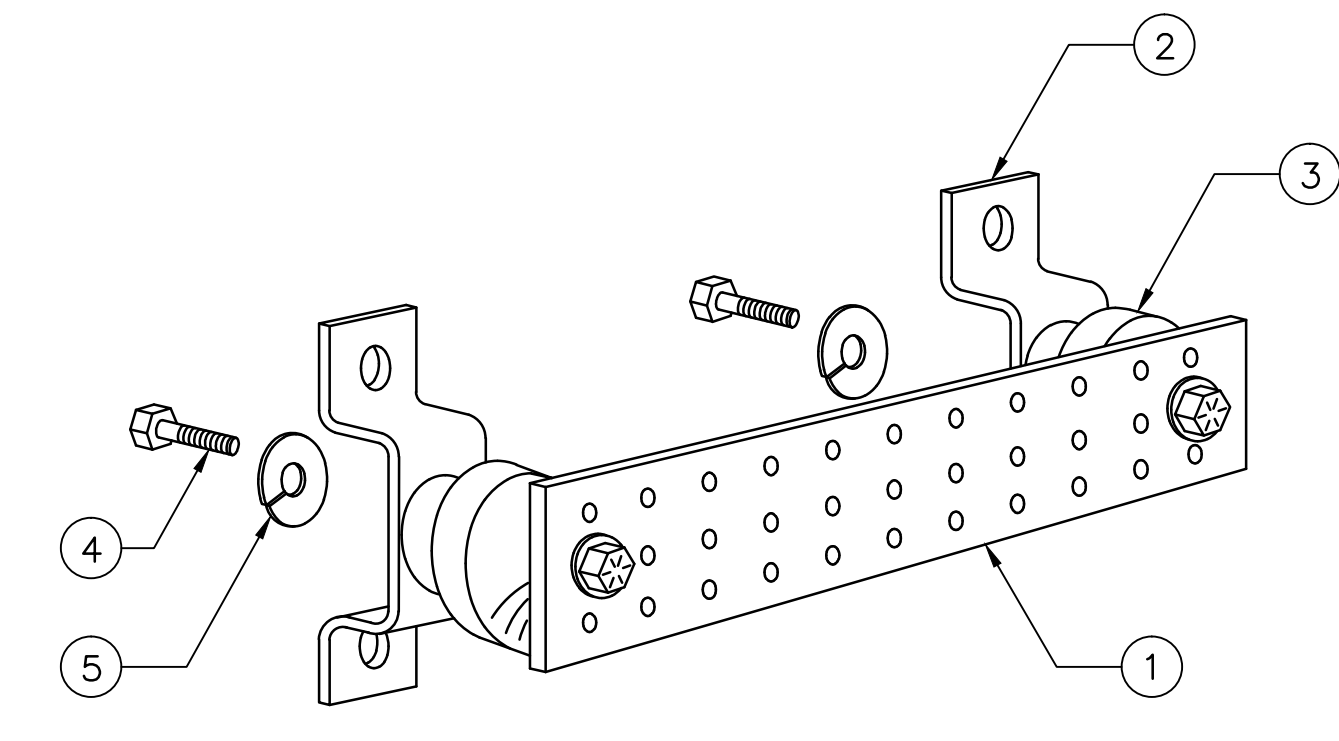

ITEM NO.	QTY.	DESCRIPTION
1	1	SOLID GROUND BAR (20"x 4"x 1/4")
2	2	WALL MOUNTING BRACKET
3	2	INSULATORS
4	4	5/8"-11x1" H.H.C.S.
5	4	5/8" LOCK WASHER

GROUND BAR DETAIL
SCALE: N.T.S.

NOTES:

EACH GROUND CONDUCTOR TERMINATING ON ANY GROUND BAR SHALL HAVE AN IDENTIFICATION TAG ATTACHED AT EACH END THAT WILL IDENTIFY ITS ORIGIN AND DESTINATION

SECTION "P" - SURGE PRODUCERS

- CABLE ENTRY PORTS (HATCH PLATES) (#2)
- GENERATOR FRAMEWORK (IF AVAILABLE) (#2)
- TELCO GROUND BAR
- COMMERCIAL POWER COMMON NEUTRAL/GROUND BOND (#2)
- +24V POWER SUPPLY RETURN BAR (#2)
- -48V POWER SUPPLY RETURN BAR (#2)
- RECTIFIER FRAMES

SECTION "A" - SURGE ABSORBERS

- INTERIOR GROUND RING (#2)
- EXTERNAL EARTH GROUND FIELD (BURIED GROUND RING) (#2)
- METALLIC COLD WATER PIPE (IF AVAILABLE) (#2)
- BUILDING STEEL (IF AVAILABLE) (#2)



Centerline Communications

95 Ryan Drive, Suite 1
Raynham, MA 02767

December 29, 2015

B+T GRP

1717 S. Boulder, Suite 300
Tulsa, OK 74119

B+T No.: 103655.001.01

**STRUCTURAL ANALYSIS
148' Monopole Tower**

AT&T DESIGNATION:	Site ID:	14635
	Site FA:	10035088
	Site Name:	Middletown SW
	AT&T Project:	MOD LTE ADD_11-23-2015

ANALYSIS CRITERIA:	Codes:	TIA/EIA-222-F (85 mph fastest mile) IBC 2006
--------------------	--------	---

SITE DATA:	290 Preston Avenue, Middletown, CT, Middlesex County Latitude 41.557353°, Longitude -72.743277° Market MA/RI/VT/NH/ME/CT
------------	--

Mr. Michael Gentile,

B+T Group is pleased to submit this Structural Analysis Report to determine the structural integrity of the aforementioned tower. The purpose of the analysis is to determine the suitability of the tower with the existing and proposed loading configuration detailed in the analysis report.

Analysis Results

Tower Stress Level with Proposed Equipment:	83.9%	Pass
Foundation Ratio with Proposed Equipment:	85.9%	Pass

We at B+T Group appreciate the opportunity of providing our continuing professional services to you and Centerline Communications. If you have any questions or need further assistance on this or any other project please give us a call.

Respectfully Submitted by:	B+T Group
Analysis Prepared by:	Leena Kantheti, E.I.T.
Analysis Reviewed by:	Chad E. Tuttle, P.E. COA: PEC.0001564 Exp: 2/10/2016

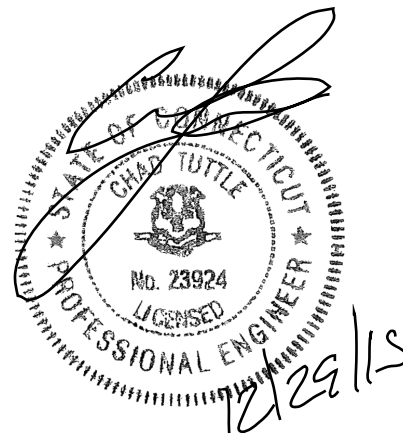

ANALYSIS RESULTS:

Table 1 - Section Capacity (Summary)

Elevation (ft)	% Capacity	Pass / Fail
148 - 111	51.8	Pass
111 - 99.333	81.9	Pass
99.333 - 90.5	83.9	Pass
90.5 - 75	76.5	Pass
75 - 60.5	83.8	Pass
60.5 - 39.75	79.3	Pass
39.75 - 30.5	79.3	Pass
30.5 - 0	83.2	Pass

Table 2 - Tower Component Stresses vs. Capacity

Notes	Component	Elevation (ft)	% Capacity	Pass / Fail
1	Anchor Rods	Base	82.9	Pass
1	Base Plate	Base	74.2	Pass
1	Base Foundation	Base	85.9	Pass

Structure Rating (max from all components) =	85.9%
---	--------------

Notes:

- 1) See additional documentation in "Appendix B - Calculations" for calculation supporting the % capacity consumed.

Recommendations:

N/A

ANALYSIS PROCEDURE:

Table 3 - Documents Provided

Document	Description	Date	Source
Tower Data	PennSummit/PJF Project # 29201-0230	2/26/2000	Siterra
Foundation Information	PennSummit/PJF Project # 29201-0230	2/26/2000	Siterra
Geotech Report	Dr. Clarence Welti, P.E., P.C.	7/25/2000	Siterra
Loading	B+T Project 86667.007.01; Sprint Legacy Removal 8/27/14	9/10/2014	On File
	Equipment Modification Form; MOD LTE ADD_11-23-2015	11/30/2015	Siterra
Previous Structural Analysis	B+T Project 86667.007.01; Sprint Legacy Removal 8/27/14	9/10/2014	On File
	B+T Project 86667.003.01b; 4_T-Mobile Modification 9-18-13	7/18/2014	On File
	B+T Project 86667.003.01; 4_Verizon PRE-NTP MOD - 2-17-14	4/1/2014	On File
Modification Documents	B+T Project 84934.003.00; 1_MOD LTE 6-15-12	11/8/2012	On File

ANALYSIS METHOD:

tnxTower, a commercially available analysis software package, was used to create a three-dimensional model of the tower and calculate member stresses for various loading cases. Selected output from the analysis is included in Appendix B.

ASSUMPTIONS:

1. Tower and structures were built in accordance with the manufacturer's specifications.
2. The tower and structures have been maintained in accordance with the manufacturer's specifications.
3. The configuration of antennas, transmission cables, mounts and other appurtenances are as specified in Appendix A of this report.
4. Mount areas and weights are assumed based on photographs provided.
5. Refer to the base level drawing for transmission line distribution.
6. All the AT&T loading a was taken from the Equipment Modification Form.
7. All other existing/reserved loading was taken from the previous analysis unless otherwise noted.

If any of these assumptions have been made in error, B+T Group should be notified to determine the effect on the structural integrity of the tower.

APPENDIX A
TOWER ANALYSIS LOADING

APPENDIX B
CALCULATIONS

DESIGNED APPURTENANCE LOADING

TYPE	ELEVATION	TYPE	ELEVATION
Lighting Rod 5/8" x 8' (E)	152	1900MHz RRH (Sprint-E)	124
(2) 7770.00.850.10 w/ Mount Pipe (ATI-E)	148	1900MHz RRH (Sprint-E)	124
(2) 7770.00.850.05 w/ Mount Pipe (ATI-E)	148	800MHz RRH (Sprint-E)	124
(2) 7770.00.850.04 w/ Mount Pipe (ATI-E)	148	800MHz RRH (Sprint-E)	124
(4) LGP21401 (ATI-E)	148	(3) 6' x 2" Mount Pipe (Sprint-E)	124
(4) LGP21401 (ATI-E)	148	(3) 6' x 2" Mount Pipe (Sprint-E)	124
(4) LGP21401 (ATI-E)	148	(3) 6' x 2" Mount Pipe (Sprint-E)	124
RRUS-11 (ATI-E)	148	Platform Mount [LP 1201-1] (Sprint-E)	124
RRUS-11 (ATI-E)	148	BXA-70063-6CF w/ Mount Pipe (E - Verizon)	110
RRUS-11 (ATI-E)	148	LNx-6514DS-T4M w/ Mount Pipe (E - Verizon)	110
DC6-48-60-18-8F (ATI-E)	148	BXA-70063-6CF w/ Mount Pipe (E - Verizon)	110
HPA-65R-BUU-H6 w/ Mount Pipe (ATI-P)	148	(2) FD9R6004/2C-3L (E - Verizon)	110
SBNHH-1D65C w/ Mount Pipe (ATI-P)	148	(2) FD9R6004/2C-3L (E - Verizon)	110
SBNHH-1D65A w/ Mount Pipe (ATI-P)	148	(2) FD9R6004/2C-3L (E - Verizon)	110
RRUS-12 (ATI-P)	148	HBX-6517DS-VTM w/ Mount Pipe (E - Verizon)	110
RRUS-12 (ATI-P)	148	HBX-6517DS-VTM w/ Mount Pipe (E - Verizon)	110
RRUS-12 (ATI-P)	148	HBX-6517DS-VTM w/ Mount Pipe (E - Verizon)	110
RRUS A2 MODULE (ATI-P)	148	HBX-6517DS-VTM w/ Mount Pipe (E - Verizon)	110
RRUS A2 MODULE (ATI-P)	148	LNx-6513DS-VTM w/ Mount Pipe (E - Verizon)	110
RRUS A2 MODULE (ATI-P)	148	LNx-6513DS-VTM w/ Mount Pipe (E - Verizon)	110
5' x 2" Pipe Mount (ATI-E)	148	LNx-6513DS-VTM w/ Mount Pipe (E - Verizon)	110
5' x 2" Pipe Mount (ATI-E)	148	LNx-6513DS-VTM w/ Mount Pipe (E - Verizon)	110
Platform Mount [LP 1201-1] (ATI-E)	148	LNx-6513DS-VTM w/ Mount Pipe (E - Verizon)	110
(2) AIR 21 w/ Mount Pipe (T-Mobile-E)	140	HBX-6516DS-VTM w/ Mount Pipe (E - Verizon)	110
(2) AIR 21 w/ Mount Pipe (T-Mobile-E)	140	HBX-6516DS-VTM w/ Mount Pipe (E - Verizon)	110
(2) AIR 21 w/ Mount Pipe (T-Mobile-E)	140	HBX-6516DS-VTM w/ Mount Pipe (E - Verizon)	110
APX16DWV-16DWVS-C w/ Mount Pipe (T-Mobile-E)	140	RRH2X40-AWS (E - Verizon)	110
APX16DWV-16DWVS-C w/ Mount Pipe (T-Mobile-E)	140	RRH2X40-AWS (E - Verizon)	110
ONEBASE TWIN DUAL DUPLEX TMA (T-Mobile-E)	140	RRH2X40-AWS (E - Verizon)	110
ONEBASE TWIN DUAL DUPLEX TMA (T-Mobile-E)	140	DB-T1-6Z-8AB-0Z (E - Verizon)	110
ONEBASE TWIN DUAL DUPLEX TMA (T-Mobile-E)	140	Platform Mount [LP 1201-1] (E - Verizon)	110
6' x 2" Mount Pipe (T-Mobile-E)	140	Collar Mount (E - Verizon)	110
(2) 6' x 2" Mount Pipe (T-Mobile-E)	140	6'x6"x4" Panel (E - Metro PCS)	90
6' x 2" Mount Pipe (T-Mobile-E)	140	6'x6"x4" Panel (E - Metro PCS)	90
Platform Mount [LP 1201-1] (T-Mobile-E)	140	6'x6"x4" Panel (E - Metro PCS)	90
APXVSP18-C-A20 w/ Mount Pipe (Sprint-E)	124	Pipe Mount [PM 601-3] (E - Metro PCS)	90
APXVSP18-C-A20 w/ Mount Pipe (Sprint-E)	124	GPS (E - Metro PCS)	55
APXVSP18-C-A20 w/ Mount Pipe (Sprint-E)	124	Side Arm Mount [SO 702-1] (E - Metro PCS)	55
APXVSP18-C-A20 w/ Mount Pipe (Sprint-E)	124	GPS (E)	50
1900MHz RRH (Sprint-E)	124	Side Arm Mount [SO 702-1] (E)	50

MATERIAL STRENGTH

GRADE	Fy	Fu	GRADE	Fy	Fu
A607-65	65 ksi	80 ksi	57.702715ksi	58 ksi	73 ksi
54.757069ksi	55 ksi	70 ksi	57.819474ksi	58 ksi	73 ksi
56.46673ksi	56 ksi	71 ksi	58.384266ksi	58 ksi	73 ksi
56.586767ksi	57 ksi	72 ksi			

TOWER DESIGN NOTES

- Tower is located in Middlesex County, Connecticut.
- Tower designed for a 85 mph basic wind in accordance with the TIA/EIA-222-F Standard.
- Tower is also designed for a 38 mph basic wind with 0.75 in ice. Ice is considered to increase in thickness with height.
- Deflections are based upon a 50 mph wind.
- TOWER RATING: 83.9%

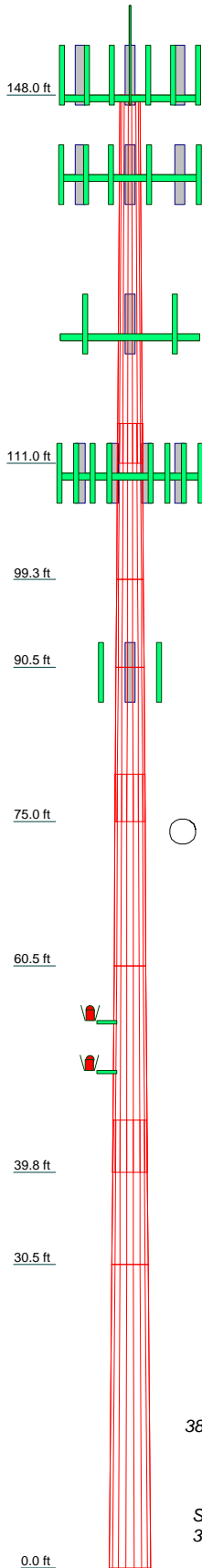

Section	Length (ft)	Number of Sides	Thickness (in)	Socket Length (ft)	Top Dia (in)	Bot Dia (in)	Grade	Weight (K)
1	148.000	18	0.250	4.000	24.000	30.661	A607-65	2.7
2	15.667	18	0.250	29.441	32.262	30.661	A607-65	1.3
3	8.833	18	0.342	33.852	33.852	30.661	A607-65	1.0
4	15.500	18	0.422	4.750	33.852	36.643	54.757069ksi	2.3
5	19.250	18	0.471	36.288	38.753	36.643	56.46673ksi	3.4
6	20.750	18	0.537	5.250	36.753	42.489	56.586767ksi	4.6
7	14.500	18	0.589	40.919	43.529	43.529	57.702715ksi	3.7
8	30.500	18	0.603	43.529	49.020	56.384266ksi	57.819474ksi	8.7
								27.8

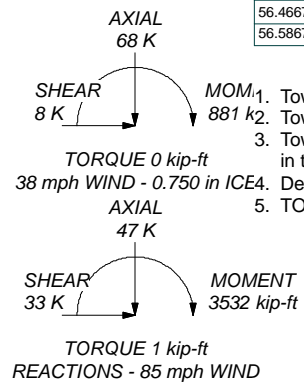



B+T Group
1717 S. Boulder, Suite 300
Tulsa, OK 74119
Phone: (918) 587-4630
FAX: (918) 295-0265

Job: **103655.001.01 - Middletown, CT (USID# 14633)**

Project: **MOD LTE ADD_11-23-2015**

Client: Centerline Communications | Drawn by: Ikanthet | App'd:

Code: TIA/EIA-222-F | Date: 12/29/15 | Scale: NTS

Path: | Dwg No. E-1

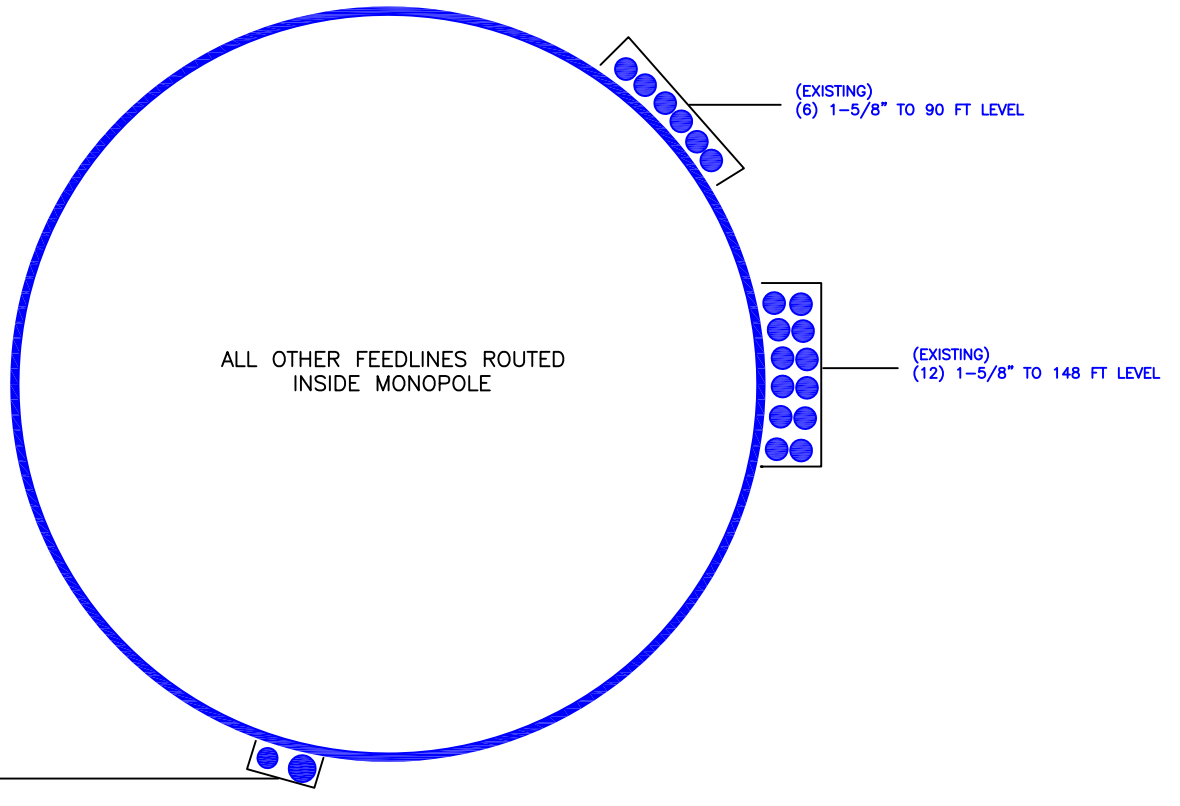



PROJECT NUMBER: 103655.001.01

Feed Line Distribution Chart

0' - 148'

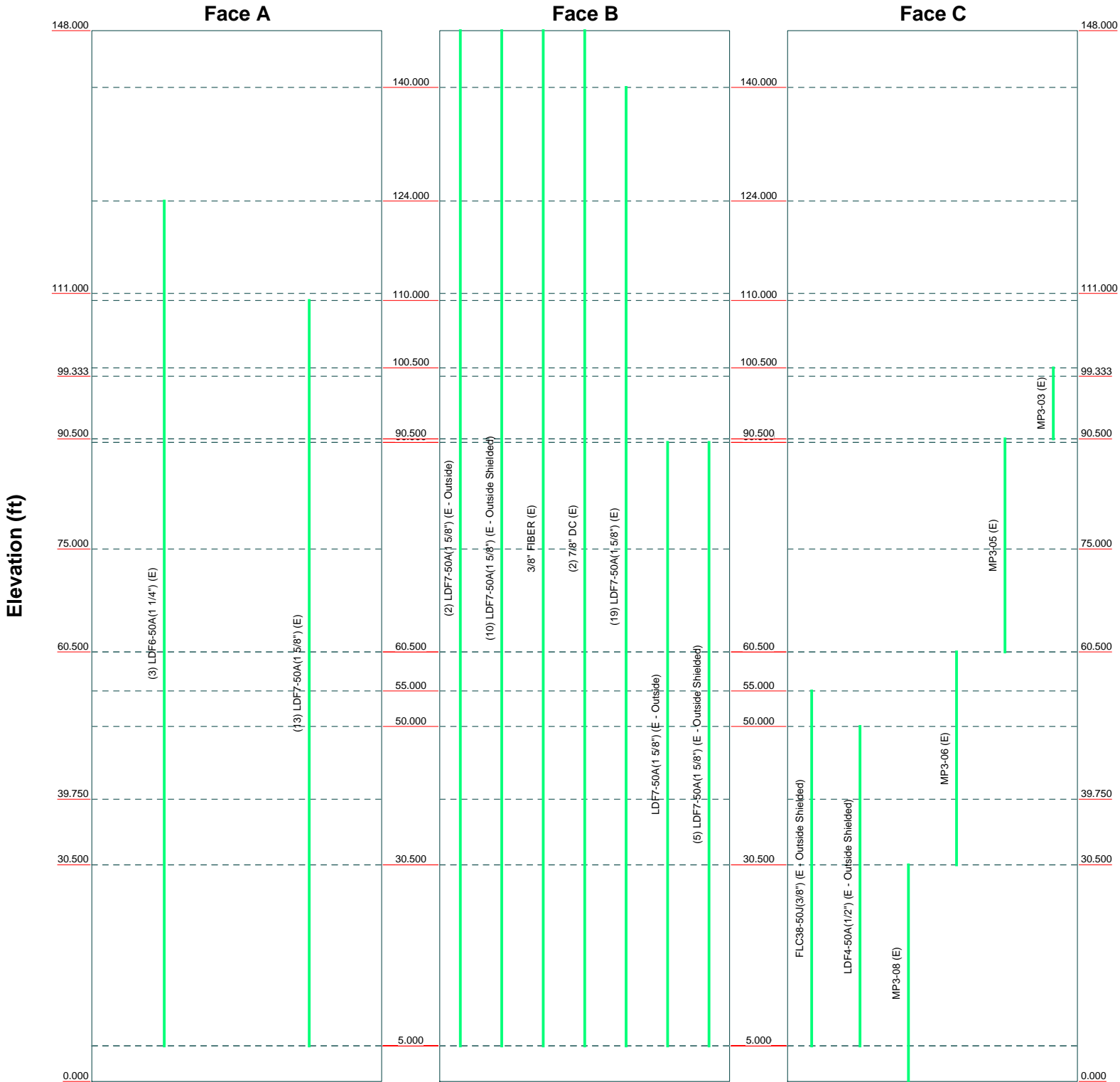
— Round
 — Flat
 — App In Face
 — App Out Face
 — Truss Leg



B+T Group
 1717 S. Boulder, Suite 300
 Tulsa, OK 74119
 Phone: (918) 587-4630
 FAX: (918) 295-0265

Job: 103655.001.01 - Middletown, CT (USID# 14633)		
Project: MOD LTE ADD_11-23-2015		
Client: Centerline Communications	Drawn by: Ikanthet	App'd:
Code: TIA/EIA-222-F	Date: 12/29/15	Scale: NTS
Path:		Dwg No. E-7

Vx

Vz

Mx

Mz

Global Mast Shear (K)

Global Mast Moment (kip-ft)

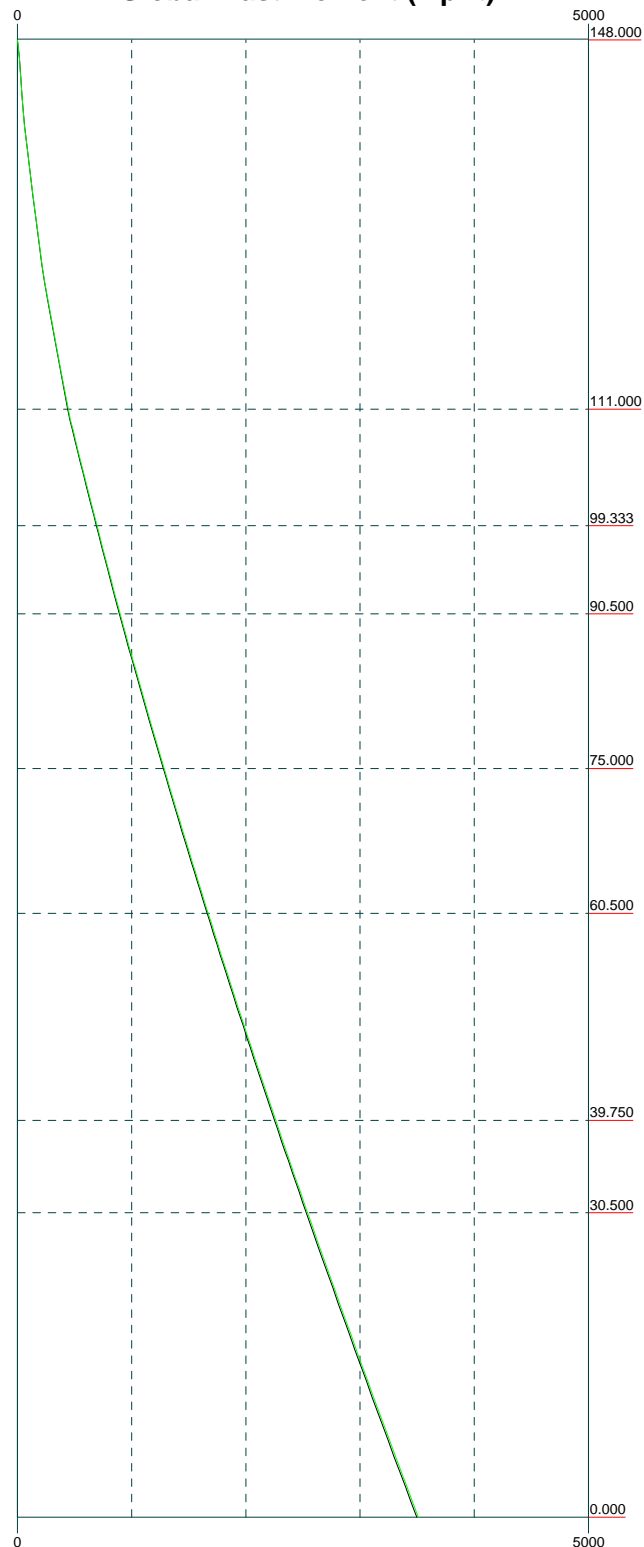
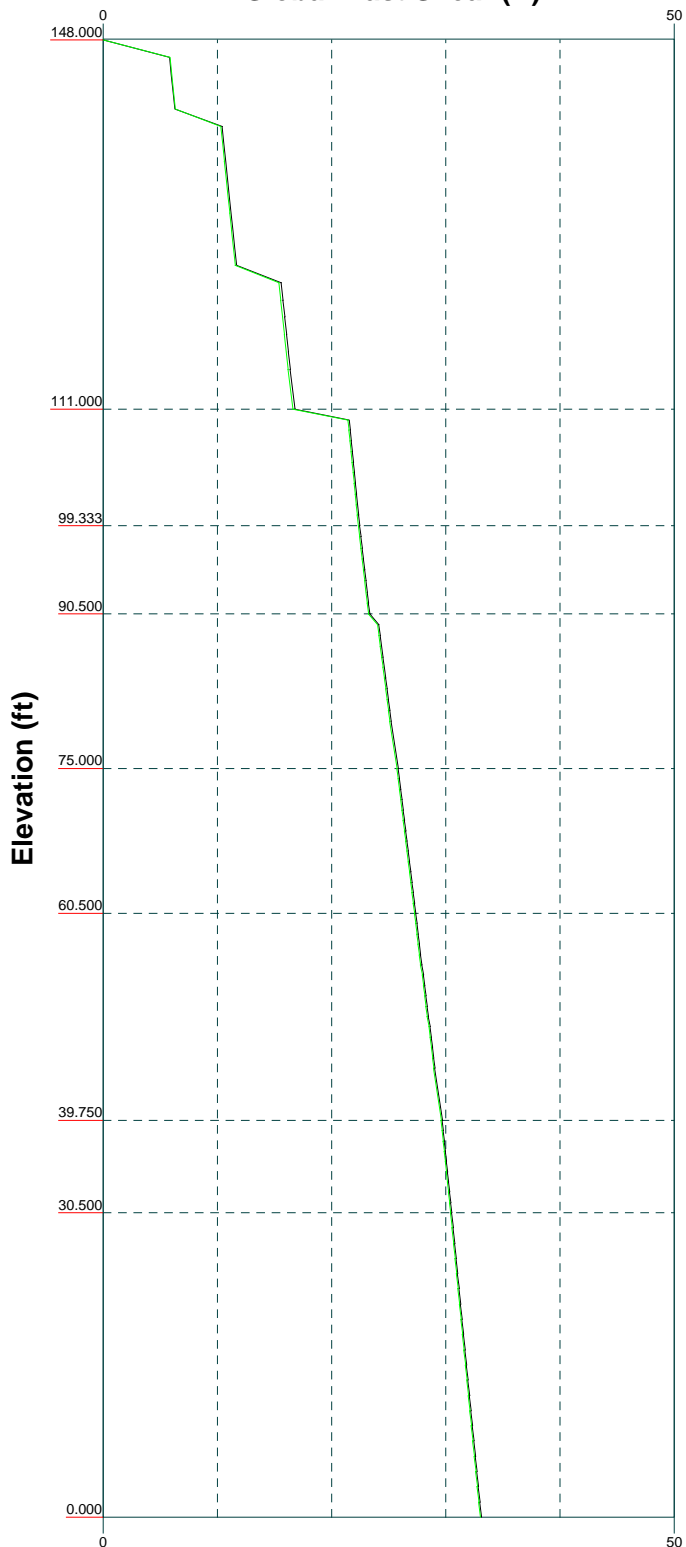

B+T Group
 1717 S. Boulder, Suite 300
 Tulsa, OK 74119
 Phone: (918) 587-4630
 FAX: (918) 295-0265

Job: 103655.001.01 - Middletown, CT (USID# 14633)		
Project: MOD LTE ADD_11-23-2015		
Client: Centerline Communications	Drawn by: lkanthet	App'd:
Code: TIA/EIA-222-F	Date: 12/29/15	Scale: NTS
Path:		Dwg No. E-4

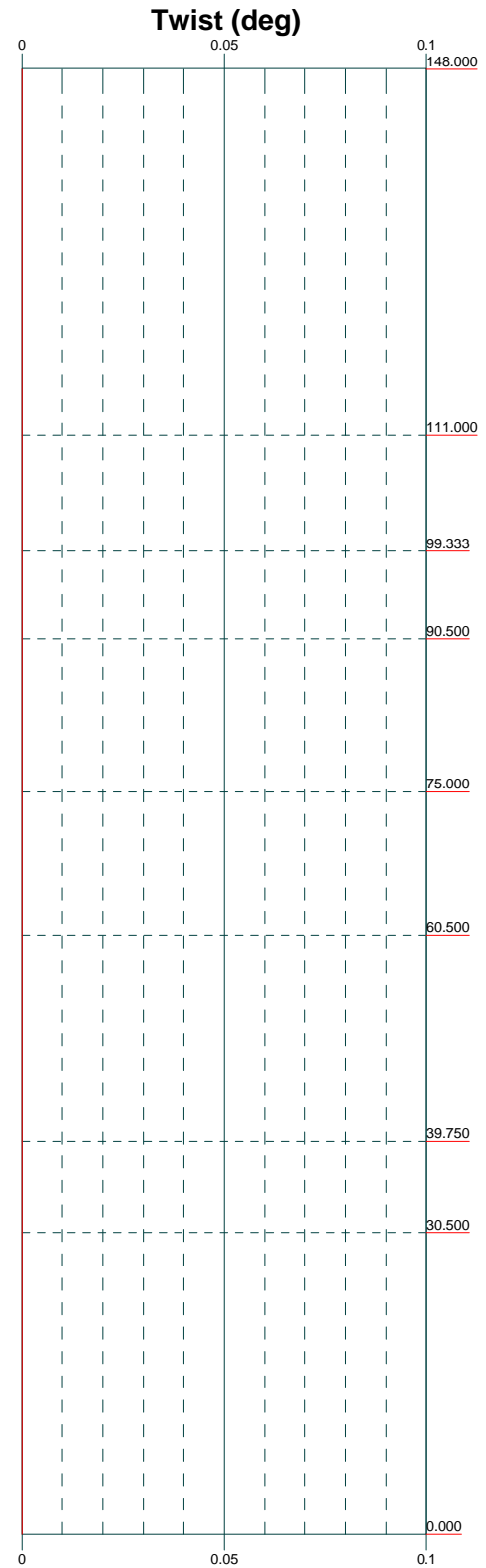
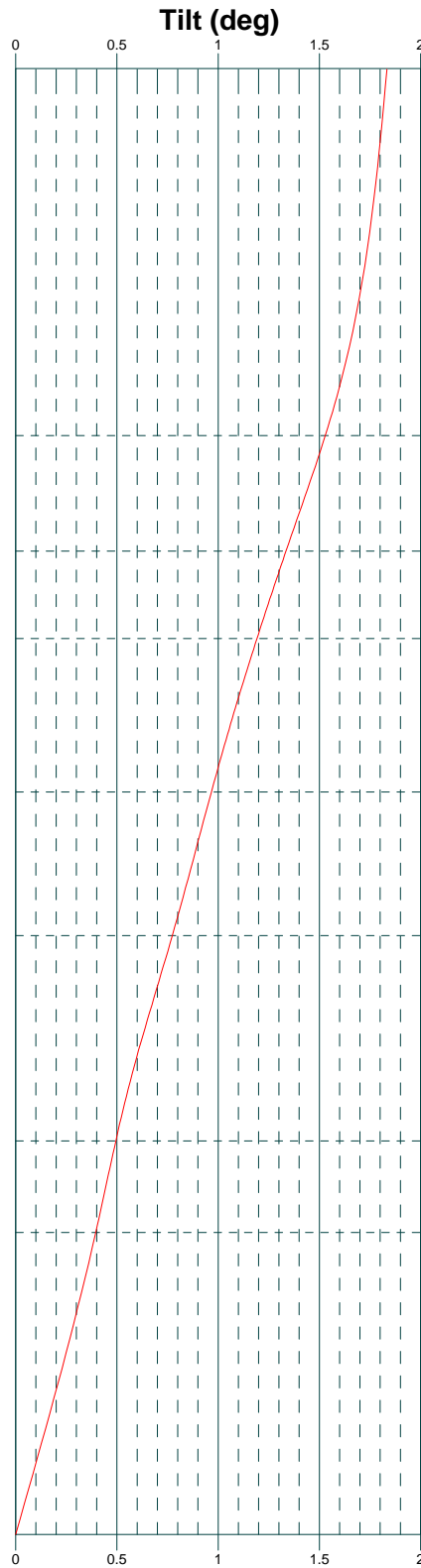
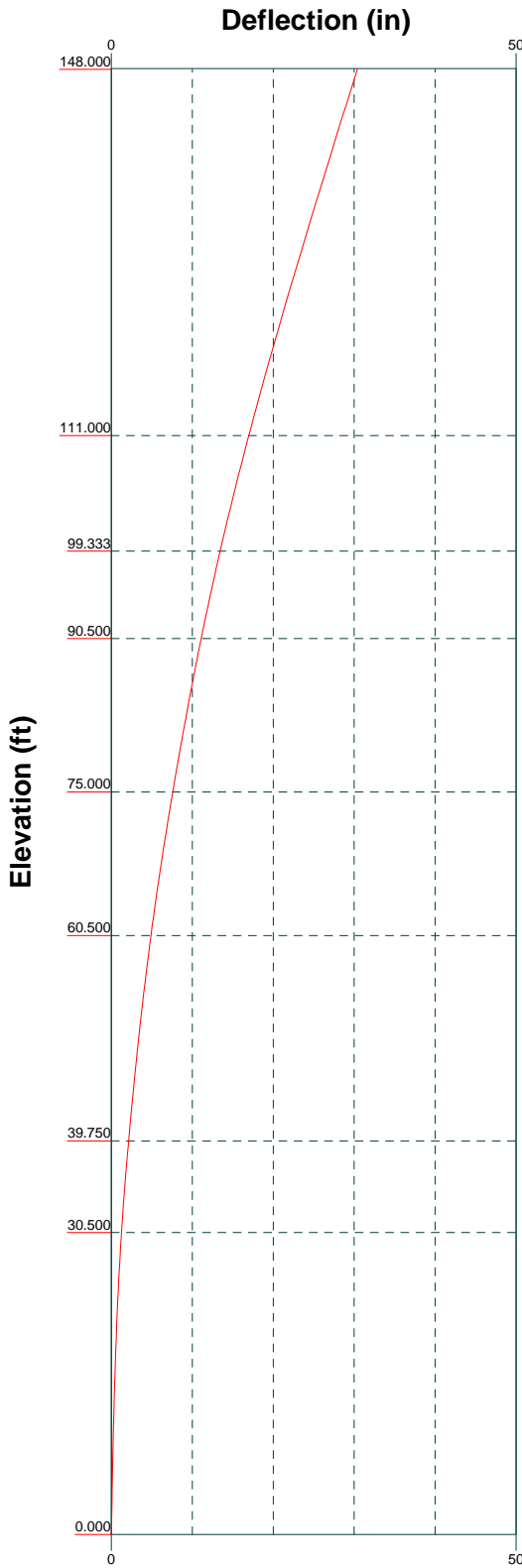

B+T Group
 1717 S. Boulder, Suite 300
 Tulsa, OK 74119
 Phone: (918) 587-4630
 FAX: (918) 295-0265

Job: 103655.001.01 - Middletown, CT (USID# 1463)		
Project: MOD LTE ADD_11-23-2015		
Client: Centerline Communications	Drawn by: lkanthet	App'd:
Code: TIA/EIA-222-F	Date: 12/29/15	Scale: NTS
Path:		Dwg No. E-5

tnxTower B+T Group 1717 S. Boulder, Suite 300 Tulsa, OK 74119 Phone: (918) 587-4630 FAX: (918) 295-0265	Job 103655.001.01 - Middletown, CT (USID# 14635)	Page 1 of 20
	Project MOD LTE ADD_11-23-2015	Date 13:23:29 12/29/15
	Client Centerline Communications	Designed by Ikantheti

Tower Input Data

There is a pole section.

This tower is designed using the TIA/EIA-222-F standard.

The following design criteria apply:

Tower is located in Middlesex County, Connecticut.

Basic wind speed of 85 mph.

Nominal ice thickness of 0.750 in.

Ice thickness is considered to increase with height.

Ice density of 56.000 pcf.

A wind speed of 38 mph is used in combination with ice.

Temperature drop of 50.000 °F.

Deflections calculated using a wind speed of 50 mph.

A non-linear (P-delta) analysis was used.

Pressures are calculated at each section.

Stress ratio used in pole design is 1.333.

Local bending stresses due to climbing loads, feed line supports, and appurtenance mounts are not considered.

Options

<ul style="list-style-type: none"> Consider Moments - Legs Consider Moments - Horizontals Consider Moments - Diagonals Use Moment Magnification √ Use Code Stress Ratios √ Use Code Safety Factors - Guys √ Escalate Ice Always Use Max Kz Use Special Wind Profile Include Bolts In Member Capacity Leg Bolts Are At Top Of Section Secondary Horizontal Braces Leg Use Diamond Inner Bracing (4 Sided) Add IBC .6D+W Combination 	<ul style="list-style-type: none"> Distribute Leg Loads As Uniform Assume Legs Pinned √ Assume Rigid Index Plate √ Use Clear Spans For Wind Area Use Clear Spans For KL/r Retension Guys To Initial Tension √ Bypass Mast Stability Checks √ Use Azimuth Dish Coefficients √ Project Wind Area of Appurt. Autocalc Torque Arm Areas SR Members Have Cut Ends Sort Capacity Reports By Component Triangulate Diamond Inner Bracing Use TIA-222-G Tension Splice Capacity Exemption 	<ul style="list-style-type: none"> Treat Feedline Bundles As Cylinder Use ASCE 10 X-Brace Ly Rules Calculate Redundant Bracing Forces Ignore Redundant Members in FEA SR Leg Bolts Resist Compression All Leg Panels Have Same Allowable Offset Girt At Foundation √ Consider Feedline Torque Include Angle Block Shear Check <li style="text-align: center;">Poles √ Include Shear-Torsion Interaction Always Use Sub-Critical Flow Use Top Mounted Sockets
--	--	---

Tapered Pole Section Geometry

Section	Elevation ft	Section Length ft	Splice Length ft	Number of Sides	Top Diameter in	Bottom Diameter in	Wall Thickness in	Bend Radius in	Pole Grade
L1	148.000-111.000	37.000	4.000	18	24.000	30.661	0.250	1.000	A607-65 (65 ksi)
L2	111.000-99.333	15.667	0.000	18	29.441	32.262	0.250	1.000	A607-65 (65 ksi)
L3	99.333-90.500	8.833	0.000	18	32.262	33.852	0.342	1.366	54.757069ksi (55 ksi)
L4	90.500-75.000	15.500	4.750	18	33.852	36.643	0.422	1.689	56.46673ksi (56 ksi)
L5	75.000-60.500	19.250	0.000	18	35.288	38.753	0.471	1.883	56.586767ksi

tnxTower B+T Group 1717 S. Boulder, Suite 300 Tulsa, OK 74119 Phone: (918) 587-4630 FAX: (918) 295-0265	Job 103655.001.01 - Middletown, CT (USID# 14635)	Page 2 of 20
	Project MOD LTE ADD_11-23-2015	Date 13:23:29 12/29/15
	Client Centerline Communications	Designed by Ikantheti

Section	Elevation ft	Section Length ft	Splice Length ft	Number of Sides	Top Diameter in	Bottom Diameter in	Wall Thickness in	Bend Radius in	Pole Grade
L6	60.500-39.750	20.750	5.250	18	38.753	42.489	0.537	2.147	(57 ksi) 57.702715ksi
L7	39.750-30.500	14.500	0.000	18	40.919	43.529	0.589	2.356	(58 ksi) 57.819474ksi
L8	30.500-0.000	30.500		18	43.529	49.020	0.603	2.413	(58 ksi) 58.384266ksi (58 ksi)

Tapered Pole Properties

Section	Tip Dia. in	Area in ²	I in ⁴	r in	C in	I/C in ³	J in ⁴	I/Q in ²	w in	w/t
L1	24.370	18.846	1342.998	8.431	12.192	110.154	2687.762	9.425	3.784	15.136
	31.134	24.131	2819.528	10.796	15.576	181.020	5642.767	12.068	4.956	19.825
L2	30.626	23.163	2493.598	10.363	14.956	166.729	4990.478	11.584	4.742	18.966
	32.759	25.401	3288.621	11.364	16.389	200.660	6581.568	12.703	5.238	20.952
L3	32.759	34.605	4454.590	11.332	16.389	271.804	8915.041	17.306	5.077	14.864
	34.374	36.329	5154.157	11.896	17.197	299.714	10315.096	18.168	5.357	15.683
L4	34.374	44.792	6324.332	11.868	17.197	367.760	12656.986	22.400	5.215	12.354
	37.208	48.532	8044.149	12.858	18.615	432.141	16098.884	24.270	5.706	13.517
L5	36.700	52.024	7967.483	12.360	17.926	444.461	15945.449	26.017	5.382	11.433
	39.351	57.202	10591.354	13.590	19.687	537.995	21196.644	28.606	5.992	12.728
L6	39.351	65.117	12015.236	13.567	19.687	610.322	24046.282	32.565	5.876	10.945
	43.144	71.482	15894.326	14.893	21.584	736.380	31809.565	35.748	6.533	12.17
L7	42.510	75.396	15493.151	14.317	20.787	745.337	31006.687	37.705	6.165	10.467
	44.201	80.276	18700.486	15.244	22.113	845.685	37425.579	40.146	6.624	11.247
L8	44.201	82.200	19135.769	15.239	22.113	865.369	38296.717	41.108	6.599	10.938
	49.776	92.714	27458.256	17.188	24.902	1102.646	54952.643	46.366	7.566	12.54

Tower Elevation	Gusset Area (per face)	Gusset Thickness	Gusset Grade	Adjust. Factor A _f	Adjust. Factor A _r	Weight Mult.	Double Angle Stitch Bolt Spacing Diagonals in	Double Angle Stitch Bolt Spacing Horizontals in
ft	ft ²	in						
L1 148.000-111.000				1	1	1		
L2 111.000-99.333				1	1	1		
L3 99.333-90.500				1	1	0.975769		
L4 90.500-75.000				1	1	0.953599		
L5 75.000-60.500				1	1	0.963571		
L6 60.500-39.750				1	1	0.949747		
L7 39.750-30.500				1	1	0.95705		
L8 30.500-0.000				1	1	0.959173		

tnxTower B+T Group 1717 S. Boulder, Suite 300 Tulsa, OK 74119 Phone: (918) 587-4630 FAX: (918) 295-0265	Job 103655.001.01 - Middletown, CT (USID# 14635)	Page 3 of 20
	Project MOD LTE ADD_11-23-2015	Date 13:23:29 12/29/15
	Client Centerline Communications	Designed by Ikantheti

Feed Line/Linear Appurtenances - Entered As Round Or Flat

Description	Face or Leg	Allow Shield	Component Type	Placement ft	Total Number	Number Per Row	Clear Spacing in	Width or Diameter in	Perimeter in	Weight klf
*										

Feed Line/Linear Appurtenances - Entered As Area

Description	Face or Leg	Allow Shield	Component Type	Placement ft	Total Number		C _A A _A ft ² /ft	Weight klf		
LDF7-50A(1 5/8") (E - Outside)	B	No	CaAa (Out Of Face)	148.000 - 5.000	2	No Ice 1/2" Ice 1" Ice 2" Ice	0.198 0.298 0.398 0.598	0.001 0.002 0.004 0.011		
LDF7-50A(1 5/8") (E - Outside Shielded)	B	No	CaAa (Out Of Face)	148.000 - 5.000	10	No Ice 1/2" Ice 1" Ice 2" Ice 4" Ice	0.000 0.000 0.000 0.000 0.000	0.001 0.002 0.004 0.011 0.030		
3/8" FIBER (E)	B	No	Inside Pole	148.000 - 5.000	1	No Ice 1/2" Ice 1" Ice 2" Ice 4" Ice	0.000 0.000 0.000 0.000 0.000	0.000 0.000 0.000 0.000 0.000		
7/8" DC (E)	B	No	Inside Pole	148.000 - 5.000	2	No Ice 1/2" Ice 1" Ice 2" Ice 4" Ice	0.000 0.000 0.000 0.000 0.000	0.001 0.001 0.001 0.001 0.001		

LDF7-50A(1 5/8") (E)	B	No	Inside Pole	140.000 - 5.000	19	No Ice 1/2" Ice 1" Ice 2" Ice 4" Ice	0.000 0.000 0.000 0.000 0.000	0.001 0.001 0.001 0.001 0.001		

LDF6-50A(1 1/4") (E)	A	No	Inside Pole	124.000 - 5.000	3	No Ice 1/2" Ice 1" Ice 2" Ice 4" Ice	0.000 0.000 0.000 0.000 0.000	0.001 0.001 0.001 0.001 0.001		

LDF7-50A(1 5/8") (E)	A	No	Inside Pole	110.000 - 5.000	13	No Ice 1/2" Ice 1" Ice 2" Ice 4" Ice	0.000 0.000 0.000 0.000 0.000	0.001 0.001 0.001 0.001 0.001		

LDF7-50A(1 5/8") (E - Outside)	B	No	CaAa (Out Of Face)	90.000 - 5.000	1	No Ice 1/2" Ice 1" Ice 2" Ice 4" Ice	0.198 0.298 0.398 0.598 0.998	0.001 0.002 0.004 0.011 0.030		
LDF7-50A(1 5/8") (E - Outside Shielded)	B	No	CaAa (Out Of Face)	90.000 - 5.000	5	No Ice 1/2" Ice 1" Ice 2" Ice	0.000 0.000 0.000 0.000	0.001 0.002 0.004 0.011		

tnxTower B+T Group 1717 S. Boulder, Suite 300 Tulsa, OK 74119 Phone: (918) 587-4630 FAX: (918) 295-0265	Job 103655.001.01 - Middletown, CT (USID# 14635)	Page 4 of 20
	Project MOD LTE ADD_11-23-2015	Date 13:23:29 12/29/15
	Client Centerline Communications	Designed by Ikantheti

Description	Face or Leg	Allow Shield	Component Type	Placement ft	Total Number		C _{AA} ft ² /ft	Weight klf
*****						4" Ice	0.000	0.030

FLC38-50J(3/8") (E - Outside Shielded)	C	No	CaAa (Out Of Face)	55.000 - 5.000	1	No Ice 1/2" Ice 1" Ice 2" Ice 4" Ice	0.000 0.000 0.000 0.000 0.000	0.000 0.001 0.002 0.006 0.022

LDF4-50A(1/2") (E - Outside Shielded)	C	No	CaAa (Out Of Face)	50.000 - 5.000	1	No Ice 1/2" Ice 1" Ice 2" Ice 4" Ice	0.000 0.000 0.000 0.000 0.000	0.000 0.001 0.002 0.007 0.023

MP3-08 (E)	C	No	CaAa (Out Of Face)	30.500 - 0.000	1	No Ice 1/2" Ice 1" Ice 2" Ice 4" Ice	0.467 0.551 0.634 0.800 1.134	0.010 0.015 0.020 0.030 0.051
MP3-06 (E)	C	No	CaAa (Out Of Face)	60.500 - 30.500	1	No Ice 1/2" Ice 1" Ice 2" Ice 4" Ice	0.434 0.518 0.601 0.768 1.101	0.010 0.015 0.020 0.030 0.051
MP3-05 (E)	C	No	CaAa (Out Of Face)	90.500 - 60.500	1	No Ice 1/2" Ice 1" Ice 2" Ice 4" Ice	0.348 0.432 0.515 0.682 1.015	0.010 0.015 0.020 0.030 0.051
MP3-03 (E)	C	No	CaAa (Out Of Face)	100.500 - 90.500	1	No Ice 1/2" Ice 1" Ice 2" Ice 4" Ice	0.262 0.345 0.428 0.595 0.928	0.010 0.015 0.020 0.030 0.051

*								

Feed Line/Linear Appurtenances Section Areas

Tower Section	Tower Elevation ft	Face	A _R ft ²	A _F ft ²	C _{AA} In Face ft ²	C _{AA} Out Face ft ²	Weight K
L1	148.000-111.000	A	0.000	0.000	0.000	0.000	0.026
		B	0.000	0.000	0.000	14.652	0.859
		C	0.000	0.000	0.000	0.000	0.000
L2	111.000-99.333	A	0.000	0.000	0.000	0.000	0.137
		B	0.000	0.000	0.000	4.620	0.310
		C	0.000	0.000	0.000	0.305	0.012
L3	99.333-90.500	A	0.000	0.000	0.000	0.000	0.112
		B	0.000	0.000	0.000	3.498	0.235
		C	0.000	0.000	0.000	2.311	0.087
L4	90.500-75.000	A	0.000	0.000	0.000	0.000	0.196
		B	0.000	0.000	0.000	9.108	0.486
		C	0.000	0.000	0.000	5.399	0.153
L5	75.000-60.500	A	0.000	0.000	0.000	0.000	0.183
		B	0.000	0.000	0.000	8.613	0.457

tnxTower B+T Group 1717 S. Boulder, Suite 300 Tulsa, OK 74119 Phone: (918) 587-4630 FAX: (918) 295-0265	Job 103655.001.01 - Middletown, CT (USID# 14635)	Page 5 of 20
	Project MOD LTE ADD_11-23-2015	Date 13:23:29 12/29/15
	Client Centerline Communications	Designed by Ikantheti

Tower Section	Tower Elevation ft	Face	A _R ft ²	A _F ft ²	C _{AA} In Face ft ²	C _{AA} Out Face ft ²	Weight K
L6	60.500-39.750	C	0.000	0.000	0.000	5.051	0.144
		A	0.000	0.000	0.000	0.000	0.262
		B	0.000	0.000	0.000	12.326	0.654
L7	39.750-30.500	C	0.000	0.000	0.000	9.012	0.208
		A	0.000	0.000	0.000	0.000	0.117
		B	0.000	0.000	0.000	5.495	0.291
L8	30.500-0.000	C	0.000	0.000	0.000	4.018	0.094
		A	0.000	0.000	0.000	0.000	0.322
		B	0.000	0.000	0.000	15.147	0.803
		C	0.000	0.000	0.000	14.249	0.308

Feed Line/Linear Appurtenances Section Areas - With Ice

Tower Section	Tower Elevation ft	Face or Leg	Ice Thickness in	A _R ft ²	A _F ft ²	C _{AA} In Face ft ²	C _{AA} Out Face ft ²	Weight K
L1	148.000-111.000	A	0.883	0.000	0.000	0.000	0.000	0.026
		B		0.000	0.000	0.000	27.724	2.255
		C		0.000	0.000	0.000	0.000	0.000
L2	111.000-99.333	A	0.862	0.000	0.000	0.000	0.000	0.137
		B		0.000	0.000	0.000	8.742	0.750
		C		0.000	0.000	0.000	0.477	0.022
L3	99.333-90.500	A	0.851	0.000	0.000	0.000	0.000	0.112
		B		0.000	0.000	0.000	6.506	0.554
		C		0.000	0.000	0.000	3.565	0.164
L4	90.500-75.000	A	0.837	0.000	0.000	0.000	0.000	0.196
		B		0.000	0.000	0.000	16.812	1.300
		C		0.000	0.000	0.000	7.562	0.285
L5	75.000-60.500	A	0.817	0.000	0.000	0.000	0.000	0.183
		B		0.000	0.000	0.000	15.898	1.227
		C		0.000	0.000	0.000	7.074	0.266
L6	60.500-39.750	A	0.788	0.000	0.000	0.000	0.000	0.262
		B		0.000	0.000	0.000	22.140	1.677
		C		0.000	0.000	0.000	11.739	0.408
L7	39.750-30.500	A	0.756	0.000	0.000	0.000	0.000	0.117
		B		0.000	0.000	0.000	9.869	0.748
		C		0.000	0.000	0.000	5.233	0.192
L8	30.500-0.000	A	0.750	0.000	0.000	0.000	0.000	0.322
		B		0.000	0.000	0.000	26.622	1.987
		C		0.000	0.000	0.000	18.061	0.604

Feed Line Center of Pressure

Section	Elevation ft	CP _X in	CP _Z in	CP _X Ice in	CP _Z Ice in
L1	148.000-111.000	0.438	0.253	0.698	0.403
L2	111.000-99.333	0.412	0.273	0.675	0.436
L3	99.333-90.500	0.141	0.398	0.295	0.584
L4	90.500-75.000	0.236	0.532	0.490	0.745
L5	75.000-60.500	0.245	0.543	0.509	0.765
L6	60.500-39.750	0.159	0.592	0.428	0.805
L7	39.750-30.500	0.161	0.598	0.435	0.819
L8	30.500-0.000	0.026	0.575	0.250	0.773

tnxTower B+T Group 1717 S. Boulder, Suite 300 Tulsa, OK 74119 Phone: (918) 587-4630 FAX: (918) 295-0265	Job	103655.001.01 - Middletown, CT (USID# 14635)	Page	6 of 20
	Project	MOD LTE ADD_11-23-2015	Date	13:23:29 12/29/15
	Client	Centerline Communications	Designed by	Ikantheti

Discrete Tower Loads

Description	Face or Leg	Offset Type	Offsets:		Azimuth Adjustment	Placement	C _{AA} Front	C _{AA} Side	Weight	
			Horz Lateral	Vert						ft
Lighting Rod 5/8" x 8' (E)	C	None			0.000	152.000	No Ice	0.500	0.500	0.031
							1/2" Ice	1.314	1.314	0.037
							1" Ice	2.144	2.144	0.047
							2" Ice	3.613	3.613	0.084
							4" Ice	5.683	5.683	0.227
***** (2) 7770.00.850.10 w/ Mount Pipe (AT&T-E)	A	From Leg	4.000	0.000	0.000	148.000	No Ice	6.119	4.254	0.055
							1/2" Ice	6.626	5.014	0.103
							1" Ice	7.128	5.711	0.157
							2" Ice	8.164	7.155	0.287
							4" Ice	10.360	10.412	0.665
(2) 7770.00.850.05 w/ Mount Pipe (AT&T-E)	B	From Leg	4.000	0.000	0.000	148.000	No Ice	6.119	4.254	0.055
							1/2" Ice	6.626	5.014	0.103
							1" Ice	7.128	5.711	0.157
							2" Ice	8.164	7.155	0.287
							4" Ice	10.360	10.412	0.665
(2) 7770.00.850.04 w/ Mount Pipe (AT&T-E)	C	From Leg	4.000	0.000	0.000	148.000	No Ice	6.119	4.254	0.055
							1/2" Ice	6.626	5.014	0.103
							1" Ice	7.128	5.711	0.157
							2" Ice	8.164	7.155	0.287
							4" Ice	10.360	10.412	0.665
(4) LGP21401 (AT&T-E)	A	From Leg	4.000	0.000	0.000	148.000	No Ice	1.288	0.233	0.014
							1/2" Ice	1.445	0.313	0.021
							1" Ice	1.611	0.403	0.030
							2" Ice	1.969	0.608	0.055
							4" Ice	2.788	1.121	0.135
(4) LGP21401 (AT&T-E)	B	From Leg	4.000	0.000	0.000	148.000	No Ice	1.288	0.233	0.014
							1/2" Ice	1.445	0.313	0.021
							1" Ice	1.611	0.403	0.030
							2" Ice	1.969	0.608	0.055
							4" Ice	2.788	1.121	0.135
(4) LGP21401 (AT&T-E)	C	From Leg	4.000	0.000	0.000	148.000	No Ice	1.288	0.233	0.014
							1/2" Ice	1.445	0.313	0.021
							1" Ice	1.611	0.403	0.030
							2" Ice	1.969	0.608	0.055
							4" Ice	2.788	1.121	0.135
RRUS-11 (AT&T-E)	A	From Leg	4.000	0.000	0.000	148.000	No Ice	3.249	1.373	0.048
							1/2" Ice	3.491	1.551	0.068
							1" Ice	3.741	1.738	0.092
							2" Ice	4.268	2.138	0.150
							4" Ice	5.426	3.042	0.310
RRUS-11 (AT&T-E)	B	From Leg	4.000	0.000	0.000	148.000	No Ice	3.249	1.373	0.048
							1/2" Ice	3.491	1.551	0.068
							1" Ice	3.741	1.738	0.092
							2" Ice	4.268	2.138	0.150
							4" Ice	5.426	3.042	0.310
RRUS-11 (AT&T-E)	C	From Leg	4.000	0.000	0.000	148.000	No Ice	3.249	1.373	0.048
							1/2" Ice	3.491	1.551	0.068
							1" Ice	3.741	1.738	0.092
							2" Ice	4.268	2.138	0.150
							4" Ice	5.426	3.042	0.310

Job	103655.001.01 - Middletown, CT (USID# 14635)	Page	7 of 20
Project	MOD LTE ADD_11-23-2015	Date	13:23:29 12/29/15
Client	Centerline Communications	Designed by	Ikantheti

Description	Face or Leg	Offset Type	Offsets:		Azimuth Adjustment	Placement	C _{AA} Front	C _{AA} Side	Weight	
			Horz	Vert						
			ft	ft	°	ft	ft ²	ft ²	K	
DC6-48-60-18-8F (AT&T-E)	A	From Leg	4.000	0.000	0.000	148.000	4" Ice	5.426	3.042	0.310
			0.000	0.000			No Ice	1.467	1.467	0.019
			0.000	0.000			1/2" Ice	1.667	1.667	0.037
			0.000	0.000			1" Ice	1.878	1.878	0.057
			0.000	0.000			2" Ice	2.333	2.333	0.105
HPA-65R-BUU-H6 w/ Mount Pipe (AT&T-P)	A	From Leg	4.000	0.000	0.000	148.000	4" Ice	3.378	3.378	0.239
			0.000	0.000			No Ice	10.598	8.113	0.077
			2.000	2.000			1/2" Ice	11.268	9.304	0.158
			0.000	0.000			1" Ice	11.906	10.209	0.248
			0.000	0.000			2" Ice	13.209	12.175	0.456
SBNHH-1D65C w/ Mount Pipe (AT&T-P)	B	From Leg	4.000	0.000	0.000	148.000	4" Ice	15.934	16.354	1.020
			0.000	0.000			No Ice	11.588	9.793	0.099
			2.000	2.000			1/2" Ice	12.306	11.311	0.188
			0.000	0.000			1" Ice	13.035	12.854	0.287
			0.000	0.000			2" Ice	14.495	15.192	0.519
SBNHH-1D65A w/ Mount Pipe (AT&T-P)	C	From Leg	4.000	0.000	0.000	148.000	4" Ice	17.758	20.047	1.162
			0.000	0.000			No Ice	6.387	5.190	0.061
			2.000	2.000			1/2" Ice	6.896	5.961	0.114
			0.000	0.000			1" Ice	7.402	6.705	0.174
			0.000	0.000			2" Ice	8.445	8.279	0.316
RRUS-12 (AT&T-P)	A	From Leg	4.000	0.000	0.000	148.000	4" Ice	10.653	11.643	0.720
			0.000	0.000			No Ice	3.669	1.488	0.058
			2.000	2.000			1/2" Ice	3.926	1.673	0.081
			0.000	0.000			1" Ice	4.191	1.866	0.108
			0.000	0.000			2" Ice	4.747	2.280	0.171
RRUS-12 (AT&T-P)	B	From Leg	4.000	0.000	0.000	148.000	4" Ice	5.963	3.211	0.344
			0.000	0.000			No Ice	3.669	1.488	0.058
			2.000	2.000			1/2" Ice	3.926	1.673	0.081
			0.000	0.000			1" Ice	4.191	1.866	0.108
			0.000	0.000			2" Ice	4.747	2.280	0.171
RRUS-12 (AT&T-P)	C	From Leg	4.000	0.000	0.000	148.000	4" Ice	5.963	3.211	0.344
			0.000	0.000			No Ice	3.669	1.488	0.058
			2.000	2.000			1/2" Ice	3.926	1.673	0.081
			0.000	0.000			1" Ice	4.191	1.866	0.108
			0.000	0.000			2" Ice	4.747	2.280	0.171
RRUS A2 MODULE (AT&T-P)	A	From Leg	4.000	0.000	0.000	148.000	4" Ice	5.963	3.211	0.344
			0.000	0.000			No Ice	1.867	0.423	0.021
			2.000	2.000			1/2" Ice	2.051	0.532	0.031
			0.000	0.000			1" Ice	2.244	0.650	0.044
			0.000	0.000			2" Ice	2.657	0.912	0.077
RRUS A2 MODULE (AT&T-P)	B	From Leg	4.000	0.000	0.000	148.000	4" Ice	3.585	1.540	0.177
			0.000	0.000			No Ice	1.867	0.423	0.021
			2.000	2.000			1/2" Ice	2.051	0.532	0.031
			0.000	0.000			1" Ice	2.244	0.650	0.044
			0.000	0.000			2" Ice	2.657	0.912	0.077
RRUS A2 MODULE (AT&T-P)	C	From Leg	4.000	0.000	0.000	148.000	4" Ice	3.585	1.540	0.177
			0.000	0.000			No Ice	1.867	0.423	0.021
			2.000	2.000			1/2" Ice	2.051	0.532	0.031
			0.000	0.000			1" Ice	2.244	0.650	0.044
			0.000	0.000			2" Ice	2.657	0.912	0.077
5' x 2" Pipe Mount (AT&T-E)	A	From Leg	4.000	0.000	0.000	148.000	4" Ice	3.585	1.540	0.177
			0.000	0.000			No Ice	1.000	1.000	0.029
			0.000	0.000			1/2" Ice	1.393	1.393	0.037
			0.000	0.000			1" Ice	1.703	1.703	0.048
			0.000	0.000			2" Ice	2.351	2.351	0.082
5' x 2" Pipe Mount	B	From Leg	4.000	0.000	148.000	4" Ice	3.778	3.778	0.196	
						No Ice	1.000	1.000	0.029	
						No Ice	1.000	1.000	0.029	

tnxTower B+T Group 1717 S. Boulder, Suite 300 Tulsa, OK 74119 Phone: (918) 587-4630 FAX: (918) 295-0265	Job	103655.001.01 - Middletown, CT (USID# 14635)	Page	8 of 20
	Project	MOD LTE ADD_11-23-2015	Date	13:23:29 12/29/15
	Client	Centerline Communications	Designed by	Ikantheti

Description	Face or Leg	Offset Type	Offsets:		Azimuth Adjustment	Placement	C _{AA} Front	C _{AA} Side	Weight
			Horz	Vert					
(AT&T-E)			0.000			1/2" Ice	1.393	1.393	0.037
			0.000			1" Ice	1.703	1.703	0.048
						2" Ice	2.351	2.351	0.082
						4" Ice	3.778	3.778	0.196
5' x 2" Pipe Mount (AT&T-E)	C	From Leg	4.000	0.000	148.000	No Ice	1.000	1.000	0.029
			0.000			1/2" Ice	1.393	1.393	0.037
			0.000			1" Ice	1.703	1.703	0.048
						2" Ice	2.351	2.351	0.082
						4" Ice	3.778	3.778	0.196
Platform Mount [LP 1201-1] (AT&T-E)	C	None		0.000	148.000	No Ice	23.100	23.100	2.100
						1/2" Ice	26.800	26.800	2.500
						1" Ice	30.500	30.500	2.900
						2" Ice	37.900	37.900	3.700
						4" Ice	52.700	52.700	5.300

(2) AIR 21 w/ Mount Pipe (T-Mobile-E)	C	From Leg	4.000	40.000	140.000	No Ice	6.624	5.470	0.100
			0.000			1/2" Ice	7.131	6.281	0.155
			0.000			1" Ice	7.637	7.039	0.217
						2" Ice	8.678	8.609	0.363
						4" Ice	10.885	11.963	0.777
(2) AIR 21 w/ Mount Pipe (T-Mobile-E)	B	From Leg	4.000	85.000	140.000	No Ice	6.624	5.470	0.100
			0.000			1/2" Ice	7.131	6.281	0.155
			0.000			1" Ice	7.637	7.039	0.217
						2" Ice	8.678	8.609	0.363
						4" Ice	10.885	11.963	0.777
(2) AIR 21 w/ Mount Pipe (T-Mobile-E)	A	From Leg	4.000	40.000	140.000	No Ice	6.624	5.470	0.100
			0.000			1/2" Ice	7.131	6.281	0.155
			0.000			1" Ice	7.637	7.039	0.217
						2" Ice	8.678	8.609	0.363
						4" Ice	10.885	11.963	0.777
APX16DWV-16DWVS-C w/ Mount Pipe (T-Mobile-E)	C	From Leg	4.000	40.000	140.000	No Ice	7.466	3.494	0.061
			0.000			1/2" Ice	7.994	4.263	0.110
			0.000			1" Ice	8.518	4.960	0.165
						2" Ice	9.595	6.403	0.298
						4" Ice	11.873	9.490	0.683
APX16DWV-16DWVS-C w/ Mount Pipe (T-Mobile-E)	A	From Leg	4.000	40.000	140.000	No Ice	7.466	3.494	0.061
			0.000			1/2" Ice	7.994	4.263	0.110
			0.000			1" Ice	8.518	4.960	0.165
						2" Ice	9.595	6.403	0.298
						4" Ice	11.873	9.490	0.683
ONEBASE TWIN DUAL DUPLEX TMA (T-Mobile-E)	C	From Leg	4.000	0.000	140.000	No Ice	0.674	0.306	0.011
			0.000			1/2" Ice	0.786	0.392	0.016
			0.000			1" Ice	0.908	0.486	0.022
						2" Ice	1.176	0.699	0.040
						4" Ice	1.816	1.231	0.103
ONEBASE TWIN DUAL DUPLEX TMA (T-Mobile-E)	B	From Leg	4.000	0.000	140.000	No Ice	0.674	0.306	0.011
			0.000			1/2" Ice	0.786	0.392	0.016
			0.000			1" Ice	0.908	0.486	0.022
						2" Ice	1.176	0.699	0.040
						4" Ice	1.816	1.231	0.103
ONEBASE TWIN DUAL DUPLEX TMA (T-Mobile-E)	A	From Leg	4.000	0.000	140.000	No Ice	0.674	0.306	0.011
			0.000			1/2" Ice	0.786	0.392	0.016
			0.000			1" Ice	0.908	0.486	0.022
						2" Ice	1.176	0.699	0.040
						4" Ice	1.816	1.231	0.103
6' x 2" Mount Pipe (T-Mobile-E)	C	From Leg	4.000	0.000	140.000	No Ice	1.425	1.425	0.022
			0.000			1/2" Ice	1.925	1.925	0.033

tnxTower B+T Group 1717 S. Boulder, Suite 300 Tulsa, OK 74119 Phone: (918) 587-4630 FAX: (918) 295-0265	Job	103655.001.01 - Middletown, CT (USID# 14635)	Page	9 of 20
	Project	MOD LTE ADD_11-23-2015	Date	13:23:29 12/29/15
	Client	Centerline Communications	Designed by	Ikantheti

Description	Face or Leg	Offset Type	Offsets:		Azimuth Adjustment	Placement	C _{AA} Front	C _{AA} Side	Weight
			Horz	Vert					
			ft	ft	°	ft	ft ²	ft ²	K
				0.000			1" Ice	2.294	0.048
							2" Ice	3.060	0.090
							4" Ice	4.702	0.231
(2) 6' x 2" Mount Pipe (T-Mobile-E)	B	From Leg	4.000	0.000	0.000	140.000	No Ice	1.425	0.022
			0.000				1/2" Ice	1.925	0.033
			0.000				1" Ice	2.294	0.048
							2" Ice	3.060	0.090
							4" Ice	4.702	0.231
6' x 2" Mount Pipe (T-Mobile-E)	A	From Leg	4.000	0.000	0.000	140.000	No Ice	1.425	0.022
			0.000				1/2" Ice	1.925	0.033
			0.000				1" Ice	2.294	0.048
							2" Ice	3.060	0.090
							4" Ice	4.702	0.231
Platform Mount [LP 1201-1] (T-Mobile-E)	C	None			0.000	140.000	No Ice	23.100	2.100
							1/2" Ice	26.800	2.500
							1" Ice	30.500	2.900
							2" Ice	37.900	3.700
							4" Ice	52.700	5.300

APXVSPP18-C-A20 w/ Mount Pipe (Sprint-E)	C	From Leg	4.000	0.000	45.000	124.000	No Ice	8.498	0.083
			1.000				1/2" Ice	9.149	0.151
							1" Ice	9.767	0.227
							2" Ice	11.031	0.406
							4" Ice	13.679	0.909
APXVSPP18-C-A20 w/ Mount Pipe (Sprint-E)	B	From Leg	4.000	0.000	90.000	124.000	No Ice	8.498	0.083
			1.000				1/2" Ice	9.149	0.151
							1" Ice	9.767	0.227
							2" Ice	11.031	0.406
							4" Ice	13.679	0.909
APXVSPP18-C-A20 w/ Mount Pipe (Sprint-E)	A	From Leg	4.000	0.000	70.000	124.000	No Ice	8.498	0.083
			1.000				1/2" Ice	9.149	0.151
							1" Ice	9.767	0.227
							2" Ice	11.031	0.406
							4" Ice	13.679	0.909
1900MHz RRH (Sprint-E)	C	From Leg	4.000	0.000	0.000	124.000	No Ice	2.907	0.044
			1.000				1/2" Ice	3.145	0.075
							1" Ice	3.391	0.110
							2" Ice	3.909	0.192
							4" Ice	5.050	0.407
1900MHz RRH (Sprint-E)	B	From Leg	4.000	0.000	0.000	124.000	No Ice	2.907	0.044
			1.000				1/2" Ice	3.145	0.075
							1" Ice	3.391	0.110
							2" Ice	3.909	0.192
							4" Ice	5.050	0.407
1900MHz RRH (Sprint-E)	A	From Leg	4.000	0.000	0.000	124.000	No Ice	2.907	0.044
			1.000				1/2" Ice	3.145	0.075
							1" Ice	3.391	0.110
							2" Ice	3.909	0.192
							4" Ice	5.050	0.407
800MHZ RRH (Sprint-E)	C	From Leg	4.000	0.000	0.000	124.000	No Ice	2.490	0.053
			1.000				1/2" Ice	2.706	0.074
							1" Ice	2.931	0.098
							2" Ice	3.407	0.157
							4" Ice	4.462	0.318
800MHZ RRH (Sprint-E)	B	From Leg	4.000	0.000	0.000	124.000	No Ice	2.490	0.053
			1.000				1/2" Ice	2.706	0.074
							1" Ice	2.931	0.098

tnxTower B+T Group 1717 S. Boulder, Suite 300 Tulsa, OK 74119 Phone: (918) 587-4630 FAX: (918) 295-0265	Job		103655.001.01 - Middletown, CT (USID# 14635)		Page		10 of 20	
	Project		MOD LTE ADD_11-23-2015		Date		13:23:29 12/29/15	
	Client		Centerline Communications		Designed by		Ikantheti	

Description	Face or Leg	Offset Type	Offsets:		Azimuth Adjustment	Placement	C _{AA} Front	C _{AA} Side	Weight	
			Horz	Vert						ft
							ft ²	ft ²	K	
800MHZ RRH (Sprint-E)	A	From Leg	4.000	0.000	0.000	124.000	2" Ice	3.407	2.928	0.157
							4" Ice	4.462	3.927	0.318
							No Ice	2.490	2.068	0.053
							1/2" Ice	2.706	2.271	0.074
							1" Ice	2.931	2.481	0.098
(3) 6' x 2" Mount Pipe (Sprint-E)	A	From Leg	4.000	0.000	0.000	124.000	2" Ice	3.407	2.928	0.157
							4" Ice	4.462	3.927	0.318
							No Ice	1.425	1.425	0.022
							1/2" Ice	1.925	1.925	0.033
							1" Ice	2.294	2.294	0.048
(3) 6' x 2" Mount Pipe (Sprint-E)	B	From Leg	4.000	0.000	0.000	124.000	2" Ice	3.060	3.060	0.090
							4" Ice	4.702	4.702	0.231
							No Ice	1.425	1.425	0.022
							1/2" Ice	1.925	1.925	0.033
							1" Ice	2.294	2.294	0.048
(3) 6' x 2" Mount Pipe (Sprint-E)	C	From Leg	4.000	0.000	0.000	124.000	2" Ice	3.060	3.060	0.090
							4" Ice	4.702	4.702	0.231
							No Ice	1.425	1.425	0.022
							1/2" Ice	1.925	1.925	0.033
							1" Ice	2.294	2.294	0.048
Platform Mount [LP 1201-1] (Sprint-E)	C	None			0.000	124.000	2" Ice	3.060	3.060	0.090
							4" Ice	4.702	4.702	0.231
							No Ice	23.100	23.100	2.100
							1/2" Ice	26.800	26.800	2.500
							1" Ice	30.500	30.500	2.900

BXA-70063-6CF w/ Mount Pipe (E - Verizon)	A	From Leg	4.000	0.000	30.000	110.000	No Ice	7.979	5.695	0.040
							1/2" Ice	8.621	6.849	0.100
							1" Ice	9.228	7.715	0.168
							2" Ice	10.473	9.497	0.331
							4" Ice	13.082	13.262	0.798
LNX-6514DS-T4M w/ Mount Pipe (E - Verizon)	B	From Leg	4.000	0.000	30.000	110.000	No Ice	8.568	7.004	0.058
							1/2" Ice	9.220	8.185	0.127
							1" Ice	9.838	9.081	0.203
							2" Ice	11.104	10.904	0.384
							4" Ice	13.754	14.926	0.889
BXA-70063-6CF w/ Mount Pipe (E - Verizon)	C	From Leg	4.000	0.000	30.000	110.000	No Ice	7.979	5.695	0.040
							1/2" Ice	8.621	6.849	0.100
							1" Ice	9.228	7.715	0.168
							2" Ice	10.473	9.497	0.331
							4" Ice	13.082	13.262	0.798
(2) FD9R6004/2C-3L (E - Verizon)	A	From Leg	4.000	0.000	0.000	110.000	No Ice	0.367	0.085	0.003
							1/2" Ice	0.451	0.136	0.005
							1" Ice	0.543	0.196	0.009
							2" Ice	0.755	0.343	0.020
							4" Ice	1.281	0.740	0.063
(2) FD9R6004/2C-3L (E - Verizon)	B	From Leg	4.000	0.000	0.000	110.000	No Ice	0.367	0.085	0.003
							1/2" Ice	0.451	0.136	0.005
							1" Ice	0.543	0.196	0.009
							2" Ice	0.755	0.343	0.020
							4" Ice	1.281	0.740	0.063
(2) FD9R6004/2C-3L (E - Verizon)	C	From Leg	4.000	0.000	0.000	110.000	No Ice	0.367	0.085	0.003
							1/2" Ice	0.451	0.136	0.005
							1" Ice	0.543	0.196	0.009
							2" Ice	0.755	0.343	0.020
							4" Ice	1.281	0.740	0.063
(2) FD9R6004/2C-3L (E - Verizon)			4.000	0.000	0.000	110.000	No Ice	0.367	0.085	0.003
							1/2" Ice	0.451	0.136	0.005
							1" Ice	0.543	0.196	0.009
							2" Ice	0.755	0.343	0.020
							4" Ice	1.281	0.740	0.063

tnxTower B+T Group 1717 S. Boulder, Suite 300 Tulsa, OK 74119 Phone: (918) 587-4630 FAX: (918) 295-0265	Job	103655.001.01 - Middletown, CT (USID# 14635)	Page	11 of 20
	Project	MOD LTE ADD_11-23-2015	Date	13:23:29 12/29/15
	Client	Centerline Communications	Designed by	Ikantheti

Description	Face or Leg	Offset Type	Offsets:		Azimuth Adjustment	Placement	C _{AA} Front	C _{AA} Side	Weight	
			Horz	Vert						
			ft	ft	°	ft	ft ²	ft ²	K	
HBX-6517DS-VTM w/ Mount Pipe (E - Verizon)	A	From Leg	4.000	0.000	0.000	110.000	4" Ice	1.281	0.740	0.063
							No Ice	5.541	5.021	0.045
							1/2" Ice	6.112	6.223	0.092
							1" Ice	6.654	7.167	0.146
							2" Ice	7.750	9.011	0.281
HBX-6517DS-VTM w/ Mount Pipe (E - Verizon)	B	From Leg	4.000	0.000	0.000	110.000	4" Ice	10.109	12.898	0.692
							No Ice	5.541	5.021	0.045
							1/2" Ice	6.112	6.223	0.092
							1" Ice	6.654	7.167	0.146
							2" Ice	7.750	9.011	0.281
HBX-6517DS-VTM w/ Mount Pipe (E - Verizon)	C	From Leg	4.000	0.000	0.000	110.000	4" Ice	10.109	12.898	0.692
							No Ice	5.541	5.021	0.045
							1/2" Ice	6.112	6.223	0.092
							1" Ice	6.654	7.167	0.146
							2" Ice	7.750	9.011	0.281
LNX-6513DS-VTM w/ Mount Pipe (E - Verizon)	A	From Leg	4.000	0.000	0.000	110.000	4" Ice	10.109	12.898	0.692
							No Ice	6.566	5.159	0.051
							1/2" Ice	7.076	5.923	0.104
							1" Ice	7.582	6.668	0.164
							2" Ice	8.626	8.236	0.307
LNX-6513DS-VTM w/ Mount Pipe (E - Verizon)	B	From Leg	4.000	0.000	0.000	110.000	4" Ice	10.837	11.586	0.714
							No Ice	6.566	5.159	0.051
							1/2" Ice	7.076	5.923	0.104
							1" Ice	7.582	6.668	0.164
							2" Ice	8.626	8.236	0.307
LNX-6513DS-VTM w/ Mount Pipe (E - Verizon)	C	From Leg	4.000	0.000	0.000	110.000	4" Ice	10.837	11.586	0.714
							No Ice	6.566	5.159	0.051
							1/2" Ice	7.076	5.923	0.104
							1" Ice	7.582	6.668	0.164
							2" Ice	8.626	8.236	0.307
HBX-6516DS-VTM w/ Mount Pipe (E - Verizon)	A	From Leg	4.000	0.000	0.000	110.000	4" Ice	10.837	11.586	0.714
							No Ice	3.598	3.241	0.029
							1/2" Ice	3.998	3.914	0.062
							1" Ice	4.435	4.564	0.101
							2" Ice	5.368	5.914	0.199
HBX-6516DS-VTM w/ Mount Pipe (E - Verizon)	B	From Leg	4.000	0.000	0.000	110.000	4" Ice	7.361	8.877	0.504
							No Ice	3.598	3.241	0.029
							1/2" Ice	3.998	3.914	0.062
							1" Ice	4.435	4.564	0.101
							2" Ice	5.368	5.914	0.199
HBX-6516DS-VTM w/ Mount Pipe (E - Verizon)	C	From Leg	4.000	0.000	0.000	110.000	4" Ice	7.361	8.877	0.504
							No Ice	3.598	3.241	0.029
							1/2" Ice	3.998	3.914	0.062
							1" Ice	4.435	4.564	0.101
							2" Ice	5.368	5.914	0.199
RRH2X40-AWS (E - Verizon)	A	From Leg	4.000	0.000	0.000	110.000	4" Ice	7.361	8.877	0.504
							No Ice	2.522	1.589	0.044
							1/2" Ice	2.753	1.795	0.061
							1" Ice	2.993	2.010	0.082
							2" Ice	3.499	2.465	0.132
RRH2X40-AWS (E - Verizon)	B	From Leg	4.000	0.000	0.000	110.000	4" Ice	4.615	3.479	0.275
							No Ice	2.522	1.589	0.044
							1/2" Ice	2.753	1.795	0.061
							1" Ice	2.993	2.010	0.082
							2" Ice	3.499	2.465	0.132
RRH2X40-AWS	C	From Leg	4.000	0.000	0.000	110.000	4" Ice	4.615	3.479	0.275
							No Ice	2.522	1.589	0.044

tnxTower B+T Group 1717 S. Boulder, Suite 300 Tulsa, OK 74119 Phone: (918) 587-4630 FAX: (918) 295-0265	Job		103655.001.01 - Middletown, CT (USID# 14635)		Page		12 of 20	
	Project		MOD LTE ADD_11-23-2015		Date		13:23:29 12/29/15	
	Client		Centerline Communications		Designed by		Ikantheti	

Description	Face or Leg	Offset Type	Offsets:		Azimuth Adjustment	Placement	C _{AA} Front	C _{AA} Side	Weight
			Horz	Lateral					
(E - Verizon)			0.000			1/2" Ice	2.753	1.795	0.061
			0.000			1" Ice	2.993	2.010	0.082
						2" Ice	3.499	2.465	0.132
						4" Ice	4.615	3.479	0.275
DB-T1-6Z-8AB-0Z	A	From Leg	4.000		0.000	No Ice	5.600	2.333	0.044
(E - Verizon)			0.000			1/2" Ice	5.915	2.558	0.080
			0.000			1" Ice	6.240	2.791	0.120
						2" Ice	6.914	3.284	0.213
						4" Ice	8.365	4.373	0.455
Platform Mount [LP 1201-1]	C	None			0.000	No Ice	23.100	23.100	2.100
(E - Verizon)						1/2" Ice	26.800	26.800	2.500
						1" Ice	30.500	30.500	2.900
						2" Ice	37.900	37.900	3.700
						4" Ice	52.700	52.700	5.300
Collar Mount	C	From Leg	0.500		0.000	No Ice	3.000	0.900	0.065
(E - Verizon)			0.000			1/2" Ice	3.740	1.120	0.079
			0.000			1" Ice	4.480	1.340	0.093
						2" Ice	5.960	1.780	0.122
						4" Ice	8.920	2.660	0.178

6'x6"x4" Panel	A	From Leg	2.000		80.000	No Ice	4.700	2.950	0.025
(E - Metro PCS)			0.000			1/2" Ice	5.147	3.381	0.049
			0.000			1" Ice	5.602	3.819	0.079
						2" Ice	6.533	4.719	0.155
						4" Ice	8.521	6.606	0.382
6'x6"x4" Panel	B	From Leg	2.000		80.000	No Ice	4.700	2.950	0.025
(E - Metro PCS)			0.000			1/2" Ice	5.147	3.381	0.049
			0.000			1" Ice	5.602	3.819	0.079
						2" Ice	6.533	4.719	0.155
						4" Ice	8.521	6.606	0.382
6'x6"x4" Panel	C	From Leg	2.000		80.000	No Ice	4.700	2.950	0.025
(E - Metro PCS)			0.000			1/2" Ice	5.147	3.381	0.049
			0.000			1" Ice	5.602	3.819	0.079
						2" Ice	6.533	4.719	0.155
						4" Ice	8.521	6.606	0.382
Pipe Mount [PM 601-3]	C	From Leg	2.000		0.000	No Ice	4.390	4.390	0.195
(E - Metro PCS)			0.000			1/2" Ice	5.480	5.480	0.237
			0.000			1" Ice	6.570	6.570	0.280
						2" Ice	8.750	8.750	0.365
						4" Ice	13.110	13.110	0.534

GPS	C	From Leg	3.000		0.000	No Ice	0.204	0.204	0.008
(E - Metro PCS)			0.000			1/2" Ice	0.273	0.273	0.010
			0.000			1" Ice	0.351	0.351	0.013
						2" Ice	0.533	0.533	0.023
						4" Ice	0.999	0.999	0.065
Side Arm Mount [SO 702-1]	C	From Leg	1.000		0.000	No Ice	1.000	1.430	0.027
(E - Metro PCS)			0.000			1/2" Ice	1.250	2.050	0.038
			0.000			1" Ice	1.500	2.670	0.049
						2" Ice	2.000	3.910	0.071
						4" Ice	3.000	6.390	0.115

GPS	C	From Leg	3.000		0.000	No Ice	0.204	0.204	0.008
(E)			0.000			1/2" Ice	0.273	0.273	0.010
			0.000			1" Ice	0.351	0.351	0.013
						2" Ice	0.533	0.533	0.023
						4" Ice	0.999	0.999	0.065

tnxTower

B+T Group
 1717 S. Boulder, Suite 300
 Tulsa, OK 74119
 Phone: (918) 587-4630
 FAX: (918) 295-0265

Job	103655.001.01 - Middletown, CT (USID# 14635)	Page	13 of 20
Project	MOD LTE ADD_11-23-2015	Date	13:23:29 12/29/15
Client	Centerline Communications	Designed by	Ikantheti

Description	Face or Leg	Offset Type	Offsets:		Azimuth Adjustment	Placement	C _{AA} Front	C _{AA} Side	Weight
			Horz. Lateral	Vert					
			ft	ft	°	ft	ft ²	ft ²	K
Side Arm Mount [SO 702-1] (E)	C	From Leg	1.000 0.000 0.000		0.000	50.000	No Ice 1.000 1/2" Ice 1.250 1" Ice 1.500 2" Ice 2.000 4" Ice 3.000	1.430 2.050 2.670 3.910 6.390	0.027 0.038 0.049 0.071 0.115

Load Combinations

Comb. No.	Description
1	Dead Only
2	Dead+Wind 0 deg - No Ice
3	Dead+Wind 30 deg - No Ice
4	Dead+Wind 60 deg - No Ice
5	Dead+Wind 90 deg - No Ice
6	Dead+Wind 120 deg - No Ice
7	Dead+Wind 150 deg - No Ice
8	Dead+Wind 180 deg - No Ice
9	Dead+Wind 210 deg - No Ice
10	Dead+Wind 240 deg - No Ice
11	Dead+Wind 270 deg - No Ice
12	Dead+Wind 300 deg - No Ice
13	Dead+Wind 330 deg - No Ice
14	Dead+Ice+Temp
15	Dead+Wind 0 deg+Ice+Temp
16	Dead+Wind 30 deg+Ice+Temp
17	Dead+Wind 60 deg+Ice+Temp
18	Dead+Wind 90 deg+Ice+Temp
19	Dead+Wind 120 deg+Ice+Temp
20	Dead+Wind 150 deg+Ice+Temp
21	Dead+Wind 180 deg+Ice+Temp
22	Dead+Wind 210 deg+Ice+Temp
23	Dead+Wind 240 deg+Ice+Temp
24	Dead+Wind 270 deg+Ice+Temp
25	Dead+Wind 300 deg+Ice+Temp
26	Dead+Wind 330 deg+Ice+Temp
27	Dead+Wind 0 deg - Service
28	Dead+Wind 30 deg - Service
29	Dead+Wind 60 deg - Service
30	Dead+Wind 90 deg - Service
31	Dead+Wind 120 deg - Service
32	Dead+Wind 150 deg - Service
33	Dead+Wind 180 deg - Service
34	Dead+Wind 210 deg - Service
35	Dead+Wind 240 deg - Service
36	Dead+Wind 270 deg - Service
37	Dead+Wind 300 deg - Service
38	Dead+Wind 330 deg - Service

tnxTower B+T Group 1717 S. Boulder, Suite 300 Tulsa, OK 74119 Phone: (918) 587-4630 FAX: (918) 295-0265	Job 103655.001.01 - Middletown, CT (USID# 14635)	Page 14 of 20
	Project MOD LTE ADD_11-23-2015	Date 13:23:29 12/29/15
	Client Centerline Communications	Designed by Ikantheti

Maximum Member Forces

Section No.	Elevation ft	Component Type	Condition	Gov. Load Comb.	Force K	Major Axis Moment kip-ft	Minor Axis Moment kip-ft
L1	148 - 111	Pole	Max Tension	1	0.000	0.000	0.000
			Max. Compression	14	-20.039	-1.633	-0.340
			Max. Mx	5	-11.030	-378.255	3.523
			Max. My	8	-11.052	3.243	-374.776
			Max. Vy	5	16.388	-378.255	3.523
			Max. Vx	8	16.194	3.243	-374.776
			Max. Torque	13			-1.107
L2	111 - 99.333	Pole	Max Tension	1	0.000	0.000	0.000
			Max. Compression	14	-28.336	-2.506	-0.464
			Max. Mx	5	-15.872	-697.237	6.767
			Max. My	8	-15.887	6.370	-691.397
			Max. Vy	5	22.467	-697.237	6.767
			Max. Vx	8	22.354	6.370	-691.397
			Max. Torque	13			-0.637
L3	99.333 - 90.5	Pole	Max Tension	1	0.000	0.000	0.000
			Max. Compression	14	-30.520	-2.834	-0.890
			Max. Mx	5	-17.454	-899.498	8.621
			Max. My	8	-17.467	8.352	-892.779
			Max. Vy	5	23.351	-899.498	8.621
			Max. Vx	8	23.238	8.352	-892.779
			Max. Torque	13			-0.637
L4	90.5 - 75	Pole	Max Tension	1	0.000	0.000	0.000
			Max. Compression	14	-34.240	-2.757	-2.061
			Max. Mx	11	-19.996	1163.354	-11.853
			Max. My	8	-20.008	11.241	-1156.348
			Max. Vy	5	25.223	-1163.244	10.512
			Max. Vx	8	25.110	11.241	-1156.348
			Max. Torque	13			-0.631
L5	75 - 60.5	Pole	Max Tension	1	0.000	0.000	0.000
			Max. Compression	14	-41.568	-4.098	-3.409
			Max. Mx	5	-25.455	-1670.286	14.439
			Max. My	8	-25.464	15.426	-1661.461
			Max. Vy	5	27.383	-1670.286	14.439
			Max. Vx	8	27.271	15.426	-1661.461
			Max. Torque	10			0.214
L6	60.5 - 39.75	Pole	Max Tension	1	0.000	0.000	0.000
			Max. Compression	14	-47.440	-4.839	-4.718
			Max. Mx	11	-29.989	2107.420	-20.321
			Max. My	8	-29.995	18.844	-2097.463
			Max. Vy	5	29.059	-2107.391	17.345
			Max. Vx	8	28.963	18.844	-2097.463
			Max. Torque	6			-0.463
L7	39.75 - 30.5	Pole	Max Tension	1	0.000	0.000	0.000
			Max. Compression	14	-54.765	-5.798	-5.789
			Max. Mx	5	-35.850	-2540.072	20.036
			Max. My	8	-35.855	21.756	-2528.965
			Max. Vy	5	30.529	-2540.072	20.036
			Max. Vx	8	30.434	21.756	-2528.965
			Max. Torque	5			-0.521
L8	30.5 - 0	Pole	Max Tension	1	0.000	0.000	0.000
			Max. Compression	14	-67.711	-7.370	-7.859
			Max. Mx	5	-46.581	-3510.414	25.602
			Max. My	8	-46.581	27.875	-3496.981
			Max. Vy	5	33.132	-3510.414	25.602
			Max. Vx	8	33.039	27.875	-3496.981
			Max. Torque	5			-0.680

tnxTower B+T Group 1717 S. Boulder, Suite 300 Tulsa, OK 74119 Phone: (918) 587-4630 FAX: (918) 295-0265	Job 103655.001.01 - Middletown, CT (USID# 14635)	Page 15 of 20
	Project MOD LTE ADD_11-23-2015	Date 13:23:29 12/29/15
	Client Centerline Communications	Designed by Ikantheti

Section No.	Elevation ft	Component Type	Condition	Gov. Load Comb.	Force K	Major Axis Moment kip-ft	Minor Axis Moment kip-ft
-------------	--------------	----------------	-----------	-----------------	---------	--------------------------	--------------------------

Maximum Reactions

Location	Condition	Gov. Load Comb.	Vertical K	Horizontal, X K	Horizontal, Z K
Pole	Max. Vert	18	67.711	-8.003	0.032
	Max. H _x	11	46.597	33.109	-0.201
	Max. H _z	2	46.597	-0.201	33.017
	Max. M _x	2	3492.042	-0.201	33.017
	Max. M _z	5	3510.414	-33.109	0.201
	Max. Torsion	11	0.667	33.109	-0.201
	Min. Vert	1	46.597	0.000	0.000
	Min. H _x	5	46.597	-33.109	0.201
	Min. H _z	8	46.597	0.201	-33.017
	Min. M _x	8	-3496.981	0.201	-33.017
	Min. M _z	11	-3510.021	33.109	-0.201
	Min. Torsion	5	-0.680	-33.109	0.201

Tower Mast Reaction Summary

Load Combination	Vertical K	Shear _x K	Shear _z K	Overturning Moment, M _x kip-ft	Overturning Moment, M _z kip-ft	Torque kip-ft
Dead Only	46.597	0.000	0.000	2.401	-0.190	0.000
Dead+Wind 0 deg - No Ice	46.597	0.201	-33.017	-3492.042	-28.276	-0.135
Dead+Wind 30 deg - No Ice	46.597	16.729	-28.694	-3037.846	-1779.613	0.218
Dead+Wind 60 deg - No Ice	46.597	28.774	-16.682	-1769.053	-3054.137	0.518
Dead+Wind 90 deg - No Ice	46.597	33.109	-0.201	-25.602	-3510.414	0.680
Dead+Wind 120 deg - No Ice	46.597	28.573	16.334	1725.432	-3026.169	0.654
Dead+Wind 150 deg - No Ice	46.597	16.381	28.493	3014.820	-1731.046	0.449
Dead+Wind 180 deg - No Ice	46.597	-0.201	33.017	3496.981	27.875	0.122
Dead+Wind 210 deg - No Ice	46.597	-16.729	28.694	3042.786	1779.208	-0.233
Dead+Wind 240 deg - No Ice	46.597	-28.774	16.682	1773.996	3053.732	-0.520
Dead+Wind 270 deg - No Ice	46.597	-33.109	0.201	30.548	3510.021	-0.667
Dead+Wind 300 deg - No Ice	46.597	-28.573	-16.334	-1720.488	3025.770	-0.640
Dead+Wind 330 deg - No Ice	46.597	-16.381	-28.493	-3009.880	1730.647	-0.447
Dead+Ice+Temp	67.711	0.000	0.000	7.859	-7.370	-0.000
Dead+Wind 0 deg+Ice+Temp	67.711	0.032	-8.000	-864.665	-12.381	0.010
Dead+Wind 30 deg+Ice+Temp	67.711	4.030	-6.944	-750.212	-448.718	0.094
Dead+Wind 60 deg+Ice+Temp	67.711	6.947	-4.028	-432.608	-766.821	0.154
Dead+Wind 90 deg+Ice+Temp	67.711	8.003	-0.032	3.044	-881.456	0.172
Dead+Wind 120 deg+Ice+Temp	67.711	6.915	3.972	440.013	-761.907	0.145
Dead+Wind 150 deg+Ice+Temp	67.711	3.974	6.912	761.213	-440.206	0.078
Dead+Wind 180 deg+Ice+Temp	67.711	-0.032	8.000	880.580	-2.552	-0.010
Dead+Wind 210 deg+Ice+Temp	67.711	-4.030	6.944	766.128	433.785	-0.096
Dead+Wind 240 deg+Ice+Temp	67.711	-6.947	4.028	448.526	751.889	-0.155
Dead+Wind 270 deg+Ice+Temp	67.711	-8.003	0.032	12.873	866.525	-0.173
Dead+Wind 300 deg+Ice+Temp	67.711	-6.915	-3.972	-424.098	746.976	-0.145
Dead+Wind 330 deg+Ice+Temp	67.711	-3.974	-6.912	-745.299	425.274	-0.078
Dead+Wind 0 deg - Service	46.597	0.070	-11.424	-1207.932	-9.927	-0.045
Dead+Wind 30 deg - Service	46.597	5.788	-9.929	-1050.631	-616.557	0.078
Dead+Wind 60 deg - Service	46.597	9.956	-5.772	-611.151	-1058.034	0.180

Job	103655.001.01 - Middletown, CT (USID# 14635)	Page	16 of 20
Project	MOD LTE ADD_11-23-2015	Date	13:23:29 12/29/15
Client	Centerline Communications	Designed by	Ikantheti

Load Combination	Vertical K	Shear _x K	Shear _z K	Overturning Moment, M _x kip-ft	Overturning Moment, M _z kip-ft	Torque kip-ft
Dead+Wind 90 deg - Service	46.597	11.456	-0.070	-7.250	-1216.064	0.234
Dead+Wind 120 deg - Service	46.597	9.887	5.652	599.259	-1048.312	0.225
Dead+Wind 150 deg - Service	46.597	5.668	9.859	1045.861	-599.713	0.155
Dead+Wind 180 deg - Service	46.597	-0.070	11.424	1212.883	9.525	0.043
Dead+Wind 210 deg - Service	46.597	-5.788	9.929	1055.583	616.154	-0.080
Dead+Wind 240 deg - Service	46.597	-9.956	5.772	616.102	1057.631	-0.180
Dead+Wind 270 deg - Service	46.597	-11.456	0.070	12.202	1215.661	-0.233
Dead+Wind 300 deg - Service	46.597	-9.887	-5.652	-594.307	1047.910	-0.223
Dead+Wind 330 deg - Service	46.597	-5.668	-9.859	-1040.910	599.311	-0.154

Solution Summary

Load Comb.	Sum of Applied Forces			Sum of Reactions			% Error
	PX K	PY K	PZ K	PX K	PY K	PZ K	
1	0.000	-46.597	0.000	0.000	46.597	0.000	0.000%
2	0.201	-46.597	-33.017	-0.201	46.597	33.017	0.000%
3	16.729	-46.597	-28.694	-16.729	46.597	28.694	0.000%
4	28.774	-46.597	-16.682	-28.774	46.597	16.682	0.000%
5	33.109	-46.597	-0.201	-33.109	46.597	0.201	0.000%
6	28.573	-46.597	16.334	-28.573	46.597	-16.334	0.000%
7	16.381	-46.597	28.493	-16.381	46.597	-28.493	0.000%
8	-0.201	-46.597	33.017	0.201	46.597	-33.017	0.000%
9	-16.729	-46.597	28.694	16.729	46.597	-28.694	0.000%
10	-28.774	-46.597	16.682	28.774	46.597	-16.682	0.000%
11	-33.109	-46.597	0.201	33.109	46.597	-0.201	0.000%
12	-28.573	-46.597	-16.334	28.573	46.597	16.334	0.000%
13	-16.381	-46.597	-28.493	16.381	46.597	28.493	0.000%
14	0.000	-67.711	0.000	-0.000	67.711	-0.000	0.000%
15	0.032	-67.711	-8.000	-0.032	67.711	8.000	0.000%
16	4.030	-67.711	-6.944	-4.030	67.711	6.944	0.000%
17	6.947	-67.711	-4.028	-6.947	67.711	4.028	0.000%
18	8.003	-67.711	-0.032	-8.003	67.711	0.032	0.000%
19	6.915	-67.711	3.972	-6.915	67.711	-3.972	0.000%
20	3.974	-67.711	6.912	-3.974	67.711	-6.912	0.000%
21	-0.032	-67.711	8.000	0.032	67.711	-8.000	0.000%
22	-4.030	-67.711	6.944	4.030	67.711	-6.944	0.000%
23	-6.947	-67.711	4.028	6.947	67.711	-4.028	0.000%
24	-8.003	-67.711	0.032	8.003	67.711	-0.032	0.000%
25	-6.915	-67.711	-3.972	6.915	67.711	3.972	0.000%
26	-3.974	-67.711	-6.912	3.974	67.711	6.912	0.000%
27	0.070	-46.597	-11.424	-0.070	46.597	11.424	0.000%
28	5.788	-46.597	-9.929	-5.788	46.597	9.929	0.000%
29	9.956	-46.597	-5.772	-9.956	46.597	5.772	0.000%
30	11.456	-46.597	-0.070	-11.456	46.597	0.070	0.000%
31	9.887	-46.597	5.652	-9.887	46.597	-5.652	0.000%
32	5.668	-46.597	9.859	-5.668	46.597	-9.859	0.000%
33	-0.070	-46.597	11.424	0.070	46.597	-11.424	0.000%
34	-5.788	-46.597	9.929	5.788	46.597	-9.929	0.000%
35	-9.956	-46.597	5.772	9.956	46.597	-5.772	0.000%
36	-11.456	-46.597	0.070	11.456	46.597	-0.070	0.000%
37	-9.887	-46.597	-5.652	9.887	46.597	5.652	0.000%
38	-5.668	-46.597	-9.859	5.668	46.597	9.859	0.000%

tnxTower B+T Group 1717 S. Boulder, Suite 300 Tulsa, OK 74119 Phone: (918) 587-4630 FAX: (918) 295-0265	Job 103655.001.01 - Middletown, CT (USID# 14635)	Page 17 of 20
	Project MOD LTE ADD_11-23-2015	Date 13:23:29 12/29/15
	Client Centerline Communications	Designed by Ikantheti

Non-Linear Convergence Results

Load Combination	Converged?	Number of Cycles	Displacement Tolerance	Force Tolerance
1	Yes	4	0.00000001	0.00000001
2	Yes	4	0.00000001	0.00088134
3	Yes	6	0.00000001	0.00005723
4	Yes	6	0.00000001	0.00005689
5	Yes	4	0.00000001	0.00063098
6	Yes	6	0.00000001	0.00005547
7	Yes	6	0.00000001	0.00005518
8	Yes	4	0.00000001	0.00074430
9	Yes	6	0.00000001	0.00005695
10	Yes	6	0.00000001	0.00005747
11	Yes	5	0.00000001	0.00004496
12	Yes	6	0.00000001	0.00005501
13	Yes	6	0.00000001	0.00005514
14	Yes	4	0.00000001	0.00008766
15	Yes	5	0.00000001	0.00046357
16	Yes	5	0.00000001	0.00054286
17	Yes	5	0.00000001	0.00054364
18	Yes	5	0.00000001	0.00047267
19	Yes	5	0.00000001	0.00054289
20	Yes	5	0.00000001	0.00054229
21	Yes	5	0.00000001	0.00047042
22	Yes	5	0.00000001	0.00054096
23	Yes	5	0.00000001	0.00054116
24	Yes	5	0.00000001	0.00046346
25	Yes	5	0.00000001	0.00052534
26	Yes	5	0.00000001	0.00052496
27	Yes	4	0.00000001	0.00022237
28	Yes	5	0.00000001	0.00010034
29	Yes	5	0.00000001	0.00009905
30	Yes	4	0.00000001	0.00021818
31	Yes	5	0.00000001	0.00009620
32	Yes	5	0.00000001	0.00009517
33	Yes	4	0.00000001	0.00021792
34	Yes	5	0.00000001	0.00009958
35	Yes	5	0.00000001	0.00010142
36	Yes	4	0.00000001	0.00023354
37	Yes	5	0.00000001	0.00009422
38	Yes	5	0.00000001	0.00009472

Maximum Tower Deflections - Service Wind

Section No.	Elevation ft	Horz. Deflection in	Gov. Load Comb.	Tilt °	Twist °
L1	148 - 111	30.375	35	1.832	0.002
L2	115 - 99.333	18.300	35	1.587	0.000
L3	99.333 - 90.5	13.438	35	1.337	0.000
L4	90.5 - 75	11.098	35	1.191	0.000
L5	79.75 - 60.5	8.593	35	1.032	0.000
L6	60.5 - 39.75	4.895	35	0.773	0.000
L7	45 - 30.5	2.735	35	0.557	0.000
L8	30.5 - 0	1.255	35	0.395	0.000

tnxTower B+T Group 1717 S. Boulder, Suite 300 Tulsa, OK 74119 Phone: (918) 587-4630 FAX: (918) 295-0265	Job 103655.001.01 - Middletown, CT (USID# 14635)	Page 18 of 20
	Project MOD LTE ADD_11-23-2015	Date 13:23:29 12/29/15
	Client Centerline Communications	Designed by Ikantheti

Critical Deflections and Radius of Curvature - Service Wind

Elevation	Appurtenance	Gov. Load Comb.	Deflection in	Tilt °	Twist °	Radius of Curvature ft
152.000	Lighting Rod 5/8" x 8'	35	30.375	1.832	0.002	28464
148.000	(2) 7770.00.850.10 w/ Mount Pipe	35	30.375	1.832	0.002	28464
140.000	(2) AIR 21 w/ Mount Pipe	35	27.333	1.795	0.001	17789
124.000	APXVSPP18-C-A20 w/ Mount Pipe	35	21.421	1.687	0.001	5929
110.000	BXA-70063-6CF w/ Mount Pipe	35	16.659	1.514	0.000	3754
90.000	6'x6"x4" Panel	35	10.973	1.183	0.000	3664
55.000	GPS	35	4.052	0.695	0.000	4113
50.000	GPS	35	3.363	0.623	0.000	4947

Maximum Tower Deflections - Design Wind

Section No.	Elevation ft	Horz. Deflection in	Gov. Load Comb.	Tilt °	Twist °
L1	148 - 111	87.486	10	5.280	0.004
L2	115 - 99.333	52.732	10	4.576	0.001
L3	99.333 - 90.5	38.733	10	3.854	0.001
L4	90.5 - 75	31.991	10	3.435	0.001
L5	79.75 - 60.5	24.774	10	2.975	0.001
L6	60.5 - 39.75	14.116	10	2.231	0.001
L7	45 - 30.5	7.888	10	1.606	0.000
L8	30.5 - 0	3.621	10	1.141	0.000

Critical Deflections and Radius of Curvature - Design Wind

Elevation	Appurtenance	Gov. Load Comb.	Deflection in	Tilt °	Twist °	Radius of Curvature ft
152.000	Lighting Rod 5/8" x 8'	10	87.486	5.280	0.004	10063
148.000	(2) 7770.00.850.10 w/ Mount Pipe	10	87.486	5.280	0.004	10063
140.000	(2) AIR 21 w/ Mount Pipe	10	78.731	5.174	0.004	6289
124.000	APXVSPP18-C-A20 w/ Mount Pipe	10	61.716	4.866	0.002	2093
110.000	BXA-70063-6CF w/ Mount Pipe	10	48.008	4.367	0.001	1321
90.000	6'x6"x4" Panel	10	31.634	3.412	0.001	1281
55.000	GPS	10	11.687	2.003	0.001	1430
50.000	GPS	10	9.700	1.797	0.000	1720

Compression Checks

Pole Design Data

tnxTower B+T Group 1717 S. Boulder, Suite 300 Tulsa, OK 74119 Phone: (918) 587-4630 FAX: (918) 295-0265	Job 103655.001.01 - Middletown, CT (USID# 14635)	Page 19 of 20
	Project MOD LTE ADD_11-23-2015	Date 13:23:29 12/29/15
	Client Centerline Communications	Designed by Ikantheti

Section No.	Elevation ft	Size	L ft	L _a ft	Kl/r	F _a ksi	A in ²	Actual P K	Allow. P _a K	Ratio P P _a
L1	148 - 111 (1)	TP30.661x24x0.25	37.000	0.000	0.0	39.000	23.560	-11.014	918.829	0.012
L2	111 - 99.333 (2)	TP32.262x29.441x0.25	15.667	0.000	0.0	39.000	25.401	-15.852	990.653	0.016
L3	99.333 - 90.5 (3)	TP33.852x32.262x0.342	8.833	0.000	0.0	32.854	36.329	-17.436	1193.570	0.015
L4	90.5 - 75 (4)	TP36.643x33.852x0.422	15.500	0.000	0.0	33.880	47.386	-19.979	1605.430	0.012
L5	75 - 60.5 (5)	TP38.753x35.288x0.471	19.250	0.000	0.0	33.952	57.202	-25.442	1942.130	0.013
L6	60.5 - 39.75 (6)	TP42.489x38.753x0.537	20.750	0.000	0.0	34.622	69.871	-29.979	2419.060	0.012
L7	39.75 - 30.5 (7)	TP43.529x40.919x0.589	14.500	0.000	0.0	34.692	80.276	-35.843	2784.920	0.013
L8	30.5 - 0 (8)	TP49.02x43.529x0.603	30.500	0.000	0.0	35.031	92.714	-46.581	3247.820	0.014

Pole Bending Design Data

Section No.	Elevation ft	Size	Actual M _x kip-ft	Actual f _{bx} ksi	Allow. F _{bx} ksi	Ratio $\frac{f_{bx}}{F_{bx}}$	Actual M _y kip-ft	Actual f _{by} ksi	Allow. F _{by} ksi	Ratio $\frac{f_{by}}{F_{by}}$
L1	148 - 111 (1)	TP30.661x24x0.25	380.457	26.464	39.000	0.679	0.000	0.000	39.000	0.000
L2	111 - 99.333 (2)	TP32.262x29.441x0.25	701.682	41.962	39.000	1.076	0.000	0.000	39.000	0.000
L3	99.333 - 90.5 (3)	TP33.852x32.262x0.342	905.342	36.248	32.854	1.103	0.000	0.000	32.854	0.000
L4	90.5 - 75 (4)	TP36.643x33.852x0.422	1171.417	34.130	33.880	1.007	0.000	0.000	33.880	0.000
L5	75 - 60.5 (5)	TP38.753x35.288x0.471	1681.592	37.508	33.952	1.105	0.000	0.000	33.952	0.000
L6	60.5 - 39.75 (6)	TP42.489x38.753x0.537	2121.558	36.196	34.622	1.045	0.000	0.000	34.622	0.000
L7	39.75 - 30.5 (7)	TP43.529x40.919x0.589	2556.475	36.276	34.692	1.046	0.000	0.000	34.692	0.000
L8	30.5 - 0 (8)	TP49.02x43.529x0.603	3531.617	38.434	35.031	1.097	0.000	0.000	35.031	0.000

Pole Shear Design Data

Section No.	Elevation ft	Size	Actual V K	Actual f _v ksi	Allow. F _v ksi	Ratio $\frac{f_v}{F_v}$	Actual T kip-ft	Actual f _{vt} ksi	Allow. F _{vt} ksi	Ratio $\frac{f_{vt}}{F_{vt}}$
L1	148 - 111 (1)	TP30.661x24x0.25	16.485	0.700	26.000	0.054	0.171	0.006	26.000	0.000
L2	111 - 99.333 (2)	TP32.262x29.441x0.25	22.631	0.891	26.000	0.069	0.013	0.000	26.000	0.000
L3	99.333 - 90.5 (3)	TP33.852x32.262x0.342	23.515	0.647	21.903	0.059	0.045	0.001	21.903	0.000
L4	90.5 - 75 (4)	TP36.643x33.852x0.422	25.388	0.536	22.587	0.047	0.106	0.001	22.587	0.000
L5	75 - 60.5 (5)	TP38.753x35.288x0.471	27.547	0.482	22.635	0.043	0.214	0.002	22.635	0.000
L6	60.5 - 39.75 (6)	TP42.489x38.753x0.537	29.214	0.418	23.081	0.036	0.300	0.002	23.081	0.000
L7	39.75 - 30.5 (7)	TP43.529x40.919x0.589	30.684	0.382	23.128	0.033	0.379	0.003	23.128	0.000
L8	30.5 - 0 (8)	TP49.02x43.529x0.603	33.283	0.359	23.354	0.031	0.520	0.003	23.354	0.000

Pole Interaction Design Data

tnxTower B+T Group 1717 S. Boulder, Suite 300 Tulsa, OK 74119 Phone: (918) 587-4630 FAX: (918) 295-0265	Job 103655.001.01 - Middletown, CT (USID# 14635)	Page 20 of 20
	Project MOD LTE ADD_11-23-2015	Date 13:23:29 12/29/15
	Client Centerline Communications	Designed by Ikantheti

Section No.	Elevation ft	Ratio P P _a	Ratio f _{bx} F _{bx}	Ratio f _{by} F _{by}	Ratio f _v F _v	Ratio f _{vt} F _{vt}	Comb. Stress Ratio	Allow. Stress Ratio	Criteria
L1	148 - 111 (1)	0.012	0.679	0.000	0.054	0.000	0.691 ✓	1.333	H1-3+VT ✓
L2	111 - 99.333 (2)	0.016	1.076	0.000	0.069	0.000	1.093 ✓	1.333	H1-3+VT ✓
L3	99.333 - 90.5 (3)	0.015	1.103	0.000	0.059	0.000	1.119 ✓	1.333	H1-3+VT ✓
L4	90.5 - 75 (4)	0.012	1.007	0.000	0.047	0.000	1.020 ✓	1.333	H1-3+VT ✓
L5	75 - 60.5 (5)	0.013	1.105	0.000	0.043	0.000	1.118 ✓	1.333	H1-3+VT ✓
L6	60.5 - 39.75 (6)	0.012	1.045	0.000	0.036	0.000	1.058 ✓	1.333	H1-3+VT ✓
L7	39.75 - 30.5 (7)	0.013	1.046	0.000	0.033	0.000	1.059 ✓	1.333	H1-3+VT ✓
L8	30.5 - 0 (8)	0.014	1.097	0.000	0.031	0.000	1.112 ✓	1.333	H1-3+VT ✓

Section Capacity Table

Section No.	Elevation ft	Component Type	Size	Critical Element	P K	SF*P _{allow} K	% Capacity	Pass Fail	
L1	148 - 111	Pole	TP30.661x24x0.25	1	-11.014	1224.799	**	**	
L2	111 - 99.333	Pole	TP32.262x29.441x0.25	2	-15.852	1320.540	**	**	
L3	99.333 - 90.5	Pole	TP33.852x32.262x0.342	3	-17.436	1591.029	**	**	
L4	90.5 - 75	Pole	TP36.643x33.852x0.422	4	-19.979	2140.038	**	**	
L5	75 - 60.5	Pole	TP38.753x35.288x0.471	5	-25.442	2588.859	**	**	
L6	60.5 - 39.75	Pole	TP42.489x38.753x0.537	6	-29.979	3224.607	**	**	
L7	39.75 - 30.5	Pole	TP43.529x40.919x0.589	7	-35.843	3712.298	**	**	
L8	30.5 - 0	Pole	TP49.02x43.529x0.603	8	-46.581	4329.344	**	**	
							Summary		
							Pole (L3)	**	**
							RATING =	**	**

** Please see the attached calculations at the end

Reinforcement 1						
Bottom	Top	QTY	Type	Position	Gap	Ten/Comp
0	30.5	3	MP308	F	0	T&C
30.5	60.5	3	MP306	F	0	T&C
60.5	90.5	3	MP305	F	0	T&C
90.5	99.333	3	MP303	F	0	T&C
				F	0	T&C
				F	0	T&C
				F	0	T&C
				F	0	T&C
				F	0	T&C
				F	0	T&C

Reinforcement 2						
Bottom	Top	QTY	Type	Position	Gap	Ten/Comp
				F	0	T&C
				F	0	T&C
				F	0	T&C
				F	0	T&C
				F	0	T&C
				F	0	T&C
				F	0	T&C
				F	0	T&C
				F	0	T&C

Reinforcement 3						
Bottom	Top	QTY	Type	Position	Gap	Ten/Comp
0				F	0	T&C
				F	0	T&C
				F	0	T&C
				F	0	T&C
				F	0	T&C
				F	0	T&C
				F	0	T&C
				F	0	T&C
				F	0	T&C
				F	0	T&C

Bottom Elevation	Top Elevation	Original Thickness	Original Yield Stress	Original Ultimate Stress	Reinforced Shaft Capacity	Reinf. 1 QTY	Reinf. 1 Type	Rein. 1 Capacity	Reinf. 2 QTY	Reinf. 2 Type	Rein. 2 Capacity	Reinf. 3 QTY	Reinf. 3 Type	Rein. 3 Capacity	Control Stress Ratio	Section				Equivalent			Bottom Elevation Failure	Top Elevation Failure	Section Failure %		
																Top Height	Length	Lap Splice	# of Sides	Top Diameter	Bottom Diameter	Shaft Thickness				Equivalent Shaft Fy	Equivalent Weight Mult.
111.0000	148.0000	0.2500	65	80	51.8%										51.8%	148.0000	37.0000	4.0000	18	24.0000	30.6610	0.2500	65.0	1.00			
99.3330	115.0000	0.2500	65	80	81.9%										81.9%	115.0000	15.6670	0.0000	18	29.4409	32.2618	0.2500	65.0	1.00			
90.5000	99.3330	0.2500	65	80	69.9%	3	MP303	83.9%							83.9%	99.3330	8.8330	0.0000	18	32.2618	33.8522	0.3416	53.2	0.98			
75.0000	90.5000	0.2500	65	80	66.0%	3	MP305	76.5%							76.5%	90.5000	15.5000	4.7500	18	33.8522	36.6430	0.4221	55.0	0.95			
60.5000	79.7500	0.3125	65	80	72.3%	3	MP305	83.8%							83.8%	79.7500	19.2500	0.0000	18	35.2878	38.7534	0.4708	55.1	0.96			
39.7500	60.5000	0.3125	65	80	69.9%	3	MP306	79.3%							79.3%	60.5000	20.7500	5.2500	18	38.7534	42.4890	0.5368	56.3	0.95			
30.5000	45.0000	0.3750	65	80	70.0%	3	MP306	79.3%							79.3%	45.0000	14.5000	0.0000	18	40.9188	43.5292	0.5890	56.4	0.96			
0.0000	30.5000	0.3750	65	80	74.3%	3	MP308	83.2%							83.2%	30.5000	30.5000	0.0000	18	43.5292	49.0200	0.6033	56.9	0.96			

Section	Loads			Pole																										Unreinforced Pole - Rev. F															Reinforced Pole						Rev. F			Reinforcement 1					Composites				
	Elevation (ft)	Moment (ft-kip)	Compression (kip)	Shear (kip)	Torsion (kip-ft)	Number of Stubs	OD (in)	Thickness (in)	Yield Strength (ksi)	Flat Width (in)	Area (in ²)	Moment of Inertia (in ⁴)	Percent of Moment of Inertia	Angle Offset to Pole Top	Distance to Extreme Fiber (in)	Section Modulus (in ³)	Torsion Constant (in ⁴)	Polygonal Compact Extension	Allowable Bonding Stress (ksi)	Allowable Bonding Moment (ft-kip)	Allowable Axial Stress (ksi)	Allowable Shear Stress (ksi)	Bonding Stress (ksi)	Axial Stress (ksi)	Shear Stress (ksi)	Torsion Shear Stress (ksi)	Stress Ratio	Moment in Pole when Reinforced (ft-kip)	Bonding Stress (ksi)	Axial Stress (ksi)	Shear Stress (ksi)	Torsion Shear Stress (ksi)	Reinforced Pole Stress Ratio	Qty	Model	Position (F Flat, C Corner)	Gap Between Pole and Back of Rein. (in)	Tension only or Tension & Comp.	Total Moment of Inertia (in ⁴)	Axial Force (kip)	Stress Ratio	Centroid Offset (in)	Area (in ²)	Moment of Inertia (in ⁴)	Controlling Stress Ratio	Thickness (in)	Weight Multiplier	Derated Yield Stress (ksi)	% Error in Derated Yield Stress														
1	148	0.0	0.0	0.0	0.0	18	24.000	0.2500	65	3.79	18.8	1341	100%	TRUB	12.17	110	2660	122	52.0	477.6	52.0	34.7	0.0	0.00	0.00	0.00	0.00	0.000	0.0	0.0	0.00	0.00	0.00	0.00	0.000	0.00	0.00								0.000	18.8	1341	0.000	0.2500	1.00	65.0	123.5%											
2	115	380.5	11.0	16.5	0.2	18	29.940	0.2500	65	4.84	23.5	2621	100%	TRUB	15.18	173	5191	156	52.0	747.8	52.0	34.7	28.4	0.47	0.00	0.01	0.518	380.5	28.4	0.47	0.00	0.00	0.518	3	MP103	F	0	TE.C	1325	107.9	0.839	0.000	31.4	5154	0.839	0.3416	0.98	53.2	1.1%														
3	111	442.2	11.8	16.9	0.2	18	30.660	0.2500	65	4.92	23.8	2691	100%	TRUB	15.51	174	5289	157	52.0	751.3	52.0	34.7	35.2	0.28	0.00	0.00	0.297	442.2	35.2	0.28	0.00	0.00	0.297	3	MP103	F	0	TE.C	1398	108.4	0.765	0.000	45.1	7488	0.765	0.4281	0.95	55.0	2.9%														
4	99.111	701.6	15.4	22.6	0.0	18	32.2418	0.2500	65	5.25	24.4	3285	100%	TRUB	16.36	201	6511	169	52.0	869.9	52.0	34.7	41.9	0.62	0.00	0.00	0.819	701.6	41.9	0.62	0.00	0.00	0.819	3	MP103	F	0	TE.C	1525	107.9	0.839	0.000	31.4	5154	0.839	0.3416	0.98	53.2	1.1%														
5	90.5	905.3	17.4	23.5	0.0	18	33.8522	0.2500	65	5.53	24.6	3799	74%	0	16.93	224	7531	178	52.0	972.4	52.0	34.7	48.4	0.65	0.00	0.00	0.944	905.3	48.4	0.65	0.00	0.00	0.944	3	MP103	F	0	TE.C	1652	107.9	0.839	0.000	31.4	5154	0.839	0.3416	0.98	53.2	1.1%														
6	79.75	1171.4	20.0	25.4	0.1	18	35.7871	0.2500	65	5.87	28.2	4495	60%	0	17.89	251	8908	189	52.0	1088.1	52.0	34.7	56.0	0.71	0.00	0.00	0.906	1171.4	56.0	0.71	0.00	0.00	0.906	3	MP105	F	0	TE.C	2091	108.4	0.765	0.000	45.1	7488	0.765	0.4281	0.95	55.0	2.9%														
7	75	1781.5	21.8	26.0	0.1	18	36.6450	0.2500	65	5.87	28.2	4495	77%	0	18.12	277	9985	191	52.0	1200.7	52.0	34.7	62.9	0.84	0.00	0.00	0.924	1781.5	62.9	0.84	0.00	0.00	0.924	3	MP105	F	0	TE.C	2320	110.0	0.765	0.000	45.1	7488	0.765	0.4281	0.95	55.0	2.9%														
8	60.5	1681.6	25.4	27.5	0.2	18	38.7314	0.2500	65	6.28	38.1	7110	67%	0	19.38	367	14094	182	52.0	1589.7	52.0	34.7	55.0	0.67	0.00	0.00	1.071	1681.6	55.0	0.67	0.00	0.00	1.071	3	MP105	F	0	TE.C	3481	217.3	0.838	0.000	55.0	10591	0.838	0.4708	0.96	55.1	2.8%														
9	45	2121.6	30.0	28.7	0.3	18	41.5418	0.2500	65	6.77	40.8	9774	59%	0	20.77	432	17791	175	52.0	1880.0	52.0	34.7	60.8	0.73	0.00	0.00	1.139	2121.6	60.8	0.73	0.00	0.00	1.139	3	MP106	F	0	TE.C	4076	215.6	0.793	0.000	66.3	14844	0.793	0.5268	0.95	56.3	2.8%														
10	39.71	2276.6	32.8	29.8	0.3	18	42.4890	0.2500	65	6.28	51.1	20099	76%	0	21.24	846	30888	191	52.0	2098.7	52.0	34.7	28.9	0.36	0.00	0.00	0.929	2276.6	28.9	0.36	0.00	0.00	0.929	3	MP106	F	0	TE.C	6331	184.3	0.468	0.000	116.5	26433	0.468	0.9175	0.96	56.3	2.8%														
11	30.5	2556.5	35.8	30.7	0.4	18	43.5292	0.2500	65	7.01	51.3	12071	65%	0	21.75	555	23929	151	52.0	2402.7	52.0	34.7	55.3	0.70	0.00	0.00	1.077	2556.5	55.3	0.70	0.00	0.00	1.077	3	MP106	F	0	TE.C	6630	315.7	0.793	0.000	76.7	18201	0.793	0.5890	0.96	56.4	2.8%														
12	0	3521.6	46.6	33.7	0.5	18	49.0200	0.2500	65	7.98	57.8	17291	63%	0	24.51	705	34272	172	52.0	2656.2	52.0	34.7	60.1	0.81	0.00	0.00	1.179	3521.6	60.1	0.81	0.00	0.00	1.179	3	MP109	F	0	TE.C	10167	425.9	0.839	0.000	89.8	27458	0.839	0.6099	0.96	56.9	2.8%														

Reinforcement Capacity

Dimensions and Properties														Compression				Axial				
Model	Weight (lb/ft)	Area (in ²)	Moment of Inertia (in ⁴)	Moment of Inertia (in ⁴)	Centroid from Mating Edge (in)	Centroid from Bolt Hole Center (in)	Web Thickness (in)	Width (in)	Flange Width (in)	Flange Thickness (in)	Hole Diameter (in)	Yield Stress (ksi)	Ultimate Stress (ksi)	Slender. Ratio Coefficient	Unbraced Length (in)	Slender. Ratio Coefficient	Unbraced Length (in)	ASD-9			LRFD	
																		Allowable Axial (kip)	Allowable Axial w/ increase (kip)	Governing Axial	Design Axial Strength (kip)	Governing Axial
MP303	9.9	2.92	0.66	6.57	0.59	0	0.30	4.06	1.57	0.64	1.21875	65	80	0.80	18	1.00	18	96.4	128.6	Rupture	144.7	Rupture
MP305	19.2	5.65	2.15	20.79	0.79	0	0.5	5.33	2.09	0.91	1.21875	65	80	0.80	18	1.00	18	194.5	259.3	Rupture	291.8	Rupture
MP306	28.8	8.47	4.95	52.50	0.93	0	0.64	6.89	2.61	1.01	1.21875	65	80	0.80	24	1.00	24	298.7	398.3	Rupture	448.1	Rupture
MP308	35.1	10.32	6.48	82.29	0.95	0	0.76	7.93	2.8	1.01	1.21875	65	80	0.80	24	1.00	24	366.0	487.9	Rupture	548.9	Rupture
PL5.75x1	19.6	5.75	0.48	15.84	0.5	0	1	5.75	0	0	1.21875	65	80	0.80	14	1.00	14	178.8	238.3	Rupture	268.1	Rupture

Anchor Rod Information for TIA/EIA-222-F and TIA-222-G-2

Site Information	
ID:	14635
Name:	MIDDLETOWN SW
App. #:	N/A



Base Reactions	
Moment:	3532 ft-kip
Axial:	47 kip
Shear:	33 kip
Base Plate Type:	Square

Design Information	
TIA Code:	F
ASIF:	1.333
Failure:	100%
eta Factor:	0.50

Original Anchor Rod Data	
Quantity:	16
Diameter:	2.25 in
Material:	A615 GR 75
Bolt Circle:	56.0 in
Bolt Spacing:	6 in
Bolt Group Area:	63.62 in ²
Bolt Group MOIx:	24938 in ⁴
<u>Reactions Seen by Original AR Group</u>	
Moment:	3069.5 kip-ft
Axial:	46.6 kip
Shear:	33.3 kip
<u>Original AR Capacity Check</u>	
Tension Load:	161.5 kip
Allowable load:	194.8 kip
AR Capacity:	82.9% Pass

First Added Anchor Rod Data	
Quantity:	3
Diameter:	1.75 in
Material:	A772
Bolt Circle:	64.5 in
Bolt Group Area:	7.22 in ²
Bolt Group MOIx:	3755 in ⁴
<u>Reactions Seen by First Added AR Group</u>	
Moment:	462.2 kip-ft
Axial:	0.0 kip
Shear:	0.0 kip
<u>First Added AR Capacity Check</u>	
Tension Load:	114.0 kip
Allowable load:	158.7 kip
AR Capacity:	71.8% Pass

Second Added Anchor Rod Data	
Quantity:	
Diameter:	
Material:	
Bolt Circle:	
Bolt Group Area:	0.00 in ²
Bolt Group MOIx:	0 in ⁴
<u>Reactions Seen by Second Added AR Group</u>	
Moment:	0.0 kip-ft
Axial:	0.0 kip
Shear:	0.0 kip
<u>Second Added AR Capacity Check</u>	
Tension Load:	0.0 kip
Allowable load:	0.0 kip
AR Capacity:	0.0%

Third Added Anchor Rod Data	
Quantity:	
Diameter:	
Material:	
Bolt Circle:	
Bolt Group Area:	0.00 in ²
Bolt Group MOIx:	0 in ⁴
<u>Reactions Seen by Second Added AR Group</u>	
Moment:	0.0 kip-ft
Axial:	0.0 kip
Shear:	0.0 kip
<u>Second Added AR Capacity Check</u>	
Tension Load:	0.0 kip
Allowable load:	0.0 kip
AR Capacity:	0.0%

Square, Stiffened / Unstiffened Base Plate, Any Rod Material - Rev. F /C

- Assumptions:
- 1) Rod groups at corners. Total # rods divisible by 4. Maximum total # of rods = 48 (12 per Corner).
 - 2) Rod Spacing = Straight Center-to-Center distance between any (2) adjacent rods (same corner)
 - 3) Clear space between bottom of leveling nut and top of concrete **not** exceeding (1)*(Rod Diameter)

Site Data

BU#:	14635
Site Name:	MIDDLETOWN SW
App #:	N/A

Anchor Rod Data

Qty:	16	
Diam:	2.25	in
Rod Material:	A615-J	
Yield, Fy:	75	ksi
Strength, Fu:	100	ksi
Bolt Circle:	56	in
Anchor Spacing:	6	in

Plate Data

W=Side:	55	in
Thick:	3	in
Grade:	55	ksi
Clip Distance:	6	in

Stiffener Data (Welding at both sides)

Configuration:	Unstiffened	
Weld Type:		**
Groove Depth:		in **
Groove Angle:		degrees
Fillet H. Weld:		<-- Disregard
Fillet V. Weld:		in
Width:		in
Height:		in
Thick:		in
Notch:		in
Grade:		ksi
Weld str.:		ksi

Pole Data

Diam:	49.02	in
Thick:	0.375	in
Grade:	65	ksi
# of Sides:	18	"0" IF Round

Stress Increase Factor

ASD ASIF:	1.333
-----------	-------

** Note: for complete joint penetration groove welds the groove depth must be exactly 1/2 the stiffener thickness for calculation purposes

Base Reactions

TIA Revision:	F	
Unfactored Moment, M:	3069.46508	ft-kips
Unfactored Axial, P:	46.5808	kips
Unfactored Shear, V:	33.282944	kips

Anchor Rod Results

TIA F --> Maximum Rod Tension	161.5 Kips
Allowable Tension:	195.0 Kips
Anchor Rod Stress Ratio:	82.9% Pass

Base Plate Results

	Flexural Check
Base Plate Stress:	40.8 ksi
Allowable PL Bending Stress:	55.0 ksi
Base Plate Stress Ratio:	74.2% Pass

N/A - Unstiffened

Stiffener Results

Horizontal Weld :	N/A
Vertical Weld:	N/A
Plate Flex+Shear, $f_b/F_b + (f_v/F_v)^2$:	N/A
Plate Tension+Shear, $f_t/F_t + (f_v/F_v)^2$:	N/A
Plate Comp. (AISC Bracket):	N/A

Pole Results

Pole Punching Shear Check:	N/A
----------------------------	-----

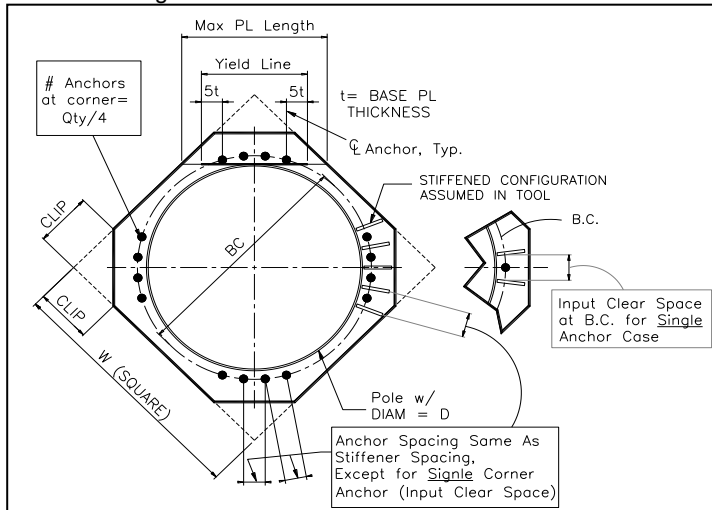

PROJECT	14635 - Middletown SW		
SUBJECT	Foundation Analysis		
DATE	12/29/15	PAGE	1 OF 1

Monopole Pad & Pier Foundation Analysis

Rev. Type: **F**

Design Loads:

Input unfactored loads

Shear:	<u>33.0</u>	kips
Moment:	<u>3,532.0</u>	ft-kips
Tower Height:	<u>148.0</u>	ft
Tower Weight:	<u>47.0</u>	kips

Pad & Pier Dimensions / Properties:

Pole Diameter at Base:	<u>49.02</u>	in
Bearing Depth:	<u>8.0</u>	ft
Pad Width:	<u>22.0</u>	ft
Neglected Depth:	<u>2.0</u>	ft
Thickness:	<u>3.0</u>	ft
Pier Diameter:	<u>7.0</u>	ft
Pier Height Above Grade:	<u>0.5</u>	ft
BP Dist. Above Pier:	<u>3.0</u>	in
Clear Cover:	<u>3.0</u>	in
Pier Rebar Size:	<u>11</u>	
Pier Rebar Quantity:	<u>28</u>	
Pad Rebar Size:	<u>11</u>	
Pad Rebar Quantity:	<u>21</u>	
Pier Tie Size:	<u>5</u>	
Tie Quantity:	<u>16</u>	
Rebar Yield Strength:	<u>60000</u>	psi
Concrete Strength:	<u>3000</u>	psi
Concrete Unit Weight:	<u>0.15</u>	kcf

22.0 FT

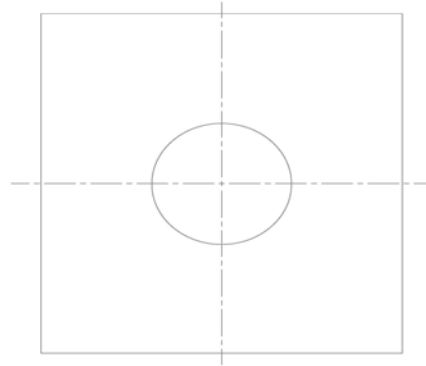

22.0 FT

Elevation Overview

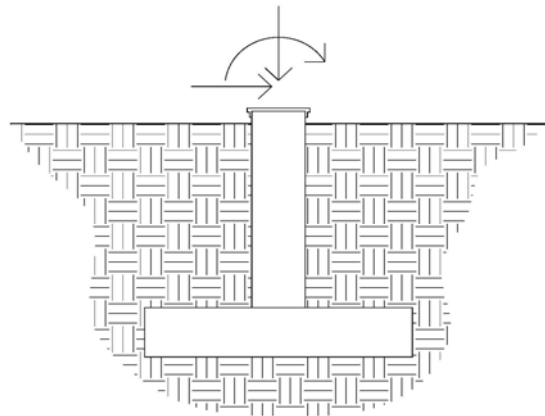

Soil Data:

Allowable Values

Soil Unit Weight:	<u>0.125</u>	kcf
Ult. Bearing Capacity:	<u>12.000</u>	ksf
Angle of Friction:	<u>34.000</u>	deg
Cohesion:	<u>0.000</u>	ksf
Passive Pressure:	<u>0.000</u>	ksf
Base Friction:	<u>0.260</u>	

** Notes:

Summary of Results

Req'd Pier Diam.	OK
Overturning	85.9%
Shear Capacity	37.5%
Bearing	57.4%
Pad Shear - 1-way	63.8%
Pad Shear - 2-way	6.4%
Pad Moment Capacity	34.1%
Pier Moment Capacity	70.6%