



10 Industrial Avenue, Suite 3  
Mahwah NJ, 07430  
Phone: (201)-951-3869  
Tom Kincaid  
Real Estate Consultant

August 11, 2014

**Hand Delivered**

Ms. Melanie A. Bachman  
Acting Executive Director  
Connecticut Siting Council  
10 Franklin Square  
New Britain, CT 06051

CC Property Owner:  
Town Of Madison  
Attn: First Selectman Office  
8 Campus Drive  
Madison, CT 06443-2562

RE: Sprint Spectrum L.P. notice of intent to modify an existing telecommunications facility located at 8 Meeting House Lane, Madison CT, 06443. Known to Sprint Spectrum L.P. as site CT60XC937.

Dear Ms. Bachman:

In order to accommodate technological changes, implement Code Division Multiple Access ("CDMA") and/or Long Term Evolution ("LTE") capabilities, and enhance system performance in the state of Connecticut, Sprint Spectrum L.P. plans to modify the equipment configurations at many of its existing cell sites. Please accept this letter and attachments as notification, pursuant to R.C.S.A. Section 16-50j-73, of construction which constitutes an exempt modification pursuant to R.C.S.A. Section 16-50j-72(b)(2). In compliance with R.C.S.A. Section 16-50j-73, a copy of this letter and its attachments is being sent to the chief elected official of the municipality in which affected cell site is located.

CDMA employs Spread-Spectrum technology and special coding scheme to allow multiple users to be multiplexed over the same physical channel.

LTE is a new high-performance air interface for cellular mobile communications. It is designed to increase the capacity and speed of mobile telephone networks.

Attached is a summary of the planned modifications, including power density calculations reflecting the change in Sprint's operations at the site. Also included is documentation of the structural sufficiency of the tower to accommodate the revised antenna configuration.

The changes to the facility do not constitute modification as defined Connecticut General Statutes ("C.G.S.") Section 16-50i(d) because the general physical characteristics of the facility will not be significantly changed or altered. Rather, the planned changes to the facility fall squarely within those activities explicitly provided for the R.C.S.A. Section 16-50j-72(b)(2).

1. The height of the overall structure will not be affected.
2. The proposed changes will not extend the site boundaries. There will be no effect on the site compound.
3. The proposed changes will not increase the noise level at the existing facility by 6 decibels or more.
4. Radio Frequency power density may increase due to the use of one or more CDMA transmissions. Moreover, LTE will utilize additional radio frequencies newly licensed by the FCC for cellular mobile communications. However, the changes will not increase the calculated "worst case" power density for the combined operations at the site to a level at or above the applicable standard for uncontrolled environments as calculated for a mixed frequency site.

For the foregoing reasons Sprint Spectrum L.P. respectfully submits that the proposed changes at the referenced site constitute exempt modifications under R.C.S.A. Section 16-50j-72(b)(2).

Please feel free to call me at (845) 499-4712 or email [JNotaro@Transcendwireless.com](mailto:JNotaro@Transcendwireless.com) with questions concerning this matter.  
Thank you for your consideration.

Sincerely,

Jennifer Notaro  
Real Estate Consultant

RADIO FREQUENCY FCC REGULATORY COMPLIANCE  
MAXIMUM PERMISSIBLE EXPOSURE (MPE) ASSESSMENT

Sprint Existing Facility

Site ID: CT60XC937

Madison CT 6

8 Meeting House Lane  
Madison, CT 06443

**August 8, 2014**

**EBI Project Number: 62144192**

August 8, 2014

Sprint  
Attn: RF Engineering Manager  
1 International Boulevard, Suite 800  
Mahwah, NJ 07495

Re: Radio Frequency Maximum Permissible Exposure (MPE) Assessment for Site:  
**CT60XC937 - Madison CT 6**

**Site Total: 63.96% - MPE% in full compliance**

EBI Consulting was directed to analyze the proposed upgrades to the existing Sprint facility located at 8 Meeting House Lane, Madison, CT, for the purpose of determining whether the radio frequency (RF) exposure levels from the proposed Sprint equipment upgrades on this property are within specified federal limits.

All information used in this report was analyzed as a percentage of current Maximum Permissible Exposure (% MPE) as listed in the FCC OET Bulletin 65 Edition 97-01 and ANSI/IEEE Std C95.1. The FCC regulates Maximum Permissible Exposure in units of microwatts per square centimeter ( $\mu\text{W}/\text{cm}^2$ ). The number of  $\mu\text{W}/\text{cm}^2$  calculated at each sample point is called the power density. The exposure limit for power density varies depending upon the frequencies being utilized. Wireless Carriers and Paging Services use different frequency bands each with different exposure limits, therefore it is necessary to report results and limits in terms of percent MPE rather than power density.

All results were compared to the FCC (Federal Communications Commission) radio frequency exposure rules, 47 CFR 1.1307(b)(1) – (b)(3), to determine compliance with the Maximum Permissible Exposure (MPE) limits for General Population/Uncontrolled environments as defined below.

General population/uncontrolled exposure limits apply to situations in which the general public may be exposed or in which persons who are exposed as a consequence of their employment may not be made fully aware of the potential for exposure or cannot exercise control over their exposure. Therefore, members of the general public would always be considered under this category when exposure is not employment related, for example, in the case of a telecommunications tower that exposes persons in a nearby residential area.

Public exposure to radio frequencies is regulated and enforced in units of microwatts per square centimeter ( $\mu\text{W}/\text{cm}^2$ ). The general population exposure limit for the cellular band (850 MHz Band) is approximately  $567 \mu\text{W}/\text{cm}^2$ , and the general population exposure limit for the 1900 MHz and 2500 MHz bands is  $1000 \mu\text{W}/\text{cm}^2$ . Because each carrier will be using different frequency bands, and each frequency band has different exposure limits, it is necessary to report percent of MPE rather than power density.

Occupational/controlled exposure limits apply to situations in which persons are exposed as a consequence of their employment and in which those persons who are exposed have been made fully aware of the potential for exposure and can exercise control over their exposure. Occupational/controlled exposure limits also apply where exposure is of a transient nature as a result of incidental passage through a location where exposure levels may be above general population/uncontrolled limits (see below), as long as the exposed person has been made fully aware of the potential for exposure and can exercise control over his or her exposure by leaving the area or by some other appropriate means.

Additional details can be found in FCC OET 65.

## **CALCULATIONS**

Calculations were done for the proposed upgrades to the existing Sprint Wireless antenna facility located at 8 Meeting House Lane, Madison, CT, using the equipment information listed below. All calculations were performed per the specifications under FCC OET 65. All calculations were performed assuming a lobe representing the maximum gain of the antenna per the antenna manufactures supplied specifications, minus 10 dB, was focused at the base of the tower. For this report the sample point is the top of a 6 foot person standing at the base of the tower.

For all calculations, all emissions were calculated using the following assumptions:

- 1) 2 channels in the 1900 MHz Band were considered for each sector of the proposed installation.
- 2) 1 channel in the 800 MHz Band was considered for each sector of the proposed installation
- 3) 2 channels in the 2500 MHz Band were considered for each sector of the proposed installation.
- 4) All radios at the proposed installation were considered to be running at full power and were uncombined in their RF transmissions paths per carrier prescribed configuration. Per FCC OET Bulletin No. 65 - Edition 97-01 recommendations to achieve the maximum anticipated value at each sample point, all power levels emitting from the proposed antenna installation are increased by a factor of 2.56 to account for possible in-phase reflections from the surrounding environment. This is rarely the case, and if so, is never continuous.
- 5) For the following calculations the sample point was the top of a six foot person standing at the base of the tower. The maximum gain of the antenna per the antenna manufactures supplied specifications minus 10 dB was used in this direction. This value is a very conservative estimate as gain reductions for these particular antennas are typically much higher in this direction.

- 6) The antennas used in this modeling are the RFS APXVSPP18-C-A20 and the RFS APXVTM14-C-I20. This is based on feedback from the carrier with regards to anticipated antenna selection. The RFS APXVSPP18-C-A20 has a 15.9 dBd gain value at its main lobe at 1900 MHz and 13.4 dBd at its main lobe for 850 MHz. The RFS APXVTM14-C-I20 has a 15.9 dBd gain value at its main lobe at 2500 MHz. The maximum gain of the antenna per the antenna manufactures supplied specifications, minus 10 dB, was used for all calculations. This value is a very conservative estimate as gain reductions for these particular antennas are typically much higher in this direction.
- 7) The antenna mounting height centerline for the proposed antennas is **97.5 feet** above ground level (AGL).
- 8) Emissions values for additional carriers were taken from the Connecticut Siting Council active database. Values in this database are provided by the individual carriers themselves.

All calculation were done with respect to uncontrolled / general public threshold limits

Site ID	CT60XC937 - Madison CT 6
Site Address	8 Meeting House Lane, Madison, CT, 06443
Site Type	Monopole

**Sector 1**

Antenna Number	Antenna Make	Antenna Model	Radio Type	Frequency Band	Technology	Power Out Per Channel (Watts)	Number of Channels	Composite Power	Antenna Gain (10 db reduction)	Antenna Height (ft)	analysis height	Cable Size	Cable Loss (dB)	Additional Loss (dB)	ERP	Power Density Percentage
1a	RFS	APXVSP18-C-A20	RRH	1900 MHz	CDMA / LTE	20	2	40	5.9	97.5	91.5	1/2 "	0.5	0	138.69	0.60%
1a	RFS	APXVSP18-C-A20	RRH	850 MHz	CDMA / LTE	20	1	20	3.4	97.5	91.5	1/2 "	0.5	0	39.00	0.30%
1B	RFS	APXVTMM14-C-120	RRH	2500 MHz	CDMA / LTE	20	2	40	5.9	97.5	91.5	1/2 "	0.5	0	138.69	1.05%
Sector total Power Density Value:																1.94%

**Sector 2**

Antenna Number	Antenna Make	Antenna Model	Radio Type	Frequency Band	Technology	Power Out Per Channel (Watts)	Number of Channels	Composite Power	Antenna Gain (10 db reduction)	Antenna Height (ft)	analysis height	Cable Size	Cable Loss (dB)	Additional Loss (dB)	ERP	Power Density Percentage
2a	RFS	APXVSP18-C-A20	RRH	1900 MHz	CDMA / LTE	20	2	40	5.9	97.5	91.5	1/2 "	0.5	0	138.69	0.60%
2a	RFS	APXVSP18-C-A20	RRH	850 MHz	CDMA / LTE	20	1	20	3.4	97.5	91.5	1/2 "	0.5	0	39.00	0.30%
2B	RFS	APXVTMM14-C-120	RRH	2500 MHz	CDMA / LTE	20	2	40	5.9	97.5	91.5	1/2 "	0.5	0	138.69	1.05%
Sector total Power Density Value:																1.94%

**Sector 3**

Antenna Number	Antenna Make	Antenna Model	Radio Type	Frequency Band	Technology	Power Out Per Channel (Watts)	Number of Channels	Composite Power	Antenna Gain (10 db reduction)	Antenna Height (ft)	analysis height	Cable Size	Cable Loss (dB)	Additional Loss (dB)	ERP	Power Density Percentage
3a	RFS	APXVSP18-C-A20	RRH	1900 MHz	CDMA / LTE	20	2	40	5.9	97.5	91.5	1/2 "	0.5	0	138.69	0.60%
3a	RFS	APXVSP18-C-A20	RRH	850 MHz	CDMA / LTE	20	1	20	3.4	97.5	91.5	1/2 "	0.5	0	39.00	0.30%
3B	RFS	APXVTMM14-C-120	RRH	2500 MHz	CDMA / LTE	20	2	40	5.9	97.5	91.5	1/2 "	0.5	0	138.69	1.05%
Sector total Power Density Value:																1.94%

Site Composite MPE %	
Carrier	MPE %
Sprint	5.82%
AT&T	16.42%
MetroPCS	9.20%
Nextel	3.10%
T-Mobile	7.50%
Verizon Wireless	19.08%
Town	1.80%
Town Fire	1.04%
<b>Total Site MPE %</b>	<b>63.96%</b>

## Summary

All calculations performed for this analysis yielded results that were well within the allowable limits for general public Maximum Permissible Exposure (MPE) to radio frequency energy.

The anticipated Maximum Composite contributions from the Sprint facility are **5.82%** (**1.94% from sector 1, 1.94% from sector 2 and 1.94% from sector 3**) of the allowable FCC established general public limit considering all three sectors simultaneously sampled at the ground level.

The anticipated composite MPE value for this site assuming all carriers present is **63.96%** of the allowable FCC established general public limit sampled at 6 feet above ground level. This total composite site value is based upon MPE values listed in the Connecticut Siting Council database for existing carrier emissions.

FCC guidelines state that if a site is found to be out of compliance (over allowable thresholds), that carriers over a 5% contribution to the composite value will require measures to bring the site into compliance. For this facility, the composite values calculated were well within the allowable 100% threshold standard per the federal government.



**Scott Heffernan**  
RF Engineering Director

**EBI Consulting**  
21 B Street  
Burlington, MA 01803





**AMERICAN TOWER®**  
CORPORATION

---

## Structural Analysis Report

**Structure** : 148 ft Monopole  
**ATC Site Name** : Madison CT 6, CT  
**ATC Site Number** : 302540  
**Engineering Number** : 59328021  
**Proposed Carrier** : Sprint Nextel  
**Carrier Site Name** : Madison  
**Carrier Site Number** : CT60XC937  
**Site Location** : 8 Old 79  
Madison, CT 06443-2685  
41.285533,-72.601342  
**County** : New Haven  
**Date** : August 1, 2014  
**Max Usage** : 79%  
**Result** : Pass

Jared Aman



Aug 1 2014 3:26 PM



**Table of Contents**

Introduction .....	1
Supporting Documents .....	1
Analysis .....	1
Conclusion.....	1
Existing and Reserved Equipment.....	2
Equipment to be Removed.....	2
Proposed Equipment .....	3
Structure Usages .....	3
Foundations .....	3
Deflection, Twist, and Sway.....	3
Standard Conditions .....	4
Calculations .....	Attached



## Introduction

The purpose of this report is to summarize results of a structural analysis performed on the 148 ft monopole to reflect the change in loading by Sprint Nextel.

## Supporting Documents

<b>Tower Drawings</b>	Summit, PJF Job #29299-729, dated November 12, 1999
<b>Foundation Drawing</b>	Spectrasite Project #F301896.00, dated August 13, 2003
<b>Geotechnical Report</b>	Dr. Clarence Welti, P.E., P.C., Site: Madison Police Station, dated November 19, 1999

## Analysis

The tower was analyzed using American Tower Corporation's tower analysis software. This program considers an elastic three-dimensional model and second-order effects per ANSI/EIA-222.

<b>Basic Wind Speed:</b>	85 mph (Fastest Mile)
<b>Basic Wind Speed w/ Ice:</b>	74 mph (Fastest Mile)w/ 1/2" radial ice concurrent
<b>Code:</b>	ANSI/TIA/EIA-222-F / 2003 IBC , Sec. 1609.1.1, Exception (4) & Sec. 3108.4 w/ 2005 CT Supplement & 2009 CT Amendment

## Conclusion

Based on the analysis results, the structure meets the requirements per the applicable codes listed above. The tower and foundation can support the equipment as described in this report.

If you have any questions or require additional information, please contact American Tower via email at [Engineering@americantower.com](mailto:Engineering@americantower.com). Please include the American Tower site name, site number, and engineering number in the subject line for any questions.



**Existing and Reserved Equipment**

Elevation <sup>1</sup> (ft)		Qty	Antenna	Mount Type	Lines	Carrier
Mount	RAD					
148.0	149.0	9	48" x 12" Panel	Low Profile Platform	(12) 1 5/8" Coax (5) 7/8" Coax	Sprint Nextel
		3	72" x 12" Panel			
	156.0	1	11' Dipole			Town Of Branford
	153.0	1	6' Omni			
		1	6' Dipole			
140.0	140.0	6	RFS FD9R6004/1C-3L	Low Profile Platform	(12) 1 5/8" Coax (1) 1 5/8" Fiber	Verizon
		3	Alcatel-Lucent RRH2X40-AWS 1700/2100 MHz			
		3	Antel BXA-171085-8BF-EDIN-X			
		3	Kathrein Scala 742 213			
		1	RFS DB-T1-6Z-8AB-OZ			
		3	Antel BXA-70063-6CF-EDIN-2			
		4	Antel LPA-80080/6CF			
		2	Antel LPA-80063/6CF			
134.0	135.0	1	Raycap DC6-48-60-18-8F	Flush	(2) 1.1" Hybrid (1) 0.28" RG6 (1) 3" Conduit	
		6	Ericsson RRUS 11 (Band 12)			
132.0	132.0	6	Powerwave Allgon LGP13519	Low Profile Platform	(12) 1 5/8" Coax	AT&T Mobility
		6	ADC DD700			
		2	KMW AM-X-CD-14-65-00T-RET			
		6	Powerwave Allgon 7770.00			
		1	Kathrein Scala 800 10736			
120.0	120.0	4	Ericsson KRY 112 144/1	Low Profile Platform	(16) 1 5/8" Coax (1) 1 5/8" Fiber	T-Mobile
		4	Ericsson AIR 21, 1.3M, B2A B4P			
		4	Ericsson AIR 21, 1.3M, B4A B2P			
106.0	107.0	2	2" x 4" GPS	Flush	-	Unknown
		3	60" x 8" Panel			
96.0	97.5	3	Alcatel-Lucent 800MHz 2X50W RRH w/ Filter	Low Profile Platform	(3) 1 1/4" Hybriflex Cable	Sprint Nextel
		3	Alcatel-Lucent 1900MHz 4x45 RRH			
		3	RFS APXVSPP18-C-A20			
86.0	86.0	3	RFS APXV18-206517S-C	Collar	(6) 1 5/8" Coax	Metro PCS

**Equipment to be Removed**

Elevation <sup>1</sup> (ft)		Qty	Antenna	Mount Type	Lines	Carrier
Mount	RAD					
97.5	97.5	3	Alcatel-Lucent 800MHz RRH	Flush	-	Sprint Nextel
96.0	96.0	6	Andrew DB980H90E-M	Low Profile Platform	(6) 1 5/8" Coax	
35.0	35.0	1	GPS	-	(1) 1/2" Coax	



**Proposed Equipment**

Elevation <sup>1</sup> (ft)		Qty	Antenna	Mount Type	Lines	Carrier
Mount	RAD					
96.0	97.5	3	Alcatel TD-RRH8x20-25 w/ SS	Low Profile Platform	(1) 1 1/4" Hybriflex	Sprint Nextel
		3	RFS APXV9TM14-ALU-I20			
70.0	73.0	1	GPS	Flush	(1) 1/2" Coax	

<sup>1</sup>Mount elevation is defined as height above bottom of steel structure to the bottom of mount, RAD elevation is defined as center of antenna above ground level (AGL).

Install proposed coax inside the pole shaft.

**Structure Usages**

Structural Component	Controlling Usage	Pass/Fail
Anchor Bolts	74%	Pass
Shaft	79%	Pass
Base Plate	67%	Pass

**Foundations**

Reaction Component	Original Design Reactions	Analysis Reactions	% of Design
Moment (Kips-Ft)	5,050.0	4,051.2	80%
Shear (Kips)	47.0	37.5	80%

The structure base reactions resulting from this analysis are acceptable when compared to those shown on the original structure drawings, therefore no modification or reinforcement of the foundation will be required.

**Deflection and Sway\***

Antenna Elevation (ft)	Deflection (ft)	Sway (Rotation) (°)
96.0	0.823	1.083
70.0	0.412	0.730

\*Deflection and Sway was evaluated considering a design wind speed of 50 mph (Fastest Mile) per ANSI/TIA/EIA-222-F.



## **Standard Conditions**

All engineering services are performed on the basis that the information used is current and correct. This information may consist of, but is not necessary limited, to:

- Information supplied by the client regarding the structure itself, antenna, mounts and feed line loading on the structure and its components, or other relevant information.
- Information from drawings in the possession of American Tower Corporation, or generated by field inspections or measurements of the structure.

It is the responsibility of the client to ensure that the information provided to ATC Tower Services, Inc. and used in the performance of our engineering services is correct and complete. In the absence of information to the contrary, we assume that all structures were constructed in accordance with the drawings and specifications and that their capacity has not significantly changed from the "as new" condition.

Unless explicitly agreed by both the client and American Tower Corporation, all services will be performed in accordance with the current revision of ANSI/TIA -222. The design basic wind speed will be determined based on the minimum basic wind speed as prescribed in ANSI/TIA-222. Although every effort is taken to ensure that the loading considered is adequate to meet the requirements of all applicable regulatory entities, we can provide no assurance to meet any other local and state codes or requirements. If wind and ice loads or other relevant parameters are to be different from the minimum values recommended by the codes, the client shall specify the exact requirement.

All services are performed, results obtained, and recommendations made in accordance with generally accepted engineering principles and practices. ATC Tower Services, Inc. is not responsible for the conclusions, opinions and recommendations made by others based on the information we supply.

© 2007 - 2014 by ATC IP LLC. All rights reserved.

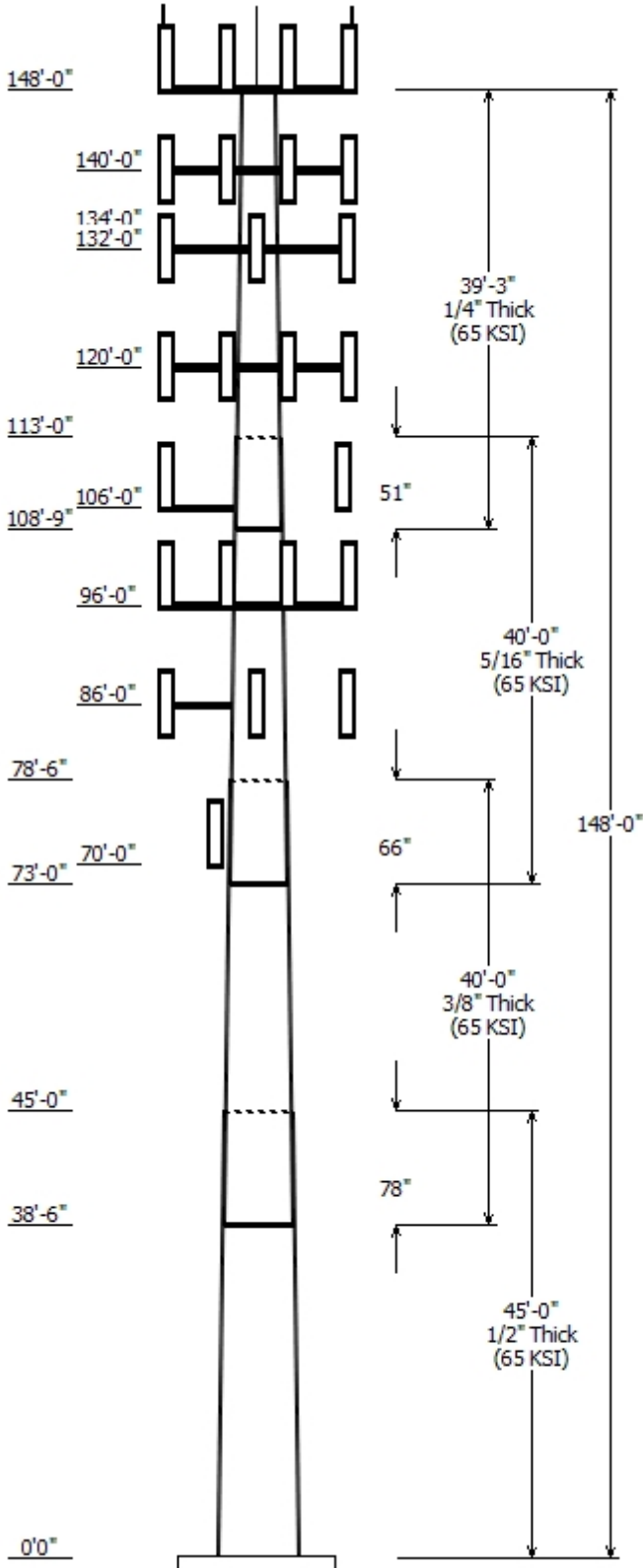

Job Information	
Pole :	302540
Code:	TIA/EIA-222 Rev F
Description :	148 ft Summit Monopole
Client :	Verizon Wireless
Location :	Madison CT 6, CT
Shape :	18 Sides
Height :	148.00 (ft)
Base Elev (ft):	0.00
Taper:	0.26300(in/ft)

Sections Properties								
Shaft Section	Length (ft)	Diameter (in)		Thick (in)	Joint Type	Overlap		Steel Grade (ksi)
		Top	Bottom			Length (in)	Taper (in/ft)	
1	45.000	49.21	61.05	0.500		0.000	0.263006	65
2	40.000	41.15	51.67	0.375	Slip Joint	78.000	0.263006	65
3	40.000	32.70	43.22	0.313	Slip Joint	66.000	0.263006	65
4	39.250	24.00	34.32	0.250	Slip Joint	51.000	0.263006	65

Discrete Appurtenance				
Attach Elev (ft)	Force Elev (ft)	Qty	Description	
148.000	149.000	3	72" x 12" Panel	
148.000	149.000	9	48" x 12" Panel	
148.000	153.000	1	6' Dipole	
148.000	148.000	1	Flat Low Profile Platform	
148.000	156.000	1	11' Dipole	
148.000	153.000	1	6' Omni	
140.000	140.000	1	RFS DB-T1-6Z-8AB-0Z	
140.000	140.000	3	Kathrein Scala 742 213	
140.000	140.000	3	Alcatel-Lucent RRH2X40-AWS	
140.000	140.000	6	RFS FD9R6004/1C-3L	
140.000	140.000	3	Antel BXA-171085-8BF-EDIN-X	
140.000	140.000	1	Flat Low Profile Platform	
140.000	140.000	3	Antel BXA-70063-6CF-EDIN-2	
140.000	140.000	2	Antel LPA-80063/6CF	
140.000	140.000	4	Antel LPA-80080/6CF	
134.000	135.000	6	Ericsson RRUS 11 (Band 12)	
134.000	135.000	1	Raycap DC6-48-60-18-8F	
132.000	132.000	1	Kathrein 800 10736	
132.000	132.000	6	Powerwave 7770.00	
132.000	132.000	2	KMW AM-X-CD-14-65-00T-RET	
132.000	132.000	1	Flat Low Profile Platform	
132.000	132.000	6	Powerwave Allgon LGP13519	
132.000	132.000	6	ADC DD700	
120.000	120.000	4	Ericsson AIR 21, 1.3M, B4A B2P	
120.000	120.000	4	Ericsson AIR 21, 1.3M, B2A B4P	
120.000	120.000	4	Ericsson KRY 112 144/1	
120.000	120.000	1	Flat Low Profile Platform	
106.000	107.000	2	2" x 4" GPS	
106.000	106.000	1	Flush	
106.000	107.000	3	60" x 8" Panel	
96.000	97.500	3	RFS APXV9TM14-ALU-I20	
96.000	97.500	3	Alcatel TD-RRH8x20-25 w/ SS	
96.000	97.500	3	Alcatel-Lucent 1900 MHz 4x45	
96.000	97.500	3	Alcatel-Lucent 800 MHz 2X50W	
96.000	97.500	3	RFS APXVSP18-C-A20	
96.000	96.000	1	Flat Low Profile Platform	
86.000	86.000	1	Collar	
86.000	86.000	3	RFS APXV18-206517S-C	
70.000	73.000	1	GPS	

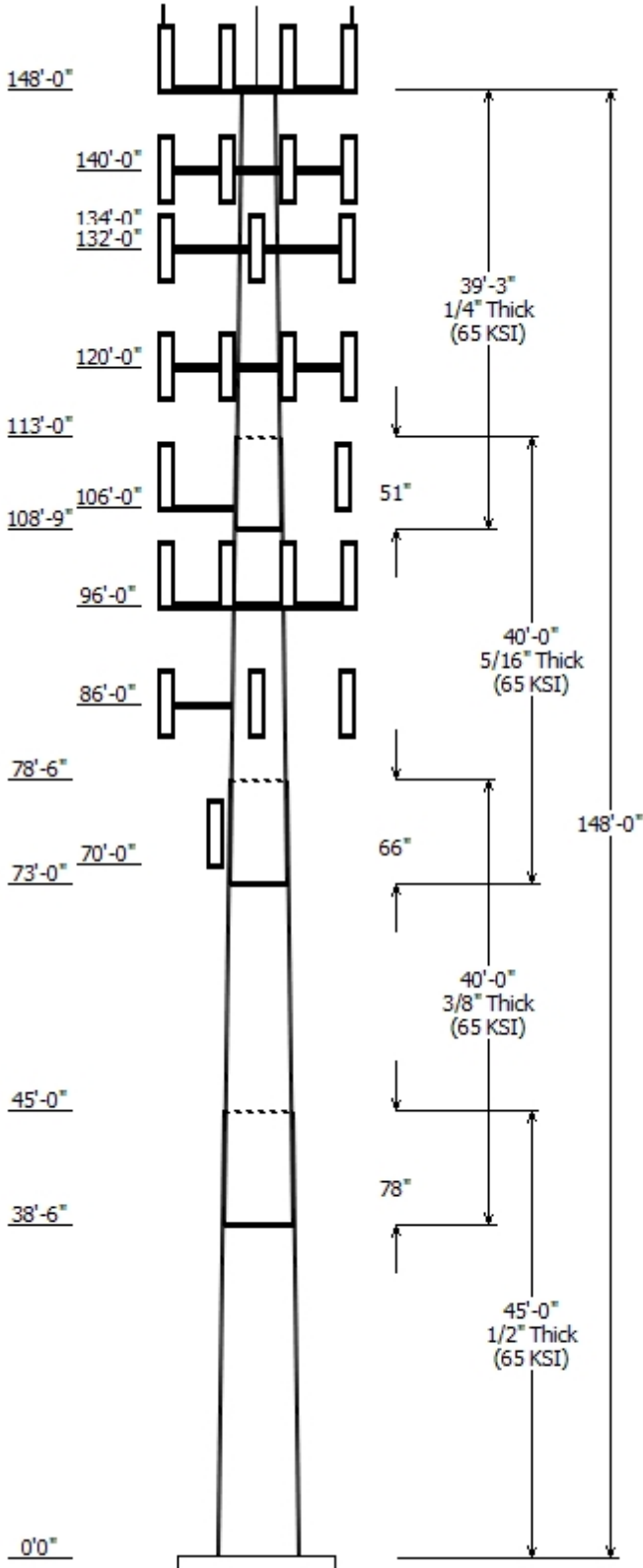

Linear Appurtenance			
Elev (ft)		Description	Exposed To Wind
From	To		
0.000	70.000	1/2" Coax	Yes
0.000	86.000	1 5/8" Coax	No
0.000	96.000	1 1/4" Hybriflex	No
0.000	96.000	1 1/4" Hybriflex	No
0.000	120.0	1 5/8" Coax	Yes
0.000	120.0	1 5/8" Fiber	No
0.000	132.0	1 5/8" Coax	No
0.000	134.0	0.28" RG6	No
0.000	134.0	1.1" Hybrid	No
0.000	134.0	3" Conduit	No
0.000	140.0	1 5/8" Coax	No
0.000	140.0	1 5/8" Fiber	No
0.000	148.0	1 5/8" Coax	No
0.000	148.0	7/8" Coax	No

Load Cases	
No Ice	85.00 mph Wind with No Ice
Ice	73.61 mph Wind with Ice
Twist/Sway	50.00 mph Wind with No Ice

Reactions			
Load Case	Moment (kip-ft)	Shear (kip)	Axial (kip)
No Ice	4051.24	37.53	49.38
Ice	3382.07	31.06	60.16
Twist/Sway	1402.80	12.99	49.41

Dish Deflections			
Load Case	Attach Elev (ft)	Deflection (in)	Rotation (deg)
	0.00	0.000	0.000



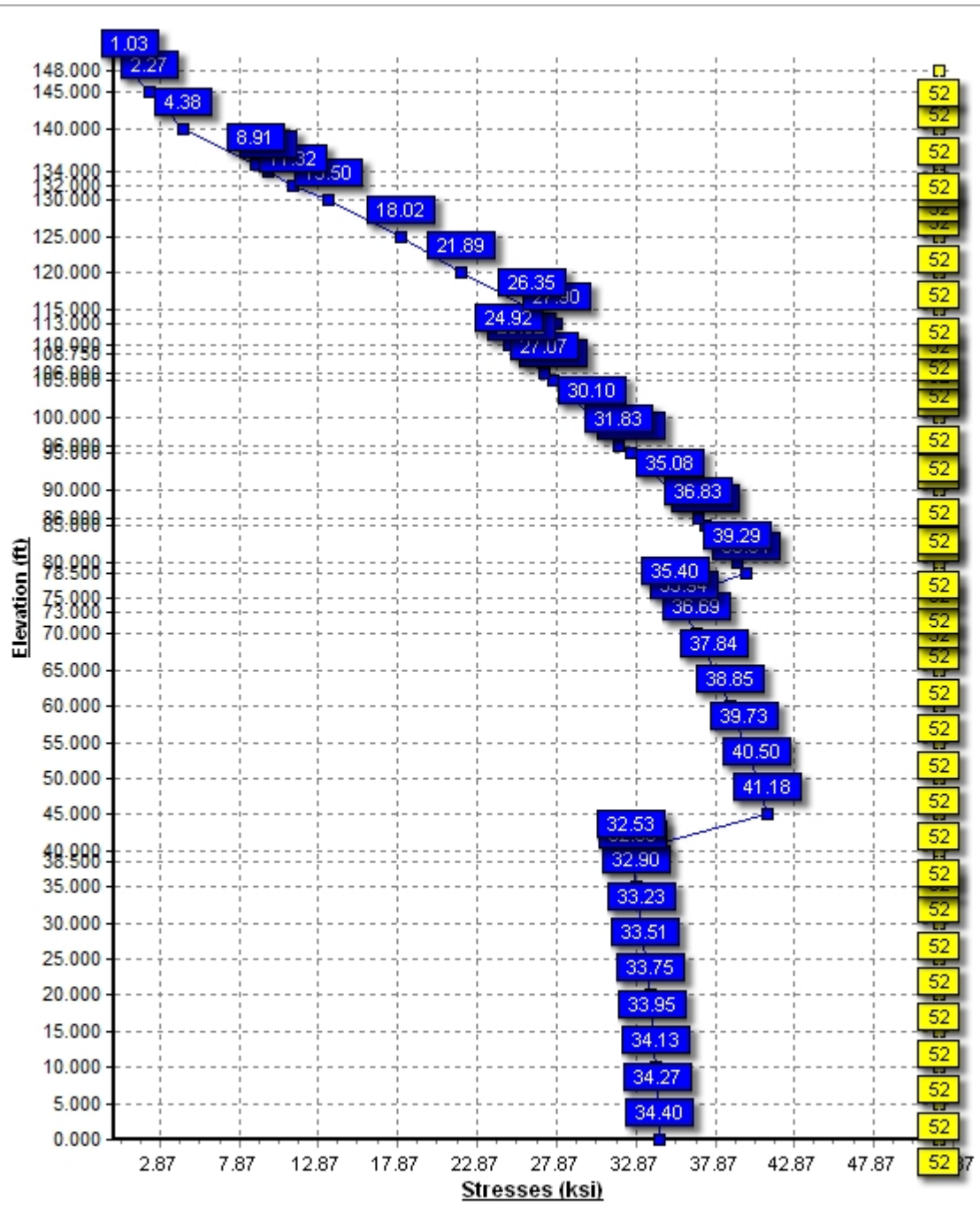

Pole : 302540  
 Location : Madison CT 6, CT  
 Height : 148.0 (ft)  
 Base Dia : 61.05 (in)  
 Top Dia : 24.00 (in)  
 Shape : 18 Sides  
 Taper : 0.263006 (in/ft)

Code: TIA/EIA-222 Rev F

Base Elev : 0.000 (ft)

© 2007 - 2014 by ATC IP LLC. All rights reserved.

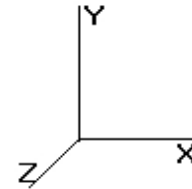

8/1/2014 8:35:38 AM

Page: 1

**Shaft Section Properties**

Sect Info	Length (ft)	Thick (in)	Fy (ksi)	Slip		Weight (lb)	Bottom						Top						
				Joint Type	Joint Len (in)		Dia (in)	Elev (ft)	Area (sqin)	Ix (in^4)	W/t Ratio	D/t Ratio	Dia (in)	Elev (ft)	Area (sqin)	Ix (in^4)	W/t Ratio	D/t Ratio	Taper (in/ft)
1-18	45.000	0.5000	65		0.00	13,276	61.05	0.00	96.09	44509.7	20.12	122.10	49.21	45.00	77.31	23178.9	15.95	98.43	0.263006
2-18	40.000	0.3750	65	Slip	78.00	7,458	51.67	38.50	61.06	20300.5	22.89	137.80	41.15	78.50	48.54	10197.2	17.94	109.74	0.263006
3-18	40.000	0.3125	65	Slip	66.00	5,083	43.22	73.00	42.56	9902.8	22.98	138.32	32.70	113.00	32.13	4259.3	17.04	104.66	0.263006
4-18	39.250	0.2500	65	Slip	51.00	3,064	34.32	108.75	27.04	3965.7	22.80	137.29	24.00	148.00	18.84	1343.0	15.52	96.00	0.263006
Shaft Weight						28,881													

**Discrete Appurtenance Properties**

Attach Elev (ft)	Description	Qty	No Ice			Ice			Distance From Face (ft)	Vert Ecc (ft)
			Weight (lb)	EPAA (sf)	Orientation Factor	Weight (lb)	EPAA (sf)	Orientation Factor		
148.00	11' Dipole	1	40.00	3.580	1.00	25.00	4.000	1.00	0.000	8.000
148.00	48" x 12" Panel	9	30.00	5.600	0.78	63.00	6.190	0.78	0.000	1.000
148.00	6' Dipole	1	20.00	2.220	1.00	39.30	3.000	1.00	0.000	5.000
148.00	6' Omni	1	25.00	1.760	1.00	38.24	2.130	1.00	0.000	5.000
148.00	72" x 12" Panel	3	45.00	8.400	0.79	92.28	9.230	0.79	0.000	1.000
148.00	Flat Low Profile Platform	1	1500.00	26.100	1.00	1,700.00	31.600	1.00	0.000	0.000
140.00	Alcatel-Lucent RRH2X40-	3	41.90	2.940	0.67	87.80	3.260	0.67	0.000	0.000
140.00	Antel BXA-171085-8BF-EDIN-X	3	10.50	2.940	0.87	27.56	3.811	0.87	0.000	0.000
140.00	Antel BXA-70063-6CF-EDIN-2	3	17.00	7.730	0.77	40.30	3.573	0.77	0.000	0.000
140.00	Antel LPA-80063/6CF	2	27.00	10.340	0.95	101.00	11.180	0.95	0.000	0.000
140.00	Antel LPA-80080/6CF	4	21.00	9.100	0.75	50.00	9.930	0.75	0.000	0.000
140.00	Flat Low Profile Platform	1	1500.00	26.100	1.00	1,700.00	31.600	1.00	0.000	0.000
140.00	Kathrein Scala 742 213	3	22.00	5.140	0.78	47.15	5.850	0.78	0.000	0.000
140.00	RFS DB-T1-6Z-8AB-0Z	1	44.00	5.600	0.67	144.50	6.080	0.67	0.000	0.000
140.00	RFS FD9R6004/1C-3L	6	3.10	0.370	0.50	5.40	0.500	0.50	0.000	0.000
134.00	Ericsson RRUS 11 (Band 12)	6	55.00	2.940	0.67	69.90	3.340	0.67	0.000	1.000
134.00	Raycap DC6-48-60-18-8F	1	31.80	2.570	1.00	49.50	1.670	1.00	0.000	1.000
132.00	ADC DD700	6	15.90	1.250	0.50	23.40	1.480	0.50	0.000	0.000
132.00	Flat Low Profile Platform	1	1500.00	26.100	1.00	1,700.00	31.600	1.00	0.000	0.000
132.00	Kathrein 800 10736	1	33.10	11.390	0.73	87.40	12.310	0.73	0.000	0.000
132.00	KMW AM-X-CD-14-65-00T-	2	36.40	5.510	0.78	68.30	6.100	0.78	0.000	0.000
132.00	Powerwave 7770.00	6	35.00	5.880	0.77	67.63	6.530	0.77	0.000	0.000
132.00	Powerwave Allgon LGP13519	6	5.30	0.340	0.50	14.00	0.440	0.50	0.000	0.000
120.00	Ericsson AIR 21, 1.3M, B2A	4	83.00	6.530	0.86	132.60	7.200	0.86	0.000	0.000
120.00	Ericsson AIR 21, 1.3M, B4A	4	81.50	6.590	0.85	132.60	7.200	0.85	0.000	0.000
120.00	Ericsson KRY 112 144/1	4	11.00	0.410	0.50	14.10	0.550	0.50	0.000	0.000
120.00	Flat Low Profile Platform	1	1500.00	26.100	1.00	1,700.00	31.600	1.00	0.000	0.000
106.00	2" x 4" GPS	2	5.00	0.040	0.50	2.50	0.260	0.50	0.000	1.000
106.00	60" x 8" Panel	3	30.00	4.720	0.79	56.74	5.400	0.79	0.000	1.000
106.00	Flush	1	560.00	8.500	0.67	680.00	10.500	0.67	0.000	0.000
96.00	Alcatel TD-RRH8x20-25 w/ SS	3	70.00	4.720	1.00	97.10	5.160	1.00	0.000	1.500
96.00	Alcatel-Lucent 1900 MHz	3	60.00	2.710	0.67	83.10	3.070	0.67	0.000	1.500
96.00	Alcatel-Lucent 800 MHz	3	64.00	2.400	0.67	86.10	2.720	0.67	0.000	1.500
96.00	Flat Low Profile Platform	1	1500.00	26.100	1.00	1,700.00	31.600	1.00	0.000	0.000
96.00	RFS APXV9TM14-ALU-I20	3	55.10	6.930	0.78	94.60	7.570	0.78	0.000	1.500
96.00	RFS APXVSP18-C-A20	3	57.00	8.260	0.83	106.50	9.080	0.83	0.000	1.500
86.00	Collar	1	560.00	8.500	0.67	680.00	10.500	0.67	0.000	0.000
86.00	RFS APXV18-206517S-C	3	26.40	5.170	0.80	53.13	5.850	0.80	0.000	0.000
70.00	GPS	1	10.00	1.000	0.50	15.00	1.300	0.50	0.000	3.000
Totals		111	12199.20			16,185.79			Number of Loadings : 39	

Pole : 302540  
 Location : Madison CT 6, CT  
 Height : 148.0 (ft)  
 Base Dia : 61.05 (in)  
 Top Dia : 24.00 (in)  
 Shape : 18 Sides  
 Taper : 0.263006 (in/ft)

Code: TIA/EIA-222 Rev F

8/1/2014 8:35:38 AM

Page: 2

Base Elev : 0.000 (ft)

© 2007 - 2014 by ATC IP LLC. All rights reserved.

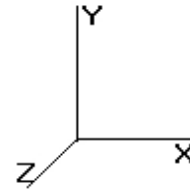

### Linear Appurtenance Properties

Elev From (ft)	Elev To (ft)	Description	No Ice		Ice		Exposed To Wind
			Weight (lb/ft)	CaAa (sf/ft)	Weight (lb/ft)	CaAa (sf/ft)	
0.00	148.00	(12) 1 5/8" Coax	9.84	0.00	0.00	0.00	N
0.00	148.00	(5) 7/8" Coax	1.65	0.00	0.00	0.00	N
0.00	140.00	(12) 1 5/8" Coax	9.84	0.00	0.00	0.00	N
0.00	140.00	(1) 1 5/8" Fiber	1.61	0.00	0.00	0.00	N
0.00	134.00	(1) 0.28" RG6	0.03	0.00	0.00	0.00	N
0.00	134.00	(2) 1.1" Hybrid	0.98	0.00	0.00	0.00	N
0.00	134.00	(1) 3" Conduit	7.58	0.00	0.00	0.00	N
0.00	132.00	(12) 1 5/8" Coax	9.84	0.00	0.00	0.00	N
0.00	120.00	(16) 1 5/8" Coax	13.12	0.40	37.36	0.60	Y
0.00	120.00	(1) 1 5/8" Fiber	1.61	0.00	0.00	0.00	N
0.00	96.00	(3) 1 1/4" Hybriflex	3.00	0.00	0.00	0.00	N
0.00	96.00	(1) 1 1/4" Hybriflex	1.00	0.00	0.00	0.00	N
0.00	86.00	(6) 1 5/8" Coax	4.92	0.00	0.00	0.00	N
0.00	70.00	(1) 1/2" Coax	0.15	0.00	0.00	0.00	Y
Total Weight			8,338.52 (lb)		4,483.19 (lb)		

Pole : 302540  
 Location : Madison CT 6, CT  
 Height : 148.0 (ft)  
 Base Dia : 61.05 (in)  
 Top Dia : 24.00 (in)  
 Shape : 18 Sides  
 Taper : 0.263006 (in/ft)

Code: TIA/EIA-222 Rev F

Base Elev : 0.000 (ft)

© 2007 - 2014 by ATC IP LLC. All rights reserved.

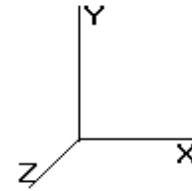

8/1/2014 8:35:38 AM

Page: 3

**Segment Properties** (Max Len : 5 ft)

Seg Top Elev (ft)	Description	Thick (in)	Flat Dia (in)	Area (in^2)	Ix (in^4)	W/t Ratio	D/t Ratio	Fy (ksi)	Fb (ksi)	Weight (lb)
0.00		0.5000	61.050	96.089	44,509.7	20.12	122.10	65	52	0.0
5.00		0.5000	59.735	94.002	41,672.2	19.66	119.47	65	52	1,617.1
10.00		0.5000	58.420	91.915	38,958.0	19.19	116.84	65	52	1,581.6
15.00		0.5000	57.105	89.829	36,364.2	18.73	114.21	65	52	1,546.1
20.00		0.5000	55.790	87.742	33,888.2	18.26	111.58	65	52	1,510.6
25.00		0.5000	54.475	85.655	31,527.3	17.80	108.95	65	52	1,475.1
30.00		0.5000	53.160	83.568	29,278.6	17.34	106.32	65	52	1,439.6
35.00		0.5000	51.845	81.481	27,139.4	16.87	103.69	65	52	1,404.1
38.50	Bot - Section 2	0.5000	50.924	80.020	25,705.8	16.55	101.85	65	52	961.7
40.00		0.5000	50.530	79.394	25,107.1	16.41	101.06	65	52	717.3
45.00	Top - Section 1	0.3750	49.965	59.022	18,337.8	22.08	133.24	65	52	2,350.6
50.00		0.3750	48.650	57.457	16,917.3	21.46	129.73	65	52	990.9
55.00		0.3750	47.335	55.892	15,572.1	20.85	126.23	65	52	964.2
60.00		0.3750	46.020	54.326	14,300.2	20.23	122.72	65	52	937.6
65.00		0.3750	44.705	52.761	13,099.5	19.61	119.21	65	52	911.0
70.00		0.3750	43.389	51.196	11,967.9	18.99	115.71	65	52	884.4
73.00	Bot - Section 3	0.3750	42.600	50.257	11,321.4	18.62	113.60	65	52	517.8
75.00		0.3750	42.074	49.631	10,903.5	18.37	112.20	65	52	627.8
78.50	Top - Section 2	0.3125	41.779	41.128	8,934.8	22.16	133.69	65	52	1,079.8
80.00		0.3125	41.384	40.737	8,682.2	21.94	132.43	65	52	208.9
85.00		0.3125	40.069	39.432	7,874.7	21.20	128.22	65	52	682.0
86.00		0.3125	39.806	39.172	7,719.4	21.05	127.38	65	52	133.7
90.00		0.3125	38.754	38.128	7,118.8	20.46	124.01	65	52	526.1
95.00		0.3125	37.439	36.824	6,412.9	19.71	119.81	65	52	637.6
96.00		0.3125	37.176	36.563	6,277.6	19.57	118.96	65	52	124.9
100.0		0.3125	36.124	35.520	5,755.4	18.97	115.60	65	52	490.6
105.0		0.3125	34.809	34.215	5,144.3	18.23	111.39	65	52	593.2
106.0		0.3125	34.546	33.954	5,027.6	18.08	110.55	65	52	116.0
108.7	Bot - Section 4	0.3125	33.823	33.237	4,715.6	17.67	108.23	65	52	314.4
110.0		0.3125	33.494	32.911	4,578.2	17.49	107.18	65	52	255.1
113.0	Top - Section 3	0.2500	33.205	26.149	3,588.0	22.01	132.82	65	52	602.1
115.0		0.2500	32.679	25.732	3,419.0	21.64	130.72	65	52	176.5
120.0		0.2500	31.364	24.688	3,019.7	20.71	125.46	65	52	428.9
125.0		0.2500	30.049	23.645	2,652.7	19.78	120.20	65	52	411.2
130.0		0.2500	28.734	22.601	2,316.8	18.86	114.94	65	52	393.4
132.0		0.2500	28.208	22.184	2,190.8	18.48	112.83	65	52	152.4
134.0		0.2500	27.682	21.767	2,069.5	18.11	110.73	65	52	149.6
135.0		0.2500	27.419	21.558	2,010.5	17.93	109.68	65	52	73.7
140.0		0.2500	26.104	20.514	1,732.5	17.00	104.42	65	52	357.9
145.0		0.2500	24.789	19.471	1,481.3	16.07	99.16	65	52	340.2
148.0		0.2500	24.000	18.845	1,343.0	15.52	96.00	65	52	195.6
										28,881.1

Pole : 302540  
 Location : Madison CT 6, CT  
 Height : 148.0 (ft)  
 Base Dia : 61.05 (in)  
 Top Dia : 24.00 (in)  
 Shape : 18 Sides  
 Taper : 0.263006 (in/ft)

Code: TIA/EIA-222 Rev F

Base Elev : 0.000 (ft)

© 2007 - 2014 by ATC IP LLC. All rights reserved.

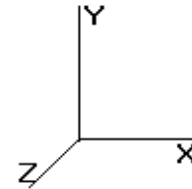

8/1/2014 8:35:38 AM

Page: 4

<b>Load Case:</b> No Ice	85.00 mph Wind with No Ice	21 Iterations
Gust Response Factor : 1.69		
Dead Load Factor : 1.00		
Wind Load Factor : 1.00		

### Shaft Segment Forces

Seg Top Elev (ft)	Description	Kz	qz (psf)	qzGh (psf)	C (mph-ft)	Cf	Ice Thick (in)	Tributary (ft)	Ap (sf)	EPAs (sf)	Wind Force X (lb)	Dead Load Ice (lb)	Tot Dead Load (lb)
0.00		0.00	1.00 18.496	31.25 432.43	0.650	0.000	0.00	0.00	0.000	0.00	0.0	0.0	0.0
5.00		0.00	1.00 18.496	31.25 423.12	0.650	0.000	5.00	25.163	16.36	511.3	511.3	0.0	1,617.1
10.00		0.00	1.00 18.496	31.25 413.80	0.650	0.000	5.00	24.616	16.00	500.1	500.1	0.0	1,581.6
15.00		0.00	1.00 18.496	31.25 404.49	0.650	0.000	5.00	24.068	15.64	489.0	489.0	0.0	1,546.1
20.00		0.00	1.00 18.496	31.25 395.17	0.650	0.000	5.00	23.520	15.29	477.9	477.9	0.0	1,510.6
25.00		0.00	1.00 18.496	31.25 385.86	0.650	0.000	5.00	22.972	14.93	466.7	466.7	0.0	1,475.1
30.00		0.00	1.00 18.496	31.25 376.54	0.650	0.000	5.00	22.424	14.58	455.6	455.6	0.0	1,439.6
35.00		0.00	1.01 18.810	31.78 370.33	0.650	0.000	5.00	21.876	14.22	452.0	452.0	0.0	1,404.1
38.50	Bot - Section 2	0.00	1.04 19.329	32.66 368.74	0.650	0.000	3.50	14.987	9.74	318.2	318.2	0.0	961.7
40.00		0.00	1.05 19.541	33.02 367.89	0.650	0.000	1.50	6.435	4.18	138.1	138.1	0.0	717.3
45.00	Top - Section 1	0.00	1.09 20.210	34.15 364.39	0.650	0.000	5.00	21.093	13.71	468.3	468.3	0.0	2,350.6
50.00		0.00	1.12 20.827	35.19 365.67	0.650	0.000	5.00	20.545	13.35	470.0	470.0	0.0	990.9
55.00		0.00	1.15 21.402	36.17 360.66	0.650	0.000	5.00	19.997	13.00	470.1	470.1	0.0	964.2
60.00		0.00	1.18 21.941	37.08 355.03	0.650	0.000	5.00	19.449	12.64	468.8	468.8	0.0	937.6
65.00		0.00	1.21 22.449	37.93 348.85	0.650	0.000	5.00	18.901	12.29	466.1	466.1	0.0	911.0
70.00	Appertunance(s)	0.00	1.24 22.929	38.75 342.19	0.650	0.000	5.00	18.353	11.93	462.3	462.3	0.0	884.4
73.00	Bot - Section 3	0.00	1.25 23.206	39.21 337.99	0.650	0.000	3.00	10.749	6.99	274.0	274.0	0.0	517.8
75.00		0.00	1.26 23.386	39.52 335.11	0.650	0.000	2.00	7.160	4.65	183.9	183.9	0.0	627.8
78.50	Top - Section 2	0.00	1.28 23.692	40.04 329.92	0.650	0.000	3.50	12.320	8.01	320.6	320.6	0.0	1,079.8
80.00		0.00	1.28 23.821	40.25 332.67	0.650	0.000	1.50	5.198	3.38	136.0	136.0	0.0	208.9
85.00		0.00	1.31 24.237	40.96 324.90	0.650	0.000	5.00	16.970	11.03	451.8	451.8	0.0	682.0
86.00	Appertunance(s)	0.00	1.31 24.318	41.09 323.30	0.650	0.000	1.00	3.328	2.16	88.9	88.9	0.0	133.7
90.00		0.00	1.33 24.636	41.63 316.81	0.650	0.000	4.00	13.093	8.51	354.3	354.3	0.0	526.1
95.00		0.00	1.35 25.020	42.28 308.43	0.650	0.000	5.00	15.874	10.32	436.3	436.3	0.0	637.6
96.00	Appertunance(s)	0.00	1.35 25.095	42.41 306.72	0.650	0.000	1.00	3.109	2.02	85.7	85.7	0.0	124.9
100.00		0.00	1.37 25.389	42.90 299.79	0.650	0.000	4.00	12.217	7.94	340.7	340.7	0.0	490.6
105.00		0.00	1.39 25.745	43.51 290.90	0.650	0.000	5.00	14.778	9.61	417.9	417.9	0.0	593.2
106.00	Appertunance(s)	0.00	1.39 25.815	43.62 289.09	0.650	0.000	1.00	2.890	1.88	81.9	81.9	0.0	116.0
108.70	Bot - Section 4	0.00	1.40 26.005	43.94 284.07	0.650	0.000	2.75	7.834	5.09	223.8	223.8	0.0	314.4
110.00		0.00	1.41 26.090	44.09 281.77	0.650	0.000	1.25	3.558	2.31	102.0	102.0	0.0	255.1
113.00	Top - Section 3	0.00	1.42 26.291	44.43 276.19	0.650	0.000	3.00	8.400	5.46	242.6	242.6	0.0	602.1
115.00		0.00	1.42 26.423	44.65 276.67	0.650	0.000	2.00	5.490	3.57	159.4	159.4	0.0	176.5
120.00	Appertunance(s)	0.00	1.44 26.747	45.20 267.15	0.650	0.000	5.00	13.342	8.67	392.0	392.0	0.0	428.9
125.00		0.00	1.46 27.060	45.73 257.45	0.650	0.000	5.00	12.794	8.32	380.3	380.3	0.0	411.2
130.00		0.00	1.48 27.365	46.24 247.56	0.650	0.000	5.00	12.247	7.96	368.1	368.1	0.0	393.4
132.00	Appertunance(s)	0.00	1.48 27.485	46.45 243.56	0.650	0.000	2.00	4.745	3.08	143.3	143.3	0.0	152.4
134.00	Appertunance(s)	0.00	1.49 27.603	46.65 239.54	0.650	0.000	2.00	4.658	3.03	141.2	141.2	0.0	149.6
135.00		0.00	1.49 27.662	46.74 237.51	0.650	0.000	1.00	2.296	1.49	69.8	69.8	0.0	73.7
140.00	Appertunance(s)	0.00	1.51 27.951	47.23 227.30	0.650	0.000	5.00	11.151	7.25	342.4	342.4	0.0	357.9
145.00		0.00	1.52 28.233	47.71 216.93	0.650	0.000	5.00	10.603	6.89	328.8	328.8	0.0	340.2
148.00	Appertunance(s)	0.00	1.53 28.398	47.99 210.64	0.650	0.000	3.00	6.099	3.96	190.2	190.2	0.0	195.6
<b>Totals:</b>								<b>148.00</b>			<b>12,870.7</b>	<b>0.0</b>	<b>28,881.1</b>

Pole : 302540  
 Location : Madison CT 6, CT  
 Height : 148.0 (ft)  
 Base Dia : 61.05 (in)  
 Top Dia : 24.00 (in)  
 Shape : 18 Sides  
 Taper : 0.263006 (in/ft)

Code: TIA/EIA-222 Rev F

Base Elev : 0.000 (ft)

© 2007 - 2014 by ATC IP LLC. All rights reserved.

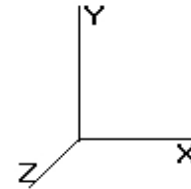

8/1/2014 8:35:38 AM

Page: 5

<b>Load Case:</b> No Ice	85.00 mph Wind with No Ice	21 Iterations
Gust Response Factor : 1.69		
Dead Load Factor : 1.00		
Wind Load Factor : 1.00		

**Discrete Appurtenance Segment Forces**

Elev (ft)	Description	Qty	qz (psf)	qzGh (psf)	Orientation Factor	Total EPAa (sf)	Horiz Ecc (ft)	Vert Ecc (ft)	Wind FX (lb)	Mom Y (lb-ft)	Mom Z (lb-ft)	Dead Load (lb)
70.00	GPS	1	23.206	39.218	0.50	0.50	0.000	3.000	19.61	0.00	58.83	10.00
86.00	RFS APXV18-206517S-	3	24.318	41.098	0.80	12.36	0.000	0.000	508.03	0.00	0.00	79.20
86.00	Collar	1	24.318	41.098	0.67	5.70	0.000	0.000	234.05	0.00	0.00	560.00
96.00	RFS APXVSP18-C-	3	25.206	42.598	0.83	20.57	0.000	1.500	876.13	0.00	1,314.20	171.00
96.00	Alcatel-Lucent 800 M	3	25.206	42.598	0.67	4.82	0.000	1.500	205.49	0.00	308.24	192.00
96.00	Alcatel-Lucent 1900	3	25.206	42.598	0.67	5.45	0.000	1.500	232.04	0.00	348.05	180.00
96.00	Alcatel TD-RRH8x20-2	3	25.206	42.598	1.00	14.16	0.000	1.500	603.19	0.00	904.78	210.00
96.00	RFS APXV9TM14-ALU-	3	25.206	42.598	0.78	16.22	0.000	1.500	690.78	0.00	1,036.17	165.30
96.00	Flat Low Profile Pla	1	25.095	42.410	1.00	26.10	0.000	0.000	1,106.90	0.00	0.00	1,500.00
106.0	60" x 8" Panel	3	25.885	43.745	0.79	11.19	0.000	1.000	489.35	0.00	489.35	90.00
106.0	Flush	1	25.815	43.628	0.67	5.70	0.000	0.000	248.46	0.00	0.00	560.00
106.0	2" x 4" GPS	2	25.885	43.745	0.50	0.04	0.000	1.000	1.75	0.00	1.75	10.00
120.0	Flat Low Profile Pla	1	26.747	45.202	1.00	26.10	0.000	0.000	1,179.77	0.00	0.00	1,500.00
120.0	Ericsson KRY 112 144	4	26.747	45.202	0.50	0.82	0.000	0.000	37.07	0.00	0.00	44.00
120.0	Ericsson AIR 21, 1.3	4	26.747	45.202	0.86	22.46	0.000	0.000	1,015.38	0.00	0.00	332.00
120.0	Ericsson AIR 21, 1.3	4	26.747	45.202	0.85	22.41	0.000	0.000	1,012.79	0.00	0.00	326.00
132.0	ADC DD700	6	27.485	46.450	0.50	3.75	0.000	0.000	174.19	0.00	0.00	95.40
132.0	Powerwave Allgon	6	27.485	46.450	0.50	1.02	0.000	0.000	47.38	0.00	0.00	31.80
132.0	Flat Low Profile Pla	1	27.485	46.450	1.00	26.10	0.000	0.000	1,212.33	0.00	0.00	1,500.00
132.0	KMW AM-X-CD-14-65-	2	27.485	46.450	0.78	8.60	0.000	0.000	399.26	0.00	0.00	72.80
132.0	Powerwave 7770.00	6	27.485	46.450	0.77	27.17	0.000	0.000	1,261.83	0.00	0.00	210.00
132.0	Kathrein 800 10736	1	27.485	46.450	0.73	8.31	0.000	0.000	386.21	0.00	0.00	33.10
134.0	Raycap DC6-48-60-18-	1	27.662	46.749	1.00	2.57	0.000	1.000	120.14	0.00	120.14	31.80
134.0	Ericsson RRUS 11 (Ba	6	27.662	46.749	0.67	11.82	0.000	1.000	552.51	0.00	552.51	330.00
140.0	Antel LPA-80080/6CF	4	27.951	47.237	0.75	27.30	0.000	0.000	1,289.57	0.00	0.00	84.00
140.0	Antel LPA-80063/6CF	2	27.951	47.237	0.95	19.65	0.000	0.000	928.02	0.00	0.00	54.00
140.0	Antel BXA-70063-6CF-	3	27.951	47.237	0.77	17.86	0.000	0.000	843.48	0.00	0.00	51.00
140.0	Flat Low Profile Pla	1	27.951	47.237	1.00	26.10	0.000	0.000	1,232.89	0.00	0.00	1,500.00
140.0	Antel BXA-171085-8BF	3	27.951	47.237	0.87	7.67	0.000	0.000	362.47	0.00	0.00	31.50
140.0	RFS FD9R6004/1C-3L	6	27.951	47.237	0.50	1.11	0.000	0.000	52.43	0.00	0.00	18.60
140.0	Alcatel-Lucent RRH2X	3	27.951	47.237	0.67	5.91	0.000	0.000	279.14	0.00	0.00	125.70
140.0	Kathrein Scala 742 2	3	27.951	47.237	0.78	12.03	0.000	0.000	568.15	0.00	0.00	66.00
140.0	RFS DB-T1-6Z-8AB-0Z	1	27.951	47.237	0.67	3.75	0.000	0.000	177.23	0.00	0.00	44.00
148.0	6' Omni	1	28.669	48.451	1.00	1.76	0.000	5.000	85.27	0.00	426.37	25.00
148.0	11' Dipole	1	28.829	48.720	1.00	3.58	0.000	8.000	174.42	0.00	1,395.35	40.00
148.0	Flat Low Profile Pla	1	28.398	47.993	1.00	26.10	0.000	0.000	1,252.62	0.00	0.00	1,500.00
148.0	6' Dipole	1	28.669	48.451	1.00	2.22	0.000	5.000	107.56	0.00	537.80	20.00
148.0	48" x 12" Panel	9	28.453	48.085	0.78	39.31	0.000	1.000	1,890.34	0.00	1,890.34	270.00
148.0	72" x 12" Panel	3	28.453	48.085	0.79	19.91	0.000	1.000	957.29	0.00	957.29	135.00
									22,815.51			12,199.20

Pole : 302540  
 Location : Madison CT 6, CT  
 Height : 148.0 (ft)  
 Base Dia : 61.05 (in)  
 Top Dia : 24.00 (in)  
 Shape : 18 Sides  
 Taper : 0.263006 (in/ft)

Code: TIA/EIA-222 Rev F

Base Elev : 0.000 (ft)

© 2007 - 2014 by ATC IP LLC. All rights reserved.

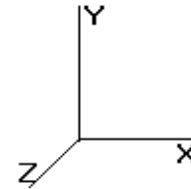

8/1/2014 8:35:38 AM

Page: 6

<b>Load Case:</b> No Ice	85.00 mph Wind with No Ice	21 Iterations
Gust Response Factor : 1.69		
Dead Load Factor : 1.00		
Wind Load Factor : 1.00		

**Linear Appurtenance Segment Forces**

Seg Top Elev (ft)	Description	Exposed To Wind	Length (ft)	Weight (lb/ft)	CaAa (sf/ft)	qz (psf)	FX (lb)	Dead Load (lb)
5.00	(16) 1 5/8" Coax	Yes	5.00	13.12	0.40	18.496	62.52	65.60
5.00	(1) 1/2" Coax	Yes	5.00	0.15	0.00	18.496	0.00	0.75
10.00	(16) 1 5/8" Coax	Yes	5.00	13.12	0.40	18.496	62.52	65.60
10.00	(1) 1/2" Coax	Yes	5.00	0.15	0.00	18.496	0.00	0.75
15.00	(16) 1 5/8" Coax	Yes	5.00	13.12	0.40	18.496	62.52	65.60
15.00	(1) 1/2" Coax	Yes	5.00	0.15	0.00	18.496	0.00	0.75
20.00	(16) 1 5/8" Coax	Yes	5.00	13.12	0.40	18.496	62.52	65.60
20.00	(1) 1/2" Coax	Yes	5.00	0.15	0.00	18.496	0.00	0.75
25.00	(16) 1 5/8" Coax	Yes	5.00	13.12	0.40	18.496	62.52	65.60
25.00	(1) 1/2" Coax	Yes	5.00	0.15	0.00	18.496	0.00	0.75
30.00	(16) 1 5/8" Coax	Yes	5.00	13.12	0.40	18.496	62.52	65.60
30.00	(1) 1/2" Coax	Yes	5.00	0.15	0.00	18.496	0.00	0.75
35.00	(16) 1 5/8" Coax	Yes	5.00	13.12	0.40	18.810	63.58	65.60
35.00	(1) 1/2" Coax	Yes	5.00	0.15	0.00	18.810	0.00	0.75
38.50	(16) 1 5/8" Coax	Yes	3.50	13.12	0.40	19.329	45.73	45.92
38.50	(1) 1/2" Coax	Yes	3.50	0.15	0.00	19.329	0.00	0.53
40.00	(16) 1 5/8" Coax	Yes	1.50	13.12	0.40	19.541	19.81	19.68
40.00	(1) 1/2" Coax	Yes	1.50	0.15	0.00	19.541	0.00	0.23
45.00	(16) 1 5/8" Coax	Yes	5.00	13.12	0.40	20.210	68.31	65.60
45.00	(1) 1/2" Coax	Yes	5.00	0.15	0.00	20.210	0.00	0.75
50.00	(16) 1 5/8" Coax	Yes	5.00	13.12	0.40	20.827	70.40	65.60
50.00	(1) 1/2" Coax	Yes	5.00	0.15	0.00	20.827	0.00	0.75
55.00	(16) 1 5/8" Coax	Yes	5.00	13.12	0.40	21.402	72.34	65.60
55.00	(1) 1/2" Coax	Yes	5.00	0.15	0.00	21.402	0.00	0.75
60.00	(16) 1 5/8" Coax	Yes	5.00	13.12	0.40	21.941	74.16	65.60
60.00	(1) 1/2" Coax	Yes	5.00	0.15	0.00	21.941	0.00	0.75
65.00	(16) 1 5/8" Coax	Yes	5.00	13.12	0.40	22.449	75.88	65.60
65.00	(1) 1/2" Coax	Yes	5.00	0.15	0.00	22.449	0.00	0.75
70.00	(16) 1 5/8" Coax	Yes	5.00	13.12	0.40	22.929	77.50	65.60
70.00	(1) 1/2" Coax	Yes	5.00	0.15	0.00	22.929	0.00	0.75
73.00	(16) 1 5/8" Coax	Yes	3.00	13.12	0.40	23.206	47.06	39.36
75.00	(16) 1 5/8" Coax	Yes	2.00	13.12	0.40	23.386	31.62	26.24
78.50	(16) 1 5/8" Coax	Yes	3.50	13.12	0.40	23.692	56.06	45.92
80.00	(16) 1 5/8" Coax	Yes	1.50	13.12	0.40	23.821	24.15	19.68
85.00	(16) 1 5/8" Coax	Yes	5.00	13.12	0.40	24.237	81.92	65.60
86.00	(16) 1 5/8" Coax	Yes	1.00	13.12	0.40	24.318	16.44	13.12
90.00	(16) 1 5/8" Coax	Yes	4.00	13.12	0.40	24.636	66.62	52.48
95.00	(16) 1 5/8" Coax	Yes	5.00	13.12	0.40	25.020	84.57	65.60
96.00	(16) 1 5/8" Coax	Yes	1.00	13.12	0.40	25.095	16.96	13.12
100.0	(16) 1 5/8" Coax	Yes	4.00	13.12	0.40	25.389	68.65	52.48
105.0	(16) 1 5/8" Coax	Yes	5.00	13.12	0.40	25.745	87.02	65.60
106.0	(16) 1 5/8" Coax	Yes	1.00	13.12	0.40	25.815	17.45	13.12
108.7	(16) 1 5/8" Coax	Yes	2.75	13.12	0.40	26.005	48.34	36.08
110.0	(16) 1 5/8" Coax	Yes	1.25	13.12	0.40	26.090	22.05	16.40
113.0	(16) 1 5/8" Coax	Yes	3.00	13.12	0.40	26.291	53.32	39.36
115.0	(16) 1 5/8" Coax	Yes	2.00	13.12	0.40	26.423	35.72	26.24
120.0	(16) 1 5/8" Coax	Yes	5.00	13.12	0.40	26.747	90.40	65.60
<b>Totals:</b>							1,791.16	1,584.89

Pole : 302540  
 Location : Madison CT 6, CT  
 Height : 148.0 (ft)  
 Base Dia : 61.05 (in)  
 Top Dia : 24.00 (in)  
 Shape : 18 Sides  
 Taper : 0.263006 (in/ft)

Code: TIA/EIA-222 Rev F

8/1/2014 8:35:38 AM

Page: 7

Base Elev : 0.000 (ft)

© 2007 - 2014 by ATC IP LLC. All rights reserved.

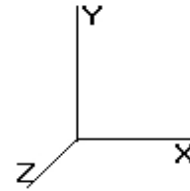

**Load Case:** No Ice

85.00 mph Wind with No Ice

21 Iterations

Gust Response Factor : 1.69

Dead Load Factor : 1.00

Wind Load Factor : 1.00

### Applied Segment Forces Summary

Seg Elev (ft)	Lateral FX (-) (lb)	Axial FY (-) (lb)	Torsion MY (lb-ft)	Moment MZ (lb-ft)
0.00	0.00	0.00	0.00	0.00
5.00	573.78	1,942.94	0.00	0.00
10.00	562.65	1,907.44	0.00	0.00
15.00	551.52	1,871.93	0.00	0.00
20.00	540.39	1,836.42	0.00	0.00
25.00	529.25	1,800.92	0.00	0.00
30.00	518.12	1,765.41	0.00	0.00
35.00	515.58	1,729.91	0.00	0.00
38.50	363.95	1,189.81	0.00	0.00
40.00	157.94	815.04	0.00	0.00
45.00	536.58	2,676.40	0.00	0.00
50.00	540.44	1,316.72	0.00	0.00
55.00	542.47	1,290.09	0.00	0.00
60.00	542.92	1,263.46	0.00	0.00
65.00	541.97	1,236.83	0.00	0.00
70.00	559.38	1,220.20	0.00	58.83
73.00	321.06	712.89	0.00	0.00
75.00	215.56	757.82	0.00	0.00
78.50	376.69	1,307.39	0.00	0.00
80.00	160.16	306.45	0.00	0.00
85.00	533.72	1,007.09	0.00	0.00
86.00	847.42	837.95	0.00	0.00
90.00	420.96	766.46	0.00	0.00
95.00	520.84	938.11	0.00	0.00
96.00	3,817.20	2,603.26	0.00	3,911.45
100.0	409.37	714.96	0.00	0.00
105.0	504.96	873.72	0.00	0.00
106.0	838.96	832.08	0.00	491.10
108.7	272.13	468.65	0.00	0.00
110.0	124.02	325.24	0.00	0.00
113.0	295.92	770.40	0.00	0.00
115.0	195.09	288.74	0.00	0.00
120.0	3,727.41	2,911.41	0.00	0.00
125.0	380.33	618.01	0.00	0.00
130.0	368.14	600.26	0.00	0.00
132.0	3,624.47	2,178.23	0.00	0.00
134.0	813.88	574.41	0.00	672.66
135.0	69.76	96.65	0.00	0.00
140.0	6,075.75	2,447.41	0.00	0.00
145.0	328.83	397.60	0.00	0.00
148.0	4,657.74	2,220.04	0.00	5,207.14
<b>Totals:</b>	<b>37,477.34</b>	<b>49,418.79</b>	<b>0.00</b>	<b>10,341.17</b>



Pole : 302540  
 Location : Madison CT 6, CT  
 Height : 148.0 (ft)  
 Base Dia : 61.05 (in)  
 Top Dia : 24.00 (in)  
 Shape : 18 Sides  
 Taper : 0.263006 (in/ft)

Code: TIA/EIA-222 Rev F

Base Elev : 0.000 (ft)

© 2007 - 2014 by ATC IP LLC. All rights reserved.

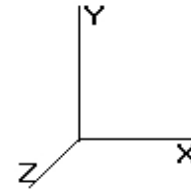

8/1/2014 8:35:38 AM

Page: 8

<b>Load Case:</b> No Ice	85.00 mph Wind with No Ice	21 Iterations
Gust Response Factor : 1.69		
Dead Load Factor : 1.00		
Wind Load Factor : 1.00		

**Calculated Shaft Forces and Deflections**

Seg Elev (ft)	Lateral FX (-) (kips)	Axial FY (-) (kips)	Lateral FZ (kips)	Moment MX (ft-kips)	Torsion MY (ft-kips)	Moment MZ (ft-kips)	X Deflect (in)	Z Deflect (in)	Total Deflect (in)	Rotation (deg)
0.00	-37.532	-49.376	0.000	0.000	0.000	-4,051.245	0.000	0.000	0.000	0.000
5.00	-37.062	-47.351	0.000	0.000	0.000	-3,863.588	-0.068	0.000	0.068	-0.126
10.00	-36.596	-45.363	0.000	0.000	0.000	-3,678.282	-0.270	0.000	0.270	-0.255
15.00	-36.134	-43.411	0.000	0.000	0.000	-3,495.308	-0.608	0.000	0.608	-0.386
20.00	-35.676	-41.495	0.000	0.000	0.000	-3,314.642	-1.085	0.000	1.085	-0.519
25.00	-35.223	-39.616	0.000	0.000	0.000	-3,136.264	-1.702	0.000	1.702	-0.655
30.00	-34.774	-37.773	0.000	0.000	0.000	-2,960.152	-2.462	0.000	2.462	-0.792
35.00	-34.308	-35.980	0.000	0.000	0.000	-2,786.285	-3.367	0.000	3.367	-0.932
38.50	-33.967	-34.754	0.000	0.000	0.000	-2,666.211	-4.088	0.000	4.088	-1.032
40.00	-33.850	-33.886	0.000	0.000	0.000	-2,615.262	-4.420	0.000	4.420	-1.076
45.00	-33.338	-31.138	0.000	0.000	0.000	-2,446.016	-5.624	0.000	5.624	-1.219
50.00	-32.854	-29.738	0.000	0.000	0.000	-2,279.329	-6.979	0.000	6.979	-1.364
55.00	-32.371	-28.358	0.000	0.000	0.000	-2,115.062	-8.508	0.000	8.508	-1.549
60.00	-31.880	-27.007	0.000	0.000	0.000	-1,953.211	-10.231	0.000	10.231	-1.735
65.00	-31.382	-25.686	0.000	0.000	0.000	-1,793.814	-12.148	0.000	12.148	-1.921
70.00	-30.844	-24.406	0.000	0.000	0.000	-1,636.847	-14.261	0.000	14.261	-2.107
73.00	-30.535	-23.656	0.000	0.000	0.000	-1,544.316	-15.622	0.000	15.622	-2.221
75.00	-30.331	-22.852	0.000	0.000	0.000	-1,483.247	-16.569	0.000	16.569	-2.297
78.50	-29.936	-21.513	0.000	0.000	0.000	-1,377.089	-18.303	0.000	18.303	-2.427
80.00	-29.812	-21.144	0.000	0.000	0.000	-1,332.185	-19.075	0.000	19.075	-2.484
85.00	-29.277	-20.100	0.000	0.000	0.000	-1,183.126	-21.788	0.000	21.788	-2.690
86.00	-28.425	-19.252	0.000	0.000	0.000	-1,153.850	-22.357	0.000	22.357	-2.732
90.00	-28.025	-18.420	0.000	0.000	0.000	-1,040.150	-24.716	0.000	24.716	-2.894
95.00	-27.491	-17.455	0.000	0.000	0.000	-900.029	-27.852	0.000	27.852	-3.088
96.00	-23.563	-15.024	0.000	0.000	0.000	-868.628	-28.503	0.000	28.503	-3.127
100.0	-23.155	-14.267	0.000	0.000	0.000	-774.378	-31.188	0.000	31.188	-3.276
105.0	-22.624	-13.383	0.000	0.000	0.000	-658.605	-34.714	0.000	34.714	-3.453
106.0	-21.751	-12.578	0.000	0.000	0.000	-635.490	-35.442	0.000	35.442	-3.489
108.7	-21.464	-12.102	0.000	0.000	0.000	-575.677	-37.479	0.000	37.479	-3.583
110.0	-21.335	-11.759	0.000	0.000	0.000	-548.847	-38.423	0.000	38.423	-3.626
113.0	-21.005	-10.980	0.000	0.000	0.000	-484.844	-40.732	0.000	40.732	-3.722
115.0	-20.813	-10.663	0.000	0.000	0.000	-442.834	-42.304	0.000	42.304	-3.784
120.0	-16.919	-7.965	0.000	0.000	0.000	-338.770	-46.356	0.000	46.356	-3.947
125.0	-16.512	-7.339	0.000	0.000	0.000	-254.177	-50.565	0.000	50.565	-4.086
130.0	-16.110	-6.746	0.000	0.000	0.000	-171.616	-54.907	0.000	54.907	-4.201
132.0	-12.338	-4.833	0.000	0.000	0.000	-139.396	-56.674	0.000	56.674	-4.239
134.0	-11.486	-4.316	0.000	0.000	0.000	-114.046	-58.456	0.000	58.456	-4.272
135.0	-11.412	-4.218	0.000	0.000	0.000	-102.560	-59.352	0.000	59.352	-4.287
140.0	-5.171	-2.231	0.000	0.000	0.000	-45.501	-63.870	0.000	63.870	-4.339
145.0	-4.813	-1.859	0.000	0.000	0.000	-19.647	-68.426	0.000	68.426	-4.366
148.0	-4.658	0.000	0.000	0.000	0.000	-5.207	-71.170	0.000	71.170	-4.373

Pole : 302540  
 Location : Madison CT 6, CT  
 Height : 148.0 (ft)  
 Base Dia : 61.05 (in)  
 Top Dia : 24.00 (in)  
 Shape : 18 Sides  
 Taper : 0.263006 (in/ft)

Code: TIA/EIA-222 Rev F

Base Elev : 0.000 (ft)

© 2007 - 2014 by ATC IP LLC. All rights reserved.

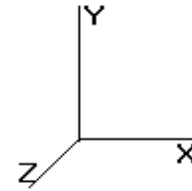

8/1/2014 8:35:38 AM

Page: 9

**Load Case:** No Ice                      85.00 mph Wind with No Ice                      21 Iterations

Gust Response Factor : 1.69  
 Dead Load Factor : 1.00  
 Wind Load Factor : 1.00

**Calculated Stresses**

Seg Elev (ft)	Applied Stresses							Allowable Stress (Fb) (ksi)	Stress Ratio	
	Axial (Y) (ksi)	Shear (X) (ksi)	Shear (Z) (ksi)	Torsion (ksi)	Bending (X) (ksi)	Bending (Z) (ksi)	Combined (ksi)			
0.00	0.51	0.79	0.00	0.00	0.00	33.85	34.40	52.0	0.0	0.662
5.00	0.50	0.79	0.00	0.00	0.00	33.74	34.27	52.0	0.0	0.659
10.00	0.49	0.80	0.00	0.00	0.00	33.61	34.13	52.0	0.0	0.657
15.00	0.48	0.81	0.00	0.00	0.00	33.44	33.95	52.0	0.0	0.653
20.00	0.47	0.82	0.00	0.00	0.00	33.25	33.75	52.0	0.0	0.649
25.00	0.46	0.83	0.00	0.00	0.00	33.02	33.51	52.0	0.0	0.645
30.00	0.45	0.84	0.00	0.00	0.00	32.75	33.23	52.0	0.0	0.639
35.00	0.44	0.85	0.00	0.00	0.00	32.43	32.90	52.0	0.0	0.633
38.50	0.43	0.86	0.00	0.00	0.00	32.18	32.65	52.0	0.0	0.628
40.00	0.43	0.86	0.00	0.00	0.00	32.07	32.53	52.0	0.0	0.626
45.00	0.53	1.14	0.00	0.00	0.00	40.60	41.18	52.0	0.0	0.792
50.00	0.52	1.15	0.00	0.00	0.00	39.94	40.50	52.0	0.0	0.779
55.00	0.51	1.17	0.00	0.00	0.00	39.17	39.73	52.0	0.0	0.764
60.00	0.50	1.18	0.00	0.00	0.00	38.30	38.85	52.0	0.0	0.747
65.00	0.49	1.20	0.00	0.00	0.00	37.30	37.84	52.0	0.0	0.728
70.00	0.48	1.21	0.00	0.00	0.00	36.16	36.69	52.0	0.0	0.706
73.00	0.47	1.22	0.00	0.00	0.00	35.40	35.94	52.0	0.0	0.691
75.00	0.46	1.23	0.00	0.00	0.00	34.87	35.40	52.0	0.0	0.681
78.50	0.52	1.47	0.00	0.00	0.00	39.23	39.84	52.0	0.0	0.766
80.00	0.52	1.47	0.00	0.00	0.00	38.69	39.29	52.0	0.0	0.756
85.00	0.51	1.50	0.00	0.00	0.00	36.68	37.28	52.0	0.0	0.717
86.00	0.49	1.46	0.00	0.00	0.00	36.25	36.83	52.0	0.0	0.709
90.00	0.48	1.48	0.00	0.00	0.00	34.50	35.08	52.0	0.0	0.675
95.00	0.47	1.50	0.00	0.00	0.00	32.01	32.59	52.0	0.0	0.627
96.00	0.41	1.30	0.00	0.00	0.00	31.34	31.83	52.0	0.0	0.612
100.00	0.40	1.31	0.00	0.00	0.00	29.61	30.10	52.0	0.0	0.579
105.00	0.39	1.33	0.00	0.00	0.00	27.15	27.64	52.0	0.0	0.532
106.00	0.37	1.29	0.00	0.00	0.00	26.60	27.07	52.0	0.0	0.521
108.75	0.36	1.30	0.00	0.00	0.00	25.16	25.62	52.0	0.0	0.493
110.00	0.36	1.31	0.00	0.00	0.00	24.46	24.92	52.0	0.0	0.479
113.00	0.42	1.62	0.00	0.00	0.00	27.34	27.90	52.0	0.0	0.537
115.00	0.41	1.63	0.00	0.00	0.00	25.79	26.35	52.0	0.0	0.507
120.00	0.32	1.38	0.00	0.00	0.00	21.44	21.89	52.0	0.0	0.421
125.00	0.31	1.41	0.00	0.00	0.00	17.54	18.02	52.0	0.0	0.347
130.00	0.30	1.44	0.00	0.00	0.00	12.97	13.50	52.0	0.0	0.260
132.00	0.22	1.12	0.00	0.00	0.00	10.93	11.32	52.0	0.0	0.218
134.00	0.20	1.06	0.00	0.00	0.00	9.29	9.67	52.0	0.0	0.186
135.00	0.20	1.07	0.00	0.00	0.00	8.52	8.91	52.0	0.0	0.171
140.00	0.11	0.51	0.00	0.00	0.00	4.18	4.38	52.0	0.0	0.084
145.00	0.10	0.50	0.00	0.00	0.00	2.00	2.27	52.0	0.0	0.044
148.00	0.00	0.50	0.00	0.00	0.00	0.57	1.03	52.0	0.0	0.020

Pole : 302540  
 Location : Madison CT 6, CT  
 Height : 148.0 (ft)  
 Base Dia : 61.05 (in)  
 Top Dia : 24.00 (in)  
 Shape : 18 Sides  
 Taper : 0.263006 (in/ft)

Code: TIA/EIA-222 Rev F

Base Elev : 0.000 (ft)

© 2007 - 2014 by ATC IP LLC. All rights reserved.

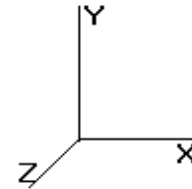

8/1/2014 8:35:38 AM

Page: 10

<b>Load Case:</b> Ice	73.61 mph Wind with Ice	21 Iterations
Gust Response Factor : 1.69		
Dead Load Factor : 1.00		
Wind Load Factor : 1.00		

### Shaft Segment Forces

Seg Top Elev (ft)	Description	Kz	qz (psf)	qzGh (psf)	C (mph-ft)	Cf	Ice Thick (in)	Tributary (ft)	Ap (sf)	EPAs (sf)	Wind Force X (lb)	Dead Load Ice (lb)	Tot Dead Load (lb)	
0.00		0.00	1.00	13.871	23.44	374.49	0.650	0.500	0.00	0.000	0.00	0.0	0.0	
5.00		0.00	1.00	13.871	23.44	366.42	0.650	0.500	5.00	25.580	16.63	389.8	185.9	1,803.0
10.00		0.00	1.00	13.871	23.44	358.35	0.650	0.500	5.00	25.032	16.27	381.4	181.8	1,763.4
15.00		0.00	1.00	13.871	23.44	350.29	0.650	0.500	5.00	24.484	15.91	373.1	177.8	1,723.8
20.00		0.00	1.00	13.871	23.44	342.22	0.650	0.500	5.00	23.936	15.56	364.7	173.7	1,684.3
25.00		0.00	1.00	13.871	23.44	334.15	0.650	0.500	5.00	23.388	15.20	356.4	169.6	1,644.7
30.00		0.00	1.00	13.871	23.44	326.09	0.650	0.500	5.00	22.841	14.85	348.0	165.6	1,605.1
35.00		0.00	1.01	14.106	23.84	320.70	0.650	0.500	5.00	22.293	14.49	345.4	161.5	1,565.6
38.50	Bot - Section 2	0.00	1.04	14.496	24.49	319.33	0.650	0.500	3.50	15.279	9.93	243.3	111.1	1,072.8
40.00		0.00	1.05	14.655	24.76	318.59	0.650	0.500	1.50	6.560	4.26	105.6	47.9	765.2
45.00	Top - Section 1	0.00	1.09	15.156	25.61	315.56	0.650	0.500	5.00	21.509	13.98	358.1	155.7	2,506.3
50.00		0.00	1.12	15.620	26.39	316.67	0.650	0.500	5.00	20.961	13.62	359.7	151.7	1,142.5
55.00		0.00	1.15	16.051	27.12	312.33	0.650	0.500	5.00	20.413	13.27	359.9	147.6	1,111.9
60.00		0.00	1.18	16.455	27.80	307.46	0.650	0.500	5.00	19.865	12.91	359.1	143.5	1,081.2
65.00		0.00	1.21	16.836	28.45	302.10	0.650	0.500	5.00	19.318	12.56	357.3	139.5	1,050.5
70.00	Appertunance(s)	0.00	1.24	17.196	29.06	296.34	0.650	0.500	5.00	18.770	12.20	354.6	135.4	1,019.8
73.00	Bot - Section 3	0.00	1.25	17.403	29.41	292.70	0.650	0.500	3.00	10.999	7.15	210.3	79.8	597.6
75.00		0.00	1.26	17.538	29.64	290.20	0.650	0.500	2.00	7.327	4.76	141.2	53.3	681.1
78.50	Top - Section 2	0.00	1.28	17.768	30.02	285.71	0.650	0.500	3.50	12.611	8.20	246.2	91.3	1,171.1
80.00		0.00	1.28	17.865	30.19	288.09	0.650	0.500	1.50	5.323	3.46	104.5	38.8	247.7
85.00		0.00	1.31	18.177	30.71	281.36	0.650	0.500	5.00	17.386	11.30	347.2	125.2	807.2
86.00	Appertunance(s)	0.00	1.31	18.238	30.82	279.98	0.650	0.500	1.00	3.411	2.22	68.3	24.9	158.6
90.00		0.00	1.33	18.476	31.22	274.36	0.650	0.500	4.00	13.427	8.73	272.5	96.9	623.0
95.00		0.00	1.35	18.764	31.71	267.10	0.650	0.500	5.00	16.290	10.59	335.8	117.1	754.7
96.00	Appertunance(s)	0.00	1.35	18.820	31.80	265.62	0.650	0.500	1.00	3.192	2.08	66.0	23.3	148.1
100.00		0.00	1.37	19.041	32.17	259.62	0.650	0.500	4.00	12.550	8.16	262.5	90.4	581.0
105.00		0.00	1.39	19.308	32.63	251.91	0.650	0.500	5.00	15.194	9.88	322.3	109.0	702.2
106.00	Appertunance(s)	0.00	1.39	19.360	32.71	250.35	0.650	0.500	1.00	2.973	1.93	63.2	21.6	137.6
108.70	Bot - Section 4	0.00	1.40	19.502	32.95	246.01	0.650	0.500	2.75	8.063	5.24	172.7	58.3	372.6
110.00		0.00	1.41	19.566	33.06	244.01	0.650	0.500	1.25	3.662	2.38	78.7	26.6	281.7
113.00	Top - Section 3	0.00	1.42	19.717	33.32	239.18	0.650	0.500	3.00	8.650	5.62	187.4	62.4	664.5
115.00		0.00	1.42	19.816	33.49	239.59	0.650	0.500	2.00	5.657	3.68	123.1	41.0	217.5
120.00	Appertunance(s)	0.00	1.44	20.059	33.89	231.35	0.650	0.500	5.00	13.759	8.94	303.2	98.3	527.2
125.00		0.00	1.46	20.294	34.29	222.95	0.650	0.500	5.00	13.211	8.59	294.5	94.3	505.4
130.00		0.00	1.48	20.523	34.68	214.39	0.650	0.500	5.00	12.663	8.23	285.5	90.2	483.6
132.00	Appertunance(s)	0.00	1.48	20.613	34.83	210.93	0.650	0.500	2.00	4.912	3.19	111.2	35.4	187.8
134.00	Appertunance(s)	0.00	1.49	20.701	34.98	207.44	0.650	0.500	2.00	4.824	3.14	109.7	34.8	184.3
135.00		0.00	1.49	20.745	35.06	205.68	0.650	0.500	1.00	2.379	1.55	54.2	17.2	90.9
140.00	Appertunance(s)	0.00	1.51	20.962	35.42	196.84	0.650	0.500	5.00	11.567	7.52	266.4	82.1	440.0
145.00		0.00	1.52	21.173	35.78	187.86	0.650	0.500	5.00	11.019	7.16	256.3	78.0	418.2
148.00	Appertunance(s)	0.00	1.53	21.297	35.99	182.42	0.650	0.500	3.00	6.349	4.13	148.5	45.4	240.9
<b>Totals:</b>								148.00				9,887.6	3,883.8	32,764.8

Pole : 302540  
 Location : Madison CT 6, CT  
 Height : 148.0 (ft)  
 Base Dia : 61.05 (in)  
 Top Dia : 24.00 (in)  
 Shape : 18 Sides  
 Taper : 0.263006 (in/ft)

Code: TIA/EIA-222 Rev F

Base Elev : 0.000 (ft)

© 2007 - 2014 by ATC IP LLC. All rights reserved.

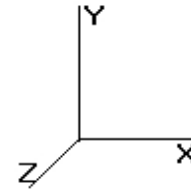

8/1/2014 8:35:38 AM

Page: 11

<b>Load Case:</b> Ice	73.61 mph Wind with Ice	21 Iterations
Gust Response Factor : 1.69		
Dead Load Factor : 1.00		
Wind Load Factor : 1.00		

**Discrete Appurtenance Segment Forces**

Elev (ft)	Description	Qty	qz (psf)	qzGh (psf)	Orientation Factor	Total EPAa (sf)	Horiz Ecc (ft)	Vert Ecc (ft)	Wind FX (lb)	Mom Y (lb-ft)	Mom Z (lb-ft)	Dead Load (lb)
70.00	GPS	1	17.403	29.411	0.50	0.65	0.000	3.000	19.12	0.00	57.35	15.00
86.00	RFS APXV18-206517S-	3	18.238	30.821	0.80	13.99	0.000	0.000	431.11	0.00	0.00	159.39
86.00	Collar	1	18.238	30.821	0.67	7.04	0.000	0.000	216.83	0.00	0.00	680.00
96.00	RFS APXVSP18-C-	3	18.903	31.947	0.83	22.61	0.000	1.500	722.29	0.00	1,083.43	319.50
96.00	Alcatel-Lucent 800 M	3	18.903	31.947	0.67	5.47	0.000	1.500	174.66	0.00	261.99	258.30
96.00	Alcatel-Lucent 1900	3	18.903	31.947	0.67	6.17	0.000	1.500	197.13	0.00	295.70	249.30
96.00	Alcatel TD-RRH8x20-2	3	18.903	31.947	1.00	15.48	0.000	1.500	494.54	0.00	741.80	291.30
96.00	RFS APXV9TM14-ALU-	3	18.903	31.947	0.78	17.71	0.000	1.500	565.90	0.00	848.85	283.80
96.00	Flat Low Profile Pla	1	18.820	31.806	1.00	31.60	0.000	0.000	1,005.05	0.00	0.00	1,700.00
106.0	60" x 8" Panel	3	19.412	32.807	0.79	12.80	0.000	1.000	419.86	0.00	419.86	170.22
106.0	Flush	1	19.360	32.719	0.67	7.04	0.000	0.000	230.18	0.00	0.00	680.00
106.0	2" x 4" GPS	2	19.412	32.807	0.50	0.26	0.000	1.000	8.53	0.00	8.53	5.00
120.0	Flat Low Profile Pla	1	20.059	33.899	1.00	31.60	0.000	0.000	1,071.22	0.00	0.00	1,700.00
120.0	Ericsson KRY 112 144	4	20.059	33.899	0.50	1.10	0.000	0.000	37.29	0.00	0.00	56.40
120.0	Ericsson AIR 21, 1.3	4	20.059	33.899	0.86	24.77	0.000	0.000	839.62	0.00	0.00	530.40
120.0	Ericsson AIR 21, 1.3	4	20.059	33.899	0.85	24.48	0.000	0.000	829.86	0.00	0.00	530.40
132.0	ADC DD700	6	20.613	34.835	0.50	4.44	0.000	0.000	154.67	0.00	0.00	140.40
132.0	Powerwave Allgon	6	20.613	34.835	0.50	1.32	0.000	0.000	45.98	0.00	0.00	84.00
132.0	Flat Low Profile Pla	1	20.613	34.835	1.00	31.60	0.000	0.000	1,100.79	0.00	0.00	1,700.00
132.0	KMW AM-X-CD-14-65-	2	20.613	34.835	0.78	9.52	0.000	0.000	331.49	0.00	0.00	136.60
132.0	Powerwave 7770.00	6	20.613	34.835	0.77	30.17	0.000	0.000	1,050.93	0.00	0.00	405.78
132.0	Kathrein 800 10736	1	20.613	34.835	0.73	8.99	0.000	0.000	313.04	0.00	0.00	87.40
134.0	Raycap DC6-48-60-18-	1	20.745	35.060	1.00	1.67	0.000	1.000	58.55	0.00	58.55	49.50
134.0	Ericsson RRUS 11 (Ba	6	20.745	35.060	0.67	13.43	0.000	1.000	470.74	0.00	470.74	419.40
140.0	Antel LPA-80080/6CF	4	20.962	35.426	0.75	29.79	0.000	0.000	1,055.33	0.00	0.00	200.00
140.0	Antel LPA-80063/6CF	2	20.962	35.426	0.95	21.24	0.000	0.000	752.51	0.00	0.00	202.00
140.0	Antel BXA-70063-6CF-	3	20.962	35.426	0.77	8.25	0.000	0.000	292.38	0.00	0.00	120.90
140.0	Flat Low Profile Pla	1	20.962	35.426	1.00	31.60	0.000	0.000	1,119.45	0.00	0.00	1,700.00
140.0	Antel BXA-171085-8BF	3	20.962	35.426	0.87	9.95	0.000	0.000	352.37	0.00	0.00	82.67
140.0	RFS FD9R6004/1C-3L	6	20.962	35.426	0.50	1.50	0.000	0.000	53.14	0.00	0.00	32.40
140.0	Alcatel-Lucent RRH2X	3	20.962	35.426	0.67	6.55	0.000	0.000	232.13	0.00	0.00	263.40
140.0	Kathrein Scala 742 2	3	20.962	35.426	0.78	13.69	0.000	0.000	484.94	0.00	0.00	141.45
140.0	RFS DB-T1-6Z-8AB-0Z	1	20.962	35.426	0.67	4.07	0.000	0.000	144.31	0.00	0.00	144.50
148.0	6' Omni	1	21.501	36.336	1.00	2.13	0.000	5.000	77.40	0.00	386.98	38.24
148.0	11' Dipole	1	21.620	36.538	1.00	4.00	0.000	8.000	146.15	0.00	1,169.22	25.00
148.0	Flat Low Profile Pla	1	21.297	35.993	1.00	31.60	0.000	0.000	1,137.37	0.00	0.00	1,700.00
148.0	6' Dipole	1	21.501	36.336	1.00	3.00	0.000	5.000	109.01	0.00	545.04	39.30
148.0	48" x 12" Panel	9	21.338	36.062	0.78	43.45	0.000	1.000	1,567.03	0.00	1,567.03	567.00
148.0	72" x 12" Panel	3	21.338	36.062	0.79	21.88	0.000	1.000	788.86	0.00	788.86	276.84
									19,101.74			16,185.79

Pole : 302540  
 Location : Madison CT 6, CT  
 Height : 148.0 (ft)  
 Base Dia : 61.05 (in)  
 Top Dia : 24.00 (in)  
 Shape : 18 Sides  
 Taper : 0.263006 (in/ft)

Code: TIA/EIA-222 Rev F

Base Elev : 0.000 (ft)

© 2007 - 2014 by ATC IP LLC. All rights reserved.

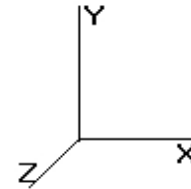

8/1/2014 8:35:38 AM

Page: 12

<b>Load Case:</b> Ice	73.61 mph Wind with Ice	21 Iterations
Gust Response Factor : 1.69		
Dead Load Factor : 1.00		
Wind Load Factor : 1.00		

**Linear Appurtenance Segment Forces**

Seg Top Elev (ft)	Description	Exposed To Wind	Length (ft)	Weight (lb/ft)	CaAa (sf/ft)	qz (psf)	FX (lb)	Dead Load (lb)
5.00	(16) 1 5/8" Coax	Yes	5.00	37.36	0.60	13.871	70.33	186.80
5.00	(1) 1/2" Coax	Yes	5.00	0.00	0.00	13.871	0.00	0.00
10.00	(16) 1 5/8" Coax	Yes	5.00	37.36	0.60	13.871	70.33	186.80
10.00	(1) 1/2" Coax	Yes	5.00	0.00	0.00	13.871	0.00	0.00
15.00	(16) 1 5/8" Coax	Yes	5.00	37.36	0.60	13.871	70.33	186.80
15.00	(1) 1/2" Coax	Yes	5.00	0.00	0.00	13.871	0.00	0.00
20.00	(16) 1 5/8" Coax	Yes	5.00	37.36	0.60	13.871	70.33	186.80
20.00	(1) 1/2" Coax	Yes	5.00	0.00	0.00	13.871	0.00	0.00
25.00	(16) 1 5/8" Coax	Yes	5.00	37.36	0.60	13.871	70.33	186.80
25.00	(1) 1/2" Coax	Yes	5.00	0.00	0.00	13.871	0.00	0.00
30.00	(16) 1 5/8" Coax	Yes	5.00	37.36	0.60	13.871	70.33	186.80
30.00	(1) 1/2" Coax	Yes	5.00	0.00	0.00	13.871	0.00	0.00
35.00	(16) 1 5/8" Coax	Yes	5.00	37.36	0.60	14.106	71.52	186.80
35.00	(1) 1/2" Coax	Yes	5.00	0.00	0.00	14.106	0.00	0.00
38.50	(16) 1 5/8" Coax	Yes	3.50	37.36	0.60	14.496	51.45	130.76
38.50	(1) 1/2" Coax	Yes	3.50	0.00	0.00	14.496	0.00	0.00
40.00	(16) 1 5/8" Coax	Yes	1.50	37.36	0.60	14.655	22.29	56.04
40.00	(1) 1/2" Coax	Yes	1.50	0.00	0.00	14.655	0.00	0.00
45.00	(16) 1 5/8" Coax	Yes	5.00	37.36	0.60	15.156	76.84	186.80
45.00	(1) 1/2" Coax	Yes	5.00	0.00	0.00	15.156	0.00	0.00
50.00	(16) 1 5/8" Coax	Yes	5.00	37.36	0.60	15.620	79.19	186.80
50.00	(1) 1/2" Coax	Yes	5.00	0.00	0.00	15.620	0.00	0.00
55.00	(16) 1 5/8" Coax	Yes	5.00	37.36	0.60	16.051	81.38	186.80
55.00	(1) 1/2" Coax	Yes	5.00	0.00	0.00	16.051	0.00	0.00
60.00	(16) 1 5/8" Coax	Yes	5.00	37.36	0.60	16.455	83.43	186.80
60.00	(1) 1/2" Coax	Yes	5.00	0.00	0.00	16.455	0.00	0.00
65.00	(16) 1 5/8" Coax	Yes	5.00	37.36	0.60	16.836	85.36	186.80
65.00	(1) 1/2" Coax	Yes	5.00	0.00	0.00	16.836	0.00	0.00
70.00	(16) 1 5/8" Coax	Yes	5.00	37.36	0.60	17.196	87.18	186.80
70.00	(1) 1/2" Coax	Yes	5.00	0.00	0.00	17.196	0.00	0.00
73.00	(16) 1 5/8" Coax	Yes	3.00	37.36	0.60	17.403	52.94	112.08
75.00	(16) 1 5/8" Coax	Yes	2.00	37.36	0.60	17.538	35.57	74.72
78.50	(16) 1 5/8" Coax	Yes	3.50	37.36	0.60	17.768	63.06	130.76
80.00	(16) 1 5/8" Coax	Yes	1.50	37.36	0.60	17.865	27.17	56.04
85.00	(16) 1 5/8" Coax	Yes	5.00	37.36	0.60	18.177	92.16	186.80
86.00	(16) 1 5/8" Coax	Yes	1.00	37.36	0.60	18.238	18.49	37.36
90.00	(16) 1 5/8" Coax	Yes	4.00	37.36	0.60	18.476	74.94	149.44
95.00	(16) 1 5/8" Coax	Yes	5.00	37.36	0.60	18.764	95.13	186.80
96.00	(16) 1 5/8" Coax	Yes	1.00	37.36	0.60	18.820	19.08	37.36
100.0	(16) 1 5/8" Coax	Yes	4.00	37.36	0.60	19.041	77.23	149.44
105.0	(16) 1 5/8" Coax	Yes	5.00	37.36	0.60	19.308	97.89	186.80
106.0	(16) 1 5/8" Coax	Yes	1.00	37.36	0.60	19.360	19.63	37.36
108.7	(16) 1 5/8" Coax	Yes	2.75	37.36	0.60	19.502	54.38	102.74
110.0	(16) 1 5/8" Coax	Yes	1.25	37.36	0.60	19.566	24.80	46.70
113.0	(16) 1 5/8" Coax	Yes	3.00	37.36	0.60	19.717	59.98	112.08
115.0	(16) 1 5/8" Coax	Yes	2.00	37.36	0.60	19.816	40.19	74.72
120.0	(16) 1 5/8" Coax	Yes	5.00	37.36	0.60	20.059	101.70	186.80
<b>Totals:</b>							<b>2,014.94</b>	<b>4,483.19</b>

Pole : 302540  
 Location : Madison CT 6, CT  
 Height : 148.0 (ft)  
 Base Dia : 61.05 (in)  
 Top Dia : 24.00 (in)  
 Shape : 18 Sides  
 Taper : 0.263006 (in/ft)

Code: TIA/EIA-222 Rev F

Base Elev : 0.000 (ft)

© 2007 - 2014 by ATC IP LLC. All rights reserved.

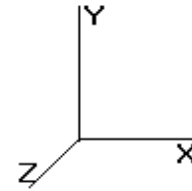

8/1/2014 8:35:38 AM

Page: 13

**Load Case:** Ice

73.61 mph Wind with Ice

21 Iterations

Gust Response Factor : 1.69

Dead Load Factor : 1.00

Wind Load Factor : 1.00

### Applied Segment Forces Summary

Seg Elev (ft)	Lateral FX (-) (lb)	Axial FY (-) (lb)	Torsion MY (lb-ft)	Moment MZ (lb-ft)
0.00	0.00	0.00	0.00	0.00
5.00	460.10	2,249.26	0.00	0.00
10.00	451.76	2,209.70	0.00	0.00
15.00	443.41	2,170.13	0.00	0.00
20.00	435.06	2,130.57	0.00	0.00
25.00	426.71	2,091.01	0.00	0.00
30.00	418.36	2,051.44	0.00	0.00
35.00	416.96	2,011.88	0.00	0.00
38.50	294.74	1,385.20	0.00	0.00
40.00	127.89	899.11	0.00	0.00
45.00	434.96	2,952.57	0.00	0.00
50.00	438.85	1,588.83	0.00	0.00
55.00	441.30	1,558.15	0.00	0.00
60.00	442.51	1,527.46	0.00	0.00
65.00	442.61	1,496.77	0.00	0.00
70.00	460.85	1,481.08	0.00	57.35
73.00	263.21	865.41	0.00	0.00
75.00	176.73	859.62	0.00	0.00
78.50	309.21	1,483.56	0.00	0.00
80.00	131.63	381.59	0.00	0.00
85.00	439.31	1,253.47	0.00	0.00
86.00	734.78	1,087.26	0.00	0.00
90.00	347.45	960.33	0.00	0.00
95.00	430.91	1,176.38	0.00	0.00
96.00	3,244.65	3,334.65	0.00	3,231.77
100.0	339.73	902.33	0.00	0.00
105.0	420.16	1,103.88	0.00	0.00
106.0	741.43	1,073.17	0.00	428.39
108.7	227.12	593.56	0.00	0.00
110.0	103.52	382.15	0.00	0.00
113.0	247.33	905.52	0.00	0.00
115.0	163.33	378.17	0.00	0.00
120.0	3,182.85	3,746.14	0.00	0.00
125.0	294.52	712.28	0.00	0.00
130.0	285.48	690.47	0.00	0.00
132.0	3,108.12	2,824.74	0.00	0.00
134.0	638.99	716.30	0.00	529.29
135.0	54.22	113.88	0.00	0.00
140.0	4,752.93	3,442.02	0.00	0.00
145.0	256.30	475.64	0.00	0.00
148.0	3,974.34	2,921.78	0.00	4,457.13
<b>Totals:</b>	<b>31,004.30</b>	<b>60,187.44</b>	<b>0.00</b>	<b>8,703.93</b>

Pole : 302540  
 Location : Madison CT 6, CT  
 Height : 148.0 (ft)  
 Base Dia : 61.05 (in)  
 Top Dia : 24.00 (in)  
 Shape : 18 Sides  
 Taper : 0.263006 (in/ft)

Code: TIA/EIA-222 Rev F

Base Elev : 0.000 (ft)

© 2007 - 2014 by ATC IP LLC. All rights reserved.

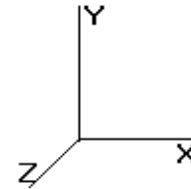

8/1/2014 8:35:38 AM

Page: 14

**Load Case:** Ice

73.61 mph Wind with Ice

21 Iterations

Gust Response Factor : 1.69  
 Dead Load Factor : 1.00  
 Wind Load Factor : 1.00

**Calculated Shaft Forces and Deflections**

Seg Elev (ft)	Lateral FX (-) (kips)	Axial FY (-) (kips)	Lateral FZ (kips)	Moment MX (ft-kips)	Torsion MY (ft-kips)	Moment MZ (ft-kips)	X Deflect (in)	Z Deflect (in)	Total Deflect (in)	Rotation (deg)
0.00	-31.060	-60.158	0.000	0.000	0.000	-3,382.070	0.000	0.000	0.000	0.000
5.00	-30.706	-57.852	0.000	0.000	0.000	-3,226.772	-0.057	0.000	0.057	-0.106
10.00	-30.353	-55.586	0.000	0.000	0.000	-3,073.247	-0.226	0.000	0.226	-0.213
15.00	-30.002	-53.360	0.000	0.000	0.000	-2,921.484	-0.508	0.000	0.508	-0.323
20.00	-29.654	-51.175	0.000	0.000	0.000	-2,771.476	-0.906	0.000	0.906	-0.434
25.00	-29.307	-49.029	0.000	0.000	0.000	-2,623.211	-1.422	0.000	1.422	-0.547
30.00	-28.962	-46.924	0.000	0.000	0.000	-2,476.680	-2.057	0.000	2.057	-0.662
35.00	-28.598	-44.868	0.000	0.000	0.000	-2,331.874	-2.814	0.000	2.814	-0.779
38.50	-28.329	-43.457	0.000	0.000	0.000	-2,231.784	-3.417	0.000	3.417	-0.863
40.00	-28.246	-42.521	0.000	0.000	0.000	-2,189.292	-3.694	0.000	3.694	-0.899
45.00	-27.845	-39.518	0.000	0.000	0.000	-2,048.066	-4.701	0.000	4.701	-1.019
50.00	-27.468	-37.871	0.000	0.000	0.000	-1,908.846	-5.834	0.000	5.834	-1.141
55.00	-27.092	-36.249	0.000	0.000	0.000	-1,771.511	-7.113	0.000	7.113	-1.296
60.00	-26.707	-34.660	0.000	0.000	0.000	-1,636.056	-8.554	0.000	8.554	-1.451
65.00	-26.315	-33.104	0.000	0.000	0.000	-1,502.525	-10.158	0.000	10.158	-1.607
70.00	-25.879	-31.581	0.000	0.000	0.000	-1,370.896	-11.926	0.000	11.926	-1.763
73.00	-25.631	-30.689	0.000	0.000	0.000	-1,293.260	-13.065	0.000	13.065	-1.858
75.00	-25.472	-29.797	0.000	0.000	0.000	-1,241.998	-13.858	0.000	13.858	-1.922
78.50	-25.150	-28.291	0.000	0.000	0.000	-1,152.849	-15.309	0.000	15.309	-2.031
80.00	-25.059	-27.866	0.000	0.000	0.000	-1,115.125	-15.955	0.000	15.955	-2.079
85.00	-24.620	-26.586	0.000	0.000	0.000	-989.833	-18.226	0.000	18.226	-2.251
86.00	-23.881	-25.493	0.000	0.000	0.000	-965.213	-18.702	0.000	18.702	-2.287
90.00	-23.559	-24.486	0.000	0.000	0.000	-869.690	-20.676	0.000	20.676	-2.422
95.00	-23.116	-23.291	0.000	0.000	0.000	-751.899	-23.301	0.000	23.301	-2.584
96.00	-19.751	-20.080	0.000	0.000	0.000	-725.552	-23.846	0.000	23.846	-2.617
100.0	-19.415	-19.148	0.000	0.000	0.000	-646.551	-26.092	0.000	26.092	-2.741
105.0	-18.969	-18.037	0.000	0.000	0.000	-549.477	-29.043	0.000	29.043	-2.889
106.0	-18.190	-16.986	0.000	0.000	0.000	-530.081	-29.652	0.000	29.652	-2.919
108.7	-17.949	-16.387	0.000	0.000	0.000	-480.059	-31.356	0.000	31.356	-2.997
110.0	-17.842	-15.993	0.000	0.000	0.000	-457.624	-32.146	0.000	32.146	-3.033
113.0	-17.563	-15.082	0.000	0.000	0.000	-404.100	-34.078	0.000	34.078	-3.113
115.0	-17.404	-14.684	0.000	0.000	0.000	-368.974	-35.393	0.000	35.393	-3.165
120.0	-14.039	-11.093	0.000	0.000	0.000	-281.954	-38.782	0.000	38.782	-3.300
125.0	-13.723	-10.373	0.000	0.000	0.000	-211.759	-42.302	0.000	42.302	-3.416
130.0	-13.406	-9.687	0.000	0.000	0.000	-143.146	-45.933	0.000	45.933	-3.512
132.0	-10.134	-7.054	0.000	0.000	0.000	-116.334	-47.411	0.000	47.411	-3.543
134.0	-9.454	-6.376	0.000	0.000	0.000	-95.537	-48.901	0.000	48.901	-3.571
135.0	-9.396	-6.260	0.000	0.000	0.000	-86.083	-49.650	0.000	49.650	-3.584
140.0	-4.438	-3.122	0.000	0.000	0.000	-39.103	-53.428	0.000	53.428	-3.628
145.0	-4.152	-2.662	0.000	0.000	0.000	-16.914	-57.239	0.000	57.239	-3.651
148.0	-3.974	0.000	0.000	0.000	0.000	-4.457	-59.534	0.000	59.534	-3.657

Pole : 302540  
 Location : Madison CT 6, CT  
 Height : 148.0 (ft)  
 Base Dia : 61.05 (in)  
 Top Dia : 24.00 (in)  
 Shape : 18 Sides  
 Taper : 0.263006 (in/ft)

Code: TIA/EIA-222 Rev F

Base Elev : 0.000 (ft)

© 2007 - 2014 by ATC IP LLC. All rights reserved.

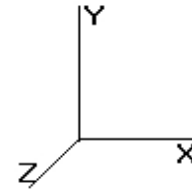

8/1/2014 8:35:38 AM

Page: 15

**Load Case: Ice**

73.61 mph Wind with Ice

21 Iterations

Gust Response Factor : 1.69  
 Dead Load Factor : 1.00  
 Wind Load Factor : 1.00

**Calculated Stresses**

Seg Elev (ft)	Applied Stresses							Allowable Stress (Fb) (ksi)	Stress Ratio	
	Axial (Y) (ksi)	Shear (X) (ksi)	Shear (Z) (ksi)	Torsion (ksi)	Bending (X) (ksi)	Bending (Z) (ksi)	Combined (ksi)			
0.00	0.63	0.65	0.00	0.00	0.00	28.26	28.91	52.0	0.0	0.556
5.00	0.62	0.66	0.00	0.00	0.00	28.18	28.82	52.0	0.0	0.554
10.00	0.60	0.67	0.00	0.00	0.00	28.08	28.71	52.0	0.0	0.552
15.00	0.59	0.67	0.00	0.00	0.00	27.95	28.57	52.0	0.0	0.550
20.00	0.58	0.68	0.00	0.00	0.00	27.80	28.41	52.0	0.0	0.546
25.00	0.57	0.69	0.00	0.00	0.00	27.61	28.21	52.0	0.0	0.543
30.00	0.56	0.70	0.00	0.00	0.00	27.40	27.98	52.0	0.0	0.538
35.00	0.55	0.71	0.00	0.00	0.00	27.14	27.72	52.0	0.0	0.533
38.50	0.54	0.71	0.00	0.00	0.00	26.94	27.51	52.0	0.0	0.529
40.00	0.54	0.72	0.00	0.00	0.00	26.84	27.41	52.0	0.0	0.527
45.00	0.67	0.95	0.00	0.00	0.00	34.00	34.71	52.0	0.0	0.668
50.00	0.66	0.96	0.00	0.00	0.00	33.44	34.14	52.0	0.0	0.657
55.00	0.65	0.98	0.00	0.00	0.00	32.81	33.50	52.0	0.0	0.644
60.00	0.64	0.99	0.00	0.00	0.00	32.08	32.76	52.0	0.0	0.630
65.00	0.63	1.01	0.00	0.00	0.00	31.24	31.92	52.0	0.0	0.614
70.00	0.62	1.02	0.00	0.00	0.00	30.28	30.95	52.0	0.0	0.595
73.00	0.61	1.03	0.00	0.00	0.00	29.65	30.31	52.0	0.0	0.583
75.00	0.60	1.03	0.00	0.00	0.00	29.20	29.85	52.0	0.0	0.574
78.50	0.69	1.23	0.00	0.00	0.00	32.84	33.60	52.0	0.0	0.646
80.00	0.68	1.24	0.00	0.00	0.00	32.38	33.14	52.0	0.0	0.638
85.00	0.67	1.26	0.00	0.00	0.00	30.69	31.44	52.0	0.0	0.605
86.00	0.65	1.23	0.00	0.00	0.00	30.32	31.05	52.0	0.0	0.597
90.00	0.64	1.25	0.00	0.00	0.00	28.85	29.57	52.0	0.0	0.569
95.00	0.63	1.27	0.00	0.00	0.00	26.74	27.46	52.0	0.0	0.528
96.00	0.55	1.09	0.00	0.00	0.00	26.18	26.79	52.0	0.0	0.515
100.00	0.54	1.10	0.00	0.00	0.00	24.72	25.34	52.0	0.0	0.487
105.00	0.53	1.12	0.00	0.00	0.00	22.65	23.26	52.0	0.0	0.447
106.00	0.50	1.08	0.00	0.00	0.00	22.19	22.77	52.0	0.0	0.438
108.75	0.49	1.09	0.00	0.00	0.00	20.98	21.55	52.0	0.0	0.415
110.00	0.49	1.09	0.00	0.00	0.00	20.40	20.97	52.0	0.0	0.403
113.00	0.58	1.35	0.00	0.00	0.00	22.78	23.48	52.0	0.0	0.452
115.00	0.57	1.36	0.00	0.00	0.00	21.49	22.18	52.0	0.0	0.427
120.00	0.45	1.15	0.00	0.00	0.00	17.84	18.40	52.0	0.0	0.354
125.00	0.44	1.17	0.00	0.00	0.00	14.61	15.19	52.0	0.0	0.292
130.00	0.43	1.20	0.00	0.00	0.00	10.82	11.43	52.0	0.0	0.220
132.00	0.32	0.92	0.00	0.00	0.00	9.13	9.58	52.0	0.0	0.184
134.00	0.29	0.88	0.00	0.00	0.00	7.79	8.22	52.0	0.0	0.158
135.00	0.29	0.88	0.00	0.00	0.00	7.15	7.60	52.0	0.0	0.146
140.00	0.15	0.44	0.00	0.00	0.00	3.59	3.82	52.0	0.0	0.073
145.00	0.14	0.43	0.00	0.00	0.00	1.72	2.00	52.0	0.0	0.039
148.00	0.00	0.43	0.00	0.00	0.00	0.49	0.88	52.0	0.0	0.017



Pole : 302540  
 Location : Madison CT 6, CT  
 Height : 148.0 (ft)  
 Base Dia : 61.05 (in)  
 Top Dia : 24.00 (in)  
 Shape : 18 Sides  
 Taper : 0.263006 (in/ft)

Code: TIA/EIA-222 Rev F

Base Elev : 0.000 (ft)

© 2007 - 2014 by ATC IP LLC. All rights reserved.

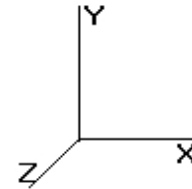

8/1/2014 8:35:38 AM

Page: 16

<b>Load Case:</b> Twist/Sway	50.00 mph Wind with No Ice	21 Iterations
Gust Response Factor : 1.69		
Dead Load Factor : 1.00		
Wind Load Factor : 1.00		

**Shaft Segment Forces**

Seg Top Elev (ft)	Description	Kz	qz (psf)	qzGh (psf)	C (mph-ft)	Cf	Ice Thick (in)	Tributary (ft)	Ap (sf)	EPAs (sf)	Wind Force X (lb)	Dead Load Ice (lb)	Tot Dead Load (lb)	
0.00		0.00	1.00	6.400	10.81	254.37	0.650	0.000	0.00	0.000	0.00	0.0	0.0	
5.00		0.00	1.00	6.400	10.81	248.89	0.650	0.000	5.00	25.163	16.36	176.9	0.0	1,617.1
10.00		0.00	1.00	6.400	10.81	243.41	0.650	0.000	5.00	24.616	16.00	173.1	0.0	1,581.6
15.00		0.00	1.00	6.400	10.81	237.93	0.650	0.000	5.00	24.068	15.64	169.2	0.0	1,546.1
20.00		0.00	1.00	6.400	10.81	232.45	0.650	0.000	5.00	23.520	15.29	165.4	0.0	1,510.6
25.00		0.00	1.00	6.400	10.81	226.97	0.650	0.000	5.00	22.972	14.93	161.5	0.0	1,475.1
30.00		0.00	1.00	6.400	10.81	221.49	0.650	0.000	5.00	22.424	14.58	157.6	0.0	1,439.6
35.00		0.00	1.01	6.509	10.99	217.84	0.650	0.000	5.00	21.876	14.22	156.4	0.0	1,404.1
38.50	Bot - Section 2	0.00	1.04	6.688	11.30	216.90	0.650	0.000	3.50	14.987	9.74	110.1	0.0	961.7
40.00		0.00	1.05	6.762	11.42	216.40	0.650	0.000	1.50	6.435	4.18	47.8	0.0	717.3
45.00	Top - Section 1	0.00	1.09	6.993	11.81	214.35	0.650	0.000	5.00	21.093	13.71	162.0	0.0	2,350.6
50.00		0.00	1.12	7.207	12.17	215.10	0.650	0.000	5.00	20.545	13.35	162.6	0.0	990.9
55.00		0.00	1.15	7.406	12.51	212.15	0.650	0.000	5.00	19.997	13.00	162.7	0.0	964.2
60.00		0.00	1.18	7.592	12.83	208.84	0.650	0.000	5.00	19.449	12.64	162.2	0.0	937.6
65.00		0.00	1.21	7.768	13.12	205.20	0.650	0.000	5.00	18.901	12.29	161.3	0.0	911.0
70.00	Appertunance(s)	0.00	1.24	7.934	13.40	201.29	0.650	0.000	5.00	18.353	11.93	160.0	0.0	884.4
73.00	Bot - Section 3	0.00	1.25	8.030	13.57	198.82	0.650	0.000	3.00	10.749	6.99	94.8	0.0	517.8
75.00		0.00	1.26	8.092	13.67	197.12	0.650	0.000	2.00	7.160	4.65	63.6	0.0	627.8
78.50	Top - Section 2	0.00	1.28	8.198	13.85	194.07	0.650	0.000	3.50	12.320	8.01	110.9	0.0	1,079.8
80.00		0.00	1.28	8.242	13.93	195.68	0.650	0.000	1.50	5.198	3.38	47.1	0.0	208.9
85.00		0.00	1.31	8.387	14.17	191.11	0.650	0.000	5.00	16.970	11.03	156.3	0.0	682.0
86.00	Appertunance(s)	0.00	1.31	8.415	14.22	190.18	0.650	0.000	1.00	3.328	2.16	30.8	0.0	133.7
90.00		0.00	1.33	8.525	14.40	186.36	0.650	0.000	4.00	13.093	8.51	122.6	0.0	526.1
95.00		0.00	1.35	8.657	14.63	181.43	0.650	0.000	5.00	15.874	10.32	151.0	0.0	637.6
96.00	Appertunance(s)	0.00	1.35	8.683	14.67	180.42	0.650	0.000	1.00	3.109	2.02	29.7	0.0	124.9
100.00		0.00	1.37	8.785	14.84	176.34	0.650	0.000	4.00	12.217	7.94	117.9	0.0	490.6
105.00		0.00	1.39	8.908	15.05	171.11	0.650	0.000	5.00	14.778	9.61	144.6	0.0	593.2
106.00	Appertunance(s)	0.00	1.39	8.933	15.09	170.05	0.650	0.000	1.00	2.890	1.88	28.4	0.0	116.0
108.70	Bot - Section 4	0.00	1.40	8.998	15.20	167.10	0.650	0.000	2.75	7.834	5.09	77.4	0.0	314.4
110.00		0.00	1.41	9.028	15.25	165.75	0.650	0.000	1.25	3.558	2.31	35.3	0.0	255.1
113.00	Top - Section 3	0.00	1.42	9.097	15.37	162.47	0.650	0.000	3.00	8.400	5.46	83.9	0.0	602.1
115.00		0.00	1.42	9.143	15.45	162.74	0.650	0.000	2.00	5.490	3.57	55.1	0.0	176.5
120.00	Appertunance(s)	0.00	1.44	9.255	15.64	157.15	0.650	0.000	5.00	13.342	8.67	135.6	0.0	428.9
125.00		0.00	1.46	9.363	15.82	151.44	0.650	0.000	5.00	12.794	8.32	131.6	0.0	411.2
130.00		0.00	1.48	9.469	16.00	145.62	0.650	0.000	5.00	12.247	7.96	127.4	0.0	393.4
132.00	Appertunance(s)	0.00	1.48	9.510	16.07	143.27	0.650	0.000	2.00	4.745	3.08	49.6	0.0	152.4
134.00	Appertunance(s)	0.00	1.49	9.551	16.14	140.90	0.650	0.000	2.00	4.658	3.03	48.9	0.0	149.6
135.00		0.00	1.49	9.572	16.17	139.71	0.650	0.000	1.00	2.296	1.49	24.1	0.0	73.7
140.00	Appertunance(s)	0.00	1.51	9.672	16.34	133.70	0.650	0.000	5.00	11.151	7.25	118.5	0.0	357.9
145.00		0.00	1.52	9.769	16.51	127.61	0.650	0.000	5.00	10.603	6.89	113.8	0.0	340.2
148.00	Appertunance(s)	0.00	1.53	9.826	16.60	123.91	0.650	0.000	3.00	6.099	3.96	65.8	0.0	195.6
<b>Totals:</b>								148.00			4,453.5	0.0	28,881.1	

Pole : 302540  
 Location : Madison CT 6, CT  
 Height : 148.0 (ft)  
 Base Dia : 61.05 (in)  
 Top Dia : 24.00 (in)  
 Shape : 18 Sides  
 Taper : 0.263006 (in/ft)

Code: TIA/EIA-222 Rev F

Base Elev : 0.000 (ft)

© 2007 - 2014 by ATC IP LLC. All rights reserved.

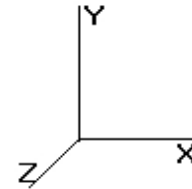

8/1/2014 8:35:38 AM

Page: 17

<b>Load Case:</b> Twist/Sway	50.00 mph Wind with No Ice	21 Iterations
Gust Response Factor : 1.69		
Dead Load Factor : 1.00		
Wind Load Factor : 1.00		

**Discrete Appurtenance Segment Forces**

Elev (ft)	Description	Qty	qz (psf)	qzGh (psf)	Orientation Factor	Total EPAa (sf)	Horiz Ecc (ft)	Vert Ecc (ft)	Wind FX (lb)	Mom Y (lb-ft)	Mom Z (lb-ft)	Dead Load (lb)
70.00	GPS	1	8.030	13.570	0.50	0.50	0.000	3.000	6.79	0.00	20.36	10.00
86.00	RFS APXV18-206517S-	3	8.415	14.221	0.80	12.36	0.000	0.000	175.79	0.00	0.00	79.20
86.00	Collar	1	8.415	14.221	0.67	5.70	0.000	0.000	80.99	0.00	0.00	560.00
96.00	RFS APXVSP18-C-	3	8.722	14.740	0.83	20.57	0.000	1.500	303.16	0.00	454.74	171.00
96.00	Alcatel-Lucent 800 M	3	8.722	14.740	0.67	4.82	0.000	1.500	71.10	0.00	106.66	192.00
96.00	Alcatel-Lucent 1900	3	8.722	14.740	0.67	5.45	0.000	1.500	80.29	0.00	120.43	180.00
96.00	Alcatel TD-RRH8x20-2	3	8.722	14.740	1.00	14.16	0.000	1.500	208.72	0.00	313.07	210.00
96.00	RFS APXV9TM14-ALU-	3	8.722	14.740	0.78	16.22	0.000	1.500	239.02	0.00	358.54	165.30
96.00	Flat Low Profile Pla	1	8.683	14.675	1.00	26.10	0.000	0.000	383.01	0.00	0.00	1,500.00
106.0	60" x 8" Panel	3	8.957	15.137	0.79	11.19	0.000	1.000	169.32	0.00	169.32	90.00
106.0	Flush	1	8.933	15.096	0.67	5.70	0.000	0.000	85.97	0.00	0.00	560.00
106.0	2" x 4" GPS	2	8.957	15.137	0.50	0.04	0.000	1.000	0.61	0.00	0.61	10.00
120.0	Flat Low Profile Pla	1	9.255	15.641	1.00	26.10	0.000	0.000	408.22	0.00	0.00	1,500.00
120.0	Ericsson KRY 112 144	4	9.255	15.641	0.50	0.82	0.000	0.000	12.83	0.00	0.00	44.00
120.0	Ericsson AIR 21, 1.3	4	9.255	15.641	0.86	22.46	0.000	0.000	351.34	0.00	0.00	332.00
120.0	Ericsson AIR 21, 1.3	4	9.255	15.641	0.85	22.41	0.000	0.000	350.45	0.00	0.00	326.00
132.0	ADC DD700	6	9.510	16.073	0.50	3.75	0.000	0.000	60.27	0.00	0.00	95.40
132.0	Powerwave Allgon	6	9.510	16.073	0.50	1.02	0.000	0.000	16.39	0.00	0.00	31.80
132.0	Flat Low Profile Pla	1	9.510	16.073	1.00	26.10	0.000	0.000	419.49	0.00	0.00	1,500.00
132.0	KMW AM-X-CD-14-65-	2	9.510	16.073	0.78	8.60	0.000	0.000	138.15	0.00	0.00	72.80
132.0	Powerwave 7770.00	6	9.510	16.073	0.77	27.17	0.000	0.000	436.62	0.00	0.00	210.00
132.0	Kathrein 800 10736	1	9.510	16.073	0.73	8.31	0.000	0.000	133.64	0.00	0.00	33.10
134.0	Raycap DC6-48-60-18-	1	9.572	16.176	1.00	2.57	0.000	1.000	41.57	0.00	41.57	31.80
134.0	Ericsson RRUS 11 (Ba	6	9.572	16.176	0.67	11.82	0.000	1.000	191.18	0.00	191.18	330.00
140.0	Antel LPA-80080/6CF	4	9.672	16.345	0.75	27.30	0.000	0.000	446.22	0.00	0.00	84.00
140.0	Antel LPA-80063/6CF	2	9.672	16.345	0.95	19.65	0.000	0.000	321.11	0.00	0.00	54.00
140.0	Antel BXA-70063-6CF-	3	9.672	16.345	0.77	17.86	0.000	0.000	291.86	0.00	0.00	51.00
140.0	Flat Low Profile Pla	1	9.672	16.345	1.00	26.10	0.000	0.000	426.60	0.00	0.00	1,500.00
140.0	Antel BXA-171085-8BF	3	9.672	16.345	0.87	7.67	0.000	0.000	125.42	0.00	0.00	31.50
140.0	RFS FD9R6004/1C-3L	6	9.672	16.345	0.50	1.11	0.000	0.000	18.14	0.00	0.00	18.60
140.0	Alcatel-Lucent RRH2X	3	9.672	16.345	0.67	5.91	0.000	0.000	96.59	0.00	0.00	125.70
140.0	Kathrein Scala 742 2	3	9.672	16.345	0.78	12.03	0.000	0.000	196.59	0.00	0.00	66.00
140.0	RFS DB-T1-6Z-8AB-0Z	1	9.672	16.345	0.67	3.75	0.000	0.000	61.33	0.00	0.00	44.00
148.0	6' Omni	1	9.920	16.765	1.00	1.76	0.000	5.000	29.51	0.00	147.53	25.00
148.0	11' Dipole	1	9.975	16.858	1.00	3.58	0.000	8.000	60.35	0.00	482.82	40.00
148.0	Flat Low Profile Pla	1	9.826	16.607	1.00	26.10	0.000	0.000	433.43	0.00	0.00	1,500.00
148.0	6' Dipole	1	9.920	16.765	1.00	2.22	0.000	5.000	37.22	0.00	186.09	20.00
148.0	48" x 12" Panel	9	9.845	16.639	0.78	39.31	0.000	1.000	654.10	0.00	654.10	270.00
148.0	72" x 12" Panel	3	9.845	16.639	0.79	19.91	0.000	1.000	331.24	0.00	331.24	135.00
									7,894.64			12,199.20

Pole : 302540  
 Location : Madison CT 6, CT  
 Height : 148.0 (ft)  
 Base Dia : 61.05 (in)  
 Top Dia : 24.00 (in)  
 Shape : 18 Sides  
 Taper : 0.263006 (in/ft)

Code: TIA/EIA-222 Rev F

Base Elev : 0.000 (ft)

© 2007 - 2014 by ATC IP LLC. All rights reserved.

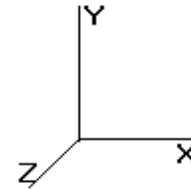

8/1/2014 8:35:38 AM

Page: 18

**Load Case:** Twist/Sway      50.00 mph Wind with No Ice      21 Iterations

Gust Response Factor : 1.69  
 Dead Load Factor : 1.00  
 Wind Load Factor : 1.00

**Linear Appurtenance Segment Forces**

Seg Top Elev (ft)	Description	Exposed To Wind	Length (ft)	Weight (lb/ft)	CaAa (sf/ft)	qz (psf)	FX (lb)	Dead Load (lb)
5.00	(16) 1 5/8" Coax	Yes	5.00	13.12	0.40	6.400	21.63	65.60
5.00	(1) 1/2" Coax	Yes	5.00	0.15	0.00	6.400	0.00	0.75
10.00	(16) 1 5/8" Coax	Yes	5.00	13.12	0.40	6.400	21.63	65.60
10.00	(1) 1/2" Coax	Yes	5.00	0.15	0.00	6.400	0.00	0.75
15.00	(16) 1 5/8" Coax	Yes	5.00	13.12	0.40	6.400	21.63	65.60
15.00	(1) 1/2" Coax	Yes	5.00	0.15	0.00	6.400	0.00	0.75
20.00	(16) 1 5/8" Coax	Yes	5.00	13.12	0.40	6.400	21.63	65.60
20.00	(1) 1/2" Coax	Yes	5.00	0.15	0.00	6.400	0.00	0.75
25.00	(16) 1 5/8" Coax	Yes	5.00	13.12	0.40	6.400	21.63	65.60
25.00	(1) 1/2" Coax	Yes	5.00	0.15	0.00	6.400	0.00	0.75
30.00	(16) 1 5/8" Coax	Yes	5.00	13.12	0.40	6.400	21.63	65.60
30.00	(1) 1/2" Coax	Yes	5.00	0.15	0.00	6.400	0.00	0.75
35.00	(16) 1 5/8" Coax	Yes	5.00	13.12	0.40	6.509	22.00	65.60
35.00	(1) 1/2" Coax	Yes	5.00	0.15	0.00	6.509	0.00	0.75
38.50	(16) 1 5/8" Coax	Yes	3.50	13.12	0.40	6.688	15.82	45.92
38.50	(1) 1/2" Coax	Yes	3.50	0.15	0.00	6.688	0.00	0.53
40.00	(16) 1 5/8" Coax	Yes	1.50	13.12	0.40	6.762	6.86	19.68
40.00	(1) 1/2" Coax	Yes	1.50	0.15	0.00	6.762	0.00	0.23
45.00	(16) 1 5/8" Coax	Yes	5.00	13.12	0.40	6.993	23.64	65.60
45.00	(1) 1/2" Coax	Yes	5.00	0.15	0.00	6.993	0.00	0.75
50.00	(16) 1 5/8" Coax	Yes	5.00	13.12	0.40	7.207	24.36	65.60
50.00	(1) 1/2" Coax	Yes	5.00	0.15	0.00	7.207	0.00	0.75
55.00	(16) 1 5/8" Coax	Yes	5.00	13.12	0.40	7.406	25.03	65.60
55.00	(1) 1/2" Coax	Yes	5.00	0.15	0.00	7.406	0.00	0.75
60.00	(16) 1 5/8" Coax	Yes	5.00	13.12	0.40	7.592	25.66	65.60
60.00	(1) 1/2" Coax	Yes	5.00	0.15	0.00	7.592	0.00	0.75
65.00	(16) 1 5/8" Coax	Yes	5.00	13.12	0.40	7.768	26.25	65.60
65.00	(1) 1/2" Coax	Yes	5.00	0.15	0.00	7.768	0.00	0.75
70.00	(16) 1 5/8" Coax	Yes	5.00	13.12	0.40	7.934	26.82	65.60
70.00	(1) 1/2" Coax	Yes	5.00	0.15	0.00	7.934	0.00	0.75
73.00	(16) 1 5/8" Coax	Yes	3.00	13.12	0.40	8.030	16.28	39.36
75.00	(16) 1 5/8" Coax	Yes	2.00	13.12	0.40	8.092	10.94	26.24
78.50	(16) 1 5/8" Coax	Yes	3.50	13.12	0.40	8.198	19.40	45.92
80.00	(16) 1 5/8" Coax	Yes	1.50	13.12	0.40	8.242	8.36	19.68
85.00	(16) 1 5/8" Coax	Yes	5.00	13.12	0.40	8.387	28.35	65.60
86.00	(16) 1 5/8" Coax	Yes	1.00	13.12	0.40	8.415	5.69	13.12
90.00	(16) 1 5/8" Coax	Yes	4.00	13.12	0.40	8.525	23.05	52.48
95.00	(16) 1 5/8" Coax	Yes	5.00	13.12	0.40	8.657	29.26	65.60
96.00	(16) 1 5/8" Coax	Yes	1.00	13.12	0.40	8.683	5.87	13.12
100.0	(16) 1 5/8" Coax	Yes	4.00	13.12	0.40	8.785	23.75	52.48
105.0	(16) 1 5/8" Coax	Yes	5.00	13.12	0.40	8.908	30.11	65.60
106.0	(16) 1 5/8" Coax	Yes	1.00	13.12	0.40	8.933	6.04	13.12
108.7	(16) 1 5/8" Coax	Yes	2.75	13.12	0.40	8.998	16.73	36.08
110.0	(16) 1 5/8" Coax	Yes	1.25	13.12	0.40	9.028	7.63	16.40
113.0	(16) 1 5/8" Coax	Yes	3.00	13.12	0.40	9.097	18.45	39.36
115.0	(16) 1 5/8" Coax	Yes	2.00	13.12	0.40	9.143	12.36	26.24
120.0	(16) 1 5/8" Coax	Yes	5.00	13.12	0.40	9.255	31.28	65.60
<b>Totals:</b>							<b>619.78</b>	<b>1,584.89</b>

Pole : 302540  
 Location : Madison CT 6, CT  
 Height : 148.0 (ft)  
 Base Dia : 61.05 (in)  
 Top Dia : 24.00 (in)  
 Shape : 18 Sides  
 Taper : 0.263006 (in/ft)

Code: TIA/EIA-222 Rev F

Base Elev : 0.000 (ft)

© 2007 - 2014 by ATC IP LLC. All rights reserved.

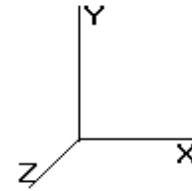

8/1/2014 8:35:38 AM

Page: 19

<b>Load Case:</b> Twist/Sway	50.00 mph Wind with No Ice	21 Iterations
Gust Response Factor : 1.69		
Dead Load Factor : 1.00		
Wind Load Factor : 1.00		

### Applied Segment Forces Summary

Seg Elev (ft)	Lateral FX (-) (lb)	Axial FY (-) (lb)	Torsion MY (lb-ft)	Moment MZ (lb-ft)
0.00	0.00	0.00	0.00	0.00
5.00	198.54	1,942.94	0.00	0.00
10.00	194.69	1,907.44	0.00	0.00
15.00	190.84	1,871.93	0.00	0.00
20.00	186.98	1,836.42	0.00	0.00
25.00	183.13	1,800.92	0.00	0.00
30.00	179.28	1,765.41	0.00	0.00
35.00	178.40	1,729.91	0.00	0.00
38.50	125.93	1,189.81	0.00	0.00
40.00	54.65	815.04	0.00	0.00
45.00	185.67	2,676.40	0.00	0.00
50.00	187.00	1,316.72	0.00	0.00
55.00	187.71	1,290.09	0.00	0.00
60.00	187.86	1,263.46	0.00	0.00
65.00	187.53	1,236.83	0.00	0.00
70.00	193.56	1,220.20	0.00	20.36
73.00	111.09	712.89	0.00	0.00
75.00	74.59	757.82	0.00	0.00
78.50	130.34	1,307.39	0.00	0.00
80.00	55.42	306.45	0.00	0.00
85.00	184.68	1,007.09	0.00	0.00
86.00	293.23	837.95	0.00	0.00
90.00	145.66	766.46	0.00	0.00
95.00	180.22	938.11	0.00	0.00
96.00	1,320.83	2,603.26	0.00	1,353.44
100.0	141.65	714.96	0.00	0.00
105.0	174.73	873.72	0.00	0.00
106.0	290.30	832.08	0.00	169.93
108.7	94.16	468.65	0.00	0.00
110.0	42.91	325.24	0.00	0.00
113.0	102.39	770.40	0.00	0.00
115.0	67.50	288.74	0.00	0.00
120.0	1,289.76	2,911.41	0.00	0.00
125.0	131.60	618.01	0.00	0.00
130.0	127.38	600.26	0.00	0.00
132.0	1,254.14	2,178.23	0.00	0.00
134.0	281.62	574.41	0.00	232.75
135.0	24.14	96.65	0.00	0.00
140.0	2,102.34	2,447.41	0.00	0.00
145.0	113.78	397.60	0.00	0.00
148.0	1,611.68	2,220.04	0.00	1,801.78
<b>Totals:</b>	<b>12,967.94</b>	<b>49,418.79</b>	<b>0.00</b>	<b>3,578.26</b>

Pole : 302540  
 Location : Madison CT 6, CT  
 Height : 148.0 (ft)  
 Base Dia : 61.05 (in)  
 Top Dia : 24.00 (in)  
 Shape : 18 Sides  
 Taper : 0.263006 (in/ft)

Code: TIA/EIA-222 Rev F

Base Elev : 0.000 (ft)

© 2007 - 2014 by ATC IP LLC. All rights reserved.

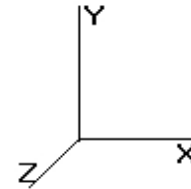

8/1/2014 8:35:38 AM

Page: 20

<b>Load Case:</b> Twist/Sway	50.00 mph Wind with No Ice	21 Iterations
Gust Response Factor : 1.69		
Dead Load Factor : 1.00		
Wind Load Factor : 1.00		

**Calculated Shaft Forces and Deflections**

Seg Elev (ft)	Lateral FX (-) (kips)	Axial FY (-) (kips)	Lateral FZ (kips)	Moment MX (ft-kips)	Torsion MY (ft-kips)	Moment MZ (ft-kips)	X Deflect (in)	Z Deflect (in)	Total Deflect (in)	Rotation (deg)
0.00	-12.987	-49.414	0.000	0.000	0.000	-1,402.796	0.000	0.000	0.000	0.000
5.00	-12.824	-47.461	0.000	0.000	0.000	-1,337.863	-0.024	0.000	0.024	-0.044
10.00	-12.663	-45.544	0.000	0.000	0.000	-1,273.743	-0.094	0.000	0.094	-0.088
15.00	-12.503	-43.662	0.000	0.000	0.000	-1,210.428	-0.211	0.000	0.211	-0.134
20.00	-12.345	-41.816	0.000	0.000	0.000	-1,147.912	-0.376	0.000	0.376	-0.180
25.00	-12.189	-40.006	0.000	0.000	0.000	-1,086.186	-0.589	0.000	0.589	-0.227
30.00	-12.034	-38.231	0.000	0.000	0.000	-1,025.243	-0.853	0.000	0.853	-0.274
35.00	-11.873	-36.494	0.000	0.000	0.000	-965.074	-1.166	0.000	1.166	-0.323
38.50	-11.755	-35.300	0.000	0.000	0.000	-923.520	-1.416	0.000	1.416	-0.357
40.00	-11.715	-34.478	0.000	0.000	0.000	-905.888	-1.531	0.000	1.531	-0.373
45.00	-11.538	-31.793	0.000	0.000	0.000	-847.314	-1.948	0.000	1.948	-0.422
50.00	-11.372	-30.467	0.000	0.000	0.000	-789.623	-2.417	0.000	2.417	-0.472
55.00	-11.205	-29.166	0.000	0.000	0.000	-732.766	-2.947	0.000	2.947	-0.536
60.00	-11.036	-27.892	0.000	0.000	0.000	-676.740	-3.543	0.000	3.543	-0.601
65.00	-10.865	-26.645	0.000	0.000	0.000	-621.560	-4.208	0.000	4.208	-0.665
70.00	-10.680	-25.418	0.000	0.000	0.000	-567.215	-4.940	0.000	4.940	-0.730
73.00	-10.573	-24.700	0.000	0.000	0.000	-535.177	-5.411	0.000	5.411	-0.769
75.00	-10.503	-23.937	0.000	0.000	0.000	-514.031	-5.739	0.000	5.739	-0.796
78.50	-10.367	-22.626	0.000	0.000	0.000	-477.269	-6.340	0.000	6.340	-0.841
80.00	-10.325	-22.312	0.000	0.000	0.000	-461.719	-6.607	0.000	6.607	-0.861
85.00	-10.141	-21.300	0.000	0.000	0.000	-410.094	-7.548	0.000	7.548	-0.932
86.00	-9.846	-20.461	0.000	0.000	0.000	-399.954	-7.745	0.000	7.745	-0.947
90.00	-9.709	-19.687	0.000	0.000	0.000	-360.569	-8.562	0.000	8.562	-1.003
95.00	-9.525	-18.745	0.000	0.000	0.000	-312.025	-9.649	0.000	9.649	-1.070
96.00	-8.165	-16.163	0.000	0.000	0.000	-301.147	-9.875	0.000	9.875	-1.083
100.0	-8.024	-15.443	0.000	0.000	0.000	-268.489	-10.805	0.000	10.805	-1.135
105.0	-7.841	-14.568	0.000	0.000	0.000	-228.367	-12.028	0.000	12.028	-1.197
106.0	-7.539	-13.739	0.000	0.000	0.000	-220.356	-12.280	0.000	12.280	-1.209
108.7	-7.440	-13.269	0.000	0.000	0.000	-199.625	-12.986	0.000	12.986	-1.242
110.0	-7.396	-12.942	0.000	0.000	0.000	-190.325	-13.314	0.000	13.314	-1.256
113.0	-7.282	-12.171	0.000	0.000	0.000	-168.138	-14.114	0.000	14.114	-1.290
115.0	-7.216	-11.878	0.000	0.000	0.000	-153.574	-14.659	0.000	14.659	-1.311
120.0	-5.867	-8.993	0.000	0.000	0.000	-117.493	-16.064	0.000	16.064	-1.368
125.0	-5.727	-8.374	0.000	0.000	0.000	-88.159	-17.524	0.000	17.524	-1.416
130.0	-5.588	-7.774	0.000	0.000	0.000	-59.525	-19.030	0.000	19.030	-1.456
132.0	-4.280	-5.628	0.000	0.000	0.000	-48.349	-19.643	0.000	19.643	-1.469
134.0	-3.984	-5.060	0.000	0.000	0.000	-39.557	-20.261	0.000	20.261	-1.480
135.0	-3.959	-4.963	0.000	0.000	0.000	-35.573	-20.571	0.000	20.571	-1.486
140.0	-1.794	-2.571	0.000	0.000	0.000	-15.780	-22.138	0.000	22.138	-1.504
145.0	-1.670	-2.177	0.000	0.000	0.000	-6.811	-23.719	0.000	23.719	-1.513
148.0	-1.612	0.000	0.000	0.000	0.000	-1.802	-24.670	0.000	24.670	-1.515

Pole : 302540  
 Location : Madison CT 6, CT  
 Height : 148.0 (ft)  
 Base Dia : 61.05 (in)  
 Top Dia : 24.00 (in)  
 Shape : 18 Sides  
 Taper : 0.263006 (in/ft)

Code: TIA/EIA-222 Rev F

8/1/2014 8:35:38 AM

Page: 21

Base Elev : 0.000 (ft)

© 2007 - 2014 by ATC IP LLC. All rights reserved.

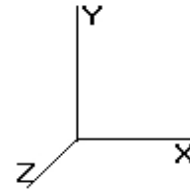

<b>Load Case:</b> Twist/Sway	50.00 mph Wind with No Ice	21 Iterations
Gust Response Factor : 1.69		
Dead Load Factor : 1.00		
Wind Load Factor : 1.00		

**Calculated Stresses**

Seg Elev (ft)	Applied Stresses							Allowable Stress (Fb) (ksi)	Stress Ratio	
	Axial (Y) (ksi)	Shear (X) (ksi)	Shear (Z) (ksi)	Torsion (ksi)	Bending (X) (ksi)	Bending (Z) (ksi)	Combined (ksi)			
0.00	0.51	0.27	0.00	0.00	0.00	11.72	12.25	52.0	0.0	0.236
5.00	0.50	0.27	0.00	0.00	0.00	11.68	12.20	52.0	0.0	0.235
10.00	0.50	0.28	0.00	0.00	0.00	11.64	12.14	52.0	0.0	0.234
15.00	0.49	0.28	0.00	0.00	0.00	11.58	12.08	52.0	0.0	0.232
20.00	0.48	0.28	0.00	0.00	0.00	11.51	12.00	52.0	0.0	0.231
25.00	0.47	0.29	0.00	0.00	0.00	11.43	11.91	52.0	0.0	0.229
30.00	0.46	0.29	0.00	0.00	0.00	11.34	11.81	52.0	0.0	0.227
35.00	0.45	0.29	0.00	0.00	0.00	11.23	11.69	52.0	0.0	0.225
38.50	0.44	0.30	0.00	0.00	0.00	11.15	11.60	52.0	0.0	0.223
40.00	0.43	0.30	0.00	0.00	0.00	11.11	11.55	52.0	0.0	0.222
45.00	0.54	0.39	0.00	0.00	0.00	14.07	14.62	52.0	0.0	0.281
50.00	0.53	0.40	0.00	0.00	0.00	13.83	14.38	52.0	0.0	0.277
55.00	0.52	0.40	0.00	0.00	0.00	13.57	14.11	52.0	0.0	0.271
60.00	0.51	0.41	0.00	0.00	0.00	13.27	13.80	52.0	0.0	0.265
65.00	0.51	0.42	0.00	0.00	0.00	12.92	13.45	52.0	0.0	0.259
70.00	0.50	0.42	0.00	0.00	0.00	12.53	13.05	52.0	0.0	0.251
73.00	0.49	0.42	0.00	0.00	0.00	12.27	12.78	52.0	0.0	0.246
75.00	0.48	0.43	0.00	0.00	0.00	12.08	12.59	52.0	0.0	0.242
78.50	0.55	0.51	0.00	0.00	0.00	13.60	14.17	52.0	0.0	0.273
80.00	0.55	0.51	0.00	0.00	0.00	13.41	13.98	52.0	0.0	0.269
85.00	0.54	0.52	0.00	0.00	0.00	12.71	13.28	52.0	0.0	0.256
86.00	0.52	0.51	0.00	0.00	0.00	12.57	13.12	52.0	0.0	0.252
90.00	0.52	0.51	0.00	0.00	0.00	11.96	12.51	52.0	0.0	0.241
95.00	0.51	0.52	0.00	0.00	0.00	11.10	11.64	52.0	0.0	0.224
96.00	0.44	0.45	0.00	0.00	0.00	10.87	11.33	52.0	0.0	0.218
100.00	0.43	0.46	0.00	0.00	0.00	10.27	10.73	52.0	0.0	0.206
105.00	0.43	0.46	0.00	0.00	0.00	9.41	9.87	52.0	0.0	0.190
106.00	0.40	0.45	0.00	0.00	0.00	9.23	9.66	52.0	0.0	0.186
108.75	0.40	0.45	0.00	0.00	0.00	8.72	9.16	52.0	0.0	0.176
110.00	0.39	0.45	0.00	0.00	0.00	8.48	8.91	52.0	0.0	0.171
113.00	0.47	0.56	0.00	0.00	0.00	9.48	9.99	52.0	0.0	0.192
115.00	0.46	0.57	0.00	0.00	0.00	8.94	9.46	52.0	0.0	0.182
120.00	0.36	0.48	0.00	0.00	0.00	7.44	7.84	52.0	0.0	0.151
125.00	0.35	0.49	0.00	0.00	0.00	6.08	6.49	52.0	0.0	0.125
130.00	0.34	0.50	0.00	0.00	0.00	4.50	4.92	52.0	0.0	0.095
132.00	0.25	0.39	0.00	0.00	0.00	3.79	4.10	52.0	0.0	0.079
134.00	0.23	0.37	0.00	0.00	0.00	3.22	3.51	52.0	0.0	0.068
135.00	0.23	0.37	0.00	0.00	0.00	2.96	3.25	52.0	0.0	0.063
140.00	0.13	0.18	0.00	0.00	0.00	1.45	1.60	52.0	0.0	0.031
145.00	0.11	0.17	0.00	0.00	0.00	0.69	0.86	52.0	0.0	0.017
148.00	0.00	0.17	0.00	0.00	0.00	0.20	0.36	52.0	0.0	0.007

Pole : 302540  
 Location : Madison CT 6, CT  
 Height : 148.0 (ft)  
 Base Dia : 61.05 (in)  
 Top Dia : 24.00 (in)  
 Shape : 18 Sides  
 Taper : 0.263006 (in/ft)

Code: TIA/EIA-222 Rev F

Base Elev : 0.000 (ft)

© 2007 - 2014 by ATC IP LLC. All rights reserved.

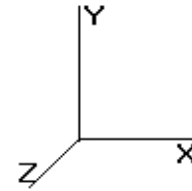

8/1/2014 8:35:39 AM

Page: 22

## Analysis Summary

Load Case	Reactions						Combined Stress (ksi)	Max Stresses		
	Shear FX (kips)	Shear FZ (kips)	Axial FY (kips)	Moment MX (ft-kips)	Moment MY (ft-kips)	Moment MZ (ft-kips)		Allowable Stress (ksi)	Elev (ft)	Stress Ratio
No Ice	37.5	0.00	49.38	0.00	0.00	4051.24	41.18	52.0	45.00	0.792
Ice	31.1	0.00	60.16	0.00	0.00	3382.07	34.71	52.0	45.00	0.668
Twist/Sway	13.0	0.00	49.41	0.00	0.00	1402.80	14.62	52.0	45.00	0.281

Pole : 302540  
 Location : Madison CT 6, CT  
 Height : 148.0 (ft)  
 Base Dia : 61.05 (in)  
 Top Dia : 24.00 (in)  
 Shape : 18 Sides  
 Taper : 0.263006 (in/ft)

Code: TIA/EIA-222 Rev F

8/1/2014 8:35:39 AM

Page: 23

Base Elev: 0.000 (ft)

© 2007 - 2014 by ATC IP LLC. All rights reserved.

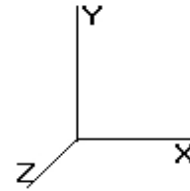

## Base Summary

### Reactions

Original Design			Analysis			Moment Design %
Moment (kip-ft)	Axial (kip)	Shear (kip)	Moment (kip-ft)	Axial (kip)	Shear (kip)	
5,050.00	35.00	47.00	4,051.25	60.16	37.53	80.22

### Base Plate

Yield (ksi)	Thick (in)	Width (in)	Style	Poly Sides	Clip Len (in)	Effective Len (in)	Moment (kip-in)	Allow Stress (ksi)	Applied Stress (ksi)	Stress Ratio
50.0	3.250	68.000	Clipped	0	15.00	9.688	572.09	50.00	33.54	0.67

### Anchor Bolts

Bolt Circle	Num Bolts	Bolt Type	Bolt Dia (in)	Yield (ksi)	Ultimate (ksi)	Arrange	Cluster Dist (in)	Start Angle (deg)	Compression			Tension		
									Force (kip)	Allow (kip)	Ratio	Force (kip)	Allow (kip)	Ratio
69.00	20	2.25" 18J	2.25	75.00	100.00	Clustered	6.00	45.0	143.92	195.00	0.74	137.90	195.00	0.71



# Sprint



# AMERICAN TOWER CORPORATION

PROJECT: 2.5 EQUIPMENT DEPLOYMENT  
 SITE NAME: MADISON CT 6  
 SITE CASCADE: CT60XC937  
 SITE NUMBER: 302540  
 SITE ADDRESS: 8 MEETING HOUSE LN  
 MADISON, CT 06443  
 SITE TYPE: MONOPOLE TOWER  
 MARKET: SOUTHERN CONNECTICUT

PLANS PREPARED FOR:  
**Sprint**  
 6580 Sprint Parkway  
 Overland Park, Kansas 66251

PLANS PREPARED BY:  
**INFINIGY** Design. Build. Deliver.  
 1033 Watervliet Shaker Rd  
 Albany, NY 12205  
 Office # (518) 690-0790  
 Fax # (518) 690-0793  
 JOB NUMBER 340-000

MLA PARTNER:  
**AMERICAN TOWER CORPORATION**  
 116 HUNTINGTON AVENUE, 11TH FLOOR  
 BOSTON, MA 02116

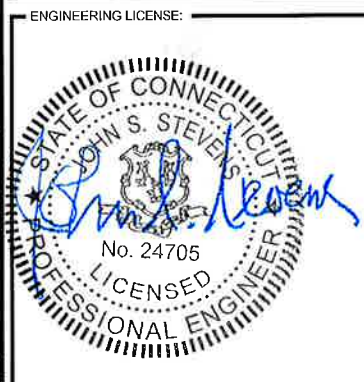

DRAWING NOTICE:  
 THESE DOCUMENTS ARE CONFIDENTIAL AND ARE THE SOLE PROPERTY OF SPRINT AND MAY NOT BE REPRODUCED, DISSEMINATED OR REDISTRIBUTED WITHOUT THE EXPRESS WRITTEN CONSENT OF SPRINT.

REVISIONS:	DESCRIPTION	DATE	BY	REV
REVISED PER COMMENT		03/13/14	MAP	B
ISSUED FOR REVIEW		02/20/14	JDV	A

SITE NAME:  
**MADISON CT 6**

SITE CASCADE:  
**CT60XC937**

SITE ADDRESS:  
 8 MEETING HOUSE LN  
 MADISON, CT 06443

SHEET DESCRIPTION:  
**TITLE SHEET & PROJECT DATA**

SHEET NUMBER:  
**T-1**

**SITE INFORMATION**

**TOWER OWNER:**  
 AMERICAN TOWER, CORP  
 116 HUNTINGTON AVE, 11 FLOOR  
 BOSTON, MA 02116

**LATITUDE (NAD83):**  
 41° 17' 7.0002" N  
 41.285278°

**LONGITUDE (NAD83):**  
 72° 36' 3.9996" W  
 -72.601111°

**COUNTY:**  
 NEW HAVEN

**ZONING JURISDICTION:**  
 TOWN OF MADISON

**ZONING DISTRICT:**  
 R-1

**POWER COMPANY:**  
 THE UNITED ILLUMINATING COMPANY  
 1-800-7-CALL-UI

**AAV PROVIDER:**  
 AT&T  
 (800) 246-2020

**SPRINT CM:**  
 GARY WOOD  
 (860) 940-9168  
 gary.wood@sprint.com

**AMERICAN TOWER CM:**  
 JON RODGERS  
 OFFICE: (781) 926-7855  
 MOBILE: (617) 839-5143  
 jon.rodgers@americantower.com

**AREA MAP**

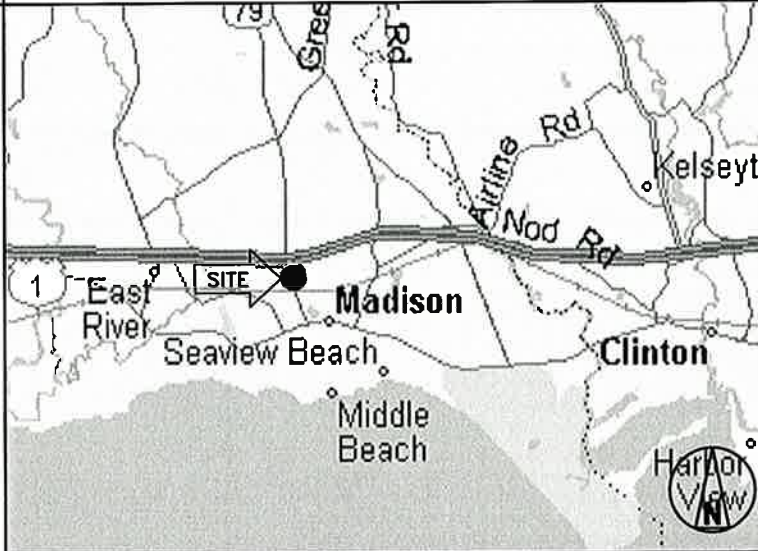

**LOCATION MAP**



**PROJECT DESCRIPTION**

SPRINT PROPOSES TO MODIFY AN EXISTING UNMANNED TELECOMMUNICATIONS FACILITY.

- INSTALL (1) 9929 EQUIPMENT CABINET IN EXISTING LEASE SPACE
- INSTALL (3) PANEL ANTENNAS
- INSTALL (3) RRU'S TO TOWER
- INSTALL (27) JUMPER CABLES
- INSTALL (1) FIBER CABLE
- INSTALL (4) BATTERIES IN EXISTING BBU CABINET

THESE PLANS HAVE BEEN DEVELOPED FOR THE MODIFICATION OF AN EXISTING UNMANNED TELECOMMUNICATIONS FACILITY OWNED OR LEASED BY SPRINT IN ACCORDANCE WITH THE SCOPE OF WORK PROVIDED BY SPRINT. INFINIGY HAS INCORPORATED THIS SCOPE OF WORK IN THE PLANS. THESE PLANS ARE NOT FOR CONSTRUCTION UNLESS ACCOMPANIED BY A PASSING STRUCTURAL STABILITY ANALYSIS PREPARED BY A LICENSED STRUCTURAL ENGINEER. STRUCTURAL ANALYSIS MUST INCLUDE BOTH TOWER AND MOUNT.

**APPLICABLE CODES**

ALL WORK SHALL BE PERFORMED AND MATERIALS INSTALL IN ACCORDANCE WITH THE CURRENT EDITIONS OF THE FOLLOWING CODES AS ADOPTED BY THE LOCAL GOVERNING AUTHORITIES. NOTHING IN THESE PLANS IS TO BE CONSTRUED TO PERMIT WORK NOT CONFORMING TO THESE CODES.

- INTERNATIONAL BUILDING CODE (2012 IBC)
- TIA-EIA-222-F OR LATEST EDITION
- NFPA 780 - LIGHTNING PROTECTION CODE
- 2011 NATIONAL ELECTRIC CODE OR LATEST EDITION
- ANY OTHER NATIONAL OR LOCAL APPLICABLE CODES, MOST RECENT EDITIONS
- CT BUILDING CODE
- LOCAL BUILDING CODE
- CITY/COUNTY ORDINANCES

**DRAWING INDEX**

SHEET NO.	SHEET TITLE	REV.
T-1	TITLE SHEET & PROJECT DATA	B
SP-1	SPRINT SPECIFICATIONS	B
SP-2	SPRINT SPECIFICATIONS	B
SP-3	SPRINT SPECIFICATIONS	B
A-1	SITE PLAN	B
A-2	TOWER ELEVATION & CABLE PLAN	B
A-3	ANTENNA LAYOUT & MOUNTING DETAILS	B
A-4	COLOR CODING & NOTES	B
A-5	EQUIPMENT & MOUNTING DETAILS	B
A-6	CIVIL DETAILS	B
A-7	PLUMBING DIAGRAM	B
E-1	ELECTRICAL & GROUNDING PLAN	B
E-2	ELECTRICAL & GROUNDING DETAILS	B





THESE OUTLINE SPECIFICATIONS IN CONJUNCTION WITH THE SPRINT STANDARD CONSTRUCTION SPECIFICATIONS, INCLUDING CONTRACT DOCUMENTS AND THE CONSTRUCTION DRAWINGS DESCRIBE THE WORK TO BE PERFORMED BY THE CONTRACTOR.

**SECTION 01 100 - SCOPE OF WORK**

**PART 1 - GENERAL**

- 1.1 THE WORK: THESE STANDARD CONSTRUCTION SPECIFICATIONS IN CONJUNCTION WITH THE SPRINT CONSTRUCTION STANDARDS FOR WIRELESS SITES, CONTRACT DOCUMENTS AND THE CONSTRUCTION DRAWINGS DESCRIBE THE WORK TO BE PERFORMED BY THE CONTRACTOR.
- 1.2 RELATED DOCUMENTS:
  - A. THE REQUIREMENTS OF THIS SECTION APPLY TO ALL SECTIONS IN THIS SPECIFICATION.
  - B. SPRINT "STANDARD CONSTRUCTION DETAILS FOR WIRELESS SITES" ARE INCLUDED IN AND MADE A PART OF THESE SPECIFICATIONS HEREWITH.
- 1.3 PRECEDENCE: SHOULD CONFLICTS OCCUR BETWEEN THE STANDARD CONSTRUCTION SPECIFICATIONS FOR WIRELESS SITES INCLUDING THE STANDARD CONSTRUCTION DETAILS FOR WIRELESS SITES AND THE CONSTRUCTION DRAWINGS, INFORMATION ON THE CONSTRUCTION DRAWINGS SHALL TAKE PRECEDENCE. NOTIFY SPRINT CONSTRUCTION MANAGER IF THIS OCCURS.
- 1.4 NATIONALLY RECOGNIZED CODES AND STANDARDS:
  - A. THE WORK SHALL COMPLY WITH APPLICABLE NATIONAL AND LOCAL CODES AND STANDARDS, LATEST EDITION, AND PORTIONS THEREOF, INCLUDED BUT NOT LIMITED TO THE FOLLOWING:
    - 1. GR-63-CORE NEBS REQUIREMENTS: PHYSICAL PROTECTION
    - 5. GR-78-CORE GENERIC REQUIREMENTS FOR THE PHYSICAL DESIGN AND MANUFACTURE OF TELECOMMUNICATIONS EQUIPMENT.
    - 3. GR-1089 CORE, ELECTROMAGNETIC COMPATIBILITY AND ELECTRICAL SAFETY -GENERIC CRITERIA FOR NETWORK TELECOMMUNICATIONS EQUIPMENT.
    - 4. NATIONAL FIRE PROTECTION ASSOCIATION CODES AND STANDARDS (NFPA) INCLUDING NFPA 70 (NATIONAL ELECTRICAL CODE - "NEC") AND NFPA 101 (LIFE SAFETY CODE).
    - 5. AMERICAN SOCIETY FOR TESTING OF MATERIALS (ASTM)
    - 6. INSTITUTE OF ELECTRONIC AND ELECTRICAL ENGINEERS (IEEE)
    - 7. AMERICAN CONCRETE INSTITUTE (ACI)
    - 8. AMERICAN WIRE PRODUCERS ASSOCIATION (AWPA)
    - 9. CONCRETE REINFORCING STEEL INSTITUTE (CRSI)
    - 10. AMERICAN ASSOCIATION OF STATE HIGHWAY AND TRANSPORTATION OFFICIALS (AASHTO)
    - 11. PORTLAND CEMENT ASSOCIATION (PCA)
    - 12. NATIONAL CONCRETE MASONRY ASSOCIATION (NCMA)
    - 13. BRICK INDUSTRY ASSOCIATION (BIA)
    - 14. AMERICAN WELDING SOCIETY (AWS)
    - 15. NATIONAL ROOFING CONTRACTORS ASSOCIATION (NRCA)
    - 16. SHEET METAL AND AIR CONDITIONING CONTRACTORS' NATIONAL ASSOCIATION (SMACNA)
    - 17. DOOR AND HARDWARE INSTITUTE (DHI)
    - 18. OCCUPATIONAL SAFETY AND HEALTH ACT (OSHA)
    - 19. APPLICABLE BUILDING CODES INCLUDING UNIFORM BUILDING CODE, SOUTHERN BUILDING CODE, BOCA, AND THE INTERNATIONAL BUILDING CODE.

**1.5 DEFINITIONS:**

- A. WORK: THE SUM OF TASKS AND RESPONSIBILITIES IDENTIFIED IN THE CONTRACT DOCUMENTS.
- B. COMPANY: SPRINT CORPORATION
- C. ENGINEER: SYNONYMOUS WITH ARCHITECT & ENGINEER AND "A&E". THE DESIGN PROFESSIONAL HAVING PROFESSIONAL RESPONSIBILITY FOR DESIGN OF THE PROJECT.
- D. CONTRACTOR: CONSTRUCTION CONTRACTOR; CONSTRUCTION VENDOR; INDIVIDUAL OR ENTITY WHO AFTER EXECUTION OF A CONTRACT IS BOUND TO ACCOMPLISH THE WORK.
- E. THIRD PARTY VENDOR OR AGENCY: A VENDOR OR AGENCY ENGAGED SEPARATELY BY THE COMPANY, A&E, OR CONTRACTOR TO PROVIDE MATERIALS OR TO ACCOMPLISH SPECIFIC TASKS RELATED TO BUT NOT INCLUDED IN THE WORK.
- F. OFCI: OWNER FURNISHED, CONTRACTOR INSTALLED EQUIPMENT.
- G. CONSTRUCTION MANAGER - ALL PROJECTS RELATED COMMUNICATION TO FLOW THROUGH SPRINT REPRESENTATIVE IN CHARGE OF PROJECT...

- 1.6 SITE FAMILIARITY: CONTRACTOR SHALL BE RESPONSIBLE FOR FAMILIARIZING HIMSELF WITH ALL CONTRACT DOCUMENTS, FIELD CONDITIONS AND DIMENSIONS PRIOR TO PROCEEDING WITH CONSTRUCTION. ANY DISCREPANCIES SHALL BE BROUGHT TO THE ATTENTION OF THE SPRINT CONSTRUCTION MANAGER PRIOR TO THE COMMENCEMENT OF WORK. NO COMPENSATION WILL BE AWARDED BASED ON CLAIM OF LACK OF KNOWLEDGE OR FIELD CONDITIONS.
- 1.7 POINT OF CONTACT: COMMUNICATION BETWEEN SPRINT AND THE CONTRACTOR SHALL FLOW THROUGH THE SINGLE SPRINT CONSTRUCTION MANAGER APPOINTED TO MANAGE THE PROJECT FOR SPRINT.
- 1.8 ON-SITE SUPERVISION: THE CONTRACTOR SHALL SUPERVISE AND DIRECT THE WORK AND SHALL BE RESPONSIBLE FOR CONSTRUCTION MEANS, METHODS, TECHNIQUES, SEQUENCES, AND PROCEDURES IN ACCORDANCE WITH THE CONTRACT DOCUMENTS. THE CONTRACTOR SHALL EMPLOY A COMPETENT SUPERINTENDENT WHO SHALL BE IN ATTENDANCE AT THE SITE AT ALL TIMES DURING PERFORMANCE OF THE WORK.
- 1.9 DRAWINGS, SPECIFICATIONS AND DETAILS REQUIRED AT JOBSITE: THE CONSTRUCTION CONTRACTOR SHALL MAINTAIN A FULL SET OF THE CONSTRUCTION DRAWINGS, STANDARD CONSTRUCTION DETAILS FOR WIRELESS SITES AND THE STANDARD CONSTRUCTION SPECIFICATIONS FOR WIRELESS SITES AT THE JOBSITE FROM MOBILIZATION THROUGH CONSTRUCTION COMPLETION.
  - A. THE JOBSITE DRAWINGS, SPECIFICATIONS AND DETAILS SHALL BE CLEARLY MARKED DAILY IN RED PENCIL WITH ANY CHANGES IN CONSTRUCTION OVER WHAT IS DEPICTED IN THE DOCUMENTS. AT CONSTRUCTION COMPLETION, THIS JOBSITE MARKUP SET SHALL BE DELIVERED TO THE COMPANY OR COMPANY'S DESIGNATED REPRESENTATIVE TO BE FORWARDED TO THE COMPANY'S A&E VENDOR FOR PRODUCTION OF "AS-BUILT" DRAWINGS.
  - B. DETAILS ARE INTENDED TO SHOW DESIGN INTENT. MODIFICATIONS MAY BE REQUIRED TO SUIT JOB DIMENSIONS OR CONDITIONS, AND SUCH MODIFICATIONS SHALL BE INCLUDED AS PART OF THE WORK. CONTRACTOR SHALL NOTIFY SPRINT CONSTRUCTION MANAGER OF ANY VARIATIONS PRIOR TO PROCEEDING WITH THE WORK.
  - C. DIMENSIONS SHOWN ARE TO FINISH SURFACES UNLESS NOTED OTHERWISE. SPACING BETWEEN EQUIPMENT IS THE REQUIRED CLEARANCE. SHOULD THERE BE ANY QUESTIONS REGARDING THE CONTRACT DOCUMENTS, EXISTING CONDITIONS AND/OR DESIGN INTENT, THE CONTRACTOR SHALL BE RESPONSIBLE FOR OBTAINING A CLARIFICATION FROM THE SPRINT CONSTRUCTION MANAGER PRIOR TO PROCEEDING WITH THE WORK.
- 1.10 USE OF JOB SITE: THE CONTRACTOR SHALL CONFINE ALL CONSTRUCTION AND RELATED OPERATIONS INCLUDING STAGING AND STORAGE OF MATERIALS AND EQUIPMENT, PARKING, TEMPORARY FACILITIES, AND WASTE STORAGE TO THE LEASE PARCEL UNLESS OTHERWISE PERMITTED BY THE CONTRACT DOCUMENTS.
- 1.11 UTILITIES SERVICES: WHERE NECESSARY TO CUT EXISTING PIPES, ELECTRICAL WIRES, CONDUITS, CABLES, ETC., OF UTILITY SERVICES, OR OF FIRE PROTECTION OR COMMUNICATIONS SYSTEMS, THEY SHALL BE CUT AND CAPPED AT SUITABLE PLACES OR WHERE SHOWN. ALL SUCH ACTIONS SHALL BE COORDINATED WITH THE UTILITY COMPANY INVOLVED.
- 1.12 PERMITS / FEES: WHEN REQUIRED THAT A PERMIT OR CONNECTION FEE BE PAID TO A PUBLIC UTILITY PROVIDER FOR NEW SERVICE TO THE CONSTRUCTION PROJECT, PAYMENT OF SUCH FEE SHALL BE THE RESPONSIBILITY OF THE CONTRACTOR.
- 1.13 CONTRACTOR SHALL TAKE ALL MEASURES AND PROVIDE ALL MATERIAL NECESSARY FOR PROTECTING EXISTING EQUIPMENT AND PROPERTY.
- 1.14 METHODS OF PROCEDURE (MOPS) FOR CONSTRUCTION: CONTRACTOR SHALL PERFORM WORK AS DESCRIBED IN THE FOLLOWING INSTALLATION AND COMMISSIONING MOPS.
 

NOTE: IN SHORT-FORM SPECIFICATIONS ON THE DRAWINGS, A/E TO INSERT LIST OF APPLICABLE MOPS INCLUDING EN-2012-001, EN-2013-002, EL-0568, AND TS-0193
- 1.15 USE OF ELECTRONIC PROJECT MANAGEMENT SYSTEMS:

**PART 2 - PRODUCTS (NOT USED)**

**PART 3 - EXECUTION**

- 3.1 TEMPORARY UTILITIES AND FACILITIES: THE CONTRACTOR SHALL BE RESPONSIBLE FOR ALL TEMPORARY UTILITIES AND FACILITIES NECESSARY EXCEPT AS OTHERWISE INDICATED IN THE CONSTRUCTION DOCUMENTS. TEMPORARY UTILITIES AND FACILITIES INCLUDE POTABLE WATER, HEAT, HVAC, ELECTRICITY, SANITARY FACILITIES, WASTE DISPOSAL FACILITIES, AND TELEPHONE/COMMUNICATION SERVICES. PROVIDE TEMPORARY UTILITIES AND FACILITIES IN ACCORDANCE WITH OSHA AND THE AUTHORITY HAVING JURISDICTION. CONTRACTOR MAY UTILIZE THE COMPANY ELECTRICAL SERVICE IN THE COMPLETION OF THE WORK WHEN IT BECOMES AVAILABLE. USE OF THE LESSORS OR SITE OWNER'S UTILITIES OR FACILITIES IS EXPRESSLY FORBIDDEN EXCEPT AS OTHERWISE ALLOWED IN THE CONTRACT DOCUMENTS.
- 3.2 ACCESS TO WORK: THE CONTRACTOR SHALL PROVIDE ACCESS TO THE JOB SITE FOR AUTHORIZED COMPANY PERSONNEL AND AUTHORIZED REPRESENTATIVES OF THE ARCHITECT/ENGINEER DURING ALL PHASES OF THE WORK.
- 3.3 TESTING: REQUIREMENTS FOR TESTING BY THIS CONTRACTOR SHALL BE AS INDICATED HEREWITH, ON THE CONSTRUCTION DRAWINGS, AND IN THE INDIVIDUAL SECTIONS OF THESE SPECIFICATIONS. SHOULD COMPANY CHOOSE TO ENGAGE ANY THIRD-PARTY TO CONDUCT ADDITIONAL TESTING, THE CONTRACTOR SHALL COOPERATE WITH AND PROVIDE A WORK AREA FOR COMPANY'S TEST AGENCY.
- 3.4 DIMENSIONS: VERIFY DIMENSIONS INDICATED ON DRAWINGS WITH FIELD DIMENSIONS BEFORE FABRICATION OR ORDERING OF MATERIALS. DO NOT SCALE DRAWINGS.

3.5 EXISTING CONDITIONS: NOTIFY THE SPRINT CONSTRUCTION MANAGER OF EXISTING CONDITIONS DIFFERING FROM THOSE INDICATED ON THE DRAWINGS. DO NOT REMOVE OR ALTER STRUCTURAL COMPONENTS WITHOUT PRIOR WRITTEN APPROVAL FROM THE ARCHITECT AND ENGINEER.

**SECTION 01 200 - COMPANY FURNISHED MATERIAL AND EQUIPMENT**

**PART 1 - GENERAL**

- 1.1 THE WORK: THESE STANDARD CONSTRUCTION SPECIFICATIONS IN CONJUNCTION WITH THE OTHER CONTRACT DOCUMENTS AND THE CONSTRUCTION DRAWINGS DESCRIBE THE WORK TO BE PERFORMED BY THE CONTRACTOR.
- 1.2 RELATED DOCUMENTS:
  - A. THE REQUIREMENTS OF THIS SECTION APPLY TO ALL SECTIONS IN THIS SPECIFICATION.
  - B. SPRINT "STANDARD CONSTRUCTION DETAILS FOR WIRELESS SITES" ARE INCLUDED IN AND MADE A PART OF THESE SPECIFICATIONS HEREWITH.

**PART 2 - PRODUCTS (NOT USED)**

**PART 3 - EXECUTION**

- 3.1 RECEIPT OF MATERIAL AND EQUIPMENT:
  - A. A COMPANY FURNISHED MATERIAL AND EQUIPMENT IS IDENTIFIED ON THE RF DATA SHEET IN THE CONSTRUCTION DOCUMENTS.
  - B. THE CONTRACTOR IS RESPONSIBLE FOR SPRINT PROVIDED MATERIAL AND EQUIPMENT AND UPON RECEIPT SHALL:
    - 1. ACCEPT DELIVERIES AS SHIPPED AND TAKE RECEIPT.
    - 2. VERIFY COMPLETENESS AND CONDITION OF ALL DELIVERIES.
    - 3. TAKE RESPONSIBILITY FOR EQUIPMENT AND PROVIDE INSURANCE PROTECTION AS REQUIRED IN AGREEMENT.
    - 4. RECORD ANY DEFECTS OR DAMAGES AND WITHIN TWENTY-FOUR HOURS AFTER RECEIPT, REPORT TO SPRINT OR ITS DESIGNATED PROJECT REPRESENTATIVE OF SUCH.
    - 5. PROVIDE SECURE AND NECESSARY WEATHER PROTECTED WAREHOUSING.
    - 6. COORDINATE SAFE AND SECURE TRANSPORTATION OF MATERIAL AND EQUIPMENT, DELIVERING AND OFF-LOADING FROM CONTRACTOR'S WAREHOUSE TO SITE.
- 3.2 DELIVERABLES:
  - A. COMPLETE SHIPPING AND RECEIPT DOCUMENTATION IN ACCORDANCE WITH COMPANY PRACTICE.
  - B. IF APPLICABLE, COMPLETE LOST/STOLEN/DAMAGED DOCUMENTATION REPORT AS NECESSARY IN ACCORDANCE WITH COMPANY PRACTICE, AND AS DIRECTED BY COMPANY.
  - C. UPLOAD DOCUMENTATION INTO SPRINT SITE MANAGEMENT SYSTEM (SMS) AND/OR PROVIDE HARD COPY DOCUMENTATION AS REQUESTED.

**SECTION 01 300 - CELL SITE CONSTRUCTION CO.**

**PART 1 - GENERAL**

- 1.1 THE WORK: THESE STANDARD CONSTRUCTION SPECIFICATIONS IN CONJUNCTION WITH THE OTHER CONTRACT DOCUMENTS AND THE CONSTRUCTION DRAWINGS DESCRIBE THE WORK TO BE PERFORMED BY THE CONTRACTOR.
- 1.2 RELATED DOCUMENTS:
  - A. THE REQUIREMENTS OF THIS SECTION APPLY TO ALL SECTIONS IN THIS SPECIFICATION.
  - B. SPRINT "STANDARD CONSTRUCTION DETAILS FOR WIRELESS SITES" ARE INCLUDED IN AND MADE A PART OF THESE SPECIFICATIONS HEREWITH.
- 1.3 NOTICE TO PROCEED
  - A. NO WORK SHALL COMMENCE PRIOR TO COMPANY'S WRITTEN NOTICE TO PROCEED AND THE ISSUANCE OF THE WORK ORDER.
  - B. UPON RECEIVING NOTICE TO PROCEED, CONTRACTOR SHALL FULLY PERFORM ALL WORK NECESSARY TO PROVIDE SPRINT WITH AN OPERATIONAL WIRELESS FACILITY.

**PART 2 - PRODUCTS (NOT USED)**

**PART 3 - EXECUTION**

- 3.1 FUNCTIONAL REQUIREMENTS:
  - A. THE ACTIVITIES DESCRIBED IN THIS PARAGRAPH REPRESENT MINIMUM ACTIONS AND PROCESSES REQUIRED TO SUCCESSFULLY COMPLETE THE WORK. THE ACTIVITIES DESCRIBED ARE NOT EXHAUSTIVE, AND CONTRACTOR SHALL TAKE ANY AND ALL ACTIONS AS NECESSARY TO SUCCESSFULLY COMPLETE THE CONSTRUCTION OF A FULLY FUNCTIONING WIRELESS FACILITY AT THE SITE IN ACCORDANCE WITH COMPANY PROCESSES.
  - B. SUBMIT SPECIFIC DOCUMENTATION AS INDICATED HEREIN, AND OBTAIN REQUIRED APPROVALS WHILE THE WORK IS BEING PERFORMED.
  - C. MANAGE AND CONDUCT ALL FIELD CONSTRUCTION SERVICE RELATED ACTIVITIES
  - D. PROVIDE CONSTRUCTION ACTIVITIES TO THE EXTENT REQUIRED BY THE CONTRACT DOCUMENTS, INCLUDING BUT NOT LIMITED TO THE FOLLOWING:

PLANS PREPARED FOR:



6580 Sprint Parkway  
Overland Park, Kansas 66251

PLANS PREPARED BY:



1033 Watervliet Shaker Rd  
Albany, NY 12205  
Office # (518) 690-0790  
Fax # (518) 690-0793

JOB NUMBER 340-000

MLA PARTNER:



116 HUNTINGTON AVENUE, 11TH FLOOR  
BOSTON, MA 02116

ENGINEERING LICENSE:



DRAWING NOTICE:

THESE DOCUMENTS ARE CONFIDENTIAL AND ARE THE SOLE PROPERTY OF SPRINT AND MAY NOT BE REPRODUCED, DISSEMINATED OR REDISTRIBUTED WITHOUT THE EXPRESS WRITTEN CONSENT OF SPRINT.

REVISIONS:				
DESCRIPTION	DATE	BY	REV	
REVISED PER COMMENT	03/13/14	MAP	B	
ISSUED FOR REVIEW	02/20/14	JDV	A	

SITE NAME:  
**MADISON CT 6**

SITE CASCADE:  
**CT60XC937**

SITE ADDRESS:  
**8 MEETING HOUSE LN  
MADISON, CT 06443**

SHEET DESCRIPTION:  
**SPRINT SPECIFICATIONS**

SHEET NUMBER:  
**SP-1**



CONTINUE FROM SP-1

- PERFORM ANY REQUIRED SITE ENVIRONMENTAL MITIGATION.
- PREPARE GROUND SITES; PROVIDE DE-GRUBBING; AND ROUGH AND FINAL GRADING, AND COMPOUND SURFACE TREATMENTS.
- MANAGE AND CONDUCT ALL ACTIVITIES FOR INSTALLATION OF UTILITIES INCLUDING ELECTRICAL AND TELCO BACKHAUL.
- INSTALL UNDERGROUND FACILITIES INCLUDING UNDERGROUND POWER AND COMMUNICATIONS CONDUITS, AND UNDERGROUND GROUNDING SYSTEM.
- INSTALL ABOVE GROUND GROUNDING SYSTEMS.
- PROVIDE NEW HVAC INSTALLATIONS AND MODIFICATIONS.
- INSTALL "H-FRAMES", CABINETS AND SHELTERS AS INDICATED.
- INSTALL ROADS, ACCESS WAYS, CURBS AND DRAINS AS INDICATED.
- ACCOMPLISH REQUIRED MODIFICATION OF EXISTING FACILITIES.
- PROVIDE ANTENNA SUPPORT STRUCTURE FOUNDATIONS.
- PROVIDE SLABS AND EQUIPMENT PLATFORMS.
- INSTALL COMPOUND FENCING, SIGHT SHIELDING, LANDSCAPING AND ACCESS BARRIERS.
- PERFORM INSPECTION AND MATERIAL TESTING AS REQUIRED HEREINAFTER.
- CONDUCT SITE RESISTANCE TO EARTH TESTING AS REQUIRED HEREINAFTER.
- INSTALL FIXED GENERATOR SETS AND OTHER STANDBY POWER SOLUTIONS.
- INSTALL TOWERS, ANTENNA SUPPORT STRUCTURES AND PLATFORMS ON EXISTING TOWERS AS REQUIRED.
- INSTALL CELL SITE RADIOS, MICROWAVE, GPS, COAXIAL MAINLINE, ANTENNAS, CROSS BAND COUPLERS, TOWER TOP AMPLIFIERS, LOW NOISE AMPLIFIERS AND RELATED EQUIPMENT.
- PERFORM, DOCUMENT, AND CLOSE OUT ANY CONSTRUCTION CONTROL DOCUMENTS THAT MAY BE REQUIRED BY GOVERNMENT AGENCIES AND LANDLORDS.
- PERFORM ANTENNA AND COAX SWEEP TESTING AND MAKE ANY AND ALL NECESSARY CORRECTIONS.
- REMAIN ON SITE MOBILIZED THROUGHOUT HAND-OFF AND INTEGRATION TO ASSIST AS NEEDED UNTIL SITE IS DEEMED SUBSTANTIALLY COMPLETE AND PLACED "ON AIR."

3.2 GENERAL REQUIREMENTS FOR CIVL CONSTRUCTION:

- CONTRACTOR SHALL KEEP THE SITE FREE FROM ACCUMULATING WASTE MATERIAL, DEBRIS, AND TRASH. AT THE COMPLETION OF THE WORK, CONTRACTOR SHALL REMOVE FROM THE SITE ALL REMAINING RUBBISH, IMPLEMENTS, TEMPORARY FACILITIES, AND SURPLUS MATERIALS.
- EQUIPMENT ROOMS SHALL AT ALL TIMES BE MAINTAINED 'BROOM CLEAN' AND CLEAR OF DEBRIS.
- CONTRACTOR SHALL TAKE ALL REASONABLE PRECAUTIONS TO DISCOVER AND LOCATE ANY HAZARDOUS CONDITION.
  - IN THE EVENT CONTRACTOR ENCOUNTERS ANY HAZARDOUS CONDITION WHICH HAS NOT BEEN ABATED OR OTHERWISE MITIGATED, CONTRACTOR AND ALL OTHER PERSONS SHALL IMMEDIATELY STOP WORK IN THE AFFECTED AREA AND NOTIFY COMPANY IN WRITING. THE WORK IN THE AFFECTED AREA SHALL NOT BE RESUMED EXCEPT BY WRITTEN NOTIFICATION BY COMPANY.
  - CONTRACTOR AGREES TO USE CARE WHILE ON THE SITE AND SHALL NOT TAKE ANY ACTION THAT WILL OR MAY RESULT IN OR CAUSE THE HAZARDOUS CONDITION TO BE FURTHER RELEASED IN THE ENVIRONMENT, OR TO FURTHER EXPOSE INDIVIDUALS TO THE HAZARD.
- CONTRACTOR'S ACTIVITIES SHALL BE RESTRICTED TO THE PROJECT LIMITS. SHOULD AREAS OUTSIDE THE PROJECT LIMITS BE AFFECTED BY CONTRACTOR'S ACTIVITIES, CONTRACTOR SHALL IMMEDIATELY RETURN THEM TO ORIGINAL CONDITION
- CONDUCT TESTING AS REQUIRED HEREIN.

3.3 DELIVERABLES:

- CONTRACTOR SHALL REVIEW, APPROVE, AND SUBMIT TO SPRINT SHOP DRAWINGS, PRODUCT DATA, SAMPLES, AND SIMILAR SUBMITTALS AS REQUIRED HEREINAFTER
- PROVIDE DOCUMENTATION INCLUDING, BUT NOT LIMITED TO, THE FOLLOWING. DOCUMENTATION SHALL BE FORWARDED IN ORIGINAL FORMAT AND/OR UPLOADED INTO SMS.
  - ALL CORRESPONDENCE AND PRELIMINARY CONSTRUCTION REPORTS.
  - PROJECT PROGRESS REPORTS.
  - CIVIL CONSTRUCTION START DATE (POPULATE FIELD IN SMS AND/OR FORWARD NOTIFICATION).
  - ELECTRICAL SERVICE COMPLETION DATE (POPULATE FIELD IN SMS AND/OR FORWARD NOTIFICATION).

- LINES AND ANTENNA INSTALL DATE (POPULATE FIELD IN SMS AND/OR FORWARD NOTIFICATION).
- POWER INSTALL DATE (POPULATE FIELD IN SMS AND/OR FORWARD NOTIFICATION).
- TELCO READY DATE (POPULATE FIELD IN SMS AND/OR FORWARD NOTIFICATION).
- PPC (OR SHELTER) INSTALL DATE (POPULATE FIELD IN SMS AND/OR FORWARD NOTIFICATION).
- TOWER CONSTRUCTION START DATE (POPULATE FIELD IN SMS AND/OR FORWARD NOTIFICATION).
- TOWER CONSTRUCTION COMPLETE DATE (POPULATE FIELD IN SMS AND/OR FORWARD NOTIFICATION).
- BTS AND RADIO EQUIPMENT DELIVERED AT SITE DATE (POPULATE FIELD IN SMS AND/OR FORWARD NOTIFICATION).
- NETWORK OPERATIONS HANDOFF CHECKLIST (HOC WALK) COMPLETE (UPLOAD FORM IN SMS)
- CIVIL CONSTRUCTION COMPLETE DATE (POPULATE FIELD IN SMS AND/OR FORWARD NOTIFICATION).
- SITE CONSTRUCTION PROGRESS PHOTOS UNLOADED INTO SMS.

SECTION 01 400 - SUBMITTALS & TESTS

PART 1 - GENERAL

- THE WORK: THESE STANDARD CONSTRUCTION SPECIFICATIONS IN CONJUNCTION WITH THE OTHER CONTRACT DOCUMENTS AND THE CONSTRUCTION DRAWINGS DESCRIBE THE WORK TO BE PERFORMED BY THE CONTRACTOR.
- RELATED DOCUMENTS:
  - THE REQUIREMENTS OF THIS SECTION APPLY TO ALL SECTIONS IN THIS SPECIFICATION.
  - SPRINT 'STANDARD CONSTRUCTION DETAILS FOR WIRELESS SITES' ARE INCLUDED IN AND MADE A PART OF THESE SPECIFICATIONS HEREWITH.
- SUBMITTALS:
  - THE WORK IN ALL ASPECTS SHALL COMPLY WITH THE CONSTRUCTION DRAWINGS AND THESE SPECIFICATIONS.
  - SUBMIT THE FOLLOWING TO COMPANY REPRESENTATIVE FOR APPROVAL
    - CONCRETE MIX-DESIGNS FOR TOWER FOUNDATIONS, ANCHORS PIERS, AND CONCRETE PAVING.
    - CONCRETE BREAK TESTS AS SPECIFIED HEREIN.
    - SPECIAL FINISHES FOR INTERIOR SPACES, IF ANY.
    - ALL EQUIPMENT AND MATERIALS SO IDENTIFIED ON THE CONSTRUCTION DRAWINGS.
    - CHEMICAL GROUNDING DESIGN
  - ALTERNATES: AT THE COMPANY'S REQUEST, ANY ALTERNATIVES TO THE MATERIALS OR METHODS SPECIFIED SHALL BE SUBMITTED TO SPRINT'S CONSTRUCTION MANAGER FOR APPROVAL PRIOR TO BEING SHIPPED TO SITE. SPRINT WILL REVIEW AND APPROVE ONLY THOSE REQUESTS MADE IN WRITING. NO VERBAL APPROVALS WILL BE CONSIDERED. SUBMITTAL FOR APPROVAL SHALL INCLUDE A STATEMENT OF COST REDUCTION PROPOSED FOR USE OF ALTERNATE PRODUCT.

1.4 TESTS AND INSPECTIONS:

- THE CONTRACTOR SHALL BE RESPONSIBLE FOR ALL CONSTRUCTION TESTS, INSPECTIONS AND PROJECT DOCUMENTATION.
- CONTRACTOR SHALL ACCOMPLISH TESTING INCLUDING BUT NOT LIMITED TO THE FOLLOWING:
  - COAX SWEEPS AND FIBER TESTS PER TS-0200 REV 4 ANTENNA LINE ACCEPTANCE STANDARDS.
  - AGL, AZIMUTH AND DOWNTILT USING ELECTRONIC COMMERCIAL MADE-FOR-THE-PURPOSE ANTENNA ALIGNMENT TOOL.
  - CONTRACTOR SHALL BE RESPONSIBLE FOR ANY AND ALL CORRECTIONS TO ANY WORK IDENTIFIED AS UNACCEPTABLE IN SITE INSPECTION ACTIVITIES AND/OR AS A RESULT OF TESTING.
- REQUIRED CLOSEOUT DOCUMENTATION INCLUDES, BUT IS NOT LIMITED TO THE FOLLOWING:
  - AZIMUTH, DOWNTILT, AGL - UPLOAD REPORT FROM ANTENNA ALIGNMENT TOOL TO SITERRA TASK 465. INSTALLED AZIMUTH, DOWNTILT, AND AGL MUST CONFORM TO THE RF DATA SHEETS. SWEEP AND FIBER TESTS
  - SCANABLE BARCODE PHOTOGRAPHS OF TOWER TOP AND INACCESSIBLE EQUIPMENT
  - ALL AVAILABLE JURISDICTIONAL INFORMATION
  - PDF SCAN OF REDLINES PRODUCED IN FIELD

- ELECTRONIC AS-BUILT DRAWINGS IN AUTOCAD AND PDF FORMATS. ANY FIELD CHANGE MUST BE REFLECTED BY MODIFYING THE PLANS, ELEVATIONS, AND DETAILS IN THE DRAWING SETS. GENERAL NOTES INDICATING MODIFICATIONS WILL NOT BE ACCEPTED. CHANGES SHALL BE HIGHLIGHTED AS "CLOUDS" IDENTIFIED AS THE "AS-BUILT" CONDITION.
- LIEN WAIVERS
- FINAL PAYMENT APPLICATION
- REQUIRED FINAL CONSTRUCTION PHOTOS
- CONSTRUCTION AND COMMISSIONING CHECKLIST COMPLETE WITH NO DEFICIENT ITEMS
- ALL POST NTP TASKS INCLUDING DOCUMENT UPLOADS COMPLETED IN SITERRA (SPRINTS DOCUMENT REPOSITORY OF RECORD).

1.5 COMMISSIONING: PERFORM ALL COMMISSIONING AS REQUIRED BY APPLICABLE MOPs

1.6 INTEGRATION: PERFORM ALL INTEGRATION ACTIVITIES AS REQUIRED BY APPLICABLE MOPs

PART 2 - PRODUCTS (NOT USED)

PART 3 - EXECUTION

3.1 REQUIREMENTS FOR TESTING:

A. THIRD PARTY TESTING AGENCY:

- WHEN THE USE OF A THIRD PARTY INDEPENDENT TESTING AGENCY IS REQUIRED, THE AGENCY THAT IS SELECTED MUST PERFORM SUCH WORK ON A REGULAR BASIS IN THE STATE WHERE THE PROJECT IS LOCATED AND HAVE A THOROUGH UNDERSTANDING OF LOCAL AVAILABLE MATERIALS, INCLUDING THE SOIL, ROCK, AND GROUNDWATER CONDITIONS.
- THE THIRD PARTY TESTING AGENCY IS TO BE FAMILIAR WITH THE APPLICABLE REQUIREMENTS FOR THE TESTS TO BE DONE, EQUIPMENT TO BE USED, AND ASSOCIATED HEALTH AND SAFETY ISSUES.
- EXPERIENCE IN SOILS, CONCRETE, MASONRY, AGGREGATE, AND ASPHALT TESTING USING ASTM, AASJTO, AND OTHER METHODS IS NEEDED.
- EXPERIENCE IN SOILS, CONCRETE, MASONRY, AGGREGATE, AND ASPHALT TESTING USING ASTM, AASJTO, AND OTHER METHODS IS NEEDED.

3.2 REQUIRED TESTS:

- CONTRACTOR SHALL ACCOMPLISH TESTING INCLUDING BUT NOT LIMITED TO THE FOLLOWING:
  - CONCRETE CYLINDER BREAK TESTS FOR THE TOWER AND ANCHOR FOUNDATIONS AS SPECIFIED IN SECTION: PORTLAND CEMENT CONCRETE PAVING.
  - ASPHALT ROADWAY COMPACTED THICKNESS, SURFACE SMOOTHNESS, AND COMPACTED DENSITY TESTING AS SPECIFIED IN SECTION: HOT MIX ASPHALT PAVING.
  - FIELD QUALITY CONTROL TESTING AS SPECIFIED IN SECTION: PORTLAND CEMENT CONCRETE PAVING.
  - TESTING REQUIRED UNDER SECTION: AGGREGATE BASE FOR ACCESS ROADS, PADS AND ANCHOR LOCATIONS
  - STRUCTURAL BACKFILL COMPACTION TESTS FOR THE TOWER FOUNDATION.
  - SITE RESISTANCE TO EARTH TESTING PER EXHIBIT: CELL SITE GROUNDING SYSTEM DESIGN.
  - ANTENNA AND COAX SWEEP TESTS PER EXHIBIT: ANTENNA TRANSMISSION LINE ACCEPTANCE STANDARDS.
  - GROUNDING AT ANTENNA MASTS FOR GPS AND ANTENNAS
  - ALL OTHER TESTS REQUIRED BY COMPANY OR JURISDICTION.

3.3 REQUIRED INSPECTIONS

- SCHEDULE INSPECTIONS WITH COMPANY REPRESENTATIVE.
- CONDUCT INSPECTIONS INCLUDING BUT NOT LIMITED TO THE FOLLOWING:
  - GROUNDING SYSTEM INSTALLATION PRIOR TO EARTH CONCEALMENT DOCUMENTED WITH DIGITAL PHOTOGRAPHS BY CONTRACTOR, APPROVED BY A&E OR SPRINT REPRESENTATIVE.
  - FORMING FOR CONCRETE AND REBAR PLACEMENT PRIOR TO POUR DOCUMENTED WITH DIGITAL PHOTOGRAPHS BY CONTRACTOR, APPROVED BY A&E OR SPRINT REPRESENTATIVE.
  - COMPACTION OF BACKFILL MATERIALS; AGGREGATE BASE FOR ROADS, PADS, AND ANCHORS; ASPHALT PAVING; AND SHAFT BACKFILL FOR CONCRETE AND WOOD POLES, BY INDEPENDENT THIRD PARTY AGENCY.
  - PRE- AND POST-CONSTRUCTION ROOFTOP AND STRUCTURAL INSPECTIONS ON EXISTING FACILITIES.
  - TOWER ERECTION SECTION STACKING AND PLATFORM ATTACHMENT DOCUMENTED BY DIGITAL PHOTOGRAPHS BY THIRD PARTY AGENCY.
  - ANTENNA AZIMUTH, DOWN TILT AND PER SUNLIGHT TOOL SUNSIGHT INSTRUMENTS - ANTENNALIGN ALIGNMENT TOOL (AAT)

PLANS PREPARED FOR:



PLANS PREPARED BY:

**INFINIGY** Design. Build. Deliver.

1033 Watervliet Shaker Rd  
Albany, NY 12205  
Office # (518) 690-0790  
Fax # (518) 690-0793

JOB NUMBER 340-000

MLA PARTNER:

**AMERICAN TOWER CORPORATION**

116 HUNTINGTON AVENUE, 11TH FLOOR  
BOSTON, MA 02116

ENGINEERING LICENSE:

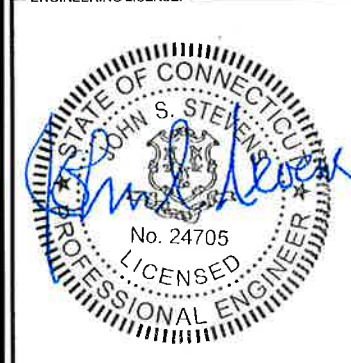

DRAWING NOTICE:

THESE DOCUMENTS ARE CONFIDENTIAL AND ARE THE SOLE PROPERTY OF SPRINT AND MAY NOT BE REPRODUCED, DISSEMINATED OR REDISTRIBUTED WITHOUT THE EXPRESS WRITTEN CONSENT OF SPRINT.

REVISIONS:

DESCRIPTION	DATE	BY	REV

SITE NAME:

MADISON CT 6

SITE CASCADE:

CT60XC937

SITE ADDRESS:

8 MEETING HOUSE LN  
MADISON, CT 06443

SHEET DESCRIPTION:

SPRINT SPECIFICATIONS

SHEET NUMBER:

SP-2



CONTINUE FROM SP-2

- 7. VERIFICATION DOCUMENTED WITH THE ANTENNA CHECKLIST REPORT, BY A&E, SITE DEVELOPMENT REP, OR RF REP.
- 8. FINAL INSPECTION CHECKLIST AND HANDOFF WALK (HOC). SIGNED FORM SHOWING ACCEPTANCE BY FIELD OPS IS TO BE UPLOADED INTO SMS.
- 9. COAX SWEEP AND FIBER TESTING DOCUMENTS SUBMITTED VIA SMS FOR RF APPROVAL.
- 10. SCAN-ABLE BARCODE PHOTOGRAPHS OF TOWER TOP AND INACCESSIBLE SERIALIZED EQUIPMENT
- 11. ALL AVAILABLE JURISDICTIONAL INFORMATION
- 12. PDF SCAN OF REDLINES PRODUCED IN FIELD
- C. THE CONTRACTOR SHALL BE RESPONSIBLE FOR ANY AND ALL CORRECTIONS TO ANY WORK IDENTIFIED AS UNACCEPTABLE IN SITE INSPECTION ACTIVITIES AND/OR AS A RESULT OF TESTING.
- D. CONSTRUCTION INSPECTIONS AND CORRECTIVE MEASURES SHALL BE DOCUMENTED BY THE CONTRACTOR WITH WRITTEN REPORTS AND PHOTOGRAPHS. PHOTOGRAPHS MUST BE DIGITAL AND OF SUFFICIENT QUALITY TO CLEARLY SHOW THE SITE CONSTRUCTION. PHOTOGRAPHS MUST CLEARLY IDENTIFY THE PHOTOGRAPHED ITEM AND BE LABELED WITH THE SITE CASCADE NUMBER, SITE NAME, DESCRIPTION, AND DATE.
- 3.4 DELIVERABLES: TEST AND INSPECTION REPORTS AND CLOSEOUT DOCUMENTATION SHALL BE UPLOADED TO THE SMS AND/OR FORWARDED TO SPRINT FOR INCLUSION INTO THE PERMANENT SITE FILES.
  - A. THE FOLLOWING TEST AND INSPECTION REPORTS SHALL BE PROVIDED AS APPLICABLE.
    - 1. CONCRETE MIX AND CYLINDER BREAK REPORTS.
    - 2. STRUCTURAL BACKFILL COMPACTION REPORTS.
    - 3. SITE RESISTANCE TO EARTH TEST.
    - 4. ANTENNA AZIMUTH AND DOWN TILT VERIFICATION
    - 5. TOWER ERECTION INSPECTIONS AND MEASUREMENTS DOCUMENTING TOWER INSTALLED PER SUPPLIER'S REQUIREMENTS AND THE APPLICABLE SECTIONS HEREIN.
    - 6. COAX CABLE SWEEP TESTS PER COMPANY'S "ANTENNA LINE ACCEPTANCE STANDARDS".
  - B. REQUIRED CLOSEOUT DOCUMENTATION INCLUDES THE FOLLOWING:
    - 1. TEST WELLS AND TRENCHES: PHOTOGRAPHS OF ALL TEST WELLS; PHOTOGRAPHS SHOWING ALL OPEN EXCAVATIONS AND TRENCHING PRIOR TO BACKFILLING SHOWING A TAPE MEASURE VISIBLE IN THE EXCAVATIONS INDICATING DEPTH.
    - 2. CONDUITS, CONDUCTORS AND GROUNDING: PHOTOGRAPHS SHOWING TYPICAL INSTALLATION OF CONDUCTORS AND CONNECTORS; PHOTOGRAPHS SHOWING TYPICAL BEND RADIUS OF INSTALLED GROUND WIRES AND GROUND ROD SPACING;
    - 3. CONCRETE FORMS AND REINFORCING: CONCRETE FORMING AT TOWER AND EQUIPMENT/SHELTER PAD/FOUNDATIONS - PHOTOGRAPHS SHOWING ALL REINFORCING STEEL, UTILITY AND CONDUIT STUB OUTS; PHOTOGRAPHS SHOWING CONCRETE POUR OF SHELTER SLAB/FOUNDATION, TOWER FOUNDATION AND GUY ANCHORS WITH VIBRATOR IN USE; PHOTOGRAPHS SHOWING EACH ANCHOR ON GUYED TOWERS, BEFORE CONCRETE POUR.
    - 4. TOWER, ANTENNAS AND MAINLINE: INSPECTION AND PHOTOGRAPHS OF SECTION STACKING; INSPECTION AND PHOTOGRAPHS OF PLATFORM COMPONENT ATTACHMENT POINTS; PHOTOGRAPHS OF TOWER TOP GROUNDING; PHOTOS OF TOWER COAX LINE COLOR CODING AT THE TOP AND AT GROUND LEVEL; INSPECTION AND PHOTOGRAPHS OF OPERATIONAL OF TOWER LIGHTING, AND PLACEMENT OF FAA REGISTRATION SIGN; PHOTOGRAPHS SHOWING ADDITIONAL GROUNDING POINTS FOR TOWERS GREATER THAN 200 FEET.; PHOTOS OF ANTENNA GROUND BAR, EQUIPMENT GROUND BAR, AND MASTER GROUND BAR; PHOTOS OF GPS ANTENNA(S); PHOTOS OF EACH SECTOR OF ANTENNAS; ONE PHOTOGRAPH LOOKING AT THE SECTOR AND ONE FROM BEHIND SHOWING THE PROJECTED COVERAGE AREA; PHOTOS OF COAX WEATHERPROOFING - TOP AND BOTTOM; PHOTOS OF COAX GROUNDING--TOP AND BOTTOM; PHOTOS OF ANTENNA AND MAST GROUNDING; PHOTOS OF COAX CABLE ENTRY INTO SHELTER; PHOTOS OF PLATFORM MECHANICAL CONNECTIONS TO TOWER/MONOPOLE.
    - 5. ROOF TOPS: PRE-CONSTRUCTION AND POST-CONSTRUCTION VISUAL INSPECTION AND PHOTOGRAPHS OF THE ROOF AND INTERIOR TO DETERMINE AND DOCUMENT CONDITIONS; ROOF TOP CONSTRUCTION INSPECTIONS AS REQUIRED BY THE JURISDICTION; PHOTOGRAPHS OF CABLE TRAY AND/OR ICE BRIDGE; PHOTOGRAPHS OF DOGHOUSE/CABLE EXIT FROM ROOF;
    - 6. SITE LAYOUT - PHOTOGRAPHS OF THE OVERALL COMPOUND, INCLUDING EQUIPMENT PLATFORM FROM ALL FOUR CORNERS.
    - 7. FINISHED UTILITIES: CLOSE-UP PHOTOGRAPHS OF THE PPC BREAKER PANEL; CLOSE-UP PHOTOGRAPH OF THE INSIDE OF THE TELCO PANEL AND NIU; CLOSE-UP PHOTOGRAPH OF THE POWER METER AND DISCONNECT; PHOTOS OF POWER AND TELCO ENTRANCE TO COMPANY ENCLOSURE; PHOTOGRAPHS AT METER BOX AND/OR FACILITY DISTRIBUTION PANEL
    - 8. REQUIRED MATERIALS CERTIFICATIONS: CONCRETE MIX DESIGNS; MILL CERTIFICATION FOR ALL REINFORCING AND STRUCTURAL STEEL; AND ASPHALT PAVING MIX DESIGN.
    - 9. ANY AND ALL SUBMITTALS BY THE JURISDICTION OR COMPANY.

SECTION 01 400 - SUBMITTALS & TESTS

PART 1 - GENERAL

1.1 THE WORK: THESE STANDARD CONSTRUCTION SPECIFICATIONS IN CONJUNCTION WITH THE OTHER CONTRACT DOCUMENTS AND THE CONSTRUCTION DRAWINGS DESCRIBE THE WORK TO BE PERFORMED BY THE CONTRACTOR.

1.2 RELATED DOCUMENTS:

- A. THE REQUIREMENTS OF THIS SECTION APPLY TO ALL SECTIONS IN THIS SPECIFICATION.
- B. SPRINT "STANDARD CONSTRUCTION DETAILS FOR WIRELESS SITES" ARE INCLUDED IN AND MADE A PART OF THESE SPECIFICATIONS HEREWITH.

PART 2 - PRODUCTS (NOT USED)

PART 3 - EXECUTION

3.1 WEEKLY REPORTS:

- A. CONTRACTOR SHALL PROVIDE SPRINT WITH WEEKLY REPORTS SHOWING PROJECT STATUS. THIS STATUS REPORT FORMAT WILL BE PROVIDED TO THE CONTRACTOR BY SPRINT. THE REPORT WILL CONTAIN SITE ID NUMBER, THE MILESTONES FOR EACH SITE, INCLUDING THE BASELINE DATE, ESTIMATED COMPLETION DATE AND ACTUAL COMPLETION DATE.
- B. REPORT INFORMATION WILL BE TRANSMITTED TO SPRINT VIA ELECTRONIC MEANS AS REQUIRED. THIS INFORMATION WILL PROVIDE A BASIS FOR PROGRESS MONITORING AND PAYMENT.

3.2 PROJECT CONFERENCE CALLS:

- A. SPRINT MAY HOLD WEEKLY PROJECT CONFERENCE CALLS. CONTRACTOR WILL BE REQUIRED TO COMMUNICATE SITE STATUS, MILESTONE COMPLETIONS AND UPCOMING MILESTONE PROJECTIONS, AND ANSWER ANY OTHER SITE STATUS QUESTIONS AS NECESSARY.

3.3 PROJECT TRACKING IN SMS:

- A. CONTRACTOR SHALL PROVIDE SCHEDULE UPDATES AND PROJECTIONS IN THE SMS SYSTEM ON A WEEKLY BASIS.

3.4 ADDITIONAL REPORTING:

- A. ADDITIONAL OR ALTERNATE REPORTING REQUIREMENTS MAY BE ADDED TO THE REPORT AS DETERMINED TO BE REASONABLY NECESSARY BY COMPANY.

3.5 PROJECT PHOTOGRAPHS:

- A. FILE DIGITAL PHOTOGRAPHS OF COMPLETED SITE IN JPEG FORMAT IN THE SMS PHOTO LIBRARY FOR THE RESPECTIVE SITE. PHOTOGRAPHS SHALL BE CLEARLY LABELED WITH SITE NUMBER, NAME AND DESCRIPTION, AND SHALL INCLUDE AT A MINIMUM THE FOLLOWING AS APPLICABLE:

- 1. SHELTER AND TOWER OVERVIEW.
- 2. TOWER FOUNDATION(S) - FORMS AND STEEL BEFORE POUR (EACH ANCHOR ON GUYED TOWERS).
- 3. TOWER FOUNDATION(S) POUR WITH VIBRATOR IN USE (EACH ANCHOR ON GUYED TOWERS).
- 4. TOWER STEEL AS BEING INSTALLED INTO HOLE (SHOW ANCHOR STEEL ON GUYED TOWERS).
- 5. PHOTOS OF TOWER SECTION STACKING.
- 6. CONCRETE TESTING / SAMPLES.
- 7. PLACING OF ANCHOR BOLTS IN TOWER FOUNDATION.
- 8. BUILDING/WATER TANK FROM ROAD FOR TENANT IMPROVEMENTS OR COMMENTS.
- 9. SHELTER FOUNDATION--FORMS AND STEEL BEFORE POURING.
- 10. SHELTER FOUNDATION POUR WITH VIBRATOR IN USE.
- 11. COAX CABLE ENTRY INTO SHELTER.
- 12. PLATFORM MECHANICAL CONNECTIONS TO TOWER/MONOPOLE.
- 13. ROOFTOP PRE AND POST CONSTRUCTION PHOTOS TO INCLUDE PENETRATIONS AND INTERIOR CEILING.
- 14. PHOTOS OF TOWER TOP COAX LINE COLOR CODING AND COLOR CODING AT GROUND LEVEL.
- 15. PHOTOS OF ALL APPROPRIATE COMPANY OR REGULATORY SIGNAGE.
- 16. PHOTOS OF EQUIPMENT BOLT DOWN INSIDE SHELTER.
- 17. POWER AND TELCO ENTRANCE TO COMPANY ENCLOSURE AND POWER AND TELCO SUPPLY LOCATIONS INCLUDING METER/DISCONNECT.
- 18. ELECTRICAL TRENCH(S) WITH ELECTRICAL / CONDUIT BEFORE BACKFILL.
- 19. ELECTRICAL TRENCH(S) WITH FOIL-BACKED TAPE BEFORE FURTHER BACKFILL.
- 20. TELCO TRENCH WITH TELEPHONE / CONDUIT BEFORE BACKFILL.
- 21. TELCO TRENCH WITH FOIL-BACKED TAPE BEFORE FURTHER BACKFILL.
- 22. SHELTER GROUND-RING TRENCH WITH GROUND-WIRE BEFORE BACKFILL (SHOW ALL CAD WELDS AND BEND RADII).
- 23. TOWER GROUND-RING TRENCH WITH GROUND-WIRE BEFORE BACKFILL (SHOW ALL CAD WELDS AND BEND RADII).

- 24. FENCE GROUND-RING TRENCH WITH GROUND-WIRE BEFORE BACKFILL (SHOW ALL CAD WELDS AND BEND RADII).
- 25. ALL BTS GROUND CONNECTIONS.
- 26. ALL GROUND TEST WELLS.
- 27. ANTENNA GROUND BAR AND EQUIPMENT GROUND BAR.
- 28. ADDITIONAL GROUNDING POINTS ON TOWERS ABOVE 200'.
- 29. HVAC UNITS INCLUDING CONDENSERS ON SPLIT SYSTEMS.
- 30. GPS ANTENNAS.
- 31. CABLE TRAY AND/OR WAVEGUIDE BRIDGE.
- 32. DOGHOUSE/CABLE EXIT FROM ROOF.
- 33. EACH SECTOR OF ANTENNAS; ONE PHOTOGRAPH LOOKING AT THE SECTOR AND ONE FROM BEHIND SHOWING THE PROJECTED COVERAGE AREA.
- 34. MASTER BUS BAR.
- 35. TELCO BOARD AND NIU.
- 36. ELECTRICAL DISTRIBUTION WALL.
- 37. CABLE ENTRY WITH SURGE SUPPRESSION.
- 38. ENTRANCE TO EQUIPMENT ROOM.
- 39. COAX WEATHERPROOFING--TOP AND BOTTOM OF TOWER.
- 40. COAX GROUNDING --TOP AND BOTTOM OF TOWER.
- 41. ANTENNA AND MAST GROUNDING.
- 42. LANDSCAPING - WHERE APPLICABLE.

3.6 FINAL PROJECT ACCEPTANCE: COMPLETE ALL REQUIRED REPORTING TASKS PER CONTRACT, CONTRACT DOCUMENTS OR THE SPRINT INTEGRATED CONSTRUCTION STANDARDS FOR WIRELESS SITES AND UPLOAD INTO SITERRA.

PLANS PREPARED FOR:



6580 Sprint Parkway  
Overland Park, Kansas 66251

PLANS PREPARED BY:



1033 Watervliet Shaker Rd  
Albany, NY 12205  
Office # (518) 690-0790  
Fax # (518) 690-0793

JOB NUMBER 340-000

MLA PARTNER:



116 HUNTINGTON AVENUE, 11TH FLOOR  
BOSTON, MA 02116

ENGINEERING LICENSE:



DRAWING NOTICE: THESE DOCUMENTS ARE CONFIDENTIAL AND ARE THE SOLE PROPERTY OF SPRINT AND MAY NOT BE REPRODUCED, DISSEMINATED OR REDISTRIBUTED WITHOUT THE EXPRESS WRITTEN CONSENT OF SPRINT.

REVISIONS:	DESCRIPTION	DATE	BY	REV
REVISED PER COMMENT		03/13/14	MAP	B
ISSUED FOR REVIEW		02/20/14	JDV	A

SITE NAME: MADISON CT 6

SITE CASCADE: CT60XC937

SITE ADDRESS: 8 MEETING HOUSE LN  
MADISON, CT 06443

SHEET DESCRIPTION: SPRINT SPECIFICATIONS

SHEET NUMBER: SP-3







**INFINIGY** Design. Build. Deliver.  
 1033 Watervliet Shaker Rd  
 Albany, NY 12205  
 Office # (518) 690-0790  
 Fax # (518) 690-0793  
 JOB NUMBER 340-000

**AMERICAN TOWER CORPORATION**  
 116 HUNTINGTON AVENUE, 11TH FLOOR  
 BOSTON, MA 02116

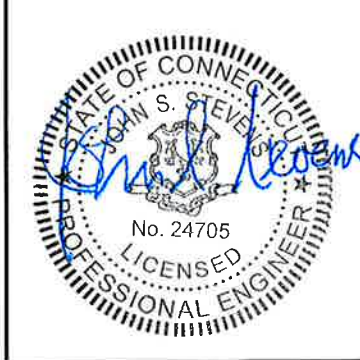

THESE DOCUMENTS ARE CONFIDENTIAL AND ARE THE SOLE PROPERTY OF SPRINT AND MAY NOT BE REPRODUCED, DISSEMINATED OR REDISTRIBUTED WITHOUT THE EXPRESS WRITTEN CONSENT OF SPRINT.

REVISIONS:	DESCRIPTION	DATE	BY	REV
REVISED PER COMMENT		03/13/14	MAP	B
ISSUED FOR REVIEW		02/20/14	JDV	A

MADISON CT 6

CT60XC937

8 MEETING HOUSE LN  
 MADISON, CT 06443

TOWER ELEVATION & CABLE PLAN

A-2

**NOTE:**  
 SPRINT TOWER TOP WORK CONTINGENT ON FOLLOWING:  
 COMPLETION OF STRUCTURAL ANALYSIS PROVIDED BY AMERICAN TOWER CORP., COMPLETION OF ANTENNA/RRH MOUNTING ASSESSMENT (PROVIDED BY AE)

**NOTE:**  
 INFINIGY ENGINEERING HAS NOT EVALUATED THE EXISTING TOWER OR MOUNT FOR THIS SITE, AND ASSUMES NO RESPONSIBILITY FOR ITS STRUCTURAL INTEGRITY. REFER TO STRUCTURAL ANALYSIS BY OTHERS PRIOR TO ANY CONSTRUCTION.

**NOTE:**  
 CONTRACTOR SHALL NOT INSTALL THE 2.5 RRU'S SUCH THAT THEY IMPEDE CLIMBING ACCESS ON THE TOWER.

**NOTE:**  
 SEE DETAIL 2 ON A-3 FOR ANTENNA LAYOUT

TOP OF HIGHEST APPURTENANCE  
 = ±161'-0" A.G.L.

TOP OF EXISTING TOWER  
 ELEV. = ±148'-0" A.G.L.

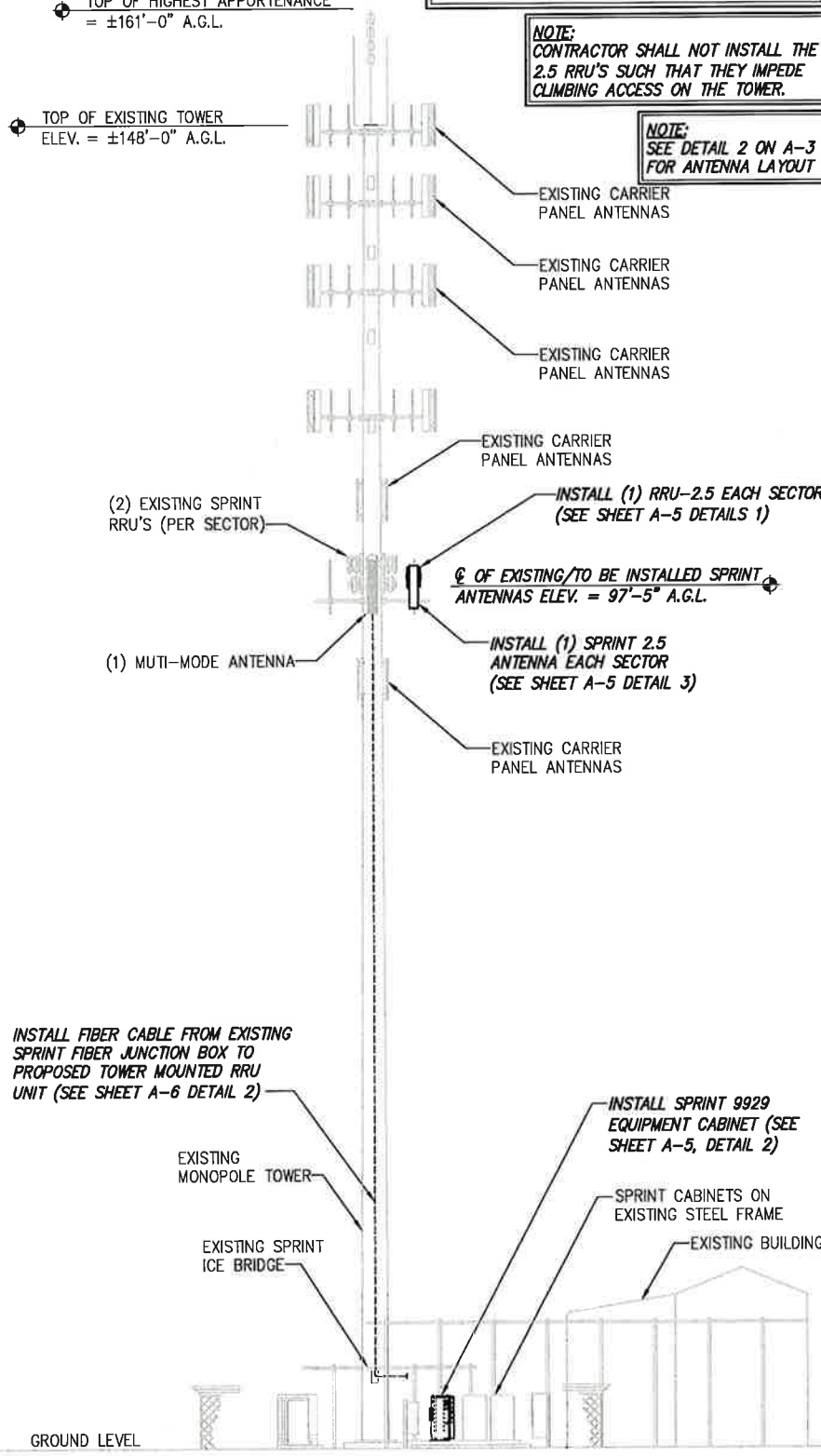

INSTALL FIBER CABLE FROM EXISTING SPRINT FIBER JUNCTION BOX TO PROPOSED TOWER MOUNTED RRU UNIT (SEE SHEET A-6 DETAIL 2)

DETAIL NOT USED NO SCALE 2

DETAIL NOT USED NO SCALE 3

DETAIL NOT USED NO SCALE 4

TOWER ELEVATION NO SCALE 1

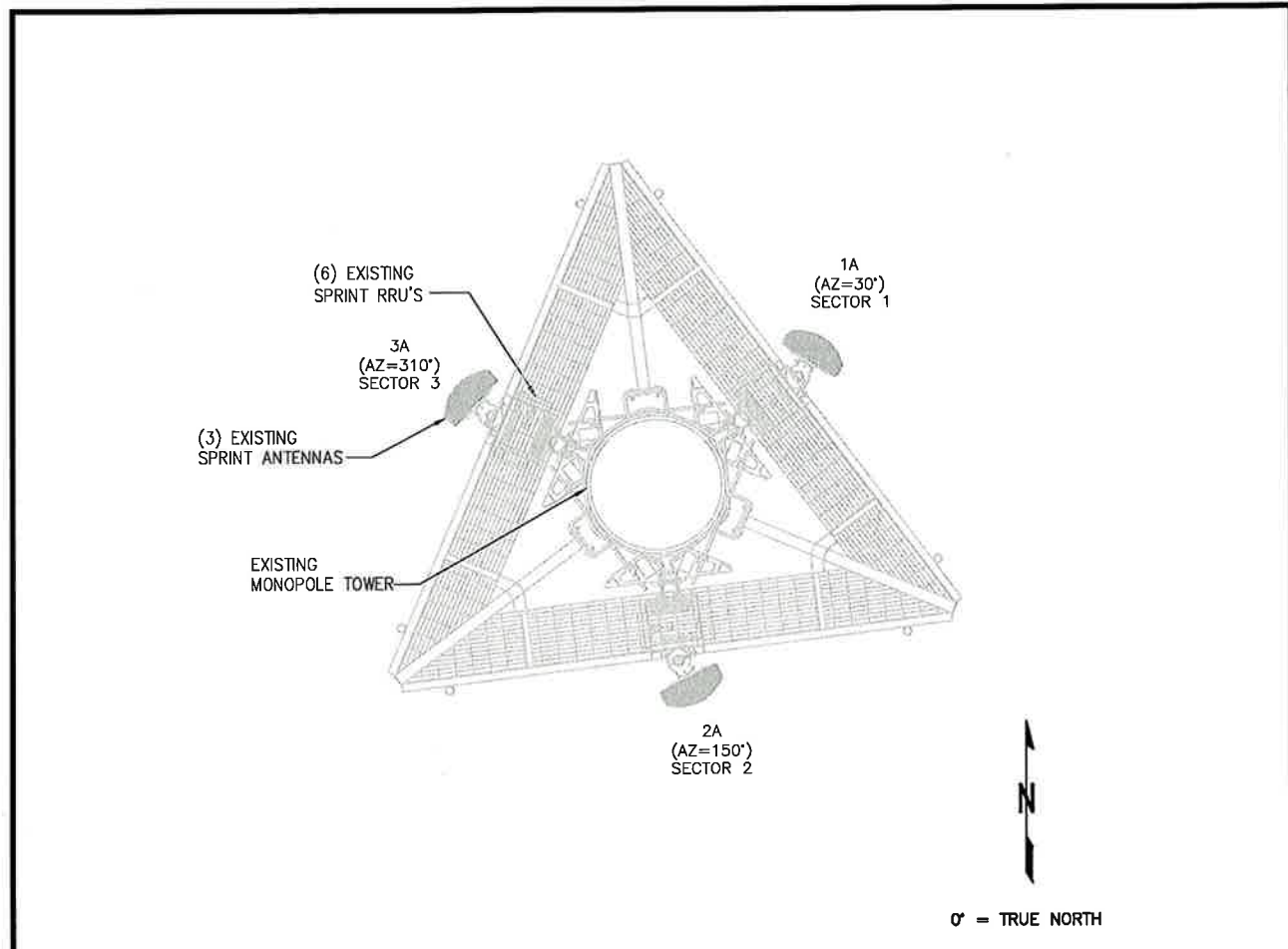

EXISTING ANTENNA & RRU LAYOUT

NO SCALE

1

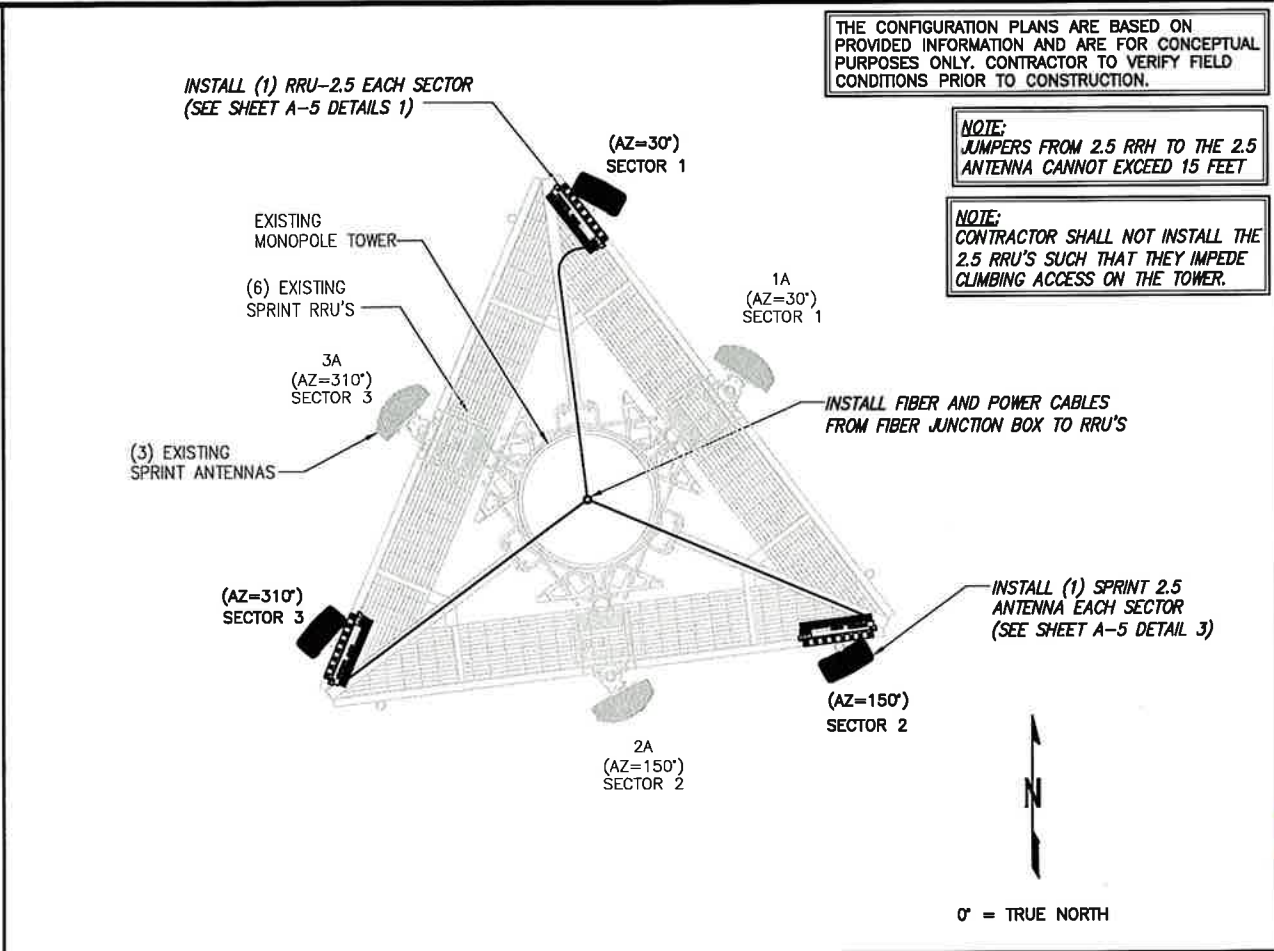

FINAL ANTENNA LAYOUT

NO SCALE

2

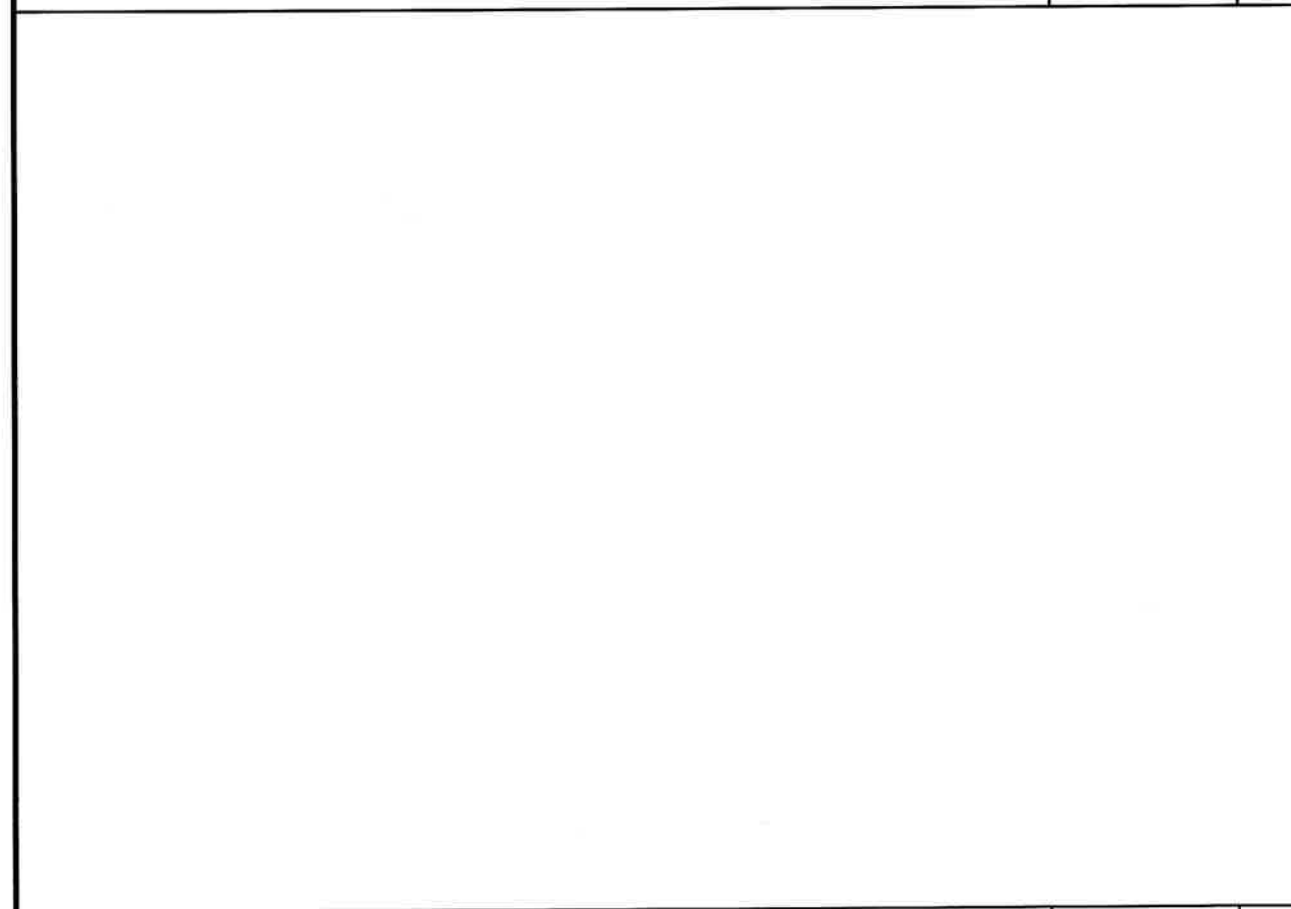

DETAIL NOT USED

NO SCALE

3

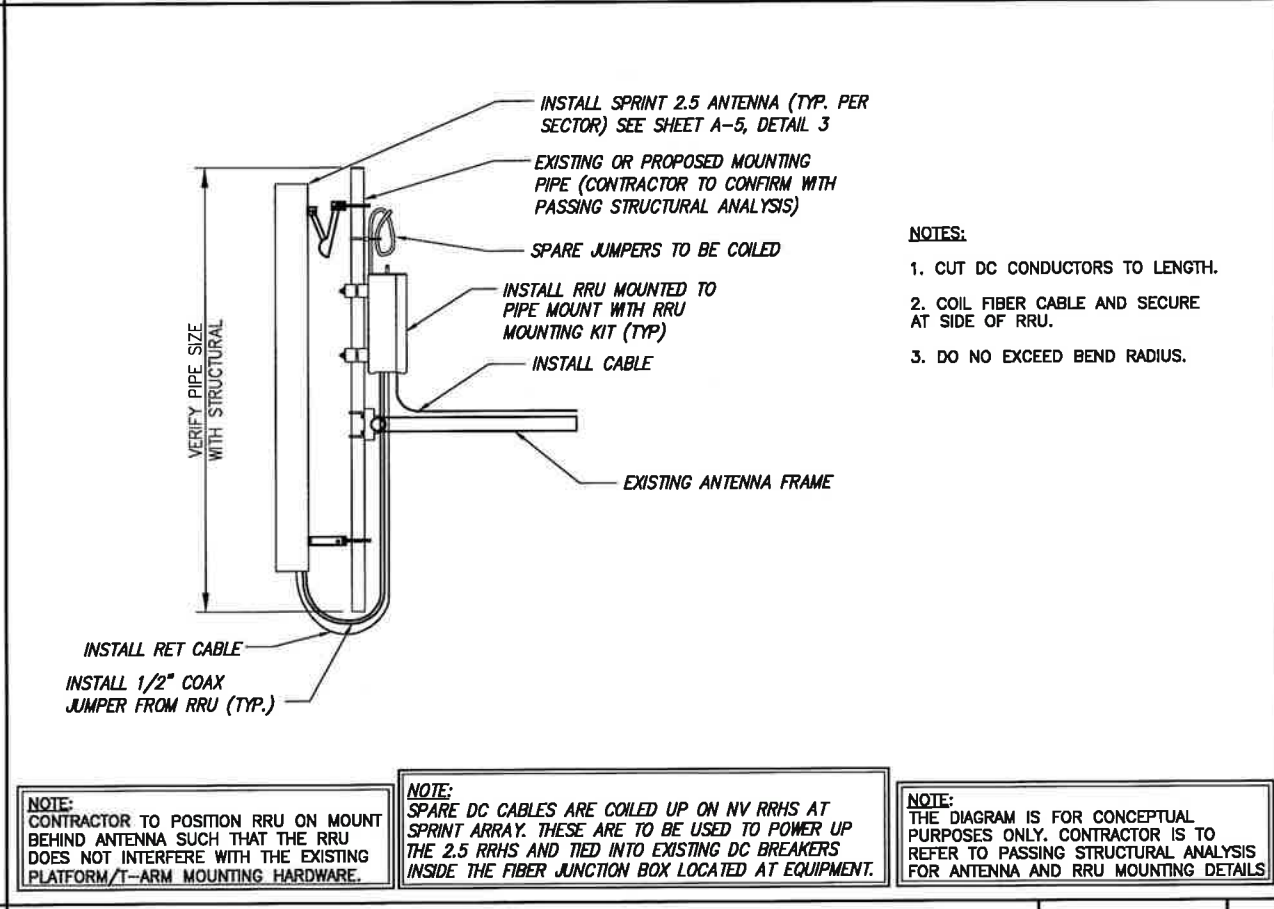

TYPICAL ANTENNA & RRU MOUNTING DETAILS

NO SCALE

4

THE CONFIGURATION PLANS ARE BASED ON PROVIDED INFORMATION AND ARE FOR CONCEPTUAL PURPOSES ONLY. CONTRACTOR TO VERIFY FIELD CONDITIONS PRIOR TO CONSTRUCTION.

NOTE: JUMPERS FROM 2.5 RRH TO THE 2.5 ANTENNA CANNOT EXCEED 15 FEET

NOTE: CONTRACTOR SHALL NOT INSTALL THE 2.5 RRU'S SUCH THAT THEY IMPEDE CLIMBING ACCESS ON THE TOWER.

PLANS PREPARED FOR:

6580 Sprint Parkway  
Overland Park, Kansas 66251

PLANS PREPARED BY:

1033 Watervliet Shaker Rd  
Albany, NY 12205  
Office # (518) 690-0790  
Fax # (518) 690-0793  
JOB NUMBER 340-000

MLA PARTNER:

116 HUNTINGTON AVENUE, 11TH FLOOR  
BOSTON, MA 02116

ENGINEERING LICENSE:

DRAWING NOTICE:  
THESE DOCUMENTS ARE CONFIDENTIAL AND ARE THE SOLE PROPERTY OF SPRINT AND MAY NOT BE REPRODUCED, DISSEMINATED OR REDISTRIBUTED WITHOUT THE EXPRESS WRITTEN CONSENT OF SPRINT.

REVISIONS:	DESCRIPTION	DATE	BY	REV
REVISED PER COMMENT		03/13/14	MAP	B
ISSUED FOR REVIEW		02/20/14	JDV	A

SITE NAME:  
**MADISON CT 6**

SITE CASCADE:  
**CT60XC937**

SITE ADDRESS:  
**8 MEETING HOUSE LN  
MADISON, CT 06443**

SHEET DESCRIPTION:  
**ANTENNA LAYOUT  
& MOUNTING DETAILS**

SHEET NUMBER:  
**A-3**



NV CABLES			
BAND	INDICATOR	PORT	COLOR
800-1	YEL GRN	NV-1	GRN
1900-1	YEL RED	NV-2	BLU
1900-2	YEL BRN	NV-3	BRN
1900-3	YEL BLU	NV-4	WHT
1900-4	YEL SLT	NV-5	RED
800-2	YEL ORG	NV-6	SLT
SPARE	YEL WHT	NV-7	PPL
2500	YEL PPL	NV-8	ORG

HYBRID	
HYBRID	COLOR
1	GRN
2	BLU
3	BRN
4	WHT
5	RED
6	SLT
7	PPL
8	ORG

2.5 Band		
2500 Radio 1	COLOR	
YEL WHT	GRN	
YEL WHT	BLU	
YEL WHT	BRN	
YEL WHT	WHT	
YEL WHT	RED	
YEL WHT	SLT	
YEL WHT	PPL	
YEL WHT	ORG	

Figure 1: Antenna Orientation

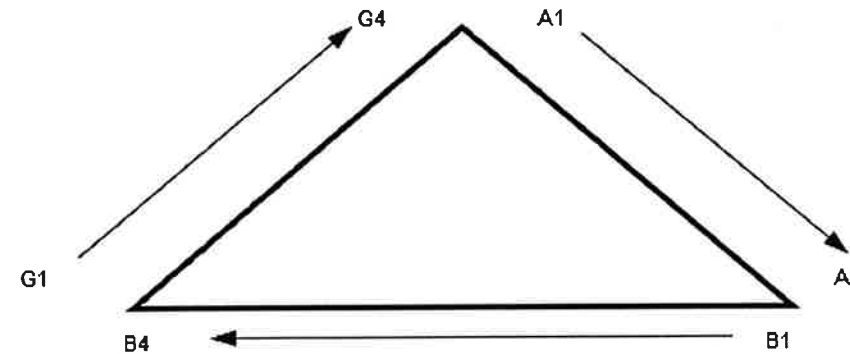

NOTES:

- ALL CABLES SHALL BE MARKED WITH 2" WIDE, UV STABILIZED, UL APPROVED TAPE.
- THE FIRST RING SHALL BE CLOSEST TO THE END OF THE CABLE AND SPACED APPROXIMATELY 2" FROM THE END CONNECTOR, WEATHERPROOFING, OR BREAK-OUT CYLINDER. THERE SHALL BE A 1" SPACE BETWEEN EACH RING FOR THE CABLE IDENTIFIER, AND NO SPACES BETWEEN THE FREQUENCY BANDS.
- A 2" GAP SHALL SEPARATE THE CABLE COLOR CODE FROM THE FREQUENCY COLOR CODE. THE 2" COLOR RINGS FOR THE FREQUENCY CODE SHALL BE PLACED NEXT TO EACH OTHER WITH NO SPACES.
- THE 2" COLORED TAPE(S) SHALL EACH BE WRAPPED A MINIMUM OF 3 TIMES AROUND THE INDIVIDUAL CABLES, AND THE TAPE SHALL BE KEPT IN THE SAME LOCATION AS MUCH AS POSSIBLE.
- SITES WITH MORE THAN FOUR (4) SECTORS WILL REQUIRE ADDITIONAL RINGS FOR EACH SECTOR, FOLLOWING THE PATTERN. HIGH CAPACITY SITES WILL USE THE NEXT COLOR IN THE SEQUENCE FOR ADDITIONAL CABLES IN EACH SECTOR.
- HYBRID FIBER CABLE SHALL BE SECTOR IDENTIFIED INSIDE THE CABINET ON FREQUENCY BUNDLES, ON THE SEALTITE, ON THE MAIN LINE UPON EXIT OF SEALTITE, AND BEFORE AND AFTER THE BREAKOUT UNIT (MEDUSA), AS WELL AS BEFORE AND AFTER ANY ENTRANCE OR EXIT.
- HFC "MAIN TRUNK" WILL NOT BE MARKED WITH THE FREQUENCY CODES, AS IT CONTAINS ALL FREQUENCIES.
- INDIVIDUAL POWER PAIRS AND FIBER BUNDLES SHALL BE LABELED WITH BOTH THE CABLE AND FREQUENCY.

Sector	Cable	First Ring	Second Ring	Third Ring
1 Alpha	1	Green	No Tape	No Tape
	2	Blue	No Tape	No Tape
	3	Brown	No Tape	No Tape
	4	White	No Tape	No Tape
	5	Red	No Tape	No Tape
	6	Grey	No Tape	No Tape
	7	Purple	No Tape	No Tape
	8	Orange	No Tape	No Tape
2 Beta	1	Green	Green	No Tape
	2	Blue	Blue	No Tape
	3	Brown	Brown	No Tape
	4	White	White	No Tape
	5	Red	Red	No Tape
	6	Grey	Grey	No Tape
	7	Purple	Purple	No Tape
	8	Orange	Orange	No Tape
3 Gamma	1	Green	Green	Green
	2	Blue	Blue	Blue
	3	Brown	Brown	Brown
	4	White	White	White
	5	Red	Red	Red
	6	Grey	Grey	Grey
	7	Purple	Purple	Purple
	8	Orange	Orange	Orange

NV FREQUENCY	INDICATOR	ID
800-1	YEL GRN	GRN
1900-1	YEL RED	RED
1900-2	YEL BRN	BRN
1900-3	YEL BLU	BLU
1900-4	YEL SLT	SLT
800-1	YEL ORG	ORG
RESERVED	YEL WHT	WHT
RESERVED	YEL PPL	PPL

2.5 FREQUENCY	INDICATOR		ID
2500 -1	YEL	WHT	GRN
2500 -2	YEL	WHT	RED
2500 -3	YEL	WHT	BRN
2500 -4	YEL	WHT	BLU
2500 -5	YEL	WHT	SLT
2500 -6	YEL	WHT	ORG
2500 -7	YEL	WHT	WHT
2500 -8	YEL	WHT	PPL

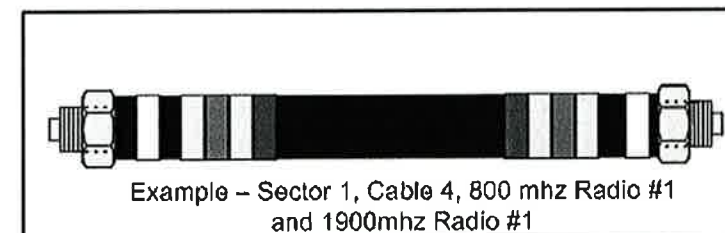
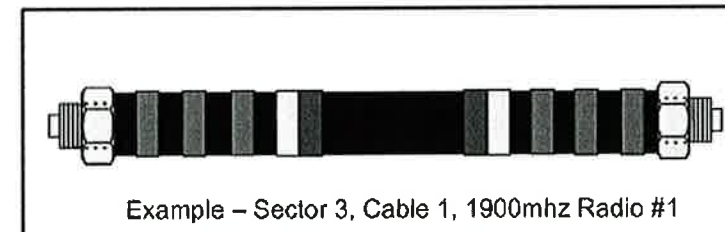
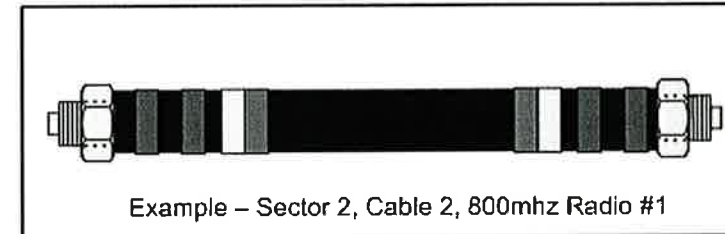

PLANS PREPARED FOR:

6580 Sprint Parkway  
Overland Park, Kansas 66251

PLANS PREPARED BY:

1033 Watervliet Shaker Rd  
Albany, NY 12205  
Office # (518) 690-0790  
Fax # (518) 690-0793  
JOB NUMBER 340-000

MLA PARTNER:

116 HUNTINGTON AVENUE, 11TH FLOOR  
BOSTON, MA 02116

ENGINEERING LICENSE:

DRAWING NOTICE:

THESE DOCUMENTS ARE CONFIDENTIAL AND ARE THE SOLE PROPERTY OF SPRINT AND MAY NOT BE REPRODUCED, DISSEMINATED OR REDISTRIBUTED WITHOUT THE EXPRESS WRITTEN CONSENT OF SPRINT.

REVISIONS:	DESCRIPTION	DATE	BY	REV
REVISED PER COMMENT		03/13/14	MAP	B
ISSUED FOR REVIEW		02/20/14	JDV	A

SITE NAME:

MADISON CT 6

SITE CASCADE:

CT60XC937

SITE ADDRESS:

8 MEETING HOUSE LN  
MADISON, CT 06443

SHEET DESCRIPTION:

COLOR CODING AND NOTES

SHEET NUMBER:

A-4



**RRU: ALCATEL LUCENT TD-RRH8X20**

COLOR: LIGHT GREY  
WEIGHT: 70 LBS.

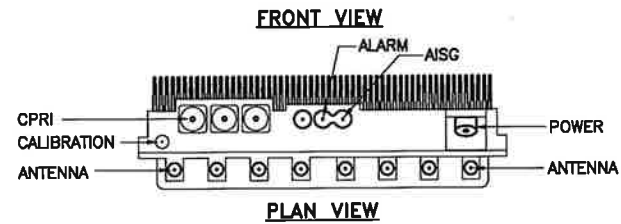
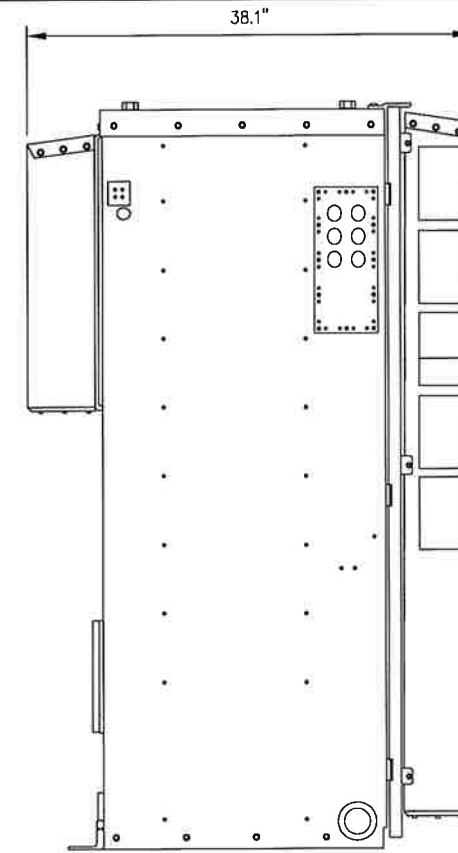
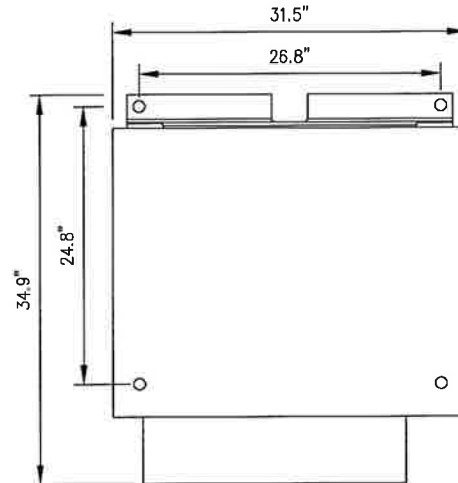
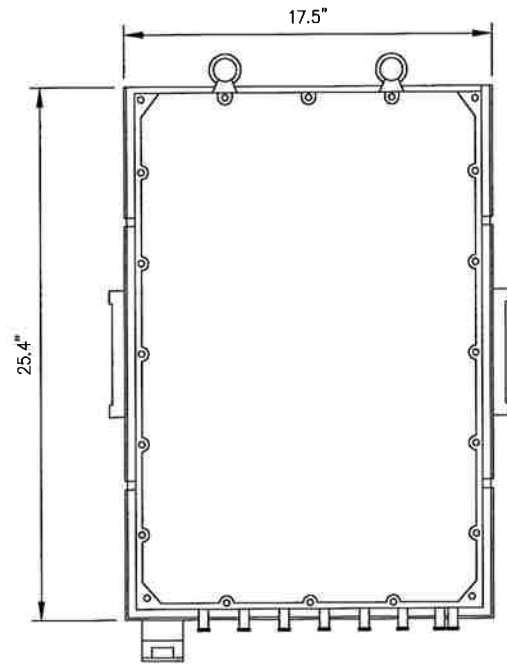
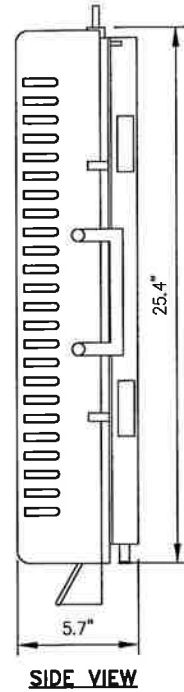

**NOTES**  
COMPLY WITH MANUFACTURERS INSTRUCTIONS TO ENSURE THAT ALL RRU'S RECEIVE ELECTRICAL POWER WITHIN 24 HOURS OF BEING REMOVED FROM THE MANUFACTURER'S PACKAGING. DO NOT OPEN RRU PACKAGES IN THE RAIN.

2.5 RRU

NO SCALE

1

2.5 9929 GROWTH CABINET

NO SCALE

2

**ANTENNA: RFS APXVTM14-C-120**

RADOME MATERIAL: ASA  
RADOME COLOR: LIGHT GREY  
DIMENSIONS, HxWxD.in(mim): 56.3"x12.6"x6.3" (1430x320x160mm)  
WEIGHT: 52.9 lba  
CONNECTORS: (8) 4.1/9.5 DIN FEMALE  
(1) NF - CALIBRATION CONNECTOR

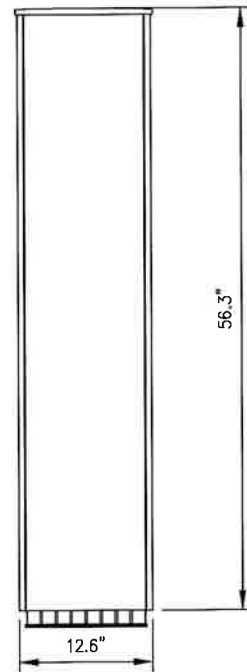
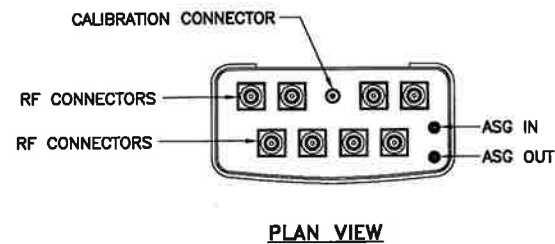

2.5 ANTENNA

NO SCALE

3

DETAIL NOT USED

NO SCALE

4

PLANS PREPARED FOR:

6580 Sprint Parkway  
Overland Park, Kansas 66251

PLANS PREPARED BY:

1033 Watervliet Shaker Rd  
Albany, NY 12205  
Office # (518) 690-0790  
Fax # (518) 690-0793  
JOB NUMBER 340-000

MLA PARTNER:

116 HUNTINGTON AVENUE, 11TH FLOOR  
BOSTON, MA 02116

ENGINEERING LICENSE:

DRAWING NOTICE:  
THESE DOCUMENTS ARE CONFIDENTIAL AND ARE THE SOLE PROPERTY OF SPRINT AND MAY NOT BE REPRODUCED, DISSEMINATED OR REDISTRIBUTED WITHOUT THE EXPRESS WRITTEN CONSENT OF SPRINT.

REVISIONS:	DESCRIPTION	DATE	BY	REV
REVISED PER COMMENT		03/13/14	MAP	B
ISSUED FOR REVIEW		02/20/14	JDV	A

SITE NAME:  
**MADISON CT 6**

SITE CASCADE:  
**CT60XC937**

SITE ADDRESS:  
8 MEETING HOUSE LN  
MADISON, CT 06443

SHEET DESCRIPTION:  
**EQUIPMENT & MOUNTING DETAILS**

SHEET NUMBER:  
**A-5**

**RFS HYBRIFLEX RISER CABLE SCHEDULE**

Fiber Only (Existing DC Power)	Hybrid cable MN: HB058-M12-050F 12x multi-mode fiber pairs, Top: Outdoor protected connectors, Bottom: LC Connectors, 5/8 cable, 50 ft	50 ft
	MN: HB058-M12-075F	75 ft
	MN: HB058-M12-100F	100 ft
	MN: HB058-M12-125F	125 ft
	MN: HB058-M12-150F	150 ft
	MN: HB058-M12-175F MN: HB058-M12-200F	175 ft 200 ft
8 AWG Power	Hybrid cable MN: HB114-08U3M12-050F 3x 8 AWG power pairs, 12x multi-mode fiber pairs, Outdoor rated connectors & LC Connectors, 1 1/4 cable, 50 ft	50 ft
	MN: HB114-08U3M12-075F	75 ft
	MN: HB114-08U3M12-100F	100 ft
	MN: HB114-08U3M12-125F	125 ft
	MN: HB114-08U3M12-150F	150 ft
	MN: HB114-08U3M12-175F MN: HB114-08U3M12-200F	175 ft 200 ft
6 AWG Power	Hybrid cable MN: HB114-13U3M12-225F 3x 6 AWG power pair, 12x multi-mode fiber pairs, Outdoor rated connectors & LC Connectors, 1 1/4 cable, 225 ft	225 ft
	MN: HB114-13U3M12-250F	250 ft
	MN: HB114-13U3M12-275F	275 ft
	MN: HB114-13U3M12-300F	300 ft
4 AWG Power	Hybrid cable MN: HB114-21U3M12-325F 3x 4 AWG power pair, 12x multi-mode fiber pairs, Outdoor rated connectors & LC Connectors, 1 1/4 cable, 325 ft	325 ft
	MN: HB114-21U3M12-350F MN: HB114-21U3M12-375F	350 ft 375 ft

**RFS HYBRIFLEX JUMPER CABLE SCHEDULE**

Fiber Only	Hybrid Jumper cable MN: HBF012-M3-5F1 5 ft, 3x multi-mode fiber pairs, Outdoor & LC connectors, 1/2 cable	5 ft
	MN: HBF012-M3-10F1	10 ft
	MN: HBF012-M3-15F1	15 ft
	MN: HBF012-M3-20F1	20 ft
	MN: HBF012-M3-25F1	25 ft
	MN: HBF012-M3-30F1	30 ft
8 AWG Power	Hybrid Jumper cable MN: HBF058-08U1M3-5F1 5 ft, 1x 8 AWG power pair, 3x multi-mode fiber pairs, Outdoor & LC Connectors, 5/8 cable	5 ft
	MN: HBF058-08U1M3-10F1	10 ft
	MN: HBF058-08U1M3-15F1	15 ft
	MN: HBF058-08U1M3-20F1	20 ft
	MN: HBF058-08U1M3-25F1	25 ft
	MN: HBF058-08U1M3-30F1	30 ft
6 AWG Power	Hybrid Jumper cable MN: HBF058-13U1M3-5F1 5 ft, 1x 6 AWG power pair, 3x multi-mode fiber pairs, Outdoor & LC Connectors, 5/8 cable	5 ft
	MN: HBF058-13U1M3-10F1	10 ft
	MN: HBF058-13U1M3-15F1	15 ft
	MN: HBF058-13U1M3-20F1	20 ft
	MN: HBF058-13U1M3-25F1	25 ft
	MN: HBF058-13U1M3-30F1	30 ft
4 AWG Power	Hybrid Jumper cable MN: HBF078-21U1M3-5F1 5 ft, 1x 4 AWG power pair, 3x multi-mode fiber pairs, Outdoor & LC Connectors, 7/8 cable	5 ft
	MN: HBF078-21U1M3-10F1	10 ft
	MN: HBF078-21U1M3-15F1	15 ft
	MN: HBF078-21U1M3-20F1	20 ft
	MN: HBF078-21U1M3-25F1	25 ft
	MN: HBF078-21U1M3-30F1	30 ft

**NOTE:**  
SPRINT CM TO CONFIRM HYBRID OR FIBER RISER CABLE AND HYBRID OR FIBER JUMPER CABLE MODEL NUMBERS IF HYBRID CABLES ARE REQUIRED BEFORE PREPARING BOM.

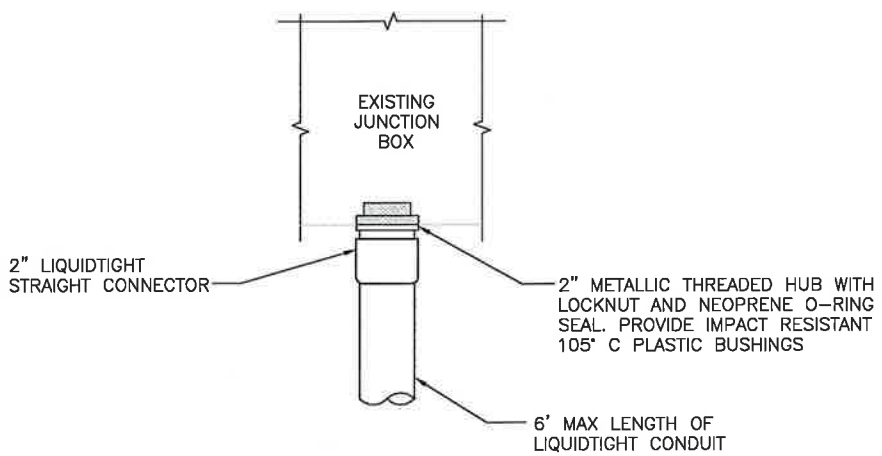
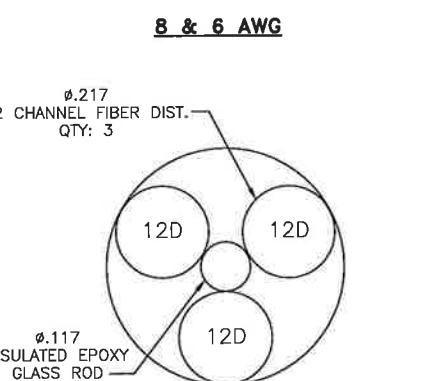
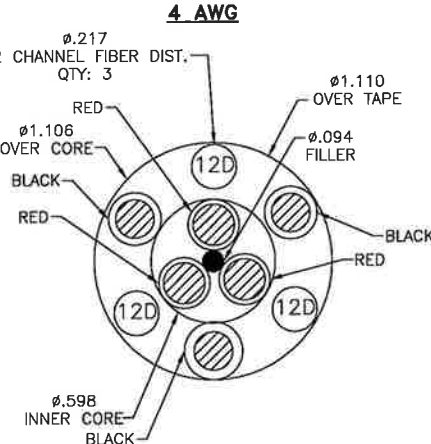
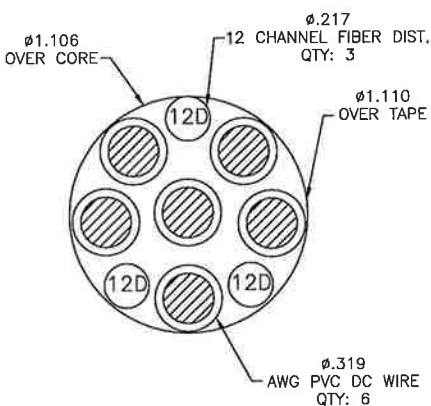

**FIBER JUNCTION BOX PENETRATION**

NO SCALE 2

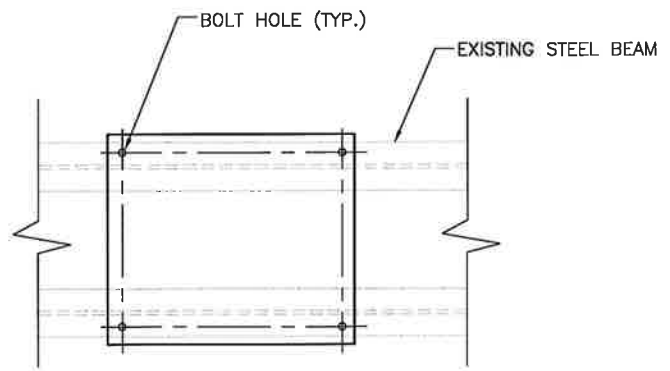

1. VERIFY BOLT HOLE SPACING WITH EQUIPMENT CUT SHEETS.
2. NEW EQUIPMENT CABINET TO BE MOUNTED TO EXISTING SUPPORT SURFACE WITH BOLT-DOWN SYSTEM PER MANUFACTURER'S SPECIFICATION AND FIELD DRILL HOLES THROUGH EXISTING STEEL BEAMS AS REQUIRED.
3. MAINTAIN A MINIMUM OF 1" DISTANCE FROM CENTER OF BOLT HOLE TO EDGE OF FLANGE.

**2.5 CABLE CROSS SECTION DATA**

NO SCALE 1

**EQUIPMENT MOUNT DETAIL**

NO SCALE 3

PLANS PREPARED FOR:



PLANS PREPARED BY:



MLA PARTNER:



ENGINEERING LICENSE:



DRAWING NOTICE:

THESE DOCUMENTS ARE CONFIDENTIAL AND ARE THE SOLE PROPERTY OF SPRINT AND MAY NOT BE REPRODUCED, DISSEMINATED OR REDISTRIBUTED WITHOUT THE EXPRESS WRITTEN CONSENT OF SPRINT.

REVISIONS:	DESCRIPTION	DATE	BY	REV
REVISED PER COMMENT		03/13/14	MAP	B
ISSUED FOR REVIEW		02/20/14	JOV	A

SITE NAME:  
**MADISON CT 6**

SITE CASCADE:  
**CT60XC937**

SITE ADDRESS:  
8 MEETING HOUSE LN  
MADISON, CT 06443

SHEET DESCRIPTION:  
**CIVIL DETAILS**

SHEET NUMBER:  
**A-6**



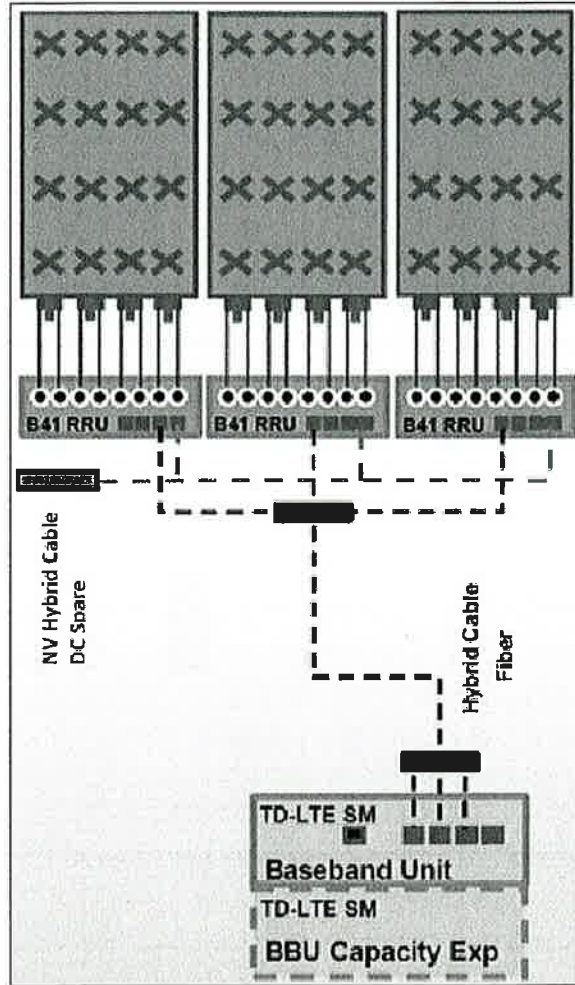

ALU 2.5 ALU SCENARIO 1

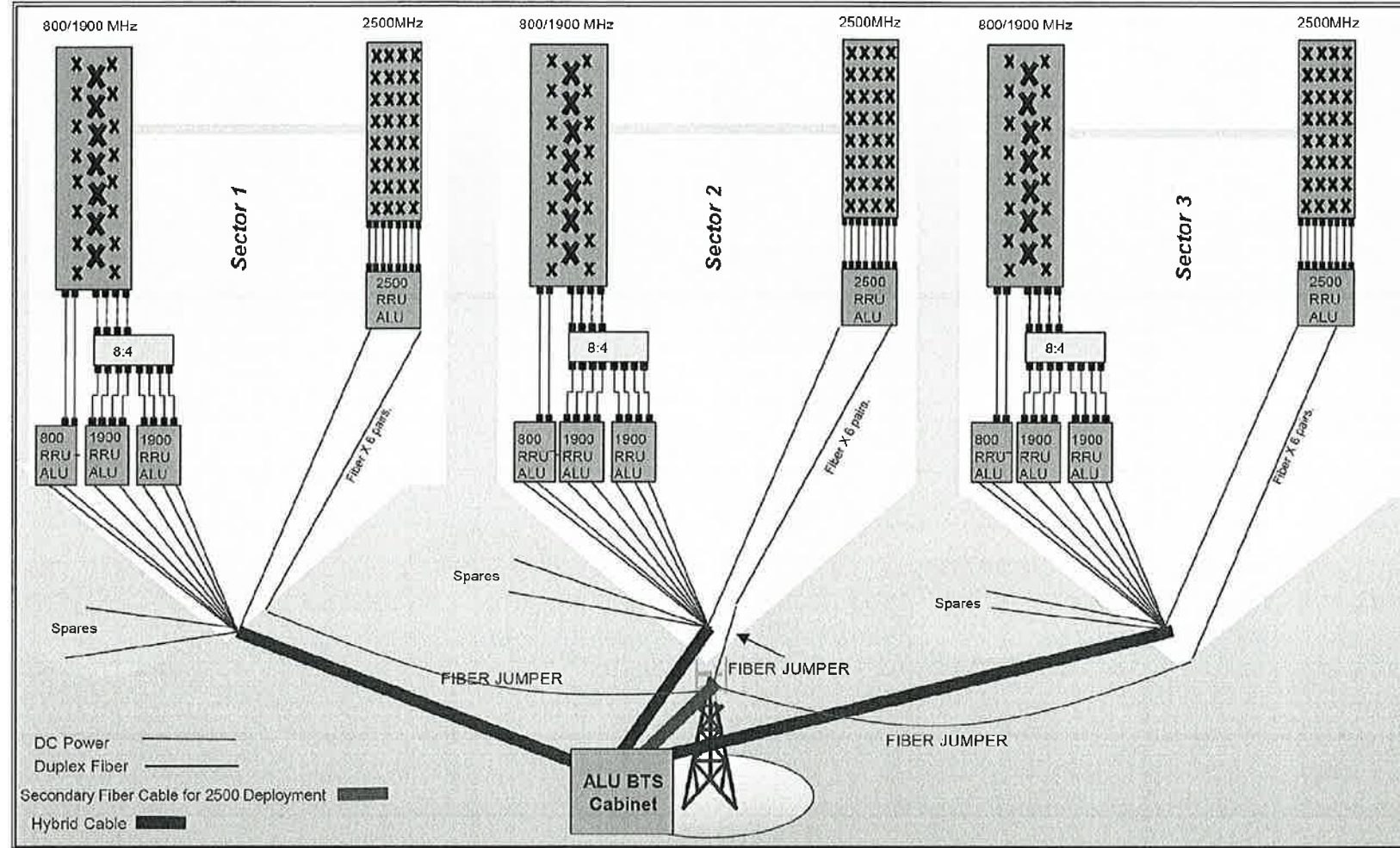

RAN WIRING DIAGRAM

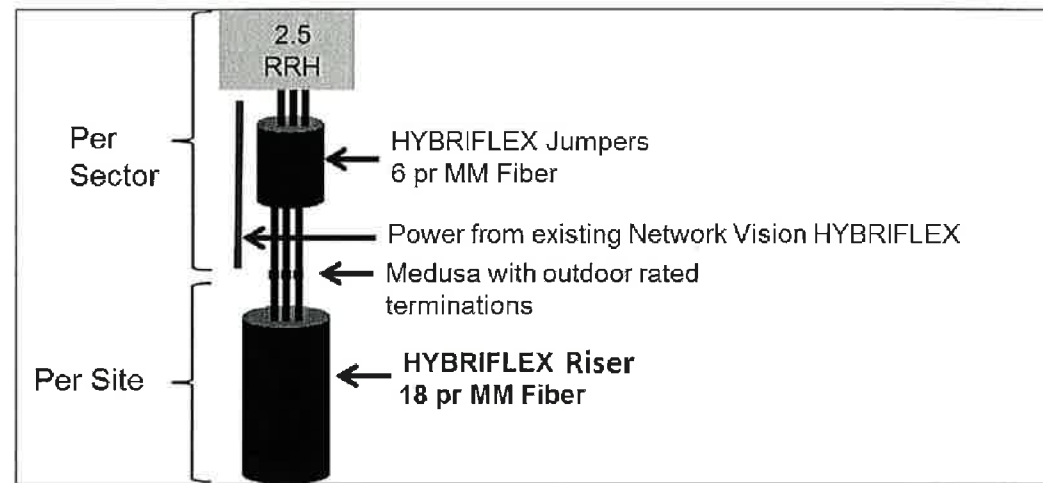

RF 2.5 ALU SCENARIO 1

PLUMBING DIAGRAM

NO SCALE

1

PLANS PREPARED FOR:

**Sprint**  
 6580 Sprint Parkway  
 Overland Park, Kansas 66251

PLANS PREPARED BY:

**INFINIGY** Design. Build. Deliver.  
 1033 Watervliet Shaker Rd  
 Albany, NY 12205  
 Office # (518) 690-0790  
 Fax # (518) 690-0793  
 JOB NUMBER 340-000

MLA PARTNER:

**AMERICAN TOWER CORPORATION**  
 116 HUNTINGTON AVENUE, 11TH FLOOR  
 BOSTON, MA 02116

ENGINEERING LICENSE:



DRAWING NOTICE:

THESE DOCUMENTS ARE CONFIDENTIAL AND ARE THE SOLE PROPERTY OF SPRINT AND MAY NOT BE REPRODUCED, DISSEMINATED OR REDISTRIBUTED WITHOUT THE EXPRESS WRITTEN CONSENT OF SPRINT.

REVISIONS:

DESCRIPTION	DATE	BY	REV
REMOVED PER COMMENT	03/13/14	MAP	B
ISSUED FOR REVIEW	02/20/14	JDV	A

SITE NAME:

MADISON CT 6

SITE CASCADE:

CT60XC937

SITE ADDRESS:

8 MEETING HOUSE LN  
 MADISON, CT 06443

SHEET DESCRIPTION:

PLUMBING DIAGRAM

SHEET NUMBER:

A-7



**NOTE:**  
CONTRACTOR IS TO ENSURE THE  
INSTALLATION INSTRUCTIONS FOR  
EACH CABINET ARE FOLLOWED  
AND THAT THE MANUFACTURER'S  
REQUIREMENTS ARE MET.

PLANS PREPARED FOR:



6580 Sprint Parkway  
Overland Park, Kansas 66251

PLANS PREPARED BY:



1033 Watervliet Shaker Rd  
Albany, NY 12205  
Office # (518) 690-0790  
Fax # (518) 690-0793

JOB NUMBER 340-000

MLA PARTNER:



116 HUNTINGTON AVENUE, 11TH FLOOR  
BOSTON, MA 02116

ENGINEERING LICENSE:



DRAWING NOTICE:

THESE DOCUMENTS ARE CONFIDENTIAL AND ARE THE SOLE PROPERTY OF SPRINT AND MAY NOT BE REPRODUCED, DISSEMINATED OR REDISTRIBUTED WITHOUT THE EXPRESS WRITTEN CONSENT OF SPRINT.

REVISIONS:

DESCRIPTION	DATE	BY	REV
REVISED PER COMMENT	03/13/14	MAP	B
ISSUED FOR REVIEW	02/20/14	JOV	A

SITE NAME:  
**MADISON CT 6**

SITE CASCADE:  
**CT60XC937**

SITE ADDRESS:  
8 MEETING HOUSE LN  
MADISON, CT 06443

SHEET DESCRIPTION:  
**ELECTRICAL & GROUNDING PLAN**

SHEET NUMBER:  
**E-1**

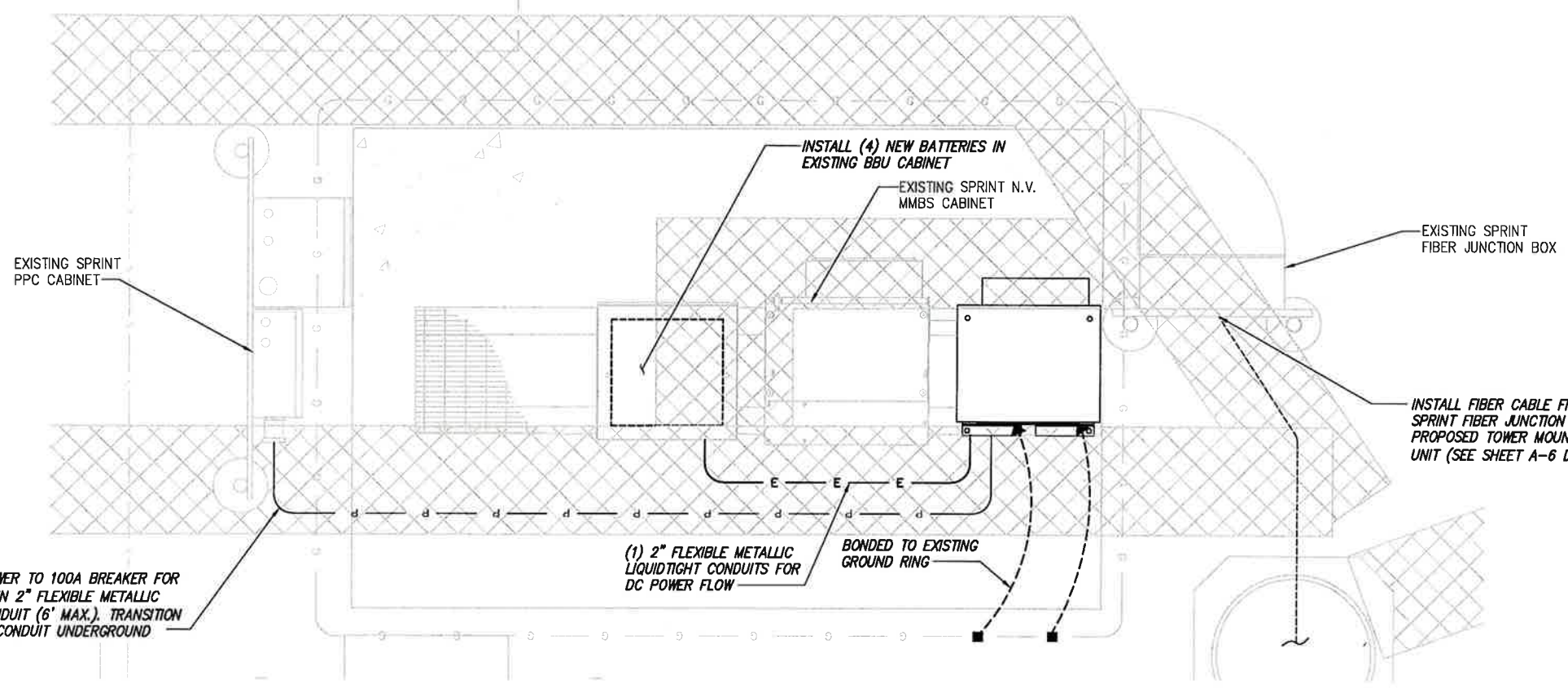

- LEGEND:**
- EXISTING GROUND RING
  - CADWELD CONNECTION (EXOTHERMIC WELD)
  - ▲ MECHANICAL CONNECTION
  - ⊗ GROUND ROD
  - CABLE GROUND KIT

**ELECTRICAL AND GROUNDING PLAN**

NO SCALE 1

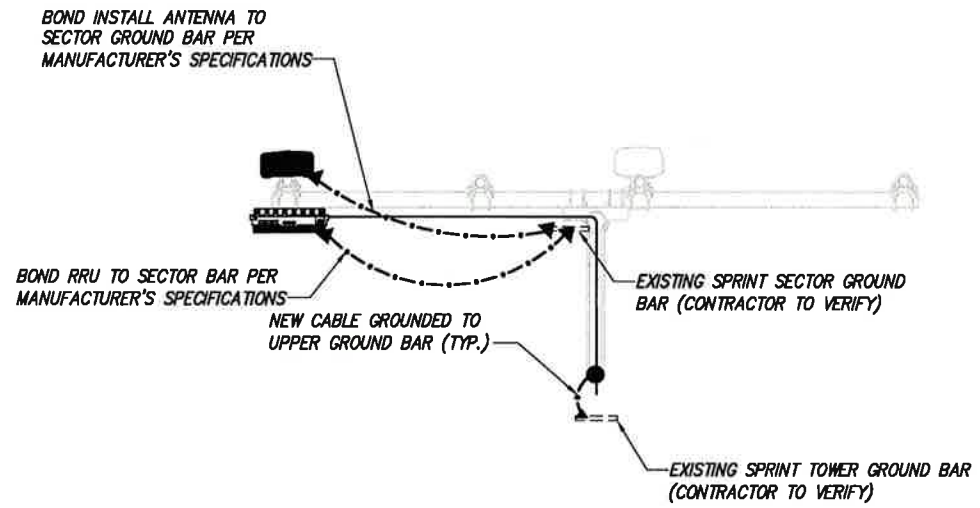

**TYPICAL ANTENNA GROUNDING PLAN**

NO SCALE 2

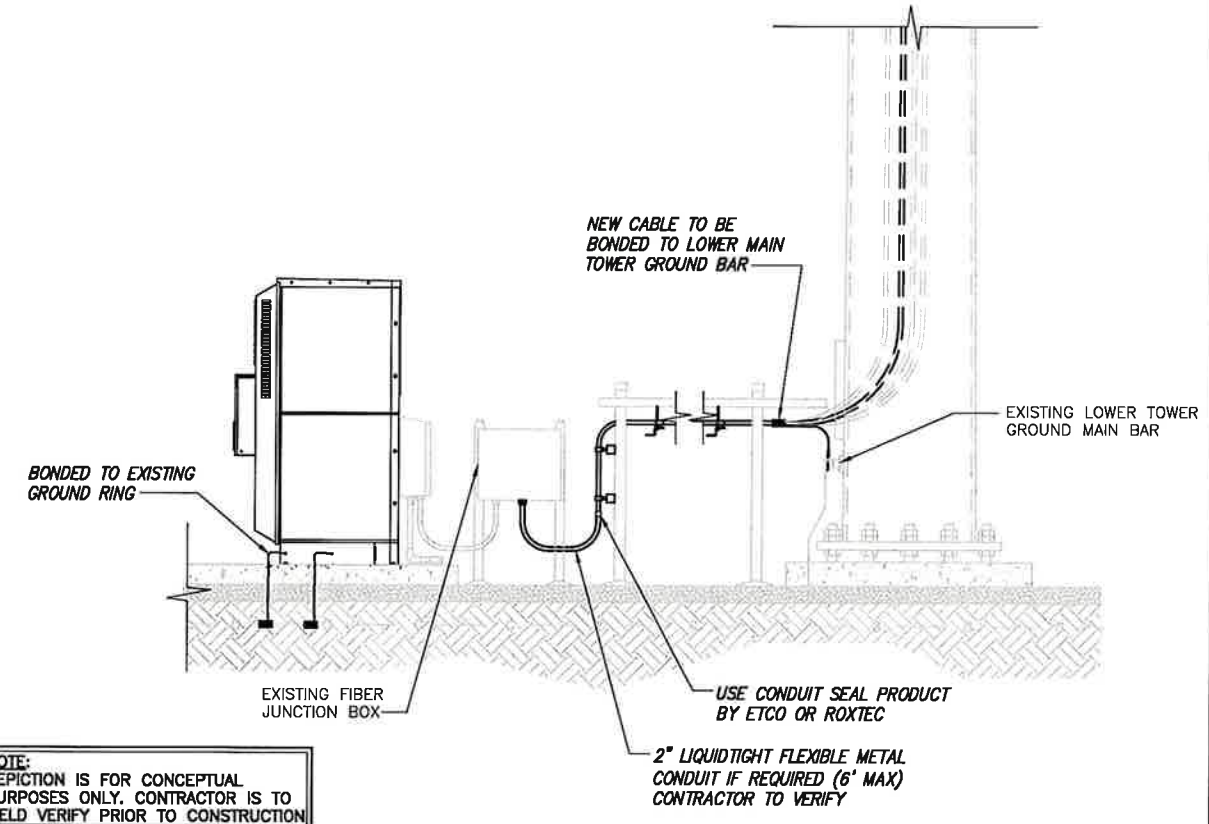

**NOTE:**  
DEPICTION IS FOR CONCEPTUAL PURPOSES ONLY. CONTRACTOR IS TO FIELD VERIFY PRIOR TO CONSTRUCTION.

**TYPICAL EQUIPMENT GROUNDING PLAN (ELEVATION)**

NO SCALE 3

**NOTES**  
GC SHALL REFERENCE ALL SPECS FOR "CONNECTING THE POWER SUPPLY" OF THE NEW INSTALLATION DOCUMENTS, FOR ALL CONNECTION SPECIFICATIONS.

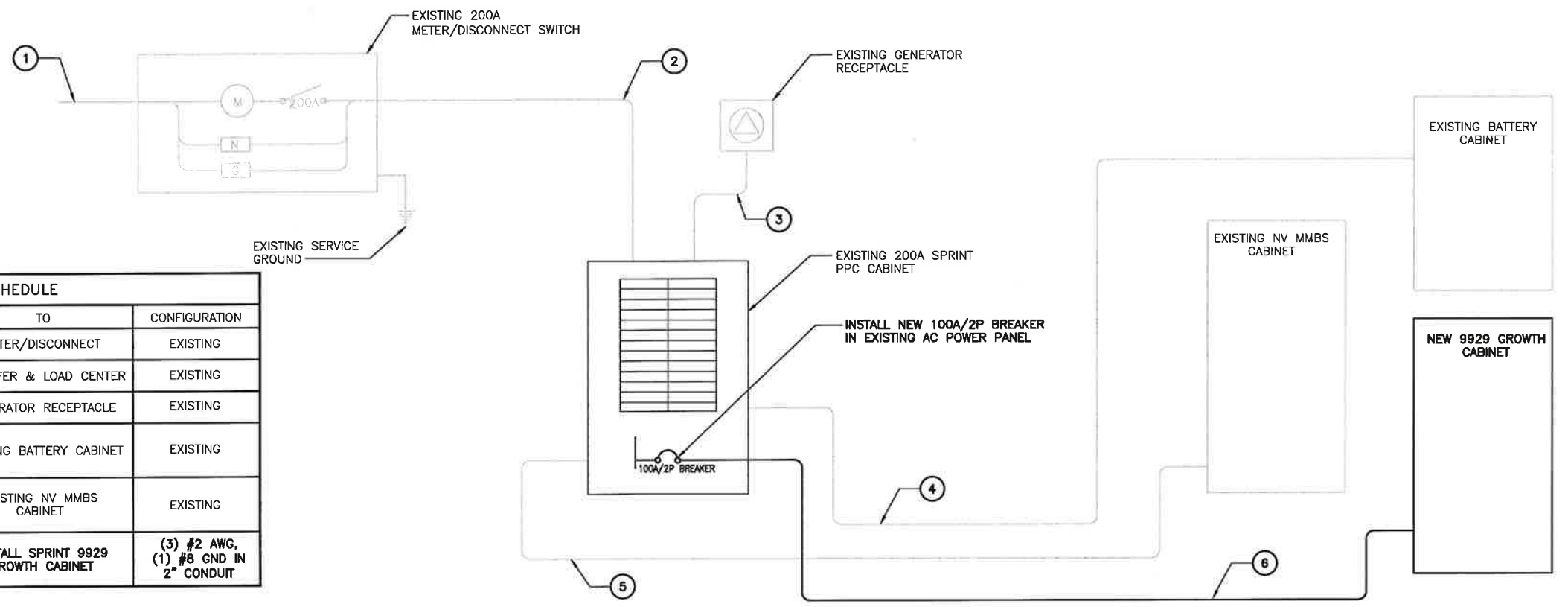

CIRCUIT SCHEDULE			
NO	FROM	TO	CONFIGURATION
1	UTILITY SOURCE	METER/DISCONNECT	EXISTING
2	METER/DISCONNECT	TRANSFER & LOAD CENTER	EXISTING
3	TRANSFER & LOAD CENTER	GENERATOR RECEPTACLE	EXISTING
4	TRANSFER & LOAD CENTER	EXISTING BATTERY CABINET	EXISTING
5	TRANSFER & LOAD CENTER	EXISTING NV MMBS CABINET	EXISTING
6	TRANSFER & LOAD CENTER	INSTALL SPRINT 9929 GROWTH CABINET	(3) #2 AWG, (1) #8 GND IN 2" CONDUIT

**ELECTRICAL ONE-LINE DIAGRAM**

NO SCALE | 1

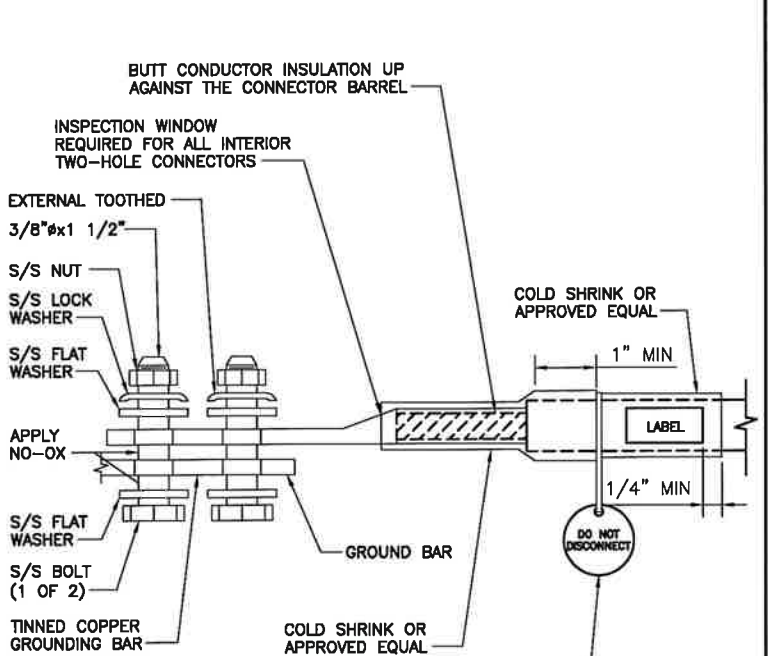
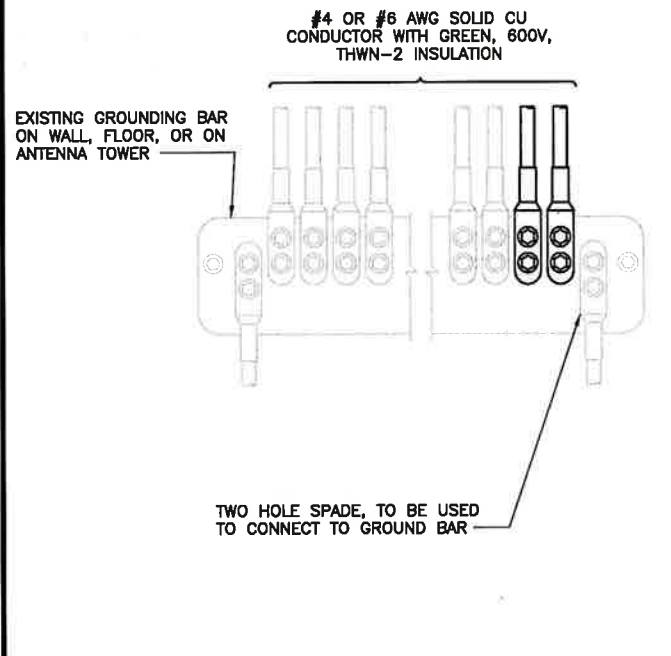

**NOTES**  
1. APPLY NO-OX TO LUG AND BAR CONTACT SURFACE. DO NOT COAT INLINE LUG.  
2. IF STOLEN GROUND BARS ARE ENCOUNTERED, CONTACT SPRINT CM FOR REPLACEMENT THREADED ROD KIT.

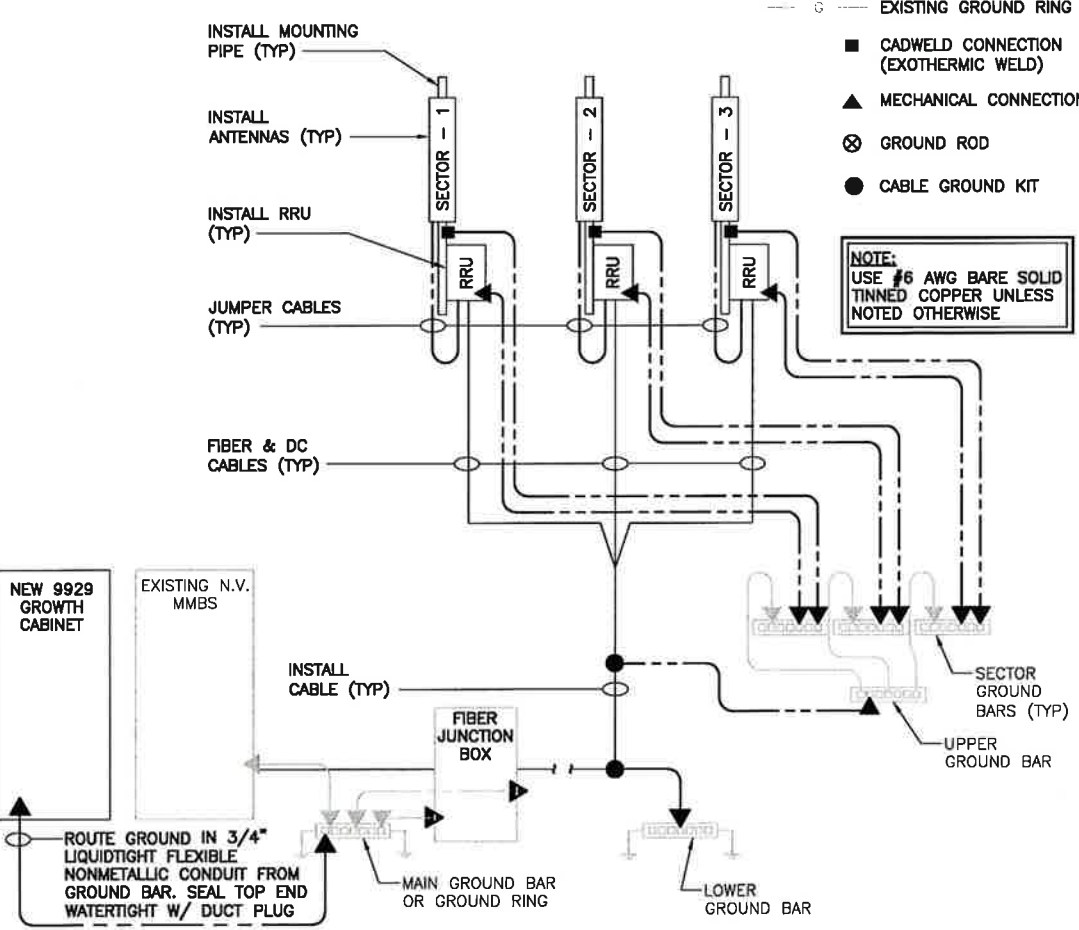

**INSTALLATION OF GROUNDING CONDUCTOR TO GROUNDING BAR**

**TWO HOLE LUG**

**GROUNDING RISER DIAGRAM**

NO SCALE | 4

DRAWING NOTICE:  
THESE DOCUMENTS ARE CONFIDENTIAL AND ARE THE SOLE PROPERTY OF SPRINT AND MAY NOT BE REPRODUCED, DISSEMINATED OR REDISTRIBUTED WITHOUT THE EXPRESS WRITTEN CONSENT OF SPRINT.

REVISIONS:	DESCRIPTION	DATE	BY	REV
REVISED PER COMMENT		03/13/14	MAP	B
ISSUED FOR REVIEW		02/20/14	JDV	A

SITE NAME:  
**MADISON CT 6**  
SITE CASCADE:  
**CT60XC937**  
SITE ADDRESS:  
8 MEETING HOUSE LN  
MADISON, CT 06443  
SHEET DESCRIPTION:  
**ELECTRICAL & GROUNDING DETAILS**  
SHEET NUMBER:  
**E-2**