

December 17, 2015

Melanie A. Bachman
Acting Executive Director
Connecticut Siting Council
10 Franklin Square
New Britain, CT 06051

Re: **Notice of Exempt Modification – Facility Modification
17 Cottage Road, Madison, Connecticut**

Dear Ms. Bachman:

Cellco Partnership d/b/a Verizon Wireless (“Cellco”) currently maintains twelve (12) wireless telecommunications antennas at the 107-foot level of the existing 130-foot tower at 17 Cottage Road in Madison, Connecticut (the “Property”). The tower is owned by SBA Communications Corporation (“SBA”). The Council approved Cellco’s use of the tower in 2014. Cellco now intends to modify its facility by replacing nine (9) of its existing antennas with three (3) model SBNHH-1D65B, 700 MHz antennas; three (3) model SBNHH-1D65B, 1900 MHz antennas; and three (3) model SBNHH-1D65B, 2100 MHz antennas, all at the same level on the tower. Cellco also intends to install nine (9) remote radio heads (“RRHs”) and two (2) HYBRIFLEX™ fiber optic antenna cables. Included in Attachment 1 are specifications for Cellco’s replacement antennas, RRHs and HYBRIFLEX™ cables.

Please accept this letter as notification pursuant to R.C.S.A. § 16-50j-73, for construction that constitutes an exempt modification pursuant to R.C.S.A. § 16-50j-72(b)(2). In accordance with R.C.S.A. § 16-50j-73, a copy of this letter is being sent to Madison’s First Selectman, Thomas Banisch. A copy of this letter is also being sent to Paul Stonehart, the owner of the Property and SBA, the tower owner.

The planned modifications to the facility fall squarely within those activities explicitly provided for in R.C.S.A. § 16-50j-72(b)(2).

Melanie A. Bachman
December 17, 2015
Page 2

1. The proposed modifications will not result in an increase in the height of the existing tower. Cellco's replacement antennas and RRHs will be located at the 107-foot level on the 130-foot tower.
2. The proposed modifications will not involve any change to ground-mounted equipment and, therefore, will not require the extension of the site boundary.
3. The proposed modifications will not increase noise levels at the facility by six decibels or more, or to levels that exceed state and/or local criteria.
4. The operation of the modified facility will not increase radio frequency (RF) emissions at the facility to a level at or above the Federal Communications Commission (FCC) safety standard. A cumulative General Power Density table for Cellco's modified facility is included behind Attachment 2.
5. The proposed modifications will not cause a change or alteration in the physical or environmental characteristics of the site.
6. The tower and its foundation can support Cellco's proposed modifications. (*See Structural Analysis Report included in Attachment 3*).

For the foregoing reasons, Cellco respectfully submits that the proposed modifications to the above-referenced telecommunications facility constitutes an exempt modification under R.C.S.A. § 16-50j-72(b)(2).

Sincerely,



Kenneth C. Baldwin

Enclosures

Copy to:

Thomas Banisch, First Selectman
Paul Stonehart
SBA
Tim Parks

ATTACHMENT 1



SBNHH-1D65B

Andrew® Tri-band Antenna, 698–896 and 2x 1695–2360 MHz, 65° horizontal beamwidth, internal RET. Both high bands share the same electrical tilt.

- Interleaved dipole technology providing for attractive, low wind load mechanical package

Electrical Specifications

Frequency Band, MHz	698–806	806–896	1695–1880	1850–1990	1920–2200	2300–2360
Gain, dBi	14.9	14.7	17.7	18.2	18.6	18.6
Beamwidth, Horizontal, degrees	68	66	69	66	63	58
Beamwidth, Vertical, degrees	12.1	10.7	5.6	5.2	5.0	4.5
Beam Tilt, degrees	0–14	0–14	0–7	0–7	0–7	0–7
USLS (First Lobe), dB	14	13	15	15	15	13
Front-to-Back Ratio at 180°, dB	27	29	28	28	28	27
CPR at Boresight, dB	20	23	20	20	17	21
CPR at Sector, dB	14	10	12	10	9	1
Isolation, dB	25	25	25	25	25	25
Isolation, Intersystem, dB	30	30	30	30	30	30
VSWR Return Loss, dB	1.5 14.0	1.5 14.0	1.5 14.0	1.5 14.0	1.5 14.0	1.5 14.0
PIM, 3rd Order, 2 x 20 W, dBc	-153	-153	-153	-153	-153	-153
Input Power per Port, maximum, watts	350	350	350	350	350	300
Polarization	±45°	±45°	±45°	±45°	±45°	±45°
Impedance	50 ohm	50 ohm	50 ohm	50 ohm	50 ohm	50 ohm

Electrical Specifications, BASTA*

Frequency Band, MHz	698–806	806–896	1695–1880	1850–1990	1920–2200	2300–2360
Gain by all Beam Tilts, average, dBi	14.5	14.3	17.4	17.9	18.2	18.3
Gain by all Beam Tilts Tolerance, dB	±0.5	±0.8	±0.4	±0.3	±0.5	±0.3
	0° 14.6	0° 14.5	0° 17.4	0° 17.8	0° 18.1	0° 18.2
Gain by Beam Tilt, average, dBi	7° 14.6	7° 14.4	3° 17.5	3° 17.9	3° 18.3	3° 18.4
	14° 14.2	14° 13.6	7° 17.4	7° 17.9	7° 18.2	7° 18.4
Beamwidth, Horizontal Tolerance, degrees	±2.2	±3.4	±2	±4.6	±5.7	±4.3
Beamwidth, Vertical Tolerance, degrees	±0.8	±1	±0.3	±0.2	±0.3	±0.2
USLS, beampeak to 20° above beampeak, dB	16	14	16	16	16	15
Front-to-Back Total Power at 180° ± 30°, dB	25	26	27	26	26	26
CPR at Boresight, dB	22	23	21	20	20	22
CPR at Sector, dB	13	11	16	12	11	4

* CommScope® supports NGMN recommendations on Base Station Antenna Standards (BASTA). To learn more about the benefits of BASTA, [download the whitepaper Time to Raise the Bar on BSAs.](#)

General Specifications

Antenna Brand	Andrew®
Antenna Type	DualPol® multiband with internal RET
Band	Multiband
Brand	DualPol® Teletilt®
Operating Frequency Band	1695 – 2360 MHz 698 – 896 MHz
Performance Note	Outdoor usage

SBNHH-1D65B

POWERED BY



Mechanical Specifications

Color	Light gray
Lightning Protection	dc Ground
Radiator Material	Aluminum Low loss circuit board
Radome Material	Fiberglass, UV resistant
Reflector Material	Aluminum
RF Connector Interface	7-16 DIN Female
RF Connector Location	Bottom
RF Connector Quantity, total	6
Wind Loading, maximum	617.7 N @ 150 km/h 138.9 lbf @ 150 km/h
Wind Speed, maximum	241 km/h 150 mph

Dimensions

Depth	180.0 mm 7.1 in
Length	1851.0 mm 72.9 in
Width	301.0 mm 11.9 in
Net Weight	18.4 kg 40.6 lb

Remote Electrical Tilt (RET) Information

Input Voltage	10–30 Vdc
Power Consumption, idle state, maximum	2.0 W
Power Consumption, normal conditions, maximum	13.0 W
Protocol	3GPP/AISG 2.0 (Multi-RET)
RET Interface	8-pin DIN Female 8-pin DIN Male
RET Interface, quantity	1 female 1 male
RET System	Teletilt®

Packed Dimensions

Depth	299.0 mm 11.8 in
Length	1970.0 mm 77.6 in
Width	409.0 mm 16.1 in
Shipping Weight	31.0 kg 68.3 lb

Regulatory Compliance/Certifications

Agency

RoHS 2011/65/EU

China RoHS SJ/T 11364-2006

ISO 9001:2008

Classification

Compliant by Exemption

Above Maximum Concentration Value (MCV)

Designed, manufactured and/or distributed under this quality management system



Included Products

Product Specifications

COMMSCOPE®

SBNHH-1D65B

POWERED BY



BSAMNT-1 — Wide Profile Antenna Downtilt Mounting Kit for 2.4 - 4.5 in (60 - 115 mm) OD round members. Kit contains one scissor top bracket set and one bottom bracket set.

* Footnotes

Performance Note Severe environmental conditions may degrade optimum performance

ALCATEL-LUCENT B13 RRH4X30-4R

Alcatel-Lucent B13 Remote Radio Head 4x30-4R is the newest addition of Remote Radio Head to the extended product line of Alcatel-Lucent's distributed Base Station solutions, aimed at facilitating smooth RF site acquisition and related civil engineering.

Supporting 2Tx/4Tx MIMO and 4-way Rx diversity, Alcatel-Lucent B13 RRH4x30-4R allows operators to have a compact radio solution to deploy LTE in the 700U band (700 MHz, 3GPP band 13), providing them with the means to achieve high capacity, high quality and high coverage with minimum site requirements.

The Alcatel-Lucent B13 RRH4x30-4R product has four transmit RF paths, offering the possibility to **select, via software only, 2Tx or 4Tx MIMO configurations** with either 2x60 W or 4x30 W RF output power. It supports also 4-way Rx diversity and up to 10MHz instantaneous bandwidth.

The Alcatel-Lucent B13 RRH4x30-4R is a near zero-footprint solution and operates noise free, simplifying negotiations with site property owners and minimizing environmental impacts.

Its compactness and slim design makes the Alcatel-Lucent B13 RRH4x30-4R easy to install close to the antenna: operators can therefore locate this Remote Radio Head where RF design conditions are deemed ideal, minimizing trade-offs between available sites and RF optimum sites, together with reducing the RF feeder needs and installation costs.



FEATURES

- Supporting LTE in 700 MHz band (700U, 3GPP band 13)
- LTE 2Tx or 4Tx MIMO (SW switchable)
- Output power: Up to 2x60W or 4x30W
- 10MHz LTE carrier with 4Rx Diversity
- Convection-cooled (fan-less)
- Supports AISG 2.0 ALD devices (RET, TMA) through RS485 or RF ports

BENEFITS

- Compact to reduce additional footprint when adding LTE in 700U band
- MIMO scheme operation selection (2Tx or 4Tx) by software only
- Improves downlink spectral efficiency through MIMO4
- Increases LTE coverage thanks to 4Rx diversity capability and best in class Rx sensitivity
- Flexible mounting options: Pole or Wall

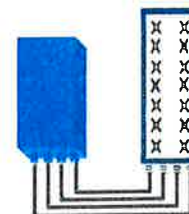

4x30W with 4T4R
or
2x60W with 2T4R
Can be switched between
modes via SW w/o site
visit

TECHNICAL SPECIFICATIONS

Features & performance	
Number of TX/RX paths	4 duplexed (either 4T4R or 2T4R by SW)
Frequency band	U700 (C) (3GPP bands 13): DL: 746 - 756 MHz / UL: 777 - 787 MHz
Instantaneous bandwidth - #carriers	10MHz = 1 LTE carrier (in 10MHz occupied bandwidth)
LTE carrier bandwidth	10 MHz
RF output power	2x60W or 4x30W (by SW)
Noise figure – RX Diversity scheme	2 dB typ. (<2.5 dB max) – 2 or 4 way Rx diversity
Sizes (HxWxD) in mm (in.)	550 x 305 x 230 (21.6" x 12.0" x 9") (with solar shield)
Volume in L	38 (with solar shield)
Weight in kg (lb) (w/o mounting HW)	26 (57.2) (with solar shield)
DC voltage range	-40.5 to -57V at full performance, -38 to -57V with relaxation on power consumption
DC power consumption	550W typical @100% RF load (in 2Tx or 4Tx mode)
Environmental conditions	-40°C (-40°F) / +55°C (+131°F)
Wind load (@150km/h or 93mph)	IP65 Frontal: <200N / Lateral : <150N
Antenna ports	4 ports 7/16 DIN female (50 ohms) VSWR < 1.5
CPRI ports	2 CPRI ports (HW ready for Rate7, 9.8 Gbps) SFP single mode dual fiber
AISG interfaces	1 AISG2.0 output (RS485) Integrated Smart Bias Tees (x2)
Misc. Interfaces	4 external alarms (1 connector) – 4 RF Tx & 4 RF Rx monitor ports - 1 DC connector (2 pins)
Installation conditions	Pole and wall mounting
Regulatory compliance	3GPP 36.141 / 3GPP 36.113 / GR-1089-CORE / GR-3108-CORE / UL 60950-1 / FCC Part 27

www.alcatel-lucent.com Alcatel, Lucent, Alcatel-Lucent and the Alcatel-Lucent logo are trademarks of Alcatel-Lucent. All other trademarks are the property of their respective owners. The information presented is subject to change without notice. Alcatel-Lucent assumes no responsibility for inaccuracies contained herein. Copyright © 2014 Alcatel-Lucent. All Rights Reserved

PCS RF MODULES

RRH1900 2X60 - HW CHARACTERISTICS

LA6.0.1/13.3

RRH2x60	
RF Output Power	2x60W
Instantaneous Bandwidth	20MHz
Transmitter	2 TX
Receiver	2 Branch RX – LA6.0.1 4 Branch RX – LR13.3
Features	AISG 2.0 for RET/TMA Internal Smart Bias-T
Power	-48VDC
CPRI Ports	2 CPRI Rate 3 Ports
External Alarms	4 External User Alarms
Monitor Ports	TX
Environmental	GR487 Compliance
RF Connectors	7/16 DIN (top mounted)

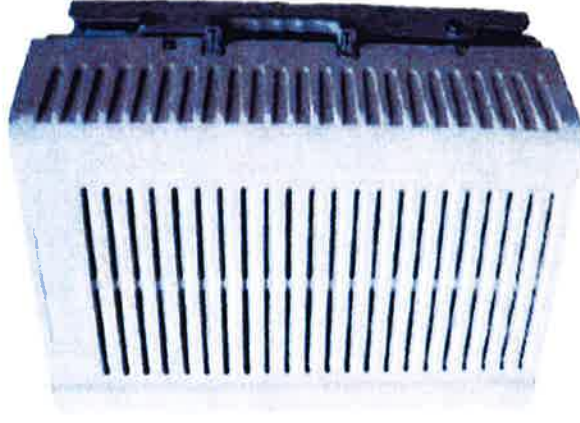

** Not a Verizon Wireless deployed product

ALCATEL-LUCENT – CONFIDENTIAL – SOLELY FOR AUTHORIZED PERSONS HAVING A NEED TO KNOW – PROPRIETARY – USE PURSUANT TO COMPANY INSTRUCTION

NEW PCS RF MODULES FOR VZW RRH2X60 - HW CHARACTERISTICS

LR14.3

RRH2X60	
RF Output Power	2x60W (4x30W HW Ready)
Instantaneous Bandwidth	60MHz
Target Reliability (Annual Return Rate)	<2%
Receiver	4 Branch Rx
Features	AISG 2.0 for RET/TMA
Power	-48VDC Internal Smart Bias-T
CPRI Ports	2 CPRI Rate 5 Ports
External Alarms	4 External User Alarms
Monitor Ports	TX, RX
Environmental	GR487 Compliance
RF Connectors	7/16 DIN (downward facing)
Dimensions	22"(h) x 12"(w) x 9.4" (d)**
Weight	55lb**

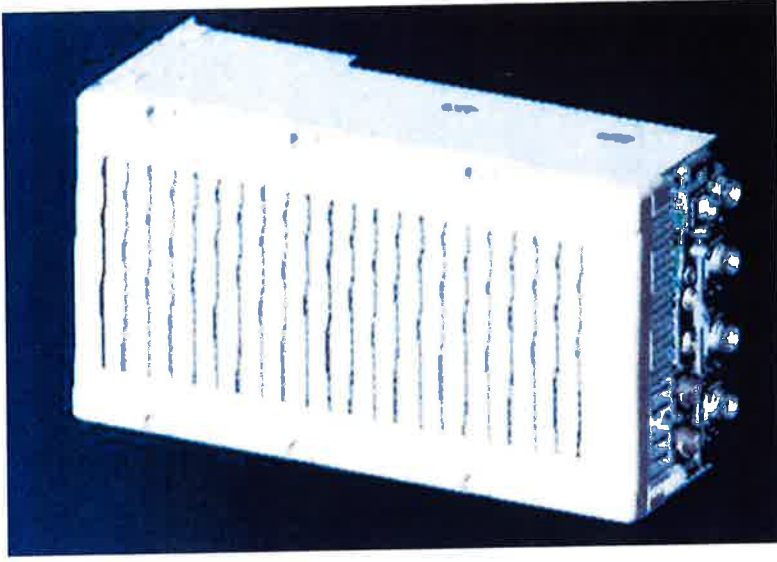

** - Includes solar shield but not mounting brackets (8 lbs.)

B66A RRH 4X45 - PHYSICAL CHARACTERISTICS- TARGET 15.1



- Commercial Product Will include B66 support of AWS 1 and 3.
- Lower AWS 3 UL Not in 3GPP Band 66 Definition

B4 RRH4x45-4R (AWS-Extension Band)	
Frequency Band	LR15.1 – B4 / LR16.1 B66 (AWS 1 and 3 only)
RF Output Power	2x90W/4x45W (SW configurable)
Operational range	2110-2180 MHz, DL/ 1710-1780 MHz UL
Instantaneous Bandwidth	70MHz
Configuration (HW readiness)	LTE: 2T2R, 2T4R, 4T4R
Carrier Bandwidths	5, 10, 15 and 20 MHz
Interfaces	2x CPRI Rate 7 Ports Antenna Connectors 4.3-10
AISG Support	AISG 2.0 for RET Internal Smart Bias T
Monitor Ports	NA (Spec An to replace ports)
Environmental	GR487 Compliance / GR3178 Compliance (with exceptions)
Mounting options	Pole/Wall
Connectors location	All bottom
External Alarms	4
Annual Return Rate (Target)	<2%
Operating Temperature	-40 C to +55 C (without solar load)

Physical Dimensions – Not to Exceed		
	W/O Solar Shield	With Solar Shield
Dimensions HxWxD	H = 26in (H=660mm) W = 11.4in (W=290mm) D = 5.9in (D=150mm)	H = 26.6in (H=675mm) W = 12in (W=304mm) D = 6.8in (D=173mm)
Volume	29l	35.5l
Weight		64lbs / 29kg



HYBRIFLEX™ RRH Hybrid Feeder Cabling Solution, 1-5/8", Single-Mode Fiber

Product Description

RFS' HYBRIFLEX Remote Radio Head (RRH) hybrid feeder cabling solution combines optical fiber and DC power for RRHs in a single lightweight aluminum corrugated cable, making it the world's most innovative solution for RRH deployments.

It was developed to reduce installation complexity and costs at Cellular sites. HYBRIFLEX allows mobile operators deploying an RRH architecture to standardize the RRH installation process and eliminate the need for and cost of cable grounding. HYBRIFLEX combines optical fiber (multi-mode or single-mode) and power in a single corrugated cable. It eliminates the need for junction boxes and can connect multiple RRHs with a single feeder. Standard RFS CELLFLEX® accessories can be used with HYBRIFLEX cable. Both pre-connectorized and on-site options are available.

Features/Benefits

- Aluminum corrugated armor with outstanding bending characteristics - minimizes installation time and enables mechanical protection and shielding
- Same accessories as 1 5/8" coaxial cable
- Outer conductor grounding - Eliminates typical grounding requirements and saves on installation costs
- Lightweight solution and compact design - Decreases tower loading
- Robust cabling - Eliminates need for expensive cable trays and ducts
- Installation of tight bundled fiber optic cable pairs directly to the RRH - Reduces CAPEX and wind load by eliminating need for interconnection
- Optical fiber and power cables housed in single corrugated cable - Saves CAPEX by standardizing RRH cable installation and reducing installation requirements
- Outdoor polyethylene jacket - Ensures long-lasting cable protection

Technical Specifications

Outer Conductor Armor	Corrugated Aluminum	(mm (in))	46.5 (1.83)
Jacket	Polyethylene, PE	(mm (in))	50.3 (1.98)
UV-Protection	Individual and External Jacket		Yes
Physical Properties			
Weight, Approximate		(kg/m (lb/ft))	1.9 (1.30)
Minimum Bending Radius, Single Bending		(mm (in))	200 (8)
Minimum Bending Radius, Repeated Bending		(mm (in))	500 (20)
Recommended/Maximum Clamp Spacing		(m (ft))	1.0 / 1.2 (3.25 / 4.0)
Electrical Properties			
DC-Resistance Outer Conductor Armor		(Ω/km (Ω/1000ft))	068 (0.295)
DC-Resistance Power Cable, 8.4mm² (8AWG)		(Ω/km (Ω/1000ft))	2.1 (0.307)
Optical Properties			
Version			Single-mode OM3
Quantity, Fiber Count			16 (8 pairs)
Core/Clad		(μm)	50/125
Primary Coating (Acrylate)		(μm)	245
Buffer Diameter, Nominal		(μm)	900
Secondary Protection, Jacket, Nominal		(mm (in))	2.0 (0.08)
Minimum Bending Radius		(mm (in))	104 (4.1)
Insertion Loss @ wavelength 850nm		dB/km	3.0
Insertion Loss @ wavelength 1310nm		dB/km	1.0
Standards (Meets or exceeds)			UL94-V0, UL1666 RoHS Compliant
Dimensions and Standards			
Size (Power)		(mm (AWG))	8.4 (8)
Quantity, Wire Count (Power)			16 (8 pairs)
Size (Alarm)		(mm (AWG))	0.8 (18)
Quantity, Wire Count (Alarm)			4 (2 pairs)
Type			UV protected
Strands			19
Primary Jacket Diameter, Nominal		(mm (in))	6.8 (0.27)
Standards (Meets or exceeds)			NFPA 130, ICEA S-95-658 UL Type XHHW-2, UL 44 UL-LS Limited Smoke, UL VW-1 IEEE-383 (1974), IEEE1202/FT4 RoHS Compliant
Environmental			
Installation Temperature		(°C (°F))	-40 to +65 (-40 to 149)
Operation Temperature		(°C (°F))	-40 to +65 (-40 to 149)

* This data is provisional and subject to change



Figure 1: HYBRIFLEX Series

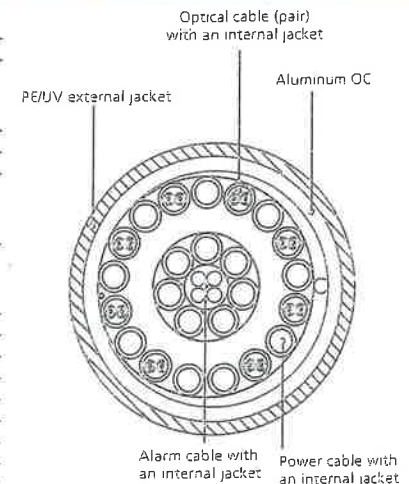

Figure 2: Construction Detail

All information contained in the present datasheet is subject to confirmation at time of ordering.

ATTACHMENT 2

Site Name: Madison 4 Tower Height: 130'		General	Power	Density				
CARRIER	# OF CHAN.	WATTS ERP	HEIGHT	CALC. POWER DENS	FREQ.	MAX. PERMISS. EXP.	FRACTION MPE	Total
*T-Mobile LTE	2	24	117	0.0014	2100	1.0000	0.01%	
*T-Mobile GSM/UMTS	2	12	117	0.0007	1950	1.0000	0.01%	
*T-Mobile UMTS	2	12	117	0.0007	2100	1.0000	0.01%	
*AT&T GSM			127	0.0218	880	0.5867	0.37%	
*AT&T GSM			127	0.0105	1900	1.0000	0.11%	
*AT&T UMTS			127	0.0123	880	0.5867	0.21%	
*AT&T UMTS			127	0.0123	1900	1.0000	0.12%	
*AT&T LTE			127	0.0123	700	0.4667	0.26%	
Verizon	7	424	107	0.0932	1970	1.0000	9.32%	
Verizon	9	411	107	0.1162	869	0.5793	20.05%	
Verizon	1	2306	107	0.0724	2145	1.0000	7.24%	
Verizon	1	1048	107	0.0329	746	0.4973	6.62%	
								44.3%
* Source: Siting Council								

ATTACHMENT 3



Tower Engineering Solutions

Phone (972) 483-0607, Fax (972) 975-9615
8445 Freeport Parkway, Suite 375, Irving, Texas 75063

Structural Analysis Report

Existing 130 ft Monopole

Customer Name: SBA Communications Corp

Customer Site Number: CT13615-A

Customer Site Name: Madison 7, CT

Carrier Name: Verizon

Carrier Site ID / Name: Madison 4

Site Location: 17 Cottage Road

Madison, Connecticut

New Haven County

Latitude: 41.275916

Longitude: -72.561444

Analysis Result:

Max Structural Usage: 71.2% [Pass]

Max Foundation Usage: 63.0% [Pass]

Report Prepared By : Farzam Yazdani



Introduction

The purpose of this report is to summarize the analysis results on the 130 ft Monopole to support the proposed antennas and transmission lines in addition to those currently installed. Any modification listed under Sources of Information was assumed completed and was included in this analysis.

Sources of Information

Tower Drawings	Radian Communication Services, Drawing No. A070592 1-3 dated 10/1/2007.
Foundation Drawing	Radian Communication Services, Drawing No. A070593 1-3 dated 10/1/2007.
Geotechnical Report	JGI, Project No. J2075395 dated 9/10/2007.
Modification Drawings	N/A

Analysis Criteria

The analysis was performed in accordance with the requirements and stipulations of the ANSI/TIA/EIA 222-F. In accordance with this standard, the structure was analyzed using **TESPoles**, a proprietary analysis software. The program considers the structure as an elastic 3-D model with second-order effects and temperature effects incorporated in the analysis. The analysis was performed using multiple wind directions.

Basic Wind Speed Used in the Analysis:	85.0 mph (fastest mile)
Basic Wind Speed with Ice:	74 mph (fastest mile) with 1/2" radial ice concurrent
Operational Wind Speed:	50 mph + 0" Radial ice
Standard/Codes:	ANSI/TIA/EIA 222-F / 2005 Connecticut State Building Code

Existing Antennas, Mounts and Transmission Lines

The table below summarizes the antennas, mounts and transmission lines that were considered in the analysis as existing on the tower.

Items	Elevation (ft)	Qty.	Antenna Descriptions	Mount Type & Qty.	Transmission Lines	Owner
1	128	6	Ericsson RRUS-11 RRUs	(1) Collar Mount	(12) 1-5/8" (1) 1/2" Fiber (2) 3/4" DC (1) 3" Flex Conduit	AT&T
2	127	6	Powerwave P90-15-XLH-RR	(1) Low Profile Platform		
3		3	KMW AM-X-CD-14-65-00T-RET			
4		6	Powerwave TT19-08BP111-001 TMAs			
5		1	Raycap DC6-48-60-18-8F Surge Arrestor			
6	117	3	Ericsson Air 21 B2A B4P	(1) 12.5' Low Profile Platform	(12) 1-5/8" (1) 1-5/8" Fiber	T-Mobile
7		3	Ericsson Air 21 B4A B2P			
8		3	Ericsson KRY 112 144 TMAs			
9	107	6	Amphenol BXA-70063-6CF_2	(1) Low Profile Platform	(12) 1-5/8"	Verizon
10		6	Amphenol BXA-171063-12CF_2			

Proposed Carrier's Final Configuration of Antennas, Mounts and Transmission Lines

Information pertaining to the proposed carrier's final configuration of antennas and transmission lines was provided by SBA Communications Corp. The proposed antennas and lines are listed below.

Items	Elevation (ft)	Qty.	Antenna Descriptions	Mount Type & Qty.	Transmission Lines	Owner
1	107	3	Commscope SBNHH-1D65B Panel	(1) Low Profile Platform	(10) 1-5/8" Coax (2) 1-5/8" Fiber	Verizon
2		3	Antel BXA-70063-6CF-2 Panel			
3		6	Commscope SBNHH-1D65B Panel			
4		3	Alcatel Lucent RRH2x60-700 RRU			
5		3	Alcatel Lucent RRH2X60-PCS RRU			
6		3	Alcatel Lucent RRH4x45AWS RRU			
7		2	Rfs Celwave DB-T1-6Z-8AB-0Z ODU			

All transmission lines are considered running inside of the pole shafts.

Analysis Results

The results of the structural analysis, performed for the wind and ice loading and antenna equipment as defined above, are summarized as the following:

	Pole shafts	Anchor Bolts	Base Plate
Max. Usage:	47.2%	57.8%	71.2%
Pass/Fail	Pass	Pass	Pass

Foundations

	Moment (Kip-Ft)	Shear (Kips)	Axial (Kips)
Original Design Reactions	5098.4	46.4	100.9
Analysis Reactions	2280.2	24.3	42.2
% of Design Reactions	44.7%	52.3%	41.9%

The foundation has been investigated using the supplied documents and soils report and was found adequate. Therefore, no modification to the foundation will be required.

Operational Condition (Rigidity):

Operational characteristics of the tower are found to be within the limits prescribed by ANSI/TIA/EIA 222-F for the installed antennas. Maximum twist/sway at the elevation of the proposed equipment is 0.7059 degrees under the operational wind speed as specified in the Analysis Criteria.

Conclusions

Based on the analysis results, the existing structure and its foundation were found to be adequate to safely support the existing and proposed equipment and meet the minimum requirements per the ANSI/TIA/EIA 222-F Standard under the design basic wind speed as specified in the Analysis Criteria.

Standard Conditions

1. This analysis was performed based on the information supplied to **(TES) Tower Engineering Solutions, LLC**. Verification of the information provided was not included in the Scope of Work for **TES**. The accuracy of the analysis is dependent on the accuracy of the information provided.
2. The analysis is based on the presumption that the tower members and components along with any existing reinforcement items have been correctly and properly designed, manufactured, installed and maintained.
3. All the existing structural members were assumed to be in good condition with no physical damage or deterioration associated with corrosion.
4. An initial tension of 10% of the break strength on all the existing guy wires was assumed in all the structural analyses of guyed towers unless different values were provided by the client. **TES** cannot take responsibility for the deviations in the analysis results because of differences in the initial tension forces of the existing guy wires.
5. Secondary component or connection secondary components, welds and bolts are assumed to be able to carry their intended original design loads. **TES** cannot take responsibility for verification of the adequacy on the connections, bolts and welds present in the structure.
6. The analyses will be performed based on the codes as specified by the client or based on the best knowledge of the engineering staff of **TES**. In the absence of information to the contrary, all work will be performed in accordance with the latest relevant revision of ANSI/TIA-222. If wind speed or/and ice loads are different from the minimum values recommended by the EIA/TIA-222 standard or other codes, **TES** should be notified in writing and the applicable minimum values provided by the client.
7. The configuration of the existing mounts, antennas, coax and other appurtenances were supplied by the customer for the current structural analysis. **TES** has not visited the tower site to verify the adequacy of the information provided. If there is any discrepancy found in the report regarding the existing conditions, **TES** should be notified immediately to evaluate the effect of the discrepancy on the analysis results.
8. The client will assume responsibility for rework associated with the differences in initially provided information, including tower and foundation information, existing and/or proposed equipment and transmission lines.
9. If a feasibility analysis was performed, final acceptance of changed conditions shall be based upon a rigorous structural analysis.

Usage Diagram - Max Stress 47.2% at 0.0ft

Structure: CT13615-A-SBA
Site Name: Madison 7, CT
Height: 130.00 (ft)
Base Elev: 0.000 (ft)

Code: EIA/TIA-222-F
Exposure: C
Gh: 1.69

12/11/2015



Page: 1

Dead Load Factor: 1.00
 Wind Load Factor: 1.00

Iterations: 20

Load Case : 85 mph Wind with 0 in Ice

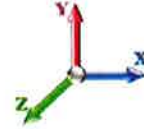

52 Allowable Stress
25 Resulting Stress

Copyright © 2015 by Tower Engineering Solutions, LLC. All rights reserved.

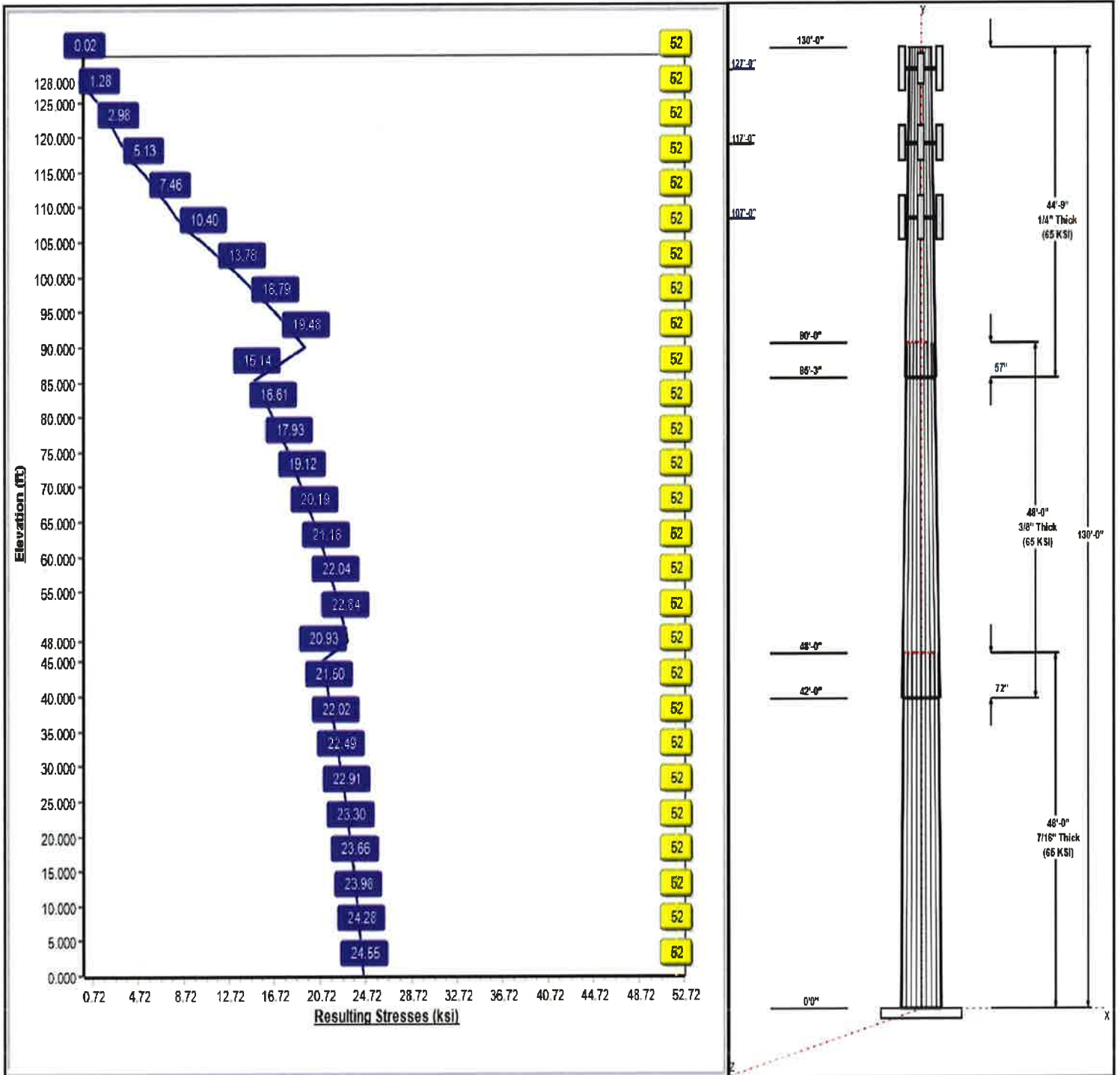

Structure: CT13615-A-SBA

Type: Tapered
Site Name: Madison 7, CT
Height: 130.00 (ft)
Base Elev: 0.00 (ft)

Base Shape: 18 Sided
Taper: 0.24800

12/11/2015



Page: 2

Shaft Properties

Seq	Length (ft)	Top (in)	Bottom (in)	Thick (in)	Joint Type	Taper	Grade (ksi)
1	48.00	46.10	58.00	0.438		0.24800	65
2	48.00	36.43	48.33	0.375	Slip	0.24800	65
3	44.75	27.01	38.11	0.250	Slip	0.24800	65

Discrete Appurtenances

Attach Elev (ft)	Force Elev (ft)	Qty	Description	Carrier
128.00	128.00	6	RRUS-11	AT&T
127.00	127.00	3	AM-X-CD-14-65-00T-RET	AT&T
127.00	127.00	1	DC6-48-60-18-8F Surge	AT&T
127.00	127.00	1	Low Profile Platform	AT&T
127.00	127.00	6	P90-15-XLH-RR	AT&T
127.00	127.00	6	TT19-08BP111-001	AT&T
117.00	117.00	1	12.5' Low Profile Platform	T-Mobile
117.00	117.00	3	Air 21 B2A B4P	T-Mobile
117.00	117.00	3	Air 21 B4A B2P	T-Mobile
117.00	117.00	3	KRY 112 144	T-Mobile
107.00	107.00	3	BXA-70063-6CF-2	Verizon
107.00	107.00	2	DB-T1-6Z-8AB-0Z	Verizon
107.00	107.00	1	Low Profile Platform	Verizon
107.00	107.00	3	RRH2x60-700	Verizon
107.00	107.00	3	RRH2X60-PCS	Verizon
107.00	107.00	3	RRH4x45AWS	Verizon
107.00	107.00	3	SBNHH-1D65B	Verizon
107.00	107.00	6	SBNHH-1D65B	Verizon

Linear Appurtenances

Elev From (ft)	Elev To (ft)	Placement	Description	Carrier
0.00	128.00	Inside	1 5/8"	AT&T
0.00	128.00	Inside	1/2" Fiber	AT&T
0.00	128.00	Inside	3" Flex Conduit	AT&T
0.00	128.00	Inside	3/4" DC	AT&T
0.00	117.00	Inside	1 5/8"	T-Mobile
0.00	117.00	Inside	1 5/8" Fiber	T-Mobile
0.00	107.00	Inside	1 5/8" Coax	Verizon
0.00	107.00	Inside	1 5/8" Fiber	Verizon

Anchor Bolts

Qty	Specifications	Grade (ksi)	Arrangement
26	1.5" F1554 105	105.0	Radial

Base Plate

Thickness (in)	Specifications (in)	Grade (ksi)	Geometry
1.7500	67.0	50.0	Round

Reactions

Load Case	Moment	Shear	Axial
85 mph Wind with 0" Ice	2280.2	24.3	35.9
73.61 mph Wind with 0.5" Ice	1866.0	19.5	42.2
50 mph Wind with 0" Ice	789.1	8.4	35.9

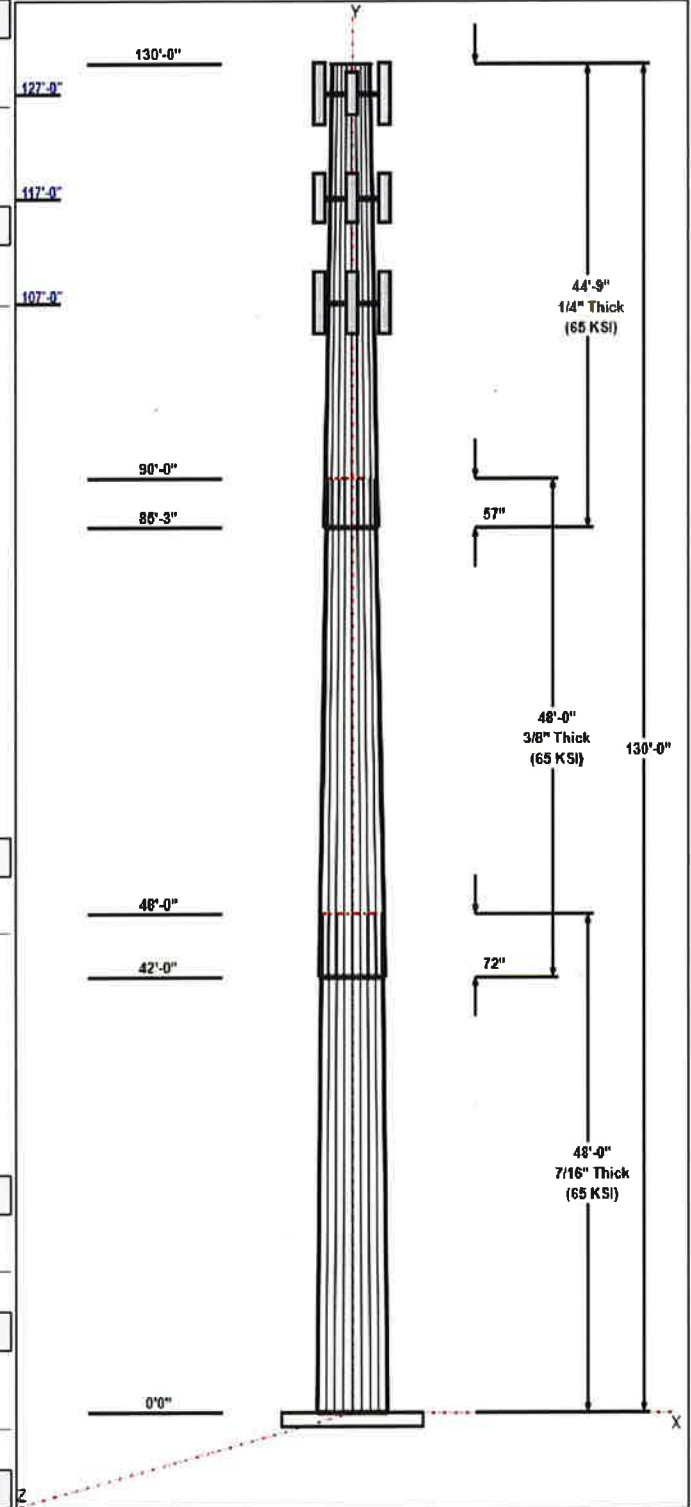

Structure: CT13615-A-SBA - Coax Line Placement

Type: Monopole
Site Name: Madison 7, CT
Height: 130.00 (ft)

12/11/2015



Page: 3

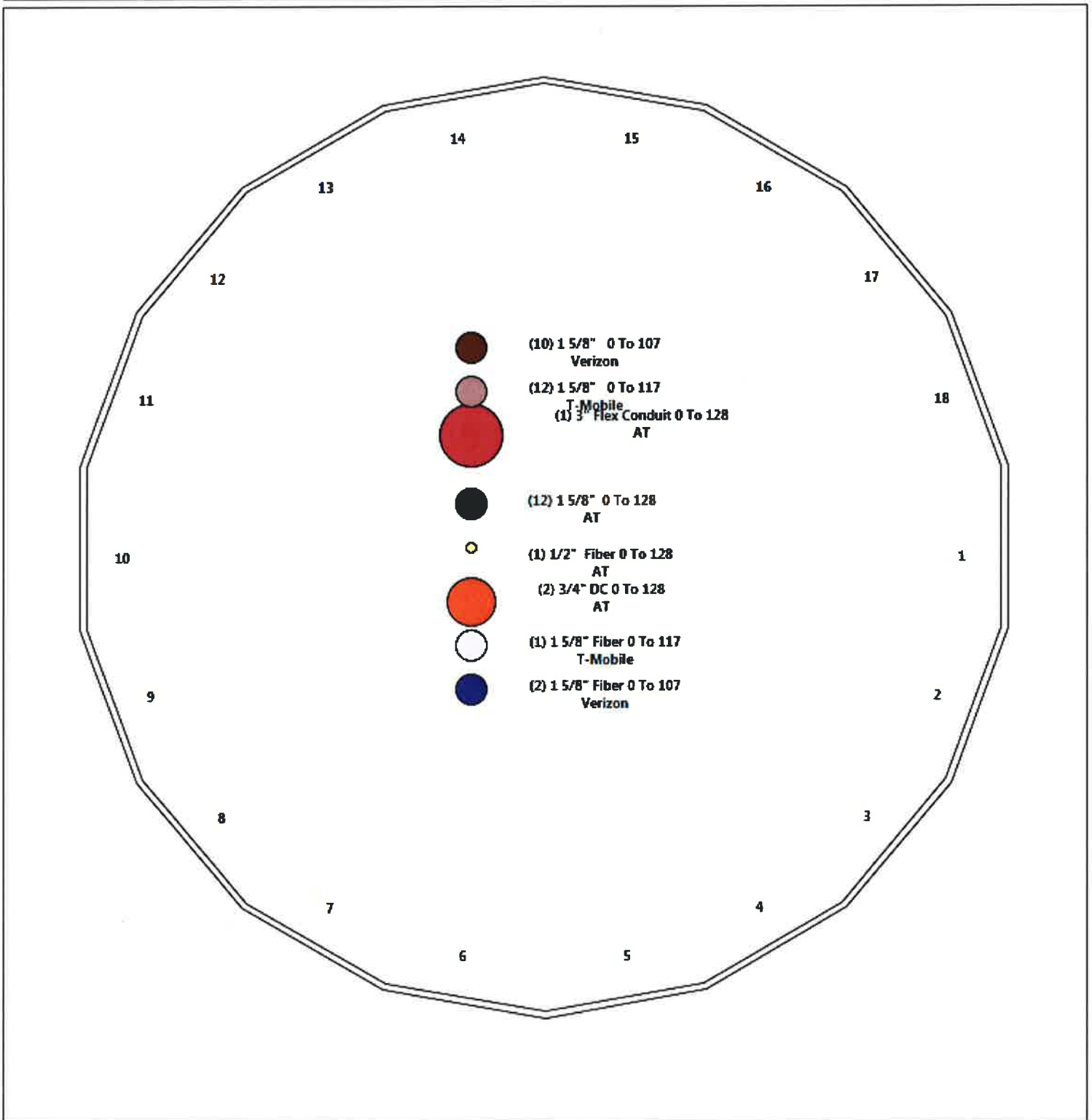

Shaft Properties

Structure: CT13615-A-SBA
Site Name: Madison 7, CT
Height: 130.00 (ft)
Base Elev: 0.000 (ft)

Code: EIA/TIA-222-F
Exposure: C
Gh: 1.69
Struct Class: II

12/11/2015

Page: 4



Sec. No.	Shape	Length (ft)	Thick (in)	Fy (ksi)	Joint Type	Overlap (in)	Weight (lb)
1	18	48.000	0.4375	65		0.00	11,705
2	18	48.000	0.3750	65	Slip	72.00	8,166
3	18	44.750	0.2500	65	Slip	57.00	3,904
Total Shaft Weight:							23,775

Bottom

Top

Sec. No.	Dia (in)	Elev (ft)	Area (sqin)	Ix (in^4)	W/t Ratio	D/t Ratio	Dia (in)	Elev (ft)	Area (sqin)	Ix (in^4)	W/t Ratio	D/t Ratio	Taper
1	58.00	0.00	79.93	33461.19	21.96	132.5	46.10	48.00	63.40	16698.8	17.16	105.3	0.248000
2	48.33	42.00	57.08	16587.69	21.31	128.8	36.43	90.00	42.91	7048.10	15.71	97.14	0.248000
3	38.11	85.25	30.04	5439.48	25.46	152.4	27.01	130.0	21.23	1921.07	17.63	108.0	0.248000

Loading Summary

Structure: CT13615-A-SBA
Site Name: Madison 7, CT
Height: 130.00 (ft)
Base Elev: 0.000 (ft)

Code: EIA/TIA-222-F
Exposure: C
Gh: 1.69
Struct Class: II

12/11/2015

Page: 5



Discrete Appurtenances

No.	Elev (ft)	Description	Qty	No Ice			Ice			Hor. Ecc. (ft)	Vert Ecc (ft)
				Weight (lb)	CaAa (sf)	CaAa Factor	Weight (lb)	CaAa (sf)	CaAa Factor		
1	128.0	RRUS-11	6	55.00	4.42	0.68	80.70	4.850	0.70	0.00	0.00
2	127.0	AM-X-CD-14-65-00T-RET	3	36.40	5.50	0.75	68.30	6.100	0.77	0.00	0.00
3	127.0	DC6-48-60-18-8F Surge Arrestor	1	32.80	1.47	1.00	50.50	1.670	1.00	0.00	0.00
4	127.0	Low Profile Platform	1	1600.00	25.55	1.00	2100.00	27.32	1.00	0.00	0.00
5	127.0	P90-15-XLH-RR	6	53.00	8.40	0.75	100.20	9.230	0.77	0.00	0.00
6	127.0	TT19-08BP111-001	6	16.00	0.64	0.90	21.80	0.820	0.92	0.00	0.00
7	117.0	12.5' Low Profile Platform	1	1600.00	25.55	1.00	2100.00	27.32	1.00	0.00	0.00
8	117.0	Air 21 B2A B4P	3	91.50	6.58	0.86	129.20	6.970	0.88	0.00	0.00
9	117.0	Air 21 B4A B2P	3	90.40	6.58	0.86	128.10	6.970	0.88	0.00	0.00
10	117.0	KRY 112 144	3	11.00	0.41	0.70	14.10	0.550	0.72	0.00	0.00
11	107.0	BXA-70063-6CF-2	3	17.00	7.73	0.73	59.50	8.540	0.75	0.00	0.00
12	107.0	DB-T1-6Z-8AB-OZ	2	18.90	5.60	0.71	46.00	5.870	0.73	0.00	0.00
13	107.0	Low Profile Platform	1	1200.00	25.00	1.00	1500.00	31.00	1.00	0.00	0.00
14	107.0	RRH2x60-700	3	60.00	3.96	0.76	80.10	4.230	0.78	0.00	0.00
15	107.0	RRH2X60-PCS	3	55.00	2.57	0.89	70.90	2.760	0.91	0.00	0.00
16	107.0	RRH4x45AWS	3	60.00	2.71	0.98	83.10	3.070	1.00	0.00	0.00
17	107.0	SBNHH-1D65B	3	40.60	8.33	0.83	87.00	8.800	0.85	0.00	0.00
18	107.0	SBNHH-1D65B	6	40.60	8.33	0.83	87.00	8.800	0.85	0.00	0.00
Totals:			57	6,843.90			9,741.60				

Linear Appurtenances

Bottom Elev. (ft)	Top Elev. (ft)	Description	No Ice		Ice		Exposed
			Weight (lb/ft)	CaAa (sf/ft)	Weight (lb/ft)	CaAa (sf/ft)	
0.00	128.0	(12) 1 5/8"	12.48	0.00	12.48	0.00	Inside
0.00	128.0	(1) 1/2" Fiber	0.16	0.00	0.16	0.00	Inside
0.00	128.0	(1) 3" Flex Conduit	2.50	0.00	2.50	0.00	Inside
0.00	128.0	(2) 3/4" DC	3.56	0.00	3.56	0.00	Inside
0.00	117.0	(12) 1 5/8"	12.48	0.00	12.48	0.00	Inside
0.00	117.0	(1) 1 5/8" Fiber	1.10	0.00	1.10	0.00	Inside
0.00	107.0	(10) 1 5/8" Coax	10.40	0.00	10.40	0.00	Inside
0.00	107.0	(2) 1 5/8" Fiber	2.20	0.00	2.20	0.00	Inside
Totals:			5,330.66		5,330.66		

Shaft Section Properties

Structure: CT13615-A-SBA
Site Name: Madison 7, CT
Height: 130.00 (ft)
Base Elev: 0.000 (ft)

Code: EIA/TIA-222-F
Exposure: C
Gh: 1.69
Struct Class: II

12/11/2015

Page: 6



Increment Length: 5 (ft)

Elev (ft)	Description	Thick (in)	Dia (in)	Area (in ²)	Ix (in ⁴)	W/t Ratio	D/t Ratio	Fy (ksi)	Fb (ksi)	Weight (lb)
0.00		0.4375	58.000	79.930	33461.2	21.97	132.57	65	52	0.0
5.00		0.4375	56.760	78.208	31345.0	21.47	129.74	65	52	1345.3
10.00		0.4375	55.520	76.486	29320.0	20.97	126.90	65	52	1316.0
15.00		0.4375	54.280	74.764	27384.1	20.47	124.07	65	52	1286.7
20.00		0.4375	53.040	73.043	25535.3	19.97	121.23	65	52	1257.4
25.00		0.4375	51.800	71.321	23771.7	19.47	118.40	65	52	1228.1
30.00		0.4375	50.560	69.599	22091.3	18.97	115.57	65	52	1198.8
35.00		0.4375	49.320	67.877	20491.9	18.47	112.73	65	52	1169.5
40.00		0.4375	48.080	66.155	18971.7	17.97	109.90	65	52	1140.2
42.00	Bot - Section 2	0.4375	47.584	65.466	18385.3	17.77	108.76	65	52	447.9
45.00		0.4375	46.840	64.433	17528.6	17.47	107.06	65	52	1241.2
48.00	Top - Section 1	0.3750	46.846	55.310	15091.1	20.62	124.92	65	52	1221.6
50.00		0.3750	46.350	54.720	14613.0	20.38	123.60	65	52	374.4
55.00		0.3750	45.110	53.244	13462.3	19.80	120.29	65	52	918.4
60.00		0.3750	43.870	51.768	12373.5	19.22	116.99	65	52	893.3
65.00		0.3750	42.630	50.292	11345.1	18.63	113.68	65	52	868.2
70.00		0.3750	41.390	48.816	10375.4	18.05	110.37	65	52	843.1
75.00		0.3750	40.150	47.340	9462.5	17.47	107.07	65	52	818.0
80.00		0.3750	38.910	45.865	8604.8	16.89	103.76	65	52	792.9
85.00		0.3750	37.670	44.389	7800.6	16.30	100.45	65	52	767.8
85.25	Bot - Section 3	0.3750	37.608	44.315	7761.8	16.27	100.29	65	52	37.7
90.00	Top - Section 2	0.2500	36.930	29.105	4947.3	24.64	147.72	65	52	1182.9
95.00		0.2500	35.690	28.121	4462.4	23.76	142.76	65	52	486.8
100.00		0.2500	34.450	27.137	4010.2	22.89	137.80	65	52	470.1
105.00		0.2500	33.210	26.153	3589.6	22.01	132.84	65	52	453.3
107.00		0.2500	32.714	25.759	3430.0	21.66	130.86	65	52	176.6
110.00		0.2500	31.970	25.169	3199.5	21.14	127.88	65	52	259.9
115.00		0.2500	30.730	24.185	2838.8	20.26	122.92	65	52	419.9
117.00		0.2500	30.234	23.791	2702.4	19.91	120.94	65	52	163.3
120.00		0.2500	29.490	23.201	2506.2	19.39	117.96	65	52	239.9
125.00		0.2500	28.250	22.217	2200.7	18.51	113.00	65	52	386.4
127.00		0.2500	27.754	21.824	2085.8	18.16	111.02	65	52	149.9
128.00		0.2500	27.506	21.627	2029.9	17.99	110.02	65	52	73.9
130.00		0.2500	27.010	21.233	1921.1	17.64	108.04	65	52	145.8
										23775.2

Wind Loading - Shaft

Structure: CT13615-A-SBA
Site Name: Madison 7, CT
Height: 130.00 (ft)
Base Elev: 0.000 (ft)

Code: EIA/TIA-222-F
Exposure: C
Gh: 1.69
Struct Class: II

12/11/2015



Page: 7

Load Case: 85 mph Wind with 0" Ice

Dead Load Factor 1.00
Wind Load Factor 1.00

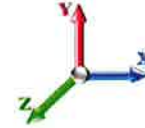

Iterations: 20

Elev (ft)	Description	Kzt	Kz	qz (psf)	qzGh (psf)	C (mph-ft)	Cf	Ice Thick (in)	Tributary (ft)	Aa (sf)	CfAa (sf)	Wind Force X (lb)	Dead Load Ice (lb)	Tot Dead Load (lb)
0.00		0.00	1.00	18.496	31.26	410.83	0.650	0.000	0.00	0.000	0.00	0.0	0.0	0.0
5.00		0.00	1.00	18.496	31.26	402.05	0.650	0.000	5.00	23.908	15.54	485.8	0.0	1345.3
10.00		0.00	1.00	18.496	31.26	393.27	0.650	0.000	5.00	23.392	15.20	475.3	0.0	1316.0
15.00		0.00	1.00	18.496	31.26	384.48	0.650	0.000	5.00	22.875	14.87	464.8	0.0	1286.7
20.00		0.00	1.00	18.496	31.26	375.70	0.650	0.000	5.00	22.358	14.53	454.3	0.0	1257.4
25.00		0.00	1.00	18.496	31.26	366.92	0.650	0.000	5.00	21.842	14.20	443.8	0.0	1228.1
30.00		0.00	1.00	18.496	31.26	358.13	0.650	0.000	5.00	21.325	13.86	433.3	0.0	1198.8
35.00		0.00	1.02	18.810	31.79	352.30	0.650	0.000	5.00	20.808	13.53	429.9	0.0	1169.5
40.00		0.00	1.06	19.541	33.02	350.06	0.650	0.000	5.00	20.292	13.19	435.6	0.0	1140.2
42.00	Bot - Section 2	0.00	1.07	19.815	33.49	348.87	0.650	0.000	2.00	7.972	5.18	173.5	0.0	447.9
45.00		0.00	1.09	20.210	34.15	346.81	0.650	0.000	3.00	11.991	7.79	266.2	0.0	1241.2
48.00	Top - Section 1	0.00	1.11	20.586	34.79	344.47	0.650	0.000	3.00	11.805	7.67	266.9	0.0	1221.6
50.00		0.00	1.13	20.827	35.20	348.39	0.650	0.000	2.00	7.766	5.05	177.7	0.0	374.4
55.00		0.00	1.16	21.402	36.17	343.72	0.650	0.000	5.00	19.054	12.39	448.0	0.0	918.4
60.00		0.00	1.19	21.941	37.08	338.45	0.650	0.000	5.00	18.538	12.05	446.8	0.0	893.3
65.00		0.00	1.21	22.449	37.94	332.67	0.650	0.000	5.00	18.021	11.71	444.4	0.0	868.2
70.00		0.00	1.24	22.929	38.75	326.43	0.650	0.000	5.00	17.504	11.38	440.9	0.0	843.1
75.00		0.00	1.26	23.386	39.52	319.79	0.650	0.000	5.00	16.988	11.04	436.4	0.0	818.0
80.00		0.00	1.29	23.821	40.26	312.78	0.650	0.000	5.00	16.471	10.71	431.0	0.0	792.9
85.00		0.00	1.31	24.237	40.96	305.45	0.650	0.000	5.00	15.954	10.37	424.8	0.0	767.8
85.25	Bot - Section 3	0.00	1.31	24.257	40.99	305.07	0.650	0.000	0.25	0.784	0.51	20.9	0.0	37.7
90.00	Top - Section 2	0.00	1.33	24.636	41.63	297.81	0.650	0.000	4.75	14.851	9.65	401.9	0.0	1182.9
95.00		0.00	1.35	25.020	42.28	294.03	0.650	0.000	5.00	15.129	9.83	415.8	0.0	486.8
100.00		0.00	1.37	25.389	42.91	285.90	0.650	0.000	5.00	14.613	9.50	407.5	0.0	470.1
105.00		0.00	1.39	25.745	43.51	277.53	0.650	0.000	5.00	14.096	9.16	398.6	0.0	453.3
107.00	Appurtenance(s)	0.00	1.40	25.885	43.74	274.13	0.650	0.000	2.00	5.494	3.57	156.2	0.0	176.6
110.00		0.00	1.41	26.090	44.09	268.95	0.650	0.000	3.00	8.085	5.26	231.7	0.0	259.9
115.00		0.00	1.43	26.423	44.66	260.17	0.650	0.000	5.00	13.063	8.49	379.2	0.0	419.9
117.00	Appurtenance(s)	0.00	1.44	26.554	44.88	256.60	0.650	0.000	2.00	5.080	3.30	148.2	0.0	163.3
120.00		0.00	1.45	26.747	45.20	251.19	0.650	0.000	3.00	7.465	4.85	219.3	0.0	239.9
125.00		0.00	1.46	27.060	45.73	242.04	0.650	0.000	5.00	12.029	7.82	357.6	0.0	386.4
127.00	Appurtenance(s)	0.00	1.47	27.183	45.94	238.33	0.650	0.000	2.00	4.667	3.03	139.4	0.0	149.9
128.00	Appurtenance(s)	0.00	1.47	27.244	46.04	236.46	0.650	0.000	1.00	2.302	1.50	68.9	0.0	73.9
130.00		0.00	1.48	27.365	46.25	232.71	0.650	0.000	2.00	4.543	2.95	136.6	0.0	145.8
								Totals:	130.00			11,061.1		23,775.2

Discrete Appurtenance Forces

Structure: CT13615-A-SB
Site Name: Madison 7, CT
Height: 130.00 (ft)
Base Elev: 0.000 (ft)

Code: EIA/TIA-222-F
Exposure: C
Gh: 1.69
Struct Class: II

12/11/2015

Page: 8



Load Case: 85 mph Wind with 0" Ice

Dead Load Factor 1.00
Wind Load Factor 1.00



Iterations: 20

No.	Elev (ft)	Description	Qty	qz (psf)	qzGh (psf)	CaAa Factor	Total CaAa (sf)	Dead Load (lb)	Horiz Ecc (ft)	Vert Ecc (ft)	Wind FX (lb)	Mom Y (lb-ft)	Mom Z (lb-ft)
1	128.00	RRUS-11	6	27.244	46.043	0.68	18.03	330.00	0.000	0.000	830.32	0.00	0.00
2	127.00	TT19-08BP111-001	6	27.183	45.940	0.90	3.46	96.00	0.000	0.000	158.77	0.00	0.00
3	127.00	P90-15-XLH-RR	6	27.183	45.940	0.75	37.80	318.00	0.000	0.000	1736.53	0.00	0.00
4	127.00	Low Profile Platform	1	27.183	45.940	1.00	25.55	1600.00	0.000	0.000	1173.76	0.00	0.00
5	127.00	DC6-48-60-18-8F Surge	1	27.183	45.940	1.00	1.47	32.80	0.000	0.000	67.53	0.00	0.00
6	127.00	AM-X-CD-14-65-00T-RET	3	27.183	45.940	0.75	12.38	109.20	0.000	0.000	568.51	0.00	0.00
7	117.00	Air 21 B2A B4P	3	26.554	44.876	0.86	16.98	274.50	0.000	0.000	761.83	0.00	0.00
8	117.00	KRY 112 144	3	26.554	44.876	0.70	0.86	33.00	0.000	0.000	38.64	0.00	0.00
9	117.00	Air 21 B4A B2P	3	26.554	44.876	0.86	16.98	271.20	0.000	0.000	761.83	0.00	0.00
10	117.00	12.5' Low Profile Platform	1	26.554	44.876	1.00	25.55	1600.00	0.000	0.000	1146.58	0.00	0.00
11	107.00	SBNHH-1D65B	6	25.885	43.745	0.83	41.48	243.60	0.000	0.000	1814.69	0.00	0.00
12	107.00	SBNHH-1D65B	3	25.885	43.745	0.83	20.74	121.80	0.000	0.000	907.34	0.00	0.00
13	107.00	RRH4x45AWS	3	25.885	43.745	0.98	7.97	180.00	0.000	0.000	348.53	0.00	0.00
14	107.00	RRH2X60-PCS	3	25.885	43.745	0.89	6.86	165.00	0.000	0.000	300.17	0.00	0.00
15	107.00	RRH2x60-700	3	25.885	43.745	0.76	9.03	180.00	0.000	0.000	394.96	0.00	0.00
16	107.00	Low Profile Platform	1	25.885	43.745	1.00	25.00	1200.00	0.000	0.000	1093.62	0.00	0.00
17	107.00	DB-T1-6Z-8AB-0Z	2	25.885	43.745	0.71	7.95	37.80	0.000	0.000	347.86	0.00	0.00
18	107.00	BXA-70063-6CF-2	3	25.885	43.745	0.73	16.93	51.00	0.000	0.000	740.54	0.00	0.00
Totals:								6,843.90			13,192.03		

Total Applied Force Summary

Structure: CT13615-A-SB
Site Name: Madison 7, CT
Height: 130.00 (ft)
Base Elev: 0.000 (ft)

Code: EIA/TIA-222-F
Exposure: C
Gh: 1.69
Struct Class: II

12/11/2015



Page: 9

Load Case: 85 mph Wind with 0" Ice

Dead Load Factor 1.00
Wind Load Factor 1.00

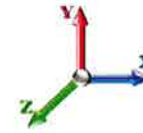

Iterations: 20

Elev (ft)	Description	Lateral FX (-) (lb)	Axial FY (-) (lb)	Torsion MY (lb-ft)	Moment MZ (lb-ft)
0.00		0.00	0.00	0.00	0.00
5.00		485.77	1569.67	0.00	0.00
10.00		475.27	1540.37	0.00	0.00
15.00		464.77	1511.08	0.00	0.00
20.00		454.27	1481.78	0.00	0.00
25.00		443.78	1452.49	0.00	0.00
30.00		433.28	1423.19	0.00	0.00
35.00		429.95	1393.90	0.00	0.00
40.00		435.58	1364.60	0.00	0.00
42.00		173.53	537.64	0.00	0.00
45.00		266.20	1375.85	0.00	0.00
48.00		266.94	1356.27	0.00	0.00
50.00		177.69	464.17	0.00	0.00
55.00		447.97	1142.84	0.00	0.00
60.00		446.80	1117.73	0.00	0.00
65.00		444.39	1092.62	0.00	0.00
70.00		440.89	1067.51	0.00	0.00
75.00		436.39	1042.40	0.00	0.00
80.00		431.00	1017.29	0.00	0.00
85.00		424.77	992.18	0.00	0.00
85.25		20.89	48.95	0.00	0.00
90.00		401.92	1396.10	0.00	0.00
95.00		415.81	711.21	0.00	0.00
100.00		407.54	694.47	0.00	0.00
105.00		398.65	677.73	0.00	0.00
107.00	(24) appurtenances	6103.93	2445.61	0.00	0.00
110.00		231.73	356.79	0.00	0.00
115.00		379.15	581.25	0.00	0.00
117.00	(10) appurtenances	2857.07	2406.51	0.00	0.00
120.00		219.34	295.96	0.00	0.00
125.00		357.58	479.87	0.00	0.00
127.00	(17) appurtenances	3844.46	2343.26	0.00	0.00
128.00	(6) appurtenances	899.23	422.63	0.00	0.00
130.00		136.57	145.84	0.00	0.00
	Totals:	24,253.10	35,949.78	0.00	0.00

Resulting Forces and Deflections

Structure: CT13615-A-SB
Site Name: Madison 7, CT
Height: 130.00 (ft)
Base Elev: 0.000 (ft)

Code: EIA/TIA-222-F
Exposure: C
Gh: 1.69
Struct Class: II

12/11/2015

Page: 10



Load Case: 85 mph Wind with 0" Ice

Dead Load Factor 1.00
Wind Load Factor 1.00



Iterations: 20

Elev (ft)	Lateral FX (-) (kips)	Axial FY (-) (kips)	Lateral FZ (kips)	Moment MX (ft-kips)	Torsion MY (ft-kips)	Moment MZ (ft-kips)	Deflect X (in)	Deflect Z (in)	Deflect Resultant (in)	Rotation Sway (deg)	Rotation Twist (deg)
0.00	-24.283	-35.929	0.000	0.000	0.000	-2280.1	0.000	0.000	0.000	0.000	0.000
5.00	-23.853	-34.320	0.000	0.000	0.000	-2158.7	-0.051	0.000	0.051	-0.094	0.000
10.00	-23.429	-32.742	0.000	0.000	0.000	-2039.4	-0.202	0.000	0.202	-0.190	0.000
15.00	-23.010	-31.194	0.000	0.000	0.000	-1922.3	-0.452	0.000	0.452	-0.286	0.000
20.00	-22.598	-29.677	0.000	0.000	0.000	-1807.2	-0.804	0.000	0.804	-0.383	0.000
25.00	-22.191	-28.190	0.000	0.000	0.000	-1694.3	-1.257	0.000	1.257	-0.480	0.000
30.00	-21.790	-26.733	0.000	0.000	0.000	-1583.3	-1.813	0.000	1.813	-0.578	0.000
35.00	-21.389	-25.308	0.000	0.000	0.000	-1474.3	-2.472	0.000	2.472	-0.677	0.000
40.00	-20.965	-23.923	0.000	0.000	0.000	-1367.4	-3.235	0.000	3.235	-0.775	0.000
42.00	-20.804	-23.370	0.000	0.000	0.000	-1325.5	-3.568	0.000	3.568	-0.816	0.000
45.00	-20.541	-21.977	0.000	0.000	0.000	-1263.1	-4.101	0.000	4.101	-0.876	0.000
48.00	-20.271	-20.607	0.000	0.000	0.000	-1201.4	-4.671	0.000	4.671	-0.936	0.000
50.00	-20.111	-20.120	0.000	0.000	0.000	-1160.9	-5.072	0.000	5.072	-0.976	0.000
55.00	-19.679	-18.948	0.000	0.000	0.000	-1060.3	-6.153	0.000	6.153	-1.084	0.000
60.00	-19.243	-17.804	0.000	0.000	0.000	-962.00	-7.346	0.000	7.346	-1.191	0.000
65.00	-18.805	-16.687	0.000	0.000	0.000	-865.79	-8.651	0.000	8.651	-1.296	0.000
70.00	-18.367	-15.598	0.000	0.000	0.000	-771.76	-10.064	0.000	10.064	-1.399	0.000
75.00	-17.929	-14.536	0.000	0.000	0.000	-679.93	-11.583	0.000	11.583	-1.498	0.000
80.00	-17.492	-13.503	0.000	0.000	0.000	-590.29	-13.205	0.000	13.205	-1.594	0.000
85.00	-17.049	-12.509	0.000	0.000	0.000	-502.83	-14.924	0.000	14.924	-1.684	0.000
85.25	-17.037	-12.448	0.000	0.000	0.000	-498.57	-15.012	0.000	15.012	-1.689	0.000
90.00	-16.608	-11.042	0.000	0.000	0.000	-417.64	-16.734	0.000	16.734	-1.768	0.000
95.00	-16.185	-10.320	0.000	0.000	0.000	-334.61	-18.628	0.000	18.628	-1.844	0.000
100.00	-15.769	-9.616	0.000	0.000	0.000	-253.68	-20.613	0.000	20.613	-1.938	0.000
105.00	-15.355	-8.940	0.000	0.000	0.000	-174.84	-22.687	0.000	22.687	-2.014	0.000
107.00	-9.172	-6.707	0.000	0.000	0.000	-144.13	-23.537	0.000	23.537	-2.039	0.000
110.00	-8.932	-6.353	0.000	0.000	0.000	-116.61	-24.829	0.000	24.829	-2.072	0.000
115.00	-8.534	-5.782	0.000	0.000	0.000	-71.959	-27.023	0.000	27.023	-2.114	0.000
117.00	-5.591	-3.482	0.000	0.000	0.000	-54.891	-27.912	0.000	27.912	-2.126	0.000
120.00	-5.361	-3.193	0.000	0.000	0.000	-38.119	-29.253	0.000	29.253	-2.141	0.000
125.00	-4.986	-2.726	0.000	0.000	0.000	-11.313	-31.504	0.000	31.504	-2.155	0.000
127.00	-1.056	-0.529	0.000	0.000	0.000	-1.340	-32.408	0.000	32.408	-2.157	0.000
128.00	-0.142	-0.141	0.000	0.000	0.000	-0.284	-32.859	0.000	32.859	-2.157	0.000
130.00	-0.137	0.000	0.000	0.000	0.000	0.000	0.000	0.000	33.763	-2.157	0.000

Resulting Stresses

Structure: CT13615-A-SBA
Site Name: Madison 7, CT
Height: 130.00 (ft)
Base Elev: 0.000 (ft)

Code: EIA/TIA-222-F
Exposure: C
Gh: 1.69
Struct Class: II

12/11/2015

Page: 11



Load Case: 85 mph Wind with 0" Ice

Dead Load Factor 1.00
Wind Load Factor 1.00

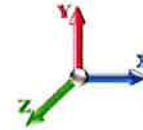

Iterations: 20

Applied Stresses

Elev (ft)	fa Axial (Y) (ksi)	fvx Shear (X) (ksi)	fvz Shear (Z) (ksi)	fvT Torsion (ksi)	fbx Bending (X) (ksi)	fbz Bending (Z) (ksi)	fb Combined (ksi)	Allow Stress (ksi)	f/Fb Stress Ratio
0.00	0.45	0.61	0.00	0.00	0.00	24.08	24.55	52.0	0.472
5.00	0.44	0.61	0.00	0.00	0.00	23.82	24.28	52.0	0.467
10.00	0.43	0.62	0.00	0.00	0.00	23.53	23.98	52.0	0.461
15.00	0.42	0.62	0.00	0.00	0.00	23.22	23.66	52.0	0.455
20.00	0.41	0.62	0.00	0.00	0.00	22.87	23.30	52.0	0.448
25.00	0.40	0.63	0.00	0.00	0.00	22.49	22.91	52.0	0.441
30.00	0.38	0.63	0.00	0.00	0.00	22.08	22.49	52.0	0.433
35.00	0.37	0.64	0.00	0.00	0.00	21.62	22.02	52.0	0.424
40.00	0.36	0.64	0.00	0.00	0.00	21.11	21.50	52.0	0.414
42.00	0.36	0.64	0.00	0.00	0.00	20.90	21.29	52.0	0.410
45.00	0.34	0.64	0.00	0.00	0.00	20.56	20.93	52.0	0.403
48.00	0.37	0.74	0.00	0.00	0.00	22.72	23.13	52.0	0.445
50.00	0.37	0.74	0.00	0.00	0.00	22.43	22.84	52.0	0.439
55.00	0.36	0.74	0.00	0.00	0.00	21.65	22.04	52.0	0.424
60.00	0.34	0.75	0.00	0.00	0.00	20.78	21.16	52.0	0.407
65.00	0.33	0.75	0.00	0.00	0.00	19.82	20.19	52.0	0.389
70.00	0.32	0.76	0.00	0.00	0.00	18.76	19.12	52.0	0.368
75.00	0.31	0.76	0.00	0.00	0.00	17.58	17.93	52.0	0.345
80.00	0.29	0.77	0.00	0.00	0.00	16.26	16.61	52.0	0.320
85.00	0.28	0.77	0.00	0.00	0.00	14.79	15.14	52.0	0.291
85.25	0.28	0.77	0.00	0.00	0.00	14.72	15.06	52.0	0.290
90.00	0.38	1.15	0.00	0.00	0.00	18.99	19.48	52.0	0.375
95.00	0.37	1.16	0.00	0.00	0.00	16.31	16.79	52.0	0.323
100.00	0.35	1.17	0.00	0.00	0.00	13.28	13.78	52.0	0.265
105.00	0.34	1.18	0.00	0.00	0.00	9.86	10.40	52.0	0.200
107.00	0.26	0.72	0.00	0.00	0.00	8.38	8.72	52.0	0.168
110.00	0.25	0.72	0.00	0.00	0.00	7.10	7.46	52.0	0.143
115.00	0.24	0.71	0.00	0.00	0.00	4.75	5.13	52.0	0.099
117.00	0.15	0.47	0.00	0.00	0.00	3.74	3.97	52.0	0.076
120.00	0.14	0.47	0.00	0.00	0.00	2.73	2.98	52.0	0.057
125.00	0.12	0.45	0.00	0.00	0.00	0.88	1.28	52.0	0.025
127.00	0.02	0.10	0.00	0.00	0.00	0.11	0.21	52.0	0.004
128.00	0.01	0.01	0.00	0.00	0.00	0.02	0.04	52.0	0.001
130.00	0.00	0.01	0.00	0.00	0.00	0.00	0.02	52.0	0.000

Wind Loading - Shaft

Structure: CT13615-A-SBA
Site Name: Madison 7, CT
Height: 130.00 (ft)
Base Elev: 0.000 (ft)

Code: EIA/TIA-222-F
Exposure: C
Gh: 1.69
Struct Class: II

12/11/2015

Page: 12



Load Case: 73.61 mph Wind with 0.5" Ice

Iterations: 20

Dead Load Factor 1.00
Wind Load Factor 1.00

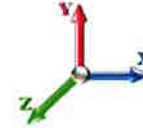

Elev (ft)	Description	Kzt	Kz	qz (psf)	qzGh (psf)	C (mph-ft)	Cf	Ice Thick (in)	Tributary (ft)	Aa (sf)	CfAa (sf)	Wind Force X (lb)	Dead Load Ice (lb)	Tot Dead Load (lb)
0.00		0.00	1.00	13.871	23.44	355.78	0.650	0.500	0.00	0.000	0.00	0.0	0.0	0.0
5.00		0.00	1.00	13.871	23.44	348.18	0.650	0.500	5.00	24.325	15.81	370.7	176.7	1522.0
10.00		0.00	1.00	13.871	23.44	340.57	0.650	0.500	5.00	23.808	15.48	362.8	172.9	1488.8
15.00		0.00	1.00	13.871	23.44	332.96	0.650	0.500	5.00	23.292	15.14	354.9	169.0	1455.7
20.00		0.00	1.00	13.871	23.44	325.36	0.650	0.500	5.00	22.775	14.80	347.0	165.2	1422.6
25.00		0.00	1.00	13.871	23.44	317.75	0.650	0.500	5.00	22.258	14.47	339.2	161.4	1389.5
30.00		0.00	1.00	13.871	23.44	310.14	0.650	0.500	5.00	21.742	14.13	331.3	157.6	1356.4
35.00		0.00	1.02	14.106	23.84	305.09	0.650	0.500	5.00	21.225	13.80	328.9	153.7	1323.2
40.00		0.00	1.06	14.655	24.77	303.15	0.650	0.500	5.00	20.708	13.46	333.4	149.9	1290.1
42.00	Bot - Section 2	0.00	1.07	14.861	25.11	302.12	0.650	0.500	2.00	8.139	5.29	132.9	59.3	507.2
45.00		0.00	1.09	15.156	25.61	300.34	0.650	0.500	3.00	12.241	7.96	203.8	89.0	1330.2
48.00	Top - Section 1	0.00	1.11	15.439	26.09	298.31	0.650	0.500	3.00	12.055	7.84	204.4	87.7	1309.3
50.00		0.00	1.13	15.620	26.40	301.71	0.650	0.500	2.00	7.933	5.16	136.1	57.8	432.2
55.00		0.00	1.16	16.051	27.13	297.66	0.650	0.500	5.00	19.471	12.66	343.3	140.7	1059.2
60.00		0.00	1.19	16.455	27.81	293.10	0.650	0.500	5.00	18.954	12.32	342.6	136.9	1030.2
65.00		0.00	1.21	16.836	28.45	288.09	0.650	0.500	5.00	18.438	11.98	341.0	133.1	1001.3
70.00		0.00	1.24	17.196	29.06	282.69	0.650	0.500	5.00	17.921	11.65	338.5	129.3	972.4
75.00		0.00	1.26	17.538	29.64	276.93	0.650	0.500	5.00	17.404	11.31	335.3	125.4	943.4
80.00		0.00	1.29	17.865	30.19	270.87	0.650	0.500	5.00	16.887	10.98	331.4	121.6	914.5
85.00		0.00	1.31	18.177	30.72	264.52	0.650	0.500	5.00	16.371	10.64	326.9	117.8	885.6
85.25	Bot - Section 3	0.00	1.31	18.192	30.74	264.19	0.650	0.500	0.25	0.805	0.52	16.1	5.9	43.6
90.00	Top - Section 2	0.00	1.33	18.476	31.22	257.91	0.650	0.500	4.75	15.247	9.91	309.5	109.7	1292.6
95.00		0.00	1.35	18.764	31.71	254.63	0.650	0.500	5.00	15.546	10.10	320.4	111.7	598.5
100.00		0.00	1.37	19.041	32.18	247.59	0.650	0.500	5.00	15.029	9.77	314.4	107.8	577.9
105.00		0.00	1.39	19.308	32.63	240.35	0.650	0.500	5.00	14.512	9.43	307.8	104.0	557.4
107.00	Appurtenance(s)	0.00	1.40	19.412	32.81	237.39	0.650	0.500	2.00	5.660	3.68	120.7	41.0	217.6
110.00		0.00	1.41	19.566	33.07	232.91	0.650	0.500	3.00	8.335	5.42	179.2	60.1	320.1
115.00		0.00	1.43	19.816	33.49	225.31	0.650	0.500	5.00	13.479	8.76	293.4	96.4	516.2
117.00	Appurtenance(s)	0.00	1.44	19.914	33.65	222.22	0.650	0.500	2.00	5.247	3.41	114.8	37.9	201.2
120.00		0.00	1.45	20.059	33.90	217.53	0.650	0.500	3.00	7.715	5.02	170.0	55.5	295.4
125.00		0.00	1.46	20.294	34.30	209.61	0.650	0.500	5.00	12.446	8.09	277.5	88.7	475.1
127.00	Appurtenance(s)	0.00	1.47	20.386	34.45	206.39	0.650	0.500	2.00	4.834	3.14	108.2	34.9	184.7
128.00	Appurtenance(s)	0.00	1.47	20.432	34.53	204.78	0.650	0.500	1.00	2.386	1.55	53.5	17.3	91.2
130.00		0.00	1.48	20.523	34.68	201.53	0.650	0.500	2.00	4.710	3.06	106.2	34.0	179.8
Totals:									130.00			8,495.9		27,185.2

Discrete Appurtenance Forces

Structure: CT13615-A-SB
Site Name: Madison 7, CT
Height: 130.00 (ft)
Base Elev: 0.000 (ft)

Code: EIA/TIA-222-F
Exposure: C
Gh: 1.69
Struct Class: II

12/11/2015

Page: 13



Load Case: 73.61 mph Wind with 0.5" Ice

Dead Load Factor 1.00
Wind Load Factor 1.00

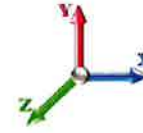

Iterations: 20

No.	Elev (ft)	Description	Qty	qz (psf)	qzGh (psf)	CaAa Factor	Total CaAa (sf)	Dead Load (lb)	Horiz Ecc (ft)	Vert Ecc (ft)	Wind FX (lb)	Mom Y (lb-ft)	Mom Z (lb-ft)
1	128.00	RRUS-11	6	20.432	34.530	0.70	20.37	484.20	0.000	0.000	703.38	0.00	0.00
2	127.00	TT19-08BP111-001	6	20.386	34.453	0.92	4.53	130.80	0.000	0.000	155.95	0.00	0.00
3	127.00	P90-15-XLH-RR	6	20.386	34.453	0.77	42.64	601.20	0.000	0.000	1469.16	0.00	0.00
4	127.00	Low Profile Platform	1	20.386	34.453	1.00	27.32	2100.00	0.000	0.000	941.25	0.00	0.00
5	127.00	DC6-48-60-18-8F Surge	1	20.386	34.453	1.00	1.67	50.50	0.000	0.000	57.54	0.00	0.00
6	127.00	AM-X-CD-14-65-00T-RET	3	20.386	34.453	0.77	14.09	204.90	0.000	0.000	485.48	0.00	0.00
7	117.00	Air 21 B2A B4P	3	19.914	33.655	0.88	18.40	387.60	0.000	0.000	619.28	0.00	0.00
8	117.00	KRY 112 144	3	19.914	33.655	0.72	1.19	42.30	0.000	0.000	39.98	0.00	0.00
9	117.00	Air 21 B4A B2P	3	19.914	33.655	0.88	18.40	384.30	0.000	0.000	619.28	0.00	0.00
10	117.00	12.5' Low Profile Platform	1	19.914	33.655	1.00	27.32	2100.00	0.000	0.000	919.45	0.00	0.00
11	107.00	SBNHH-1D65B	6	19.412	32.807	0.85	44.88	522.00	0.000	0.000	1472.37	0.00	0.00
12	107.00	SBNHH-1D65B	3	19.412	32.807	0.85	22.44	261.00	0.000	0.000	736.18	0.00	0.00
13	107.00	RRH4x45AWS	3	19.412	32.807	1.00	9.21	249.30	0.000	0.000	302.15	0.00	0.00
14	107.00	RRH2X60-PCS	3	19.412	32.807	0.91	7.53	212.70	0.000	0.000	247.19	0.00	0.00
15	107.00	RRH2x60-700	3	19.412	32.807	0.78	9.90	240.30	0.000	0.000	324.73	0.00	0.00
16	107.00	Low Profile Platform	1	19.412	32.807	1.00	31.00	1500.00	0.000	0.000	1017.01	0.00	0.00
17	107.00	DB-T1-6Z-8AB-0Z	2	19.412	32.807	0.73	8.57	92.00	0.000	0.000	281.16	0.00	0.00
18	107.00	BXA-70063-6CF-2	3	19.412	32.807	0.75	19.21	178.50	0.000	0.000	630.38	0.00	0.00
Totals:								9,741.60			11,021.92		

Total Applied Force Summary

Structure: CT13615-A-SB
Site Name: Madison 7, CT
Height: 130.00 (ft)
Base Elev: 0.000 (ft)

Code: EIA/TIA-222-F
Exposure: C
Gh: 1.69
Struct Class: II

12/11/2015

Page: 14



Load Case: 73.61 mph Wind with 0.5" Ice

Dead Load Factor 1.00

Wind Load Factor 1.00

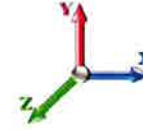

Iterations: 20

Elev (ft)	Description	Lateral FX (-) (lb)	Axial FY (-) (lb)	Torsion MY (lb-ft)	Moment MZ (lb-ft)
0.00		0.00	0.00	0.00	0.00
5.00		370.65	1746.36	0.00	0.00
10.00		362.78	1713.24	0.00	0.00
15.00		354.91	1680.12	0.00	0.00
20.00		347.03	1646.99	0.00	0.00
25.00		339.16	1613.87	0.00	0.00
30.00		331.29	1580.75	0.00	0.00
35.00		328.90	1547.63	0.00	0.00
40.00		333.37	1514.51	0.00	0.00
42.00		132.86	596.99	0.00	0.00
45.00		203.80	1464.89	0.00	0.00
48.00		204.44	1443.93	0.00	0.00
50.00		136.12	521.99	0.00	0.00
55.00		343.31	1283.58	0.00	0.00
60.00		342.61	1254.64	0.00	0.00
65.00		340.98	1225.71	0.00	0.00
70.00		338.52	1196.77	0.00	0.00
75.00		335.30	1167.84	0.00	0.00
80.00		331.40	1138.90	0.00	0.00
85.00		326.88	1109.96	0.00	0.00
85.25		16.09	54.83	0.00	0.00
90.00		309.45	1505.82	0.00	0.00
95.00		320.43	822.88	0.00	0.00
100.00		314.35	802.32	0.00	0.00
105.00		307.81	781.75	0.00	0.00
107.00	(24) appurtenances	5131.87	3563.20	0.00	0.00
110.00		179.16	416.90	0.00	0.00
115.00		293.42	677.62	0.00	0.00
117.00	(10) appurtenances	2312.78	3179.95	0.00	0.00
120.00		170.01	351.48	0.00	0.00
125.00		277.46	568.59	0.00	0.00
127.00	(17) appurtenances	3217.62	3309.53	0.00	0.00
128.00	(6) appurtenances	756.93	594.11	0.00	0.00
130.00		106.18	179.80	0.00	0.00
	Totals:	19,517.85	42,257.45	0.00	0.00

Resulting Forces and Deflections

Structure: CT13615-A-SB
Site Name: Madison 7, CT
Height: 130.00 (ft)
Base Elev: 0.000 (ft)

Code: EIA/TIA-222-F
Exposure: C
Gh: 1.69
Struct Class: II

12/11/2015

Page: 15



Load Case: 73.61 mph Wind with 0.5" Ice

Dead Load Factor 1.00
Wind Load Factor 1.00

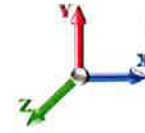

Iterations: 20

Elev (ft)	Lateral FX (-) (kips)	Axial FY (-) (kips)	Lateral FZ (kips)	Moment MX (ft-kips)	Torsion MY (ft-kips)	Moment MZ (ft-kips)	Deflect X (in)	Deflect Z (in)	Deflect Resultant (in)	Rotation Sway (deg)	Rotation Twist (deg)
0.00	-19.547	-42.244	0.000	0.000	0.000	-1865.9	0.000	0.000	0.000	0.000	0.000
5.00	-19.230	-40.472	0.000	0.000	0.000	-1768.2	-0.042	0.000	0.042	-0.077	0.000
10.00	-18.917	-38.733	0.000	0.000	0.000	-1672.0	-0.165	0.000	0.165	-0.155	0.000
15.00	-18.607	-37.029	0.000	0.000	0.000	-1577.4	-0.370	0.000	0.370	-0.234	0.000
20.00	-18.302	-35.358	0.000	0.000	0.000	-1484.4	-0.659	0.000	0.659	-0.314	0.000
25.00	-18.000	-33.721	0.000	0.000	0.000	-1392.9	-1.031	0.000	1.031	-0.394	0.000
30.00	-17.702	-32.118	0.000	0.000	0.000	-1302.9	-1.487	0.000	1.487	-0.474	0.000
35.00	-17.402	-30.549	0.000	0.000	0.000	-1214.4	-2.028	0.000	2.028	-0.556	0.000
40.00	-17.082	-29.021	0.000	0.000	0.000	-1127.4	-2.653	0.000	2.653	-0.637	0.000
42.00	-16.963	-28.413	0.000	0.000	0.000	-1093.2	-2.928	0.000	2.928	-0.670	0.000
45.00	-16.765	-26.936	0.000	0.000	0.000	-1042.3	-3.365	0.000	3.365	-0.720	0.000
48.00	-16.560	-25.483	0.000	0.000	0.000	-992.08	-3.833	0.000	3.833	-0.769	0.000
50.00	-16.444	-24.945	0.000	0.000	0.000	-958.96	-4.163	0.000	4.163	-0.802	0.000
55.00	-16.118	-23.642	0.000	0.000	0.000	-876.75	-5.052	0.000	5.052	-0.892	0.000
60.00	-15.789	-22.369	0.000	0.000	0.000	-796.16	-6.034	0.000	6.034	-0.980	0.000
65.00	-15.458	-21.126	0.000	0.000	0.000	-717.21	-7.108	0.000	7.108	-1.067	0.000
70.00	-15.126	-19.914	0.000	0.000	0.000	-639.92	-8.272	0.000	8.272	-1.152	0.000
75.00	-14.793	-18.733	0.000	0.000	0.000	-564.29	-9.524	0.000	9.524	-1.235	0.000
80.00	-14.460	-17.582	0.000	0.000	0.000	-490.33	-10.861	0.000	10.861	-1.314	0.000
85.00	-14.118	-16.471	0.000	0.000	0.000	-418.04	-12.279	0.000	12.279	-1.389	0.000
85.25	-14.111	-16.407	0.000	0.000	0.000	-414.51	-12.352	0.000	12.352	-1.393	0.000
90.00	-13.781	-14.894	0.000	0.000	0.000	-347.48	-13.772	0.000	13.772	-1.459	0.000
95.00	-13.457	-14.063	0.000	0.000	0.000	-278.58	-15.336	0.000	15.336	-1.522	0.000
100.00	-13.137	-13.253	0.000	0.000	0.000	-211.30	-16.975	0.000	16.975	-1.601	0.000
105.00	-12.816	-12.472	0.000	0.000	0.000	-145.61	-18.688	0.000	18.688	-1.664	0.000
107.00	-7.585	-9.057	0.000	0.000	0.000	-119.98	-19.390	0.000	19.390	-1.685	0.000
110.00	-7.399	-8.641	0.000	0.000	0.000	-97.233	-20.458	0.000	20.458	-1.712	0.000
115.00	-7.088	-7.970	0.000	0.000	0.000	-60.239	-22.272	0.000	22.272	-1.747	0.000
117.00	-4.680	-4.862	0.000	0.000	0.000	-46.063	-23.006	0.000	23.006	-1.758	0.000
120.00	-4.500	-4.515	0.000	0.000	0.000	-32.023	-24.115	0.000	24.115	-1.770	0.000
125.00	-4.206	-3.954	0.000	0.000	0.000	-9.522	-25.976	0.000	25.976	-1.782	0.000
127.00	-0.887	-0.747	0.000	0.000	0.000	-1.110	-26.723	0.000	26.723	-1.783	0.000
128.00	-0.112	-0.176	0.000	0.000	0.000	-0.223	-27.096	0.000	27.096	-1.783	0.000
130.00	-0.106	0.000	0.000	0.000	0.000	0.000	0.000	0.000	27.843	-1.783	0.000

Resulting Stresses

Structure: CT13615-A-SBA
Site Name: Madison 7, CT
Height: 130.00 (ft)
Base Elev: 0.000 (ft)

Code: EIA/TIA-222-F
Exposure: C
Gh: 1.69
Struct Class: II

12/11/2015



Page: 16

Load Case: 73.61 mph Wind with 0.5" Ice

Dead Load Factor 1.00
Wind Load Factor 1.00

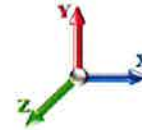

Iterations: 20

Applied Stresses

Elev (ft)	fa Axial (Y) (ksi)	fvx Shear (X) (ksi)	fvz Shear (Z) (ksi)	fvt Torsion (ksi)	fbx Bending (X) (ksi)	fbz Bending (Z) (ksi)	fb Combined (ksi)	Allow Stress (ksi)	f/Fb Stress Ratio
0.00	0.53	0.49	0.00	0.00	0.00	19.71	20.25	52.0	0.390
5.00	0.52	0.50	0.00	0.00	0.00	19.51	20.04	52.0	0.386
10.00	0.51	0.50	0.00	0.00	0.00	19.29	19.82	52.0	0.381
15.00	0.50	0.50	0.00	0.00	0.00	19.05	19.57	52.0	0.376
20.00	0.48	0.50	0.00	0.00	0.00	18.79	19.29	52.0	0.371
25.00	0.47	0.51	0.00	0.00	0.00	18.49	18.99	52.0	0.365
30.00	0.46	0.51	0.00	0.00	0.00	18.17	18.65	52.0	0.359
35.00	0.45	0.52	0.00	0.00	0.00	17.81	18.28	52.0	0.352
40.00	0.44	0.52	0.00	0.00	0.00	17.41	17.87	52.0	0.344
42.00	0.43	0.52	0.00	0.00	0.00	17.24	17.70	52.0	0.340
45.00	0.42	0.52	0.00	0.00	0.00	16.97	17.41	52.0	0.335
48.00	0.46	0.60	0.00	0.00	0.00	18.76	19.25	52.0	0.370
50.00	0.46	0.61	0.00	0.00	0.00	18.53	19.02	52.0	0.366
55.00	0.44	0.61	0.00	0.00	0.00	17.90	18.37	52.0	0.353
60.00	0.43	0.61	0.00	0.00	0.00	17.20	17.66	52.0	0.340
65.00	0.42	0.62	0.00	0.00	0.00	16.42	16.87	52.0	0.325
70.00	0.41	0.62	0.00	0.00	0.00	15.55	16.00	52.0	0.308
75.00	0.40	0.63	0.00	0.00	0.00	14.59	15.02	52.0	0.289
80.00	0.38	0.64	0.00	0.00	0.00	13.51	13.94	52.0	0.268
85.00	0.37	0.64	0.00	0.00	0.00	12.30	12.72	52.0	0.245
85.25	0.37	0.64	0.00	0.00	0.00	12.24	12.66	52.0	0.243
90.00	0.51	0.95	0.00	0.00	0.00	15.80	16.40	52.0	0.315
95.00	0.50	0.96	0.00	0.00	0.00	13.57	14.17	52.0	0.273
100.00	0.49	0.98	0.00	0.00	0.00	11.06	11.67	52.0	0.225
105.00	0.48	0.99	0.00	0.00	0.00	8.21	8.85	52.0	0.170
107.00	0.35	0.59	0.00	0.00	0.00	6.97	7.40	52.0	0.142
110.00	0.34	0.59	0.00	0.00	0.00	5.92	6.35	52.0	0.122
115.00	0.33	0.59	0.00	0.00	0.00	3.97	4.42	52.0	0.085
117.00	0.20	0.40	0.00	0.00	0.00	3.14	3.41	52.0	0.066
120.00	0.19	0.39	0.00	0.00	0.00	2.30	2.58	52.0	0.050
125.00	0.18	0.38	0.00	0.00	0.00	0.74	1.13	52.0	0.022
127.00	0.03	0.08	0.00	0.00	0.00	0.09	0.19	52.0	0.004
128.00	0.01	0.01	0.00	0.00	0.00	0.02	0.03	52.0	0.001
130.00	0.00	0.01	0.00	0.00	0.00	0.00	0.02	52.0	0.000

Wind Loading - Shaft

Structure: CT13615-A-SBA
Site Name: Madison 7, CT
Height: 130.00 (ft)
Base Elev: 0.000 (ft)

Code: EIA/TIA-222-F
Exposure: C
Gh: 1.69
Struct Class: II

12/11/2015

Page: 17



Load Case: 50 mph Wind with 0" Ice

Dead Load Factor 1.00
Wind Load Factor 1.00

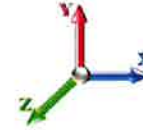

Iterations: 19

Elev (ft)	Description	Kzt	Kz	qz (psf)	qzGh (psf)	C (mph-ft)	Cf	Ice Thick (in)	Tributary (ft)	Aa (sf)	CfAa (sf)	Wind Force X (lb)	Dead Load Ice (lb)	Tot Dead Load (lb)
0.00		0.00	1.00	6.400	10.82	241.67	0.650	0.000	0.00	0.000	0.00	0.0	0.0	0.0
5.00		0.00	1.00	6.400	10.82	236.50	0.650	0.000	5.00	23.908	15.54	168.1	0.0	1345.3
10.00		0.00	1.00	6.400	10.82	231.33	0.650	0.000	5.00	23.392	15.20	164.5	0.0	1316.0
15.00		0.00	1.00	6.400	10.82	226.17	0.650	0.000	5.00	22.875	14.87	160.8	0.0	1286.7
20.00		0.00	1.00	6.400	10.82	221.00	0.650	0.000	5.00	22.358	14.53	157.2	0.0	1257.4
25.00		0.00	1.00	6.400	10.82	215.83	0.650	0.000	5.00	21.842	14.20	153.6	0.0	1228.1
30.00		0.00	1.00	6.400	10.82	210.67	0.650	0.000	5.00	21.325	13.86	149.9	0.0	1198.8
35.00		0.00	1.02	6.509	11.00	207.23	0.650	0.000	5.00	20.808	13.53	148.8	0.0	1169.5
40.00		0.00	1.06	6.762	11.43	205.92	0.650	0.000	5.00	20.292	13.19	150.7	0.0	1140.2
42.00	Bot - Section 2	0.00	1.07	6.857	11.59	205.22	0.650	0.000	2.00	7.972	5.18	60.0	0.0	447.9
45.00		0.00	1.09	6.993	11.82	204.01	0.650	0.000	3.00	11.991	7.79	92.1	0.0	1241.2
48.00	Top - Section 1	0.00	1.11	7.123	12.04	202.63	0.650	0.000	3.00	11.805	7.67	92.4	0.0	1221.6
50.00		0.00	1.13	7.207	12.18	204.94	0.650	0.000	2.00	7.766	5.05	61.5	0.0	374.4
55.00		0.00	1.16	7.406	12.52	202.19	0.650	0.000	5.00	19.054	12.39	155.0	0.0	918.4
60.00		0.00	1.19	7.592	12.83	199.09	0.650	0.000	5.00	18.538	12.05	154.6	0.0	893.3
65.00		0.00	1.21	7.768	13.13	195.69	0.650	0.000	5.00	18.021	11.71	153.8	0.0	868.2
70.00		0.00	1.24	7.934	13.41	192.02	0.650	0.000	5.00	17.504	11.38	152.6	0.0	843.1
75.00		0.00	1.26	8.092	13.68	188.11	0.650	0.000	5.00	16.988	11.04	151.0	0.0	818.0
80.00		0.00	1.29	8.242	13.93	183.99	0.650	0.000	5.00	16.471	10.71	149.1	0.0	792.9
85.00		0.00	1.31	8.387	14.17	179.67	0.650	0.000	5.00	15.954	10.37	147.0	0.0	767.8
85.25	Bot - Section 3	0.00	1.31	8.394	14.19	179.45	0.650	0.000	0.25	0.784	0.51	7.2	0.0	37.7
90.00	Top - Section 2	0.00	1.33	8.525	14.41	175.18	0.650	0.000	4.75	14.851	9.65	139.1	0.0	1182.9
95.00		0.00	1.35	8.657	14.63	172.96	0.650	0.000	5.00	15.129	9.83	143.9	0.0	486.8
100.00		0.00	1.37	8.785	14.85	168.18	0.650	0.000	5.00	14.613	9.50	141.0	0.0	470.1
105.00		0.00	1.39	8.908	15.06	163.26	0.650	0.000	5.00	14.096	9.16	137.9	0.0	453.3
107.00	Appurtenance(s)	0.00	1.40	8.957	15.14	161.25	0.650	0.000	2.00	5.494	3.57	54.1	0.0	176.6
110.00		0.00	1.41	9.028	15.26	158.21	0.650	0.000	3.00	8.085	5.26	80.2	0.0	259.9
115.00		0.00	1.43	9.143	15.45	153.04	0.650	0.000	5.00	13.063	8.49	131.2	0.0	419.9
117.00	Appurtenance(s)	0.00	1.44	9.188	15.53	150.94	0.650	0.000	2.00	5.080	3.30	51.3	0.0	163.3
120.00		0.00	1.45	9.255	15.64	147.76	0.650	0.000	3.00	7.465	4.85	75.9	0.0	239.9
125.00		0.00	1.46	9.363	15.82	142.38	0.650	0.000	5.00	12.029	7.82	123.7	0.0	386.4
127.00	Appurtenance(s)	0.00	1.47	9.406	15.90	140.19	0.650	0.000	2.00	4.667	3.03	48.2	0.0	149.9
128.00	Appurtenance(s)	0.00	1.47	9.427	15.93	139.10	0.650	0.000	1.00	2.302	1.50	23.8	0.0	73.9
130.00		0.00	1.48	9.469	16.00	136.89	0.650	0.000	2.00	4.543	2.95	47.3	0.0	145.8
								Totals:	130.00			3,827.4	23,775.2	

Discrete Appurtenance Forces

Structure: CT13615-A-SB
Site Name: Madison 7, CT
Height: 130.00 (ft)
Base Elev: 0.000 (ft)

Code: EIA/TIA-222-F
Exposure: C
Gh: 1.69
Struct Class: II

12/11/2015

Page: 18



Load Case: 50 mph Wind with 0" Ice

Dead Load Factor 1.00
Wind Load Factor 1.00



Iterations: 19

No.	Elev (ft)	Description	Qty	qz (psf)	qzGh (psf)	CaAa Factor	Total CaAa (sf)	Dead Load (lb)	Horiz Ecc (ft)	Vert Ecc (ft)	Wind FX (lb)	Mom Y (lb-ft)	Mom Z (lb-ft)
1	128.00	RRUS-11	6	9.427	15.932	0.68	18.03	330.00	0.000	0.000	287.31	0.00	0.00
2	127.00	TT19-08BP111-001	6	9.406	15.896	0.90	3.46	96.00	0.000	0.000	54.94	0.00	0.00
3	127.00	P90-15-XLH-RR	6	9.406	15.896	0.75	37.80	318.00	0.000	0.000	600.87	0.00	0.00
4	127.00	Low Profile Platform	1	9.406	15.896	1.00	25.55	1600.00	0.000	0.000	406.15	0.00	0.00
5	127.00	DC6-48-60-18-8F Surge	1	9.406	15.896	1.00	1.47	32.80	0.000	0.000	23.37	0.00	0.00
6	127.00	AM-X-CD-14-65-00T-RET	3	9.406	15.896	0.75	12.38	109.20	0.000	0.000	196.72	0.00	0.00
7	117.00	Air 21 B2A B4P	3	9.188	15.528	0.86	16.98	274.50	0.000	0.000	263.61	0.00	0.00
8	117.00	KRY 112 144	3	9.188	15.528	0.70	0.86	33.00	0.000	0.000	13.37	0.00	0.00
9	117.00	Air 21 B4A B2P	3	9.188	15.528	0.86	16.98	271.20	0.000	0.000	263.61	0.00	0.00
10	117.00	12.5' Low Profile Platform	1	9.188	15.528	1.00	25.55	1600.00	0.000	0.000	396.74	0.00	0.00
11	107.00	SBNHH-1D65B	6	8.957	15.137	0.83	41.48	243.60	0.000	0.000	627.92	0.00	0.00
12	107.00	SBNHH-1D65B	3	8.957	15.137	0.83	20.74	121.80	0.000	0.000	313.96	0.00	0.00
13	107.00	RRH4x45AWS	3	8.957	15.137	0.98	7.97	180.00	0.000	0.000	120.60	0.00	0.00
14	107.00	RRH2X60-PCS	3	8.957	15.137	0.89	6.86	165.00	0.000	0.000	103.87	0.00	0.00
15	107.00	RRH2x60-700	3	8.957	15.137	0.76	9.03	180.00	0.000	0.000	136.67	0.00	0.00
16	107.00	Low Profile Platform	1	8.957	15.137	1.00	25.00	1200.00	0.000	0.000	378.42	0.00	0.00
17	107.00	DB-T1-6Z-8AB-0Z	2	8.957	15.137	0.71	7.95	37.80	0.000	0.000	120.37	0.00	0.00
18	107.00	BXA-70063-6CF-2	3	8.957	15.137	0.73	16.93	51.00	0.000	0.000	256.24	0.00	0.00
Totals:								6,843.90			4,564.72		

Total Applied Force Summary

Structure: CT13615-A-SB
Site Name: Madison 7, CT
Height: 130.00 (ft)
Base Elev: 0.000 (ft)

Code: EIA/TIA-222-F
Exposure: C
Gh: 1.69
Struct Class: II

12/11/2015

Page: 19



Load Case: 50 mph Wind with 0" Ice

Dead Load Factor 1.00
Wind Load Factor 1.00



Iterations: 19

Elev (ft)	Description	Lateral FX (-) (lb)	Axial FY (-) (lb)	Torsion MY (lb-ft)	Moment MZ (lb-ft)
0.00		0.00	0.00	0.00	0.00
5.00		168.09	1569.67	0.00	0.00
10.00		164.45	1540.37	0.00	0.00
15.00		160.82	1511.08	0.00	0.00
20.00		157.19	1481.78	0.00	0.00
25.00		153.56	1452.49	0.00	0.00
30.00		149.92	1423.19	0.00	0.00
35.00		148.77	1393.90	0.00	0.00
40.00		150.72	1364.60	0.00	0.00
42.00		60.04	537.64	0.00	0.00
45.00		92.11	1375.85	0.00	0.00
48.00		92.37	1356.27	0.00	0.00
50.00		61.48	464.17	0.00	0.00
55.00		155.01	1142.84	0.00	0.00
60.00		154.60	1117.73	0.00	0.00
65.00		153.77	1092.62	0.00	0.00
70.00		152.56	1067.51	0.00	0.00
75.00		151.00	1042.40	0.00	0.00
80.00		149.13	1017.29	0.00	0.00
85.00		146.98	992.18	0.00	0.00
85.25		7.23	48.95	0.00	0.00
90.00		139.07	1396.10	0.00	0.00
95.00		143.88	711.21	0.00	0.00
100.00		141.02	694.47	0.00	0.00
105.00		137.94	677.73	0.00	0.00
107.00	(24) appurtenances	2112.09	2445.61	0.00	0.00
110.00		80.18	356.79	0.00	0.00
115.00		131.19	581.25	0.00	0.00
117.00	(10) appurtenances	988.61	2406.51	0.00	0.00
120.00		75.90	295.96	0.00	0.00
125.00		123.73	479.87	0.00	0.00
127.00	(17) appurtenances	1330.26	2343.26	0.00	0.00
128.00	(6) appurtenances	311.15	422.63	0.00	0.00
130.00		47.25	145.84	0.00	0.00
	Totals:	8,392.08	35,949.78	0.00	0.00

Resulting Forces and Deflections

Structure: CT13615-A-SB
Site Name: Madison 7, CT
Height: 130.00 (ft)
Base Elev: 0.000 (ft)

Code: EIA/TIA-222-F
Exposure: C
Gh: 1.69
Struct Class: II

12/11/2015
 Page: 20



Load Case: 50 mph Wind with 0" Ice

Dead Load Factor 1.00
Wind Load Factor 1.00



Iterations: 19

Elev (ft)	Lateral FX (-) (kips)	Axial FY (-) (kips)	Lateral FZ (kips)	Moment MX (ft-kips)	Torsion MY (ft-kips)	Moment MZ (ft-kips)	Deflect X (in)	Deflect Z (in)	Deflect Resultant (in)	Rotation Sway (deg)	Rotation Twist (deg)
0.00	-8.402	-35.947	0.000	0.000	0.000	-789.09	0.000	0.000	0.000	0.000	0.000
5.00	-8.253	-34.373	0.000	0.000	0.000	-747.08	-0.018	0.000	0.018	-0.033	0.000
10.00	-8.106	-32.828	0.000	0.000	0.000	-705.81	-0.070	0.000	0.070	-0.066	0.000
15.00	-7.962	-31.313	0.000	0.000	0.000	-665.28	-0.156	0.000	0.156	-0.099	0.000
20.00	-7.819	-29.826	0.000	0.000	0.000	-625.47	-0.278	0.000	0.278	-0.132	0.000
25.00	-7.678	-28.370	0.000	0.000	0.000	-586.38	-0.435	0.000	0.435	-0.166	0.000
30.00	-7.540	-26.943	0.000	0.000	0.000	-547.99	-0.628	0.000	0.628	-0.200	0.000
35.00	-7.401	-25.545	0.000	0.000	0.000	-510.29	-0.856	0.000	0.856	-0.234	0.000
40.00	-7.254	-24.178	0.000	0.000	0.000	-473.28	-1.119	0.000	1.119	-0.268	0.000
42.00	-7.199	-23.639	0.000	0.000	0.000	-458.77	-1.235	0.000	1.235	-0.282	0.000
45.00	-7.108	-22.261	0.000	0.000	0.000	-437.18	-1.419	0.000	1.419	-0.303	0.000
48.00	-7.014	-20.903	0.000	0.000	0.000	-415.85	-1.616	0.000	1.616	-0.324	0.000
50.00	-6.960	-20.436	0.000	0.000	0.000	-401.83	-1.755	0.000	1.755	-0.338	0.000
55.00	-6.810	-19.289	0.000	0.000	0.000	-367.03	-2.129	0.000	2.129	-0.375	0.000
60.00	-6.659	-18.169	0.000	0.000	0.000	-332.98	-2.542	0.000	2.542	-0.412	0.000
65.00	-6.508	-17.073	0.000	0.000	0.000	-299.68	-2.994	0.000	2.994	-0.449	0.000
70.00	-6.357	-16.003	0.000	0.000	0.000	-267.14	-3.483	0.000	3.483	-0.484	0.000
75.00	-6.205	-14.958	0.000	0.000	0.000	-235.36	-4.009	0.000	4.009	-0.519	0.000
80.00	-6.055	-13.939	0.000	0.000	0.000	-204.33	-4.570	0.000	4.570	-0.552	0.000
85.00	-5.901	-12.947	0.000	0.000	0.000	-174.06	-5.165	0.000	5.165	-0.583	0.000
85.25	-5.897	-12.896	0.000	0.000	0.000	-172.59	-5.196	0.000	5.196	-0.584	0.000
90.00	-5.749	-11.499	0.000	0.000	0.000	-144.58	-5.792	0.000	5.792	-0.612	0.000
95.00	-5.603	-10.786	0.000	0.000	0.000	-115.83	-6.448	0.000	6.448	-0.638	0.000
100.00	-5.459	-10.091	0.000	0.000	0.000	-87.824	-7.135	0.000	7.135	-0.671	0.000
105.00	-5.316	-9.413	0.000	0.000	0.000	-60.529	-7.853	0.000	7.853	-0.697	0.000
107.00	-3.175	-6.993	0.000	0.000	0.000	-49.898	-8.147	0.000	8.147	-0.706	0.000
110.00	-3.092	-6.637	0.000	0.000	0.000	-40.373	-8.594	0.000	8.594	-0.717	0.000
115.00	-2.955	-6.057	0.000	0.000	0.000	-24.912	-9.354	0.000	9.354	-0.732	0.000
117.00	-1.935	-3.663	0.000	0.000	0.000	-19.003	-9.662	0.000	9.662	-0.736	0.000
120.00	-1.856	-3.368	0.000	0.000	0.000	-13.197	-10.126	0.000	10.126	-0.741	0.000
125.00	-1.726	-2.889	0.000	0.000	0.000	-3.917	-10.905	0.000	10.905	-0.746	0.000
127.00	-0.366	-0.564	0.000	0.000	0.000	-0.464	-11.218	0.000	11.218	-0.747	0.000
128.00	-0.049	-0.145	0.000	0.000	0.000	-0.098	-11.375	0.000	11.375	-0.747	0.000
130.00	-0.047	0.000	0.000	0.000	0.000	0.000	0.000	0.000	11.687	-0.747	0.000

Resulting Stresses

Structure: CT13615-A-SBA
Site Name: Madison 7, CT
Height: 130.00 (ft)
Base Elev: 0.000 (ft)

Code: EIA/TIA-222-F
Exposure: C
Gh: 1.69
Struct Class: II

12/11/2015
 Page: 21



Load Case: 50 mph Wind with 0" Ice

Dead Load Factor 1.00
Wind Load Factor 1.00

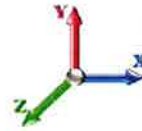

Iterations: 19

Applied Stresses

Elev (ft)	fa Axial (Y) (ksi)	fvx Shear (X) (ksi)	fvz Shear (Z) (ksi)	fvt Torsion (ksi)	fbx Bending (X) (ksi)	fbz Bending (Z) (ksi)	fb Combined (ksi)	Allow Stress (ksi)	f/Fb Stress Ratio
0.00	0.45	0.21	0.00	0.00	0.00	8.33	8.79	52.0	0.169
5.00	0.44	0.21	0.00	0.00	0.00	8.24	8.69	52.0	0.167
10.00	0.43	0.21	0.00	0.00	0.00	8.14	8.58	52.0	0.165
15.00	0.42	0.21	0.00	0.00	0.00	8.03	8.46	52.0	0.163
20.00	0.41	0.22	0.00	0.00	0.00	7.92	8.33	52.0	0.160
25.00	0.40	0.22	0.00	0.00	0.00	7.78	8.19	52.0	0.158
30.00	0.39	0.22	0.00	0.00	0.00	7.64	8.04	52.0	0.155
35.00	0.38	0.22	0.00	0.00	0.00	7.48	7.87	52.0	0.151
40.00	0.37	0.22	0.00	0.00	0.00	7.31	7.68	52.0	0.148
42.00	0.36	0.22	0.00	0.00	0.00	7.23	7.61	52.0	0.146
45.00	0.35	0.22	0.00	0.00	0.00	7.12	7.47	52.0	0.144
48.00	0.38	0.26	0.00	0.00	0.00	7.86	8.25	52.0	0.159
50.00	0.37	0.26	0.00	0.00	0.00	7.77	8.15	52.0	0.157
55.00	0.36	0.26	0.00	0.00	0.00	7.49	7.87	52.0	0.151
60.00	0.35	0.26	0.00	0.00	0.00	7.19	7.56	52.0	0.145
65.00	0.34	0.26	0.00	0.00	0.00	6.86	7.21	52.0	0.139
70.00	0.33	0.26	0.00	0.00	0.00	6.49	6.84	52.0	0.132
75.00	0.32	0.26	0.00	0.00	0.00	6.08	6.42	52.0	0.123
80.00	0.30	0.27	0.00	0.00	0.00	5.63	5.95	52.0	0.114
85.00	0.29	0.27	0.00	0.00	0.00	5.12	5.43	52.0	0.105
85.25	0.29	0.27	0.00	0.00	0.00	5.09	5.41	52.0	0.104
90.00	0.40	0.40	0.00	0.00	0.00	6.58	7.00	52.0	0.135
95.00	0.38	0.40	0.00	0.00	0.00	5.64	6.07	52.0	0.117
100.00	0.37	0.41	0.00	0.00	0.00	4.60	5.02	52.0	0.097
105.00	0.36	0.41	0.00	0.00	0.00	3.41	3.84	52.0	0.074
107.00	0.27	0.25	0.00	0.00	0.00	2.90	3.20	52.0	0.062
110.00	0.26	0.25	0.00	0.00	0.00	2.46	2.76	52.0	0.053
115.00	0.25	0.25	0.00	0.00	0.00	1.64	1.94	52.0	0.037
117.00	0.15	0.16	0.00	0.00	0.00	1.30	1.48	52.0	0.028
120.00	0.15	0.16	0.00	0.00	0.00	0.95	1.13	52.0	0.022
125.00	0.13	0.16	0.00	0.00	0.00	0.31	0.51	52.0	0.010
127.00	0.03	0.03	0.00	0.00	0.00	0.04	0.09	52.0	0.002
128.00	0.01	0.00	0.00	0.00	0.00	0.01	0.02	52.0	0.000
130.00	0.00	0.00	0.00	0.00	0.00	0.00	0.01	52.0	0.000

Final Analysis Summary

Structure: CT13615-A-SBA
Site Name: Madison 7, CT
Height: 130.00 (ft)
Base Elev: 0.000 (ft)

Code: EIA/TIA-222-F
Exposure: C
Gh: 1.69
Struct Class: II

12/11/2015

Page: 22



Reactions

Load Case	Shear FX (kips)	Shear FZ (kips)	Axial FY (kips)	Moment MX (ft-kips)	Moment MY (ft-kips)	t MZ (ft-kips)
85 mph Wind with 0" Ice	24.3	0.00	35.93	0.00	0.00	2280.16
73.61 mph Wind with 0.5" Ice	19.5	0.00	42.24	0.00	0.00	1865.96
50 mph Wind with 0" Ice	8.4	0.00	35.95	0.00	0.00	789.09

Max Stresses

Load Case	fa Axial (Y) (ksi)	fvx Shear (X) (ksi)	fvz Shear (Z) (ksi)	fvT Torsion (ksi)	fbx Bending (X) (ksi)	fbz Bending (Z) (ksi)	Combined Stress (ksi)	Allowable Stress (ksi)	Elev (ft)	Stress Ratio
85 mph Wind with 0" Ice	0.45	0.61	0.00	0.00	0.00	24.08	24.55	52.0	0.00	0.472
73.61 mph Wind with 0.5" Ice	0.53	0.49	0.00	0.00	0.00	19.71	20.25	52.0	0.00	0.390
50 mph Wind with 0" Ice	0.45	0.21	0.00	0.00	0.00	8.33	8.79	52.0	0.00	0.169

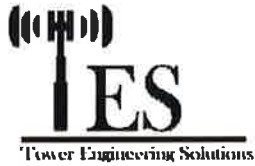

Monopole Mat Foundation Design

Date
12/3/2015

Customer Name:	Verizon	EIA/TIA Standard:	EIA-222-F
Site Name:		Structure Height (Ft.):	130
Site Number:	CT13615-A-SBA	Engineer Name:	F. Yazdani
Engr. Number:	18882	Engineer Login ID:	TES

Foundation Info Obtained from:

Drawings/Calculations

Structure Type:

Monopole

Analysis or Design?

Analysis

Base Reactions (Unfactored)

Axial Load (Kips):	35.9	Shear Force (Kips):	24.3
Uplift Force (Kips):	0.0	Moment (Kips-ft):	2280.2

Foundation Geometries:

		Mods required -Yes/No ?:	No
Diameter of Pier (ft.):	7.5	Depth of Base BG (ft.):	4.0
Pier Height A. G. (ft.):	2.50	Thickness of Pad (ft):	3.50
Length of Pad (ft.):	26	Width of Pad (ft.):	26
Final Length of pad (ft)	26.0	Final width of pad (ft):	26.0
Control Value for Cell D18:	0	Control Value for Cell F18:	0

Material Properties and Rebar Info:

Concrete Strength (psi):	4000	Steel Elastic Modulus:	29000	ksi
Vertical bar yield (ksi)	60	Tie steel yield (ksi):	60	
Vertical Rebar Size #:	9	Tie / Stirrup Size #:	5	
Qty. of Vertical Rebars:	32	Tie Spacing (in):	3.0	
Pad Rebar Yield (Ksi):	60	Pad Steel Rebar Size (#):	9	
Concrete Cover (in.):	3	Unit Weight of Concrete:	150.0	pcf
Rebar at the bottom of the concrete pad:				
Qty. of Rebar in Pad (L):	28	Qty. of Rebar in Pad (W):	28	
Rebar at the top of the concrete pad:				
Qty. of Rebar in Pad (L):	28	Qty. of Rebar in Pad (W):	28	

Soil Design Parameters:

Soil Unit Weight (pcf):	110.0	Soil Buoyant Weight:	50.0	Pcf
Water Table B.G.S. (ft):	99.0	Unit Weight of Water:	62.4	pcf
Allowable Net Soil Bearing (psf):	15000	Allowable Skin Friction:	0	Psf
Consider Friction for O.T.M. (Y/N):	No	Consider Friction for bearing (Y/N):	No	
Consider soil hori. force for O.T.M.:	No	Reduction factor on the maximum soil bearing pressure:	1.00	
		Angle from Top of Pad:	30	
		Angle from Bottm of Pad:	25	
		Angle from Bottm of Pad:	25	

Foundation Analysis and Design:

Total Dry Soil Volume (cu. Ft.):	315.91	Total Dry Soil Weight (Kips):	34.75
Total Buoyant Soil Volume (cu. Ft.):	0.00	Total Buoyant Soil Weight (Kips):	0.00
Total Effective Soil Weight (Kips):	34.75	Weight from the Concrete Block at Top (K):	0.00
Total Dry Concrete Volume (cu. Ft.):	2498.54	Total Dry Concrete Weight (Kips):	374.78
Total Buoyant Concrete Volume (cu. Ft.):	0.00	Total Buoyant Concrete Weight (Kips):	0.00
Total Effective Concrete Weight (Kips):	374.78	Total Vertical Load on Base (Kips):	445.46

Check Soil Capacities:

Calculated Maxium Net Soil Pressure under the base (psf):	1461	<	Allowable Soil Bearing (psf):	15000	0.10	OK!
Allowable Foundation Overturning Resistance (SF=1.5, kips-ft.):	3860.7	>	Applied Momont (kips-ft):	2438	0.63	OK!
Factor of Safety Against Overturning (O. R. Moment/Design Moment):	2.38					OK!

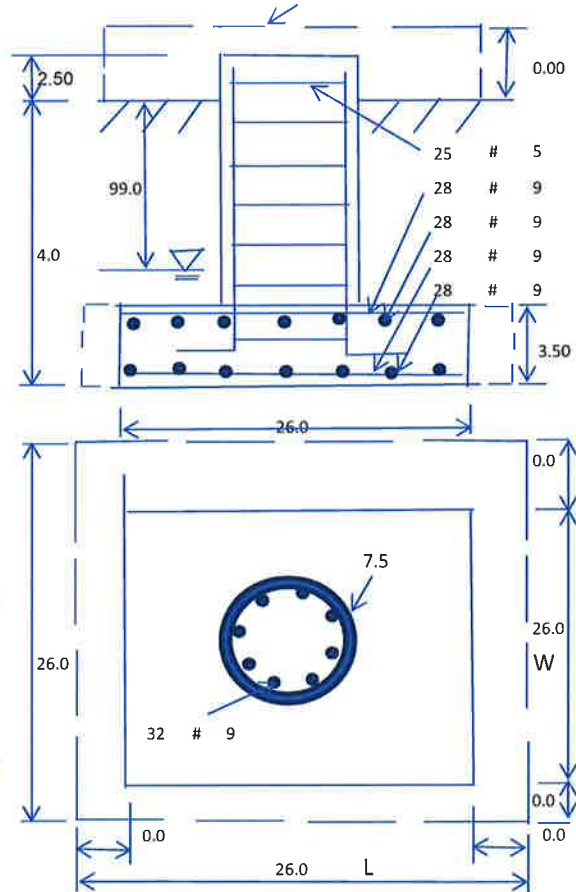

Check the capacities of Reinforcing Concrete:

Strength reduction factor (Flexure and axial tension):	0.90	Strength reduction factor (Shear):	0.75
Strength reduction factor (Axial compression):	0.65	Wind Load Factor on Concrete Design:	1.30

Load/
Capacity
Ratio

(1) Concrete Pier:

Vertical Steel Rebar Area (sq. in./each):	1.00	Tie / Stirrup Area (sq. in./each):	0.31		
Calculated Moment Capacity (Mn,Kips-Ft):	5835.6	> Design Factored Moment (Mu, Kips-Ft)	2353.1	0.40	OK!
Calculated Shear Capacity (Kips):	1496.3	> Design Factored Shear (Kips):	31.6	0.02	OK!
Calculated Tension Capacity (Tn, Kips):	1728.0	> Design Factored Tension (Tu Kips):	0.0	0.00	OK!
Calculated Compression Capacity (Pn, Kips):	11191.0	> Design Factored Axial Load (Pu Kips):	46.7	0.00	OK!
Moment & Axial Strength Combination:	0.40	OK! Check Tie Spacing (Design/Required):		0.25	OK!
Pier Reinforcement Ratio:	0.005	Reinforcement Ratio is satisfied per ACI			

(2).Concrete Pad:

One-Way Design Shear Capacity (L-Direction, Kips):	1137.7	> One-Way Factored Shear (L-D. Kips):	178.7	0.16	OK!
One-Way Design Shear Capacity (W-Direction, Kips):	1137.7	> One-Way Factored Shear (W-D., Kips):	178.7	0.16	OK!
One-Way Design Shear Capacity (Corner-Corner. Kips):	1280.8	> One-Way Factored Shear (C-C, Kips):	297.5	0.23	OK!
Lower Steel Pad Reinforcement Ratio (L-Direct.):	0.0023	OK! Lower Steel Pad Reinf. Ratio (W-Direct	0.0023		
Lower Steel Pad Moment Capacity (L-Direction. Kips-ft):	4743.4	> Moment at Bottom (L-Direct. K-Ft):	415.6	0.09	OK!
Lower Steel Pad Moment Capacity (W-Direction. Kips-ft):	4743.4	> Moment at Bottom (W-Direct. K-Ft):	415.6	0.09	OK!
Lower Steel Pad Moment Capacity (Corner-Corner,K-ft):	6672.0	> Moment at Bottom (C-C Dir. K-Ft):	587.7	0.09	OK!
Upper Steel Pad Reinforcement Ratio (L-Direct.):	0.0023	OK! Upper Steel Reinf. Ratio (W-Direct.):	0.0023		
Upper Steel Pad Moment Capacity (L-Direction. Kips-ft):	4743.4	> Moment at the top (L-Dir Kips-Ft):	81.7	0.02	OK!
Upper Steel Pad Moment Capacity (W-Direction. Kips-ft):	4743.4	> Moment at the top (W-Dir Kips-Ft):	81.7	0.02	OK!
Upper Steel Pad Moment Capacity (Corner-Corner. K-ft):	6672.0	> Moment at the top (C-C Direc. K-Ft):	497.5	0.07	OK!