



Centek Engineering, Inc.
3-2 North Branford Road
Branford, Connecticut 06405
Phone: (203) 488-0580
Fax: (203) 488-8587

Steven L. Levine
Real Estate Consultant

HAND DELIVERED

May 16, 2014

Attorney Melanie Bachman
Acting Executive Director
Connecticut Siting Council
10 Franklin Square
New Britain, Connecticut 06051

Re: New Cingular Wireless PCS, LLC notice of intent to modify an existing telecommunications facility located at 79 Putnam Pike, Killingly (owner, Town of Killingly)

Dear Ms. Bachman:

In order to accommodate technological changes, implement Uniform Mobile Telecommunications System (“UMTS”) and/or Long Term Evolution (“LTE”) capabilities, and enhance system performance in the State of Connecticut, New Cingular Wireless PCS, LLC (“AT&T”) plans to modify the equipment configurations at many of its existing cell sites. Please accept this letter and attachments as notification, pursuant to R.C.S.A. Section 16-50j-73, of construction which constitutes an exempt modification pursuant to R.C.S.A. Section 16-50j-72(b)(2). In compliance with R.C.S.A. Section 16-50j-73, a copy of this letter and attachments is being sent to the chief elected official of the municipality in which the affected cell site is located.

UMTS technology offers services to mobile computer and phone users anywhere in the world. Based on the Global System for Mobile (“GSM”) communication standard, UMTS is the planned worldwide standard for mobile users. UMTS, fully implemented, gives computer and phone users high-speed access to the Internet as they travel. They have the same capabilities even when they roam, through both terrestrial wireless and satellite transmissions.

LTE is a high-performance air interface for cellular mobile communications. It is designed to increase the capacity and speed of mobile telephone networks.

Attached is a summary of the planned modifications, including power density calculations reflecting the change in AT&T’s operations at the site. Also included is documentation of the structural sufficiency of the tower to accommodate the revised antenna configuration.

The changes to the facility do not constitute modifications as defined in Connecticut General Statutes ("C.G.S.") Section 16-50i(d) because the general physical characteristics of the facility will not be significantly changed or altered. Rather, the planned changes to the facility fall squarely within those activities explicitly provided for in R.C.S.A. Section 16-50j-72(b)(2).

1. The height of the overall structure will be unaffected.
2. The proposed changes will not extend the site boundaries. There will be no effect on the site compound other than some enlarged equipment pads as may be noted in the attachments.
3. The proposed changes will not increase the noise level at the existing facility by six decibels or more.
4. Radio frequency power density may increase due to use of one or more GSM channel for UMTS transmissions. Moreover, LTE will utilize additional radio frequencies newly-licensed by the FCC for cellular mobile communications. However, the changes will not increase the calculated "worst case" power density for the combined operations at the site to a level at or above the applicable standard for uncontrolled environments as calculated for a mixed frequency site.

For the foregoing reasons, AT&T respectfully submits that the proposed changes at the referenced site constitute exempt modifications under R.C.S.A. Section 16-50j-72(b)(2).

Please feel free to call me at (860) 830-0380 with questions concerning this matter. Thank you for your consideration.

Sincerely,

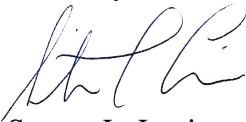

Steven L. Levine
Real Estate Consultant

cc: Bruce Benway, Town Manager, Town of Killingly

Attachments

**NEW CINGULAR WIRELESS PCS, LLC
Equipment Modification**

79 Putnam Pike, Killingly, CT

Site Number 5463

Prior Decisions: Exempt Mods 5/03, 6/08, 12/08, 11/12, 2/14

Tower Owner/Manager: Town of Killingly (managed by TowerCo, LLC)

Lease Area: The Killingly site was originally approved by local zoning as a town-owned tower facility. Its original footprint dimensions were approximately 25 ft x 25 ft. The Council approved expansions of the site to accommodate colocation by AT&T in EM-AT&T-069-030501 and by Verizon in EM-VER-069-080725. The Council approved a third size increase for Metro PCS in 2009, but this expansion does not appear to have been constructed. Since all proposed equipment modifications will occur either on the existing tower structure or AT&T's existing equipment pad areas, the proposed modifications will not extend either AT&T's lease area or the overall site boundaries.

Equipment configuration: Monopole

Current and/or approved: Platform mount @ 128 ft
Six PowerWave 7770 antennas @ 130 ft c.l.
Three KMW AM-X-CD-17-65-00T-RET antennas @ 130 ft c.l.
Six PowerWave TMA's @ 130 ft
Three remote radio heads @ 130 ft
Twelve lines 1 5/8 inch coax
One fiber and two DC cables
Concrete Equipment Pad
Diesel generator on pad

Proposed modifications: Remove existing platform, all antennas, and all associated equipment from the 128-130 ft level.
Remove six lines 1 5/8 inch coax. (Six to remain)
Install new Commscope MTC3607R platform @ 127 ft.
Re-install three PowerWave 7770 antennas @ 130 ft c.l.
Install nine CCI HPA-65R-BUU-H8 antennas @ 130 ft c.l.
Install three CCI DTMABP7819VG12A TMA's @ 130 ft.
Install 18 remote radio heads and six associated A2 modules @ 130 ft.
Install three Raycap DC6-48-60-18-8F surge arrestors @ 130 ft.
Install four additional DC cables.

Power Density:

Calculations for AT&T's current operations at the site indicate a radio frequency electromagnetic radiation power density, measured at the tower base, of approximately 85.4 % of the standard adopted by the FCC. As depicted in the second table below, the total radio frequency electromagnetic radiation power density for AT&T's planned operations would be approximately 73.5 % of the standard.

Existing

Company	Centerline Ht (feet)	Frequency (MHz)	Number of Channels	Power Per Channel (Watts)	Power Density (mW/cm ²)	Standard Limits (mW/cm ²)	Percent of Limit
Other Users *							64.39
AT&T UMTS	130	880 - 894	2	565	0.0240	0.5867	4.10
AT&T UMTS	130	1900 Band	2	875	0.0372	1.0000	3.72
AT&T GSM	130	880 - 894	1	283	0.0060	0.5867	1.03
AT&T GSM	130	1900 Band	4	525	0.0447	1.0000	4.47
AT&T LTE	130	734	1	1771	0.0377	0.4893	7.70
Total							85.4%

* Per CSC records

Proposed

Company	Centerline Ht (feet)	Frequency (MHz)	Number of Channels	Power Per Channel (Watts)	Power Density (mW/cm ²)	Standard Limits (mW/cm ²)	Percent of Limit
Other Users *							64.39
AT&T LTE	130	700 Band	1	500	0.0106	0.4667	2.28
AT&T LTE	130	1900 Band	1	500	0.0106	1.0000	1.06
AT&T LTE	130	2300 Band	1	500	0.0106	1.0000	1.06
AT&T UMTS	130	880 - 894	2	500	0.0213	0.5867	3.63
AT&T UMTS	130	1900 Band	1	500	0.0106	1.0000	1.06
Total							73.5%

* Per CSC records

Structural information:

The attached structural analysis demonstrates that the tower and foundation have adequate structural capacity to accommodate the proposed equipment modifications. (Hudson Design Group, 5/1/14)

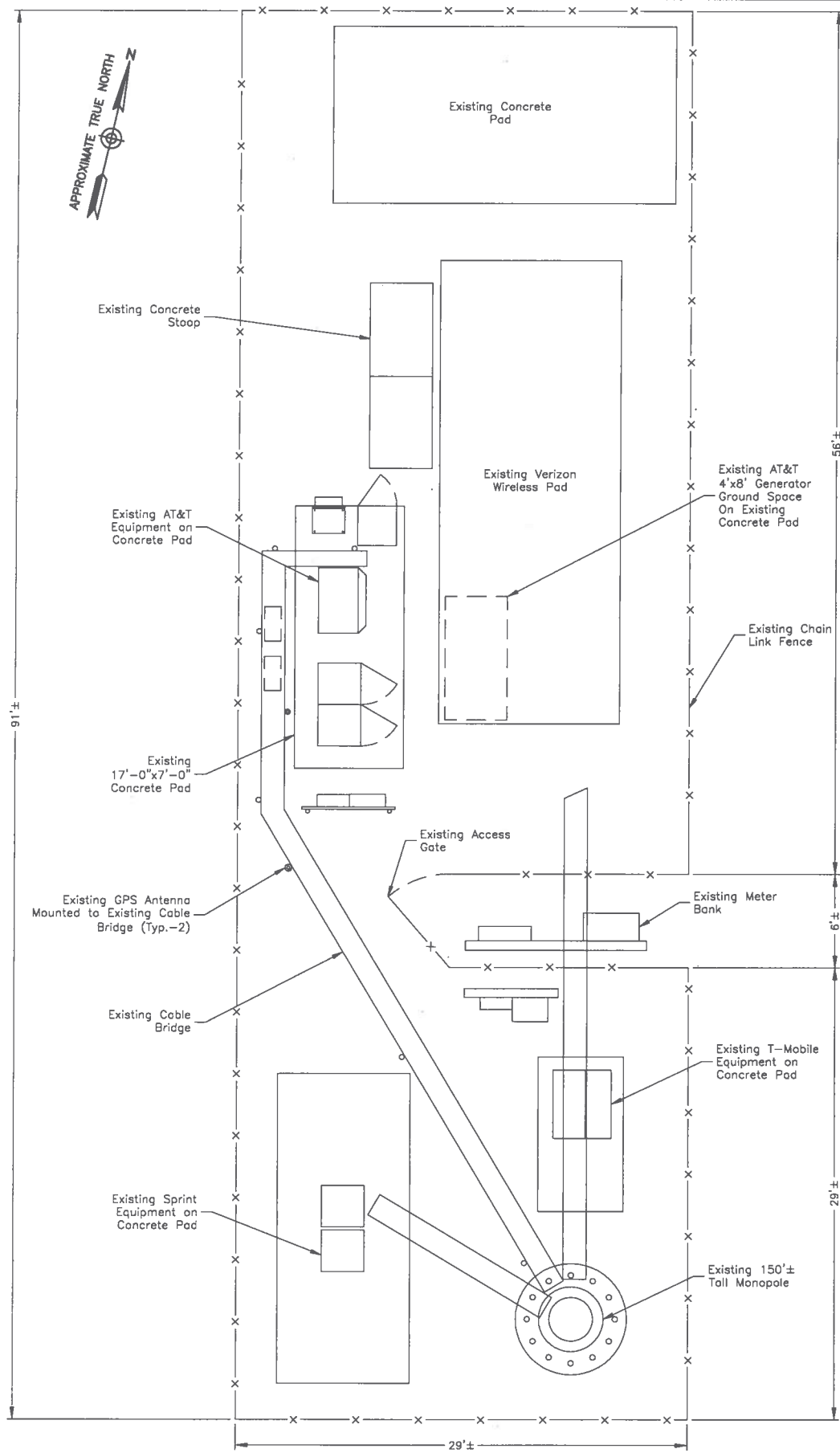

SITE PLAN
 SCALE: 1"=10' FOR 11"x17"
 1"=5' FOR 22"x34"
 0' 5' 10'

- NOTES:**
1. NORTH ARROW SHOWN AS APPROXIMATE.
 2. SOME EXISTING & PROPOSED INFORMATION NOT SHOWN FOR CLARITY.
 3. MOUNT ALL ANTENNAS, COAX, SURGE ARRESTORS, RRUS, ETC. IN ACCORDANCE WITH STRUCTURAL ANALYSIS.

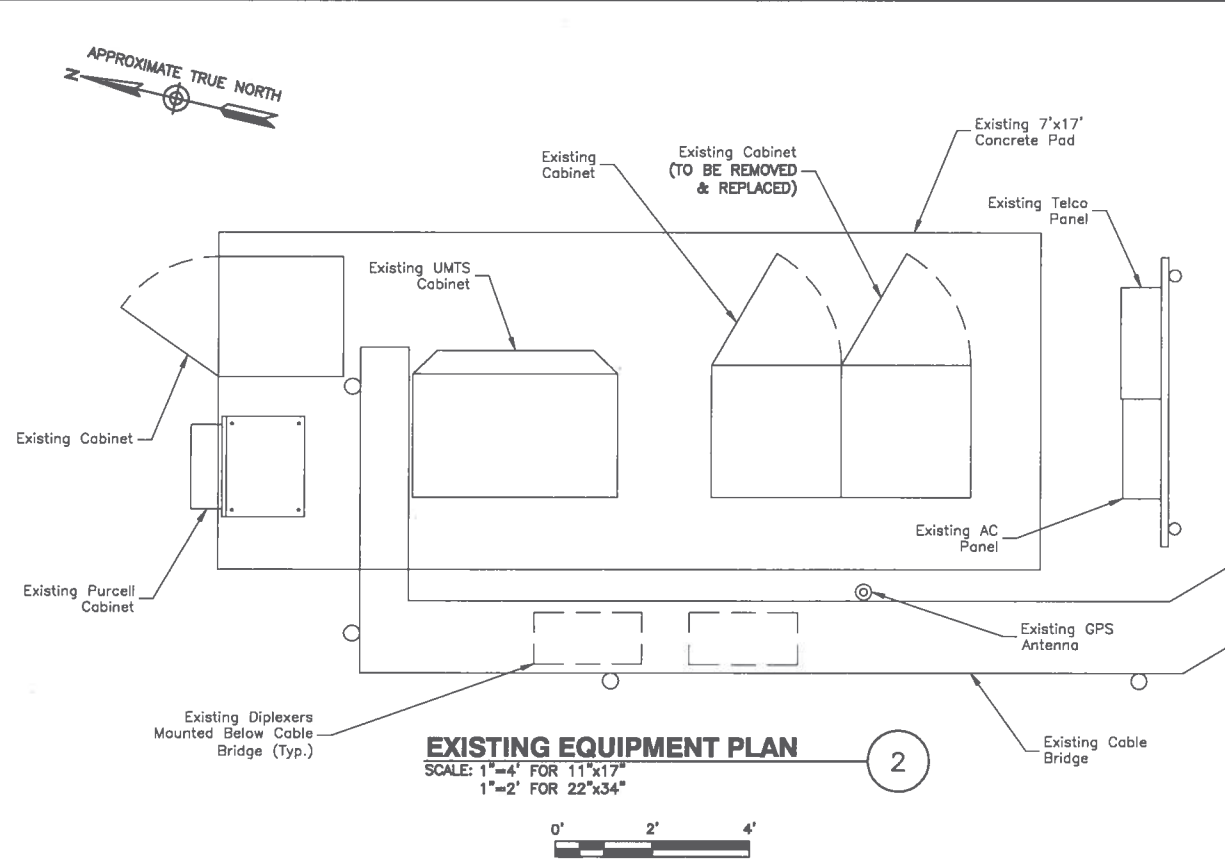

EXISTING EQUIPMENT PLAN
 SCALE: 1"=4' FOR 11"x17"
 1"=2' FOR 22"x34"
 0' 2' 4'

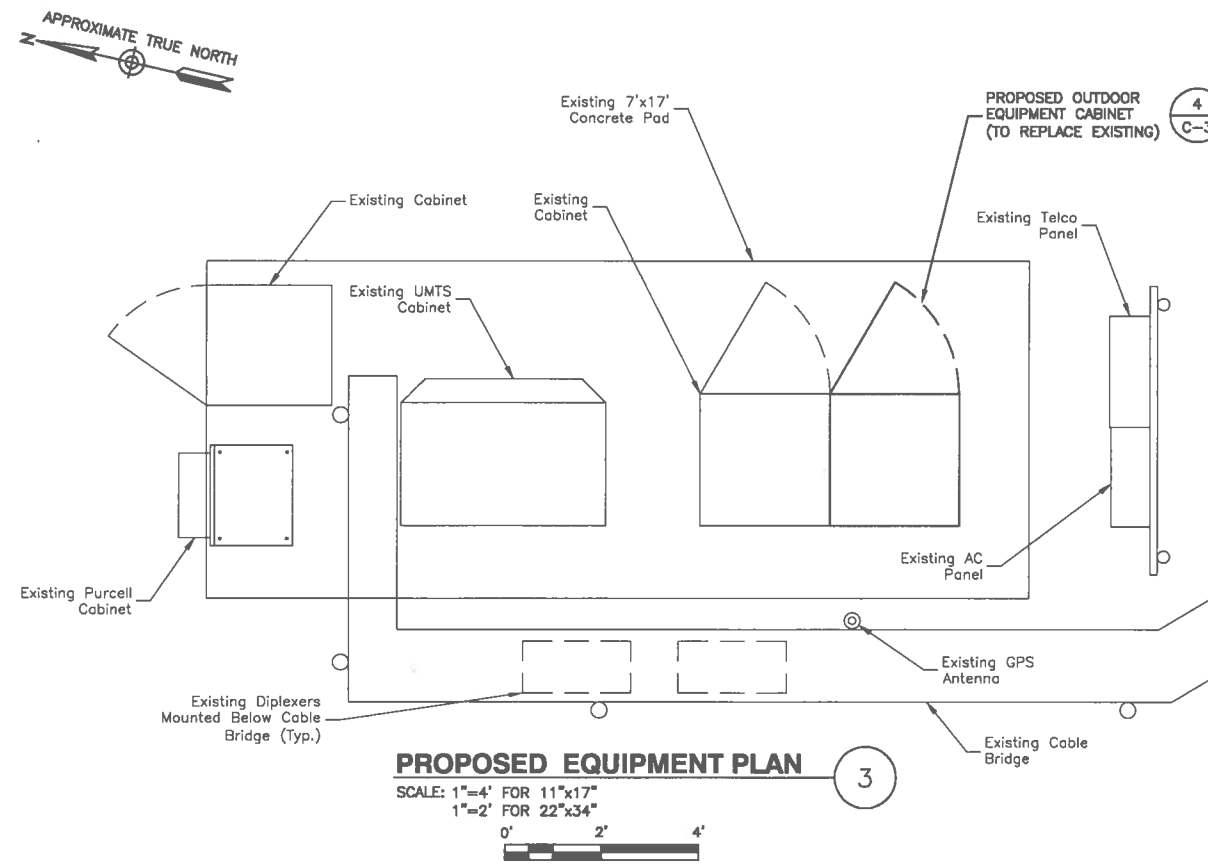

PROPOSED EQUIPMENT PLAN
 SCALE: 1"=4' FOR 11"x17"
 1"=2' FOR 22"x34"
 0' 2' 4'



500 ENTERPRISE DRIVE SUITE 3A
 ROCKY HILL, CT 06067



500 ENTERPRISE DRIVE SUITE 3A
 ROCKY HILL, CT 06067

CT5463
KILLINGLY NORTH

CONSTRUCTION DRAWING	
1 05/13/14	ISSUED AS FINAL
0 03/10/14	PRELIMINARY SUBMISSION

Dewberry
 Dewberry Engineers Inc.
 600 PARSIPPANY ROAD
 SUITE 301
 PARSIPPANY, NJ 07054
 PHONE: 973.739.9400
 FAX: 973.739.0710

Professional Engineer Seal for Robert J. Foley, P.E., License No. PEN.0029056. Text: "IT IS A VIOLATION OF LAW FOR ANY PERSON, UNLESS THEY ARE ACTING UNDER THE DIRECTION OF A LICENSED PROFESSIONAL ENGINEER TO ALTER THIS DOCUMENT."

DRAWN BY:	JC
REVIEWED BY:	PD
CHECKED BY:	GHN
PROJECT NUMBER:	50055106
JOB NUMBER:	50082686
SITE ADDRESS:	

79 PUTNAM PIKE
 DAYVILLE, CT 06241
 WINDHAM COUNTY

SHEET TITLE	
SITE PLAN & EQUIPMENT PLANS	
SHEET NUMBER	

C-1



500 ENTERPRISE DRIVE SUITE 3A
ROCKY HILL, CT 06067



500 ENTERPRISE DRIVE SUITE 3A
ROCKY HILL, CT 06067

CT5463
KILLINGLY NORTH

CONSTRUCTION DRAWING	
1	05/13/14 ISSUED AS FINAL
0	03/10/14 PRELIMINARY SUBMISSION

Dewberry
Dewberry Engineers Inc.
600 PARSIPPANY ROAD
SUITE 301
PARSIPPANY, NJ 07054
PHONE: 973.738.9400
FAX: 973.738.9710

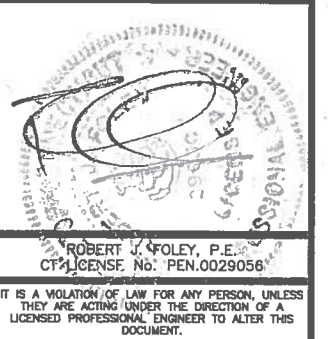

DRAWN BY:	JC
REVIEWED BY:	PD
CHECKED BY:	GHN
PROJECT NUMBER:	50055106
JOB NUMBER:	50062686
SITE ADDRESS:	

79 PUTNAM PIKE
DAYVILLE, CT 06241
WINDHAM COUNTY

SHEET TITLE	ANTENNA LAYOUTS & ELEVATIONS
SHEET NUMBER	C-2

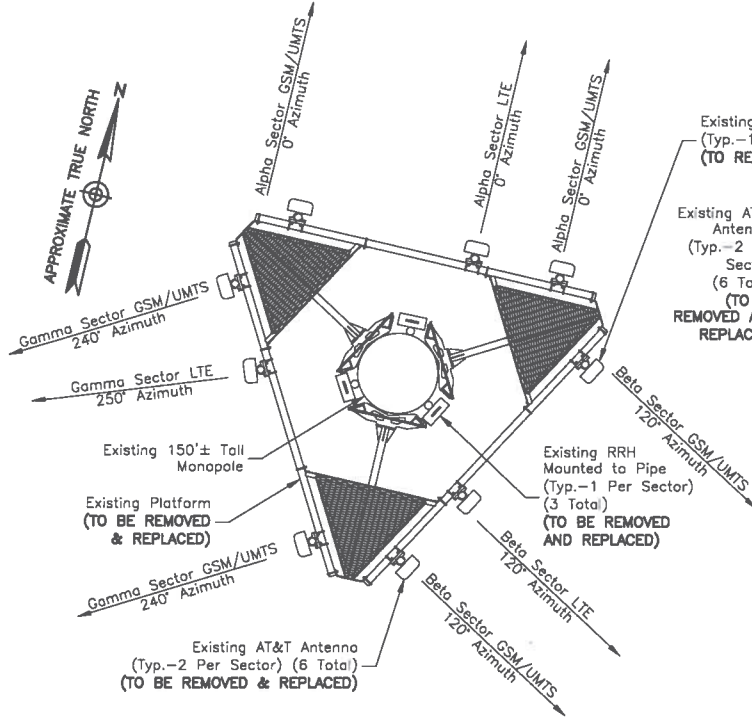

- NOTES:**
- EXISTING TMA'S NOT SHOWN FOR CLARITY.
 - ALL EXISTING TMA'S ARE TUBE REMOVED & REPLACED.

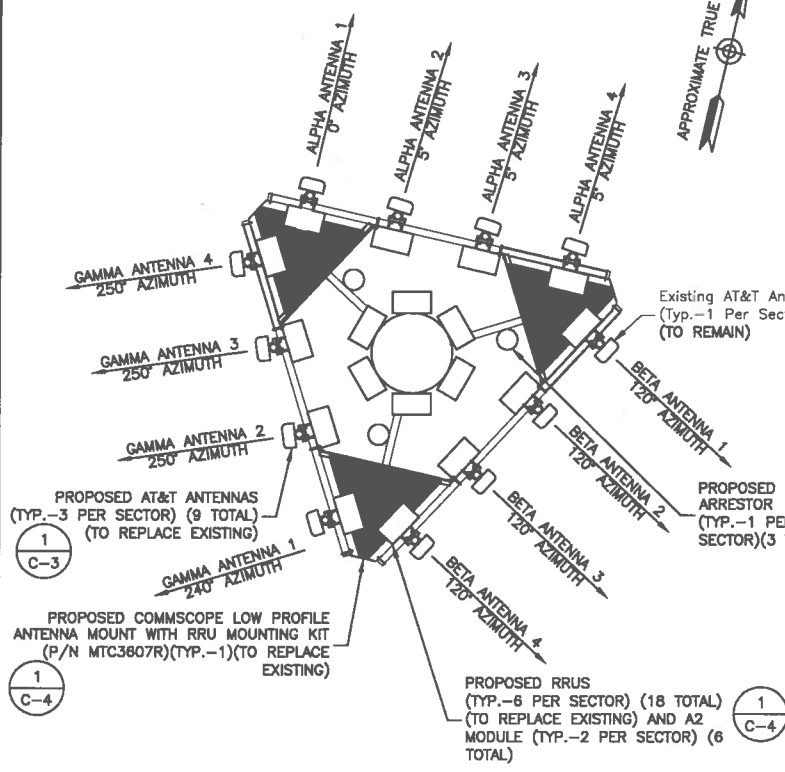

- NOTES:**
- PROPOSED TMA'S NOT SHOWN FOR CLARITY.
 - PROPOSED TMA'S TO REPLACE EXISTING TMA'S (TYP.-1 PER SECTOR) (3 TOTAL)

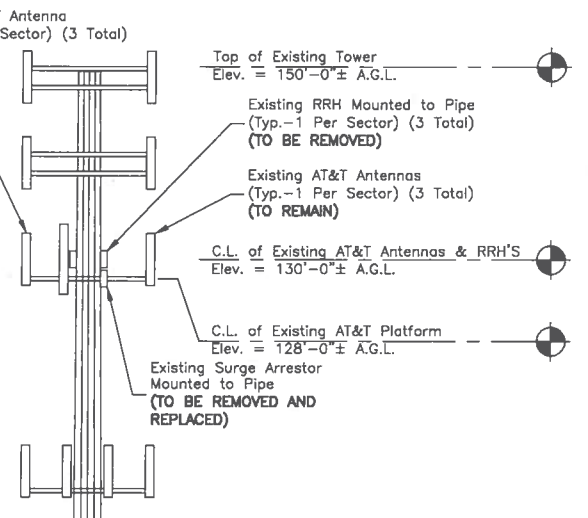

EXISTING EAST ELEVATION
SCALE: 1"=20' FOR 11"x17"
1"=10' FOR 22"x34"

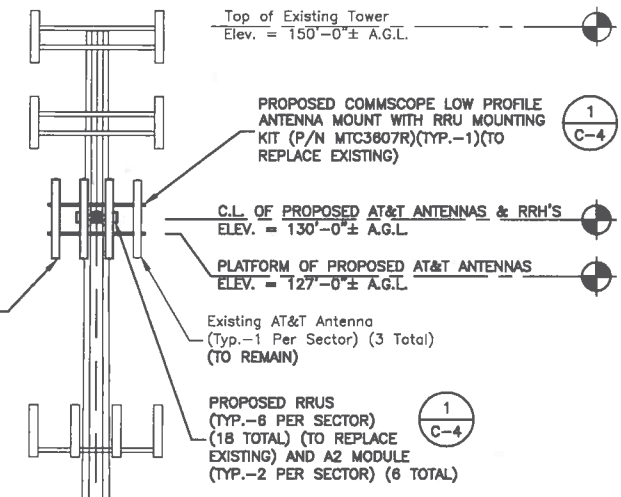

PROPOSED EAST ELEVATION
SCALE: 1"=20' FOR 11"x17"
1"=10' FOR 22"x34"

- NOTES:**
- PRIOR TO START OF ANY WORK, A PASSING STRUCTURAL ANALYSIS SHALL BE PROVIDED BY A CONNECTICUT LICENSED P.E. CONTRACTOR TO OBTAIN A COPY BEFORE STARTING ANY WORK.
 - ALL ANTENNAS, COAX, SURGE ARRESTORS, RRUS, ETC. TO BE INSTALLED IN ACCORDANCE WITH STRUCTURAL ANALYSIS AND FINAL AT&T RF DATA SHEET.

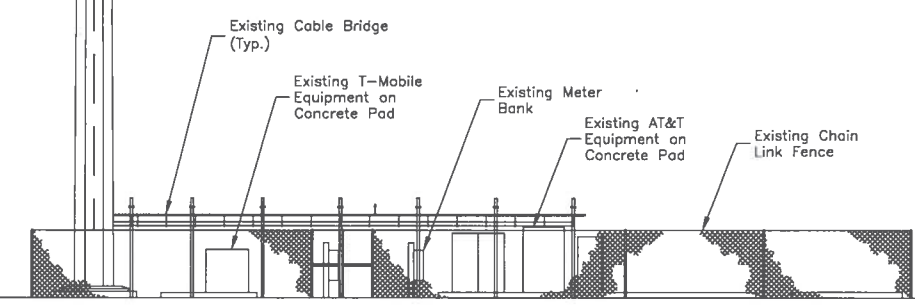
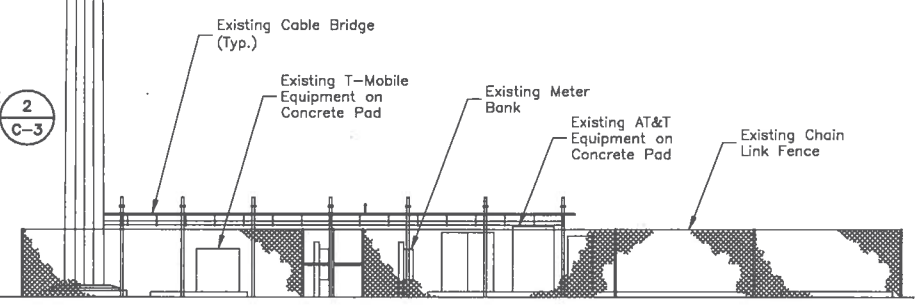

STRUCTURAL ANALYSIS REPORT

For

CT5463

KILLINGLY NORTH

79 Putnam Pike
Dayville, CT 06241

Antennas Mounted to the Monopole



Prepared for:



at&t

500 ENTERPRISE DRIVE, SUITE 3A
ROCKY HILL, CT 06067

Dated: May 1, 2014

Prepared by:

Hudson
Design Group LLC



1600 Osgood Street Building 20 North, Suite 3090
North Andover, MA 01845
Phone: (978) 557-5553

www.hudsondesigngroupllc.com

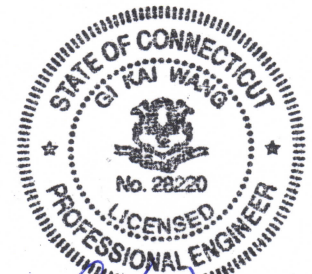

John Wang 5/1/2014



SCOPE OF WORK:

Hudson Design Group LLC (HDG) has been authorized by AT&T to conduct a structural evaluation of the 150' monopole supporting the proposed AT&T antennas located at elevation 130' above the ground level.

This report represents this office's findings, conclusions and recommendations pertaining to the support of AT&T's existing and proposed antennas listed below.

Manufacturer drawing of the existing monopole prepared by Fred A. Nudd Corporation, dated July 24, 1998 was available and obtained for our use. This office conducted an on-site visual survey and tower mapping on October 1, 2012 to record dimensional properties of the existing monopole and its appurtenances. Attendees included Bradley Loeb (HDG – Associate) and Nick Marshall (HDG - Associate).

The previous structural analysis report prepared by this office, dated October 18, 2012 was available for our use.

CONCLUSION SUMMARY:

Based on our evaluation, we have determined that the existing monopole **is in conformance** with the ANSI/TIA-222-F Standard for the loading considered under the criteria listed in this report. The monopole structure is rated at **91.9%** - (Pole Section L6 from El.40' to El.51' Controlling).



APPURTENANCES CONFIGURATION:

Tenant	Appurtenances	Elev.	Mount
	Lighting Rod	152.5'	Top of Monopole
	(2) 4' Omni	153'	10.5' Pipe
	(6) RV90-17-02DP Antennas	149'	12' T-Frame
	(6) TMA	149'	12' T-Frame
	(6) DB980H90E-M Antennas	138'	12' T-Frame
AT&T	(3) Powerwave 7770 Antennas	130'	Low Profile Platform
AT&T	(9) HPA-65R-BUU-H8 Antennas	130'	Low Profile Platform
AT&T	(6) RRUS-11	130'	Low Profile Platform
AT&T	(6) RRUS-12	130'	Low Profile Platform
AT&T	(3) RRUS-E2	130'	Low Profile Platform
AT&T	(3) RRUS-32	130'	Low Profile Platform
AT&T	(6) A2 Module	130'	Low Profile Platform
AT&T	(3) DTMABP7819VG12A	130'	Low Profile Platform
AT&T	(6) DBC2055F1V1	130'	Low Profile Platform
AT&T	(3) Surge Arrestors	130'	Low Profile Platform
	4' Omni	124.3'	6' Side Mount Standoff
	4' Omni	123.7'	6' Side Mount Standoff
	(6) LPA-185063-12CF Antennas	106'	Low Profile Platform
	(6) LPA-80063-6CF Antennas	106'	Low Profile Platform

**Proposed AT&T Appurtenances shown in Bold.*

AT&T EXISTING/PROPOSED COAX CABLES:

Tenant	Coax Cables	Elev.	Mount
AT&T	(12) 1 5/8" Cables	130'	Inside Monopole
AT&T	Fiber Cable	130'	Inside Monopole
AT&T	(2) DC Power Cables	130'	Inside Monopole

**Proposed AT&T Coax Cables shown in Bold.*



ANALYSIS RESULTS SUMMARY:

Component	Max. Stress Ratio	Elev. of Component (ft)	Pass/Fail	Comments
Pole Section-L1	11.8 %	130 – 150	PASS	
Pole Section-L2	49.7 %	115 – 130	PASS	
Pole Section-L3	56.0 %	95 – 115	PASS	
Pole Section-L4	70.0 %	91 – 95	PASS	
Pole Section-L5	78.5 %	51 – 91	PASS	
Pole Section-L6	91.9 %	40 – 51	PASS	Controlling
Pole Section-L7	77.7 %	19 – 40	PASS	
Pole Section-L8	89.7 %	0 – 19	PASS	



DESIGN CRITERIA:

1. EIA/TIA-222-F Structural Standards for Steel Antenna Towers and Antenna Supporting Structures

County: Windham
Wind Load: 85 mph (fastest mile)
105 mph (3 second gust)
Nominal Ice Thickness: 1/2 inch

2. Approximate height above grade to proposed antennas: 130'

***Calculations and referenced documents are attached.**

ASSUMPTIONS:

1. The monopole and foundation are properly constructed and maintained. All structural members and their connections are assumed to be in good condition and are free from defects with no deterioration to its member capacities.
2. The appurtenances configuration is as stated in this report. All antennas, coax cables and waveguide cables are assumed to be properly installed and supported as per the manufacturer requirements.
3. The support mounts and platforms are not analyzed and are considered adequate to support the loading. The analysis is limited to the primary support structure itself.
4. All prior structural modification, if any, are assumed to be as per the data supplied (if available), and installed properly.
5. The foundation of the tower was not checked due to lack of information. As-built foundation drawings and geotechnical report would be required to determine whether the foundation is capable of supporting the proposed loadings.

SUPPORT RECOMMENDATIONS:

HDG recommends that the proposed antennas, RRHs and surge arrestors be mounted on the existing steel platform supported by the monopole.

Section	1	2	3	4	5	6	7	8	
Length (ft)	20.00	20.00	20.00	10.00	40.00	19.00	21.00	28.00	
Number of Sides	12	12	12	12	12	12	12	12	
Thickness (in)	0.2500	0.2500	0.3125	0.3125	0.3750	0.3750	0.4375	0.4375	
Socket Length (ft)	5.00		6.00		8.00		9.00		
Top Dia (in)	27.8125		38.6875		45.8125		61.6875	64.7064	
Bot Dia (in)	34.3125		45.1875		58.8750		68.5000	73.8125	
Grade			A36M-45						
Weight (lb)	1688.1	1927.7	2850.5	1503.2	8541.3	4545.5	6508.7	9237.4	36802.4

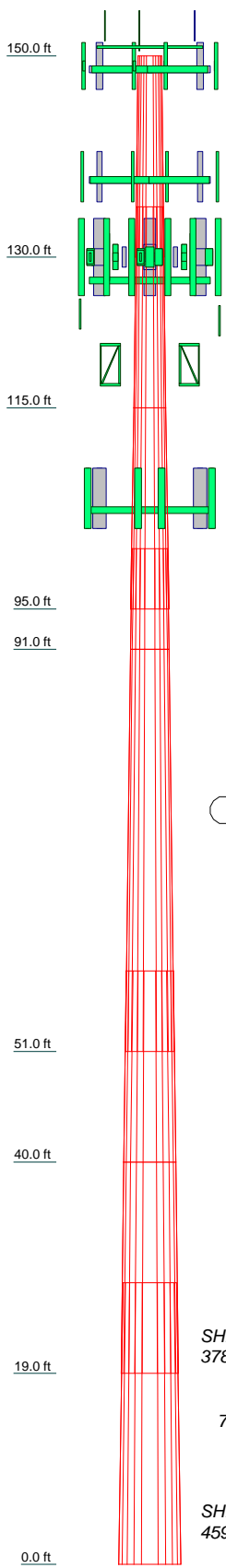

DESIGNED APPURTENANCE LOADING

TYPE	ELEVATION	TYPE	ELEVATION
Omni 3"x4'	153	Ericsson RRUS-E2 (ATI - proposed)	130
Omni 3"x4'	153	Ericsson RRUS-32 (ATI - proposed)	130
Lightning Rod 3/4"x6'	152.5	Ericsson RRUS-32 (ATI - proposed)	130
10.5' horizontal pipe	150.9	Ericsson RRUS-32 (ATI - proposed)	130
PIROD 12' T-Frame	149	(2) Ericsson A2 Module (ATI - proposed)	130
PIROD 12' T-Frame	149	(2) Ericsson A2 Module (ATI - proposed)	130
PIROD 12' T-Frame	149	(2) Ericsson A2 Module (ATI - proposed)	130
(2) RV90-17-02DP w/Mount Pipe	149	(2) Ericsson A2 Module (ATI - proposed)	130
(2) RV90-17-02DP w/Mount Pipe	149	(2) Ericsson A2 Module (ATI - proposed)	130
(2) RV90-17-02DP w/Mount Pipe	149	DTMABP7819VG12A TMA (ATI - proposed)	130
(2) Gen. TMA	149	DTMABP7819VG12A TMA (ATI - proposed)	130
(2) Gen. TMA	149	DTMABP7819VG12A TMA (ATI - proposed)	130
(2) Gen. TMA	149	DTMABP7819VG12A TMA (ATI - proposed)	130
PIROD 12' T-Frame	138	DTMABP7819VG12A TMA (ATI - proposed)	130
PIROD 12' T-Frame	138	(2) DBC2055F1V1 Diplexer (ATI - proposed)	130
PIROD 12' T-Frame	138	(2) DBC2055F1V1 Diplexer (ATI - proposed)	130
(2) DB980H90E-M w/Mount Pipe	138	(2) DBC2055F1V1 Diplexer (ATI - proposed)	130
(2) DB980H90E-M w/Mount Pipe	138	(2) DBC2055F1V1 Diplexer (ATI - proposed)	130
(2) DB980H90E-M w/Mount Pipe	138	(2) DBC2055F1V1 Diplexer (ATI - proposed)	130
Powerwave 7770 w/mount pipe (ATI - existing)	130	Surge Arrestor DC6-48-60-18-8F (ATI - proposed)	130
Powerwave 7770 w/mount pipe (ATI - existing)	130	Surge Arrestor DC6-48-60-18-8F (ATI - proposed)	130
Powerwave 7770 w/mount pipe (ATI - existing)	130	Surge Arrestor DC6-48-60-18-8F (ATI - proposed)	130
(3) HPA-65R-BUU-H8 w/mount pipe (ATI - proposed)	130	14' Low Profile Platform (ATI - existing)	128
(3) HPA-65R-BUU-H8 w/mount pipe (ATI - proposed)	130	Omni 3"x4'	124.3
(3) HPA-65R-BUU-H8 w/mount pipe (ATI - proposed)	130	Omni 3"x4'	123.7
(2) Ericsson RRUS-11 (ATI - proposed)	130	Pirod 6' Side Mount Standoff (1)	119.3
(2) Ericsson RRUS-11 (ATI - proposed)	130	Pirod 6' Side Mount Standoff (1)	119.3
(2) Ericsson RRUS-11 (ATI - proposed)	130	2' Side Mount Standoff	119.3
(2) Ericsson RRUS-11 (ATI - proposed)	130	(2) LPA-185063/12CF w/mount pipe	106
(2) Ericsson RRUS-11 (ATI - proposed)	130	(2) LPA-185063/12CF w/mount pipe	106
(2) Ericsson RRUS-12 (ATI - proposed)	130	(2) LPA-185063/12CF w/mount pipe	106
(2) Ericsson RRUS-12 (ATI - proposed)	130	(2) LPA-80063-6CF-EDIN w/mount pipe	106
(2) Ericsson RRUS-12 (ATI - proposed)	130	(2) LPA-80063-6CF-EDIN w/mount pipe	106
(2) Ericsson RRUS-12 (ATI - proposed)	130	(2) LPA-80063-6CF-EDIN w/mount pipe	106
Ericsson RRUS-E2 (ATI - proposed)	130	14' Low Profile Platform	105.2
Ericsson RRUS-E2 (ATI - proposed)	130		

MATERIAL STRENGTH

GRADE	Fy	Fu	GRADE	Fy	Fu
A36M-45	45 ksi	60 ksi			

TOWER DESIGN NOTES

1. Tower is located in Windham County, Connecticut.
2. Tower designed for a 85.0 mph basic wind in accordance with the TIA/EIA-222-F Standard.
3. Tower is also designed for a 73.6 mph basic wind with 0.500 in ice.
4. Deflections are based upon a 50.0 mph wind.
5. TOWER RATING: 91.9%

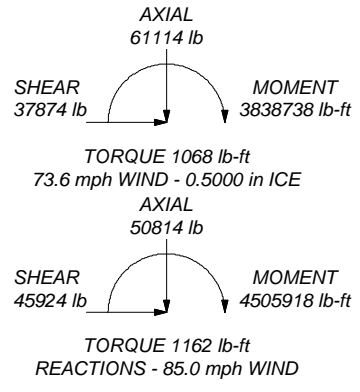

Hudson Design Group, LLC		Job: CT 5463 LTE 2C Dayville, CT	
1600 Osgood Street, Building 20 North, Suite 3090		Project: 150 ft Monopole	
North Andover, MA 01845		Client: AT&T	Drawn by: kw
Phone: (978) 557-5553		Code: TIA/EIA-222-F	Date: 05/01/14
FAX: (978) 226-5586		Path:	Scale: NTS
		Dwg No. E-1	



Centek Engineering, Inc.
3-2 North Branford Road
Branford, Connecticut 06405
Phone: (203) 488-0580
Fax: (203) 488-8587

Steven L. Levine
Real Estate Consultant

May 16, 2014

Bruce Benway, Town Manager
Town of Killingly
Town Hall 172 Main Street
Danielson, CT 06239

Notice of Exempt Modification: Existing Telecommunications Facility at 79 Putnam Pike, Killingly, CT

Dear Mr. Benway:

In order to accommodate technological changes, implement Uniform Mobile Telecommunications System (“UMTS”) and Long Term Evolution (“LTE”) capabilities, and enhance system performance in the State of Connecticut, New Cingular Wireless PCS, LLC (“AT&T”) will be changing its equipment configuration at certain cell sites.

As required by Regulations of Connecticut State Agencies (“R.C.S.A.”) Section 16-50j-73, the Connecticut Siting Council has been notified of the changes and will review AT&T’s proposal. Please accept this letter as notification under Section 16-50j-73 of construction which constitutes an exempt modification pursuant to R.C.S.A. Section 16-50j-72(b)(2).

The enclosed Notice fully sets forth the AT&T proposal. However, if you have any questions or require any further information on the plans for the site or the Siting Council’s procedures, please contact the undersigned at 860-830-0380 or Ms. Melanie Bachman, Acting Executive Director, Connecticut Siting Council at (860) 827-2935

Sincerely,

Steven L. Levine
Real Estate Consultant

Enclosure

STRUCTURAL ANALYSIS REPORT

For

CT5463

KILLINGLY NORTH

79 Putnam Pike
Dayville, CT 06241

Antennas Mounted to the Monopole



Prepared for:



at&t

500 ENTERPRISE DRIVE, SUITE 3A
ROCKY HILL, CT 06067

Dated: May 1, 2014

Prepared by:

Hudson
Design Group LLC



1600 Osgood Street Building 20 North, Suite 3090
North Andover, MA 01845
Phone: (978) 557-5553

www.hudsondesigngroupllc.com

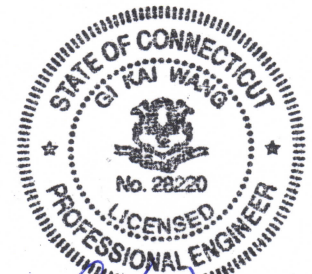

John Wang 5/1/2014



SCOPE OF WORK:

Hudson Design Group LLC (HDG) has been authorized by AT&T to conduct a structural evaluation of the 150' monopole supporting the proposed AT&T antennas located at elevation 130' above the ground level.

This report represents this office's findings, conclusions and recommendations pertaining to the support of AT&T's existing and proposed antennas listed below.

Manufacturer drawing of the existing monopole prepared by Fred A. Nudd Corporation, dated July 24, 1998 was available and obtained for our use. This office conducted an on-site visual survey and tower mapping on October 1, 2012 to record dimensional properties of the existing monopole and its appurtenances. Attendees included Bradley Loeb (HDG – Associate) and Nick Marshall (HDG - Associate).

The previous structural analysis report prepared by this office, dated October 18, 2012 was available for our use.

CONCLUSION SUMMARY:

Based on our evaluation, we have determined that the existing monopole **is in conformance** with the ANSI/TIA-222-F Standard for the loading considered under the criteria listed in this report. The monopole structure is rated at **91.9%** - (Pole Section L6 from El.40' to El.51' Controlling).



APPURTENANCES CONFIGURATION:

Tenant	Appurtenances	Elev.	Mount
	Lighting Rod	152.5'	Top of Monopole
	(2) 4' Omni	153'	10.5' Pipe
	(6) RV90-17-02DP Antennas	149'	12' T-Frame
	(6) TMA	149'	12' T-Frame
	(6) DB980H90E-M Antennas	138'	12' T-Frame
AT&T	(3) Powerwave 7770 Antennas	130'	Low Profile Platform
AT&T	(9) HPA-65R-BUU-H8 Antennas	130'	Low Profile Platform
AT&T	(6) RRUS-11	130'	Low Profile Platform
AT&T	(6) RRUS-12	130'	Low Profile Platform
AT&T	(3) RRUS-E2	130'	Low Profile Platform
AT&T	(3) RRUS-32	130'	Low Profile Platform
AT&T	(6) A2 Module	130'	Low Profile Platform
AT&T	(3) DTMABP7819VG12A	130'	Low Profile Platform
AT&T	(6) DBC2055F1V1	130'	Low Profile Platform
AT&T	(3) Surge Arrestors	130'	Low Profile Platform
	4' Omni	124.3'	6' Side Mount Standoff
	4' Omni	123.7'	6' Side Mount Standoff
	(6) LPA-185063-12CF Antennas	106'	Low Profile Platform
	(6) LPA-80063-6CF Antennas	106'	Low Profile Platform

**Proposed AT&T Appurtenances shown in Bold.*

AT&T EXISTING/PROPOSED COAX CABLES:

Tenant	Coax Cables	Elev.	Mount
AT&T	(12) 1 5/8" Cables	130'	Inside Monopole
AT&T	Fiber Cable	130'	Inside Monopole
AT&T	(2) DC Power Cables	130'	Inside Monopole

**Proposed AT&T Coax Cables shown in Bold.*



ANALYSIS RESULTS SUMMARY:

Component	Max. Stress Ratio	Elev. of Component (ft)	Pass/Fail	Comments
Pole Section-L1	11.8 %	130 – 150	PASS	
Pole Section-L2	49.7 %	115 – 130	PASS	
Pole Section-L3	56.0 %	95 – 115	PASS	
Pole Section-L4	70.0 %	91 – 95	PASS	
Pole Section-L5	78.5 %	51 – 91	PASS	
Pole Section-L6	91.9 %	40 – 51	PASS	Controlling
Pole Section-L7	77.7 %	19 – 40	PASS	
Pole Section-L8	89.7 %	0 – 19	PASS	



DESIGN CRITERIA:

1. EIA/TIA-222-F Structural Standards for Steel Antenna Towers and Antenna Supporting Structures

County: Windham
Wind Load: 85 mph (fastest mile)
105 mph (3 second gust)
Nominal Ice Thickness: 1/2 inch

2. Approximate height above grade to proposed antennas: 130'

***Calculations and referenced documents are attached.**

ASSUMPTIONS:

1. The monopole and foundation are properly constructed and maintained. All structural members and their connections are assumed to be in good condition and are free from defects with no deterioration to its member capacities.
2. The appurtenances configuration is as stated in this report. All antennas, coax cables and waveguide cables are assumed to be properly installed and supported as per the manufacturer requirements.
3. The support mounts and platforms are not analyzed and are considered adequate to support the loading. The analysis is limited to the primary support structure itself.
4. All prior structural modification, if any, are assumed to be as per the data supplied (if available), and installed properly.
5. The foundation of the tower was not checked due to lack of information. As-built foundation drawings and geotechnical report would be required to determine whether the foundation is capable of supporting the proposed loadings.

SUPPORT RECOMMENDATIONS:

HDG recommends that the proposed antennas, RRHs and surge arrestors be mounted on the existing steel platform supported by the monopole.

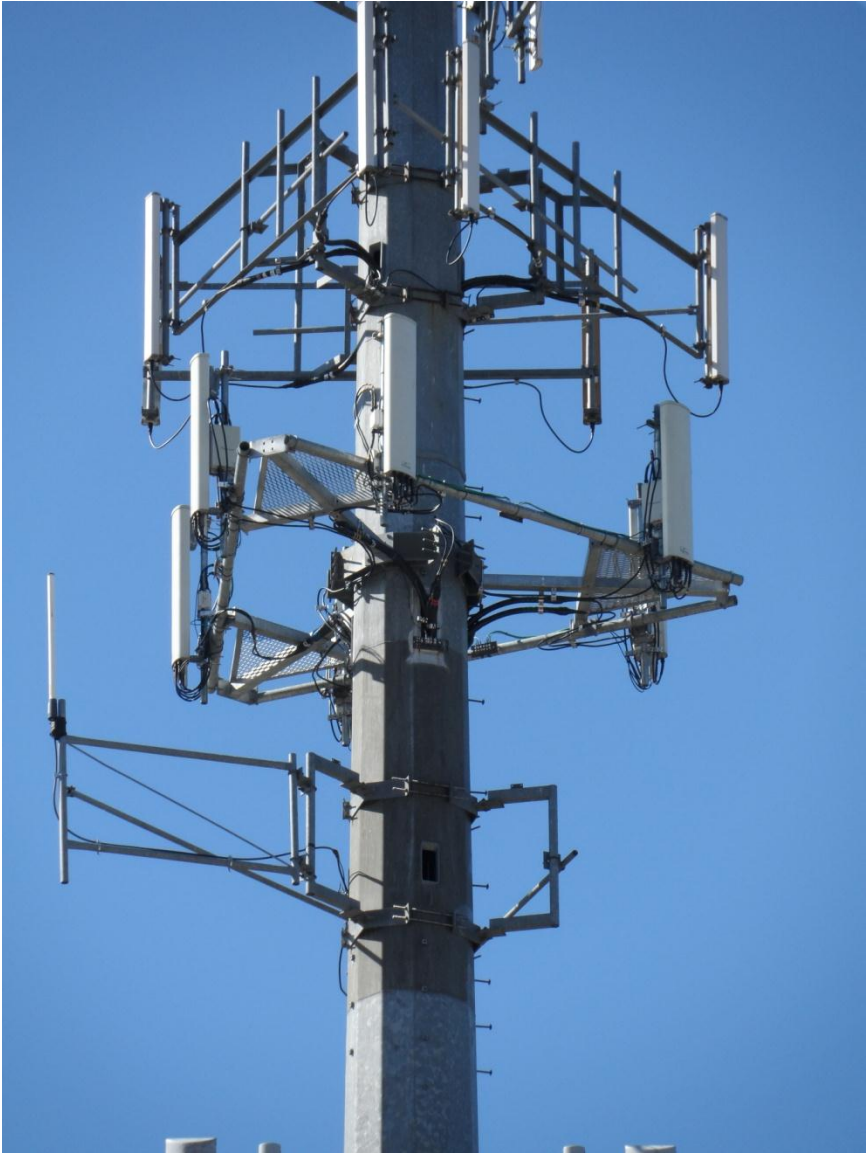
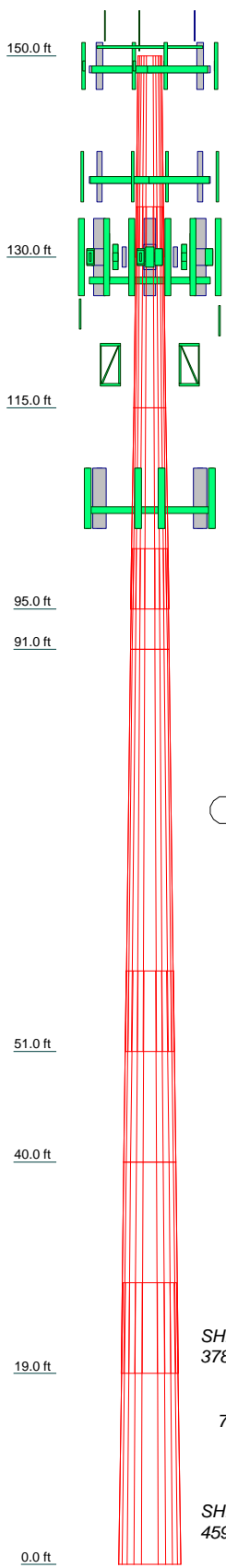

Photo 1: Photo illustrating the monopole with Appurtenances shown.



CALCULATIONS

Section	1	2	3	4	5	6	7	8
Length (ft)	20.00	20.00	20.00	10.00	40.00	19.00	21.00	28.00
Number of Sides	12	12	12	12	12	12	12	12
Thickness (in)	0.2500	0.2500	0.3125	0.3125	0.3750	0.3750	0.4375	0.4375
Socket Length (ft)	5.00		6.00		8.00		9.00	
Top Dia (in)	27.8125		38.6875		45.8125		61.6875	
Bot Dia (in)	34.3125		45.1875		58.8750		68.5000	
Grade			A36M-45					
Weight (lb)	1688.1	1927.7	2850.5	1503.2	8541.3	4545.5	6508.7	9237.4



DESIGNED APPURTENANCE LOADING

TYPE	ELEVATION	TYPE	ELEVATION
Omni 3"x4'	153	Ericsson RRUS-E2 (ATI - proposed)	130
Omni 3"x4'	153	Ericsson RRUS-32 (ATI - proposed)	130
Lightning Rod 3/4"x6'	152.5	Ericsson RRUS-32 (ATI - proposed)	130
10.5' horizontal pipe	150.9	Ericsson RRUS-32 (ATI - proposed)	130
PIROD 12' T-Frame	149	(2) Ericsson A2 Module (ATI - proposed)	130
PIROD 12' T-Frame	149	(2) Ericsson A2 Module (ATI - proposed)	130
PIROD 12' T-Frame	149	(2) Ericsson A2 Module (ATI - proposed)	130
(2) RV90-17-02DP w/Mount Pipe	149	(2) Ericsson A2 Module (ATI - proposed)	130
(2) RV90-17-02DP w/Mount Pipe	149	(2) Ericsson A2 Module (ATI - proposed)	130
(2) RV90-17-02DP w/Mount Pipe	149	DTMABP7819VG12A TMA (ATI - proposed)	130
(2) Gen. TMA	149	DTMABP7819VG12A TMA (ATI - proposed)	130
(2) Gen. TMA	149	DTMABP7819VG12A TMA (ATI - proposed)	130
(2) Gen. TMA	149	DTMABP7819VG12A TMA (ATI - proposed)	130
PIROD 12' T-Frame	138	DTMABP7819VG12A TMA (ATI - proposed)	130
PIROD 12' T-Frame	138	(2) DBC2055F1V1 Diplexer (ATI - proposed)	130
PIROD 12' T-Frame	138	(2) DBC2055F1V1 Diplexer (ATI - proposed)	130
(2) DB980H90E-M w/Mount Pipe	138	(2) DBC2055F1V1 Diplexer (ATI - proposed)	130
(2) DB980H90E-M w/Mount Pipe	138	(2) DBC2055F1V1 Diplexer (ATI - proposed)	130
(2) DB980H90E-M w/Mount Pipe	138	(2) DBC2055F1V1 Diplexer (ATI - proposed)	130
Powerwave 7770 w/mount pipe (ATI - existing)	130	Surge Arrestor DC6-48-60-18-8F (ATI - proposed)	130
Powerwave 7770 w/mount pipe (ATI - existing)	130	Surge Arrestor DC6-48-60-18-8F (ATI - proposed)	130
Powerwave 7770 w/mount pipe (ATI - existing)	130	Surge Arrestor DC6-48-60-18-8F (ATI - proposed)	130
(3) HPA-65R-BUU-H8 w/mount pipe (ATI - proposed)	130	14' Low Profile Platform (ATI - existing)	128
(3) HPA-65R-BUU-H8 w/mount pipe (ATI - proposed)	130	Omni 3"x4'	124.3
(3) HPA-65R-BUU-H8 w/mount pipe (ATI - proposed)	130	Omni 3"x4'	123.7
(2) Ericsson RRUS-11 (ATI - proposed)	130	Pirot 6' Side Mount Standoff (1)	119.3
(2) Ericsson RRUS-11 (ATI - proposed)	130	Pirot 6' Side Mount Standoff (1)	119.3
(2) Ericsson RRUS-11 (ATI - proposed)	130	2' Side Mount Standoff	119.3
(2) Ericsson RRUS-11 (ATI - proposed)	130	(2) LPA-185063/12CF w/mount pipe	106
(2) Ericsson RRUS-11 (ATI - proposed)	130	(2) LPA-185063/12CF w/mount pipe	106
(2) Ericsson RRUS-12 (ATI - proposed)	130	(2) LPA-185063/12CF w/mount pipe	106
(2) Ericsson RRUS-12 (ATI - proposed)	130	(2) LPA-80063-6CF-EDIN w/mount pipe	106
(2) Ericsson RRUS-12 (ATI - proposed)	130	(2) LPA-80063-6CF-EDIN w/mount pipe	106
(2) Ericsson RRUS-12 (ATI - proposed)	130	(2) LPA-80063-6CF-EDIN w/mount pipe	106
(2) Ericsson RRUS-12 (ATI - proposed)	130	(2) LPA-80063-6CF-EDIN w/mount pipe	106
Ericsson RRUS-E2 (ATI - proposed)	130	14' Low Profile Platform	105.2
Ericsson RRUS-E2 (ATI - proposed)	130		

MATERIAL STRENGTH

GRADE	Fy	Fu	GRADE	Fy	Fu
A36M-45	45 ksi	60 ksi			

TOWER DESIGN NOTES

1. Tower is located in Windham County, Connecticut.
2. Tower designed for a 85.0 mph basic wind in accordance with the TIA/EIA-222-F Standard.
3. Tower is also designed for a 73.6 mph basic wind with 0.500 in ice.
4. Deflections are based upon a 50.0 mph wind.
5. TOWER RATING: 91.9%

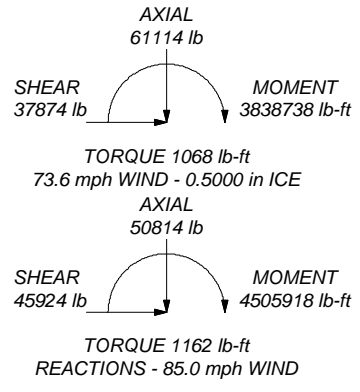

Hudson Design Group, LLC
 1600 Osgood Street, Building 20 North, Suite 3090
 North Andover, MA 01845
 Phone: (978) 557-5553
 FAX: (978) 226-5586

Job: **CT 5463 LTE 2C Dayville, CT**
 Project: **150 ft Monopole**
 Client: **AT&T** Drawn by: **kw** App'd:
 Code: **TIA/EIA-222-F** Date: **05/01/14** Scale: **NTS**
 Path: Dwg No. **E-1**

tnxTower Hudson Design Group, LLC 1600 Osgood Street, Building 20 North, Suite 3090 North Andover, MA 01845 Phone: (978) 557-5553 FAX: (978) 226-5586	Job CT 5463 LTE 2C Dayville, CT	Page 1 of 9
	Project 150 ft Monopole	Date 08:52:31 05/01/14
	Client AT&T	Designed by kw

Tower Input Data

There is a pole section.

This tower is designed using the TIA/EIA-222-F standard.

The following design criteria apply:

Tower is located in Windham County, Connecticut.

Basic wind speed of 85.0 mph.

Nominal ice thickness of 0.5000 in.

Ice density of 56.0 pcf.

A wind speed of 73.6 mph is used in combination with ice.

Temperature drop of 50.0 °F.

Deflections calculated using a wind speed of 50.0 mph.

A non-linear (P-delta) analysis was used.

Pressures are calculated at each section.

Stress ratio used in pole design is 1.333.

Local bending stresses due to climbing loads, feed line supports, and appurtenance mounts are not considered.

Tapered Pole Section Geometry

Section	Elevation ft	Section Length ft	Splice Length ft	Number of Sides	Top Diameter in	Bottom Diameter in	Wall Thickness in	Bend Radius in	Pole Grade
L1	150.00-130.00	20.00	5.00	12	27.8125	34.3125	0.2500	1.0000	A36M-45 (45 ksi)
L2	130.00-115.00	20.00	0.00	12	32.1875	38.6875	0.2500	1.0000	A36M-45 (45 ksi)
L3	115.00-95.00	20.00	6.00	12	38.6875	45.1875	0.3125	1.2500	A36M-45 (45 ksi)
L4	95.00-91.00	10.00	0.00	12	42.6125	45.8125	0.3125	1.2500	A36M-45 (45 ksi)
L5	91.00-51.00	40.00	8.00	12	45.8125	58.8750	0.3750	1.5000	A36M-45 (45 ksi)
L6	51.00-40.00	19.00	0.00	12	55.5125	61.6875	0.3750	1.5000	A36M-45 (45 ksi)
L7	40.00-19.00	21.00	9.00	12	61.6875	68.5000	0.4375	1.7500	A36M-45 (45 ksi)
L8	19.00-0.00	28.00		12	64.7054	73.8125	0.4375	1.7500	A36M-45 (45 ksi)

Feed Line/Linear Appurtenances - Entered As Area

Description	Face or Leg	Allow Shield	Component Type	Placement ft	Total Number		C _A A _A ft ² /ft	Weight plf
7/8	A	No	Inside Pole	150.00 - 7.00	2	No Ice	0.00	0.54
						1/2" Ice	0.00	0.54
1 5/8	A	No	Inside Pole	149.00 - 7.00	6	No Ice	0.00	1.04
						1/2" Ice	0.00	1.04
1 5/8	A	No	Inside Pole	138.00 - 7.00	6	No Ice	0.00	1.04
						1/2" Ice	0.00	1.04

tnxTower Hudson Design Group, LLC 1600 Osgood Street, Building 20 North, Suite 3090 North Andover, MA 01845 Phone: (978) 557-5553 FAX: (978) 226-5586	Job CT 5463 LTE 2C Dayville, CT	Page 2 of 9
	Project 150 ft Monopole	Date 08:52:31 05/01/14
	Client AT&T	Designed by kw

Description	Face or Leg	Allow Shield	Component Type	Placement ft	Total Number		C _A A _A ft ² /ft	Weight plf
1 5/8 (AT&T - existing)	A	No	Inside Pole	130.00 - 7.00	12	No Ice	0.00	1.04
1/2	A	No	Inside Pole	120.00 - 7.00	2	1/2" Ice	0.00	1.04
						No Ice	0.00	0.25
						1/2" Ice	0.00	0.25
1 5/8	A	No	Inside Pole	106.00 - 7.00	12	No Ice	0.00	1.04
						1/2" Ice	0.00	1.04

FB-L98B-002 (AT&T - existing)	C	No	Inside Pole	130.00 - 7.00	1	No Ice	0.00	0.25
						1/2" Ice	0.00	0.25
WR-VG122ST-BRDA (AT&T - existing)	C	No	Inside Pole	130.00 - 7.00	2	No Ice	0.00	0.25
						1/2" Ice	0.00	0.25

Discrete Tower Loads

Description	Face or Leg	Offset Type	Offsets: Horz Lateral Vert ft ft ft	Azimuth Adjustment °	Placement ft		C _A A _A Front ft ²	C _A A _A Side ft ²	Weight lb
Lightning Rod 3/4"x6'	C	From Leg	0.00	0.0000	152.50	No Ice	0.45	0.45	30.00
			0.00			1/2" Ice	1.06	1.06	34.66
			0.00						
10.5' horizontal pipe	C	None		0.0000	150.90	No Ice	2.01	2.01	61.00
						1/2" Ice	2.73	2.73	490.04
Omni 3"x4'	C	From Leg	4.00	0.0000	153.00	No Ice	0.68	0.68	15.00
			0.00			1/2" Ice	0.87	0.87	21.82
			0.00						
Omni 3"x4'	B	From Face	4.00	0.0000	153.00	No Ice	0.68	0.68	15.00
			0.00			1/2" Ice	0.87	0.87	21.82
			0.00						

PiROD 12' T-Frame	A	From Leg	2.00	0.0000	149.00	No Ice	12.20	12.20	360.00
			0.00			1/2" Ice	17.60	17.60	490.00
			0.00						
PiROD 12' T-Frame	B	From Leg	2.00	0.0000	149.00	No Ice	12.20	12.20	360.00
			0.00			1/2" Ice	17.60	17.60	490.00
			0.00						
PiROD 12' T-Frame	C	From Leg	2.00	0.0000	149.00	No Ice	12.20	12.20	360.00
			0.00			1/2" Ice	17.60	17.60	490.00
			0.00						
(2) RV90-17-02DP w/Mount Pipe	A	From Leg	3.50	0.0000	149.00	No Ice	4.91	3.64	43.55
			0.00			1/2" Ice	5.57	4.70	84.46
			0.00						
(2) RV90-17-02DP w/Mount Pipe	B	From Leg	3.50	0.0000	149.00	No Ice	4.91	3.64	43.55
			0.00			1/2" Ice	5.57	4.70	84.46
			0.00						
(2) RV90-17-02DP w/Mount Pipe	C	From Leg	3.50	0.0000	149.00	No Ice	4.91	3.64	43.55
			0.00			1/2" Ice	5.57	4.70	84.46
			0.00						
(2) Gen. TMA	A	From Leg	3.50	0.0000	149.00	No Ice	0.68	0.45	13.20
			0.00			1/2" Ice	0.80	0.56	18.38
			0.00						
(2) Gen. TMA	B	From Leg	3.50	0.0000	149.00	No Ice	0.68	0.45	13.20
			0.00			1/2" Ice	0.80	0.56	18.38
			0.00						

tnxTower Hudson Design Group, LLC 1600 Osgood Street, Building 20 North, Suite 3090 North Andover, MA 01845 Phone: (978) 557-5553 FAX: (978) 226-5586	Job	CT 5463 LTE 2C Dayville, CT	Page	3 of 9
	Project	150 ft Monopole	Date	08:52:31 05/01/14
	Client	AT&T	Designed by	kw

Description	Face or Leg	Offset Type	Offsets: Horz Lateral Vert ft ft ft	Azimuth Adjustment °	Placement ft	C _{AA} Front ft ²	C _{AA} Side ft ²	Weight lb
(2) Gen. TMA	C	From Leg	3.50 0.00 0.00	0.0000	149.00	No Ice 1/2" Ice 0.68 0.80	0.45 0.56	13.20 18.38

PiROD 12' T-Frame	A	From Leg	2.00 0.00 0.00	0.0000	138.00	No Ice 1/2" Ice 12.20 17.60	12.20 17.60	360.00 490.00
PiROD 12' T-Frame	B	From Leg	2.00 0.00 0.00	0.0000	138.00	No Ice 1/2" Ice 12.20 17.60	12.20 17.60	360.00 490.00
PiROD 12' T-Frame	C	From Leg	2.00 0.00 0.00	0.0000	138.00	No Ice 1/2" Ice 12.20 17.60	12.20 17.60	360.00 490.00
(2) DB980H90E-M w/Mount Pipe	A	From Leg	3.50 0.00 0.00	0.0000	138.00	No Ice 1/2" Ice 4.27 4.86	3.86 4.95	34.05 72.67
(2) DB980H90E-M w/Mount Pipe	B	From Leg	3.50 0.00 0.00	0.0000	138.00	No Ice 1/2" Ice 4.27 4.86	3.86 4.95	34.05 72.67
(2) DB980H90E-M w/Mount Pipe	C	From Leg	3.50 0.00 0.00	0.0000	138.00	No Ice 1/2" Ice 4.27 4.86	3.86 4.95	34.05 72.67

14' Low Profile Platform (AT&T - existing)	A	None		0.0000	128.00	No Ice 1/2" Ice 17.30 22.10	17.30 22.10	1500.00 2030.00
Powerwave 7770 w/mount pipe (AT&T - existing)	A	From Leg	3.50 0.00 0.00	0.0000	130.00	No Ice 1/2" Ice 6.02 6.47	4.10 4.75	57.25 103.17
Powerwave 7770 w/mount pipe (AT&T - existing)	B	From Leg	3.50 0.00 0.00	0.0000	130.00	No Ice 1/2" Ice 6.02 6.47	4.10 4.75	57.25 103.17
Powerwave 7770 w/mount pipe (AT&T - existing)	C	From Leg	3.50 0.00 0.00	0.0000	130.00	No Ice 1/2" Ice 6.02 6.47	4.10 4.75	57.25 103.17

(3) HPA-65R-BUU-H8 w/mount pipe (AT&T - proposed)	A	From Leg	3.50 0.00 0.00	0.0000	130.00	No Ice 1/2" Ice 13.67 14.50	10.10 11.61	120.11 221.82
(3) HPA-65R-BUU-H8 w/mount pipe (AT&T - proposed)	B	From Leg	3.50 0.00 0.00	0.0000	130.00	No Ice 1/2" Ice 13.67 14.50	10.10 11.61	120.11 221.82
(3) HPA-65R-BUU-H8 w/mount pipe (AT&T - proposed)	C	From Leg	3.50 0.00 0.00	0.0000	130.00	No Ice 1/2" Ice 13.67 14.50	10.10 11.61	120.11 221.82
(2) Ericsson RRUS-11 (AT&T - proposed)	A	From Leg	2.50 0.00 0.00	0.0000	130.00	No Ice 1/2" Ice 3.26 3.50	1.38 1.56	50.70 71.57
(2) Ericsson RRUS-11 (AT&T - proposed)	B	From Leg	2.50 0.00 0.00	0.0000	130.00	No Ice 1/2" Ice 3.26 3.50	1.38 1.56	50.70 71.57
(2) Ericsson RRUS-11 (AT&T - proposed)	C	From Leg	2.50 0.00 0.00	0.0000	130.00	No Ice 1/2" Ice 3.26 3.50	1.38 1.56	50.70 71.57
(2) Ericsson RRUS-12 (AT&T - proposed)	A	From Leg	2.50 0.00 0.00	0.0000	130.00	No Ice 1/2" Ice 3.67 3.93	1.49 1.67	58.00 81.22
(2) Ericsson RRUS-12	B	From Leg	2.50	0.0000	130.00	No Ice	1.49	58.00

tnxTower Hudson Design Group, LLC 1600 Osgood Street, Building 20 North, Suite 3090 North Andover, MA 01845 Phone: (978) 557-5553 FAX: (978) 226-5586	Job		CT 5463 LTE 2C Dayville, CT		Page		4 of 9	
	Project		150 ft Monopole		Date		08:52:31 05/01/14	
	Client		AT&T		Designed by		kw	

Description	Face or Leg	Offset Type	Offsets:		Azimuth Adjustment °	Placement ft	C _{AA} Front ft ²	C _{AA} Side ft ²	Weight lb
			Horz ft	Lateral ft					
(AT&T - proposed)			0.00	0.00		1/2" Ice	3.93	1.67	81.22
(2) Ericsson RRUS-12 (AT&T - proposed)	C	From Leg	2.50	0.0000	130.00	No Ice	3.67	1.49	58.00
			0.00	0.00		1/2" Ice	3.93	1.67	81.22
			0.00	0.00					
Ericsson RRUS-E2 (AT&T - proposed)	A	From Leg	2.50	0.0000	130.00	No Ice	3.87	2.76	77.00
			0.00	0.00		1/2" Ice	4.15	3.02	104.93
			0.00	0.00					
Ericsson RRUS-E2 (AT&T - proposed)	B	From Leg	2.50	0.0000	130.00	No Ice	3.87	2.76	77.00
			0.00	0.00		1/2" Ice	4.15	3.02	104.93
			0.00	0.00					
Ericsson RRUS-E2 (AT&T - proposed)	C	From Leg	2.50	0.0000	130.00	No Ice	3.87	2.76	77.00
			0.00	0.00		1/2" Ice	4.15	3.02	104.93
			0.00	0.00					
Ericsson RRUS-32 (AT&T - proposed)	A	From Leg	2.50	0.0000	130.00	No Ice	3.87	2.76	77.00
			0.00	0.00		1/2" Ice	4.15	3.02	104.93
			0.00	0.00					
Ericsson RRUS-32 (AT&T - proposed)	B	From Leg	2.50	0.0000	130.00	No Ice	3.87	2.76	77.00
			0.00	0.00		1/2" Ice	4.15	3.02	104.93
			0.00	0.00					
Ericsson RRUS-32 (AT&T - proposed)	C	From Leg	2.50	0.0000	130.00	No Ice	3.87	2.76	77.00
			0.00	0.00		1/2" Ice	4.15	3.02	104.93
			0.00	0.00					
(2) Ericsson A2 Module (AT&T - proposed)	A	From Leg	2.50	0.0000	130.00	No Ice	2.42	0.54	22.00
			0.00	0.00		1/2" Ice	2.63	0.67	34.73
			0.00	0.00					
(2) Ericsson A2 Module (AT&T - proposed)	B	From Leg	2.50	0.0000	130.00	No Ice	2.42	0.54	22.00
			0.00	0.00		1/2" Ice	2.63	0.67	34.73
			0.00	0.00					
(2) Ericsson A2 Module (AT&T - proposed)	C	From Leg	2.50	0.0000	130.00	No Ice	2.42	0.54	22.00
			0.00	0.00		1/2" Ice	2.63	0.67	34.73
			0.00	0.00					
DTMABP7819VG12A TMA (AT&T - proposed)	A	From Leg	2.50	0.0000	130.00	No Ice	1.13	0.39	19.20
			0.00	0.00		1/2" Ice	1.28	0.49	26.49
			0.00	0.00					
DTMABP7819VG12A TMA (AT&T - proposed)	B	From Leg	2.50	0.0000	130.00	No Ice	1.13	0.39	19.20
			0.00	0.00		1/2" Ice	1.28	0.49	26.49
			0.00	0.00					
DTMABP7819VG12A TMA (AT&T - proposed)	C	From Leg	2.50	0.0000	130.00	No Ice	1.13	0.39	19.20
			0.00	0.00		1/2" Ice	1.28	0.49	26.49
			0.00	0.00					
(2) DBC2055F1V1 Diplexer (AT&T - proposed)	A	From Leg	2.50	0.0000	130.00	No Ice	0.48	0.24	7.00
			0.00	0.00		1/2" Ice	0.58	0.33	10.36
			0.00	0.00					
(2) DBC2055F1V1 Diplexer (AT&T - proposed)	B	From Leg	2.50	0.0000	130.00	No Ice	0.48	0.24	7.00
			0.00	0.00		1/2" Ice	0.58	0.33	10.36
			0.00	0.00					
(2) DBC2055F1V1 Diplexer (AT&T - proposed)	C	From Leg	2.50	0.0000	130.00	No Ice	0.48	0.24	7.00
			0.00	0.00		1/2" Ice	0.58	0.33	10.36
			0.00	0.00					
Surge Arrestor DC6-48-60-18-8F (AT&T - proposed)	A	From Face	1.50	0.0000	130.00	No Ice	1.27	1.27	20.00
			0.00	0.00		1/2" Ice	1.46	1.46	35.12
			0.00	0.00					
Surge Arrestor DC6-48-60-18-8F (AT&T - proposed)	B	From Face	1.50	0.0000	130.00	No Ice	1.27	1.27	20.00
			0.00	0.00		1/2" Ice	1.46	1.46	35.12
			0.00	0.00					
Surge Arrestor (AT&T - proposed)	C	From Face	1.50	0.0000	130.00	No Ice	1.27	1.27	20.00

tnxTower Hudson Design Group, LLC 1600 Osgood Street, Building 20 North, Suite 3090 North Andover, MA 01845 Phone: (978) 557-5553 FAX: (978) 226-5586	Job	CT 5463 LTE 2C Dayville, CT	Page	5 of 9
	Project	150 ft Monopole	Date	08:52:31 05/01/14
	Client	AT&T	Designed by	kw

Description	Face or Leg	Offset Type	Offsets: Horz Lateral Vert ft ft ft	Azimuth Adjustment °	Placement ft	C _{AA} Front ft ²	C _{AA} Side ft ²	Weight lb	
DC6-48-60-18-8F (AT&T - proposed) *****			0.00 0.00		1/2" Ice	1.46	1.46	35.12	
Pirod 6' Side Mount Standoff (1)	C	From Leg	3.00 0.00 0.00	0.0000	119.30	No Ice 1/2" Ice	4.97 6.12	4.97 6.12	70.00 130.00
Omni 3"x4'	C	From Leg	6.50 0.00 0.00	0.0000	124.30	No Ice 1/2" Ice	0.68 0.87	0.68 0.87	15.00 21.82
Pirod 6' Side Mount Standoff (1)	B	From Leg	3.00 0.00 0.00	0.0000	119.30	No Ice 1/2" Ice	4.97 6.12	4.97 6.12	70.00 130.00
Omni 3"x4'	B	From Leg	6.50 0.00 0.00	0.0000	123.70	No Ice 1/2" Ice	0.68 0.87	0.68 0.87	15.00 21.82
2' Side Mount Standoff	A	From Leg	1.00 0.00 0.00	0.0000	119.30	No Ice 1/2" Ice	1.00 1.50	1.00 1.50	30.00 50.00

14' Low Profile Platform	A	None		0.0000	105.20	No Ice 1/2" Ice	17.30 22.10	17.30 22.10	1500.00 2030.00
(2) LPA-185063/12CF w/mount pipe	A	From Leg	2.50 0.00 0.00	0.0000	106.00	No Ice 1/2" Ice	5.23 5.78	6.17 7.34	39.05 90.09
(2) LPA-185063/12CF w/mount pipe	B	From Leg	2.50 0.00 0.00	0.0000	106.00	No Ice 1/2" Ice	5.23 5.78	6.17 7.34	39.05 90.09
(2) LPA-185063/12CF w/mount pipe	C	From Leg	2.50 0.00 0.00	0.0000	106.00	No Ice 1/2" Ice	5.23 5.78	6.17 7.34	39.05 90.09
(2) LPA-80063-6CF-EDIN w/mount pipe	A	From Leg	2.50 0.00 0.00	0.0000	106.00	No Ice 1/2" Ice	10.76 11.44	10.72 12.00	52.55 145.96
(2) LPA-80063-6CF-EDIN w/mount pipe	B	From Leg	2.50 0.00 0.00	0.0000	106.00	No Ice 1/2" Ice	10.76 11.44	10.72 12.00	52.55 145.96
(2) LPA-80063-6CF-EDIN w/mount pipe	C	From Leg	2.50 0.00 0.00	0.0000	106.00	No Ice 1/2" Ice	10.76 11.44	10.72 12.00	52.55 145.96

Load Combinations

Comb. No.	Description
1	Dead Only
2	Dead+Wind 0 deg - No Ice
3	Dead+Wind 30 deg - No Ice
4	Dead+Wind 60 deg - No Ice
5	Dead+Wind 90 deg - No Ice
6	Dead+Wind 120 deg - No Ice
7	Dead+Wind 150 deg - No Ice
8	Dead+Wind 180 deg - No Ice
9	Dead+Wind 210 deg - No Ice

<p style="text-align: center;">tnxTower</p> <p style="text-align: center;">Hudson Design Group, LLC 1600 Osgood Street, Building 20 North, Suite 3090 North Andover, MA 01845 Phone: (978) 557-5553 FAX: (978) 226-5586</p>	Job CT 5463 LTE 2C Dayville, CT	Page 6 of 9
	Project 150 ft Monopole	Date 08:52:31 05/01/14
	Client AT&T	Designed by kw

Comb. No.	Description
10	Dead+Wind 240 deg - No Ice
11	Dead+Wind 270 deg - No Ice
12	Dead+Wind 300 deg - No Ice
13	Dead+Wind 330 deg - No Ice
14	Dead+Ice+Temp
15	Dead+Wind 0 deg+Ice+Temp
16	Dead+Wind 30 deg+Ice+Temp
17	Dead+Wind 60 deg+Ice+Temp
18	Dead+Wind 90 deg+Ice+Temp
19	Dead+Wind 120 deg+Ice+Temp
20	Dead+Wind 150 deg+Ice+Temp
21	Dead+Wind 180 deg+Ice+Temp
22	Dead+Wind 210 deg+Ice+Temp
23	Dead+Wind 240 deg+Ice+Temp
24	Dead+Wind 270 deg+Ice+Temp
25	Dead+Wind 300 deg+Ice+Temp
26	Dead+Wind 330 deg+Ice+Temp
27	Dead+Wind 0 deg - Service
28	Dead+Wind 30 deg - Service
29	Dead+Wind 60 deg - Service
30	Dead+Wind 90 deg - Service
31	Dead+Wind 120 deg - Service
32	Dead+Wind 150 deg - Service
33	Dead+Wind 180 deg - Service
34	Dead+Wind 210 deg - Service
35	Dead+Wind 240 deg - Service
36	Dead+Wind 270 deg - Service
37	Dead+Wind 300 deg - Service
38	Dead+Wind 330 deg - Service

Maximum Reactions

Location	Condition	Gov. Load Comb.	Vertical lb	Horizontal, X lb	Horizontal, Z lb
Pole	Max. Vert	21	61113.90	-0.00	-37874.33
	Max. H _x	11	50813.64	45923.64	-0.00
	Max. H _z	2	50813.64	0.00	45923.64
	Max. M _x	2	4505142.07	0.00	45923.64
	Max. M _z	5	4505499.27	-45923.64	-0.00
	Max. Torsion	11	1162.49	45923.64	-0.00
	Min. Vert	33	50813.64	0.00	-15890.53
	Min. H _x	5	50813.64	-45923.64	-0.00
	Min. H _z	8	50813.64	0.00	-45923.64
	Min. M _x	8	-4505917.97	0.00	-45923.64
	Min. M _z	11	-4505560.78	45923.64	-0.00
	Min. Torsion	5	-1162.49	-45923.64	-0.00

Tower Mast Reaction Summary

Load Combination	Vertical lb	Shear _x lb	Shear _z lb	Overturning Moment, M _x lb-ft	Overturning Moment, M _z lb-ft	Torque lb-ft
Dead Only	50813.64	0.00	0.00	379.38	30.00	0.00

<p style="text-align: center;">tnxTower</p> <p style="text-align: center;">Hudson Design Group, LLC 1600 Osgood Street, Building 20 North, Suite 3090 North Andover, MA 01845 Phone: (978) 557-5553 FAX: (978) 226-5586</p>	Job	CT 5463 LTE 2C Dayville, CT	Page	7 of 9	
	Project	150 ft Monopole		Date	08:52:31 05/01/14
	Client	AT&T		Designed by	kw

Load Combination	Vertical	Shear _x	Shear _z	Overturning Moment, M _x	Overturning Moment, M _z	Torque
	lb	lb	lb	lb-ft	lb-ft	lb-ft
Dead+Wind 0 deg - No Ice	50813.64	-0.00	-45923.64	-4505142.07	30.76	-23.13
Dead+Wind 30 deg - No Ice	50813.64	22961.82	-39771.03	-3901515.92	-2252733.94	561.21
Dead+Wind 60 deg - No Ice	50813.64	39771.03	-22961.82	-2252377.87	-3901872.47	995.18
Dead+Wind 90 deg - No Ice	50813.64	45923.64	0.00	387.01	-4505499.27	1162.49
Dead+Wind 120 deg - No Ice	50813.64	39771.03	22961.82	2253152.36	-3901873.28	1018.31
Dead+Wind 150 deg - No Ice	50813.64	22961.82	39771.03	3902291.35	-2252734.76	601.28
Dead+Wind 180 deg - No Ice	50813.64	-0.00	45923.64	4505917.97	30.76	23.14
Dead+Wind 210 deg - No Ice	50813.64	-22961.82	39771.03	3902291.34	2252796.28	-561.21
Dead+Wind 240 deg - No Ice	50813.64	-39771.03	22961.82	2253152.36	3901934.79	-995.17
Dead+Wind 270 deg - No Ice	50813.64	-45923.64	0.00	387.01	4505560.78	-1162.49
Dead+Wind 300 deg - No Ice	50813.64	-39771.03	-22961.82	-2252377.86	3901933.98	-1018.31
Dead+Wind 330 deg - No Ice	50813.64	-22961.82	-39771.03	-3901515.91	2252795.47	-601.28
Dead+Ice+Temp	61113.90	0.00	0.00	658.74	34.63	0.00
Dead+Wind 0 deg+Ice+Temp	61113.90	0.00	-37874.33	-3837377.68	35.84	-40.06
Dead+Wind 30 deg+Ice+Temp	61113.90	18937.17	-32800.13	-3323175.68	-1918992.59	499.41
Dead+Wind 60 deg+Ice+Temp	61113.90	32800.13	-18937.17	-1918349.54	-3323819.19	905.07
Dead+Wind 90 deg+Ice+Temp	61113.90	37874.33	-0.00	679.06	-3838021.83	1068.21
Dead+Wind 120 deg+Ice+Temp	61113.90	32800.13	18937.17	1919708.13	-3323820.02	945.12
Dead+Wind 150 deg+Ice+Temp	61113.90	18937.17	32800.13	3324535.23	-1918993.42	568.79
Dead+Wind 180 deg+Ice+Temp	61113.90	0.00	37874.33	3838737.71	35.84	40.06
Dead+Wind 210 deg+Ice+Temp	61113.90	-18937.17	32800.13	3324535.25	1919065.11	-499.41
Dead+Wind 240 deg+Ice+Temp	61113.90	-32800.13	18937.17	1919708.16	3323891.74	-905.06
Dead+Wind 270 deg+Ice+Temp	61113.90	-37874.33	-0.00	679.06	3838093.57	-1068.21
Dead+Wind 300 deg+Ice+Temp	61113.90	-32800.13	-18937.17	-1918349.56	3323890.91	-945.12
Dead+Wind 330 deg+Ice+Temp	61113.90	-18937.17	-32800.13	-3323175.70	1919064.28	-568.80
Dead+Wind 0 deg - Service	50813.64	-0.00	-15890.53	-1558951.77	30.79	-8.02
Dead+Wind 30 deg - Service	50813.64	7945.27	-13761.60	-1350039.80	-779639.38	194.53
Dead+Wind 60 deg - Service	50813.64	13761.60	-7945.27	-779281.64	-1350397.59	344.96
Dead+Wind 90 deg - Service	50813.64	15890.53	-0.00	388.56	-1559309.65	402.96
Dead+Wind 120 deg - Service	50813.64	13761.60	7945.27	780058.81	-1350397.69	352.99
Dead+Wind 150 deg - Service	50813.64	7945.27	13761.60	1350817.08	-779639.48	208.43
Dead+Wind 180 deg - Service	50813.64	-0.00	15890.53	1559729.11	30.79	8.02
Dead+Wind 210 deg - Service	50813.64	-7945.27	13761.60	1350817.08	779701.06	-194.53
Dead+Wind 240 deg - Service	50813.64	-13761.60	7945.27	780058.80	1350459.28	-344.96
Dead+Wind 270 deg - Service	50813.64	-15890.53	-0.00	388.56	1559371.23	-402.96
Dead+Wind 300 deg - Service	50813.64	-13761.60	-7945.27	-779281.64	1350459.18	-352.99
Dead+Wind 330 deg - Service	50813.64	-7945.27	-13761.60	-1350039.79	779700.97	-208.43

Solution Summary

Load Comb.	Sum of Applied Forces			Sum of Reactions			% Error
	PX lb	PY lb	PZ lb	PX lb	PY lb	PZ lb	
1	0.00	-50813.64	0.00	0.00	50813.64	0.00	0.000%
2	0.00	-50813.64	-45923.64	0.00	50813.64	45923.64	0.000%
3	22961.82	-50813.64	-39771.03	-22961.82	50813.64	39771.03	0.000%
4	39771.03	-50813.64	-22961.82	-39771.03	50813.64	22961.82	0.000%
5	45923.64	-50813.64	0.00	-45923.64	50813.64	-0.00	0.000%
6	39771.03	-50813.64	22961.82	-39771.03	50813.64	-22961.82	0.000%
7	22961.82	-50813.64	39771.03	-22961.82	50813.64	-39771.03	0.000%
8	0.00	-50813.64	45923.64	0.00	50813.64	-45923.64	0.000%
9	-22961.82	-50813.64	39771.03	22961.82	50813.64	-39771.03	0.000%
10	-39771.03	-50813.64	22961.82	39771.03	50813.64	-22961.82	0.000%
11	-45923.64	-50813.64	0.00	45923.64	50813.64	-0.00	0.000%
12	-39771.03	-50813.64	-22961.82	39771.03	50813.64	22961.82	0.000%
13	-22961.82	-50813.64	-39771.03	22961.82	50813.64	39771.03	0.000%
14	0.00	-61113.90	0.00	0.00	61113.90	0.00	0.000%

tnxTower Hudson Design Group, LLC 1600 Osgood Street, Building 20 North, Suite 3090 North Andover, MA 01845 Phone: (978) 557-5553 FAX: (978) 226-5586	Job	CT 5463 LTE 2C Dayville, CT	Page	8 of 9
	Project	150 ft Monopole	Date	08:52:31 05/01/14
	Client	AT&T	Designed by	kw

Load Comb.	Sum of Applied Forces			Sum of Reactions			% Error
	PX lb	PY lb	PZ lb	PX lb	PY lb	PZ lb	
15	0.00	-61113.90	-37874.33	-0.00	61113.90	37874.33	0.000%
16	18937.17	-61113.90	-32800.13	-18937.17	61113.90	32800.13	0.000%
17	32800.13	-61113.90	-18937.17	-32800.13	61113.90	18937.17	0.000%
18	37874.33	-61113.90	0.00	-37874.33	61113.90	0.00	0.000%
19	32800.13	-61113.90	18937.17	-32800.13	61113.90	-18937.17	0.000%
20	18937.17	-61113.90	32800.13	-18937.17	61113.90	-32800.13	0.000%
21	0.00	-61113.90	37874.33	-0.00	61113.90	-37874.33	0.000%
22	-18937.17	-61113.90	32800.13	18937.17	61113.90	-32800.13	0.000%
23	-32800.13	-61113.90	18937.17	32800.13	61113.90	-18937.17	0.000%
24	-37874.33	-61113.90	0.00	37874.33	61113.90	0.00	0.000%
25	-32800.13	-61113.90	-18937.17	32800.13	61113.90	18937.17	0.000%
26	-18937.17	-61113.90	-32800.13	18937.17	61113.90	32800.13	0.000%
27	0.00	-50813.64	-15890.53	0.00	50813.64	15890.53	0.000%
28	7945.27	-50813.64	-13761.60	-7945.27	50813.64	13761.60	0.000%
29	13761.60	-50813.64	-7945.27	-13761.60	50813.64	7945.27	0.000%
30	15890.53	-50813.64	0.00	-15890.53	50813.64	0.00	0.000%
31	13761.60	-50813.64	7945.27	-13761.60	50813.64	-7945.27	0.000%
32	7945.27	-50813.64	13761.60	-7945.27	50813.64	-13761.60	0.000%
33	0.00	-50813.64	15890.53	0.00	50813.64	-15890.53	0.000%
34	-7945.27	-50813.64	13761.60	7945.27	50813.64	-13761.60	0.000%
35	-13761.60	-50813.64	7945.27	13761.60	50813.64	-7945.27	0.000%
36	-15890.53	-50813.64	0.00	15890.53	50813.64	0.00	0.000%
37	-13761.60	-50813.64	-7945.27	13761.60	50813.64	7945.27	0.000%
38	-7945.27	-50813.64	-13761.60	7945.27	50813.64	13761.60	0.000%

Maximum Tower Deflections - Service Wind

Section No.	Elevation ft	Horz. Deflection in	Gov. Load Comb.	Tilt °	Twist °
L1	150 - 130	14.5830	33	0.8339	0.0009
L2	135 - 115	11.9772	33	0.8202	0.0009
L3	115 - 95	8.6692	33	0.7370	0.0007
L4	101 - 91	6.6348	33	0.6469	0.0005
L5	91 - 51	5.3274	33	0.5903	0.0004
L6	59 - 40	2.1708	33	0.3488	0.0002
L7	40 - 19	0.9802	33	0.2311	0.0001
L8	28 - 0	0.4996	33	0.1517	0.0001

Critical Deflections and Radius of Curvature - Service Wind

Elevation ft	Appurtenance	Gov. Load Comb.	Deflection in	Tilt °	Twist °	Radius of Curvature ft
153.00	Omni 3"x4'	33	14.5830	0.8339	0.0009	122470
152.50	Lightning Rod 3/4"x6'	33	14.5830	0.8339	0.0009	122470
150.90	10.5' horizontal pipe	33	14.5830	0.8339	0.0009	122470
149.00	PiROD 12' T-Frame	33	14.4086	0.8336	0.0009	122470
138.00	PiROD 12' T-Frame	33	12.4952	0.8254	0.0009	50581
130.00	Powerwave 7770 w/mount pipe	33	11.1208	0.8071	0.0009	20425
128.00	14' Low Profile Platform	33	10.7819	0.8003	0.0009	17018
124.30	Omni 3"x4'	33	10.1629	0.7856	0.0008	13004
123.70	Omni 3"x4'	33	10.0636	0.7830	0.0008	12524

tnxTower Hudson Design Group, LLC 1600 Osgood Street, Building 20 North, Suite 3090 North Andover, MA 01845 Phone: (978) 557-5553 FAX: (978) 226-5586	Job CT 5463 LTE 2C Dayville, CT	Page 9 of 9
	Project 150 ft Monopole	Date 08:52:31 05/01/14
	Client AT&T	Designed by kw

Elevation	Appurtenance	Gov. Load Comb.	Deflection in	Tilt °	Twist °	Radius of Curvature ft
119.30	Pirod 6' Side Mount Standoff (1)	33	9.3469	0.7615	0.0008	9861
106.00	(2) LPA-185063/12CF w/mount pipe	33	7.3335	0.6784	0.0006	10024
105.20	14' Low Profile Platform	33	7.2198	0.6732	0.0006	10229

Section Capacity Table

Section No.	Elevation ft	Component Type	Size	Critical Element	P lb	SF*P _{allow} lb	% Capacity	Pass Fail	
L1	150 - 130	Pole	TP34.3125x27.8125x0.25	1	-3864.54	939803.62	11.8	Pass	
L2	130 - 115	Pole	TP38.6875x32.1875x0.25	2	-10606.20	1072699.71	49.7	Pass	
L3	115 - 95	Pole	TP45.1875x38.6875x0.3125	3	-14940.70	1554571.20	56.0	Pass	
L4	95 - 91	Pole	TP45.8125x42.6125x0.3125	4	-17740.00	1632405.06	70.0	Pass	
L5	91 - 51	Pole	TP58.875x45.8125x0.375	5	-25938.20	2378058.57	78.5	Pass	
L6	51 - 40	Pole	TP61.6875x55.5125x0.375	6	-33294.80	2479259.93	91.9	Pass	
L7	40 - 19	Pole	TP68.5x61.6875x0.4375	7	-37548.40	3235364.16	77.7	Pass	
L8	19 - 0	Pole	TP73.8125x64.7054x0.4375	8	-50806.40	3408814.11	89.7	Pass	
							Summary		
							Pole (L6)	91.9	Pass
							RATING =	91.9	Pass