



Filed by:

Kri Pelletier, Property Specialist - SBA Communications  
134 Flanders Rd., Suite 125, Westborough, MA 01581  
508.251.0720 x 3804 - kpelletier@sbsite.com

August 13, 2018

Melanie A. Bachman  
Acting Executive Director  
Connecticut Siting Council  
Ten Franklin Square  
New Britain, CT 06051

**Notice of Exempt Modification**

**66 Wall Street, Hebron, CT**

**41 39 52.67 N**

**-72 21 40.77 W**

**Sprint #: CT54XC731**

Dear Ms. Bachman:

Sprint currently maintains antennas at the 127-foot level of the existing 150-Valmont Monopole Tower at 66 Wall Street, Hebron, CT. The tower is owned by SBA Properties, LLC. The property is owned by the Town of Hebron. Sprint now intends to replace (3) existing cell antennas with (3) newer technology cell antennas at the 127-foot level of the tower. The proposed full scope of work is as follows:

Remove: N/A

Remove and Replace:

- Remove:
  - (3) EMS - RR90-17 – Panel Antennas
- Replace with:
  - (3) Commscope - DHHTT65B-3XR – Panel Antennas
- Remove:
  - (1) 24" canister
- Replace with:
  - (1) 36" canister
- Remove:
  - (6) 1-5/8" lines
- Replace with:
  - (3) 3/8" RET
  - (12) 7/8 lines

Install:

- (3) RFS - KIT-FD9R6004/1C-DL – Diplexers
  - (3) CCI - DPO-7126Y-0-T1 - Diplexers
- At ground level (within existing leased area within compound)*
- (4) steel posts / (6) unitstrut

Existing Equipment to Remain (Including entitlements): N/A



This facility was originally approved prior to the Council's jurisdiction. Petition 2000-21 was approved by the Hebron Planning & Zoning Commission on 7/17/2000 by Special Permit. No antennas were to be located outside of the flagpole. An RF report was to be submitted after 90 days of operation. Lighting for the flag was to be kept at a minimum level in consultation with town staff. The flag size was to be determined by the town. And any subsequent co-locations were to be submitted by application to the Planning & Zoning Commission. This modification complies with all conditions.

Please accept this letter as notification pursuant to Regulations of Connecticut State Agencies §16-50j-73, for construction that constitutes an exempt modification pursuant to R.C.S.A. §16.50j-72(b)(2). In accordance with R.C.S.A. § 16.50j-73, a copy of this letter is being sent to Town of Hebron's Town Manager and representative for the Town as property owner, Andrew Tierney, and to Town Planner, Michael O'Leary. (Separate notice is not being sent to tower owner, as it belongs to SBA.)

The planned modifications to the facility fall squarely within those activities explicitly provided for in R.C.S.A. §16.50j-72(b)(2).

1. The proposed modifications will not result in an increase in the height of the existing structure.
2. The proposed modification will not require the extension of the site boundary.
3. The proposed modifications will not increase noise levels at the facility by six decibels or more, or to levels that exceed state and local criteria.
4. The operation of the replacement antennas will not increase radio frequency emissions at the facility to a level at or above the Federal Communications Commission safety standard.
5. The proposed modification will not cause a change or alteration in the physical or environmental characteristics of the site.
6. The existing structure and its foundation can support the proposed loading.

For the foregoing reasons, Sprint respectfully submits that the proposed modifications to the above-referenced telecommunication facility constitute an exempt modifications under R.C.S.A. § 16-50j-72(b)(2).

Sincerely,

Kri Pelletier  
Property Specialist  
SBA COMMUNICATIONS CORPORATION  
134 Flanders Rd., Suite 125  
Westborough, MA 01581  
508.251.0720 x3804 + T  
508.366.2610 + F  
203.446.7700 + C  
kpelletier@sbsite.com

Attachments

cc: Andrew Tierney, Town Manager / with attachments  
*Town of Hebron, 15 Gilead Street Hebron CT 06248-1501*  
Michael O'Leary, Town Planner / with attachments  
*Town of Hebron, 15 Gilead Street Hebron CT 06248-1501*



## POWER DENSITY

### SPRINT Site Inventory and Power Data by Antenna

Sector:	A	Sector:	B	Sector:	C
Antenna #:	<b>1</b>	Antenna #:	<b>1</b>	Antenna #:	<b>1</b>
Make / Model:	Commscope DHHTT65B-3XR	Make / Model:	Commscope DHHTT65B-3XR	Make / Model:	Commscope DHHTT65B-3XR
Gain:	13.35 / 15.25/15.05 dBd	Gain:	13.35 / 15.25 / 15.05 dBd	Gain:	13.35 / 15.25 / 15.05 dBd
Height (AGL):	<b>127 feet</b>	Height (AGL):	<b>127 feet</b>	Height (AGL):	<b>127 feet</b>
Frequency Bands	850 MHz / 1900 MHz (PCS) / 2500 MHz (BRS)	Frequency Bands	850 MHz / 1900 MHz (PCS) / 2500 MHz (BRS)	Frequency Bands	850 MHz / 1900 MHz (PCS) / 2500 MHz (BRS)
Channel Count	18	Channel Count	18	Channel Count	18
Total TX Power(W):	440 Watts	Total TX Power(W):	440 Watts	Total TX Power(W):	440 Watts
ERP (W):	13,072.94	ERP (W):	13,072.94	ERP (W):	13,072.94
Antenna A1 MPE%	<b>3.70 %</b>	Antenna B1 MPE%	<b>3.70 %</b>	Antenna C1 MPE%	<b>3.70 %</b>

Site Composite MPE%	
Carrier	MPE%
SPRINT – Max per sector	<b>3.70 %</b>
Verizon Wireless	2.01 %
AT&T	3.88 %
Site Total MPE %:	<b>9.59 %</b>

SPRINT Sector A Total:	3.70 %
SPRINT Sector B Total:	3.70 %
SPRINT Sector C Total:	3.70 %
Site Total:	<b>9.59 %</b>

SPRINT _ Frequency Band / Technology (Per Sector)	# Channels	Watts ERP (Per Channel)	Height (feet)	Total Power Density ( $\mu\text{W}/\text{cm}^2$ )	Frequency (MHz)	Allowable MPE ( $\mu\text{W}/\text{cm}^2$ )	Calculated % MPE
Sprint 850 MHz CDMA	1	432.54	127	1.06	850 MHz	567	0.18%
Sprint 850 MHz LTE	2	1,081.36	127	5.31	850 MHz	567	0.94%
Sprint 1900 MHz (PCS) CDMA	5	535.94	127	6.58	1900 MHz (PCS)	1000	0.66%
Sprint 1900 MHz (PCS) LTE	2	1,339.86	127	6.58	1900 MHz (PCS)	1000	0.66%
Sprint 2500 MHz (BRS) LTE	8	639.78	127	12.57	2500 MHz (BRS)	1000	1.26%
<b>Total:</b>						<b>567</b>	<b>3.70%</b>



ORIGIN ID:BBFA (508) 254-0720  
KRIPELLETER  
SBA COMMUNICATIONS CORPORATION  
134 FLANDERS RD  
SUITE 125  
WESTBOROUGH, MA 01581  
UNITED STATES US

SHIP DATE: 13AUG18  
ACTWGT: 1.00 LB  
CAD: 105843304/NET/4040  
BILL SENDER

TO ANDREW TIERNEY, TOWN MANAGER  
TOWN OF HEBRON  
15 GILEAD STREET

HEBRON CT 06248

(508) 254-0720 X 3804 REF: 10-56-92009-9099  
INV:  
PO: DEPT:

552.J1/3309/DCA5

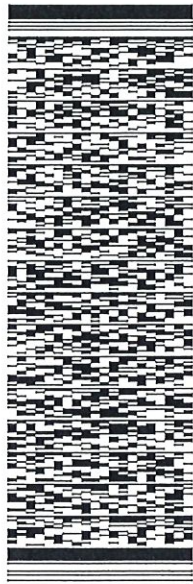

J182018072201uv

TRK# 7729 5997 3895  
#0201

TUE - 14 AUG 12:00P  
PRIORITY OVERNIGHT

EB SKKA

06248  
CT-US BDL



**After printing this label:**

1. Use the 'Print' button on this page to print your label to your laser or inkjet printer.
2. Fold the printed page along the horizontal line.
3. Place label in shipping pouch and affix it to your shipment so that the barcode portion of the label can be read and scanned.

**Warning:** Use only the printed original label for shipping. Using a photocopy of this label for shipping purposes is fraudulent and could result in additional billing charges, along with the cancellation of your FedEx account number.

Use of this system constitutes your agreement to the service conditions in the current FedEx Service Guide, available on fedex.com. FedEx will not be responsible for any claim in excess of \$100 per package, whether the result of loss, damage, delay, non-delivery, misdelivery, or misinformation, unless you declare a higher value, pay an additional charge, document your actual loss and file a timely claim. Limitations found in the current FedEx Service Guide apply. Your right to recover from FedEx for any loss, including intrinsic value of the package, loss of sales, income interest, profit, attorney's fees, costs, and other forms of damage whether direct, incidental, consequential, or special is limited to the greater of \$100 or the authorized declared value. Recovery cannot exceed actual documented loss. Maximum for items of extraordinary value is \$1,000, e.g. jewelry, precious metals, negotiable instruments and other items listed in our ServiceGuide. Written claims must be filed within strict time limits, see current FedEx Service Guide.



ORIGIN ID:BBEA (508) 251-0720  
KRIPELLETTER  
SBA COMMUNICATIONS CORPORATION  
134 FLANDERS RD  
SUITE 125  
WESTBOROUGH, MA 01581  
UNITED STATES US

SHIP DATE: 13AUG18  
ACT WT: 1.00 LB  
CAD: 105843304/NET/4040  
BILL SENDER

TO TOWN OF HEBRON  
MICHAEL O'LEARY - TOWN PLANNER  
15 GILEAD STREET

HEBRON CT 06248

(508) 251-0720 X 3804 REF: 10-56-92009-6099  
INV/ PO: DEPT:

552J11/3309/DCA5

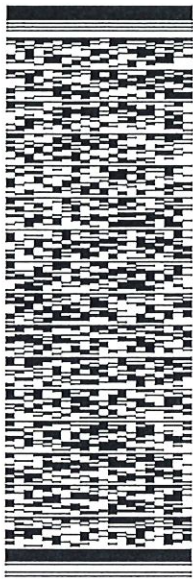

TRK# 7729 6000 7735  
0201

TUE - 14 AUG 12:00P  
PRIORITY OVERNIGHT

EB SKKA

06248  
CT-US BDL



**After printing this label:**

1. Use the 'Print' button on this page to print your label to your laser or inkjet printer.
2. Fold the printed page along the horizontal line.
3. Place label in shipping pouch and affix it to your shipment so that the barcode portion of the label can be read and scanned.

**Warning: Use only the printed original label for shipping. Using a photocopy of this label for shipping purposes is fraudulent and could result in additional billing charges, along with the cancellation of your FedEx account number.**

Use of this system constitutes your agreement to the service conditions in the current FedEx Service Guide, available on fedex.com. FedEx will not be responsible for any claim in excess of \$100 per package, whether the result of loss, damage, delay, non-delivery, misdelivery, or misinformation, unless you declare a higher value, pay an additional charge, document your actual loss and file a timely claim. Limitations found in the current FedEx Service Guide apply. Your right to recover from FedEx for any loss, including intrinsic value of the package, loss of sales, income interest, profit, attorney's fees, costs, and other forms of damage whether direct, incidental, consequential, or special is limited to the greater of \$100 or the authorized declared value. Recovery cannot exceed actual documented loss. Maximum for items of extraordinary value is \$1,000, e.g. jewelry, precious metals, negotiable instruments and other items listed in our Service Guide. Written claims must be filed within strict time limits, see current FedEx Service Guide.



**Town of Hebron, Connecticut**  
Property Record Card

**66 WALL ST**  
Parcel ID: 13-15

ID: 2347

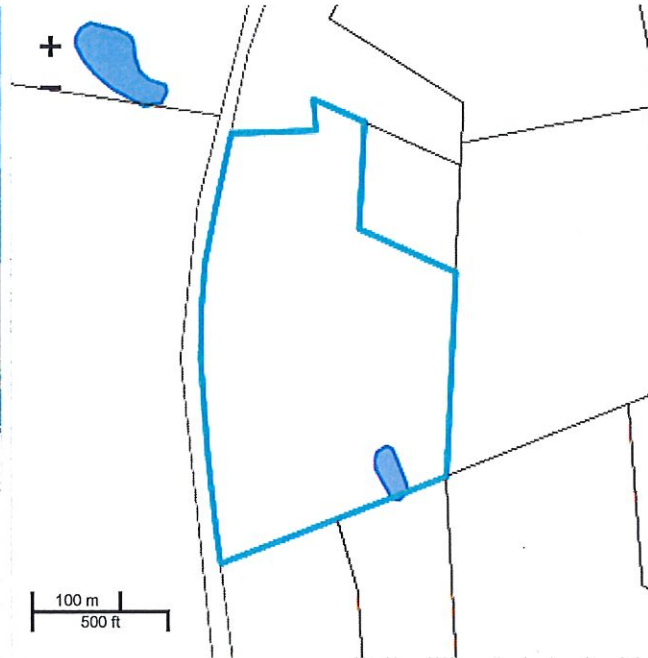

Owner: HEBRON TOWN OF  
Co-Owner: /  
Address: 15 GILEAD ST  
HEBRON CT 06248-1501

Assessment: Total: \$591,300  
Building: \$68,220 Land: \$468,140 Other: \$54,940

**Sales History**

Grantee	Book / Page	Sale Date	Sale Price
HEBRON TOWN OF	0141 / 0673	5/1/1990	\$340,000



**Land Information**  
Land Area: 15.67 AC / 682585.2 SF  
Zoning: R-1 (See Map)  
Land Use: Pavilion  
Neighborhood: Comm

**Building Information**  
Style:  
Year Built: 2005  
Stories: 1  
Rooms: 0 Bedrooms: 0  
Baths: 0 Half Baths: 1  
Total Living Area: 945  
Condition: Average

Heat Type: None  
Heat Fuel: None  
AC Type:  
Fireplaces: 0  
Roof Structure: Gable  
Roof Covering: Arch Shingles  
Exterior Wall: /  
Interior Floor: Concrete /  
Basement: 0

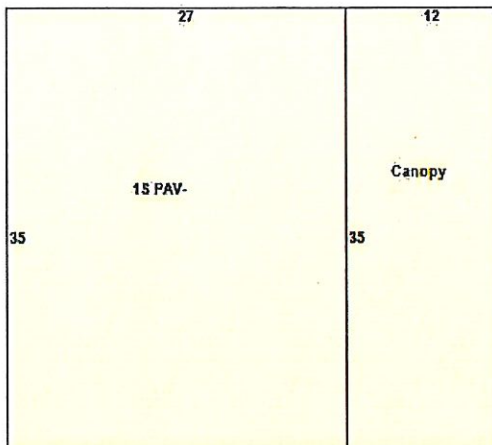

Extra Features Description	Area / Units
Asphalt Paving	22500
Open Porch	80
Lean To Shed	240
Canopy	420
Light Poles	4
4 Ft Chain Fence	1000
Frame Shed	128
Basketball Court	1800
Lean To Shed	240

Sub Areas Description	Living Area	Gross Area

Printed on 5/7/2018 from: <http://www.mainstreetmaps.com/ct/hebron/>



The Assessor's office is responsible for the maintenance of records on the ownership of properties. Assessments are computed at 70% of the estimated market value of real property at the time of the last revaluation which was 2016.



Information on the Property Records for the Municipality of Hebron was last updated on 4/6/2018.

### Property Summary Information

Parcel Data And Values

Building ▾

Outbuildings

Sales

Permits

Google Map

#### Parcel Information

Location:	66 WALL ST	Property Use:	Entertainment	Primary Use:	Pavilion
Unique ID:	2347	Map Block Lot:	13-15	Acres:	15.67
490 Acres:	0.00	Zone:	R-1	Volume / Page:	0141/0673
Developers Map / Lot:		Census:	5261		

#### Value Information



	Appraised Value	Assessed Value
Land	668,781	468,140
Buildings	97,456	68,220
Detached Outbuildings	78,480	54,940
Total	844,717	591,300

**Owner's Information**

**Owner's Data**

HEBRON TOWN OF  
15 GILEAD ST  
HEBRON CT 06248-1501

[Back To Search \(JavaScript>window.history.back\(1\);\)](#)

[Print View \(PrintPage.aspx?towncode=067&uniqueid=2347\)](#)

Information Published With Permission From The Assessor



## RADIO FREQUENCY EMISSIONS ANALYSIS REPORT EVALUATION OF HUMAN EXPOSURE POTENTIAL TO NON-IONIZING EMISSIONS

SPRINT Existing Facility

Site ID: CT54XC731

Central Hebron  
66 Wall Street  
Hebron, CT 06248

**August 3, 2018**

**EBI Project Number: 6218005291**

Site Compliance Summary	
Compliance Status:	<b>COMPLIANT</b>
Site total MPE% of FCC general population allowable limit:	<b>9.59 %</b>



August 3, 2018

SPRINT

Attn: RF Engineering Manager  
1 International Boulevard, Suite 800  
Mahwah, NJ 07495

## Emissions Analysis for Site: **CT54XC731 – Central Hebron**

EBI Consulting was directed to analyze the proposed SPRINT facility located at **66 Wall Street, Hebron, CT**, for the purpose of determining whether the emissions from the Proposed SPRINT Antenna Installation located on this property are within specified federal limits.

All information used in this report was analyzed as a percentage of current Maximum Permissible Exposure (% MPE) as listed in the FCC OET Bulletin 65 Edition 97-01 and ANSI/IEEE Std C95.1. The FCC regulates Maximum Permissible Exposure in units of microwatts per square centimeter ( $\mu\text{W}/\text{cm}^2$ ). The number of  $\mu\text{W}/\text{cm}^2$  calculated at each sample point is called the power density. The exposure limit for power density varies depending upon the frequencies being utilized. Wireless Carriers and Paging Services use different frequency bands each with different exposure limits, therefore it is necessary to report results and limits in terms of percent MPE rather than power density.

All results were compared to the FCC (Federal Communications Commission) radio frequency exposure rules, 47 CFR 1.1307(b)(1) – (b)(3), to determine compliance with the Maximum Permissible Exposure (MPE) limits for General Population/Uncontrolled environments as defined below.

General population/uncontrolled exposure limits apply to situations in which the general population may be exposed or in which persons who are exposed as a consequence of their employment may not be made fully aware of the potential for exposure or cannot exercise control over their exposure. Therefore, members of the general population would always be considered under this category when exposure is not employment related, for example, in the case of a telecommunications tower that exposes persons in a nearby residential area.

General population exposure to radio frequencies is regulated and enforced in units of microwatts per square centimeter ( $\mu\text{W}/\text{cm}^2$ ). The general population exposure limits for the 850 MHz Band is approximately  $567 \mu\text{W}/\text{cm}^2$ . The general population exposure limit for the 1900 MHz (PCS) and 2500 MHz (BRS) bands is  $1000 \mu\text{W}/\text{cm}^2$ . Because each carrier will be using different frequency bands, and each frequency band has different exposure limits, it is necessary to report percent of MPE rather than power density.





Occupational/controlled exposure limits apply to situations in which persons are exposed as a consequence of their employment and in which those persons who are exposed have been made fully aware of the potential for exposure and can exercise control over their exposure. Occupational/controlled exposure limits also apply where exposure is of a transient nature as a result of incidental passage through a location where exposure levels may be above general population/uncontrolled limits (see below), as long as the exposed person has been made fully aware of the potential for exposure and can exercise control over his or her exposure by leaving the area or by some other appropriate means.

Additional details can be found in FCC OET 65.

## CALCULATIONS

Calculations were done for the proposed SPRINT Wireless antenna facility located at **66 Wall Street, Hebron, CT**, using the equipment information listed below. All calculations were performed per the specifications under FCC OET 65. Since SPRINT is proposing highly focused directional panel antennas, which project most of the emitted energy out toward the horizon, all calculations were performed assuming a lobe representing the maximum gain of the antenna per the antenna manufactures supplied specifications, minus 10 dB for directional panel antennas, was focused at the base of the tower. For this report the sample point is the top of a 6-foot person standing at the base of the tower.

For all calculations, all equipment was calculated using the following assumptions:

- 1) 1 CDMA channels (850 MHz) were considered for each sector of the proposed installation. These Channels have a transmit power of 20 Watts per Channel.
- 2) 2 LTE channels (850 MHz) were considered for each sector of the proposed installation. These Channels have a transmit power of 50 Watts per Channel.
- 3) 5 CDMA channels (1900 MHz (PCS)) were considered for each sector of the proposed installation. These Channels have a transmit power of 16 Watts per Channel.
- 4) 2 LTE channels (1900 MHz (PCS)) were considered for each sector of the proposed installation. These Channels have a transmit power of 40 Watts per Channel.
- 5) 8 LTE channels (2500 MHz (BRS)) were considered for each sector of the proposed installation. These Channels have a transmit power of 20 Watts per Channel.



- 6) All radios at the proposed installation were considered to be running at full power and were uncombined in their RF transmissions paths per carrier prescribed configuration. Per FCC OET Bulletin No. 65 - Edition 97-01 recommendations to achieve the maximum anticipated value at each sample point, all power levels emitting from the proposed antenna installation are increased by a factor of 2.56 to account for possible in-phase reflections from the surrounding environment. This is rarely the case, and if so, is never continuous.
- 7) For the following calculations, the sample point was the top of a 6-foot person standing at the base of the tower. The maximum gain of the antenna per the antenna manufactures supplied specifications, minus 10 dB for directional panel antennas, was used in this direction. This value is a very conservative estimate as gain reductions for these particular antennas are typically much higher in this direction.
- 8) The antennas used in this modeling are the **Commscope DHHTT65B-3XR** for transmission in the 850 MHz, 1900 MHz (PCS) and 2500 MHz (BRS) frequency bands. This is based on feedback from the carrier with regards to anticipated antenna selection. Maximum gain values for all antennas are listed in the Inventory and Power Data table below. The maximum gain of the antenna per the antenna manufactures supplied specifications, minus 10 dB for directional panel antennas, was used for all calculations. This value is a very conservative estimate as gain reductions for these particular antennas are typically much higher in this direction.
- 9) The antenna mounting height centerlines of the proposed antennas are **127 feet** above ground level (AGL) for **Sector A**, **127 feet** above ground level (AGL) for **Sector B** and **127 feet** above ground level (AGL) for Sector C.
- 10) Emissions values for additional carriers were taken from the Connecticut Siting Council active database. Values in this database are provided by the individual carriers themselves.

All calculations were done with respect to uncontrolled / general population threshold limits.



## SPRINT Site Inventory and Power Data by Antenna

Sector:	A	Sector:	B	Sector:	C
Antenna #:	1	Antenna #:	1	Antenna #:	1
Make / Model:	Commscope DHHTT65B-3XR	Make / Model:	Commscope DHHTT65B-3XR	Make / Model:	Commscope DHHTT65B-3XR
Gain:	13.35 / 15.25/15.05 dBd	Gain:	13.35 / 15.25 / 15.05 dBd	Gain:	13.35 / 15.25 / 15.05 dBd
Height (AGL):	127 feet	Height (AGL):	127 feet	Height (AGL):	127 feet
Frequency Bands	850 MHz / 1900 MHz (PCS) / 2500 MHz (BRS)	Frequency Bands	850 MHz / 1900 MHz (PCS) / 2500 MHz (BRS)	Frequency Bands	850 MHz / 1900 MHz (PCS) / 2500 MHz (BRS)
Channel Count	18	Channel Count	18	Channel Count	18
Total TX Power(W):	440 Watts	Total TX Power(W):	440 Watts	Total TX Power(W):	440 Watts
ERP (W):	13,072.94	ERP (W):	13,072.94	ERP (W):	13,072.94
Antenna A1 MPE%	3.70 %	Antenna B1 MPE%	3.70 %	Antenna C1 MPE%	3.70 %

Site Composite MPE%	
Carrier	MPE%
SPRINT – Max per sector	3.70 %
Verizon Wireless	2.01 %
AT&T	3.88 %
<b>Site Total MPE %:</b>	<b>9.59 %</b>

SPRINT Sector A Total:	3.70 %
SPRINT Sector B Total:	3.70 %
SPRINT Sector C Total:	3.70 %
<b>Site Total:</b>	<b>9.59 %</b>

SPRINT Frequency Band / Technology (Per Sector)	# Channels	Watts ERP (Per Channel)	Height (feet)	Total Power Density ( $\mu\text{W}/\text{cm}^2$ )	Frequency (MHz)	Allowable MPE ( $\mu\text{W}/\text{cm}^2$ )	Calculated % MPE
Sprint 850 MHz CDMA	1	432.54	127	1.06	850 MHz	567	0.18%
Sprint 850 MHz LTE	2	1,081.36	127	5.31	850 MHz	567	0.94%
Sprint 1900 MHz (PCS) CDMA	5	535.94	127	6.58	1900 MHz (PCS)	1000	0.66%
Sprint 1900 MHz (PCS) LTE	2	1,339.86	127	6.58	1900 MHz (PCS)	1000	0.66%
Sprint 2500 MHz (BRS) LTE	8	639.78	127	12.57	2500 MHz (BRS)	1000	1.26%
						<b>Total:</b>	<b>3.70%</b>





## Summary

All calculations performed for this analysis yielded results that were **within** the allowable limits for general population exposure to RF Emissions.

The anticipated maximum composite contributions from the SPRINT facility as well as the site composite emissions value with regards to compliance with FCC's allowable limits for general population exposure to RF Emissions are shown here:

SPRINT Sector	Power Density Value (%)
Sector A:	3.70 %
Sector B:	3.70 %
Sector C:	3.70 %
SPRINT Maximum MPE % (per sector):	3.70 %
Site Total:	9.59 %
Site Compliance Status:	<b>COMPLIANT</b>

The anticipated composite MPE value for this site assuming all carriers present is **9.59 %** of the allowable FCC established general population limit sampled at the ground level. This is based upon values listed in the Connecticut Siting Council database for existing carrier emissions.

FCC guidelines state that if a site is found to be out of compliance (over allowable thresholds), that carriers over a 5% contribution to the composite value will require measures to bring the site into compliance. For this facility, the composite values calculated were well within the allowable 100% threshold standard per the federal government.



**Tower Engineering Solutions**

Phone (972) 483-0607, Fax (972) 975-9615  
8445 Freeport Parkway, Suite 375, Irving, Texas 75063

---

## Post-Mod Structural Analysis Report

**Existing 150 ft. Valmont Monopole**  
**Customer Name: SBA Communications Corp**  
**Customer Site Number: CT04374-S**  
**Customer Site Name: Central Hebron**  
**Carrier Name: Sprint Nextel**  
**Carrier Site ID / Name: CT54XC731 / Central Hebron**  
**Site Location: 66 Wall Street**  
**Hebron, Connecticut**  
**Tolland County**  
**Latitude: 41.664631**  
**Longitude: -72.361325**

### Analysis Result:

**Max Structural Usage: 95.4% [Pass]**

**Max Foundation Usage: 94% [Pass]**

**Report Prepared By : Stacey Hesselbein**

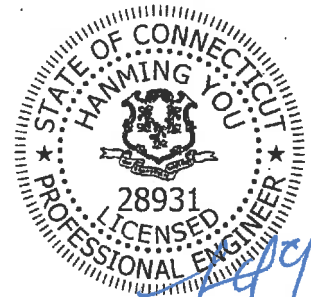

## Introduction

The purpose of this report is to summarize the analysis results on the 150 ft. Valmont Monopole to support the proposed antennas and transmission lines in addition to those currently installed. Any existing modification listed under Sources of Information was assumed completed and was included in this analysis.

The proposed modification by **TES** listed under Sources of Information was considered completed and was included in this analysis.

## Sources of Information

<b>Tower Drawings</b>	Valmont, Eng. File # A-117319, Dated 07/19/2000
<b>Foundation Drawing</b>	Valmont, Eng. File # A-117319, Dated 07/19/2000
<b>Geotechnical Report</b>	FDH, Project # 1201291EG1 Dated 02/14/2012
<b>Existing Modification</b>	N/A
<b>Proposed Modification</b>	TES Job # 48686

## Analysis Criteria

The rigorous analysis was performed in accordance with the requirements and stipulations of the ANSI/TIA/EIA 222-G. In accordance with this standard, the structure was analyzed using **TESPoles**, a proprietary analysis software. The program considers the structure as an elastic 3-D model with second-order effects and temperature effects incorporated in the analysis. The analysis was performed using multiple wind directions.

<b>Wind Speed Used in the Analysis:</b>	Ultimate Design Wind Speed $V_{ult} = 130$ mph (3-Sec. Gust)/ Nominal Design Wind Speed $V_{asd} = 101.0$ mph (3-Sec. Gust)
<b>Basic Wind Speed with Ice:</b>	50 mph (3-Sec. Gust) with 1" radial ice concurrent
<b>Operational Wind Speed:</b>	60 mph + 0" Radial ice
<b>Standard/Codes:</b>	ANSI/TIA/EIA 222-G / 2012 IBC / 2016 Connecticut State Building Code
<b>Exposure Category:</b>	C
<b>Structure Class:</b>	II
<b>Topographic Category:</b>	1
<b>Crest Height:</b>	0 ft.
<b>Seismic Parameters:</b>	$SS = 0.177, S1 = 0.063$

This structural analysis is based upon the tower being classified as a Structure Class II; however, if a different classification is required subsequent to the date hereof, the tower classification will be changed to meet such requirement and a new structural analysis will be run.



## **Existing Antennas, Mounts and Transmission Lines**

The table below summarizes the antennas, mounts and transmission lines that were considered in the analysis as existing on the tower.

Items	Elevation (ft.)	Qty.	Antenna Descriptions	Mount Type & Qty.	Transmission Lines	Owner
1	135.0	3	Andrew - SBNHH-1D65A - Panel	Inside 24" Canister*	(2) 1 5/8" Hybriflex (12) 7/8"	Verizon
2		6	RFS Celwave - FDL85002/1C-3L			
3		2	RFS Celwave - DB-T1-6Z-8AB-0Z			
-	125.0	3	EMS - RR90-17 - Panel	Inside 24" Canister*	(6) 7/8"	Sprint Nextel
7	115.0	3	Powerwave - 7770 - Panel	Inside 36" Canister	(6) 1 5/8"	AT&T
8		6	Powerwave - LGP21401 - TMA			

\* Canisters are to be replaced and are considered as 36" Canisters in the analysis

## **Proposed Carrier's Final Configuration of Antennas, Mounts and Transmission Lines**

Information pertaining to the proposed carrier's final configuration of antennas and transmission lines was provided by SBA Communications Corp. The proposed antennas and lines are listed below.

Items	Elevation (ft.)	Qty.	Antenna Descriptions	Mount Type & Qty.	Transmission Lines	Owner
4	127.0	3	Commscope - DHHTT65B-3XR - Panel	Inside 36" Canister	(3) 3/8" RET (12) 7/8"	Sprint Nextel
5		3	RFS - KIT-FD9R6004/1C-DL - Diplexer			
6		3	CCI - DPO-7126Y-0-T1 - Diplexer			

All transmission lines are considered running inside of the pole shafts.

## **Analysis Results**

The results of the structural analysis, performed for the wind and ice loading and antenna equipment as defined above, are summarized as the following:

	Pole shafts	Anchor Bolts	Base Plate	Flange
Max. Usage:	<b>95.4%</b>	<b>82.4%</b>	<b>54.3%</b>	<b>99.3%</b>
Pass/Fail	<b>Pass</b>	<b>Pass</b>	<b>Pass</b>	<b>Pass</b>

## **Foundations**

	Moment (Kip-Ft)	Shear (Kips)	Axial (Kips)
Original Design Reactions	666.5	8.0	16.5
Analysis Reactions	1087.4	12.0	35.0
Factored Reactions*	899.8	10.8	22.3
% of Design Reactions	120.9%	110.9%	157.1%

\* Per section 15.5.1 of the TIA-222-G standard, factored reactions were obtained by multiplying a 1.35 factor to the original design reactions.

The foundation, with the proposed TES modifications referenced in this analysis included, was analyzed using the supplied documents and soils report and was found adequate.

## **Operational Condition (Rigidity):**

Operational characteristics of the tower are found to be within the limits prescribed by ANSI/TIA/EIA 222-G for the installed antennas. The maximum twist/sway at the elevation of the proposed equipment is 2.1175 degrees under the operational wind speed as specified in the Analysis Criteria.

## **Conclusions**

Based on the analysis results, the structure and its foundation will be adequate to safely support the existing and proposed equipment and meet the minimum requirements per the design ANSI/TIA/EIA 222-G standards under a basic wind speed of 101 mph no ice and 50 mph with 1" radial ice after the following proposed modification is successfully completed.

- Proposed modification design drawing by **TES** Job # 48686

## **Pre-Mod Installation Determination**

We have also checked this tower to determine if the proposed Sprint Nextel equipment loading can be installed prior to the completion of the required modifications.

Since the proposed equipment will be installed inside of the proposed canister expansion, the Carrier cannot install their proposed loading prior to the mods completion.

## Standard Conditions

1. This analysis was performed based on the information supplied to **(TES) Tower Engineering Solutions, LLC**. Verification of the information provided was not included in the Scope of Work for **TES**. The accuracy of the analysis is dependent on the accuracy of the information provided.
2. The analysis is based on the presumption that the tower members and components along with any existing reinforcement items have been correctly and properly designed, manufactured, installed and maintained.
3. All the existing structural members were assumed to be in good condition with no physical damage or deterioration associated with corrosion.
4. An initial tension of 10% of the break strength on all the existing guy wires was assumed in all the structural analyses of guyed towers unless different values were provided by the client. **TES** cannot take responsibility for the deviations in the analysis results because of differences in the initial tension forces of the existing guy wires.
5. Secondary component or connection secondary components, welds and bolts are assumed to be able to carry their intended original design loads. **TES** cannot take responsibility for verification of the adequacy on the connections, bolts and welds present in the structure.
6. The analyses will be performed based on the codes as specified by the client or based on the best knowledge of the engineering staff of **TES**. In the absence of information to the contrary, all work will be performed in accordance with the latest relevant revision of ANSI/TIA-222. If wind speed or/and ice loads are different from the minimum values recommended by the EIA/TIA-222 standard or other codes, **TES** should be notified in writing and the applicable minimum values provided by the client.
7. The configuration of the existing mounts, antennas, coax and other appurtenances were supplied by the customer for the current structural analysis. **TES** has not visited the tower site to verify the adequacy of the information provided. If there is any discrepancy found in the report regarding the existing conditions, **TES** should be notified immediately to evaluate the effect of the discrepancy on the analysis results.
8. The client will assume responsibility for rework associated with the differences in initially provided information, including tower and foundation information, existing and/or proposed equipment and transmission lines.
9. If a feasibility analysis was performed, final acceptance of changed conditions shall be based upon a rigorous structural analysis.



## Usage Diagram - Max Ratio 95.38% at 112.0ft

**Structure:** CT04374-S-SBA  
**Site Name:** Central Hebron  
**Height:** 150.00 (ft)  
**Base Elev:** 0.000 (ft)

**Code:** EIA/TIA-222-G  
**Exposure:** C  
**Gh:** 1.1

5/7/2018



Page: 1

**Dead Load Factor:** 1.20  
**Wind Load Factor:** 1.60

**Load Case : 1.2D + 1.6W 101 mph Wind**

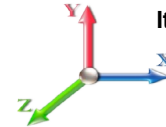

**Iterations:** 38

*Copyright © 2018 by Tower Engineering Solutions, LLC. All rights reserved.*

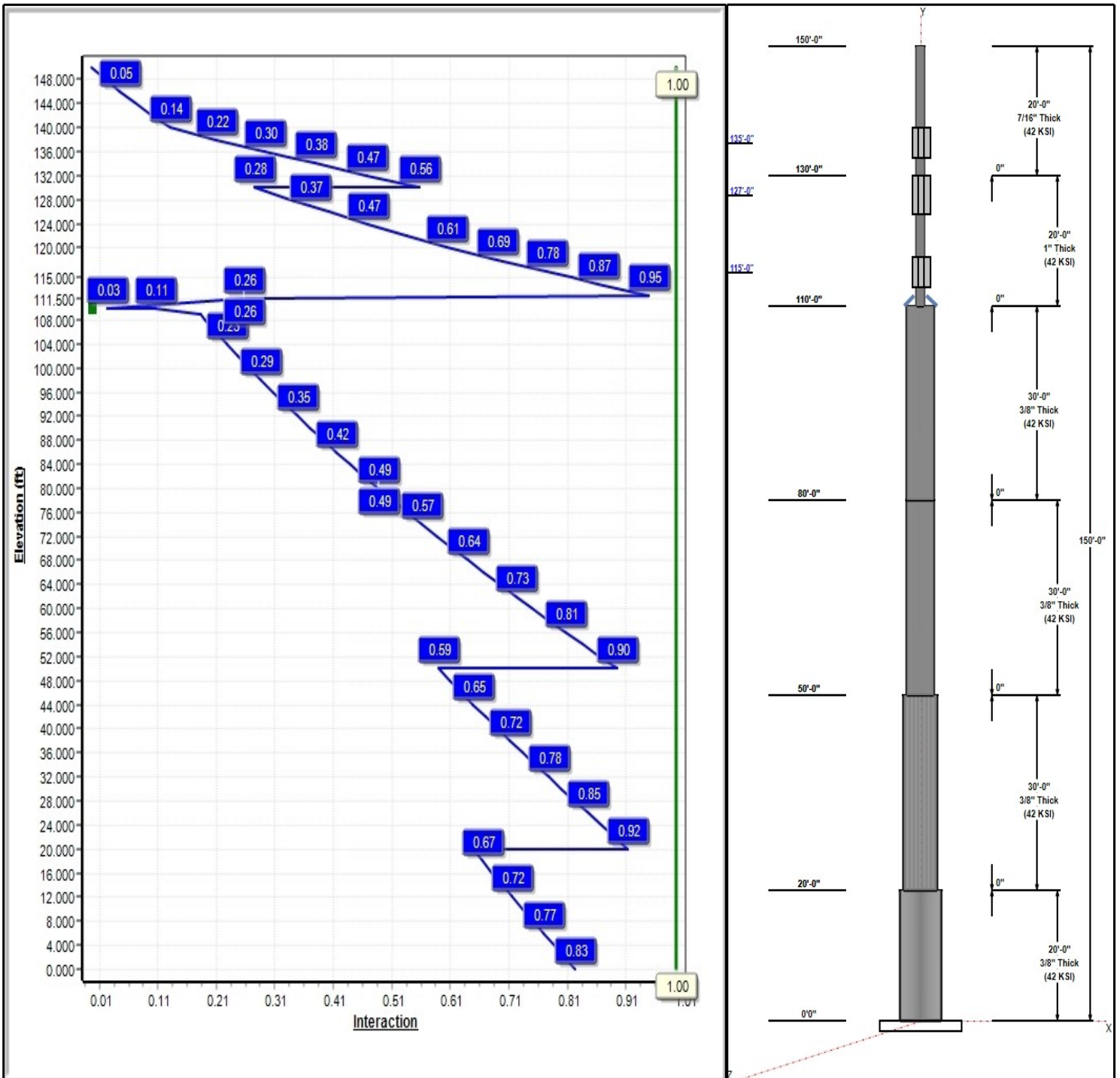

## Structure: CT04374-S-SBA

**Type:** Stepped  
**Site Name:** Central Hebron  
**Height:** 150.00 (ft)  
**Base Elev:** 0.00 (ft)

**Base Shape:** Round  
**Taper:** 0.00000

5/7/2018

Page: 2



### Shaft Properties

Seq	Length (ft)	Top (in)	Bottom (in)	Thick (in)	Joint Type	Taper	Grade (ksi)
1	20.00	36.00	36.00	0.375		0.00000	42
2	30.00	30.00	30.00	0.375		0.00000	42
3	30.00	24.00	24.00	0.375		0.00000	42
4	30.00	24.00	24.00	0.375		0.00000	42
5	20.00	6.75	6.75	1.000		0.00000	42
6	20.00	6.63	6.63	0.432		0.00000	42

### Discrete Appurtenances

Attach Elev (ft)	Force Elev (ft)	Qty	Description	Carrier
150.00	150.00	1	36" Canister	Sprint Nextel
150.00	150.50	1	Truck Ball	Sprint Nextel
140.00	140.00	1	36" Canister	Sprint Nextel
140.00	140.00	1	Flag	Sprint Nextel
135.00	135.00	3	SBNHH-1D65A	Verizon
135.00	135.00	6	FDL85002/1C-3L	Verizon
135.00	135.00	2	DB-T1-6Z-8AB-0Z	Verizon
135.00	135.00	1	Flush Mount	Verizon
130.00	130.00	1	36" Canister	Sprint Nextel
127.00	127.00	3	DHHTT65B-3XR	Sprint Nextel
127.00	127.00	3	FD9R6004/1C-3L	Sprint Nextel
127.00	127.00	3	DPO-7126Y-0-T1	Sprint Nextel
127.00	127.00	1	Flush Mount	Sprint Nextel
120.00	120.00	1	36" Canister	Sprint Nextel
115.00	115.00	3	7770.00	AT&T
115.00	115.00	6	LGP21401	AT&T
115.00	115.00	1	Flush Mount	AT&T
110.00	110.00	1	36" Canister	Sprint Nextel
109.00	109.00	1	36" Canister	Sprint Nextel

### Linear Appurtenances

Elev From (ft)	Elev To (ft)	Placement	Description	Carrier
0.00	135.00	Inside	1 5/8" Hybriflex	Verizon
0.00	135.00	Inside	7/8" Coax	Verizon
0.00	127.00	Inside	3/8" RET	Sprint Nextel
0.00	127.00	Inside	7/8" Coax	Sprint Nextel
0.00	115.00	Inside	1 5/8" Coax	AT&T

### Anchor Bolts

Qty	Specifications	Grade (ksi)	Arrangement
28	1.0" F1554 105	105.0	Radial

### Base Plate

Thickness (in)	Specifications (in)	Grade (ksi)	Geometry
1.2500	42.4	36.0	Round

### Reactions

Load Case	Moment (FT-Kips)	Shear (Kips)	Axial (Kips)
1.2D + 1.6W 101 mph Wind	1087.4	12.0	22.1
0.9D + 1.6W 101 mph Wind	1070.9	12.0	16.6

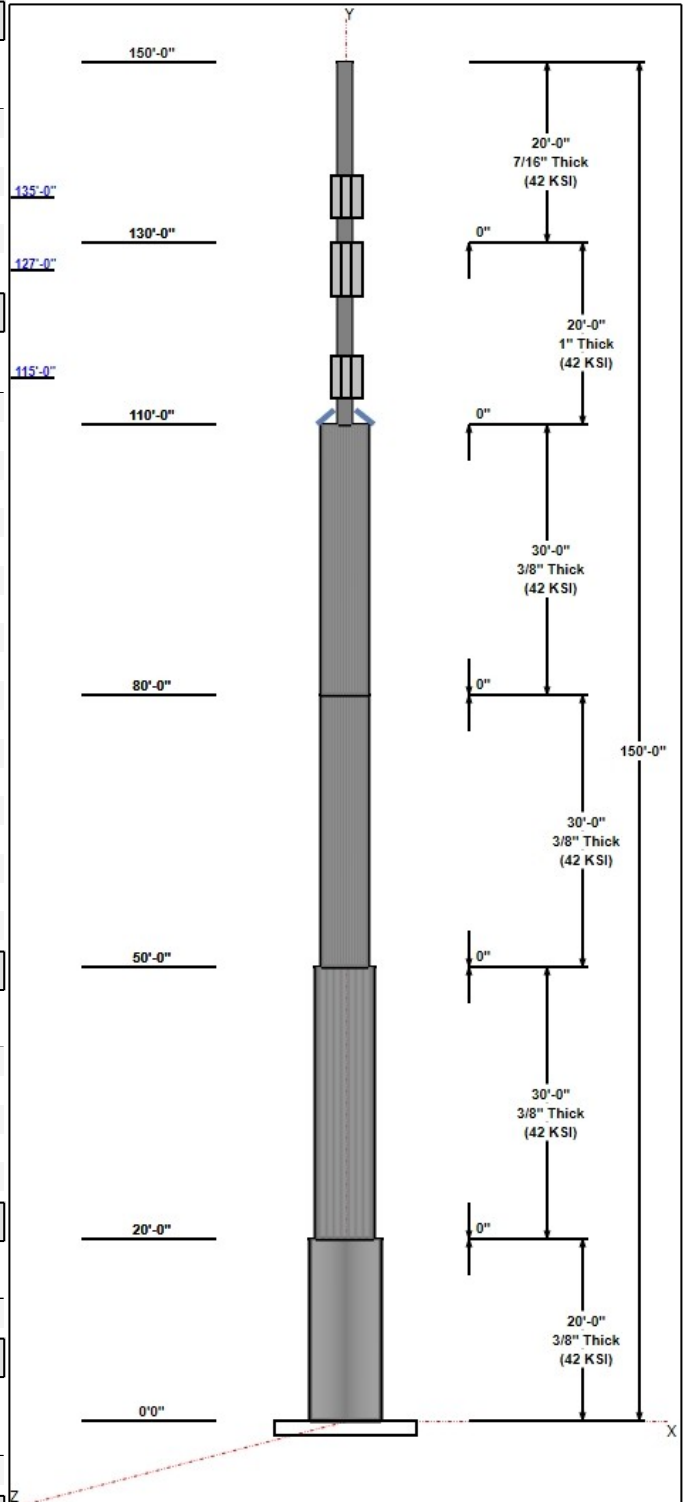

## Structure: CT04374-S-SBA

**Type:** Stepped  
**Site Name:** Central Hebron  
**Height:** 150.00 (ft)  
**Base Elev:** 0.00 (ft)

**Base Shape:** Round  
**Taper:** 0.00000

5/7/2018

Page: 3



1.2D + 1.0Di + 1.0Wi 50 mph Wind	508.0	4.9	35.0
1.2D + 1.0E	45.2	0.5	22.1
0.9D + 1.0E	44.5	0.5	16.6
1.0D + 1.0W 60 mph Wind	253.5	2.8	18.4

# Structure: CT04374-S-SBA - Coax Line Placement

**Type:** Monopole  
**Site Name:** Central Hebron  
**Height:** 150.00 (ft)

5/7/2018

Page: 4



## Shaft Properties

<b>Structure:</b> CT04374-S-SBA	<b>Code:</b> EIA/TIA-222-G	5/7/2018
<b>Site Name:</b> Central Hebron	<b>Exposure:</b> C	
<b>Height:</b> 150.00 (ft)	<b>Crest Height:</b> 0.00	
<b>Base Elev:</b> 0.000 (ft)	<b>Site Class:</b> D - Stiff Soil	
<b>Gh:</b> 1.1	<b>Topography:</b> 1	<b>Struct Class:</b> II



Page: 5

Sec. No.	Shape	Length (ft)	Thick (in)	Fy (ksi)	Joint Type	Overlap (in)	Weight (lb)
1	R	20.000	0.3750	42		0.00	2,856
2	R	30.000	0.3750	42		0.00	3,563
3	R	30.000	0.3750	42		0.00	2,841
4	R	30.000	0.3750	42		0.00	2,841
5	R	20.000	1.0000	42		0.00	1,229
6	R	20.000	0.4320	42		0.00	572
<b>Total Shaft Weight:</b>							<b>13,903</b>

Bottom

Top

Sec. No.	Dia (in)	Elev (ft)	Area (sqin)	Ix (in^4)	W/t Ratio	D/t Ratio	Dia (in)	Elev (ft)	Area (sqin)	Ix (in^4)	W/t Ratio	D/t Ratio	Taper
1	36.00	0.00	41.97	6663.29	0.00	96.00	36.00	20.00	41.97	6663.29	0.00	96.00	0.000000
2	30.00	20.00	34.90	3831.77	0.00	80.00	30.00	50.00	34.90	3831.77	0.00	80.00	0.000000
3	24.00	50.00	27.83	1943.30	0.00	64.00	24.00	80.00	27.83	1943.30	0.00	64.00	0.000000
4	24.00	80.00	27.83	1943.30	0.00	64.00	24.00	110.00	27.83	1943.30	0.00	64.00	0.000000
5	6.75	110.0	18.06	74.71	0.00	6.75	6.75	130.00	18.06	74.71	0.00	6.75	0.000000
6	6.63	130.0	8.41	40.42	0.00	15.35	6.63	150.00	8.41	40.42	0.00	15.35	0.000000

### Additional Steel

Elev From (ft)	Elev To (ft)	Qty	Description	Fy (ksi)	Fu (ksi)	Offset (in)	Intermediate Connectors		Termination Connectors			
							Spacing (in)	Description	Spacing (in)	Lower Qty	Upper Qty	
110.0	111.5	3	PLT 5"x3/4" STFNR	36	48	0.00	5/8" Hollo Bolt	0.00	5/8" Hollo Bolt			



## Load Summary

<b>Structure:</b> CT04374-S-SBA	<b>Code:</b> EIA/TIA-222-G	5/7/2018
<b>Site Name:</b> Central Hebron	<b>Exposure:</b> C	
<b>Height:</b> 150.00 (ft)	<b>Crest Height:</b> 0.00	
<b>Base Elev:</b> 0.000 (ft)	<b>Site Class:</b> D - Stiff Soil	
<b>Gh:</b> 1.1	<b>Topography:</b> 1	<b>Struct Class:</b> II



Page: 6

### Discrete Appurtenances

No.	Elev (ft)	Description	Qty	No Ice			Ice			Hor. Ecc. (ft)	Vert Ecc (ft)
				Weight (lb)	CaAa (sf)	CaAa Factor	Weight (lb)	CaAa (sf)	CaAa Factor		
1	150.00	36" Canister	1	100.00	7.35	1.00	181.44	15.902	1.00	0.00	0.00
2	150.00	Truck Ball	1	10.00	1.41	1.00	10.93	1.541	1.00	0.00	0.50
3	140.00	36" Canister	1	200.00	14.69	1.00	361.77	31.664	1.00	0.00	0.00
4	140.00	Flag	1	50.00	5.56	1.00	54.62	6.074	1.00	0.00	0.00
5	135.00	SBNHH-1D65A	3	33.50	0.00	0.00	256.09	7.336	0.00	0.00	0.00
6	135.00	FDL85002/1C-3L	6	7.00	0.00	0.00	22.89	0.000	0.00	0.00	0.00
7	135.00	DB-T1-6Z-8AB-0Z	2	18.90	0.00	0.00	219.52	5.978	0.00	0.00	0.00
8	135.00	Flush Mount	1	150.00	0.00	0.00	315.78	0.000	0.00	0.00	0.00
9	130.00	36" Canister	1	200.00	14.66	1.00	360.57	31.474	1.00	0.00	0.00
10	127.00	DHHTT65B-3XR	3	45.40	0.00	0.00	326.09	9.826	0.00	0.00	0.00
11	127.00	FD9R6004/1C-3L	3	3.10	0.00	0.00	13.63	0.000	0.00	0.00	0.00
12	127.00	DPO-7126Y-0-T1	3	7.30	0.00	0.77	37.74	0.795	0.78	0.00	0.00
13	127.00	Flush Mount	1	150.00	0.00	0.00	314.78	0.000	0.00	0.00	0.00
14	120.00	36" Canister	1	200.00	14.62	1.00	359.29	31.255	1.00	0.00	0.00
15	115.00	7770.00	3	35.00	0.00	0.00	222.59	6.910	0.00	0.00	0.00
16	115.00	LGP21401	6	14.10	0.00	0.00	46.56	0.000	0.00	0.00	0.00
17	115.00	Flush Mount	1	150.00	0.00	0.00	313.15	0.000	0.00	0.00	0.00
18	110.00	36" Canister	1	100.00	7.31	1.00	178.96	15.555	1.00	0.00	0.00
19	109.00	36" Canister	1	25.00	3.60	1.00	27.25	3.925	1.00	0.00	0.00
<b>Totals:</b>			<b>40</b>	<b>1,872.30</b>			<b>5,902.68</b>				

### Linear Appurtenances

Bottom Elev. (ft)	Top Elev. (ft)	Description	Exposed Width	Exposed
0.00	135.00	(2) 1 5/8" Hybriflex	0.00	Inside
0.00	135.00	(12) 7/8" Coax	0.00	Inside
0.00	127.00	(3) 3/8" RET	0.00	Inside
0.00	127.00	(12) 7/8" Coax	0.00	Inside
0.00	115.00	(6) 1 5/8" Coax	0.00	Inside

## Shaft Section Properties

<b>Structure:</b> CT04374-S-SBA	<b>Code:</b> EIA/TIA-222-G	5/7/2018
<b>Site Name:</b> Central Hebron	<b>Exposure:</b> C	
<b>Height:</b> 150.00 (ft)	<b>Crest Height:</b> 0.00	
<b>Base Elev:</b> 0.000 (ft)	<b>Site Class:</b> D - Stiff Soil	
<b>Gh:</b> 1.1	<b>Topography:</b> 1	<b>Struct Class:</b> II



Page: 7

**Increment Length:** 2 (ft)

Additional Reinforcing
------------------------

Elev (ft)	Description	Thick (in)	Flat Dia (in)	Area (in <sup>2</sup> )	Ix (in <sup>4</sup> )	W/t Ratio	D/t Ratio	Fy (ksi)	Fb (ksi)	Weight (lb)	Area (in <sup>2</sup> )	Ixp (in <sup>4</sup> )	Iyp (in <sup>4</sup> )	Weight (lb)
0.00		0.3750	36.000	41.970	6663.3	0.00	96.00	42	39	0.0				
2.00		0.3750	36.000	41.970	6663.3	0.00	96.00	42	39	285.6				
4.00		0.3750	36.000	41.970	6663.3	0.00	96.00	42	39	285.6				
6.00		0.3750	36.000	41.970	6663.3	0.00	96.00	42	39	285.6				
8.00		0.3750	36.000	41.970	6663.3	0.00	96.00	42	39	285.6				
10.00		0.3750	36.000	41.970	6663.3	0.00	96.00	42	39	285.6				
12.00		0.3750	36.000	41.970	6663.3	0.00	96.00	42	39	285.6				
14.00		0.3750	36.000	41.970	6663.3	0.00	96.00	42	39	285.6				
16.00		0.3750	36.000	41.970	6663.3	0.00	96.00	42	39	285.6				
18.00		0.3750	36.000	41.970	6663.3	0.00	96.00	42	39	285.6				
20.00	Top - Section 1	0.3750	36.000	41.970	6663.3	0.00	96.00	42	39	285.6				
20.00	Bot - Section 2	0.3750	30.000	34.901	3831.8	0.00	96.00	42	42					
22.00		0.3750	30.000	34.901	3831.8	0.00	80.00	42	42	237.5				
24.00		0.3750	30.000	34.901	3831.8	0.00	80.00	42	42	237.5				
26.00		0.3750	30.000	34.901	3831.8	0.00	80.00	42	42	237.5				
28.00		0.3750	30.000	34.901	3831.8	0.00	80.00	42	42	237.5				
30.00		0.3750	30.000	34.901	3831.8	0.00	80.00	42	42	237.5				
32.00		0.3750	30.000	34.901	3831.8	0.00	80.00	42	42	237.5				
34.00		0.3750	30.000	34.901	3831.8	0.00	80.00	42	42	237.5				
36.00		0.3750	30.000	34.901	3831.8	0.00	80.00	42	42	237.5				
38.00		0.3750	30.000	34.901	3831.8	0.00	80.00	42	42	237.5				
40.00		0.3750	30.000	34.901	3831.8	0.00	80.00	42	42	237.5				
42.00		0.3750	30.000	34.901	3831.8	0.00	80.00	42	42	237.5				
44.00		0.3750	30.000	34.901	3831.8	0.00	80.00	42	42	237.5				
46.00		0.3750	30.000	34.901	3831.8	0.00	80.00	42	42	237.5				
48.00		0.3750	30.000	34.901	3831.8	0.00	80.00	42	42	237.5				
50.00	Top - Section 2	0.3750	30.000	34.901	3831.8	0.00	80.00	42	42	237.5				
50.00	Bot - Section 3	0.3750	24.000	27.833	1943.3	0.00	80.00	42	42					
52.00		0.3750	24.000	27.833	1943.3	0.00	64.00	42	42	189.4				
54.00		0.3750	24.000	27.833	1943.3	0.00	64.00	42	42	189.4				
56.00		0.3750	24.000	27.833	1943.3	0.00	64.00	42	42	189.4				
58.00		0.3750	24.000	27.833	1943.3	0.00	64.00	42	42	189.4				
60.00		0.3750	24.000	27.833	1943.3	0.00	64.00	42	42	189.4				
62.00		0.3750	24.000	27.833	1943.3	0.00	64.00	42	42	189.4				
64.00		0.3750	24.000	27.833	1943.3	0.00	64.00	42	42	189.4				
66.00		0.3750	24.000	27.833	1943.3	0.00	64.00	42	42	189.4				
68.00		0.3750	24.000	27.833	1943.3	0.00	64.00	42	42	189.4				
70.00		0.3750	24.000	27.833	1943.3	0.00	64.00	42	42	189.4				
72.00		0.3750	24.000	27.833	1943.3	0.00	64.00	42	42	189.4				
74.00		0.3750	24.000	27.833	1943.3	0.00	64.00	42	42	189.4				
76.00		0.3750	24.000	27.833	1943.3	0.00	64.00	42	42	189.4				
78.00		0.3750	24.000	27.833	1943.3	0.00	64.00	42	42	189.4				
80.00	Top - Section 3	0.3750	24.000	27.833	1943.3	0.00	64.00	42	42	189.4				
80.00	Bot - Section 4	0.3750	24.000	27.833	1943.3	0.00	64.00	42	42					
82.00		0.3750	24.000	27.833	1943.3	0.00	64.00	42	42	189.4				
84.00		0.3750	24.000	27.833	1943.3	0.00	64.00	42	42	189.4				
86.00		0.3750	24.000	27.833	1943.3	0.00	64.00	42	42	189.4				
88.00		0.3750	24.000	27.833	1943.3	0.00	64.00	42	42	189.4				
90.00		0.3750	24.000	27.833	1943.3	0.00	64.00	42	42	189.4				
92.00		0.3750	24.000	27.833	1943.3	0.00	64.00	42	42	189.4				

Increment Length: 2 (ft)

Elev (ft)	Description	Thick (in)	Flat Dia (in)	Area (in^2)	Ix (in^4)	W/t Ratio	D/t Ratio	Fy (ksi)	Fb (ksi)	Weight (lb)	Additional Reinforcing			
											Area (in^2)	Ixp (in^4)	Iyp (in^4)	Weight (lb)
94.00		0.3750	24.000	27.833	1943.3	0.00	64.00	42	42	189.4				
96.00		0.3750	24.000	27.833	1943.3	0.00	64.00	42	42	189.4				
98.00		0.3750	24.000	27.833	1943.3	0.00	64.00	42	42	189.4				
100.00		0.3750	24.000	27.833	1943.3	0.00	64.00	42	42	189.4				
102.00		0.3750	24.000	27.833	1943.3	0.00	64.00	42	42	189.4				
104.00		0.3750	24.000	27.833	1943.3	0.00	64.00	42	42	189.4				
106.00		0.3750	24.000	27.833	1943.3	0.00	64.00	42	42	189.4				
108.00		0.3750	24.000	27.833	1943.3	0.00	64.00	42	42	189.4				
109.00		0.3750	24.000	27.833	1943.3	0.00	64.00	42	42	94.7				
110.00	Top - Section 4 RB1	0.3750	24.000	27.833	1943.3	0.00	64.00	42	42	94.7	11.25	1194.6	1194.6	38.3
110.00	Bot - Section 5	1.0000	6.750	18.064	74.7	0.00	24.00	42	42					
111.50	RT1	1.0000	6.750	18.064	74.7	0.00	6.75	42	42	92.2	11.25	206.1	206.1	57.4
112.00		1.0000	6.750	18.064	74.7	0.00	6.75	42	42	30.7				
114.00		1.0000	6.750	18.064	74.7	0.00	6.75	42	42	122.9				
115.00		1.0000	6.750	18.064	74.7	0.00	6.75	42	42	61.5				
116.00		1.0000	6.750	18.064	74.7	0.00	6.75	42	42	61.5				
118.00		1.0000	6.750	18.064	74.7	0.00	6.75	42	42	122.9				
120.00		1.0000	6.750	18.064	74.7	0.00	6.75	42	42	122.9				
122.00		1.0000	6.750	18.064	74.7	0.00	6.75	42	42	122.9				
124.00		1.0000	6.750	18.064	74.7	0.00	6.75	42	42	122.9				
126.00		1.0000	6.750	18.064	74.7	0.00	6.75	42	42	122.9				
127.00		1.0000	6.750	18.064	74.7	0.00	6.75	42	42	61.5				
128.00		1.0000	6.750	18.064	74.7	0.00	6.75	42	42	61.5				
130.00	Top - Section 5	1.0000	6.750	18.064	74.7	0.00	6.75	42	42	122.9				
130.00	Bot - Section 6	0.4320	6.630	8.412	40.4	0.00	15.63	42	42					
132.00		0.4320	6.630	8.412	40.4	0.00	15.35	42	42	57.2				
134.00		0.4320	6.630	8.412	40.4	0.00	15.35	42	42	57.2				
135.00		0.4320	6.630	8.412	40.4	0.00	15.35	42	42	28.6				
136.00		0.4320	6.630	8.412	40.4	0.00	15.35	42	42	28.6				
138.00		0.4320	6.630	8.412	40.4	0.00	15.35	42	42	57.2				
140.00		0.4320	6.630	8.412	40.4	0.00	15.35	42	42	57.2				
142.00		0.4320	6.630	8.412	40.4	0.00	15.35	42	42	57.2				
144.00		0.4320	6.630	8.412	40.4	0.00	15.35	42	42	57.2				
146.00		0.4320	6.630	8.412	40.4	0.00	15.35	42	42	57.2				
148.00		0.4320	6.630	8.412	40.4	0.00	15.35	42	42	57.2				
150.00		0.4320	6.630	8.412	40.4	0.00	15.35	42	42	57.2				
<b>Total Weight</b>										<b>13903.4</b>				
											<b>95.7</b>			

## Wind Loading - Shaft

<b>Structure:</b> CT04374-S-SBA	<b>Code:</b> EIA/TIA-222-G	5/7/2018
<b>Site Name:</b> Central Hebron	<b>Exposure:</b> C	
<b>Height:</b> 150.00 (ft)	<b>Crest Height:</b> 0.00	
<b>Base Elev:</b> 0.000 (ft)	<b>Site Class:</b> D - Stiff Soil	
<b>Gh:</b> 1.1	<b>Topography:</b> 1	<b>Struct Class:</b> II



**Load Case:** 1.2D + 1.6W 101 mph Wind

**Dead Load Factor** 1.20  
**Wind Load Factor** 1.60

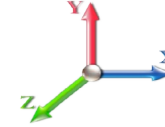

**Iterations** 38

Elev (ft)	Description	Kzt	Kz	qz (psf)	qzGh (psf)	C (mph-ft)	Cf	Ice Thick (in)	Tributary (ft)	Aa (sf)	CfAa (sf)	Wind Force X (lb)	Dead Load Ice (lb)	Tot Dead Load (lb)
0.00		1.00	0.85	21.088	23.20	279.35	0.600	0.000	0.00	0.000	0.00	0.0	0.0	0.0
2.00		1.00	0.85	21.088	23.20	279.35	0.600	0.000	2.00	6.000	3.60	133.6	0.0	342.8
4.00		1.00	0.85	21.088	23.20	279.35	0.600	0.000	2.00	6.000	3.60	133.6	0.0	342.8
6.00		1.00	0.85	21.088	23.20	279.35	0.600	0.000	2.00	6.000	3.60	133.6	0.0	342.8
8.00		1.00	0.85	21.088	23.20	279.35	0.600	0.000	2.00	6.000	3.60	133.6	0.0	342.8
10.00		1.00	0.85	21.088	23.20	279.35	0.600	0.000	2.00	6.000	3.60	133.6	0.0	342.8
12.00		1.00	0.85	21.088	23.20	279.35	0.600	0.000	2.00	6.000	3.60	133.6	0.0	342.8
14.00		1.00	0.85	21.088	23.20	279.35	0.600	0.000	2.00	6.000	3.60	133.6	0.0	342.8
16.00		1.00	0.86	21.348	23.48	281.07	0.600	0.000	2.00	6.000	3.60	135.3	0.0	342.8
18.00		1.00	0.88	21.884	24.07	284.58	0.600	0.000	2.00	6.000	3.60	138.7	0.0	342.8
20.00	Top - Section 1	1.00	0.90	22.375	24.61	287.75	0.600	0.000	2.00	6.000	3.60	141.8	0.0	342.8
22.00		1.00	0.92	22.828	25.11	242.21	0.600	0.000	2.00	5.000	3.00	120.5	0.0	285.0
24.00		1.00	0.94	23.250	25.58	244.44	0.600	0.000	2.00	5.000	3.00	122.8	0.0	285.0
26.00		1.00	0.95	23.645	26.01	246.51	0.600	0.000	2.00	5.000	3.00	124.8	0.0	285.0
28.00		1.00	0.97	24.017	26.42	248.44	0.600	0.000	2.00	5.000	3.00	126.8	0.0	285.0
30.00		1.00	0.98	24.369	26.81	250.25	0.600	0.000	2.00	5.000	3.00	128.7	0.0	285.0
32.00		1.00	1.00	24.702	27.17	251.96	0.600	0.000	2.00	5.000	3.00	130.4	0.0	285.0
34.00		1.00	1.01	25.019	27.52	253.57	0.600	0.000	2.00	5.000	3.00	132.1	0.0	285.0
36.00		1.00	1.02	25.322	27.85	255.10	0.600	0.000	2.00	5.000	3.00	133.7	0.0	285.0
38.00		1.00	1.03	25.612	28.17	256.55	0.600	0.000	2.00	5.000	3.00	135.2	0.0	285.0
40.00		1.00	1.04	25.890	28.48	257.94	0.600	0.000	2.00	5.000	3.00	136.7	0.0	285.0
42.00		1.00	1.05	26.157	28.77	259.27	0.600	0.000	2.00	5.000	3.00	138.1	0.0	285.0
44.00		1.00	1.06	26.415	29.06	260.54	0.600	0.000	2.00	5.000	3.00	139.5	0.0	285.0
46.00		1.00	1.07	26.663	29.33	261.77	0.600	0.000	2.00	5.000	3.00	140.8	0.0	285.0
48.00		1.00	1.08	26.903	29.59	262.94	0.600	0.000	2.00	5.000	3.00	142.0	0.0	285.0
50.00	Top - Section 2	1.00	1.09	27.135	29.85	264.07	0.600	0.000	2.00	5.000	3.00	143.3	0.0	285.0
52.00		1.00	1.10	27.360	30.10	212.13	0.600	0.000	2.00	4.000	2.40	115.6	0.0	227.3
54.00		1.00	1.11	27.579	30.34	212.98	0.600	0.000	2.00	4.000	2.40	116.5	0.0	227.3
56.00		1.00	1.12	27.790	30.57	213.79	0.600	0.000	2.00	4.000	2.40	117.4	0.0	227.3
58.00		1.00	1.13	27.997	30.80	214.59	0.600	0.000	2.00	4.000	2.40	118.3	0.0	227.3
60.00		1.00	1.14	28.197	31.02	215.35	0.600	0.000	2.00	4.000	2.40	119.1	0.0	227.3
62.00		1.00	1.14	28.392	31.23	216.10	0.600	0.000	2.00	4.000	2.40	119.9	0.0	227.3
64.00		1.00	1.15	28.583	31.44	216.82	0.600	0.000	2.00	4.000	2.40	120.7	0.0	227.3
66.00		1.00	1.16	28.769	31.65	217.52	0.600	0.000	2.00	4.000	2.40	121.5	0.0	227.3
68.00		1.00	1.17	28.950	31.84	218.21	0.600	0.000	2.00	4.000	2.40	122.3	0.0	227.3
70.00		1.00	1.17	29.127	32.04	218.88	0.600	0.000	2.00	4.000	2.40	123.0	0.0	227.3
72.00		1.00	1.18	29.300	32.23	219.53	0.600	0.000	2.00	4.000	2.40	123.8	0.0	227.3
74.00		1.00	1.19	29.470	32.42	220.16	0.600	0.000	2.00	4.000	2.40	124.5	0.0	227.3
76.00		1.00	1.19	29.636	32.60	220.78	0.600	0.000	2.00	4.000	2.40	125.2	0.0	227.3
78.00		1.00	1.20	29.798	32.78	221.38	0.600	0.000	2.00	4.000	2.40	125.9	0.0	227.3
80.00	Top - Section 3	1.00	1.21	29.958	32.95	221.97	0.600	0.000	2.00	4.000	2.40	126.5	0.0	227.3
82.00		1.00	1.21	30.114	33.13	222.55	0.600	0.000	2.00	4.000	2.40	127.2	0.0	227.3
84.00		1.00	1.22	30.267	33.29	223.12	0.600	0.000	2.00	4.000	2.40	127.8	0.0	227.3
86.00		1.00	1.23	30.417	33.46	223.67	0.600	0.000	2.00	4.000	2.40	128.5	0.0	227.3
88.00		1.00	1.23	30.565	33.62	224.21	0.600	0.000	2.00	4.000	2.40	129.1	0.0	227.3
90.00		1.00	1.24	30.710	33.78	224.74	0.600	0.000	2.00	4.000	2.40	129.7	0.0	227.3
92.00		1.00	1.24	30.852	33.94	225.26	0.600	0.000	2.00	4.000	2.40	130.3	0.0	227.3

## Wind Loading - Shaft

<b>Structure:</b> CT04374-S-SBA	<b>Code:</b> EIA/TIA-222-G	<b>5/7/2018</b>
<b>Site Name:</b> Central Hebron	<b>Exposure:</b> C	
<b>Height:</b> 150.00 (ft)	<b>Crest Height:</b> 0.00	
<b>Base Elev:</b> 0.000 (ft)	<b>Site Class:</b> D - Stiff Soil	
<b>Gh:</b> 1.1	<b>Topography:</b> 1	<b>Struct Class:</b> II



Page: 10

94.00	1.00	1.25	30.992	34.09	225.77	0.600	0.000	2.00	4.000	2.40	130.9	0.0	227.3
96.00	1.00	1.25	31.130	34.24	226.28	0.600	0.000	2.00	4.000	2.40	131.5	0.0	227.3
98.00	1.00	1.26	31.265	34.39	226.77	0.600	0.000	2.00	4.000	2.40	132.1	0.0	227.3
100.00	1.00	1.27	31.399	34.54	227.25	0.600	0.000	2.00	4.000	2.40	132.6	0.0	227.3
102.00	1.00	1.27	31.530	34.68	227.72	0.600	0.000	2.00	4.000	2.40	133.2	0.0	227.3
104.00	1.00	1.28	31.659	34.82	228.19	0.600	0.000	2.00	4.000	2.40	133.7	0.0	227.3
106.00	1.00	1.28	31.786	34.96	228.65	0.600	0.000	2.00	4.000	2.40	134.3	0.0	227.3
108.00	1.00	1.29	31.911	35.10	229.10	0.600	0.000	2.00	4.000	2.40	134.8	0.0	227.3
109.00 Appurtenance(s)	1.00	1.29	31.973	35.17	229.32	0.600	0.000	1.00	2.000	1.20	67.5	0.0	113.6
110.00 Top - Section 4 RB1	1.00	1.29	32.035	35.24	229.54	0.600	0.000	1.00	2.000	1.20	67.7	0.0	113.6
111.50 RT1	1.00	1.29	32.126	35.34	64.65	0.600	0.000	1.50	0.844	0.51	28.6	0.0	110.6
112.00	1.00	1.30	32.157	35.37	64.68	0.600	0.000	0.50	0.281	0.17	9.6	0.0	36.9
114.00	1.00	1.30	32.277	35.50	64.80	0.600	0.000	2.00	1.125	0.67	38.3	0.0	147.5
115.00 Appurtenance(s)	1.00	1.30	32.336	35.57	64.86	0.600	0.000	1.00	0.563	0.34	19.2	0.0	73.8
116.00	1.00	1.31	32.395	35.63	64.92	0.600	0.000	1.00	0.563	0.34	19.2	0.0	73.8
118.00	1.00	1.31	32.512	35.76	65.04	0.600	0.000	2.00	1.125	0.67	38.6	0.0	147.5
120.00 Appurtenance(s)	1.00	1.32	32.627	35.89	65.15	0.600	0.000	2.00	1.125	0.67	38.8	0.0	147.5
122.00	1.00	1.32	32.741	36.01	65.27	0.600	0.000	2.00	1.125	0.67	38.9	0.0	147.5
124.00	1.00	1.32	32.853	36.14	65.38	0.600	0.000	2.00	1.125	0.67	39.0	0.0	147.5
126.00	1.00	1.33	32.964	36.26	65.49	0.600	0.000	2.00	1.125	0.67	39.2	0.0	147.5
127.00 Appurtenance(s)	1.00	1.33	33.019	36.32	65.54	0.600	0.000	1.00	0.563	0.34	19.6	0.0	73.8
128.00	1.00	1.33	33.073	36.38	65.60	0.600	0.000	1.00	0.563	0.34	19.6	0.0	73.8
130.00 Top - Section 5	1.00	1.34	33.182	36.50	65.70	0.600	0.000	2.00	1.125	0.67	39.4	0.0	147.5
132.00	1.00	1.34	33.288	36.62	64.64	0.600	0.000	2.00	1.105	0.66	38.8	0.0	68.7
134.00	1.00	1.35	33.394	36.73	64.74	0.600	0.000	2.00	1.105	0.66	39.0	0.0	68.7
135.00 Appurtenance(s)	1.00	1.35	33.446	36.79	64.79	0.600	0.000	1.00	0.552	0.33	19.5	0.0	34.3
136.00	1.00	1.35	33.498	36.85	64.84	0.600	0.000	1.00	0.552	0.33	19.5	0.0	34.3
138.00	1.00	1.35	33.601	36.96	64.94	0.600	0.000	2.00	1.105	0.66	39.2	0.0	68.7
140.00 Appurtenance(s)	1.00	1.36	33.703	37.07	65.04	0.600	0.000	2.00	1.105	0.66	39.3	0.0	68.7
142.00	1.00	1.36	33.804	37.18	65.14	0.600	0.000	2.00	1.105	0.66	39.4	0.0	68.7
144.00	1.00	1.37	33.904	37.29	65.23	0.600	0.000	2.00	1.105	0.66	39.6	0.0	68.7
146.00	1.00	1.37	34.002	37.40	65.33	0.600	0.000	2.00	1.105	0.66	39.7	0.0	68.7
148.00	1.00	1.37	34.100	37.51	65.42	0.600	0.000	2.00	1.105	0.66	39.8	0.0	68.7
150.00 Appurtenance(s)	1.00	1.38	34.196	37.62	65.52	0.600	0.000	2.00	1.105	0.66	39.9	0.0	68.7
<b>Totals:</b>								<b>150.00</b>			<b>7,919.4</b>		<b>16,684.1</b>



## Discrete Appurtenance Forces

<b>Structure:</b> CT04374-S-SBA	<b>Code:</b> EIA/TIA-222-G	5/7/2018
<b>Site Name:</b> Central Hebron	<b>Exposure:</b> C	
<b>Height:</b> 150.00 (ft)	<b>Crest Height:</b> 0.00	
<b>Base Elev:</b> 0.000 (ft)	<b>Site Class:</b> D - Stiff Soil	
<b>Gh:</b> 1.1	<b>Topography:</b> 1	<b>Struct Class:</b> II



Page: 11

**Load Case:** 1.2D + 1.6W 101 mph Wind

**Dead Load Factor** 1.20  
**Wind Load Factor** 1.60

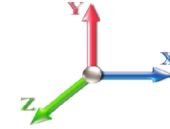

**Iterations** 38

No.	Elev (ft)	Description	Qty	qz (psf)	qzGh (psf)	CaAa x Ka	Ka	Total CaAa (sf)	Dead Load (lb)	Horiz Ecc (ft)	Vert Ecc (ft)	Wind FX (lb)	Mom Y (lb-ft)	Mom Z (lb-ft)
1	150.00	Truck Ball	1	34.220	37.642	1.00	1.00	1.41	12.00	0.000	0.500	84.92	0.00	42.46
2	150.00	36" Canister	1	34.196	37.616	1.00	1.00	7.35	120.00	0.000	0.000	442.37	0.00	0.00
3	140.00	Flag	1	33.703	37.074	1.00	1.00	5.56	60.00	0.000	0.000	329.81	0.00	0.00
4	140.00	36" Canister	1	33.703	37.074	1.00	1.00	14.69	240.00	0.000	0.000	871.38	0.00	0.00
5	135.00	Flush Mount	1	33.446	36.791	0.00	1.00	0.00	180.00	0.000	0.000	0.00	0.00	0.00
6	135.00	DB-T1-6Z-8AB-0Z	2	33.446	36.791	0.00	1.00	0.00	45.36	0.000	0.000	0.00	0.00	0.00
7	135.00	FDL85002/1C-3L	6	33.446	36.791	0.00	1.00	0.00	50.40	0.000	0.000	0.00	0.00	0.00
8	135.00	SBNHH-1D65A	3	33.446	36.791	0.00	1.00	0.00	120.60	0.000	0.000	0.00	0.00	0.00
9	130.00	36" Canister	1	33.182	36.500	1.00	1.00	14.66	240.00	0.000	0.000	856.14	0.00	0.00
10	127.00	Flush Mount	1	33.019	36.321	0.00	1.00	0.00	180.00	0.000	0.000	0.00	0.00	0.00
11	127.00	DPO-7126Y-0-T1	3	33.019	36.321	0.62	0.80	0.00	26.28	0.000	0.000	0.00	0.00	0.00
12	127.00	FD9R6004/1C-3L	3	33.019	36.321	0.00	1.00	0.00	11.16	0.000	0.000	0.00	0.00	0.00
13	127.00	DHHTT65B-3XR	3	33.019	36.321	0.00	1.00	0.00	163.44	0.000	0.000	0.00	0.00	0.00
14	120.00	36" Canister	1	32.627	35.890	1.00	1.00	14.62	240.00	0.000	0.000	839.54	0.00	0.00
15	115.00	Flush Mount	1	32.336	35.570	0.00	1.00	0.00	180.00	0.000	0.000	0.00	0.00	0.00
16	115.00	LGP21401	6	32.336	35.570	0.00	1.00	0.00	101.52	0.000	0.000	0.00	0.00	0.00
17	115.00	7770.00	3	32.336	35.570	0.00	1.00	0.00	126.00	0.000	0.000	0.00	0.00	0.00
18	110.00	36" Canister	1	32.035	35.238	1.00	1.00	7.31	120.00	0.000	0.000	412.15	0.00	0.00
19	109.00	36" Canister	1	31.973	35.171	1.00	1.00	3.60	30.00	0.000	0.000	202.58	0.00	0.00
<b>Totals:</b>									<b>2,246.76</b>			<b>4,038.88</b>		

## Total Applied Force Summary

<b>Structure:</b> CT04374-S-SBA	<b>Code:</b> EIA/TIA-222-G	5/7/2018
<b>Site Name:</b> Central Hebron	<b>Exposure:</b> C	
<b>Height:</b> 150.00 (ft)	<b>Crest Height:</b> 0.00	
<b>Base Elev:</b> 0.000 (ft)	<b>Site Class:</b> D - Stiff Soil	
<b>Gh:</b> 1.1	<b>Topography:</b> 1	<b>Struct Class:</b> II



Page: 12

**Load Case:** 1.2D + 1.6W 101 mph Wind

**Dead Load Factor** 1.20  
**Wind Load Factor** 1.60

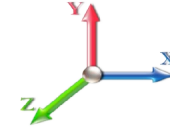

**Iterations** 38

Elev (ft)	Description	Lateral FX (-) (lb)	Axial FY (-) (lb)	Torsion MY (lb-ft)	Moment MZ (lb-ft)
0.00		0.00	0.00	0.00	0.00
2.00		133.61	393.39	0.00	0.00
4.00		133.61	393.39	0.00	0.00
6.00		133.61	393.39	0.00	0.00
8.00		133.61	393.39	0.00	0.00
10.00		133.61	393.39	0.00	0.00
12.00		133.61	393.39	0.00	0.00
14.00		133.61	393.39	0.00	0.00
16.00		135.26	393.39	0.00	0.00
18.00		138.66	393.39	0.00	0.00
20.00		141.77	393.39	0.00	0.00
22.00		120.53	335.67	0.00	0.00
24.00		122.76	335.67	0.00	0.00
26.00		124.85	335.67	0.00	0.00
28.00		126.81	335.67	0.00	0.00
30.00		128.67	335.67	0.00	0.00
32.00		130.43	335.67	0.00	0.00
34.00		132.10	335.67	0.00	0.00
36.00		133.70	335.67	0.00	0.00
38.00		135.23	335.67	0.00	0.00
40.00		136.70	335.67	0.00	0.00
42.00		138.11	335.67	0.00	0.00
44.00		139.47	335.67	0.00	0.00
46.00		140.78	335.67	0.00	0.00
48.00		142.05	335.67	0.00	0.00
50.00		143.27	335.67	0.00	0.00
52.00		115.57	277.94	0.00	0.00
54.00		116.49	277.94	0.00	0.00
56.00		117.39	277.94	0.00	0.00
58.00		118.26	277.94	0.00	0.00
60.00		119.10	277.94	0.00	0.00
62.00		119.93	277.94	0.00	0.00
64.00		120.73	277.94	0.00	0.00
66.00		121.52	277.94	0.00	0.00
68.00		122.28	277.94	0.00	0.00
70.00		123.03	277.94	0.00	0.00
72.00		123.77	277.94	0.00	0.00
74.00		124.48	277.94	0.00	0.00
76.00		125.18	277.94	0.00	0.00
78.00		125.87	277.94	0.00	0.00
80.00		126.54	277.94	0.00	0.00
82.00		127.20	277.94	0.00	0.00
84.00		127.85	277.94	0.00	0.00
86.00		128.48	277.94	0.00	0.00
88.00		129.11	277.94	0.00	0.00
90.00		129.72	277.94	0.00	0.00
92.00		130.32	277.94	0.00	0.00

## Total Applied Force Summary

<b>Structure:</b> CT04374-S-SBA	<b>Code:</b> EIA/TIA-222-G	5/7/2018
<b>Site Name:</b> Central Hebron	<b>Exposure:</b> C	
<b>Height:</b> 150.00 (ft)	<b>Crest Height:</b> 0.00	
<b>Base Elev:</b> 0.000 (ft)	<b>Site Class:</b> D - Stiff Soil	
<b>Gh:</b> 1.1	<b>Topography:</b> 1	<b>Struct Class:</b> II



Page: 13

94.00	130.91	277.94	0.00	0.00
96.00	131.49	277.94	0.00	0.00
98.00	132.06	277.94	0.00	0.00
100.00	132.63	277.94	0.00	0.00
102.00	133.18	277.94	0.00	0.00
104.00	133.73	277.94	0.00	0.00
106.00	134.26	277.94	0.00	0.00
108.00	134.79	277.94	0.00	0.00
109.00	(1) attachments 270.11	168.97	0.00	0.00
110.00	(1) attachments 479.81	258.97	0.00	0.00
111.50	28.62	148.62	0.00	0.00
112.00	9.55	49.54	0.00	0.00
114.00	38.34	198.16	0.00	0.00
115.00	(10) attachments 19.21	506.60	0.00	0.00
116.00	19.24	91.59	0.00	0.00
118.00	38.62	183.19	0.00	0.00
120.00	(1) attachments 878.30	423.19	0.00	0.00
122.00	38.90	183.19	0.00	0.00
124.00	39.03	183.19	0.00	0.00
126.00	39.16	183.19	0.00	0.00
127.00	(10) attachments 19.61	472.47	0.00	0.00
128.00	19.65	83.89	0.00	0.00
130.00	(1) attachments 895.56	407.78	0.00	0.00
132.00	38.84	88.95	0.00	0.00
134.00	38.97	88.95	0.00	0.00
135.00	(12) attachments 19.51	440.84	0.00	0.00
136.00	19.54	34.35	0.00	0.00
138.00	39.21	68.70	0.00	0.00
140.00	(2) attachments 1240.51	368.70	0.00	0.00
142.00	39.45	68.70	0.00	0.00
144.00	39.56	68.70	0.00	0.00
146.00	39.68	68.70	0.00	0.00
148.00	39.79	68.70	0.00	0.00
150.00	(2) attachments 567.19	200.70	0.00	42.46
<b>Totals:</b>	<b>11,958.27</b>	<b>22,137.65</b>	<b>0.00</b>	<b>42.46</b>

## Calculated Forces

<b>Structure:</b> CT04374-S-SBA	<b>Code:</b> EIA/TIA-222-G	5/7/2018
<b>Site Name:</b> Central Hebron	<b>Exposure:</b> C	
<b>Height:</b> 150.00 (ft)	<b>Crest Height:</b> 0.00	
<b>Base Elev:</b> 0.000 (ft)	<b>Site Class:</b> D - Stiff Soil	
<b>Gh:</b> 1.1	<b>Topography:</b> 1	<b>Struct Class:</b> II



Page: 14

**Load Case:** 1.2D + 1.6W 101 mph Wind

**Iterations** 38

**Dead Load Factor** 1.20  
**Wind Load Factor** 1.60

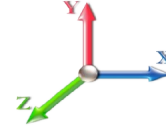

Seg Elev (ft)	Pu FY (-) (kips)	Vu FX (-) (kips)	Tu MY (-) (ft-kips)	Mu MZ (ft-kips)	Mu MX (ft-kips)	Resultant Moment (ft-kips)	phi Pn (kips)	phi Vn (kips)	phi Tn (ft-kips)	phi Mn (ft-kips)	Total Deflect (in)	Rotation Sway (deg)	Rotation Twist (deg)	Stress Ratio
0.00	-22.13	-11.98	0.00	-1087.4	0.00	1087.42	1490.10	745.05	2187.51	1339.68	0.00	0.000	0.000	0.827
2.00	-21.72	-11.88	0.00	-1063.4	0.00	1063.47	1490.10	745.05	2187.51	1339.68	0.02	-0.092	0.000	0.809
4.00	-21.30	-11.77	0.00	-1039.7	0.00	1039.72	1490.10	745.05	2187.51	1339.68	0.08	-0.182	0.000	0.791
6.00	-20.89	-11.67	0.00	-1016.1	0.00	1016.17	1490.10	745.05	2187.51	1339.68	0.17	-0.269	0.000	0.773
8.00	-20.48	-11.57	0.00	-992.83	0.00	992.83	1490.10	745.05	2187.51	1339.68	0.30	-0.355	0.000	0.755
10.00	-20.08	-11.46	0.00	-969.70	0.00	969.70	1490.10	745.05	2187.51	1339.68	0.47	-0.439	0.000	0.738
12.00	-19.67	-11.35	0.00	-946.78	0.00	946.78	1490.10	745.05	2187.51	1339.68	0.67	-0.521	0.000	0.720
14.00	-19.26	-11.24	0.00	-924.08	0.00	924.08	1490.10	745.05	2187.51	1339.68	0.91	-0.601	0.000	0.703
16.00	-18.85	-11.12	0.00	-901.61	0.00	901.61	1490.10	745.05	2187.51	1339.68	1.18	-0.679	0.000	0.686
18.00	-18.45	-11.00	0.00	-879.36	0.00	879.36	1490.10	745.05	2187.51	1339.68	1.48	-0.755	0.000	0.669
20.00	-18.04	-10.88	0.00	-857.35	0.00	857.35	1490.10	745.05	2187.51	1339.68	1.81	-0.829	0.000	0.652
20.00	-18.04	-10.88	0.00	-857.35	0.00	857.35	1311.06	655.53	1597.15	948.43	1.81	-0.829	0.000	0.918
22.00	-17.69	-10.79	0.00	-835.59	0.00	835.59	1311.06	655.53	1597.15	948.43	2.17	-0.901	0.000	0.895
24.00	-17.33	-10.69	0.00	-814.02	0.00	814.02	1311.06	655.53	1597.15	948.43	2.58	-1.024	0.000	0.872
26.00	-16.98	-10.60	0.00	-792.63	0.00	792.63	1311.06	655.53	1597.15	948.43	3.03	-1.143	0.000	0.849
28.00	-16.62	-10.50	0.00	-771.44	0.00	771.44	1311.06	655.53	1597.15	948.43	3.53	-1.259	0.000	0.826
30.00	-16.27	-10.39	0.00	-750.44	0.00	750.44	1311.06	655.53	1597.15	948.43	4.09	-1.372	0.000	0.804
32.00	-15.92	-10.28	0.00	-729.66	0.00	729.66	1311.06	655.53	1597.15	948.43	4.68	-1.482	0.000	0.782
34.00	-15.57	-10.17	0.00	-709.09	0.00	709.09	1311.06	655.53	1597.15	948.43	5.33	-1.589	0.000	0.760
36.00	-15.22	-10.05	0.00	-688.75	0.00	688.75	1311.06	655.53	1597.15	948.43	6.01	-1.693	0.000	0.738
38.00	-14.87	-9.94	0.00	-668.64	0.00	668.64	1311.06	655.53	1597.15	948.43	6.75	-1.793	0.000	0.717
40.00	-14.52	-9.81	0.00	-648.77	0.00	648.77	1311.06	655.53	1597.15	948.43	7.52	-1.891	0.000	0.695
42.00	-14.18	-9.69	0.00	-629.15	0.00	629.15	1311.06	655.53	1597.15	948.43	8.33	-1.986	0.000	0.674
44.00	-13.83	-9.56	0.00	-609.78	0.00	609.78	1311.06	655.53	1597.15	948.43	9.18	-2.078	0.000	0.654
46.00	-13.49	-9.42	0.00	-590.66	0.00	590.66	1311.06	655.53	1597.15	948.43	10.07	-2.167	0.000	0.633
48.00	-13.14	-9.29	0.00	-571.82	0.00	571.82	1311.06	655.53	1597.15	948.43	11.00	-2.253	0.000	0.613
50.00	-12.80	-9.15	0.00	-553.24	0.00	553.24	1311.06	655.53	1597.15	948.43	11.96	-2.337	0.000	0.593
50.00	-12.80	-9.15	0.00	-553.24	0.00	553.24	1052.07	526.04	1018.84	624.04	11.96	-2.337	0.000	0.899
52.00	-12.51	-9.05	0.00	-534.94	0.00	534.94	1052.07	526.04	1018.84	624.04	12.95	-2.418	0.000	0.869
54.00	-12.21	-8.95	0.00	-516.84	0.00	516.84	1052.07	526.04	1018.84	624.04	14.00	-2.572	0.000	0.840
56.00	-11.92	-8.85	0.00	-498.94	0.00	498.94	1052.07	526.04	1018.84	624.04	15.11	-2.720	0.000	0.811
58.00	-11.62	-8.75	0.00	-481.23	0.00	481.23	1052.07	526.04	1018.84	624.04	16.28	-2.864	0.000	0.782
60.00	-11.33	-8.64	0.00	-463.73	0.00	463.73	1052.07	526.04	1018.84	624.04	17.51	-3.002	0.000	0.754
62.00	-11.04	-8.53	0.00	-446.44	0.00	446.44	1052.07	526.04	1018.84	624.04	18.79	-3.136	0.000	0.726
64.00	-10.75	-8.42	0.00	-429.37	0.00	429.37	1052.07	526.04	1018.84	624.04	20.13	-3.264	0.000	0.699
66.00	-10.46	-8.31	0.00	-412.53	0.00	412.53	1052.07	526.04	1018.84	624.04	21.53	-3.387	0.000	0.671
68.00	-10.18	-8.19	0.00	-395.92	0.00	395.92	1052.07	526.04	1018.84	624.04	22.97	-3.505	0.000	0.644
70.00	-9.89	-8.07	0.00	-379.54	0.00	379.54	1052.07	526.04	1018.84	624.04	24.46	-3.619	0.000	0.618
72.00	-9.61	-7.94	0.00	-363.40	0.00	363.40	1052.07	526.04	1018.84	624.04	26.00	-3.728	0.000	0.592
74.00	-9.33	-7.82	0.00	-347.52	0.00	347.52	1052.07	526.04	1018.84	624.04	27.58	-3.832	0.000	0.566
76.00	-9.04	-7.69	0.00	-331.88	0.00	331.88	1052.07	526.04	1018.84	624.04	29.21	-3.931	0.000	0.541
78.00	-8.76	-7.56	0.00	-316.50	0.00	316.50	1052.07	526.04	1018.84	624.04	30.87	-4.026	0.000	0.516
80.00	-8.48	-7.43	0.00	-301.38	0.00	301.38	1052.07	526.04	1018.84	624.04	32.58	-4.117	0.000	0.491
80.00	-8.48	-7.43	0.00	-301.38	0.00	301.38	1052.07	526.04	1018.84	624.04	32.58	-4.117	0.000	0.491
82.00	-8.20	-7.29	0.00	-286.53	0.00	286.53	1052.07	526.04	1018.84	624.04	34.32	-4.203	0.000	0.467
84.00	-7.93	-7.15	0.00	-271.95	0.00	271.95	1052.07	526.04	1018.84	624.04	36.10	-4.284	0.000	0.444
86.00	-7.65	-7.02	0.00	-257.64	0.00	257.64	1052.07	526.04	1018.84	624.04	37.91	-4.362	0.000	0.420
88.00	-7.37	-6.87	0.00	-243.61	0.00	243.61	1052.07	526.04	1018.84	624.04	39.75	-4.435	0.000	0.398

## Calculated Forces

<b>Structure:</b> CT04374-S-SBA	<b>Code:</b> EIA/TIA-222-G	5/7/2018
<b>Site Name:</b> Central Hebron	<b>Exposure:</b> C	
<b>Height:</b> 150.00 (ft)	<b>Crest Height:</b> 0.00	
<b>Base Elev:</b> 0.000 (ft)	<b>Site Class:</b> D - Stiff Soil	
<b>Gh:</b> 1.1	<b>Topography:</b> 1	<b>Struct Class:</b> II



Page: 15

90.00	-7.10	-6.73	0.00	-229.86	0.00	229.86	1052.07	526.04	1018.84	624.04	41.62	-4.505	0.000	0.375
92.00	-6.83	-6.59	0.00	-216.40	0.00	216.40	1052.07	526.04	1018.84	624.04	43.52	-4.570	0.000	0.353
94.00	-6.55	-6.44	0.00	-203.22	0.00	203.22	1052.07	526.04	1018.84	624.04	45.44	-4.631	0.000	0.332
96.00	-6.28	-6.29	0.00	-190.34	0.00	190.34	1052.07	526.04	1018.84	624.04	47.39	-4.689	0.000	0.311
98.00	-6.01	-6.14	0.00	-177.75	0.00	177.75	1052.07	526.04	1018.84	624.04	49.37	-4.743	0.000	0.291
100.00	-5.74	-5.99	0.00	-165.46	0.00	165.46	1052.07	526.04	1018.84	624.04	51.36	-4.793	0.000	0.271
102.00	-5.47	-5.84	0.00	-153.47	0.00	153.47	1052.07	526.04	1018.84	624.04	53.38	-4.840	0.000	0.251
104.00	-5.20	-5.69	0.00	-141.79	0.00	141.79	1052.07	526.04	1018.84	624.04	55.41	-4.883	0.000	0.232
106.00	-4.93	-5.54	0.00	-130.41	0.00	130.41	1052.07	526.04	1018.84	624.04	57.46	-4.923	0.000	0.214
108.00	-4.66	-5.38	0.00	-119.34	0.00	119.34	1052.07	526.04	1018.84	624.04	59.53	-4.960	0.000	0.196
109.00	-4.51	-5.10	0.00	-113.96	0.00	113.96	1052.07	526.04	1018.84	624.04	60.57	-4.977	0.000	0.187
110.00	-4.30	-4.60	0.00	-108.86	0.00	108.86	1052.07	526.04	1018.84	624.04	61.61	-4.993	0.000	0.111
110.00	-4.30	-4.60	0.00	-108.86	0.00	108.86	682.83	341.41	139.27	105.20	61.61	-4.993	0.000	0.028
111.50	-4.15	-4.56	0.00	-101.97	0.00	101.97	682.83	341.41	139.27	105.20	63.18	-5.007	0.000	0.262
111.50	-4.15	-4.56	0.00	-101.97	0.00	101.97	682.83	341.41	139.27	105.20	63.18	-5.007	0.000	0.262
112.00	-4.07	-4.57	0.00	-99.69	0.00	99.69	682.83	341.41	139.27	105.20	63.71	-5.058	0.000	0.954
114.00	-3.83	-4.55	0.00	-90.54	0.00	90.54	682.83	341.41	139.27	105.20	65.98	-5.783	0.000	0.866
115.00	-3.31	-4.50	0.00	-85.99	0.00	85.99	682.83	341.41	139.27	105.20	67.22	-6.119	0.000	0.822
116.00	-3.18	-4.49	0.00	-81.49	0.00	81.49	682.83	341.41	139.27	105.20	68.54	-6.438	0.000	0.779
118.00	-2.96	-4.46	0.00	-72.50	0.00	72.50	682.83	341.41	139.27	105.20	71.35	-7.024	0.000	0.694
120.00	-2.62	-3.56	0.00	-63.57	0.00	63.57	682.83	341.41	139.27	105.20	74.40	-7.542	0.000	0.608
122.00	-2.42	-3.52	0.00	-56.45	0.00	56.45	682.83	341.41	139.27	105.20	77.64	-7.999	0.000	0.540
124.00	-2.22	-3.47	0.00	-49.42	0.00	49.42	682.83	341.41	139.27	105.20	81.07	-8.402	0.000	0.473
126.00	-2.03	-3.41	0.00	-42.49	0.00	42.49	682.83	341.41	139.27	105.20	84.65	-8.752	0.000	0.407
127.00	-1.56	-3.32	0.00	-39.08	0.00	39.08	682.83	341.41	139.27	105.20	86.49	-8.908	0.000	0.374
128.00	-1.47	-3.29	0.00	-35.76	0.00	35.76	682.83	341.41	139.27	105.20	88.37	-9.050	0.000	0.342
130.00	-1.20	-2.35	0.00	-29.17	0.00	29.17	682.83	341.41	139.27	105.20	92.20	-9.297	0.000	0.279
130.00	-1.20	-2.35	0.00	-29.17	0.00	29.17	317.96	158.98	76.72	52.36	92.20	-9.297	0.000	0.561
132.00	-1.11	-2.30	0.00	-24.47	0.00	24.47	317.96	158.98	76.72	52.36	96.12	-9.502	0.000	0.471
134.00	-1.02	-2.25	0.00	-19.87	0.00	19.87	317.96	158.98	76.72	52.36	100.15	-9.814	0.000	0.383
135.00	-0.58	-2.16	0.00	-17.61	0.00	17.61	317.96	158.98	76.72	52.36	102.21	-9.946	0.000	0.338
136.00	-0.54	-2.13	0.00	-15.46	0.00	15.46	317.96	158.98	76.72	52.36	104.29	-10.062	0.000	0.297
138.00	-0.48	-2.09	0.00	-11.19	0.00	11.19	317.96	158.98	76.72	52.36	108.52	-10.250	0.000	0.215
140.00	-0.34	-0.80	0.00	-7.02	0.00	7.02	317.96	158.98	76.72	52.36	112.82	-10.378	0.000	0.135
142.00	-0.27	-0.75	0.00	-5.42	0.00	5.42	317.96	158.98	76.72	52.36	117.17	-10.465	0.000	0.104
144.00	-0.21	-0.70	0.00	-3.92	0.00	3.92	317.96	158.98	76.72	52.36	121.54	-10.531	0.000	0.076
146.00	-0.15	-0.65	0.00	-2.52	0.00	2.52	317.96	158.98	76.72	52.36	125.94	-10.576	0.000	0.049
148.00	-0.09	-0.59	0.00	-1.23	0.00	1.23	317.96	158.98	76.72	52.36	130.35	-10.603	0.000	0.024
150.00	0.00	-0.57	0.00	-0.04	0.00	0.04	317.96	158.98	76.72	52.36	134.77	-10.612	0.000	0.001



## Wind Loading - Shaft

<b>Structure:</b> CT04374-S-SBA	<b>Code:</b> EIA/TIA-222-G	5/7/2018
<b>Site Name:</b> Central Hebron	<b>Exposure:</b> C	
<b>Height:</b> 150.00 (ft)	<b>Crest Height:</b> 0.00	
<b>Base Elev:</b> 0.000 (ft)	<b>Site Class:</b> D - Stiff Soil	
<b>Gh:</b> 1.1	<b>Topography:</b> 1	<b>Struct Class:</b> II



Page: 16

**Load Case:** 0.9D + 1.6W 101 mph Wind

**Dead Load Factor** 0.90  
**Wind Load Factor** 1.60

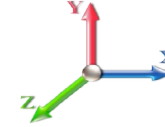

**Iterations** 38

Elev (ft)	Description	Kzt	Kz	qz (psf)	qzGh (psf)	C (mph-ft)	Cf	Ice Thick (in)	Tributary (ft)	Aa (sf)	CfAa (sf)	Wind Force X (lb)	Dead Load Ice (lb)	Tot Dead Load (lb)
0.00		1.00	0.85	21.088	23.20	279.35	0.600	0.000	0.00	0.000	0.00	0.0	0.0	0.0
2.00		1.00	0.85	21.088	23.20	279.35	0.600	0.000	2.00	6.000	3.60	133.6	0.0	257.1
4.00		1.00	0.85	21.088	23.20	279.35	0.600	0.000	2.00	6.000	3.60	133.6	0.0	257.1
6.00		1.00	0.85	21.088	23.20	279.35	0.600	0.000	2.00	6.000	3.60	133.6	0.0	257.1
8.00		1.00	0.85	21.088	23.20	279.35	0.600	0.000	2.00	6.000	3.60	133.6	0.0	257.1
10.00		1.00	0.85	21.088	23.20	279.35	0.600	0.000	2.00	6.000	3.60	133.6	0.0	257.1
12.00		1.00	0.85	21.088	23.20	279.35	0.600	0.000	2.00	6.000	3.60	133.6	0.0	257.1
14.00		1.00	0.85	21.088	23.20	279.35	0.600	0.000	2.00	6.000	3.60	133.6	0.0	257.1
16.00		1.00	0.86	21.348	23.48	281.07	0.600	0.000	2.00	6.000	3.60	135.3	0.0	257.1
18.00		1.00	0.88	21.884	24.07	284.58	0.600	0.000	2.00	6.000	3.60	138.7	0.0	257.1
20.00	Top - Section 1	1.00	0.90	22.375	24.61	287.75	0.600	0.000	2.00	6.000	3.60	141.8	0.0	257.1
22.00		1.00	0.92	22.828	25.11	242.21	0.600	0.000	2.00	5.000	3.00	120.5	0.0	213.8
24.00		1.00	0.94	23.250	25.58	244.44	0.600	0.000	2.00	5.000	3.00	122.8	0.0	213.8
26.00		1.00	0.95	23.645	26.01	246.51	0.600	0.000	2.00	5.000	3.00	124.8	0.0	213.8
28.00		1.00	0.97	24.017	26.42	248.44	0.600	0.000	2.00	5.000	3.00	126.8	0.0	213.8
30.00		1.00	0.98	24.369	26.81	250.25	0.600	0.000	2.00	5.000	3.00	128.7	0.0	213.8
32.00		1.00	1.00	24.702	27.17	251.96	0.600	0.000	2.00	5.000	3.00	130.4	0.0	213.8
34.00		1.00	1.01	25.019	27.52	253.57	0.600	0.000	2.00	5.000	3.00	132.1	0.0	213.8
36.00		1.00	1.02	25.322	27.85	255.10	0.600	0.000	2.00	5.000	3.00	133.7	0.0	213.8
38.00		1.00	1.03	25.612	28.17	256.55	0.600	0.000	2.00	5.000	3.00	135.2	0.0	213.8
40.00		1.00	1.04	25.890	28.48	257.94	0.600	0.000	2.00	5.000	3.00	136.7	0.0	213.8
42.00		1.00	1.05	26.157	28.77	259.27	0.600	0.000	2.00	5.000	3.00	138.1	0.0	213.8
44.00		1.00	1.06	26.415	29.06	260.54	0.600	0.000	2.00	5.000	3.00	139.5	0.0	213.8
46.00		1.00	1.07	26.663	29.33	261.77	0.600	0.000	2.00	5.000	3.00	140.8	0.0	213.8
48.00		1.00	1.08	26.903	29.59	262.94	0.600	0.000	2.00	5.000	3.00	142.0	0.0	213.8
50.00	Top - Section 2	1.00	1.09	27.135	29.85	264.07	0.600	0.000	2.00	5.000	3.00	143.3	0.0	213.8
52.00		1.00	1.10	27.360	30.10	212.13	0.600	0.000	2.00	4.000	2.40	115.6	0.0	170.5
54.00		1.00	1.11	27.579	30.34	212.98	0.600	0.000	2.00	4.000	2.40	116.5	0.0	170.5
56.00		1.00	1.12	27.790	30.57	213.79	0.600	0.000	2.00	4.000	2.40	117.4	0.0	170.5
58.00		1.00	1.13	27.997	30.80	214.59	0.600	0.000	2.00	4.000	2.40	118.3	0.0	170.5
60.00		1.00	1.14	28.197	31.02	215.35	0.600	0.000	2.00	4.000	2.40	119.1	0.0	170.5
62.00		1.00	1.14	28.392	31.23	216.10	0.600	0.000	2.00	4.000	2.40	119.9	0.0	170.5
64.00		1.00	1.15	28.583	31.44	216.82	0.600	0.000	2.00	4.000	2.40	120.7	0.0	170.5
66.00		1.00	1.16	28.769	31.65	217.52	0.600	0.000	2.00	4.000	2.40	121.5	0.0	170.5
68.00		1.00	1.17	28.950	31.84	218.21	0.600	0.000	2.00	4.000	2.40	122.3	0.0	170.5
70.00		1.00	1.17	29.127	32.04	218.88	0.600	0.000	2.00	4.000	2.40	123.0	0.0	170.5
72.00		1.00	1.18	29.300	32.23	219.53	0.600	0.000	2.00	4.000	2.40	123.8	0.0	170.5
74.00		1.00	1.19	29.470	32.42	220.16	0.600	0.000	2.00	4.000	2.40	124.5	0.0	170.5
76.00		1.00	1.19	29.636	32.60	220.78	0.600	0.000	2.00	4.000	2.40	125.2	0.0	170.5
78.00		1.00	1.20	29.798	32.78	221.38	0.600	0.000	2.00	4.000	2.40	125.9	0.0	170.5
80.00	Top - Section 3	1.00	1.21	29.958	32.95	221.97	0.600	0.000	2.00	4.000	2.40	126.5	0.0	170.5
82.00		1.00	1.21	30.114	33.13	222.55	0.600	0.000	2.00	4.000	2.40	127.2	0.0	170.5
84.00		1.00	1.22	30.267	33.29	223.12	0.600	0.000	2.00	4.000	2.40	127.8	0.0	170.5
86.00		1.00	1.23	30.417	33.46	223.67	0.600	0.000	2.00	4.000	2.40	128.5	0.0	170.5
88.00		1.00	1.23	30.565	33.62	224.21	0.600	0.000	2.00	4.000	2.40	129.1	0.0	170.5
90.00		1.00	1.24	30.710	33.78	224.74	0.600	0.000	2.00	4.000	2.40	129.7	0.0	170.5
92.00		1.00	1.24	30.852	33.94	225.26	0.600	0.000	2.00	4.000	2.40	130.3	0.0	170.5

## Wind Loading - Shaft

<b>Structure:</b> CT04374-S-SBA	<b>Code:</b> EIA/TIA-222-G	5/7/2018
<b>Site Name:</b> Central Hebron	<b>Exposure:</b> C	
<b>Height:</b> 150.00 (ft)	<b>Crest Height:</b> 0.00	
<b>Base Elev:</b> 0.000 (ft)	<b>Site Class:</b> D - Stiff Soil	
<b>Gh:</b> 1.1	<b>Topography:</b> 1	<b>Struct Class:</b> II



Page: 17

94.00	1.00	1.25	30.992	34.09	225.77	0.600	0.000	2.00	4.000	2.40	130.9	0.0	170.5
96.00	1.00	1.25	31.130	34.24	226.28	0.600	0.000	2.00	4.000	2.40	131.5	0.0	170.5
98.00	1.00	1.26	31.265	34.39	226.77	0.600	0.000	2.00	4.000	2.40	132.1	0.0	170.5
100.00	1.00	1.27	31.399	34.54	227.25	0.600	0.000	2.00	4.000	2.40	132.6	0.0	170.5
102.00	1.00	1.27	31.530	34.68	227.72	0.600	0.000	2.00	4.000	2.40	133.2	0.0	170.5
104.00	1.00	1.28	31.659	34.82	228.19	0.600	0.000	2.00	4.000	2.40	133.7	0.0	170.5
106.00	1.00	1.28	31.786	34.96	228.65	0.600	0.000	2.00	4.000	2.40	134.3	0.0	170.5
108.00	1.00	1.29	31.911	35.10	229.10	0.600	0.000	2.00	4.000	2.40	134.8	0.0	170.5
109.00 Appurtenance(s)	1.00	1.29	31.973	35.17	229.32	0.600	0.000	1.00	2.000	1.20	67.5	0.0	85.2
110.00 Top - Section 4 RB1	1.00	1.29	32.035	35.24	229.54	0.600	0.000	1.00	2.000	1.20	67.7	0.0	85.2
111.50 RT1	1.00	1.29	32.126	35.34	64.65	0.600	0.000	1.50	0.844	0.51	28.6	0.0	83.0
112.00	1.00	1.30	32.157	35.37	64.68	0.600	0.000	0.50	0.281	0.17	9.6	0.0	27.7
114.00	1.00	1.30	32.277	35.50	64.80	0.600	0.000	2.00	1.125	0.67	38.3	0.0	110.6
115.00 Appurtenance(s)	1.00	1.30	32.336	35.57	64.86	0.600	0.000	1.00	0.563	0.34	19.2	0.0	55.3
116.00	1.00	1.31	32.395	35.63	64.92	0.600	0.000	1.00	0.563	0.34	19.2	0.0	55.3
118.00	1.00	1.31	32.512	35.76	65.04	0.600	0.000	2.00	1.125	0.67	38.6	0.0	110.6
120.00 Appurtenance(s)	1.00	1.32	32.627	35.89	65.15	0.600	0.000	2.00	1.125	0.67	38.8	0.0	110.6
122.00	1.00	1.32	32.741	36.01	65.27	0.600	0.000	2.00	1.125	0.67	38.9	0.0	110.6
124.00	1.00	1.32	32.853	36.14	65.38	0.600	0.000	2.00	1.125	0.67	39.0	0.0	110.6
126.00	1.00	1.33	32.964	36.26	65.49	0.600	0.000	2.00	1.125	0.67	39.2	0.0	110.6
127.00 Appurtenance(s)	1.00	1.33	33.019	36.32	65.54	0.600	0.000	1.00	0.563	0.34	19.6	0.0	55.3
128.00	1.00	1.33	33.073	36.38	65.60	0.600	0.000	1.00	0.563	0.34	19.6	0.0	55.3
130.00 Top - Section 5	1.00	1.34	33.182	36.50	65.70	0.600	0.000	2.00	1.125	0.67	39.4	0.0	110.6
132.00	1.00	1.34	33.288	36.62	64.64	0.600	0.000	2.00	1.105	0.66	38.8	0.0	51.5
134.00	1.00	1.35	33.394	36.73	64.74	0.600	0.000	2.00	1.105	0.66	39.0	0.0	51.5
135.00 Appurtenance(s)	1.00	1.35	33.446	36.79	64.79	0.600	0.000	1.00	0.552	0.33	19.5	0.0	25.8
136.00	1.00	1.35	33.498	36.85	64.84	0.600	0.000	1.00	0.552	0.33	19.5	0.0	25.8
138.00	1.00	1.35	33.601	36.96	64.94	0.600	0.000	2.00	1.105	0.66	39.2	0.0	51.5
140.00 Appurtenance(s)	1.00	1.36	33.703	37.07	65.04	0.600	0.000	2.00	1.105	0.66	39.3	0.0	51.5
142.00	1.00	1.36	33.804	37.18	65.14	0.600	0.000	2.00	1.105	0.66	39.4	0.0	51.5
144.00	1.00	1.37	33.904	37.29	65.23	0.600	0.000	2.00	1.105	0.66	39.6	0.0	51.5
146.00	1.00	1.37	34.002	37.40	65.33	0.600	0.000	2.00	1.105	0.66	39.7	0.0	51.5
148.00	1.00	1.37	34.100	37.51	65.42	0.600	0.000	2.00	1.105	0.66	39.8	0.0	51.5
150.00 Appurtenance(s)	1.00	1.38	34.196	37.62	65.52	0.600	0.000	2.00	1.105	0.66	39.9	0.0	51.5
<b>Totals:</b>								<b>150.00</b>			<b>7,919.4</b>		<b>12,513.1</b>

## Discrete Appurtenance Forces

<b>Structure:</b> CT04374-S-SBA	<b>Code:</b> EIA/TIA-222-G	5/7/2018
<b>Site Name:</b> Central Hebron	<b>Exposure:</b> C	
<b>Height:</b> 150.00 (ft)	<b>Crest Height:</b> 0.00	
<b>Base Elev:</b> 0.000 (ft)	<b>Site Class:</b> D - Stiff Soil	
<b>Gh:</b> 1.1	<b>Topography:</b> 1	<b>Struct Class:</b> II



Page: 18

**Load Case:** 0.9D + 1.6W 101 mph Wind

**Dead Load Factor** 0.90  
**Wind Load Factor** 1.60

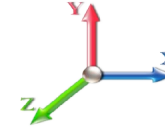

**Iterations** 38

No.	Elev (ft)	Description	Qty	qz (psf)	qzGh (psf)	CaAa x Ka	Ka	Total CaAa (sf)	Dead Load (lb)	Horiz Ecc (ft)	Vert Ecc (ft)	Wind FX (lb)	Mom Y (lb-ft)	Mom Z (lb-ft)	
1	150.00	Truck Ball	1	34.220	37.642	1.00	1.00	1.41	9.00	0.000	0.500	84.92	0.00	42.46	
2	150.00	36" Canister	1	34.196	37.616	1.00	1.00	7.35	90.00	0.000	0.000	442.37	0.00	0.00	
3	140.00	Flag	1	33.703	37.074	1.00	1.00	5.56	45.00	0.000	0.000	329.81	0.00	0.00	
4	140.00	36" Canister	1	33.703	37.074	1.00	1.00	14.69	180.00	0.000	0.000	871.38	0.00	0.00	
5	135.00	Flush Mount	1	33.446	36.791	0.00	1.00	0.00	135.00	0.000	0.000	0.00	0.00	0.00	
6	135.00	DB-T1-6Z-8AB-0Z	2	33.446	36.791	0.00	1.00	0.00	34.02	0.000	0.000	0.00	0.00	0.00	
7	135.00	FDL85002/1C-3L	6	33.446	36.791	0.00	1.00	0.00	37.80	0.000	0.000	0.00	0.00	0.00	
8	135.00	SBNHH-1D65A	3	33.446	36.791	0.00	1.00	0.00	90.45	0.000	0.000	0.00	0.00	0.00	
9	130.00	36" Canister	1	33.182	36.500	1.00	1.00	14.66	180.00	0.000	0.000	856.14	0.00	0.00	
10	127.00	Flush Mount	1	33.019	36.321	0.00	1.00	0.00	135.00	0.000	0.000	0.00	0.00	0.00	
11	127.00	DPO-7126Y-0-T1	3	33.019	36.321	0.62	0.80	0.00	19.71	0.000	0.000	0.00	0.00	0.00	
12	127.00	FD9R6004/1C-3L	3	33.019	36.321	0.00	1.00	0.00	8.37	0.000	0.000	0.00	0.00	0.00	
13	127.00	DHHTT65B-3XR	3	33.019	36.321	0.00	1.00	0.00	122.58	0.000	0.000	0.00	0.00	0.00	
14	120.00	36" Canister	1	32.627	35.890	1.00	1.00	14.62	180.00	0.000	0.000	839.54	0.00	0.00	
15	115.00	Flush Mount	1	32.336	35.570	0.00	1.00	0.00	135.00	0.000	0.000	0.00	0.00	0.00	
16	115.00	LGP21401	6	32.336	35.570	0.00	1.00	0.00	76.14	0.000	0.000	0.00	0.00	0.00	
17	115.00	7770.00	3	32.336	35.570	0.00	1.00	0.00	94.50	0.000	0.000	0.00	0.00	0.00	
18	110.00	36" Canister	1	32.035	35.238	1.00	1.00	7.31	90.00	0.000	0.000	412.15	0.00	0.00	
19	109.00	36" Canister	1	31.973	35.171	1.00	1.00	3.60	22.50	0.000	0.000	202.58	0.00	0.00	
<b>Totals:</b>									<b>1,685.07</b>						<b>4,038.88</b>

## Total Applied Force Summary

<b>Structure:</b> CT04374-S-SBA	<b>Code:</b> EIA/TIA-222-G	5/7/2018
<b>Site Name:</b> Central Hebron	<b>Exposure:</b> C	
<b>Height:</b> 150.00 (ft)	<b>Crest Height:</b> 0.00	
<b>Base Elev:</b> 0.000 (ft)	<b>Site Class:</b> D - Stiff Soil	
<b>Gh:</b> 1.1	<b>Topography:</b> 1	<b>Struct Class:</b> II



Page: 19

**Load Case:** 0.9D + 1.6W 101 mph Wind

**Dead Load Factor** 0.90  
**Wind Load Factor** 1.60

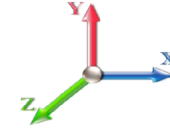

**Iterations** 38

Elev (ft)	Description	Lateral FX (-) (lb)	Axial FY (-) (lb)	Torsion MY (lb-ft)	Moment MZ (lb-ft)
0.00		0.00	0.00	0.00	0.00
2.00		133.61	295.04	0.00	0.00
4.00		133.61	295.04	0.00	0.00
6.00		133.61	295.04	0.00	0.00
8.00		133.61	295.04	0.00	0.00
10.00		133.61	295.04	0.00	0.00
12.00		133.61	295.04	0.00	0.00
14.00		133.61	295.04	0.00	0.00
16.00		135.26	295.04	0.00	0.00
18.00		138.66	295.04	0.00	0.00
20.00		141.77	295.04	0.00	0.00
22.00		120.53	251.75	0.00	0.00
24.00		122.76	251.75	0.00	0.00
26.00		124.85	251.75	0.00	0.00
28.00		126.81	251.75	0.00	0.00
30.00		128.67	251.75	0.00	0.00
32.00		130.43	251.75	0.00	0.00
34.00		132.10	251.75	0.00	0.00
36.00		133.70	251.75	0.00	0.00
38.00		135.23	251.75	0.00	0.00
40.00		136.70	251.75	0.00	0.00
42.00		138.11	251.75	0.00	0.00
44.00		139.47	251.75	0.00	0.00
46.00		140.78	251.75	0.00	0.00
48.00		142.05	251.75	0.00	0.00
50.00		143.27	251.75	0.00	0.00
52.00		115.57	208.45	0.00	0.00
54.00		116.49	208.45	0.00	0.00
56.00		117.39	208.45	0.00	0.00
58.00		118.26	208.45	0.00	0.00
60.00		119.10	208.45	0.00	0.00
62.00		119.93	208.45	0.00	0.00
64.00		120.73	208.45	0.00	0.00
66.00		121.52	208.45	0.00	0.00
68.00		122.28	208.45	0.00	0.00
70.00		123.03	208.45	0.00	0.00
72.00		123.77	208.45	0.00	0.00
74.00		124.48	208.45	0.00	0.00
76.00		125.18	208.45	0.00	0.00
78.00		125.87	208.45	0.00	0.00
80.00		126.54	208.45	0.00	0.00
82.00		127.20	208.45	0.00	0.00
84.00		127.85	208.45	0.00	0.00
86.00		128.48	208.45	0.00	0.00
88.00		129.11	208.45	0.00	0.00
90.00		129.72	208.45	0.00	0.00
92.00		130.32	208.45	0.00	0.00

## Total Applied Force Summary

<b>Structure:</b> CT04374-S-SBA	<b>Code:</b> EIA/TIA-222-G	5/7/2018
<b>Site Name:</b> Central Hebron	<b>Exposure:</b> C	
<b>Height:</b> 150.00 (ft)	<b>Crest Height:</b> 0.00	
<b>Base Elev:</b> 0.000 (ft)	<b>Site Class:</b> D - Stiff Soil	
<b>Gh:</b> 1.1	<b>Topography:</b> 1	<b>Struct Class:</b> II



Page: 20

94.00	130.91	208.45	0.00	0.00
96.00	131.49	208.45	0.00	0.00
98.00	132.06	208.45	0.00	0.00
100.00	132.63	208.45	0.00	0.00
102.00	133.18	208.45	0.00	0.00
104.00	133.73	208.45	0.00	0.00
106.00	134.26	208.45	0.00	0.00
108.00	134.79	208.45	0.00	0.00
109.00	(1) attachments 270.11	126.73	0.00	0.00
110.00	(1) attachments 479.81	194.23	0.00	0.00
111.50	28.62	111.47	0.00	0.00
112.00	9.55	37.16	0.00	0.00
114.00	38.34	148.62	0.00	0.00
115.00	(10) attachments 19.21	379.95	0.00	0.00
116.00	19.24	68.70	0.00	0.00
118.00	38.62	137.39	0.00	0.00
120.00	(1) attachments 878.30	317.39	0.00	0.00
122.00	38.90	137.39	0.00	0.00
124.00	39.03	137.39	0.00	0.00
126.00	39.16	137.39	0.00	0.00
127.00	(10) attachments 19.61	354.36	0.00	0.00
128.00	19.65	62.92	0.00	0.00
130.00	(1) attachments 895.56	305.83	0.00	0.00
132.00	38.84	66.71	0.00	0.00
134.00	38.97	66.71	0.00	0.00
135.00	(12) attachments 19.51	330.63	0.00	0.00
136.00	19.54	25.76	0.00	0.00
138.00	39.21	51.52	0.00	0.00
140.00	(2) attachments 1240.51	276.52	0.00	0.00
142.00	39.45	51.52	0.00	0.00
144.00	39.56	51.52	0.00	0.00
146.00	39.68	51.52	0.00	0.00
148.00	39.79	51.52	0.00	0.00
150.00	(2) attachments 567.19	150.52	0.00	42.46
<b>Totals:</b>	<b>11,958.27</b>	<b>16,603.24</b>	<b>0.00</b>	<b>42.46</b>



## Calculated Forces

<b>Structure:</b> CT04374-S-SBA	<b>Code:</b> EIA/TIA-222-G	5/7/2018
<b>Site Name:</b> Central Hebron	<b>Exposure:</b> C	
<b>Height:</b> 150.00 (ft)	<b>Crest Height:</b> 0.00	
<b>Base Elev:</b> 0.000 (ft)	<b>Site Class:</b> D - Stiff Soil	
<b>Gh:</b> 1.1	<b>Topography:</b> 1	<b>Struct Class:</b> II



Page: 21

**Load Case:** 0.9D + 1.6W 101 mph Wind

**Iterations** 38

**Dead Load Factor** 0.90  
**Wind Load Factor** 1.60

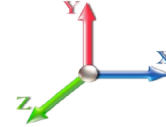

Seg Elev (ft)	Pu FY (-) (kips)	Vu FX (-) (kips)	Tu MY (-) (ft-kips)	Mu MZ (ft-kips)	Mu MX (ft-kips)	Resultant Moment (ft-kips)	phi Pn (kips)	phi Vn (kips)	phi Tn (ft-kips)	phi Mn (ft-kips)	Total Deflect (in)	Rotation Sway (deg)	Rotation Twist (deg)	Stress Ratio
0.00	-16.59	-11.97	0.00	-1070.9	0.00	1070.92	1490.10	745.05	2187.51	1339.68	0.00	0.000	0.000	0.811
2.00	-16.28	-11.86	0.00	-1046.9	0.00	1046.98	1490.10	745.05	2187.51	1339.68	0.02	-0.090	0.000	0.793
4.00	-15.97	-11.75	0.00	-1023.2	0.00	1023.25	1490.10	745.05	2187.51	1339.68	0.08	-0.179	0.000	0.775
6.00	-15.66	-11.64	0.00	-999.75	0.00	999.75	1490.10	745.05	2187.51	1339.68	0.17	-0.265	0.000	0.757
8.00	-15.34	-11.53	0.00	-976.46	0.00	976.46	1490.10	745.05	2187.51	1339.68	0.30	-0.350	0.000	0.739
10.00	-15.03	-11.41	0.00	-953.41	0.00	953.41	1490.10	745.05	2187.51	1339.68	0.46	-0.432	0.000	0.722
12.00	-14.72	-11.30	0.00	-930.58	0.00	930.58	1490.10	745.05	2187.51	1339.68	0.66	-0.512	0.000	0.705
14.00	-14.42	-11.18	0.00	-907.98	0.00	907.98	1490.10	745.05	2187.51	1339.68	0.89	-0.591	0.000	0.688
16.00	-14.11	-11.06	0.00	-885.62	0.00	885.62	1490.10	745.05	2187.51	1339.68	1.16	-0.667	0.000	0.671
18.00	-13.80	-10.94	0.00	-863.49	0.00	863.49	1490.10	745.05	2187.51	1339.68	1.45	-0.742	0.000	0.654
20.00	-13.49	-10.81	0.00	-841.62	0.00	841.62	1490.10	745.05	2187.51	1339.68	1.78	-0.815	0.000	0.637
20.00	-13.49	-10.81	0.00	-841.62	0.00	841.62	1311.06	655.53	1597.15	948.43	1.78	-0.815	0.000	0.898
22.00	-13.23	-10.71	0.00	-820.00	0.00	820.00	1311.06	655.53	1597.15	948.43	2.14	-0.886	0.000	0.875
24.00	-12.95	-10.61	0.00	-798.59	0.00	798.59	1311.06	655.53	1597.15	948.43	2.53	-1.006	0.000	0.852
26.00	-12.68	-10.50	0.00	-777.38	0.00	777.38	1311.06	655.53	1597.15	948.43	2.98	-1.123	0.000	0.830
28.00	-12.41	-10.39	0.00	-756.37	0.00	756.37	1311.06	655.53	1597.15	948.43	3.47	-1.237	0.000	0.807
30.00	-12.15	-10.28	0.00	-735.58	0.00	735.58	1311.06	655.53	1597.15	948.43	4.02	-1.348	0.000	0.785
32.00	-11.88	-10.17	0.00	-715.02	0.00	715.02	1311.06	655.53	1597.15	948.43	4.60	-1.455	0.000	0.763
34.00	-11.61	-10.05	0.00	-694.68	0.00	694.68	1311.06	655.53	1597.15	948.43	5.24	-1.560	0.000	0.742
36.00	-11.35	-9.93	0.00	-674.58	0.00	674.58	1311.06	655.53	1597.15	948.43	5.91	-1.662	0.000	0.720
38.00	-11.08	-9.81	0.00	-654.72	0.00	654.72	1311.06	655.53	1597.15	948.43	6.63	-1.761	0.000	0.699
40.00	-10.82	-9.68	0.00	-635.10	0.00	635.10	1311.06	655.53	1597.15	948.43	7.39	-1.856	0.000	0.678
42.00	-10.56	-9.55	0.00	-615.74	0.00	615.74	1311.06	655.53	1597.15	948.43	8.18	-1.949	0.000	0.657
44.00	-10.30	-9.42	0.00	-596.64	0.00	596.64	1311.06	655.53	1597.15	948.43	9.02	-2.039	0.000	0.637
46.00	-10.04	-9.28	0.00	-577.81	0.00	577.81	1311.06	655.53	1597.15	948.43	9.89	-2.126	0.000	0.617
48.00	-9.78	-9.15	0.00	-559.24	0.00	559.24	1311.06	655.53	1597.15	948.43	10.80	-2.211	0.000	0.597
50.00	-9.52	-9.01	0.00	-540.95	0.00	540.95	1311.06	655.53	1597.15	948.43	11.74	-2.292	0.000	0.578
50.00	-9.52	-9.01	0.00	-540.95	0.00	540.95	1052.07	526.04	1018.84	624.04	11.74	-2.292	0.000	0.876
52.00	-9.30	-8.90	0.00	-522.94	0.00	522.94	1052.07	526.04	1018.84	624.04	12.72	-2.371	0.000	0.847
54.00	-9.07	-8.80	0.00	-505.13	0.00	505.13	1052.07	526.04	1018.84	624.04	13.75	-2.522	0.000	0.818
56.00	-8.85	-8.69	0.00	-487.54	0.00	487.54	1052.07	526.04	1018.84	624.04	14.83	-2.667	0.000	0.790
58.00	-8.62	-8.59	0.00	-470.15	0.00	470.15	1052.07	526.04	1018.84	624.04	15.98	-2.808	0.000	0.762
60.00	-8.40	-8.48	0.00	-452.97	0.00	452.97	1052.07	526.04	1018.84	624.04	17.19	-2.943	0.000	0.734
62.00	-8.18	-8.36	0.00	-436.02	0.00	436.02	1052.07	526.04	1018.84	624.04	18.45	-3.073	0.000	0.707
64.00	-7.96	-8.25	0.00	-419.29	0.00	419.29	1052.07	526.04	1018.84	624.04	19.76	-3.198	0.000	0.680
66.00	-7.74	-8.13	0.00	-402.79	0.00	402.79	1052.07	526.04	1018.84	624.04	21.12	-3.318	0.000	0.653
68.00	-7.53	-8.01	0.00	-386.52	0.00	386.52	1052.07	526.04	1018.84	624.04	22.54	-3.434	0.000	0.627
70.00	-7.31	-7.89	0.00	-370.50	0.00	370.50	1052.07	526.04	1018.84	624.04	24.00	-3.545	0.000	0.601
72.00	-7.10	-7.77	0.00	-354.71	0.00	354.71	1052.07	526.04	1018.84	624.04	25.51	-3.651	0.000	0.575
74.00	-6.88	-7.64	0.00	-339.18	0.00	339.18	1052.07	526.04	1018.84	624.04	27.06	-3.753	0.000	0.550
76.00	-6.67	-7.51	0.00	-323.89	0.00	323.89	1052.07	526.04	1018.84	624.04	28.65	-3.850	0.000	0.526
78.00	-6.46	-7.38	0.00	-308.87	0.00	308.87	1052.07	526.04	1018.84	624.04	30.28	-3.942	0.000	0.501
80.00	-6.25	-7.25	0.00	-294.10	0.00	294.10	1052.07	526.04	1018.84	624.04	31.95	-4.031	0.000	0.477
80.00	-6.25	-7.25	0.00	-294.10	0.00	294.10	1052.07	526.04	1018.84	624.04	31.95	-4.031	0.000	0.477
82.00	-6.04	-7.12	0.00	-279.59	0.00	279.59	1052.07	526.04	1018.84	624.04	33.65	-4.115	0.000	0.454
84.00	-5.83	-6.99	0.00	-265.35	0.00	265.35	1052.07	526.04	1018.84	624.04	35.39	-4.194	0.000	0.431
86.00	-5.63	-6.85	0.00	-251.38	0.00	251.38	1052.07	526.04	1018.84	624.04	37.16	-4.270	0.000	0.408
88.00	-5.42	-6.71	0.00	-237.68	0.00	237.68	1052.07	526.04	1018.84	624.04	38.97	-4.342	0.000	0.386

## Calculated Forces

<b>Structure:</b> CT04374-S-SBA	<b>Code:</b> EIA/TIA-222-G	5/7/2018
<b>Site Name:</b> Central Hebron	<b>Exposure:</b> C	
<b>Height:</b> 150.00 (ft)	<b>Crest Height:</b> 0.00	
<b>Base Elev:</b> 0.000 (ft)	<b>Site Class:</b> D - Stiff Soil	
<b>Gh:</b> 1.1	<b>Topography:</b> 1	<b>Struct Class:</b> II



Page: 22

90.00	-5.21	-6.57	0.00	-224.25	0.00	224.25	1052.07	526.04	1018.84	624.04	40.80	-4.409	0.000	0.364
92.00	-5.01	-6.43	0.00	-211.11	0.00	211.11	1052.07	526.04	1018.84	624.04	42.66	-4.473	0.000	0.343
94.00	-4.81	-6.29	0.00	-198.25	0.00	198.25	1052.07	526.04	1018.84	624.04	44.54	-4.533	0.000	0.322
96.00	-4.60	-6.15	0.00	-185.67	0.00	185.67	1052.07	526.04	1018.84	624.04	46.45	-4.589	0.000	0.302
98.00	-4.40	-6.00	0.00	-173.37	0.00	173.37	1052.07	526.04	1018.84	624.04	48.38	-4.642	0.000	0.282
100.00	-4.20	-5.86	0.00	-161.37	0.00	161.37	1052.07	526.04	1018.84	624.04	50.33	-4.691	0.000	0.263
102.00	-4.00	-5.71	0.00	-149.66	0.00	149.66	1052.07	526.04	1018.84	624.04	52.31	-4.736	0.000	0.244
104.00	-3.80	-5.56	0.00	-138.24	0.00	138.24	1052.07	526.04	1018.84	624.04	54.30	-4.778	0.000	0.225
106.00	-3.60	-5.41	0.00	-127.11	0.00	127.11	1052.07	526.04	1018.84	624.04	56.31	-4.817	0.000	0.207
108.00	-3.40	-5.26	0.00	-116.29	0.00	116.29	1052.07	526.04	1018.84	624.04	58.33	-4.853	0.000	0.190
109.00	-3.29	-4.98	0.00	-111.03	0.00	111.03	1052.07	526.04	1018.84	624.04	59.35	-4.869	0.000	0.181
110.00	-3.14	-4.49	0.00	-106.04	0.00	106.04	1052.07	526.04	1018.84	624.04	60.37	-4.885	0.000	0.107
110.00	-3.14	-4.49	0.00	-106.04	0.00	106.04	682.83	341.41	139.27	105.20	60.37	-4.885	0.000	0.026
111.50	-3.03	-4.45	0.00	-99.31	0.00	99.31	682.83	341.41	139.27	105.20	61.90	-4.899	0.000	0.254
111.50	-3.03	-4.45	0.00	-99.31	0.00	99.31	682.83	341.41	139.27	105.20	61.90	-4.899	0.000	0.254
112.00	-2.96	-4.46	0.00	-97.08	0.00	97.08	682.83	341.41	139.27	105.20	62.42	-4.949	0.000	0.927
114.00	-2.78	-4.43	0.00	-88.16	0.00	88.16	682.83	341.41	139.27	105.20	64.64	-5.654	0.000	0.842
115.00	-2.38	-4.39	0.00	-83.73	0.00	83.73	682.83	341.41	139.27	105.20	65.85	-5.982	0.000	0.800
116.00	-2.28	-4.38	0.00	-79.34	0.00	79.34	682.83	341.41	139.27	105.20	67.14	-6.292	0.000	0.758
118.00	-2.10	-4.35	0.00	-70.57	0.00	70.57	682.83	341.41	139.27	105.20	69.89	-6.863	0.000	0.674
120.00	-1.87	-3.45	0.00	-61.88	0.00	61.88	682.83	341.41	139.27	105.20	72.86	-7.367	0.000	0.591
122.00	-1.71	-3.41	0.00	-54.98	0.00	54.98	682.83	341.41	139.27	105.20	76.04	-7.812	0.000	0.525
124.00	-1.56	-3.36	0.00	-48.16	0.00	48.16	682.83	341.41	139.27	105.20	79.38	-8.205	0.000	0.460
126.00	-1.42	-3.31	0.00	-41.45	0.00	41.45	682.83	341.41	139.27	105.20	82.88	-8.546	0.000	0.396
127.00	-1.06	-3.24	0.00	-38.14	0.00	38.14	682.83	341.41	139.27	105.20	84.68	-8.698	0.000	0.364
128.00	-0.99	-3.21	0.00	-34.90	0.00	34.90	682.83	341.41	139.27	105.20	86.51	-8.837	0.000	0.333
130.00	-0.82	-2.28	0.00	-28.48	0.00	28.48	682.83	341.41	139.27	105.20	90.25	-9.078	0.000	0.272
130.00	-0.82	-2.28	0.00	-28.48	0.00	28.48	317.96	158.98	76.72	52.36	90.25	-9.078	0.000	0.547
132.00	-0.75	-2.24	0.00	-23.91	0.00	23.91	317.96	158.98	76.72	52.36	94.08	-9.278	0.000	0.459
134.00	-0.68	-2.19	0.00	-19.44	0.00	19.44	317.96	158.98	76.72	52.36	98.01	-9.583	0.000	0.374
135.00	-0.36	-2.12	0.00	-17.25	0.00	17.25	317.96	158.98	76.72	52.36	100.02	-9.712	0.000	0.331
136.00	-0.33	-2.09	0.00	-15.14	0.00	15.14	317.96	158.98	76.72	52.36	102.06	-9.826	0.000	0.290
138.00	-0.28	-2.05	0.00	-10.95	0.00	10.95	317.96	158.98	76.72	52.36	106.20	-10.010	0.000	0.210
140.00	-0.22	-0.78	0.00	-6.86	0.00	6.86	317.96	158.98	76.72	52.36	110.40	-10.135	0.000	0.132
142.00	-0.18	-0.73	0.00	-5.30	0.00	5.30	317.96	158.98	76.72	52.36	114.64	-10.220	0.000	0.102
144.00	-0.13	-0.68	0.00	-3.84	0.00	3.84	317.96	158.98	76.72	52.36	118.91	-10.285	0.000	0.074
146.00	-0.09	-0.63	0.00	-2.48	0.00	2.48	317.96	158.98	76.72	52.36	123.21	-10.329	0.000	0.048
148.00	-0.05	-0.58	0.00	-1.21	0.00	1.21	317.96	158.98	76.72	52.36	127.52	-10.355	0.000	0.023
150.00	0.00	-0.57	0.00	-0.04	0.00	0.04	317.96	158.98	76.72	52.36	131.83	-10.364	0.000	0.001

## Wind Loading - Shaft

<b>Structure:</b> CT04374-S-SBA	<b>Code:</b> EIA/TIA-222-G	5/7/2018
<b>Site Name:</b> Central Hebron	<b>Exposure:</b> C	
<b>Height:</b> 150.00 (ft)	<b>Crest Height:</b> 0.00	
<b>Base Elev:</b> 0.000 (ft)	<b>Site Class:</b> D - Stiff Soil	
<b>Gh:</b> 1.1	<b>Topography:</b> 1	<b>Struct Class:</b> II



Page: 23

**Load Case:** 1.2D + 1.0Di + 1.0Wi 50 mph Wind

**Dead Load Factor**    1.20  
**Wind Load Factor**    1.00

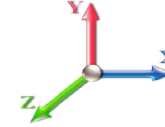

**Iterations**    38

Elev (ft)	Description	Kzt	Kz	qz (psf)	qzGh (psf)	C (mph-ft)	Cf	Ice Thick (in)	Tributary (ft)	Aa (sf)	CfAa (sf)	Wind Force X (lb)	Dead Load Ice (lb)	Tot Dead Load (lb)
0.00		1.00	0.85	5.168	5.68	0.00	1.200	0.000	0.00	0.000	0.00	0.0	0.0	0.0
2.00		1.00	0.85	5.168	5.68	0.00	1.200	1.511	2.00	6.504	7.80	44.4	138.5	481.3
4.00		1.00	0.85	5.168	5.68	0.00	1.200	1.620	2.00	6.540	7.85	44.6	148.9	491.6
6.00		1.00	0.85	5.168	5.68	0.00	1.200	1.687	2.00	6.562	7.87	44.8	155.3	498.1
8.00		1.00	0.85	5.168	5.68	0.00	1.200	1.736	2.00	6.579	7.89	44.9	160.0	502.8
10.00		1.00	0.85	5.168	5.68	0.00	1.200	1.775	2.00	6.592	7.91	45.0	163.8	506.6
12.00		1.00	0.85	5.168	5.68	0.00	1.200	1.808	2.00	6.603	7.92	45.0	167.0	509.7
14.00		1.00	0.85	5.168	5.68	0.00	1.200	1.836	2.00	6.612	7.93	45.1	169.7	512.5
16.00		1.00	0.86	5.232	5.76	0.00	1.200	1.860	2.00	6.620	7.94	45.7	172.1	514.9
18.00		1.00	0.88	5.363	5.90	0.00	1.200	1.882	2.00	6.627	7.95	46.9	174.2	517.0
20.00	Top - Section 1	1.00	0.90	5.483	6.03	0.00	1.200	1.902	2.00	6.634	7.96	48.0	176.2	518.9
22.00		1.00	0.92	5.595	6.15	0.00	1.200	1.921	2.00	6.640	6.77	41.7	149.8	434.8
24.00		1.00	0.94	5.698	6.27	0.00	1.200	1.937	2.00	6.646	6.77	42.5	151.2	436.2
26.00		1.00	0.95	5.795	6.37	0.00	1.200	1.953	2.00	6.651	6.78	43.2	152.5	437.5
28.00		1.00	0.97	5.886	6.47	0.00	1.200	1.967	2.00	6.656	6.79	43.9	153.7	438.7
30.00		1.00	0.98	5.972	6.57	0.00	1.200	1.981	2.00	6.660	6.79	44.6	154.8	439.8
32.00		1.00	1.00	6.054	6.66	0.00	1.200	1.994	2.00	6.665	6.80	45.3	155.9	440.9
34.00		1.00	1.01	6.132	6.74	0.00	1.200	2.006	2.00	6.669	6.80	45.9	156.9	441.9
36.00		1.00	1.02	6.206	6.83	0.00	1.200	2.017	2.00	6.672	6.81	46.5	157.8	442.9
38.00		1.00	1.03	6.277	6.90	0.00	1.200	2.028	2.00	6.676	6.81	47.0	158.7	443.8
40.00		1.00	1.04	6.345	6.98	0.00	1.200	2.039	2.00	6.680	6.82	47.6	159.6	444.6
42.00		1.00	1.05	6.410	7.05	0.00	1.200	2.049	2.00	6.683	6.82	48.1	160.4	445.5
44.00		1.00	1.06	6.474	7.12	0.00	1.200	2.058	2.00	6.686	6.82	48.6	161.2	446.3
46.00		1.00	1.07	6.534	7.19	0.00	1.200	2.068	2.00	6.689	6.83	49.1	162.0	447.0
48.00		1.00	1.08	6.593	7.25	0.00	1.200	2.076	2.00	6.692	6.83	49.5	162.7	447.8
50.00	Top - Section 2	1.00	1.09	6.650	7.32	0.00	1.200	2.085	2.00	6.695	6.83	50.0	163.4	448.5
52.00		1.00	1.10	6.705	7.38	0.00	1.200	2.093	2.00	4.698	5.64	41.6	133.4	360.7
54.00		1.00	1.11	6.759	7.43	0.00	1.200	2.101	2.00	4.700	5.64	41.9	134.0	361.3
56.00		1.00	1.12	6.811	7.49	0.00	1.200	2.109	2.00	4.703	5.64	42.3	134.5	361.8
58.00		1.00	1.13	6.861	7.55	0.00	1.200	2.116	2.00	4.705	5.65	42.6	135.0	362.3
60.00		1.00	1.14	6.910	7.60	0.00	1.200	2.123	2.00	4.708	5.65	42.9	135.5	362.8
62.00		1.00	1.14	6.958	7.65	0.00	1.200	2.130	2.00	4.710	5.65	43.3	136.0	363.3
64.00		1.00	1.15	7.005	7.71	0.00	1.200	2.137	2.00	4.712	5.65	43.6	136.5	363.8
66.00		1.00	1.16	7.050	7.76	0.00	1.200	2.144	2.00	4.715	5.66	43.9	136.9	364.2
68.00		1.00	1.17	7.095	7.80	0.00	1.200	2.150	2.00	4.717	5.66	44.2	137.4	364.7
70.00		1.00	1.17	7.138	7.85	0.00	1.200	2.156	2.00	4.719	5.66	44.5	137.8	365.1
72.00		1.00	1.18	7.181	7.90	0.00	1.200	2.162	2.00	4.721	5.66	44.7	138.2	365.5
74.00		1.00	1.19	7.222	7.94	0.00	1.200	2.168	2.00	4.723	5.67	45.0	138.6	365.9
76.00		1.00	1.19	7.263	7.99	0.00	1.200	2.174	2.00	4.725	5.67	45.3	139.0	366.3
78.00		1.00	1.20	7.303	8.03	0.00	1.200	2.180	2.00	4.727	5.67	45.6	139.4	366.7
80.00	Top - Section 3	1.00	1.21	7.342	8.08	0.00	1.200	2.185	2.00	4.728	5.67	45.8	139.8	367.1
82.00		1.00	1.21	7.380	8.12	0.00	1.200	2.191	2.00	4.730	5.68	46.1	140.2	367.5
84.00		1.00	1.22	7.418	8.16	0.00	1.200	2.196	2.00	4.732	5.68	46.3	140.6	367.9
86.00		1.00	1.23	7.454	8.20	0.00	1.200	2.201	2.00	4.734	5.68	46.6	140.9	368.2
88.00		1.00	1.23	7.491	8.24	0.00	1.200	2.206	2.00	4.735	5.68	46.8	141.3	368.6
90.00		1.00	1.24	7.526	8.28	0.00	1.200	2.211	2.00	4.737	5.68	47.1	141.6	368.9
92.00		1.00	1.24	7.561	8.32	0.00	1.200	2.216	2.00	4.739	5.69	47.3	141.9	369.2

## Wind Loading - Shaft

<b>Structure:</b> CT04374-S-SBA	<b>Code:</b> EIA/TIA-222-G	5/7/2018
<b>Site Name:</b> Central Hebron	<b>Exposure:</b> C	
<b>Height:</b> 150.00 (ft)	<b>Crest Height:</b> 0.00	
<b>Base Elev:</b> 0.000 (ft)	<b>Site Class:</b> D - Stiff Soil	
<b>Gh:</b> 1.1	<b>Topography:</b> 1	<b>Struct Class:</b> II



Page: 24

94.00	1.00	1.25	7.595	8.35	0.00	1.200	2.221	2.00	4.740	5.69	47.5	142.3	369.6	
96.00	1.00	1.25	7.629	8.39	0.00	1.200	2.225	2.00	4.742	5.69	47.8	142.6	369.9	
98.00	1.00	1.26	7.662	8.43	0.00	1.200	2.230	2.00	4.743	5.69	48.0	142.9	370.2	
100.00	1.00	1.27	7.695	8.46	0.00	1.200	2.234	2.00	4.745	5.69	48.2	143.2	370.5	
102.00	1.00	1.27	7.727	8.50	0.00	1.200	2.239	2.00	4.746	5.70	48.4	143.5	370.8	
104.00	1.00	1.28	7.759	8.53	0.00	1.200	2.243	2.00	4.748	5.70	48.6	143.8	371.1	
106.00	1.00	1.28	7.790	8.57	0.00	1.200	2.248	2.00	4.749	5.70	48.8	144.1	371.4	
108.00	1.00	1.29	7.821	8.60	0.00	1.200	2.252	2.00	4.751	5.70	49.0	144.4	371.7	
109.00 Appurtenance(s)	1.00	1.29	7.836	8.62	0.00	1.200	2.254	1.00	2.376	2.85	24.6	72.3	185.9	
110.00 Top - Section 4 RB1	1.00	1.29	7.851	8.64	0.00	1.200	2.256	1.00	2.376	2.85	24.6	72.4	186.0	
111.50 RT1	1.00	1.29	7.873	8.66	0.00	1.200	2.259	1.50	1.408	1.69	14.6	37.3	147.9	
112.00	1.00	1.30	7.881	8.67	0.00	1.200	2.260	0.50	0.470	0.56	4.9	12.4	49.3	
114.00	1.00	1.30	7.910	8.70	0.00	1.200	2.264	2.00	1.880	2.26	19.6	49.9	197.4	
115.00 Appurtenance(s)	1.00	1.30	7.925	8.72	0.00	1.200	2.266	1.00	0.940	1.13	9.8	25.0	98.7	
116.00	1.00	1.31	7.939	8.73	0.00	1.200	2.268	1.00	0.940	1.13	9.9	25.0	98.7	
118.00	1.00	1.31	7.968	8.76	0.00	1.200	2.272	2.00	1.882	2.26	19.8	50.1	197.6	
120.00 Appurtenance(s)	1.00	1.32	7.996	8.80	0.00	1.200	2.276	2.00	1.884	2.26	19.9	50.2	197.7	
122.00	1.00	1.32	8.024	8.83	0.00	1.200	2.279	2.00	1.885	2.26	20.0	50.3	197.8	
124.00	1.00	1.32	8.051	8.86	0.00	1.200	2.283	2.00	1.886	2.26	20.0	50.4	197.9	
126.00	1.00	1.33	8.079	8.89	0.00	1.200	2.287	2.00	1.887	2.26	20.1	50.5	198.0	
127.00 Appurtenance(s)	1.00	1.33	8.092	8.90	0.00	1.200	2.289	1.00	0.944	1.13	10.1	25.3	99.0	
128.00	1.00	1.33	8.105	8.92	0.00	1.200	2.290	1.00	0.944	1.13	10.1	25.3	99.1	
130.00 Top - Section 5	1.00	1.34	8.132	8.95	0.00	1.200	2.294	2.00	1.890	2.27	20.3	50.7	198.2	
132.00	1.00	1.34	8.158	8.97	32.00	1.200	2.297	2.00	1.871	2.24	20.1	50.1	118.8	
134.00	1.00	1.35	8.184	9.00	0.00	1.200	2.301	2.00	1.872	2.25	20.2	50.2	118.9	
135.00 Appurtenance(s)	1.00	1.35	8.197	9.02	0.00	1.200	2.303	1.00	0.936	1.12	10.1	25.1	59.5	
136.00	1.00	1.35	8.210	9.03	0.00	1.200	2.304	1.00	0.937	1.12	10.1	25.2	59.5	
138.00	1.00	1.35	8.235	9.06	0.00	1.200	2.308	2.00	1.874	2.25	20.4	50.4	119.1	
140.00 Appurtenance(s)	1.00	1.36	8.260	9.09	0.00	1.200	2.311	2.00	1.875	2.25	20.4	50.5	119.2	
142.00	1.00	1.36	8.285	9.11	0.00	1.200	2.314	2.00	1.876	2.25	20.5	50.6	119.3	
144.00	1.00	1.37	8.309	9.14	0.00	1.200	2.317	2.00	1.877	2.25	20.6	50.7	119.4	
146.00	1.00	1.37	8.333	9.17	0.00	1.200	2.321	2.00	1.879	2.25	20.7	50.8	119.5	
148.00	1.00	1.37	8.357	9.19	0.00	1.200	2.324	2.00	1.880	2.26	20.7	50.8	119.5	
150.00 Appurtenance(s)	1.00	1.38	8.381	9.22	0.00	1.200	2.327	2.00	1.881	2.26	20.8	50.9	119.6	
<b>Totals:</b>								<b>150.00</b>				<b>2,924.6</b>	<b>25,868.5</b>	

## Discrete Appurtenance Forces

<b>Structure:</b> CT04374-S-SBA	<b>Code:</b> EIA/TIA-222-G	5/7/2018
<b>Site Name:</b> Central Hebron	<b>Exposure:</b> C	
<b>Height:</b> 150.00 (ft)	<b>Crest Height:</b> 0.00	
<b>Base Elev:</b> 0.000 (ft)	<b>Site Class:</b> D - Stiff Soil	
<b>Gh:</b> 1.1	<b>Topography:</b> 1	<b>Struct Class:</b> II



Page: 25

**Load Case:** 1.2D + 1.0Di + 1.0Wi 50 mph Wind

**Dead Load Factor** 1.20  
**Wind Load Factor** 1.00

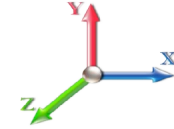

**Iterations** 38

No.	Elev (ft)	Description	Qty	qz (psf)	qzGh (psf)	CaAa x Ka	Ka	Total CaAa (sf)	Dead Load (lb)	Horiz Ecc (ft)	Vert Ecc (ft)	Wind FX (lb)	Mom Y (lb-ft)	Mom Z (lb-ft)	
1	150.00	Truck Ball	1	8.387	9.225	1.00	1.00	1.54	12.00	0.000	0.500	14.22	0.00	7.11	
2	150.00	36" Canister	1	8.381	9.219	1.00	1.00	15.90	210.72	0.000	0.000	146.59	0.00	0.00	
3	140.00	Flag	1	8.260	9.086	1.00	1.00	6.07	114.62	0.000	0.000	55.19	0.00	0.00	
4	140.00	36" Canister	1	8.260	9.086	1.00	1.00	31.66	601.77	0.000	0.000	287.69	0.00	0.00	
5	135.00	Flush Mount	1	8.197	9.016	0.00	1.00	0.00	45.78	0.000	0.000	0.00	0.00	0.00	
6	135.00	DB-T1-6Z-8AB-0Z	2	8.197	9.016	0.00	1.00	11.96	446.61	0.000	0.000	107.79	0.00	0.00	
7	135.00	FDL85002/1C-3L	6	8.197	9.016	0.00	1.00	0.00	125.32	0.000	0.000	0.00	0.00	0.00	
8	135.00	SBNHH-1D65A	3	8.197	9.016	0.00	1.00	22.01	788.37	0.000	0.000	198.43	0.00	0.00	
9	130.00	36" Canister	1	8.132	8.945	1.00	1.00	31.47	600.57	0.000	0.000	281.54	0.00	0.00	
10	127.00	Flush Mount	1	8.092	8.901	0.00	1.00	0.00	44.78	0.000	0.000	0.00	0.00	0.00	
11	127.00	DPO-7126Y-0-T1	3	8.092	8.901	0.62	0.80	1.49	117.60	0.000	0.000	13.25	0.00	0.00	
12	127.00	FD9R6004/1C-3L	3	8.092	8.901	0.00	1.00	0.00	35.84	0.000	0.000	0.00	0.00	0.00	
13	127.00	DHHTT65B-3XR	3	8.092	8.901	0.00	1.00	29.48	1005.51	0.000	0.000	262.39	0.00	0.00	
14	120.00	36" Canister	1	7.996	8.796	1.00	1.00	31.25	599.29	0.000	0.000	274.91	0.00	0.00	
15	115.00	Flush Mount	1	7.925	8.717	0.00	1.00	0.00	43.15	0.000	0.000	0.00	0.00	0.00	
16	115.00	LGP21401	6	7.925	8.717	0.00	1.00	0.00	253.69	0.000	0.000	0.00	0.00	0.00	
17	115.00	7770.00	3	7.925	8.717	0.00	1.00	20.73	688.78	0.000	0.000	180.71	0.00	0.00	
18	110.00	36" Canister	1	7.851	8.636	1.00	1.00	15.56	120.00	0.000	0.000	134.34	0.00	0.00	
19	109.00	36" Canister	1	7.836	8.619	1.00	1.00	3.92	57.25	0.000	0.000	33.83	0.00	0.00	
<b>Totals:</b>									<b>5,911.63</b>						<b>1,990.87</b>

## Total Applied Force Summary

<b>Structure:</b> CT04374-S-SBA	<b>Code:</b> EIA/TIA-222-G	5/7/2018
<b>Site Name:</b> Central Hebron	<b>Exposure:</b> C	
<b>Height:</b> 150.00 (ft)	<b>Crest Height:</b> 0.00	
<b>Base Elev:</b> 0.000 (ft)	<b>Site Class:</b> D - Stiff Soil	
<b>Gh:</b> 1.1	<b>Topography:</b> 1	<b>Struct Class:</b> II



Page: 26

**Load Case:** 1.2D + 1.0Di + 1.0Wi 50 mph Wind

**Dead Load Factor** 1.20  
**Wind Load Factor** 1.00

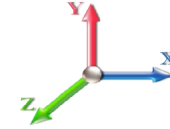

**Iterations** 38

Elev (ft)	Description	Lateral FX (-) (lb)	Axial FY (-) (lb)	Torsion MY (lb-ft)	Moment MZ (lb-ft)
0.00		0.00	0.00	0.00	0.00
2.00		44.37	531.89	0.00	0.00
4.00		44.61	542.26	0.00	0.00
6.00		44.77	548.70	0.00	0.00
8.00		44.88	553.44	0.00	0.00
10.00		44.97	557.22	0.00	0.00
12.00		45.04	560.38	0.00	0.00
14.00		45.10	563.10	0.00	0.00
16.00		45.72	565.49	0.00	0.00
18.00		46.92	567.63	0.00	0.00
20.00		48.02	569.57	0.00	0.00
22.00		41.65	485.46	0.00	0.00
24.00		42.46	486.85	0.00	0.00
26.00		43.23	488.14	0.00	0.00
28.00		43.94	489.34	0.00	0.00
30.00		44.62	490.47	0.00	0.00
32.00		45.27	491.54	0.00	0.00
34.00		45.88	492.54	0.00	0.00
36.00		46.47	493.50	0.00	0.00
38.00		47.03	494.41	0.00	0.00
40.00		47.57	495.28	0.00	0.00
42.00		48.09	496.11	0.00	0.00
44.00		48.59	496.91	0.00	0.00
46.00		49.07	497.67	0.00	0.00
48.00		49.54	498.41	0.00	0.00
50.00		49.99	499.11	0.00	0.00
52.00		41.58	411.39	0.00	0.00
54.00		41.93	411.93	0.00	0.00
56.00		42.28	412.46	0.00	0.00
58.00		42.62	412.97	0.00	0.00
60.00		42.94	413.47	0.00	0.00
62.00		43.26	413.95	0.00	0.00
64.00		43.57	414.42	0.00	0.00
66.00		43.88	414.87	0.00	0.00
68.00		44.17	415.31	0.00	0.00
70.00		44.46	415.75	0.00	0.00
72.00		44.75	416.17	0.00	0.00
74.00		45.02	416.58	0.00	0.00
76.00		45.30	416.98	0.00	0.00
78.00		45.56	417.37	0.00	0.00
80.00		45.82	417.75	0.00	0.00
82.00		46.08	418.13	0.00	0.00
84.00		46.33	418.49	0.00	0.00
86.00		46.58	418.85	0.00	0.00
88.00		46.82	419.20	0.00	0.00
90.00		47.06	419.55	0.00	0.00
92.00		47.29	419.89	0.00	0.00



## Total Applied Force Summary

<b>Structure:</b> CT04374-S-SBA	<b>Code:</b> EIA/TIA-222-G	5/7/2018
<b>Site Name:</b> Central Hebron	<b>Exposure:</b> C	
<b>Height:</b> 150.00 (ft)	<b>Crest Height:</b> 0.00	
<b>Base Elev:</b> 0.000 (ft)	<b>Site Class:</b> D - Stiff Soil	
<b>Gh:</b> 1.1	<b>Topography:</b> 1	<b>Struct Class:</b> II



Page: 27

94.00		47.53	420.22	0.00	0.00
96.00		47.75	420.54	0.00	0.00
98.00		47.98	420.86	0.00	0.00
100.00		48.19	421.18	0.00	0.00
102.00		48.41	421.48	0.00	0.00
104.00		48.62	421.79	0.00	0.00
106.00		48.83	422.09	0.00	0.00
108.00		49.04	422.38	0.00	0.00
109.00	(1) attachments	58.40	268.52	0.00	0.00
110.00	(1) attachments	158.96	331.33	0.00	0.00
111.50		14.64	185.92	0.00	0.00
112.00		4.88	61.98	0.00	0.00
114.00		19.63	248.03	0.00	0.00
115.00	(10) attachments	190.55	1109.65	0.00	0.00
116.00		9.86	116.58	0.00	0.00
118.00		19.80	233.27	0.00	0.00
120.00	(1) attachments	294.79	832.67	0.00	0.00
122.00		19.96	233.48	0.00	0.00
124.00		20.04	233.58	0.00	0.00
126.00		20.13	233.68	0.00	0.00
127.00	(10) attachments	285.72	1320.58	0.00	0.00
128.00		10.10	109.19	0.00	0.00
130.00	(1) attachments	301.83	819.04	0.00	0.00
132.00		20.15	139.07	0.00	0.00
134.00		20.22	139.16	0.00	0.00
135.00	(12) attachments	316.36	1475.68	0.00	0.00
136.00		10.15	59.50	0.00	0.00
138.00		20.37	119.09	0.00	0.00
140.00	(2) attachments	363.33	835.57	0.00	0.00
142.00		20.52	119.27	0.00	0.00
144.00		20.59	119.36	0.00	0.00
146.00		20.66	119.45	0.00	0.00
148.00		20.73	119.54	0.00	0.00
150.00	(2) attachments	181.61	342.35	0.00	7.11
<b>Totals:</b>		<b>4,915.43</b>	<b>34,986.95</b>	<b>0.00</b>	<b>7.11</b>

## Calculated Forces

<b>Structure:</b> CT04374-S-SBA	<b>Code:</b> EIA/TIA-222-G	5/7/2018
<b>Site Name:</b> Central Hebron	<b>Exposure:</b> C	
<b>Height:</b> 150.00 (ft)	<b>Crest Height:</b> 0.00	
<b>Base Elev:</b> 0.000 (ft)	<b>Site Class:</b> D - Stiff Soil	
<b>Gh:</b> 1.1	<b>Topography:</b> 1	<b>Struct Class:</b> II



Page: 28

**Load Case:** 1.2D + 1.0Di + 1.0Wi 50 mph Wind

**Iterations** 38

**Dead Load Factor** 1.20  
**Wind Load Factor** 1.00

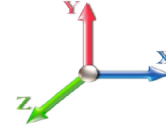

Seg Elev (ft)	Pu FY (-) (kips)	Vu FX (-) (kips)	Tu MY (-) (ft-kips)	Mu MZ (ft-kips)	Mu MX (ft-kips)	Resultant Moment (ft-kips)	phi Pn (kips)	phi Vn (kips)	phi Tn (ft-kips)	phi Mn (ft-kips)	Total Deflect (in)	Rotation Sway (deg)	Rotation Twist (deg)	Stress Ratio
0.00	-34.99	-4.93	0.00	-507.95	0.00	507.95	1490.10	745.05	2187.51	1339.68	0.00	0.000	0.000	0.403
2.00	-34.45	-4.91	0.00	-498.09	0.00	498.09	1490.10	745.05	2187.51	1339.68	0.01	-0.043	0.000	0.395
4.00	-33.90	-4.89	0.00	-488.28	0.00	488.28	1490.10	745.05	2187.51	1339.68	0.04	-0.085	0.000	0.387
6.00	-33.35	-4.87	0.00	-478.50	0.00	478.50	1490.10	745.05	2187.51	1339.68	0.08	-0.126	0.000	0.380
8.00	-32.80	-4.84	0.00	-468.76	0.00	468.76	1490.10	745.05	2187.51	1339.68	0.14	-0.167	0.000	0.372
10.00	-32.23	-4.82	0.00	-459.08	0.00	459.08	1490.10	745.05	2187.51	1339.68	0.22	-0.206	0.000	0.364
12.00	-31.67	-4.79	0.00	-449.44	0.00	449.44	1490.10	745.05	2187.51	1339.68	0.32	-0.245	0.000	0.357
14.00	-31.11	-4.77	0.00	-439.85	0.00	439.85	1490.10	745.05	2187.51	1339.68	0.43	-0.283	0.000	0.349
16.00	-30.54	-4.74	0.00	-430.32	0.00	430.32	1490.10	745.05	2187.51	1339.68	0.55	-0.320	0.000	0.342
18.00	-29.97	-4.70	0.00	-420.85	0.00	420.85	1490.10	745.05	2187.51	1339.68	0.70	-0.357	0.000	0.334
20.00	-29.39	-4.67	0.00	-411.44	0.00	411.44	1490.10	745.05	2187.51	1339.68	0.85	-0.392	0.000	0.327
20.00	-29.39	-4.67	0.00	-411.44	0.00	411.44	1311.06	655.53	1597.15	948.43	0.85	-0.392	0.000	0.456
22.00	-28.91	-4.65	0.00	-402.10	0.00	402.10	1311.06	655.53	1597.15	948.43	1.02	-0.427	0.000	0.446
24.00	-28.41	-4.63	0.00	-392.80	0.00	392.80	1311.06	655.53	1597.15	948.43	1.22	-0.486	0.000	0.436
26.00	-27.92	-4.61	0.00	-383.54	0.00	383.54	1311.06	655.53	1597.15	948.43	1.43	-0.544	0.000	0.426
28.00	-27.43	-4.59	0.00	-374.31	0.00	374.31	1311.06	655.53	1597.15	948.43	1.67	-0.600	0.000	0.416
30.00	-26.93	-4.57	0.00	-365.13	0.00	365.13	1311.06	655.53	1597.15	948.43	1.93	-0.655	0.000	0.406
32.00	-26.44	-4.54	0.00	-356.00	0.00	356.00	1311.06	655.53	1597.15	948.43	2.22	-0.708	0.000	0.396
34.00	-25.94	-4.51	0.00	-346.92	0.00	346.92	1311.06	655.53	1597.15	948.43	2.53	-0.761	0.000	0.386
36.00	-25.45	-4.48	0.00	-337.90	0.00	337.90	1311.06	655.53	1597.15	948.43	2.86	-0.811	0.000	0.376
38.00	-24.95	-4.45	0.00	-328.95	0.00	328.95	1311.06	655.53	1597.15	948.43	3.21	-0.861	0.000	0.366
40.00	-24.45	-4.41	0.00	-320.05	0.00	320.05	1311.06	655.53	1597.15	948.43	3.58	-0.909	0.000	0.356
42.00	-23.95	-4.37	0.00	-311.23	0.00	311.23	1311.06	655.53	1597.15	948.43	3.97	-0.956	0.000	0.346
44.00	-23.45	-4.34	0.00	-302.48	0.00	302.48	1311.06	655.53	1597.15	948.43	4.38	-1.001	0.000	0.337
46.00	-22.95	-4.30	0.00	-293.81	0.00	293.81	1311.06	655.53	1597.15	948.43	4.81	-1.046	0.000	0.327
48.00	-22.45	-4.25	0.00	-285.22	0.00	285.22	1311.06	655.53	1597.15	948.43	5.26	-1.089	0.000	0.318
50.00	-21.95	-4.21	0.00	-276.71	0.00	276.71	1311.06	655.53	1597.15	948.43	5.72	-1.130	0.000	0.309
50.00	-21.95	-4.21	0.00	-276.71	0.00	276.71	1052.07	526.04	1018.84	624.04	5.72	-1.130	0.000	0.464
52.00	-21.54	-4.18	0.00	-268.30	0.00	268.30	1052.07	526.04	1018.84	624.04	6.20	-1.171	0.000	0.450
54.00	-21.12	-4.16	0.00	-259.93	0.00	259.93	1052.07	526.04	1018.84	624.04	6.71	-1.248	0.000	0.437
56.00	-20.70	-4.13	0.00	-251.62	0.00	251.62	1052.07	526.04	1018.84	624.04	7.25	-1.323	0.000	0.423
58.00	-20.29	-4.11	0.00	-243.35	0.00	243.35	1052.07	526.04	1018.84	624.04	7.82	-1.396	0.000	0.409
60.00	-19.87	-4.08	0.00	-235.13	0.00	235.13	1052.07	526.04	1018.84	624.04	8.42	-1.466	0.000	0.396
62.00	-19.45	-4.05	0.00	-226.98	0.00	226.98	1052.07	526.04	1018.84	624.04	9.05	-1.533	0.000	0.382
64.00	-19.03	-4.01	0.00	-218.89	0.00	218.89	1052.07	526.04	1018.84	624.04	9.70	-1.599	0.000	0.369
66.00	-18.62	-3.98	0.00	-210.86	0.00	210.86	1052.07	526.04	1018.84	624.04	10.39	-1.662	0.000	0.356
68.00	-18.20	-3.94	0.00	-202.91	0.00	202.91	1052.07	526.04	1018.84	624.04	11.09	-1.722	0.000	0.343
70.00	-17.78	-3.90	0.00	-195.03	0.00	195.03	1052.07	526.04	1018.84	624.04	11.83	-1.780	0.000	0.329
72.00	-17.36	-3.86	0.00	-187.23	0.00	187.23	1052.07	526.04	1018.84	624.04	12.59	-1.836	0.000	0.317
74.00	-16.94	-3.82	0.00	-179.51	0.00	179.51	1052.07	526.04	1018.84	624.04	13.37	-1.890	0.000	0.304
76.00	-16.53	-3.77	0.00	-171.88	0.00	171.88	1052.07	526.04	1018.84	624.04	14.17	-1.941	0.000	0.291
78.00	-16.11	-3.72	0.00	-164.34	0.00	164.34	1052.07	526.04	1018.84	624.04	14.99	-1.991	0.000	0.279
80.00	-15.69	-3.68	0.00	-156.89	0.00	156.89	1052.07	526.04	1018.84	624.04	15.84	-2.038	0.000	0.266
80.00	-15.69	-3.68	0.00	-156.89	0.00	156.89	1052.07	526.04	1018.84	624.04	15.84	-2.038	0.000	0.266
82.00	-15.27	-3.63	0.00	-149.54	0.00	149.54	1052.07	526.04	1018.84	624.04	16.70	-2.083	0.000	0.254
84.00	-14.85	-3.58	0.00	-142.29	0.00	142.29	1052.07	526.04	1018.84	624.04	17.58	-2.125	0.000	0.242
86.00	-14.43	-3.52	0.00	-135.13	0.00	135.13	1052.07	526.04	1018.84	624.04	18.48	-2.166	0.000	0.230
88.00	-14.01	-3.47	0.00	-128.09	0.00	128.09	1052.07	526.04	1018.84	624.04	19.40	-2.204	0.000	0.219

## Calculated Forces

<b>Structure:</b> CT04374-S-SBA	<b>Code:</b> EIA/TIA-222-G	5/7/2018
<b>Site Name:</b> Central Hebron	<b>Exposure:</b> C	
<b>Height:</b> 150.00 (ft)	<b>Crest Height:</b> 0.00	
<b>Base Elev:</b> 0.000 (ft)	<b>Site Class:</b> D - Stiff Soil	
<b>Gh:</b> 1.1	<b>Topography:</b> 1	<b>Struct Class:</b> II



Page: 29

90.00	-13.59	-3.42	0.00	-121.14	0.00	121.14	1052.07	526.04	1018.84	624.04	20.33	-2.241	0.000	0.207
92.00	-13.17	-3.36	0.00	-114.31	0.00	114.31	1052.07	526.04	1018.84	624.04	21.27	-2.275	0.000	0.196
94.00	-12.75	-3.30	0.00	-107.59	0.00	107.59	1052.07	526.04	1018.84	624.04	22.23	-2.308	0.000	0.185
96.00	-12.33	-3.24	0.00	-100.99	0.00	100.99	1052.07	526.04	1018.84	624.04	23.21	-2.338	0.000	0.174
98.00	-11.91	-3.18	0.00	-94.50	0.00	94.50	1052.07	526.04	1018.84	624.04	24.19	-2.367	0.000	0.163
100.00	-11.49	-3.12	0.00	-88.13	0.00	88.13	1052.07	526.04	1018.84	624.04	25.19	-2.394	0.000	0.152
102.00	-11.07	-3.06	0.00	-81.89	0.00	81.89	1052.07	526.04	1018.84	624.04	26.20	-2.419	0.000	0.142
104.00	-10.65	-3.00	0.00	-75.76	0.00	75.76	1052.07	526.04	1018.84	624.04	27.21	-2.442	0.000	0.132
106.00	-10.23	-2.94	0.00	-69.76	0.00	69.76	1052.07	526.04	1018.84	624.04	28.24	-2.463	0.000	0.122
108.00	-9.81	-2.87	0.00	-63.89	0.00	63.89	1052.07	526.04	1018.84	624.04	29.28	-2.483	0.000	0.112
109.00	-9.54	-2.80	0.00	-61.01	0.00	61.01	1052.07	526.04	1018.84	624.04	29.80	-2.492	0.000	0.107
110.00	-9.22	-2.63	0.00	-58.21	0.00	58.21	1052.07	526.04	1018.84	624.04	30.32	-2.501	0.000	0.064
110.00	-9.22	-2.63	0.00	-58.21	0.00	58.21	682.83	341.41	139.27	105.20	30.32	-2.501	0.000	0.019
111.50	-9.03	-2.61	0.00	-54.26	0.00	54.26	682.83	341.41	139.27	105.20	31.11	-2.508	0.000	0.145
111.50	-9.03	-2.61	0.00	-54.26	0.00	54.26	682.83	341.41	139.27	105.20	31.11	-2.508	0.000	0.145
112.00	-8.96	-2.64	0.00	-52.96	0.00	52.96	682.83	341.41	139.27	105.20	31.37	-2.535	0.000	0.517
114.00	-8.70	-2.65	0.00	-47.68	0.00	47.68	682.83	341.41	139.27	105.20	32.51	-2.919	0.000	0.466
115.00	-7.60	-2.42	0.00	-45.04	0.00	45.04	682.83	341.41	139.27	105.20	33.14	-3.095	0.000	0.439
116.00	-7.47	-2.44	0.00	-42.61	0.00	42.61	682.83	341.41	139.27	105.20	33.81	-3.262	0.000	0.416
118.00	-7.23	-2.44	0.00	-37.74	0.00	37.74	682.83	341.41	139.27	105.20	35.24	-3.568	0.000	0.369
120.00	-6.41	-2.12	0.00	-32.86	0.00	32.86	682.83	341.41	139.27	105.20	36.79	-3.837	0.000	0.322
122.00	-6.17	-2.11	0.00	-28.62	0.00	28.62	682.83	341.41	139.27	105.20	38.45	-4.071	0.000	0.281
124.00	-5.93	-2.09	0.00	-24.41	0.00	24.41	682.83	341.41	139.27	105.20	40.20	-4.273	0.000	0.241
126.00	-5.69	-2.06	0.00	-20.23	0.00	20.23	682.83	341.41	139.27	105.20	42.02	-4.443	0.000	0.201
127.00	-4.40	-1.68	0.00	-18.17	0.00	18.17	682.83	341.41	139.27	105.20	42.96	-4.516	0.000	0.179
128.00	-4.29	-1.67	0.00	-16.49	0.00	16.49	682.83	341.41	139.27	105.20	43.91	-4.582	0.000	0.163
130.00	-3.49	-1.31	0.00	-13.15	0.00	13.15	682.83	341.41	139.27	105.20	45.85	-4.695	0.000	0.130
130.00	-3.49	-1.31	0.00	-13.15	0.00	13.15	317.96	158.98	76.72	52.36	45.85	-4.695	0.000	0.262
132.00	-3.35	-1.28	0.00	-10.54	0.00	10.54	317.96	158.98	76.72	52.36	47.84	-4.785	0.000	0.212
134.00	-3.21	-1.26	0.00	-7.97	0.00	7.97	317.96	158.98	76.72	52.36	49.87	-4.915	0.000	0.162
135.00	-1.77	-0.81	0.00	-6.71	0.00	6.71	317.96	158.98	76.72	52.36	50.90	-4.967	0.000	0.134
136.00	-1.71	-0.80	0.00	-5.90	0.00	5.90	317.96	158.98	76.72	52.36	51.94	-5.011	0.000	0.118
138.00	-1.59	-0.77	0.00	-4.30	0.00	4.30	317.96	158.98	76.72	52.36	54.06	-5.083	0.000	0.087
140.00	-0.79	-0.34	0.00	-2.75	0.00	2.75	317.96	158.98	76.72	52.36	56.19	-5.133	0.000	0.055
142.00	-0.68	-0.31	0.00	-2.08	0.00	2.08	317.96	158.98	76.72	52.36	58.35	-5.167	0.000	0.042
144.00	-0.56	-0.27	0.00	-1.47	0.00	1.47	317.96	158.98	76.72	52.36	60.52	-5.192	0.000	0.030
146.00	-0.44	-0.24	0.00	-0.92	0.00	0.92	317.96	158.98	76.72	52.36	62.69	-5.208	0.000	0.019
148.00	-0.32	-0.21	0.00	-0.43	0.00	0.43	317.96	158.98	76.72	52.36	64.87	-5.218	0.000	0.009
150.00	0.00	-0.18	0.00	-0.01	0.00	0.01	317.96	158.98	76.72	52.36	67.06	-5.221	0.000	0.000

## Seismic Segment Forces (Factored)

<b>Structure:</b> CT04374-S-SBA	<b>Code:</b> EIA/TIA-222-G	5/7/2018
<b>Site Name:</b> Central Hebron	<b>Exposure:</b> C	
<b>Height:</b> 150.00 (ft)	<b>Crest Height:</b> 0.00	
<b>Base Elev:</b> 0.000 (ft)	<b>Site Class:</b> D - Stiff Soil	
<b>Gh:</b> 1.1	<b>Topography:</b> 1	<b>Struct Class:</b> II



Page: 30

<b>Load Case:</b> 1.2D + 1.0E				<b>Iterations</b> 33
<b>Gust Response Factor</b>	1.10	<b>Sds</b>	0.19	<b>Ss</b> 0.18
<b>Dead Load Factor</b>	1.20	<b>Seismic Load Factor</b>	1.00	<b>S1</b> 0.06
<b>Wind Load Factor</b>	0.00	<b>Structure Frequency</b>	0.31	<b>SA</b> 0.03
				<b>Seismic Importance Factor</b> 1.00

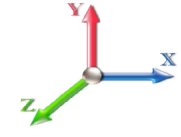

Top Elev (ft)	Description	Wz (lb)	a	b	c	Lateral Fs (lb)	R: 1.50
0.00		0.00	0.00	0.00	0.00	0.00	
2.00		285.63	0.00	0.01	0.01	2.87	
4.00		285.63	0.00	0.03	0.01	4.80	
6.00		285.63	0.00	0.04	0.02	6.17	
8.00		285.63	0.01	0.05	0.03	7.17	
10.00		285.63	0.01	0.05	0.03	7.91	
12.00		285.63	0.01	0.06	0.03	8.47	
14.00		285.63	0.02	0.06	0.04	8.89	
16.00		285.63	0.02	0.06	0.04	9.21	
18.00		285.63	0.03	0.07	0.04	9.45	
20.00	Top - Section 1	285.63	0.03	0.07	0.04	9.64	
22.00		237.52	0.04	0.07	0.04	8.15	
24.00		237.52	0.05	0.07	0.04	8.25	
26.00		237.52	0.06	0.07	0.04	8.34	
28.00		237.52	0.07	0.07	0.04	8.43	
30.00		237.52	0.08	0.07	0.04	8.51	
32.00		237.52	0.09	0.07	0.04	8.60	
34.00		237.52	0.10	0.07	0.04	8.68	
36.00		237.52	0.11	0.07	0.04	8.76	
38.00		237.52	0.12	0.07	0.03	8.85	
40.00		237.52	0.13	0.07	0.03	8.92	
42.00		237.52	0.15	0.07	0.03	9.00	
44.00		237.52	0.16	0.07	0.03	9.06	
46.00		237.52	0.18	0.07	0.03	9.10	
48.00		237.52	0.19	0.06	0.02	9.11	
50.00	Top - Section 2	237.52	0.21	0.06	0.02	9.09	
52.00		189.42	0.23	0.06	0.02	7.19	
54.00		189.42	0.24	0.06	0.02	7.09	
56.00		189.42	0.26	0.05	0.02	6.93	
58.00		189.42	0.28	0.05	0.01	6.70	
60.00		189.42	0.30	0.04	0.01	6.39	
62.00		189.42	0.32	0.04	0.01	5.99	
64.00		189.42	0.34	0.03	0.01	5.49	
66.00		189.42	0.37	0.03	0.01	4.89	
68.00		189.42	0.39	0.02	0.01	4.17	
70.00		189.42	0.41	0.01	0.01	3.34	
72.00		189.42	0.44	0.01	0.01	2.40	
74.00		189.42	0.46	0.00	0.01	1.38	
76.00		189.42	0.49	-0.01	0.01	0.30	
78.00		189.42	0.51	-0.02	0.01	-0.83	
80.00	Top - Section 3	189.42	0.54	-0.03	0.01	-1.95	
82.00		189.42	0.56	-0.04	0.01	-3.04	
84.00		189.42	0.59	-0.05	0.01	-4.06	
86.00		189.42	0.62	-0.06	0.02	-4.99	
88.00		189.42	0.65	-0.07	0.02	-5.79	
90.00		189.42	0.68	-0.08	0.03	-6.46	

## Seismic Segment Forces (Factored)

<b>Structure:</b> CT04374-S-SBA	<b>Code:</b> EIA/TIA-222-G	5/7/2018
<b>Site Name:</b> Central Hebron	<b>Exposure:</b> C	
<b>Height:</b> 150.00 (ft)	<b>Crest Height:</b> 0.00	
<b>Base Elev:</b> 0.000 (ft)	<b>Site Class:</b> D - Stiff Soil	
<b>Gh:</b> 1.1	<b>Topography:</b> 1	<b>Struct Class:</b> II



Page: 31

92.00		189.42	0.71	-0.09	0.03	-6.98
94.00		189.42	0.74	-0.10	0.04	-7.34
96.00		189.42	0.77	-0.11	0.05	-7.54
98.00		189.42	0.81	-0.11	0.06	-7.58
100.00		189.42	0.84	-0.12	0.07	-7.46
102.00		189.42	0.87	-0.12	0.08	-7.19
104.00		189.42	0.91	-0.12	0.09	-6.76
106.00		189.42	0.94	-0.12	0.11	-6.18
108.00		189.42	0.98	-0.11	0.12	-5.45
109.00	Appurtenance(s)	119.71	1.00	-0.11	0.13	-3.17
110.00	Top - Section 4 RB1	194.71	1.02	-0.11	0.14	-4.69
111.50	RT1	92.20	1.04	-0.10	0.15	-1.85
112.00		30.73	1.05	-0.09	0.16	-0.57
114.00		122.94	1.09	-0.07	0.18	-1.53
115.00	Appurtenance(s)	401.07	1.11	-0.06	0.19	-3.62
116.00		61.47	1.13	-0.05	0.21	-0.33
118.00		122.94	1.17	-0.02	0.23	0.29
120.00	Appurtenance(s)	322.94	1.21	0.01	0.26	3.52
122.00		122.94	1.25	0.06	0.29	2.49
124.00		122.94	1.29	0.11	0.33	3.73
126.00		122.94	1.33	0.17	0.37	5.07
127.00	Appurtenance(s)	378.87	1.35	0.20	0.39	17.81
128.00		61.47	1.38	0.24	0.41	3.26
130.00	Top - Section 5	322.94	1.42	0.32	0.45	21.15
132.00		57.25	1.46	0.42	0.50	4.51
134.00		57.25	1.51	0.52	0.55	5.32
135.00	Appurtenance(s)	358.92	1.53	0.58	0.58	36.02
136.00		28.62	1.55	0.64	0.61	3.09
138.00		57.25	1.60	0.78	0.67	7.08
140.00	Appurtenance(s)	307.25	1.65	0.93	0.73	43.14
142.00		57.25	1.69	1.10	0.81	9.04
144.00		57.25	1.74	1.29	0.88	10.09
146.00		57.25	1.79	1.50	0.96	11.19
148.00		57.25	1.84	1.73	1.05	12.34
150.00	Appurtenance(s)	167.25	1.89	1.98	1.14	39.58

**Totals: 15,775.7**

**401.0**

**Total Wind: 11,958.3**

Seismic Base Shear is Less Than 50% of Wind Force - An Analysis is NOT Required

## Calculated Forces

<b>Structure:</b> CT04374-S-SBA	<b>Code:</b> EIA/TIA-222-G	5/7/2018
<b>Site Name:</b> Central Hebron	<b>Exposure:</b> C	
<b>Height:</b> 150.00 (ft)	<b>Crest Height:</b> 0.00	
<b>Base Elev:</b> 0.000 (ft)	<b>Site Class:</b> D - Stiff Soil	
<b>Gh:</b> 1.1	<b>Topography:</b> 1	<b>Struct Class:</b> II



Page: 32

**Load Case:** 1.2D + 1.0E

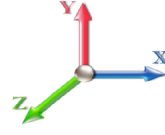

**Iterations** 33

<b>Gust Response Factor</b> 1.10	<b>Sds</b> 0.19	<b>Ss</b> 0.18
<b>Dead Load Factor</b> 1.20	<b>Seismic Load Factor</b> 1.00	<b>Sd1</b> 0.10
<b>Wind Load Factor</b> 0.00	<b>Structure Frequency</b> 0.31	<b>SA</b> 0.03
	<b>Seismic Importance Factor</b> 1.00	<b>S1</b> 0.06

Seg Elev (ft)	Pu FY (-) (kips)	Vu FX (-) (kips)	Tu MY (-) (ft-kips)	Mu MZ (ft-kips)	Mu MX (ft-kips)	Resultant Moment (ft-kips)	phi Pn (kips)	phi Vn (kips)	phi Tn (ft-kips)	phi Mn (ft-kips)	Total Deflect (in)	Rotation Sway (deg)	Rotation Twist (deg)	Stress Ratio
0.00	-22.14	-0.51	0.00	-45.21	0.00	45.21	1490.10	745.05	2187.51	1339.68	0.00	0.00	0.00	0.049
2.00	-21.74	-0.50	0.00	-44.20	0.00	44.20	1490.10	745.05	2187.51	1339.68	0.00	0.00	0.00	0.048
4.00	-21.35	-0.50	0.00	-43.19	0.00	43.19	1490.10	745.05	2187.51	1339.68	0.00	-0.01	-0.01	0.047
6.00	-20.96	-0.50	0.00	-42.18	0.00	42.18	1490.10	745.05	2187.51	1339.68	0.01	-0.01	-0.01	0.046
8.00	-20.56	-0.49	0.00	-41.19	0.00	41.19	1490.10	745.05	2187.51	1339.68	0.01	-0.01	-0.01	0.045
10.00	-20.17	-0.48	0.00	-40.21	0.00	40.21	1490.10	745.05	2187.51	1339.68	0.02	-0.02	-0.02	0.044
12.00	-19.78	-0.48	0.00	-39.24	0.00	39.24	1490.10	745.05	2187.51	1339.68	0.03	-0.02	-0.02	0.043
14.00	-19.38	-0.47	0.00	-38.29	0.00	38.29	1490.10	745.05	2187.51	1339.68	0.04	-0.02	-0.02	0.042
16.00	-18.99	-0.46	0.00	-37.35	0.00	37.35	1490.10	745.05	2187.51	1339.68	0.05	-0.03	-0.03	0.041
18.00	-18.60	-0.45	0.00	-36.43	0.00	36.43	1490.10	745.05	2187.51	1339.68	0.06	-0.03	-0.03	0.040
20.00	-18.20	-0.44	0.00	-35.53	0.00	35.53	1490.10	745.05	2187.51	1339.68	0.08	-0.03	-0.03	0.039
20.00	-18.20	-0.44	0.00	-35.53	0.00	35.53	1311.06	655.53	1597.15	948.43	0.08	-0.03	-0.03	0.051
22.00	-17.87	-0.44	0.00	-34.65	0.00	34.65	1311.06	655.53	1597.15	948.43	0.09	-0.04	-0.04	0.050
24.00	-17.53	-0.43	0.00	-33.78	0.00	33.78	1311.06	655.53	1597.15	948.43	0.11	-0.04	-0.04	0.049
26.00	-17.20	-0.42	0.00	-32.92	0.00	32.92	1311.06	655.53	1597.15	948.43	0.13	-0.05	-0.05	0.048
28.00	-16.86	-0.41	0.00	-32.08	0.00	32.08	1311.06	655.53	1597.15	948.43	0.15	-0.05	-0.05	0.047
30.00	-16.53	-0.41	0.00	-31.25	0.00	31.25	1311.06	655.53	1597.15	948.43	0.17	-0.06	-0.06	0.046
32.00	-16.19	-0.40	0.00	-30.44	0.00	30.44	1311.06	655.53	1597.15	948.43	0.19	-0.06	-0.06	0.044
34.00	-15.85	-0.39	0.00	-29.64	0.00	29.64	1311.06	655.53	1597.15	948.43	0.22	-0.07	-0.07	0.043
36.00	-15.52	-0.38	0.00	-28.86	0.00	28.86	1311.06	655.53	1597.15	948.43	0.25	-0.07	-0.07	0.042
38.00	-15.18	-0.37	0.00	-28.09	0.00	28.09	1311.06	655.53	1597.15	948.43	0.28	-0.07	-0.07	0.041
40.00	-14.85	-0.37	0.00	-27.34	0.00	27.34	1311.06	655.53	1597.15	948.43	0.31	-0.08	-0.08	0.040
42.00	-14.51	-0.36	0.00	-26.61	0.00	26.61	1311.06	655.53	1597.15	948.43	0.35	-0.08	-0.08	0.039
44.00	-14.18	-0.35	0.00	-25.90	0.00	25.90	1311.06	655.53	1597.15	948.43	0.38	-0.09	-0.09	0.038
46.00	-13.84	-0.34	0.00	-25.20	0.00	25.20	1311.06	655.53	1597.15	948.43	0.42	-0.09	-0.09	0.037
48.00	-13.50	-0.33	0.00	-24.52	0.00	24.52	1311.06	655.53	1597.15	948.43	0.46	-0.09	-0.09	0.036
50.00	-13.17	-0.32	0.00	-23.85	0.00	23.85	1311.06	655.53	1597.15	948.43	0.50	-0.10	-0.10	0.035
50.00	-13.17	-0.32	0.00	-23.85	0.00	23.85	1052.07	526.04	1018.84	624.04	0.50	-0.10	-0.10	0.051
52.00	-12.89	-0.32	0.00	-23.21	0.00	23.21	1052.07	526.04	1018.84	624.04	0.54	-0.10	-0.10	0.049
54.00	-12.61	-0.31	0.00	-22.57	0.00	22.57	1052.07	526.04	1018.84	624.04	0.58	-0.11	-0.11	0.048
56.00	-12.33	-0.30	0.00	-21.95	0.00	21.95	1052.07	526.04	1018.84	624.04	0.63	-0.11	-0.11	0.047
58.00	-12.06	-0.30	0.00	-21.34	0.00	21.34	1052.07	526.04	1018.84	624.04	0.68	-0.12	-0.12	0.046
60.00	-11.78	-0.29	0.00	-20.75	0.00	20.75	1052.07	526.04	1018.84	624.04	0.73	-0.13	-0.13	0.044
62.00	-11.50	-0.29	0.00	-20.16	0.00	20.16	1052.07	526.04	1018.84	624.04	0.78	-0.13	-0.13	0.043
64.00	-11.22	-0.28	0.00	-19.59	0.00	19.59	1052.07	526.04	1018.84	624.04	0.84	-0.14	-0.14	0.042
66.00	-10.94	-0.28	0.00	-19.02	0.00	19.02	1052.07	526.04	1018.84	624.04	0.90	-0.14	-0.14	0.041
68.00	-10.67	-0.27	0.00	-18.47	0.00	18.47	1052.07	526.04	1018.84	624.04	0.96	-0.15	-0.15	0.040
70.00	-10.39	-0.27	0.00	-17.92	0.00	17.92	1052.07	526.04	1018.84	624.04	1.03	-0.16	-0.16	0.039
72.00	-10.11	-0.27	0.00	-17.38	0.00	17.38	1052.07	526.04	1018.84	624.04	1.09	-0.16	-0.16	0.037
74.00	-9.83	-0.27	0.00	-16.84	0.00	16.84	1052.07	526.04	1018.84	624.04	1.16	-0.17	-0.17	0.036
76.00	-9.55	-0.27	0.00	-16.31	0.00	16.31	1052.07	526.04	1018.84	624.04	1.23	-0.17	-0.17	0.035
78.00	-9.28	-0.27	0.00	-15.78	0.00	15.78	1052.07	526.04	1018.84	624.04	1.30	-0.17	-0.17	0.034
80.00	-9.00	-0.27	0.00	-15.24	0.00	15.24	1052.07	526.04	1018.84	624.04	1.38	-0.18	-0.18	0.033
80.00	-9.00	-0.27	0.00	-15.24	0.00	15.24	1052.07	526.04	1018.84	624.04	1.38	-0.18	-0.18	0.033
82.00	-8.72	-0.27	0.00	-14.71	0.00	14.71	1052.07	526.04	1018.84	624.04	1.45	-0.18	-0.18	0.032
84.00	-8.44	-0.27	0.00	-14.18	0.00	14.18	1052.07	526.04	1018.84	624.04	1.53	-0.19	-0.19	0.031
86.00	-8.16	-0.27	0.00	-13.65	0.00	13.65	1052.07	526.04	1018.84	624.04	1.61	-0.19	-0.19	0.030



## Calculated Forces

<b>Structure:</b> CT04374-S-SBA	<b>Code:</b> EIA/TIA-222-G	5/7/2018
<b>Site Name:</b> Central Hebron	<b>Exposure:</b> C	
<b>Height:</b> 150.00 (ft)	<b>Crest Height:</b> 0.00	
<b>Base Elev:</b> 0.000 (ft)	<b>Site Class:</b> D - Stiff Soil	
<b>Gh:</b> 1.1	<b>Topography:</b> 1	<b>Struct Class:</b> II



Page: 33

88.00	-7.89	-0.27	0.00	-13.12	0.00	13.12	1052.07	526.04	1018.84	624.04	1.69	-0.20	0.029
90.00	-7.61	-0.26	0.00	-12.58	0.00	12.58	1052.07	526.04	1018.84	624.04	1.78	-0.20	0.027
92.00	-7.33	-0.26	0.00	-12.06	0.00	12.06	1052.07	526.04	1018.84	624.04	1.86	-0.20	0.026
94.00	-7.05	-0.26	0.00	-11.53	0.00	11.53	1052.07	526.04	1018.84	624.04	1.95	-0.21	0.025
96.00	-6.78	-0.26	0.00	-11.00	0.00	11.00	1052.07	526.04	1018.84	624.04	2.03	-0.21	0.024
98.00	-6.50	-0.26	0.00	-10.47	0.00	10.47	1052.07	526.04	1018.84	624.04	2.12	-0.21	0.023
100.00	-6.22	-0.26	0.00	-9.95	0.00	9.95	1052.07	526.04	1018.84	624.04	2.21	-0.22	0.022
102.00	-5.94	-0.26	0.00	-9.43	0.00	9.43	1052.07	526.04	1018.84	624.04	2.30	-0.22	0.021
104.00	-5.66	-0.26	0.00	-8.90	0.00	8.90	1052.07	526.04	1018.84	624.04	2.40	-0.22	0.020
106.00	-5.39	-0.26	0.00	-8.38	0.00	8.38	1052.07	526.04	1018.84	624.04	2.49	-0.22	0.019
108.00	-5.11	-0.26	0.00	-7.86	0.00	7.86	1052.07	526.04	1018.84	624.04	2.58	-0.23	0.017
109.00	-4.94	-0.26	0.00	-7.61	0.00	7.61	1052.07	526.04	1018.84	624.04	2.63	-0.23	0.017
110.00	-4.68	-0.26	0.00	-7.35	0.00	7.35	1052.07	526.04	1018.84	624.04	2.68	-0.23	0.010
110.00	-4.68	-0.26	0.00	-7.35	0.00	7.35	682.83	341.41	139.27	105.20	2.68	-0.23	0.005
111.50	-4.53	-0.26	0.00	-6.96	0.00	6.96	682.83	341.41	139.27	105.20	2.75	-0.23	0.022
111.50	-4.53	-0.26	0.00	-6.96	0.00	6.96	682.83	341.41	139.27	105.20	2.75	-0.23	0.022
112.00	-4.48	-0.26	0.00	-6.84	0.00	6.84	682.83	341.41	139.27	105.20	2.78	-0.23	0.072
114.00	-4.28	-0.26	0.00	-6.32	0.00	6.32	682.83	341.41	139.27	105.20	2.88	-0.28	0.066
115.00	-3.78	-0.26	0.00	-6.06	0.00	6.06	682.83	341.41	139.27	105.20	2.95	-0.31	0.063
116.00	-3.68	-0.26	0.00	-5.80	0.00	5.80	682.83	341.41	139.27	105.20	3.01	-0.33	0.061
118.00	-3.50	-0.26	0.00	-5.28	0.00	5.28	682.83	341.41	139.27	105.20	3.16	-0.37	0.055
120.00	-3.08	-0.26	0.00	-4.75	0.00	4.75	682.83	341.41	139.27	105.20	3.32	-0.41	0.050
122.00	-2.89	-0.26	0.00	-4.24	0.00	4.24	682.83	341.41	139.27	105.20	3.50	-0.44	0.045
124.00	-2.71	-0.25	0.00	-3.73	0.00	3.73	682.83	341.41	139.27	105.20	3.69	-0.47	0.039
126.00	-2.53	-0.25	0.00	-3.23	0.00	3.23	682.83	341.41	139.27	105.20	3.90	-0.50	0.034
127.00	-2.06	-0.22	0.00	-2.98	0.00	2.98	682.83	341.41	139.27	105.20	4.01	-0.51	0.031
128.00	-1.97	-0.22	0.00	-2.76	0.00	2.76	682.83	341.41	139.27	105.20	4.11	-0.52	0.029
130.00	-1.56	-0.20	0.00	-2.31	0.00	2.31	682.83	341.41	139.27	105.20	4.34	-0.54	0.024
130.00	-1.56	-0.20	0.00	-2.31	0.00	2.31	317.96	158.98	76.72	52.36	4.34	-0.54	0.049
132.00	-1.48	-0.19	0.00	-1.92	0.00	1.92	317.96	158.98	76.72	52.36	4.57	-0.56	0.041
134.00	-1.39	-0.19	0.00	-1.54	0.00	1.54	317.96	158.98	76.72	52.36	4.81	-0.58	0.034
135.00	-0.95	-0.15	0.00	-1.35	0.00	1.35	317.96	158.98	76.72	52.36	4.93	-0.59	0.029
136.00	-0.91	-0.14	0.00	-1.21	0.00	1.21	317.96	158.98	76.72	52.36	5.06	-0.60	0.026
138.00	-0.84	-0.13	0.00	-0.93	0.00	0.93	317.96	158.98	76.72	52.36	5.31	-0.62	0.020
140.00	-0.47	-0.09	0.00	-0.66	0.00	0.66	317.96	158.98	76.72	52.36	5.57	-0.63	0.014
142.00	-0.41	-0.08	0.00	-0.48	0.00	0.48	317.96	158.98	76.72	52.36	5.84	-0.64	0.010
144.00	-0.34	-0.07	0.00	-0.33	0.00	0.33	317.96	158.98	76.72	52.36	6.11	-0.64	0.007
146.00	-0.27	-0.05	0.00	-0.19	0.00	0.19	317.96	158.98	76.72	52.36	6.38	-0.65	0.005
148.00	-0.20	-0.04	0.00	-0.08	0.00	0.08	317.96	158.98	76.72	52.36	6.65	-0.65	0.002
150.00	0.00	-0.04	0.00	0.00	0.00	0.00	317.96	158.98	76.72	52.36	6.92	-0.65	0.000

## Seismic Segment Forces (Factored)

<b>Structure:</b> CT04374-S-SBA	<b>Code:</b> EIA/TIA-222-G	5/7/2018
<b>Site Name:</b> Central Hebron	<b>Exposure:</b> C	
<b>Height:</b> 150.00 (ft)	<b>Crest Height:</b> 0.00	
<b>Base Elev:</b> 0.000 (ft)	<b>Site Class:</b> D - Stiff Soil	
<b>Gh:</b> 1.1	<b>Topography:</b> 1	<b>Struct Class:</b> II



Page: 34

**Load Case:** 0.9D + 1.0E

**Iterations** 33

<b>Gust Response Factor</b> 1.10	<b>Sds</b> 0.19	<b>Ss</b> 0.18		
<b>Dead Load Factor</b> 0.90	<b>Seismic Load Factor</b> 1.00	<b>Sd1</b> 0.10		<b>S1</b> 0.06
<b>Wind Load Factor</b> 0.00	<b>Structure Frequency</b> 0.31	<b>SA</b> 0.03		<b>Seismic Importance Factor</b> 1.00

Top Elev (ft)	Description	Wz (lb)	a	b	c	Lateral Fs (lb)	R: 1.50
0.00		0.00	0.00	0.00	0.00	0.00	
2.00		285.63	0.00	0.01	0.01	2.87	
4.00		285.63	0.00	0.03	0.01	4.80	
6.00		285.63	0.00	0.04	0.02	6.17	
8.00		285.63	0.01	0.05	0.03	7.17	
10.00		285.63	0.01	0.05	0.03	7.91	
12.00		285.63	0.01	0.06	0.03	8.47	
14.00		285.63	0.02	0.06	0.04	8.89	
16.00		285.63	0.02	0.06	0.04	9.21	
18.00		285.63	0.03	0.07	0.04	9.45	
20.00	Top - Section 1	285.63	0.03	0.07	0.04	9.64	
22.00		237.52	0.04	0.07	0.04	8.15	
24.00		237.52	0.05	0.07	0.04	8.25	
26.00		237.52	0.06	0.07	0.04	8.34	
28.00		237.52	0.07	0.07	0.04	8.43	
30.00		237.52	0.08	0.07	0.04	8.51	
32.00		237.52	0.09	0.07	0.04	8.60	
34.00		237.52	0.10	0.07	0.04	8.68	
36.00		237.52	0.11	0.07	0.04	8.76	
38.00		237.52	0.12	0.07	0.03	8.85	
40.00		237.52	0.13	0.07	0.03	8.92	
42.00		237.52	0.15	0.07	0.03	9.00	
44.00		237.52	0.16	0.07	0.03	9.06	
46.00		237.52	0.18	0.07	0.03	9.10	
48.00		237.52	0.19	0.06	0.02	9.11	
50.00	Top - Section 2	237.52	0.21	0.06	0.02	9.09	
52.00		189.42	0.23	0.06	0.02	7.19	
54.00		189.42	0.24	0.06	0.02	7.09	
56.00		189.42	0.26	0.05	0.02	6.93	
58.00		189.42	0.28	0.05	0.01	6.70	
60.00		189.42	0.30	0.04	0.01	6.39	
62.00		189.42	0.32	0.04	0.01	5.99	
64.00		189.42	0.34	0.03	0.01	5.49	
66.00		189.42	0.37	0.03	0.01	4.89	
68.00		189.42	0.39	0.02	0.01	4.17	
70.00		189.42	0.41	0.01	0.01	3.34	
72.00		189.42	0.44	0.01	0.01	2.40	
74.00		189.42	0.46	0.00	0.01	1.38	
76.00		189.42	0.49	-0.01	0.01	0.30	
78.00		189.42	0.51	-0.02	0.01	-0.83	
80.00	Top - Section 3	189.42	0.54	-0.03	0.01	-1.95	
82.00		189.42	0.56	-0.04	0.01	-3.04	
84.00		189.42	0.59	-0.05	0.01	-4.06	
86.00		189.42	0.62	-0.06	0.02	-4.99	
88.00		189.42	0.65	-0.07	0.02	-5.79	
90.00		189.42	0.68	-0.08	0.03	-6.46	

## Seismic Segment Forces (Factored)

<b>Structure:</b> CT04374-S-SBA	<b>Code:</b> EIA/TIA-222-G	5/7/2018
<b>Site Name:</b> Central Hebron	<b>Exposure:</b> C	
<b>Height:</b> 150.00 (ft)	<b>Crest Height:</b> 0.00	
<b>Base Elev:</b> 0.000 (ft)	<b>Site Class:</b> D - Stiff Soil	
<b>Gh:</b> 1.1	<b>Topography:</b> 1	<b>Struct Class:</b> II



Page: 35

92.00		189.42	0.71	-0.09	0.03	-6.98	
94.00		189.42	0.74	-0.10	0.04	-7.34	
96.00		189.42	0.77	-0.11	0.05	-7.54	
98.00		189.42	0.81	-0.11	0.06	-7.58	
100.00		189.42	0.84	-0.12	0.07	-7.46	
102.00		189.42	0.87	-0.12	0.08	-7.19	
104.00		189.42	0.91	-0.12	0.09	-6.76	
106.00		189.42	0.94	-0.12	0.11	-6.18	
108.00		189.42	0.98	-0.11	0.12	-5.45	
109.00	Appurtenance(s)	119.71	1.00	-0.11	0.13	-3.17	
110.00	Top - Section 4 RB1	194.71	1.02	-0.11	0.14	-4.69	
111.50	RT1	92.20	1.04	-0.10	0.15	-1.85	
112.00		30.73	1.05	-0.09	0.16	-0.57	
114.00		122.94	1.09	-0.07	0.18	-1.53	
115.00	Appurtenance(s)	401.07	1.11	-0.06	0.19	-3.62	
116.00		61.47	1.13	-0.05	0.21	-0.33	
118.00		122.94	1.17	-0.02	0.23	0.29	
120.00	Appurtenance(s)	322.94	1.21	0.01	0.26	3.52	
122.00		122.94	1.25	0.06	0.29	2.49	
124.00		122.94	1.29	0.11	0.33	3.73	
126.00		122.94	1.33	0.17	0.37	5.07	
127.00	Appurtenance(s)	378.87	1.35	0.20	0.39	17.81	
128.00		61.47	1.38	0.24	0.41	3.26	
130.00	Top - Section 5	322.94	1.42	0.32	0.45	21.15	
132.00		57.25	1.46	0.42	0.50	4.51	
134.00		57.25	1.51	0.52	0.55	5.32	
135.00	Appurtenance(s)	358.92	1.53	0.58	0.58	36.02	
136.00		28.62	1.55	0.64	0.61	3.09	
138.00		57.25	1.60	0.78	0.67	7.08	
140.00	Appurtenance(s)	307.25	1.65	0.93	0.73	43.14	
142.00		57.25	1.69	1.10	0.81	9.04	
144.00		57.25	1.74	1.29	0.88	10.09	
146.00		57.25	1.79	1.50	0.96	11.19	
148.00		57.25	1.84	1.73	1.05	12.34	
150.00	Appurtenance(s)	167.25	1.89	1.98	1.14	39.58	
<b>Totals:</b>		<b>15,775.7</b>				<b>401.0</b>	<b>Total Wind: 11,958.3</b>

Seismic Base Shear is Less Than 50% of Wind Force - An Analysis is NOT Required

## Calculated Forces

<b>Structure:</b> CT04374-S-SBA	<b>Code:</b> EIA/TIA-222-G	5/7/2018
<b>Site Name:</b> Central Hebron	<b>Exposure:</b> C	
<b>Height:</b> 150.00 (ft)	<b>Crest Height:</b> 0.00	
<b>Base Elev:</b> 0.000 (ft)	<b>Site Class:</b> D - Stiff Soil	
<b>Gh:</b> 1.1	<b>Topography:</b> 1	<b>Struct Class:</b> II



<b>Load Case: 0.9D + 1.0E</b>										<b>Iterations</b> 33
<b>Gust Response Factor</b> 1.10						<b>Sds</b> 0.19				<b>Ss</b> 0.18
<b>Dead Load Factor</b> 0.90		<b>Seismic Load Factor</b> 1.00				<b>Sd1</b> 0.10				<b>S1</b> 0.06
<b>Wind Load Factor</b> 0.00		<b>Structure Frequency</b> 0.31				<b>SA</b> 0.03		<b>Seismic Importance Factor</b> 1.00		

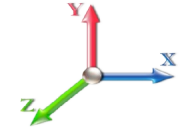

Seg Elev (ft)	Pu FY (-) (kips)	Vu FX (-) (kips)	Tu MY (-) (ft-kips)	Mu MZ (ft-kips)	Mu MX (ft-kips)	Resultant Moment (ft-kips)	phi Pn (kips)	phi Vn (kips)	phi Tn (ft-kips)	phi Mn (ft-kips)	Total Deflect (in)	Rotation Sway (deg)	Rotation Twist (deg)	Stress Ratio
0.00	-16.60	-0.51	0.00	-44.47	0.00	44.47	1490.10	745.05	2187.51	1339.68	0.00	0.00	0.00	0.044
2.00	-16.31	-0.50	0.00	-43.46	0.00	43.46	1490.10	745.05	2187.51	1339.68	0.00	0.00	0.00	0.043
4.00	-16.01	-0.50	0.00	-42.45	0.00	42.45	1490.10	745.05	2187.51	1339.68	0.00	0.00	-0.01	0.042
6.00	-15.72	-0.50	0.00	-41.45	0.00	41.45	1490.10	745.05	2187.51	1339.68	0.01	0.01	-0.01	0.041
8.00	-15.42	-0.49	0.00	-40.46	0.00	40.46	1490.10	745.05	2187.51	1339.68	0.01	0.01	-0.01	0.041
10.00	-15.13	-0.48	0.00	-39.48	0.00	39.48	1490.10	745.05	2187.51	1339.68	0.02	0.02	-0.02	0.040
12.00	-14.83	-0.47	0.00	-38.52	0.00	38.52	1490.10	745.05	2187.51	1339.68	0.03	0.03	-0.02	0.039
14.00	-14.54	-0.47	0.00	-37.57	0.00	37.57	1490.10	745.05	2187.51	1339.68	0.04	0.04	-0.02	0.038
16.00	-14.24	-0.46	0.00	-36.64	0.00	36.64	1490.10	745.05	2187.51	1339.68	0.05	0.05	-0.03	0.037
18.00	-13.95	-0.45	0.00	-35.72	0.00	35.72	1490.10	745.05	2187.51	1339.68	0.06	0.06	-0.03	0.036
20.00	-13.65	-0.44	0.00	-34.82	0.00	34.82	1490.10	745.05	2187.51	1339.68	0.07	0.07	-0.03	0.035
20.00	-13.65	-0.44	0.00	-34.82	0.00	34.82	1311.06	655.53	1597.15	948.43	0.07	0.07	-0.03	0.047
22.00	-13.40	-0.43	0.00	-33.95	0.00	33.95	1311.06	655.53	1597.15	948.43	0.09	0.09	-0.04	0.046
24.00	-13.15	-0.42	0.00	-33.08	0.00	33.08	1311.06	655.53	1597.15	948.43	0.11	0.11	-0.04	0.045
26.00	-12.90	-0.42	0.00	-32.23	0.00	32.23	1311.06	655.53	1597.15	948.43	0.12	0.12	-0.05	0.044
28.00	-12.65	-0.41	0.00	-31.40	0.00	31.40	1311.06	655.53	1597.15	948.43	0.14	0.14	-0.05	0.043
30.00	-12.39	-0.40	0.00	-30.58	0.00	30.58	1311.06	655.53	1597.15	948.43	0.17	0.17	-0.06	0.042
32.00	-12.14	-0.39	0.00	-29.77	0.00	29.77	1311.06	655.53	1597.15	948.43	0.19	0.19	-0.06	0.041
34.00	-11.89	-0.39	0.00	-28.99	0.00	28.99	1311.06	655.53	1597.15	948.43	0.22	0.22	-0.06	0.040
36.00	-11.64	-0.38	0.00	-28.21	0.00	28.21	1311.06	655.53	1597.15	948.43	0.25	0.25	-0.07	0.039
38.00	-11.39	-0.37	0.00	-27.46	0.00	27.46	1311.06	655.53	1597.15	948.43	0.27	0.27	-0.07	0.038
40.00	-11.13	-0.36	0.00	-26.72	0.00	26.72	1311.06	655.53	1597.15	948.43	0.31	0.31	-0.08	0.037
42.00	-10.88	-0.35	0.00	-26.00	0.00	26.00	1311.06	655.53	1597.15	948.43	0.34	0.34	-0.08	0.036
44.00	-10.63	-0.34	0.00	-25.29	0.00	25.29	1311.06	655.53	1597.15	948.43	0.37	0.37	-0.08	0.035
46.00	-10.38	-0.33	0.00	-24.61	0.00	24.61	1311.06	655.53	1597.15	948.43	0.41	0.41	-0.09	0.034
48.00	-10.13	-0.33	0.00	-23.94	0.00	23.94	1311.06	655.53	1597.15	948.43	0.45	0.45	-0.09	0.033
50.00	-9.88	-0.32	0.00	-23.28	0.00	23.28	1311.06	655.53	1597.15	948.43	0.49	0.49	-0.10	0.032
50.00	-9.88	-0.32	0.00	-23.28	0.00	23.28	1052.07	526.04	1018.84	624.04	0.49	0.49	-0.10	0.047
52.00	-9.67	-0.31	0.00	-22.65	0.00	22.65	1052.07	526.04	1018.84	624.04	0.53	0.53	-0.10	0.045
54.00	-9.46	-0.30	0.00	-22.03	0.00	22.03	1052.07	526.04	1018.84	624.04	0.57	0.57	-0.11	0.044
56.00	-9.25	-0.30	0.00	-21.42	0.00	21.42	1052.07	526.04	1018.84	624.04	0.62	0.62	-0.11	0.043
58.00	-9.04	-0.29	0.00	-20.83	0.00	20.83	1052.07	526.04	1018.84	624.04	0.67	0.67	-0.12	0.042
60.00	-8.83	-0.29	0.00	-20.24	0.00	20.24	1052.07	526.04	1018.84	624.04	0.72	0.72	-0.12	0.041
62.00	-8.63	-0.28	0.00	-19.67	0.00	19.67	1052.07	526.04	1018.84	624.04	0.77	0.77	-0.13	0.040
64.00	-8.42	-0.27	0.00	-19.11	0.00	19.11	1052.07	526.04	1018.84	624.04	0.82	0.82	-0.14	0.039
66.00	-8.21	-0.27	0.00	-18.56	0.00	18.56	1052.07	526.04	1018.84	624.04	0.88	0.88	-0.14	0.038
68.00	-8.00	-0.27	0.00	-18.02	0.00	18.02	1052.07	526.04	1018.84	624.04	0.94	0.94	-0.15	0.036
70.00	-7.79	-0.26	0.00	-17.49	0.00	17.49	1052.07	526.04	1018.84	624.04	1.01	1.01	-0.15	0.035
72.00	-7.58	-0.26	0.00	-16.97	0.00	16.97	1052.07	526.04	1018.84	624.04	1.07	1.07	-0.16	0.034
74.00	-7.37	-0.26	0.00	-16.44	0.00	16.44	1052.07	526.04	1018.84	624.04	1.14	1.14	-0.16	0.033
76.00	-7.17	-0.26	0.00	-15.93	0.00	15.93	1052.07	526.04	1018.84	624.04	1.21	1.21	-0.17	0.032
78.00	-6.96	-0.26	0.00	-15.41	0.00	15.41	1052.07	526.04	1018.84	624.04	1.28	1.28	-0.17	0.031
80.00	-6.75	-0.26	0.00	-14.89	0.00	14.89	1052.07	526.04	1018.84	624.04	1.35	1.35	-0.18	0.030
80.00	-6.75	-0.26	0.00	-14.89	0.00	14.89	1052.07	526.04	1018.84	624.04	1.35	1.35	-0.18	0.030
82.00	-6.54	-0.26	0.00	-14.37	0.00	14.37	1052.07	526.04	1018.84	624.04	1.42	1.42	-0.18	0.029
84.00	-6.33	-0.26	0.00	-13.85	0.00	13.85	1052.07	526.04	1018.84	624.04	1.50	1.50	-0.18	0.028
86.00	-6.12	-0.26	0.00	-13.34	0.00	13.34	1052.07	526.04	1018.84	624.04	1.58	1.58	-0.19	0.027

## Calculated Forces

<b>Structure:</b> CT04374-S-SBA	<b>Code:</b> EIA/TIA-222-G	5/7/2018
<b>Site Name:</b> Central Hebron	<b>Exposure:</b> C	
<b>Height:</b> 150.00 (ft)	<b>Crest Height:</b> 0.00	
<b>Base Elev:</b> 0.000 (ft)	<b>Site Class:</b> D - Stiff Soil	
<b>Gh:</b> 1.1	<b>Topography:</b> 1	<b>Struct Class:</b> II



Page: 37

88.00	-5.92	-0.26	0.00	-12.82	0.00	12.82	1052.07	526.04	1018.84	624.04	1.66	-0.19	0.026
90.00	-5.71	-0.26	0.00	-12.30	0.00	12.30	1052.07	526.04	1018.84	624.04	1.74	-0.20	0.025
92.00	-5.50	-0.26	0.00	-11.79	0.00	11.79	1052.07	526.04	1018.84	624.04	1.82	-0.20	0.024
94.00	-5.29	-0.26	0.00	-11.27	0.00	11.27	1052.07	526.04	1018.84	624.04	1.90	-0.20	0.023
96.00	-5.08	-0.26	0.00	-10.76	0.00	10.76	1052.07	526.04	1018.84	624.04	1.99	-0.21	0.022
98.00	-4.87	-0.26	0.00	-10.25	0.00	10.25	1052.07	526.04	1018.84	624.04	2.08	-0.21	0.021
100.00	-4.66	-0.26	0.00	-9.74	0.00	9.74	1052.07	526.04	1018.84	624.04	2.16	-0.21	0.020
102.00	-4.46	-0.25	0.00	-9.22	0.00	9.22	1052.07	526.04	1018.84	624.04	2.25	-0.21	0.019
104.00	-4.25	-0.25	0.00	-8.71	0.00	8.71	1052.07	526.04	1018.84	624.04	2.34	-0.22	0.018
106.00	-4.04	-0.25	0.00	-8.21	0.00	8.21	1052.07	526.04	1018.84	624.04	2.44	-0.22	0.017
108.00	-3.83	-0.25	0.00	-7.70	0.00	7.70	1052.07	526.04	1018.84	624.04	2.53	-0.22	0.016
109.00	-3.70	-0.25	0.00	-7.45	0.00	7.45	1052.07	526.04	1018.84	624.04	2.57	-0.22	0.015
110.00	-3.51	-0.25	0.00	-7.19	0.00	7.19	1052.07	526.04	1018.84	624.04	2.62	-0.22	0.010
110.00	-3.51	-0.25	0.00	-7.19	0.00	7.19	682.83	341.41	139.27	105.20	2.62	-0.22	0.004
111.50	-3.40	-0.25	0.00	-6.82	0.00	6.82	682.83	341.41	139.27	105.20	2.69	-0.22	0.020
111.50	-3.40	-0.25	0.00	-6.82	0.00	6.82	682.83	341.41	139.27	105.20	2.69	-0.22	0.020
112.00	-3.36	-0.25	0.00	-6.69	0.00	6.69	682.83	341.41	139.27	105.20	2.72	-0.23	0.069
114.00	-3.21	-0.25	0.00	-6.18	0.00	6.18	682.83	341.41	139.27	105.20	2.82	-0.28	0.063
115.00	-2.83	-0.25	0.00	-5.93	0.00	5.93	682.83	341.41	139.27	105.20	2.88	-0.30	0.061
116.00	-2.76	-0.25	0.00	-5.68	0.00	5.68	682.83	341.41	139.27	105.20	2.95	-0.32	0.058
118.00	-2.63	-0.26	0.00	-5.17	0.00	5.17	682.83	341.41	139.27	105.20	3.09	-0.36	0.053
120.00	-2.31	-0.25	0.00	-4.65	0.00	4.65	682.83	341.41	139.27	105.20	3.25	-0.40	0.048
122.00	-2.17	-0.25	0.00	-4.15	0.00	4.15	682.83	341.41	139.27	105.20	3.43	-0.43	0.043
124.00	-2.03	-0.25	0.00	-3.65	0.00	3.65	682.83	341.41	139.27	105.20	3.62	-0.46	0.038
126.00	-1.90	-0.24	0.00	-3.16	0.00	3.16	682.83	341.41	139.27	105.20	3.82	-0.49	0.033
127.00	-1.54	-0.22	0.00	-2.92	0.00	2.92	682.83	341.41	139.27	105.20	3.92	-0.50	0.030
128.00	-1.48	-0.22	0.00	-2.70	0.00	2.70	682.83	341.41	139.27	105.20	4.03	-0.51	0.028
130.00	-1.17	-0.19	0.00	-2.27	0.00	2.27	682.83	341.41	139.27	105.20	4.24	-0.53	0.023
130.00	-1.17	-0.19	0.00	-2.27	0.00	2.27	317.96	158.98	76.72	52.36	4.24	-0.53	0.047
132.00	-1.11	-0.19	0.00	-1.89	0.00	1.89	317.96	158.98	76.72	52.36	4.47	-0.55	0.040
134.00	-1.04	-0.18	0.00	-1.51	0.00	1.51	317.96	158.98	76.72	52.36	4.70	-0.57	0.032
135.00	-0.71	-0.14	0.00	-1.33	0.00	1.33	317.96	158.98	76.72	52.36	4.83	-0.58	0.028
136.00	-0.68	-0.14	0.00	-1.19	0.00	1.19	317.96	158.98	76.72	52.36	4.95	-0.59	0.025
138.00	-0.63	-0.13	0.00	-0.91	0.00	0.91	317.96	158.98	76.72	52.36	5.20	-0.61	0.019
140.00	-0.36	-0.09	0.00	-0.65	0.00	0.65	317.96	158.98	76.72	52.36	5.45	-0.62	0.013
142.00	-0.30	-0.08	0.00	-0.48	0.00	0.48	317.96	158.98	76.72	52.36	5.71	-0.62	0.010
144.00	-0.25	-0.07	0.00	-0.32	0.00	0.32	317.96	158.98	76.72	52.36	5.98	-0.63	0.007
146.00	-0.20	-0.05	0.00	-0.19	0.00	0.19	317.96	158.98	76.72	52.36	6.24	-0.63	0.004
148.00	-0.15	-0.04	0.00	-0.08	0.00	0.08	317.96	158.98	76.72	52.36	6.51	-0.64	0.002
150.00	0.00	-0.04	0.00	0.00	0.00	0.00	317.96	158.98	76.72	52.36	6.77	-0.64	0.000

## Wind Loading - Shaft

<b>Structure:</b> CT04374-S-SBA	<b>Code:</b> EIA/TIA-222-G	5/7/2018
<b>Site Name:</b> Central Hebron	<b>Exposure:</b> C	
<b>Height:</b> 150.00 (ft)	<b>Crest Height:</b> 0.00	
<b>Base Elev:</b> 0.000 (ft)	<b>Site Class:</b> D - Stiff Soil	
<b>Gh:</b> 1.1	<b>Topography:</b> 1	<b>Struct Class:</b> II



**Load Case:** 1.0D + 1.0W 60 mph Wind

**Dead Load Factor** 1.00  
**Wind Load Factor** 1.00

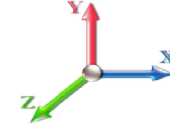

**Iterations** 36

Elev (ft)	Description	Kzt	Kz	qz (psf)	qzGh (psf)	C (mph-ft)	Cf	Ice Thick (in)	Tributary (ft)	Aa (sf)	CfAa (sf)	Wind Force X (lb)	Dead Load Ice (lb)	Tot Dead Load (lb)
0.00		1.00	0.85	7.442	8.19	165.95	0.600	0.000	0.00	0.000	0.00	0.0	0.0	0.0
2.00		1.00	0.85	7.442	8.19	165.95	0.600	0.000	2.00	6.000	3.60	29.5	0.0	285.6
4.00		1.00	0.85	7.442	8.19	165.95	0.600	0.000	2.00	6.000	3.60	29.5	0.0	285.6
6.00		1.00	0.85	7.442	8.19	165.95	0.600	0.000	2.00	6.000	3.60	29.5	0.0	285.6
8.00		1.00	0.85	7.442	8.19	165.95	0.600	0.000	2.00	6.000	3.60	29.5	0.0	285.6
10.00		1.00	0.85	7.442	8.19	165.95	0.600	0.000	2.00	6.000	3.60	29.5	0.0	285.6
12.00		1.00	0.85	7.442	8.19	165.95	0.600	0.000	2.00	6.000	3.60	29.5	0.0	285.6
14.00		1.00	0.85	7.442	8.19	165.95	0.600	0.000	2.00	6.000	3.60	29.5	0.0	285.6
16.00		1.00	0.86	7.534	8.29	166.97	0.600	0.000	2.00	6.000	3.60	29.8	0.0	285.6
18.00		1.00	0.88	7.723	8.50	169.06	0.600	0.000	2.00	6.000	3.60	30.6	0.0	285.6
20.00	Top - Section 1	1.00	0.90	7.896	8.69	170.94	0.600	0.000	2.00	6.000	3.60	31.3	0.0	285.6
22.00		1.00	0.92	8.056	8.86	143.89	0.600	0.000	2.00	5.000	3.00	26.6	0.0	237.5
24.00		1.00	0.94	8.205	9.03	145.21	0.600	0.000	2.00	5.000	3.00	27.1	0.0	237.5
26.00		1.00	0.95	8.345	9.18	146.44	0.600	0.000	2.00	5.000	3.00	27.5	0.0	237.5
28.00		1.00	0.97	8.476	9.32	147.59	0.600	0.000	2.00	5.000	3.00	28.0	0.0	237.5
30.00		1.00	0.98	8.600	9.46	148.66	0.600	0.000	2.00	5.000	3.00	28.4	0.0	237.5
32.00		1.00	1.00	8.717	9.59	149.68	0.600	0.000	2.00	5.000	3.00	28.8	0.0	237.5
34.00		1.00	1.01	8.829	9.71	150.63	0.600	0.000	2.00	5.000	3.00	29.1	0.0	237.5
36.00		1.00	1.02	8.936	9.83	151.54	0.600	0.000	2.00	5.000	3.00	29.5	0.0	237.5
38.00		1.00	1.03	9.039	9.94	152.41	0.600	0.000	2.00	5.000	3.00	29.8	0.0	237.5
40.00		1.00	1.04	9.137	10.05	153.23	0.600	0.000	2.00	5.000	3.00	30.2	0.0	237.5
42.00		1.00	1.05	9.231	10.15	154.02	0.600	0.000	2.00	5.000	3.00	30.5	0.0	237.5
44.00		1.00	1.06	9.322	10.25	154.78	0.600	0.000	2.00	5.000	3.00	30.8	0.0	237.5
46.00		1.00	1.07	9.410	10.35	155.50	0.600	0.000	2.00	5.000	3.00	31.1	0.0	237.5
48.00		1.00	1.08	9.494	10.44	156.20	0.600	0.000	2.00	5.000	3.00	31.3	0.0	237.5
50.00	Top - Section 2	1.00	1.09	9.576	10.53	156.88	0.600	0.000	2.00	5.000	3.00	31.6	0.0	237.5
52.00		1.00	1.10	9.656	10.62	126.02	0.600	0.000	2.00	4.000	2.40	25.5	0.0	189.4
54.00		1.00	1.11	9.733	10.71	126.52	0.600	0.000	2.00	4.000	2.40	25.7	0.0	189.4
56.00		1.00	1.12	9.807	10.79	127.01	0.600	0.000	2.00	4.000	2.40	25.9	0.0	189.4
58.00		1.00	1.13	9.880	10.87	127.48	0.600	0.000	2.00	4.000	2.40	26.1	0.0	189.4
60.00		1.00	1.14	9.951	10.95	127.93	0.600	0.000	2.00	4.000	2.40	26.3	0.0	189.4
62.00		1.00	1.14	10.020	11.02	128.37	0.600	0.000	2.00	4.000	2.40	26.5	0.0	189.4
64.00		1.00	1.15	10.087	11.10	128.80	0.600	0.000	2.00	4.000	2.40	26.6	0.0	189.4
66.00		1.00	1.16	10.153	11.17	129.22	0.600	0.000	2.00	4.000	2.40	26.8	0.0	189.4
68.00		1.00	1.17	10.217	11.24	129.63	0.600	0.000	2.00	4.000	2.40	27.0	0.0	189.4
70.00		1.00	1.17	10.279	11.31	130.03	0.600	0.000	2.00	4.000	2.40	27.1	0.0	189.4
72.00		1.00	1.18	10.340	11.37	130.41	0.600	0.000	2.00	4.000	2.40	27.3	0.0	189.4
74.00		1.00	1.19	10.400	11.44	130.79	0.600	0.000	2.00	4.000	2.40	27.5	0.0	189.4
76.00		1.00	1.19	10.459	11.50	131.16	0.600	0.000	2.00	4.000	2.40	27.6	0.0	189.4
78.00		1.00	1.20	10.516	11.57	131.51	0.600	0.000	2.00	4.000	2.40	27.8	0.0	189.4
80.00	Top - Section 3	1.00	1.21	10.572	11.63	131.87	0.600	0.000	2.00	4.000	2.40	27.9	0.0	189.4
82.00		1.00	1.21	10.627	11.69	132.21	0.600	0.000	2.00	4.000	2.40	28.1	0.0	189.4
84.00		1.00	1.22	10.681	11.75	132.54	0.600	0.000	2.00	4.000	2.40	28.2	0.0	189.4
86.00		1.00	1.23	10.734	11.81	132.87	0.600	0.000	2.00	4.000	2.40	28.3	0.0	189.4
88.00		1.00	1.23	10.787	11.87	133.20	0.600	0.000	2.00	4.000	2.40	28.5	0.0	189.4
90.00		1.00	1.24	10.838	11.92	133.51	0.600	0.000	2.00	4.000	2.40	28.6	0.0	189.4
92.00		1.00	1.24	10.888	11.98	133.82	0.600	0.000	2.00	4.000	2.40	28.7	0.0	189.4



## Wind Loading - Shaft

<b>Structure:</b> CT04374-S-SBA	<b>Code:</b> EIA/TIA-222-G	<b>5/7/2018</b>
<b>Site Name:</b> Central Hebron	<b>Exposure:</b> C	
<b>Height:</b> 150.00 (ft)	<b>Crest Height:</b> 0.00	
<b>Base Elev:</b> 0.000 (ft)	<b>Site Class:</b> D - Stiff Soil	
<b>Gh:</b> 1.1	<b>Topography:</b> 1	<b>Struct Class:</b> II



Page: 39

94.00	1.00	1.25	10.937	12.03	134.12	0.600	0.000	2.00	4.000	2.40	28.9	0.0	189.4
96.00	1.00	1.25	10.986	12.08	134.42	0.600	0.000	2.00	4.000	2.40	29.0	0.0	189.4
98.00	1.00	1.26	11.034	12.14	134.71	0.600	0.000	2.00	4.000	2.40	29.1	0.0	189.4
100.00	1.00	1.27	11.081	12.19	135.00	0.600	0.000	2.00	4.000	2.40	29.3	0.0	189.4
102.00	1.00	1.27	11.127	12.24	135.28	0.600	0.000	2.00	4.000	2.40	29.4	0.0	189.4
104.00	1.00	1.28	11.173	12.29	135.56	0.600	0.000	2.00	4.000	2.40	29.5	0.0	189.4
106.00	1.00	1.28	11.218	12.34	135.83	0.600	0.000	2.00	4.000	2.40	29.6	0.0	189.4
108.00	1.00	1.29	11.262	12.39	136.10	0.600	0.000	2.00	4.000	2.40	29.7	0.0	189.4
109.00 Appurtenance(s)	1.00	1.29	11.284	12.41	136.23	0.600	0.000	1.00	2.000	1.20	14.9	0.0	94.7
110.00 Top - Section 4 RB1	1.00	1.29	11.305	12.44	136.36	0.600	0.000	1.00	2.000	1.20	14.9	0.0	94.7
111.50 RT1	1.00	1.29	11.338	12.47	38.41	1.000	0.000	1.50	0.844	0.84	10.5	0.0	92.2
112.00	1.00	1.30	11.348	12.48	38.42	0.999	0.000	0.50	0.281	0.28	3.5	0.0	30.7
114.00	1.00	1.30	11.391	12.53	38.50	0.998	0.000	2.00	1.125	1.12	14.1	0.0	122.9
115.00 Appurtenance(s)	1.00	1.30	11.412	12.55	38.53	0.997	0.000	1.00	0.563	0.56	7.0	0.0	61.5
116.00	1.00	1.31	11.432	12.58	38.57	0.996	0.000	1.00	0.563	0.56	7.0	0.0	61.5
118.00	1.00	1.31	11.474	12.62	38.64	0.994	0.000	2.00	1.125	1.12	14.1	0.0	122.9
120.00 Appurtenance(s)	1.00	1.32	11.514	12.67	38.70	0.992	0.000	2.00	1.125	1.12	14.1	0.0	122.9
122.00	1.00	1.32	11.554	12.71	38.77	0.990	0.000	2.00	1.125	1.11	14.2	0.0	122.9
124.00	1.00	1.32	11.594	12.75	38.84	0.989	0.000	2.00	1.125	1.11	14.2	0.0	122.9
126.00	1.00	1.33	11.633	12.80	38.90	0.987	0.000	2.00	1.125	1.11	14.2	0.0	122.9
127.00 Appurtenance(s)	1.00	1.33	11.653	12.82	38.94	0.986	0.000	1.00	0.563	0.55	7.1	0.0	61.5
128.00	1.00	1.33	11.672	12.84	38.97	0.985	0.000	1.00	0.563	0.55	7.1	0.0	61.5
130.00 Top - Section 5	1.00	1.34	11.710	12.88	39.03	0.984	0.000	2.00	1.125	1.11	14.3	0.0	122.9
132.00	1.00	1.34	11.748	12.92	38.40	1.000	0.000	2.00	1.105	1.11	14.3	0.0	57.2
134.00	1.00	1.35	11.785	12.96	38.46	0.998	0.000	2.00	1.105	1.10	14.3	0.0	57.2
135.00 Appurtenance(s)	1.00	1.35	11.803	12.98	38.49	0.998	0.000	1.00	0.552	0.55	7.2	0.0	28.6
136.00	1.00	1.35	11.822	13.00	38.52	0.997	0.000	1.00	0.552	0.55	7.2	0.0	28.6
138.00	1.00	1.35	11.858	13.04	38.58	0.995	0.000	2.00	1.105	1.10	14.3	0.0	57.2
140.00 Appurtenance(s)	1.00	1.36	11.894	13.08	38.64	0.994	0.000	2.00	1.105	1.10	14.4	0.0	57.2
142.00	1.00	1.36	11.930	13.12	38.70	0.992	0.000	2.00	1.105	1.10	14.4	0.0	57.2
144.00	1.00	1.37	11.965	13.16	38.75	0.991	0.000	2.00	1.105	1.09	14.4	0.0	57.2
146.00	1.00	1.37	12.000	13.20	38.81	0.989	0.000	2.00	1.105	1.09	14.4	0.0	57.2
148.00	1.00	1.37	12.034	13.24	38.86	0.988	0.000	2.00	1.105	1.09	14.5	0.0	57.2
150.00 Appurtenance(s)	1.00	1.38	12.068	13.27	38.92	0.987	0.000	2.00	1.105	1.09	14.5	0.0	57.2
<b>Totals:</b>								<b>150.00</b>			<b>1,859.5</b>		<b>13,903.4</b>

## Discrete Appurtenance Forces

<b>Structure:</b> CT04374-S-SBA	<b>Code:</b> EIA/TIA-222-G	5/7/2018
<b>Site Name:</b> Central Hebron	<b>Exposure:</b> C	
<b>Height:</b> 150.00 (ft)	<b>Crest Height:</b> 0.00	
<b>Base Elev:</b> 0.000 (ft)	<b>Site Class:</b> D - Stiff Soil	
<b>Gh:</b> 1.1	<b>Topography:</b> 1	<b>Struct Class:</b> II



Page: 40

**Load Case:** 1.0D + 1.0W 60 mph Wind

**Dead Load Factor** 1.00  
**Wind Load Factor** 1.00

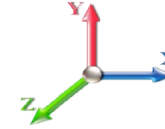

**Iterations** 36

No.	Elev (ft)	Description	Qty	qz (psf)	qzGh (psf)	CaAa x Ka	Ka	Total CaAa (sf)	Dead Load (lb)	Horiz Ecc (ft)	Vert Ecc (ft)	Wind FX (lb)	Mom Y (lb-ft)	Mom Z (lb-ft)	
1	150.00	Truck Ball	1	12.077	13.284	1.00	1.00	1.41	10.00	0.000	0.500	18.73	0.00	9.37	
2	150.00	36" Canister	1	12.068	13.275	1.00	1.00	7.35	100.00	0.000	0.000	97.57	0.00	0.00	
3	140.00	Flag	1	11.894	13.084	1.00	1.00	5.56	50.00	0.000	0.000	72.74	0.00	0.00	
4	140.00	36" Canister	1	11.894	13.084	1.00	1.00	14.69	200.00	0.000	0.000	192.20	0.00	0.00	
5	135.00	Flush Mount	1	11.803	12.984	0.00	1.00	0.00	150.00	0.000	0.000	0.00	0.00	0.00	
6	135.00	DB-T1-6Z-8AB-0Z	2	11.803	12.984	0.00	1.00	0.00	37.80	0.000	0.000	0.00	0.00	0.00	
7	135.00	FDL85002/1C-3L	6	11.803	12.984	0.00	1.00	0.00	42.00	0.000	0.000	0.00	0.00	0.00	
8	135.00	SBNHH-1D65A	3	11.803	12.984	0.00	1.00	0.00	100.50	0.000	0.000	0.00	0.00	0.00	
9	130.00	36" Canister	1	11.710	12.881	1.00	1.00	14.66	200.00	0.000	0.000	188.84	0.00	0.00	
10	127.00	Flush Mount	1	11.653	12.818	0.00	1.00	0.00	150.00	0.000	0.000	0.00	0.00	0.00	
11	127.00	DPO-7126Y-0-T1	3	11.653	12.818	0.62	0.80	0.00	21.90	0.000	0.000	0.00	0.00	0.00	
12	127.00	FD9R6004/1C-3L	3	11.653	12.818	0.00	1.00	0.00	9.30	0.000	0.000	0.00	0.00	0.00	
13	127.00	DHHTT65B-3XR	3	11.653	12.818	0.00	1.00	0.00	136.20	0.000	0.000	0.00	0.00	0.00	
14	120.00	36" Canister	1	11.514	12.666	1.00	1.00	14.62	200.00	0.000	0.000	185.17	0.00	0.00	
15	115.00	Flush Mount	1	11.412	12.553	0.00	1.00	0.00	150.00	0.000	0.000	0.00	0.00	0.00	
16	115.00	LGP21401	6	11.412	12.553	0.00	1.00	0.00	84.60	0.000	0.000	0.00	0.00	0.00	
17	115.00	7770.00	3	11.412	12.553	0.00	1.00	0.00	105.00	0.000	0.000	0.00	0.00	0.00	
18	110.00	36" Canister	1	11.305	12.436	1.00	1.00	7.31	100.00	0.000	0.000	90.91	0.00	0.00	
19	109.00	36" Canister	1	11.284	12.412	1.00	1.00	3.60	25.00	0.000	0.000	44.68	0.00	0.00	
<b>Totals:</b>									<b>1,872.30</b>						<b>890.84</b>

## Total Applied Force Summary

<b>Structure:</b> CT04374-S-SBA	<b>Code:</b> EIA/TIA-222-G	5/7/2018
<b>Site Name:</b> Central Hebron	<b>Exposure:</b> C	
<b>Height:</b> 150.00 (ft)	<b>Crest Height:</b> 0.00	
<b>Base Elev:</b> 0.000 (ft)	<b>Site Class:</b> D - Stiff Soil	
<b>Gh:</b> 1.1	<b>Topography:</b> 1	<b>Struct Class:</b> II



Page: 41

**Load Case:** 1.0D + 1.0W 60 mph Wind

**Dead Load Factor** 1.00  
**Wind Load Factor** 1.00

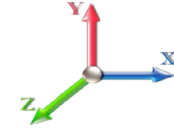

**Iterations** 36

Elev (ft)	Description	Lateral FX (-) (lb)	Axial FY (-) (lb)	Torsion MY (lb-ft)	Moment MZ (lb-ft)
0.00		0.00	0.00	0.00	0.00
2.00		29.47	327.83	0.00	0.00
4.00		29.47	327.83	0.00	0.00
6.00		29.47	327.83	0.00	0.00
8.00		29.47	327.83	0.00	0.00
10.00		29.47	327.83	0.00	0.00
12.00		29.47	327.83	0.00	0.00
14.00		29.47	327.83	0.00	0.00
16.00		29.83	327.83	0.00	0.00
18.00		30.58	327.83	0.00	0.00
20.00		31.27	327.83	0.00	0.00
22.00		26.59	279.72	0.00	0.00
24.00		27.08	279.72	0.00	0.00
26.00		27.54	279.72	0.00	0.00
28.00		27.97	279.72	0.00	0.00
30.00		28.38	279.72	0.00	0.00
32.00		28.77	279.72	0.00	0.00
34.00		29.14	279.72	0.00	0.00
36.00		29.49	279.72	0.00	0.00
38.00		29.83	279.72	0.00	0.00
40.00		30.15	279.72	0.00	0.00
42.00		30.46	279.72	0.00	0.00
44.00		30.76	279.72	0.00	0.00
46.00		31.05	279.72	0.00	0.00
48.00		31.33	279.72	0.00	0.00
50.00		31.60	279.72	0.00	0.00
52.00		25.49	231.62	0.00	0.00
54.00		25.69	231.62	0.00	0.00
56.00		25.89	231.62	0.00	0.00
58.00		26.08	231.62	0.00	0.00
60.00		26.27	231.62	0.00	0.00
62.00		26.45	231.62	0.00	0.00
64.00		26.63	231.62	0.00	0.00
66.00		26.80	231.62	0.00	0.00
68.00		26.97	231.62	0.00	0.00
70.00		27.14	231.62	0.00	0.00
72.00		27.30	231.62	0.00	0.00
74.00		27.46	231.62	0.00	0.00
76.00		27.61	231.62	0.00	0.00
78.00		27.76	231.62	0.00	0.00
80.00		27.91	231.62	0.00	0.00
82.00		28.06	231.62	0.00	0.00
84.00		28.20	231.62	0.00	0.00
86.00		28.34	231.62	0.00	0.00
88.00		28.48	231.62	0.00	0.00
90.00		28.61	231.62	0.00	0.00
92.00		28.74	231.62	0.00	0.00

## Total Applied Force Summary

<b>Structure:</b> CT04374-S-SBA	<b>Code:</b> EIA/TIA-222-G	5/7/2018
<b>Site Name:</b> Central Hebron	<b>Exposure:</b> C	
<b>Height:</b> 150.00 (ft)	<b>Crest Height:</b> 0.00	
<b>Base Elev:</b> 0.000 (ft)	<b>Site Class:</b> D - Stiff Soil	
<b>Gh:</b> 1.1	<b>Topography:</b> 1	<b>Struct Class:</b> II



Page: 42

94.00	28.87	231.62	0.00	0.00
96.00	29.00	231.62	0.00	0.00
98.00	29.13	231.62	0.00	0.00
100.00	29.25	231.62	0.00	0.00
102.00	29.38	231.62	0.00	0.00
104.00	29.50	231.62	0.00	0.00
106.00	29.61	231.62	0.00	0.00
108.00	29.73	231.62	0.00	0.00
109.00	(1) attachments	59.58	140.81	0.00
110.00	(1) attachments	105.83	215.81	0.00
111.50		10.52	123.85	0.00
112.00		3.51	41.28	0.00
114.00		14.06	165.14	0.00
115.00	(10) attachments	7.04	422.17	0.00
116.00		7.04	76.33	0.00
118.00		14.11	152.66	0.00
120.00	(1) attachments	199.31	352.66	0.00
122.00		14.16	152.66	0.00
124.00		14.19	152.66	0.00
126.00		14.21	152.66	0.00
127.00	(10) attachments	7.11	393.73	0.00
128.00		7.12	69.91	0.00
130.00	(1) attachments	203.09	339.82	0.00
132.00		14.28	74.13	0.00
134.00		14.30	74.13	0.00
135.00	(12) attachments	7.16	367.36	0.00
136.00		7.16	28.62	0.00
138.00		14.35	57.25	0.00
140.00	(2) attachments	279.31	307.25	0.00
142.00		14.39	57.25	0.00
144.00		14.41	57.25	0.00
146.00		14.43	57.25	0.00
148.00		14.45	57.25	0.00
150.00	(2) attachments	130.77	167.25	0.00
	<b>Totals:</b>	<b>2,750.37</b>	<b>18,448.05</b>	<b>0.00</b>
				<b>9.37</b>

## Calculated Forces

<b>Structure:</b> CT04374-S-SBA	<b>Code:</b> EIA/TIA-222-G	5/7/2018
<b>Site Name:</b> Central Hebron	<b>Exposure:</b> C	
<b>Height:</b> 150.00 (ft)	<b>Crest Height:</b> 0.00	
<b>Base Elev:</b> 0.000 (ft)	<b>Site Class:</b> D - Stiff Soil	
<b>Gh:</b> 1.1	<b>Topography:</b> 1	<b>Struct Class:</b> II



Page: 43

**Load Case:** 1.0D + 1.0W 60 mph Wind

**Dead Load Factor** 1.00  
**Wind Load Factor** 1.00

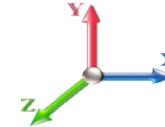

**Iterations** 36

Seg Elev (ft)	Pu FY (-) (kips)	Vu FX (-) (kips)	Tu MY (-) (ft-kips)	Mu MZ (ft-kips)	Mu MX (ft-kips)	Resultant Moment (ft-kips)	phi Pn (kips)	phi Vn (kips)	phi Tn (ft-kips)	phi Mn (ft-kips)	Total Deflect (in)	Rotation Sway (deg)	Rotation Twist (deg)	Stress Ratio
0.00	-18.45	-2.75	0.00	-253.49	0.00	253.49	1490.10	745.05	2187.51	1339.68	0.00	0.000	0.000	0.202
2.00	-18.12	-2.73	0.00	-247.99	0.00	247.99	1490.10	745.05	2187.51	1339.68	0.00	-0.021	0.000	0.197
4.00	-17.79	-2.71	0.00	-242.53	0.00	242.53	1490.10	745.05	2187.51	1339.68	0.02	-0.042	0.000	0.193
6.00	-17.46	-2.68	0.00	-237.11	0.00	237.11	1490.10	745.05	2187.51	1339.68	0.04	-0.063	0.000	0.189
8.00	-17.13	-2.66	0.00	-231.74	0.00	231.74	1490.10	745.05	2187.51	1339.68	0.07	-0.083	0.000	0.184
10.00	-16.80	-2.64	0.00	-226.42	0.00	226.42	1490.10	745.05	2187.51	1339.68	0.11	-0.102	0.000	0.180
12.00	-16.48	-2.61	0.00	-221.15	0.00	221.15	1490.10	745.05	2187.51	1339.68	0.16	-0.122	0.000	0.176
14.00	-16.15	-2.59	0.00	-215.93	0.00	215.93	1490.10	745.05	2187.51	1339.68	0.21	-0.140	0.000	0.172
16.00	-15.82	-2.56	0.00	-210.76	0.00	210.76	1490.10	745.05	2187.51	1339.68	0.27	-0.158	0.000	0.168
18.00	-15.49	-2.53	0.00	-205.64	0.00	205.64	1490.10	745.05	2187.51	1339.68	0.34	-0.176	0.000	0.164
20.00	-15.16	-2.51	0.00	-200.57	0.00	200.57	1490.10	745.05	2187.51	1339.68	0.42	-0.194	0.000	0.160
20.00	-15.16	-2.51	0.00	-200.57	0.00	200.57	1311.06	655.53	1597.15	948.43	0.42	-0.194	0.000	0.223
22.00	-14.88	-2.48	0.00	-195.56	0.00	195.56	1311.06	655.53	1597.15	948.43	0.51	-0.210	0.000	0.218
24.00	-14.60	-2.46	0.00	-190.60	0.00	190.60	1311.06	655.53	1597.15	948.43	0.60	-0.239	0.000	0.212
26.00	-14.32	-2.44	0.00	-185.67	0.00	185.67	1311.06	655.53	1597.15	948.43	0.71	-0.267	0.000	0.207
28.00	-14.04	-2.42	0.00	-180.79	0.00	180.79	1311.06	655.53	1597.15	948.43	0.83	-0.294	0.000	0.201
30.00	-13.76	-2.39	0.00	-175.95	0.00	175.95	1311.06	655.53	1597.15	948.43	0.95	-0.321	0.000	0.196
32.00	-13.48	-2.37	0.00	-171.16	0.00	171.16	1311.06	655.53	1597.15	948.43	1.09	-0.347	0.000	0.191
34.00	-13.20	-2.34	0.00	-166.42	0.00	166.42	1311.06	655.53	1597.15	948.43	1.24	-0.372	0.000	0.186
36.00	-12.92	-2.32	0.00	-161.73	0.00	161.73	1311.06	655.53	1597.15	948.43	1.41	-0.396	0.000	0.180
38.00	-12.64	-2.29	0.00	-157.10	0.00	157.10	1311.06	655.53	1597.15	948.43	1.58	-0.420	0.000	0.175
40.00	-12.36	-2.26	0.00	-152.51	0.00	152.51	1311.06	655.53	1597.15	948.43	1.76	-0.443	0.000	0.170
42.00	-12.07	-2.24	0.00	-147.98	0.00	147.98	1311.06	655.53	1597.15	948.43	1.95	-0.465	0.000	0.165
44.00	-11.79	-2.21	0.00	-143.51	0.00	143.51	1311.06	655.53	1597.15	948.43	2.15	-0.487	0.000	0.160
46.00	-11.51	-2.18	0.00	-139.09	0.00	139.09	1311.06	655.53	1597.15	948.43	2.35	-0.508	0.000	0.155
48.00	-11.23	-2.15	0.00	-134.73	0.00	134.73	1311.06	655.53	1597.15	948.43	2.57	-0.528	0.000	0.151
50.00	-10.95	-2.12	0.00	-130.44	0.00	130.44	1311.06	655.53	1597.15	948.43	2.80	-0.548	0.000	0.146
50.00	-10.95	-2.12	0.00	-130.44	0.00	130.44	1052.07	526.04	1018.84	624.04	2.80	-0.548	0.000	0.219
52.00	-10.72	-2.10	0.00	-126.20	0.00	126.20	1052.07	526.04	1018.84	624.04	3.03	-0.567	0.000	0.212
54.00	-10.49	-2.07	0.00	-122.01	0.00	122.01	1052.07	526.04	1018.84	624.04	3.28	-0.603	0.000	0.205
56.00	-10.26	-2.05	0.00	-117.86	0.00	117.86	1052.07	526.04	1018.84	624.04	3.54	-0.638	0.000	0.199
58.00	-10.02	-2.03	0.00	-113.75	0.00	113.75	1052.07	526.04	1018.84	624.04	3.81	-0.672	0.000	0.192
60.00	-9.79	-2.01	0.00	-109.70	0.00	109.70	1052.07	526.04	1018.84	624.04	4.10	-0.705	0.000	0.185
62.00	-9.56	-1.98	0.00	-105.69	0.00	105.69	1052.07	526.04	1018.84	624.04	4.40	-0.736	0.000	0.178
64.00	-9.33	-1.96	0.00	-101.72	0.00	101.72	1052.07	526.04	1018.84	624.04	4.72	-0.767	0.000	0.172
66.00	-9.09	-1.93	0.00	-97.81	0.00	97.81	1052.07	526.04	1018.84	624.04	5.04	-0.796	0.000	0.165
68.00	-8.86	-1.91	0.00	-93.95	0.00	93.95	1052.07	526.04	1018.84	624.04	5.38	-0.824	0.000	0.159
70.00	-8.63	-1.88	0.00	-90.14	0.00	90.14	1052.07	526.04	1018.84	624.04	5.73	-0.851	0.000	0.153
72.00	-8.40	-1.85	0.00	-86.38	0.00	86.38	1052.07	526.04	1018.84	624.04	6.10	-0.877	0.000	0.146
74.00	-8.17	-1.82	0.00	-82.68	0.00	82.68	1052.07	526.04	1018.84	624.04	6.47	-0.901	0.000	0.140
76.00	-7.93	-1.80	0.00	-79.03	0.00	79.03	1052.07	526.04	1018.84	624.04	6.85	-0.925	0.000	0.134
78.00	-7.70	-1.77	0.00	-75.44	0.00	75.44	1052.07	526.04	1018.84	624.04	7.24	-0.948	0.000	0.128
80.00	-7.47	-1.74	0.00	-71.90	0.00	71.90	1052.07	526.04	1018.84	624.04	7.64	-0.969	0.000	0.122
80.00	-7.47	-1.74	0.00	-71.90	0.00	71.90	1052.07	526.04	1018.84	624.04	7.64	-0.969	0.000	0.122
82.00	-7.24	-1.71	0.00	-68.42	0.00	68.42	1052.07	526.04	1018.84	624.04	8.05	-0.990	0.000	0.117
84.00	-7.01	-1.68	0.00	-65.01	0.00	65.01	1052.07	526.04	1018.84	624.04	8.47	-1.009	0.000	0.111
86.00	-6.78	-1.65	0.00	-61.65	0.00	61.65	1052.07	526.04	1018.84	624.04	8.90	-1.028	0.000	0.105
88.00	-6.54	-1.62	0.00	-58.35	0.00	58.35	1052.07	526.04	1018.84	624.04	9.33	-1.045	0.000	0.100

## Calculated Forces

<b>Structure:</b> CT04374-S-SBA	<b>Code:</b> EIA/TIA-222-G	5/7/2018
<b>Site Name:</b> Central Hebron	<b>Exposure:</b> C	
<b>Height:</b> 150.00 (ft)	<b>Crest Height:</b> 0.00	
<b>Base Elev:</b> 0.000 (ft)	<b>Site Class:</b> D - Stiff Soil	
<b>Gh:</b> 1.1	<b>Topography:</b> 1	<b>Struct Class:</b> II



Page: 44

90.00	-6.31	-1.59	0.00	-55.12	0.00	55.12	1052.07	526.04	1018.84	624.04	9.78	-1.062	0.000	0.094
92.00	-6.08	-1.56	0.00	-51.94	0.00	51.94	1052.07	526.04	1018.84	624.04	10.22	-1.078	0.000	0.089
94.00	-5.85	-1.52	0.00	-48.83	0.00	48.83	1052.07	526.04	1018.84	624.04	10.68	-1.093	0.000	0.084
96.00	-5.62	-1.49	0.00	-45.78	0.00	45.78	1052.07	526.04	1018.84	624.04	11.14	-1.106	0.000	0.079
98.00	-5.39	-1.46	0.00	-42.80	0.00	42.80	1052.07	526.04	1018.84	624.04	11.61	-1.119	0.000	0.074
100.00	-5.16	-1.43	0.00	-39.88	0.00	39.88	1052.07	526.04	1018.84	624.04	12.08	-1.131	0.000	0.069
102.00	-4.93	-1.39	0.00	-37.03	0.00	37.03	1052.07	526.04	1018.84	624.04	12.55	-1.143	0.000	0.064
104.00	-4.69	-1.36	0.00	-34.24	0.00	34.24	1052.07	526.04	1018.84	624.04	13.03	-1.153	0.000	0.059
106.00	-4.46	-1.33	0.00	-31.52	0.00	31.52	1052.07	526.04	1018.84	624.04	13.52	-1.163	0.000	0.055
108.00	-4.23	-1.29	0.00	-28.87	0.00	28.87	1052.07	526.04	1018.84	624.04	14.01	-1.172	0.000	0.050
109.00	-4.09	-1.23	0.00	-27.58	0.00	27.58	1052.07	526.04	1018.84	624.04	14.25	-1.176	0.000	0.048
110.00	-3.88	-1.12	0.00	-26.35	0.00	26.35	1052.07	526.04	1018.84	624.04	14.50	-1.180	0.000	0.029
110.00	-3.88	-1.12	0.00	-26.35	0.00	26.35	682.83	341.41	139.27	105.20	14.50	-1.180	0.000	0.009
111.50	-3.75	-1.11	0.00	-24.67	0.00	24.67	682.83	341.41	139.27	105.20	14.87	-1.183	0.000	0.066
111.50	-3.75	-1.11	0.00	-24.67	0.00	24.67	682.83	341.41	139.27	105.20	14.87	-1.183	0.000	0.066
112.00	-3.71	-1.11	0.00	-24.11	0.00	24.11	682.83	341.41	139.27	105.20	15.00	-1.196	0.000	0.235
114.00	-3.54	-1.10	0.00	-21.89	0.00	21.89	682.83	341.41	139.27	105.20	15.54	-1.371	0.000	0.213
115.00	-3.12	-1.09	0.00	-20.79	0.00	20.79	682.83	341.41	139.27	105.20	15.83	-1.452	0.000	0.202
116.00	-3.04	-1.08	0.00	-19.71	0.00	19.71	682.83	341.41	139.27	105.20	16.14	-1.529	0.000	0.192
118.00	-2.89	-1.07	0.00	-17.54	0.00	17.54	682.83	341.41	139.27	105.20	16.81	-1.671	0.000	0.171
120.00	-2.54	-0.87	0.00	-15.40	0.00	15.40	682.83	341.41	139.27	105.20	17.54	-1.796	0.000	0.150
122.00	-2.39	-0.85	0.00	-13.66	0.00	13.66	682.83	341.41	139.27	105.20	18.32	-1.907	0.000	0.133
124.00	-2.23	-0.84	0.00	-11.96	0.00	11.96	682.83	341.41	139.27	105.20	19.14	-2.005	0.000	0.117
126.00	-2.08	-0.82	0.00	-10.28	0.00	10.28	682.83	341.41	139.27	105.20	19.99	-2.089	0.000	0.101
127.00	-1.69	-0.80	0.00	-9.46	0.00	9.46	682.83	341.41	139.27	105.20	20.44	-2.127	0.000	0.092
128.00	-1.62	-0.79	0.00	-8.67	0.00	8.67	682.83	341.41	139.27	105.20	20.88	-2.161	0.000	0.085
130.00	-1.28	-0.58	0.00	-7.09	0.00	7.09	682.83	341.41	139.27	105.20	21.80	-2.221	0.000	0.069
130.00	-1.28	-0.58	0.00	-7.09	0.00	7.09	317.96	158.98	76.72	52.36	21.80	-2.221	0.000	0.139
132.00	-1.21	-0.56	0.00	-5.93	0.00	5.93	317.96	158.98	76.72	52.36	22.74	-2.271	0.000	0.117
134.00	-1.14	-0.54	0.00	-4.82	0.00	4.82	317.96	158.98	76.72	52.36	23.71	-2.347	0.000	0.096
135.00	-0.77	-0.52	0.00	-4.27	0.00	4.27	317.96	158.98	76.72	52.36	24.21	-2.379	0.000	0.084
136.00	-0.74	-0.51	0.00	-3.75	0.00	3.75	317.96	158.98	76.72	52.36	24.71	-2.407	0.000	0.074
138.00	-0.68	-0.50	0.00	-2.72	0.00	2.72	317.96	158.98	76.72	52.36	25.73	-2.452	0.000	0.054
140.00	-0.39	-0.21	0.00	-1.73	0.00	1.73	317.96	158.98	76.72	52.36	26.76	-2.484	0.000	0.034
142.00	-0.33	-0.19	0.00	-1.32	0.00	1.32	317.96	158.98	76.72	52.36	27.80	-2.505	0.000	0.026
144.00	-0.27	-0.17	0.00	-0.94	0.00	0.94	317.96	158.98	76.72	52.36	28.86	-2.521	0.000	0.019
146.00	-0.22	-0.15	0.00	-0.60	0.00	0.60	317.96	158.98	76.72	52.36	29.91	-2.532	0.000	0.012
148.00	-0.16	-0.14	0.00	-0.29	0.00	0.29	317.96	158.98	76.72	52.36	30.98	-2.538	0.000	0.006
150.00	0.00	-0.13	0.00	-0.01	0.00	0.01	317.96	158.98	76.72	52.36	32.04	-2.540	0.000	0.000



## Final Analysis Summary

<b>Structure:</b> CT04374-S-SBA	<b>Code:</b> EIA/TIA-222-G	5/7/2018
<b>Site Name:</b> Central Hebron	<b>Exposure:</b> C	
<b>Height:</b> 150.00 (ft)	<b>Crest Height:</b> 0.00	
<b>Base Elev:</b> 0.000 (ft)	<b>Site Class:</b> D - Stiff Soil	
<b>Gh:</b> 1.1	<b>Topography:</b> 1	<b>Struct Class:</b> II



Page: 45

### Reactions

Load Case	Shear FX (kips)	Shear FZ (kips)	Axial FY (kips)	Moment MX (ft-kips)	Moment MY (ft-kips)	Moment MZ (ft-kips)
1.2D + 1.6W 101 mph Wind	12.0	0.00	22.13	0.00	0.00	1087.42
0.9D + 1.6W 101 mph Wind	12.0	0.00	16.59	0.00	0.00	1070.92
1.2D + 1.0Di + 1.0Wi 50 mph Wind	4.9	0.00	34.99	0.00	0.00	507.95
1.2D + 1.0E	0.5	0.00	22.14	0.00	0.00	45.21
0.9D + 1.0E	0.5	0.00	16.60	0.00	0.00	44.47
1.0D + 1.0W 60 mph Wind	2.8	0.00	18.45	0.00	0.00	253.49

### Max Stresses

Load Case	Pu FY (-) (kips)	Vu FX (-) (kips)	Tu MY (-) (ft-kips)	Mu MZ (ft-kips)	Mu MX (ft-kips)	Resultant Moment (ft-kips)	phi Pn (kips)	phi Vn (kips)	phi Tn (ft-kips)	phi Mn (ft-kips)	Elev (ft)	Stress Ratio
1.2D + 1.6W 101 mph Wind	-4.07	-4.57	0.00	-99.69	0.00	-99.69	682.83	341.41	139.27	105.20	112.00	0.954
0.9D + 1.6W 101 mph Wind	-2.96	-4.46	0.00	-97.08	0.00	-97.08	682.83	341.41	139.27	105.20	112.00	0.927
1.2D + 1.0Di + 1.0Wi 50 mph Wind	-8.96	-2.64	0.00	-52.96	0.00	-52.96	682.83	341.41	139.27	105.20	112.00	0.517
1.2D + 1.0E	-4.48	-0.26	0.00	-6.84	0.00	-6.84	682.83	341.41	139.27	105.20	112.00	0.072
0.9D + 1.0E	-3.36	-0.25	0.00	-6.69	0.00	-6.69	682.83	341.41	139.27	105.20	112.00	0.069
1.0D + 1.0W 60 mph Wind	-3.71	-1.11	0.00	-24.11	0.00	-24.11	682.83	341.41	139.27	105.20	112.00	0.235

### Additional Steel Summary

Elev From (ft)	Elev To (ft)	Member	Intermediate Connectors			Lower Termination				Upper Termination				Max Member			
			VQ/I (lb/in)	Vu (kips)	phi Vn (kips)	MQ/I (kips)	phi Vn (kips)	Num Reqd	Num Actual	MQ/I (kips)	phi Vn (kips)	Num Reqd	Num Actual	Pu (kips)	phi Pn (kips)	phi Tn (kips)	Ratio
110.0	111.5	(3) PLT-5"x3/4" STFNR	357.6	0.00	25.3	22.6	25.3	1	0	96.0	25.3	4	0	95.99	121.5	121.50	0.790

## Base Plate Summary

<b>Structure:</b> CT04374-S-SB	<b>Code:</b> EIA/TIA-222-G	5/7/2018
<b>Site Name:</b> Central Hebron	<b>Exposure:</b> C	
<b>Height:</b> 150.00 (ft)	<b>Crest Height:</b> 0.00	
<b>Base Elev:</b> 0.000 (ft)	<b>Site Class:</b> D - Stiff Soil	
<b>Gh:</b> 1.1	<b>Topography:</b> 1	<b>Struct Class:</b> II
		Page: 46



Reactions	Base Plate	Anchor Bolts
Original Design	<b>Yield (ksi):</b> 36.00	<b>Bolt Circle:</b> 39.00
<b>Moment (kip-ft):</b> 666.50	<b>Width (in):</b> 42.38	<b>Number Bolts:</b> 28.00
<b>Axial (kip):</b> 16.50	<b>Style:</b> Round	<b>Bolt Type:</b> 1.0" F1554 105
<b>Shear (kip):</b> 8.00	<b>Polygon Sides:</b> 0.00	<b>Bolt Diameter (in):</b> 1.00
Analysis	<b>Clip Length (in):</b> 0.00	<b>Yield (ksi):</b> 105.00
<b>Moment (kip-ft):</b> 1087.42	<b>Effective Len (in):</b> 10.71	<b>Ultimate (ksi):</b> 125.00
<b>Axial (kip):</b> 34.99	<b>Moment (kip-in):</b> 73.57	<b>Arrangement:</b> Radial
<b>Shear (kip):</b> 11.98	<b>Allow Stress (ksi):</b> 48.60	<b>Cluster Dist (in):</b> 0.00
	<b>Applied Stress (ksi):</b> 0.00	<b>Start Angle (deg):</b> 0.00
<b>Moment Design %:</b> 163.15	<b>Stress Ratio:</b> 0.54	<b>Compression</b>
		<b>Force (kip):</b> 49.05
		<b>Allowable (kip):</b> 60.57
		<b>Ratio:</b> 0.82
		<b>Tension</b>
		<b>Force (kip):</b> 46.55
		<b>Allowable (kip):</b> 60.57
		<b>Ratio:</b> 0.78

	<b>Monopole Mat Foundation Design</b>			Date
				5/3/2018
	<b>Customer Name:</b>	Sprint Nextel	<b>EIA/TIA Standard:</b>	EIA-222-G
	<b>Site Name:</b>	Central Hebron	<b>Structure Height (Ft.):</b>	150
	<b>Site Number:</b>	CT04374-S-SBA	<b>Engineer Name:</b>	S. Hesselbeir
<b>Engr. Number:</b>	48686	<b>Engineer Login ID:</b>		

**Foundation Info Obtained from:**

Drawings/Calculations
Monopole
Analysis

**Structure Type:**

**Analysis or Design?**

**Base Reactions (Factored):**

Axial Load (Kips):	22.1	Shear Force (Kips):	11.8
Uplift Force (Kips):	0.0	Moment (Kips-ft):	1096.4

Allowable overstress %: 5.0%

**Foundation Geometries:**

		Mods required -Yes/No ?:	No
Diameter of Pier (ft.):	4.5	Depth of Base BG (ft.):	4.5
Pier Height A. G. (ft.):	0.50	Thickness of Pad (ft):	2.00
Length of Pad (ft.):	16.5	Width of Pad (ft.):	16.5
Final Length of pad (ft)	16.5	Final width of pad (ft):	16.5
Control Value for Cell D18:	0	Control Value for Cell F18:	0

**Material Properties and Rebar Info:**

Concrete Strength (psi):	4000	Steel Elastic Modulus:	29000	ksi
Vertical bar yield (ksi)	60	Tie steel yield (ksi):	60	
Vertical Rebar Size #:	8	Tie / Stirrup Size #:	4	
Qty. of Vertical Rebars:	15	Tie Spacing (in):	12.0	
Pad Rebar Yield (Ksi):	60	Pad Steel Rebar Size (#):	6	
Concrete Cover (in.):	3	Unit Weight of Concrete:	150.0	pcf
Rebar at the bottom of the concrete pad:				
Qty. of Rebar in Pad (L):	15	Qty. of Rebar in Pad (W):	15	
Rebar at the top of the concrete pad:				
Qty. of Rebar in Pad (L):	15	Qty. of Rebar in Pad (W):	15	

Apply 1.35 factor for e/w Per G: 1.35

**Soil Design Parameters:**

Soil Unit Weight (pcf):	130.0	Soil Buoyant Weight:	50.0	Pcf
Water Table B.G.S. (ft):	99.0	Unit Weight of Water:	62.4	pcf
Ultimate Bearing Pressure (psf):	30000	Ultimate Skin Friction:	0	Psf
Consider Friction for O.T.M. (Y/N):	No	Consider Friction for bearing (Y/N):	No	
Consider soil hor. resist. for OTM.:	No	Reduction factor on the maximum soil bearing pressure:	1.00	
		Angle from Top of Pad:	30	
		Angle from Bottm of Pad:	25	
		Angle from Bottm of Pad:	25	

**Foundation Analysis and Design:**

Uplift Strength Reduction Factor:	0.75	Compression Strength Reduction Factor:	0.75
Total Dry Soil Volume (cu. Ft.):	640.86	Total Dry Soil Weight (Kips):	83.31
Total Buoyant Soil Volume (cu. Ft.):	0.00	Total Buoyant Soil Weight (Kips):	0.00
Total Effective Soil Weight (Kips):	83.31	Weight from the Concrete Block at Top (K):	0.00
Total Dry Concrete Volume (cu. Ft.):	592.21	Total Dry Concrete Weight (Kips):	88.83
Total Buoyant Concrete Volume (cu. Ft.):	0.00	Total Buoyant Concrete Weight (Kips):	0.00
Total Effective Concrete Weight (Kips):	88.83	Total Vertical Load on Base (Kips):	194.24

**Check Soil Capacities:**

Calculated Maxium Net Soil Pressure under the base (psf):	3008	<	Allowable Factored Soil Bearing (psf):	22500	0.13	OK!
Allowable Foundation Overturning Resistance (kips-ft.):	1460.5	>	Design Factored Momont (kips-ft):	1155	0.79	OK!
Factor of Safety Against Overturning (O. R. Moment/Design Moment):	1.26					OK!

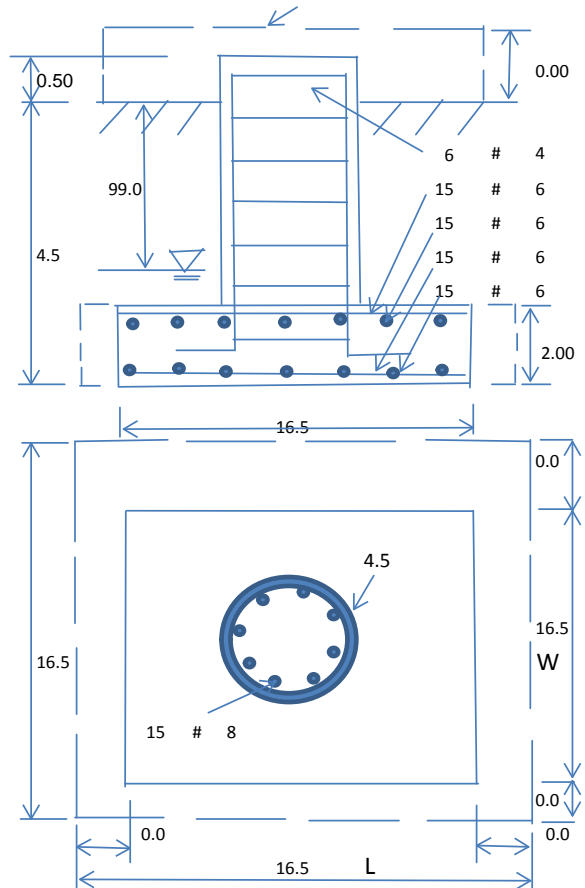

**Check the capacities of Reinforcing Concrete:**

Strength reduction factor (Flexure and axial tension):	0.90	Strength reduction factor (Shear):	0.75
Strength reduction factor (Axial compression):	0.65	Wind Load Factor on Concrete Design:	1.00

Load/  
Capacity  
Ratio

(1) Concrete Pier:

Vertical Steel Rebar Area (sq. in./each):	0.79	Tie / Stirrup Area (sq. in./each):	0.20		
Calculated Moment Capacity (Mn,Kips-Ft):	1204.2	>	Design Factored Moment (Mu, Kips-Ft)	1131.8	0.94 OK!
Calculated Shear Capacity (Kips):	303.7	>	Design Factored Shear (Kips):	11.8	0.04 OK!
Calculated Tension Capacity (Tn, Kips):	639.9	>	Design Factored Tension (Tu Kips):	0.0	0.00 OK!
Calculated Compression Capacity (Pn, Kips):	4028.2	>	Design Factored Axial Load (Pu Kips):	22.1	0.01 OK!
Moment & Axial Strength Combination:	0.94	OK!	Check Tie Spacing (Design/Required):	1	OK!
Pier Reinforcement Ratio:	0.005	Reinforcement Ratio is satisfied per ACI			

(2).Concrete Pad:

One-Way Design Shear Capacity (L-Direction, Kips):	387.4	>	One-Way Factored Shear (L-D. Kips):	104.0	0.27 OK!
One-Way Design Shear Capacity (W-Direction, Kips):	387.4	>	One-Way Factored Shear (W-D., Kips)	104.0	0.27 OK!
One-Way Design Shear Capacity (Corner-Corner. Kips):	361.5	>	One-Way Factored Shear (C-C, Kips):	105.2	0.29 OK!
Lower Steel Pad Reinforcement Ratio (L-Direct. ):	0.0016	OK!	Lower Steel Pad Reinf. Ratio (W-Direc	0.0016	
Lower Steel Pad Moment Capacity (L-Direction. Kips-ft):	603.8	>	Moment at Bottom ( L-Dir. K-Ft):	355.9	0.59 OK!
Lower Steel Pad Moment Capacity (W-Direction. Kips-ft):	603.8	>	Moment at Bottom ( W-Dir. K-Ft):	355.9	0.59 OK!
Lower Steel Pad Moment Capacity (Corner-Corner,K-ft):	851.0	>	Moment at Bottom ( C-C Dir. K-Ft):	503.3	0.59 OK!
Upper Steel Pad Reinforcement Ratio (L-Direct. ):	0.0016	OK!	Upper Steel Reinf. Ratio (W-Dir. ):	0.0016	
Upper Steel Pad Moment Capacity (L-Direc. Kips-ft):	603.8	>	Moment at the top (L-Dir K-Ft):	176.2	0.29 OK!
Upper Steel Pad Moment Capacity (W-Direc. Kips-ft):	603.8	>	Moment at the top (W-Dir K-Ft):	176.2	0.29 OK!
Upper Steel Pad Moment Capacity (Corner-Corner. K-ft):	851.0	>	Moment at the top (C-C Dir. K-Ft):	165.2	0.19 OK!

(3).Check Punching Shear Capacity due to Moment in the Pier:

Moment transferred by punching shear:	438.5	k-ft.	Max. factored shear stress $v_{u\_cd}$ :	4.4	Psi
Max. factored shear stress $v_{u\_AB}$ :	11.6	Psi	Factored shear Strength $\phi v_n$ :	189.7	Psi
Max. factored shear stress $v_u$ :	11.6	Psi	Check Usage of Punching Shear Capacity:	0.06	OK!



Date: **January 23, 2018**

Bryan Bakis  
SBA Communications Corporation  
134 Flanders Road, Suite 125  
Westborough, MA 01581

**ARCHITECTURE & ENGINEERING DIVISION**  
604 FOX GLEN, BARRINGTON, IL 60010  
847/277-0070. FAX: 847/277-0080  
AE@westchesterservices.com / www.westchesterservices.com

**Subject: Mount Assessment Letter**  
**Sprint Co-Locate**  
**Site Number:** CT54XC731  
**Site Name:** Central Hebron  
**Project:** DO Macro Upgrade

**Engineering Firm Designation:** Westchester Services, LLC

**Site Data:** 66 Wall St, Hebron, CT 06248  
Tolland County – 150ft Monopole

Bryan Bakis,

Westchester Services, LLC is pleased to submit this **“Mount Assessment Letter”** to determine the structural integrity of the existing and proposed antenna mounts.

The purpose of the assessment is to determine acceptability of the existing antenna mounts and proposed premanufactured components to adequately support the proposed appurtenances in each sector. The final antenna and equipment configurations are as follows:

**Proposed Antenna and Equipment:**

- (3) KMW ETCR-654L12H6 ((1) per sector)
- (3) RFS KIT-FD9R6004/1C-DL ((1) per sector)
- (3) CCI DPO-7126Y-0-T1 ((1) per sector)

**Proposed Pre-manufactured Components for Antenna Mount Modification:**

- (Schematic Design Only)
- (1) 36” dia. 10ft tall stealth canister
- (3) SitePro1 UPC2 clamp sets
- (3) 2” STD Pipes x 8’-6” long

The existing mounts currently support one antenna per sector, all located inside of an RF transparent canister. Based on the antenna cut sheets and field photographs we feel that the current antenna mount condition is insufficient for the proposed upgrades. However, we feel that it would be sufficient if the proposed pre-manufactured mounting components listed above are installed to modify the existing antenna mounts. Further investigation/calculations would be required to verify the existing antenna shroud pipe mast is indeed adequate and is not a part of this assessment.

**Existing and Proposed Equipment**

**Sufficient Capacity**

We at Westchester Services, LLC appreciate the opportunity of providing our continuing professional services to you. If you have any questions or need further assistance on this or any other projects please give us a call.

I certify that this report was prepared by me or under my direct supervision and that I am a licensed Professional Engineer under the laws of the State of Connecticut.

Philip Koziol, PE  
Professional Engineer



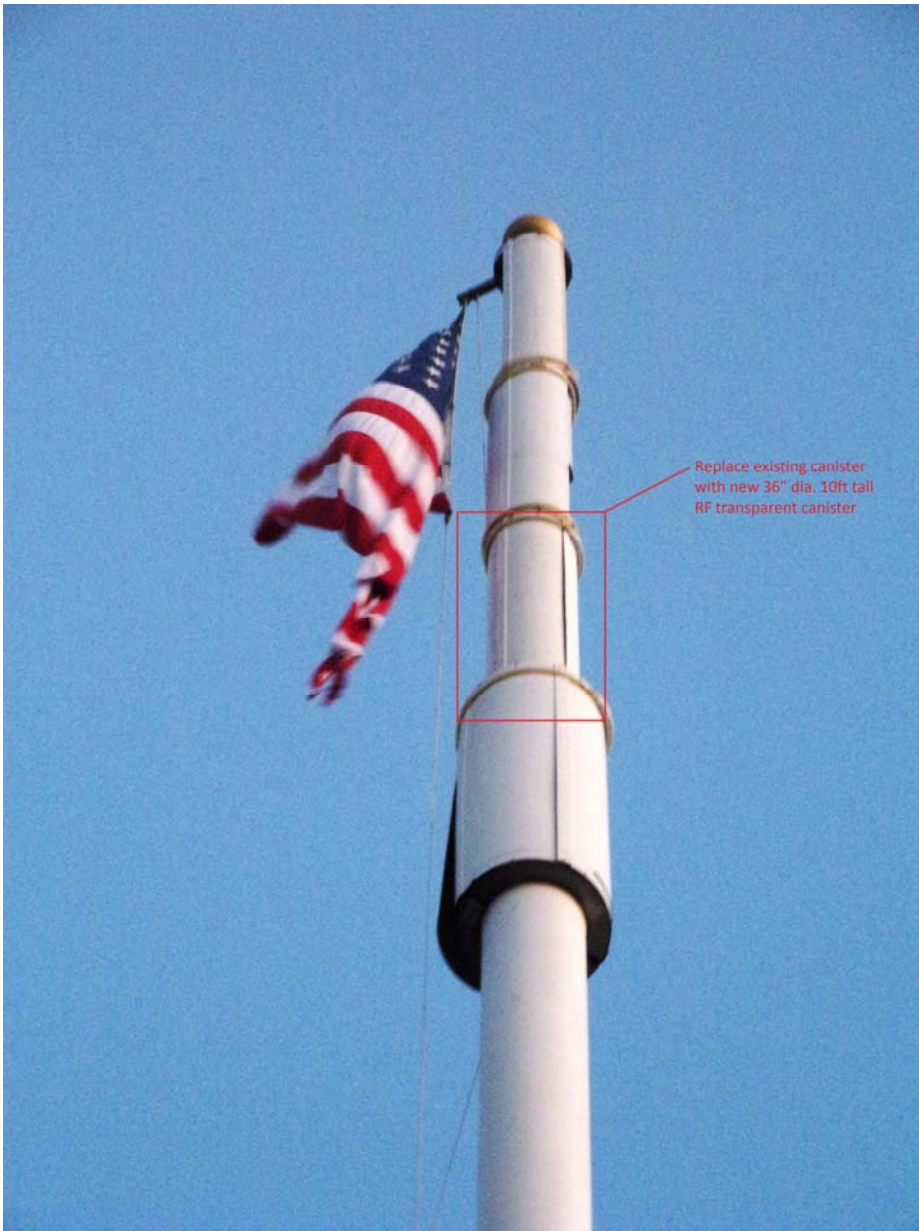



**SPECIAL CONSTRUCTION NOTE:**  
 SPRINT WORK IS CONTINGENT ON THE FOLLOWING:  
 \* COMPLETION OF A GLOBAL STRUCTURAL STABILITY ANALYSIS.  
 \* COMPLETION OF AN ANTENNA/RRH MOUNT STRUCTURAL ASSESSMENT.  
 \* GC SHALL FURNISH, INSTALL AND COMPLETE ALL REQUIRED STRUCTURAL MODIFICATIONS AS INDICATED IN BEFORE-MENTIONED ANALYSIS AND ASSESSMENT.



**SITE NAME:** CENTRAL HEBRON  
**SITE NUMBER:** CT54XC731  
**AUGMENT ID:** CT54XC731Q17.2  
**SITE ADDRESS:** 66 WALL STREET  
 HEBRON, CT 06248  
**JURISDICTION:** TOWN OF HEBRON  
**SITE TYPE:** EXISTING 150' FLAGPOLE  
**PROGRAM:** DO MACRO UPGRADE EQUIPMENT DEPLOYMENT

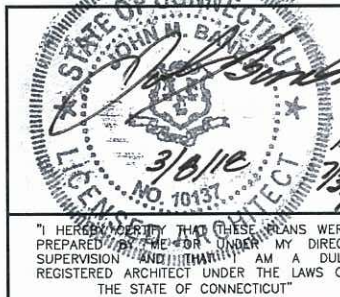

CHECKED BY: JK

APPROVED BY: JMB

SUBMITTALS			
REV.	DATE	DESCRIPTION	BY
1	03/08/16	ISSUED FOR CONSTRUCTION	SDB
0	01/23/16	ISSUED FOR CONSTRUCTION	SH

**SITE NUMBER:** CT54XC731  
**SITE NAME:** CENTRAL HEBRON  
**SITE ADDRESS:** 66 WALL STREET  
 HEBRON, CT 06248

**SHEET TITLE:**  
 TITLE SHEET

**SHEET NUMBER:**  
 T-1

**PROJECT INFORMATION**

**SITE INFORMATION:**  
 LATITUDE: 41° 39' 52.65" N (41.664625°)  
 LONGITUDE: 72° 21' 40.75" W (72.361319°)  
 GROUND ELEVATION: 586± AMSL (PER 2C DOCUMENT)  
 STRUCTURE HEIGHT: 150'± AGL (FROM RECORD STRUCTURAL)  
 STRUCTURE TYPE: FLAGPOLE  
 ZONING JURISDICTION: TOWN OF HEBRON  
 ZONING DISTRICT/OCCUPANCY: R-1 (RESIDENTIAL)

**APPLICANT:**  
 SPRINT  
 1 INTERNATIONAL BLVD, SUITE 800  
 MAHWAH, NJ 07495

**PROPERTY OWNER:**  
 TOWN OF HEBRON  
 15 GILEAD STREET  
 HEBRON, CT 06248

**TOWER OWNER:**  
 SBA PROPERTIES, LLC  
 8051 CONGRESS AVENUE  
 BOCA RATON, FL 33487

SBA SITE ID: CT04374  
 SBA SITE NAME: CENTRAL HEBRON

**SBA CONTACT:**  
 STEPHEN ROTH  
 SROTH@SBASITE.COM  
 (617) 794-1405

**A&E FIRM:**  
 WESTCHESTER SERVICES, L.L.C.  
 604 FOX GLEN  
 BARRINGTON, IL 60010  
 PHONE: (224) 277-0070

TO OBTAIN LOCATION OF PARTICIPANTS UNDERGROUND FACILITIES BEFORE YOU DIG IN CONNECTICUT, CONTACT CALL BEFORE YOU DIG  
 TOLL FREE: 1-800-922-4455 OR www.cbyd.com  
 CONNECTICUT STATUTE REQUIRES MIN OF 2 WORKING DAYS NOTICE BEFORE YOU EXCAVATE  
**Know what's below. Call before you dig.**

**LOCATION MAP N.T.S.**

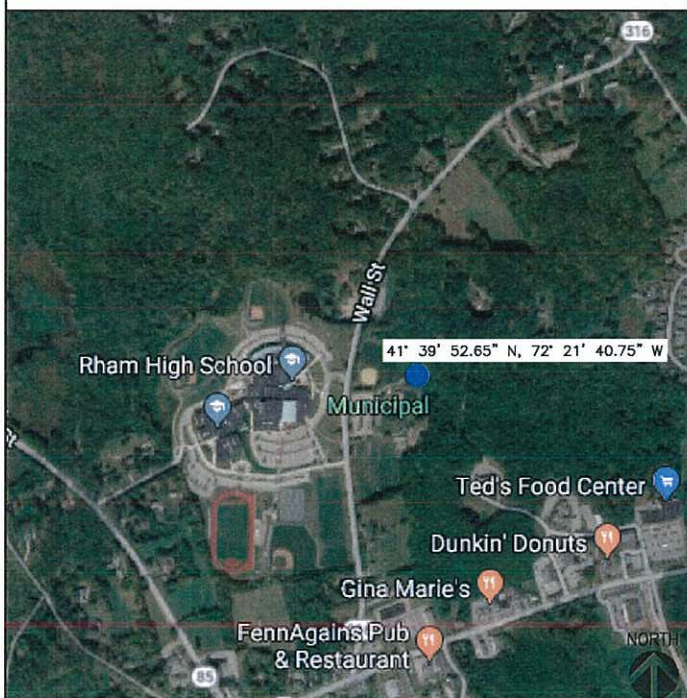

**SCOPE OF WORK**

- REMOVE EXISTING STEALTH CANISTER AND INSTALL (1) NEW 36"Ø STEALTH CANISTER (BY SBA)
- REMOVE (3) EXISTING SPRINT PANEL ANTENNAS & REPLACE W/(3) NEW SPRINT TRI-BAND PANEL ANTENNAS.
- INSTALL (3) NEW 2500 MHZ RRHS AT GRADE.
- INSTALL (3) NEW 800 MHZ RRHS AT GRADE.
- INSTALL (6) NEW DIPLEXERS AT TOWER.
- INSTALL (6) NEW DIPLEXERS AT GRADE.
- INSTALL (3) NEW COMBINERS AT GRADE.
- REMOVE (6) EXISTING 1-5/8" COAX CABLES.
- INSTALL (3) NEW 3/8" RET CABLES.
- INSTALL (12) NEW 7/8" COAX.

**AREA MAP N.T.S.**

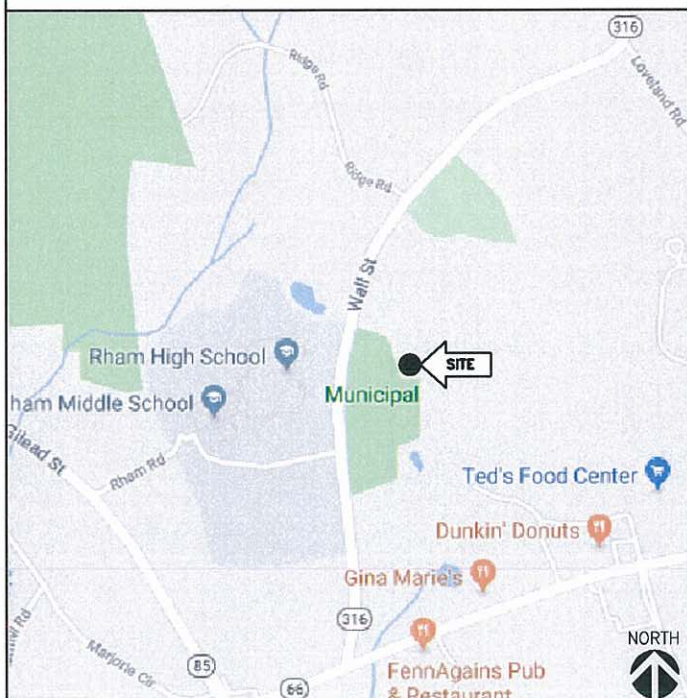

**GENERAL NOTES**

- THIS IS AN UNMANNED TELECOMMUNICATION FACILITY AND NOT FOR HUMAN HABITATION:  
 • ADA COMPLIANCE NOT REQUIRED.  
 • POTABLE WATER OR SANITARY SERVICE IS NOT REQUIRED.  
 • NO OUTDOOR STORAGE OR ANY SOLID WASTE RECEPTACLES REQUIRED.
- CONTRACTOR SHALL VERIFY ALL PLANS, EXISTING DIMENSIONS, AND CONDITIONS ON JOB SITE. CONTRACTOR SHALL IMMEDIATELY NOTIFY THE ARCHITECT/ENGINEER IN WRITING OF ANY DISCREPANCIES BEFORE PROCEEDING WITH THE WORK. FAILURE TO NOTIFY THE ARCHITECT/ENGINEER PLACE THE RESPONSIBILITY ON THE CONTRACTOR TO CORRECT THE DISCREPANCIES AT THE CONTRACTOR'S EXPENSE.

**DRAWING INDEX**

SHEET NO.	SHEET DESCRIPTION	REV. NO.
T-1	TITLE SHEET	1
SP-1	OUTLINE SPECIFICATIONS	1
SP-2	OUTLINE SPECIFICATIONS	1
SP-3	OUTLINE SPECIFICATIONS	1
A-1	COMPOUND PLAN	1
A-2	ELEVATION AND ANTENNA PLANS	1
A-3	TOWER EQUIPMENT DETAILS	1
S-1	ANTENNA AND RRH MOUNTING DETAILS	1
E-1	ELECTRICAL AND GROUNDING DETAILS	1
RF-1	RF DATA SHEET	1
RF-2	PLUMBING DIAGRAM AND RAN WIRING	1

**CODE COMPLIANCE**

- 2016 CONNECTICUT STATE BUILDING CODE WITH AMENDMENTS.
- 2014 NATIONAL ELECTRICAL CODE WITH AMENDMENTS
- TIA-EIA-222-G

BASED ON INFORMATION PROVIDED BY SPRINT, THIS TELECOMMUNICATIONS EQUIPMENT DEPLOYMENT IS CONSIDERED AN ELIGIBLE FACILITY UNDER THE TAX RELIEF ACT OF 2012, 47 USC 1455(A), AND IS SUBJECT TO AN EXPEDITED ELIGIBLE FACILITIES REQUEST/REVIEW AND ZONING PRE-EMPTION FOR LOCAL DISCRETIONARY PERMITS (VARIANCE, SPECIAL PERMIT, SITE PLAN REVIEW).

**APPROVALS**

TITLE	SIGNATURE	DATE
PROJECT MANAGER:		
CONSTRUCTION:		
RF ENGINEER:		
ZONING/SITE ACQ:		
OPERATIONS:		
TOWER OWNER:		

THE FOLLOWING PARTIES HEREBY APPROVE AND ACCEPT THESE DOCUMENTS AND AUTHORIZE THE CONTRACTOR TO PROCEED WITH THE CONSTRUCTION DESCRIBED HEREIN. ALL DOCUMENTS ARE SUBJECT TO REVIEW BY THE LOCAL BUILDING DEPARTMENT AND MAY IMPOSE CHANGES OR MODIFICATIONS.

THE INFORMATION CONTAINED IN THIS SET OF CONSTRUCTION DOCUMENTS IS PROPRIETARY BY NATURE. ANY USE OR DISCLOSURE OTHER THAN THAT WHICH RELATES TO CARRIER SERVICES IS STRICTLY PROHIBITED.



**THESE OUTLINE SPECIFICATIONS IN CONJUNCTION WITH THE SPRINT STANDARD CONSTRUCTION SPECIFICATIONS, INCLUDING CONTRACT DOCUMENTS AND THE CONSTRUCTION DRAWINGS DESCRIBE THE WORK TO BE PERFORMED BY THE CONTRACTOR.**

**SECTION 01 100 - SCOPE OF WORK**

**PART 1 - GENERAL**

1.1 **THE WORK:** THESE STANDARD CONSTRUCTION SPECIFICATIONS IN CONJUNCTION WITH THE SPRINT CONSTRUCTION STANDARDS FOR WIRELESS SITES, CONTRACT DOCUMENTS AND THE CONSTRUCTION DRAWINGS DESCRIBE THE WORK TO BE PERFORMED BY THE CONTRACTOR.

1.2 **RELATED DOCUMENTS:**

A. THE REQUIREMENTS OF THIS SECTION APPLY TO ALL SECTIONS IN THIS SPECIFICATION.  
B. SPRINT "STANDARD CONSTRUCTION DETAILS FOR WIRELESS SITES" ARE INCLUDED IN AND MADE A PART OF THESE SPECIFICATIONS HERewith.

1.3 **PRECEDENCE:** SHOULD CONFLICTS OCCUR BETWEEN THE STANDARD CONSTRUCTION SPECIFICATIONS FOR WIRELESS SITES INCLUDING THE STANDARD CONSTRUCTION DETAILS FOR WIRELESS SITES AND THE CONSTRUCTION DRAWINGS, INFORMATION ON THE CONSTRUCTION DRAWINGS SHALL TAKE PRECEDENCE. NOTIFY SPRINT CONSTRUCTION MANAGER IF THIS OCCURS.

1.4 **NATIONALLY RECOGNIZED CODES AND STANDARDS:**

A. THE WORK SHALL COMPLY WITH APPLICABLE NATIONAL AND LOCAL CODES AND STANDARDS, LATEST EDITION, AND PORTIONS THEREOF, INCLUDED BUT NOT LIMITED TO THE FOLLOWING:

1. GR-78-CORE GENERIC REQUIREMENTS FOR THE PHYSICAL DESIGN AND MANUFACTURE OF TELECOMMUNICATIONS EQUIPMENT.
2. GR-1089 CORE, ELECTROMAGNETIC COMPATIBILITY AND ELECTRICAL SAFETY -GENERIC CRITERIA FOR NETWORK TELECOMMUNICATIONS EQUIPMENT.
3. NATIONAL FIRE PROTECTION ASSOCIATION CODES AND STANDARDS (NFPA) INCLUDING NFPA 70 (NATIONAL ELECTRICAL CODE - "NEC") AND NFPA 101 (LIFE SAFETY CODE).
4. AMERICAN SOCIETY FOR TESTING OF MATERIALS (ASTM)
5. INSTITUTE OF ELECTRONIC AND ELECTRICAL ENGINEERS (IEEE)
6. AMERICAN CONCRETE INSTITUTE (ACI)
7. AMERICAN WIRE PRODUCERS ASSOCIATION (AWPA)
8. CONCRETE REINFORCING STEEL INSTITUTE (CRSI)
9. AMERICAN ASSOCIATION OF STATE HIGHWAY AND TRANSPORTATION OFFICIALS (AASHTO)
10. PORTLAND CEMENT ASSOCIATION (PCA)
11. NATIONAL CONCRETE MASONRY ASSOCIATION (NCMA)
12. BRICK INDUSTRY ASSOCIATION (BIA)
13. AMERICAN WELDING SOCIETY (AWS)
14. NATIONAL ROOFING CONTRACTORS ASSOCIATION (NRCA)
15. SHEET METAL AND AIR CONDITIONING CONTRACTORS' NATIONAL ASSOCIATION (SMACNA)
16. DOOR AND HARDWARE INSTITUTE (DHI)
17. OCCUPATIONAL SAFETY AND HEALTH ACT (OSHA)
18. APPLICABLE BUILDING CODES INCLUDING UNIFORM BUILDING CODE, SOUTHERN BUILDING CODE, BOCA, AND THE INTERNATIONAL BUILDING CODE.

1.5 **DEFINITIONS:**

- A. WORK: THE SUM OF TASKS AND RESPONSIBILITIES IDENTIFIED IN THE CONTRACT DOCUMENTS.
- B. COMPANY: SPRINT CORPORATION
- C. ENGINEER: SYNONYMOUS WITH ARCHITECT & ENGINEER AND "A&E": THE DESIGN PROFESSIONAL HAVING PROFESSIONAL RESPONSIBILITY FOR DESIGN OF THE PROJECT.
- D. CONTRACTOR: CONSTRUCTION CONTRACTOR; CONSTRUCTION VENDOR; INDIVIDUAL OR ENTITY WHO AFTER EXECUTION OF A CONTRACT IS BOUND TO ACCOMPLISH THE WORK.
- E. THIRD PARTY VENDOR OR AGENCY: A VENDOR OR AGENCY ENGAGED SEPARATELY BY THE COMPANY, A&E, OR CONTRACTOR TO PROVIDE MATERIALS OR TO ACCOMPLISH SPECIFIC TASKS RELATED TO BUT NOT INCLUDED IN THE WORK.
- F. OFCI: OWNER FURNISHED, CONTRACTOR INSTALLED EQUIPMENT.
- G. CONSTRUCTION MANAGER - ALL PROJECTS RELATED COMMUNICATION TO FLOW THROUGH SPRINT REPRESENTATIVE IN CHARGE OF PROJECT...

1.6 **SITE FAMILIARITY:** CONTRACTOR SHALL BE RESPONSIBLE FOR FAMILIARIZING HIMSELF WITH ALL CONTRACT DOCUMENTS, FIELD CONDITIONS AND DIMENSIONS PRIOR TO PROCEEDING WITH CONSTRUCTION. ANY DISCREPANCIES SHALL BE BROUGHT TO THE ATTENTION OF THE SPRINT CONSTRUCTION MANAGER PRIOR TO THE COMMENCEMENT OF WORK. NO COMPENSATION WILL BE AWARDED BASED ON CLAIM OF LACK OF KNOWLEDGE OR FIELD CONDITIONS.

1.7 **POINT OF CONTACT:** COMMUNICATION BETWEEN SPRINT AND THE CONTRACTOR SHALL FLOW THROUGH THE SINGLE SPRINT CONSTRUCTION MANAGER APPOINTED TO MANAGE THE PROJECT FOR SPRINT.

1.8 **ON-SITE SUPERVISION:** THE CONTRACTOR SHALL SUPERVISE AND DIRECT THE WORK AND SHALL BE RESPONSIBLE FOR CONSTRUCTION MEANS, METHODS, TECHNIQUES, SEQUENCES, AND PROCEDURES IN ACCORDANCE WITH THE CONTRACT DOCUMENTS. THE CONTRACTOR SHALL EMPLOY A COMPETENT SUPERINTENDENT WHO SHALL BE IN ATTENDANCE AT THE SITE AT ALL TIMES DURING PERFORMANCE OF THE WORK.

1.9 **DRAWINGS, SPECIFICATIONS AND DETAILS REQUIRED AT JOBSITE:** THE CONSTRUCTION CONTRACTOR SHALL MAINTAIN A FULL SET OF THE CONSTRUCTION DRAWINGS, STANDARD CONSTRUCTION DETAILS FOR WIRELESS SITES AND THE STANDARD CONSTRUCTION SPECIFICATIONS FOR WIRELESS SITES AT THE JOBSITE FROM MOBILIZATION THROUGH CONSTRUCTION COMPLETION.

- A. THE JOBSITE DRAWINGS, SPECIFICATIONS AND DETAILS SHALL BE CLEARLY MARKED DAILY IN RED PENCIL WITH ANY CHANGES IN CONSTRUCTION OVER WHAT IS DEPICTED IN THE DOCUMENTS. AT CONSTRUCTION COMPLETION, THIS JOBSITE MARKUP SET SHALL BE DELIVERED TO THE COMPANY OR COMPANY'S DESIGNATED REPRESENTATIVE TO BE FORWARDED TO THE COMPANY'S A&E VENDOR FOR PRODUCTION OF "AS-BUILT" DRAWINGS.
- B. DETAILS ARE INTENDED TO SHOW DESIGN INTENT. MODIFICATIONS MAY BE REQUIRED TO SUIT JOB DIMENSIONS OR CONDITIONS, AND SUCH MODIFICATIONS SHALL BE INCLUDED AS PART OF THE WORK. CONTRACTOR SHALL NOTIFY SPRINT CONSTRUCTION MANAGER OF ANY VARIATIONS PRIOR TO PROCEEDING WITH THE WORK.
- C. DIMENSIONS SHOWN ARE TO FINISH SURFACES UNLESS NOTED OTHERWISE. SPACING BETWEEN EQUIPMENT IS THE REQUIRED CLEARANCE. SHOULD THERE BE ANY QUESTIONS REGARDING THE CONTRACT DOCUMENTS, EXISTING CONDITIONS AND/OR DESIGN INTENT, THE CONTRACTOR SHALL BE RESPONSIBLE FOR OBTAINING A CLARIFICATION FROM THE SPRINT CONSTRUCTION MANAGER PRIOR TO PROCEEDING WITH THE WORK.

1.10 **USE OF JOB SITE:** THE CONTRACTOR SHALL CONFINE ALL CONSTRUCTION AND RELATED OPERATIONS INCLUDING STAGING AND STORAGE OF MATERIALS AND EQUIPMENT, PARKING, TEMPORARY FACILITIES, AND WASTE STORAGE TO THE LEASE PARCEL UNLESS OTHERWISE PERMITTED BY THE CONTRACT DOCUMENTS.

1.11 **UTILITIES SERVICES:** WHERE NECESSARY TO CUT EXISTING PIPES, ELECTRICAL WIRES, CONDUITS, CABLES, ETC., OF UTILITY SERVICES, OR OF FIRE PROTECTION OR COMMUNICATIONS SYSTEMS, THEY SHALL BE CUT AND CAPPED AT SUITABLE PLACES OR WHERE SHOWN. ALL SUCH ACTIONS SHALL BE COORDINATED WITH THE UTILITY COMPANY INVOLVED:

1.12 **PERMITS / FEES:** WHEN REQUIRED THAT A PERMIT OR CONNECTION FEE BE PAID TO A PUBLIC UTILITY PROVIDER FOR NEW SERVICE TO THE CONSTRUCTION PROJECT, PAYMENT OF SUCH FEE SHALL BE THE RESPONSIBILITY OF THE CONTRACTOR.

1.13 **CONTRACTOR SHALL TAKE ALL MEASURES AND PROVIDE ALL MATERIAL NECESSARY FOR PROTECTING EXISTING EQUIPMENT AND PROPERTY.**

1.14 **METHODS OF PROCEDURE (MOPS) FOR CONSTRUCTION:** CONTRACTOR SHALL PERFORM WORK AS DESCRIBED IN THE FOLLOWING INSTALLATION AND COMMISSIONING MOPS.

- A. TOP HAT
- B. HOW TO INSTALL A NEW CABINET
- C. BASE BAND UNIT IN EXISTING UNIT
- D. INSTALLATION OF BATTERIES
- E. INSTALLATION OF HYBRID CABLE
- F. INSTALLATION OF RRH'S
- G. CABLING
- H. TS-0200 REV 4 - ANTENNA LINE ACCEPTANCE STANDARDS
- I. SPRINT CELL SITE ENGINEERING NOTICE - EN 2012-001, REV 1.
- J. COMMISSIONING MOPS
- K. SPRINT CELL SITE ENGINEERING NOTICE - EN-2013-002
- L. SPRINT ENGINEERING LETTER - EL-0504
- M. SPRINT ENGINEERING LETTER - EL-0568
- N. SPRINT TECHNICAL SPECIFICATION - TS-0193

1.15 **USE OF ELECTRONIC PROJECT MANAGEMENT SYSTEMS:**

A. CONTRACTOR WILL UTILIZE ITS BEST EFFORTS TO WORK WITH SPRINT ELECTRONIC PROJECT MANAGEMENT SYSTEMS. CONTRACTOR UNDERSTANDS THAT SUFFICIENT INTERNET ACCESS, EQUIVALENT TO "BROADBAND" OR BETTER, IS REQUIRED TO TIMELY AND EFFECTIVELY UTILIZE SPRINT DATA AND DOCUMENT MANAGEMENT SYSTEMS AND AGREES TO MAINTAIN APPROPRIATE CONNECTIONS FOR CONTRACTOR'S STAFF AND OFFICES THAT ARE COMPATIBLE WITH SPRINT DATA AND DOCUMENT MANAGEMENT SYSTEMS

**PART 2 - PRODUCTS (NOT USED)**

**PART 3 - EXECUTION**

3.1 **TEMPORARY UTILITIES AND FACILITIES:** THE CONTRACTOR SHALL BE RESPONSIBLE FOR ALL TEMPORARY UTILITIES AND FACILITIES NECESSARY EXCEPT AS OTHERWISE INDICATED IN THE CONSTRUCTION DOCUMENTS. TEMPORARY UTILITIES AND FACILITIES INCLUDE POTABLE WATER, HEAT, HVAC, ELECTRICITY, SANITARY FACILITIES, WASTE DISPOSAL FACILITIES, AND TELEPHONE/COMMUNICATION SERVICES. PROVIDE TEMPORARY UTILITIES AND FACILITIES IN ACCORDANCE WITH OSHA AND THE AUTHORITY HAVING JURISDICTION. CONTRACTOR MAY UTILIZE THE COMPANY ELECTRICAL SERVICE IN THE COMPLETION OF THE WORK WHEN IT BECOMES AVAILABLE. USE OF THE LESSORS OR SITE OWNER'S UTILITIES OR FACILITIES IS EXPRESSLY FORBIDDEN EXCEPT AS OTHERWISE ALLOWED IN THE CONTRACT DOCUMENTS.

3.2 **ACCESS TO WORK:** THE CONTRACTOR SHALL PROVIDE ACCESS TO THE JOB SITE FOR AUTHORIZED COMPANY PERSONNEL AND AUTHORIZED REPRESENTATIVES OF THE ARCHITECT/ENGINEER DURING ALL PHASES OF THE WORK.

3.3 **TESTING: REQUIREMENTS FOR TESTING BY THIS CONTRACTOR SHALL BE AS INDICATED HERewith ON THE CONSTRUCTION DRAWINGS, AND IN THE INDIVIDUAL SECTIONS OF THESE SPECIFICATIONS. SHOULD COMPANY CHOOSE TO ENGAGE ANY THIRD-PARTY TO CONDUCT ADDITIONAL TESTING, THE CONTRACTOR SHALL COOPERATE WITH AND PROVIDE A WORK AREA FOR COMPANY'S TEST AGENCY.**

3.4 **DIMENSIONS:** VERIFY DIMENSIONS INDICATED ON DRAWINGS WITH FIELD DIMENSIONS BEFORE FABRICATION OR ORDERING OF MATERIALS. DO NOT SCALE DRAWINGS.

3.5 **EXISTING CONDITIONS:** NOTIFY THE SPRINT CONSTRUCTION MANAGER OF EXISTING CONDITIONS DIFFERING FROM THOSE INDICATED ON THE DRAWINGS. DO NOT REMOVE OR ALTER STRUCTURAL COMPONENTS WITHOUT PRIOR WRITTEN APPROVAL FROM THE ARCHITECT AND ENGINEER.

**SECTION 01 200 - COMPANY FURNISHED MATERIAL AND EQUIPMENT**

**PART 1 - GENERAL**

1.1 **THE WORK:** THESE STANDARD CONSTRUCTION SPECIFICATIONS IN CONJUNCTION WITH THE OTHER CONTRACT DOCUMENTS AND THE CONSTRUCTION DRAWINGS DESCRIBE THE WORK TO BE PERFORMED BY THE CONTRACTOR.

1.2 **RELATED DOCUMENTS:**

A. THE REQUIREMENTS OF THIS SECTION APPLY TO ALL SECTIONS IN THIS SPECIFICATION.  
B. SPRINT "STANDARD CONSTRUCTION DETAILS FOR WIRELESS SITES" ARE INCLUDED IN AND MADE A PART OF THESE SPECIFICATIONS HERewith.

**PART 2 - PRODUCTS (NOT USED)**

**PART 3 - EXECUTION**

3.1 **RECEIPT OF MATERIAL AND EQUIPMENT:**

- A. COMPANY FURNISHED MATERIAL AND EQUIPMENT IS IDENTIFIED ON THE RF DATA SHEET IN THE CONSTRUCTION DOCUMENTS.
- B. THE CONTRACTOR IS RESPONSIBLE FOR SPRINT PROVIDED MATERIAL AND EQUIPMENT AND UPON RECEIPT SHALL:

1. ACCEPT DELIVERIES AS SHIPPED AND TAKE RECEIPT.
2. VERIFY COMPLETENESS AND CONDITION OF ALL DELIVERIES.
3. TAKE RESPONSIBILITY FOR EQUIPMENT AND PROVIDE INSURANCE PROTECTION AS REQUIRED IN AGREEMENT.
4. RECORD ANY DEFECTS OR DAMAGES AND WITHIN TWENTY-FOUR HOURS AFTER RECEIPT, REPORT TO SPRINT OR ITS DESIGNATED PROJECT REPRESENTATIVE OF SUCH.
5. PROVIDE SECURE AND NECESSARY WEATHER PROTECTED WAREHOUSING.
6. COORDINATE SAFE AND SECURE TRANSPORTATION OF MATERIAL AND EQUIPMENT, DELIVERING AND OFF-LOADING FROM CONTRACTOR'S WAREHOUSE TO SITE.

3.2 **DELIVERABLES:**

- A. COMPLETE SHIPPING AND RECEIPT DOCUMENTATION IN ACCORDANCE WITH COMPANY PRACTICE.
- B. IF APPLICABLE, COMPLETE LOST/STOLEN/DAMAGED DOCUMENTATION REPORT AS NECESSARY IN ACCORDANCE WITH COMPANY PRACTICE, AND AS DIRECTED BY COMPANY.
- C. UPLOAD DOCUMENTATION INTO SPRINT SITE MANAGEMENT SYSTEM (SMS) AND/OR PROVIDE HARD COPY DOCUMENTATION AS REQUESTED.

**SECTION 01 300 - CELL SITE CONSTRUCTION**

**PART 1 - GENERAL**

1.1 **THE WORK:** THESE STANDARD CONSTRUCTION SPECIFICATIONS IN CONJUNCTION WITH THE OTHER CONTRACT DOCUMENTS AND THE CONSTRUCTION DRAWINGS DESCRIBE THE WORK TO BE PERFORMED BY THE CONTRACTOR.

1.2 **RELATED DOCUMENTS:**

A. THE REQUIREMENTS OF THIS SECTION APPLY TO ALL SECTIONS IN THIS SPECIFICATION.  
B. SPRINT "STANDARD CONSTRUCTION DETAILS FOR WIRELESS SITES" ARE INCLUDED IN AND MADE A PART OF THESE SPECIFICATIONS HERewith.

1.3 **NOTICE TO PROCEED:**

- A. NO WORK SHALL COMMENCE PRIOR TO COMPANY'S WRITTEN NOTICE TO PROCEED AND THE ISSUANCE OF THE WORK ORDER.
- B. UPON RECEIVING NOTICE TO PROCEED, CONTRACTOR SHALL FULLY PERFORM ALL WORK NECESSARY TO PROVIDE SPRINT WITH AN OPERATIONAL WIRELESS FACILITY.

**PART 2 - PRODUCTS (NOT USED)**

**PART 3 - EXECUTION**

3.1 **FUNCTIONAL REQUIREMENTS:**

- A. THE ACTIVITIES DESCRIBED IN THIS PARAGRAPH REPRESENT MINIMUM ACTIONS AND PROCESSES REQUIRED TO SUCCESSFULLY COMPLETE THE WORK. THE ACTIVITIES DESCRIBED ARE NOT EXHAUSTIVE, AND CONTRACTOR SHALL TAKE ANY AND ALL ACTIONS AS NECESSARY TO SUCCESSFULLY COMPLETE THE CONSTRUCTION OF A FULLY FUNCTIONING WIRELESS FACILITY AT THE SITE IN ACCORDANCE WITH COMPANY PROCESSES.
- B. SUBMIT SPECIFIC DOCUMENTATION AS INDICATED HEREIN, AND OBTAIN REQUIRED APPROVALS WHILE THE WORK IS BEING PERFORMED.
- C. MANAGE AND CONDUCT ALL FIELD CONSTRUCTION SERVICE RELATED ACTIVITIES
- D. PROVIDE CONSTRUCTION ACTIVITIES TO THE EXTENT REQUIRED BY THE CONTRACT DOCUMENTS, INCLUDING BUT NOT LIMITED TO THE FOLLOWING:

1. PERFORM ANY REQUIRED SITE ENVIRONMENTAL MITIGATION.
2. PREPARE GROUND SITES; PROVIDE DE-GRUBBING; AND ROUGH AND FINAL GRADING, AND COMPOUND SURFACE TREATMENTS.
3. MANAGE AND CONDUCT ALL ACTIVITIES FOR INSTALLATION OF UTILITIES INCLUDING ELECTRICAL AND TELCO BACKHAUL.
4. INSTALL UNDERGROUND FACILITIES INCLUDING UNDERGROUND POWER AND COMMUNICATIONS CONDUITS, AND UNDERGROUND GROUNDING SYSTEM.
5. INSTALL ABOVE GROUND GROUNDING SYSTEMS.
6. PROVIDE NEW HVAC INSTALLATIONS AND MODIFICATIONS.
7. INSTALL "H-FRAMES", CABINETS AND SHELTERS AS INDICATED.
8. INSTALL ROADS, ACCESS WAYS, CURBS AND DRAINS AS INDICATED.
9. ACCOMPLISH REQUIRED MODIFICATION OF EXISTING FACILITIES.
10. PROVIDE ANTENNA SUPPORT STRUCTURE FOUNDATIONS.
11. PROVIDE SLABS AND EQUIPMENT PLATFORMS.
12. INSTALL COMPOUND FENCING, SIGHT SHIELDING, LANDSCAPING AND ACCESS BARRIERS.
13. PERFORM INSPECTION AND MATERIAL TESTING AS REQUIRED HEREAFTER.
14. CONDUCT SITE RESISTANCE TO EARTH TESTING AS REQUIRED HEREAFTER
15. INSTALL FIXED GENERATOR SETS AND OTHER STANDBY POWER SOLUTIONS.
16. INSTALL TOWERS, ANTENNA SUPPORT STRUCTURES AND PLATFORMS ON EXISTING TOWERS AS REQUIRED.
17. INSTALL CELL SITE RADIOS, MICROWAVE, GPS, COAXIAL MAINLINE, ANTENNAS, CROSS BAND COUPLERS, TOWER TOP AMPLIFIERS, LOW NOISE AMPLIFIERS AND RELATED EQUIPMENT.
18. PERFORM, DOCUMENT, AND CLOSE OUT ANY CONSTRUCTION CONTROL DOCUMENTS THAT MAY BE REQUIRED BY GOVERNMENT AGENCIES AND LANDLORDS.
19. PERFORM ANTENNA AND COAX SWEEP TESTING AND MAKE ANY AND ALL NECESSARY CORRECTIONS.
20. REMAIN ON SITE MOBILIZED THROUGHOUT HAND-OFF AND INTEGRATION TO ASSIST AS NEEDED UNTIL SITE IS DEEMED SUBSTANTIALLY COMPLETE AND PLACED "ON AIR."

3.2 **GENERAL REQUIREMENTS FOR CIVIL CONSTRUCTION:**

- A. CONTRACTOR SHALL KEEP THE SITE FREE FROM ACCUMULATING WASTE MATERIAL, DEBRIS, AND TRASH. AT THE COMPLETION OF THE WORK, CONTRACTOR SHALL REMOVE FROM THE SITE ALL REMAINING RUBBISH, IMPLEMENTS, TEMPORARY FACILITIES, AND SURPLUS MATERIALS.
- B. EQUIPMENT ROOMS SHALL AT ALL TIMES BE MAINTAINED "BROOM CLEAN" AND CLEAR OF DEBRIS.
- C. CONTRACTOR SHALL TAKE ALL REASONABLE PRECAUTIONS TO DISCOVER AND LOCATE ANY HAZARDOUS CONDITION.
1. IN THE EVENT CONTRACTOR ENCOUNTERS ANY HAZARDOUS CONDITION WHICH HAS NOT BEEN ABATED OR OTHERWISE MITIGATED, CONTRACTOR AND ALL OTHER PERSONS SHALL IMMEDIATELY STOP WORK IN THE AFFECTED AREA AND NOTIFY COMPANY IN WRITING. THE WORK IN THE AFFECTED AREA SHALL NOT BE RESUMED EXCEPT BY WRITTEN NOTIFICATION BY COMPANY.
2. CONTRACTOR AGREES TO USE CARE WHILE ON THE SITE AND SHALL NOT TAKE ANY ACTION THAT WILL OR MAY RESULT IN OR CAUSE THE HAZARDOUS CONDITION TO BE FURTHER RELEASED IN THE ENVIRONMENT, OR TO FURTHER EXPOSE INDIVIDUALS TO THE HAZARD.
- D. CONTRACTOR'S ACTIVITIES SHALL BE RESTRICTED TO THE PROJECT LIMITS. SHOULD AREAS OUTSIDE THE PROJECT LIMITS BE AFFECTED BY CONTRACTOR'S ACTIVITIES, CONTRACTOR SHALL IMMEDIATELY RETURN THEM TO ORIGINAL CONDITION
- E. CONDUCT TESTING AS REQUIRED HEREIN.

3.3 **DELIVERABLES:**

- A. CONTRACTOR SHALL REVIEW, APPROVE, AND SUBMIT TO SPRINT SHOP DRAWINGS, PRODUCT DATA, SAMPLES, AND SIMILAR SUBMITTALS AS REQUIRED HEREAFTER
- B. PROVIDE DOCUMENTATION INCLUDING, BUT NOT LIMITED TO, THE FOLLOWING. DOCUMENTATION SHALL BE FORWARDED IN ORIGINAL FORMAT AND/OR UPLOADED INTO SMS.
  1. ALL CORRESPONDENCE AND PRELIMINARY CONSTRUCTION REPORTS.
  2. PROJECT PROGRESS REPORTS.
  3. CIVIL CONSTRUCTION START DATE (POPULATE FIELD IN SMS AND/OR FORWARD NOTIFICATION).
  4. ELECTRICAL SERVICE COMPLETION DATE (POPULATE FIELD IN SMS AND/OR FORWARD NOTIFICATION).
  5. LINES AND ANTENNA INSTALL DATE (POPULATE FIELD IN SMS AND/OR FORWARD NOTIFICATION).
  6. POWER INSTALL DATE (POPULATE FIELD IN SMS AND/OR FORWARD NOTIFICATION).
  7. TELCO READY DATE (POPULATE FIELD IN SMS AND/OR FORWARD NOTIFICATION).
  8. PPC (OR SHELTER) INSTALL DATE (POPULATE FIELD IN SMS AND/OR FORWARD NOTIFICATION).
  9. TOWER CONSTRUCTION START DATE (POPULATE FIELD IN SMS AND/OR FORWARD NOTIFICATION).
  10. TOWER CONSTRUCTION COMPLETE DATE (POPULATE FIELD IN SMS AND/OR FORWARD NOTIFICATION).
  11. BTS AND RADIO EQUIPMENT DELIVERED AT SITE DATE (POPULATE FIELD IN SMS AND/OR FORWARD NOTIFICATION).
  12. NETWORK OPERATIONS HANDOFF CHECKLIST (HOC WALK) COMPLETE (UPLOAD FORM IN SMS)
  13. CIVIL CONSTRUCTION COMPLETE DATE (POPULATE FIELD IN SMS AND/OR FORWARD NOTIFICATION).
  14. SITE CONSTRUCTION PROGRESS PHOTOS UNLOADED INTO SMS.



1 INTERNATIONAL BLVD., SUITE 800  
MAHWAH, NJ 07485  
TEL: (800) 357-7841



SBA COMMUNICATIONS CORP.  
134 FLANDERS ROAD, SUITE 125  
WESTBROOK, MA 01581 TEL: (508) 251-0720



604 FOX GLEN  
BARRINGTON, IL 60010  
TELEPHONE: 847.277.0070  
FAX : 847.277.0080  
ae@westchesterservices.com



"I HEREBY CERTIFY THAT THESE DRAWINGS WERE PREPARED BY ME OR UNDER MY DIRECT SUPERVISION AND THAT I AM A DULY REGISTERED ARCHITECT UNDER THE LAWS OF THE STATE OF CONNECTICUT"

CHECKED BY: JK

APPROVED BY: JMB

SUBMITTALS			
REV.	DATE	DESCRIPTION	BY
1	03/08/18	ISSUED FOR CONSTRUCTION	SDB
0	01/23/18	ISSUED FOR CONSTRUCTION	SH

SITE NUMBER:  
CT54XC731  
SITE NAME:  
CENTRAL HEBRON  
SITE ADDRESS:  
66 WALL STREET  
HEBRON, CT 06248

SHEET TITLE  
OUTLINE  
SPECIFICATIONS

SHEET NUMBER  
SP-1



CONTINUED FROM SP-1:

SECTION 01 400 - SUBMITTALS, TESTS, AND INSPECTIONS

PART 1 - GENERAL

1.1 THE WORK: THESE STANDARD CONSTRUCTION SPECIFICATIONS IN CONJUNCTION WITH THE OTHER CONTRACT DOCUMENTS AND THE CONSTRUCTION DRAWINGS DESCRIBE THE WORK TO BE PERFORMED BY THE CONTRACTOR.

1.2 RELATED DOCUMENTS:

A. THE REQUIREMENTS OF THIS SECTION APPLY TO ALL SECTIONS IN THIS SPECIFICATION. B. SPRINT "STANDARD CONSTRUCTION DETAILS FOR WIRELESS SITES" ARE INCLUDED IN AND MADE A PART OF THESE SPECIFICATIONS HEREWITH.

1.3 SUBMITTALS:

A. THE WORK IN ALL ASPECTS SHALL COMPLY WITH THE CONSTRUCTION DRAWINGS AND THESE SPECIFICATIONS. B. SUBMIT THE FOLLOWING TO COMPANY REPRESENTATIVE FOR APPROVAL.

- 1. CONCRETE MIX-DESIGNS FOR TOWER FOUNDATIONS, ANCHORS PIERS, AND CONCRETE PAVING.
2. CONCRETE BREAK TESTS AS SPECIFIED HEREIN.
3. SPECIAL FINISHES FOR INTERIOR SPACES, IF ANY.
4. ALL EQUIPMENT AND MATERIALS SO IDENTIFIED ON THE CONSTRUCTION DRAWINGS.
5. CHEMICAL GROUNDING DESIGN.
C. ALTERNATES: AT THE COMPANY'S REQUEST, ANY ALTERNATIVES TO THE MATERIALS OR METHODS SPECIFIED SHALL BE SUBMITTED TO SPRINT'S CONSTRUCTION MANAGER FOR APPROVAL PRIOR TO BEING SHIPPED TO SITE.

1.4 TESTS AND INSPECTIONS:

- A. THE CONTRACTOR SHALL BE RESPONSIBLE FOR ALL CONSTRUCTION TESTS, INSPECTIONS AND PROJECT DOCUMENTATION.
B. CONTRACTOR SHALL ACCOMPLISH TESTING INCLUDING BUT NOT LIMITED TO THE FOLLOWING:
1. COAX SWEEPS AND FIBER TESTS PER SPRINT TS-0200 CURRENT VERSION ANTENNA LINE ACCEPTANCE STANDARDS.
2. AZIMUTH AND DOWNTILT USING ELECTRONIC COMMERCIAL MADE-FOR-THE-PURPOSE ANTENNA ALIGNMENT TOOL.
3. CONTRACTOR SHALL BE RESPONSIBLE FOR ANY AND ALL CORRECTIONS TO ANY WORK IDENTIFIED AS UNACCEPTABLE IN SITE INSPECTION ACTIVITIES AND/OR AS A RESULT OF TESTING.
C. REQUIRED CLOSEOUT DOCUMENTATION INCLUDES, BUT IS NOT LIMITED TO THE FOLLOWING:
1. AZIMUTH, DOWNTILT, AGL - UPLOAD REPORT FROM ANTENNA ALIGNMENT TOOL TO SITERRA TASK 465.
2. SCANABLE BARCODE PHOTOGRAPHS OF TOWER TOP AND INACCESSIBLE SERIALIZED EQUIPMENT
3. ALL AVAILABLE JURISDICTIONAL INFORMATION
4. PDF SCAN OF REDLINES PRODUCED IN FIELD
5. ELECTRONIC AS-BUILT DRAWINGS IN AUTOCAD AND PDF FORMATS.
6. LIEN WAIVERS
7. FINAL PAYMENT APPLICATION
8. REQUIRED FINAL CONSTRUCTION PHOTOS
9. CONSTRUCTION AND COMMISSIONING CHECKLIST COMPLETE WITH NO DEFICIENT ITEMS
10. ALL POST NTP TASKS INCLUDING DOCUMENT UPLOADS COMPLETED IN SITERRA (SPRINTS DOCUMENT REPOSITORY OF RECORD).

1.5 COMMISSIONING: PERFORM ALL COMMISSIONING AS REQUIRED BY APPLICABLE MOPS

1.6 INTEGRATION: PERFORM ALL INTEGRATION ACTIVITIES AS REQUIRED BY APPLICABLE MOPS

PART 2 - PRODUCTS (NOT USED)

PART 3 - EXECUTION

3.1 REQUIREMENTS FOR TESTING:

- A. THIRD PARTY TESTING AGENCY: WHEN THE USE OF A THIRD PARTY INDEPENDENT TESTING AGENCY IS REQUIRED, THE AGENCY THAT IS SELECTED MUST PERFORM SUCH WORK ON A REGULAR BASIS IN THE STATE WHERE THE PROJECT IS LOCATED AND HAVE A THOROUGH UNDERSTANDING OF LOCAL AVAILABLE MATERIALS, INCLUDING THE SOIL, ROCK, AND GROUNDWATER CONDITIONS.
1. THE THIRD PARTY TESTING AGENCY IS TO BE FAMILIAR WITH THE APPLICABLE REQUIREMENTS FOR THE TESTS TO BE DONE, EQUIPMENT TO BE USED, AND ASSOCIATED HEALTH AND SAFETY ISSUES.
2. EXPERIENCE IN SOILS, CONCRETE, MASONRY, AGGREGATE, AND ASPHALT TESTING USING ASTM, AASJTO, AND OTHER METHODS IS NEEDED.
3. EXPERIENCE IN SOILS, CONCRETE, MASONRY, AGGREGATE, AND ASPHALT TESTING USING ASTM, AASJTO, AND OTHER METHODS IS NEEDED.

3.2 REQUIRED TESTS:

- A. CONTRACTOR SHALL ACCOMPLISH TESTING INCLUDING BUT NOT LIMITED TO THE FOLLOWING:
1. CONCRETE CYLINDER BREAK TESTS FOR THE TOWER AND ANCHOR FOUNDATIONS AS SPECIFIED IN SECTION: PORTLAND CEMENT CONCRETE PAVING.
2. ASPHALT ROADWAY COMPACTED THICKNESS, SURFACE SMOOTHNESS, AND COMPACTED DENSITY TESTING AS SPECIFIED IN SECTION: HOT MIX ASPHALT PAVING.
3. FIELD QUALITY CONTROL TESTING AS SPECIFIED IN SECTION: PORTLAND CEMENT CONCRETE PAVING.
4. TESTING REQUIRED UNDER SECTION: AGGREGATE BASE FOR ACCESS ROADS, PADS AND ANCHOR LOCATIONS
5. STRUCTURAL BACKFILL COMPACTION TESTS FOR THE TOWER FOUNDATION.
6. SITE RESISTANCE TO EARTH TESTING PER EXHIBIT: CELL SITE GROUNDING SYSTEM DESIGN.
7. ANTENNA AND COAX SWEEP TESTS PER EXHIBIT: ANTENNA TRANSMISSION LINE ACCEPTANCE STANDARDS.
8. GROUNDING AT ANTENNA MASTS FOR GPS AND ANTENNAS
9. ALL OTHER TESTS REQUIRED BY COMPANY OR JURISDICTION.

3.3 REQUIRED INSPECTIONS:

- A. SCHEDULE INSPECTIONS WITH COMPANY REPRESENTATIVE.
B. CONDUCT INSPECTIONS INCLUDING BUT NOT LIMITED TO THE FOLLOWING:
1. GROUNDING SYSTEM INSTALLATION PRIOR TO EARTH CONCEALMENT DOCUMENTED WITH DIGITAL PHOTOGRAPHS BY CONTRACTOR, APPROVED BY A&E OR SPRINT REPRESENTATIVE.
2. FORMING FOR CONCRETE AND REBAR PLACEMENT PRIOR TO POUR DOCUMENTED WITH DIGITAL PHOTOGRAPHS BY CONTRACTOR, APPROVED BY A&E OR SPRINT REPRESENTATIVE.
3. COMPACTION OF BACKFILL MATERIALS; AGGREGATE BASE FOR ROADS, PADS, AND ANCHORS; ASPHALT PAVING; AND SHAFT BACKFILL FOR CONCRETE AND WOOD POLES, BY INDEPENDENT THIRD PARTY AGENCY.
4. PRE- AND POST-CONSTRUCTION ROOFTOP AND STRUCTURAL INSPECTIONS ON EXISTING FACILITIES.
5. TOWER ERECTION SECTION STACKING AND PLATFORM ATTACHMENT DOCUMENTED BY DIGITAL PHOTOGRAPHS BY THIRD PARTY AGENCY.
6. ANTENNA AZIMUTH, DOWN TILT AND PER SUNLIGHT TOOL SUNSIGHT INSTRUMENTS - ANTENNALIGN ALIGNMENT TOOL (AAT)
7. VERIFICATION DOCUMENTED WITH THE ANTENNA CHECKLIST REPORT, BY A&E, SITE DEVELOPMENT REP, OR RF REP.
8. FINAL INSPECTION CHECKLIST AND HANDOFF WALK (HOC). SIGNED FORM SHOWING ACCEPTANCE BY FIELD OPS IS TO BE UPLOADED INTO SMS.
9. COAX SWEEP AND FIBER TESTING DOCUMENTS SUBMITTED VIA SMS FOR RF APPROVAL.
10. SCAN-ABLE BARCODE PHOTOGRAPHS OF TOWER TOP AND INACCESSIBLE SERIALIZED EQUIPMENT
11. ALL AVAILABLE JURISDICTIONAL INFORMATION
12. PDF SCAN OF REDLINES PRODUCED IN FIELD
E. THE CONTRACTOR SHALL BE RESPONSIBLE FOR ANY AND ALL CORRECTIONS TO ANY WORK IDENTIFIED AS UNACCEPTABLE IN SITE INSPECTION ACTIVITIES AND/OR AS A RESULT OF TESTING.
F. CONSTRUCTION INSPECTIONS AND CORRECTIVE MEASURES SHALL BE DOCUMENTED BY THE CONTRACTOR WITH WRITTEN REPORTS AND PHOTOGRAPHS. PHOTOGRAPHS MUST BE DIGITAL AND OF SUFFICIENT QUALITY TO CLEARLY SHOW THE SITE CONSTRUCTION. PHOTOGRAPHS MUST CLEARLY IDENTIFY THE PHOTOGRAPHED ITEM AND BE LABELED WITH THE SITE CASCADE NUMBER, SITE NAME, DESCRIPTION, AND DATE.

3.4 DELIVERABLES: TEST AND INSPECTION REPORTS AND CLOSEOUT DOCUMENTATION SHALL BE UPLOADED TO THE SMS AND/OR FORWARDED TO SPRINT FOR INCLUSION INTO THE PERMANENT SITE FILES.

A. THE FOLLOWING TEST AND INSPECTION REPORTS SHALL BE PROVIDED AS APPLICABLE.

- 1. CONCRETE MIX AND CYLINDER BREAK REPORTS.
2. STRUCTURAL BACKFILL COMPACTION REPORTS.
3. SITE RESISTANCE TO EARTH TEST.
4. ANTENNA AZIMUTH AND DOWN TILT VERIFICATION
5. TOWER ERECTION INSPECTIONS AND MEASUREMENTS DOCUMENTING TOWER INSTALLED PER SUPPLIER'S REQUIREMENTS AND THE APPLICABLE SECTIONS HEREIN.
6. COAX CABLE SWEEP TESTS PER COMPANY'S "ANTENNA LINE ACCEPTANCE STANDARDS".
B. REQUIRED CLOSEOUT DOCUMENTATION INCLUDES THE FOLLOWING:
1. TEST WELLS AND TRENCHES: PHOTOGRAPHS OF ALL TEST WELLS; PHOTOGRAPHS SHOWING ALL OPEN EXCAVATIONS AND TRENCHING PRIOR TO BACKFILLING SHOWING A TAPE MEASURE VISIBLE IN THE EXCAVATIONS INDICATING DEPTH.
2. CONDUITS, CONDUCTORS AND GROUNDING: PHOTOGRAPHS SHOWING TYPICAL INSTALLATION OF CONDUCTORS AND CONNECTORS; PHOTOGRAPHS SHOWING TYPICAL BEND RADIUS OF INSTALLED GROUND WIRES AND GROUND ROD SPACING;
3. CONCRETE FORMS AND REINFORCING: CONCRETE FORMING AT TOWER AND EQUIPMENT/SHELTER PAD/FOUNDATIONS - PHOTOGRAPHS SHOWING ALL REINFORCING STEEL, UTILITY AND CONDUIT STUB OUTS; PHOTOGRAPHS SHOWING CONCRETE POUR OF SHELTER SLAB/FOUNDATION, TOWER FOUNDATION AND GUY ANCHORS WITH VIBRATOR IN USE; PHOTOGRAPHS SHOWING EACH ANCHOR ON GUYED TOWERS BEFORE CONCRETE POUR.
4. TOWER ANTENNAS AND MAINLINE: INSPECTION AND PHOTOGRAPHS OF SECTION STACKING; INSPECTION AND PHOTOGRAPHS OF PLATFORM COMPONENT ATTACHMENT POINTS; PHOTOGRAPHS OF TOWER TOP GROUNDING; PHOTOS OF TOWER COAX LINE COLOR CODING AT THE TOP AND AT GROUND LEVEL; INSPECTION AND PHOTOGRAPHS OF OPERATIONAL OF TOWER LIGHTING, AND PLACEMENT OF FAA REGISTRATION SIGN; PHOTOGRAPHS SHOWING ADDITIONAL GROUNDING POINTS FOR TOWERS GREATER THAN 200 FEET.; PHOTOS OF ANTENNA GROUND BAR, EQUIPMENT GROUND BAR, AND MASTER GROUND BAR; PHOTOS OF GPS ANTENNA(S); PHOTOS OF EACH SECTOR OF ANTENNAS; ONE PHOTOGRAPH LOOKING AT THE SECTOR AND ONE FROM BEHIND SHOWING THE PROJECTED COVERAGE AREA; PHOTOS OF COAX WEATHERPROOFING - TOP AND BOTTOM; PHOTOS OF COAX GROUNDING--TOP AND BOTTOM; PHOTOS OF ANTENNA AND MAST GROUNDING; PHOTOS OF COAX CABLE ENTRY INTO SHELTER; PHOTOS OF PLATFORM MECHANICAL CONNECTIONS TO TOWER/MONOPOLE.
5. ROOF TOPS: PRE-CONSTRUCTION AND POST-CONSTRUCTION VISUAL INSPECTION AND PHOTOGRAPHS OF THE ROOF AND INTERIOR TO DETERMINE AND DOCUMENT CONDITIONS; ROOF TOP CONSTRUCTION INSPECTIONS AS REQUIRED BY THE JURISDICTION; PHOTOGRAPHS OF CABLE TRAY AND/OR ICE BRIDGE; PHOTOGRAPHS OF DOGHOUSE/CABLE EXIT FROM ROOF;
6. SITE LAYOUT - PHOTOGRAPHS OF THE OVERALL COMPOUND, INCLUDING EQUIPMENT PLATFORM FROM ALL FOUR CORNERS.
7. FINISHED UTILITIES: CLOSE-UP PHOTOGRAPHS OF THE PPC BREAKER PANEL; CLOSE-UP PHOTOGRAPH OF THE INSIDE OF THE TELCO PANEL AND NIU; CLOSE-UP PHOTOGRAPH OF THE POWER METER AND DISCONNECT; PHOTOS OF POWER AND TELCO ENTRANCE TO COMPANY ENCLOSURE; PHOTOGRAPHS AT METER BOX AND/OR FACILITY DISTRIBUTION PANEL.
8. REQUIRED MATERIALS CERTIFICATIONS: CONCRETE MIX DESIGNS; MILL CERTIFICATION FOR ALL REINFORCING AND STRUCTURAL STEEL; AND ASPHALT PAVING MIX DESIGN.
9. ANY AND ALL SUBMITTALS BY THE JURISDICTION OR COMPANY.

SECTION 01 500 - PROJECT REPORTING

PART 1 - GENERAL

1.1 THE WORK: THESE STANDARD CONSTRUCTION SPECIFICATIONS IN CONJUNCTION WITH THE OTHER CONTRACT DOCUMENTS AND THE CONSTRUCTION DRAWINGS DESCRIBE THE WORK TO BE PERFORMED BY THE CONTRACTOR.

1.2 RELATED DOCUMENTS:

A. THE REQUIREMENTS OF THIS SECTION APPLY TO ALL SECTIONS IN THIS SPECIFICATION. B. SPRINT "STANDARD CONSTRUCTION DETAILS FOR WIRELESS SITES" ARE INCLUDED IN AND MADE A PART OF THESE SPECIFICATIONS HEREWITH.

PART 2 - PRODUCTS (NOT USED)

PART 3 - EXECUTION

3.1 WEEKLY REPORTS:

A. CONTRACTOR SHALL PROVIDE SPRINT WITH WEEKLY REPORTS SHOWING PROJECT STATUS. THIS STATUS REPORT FORMAT WILL BE PROVIDED TO THE CONTRACTOR BY SPRINT. THE REPORT WILL CONTAIN SITE ID NUMBER, THE MILESTONES FOR EACH SITE, INCLUDING THE BASELINE DATE, ESTIMATED COMPLETION DATE AND ACTUAL COMPLETION DATE.

B. REPORT INFORMATION WILL BE TRANSMITTED TO SPRINT VIA ELECTRONIC MEANS AS REQUIRED. THIS INFORMATION WILL PROVIDE A BASIS FOR PROGRESS MONITORING AND PAYMENT.

3.2 PROJECT CONFERENCE CALLS:

A. SPRINT MAY HOLD WEEKLY PROJECT CONFERENCE CALLS. CONTRACTOR WILL BE REQUIRED TO COMMUNICATE SITE STATUS, MILESTONE COMPLETIONS AND UPCOMING MILESTONE PROJECTIONS, AND ANSWER ANY OTHER SITE STATUS QUESTIONS AS NECESSARY.

3.3 PROJECT TRACKING IN SMS:

A. CONTRACTOR SHALL PROVIDE SCHEDULE UPDATES AND PROJECTIONS IN THE SMS SYSTEM ON A WEEKLY BASIS.

3.4 ADDITIONAL REPORTING:

A. ADDITIONAL OR ALTERNATE REPORTING REQUIREMENTS MAY BE ADDED TO THE REPORT AS DETERMINED TO BE REASONABLY NECESSARY BY COMPANY.

3.5 PROJECT PHOTOGRAPHS:

- A. FILE DIGITAL PHOTOGRAPHS OF COMPLETED SITE IN JPEG FORMAT IN THE SMS PHOTO LIBRARY FOR THE RESPECTIVE SITE. PHOTOGRAPHS SHALL BE CLEARLY LABELED WITH SITE NUMBER, NAME AND DESCRIPTION, AND SHALL INCLUDE AT A MINIMUM THE FOLLOWING AS APPLICABLE:
1. SHELTER AND TOWER OVERVIEW.
2. TOWER FOUNDATION(S) - FORMS AND STEEL BEFORE POUR (EACH ANCHOR ON GUYED TOWERS).
3. TOWER FOUNDATION(S) POUR WITH VIBRATOR IN USE (EACH ANCHOR ON GUYED TOWERS).
4. TOWER STEEL AS BEING INSTALLED INTO HOLE (SHOW ANCHOR STEEL ON GUYED TOWERS).
5. PHOTOS OF TOWER SECTION STACKING.
6. CONCRETE TESTING / SAMPLES.
7. PLACING OF ANCHOR BOLTS IN TOWER FOUNDATION.
8. BUILDING/WATER TANK FROM ROAD FOR TENANT IMPROVEMENTS OR COMMENTS.
9. SHELTER FOUNDATION--FORMS AND STEEL BEFORE POURING.
10. SHELTER FOUNDATION POUR WITH VIBRATOR IN USE.
11. COAX CABLE ENTRY INTO SHELTER.
12. PLATFORM MECHANICAL CONNECTIONS TO TOWER/MONOPOLE.
13. ROOFTOP PRE AND POST CONSTRUCTION PHOTOS TO INCLUDE PENETRATIONS AND INTERIOR CEILING.
14. PHOTOS OF TOWER TOP COAX LINE COLOR CODING AND COLOR CODING AT GROUND LEVEL.
15. PHOTOS OF ALL APPROPRIATE COMPANY OR REGULATORY SIGNAGE.
16. PHOTOS OF EQUIPMENT BOLT DOWN INSIDE SHELTER.
17. POWER AND TELCO ENTRANCE TO COMPANY ENCLOSURE AND POWER AND TELCO SUPPLY LOCATIONS INCLUDING METER/DISCONNECT.
18. ELECTRICAL TRENCH(S) WITH ELECTRICAL / CONDUIT BEFORE BACKFILL.
19. ELECTRICAL TRENCH(S) WITH FOIL-BACKED TAPE BEFORE FURTHER BACKFILL.
20. TELCO TRENCH WITH TELEPHONE / CONDUIT BEFORE BACKFILL.
21. TELCO TRENCH WITH FOIL-BACKED TAPE BEFORE FURTHER BACKFILL.
22. SHELTER GROUND-RING TRENCH WITH GROUND-WIRE BEFORE BACKFILL (SHOW ALL CAD WELDS AND BEND RADI).
23. TOWER GROUND-RING TRENCH WITH GROUND-WIRE BEFORE BACKFILL (SHOW ALL CAD WELDS AND BEND RADI).
24. FENCE GROUND-RING TRENCH WITH GROUND-WIRE BEFORE BACKFILL (SHOW ALL CAD WELDS AND BEND RADI).
25. ALL BTS GROUND CONNECTIONS.
26. ALL GROUND TEST WELLS.
27. ANTENNA GROUND BAR AND EQUIPMENT GROUND BAR.
28. ADDITIONAL GROUNDING POINTS ON TOWERS ABOVE 200'.
29. HVAC UNITS INCLUDING CONDENSERS ON SPLIT SYSTEMS.
30. GPS ANTENNAS.
31. CABLE TRAY AND/OR WAVEGUIDE BRIDGE.
32. DOGHOUSE/CABLE EXIT FROM ROOF.
33. EACH SECTOR OF ANTENNAS; ONE PHOTOGRAPH LOOKING AT THE SECTOR AND ONE FROM BEHIND SHOWING THE PROJECTED COVERAGE AREA.
34. MASTER BUS BAR.
35. TELCO BOARD AND NIU.
36. ELECTRICAL DISTRIBUTION WALL.
37. CABLE ENTRY WITH SURGE SUPPRESSION.
38. ENTRANCE TO EQUIPMENT ROOM.
39. COAX WEATHERPROOFING--TOP AND BOTTOM OF TOWER.
40. COAX GROUNDING --TOP AND BOTTOM OF TOWER.
41. ANTENNA AND MAST GROUNDING.
42. LANDSCAPING - WHERE APPLICABLE.
3.6 FINAL PROJECT ACCEPTANCE: COMPLETE ALL REQUIRED REPORTING TASKS PER CONTRACT, CONTRACT DOCUMENTS OR THE SPRINT INTEGRATED CONSTRUCTION STANDARDS FOR WIRELESS SITES AND UPLOAD INTO SITERRA.

SECTION 07 500 - ROOF CUTTING, PATCHING AND REPAIR

SUMMARY:

THIS SECTION SPECIFIES CUTTING AND PATCHING EXISTING ROOFING SYSTEMS WHERE CONDUIT OR CABLES EXIT THE BUILDING ONTO THE ROOF OR BUILDING-MOUNTED ANTENNAS, AND AS REQUIRED FOR WATERTIGHT PERFORMANCE. ROOFTOP ENTRY OPENINGS IN MEMBRANE ROOFTOPS SHALL BE CONSTRUCTED TO COMPLY WITH LANDLORD, ANY EXISTING WARRANTY, AND LOCAL JURISDICTIONAL STANDARDS.

1.4 SUBMITTALS:

- A. PRE-CONSTRUCTION ROOF PHOTOS: COMPLETE A ROOF INSPECTION PRIOR TO THE INSTALLATION OF SPRINT EQUIPMENT ON ANY ROOFTOP BUILD. AT A MINIMUM INSPECT AND PHOTOGRAPH (MINIMUM 3 EA.) ALL AREAS IMPACTED BY THE ADDITION OF THE SPRINT EQUIPMENT.
B. PROVIDE SIMILAR PHOTOGRAPHS SHOWING ROOF CONDITIONS AFTER CONSTRUCTION (MINIMUM 3 EA.)
C. ROOF INSPECTION PHOTOGRAPHS SHOULD BE UPLOADED WITH CLOSEOUT PHOTOGRAPHS.

SECTION 09 900 - PAINTING

QUALITY ASSURANCE:

- A. COMPLY WITH GOVERNING CODES AND REGULATIONS. PROVIDE PRODUCTS OF ACCEPTABLE MANUFACTURERS WHICH HAVE BEEN IN SATISFACTORY USE IN SIMILAR SERVICE FOR THREE YEARS. USE EXPERIENCED INSTALLERS. DELIVER, HANDLE, AND STORE MATERIALS IN ACCORDANCE WITH MANUFACTURER'S INSTRUCTIONS.
B. COMPLY WITH ALL ENVIRONMENTAL REGULATIONS FOR VOLATILE ORGANIC COMPOUNDS.

CONTINUE SHEET SP-3



1 INTERNATIONAL BLVD., SUITE 800
MAHWAH, NJ 07495
TEL: (800) 357-7841



SBA COMMUNICATIONS CORP.
134 FLANDERS ROAD, SUITE 125
WESTBOROUGH, MA 01581 TEL: (508) 251-0720



604 FOX GLEN
BARRINGTON, IL 60010
TELEPHONE: 847.277.0070



"I HEREBY CERTIFY THAT THESE PLANS WERE PREPARED BY ME OR UNDER MY DIRECT SUPERVISION AND THAT I AM A DULY REGISTERED ARCHITECT UNDER THE LAWS OF THE STATE OF CONNECTICUT"

CHECKED BY: JK

APPROVED BY: JMB

Table with columns: REV., DATE, DESCRIPTION, BY. Contains two rows of submittal data.

SITE NUMBER: CT54XC731
SITE NAME: CENTRAL HEBRON
SITE ADDRESS: 66 WALL STREET HEBRON, CT 06248

SHEET TITLE: OUTLINE SPECIFICATIONS

SHEET NUMBER: SP-2

THE INFORMATION CONTAINED IN THIS SET OF CONSTRUCTION DOCUMENTS IS PROPRIETARY BY NATURE. ANY USE OR DISCLOSURE OTHER THAN THAT WHICH RELATES TO CARRIER SERVICES IS STRICTLY PROHIBITED.



THE INFORMATION CONTAINED IN THIS SET OF CONSTRUCTION DOCUMENTS IS PROPRIETARY BY NATURE. ANY USE OR DISCLOSURE OTHER THAN THAT WHICH RELATES TO CARRIER SERVICES IS STRICTLY PROHIBITED.

**CONTINUED FROM SP-2:**

**MATERIALS:**

- A. MANUFACTURERS: BENJAMIN MOORE, ICI DEVOE COATINGS, PPG, SHERWIN WILLIAMS OR APPROVED EQUAL. PROVIDE PREMIUM GRADE, PROFESSIONAL-QUALITY PRODUCTS FOR COATING SYSTEMS.

**PAINT SCHEDULE:**

- A. EXTERIOR ANTENNAE AND ANTENNA MOUNTING HARDWARE: ONE COAT OF PRIMER AND TWO FINISH COATS. PAINT FOR ANTENNAE SHALL BE NON-METALLIC BASED AND CONTAIN NO METALLIC PARTICLES. PROVIDE COLORS AND PATTERNS AS REQUIRED TO MASK APPEARANCE OF ANTENNAE ON ADJACENT BUILDING SURFACES AND AS ACCEPTABLE TO THE OWNER. REFER TO ANTENNA MANUFACTURER'S INSTRUCTIONS WHENEVER POSSIBLE.
- B. ROOF TOP CONSTRUCTION: TOUCH UP - PREPARE SURFACES TO BE REPAIRED. FOLLOW INDUSTRY STANDARDS AND REQUIREMENTS OF OWNER TO MATCH EXISTING COATING AND FINISH.

**PAINTING APPLICATION:**

- 1. INSPECT SURFACES, REPORT UNSATISFACTORY CONDITIONS IN WRITING; BEGINNING WORK MEANS ACCEPTANCE OF SUBSTRATE.
- 2. COMPLY WITH MANUFACTURER'S INSTRUCTIONS AND RECOMMENDATIONS FOR PREPARATION, PRIMING AND COATING WORK. COORDINATE WITH WORK OF OTHER SECTIONS.
- 3. MATCH APPROVED MOCK-UPS FOR COLOR, TEXTURE, AND PATTERN. RE-COAT OR REMOVE AND REPLACE WORK WHICH DOES NOT MATCH OR SHOWS LOSS OF ADHESION.
- 4. CLEAN UP, TOUCH UP AND PROTECT WORK.

**TOUCHUP PAINTING:**

- 1. GALVANIZING DAMAGE AND ALL BOLTS AND NUTS SHALL BE TOUCHED UP AFTER TOWER ERECTION WITH "GALVANOX," "DRY GALV," OR "ZINC-IT."
- 2. FIELD TOUCHUP PAINT SHALL BE DONE IN ACCORDANCE WITH THE MANUFACTURER'S WRITTEN INSTRUCTIONS.
- 3. ALL METAL COMPONENTS SHALL BE HANDLED WITH CARE TO PREVENT DAMAGE TO THE COMPONENTS, THEIR PRESERVATIVE TREATMENT, OR THEIR PROTECTIVE COATINGS.

**SECTION 11 700 - ANTENNA ASSEMBLY, REMOTE RADIO HEADS AND CABLE INSTALLATION**

**SUMMARY:**

THIS SECTION SPECIFIES INSTALLATION OF ANTENNAS, RRH'S, AND CABLE EQUIPMENT, INSTALLATION, AND TESTING OF COAXIAL FIBER CABLE.

**ANTENNAS AND RRH'S:**

THE NUMBER AND TYPE OF ANTENNAS AND RRH'S TO BE INSTALLED IS DETAILED ON THE CONSTRUCTION DRAWINGS.

**HYBRID CABLE:**

HYBRID CABLE WILL BE DC/FIBER AND FURNISHED FOR INSTALLATION AT EACH SITE. CABLE SHALL BE INSTALLED PER THE CONSTRUCTION DRAWINGS AND THE APPLICABLE MANUFACTURER'S REQUIREMENTS.

**JUMPERS AND CONNECTORS:**

FURNISH AND INSTALL 1/2" COAX JUMPER CABLES BETWEEN THE RRH'S AND ANTENNAS. JUMPERS SHALL BE TYPE LDF 4, FLC 12-50, CR 540, OR FXL 540. SUPER-FLEX CABLES ARE NOT ACCEPTABLE. JUMPERS BETWEEN THE RRH'S AND ANTENNAS OR TOWER TOP AMPLIFIERS SHALL CONSIST OF 1/2 INCH FOAM DIELECTRIC, OUTDOOR RATED COAXIAL CABLE. DO NOT USE SUPERFLEX OUTDOORS. JUMPERS SHALL BE FACTORY FABRICATED IN APPROPRIATE LENGTHS WITH A MAXIMUM OF 4 FEET EXCESS PER JUMPER AND HAVE CONNECTORS AT EACH END, MANUFACTURED BY SUPPLIER. IF JUMPERS ARE FIELD FABRICATED, FOLLOW MANUFACTURER'S REQUIREMENTS FOR INSTALLATION OF CONNECTORS

**REMOTE ELECTRICAL TILT (RET) CABLES:**

**MISCELLANEOUS:**

INSTALL SPLITTERS, COMBINERS, FILTERS PER RF DATA SHEET, FURNISHED BY SPRINT.

**ANTENNA INSTALLATION:**

THE CONTRACTOR SHALL ASSEMBLE ALL ANTENNAS ONSITE IN ACCORDANCE WITH THE INSTRUCTIONS SUPPLIED BY THE MANUFACTURER. ANTENNA HEIGHT, AZIMUTH, AND FEED ORIENTATION INFORMATION SHALL BE A DESIGNATED ON THE CONSTRUCTION DRAWINGS.

- A. THE CONTRACTOR SHALL POSITION THE ANTENNA ON TOWER PIPE MOUNTS SO THAT THE BOTTOM STRUT IS LEVEL. THE PIPE MOUNTS SHALL BE PLUMB TO WITHIN 1 DEGREE.
- B. ANTENNA MOUNTING REQUIREMENTS: PROVIDE ANTENNA MOUNTING HARDWARE AS INDICATED ON THE DRAWINGS.

**HYBRID CABLES INSTALLATION:**

- A. THE CONTRACTOR SHALL ROUTE, TEST, AND INSTALL ALL CABLES AS INDICATED ON THE CONSTRUCTION DRAWINGS AND IN ACCORDANCE WITH THE MANUFACTURER'S RECOMMENDATIONS.
- B. THE INSTALLED RADIUS OF THE CABLES SHALL NOT BE LESS THAN THE MANUFACTURER'S SPECIFICATIONS FOR BENDING RADII.
- C. EXTREME CARE SHALL BE TAKEN TO AVOID DAMAGE TO THE CABLES DURING HANDLING AND INSTALLATION.
  - 1. FASTENING MAIN HYBRID CABLES: ALL CABLES SHALL BE PERMANENTLY FASTENED TO THE COAX LADDER AT 4'-0" OC USING NON-MAGNETIC STAINLESS STEEL CLIPS.
  - 2. FASTENING INDIVIDUAL FIBER AND DC CABLES ABOVE BREAKOUT ENCLOSURE (MEDUSA), WITHIN THE MMBTS CABINET AND ANY INTERMEDIATE DISTRIBUTION BOXES:
    - a. FIBER: SUPPORT FIBER BUNDLES USING 1/2" VELCRO STRAPS OF THE REQUIRED LENGTH @ 18" OC. STRAPS SHALL BE UV, OIL AND WATER RESISTANT AND SUITABLE FOR INDUSTRIAL INSTALLATIONS AS MANUFACTURED BY TEXTOL OR APPROVED EQUAL.
    - b. DC: SUPPORT DC BUNDLES WITH ZIP TIES OF THE ADEQUATE LENGTH. ZIP TIES TO BE UV STABILIZED, BLACK NYLON, WITH TENSILE STRENGTH AT 12,000 PSI AS MANUFACTURED BY NELCO PRODUCTS OR EQUAL.
  - 3. FASTENING JUMPERS: SECURE JUMPERS TO THE SIDE ARMS OR HEAD FRAMES USING STAINLESS STEEL TIE WRAPS OR STAINLESS STEEL BUTTERFLY CLIPS.
  - 4. CABLE INSTALLATION:
    - a. INSPECT CABLE PRIOR TO USE FOR SHIPPING DAMAGE, NOTIFY THE CONSTRUCTION MANAGER.
    - b. CABLE ROUTING: CABLE INSTALLATION SHALL BE PLANNED TO ENSURE THAT THE LINES WILL BE PROPERLY ROUTED IN THE CABLE ENVELOP AS INDICATED ON THE DRAWINGS. AVOID TWISTING AND CROSSOVERS.
    - c. HOIST CABLE USING PROPER HOISTING GRIPS. DO NOT EXCEED MANUFACTURERS RECOMMENDED MAXIMUM BEND RADIUS.

- 5. GROUNDING OF TRANSMISSION LINES: ALL TRANSMISSION LINES SHALL BE GROUNDED AS INDICATED ON DRAWINGS.
- 6. HYBRID CABLE COLOR CODING: ALL COLOR CODING SHALL BE AS REQUIRED PER SPRINT TS 0200 CURRENT VERSION.
- 7. HYBRID CABLE LABELING: INDIVIDUAL HYBRID AND DC BUNDLES SHALL BE LABELED ALPHA-NUMERICALLY ACCORDING TO SPRINT CELL SITE ENGINEERING NOTICE-EN 2012-001, REV 1

**WEATHERPROOFING EXTERIOR CONNECTORS AND HYBRID CABLE GROUND KITS:**

- A. ALL FIBER & COAX CONNECTORS AND GROUND KITS SHALL BE WEATHERPROOFED.
- B. WEATHERPROOFED USING ONE OF THE FOLLOWING METHODS. ALL INSTALLATIONS MUST BE DONE IN ACCORDANCE WITH THE MANUFACTURER'S RECOMMENDATIONS AND INDUSTRY BEST PRACTICES.

- 1. COLD SHRINK: ENCOMPASS CONNECTOR IN COLD SHRINK TUBING AND PROVIDE A DOUBLE WRAP OF 2" ELECTRICAL TAPE EXTENDING 2" BEYOND TUBING. PROVIDE 3M COLD SHRINK CXS SERIES OR EQUAL.
- 2. SELF-AMALGAMATING TAPE: CLEAN SURFACES. APPLY A DOUBLE WRAP OF SELF-AMALGAMATING TAPE 2" BEYOND CONNECTOR. APPLY A SECOND WRAP OF SELF-AMALGAMATING TAPE IN OPPOSITE DIRECTION. APPLY DOUBLE WRAP OF 2" WIDE ELECTRICAL TAPE EXTENDING 2" BEYOND THE SELF-AMALGAMATING TAPE.
- 3. 3M SLIM LOCK CLOSURE 716: SUBSTITUTIONS WILL NOT BE ALLOWED.
- 4. OPEN FLAME ON JOB SITE IS NOT ACCEPTABLE.

**SECTION 11 800 - INSTALLATION OF MULTIMODAL BASE STATIONS (MMBTS) AND RELATED EQUIPMENT**

**SUMMARY:**

- A. THIS SECTION SPECIFIES MMBTS CABINETS, POWER CABINETS, AND INTERNAL EQUIPMENT INCLUDING BY NOT LIMITED TO RECTIFIERS, POWER DISTRIBUTION UNITS, BASE BAND UNITS, SURGE ARRESTORS, BATTERIES, AND SIMILAR EQUIPMENT FURNISHED BY THE COMPANY FOR INSTALLATION BY THE CONTRACTOR (OFCI).
- B. CONTRACTOR SHALL PROVIDE AND INSTALL ALL MISCELLANEOUS MATERIALS AND PROVIDE ALL LABOR REQUIRED FOR INSTALLATION EQUIPMENT IN EXISTING CABINET OR NEW CABINET AS SHOWN ON DRAWINGS AND AS REQUIRE BY THE APPLICABLE INSTALLATION MOPS.
- C. COMPLY WITH MANUFACTURERS INSTALLATION AND START-UP REQUIREMENTS

**DC CIRCUIT BREAKER LABELING**

- A. LABEL CIRCUIT BREAKERS ACCORDING TO SPRINT CELL SITE ENGINEERING NOTICE - EN 2012-001, REV 1.

**SECTION 11 800 - INSTALLATION OF MULTIMODAL BASE TRANSCIEVER STATIONS (MMBTS) AND RELATED EQUIPMENT**

**SUMMARY:**

- A. THIS SECTION SPECIFIES MMBTS CABINETS, POWER CABINETS, AND INTERNAL EQUIPMENT INCLUDING BY NOT LIMITED TO RECTIFIERS, POWER DISTRIBUTION UNITS, BASE BAND UNITS, SURGE ARRESTORS, BATTERIES, AND SIMILAR EQUIPMENT FURNISHED BY THE COMPANY FOR INSTALLATION BY THE CONTRACTOR (OFCI).
- B. CONTRACTOR SHALL PROVIDE AND INSTALL ALL MISCELLANEOUS MATERIALS AND PROVIDE ALL LABOR REQUIRED FOR INSTALLATION EQUIPMENT IN EXISTING CABINET OR NEW CABINET AS SHOWN ON DRAWINGS AND AS REQUIRE BY THE APPLICABLE INSTALLATION MOPS.
- C. COMPLY WITH MANUFACTURERS INSTALLATION AND START-UP REQUIREMENTS

**SUPPORTING DEVICES:**

- A. MANUFACTURED STRUCTURAL SUPPORT MATERIALS: SUBJECT TO COMPLIANCE WITH REQUIREMENTS, PROVIDE PRODUCTS BY THE FOLLOWING:
  - 1. ALLIED TUBE AND CONDUIT
  - 2. B-LINE SYSTEM
  - 3. UNISTRUT DIVERSIFIED PRODUCTS
  - 4. THOMAS & BETTS
- B. FASTENERS: TYPES, MATERIALS, AND CONSTRUCTION FEATURES AS FOLLOWS:
  - 1. EXPANSION ANCHORS: CARBON STEEL WEDGE OR SLEEVE TYPE.
  - 2. POWER-DRIVEN THREADED STUDS: HEAT-TREATED STEEL, DESIGNED SPECIFICALLY FOR THE INTENDED SERVICE.
  - 3. FASTEN BY MEANS OF WOOD SCREWS ON WOOD.
  - 4. TOGGLE BOLTS ON HOLLOW MASONRY UNITS.
  - 5. CONCRETE INSERTS OR EXPANSION BOLTS ON CONCRETE OR SOLID MASONRY.
  - 6. MACHINE SCREWS, WELDED THREADED STUDS, OR SPRING-TENSION CLAMPS ON STEEL.
  - 7. EXPLOSIVE DEVICES FOR ATTACHING HANGERS TO STRUCTURE SHALL NOT BE PERMITTED.
  - 8. DO NOT WELD CONDUIT, PIPE STRAPS, OR ITEMS OTHER THAN THREADED STUDS TO STEEL STRUCTURES.
  - 9. IN PARTITIONS OF LIGHT STEEL CONSTRUCTION, USE SHEET METAL SCREWS.

**SUPPORTING DEVICES:**

- A. INSTALL SUPPORTING DEVICES TO FASTEN ELECTRICAL COMPONENTS SECURELY AND PERMANENTLY IN ACCORDANCE WITH NEC.
- B. COORDINATE WITH THE BUILDING STRUCTURAL SYSTEM AND WITH OTHER TRADES.
- C. UNLESS OTHERWISE INDICATED ON THE DRAWINGS, FASTEN ELECTRICAL ITEMS AND THEIR SUPPORTING HARDWARE SECURELY TO THE STRUCTURE IN ACCORDANCE WITH THE FOLLOWING:
- D. ENSURE THAT THE LOAD APPLIED BY ANY FASTENER DOES NOT EXCEED 25 PERCENT OF THE PROOF TEST LOAD.
- E. USE VIBRATION AND SHOCK-RESISTANT FASTENERS FOR ATTACHMENTS TO CONCRETE SLABS.

**ELECTRICAL IDENTIFICATION:**

- A. UPDATE AND PROVIDE TYPED CIRCUIT BREAKER SCHEDULES IN THE MOUNTING BRACKET, INSIDE DOORS OF AC PANEL BOARDS WITH ANY CHANGES MADE TO THE AC SYSTEM.
- B. BRANCH CIRCUITS FEEDING AVIATION OBSTRUCTION LIGHTING EQUIPMENT SHALL BE CLEARLY IDENTIFIED AS SUCH AT THE BRANCH CIRCUIT PANELBOARD.

**SECTION 26 200 - ELECTRICAL MATERIALS AND EQUIPMENT**

**CONDUIT:**

- A. RIGID GALVANIZED STEEL (RGS) CONDUIT SHALL BE USED FOR EXTERIOR LOCATIONS ABOVE GROUND AND IN UNFINISHED INTERIOR LOCATIONS AND FOR ENCASED RUNS IN CONCRETE. RIGID CONDUIT AND FITTINGS SHALL BE STEEL, COATED WITH ZINC EXTERIOR AND INTERIOR BY THE HOT DIP GALVANIZING PROCESS. CONDUIT SHALL BE PRODUCED TO ANSI SPECIFICATIONS C80.1, FEDERAL SPECIFICATION WW-C-581 AND SHALL BE LISTED WITH THE UNDERWRITERS' LABORATORIES. FITTINGS SHALL BE THREADED - SET SCREW OR COMPRESSION FITTINGS WILL NOT BE ACCEPTABLE. RGS CONDUITS SHALL BE MANUFACTURED BY ALLIED, REPUBLIC OR WHEATLAND.
- B. UNDERGROUND CONDUIT IN CONCRETE SHALL BE POLYVINYLCHLORIDE (PVC) SUITABLE FOR DIRECT BURIAL AS APPLICABLE. JOINTS SHALL BE BELLED, AND FLUSH SOLVENT WELDED IN ACCORDANCE WITH MANUFACTURER'S INSTRUCTIONS. CONDUIT SHALL BE CARLON ELECTRICAL PRODUCTS OR APPROVED EQUAL.
- C. TRANSITIONS BETWEEN PVC AND RIGID (RGS) SHALL BE MADE WITH PVC COATED METALLIC LONG SWEEP RADIUS ELBOWS.
- D. EMT OR RIGID GALVANIZED STEEL CONDUIT MAY BE USED IN FINISHED SPACES CONCEALED IN WALLS AND CEILINGS. EMT SHALL BE MILD STEEL, ELECTRICALLY WELDED, ELECTRO-GALVANIZED OR HOT-DIPPED GALVANIZED AND PRODUCED TO ANSI SPECIFICATION C80.3, FEDERAL SPECIFICATION WW-C-583, AND SHALL BE UL LISTED. EMT SHALL BE MANUFACTURED BY ALLIED, REPUBLIC OR WHEATLAND, OR APPROVED EQUAL. FITTINGS SHALL BE METALLIC COMPRESSION. SET SCREW CONNECTIONS SHALL NOT BE ACCEPTABLE.
- E. LIQUID TIGHT FLEXIBLE METALLIC CONDUIT SHALL BE USED FOR FINAL CONNECTION TO EQUIPMENT. FITTINGS SHALL BE METALLIC GLAND TYPE COMPRESSION FITTINGS, MAINTAINING THE INTEGRITY OF CONDUIT SYSTEM. SET SCREW CONNECTIONS SHALL NOT BE ACCEPTABLE. MAXIMUM LENGTH OF FLEXIBLE CONDUIT SHALL NOT EXCEED 6- FEET. LFMC SHALL BE PROTECTED AND SUPPORTED AS REQUIRE BY NEC. MANUFACTURERS OF FLEXIBLE CONDUITS SHALL BE CAROL, ANACONDA METAL HOSE OR UNIVERSAL METAL HOSE, OR APPROVED EQUAL.
- F. MINIMUM SIZE CONDUIT SHALL BE 3/4 INCH (21MM).

**HUBS AND BOXES:**

- A. AT ENTRANCES TO CABINETS OR OTHER EQUIPMENT NOT HAVING INTEGRAL THREADED HUBS PROVIDE METALLIC THREADED HUBS OF THE SIZE AND CONFIGURATION REQUIRED. HUB SHALL INCLUDE LOCKNUT AND NEOPRENE O-RING SEAL. PROVIDE IMPACT RESISTANT 105 DEGREE C PLASTIC BUSHINGS TO PROTECT CABLE INSULATION.
- B. CABLE TERMINATION FITTINGS FOR CONDUIT
  - 1. CABLE TERMINATORS FOR RGS CONDUITS SHALL BE TYPE CRC BY O-Z/GEDNEY OR EQUAL.
  - 2. CABLE TERMINATORS FOR LFMC SHALL BE ETCO - CL2075; OR MADE FOR THE PURPOSE PRODUCTS BY ROXTEC.
- C. EXTERIOR PULL BOXES AND PULL BOXES IN INTERIOR INDUSTRIAL AREAS SHALL BE PLATED CAST ALLOY, HEAVY DUTY, WEATHERPROOF, DUST PROOF, WITH GASKET, PLATED IRON ALLOY COVER AND STAINLESS STEEL COVER SCREWS, CROUSE-HINDS WAB SERIES OR EQUAL.
- D. CONDUIT OUTLET BODIES SHALL BE PLATED CAST ALLOY WITH SIMILAR GASKETED COVERS. OUTLET BODIES SHALL BE OF THE CONFIGURATION AND SIZE SUITABLE FOR THE APPLICATION. PROVIDE CROUSE-HINDS FORM 8 OR EQUAL.
- E. MANUFACTURER FOR BOXES AND COVERS SHALL BE HOFFMAN, SQUARE "D", CROUSE-HINDS, COOPER, ADALET, APPLETON, O-Z GEDNEY, RACO, OR APPROVED EQUAL.

**SUPPLEMENTAL GROUNDING SYSTEM**

- A. FURNISH AND INSTALL A SUPPLEMENTAL GROUNDING SYSTEM AS INDICATED ON THE DRAWINGS. SUPPORT SYSTEM WITH NON-MAGNETIC STAINLESS STEEL CLIPS WITH RUBBER GROMMETS. GROUNDING CONNECTORS SHALL BE TINNED COPPER WIRE, SIZES AS INDICATED ON THE DRAWINGS. PROVIDE STRANDED OR SOLID BARE OR INSULATED CONDUCTORS AS INDICATED.
- B. SUPPLEMENTAL GROUNDING SYSTEM: ALL CONNECTIONS TO BE MADE WITH CAD WELDS, EXCEPT AT EQUIPMENT USE LUGS OR OTHER AVAILABLE GROUNDING MEANS AS REQUIRED BY MANUFACTURER; AT GROUND BARS USE TWO HOLE SPADES WITH NO OX.
- C. STOLEN GROUND-BARS: IN THE EVENT OF STOLEN GROUND BARS, CONTACT SPRINT CM FOR REPLACEMENT INSTRUCTION USING THREADED ROD KITS.

**EXISTING STRUCTURE:**

- A. EXISTING EXPOSED WIRING AND ALL EXPOSED OUTLETS, RECEPTACLES, SWITCHES, DEVICES, BOXES, AND OTHER EQUIPMENT THAT ARE NOT TO BE UTILIZED IN THE COMPLETED PROJECT SHALL BE REMOVED OR DE-ENERGIZED AND CAPPED IN THE WALL, CEILING, OR FLOOR SO THAT THEY ARE CONCEALED AND SAFE. WALL, CEILING, OR FLOOR SHALL BE PATCHED TO MATCH THE ADJACENT CONSTRUCTION.

**CONDUIT AND CONDUCTOR INSTALLATION:**

- A. CONDUITS SHALL BE FASTENED SECURELY IN PLACE WITH APPROVED NON-PERFORATED STRAPS AND HANGERS. EXPLOSIVE DEVICES FOR ATTACHING HANGERS TO STRUCTURE WILL NOT BE PERMITTED. CLOSELY FOLLOW THE LINES OF THE STRUCTURE, MAINTAIN CLOSE PROXIMITY TO THE STRUCTURE AND KEEP CONDUITS IN TIGHT ENVELOPES. CHANGES IN DIRECTION TO ROUTE AROUND OBSTACLES SHALL BE MADE WITH CONDUIT OUTLET BODIES. CONDUIT SHALL BE INSTALLED IN A NEAT AND WORKMANLIKE MANNER, PARALLEL AND PERPENDICULAR TO STRUCTURE WALL AND CEILING LINES. ALL CONDUIT SHALL BE FISHED TO CLEAR OBSTRUCTIONS. ENDS OF CONDUITS SHALL BE TEMPORARILY CAPPED TO PREVENT CONCRETE, PLASTER OR DIRT FROM ENTERING. CONDUITS SHALL BE RIGIDLY CLAMPED TO BOXES BY GALVANIZED MALLEABLE IRON BUSHING ON INSIDE AND GALVANIZED MALLEABLE IRON LOCKNUT ON OUTSIDE AND INSIDE.
- B. CONDUCTORS SHALL BE PULLED IN ACCORDANCE WITH ACCEPTED GOOD PRACTICE.



1 INTERNATIONAL BLVD., SUITE 800  
MAHWAH, NJ 07495  
TEL: (800) 357-7641



SBA COMMUNICATIONS CORP.  
134 FLANDERS ROAD, SUITE 125  
WESTBOROUGH, MA 01581 TEL: (508) 251-0720



604 FOX GLEN  
BARRINGTON, IL 60010  
TELEPHONE: 847.277.0070  
FAX : 847.277.0080  
ae@westchesterservices.com



"I HEREBY CERTIFY THAT THESE PLANS WERE PREPARED BY AND THAT I AM A DULY REGISTERED ARCHITECT UNDER THE LAWS OF THE STATE OF CONNECTICUT"

CHECKED BY: JK

APPROVED BY: JMB

SUBMITTALS			
REV.	DATE	DESCRIPTION	BY
1	03/08/18	ISSUED FOR CONSTRUCTION	SDB
0	01/23/18	ISSUED FOR CONSTRUCTION	SH

SITE NUMBER:  
CT54XC731  
  
SITE NAME:  
CENTRAL HEBRON  
  
SITE ADDRESS:  
66 WALL STREET  
HEBRON, CT 06248

SHEET TITLE  
OUTLINE  
SPECIFICATIONS

SHEET NUMBER  
SP-3



THE INFORMATION CONTAINED IN THIS SET OF CONSTRUCTION DOCUMENTS IS PROPRIETARY BY NATURE. ANY USE OR DISCLOSURE OTHER THAN THAT WHICH RELATES TO CARRIER SERVICES IS STRICTLY PROHIBITED.

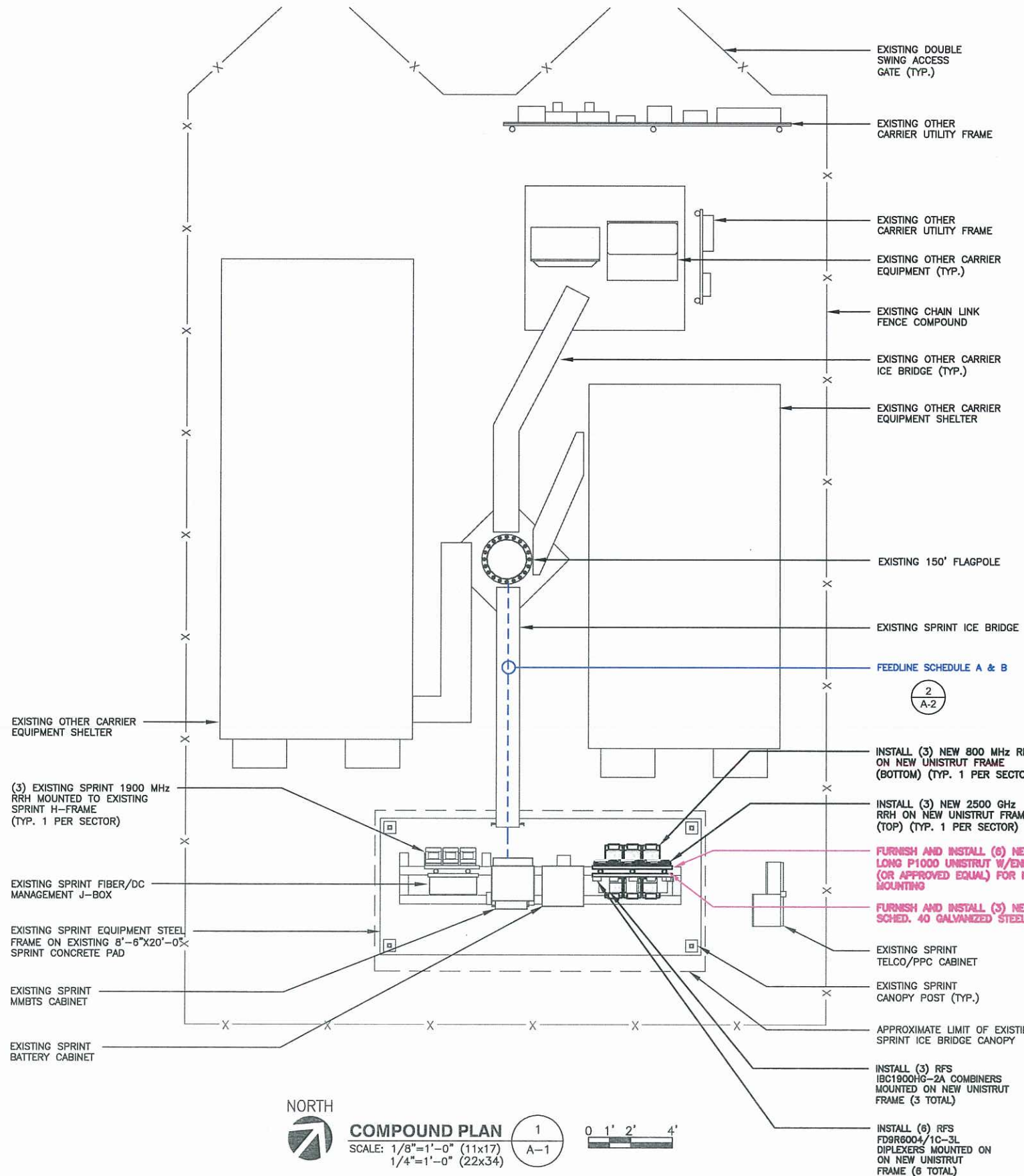

**COMPOUND PLAN**  
 SCALE: 1/8"=1'-0" (11x17)  
 1/4"=1'-0" (22x34)

1  
A-1

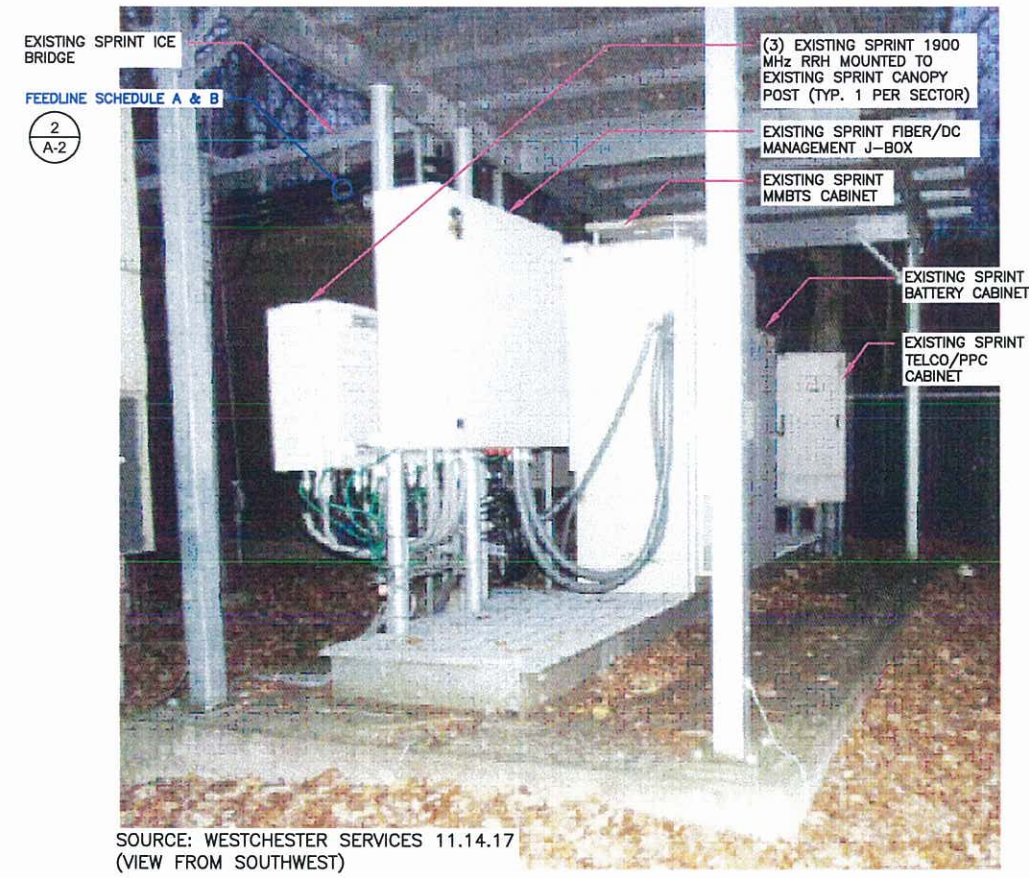

SOURCE: WESTCHESTER SERVICES 11.14.17  
 (VIEW FROM SOUTHWEST)

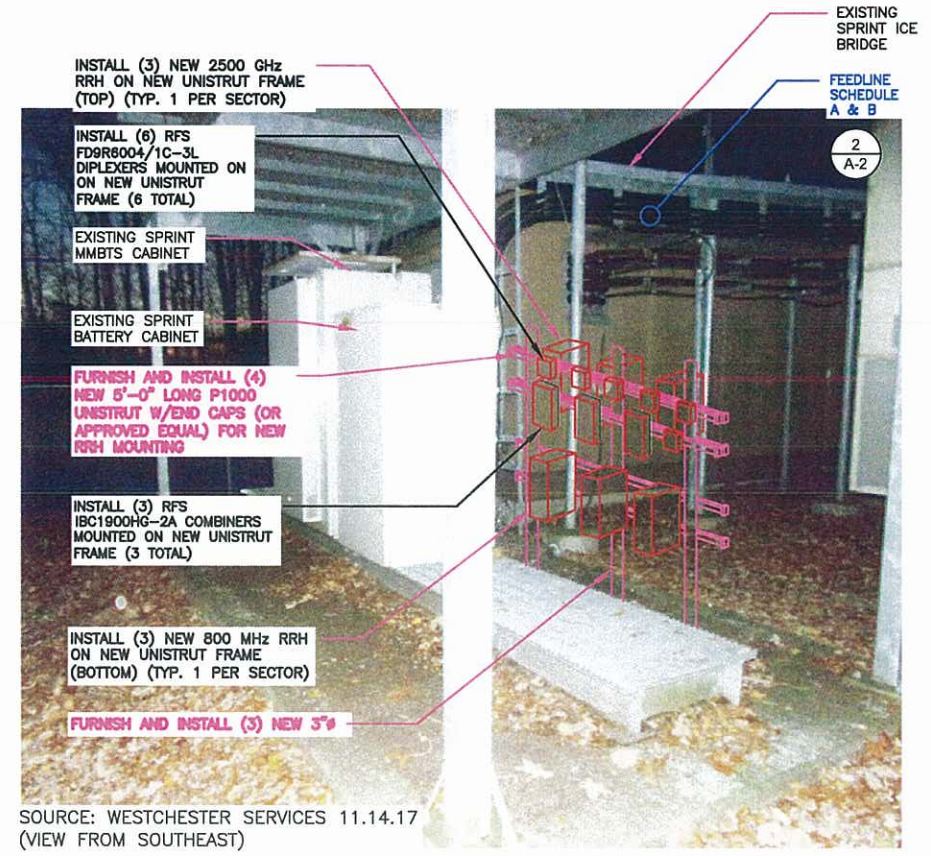

SOURCE: WESTCHESTER SERVICES 11.14.17  
 (VIEW FROM SOUTHEAST)

**EQUIPMENT PLAN PHOTO DETAIL**  
 SCALE: N.T.S.

2  
A-1

**Sprint**  
 1 INTERNATIONAL BLVD., SUITE 800  
 MAHWAH, NJ 07495  
 TEL: (800) 357-7841

**SBA**  
 SBA COMMUNICATIONS CORP.  
 134 FLANDERS ROAD, SUITE 125  
 WESTBOROUGH, MA 01581  
 TEL: (508) 251-0720

**WESTCHESTER SERVICES LLC**  
 604 FOX GLEN  
 BARRINGTON, IL 60010  
 TELEPHONE: 847.277.0070  
 FAX: 847.277.0080  
 ae@westchesterservices.com

STATE OF CONNECTICUT  
 JOHN M. WESTCHESTER  
 LICENSED ARCHITECT  
 NO. 10137  
 3/9/18

I HEREBY CERTIFY THAT THESE PLANS WERE PREPARED BY ME OR UNDER MY DIRECT SUPERVISION AND THAT I AM A DULY REGISTERED ARCHITECT UNDER THE LAWS OF THE STATE OF CONNECTICUT.

CHECKED BY: JK  
 APPROVED BY: JMB

SUBMITTALS			
REV.	DATE	DESCRIPTION	BY
1	03/08/18	ISSUED FOR CONSTRUCTION	SDB
0	01/23/18	ISSUED FOR CONSTRUCTION	SH

SITE NUMBER:  
 CT54XC731  
 SITE NAME:  
 CENTRAL HEBRON  
 SITE ADDRESS:  
 66 WALL STREET  
 HEBRON, CT 06248

SHEET TITLE  
**COMPOUND PLAN**

SHEET NUMBER  
**A-1**



THE INFORMATION CONTAINED IN THIS SET OF CONSTRUCTION DOCUMENTS IS PROPRIETARY BY NATURE. ANY USE OR DISCLOSURE OTHER THAN THAT WHICH RELATES TO CARRIER SERVICES IS STRICTLY PROHIBITED.

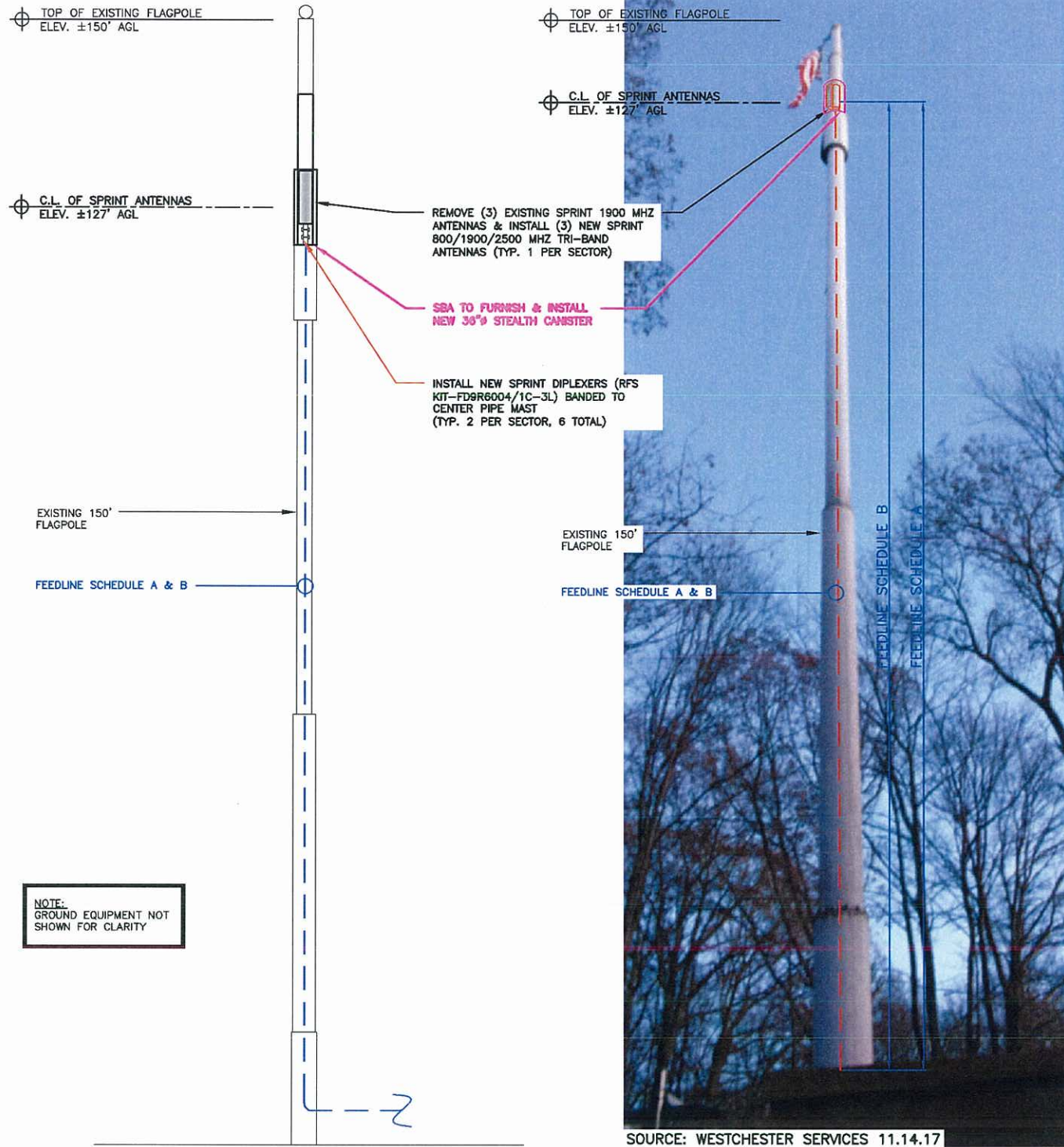

SOURCE: WESTCHESTER SERVICES 11.14.17

FEEDLINES		
FEEDLINE SCHEDULE	FEEDLINE DESCRIPTION	LOCATION
A	(6) EXISTING 1-5/8" COAX CABLES TO BE REMOVED	ROUTED INSIDE TOWER
B	(3) NEW 3/8" RET CABLES TO FOLLOW EXISTING ROUTING (12) NEW 7/8" COAX TO FOLLOW EXISTING ROUTING	ROUTED INSIDE TOWER

NOTE: EXISTING SPRINT EQUIPMENT FEEDLINE INVENTORY BASED ON OBSERVED FIELD CONDITIONS, RFS AND FEEDLINE LEASING ENTITLEMENTS MAY DIFFER.

TOWER ELEVATION PHOTO DETAIL

SCALE: N.T.S.

**SPECIAL CONSTRUCTION NOTE:**  
 SPRINT WORK IS CONTINGENT ON THE FOLLOWING:  
 \* COMPLETION OF A GLOBAL STRUCTURAL STABILITY ANALYSIS.  
 \* COMPLETION OF AN ANTENNA/RRH MOUNT STRUCTURAL ASSESSMENT.  
 \* GC SHALL FURNISH, INSTALL AND COMPLETE ALL REQUIRED STRUCTURAL MODIFICATIONS AS INDICATED IN BEFORE-MENTIONED ANALYSIS AND ASSESSMENT.

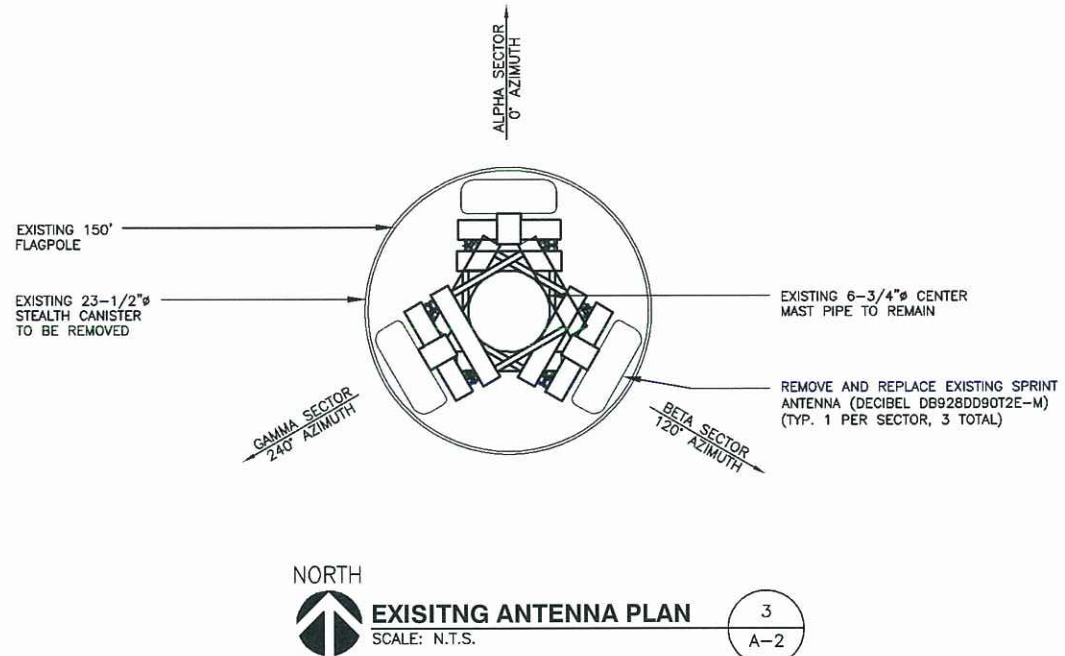

EXISTING ANTENNA PLAN

SCALE: N.T.S.

3  
A-2

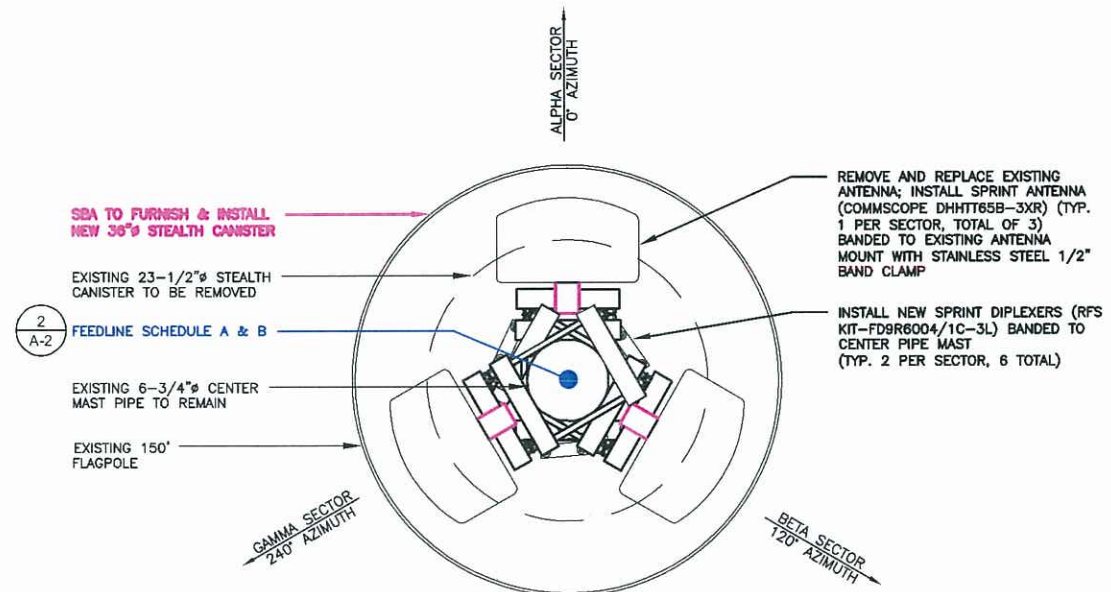

PROPOSED ANTENNA PLAN

SCALE: N.T.S.

4  
A-2

**SPECIAL INSTALLATION NOTE:**  
 JUMPERS FROM RRHs TO ANTENNA SHALL NOT EXCEED 15'. NOTIFY SPRINT CONSTRUCTION MANAGER OF ANY DISCREPANCY

NOTE: VERIFY PROPOSED AZIMUTHS WITH RF ENGINEER PRIOR TO INSTALLATION

1 INTERNATIONAL BLVD., SUITE 800  
 MAHWAH, NJ 07495  
 TEL: (800) 357-7841

SBA COMMUNICATIONS CORP.  
 134 FLANDERS ROAD, SUITE 125  
 WESTBOROUGH, MA 01581  
 TEL: (508) 251-0720

604 FOX GLEN  
 BARRINGTON, IL 60010  
 TELEPHONE: 847.277.0070  
 FAX: 847.277.0080  
 ae@westchesterservices.com

I HEREBY CERTIFY THAT THESE PLANS WERE PREPARED BY ME OR UNDER MY DIRECT SUPERVISION AND THAT I AM A DULY REGISTERED ARCHITECT UNDER THE LAWS OF THE STATE OF CONNECTICUT

CHECKED BY: JK

APPROVED BY: JMB

SUBMITTALS			
REV.	DATE	DESCRIPTION	BY
1	03/08/18	ISSUED FOR CONSTRUCTION	SDB
0	01/23/18	ISSUED FOR CONSTRUCTION	SH

SITE NUMBER:  
 CT54XC731

SITE NAME:  
 CENTRAL HEBRON

SITE ADDRESS:  
 66 WALL STREET  
 HEBRON, CT 06248

SHEET TITLE  
 ELEVATION &  
 ANTENNA PLANS

SHEET NUMBER  
**A-2**



THE INFORMATION CONTAINED IN THIS SET OF CONSTRUCTION DOCUMENTS IS PROPRIETARY BY NATURE. ANY USE OR DISCLOSURE OTHER THAN THAT WHICH RELATES TO CARRIER SERVICES IS STRICTLY PROHIBITED.



1 INTERNATIONAL BLVD., SUITE 800  
MAHWAH, NJ 07495  
TEL: (800) 357-7641



SBA COMMUNICATIONS CORP.  
134 FLANDERS ROAD, SUITE 125  
WESTBOROUGH, MA 01581 TEL: (508) 251-0720



604 FOX GLEN  
BARRINGTON, IL 60010  
TELEPHONE: 847.277.0070  
FAX: 847.277.0080  
ae@westchesterservices.com



I HEREBY CERTIFY THAT THESE PLANS WERE PREPARED BY ME OR UNDER MY DIRECT SUPERVISION AND THAT I AM A DULY REGISTERED ARCHITECT UNDER THE LAWS OF THE STATE OF CONNECTICUT

CHECKED BY: JK

APPROVED BY: JMB

SUBMITTALS			
REV.	DATE	DESCRIPTION	BY
1	03/08/18	ISSUED FOR CONSTRUCTION	SDB
0	01/23/18	ISSUED FOR CONSTRUCTION	SH

SITE NUMBER:  
CT54XC731

SITE NAME:  
CENTRAL HEBRON

SITE ADDRESS:  
66 WALL STREET  
HEBRON, CT 06248

SHEET TITLE  
TOWER EQUIPMENT  
DETAILS

SHEET NUMBER  
**A-3**

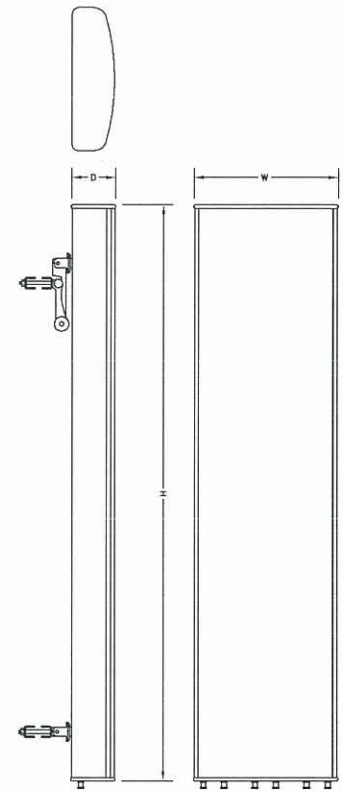

ANTENNA SPECIFICATIONS	
MANUF.	COMMSCOPE
MODEL #	DHHTT65B-3XR
HEIGHT	84.9"
WIDTH	21"
DEPTH	6.3"
WEIGHT	85± LBS.

ANTENNA DETAIL 1  
SCALE: N.T.S. A-3

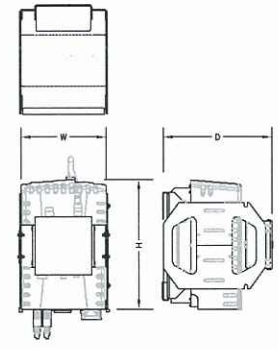

800 MHZ RRH SPECIFICATIONS	
MANUF.	NOKIA (ALU)
MODEL #	800MHZ 2X50W
HEIGHT	19.7"
WIDTH	13"
DEPTH	10.8"
WEIGHT	53± LBS

800 MHz RRH DETAIL 2  
SCALE: N.T.S. A-3

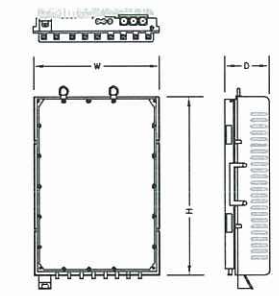

2.5 GHZ RRH SPECIFICATIONS	
MANUF.	NOKIA (ALU)
MODEL #	TD-RRH8X20-25
HEIGHT	26.1"
WIDTH	18.6"
DEPTH	6.7"
WEIGHT	70± LBS

2.5 GHz RRH DETAIL 3  
SCALE: N.T.S. A-3



DIPLEXER SPECIFICATIONS	
MANUF.	RFS
MODEL #	KIT-FD9R6004/1C-3L
HEIGHT	5.8"
WIDTH	6.5"
DEPTH	1.5"
WEIGHT	2.6± LBS

DIPLEXER DETAIL 4  
SCALE: N.T.S. A-3

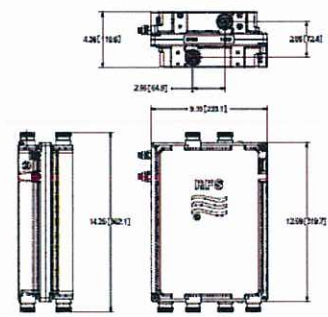

COMBINER SPECIFICATIONS	
MANUF.	RFS
MODEL #	IBC1900HG-2A
HEIGHT	12.6"
WIDTH	9.2"
DEPTH	4.35"
WEIGHT	22± LBS

COMBINER DETAIL 5  
SCALE: N.T.S. A-3

RAN EQUIPMENT LIST (G.C. SHALL FURNISH AND INSTALL ALL OTHER MATERIALS & EQUIPMENT NOT SUPPLIED BY SPRINT)				
DESCRIPTION	# UNITS	QUANTITY	MAKE/MODEL/MATERIAL	PROVIDED BY
ANTENNA	3	3	COMMSCOPE DHHTT65B-3XR	SPRINT
RRU (AT GROUND LEVEL)	3	3	ALCATEL LUCENT RRU TD-RRH8X20-25 (2500 MHZ)	SPRINT
RRU (AT GROUND LEVEL)	3	3	ALCATEL-LUCENT RRU-2x50-800 (800 MHZ)	SPRINT
RRU (AT GROUND LEVEL)	3	3	ALCATEL-LUCENT RRU-4x45-1900 (1900 MHZ)	SPRINT
DIPLEXERS	12	6 (TOWER TOP) 6 (TOWER BOTTOM)	RFS FD9R6004/1C-3L DIPLEXERS	SPRINT
COMBINERS	3	3 (TOWER BOTTOM)	RFS IBC1900HG-2A COMBINERS	SPRINT
COAX	12	12	7/8" COAX CABLE AT ±160'	SPRINT
RET	3	3	3/8" RET CABLE	SPRINT
RF JUMPERS	18	18	RF JUMPER CABLES	SPRINT

SPRINT-PROVIDED EQUIPMENT SCHEDULE 6  
SCALE: N.T.S. A-3



THE INFORMATION CONTAINED IN THIS SET OF CONSTRUCTION DOCUMENTS IS PROPRIETARY BY NATURE. ANY USE OR DISCLOSURE OTHER THAN THAT WHICH RELATES TO CARRIER SERVICES IS STRICTLY PROHIBITED.

**SPECIAL CONSTRUCTION NOTE:**  
 SPRINT WORK IS CONTINGENT ON THE FOLLOWING:  
 \* COMPLETION OF A GLOBAL STRUCTURAL STABILITY ANALYSIS.  
 \* COMPLETION OF AN ANTENNA/RRH MOUNT STRUCTURAL ASSESSMENT.  
 \* GC SHALL FURNISH, INSTALL AND COMPLETE ALL REQUIRED STRUCTURAL MODIFICATIONS AS INDICATED IN BEFORE-MENTIONED ANALYSIS AND ASSESSMENT.

**NOTE:**  
 VERIFY PROPOSED AZIMUTHS WITH RF ENGINEER PRIOR TO INSTALLATION

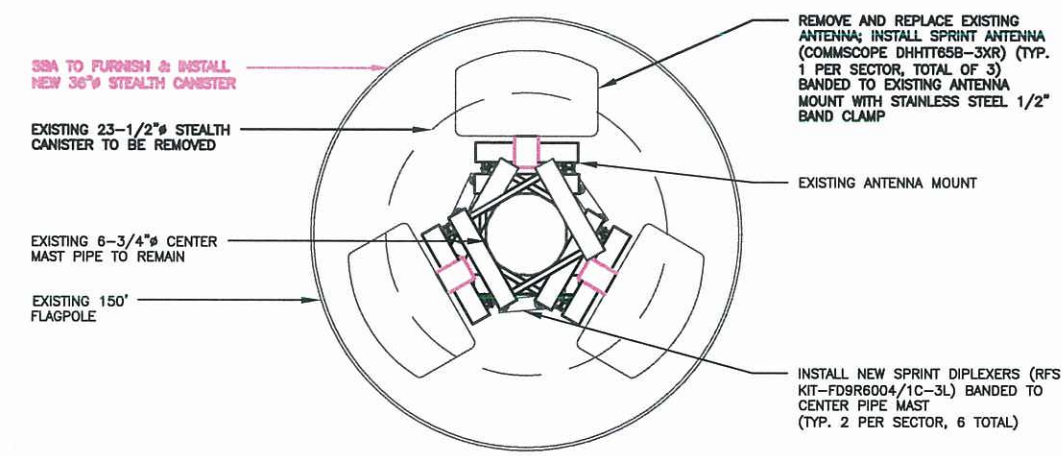

**SECTOR FRAME PLAN DETAIL**  
 SCALE: N.T.S.  
 1  
 S-1

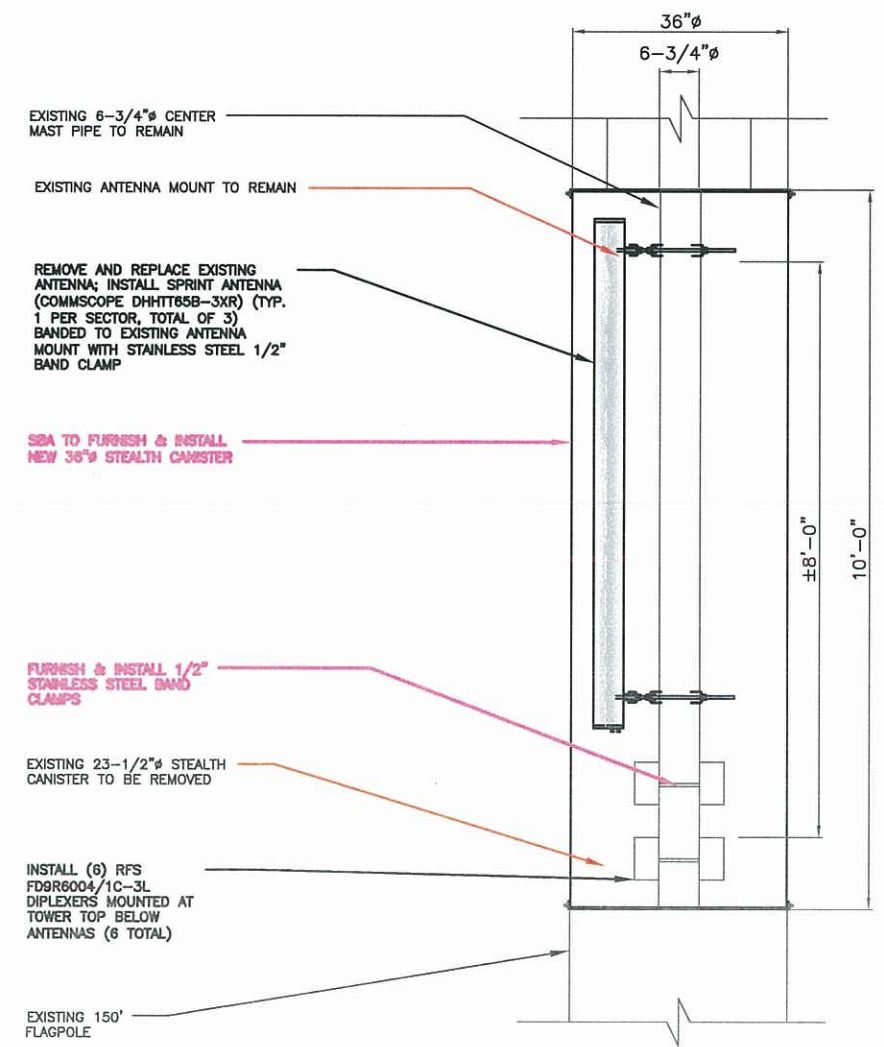

**ANTENNA MOUNTING DETAIL**  
 SCALE: N.T.S.  
 2  
 S-1

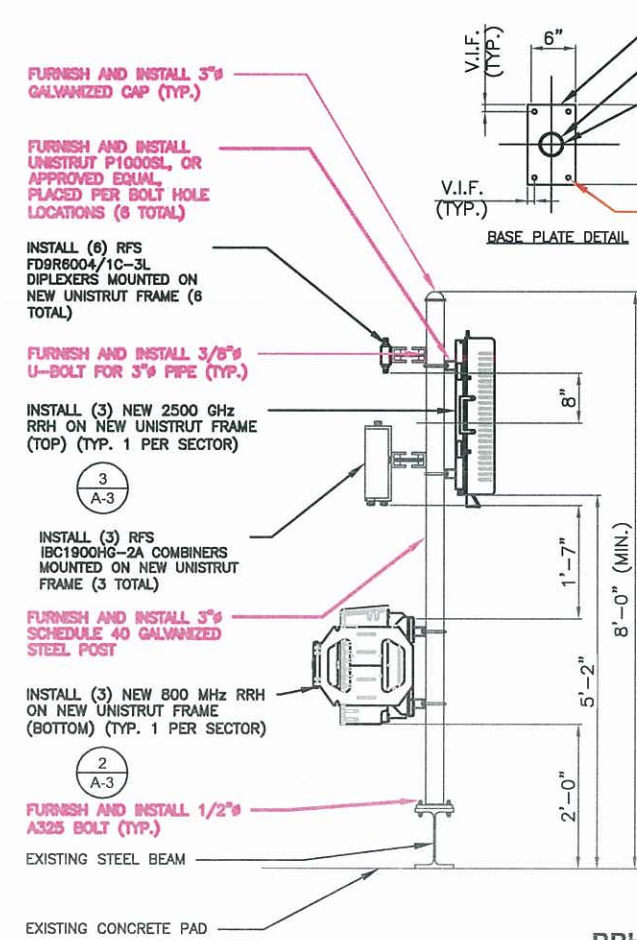

**RRH MOUNTING DETAIL**  
 SCALE: N.T.S.  
 4  
 S-1

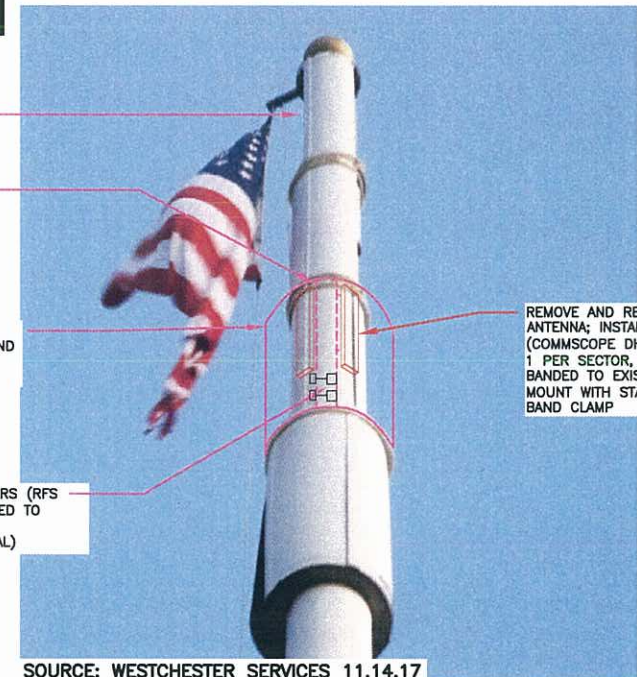
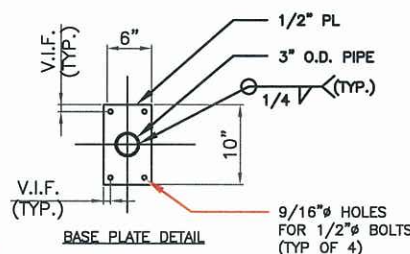

SOURCE: WESTCHESTER SERVICES 11.14.17

**ANTENNA MOUNT PHOTO DETAIL**  
 SCALE: N.T.S.  
 3  
 S-1

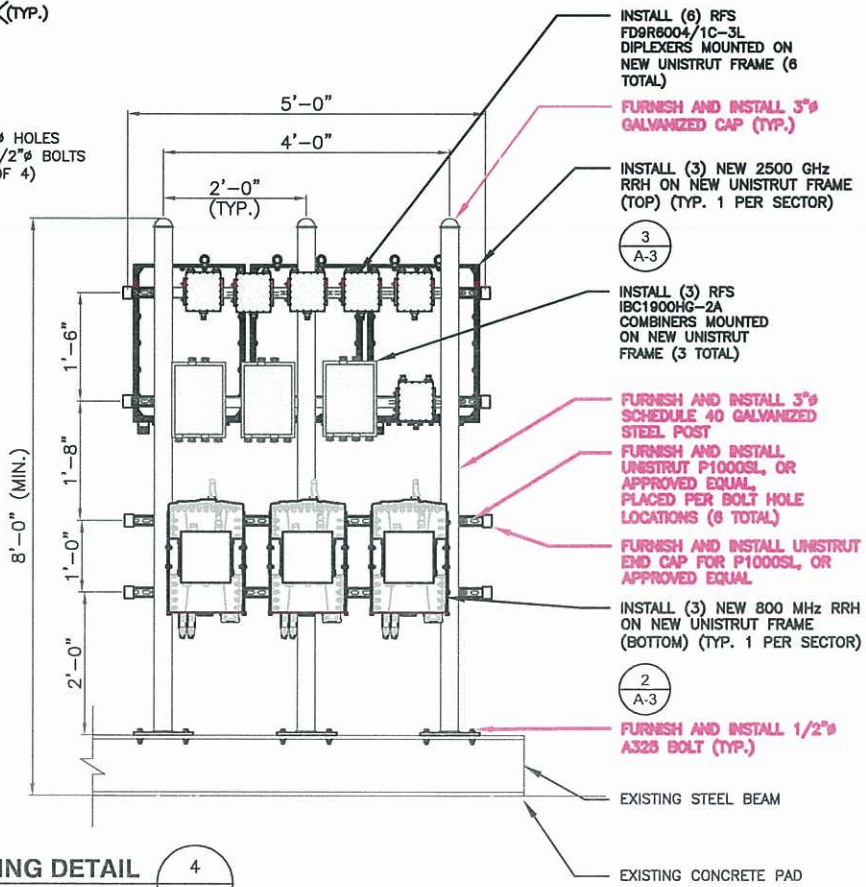

**Sprint**  
 1 INTERNATIONAL BLVD., SUITE 800  
 MAHWAH, NJ 07495  
 TEL: (800) 357-7841

**SBA**  
 SBA COMMUNICATIONS CORP.  
 134 FLANDERS ROAD, SUITE 125  
 WESTBOROUGH, MA 01581  
 TEL: (508) 251-0720

**WESTCHESTER SERVICES LLC**  
 604 FOX GLEN  
 BARRINGTON, IL 60010  
 TELEPHONE: 847.277.0070  
 FAX: 847.277.0080  
 ae@westchester-services.com



"I HEREBY CERTIFY THAT THESE PLANS WERE PREPARED BY ME OR UNDER MY DIRECT SUPERVISION AND THAT I AM A DULY REGISTERED ARCHITECT UNDER THE LAWS OF THE STATE OF CONNECTICUT"

CHECKED BY: JK

APPROVED BY: JMB

**SUBMITTALS**

REV.	DATE	DESCRIPTION	BY
1	03/08/18	ISSUED FOR CONSTRUCTION	SDB
0	01/23/18	ISSUED FOR CONSTRUCTION	SH

SITE NUMBER:  
 CT54XC731  
 SITE NAME:  
 CENTRAL HEBRON  
 SITE ADDRESS:  
 66 WALL STREET  
 HEBRON, CT 06248

SHEET TITLE  
**ANTENNA & RRH MOUNTING DETAILS**

SHEET NUMBER  
**S-1**



THE INFORMATION CONTAINED IN THIS SET OF CONSTRUCTION DOCUMENTS IS PROPRIETARY BY NATURE. ANY USE OR DISCLOSURE OTHER THAN THAT WHICH RELATES TO CARRIER SERVICES IS STRICTLY PROHIBITED.

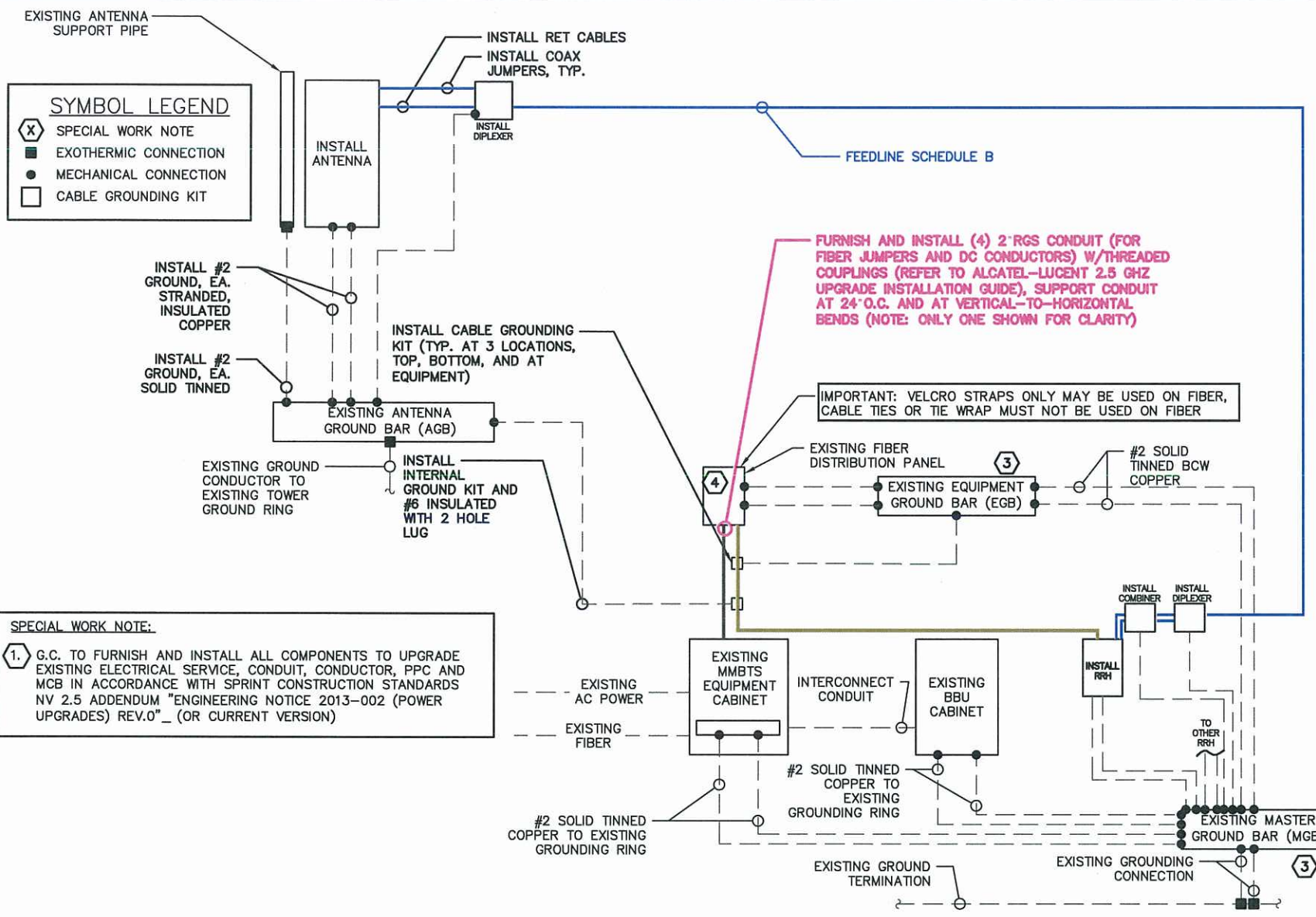

**TYPICAL POWER AND GROUNDING ONE LINE DIAGRAMS**  
SCALE: N.T.S.

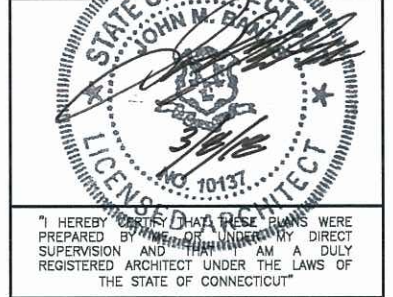
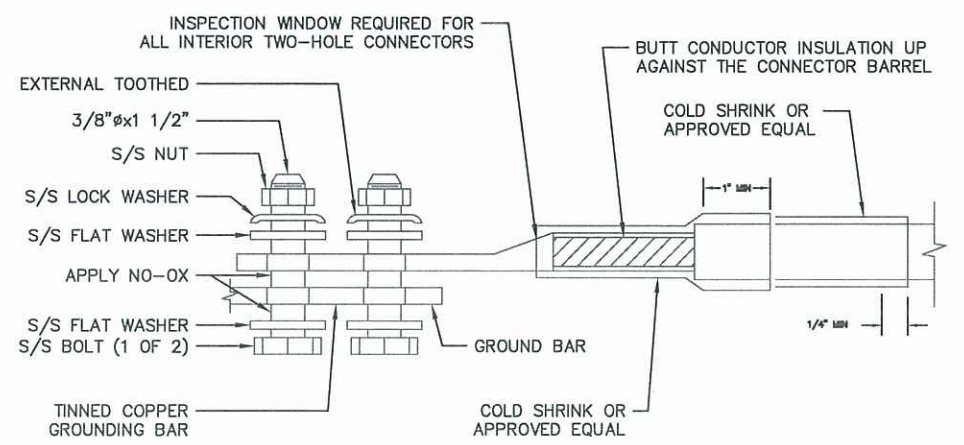
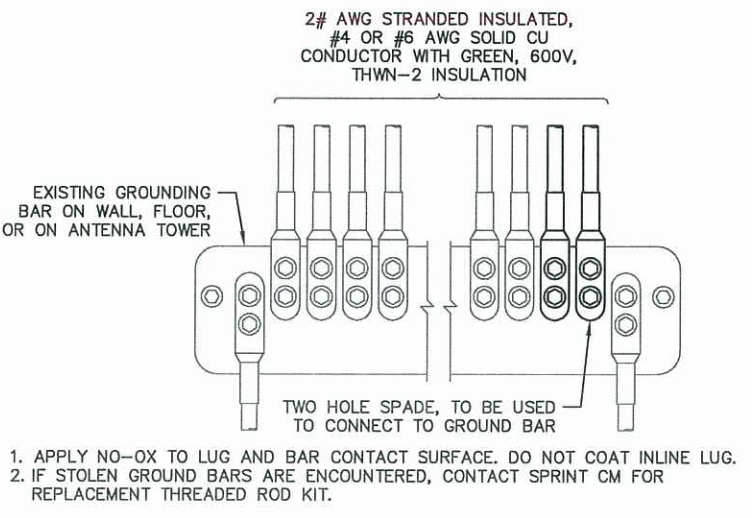

CHECKED BY: JK  
APPROVED BY: JMB

SUBMITTALS			
REV.	DATE	DESCRIPTION	BY
1	03/08/18	ISSUED FOR CONSTRUCTION	SDB
0	01/23/18	ISSUED FOR CONSTRUCTION	SH

SITE NUMBER: CT54XC731  
SITE NAME: CENTRAL HEBRON  
SITE ADDRESS: 66 WALL STREET HEBRON, CT 06248

SHEET TITLE: ELECTRICAL & GROUNDING DETAILS

SHEET NUMBER: E-1





RF Design Sheet

Site Identification	
Cascade	CT54XC731
SMS Schedule ID	12323510
SMS Schedule Name	DO Macro Upgrade
PID	
RRU OEM	Alcatel-Lucent
Switch DEM	ALU
RFDS Issue Date	2017-08-15 00:00:00.0
RFDS Revision Date	
RFDS Revision	

Contact Information	
Engineer Email	Bill.M.Hastings@sprint.com
Sprint Badged RF Engineer	Bill Hastings
RF Engineer Email	Bill.M.Hastings@sprint.com
RF Engineer Phone	978-590-9700
RF Manager	Jonathan Hull
RF Manager Email	Jonathan.Hull@sprint.com
RF Manager Phone	817-233-2920

Location Details	
Latitude	41.86464
Longitude	-72.36133
Market	Northern Connecticut
Region	Northeast
City	Hebron
State	CT
Zip Code	CT06248
County	Tolland

Carrier Count	
2500 LTE	3
1900 LTE	1
1900 EVDO	
1900 Voice	1
800 LTE	1
800 Voice	1

2500MHz	3
1900MHz	3
800MHz	3

Filter Analysis Complete	YES
RFDS - Issue Date	08/15/2017
Design Status	Complete
Border Analysis Complete	YES
Project Description	DO Macro Upgrade - Add 800MHz (2G) + 4G and 2500 MHz

Battery Backup Cabinet Model	
Model Number	
Weight (Lbs.)	
Dimensions (In.)	
Manufacturer	

BTS #1 Model	
Model Number	
Weight (Lbs.)	
Dimensions (In.)	
Manufacturer	
Number of BTS #1	



RF Design Sheet

Band: 2500	Alpha	Beta	Gamma	Delta	Epsilon	Zeta
<b>Radio Model</b>						
Model Number	TD-RRH8x20-25	TD-RRH8x20-25	TD-RRH8x20-25	N/A	N/A	N/A
Weight (lbs)	76.2	76.2	76.2	N/A	N/A	N/A
Dimensions	26 x 18.6 x 6.7	26 x 18.6 x 6.7	26 x 18.6 x 6.7	N/A	N/A	N/A
Manufacturer	ALU	ALU	ALU	N/A	N/A	N/A
Number of RRUs needed	1	1	1	0	0	0

Trunk Cable 1						
Model Number	Hybriflex	N/A	N/A	N/A	N/A	N/A
Weight (Lbs.)	1	N/A	N/A	N/A	N/A	N/A
Dimensions (In.)	1.54	N/A	N/A	N/A	N/A	N/A
Manufacturer	ALU	N/A	N/A	N/A	N/A	N/A

Band: 1500	Alpha	Beta	Gamma	Delta	Epsilon	Zeta
<b>Radio Model</b>						
Model Number	N/A	N/A	N/A	N/A	N/A	N/A
Weight (lbs)	N/A	N/A	N/A	N/A	N/A	N/A
Dimensions	N/A	N/A	N/A	N/A	N/A	N/A
Manufacturer	N/A	N/A	N/A	N/A	N/A	N/A
Number of RRUs needed	0	0	0	0	0	0

Band: 800	Alpha	Beta	Gamma	Delta	Epsilon	Zeta
<b>Radio Model</b>						
Model Number	RRH-2x50-800	RRH-2x50-800	RRH-2x50-800	N/A	N/A	N/A
Weight (lbs)	69.1	69.1	69.1	N/A	N/A	N/A
Dimensions	16 x 13 x 10	16 x 13 x 10	16 x 13 x 10	N/A	N/A	N/A
Manufacturer	ALU	ALU	ALU	N/A	N/A	N/A
Number of RRUs needed	2	2	2	0	0	0



RF Design Sheet

Band: 1900	Alpha	Beta	Gamma	Delta	Epsilon	Zeta
<b>Antenna 1</b>						
Model Number	ETCR-654L12H6	ETCR-654L12H6	ETCR-654L12H6			
Weight (lbs)	85	85	85	N/A	N/A	N/A
Dimensions	84.9 x 21 x 6.3	84.9 x 21 x 6.3	84.9 x 21 x 6.3	N/A	N/A	N/A
Manufacturer	KMW	KMW	KMW	N/A	N/A	N/A
Ant 1 Top Jumper Make/Model/Qty	N/A	N/A	N/A	N/A	N/A	N/A
Ant 1 RF requested Diameter	1/2"	1/2"	1/2"	N/A	N/A	N/A
Ant 1 RF requested Top Jumper Length(ft)	8	8	8	N/A	N/A	N/A
Antenna 1 Azimuth	U	120	240	N/A	N/A	N/A
Antenna 1 Mechanical DT	N/A	N/A	N/A	N/A	N/A	N/A
Antenna 1 Center Line (ft)	126.968508	126.968508	126.968508	N/A	N/A	N/A
Antenna 1 Electrical DT	3	3	3	N/A	N/A	N/A
Antenna 1 Electrical DT 2	N/A	N/A	N/A	N/A	N/A	N/A
Antenna 1 Electrical DT 3	N/A	N/A	N/A	N/A	N/A	N/A
Antenna 1 Twist	N/A	N/A	N/A	N/A	N/A	N/A

SPRINT CONSTRUCTION STANDARDS:

GENERAL CONTRACTOR SHALL ADHERE TO THE FOLLOWING SPRINT CONSTRUCTION STANDARDS.

- CONSTRUCTION STANDARDS: INTEGRATED CONSTRUCTION STANDARDS FOR WIRELESS SITES - CURRENT VERSION, INCLUDING EXHIBITS A-M.
- CONSTRUCTION SPECIFICATIONS: CONSTRUCTION STANDARDS EXHIBIT A - STANDARD CONSTRUCTION SPECIFICATIONS FOR WIRELESS SITES (CURRENT VERSION).
- GROUNDING STANDARDS: EXTERIOR GROUNDING SYSTEM DESIGN. GROUNDING STANDARDS (SUPPLEMENT): ANTI-THEFT UPDATE TO SPRINT GROUNDING 082412 AND SPRINT ENGINEERING LETTER EL-0504 DATED 04.20.12.
- WEATHER PROOFING STANDARDS: EXCERPT FROM CONSTRUCTION STANDARDS EXHIBIT A, SECTION 3.6 WEATHERPROOFING CONNECTORS AND GROUND KITS.
- COLOR CODING: SPRINT NEXTEL ANT AND LINE COLOR CODING PER SPRINT TS-0200 CURRENT VERSION.
- GENERAL CONTRACTOR TO FIELD VERIFY AZIMUTH AND CL HEIGHT AND MECHANICAL DOWNTILT. IF DIFFERENT THAN CALLED OUT IN RFDS, HALT ANTENNA WORK FOR ONE HOUR, CALL SPRINT RF ENGINEER (OR MANAGER IF RF ENGINEER DOES NOT ANSWER, BUT STILL LEAVE A MESSAGE TO RF ENGINEER) USING SPRINT-PROVIDED CONTACT INFORMATION FOR FURTHER INSTRUCTIONS. IF SPRINT DOES NOT RESPOND WITHIN ONE HOUR, PLACE ANTENNA AT SAME CL HEIGHT AS PLAN AND EMAIL CORRECT CL HEIGHT AND AZIMUTH TO SPRINT RF ENGINEER. UPDATE AS-BUILT DRAWING WITH CORRECT CL HEIGHT. ALSO EMAIL CORRECT ANTENNA CL HEIGHT, AZIMUTH AND MECHANICAL DOWNTILT TO RF ENGINEER.
- AISG TESTS TO VERIFY OPERATION IS TO BE PERFORMED AFTER FINAL INSTALLATION OF ANTENNAS AND AISG CABLES HAVE BEEN CONNECTED. VERIFY OPERATION OF ALL EXISTING SPRINT AISG EQUIPMENT INCLUDING 800MHZ, 1.9GHZ AND 2.5G. TEST INCLUDE COMPLETE DOWNTILT, AZIMUTH (IF APPLICABLE) AND BEAMWIDTH SWINGS (IF APPLICABLE). DOCUMENT AISG TEST RESULTS IN COAX SWEEP TEST SPREADSHEET.
- GENERAL CONTRACTOR MUST INSURE THAT NO OBJECT IS LOCATED IN FRONT OF ANTENNA. THIS MEANS NO OBJECT IS TO BE LOCATED 45 DEGREES LEFT AND RIGHT OF FRONT OF ANTENNA OR 7 DEGREES UP AND DOWN FROM CENTER OF ANTENNA. IF THIS IS NOT POSSIBLE, CONTACT RF ENGINEER FOR FURTHER INSTRUCTION.
- GENERAL CONTRACT IS REQUIRED TO USE A DIGITAL ALIGNMENT TOOL TO SET AZIMUTH, ROLL AND DOWNTILT. AZIMUTH ACCURACY IS TO BE WITHIN 1 DEGREES. DOWNTILT AND ROLL (LEFT TO RIGHT TILT) IS TO BE WITHIN 0.1 DEGREES. IF FOR SOME REASON THIS ACCURACY CANNOT BE ACHIEVED, UPDATE AS-BUILT DRAWINGS AND EMAIL SPRINT RF ENGINEER WITH AS-BUILT SETTINGS. USE 3Z RF ALIGNMENT TOOL OR EQUIVALENT TOOL.
- HTTP://WWW.3ZTELECOM.COM/ANTENNA-ALIGNMENT-TOOL/.

NOTE:  
VERIFY PROPOSED AZIMUTHS WITH RF ENGINEER PRIOR TO INSTALLATION



1 INTERNATIONAL BLVD., SUITE 800  
MAHWAH, NJ 07495  
TEL: (800) 357-7641



SBA COMMUNICATIONS CORP.  
134 FLANDERS ROAD, SUITE 125  
WESTBOROUGH, MA 01581  
TEL: (508) 251-0720



604 FOX GLEN  
BARRINGTON, IL 60010  
TELEPHONE: 847.277.0070  
FAX: 847.477.0080  
ae@westchesterservices.com



"I HEREBY CERTIFY THAT THESE PLANS WERE PREPARED BY ME OR UNDER MY DIRECT SUPERVISION AND THAT I AM A DULY REGISTERED ARCHITECT UNDER THE LAWS OF THE STATE OF CONNECTICUT"

CHECKED BY: JK

APPROVED BY: JMB

SUBMITTALS			
REV.	DATE	DESCRIPTION	BY
1	03/08/18	ISSUED FOR CONSTRUCTION	SDB
0	01/23/18	ISSUED FOR CONSTRUCTION	SH

SITE NUMBER:  
CT54XC731  
  
SITE NAME:  
CENTRAL HEBRON  
  
SITE ADDRESS:  
66 WALL STREET  
HEBRON, CT 06248

SHEET TITLE  
RF DATA SHEET

SHEET NUMBER  
RF-1

THE INFORMATION CONTAINED IN THIS SET OF CONSTRUCTION DOCUMENTS IS PROPRIETARY BY NATURE. ANY USE OR DISCLOSURE OTHER THAN THAT WHICH RELATES TO CARRIER SERVICES IS STRICTLY PROHIBITED.









Tower Engineering Solutions  
 8445 FREEPORT PARKWAY, SUITE 375  
 IRVING, TX 75063  
 PH: (972) 483-0607



5900 BROKEN SOUND PARKWAY, NW  
 BOCA RATON, FL 33487  
 (800)-487-SITE

TES JOB NO:  
 48686

CUSTOMER SITE NO:  
 CT04374-S-SBA  
 CUSTOMER SITE NAME:  
 CENTRAL HEBRON  
 66 WALL STREET  
 HEBRON, CT 06248

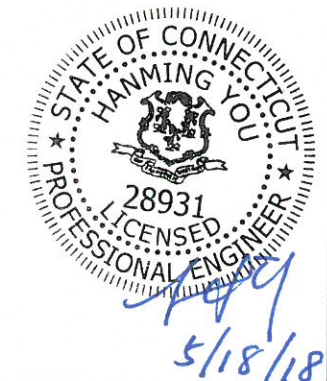

DRAWN BY: KMM | CHECKED BY: SH/HMA

REV.	DESCRIPTION	BY	DATE
0	FIRST ISSUE	KMM	05/18/18
△			
△			
△			

SHEET TITLE:

TITLE SHEET

This drawing/document is the property of Tower Engineering Solutions, LLC. Information contained herein is considered confidential in nature and is to be used only for the specific site that it was intended for. Reproduction, transmission, publication or disclosure by any method is prohibited except by express written permission from Tower Engineering Solutions, LLC. Without exception, the information on this drawing/document remains the property of Tower Engineering Solutions, LLC.

SHEET NUMBER: T-1 | REV #: 0

# MODIFICATION AND DESIGN DRAWINGS FOR AN EXISTING 150' VALMONT MONOPOLE TOWER

PROPOSED CARRIER: SPRINT NEXTEL

SITE: CT04374-S-SBA / CENTRAL HEBRON

COORDINATES (LATITUDE: 41.664631°, LONGITUDE: -72.361325°)

## CONSTRUCTION CLASS

TES HAS DETERMINED THIS AS A  
 CLASS IV CONSTRUCTION PROJECT  
 PER ANSI/ASSE A10.48

COMPLETE FABRICATION DRAWINGS FOR ALL MATERIALS REQUIRED FOR THIS PROJECT ARE AVAILABLE FROM TOWER ENGINEERING SOLUTIONS (TES). PLEASE CONTACT TES FOR MORE INFORMATION.

SHEET	SHEET TITLE	REV
T-1	TITLE SHEET	0
BOM	BILL OF MATERIALS	0
GN-1	GENERAL NOTES	0
A-1	TOWER PROFILE	0
FND-1	MONOPOLE FOUNDATION MODIFICATION DETAILS	0
RBL-1	REBAR CHART	0
A-2	MONOPOLE MODIFICATION DETAILS	0

NOTE:

1. THE MODIFICATION DRAWINGS ARE BASED ON THE TES PROJECT NO. 48665, DATED 03/01/18.





**GENERAL NOTES**

1. ALL WORK SHALL COMPLY WITH THE ANSI/TIA-222-G, ANSI/ASSE A10.48, 2016 CONNECTICUT STATE BUILDING CODE AND ANY OTHER GOVERNING BUILDING CODES AND OSHA SAFETY REGULATIONS.
2. ALL WORK INDICATED ON THE DRAWINGS SHALL BE PERFORMED BY QUALIFIED CONTRACTORS EXPERIENCED IN TELECOMMUNICATIONS TOWER, POLE AND FOUNDATION CONSTRUCTION.
3. THE CONTRACTOR SHALL BE RESPONSIBLE FOR THE DESIGN AND FABRICATION OF ALL MISCELLANEOUS PARTS (SUCH AS SHIMS), TEMPORARY SUPPORTS, AND GUYINGS, ETC., PER TIA-1019-A, TO COMPLETE THE ASSEMBLY AS SHOWN IN THE DRAWINGS.
4. CONTRACTOR SHALL PROCEED WITH THE INSTALLATION WORK CAREFULLY SO THE WORK WILL NOT DAMAGE ANY EXISTING CABLE, EQUIPMENT OR THE STRUCTURE.
5. THE USE OF GAS TORCH OR WELDER, ARE NOT ALLOWED ON ANY TOWER STRUCTURE WITHOUT THE CONSENT OF THE TOWER OWNER.
6. GENERALLY THE CONTRACTOR IS RESPONSIBLE TO CONDUCT AN ONSITE VISIT SURVEY OF THE JOB SITE AFTER AWARD, AND REPORT ANY ISSUES WITH THE SITE TO **TES** BEFORE PROCEEDING CONSTRUCTION.

**FABRICATION**

1. ALL STEEL SHALL MEET OR EXCEED THE MINIMUM STRENGTH AS SPECIFIED IN THE DRAWINGS. IF YIELD STRENGTH WAS NOT NOTED IN THE DRAWINGS, CONTRACTORS SHALL CONTACT TES FOR DIRECTION.
2. ALL FIELD CUT EDGES SHALL BE GROUND SMOOTH. ALL FIELD CUT AND DRILLED SURFACES SHALL BE REPAIRED WITH A MINIMUM OF TWO COATS OF ZRC GALVILITE COLD GALVANIZING COMPOUND PER ASTM A780 AND MANUFACTURER'S RECOMMENDATIONS.

**WELDING**

1. ALL WELDING SHALL BE PERFORMED BY AWS CERTIFIED WELDERS AND IN ACCORDANCE WITH THE LATEST EDITION OF THE AWS WELDING CODE D1.1. ALL ELECTRODES TO BE LOW HYDROGEN, MATCHING FILLER METAL, PER AWS D1.1, UNO. (E70XX UNLESS NOTED OTHERWISE).
2. PRIOR TO FIELD WELDING GALVANIZED MATERIAL, CONTRACTOR SHALL GRIND OFF GALVANIZING APPROX. 0.5" BEYOND THE PROPOSED FIELD WELD SURFACES.
3. ALL WELDS SHALL BE INSPECTED VISUALLY. A MINIMUM OF 25% OF WELDS SHALL BE INSPECTED WITH DYE PENETRANT OR MAGNETIC PARTICLE TO MEET THE ACCEPTANCE CRITERIA OF AWS D1.1. 100% OF WELDS SHALL BE INSPECTED IF DEFECTS ARE FOUND.
4. WELD INSPECTIONS SHALL BE PERFORMED BY AN AWS CERTIFIED WELD INSPECTOR.
5. AFTER INSPECTION, ALL FIELD WELDED SURFACES SHALL BE REPAIRED WITH A MINIMUM OF TWO COATS OF ZRC GALVILITE COLD GALVANIZING COMPOUND PER ASTM A780 AND MANUFACTURER'S RECOMMENDATIONS.

**BOLTED ASSEMBLIES AND TIGHTENING OF CONNECTIONS**

1. ALL HIGH STRENGTH BOLTS SHALL CONFORM TO THE PROVISIONS OF THE SPECIFICATIONS FOR STRUCTURAL JOINTS USING A325 OR A490 BOLTS AS APPROVED BY THE RCSC.
2. FLANGE BOLTS SHALL BE TIGHTENED BY THE AISC "TURN-OF-THE-NUT" METHOD. THE FOLLOWING TABLE SHOULD BE USED FOR THE "TURN-OF-THE-NUT" TIGHTENING.
3. SPLICE BOLTS AND ALL OTHER BOLTS IN BEARING TYPE CONNECTIONS SHALL BE TIGHTENED TO A SNUG-TIGHT CONDITION.
4. THE SNUG-TIGHT CONDITION IS DEFINED AS THE TIGHTNESS ATTAINED BY EITHER A FEW IMPACTS OF AN IMPACT WRENCH OR THE FULL EFFORT OF AN IRONWORKER WITH AN ORDINARY SPUD WRENCH TO BRING THE CONNECTED PLIES INTO FIRM CONTACT.
5. HB HOLLO-BOLT SHALL BE INSTALLED PER ICC ESR-3330 INSTRUCTIONS.

**VERIFICATION AND INSPECTION**

1. IF APPLICABLE, VERIFICATION INSPECTION TO BE PERFORMED SHALL BE IN ACCORDANCE TO IBC-2012 SECTION 1705 - TABLE 1705.2.2 FOR STEEL CONSTRUCTION AND TABLE 1705.3 FOR CONCRETE CONSTRUCTION.

**POST INSTALLED EPOXY INJECTED ANCHOR BOLTS:**

1. CONCRETE MUST BE A MINIMUM OF 28 DAYS OLD.
2. FOLLOW MANUFACTURER'S REQUIREMENTS FOR CURE TIME VS. AMBIENT TEMPERATURE.
3. DRILL HOLE TO REQUIRED DIAMETER AND DEPTH. ALL WATER, DIRT, OIL, DEBRIS, GREASE OR DUST MUST BE REMOVED FROM EACH CORE HOLE. FOLLOW MANUFACTURER'S RECOMMENDATION FOR CORRECT TYPE OF CORE BIT. AVOID DAMAGING EXISTING REINFORCING STEEL OR OTHER EMBEDDED ITEMS. NOTIFY TES ENGINEERING IF VOIDS IN THE CONCRETE, REINFORCING STEEL OR OTHER EMBEDDED ITEMS ARE ENCOUNTERED. STOP CORING IMMEDIATELY IF THIS OCCURS.
4. A HOLE ROUGHENING DEVICE FROM EITHER HILTI OR ALLFASTENERS SHALL BE USED WITH ALL HOLES. FOLLOW ALL MANUFACTURER'S RECOMMENDED CORING AND INSTALLATION INSTRUCTIONS.
5. AFTER CORING AND ROUGHENING, FLUSH EACH HOLE WITH RUNNING WATER TO REMOVE ANY SLURRY OR DEBRIS. REMOVE ALL WATER FROM THE HOLE BY MECHANICAL PUMPING.
6. BRUSH EACH HOLE WITH AN APPROPRIATE SIZED NYLON BRUSH AND FLUSH WITH RUNNING WATER A SECOND TIME. REMOVE ALL WATER FROM THE HOLE.
7. AFTER THE SECOND WATER FLUSH BRUSH THE HOLE AGAIN WITH THE APPROPRIATE SIZED NYLON BRUSH.
8. BLOW EACH HOLE WITH COMPRESSED AIR TWO TIMES MINIMUM.
9. CONFIRM THAT EACH HOLE IS PROPERLY ROUGHED AND DRY.
10. NO EPOXY INJECTION SHALL TAKE PLACE IN RAINY CONDITIONS.
11. EPOXY SHOULD BE VISIBLE AT THE TOP OF THE CORE HOLE AFTER INSTALLATION.
12. CONTRACTOR TO SUPPLY ONE PHOTO OF EACH ROUGHED AND CLEANED HOLE IN CLOSEOUT PHOTO PACKAGE.

TABLE 8.2 NUT ROTATION FROM SNUG-TIGHT CONDITION FOR TURN-OF-NUT PRETENSIONING<sup>a,b</sup>

BOLT LENGTH <sup>f</sup>	DISPOSITION OF OUTER FACE OF BOLTED PARTS		
	BOTH FACES NORMAL TO BOLT AXIS	ONE FACE NORMAL TO BOLT AXIS, OTHER SLOPED NOT MORE THAN 1:20 <sup>d</sup>	BOTH FACES SLOPED NOT MORE THAN 1:20 FROM NORMAL TO BOLT AXIS <sup>d</sup>
NOT MORE THAN 4d <sub>b</sub>	1/3 TURN	1/2 TURN	2/3 TURN
MORE THAN 4d <sub>b</sub> BUT NOT MORE THAN 8d <sub>b</sub>	1/2 TURN	2/3 TURN	5/6 TURN
MORE THAN 8d <sub>b</sub> BUT NOT MORE THAN 12d <sub>b</sub>	2/3 TURN	5/6 TURN	1 TURN

<sup>a</sup> NUT ROTATION IS RELATIVE TO BOLT REGARDLESS OF THE ELEMENT (NUT OR BOLT) BEING TURNED. FOR REQUIRED NUT ROTATIONS OF 1/2 TURN AND LESS, THE TOLERANCE IS PLUS OR MINUS 30 DEGREES; FOR REQUIRED NUT ROTATIONS OF 2/3 TURN AND MORE, THE TOLERANCE IS PLUS OR MINUS 45 DEGREES.

<sup>b</sup> APPLICABLE ONLY TO JOINTS IN WHICH ALL MATERIAL WITHIN THE GRIP IS STEEL.

<sup>c</sup> WHEN THE BOLT LENGTH EXCEEDS 12d<sub>b</sub>, THE REQUIRED NUT ROTATION SHALL BE DETERMINED BY ACTUAL TESTING IN A SUITABLE TENSION CALIBRATOR THAT SIMULATES THE CONDITIONS OF SOLIDLY FITTING STEEL.

<sup>d</sup> BEVELED WASHER NOT USED.

SPECIFICATION FOR STRUCTURAL JOINTS USING ASTM A325 OR A490 BOLTS, JUNE 30, 2004 RESEARCH COUNCIL ON STRUCTURAL CONNECTIONS

**INSTALLATION TORQUE REQUIRED FOR HOLLO BOLTS AND AJAX BOLTS:**

1. HB12 HOLLO BOLT: 59 FT-LBS
2. HB16 HOLLO BOLT: 140 FT-LBS
3. HB20 HOLLO BOLT: 221 FT-LBS
4. M20 AJAX BOLT: 280 FT-LBS.

**FIELD HOT WORK PLAN NOTES:**

FOLLOWING GUIDELINES SHALL BE COMPLIED WITH:

1. CONTRACTOR'S RESPONSIBILITY TO COMPLETE A HOT WORK PLAN IF AWARDED PER CUSTOMER SPECIFICATIONS GUIDELINES FOR WELDING, CUTTING & SPARK PRODUCING WORK.
2. HAVE A FIRE PLAN APPROVED BY THE CUSTOMER AND THEIR SAFETY MANAGEMENT DEPT.
3. CONTRACTOR MUST OBTAIN THE CONTACT INFO OF THE LOCAL FIRE DEPARTMENT AND THE 911 ADDRESS OF THE TOWER SITE BEFORE CONSTRUCTION.
4. CONTRACTOR SHALL MAKE SURE THAT CELL PHONE COVERAGE IS AVAILABLE IN THE TOWER SITE. IF CELL COVERAGE IS NOT AVAILABLE, AN IMMEDIATE AVAILABLE MEANS OF DIRECT COMMUNICATION WITH THE FIRE DEPARTMENT SHALL BE DETERMINED PRIOR TO CONSTRUCTION START.
5. ALL CONSTRUCTION SHALL BE PERFORMED UNDER WIND SPEED LESS THAN 10 MPH ON THE GROUND LEVEL. IF WIND SPEED INCREASE, CONTRACTOR MUST DETERMINE IF CONSTRUCTION SHALL BE DISCONTINUED.
6. FIRE SUPPRESSION EQUIPMENT MUST BE MADE AVAILABLE ON SITE AND READY TO USE.
7. CONTRACTOR SHALL ASSIGN A FIRE WATCHER TO PERFORM FIRE-FIGHTING DUTIES.
8. ALL WELDERS SHALL BE AWS OR STATE CERTIFIED. THEY MUST ALSO BE EXPERIENCED IN WELDING ON GALVANIZED MATERIALS.
9. IF IT IS POSSIBLE, ALL EXISTING COAX NEAR WELDING AREA SHALL BE TEMPORARILY MOVED AWAY FROM THE WELDING AREA BEFORE WELDING THE PLATES.
10. PLEASE REPORT ANY FIELD ISSUE TO TES @ 972-483-0607.

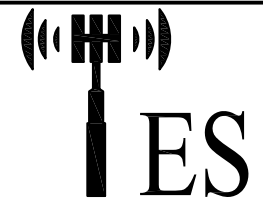

**Tower Engineering Solutions**

8445 FREEPORT PARKWAY, SUITE 375  
IRVING, TX 75063  
PH: (972) 483-0607



5900 BROKEN SOUND PARKWAY, NW  
BOCA RATON, FL 33487  
(800)-487-SITE

TES JOB NO:  
48686

CUSTOMER SITE NO:  
CT04374-S-SBA  
CUSTOMER SITE NAME:  
CENTRAL HEBRON  
66 WALL STREET  
HEBRON, CT 06248

DRAWN BY: **KMM** CHECKED BY: **SH/HMA**

REV.	DESCRIPTION	BY	DATE
0	FIRST ISSUE	KMM	05/18/18

SHEET TITLE:

GENERAL NOTES

This drawing/document is the property of Tower Engineering Solutions, LLC. Information contained herein is considered confidential in nature and is to be used only for the specific site that it was intended for. Reproduction, transmission, publication or disclosure by any method is prohibited except by express written permission from Tower Engineering Solutions, LLC. Without exception, the information on this drawing/document remains the property of Tower Engineering Solutions, LLC.

SHEET NUMBER: REV #:

GN-1 0

**NOTES:**

1. TEMPORARILY RELOCATE ANY EXISTING COAX ATTACHED TO THE MONOPOLE AND ANY OTHER MEMBERS WHERE OBSTRUCTION WITH THE PROPOSED MODIFICATION MAY OCCUR.
2. TEMPORARY RELOCATION OF EXISTING EQUIPMENT AROUND THE FOUNDATION MAY BE REQUIRED DURING CONSTRUCTION.

**SCOPE OF WORK**

- 1 A. INSTALL NEW MULTI-PART EXPANSION KITS FOR 36" O.D. X 10'-0" SMOOTH ROUND SHROUDS TO BE DESIGNED AND PROVIDED BY OTHERS. NEW SHROUD COLOR TO MATCH EXISTING COLOR  
B. REPLACE EXISTING 24" O.D. X 10'-0" SHROUDS W/NEW (3) 36" O.D. 10'-0" SMOOTH ROUND SHROUDS, TO BE PROVIDED BY OTHERS.  
C. INSTALL NEW EXPANSION KITS PER MANUFACTURER'S INSTRUCTIONS.
- 2 REPLACE EXISTING TOP PLATE, FLAG TRUCK AND BALL, W/ NEW TOP PLATE, FLAG TRUCK AND GOLD BALL FOR 36" O.D. SHROUDS.
- 3 A. INSTALL FLANGE REINFORCEMENT AT 110' ELEV. SEE SHEET A-2 FOR DETAILS.  
B. INSTALL NEW TRANSITION CONE, PROVIDED BY OTHERS.
- 4 INSTALL FOUNDATION MODIFICATION. SEE SHEET FND-1 FOR DETAILS.
- 5 THE CONTRACTOR SHALL BE RESPONSIBLE FOR THE CLEAN-UP, REMOVAL AND DISPOSAL OF EXCESS MATERIALS USED AND REMOVED FROM THE STRUCTURE AT THE COMPLETION OF THE PROJECT.



MONOPOLE TOWER BASE FOUNDATION PHOTO

**FOUNDATION COATING NOTES:**

1. THE COATING MATERIALS SHALL BE LANCO WHITE ACRYLIC ELASTOMERIC COATING AND SEALER, OR HYDRO ARMOR COATING.
2. THE COATING CAN BE PLACED AT LEAST (2) DAYS AFTER THE PLACEMENT OF THE CONCRETE FOR FOUNDATION REINFORCEMENT, AND MINIMUM (4) DAYS FOR NEW FOUNDATION CONSTRUCTION.
3. THE CONCRETE SURFACE SHALL BE CLEAN AND DRY PRIOR TO THE APPLICATION OF THE COATING.
4. THE COATING SHALL BE APPLIED TO ALL THE SURFACES OF THE CONCRETE ABOVE THE GROUND AND 6" BELOW THE GRADE SURFACE IF APPLICABLE.
5. MINIMUM 30 MILS COATING IS REQUIRED.

EXISTING ROUND VALMONT MONOPOLE  
REFERENCE VALMONT DRAWING #150464-B,  
ENGINEERING# A-117319, DATED 07/19/00.

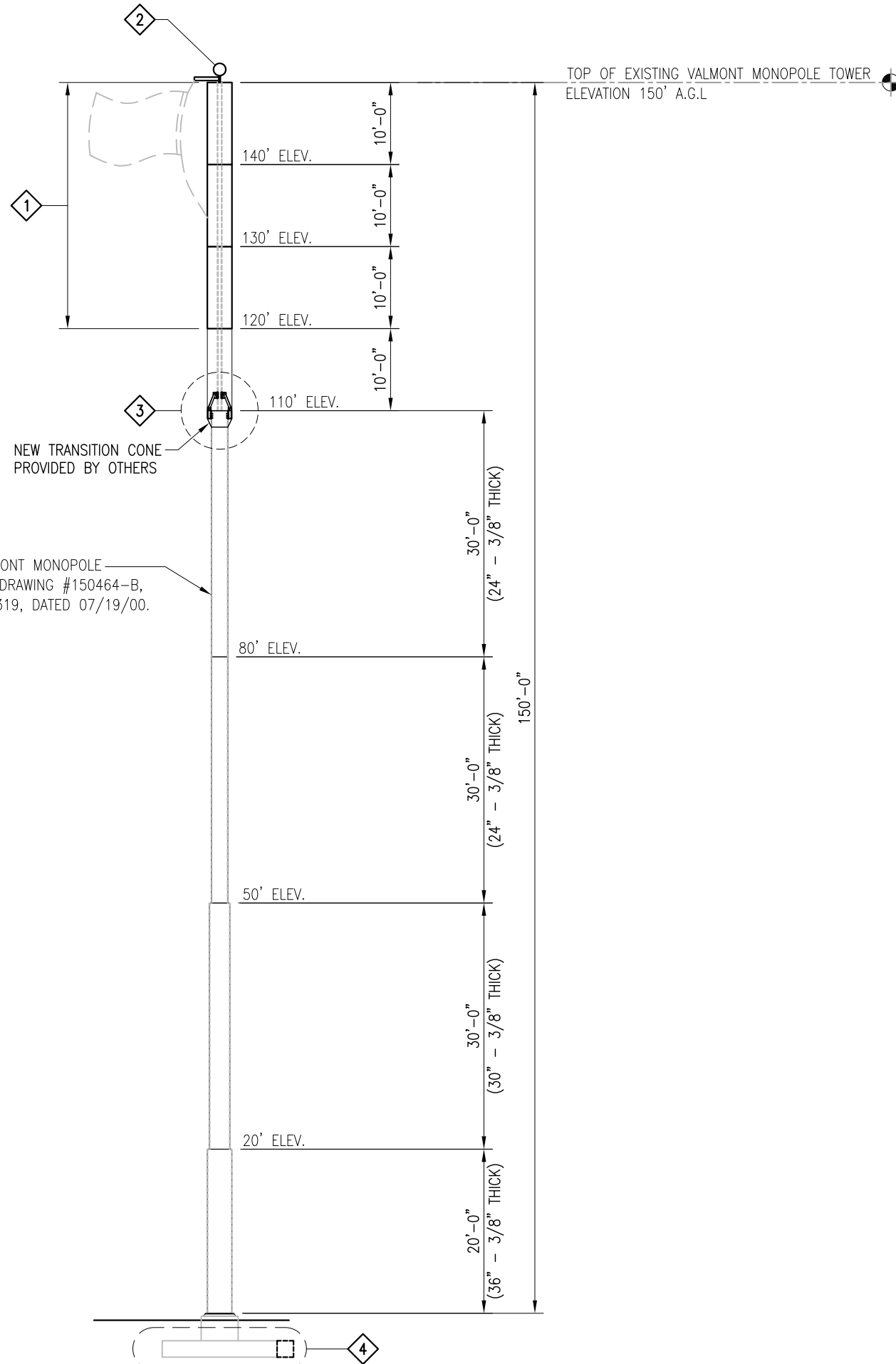

**Tower Engineering Solutions**  
8445 FREEPORT PARKWAY, SUITE 375  
IRVING, TX 75063  
PH: (972) 483-0607



5900 BROKEN SOUND PARKWAY, NW  
BOCA RATON, FL 33487  
(800)-487-SITE

TES JOB NO:  
48686

CUSTOMER SITE NO:  
CT04374-S-SBA  
CUSTOMER SITE NAME:  
CENTRAL HEBRON  
66 WALL STREET  
HEBRON, CT 06248

DRAWN BY: **KMM** CHECKED BY: **SH/HMA**

REV.	DESCRIPTION	BY	DATE
1	FIRST ISSUE	KMM	05/18/18

SHEET TITLE:

TOWER PROFILE

This drawing/document is the property of Tower Engineering Solutions, LLC. Information contained herein is considered confidential in nature and is to be used only for the specific site that it was intended for. Reproduction, transmission, publication or disclosure by any method is prohibited except by express written permission from Tower Engineering Solutions, LLC. Without exception, the information on this drawing/document remains the property of Tower Engineering Solutions, LLC.

SHEET NUMBER: **A-1** REV #: **0**

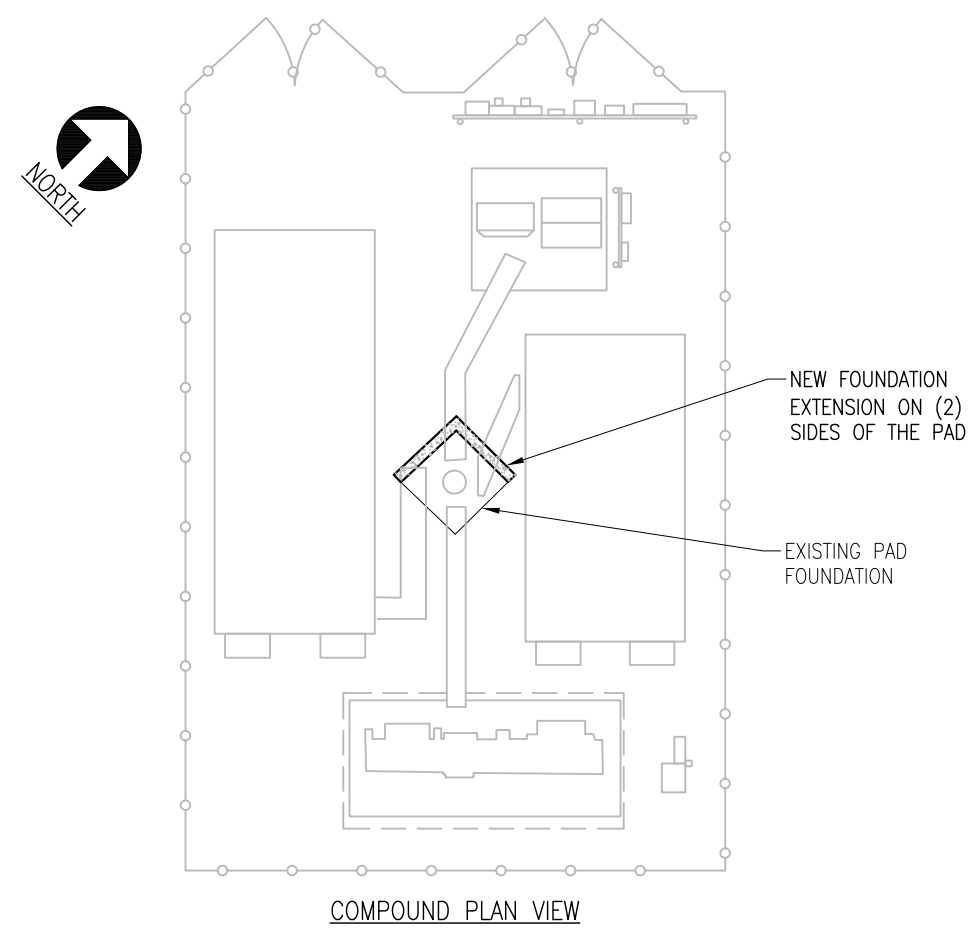
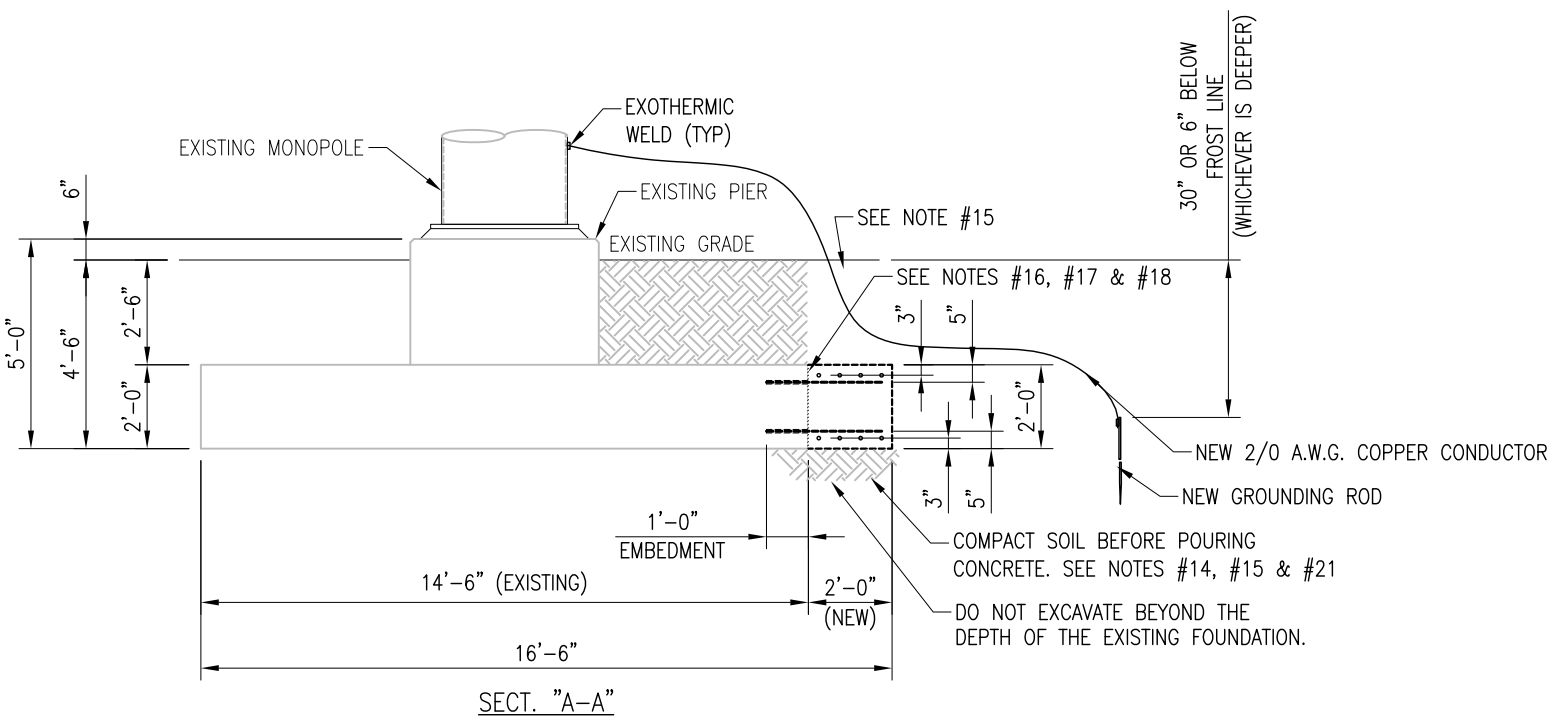
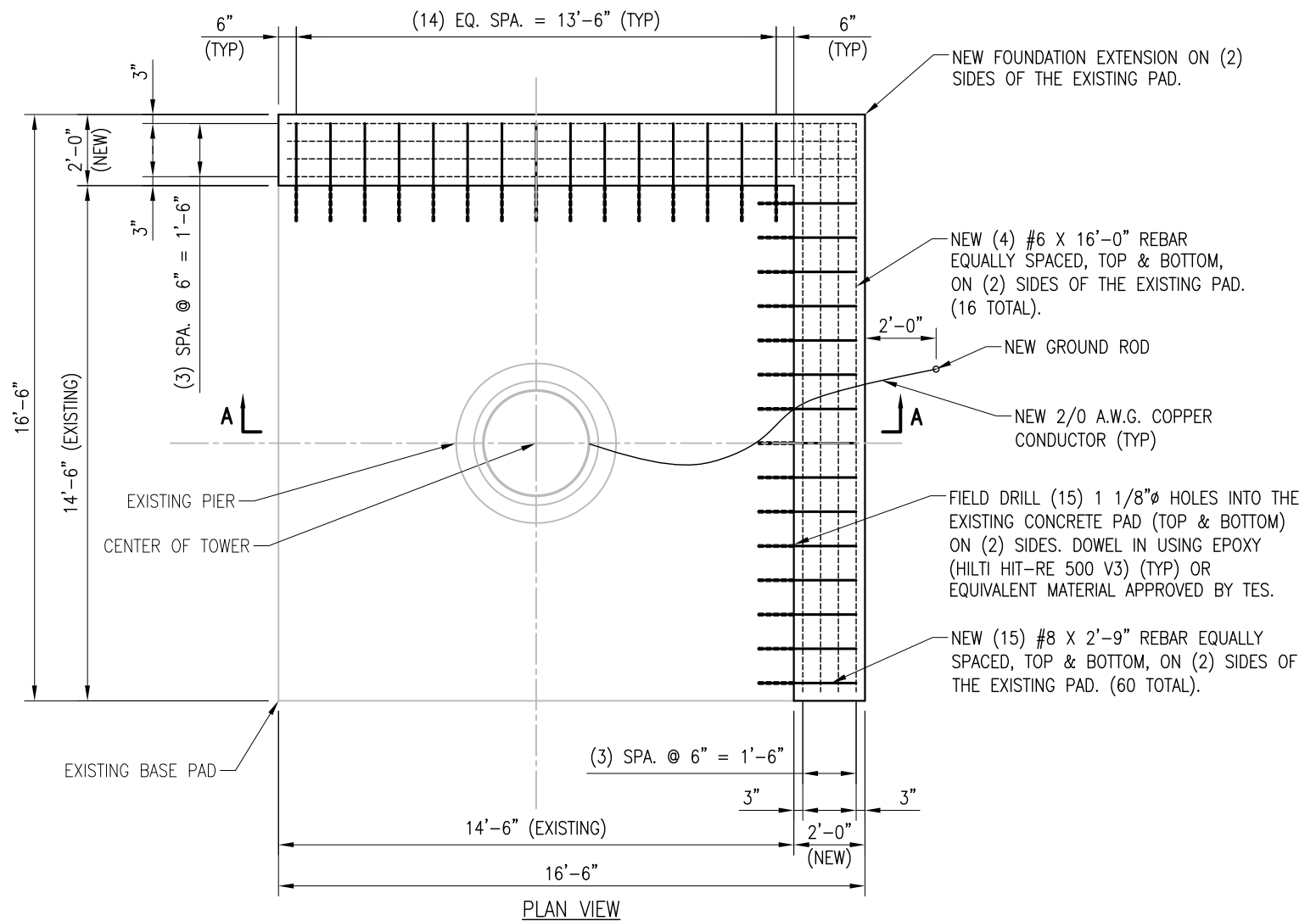

**NOTES:**

1. THE FOUNDATION MODIFICATION DESIGN IS BASED ON THE **FDH ENGINEERING, INC. PROJECT# 1201291EG1, DATE 02/14/12.**
2. CONCRETE TO HAVE A MINIMUM COMPRESSIVE STRENGTH OF **4000** PSI AT 28 DAYS.
3. TEST CYLINDERS SHALL BE MOLDED AND LABORATORY CURED IN ACCORDANCE WITH ASTM C31. THREE PAIRS OF CONCRETE COMPRESSION TEST CYLINDERS SHALL BE MADE FROM EACH TRUCK LOAD OF CONCRETE. TWO CYLINDERS SHALL BE TESTED AT 7 DAYS AND TWO CYLINDERS SHALL BE TESTED AT 28 DAYS. (REMAINING PAIR OF CYLINDERS ARE FOR REDUNDANCY).
4. REINFORCED CONCRETE CONSTRUCTION AND MATERIALS SHALL BE IN ACCORDANCE WITH ACI STANDARDS 318.
5. ALL REBAR SHALL BE SECURELY WIRE TIED TO PREVENT DISPLACEMENT DURING POURING OF CONCRETE.
6. VERTICAL EMBEDMENTS OUT OF PLUMB: 1.0 DEGREE.
7. DEPTH OF FOUNDATION: PLUS 1" OR MINUS 0".
8. CONCRETE DIMENSIONS: PLUS OR MINUS 1/2".
9. REINFORCING STEEL PLACEMENT: PLUS OR MINUS 1/2" INCLUDING CONCRETE COVER.
10. CONCRETE VOLUME: **4.6** CUBIC YARDS.
11. MATERIALS FOR REINFORCING SHALL BE IN ACCORDANCE WITH ASTM SPECIFICATION A615-85.
12. ALL REBAR TO BE GRADE 60 (UNLESS NOTED OTHERWISE).
13. CONCRETE SLUMP: **2"~4"**.
14. FOUNDATION BASE SHOULD REST ON FIRM AND LEVELED SURFACE.
15. FILL MATERIALS SHALL BE COMPACTED USING LAYERS OF NO MORE THAN 6". FINAL COMPACTION MUST BE A MINIMUM OF 95% DENSITY (THE MAXIMUM DRY UNIT OF WEIGHT). BACKFILL MATERIALS SHALL BE SANDY SILT (ML), SILT SAND (SM), CLAYED SAND (SC). NO ORGANIC MATERIALS, ROOTS, PLASTIC SILTS OR CLAYS, DELETERIOUS MATERIALS AND STONES SHALL BE USED. IF ROCK/SOIL MIXTURE IS USED AS BACKFILL, THE ROCK SIZE SHOULD BE LESS THAN 4" IN GREATEST DIMENSION AND NOT MORE THAN 15% BY WEIGHT SHALL BE LARGER THAN 2" IN GREATEST DIMENSION.
16. CLEAN AND ROUGHEN THE SURFACE. THE SURFACE MUST BE PREPARED MECHANICALLY GIVING A SURFACE PROFILE OF MINIMUM 1/8", EXPOSING THE COARSE AGGREGATE OF THE OLD CONCRETE.
17. APPLY WELD-CRETE OR CORR-BOND AGENT OVER THE SURFACE OF THE OLD CONCRETE PER THE MANUFACTURER'S SPECIFICATIONS.
18. NEW CONCRETE MUST BE PLACED OVER THE BONDING AGENT WITHIN THE MAXIMUM ALLOWABLE TIME PER THE MANUFACTURER'S SPECIFICATIONS.
19. THE FOUNDATION MODIFICATION MUST BE PERFORMED AT A WIND SPEED LESS THAN **15** MPH.
20. THE FOUNDATION MODIFICATION MUST BE COMPLETED IN THE SAME DAY IT WAS STARTED.
21. DON'T OVER EXCAVATE SOILS BOTH VERTICALLY AND HORIZONTALLY.



**Tower Engineering Solutions**  
 8445 FREEPORT PARKWAY, SUITE 375  
 IRVING, TX 75063  
 PH: (972) 483-0607



5900 BROKEN SOUND PARKWAY, NW  
 BOCA RATON, FL 33487  
 (800)-487-SITE

TES JOB NO:  
**48686**  
 CUSTOMER SITE NO:  
**CT04374-S-SBA**  
 CUSTOMER SITE NAME:  
**CENTRAL HEBRON**  
 66 WALL STREET  
 HEBRON, CT 06248

DRAWN BY: **KMM** | CHECKED BY: **SH/HMA**

REV.	DESCRIPTION	BY	DATE
0	FIRST ISSUE	KMM	05/18/18

SHEET TITLE:  
**MONOPOLE FOUNDATION  
 MODIFICATION DETAILS**

This drawing/document is the property of **Tower Engineering Solutions, LLC**. Information contained herein is considered confidential in nature and is to be used only for the specific site that it was intended for. Reproduction, transmission, publication or disclosure by any method is prohibited except by express written permission from **Tower Engineering Solutions, LLC**. Without exception, the information on this drawing/document remains the property of **Tower Engineering Solutions, LLC**.

SHEET NUMBER: **FND-1** | REV #: **0**

**REBAR CHART**

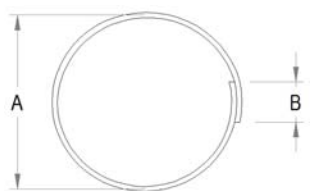
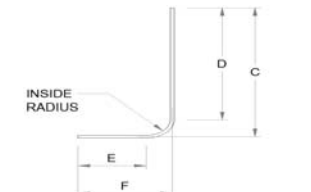
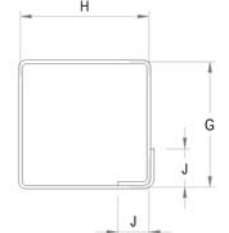
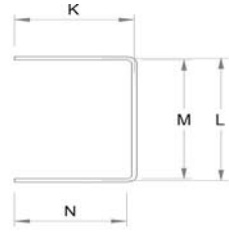
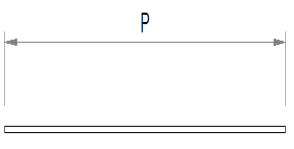
TYPE OF REBAR DIAGRAM	ITEMS	QTY. REQ'D	REBAR SIZE	LENGTH REQ'D (FT.)	TOTAL WEIGHT (LBS)	DETAILS OF BAR DIMENSIONS						REBAR DIAGRAM	
						A (FT.)	A	B	B (FT.)				
ROUND TIE		-	-	-	-	A (FT.)	A	B	B (FT.)				
90° BEND VERTICAL BAR		-	-	-	-	C (FT.)	C	D (ft)	D	E	F	RADIUS	
SQUARE OR RECTANGULAR TIE		-	-	-	-	G (FT.)	G	H (ft)	H	J	RADIUS		
U-SHAPE 90° BEND		-	-	-	-	K (FT.)	K	L (ft)	L	M	N	RADIUS	
STRAIGHT		-	-	-	-	P (FT.)	P	<b>MINIMUM SPLICE LENGTHS REQUIRED</b>					
	1	16	6	16'-0"	384.5	16.000	16'-0"	<b>BAR SIZE</b>	<b>LENGTH REQ'D</b>				
	2	60	8	2'-9"	440.6	2.750	2'-9"	#6	3'-7/8"				
								#7	4'-4 1/2"				
								#8	5'-1 1/2"				
								#9	5'-9"				
								#10	6'-6"				
							#11	7'-1 1/2"					

**BILL OF MATERIALS**

TYPES OF REBAR CONFIGURATIONS	QTY. REQ'D	REBAR SIZE	LENGTH REQ'D (FT.)	TOTAL WEIGHT (LBS)
STRAIGHT	16	6	16'-0"	384.5
STRAIGHT	60	8	2'-9"	440.6
<b>TOTAL STEEL WEIGHT (LBS):</b>	<b>825.1</b>			



Tower Engineering Solutions  
8445 FREEPORT PARKWAY, SUITE 375  
IRVING, TX 75063  
PH: (972) 483-0607



5900 BROKEN SOUND PARKWAY, NW  
BOCA RATON, FL 33487  
(800)-487-SITE

TES JOB NO:  
48686

CUSTOMER SITE NO:  
CT04374-S-SBA  
CUSTOMER SITE NAME:  
CENTRAL HEBRON  
66 WALL STREET  
HEBRON, CT 06248

DRAWN BY: **KMM** | CHECKED BY: **SH/HMA**

REV.	DESCRIPTION	BY	DATE
1	FIRST ISSUE	KMM	05/18/18

SHEET TITLE:

REBAR CHART

This drawing/document is the property of Tower Engineering Solutions, LLC. Information contained herein is considered confidential in nature and is to be used only for the specific site that it was intended for. Reproduction, transmission, publication or disclosure by any method is prohibited except by express written permission from Tower Engineering Solutions, LLC. Without exception, the information on this drawing/document remains the property of Tower Engineering Solutions, LLC.

SHEET NUMBER: **RBL-1** | REV #: **0**



Copyright 2018 Tower Engineering Solutions, LLC

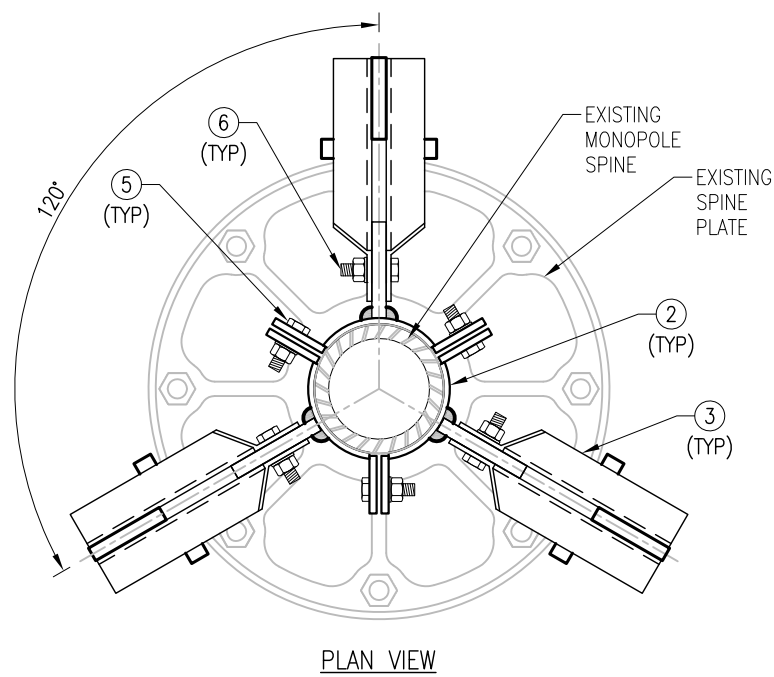

PLAN VIEW

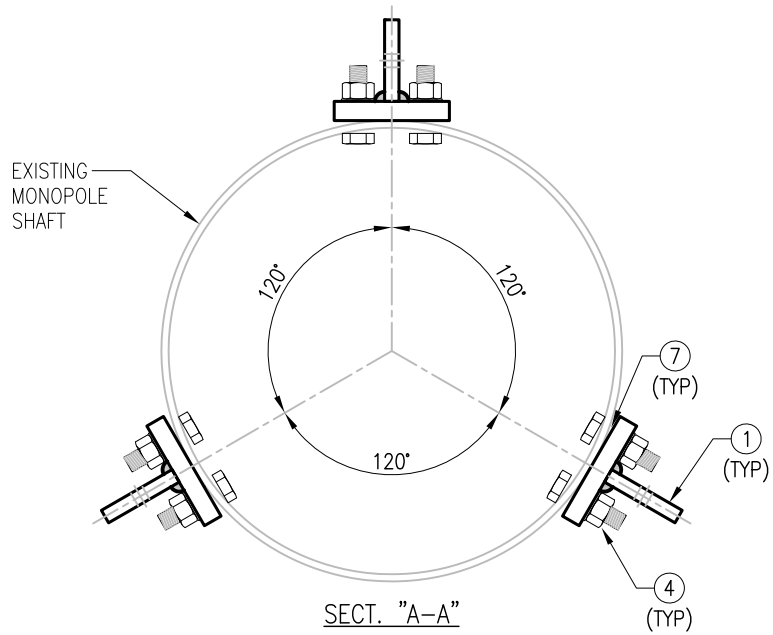

SECT. "A-A"

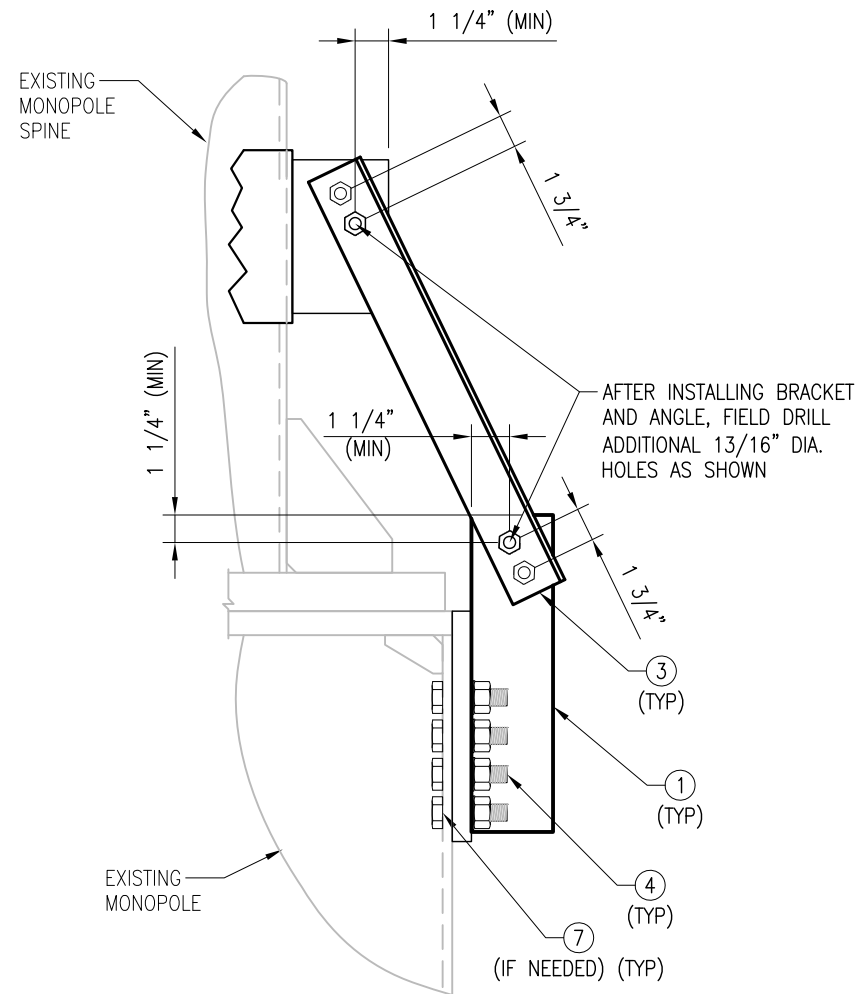

DETAIL "B"

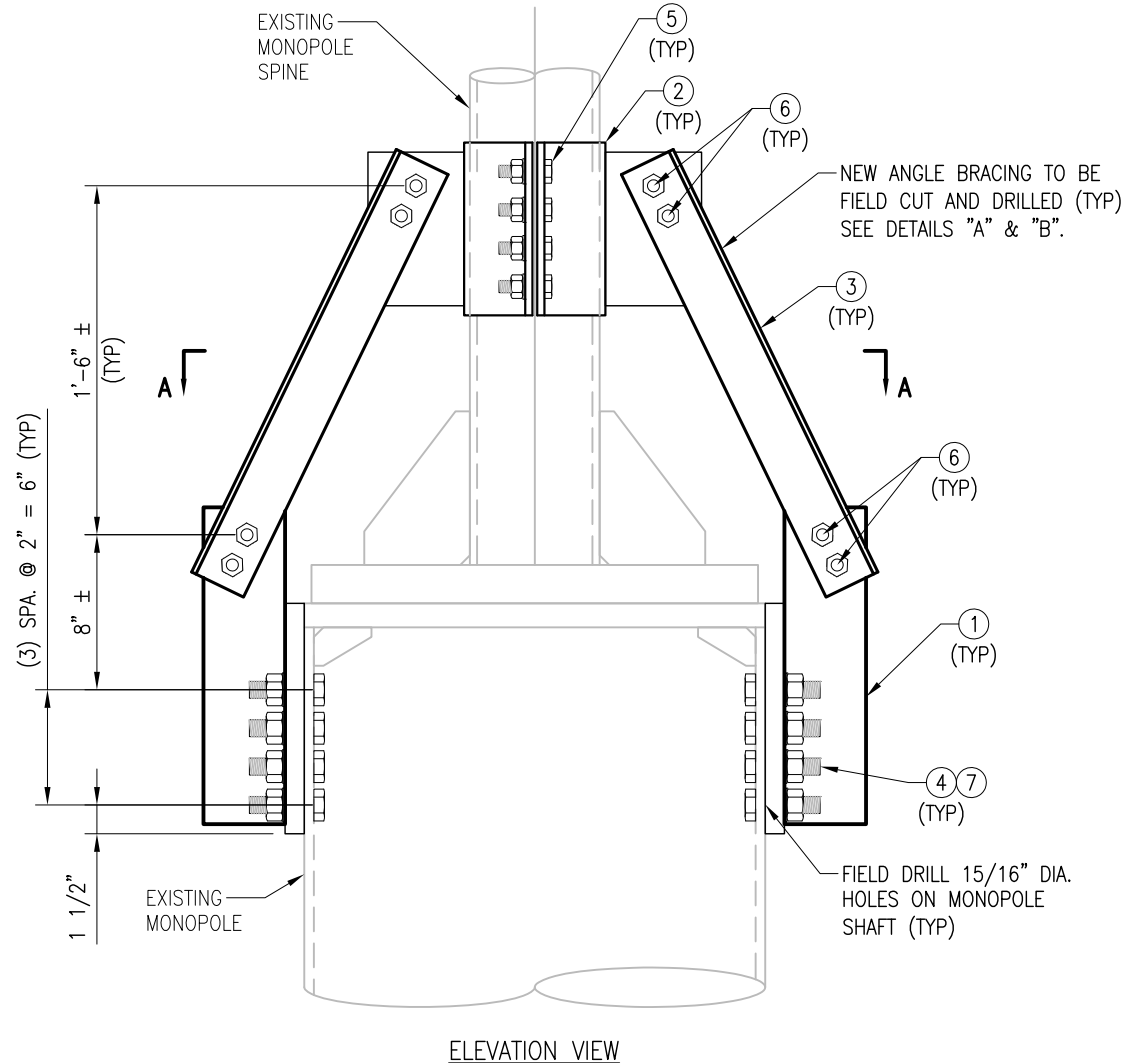

ELEVATION VIEW

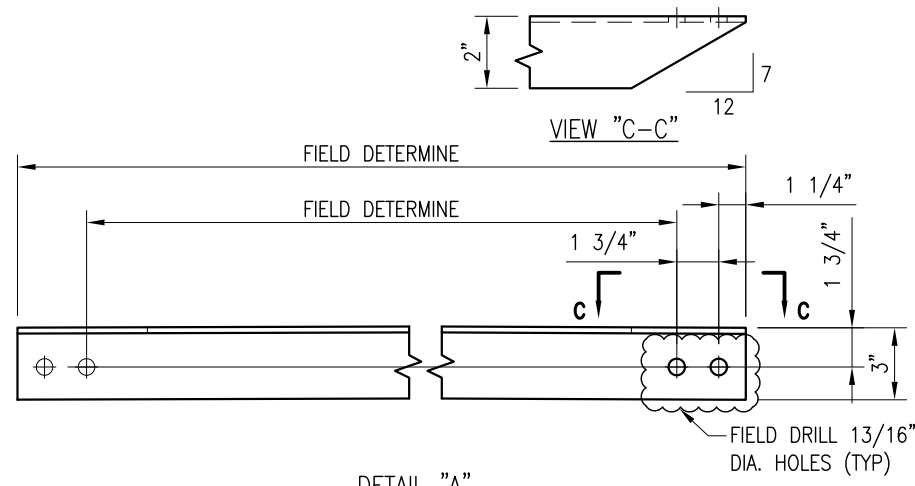

DETAIL "A"

**NOTES:**

1. SEE SHEET A-1 FOR LOCATION OF REQUIRED SECTION MODIFICATIONS.
2. TEMPORARILY RELOCATE ANY EXISTING COAX ATTACHED TO THE LEGS AND/OR ANY OTHER MEMBERS WHERE OBSTRUCTION WITH THE PROPOSED MODIFICATION MAY OCCUR.
3. WHEN FIELD CUTTING AND DRILLING ANGLES, USE SAME GAGE LINES AND EDGE DISTANCES AS INDICATED ON SHOP CUT AND DRILLED ENDS.
4. APPLY (2) COATS OF ZINC RICH GALVANIZING COMPOUND AS PER THE MANUFACTURER'S SPECIFICATIONS TO ALL FIELD CUT AND DRILLED AREAS.

ITEM NO.	QTY.	PART NO.	DESCRIPTION
7	24	---	BEVEL WASHER, 7/8" (IF NEEDED)
6	12	---	BOLT 3/4" X 2 1/2" A325
5	12	---	BOLT 3/4" X 2 1/4" A325
4	24	---	BOLT 7/8" X 3" A325
3	6	L-1	L 3" X 2" X 1/4" X 4'-0" A36
2	3	BRKW-2	ROLLED PLATE WELDMENT A572-50
1	3	BRKW-1	PL 1" X 6" PLATE WELDMENT



**Tower Engineering Solutions**  
 8445 FREEPORT PARKWAY, SUITE 375  
 IRVING, TX 75063  
 PH: (972) 483-0607



5900 BROKEN SOUND PARKWAY, NW  
 BOCA RATON, FL 33487  
 (800)-487-SITE

TES JOB NO:  
**48686**  
 CUSTOMER SITE NO:  
**CT04374-S-SBA**  
 CUSTOMER SITE NAME:  
**CENTRAL HEBRON**  
 66 WALL STREET  
 HEBRON, CT 06248

DRAWN BY: <b>KMM</b>	CHECKED BY: <b>SH/HMA</b>		
REV.	DESCRIPTION	BY	DATE
1	FIRST ISSUE	KMM	05/18/18

SHEET TITLE:  
**MONOPOLE MODIFICATION DETAILS**

This drawing/document is the property of Tower Engineering Solutions, LLC. Information contained herein is considered confidential in nature and is to be used only for the specific site that it was intended for. Reproduction, transmission, publication or disclosure by any method is prohibited except by express written permission from Tower Engineering Solutions, LLC. Without exception, the information on this drawing/document remains the property of Tower Engineering Solutions, LLC.

SHEET NUMBER:  
**A-2**  
 REV #:  
**0**