



New Cingular Wireless PCS, LLC  
500 Enterprise Drive  
Rocky Hill, Connecticut 06067-3900  
Phone: (860) 513-7636  
Fax: (860) 513-7190

Steven L. Levine  
Real Estate Consultant

HAND DELIVERED

September 19, 2008

Honorable Daniel F. Caruso, Chairman,  
and Members of the Connecticut Siting Council  
Connecticut Siting Council  
10 Franklin Square  
New Britain, Connecticut 06051

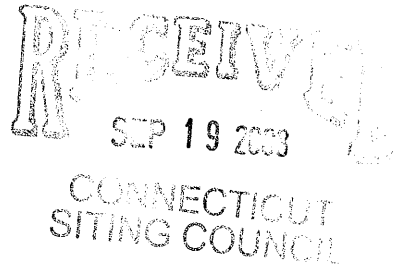

Re: New Cingular Wireless PCS, LLC Request for Re-Acknowledgment of a  
Previously-Acknowledged Notice of Exempt Modification

EM-CING-064-080917      92 Weston Street, Hartford

Dear Chairman Caruso and Members of the Council:

On September 17, 2008, New Cingular Wireless ("AT&T") submitted a letter and checks totaling \$8,000, requesting re-acknowledgment of 16 notices of exempt modification. These notices had been filed and approved in 2006 with a 1-year expiration date, but AT&T had not initiated or completed the approved site modifications within the year allowed by the Council. Accordingly, the acknowledgments expired and AT&T is now requesting re-acknowledgment so the site modifications may proceed.

Acting upon the 9/17/08 letter, Council staff assigned 16 new EM numbers and requested additional information from AT&T for each site. The request concerned the status of structural analysis records presently in the Council's files, i.e., did the latest structural in Council files for each site incorporate the modifications approved for AT&T in 2006?

We have assessed this matter and have found that the existing structural analysis in Council files for the referenced site *does* include AT&T's modifications approved by the Council in 2006. The 2006 approval for Cingular is the latest action for the site that affects tower loading.

AT&T, therefore, respectfully requests that the Council acknowledge the referenced Notice of Exempt Modification so that its planned site modifications may proceed.

Please feel free to call me at (860) 513-7636 with questions concerning this matter. Thank you for your consideration.

Sincerely,

Steven L. Levine  
Real Estate Consultant



New Cingular Wireless PCS, LLC  
500 Enterprise Drive  
Rocky Hill, Connecticut 06067-3900  
Phone: (860) 513-7636  
Fax: (860) 513-7190

Steven L. Levine  
Real Estate Consultant

HAND DELIVERED

September 17, 2008

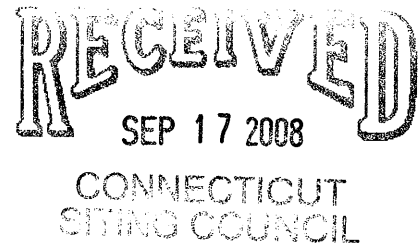

Honorable Daniel F. Caruso, Chairman,  
and Members of the Connecticut Siting Council  
Connecticut Siting Council  
10 Franklin Square  
New Britain, Connecticut 06051

Re: New Cingular Wireless PCS, LLC Request for Re-Acknowledgment of Sixteen Previously-Acknowledged Notices of Exempt Modification

Dear Chairman Caruso and Members of the Council:

In order to accommodate technological changes, implement Uniform Mobile Telecommunications System ("UMTS") capability, and enhance system performance in the State of Connecticut, New Cingular Wireless PCS, LLC ("AT&T") plans to modify the equipment configurations at many of its existing cell sites. This program has been in progress since 2006.

In 2006, AT&T submitted a number of Notices of Exempt Modification and received the Council's acknowledgments, each carrying a 1-yr expiration provision. On-site installation was completed at most of the cell sites within the ensuing year. However, for a number of sites the work was either not begun or not completed before expiration of the Council's approval.

At this time AT&T intends to finish UMTS modifications at the affected sites and hereby requests the Council's re-acknowledgment for sixteen of the earlier Notices of Exempt Modification. For each site, we herewith submit a filing fee of \$500.

For each site, the materials required for a notice of exempt modification are already in the Council's files owing to the earlier filings, and the currently-proposed modifications are the same as those previously acknowledged by the Council. Therefore, we are submitting AT&T's request for re-acknowledgment in this form to avoid needless waste of paper.

The sites and the earlier Exempt Modification Notices are:

2 West Street, Rocky Hill	EM-CING-119-007-155-064-060623
260 Beckley Road, Berlin	EM-CING-119-007-155-064-060623
123 Costello Road, Newington	EM-CING-064-043-155-094-060609
179 Shunpike Road, Cromwell	EM-CING-033-017-060728
290 Preston Avenue, Middletown	EM-CING-033-080-083-060525
945 East Center Street, Wallingford	EM-CING-148-101-060-060609
992 Northrop Road, Wallingford	EM-CING-084-148-014-060623
10 Bona Street, Milford	EM-CING-014-084-060602
438 Bridgeport Avenue, Milford	EM-CING-084-060728
185 Research Drive, Milford	EM-CING-084-148-014-060623
4 Beaver Road, Branford	EM-CING-084-148-014-060623
150 North Main Street, Branford	EM-CING-014-148-060707
123 Meadow Street, Hartford	EM-CING-119-007-155-064-060623
92 Weston Street, Hartford	EM-CING-064-119-060707
1030 New Britain Avenue, West Hartford	EM-CING-119-007-155-064-060623
310 Orange Street, New Haven	EM-CING-093-084-060613

For the foregoing reasons, AT&T respectfully requests that the Council re-acknowledge the sixteen referenced Notices of Exempt Modification so that its planned site modifications may proceed.

Please feel free to call me at (860) 513-7636 with questions concerning this matter. Thank you for your consideration.

Sincerely,



Steven L. Levine  
Real Estate Consultant

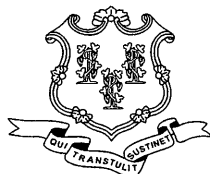

# STATE OF CONNECTICUT

## CONNECTICUT SITING COUNCIL

Ten Franklin Square, New Britain, CT 06051

Phone: (860) 827-2935 Fax: (860) 827-2950

E-Mail: [siting.council@ct.gov](mailto:siting.council@ct.gov)

[www.ct.gov/csc](http://www.ct.gov/csc)

July 31, 2006

Elizabeth H. Lankenau, AICP  
Planner

Kise Straw & Kolodner Inc.  
123 South Broad Street, Suite 1270  
Philadelphia, PA 19109

**RE: EM-CING-064-119-060707** - New Cingular Wireless PCS, LLC notice of intent to modify existing telecommunications facilities located at 92 Weston Street, Hartford; and 52 New Britain Avenue, Rocky Hill, Connecticut.

Dear Ms. Lankenau:

At a public meeting held on July 27, 2006, the Connecticut Siting Council (Council) acknowledged your notice to modify these existing telecommunications facilities, pursuant to Section 16-50j-73 of the Regulations of Connecticut State Agencies with the condition that the modifications specified on the attached drawings sealed by Robert Semaan, P.E. are performed at the Hartford site prior to the antenna installation and a signed letter from a Professional Engineer is submitted to the Council to certify that the modifications have been properly completed.

The proposed modifications are to be implemented as specified here and in your notice dated July 6, 2006 and errata sheet dated July 20, 2006, including the placement of all necessary equipment and shelters within the tower compounds. The modifications are in compliance with the exception criteria in Section 16-50j-72 (b) of the Regulations of Connecticut State Agencies as changes to existing facility sites that would not increase tower heights, extend the boundaries of the tower sites, increase noise levels at the tower site boundaries by six decibels, and increase the total radio frequencies electromagnetic radiation power densities measured at the tower site boundaries to or above the standard adopted by the State Department of Environmental Protection pursuant to General Statutes § 22a-162. These facilities have also been carefully modeled to ensure that radio frequency emissions are conservatively below State and federal standards applicable to the frequencies now used on these towers.

This decision is under the exclusive jurisdiction of the Council. Please be advised that the validity of this action shall expire one year from the date of this letter. Any additional change to any of these facilities will require explicit notice to this agency pursuant to Regulations of Connecticut State Agencies Section 16-50j-73. Such notice shall include all relevant information regarding the proposed change with cumulative worst-case modeling of radio frequency exposure at the closest point of uncontrolled access to the tower base, consistent with Federal Communications Commission, Office of Engineering and Technology, Bulletin 65. Any deviation from this format may result in the Council implementing enforcement proceedings pursuant to General Statutes § 16-50u including, without limitation, imposition of expenses resulting from such failure and of civil penalties in an amount not less than one thousand dollars per day for each day of construction or operation in material violation.

Thank you for your attention and cooperation.

Very truly yours,

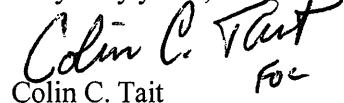
  
Colin C. Tait

Chairman

CCT/laf

c: See Attached List.

List Attachment.

- c: The Honorable Eddie A. Perez, Mayor, City of Hartford
- Roger J. O'Brien, Director of Planning, City of Hartford
- Lee C. Erdmann, Chief Operating Officer, City of Hartford
- The Honorable Anthony P LaRosa, Mayor, Town of Rocky Hill
- Barbara Gilbert, Town Manager, Town of Rocky Hill
- Kimberly Ricci, Director of Planning, Town of Rocky Hill
- Karen L. Couture, Site Acquisition Specialist
- Thomas J. Regan, Esq., Brown Rudnick Berlack Israels LLP
- Christine Farrell, T-Mobile
- Christopher B. Fisher, Esq., Cuddy & Feder LLP
- Michele G. Briggs, New Cingular Wireless PCS, LLC
- Global Signal

**Perrone, Michael**

EM-CING-064-119-060707

**From:** Karen Couture [karencouture@myeastern.com]  
**Sent:** Thursday, July 20, 2006 3:39 PM  
**To:** Perrone, Michael  
**Subject:** 52 New Britain Avenue, Rocky Hill, CT-Errata Sheet  
**Importance:** High

Dear Mr. Perrone,

Attached you will find an errata sheet for 52 New Britain Avenue, Rocky Hill, CT. The power density sheet has been revised to show Verizon at 90'.

Should you have any further questions, please do not hesitate to call.

Thank you.

Karen L. Couture  
Site Acquisition Specialist  
Mobile: 860-389-4924  
E-Fax: 888-281-6394  
Email: [karencouture@myeastern.com](mailto:karencouture@myeastern.com)

RECEIVED  
JUL 21 2006  
CONNECTICUT  
SITING COUNCIL

Addition of the UMTS broadcasts will not increase the exposure to radio frequency electromagnetic energy, measured at the base of the tower, to or above the standard adopted by the state of Connecticut and the Federal Communications Commission. The table below summarizes the cumulative results for a point of interest at the tower's base of the "worst-case" exposure calculations resulting from all carriers co-located on this tower. The calculations are in accordance with FCC OET Bulletin No. 65 (1997), and for simplicity an assumption is made that the antennas are all pointed down, thus focusing their energy at the tower's base.

Site # 5123								
Carrier	Antenna Height (ft)	Freq. (MHz) For Limit	# of Channels	W ERP/Channel (ref 1/2-w dipole)	W EIRP/Sector	Power Density ( $\mu\text{W}/\text{cm}^2$ )	FCC Limit ( $\mu\text{W}/\text{cm}^2$ )	Percent of Limit (%)
Cingular UMTS	170	1935.0	1	500.0	820.0	6.2	1000	0.62%
Rocky Hill	180	-	-	-	-	-	-	2.00%
AT&T	170	1900.0	10	100.0	1640.0	12.4	1000	1.24%
T-Mobile	160	1900.0	8	276.1	3622.0	31.0	1000	3.10%
Sprint	140	1900.0	11	445.3	8032.3	89.9	1000	8.99%
Verizon 800	90	880.0	19	100.0	3116.0	84.4	587	14.38%
Verizon 1900	90	1900.0	3	285.0	1402.2	38.0	1000	3.80%
<b>TOTAL</b>								<b>34.13%</b>

ORIGINAL

RECEIVED  
JUL 07 2006CONNECTICUT  
SITING COUNCIL

6 July 2006

Mr. Colin C. Tait, Chairman, and  
Members of the Connecticut Siting Council  
10 Franklin Square  
New Britain, CT 06051

**RE: Notice of Exempt Modification –Two (2) Existing Telecommunications  
Tower Facilities in Hartford County**  
**Site 1: 92 Weston Street, Hartford**  
**Site 2: 52 New Britain Avenue, Rocky Hill**

Dear Chairman Tait and Members of the Council:

Kise Straw & Kolodner Inc., in association with Network Building & Consulting, LLC, submits this notice of intent to modify existing telecommunications facilities. New Cingular Wireless PCS, LLC (“Cingular”) proposes to remove and replace telecommunications antennas and associated equipment located on an existing facility in the above-referenced municipalities. Cingular operates under licenses issued by the Federal Communications Commission (FCC) to provide cellular and PCS mobile telephone service in the areas to be served by the proposed installations.

Please accept this letter and attachments as notification to the Council, pursuant to Regulations of Connecticut State Agencies (RCSA) Section 16-50j-73. This submission will demonstrate that the proposed changes fall within the limits of an exempt modification as described under the RCSA Section 16-50j-72(b)(2).

In accordance with RCSA Section 16-50j-73, the chief elected officials will receive notification of the work proposed at locations within their jurisdiction.

Attached you will find summary sheets detailing the planned changes, including power density calculations reflecting the change in the effect of Cingular’s operations at each site. Also included is documentation of the structural sufficiency of each tower to accommodate the revised antenna configuration.

The planned changes to these facilities fall within those activities explicitly provided for in RCSA Section 16-50j-72(b)(2). As such, the proposed work does not result in any substantial adverse environmental effect:

*James Bennett Straw, AIA**Harvey D. Kolodner, MBA**James Nelson Kise, AIA/AICP/PP**Scott W. Killinger, AIA**John R. Gibbons, AIA/AICP**Philip E. Scott, EA**Suzanna Barucco**Katherine Bottom, LEED**LaVern Browne**Johnette Davies**Petar D. Glumac, Ph.D**Douglas S. Heckrotte, RA/LEED**Jody Holton, AICP**Marian Maxfield Hull, AICP/PP*

Kise Straw &amp; Kolodner Inc.

123 South Broad St.

Suite 1270

Philadelphia, PA 19109

(215) 790-1050 FAX (215) 790-0215

www.ksk1.com



1. The proposed work does not affect the height of the structure.
2. The proposed changes do not affect the existing property boundaries. All proposed work will occur on the property controlled by Cingular.
3. The proposed work will not increase noise levels at the site boundary by six (6) decibels or more.
4. Addition of the UMTS broadcasts will not increase the exposure to radio frequency electromagnetic energy, measured at the base of the tower, to or above the standard adopted by the state of Connecticut and the FCC. The power density tables provided for each facility summarize the cumulative results for a point of interest at the tower's base of the "worst-case" exposure calculations resulting from all carriers co-located on this tower. The calculations are in accordance with the Federal Communications Commission's Office of Engineering and Technology Bulletin No. 65 (1997), and for simplicity, an assumption is made that the antennas are all pointed down, thus focusing their energy at the tower's base.

For the foregoing reasons, Cingular respectfully submits that proposed changes at the these facilities constitute an exempt modification under RCSA Section 16-50j-72(b)(2).

Please do not hesitate to call me at 215.790.1050 ext. 138 with questions concerning this notice. Thank you for your consideration of this matter.

Sincerely,



Elizabeth H. Lankenau, AICP  
Planner

Attachments

cc: Honorable Eddy A. Perez., Mayor, City of Hartford  
Honorable Anthony LaRosa, Mayor, Town of Rocky Hill

**92 Weston Street, Hartford, CT**

---

**Summary Sheet  
Project Location Map  
Site Plan and Elevation  
Tower Modification Information  
Structural Analysis  
Elected Official Letter**

**CINGULAR WIRELESS  
Proposed Modifications**

---

**Site Address:** 92 Weston Street, Hartford, CT; *Project Location Map* attached

**Coordinates:** Lat: 41' 47' 12.2"; Long: 72' 39' 44.24"

**Site Owner:** Global Signal

**Type of Existing Facility:** 110' monopole; irregularly shaped compound with existing equipment shelter

**Antenna Configuration:** Center line – 92' above ground level; remove existing antennas and replace with six (6) Powerwave 7770 units; *specification attached*

**TMA Configuration:** Existing units to be removed and add twelve (12) new LGP 214nn units; *specification attached*

**Coaxial Cables:** Nine (9) existing 1 5/8" diameter coaxial cables to remain and add three (3) new cables of the same dimension

**Other Work:** Add one (1) new Ericsson RBS 3206 equipment cabinet

**Power Density:**

As the table demonstrates, the cumulative worst-case exposure would be approximately 57.16% of the ANSI/IEEE standard, as calculated for mixed frequency sites. Total power density levels resulting from Cingular's use of the facility would be within applicable standards.

Site # 5152								
Carrier	Antenna Height (ft)	Freq. (MHz) For Limit	# of Channels	W ERP/Channel (ref 1/2-w dipole)	W EIRP/Sector	Power Density ( $\mu\text{W}/\text{cm}^2$ )	FCC Limit ( $\mu\text{W}/\text{cm}^2$ )	Percent of Limit (%)
Cingular UMTS	92	1935.0	1	500.0	820.0	19.1	1000	1.91%
Sprint	107	1900.0	12	500.0	9840.0	188.5	1000	18.85%
Cingular TDMA	92	880.0	12	250.0	4920.0	114.7	587	19.55%
T-Mobile	80	1900.0	12	250.0	4920.0	168.6	1000	16.86%
<b>TOTAL</b>								<b>57.16%</b>

**Structural Analysis:** *Structural Analysis* attached.

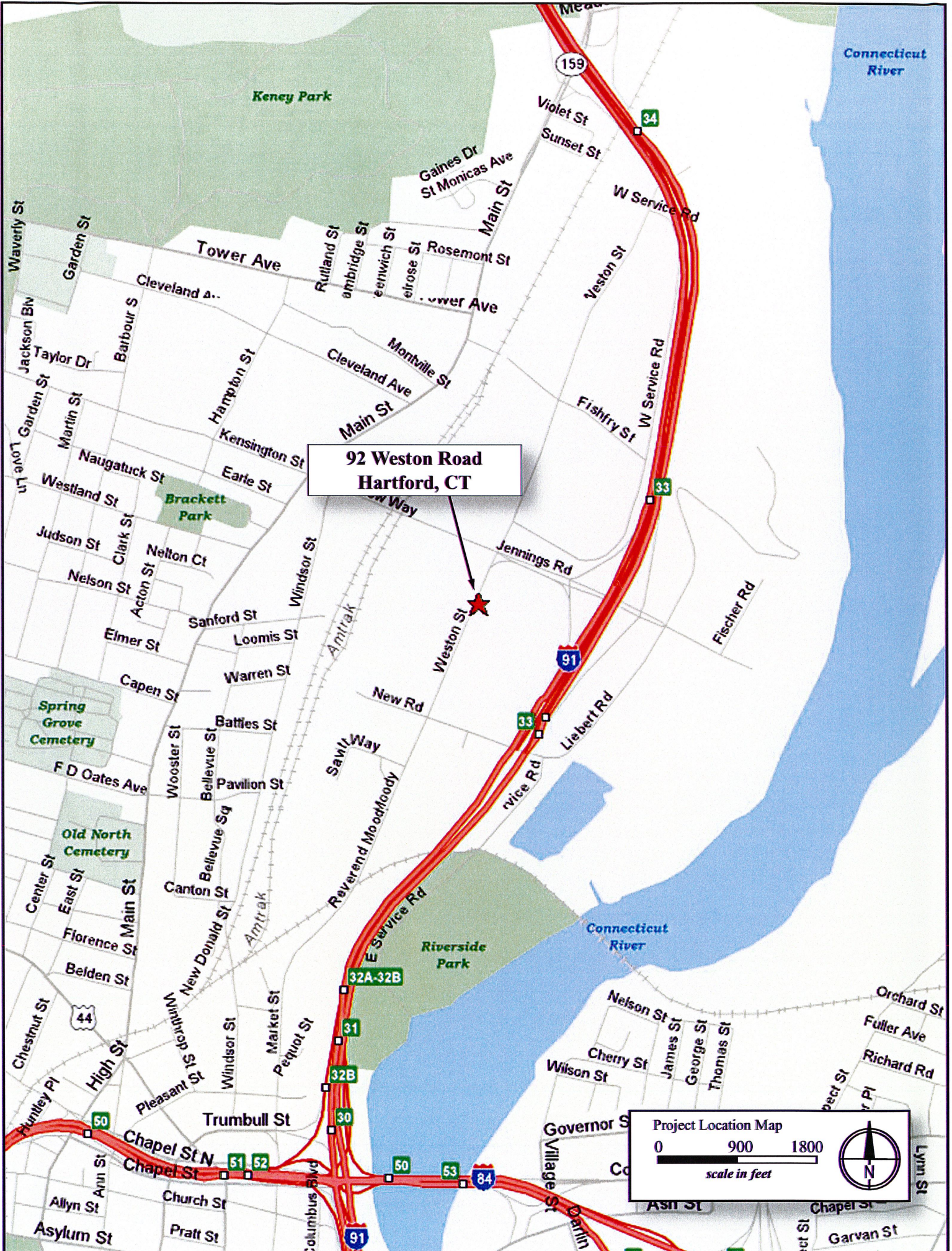

92 Weston Road  
Hartford, CT

Project Location Map

0 900 1800

scale in feet



EXISTING MONOPOLE TOWER  
 (E) TOWER TO BE RE-ENFORCED.  
 SEE STRUCTURAL DESIGN BY  
 SEMAAN ENGINEERING SOLUTIONS,  
 INC. DATED 6-21-06.

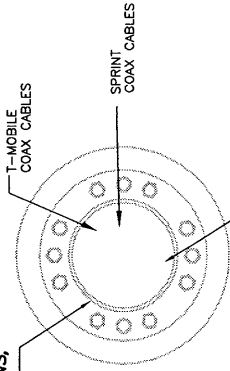

(E) (9) 1 5/8" ANDREW  
 COAX CABLES TO REMAIN -  
 ADD (N) (3) 1 5/8"  
 ANDREW COAX CABLE

SECTION VIEW

ANTENNA CONTRACTOR TO  
 INSTALL (12) NEW TMA UNITS.  
 (TOTAL TMA UNITS = 12)

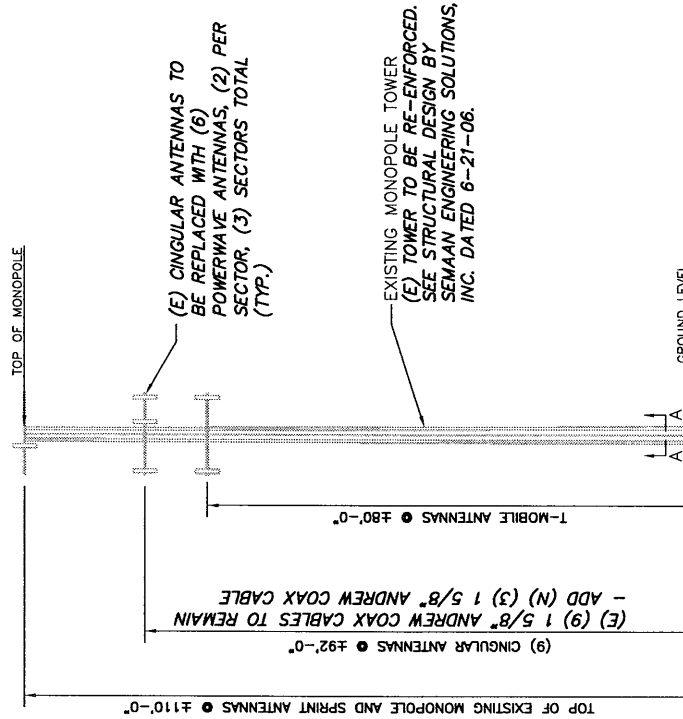

TOWER ELEVATION  
 SCALE: 1" = 30'-0"

LATITUDE: 41° 47' 12.2"  
 LONGITUDE: 72° 39' 44.24"



ERICSSON  
 6300 LEGACY DRIVE  
 PLANO, TX 75024

CH2MHILL  
 8619 WEST BRYN MAWR  
 CHICAGO, ILLINOIS 60631

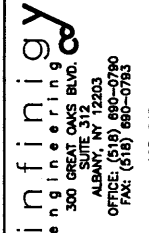

300 PERRY DAMS BLVD.  
 SUITE 312  
 ALBANY, NY 12203  
 OFFICE: (518) 690-0790  
 FAX: (518) 690-0793

SITE NAME: HARTFORD NORTH  
 SITE NUMBER: 5152  
 92 WESTON STREET  
 HARTFORD, CT 06103

NO.	DATE	REVISION DESCRIPTION	BY	CHK	APP'D
4	07/05/06	MISC. REVISIONS	MAK	CJW	CJW
3	06/22/06	MISC. REVISIONS	PHR	CJW	CJW
2	05/18/06	MISC. REVISIONS	PHR	CJW	CJW
1	05/05/06	MISC. REVISIONS	PHR	CJW	CJW
0	04/21/06	MISC. REVISIONS	PHR	CJW	CJW
SITE NUMBER: 5152					

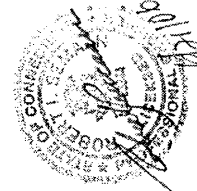
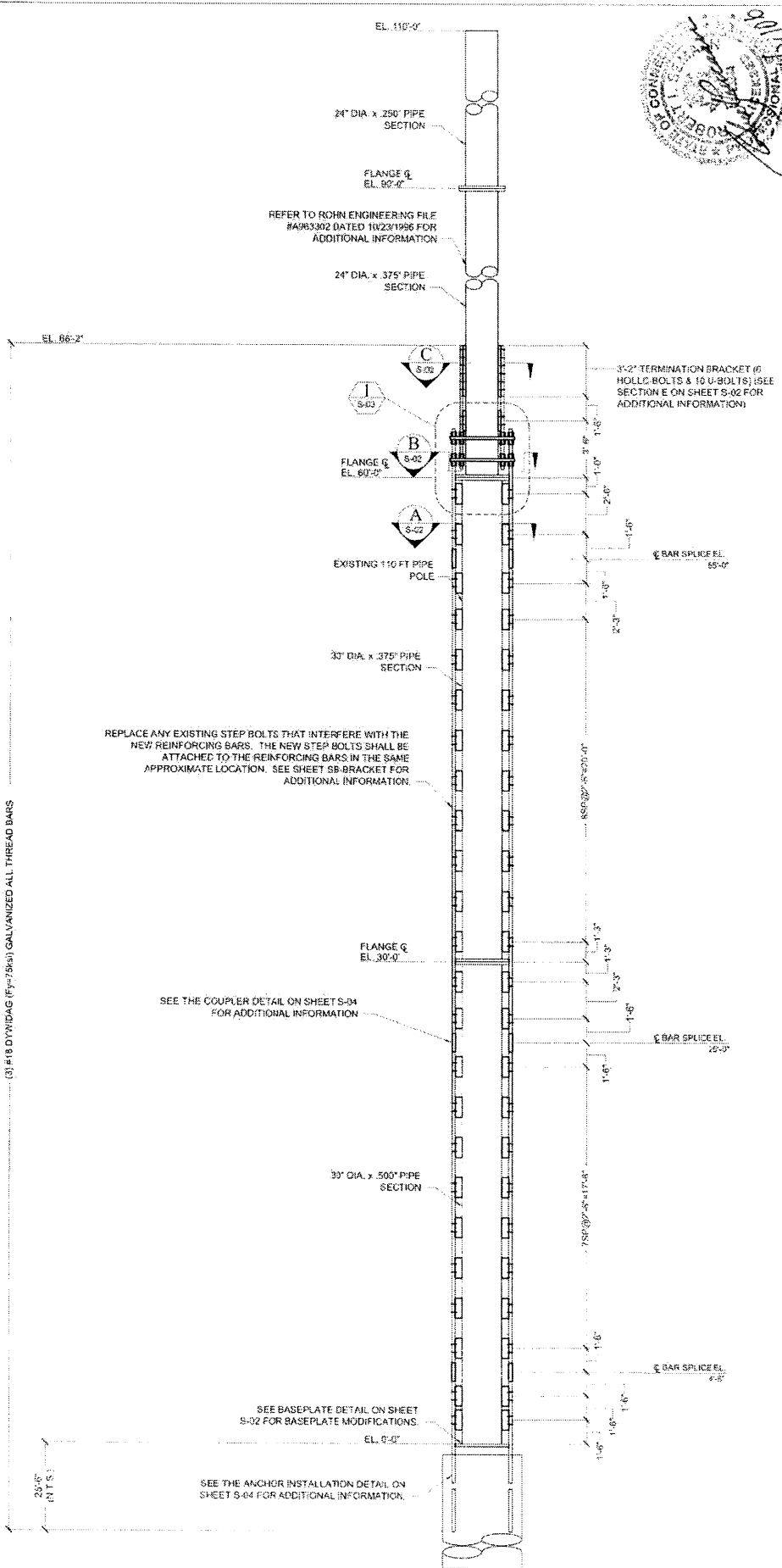

NOTE:  
 30 FT BAR LENGTHS ARE BASED ON 60 FT MILL LENGTHS CUT IN HALF.  
**Semaan Engineering Solutions, Inc.**

PROJECT NO.	2017172
PROJECT NAME	C103X0064
PROJECT ADDRESS	1079 N. 26th Avenue, Elkhorn Nebraska 68022
DATE	06/20/2006
DESIGNED BY	NONE
CHECKED BY	
DATE	
ISSUE FOR CONSTRUCTION	
REVISION DESCRIPTION	
ISSUED BY	
DATE	
PROJECT LOCATION	HARTFORD, CT
CLIENT	
PROJECT TYPE	MONOPOLE REINFORCEMENT DRAWINGS
SHEET NO.	S-01

REPLACE ANY EXISTING STEP BOLTS THAT INTERFERE WITH THE NEW REINFORCING BARS. THE NEW STEP BOLTS SHALL BE ATTACHED TO THE REINFORCING BARS IN THE SAME APPROXIMATE LOCATION. SEE SHEET SB-BRACKET FOR ADDITIONAL INFORMATION.

SEE THE COUPLER DETAIL ON SHEET S-04 FOR ADDITIONAL INFORMATION.

SEE BASEPLATE DETAIL ON SHEET S-02 FOR BASEPLATE MODIFICATIONS.

SEE THE ANCHOR INSTALLATION DETAIL ON SHEET S-04 FOR ADDITIONAL INFORMATION.

**MONOPOLE ELEVATION**  
 NOT TO SCALE

**DO NOT CUT ANY EXISTING REBAR TIES IN THE CAISSON**  
 CONTRACTOR TO VERIFY PORT CONTRACTOR TO VERIFY PORT CONSTRUCTION

EXISTING 2' x 4' ROUND BASEPLATE  
 (12) EXISTING 1 1/2" DIA ANCHOR BOLTS ON A 36" DIA BOLT CIRCLE  
 EXISTING 3'-0" DIA CAISSON  
 CONTRACTOR TO VERIFY PORT CONSTRUCTION

EXISTING 110 FT PIPE MONOPOLE (ID. = 35")  
 W5X19 BRACKET (TYP)

SECTION A  
 NOT TO SCALE

SECTION B  
 NOT TO SCALE

SECTION C  
 NOT TO SCALE

SECTION D  
 NOT TO SCALE

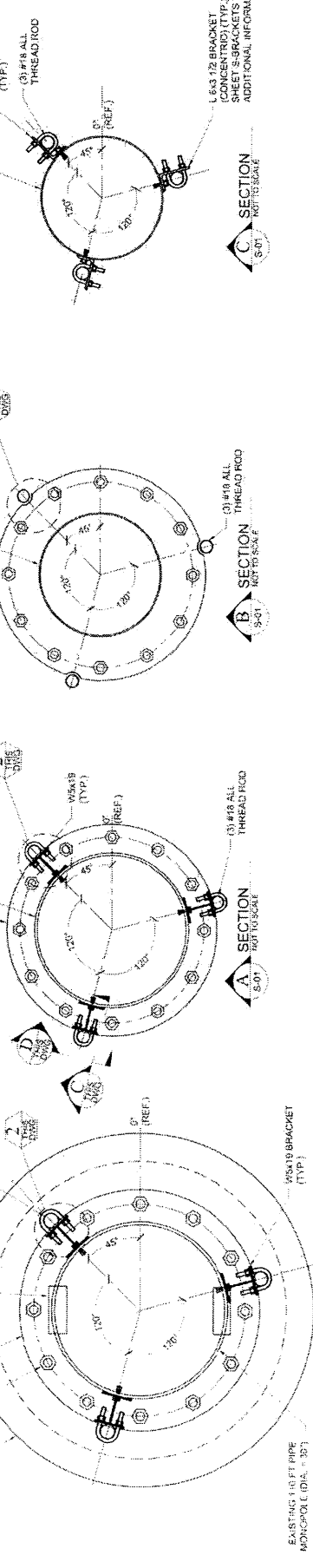

**BASPLATE DETAIL**  
 NOT TO SCALE

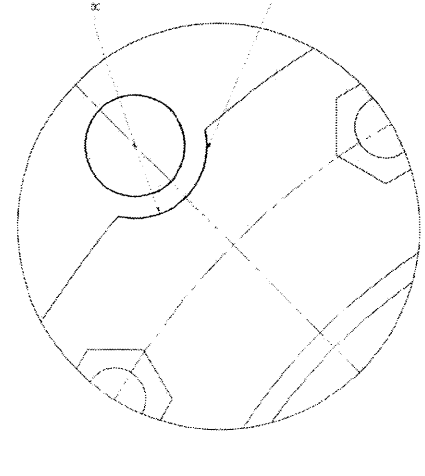

**SECTION 2**  
 NOT TO SCALE

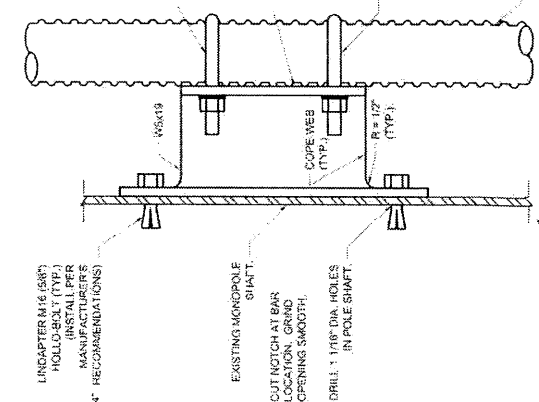

**SECTION C**  
 NOT TO SCALE

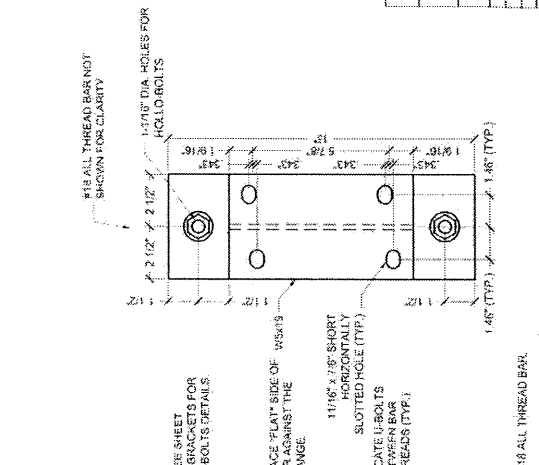

**SECTION D**  
 NOT TO SCALE



**Semaan Engineering Solutions, Inc.**  
 3017845-  
 CT03-C064  
 HARTFORD, CT

PROJECT: 06220208  
 SHEET: S-01

DATE: 06/22/2008  
 DRAWN: [Name]  
 CHECKED: [Name]  
 DESIGNED: [Name]  
 PROJECT: [Name]

SCALE: [Scale]  
 TITLE: MONOPOLE REINFORCEMENT DRAWINGS  
 SHEET NO.: S-02





**NOTES AND SPECIFICATIONS**

1. THE MODIFICATIONS OUTLINED IN THESE DOCUMENTS WERE DESIGNED IN ACCORDANCE WITH THE EM11A REV. F CODE.
2. THE CONTRACTOR SHALL FIELD VERIFY ALL EXISTING DIMENSIONS, ELEVATIONS, AND CONDITIONS PRIOR TO COMMENCEMENT OF WORK. THE CONTRACTOR SHALL BE RESPONSIBLE FOR THE PROPER FIT AND CLEARANCE IN THE FIELD. CONTACT SEMAN ENGINEERING IF ANY DISCREPANCIES EXIST.
3. REFERENCE THE SEMAN ENGINEERING SOLUTIONS ANALYSIS FOR THIS SITE DATED 06/21/2008 FOR THE PROPOSED AND EXISTING LOADS CONSIDERED. THIS DRAWING IS NOT VALID IF LOADS OTHER THAN THOSE CONSIDERED IN THE ANALYSIS ARE ADDED TO OR REMOVED FROM THE STRUCTURE UNLESS APPROVED IN WRITING BY SES, INC. APPROVED BY THE DESIGN INSTRUCTOR.
4. THE DRAWING DOES NOT INDICATE THE METHOD OF CONSTRUCTION THE CONTRACTOR SHALL SUPERVISE AND DETECT THE WORK AND HE SHALL BE SOLELY RESPONSIBLE FOR ALL THE CONSTRUCTION MEANS, TECHNIQUES, SEQUENCES AND PROCEDURES.
5. THE CONTRACTOR SHALL BE SOLELY RESPONSIBLE FOR THE ON-SITE SAFETY ASSOCIATED WITH THE WORK TO BE FOLLOWED. ALL SAFETY REQUIREMENTS AS ENACTED BY OSHA AND THE LOCAL JURISDICTIONS SHALL BE FOLLOWED.
6. THE CONTRACTOR SHALL BE RESPONSIBLE FOR THE SAFETY OF ITS OWN PERSONNEL AS WELL AS THE PUBLIC AFFECTED BY THE WORK IN THE VICINITY OF THE JOB SITE.
7. THE CONTRACTOR SHALL ALSO BE RESPONSIBLE FOR THE PROTECTION OF THE PROPERTY IN THE VICINITY OF THE JOB SITE. THE CONTRACTOR SHALL USE THE PRECAUTIONARY MEANS NECESSARY FOR ADEQUATE PROTECTION.

**STEEL CONSTRUCTION**

1. STRUCTURAL STEEL SHALL CONFORM TO THE AISC MANUAL OF STEEL CONSTRUCTION, NINTH EDITION, FOR THE DESIGN AND FABRICATION OF STEEL COMPONENTS.
2. ALL PLATE STEEL SHALL CONFORM TO A572-50 UNLESS NOTED OTHERWISE. ALL CHANNELS OF AN EQUAL OR LARGER SHALL CONFORM TO A572-50 UNLESS NOTED OTHERWISE.
3. SHOP DRAWINGS SHALL BE SUBMITTED TO SES FOR APPROVAL PRIOR TO FABRICATION. SHOP DRAWINGS SHALL INCLUDE ALL FABRICATED STEEL ASSEMBLIES INCLUDING MONOPOLE EXTENSION, ETC. SHOP DRAWINGS SHALL INCLUDE ALL EXTERIOR STEEL WORK SHALL BE GALVANIZED IN ACCORDANCE WITH ASTM A122 AND AS FOLLOWS, UNLESS OTHERWISE NOTED:
  - A. GALVANIZING SHALL BE PERFORMED AFTER SHOP FABRICATION AND WELDING TO THE GREATEST EXTENT
  - B. ALL DRILLS, SCRAPES, MARKS AND WELDS IN THE GALVANIZED AREA SHALL BE COATED WITH A ZINC-RICH PAINT, APPLIED IN STRICT ACCORDANCE WITH MANUFACTURER'S RECOMMENDATIONS.
  - C. IF THE STRUCTURE WAS ORIGINALLY PAINTED, AFTER ZINC-RICH PAINT IS DRY, OVERCOAT WITH AN APPROPRIATE PAINT WITH THE SAME COLOR AS THE EXISTING.
4. CONNECTIONS SHALL BE CONSTRUCTED AS FOLLOWS:
  - A. ALL WELDING SHALL BE DONE USING E70XX ELECTRODES.
  - B. ALL WELDING SHALL CONFORM TO AISC AND AWS D1.1 LATEST EDITION.
  - C. EXPOSED WELDS SHALL BE COATED WITH ZINC-RICH PAINT. THE METHODS AND POSITIONS TO BE USED ARE SHOWN ON DRAWINGS.
  - D. WHERE FILLET WELD SIZES ARE NOT SHOWN, PROVIDE THE MINIMUM SIZE PER TABLE 12.4 IN THE AISC MANUAL OF STEEL CONSTRUCTION, NINTH EDITION.
  - E. ALL EXISTING GALVANIZING IN WELD AREAS SHALL BE REMOVED OFF PRIOR TO WELDING.
  - F. ALL WELDS SHALL BE INSPECTED VISUALLY TO 25% OF WELDS SHALL BE INSPECTED WITH DYE PENETRANT OR ULTRASONIC TESTING TO BE DETERMINED IF ANY DEFECTS ARE FOUND TO MEET THE ACCEPTANCE CRITERIA OF AWS D1.1 PERAIN ALL WELDS AS NECESSARY.
  - G. INSPECTION SHALL BE PERFORMED BY AN AWS CERTIFIED WELD INSPECTOR.
  - H. ALL BOLTS SHALL BE TIGHTENED TO A "SNUG TIGHT" CONDITION AS DEFINED BY AISC.
  - I. ALL DRUMTOR HOLLOW BOLTS SHALL BE INSTALLED PER THE MANUFACTURER'S RECOMMENDATIONS.

**CONTINUOUS STRUCTURE INSPECTION AND MAINTENANCE**

1. CONTINUOUS VISUAL INSPECTION OF THE STRUCTURE AND THE ADDED REINFORCING SHALL BE REQUIRED BY THE OWNER. ANY FUTURE CORROSION OR OTHER DETERIORATION OF THE STRUCTURE OR ITS REINFORCING WILL BE REPAIRED AT THE CONTRACTOR'S EXPENSE. ANY DEFECTS SHALL BE REPAIRED TO ENSURE THE STRUCTURAL INTEGRITY FOR THE LIFE OF THE STRUCTURE.

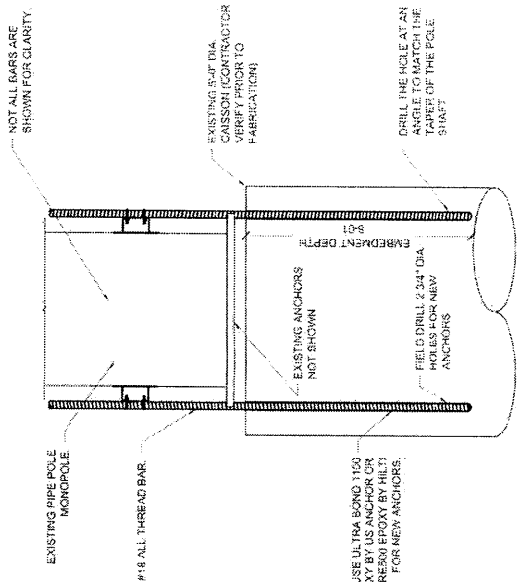

**ANCHOR INSTALLATION DETAIL**  
NOT TO SCALE

USE ULTRA BOND 1150 EPOXY BY US ANCHOR OR HIT REKON EPOXY BY HILTI FOR NEW ANCHORS.

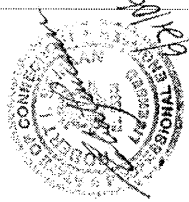

<b>Seman Engineering Solutions, Inc.</b>	
PHONE NUMBER: (402) 288-1888 Fax Number: (402) 288-1981	PROJECT NUMBER: 001370064
ADDRESS: 1976 N. 27th Avenue, Elkhorn Nebraska 68022	CITY: HARTFORD, CT
STATE: NEBRASKA	DATE: 08/20/2006
DESIGNED BY: S-01, S-02, S-03	CHECKED BY: S-01, S-02, S-03
SCALE: AS SHOWN FOR CONSTRUCTION	DATE: 08/20/2006
PROJECT: GLOBAL SIGNAL	CLIENT: SEMAN ENGINEERING SOLUTIONS, INC.
DRAWN BY: S-01, S-02, S-03	CHECKED BY: S-01, S-02, S-03
DATE: 08/20/2006	SCALE: AS SHOWN FOR CONSTRUCTION
PROJECT: GLOBAL SIGNAL	CLIENT: SEMAN ENGINEERING SOLUTIONS, INC.
DRAWN BY: S-01, S-02, S-03	CHECKED BY: S-01, S-02, S-03
DATE: 08/20/2006	SCALE: AS SHOWN FOR CONSTRUCTION
PROJECT: GLOBAL SIGNAL	CLIENT: SEMAN ENGINEERING SOLUTIONS, INC.

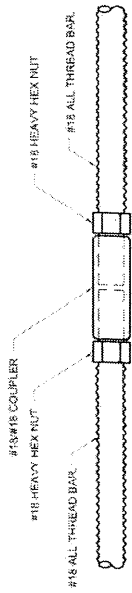

**COUPLER DETAIL**  
NOT TO SCALE





**SEMAAN ENGINEERING SOLUTIONS**  
 1075 N.20th Avenue  
 Phoenix, AZ 85024  
 Phone: 402-268-1688  
 Fax: 402-268-1681

Copyright Semaan Engineering Solutions, Inc

**Job Information**

File : C703XC064\_FIX Code: TIA/EIA-222 Rev F  
 Description : Global Signal  
 Location : 3017645 - Hartford, CT  
 Shape : Round Base Elev (ft): 0.00  
 Height : 110.00 (ft) Taper: 0.0000000(in/ft)

**Sections Properties**

Section	Length (ft)	Diameter (in)	Access	Flets	Thick	Joint	Type	Overlan Length (in)	Taper (in/ft)	Steel Grade (ksi)
1	30.000	30.000	30.000	0.500	0.375	Butt Joint		0.000	0.0000000	42
2	30.000	30.000	30.000	0.375	0.375	Butt Joint		0.000	0.0000000	42
3	30.000	24.000	24.000	0.375	0.375	Butt Joint		0.000	0.0000000	42
4	20.000	24.000	24.000	0.250	0.250	Butt Joint		0.000	0.0000000	42

**Discrete Appurtenance**

Attach Elev (ft)	Force Elev (ft)	Oly	Description
107.000	108.500	1	Platform w/Rail
107.000	107.000	9	UMWD-06S7-XD
92.000	92.000	12	7770.00
92.000	93.500	1	Platform w/Rail
92.000	92.000	12	LGP 2140 TMA
80.000	80.000	5	Aligon 7250.01
80.000	80.000	2	RR90-17-00NP
80.000	81.500	1	Platform w/Rail

**Linear Appurtenance**

Elev (ft)	From	To	Description	Exposed	To Wind
0.000	70.000		bar reinforcing	Yes	
0.000	80.000		7/8 Coax	No	
0.000	80.000		7/8 Coax	No	
0.000	82.000		7/8 Coax	No	
0.000	107.00		1.5/8 Coax	No	

**Load Cases**

No Ice	80.00 mph Wind with No Ice
Ice	89.88 mph Wind with Ice

**Reactions**

Load Case	Moment (Kip-ft)	Shear (Kips)	Axial (Kips)
No Ice	1226.20	15.81	23.67
Ice	1021.74	12.89	29.45

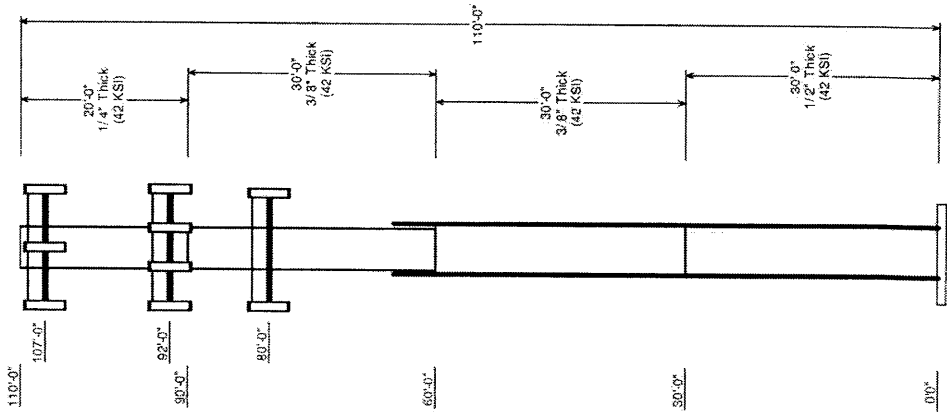

1079 N. 204<sup>th</sup> Avenue  
Elkhorn, NE 68022  
Ph: 402-289-1888  
Fax: 402-289-1861

# SEMAAN ENGINEERING SOLUTIONS

## 110 ft Rohn Monopole Structural Analysis

Prepared for:  
Global Signal  
301 North Cattlemen Road, Suite 300  
Sarasota, FL 34232

Site: 3017645 / CT03XC064  
Cingular  
Hartford, CT

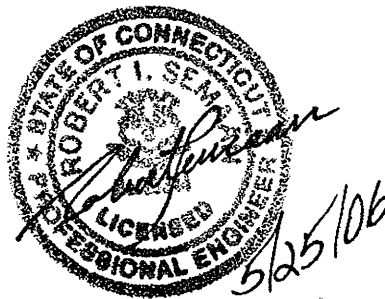

May 25, 2006

Mr. Louis Belizaire  
Global Signal  
301 North Cattlemen Road, Suite 300  
Sarasota, FL 34232

**Re: Site Number 3017645 / CT03XC064 –Hartford, CT.**

Dear Mr. Belizaire:

We have completed the structural analysis for the existing monopole, located at the above referenced site. The purpose of this analysis is to determine that the existing monopole design is in conformance with the TIA/EIA-222 Rev F standard and local building codes for the proposed antennae loads installation. Refer to the Review and Recommendations section at the end of this report for the analysis results.

**Description of Structure:**

The structure is a 110 ft Rohn Monopole.

Refer to Rohn drawing A963302 dated October 23, 1996 for a detailed description of the structure.

**Method of analysis:**

The tower was analyzed using Semaan Engineering Solutions' software suite for communication structures. The structural analysis is performed using the SAPS finite element engine. The method is 3D, non-linear, which accounts for the second order geometric effects due to the displacements. It also treats guys as exact cable elements and therefore is ideal for guyed towers. The analysis was performed in conformance with **TIA/EIA-222 Rev F and local building codes for a basic wind speed of 80 mph and 1/2" radial ice with reduced wind speed (fastest mile)**. This is in conformance with the IBC 2003: Section 1609.1.1, Exception (5) and Section 3108.4. Wind is applied to the structure, accessories and antennas.

**Structure loading:**

The following loads were used in the tower analysis:

Elev (ft)	Qty	Antennas	Mounts	Coax	Carrier
107.0	9	UMWD-06517-XD	Platform w/Rail	(9) 1 5/8	Sprint
80.0	5	Allgon 7250.01	Platform w/Rail	(12) 1 5/8	T-Mobile
	2	RR90-17-00NP			

Proposed Loads:

Elev (ft)	Qty	Antennas	Mounts	Coax	Carrier
92.0	12	7770.00	Platform w/Rail	(12) 1 5/8	Cingular
	12	LGP 2140 TMA			

**All new access holes shall be reinforced with welded rims that are compatible with the pole and to be sized and supplied by pole manufacturer.  
All transmission lines are assumed running inside of pole shaft.**

**Results of Analysis:**

Refer to the attached Computer Summary sheets for detailed analysis results.

**Structure:**

The existing pole shaft is significantly overstressed at the base (by 23.6%). The maximum structure usage is: 123.6%.

**Foundation:**

Pole Reactions	Original Design Reactions	Current Analysis Reactions	% Of Design
Moment (ft-kips)	937.00	1,150.71	122.8
Shear (kips)	10.80	13.52	125.2

The reactions calculated from the analysis greatly exceed the ones indicated on the original structure drawings.

**Review and Recommendations:**

Based on the analysis results, the existing structure does not meet the requirements per the TIA/EIA-222 Rev F standards for a basic wind speed of 80 mph and 1/2" radial ice with reduced wind speed.

**SEMAAN ENGINEERING SOLUTIONS**

1079 N.204<sup>th</sup> Avenue  
 Elkhorn, NE 68022  
 Phone: 402-289-1888  
 Fax: 402-289-1861

Copyright Semaan Engineering Solutions, Inc

Job Information	
Pole: CT03XC064	Code: TIA/EIA-222 Rev F
Description:	
Client: Global Signal	
Location: 3017645 - Hartford, CT	
Shape: Round	Base Elev (ft): 0.00
Height: 110.00 (ft)	Taper: 0.000000(in/ft)

Sections Properties								
Shaft Section	Length (ft)	Diameter (in)		Thick Joint (in)	Type	Overlap		Steel Grade (ksi)
		Across Top	Flats Bottom			Length (in)	Taper (in/ft)	
1	30.000	30.00	30.00	0.500		0.000	0.000000	42
2	30.000	30.00	30.00	0.375	Butt Joint	0.000	0.000000	42
3	30.000	24.00	24.00	0.375	Butt Joint	0.000	0.000000	42
4	20.000	24.00	24.00	0.250	Butt Joint	0.000	0.000000	42

Discrete Appurtenance				
Attach Elev (ft)	Force Elev (ft)	Qty	Description	
107.000	107.000	9	UMWD-06517-XD	
107.000	108.500	1	Platform w/Rail	
92.000	92.000	12	LGP 2140 TMA	
92.000	93.500	1	Platform w/Rail	
92.000	92.000	12	7770.00	
80.000	81.500	1	Platform w/Rail	
80.000	80.000	2	RR90-17-00NP	
80.000	80.000	5	Allgon 7250.01	

Linear Appurtenance				
Elev (ft)		Description	Exposed To Wind	
From	To			
0.000	70.000	7/8 Coax	No	
0.000	80.000	7/8 Coax	No	
0.000	80.000	7/8 Coax	No	
0.000	92.000	7/8 Coax	No	
0.000	107.0	1 5/8 Coax	No	

Load Cases	
No Ice	80.00 mph Wind with No Ice
Ice	69.28 mph Wind with Ice

Reactions			
Load Case	Moment (Kip-ft)	Shear (Kips)	Axial (Kips)
No Ice	1150.71	13.52	21.05
Ice	970.10	11.13	26.83

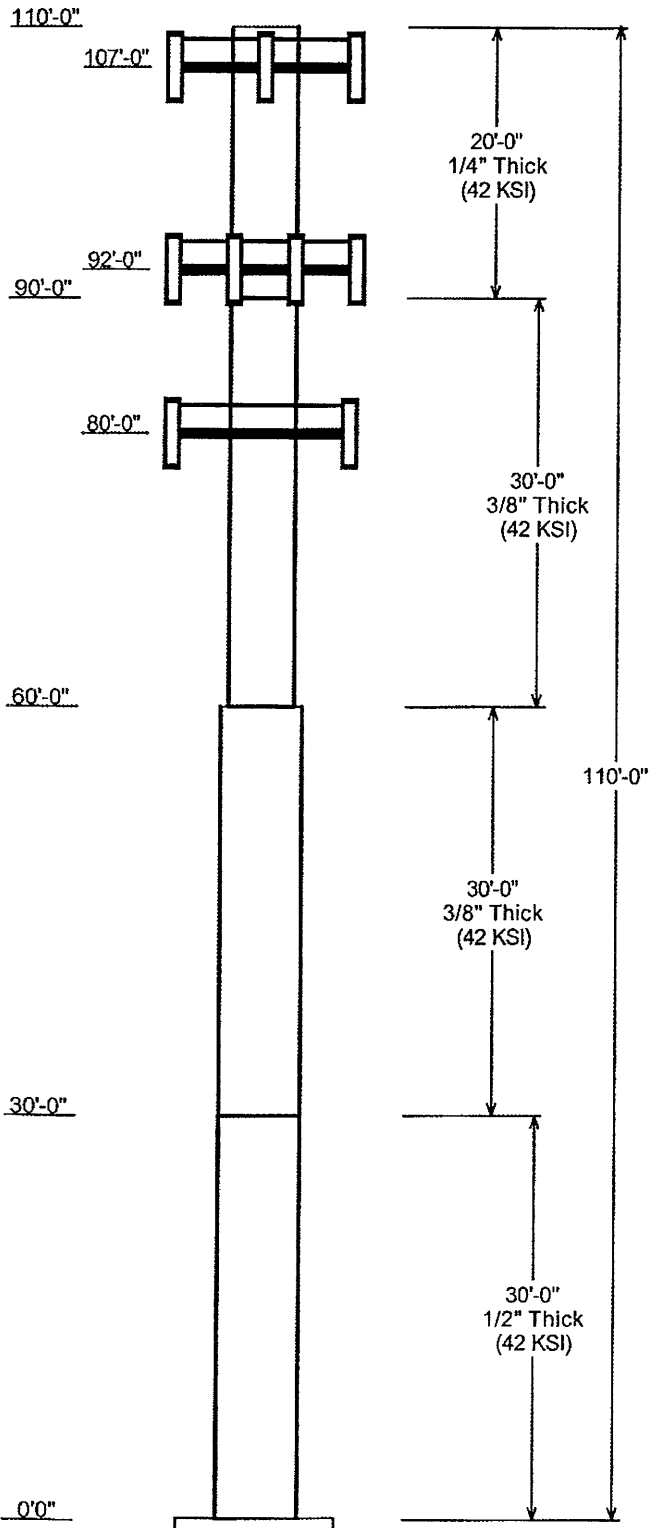



6 July 2006

Honorable Eddie A. Perez  
Mayor, City of Hartford  
550 Main Street  
Hartford, CT 06103

**RE: Notice of Exempt Modification – Existing Cingular  
Telecommunications Tower Facility at 92 Weston Street,  
Hartford, Connecticut**

Dear Mr. Perez:

New Cingular Wireless PCS, LLC (“Cingular”) proposes to remove and replace telecommunications antennas and associated equipment located on an existing tower at the above-referenced location. The facility is now controlled and operated by Cingular whose corporate office is located at 500 Enterprise Drive, Rocky Hill, CT 06067.

**Proposed Modifications**

Cingular proposes to remove the existing antennas and replace them with a total of six (6) new antennas, located at an existing centerline height of approximately 92’ above ground level. Cingular will keep nine (9) of the existing 1 5/8” diameter coaxial cables and add three (3) of the same dimension. It will remove the existing tower mounted amplifiers and replace them with twelve (12) new units, located at the same height as the antennas.

In summary, the final antenna configuration at 92 Weston Street will include:

- 6 antennas,
- 12 coaxial cables, and
- 12 tower mounted amplifiers.

A structural evaluation has demonstrated that the tower will be structurally capable of supporting the proposed Cingular telecommunications equipment once the proposed modifications are complete.

*James Nelson Kise, AIA/AICP/PP*

*James Bennett Straw, AIA*

*Harvey D. Kolodner, MBA*

*John R. Gibbons, AIA/AICP*

*Philip E. Scott, RA*

*Suzanna Barucco*

*LaVern Browne*

*Katherine E. Cowing, LEED*

*Johnette Davies*

*Petar D. Glumac, Ph.D.*

*Douglas S. Heckrotte, RA/LEED*

*Jody Holton, AICP*

*Marian Maxfield Hull, AICP/PP*

---

**Kise Straw & Kolodner Inc.**  
123 South Broad St.  
Suite 1270  
Philadelphia, PA 19109  
(215) 790-1050 FAX (215) 790-0213  
www.ksk1.com

**Statutory Considerations**

The proposed work will not affect the height of the existing structure, nor will it alter the existing property boundaries. Furthermore, the proposed work will not increase noise levels at the facility's site boundary by six (6) decibels or more. Operation of additional antennas will not increase the radio frequency electromagnetic radiation power density, measured at the tower base, to or above the standard adopted by the State of Connecticut and the Federal Communications Commission.

A Notice of Exempt Modification has been filed with the Connecticut Siting Council (CSC) as required by the Regulations of Connecticut State Agencies (RCSA), Section 16-50j-73. Please accept this letter as notification to the City of Hartford under Section 16-50j-73 that the proposed work constitutes an exempt modification pursuant to RCSA Section 16-50j-72(b)(2).

Should you have any questions or require additional information about the plans or the CSC's procedures, please do not hesitate to contact me (215.790.1050 ext. 138) or Mr. Derek Phelps, Executive Director, Connecticut Siting Council (860.827.2935).

Sincerely,

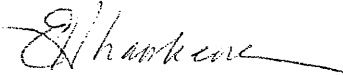

Elizabeth H. Lanckenau, AICP  
Planner

**52 New Britain Avenue, Rocky Hill, CT**

---

**Summary Sheet  
Project Location Map  
Site Plan and Elevation  
Structural Analysis  
Elected Official Letter**

**CINGULAR WIRELESS**  
**Proposed Modifications**

---

**Site Address:** 52 New Britain Avenue, Rocky Hill, CT; *Project Location Map* attached

**Coordinates:** Lat: 41° 40' 02.4"; Long: 72° 38' 14.3"

**Site Owner:** Cingular

**Type of Existing Facility:** 180' monopole and a 13'8" x 9'2" equipment shelter

**Antenna Configuration:** Center line – 170' above ground level; remove existing antennas and replace with three (3) Powerwave 7770 units; *specification attached*

**TMA Configuration:** Remove existing units and replace with six (6) new LGP 214nn units; *specification attached*

**Coaxial Cables:** Nine (9) existing cables to remain and add three (3) new 1 5/8" diameter cables

**Other Work:** Add one (1) Ericsson RBS 3206 equipment cabinet inside an existing equipment shelter

**Power Density:**

As the table demonstrates, the cumulative worst-case exposure would be approximately 15.96% of the ANSI/IEEE standard, as calculated for mixed frequency sites. Total power density levels resulting from Cingular's use of the facility would be within applicable standards.

Site # 5123								
Carrier	Antenna Height (ft)	Freq. (MHz) For Limit	# of Channels	W ERP/Channel (ref 1/2-w dipole)	W EIRP/Sector	Power Density ( $\mu\text{W}/\text{cm}^2$ )	FCC Limit ( $\mu\text{W}/\text{cm}^2$ )	Percent of Limit (%)
Cingular UMTS	170	1935.0	1	500.0	820.0	6.2	1000	0.62%
Rocky Hill	180	-	-	-	-	-	-	2.00%
AT&T	170	1900.0	10	100.0	1640.0	12.4	1000	1.24%
T-Mobile	160	1900.0	8	276.1	3622.0	31.0	1000	3.10%
Sprint	140	1900.0	11	445.3	8032.3	89.9	1000	8.99%
<b>TOTAL</b>								<b>15.96%</b>

**Structural Analysis:** *Structural Analysis* attached.



**NEW ANTENNA CONFIGURATION  
(TYP. EACH SECTOR)**

(N) (3) POWERWAVE ANTENNAS (1) PER SECTOR (3) SECTORS TOTAL

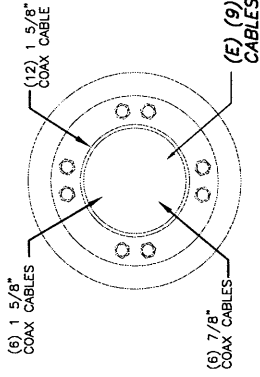
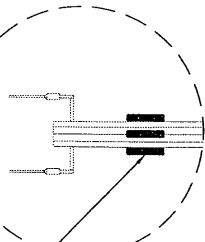

(E) CINGULAR ANTENNAS TO BE REPLACED WITH (3) POWERWAVE ANTENNAS WITH FLUSH MOUNT KIT (1) PER SECTOR (3) SECTORS TOTAL

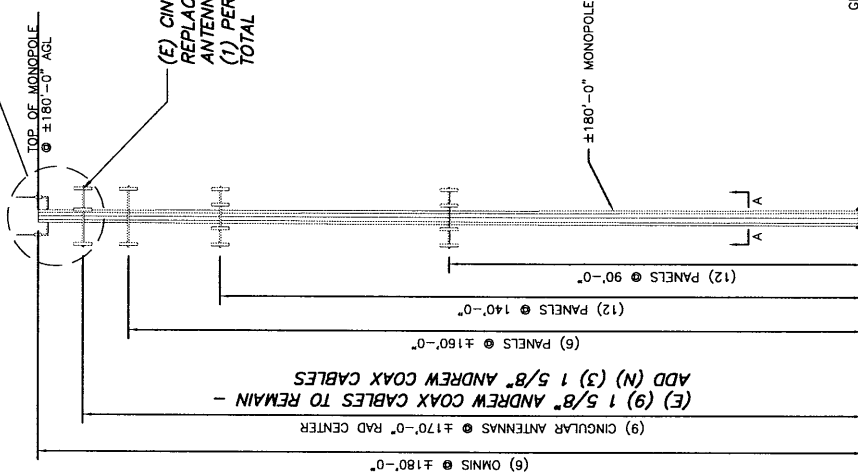

GROUND LEVEL

**TOWER ELEVATION**

SCALE: 1" = 40'-0"

LATITUDE: 41° 40' 02.4"  
LONGITUDE: 72° 38' 14.3"



CINGULAR WIRELESS  
800 MAIN STREET  
BOLTON, MA 01740

ERICSSON  
6300 LEGACY DRIVE  
PLANO, TX 75024

**CH2MHILL**  
8619 WEST BRYN MAWR  
CHICAGO, ILLINOIS 60631

**infinigy**  
engineering  
300 GREAT OAKS BLVD.  
SUITE 312  
ALBANY, NY 12203  
OFFICE: (518) 880-0790  
FAX: (518) 880-0793  
185-037

SITE NAME: ROCKY HILL  
CT  
SITE NUMBER: 5123  
82 NEW BRITAIN AVE.  
ROCKY HILL, CT 06067

NO.	DATE	REVISION DESCRIPTION	BY	CHK	APP'D
3	06/20/06	MISC. REVISIONS	PHR	CW	CW
2	06/07/06	MISC. REVISIONS	PHR	CW	CW
1	05/09/06	MISC. REVISIONS	PHR	CW	CW
0	05/09/06	MISC. REVISIONS	PHR	CW	CW
SITE NUMBER			5123		

---

# DETAILED STRUCTURAL ANALYSIS AND EVALUATION OF EXISTING 182' MONOPOLE FOR NEW ANTENNA ARRANGEMENT

Cingular Site #5123  
53 New Britain Avenue  
Rocky Hill, Connecticut

---

*prepared for*

**CH2MHILL**

8619 West Bryn Mawr, Suite 615  
Chicago, IL 60631



Cingular Wireless  
580 Main Street  
Bolton, MA 01740

*prepared by*



URS CORPORATION  
500 ENTERPRISE DR, SUITE 3B  
ROCKY HILL, CT 06067  
TEL. 860-529-8882

36922935.00008  
CH2-025

Revision 1 June 7, 2006

## **TABLE OF CONTENTS**

- 1. EXECUTIVE SUMMARY**
- 2. INTRODUCTION**
- 3. ANALYSIS METHODOLOGY AND LOADING CONDITIONS**
- 4. FINDINGS AND EVALUATION**
- 5. CONCLUSIONS AND RECOMMENDATIONS**
- 6. DRAWINGS AND DATA**
  - **ERI TOWER INPUT / OUTPUT SUMMARY**
  - **ERI TOWER DETAILED OUTPUT**
  - **ANCHOR BOLT AND BASE PLATE ANALYSIS**
  - **FOUNDATION ANALYSIS**



1. EXECUTIVE SUMMARY

This report summarizes the structural analysis of the existing 182' steel monopole structure located at 52 New Britain Avenue in Rocky Hill, Connecticut. The analysis was conducted in accordance with the 2005 Connecticut State Building Code and the TIA/EIA-222-F standard for wind velocity of 80 mph and 69 mph concurrent with 1/2" ice. The antenna loading considered in the analysis consists of all existing and proposed antennas, transmission lines, and ancillary items as outlined in the Introduction Section of this report. The proposed Cingular modification is as follows:

Proposed Antenna and Mount	Carrier	Antenna Center Elevation
<b>Remove:</b> (9) existing Allgon 7184.14 antennas and (1) Low Profile Platform		
<b>Install:</b> (1) Valmont Flush Mount (P/N 840502), (3) Powerwave 7770.00 antennas (6) Powerwave LGP21401 TMA's with (9) existing 1 5/8" coax cables within the monopole and (3) new 1 5/8" coax cables within the monopole.	Cingular (Proposed)	@ 170'

The results of the analysis indicate that the tower structure, anchor bolts, base plate, and foundation are in compliance with the proposed loading conditions. **The tower is considered structurally adequate with the wind load classification specified above and all the existing and proposed antenna loading.**

This analysis is based on:

- 1) The tower structure's theoretical capacity, not including any assessment of the condition of the tower.
- 2) Tower geometry and structural member sizes taken from original construction drawings and structural calculations prepared by Engineer Endeavors, Inc., job number 5554, dated September 9, 1999.
- 3) Antenna and mount configuration as specified on the following page of this report.

This report is only valid as per the assumptions and data utilized in this report for antenna inventory, mounts and associated cables. The user of this report shall field verify the assumption of the antenna and mount configuration as well as the physical condition of the tower. Notify the engineer in writing immediately if any of the information in this report is found to be other than specified.

If you should have any questions, please call.

Sincerely,

URS Corporation

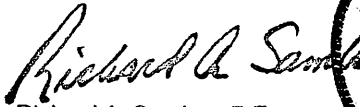

Richard A. Sambor, P.E.  
Manager Facilities Design



RAS/jek

cc: AA, DR, IA, CF/Book – URS

## 2. INTRODUCTION

The subject tower is located at 52 New Britain Avenue in Rocky Hill, Connecticut. The structure is a 182' steel monopole designed and manufactured by Engineered Endeavors, Inc.

The inventory is summarized in the table below:

<i>Antenna Type</i>	<i>Carrier</i>	<i>Mount</i>	<i>Antenna Centerline Elevation</i>	<i>Cable</i>
(6) Cellwave PD-220 omni antennas	Town (existing)	(3) Standoff Mounts	180'	(6) 7/8" coax cables (within monopole)
<b>(3) Powerwave 7770.00 antennas and (6) Powerwave LGP21401 TMA's</b>	<b>Cingular (proposed)</b>	<b>(1) Valmont Flush Mount (P/N 840502)</b>	<b>170'</b>	<b>(9) existing 1 5/8" coax cables (within monopole) and (3) new 1 5/8" coax cables (within monopole)</b>
(6) EMS RR90-17-00DP antennas	T-Mobile (existing)	Low-Profile Platform	160'	(12) 1 5/8" coax cables (within monopole)
(6) Decibel DB980H65T2E-M antennas	Sprint (existing)	Low-Profile Platform	140'	(6) 1 5/8" coax cables (outside monopole)
(6) Decibel DB844H90E-XY antennas and (6) Decibel DB950F85E-M antennas	Verizon (existing)	Low-Profile Platform	90'	(12) 1 5/8" coax cables (within monopole)

This structural analysis of the communications tower was performed by URS Corporation (URS) for CH2Mhill/Cingular Wireless. The purpose of this analysis was to investigate the structural integrity of the existing tower with its existing and proposed antenna loads. This analysis was conducted to evaluate stress on the tower and the effect of forces to the foundation of the tower resulting from existing and proposed antenna arrangements.

### 3. ANALYSIS METHODOLOGY AND LOADING CONDITIONS

The structural analysis was done in accordance with the 2005 Connecticut State Building Code, TIA/EIA-222-F—Structural Standard for Steel Antenna Towers and Antenna Supporting Structures, and the American Institute of Steel Construction (AISC) Manual of Steel Construction—Allowable Stress Design (ASD).

The analysis was conducted using RISA Tower 4.5. Two load conditions were evaluated as shown below which were compared to allowable stresses according to AISC and TIA/EIA.

Load Condition 1 = 80 mph Wind Load (without ice) + Tower Dead Load  
Load Condition 2 = 69 mph Wind Load (with ice) + Ice Load + Tower Dead Load

Please note that wind pressure is a function of velocity squared. Under Load Condition 2, a 25 percent reduction in wind pressure is allowed by code to account for the unlikelihood of the full wind pressure and ice load occurring at the same time. The same results may be achieved by utilizing a lower wind pressure without taking the 25 percent reduction, as shown above.

The TIA/EIA standard permits a one-third increase in allowable stresses for towers and monopoles less than 700 feet tall. For the purposes of this analysis, in computing the load capacity the allowable stresses of the tower members were increased by one-third.

### 4. FINDINGS AND EVALUATION

Combined axial and bending stresses on the monopole structure were evaluated to compare with allowable stresses in accordance with AISC. The calculated stresses under the proposed loading were within the allowable limits. Detailed analysis and calculations for the proposed load condition are provided in section 6 of this report. The anchor bolts, base plate, and foundation were also found to be within allowable limits.

## 5. CONCLUSIONS AND RECOMMENDATIONS

The results of the analysis indicate that the tower structure, anchor bolts, base plate, and foundation are in compliance with the proposed loading conditions. **The tower is structurally adequate under the wind load classification specified above and the proposed antenna loadings.**

### Limitations/Assumptions:

This report is based on the following:

1. Tower inventory as listed in this report.
2. Tower is properly installed and maintained.
3. All members are as specified in the original design documents and are in good condition.
4. All required members are in place.
5. All bolts are in place and are properly tightened.
6. Tower is in plumb condition.
7. All member protective coatings are in good condition.
8. All tower members were properly designed, detailed, fabricated, and installed and have been properly maintained since erection.
9. Foundations were properly constructed to support original design loads as specified in the original design documents.
10. All coaxial cable is installed within the monopole unless specified otherwise.

URS is not responsible for any modifications completed prior to or hereafter in which URS is not or was not directly involved. Modifications include but are not limited to:

- A. Adding antennas
- B. Removing/replacing antennas
- C. Adding coaxial cables

URS hereby states that this document represents the entire report and that it assumes no liability for any factual changes that may occur after the date of this report. All representations, recommendations, and conclusions are based upon information contained and set forth herein. If you are aware of any information which conflicts with that which is contained herein, or you are aware of any defects arising from original design, material, fabrication, or erection deficiencies, you should disregard this report and immediately contact URS. URS disclaims all liability for any representation, recommendation, or conclusion not expressly stated herein.

### Ongoing and Periodic Inspection and Maintenance:

After the Contractor has successfully completed the installation and the work has been accepted, the owner will be responsible for the ongoing and periodic inspection and maintenance of the tower.

The owner shall refer to TIA/EIA-222-F for recommendations for maintenance and inspection. The frequency of the inspection and maintenance intervals is to be determined by the owner based upon actual site and environmental conditions. It is recommended that a complete and thorough inspection of the entire tower structural system be performed at least yearly and more frequently as conditions warrant. According to TIA/EIA-222-F section 14.1, Note 1: It is recommended that the structure be inspected after severe wind and/or ice storms or other extreme loading conditions.

6 July 2006

Honorable Anthony LaRosa  
Mayor, Town of Rocky Hill  
761 Old Main Street  
Rocky Hill, CT 06067

**RE: Notice of Exempt Modification – Existing Cingular  
Telecommunications Tower Facility at 52 New Britain Avenue,  
Rocky Hill, Connecticut**

Dear Mr. LaRosa:

New Cingular Wireless PCS, LLC (“Cingular”) proposes to remove and replace telecommunications antennas and associated equipment located on an existing tower at the above-referenced location. The facility is now controlled and operated by Cingular whose corporate office is located at 500 Enterprise Drive, Rocky Hill, CT 06067.

**Proposed Modifications**

Cingular proposes to add one (1) new equipment cabinet inside an existing shelter and remove the existing antennas and replace them with a total of six (6) new antennas, located at an existing centerline height of approximately 170’ above ground level. Cingular will keep nine (9) of the existing 1 5/8” diameter coaxial cables and add three (3) of the same dimension. It will remove the existing tower mounted amplifiers and replace them with six (6) new units, located at the same height as the antennas.

In summary, the final antenna configuration at 52 New Britain Avenue will include:

- 6 antennas,
- 12 coaxial cables, and
- 12 tower mounted amplifiers.

*James Nelson Kise, AIA/AICP/PP*

*James Bennett Straw, AIA*

*Harvey D. Kolodner, MBA*

*John R. Gibbons, AIA/AICP*

*Philip E. Scott, RA*

*Suzanna Barucco*

*LaVern Browne*

*Katherine E. Cowing, LEED*

*Johnette Davies*

*Petar D. Glumac, Ph.D.*

*Douglas S. Heckrotte, RA/LEED*

*Jody Holton, AICP*

*Marian Maxfield Hull, AICP/PP*

---

**Kise Straw & Kolodner Inc.**

123 South Broad St.

Suite 1270

Philadelphia, PA 19109

(215) 790-1050 FAX (215) 790-0215

www.ksk1.com

A structural evaluation has demonstrated that the tower will be structurally capable of supporting the proposed Cingular telecommunications equipment once the proposed modifications are complete.

**Statutory Considerations**

The proposed work will not affect the height of the existing structure, nor will it alter the existing property boundaries. Furthermore, the proposed work will not increase noise levels at the facility's site boundary by six (6) decibels or more. Operation of additional antennas will not increase the radio frequency electromagnetic radiation power density, measured at the tower base, to or above the standard adopted by the State of Connecticut and the Federal Communications Commission.

A Notice of Exempt Modification has been filed with the Connecticut Siting Council (CSC) as required by the Regulations of Connecticut State Agencies (RCSA), Section 16-50j-73. Please accept this letter as notification to the Town of Rocky Hill under Section 16-50j-73 that the proposed work constitutes an exempt modification pursuant to RCSA Section 16-50j-72(b)(2).

Should you have any questions or require additional information about the plans or the CSC's procedures, please do not hesitate to contact me (215.790.1050 ext. 138) or Mr. Derek Phelps, Executive Director, Connecticut Siting Council (860.827.2935).

Sincerely,

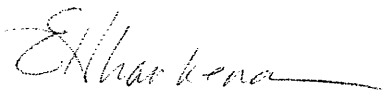

Elizabeth H. Lanckenau, AICP  
Planner

## **Specifications for Proposed New Equipment**

---

**Ericsson RBS Equipment Cabinet  
Powerwave 7770 Antenna  
Powerwave LGP 214nn Tower Mounted Amplifier**

### 3 Dimensions

This section describes the physical characteristics of the RBS: dimensions, weight, and color.

Table 1 The RBS Dimensions

Unit	Dimensions (mm)
Height	1626
Width	1300
Depth	710
Depth including door	926

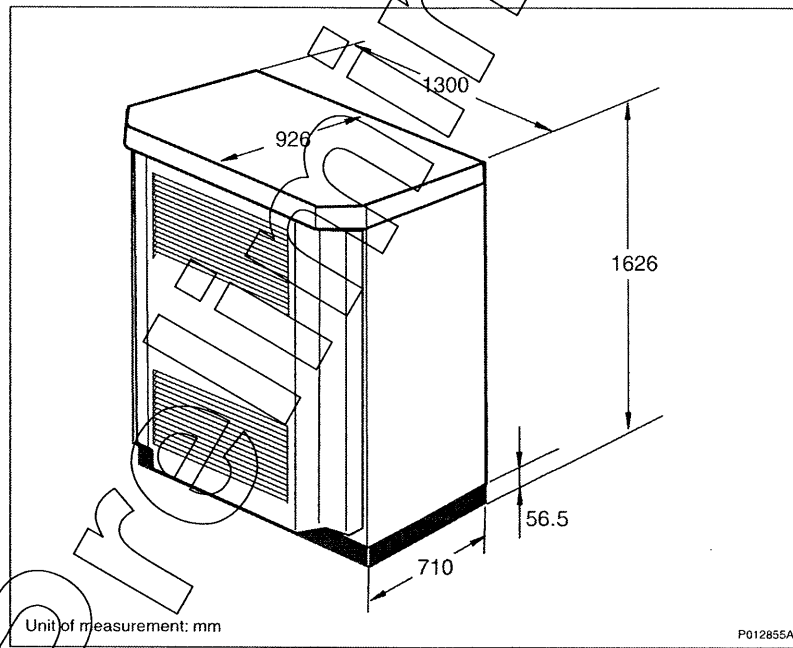

Figure 2 RBS 3106 Dimensions

The RBS weight is shown in the table below.



*Table 2 The RBS Weight*

<b>Unit</b>	<b>Weight (kg)</b>
RBS fully equipped excluding batteries	560
RBS fully equipped including batteries	850
RBS fully equipped including batteries and future expansion of hardware (not yet available)	875
Installation frame	12

The RBS color is shown in the table below.

*Table 3 The RBS Color*

<b>Color</b>	<b>Color Standard</b>
Grey	RAL 7035
Green	NCS 8010-G 10 Y

Preliminary

# Dual Broadband Antenna

90° 1.4 m MET Antenna

806-960/1710-2170 MHz

Part Number:  
7770.00

Horizontal Beamwidth: 90°  
Gain: 13.5/16 dBi

Electrical Downtilt: Adjustable  
Connector Type: 7/16 female

The Powerwave dual band dual polarized broadband antenna has individual adjustable electrical downtilt per band (upgradeable to Remote Electrical Tilt (RET)). Four connector ports allow separate tilts on each frequency band and ensure the use of diversity concepts. The phase shifter technology, based on a patented sliding dielectric, minimizes intermodulation distortion and maximizes efficiency. The slant +/- 45° dual polarization system provides the independent fading signals needed for achieving top-quality coverage via diversity concepts. The Powerwave Broadband antenna design is based on a patented stacked aperture-coupled patch technology, which provides high isolation performance and a wide VSWR bandwidth. The antennas have superior radiation patterns due to a unique reflector design which provides a very small variation of the -3dB horizontal beam width over the frequency band as well as a high front-to-back ratio.

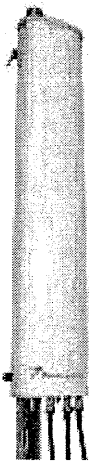

## Key Benefits

- Excellent broad- and multi-band capabilities
- Polarization purity makes good diversity gain
- Excellent pattern performance and high gain over frequency
- High passive intermodulation performance
- Light, slim and robust design

# Preliminary

ANTENNA  
SYSTEMS

BASE STATION  
SYSTEMS

COVERAGE  
SYSTEMS

THE POWER IN WIRELESS®

 **Powerwave**  
technologies

# Dual Broadband Antenna

806-960/1710-2170 MHz

## Electrical Specifications (Preliminary)

Frequency band (MHz)	806-960	1710-2170
Gain, $\pm 0.5$ dB (dBi)	13.5	16.0
Polarization	Dual linear $\pm 45^\circ$	
Nominal Impedance (Ohm)	50	
VSWR	1.5:1	1.5:1
Isolation between inputs (dB)	30	30
Inter band isolation (dB)	40	30
Horizontal -3 dB beamwidth	$85 \pm 5^\circ$	$85 \pm 5^\circ$
Tracking, Horizontal plane, $\pm 60^\circ$ (dB)	$< 2.0$	$< 2.0$
Tracking, Horizontal plane, $\pm 60^\circ$ (dB)		$< 2.0$
Electrical downtilt range (adjustable)	$0^\circ$ to $10^\circ$	$0^\circ$ to $8^\circ$
Vertical -3 dB beamwidth	$14.3 \pm 2.0^\circ$	$6.6 \pm 1^\circ$
Sidelobe suppression, Vertical 1 st upper (dB)	$> 17, 16, 15$ $x=0, 5, 10^\circ$ MET	$> 17, 16, 15$ $x=0, 4, 8^\circ$ MET
Vertical beam squint	$< 0.8^\circ$	$< 0.5^\circ$
First null-fill (dB)	$< -25$	$< -25$
Front-to-back ratio (dB)	$> 25$	$> 27$
Front-to-back ratio, total power (dB)	$> 20$	$> 23$
IM3, 2Tx@43dBm (dBc)	$< -153$	
IM3, 2Tx@43dBm (dBc)		$< -153$
IM7, 2Tx@43dBm (dBc)		$< -160$
Power Handling, Average per input (W)	400	250
Power Handling, Average total (W)	800	500

All specifications are subject to change without notice.  
Contact your Powerwave representative for complete performance data.

## Mechanical Specifications

Connector Type	4 x 7/16 DIN female
Connector Position	Bottom
Dimensions, HxWxD	1408mm x 280mm x 125mm (55"x11"x5")
Weight Including Brackets	15.8 kg (35 lbs)
Wind Load, Frontal, 42m/s Cd=1	435N (98 lbf)
Survival Wind Speed (m/s)	70 (156mph)
Lightning Protection	DC grounded
Radome Material	GRP
Radome Color	Light Gray
Mounting	Pre-mounted Standard Brackets
Packing Size	1550mm x 355mm x 255mm (61"x14"x10")

**Corporate Headquarters**  
Powerwave Technologies, Inc.  
1801 East St. Andrew Place  
Santa Ana, CA 92705 USA  
Tel: 714-466-1000  
Fax: 714-466-5800  
www.powerwave.com

**Main European Office**  
Antennvägen 6  
SE-187 80 Täby  
Sweden  
Tel: +46 8 540 822 00  
Fax: +46 8 540 823 40

**Main Asia Pacific Office**  
23 F Tai Yau Building  
181 Johnston Road  
Wanchai, Hong Kong  
Tel: +852 2512 6123  
Fax: +852 2575 4860



©Copyright March 2005, Powerwave Technologies, Inc. All Rights reserved. Powerwave, Powerwave Technologies, The Power in Wireless and the Powerwave logo are registered trademarks of Powerwave Technologies, Inc.

COVERAGE AND CAPACITY

TECHNOLOGY LEADERSHIP

GLOBAL PARTNER

INTEGRATED SOLUTIONS

QUALITY AND RELIABILITY

# Tower Mounted Amplifier

Dual Band 1900 MHz with 850 MHz Bypass

1900/850 MHz

Part Number:  
LGP 214nn

Up-link: 1850-1910 MHz  
Down-link: 1930-1990 MHz  
Bypass: 824-894 MHz

Gain: 12 dB  
Noise Figure: < 1.7 dB

The Powerwave® TMA-DD 1900/850 is a dual band Tower Mounted Amplifier (TMA) to be installed near the antenna. Deployed in an AMPS, GSM, GPRS, EDGE and CDMA network it will increase capacity and coverage as well as extend the battery life time for the handsets. The TMA System will provide enhanced coverage and improved up-link signal quality. Appropriate for new rollouts by optimizing coverage with a reduced number of BTSs or as an upgrade to existing BTSs for enhancing the existing coverage.

Extended band TMA facilitates simplified logistics, especially when the frequency bands are scattered. The unit comprises of high Q band-pass filters, dual balanced low noise amplifiers with circuits for active bias, supervision, alarms and lightning protection circuit. The Powerwave patented design with all active components integrated within the filter body provides an extremely reliable, compact and lightweight TMA solution. The vented enclosure design is employed to prevent the effect of condensation, thereby guaranteeing long, reliable, maintenance-free service in all environmental conditions. These TMAs offer an easy to install, maintenance free, cost effective solution for coverage enhancement and increased quality in mobile communication networks.

ANTENNA  
SYSTEMS

BASE STATION  
SYSTEMS

COVERAGE  
SYSTEMS

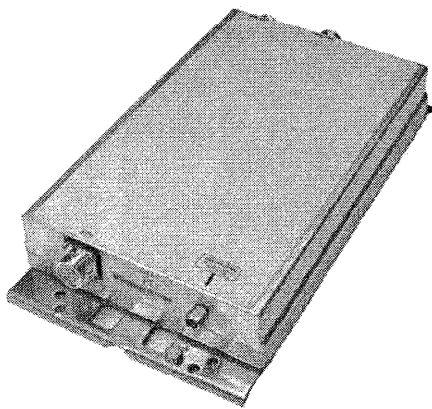

## Key Benefits:

- 850 MHz Bypass
- Improved Network Quality
- Increased Coverage
- State of the Art Performance
- Excellent Power Handling
- Low Tx Loss
- Exceptional Reliability

# Tower Mounted Amplifier



1900/850 MHz

## Technical Specifications

Product Number	LGP214nn	
850 MHz	Bypass (MHz)	824-894
	Return loss* (dB)	> 20
	Insertion loss* (dB)	< 0.3
1900 MHz		
Up-link	Frequency range, full band (60 MHz)	1850-1910
	Nominal gain (dB)	12
	Return loss* (dB)	> 20
	Noise figure* (dB)	< 1.7
	Output 3rd order Intercept Point* (dBm)	> +23
Down-link	Frequency range, full band (60 MHz)	1930-1990
	Insertion loss* (dB)	< 0.6
	Return loss* (dB)	> 20
Intermodulation	2 Tx@x43 dBm (dBc)	<-158
Alarm Functionality	Two levels, individually supervised LNAs	
Power Consumption	@12 VDC	1.2 W

\* Typical

All specifications subject to change without notice. Please contact your Powerwave representative for complete performance data.

## Mechanical Specifications

Size, W x H x D (without mounting plate)	235 x 366 x 66 mm (9.2 x 14.4 x 2.6 in)
Weight	6.4 kg (14.1 lbs)
Color	Off white (NCS 1502-R)
Housing	Aluminum
RF-connectors	DIN 7/16 female.
Mounting kit	Mounting kit for pole and wall is included
Temperature range	-40 °C to +65 °C (-40 °F to +149 °F)
MTBF	>1 million hours
Safety	UL 60 950
Ingress protection, IP 65	EN 60 529
Environmental	ETS 300 019
EMC	FCC Part 15

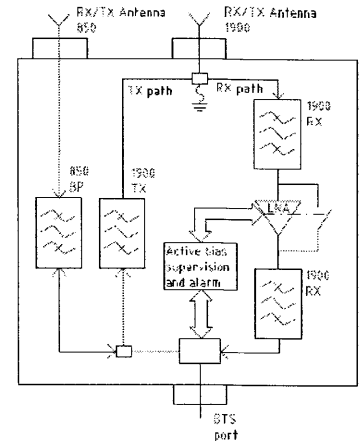

D031-08422 Rev. A Pg. 2 of 2

**Corporate Headquarters**  
 Powerwave Technologies, Inc.  
 1801 East St. Andrew Place  
 Santa Ana, CA 92705 USA  
 Tel: 714-466-1000  
 Fax: 714-466-5800  
 www.powerwave.com

**Main European Office**  
 Antennvägen 6  
 SE-187 80 Täby  
 Sweden  
 Tel: +46 8 540 822 00  
 Fax: +46 8 540 823 40

**Main Asia-Pacific Office**  
 23 F Tai Yau Building  
 181 Johnston Road  
 Wanchai, Hong Kong  
 Tel: +852 2512 6123  
 Fax: +852 2575 4860



©Copyright 2006, Powerwave Technologies, Inc. All Rights reserved. Powerwave, Powerwave Technologies, The Power in Wireless and the Powerwave logo are registered trademarks of Powerwave Technologies, Inc.

COVERAGE AND CAPACITY

TECHNOLOGY LEADERSHIP

GLOBAL PARTNER

INTEGRATED SOLUTIONS

QUALITY AND RELIABILITY

## **Specifications for Existing Antennas**

---

**Allgon 7184**

# Single Band Metro Antenna

90° 1.3 m vertical polarized FET Antenna

1850-1990 MHz

Part Number:  
7184.42

Horizontal Beamwidth: 90°  
Gain: 16.5 dBi / 14.4 dBd

Electrical Downtilt: 2°  
Connector Type: 7/16 DIN female

The Powerwave single band Metro antenna has a slim design and sophisticated electrical performance, typical of Powerwave antennas. This ensures maximum efficiency as well as stable pattern over the entire frequency range. The design relies on a micro strip PCB network. Special attention has been paid to ensure antenna pattern peak performance, making the Metro an excellent choice for optimal cell planning.

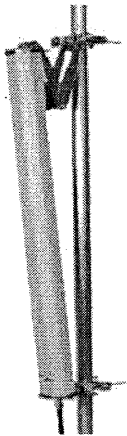

## Key Benefits

- High gain performance
- Light and slim design
- Robust and reliable
- Pre-mounted brackets
- Guaranteed passive intermodulation performance

ANTENNA  
SYSTEMS

BASE STATION  
SYSTEMS

COVERAGE  
SYSTEMS

THE POWER IN WIRELESS®

 **Powerwave**  
technologies

# Single Band Metro Antenna

1850-1990 MHz

## Electrical Specifications

Frequency Band (MHz)	1850 – 1990
Gain (dBi / dBd)	16.5 / 14.4
Polarization	Linear vertical
Nominal Impedance (Ohm)	50
VSWR (1850-1990 MHz)	< 1.3:1
Horizontal -3 dB beamwidth	90°
Electrical downtilt	2°
Vertical -3 dB beamwidth	6.5°
First upper sidelobe suppression (dB)	> 18
Front-to-back ratio, co-polar (dB)	> 27
Power Handling, Average total (W)	400
IM3, @2x43dBm (dBc)	<-146

All specifications are subject to change without notice.  
Contact your Powerwave representative for complete performance data.

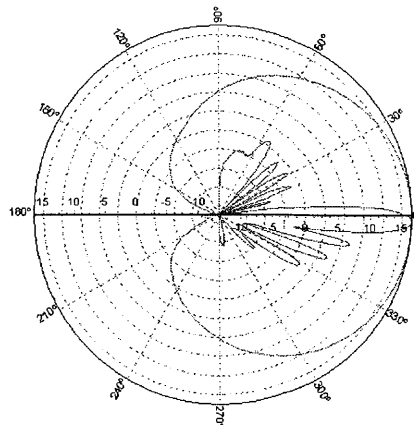

Typical Horizontal and Vertical 7184.42 Patterns

## Mechanical Specifications

Connector Type	7/16 DIN female
Connector Position	Bottom
Dimensions, HxWxD	1300x126x80mm (4' 3"x5"x3" )
Weight Including Bracket	8.7 kg (19 lbs)
Wind Load, Frontal, 42 m/s, Cd=1	181N (41 lbf)
Survival Wind Speed	70m/s (156 mph)
Lightning Protection	DC grounded
Radome Material	PVC
Radome Color	Light gray
Packing Size	1410x190x140mm (4' 7"x7"x6")
Shipping Weight	9.7 kg (21.1lbs)

**Corporate Headquarters**  
Powerwave Technologies, Inc.  
1801 East St. Andrew Place  
Santa Ana, CA 92705 USA  
Tel: 714-466-1000  
Fax: 714-466-5800  
www.powerwave.com

**Main European Office**  
Antennvägen 6  
SE-187 80 Täby  
Sweden  
Tel: +46 8 540 822 00  
Fax: +46 8 540 823 40

**Main Asia Pacific Office**  
23 F Tai Yau Building  
181 Johnston Road  
Wanchai, Hong Kong  
Tel: +852 2512 6123  
Fax: +852 2575 4860



©Copyright February 2003, Powerwave Technologies, Inc. All Rights reserved. Powerwave, Powerwave Technologies, The Power in Wireless and the Powerwave logo are registered trademarks of Powerwave Technologies, Inc.

COVERAGE AND CAPACITY

TECHNOLOGY LEADERSHIP

GLOBAL PARTNER

INTEGRATED SOLUTIONS

QUALITY AND RELIABILITY





# STATE OF CONNECTICUT

## CONNECTICUT SITING COUNCIL

Ten Franklin Square, New Britain, CT 06051

Phone: (860) 827-2935 Fax: (860) 827-2950

E-Mail: [siting.council@ct.gov](mailto:siting.council@ct.gov)

[www.ct.gov/csc](http://www.ct.gov/csc)

July 19, 2006

The Honorable Anthony P. LaRosa  
Mayor  
Town of Rocky Hill  
Town Hall  
699 Old Main Street  
P. O. Box 657  
Rocky Hill, CT 06067

RE: **EM-CING-064-119-060707** - New Cingular Wireless PCS, LLC notice of intent to modify existing telecommunications facilities located at 92 Weston Street, Hartford; and 52 New Britain Avenue, Rocky Hill, Connecticut.

Dear Mayor LaRosa:

The Connecticut Siting Council (Council) received this request to modify an existing telecommunications facility, pursuant to Regulations of Connecticut State Agencies Section 16-50j-72.

The Council will consider this item at the next meeting scheduled for July 27, 2006 at 1:30 p.m. in Hearing Room Two, Ten Franklin Square, New Britain, Connecticut.

If you have any questions or comments regarding this proposal, please call me or inform the council by July 26, 2006.

Thank you for your cooperation and consideration.

Very truly yours,

S. Derek Phelps  
Executive Director

SDP/ap

Enclosure: Notice of Intent

c: Kimberly Ricci, Director of Planning, Town of Rocky Hill  
Barbara Gilbert, Town Manager, Town of Rocky Hill

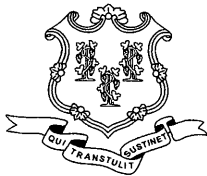

# STATE OF CONNECTICUT

## CONNECTICUT SITING COUNCIL

Ten Franklin Square, New Britain, CT 06051

Phone: (860) 827-2935 Fax: (860) 827-2950

E-Mail: [siting.council@ct.gov](mailto:siting.council@ct.gov)

[www.ct.gov/csc](http://www.ct.gov/csc)

July 19, 2006

The Honorable Eddie A. Perez  
Mayor  
City of Hartford  
Municipal Building  
550 Main Street  
Hartford, CT 06103

RE: **EM-CING-064-119-060707** - New Cingular Wireless PCS, LLC notice of intent to modify existing telecommunications facilities located at 92 Weston Street, Hartford; and 52 New Britain Avenue, Rocky Hill, Connecticut.

Dear Mayor Perez:

The Connecticut Siting Council (Council) received this request to modify an existing telecommunications facility, pursuant to Regulations of Connecticut State Agencies Section 16-50j-72.

The Council will consider this item at the next meeting scheduled for July 27, 2006 at 1:30 p.m. in Hearing Room Two, Ten Franklin Square, New Britain, Connecticut.

If you have any questions or comments regarding this proposal, please call me or inform the council by July 26, 2006.

Thank you for your cooperation and consideration.

Very truly yours,

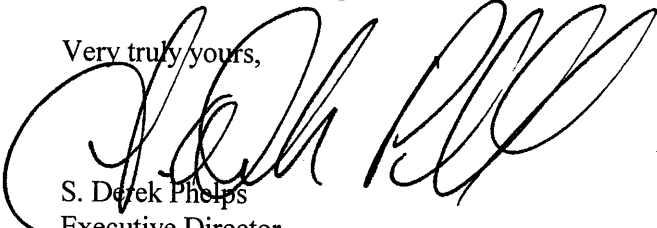

S. Derek Phelps  
Executive Director

SDP/ap

Enclosure: Notice of Intent

c: Rogert J. O'Brien, Director of Planning, City of Hartford  
Lee C. Erdmann, Chief Operating Officer, City of Hartford

**Perrone, Michael**

EM-CING-064-119-060707

**From:** Karen Couture [karencouture@myeastern.com]  
**Sent:** Thursday, July 20, 2006 3:39 PM  
**To:** Perrone, Michael  
**Subject:** 52 New Britain Avenue, Rocky Hill, CT-Errata Sheet  
**Importance:** High

Dear Mr. Perrone,

Attached you will find an errata sheet for 52 New Britain Avenue, Rocky Hill, CT. The power density sheet has been revised to show Verizon at 90'.

Should you have any further questions, please do not hesitate to call.

Thank you.

Karen L. Couture  
Site Acquisition Specialist  
Mobile: 860-389-4924  
E-Fax: 888-281-6394  
Email: [karencouture@myeastern.com](mailto:karencouture@myeastern.com)

RECEIVED  
JUL 21 2006  
CONNECTICUT  
SITING COUNCIL

