



20 Commercial St  
Branford, CT 06405  
Phone: (203) 208-0806  
Fax: (203) 488-4820

September 21, 2015

Connecticut Siting Council  
Ten Franklin Square  
New Britain, CT 06051  
Attn: Ms. Melanie Bachman, Executive Director

**Re: Notice of Exempt Modification Application**  
275 Mount Carmel Ave.  
Hamden, CT 06518

Dear Ms. Bachman,

On behalf of New Cingular Wireless PCS, LLC ("AT&T"), enclosed for filing are an original and two (2) copies of AT&T's Notice of Exempt Modification for Proposed Modifications to an Existing Telecommunications Facility located at the above-referenced site.

I also enclose herewith a check in the amount of \$625.00 representing the fee for the Notice of Exempt Modification.

If you have any questions, please feel free to contact me.

Thank you,

By: \_\_\_\_\_

Name: Paul Sagristano  
Vertical Development LLC  
Phone- 917-841-0247  
Fax- 401-633-6202  
[psagristano@verticaldevelopmentllc.com](mailto:psagristano@verticaldevelopmentllc.com)

cc:

Hon. Scott D. Jackson 2750 Dixwell Ave. Hamden, CT 06518 203-287-7100		Quinnipiac University 275 Mount Carmel Ave. Hamden, CT 06518 203-582-8200
--	--	--

[siting.council@ct.gov](mailto:siting.council@ct.gov) (electronic copy)

**Notice of Exempt Modification**  
**275 Mount Carmel Ave.**  
**Hamden, CT 06518**

New Cingular Wireless PCS, LLC ("AT&T") submits this Notice of Exempt Modification to the Connecticut Siting Council ("Council") pursuant to Sections 16-50j-73 and 16-50j-72(b) of the Regulations of Connecticut State Agencies ("Regulations") in connection with AT&T's planned modification of antennas and associated equipment on an existing 25' monopole located atop the roof of a Quinnipiac University building at 275 Mount Carmel Ave., Connecticut. The monopole has an AGL of 60' as it is on the top of a 35' building. More particularly, AT&T plans to upgrade this site by adding LTE technology to its facilities. The proposed modifications will not increase the tower height, cause a significant adverse change or alteration in the physical or environmental characteristics of the site, extend the boundaries of the tower site, increase noise levels at the tower site boundary by six (6) decibels, add radio frequency sending or receiving capability which increases the total radio frequency electromagnetic radiation power density measured at the tower site boundary to or above the standard adopted by the Federal Communications Commission pursuant to Section 704 of the Telecommunications Act of 1996, as amended, and the State Department of Energy and Environmental Protection, pursuant to Section 22a-162 of the Connecticut General Statutes, or impair the structural integrity of the facility, as determined in a certification provided by a professional engineer licensed in Connecticut.

To better meet the growing voice and data demands of its wireless customers, AT&T is upgrading their network nationwide to include LTE technology, which will provide faster service and better overall performance. Pursuant to the LTE technology upgrade at this site, AT&T will add panel antennas, install RRHs, and install related equipment to its equipment area within the fenced tower compound.

The monopole tower located at 275 Mount Carmel Ave, in the Town of Hamden, Connecticut (lat. 41.41811°, long. -72.88899°) is owned and operated by Quinnipiac University, Inc, a Connecticut not-for-profit corporation (“Landlord”). AT&T’s existing facility is located on the roof of the building @ 275 Mount Carmel Ave. AT&T currently has Twelve (3) panel antennas (one (1) per sector) with a centerline of 56’ installed inside the stealth monopole tower. AT&T’s base station equipment is located inside the penthouse of the building. A site plan depicting this is attached.

AT&T currently has three (3) LTE antennas, and three (3) Ericsson RRUS-11 (one (1) per sector) which are connected and located at the base of the tower, and one (1) DC-6 Surge Suppressor.

AT&T plans to replace the three (3) existing LTE antennas with three (3) CCI OPA-65R-LCUU-H6 panel antennas, and add three (3) RRUS-12 (1 per sector), three (3) Ericsson A2 modules (1) per sector (also to be attached at the base of the tower). The height of the tower will not be increased and all antennas, surge suppressors, and RRHs will be installed at the existing 56’ centerline.

AT&T will make no modifications to their existing ground based communications platform. The compound’s boundaries will not need to be extended. The proposed modifications will not cause a significant adverse change or alteration in the physical or environmental characteristics of the site, since it is already a telecommunications installation and the modifications will be compatible with this. Other than brief, construction-related noise, these modifications will not increase noise levels at the tower site boundary by six (6) decibels.

The proposed modifications will not add radio frequency sending or receiving capability which increases the total radio frequency electromagnetic radiation power density measured at the tower site boundary to or above the standard adopted by the Federal Communications Commission pursuant to Section 704 of the Telecommunications Act of 1996, as amended, and the State Department of Energy and Environmental Protection, pursuant to Section 22a-

162 of the Connecticut General Statutes. A radio frequency emissions analysis prepared by SiteSafe Consulting concludes that the proposed final configuration (including other carriers on the tower) will emit less than 5% the allowable FCC established general public limits sampled at the ground level (see page 8 of the Site Compliance Report an Evaluation of Exposure in regard to the cumulative allowable emission levels (the “MPE” Assessment) dated August 19, 2015). Emissions values for additional carriers were not completed as only AT&T antennas are present at this location. The information used in the report was analyzed as a percentage of current Maximum Permissible Exposure (%MPE) as listed in the FCC OET Bulletin 65 Edition 97-01 and ANSI/IEEE Std C95.1 (see the 3<sup>rd</sup> page of the MPE Assessment).

The proposed modifications will not overtax the structural integrity of the facility. Destek Engineering structural engineers performed a structural analysis of the tower on September 8, 2015 to verify that it can support the proposed loading as the stealth tower is not being modified therefore the wind profile and the wind loading on the tower is not changed. The monopole will comply with the specified ANSI-TIA-222-G requirements and adequately structurally support the proposed loading.

In conclusion, AT&T’s proposed modifications do not constitute a modification subject to the Council’s review because AT&T will not change the height of the tower, will not extend the boundaries of the compound, will not cause a significant adverse change or alteration in the physical or environmental characteristics of the site, will not increase the noise levels at the site, will not increase the total radio frequency electromagnetic radiation power density at the site to levels above applicable standards, and will not impair the structural integrity of the facility. Therefore, AT&T respectfully requests that the Council acknowledge that this Notice of Exempt Modification meets the Council’s exemption criteria.

**PROJECT INFORMATION**

SCOPE OF WORK:

- AT&T ANTENNAS: (3) EXISTING ANTENNAS TO BE REPLACED WITH (3) PROPOSED LTE ANTENNAS
- AT&T RRUs: (1) NEW RRU PER SECTOR WITH (3) SECTORS, FOR A TOTAL OF (3) NEW RRUs; (1) NEW A2 MODULE PER SECTOR, FOR A TOTAL OF (3) A2 MODULES; (1) EXISTING RRU PER SECTOR TO REMAIN, FOR A TOTAL OF (3) EXISTING RRUs. MOUNTED TO FLAGPOLE FRAMING

SITE ADDRESS: 275 MOUNT CARMEL AVENUE  
HAMDEN, CT 06518

LATITUDE: 41.4181339 41° 25' 5.28204"N  
LONGITUDE: -72.8889911 72° 53' 20.36796"W

USID: 61184

PROPERTY OWNER: QUINNIPIAC UNIVERSITY  
275 MT. CARMEL AVE  
HAMDEN, CT 06518

TYPE OF SITE: ROOFTOP/INDOOR EQUIPMENT

RAD CENTER: 56'-0"±

CURRENT USE: UNMANNED WIRELESS TELECOMMUNICATIONS FACILITY

PROPOSED USE: UNMANNED WIRELESS TELECOMMUNICATIONS FACILITY

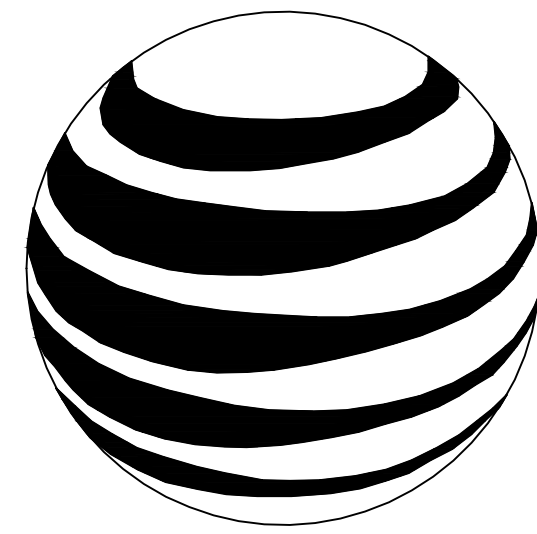

**at&t**  
MOBILITY

**FA CODE: 10035055**  
**SITE NUMBER: CTU2041**  
**SITE NAME: HAMDEN**  
**MT CARMEL AVE**

**PROJECT TEAM**

**CLIENT REPRESENTATIVE**

COMPANY: EMPIRE TELECOM  
ADDRESS: 16 ESQUIRE ROAD  
BILLERICA, MA 01821  
CONTACT: DAVID COOPER  
PHONE: 617-639-4908  
EMAIL: dcooper@empiretelecomm.com

**SITE ACQUISITION:**

COMPANY: VERTICAL DEVELOPMENT, LLC  
ADDRESS: 20 COMMERCIAL STREET  
BRANFORD, CT 06405  
CONTACT: PAUL SAGRISTANO  
PHONE: 917-841-0247  
EMAIL: psagrystano@verticaldevelopmentllc.com

**ZONING:**

COMPANY: VERTICAL DEVELOPMENT, LLC  
ADDRESS: 20 COMMERCIAL STREET  
BRANFORD, CT 06405  
CONTACT: PAUL SAGRISTANO  
PHONE: 917-841-0247  
EMAIL: psagrystano@verticaldevelopmentllc.com

**ENGINEERING:**

COMPANY: COM-EX CONSULTANTS, LLC  
ADDRESS: 4 SECOND AVENUE  
SUITE 204  
DENVER, NJ 07834  
CONTACT: NICHOLAS D. BARILE, P.E.  
PHONE: 862-209-4300  
EMAIL: nbarile@comexconsultants.com

**RF ENGINEER:**

COMPANY: AT&T MOBILITY – NEW ENGLAND  
ADDRESS: 550 COCHITUATE ROAD  
SUITE 550 13 & 14  
FRAMINGHAM, MA 01701  
CONTACT: CAMERON SYME  
PHONE: 508-596-7146  
EMAIL: cs6970@att.com

**CONSTRUCTION MANAGEMENT:**

COMPANY: EMPIRE TELECOM  
ADDRESS: 16 ESQUIRE ROAD  
BILLERICA, MA 01821  
CONTACT: GRZEGORZ "GREG" DORMAN  
PHONE: 484-683-1750  
EMAIL: gdorman@empiretelecomm.com

**DRAWING INDEX**

**REV.**

T-1	TITLE SHEET	0
GN-1	GROUNDING & GENERAL NOTES	0
A-1	PARTIAL ROOF PLAN	0
A-2	EQUIPMENT LAYOUT	0
A-3	ANTENNA LAYOUTS & ELEVATION	0
A-4	DETAILS	0
G-1	GROUNDING DETAILS	0

**VICINITY MAP**

1. GET ON I-90 E/MASSACHUSETTS TURNPIKE FROM SPEEN ST. 2. CONTINUE ON I-90 W/MASSACHUSETTS TURNPIKE. TAKE I-84, I-91 S AND CT-15 S TO HARTFORD TURNPIKE IN NORTH HAVEN. TAKE EXIT 63 FROM CT-15 S. 3. TAKE BISHOP ST, CT-22 W AND NEW RD TO HILL TOP RD IN HAMDEN. 4. TURN LEFT ONTO HARTFORD TURNPIKE, TURN RIGHT ONTO BISHOP ST. 5. CONTINUE ONTO RIDGE RD. 6. TURN RIGHT ONTO CT-22 W/DAVIS RD, TURN RIGHT ONTO NEW RD. 7. TURN RIGHT ONTO BOBCAT WAY, TURN RIGHT TOWARD HILL TOP RD. 8. TURN RIGHT TOWARD HILL TOP RD, TURN LEFT TOWARD HILL TOP RD. 9. CONTINUE ONTO HILL TOP RD, DESTINATION WILL BE ON THE RIGHT.

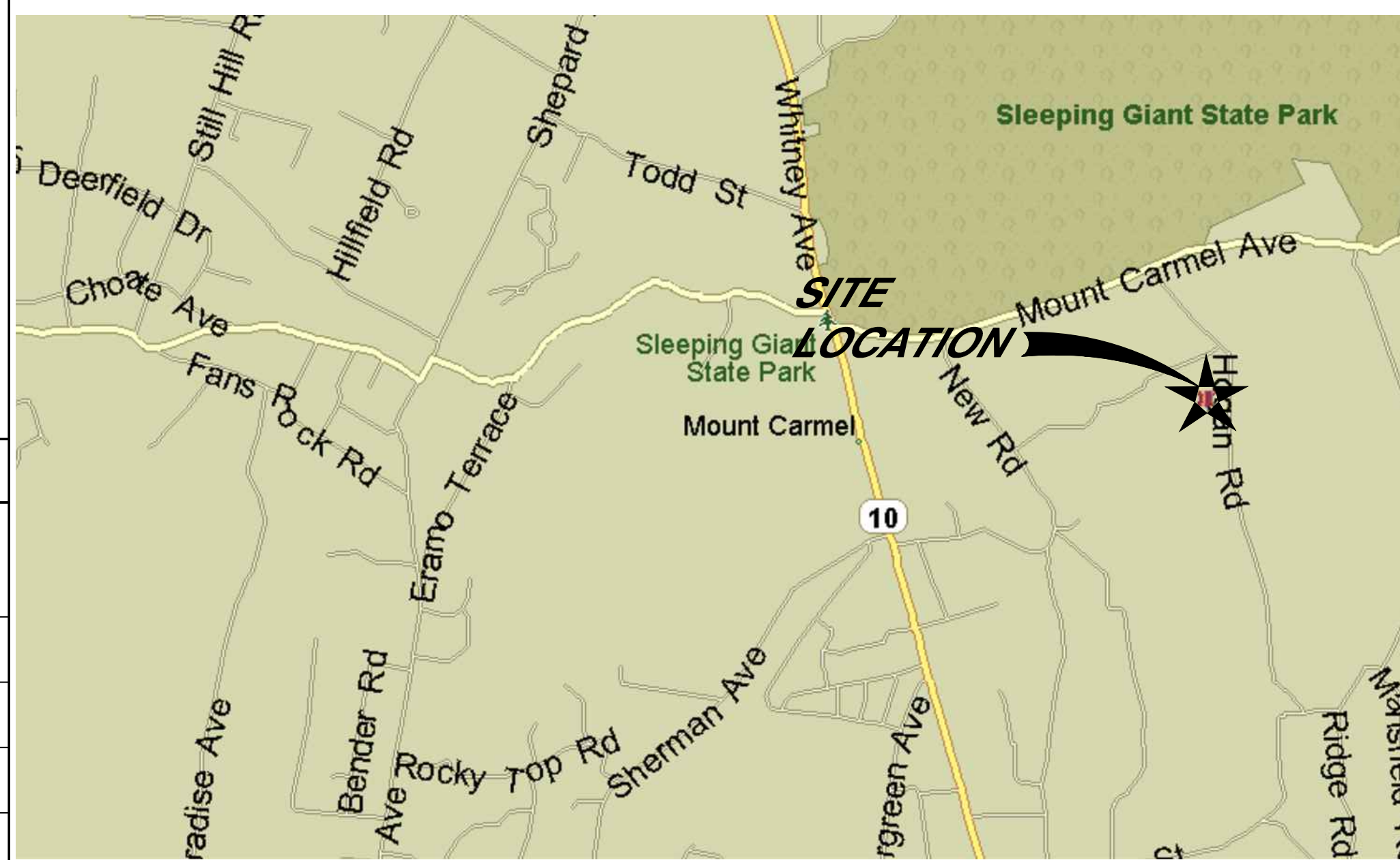

**GENERAL NOTES**

1. THIS DOCUMENT IS THE CREATION, DESIGN, PROPERTY, AND COPYRIGHTED WORK OF AT&T. ANY DUPLICATION OR USE WITHOUT EXPRESS WRITTEN CONSENT IS STRICTLY PROHIBITED. DUPLICATION AND USE BY GOVERNMENT AGENCIES FOR THE PURPOSES OF CONDUCTING THEIR LAWFULLY AUTHORIZED REGULATORY AND ADMINISTRATIVE FUNCTIONS IS SPECIFICALLY ALLOWED.
2. THE FACILITY IS AN UNMANNED PRIVATE AND SECURED EQUIPMENT INSTALLATION. IT IS ONLY ACCESSED BY TRAINED TECHNICIANS FOR PERIODIC ROUTINE MAINTENANCE AND THEREFORE DOES NOT REQUIRE ANY WATER OR SANITARY SEWER SERVICE. THE FACILITY IS NOT GOVERNED BY REGULATIONS REQUIRING PUBLIC ACCESS PER ADA REQUIREMENTS.
3. CONTRACTOR SHALL VERIFY ALL PLANS AND EXISTING DIMENSIONS AND CONDITIONS ON THE JOB SITE AND SHALL IMMEDIATELY NOTIFY THE AT&T REPRESENTATIVE IN WRITING OF DISCREPANCIES BEFORE PROCEEDING WITH THE WORK OR BE RESPONSIBLE FOR SAME.

**APPROVALS**

THE FOLLOWING PARTIES HEREBY APPROVE AND ACCEPT THESE DOCUMENTS AND AUTHORIZE THE SUBCONTRACTOR TO PROCEED WITH THE CONSTRUCTION DESCRIBED HEREIN, ALL DOCUMENTS ARE SUBJECT TO REVIEW BY THE LOCAL BUILDING DEPARTMENT AND MAY IMPOSE CHANGES OR SITE MODIFICATIONS.

DISCIPLINE:	NAME:	DATE:
SITE ACQUISITION:		
CONSTRUCTION MANAGER:		
AT&T PROJECT MANAGER:		



CONNECTICUT LAW REQUIRES TWO WORKING DAYS NOTICE PRIOR TO ANY EARTH MOVING ACTIVITIES BY CALLING 800-922-4455 OR DIAL 811



**SITE NUMBER: CT2041**  
**SITE NAME: HAMDEN**  
**MT CARMEL AVENUE**  
275 MOUNT CARMEL AVENUE  
HAMDEN, CT 06518  
NEW HAVEN COUNTY



0	09/21/15	ISSUED AS FINAL	KCD	NDB	NDB
NO.	DATE	REVISIONS	BY	CHK	APP'D
SCALE: AS SHOWN			DESIGNED BY: CJT		DRAWN BY: CJT

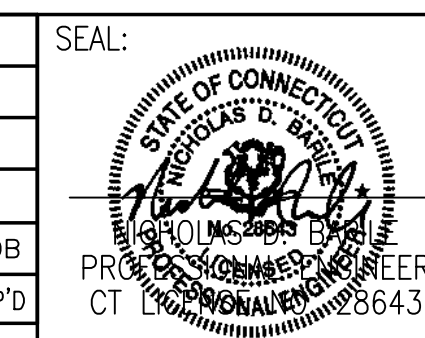

<b>AT&amp;T</b>		
DRAWING TITLE: <b>TITLE SHEET</b>		
JOB NUMBER 14196-EMP	DRAWING NUMBER T-1	REV 0

**GROUNDING NOTES:**

1. THE SUBCONTRACTOR SHALL REVIEW AND INSPECT THE EXISTING FACILITY GROUNDING SYSTEM AND LIGHTNING PROTECTION SYSTEM (AS DESIGNED AND INSTALLED) FOR STRICT COMPLIANCE WITH THE NEC (AS ADOPTED BY THE AHJ), THE SITE-SPECIFIC (UL, LPI, OR NFPA) LIGHTING PROTECTION CODE, AND GENERAL COMPLIANCE WITH TELCORDIA AND TIA GROUNDING STANDARDS. THE SUBCONTRACTOR SHALL REPORT ANY VIOLATIONS OR ADVERSE FINDINGS TO THE CONTRACTOR FOR RESOLUTION.
2. ALL GROUND ELECTRODE SYSTEMS (INCLUDING TELECOMMUNICATION, RADIO, LIGHTNING PROTECTION, AND AC POWER GES'S) SHALL BE BONDED TOGETHER, AT OR BELOW GRADE, BY TWO OR MORE COPPER BONDING CONDUCTORS IN ACCORDANCE WITH THE NEC.
3. THE SUBCONTRACTOR SHALL PERFORM IEEE FALL-OF-POTENTIAL RESISTANCE TO EARTH TESTING (PER IEEE 1100 AND 81) FOR NEW GROUND ELECTRODE SYSTEMS. THE SUBCONTRACTOR SHALL FURNISH AND INSTALL SUPPLEMENTAL GROUND ELECTRODES AS NEEDED TO ACHIEVE A TEST RESULT OF 5 OHMS OR LESS. TESTS SHALL BE PERFORMED IN ACCORDANCE WITH 25471-000-3PS-EG00-0001, DESIGN & TESTING OF FACILITY GROUNDING FOR CELL SITES.
4. METAL RACEWAY SHALL NOT BE USED AS THE NEC REQUIRED EQUIPMENT GROUND CONDUCTOR. STRANDED COPPER CONDUCTORS WITH GREEN INSULATION, SIZED IN ACCORDANCE WITH THE NEC, SHALL BE FURNISHED AND INSTALLED WITH THE POWER CIRCUITS TO BTS EQUIPMENT.
5. EACH BTS CABINET FRAME SHALL BE DIRECTLY CONNECTED TO THE MASTER GROUND BAR WITH GREEN INSULATED SUPPLEMENTAL EQUIPMENT GROUND WIRES, 6 AWG STRANDED COPPER OR LARGER FOR INDOOR BTS; 2 AWG STRANDED COPPER FOR OUTDOOR BTS.
6. EXOTHERMIC WELDS SHALL BE USED FOR ALL GROUNDING CONNECTIONS BELOW GRADE.
7. APPROVED ANTIOXIDANT COATINGS (I.E., CONDUCTIVE GEL OR PASTE) SHALL BE USED ON ALL COMPRESSION AND BOLTED GROUND CONNECTIONS.
8. ICE BRIDGE BONDING CONDUCTORS SHALL BE EXOTHERMICALLY BONDED OR BOLTED WITH STAINLESS STEEL HARDWARE TO THE BRIDGE AND THE TOWER GROUND BAR.
9. ALUMINUM CONDUCTOR OR COPPER CLAD STEEL CONDUCTOR SHALL NOT BE USED FOR GROUNDING CONNECTIONS.
10. MISCELLANEOUS ELECTRICAL AND NON-ELECTRICAL METAL BOXES, FRAMES AND SUPPORTS SHALL BE BONDED TO THE GROUND RING, IN ACCORDANCE WITH THE NEC.
11. METAL CONDUIT AND TRAY SHALL BE GROUNDED AND MADE ELECTRICALLY CONTINUOUS WITH LISTED BONDING FITTINGS OR BY BONDING ACROSS THE DISCONTINUITY WITH 6 AWG COPPER WIRE UL APPROVED GROUNDING TYPE CONDUIT CLAMPS.
12. GROUND CONDUCTORS USED IN THE FACILITY GROUND AND LIGHTNING PROTECTION SYSTEMS SHALL NOT BE ROUTED THROUGH METALLIC OBJECTS THAT FORM A RING AROUND THE CONDUCTOR, SUCH AS METALLIC CONDUITS, METAL SUPPORT CLIPS OR SLEEVES THROUGH WALLS OR FLOORS. WHEN IT IS REQUIRED TO BE HOUSED IN CONDUIT TO MEET CODE REQUIREMENTS OR LOCAL CONDITIONS, NON-METALLIC MATERIAL SUCH AS PVC PLASTIC CONDUIT SHALL BE USED. WHERE USE OF METAL CONDUIT IS UNAVOIDABLE (E.G., NON-METALLIC CONDUIT PROHIBITED BY LOCAL CODE) THE GROUND CONDUCTOR SHALL BE BONDED TO EACH END OF THE METAL CONDUIT.
13. ALL TOWER GROUNDING SYSTEMS SHALL COMPLY WITH THE REQUIREMENTS OF ANSI/TIA 222. FOR TOWERS BEING BUILT TO REV-G OF THE STANDARD, THE WIRE SIZE OF THE BURIED GROUND RING AND CONNECTIONS BETWEEN THE TOWER AND THE BURIED GROUND RING SHALL BE CHANGED FROM 2 AWG TO 2/0 AWG. IN ADDITION, THE MINIMUM LENGTH OF THE GROUND RODS SHALL BE INCREASED FROM EIGHT FEET (8') TO TEN FEET (10').
14. ALL NEW STRUCTURES WITH A FOUNDATION AND/OR FOOTING HAVING 20 FT. OR MORE 1/2" OR GREATER ELECTRICALLY CONDUCTIVE REINFORCING STEEL MUST HAVE IT BONDED TO THE GROUND RING USING AN EXOTHERMIC WELD CONNECTION USING #2 AWG SOLID TINNED COPPER GROUND WIRE, PER NEC 250.50.

**GENERAL NOTES:**

1. FOR THE PURPOSE OF CONSTRUCTION DRAWING, THE FOLLOWING DEFINITIONS SHALL APPLY:  
 CONTRACTOR - EMPIRE TELECOM  
 SUBCONTRACTOR - GENERAL CONTRACTOR (CONSTRUCTION)  
 OWNER - AT&T MOBILITY  
 OEM - ORIGINAL EQUIPMENT MANUFACTURER
2. PRIOR TO THE SUBMISSION OF BIDS, THE BIDDING SUBCONTRACTOR SHALL VISIT THE CELL SITE TO FAMILIARIZE WITH THE EXISTING CONDITIONS AND TO CONFIRM THAT THE WORK CAN BE ACCOMPLISHED AS SHOWN ON THE CONSTRUCTION DRAWINGS. ANY DISCREPANCY FOUND SHALL BE BROUGHT TO THE ATTENTION OF CONTRACTOR.
3. ALL MATERIALS FURNISHED AND INSTALLED SHALL BE IN STRICT ACCORDANCE WITH ALL APPLICABLE CODES, REGULATIONS, AND ORDINANCES. SUBCONTRACTOR SHALL ISSUE ALL APPROPRIATE NOTICES AND COMPLY WITH ALL LAWS, ORDINANCES, RULES, REGULATIONS, AND LAWFUL ORDERS OF ANY PUBLIC AUTHORITY REGARDING THE PERFORMANCE OF THE WORK. ALL WORK CARRIED OUT SHALL COMPLY WITH ALL APPLICABLE MUNICIPAL AND UTILITY COMPANY SPECIFICATIONS AND LOCAL JURISDICTIONAL CODES, ORDINANCES AND APPLICABLE REGULATIONS.
4. DRAWINGS PROVIDED HERE ARE NOT TO BE SCALED AND ARE INTENDED TO SHOW OUTLINE ONLY.
5. UNLESS NOTED OTHERWISE, THE WORK SHALL INCLUDE FURNISHING MATERIALS, EQUIPMENT, APPURTENANCES, AND LABOR NECESSARY TO COMPLETE ALL INSTALLATIONS AS INDICATED ON THE DRAWINGS.
6. THE SUBCONTRACTOR SHALL INSTALL ALL EQUIPMENT AND MATERIALS IN ACCORDANCE WITH MANUFACTURER'S RECOMMENDATIONS UNLESS SPECIFICALLY STATED OTHERWISE.
7. IF THE SPECIFIED EQUIPMENT CANNOT BE INSTALLED AS SHOWN ON THESE DRAWINGS, THE SUBCONTRACTOR SHALL PROPOSE AN ALTERNATIVE INSTALLATION SPACE FOR APPROVAL BY THE CONTRACTOR.
8. SUBCONTRACTOR SHALL DETERMINE ACTUAL ROUTING OF CONDUIT, POWER AND T1 CABLES, GROUNDING CABLES AS SHOWN ON THE POWER, GROUNDING AND TELCO PLAN DRAWING. SUBCONTRACTOR SHALL UTILIZE EXISTING TRAYS AND/OR SHALL ADD NEW TRAYS AS NECESSARY. SUBCONTRACTOR SHALL CONFIRM THE ACTUAL ROUTING WITH THE CONTRACTOR. ROUTING OF TRENCHING SHALL BE APPROVED BY CONTRACTOR
9. THE SUBCONTRACTOR SHALL PROTECT EXISTING IMPROVEMENTS, PAVEMENTS, CURBS, LANDSCAPING AND STRUCTURES. ANY DAMAGED PART SHALL BE REPAIRED AT SUBCONTRACTOR'S EXPENSE TO THE SATISFACTION OF OWNER.
10. SUBCONTRACTOR SHALL LEGALLY AND PROPERLY DISPOSE OFF ALL SCRAP MATERIALS SUCH AS COAXIAL CABLES AND OTHER ITEMS REMOVED FROM THE EXISTING FACILITY. ANTENNAS REMOVED SHALL BE RETURNED TO THE OWNER'S DESIGNATED LOCATION.
11. SUBCONTRACTOR SHALL LEAVE PREMISES IN CLEAN CONDITION.
12. ALL CONCRETE REPAIR WORK SHALL BE DONE IN ACCORDANCE WITH AMERICAN CONCRETE INSTITUTE (ACI) 301.
13. ANY NEW CONCRETE NEEDED FOR THE CONSTRUCTION SHALL HAVE 4000 PSI STRENGTH AT 28 DAYS UNLESS OTHERWISE SPECIFIED. ALL CONCRETING WORK SHALL BE DONE IN ACCORDANCE WITH ACI 318 CODE REQUIREMENTS.
14. ALL STRUCTURAL STEEL WORK SHALL BE DETAILED, FABRICATED AND ERECTED IN ACCORDANCE WITH AISC SPECIFICATIONS. ALL STRUCTURAL STEEL SHALL BE ASTM A36 (Fy=36 ksi). ALL STEEL EXPOSED TO WEATHER SHALL BE HOT DIPPED GALVANIZED. TOUCH UP ALL SCRATCHES AND OTHER MARKS IN THE FIELD AFTER STEEL IS ERECTED USING A COMPATIBLE ZINC RICH PAINT.
15. CONSTRUCTION SHALL COMPLY WITH SPECIFICATION 25741-000-3APS-A00Z-00002, "GENERAL CONSTRUCTION SERVICES FOR CONSTRUCTION OF AT&T MOBILITY SITES."
16. SUBCONTRACTOR SHALL VERIFY ALL EXISTING DIMENSIONS AND CONDITIONS PRIOR TO COMMENCING ANY WORK. ALL DIMENSIONS OF EXISTING CONSTRUCTION SHOWN ON THE DRAWINGS MUST BE VERIFIED. SUBCONTRACTOR SHALL NOTIFY THE CONTRACTOR OF ANY DISCREPANCIES PRIOR TO ORDERING MATERIAL OR PROCEEDING WITH CONSTRUCTION.
17. THE EXISTING CELL SITE IS IN FULL COMMERCIAL OPERATION. ANY CONSTRUCTION WORK BY SUBCONTRACTOR SHALL NOT DISRUPT THE EXISTING NORMAL OPERATION. ANY WORK ON EXISTING EQUIPMENT MUST BE COORDINATED WITH CONTRACTOR. ALSO, WORK MAY NEED TO BE SCHEDULED FOR AN APPROPRIATE MAINTENANCE WINDOW USUALLY IN LOW TRAFFIC PERIODS AFTER MIDNIGHT.
18. SINCE THE CELL SITE MAY BE ACTIVE, ALL SAFETY PRECAUTIONS MUST BE TAKEN WHEN WORKING AROUND HIGH LEVELS OF ELECTROMAGNETIC RADIATION. EQUIPMENT SHOULD BE SHUTDOWN PRIOR TO PERFORMING ANY WORK THAT COULD EXPOSE THE WORKERS TO DANGER. PERSONAL RF EXPOSURE MONITORS ARE REQUIRED TO BE WORN TO ALERT OF ANY DANGEROUS EXPOSURE LEVELS.

19. SUBCONTRACTOR'S WORK SHALL COMPLY WITH ALL APPLICABLE NATIONAL, STATE, AND LOCAL CODES AS ADOPTED BY THE LOCAL AUTHORITY HAVING JURISDICTION (AHJ) FOR THE LOCATION. THE EDITION OF THE AHJ ADOPTED CODES AND STANDARDS IN EFFECT ON THE DATE OF CONTRACT AWARD SHALL GOVERN THE DESIGN.
  - INTERNATIONAL BUILDING CODE: IBC 2009 WITH LOCAL & COUNTY AMENDMENTS
  - NATIONAL ELECTRICAL CODE: NEC 2011 WITH LOCAL & COUNTY AMENDMENTS
  - FIRE/LIFE SAFETY CODE: NFPA-101 2009 WITH LOCAL & COUNTY AMENDMENTS
20. SUBCONTRACTOR'S WORK SHALL COMPLY WITH THE LATEST EDITION OF THE FOLLOWING STANDARDS:
  - AMERICAN CONCRETE INSTITUTE (ACI) 318, BUILDING CODE REQUIREMENTS FOR STRUCTURAL CONCRETE
  - AMERICAN INSTITUTE OF STEEL CONSTRUCTION (AISC), MANUAL OF STEEL CONSTRUCTION, THIRTEENTH EDITION
  - AMERICAN SOCIETY OF TESTING OF MATERIALS, ASTM
  - TELECOMMUNICATIONS INDUSTRY ASSOCIATION (ANSI/TIA-222-G-1), STRUCTURAL STANDARDS FOR STEEL ANTENNA TOWER AND ANTENNA SUPPORTING STRUCTURES:
  - TIA 607, COMMERCIAL BUILDING GROUNDING AND BONDING REQUIREMENTS FOR TELECOMMUNICATIONS
  - OCCUPATIONAL SAFETY AND HEALTH ADMINISTRATION, OSHA
  - INSTITUTE FOR ELECTRICAL AND ELECTRONICS ENGINEERS (IEEE) 81, GUIDE FOR MEASURING EARTH RESISTIVELY, GROUND IMPEDANCE, AND EARTH SURFACE POTENTIALS OF A GROUND SYSTEM IEEE 1100 (1999) RECOMMENDED PRACTICE FOR POWERING AND GROUNDING OF ELECTRONIC EQUIPMENT
  - TELCORDIA GR-1503, COAXIAL CABLE CONNECTIONS
21. FOR ANY CONFLICTS BETWEEN SECTIONS OF LISTED CODES AND STANDARDS REGARDING MATERIAL, METHODS OF CONSTRUCTION, OR OTHER REQUIREMENTS, THE MOST RESTRICTIVE REQUIREMENT SHALL GOVERN. WHERE THERE IS CONFLICT BETWEEN A GENERAL REQUIREMENT AND A SPECIFIC REQUIREMENT, THE SPECIFIC REQUIREMENT SHALL GOVERN.



**SITE NUMBER: CT2041**  
**SITE NAME: HAMDEN**  
**MT CARMEL AVENUE**  
 275 MOUNT CARMEL AVENUE  
 HAMDEN, CT 06518  
 NEW HAVEN COUNTY



0	09/21/15	ISSUED AS FINAL	KCD	NDB	NDB
NO.	DATE	REVISIONS	BY	CHK	APP'D
SCALE: AS SHOWN			DESIGNED BY: CJT		DRAWN BY: CJT

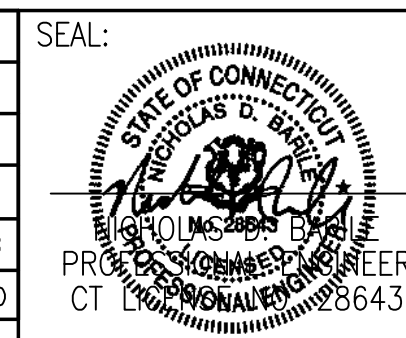

<b>AT&amp;T</b>		
DRAWING TITLE: <b>GROUNDING NOTES &amp; GENERAL NOTES</b>		
JOB NUMBER 14196-EMP	DRAWING NUMBER GN-1	REV 0

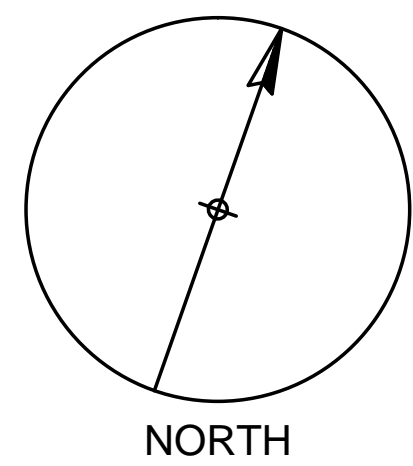
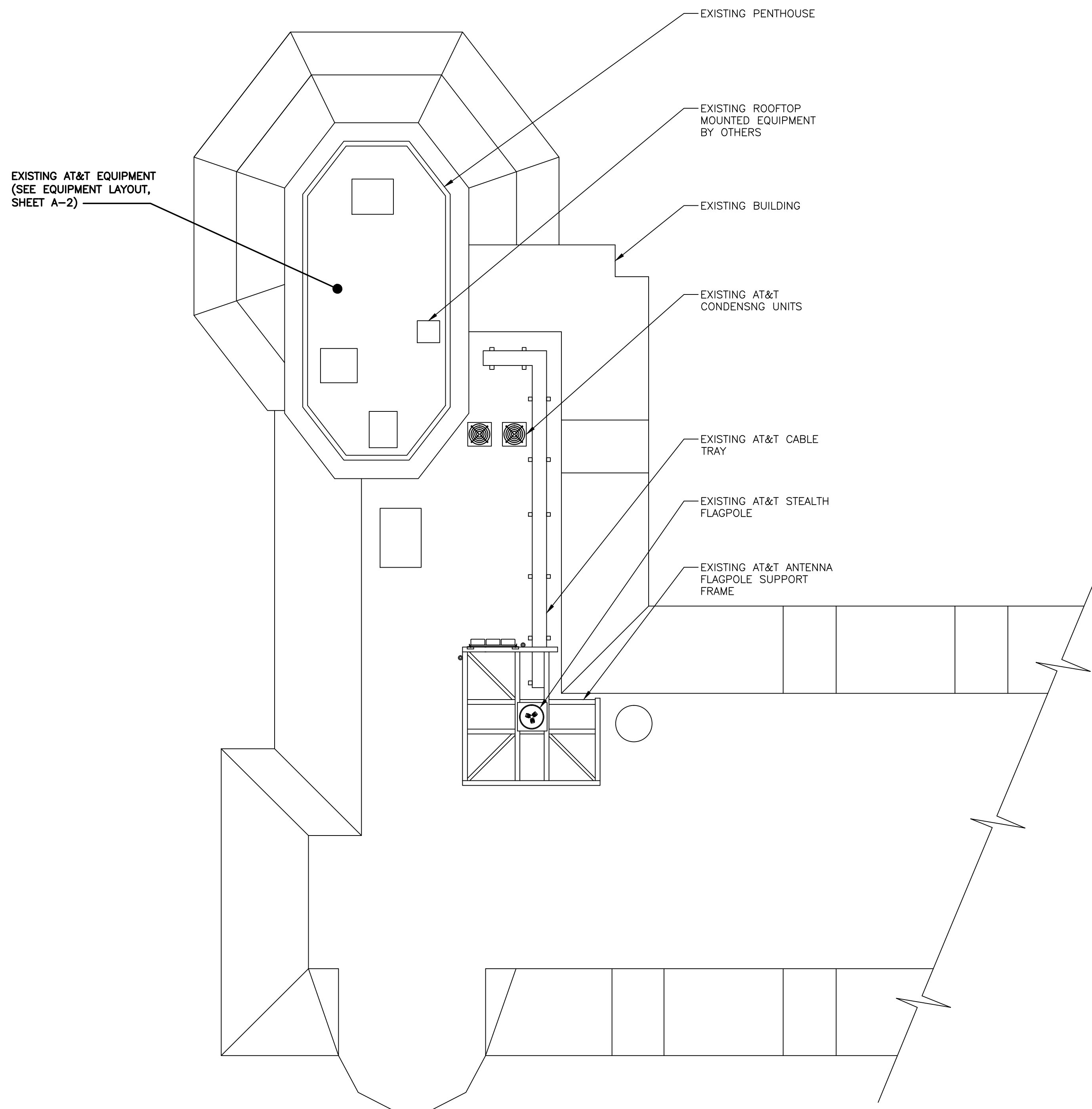

**PARTIAL ROOF PLAN**  
SCALE: 1/8" = 1'-0"

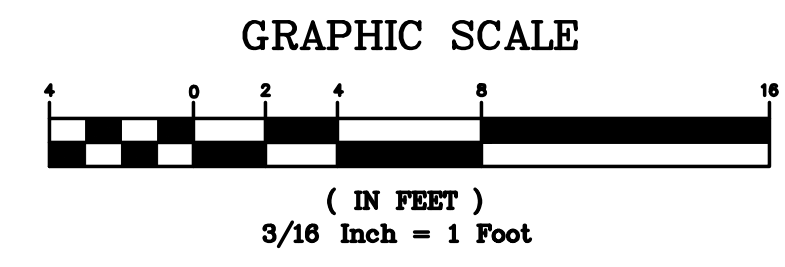

**COM-EX**  
Consultants  
4 SECOND AVENUE  
SUITE 204  
DENVER, NJ 07834  
PHONE: 862.209.4300  
FAX: 862.209.4301

**EMPIRE**  
telecom  
16 ESQUIRE ROAD  
BILLERICA, MA 01821

**SITE NUMBER: CT2041**  
**SITE NAME: HAMDEN**  
**MT CARMEL AVENUE**  
275 MOUNT CARMEL AVENUE  
HAMDEN, CT 06518  
NEW HAVEN COUNTY

**at&t**  
MOBILITY  
550 COCHITUATE ROAD  
FRAMINGHAM, MA 01701

NO.	DATE	REVISIONS	BY	CHK	APP'D
0	09/21/15	ISSUED AS FINAL	KCD	NDB	NDB
SCALE: AS SHOWN		DESIGNED BY: CJT	DRAWN BY: CJT		

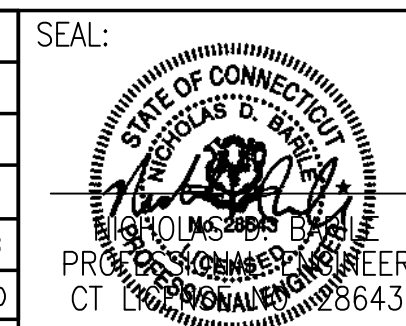

AT&T		
DRAWING TITLE:		
COMPOUND LAYOUT		
JOB NUMBER	DRAWING NUMBER	REV
14196-EMP	A-1	0

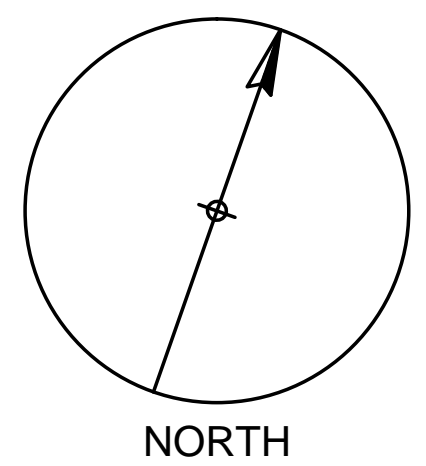
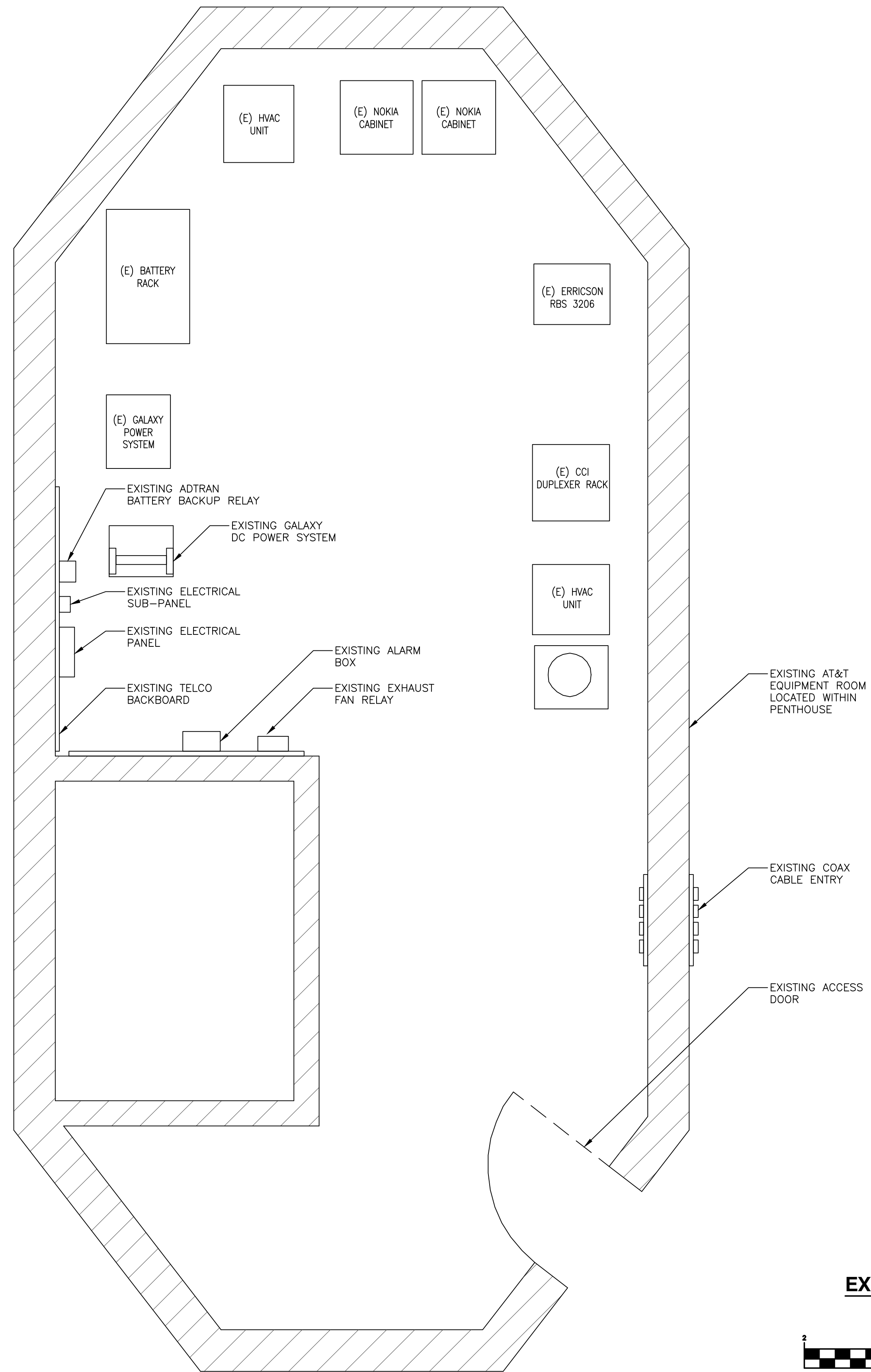

**EXISTING EQUIPMENT LAYOUT**  
SCALE: 1/2" = 1'-0"

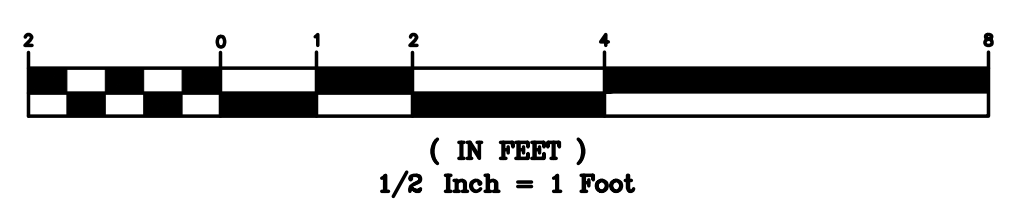

**COM-EX**  
Consultants  
4 SECOND AVENUE  
SUITE 204  
DENVER, NJ 07834  
PHONE: 862.209.4300  
FAX: 862.209.4301

**EMPIRE**  
telecom  
16 ESQUIRE ROAD  
BILLERICA, MA 01821

**SITE NUMBER: CT2041**  
**SITE NAME: HAMDEN**  
**MT CARMEL AVENUE**  
275 MOUNT CARMEL AVENURE  
HAMDEN, CT 06518  
NEW HAVEN COUNTY

 **at&t**  
MOBILITY  
550 COCHITUATE ROAD  
FRAMINGHAM, MA 01701

0	09/21/15	ISSUED AS FINAL	KCD	NDB	NDB
NO.	DATE	REVISIONS	BY	CHK	APP'D
SCALE: AS SHOWN		DESIGNED BY: CJT	DRAWN BY: CJT		

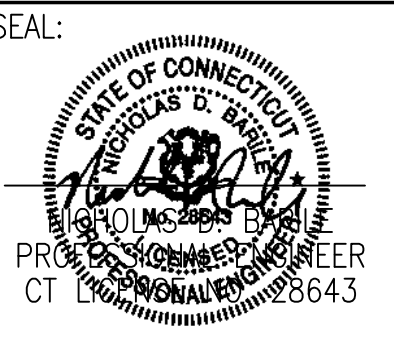

<b>AT&amp;T</b>		
DRAWING TITLE: <b>EQUIPMENT LAYOUT</b>		
JOB NUMBER 14196-EMP	DRAWING NUMBER A-2	REV 0



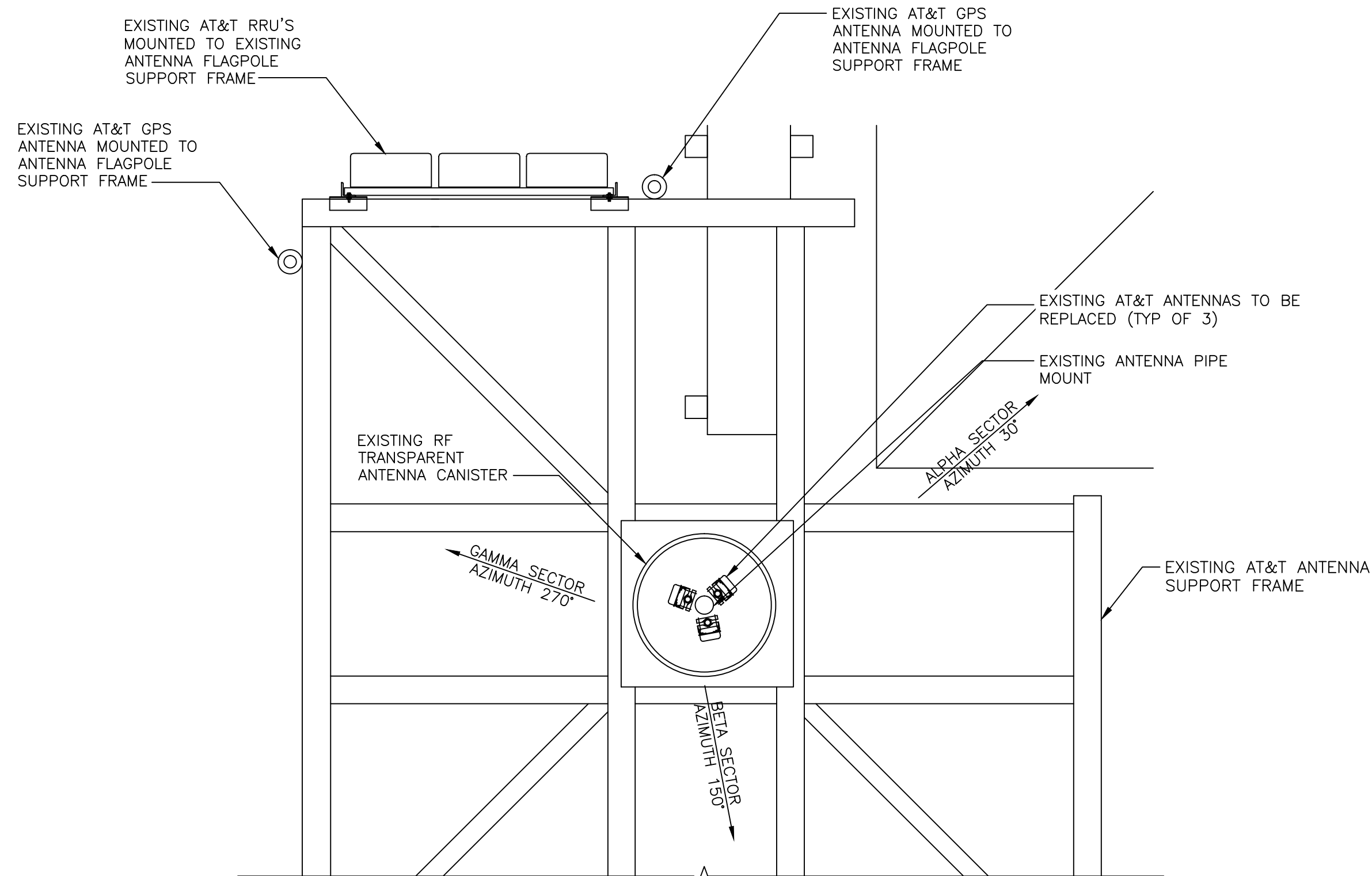

**EXISTING ANTENNA LAYOUT**  
SCALE: N.T.S.

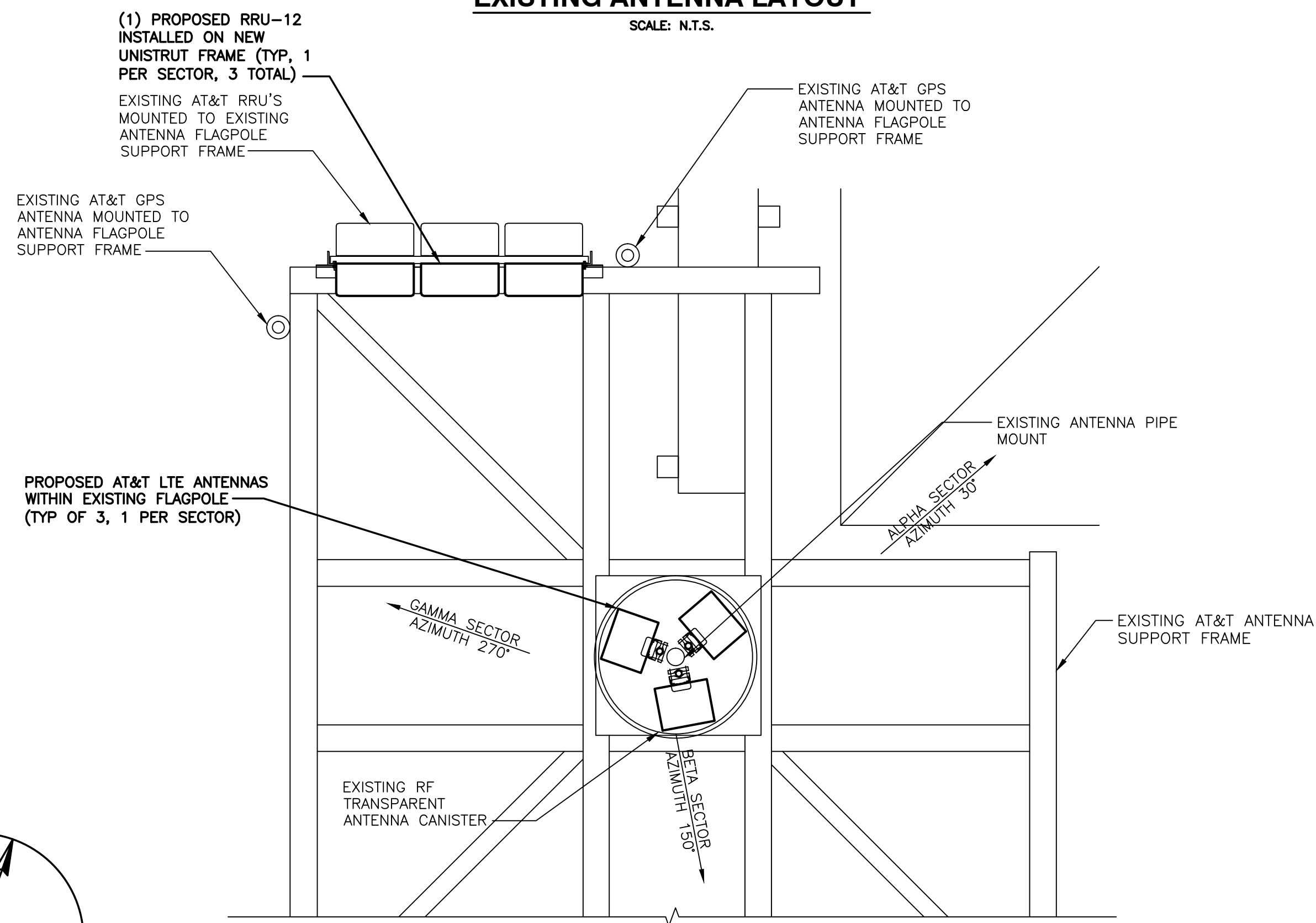

**PROPOSED ANTENNA LAYOUT**  
SCALE: N.T.S.

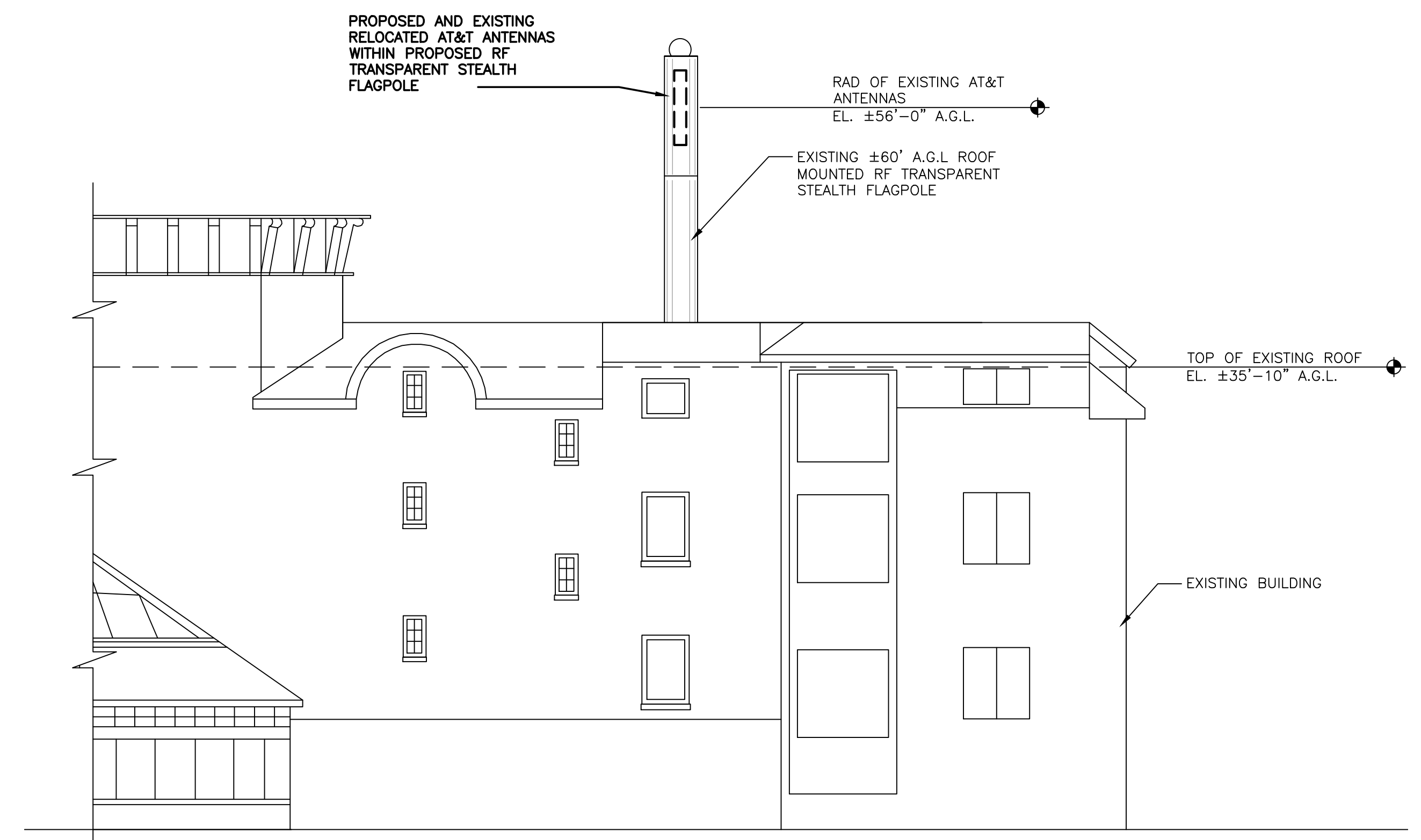
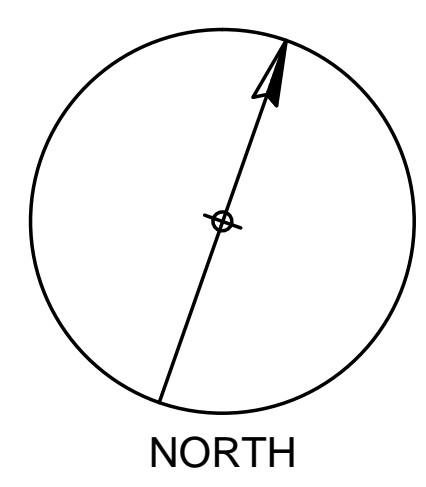

**BUILDING ELEVATION**  
SCALE: NTS

PROJECT OWNER IS RESPONSIBLE FOR PROVIDING A STRUCTURAL STABILITY ANALYSIS TO DETERMINE THE CAPACITY AND SUITABILITY OF THE EXISTING ANTENNA SUPPORT STRUCTURE TO SAFELY CARRY ALL ADDITIONAL LOADS IMPOSED BY THE PROPOSED EQUIPMENT AS SHOWN HEREIN. GENERAL CONTRACTOR SHALL BE RESPONSIBLE FOR INCORPORATING ANY REQUIRED STRUCTURAL MODIFICATIONS INTO THEIR SCOPE OF WORK.

**COM-EX**  
Consultants  
4 SECOND AVENUE  
SUITE 204  
DENVER, NJ 07834  
PHONE: 862.209.4300  
FAX: 862.209.4301

**EMPIRE**  
telecom  
16 ESQUIRE ROAD  
BILLERICA, MA 01821

**SITE NUMBER: CT2041**  
**SITE NAME: HAMDEN**  
**MT CARMEL AVENUE**  
275 MOUNT CARMEL AVENURE  
HAMDEN, CT 06518  
NEW HAVEN COUNTY

**at&t**  
MOBILITY  
550 COCHITUATE ROAD  
FRAMINGHAM, MA 01701

0	09/21/15	ISSUED AS FINAL	KCD	NDB	NDB
NO.	DATE	REVISIONS	BY	CHK	APP'D
SCALE: AS SHOWN		DESIGNED BY: CJT	DRAWN BY: CJT		

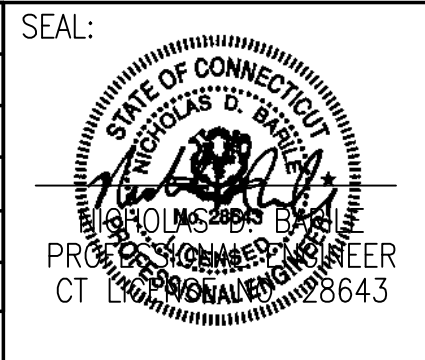

<b>AT&amp;T</b>		
DRAWING TITLE: <b>ANTENNA LAYOUTS &amp; ELEVATIONS</b>		
JOB NUMBER 14196-EMP	DRAWING NUMBER A-3	REV 0

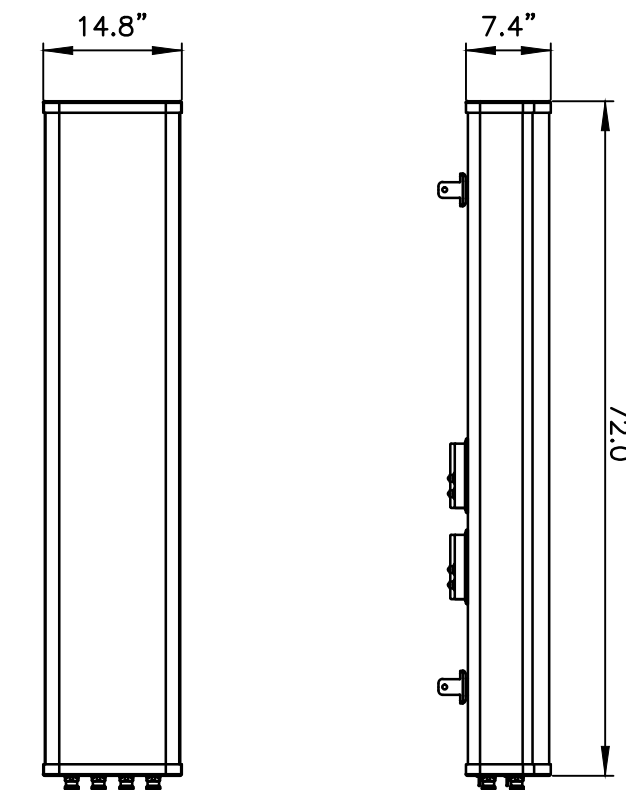

FRONT VIEW

SIDE VIEW

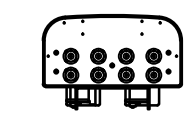

BOTTOM VIEW

MANUFACTURER	QUINTEL
MODEL	QS66512-3
WEIGHT	105.0 LBS

**LTE ANTENNA DETAIL**

SCALE: N.T.S.

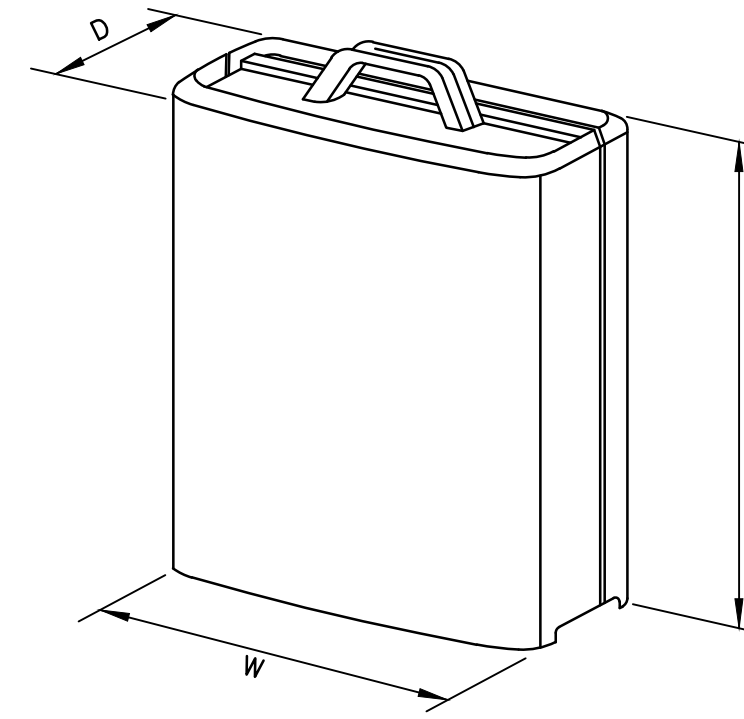

MODEL	L x W x H	WEIGHT
*RRUS-11	19.69" x 16.97" x 7.17"	50.7 LBS
RRUS-12	20.4" x 18.5" x 7.5"	58 LBS
A2 MODULE	16.4" x 15.2" x 3.4"	22 LBS

\*DENOTES EXISTING.

**RRUS DETAIL**

SCALE: N.T.S.

**EXISTING ANTENNA SCHEDULE**

SECTOR	POSITION	MAKE	MODEL	SIZE (INCHES)
ALPHA	A1	KMW	AM-X-CD-16-65-00T-RET	72"x11.8"x5.9"
	A2	-	-	-
	A3	-	-	-
	A4	-	-	-
BETA	B1	KMW	AM-X-CD-16-65-00T-RET	72"x11.8"x5.9"
	B2	-	-	-
	B3	-	-	-
	B4	-	-	-
GAMMA	G1	KMW	AM-X-CD-16-65-00T-RET	72"x11.8"x5.9"
	G2	-	-	-
	G3	-	-	-
	G4	-	-	-

**FINAL ANTENNA SCHEDULE**

SECTOR	POSITION	MAKE	MODEL	SIZE (INCHES)
ALPHA	A1	QUINTEL	QS66512-3	72"x12"x9.6"
	A2	-	-	-
	A3	-	-	-
	A4	-	-	-
BETA	B1	QUINTEL	QS66512-3	72"x12"x9.6"
	B2	-	-	-
	B3	-	-	-
	B4	-	-	-
GAMMA	G1	QUINTEL	QS66512-3	72"x12"x9.6"
	G2	-	-	-
	G3	-	-	-
	G4	-	-	-

**FINAL RRH SCHEDULE**

SECTOR	MAKE	MODEL	SIZE (INCHES)	ADDITIONAL COMPONENT	SIZE (INCHES)
ALPHA	ERICSSON	RRUS-12	20.4"x18.5"x7.5"	ERICSSON A2 MODULE	16.4"x15.2"x3.4"
	ERICSSON	RRUS-11*	19.7"x16.9"x7.2"		
BETA	ERICSSON	RRUS-12	20.4"x18.5"x7.5"	ERICSSON A2 MODULE	16.4"x15.2"x3.4"
	ERICSSON	RRUS-11*	19.7"x16.9"x7.2"		
GAMMA	ERICSSON	RRUS-12	20.4"x18.5"x7.5"	ERICSSON A2 MODULE	16.4"x15.2"x3.4"
	ERICSSON	RRUS-11*	19.7"x16.9"x7.2"		

\*DENOTES EXISTING

PROJECT OWNER IS RESPONSIBLE FOR PROVIDING A STRUCTURAL STABILITY ANALYSIS TO DETERMINE THE CAPACITY AND SUITABILITY OF THE EXISTING ANTENNA SUPPORT STRUCTURE TO SAFELY CARRY ALL ADDITIONAL LOADS IMPOSED BY THE PROPOSED EQUIPMENT AS SHOWN HEREIN. GENERAL CONTRACTOR SHALL BE RESPONSIBLE FOR INCORPORATING ANY REQUIRED STRUCTURAL MODIFICATIONS INTO THEIR SCOPE OF WORK.

NOTE:  
NO ANTENNA CHANGES ARE PROPOSED UNDER THIS SCOPE OF WORK. EXISTING ANTENNA CONFIGURATION TO REMAIN.

NO.	DATE	REVISIONS	BY	CHK	APP'D
0	09/21/15	ISSUED AS FINAL	KCD	NDB	NDB
SCALE: AS SHOWN		DESIGNED BY: CJT	DRAWN BY: CJT		

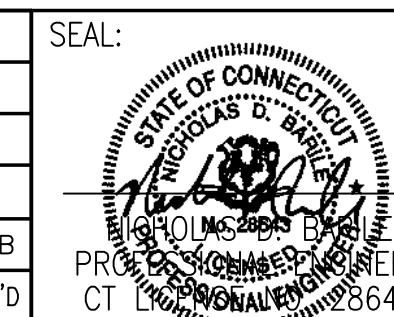

<b>AT&amp;T</b>		
DRAWING TITLE: <b>DETAILS</b>		
JOB NUMBER 14196-EMP	DRAWING NUMBER A-4	REV 0

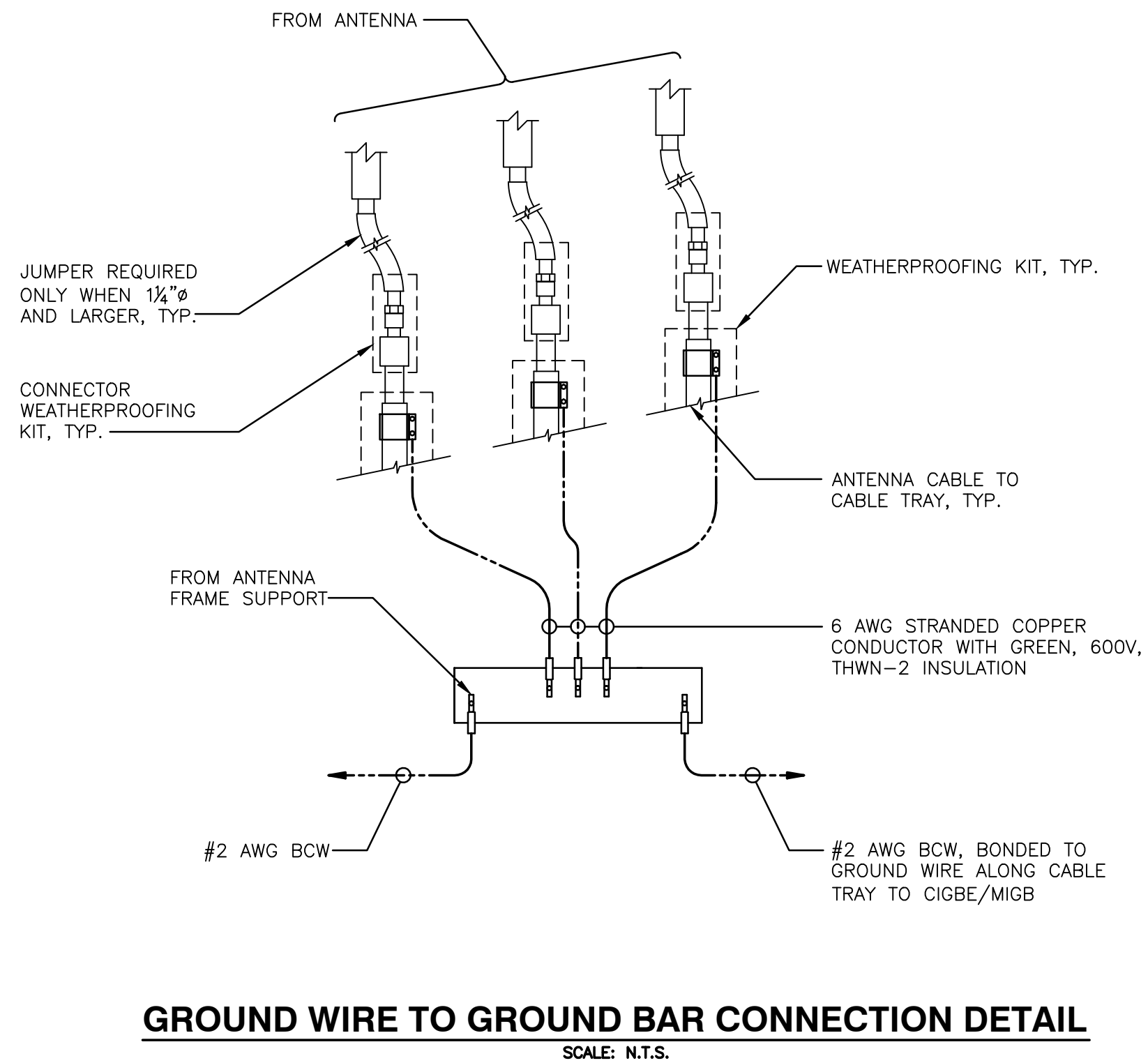

**GROUND WIRE TO GROUND BAR CONNECTION DETAIL**  
SCALE: N.T.S.

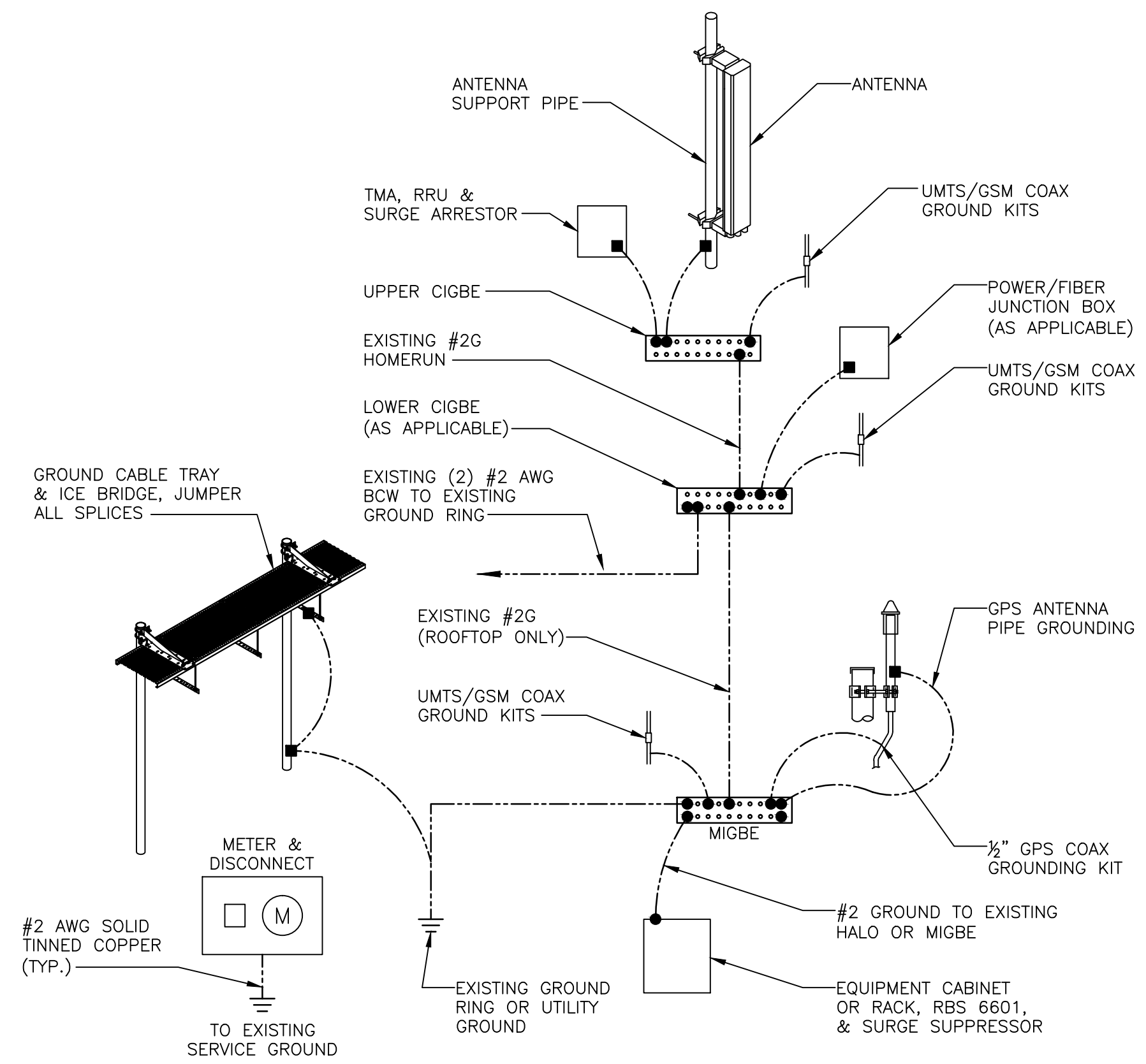

**GROUNDING RISER DIAGRAM**  
SCALE: N.T.S.

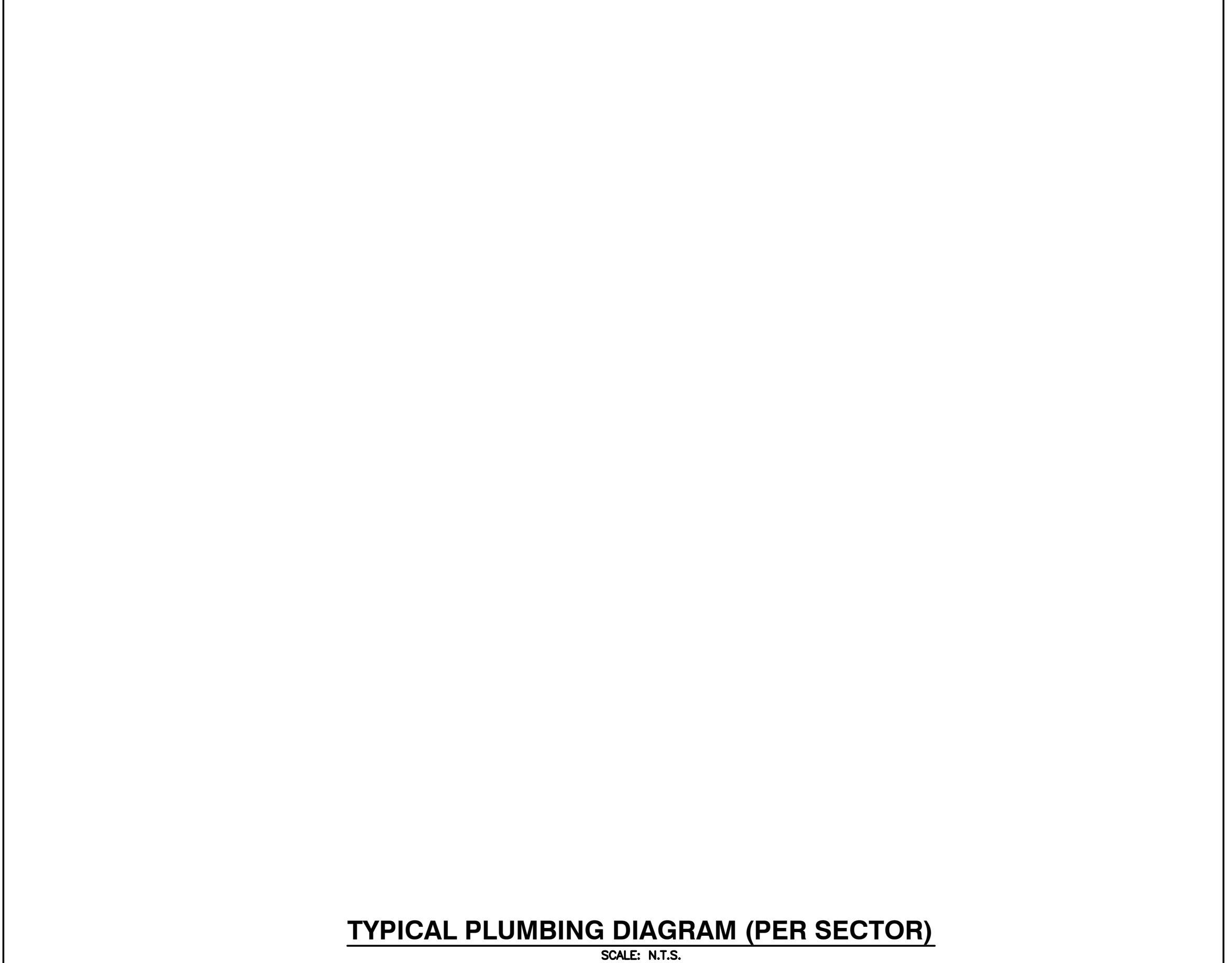

**TYPICAL PLUMBING DIAGRAM (PER SECTOR)**  
SCALE: N.T.S.

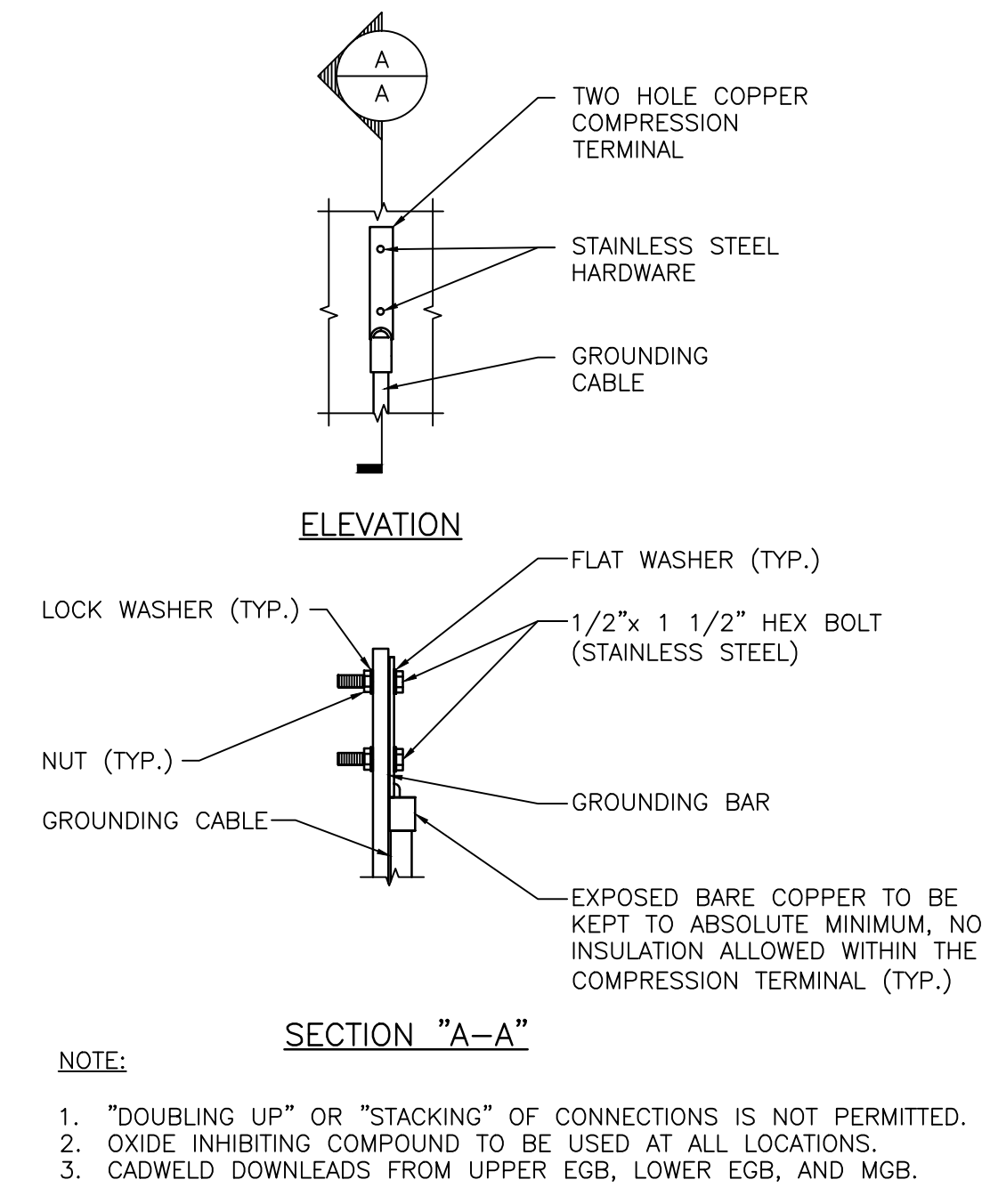

**TYPICAL GROUND BAR CONNECTION DETAIL**  
SCALE: N.T.S.

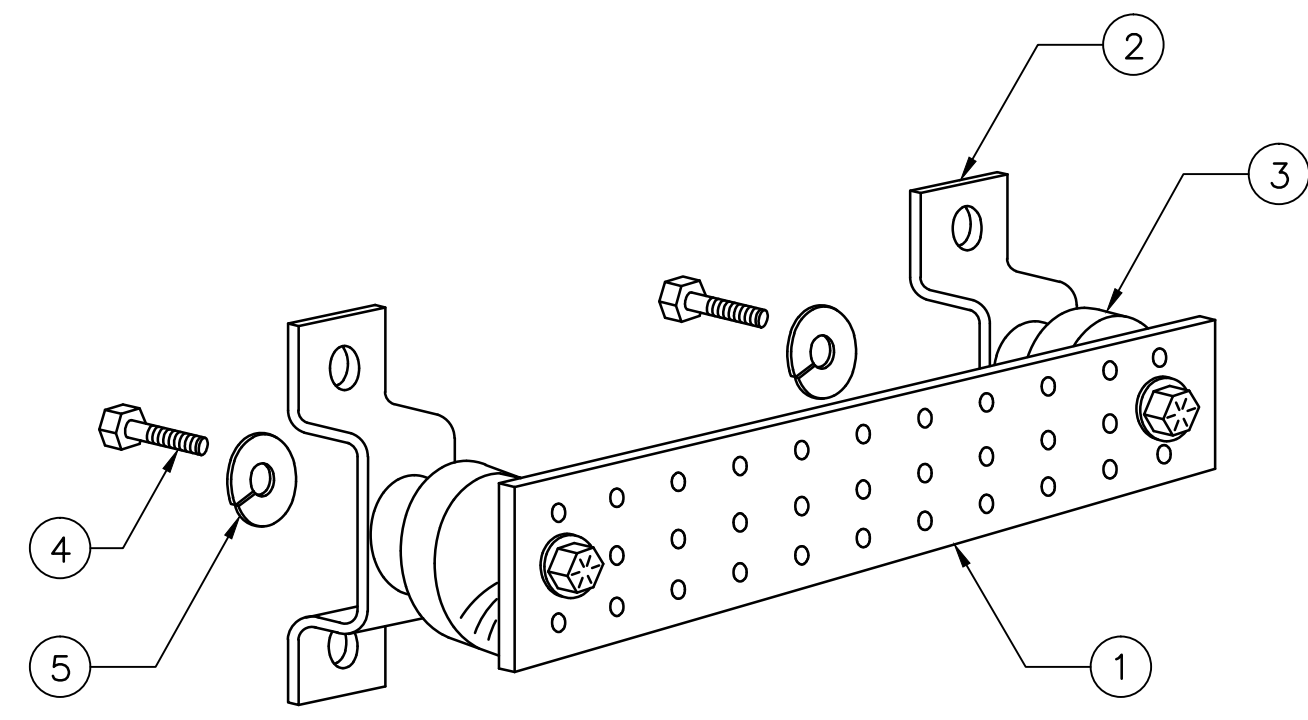

ITEM NO.	QTY.	DESCRIPTION
1	1	SOLID GROUND BAR (20"x 4"x 1/4")
2	2	WALL MOUNTING BRACKET
3	2	INSULATORS
4	4	5/8"-11x1" H.H.C.S.
5	4	5/8" LOCK WASHER

- NOTES:
- EACH GROUND CONDUCTOR TERMINATING ON ANY GROUND BAR SHALL HAVE AN IDENTIFICATION TAG ATTACHED AT EACH END THAT WILL IDENTIFY ITS ORIGIN AND DESTINATION
- SECTION "P" - SURGE PRODUCERS**
- CABLE ENTRY PORTS (HATCH PLATES) (#2)
  - GENERATOR FRAMEWORK (IF AVAILABLE) (#2)
  - TELCO GROUND BAR
  - COMMERCIAL POWER COMMON NEUTRAL/GROUND BOND (#2)
  - +24V POWER SUPPLY RETURN BAR (#2)
  - 48V POWER SUPPLY RETURN BAR (#2)
  - RECTIFIER FRAMES
- SECTION "A" - SURGE ABSORBERS**
- INTERIOR GROUND RING (#2)
  - EXTERNAL EARTH GROUND FIELD (BURIED GROUND RING) (#2)
  - METALLIC COLD WATER PIPE (IF AVAILABLE) (#2)
  - BUILDING STEEL (IF AVAILABLE) (#2)

**GROUND BAR DETAIL**  
SCALE: N.T.S.



September 8, 2015

Re: Structural Evaluation Letter  
AT&T Site Name: Hamden MT Carmel Ave  
AT&T Site ID/ FA Number: CT2041/10035055  
Site Address: 275 Mount Carmel Avenue, Hamden, CT 06518

In accordance with your request, Destek Engineering, LLC (Destek) evaluated the structural capacity of the existing wireless telecommunication installation on the rooftop of the building at the above referenced address for the additions and alterations proposed by AT&T. This evaluation is based on the following documents:

- Structural Analysis Report, prepared by Hudson Design Group, LLC., dated 03/07/2012.
- Construction Drawings prepared by Com-Ex Consultants, dated 07/28/2015.

**Proposed Changes:** AT&T is proposing to replace the existing (3) KMW AM-X-CD-16-65-00T-RET panel antennas with (3) new Quintel QS66512-3 panel antennas. In addition, (3) proposed RRUS-12 and (3) A2 modules that are proposed to be attached to the equipment platform. Details of the proposed changes are on the attached drawings by Com-Ex Consultants, dated 07/28/2015.

**Evaluation Conditions:** It is assumed that all prior additions and alterations by AT&T have been properly designed, constructed accordingly, and structural components, including the main structure itself, have been qualified for the changed conditions. Unless otherwise noted, the structure is assumed to be in good condition, free of defects and can achieve theoretical strength. Destek does not assume any liability which may arise due to invalidity of these assumptions or any existing design or construction deficiency. The evaluation results presented in this letter are only applicable for the previously mentioned existing and proposed appurtenances. Any deviation of the appurtenances and their placement will require a new evaluation.

**Engineering Evaluation and Conclusion:** The existing antennas are mounted inside a  $\pm 25$  feet tall RF transparent canister that serves as a flagpole. The flagpole is mounted on a steel frame that is directly supported on the building roof structure. The existing antennas inside the canister will be replaced with new antennas. This alteration will not require a change of the canister diameter, thus the wind profile and wind load on the structure does not change. As a result, the design and structural analysis conditions of the original addition/alteration do not change and the structure is considered to have **adequate** structural capacity for the proposed changes per 2003 IEBC Sections 903.2, 903.3, 507, 607 and 707.

Therefore, the additions and alterations proposed by AT&T **can be implemented as intended** with the conditions and recommendations outlined in this letter. Should you need any clarifications about this letter, please contact me at (770) 693-0835 or [acolakoglu@destekengineering.com](mailto:acolakoglu@destekengineering.com).

Sincerely,  
Destek Engineering, LLC

9-8-2015



Ahmet Colakoglu, PE  
Connecticut Professional Engineer

License No: 27057



**SITE SAFE**  
RF COMPLIANCE EXPERTS

A BUSINESS OF FDH VELOCITEL

200 North Glebe Road, Suite 1000, Arlington, VA 22203-3728  
703.276.1100 • 703.276.1169 fax  
info@sitesafe.com • www.sitesafe.com



**Empire Telecom on behalf of  
AT&T Mobility, LLC  
Site FA – 10035055  
Site ID – CT2041  
USID – 61184  
Site Name – Hamden Mount  
Carmel Avenue  
Site Compliance Report**

**275 Mount Carmel Avenue  
Hamden, CT 06518**

Latitude: N41-25-07.25  
Longitude: W75-53-35.72  
Structure Type: Rooftop

Report generated date: August 19, 2015  
Report by: Tony DeMattia  
Customer Contact: Kathryn Emmitt

**AT&T Mobility, LLC Will Be Compliant Based on  
FCC Rules and Regulations.**

© 2015 Sitesafe, Inc. Arlington, VA



**David C. Cotton, Jr.**  
**Licensed Professional Engineer (Electrical)**  
**State of Connecticut, PEN.0027481**  
**Date: 2015-August-19**



# Table of Contents

- 1 GENERAL SITE SUMMARY ..... 2**
  - 1.1 REPORT SUMMARY ..... 2
- 2 MAP OF SITE ..... 3**
- 3 ANTENNA INVENTORY ..... 5**
- 4 EMISSION PREDICTIONS ..... 6**
- 5 SITE COMPLIANCE ..... 7**
  - 5.1 SITE COMPLIANCE STATEMENT ..... 7
  - 5.2 ACTIONS FOR SITE COMPLIANCE ..... 7
- 6 ENGINEER CERTIFICATION..... 8**
- APPENDIX A – STATEMENT OF LIMITING CONDITIONS ..... 9**
- APPENDIX B – REGULATORY BACKGROUND INFORMATION ..... 10**
  - FCC RULES AND REGULATIONS ..... 10
  - OSHA STATEMENT..... 11
- APPENDIX C – SAFETY PLAN AND PROCEDURES..... 12**
- APPENDIX D – RF EMISSIONS..... 13**
- APPENDIX E – ASSUMPTIONS AND DEFINITIONS ..... 14**
  - GENERAL MODEL ASSUMPTIONS ..... 14
  - USE OF GENERIC ANTENNAS..... 14
  - DEFINITIONS ..... 15
- APPENDIX F – REFERENCES ..... 17**

# 1 General Site Summary

## 1.1 Report Summary

AT&T Mobility, LLC	Summary
Access to Antennas Locked?	No
RF Sign(s) @ access point(s)	N/A
RF Sign(s) @ antennas	Caution 2 sign required to be posted at base of monopole
Barrier(s) @ sectors	N/A
Max cumulative simulated Radio Frequency Exposure (RFE) level on Rooftop	<5% of General Public limit
FCC & AT&T Compliant?	Yes - with Recommendations

The following documents were provided by the client and were utilized to create this report:

RFDS: NEW-ENGLAND\_CONNECTICUT\_CTU2041\_2015-LTE-Next-Carrier\_LTE-2C\_mm093q\_PTN\_10035055\_61184\_09-25-2014\_Final-Modification-Recommended\_v2.00

CD's: CT2041 Hamden Mt Carmel Ave RCD RevC.072915



## 2 Map of Site

In the RF Emissions Simulations below all heights are reflected with respect to main site level. In most rooftop cases this is the height of the main rooftop and in other cases this can be ground level. Each different height area, rooftop, or platform level is labeled with its height relative to the main site level. Emissions are calculated appropriately based on the relative height and location of that area to all antennas.

The Antenna Inventory heights are referenced to the same level.

The following diagrams are included:

- Site Map
- Composite View

# RF Emissions Simulation For: Hamden Mount Carmel Avenue Site Map

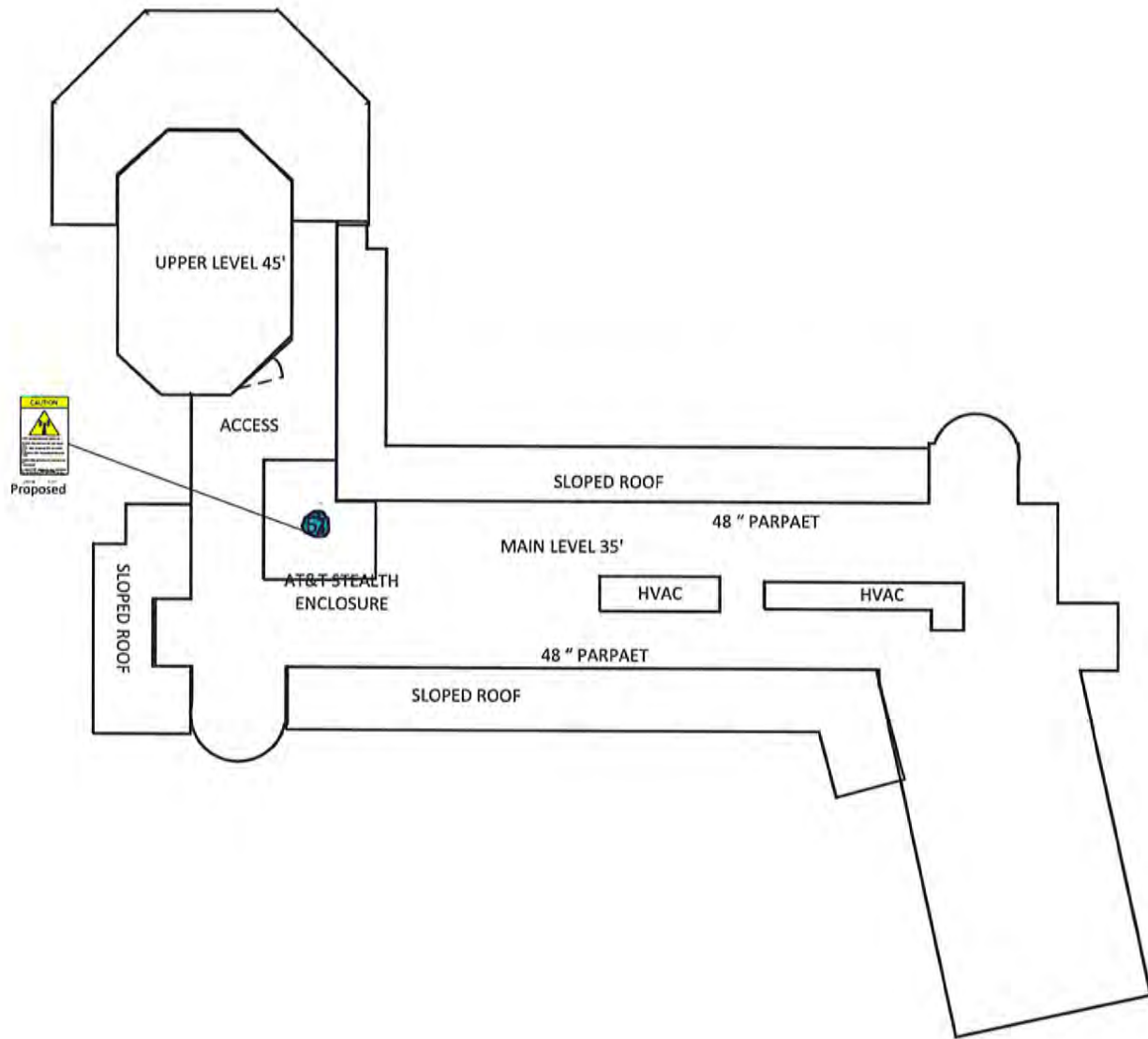

Proposed



(Feet)

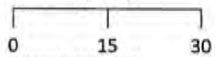

www.sitesafe.com  
Site Name: Hamden Mount Carmel Avenue

AT&T MOBILITY LLC	VERIZON WIRELESS	T-MOBILE	METROPCS	CRICKET COMMUNICATIONS	CLEARWIRE	SPRINT

Sitesafe Inc. assumes no responsibility for modeling results not verified by Sitesafe personnel.  
Contact Sitesafe Inc. for modeling assistance at (703) 276-1100  
SiteSafeTC Version: 1.0.0.0  
8/19/2015 11:32:57 PM



### 3 Antenna Inventory

The following antenna inventory on this and the following page, were obtained by the customer and were utilized to create the site model diagrams:

Ant ID	Operator	Antenna Make & Model	Type	TX Freq (MHz)	Az (Deg)	Hor BW (Deg)	Ant Len (ft)	Ant Gain (dBi)	2G GSM Radio(s)	3G UMTS Radio(s)	4G Radio(s)	Total ERP (Watts)	X	Y	Z
1	AT&T MOBILITY LLC	KMW AM-X-CD-16-65-00T	Panel	850	30	63	6	13.86	0	2	0	1945.8	99.7	163.5	53'
1	AT&T MOBILITY LLC	KMW AM-X-CD-16-65-00T	Panel	1920	30	67	6	15.26	0	1	0	2685.9	99.7	163.5	53'
1	AT&T MOBILITY LLC	KMW AM-X-CD-16-65-00T	Panel	850	30	63	6	13.86	1	0	0	972.9	99.7	163.5	53'
2	AT&T MOBILITY LLC	CCI Antennas OPA-65R-LCUU-H6 (Proposed)	Panel	737	30	66	6	11.66	0	0	1	879.3	99.7	163.5	53'
2	AT&T MOBILITY LLC	CCI Antennas OPA-65R-LCUU-H6 (Proposed)	Panel	1930	30	60	6	14.86	0	0	1	2449.6	99.7	163.5	53'
3	AT&T MOBILITY LLC	KMW AM-X-CD-16-65-00T	Panel	850	150	63	6	13.86	0	2	0	1945.8	100.3	162.3	53'
3	AT&T MOBILITY LLC	KMW AM-X-CD-16-65-00T	Panel	1920	150	67	6	15.26	0	1	0	2685.9	100.3	162.3	53'
3	AT&T MOBILITY LLC	KMW AM-X-CD-16-65-00T	Panel	850	150	63	6	13.86	1	0	0	972.9	100.3	162.3	53'
4	AT&T MOBILITY LLC	CCI Antennas OPA-65R-LCUU-H6 (Proposed)	Panel	737	150	66	6	11.66	0	0	1	879.3	100.3	162.2	53'
4	AT&T MOBILITY LLC	CCI Antennas OPA-65R-LCUU-H6 (Proposed)	Panel	1930	150	60	6	14.86	0	0	1	2449.6	100.3	162.2	53'
5	AT&T MOBILITY LLC	KMW AM-X-CD-16-65-00T	Panel	850	270	63	6	13.86	0	2	0	1945.8	99'	162.6'	53'
5	AT&T MOBILITY LLC	KMW AM-X-CD-16-65-00T	Panel	1920	270	67	6	15.26	0	1	0	2685.9	99'	162.6'	53'
5	AT&T MOBILITY LLC	KMW AM-X-CD-16-65-00T	Panel	850	270	63	6	13.86	1	0	0	972.9	99'	162.6'	53'
6	AT&T MOBILITY LLC	CCI Antennas OPA-65R-LCUU-H6 (Proposed)	Panel	737	270	66	6	11.66	0	0	1	879.3	98.8	162.5'	53'
6	AT&T MOBILITY LLC	CCI Antennas OPA-65R-LCUU-H6 (Proposed)	Panel	1930	270	60	6	14.86	0	0	1	2449.6	98.8	162.5'	53'

NOTE: X, Y and Z indicate relative position of the antenna to the origin location on the site, displayed in the model results diagram. Specifically, the Z reference indicates the bottom of the antenna height above the main site level unless otherwise indicated. The distance to the bottom of the antenna is calculated by subtracting half of the length of the antenna from the antenna centerline. Effective Radiated Power (ERP) is provided by the operator or based on Sitesafe experience. The values used in the modeling may be greater than are currently deployed. For other operators at this site the use of "Generic" as an antenna model or "Unknown" for a wireless operator means the information with regard to operator, their FCC license and/or antenna information was not available nor could it be secured while on site. Other operator's equipment, antenna models and powers used for modeling are based on obtained information or Sitesafe experience.

# RF Emissions Simulation For: Hamden Mount Carmel Avenue Composite View

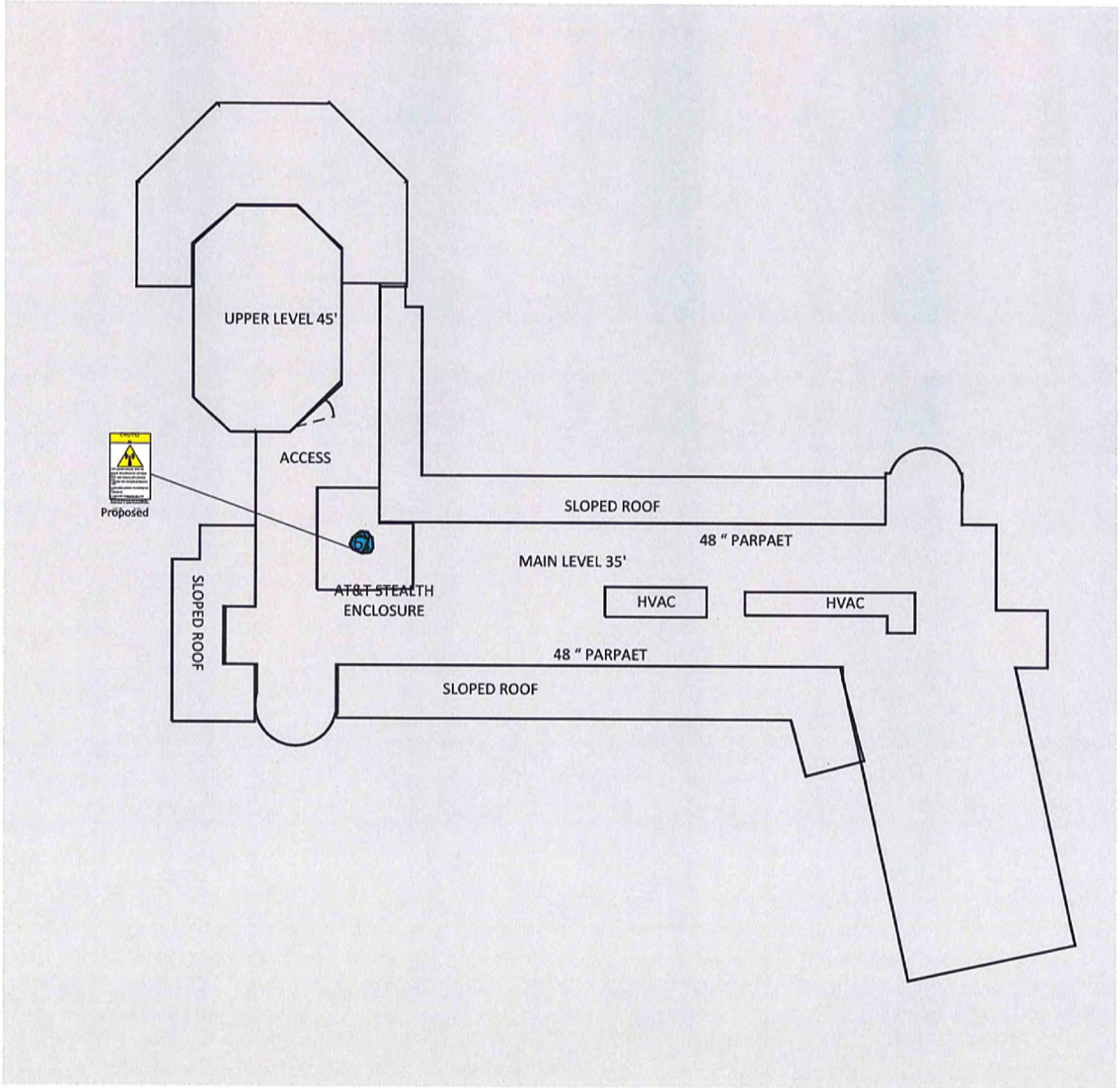

% of FCC Public Exposure Limit  
Spatial average 0' - 6'



(Feet)

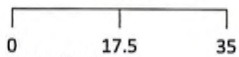

www.sitesafe.com  
Site Name: Hamden Mount Carmel Avenue

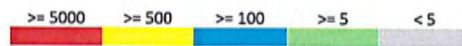

AT&T MOBILITY LLC	VERIZON WIRELESS	T-MOBILE	METROPCS	CRICKET COMMUNICATIONS	CLEARWIRE	SPRINT

Sitesafe Inc. assumes no responsibility for modeling results not verified by Sitesafe personnel. Contact Sitesafe Inc. for modeling assistance at (703) 276-1100. SitesafeTC Version: 1.0.0.0 8/19/2015 8:34:17 PM

## 5 Site Compliance

### 5.1 Site Compliance Statement

Upon evaluation of the cumulative RF emission levels from all operators at this site, RF hazard signage and antenna locations, Sitesafe have determined that:

This site will be compliant with the FCC rules and regulations, as described in OET Bulletin 65.

The compliance determination is based on General Public RFE levels derived from theoretical modeling, RF signage placement, proposed antenna inventory and the level of restricted access to the antennas at the site. Any deviation from the AT&T Mobility, LLC's proposed deployment plan could result in the site being rendered non-compliant.

Modeling is used for determining compliance and the percentage of MPE contribution.

### 5.2 Actions for Site Compliance

Based on FCC regulations, common industry practice, and our understanding of AT&T Mobility, LLC RF Safety Policy requirements, this section provides a statement of recommendations for site compliance. Recommendations have been proposed based on our understanding of existing access restrictions, signage, and an analysis of predicted RFE levels.

The site will be made compliant if the following changes are implemented:

#### **Site Access Location**

No action required.

#### **AT&T Mobility, LLC Proposed Alpha/Beta/Gamma Sector Monopole Base Location**

Yellow caution 2 sign required.

## **6 Engineer Certification**

The professional engineer whose seal appears on the cover of this document hereby certifies and affirms that:

I am registered as a Professional Engineer in the jurisdiction indicated in the professional engineering stamp on the cover of this document; and

That I am an employee of Sitesafe, Inc., in Arlington, Virginia, at which place the staff and I provide RF compliance services to clients in the wireless communications industry; and

That I am thoroughly familiar with the Rules and Regulations of the Federal Communications Commission (FCC) as well as the regulations of the Occupational Safety and Health Administration (OSHA), both in general and specifically as they apply to the FCC Guidelines for Human Exposure to Radio-frequency Radiation; and

That I have thoroughly reviewed this Site Compliance Report and believe it to be true and accurate to the best of my knowledge as assembled by and attested to by Tony DeMattia.

August 19, 2015

## **Appendix A – Statement of Limiting Conditions**

Sitesafe has provided computer generated model(s) in this Site Compliance Report to show approximate dimensions of the site, and the model is included to assist the reader of the compliance report to visualize the site area, and to provide supporting documentation for Sitesafe's recommendations.

Sitesafe may note in the Site Compliance Report any adverse physical conditions, such as needed repairs, that Sitesafe became aware of during the normal research involved in creating this report. Sitesafe will not be responsible for any such conditions that do exist or for any engineering or testing that might be required to discover whether such conditions exist. Because Sitesafe is not an expert in the field of mechanical engineering or building maintenance, the Site Compliance Report must not be considered a structural or physical engineering report.

Sitesafe obtained information used in this Site Compliance Report from sources that Sitesafe considers reliable and believes them to be true and correct. Sitesafe does not assume any responsibility for the accuracy of such items that were furnished by other parties. When conflicts in information occur between data collected by Sitesafe provided by a second party and data collected by Sitesafe, the data will be used.

## Appendix B – Regulatory Background Information

### FCC Rules and Regulations

In 1996, the Federal Communication Commission (FCC) adopted regulations for the evaluating of the effects of RF emissions in 47 CFR § 1.1307 and 1.1310. The guideline from the FCC Office of Engineering and Technology is Bulletin 65 ("OET Bulletin 65"), *Evaluating Compliance with FCC Guidelines for Human Exposure to Radio Frequency Electromagnetic Fields*, Edition 97-01, published August 1997. Since 1996 the FCC periodically reviews these rules and regulations as per their congressional mandate.

FCC regulations define two separate tiers of exposure limits: Occupational or "Controlled environment" and General Public or "Uncontrolled environment". The General Public limits are generally five times more conservative or restrictive than the Occupational limit. These limits apply to *accessible* areas where workers or the general public may be exposed to Radio Frequency (RF) electromagnetic fields.

Occupational or Controlled limits apply in situations in which persons are exposed as a consequence of their employment and where those persons exposed have been made fully aware of the potential for exposure and can exercise control over their exposure.

An area is considered a Controlled environment when access is limited to these aware personnel. Typical criteria are restricted access (i.e. locked or alarmed doors, barriers, etc.) to the areas where antennas are located coupled with proper RF warning signage. A site with Controlled environments is evaluated with Occupational limits.

All other areas are considered Uncontrolled environments. If a site has no access controls or no RF warning signage it is evaluated with General Public limits.

The theoretical modeling of the RF electromagnetic fields has been performed in accordance with OET Bulletin 65. The Maximum Permissible Exposure (MPE) limits utilized in this analysis are outlined in the following diagram:

**FCC Limits for Maximum Permissible Exposure (MPE)**

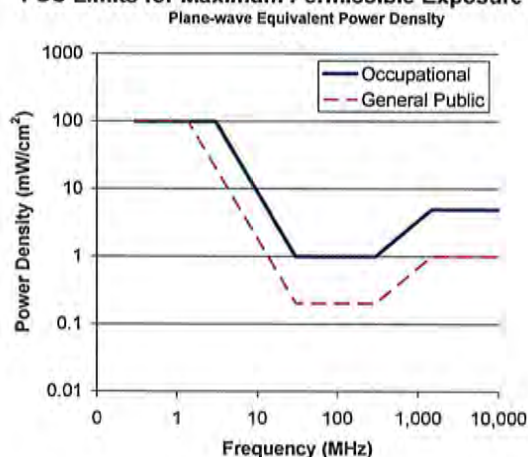



**Limits for Occupational/Controlled Exposure (MPE)**

Frequency Range (MHz)	Electric Field Strength (E) (V/m)	Magnetic Field Strength (H) (A/m)	Power Density (S) (mW/cm <sup>2</sup> )	Averaging Time (minutes)
0.3-3.0	614	1.63	(100)*	6
3.0-30	1842/f	4.89/f	(900/f <sup>2</sup> )*	6
30-300	61.4	0.163	1.0	6
300-1500	—	—	f/300	6
1500-100,000	—	—	5	6

**Limits for General Population/Uncontrolled Exposure (MPE)**

Frequency Range (MHz)	Electric Field Strength (E) (V/m)	Magnetic Field Strength (H) (A/m)	Power Density (S) (mW/cm <sup>2</sup> )	Averaging Time (minutes)
0.3-1.34	614	1.63	(100)*	30
1.34-30	824/f	2.19/f	(180/f <sup>2</sup> )*	30
30-300	27.5	0.073	0.2	30
300-1500	—	—	f/1500	30
1500-100,000	—	—	1.0	30

f = frequency in MHz \*Plane-wave equivalent power density

**OSHA Statement**

The General Duty clause of the OSHA Act (Section 5) outlines the occupational safety and health responsibilities of the employer and employee. The General Duty clause in Section 5 states:

- (a) Each employer –
  - (1) shall furnish to each of his employees employment and a place of employment which are free from recognized hazards that are causing or are likely to cause death or serious physical harm to his employees;
  - (2) shall comply with occupational safety and health standards promulgated under this Act.
- (b) Each employee shall comply with occupational safety and health standards and all rules, regulations, and orders issued pursuant to this Act which are applicable to his own actions and conduct.

OSHA has defined Radiofrequency and Microwave Radiation safety standards for workers who may enter hazardous RF areas. Regulation Standards 29 CFR § 1910.147 identify a generic Lock Out Tag Out procedure aimed to control the unexpected energization or start up of machines when maintenance or service is being performed.

## Appendix C – Safety Plan and Procedures

The following items are general safety recommendations that should be administered on a site by site basis as needed by the carrier.

**General Maintenance Work:** Any maintenance personnel required to work immediately in front of antennas and / or in areas indicated as above 100% of the Occupational MPE limits should coordinate with the wireless operators to disable transmitters during their work activities.

**Training and Qualification Verification:** All personnel accessing areas indicated as exceeding the General Population MPE limits should have a basic understanding of EME awareness and RF Safety procedures when working around transmitting antennas. Awareness training increases a workers understanding to potential RF exposure scenarios. Awareness can be achieved in a number of ways (e.g. videos, formal classroom lecture or internet based courses).

**Physical Access Control:** Access restrictions to transmitting antennas locations is the primary element in a site safety plan. Examples of access restrictions are as follows:

- Locked door or gate
- Alarmed door
- Locked ladder access
- Restrictive Barrier at antenna (e.g. Chain link with posted RF Sign)

**RF Signage:** Everyone should obey all posted signs at all times. RF signs play an important role in properly warning a worker prior to entering into a potential RF Exposure area.

**Assume all antennas are active:** Due to the nature of telecommunications transmissions, an antenna transmits intermittently. Always assume an antenna is transmitting. Never stop in front of an antenna. If you have to pass by an antenna, move through as quickly and safely as possible thereby reducing any exposure to a minimum.

**Maintain a 3 foot clearance from all antennas:** There is a direct correlation between the strength of an EME field and the distance from the transmitting antenna. The further away from an antenna, the lower the corresponding EME field is.

**Site RF Emissions Diagram:** Section 4 of this report contains an RF Diagram that outlines various theoretical Maximum Permissible Exposure (MPE) areas at the site. The modeling is a worst case scenario assuming a duty cycle of 100% for each transmitting antenna at full power. This analysis is based on one of two access control criteria: General Public criteria means the access to the site is uncontrolled and anyone can gain access. Occupational criteria means the access is restricted and only properly trained individuals can gain access to the antenna locations.

## Appendix D – RF Emissions

The RF Emissions Simulation(s) in this report display theoretical spatially averaged percentage of the Maximum Permissible Exposure for all systems at the site unless otherwise noted. These diagrams use modeling as prescribed in OET Bulletin 65 and assumptions detailed in Appendix E.

The key at the bottom of each RF Emissions Simulation indicates percentages displayed referenced to FCC General Public Maximum Permissible Exposure (MPE) limits. Color coding on the diagram is as follows:

- Areas indicated as Gray are predicted to be below 5% of the MPE limits. **Gray represents areas more than 20 times below the most conservative exposure limit.**
- Green represents areas are predicted to be between 5% and 100% of the MPE limits. **Green areas are accessible to anyone.**
- Blue represents areas predicted to exceed the General Public MPE limits but are less than Occupational limits. **Blue areas should be accessible only to RF trained workers.**
- Yellow represents areas predicted to exceed Occupational MPE limits. **Yellow areas should be accessible only to RF trained workers able to assess current exposure levels.**
- Red represents areas predicted to have exposure more than 10 times the Occupational MPE limits. **Red indicates that the RF levels must be reduced prior to access.** An RF Safety Plan is required which outlines how to reduce the RF energy in these areas prior to access.

## Appendix E – Assumptions and Definitions

### General Model Assumptions

In this site compliance report, it is assumed that all antennas are operating at **full power at all times**. Software modeling was performed for all transmitting antennas located on the site. Sitesafe has further assumed a 100% duty cycle and maximum radiated power.

The site has been modeled with these assumptions to show the maximum RF energy density. Sitesafe believes this to be a *worst-case* analysis, based on best available data. Areas modeled to predict emissions greater than 100% of the applicable MPE level may not actually occur, but are shown as a *worst-case* prediction that could be realized real time. Sitesafe believes these areas to be safe for entry by occupationally trained personnel utilizing appropriate personal protective equipment (in most cases, a personal monitor).

Thus, at any time, if power density measurements were made, we believe the real-time measurements would indicate levels below those depicted in the RF emission diagram(s) in this report. By modeling in this way, Sitesafe has conservatively shown exclusion areas – areas that should not be entered without the use of a personal monitor, carriers reducing power, or performing real-time measurements to indicate real-time exposure levels.

### Use of Generic Antennas

For the purposes of this report, the use of "Generic" as an antenna model, or "Unknown" for an operator means the information about a carrier, their FCC license and/or antenna information was not provided and could not be obtained while on site. In the event of unknown information, Sitesafe will use our industry specific knowledge of equipment, antenna models, and transmit power to model the site. If more specific information can be obtained for the unknown measurement criteria, Sitesafe recommends remodeling of the site utilizing the more complete and accurate data. Information about similar facilities is used when the service is identified and associated with a particular antenna. If no information is available regarding the transmitting service associated with an unidentified antenna, using the antenna manufacturer's published data regarding the antenna's physical characteristics makes more conservative assumptions.

Where the frequency is unknown, Sitesafe uses the closest frequency in the antenna's range that corresponds to the highest Maximum Permissible Exposure (MPE), resulting in a conservative analysis.

## Definitions

**5% Rule** – The rules adopted by the FCC specify that, in general, at multiple transmitter sites actions necessary to bring the area into compliance with the guidelines are the shared responsibility of all licensees whose transmitters produce field strengths or power density levels at the area in question in excess of 5% of the exposure limits. In other words, any wireless operator that contributes 5% or greater of the MPE limit in an area that is identified to be greater than 100% of the MPE limit is responsible taking corrective actions to bring the site into compliance.

**Compliance** – The determination of whether a site is safe or not with regards to Human Exposure to Radio Frequency Radiation from transmitting antennas.

**Decibel (dB)** – A unit for measuring power or strength of a signal.

**Duty Cycle** – The percent of pulse duration to the pulse period of a periodic pulse train. Also, may be a measure of the temporal transmission characteristic of an intermittently transmitting RF source such as a paging antenna by dividing average transmission duration by the average period for transmission. A duty cycle of 100% corresponds to continuous operation.

**Effective (or Equivalent) Isotropic Radiated Power (EIRP)** – The product of the power supplied to the antenna and the antenna gain in a given direction relative to an isotropic antenna.

**Effective Radiated Power (ERP)** – In a given direction, the relative gain of a transmitting antenna with respect to the maximum directivity of a half wave dipole multiplied by the net power accepted by the antenna from the connecting transmitter.

**Gain (of an antenna)** – The ratio of the maximum intensity in a given direction to the maximum radiation in the same direction from an isotropic radiator. Gain is a measure of the relative efficiency of a directional antennas as compared to an omni directional antenna.

**General Population/Uncontrolled Environment** – Defined by the FCC, as an area where exposure to RF energy may occur to persons who are **unaware** of the potential for exposure and who have no control of their exposure. General Population is also referenced as General Public.

**Generic Antenna** – For the purposes of this report, the use of "Generic" as an antenna model means the antenna information was not provided and could not be obtained while on site. In the event of unknown information, Sitesafe will use our industry specific knowledge of antenna models to select a worst case scenario antenna to model the site.

**Isotropic Antenna** – An antenna that is completely non-directional. In other words, an antenna that radiates energy equally in all directions.

**Maximum Measurement** – This measurement represents the single largest measurement recorded when performing a spatial average measurement.

**Maximum Permissible Exposure (MPE)** – The maximum levels of RF exposure a person may be exposed to without harmful effect and with acceptable safety factor.

**Occupational/Controlled Environment** – Defined by the FCC, as an area where Radio Frequency Radiation (RFR) exposure may occur to persons who are **aware** of the

potential for exposure as a condition of employment or specific activity and can exercise control over their exposure.

**OET Bulletin 65** – Technical guideline developed by the FCC's Office of Engineering and Technology to determine the impact of Radio Frequency radiation on Humans. The guideline was published in August 1997.

**OSHA (Occupational Safety and Health Administration)** – Under the Occupational Safety and Health Act of 1970, employers are responsible for providing a safe and healthy workplace for their employees. OSHA's role is to promote the safety and health of America's working men and women by setting and enforcing standards; providing training, outreach and education; establishing partnerships; and encouraging continual process improvement in workplace safety and health. For more information, visit [www.osha.gov](http://www.osha.gov).

**Radio Frequency (RF)** – The frequencies of electromagnetic waves which are used for radio communications. Approximately 3 kHz to 300 GHz.

**Radio Frequency Exposure (RFE)** – The amount of RF power density that a person is or might be exposed to.

**Spatial Average Measurement** – A technique used to average a minimum of ten (10) measurements taken in a ten (10) second interval from zero (0) to six (6) feet. This measurement is intended to model the average power density an average sized human will be exposed to at a location.

**Transmitter Power Output (TPO)** – The radio frequency output power of a transmitter's final radio frequency stage as measured at the output terminal while connected to a load.

## Appendix F – References

The following references can be followed for further information about RF Health and Safety.

Sitesafe, Inc.

<http://www.sitesafe.com>

FCC Radio Frequency Safety

<http://www.fcc.gov/encyclopedia/radio-frequency-safety>

National Council on Radiation Protection and Measurements (NCRP)

<http://www.ncrponline.org>

Institute of Electrical and Electronics Engineers, Inc., (IEEE)

<http://www.ieee.org>

American National Standards Institute (ANSI)

<http://www.ansi.org>

Environmental Protection Agency (EPA)

<http://www.epa.gov/radtown/wireless-tech.html>

National Institutes of Health (NIH)

<http://www.niehs.nih.gov/health/topics/agents/emf/>

Occupational Safety and Health Agency (OSHA)

<http://www.osha.gov/SLTC/radiofrequencyradiation/>

International Commission on Non-Ionizing Radiation Protection (ICNIRP)

<http://www.icnirp.org>

World Health Organization (WHO)

<http://www.who.int/peh-emf/en/>

National Cancer Institute

<http://www.cancer.gov/cancertopics/factsheet/Risk/cellphones>

American Cancer Society (ACS)

[http://www.cancer.org/docroot/PED/content/PED\\_1\\_3X\\_Cellular\\_Phone\\_Towers.asp?sitearea=PED](http://www.cancer.org/docroot/PED/content/PED_1_3X_Cellular_Phone_Towers.asp?sitearea=PED)

European Commission Scientific Committee on Emerging and Newly Identified Health Risks

[http://ec.europa.eu/health/ph\\_risk/committees/04\\_scenihr/docs/scenihr\\_o\\_022.pdf](http://ec.europa.eu/health/ph_risk/committees/04_scenihr/docs/scenihr_o_022.pdf)

Fairfax County, Virginia Public School Survey

<http://www.fcps.edu/fts/safety-security/RFEESurvey/>

UK Health Protection Agency Advisory Group on Non-ionising Radiation

[http://www.hpa.org.uk/webw/HPAweb&HPAwebStandard/HPAweb\\_C/1317133826368](http://www.hpa.org.uk/webw/HPAweb&HPAwebStandard/HPAweb_C/1317133826368)

Norwegian Institute of Public Health

<http://www.fhi.no/dokumenter/545eea7147.pdf>