

Tectonic Engineering
Theresa Ranciato-Viele
63-3 N. Branford Road
Branford, CT 06405
Tranciato@Tectonicengineering.com
203-606-5127

November 1, 2022

Ms. Melanie Bachman, Executive Director
Connecticut Siting Council
Ten Franklin Square
New Britain, CT 06051

RE: **Notice of Tower Share to an existing 115' flag pole/monopole tower located at 395 Round Hill Road, Greenwich, Connecticut**

Latitude: 41.095117 / Longitude: -73.664219

Dear Ms. Bachman:

This letter and attachments are submitted on behalf of Dish Wireless, LLC ("Dish"). Dish plans to install antennas and related equipment to the tower site at the existing 115' flagpole/monopole tower facility located at 395 Round Hill Road, Greenwich, Connecticut. The facility was originally approved by the Connecticut Siting Council (See Exhibit A). The property is owned by Round Hill Community Church, Inc.

Dish proposes to install three (3) FVV-65B-R3 antennas and six (6) CDX623T-DS-T diplexers on the tower at the ninety foot (90') centerline AGL. Dish further proposes to install twelve (12) 7/8" cables. Dish will also install its equipment cabinets on a 8' X 10' concrete pad within its 10' X 15' lease area. The installation is shown on plans completed by Tectonic Engineering, dated March 25, 2022, and attached hereto as Exhibit B.

Dish requests that the Connecticut Siting Council ("Council") find that the proposed shared use of this Facility satisfies the criteria of C.G.S. sec. 16-50aa and accordingly issue an order approving the proposed shared use. This proposed installation constitutes an exempt modification pursuant to R.C.S.A. 16-50j-89. Pursuant to R.C.S.A. 16-50j-73, Dish is providing notice to Fred Camilo, First Selectman of the Town of Greenwich, Katie DeLuca, Director of Planning and Zoning for the Town of Greenwich, and the property owner, Round Hill Community Church, Inc.

Under the Council's regulations, Dish's plans do not constitute a modification subject to the Council's review in that:

Dish will not change the existing 115' height of the Tower as the Dish antennas will be installed at a height of 90'.

The proposed installation will not extend the existing boundaries of the approved fenced compound as depicted in Exhibit B;

The proposed installation will not increase the noise levels at the facility by six (6) decibels or more, or to levels that exceed local and state criteria; and

The proposed antennas will not increase radio frequency emissions at the facility to a level at or above the Federal Communications Commission safety standard. The attached Exhibit E indicates that the combined site operations will result in a total power density of .72%.

Tower

The Facility consists of a one hundred fifteen foot (115') flagpole/monopole tower located at 385 Round Hill Road, Greenwich, Connecticut. As indicated above, the tower is owned by Round Hill Community Church, Inc. The tower currently supports T-Mobile at the one hundred ten foot (110') centerline AGL, Sprint at the one hundred foot (100') and eighty two foot (82') centerline AGL. The antenna locations are set forth on Sheet A-2 of the attached drawings in Exhibit B.

A. TECHNICAL FEASIBILITY

The existing monopole has been deemed structurally capable of supporting the proposed Dish loading. The structural analysis is attached hereto as Exhibit C.

B. LEGAL FEASIBILITY

C.G.S. Se. 16-50aa authorizes the Council to issue orders approving the shared use of existing towers such as the above referenced tower. Under the authority granted to the Council, an order of the Council approving the requested shared use would permit Dish to obtain a building permit from the Town of Greenwich to proceed with the proposed installation. Additionally, a copy of the Lease Agreement is attached as Exhibit D, granting Dish the authority from the tower owner to proceed with this application for shared use.

C. ENVIRONMENTAL FEASIBILITY

The proposed shared use of this Facility would have a minimal environmental impact. The installation of the Dish equipment at the 90' level of the existing tower would have an insignificant visual impact on the area surrounding the tower. The proposed Dish ground equipment would be installed within the existing Facility compound. The Dish installation would not cause any significant alteration to the physical or environmental characteristics of the existing Facility. Additionally, as evidenced by Exhibit E, the proposed antennas would not

increase the radio frequency emissions to a level at or above the Federal Communications Commission safety standards.

D. ECONOMIC FEASIBILITY

Dish has entered into a Lease Agreement (Exhibit D) with the Facility owner for the proposed colocation. Therefore, this shared use is economically feasible.

E. PUBLIC SAFETY CONCERNS

As set forth above, the tower is structurally capable of supporting the proposed Dish loading. Dish is not aware of any public safety concerns relative to the proposed sharing of the existing tower.

For the reasons set forth herein, the proposed shared use of the existing tower at 395 Round Hill Road, Greenwich, satisfies the criteria stated in C.G.S. sec. 16-50aa, and supports the general goal of preventing the unnecessary proliferation of tower sites in Connecticut. Dish respectfully requests the Council issue an order approving the proposed shared use.

Respectfully submitted,
Dish Wireless, LLC

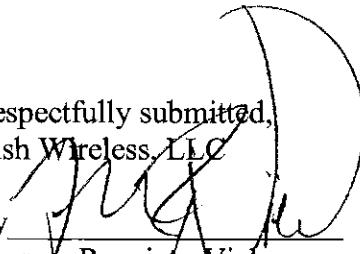
By 
Theresa Ranciato-Viele, consultant
63-3 N. Branford Road
Branford, CT 06405
Tranciato@Tectonicengineering.com
203-606-5127

cc: Greenwich First Selectman, Honorable Fred Camilo
101 Field Point Rd.
Greenwich, CT 06830

Greenwich Director of Planning and Zoning, Katie DeLuca
101 Field Point Rd., 2nd Fl.
Greenwich, CT 06830

Property Owner: Round Hill Community Church, Inc.
395 Round Hill Road
Greenwich, CT 06830

Exhibit A
Original Facility Approval

DOCKET NO. 309 - Cellco Partnership d/b/a Verizon Wireless }
application for a Certificate of Environmental Compatibility and }
Public Need for the construction, maintenance, and operation of a }
wireless telecommunications facility located at the Round Hill }
Community Church, 395 Round Hill Road, Greenwich, }
Connecticut.

Connecticut

Siting

Council

February 6, 2007

Decision and Order

Pursuant to the foregoing Findings of Fact and Opinion, the Connecticut Siting Council (Council) finds that the effects associated with the construction, operation, and maintenance of a telecommunications facility, including effects on the natural environment; ecological integrity and balance; public health and safety; scenic, historic, and recreational values; forests and parks; air and water purity; and fish and wildlife are not disproportionate, either alone or cumulatively with other effects, when compared to need, are not in conflict with the policies of the State concerning such effects, and are not sufficient reason to deny the application, and therefore directs that a Certificate of Environmental Compatibility and Public Need, as provided by General Statutes § 16-50k, be issued to Cellco Partnership d/b/a Verizon Wireless, hereinafter referred to as the Certificate Holder, for a telecommunications facility at 395 Round Hill Road Greenwich, Connecticut.

The facility shall be constructed, operated, and maintained substantially as specified in the Council's record in this matter, and subject to the following conditions:

1. The facility shall be constructed as a two-monopole facility with internally mounted antennas, no taller than necessary to provide the proposed telecommunications services, sufficient to accommodate the antennas of Cellco Partnership d/b/a Verizon Wireless and other entities, both public and private, but such towers shall not exceed a height of 115 feet above ground level.
2. The Certificate Holder shall prepare a Development and Management (D&M) Plan for this site in compliance with Sections 16-50j-75 through 16-50j-77 of the Regulations of Connecticut State Agencies. The D&M Plan shall be served on the Town of Greenwich for comment, and all parties and intervenors as listed in the service list, and submitted to and approved by the Council prior to the commencement of facility construction and shall include:
 - a) a final site plan(s) of site development to include specifications for the towers, tower foundations, antennas, equipment compound, radio equipment, access road, utility line, and landscaping; and
 - b) construction plans for site clearing, water drainage, and erosion and sedimentation control consistent with the 2002 Connecticut Guidelines for Soil Erosion and Sediment Control, as amended.
3. The Certificate Holder shall, prior to the commencement of operation, provide the Council worst-case modeling of electromagnetic radio frequency power density of all proposed entities' antennas at the closest point of uncontrolled access to the base of the facility, consistent with Federal Communications Commission, Office of Engineering and Technology, Bulletin No. 65, August 1997. The Certificate Holder shall ensure a recalculated report of electromagnetic radio frequency power density is submitted to the Council if and when circumstances in operation cause a change in power density above the levels calculated and provided pursuant to this Decision and Order.

4. Upon the establishment of any new State or federal radio frequency standards applicable to frequencies of this facility, the facility granted herein shall be brought into compliance with such standards.
5. The Certificate Holder shall permit public or private entities to share space on the proposed facility for fair consideration, or shall provide any requesting entity with specific legal, technical, environmental, or economic reasons precluding such tower sharing.
6. The Certificate Holder shall provide reasonable space within one of the towers for no compensation for any Town of Greenwich public safety services (police, fire and medical services), provided such use can be accommodated and is compatible with the structural integrity of the tower.
7. If the facility authorized herein is not fully constructed and providing wireless services within eighteen months from the date of the mailing of the Council's Findings of Fact, Opinion, and Decision and Order (collectively called "Final Decision"), this Decision and Order shall be void, and the Certificate Holder shall dismantle both towers and remove all associated equipment or reapply for any continued or new use to the Council before any such use is made. The time between the filing and resolution of any appeals of the Council's Final Decision shall not be counted in calculating this deadline.
8. If the one or both towers of the facility ceases to provide wireless services for a period of one year, this Decision and Order shall be void, and the Certificate Holder shall dismantle the unused portion of the facility and remove all associated equipment or reapply for any continued or new use to the Council before any such use is made.
9. The Certificate Holder shall remove any nonfunctioning antenna, and associated antenna mounting equipment, within 60 days of the date the antenna ceased to function.
10. Any request for extension of the time periods referred to in Conditions 7 & 8 shall be filed with the Council not later than sixty days prior to the expiration date of this Certificate and shall be served on all parties and intervenors, as listed in the service list, and the Town of Greenwich. Any proposed modifications to this Decision and Order shall likewise be so served.
11. In accordance with Section 16-50j-77 of the Regulations of Connecticut State Agencies, the Certificate Holder shall provide the Council with written notice two weeks prior to the commencement of site construction activities. In addition, the Certificate Holder shall provide the Council with written notice of the completion of site construction and the commencement of site operation.

Pursuant to General Statutes § 16-50p, the Council hereby directs that a copy of the Findings of Fact, Opinion, and Decision and Order be served on each person listed below, and notice of issuance shall be published in The Greenwich Time.

By this Decision and Order, the Council disposes of the legal rights, duties, and privileges of each party named or admitted to the proceeding in accordance with Section 16-50j-17 of the Regulations of Connecticut State Agencies.

The parties and intervenors to this proceeding are:

Applicant

Cellco Partnership d/b/a
Verizon Wireless

Intervenor

Omnipoint Communications, Inc.
(T-Mobile USA, Inc.)

Intervenor

Cliff Berger

Intervenor

New Cingular Wireless PCS, LLC

Intervenor

Sprint Nextel Corporation

Intervenor

Elizabeth Galt

Representatives

Sandy Carter, Regulatory Manager
Verizon Wireless
99 East River Drive
East Hartford, CT 06108

Kenneth C. Baldwin, Esq.
Robinson & Cole LLP
280 Trumbull Street
Hartford, CT 06103-3597

Representative

Diane Whitney, Esq.
Pullman & Comley
80 State House Square
Hartford, CT 06103

Representative

Ira W. Bloom, Esq.
Wake, See, Dimes, Brynizcka, Day &
Bloom
27 Imperial Avenue, P.O. Box 777
Westport, CT 06881-0777

Representative

Christopher B. Fisher, Esq.
Cuddy & Feder LLP
90 Maple Avenue
White Plains, New York 10601

Representative

Thomas J. Regan, Esq.
Brown Rudnick Berlack Israels LLP
CityPlace I, 185 Asylum Street
Hartford, CT 06103-3402

Representative

Ira W. Bloom, Esq.
Wake, See, Dimes, Brynizcka, Day &
Bloom
27 Imperial Avenue, P.O. Box 777
Westport, CT 06881-0777

Exhibit B
Project Plans

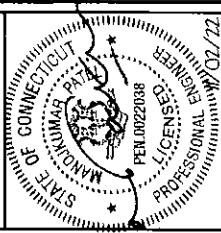

IT IS A VIOLATION OF LAW FOR ANY PERSON, UNLESS THEY ARE ACTING UNDER THE DIRECTION OF AN ENGINEER, TO ALTER THIS DOCUMENT.

DRAWN BY: [] CHECKED BY: [] APPROVED BY: []
DATE: []

PROJ. NO. [] JO [] MP []
SHEET NO. [] OF []

CONSTRUCTION DOCUMENTS

REV	DATE	DESCRIPTION
0	11/01/22	ISSUED FOR PERMITS

AME PROJECT NUMBER
10710.NJER01125A

DISH Wireless LLC. PROJECT INFORMATION
NJER01125A

395 ROUND HILL ROAD
GREENWICH, CT 06831

SHEET TITLE
OVERALL SITE PLAN

SHEET NUMBER
A-1

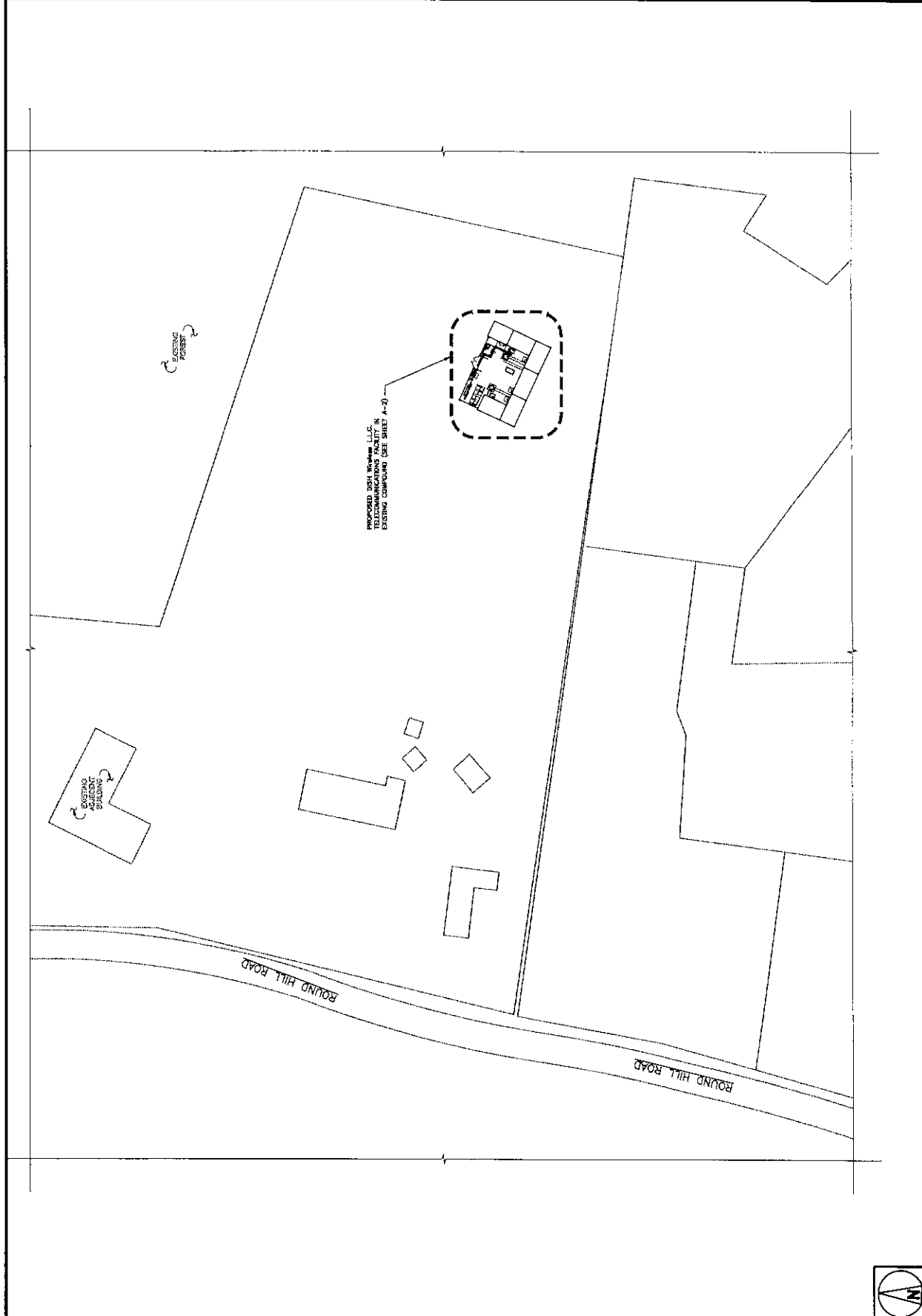

OVERALL SITE PLAN



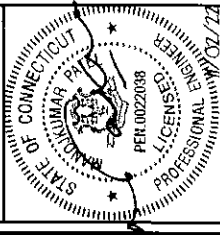

IT IS A VIOLATION OF LAW FOR ANY PERSON
UNLESS THEY ARE, USING UNDER THE SUPERVISION
OF A LICENSED PROFESSIONAL ENGINEER,
TO ALTER THIS DOCUMENT.

DRAWN BY	CHECKED BY	APPROVED BY
MM	JD	MP

REDS REV #	3
------------	---

CONSTRUCTION DOCUMENTS

REV	DATE	DESCRIPTION
0	11/29/22	ISSUED FOR PERMITS

ARE PROJECT NUMBER
10710 NJJER01125A

DISH Wireless LLC PROJECT INFORMATION
NJJER01125A

395 ROUND HILL ROAD
GREENWICH, CT 06831

SHEET TITLE
ENLARGED SITE &
EQUIPMENT PLAN

SHEET NUMBER
A-2

NOTES

1. CONTRACTOR SHALL FIELD VERIFY ALL DIMENSIONS.
2. ANTENNAS AND MOUNTS OMITTED FOR CLARITY.
3. REFER TO STRUCTURAL ANALYSIS REPORT BY SEMAN ENGINEERING SOLUTIONS DATED 02/17/22

ANTENNA DIMENSIONS
ALPHA 100'
BETA 220'
GAMMA 340'

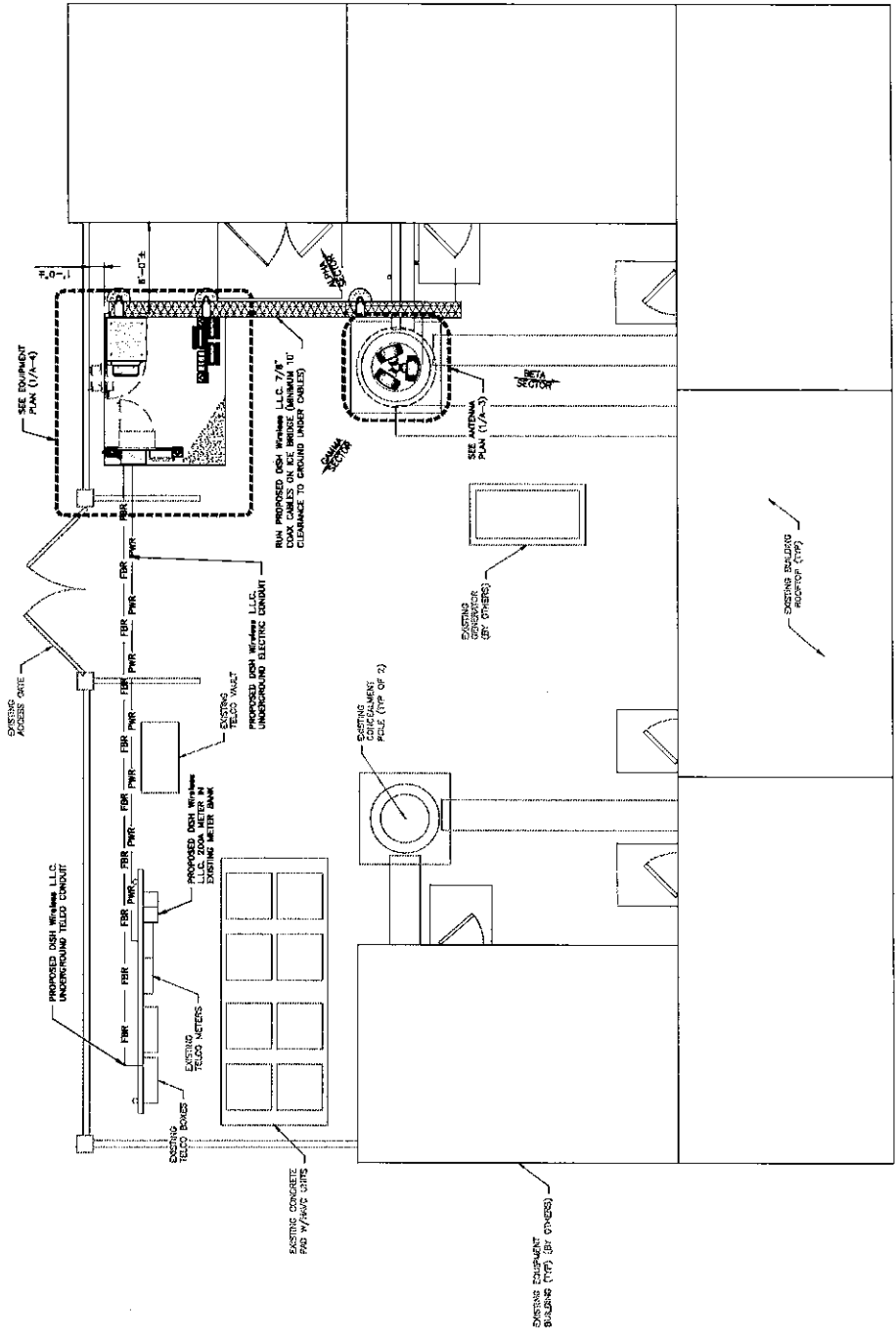

ENLARGED SITE PLAN



dish
wireless.

3701 SOUTH SANTA FE DRIVE
LITTLETON, CO 80120

Tectonic
ENGINEERING & ARCHITECTURE, P.C.
1000 WEST 10TH AVENUE, SUITE 100
DENVER, CO 80202
TEL: 303.733.8800
WWW.TECTONICEA.COM

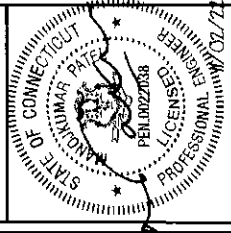

IT IS A VIOLATION OF LAW FOR ANY PERSON, UNLESS HE OR SHE IS LICENSED PROFESSIONAL ENGINEER, TO SEAL THIS DOCUMENT.

DRAWN BY: CHECKED BY: APPROVED BY:

DATE: 11/10/12

PROJECT NO: 12727

DATE: 11/10/12

PROJECT NO: 12727

DATE: 11/10/12

PROJECT NO: 12727

DATE: 11/10/12

PROJECT NO: 12727

DATE: 11/10/12

PROJECT NO: 12727

DATE: 11/10/12

PROJECT NO: 12727

CONSTRUCTION DOCUMENTS

NO. 1

NO. 2

NO. 3

NO. 4

NO. 5

NO. 6

NO. 7

NO. 8

NO. 9

NO. 10

AME PROJECT NUMBER
10710.NJER01125A

DISH Wireless L.L.C. PROJECT INFORMATION
NJER01125A

395 ROUND HILL ROAD
GREENWICH, CT 06831

SHEET TITLE
EQUIPMENT DETAILS

SHEET NUMBER
A-4

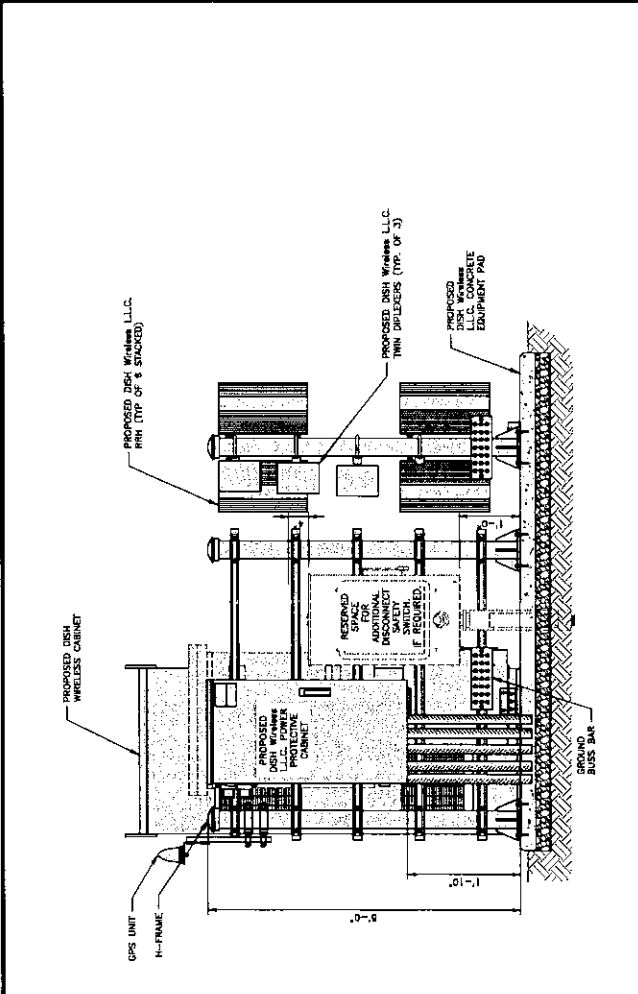

EQUIPMENT AREA PLAN
NO SCALE 1

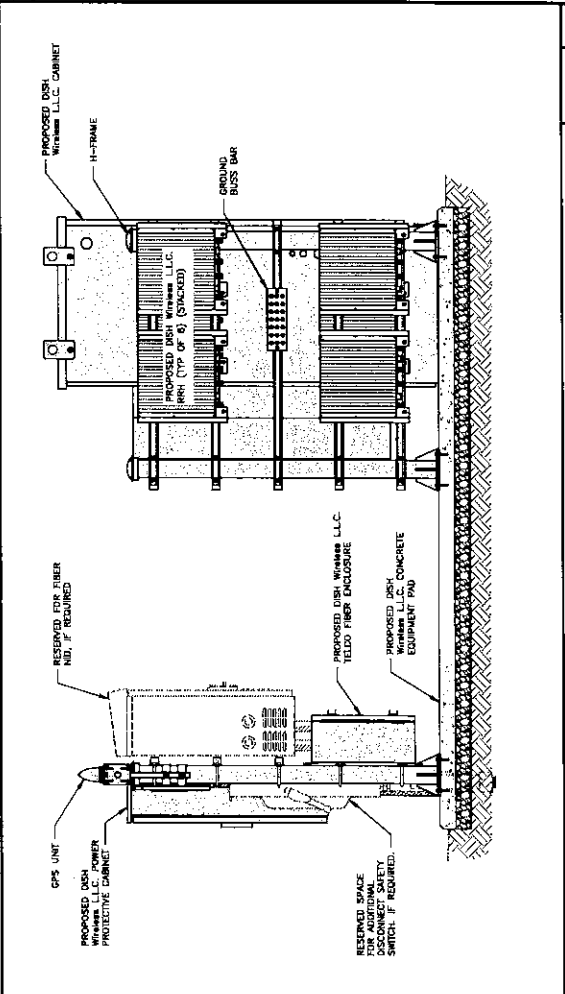

H-FRAME EQUIPMENT ELEVATION
NO SCALE 2

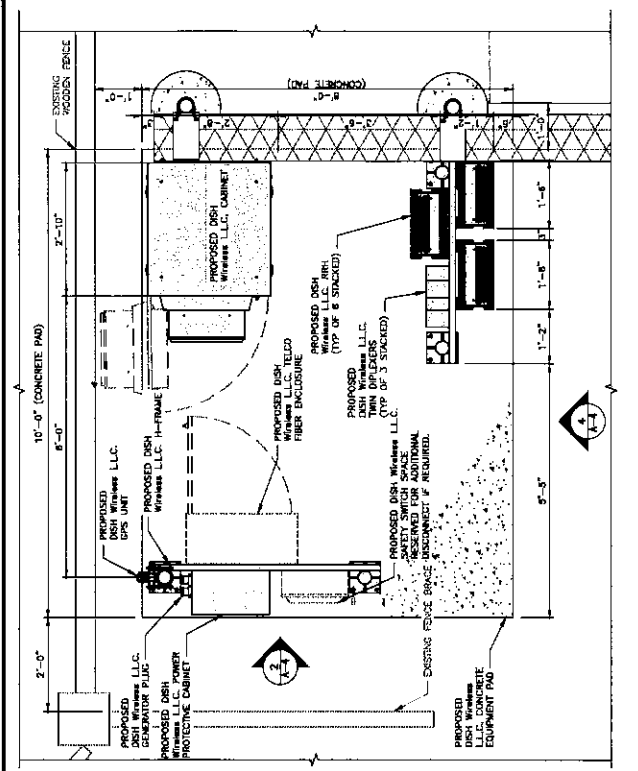

H-FRAME EQUIPMENT ELEVATION
NO SCALE 3

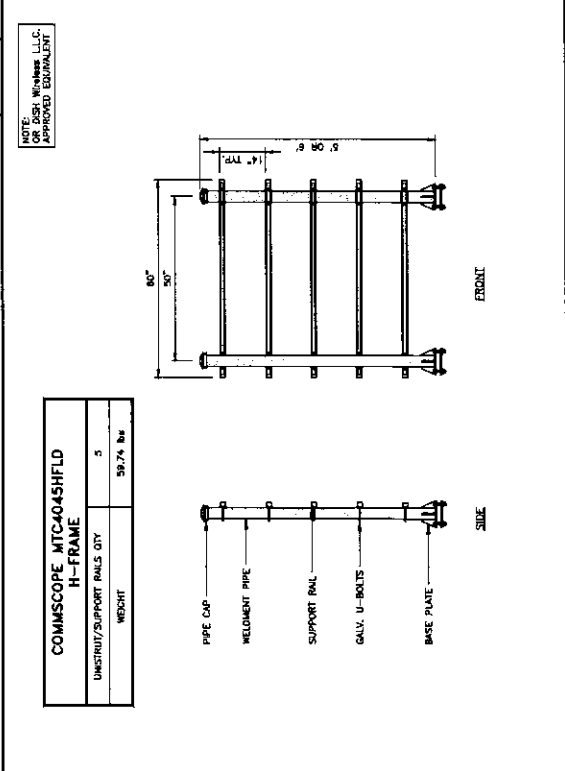

H-FRAME DETAIL
NO SCALE 4

COMMSCOPE MTC4045HFD H-FRAME	5	59.74 lbs
UNITS/INSTR/SUPPORT RAILS QTY		
WEIGHT		

- PIPE CAP
- WELDMENT PIPE
- SUPPORT RAIL
- GALV. U-BOLTS
- BASE PLATE

SIDE

FRONT



5701 SOUTH SANTA FE DRIVE
LITTLETON, CO 80120



10000 W. 16th Ave., Suite 100
Greenwood Village, CO 80120
Phone: (303) 440-8888
Fax: (303) 440-8889
www.tectonicinc.com

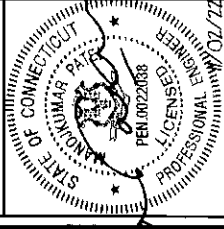

IT IS A VIOLATION OF LAW FOR ANY PERSON, UNLESS HE IS LICENSED, TO SIGN OR SEAL ANY DRAWING OR SPECIFICATION TO ANY OTHER DOCUMENT.

DRAWN BY: [] CHECKED BY: [] APPROVED BY: []
DATE: []
REV. NO. []

CONSTRUCTION DOCUMENTS

REV.	DATE	DESCRIPTION
0	11/19/22	ISSUED FOR PERM

AKAE PROJECT NUMBER
10710.NJER01125A

DISH Wireless LLC PROJECT INFORMATION
NJER01125A

395 ROUND HILL ROAD
GREENWICH, CT 06651

SHEET TITLE
EQUIPMENT DETAILS

SHEET NUMBER
A-5

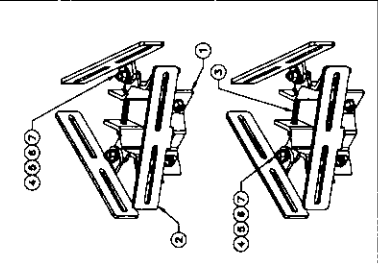

EEI FPS-AB TRIAD FLUSHED MOUNT	
DESCRIPTION	PART # - QTY
TRAD-FLS - 1/4"	PART 1 - QTY: 6
BRACKET ASSEMBLY	PART 2 - QTY: 6
TRAD-FLS-1/4" ANGLE GASKET ASSEMBLY	PART 3 - QTY: 6
3/8"x5-1/2" ANGLE THREADED ROD	PART 4 - QTY: 6
3/8"x1-1/4" A307 BOLT	PART 5 - QTY: 6
3/8" HEX NUT	PART 6 - QTY: 6
3/8" FLAT WASHER	PART 7 - QTY: 6
3/8" LOCK WASHER	PART 8 - QTY: 6
TOTAL WEIGHT	4.532 lbs
POLE DIAMETER	3" - 7"

NOTE: Tectonic Wireless LLC APPROVED EQUIPMENT

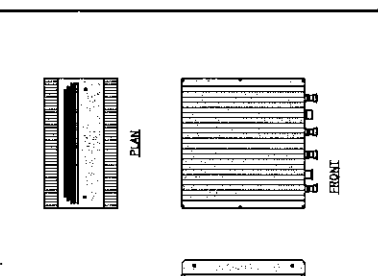

FUJITSU TRIPLE BAND TA8023-8B05	
DIMENSIONS (HxWxD)	14.9" x 13.2" x 8"
WEIGHT	74.69 lbs
CONNECTOR TYPE	75 OHM SMA FEMALE CONNECTOR
POWER SUPPLY	DC -50V -30W

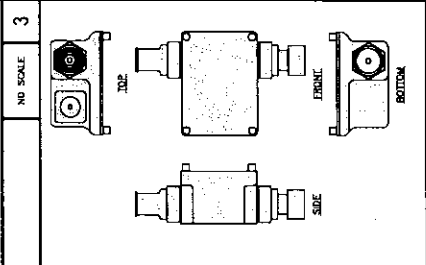

KAEIUS SMART BIAS TEE SBT0003F1V2 (TOP OF TOWER)	
DIMENSIONS (HxWxD)	3.41" x 3.27" x 1.88"
WEIGHT	0.86 lbs
RF TO RF+LOSS	350-3800 MHz
PASSBAND	0.1dB MAX
INSERTION LOSS	20dB MIN
RETURN LOSS	750W CW/50W PEP
MAX INPUT POWER	-150dBm/100dBm/200W CW CARRIER
INTERMODULATION PRODUCTS	50 Other
RF IMPEDANCE	

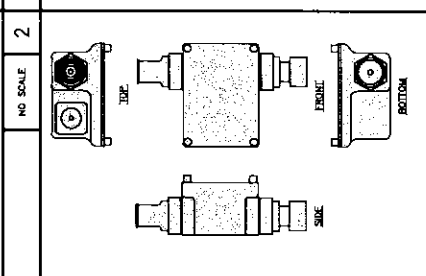

KAEIUS SMART BIAS TEE SBT0003F1V1 (BOTTOM OF TOWER)	
DIMENSIONS (HxWxD)	3.41" x 3.27" x 1.88"
WEIGHT	0.86 lbs
RF TO RF+LOSS	350-3800 MHz
PASSBAND	0.1dB MAX
INSERTION LOSS	20dB MIN
RETURN LOSS	750W CW/50W PEP
MAX INPUT POWER	-150dBm/100dBm/200W CW CARRIER
INTERMODULATION PRODUCTS	50 Other
RF IMPEDANCE	

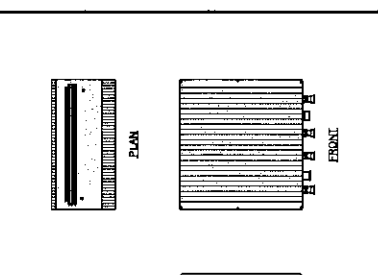

FUJITSU DUAL BAND TA8023-8B04	
DIMENSIONS (HxWxD)	14.9" x 13.2" x 7.8"
WEIGHT	63.0 lbs
CONNECTOR TYPE	75 OHM SMA FEMALE CONNECTOR
POWER SUPPLY	DC -50V -30W

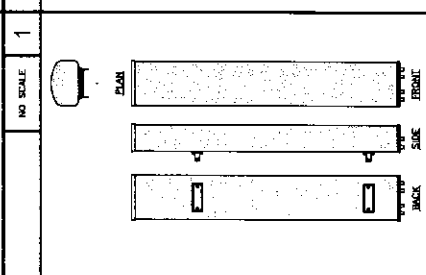

COMMSCOPE FW-65B-R3	
DIMENSIONS (HxWxD)(HxWxD)	10.0x10.0x11.0 (7.1x7.1x11.7)
RF CONNECTOR INTERFACE	4.3-10 FEMALE
WEIGHT	43.0 lbs
WEIGHT WITH BRACKETS	70.0 lbs

RRH DETAIL 1 NO SCALE

RRH DETAIL 2 NO SCALE

MAST MOUNT DETAIL 3 NO SCALE

NO SCALE

NO SCALE

NO SCALE

NO SCALE

NO SCALE

NO SCALE

NO SCALE

NO SCALE

NO SCALE

NO SCALE

NO SCALE

NO SCALE

NO SCALE

NO SCALE

NO SCALE

NO SCALE

NO SCALE

NO SCALE

NO SCALE

NO SCALE

NO SCALE

NO SCALE

NO SCALE

NO SCALE

NO SCALE

NO SCALE

NO SCALE

NO SCALE

NO SCALE

NO SCALE

NO SCALE

NO SCALE

NO SCALE

NO SCALE

NO SCALE

NO SCALE

NO SCALE

NO SCALE

NO SCALE

NO SCALE

NO SCALE

NO SCALE

NO SCALE

NO SCALE

NO SCALE

NO SCALE

NO SCALE

NO SCALE

NO SCALE

NO SCALE

NO SCALE

NO SCALE

NO SCALE

NO SCALE

NO SCALE

NO SCALE

NO SCALE

NO SCALE

NO SCALE

NO SCALE

NO SCALE

NO SCALE

NO SCALE

NO SCALE

NO SCALE

NO SCALE

NO SCALE

NO SCALE

NO SCALE

NO SCALE

NO SCALE

NO SCALE

NO SCALE

NO SCALE

NO SCALE

NO SCALE

NO SCALE

NO SCALE

NO SCALE

NO SCALE

NO SCALE

NO SCALE

NO SCALE

NO SCALE

NO SCALE

NO SCALE

NO SCALE

NO SCALE

NO SCALE

NO SCALE

NO SCALE

NO SCALE

NO SCALE

NO SCALE

NO SCALE

NO SCALE

NO SCALE

NO SCALE

NO SCALE

NO SCALE

NO SCALE

NO SCALE

NO SCALE

NO SCALE

NO SCALE

NO SCALE

NO SCALE

NO SCALE

NO SCALE

NO SCALE

NO SCALE

NO SCALE

NO SCALE

NO SCALE

NO SCALE

NO SCALE

NO SCALE

NO SCALE

NO SCALE

NO SCALE

NO SCALE

NO SCALE

NO SCALE

NO SCALE

NO SCALE

NO SCALE

NO SCALE

NO SCALE

NO SCALE

NO SCALE

NO SCALE

NO SCALE

NO SCALE

NO SCALE

NO SCALE

NO SCALE

NO SCALE

NO SCALE

NO SCALE

NO SCALE

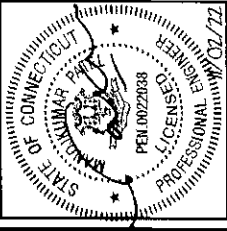

IT IS A VIOLATION OF LAW FOR ANY PERSON, UNLESS THEY ARE BEING UNDER THE SUPERVISION OF AN ENGINEER, TO SEAL THIS DOCUMENT.

DRAWN BY: [] CHECKED BY: [] APPROVED BY: []
DATE: []
REV: []

RFDS REV. # []

CONSTRUCTION DOCUMENTS

DATE: [] DESCRIPTION: []

REV: [] DATE: [] DESCRIPTION: []

REV: [] DATE: [] DESCRIPTION: []

REV: [] DATE: [] DESCRIPTION: []

REV: [] DATE: [] DESCRIPTION: []

REV: [] DATE: [] DESCRIPTION: []

REV: [] DATE: [] DESCRIPTION: []

REV: [] DATE: [] DESCRIPTION: []

REV: [] DATE: [] DESCRIPTION: []

REV: [] DATE: [] DESCRIPTION: []

REV: [] DATE: [] DESCRIPTION: []

REV: [] DATE: [] DESCRIPTION: []

REV: [] DATE: [] DESCRIPTION: []

REV: [] DATE: [] DESCRIPTION: []

REV: [] DATE: [] DESCRIPTION: []

REV: [] DATE: [] DESCRIPTION: []

REV: [] DATE: [] DESCRIPTION: []

REV: [] DATE: [] DESCRIPTION: []

REV: [] DATE: [] DESCRIPTION: []

REV: [] DATE: [] DESCRIPTION: []

REV: [] DATE: [] DESCRIPTION: []

REV: [] DATE: [] DESCRIPTION: []

REV: [] DATE: [] DESCRIPTION: []

REV: [] DATE: [] DESCRIPTION: []

REV: [] DATE: [] DESCRIPTION: []

REV: [] DATE: [] DESCRIPTION: []

REV: [] DATE: [] DESCRIPTION: []

REV: [] DATE: [] DESCRIPTION: []

REV: [] DATE: [] DESCRIPTION: []

REV: [] DATE: [] DESCRIPTION: []

RAYCAP PPC
RD1AC-2465-P-240-MTS

ENCLOSURE DIMENSIONS (HxWxD):	3P-X22.85X12.593
WEIGHT:	80 lbs
OPERATING AC VOLTAGE:	240/120 1 PHASE 3W+G

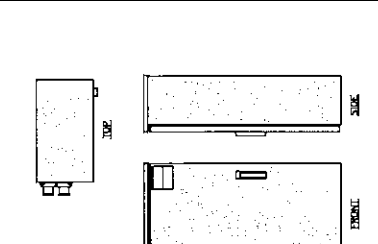

CABINET DETAIL

NO SCALE

SQUARE D SAFETY SWITCHES
D224NRB

ENCLOSURE DIM (HxWxD):	29.25"X19.00"X6.50"
ENCLOSURE TYPE:	NEMA 3R RAINPROOF
UL LISTED:	FILE E-2875

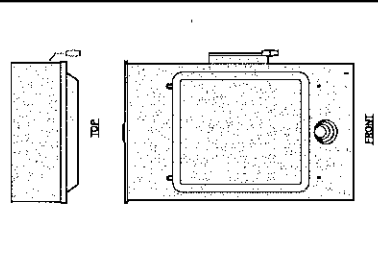

SAFETY SWITCH DETAIL

NO SCALE

DELTA ELECTRONICS, INC.
ES0A600-HCB04 (HX)

DIMENSIONS (HxWxD):	75"X27"X32"
WEIGHT (EMPTY):	825 lbs (approx)

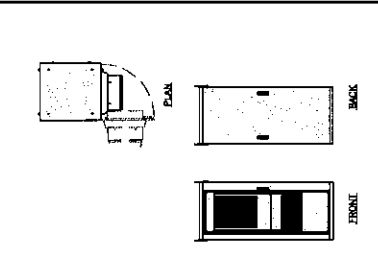

CABINET DETAIL

NO SCALE

CHARLES CFIT-PF2020D5H1
FIBER TELCO ENCLOSURE

ENCLOSURE DIMS (HxWxD):	20"X20"X8"
ENCLOSURE WEIGHT:	20 lbs
MOUNTING:	WALL
COMPLIANCE:	TYPE 4

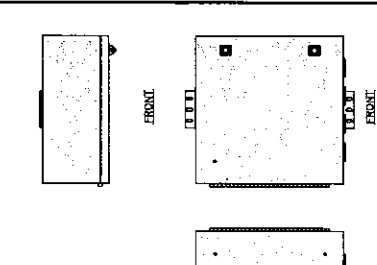

FIBER TELCO ENCLOSURE DETAIL

NO SCALE

ZAYO SRU (LEFT SWING DOOR)
FIBER NID ENCLOSURE

DIMENSIONS (HxWxD):	36.1"X29"X12.9"
WEIGHT:	85 lbs

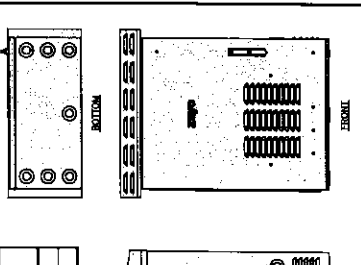

FIBER NID ENCLOSURE DETAIL

NO SCALE

PCTEL
GPSGL-TMG-SPI-40NCB

DIMENSIONS (DxHxT) (HxWxD):	0.5"X1.0"X0.5"
WEIGHT W/ACCESSORIES:	0.75 lbs
CONNECTOR:	N-FEMALE
FREQUENCY RANGE:	1580 ± 30MHz

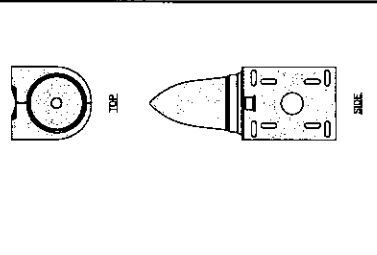

GPS DETAIL

NO SCALE

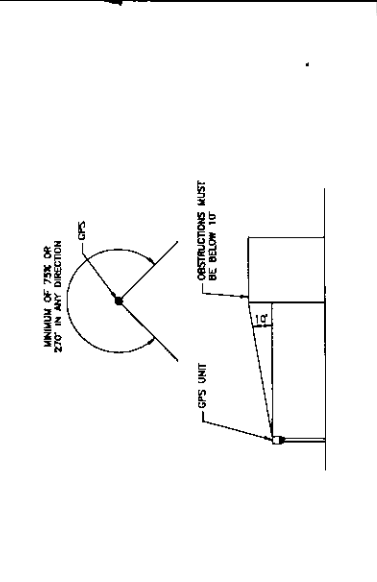

GPS MINIMUM SKY VIEW REQUIREMENTS

NO SCALE

SHEET TITLE
EQUIPMENT DETAILS

SHEET NUMBER
A-7

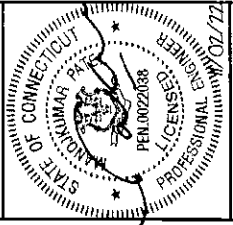

IT IS A VIOLATION OF LAW FOR ANY PERSON, UNLESS HE OR SHE IS A LICENSED PROFESSIONAL ENGINEER, TO SEAL THIS DOCUMENT TO ATTEST THE DOCUMENT.

DATE	DESCRIPTION
11/11/21	ISSUED FOR PERMITS

DRAWN BY: CHECKED BY: APPROVED BY:

DATE	DESCRIPTION
11/11/21	ISSUED FOR PERMITS

REFS REV #

1	
2	
3	

CONSTRUCTION DOCUMENTS

PROJECT NUMBER
10710.NJER01125A

DISH Wireless LLC PROJECT INFORMATION
NJER01125A

395 ROUND HILL ROAD
GREENWICH, CT 06831

SHEET TITLE
ELECTRICAL/FIBER ROUTE
PLAN AND NOTES

SHEET NUMBER
E-1

DC POWER WIRING SHALL BE COLOR CODED AT EACH END FOR IDENTIFYING +24V AND -48V CONDUCTORS. RED MARKINGS SHALL IDENTIFY +24V AND BLUE MARKINGS SHALL IDENTIFY -48V.

CONTRACTOR SHALL INSPECT THE EXISTING CONDITIONS PRIOR TO SUBMITTING A BID. ANY QUESTIONS ARISING DURING THE BID PERIOD IN REGARD TO THE CONTRACTOR'S FUNCTIONS, THE SCOPE OF WORK, OR ANY OTHER ISSUES RELATED TO THE PROJECT SHALL BE REPORTED TO THE BID PERSON WITH THE PROJECT MANAGER FOR CONSIDERATION. NOT AFTER THE CONTRACT HAS BEEN AWARDED.

ALL ELECTRICAL WORK SHALL BE DONE IN ACCORDANCE WITH CURRENT NATIONAL ELECTRICAL CODES AND ALL RELATED CODES AND ORDINANCES. PROVIDE ALL COMPONENTS AND WIRING SIZES AS REQUIRED TO MEET NEC STANDARDS.

LOCATION OF EQUIPMENT, CONDUIT AND DEVICES SHOWN ON THE DRAWINGS ARE APPROXIMATE AND SHALL BE COORDINATED WITH FIELD CONDITIONS PRIOR TO CONSTRUCTION.

CONDUIT ROUTING SHALL BE COORDINATED WITH THE MECHANICAL EQUIPMENT TO AVOID LOCATION CONFLICTS. VERIFY WITH THE MECHANICAL EQUIPMENT CONTRACTOR AND COMPLY AS REQUIRED.

CONTRACTOR SHALL PROVIDE ALL BREAKERS, CONDUITS AND CIRCUITS AS REQUIRED FOR A COMPLETE SYSTEM.

CONTRACTOR SHALL PROVIDE FULL BOXES AND JUNCTION BOXES AS REQUIRED BY THE NEC ARTICLE 314.

CONTRACTOR SHALL PROVIDE ALL STRAIN RELIEF AND CABLE SUPPORTS FOR ALL CABLE ASSEMBLIES.

INSTALLATION SHALL BE IN ACCORDANCE WITH MANUFACTURER'S SPECIFICATIONS AND RECOMMENDATIONS.

ALL DISCONNECTS AND CONTROLLING DEVICES SHALL BE PROVIDED WITH ENGRAVED PNEUMATIC MANIPULATORS INDICATING EQUIPMENT CONTROLLED. BRANCH CIRCUITS INSTALLED ON AND PANEL FIELD LOCATIONS FED FROM

INSTALL AN EQUIPMENT GROUNDING CONDUCTOR IN ALL CONDUITS FOR THE SPECIFICATIONS AND NEC 250. THE EQUIPMENT GROUNDING CONDUCTORS SHALL BE BONDED AT ALL JUNCTION BOXES, PULL BOXES, AND ALL DISCONNECT, SWITCHES, AND EQUIPMENT CABINETS.

ALL NEW MATERIAL SHALL HAVE A U.L. LABEL.

PANEL SCHEDULE LOADS AND CIRCUIT ARRANGEMENTS REFLECT POST-CONSTRUCTION EQUIPMENT.

CONTRACTOR SHALL BE RESPONSIBLE FOR AS-BUILT PANEL SCHEDULE AND SITE DRAWINGS.

ALL TRENCHES IN COMPOUND TO BE HAND DUG

NOTES

1. CONTRACTOR SHALL FIELD VERIFY ALL PROPOSED UNDERGROUND UTILITY CONDUIT ROUTE.

2. ANTENNAS AND MOUNTS OMITTED FOR CLARITY.

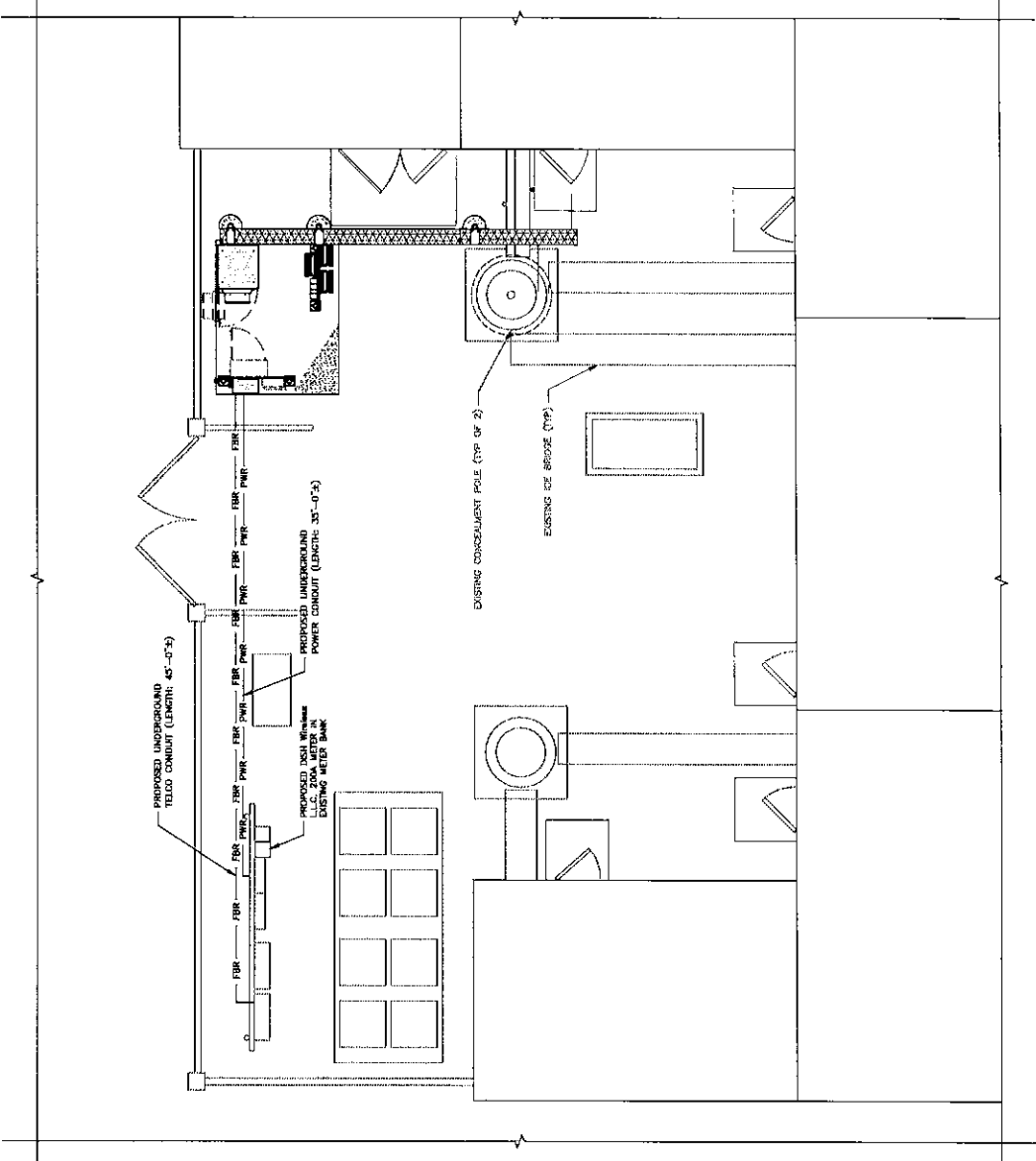

UTILITY ROUTE PLAN

1 2 4 6 8
1/4"=1'-0"

ELECTRICAL NOTES

NO SCALE 2

COUPLING END PART NUMBER	MALE TERMINAL PART NUMBER	SIZE	TRAVEL LENGTH
E8490	E8490A	1/2"	4"
E8491	E8491A	3/4"	4"
E8492	E8492A	1"	4"
E8493	E8493A	1 1/4"	4"
E8494	E8494A	1 1/2"	4"
E8495	E8495A	2"	4"
E8496	E8496A	2 1/2"	8"
E8497	E8497A	3"	8"
E8498	E8498A	3 1/2"	8"
E8499	E8499A	4"	8"
E8500	E8500A	5"	8"
E8501	E8501A	6"	8"

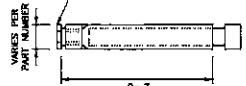

NOTE: FACTOR TO INSTALL CONDUIT, FITTING TERMINATION, AS PER LOCAL UTILITY POLICY, CLEARANCE AND/OR SPECIAL REQUIREMENT.

EXPANSION JOINT DETAIL

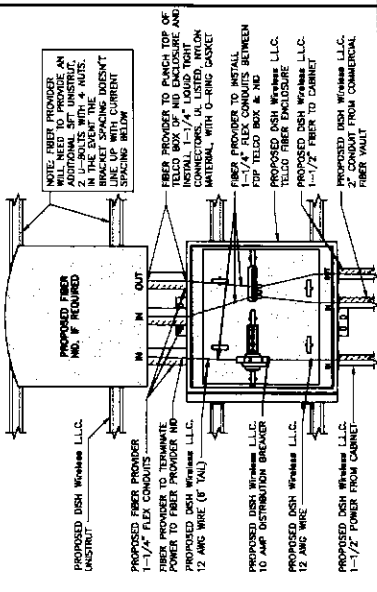

UT. TELCO BOX - INTERIOR WIRING LAYOUT (OPTIONAL)

NO SCALE	4	NO SCALE	7
----------	---	----------	---

TRENCHING NOTES:

- CONTRACTOR SHALL RESTORE THE EXISTING SURFACE TO ORIGINAL CONDITION BY EITHER SODDING OR REPLICATING GRASS AREAS, OR REPLICATING ASPHALT OR CONCRETE SURFACE TO ITS ORIGINAL CROSS SECTION.
- TRENCHING SAFETY, INCLUDING, BUT NOT LIMITED TO SOIL CLASSIFICATION, SLURRING, AND SHORING, SHALL BE GOVERNED BY THE CURRENT OSHA REGULATIONS AND ALL APPLICABLE SAFETY STANDARDS.
- ALL CONDUITS SHALL BE INSTALLED IN COMPLIANCE WITH THE CURRENT NATIONAL ELECTRIC CODE (NEC) OR AS REQUIRED BY THE LOCAL REGULATIONS. THE LOCAL CODE IS THE MOST STRINGENT.

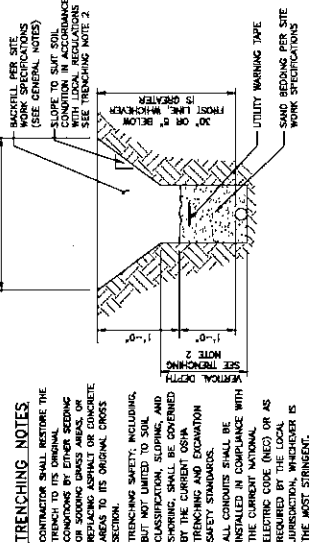

TYPICAL UNDERGROUND TRENCH DETAIL

NO SCALE	2	NO SCALE	6
----------	---	----------	---

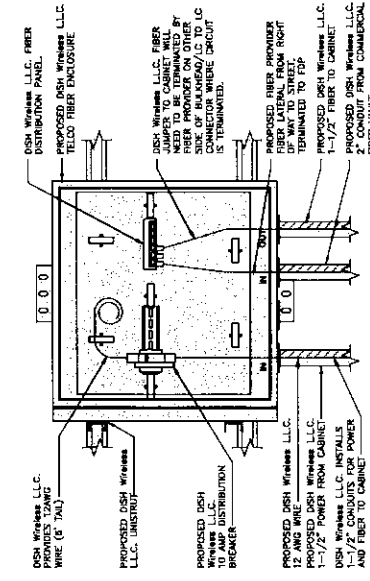

DARK TELCO BOX - INTERIOR WIRING LAYOUT

NO SCALE	3	NO SCALE	9
----------	---	----------	---

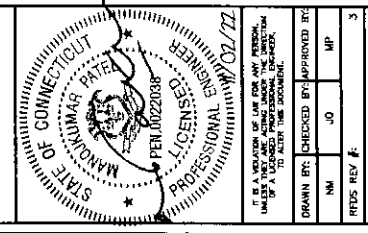
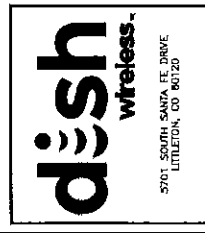

IT IS A VIOLATION OF LAW FOR ANY PERSON, WITHOUT A VALID PROFESSIONAL ENGINEERING LICENSE, TO ADAPT THIS DOCUMENT.

DRAWN BY:	CHECKED BY:	APPROVED BY:
NM	JO	MP
REDS REV #:		3

CONSTRUCTION DOCUMENTS

REV	DATE	DESCRIPTION
0	11/07/20	ISSUED FOR TAKE

AGE PROJECT NUMBER: 10710-NJIER01125A

DSH WIRELESS L.L.C. PROJECT INFORMATION: NJIER01125A

395 ROUND HILL ROAD
GREENWICH, CT 06831

SHEET TITLE: ELECTRICAL DETAILS

SHEET NUMBER: E-2

NO SCALE	5	NO SCALE	8	NO SCALE	9
NOT USED	NOT USED	NOT USED	NOT USED	NOT USED	NOT USED

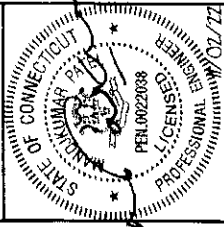

IT IS A VIOLATION OF LAW FOR ANY PERSON, UNLESS HE IS LICENSED AND REGISTERED TO SIGN THESE DOCUMENTS, TO SIGN THE SEALS OF ANY ENGINEER OR ARCHITECT TO SIGN THESE DOCUMENTS.

DRAWN BY	CHECKED BY	APPROVED BY
NM	JQ	MP

REVIS REV #

CONSTRUCTION DOCUMENTS	
KEY	SUBMITTALS
DATE	DESCRIPTION
9/11/12	ISSUE FOR PERMITS

AGE PROJECT NUMBER
10710.NJER01125A

DISH Wireless LLC, PROJECT INFORMATION
NJER01125A

395 ROUND HILL ROAD
GREENWICH, CT 06851

SHEET TITLE
GROUNDING PLANS
AND NOTES

SHEET NUMBER
G-1

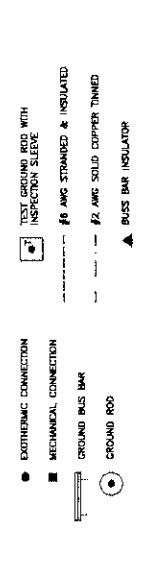

1. GROUNDING IS SHOWN DIAGRAMMATICALLY ONLY.
2. CONTRACTOR SHALL VERIFY ALL EQUIPMENT IS A COMPLETE SYSTEM. GROUNDING SHALL BE IN COMPLIANCE WITH NEC SECTION 250 AND DISH Wireless LLC GROUNDING AND BONDING REQUIREMENTS AND MANUFACTURER'S SPECIFICATIONS.
3. ALL GROUND CONDUCTORS SHALL BE COPPER. NO ALUMINUM CONDUCTORS SHALL BE USED.

GROUNDING KEY NOTES

- A. EXTERIOR GROUND RINGS:** #2 AWG SOLID COPPER, BURIED AT A DEPTH OF AT LEAST 30 INCHES BELOW GRADE, WITH 6 INCHES BELOW THE FIRST LINE AND APPROXIMATELY 24 INCHES FROM THE EXTERIOR WALL ON EACH SIDE.
- B. TOWER GROUNDING:** THE GROUND RING SYSTEM SHALL BE INSTALLED AROUND AN ANTENNA TOWER'S LEGS, AND/OR CUT ANCHORS, WHERE SEPARATE SYSTEMS HAVE BEEN PROVIDED FOR THE TOWER AND THE BUILDING. THE GROUND RING SYSTEM SHALL BE INSTALLED AROUND THE TOWER AND THE BUILDING GROUND SYSTEM USING MINIMUM #2 AWG SOLID COPPER CONDUCTORS.
- C. INTERIOR GROUND RINGS:** #2 AWG STRANDED GREEN INSULATED COPPER CONDUCTOR EXTENDED AROUND THE PERIMETER OF THE BUILDING. THE GROUND RING SHALL BE BONDING TO THE INTERIOR GROUND RING WITH #8 AWG STRANDED GREEN INSULATED CONDUCTOR.
- D. BOND TO EXTERIOR GROUND RINGS:** #2 AWG SOLID THINNED COPPER WIRE PRIMARY WIRE SHALL BE PROVIDED AT LEAST AT FOUR POINTS ON THE INTERIOR GROUND RING, LOCATED AT THE CORNERS OF THE BUILDING.
- E. GROUND RODS:** 1/2" LATED COPPER CLAD STEEL, MINIMUM 1/2" DIAMETER BY 80" FEET LONG. GROUND RODS SHALL BE INSTALLED WITH INSULATION BELOW. GROUND RODS SHALL BE DRIVEN TO THE DEPTH OF GROUND RING CONDUCTOR.
- F. CELL REFERENCE GROUND BAR:** POINT OF GROUND REFERENCE FOR ALL COMMUNICATIONS EQUIPMENT FRAMES. ALL BONDS ARE MADE WITH #2 AWG UNLESS NOTED OTHERWISE. STRANDED GREEN INSULATED COPPER CONDUCTORS, BOND TO GROUND RING WITH (2) #2 SOLID THINNED COPPER CONDUCTORS.
- G. METAL PLATE GROUND BARS:** BOND TO THE INTERIOR GROUND RING WITH TWO #2 AWG STRANDED GREEN INSULATED COPPER CONDUCTORS. WHEN A METAL PLATE AND A CELL REFERENCE GROUND BAR ARE BOTH PRESENT, THE CABLE MUST BE CONNECTED TO THE METAL PLATE AND TO THE INTERIOR GROUND RING USING (2) TWO #2 AWG STRANDED GREEN INSULATED COPPER CONDUCTORS EACH.
- H. EXTERIOR CABLE ENTRY POINT GROUND BARS:** LOCATED AT THE ENTRANCE TO THE CELL SITE BUILDING, BOND TO GROUND RING WITH #2 AWG SOLID THINNED COPPER CONDUCTORS WITH AN EXOTHERMIC WELD AND INSPECTION SLEEVE.
- I. TELLER GROUND BAR:** BOND TO BOTH CELL REFERENCE GROUND BAR OR EXTERIOR GROUND RING.
- J. FRAME BONDING:** THE BONDING POINT FOR TELECOM EQUIPMENT FRAMES SHALL BE THE GROUND BUS THAT IS NOT LOCATED FROM THE EQUIPMENT'S METAL FRAMEWORK.
- K. INTERIOR LIGHT BONDING:** METAL FRAMES, CABINETS AND INDIVIDUAL METALLIC UNITS LOCATED WITHIN THE AREA OF THE INTERIOR GROUND RING REQUIRE A #8 AWG STRANDED GREEN INSULATED COPPER BOND TO THE INTERIOR GROUND RING.
- L. FENCE AND METAL BOUNDING:** METAL FENCES WITHIN 7 FEET OF THE EXTERIOR GROUND RING OR GALLEYS BOND TO THE EXTERIOR GROUND RING WITH TWO #2 AWG STRANDED GREEN INSULATED COPPER CONDUCTORS. METAL FENCES SHALL BE BONDING TO THE EXTERIOR GROUND RING WITH TWO #2 AWG STRANDED GREEN INSULATED COPPER CONDUCTORS. METAL FENCES SHALL BE BONDING TO THE EXTERIOR GROUND RING WITH TWO #2 AWG STRANDED GREEN INSULATED COPPER CONDUCTORS. METAL FENCES SHALL BE BONDING TO THE EXTERIOR GROUND RING WITH TWO #2 AWG STRANDED GREEN INSULATED COPPER CONDUCTORS.
- M. EXTERIOR LIGHT BONDING:** METALLIC OBJECTS, EXTERNA TO OR ADJACENT TO THE BUILDING, SHALL BE BONDING TO THE EXTERIOR GROUND RING USING #2 THINNED SOLID COPPER WIRE.
- N. ICE BRIDGE SUPPLEMENTS:** EACH ICE BRIDGE LEG SHALL BE BONDING TO THE GROUND RING WITH #2 AWG BARE STRANDED COPPER CONDUCTOR. PROMOTE EXOTHERMIC WELDS AT BOTH THE ICE BRIDGE LEG AND BONDING GROUND RING.
- O. DURING ALL DC POWER SYSTEM CHANGES INCLUDING DC SYSTEM CHANGE OUTS, RECEIVER REPLACEMENTS AND ANTENNA REPLACEMENTS, CONTRACTORS SHALL VERIFY ALL DC POWER SYSTEMS ARE EQUIPPED WITH A MASTER DC SYSTEM RETURN GROUNDING CONNECTION TO THE COMMON RETURN BUS DIRECTLY CONNECTED TO THE CELL SITE REFERENCE GROUND BAR.**
- P. TOWER TOP COLLECTOR BUSS BAR IS TO BE MECHANICALLY BONDED TO PROPOSED ANTENNA MOUNT COLLAR.** REFER TO DISH Wireless LLC GROUNDING NOTES.

NO SCALE	NO SCALE	3
----------	----------	---

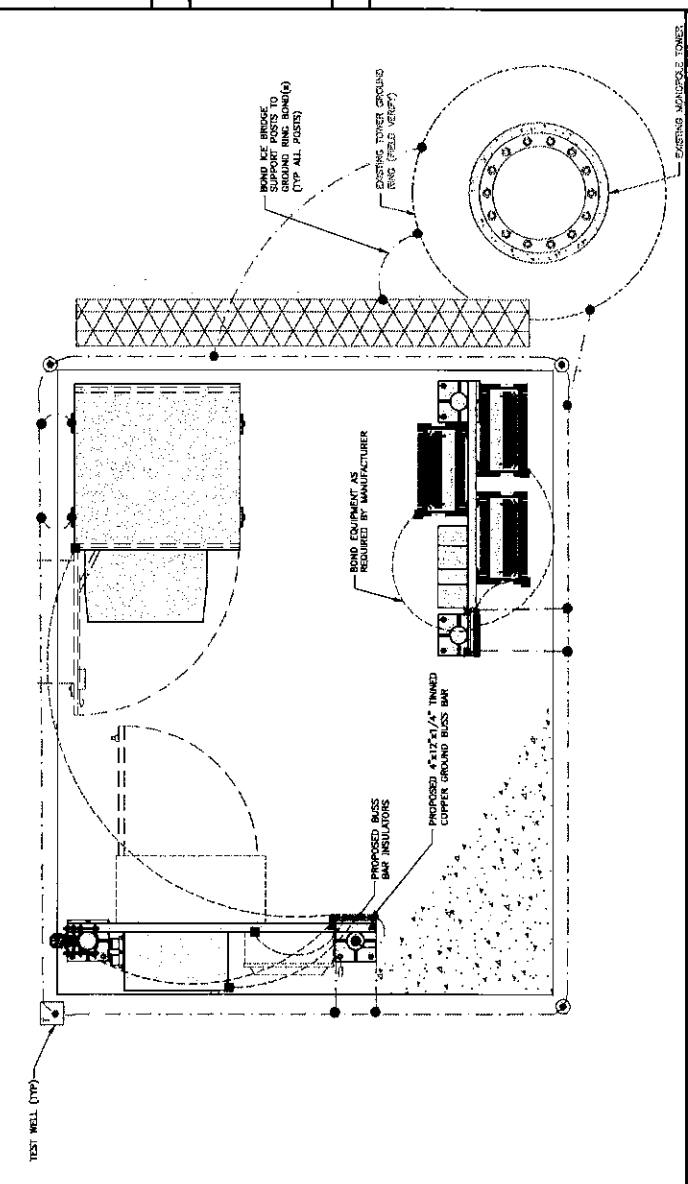

EQUIPMENT GROUNDING PLAN
NO SCALE

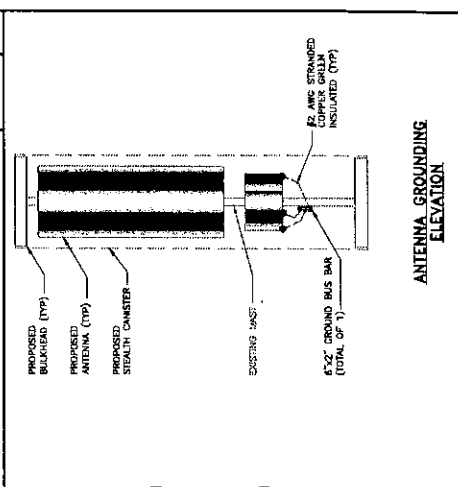

ANTENNA GROUNDING ELEVATION
NO SCALE

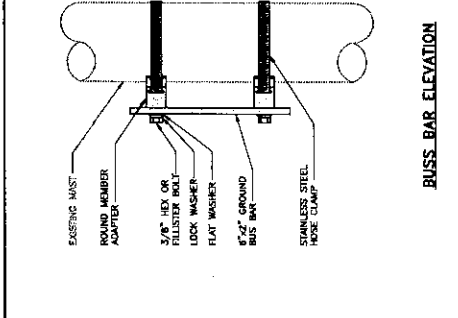

BUSS BAR ELEVATION
NO SCALE

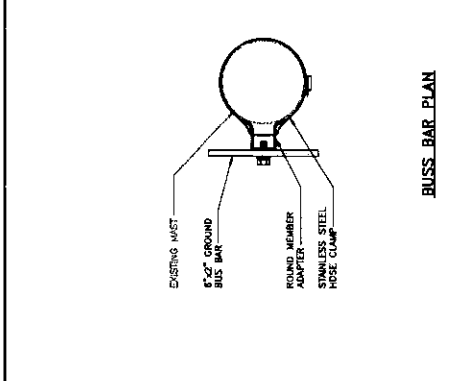

BUSS BAR PLAN
NO SCALE

GROUNDING KEY NOTES		3
TYPICAL ANTENNA GROUNDING DETAIL		2



3701 SOUTH SANTA FE DRIVE
LITTLETON, CO 80120

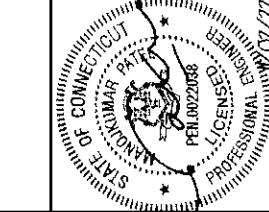

IT IS A VIOLATION OF LAW FOR ANY PERSON, UNLESS THEY ARE A LICENSED PROFESSIONAL ENGINEER, TO PREPARE THESE DOCUMENTS.

DESIGN BY:	APPROVED BY:
NAME	NAME
JOB	DATE
REVISION #	

CONSTRUCTION DOCUMENTS

REV	DATE	DESCRIPTION
0	11/19/24	ISSUE FOR PERMITS

ASE PROJECT NUMBER
10710-NJERO1125A

DISH Wireless LLC, PROJECT INFORMATION
NJERO1125A

395 ROUND HILL ROAD
GREENWICH, CT 06831

SHEET TITLE
GROUNDING DETAILS

SHEET NUMBER
G-2

NOTES

CABLE GROUNDING NOT REQUIRED WHEN ANTENNA IS LESS THAN 12" FROM CABINET

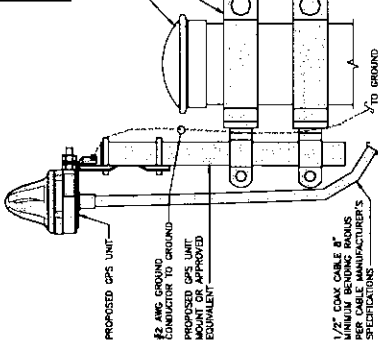

TYPICAL GPS UNIT GROUNDING

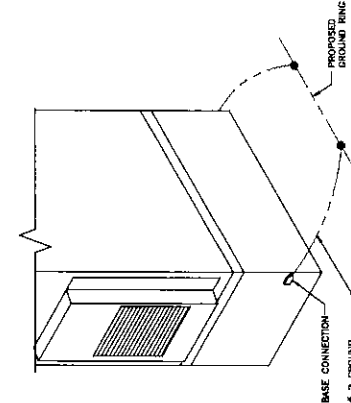

OUTDOOR CABINET GROUNDING

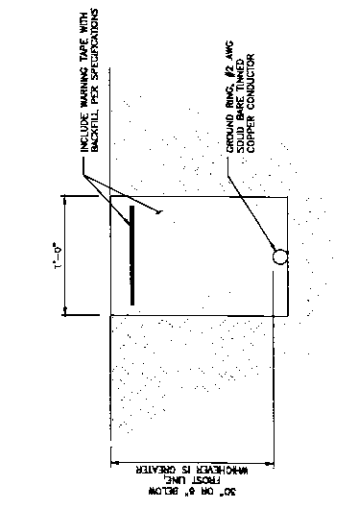

TYPICAL GROUND RING TRENCH

NOTES

EQUIPMENT CABINET LIMITED FOR CLARITY

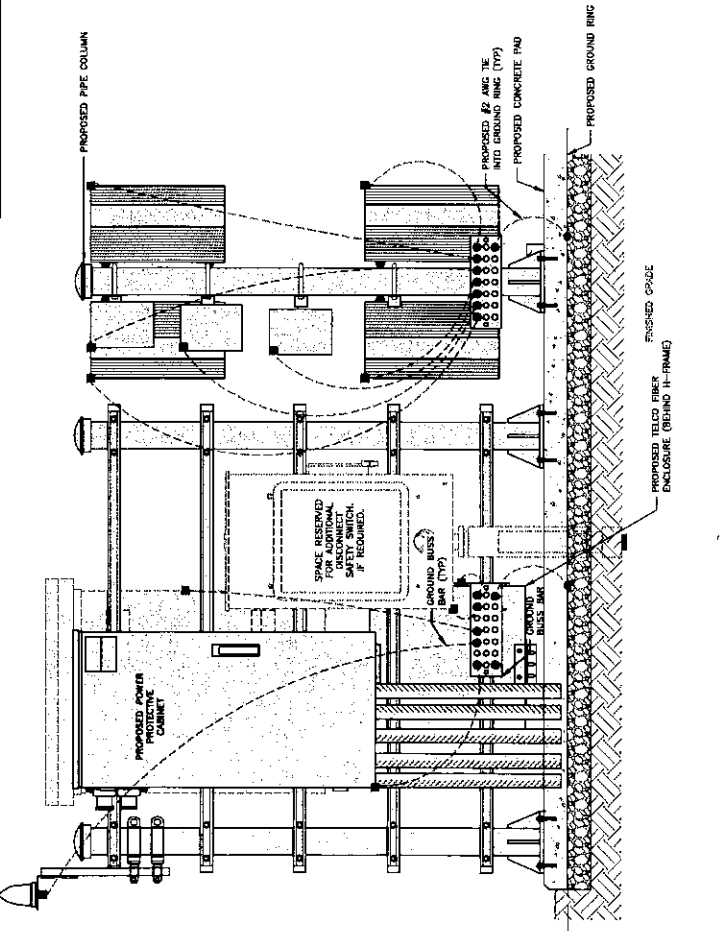

H-FRAME GROUNDING DETAIL

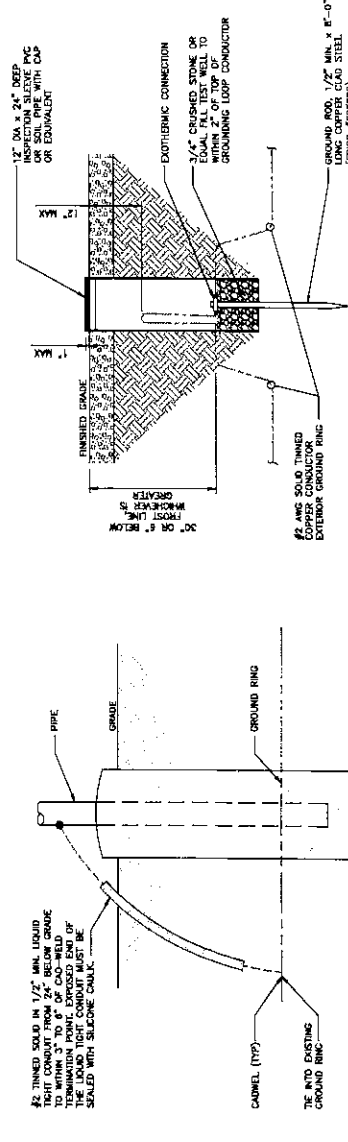

TYPICAL TEST GROUND ROD WITH INSPECTION SLEEVE

TRANSITIONING GROUND DETAIL

NO SCALE

NO SCALE

NO SCALE

NO SCALE

NO SCALE

NO SCALE

NO SCALE

NO SCALE

NO SCALE

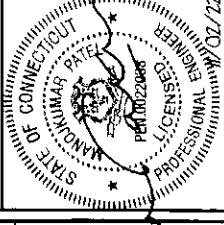

IT IS A VIOLATION OF LAW FOR ANY PERSON, UNLESS HE OR SHE IS A LICENSED PROFESSIONAL ENGINEER, TO ALTER THIS DOCUMENT.

DRAWN BY: [] CHECKED BY: APPROVED BY: []
DATE: []
REVISION # []

CONSTRUCTION DOCUMENTS

REV	DATE	DESCRIPTION
0	11/01/12	ISSUED FOR TAKE

486 PROJECT NUMBER
10710.NJERO1125A

DISH Wireless LLC. PROJECT INFORMATION
NJERO1125A

395 ROUND HILL ROAD
GREENWICH, CT 06851

SHEET TITLE
GROUNDING DETAILS

SHEET NUMBER
G-3

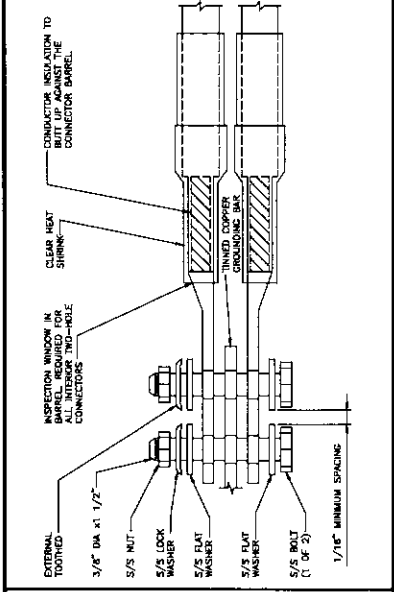

TYPICAL INTERIOR TWO HOLE LUG NO SCALE 3

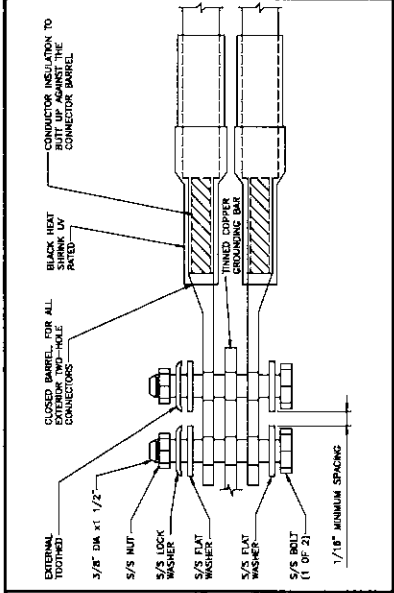

TYPICAL EXTERIOR TWO HOLE LUG NO SCALE 2

- TYPICAL GROUNDING NOTES**
- EXOTHERMIC WELD (E) TWO #2 ANNEaled SOLID COPPER CONDUCTORS TO GROUND BAR. ROUTE CONDUCTORS TO BURIED GROUND RING AND PROVIDE PARALLEL, EXOTHERMIC WELD.
 - ALL EXTERIOR GROUNDING HARDWARE SHALL BE STAINLESS STEEL 3/8" DIAMETER OR LARGER.
 - FOR GROUND BEND TO STEEL ONLY. COAT ALL SURFACES WITH AN ANTI-OXIDANT COMPOUND BEFORE MATING.
 - DO NOT INSTALL CABLE GROUNDING KIT AT A BEND AND ALWAYS DIRECT GROUND CONDUCTOR DOWN TO GROUNDING BUS.
 - NUT & WASHER SHALL BE PLACED ON THE FRONT SIDE OF THE GROUND BAR AND BOLTED ON THE BACK SIDE.
 - ALL GROUNDING PARTS AND EQUIPMENT TO BE SUPPLIED AND INSTALLED BY CONTRACTOR.
 - THE CONTRACTOR SHALL BE RESPONSIBLE FOR INSTALLING ADDITIONAL GROUND BAR AS REQUIRED.
 - ENSURE THE WIRE INSULATION TERMINATION IS WITHIN 1/8" OF THE BARREL (NO SHIMMERS).

TYPICAL GROUNDING NOTES NO SCALE 1

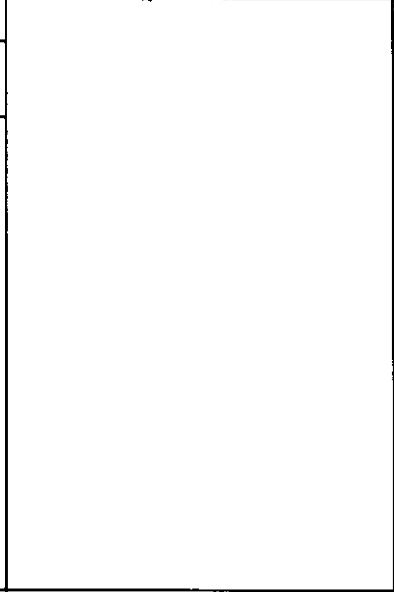

LUG DETAIL NO SCALE 4

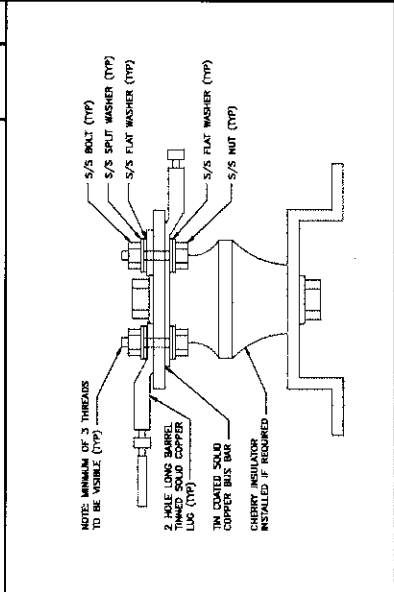

TYPICAL EXTERIOR TWO HOLE LUG NO SCALE 2

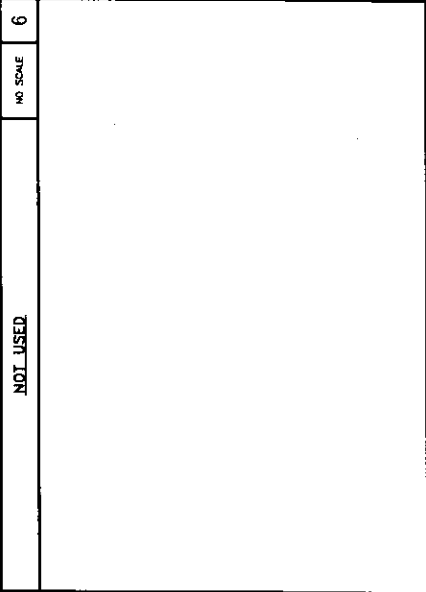

TYPICAL INTERIOR TWO HOLE LUG NO SCALE 3

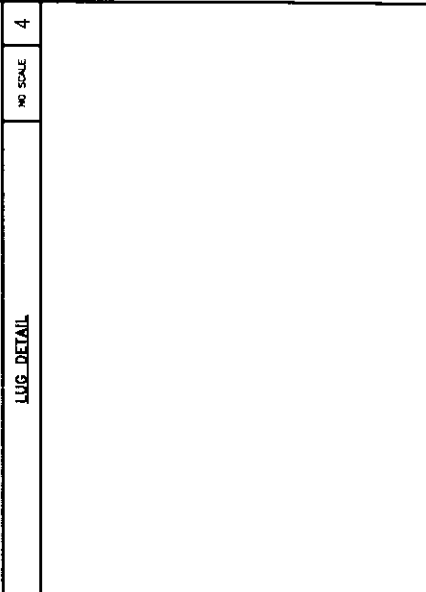

TYPICAL EXTERIOR TWO HOLE LUG NO SCALE 2

NO	SCALE	NOT USED
5	NO SCALE	NOT USED
6	NO SCALE	NOT USED

NO	SCALE	NOT USED
7	NO SCALE	NOT USED
8	NO SCALE	NOT USED

NO	SCALE	NOT USED
9	NO SCALE	NOT USED

RF JUMPER COLOR CODING

LOW-BAND RIN - (RANGE 871-950) **
 (RANGE 871-950) **
 (RANGE 871-950) **
 (OPTIONAL PER MARKET)

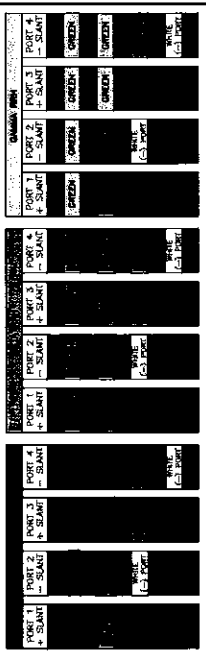

NO FREQUENCY COLOR TO SECTOR BAND CODES WILL USE YELLOW BANDS

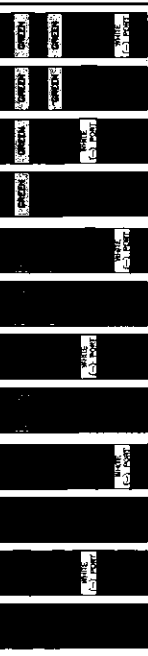

NO-FREQUENCY COLOR TO SECTOR BAND CODES WILL USE YELLOW BANDS



HYBRID/JUMPER CABLES

INCLUDE SECTOR BANDS BEING SUPPORTED ALONG WITH FREQUENCY BANDS
 EXAMPLE 1 = HYBRID, OR DISCREET SUPPORTS ALL SECTORS, BOTH LOW-BANDS AND NO-BANDS
 EXAMPLE 2 = HYBRID, OR DISCREET, SUPPORTS ONLY LOW-BANDS, ALL SECTORS

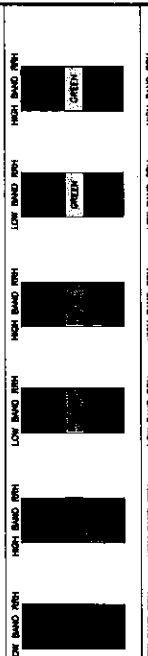

FIBER JUMPERS TO RINs

LOW-BAND RIN - FIBER COILES HAVE SECTOR STRIPE ONLY



POWER CABLES TO RINs

LOW-BAND RIN - POWER CABLES HAVE SECTOR STRIPE ONLY

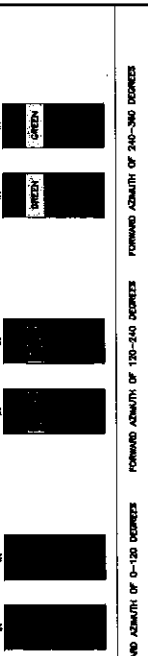

RET MOTORS AT ANTENNAS

ANTENNA 1 LOW-BAND/ HIGH-BAND/ NO-BAND/ STRIPE ONLY

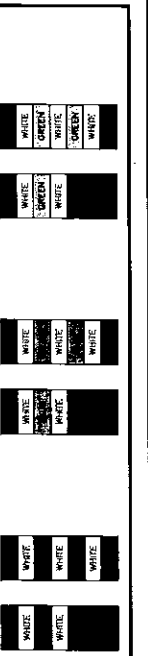

MICROWAVE RADIO LINKS

LINKS WILL HAVE A 1.5-2 INCH WHITE WRAP WITH THE ASSEMBLY CODE. DISCREET SUPPORTS IN THE MIDDLE OF THE WRAP. COLOR CODING SUPPORTS IN THE MIDDLE OF THE WRAP. ADDITIONAL W/R ADDITIONAL, NOT RADIO.

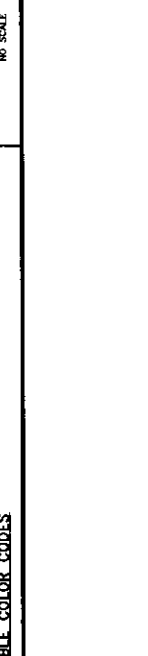

5701 SOUTH SANDY BE DRIVE
 LITTLETON, CO 80120

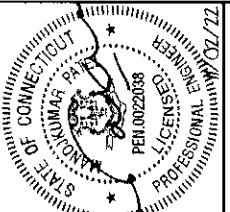

IT IS A VIOLATION OF LAW FOR ANY PERSON, UNLESS A LICENSED PROFESSIONAL ENGINEER TO SEAL THIS DOCUMENT.
 DRAWN BY: CHECKED BY: APPROVED BY:
 DATE: / /

CONSTRUCTION DOCUMENTS

NO. 1 DATE DESCRIPTION
 1 1/1/12 REVISION FOR PLANS

PROJECT NUMBER
 10710.NJNER01125A
 NJNER01125A
 JSR Wireless LLC. PROJECT INFORMATION

SHEET TITLE
 RF
 CABLE COLOR CODES

SHEET NUMBER
 RF-1

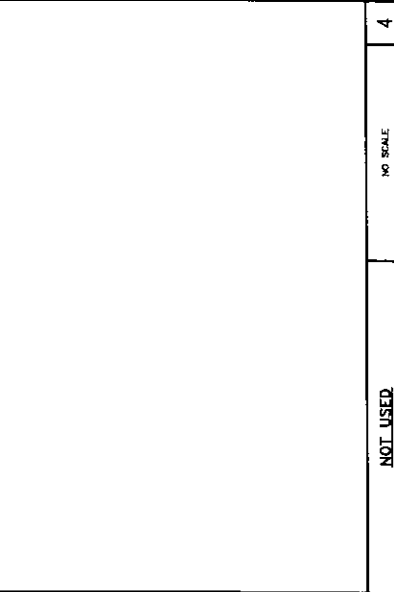
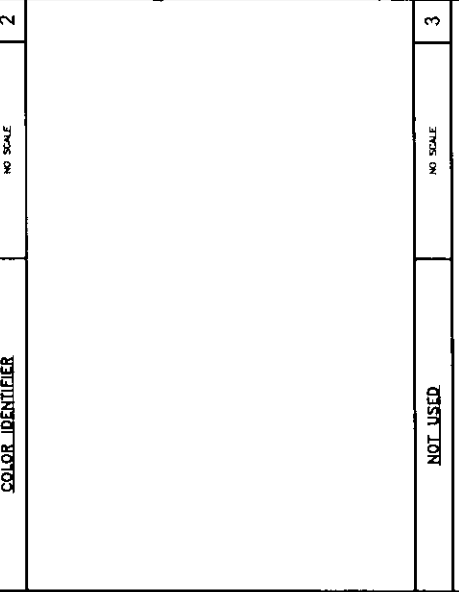
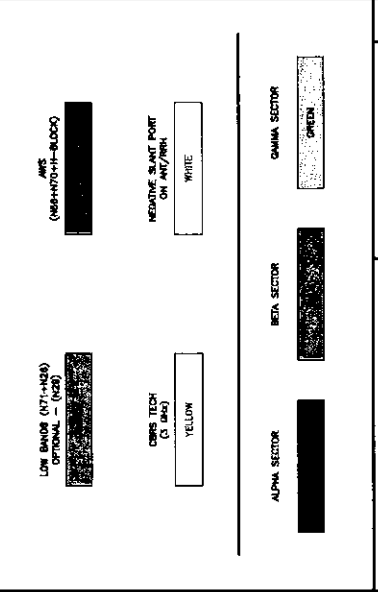

LOW-BANDS RIN - (RANGE 871-950) **
 (RANGE 871-950) **
 (RANGE 871-950) **
 (OPTIONAL PER MARKET)

NO FREQUENCY COLOR TO SECTOR BAND CODES WILL USE YELLOW BANDS

NO-FREQUENCY COLOR TO SECTOR BAND CODES WILL USE YELLOW BANDS

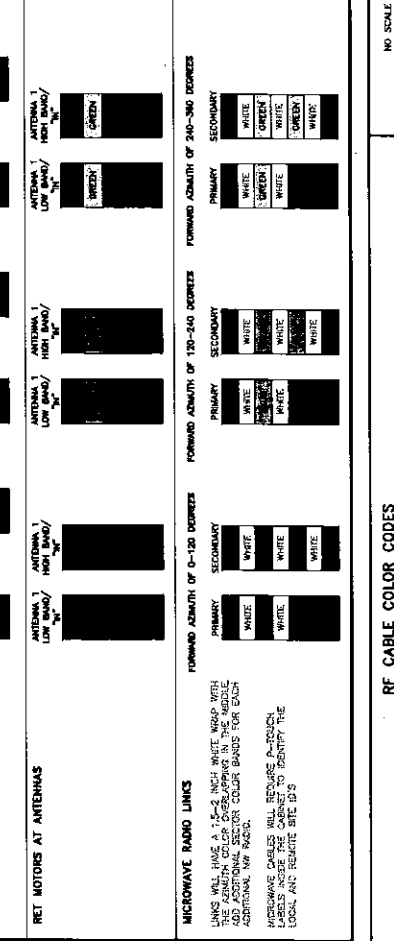
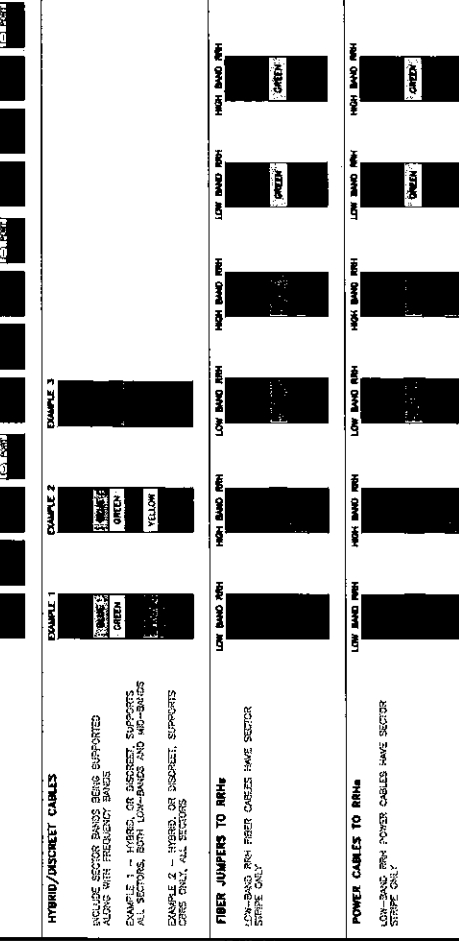
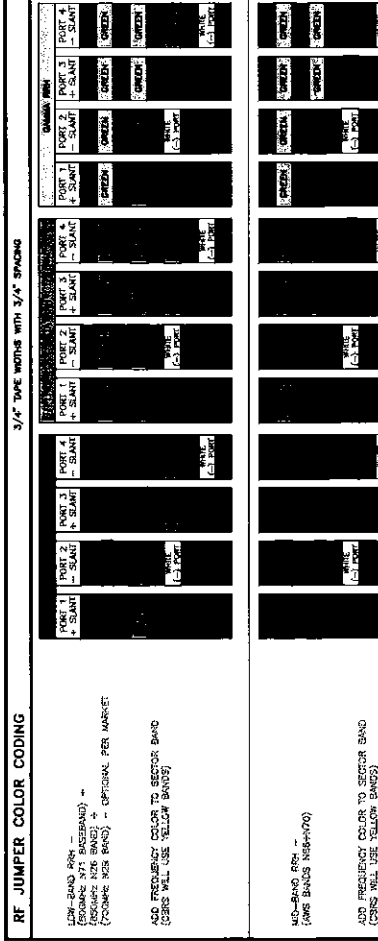

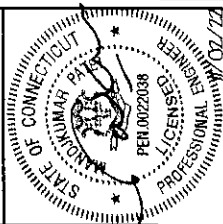

IT IS A VIOLATION OF LAW FOR ANY PERSON, UNLESS A LICENSED PROFESSIONAL ENGINEER, TO ALTER THIS DOCUMENT.

DRAWN BY: CHECKED BY: APPROVED BY:

DATE: 11/01/12

PROJECT NUMBER: 10710.NJ.JER01125A

PROJECT INFORMATION: DISH Wireless LLC

395 ROUND HILL ROAD GREENWICH, CT 06831

SHEET TITLE: LEGEND AND ABBREVIATIONS

SHEET NUMBER: GN-1

CONSTRUCTION DOCUMENTS

REV	DATE	DESCRIPTION
0	11/01/12	ISSUED FOR PERMITS

DATE	DESCRIPTION
11/01/12	ISSUED FOR PERMITS

DATE	DESCRIPTION
11/01/12	ISSUED FOR PERMITS

DATE	DESCRIPTION
11/01/12	ISSUED FOR PERMITS

DATE	DESCRIPTION
11/01/12	ISSUED FOR PERMITS

DATE	DESCRIPTION
11/01/12	ISSUED FOR PERMITS

DATE	DESCRIPTION
11/01/12	ISSUED FOR PERMITS

DATE	DESCRIPTION
11/01/12	ISSUED FOR PERMITS

DATE	DESCRIPTION
11/01/12	ISSUED FOR PERMITS

DATE	DESCRIPTION
11/01/12	ISSUED FOR PERMITS

DATE	DESCRIPTION
11/01/12	ISSUED FOR PERMITS

DATE	DESCRIPTION
11/01/12	ISSUED FOR PERMITS

DATE	DESCRIPTION
11/01/12	ISSUED FOR PERMITS

REV	DATE	DESCRIPTION
0	11/01/12	ISSUED FOR PERMITS

AB	INCH	IN	INCH
AB	ANCHOR BOLT	IN	INCH
AC	ALTERNATING CURRENT	IRIS	IRIS
ADD	ADDITIONAL	LF	LONG TERM EVOLUTION
AFD	ABOVE FINISHED FLOOR	LIE	LINE
AFS	ABOVE FINISHED GRADE	MAS	MASS
AG	ABOVE GRADE	MBS	MASS BUILT
AGC	ADDITIONAL INTERRUPTION CAPACITY	MB	MASS BUILT
AL	ALUMINUM	MBS	MASS BUILT
ALT	ALTERNATE	MBS	MASS BUILT
ANT	ANTENNA	MBS	MASS BUILT
APPROX	APPROXIMATE	MBS	MASS BUILT
ARCH	ARCHITECTURAL	MBS	MASS BUILT
ATS	AUTOMATIC TRANSFER SWITCH	MBS	MASS BUILT
AWG	AMERICAN WIRE GAUGE	MBS	MASS BUILT
BATT	BATTERY	MBS	MASS BUILT
BLDG	BUILDING	MBS	MASS BUILT
BLK	BLOCK	MBS	MASS BUILT
BLG	BLOCKING	MBS	MASS BUILT
BM	BEAM	MBS	MASS BUILT
BTC	BARE THINNED COPPER CONDUCTOR	MBS	MASS BUILT
BOF	BOTTOM OF FOOTING	MBS	MASS BUILT
CAB	CABINET	MBS	MASS BUILT
CANT	CANTILEVERED	MBS	MASS BUILT
CHG	CHARGING	MBS	MASS BUILT
CLG	CEILING	MBS	MASS BUILT
CLR	CLEAR	MBS	MASS BUILT
COL	COLUMN	MBS	MASS BUILT
COM	COMMON	MBS	MASS BUILT
CONC	CONCRETE	MBS	MASS BUILT
CONSTR	CONSTRUCTION	MBS	MASS BUILT
DBL	DOUBLE	MBS	MASS BUILT
DC	DIRECT CURRENT	MBS	MASS BUILT
DEPT	DEPTH	MBS	MASS BUILT
DF	DOWN FEED	MBS	MASS BUILT
DWG	DRAWING	MBS	MASS BUILT
DMS	DIMENSION	MBS	MASS BUILT
DNR	DRAWING	MBS	MASS BUILT
DWL	DOWEL	MBS	MASS BUILT
EA	EACH	MBS	MASS BUILT
EL	ELECTRICAL CONDUCTOR	MBS	MASS BUILT
ELEV	ELEVATION	MBS	MASS BUILT
ELEC	ELECTRICAL	MBS	MASS BUILT
EMT	ELECTRICAL METALLIC TUBING	MBS	MASS BUILT
ENG	ENGINEER	MBS	MASS BUILT
EQ	EQUAL	MBS	MASS BUILT
EXP	EXPANSION	MBS	MASS BUILT
EXT	EXTERIOR	MBS	MASS BUILT
EW	EACH WAY	MBS	MASS BUILT
FAB	FABRICATION	MBS	MASS BUILT
FF	FINISH FLOOR	MBS	MASS BUILT
FG	FINISH GRADE	MBS	MASS BUILT
FF	FACILITY INTERFACE FRAME	MBS	MASS BUILT
FIN	FINISH	MBS	MASS BUILT
FLR	FLOOR	MBS	MASS BUILT
FND	FOUNDATION	MBS	MASS BUILT
FDC	FACE OF CONCRETE	MBS	MASS BUILT
FSM	FACE OF MASONRY	MBS	MASS BUILT
FOS	FACE OF STUD	MBS	MASS BUILT
FS	FINISH SURFACE	MBS	MASS BUILT
FT	FOOT	MBS	MASS BUILT
FTG	FOOTING	MBS	MASS BUILT
GA	GAUGE	MBS	MASS BUILT
GEN	GENERATOR	MBS	MASS BUILT
GFCI	GROUND FAULT CIRCUIT INTERRUPTER	MBS	MASS BUILT
GLB	GLUE LAMINATED BEAM	MBS	MASS BUILT
GPS	GLOBAL POSITIONING SYSTEM	MBS	MASS BUILT
GRD	GROUND	MBS	MASS BUILT
GRM	GROUNDING SYSTEM FOR MOBILE	MBS	MASS BUILT
HCC	HOT DIPPED GALVANIZED	MBS	MASS BUILT
HOR	HANGER	MBS	MASS BUILT
HOR	HANGER	MBS	MASS BUILT
HMAG	HEAT/VENTILATION/AIR CONDITIONING	MBS	MASS BUILT
HT	HEIGHT	MBS	MASS BUILT
ISR	INTERIOR GROUND RING	MBS	MASS BUILT

AB	INCH	IN	INCH
AB	ANCHOR BOLT	IN	INCH
AC	ALTERNATING CURRENT	IRIS	IRIS
ADD	ADDITIONAL	LF	LONG TERM EVOLUTION
AFD	ABOVE FINISHED FLOOR	LIE	LINE
AFS	ABOVE FINISHED GRADE	MAS	MASS
AG	ABOVE GRADE	MBS	MASS BUILT
AGC	ADDITIONAL INTERRUPTION CAPACITY	MB	MASS BUILT
AL	ALUMINUM	MBS	MASS BUILT
ALT	ALTERNATE	MBS	MASS BUILT
ANT	ANTENNA	MBS	MASS BUILT
APPROX	APPROXIMATE	MBS	MASS BUILT
ARCH	ARCHITECTURAL	MBS	MASS BUILT
ATS	AUTOMATIC TRANSFER SWITCH	MBS	MASS BUILT
AWG	AMERICAN WIRE GAUGE	MBS	MASS BUILT
BATT	BATTERY	MBS	MASS BUILT
BLDG	BUILDING	MBS	MASS BUILT
BLK	BLOCK	MBS	MASS BUILT
BLG	BLOCKING	MBS	MASS BUILT
BM	BEAM	MBS	MASS BUILT
BTC	BARE THINNED COPPER CONDUCTOR	MBS	MASS BUILT
BOF	BOTTOM OF FOOTING	MBS	MASS BUILT
CAB	CABINET	MBS	MASS BUILT
CANT	CANTILEVERED	MBS	MASS BUILT
CHG	CHARGING	MBS	MASS BUILT
CLG	CEILING	MBS	MASS BUILT
CLR	CLEAR	MBS	MASS BUILT
COL	COLUMN	MBS	MASS BUILT
COM	COMMON	MBS	MASS BUILT
CONC	CONCRETE	MBS	MASS BUILT
CONSTR	CONSTRUCTION	MBS	MASS BUILT
DBL	DOUBLE	MBS	MASS BUILT
DC	DIRECT CURRENT	MBS	MASS BUILT
DEPT	DEPTH	MBS	MASS BUILT
DF	DOWN FEED	MBS	MASS BUILT
DWG	DRAWING	MBS	MASS BUILT
DMS	DIMENSION	MBS	MASS BUILT
DNR	DRAWING	MBS	MASS BUILT
DWL	DOWEL	MBS	MASS BUILT
EA	EACH	MBS	MASS BUILT
EL	ELECTRICAL CONDUCTOR	MBS	MASS BUILT
ELEV	ELEVATION	MBS	MASS BUILT
ELEC	ELECTRICAL	MBS	MASS BUILT
EMT	ELECTRICAL METALLIC TUBING	MBS	MASS BUILT
ENG	ENGINEER	MBS	MASS BUILT
EQ	EQUAL	MBS	MASS BUILT
EXP	EXPANSION	MBS	MASS BUILT
EXT	EXTERIOR	MBS	MASS BUILT
EW	EACH WAY	MBS	MASS BUILT
FAB	FABRICATION	MBS	MASS BUILT
FF	FINISH FLOOR	MBS	MASS BUILT
FG	FINISH GRADE	MBS	MASS BUILT
FF	FACILITY INTERFACE FRAME	MBS	MASS BUILT
FIN	FINISH	MBS	MASS BUILT
FLR	FLOOR	MBS	MASS BUILT
FND	FOUNDATION	MBS	MASS BUILT
FDC	FACE OF CONCRETE	MBS	MASS BUILT
FSM	FACE OF MASONRY	MBS	MASS BUILT
FOS	FACE OF STUD	MBS	MASS BUILT
FS	FINISH SURFACE	MBS	MASS BUILT
FT	FOOT	MBS	MASS BUILT
FTG	FOOTING	MBS	MASS BUILT
GA	GAUGE	MBS	MASS BUILT
GEN	GENERATOR	MBS	MASS BUILT
GFCI	GROUND FAULT CIRCUIT INTERRUPTER	MBS	MASS BUILT
GLB	GLUE LAMINATED BEAM	MBS	MASS BUILT
GPS	GLOBAL POSITIONING SYSTEM	MBS	MASS BUILT
GRD	GROUND	MBS	MASS BUILT
GRM	GROUNDING SYSTEM FOR MOBILE	MBS	MASS BUILT
HCC	HOT DIPPED GALVANIZED	MBS	MASS BUILT
HOR	HANGER	MBS	MASS BUILT
HOR	HANGER	MBS	MASS BUILT
HMAG	HEAT/VENTILATION/AIR CONDITIONING	MBS	MASS BUILT
HT	HEIGHT	MBS	MASS BUILT
ISR	INTERIOR GROUND RING	MBS	MASS BUILT



ABBREVIATIONS

LEGEND

dish
wireless.

3701 SOUTH SANTA FE DRIVE
LITTLETON, CO 80120

Tectonic
PROFESSIONAL ENGINEERING
10000 E. 17th Avenue, Suite 100
Denver, CO 80232
Phone: (303) 440-4400
Fax: (303) 440-4401

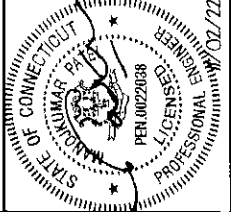

IT IS A VIOLATION OF LAW FOR ANY PERSON, UNDER PENALTY OF PERSECUTION, TO REPRODUCE OR ALTER THIS DOCUMENT.

DATE	BY	DESCRIPTION

CONSTRUCTION DOCUMENTS

REV	DATE	DESCRIPTION
1	1/16/22	ISSUE FOR PERM

AME PROJECT NUMBER
107710-NJER01125A

DISH Wireless LLC. PROJECT INFORMATION
NJER01125A

395 ROUND HILL ROAD
GREENWICH, CT 06831

SHEET TITLE
RF SIGNAGE

SHEET NUMBER
GN-2

INFORMATION

This is an access point to an area with transmitting antennas.

Obey all signs and barriers beyond this point.
Call the DISH Wireless L.L.C. NOC at 1-866-624-6874



Site ID: _____

THIS SIGN IS FOR REFERENCE PURPOSES ONLY

TYPE	COLOR	CODE	PURPOSE
INFORMATION	GREEN	"INFORMATIONAL SIGN"	TO NOTIFY OTHERS OF SITE OWNERSHIP & CONTACT NUMBER AND POTENTIAL RF EXPOSURE.
NOTICE	BLUE	NOTICE BEYOND THIS POINT	RF FIELDS BEYOND THIS POINT MAY EXCEED THE FCC GENERAL PUBLIC EXPOSURE LIMIT. OBEY ALL POSTED SIGNS AND SITE GUIDELINES FOR WORKING IN RF ENVIRONMENTS IN ACCORDANCE WITH FEDERAL COMMUNICATIONS COMMISSION RULES ON RADIO FREQUENCY EMISSIONS 47 CFR-1.1307(D).
CAUTION	YELLOW	"CAUTION BEYOND THIS POINT"	RF FIELDS BEYOND THIS POINT MAY EXCEED THE FCC GENERAL PUBLIC EXPOSURE LIMIT. OBEY ALL POSTED SIGNS AND SITE GUIDELINES FOR WORKING IN RF ENVIRONMENTS IN ACCORDANCE WITH FEDERAL COMMUNICATIONS COMMISSION RULES ON RADIO FREQUENCY EMISSIONS 47 CFR-1.1307(D).
WARNING	ORANGE/RED	"WARNING BEYOND THIS POINT"	RF FIELDS AT THIS SITE EXCEED FCC RULES FOR HUMAN EXPOSURE. FAILURE TO OBEY ALL POSTED SIGNS AND SITE GUIDELINES FOR WORKING IN RF ENVIRONMENTS COULD RESULT IN SERIOUS INJURY. IN ACCORDANCE WITH FEDERAL COMMUNICATIONS COMMISSION RULES ON RADIO FREQUENCY EMISSIONS 47 CFR-1.1307(D).

SIGN PLACEMENT:
- RF SIGNAGE PLACEMENT SHALL FOLLOW THE RECOMMENDATIONS OF AN EXISTING EME REPORT, CREATED BY A THIRD PARTY PREVIOUSLY AUTHORIZED BY DISH Wireless L.L.C.
- INFORMATION SIGN (GREEN) SHALL BE LOCATED ON EXISTING DISH Wireless L.L.C. EQUIPMENT.
A) IF THE INFORMATION SIGN IS A SIGNAGE, IT SHALL BE PLACED ON EXISTING DISH Wireless L.L.C. CONSTRUCTION MANAGER RECOMMENDATIONS.
B) IF THE INFORMATION SIGN IS A METAL SIGN IT SHALL BE PLACED ON EXISTING DISH Wireless L.L.C. N-FRAME WITH A SECURE ATTACH METHOD.
- IF EME REPORT IS NOT AVAILABLE AT THE TIME OF CREATION OF CONSTRUCTION DOCUMENTS, PLEASE CONTACT DISH Wireless L.L.C. CONSTRUCTION MANAGER FOR FURTHER INSTRUCTION ON HOW TO PROCEED.

- NOTES:**
- FOR DISH Wireless L.L.C. LOGO, SEE DISH Wireless L.L.C. DESIGN SPECIFICATIONS (PROVIDED BY DISH Wireless L.L.C.)
 - SITE ID SHALL BE APPLIED TO SIGNS USING "LASER ENGRAVING" OR ANY OTHER WEATHER RESISTANT METHOD (DISH Wireless L.L.C. APPROVAL REQUIRED)
 - TEXT FOR SIGNAGE SHALL INDICATE CORRECT SITE NAME AND NUMBER AS PER DISH Wireless L.L.C. CONSTRUCTION MANAGER RECOMMENDATIONS.
 - CORNER/SHIELDER MOUNTING APPLICATION REQUIRES ANOTHER PLATE APPLIED TO THE FACE OF THE CABINET WITH WATER PROOF POLYURETHANE ADHESIVE
 - ALL SIGNS WILL BE SECURED WITH EITHER STAINLESS STEEL ZIP TIES OR STAINLESS STEEL TECH SCREWS
 - ALL SIGNS TO BE 8.5"x11" AND MADE WITH 6061 OF ALUMINUM INTERNAL

NOTICE



Transmitting Antenna(s)
Radio frequency fields beyond this point MAY EXCEED the FCC Occupational exposure limit.
Obey all posted signs and site guidelines for working in radio frequency environments.
Call the DISH Wireless L.L.C. NOC at 1-866-624-6874 prior to working beyond this point.

Site ID: _____



THIS SIGN IS FOR REFERENCE PURPOSES ONLY

CAUTION



Transmitting Antenna(s)
Radio frequency fields beyond this point MAY EXCEED the FCC Occupational exposure limit.
Obey all posted signs and site guidelines for working in radio frequency environments.
Call the DISH Wireless L.L.C. NOC at 1-866-624-6874 prior to working beyond this point.

Site ID: _____



THIS SIGN IS FOR REFERENCE PURPOSES ONLY

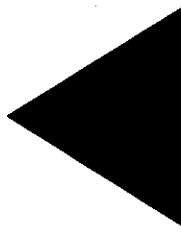

Transmitting Antenna(s)
Radio frequency fields beyond this point EXCEED the FCC Occupational exposure limit.
Obey all posted signs and site guidelines for working in radio frequency environments.
Call the DISH Wireless L.L.C. NOC at 1-866-624-6874 prior to working beyond this point.

Site ID: _____



THIS SIGN IS FOR REFERENCE PURPOSES ONLY

RF_SIGNAGE

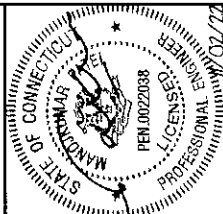

THIS IS A PORTION OF THE JOB FOR WHICH THE CONTRACTOR HAS BEEN LICENSED UNDER THE PROFESSIONAL ENGINEER ACT OF THE STATE OF CONNECTICUT. IT IS TO BE USED ONLY FOR THE PROJECT AND TO REMAIN THE PROPERTY OF THE CONTRACTOR.

DATE:	01/22	
DRAWN BY:	CK	
CHECKED BY:	APPROVED BY:	
NM	JO	MP
REVISED BY:		

CONSTRUCTION DOCUMENTS

SUBMITTALS	
REV	DATE
0	1/14/22
	ISSUED FOR PERMIT
	ISSUED FOR BIDDING
	ISSUED FOR CONSTRUCTION

A&E PROJECT NUMBER	10710.NJ.10710125A
DISH WIRELESS LLC PROJECT INFORMATION	
NJ10710125A	
395 ROUND HILL ROAD	
GREENWICH, CT 06831	
SHEET TITLE	GENERAL NOTES
SHEET NUMBER	GN-3

GENERAL NOTES:

1. FOR THE PURPOSE OF CONSTRUCTION DRAWING, THE FOLLOWING DEFINITIONS SHALL APPLY:
 CONTRACTOR=GENERAL CONTRACTOR RESPONSIBLE FOR CONSTRUCTION
 CARRIER=DISH WIRELESS
 TOWER OWNER=TOWER OWNER

2. THESE DRAWINGS HAVE BEEN PREPARED USING STANDARDS OF PROFESSIONAL CARE AND COMPLETENESS NORMALLY EXERCISED UNDER SIMILAR CIRCUMSTANCES BY REPUTABLE ENGINEERS IN THIS OR SIMILAR LOCALITIES. IT IS ASSUMED THAT THE WORK DEPICTED WILL BE PERFORMED BY AN EXPERIENCED CONTRACTOR AND/OR WORKPERSONS WHO HAVE ADEQUATE KNOWLEDGE OF THE APPLICABLE CODES (FOR NECA AND NETA), AS WELL AS THE PRACTICES AND PROCEDURES OF THE INDUSTRY. THE CONTRACTOR SHALL USE INDUSTRY ACCEPTED STANDARD GOOD PRACTICE FOR MISCELLANEOUS WORK NOT EXPLICITLY SHOWN.

3. THESE DRAWINGS REPRESENT THE FINISHED STRUCTURE. THEY DO NOT INDICATE THE MEANS OR METHODS OF CONSTRUCTION. THE CONTRACTOR SHALL BE SOLELY RESPONSIBLE FOR THE CONSTRUCTION MEANS, METHODS, TECHNIQUES, AND SEQUENCES TO BE USED TO CONSTRUCT THE STRUCTURE SHOWN. SUCH MEASURES SHALL INCLUDE, BUT NOT BE LIMITED TO, BRACING, FORMWORK, SHORING, ETC. SITE VISITS BY THE ENGINEER OR HIS REPRESENTATIVE WILL NOT INCLUDE INSPECTION OF THESE ITEMS AND IS FOR STRUCTURAL OBSERVATION OF THE FINISHED STRUCTURE ONLY.

4. NOTES AND DETAILS IN THE CONSTRUCTION DRAWINGS SHALL TAKE PRECEDENCE OVER GENERAL NOTES AND TYPICAL DETAILS WHERE NO DETAILS ARE SHOWN. CONSTRUCTION SHALL CONFORM TO SIMILAR WORK ON THE PROJECT AND/OR AS PROVIDED FOR IN THE CONTRACT DOCUMENTS. WHERE DISCREPANCIES OCCUR BETWEEN PLANS, DETAILS, GENERAL NOTES, AND SPECIFICATIONS, THE GREATER, MORE STRICT REQUIREMENTS, SHALL GOVERN. IF FURTHER CLARIFICATION IS REQUIRED CONTACT THE ENGINEER OF RECORD.

5. SUBSTANTIAL EFFORT HAS BEEN MADE TO PROVIDE ACCURATE DIMENSIONS AND MEASUREMENTS ON THE DRAWINGS TO ASSIST IN THE FABRICATION AND/OR PLACEMENT OF CONSTRUCTION ELEMENTS BUT IT IS THE SOLE RESPONSIBILITY OF THE CONTRACTOR TO FIELD VERIFY THE DIMENSIONS, MEASUREMENTS AND/OR CLEARANCES SHOWN IN THE CONSTRUCTION DRAWINGS PRIOR TO FABRICATION OR CUTTING OF ANY NEW OR EXISTING CONSTRUCTION ELEMENTS. IF IT IS DETERMINED THAT THERE ARE DISCREPANCIES AND/OR CONFLICTS WITH THE CONSTRUCTION DRAWINGS THE ENGINEER OF RECORD IS TO BE NOTIFIED AS SOON AS POSSIBLE.

6. PRIOR TO THE SUBMISSION OF BIDS, THE BIDDING CONTRACTOR SHALL VISIT THE CELL SITE TO FAMILIARIZE WITH THE EXISTING CONDITIONS AND TO VERIFY THAT THE CONDITIONS SHOWN ON THE CONSTRUCTION DRAWINGS ARE CORRECT. ANY DISCREPANCY FOUND SHALL BE BROUGHT TO THE ATTENTION OF CARRIER POC AND TOWER OWNER.

7. ALL MATERIALS FURNISHED AND INSTALLED SHALL BE IN STRICT ACCORDANCE WITH ALL APPLICABLE CODES, REGULATIONS AND ORDINANCES. CONTRACTOR SHALL ISSUE ALL APPROPRIATE NOTICES AND COMPLIANCE WITH ALL APPLICABLE LOCAL, STATE, AND FEDERAL REQUIREMENTS. ALL MATERIALS AND WORKMANSHIP SHALL COMPLY WITH ALL APPLICABLE MUNICIPAL AND UTILITY COMPANY SPECIFICATIONS AND LOCAL JURISDICTIONAL CODES, ORDINANCES AND APPLICABLE REGULATIONS.

8. UNLESS NOTED OTHERWISE, THE WORK SHALL INCLUDE FURNISHING MATERIALS, EQUIPMENT, APPURTENANCES AND LABOR NECESSARY TO COMPLETE ALL INSTALLATIONS AS INDICATED ON THE DRAWINGS.

9. THE CONTRACTOR SHALL INSTALL ALL EQUIPMENT AND MATERIALS IN ACCORDANCE WITH MANUFACTURER'S RECOMMENDATIONS UNLESS SPECIFICALLY STATED OTHERWISE.

10. IF THE SPECIFIED EQUIPMENT CAN NOT BE INSTALLED AS SHOWN ON THESE DRAWINGS, THE CONTRACTOR SHALL PROPOSE AN ALTERNATIVE INSTALLATION FOR APPROVAL BY THE CARRIER AND TOWER OWNER PRIOR TO PROCEEDING WITH ANY SUCH CHANGE OF INSTALLATION.

11. CONTRACTOR IS TO PERFORM A SITE INVESTIGATION, BEFORE SUBMITTING BIDS, TO DETERMINE THE BEST ROUTING OF ALL CONDUITS FOR POWER, AND TELCO AND FOR GROUNDING CABLES AS SHOWN IN THE POWER, TELCO, AND GROUNDING PLAN DRAWINGS.

12. THE CONTRACTOR SHALL PROTECT EXISTING IMPROVEMENTS, PAVEMENTS, CURBS, LANDSCAPING AND STRUCTURES. ANY DAMAGED PART SHALL BE REPAIRED AT CONTRACTOR'S EXPENSE TO THE SATISFACTION OF DISH WIRELESS AND TOWER OWNER.

13. CONTRACTOR SHALL LEGALLY AND PROPERLY DISPOSE OF ALL SCRAP MATERIALS SUCH AS COAXIAL CABLES AND OTHER ITEMS REMOVED FROM THE EXISTING FACILITY. ANTENNAS REMOVED SHALL BE RETURNED TO THE OWNER'S DESIGNATED LOCATION.

14. CONTRACTOR SHALL LEAVE PREMISES IN CLEAN CONDITION. TRASH AND DEBRIS SHOULD BE REMOVED FROM SITE ON A DAILY BASIS.

GENERAL NOTES:

1. NOTICE TO PROCEED - NO WORK SHALL COMMENCE PRIOR TO CONTRACTOR RECEIVING A WRITTEN NOTICE TO PROCEED (NTP) AND THE ISSUANCE OF A PURCHASE ORDER. PRIOR TO ACCESSING/ENTERING THE SITE YOU MUST CONTACT THE DISH WIRELESS AND TOWER OWNER POC & THE DISH WIRELESS AND TOWER OWNER CONSTRUCTION MANAGER.

2. "LOOK UP" - DISH WIRELESS AND TOWER OWNER SAFETY CLIMB REQUIREMENT:
 THE INTEGRITY OF THE SAFETY CLIMB AND ALL COMPONENTS OF THE CLIMBING FACILITY SHALL BE CONSIDERED DURING ALL STAGES OF DESIGN, INSTALLATION, AND INSPECTION. TOWER MODIFICATION, MOUNT REINFORCEMENTS, AND/OR EQUIPMENT INSTALLATIONS SHALL NOT COMPROMISE THE INTEGRITY OR FUNCTIONAL USE OF THE SAFETY CLIMB OR ANY COMPONENTS OF THE CLIMBING FACILITY ON THE STRUCTURE. THIS CONTACT OR CLOSE PROXIMITY TO THE WIRE ROPE WHICH MAY CAUSE FRICTIONAL WEAR, IMPACT TO THE ANCHORAGE POINTS IN ANY WAY, OR TO IMPEDE/BLOCK ITS INTENDED USE. ANY COMPROMISED SAFETY CLIMB, INCLUDING EXISTING EQUIPMENT AND/OR MATERIALS, SHALL BE IMMEDIATELY REPORTED TO THE DISH WIRELESS AND TOWER OWNER POC OR CALL THE POC TO GENERATE A SAFETY CLIMB MAINTENANCE AND CONTRACTOR NOTICE TOWER.

3. PRIOR TO THE START OF CONSTRUCTION, ALL REQUIRED JURISDICTIONAL PERMITS SHALL BE OBTAINED. THIS INCLUDES, BUT IS NOT LIMITED TO, BUILDING, ELECTRICAL, MECHANICAL, FIRE FLOOD ZONE, ENVIRONMENTAL, AND ZONING. AFTER ON-SITE ACTIVITIES BEGAIN, ALL REQUIRED PERMITS SHALL BE OBTAINED AND CLOSED OUT ACCORDING TO LOCAL JURISDICTIONAL REQUIREMENTS.

4. ALL CONSTRUCTION MEANS AND METHODS, INCLUDING BUT NOT LIMITED TO, ERECTION PLANS, RIGGING PLANS, CLIMBING PLANS, AND RESCUE PLANS SHALL BE THE RESPONSIBILITY OF THE GENERAL CONTRACTOR RESPONSIBLE FOR THE EXECUTION OF THE WORK SHOWN HEREIN, AND SHALL MEET ANSI/ASSE A10.49 (LATEST EDITION); FEDERAL, STATE, AND LOCAL REGULATIONS; AND SHALL COMPLY WITH OSHA 1926.550 (LATEST EDITION) AND DISH WIRELESS AND TOWER OWNER STANDARDS. INCLUDING THE REQUIRED INVOLVEMENT OF A QUALIFIED ENGINEER FOR CLASS IV CONSTRUCTION, TO VERIFY THE SUPPORTING STRUCTURES IN ACCORDANCE WITH ANSI/TIA-322 (LATEST EDITION).

5. ALL SITE WORK TO COMPLY WITH DISH WIRELESS AND TOWER OWNER INSTALLATION STANDARDS FOR CONSTRUCTION ACTIVITIES ON DISH WIRELESS AND TOWER OWNER TOWER SITE AND LATEST VERSION OF ANSI/TIA-1019-A-2012 "STANDARD FOR INSTALLATION, ALTERATION, AND MAINTENANCE OF ANTENNA SUPPORTING STRUCTURES AND ANTENNAS."

6. IF THE SPECIFIED EQUIPMENT CAN NOT BE INSTALLED AS SHOWN ON THESE DRAWINGS, THE CONTRACTOR SHALL PROPOSE AN ALTERNATIVE INSTALLATION FOR APPROVAL BY DISH WIRELESS AND TOWER OWNER PRIOR TO PROCEEDING WITH ANY SUCH CHANGE OF INSTALLATION.

7. ALL MATERIALS FURNISHED AND INSTALLED SHALL BE IN STRICT ACCORDANCE WITH ALL APPLICABLE CODES, REGULATIONS AND ORDINANCES. CONTRACTOR SHALL ISSUE ALL APPROPRIATE NOTICES AND COMPLY WITH ALL LAWS, ORDINANCES, RULES, REGULATIONS AND LAWFUL ORDERS OF ANY PUBLIC AUTHORITY REGARDING THE PERFORMANCE OF THE WORK. ALL WORK CARRIED OUT SHALL COMPLY WITH ALL APPLICABLE MUNICIPAL AND UTILITY COMPANY SPECIFICATIONS AND LOCAL JURISDICTIONAL CODES, ORDINANCES AND APPLICABLE REGULATIONS.

8. THE CONTRACTOR SHALL INSTALL ALL EQUIPMENT AND MATERIALS IN ACCORDANCE WITH MANUFACTURER'S RECOMMENDATIONS UNLESS SPECIFICALLY STATED OTHERWISE.

9. THE CONTRACTOR SHALL CONTACT UTILITY LOCATING SERVICES INCLUDING PRIVATE LOCATES SERVICES PRIOR TO THE START OF CONSTRUCTION.

10. ALL EXISTING ACTIVE SEWER, WATER, GAS, ELECTRIC AND OTHER UTILITIES WHERE ENCOUNTERED IN THE WORK, SHALL BE PROTECTED AT ALL TIMES AND WHERE REQUIRED FOR THE PROPER EXECUTION OF THE WORK, SHALL BE RELOCATED AS DIRECTED BY CONTRACTOR. EXTREME CAUTION SHOULD BE USED BY THE CONTRACTOR WHEN EXCAVATING OR DRILLING PIERS AROUND OR NEAR UTILITIES. CONTRACTOR SHALL PROVIDE SAFETY TRAINING FOR THE WORKING CREW. THIS WILL INCLUDE BUT NOT BE LIMITED TO A) FALL PROTECTION B) CONFINED SPACE C) ELECTRICAL SAFETY D) TRENCHING AND EXCAVATION E) CONSTRUCTION SAFETY PROCEDURES.

11. ALL SITE WORK SHALL BE AS INDICATED ON THE STAMPED CONSTRUCTION DRAWINGS AND DISH PROJECT SPECIFICATIONS, LATEST APPROVED REVISION.

12. CONTRACTOR SHALL KEEP THE SITE FREE FROM ACCUMULATING WASTE MATERIAL, DEBRIS, AND TRASH AT THE COMPLETION OF THE WORK, IF NECESSARY, RUBBISH, STUMPS, DEBRIS, STICKS, STONES AND OTHER REFUSE SHALL BE REMOVED FROM THE SITE AND DISPOSED OF LEGALLY.

13. ALL EXISTING INACTIVE SEWER, WATER, GAS, ELECTRIC AND OTHER UTILITIES, WHICH INTERFERE WITH THE EXECUTION OF THE WORK, SHALL BE REMOVED AND/OR CAPPED, PLUGGED OR OTHERWISE DISCONTINUED AT POINTS WHICH WILL NOT INTERFERE WITH THE EXECUTION OF THE WORK. SUBJECT TO THE APPROVAL OF DISH WIRELESS AND TOWER OWNER, AND/OR LOCAL UTILITIES.

14. THE CONTRACTOR SHALL PROVIDE SITE SIGNAGE IN ACCORDANCE WITH THE TECHNICAL SPECIFICATION FOR SITE SIGNAGE REQUIRED BY LOCAL JURISDICTION AND SIGNAGE REQUIRED ON INDIVIDUAL PIECES OF EQUIPMENT, ROOMS, AND SHELTERS.

15. THE SITE SHALL BE GRADED TO CAUSE SURFACE WATER TO FLOW AWAY FROM THE CARRIER'S EQUIPMENT AND TOWER AREAS.

16. THE SUB GRADE SHALL BE COMPACTED AND BROUGHT TO A SMOOTH UNIFORM GRADE PRIOR TO FINISHED SURFACE APPLICATION.

17. THE AREAS OF THE OWNERS PROPERTY, DISTURBED BY THE WORK AND NOT COVERED BY THE TOWER, EQUIPMENT OR DRAINWAY, SHALL BE GRADED TO A UNIFORM SLOPE, AND STABILIZED TO PREVENT EROSION AS SPECIFIED ON THE CONSTRUCTION DRAWINGS AND/OR PROJECT SPECIFICATIONS.

18. CONTRACTOR SHALL MINIMIZE DISTURBANCE TO EXISTING SITE DURING CONSTRUCTION. EROSION CONTROL MEASURES, IF REQUIRED DURING CONSTRUCTION, SHALL BE IN CONFORMANCE WITH THE LOCAL GUIDELINES FOR EROSION AND SEDIMENT CONTROL.

19. THE CONTRACTOR SHALL PROTECT EXISTING IMPROVEMENTS, PAVEMENTS, CURBS, LANDSCAPING AND STRUCTURES. ANY DAMAGED PART SHALL BE REPAIRED AT CONTRACTOR'S EXPENSE TO THE SATISFACTION OF OWNER.

20. CONTRACTOR SHALL LEGALLY AND PROPERLY DISPOSE OF ALL SCRAP MATERIALS SUCH AS COAXIAL CABLES AND OTHER ITEMS REMOVED FROM THE EXISTING FACILITY. ANTENNAS AND RADIOS REMOVED SHALL BE RETURNED TO THE OWNER'S DESIGNATED LOCATION.

21. CONTRACTOR SHALL LEAVE PREMISES IN CLEAN CONDITION. TRASH AND DEBRIS SHOULD BE REMOVED FROM SITE ON A DAILY BASIS.

22. NO FILL OR EMBANKMENT MATERIAL SHALL BE PLACED ON FROZEN GROUND. FROZEN MATERIALS, SNOW OR ICE SHALL NOT BE PLACED IN ANY FILL OR EMBANKMENT.

GENERAL NOTES:

1. FOR THE PURPOSE OF CONSTRUCTION DRAWING, THE FOLLOWING DEFINITIONS SHALL APPLY:
 CONTRACTOR=GENERAL CONTRACTOR RESPONSIBLE FOR CONSTRUCTION
 CARRIER=DISH WIRELESS
 TOWER OWNER=TOWER OWNER

2. THESE DRAWINGS HAVE BEEN PREPARED USING STANDARDS OF PROFESSIONAL CARE AND COMPLETENESS NORMALLY EXERCISED UNDER SIMILAR CIRCUMSTANCES BY REPUTABLE ENGINEERS IN THIS OR SIMILAR LOCALITIES. IT IS ASSUMED THAT THE WORK DEPICTED WILL BE PERFORMED BY AN EXPERIENCED CONTRACTOR AND/OR WORKPERSONS WHO HAVE ADEQUATE KNOWLEDGE OF THE APPLICABLE CODES (FOR NECA AND NETA), AS WELL AS THE PRACTICES AND PROCEDURES OF THE INDUSTRY. THE CONTRACTOR SHALL USE INDUSTRY ACCEPTED STANDARD GOOD PRACTICE FOR MISCELLANEOUS WORK NOT EXPLICITLY SHOWN.

3. THESE DRAWINGS REPRESENT THE FINISHED STRUCTURE. THEY DO NOT INDICATE THE MEANS OR METHODS OF CONSTRUCTION. THE CONTRACTOR SHALL BE SOLELY RESPONSIBLE FOR THE CONSTRUCTION MEANS, METHODS, TECHNIQUES, AND SEQUENCES TO BE USED TO CONSTRUCT THE STRUCTURE SHOWN. SUCH MEASURES SHALL INCLUDE, BUT NOT BE LIMITED TO, BRACING, FORMWORK, SHORING, ETC. SITE VISITS BY THE ENGINEER OR HIS REPRESENTATIVE WILL NOT INCLUDE INSPECTION OF THESE ITEMS AND IS FOR STRUCTURAL OBSERVATION OF THE FINISHED STRUCTURE ONLY.

4. NOTES AND DETAILS IN THE CONSTRUCTION DRAWINGS SHALL TAKE PRECEDENCE OVER GENERAL NOTES AND TYPICAL DETAILS WHERE NO DETAILS ARE SHOWN. CONSTRUCTION SHALL CONFORM TO SIMILAR WORK ON THE PROJECT AND/OR AS PROVIDED FOR IN THE CONTRACT DOCUMENTS. WHERE DISCREPANCIES OCCUR BETWEEN PLANS, DETAILS, GENERAL NOTES, AND SPECIFICATIONS, THE GREATER, MORE STRICT REQUIREMENTS, SHALL GOVERN. IF FURTHER CLARIFICATION IS REQUIRED CONTACT THE ENGINEER OF RECORD.

5. SUBSTANTIAL EFFORT HAS BEEN MADE TO PROVIDE ACCURATE DIMENSIONS AND MEASUREMENTS ON THE DRAWINGS TO ASSIST IN THE FABRICATION AND/OR PLACEMENT OF CONSTRUCTION ELEMENTS BUT IT IS THE SOLE RESPONSIBILITY OF THE CONTRACTOR TO FIELD VERIFY THE DIMENSIONS, MEASUREMENTS AND/OR CLEARANCES SHOWN IN THE CONSTRUCTION DRAWINGS PRIOR TO FABRICATION OR CUTTING OF ANY NEW OR EXISTING CONSTRUCTION ELEMENTS. IF IT IS DETERMINED THAT THERE ARE DISCREPANCIES AND/OR CONFLICTS WITH THE CONSTRUCTION DRAWINGS THE ENGINEER OF RECORD IS TO BE NOTIFIED AS SOON AS POSSIBLE.

6. PRIOR TO THE SUBMISSION OF BIDS, THE BIDDING CONTRACTOR SHALL VISIT THE CELL SITE TO FAMILIARIZE WITH THE EXISTING CONDITIONS AND TO VERIFY THAT THE CONDITIONS SHOWN ON THE CONSTRUCTION DRAWINGS ARE CORRECT. ANY DISCREPANCY FOUND SHALL BE BROUGHT TO THE ATTENTION OF CARRIER POC AND TOWER OWNER.

7. ALL MATERIALS FURNISHED AND INSTALLED SHALL BE IN STRICT ACCORDANCE WITH ALL APPLICABLE CODES, REGULATIONS AND ORDINANCES. CONTRACTOR SHALL ISSUE ALL APPROPRIATE NOTICES AND COMPLIANCE WITH ALL APPLICABLE LOCAL, STATE, AND FEDERAL REQUIREMENTS. ALL MATERIALS AND WORKMANSHIP SHALL COMPLY WITH ALL APPLICABLE MUNICIPAL AND UTILITY COMPANY SPECIFICATIONS AND LOCAL JURISDICTIONAL CODES, ORDINANCES AND APPLICABLE REGULATIONS.

8. UNLESS NOTED OTHERWISE, THE WORK SHALL INCLUDE FURNISHING MATERIALS, EQUIPMENT, APPURTENANCES AND LABOR NECESSARY TO COMPLETE ALL INSTALLATIONS AS INDICATED ON THE DRAWINGS.

9. THE CONTRACTOR SHALL INSTALL ALL EQUIPMENT AND MATERIALS IN ACCORDANCE WITH MANUFACTURER'S RECOMMENDATIONS UNLESS SPECIFICALLY STATED OTHERWISE.

10. IF THE SPECIFIED EQUIPMENT CAN NOT BE INSTALLED AS SHOWN ON THESE DRAWINGS, THE CONTRACTOR SHALL PROPOSE AN ALTERNATIVE INSTALLATION FOR APPROVAL BY THE CARRIER AND TOWER OWNER PRIOR TO PROCEEDING WITH ANY SUCH CHANGE OF INSTALLATION.

11. CONTRACTOR IS TO PERFORM A SITE INVESTIGATION, BEFORE SUBMITTING BIDS, TO DETERMINE THE BEST ROUTING OF ALL CONDUITS FOR POWER, AND TELCO AND FOR GROUNDING CABLES AS SHOWN IN THE POWER, TELCO, AND GROUNDING PLAN DRAWINGS.

12. THE CONTRACTOR SHALL PROTECT EXISTING IMPROVEMENTS, PAVEMENTS, CURBS, LANDSCAPING AND STRUCTURES. ANY DAMAGED PART SHALL BE REPAIRED AT CONTRACTOR'S EXPENSE TO THE SATISFACTION OF DISH WIRELESS AND TOWER OWNER.

13. CONTRACTOR SHALL LEGALLY AND PROPERLY DISPOSE OF ALL SCRAP MATERIALS SUCH AS COAXIAL CABLES AND OTHER ITEMS REMOVED FROM THE EXISTING FACILITY. ANTENNAS REMOVED SHALL BE RETURNED TO THE OWNER'S DESIGNATED LOCATION.

14. CONTRACTOR SHALL LEAVE PREMISES IN CLEAN CONDITION. TRASH AND DEBRIS SHOULD BE REMOVED FROM SITE ON A DAILY BASIS.



5701 SOUTH SANTA FE DRIVE
LITTLETON, CO 80120



10000 W. ALPINE AVE. SUITE 100
DENVER, CO 80231
TEL: 303.751.1000
WWW.TECTONIC.COM

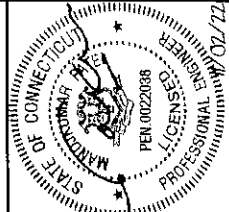

IT IS A VIOLATION OF LAW FOR ANY PERSON TO REPRODUCE OR TRANSMIT THIS DOCUMENT TO ANY OTHER PERSON WITHOUT THE WRITTEN PERMISSION OF THE ENGINEER.

DRAWN BY	CHECKED BY	APPROVED BY
MM	JO	MP
REVISION #		
3		

CONSTRUCTION DOCUMENTS

REV#	DATE	DESCRIPTION
5	11/01/20	ISSUED FOR PERMITS

AEK PROJECT NUMBER
10710.NJ.JR01125A

DISH Wireless LLC PROJECT INFORMATION
NJ.JR01125A

395 ROUND HILL ROAD
GREENWICH, CT 06831

SHEET TITLE
GENERAL NOTES

SHEET NUMBER
GN-4

- ELECTRICAL METALLIC TUBING (EMT) OR METAL-CLAD CABLE (MCC) SHALL BE USED FOR CONCEALED INDOOR LOCATIONS.
- SCHEDULE 40 PVC UNDERGROUND ON STRAIGHTS AND SCHEDULE 80 PVC FOR ALL ELBOWS/90s AND ALL APPROVED ABOVE GRADE PVC CONDUIT.
- LIQUID-TIGHT FLEXIBLE METALLIC CONDUIT (LIQUID-TITE FLEX) SHALL BE USED INDOORS AND OUTDOORS, WHERE VIBRATION OCCURS OR FLEXIBILITY IS NEEDED.
- CONDUIT AND TUBING FITTINGS SHALL BE THREADED OR COMPRESSION-TYPE AND APPROVED FOR THE LOCATION USED. SET SCREW FITTINGS ARE NOT ACCEPTABLE.
- CABINETS, BOXES AND WIRE WAYS SHALL BE LABELED FOR ELECTRICAL USE IN ACCORDANCE WITH NEMA, UL, ANSI/IEEC AND THE NEC.
- WIRWAYS SHALL BE METAL WITH AN ENAMEL FINISH AND INCLUDE A HINGED COVER, DESIGNED TO SWING OPEN DOWNWARDS (WIRESOLD SPECIMATE WIREWAY).
- SLOTTED WIRING DUCT SHALL BE PVC AND INCLUDE COVER (PANDUIT TYPE E OR EQUAL).
- CONDUITS SHALL BE FASTENED SECURELY IN PLACE WITH APPROVED NON-PERFORATED STRAPS AND HANGERS. EXPLOSIVE DEVICES (i.e. POWDER-ACTUATED) FOR ATTACHING HANGERS TO STRUCTURE WILL NOT BE PERMITTED. CLOSELY FOLLOW THE LINES OF THE STRUCTURE. MAINTAIN CLOSE PROXIMITY TO THE STRUCTURE AND KEEP CONDUITS IN TIGHT ENVELOPES. CHANGES IN DIRECTION TO ROUTE AROUND OBSTACLES SHALL BE MADE WITH CONDUIT OUTLET BOXES. CONDUIT SHALL BE LABELED TO SHOW THE WORKMANLIKE ROUTE TO THE EQUIPMENT. CONDUITS SHALL BE IDENTIFIED BY COLOR AND NUMBER. CONDUITS SHALL BE FISHED TO CLEAR OBSTRUCTIONS. ENDS OF CONDUITS SHALL BE TEMPORARILY CAPPED PLUSH TO FINISH GRADE TO PREVENT CONCRETE, PLASTER OR DIRT FROM ENTERING. CONDUITS SHALL BE RIGIDLY CLAMPED TO BOXES BY GALVANIZED MALLEABLE IRON BUSHING ON INSIDE AND GALVANIZED MALLEABLE IRON LOCKNUT ON OUTSIDE AND INSIDE.
- EQUIPMENT CABINETS, TERMINAL BOXES, JUNCTION BOXES AND PULL BOXES SHALL BE GALVANIZED OR EPOXY-COATED SHEET STEEL SHALL MEET OR EXCEED UL 50 AND BE RATED NEMA 1 (OR BETTER) FOR INTERIOR LOCATIONS AND NEMA 3 (OR BETTER) FOR EXTERIOR LOCATIONS.
- METAL RECEPTACLE, SWITCH AND DEVICE BOXES SHALL BE GALVANIZED, EPOXY-COATED OR NON-CORRODING. SHALL MEET OR EXCEED UL 514A AND NEMA OS 1 AND BE RATED NEMA 1 (OR BETTER) FOR INTERIOR LOCATIONS AND WEATHER PROTECTED (WP OR BETTER) FOR EXTERIOR LOCATIONS.
- NONMETALLIC RECEPTACLE, SWITCH AND DEVICE BOXES SHALL MEET OR EXCEED NEMA OS 2 (NEWEST REVISION) AND BE RATED NEMA 1 (OR BETTER) FOR INTERIOR LOCATIONS AND WEATHER PROTECTED (WP OR BETTER) FOR EXTERIOR LOCATIONS.
- THE CONTRACTOR SHALL NOTIFY AND OBTAIN NECESSARY AUTHORIZATION FROM THE CARRIER AND/OR DISH Wireless L.L.C. AND TOWER OWNER BEFORE COMMENCING WORK ON THE AC POWER DISTRIBUTION PANELS.
- THE CONTRACTOR SHALL PROVIDE NECESSARY TAGGING ON THE BREAKERS, CABLES AND DISTRIBUTION PANELS IN ACCORDANCE WITH THE APPLICABLE CODES AND STANDARDS TO SAFEGUARD LIFE AND PROPERTY.
- INSTALL LAMICOID LABEL ON THE METER CENTER TO SHOW "DISH Wireless L.L.C."
- ALL EMPTY/SPARE CONDUITS THAT ARE INSTALLED ARE TO HAVE A METERED MULE TAPE PULL CORD INSTALLED.

- CONCRETE, FOUNDATIONS, AND REINFORCING STEEL**
- ALL CONCRETE WORK SHALL BE IN ACCORDANCE WITH THE ACI 301, ACI 318, ACI 336, ASTM A184, ASTM A185 AND THE DESIGN AND CONSTRUCTION SPECIFICATION FOR CAST-IN-PLACE CONCRETE.
 - UNLESS NOTED OTHERWISE, SOIL BEARING PRESSURE USED FOR DESIGN OF SLABS AND FOUNDATIONS IS ASSUMED TO BE 1000 psf.
 - ALL CONCRETE SHALL HAVE A MINIMUM COMPRESSIVE STRENGTH (f'c) OF 3000 psi AT 28 DAYS, UNLESS NOTED OTHERWISE. NO MORE THAN 90 MINUTES SHALL ELAPSE FROM BATCH TIME TO TIME OF PLACEMENT UNLESS APPROVED BY THE ENGINEER OF RECORD. TEMPERATURE OF CONCRETE SHALL NOT EXCEED 90° AT TIME OF PLACEMENT.
 - CONCRETE EXPOSED TO FREEZE-THAW CYCLES SHALL CONTAIN AIR ENTRAINMENT TO BE BASED ON SIZE OF AGGREGATE AND F3 CLASS EXPOSURE (VERY SEVERE). CEMENT USED TO BE TYPE II PORTLAND CEMENT WITH A MAXIMUM WATER-TO-CEMENT RATIO (W/C) OF 0.45.
 - ALL STEEL REINFORCING SHALL CONFORM TO ASTM A615. ALL WELDED WIRE FABRIC (WFF) SHALL CONFORM TO ASTM A185. ALL SPLICES SHALL BE CLASS "B" TENSION SPLICES, UNLESS NOTED OTHERWISE. ALL HOOKS SHALL BE STANDARD 90 DEGREE HOOKS. UNLESS NOTED OTHERWISE, YIELD STRENGTH (fy) OF STANDARD DEFORMED BARS ARE AS FOLLOWS:
#4 BARS AND SMALLER 40 ksi
#5 BARS AND LARGER 60 ksi
 - THE FOLLOWING MINIMUM CONCRETE COVER SHALL BE PROVIDED FOR REINFORCING STEEL UNLESS SHOWN OTHERWISE ON DRAWINGS:
 - CONCRETE CAST AGAINST AND PERMANENTLY EXPOSED TO EARTH 3"
 - CONCRETE EXPOSED TO EARTH OR WEATHER:
 - #4 BARS AND LARGER 2"
 - #5 BARS AND SMALLER 1-1/2"
 - CONCRETE NOT EXPOSED TO EARTH OR WEATHER:
 - SLAB AND WALLS 3/4"
 - BEAMS AND COLUMNS 1-1/2"
 - A TOOLED EDGE OR A 3/4" CHAMFER SHALL BE PROVIDED AT ALL EXPOSED EDGES OF CONCRETE, UNLESS NOTED OTHERWISE, IN ACCORDANCE WITH ACI 301 SECTION 4.2.4.
- ELECTRICAL INSTALLATION NOTES**
- ALL ELECTRICAL WORK SHALL BE PERFORMED IN ACCORDANCE WITH THE PROJECT SPECIFICATIONS, NEC AND ALL APPLICABLE FEDERAL, STATE, AND LOCAL CODES/ORDINANCES.
 - CONDUIT ROUTINGS ARE SCHEMATIC. CONTRACTOR SHALL INSTALL CONDUITS SO THAT ACCESS TO EQUIPMENT IS NOT BLOCKED AND TRIP HAZARDS ARE ELIMINATED.
 - WIRING, RACEWAY AND SUPPORT METHODS AND MATERIALS SHALL COMPLY WITH THE REQUIREMENTS OF THE NEC.
 - ALL CIRCUITS SHALL BE SEGREGATED AND MAINTAIN MINIMUM CABLE SEPARATION AS REQUIRED BY THE NEC.
 - ALL EQUIPMENT SHALL BEAR THE UNDERWRITERS LABORATORIES LABEL OF APPROVAL, AND SHALL CONFORM TO REQUIREMENT OF THE NATIONAL ELECTRICAL CODE.
 - ALL OVERCURRENT DEVICES SHALL HAVE AN INTERRUPTING CURRENT RATING THAT SHALL BE GREATER THAN THE SHORT CIRCUIT CURRENT TO WHICH THEY ARE SUBJECTED. OVERCURRENT DEVICES SHALL BE CURRENTLY RATED AND SHALL NOT EXCEED THE RATING OF THE EQUIPMENT IN ACCORDANCE WITH ARTICLE 110.24 NEC OR THE MOST CURRENT ADOPTED CODE PRE THE GOVERNING JURISDICTION.
 - EACH END OF EVERY POWER PHASE CONDUCTOR, GROUNDING CONDUCTOR, AND TELCO CONDUCTOR OR CABLE SHALL BE LABELED WITH COLOR-CODED INSULATION OR ELECTRICAL TAPE (3M BRAND, 1/2" PLASTIC ELECTRICAL TAPE WITH UV PROTECTION, OR EQUAL). THE IDENTIFICATION METHOD SHALL CONFORM WITH NEC AND OSHA.
 - ALL ELECTRICAL COMPONENTS SHALL BE CLEARLY LABELED WITH LAMICOID TAGS SHOWING THEIR RATED VOLTAGE, PHASE CONFIGURATION, WIRE CONFIGURATION, POWER OR AMPACITY RATING AND BRANCH CIRCUIT ID NUMBERS (i.e. PANEL BOARD AND CIRCUIT ID'S).
 - PANEL BOARDS (ID NUMBERS) SHALL BE CLEARLY LABELED WITH PLASTIC LABELS.
 - TIE WRAPS ARE NOT ALLOWED.
 - ALL POWER AND EQUIPMENT GROUND WIRING IN TUBING OR CONDUIT SHALL BE SINGLE COPPER CONDUCTOR (#14 OR LARGER) WITH TYPE THHW, THWN, THWN-2, XHHW, XHHW-2, THW, THW-2, RHW, OR RHW-2 INSULATION UNLESS OTHERWISE SPECIFIED.
 - SUPPLEMENTAL EQUIPMENT GROUND WIRING LOCATED INDOORS SHALL BE SINGLE COPPER CONDUCTOR (#6 OR LARGER) WITH TYPE THHW, THWN, THWN-2, XHHW, XHHW-2, THW, THW-2, RHW, OR RHW-2 INSULATION UNLESS OTHERWISE SPECIFIED.
 - POWER AND CONTROL WIRING IN FLEXIBLE CORD SHALL BE MULTI-CONDUCTOR, TYPE SOOW CORD (#14 OR LARGER) UNLESS OTHERWISE SPECIFIED.
 - POWER AND CONTROL WIRING FOR USE IN CABLE TRAY SHALL BE MULTI-CONDUCTOR, TYPE TC CABLE (#14 OR LARGER), WITH TYPE THHW, THWN, THWN-2, XHHW, XHHW-2, THW, THW-2, RHW, OR RHW-2 INSULATION UNLESS OTHERWISE SPECIFIED.
 - ALL POWER AND GROUNDING CONNECTIONS SHALL BE CRIMP-STYLE. COMPRESSION WIRE LUGS AND WIRE NUTS BY THOMAS AND BETTS (OR EQUAL). LUGS AND WIRE NUTS SHALL BE RATED FOR OPERATION NOT LESS THAN 75° C (90° C IF AVAILABLE).
 - RACEWAY AND CABLE TRAY SHALL BE LISTED OR LABELED FOR ELECTRICAL USE IN ACCORDANCE WITH NEMA, UL, ANSI/IEEC AND NEC.
 - ELECTRICAL METALLIC TUBING (EMT), INTERMEDIATE METAL CONDUIT (IMC), OR RIGID METAL CONDUIT (RMC) SHALL BE USED FOR EXPOSED INDOOR LOCATIONS.



5701 SOUTH SANTA FE DRIVE
LITTLETON, CO 80120

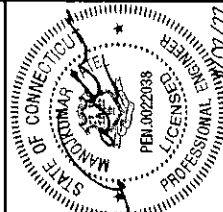

I, **MATTHEW J. PAPPALARDO**, DO HEREBY CERTIFY THAT I AM THE AUTHOR OF THE ABOVE-ENTITLED PROFESSIONAL DOCUMENT.
DATE: 02/17/22

DRAWN BY: []
CHECKED BY: []
APPROVED BY: []

DATE: []
TIME: []
REV: []

CONSTRUCTION DOCUMENTS

REV	DATE	DESCRIPTION
0	11/07/22	ISSUED FOR PERM

AAE PROJECT NUMBER
10710.NJ.JER01125A

DISH Wireless LLC - PROJECT INFORMATION
NJ.JER01125A

395 ROUND HILL ROAD
GREENWICH, CT 06831

SHEET TITLE
GENERAL NOTES

SHEET NUMBER
GN-5

GROUNDING NOTES:

- ALL GROUND ELECTRODE SYSTEMS (INCLUDING TELECOMMUNICATION, RADIO, LIGHTNING PROTECTION AND AC POWER GES'S) SHALL BE BONDED TOGETHER AT OR BELOW GRADE, BY TWO OR MORE COPPER BONDING CONDUCTORS IN ACCORDANCE WITH THE NEC.
- THE CONTRACTOR SHALL PERFORM IEEE FALL-OF-POTENTIAL RESISTANCE TO EARTH TESTING (PER IEEE 1180 AND 81) FOR GROUND ELECTRODE SYSTEMS; THE CONTRACTOR SHALL FURNISH AND INSTALL SUPPLEMENTAL GROUND ELECTRODES AS NEEDED TO ACHIEVE A TEST RESULT OF 5 OHMS OR LESS.
- THE CONTRACTOR IS RESPONSIBLE FOR PROPERLY SEQUENCING GROUNDING AND UNDERGROUND CONDUIT INSTALLATION AS TO PREVENT ANY LOSS OF CONTINUITY IN THE GROUNDING SYSTEM OR DAMAGE TO THE CONDUIT AND PROVIDE TESTING RESULTS.
- METAL CONDUIT AND TRAY SHALL BE GROUNDED AND MADE ELECTRICALLY CONTINUOUS WITH LISTED BONDING FITTINGS OR BY BONDING ACROSS THE DISCONTINUITY WITH #6 COPPER WIRE UL APPROVED GROUNDING TYPE CONDUIT CLAMPS.
- METAL RACEWAY SHALL NOT BE USED AS THE NEC REQUIRED EQUIPMENT GROUND CONDUCTOR. STRANDED COPPER CONDUCTORS WITH GREEN INSULATION, SIZED IN ACCORDANCE WITH THE NEC, SHALL BE FURNISHED AND INSTALLED WITH THE POWER CIRCUITS TO BITS EQUIPMENT.
- EACH CABINET FRAME SHALL BE DIRECTLY CONNECTED TO THE MASTER GROUND BAR WITH GREEN INSULATED SUPPLEMENTAL EQUIPMENT GROUND WIRES, #6 STRANDED COPPER OR LARGER FOR INDOOR BITS; #2 BARE SOLID TINNED COPPER FOR OUTDOOR BITS.
- CONNECTIONS TO THE GROUND BUS SHALL NOT BE DOUBLED UP OR STACKED BACK TO BACK CONNECTIONS ON OPPOSITE SIDE OF THE GROUND BUS ARE PERMITTED.
- ALL EXTERIOR GROUND CONDUCTORS BETWEEN EQUIPMENT/GROUND BARS AND THE GROUND RING SHALL BE #2 SOLID TINNED COPPER UNLESS OTHERWISE INDICATED.
- ALUMINUM CONDUCTOR OR COPPER CLAD STEEL CONDUCTOR SHALL NOT BE USED FOR GROUNDING CONNECTIONS.
- USE OF 90° BENDS IN THE PROTECTION GROUNDING CONDUCTORS SHALL BE AVOIDED WHEN 45° BENDS CAN BE ADEQUATELY SUPPORTED.
- EXOTHERMIC WELDS SHALL BE USED FOR ALL GROUNDING CONNECTIONS BELOW GRADE.
- ALL GROUND CONNECTIONS ABOVE GRADE (INTERIOR AND EXTERIOR) SHALL BE FORMED USING HIGH PRESS CRIMPS.
- COMPRESSION GROUND CONNECTIONS MAY BE REPLACED BY EXOTHERMIC WELD CONNECTIONS.
- ICE BRIDGE BONDING CONDUCTORS SHALL BE EXOTHERMICALLY BONDED OR BOLTED TO THE BRIDGE AND THE TOWER GROUND BAR.
- APPROVED ANTIOXIDANT COATINGS (i.e. CONDUCTIVE GEL OR PASTE) SHALL BE USED ON ALL COMPRESSION AND BOLTED GROUND CONNECTIONS.
- ALL EXTERIOR GROUND CONNECTIONS SHALL BE COATED WITH A CORROSION RESISTANT MATERIAL.
- MISCELLANEOUS ELECTRICAL AND NON-ELECTRICAL METAL BOXES, FRAMES AND SUPPORTS SHALL BE BONDED TO THE GROUND RING, IN ACCORDANCE WITH THE NEC.
- BOND ALL METALLIC OBJECTS WITHIN 6 FT. OF MAIN GROUND RING WITH (1) #2 BARE SOLID TINNED COPPER GROUND CONDUCTOR.
- GROUND CONDUCTORS USED FOR THE FACILITY GROUNDING AND LIGHTNING PROTECTION SYSTEMS SHALL NOT BE ROUTED THROUGH METALLIC OBJECTS THAT FORM A RING AROUND THE CONDUCTOR, SUCH AS METALLIC CONDUITS, METAL SUPPORT CLIPS OR SLEEVES THROUGH WALLS OR FLOORS, WHEN IT IS REQUIRED TO BE HOUSED IN CONDUIT TO MEET CODE REQUIREMENTS OR LOCAL CONDITIONS, NON-METALLIC MATERIAL SUCH AS PVC CONDUIT SHALL BE USED, WHERE USE OF METAL CONDUIT IS UNAVOIDABLE (i.e., NONMETALLIC CONDUIT PROHIBITED BY LOCAL CODE) THE GROUND CONDUCTOR SHALL BE BONDED TO EACH END OF THE METAL CONDUIT.
- ALL GROUNDS THAT TRANSITION FROM BELOW GRADE TO ABOVE GRADE MUST BE #2 BARE SOLID TINNED COPPER IN 3/4" NON-METALLIC FLEXIBLE CONDUIT FROM 24" BELOW GRADE TO WITHIN 3" TO 8" OF CAD-WELDED TERMINATION POINT. THE EXPOSED END OF THE CONDUIT MUST BE SEALED WITH SILICONE CAULK. (ADD TRANSITIONING GROUND STANDARD DETAIL AS WELL).
- BUILDINGS WHERE THE MAIN GROUNDING CONDUCTORS ARE REQUIRED TO BE ROUTED TO GRADE, THE CONTRACTOR SHALL ROUTE TWO GROUNDING CONDUCTORS FROM THE ROOFTOP, TOWERS, AND WATER TOWERS GROUNDING RING, TO THE EXISTING GROUNDING SYSTEM. THE GROUNDING CONDUCTORS SHALL NOT BE SMALLER THAN 2/0 COPPER. ROOFTOP GROUNDING RING SHALL BE BONDED TO THE EXISTING GROUNDING SYSTEM. THE BUILDING STEEL COLUMNS, LIGHTNING PROTECTION SYSTEM, AND BUILDING MAIN WATER LINE (FERROUS OR NONFERROUS METAL PIPING ONLY). DO NOT ATTACH GROUNDING TO FIRE SPRINKLER SYSTEM PIPES.

Exhibit C
Structural Analysis



Structural Analysis Report

Prepared for:

KGI

805 Las Cimas Parkway, Building Three, Suite 370

Austin, TX 78746

ATTN: Ms. Jacquie Cossey

Structure : 114 ft Monopole
Site ID : 27741_B
Proposed Carrier : Dish Wireless
Site Name : Round Hill CT
Site Location : 395 Round Hill Road
Greenwich, CT
41.095117, -73.664219
County : Fairfield
Date : February 17, 2022
Max Structure Usage : 81%
Max Foundation Usage : 59%
Result : Pass

Prepared By:
Trevor Kuper, E.I.T.
Structural Engineer

A handwritten signature in black ink, appearing to read 'Trevor Kuper'.

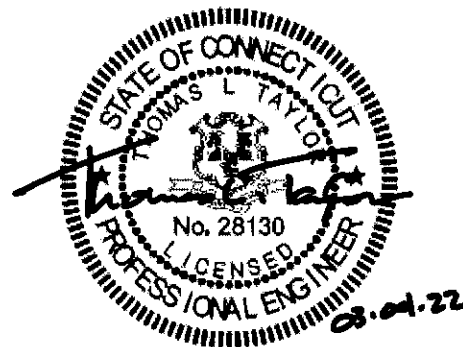

EXP. 01/31/2023

Thomas L. Taylor
Digitally signed by
Thomas L. Taylor
Date: 2022.03.04
13:45:18 -06'00'



Table of Contents

Introduction -----	1
Supporting Documents -----	1
Analysis -----	1
Conclusion -----	1
Existing and Reserved Equipment-----	2
Equipment to be Removed -----	2
Proposed Equipment -----	2
Structure Usages -----	3
Foundations -----	3
Standard Conditions -----	4
Calculations -----	Attached

Introduction

The purpose of this report is to summarize results of a structural analysis performed on the 114 ft Monopole to reflect the change in loading by Dish Wireless.

Supporting Documents

Tower Drawing	EEl Drawing # GS56652-2, dated September 28, 2007
Foundation Drawing	EEl Drawing # 14679S-115.0, dated February 12, 2007
Geotechnical Report	Clarence Welti Associates Project Name Verion Wireless Site, dated February 6, 2007
Tower Loadings	KGI/Dish Wireless TLF, dated January 30, 2022
Proposed Loading	Tectonic Construction Drawings Project # 10710.NJJER01125A, dated August 3, 2021

Analysis

The tower was analyzed using TNX tower analysis software. This program considers an elastic three-dimensional model and second-order effects per ANSI/TIA-222.

Basic Wind Speed *	120 mph (3-Second Gust) Vult
Basic Wind Speed w/Ice	50 mph (3-Second Gust) w/ 1" radial ice concurrent
Code	ANSI/TIA-222-H / 2018 IBC / 2018 Connecticut State Building Code
Risk Category	II
Exposure Category	C
Topographic Category	1
Crest Height	0 ft
Spectral Response	Ss = 0.279 , S1 = 0.06
Site Class	B - Competent Rock
Ground Elevation	378.96 ft

* Tower is located in a Hurricane Prone Region per 2018 Connecticut State Building Code.

Conclusion

Based on the analysis results, the structure meets the requirements per the applicable codes listed above. The tower and foundation can support the equipment as described in this report.

If you have any questions or require additional information, please contact Semaan Engineering Solutions at 402-289-1888.

Existing and Reserved Equipment

This loading **is** included in the analysis.

Centerline Elevation (ft)		Qty.	Antenna	Mount Type	Coax (in)	Carrier
Mount	Equip.					
110.0	110.0	3	782 11066	(2) Flush Canister Mounts	(12) 1 5/8"	T-Mobile
		3	DBXNH-6565A-A2M			
		3	TMAT1921XB6811A			
100.0	100.0	9	IBC1900HG-SA	(2) Flush Canister Mounts	(2) 1 1/4" (6) 1 5/8"	Sprint
		6	KIT-FD9R6004/1C-DL			
		3	APXVSP18-C-A20			
90.0	90.0	-	-	(2) Flush Canister Mounts	-	-
82.0	83.0	1	GPS	(1) 3' Sidearm	(1) 1/2"	Sprint

Equipment to be Removed

This loading **is not** included in the analysis.

Centerline Elevation (ft)		Qty.	Antenna	Mount Type	Coax (in)	Carrier
Mount	Equip.					
90.0	90.0	1	10' 30" Dia. Canister	-	-	-

Proposed Equipment

This loading **is** included in the analysis.

Centerline Elevation (ft)		Qty.	Antenna	Mount Type	Coax (in)	Carrier
Mount	Equip.					
90.0	90.0	6	CDX623T-DS-T	(2) Flush Canister Mounts	(12) 7/8"	Dish Wireless
		1	10' 40" Dia. Canister			
		3	FVV-65B-R3			

Install proposed coax inside the pole shaft.

Structure Usages

Structural Component	Controlling Usage	Pass/Fail
Shaft	41%	Pass
Anchor Bolts	58%	Pass
Baseplate	52%	Pass
Flange	81%	Pass

Foundations

Reaction Component	Analysis Reactions	% of Usage
Moment (Kips-Ft)	592.2	59%
Axial (Kips)	17.9	28%
Shear (Kips)	9.3	10%
Reinf. Conc. Fnd. Capacity	N/A	25%

The structure base reactions resulting from this analysis were found to be acceptable through analysis based on geotechnical and foundation information, therefore no modification or reinforcement of the foundation will be required.



Standard Conditions

All engineering services are performed on the basis that the information used is current and correct. This information may consist of, but is not necessary limited, to:

-- Information supplied by the client regarding the structure itself, antenna, mounts and feed line loading on the structure and its components, or other relevant information.

-- Information from drawings in the possession of Semaan Engineering Solutions, or generated by field inspections or measurements of the structure.

It is the responsibility of the client to ensure that the information provided to Semaan Engineering Solutions Holdings and used in the performance of our engineering services is correct and complete. In the absence of information to the contrary, we assume that all structures were constructed in accordance with the drawings and specifications and that their capacity has not significantly changed from the "as new" condition.

Unless explicitly agreed by both the client and Semaan Engineering Solutions, all services will be performed in accordance with the current revision of ANSI/TIA -222. The design basic wind speed will be determined based on the minimum basic wind speed as prescribed in ANSI/TIA-222. Although every effort is taken to ensure that the loading considered is adequate to meet the requirements of all applicable regulatory entities, we can provide no assurance to meet any other local and state codes or requirements. If wind and ice loads or other relevant parameters are to be different from the minimum values recommended by the codes, the client shall specify the exact requirement.

All services are performed, results obtained, and recommendations made in accordance with generally accepted engineering principles and practices. Semaan Engineering Solutions Holdings is not responsible for the conclusions, opinions and recommendations made by others based on the information we supply.

Vx

Vz

Mx

Mz

Global Mast Shear (lb)

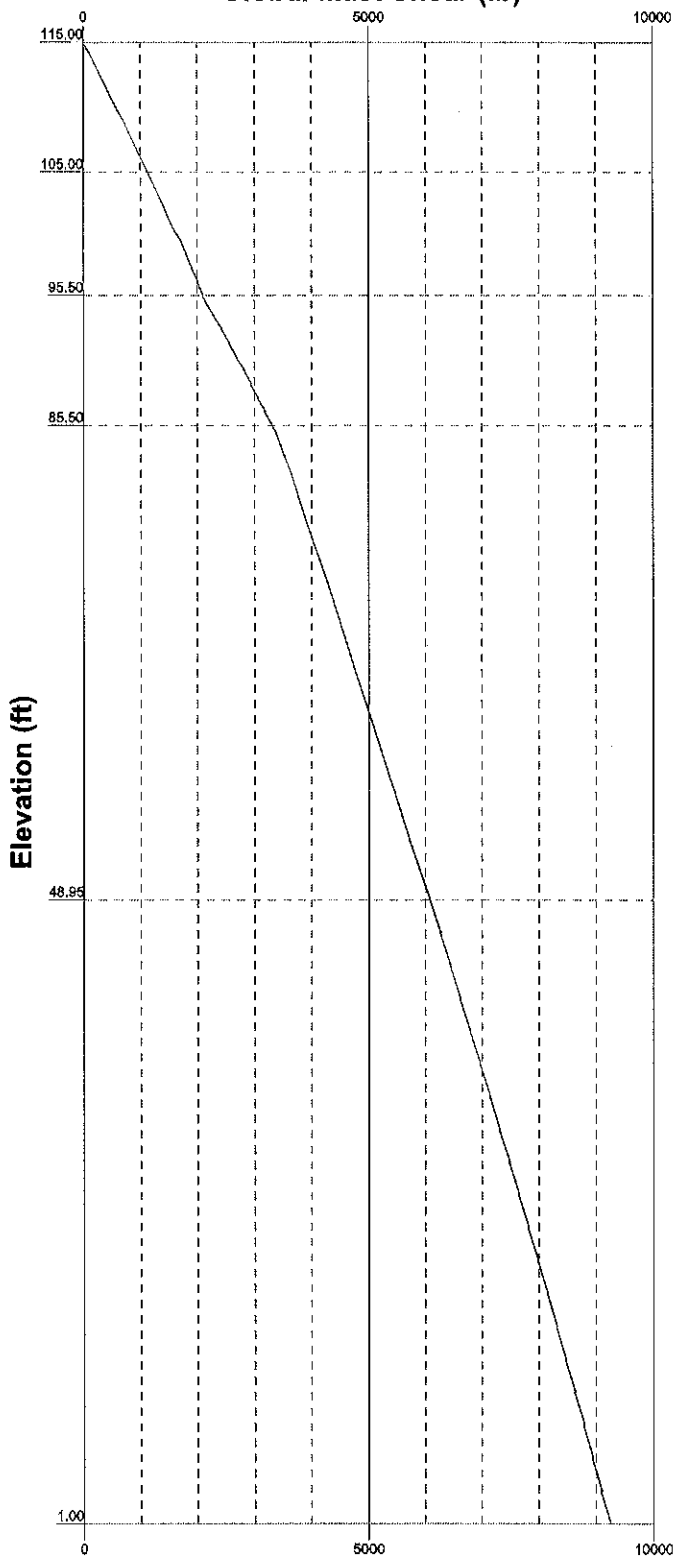

Global Mast Moment (kip-ft)

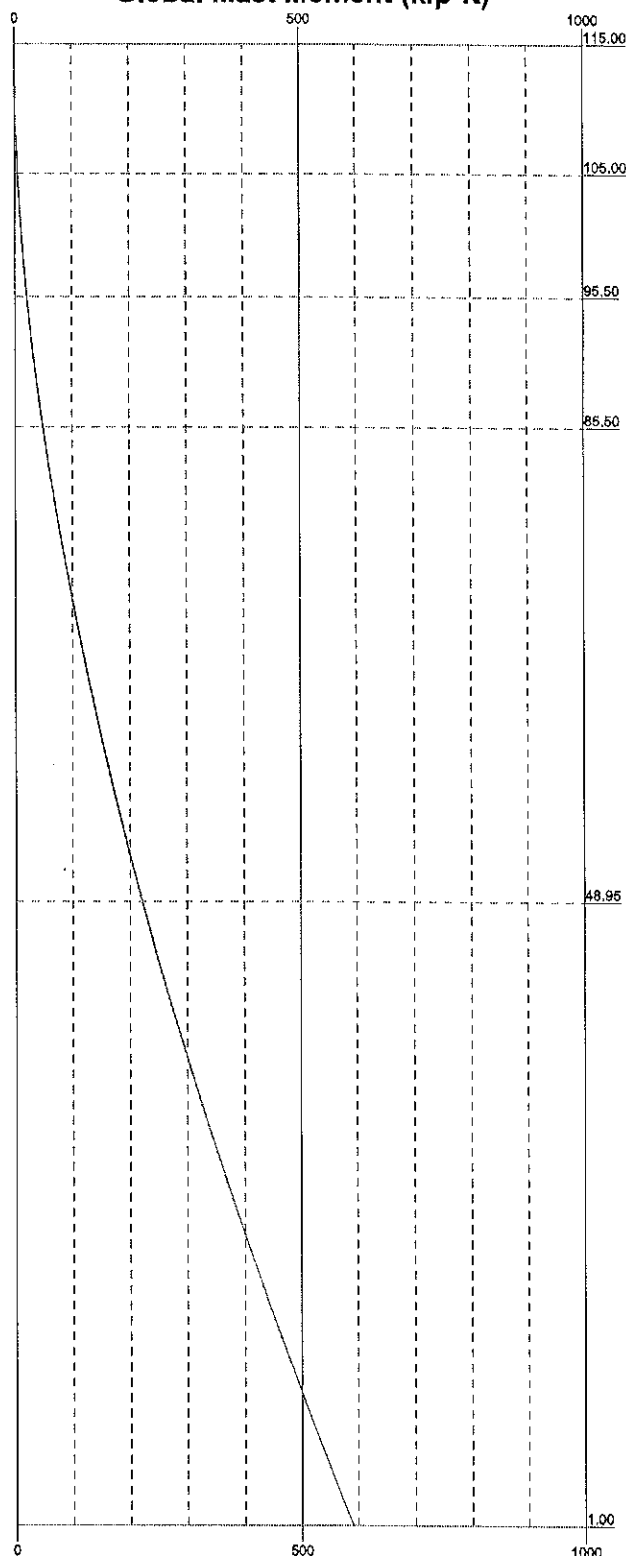

Semaan Engineering Solutions, LLC

1047 S. 205th St.
Elkhorn, NE, 68022
Phone: (402)-289-1888
FAX: (402)-289-1861

Job: 27741_B_Round Hill CT

Project: REV02

Client: KGI

Drawn by: Trevork

App'd:

Code: TIA-222-H

Date: 02/17/22

Scale: 1

Path: \\COM7353SERV\B011\Commod\TIA-222\27741_B_REV02.dwg

Dwg No.

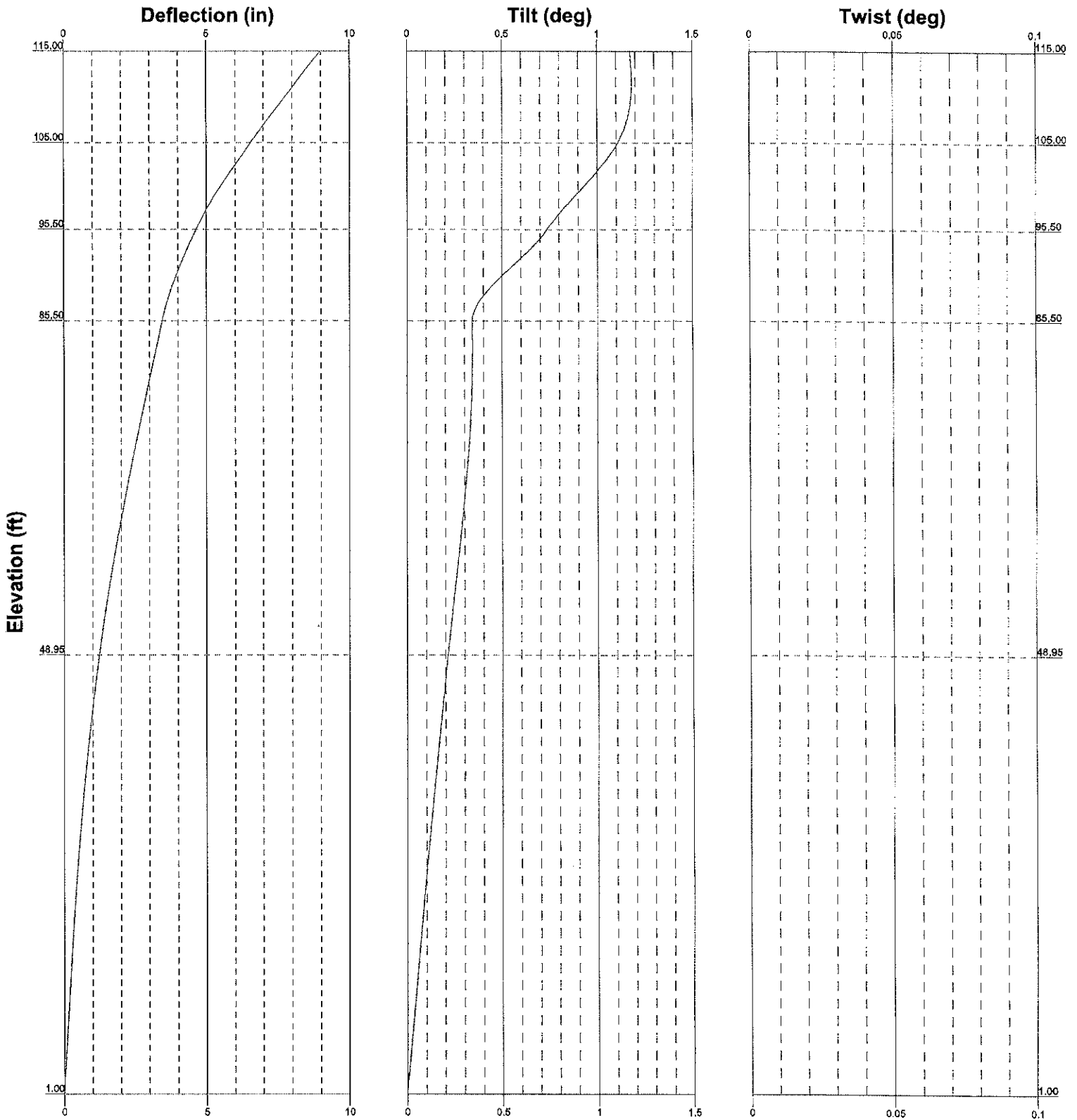

Semaan Engineering Solutions, LLC		
1047 S. 205th St. Elkhorn, NE, 68022 Phone: (402)-289-1888 FAX: (402)-289-1861		
Job: 27741 B Round Hill CT		
Project: REV02		
Client: KGI	Drawn by: Trevork	App'd:
Code: TIA-222-H	Date: 02/17/22	Scale: N
Path:		Dwg No.

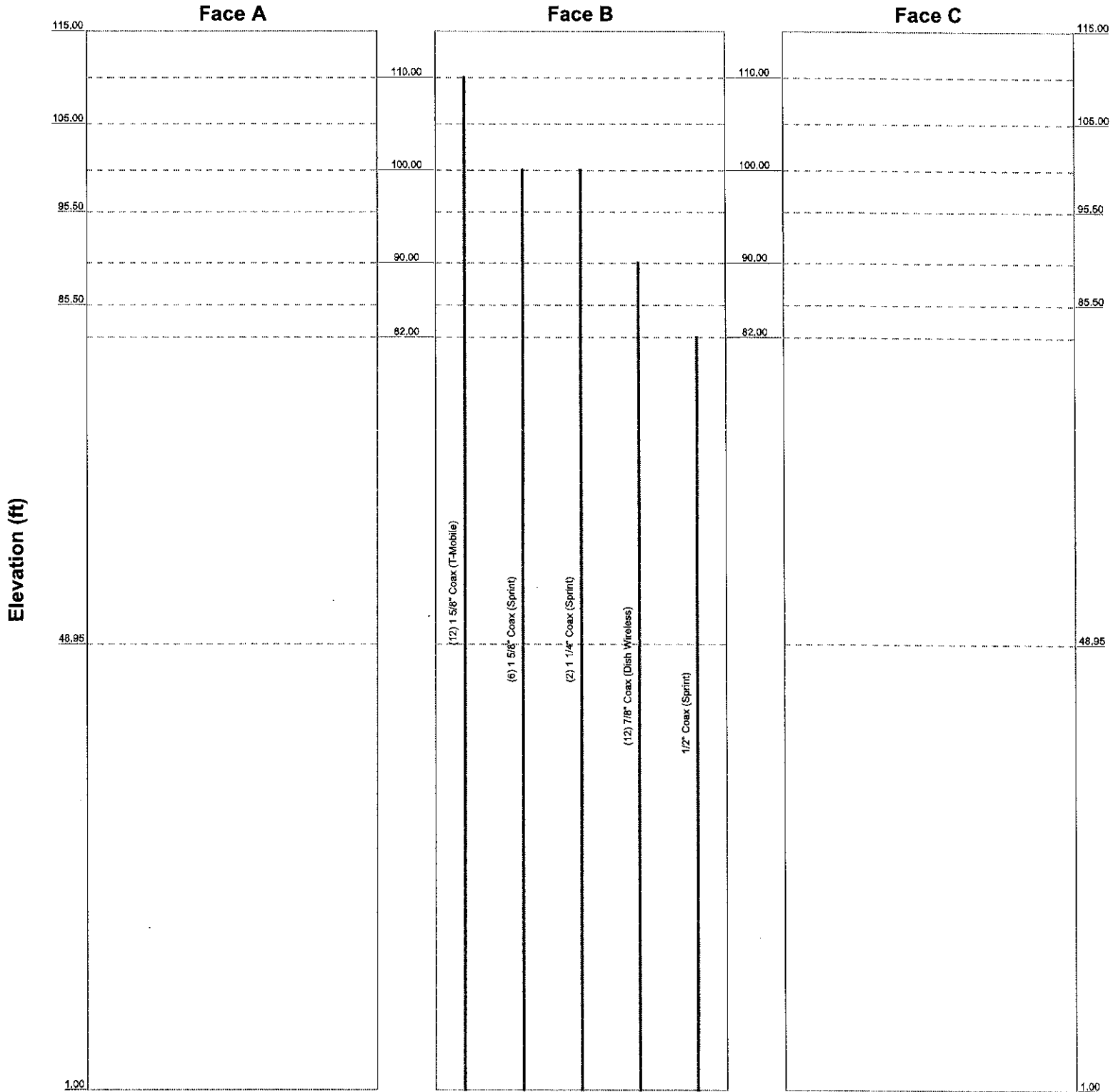

Semaan Engineering Solutions, LLC		
1047 S. 205th St. Elkhorn, NE, 68022 Phone: (402)-289-1888 FAX: (402)-289-1861		
Job: 27741_B_Round Hill CT		
Project: REV02		
Client: KGI	Drawn by: TrevorK	App'd:
Code: TIA-222-H	Date: 02/17/22	Scale: N
Path:		Dwg No.

tnxTower Semaan Engineering Solutions, LLC 1047 S. 205th St. Elkhorn, NE, 68022 Phone: (402)-289-1888 FAX: (402)-289-1861	Job 27741_B_Round Hill CT	Page 1 of 30
	Project REV02	Date 11:43:44 02/17/22
	Client KGI	Designed by TrevorK

Tower Input Data

The tower is a monopole.

This tower is designed using the TIA-222-H standard.

The following design criteria apply:

- Tower is located in Fairfield County, Connecticut.
- Tower base elevation above sea level: 379.96 ft.
- Basic wind speed of 120 mph.
- Risk Category II.
- Exposure Category C.
- Simplified Topographic Factor Procedure for wind speed-up calculations is used.
- Topographic Category: 1.
- Crest Height: 0.00 ft.
- Nominal ice thickness of 1.00 in.
- Ice thickness is considered to increase with height.
- Ice density of 56 pcf.
- A wind speed of 50 mph is used in combination with ice.
- Deflections calculated using a wind speed of 60 mph.
- CCISeismic Note: Seismic loads generated by CCISeismic 3.3.6.
- CCISeismic Note: Seismic calculations are in accordance with TIA-222-H-1.
- A non-linear (P-delta) analysis was used.
- Pressures are calculated at each section.
- Stress ratio used in pole design is 1.
- Local bending stresses due to climbing loads, feed line supports, and appurtenance mounts are not considered.

Options

- | | | |
|--------------------------------------------------------------------------------------------------------------------------------------------------------------------------------------------------------------------------------------------------------------------------------------------------------------------------------------------------------------------------------------------------------------------------------------------------------------------------------------------------------------------------------------------------------------------------------------------------------|-------------------------------------------------------------------------------------------------------------------------------------------------------------------------------------------------------------------------------------------------------------------------------------------------------------------------------------------------------------------------------------------------------------------------------------------------------------------------------------------------------------------------------------------------------------------------------------------------------------------------------------------------------------|-----------------------------------------------------------------------------------------------------------------------------------------------------------------------------------------------------------------------------------------------------------------------------------------------------------------------------------------------------------------------------------------------------------------------------------------------------------------------------------------------------------------------------------------------------------------------------------------------------------------------------------------------------------------------------------------------------------------------------------------------------------------------------------------------|
| <ul style="list-style-type: none"> Consider Moments - Legs Consider Moments - Horizontals Consider Moments - Diagonals Use Moment Magnification √ Use Code Stress Ratios √ Use Code Safety Factors - Guys Escalate Ice Always Use Max Kz Use Special Wind Profile Include Bolts In Member Capacity Leg Bolts Are At Top Of Section Secondary Horizontal Braces Leg Use Diamond Inner Bracing (4 Sided) SR Members Have Cut Ends SR Members Are Concentric | <ul style="list-style-type: none"> Distribute Leg Loads As Uniform Assume Legs Pinned √ Assume Rigid Index Plate √ Use Clear Spans For Wind Area √ Use Clear Spans For KL/r Retension Guys To Initial Tension √ Bypass Mast Stability Checks √ Use Azimuth Dish Coefficients √ Project Wind Area of Appurt. Autocalc Torque Arm Areas Add IBC .6D+W Combination Sort Capacity Reports By Component Triangulate Diamond Inner Bracing Treat Feed Line Bundles As Cylinder √ Ignore KL/ry For 60 Deg. Angle Legs | <ul style="list-style-type: none"> Use ASCE 10 X-Brace Ly Rules √ Calculate Redundant Bracing Forces Ignore Redundant Members in FEA √ SR Leg Bolts Resist Compression √ All Leg Panels Have Same Allowable Offset Girt At Foundation √ Consider Feed Line Torque √ Include Angle Block Shear Check Use TIA-222-H Bracing Resist. Exemption Use TIA-222-H Tension Splice Exemption <li style="text-align: center;">Poles √ Include Shear-Torsion Interaction Always Use Sub-Critical Flow Use Top Mounted Sockets √ Pole Without Linear Attachments Pole With Shroud Or No Appurtenances Outside and Inside Corner Radii Are Known |
|--------------------------------------------------------------------------------------------------------------------------------------------------------------------------------------------------------------------------------------------------------------------------------------------------------------------------------------------------------------------------------------------------------------------------------------------------------------------------------------------------------------------------------------------------------------------------------------------------------|-------------------------------------------------------------------------------------------------------------------------------------------------------------------------------------------------------------------------------------------------------------------------------------------------------------------------------------------------------------------------------------------------------------------------------------------------------------------------------------------------------------------------------------------------------------------------------------------------------------------------------------------------------------|-----------------------------------------------------------------------------------------------------------------------------------------------------------------------------------------------------------------------------------------------------------------------------------------------------------------------------------------------------------------------------------------------------------------------------------------------------------------------------------------------------------------------------------------------------------------------------------------------------------------------------------------------------------------------------------------------------------------------------------------------------------------------------------------------|

Tapered Pole Section Geometry

tnxTower Semaan Engineering Solutions, LLC 1047 S. 205th St. Elkhorn, NE, 68022 Phone: (402)-289-1888 FAX: (402)-289-1861	Job	27741_B_Round Hill CT	Page	2 of 30
	Project	REV02	Date	11:43:44 02/17/22
	Client	KGI	Designed by	TrevorK

Section	Elevation ft	Section Length ft	Splice Length ft	Number of Sides	Top Diameter in	Bottom Diameter in	Wall Thickness in	Bend Radius in	Pole Grade
L1	115.00-105.00	10.00	0.00	Round	4.50	4.50	2.25		A572-50 (50 ksi)
L2	105.00-95.50	9.50	0.00	Round	4.50	4.50	2.25		A572-50 (50 ksi)
L3	95.50-95.00	0.50	0.00	Round	4.50	5.75	2.25		A572-50 (50 ksi)
L4	95.00-85.50	9.50	0.00	Round	5.75	5.75	2.88		A572-50 (50 ksi)
L5	85.50-85.00	0.50	0.00	Round	5.75	29.25	2.88		A572-50 (50 ksi)
L6	85.00-48.95	36.05	4.82	18	29.25	33.32	0.19	0.75	A572-65 (65 ksi)
L7	48.95-1.00	52.76		18	32.40	41.00	0.25	1.00	A572-65 (65 ksi)

Tapered Pole Properties

Section	Tip Dia. in	Area in ²	I in ⁴	r in	C in	I/C in ³	J in ⁴	I/Q in ²	w in	w/t
L1	4.50	15.90	20.13	1.13	2.25	8.95	40.26	7.95	0.00	0
	4.50	15.90	20.13	1.13	2.25	8.95	40.26	7.95	0.00	0
L2	4.50	15.90	20.13	1.13	2.25	8.95	40.26	7.95	0.00	0
	4.50	15.90	20.13	1.13	2.25	8.95	40.26	7.95	0.00	0
L3	4.50	15.90	20.13	1.13	2.25	8.95	40.26	7.95	0.00	0
	5.75	24.74	53.54	1.47	2.88	18.62	107.08	12.36	0.00	0
L4	5.75	25.97	53.66	1.44	2.88	18.66	107.32	12.98	0.00	0
	5.75	25.97	53.66	1.44	2.88	18.66	107.32	12.98	0.00	0
L5	5.75	25.97	53.66	1.44	2.88	18.66	107.32	12.98	0.00	0
	29.25	238.22	20960.66	9.38	14.63	1433.21	41921.33	119.04	0.00	0
L6	29.67	17.30	1845.63	10.32	14.86	124.21	3693.69	8.65	4.82	25.696
	33.81	19.72	2734.77	11.76	16.93	161.57	5473.13	9.86	5.53	29.517
L7	33.66	25.51	3331.94	11.41	16.46	202.43	6668.26	12.76	5.26	21.051
	41.59	32.34	6783.71	14.47	20.83	325.70	13576.34	16.17	6.78	27.104

Tower Elevation ft	Gusset Area (per face) ft ²	Gusset Thickness in	Gusset Grade	Adjust. Factor A _f	Adjust. Factor A _r	Weight Mult.	Double Angle Stitch Bolt Spacing Diagonals in	Double Angle Stitch Bolt Spacing Horizontals in	Double Angle Stitch Bolt Spacing Redundants in
L1 115.00-105.00				1	0	1			
L2 105.00-95.50				1	0	1			
L3 95.50-95.00				1	0	1			
L4 95.00-85.50				1	0	1			
L5 85.50-85.00				1	0	1			
L6 85.00-48.95				1	1	1			
L7 48.95-1.00				1	1	1			

Feed Line/Linear Appurtenances - Entered As Area

tnxTower Semaan Engineering Solutions, LLC 1047 S. 205th St. Elkhorn, NE, 68022 Phone: (402)-289-1888 FAX: (402)-289-1861	Job 27741_B_Round Hill CT	Page 3 of 30
	Project REV02	Date 11:43:44 02/17/22
	Client KGI	Designed by Trevork

Description	Face or Leg	Allow Shield	Exclude From Torque Calculation	Component Type	Placement ft	Total Number		C _{AA} ft ² /ft	Weight plf
1 5/8" Coax (T-Mobile)	B	No	No	Inside Pole	110.00 - 1.00	12	No Ice	0.00	1.040
							1/2" Ice	0.00	1.040
							1" Ice	0.00	1.040
1 5/8" Coax (Sprint)	B	No	No	Inside Pole	100.00 - 1.00	6	No Ice	0.00	1.040
							1/2" Ice	0.00	1.040
							1" Ice	0.00	1.040
1 1/4" Coax (Sprint)	B	No	No	Inside Pole	100.00 - 1.00	2	No Ice	0.00	0.660
							1/2" Ice	0.00	0.660
							1" Ice	0.00	0.660
7/8" Coax (Dish Wireless)	B	No	No	Inside Pole	90.00 - 1.00	12	No Ice	0.00	0.520
							1/2" Ice	0.00	0.520
							1" Ice	0.00	0.520
1/2" Coax (Sprint)	B	No	No	Inside Pole	82.00 - 1.00	1	No Ice	0.00	0.160
							1/2" Ice	0.00	0.160
							1" Ice	0.00	0.160

Feed Line/Linear Appurtenances Section Areas

Tower Section	Tower Elevation ft	Face	A _R ft ²	A _F ft ²	C _{AA} In Face ft ²	C _{AA} Out Face ft ²	Weight lb
L1	115.00-105.00	A	0.000	0.000	0.000	0.000	0.00
		B	0.000	0.000	0.000	0.000	62.40
		C	0.000	0.000	0.000	0.000	0.00
L2	105.00-95.50	A	0.000	0.000	0.000	0.000	0.00
		B	0.000	0.000	0.000	0.000	152.58
		C	0.000	0.000	0.000	0.000	0.00
L3	95.50-95.00	A	0.000	0.000	0.000	0.000	0.00
		B	0.000	0.000	0.000	0.000	10.02
		C	0.000	0.000	0.000	0.000	0.00
L4	95.00-85.50	A	0.000	0.000	0.000	0.000	0.00
		B	0.000	0.000	0.000	0.000	218.46
		C	0.000	0.000	0.000	0.000	0.00
L5	85.50-85.00	A	0.000	0.000	0.000	0.000	0.00
		B	0.000	0.000	0.000	0.000	13.14
		C	0.000	0.000	0.000	0.000	0.00
L6	85.00-48.95	A	0.000	0.000	0.000	0.000	0.00
		B	0.000	0.000	0.000	0.000	952.81
		C	0.000	0.000	0.000	0.000	0.00
L7	48.95-1.00	A	0.000	0.000	0.000	0.000	0.00
		B	0.000	0.000	0.000	0.000	1267.67
		C	0.000	0.000	0.000	0.000	0.00

Feed Line/Linear Appurtenances Section Areas - With Ice

Tower Section	Tower Elevation ft	Face or Leg	Ice Thickness in	A _R ft ²	A _F ft ²	C _{AA} In Face ft ²	C _{AA} Out Face ft ²	Weight lb
L1	115.00-105.00	A	1.128	0.000	0.000	0.000	0.000	0.00
		B		0.000	0.000	0.000	0.000	62.40
		C		0.000	0.000	0.000	0.000	0.00

tnxTower Semaan Engineering Solutions, LLC 1047 S. 205th St. Elkhorn, NE, 68022 Phone: (402)-289-1888 FAX: (402)-289-1861	Job	27741_B_Round Hill CT	Page	4 of 30
	Project	REV02	Date	11:43:44 02/17/22
	Client	KGI	Designed by	TrevorK

Tower Section	Tower Elevation ft	Face or Leg	Ice Thickness in	A _R ft ²	A _F ft ²	C _A A _A In Face ft ²	C _A A _A Out Face ft ²	Weight lb
L2	105.00-95.50	A	1.118	0.000	0.000	0.000	0.000	0.00
		B		0.000	0.000	0.000	0.000	152.58
		C		0.000	0.000	0.000	0.000	0.00
L3	95.50-95.00	A	1.112	0.000	0.000	0.000	0.000	0.00
		B		0.000	0.000	0.000	0.000	10.02
		C		0.000	0.000	0.000	0.000	0.00
L4	95.00-85.50	A	1.106	0.000	0.000	0.000	0.000	0.00
		B		0.000	0.000	0.000	0.000	218.46
		C		0.000	0.000	0.000	0.000	0.00
L5	85.50-85.00	A	1.099	0.000	0.000	0.000	0.000	0.00
		B		0.000	0.000	0.000	0.000	13.14
		C		0.000	0.000	0.000	0.000	0.00
L6	85.00-48.95	A	1.073	0.000	0.000	0.000	0.000	0.00
		B		0.000	0.000	0.000	0.000	952.81
		C		0.000	0.000	0.000	0.000	0.00
L7	48.95-1.00	A	0.974	0.000	0.000	0.000	0.000	0.00
		B		0.000	0.000	0.000	0.000	1267.67
		C		0.000	0.000	0.000	0.000	0.00

Feed Line Center of Pressure

Section	Elevation ft	CP _X in	CP _Z in	CP _X Ice in	CP _Z Ice in
L1	115.00-105.00	0.00	0.00	0.00	0.00
L2	105.00-95.50	0.00	0.00	0.00	0.00
L3	95.50-95.00	0.00	0.00	0.00	0.00
L4	95.00-85.50	0.00	0.00	0.00	0.00
L5	85.50-85.00	0.00	0.00	0.00	0.00
L6	85.00-48.95	0.00	0.00	0.00	0.00
L7	48.95-1.00	0.00	0.00	0.00	0.00

Note: For pole sections, center of pressure calculations do not consider feed line shielding.

User Defined Loads - Seismic

Description	Elevation ft	Offset From Centroid ft	Azimuth Angle °	E _x lb	E _{ky} lb	E _{kz} lb	E _k lb
CCISeismic Tower Section 1 - 1	110.00	0.000	0.000	18.12	0.00	0.00	41.39
CCISeismic Tower Section 2 - 1	100.25	0.000	0.000	17.21	0.00	0.00	32.79
CCISeismic Tower Section 3 - 1	95.25	0.000	0.000	0.91	0.00	0.00	1.56
CCISeismic Tower Section 4 - 1	90.25	0.000	0.000	28.10	0.00	0.00	43.57
CCISeismic Tower Section 5 - 1	85.25	0.000	0.000	1.48	0.00	0.00	2.05
CCISeismic Tower Section 6 - 1	81.97	0.000	0.000	12.07	0.00	0.00	15.49
CCISeismic Tower Section 6 - 2	73.95	0.000	0.000	20.55	0.00	0.00	21.55
CCISeismic Tower Section 6 - 3	63.95	0.000	0.000	21.32	0.00	0.00	16.79
CCISeismic Tower Section 6 - 4	53.95	0.000	0.000	22.08	0.00	0.00	12.44
CCISeismic Tower Section 7 - 1	52.38	0.000	0.000	8.08	0.00	0.00	4.29
CCISeismic Tower Section 7 - 2	46.00	0.000	0.000	30.21	0.00	0.00	12.42

tnxTower Semaan Engineering Solutions, LLC 1047 S. 205th St. Elkhorn, NE, 68022 Phone: (402)-289-1888 FAX: (402)-289-1861	Job 27741_B_Round Hill CT	Page 5 of 30
	Project REV02	Date 11:43:44 02/17/22
	Client KGI	Designed by Trevork

Description	Elevation	Offset From Centroid	Azimuth Angle	E _v	E _{hx}	E _{hc}	E _h
	ft	ft	°	lb	lb	lb	lb
CCISeismic Tower Section 7 - 3	36.00	0.000	0.000	31.68	0.00	0.00	8.00
CCISeismic Tower Section 7 - 4	26.00	0.000	0.000	33.15	0.00	0.00	4.36
CCISeismic Tower Section 7 - 5	16.00	0.000	0.000	34.63	0.00	0.00	1.69
CCISeismic Tower Section 7 - 6	6.00	0.000	0.000	36.10	0.00	0.00	0.21
CCISeismic miscel 10' 30" Dia. Canister	110.00	0.000	0.000	9.94	0.00	0.00	22.71
CCISeismic miscel 10' 30" Dia. Canister	100.00	0.000	0.000	9.94	0.00	0.00	18.85
CCISeismic miscel 10' 40" Dia. Canister	90.00	0.000	0.000	13.26	0.00	0.00	20.44
CCISeismic (2) Canister Mount	110.00	0.000	0.000	1.87	0.00	0.00	4.28
CCISeismic	110.00	0.000	0.000	1.15	0.00	0.00	2.62
DBXNH-6565A-A2M							
CCISeismic	110.00	0.000	0.000	1.15	0.00	0.00	2.62
DBXNH-6565A-A2M							
CCISeismic	110.00	0.000	0.000	1.15	0.00	0.00	2.62
DBXNH-6565A-A2M							
CCISeismic	110.00	0.000	0.000	0.59	0.00	0.00	1.35
TMAT1921XB6811A							
CCISeismic	110.00	0.000	0.000	0.59	0.00	0.00	1.35
TMAT1921XB6811A							
CCISeismic	110.00	0.000	0.000	0.59	0.00	0.00	1.35
TMAT1921XB6811A							
CCISeismic 782 11066	110.00	0.000	0.000	0.06	0.00	0.00	0.13
CCISeismic 782 11066	110.00	0.000	0.000	0.06	0.00	0.00	0.13
CCISeismic 782 11066	110.00	0.000	0.000	0.06	0.00	0.00	0.13
CCISeismic (2) Canister Mount	100.00	0.000	0.000	1.87	0.00	0.00	3.55
CCISeismic	100.00	0.000	0.000	2.08	0.00	0.00	3.93
APXVSP18-C-A20							
CCISeismic	100.00	0.000	0.000	2.08	0.00	0.00	3.93
APXVSP18-C-A20							
CCISeismic	100.00	0.000	0.000	2.08	0.00	0.00	3.93
APXVSP18-C-A20							
CCISeismic (2)	100.00	0.000	0.000	0.43	0.00	0.00	0.81
KIT-FD9R6004/1C-DL							
CCISeismic (2)	100.00	0.000	0.000	0.43	0.00	0.00	0.81
KIT-FD9R6004/1C-DL							
CCISeismic (2)	100.00	0.000	0.000	0.43	0.00	0.00	0.81
KIT-FD9R6004/1C-DL							
CCISeismic (3)	100.00	0.000	0.000	2.21	0.00	0.00	4.19
IBC1900HG-SA							
CCISeismic (3)	100.00	0.000	0.000	2.21	0.00	0.00	4.19
IBC1900HG-SA							
CCISeismic (3)	100.00	0.000	0.000	2.21	0.00	0.00	4.19
IBC1900HG-SA							
CCISeismic (2) Canister Mount	90.00	0.000	0.000	1.87	0.00	0.00	2.89
CCISeismic FVV-65B-R3	90.00	0.000	0.000	1.47	0.00	0.00	2.26
CCISeismic FVV-65B-R3	90.00	0.000	0.000	1.47	0.00	0.00	2.26
CCISeismic FVV-65B-R3	90.00	0.000	0.000	1.47	0.00	0.00	2.26
CCISeismic (2)	90.00	0.000	0.000	0.68	0.00	0.00	1.05
CDX623T-DS-T							
CCISeismic (2)	90.00	0.000	0.000	0.68	0.00	0.00	1.05
CDX623T-DS-T							
CCISeismic (2)	90.00	0.000	0.000	0.68	0.00	0.00	1.05
CDX623T-DS-T							
CCISeismic 3' Sidearm	82.00	0.000	0.000	0.70	0.00	0.00	0.90
CCISeismic GPS	82.00	0.000	0.000	0.02	0.00	0.00	0.03
CCISeismic Spoke Flanges	85.00	0.000	0.000	11.31	0.00	0.00	15.58
CCISeismic Spoke Flanges	95.00	0.000	0.000	4.64	0.00	0.00	7.95
CCISeismic Spoke Flanges	105.00	0.000	0.000	3.57	0.00	0.00	7.44

tnxTower Semaan Engineering Solutions, LLC 1047 S. 205th St. Elkhorn, NE, 68022 Phone: (402)-289-1888 FAX: (402)-289-1861	Job 27741_B_Round Hill CT	Page 6 of 30
	Project REV02	Date 11:43:44 02/17/22
	Client KGI	Designed by TrevorK

Description	Elevation	Offset From Centroid	Azimuth Angle	E _v	E _{hx}	E _{hz}	E _h
	ft	ft	°	lb	lb	lb	lb
CCISeismic Top Flange	115.00	0.000	0.000	3.55	0.00	0.00	8.86
CCISeismic (12) general cable 1 5/8" Coax From 0 to 109 (104ft to 109ft)	107.50	0.000	0.000	2.09	0.00	0.00	4.56
CCISeismic (12) general cable 1 5/8" Coax From 0 to 109 (94ft to 104ft)	100.00	0.000	0.000	4.18	0.00	0.00	7.92
CCISeismic (12) general cable 1 5/8" Coax From 0 to 109 (84ft to 94ft)	90.00	0.000	0.000	4.18	0.00	0.00	6.44
CCISeismic (12) general cable 1 5/8" Coax From 0 to 109 (74ft to 84ft)	80.00	0.000	0.000	4.18	0.00	0.00	5.11
CCISeismic (12) general cable 1 5/8" Coax From 0 to 109 (64ft to 74ft)	70.00	0.000	0.000	4.18	0.00	0.00	3.93
CCISeismic (12) general cable 1 5/8" Coax From 0 to 109 (54ft to 64ft)	60.00	0.000	0.000	4.18	0.00	0.00	2.90
CCISeismic (12) general cable 1 5/8" Coax From 0 to 109 (44ft to 54ft)	50.00	0.000	0.000	4.18	0.00	0.00	2.03
CCISeismic (12) general cable 1 5/8" Coax From 0 to 109 (34ft to 44ft)	40.00	0.000	0.000	4.18	0.00	0.00	1.30
CCISeismic (12) general cable 1 5/8" Coax From 0 to 109 (24ft to 34ft)	30.00	0.000	0.000	4.18	0.00	0.00	0.73
CCISeismic (12) general cable 1 5/8" Coax From 0 to 109 (14ft to 24ft)	20.00	0.000	0.000	4.18	0.00	0.00	0.32
CCISeismic (12) general cable 1 5/8" Coax From 0 to 109 (4ft to 14ft)	10.00	0.000	0.000	4.18	0.00	0.00	0.08
CCISeismic (12) general cable 1 5/8" Coax From 0 to 109 (0ft to 4ft)	3.00	0.000	0.000	1.67	0.00	0.00	0.00
CCISeismic (6) general cable 1 5/8" Coax From 0 to 99 (94ft to 99ft)	97.50	0.000	0.000	1.04	0.00	0.00	1.88
CCISeismic (6) general cable 1 5/8" Coax From 0 to 99 (84ft to 94ft)	90.00	0.000	0.000	2.09	0.00	0.00	3.22
CCISeismic (6) general cable 1 5/8" Coax From 0 to 99 (74ft to 84ft)	80.00	0.000	0.000	2.09	0.00	0.00	2.56
CCISeismic (6) general cable 1 5/8" Coax From 0 to 99 (64ft to 74ft)	70.00	0.000	0.000	2.09	0.00	0.00	1.97
CCISeismic (6) general cable 1 5/8" Coax From 0 to 99 (54ft to 64ft)	60.00	0.000	0.000	2.09	0.00	0.00	1.45
CCISeismic (6) general cable 1 5/8" Coax From 0 to 99 (44ft to 54ft)	50.00	0.000	0.000	2.09	0.00	0.00	1.01
CCISeismic (6) general cable 1 5/8" Coax From 0 to 99 (34ft to 44ft)	40.00	0.000	0.000	2.09	0.00	0.00	0.65
CCISeismic (6) general cable 1 5/8" Coax From 0 to 99 (24ft to 34ft)	30.00	0.000	0.000	2.09	0.00	0.00	0.37

tnxTower Semaan Engineering Solutions, LLC 1047 S. 205th St. Elkhorn, NE, 68022 Phone: (402)-289-1888 FAX: (402)-289-1861	Job 27741_B_Round Hill CT	Page 7 of 30
	Project REV02	Date 11:43:44 02/17/22
	Client KGI	Designed by TrevorK

Description	Elevation	Offset From Centroid	Azimuth Angle	E _v	E _{hx}	E _{hz}	E _h
	ft	ft	°	lb	lb	lb	lb
to34ft)							
CCISEismic (6) general cable 1 5/8" Coax From 0 to 99 (14ft to24ft)	20.00	0.000	0.000	2.09	0.00	0.00	0.16
CCISEismic (6) general cable 1 5/8" Coax From 0 to 99 (4ft to14ft)	10.00	0.000	0.000	2.09	0.00	0.00	0.04
CCISEismic (6) general cable 1 5/8" Coax From 0 to 99 (0ft to4ft)	3.00	0.000	0.000	0.84	0.00	0.00	0.00
CCISEismic (2) general cable 1 1/4" Coax From 0 to 99 (94ft to99ft)	97.50	0.000	0.000	0.22	0.00	0.00	0.40
CCISEismic (2) general cable 1 1/4" Coax From 0 to 99 (84ft to94ft)	90.00	0.000	0.000	0.44	0.00	0.00	0.68
CCISEismic (2) general cable 1 1/4" Coax From 0 to 99 (74ft to84ft)	80.00	0.000	0.000	0.44	0.00	0.00	0.54
CCISEismic (2) general cable 1 1/4" Coax From 0 to 99 (64ft to74ft)	70.00	0.000	0.000	0.44	0.00	0.00	0.42
CCISEismic (2) general cable 1 1/4" Coax From 0 to 99 (54ft to64ft)	60.00	0.000	0.000	0.44	0.00	0.00	0.31
CCISEismic (2) general cable 1 1/4" Coax From 0 to 99 (44ft to54ft)	50.00	0.000	0.000	0.44	0.00	0.00	0.21
CCISEismic (2) general cable 1 1/4" Coax From 0 to 99 (34ft to44ft)	40.00	0.000	0.000	0.44	0.00	0.00	0.14
CCISEismic (2) general cable 1 1/4" Coax From 0 to 99 (24ft to34ft)	30.00	0.000	0.000	0.44	0.00	0.00	0.08
CCISEismic (2) general cable 1 1/4" Coax From 0 to 99 (14ft to24ft)	20.00	0.000	0.000	0.44	0.00	0.00	0.03
CCISEismic (2) general cable 1 1/4" Coax From 0 to 99 (4ft to14ft)	10.00	0.000	0.000	0.44	0.00	0.00	0.01
CCISEismic (2) general cable 1 1/4" Coax From 0 to 99 (0ft to4ft)	3.00	0.000	0.000	0.18	0.00	0.00	0.00
CCISEismic (12) general cable 7/8" Coax From 0 to 89 (84ft to89ft)	87.50	0.000	0.000	1.04	0.00	0.00	1.52
CCISEismic (12) general cable 7/8" Coax From 0 to 89 (74ft to84ft)	80.00	0.000	0.000	2.09	0.00	0.00	2.56
CCISEismic (12) general cable 7/8" Coax From 0 to 89 (64ft to74ft)	70.00	0.000	0.000	2.09	0.00	0.00	1.97
CCISEismic (12) general cable 7/8" Coax From 0 to 89 (54ft to64ft)	60.00	0.000	0.000	2.09	0.00	0.00	1.45
CCISEismic (12) general cable 7/8" Coax From 0 to 89 (44ft to54ft)	50.00	0.000	0.000	2.09	0.00	0.00	1.01
CCISEismic (12) general cable 7/8" Coax From 0 to 89 (34ft to44ft)	40.00	0.000	0.000	2.09	0.00	0.00	0.65

tnxTower Semaan Engineering Solutions, LLC 1047 S. 205th St. Elkhorn, NE, 68022 Phone: (402)-289-1888 FAX: (402)-289-1861	Job 27741_B_Round Hill CT	Page 8 of 30
	Project REV02	Date 11:43:44 02/17/22
	Client KGI	Designed by TrevorK

Description	Elevation	Offset From Centroid	Azimuth Angle	E _y	E _{xx}	E _{zz}	E _n
	ft	ft	°	lb	lb	lb	lb
to44ft)							
CCISeismic (12) general cable 7/8" Coax From 0 to 89 (24ft to34ft)	30.00	0.000	0.000	2.09	0.00	0.00	0.37
CCISeismic (12) general cable 7/8" Coax From 0 to 89 (14ft to24ft)	20.00	0.000	0.000	2.09	0.00	0.00	0.16
CCISeismic (12) general cable 7/8" Coax From 0 to 89 (4ft to14ft)	10.00	0.000	0.000	2.09	0.00	0.00	0.04
CCISeismic (12) general cable 7/8" Coax From 0 to 89 (0ft to4ft)	3.00	0.000	0.000	0.84	0.00	0.00	0.00
CCISeismic general cable 1/2" Coax From 0 to 81 (74ft to81ft)	78.50	0.000	0.000	0.04	0.00	0.00	0.04
CCISeismic general cable 1/2" Coax From 0 to 81 (64ft to74ft)	70.00	0.000	0.000	0.05	0.00	0.00	0.05
CCISeismic general cable 1/2" Coax From 0 to 81 (54ft to64ft)	60.00	0.000	0.000	0.05	0.00	0.00	0.04
CCISeismic general cable 1/2" Coax From 0 to 81 (44ft to54ft)	50.00	0.000	0.000	0.05	0.00	0.00	0.03
CCISeismic general cable 1/2" Coax From 0 to 81 (34ft to44ft)	40.00	0.000	0.000	0.05	0.00	0.00	0.02
CCISeismic general cable 1/2" Coax From 0 to 81 (24ft to34ft)	30.00	0.000	0.000	0.05	0.00	0.00	0.01
CCISeismic general cable 1/2" Coax From 0 to 81 (14ft to24ft)	20.00	0.000	0.000	0.05	0.00	0.00	0.00
CCISeismic general cable 1/2" Coax From 0 to 81 (4ft to14ft)	10.00	0.000	0.000	0.05	0.00	0.00	0.00
CCISeismic general cable 1/2" Coax From 0 to 81 (0ft to4ft)	3.00	0.000	0.000	0.02	0.00	0.00	0.00

Discrete Tower Loads

Description	Face or Leg	Offset Type	Offsets: Horz Lateral Vert	Azimuth Adjustment	Placement	C _A A _z Front	C _A A _x Side	Weight	
			ft ft ft	°	ft	ft ²	ft ²	lb	
10' 30" Dia. Canister	C	None		0.000	115.00 - 105.00	No Ice	20.00	20.00	297.00
						1/2" Ice	20.84	20.84	389.40
						1" Ice	21.69	21.69	481.80
10' 30" Dia. Canister	C	None		0.000	105.00 - 95.00	No Ice	20.00	20.00	297.00
						1/2" Ice	20.84	20.84	389.40
						1" Ice	21.69	21.69	481.80
10' 40" Dia. Canister	C	None		0.000	95.00 - 85.00	No Ice	26.67	26.67	396.00
						1/2" Ice	27.56	27.56	518.91
						1" Ice	28.47	28.47	641.82
* (2) Canister Mount (T-Mobile)	C	None		0.000	110.00	No Ice	0.00	0.00	28.00
						1/2" Ice	0.00	0.00	28.00
						1" Ice	0.00	0.00	28.00
DBXNH-6565A-A2M	A	From	1.00	0.000	110.00	No Ice	0.00	0.00	34.20

tnxTower Semaan Engineering Solutions, LLC 1047 S. 205th St. Elkhorn, NE, 68022 Phone: (402)-289-1888 FAX: (402)-289-1861	Job	27741_B_Round Hill CT	Page	9 of 30
	Project	REV02	Date	11:43:44 02/17/22
	Client	KGI	Designed by	TrevorK

Description	Face or Leg	Offset Type	Offsets: Horz Lateral Vert ft ft ft	Azimuth Adjustment °	Placement ft	C _{AA} Front ft ²	C _{AA} Side ft ²	Weight lb	
(T-Mobile)		Centroid-Face	0.000			1/2" Ice	0.00	0.00	34.20
		ce	0.000			1" Ice	0.00	0.00	34.20
DBXNH-6565A-A2M (T-Mobile)	B	From	1.00	0.000	110.00	No Ice	0.00	0.00	34.20
		Centroid-Face	0.000			1/2" Ice	0.00	0.00	34.20
		ce	0.000			1" Ice	0.00	0.00	34.20
DBXNH-6565A-A2M (T-Mobile)	C	From	1.00	0.000	110.00	No Ice	0.00	0.00	34.20
		Centroid-Face	0.000			1/2" Ice	0.00	0.00	34.20
		ce	0.000			1" Ice	0.00	0.00	34.20
TMAT1921XB6811A (T-Mobile)	A	From	0.50	0.000	110.00	No Ice	0.00	0.00	17.60
		Centroid-Face	0.000			1/2" Ice	0.00	0.00	17.60
		ce	0.000			1" Ice	0.00	0.00	17.60
TMAT1921XB6811A (T-Mobile)	B	From	0.50	0.000	110.00	No Ice	0.00	0.00	17.60
		Centroid-Face	0.000			1/2" Ice	0.00	0.00	17.60
		ce	0.000			1" Ice	0.00	0.00	17.60
TMAT1921XB6811A (T-Mobile)	C	From	0.50	0.000	110.00	No Ice	0.00	0.00	17.60
		Centroid-Face	0.000			1/2" Ice	0.00	0.00	17.60
		ce	0.000			1" Ice	0.00	0.00	17.60
782 11066 (T-Mobile)	A	From	0.50	0.000	110.00	No Ice	0.00	0.00	1.76
		Centroid-Face	0.000			1/2" Ice	0.00	0.00	1.76
		ce	0.000			1" Ice	0.00	0.00	1.76
782 11066 (T-Mobile)	B	From	0.50	0.000	110.00	No Ice	0.00	0.00	1.76
		Centroid-Face	0.000			1/2" Ice	0.00	0.00	1.76
		ce	0.000			1" Ice	0.00	0.00	1.76
782 11066 (T-Mobile)	C	From	0.50	0.000	110.00	No Ice	0.00	0.00	1.76
		Centroid-Face	0.000			1/2" Ice	0.00	0.00	1.76
		ce	0.000			1" Ice	0.00	0.00	1.76
*									
(2) Canister Mount (Sprint)	C	None		0.000	100.00	No Ice	0.00	0.00	28.00
						1/2" Ice	0.00	0.00	28.00
						1" Ice	0.00	0.00	28.00
APXVSPPI8-C-A20 (Sprint)	A	From	1.00	0.000	100.00	No Ice	0.00	0.00	62.00
		Centroid-Face	0.000			1/2" Ice	0.00	0.00	62.00
		ce	0.000			1" Ice	0.00	0.00	62.00
APXVSPPI8-C-A20 (Sprint)	B	From	1.00	0.000	100.00	No Ice	0.00	0.00	62.00
		Centroid-Face	0.000			1/2" Ice	0.00	0.00	62.00
		ce	0.000			1" Ice	0.00	0.00	62.00
APXVSPPI8-C-A20 (Sprint)	C	From	1.00	0.000	100.00	No Ice	0.00	0.00	62.00
		Centroid-Face	0.000			1/2" Ice	0.00	0.00	62.00
		ce	0.000			1" Ice	0.00	0.00	62.00
(2) KIT-FD9R6004/1C-DL (Sprint)	A	From	0.50	0.000	100.00	No Ice	0.00	0.00	6.40
		Centroid-Face	0.000			1/2" Ice	0.00	0.00	6.40
		ce	0.000			1" Ice	0.00	0.00	6.40
(2) KIT-FD9R6004/1C-DL (Sprint)	B	From	0.50	0.000	100.00	No Ice	0.00	0.00	6.40
		Centroid-Face	0.000			1/2" Ice	0.00	0.00	6.40
		ce	0.000			1" Ice	0.00	0.00	6.40
(2) KIT-FD9R6004/1C-DL (Sprint)	C	From	0.50	0.000	100.00	No Ice	0.00	0.00	6.40
		Centroid-Face	0.000			1/2" Ice	0.00	0.00	6.40
		ce	0.000			1" Ice	0.00	0.00	6.40
(3) IBC1900HG-SA (Sprint)	A	From	0.50	0.000	100.00	No Ice	0.00	0.00	22.00
		Centroid-Face	0.000			1/2" Ice	0.00	0.00	22.00
		ce	0.000			1" Ice	0.00	0.00	22.00
(3) IBC1900HG-SA (Sprint)	B	From	0.50	0.000	100.00	No Ice	0.00	0.00	22.00
		Centroid-Face	0.000			1/2" Ice	0.00	0.00	22.00
		ce	0.000			1" Ice	0.00	0.00	22.00
(3) IBC1900HG-SA (Sprint)	C	From	0.50	0.000	100.00	No Ice	0.00	0.00	22.00
		Centroid-Face	0.000			1/2" Ice	0.00	0.00	22.00
		ce	0.000			1" Ice	0.00	0.00	22.00

tnxTower Semaan Engineering Solutions, LLC 1047 S. 205th St. Elkhorn, NE, 68022 Phone: (402)-289-1888 FAX: (402)-289-1861	Job 27741_B_Round Hill CT	Page 10 of 30
	Project REV02	Date 11:43:44 02/17/22
	Client KGI	Designed by TrevorK

Description	Face or Leg	Offset Type	Offsets:		Azimuth Adjustment	Placement	C _A A _A Front	C _A A _A Side	Weight	
			Horz Lateral	Vert						
			ft	ft	°	ft	ft ²	ft ²	lb	
*										
(2) Canister Mount (Dish Wireless)	C	None			0.000	90.00	No Ice 1/2" Ice 1" Ice	0.00 0.00 0.00	0.00 0.00 0.00	28.00 28.00 28.00
FVV-65B-R3 (Dish Wireless)	A	From Centroid-Face	1.00 0.000		0.000	90.00	No Ice 1/2" Ice 1" Ice	0.00 0.00 0.00	0.00 0.00 0.00	43.87 43.87 43.87
FVV-65B-R3 (Dish Wireless)	B	From Centroid-Face	1.00 0.000		0.000	90.00	No Ice 1/2" Ice 1" Ice	0.00 0.00 0.00	0.00 0.00 0.00	43.87 43.87 43.87
FVV-65B-R3 (Dish Wireless)	C	From Centroid-Face	1.00 0.000		0.000	90.00	No Ice 1/2" Ice 1" Ice	0.00 0.00 0.00	0.00 0.00 0.00	43.87 43.87 43.87
(2) CDX623T-DS-T (Dish Wireless)	A	From Centroid-Face	1.00 0.000		0.000	90.00	No Ice 1/2" Ice 1" Ice	0.00 0.00 0.00	0.00 0.00 0.00	10.14 10.14 10.14
(2) CDX623T-DS-T (Dish Wireless)	B	From Centroid-Face	1.00 0.000		0.000	90.00	No Ice 1/2" Ice 1" Ice	0.00 0.00 0.00	0.00 0.00 0.00	10.14 10.14 10.14
(2) CDX623T-DS-T (Dish Wireless)	C	From Centroid-Face	1.00 0.000		0.000	90.00	No Ice 1/2" Ice 1" Ice	0.00 0.00 0.00	0.00 0.00 0.00	10.14 10.14 10.14
*										
3' Sidearm (Sprint)	C	From Leg	1.50 0.000		0.000	82.00	No Ice 1/2" Ice 1" Ice	0.27 0.48 0.69	0.90 1.68 2.46	21.00 33.00 45.00
GPS (Sprint)	C	From Leg	3.00 0.000		0.000	82.00	No Ice 1/2" Ice 1" Ice	0.08 0.12 0.18	0.08 0.12 0.18	0.60 1.99 4.11
*										
Spoke Flanges	C	None			0.000	85.00	No Ice 1/2" Ice 1" Ice	0.00 0.00 0.00	0.00 0.00 0.00	337.70 337.70 337.70
Spoke Flanges	C	None			0.000	95.00	No Ice 1/2" Ice 1" Ice	0.00 0.00 0.00	0.00 0.00 0.00	138.50 138.50 138.50
Spoke Flanges	C	None			0.000	105.00	No Ice 1/2" Ice 1" Ice	0.00 0.00 0.00	0.00 0.00 0.00	106.60 106.60 106.60
Top Flange	C	None			0.000	115.00	No Ice 1/2" Ice 1" Ice	0.34 0.58 0.82	0.34 0.58 0.82	106.17 120.67 135.17

Tower Pressures - No Ice

$G_H = 1.100$

tnxTower Semaan Engineering Solutions, LLC 1047 S. 205th St. Elkhorn, NE, 68022 Phone: (402)-289-1888 FAX: (402)-289-1861	Job 27741_B_Round Hill CT	Page 11 of 30
	Project REV02	Date 11:43:44 02/17/22
	Client KGI	Designed by Trevork

Section Elevation	z	K _Z	q _z	A _G	F a c e	A _F	A _R	A _{leg}	Leg %	C _A A _A In Face	C _A A _A Out Face
ft	ft		ksf	ft ²		ft ²	ft ²	ft ²		ft ²	ft ²
L1 115.00-105.00	110.00	1.291	0.045	3.750	A	0.000	0.000	0.000	0.00	0.000	0.000
					B	0.000	0.000		0.00	0.000	0.000
					C	0.000	0.000		0.00	0.000	0.000
L2 105.00-95.50	100.25	1.266	0.044	3.563	A	0.000	0.000	0.000	0.00	0.000	0.000
					B	0.000	0.000		0.00	0.000	0.000
					C	0.000	0.000		0.00	0.000	0.000
L3 95.50-95.00	95.24	1.253	0.043	0.214	A	0.000	0.000	0.000	0.00	0.000	0.000
					B	0.000	0.000		0.00	0.000	0.000
					C	0.000	0.000		0.00	0.000	0.000
L4 95.00-85.50	90.25	1.239	0.043	4.552	A	0.000	0.000	0.000	0.00	0.000	0.000
					B	0.000	0.000		0.00	0.000	0.000
					C	0.000	0.000		0.00	0.000	0.000
L5 85.50-85.00	85.19	1.224	0.042	0.729	A	0.000	0.000	0.000	0.00	0.000	0.000
					B	0.000	0.000		0.00	0.000	0.000
					C	0.000	0.000		0.00	0.000	0.000
L6 85.00-48.95	66.84	1.163	0.040	95.361	A	0.000	95.361	95.361	100.00	0.000	0.000
					B	0.000	95.361		100.00	0.000	0.000
					C	0.000	95.361		100.00	0.000	0.000
L7 48.95-1.00	25.25	0.947	0.032	150.336	A	0.000	150.336	150.336	100.00	0.000	0.000
					B	0.000	150.336		100.00	0.000	0.000
					C	0.000	150.336		100.00	0.000	0.000

Tower Pressure - With Ice

$G_H = 1.100$

Section Elevation	z	K _Z	q _z	t _z	A _G	F a c e	A _F	A _R	A _{leg}	Leg %	C _A A _A In Face	C _A A _A Out Face
ft	ft		ksf	in	ft ²		ft ²	ft ²	ft ²		ft ²	ft ²
L1 115.00-105.00	110.00	1.291	0.008	1.13	5.630	A	0.000	0.000	0.000	0.00	0.000	0.000
						B	0.000	0.000		0.00	0.000	0.000
						C	0.000	0.000		0.00	0.000	0.000
L2 105.00-95.50	100.25	1.266	0.008	1.12	5.332	A	0.000	0.000	0.000	0.00	0.000	0.000
						B	0.000	0.000		0.00	0.000	0.000
						C	0.000	0.000		0.00	0.000	0.000
L3 95.50-95.00	95.24	1.253	0.008	1.11	0.306	A	0.000	0.000	0.000	0.00	0.000	0.000
						B	0.000	0.000		0.00	0.000	0.000
						C	0.000	0.000		0.00	0.000	0.000
L4 95.00-85.50	90.25	1.239	0.007	1.11	6.303	A	0.000	0.000	0.000	0.00	0.000	0.000
						B	0.000	0.000		0.00	0.000	0.000
						C	0.000	0.000		0.00	0.000	0.000
L5 85.50-85.00	85.19	1.224	0.007	1.10	0.821	A	0.000	0.000	0.000	0.00	0.000	0.000
						B	0.000	0.000		0.00	0.000	0.000
						C	0.000	0.000		0.00	0.000	0.000
L6 85.00-48.95	66.84	1.163	0.007	1.07	101.810	A	0.000	101.810	101.810	100.00	0.000	0.000
						B	0.000	101.810		100.00	0.000	0.000
						C	0.000	101.810		100.00	0.000	0.000
L7 48.95-1.00	25.25	0.947	0.006	0.97	158.911	A	0.000	158.911	158.911	100.00	0.000	0.000
						B	0.000	158.911		100.00	0.000	0.000
						C	0.000	158.911		100.00	0.000	0.000

tnxTower Semaan Engineering Solutions, LLC 1047 S. 205th St. Elkhorn, NE, 68022 Phone: (402)-289-1888 FAX: (402)-289-1861	Job 27741_B_Round Hill CT	Page 12 of 30
	Project REV02	Date 11:43:44 02/17/22
	Client KGI	Designed by TrevorK

Tower Pressure - Service

$G_H = 1.100$

Section Elevation	z	K _Z	q _z	A _G	F _{a c e}	A _F	A _R	A _{leg}	Leg %	C _{A A} In Face	C _{A A} Out Face
ft	ft		ksf	ft ²		ft ²	ft ²	ft ²		ft ²	ft ²
L1 115.00-105.00	110.00	1.291	0.010	3.750	A	0.000	0.000	0.000	0.00	0.000	0.000
					B	0.000	0.000		0.00	0.000	0.000
					C	0.000	0.000		0.00	0.000	0.000
L2 105.00-95.50	100.25	1.266	0.010	3.563	A	0.000	0.000	0.000	0.00	0.000	0.000
					B	0.000	0.000		0.00	0.000	0.000
					C	0.000	0.000		0.00	0.000	0.000
L3 95.50-95.00	95.24	1.253	0.010	0.214	A	0.000	0.000	0.000	0.00	0.000	0.000
					B	0.000	0.000		0.00	0.000	0.000
					C	0.000	0.000		0.00	0.000	0.000
L4 95.00-85.50	90.25	1.239	0.010	4.552	A	0.000	0.000	0.000	0.00	0.000	0.000
					B	0.000	0.000		0.00	0.000	0.000
					C	0.000	0.000		0.00	0.000	0.000
L5 85.50-85.00	85.19	1.224	0.009	0.729	A	0.000	0.000	0.000	0.00	0.000	0.000
					B	0.000	0.000		0.00	0.000	0.000
					C	0.000	0.000		0.00	0.000	0.000
L6 85.00-48.95	66.84	1.163	0.009	95.361	A	0.000	95.361	95.361	100.00	0.000	0.000
					B	0.000	95.361		100.00	0.000	0.000
					C	0.000	95.361		100.00	0.000	0.000
L7 48.95-1.00	25.25	0.947	0.007	150.336	A	0.000	150.336	150.336	100.00	0.000	0.000
					B	0.000	150.336		100.00	0.000	0.000
					C	0.000	150.336		100.00	0.000	0.000

Tower Forces - No Ice - Wind Normal To Face

Section Elevation	Add Weight	Self Weight	F _{a c e}	e	C _F	q _z	D _F	D _R	A _E	F	w	Ctrl. Face
ft	lb	lb				ksf			ft ²	lb	plf	
L1 115.00-105.00	62.40	541.19	A	0	0.782	0.045	1	1	0.000	0.00	0.000	C
			B	0	0.782		1	1	0.000			
			C	0	0.782		1	1	0.000			
L2 105.00-95.50	152.58	514.13	A	0	0.792	0.044	1	1	0.000	0.00	0.000	C
			B	0	0.792		1	1	0.000			
			C	0	0.792		1	1	0.000			
L3 95.50-95.00	10.02	34.58	A	0	0.674	0.043	1	1	0.000	0.00	0.000	C
			B	0	0.674		1	1	0.000			
			C	0	0.674		1	1	0.000			
L4 95.00-85.50	218.46	839.43	A	0	0.585	0.043	1	1	0.000	0.00	0.000	C
			B	0	0.585		1	1	0.000			
			C	0	0.585		1	1	0.000			
L5 85.50-85.00	13.14	224.74	A	0	0.45	0.042	1	1	0.000	0.00	0.000	C
			B	0	0.45		1	1	0.000			
			C	0	0.45		1	1	0.000			
L6 85.00-48.95	952.81	2270.56	A	1	0.63	0.040	1	1	95.361	2648.04	73.445	C
			B	1	0.63		1	1	95.361			
			C	1	0.63		1	1	95.361			
L7 48.95-1.00	1267.67	5192.76	A	1	0.63	0.032	1	1	150.336	3357.41	70.026	C
			B	1	0.63		1	1	150.336			
			C	1	0.63		1	1	150.336			
Sum Weight:	2677.08	9617.39						OTM	255.76 kip-ft	6005.45		

tnxTower Semaan Engineering Solutions, LLC 1047 S. 205th St. Elkhorn, NE, 68022 Phone: (402)-289-1888 FAX: (402)-289-1861	Job 27741_B_Round Hill CT	Page 13 of 30
	Project REV02	Date 11:43:44 02/17/22
	Client KGI	Designed by TrevorK

Tower Forces - No Ice - Wind 60 To Face

Section Elevation ft	Add Weight lb	Self Weight lb	F a c e	e	C _P	q _s ksf	D _F	D _R	A _E ft ²	F lb	w plf	Ctrl. Face
L1 115.00-105.00	62.40	541.19	A	0	0.782	0.045	1	1	0.000	0.00	0.000	C
			B	0	0.782	1	1	0.000				
			C	0	0.782	1	1	0.000				
L2 105.00-95.50	152.58	514.13	A	0	0.792	0.044	1	1	0.000	0.00	0.000	C
			B	0	0.792	1	1	0.000				
			C	0	0.792	1	1	0.000				
L3 95.50-95.00	10.02	34.58	A	0	0.674	0.043	1	1	0.000	0.00	0.000	C
			B	0	0.674	1	1	0.000				
			C	0	0.674	1	1	0.000				
L4 95.00-85.50	218.46	839.43	A	0	0.585	0.043	1	1	0.000	0.00	0.000	C
			B	0	0.585	1	1	0.000				
			C	0	0.585	1	1	0.000				
L5 85.50-85.00	13.14	224.74	A	0	0.45	0.042	1	1	0.000	0.00	0.000	C
			B	0	0.45	1	1	0.000				
			C	0	0.45	1	1	0.000				
L6 85.00-48.95	952.81	2270.56	A	1	0.63	0.040	1	1	95.361	2648.04	73.445	C
			B	1	0.63	1	1	95.361				
			C	1	0.63	1	1	95.361				
L7 48.95-1.00	1267.67	5192.76	A	1	0.63	0.032	1	1	150.336	3357.41	70.026	C
			B	1	0.63	1	1	150.336				
			C	1	0.63	1	1	150.336				
Sum Weight:	2677.08	9617.39						OTM	255.76 kip-ft	6005.45		

Tower Forces - No Ice - Wind 90 To Face

Section Elevation ft	Add Weight lb	Self Weight lb	F a c e	e	C _P	q _s ksf	D _F	D _R	A _E ft ²	F lb	w plf	Ctrl. Face
L1 115.00-105.00	62.40	541.19	A	0	0.782	0.045	1	1	0.000	0.00	0.000	C
			B	0	0.782	1	1	0.000				
			C	0	0.782	1	1	0.000				
L2 105.00-95.50	152.58	514.13	A	0	0.792	0.044	1	1	0.000	0.00	0.000	C
			B	0	0.792	1	1	0.000				
			C	0	0.792	1	1	0.000				
L3 95.50-95.00	10.02	34.58	A	0	0.674	0.043	1	1	0.000	0.00	0.000	C
			B	0	0.674	1	1	0.000				
			C	0	0.674	1	1	0.000				
L4 95.00-85.50	218.46	839.43	A	0	0.585	0.043	1	1	0.000	0.00	0.000	C
			B	0	0.585	1	1	0.000				
			C	0	0.585	1	1	0.000				
L5 85.50-85.00	13.14	224.74	A	0	0.45	0.042	1	1	0.000	0.00	0.000	C
			B	0	0.45	1	1	0.000				
			C	0	0.45	1	1	0.000				
L6	952.81	2270.56	A	1	0.63	0.040	1	1	95.361	2648.04	73.445	C

tnxTower Semaan Engineering Solutions, LLC 1047 S. 205th St. Elkhorn, NE, 68022 Phone: (402)-289-1888 FAX: (402)-289-1861	Job 27741_B_Round Hill CT	Page 14 of 30
	Project REV02	Date 11:43:44 02/17/22
	Client KGI	Designed by Trevork

Section Elevation ft	Add Weight lb	Self Weight lb	Face	e	C _P	q _z ksf	D _F	D _R	A _E ft ²	F lb	w plf	Ctrl. Face
85.00-48.95			B	1	0.63		1	1	95.361			
			C	1	0.63		1	1	95.361			
L7 48.95-1.00	1267.67	5192.76	A	1	0.63	0.032	1	1	150.336	3357.41	70.026	C
			B	1	0.63		1	1	150.336			
			C	1	0.63		1	1	150.336			
Sum Weight:	2677.08	9617.39						OTM	255.76 kip-ft	6005.45		

Tower Forces - With Ice - Wind Normal To Face

Section Elevation ft	Add Weight lb	Self Weight lb	Face	e	C _P	q _z ksf	D _F	D _R	A _E ft ²	F lb	w plf	Ctrl. Face
L1 115.00-105.00	62.40	618.75	A	0	1.1	0.008	1	1	0.000	0.00	0.000	C
			B	0	1.1		1	1	0.000			
			C	0	1.1		1	1	0.000			
L2 105.00-95.50	152.58	586.99	A	0	1.1	0.008	1	1	0.000	0.00	0.000	C
			B	0	1.1		1	1	0.000			
			C	0	1.1		1	1	0.000			
L3 95.50-95.00	10.02	38.81	A	0	1.1	0.008	1	1	0.000	0.00	0.000	C
			B	0	1.1		1	1	0.000			
			C	0	1.1		1	1	0.000			
L4 95.00-85.50	218.46	927.42	A	0	1.1	0.007	1	1	0.000	0.00	0.000	C
			B	0	1.1		1	1	0.000			
			C	0	1.1		1	1	0.000			
L5 85.50-85.00	13.14	237.24	A	0	1.1	0.007	1	1	0.000	0.00	0.000	C
			B	0	1.1		1	1	0.000			
			C	0	1.1		1	1	0.000			
L6 85.00-48.95	952.81	3815.92	A	1	1.1	0.007	1	1	101.810	856.98	23.769	C
			B	1	1.1		1	1	101.810			
			C	1	1.1		1	1	101.810			
L7 48.95-1.00	1267.67	7386.07	A	1	1.1	0.006	1	1	158.116	1070.40	22.325	C
			B	1	1.1		1	1	158.116			
			C	1	1.1		1	1	158.116			
Sum Weight:	2677.08	13611.21						OTM	82.38 kip-ft	1927.38		

Tower Forces - With Ice - Wind 60 To Face

Section Elevation ft	Add Weight lb	Self Weight lb	Face	e	C _P	q _z ksf	D _F	D _R	A _E ft ²	F lb	w plf	Ctrl. Face
L1 115.00-105.00	62.40	618.75	A	0	1.1	0.008	1	1	0.000	0.00	0.000	C
			B	0	1.1		1	1	0.000			
			C	0	1.1		1	1	0.000			
L2 105.00-95.50	152.58	586.99	A	0	1.1	0.008	1	1	0.000	0.00	0.000	C
			B	0	1.1		1	1	0.000			

tnxTower Semaan Engineering Solutions, LLC 1047 S. 205th St. Elkhorn, NE, 68022 Phone: (402)-289-1888 FAX: (402)-289-1861	Job	27741_B_Round Hill CT	Page	15 of 30
	Project	REV02	Date	11:43:44 02/17/22
	Client	KGI	Designed by	TrevorK

Section Elevation ft	Add Weight lb	Self Weight lb	F a c e	e	C _F	q _s ksf	D _F	D _R	A _G ft ²	F lb	w plf	Ctrl. Face
L3 95.50-95.00	10.02	38.81	C	0	1.1		1	1	0.000			
			A	0	1.1	0.008	1	1	0.000	0.00	0.000	C
			B	0	1.1		1	1	0.000			
L4 95.00-85.50	218.46	927.42	C	0	1.1		1	1	0.000			
			A	0	1.1	0.007	1	1	0.000	0.00	0.000	C
			B	0	1.1		1	1	0.000			
L5 85.50-85.00	13.14	237.24	C	0	1.1		1	1	0.000			
			A	0	1.1	0.007	1	1	0.000	0.00	0.000	C
			B	0	1.1		1	1	0.000			
L6 85.00-48.95	952.81	3815.92	C	0	1.1		1	1	0.000			
			A	1	1.1	0.007	1	1	101.810	856.98	23.769	C
			B	1	1.1		1	1	101.810			
L7 48.95-1.00	1267.67	7386.07	C	0	1.1		1	1	0.000			
			A	1	1.1	0.006	1	1	158.116	1070.40	22.325	C
			B	1	1.1		1	1	158.116			
Sum Weight:	2677.08	13611.21	C	1	1.1		1	1	158.116			
								OTM	82.38 kip-ft	1927.38		

Tower Forces - With Ice - Wind 90 To Face

Section Elevation ft	Add Weight lb	Self Weight lb	F a c e	e	C _F	q _s ksf	D _F	D _R	A _E ft ²	F lb	w plf	Ctrl. Face
L1 115.00-105.00	62.40	618.75	C	0	1.1		1	1	0.000			
			A	0	1.1	0.008	1	1	0.000	0.00	0.000	C
			B	0	1.1		1	1	0.000			
L2 105.00-95.50	152.58	586.99	C	0	1.1		1	1	0.000			
			A	0	1.1	0.008	1	1	0.000	0.00	0.000	C
			B	0	1.1		1	1	0.000			
L3 95.50-95.00	10.02	38.81	C	0	1.1		1	1	0.000			
			A	0	1.1	0.008	1	1	0.000	0.00	0.000	C
			B	0	1.1		1	1	0.000			
L4 95.00-85.50	218.46	927.42	C	0	1.1		1	1	0.000			
			A	0	1.1	0.007	1	1	0.000	0.00	0.000	C
			B	0	1.1		1	1	0.000			
L5 85.50-85.00	13.14	237.24	C	0	1.1		1	1	0.000			
			A	0	1.1	0.007	1	1	0.000	0.00	0.000	C
			B	0	1.1		1	1	0.000			
L6 85.00-48.95	952.81	3815.92	C	0	1.1		1	1	0.000			
			A	1	1.1	0.007	1	1	101.810	856.98	23.769	C
			B	1	1.1		1	1	101.810			
L7 48.95-1.00	1267.67	7386.07	C	0	1.1		1	1	0.000			
			A	1	1.1	0.006	1	1	158.116	1070.40	22.325	C
			B	1	1.1		1	1	158.116			
Sum Weight:	2677.08	13611.21	C	1	1.1		1	1	158.116			
								OTM	82.38 kip-ft	1927.38		

tnxTower Semaan Engineering Solutions, LLC 1047 S. 205th St. Elkhorn, NE, 68022 Phone: (402)-289-1888 FAX: (402)-289-1861	Job 27741_B_Round Hill CT	Page 16 of 30
	Project REV02	Date 11:43:44 02/17/22
	Client KGI	Designed by Trevork

Tower Forces - Service - Wind Normal To Face

Section Elevation ft	Add Weight lb	Self Weight lb	F a c e	e	C _F	q _s ksf	D _F	D _R	A _E ft ²	F lb	w plf	Ctrl. Face
L1 115.00-105.00	62.40	541.19	A	0	1.1	0.010	1	1	0.000	0.00	0.000	C
			B	0	1.1	1	1	0.000				
			C	0	1.1	1	1	0.000				
L2 105.00-95.50	152.58	514.13	A	0	1.1	0.010	1	1	0.000	0.00	0.000	C
			B	0	1.1	1	1	0.000				
			C	0	1.1	1	1	0.000				
L3 95.50-95.00	10.02	34.58	A	0	1.1	0.010	1	1	0.000	0.00	0.000	C
			B	0	1.1	1	1	0.000				
			C	0	1.1	1	1	0.000				
L4 95.00-85.50	218.46	839.43	A	0	1.1	0.010	1	1	0.000	0.00	0.000	C
			B	0	1.1	1	1	0.000				
			C	0	1.1	1	1	0.000				
L5 85.50-85.00	13.14	224.74	A	0	0.45	0.009	1	1	0.000	0.00	0.000	C
			B	0	0.45	1	1	0.000				
			C	0	0.45	1	1	0.000				
L6 85.00-48.95	952.81	2270.56	A	1	0.63	0.009	1	1	95.361	592.33	16.429	C
			B	1	0.63	1	1	95.361				
			C	1	0.63	1	1	95.361				
L7 48.95-1.00	1267.67	5192.76	A	1	0.63	0.007	1	1	150.336	751.00	15.664	C
			B	1	0.63	1	1	150.336				
			C	1	0.63	1	1	150.336				
Sum Weight:	2677.08	9617.39						OTM 57.21 kip-ft	1343.33			

Tower Forces - Service - Wind 60 To Face

Section Elevation ft	Add Weight lb	Self Weight lb	F a c e	e	C _F	q _s ksf	D _F	D _R	A _E ft ²	F lb	w plf	Ctrl. Face
L1 115.00-105.00	62.40	541.19	A	0	1.1	0.010	1	1	0.000	0.00	0.000	C
			B	0	1.1	1	1	0.000				
			C	0	1.1	1	1	0.000				
L2 105.00-95.50	152.58	514.13	A	0	1.1	0.010	1	1	0.000	0.00	0.000	C
			B	0	1.1	1	1	0.000				
			C	0	1.1	1	1	0.000				
L3 95.50-95.00	10.02	34.58	A	0	1.1	0.010	1	1	0.000	0.00	0.000	C
			B	0	1.1	1	1	0.000				
			C	0	1.1	1	1	0.000				
L4 95.00-85.50	218.46	839.43	A	0	1.1	0.010	1	1	0.000	0.00	0.000	C
			B	0	1.1	1	1	0.000				
			C	0	1.1	1	1	0.000				
L5 85.50-85.00	13.14	224.74	A	0	0.45	0.009	1	1	0.000	0.00	0.000	C
			B	0	0.45	1	1	0.000				
			C	0	0.45	1	1	0.000				
L6 85.00-48.95	952.81	2270.56	A	1	0.63	0.009	1	1	95.361	592.33	16.429	C
			B	1	0.63	1	1	95.361				
			C	1	0.63	1	1	95.361				
L7 48.95-1.00	1267.67	5192.76	A	1	0.63	0.007	1	1	150.336	751.00	15.664	C
			B	1	0.63	1	1	150.336				
			C	1	0.63	1	1	150.336				

tnxTower Semaan Engineering Solutions, LLC 1047 S. 205th St. Elkhorn, NE, 68022 Phone: (402)-289-1888 FAX: (402)-289-1861	Job 27741_B_Round Hill CT	Page 17 of 30
	Project REV02	Date 11:43:44 02/17/22
	Client KGI	Designed by Trevork

Section Elevation	Add Weight	Self Weight	F a c e	e	C _F	q _z	D _F	D _R	A _R	F	w	Ctrl. Face
ft	lb	lb				ksf			ft ²	lb	plf	
Sum Weight:	2677.08	9617.39						OTM	57.21 kip-ft	1343.33		

Tower Forces - Service - Wind 90 To Face

Section Elevation	Add Weight	Self Weight	F a c e	e	C _F	q _z	D _F	D _R	A _R	F	w	Ctrl. Face
ft	lb	lb				ksf			ft ²	lb	plf	
L1 115.00-105.00	62.40	541.19	A	0	1.1	0.010	1	1	0.000	0.00	0.000	C
			B	0	1.1		1	1	0.000			
			C	0	1.1		1	1	0.000			
L2 105.00-95.50	152.58	514.13	A	0	1.1	0.010	1	1	0.000	0.00	0.000	C
			B	0	1.1		1	1	0.000			
			C	0	1.1		1	1	0.000			
L3 95.50-95.00	10.02	34.58	A	0	1.1	0.010	1	1	0.000	0.00	0.000	C
			B	0	1.1		1	1	0.000			
			C	0	1.1		1	1	0.000			
L4 95.00-85.50	218.46	839.43	A	0	1.1	0.010	1	1	0.000	0.00	0.000	C
			B	0	1.1		1	1	0.000			
			C	0	1.1		1	1	0.000			
L5 85.50-85.00	13.14	224.74	A	0	0.45	0.009	1	1	0.000	0.00	0.000	C
			B	0	0.45		1	1	0.000			
			C	0	0.45		1	1	0.000			
L6 85.00-48.95	952.81	2270.56	A	1	0.63	0.009	1	1	95.361	592.33	16.429	C
			B	1	0.63		1	1	95.361			
			C	1	0.63		1	1	95.361			
L7 48.95-1.00	1267.67	5192.76	A	1	0.63	0.007	1	1	150.336	751.00	15.664	C
			B	1	0.63		1	1	150.336			
			C	1	0.63		1	1	150.336			
Sum Weight:	2677.08	9617.39						OTM	57.21 kip-ft	1343.33		

Force Totals

Load Case	Vertical Forces	Sum of Forces X	Sum of Forces Z	Sum of Overturning Moments, M _x	Sum of Overturning Moments, M _z	Sum of Torques
	lb	lb	lb	kip-ft	kip-ft	kip-ft
Leg Weight	9617.39					
Bracing Weight	0.00					
Total Member Self-Weight	9617.39			0.03	0.05	
Total Weight	14938.57			0.03	0.05	
Wind 0 deg - No Ice		-12.58	-9257.49	-574.53	1.07	-0.11
Wind 30 deg - No Ice		4610.59	-8010.93	-497.04	-285.76	-0.06
Wind 60 deg - No Ice		7998.35	-4617.85	-286.37	-496.00	0.00
Wind 90 deg - No Ice		9242.96	12.58	1.05	-573.33	0.06
Wind 120 deg - No Ice		8010.93	4639.64	288.19	-497.02	0.11
Wind 150 deg - No Ice		4632.38	8023.51	498.12	-287.52	0.13

tnxTower Semaan Engineering Solutions, LLC 1047 S. 205th St. Elkhorn, NE, 68022 Phone: (402)-289-1888 FAX: (402)-289-1861	Job 27741_B_Round Hill CT	Page 18 of 30
	Project REV02	Date 11:43:44 02/17/22
	Client KGI	Designed by TrevorK

Load Case	Vertical Forces lb	Sum of Forces X lb	Sum of Forces Z lb	Sum of Overturning Moments, M_x kip-ft	Sum of Overturning Moments, M_z kip-ft	Sum of Torques kip-ft
Wind 180 deg - No Ice		12.58	9257.49	574.59	-0.97	0.11
Wind 210 deg - No Ice		-4610.59	8010.93	497.10	285.86	0.06
Wind 240 deg - No Ice		-7998.35	4617.85	286.43	496.10	0.00
Wind 270 deg - No Ice		-9242.96	-12.58	-0.99	573.43	-0.06
Wind 300 deg - No Ice		-8010.93	-4639.64	-288.13	497.12	-0.11
Wind 330 deg - No Ice		-4632.38	-8023.51	-498.06	287.63	-0.13
Member Ice	3993.82					
Total Weight Ice	19682.40			0.07	0.13	
Wind 0 deg - Ice		-6.51	-2557.16	-143.96	0.66	-0.06
Wind 30 deg - Ice		1269.18	-2211.31	-124.40	-71.13	-0.03
Wind 60 deg - Ice		2204.79	-1272.94	-71.49	-123.82	0.00
Wind 90 deg - Ice		2549.64	6.51	0.60	-143.30	0.03
Wind 120 deg - Ice		2211.31	1284.22	72.55	-124.34	0.06
Wind 150 deg - Ice		1280.46	2217.82	125.08	-72.04	0.06
Wind 180 deg - Ice		6.51	2557.16	144.11	-0.40	0.06
Wind 210 deg - Ice		-1269.18	2211.31	124.55	71.38	0.03
Wind 240 deg - Ice		-2204.79	1272.94	71.63	124.08	0.00
Wind 270 deg - Ice		-2549.64	-6.51	-0.45	143.55	-0.03
Wind 300 deg - Ice		-2211.31	-1284.22	-72.40	124.60	-0.06
Wind 330 deg - Ice		-1280.46	-2217.82	-124.93	72.30	-0.06
Total Weight	14938.57			0.03	0.05	
Wind 0 deg - Service		-2.81	-2070.75	-128.49	0.28	-0.02
Wind 30 deg - Service		1031.32	-1791.92	-111.16	-63.88	-0.01
Wind 60 deg - Service		1789.10	-1032.94	-64.03	-110.91	0.00
Wind 90 deg - Service		2067.50	2.81	0.26	-128.20	0.01
Wind 120 deg - Service		1791.92	1037.81	64.49	-111.14	0.02
Wind 150 deg - Service		1036.19	1794.73	111.45	-64.27	0.03
Wind 180 deg - Service		2.81	2070.75	128.55	-0.18	0.02
Wind 210 deg - Service		-1031.32	1791.92	111.22	63.98	0.01
Wind 240 deg - Service		-1789.10	1032.94	64.09	111.01	0.00
Wind 270 deg - Service		-2067.50	-2.81	-0.20	128.31	-0.01
Wind 300 deg - Service		-1791.92	-1037.81	-64.43	111.24	-0.02
Wind 330 deg - Service		-1036.19	-1794.73	-111.39	64.38	-0.03
Seismic Vertical	493.84					
Seismic Horizontal 0 deg		0.00	-442.50	-38.45	0.00	0.00
Seismic Horizontal 30 deg		221.25	-383.22	-33.30	-19.23	0.00
Seismic Horizontal 60 deg		383.22	-221.25	-19.23	-33.30	0.00
Seismic Horizontal 90 deg		442.50	0.00	0.00	-38.45	0.00
Seismic Horizontal 120 deg		383.22	221.25	19.23	-33.30	0.00
Seismic Horizontal 150 deg		221.25	383.22	33.30	-19.23	0.00
Seismic Horizontal 180 deg		0.00	442.50	38.45	0.00	0.00
Seismic Horizontal 210 deg		-221.25	383.22	33.30	19.23	0.00
Seismic Horizontal 240 deg		-383.22	221.25	19.23	33.30	0.00
Seismic Horizontal 270 deg		-442.50	0.00	0.00	38.45	0.00
Seismic Horizontal 300 deg		-383.22	-221.25	-19.23	33.30	0.00
Seismic Horizontal 330 deg		-221.25	-383.22	-33.30	19.23	0.00

Load Combinations

Comb. No.	Description
1	Dead Only
2	1.2 Dead+1.0 Wind 0 deg - No Ice
3	0.9 Dead+1.0 Wind 0 deg - No Ice
4	1.2 Dead+1.0 Wind 30 deg - No Ice
5	0.9 Dead+1.0 Wind 30 deg - No Ice

tnxTower Semaan Engineering Solutions, LLC 1047 S. 205th St. Elkhorn, NE, 68022 Phone: (402)-289-1888 FAX: (402)-289-1861	Job 27741_B_Round Hill CT	Page 19 of 30
	Project REV02	Date 11:43:44 02/17/22
	Client KGI	Designed by TrevorK

Comb. No.	Description
6	1.2 Dead+1.0 Wind 60 deg - No Ice
7	0.9 Dead+1.0 Wind 60 deg - No Ice
8	1.2 Dead+1.0 Wind 90 deg - No Ice
9	0.9 Dead+1.0 Wind 90 deg - No Ice
10	1.2 Dead+1.0 Wind 120 deg - No Ice
11	0.9 Dead+1.0 Wind 120 deg - No Ice
12	1.2 Dead+1.0 Wind 150 deg - No Ice
13	0.9 Dead+1.0 Wind 150 deg - No Ice
14	1.2 Dead+1.0 Wind 180 deg - No Ice
15	0.9 Dead+1.0 Wind 180 deg - No Ice
16	1.2 Dead+1.0 Wind 210 deg - No Ice
17	0.9 Dead+1.0 Wind 210 deg - No Ice
18	1.2 Dead+1.0 Wind 240 deg - No Ice
19	0.9 Dead+1.0 Wind 240 deg - No Ice
20	1.2 Dead+1.0 Wind 270 deg - No Ice
21	0.9 Dead+1.0 Wind 270 deg - No Ice
22	1.2 Dead+1.0 Wind 300 deg - No Ice
23	0.9 Dead+1.0 Wind 300 deg - No Ice
24	1.2 Dead+1.0 Wind 330 deg - No Ice
25	0.9 Dead+1.0 Wind 330 deg - No Ice
26	1.2 Dead+1.0 Ice
27	1.2 Dead+1.0 Wind 0 deg+1.0 Ice
28	1.2 Dead+1.0 Wind 30 deg+1.0 Ice
29	1.2 Dead+1.0 Wind 60 deg+1.0 Ice
30	1.2 Dead+1.0 Wind 90 deg+1.0 Ice
31	1.2 Dead+1.0 Wind 120 deg+1.0 Ice
32	1.2 Dead+1.0 Wind 150 deg+1.0 Ice
33	1.2 Dead+1.0 Wind 180 deg+1.0 Ice
34	1.2 Dead+1.0 Wind 210 deg+1.0 Ice
35	1.2 Dead+1.0 Wind 240 deg+1.0 Ice
36	1.2 Dead+1.0 Wind 270 deg+1.0 Ice
37	1.2 Dead+1.0 Wind 300 deg+1.0 Ice
38	1.2 Dead+1.0 Wind 330 deg+1.0 Ice
39	Dead+Wind 0 deg - Service
40	Dead+Wind 30 deg - Service
41	Dead+Wind 60 deg - Service
42	Dead+Wind 90 deg - Service
43	Dead+Wind 120 deg - Service
44	Dead+Wind 150 deg - Service
45	Dead+Wind 180 deg - Service
46	Dead+Wind 210 deg - Service
47	Dead+Wind 240 deg - Service
48	Dead+Wind 270 deg - Service
49	Dead+Wind 300 deg - Service
50	Dead+Wind 330 deg - Service
51	1.2 Dead+1.0 Ev+1.0 Eh 0 deg
52	0.9 Dead-1.0 Ev+1.0 Eh 0 deg
53	1.2 Dead+1.0 Ev+1.0 Eh 30 deg
54	0.9 Dead-1.0 Ev+1.0 Eh 30 deg
55	1.2 Dead+1.0 Ev+1.0 Eh 60 deg
56	0.9 Dead-1.0 Ev+1.0 Eh 60 deg
57	1.2 Dead+1.0 Ev+1.0 Eh 90 deg
58	0.9 Dead-1.0 Ev+1.0 Eh 90 deg
59	1.2 Dead+1.0 Ev+1.0 Eh 120 deg
60	0.9 Dead-1.0 Ev+1.0 Eh 120 deg
61	1.2 Dead+1.0 Ev+1.0 Eh 150 deg
62	0.9 Dead-1.0 Ev+1.0 Eh 150 deg
63	1.2 Dead+1.0 Ev+1.0 Eh 180 deg
64	0.9 Dead-1.0 Ev+1.0 Eh 180 deg
65	1.2 Dead+1.0 Ev+1.0 Eh 210 deg
66	0.9 Dead-1.0 Ev+1.0 Eh 210 deg
67	1.2 Dead+1.0 Ev+1.0 Eh 240 deg

tnxTower Semaan Engineering Solutions, LLC 1047 S. 205th St. Elkhorn, NE, 68022 Phone: (402)-289-1888 FAX: (402)-289-1861	Job	27741_B_Round Hill CT	Page	20 of 30
	Project	REV02	Date	11:43:44 02/17/22
	Client	KGI	Designed by	TrevorK

Comb. No.	Description
68	0.9 Dead-1.0 Ev+1.0 Eh 240 deg
69	1.2 Dead+1.0 Ev+1.0 Eh 270 deg
70	0.9 Dead-1.0 Ev+1.0 Eh 270 deg
71	1.2 Dead+1.0 Ev+1.0 Eh 300 deg
72	0.9 Dead-1.0 Ev+1.0 Eh 300 deg
73	1.2 Dead+1.0 Ev+1.0 Eh 330 deg
74	0.9 Dead-1.0 Ev+1.0 Eh 330 deg

Maximum Member Forces

Section No.	Elevation ft	Component Type	Condition	Gov. Load Comb.	Axial lb	Major Axis Moment kip-ft	Minor Axis Moment kip-ft
L1	115 - 105	Pole	Max Tension	33	0.08	-0.00	0.00
			Max. Compression	26	-1786.98	0.00	0.00
			Max. Mx	20	-1373.96	5.78	0.00
			Max. My	14	-1373.90	-0.00	-5.78
			Max. Vy	20	-1124.19	5.78	0.00
			Max. Vx	14	1124.27	-0.00	-5.78
			Max. Torque	12			0.00
L2	105 - 95.5	Pole	Max Tension	1	0.00	0.00	0.00
			Max. Compression	26	-3896.62	0.00	0.00
			Max. Mx	20	-3186.41	21.28	0.00
			Max. My	14	-3186.30	-0.00	-21.28
			Max. Vy	20	-2109.43	21.28	0.00
			Max. Vx	14	2109.60	-0.00	-21.28
			Max. Torque	2			-0.00
L3	95.5 - 95	Pole	Max Tension	1	0.00	0.00	0.00
			Max. Compression	26	-3982.52	0.00	0.00
			Max. Mx	20	-3261.54	22.34	0.00
			Max. My	14	-3261.43	-0.00	-22.34
			Max. Vy	20	-2151.42	22.34	0.00
			Max. Vx	14	2151.60	-0.00	-22.34
			Max. Torque	2			-0.00
L4	95 - 85.5	Pole	Max Tension	1	0.00	0.00	0.00
			Max. Compression	26	-6513.93	0.00	0.00
			Max. Mx	20	-5471.14	48.44	0.00
			Max. My	14	-5470.97	-0.00	-48.44
			Max. Vy	20	-3312.33	48.44	0.00
			Max. Vx	14	3312.61	-0.00	-48.44
			Max. Torque	12			0.00
L5	85.5 - 85	Pole	Max Tension	1	0.00	0.00	0.00
			Max. Compression	26	-6849.24	0.00	0.00
			Max. Mx	20	-5786.21	50.11	0.00
			Max. My	14	-5786.04	-0.00	-50.11
			Max. Vy	20	-3370.71	50.11	0.00
			Max. Vx	14	3371.01	-0.00	-50.11
			Max. Torque	12			0.00
L6	85 - 48.9453	Pole	Max Tension	1	0.00	0.00	0.00
			Max. Compression	26	-11980.69	0.14	-0.08
			Max. Mx	20	-9528.45	192.47	0.33
			Max. My	14	-9527.93	-0.31	-192.87
			Max. Vy	20	-5709.49	192.47	0.33
			Max. Vx	14	5724.40	-0.31	-192.87
			Max. Torque	24			0.13
L7	48.9453 - 1	Pole	Max Tension	1	0.00	0.00	0.00
			Max. Compression	26	-22890.39	0.14	-0.08
			Max. Mx	20	-17921.23	590.42	1.01
			Max. My	14	-17921.22	-0.98	-591.60

tnxTower Semaan Engineering Solutions, LLC 1047 S. 205th St. Elkhorn, NE, 68022 Phone: (402)-289-1888 FAX: (402)-289-1861	Job 27741_B_Round Hill CT	Page 21 of 30
	Project REV02	Date 11:43:44 02/17/22
	Client KGI	Designed by Trevork

Section No.	Elevation ft	Component Type	Condition	Gov. Load Comb.	Axial lb	Major Axis Moment kip-ft	Minor Axis Moment kip-ft
			Max. Vy	20	-9252.76	590.42	1.01
			Max. Vx	14	9267.30	-0.98	-591.60
			Max. Torque	24			0.13

Maximum Reactions

Location	Condition	Gov. Load Comb.	Vertical lb	Horizontal, X lb	Horizontal, Z lb
Pole	Max. Vert	32	22890.39	-1280.46	-2217.82
	Max. H _x	21	13444.71	9242.96	12.58
	Max. H _z	2	17926.29	12.58	9257.49
	Max. M _x	2	591.52	12.58	9257.49
	Max. M _z	8	590.29	-9242.96	-12.58
	Max. Torsion	24	0.13	4632.38	8023.51
	Min. Vert	68	12950.88	383.22	-221.25
	Min. H _x	8	17926.29	-9242.96	-12.58
	Min. H _z	14	17926.29	-12.58	-9257.49
	Min. M _x	14	-591.60	-12.58	-9257.49
	Min. M _z	20	-590.42	9242.96	12.58
	Min. Torsion	12	-0.13	-4632.38	-8023.51

Tower Mast Reaction Summary

Load Combination	Vertical lb	Shear _x lb	Shear _z lb	Overturning Moment, M _x kip-ft	Overturning Moment, M _z kip-ft	Torque kip-ft
Dead Only	14938.57	0.00	0.00	0.03	0.05	0.00
1.2 Dead+1.0 Wind 0 deg - No Ice	17926.29	-12.58	-9257.49	-591.52	1.11	-0.11
0.9 Dead+1.0 Wind 0 deg - No Ice	13444.71	-12.58	-9257.49	-587.08	1.09	-0.11
1.2 Dead+1.0 Wind 30 deg - No Ice	17926.29	4610.59	-8010.93	-511.74	-294.20	-0.06
0.9 Dead+1.0 Wind 30 deg - No Ice	13444.71	4610.59	-8010.93	-507.91	-292.01	-0.06
1.2 Dead+1.0 Wind 60 deg - No Ice	17926.29	7998.35	-4617.85	-294.84	-510.67	-0.00
0.9 Dead+1.0 Wind 60 deg - No Ice	13444.71	7998.35	-4617.85	-292.63	-506.85	-0.00
1.2 Dead+1.0 Wind 90 deg - No Ice	17926.29	9242.96	12.58	1.08	-590.29	0.06
0.9 Dead+1.0 Wind 90 deg - No Ice	13444.71	9242.96	12.58	1.07	-585.86	0.06
1.2 Dead+1.0 Wind 120 deg - No Ice	17926.29	8010.93	4639.64	296.72	-511.72	0.11
0.9 Dead+1.0 Wind 120 deg - No Ice	13444.71	8010.93	4639.64	294.48	-507.89	0.11
1.2 Dead+1.0 Wind 150 deg - No Ice	17926.29	4632.38	8023.51	512.87	-296.02	0.13
0.9 Dead+1.0 Wind 150 deg - No Ice	13444.71	4632.38	8023.51	509.00	-293.81	0.13
1.2 Dead+1.0 Wind 180 deg - No Ice	17926.29	12.58	9257.49	591.60	-0.98	0.11

tnxTower Semaan Engineering Solutions, LLC 1047 S. 205th St. Elkhorn, NE, 68022 Phone: (402)-289-1888 FAX: (402)-289-1861	Job	27741_B_Round Hill CT	Page	22 of 30
	Project	REV02	Date	11:43:44 02/17/22
	Client	KGI	Designed by	TrevorK

Load Combination	Vertical lb	Shear _x lb	Shear _z lb	Overturning Moment, M _x kip-ft	Overturning Moment, M _z kip-ft	Torque kip-ft
No Ice						
0.9 Dead+1.0 Wind 180 deg - No Ice	13444.71	12.58	9257.49	587.14	-0.99	0.11
1.2 Dead+1.0 Wind 210 deg - No Ice	17926.29	-4610.59	8010.93	511.82	294.33	0.06
0.9 Dead+1.0 Wind 210 deg - No Ice	13444.71	-4610.59	8010.93	507.96	292.10	0.06
1.2 Dead+1.0 Wind 240 deg - No Ice	17926.29	-7998.35	4617.85	294.91	510.80	-0.00
0.9 Dead+1.0 Wind 240 deg - No Ice	13444.71	-7998.35	4617.85	292.68	506.94	-0.00
1.2 Dead+1.0 Wind 270 deg - No Ice	17926.29	-9242.96	-12.58	-1.01	590.42	-0.06
0.9 Dead+1.0 Wind 270 deg - No Ice	13444.71	-9242.96	-12.58	-1.01	585.96	-0.06
1.2 Dead+1.0 Wind 300 deg - No Ice	17926.29	-8010.93	-4639.64	-296.65	511.85	-0.11
0.9 Dead+1.0 Wind 300 deg - No Ice	13444.71	-8010.93	-4639.64	-294.43	507.98	-0.11
1.2 Dead+1.0 Wind 330 deg - No Ice	17926.29	-4632.38	-8023.51	-512.79	296.15	-0.13
0.9 Dead+1.0 Wind 330 deg - No Ice	13444.71	-4632.38	-8023.51	-508.95	293.90	-0.13
1.2 Dead+1.0 Ice	22890.39	0.00	0.00	0.08	0.14	0.00
1.2 Dead+1.0 Wind 0 deg+1.0 Ice	22890.39	-6.51	-2557.16	-148.87	0.69	-0.06
1.2 Dead+1.0 Wind 30 deg+1.0 Ice	22890.39	1269.18	-2211.31	-128.64	-73.54	-0.03
1.2 Dead+1.0 Wind 60 deg+1.0 Ice	22890.39	2204.79	-1272.94	-73.92	-128.03	-0.00
1.2 Dead+1.0 Wind 90 deg+1.0 Ice	22890.39	2549.64	6.51	0.63	-148.18	0.03
1.2 Dead+1.0 Wind 120 deg+1.0 Ice	22890.39	2211.31	1284.22	75.04	-128.58	0.06
1.2 Dead+1.0 Wind 150 deg+1.0 Ice	22890.39	1280.46	2217.82	129.36	-74.49	0.06
1.2 Dead+1.0 Wind 180 deg+1.0 Ice	22890.39	6.51	2557.16	149.04	-0.40	0.06
1.2 Dead+1.0 Wind 210 deg+1.0 Ice	22890.39	-1269.18	2211.31	128.81	73.84	0.03
1.2 Dead+1.0 Wind 240 deg+1.0 Ice	22890.39	-2204.79	1272.94	74.09	128.33	-0.00
1.2 Dead+1.0 Wind 270 deg+1.0 Ice	22890.39	-2549.64	-6.51	-0.46	148.47	-0.03
1.2 Dead+1.0 Wind 300 deg+1.0 Ice	22890.39	-2211.31	-1284.22	-74.86	128.87	-0.06
1.2 Dead+1.0 Wind 330 deg+1.0 Ice	22890.39	-1280.46	-2217.82	-129.19	74.78	-0.06
Dead+Wind 0 deg - Service	14938.57	-2.81	-2070.75	-131.66	0.29	-0.02
Dead+Wind 30 deg - Service	14938.57	1031.32	-1791.92	-113.90	-65.45	-0.01
Dead+Wind 60 deg - Service	14938.57	1789.10	-1032.94	-65.61	-113.64	-0.00
Dead+Wind 90 deg - Service	14938.57	2067.51	2.81	0.26	-131.37	0.01
Dead+Wind 120 deg - Service	14938.57	1791.92	1037.81	66.08	-113.88	0.02
Dead+Wind 150 deg - Service	14938.57	1036.19	1794.73	114.19	-65.86	0.03
Dead+Wind 180 deg - Service	14938.57	2.81	2070.75	131.72	-0.18	0.02
Dead+Wind 210 deg - Service	14938.57	-1031.32	1791.92	113.96	65.56	0.01
Dead+Wind 240 deg - Service	14938.57	-1789.10	1032.94	65.67	113.75	-0.00
Dead+Wind 270 deg - Service	14938.57	-2067.51	-2.81	-0.20	131.47	-0.01
Dead+Wind 300 deg - Service	14938.57	-1791.92	-1037.81	-66.02	113.98	-0.02
Dead+Wind 330 deg - Service	14938.57	-1036.19	-1794.73	-114.13	65.97	-0.03
1.2 Dead+1.0 Ev+1.0 Eh 0 deg	18420.12	-0.00	-442.51	-39.80	0.07	-0.00

tnxTower Semaan Engineering Solutions, LLC 1047 S. 205th St. Elkhorn, NE, 68022 Phone: (402)-289-1888 FAX: (402)-289-1861	Job	27741_B_Round Hill CT	Page	23 of 30
	Project	REV02	Date	11:43:44 02/17/22
	Client	KGI	Designed by	TrevorK

Load Combination	Vertical lb	Shear _x lb	Shear _y lb	Overturning Moment, M _x kip-ft	Overturning Moment, M _y kip-ft	Torque kip-ft
0.9 Dead-1.0 Ev+1.0 Eh 0 deg	12950.88	-0.00	-442.50	-39.38	0.05	-0.00
1.2 Dead+1.0 Ev+1.0 Eh 30 deg	18420.12	221.25	-383.22	-34.46	-19.85	-0.00
0.9 Dead-1.0 Ev+1.0 Eh 30 deg	12950.88	221.25	-383.22	-34.10	-19.66	-0.00
1.2 Dead+1.0 Ev+1.0 Eh 60 deg	18420.12	383.22	-221.25	-19.88	-34.43	0.00
0.9 Dead-1.0 Ev+1.0 Eh 60 deg	12950.88	383.22	-221.25	-19.68	-34.08	0.00
1.2 Dead+1.0 Ev+1.0 Eh 90 deg	18420.12	442.51	0.00	0.04	-39.77	0.00
0.9 Dead-1.0 Ev+1.0 Eh 90 deg	12950.88	442.50	0.00	0.03	-39.36	0.00
1.2 Dead+1.0 Ev+1.0 Eh 120 deg	18420.12	383.22	221.25	19.96	-34.43	0.00
0.9 Dead-1.0 Ev+1.0 Eh 120 deg	12950.88	383.22	221.25	19.73	-34.08	0.00
1.2 Dead+1.0 Ev+1.0 Eh 150 deg	18420.12	221.25	383.22	34.54	-19.85	0.00
0.9 Dead-1.0 Ev+1.0 Eh 150 deg	12950.88	221.25	383.22	34.16	-19.66	0.00
1.2 Dead+1.0 Ev+1.0 Eh 180 deg	18420.12	-0.00	442.51	39.87	0.07	0.00
0.9 Dead-1.0 Ev+1.0 Eh 180 deg	12950.88	-0.00	442.50	39.44	0.05	0.00
1.2 Dead+1.0 Ev+1.0 Eh 210 deg	18420.12	-221.25	383.22	34.54	19.98	0.00
0.9 Dead-1.0 Ev+1.0 Eh 210 deg	12950.88	-221.25	383.22	34.16	19.75	0.00
1.2 Dead+1.0 Ev+1.0 Eh 240 deg	18420.12	-383.22	221.25	19.96	34.56	0.00
0.9 Dead-1.0 Ev+1.0 Eh 240 deg	12950.88	-383.22	221.25	19.73	34.18	0.00
1.2 Dead+1.0 Ev+1.0 Eh 270 deg	18420.12	-442.51	0.00	0.04	39.90	-0.00
0.9 Dead-1.0 Ev+1.0 Eh 270 deg	12950.88	-442.50	0.00	0.03	39.46	-0.00
1.2 Dead+1.0 Ev+1.0 Eh 300 deg	18420.12	-383.22	-221.25	-19.88	34.56	-0.00
0.9 Dead-1.0 Ev+1.0 Eh 300 deg	12950.88	-383.22	-221.25	-19.68	34.18	-0.00
1.2 Dead+1.0 Ev+1.0 Eh 330 deg	18420.12	-221.25	-383.22	-34.46	19.98	-0.00
0.9 Dead-1.0 Ev+1.0 Eh 330 deg	12950.88	-221.25	-383.22	-34.10	19.75	-0.00

Solution Summary

Load Comb.	Sum of Applied Forces			Sum of Reactions			% Error
	PX lb	PY lb	PZ lb	PX lb	PY lb	PZ lb	
1	0.00	-14938.57	0.00	0.00	14938.57	0.00	0.000%
2	-12.58	-17926.29	-9257.49	12.58	17926.29	9257.49	0.000%
3	-12.58	-13444.71	-9257.49	12.58	13444.71	9257.49	0.000%
4	4610.59	-17926.29	-8010.93	-4610.59	17926.29	8010.93	0.000%
5	4610.59	-13444.71	-8010.93	-4610.59	13444.71	8010.93	0.000%
6	7998.35	-17926.29	-4617.85	-7998.35	17926.29	4617.85	0.000%
7	7998.35	-13444.71	-4617.85	-7998.35	13444.71	4617.85	0.000%
8	9242.96	-17926.29	12.58	-9242.96	17926.29	-12.58	0.000%
9	9242.96	-13444.71	12.58	-9242.96	13444.71	-12.58	0.000%
10	8010.93	-17926.29	4639.64	-8010.93	17926.29	-4639.64	0.000%
11	8010.93	-13444.71	4639.64	-8010.93	13444.71	-4639.64	0.000%
12	4632.38	-17926.29	8023.51	-4632.38	17926.29	-8023.51	0.000%
13	4632.38	-13444.71	8023.51	-4632.38	13444.71	-8023.51	0.000%

tnxTower Semaan Engineering Solutions, LLC 1047 S. 205th St. Elkhorn, NE, 68022 Phone: (402)-289-1888 FAX: (402)-289-1861	Job	27741_B_Round Hill CT	Page	24 of 30
	Project	REV02	Date	11:43:44 02/17/22
	Client	KGI	Designed by	TrevorK

Load Comb.	Sum of Applied Forces			Sum of Reactions			% Error
	PX lb	PY lb	PZ lb	PX lb	PY lb	PZ lb	
14	12.58	-17926.29	9257.49	-12.58	17926.29	-9257.49	0.000%
15	12.58	-13444.71	9257.49	-12.58	13444.71	-9257.49	0.000%
16	-4610.59	-17926.29	8010.93	4610.59	17926.29	-8010.93	0.000%
17	-4610.59	-13444.71	8010.93	4610.59	13444.71	-8010.93	0.000%
18	-7998.35	-17926.29	4617.85	7998.35	17926.29	-4617.85	0.000%
19	-7998.35	-13444.71	4617.85	7998.35	13444.71	-4617.85	0.000%
20	-9242.96	-17926.29	-12.58	9242.96	17926.29	12.58	0.000%
21	-9242.96	-13444.71	-12.58	9242.96	13444.71	12.58	0.000%
22	-8010.93	-17926.29	-4639.64	8010.93	17926.29	4639.64	0.000%
23	-8010.93	-13444.71	-4639.64	8010.93	13444.71	4639.64	0.000%
24	-4632.38	-17926.29	-8023.51	4632.38	17926.29	8023.51	0.000%
25	-4632.38	-13444.71	-8023.51	4632.38	13444.71	8023.51	0.000%
26	0.00	-22890.39	0.00	0.00	22890.39	0.00	0.000%
27	-6.51	-22890.39	-2557.16	6.51	22890.39	2557.16	0.000%
28	1269.18	-22890.39	-2211.31	-1269.18	22890.39	2211.31	0.000%
29	2204.79	-22890.39	-1272.94	-2204.79	22890.39	1272.94	0.000%
30	2549.64	-22890.39	6.51	-2549.64	22890.39	-6.51	0.000%
31	2211.31	-22890.39	1284.22	-2211.31	22890.39	-1284.22	0.000%
32	1280.46	-22890.39	2217.82	-1280.46	22890.39	-2217.82	0.000%
33	6.51	-22890.39	2557.16	-6.51	22890.39	-2557.16	0.000%
34	-1269.18	-22890.39	2211.31	1269.18	22890.39	-2211.31	0.000%
35	-2204.79	-22890.39	1272.94	2204.79	22890.39	-1272.94	0.000%
36	-2549.64	-22890.39	-6.51	2549.64	22890.39	6.51	0.000%
37	-2211.31	-22890.39	-1284.22	2211.31	22890.39	1284.22	0.000%
38	-1280.46	-22890.39	-2217.82	1280.46	22890.39	2217.82	0.000%
39	-2.81	-14938.57	-2070.75	2.81	14938.57	2070.75	0.000%
40	1031.32	-14938.57	-1791.92	-1031.32	14938.57	1791.92	0.000%
41	1789.10	-14938.57	-1032.94	-1789.10	14938.57	1032.94	0.000%
42	2067.50	-14938.57	2.81	-2067.51	14938.57	-2.81	0.000%
43	1791.92	-14938.57	1037.81	-1791.92	14938.57	-1037.81	0.000%
44	1036.19	-14938.57	1794.73	-1036.19	14938.57	-1794.73	0.000%
45	2.81	-14938.57	2070.75	-2.81	14938.57	-2070.75	0.000%
46	-1031.32	-14938.57	1791.92	1031.32	14938.57	-1791.92	0.000%
47	-1789.10	-14938.57	1032.94	1789.10	14938.57	-1032.94	0.000%
48	-2067.50	-14938.57	-2.81	2067.51	14938.57	2.81	0.000%
49	-1791.92	-14938.57	-1037.81	1791.92	14938.57	1037.81	0.000%
50	-1036.19	-14938.57	-1794.73	1036.19	14938.57	1794.73	0.000%
51	0.00	-18420.12	-442.50	0.00	18420.12	442.51	0.000%
52	0.00	-12950.88	-442.50	0.00	12950.88	442.50	0.000%
53	221.25	-18420.12	-383.22	-221.25	18420.12	383.22	0.000%
54	221.25	-12950.88	-383.22	-221.25	12950.88	383.22	0.000%
55	383.22	-18420.12	-221.25	-383.22	18420.12	221.25	0.000%
56	383.22	-12950.88	-221.25	-383.22	12950.88	221.25	0.000%
57	442.50	-18420.12	0.00	-442.51	18420.12	-0.00	0.000%
58	442.50	-12950.88	0.00	-442.50	12950.88	-0.00	0.000%
59	383.22	-18420.12	221.25	-383.22	18420.12	-221.25	0.000%
60	383.22	-12950.88	221.25	-383.22	12950.88	-221.25	0.000%
61	221.25	-18420.12	383.22	-221.25	18420.12	-383.22	0.000%
62	221.25	-12950.88	383.22	-221.25	12950.88	-383.22	0.000%
63	0.00	-18420.12	442.50	0.00	18420.12	-442.51	0.000%
64	0.00	-12950.88	442.50	0.00	12950.88	-442.50	0.000%
65	-221.25	-18420.12	383.22	221.25	18420.12	-383.22	0.000%
66	-221.25	-12950.88	383.22	221.25	12950.88	-383.22	0.000%
67	-383.22	-18420.12	221.25	383.22	18420.12	-221.25	0.000%
68	-383.22	-12950.88	221.25	383.22	12950.88	-221.25	0.000%
69	-442.50	-18420.12	0.00	442.51	18420.12	-0.00	0.000%
70	-442.50	-12950.88	0.00	442.50	12950.88	-0.00	0.000%
71	-383.22	-18420.12	-221.25	383.22	18420.12	221.25	0.000%
72	-383.22	-12950.88	-221.25	383.22	12950.88	221.25	0.000%
73	-221.25	-18420.12	-383.22	221.25	18420.12	383.22	0.000%
74	-221.25	-12950.88	-383.22	221.25	12950.88	383.22	0.000%

tnxTower Semaan Engineering Solutions, LLC 1047 S. 205th St. Elkhorn, NE, 68022 Phone: (402)-289-1888 FAX: (402)-289-1861	Job	27741_B_Round Hill CT	Page	25 of 30
	Project	REV02	Date	11:43:44 02/17/22
	Client	KGI	Designed by	TrevorK

Non-Linear Convergence Results

Load Combination	Converged?	Number of Cycles	Displacement Tolerance	Force Tolerance
1	Yes	4	0.0000001	0.0000001
2	Yes	5	0.0000001	0.00017116
3	Yes	5	0.0000001	0.00008759
4	Yes	6	0.0000001	0.00019156
5	Yes	6	0.0000001	0.00007032
6	Yes	6	0.0000001	0.00019469
7	Yes	6	0.0000001	0.00007155
8	Yes	5	0.0000001	0.00010548
9	Yes	5	0.0000001	0.00005339
10	Yes	6	0.0000001	0.00020228
11	Yes	6	0.0000001	0.00007442
12	Yes	6	0.0000001	0.00019036
13	Yes	6	0.0000001	0.00006977
14	Yes	5	0.0000001	0.00014610
15	Yes	5	0.0000001	0.00007482
16	Yes	6	0.0000001	0.00019831
17	Yes	6	0.0000001	0.00007291
18	Yes	6	0.0000001	0.00019498
19	Yes	6	0.0000001	0.00007162
20	Yes	5	0.0000001	0.00008093
21	Yes	5	0.0000001	0.00004070
22	Yes	6	0.0000001	0.00019122
23	Yes	6	0.0000001	0.00007011
24	Yes	6	0.0000001	0.00020334
25	Yes	6	0.0000001	0.00007481
26	Yes	4	0.0000001	0.00000001
27	Yes	4	0.0000001	0.00050488
28	Yes	4	0.0000001	0.00074136
29	Yes	4	0.0000001	0.00080547
30	Yes	4	0.0000001	0.00040966
31	Yes	5	0.0000001	0.00007548
32	Yes	4	0.0000001	0.00074568
33	Yes	4	0.0000001	0.00049669
34	Yes	4	0.0000001	0.00092368
35	Yes	4	0.0000001	0.00081670
36	Yes	4	0.0000001	0.00040499
37	Yes	4	0.0000001	0.00074764
38	Yes	5	0.0000001	0.00007902
39	Yes	4	0.0000001	0.00018440
40	Yes	4	0.0000001	0.00049712
41	Yes	4	0.0000001	0.00052531
42	Yes	4	0.0000001	0.00015507
43	Yes	4	0.0000001	0.00059615
44	Yes	4	0.0000001	0.00048289
45	Yes	4	0.0000001	0.00018176
46	Yes	4	0.0000001	0.00056402
47	Yes	4	0.0000001	0.00052829
48	Yes	4	0.0000001	0.00015342
49	Yes	4	0.0000001	0.00048822
50	Yes	4	0.0000001	0.00060898
51	Yes	4	0.0000001	0.00004268
52	Yes	4	0.0000001	0.00001574
53	Yes	4	0.0000001	0.00005734
54	Yes	4	0.0000001	0.00002983
55	Yes	4	0.0000001	0.00005735

tnxTower Semaan Engineering Solutions, LLC 1047 S. 205th St. Elkhorn, NE, 68022 Phone: (402)-289-1888 FAX: (402)-289-1861	Job	27741_B_Round Hill CT	Page	26 of 30
	Project	REV02	Date	11:43:44 02/17/22
	Client	KGI	Designed by	TrevorK

56	Yes	4	0.00000001	0.00002984
57	Yes	4	0.00000001	0.00004263
58	Yes	4	0.00000001	0.00001573
59	Yes	4	0.00000001	0.00005759
60	Yes	4	0.00000001	0.00002998
61	Yes	4	0.00000001	0.00005757
62	Yes	4	0.00000001	0.00002994
63	Yes	4	0.00000001	0.00004282
64	Yes	4	0.00000001	0.00001578
65	Yes	4	0.00000001	0.00005800
66	Yes	4	0.00000001	0.00003017
67	Yes	4	0.00000001	0.00005799
68	Yes	4	0.00000001	0.00003016
69	Yes	4	0.00000001	0.00004286
70	Yes	4	0.00000001	0.00001579
71	Yes	4	0.00000001	0.00005774
72	Yes	4	0.00000001	0.00003003
73	Yes	4	0.00000001	0.00005777
74	Yes	4	0.00000001	0.00003006

Maximum Tower Deflections - Service Wind

Section No.	Elevation ft	Horz. Deflection in	Gov. Load Comb.	Tilt °	Twist °
L1	115 - 105	8.994	44	1.174	0.000
L2	105 - 95.5	6.568	44	1.113	0.000
L3	95.5 - 95	4.651	44	0.737	0.000
L4	95 - 85.5	4.575	44	0.725	0.000
L5	85.5 - 85	3.465	44	0.342	0.000
L6	85 - 48.9453	3.429	44	0.342	0.000
L7	53.7604 - 1	1.467	44	0.242	0.000

Critical Deflections and Radius of Curvature - Service Wind

Elevation ft	Appurtenance	Gov. Load Comb.	Deflection in	Tilt °	Twist °	Radius of Curvature ft
115.00	10' 30" Dia. Canister	44	8.994	1.174	0.000	7684
110.00	10' 30" Dia. Canister	44	7.762	1.188	0.000	7684
107.50	CCISeismic (12) general cable 1 5/8" Coax From 0 to 109 (104ft to109ft)	44	7.158	1.167	0.000	4963
105.00	10' 30" Dia. Canister	44	6.568	1.113	0.000	3219
100.25	CCISeismic Tower Section 2 - 1	44	5.519	0.920	0.000	1491
100.00	10' 30" Dia. Canister	44	5.468	0.909	0.000	1447
97.50	CCISeismic (6) general cable 1 5/8" Coax From 0 to 99 (94ft to99ft)	44	4.987	0.802	0.000	1247
95.25	CCISeismic Tower Section 3 - 1	44	4.613	0.731	0.000	1357
95.00	10' 30" Dia. Canister	44	4.575	0.725	0.000	1386
90.25	CCISeismic Tower Section 4 - 1	44	3.928	0.505	0.000	1469
90.00	10' 40" Dia. Canister	44	3.898	0.492	0.000	1446
87.50	CCISeismic (12) general cable 7/8" Coax From 0 to 89 (84ft to89ft)	44	3.633	0.381	0.000	1490
85.25	CCISeismic Tower Section 5 - 1	44	3.447	0.342	0.000	2320
85.00	10' 40" Dia. Canister	44	3.429	0.342	0.000	2544

tnxTower Semaan Engineering Solutions, LLC 1047 S. 205th St. Elkhorn, NE, 68022 Phone: (402)-289-1888 FAX: (402)-289-1861	Job 27741_B_Round Hill CT	Page 27 of 30
	Project REV02	Date 11:43:44 02/17/22
	Client KGI	Designed by TrevorK

Elevation	Appurtenance	Gov. Load Comb.	Deflection in	Tilt °	Twist °	Radius of Curvature ft
82.00	3' Sidearm	44	3.218	0.344	0.000	13159
81.97	CCISeismic Tower Section 6 - 1	44	3.216	0.344	0.000	13438
80.00	CCISeismic (12) general cable 1 5/8" Coax From 0 to 109 (74ft to84ft)	44	3.078	0.343	0.000	37129
78.50	CCISeismic general cable 1/2" Coax From 0 to 81 (74ft to81ft)	44	2.974	0.342	0.000	32058
73.95	CCISeismic Tower Section 6 - 2	44	2.664	0.333	0.000	22639
70.00	CCISeismic (12) general cable 1 5/8" Coax From 0 to 109 (64ft to74ft)	44	2.405	0.320	0.000	18042
63.95	CCISeismic Tower Section 6 - 3	44	2.027	0.294	0.000	13752
60.00	CCISeismic (12) general cable 1 5/8" Coax From 0 to 109 (54ft to64ft)	44	1.797	0.274	0.000	11907
53.95	CCISeismic Tower Section 6 - 4	44	1.476	0.243	0.000	10233
52.38	CCISeismic Tower Section 7 - 1	44	1.400	0.235	0.000	10242
50.00	CCISeismic (12) general cable 1 5/8" Coax From 0 to 109 (44ft to54ft)	44	1.290	0.223	0.000	10583
46.00	CCISeismic Tower Section 7 - 2	44	1.120	0.203	0.000	11516
40.00	CCISeismic (12) general cable 1 5/8" Coax From 0 to 109 (34ft to44ft)	44	0.895	0.173	0.000	13287
36.00	CCISeismic Tower Section 7 - 3	50	0.763	0.155	0.000	14806
30.00	CCISeismic (12) general cable 1 5/8" Coax From 0 to 109 (24ft to34ft)	50	0.589	0.127	0.000	17869
26.00	CCISeismic Tower Section 7 - 4	50	0.487	0.109	0.000	20728
20.00	CCISeismic (12) general cable 1 5/8" Coax From 0 to 109 (14ft to24ft)	50	0.351	0.082	0.000	27274
16.00	CCISeismic Tower Section 7 - 5	50	0.269	0.065	0.000	34547
10.00	CCISeismic (12) general cable 1 5/8" Coax From 0 to 109 (4ft to14ft)	50	0.156	0.039	0.000	57578
6.00	CCISeismic Tower Section 7 - 6	50	0.086	0.021	0.000	103640
3.00	CCISeismic (12) general cable 1 5/8" Coax From 0 to 109 (0ft to4ft)	50	0.034	0.009	0.000	103640

Maximum Tower Deflections - Design Wind

Section No.	Elevation ft	Horz. Deflection in	Gov. Load Comb.	Tilt °	Twist °
L1	115 - 105	40.601	12	5.326	0.001
L2	105 - 95.5	29.622	12	5.048	0.001
L3	95.5 - 95	20.950	12	3.337	0.001
L4	95 - 85.5	20.604	12	3.279	0.001
L5	85.5 - 85	15.593	12	1.542	0.001
L6	85 - 48.9453	15.432	12	1.542	0.001
L7	53.7604 - 1	6.599	12	1.089	0.001

Critical Deflections and Radius of Curvature - Design Wind

tnxTower Semaan Engineering Solutions, LLC 1047 S. 205th St. Elkhorn, NE, 68022 Phone: (402)-289-1888 FAX: (402)-289-1861	Job 27741_B_Round Hill CT	Page 28 of 30
	Project REV02	Date 11:43:44 02/17/22
	Client KGI	Designed by TrevorK

<i>Elevation</i>	<i>Appurtenance</i>	<i>Gov. Load Comb.</i>	<i>Deflection in</i>	<i>Tilt °</i>	<i>Twist °</i>	<i>Radius of Curvature ft</i>
115.00	10' 30" Dia. Canister	12	40.601	5.326	0.001	1713
110.00	10' 30" Dia. Canister	12	35.023	5.388	0.001	1713
107.50	CCISeismic (12) general cable 1 5/8" Coax From 0 to 109 (104ft to109ft)	12	32.289	5.294	0.001	1106
105.00	10' 30" Dia. Canister	12	29.622	5.048	0.001	717
100.25	CCISeismic Tower Section 2 - 1	12	24.874	4.170	0.001	331
100.00	10' 30" Dia. Canister	12	24.643	4.119	0.001	321
97.50	CCISeismic (6) general cable 1 5/8" Coax From 0 to 99 (94ft to99ft)	12	22.470	3.633	0.001	276
95.25	CCISeismic Tower Section 3 - 1	12	20.776	3.308	0.001	300
95.00	10' 30" Dia. Canister	12	20.604	3.279	0.001	307
90.25	CCISeismic Tower Section 4 - 1	12	17.681	2.281	0.001	325
90.00	10' 40" Dia. Canister	12	17.547	2.222	0.001	320
87.50	CCISeismic (12) general cable 7/8" Coax From 0 to 89 (84ft to89ft)	12	16.352	1.718	0.001	329
85.25	CCISeismic Tower Section 5 - 1	12	15.512	1.541	0.001	512
85.00	10' 40" Dia. Canister	12	15.432	1.542	0.001	562
82.00	3' Sidearm	12	14.480	1.551	0.001	2907
81.97	CCISeismic Tower Section 6 - 1	12	14.471	1.551	0.001	2968
80.00	CCISeismic (12) general cable 1 5/8" Coax From 0 to 109 (74ft to84ft)	12	13.851	1.547	0.001	8225
78.50	CCISeismic general cable 1/2" Coax From 0 to 81 (74ft to81ft)	12	13.383	1.540	0.001	7102
73.95	CCISeismic Tower Section 6 - 2	12	11.987	1.498	0.001	5020
70.00	CCISeismic (12) general cable 1 5/8" Coax From 0 to 109 (64ft to74ft)	12	10.817	1.441	0.001	4003
63.95	CCISeismic Tower Section 6 - 3	12	9.117	1.324	0.001	3053
60.00	CCISeismic (12) general cable 1 5/8" Coax From 0 to 109 (54ft to64ft)	12	8.084	1.236	0.001	2644
53.95	CCISeismic Tower Section 6 - 4	12	6.640	1.093	0.001	2273
52.38	CCISeismic Tower Section 7 - 1	12	6.298	1.057	0.000	2275
50.00	CCISeismic (12) general cable 1 5/8" Coax From 0 to 109 (44ft to54ft)	12	5.803	1.002	0.000	2351
46.00	CCISeismic Tower Section 7 - 2	12	5.035	0.911	0.000	2558
40.00	CCISeismic (12) general cable 1 5/8" Coax From 0 to 109 (34ft to44ft)	12	4.022	0.780	0.000	2951
36.00	CCISeismic Tower Section 7 - 3	24	3.429	0.695	0.000	3288
30.00	CCISeismic (12) general cable 1 5/8" Coax From 0 to 109 (24ft to34ft)	24	2.648	0.570	0.000	3968
26.00	CCISeismic Tower Section 7 - 4	24	2.189	0.489	0.000	4603
20.00	CCISeismic (12) general cable 1 5/8" Coax From 0 to 109 (14ft to24ft)	24	1.576	0.369	0.000	6056
16.00	CCISeismic Tower Section 7 - 5	24	1.209	0.290	0.000	7671
10.00	CCISeismic (12) general cable 1 5/8" Coax From 0 to 109 (4ft to14ft)	24	0.703	0.173	0.000	12784
6.00	CCISeismic Tower Section 7 - 6	24	0.386	0.096	0.000	23012
3.00	CCISeismic (12) general cable 1 5/8" Coax From 0 to 109 (0ft to4ft)	24	0.154	0.038	0.000	23012

tnxTower Semaan Engineering Solutions, LLC 1047 S. 205th St. Elkhorn, NE, 68022 Phone: (402)-289-1888 FAX: (402)-289-1861	Job	27741_B_Round Hill CT	Page	29 of 30
	Project	REV02	Date	11:43:44 02/17/22
	Client	KGI	Designed by	TrevorK

Compression Checks

Pole Design Data

Section No.	Elevation ft	Size	L ft	L _u ft	Kl/r	A in ²	P _u lb	φP _n lb	Ratio $\frac{P_u}{\phi P_n}$
L1	115 - 105 (1)	TP4.5x4.5x2.25	10.00	0.00	0.0	15.90	-1373.87	715694.00	0.002
L2	105 - 95.5 (2)	TP4.5x4.5x2.25	9.50	0.00	0.0	15.90	-3186.25	715694.00	0.004
L3	95.5 - 95 (3)	TP5.75x4.5x2.25	0.50	0.00	0.0	15.90	-3192.93	715694.00	0.004
L4	95 - 85.5 (4)	TP5.75x5.75x2.88	9.50	0.00	0.0	25.97	-5470.89	1168530.00	0.005
L5	85.5 - 85 (5)	TP29.25x5.75x2.88	0.50	0.00	0.0	25.97	-5632.33	1168530.00	0.005
L6	85 - 48.9453 (6)	TP33.32x29.25x0.19	36.05	0.00	0.0	19.39	-9527.68	1134590.00	0.008
L7	48.9453 - 1 (7)	TP41x32.4x0.25	52.76	0.00	0.0	32.34	-17921.20	1891600.00	0.009

Pole Bending Design Data

Section No.	Elevation ft	Size	M _{ux} kip-ft	φM _{ux} kip-ft	Ratio $\frac{M_{ux}}{\phi M_{ux}}$	M _{uy} kip-ft	φM _{uy} kip-ft	Ratio $\frac{M_{uy}}{\phi M_{uy}}$
L1	115 - 105 (1)	TP4.5x4.5x2.25	5.78	56.95	0.101	0.00	56.95	0.000
L2	105 - 95.5 (2)	TP4.5x4.5x2.25	21.28	56.95	0.374	0.00	56.95	0.000
L3	95.5 - 95 (3)	TP5.75x4.5x2.25	21.28	56.95	0.374	0.00	56.95	0.000
L4	95 - 85.5 (4)	TP5.75x5.75x2.88	48.45	118.82	0.408	0.00	118.82	0.000
L5	85.5 - 85 (5)	TP29.25x5.75x2.88	48.44	118.82	0.408	0.00	118.82	0.000
L6	85 - 48.9453 (6)	TP33.32x29.25x0.19	193.04	776.57	0.249	0.00	776.57	0.000
L7	48.9453 - 1 (7)	TP41x32.4x0.25	592.16	1672.97	0.354	0.00	1672.97	0.000

Pole Shear Design Data

Section No.	Elevation ft	Size	Actual V _u lb	φV _n lb	Ratio $\frac{V_u}{\phi V_n}$	Actual T _u kip-ft	φT _n kip-ft	Ratio $\frac{T_u}{\phi T_n}$
L1	115 - 105 (1)	TP4.5x4.5x2.25	1124.33	214708.00	0.005	0.00	42.47	0.000
L2	105 - 95.5 (2)	TP4.5x4.5x2.25	2109.69	214708.00	0.010	0.00	42.47	0.000
L3	95.5 - 95 (3)	TP5.75x4.5x2.25	2151.74	333991.00	0.006	0.00	42.47	0.000
L4	95 - 85.5 (4)	TP5.75x5.75x2.88	3312.74	350558.00	0.009	0.00	88.61	0.000
L5	85.5 - 85 (5)	TP29.25x5.75x2.88	3371.01	350558.00	0.010	0.00	88.61	0.000
L6	85 - 48.9453 (6)	TP33.32x29.25x0.19	5731.85	340376.00	0.017	0.13	971.43	0.000
L7	48.9453 - 1 (7)	TP41x32.4x0.25	9274.58	567481.00	0.016	0.13	2025.16	0.000

Pole Interaction Design Data

tnxTower Semaan Engineering Solutions, LLC 1047 S. 205th St. Elkhorn, NE, 68022 Phone: (402)-289-1888 FAX: (402)-289-1861	Job	27741_B_Round Hill CT	Page	30 of 30
	Project	REV02	Date	11:43:44 02/17/22
	Client	KGI	Designed by	TrevorK

Section No.	Elevation ft	Ratio P_u	Ratio M_{ux}	Ratio M_{uy}	Ratio V_u	Ratio T_u	Comb. Stress Ratio	Allow. Stress Ratio	Criteria
L1	115 - 105 (1)	0.002	0.101	0.000	0.005	0.000	0.103	1.000	4.8.2 ✓
L2	105 - 95.5 (2)	0.004	0.374	0.000	0.010	0.000	0.378	1.000	4.8.2 ✓
L3	95.5 - 95 (3)	0.004	0.374	0.000	0.006	0.000	0.378	1.000	4.8.2 ✓
L4	95 - 85.5 (4)	0.005	0.408	0.000	0.009	0.000	0.412	1.000	4.8.2 ✓
L5	85.5 - 85 (5)	0.005	0.408	0.000	0.010	0.000	0.413	1.000	4.8.2 ✓
L6	85 - 48.9453 (6)	0.008	0.249	0.000	0.017	0.000	0.257	1.000	4.8.2 ✓
L7	48.9453 - 1 (7)	0.009	0.354	0.000	0.016	0.000	0.364	1.000	4.8.2 ✓

Section Capacity Table

Section No.	Elevation ft	Component Type	Size	Critical Element	P lb	ϕP_{allow} lb	% Capacity	Pass Fail	
L1	115 - 105	Pole	TP4.5x4.5x2.25	1	-1373.87	715694.00	10.3	Pass	
L2	105 - 95.5	Pole	TP4.5x4.5x2.25	2	-3186.25	715694.00	37.8	Pass	
L3	95.5 - 95	Pole	TP5.75x4.5x2.25	3	-3192.93	715694.00	37.8	Pass	
L4	95 - 85.5	Pole	TP5.75x5.75x2.88	4	-5470.89	1168530.00	41.2	Pass	
L5	85.5 - 85	Pole	TP29.25x5.75x2.88	5	-5632.33	1168530.00	41.3	Pass	
L6	85 - 48.9453	Pole	TP33.32x29.25x0.19	6	-9527.68	1134590.00	25.7	Pass	
L7	48.9453 - 1	Pole	TP41x32.4x0.25	7	-17921.20	1891600.00	36.4	Pass	
							Summary		
							Pole (L5)	41.3	Pass
							RATING =	41.3	Pass



BU: 27741 B
 WO: Round Hill CT
 Order: REV02

Structure:
 Rev:

Location				
	Decimal Degrees	Deg	Min	Sec
Lat:	41.095117	+ 41	5	42.42
Long:	-73.664219	- 73	39	51.19

Code and Site Parameters

Seismic Design Code:	TIA-222-H-1	
Site Soil:	B	Rock
Risk Category:	II	
<u>USGS Seismic Reference</u>		
S _s :	0.2790	g
S ₁ :	0.0600	g
T ₁ :	6	s

Seismic Design Category Determination

Importance Factor, I _e :	1
Acceleration-based site coefficient, F _a :	0.9000
Velocity-based site coefficient, F _v :	0.8000
Design spectral response acceleration short period, S _{DS} :	0.1674 g
Design spectral response acceleration 1 s period, S _{D1} :	0.0320 g
T _s :	0.1912
Seismic Design Category Based on S _{DS} :	B
Seismic Design Category Based on S _{D1} :	A
Seismic Design Category Based on S ₁ :	N/A
Controlling Seismic Design Category:	



BU: 27741_B
 WO: Round Hill CT
 Order: REV02

Structure:
 Rev:

Tower Details

Tower Type:	Tapered Monopole	
Height, h:	114	ft
Effective Seismic Weight, W:	14.75	kips
Amplification Factor, A _s :	1.0	2.7.8.1

Seismic Base Shear

Response Modification Factor, R:	1.5	
Discrete Appurtenance Weight in Top 1/3 of Structure, W _U :	2.6441	kips
W _L :	12.10608359	kips
E:	29000.0	ksi
g:	386.088	in/s ²
Average Moment of Inertia, I _{avg} :	2928.521143	in ⁴
F _a :	0.420621788	hz
Approximate Fundamental Period Monopole, T _a :	2.3774	s
		2.7.7.1.3.3
Seismic Response Coefficient, C _s	0.1116	2.7.7.1.1
Seismic Response Coefficient Max 1, C _{smax}	0.0090	2.7.7.1.1
Seismic Response Coefficient Max 2, C _{smax}	N/A	2.7.7.1.1
Seismic Response Coefficient Min 1, C _{smin}	0.0300	2.7.7.1.1
Seismic Response Coefficient Min 2, C _{smin}	N/A	2.7.7.1.1
Controlling Seismic Response Coefficient, C _{sc}	0.0300	
Seismic Base Shear, V		kips
		2.7.7.1.1

Vertical Distribution Factors

Period Related Exponent, k:	1.939
Sum of w _i h _i ^k	51568.10

Section Number	Length	Top Height	Mid Height, h _m	Section Weight, w _s	w _s h _m ²	C _s	F _s	F _s
2-1	9.50	104.00	99.25	0.5141	3820.90	0.0741	0.0328	0.0172
4-1	9.50	94.00	89.25	0.8394	5077.60	0.0985	0.0436	0.0281
6-1	6.05	84.00	80.97	0.3605	1805.74	0.0350	0.0155	0.0121
6-3	10.00	67.95	62.95	0.6366	1956.95	0.0379	0.0168	0.0213
7-1	2.76	52.76	51.38	0.2413	500.40	0.0097	0.0043	0.0081
7-3	10.00	40.00	35.00	0.9462	932.21	0.0181	0.0080	0.0317
7-5	10.00	20.00	15.00	1.0343	197.12	0.0038	0.0017	0.0346
Sum								

Name	h_i	w_i	$w_i h_i^2$	C_i	F_i	F_i
misc 10' 30" Dia. Canister	99.00	0.2970	2196.48	0.0425	0.0188	0.0099
(2) Canister Mount	109.00	0.0560	499.09	0.0097	0.0043	0.0019
DBXNH-6565A-A2M	109.00	0.0342	304.80	0.0059	0.0026	0.0011
TMAT1921XB6811A	109.00	0.0176	156.86	0.0030	0.0013	0.0006
TMAT1921XB6811A	109.00	0.0176	156.86	0.0030	0.0013	0.0006
TMAT1921XB6811A	109.00	0.0176	156.86	0.0030	0.0013	0.0006
782 11066	109.00	0.0018	15.69	0.0003	0.0001	0.0001
(2) Canister Mount	99.00	0.0560	414.15	0.0080	0.0036	0.0019
APXVSP18-C-A20	99.00	0.0620	458.52	0.0089	0.0039	0.0021
(2) KIT-FD9R6004/1C-DL	99.00	0.0128	94.66	0.0018	0.0008	0.0004
(2) KIT-FD9R6004/1C-DL	99.00	0.0128	94.66	0.0018	0.0008	0.0004
(3) IBC1900HG-SA	99.00	0.0660	488.11	0.0095	0.0042	0.0022
(2) Canister Mount	89.00	0.0560	336.90	0.0065	0.0029	0.0019
FVV-65B-R3	89.00	0.0439	263.93	0.0051	0.0023	0.0015
(2) CDX623T-DS-T	89.00	0.0203	122.01	0.0024	0.0010	0.0007
(2) CDX623T-DS-T	89.00	0.0203	122.01	0.0024	0.0010	0.0007
GPS	81.00	0.0006	3.01	0.0001	0.0000	0.0000
Spoke Flanges	94.00	0.1385	926.37	0.0180	0.0079	0.0046
Top Flange	114.00	0.1062	1032.18	0.0200	0.0089	0.0036
Sum						

Name	Start Height	End Height	h	w	w/h	C _v	F _v	F _h
(12) general cable 1 5/8" Coax From 0 to 109	94.00	104.00	99.00	0.1248	922.96	0.0179	0.0079	0.0042
(12) general cable 1 5/8" Coax From 0 to 109	64.00	64.00	59.00	0.1248	338.37	0.0066	0.0029	0.0042
(12) general cable 1 5/8" Coax From 0 to 109	74.00	84.00	79.00	0.1248	595.90	0.0116	0.0051	0.0042
(12) general cable 1 5/8" Coax From 0 to 109	64.00	64.00	59.00	0.1248	338.37	0.0066	0.0029	0.0042
(12) general cable 1 5/8" Coax From 0 to 109	54.00	64.00	59.00	0.1248	338.37	0.0066	0.0029	0.0042
(12) general cable 1 5/8" Coax From 0 to 109	34.00	44.00	39.00	0.1248	151.65	0.0029	0.0013	0.0042
(12) general cable 1 5/8" Coax From 0 to 109	24.00	34.00	29.00	0.1248	101.09	0.0020	0.0007	0.0042
(12) general cable 1 5/8" Coax From 0 to 109	14.00	24.00	19.00	0.1248	37.61	0.0007	0.0003	0.0042
(12) general cable 1 5/8" Coax From 0 to 109	4.00	14.00	9.00	0.1248	14.00	0.0002	0.0001	0.0042
(12) general cable 1 5/8" Coax From 0 to 109	0.00	4.00	2.00	0.0499	0.19	0.0000	0.0000	0.0017
(6) general cable 1 5/8" Coax From 0 to 99	84.00	94.00	89.00	0.0624	375.40	0.0073	0.0032	0.0021
(6) general cable 1 5/8" Coax From 0 to 99	64.00	74.00	69.00	0.0624	229.19	0.0044	0.0020	0.0021
(6) general cable 1 5/8" Coax From 0 to 99	44.00	54.00	49.00	0.0624	118.03	0.0023	0.0010	0.0021
(6) general cable 1 5/8" Coax From 0 to 99	24.00	34.00	29.00	0.0624	42.89	0.0008	0.0004	0.0021
(6) general cable 1 5/8" Coax From 0 to 99	14.00	24.00	19.00	0.0624	18.81	0.0004	0.0002	0.0021
(6) general cable 1 5/8" Coax From 0 to 99	4.00	14.00	9.00	0.0624	4.42	0.0001	0.0000	0.0021
(2) general cable 1 1/4" Coax From 0 to 99	94.00	99.00	96.50	0.0066	46.45	0.0009	0.0004	0.0002
(2) general cable 1 1/4" Coax From 0 to 99	74.00	84.00	79.00	0.0132	63.03	0.0012	0.0005	0.0004
(2) general cable 1 1/4" Coax From 0 to 99	54.00	64.00	59.00	0.0132	35.79	0.0007	0.0003	0.0004
(2) general cable 1 1/4" Coax From 0 to 99	34.00	44.00	39.00	0.0132	16.04	0.0003	0.0001	0.0004
(2) general cable 1 1/4" Coax From 0 to 99	14.00	24.00	19.00	0.0132	3.98	0.0001	0.0000	0.0004
(2) general cable 1 1/4" Coax From 0 to 99	4.00	14.00	3.00	0.0053	0.21	0.0000	0.0000	0.0004
(2) general cable 1 1/4" Coax From 0 to 99	0.00	4.00	2.00	0.0053	0.02	0.0000	0.0000	0.0002
(12) general cable 7/8" Coax From 0 to 89	74.00	84.00	79.00	0.0624	297.95	0.0058	0.0026	0.0021
(12) general cable 7/8" Coax From 0 to 89	54.00	64.00	59.00	0.0624	169.19	0.0033	0.0015	0.0021
(12) general cable 7/8" Coax From 0 to 89	34.00	44.00	39.00	0.0624	75.82	0.0015	0.0007	0.0021
(12) general cable 7/8" Coax From 0 to 89	14.00	24.00	19.00	0.0624	18.81	0.0004	0.0002	0.0021
(12) general cable 7/8" Coax From 0 to 89	4.00	14.00	9.00	0.0624	4.42	0.0001	0.0000	0.0021
(12) general cable 7/8" Coax From 0 to 89	0.00	4.00	2.00	0.0250	0.10	0.0000	0.0000	0.0008
general cable 1/2" Coax From 0 to 81	64.00	74.00	69.00	0.0016	5.88	0.0001	0.0001	0.0001
general cable 1/2" Coax From 0 to 81	44.00	54.00	49.00	0.0016	3.03	0.0001	0.0000	0.0001
general cable 1/2" Coax From 0 to 81	24.00	34.00	29.00	0.0016	1.09	0.0000	0.0000	0.0001
general cable 1/2" Coax From 0 to 81	4.00	14.00	9.00	0.0016	0.11	0.0000	0.0000	0.0001
general cable 1/2" Coax From 0 to 81	0.00	4.00	2.00	0.0008	0.00	0.0000	0.0000	0.0001

Sum

Site Number: **27741_B**
 Site Name: **Round Hill CT**
 Job Number: **REV02**
 Engineer: **TMK**
 Date: **2/17/2022**

Flange @ 85.0 EEI DWG # K11669

Moment: **48.4 k-ft**
 Shear: **3.4 k**
 Compression: **5.6 k**
 TIA-222 Code Revision: **G**
 Mast Diameter (in): **6.00**
 Upper Stiffener Height: **9.00 in**
 Upper Stiffener Width: **10.75 in**
 Upper Stiffener Thickness: **1.00 in**
 Upper Stiffener Material: **A572 Gr. 60**
 Upper Stiffener Yield Strength: **60 ksi**
 Upper Stiffener Ultimate Strength: **75 ksi**

Ring Flange Outer Diameter / Length: **28.50 in**
 Ring Flange Inner Diameter / Length: **23.50 in**
 Ring Flange Width: **2.50 in**
 Ring Flange Thickness: **1.25 in**
 Ring Flange Material: **A572 Gr. 60**
 Ring Flange Yield Strength: **60 ksi**
 Ring Flange Ultimate Strength: **75 ksi**
 Flange Detail Type: **B**

Connection Bolts

Connection Bolt Arrangement: **Round**
 Connection Bolt Yield Strength: **92 ksi**
 Connection Ultimate Strength: **120 ksi**
 Connection Bolt Diameter: **1.00 in**
 Connection Bolt Circle: **26.00 in**
 # of Connection Bolts: **12**
 Minimum Connection Bolt Separation: **2.67 in**
 Additional Connection Bolts Installed: **N**

Weld Strength: **70 ksi**
 Weld Size at Flange: **0.375 in**
 # of sides: **2**
 Weld Length at Flange: **2 in.**
 Angle of separation of stiffeners: **60.00 degrees**
 Weld Size at Mast: **0.75 in.**
 Weld Height at Mast: **9 in.**

Diameter of Flange Welds: **26.50 in**

Max Tension at weld connection: **21.9 k**

Connection Bolt Capacity

Area of Bolt: **0.61 in²**
 Maximum Bolt Tension (stiffener load /2): **11.0 k**
 Bolt Tensile Capacity: **54.5 k**
 Interaction Equation: **0.20** Result: **OK**

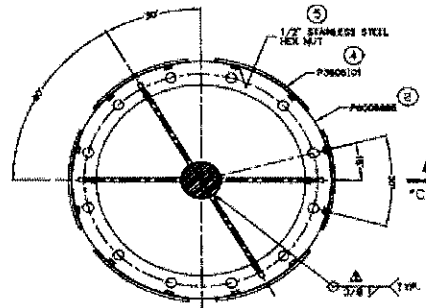

Ring Flange Capacity

Length between bolts: **6.81 in**
 Mu (Fixed Ends PL/8) = **18.66 k-in**

Flange Moment Capacity (.9Fy x bt²/4): **26.37 k-in**

Interaction Equation: **0.71** Result: **OK**

Weld Capacity:

Weld Capacity at Ring circumference:
 fw = **5.48**
 Fw = **8.35 k**
 Interaction Equation: **0.66** Result: **OK**

Weld capacity at mast:
 Mu = **224.83 k-in**
 fw = **8.33 k/in**
 Fw = **16.70**
 Interaction Equation: **0.50** Result: **OK**

Site Number: **27741_B**
 Site Name: **Round Hill CT**
 Job Number: **REV02**
 Engineer: **TMK**
 Date: **2/17/2022**

Flange @ 95.0 EEI DWG # K11597

Moment: **21.3 k-ft**
 Shear: **2.2 k**
 Compression: **3.2 k**
 TIA-222 Code Revision: **G**
 Mast Diameter (in): **4.50**
 Upper Stiffener Height: **9.00 in**
 Upper Stiffener Width: **11.50 in**
 Upper Stiffener Thickness: **0.75 in**
 Upper Stiffener Material: **A36 Gr. 36**
 Upper Stiffener Yield Strength: **36 ksi**
 Upper Stiffener Ultimate Strength: **58 ksi**

Ring Flange Outer Diameter / Length: **29.25 in**
 Ring Flange Inner Diameter / Length: **24.25 in**
 Ring Flange Width: **2.50 in**
 Ring Flange Thickness: **1.00 in**
 Ring Flange Material: **A572 Gr. 60**
 Ring Flange Yield Strength: **60 ksi**
 Ring Flange Ultimate Strength: **75 ksi**
 Flange Detail Type: **B**

Connection Bolts

Connection Bolt Arrangement: **Round**
 Connection Bolt Yield Strength: **92 ksi**
 Connection Ultimate Strength: **120 ksi**
 Connection Bolt Diameter: **1.00 in**
 Connection Bolt Circle: **26.00 in**
 # of Connection Bolts: **12**
 Minimum Connection Bolt Separation: **2.67 in**
 Additional Connection Bolts Installed: **N**

Weld Strength: **70 ksi**
 Weld Size at Flange: **0.250 in**
 # of sides: **2**
 Weld Length at Flange: **2 in.**
 Angle of separation of stiffeners: **60.00 degrees**
 Weld Size at Mast: **0.375 in.**
 Weld Height at Mast: **9 in.**

Diameter of Flange Welds: **26.50 in**

Max Tension at weld connection: **9.6 k**

Connection Bolt Capacity

Area of Bolt: **0.61 in²**
 Maximum Bolt Tension (stiffener load /2): **4.8 k**
 Bolt Tensile Capacity: **54.5 k**
 Interaction Equation: **0.09** Result: **OK**

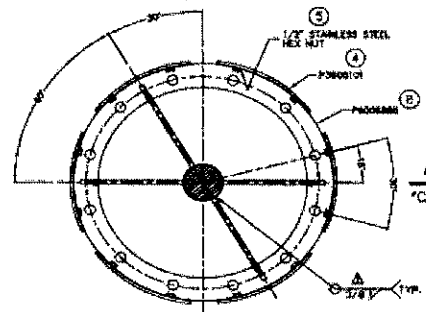

Ring Flange Capacity

Length between bolts: **6.81 in**
 Mu (Fixed Ends PL/8) = **8.20 k-in**

Flange Moment Capacity (.9Fy x bt²/4): **10.13 k-in**

Interaction Equation: **0.81** Result: **OK**

Weld Capacity:

Weld Capacity at Ring circumference:

fw = **2.41**
 Fw = **5.57 k**
 Interaction Equation: **0.43** Result: **OK**

Weld capacity at mast:

Mu = **106.00 k-in**
 fw = **3.93 k/in**
 Fw = **8.35**
 Interaction Equation: **0.47** Result: **OK**

Site Number: **27741_B**
 Site Name: **Round Hill CT**
 Job Number: **REV02**
 Engineer: **TMK**
 Date: **2/17/2022**

Flange @ 105.0 EEI DWG # K11587

Moment: 5.8 k-ft
 Shear: 1.1 k
 Compression: 1.4 k
 TIA-222 Code Revision: G
 Mast Diameter (in): 4.50
 Upper Stiffener Height: 9.00 in
 Upper Stiffener Width: 11.50 in
 Upper Stiffener Thickness: 0.50 in
 Upper Stiffener Material: A36 Gr. 36
 Upper Stiffener Yield Strength: 36 ksi
 Upper Stiffener Ultimate Strength: 58 ksi

Ring Flange Outer Diameter / Length: 29.25 in
 Ring Flange Inner Diameter / Length: 24.25 in
 Ring Flange Width: 2.50 in
 Ring Flange Thickness: 0.75 in
 Ring Flange Material: A36 Gr. 36
 Ring Flange Yield Strength: 36 ksi
 Ring Flange Ultimate Strength: 58 ksi
 Flange Detail Type: B

Connection Bolts

Connection Bolt Arrangement: Round
 Connection Bolt Yield Strength: 92 ksi
 Connection Ultimate Strength: 120 ksi
 Connection Bolt Diameter: 1.00 in
 Connection Bolt Circle: 26.00 in
 # of Connection Bolts: 12
 Minimum Connection Bolt Separation: 2.67 in
 Additional Connection Bolts Installed: N

Weld Strength: 70 ksi
 Weld Size at Flange: 0.250 in
 # of sides: 2
 Weld Length at Flange: 2 in.
 Angle of separation of stiffeners: 60.00 degrees
 Weld Size at Mast: 0.250 in.
 Weld Height at Mast: 9 in.

Diameter of Flange Welds: 26.50 in
 Max Tension at weld connection: 2.6 k

Connection Bolt Capacity

Area of Bolt: 0.61 in²
 Maximum Bolt Tension (stiffener load /2): 1.3 k
 Bolt Tensile Capacity: 54.5 k
 Interaction Equation: 0.02 Result: OK

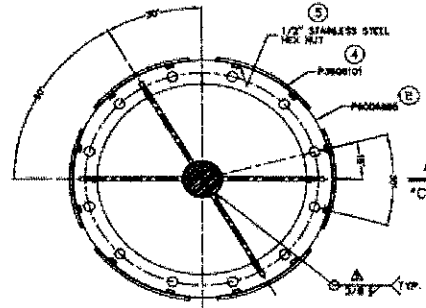

Ring Flange Capacity

Length between bolts: 6.81 in
 Mu (Fixed Ends PL/8) = 2.23 k-in

Flange Moment Capacity (.9Fy x bt²/4): 5.70 k-in

Interaction Equation: 0.39 Result: OK

Weld Capacity:

Weld Capacity at Ring circumference:

fw = 0.65
 Fw = 5.57 k
 Interaction Equation: 0.12 Result: OK

Weld capacity at mast:

Mu = 28.79 k-in
 fw = 1.07 k/in
 Fw = 5.57
 0.19 Result:

Monopole Base Plate Connection



Site Info	
BU #	27741_B
Site Name	Round Hill CT
Order #	

Analysis Considerations	
TIA-222 Revision	H
Grout Considered:	No
t_{ar} (in)	0.75

Applied Loads	
Moment (kip-ft)	592.16
Axial Force (klps)	17.92
Shear Force (klps)	9.27

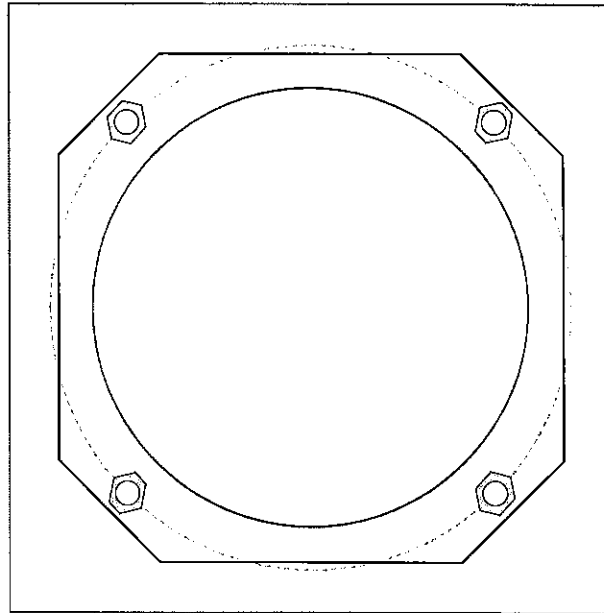

Connection Properties	Analysis Results
-----------------------	------------------

Anchor Rod Data
(4) 2-1/4" ϕ bolts (A615-75 N; $F_y=75$ ksi, $F_u=100$ ksi) on 49" BC
Base Plate Data
47.5" W x 2" Plate (A572-60; $F_y=60$ ksi, $F_u=75$ ksi); Clip: 9.5 in
Stiffener Data
N/A
Pole Data
41" x 0.25" 18-sided pole (A572-65; $F_y=65$ ksi, $F_u=80$ ksi)

Anchor Rod Summary	<i>(units of kips, kip-in)</i>	
$P_{u,t} = 140.41$	$\phi P_{n,t} = 243.75$	Stress Rating
$V_u = 2.32$	$\phi V_n = 149.1$	57.6%
$M_u = n/a$	$\phi M_n = n/a$	Pass
Base Plate Summary		
Max Stress (ksi):	22.83	(Flexural)
Allowable Stress (ksi):	54	
Stress Rating:	42.3%	Pass

Monopole Base Plate Connection - Seismic



Site Info	
BU #	27741_B
Site Name	Round Hill CT
Order #	

Analysis Considerations	
TIA-222 Revision	H
Grout Considered:	No
l_{ar} (In)	0.75

Applied Loads	
Moment (kip-ft)	39.91
Axial Force (klips)	18.42
Shear Force (klips)	0.44

*1.5 Overstrength Factor Applied

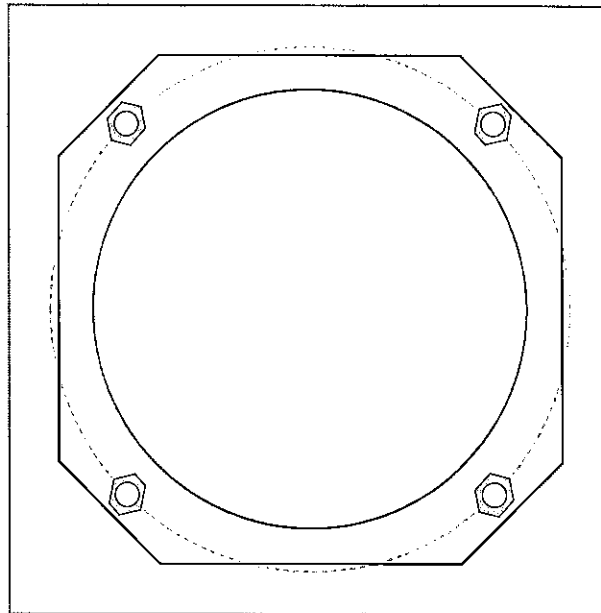

Connection Properties	Analysis Results
-----------------------	------------------

Anchor Rod Data
(4) 2-1/4" \emptyset bolts (A615-75 N; $F_y=75$ ksi, $F_u=100$ ksi) on 49" BC
Base Plate Data
47.5" W x 2" Plate (A572-60; $F_y=60$ ksi, $F_u=75$ ksi); C_{lp} : 9.5 in
Stiffener Data
N/A
Pole Data
41" x 0.25" 18-sided pole (A572-65; $F_y=65$ ksi, $F_u=80$ ksi)

Anchor Rod Summary	<i>(units of kips, kip-in)</i>	
$P_{u,c} = 19.25$	$\phi P_{n,c} = 268.39$	Stress Rating
$V_u = 0.17$	$\phi V_n = 120.77$	7.2%
$M_u = n/a$	$\phi M_n = n/a$	Pass
Base Plate Summary		
Max Stress (ksi):	2.2	(Flexural)
Allowable Stress (ksi):	54	
Stress Rating:	4.1%	Pass

Pier and Pad Foundation



Site Number: 27741_B
 Site Name: Round Hill CT
 REV02

TIA-222 Revision: H
 Tower Type: Monopole

Top & Bot. Pad ReIn. Different?:
 Block Foundation?:
 Rectangular Pad?:

Superstructure Analysis Reactions		
Compression, P_{comp} :	17.92	kips
Base Shear, V_u_{comp} :	9.27	kips
Moment, M_u :	592.16	ft-kips
Tower Height, H :	114	ft
BP Dist. Above Fdn, bp_{dist} :	3	in

Foundation Analysis Checks				
	Capacity	Demand	Rating	Check
Lateral (Sliding) (kips)	93.55	9.27	9.9%	Pass
Bearing Pressure (ksf)	9.38	2.63	28.0%	Pass
Overtuning (kip*ft)	1103.99	650.10	58.9%	Pass
Pier Flexure (Comp.) (kip*ft)	2469.56	619.97	25.1%	Pass
Pier Compression (kip)	22913.28	37.36	0.2%	Pass
Pad Flexure (kip*ft)	1756.48	179.95	10.2%	Pass
Pad Shear - 1-way (kips)	537.90	36.71	6.8%	Pass
Pad Shear - 2-way (Comp) (ksi)	0.190	0.009	4.8%	Pass
Flexural 2-way (Comp) (kip*ft)	3512.95	371.98	10.6%	Pass

Pier Properties		
Pier Shape:	Square	
Pier Diameter, d_{pier} :	6	ft
Ext. Above Grade, E :	1	ft
Pier Rebar Size, S_c :	8	
Pier Rebar Quantity, m_c :	22	
Pier Tie/Spiral Size, S_t :	4	
Pier Tie/Spiral Quantity, m_t :	6	
Pier Reinforcement Type:	Tie	
Pier Clear Cover, cc_{pier} :	3	in

Structural Rating: 25.1%
 Soil Rating: 58.9%

Pad Properties		
Depth, D :	5	ft
Pad Width, W_1 :	15	ft
Pad Thickness, T :	3	ft
Pad Rebar Size (Bottom dir. 2), S_{p2} :	8	
Pad Rebar Quantity (Bottom dir. 2), m_{p2} :	16	
Pad Clear Cover, cc_{pad} :	3	in

Material Properties		
Rebar Grade, F_y :	60	ksi
Concrete Compressive Strength, F'_c :	4	ksi
Dry Concrete Density, δ_c :	150	pcf

Soil Properties		
Total Soil Unit Weight, γ :	100	pcf
Ultimate Net Bearing, Q_{net} :	12.000	ksf
Cohesion, C_u :	0.000	ksf
Friction Angle, ϕ :	43	degrees
SPT Blow Count, N_{blows} :	90	
Base Friction, μ :	0.4	
Neglected Depth, N :	3.00	ft
Foundation Bearing on Rock?	Yes	
Groundwater Depth, gw :	None	ft

<-Toggle between Gross and Net

Site ID: 27741_B
 Site Name: Round Hill CT
 Engineer: TMK
 Date: 2/17/2022

Exposure Determination
per Section C26.7 in ASCE7

Tower Height: 115 ft
 Radius: 2,600 ft

Result:
Use Exposure C
 63.0% of the 500ft Radius Sector Area.

Open Areas (Exp C)	Open Area (x1000 ft ²)	Length (ft)	Distance From Tower (ft)	Width (ft) (equivalent)	Defined as "Open Patch":
1	62	210	290	293	Yes: Open Patch
2	115	323	1,200	356	Not an Open Patch

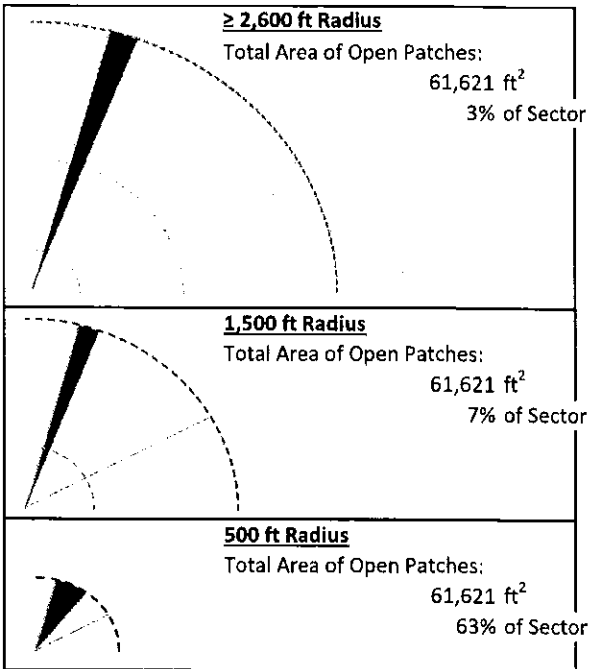
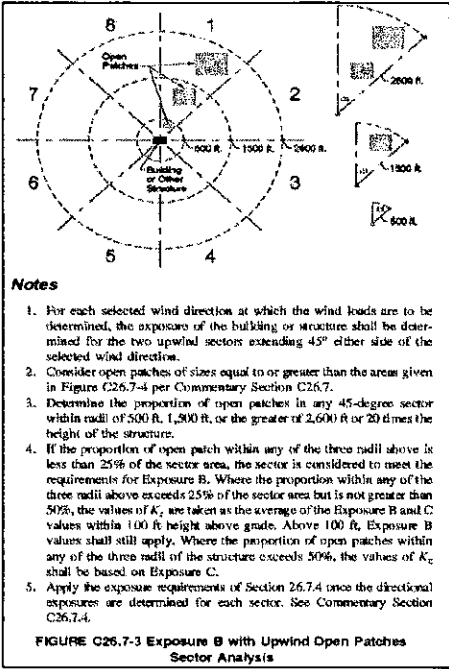
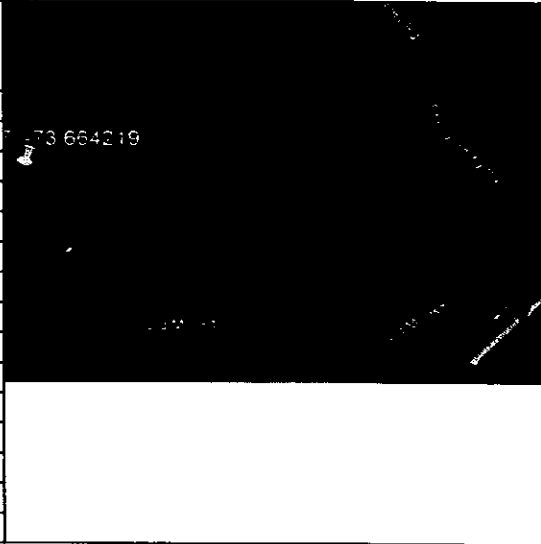

ASCE 7 Hazards Report

Address:
No Address at This Location

Standard: ASCE/SEI 7-16
Risk Category: II
Soil Class: B - Rock

Elevation: 378.96 ft (NAVD 88)
Latitude: 41.095117
Longitude: -73.664219

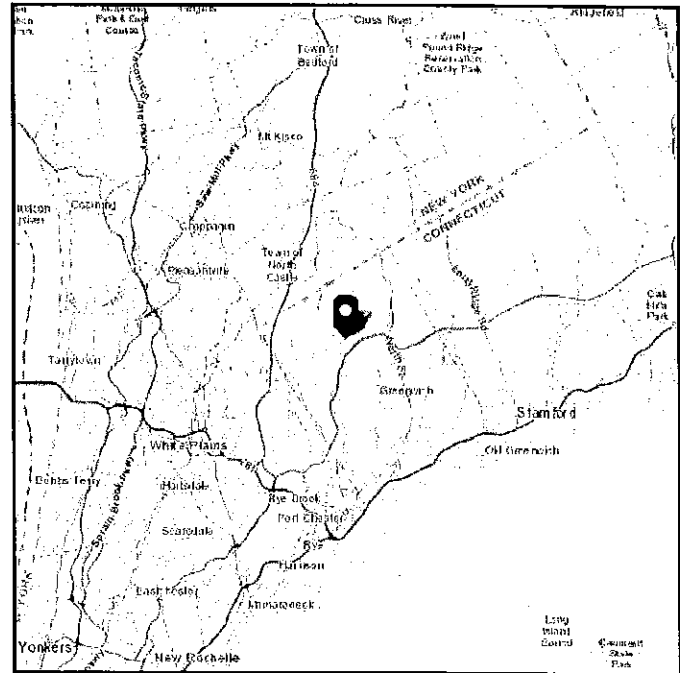
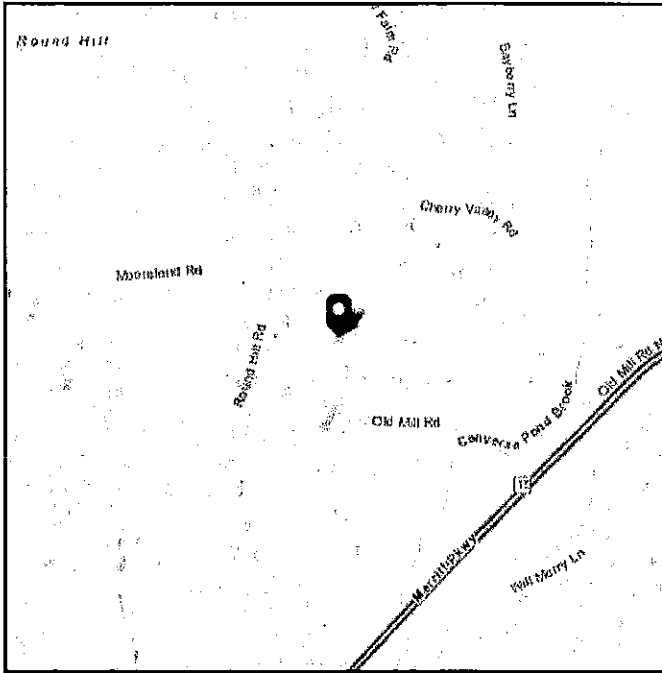

Wind

Results:

Wind Speed	115 Vmph
10-year MRI	75 Vmph
25-year MRI	84 Vmph
50-year MRI	90 Vmph
100-year MRI	96 Vmph

Data Source: ASCE/SEI 7-16, Fig. 26.5-1B and Figs. CC.2-1–CC.2-4, and Section 26.5.2
Date Accessed: Fri Feb 11 2022

Value provided is 3-second gust wind speeds at 33 ft above ground for Exposure C Category, based on linear interpolation between contours. Wind speeds are interpolated in accordance with the 7-16 Standard. Wind speeds correspond to approximately a 7% probability of exceedance in 50 years (annual exceedance probability = 0.00143, MRI = 700 years).

Site is in a hurricane-prone region as defined in ASCE/SEI 7-16 Section 26.2. Glazed openings need not be protected against wind-borne debris.

Site Soil Class: B - Rock

Results:

S_s :	0.279	S_{D1} :	0.032
S_1 :	0.06	T_L :	6
F_a :	0.9	PGA :	0.171
F_v :	0.8	PGA _M :	0.154
S_{MS} :	0.251	F_{PGA} :	0.9
S_{M1} :	0.048	I_e :	1
S_{DS} :	0.168	C_v :	0.779

Seismic Design Category B

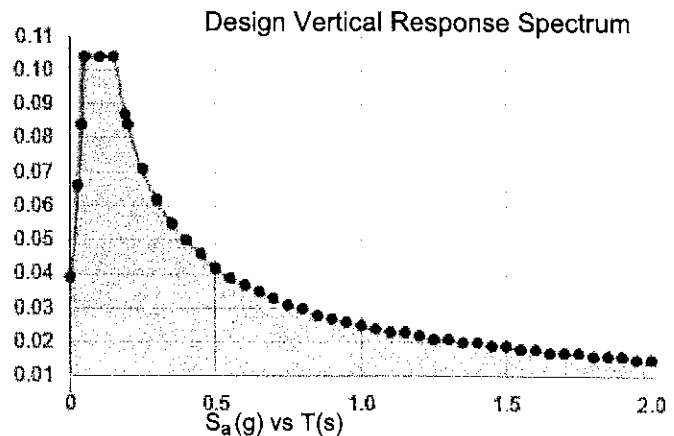
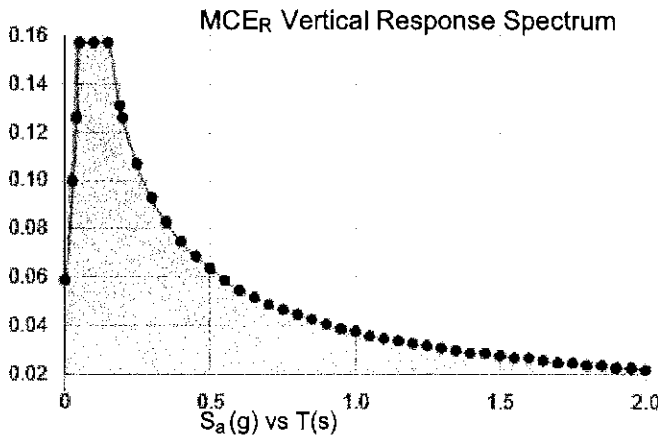
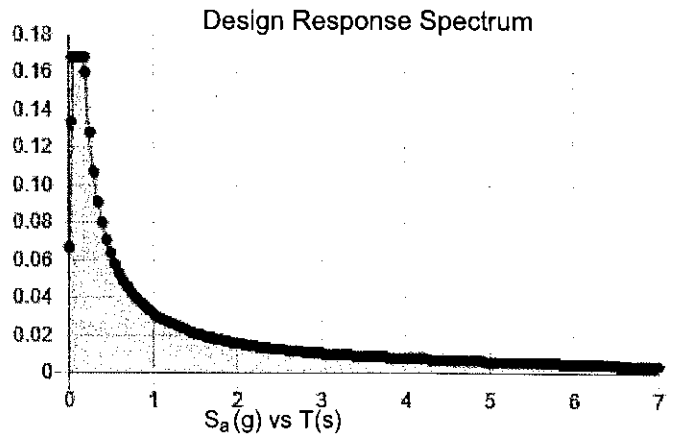
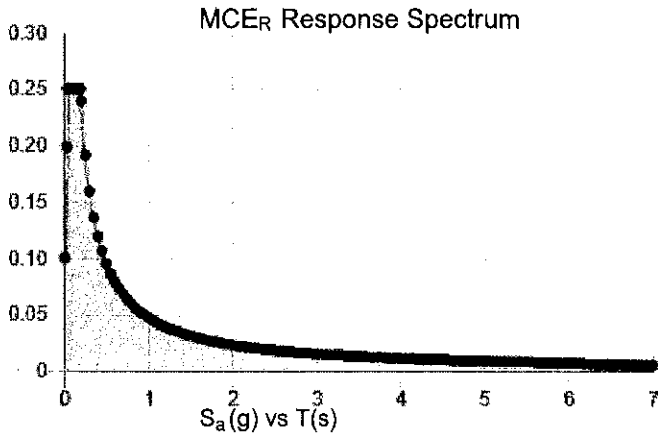

Data Accessed: Fri Feb 11 2022

Date Source:

USGS Seismic Design Maps based on ASCE/SEI 7-16 and ASCE/SEI 7-16 Table 1.5-2. Additional data for site-specific ground motion procedures in accordance with ASCE/SEI 7-16 Ch. 21 are available from USGS.

Ice

Results:

Ice Thickness: 1.00 in.
Concurrent Temperature: 15 F
Gust Speed 50 mph

Data Source: Standard ASCE/SEI 7-16, Figs. 10-2 through 10-8

Date Accessed: Fri Feb 11 2022

Ice thicknesses on structures in exposed locations at elevations higher than the surrounding terrain and in valleys and gorges may exceed the mapped values.

Values provided are equivalent radial ice thicknesses due to freezing rain with concurrent 3-second gust speeds, for a 500-year mean recurrence interval, and temperatures concurrent with ice thicknesses due to freezing rain. Thicknesses for ice accretions caused by other sources shall be obtained from local meteorological studies. Ice thicknesses in exposed locations at elevations higher than the surrounding terrain and in valleys and gorges may exceed the mapped values.

The ASCE 7 Hazard Tool is provided for your convenience, for informational purposes only, and is provided "as is" and without warranties of any kind. The location data included herein has been obtained from information developed, produced, and maintained by third party providers; or has been extrapolated from maps incorporated in the ASCE 7 standard. While ASCE has made every effort to use data obtained from reliable sources or methodologies, ASCE does not make any representations or warranties as to the accuracy, completeness, reliability, currency, or quality of any data provided herein. Any third-party links provided by this Tool should not be construed as an endorsement, affiliation, relationship, or sponsorship of such third-party content by or from ASCE.

ASCE does not intend, nor should anyone interpret, the results provided by this Tool to replace the sound judgment of a competent professional, having knowledge and experience in the appropriate field(s) of practice, nor to substitute for the standard of care required of such professionals in interpreting and applying the contents of this Tool or the ASCE 7 standard.

In using this Tool, you expressly assume all risks associated with your use. Under no circumstances shall ASCE or its officers, directors, employees, members, affiliates, or agents be liable to you or any other person for any direct, indirect, special, incidental, or consequential damages arising from or related to your use of, or reliance on, the Tool or any information obtained therein. To the fullest extent permitted by law, you agree to release and hold harmless ASCE from any and all liability of any nature arising out of or resulting from any use of data provided by the ASCE 7 Hazard Tool.

Lessor Site ID & No.: Round Hill / 467146
Lessee Site ID & No.: NJJER01125A

CONTRACT # _____

LEASE SUPPLEMENT

This Supplement ("Supplement"), is made this 4th day of October, 2022 (the "Supplement Effective Date"), between Cellco Partnership, a Delaware general partnership, d/b/a Verizon Wireless, with its principal offices at One Verizon Way, Mail Stop 4AW100, Basking Ridge, New Jersey 07920, hereinafter designated LESSOR and DISH Wireless L.L.C., a Colorado limited liability company, with its principal offices at 9601 S. Meridian Blvd., Englewood, Colorado 80112, hereinafter designated LESSEE.

1. This Supplement is made pursuant to that certain Master Tower Lease Agreement between Cellco Partnership d/b/a Verizon Wireless and DISH Wireless L.L.C. dated August 6, 2021 (the "Agreement"). All of the terms and conditions of the Agreement are incorporated hereby by reference and made a part hereof without the necessity of repeating or attaching the Agreement. In the event of a contradiction, modification or inconsistency between the terms of the Agreement and this Supplement, the terms of the Agreement shall govern, except as it pertains to Exhibits, Rent that is negotiated in accordance with the terms of the Agreement, and any other site specific terms that are expressly included in a Supplement. Capitalized terms used in this Supplement shall have the same meaning described for them in the Agreement unless otherwise indicated herein.

2. The Premises leased by the LESSOR to the LESSEE hereunder is described as follows:

80 square feet of Ground Space located at 395 Round Hill Road, Greenwich, Fairfield County, Connecticut 06831 for the placement of LESSEE's equipment shelter or cabinets and ancillary equipment, and certain Tower Space for the installation of LESSEE's antennas and related equipment, together with certain easements, as more particularly described on **Exhibit 1** attached hereto and made a part hereof.

3. In the event an **Exhibit 1** is attached hereto describing the Premises, the LESSEE may have the right to survey the Premises and said survey may then become **Exhibit 2** which shall be attached hereto and made a part hereof and shall control in the event of any discrepancies between it and **Exhibit 1**. The cost for such work shall be borne by the LESSEE.

4. LESSOR hereby grants permission to LESSEE to install, maintain and operate the communications equipment, antennas, technology, frequencies and appurtenances described in **Exhibit 3** attached hereto (the "LESSEE Equipment"). LESSEE reserves the right to replace, repair, augment, add or otherwise modify the LESSEE Equipment as provided in **Paragraph 4** of the Agreement.

5. If the Premises are subject to a prime lease, license or other such agreement, a copy of such agreement is attached hereto as **Exhibit 4** (the "Prime Lease"). This Supplement shall not be effective until LESSEE has approved the Prime Lease, and Lessee shall be under no obligation to proceed under this Supplement unless and until the form and substance of the Prime Lease is acceptable to LESSEE. LESSEE'S execution of this Supplement shall convey its approval of the Prime Lease.

Lessor Site ID & No.: Round Hill / 467146
Lessee Site ID & No.: NJJER01125A

CONTRACT # _____

6. Notwithstanding anything contained in the Agreement to the contrary, pursuant to Paragraph 19A of the Prime Lease, the Supplement Term shall be as follows: The initial term of this Supplement will be five (5) years from its Commencement Date, as defined pursuant to Section 3 of the Prime Lease as the first (1st) day of the month following the date this Supplement is executed by the parties or the first (1st) day of the month following the date LESSEE is granted a building permit by the governmental agency charged with issuing such permits, whichever event occurs last. Subject to the terms of the Prime Lease for the Premises, the term of this Supplement shall automatically be extended for four (4) additional five (5) year terms unless LESSEE terminates it at the end of the then current term by giving LESSOR written notice of the intent to terminate at least six (6) months prior to the end of the then current term. LESSOR and LESSEE agree that they shall acknowledge in writing the Commencement Date using the form attached as "**Exhibit 5**" to this Supplement.

7. The Rent due for the Term of this Supplement shall be in accordance with the Prime Lease and shall be an annual amount of Thirty-Three Thousand and 00/100 Dollars (\$33,000.00) to be paid in equal monthly installments on the first day of each month, in advance, to the owner of the property, Round Hill Community Church, Inc., hereinafter designated as the CHURCH, at 395 Round Hill Road, Greenwich, Connecticut 06830, or to such other person, firm or place as the CHURCH may, from time to time, designate in writing at least sixty (60) calendar days in advance of any Rent payment date. Notwithstanding anything to the contrary in the Agreement, the annual rental for each year after the first year of the initial term (including all renewals) shall be increased by four percent (4%) per year. The foregoing Rent reflects the Site Rent, any Microwave Rent, any Additional Wind Load Surface Area Rent, any Additional Ground Space Rent, and any Prime Lease Payment and shall commence on a date to be determined in accordance with **Paragraph 6** of the Agreement.

8. LESSOR and LESSEE mutually acknowledge that the LESSOR'S facilities are designed to accommodate additional wireless carriers or other communications providers, hereinafter designated the "Additional Carriers," on the monopoles and that LESSOR has agreed to assist the CHURCH with its efforts from time to time to enter into agreements with the Additional Carriers, hereinafter designated the "Additional Carrier Agreements," including but not limited to, the review and processing of all applications submitted to LESSOR by the Additional Carriers. The CHURCH shall be entitled to 100% of the rental revenue from the Additional Carriers. LESSEE acknowledges that its rights shall be expressly subject to the terms, conditions and limitations of LESSOR'S lease with the CHURCH, hereinafter designated the Prime Lease, and that LESSEE shall not relieve or release LESSOR from its obligations to the CHURCH under this Agreement. LESSEE further acknowledges that it shall not be entitled to remain in possession of all or any portion of the Premises after expiration or termination of the Prime Lease.

LESSOR and LESSEE mutually and expressly intend that the CHURCH be an authorized third party beneficiary as to each Additional Carrier Agreement, with the CHURCH being fully entitled to commence direct actions with respect to any monetary default by any Additional Carrier under any Additional Carrier Agreement following Notice to LESSEE of such action to be taken by the CHURCH. With respect to non-monetary defaults which appear likely to threaten termination or suspension of payments under any Additional Carrier Agreement, the CHURCH shall take no action

Lessor Site ID & No.: Round Hill / 467146
Lessee Site ID & No.: NJJER01125A

CONTRACT # _____

(except in the event of an emergency) to enforce any such non-monetary default against any Additional Carrier unless the CHURCH has given LESSOR and LESSEE written notice of such Additional Carrier default, together with thirty (30) days' time within which to bring such Additional Carrier into compliance with respect to such non-monetary default. LESSEE acknowledges that in the event of any conflicts between the Additional Carrier Agreement and the Prime Lease, the Prime Lease shall govern.

LESSEE acknowledges that LESSOR and LESSEE shall be entitled to make minor modifications to each Additional Carrier Agreement, provided, however, that no such modification shall be permitted without the express written consent of the CHURCH if such modification would reduce the rents payable to the CHURCH, reduce the term of such Additional Carrier Agreement, or otherwise modify the financial interest of the CHURCH therein.

9. LESSEE shall pay LESSOR a one (1) time fee in the amount of Ten Thousand and 00/100 Dollars (\$10,000.00) to defray LESSOR's costs associated with the CHURCH's legal review fees, which is a condition precedent to LESSEE's use of the Site ("Site Development Fee"). LESSEE shall pay the Site Development Fee within ninety (90) days following the Effective Date of this Agreement.

[SIGNATURE PAGE TO FOLLOW]

Exhibit D
Lease Agreement

Lessor Site ID & No.: Round Hill / 467146
Lessee Site ID & No.: NJJER01125A

CONTRACT # _____

LEASE SUPPLEMENT

This Supplement ("Supplement"), is made this 4th day of October, 2022 (the "Supplement Effective Date"), between Cellco Partnership, a Delaware general partnership, d/b/a Verizon Wireless, with its principal offices at One Verizon Way, Mail Stop 4AW100, Basking Ridge, New Jersey 07920, hereinafter designated LESSOR and DISH Wireless L.L.C., a Colorado limited liability company, with its principal offices at 9601 S. Meridian Blvd., Englewood, Colorado 80112, hereinafter designated LESSEE.

1. This Supplement is made pursuant to that certain Master Tower Lease Agreement between Cellco Partnership d/b/a Verizon Wireless and DISH Wireless L.L.C. dated August 6, 2021 (the "Agreement"). All of the terms and conditions of the Agreement are incorporated hereby by reference and made a part hereof without the necessity of repeating or attaching the Agreement. In the event of a contradiction, modification or inconsistency between the terms of the Agreement and this Supplement, the terms of the Agreement shall govern, except as it pertains to Exhibits, Rent that is negotiated in accordance with the terms of the Agreement, and any other site specific terms that are expressly included in a Supplement. Capitalized terms used in this Supplement shall have the same meaning described for them in the Agreement unless otherwise indicated herein.

2. The Premises leased by the LESSOR to the LESSEE hereunder is described as follows:

80 square feet of Ground Space located at 395 Round Hill Road, Greenwich, Fairfield County, Connecticut 06831 for the placement of LESSEE's equipment shelter or cabinets and ancillary equipment, and certain Tower Space for the installation of LESSEE's antennas and related equipment, together with certain easements, as more particularly described on **Exhibit 1** attached hereto and made a part hereof.

3. In the event an **Exhibit 1** is attached hereto describing the Premises, the LESSEE may have the right to survey the Premises and said survey may then become **Exhibit 2** which shall be attached hereto and made a part hereof and shall control in the event of any discrepancies between it and **Exhibit 1**. The cost for such work shall be borne by the LESSEE.

4. LESSOR hereby grants permission to LESSEE to install, maintain and operate the communications equipment, antennas, technology, frequencies and appurtenances described in **Exhibit 3** attached hereto (the "LESSEE Equipment"). LESSEE reserves the right to replace, repair, augment, add or otherwise modify the LESSEE Equipment as provided in **Paragraph 4** of the Agreement.

5. If the Premises are subject to a prime lease, license or other such agreement, a copy of such agreement is attached hereto as **Exhibit 4** (the "Prime Lease"). This Supplement shall not be effective until LESSEE has approved the Prime Lease, and Lessee shall be under no obligation to proceed under this Supplement unless and until the form and substance of the Prime Lease is acceptable to LESSEE. LESSEE'S execution of this Supplement shall convey its approval of the Prime Lease.

Lessor Site ID & No.: Round Hill / 467146
Lessee Site ID & No.: NJJER01125A

CONTRACT # _____

6. Notwithstanding anything contained in the Agreement to the contrary, pursuant to Paragraph 19A of the Prime Lease, the Supplement Term shall be as follows: The initial term of this Supplement will be [REDACTED] years from its Commencement Date, as defined pursuant to Section 3 of the Prime Lease as the first (1st) day of the month following the date this Supplement is executed by the parties or the first (1st) day of the month following the date LESSEE is granted a building permit by the governmental agency charged with issuing such permits, whichever event occurs last. Subject to the terms of the Prime Lease for the Premises, the term of this Supplement shall automatically be extended for [REDACTED] terms unless LESSEE terminates it at the end of the then current term by giving LESSOR written notice of the intent to terminate at least six (6) months prior to the end of the then current term. LESSOR and LESSEE agree that they shall acknowledge in writing the Commencement Date using the form attached as "Exhibit 5" to this Supplement.

7. The Rent due for the Term of this Supplement shall be in accordance with the Prime Lease and shall be an annual amount of [REDACTED] to be paid in equal monthly installments on the first day of each month, in advance, to the owner of the property, Round Hill Community Church, Inc., hereinafter designated as the CHURCH, at 395 Round Hill Road, Greenwich, Connecticut 06830, or to such other person, firm or place as the CHURCH may, from time to time, designate in writing at least sixty (60) calendar days in advance of any Rent payment date. Notwithstanding anything to the contrary in the Agreement, the annual rental for each year after the first year of the initial term (including all renewals) shall be increased by [REDACTED] per year. The foregoing Rent reflects the Site Rent, any Microwave Rent, any Additional Wind Load Surface Area Rent, any Additional Ground Space Rent, and any Prime Lease Payment and shall commence on a date to be determined in accordance with Paragraph 6 of the Agreement.

8. LESSOR and LESSEE mutually acknowledge that the LESSOR'S facilities are designed to accommodate additional wireless carriers or other communications providers, hereinafter designated the "Additional Carriers," on the monopoles and that LESSOR has agreed to assist the CHURCH with its efforts from time to time to enter into agreements with the Additional Carriers, hereinafter designated the "Additional Carrier Agreements," including but not limited to, the review and processing of all applications submitted to LESSOR by the Additional Carriers. [REDACTED]

[REDACTED] LESSEE acknowledges that its rights shall be expressly subject to the terms, conditions and limitations of LESSOR'S lease with the CHURCH, hereinafter designated the Prime Lease, and that LESSEE shall not relieve or release LESSOR from its obligations to the CHURCH under this Agreement. LESSEE further acknowledges that it shall not be entitled to remain in possession of all or any portion of the Premises after expiration or termination of the Prime Lease.

LESSOR and LESSEE mutually and expressly intend that the CHURCH be an authorized third party beneficiary as to each Additional Carrier Agreement, with the CHURCH being fully entitled to commence direct actions with respect to any monetary default by any Additional Carrier under any Additional Carrier Agreement following Notice to LESSEE of such action to be taken by the CHURCH. With respect to non-monetary defaults which appear likely to threaten termination or suspension of payments under any Additional Carrier Agreement, the CHURCH shall take no action

Lessor Site ID & No.: Round Hill / 467146
Lessee Site ID & No.: NJJER01125A

CONTRACT # _____

(except in the event of an emergency) to enforce any such non-monetary default against any Additional Carrier unless the CHURCH has given LESSOR and LESSEE written notice of such Additional Carrier default, together with thirty (30) days' time within which to bring such Additional Carrier into compliance with respect to such non-monetary default. LESSEE acknowledges that in the event of any conflicts between the Additional Carrier Agreement and the Prime Lease, the Prime Lease shall govern.

LESSEE acknowledges that LESSOR and LESSEE shall be entitled to make minor modifications to each Additional Carrier Agreement, provided, however, that no such modification shall be permitted without the express written consent of the CHURCH if such modification would reduce the rents payable to the CHURCH, reduce the term of such Additional Carrier Agreement, or otherwise modify the financial interest of the CHURCH therein.

9. LESSEE shall pay LESSOR a [REDACTED] to defray LESSOR's costs associated with the CHURCH's legal review fees, which is a condition precedent to LESSEE's use of the Site ("Site Development Fee"). LESSEE shall pay the Site Development Fee within ninety (90) days following the Effective Date of this Agreement.

[SIGNATURE PAGE TO FOLLOW]

Lessor Site ID & No.: Round Hill / 467146
Lessee Site ID & No.: NJJER01125A

CONTRACT # _____

IN WITNESS WHEREOF, the Parties hereto have set their hands and affixed their respective seals as of the Supplement Effective Date.

LESSOR:
Cellco Partnership
d/b/a Verizon Wireless

LESSEE:
DISH Wireless L.L.C.

DocuSigned by:
By: Sergei Mislevy
59573E56490F407...

DocuSigned by:
By: [Signature]
F0DA1A106A864B7...

Name: Sergei Mislevy

Name: Dave Mayo

Title: Executive Director, Network Engineering & Operations

Title: EVP

Date: 04-Oct-2022

Date: 9/28/2022

DS
MF
9/14/2022

DS
LA
DS
AA

Lessor Site ID & No.: Round Hill / 467146
Lessee Site ID & No.: NJJER01125A

CONTRACT # _____

**EXHIBIT 1 TO SUPPLEMENT
PREMISES
PAGE 1 OF 4**

Approximately 10,000 square feet of land (together with the appurtenant access and utility rights set forth in Section 1 above, and located as shown on Plan SC-1, revised 5-11-05, by URS Corporation, Job V21-049) and located on that certain tract, piece or parcel of land with the buildings and improvements thereon, situated in the Town of Greenwich, County of Fairfield and State of Connecticut, and bounded as follows:

Northerly by other land of the Round Hill Community Church, Inc. (being known as the Mead Tract), easterly by land now or formerly of Arthur Hershaft and Eleanor Hershaft, southerly by land now or formerly of Jean Marie Van Waveren and land now or formerly of Howard P. Serrell, Jr. and Diana G. Serrell, and westerly by Round Hill Road and containing 11.2 acres more or less.

Excepting therefrom a 3.200 acre parcel conveyed to Jean Van Waveren by a deed recorded in Volume 1442 at Page 281 of the Greenwich Land Records.

Lessor Site ID & No.: Round Hill / 467146

Lessee Site ID & No.: NJJER01125A

CONTRACT # _____

**EXHIBIT 1 TO SUPPLEMENT
PREMISES
PAGE 3 OF 4**

Enlarged Site Plan

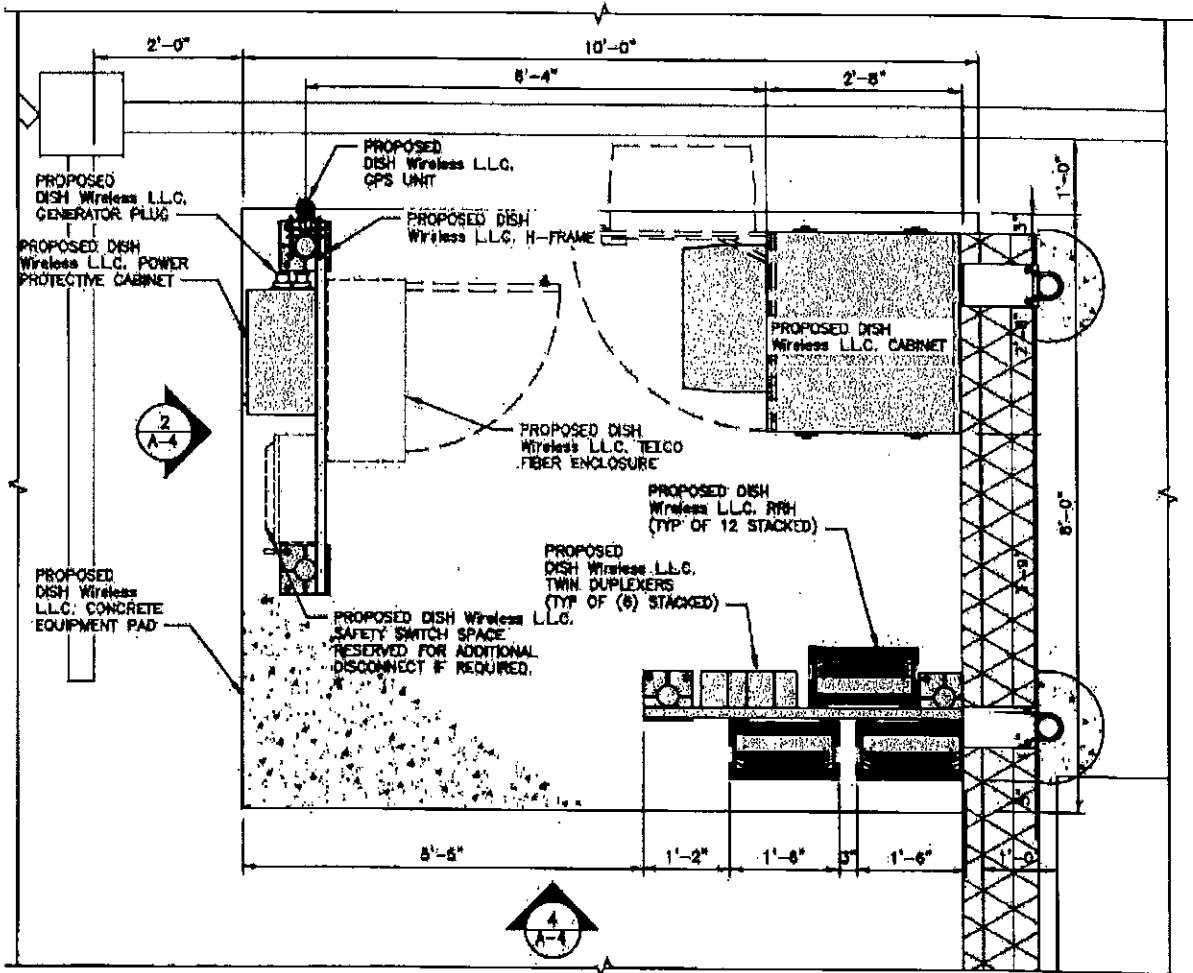

Lessor Site ID & No.: Round Hill / 467146
Lessee Site ID & No.: NJJER01125A

CONTRACT # _____

EXHIBIT 1 TO SUPPLEMENT PREMISES PAGE 4 OF 4

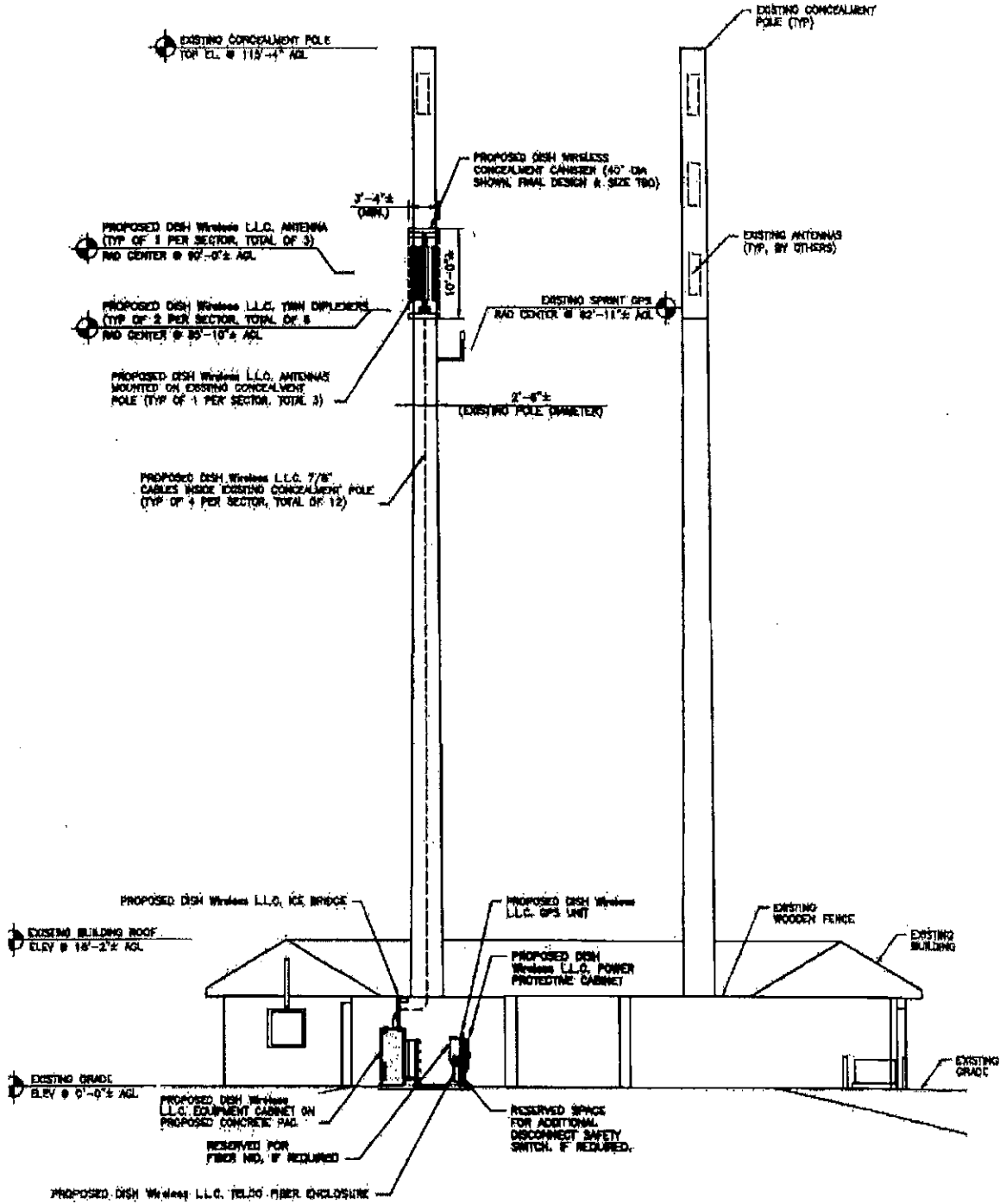

Lessor Site ID & No.: Round Hill / 467146
Lessee Site ID & No.: NJJER01125A

CONTRACT # _____

**EXHIBIT 2 TO SUPPLEMENT
SURVEY**

N/A

Lessor Site ID & No.: Round Hill / 467146
Lessee Site ID & No.: NJJER01125A

CONTRACT # _____

**EXHIBIT 3 TO SUPPLEMENT
LESSEE'S COMMUNICATIONS EQUIPMENT**

Number of Antennas:	Three (3)
Antenna Manufacturer, Model and Type:	Commscope (FVV-65B-R3) Panels
Dimension and Weight of Antenna:	72.0 x 11.8 x 7.0 inches & 43.9 lb
Number of Transmission Lines (Coax and/or Hybrid):	Twelve (12)
Diameter of Transmission Lines (Coax and/or Hybrid):	7/8" Coax Cables
Location of Antenna(s) (Approved RAD Center):	90'
Direction of Radiation (Azimuth):	100, 220, 340
Additional Equipment to be placed on Tower:	Six (6) Commscope (CDX623T-DS-T) Diplexers 8.9 x 5.0 x 4.5 inches & 10.1 lb
Dimensions of Lessee's Shelter (for additional equipment not scheduled hereon):	80 SF (8' x 10')
Generator Specifications:	No generator proposed
Additional Ground Space for Generator	N/A

Lessor Site ID & No.: Round Hill / 467146

Lessee Site ID & No.: NJJER01125A

CONTRACT # _____

**EXHIBIT 4 TO SUPPLEMENT
PRIME LEASE**

SITE NAME: Greenwich, CT
ATTY/DATE: Saunders/2012

FIRST AMENDMENT TO LAND LEASE AGREEMENT

This First Amendment to Land Lease Agreement ("First Amendment") is made as of the ~~10th~~ ^{4th} day of ~~May~~ ^{May}, 2012, between Round Hill Community Church, Inc., with a mailing address of 395 Round Hill Road, Greenwich, Connecticut, hereinafter designated LESSOR and Celco Partnership d/b/a Verizon Wireless, with its principal office located at One Verizon Way, Mail Stop 4AW100, Basking Ridge, New Jersey 07920, hereinafter designated LESSEE.

WHEREAS, LESSOR and LESSEE entered into a certain Land Lease Agreement dated August 12, 2005 (the "Lease"), for ground space on LESSOR's property located at 395 Round Hill Road, Greenwich, Connecticut (the "Property"), for the construction and operation of a communications facility (the "Facilities"); and

WHEREAS, LESSEE is currently operating its Facilities at the Property;

WHEREAS, LESSEE desires to alter the communications technology of the Facilities by adding 4G LTE capable equipment to its existing installation, in exchange for an increase to the monthly rental.

NOW THEREFORE, in consideration of the promises and intending to be legally bound hereby, LESSOR and LESSEE agree as follows:

1. Effective upon full execution of this First Amendment, LESSEE shall have rights to alter the communications technology of the Facilities by installing, operating, and maintaining three 4G LTE antennas and associated equipment, within the Facilities.
2. Effective upon the earlier of (i) 90 days from full execution of this First Amendment; or (ii) the first day of the month following the start of installation of the 4G LTE antennas, the monthly rental payable by LESSEE to LESSOR shall increase by [REDACTED] payable with each monthly installment of rent.
3. Capitalized terms used in this First Amendment shall have the same meaning described for them in the Lease.
4. In the event of a conflict between the terms of the Lease and the terms of this First Amendment, the terms hereof shall control.
5. In all other respects, the Lease shall remain unchanged and in full force and effect.

(W2007699)

Lessor Site ID & No.: Round Hill / 467146
Lessee Site ID & No.: NJJER01125A

CONTRACT # _____

IN WITNESS WHEREOF, the parties hereto have executed this First Amendment to Land Lease Agreement as of the day and year first written above.

LESSOR:
Round Hill Community Church, Inc.

WITNESS:

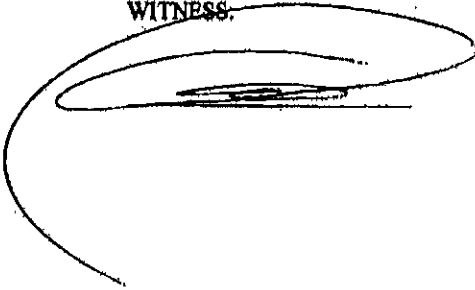

By: 

Name: Richard V. Bergstresser
Its: Chairman

LESSEE:
Cellco Partnership d/b/a Verizon Wireless

WITNESS:

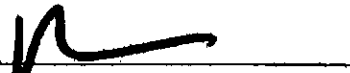

By: 

David R. Heverling
Area Vice President Network

7912

{W2087689}

Lessor Site ID & No.: Round Hill / 467146
 Lessee Site ID & No.: NJJER01125A

CONTRACT # _____

DOC# 07-22-96(5) Rev. 11/17/98

Greenwich, CT

LAND LEASE AGREEMENT

This Agreement ("Agreement" or "Lease") made this ^{August} 12th day of August, 2005, between Round Hill Community Church, Inc., with its principal offices located at 395 Round Hill Road, Greenwich, Connecticut, 06831, Tax ID #06-0662171, hereinafter designated LESSOR and Celco Partnership, a Delaware general partnership d/b/a Verizon Wireless, with its principal office located at 180 Washington Valley Road, Bedminster, New Jersey, 07921, hereinafter designated LESSEE. The LESSOR and LESSEE are at times collectively referred to hereinafter as the "Parties" or individually as the "Party".

1. **PREMISES.** LESSOR hereby leases to LESSEE a portion of that certain parcel of property (the entirety of LESSOR's property is referred to hereinafter as the "Property") owned by LESSOR located at 395 Round Hill Road, in Greenwich, Fairfield County, State of Connecticut, containing approximately 10,000 square feet situated as shown on the Tax Map 183 of the Town of Greenwich as part of Lot 27 and Lot 28, and being further described in Deed Book 1236, Page 6 and Deed Book 1248, Page 258, as recorded in the office of the Greenwich Town Clerk, together with the non-exclusive right for ingress and egress, seven (7) days a week, twenty-four (24) hours a day, on foot or motor vehicle, including trucks, and for the installation and maintenance of utility wires, poles, cables, conduits, and pipes over, under, or along an eighteen (18) foot wide access road which may be entered from the nearest public right-of-way, Round Hill Road, through the existing parking lot of LESSOR and which extends from said parking lot to the demised premises, said demised premises, access road and parking lot (hereinafter collectively referred to as the "Premises") being substantially as described herein in Exhibit "A" attached hereto and made a part hereof.

LESSOR hereby grants permission to LESSEE to install, maintain and operate the communications equipment, antennas and appurtenances shown on Exhibit "B" attached hereto and associated wires, cables, conduits and pipes to be utilized in connection therewith (hereinafter referred to as the "Facilities"). LESSOR and LESSEE agree that the Exhibit "B" plans and specifications for the Facilities are not fully complete and that additional construction details of the Facilities shall be subject to the prior approval of the LESSOR, which shall not be unreasonably withheld, delayed or conditioned.

In the event any public utility is unable to use the aforementioned access road and/or parking lot, LESSOR agrees to grant an additional right-of-way either to the LESSEE or to the public utility at no cost to the LESSEE.

LESSEE agrees that its access rights shall be subject to reasonable rules and regulations of general application from time to time promulgated by LESSOR, with written notice of the same provided to LESSEE. LESSEE further agrees that after initial construction of the Facilities, its access to the Premises for routine maintenance purposes shall be limited to the hours between 8:00 a.m. and 5:00 p.m. local time Monday through Friday. In the event of an emergency requiring access to the Premises beyond the aforementioned hours, LESSEE agrees to provide LESSOR with written documentation of such emergency within 72 hours after such entry.

2. **SURVEY.** LESSOR hereby grants to LESSEE the right to survey the Property and the Premises, and said survey shall then become Exhibit "C" which shall be attached hereto and made a part hereof (which survey shall supercede inconsistent property boundary determinations on Exhibit "B" but shall not otherwise modify the requirements of Section 34 below). All costs for such work shall be borne by the LESSEE.

3. **TERM.** This Agreement shall be for an initial term of five (5) years, and shall commence on the Commencement Date (as hereinafter defined) at which time rental payments shall be due at an annual rental of [REDACTED] to be paid in equal monthly installments on the first day of the month, in advance, to LESSOR, or to such other person, firm or place as the LESSOR may, from time to time, designate in writing at least thirty (30) days in advance of any rental payment date. The annual rental for the second and each following year of the initial term shall be the rental rate for the immediately prior year increased by [REDACTED]. The Commencement Date is defined as the first (1st) day of the month following the date this Agreement is executed by the parties or the first

(W2286690;12)

Lessor Site ID & No.: Round Hill / 467146

Lessee Site ID & No.: NJJER01125A

CONTRACT # _____

(1st) day of the month following the date LESSEE is granted a building permit by the governmental agency charged with issuing such permits, whichever event occurs last.

4. **EXTENSIONS.** This Agreement shall automatically be extended for four (4) additional five (5) year terms unless the LESSEE terminates it at the end of the then current term by giving the LESSOR written notice of the intent to terminate at least six (6) months prior to the end of the then current term.

5. **EXTENSION RENTALS.** The annual rental for each year of each extension term shall be the rental rate for the immediately prior lease year increased by

6. **INTENTIONALLY DELETED.**

7. **USE: GOVERNMENTAL APPROVALS.** LESSEE shall use the Premises solely for the purpose of constructing, maintaining and operating a communications facility and uses incidental and all necessary appurtenances and for no other purpose. A security fence as specified on Exhibit "B" shall be placed around a portion of the perimeter of the Premises. All improvements shall be at LESSEE's expense and the installation of all improvements shall be at the discretion and option of the LESSOR. Subject to Section 36, LESSEE shall have the right to replace, repair, add or otherwise modify its equipment or any portion thereof, whether the equipment is specified or not on any exhibit attached hereto, during the term of this Agreement. LESSEE will maintain the Premises in a good condition reasonable wear and tear excepted. LESSOR will maintain the Property, excluding the Premises, in good condition, reasonable wear and tear excepted. It is understood and agreed that LESSEE's ability to use the Premises is contingent upon its obtaining after the execution date of this Agreement all of the certificates, permits and other approvals that may be required by any Federal, State or Local authorities as well as satisfactory soil boring tests which will permit LESSEE use of the Premises as set forth above. LESSOR shall cooperate with LESSEE in its effort to obtain such approvals and shall take no action which would adversely affect the status of the Property with respect to the proposed use by LESSEE. LESSEE agrees to promptly commence and thereafter diligently pursue all approvals required for construction and operation of the Facilities. In the event that any of such applications should be finally rejected and/or LESSOR is unable to obtain the necessary approvals and/or soil boring test results are deemed unsatisfactory by LESSEE prior to September 1, 2006, LESSEE shall have the right to terminate this Agreement. Notice of the LESSEE's exercise of its right to terminate shall be given to LESSOR in writing by certified mail, return receipt requested, by or before September 1, 2006 and shall be effective upon the mailing of such notice by the LESSEE. All rentals paid to said termination date shall be retained by the LESSOR. Upon such termination, this Agreement shall become null and void and all the Parties shall have no further obligations including the payment of money, to each other, except as set forth in Section 30.

LESSOR's use of the Premises shall at all times be in compliance with all Federal, State and Local requirements from time to time applicable to the construction, operation and safety of wireless facilities, excepting only those requirements applicable to the LESSOR as owner of the Property (hereinafter referred to as the "Governmental Requirements"). LESSEE's obligation to comply with Governmental Requirements shall include, without limitation, (a) obtaining regulatory approvals from Town of Greenwich agencies, commissions and/or emergency service providers, if any are required under governing law, and any required certifications or rulings from the Connecticut State Council related to the Premises and or any equipment changes thereto; and (b) satisfying all applicable rules and regulations of the Federal Communications Commission (collectively the "Governmental Approvals"), it being expressly agreed that the LESSOR assumes no responsibility for the licensing, operation and/or maintenance of the Premises or the Facilities.

8. **INDEMNIFICATION.** Each Party shall indemnify and hold the other harmless against any claim of liability or loss from personal injury or property damage resulting from or arising out of the use and occupancy of the Premises or the Property by the Party, its servants or agents, excepting, however, such claims or damages as may be due to or caused by the acts or omissions of the other Party, or its servants or agents. Without limiting the foregoing, LESSEE covenants and agrees to indemnify and hold LESSOR, including without limitation its officers, trustees, directors, members, affiliates, employees and agents (hereinafter referred to as the "LESSOR Indemnified Parties"), harmless from all loss, cost or expense (including without limitation reasonable legal fees and expenses) incurred by any such LESSOR Indemnified Parties in connection with any claim, litigation, permitting challenge or similar contest arising out of this Lease, or the permitting, construction, or operation of the Facilities by LESSEE, provided that such LESSOR Indemnified Parties shall not be entitled to any such indemnification relating to (i) the LESSOR's

(W1286490;12)06/06/05

Lessor Site ID & No.: Round Hill / 467146

Lessee Site ID & No.: NJJER01125A

CONTRACT # _____

rights, title or interest in the Property or (ii) any agreement by LESSOR or restriction upon LESSOR limiting such construction or operation of the Facilities.

9. **INSURANCE.** The Parties hereby waive any and all rights of action for negligence against the other which may hereafter arise on account of damage to the Premises or to the Property resulting from any fire, or other casualty of the kind covered by standard fire insurance policies with extended coverage, regardless of whether or not, or in what amount, such insurance is now or hereafter carried by the Parties, or either of them. The Parties agree to obtain a waiver of subrogation on their respective first party property insurance policies. LESSOR agrees that, at its own cost and expense, it will maintain comprehensive general liability and property liability insurance with liability limits of not less than \$1,000,000 for injury to or death of one or more persons in any one occurrence and \$500,000 for damage or destruction to property in any one occurrence. LESSEE agrees that, at its own cost and expense, it will maintain comprehensive general liability and property liability insurance with combined single liability limits of not less than \$3,000,000 for injury to or death of one or more persons and/or damage or destruction to property in any one occurrence. LESSEE shall list the LESSOR Indemnified Parties as Additional Insureds.

10. **INTENTIONALLY DELETED.**

11. **INTERFERENCE.** LESSOR agrees that LESSOR and/or any other tenants of the Property who currently have or in the future take possession of the Property will be permitted to install only such radio equipment that is of the type and frequency which will not cause measurable interference with the existing equipment of the LESSEE. The Parties acknowledge that there will not be an adequate remedy at law for non-compliance with the provisions of this paragraph and therefore, LESSEE shall have the right to specifically enforce the provisions of this paragraph in a court of competent jurisdiction.

12. **REMOVAL UPON TERMINATION.** LESSEE, upon termination of the Agreement, shall, within ninety (90) days thereafter, remove its building(s), antenna structure(s) (except footings), fixtures and all personal property and otherwise restore the Property to its original condition, reasonable wear and tear excepted. LESSEE shall post with LESSOR, not less than six (6) months prior to the expiration of this Lease, a bond in the amount of \$_____ to secure such removal. If such bond is not so posted, LESSOR may obtain same at the cost of LESSEE, payment of which shall be additional rent due hereunder. If such time for removal causes LESSEE to remain on the Property after termination of this Agreement, LESSEE shall pay rent _____ of the then existing monthly rate, until such time as the removal of the building, antenna structure, fixtures and all personal property are completed. In the event that LESSEE desires to abandon in place any of such building(s), antenna structure(s), fixtures or personal property instead of removing same, LESSEE shall notify LESSOR not less than five (5) months prior to the expiration hereof, specifying such items proposed to be abandoned, and LESSEE shall be permitted to abandon any of such items as are selected to remain by LESSOR by written notice given within 30 days after LESSEE's notice.

13. **INTENTIONALLY DELETED.**

14. **RIGHTS UPON SALE.** Should the LESSOR, at any time during the term of this Agreement, decide to sell all or any part of the Property to a purchaser other than LESSEE, such sale shall be under and subject to this Agreement and LESSEE's rights hereunder, and any sale by the LESSOR of the portion of the Property underlying the right-of-way herein granted shall be under and subject to the right of the LESSEE in and to such right-of-way.

15. **QUIET ENJOYMENT.** LESSOR covenants that LESSEE, on paying rent and performing the covenants shall peaceably and quietly have, hold and enjoy the Premises.

16. **COVENANTS.** LESSOR covenants that LESSOR has full authority to enter into and execute this Agreement and that LESSOR has delivered to LESSEE copies of all reports, memoranda, and surveys and other written materials known to LESSOR's officers relevant to LESSEE's evaluation of title and survey. To the best of LESSOR's knowledge, there are no covenants, easements or restrictions not previously disclosed in writing, which would interfere with or prevent the use of the Premises by the LESSEE as set forth above.

(W1286490;12)06/06/05

Lessor Site ID & No.: Round Hill / 467146

Lessee Site ID & No.: NJJER01125A

CONTRACT # _____

LESSEE covenants that (i) it has all the requisite authority to enter into and perform under this Lease; (ii) it will properly and in compliance with all Governmental Requirements remove from the Premises any oil, hazardous materials, or other contaminants brought onto the Premises as a result of the operations of LESSEE; and (iii) LESSEE has not dealt with, nor is any commission due to any broker that dealt with LESSEE in connection with this Lease, other than any commission that shall be solely payable by LESSEE.

17. **INTEGRATION.** It is agreed and understood that this Agreement contains all agreements, promises and understandings between the LESSOR and LESSEE and that no verbal or oral agreements, promises or understandings shall be binding upon either the LESSOR or LESSEE in any dispute, controversy or proceeding at law, and any addition, variation or modification to this Agreement shall be void and ineffective unless made in writing and signed by the Parties. In the event any provision of the Agreement is found to be invalid or unenforceable, such finding shall not affect the validity and enforceability of the remaining provisions of this Agreement. The failure of either Party to insist upon strict performance of any of the terms or conditions of this Agreement or to exercise any of its rights under the Agreement shall not waive such rights and such Party shall have the right to enforce such rights at any time and take such action as may be lawful and authorized under this Agreement, either in law or in equity.

18. **GOVERNING LAW.** This Agreement and the performance thereof shall be governed, interpreted, construed and regulated by the laws of the State of Connecticut.

19. **ASSIGNMENT.** This Agreement may be sold, assigned or transferred by the LESSEE without any approval or consent of the LESSOR to the LESSEE's principal, affiliates, subsidiaries of its principal; to any entity which acquires all or substantially all of LESSEE's assets in the market defined by the Federal Communications Commission in which the Property is located by reason of a merger, acquisition or other business reorganization; or to any entity which acquires or receives an interest in the majority of communication towers of the LESSEE in the market defined by the Federal Communications Commission in which the Property is located. As to other parties, this Agreement may not be sold, assigned or transferred without the written consent of the LESSOR, which such consent will not be unreasonably withheld or delayed.

19A. **ADDITIONAL CARRIERS.**

(a) **General.** LESSOR and LESSEE mutually acknowledge that the Facilities are designed to accommodate additional wireless carriers or other communications providers (hereinafter referred to as the "Additional Carriers") on the monopoles (hereinafter referred to as the "Monopoles"). LESSEE agrees to assist LESSOR with its efforts from time to time to enter into agreements with the Additional Carriers, as contemplated in Section 19A (c) below (hereinafter referred to as the "Additional Carrier Agreements"), including but not limited to, the review and processing of all applications submitted to LESSOR by the Additional Carriers. LESSOR shall be entitled to 100% of the rental revenue from the Additional Carriers. LESSOR hereby consents to LESSEE providing space on the Monopoles to the Additional Carriers, provided that all the Additional Carrier Agreements shall be expressly subject to the terms, conditions and limitations of this Lease, and no Additional Carrier shall relieve or release LESSEE from its obligations to LESSOR under this Lease. LESSOR and LESSEE acknowledge that LESSEE shall be entitled to occupy space on one or both of the Monopoles at a maximum of two (2) different heights and that the rental payments to be paid by LESSEE as provided for in this Lease have been based on LESSEE's use of such space at two (2) different heights in total. In no event shall LESSEE have any obligation to pay the rental payments of any of the Additional Carriers if any such Additional Carrier does not do so, and LESSOR's rights to enforce such payments shall be solely as set forth in Section 19A (b) below.

(b) **Enforcement Rights.** LESSEE and LESSOR mutually and expressly intend that LESSOR be an authorized third party beneficiary as to each Additional Carrier Agreement, with Lessor being fully entitled to commence direct actions with respect to any monetary default by any Additional Carrier under any Additional Carrier Agreement. With respect to non-monetary defaults which appear likely to threaten termination or suspension of payments under any Additional Carrier Agreement, LESSOR shall take no action (except in the event of an emergency) to enforce any such non-monetary default against any Additional Carrier unless LESSOR has given LESSEE written notice of such Additional Carrier default, together with thirty (30) days' time within which to bring such Additional Carrier into compliance with respect to such non-monetary default. Each such Additional Carrier Agreement shall expressly state that LESSOR is an intended third party beneficiary with direct enforcement rights as

(W128690;12)06/06/05

Lessor Site ID & No.: Round Hill / 467146
Lessee Site ID & No.: NJJER01125A

CONTRACT # _____

set forth herein and that, in the event of any conflicts between the Additional Carrier Agreement and this Agreement, this Agreement shall govern. LESSEE agrees to give LESSOR written notice of any dispute between LESSEE and any Additional Carrier which appears likely to threaten termination or suspension of payments under any Additional Carrier Agreement.

(c) Initial Leasing. LESSEE shall be entitled to enter into Additional Carrier Agreements with Additional Carriers on terms which otherwise comply with this Agreement and provide for not less than \$2,750 per month for each of six (6) Additional Carrier locations for a term of not less than five (5) years. All such Additional Carrier Agreements shall have a five (5) year initial term, with each Additional Carrier having automatic extensions for four (4) additional five (5) terms, unless any Additional Carrier terminates its agreement at the end of a term by giving LESSEE six (6) months' prior written notice, with annual four percent (4%) rental increases as set forth in Sections 3, 4 and 5 above. If three (3) such Additional Carrier Agreements have not been secured within five (5) months from the date hereof, LESSOR shall be entitled to terminate this Lease by written notice to LESSEE delivered within six (6) months from the date hereof.

(d) Modification. LESSEE and each Additional Carrier shall be entitled to make minor modifications to each Additional Carrier Agreement, provided, however, that no such modification shall be permitted without the express written consent of LESSOR if such modification would reduce the rents payable to LESSOR, reduce the term of such Additional Carrier Agreement, or otherwise modify the financial interest of LESSOR therein.

(e) Additional Carrier Renewals. All such Additional Carrier Agreements shall be expressly subject to the terms and provisions of this Agreement, and no Additional Carrier Agreement shall entitle any Additional Carrier to remain in possession of all or any portion of the Premises after expiration or termination of this Agreement. If during the term of this Agreement any Additional Carrier Agreement expires or is terminated, then (i) LESSEE shall use good faith and diligent efforts, for a period of not less than thirty (30) days ("LESSEE Priority Period") to replace such Additional Carrier, and LESSEE shall be entitled to replace such Additional Carrier Agreement with any replacement Additional Carrier Agreement which provides LESSOR with not less than the amounts set forth in Section 19A(e); (ii) after the expiration of the LESSEE Priority Period, LESSOR shall be entitled to seek replacement Additional Carriers, and LESSEE shall be obligated to enter into a customary form Additional Carrier Agreement with any such proposed Additional Carrier obtained by LESSOR, unless LESSEE provides LESSOR with written certification, accompanied by detailed explanatory back up materials, documenting why the location of such Additional Carrier at the Facilities is not feasible or technically compatible with the existing facilities of LESSEE or any of the Additional Carriers.

LESSEE shall be entitled to 100% of the payments from the Additional Carriers as part of any sharing or contribution agreement for the costs and expenses incurred by LESSEE in the design, planning, permitting, construction and maintenance of the Monopoles.

20. **NOTICES.** All notices hereunder must be in writing and shall be deemed validly given if sent by certified mail, return receipt requested or by commercial courier, provided the courier's regular business is delivery service and provided further that it guarantees delivery to the addressee by the end of the next business day following the courier's receipt from the sender, addressed as follows (or any other address that the Party to be notified may have designated to the sender by like notice):

LESSOR: Round Hill Community Church, Inc.
395 Round Hill Road
Greenwich, Connecticut 06831
Attention: Church Administrator

LESSEE: Cellco Partnership
d/b/a Verizon Wireless
180 Washington Valley Road
Bedminster, New Jersey 07921
Attention: Network Real Estate

(W128699;12)06/06/05

Lessor Site ID & No.: Round Hill / 467146
Lessee Site ID & No.: NJJER01125A

CONTRACT # _____

Notice shall be effective upon mailing or delivering the same to a commercial courier, as permitted above.

21. **SUCCESSORS.** This Agreement shall extend to and bind the heirs, personal representatives, successors and assigns of the Parties hereto.

22. **SUBORDINATION AND NON-DISTURBANCE.** At LESSOR's option, this Agreement shall be subordinate to any mortgage or other security interest by LESSOR which from time to time may encumber all or part of the Property or right-of-way; provided, however, every such mortgage or other security interest shall recognize the validity of this Agreement in the event of a foreclosure of LESSOR's interest and also LESSEE's right to remain in occupancy of and have access to the Premises as long as LESSEE is not in default of this Agreement. LESSEE shall execute whatever instruments may reasonably be required to evidence this subordination clause. In the event the Property is encumbered by a mortgage or other security interest, the LESSOR immediately after this Agreement is executed, will obtain and furnish to LESSEE, a non-disturbance agreement for each such mortgage or other security interest in recordable form. In the event the LESSOR defaults in the payment and/or other performance of any mortgage or other security interest encumbering the Property, LESSEE, may, at its sole option and without obligation, cure or correct LESSOR's default and upon doing so, LESSEE shall be subrogated to any and all rights, titles, liens and equities of the holders of such mortgage or other security interest and the LESSEE shall be entitled to deduct and setoff against all rents that may otherwise become due under this Agreement the sums paid by LESSEE to cure or correct such defaults.

23. **RECORDING.** LESSOR agrees to execute a memorandum of this Lease Agreement which LESSEE may record with the appropriate Recording Officer. The date set forth in the Memorandum of Lease is for recording purposes only and bears no reference to commencement of either term or rent payments.

24. **DEFAULT.** In the event there is a default by the LESSEE with respect to any of the provisions of this Agreement or its obligations under it, including the payment of rent, the LESSOR shall give LESSEE written notice of such default. After receipt of such written notice, the LESSEE shall have seven (7) days in which to cure any monetary default and thirty (30) days in which to cure any non-monetary default, provided the LESSEE shall have such extended period as may be required beyond the thirty (30) days if the nature of such non-monetary cure is such that it inherently requires more than thirty (30) days and the LESSEE commences the cure within the thirty (30) day period and thereafter continuously and diligently pursues the cure to completion. The LESSOR may not maintain any action or effect any remedies for default against the LESSEE unless and until the LESSEE has failed to cure the same or commenced to cure the same, as the case may be, within the time periods provided in this Paragraph.

25. **ENVIRONMENTAL.** Each party shall hold the other harmless and indemnify the other from and assume all duties, responsibility and liability at its sole cost and expense, for all duties, responsibilities, and liability (for payment of penalties, sanctions, forfeitures, losses, costs, or damages) and for responding to any action, notice, claim, order, summons, citation, directive, litigation, investigation or proceeding which is in any way related to: a) failure to comply with any environmental or industrial hygiene law, including without limitation any regulations, guidelines, standards, or policies of any governmental authorities regulating or imposing standards of liability or standards of conduct with regard to any environmental or industrial hygiene concerns or conditions as may now or at any time hereafter be in effect; and b) any environmental or industrial hygiene conditions arising out of or in any way related to the condition of the Property or activities conducted thereon caused by such indemnifying party, its contractors, employees or invitees.

26. **CASUALTY.** In the event of damage by fire or other casualty to the Premises that cannot reasonably be expected to be repaired within ninety (90) days following same or, if the Property is damaged by fire or other casualty so that such damage may reasonably be expected to disrupt LESSEE's operations at the Premises for more than ninety (90) days, then LESSEE may at any time following such fire or other casualty, terminate this Lease upon fifteen (15) days' written notice to LESSOR. Any such notice of termination shall cause this Lease to expire with the same force and effect as though the date set forth in such notice were the date originally set as the expiration date of this Lease and the parties shall make an appropriate adjustment, as of such termination date, with respect to payments due to the other under this Lease. Notwithstanding the foregoing, all rental shall abate during the period of such fire or other casualty.

(W1284490;1)06/06/05

Lessor Site ID & No.: Round Hill / 467146
Lessee Site ID & No.: NJJER01125A

CONTRACT # _____

7

27. **CONDEMNATION.** In the event of any condemnation of the Property, LESSEE may terminate this Lease upon fifteen (15) days' written notice to LESSOR if such condemnation may reasonably be expected to materially disrupt LESSEE's operations at the Premises for more than forty-five (45) days. LESSEE may on its own behalf make a claim in any condemnation proceeding involving the Premises for losses related to the antennas, equipment, its relocation costs and its damages and losses (but not for the loss of its leasehold interest). Any such notice of termination shall cause this Lease to expire with the same force and effect as though the date set forth in such notice were the date originally set as the expiration date of this Lease and the parties shall make an appropriate adjustment as of such termination date with respect to payments due to the other under this Lease.

28. **SUBMISSION OF LEASE.** The submission of this Lease for examination does not constitute an offer to lease the Premises and this Lease becomes effective only upon the full execution of this Lease by the Parties. If any provision herein is invalid, it shall be considered deleted from this Lease and shall not invalidate the remaining provisions of this Lease.

29. **INTENTIONALLY DELETED.**

30. **SURVIVAL.** The provisions of the Agreement relating to indemnification from one Party to the other Party shall survive any termination or expiration of this Agreement. Additionally, any provisions of this Agreement which require performance subsequent to the termination or expiration of this Agreement shall also survive such termination or expiration.

31. **CAPTIONS.** The captions contained in this Agreement are inserted for convenience only and are not intended to be part of the Agreement. They shall not affect or be utilized in the construction or interpretation of the Agreement.

32. **ATTORNEYS' FEES/EXPERT FEES.** Within fifteen (15) days of receipt of an invoice from LESSOR, LESSEE shall reimburse LESSOR for legal, consulting and other related expenses paid by LESSOR in connection with this Agreement, up to a maximum of Fifty Thousand Dollars (\$50,000.00). LESSOR agrees to provide reasonable documentation substantiating such expenses.

33. **UTILITIES; REAL PROPERTY TAXES.** LESSEE agrees to promptly pay for its share (and pro rata share, if not separately assessed) of any and all electrical charges, utility assessments, and/or real property taxes attributable to LESSEE'S construction, operation and maintenance of the Premises, said payments to be made directly to the appropriate service provider upon LESSEE'S direct receipt of invoice or to be made to LESSOR within thirty (30) days of receipt of written notice and invoice to LESSEE from LESSOR.

34. **INITIAL CONSTRUCTION.** Initial construction of the Facilities in accordance with Exhibit B shall be commenced upon issuance of the Governmental Approvals and shall be diligently prosecuted thereafter through completion. Such completion shall include underground installation of any additional utilities to support the Facilities, and restoration of any prior surfacing or landscaping disturbed in connection with such construction. LESSEE agrees that the landscaping and screening items set forth on Exhibit "B" shall be included in such initial construction, and LESSEE agrees to continuously thereafter maintain such landscaping and screening in good order and condition. The installation and construction of the Facilities shall be at the sole cost and expense of the LESSEE, and such construction and installation may in no event proceed prior to LESSEE obtaining all approvals under Governmental Requirements, with all applicable appeal periods either having lapsed unexercised or subject to a final decision by a court of competent jurisdiction.

35. **OPERATION AND MAINTENANCE.** LESSEE agrees to operate the Facilities in compliance with good business practices and all Governmental Requirements. Without limiting the foregoing, LESSEE agrees that no operation of the Facilities shall be permitted to the extent that such operation interferes with Town of Greenwich emergency services. LESSEE will maintain the Premises in a good and safe condition, reasonable wear and tear excepted but in compliance with all Governmental Requirements. LESSOR will maintain the Property, excluding the Premises, in good and safe condition, reasonable wear and tear excepted.

[W1286690;13] 06/06/05

Lessor Site ID & No.: Round Hill / 467146

Lessee Site ID & No.: NJJER01125A

CONTRACT # _____

36. **EQUIPMENT CHANGES.** LESSEE reserves the right to replace the Facilities with similar and comparable equipment provided said replacement does not (a) alter the appearance, noise level, lighting or other external appearance or features of the equipment building or Monopoles in any material respect, or (b) interfere with any other radio communications or other electronic equipment located at the Property or operated by Town of Greenwich emergency services, or (c) increase total radio frequency electromagnetic radiation power density or cause a significant change or alteration in the physical or environmental characteristics at the Premises, or (d) alter the frequency group or communications technology of the Facilities, or (e) operate in any manner other than in compliance with all Governmental Requirements.

IN WITNESS WHEREOF, the Parties hereto have set their hands and affixed their respective seals the day and year first above written.

LESSOR:
Round Hill Community Church, Inc

Robert L. Moore
WITNESS

BY: *Charles T. Lee*
Charles T. Lee, Chairman

James Wright
WITNESS

BY: _____

LESSEE:
Cello Partnership d/b/a Verizon Wireless

Thomas Longola
WITNESS

BY: *David R. Heverling*
David R. Heverling
Network Vice President
Northeast Area

81305

(W128690;12)06/06/05

Lessor Site ID & No.: Round Hill / 467146
Lessee Site ID & No.: NJJER01125A

CONTRACT # _____

Exhibit "A"

Approximately 10,000 square feet of land (together with the appurtenant access and utility rights set forth in Section 1 above, and located as shown on Plan SC-1, revised 5-11-05, by URS Corporation, Job V21-049) and located on that certain tract, piece or parcel of land with the buildings and improvements thereon, situated in the Town of Greenwich, County of Fairfield and State of Connecticut, and bounded as follows:

Northerly by other land of the Round Hill Community Church, Inc. (being known as the Mead Tract), easterly by land now or formerly of Arthur Hershaft and Eleanor Hershaft, southerly by land now or formerly of Jean Marie Van Waveren and land now or formerly of Howard P. Serrell, Jr. and Diann G. Serrell, and westerly by Round Hill Road and containing 11.2 acres more or less.

Excepting therefrom a 3.200 acre parcel conveyed to Jean Van Waveren by a deed recorded in Volume 1442 at Page 281 of the Greenwich Land Records.

(W1286460;12)06/06/05

Lessor Site ID & No.: Round Hill / 467146
Lessee Site ID & No.: NJJER01125A

CONTRACT # _____

Exhibit "B"
(Drawings)

(W1286690;12) 06/06/05

Lessor Site ID & No.: Round Hill / 467146
 Lessee Site ID & No.: NJJER01125A

CONTRACT # _____

CELLCO PARTNERSHIP
 DBA
Verizon wireless

ROUND HILL COMMUNITY CHURCH

ROUND HILL ROAD
 GREENWICH, CONNECTICUT

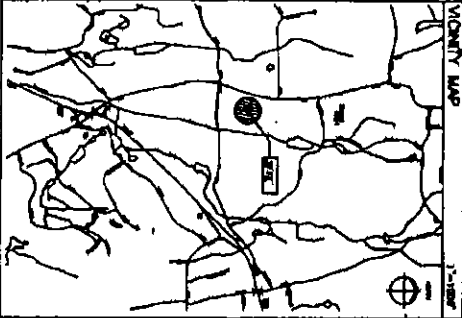

VICINITY MAP

<p>PROJECT SUMMARY</p> <p>PROJECT NO. _____</p> <p>DATE _____</p> <p>OWNER _____</p> <p>DESIGNER _____</p> <p>CONTRACT NO. _____</p> <p>PROJECT NAME _____</p> <p>PROJECT ADDRESS _____</p> <p>PROJECT CITY _____</p> <p>PROJECT STATE _____</p> <p>PROJECT ZIP _____</p>	<p>LEGEND</p> <p>--- BOUNDARY</p> <p>--- EASEMENT</p> <p>--- EGRESS</p> <p>--- PROPERTY</p> <p>--- ROAD</p> <p>--- WATER</p> <p>--- WETLAND</p>	<p>ABBREVIATIONS</p> <p>--- BOUNDARY</p> <p>--- EASEMENT</p> <p>--- EGRESS</p> <p>--- PROPERTY</p> <p>--- ROAD</p> <p>--- WATER</p> <p>--- WETLAND</p>	<p>SHEET INDEX</p> <table border="1" style="width: 100%; border-collapse: collapse;"> <tr> <th>NO.</th> <th>DESCRIPTION</th> </tr> <tr> <td>1</td> <td>ROUND HILL COMMUNITY CHURCH</td> </tr> <tr> <td>2</td> <td>ROUND HILL COMMUNITY CHURCH</td> </tr> <tr> <td>3</td> <td>ROUND HILL COMMUNITY CHURCH</td> </tr> <tr> <td>4</td> <td>ROUND HILL COMMUNITY CHURCH</td> </tr> <tr> <td>5</td> <td>ROUND HILL COMMUNITY CHURCH</td> </tr> <tr> <td>6</td> <td>ROUND HILL COMMUNITY CHURCH</td> </tr> <tr> <td>7</td> <td>ROUND HILL COMMUNITY CHURCH</td> </tr> <tr> <td>8</td> <td>ROUND HILL COMMUNITY CHURCH</td> </tr> <tr> <td>9</td> <td>ROUND HILL COMMUNITY CHURCH</td> </tr> <tr> <td>10</td> <td>ROUND HILL COMMUNITY CHURCH</td> </tr> </table>	NO.	DESCRIPTION	1	ROUND HILL COMMUNITY CHURCH	2	ROUND HILL COMMUNITY CHURCH	3	ROUND HILL COMMUNITY CHURCH	4	ROUND HILL COMMUNITY CHURCH	5	ROUND HILL COMMUNITY CHURCH	6	ROUND HILL COMMUNITY CHURCH	7	ROUND HILL COMMUNITY CHURCH	8	ROUND HILL COMMUNITY CHURCH	9	ROUND HILL COMMUNITY CHURCH	10	ROUND HILL COMMUNITY CHURCH
NO.	DESCRIPTION																								
1	ROUND HILL COMMUNITY CHURCH																								
2	ROUND HILL COMMUNITY CHURCH																								
3	ROUND HILL COMMUNITY CHURCH																								
4	ROUND HILL COMMUNITY CHURCH																								
5	ROUND HILL COMMUNITY CHURCH																								
6	ROUND HILL COMMUNITY CHURCH																								
7	ROUND HILL COMMUNITY CHURCH																								
8	ROUND HILL COMMUNITY CHURCH																								
9	ROUND HILL COMMUNITY CHURCH																								
10	ROUND HILL COMMUNITY CHURCH																								

	<p>ROUND HILL COMMUNITY CHURCH</p> <p>1711 E. 8th Street</p> <p>GREENWICH, CONNECTICUT</p> <p>06830</p>	<p>T-1</p>
---------------------------------------------------------------------------------------	---------------------------------------------------------------------------------------------------------	------------

Lessor Site ID & No.: Round Hill / 467146
Lessee Site ID & No.: NJJER01125A

CONTRACT # _____

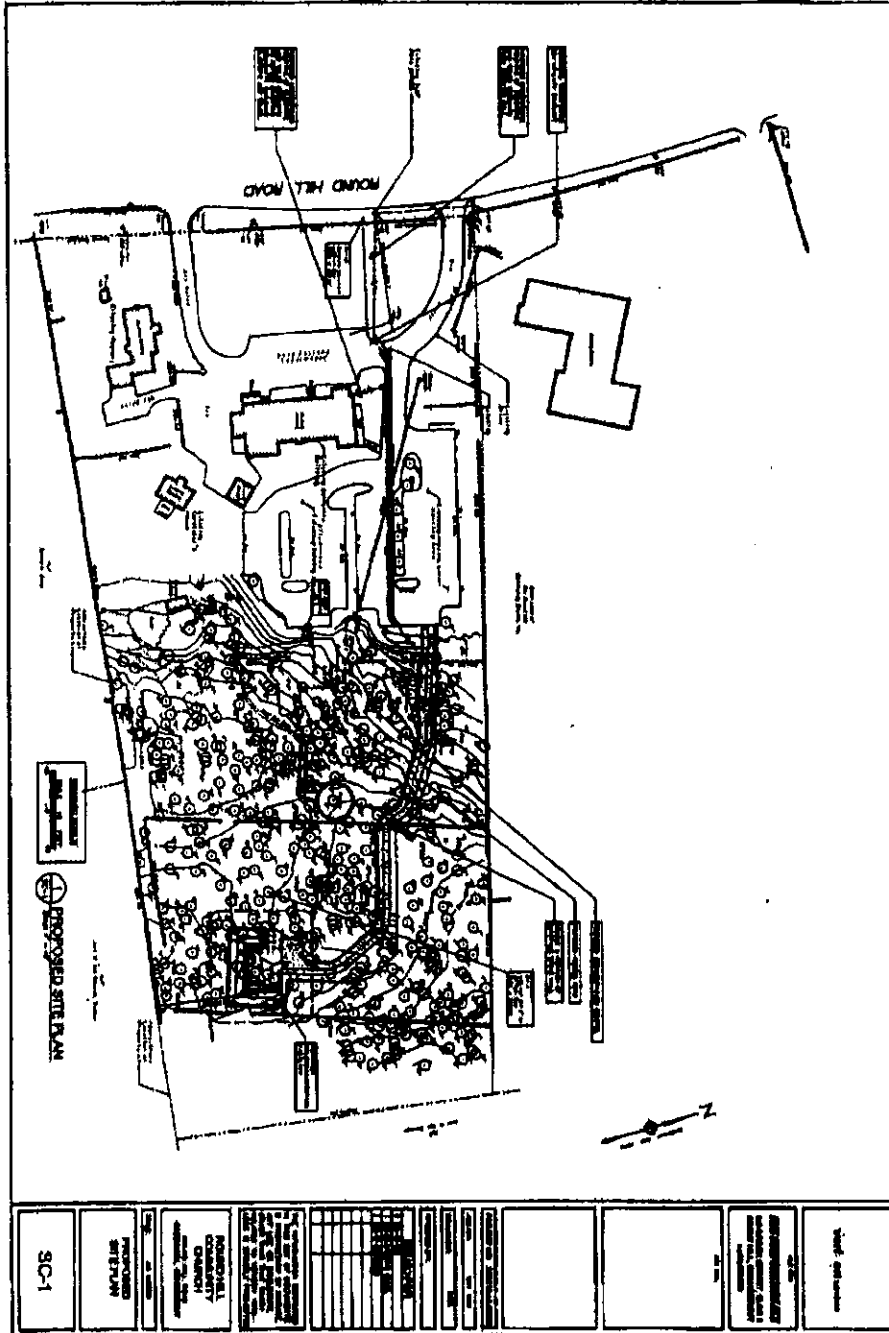

Lessor Site ID & No.: Round Hill / 467146
Lessee Site ID & No.: NJJER01125A

CONTRACT # _____

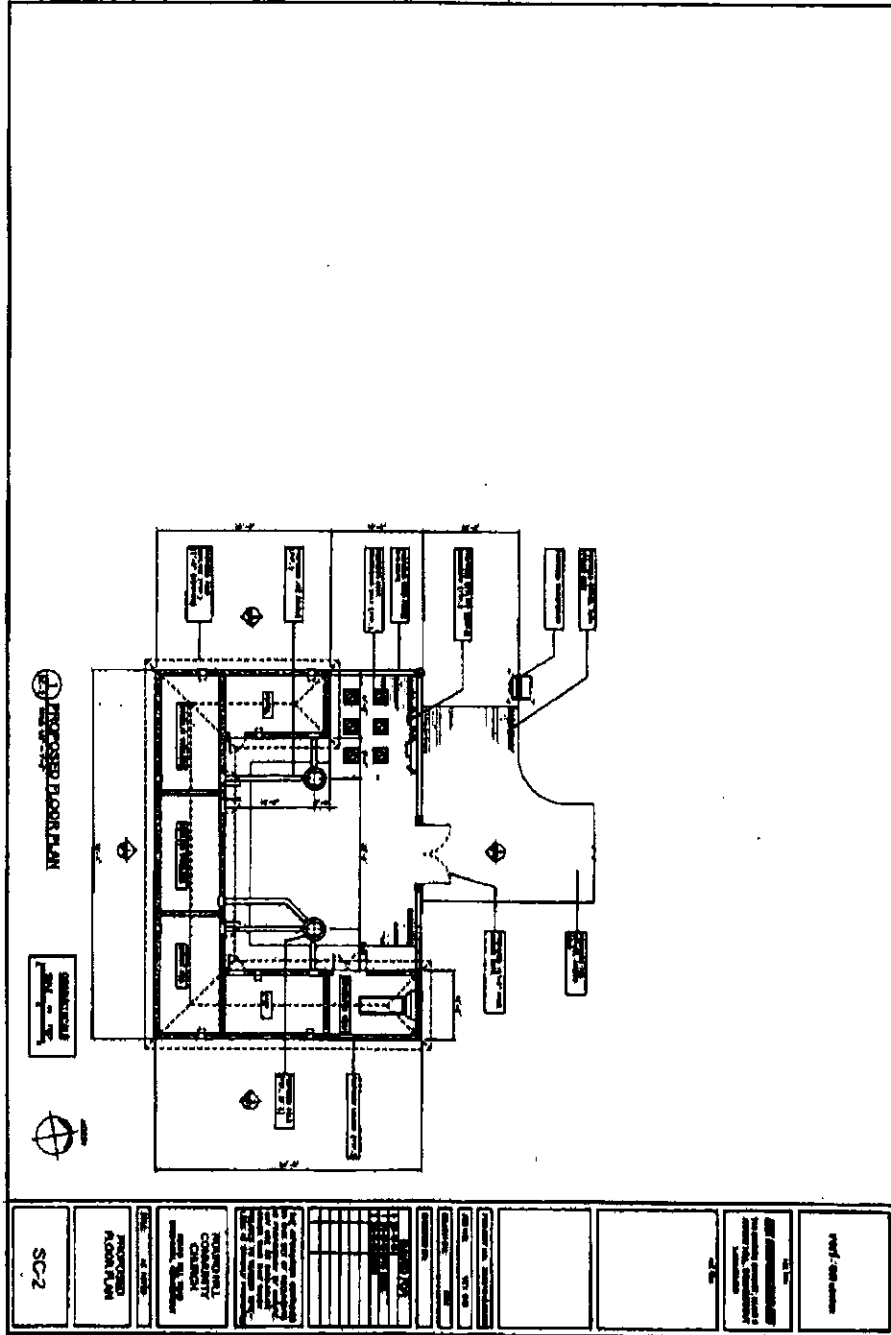

Lessor Site ID & No.: Round Hill / 467146
Lessee Site ID & No.: NJJER01125A

CONTRACT # _____

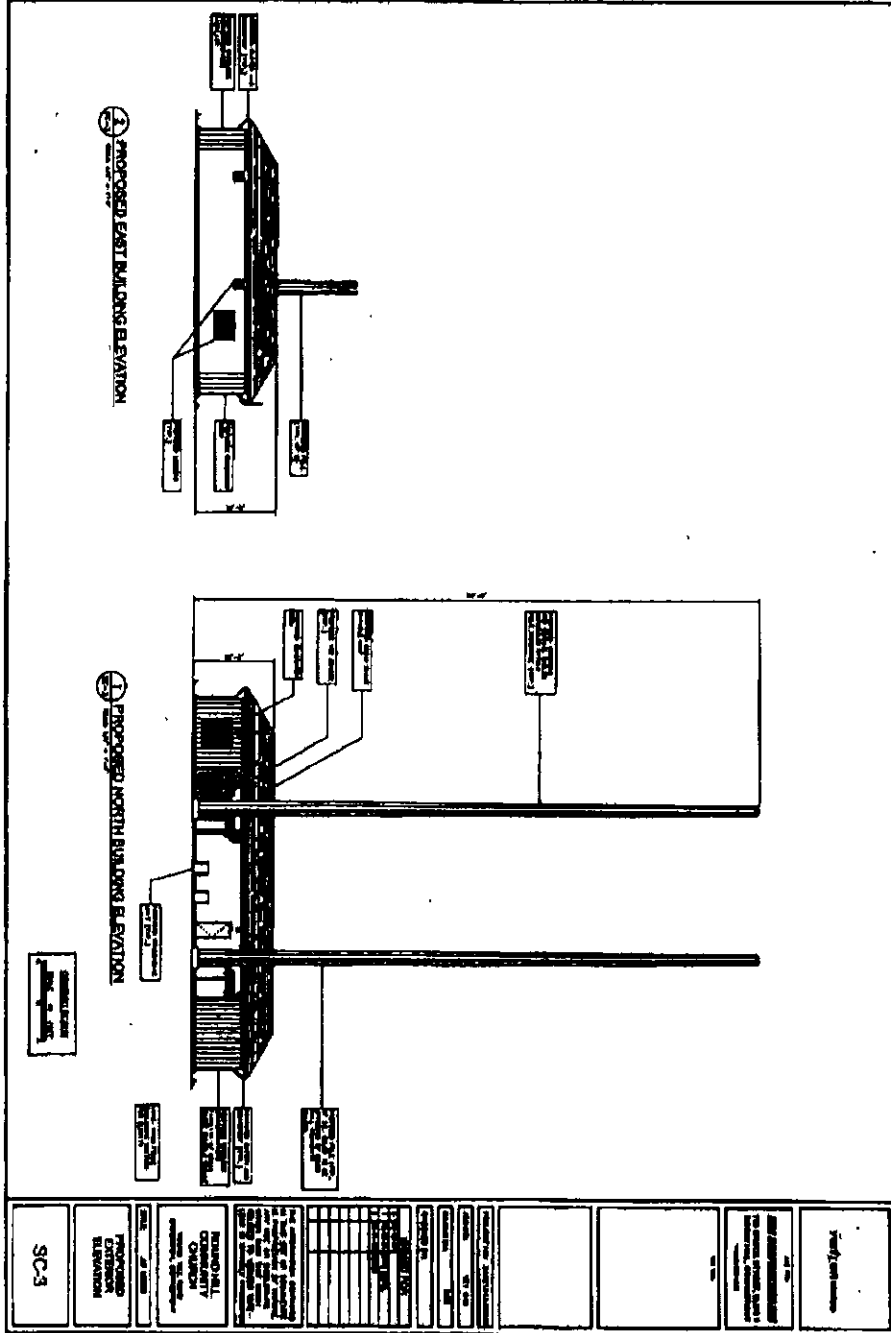

Lessor Site ID & No.: Round Hill / 467146
Lessee Site ID & No.: NJJER01125A

CONTRACT # _____

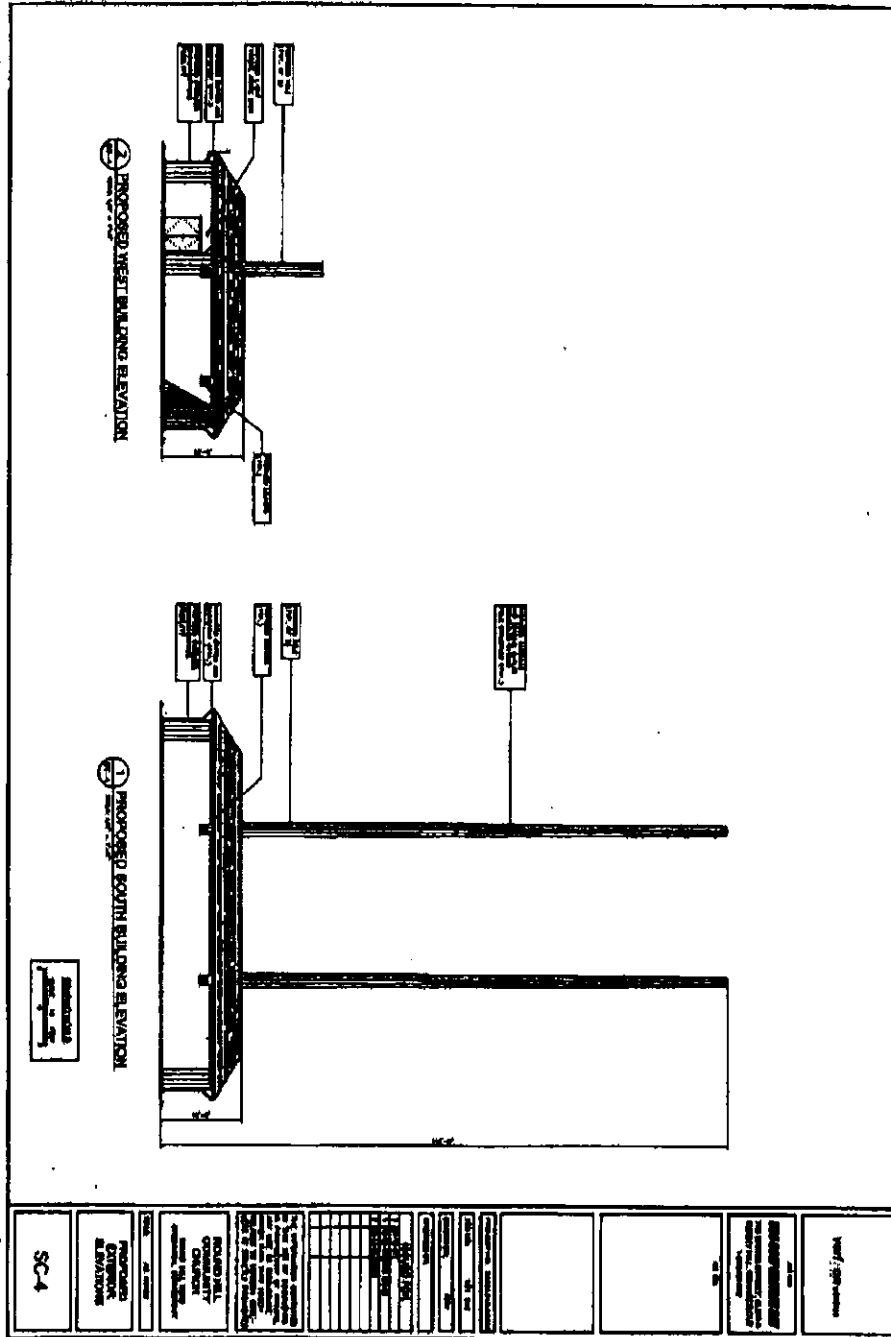

Lessor Site ID & No.: Round Hill / 467146
Lessee Site ID & No.: NJJER01125A

CONTRACT # _____

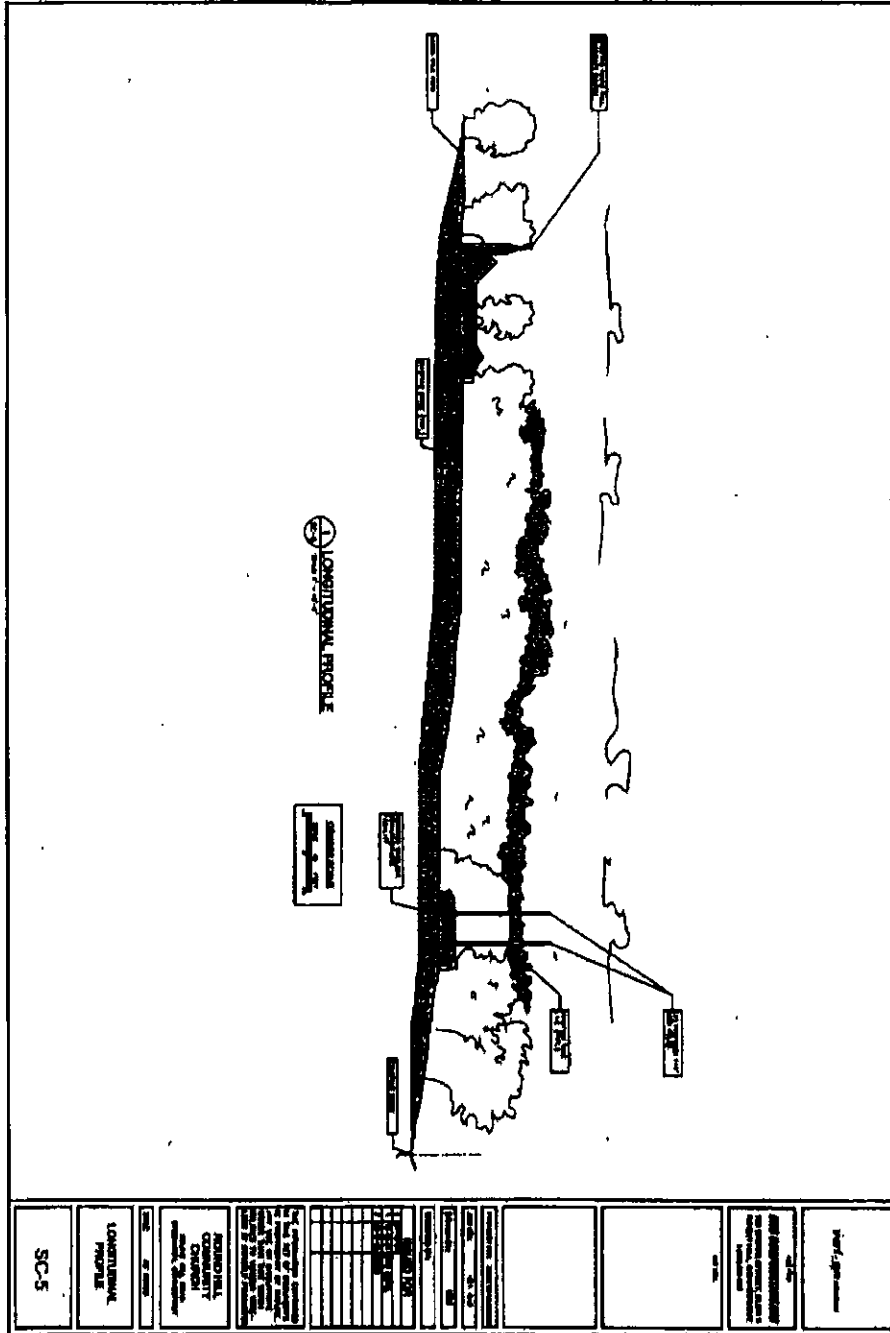

Lessor Site ID & No.: Round Hill / 467146
Lessee Site ID & No.: NJJER01125A

CONTRACT # _____

EXHIBIT 5 TO SUPPLEMENT

WRITTEN ACKNOWLEDGMENT OF LEASE COMMENCEMENT

Re: **COMMENCEMENT LETTER**
Supplement by and between Celco Partnership d/b/a Verizon Wireless ("LESSOR") and
DISH Wireless L.L.C. ("LESSEE") dated _____.
Site Reference: Round Hill / 467146
LESSEE Site Reference: NJJER01125A

Dear _____:

The Master Tower Lease Agreement between LESSOR and LESSEE defines the Commencement Date of any Supplement as the earlier of three (3) months from full execution of the Supplement or the first day of the calendar month following the commencement of installation of LESSEE's communications equipment at such Site.

This letter is to notify you that three (3) months expired on _____ and the **Commencement Date is hereby established as _____**. **That date is also the date that rent commences under the Supplement.** LESSEE agrees to provide a copy of this signed Commencement Letter to LESSEE's accounting group to ensure proper rent credit.

Or

This letter is to notify you that installation started on _____ thereby the **Commencement Date is hereby established as _____**. **That date is also the date that rent commences under the Supplement.** LESSEE agrees to provide a copy of this signed Commencement Letter to LESSEE's accounting group to ensure proper rent credit.

If you have any questions, please feel free to call me at _____.

Sincerely,

Certificate Of Completion

Envelope Id: 8F25C2895FB7476EBA138D30A14D64F3
 Subject: DocuSign: 467146 PE DISH Round Hill SLA
 Source Envelope:
 Document Pages: 30
 Certificate Pages: 1
 AutoNav: Enabled
 Envelope Stamping: Disabled
 Time Zone: (UTC-05:00) Eastern Time (US & Canada)

Status: Completed

Signatures: 1
 Initials: 0

Envelope Originator:
 Tammy Yeadon
 1095 Ave of The Americas
 New York, NY 10036-6704
 tammy.yeadon@verizonwireless.com
 IP Address: 137.188.108.39

Record Tracking

Status: Original
 9/30/2022 | 03:58 PM
 Holder: Tammy Yeadon
 tammy.yeadon@verizonwireless.com
 Location: DocuSign

Signer Events

Sergel Mislavy
 sergel.l.mislavy@verizonwireless.com
 Executive Director
 Security Level: Email, Account Authentication (None)

Signature

DocuSigned by:

 Signature Adoption: Pre-selected Style
 Using IP Address: 137.188.108.39

Timestamp

Sent: 9/30/2022 | 04:02 PM
 Viewed: 10/4/2022 | 03:33 PM
 Signed: 10/4/2022 | 03:33 PM

Electronic Record and Signature Disclosure:
 Not Offered via DocuSign

In Person Signer Events	Signature	Timestamp
Editor Delivery Events	Status	Timestamp
Agent Delivery Events	Status	Timestamp
Intermediary Delivery Events	Status	Timestamp
Certified Delivery Events	Status	Timestamp
Carbon Copy Events	Status	Timestamp
Witness Events	Signature	Timestamp
Notary Events	Signature	Timestamp
Envelope Summary Events	Status	Timestamps
Envelope Sent	Hashed/Encrypted	9/30/2022 04:02 PM
Certified Delivered	Security Checked	10/4/2022 03:33 PM
Signing Complete	Security Checked	10/4/2022 03:33 PM
Completed	Security Checked	10/4/2022 03:33 PM
Payment Events	Status	Timestamps

Exhibit E
Emissions Report

Radio Frequency - Electromagnetic Energy (RF-EME) Jurisdictional Report

Site No. NJJER01125A

395 Round Hill Road
Greenwich, Connecticut 06831
41° 5' 42.32" N, -73° 39' 50.84" W NAD83

EBI Project No. 6222002081
April 1, 2022

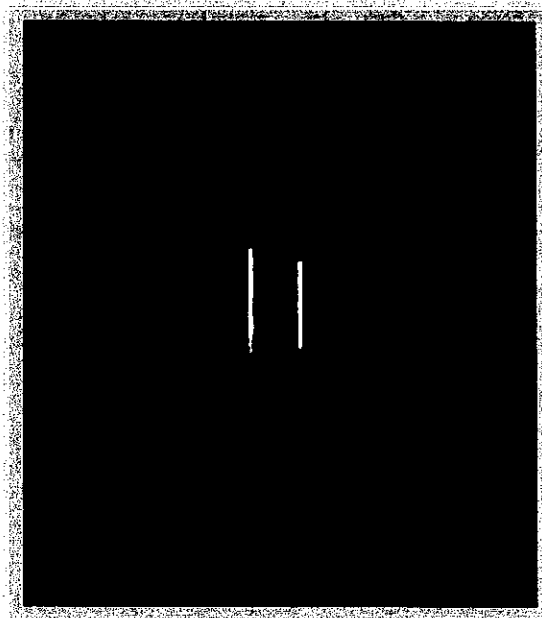

Prepared for:
Dish Wireless

Prepared by:
 **EBI Consulting**
environmental | engineering | due diligence

TABLE OF CONTENTS

EXECUTIVE SUMMARY	1
1.0 INTRODUCTION	2
2.0 SITE DESCRIPTION	2
3.0 WORST-CASE PREDICTIVE MODELING	4
4.0 MITIGATION/SITE CONTROL OPTIONS	5
5.0 SUMMARY AND CONCLUSIONS	6
6.0 LIMITATIONS	6

APPENDICES

APPENDIX A CERTIFICATIONS

APPENDIX B RADIO FREQUENCY ELECTROMAGNETIC ENERGY SAFETY / SIGNAGE PLANS

APPENDIX C FEDERAL COMMUNICATIONS COMMISSION (FCC) REQUIREMENTS

REFERENCE DOCUMENTS (NOT ATTACHED)

CDs: NJJER01125A_ZD_20220121073806

RFDS: RFDS-NJJER01125A-PRELIMINARY-2021101-v.1_2021101103838

EXECUTIVE SUMMARY

Purpose of Report

EnviroBusiness Inc. (dba EBI Consulting) has been contracted by Dish Wireless to conduct radio frequency electromagnetic (RF-EME) modeling for Dish Wireless Site NJJER01125A located at 395 Round Hill Road in Greenwich, Connecticut to determine RF-EME exposure levels from proposed Dish Wireless communications equipment at this site. As described in greater detail in Appendix C of this report, the Federal Communications Commission (FCC) has developed Maximum Permissible Exposure (MPE) Limits for the general public and for occupational activities. This report summarizes the results of RF-EME modeling in relation to relevant FCC RF-EME compliance standards for limiting human exposure to RF-EME fields.

Statement of Compliance

A site is considered out of compliance with FCC regulations if there are areas that exceed the FCC exposure limits and there are no RF hazard mitigation measures in place. Any carrier which has an installation that contributes more than 5% of the applicable MPE must participate in mitigating these RF hazards.

As presented in the sections below, based on worst-case predictive modeling, there are no modeled areas on any accessible rooftop or ground-level walking/working surface related to the proposed antennas that exceed the FCC's occupational or general public exposure limits at this site. Additionally, there are areas where workers who may be elevated above the rooftop and/or ground may be exposed to power densities greater than the occupational limits. Therefore, workers should be informed about the presence and locations of antennas and their associated fields.

At the nearest walking/working surfaces to the Dish Wireless antennas, the maximum power density generated by the DISH antennas is approximately **0.56** percent of the FCC's general public limit (**0.11** percent of the FCC's occupational limit).

The composite exposure level from all carriers on this site is approximately **0.72** percent of the FCC's general public limit (**0.14** percent of the FCC's occupational limit) at the nearest walking/working surface to each antenna.

Recommended control measures are outlined in Section 4.0 and within the Site Safety Plan (attached); Dish Wireless should also provide procedures to shut down and lockout/tagout this wireless equipment in accordance with their own standard operating protocol. Non-telecom workers who will be working in areas of exceedance are required to contact Dish Wireless since only DISH has the ability to lockout/tagout the facility, or to authorize others to do so.

1.0 INTRODUCTION

Radio frequency waves are electromagnetic waves from the portion of the electromagnetic spectrum at frequencies lower than visible light and microwaves. The wavelengths of radio waves range from thousands of meters to around 30 centimeters. These wavelengths correspond to frequencies as low as 3 cycles per second (or hertz [Hz]) to as high as one gigahertz (one billion cycles per second).

Personal Communication (PCS) facilities used by Dish Wireless in this area will potentially operate within a frequency range of 600 to 5000 MHz. Facilities typically consist of: 1) electronic transceivers (the radios or cabinets) connected to wired telephone lines; and 2) antennas that send the wireless signals created by the transceivers to be received by individual subscriber units (PCS telephones). Transceivers are typically connected to antennas by coaxial cables.

Because of the short wavelength of PCS services, the antennas require line-of-site paths for good propagation, and are typically installed a distance above ground level. Antennas are constructed to concentrate energy towards the horizon, with as little energy as possible scattered towards the ground or the sky. This design, combined with the low power of PCS facilities, generally results in no possibility for exposure to approach Maximum Permissible Exposure (MPE) levels, with the exception of in areas in the immediate vicinity of the antennas.

MPE limits do not represent levels where a health risk exists, since they are designed to provide a substantial margin of safety. These limits apply for continuous exposures and are intended to provide a prudent margin of safety for all persons, regardless of age, gender, size or health.

2.0 SITE DESCRIPTION

This project site includes the following proposed wireless telecommunication antennas on a monopole located at 395 Round Hill Road in Greenwich, Connecticut.

Ant #	Operator	Antenna Make	Antenna Model	Frequency (MHz)	Azimuth (deg.)	Mechanical Downtilt (deg.)	Horizontal Beamwidth (Degrees)	Aperture (feet)	Total Power Input (Watts)	Gain (dBd)*	Total ERP (Watts)	Total EIRP (Watts)
1	Dish	COMMSCOPE	FFVY-65B-R3-VI 02DT 600	600	100	0	71	6.0	120	17.55	6083.89	9977.58
1	Dish	COMMSCOPE	FFVY-65B-R3-VI 02DT 1900	1900	100	0	64	6.0	160	22.05	22862.30	37494.18
1	Dish	COMMSCOPE	FFVY-65B-R3-VI 02DT 2100	2100	100	0	64	6.0	160	22.05	22862.30	37494.18
2	Dish	COMMSCOPE	FFVY-65B-R3-VI 02DT 600	600	220	0	71	6.0	120	17.55	6083.89	9977.58
2	Dish	COMMSCOPE	FFVY-65B-R3-VI 02DT 1900	1900	220	0	64	6.0	160	22.05	22862.30	37494.18
2	Dish	COMMSCOPE	FFVY-65B-R3-VI 02DT 2100	2100	220	0	64	6.0	160	22.05	22862.30	37494.18
3	Dish	COMMSCOPE	FFVY-65B-R3-VI 02DT 600	600	340	0	71	6.0	120	17.55	6083.89	9977.58
3	Dish	COMMSCOPE	FFVY-65B-R3-VI 02DT 1900	1900	340	0	64	6.0	160	22.05	22862.30	37494.18
3	Dish	COMMSCOPE	FFVY-65B-R3-VI 02DT 2100	2100	340	0	64	6.0	160	22.05	22862.30	37494.18
4	T-Mobile	GENERIC	PANEL 6FT 00DT 600	600	100	0	68	6.0	30	12.33	513.00	841.33
4	T-Mobile	GENERIC	PANEL 6FT 00DT 700	700	100	0	68	6.0	30	12.33	513.00	841.33
4	T-Mobile	GENERIC	PANEL 6FT 00DT 1900	1900	100	0	66	6.0	60	15.84	2302.24	3775.68
4	T-Mobile	GENERIC	PANEL 6FT 00DT 2100	2100	100	0	63	6.0	60	16.39	2613.07	4285.44
5	T-Mobile	GENERIC	PANEL 6FT 00DT 600	600	220	0	68	6.0	30	12.33	513.00	841.33
5	T-Mobile	GENERIC	PANEL 6FT 00DT 700	700	220	0	68	6.0	30	12.33	513.00	841.33
5	T-Mobile	GENERIC	PANEL 6FT 00DT 1900	1900	220	0	66	6.0	60	15.84	2302.24	3775.68
5	T-Mobile	GENERIC	PANEL 6FT 00DT 2100	2100	220	0	63	6.0	60	16.39	2613.07	4285.44

Ant #	Operator	Antenna Make	Antenna Model	Frequency (MHz)	Azimuth (deg.)	Mechanical Downtilt (deg.)	Horizontal Beamwidth (Degrees)	Aperture (feet)	Total Power Input (Watts)	Gain (dBi)*	Total ERP (Watts)	Total EIRP (Watts)
6	T-Mobile	GENERIC	PANEL 6FT 00DT 600	600	340	0	68	6.0	30	12.33	513.00	841.33
6	T-Mobile	GENERIC	PANEL 6FT 00DT 700	700	340	0	68	6.0	30	12.33	513.00	841.33
6	T-Mobile	GENERIC	PANEL 6FT 00DT 1900	1900	340	0	66	6.0	60	15.84	2302.24	3775.68
6	T-Mobile	GENERIC	PANEL 6FT 00DT 2100	2100	340	0	63	6.0	60	16.39	2613.07	4285.44
7	Sprint	GENERIC	PANEL 6FT 00DT 850	850	100	0	66	6.0	100	12.62	1828.10	2998.08
7	Sprint	GENERIC	PANEL 6FT 00DT 1900	1900	100	0	66	6.0	160	15.84	6139.32	10068.48
7	Sprint	GENERIC	PANEL 6FT 00DT 2500	2500	100	0	60	6.0	120	14.49	3374.28	5533.82
8	Sprint	GENERIC	PANEL 6FT 00DT 850	850	220	0	66	6.0	100	12.62	1828.10	2998.08
8	Sprint	GENERIC	PANEL 6FT 00DT 1900	1900	220	0	66	6.0	160	15.84	6139.32	10068.48
8	Sprint	GENERIC	PANEL 6FT 00DT 2500	2500	220	0	60	6.0	120	14.49	3374.28	5533.82
9	Sprint	GENERIC	PANEL 6FT 00DT 850	850	340	0	66	6.0	100	12.62	1828.10	2998.08
9	Sprint	GENERIC	PANEL 6FT 00DT 1900	1900	340	0	66	6.0	160	15.84	6139.32	10068.48
9	Sprint	GENERIC	PANEL 6FT 00DT 2500	2500	340	0	60	6.0	120	14.49	3374.28	5533.82
10	Verizon	COMMSCOPE	NNH4-65B-R6H4 02DT 700	700	30	0	71	6.0	160	11.45	1991.22	3265.61
10	Verizon	COMMSCOPE	NNH4-65B-R6H4 02DT 850	850	30	0	65	6.0	160	12.35	2449.74	4017.57
10	Verizon	COMMSCOPE	NNH4-65B-R6H4 02DT 850	850	30	0	65	6.0	40	12.35	486.47	797.82
10	Verizon	COMMSCOPE	NNH4-65B-R6H4 02DT 1900	1900	30	0	75	6.0	160	13.95	3540.95	5807.16
10	Verizon	COMMSCOPE	NNH4-65B-R6H4 02DT 2100	2100	30	0	65	6.0	160	14.98	4488.69	7361.46
11	Verizon	JMA	MX08FIT265-01 8T8R Broadcast 02DT 3700	3700	30	0	62	2.0	200	19	15886.56	26053.97
12	Verizon	COMMSCOPE	NNH4-65B-R6H4 02DT 700	700	150	0	71	6.0	160	11.45	1991.22	3265.61
12	Verizon	COMMSCOPE	NNH4-65B-R6H4 11DT 850	850	150	0	65	6.0	160	12.37	2461.05	4036.12
12	Verizon	COMMSCOPE	NNH4-65B-R6H4 02DT 850	850	150	0	65	6.0	40	12.35	486.47	797.82
12	Verizon	COMMSCOPE	NNH4-65B-R6H4 02DT 1900	1900	150	0	75	6.0	160	13.95	3540.95	5807.16
12	Verizon	COMMSCOPE	NNH4-65B-R6H4 02DT 2100	2100	150	0	65	6.0	160	14.98	4488.69	7361.46
13	Verizon	JMA	MX08FIT265-01 8T8R Broadcast 02DT 3700	3700	150	0	62	2.0	200	19	15886.56	26053.97
14	Verizon	COMMSCOPE	NNH4-65B-R6H4 02DT 700	700	270	0	71	6.0	160	11.45	1991.22	3265.61
14	Verizon	COMMSCOPE	NNH4-65B-R6H4 02DT 850	850	270	0	65	6.0	160	12.35	2449.74	4017.57
14	Verizon	COMMSCOPE	NNH4-65B-R6H4 02DT 850	850	270	0	65	6.0	40	12.35	486.47	797.82
14	Verizon	COMMSCOPE	NNH4-65B-R6H4 02DT 1900	1900	270	0	75	6.0	160	13.95	3540.95	5807.16
14	Verizon	COMMSCOPE	NNH4-65B-R6H4 02DT 2100	2100	270	0	65	6.0	160	14.98	4488.69	7361.46
15	Verizon	JMA	MX08FIT265-01 8T8R Broadcast 02DT 3700	3700	270	0	62	2.0	200	19	15886.56	26053.97
16	Unknown	GENERIC	PANEL 4FT 00DT 850	850	30	0	61	4.0	50	11.52	709.53	1163.63
16	Unknown	GENERIC	PANEL 4FT 00DT 1900	1900	30	0	65	4.0	50	14.65	1458.71	2392.29
17	Unknown	GENERIC	PANEL 4FT 00DT 850	850	150	0	61	4.0	50	11.52	709.53	1163.63
17	Unknown	GENERIC	PANEL 4FT 00DT 1900	1900	150	0	65	4.0	50	14.65	1458.71	2392.29
18	Unknown	GENERIC	PANEL 4FT 00DT 850	850	270	0	61	4.0	50	11.52	709.53	1163.63
18	Unknown	GENERIC	PANEL 4FT 00DT 1900	1900	270	0	65	4.0	50	14.65	1458.71	2392.29

- * Note there is 1 Dish Wireless antenna per sector at this site. For clarity, the different frequencies for each antenna are entered on separate lines.
- * Gain includes antenna and combiner.

Ant #	NAME	X	Y	Antenna Radiation Centerline	Z-Height Equipment Building Roof	Z-Height Ground
1	Dish	52.9	33.0	90.0	73.8	90.0
2	Dish	52.0	31.5	90.0	73.8	90.0
3	Dish	51.1	33.2	90.0	73.8	90.0
4	T-Mobile	52.9	33.0	110.0	93.8	110.0
5	T-Mobile	52.0	31.5	110.0	93.8	110.0
6	T-Mobile	51.1	33.2	110.0	93.8	110.0
7	Sprint	52.9	33.0	100.0	83.8	100.0
8	Sprint	52.0	31.5	100.0	83.8	100.0
9	Sprint	51.1	33.2	100.0	83.8	100.0
10	Verizon	22.6	33.0	110.0	93.8	110.0
11	Verizon	22.6	33.0	100.0	83.8	100.0
12	Verizon	23.3	31.4	110.0	93.8	110.0
13	Verizon	23.3	31.4	100.0	83.8	100.0
14	Verizon	21.5	31.7	110.0	93.8	110.0
15	Verizon	21.5	31.7	100.0	83.8	100.0
16	Unknown	22.6	33.0	90.0	73.8	90.0
17	Unknown	23.3	31.4	90.0	73.8	90.0
18	Unknown	21.5	31.7	90.0	73.8	90.0

* Note the Z-Height represents the distance from the antenna centerline in feet.

The above tables contain an inventory of proposed Dish Wireless antennas and other carrier antennas if sufficient information was available to model them. Note that EBI uses an assumed set of antenna specifications and powers for unknown and other carrier antennas for modeling purposes. The FCC guidelines incorporate two separate tiers of exposure limits that are based upon occupational/controlled exposure limits (for workers) and general population/uncontrolled exposure limits for members of the general public that may be exposed to antenna fields. While access to this site is considered controlled, the analysis has considered exposures with respect to both controlled and uncontrolled limits as an untrained worker may access adjacent rooftop locations. Additional information regarding controlled/uncontrolled exposure limits is provided in Appendix C. Appendix B presents a site safety plan that provides a plan view of the monopole with antenna locations.

3.0 WORST-CASE PREDICTIVE MODELING

EBI has performed theoretical MPE modeling using RoofMaster™ software to estimate the worst-case power density at the site's nearby broadcast levels resulting from operation of the antennas. RoofMaster™ is a widely-used predictive modeling program that has been developed by Waterford Consultants to predict RF power density values for rooftop and tower telecommunications sites produced by vertical collinear antennas that are typically used in the cellular, PCS, paging and other communications services. Using the computational methods set forth in Federal Communications Commission (FCC) Office of Engineering & Technology (OET) Bulletin 65, "Evaluating Compliance with FCC Guidelines for Human Exposure to Radiofrequency Electromagnetic Fields" (OET-65), RoofMaster™ calculates predicted power density in a scalable grid based on the contributions of all RF sources characterized in the study scenario. At each grid location, the cumulative power density is expressed as a percentage of the FCC limits. Manufacturer antenna pattern data is utilized in these calculations. RoofMaster™ models consist of the Far Field model as specified in OET-65 and an implementation of the OET-65 Cylindrical Model (Sula9). The models utilize several operational specifications for different types of antennas to produce a plot of spatially-averaged power densities that can be expressed as a percentage of the applicable exposure limit.

For this report, EBI utilized antenna and power data provided by Dish Wireless and compared the resultant worst-case MPE levels to the FCC's occupational/controlled exposure limits outlined in OET Bulletin 65. The assumptions used in the modeling are based upon information provided by Dish Wireless and information gathered from other sources. Elevations of walking/working surfaces were estimated based on elevations provided and available aerial imagery. Sector orientation assignments were made assuming coverage is directed to areas of site. Changes to antenna mount heights or placement will impact site compliance. The parameters used for modeling are summarized in the Site Description antenna inventory table in Section 2.0.

T-Mobile and Sprint also have antennas on the monopole, and Verizon and an Unknown Carrier have antennas on an adjacent monopole. Information about these antennas was included in the modeling analysis.

Based on worst-case predictive modeling, there are no modeled areas on any accessible rooftop or ground-level walking/working surface related to the proposed Dish Wireless antennas that exceed the FCC's occupational or general public exposure limits at this site. At the nearest walking/working surfaces to the Dish Wireless antennas, the maximum power density generated by the Dish Wireless antennas is approximately 0.56 percent of the FCC's general public limit (0.11 percent of the FCC's occupational limit). The composite exposure level from all carriers on this site is approximately 0.72 percent of the FCC's general public limit (0.14 percent of the FCC's occupational limit) at the nearest walking/working surface to each antenna.

The Site Safety Plan also presents areas where Dish Wireless antennas contribute greater than 5% of the applicable MPE limit for a site. A site is considered out of compliance with FCC regulations if there are areas that exceed the FCC exposure limits and there are no RF hazard mitigation measures in place. Any carrier which has an installation that contributes more than 5% of the applicable MPE must participate in mitigating these RF hazards.

There are no modeled areas on the rooftop and ground that exceed the FCC's limits for general public or occupational exposure in front of the other carrier antennas.

The inputs used in the modeling are summarized in the Site Description antenna inventory table in Section 2.0. A graphical representation of the RoofMaster™ modeling results is presented in Appendix B. Microwave dish antennas are designed for point-to-point operations at the elevations of the installed equipment rather than ground level coverage. The maximum power density generated by all carrier antennas, including microwaves and panel antennas, is included in the modeling results presented within this report.

4.0 MITIGATION/SITE CONTROL OPTIONS

EBI's modeling indicates that there are no areas in front of the Dish Wireless antennas that exceed the FCC standards for occupational or general public exposure. All exposures above the FCC's safe limits require that individuals be elevated above the ground. In order to alert people accessing the monopole, a Warning sign and an NOC Information sign are recommended for installation 10 feet above ground level at the base of the monopole.

Barriers are recommended for installation when possible to block access to the areas in front of the antennas that exceed the FCC general public and/or occupational limits. Barriers may consist of rope, chain, or fencing. Painted stripes should only be used as a last resort. There are no barriers recommended at this site. Barriers are not recommended for installation because there are no exceedances on any walking/working surface.

These protocols and recommended control measures have been summarized and included with a graphic representation of the antennas and associated signage and control areas in a RF-EME Site Safety Plan, which is included as Appendix B. Individuals and workers accessing the monopole should be provided with a copy of the attached Site Safety Plan, made aware of the posted signage, and signify their understanding of the Site Safety Plan.

To reduce the risk of exposure, EBI recommends that access to areas associated with the active antenna installation be restricted and secured where possible.

Implementation of the signage recommended in the Site Safety Plan and in this report will bring this site into compliance with the FCC's rules and regulations.

5.0 SUMMARY AND CONCLUSIONS

EBI has prepared a Radiofrequency – Electromagnetic Energy (RF-EME) Compliance Report for telecommunications equipment installed by Dish Wireless Site Number NJJER01125A located at 395 Round Hill Road in Greenwich, Connecticut to determine worst-case predicted RF-EME exposure levels from wireless communications equipment installed at this site. This report summarizes the results of RF-EME modeling in relation to relevant Federal Communications Commission (FCC) RF-EME compliance standards for limiting human exposure to RF-EME fields.

As presented in the sections above, based on the FCC criteria, there are no modeled areas on any accessible rooftop or ground-level walking/working surface related to the proposed antennas that exceed the FCC's occupational or general public exposure limits at this site.

Workers should be informed about the presence and locations of antennas and their associated fields. Recommended control measures are outlined in Section 4.0 and within the Site Safety Plan (attached); Dish Wireless should also provide procedures to shut down and lockout/tagout this wireless equipment in accordance with their own standard operating protocol. Non-telecom workers who will be working in areas of exceedance are required to contact Dish Wireless since only Dish Wireless has the ability to lockout/tagout the facility, or to authorize others to do so.

6.0 LIMITATIONS

This report was prepared for the use of Dish Wireless. It was performed in accordance with generally accepted practices of other consultants undertaking similar studies at the same time and in the same locale under like circumstances. The conclusions provided by EBI are based solely on the information provided by the client. The observations in this report are valid on the date of the investigation. Any additional information that becomes available concerning the site should be provided to EBI so that our conclusions may be revised and modified, if necessary. This report has been prepared in accordance with Standard Conditions for Engagement and authorized proposal, both of which are integral parts of this report. No other warranty, expressed or implied, is made.

Appendix A

Certifications

Preparer Certification

I, David Keirstead, state that:

- I am an employee of EnviroBusiness Inc. (d/b/a EBI Consulting), which provides RF-EME safety and compliance services to the wireless communications industry.
- I have successfully completed RF-EME safety training, and I am aware of the potential hazards from RF-EME and would be classified "occupational" under the FCC regulations.
- I am fully aware of and familiar with the Rules and Regulations of both the Federal Communications Commissions (FCC) and the Occupational Safety and Health Administration (OSHA) with regard to Human Exposure to Radio Frequency Radiation.
- I have reviewed the data provided by the client and incorporated it into this Site Compliance Report such that the information contained in this report is true and accurate to the best of my knowledge.

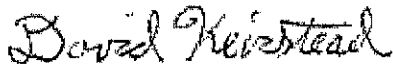
A rectangular box containing a handwritten signature in cursive script that reads "David Keirstead".

Reviewed and Approved by:

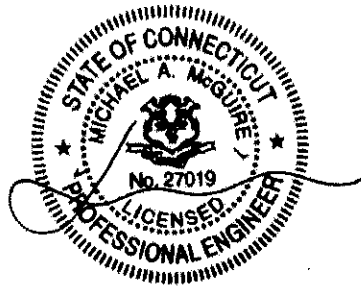

sealed 01apr2022 mike@h2dc.com
H2DC PLLC CT CoA #: PEC.0001714

Michael McGuire
Electrical Engineer
mike@h2dc.com

Note that EBI's scope of work is limited to an evaluation of the Radio Frequency – Electromagnetic Energy (RF-EME) field generated by the antennas and broadcast equipment noted in this report. The engineering and design of the building and related structures, as well as the impact of the antennas and broadcast equipment on the structural integrity of the building, are specifically excluded from EBI's scope of work.

Appendix B
Radio Frequency Electromagnetic Energy
Safety Information and Signage Plans

Nearest Walking Surface (Equipment Building Roof Level) Simulation

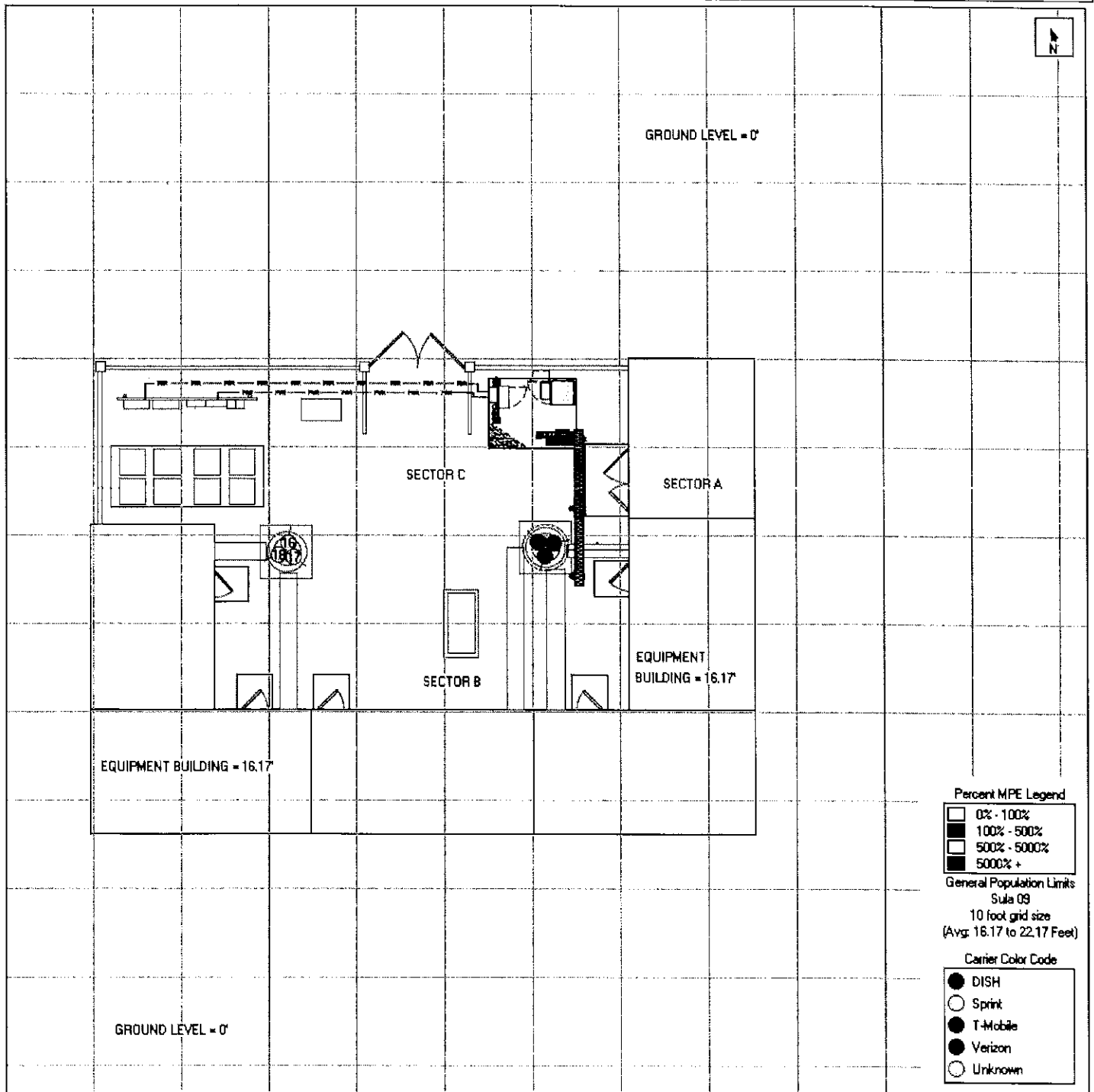

Antenna Face Level Simulation

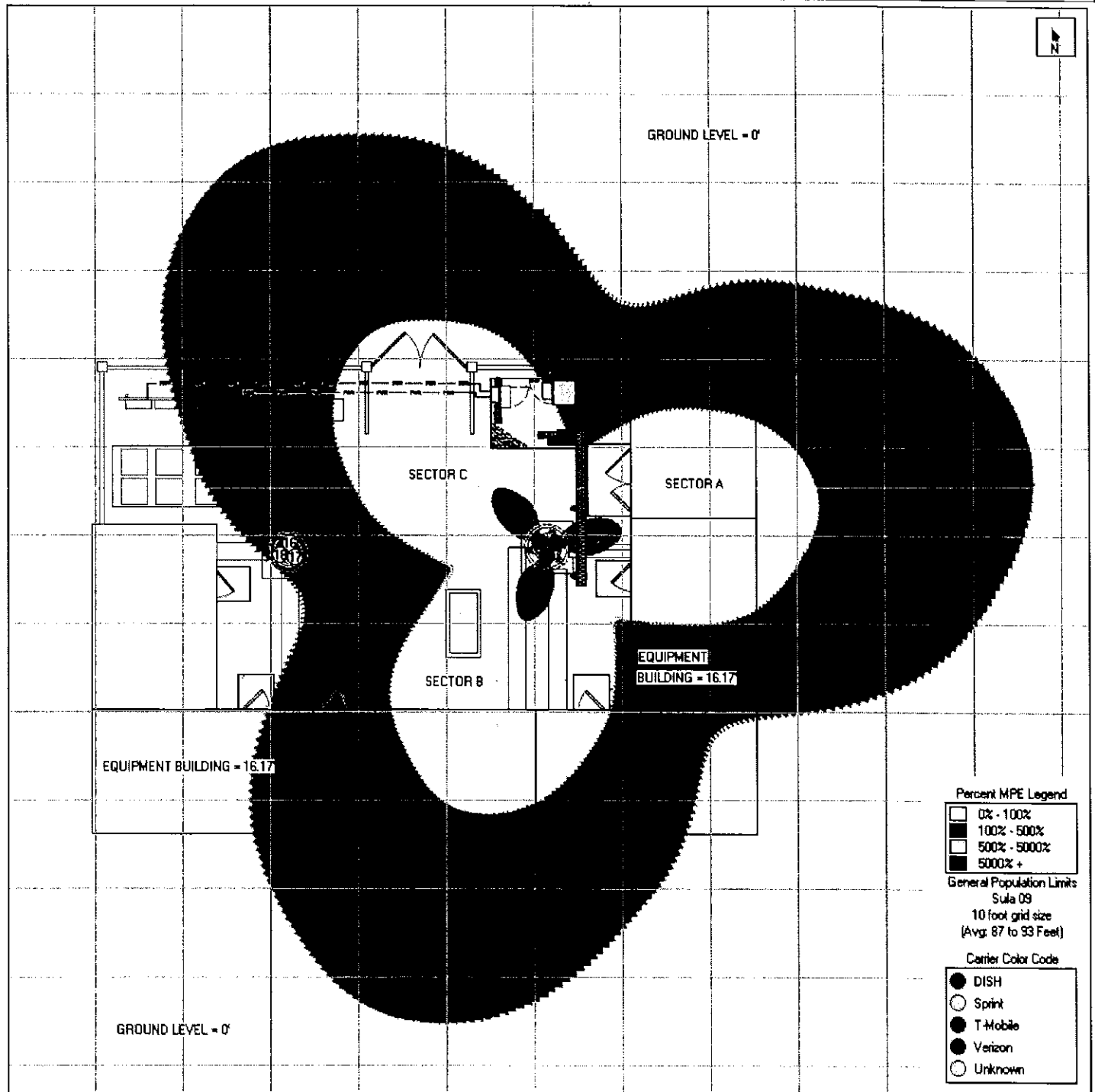



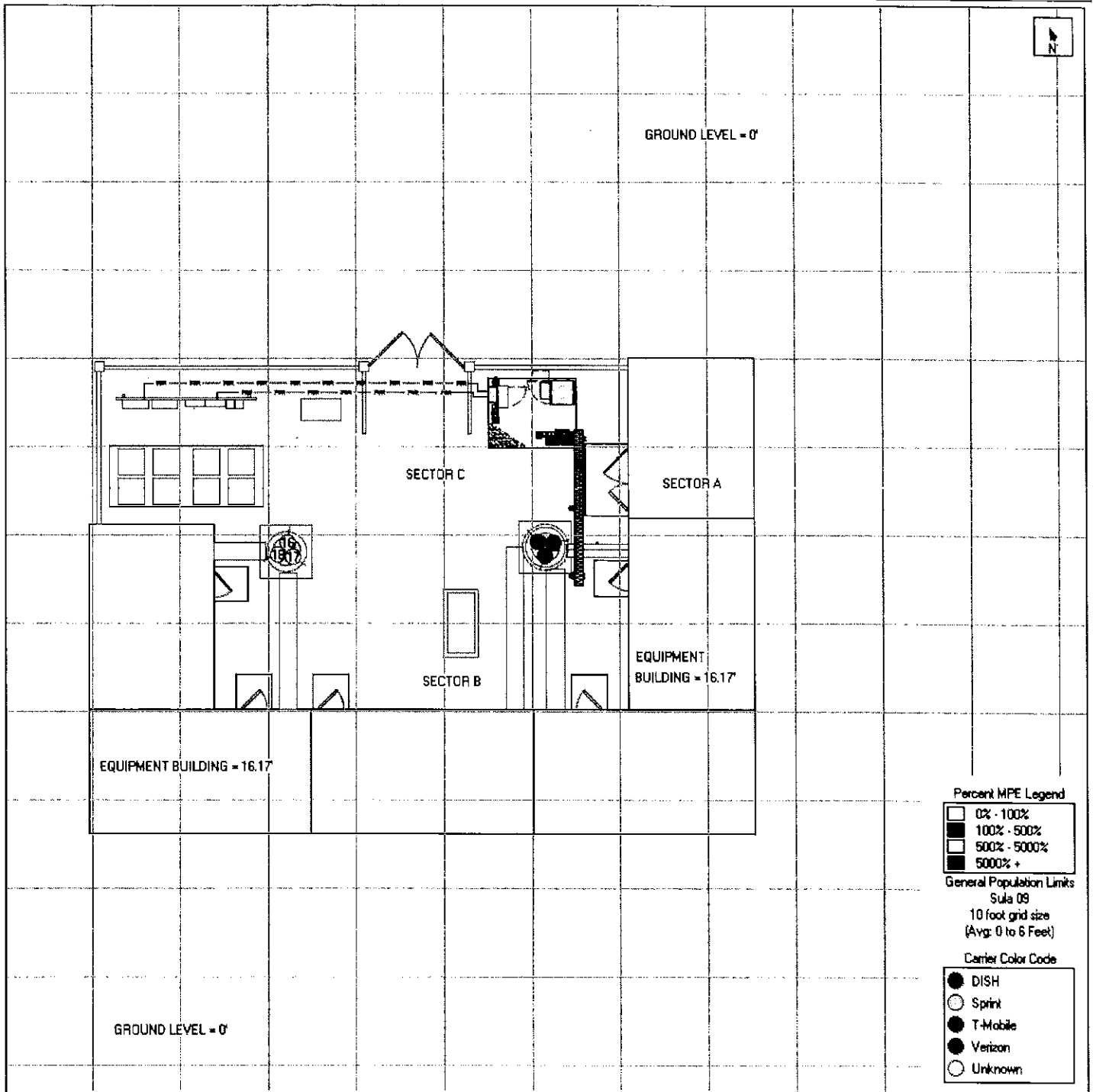

Ground Level Simulation

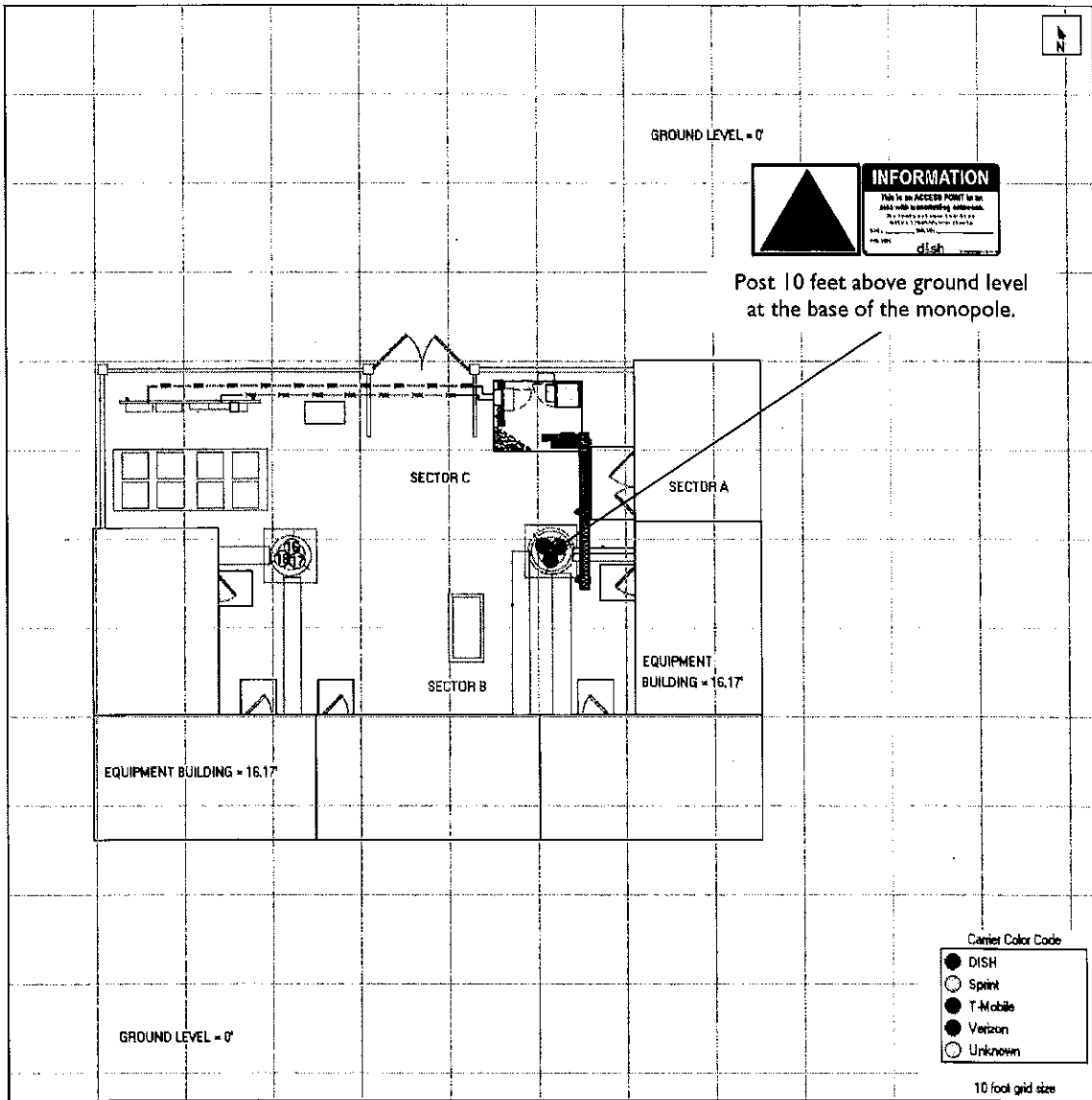

Dish Wireless Safety (Signage) Plan



Sign	Posting Instructions	Required Signage / Mitigation
	NOC Information Information signs are used to provide contact information for any questions or concerns for personnel accessing the site.	Securely post 10 feet above ground level at the base of the monopole in a manner conspicuous to all individuals entering thereon as indicated in the signage plan.
	Guidelines Informational sign used to notify workers that there are active antennas installed and provide guidelines for working in RF environments.	Signage not required.
	Notice Used to notify individuals they are entering an area where the power density emitted from transmitting antennas may exceed the FCC's MPE limit for the general public or occupational exposures.	Signage not required.
	Caution Used to notify individuals that they are entering a hot spot where either the general public or occupational FCC's MPE limit is or could be exceeded.	Signage not required.
	Warning Used to notify individuals that they are entering a hot zone where the occupational FCC's MPE limit has been exceeded by 10x.	Securely post 10 feet above ground level at the base of the monopole in a manner conspicuous to all individuals entering thereon as indicated in the signage plan.

Appendix C
Federal Communications
Commission (FCC) Requirements

The FCC has established Maximum Permissible Exposure (MPE) limits for human exposure to Radiofrequency Electromagnetic (RF-EME) energy fields, based on exposure limits recommended by the National Council on Radiation Protection and Measurements (NCRP) and, over a wide range of frequencies, the exposure limits developed by the Institute of Electrical and Electronics Engineers, Inc. (IEEE) and adopted by the American National Standards Institute (ANSI) to replace the 1982 ANSI guidelines. Limits for localized absorption are based on recommendations of both ANSI/IEEE and NCRP.

The FCC guidelines incorporate two separate tiers of exposure limits that are based upon occupational/controlled exposure limits (for workers) and general public/uncontrolled exposure limits for members of the general public.

Occupational/controlled exposure limits apply to situations in which persons are exposed as a consequence of their employment and in which those persons who are exposed have been made fully aware of the potential for exposure and can exercise control over their exposure. Occupational/controlled exposure limits also apply where exposure is of a transient nature as a result of incidental passage through a location where exposure levels may be above general public/uncontrolled limits (see below), as long as the exposed person has been made fully aware of the potential for exposure and can exercise control over his or her exposure by leaving the area or by some other appropriate means.

General public/uncontrolled exposure limits apply to situations in which the general public may be exposed or in which persons who are exposed as a consequence of their employment may not be made fully aware of the potential for exposure or cannot exercise control over their exposure. Therefore, members of the general public would always be considered under this category when exposure is not employment-related, for example, in the case of a telecommunications tower that exposes persons in a nearby residential area.

Table I and Figure I (below), which are included within the FCC's OET Bulletin 65, summarize the MPE limits for RF emissions. These limits are designed to provide a substantial margin of safety. They vary by frequency to take into account the different types of equipment that may be in operation at a particular facility and are "time-averaged" limits to reflect different durations resulting from controlled and uncontrolled exposures.

The FCC's MPEs are measured in terms of power (mW) over a unit surface area (cm²). Known as the power density, the FCC has established an occupational MPE of 5 milliwatts per square centimeter (mW/cm²) and an uncontrolled MPE of 1 mW/cm² for equipment operating in the 1900 MHz frequency range. For the Dish Wireless equipment operating at 600 MHz or 850 MHz, the FCC's occupational MPE is 2.83 mW/cm² and an uncontrolled MPE of 0.57 mW/cm². For the Dish Wireless equipment operating at 1900 MHz, the FCC's occupational MPE is 5.0 mW/cm² and an uncontrolled MPE limit of 1.0 mW/cm². These limits are considered protective of these populations.

Table I: Limits for Maximum Permissible Exposure (MPE)				
(A) Limits for Occupational/Controlled Exposure				
Frequency Range (MHz)	Electric Field Strength (E) (V/m)	Magnetic Field Strength (H) (A/m)	Power Density (S) (mW/cm ²)	Averaging Time [E] ² , [H] ² , or S (minutes)
0.3-3.0	614	1.63	(100)*	6
3.0-30	1842/f	4.89/f	(900/f ²)*	6
30-300	61.4	0.163	1.0	6
300-1,500	--	--	f/300	6
1,500-100,000	--	--	5	6
(B) Limits for General Public/Uncontrolled Exposure				
Frequency Range (MHz)	Electric Field Strength (E) (V/m)	Magnetic Field Strength (H) (A/m)	Power Density (S) (mW/cm ²)	Averaging Time [E] ² , [H] ² , or S (minutes)
0.3-1.34	614	1.63	(100)*	30
1.34-30	824/f	2.19/f	(180/f ²)*	30
30-300	27.5	0.073	0.2	30
300-1,500	--	--	f/1,500	30
1,500-100,000	--	--	1.0	30

f = Frequency in (MHz)

* Plane-wave equivalent power density

Figure 1. FCC Limits for Maximum Permissible Exposure (MPE)
 Plane-wave Equivalent Power Density

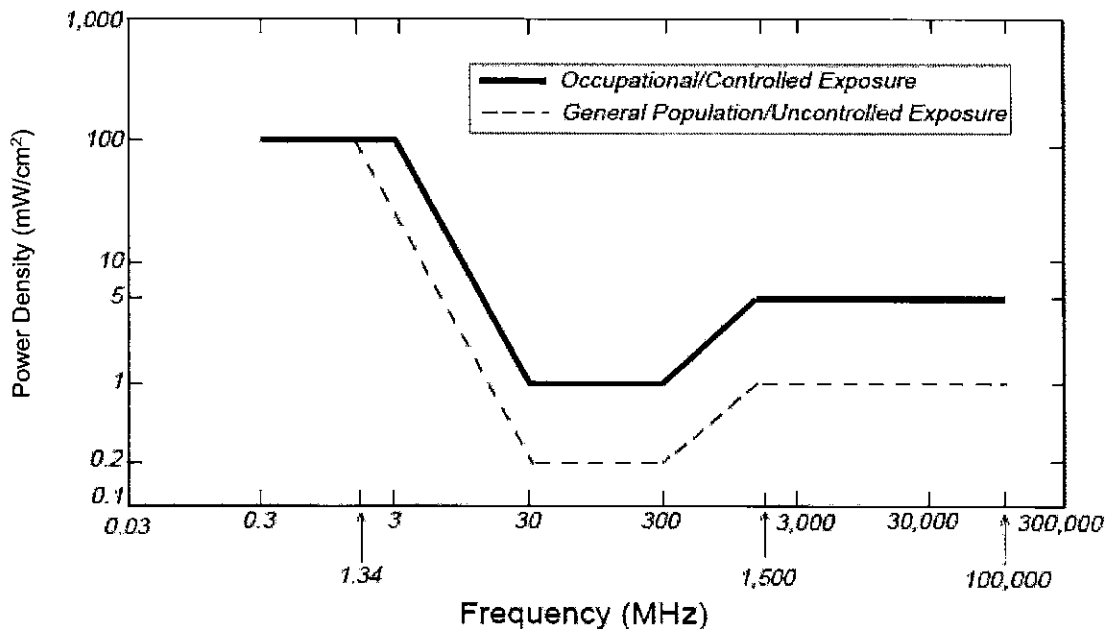

Based on the above, the most restrictive thresholds for exposures of unlimited duration to RF energy for several personal wireless services are summarized below:

Personal Wireless Service	Approximate Frequency	Occupational MPE	Public MPE
Microwave (Point-to-Point)	5,000 - 80,000 MHz	5.00 mW/cm ²	1.00 mW/cm ²
Broadband Radio (BRS)	2,600 MHz	5.00 mW/cm ²	1.00 mW/cm ²
Wireless Communication (WCS)	2,300 MHz	5.00 mW/cm ²	1.00 mW/cm ²
Advanced Wireless (AWS)	2,100 MHz	5.00 mW/cm ²	1.00 mW/cm ²
Personal Communication (PCS)	1,950 MHz	5.00 mW/cm ²	1.00 mW/cm ²
Cellular Telephone	870 MHz	2.90 mW/cm ²	0.58 mW/cm ²
Specialized Mobile Radio (SMR)	855 MHz	2.85 mW/cm ²	0.57 mW/cm ²
Long Term Evolution (LTE)	700 MHz	2.33 mW/cm ²	0.47 mW/cm ²
Most Restrictive Frequency Range	30-300 MHz	1.00 mW/cm ²	0.20 mW/cm ²

MPE limits are designed to provide a substantial margin of safety. These limits apply for continuous exposures and are intended to provide a prudent margin of safety for all persons, regardless of age, gender, size, or health.

Personal Communication (PCS) facilities used by Dish Wireless in this area will potentially operate within a frequency range of 600 to 2100 MHz. Facilities typically consist of: 1) electronic transceivers (the radios or cabinets) connected to wired telephone lines; and 2) antennas that send the wireless signals created by the transceivers to be received by individual subscriber units (PCS telephones). Transceivers are typically connected to antennas by coaxial cables.

Because of the short wavelength of PCS services, the antennas require line-of-site paths for good propagation, and are typically installed above ground level. Antennas are constructed to concentrate energy towards the horizon, with as little energy as possible scattered towards the ground or the sky. This design, combined with the low power of PCS facilities, generally results in no possibility for exposure to approach Maximum Permissible Exposure (MPE) levels, with the exception of areas directly in front of the antennas.

FCC Compliance Requirement

A site is considered out of compliance with FCC regulations if there are areas that exceed the FCC exposure limits and there are no RF hazard mitigation measures in place. Any carrier which has an installation that contributes more than 5% of the applicable MPE must participate in mitigating these RF hazards.

Exhibit F
Mailing Receipts

FROM:
LEV MAYZLER
(203) 488-0712
CONSTRUCTION SERVICES OF BRANF
63-3 NORTH BRANFORD ROAD
BRANFORD CT 06405-2848

LIR 1 OF 1

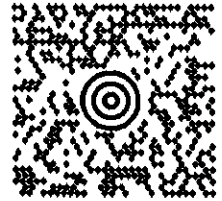

CT 069 9-01



SHIP TO:
GREENWICH PLANNING & ZONING
KATIE DELUCA, DIRECTOR
2ND FL
101 FIELD POINT RD.
GREENWICH CT 06830

UPS 2ND DAY AIR

TRACKING #: 1Z E05 345 02 6181 4147

2



BILLING: P/P

WS 22.0.17 SHARP MX-3070 45,0A 10/2022

Fold here and place in label pouch

FROM:
LEV MAYZLER
(203) 488-0712
CONSTRUCTION SERVICES OF BRANF
63-3 NORTH BRANFORD ROAD
BRANFORD CT 06405-2848

LTR 1 OF 1

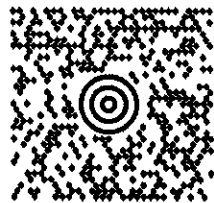

CT 069 9-01



SHIP TO:

HON. FRED CAMILLO
101 FIELD POINT RD.
GREENWICH CT 06830

UPS 2ND DAY AIR

TRACKING #: 1Z E05 345 02 6160 9539

2

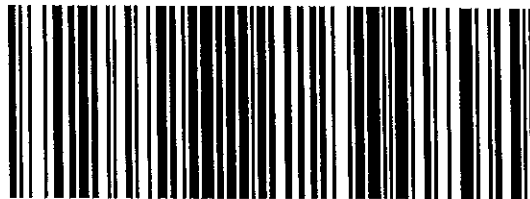

BILLING: P/P

WS 22.0.17 SHARP MX-3070 45.0A 10/2022

Fold here and place in label pouch

FROM:
LEV MAYZLER
(203) 488-0712
CONSTRUCTION SERVICES OF BRANF
63-3 NORTH BRANFORD ROAD
BRANFORD CT 06405-2848

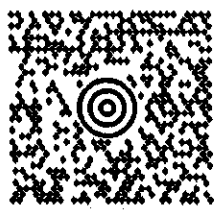

CT 069 9-01



SHIP TO:

LINDA KINNEY
ROUND HILL COMMUNITY CHURCH
395 ROUND HILL RD.
GREENWICH CT 06831

UPS 2ND DAY AIR

TRACKING #: 1Z E05 345 02 6306 1555

2

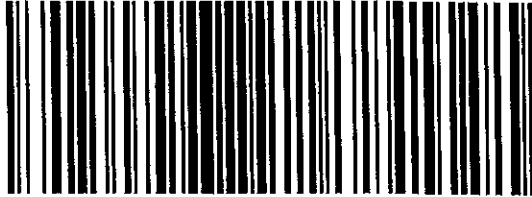

BILLING: P/P

Fold here and place in label pouch

Proof of Delivery

Dear Customer,

This notice serves as proof of delivery for the shipment listed below.

Tracking Number

1ZE053450263061555

Service

UPS 2nd Day Air®

Delivered On

11/07/2022 1:56 P.M.

Delivered To

395 ROUND HILL RD
GREENWICH, CT, 06831, US

Received By

KINNEY

Left At

Office

Thank you for giving us this opportunity to serve you. Details are only available for shipments delivered within the last 120 days. Please print for your records if you require this information after 120 days.

Sincerely,

UPS

Tracking results provided by UPS: 11/08/2022 10:48 A.M. EST