

1 OF 1

1 LBS

MARY CAULFIELD  
978-994-0252  
CENTERLINE COMMUNICATIONS  
750 WEST CENTER STREET  
WEST BRIDGEWATER MA 02379

**SHIP TO:**

CONNECTICUT SITING COUNCIL  
860-827-2935  
TEN FRANKLIN SQUARE  
**NEW BRITAIN CT 06051-2655**

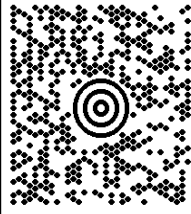

**CT 067 9-06**

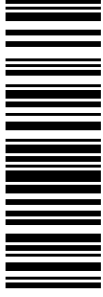

**UPS GROUND**

TRACKING #: 1Z 9Y4 503 03 0243 7342

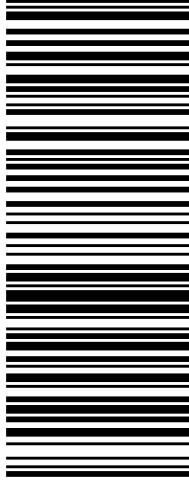

BILLING: P/P

Reference#1: CT2303; CSC filing sent to CSC



US 20.5.12. WNTNVS0 99.04.04/2018

1 OF 1

1 LBS

MARY CAULFIELD  
978-994-0252  
CENTERLINE COMMUNICATIONS  
750 WEST CENTER STREET  
WEST BRIDGEWATER MA 02379

**SHIP TO:**

PETER TESEI - FIRST SELECTMAN  
TOWN OF GREENWICH  
101 FIELD POINT ROAD  
GREENWICH CT 06830-6463

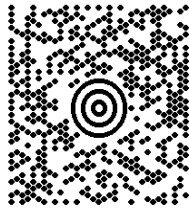

**CT 069 9-01**



**UPS GROUND**

TRACKING #: 1Z 9Y4 503 03 0990 8357

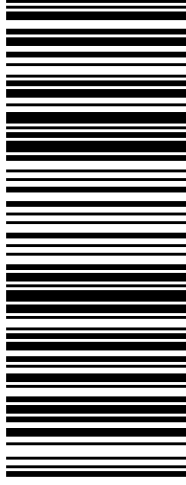

BILLING: P/P

Reference#1: CT2303; CSC filing to Selectman



US 20.5.12. WNTNVS0 99.04.04./2018

1 OF 1

1 LBS

MARY CAULFIELD  
978-994-0252  
CENTERLINE COMMUNICATIONS  
750 WEST CENTER STREET  
WEST BRIDGEWATER MA 02379

**SHIP TO:**

KATIE DELUCA, AICP - PLAN & ZONING  
TOWN OF GREENWICH  
101 FIELD POINT ROAD  
GREENWICH CT 06830-6463

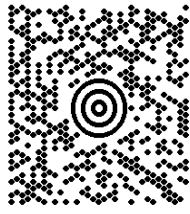

**CT 069 9-01**



**UPS GROUND**

TRACKING #: 1Z 9Y4 503 03 1158 1366

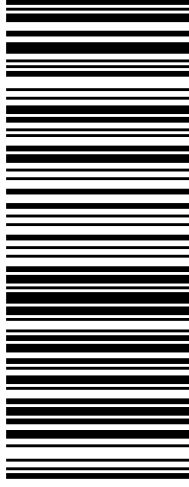

BILLING: P/P

Reference#1: CT2303; CSC to Town Planner

US 20.5.12. WNTNVS0 99.04.04/2018



1 OF 1

1 LBS

MARY CAULFIELD  
978-994-0252  
CENTERLINE COMMUNICATIONS  
750 WEST CENTER STREET  
WEST BRIDGEWATER MA 02379

**SHIP TO:**

LYNDA KINNEY, CHURCH ADMINSTRATOR  
ROUND HILL COMMUNITY CHURCH  
395 ROUND HILL ROAD  
**GREENWICH CT 06831-2617**

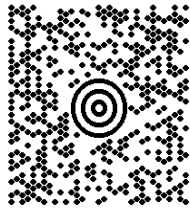

**CT 069 9-01**

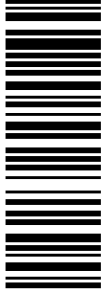

**UPS GROUND**

TRACKING #: 1Z 9Y4 503 03 0785 6372

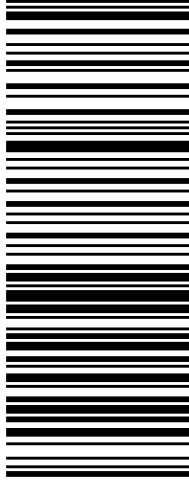

BILLING: P/P

Reference#1: CT2303; CSC filing to ground owner



US 20.5.12. WNTNVS0 99.04.04/2018

1 OF 1

1 LBS

MARY CAULFIELD  
978-994-0252  
CENTERLINE COMMUNICATIONS  
750 WEST CENTER STREET  
WEST BRIDGEWATER MA 02379

**SHIP TO:**

SEAN ROCK  
KGI  
BUILDING THREE, SUITE 370  
805 LAS CIMAS PARKWAY  
AUSTIN TX 78746-5493

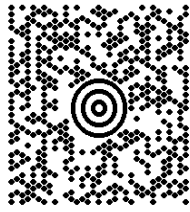

**TX 787 9-75**

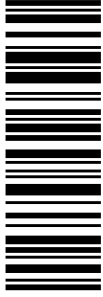

**UPS GROUND**

TRACKING #: 1Z 9Y4 503 03 1913 3380

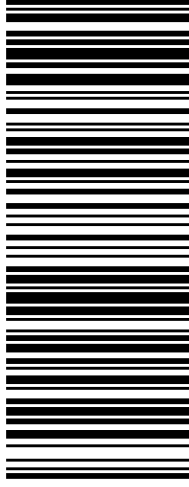

BILLING: P/P

Reference#1: CT2303; CSC filing to Tower Owner



UIS 20.5.12. WNTNVS0 99.04.04./2018

Mary Caulfield, Site Acquisition Consultant  
c/o New Cingular Wireless, PCS LLC (AT&T)  
Centerline Communications, LLC  
750 West Center Street, Suite 301  
West Bridgewater, MA 02379  
Mobile: (978) 994-0252  
[MCaulfield@centerlinecommunications.com](mailto:MCaulfield@centerlinecommunications.com)

July 12, 2018

Melanie A. Bachman  
Acting Executive Director  
Connecticut Siting Council  
10 Franklin Square  
New Britain, CT 06051

**RE: Notice of Exempt Modification // Site Number: CT2303 (Name: Greenwich Round Hill Road)  
395 Round Hill Road, Greenwich, CT  
N 41.0951166666667 // W -73.6642194444445**

Dear Ms. Bachman:

New Cingular Wireless, PCS, LLC (“AT&T”) currently maintains 3 total antennas at the 90-foot mount on the existing 115-foot flagpole tower, located at 395 Round Hill Road, Greenwich, CT. The tower is owned by Cellco Partnership d/b/a Verizon Wireless c/o KGI Wireless. The property is owned by Round Hill Community Church. AT&T now intends to replace three (3) existing antennas with three (3) new LTE (850/700/1900/2300 band) antennas for its LTE upgrade. AT&T also intends to install six (6) new tower mounted amplifiers; and certain in-cabinet upgrades at the base.

Note that this facility was originally approved by the Connecticut Siting Council on February 6, 2007, Docket No. 309.

Please accept this letter as notification pursuant to Regulations of Connecticut State Agencies §16-50j-73, for construction that constitutes an exempt modification pursuant to R.C.S.A. § 16-50j-72(b)(2). In accordance with R.C.S.A. § 16-50j-73, a copy of this letter is being sent to Peter Tesei, First Selectman for the Town of Greenwich, Katie DeLuca, AICP, Director of Planning & Zoning for the Town of Greenwich, as well as Verizon Wireless c/o KGI Wireless, the tower owner representative and Round Hill Community Church, the ground owner.

The planned modifications to the facility fall squarely within those activities explicitly provided for in R.C.S.A. § 16-50j-72(b)(2).

Attached to accommodate this filing are construction drawings dated a June 12, 2018 by Hudson Design Group LLC, a structural analysis dated July 6, 2018 by Semaan Engineering Solutions, and an Emissions Analysis Report dated June 13, 2018 by Centerline Communications, LLC.

1. The proposed modifications will not result in an increase in the height of the existing structure.
2. The proposed modifications will not require the extension of the site boundary.
3. The proposed modifications will not increase noise levels at the facility by six decibels or more, or to levels that exceed state and local criteria.
4. The operation of the replacement antennas will not increase radio frequency emissions at the facility to a level at or above the Federal Communications Commission safety standard.
5. The proposed modifications will not cause an ineligible change or alteration in the physical or environmental characteristics of the site.
6. The existing structure and its foundation can support the proposed loading, pursuant to the structural analysis by Semaan Engineering Solutions dated July 6, 2018.

For the foregoing reasons, AT&T respectfully submits that the proposed modifications to the above referenced telecommunications facility constitute an exempt modification under R.C.S.A. § 16-50j-72(b)(2).

Sincerely,

---

Mary Caulfield, Site Acquisition Consultant  
c/o New Cingular Wireless, PCS LLC (AT&T)  
Centerline Communications, LLC  
750 West Center Street, Suite 301  
West Bridgewater, MA 02379  
Mobile: (978) 994-0252  
[MCaulfield@centerlinecommunications.com](mailto:MCaulfield@centerlinecommunications.com)

cc: Peter Tesei, First Selectman, Town of Greenwich  
Katie DeLuca, AICP, Director of Planning & Zoning, Town of Greenwich  
Sean Rock, Verizon Wireless c/o KGI Wireless, Tower Owner  
Lynda C. Kinney, Church Administrator of Round Hill Community Church, Ground Owner



---

## Structural Analysis Report

Prepared for:

**KGI**

805 Las Cimas Parkway  
Building Three, Suite 370  
Austin, TX 78746

ATTN: Mr. Sean Rock

Structure : 114 ft Monopole  
Site ID : 27741  
Proposed Carrier : AT&T  
Site Name : Round Hill CT  
Site Location : 395 Round Hill Road  
Greenwich, CT  
41.095117, -73.664219  
County : Fairfield  
Date : July 6, 2018  
Max Usage : 44%  
Result : Pass

Prepared By:  
Courtney Bateman  
Structural Engineer

A handwritten signature in black ink that reads "Courtney Bateman".

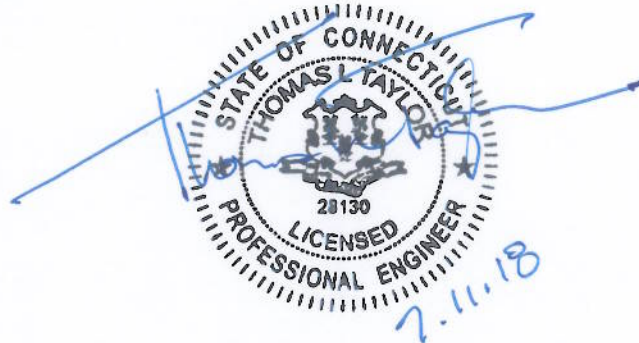





**Table of Contents**

Introduction .....	1
Supporting Documents .....	1
Analysis .....	1
Conclusion.....	1
Existing and Reserved Equipment.....	2
Equipment to be Removed.....	2
Proposed Equipment .....	2
Structure Usages .....	3
Foundations .....	3
Deflection, Twist, and Sway.....	3
Standard Conditions .....	4
Calculations .....	Attached

**Introduction**

The purpose of this report is to summarize results of a structural analysis performed on the 114 ft monopole to reflect the change in loading by AT&T.

**Supporting Documents**

<b>Tower Drawings</b>	EI Project #14679, dated December 15, 2006
<b>Foundation Drawing</b>	EI Project #14679, dated February 12, 2007
<b>Geotechnical Report</b>	Clarence Welti Associates Site: 395 Round Hill Road, dated February 6, 2007

**Analysis**

The tower was analyzed using American Tower Corporation’s tower analysis software. This program considers an elastic three-dimensional model and second-order effects per ANSI/TIA-222.

<b>Basic Wind Speed:</b>	100 mph (3-Second Gust) Vasd / 129 mph (3-Second Gust) Vult
<b>Basic Wind Speed w/ Ice:</b>	50 mph (3-Second Gust) w/ 3/4" radial ice concurrent
<b>Code:</b>	ANSI/TIA-222-G / 2012 IBC / 2016 Connecticut State Building Code
<b>Structure Class:</b>	II
<b>Exposure Category:</b>	B
<b>Topographic Category:</b>	1
<b>Crest Height:</b>	0 ft
<b>Spectral Response:</b>	$S_s = 0.26, S_1 = 0.07$
<b>Site Class:</b>	D - Stiff Soil

**Conclusion**

Based on the analysis results, the structure meets the requirements per the applicable codes listed above. The tower and foundation can support the equipment as described in this report.

If you have any questions or require additional information, please contact Semaan Engineering Solutions at 402-289-1888.

**Existing and Reserved Equipment**

Centerline Elevation (ft)		Qty.	Antenna	Mount Type	Coax (in)	Carrier
Mount	Equip.					
110.0	110.0	3	QXW-636X6312XBF-EDIN	Flush Mount Inside Canister	(12) 1 5/8"	Verizon
100.0	100.0	3	BXA-70063/6CF	Flush Mount Inside Canister	(6) 1 5/8"	
90.0	-	-	-	Flush Mount Inside Canister	(6) 1 5/8"	AT&T
30.0	30.0	1	GPS	Flush	(1) 1/2"	

**Equipment to be Removed**

Centerline Elevation (ft)		Qty.	Antenna	Mount Type	Coax (in)	Carrier
Mount	Equip.					
90.0	90.0	3	P65-16-XLH-RR	-	-	AT&T
		3	DTMABP7819VG12A			

**Proposed Equipment**

Centerline Elevation (ft)		Qty.	Antenna	Mount Type	Coax (in)	Carrier
Mount	Equip.					
90.0	90.0	3	QS66512-2	Existing Flush Mount Inside Canister	(6) 1 5/8"	AT&T
		6	TMA2117F00V1-1			

Install proposed coax inside the pole shaft.

**Structure Usages**

Structural Component	Controlling Usage	Pass/Fail
Anchor Bolts	44%	Pass
Shaft	26%	Pass
Base Plate	26%	Pass

**Foundations**

Reaction Component	Analysis Reactions	% of Usage
Moment (Kips-Ft)	427.0	42%
Axial (Kips)	17.4	17%
Shear (Kips)	7.2	16%

The structure base reactions resulting from this analysis were found to be acceptable through analysis based on geotechnical and foundation information, therefore no modification or reinforcement of the foundation will be required.

**Deflection and Sway\***

Antenna Elevation (ft)	Antenna	Carrier	Deflection (ft)	Sway (Rotation) (°)
90.0	QS66512-2	AT&T	0.212	0.224
	TMA2117F00V1-1			

\*Deflection and Sway was evaluated considering a design wind speed of 60 mph (3-Second Gust) per ANSI/TIA-222-G



## **Standard Conditions**

All engineering services are performed on the basis that the information used is current and correct. This information may consist of, but is not necessary limited, to:

- Information supplied by the client regarding the structure itself, antenna, mounts and feed line loading on the structure and its components, or other relevant information.
- Information from drawings in the possession of Semaan Engineering Solutions, or generated by field inspections or measurements of the structure.

It is the responsibility of the client to ensure that the information provided to Semaan Engineering Solutions Holdings and used in the performance of our engineering services is correct and complete. In the absence of information to the contrary, we assume that all structures were constructed in accordance with the drawings and specifications and that their capacity has not significantly changed from the "as new" condition.

Unless explicitly agreed by both the client and Semaan Engineering Solutions, all services will be performed in accordance with the current revision of ANSI/TIA -222. The design basic wind speed will be determined based on the minimum basic wind speed as prescribed in ANSI/TIA-222. Although every effort is taken to ensure that the loading considered is adequate to meet the requirements of all applicable regulatory entities, we can provide no assurance to meet any other local and state codes or requirements. If wind and ice loads or other relevant parameters are to be different from the minimum values recommended by the codes, the client shall specify the exact requirement.

All services are performed, results obtained, and recommendations made in accordance with generally accepted engineering principles and practices. Semaan Engineering Solutions Holdings is not responsible for the conclusions, opinions and recommendations made by others based on the information we supply.

SEMAAN ENGINEERING SOLUTIONS, LLC  
 1079 N.205th Street  
 Elkhorn, NE 68022  
 Phone: 402-289-1888  
 Fax: 402-289-1861

© 2007 - 2018 by ATC IP LLC. All rights reserved.

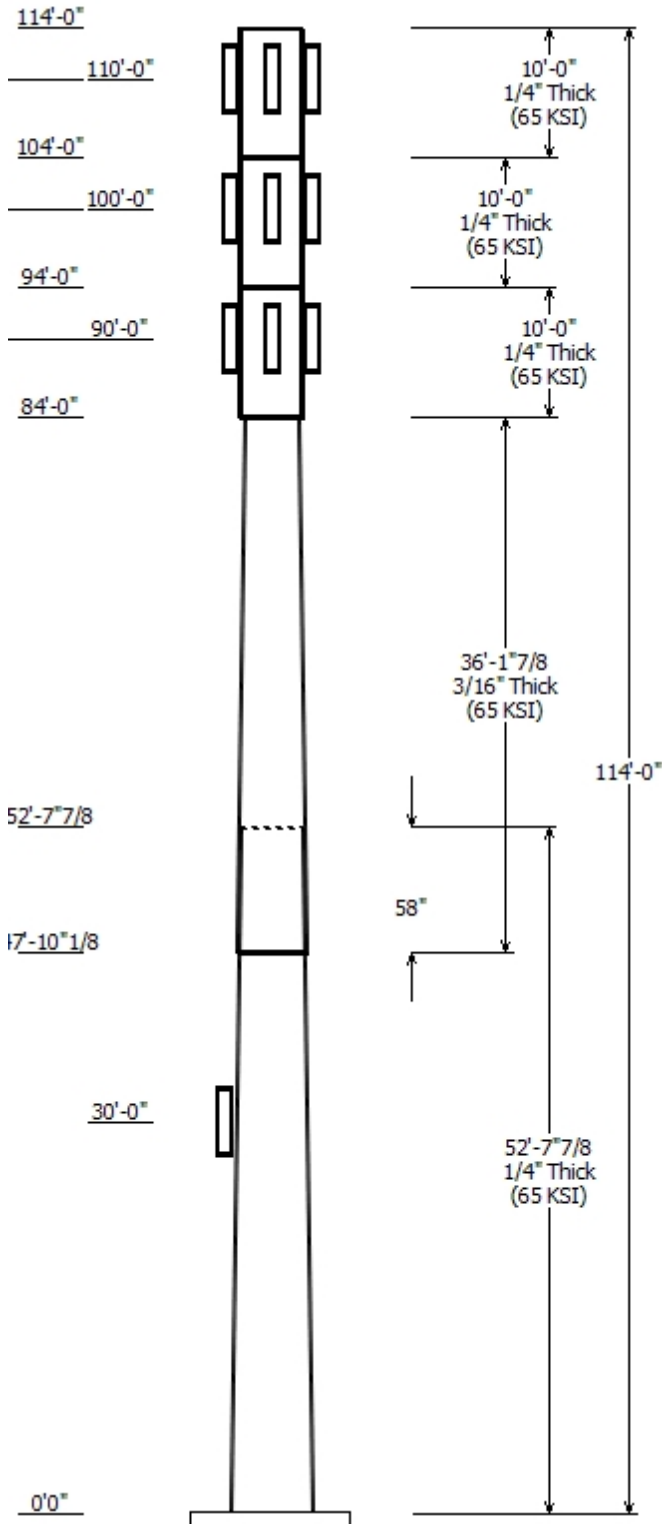

Job Information	
Pole : 27741	Code: ANSI/TIA-222-G
Description :	
Client : KGI	Struct Class : II
Location : Round Hill CT, Greenwich, CT	
Shape : 18 Sides	Exposure : B
Height : 114.00 (ft)	Topo : 1
Base Elev (ft): 1.00	
Taper: 0.14434(in/ft)	

Sections Properties								
Shaft Section	Length (ft)	Diameter (in)			Joint Type	Overlap Length (in)	Taper (in/ft)	Steel Grade (ksi)
		Across Flats Top	Across Flats Bottom	Thick (in)				
1	52.659	33.39	41.00	0.250		0.000	0.144341	65
2	36.156	29.25	34.46	0.188	Slip Joint	57.781	0.144341	65
3	10.000	30.00	30.00	0.250	Butt Joint	0.000	0.000000	65
4	10.000	30.00	30.00	0.250	Butt Joint	0.000	0.000000	65
5	10.000	30.00	30.00	0.250	Butt Joint	0.000	0.000000	65

Discrete Appurtenance				
Attach Elev (ft)	Force Elev (ft)	Qty	Description	
110.000	110.000	3	QXW-636X6312XBF-EDIN	
110.000	110.000	1	Flush Mount	
100.000	100.000	1	Flush Mount	
100.000	100.000	3	BXA-70063/6CF	
90.000	90.000	6	TMA2117F00V1-1	
90.000	90.000	1	Flush Mount	
90.000	90.000	3	QS66512-2	
30.000	30.000	1	GPS	

Linear Appurtenance				
Elev (ft) From	To	Description	Exposed To Wind	
0.000	30.000	1/2" Coax	No	
0.000	90.000	1 5/8" Coax	No	
0.000	90.000	1 5/8" Coax	No	
0.000	100.0	1 5/8" Coax	No	
0.000	110.0	1 5/8" Coax	No	

Load Cases	
1.2D + 1.6W	100 mph with No Ice
0.9D + 1.6W	100 mph with No Ice (Reduced DL)
1.2D + 1.0Di + 1.0Wi	50 mph with 0.75 in Radial Ice
(1.2 + 0.2Sds) * DL + E	Seismic Equivalent Lateral Forces Method
(1.2 + 0.2Sds) * DL + E	Seismic Equivalent Modal Analysis Method
(0.9 - 0.2Sds) * DL + E	Seismic (Reduced DL) Equivalent Lateral
(0.9 - 0.2Sds) * DL + E	Seismic (Reduced DL) Equivalent Modal
1.0D + 1.0W	Serviceability 60 mph

Reactions			
Load Case	Moment (kip-ft)	Shear (kip)	Axial (kip)
1.2D + 1.6W	427.04	7.18	17.38
0.9D + 1.6W	424.68	7.18	13.03
1.2D + 1.0Di + 1.0Wi	157.24	2.45	29.18
(1.2 + 0.2Sds) * DL + E ELFM	79.29	0.97	17.30
(1.2 + 0.2Sds) * DL + E EMAM	77.65	0.97	17.30

(0.9 - 0.2Sds) * DL + E ELFM	78.68	0.97	11.65
(0.9 - 0.2Sds) * DL + E EMAM	77.02	0.97	11.65
1.0D + 1.0W	95.70	1.61	14.49

### Dish Deflections

Load Case	Attach Elev (ft)	Deflection (in)	Rotation (deg)
	0.00	0.000	0.000

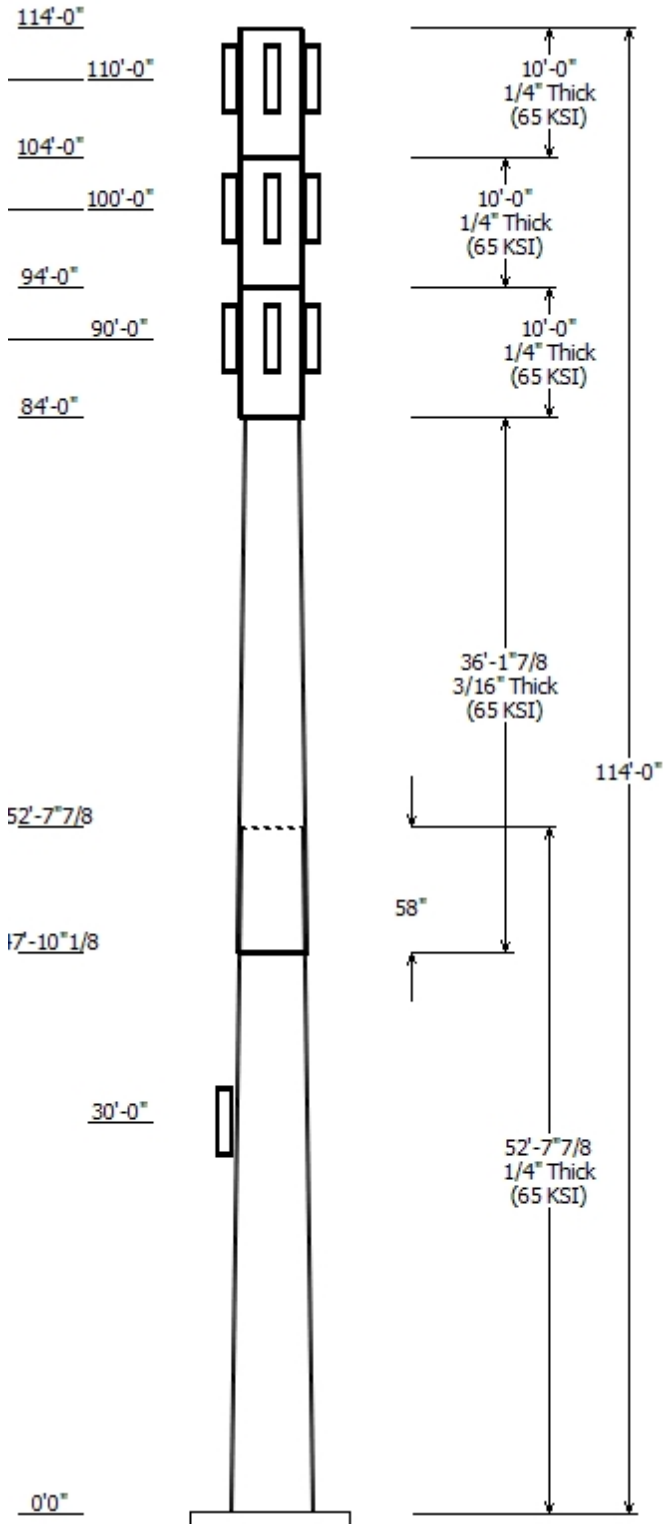

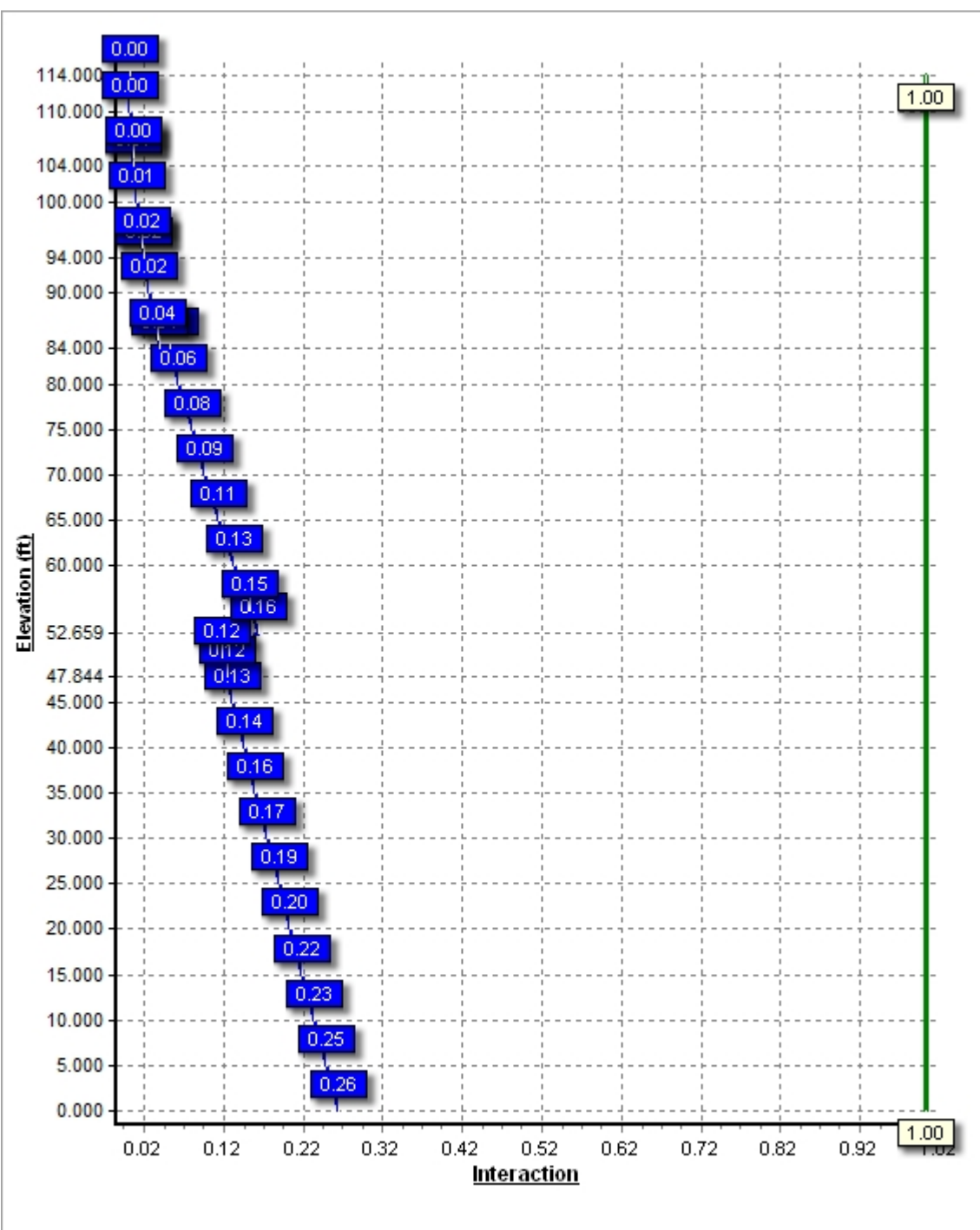



Site Number: 27741

Code: ANSI/TIA-222-G

© 2007 - 2018 by ATC IP LLC. All rights reserved.

Site Name: Round Hill CT, Greenwich, CT

Engineering Number: REV01

7/6/2018 10:30:40 AM

Customer: KGI

### Analysis Parameters

Location:	Fairfield County, CT	Height (ft):	114
Code:	ANSI/TIA-222-G	Shape:	18 Sides. Sect 3: Round. Sect 4: Round. Sect 5: Round in): 41.00
Pole Type:	Custom	Top Diameter (in):	30.00
Pole Manufacturer:	EEL	Taper (in/ft) :	0.144

### Ice & Wind Parameters

Structure Class:	II	Design Wind Speed Without Ice:	100 mph
Exposure Category:	B	Design Wind Speed With Ice:	50 mph
Topographic Category:	1	Operational Wind Speed:	60 mph
Crest Height:	0.0 ft	Design Ice Thickness:	0.75 in

### Seismic Parameters

Analysis Method:	Equivalent Modal Analysis & Equivalent Lateral Force Methods		
Site Class:	D - Stiff Soil		
Period Based on Rayleigh Method (sec):	1.48		
$T_L$ (sec):	6	$p$ :	1.3
$S_s$ :	0.259	$S_1$ :	0.071
$F_a$ :	1.593	$F_v$ :	2.400
$S_{ds}$ :	0.275	$S_{d1}$ :	0.114
		$C_s$ :	0.051
		$C_s$ Max:	0.051
		$C_s$ Min:	0.030

### Load Cases

1.2D + 1.6W	100 mph with No Ice
0.9D + 1.6W	100 mph with No Ice (Reduced DL)
1.2D + 1.0Di + 1.0Wi	50 mph with 0.75 in Radial Ice
(1.2 + 0.2Sds) * DL + E ELFM	Seismic Equivalent Lateral Forces Method
(1.2 + 0.2Sds) * DL + E EMAM	Seismic Equivalent Modal Analysis Method
(0.9 - 0.2Sds) * DL + E ELFM	Seismic (Reduced DL) Equivalent Lateral Forces Method
(0.9 - 0.2Sds) * DL + E EMAM	Seismic (Reduced DL) Equivalent Modal Analysis Method
1.0D + 1.0W	Serviceability 60 mph

Site Number: 27741

Code: ANSI/TIA-222-G

© 2007 - 2018 by ATC IP LLC. All rights reserved.

Site Name: Round Hill CT, Greenwich, CT

Engineering Number: REV01

7/6/2018 10:30:40 AM

Customer: KGI

**Shaft Section Properties**

Sect Info	Length (ft)	Thick (in)	Fy (ksi)	Joint Type	Slip Joint Len (in)	Weight (lb)	Bottom					Top					Taper (in/ft)		
							Dia (in)	Elev (ft)	Area (in <sup>2</sup> )	Ix (in <sup>4</sup> )	W/t Ratio	D/t Ratio	Dia (in)	Elev (ft)	Area (in <sup>2</sup> )	Ix (in <sup>4</sup> )		W/t Ratio	D/t Ratio
1-18	52.659	0.2500	65		0.00	5,253	41.00	0.00	32.33	6783.7	27.51	164.00	33.39	52.66	26.30	3651.8	22.15	133.60	0.144341
2-18	36.156	0.1875	65	Slip	57.78	2,319	34.46	47.84	20.40	3029.2	31.00	183.84	29.25	84.00	17.30	1845.7	26.10	156.00	0.144341
3-R	10.000	0.2500	65	Butt	0.00	795	30.00	84.00	23.37	2587.0	0.00	120.00	30.00	94.00	23.37	2587.0	0.00	120.00	0.000000
4-R	10.000	0.2500	65	Butt	0.00	795	30.00	94.00	23.37	2587.0	0.00	120.00	30.00	104.00	23.37	2587.0	0.00	120.00	0.000000
5-R	10.000	0.2500	65	Butt	0.00	795	30.00	104.00	23.37	2587.0	0.00	120.00	30.00	114.00	23.37	2587.0	0.00	120.00	0.000000
Shaft Weight						9,958													

**Discrete Appurtenance Properties**

Attach Elev (ft)	Description	Qty	Weight (lb)	No Ice EPAa (sf)	Orientation Factor	Weight (lb)	Ice EPAa (sf)	Orientation Factor	Distance From Face (ft)	Vert Ecc (ft)
110.00	Flush Mount	1	250.00	0.000	1.00	841.36	0.000	1.00	0.000	0.000
110.00	QXW-636X6312XBF-EDIN	3	38.00	0.000	0.83	225.48	0.000	0.83	0.000	0.000
100.00	BXA-70063/6CF	3	17.00	0.000	0.70	176.05	8.774	0.70	0.000	0.000
100.00	Flush Mount	1	250.00	0.000	1.00	835.67	0.000	1.00	0.000	0.000
90.00	Flush Mount	1	250.00	0.000	1.00	829.43	0.000	1.00	0.000	0.000
90.00	QS66512-2	3	111.00	0.000	0.92	295.28	0.000	0.92	0.000	0.000
90.00	TMA2117F00V1-1	6	26.00	0.000	0.74	59.70	1.365	0.74	0.000	0.000
30.00	GPS	1	0.60	0.280	1.00	13.44	0.492	1.00	0.000	0.000
Totals		19	1404.60			4,968.48			Number of Loadings :	8

**Linear Appurtenance Properties**

Elev From (ft)	Elev To (ft)	Qty	Description	Coax Diameter (in)	Coax Weight (lb/ft)	Flat	Protected Width (in)	Exposed To Wind	Carrier
0.00	110.00	12	1 5/8" Coax	1.98	1.04	N	0.00	N	Verizon
0.00	100.00	6	1 5/8" Coax	1.98	1.04	N	0.00	N	Verizon
0.00	90.00	6	1 5/8" Coax	1.98	1.04	N	0.00	N	AT&T
0.00	90.00	6	1 5/8" Coax	1.98	1.04	N	0.00	N	AT&T
0.00	30.00	1	1/2" Coax	0.65	0.16	N	0.00	N	AT&T

Site Number: 27741

Code: ANSI/TIA-222-G

© 2007 - 2018 by ATC IP LLC. All rights reserved.

Site Name: Round Hill CT, Greenwich, CT

Engineering Number: REV01

7/6/2018 10:30:40 AM

Customer: KGI

**Segment Properties** (Max Len : 5.ft)

Seg Top Elev (ft)	Description	Thick (in)	Flat Dia (in)	Area (in <sup>2</sup> )	Ix (in <sup>4</sup> )	W/t Ratio	D/t Ratio	Fy (ksi)	S (in <sup>3</sup> )	Z (in <sup>3</sup> )	Weight (lb)
0.00		0.2500	41.000	32.334	6,783.7	27.51	164.00	69.0	325.9	0.0	0.0
5.00		0.2500	40.278	31.761	6,429.6	27.00	161.11	69.6	314.4	0.0	545.3
10.00		0.2500	39.557	31.189	6,088.1	26.49	158.23	70.2	303.1	0.0	535.5
15.00		0.2500	38.835	30.616	5,758.9	25.98	155.34	70.8	292.1	0.0	525.8
20.00		0.2500	38.113	30.043	5,441.7	25.47	152.45	71.4	281.2	0.0	516.0
25.00		0.2500	37.391	29.471	5,136.4	24.96	149.57	72.0	270.6	0.0	506.3
30.00		0.2500	36.670	28.898	4,842.8	24.45	146.68	72.6	260.1	0.0	496.5
35.00		0.2500	35.948	28.325	4,560.6	23.94	143.79	73.2	249.9	0.0	486.8
40.00		0.2500	35.226	27.753	4,289.5	23.43	140.91	73.8	239.8	0.0	477.1
45.00		0.2500	34.505	27.180	4,029.4	22.93	138.02	74.4	230.0	0.0	467.3
47.84	Bot - Section 2	0.2500	34.094	26.854	3,886.3	22.64	136.38	74.8	224.5	0.0	261.4
50.00		0.2500	33.783	26.607	3,780.1	22.42	135.13	75.0	220.4	0.0	345.1
52.66	Top - Section 1	0.1875	33.774	19.988	2,848.7	30.35	180.13	65.7	166.1	0.0	421.2
55.00		0.1875	33.436	19.786	2,763.6	30.03	178.33	66.1	162.8	0.0	158.4
60.00		0.1875	32.715	19.357	2,587.5	29.35	174.48	66.9	155.8	0.0	333.0
65.00		0.1875	31.993	18.927	2,419.1	28.68	170.63	67.7	148.9	0.0	325.7
70.00		0.1875	31.271	18.498	2,258.1	28.00	166.78	68.5	142.2	0.0	318.4
75.00		0.1875	30.549	18.069	2,104.4	27.32	162.93	69.3	135.7	0.0	311.1
80.00		0.1875	29.828	17.639	1,957.9	26.64	159.08	70.1	129.3	0.0	303.8
84.00	Top - Section 2	0.1875	29.250	17.295	1,845.7	26.10	156.00	70.7	124.3	0.0	237.7
84.00	Bot - Section 3	0.2500	30.000	23.366	2,587.0	0.00	120.00	52.5	172.5	221.3	
85.00		0.2500	30.000	23.366	2,587.0	0.00	120.00	52.5	172.5	221.3	79.5
90.00		0.2500	30.000	23.366	2,587.0	0.00	120.00	52.5	172.5	221.3	397.5
94.00	Top - Section 3	0.2500	30.000	23.366	2,587.0	0.00	120.00	52.5	172.5	221.3	318.0
94.00	Bot - Section 4	0.2500	30.000	23.366	2,587.0	0.00	120.00	52.5	172.5	221.3	
95.00		0.2500	30.000	23.366	2,587.0	0.00	120.00	52.5	172.5	221.3	79.5
100.0		0.2500	30.000	23.366	2,587.0	0.00	120.00	52.5	172.5	221.3	397.5
104.0	Top - Section 4	0.2500	30.000	23.366	2,587.0	0.00	120.00	52.5	172.5	221.3	318.0
104.0	Bot - Section 5	0.2500	30.000	23.366	2,587.0	0.00	120.00	52.5	172.5	221.3	
105.0		0.2500	30.000	23.366	2,587.0	0.00	120.00	52.5	172.5	221.3	79.5
110.0		0.2500	30.000	23.366	2,587.0	0.00	120.00	52.5	172.5	221.3	397.5
114.0		0.2500	30.000	23.366	2,587.0	0.00	120.00	52.5	172.5	221.3	318.0
9,957.6											

Site Number: 27741

Code: ANSI/TIA-222-G

© 2007 - 2018 by ATC IP LLC. All rights reserved.

Site Name: Round Hill CT, Greenwich, CT

Engineering Number: REV01

7/6/2018 10:30:40 AM

Customer: KGI

**Load Case:** 1.2D + 1.6W

100 mph with No Ice

22 Iterations

Gust Response Factor : 1.10

Wind Importance Factor : 1.00

Dead Load Factor : 1.20

Wind Load Factor : 1.60

**Applied Segment Forces Summary**

Seg Elev (ft)	Description	Shaft Forces		Discrete Forces			Linear Forces		Sum of Forces				
		Wind FX (lb)	Dead Load (lb)	Wind FX (lb)	Torsion MY (lb-ft)	Moment MZ (lb-ft)	Dead Load (lb)	Wind FX (lb)	Dead Load (lb)	Wind FX (lb)	Dead Load (lb)	Torsion MY (lb-ft)	Moment MZ (lb)
0.00		167.4	0.0					0.0	0.0	167.4	0.0	0.0	0.0
5.00		331.9	654.3					0.0	188.2	331.9	842.5	0.0	0.0
10.00		325.9	642.6					0.0	188.2	325.9	830.8	0.0	0.0
15.00		320.0	630.9					0.0	188.2	320.0	819.1	0.0	0.0
20.00		314.1	619.2					0.0	188.2	314.1	807.4	0.0	0.0
25.00		308.1	607.5					0.0	188.2	308.1	795.7	0.0	0.0
30.00	Appertunance(s)	307.1	595.8	6.8	0.0	0.0	0.7	0.0	188.2	313.9	784.7	0.0	0.0
35.00		312.1	584.2					0.0	187.2	312.1	771.4	0.0	0.0
40.00		317.5	572.5					0.0	187.2	317.5	759.7	0.0	0.0
45.00		251.6	560.8					0.0	187.2	251.6	748.0	0.0	0.0
47.84	Bot - Section 2	162.3	313.7					0.0	106.5	162.3	420.2	0.0	0.0
50.00		157.9	414.2					0.0	80.7	157.9	494.9	0.0	0.0
52.66	Top - Section 1	164.4	505.5					0.0	99.5	164.4	605.0	0.0	0.0
55.00		242.1	190.1					0.0	87.7	242.1	277.8	0.0	0.0
60.00		330.3	399.6					0.0	187.2	330.3	586.8	0.0	0.0
65.00		330.4	390.8					0.0	187.2	330.4	578.0	0.0	0.0
70.00		329.8	382.1					0.0	187.2	329.8	569.3	0.0	0.0
75.00		328.5	373.3					0.0	187.2	328.5	560.5	0.0	0.0
80.00		294.2	364.5					0.0	187.2	294.2	551.7	0.0	0.0
84.00	Top - Section 2	160.7	285.3					0.0	149.8	160.7	435.1	0.0	0.0
85.00		183.5	95.4					0.0	37.4	183.5	132.8	0.0	0.0
90.00	Appertunance(s)	277.5	477.0	0.0	0.0	0.0	886.8	0.0	187.2	277.5	1,551.0	0.0	0.0
94.00	Top - Section 3	155.6	381.6					0.0	89.9	155.6	471.5	0.0	0.0
95.00		189.2	95.4					0.0	22.5	189.2	117.9	0.0	0.0
100.00	Appertunance(s)	285.9	477.0	0.0	0.0	0.0	361.2	0.0	112.3	285.9	950.6	0.0	0.0
104.00	Top - Section 4	160.2	381.6					0.0	59.9	160.2	441.5	0.0	0.0
105.00		194.6	95.4					0.0	15.0	194.6	110.4	0.0	0.0
110.00	Appertunance(s)	293.8	477.0	0.0	0.0	0.0	436.8	0.0	74.9	293.8	988.7	0.0	0.0
114.00		131.4	381.6					0.0	0.0	131.4	381.6	0.0	0.0
<b>Totals:</b>										7,334.64	17,384.4	0.00	0.00

Site Number: 27741

Code: ANSI/TIA-222-G

© 2007 - 2018 by ATC IP LLC. All rights reserved.

Site Name: Round Hill CT, Greenwich, CT

Engineering Number: REV01

7/6/2018 10:30:40 AM

Customer: KGI

**Load Case: 1.2D + 1.6W**

100 mph with No Ice

22 Iterations

Gust Response Factor : 1.10

Wind Importance Factor : 1.00

Dead Load Factor : 1.20

Wind Load Factor : 1.60

**Calculated Forces**

Seg Elev (ft)	Pu FY (-) (kips)	Vu FX (-) (kips)	Tu MY (ft-kips)	Mu MZ (ft-kips)	Mu MX (ft-kips)	Resultant Moment (ft-kips)	phi Pn (kips)	phi Vn (kips)	phi Tn (ft-kips)	phi Mn (ft-kips)	Total Deflect (in)	Rotation (deg)	Ratio
0.00	-17.38	-7.18	0.00	-427.04	0.00	427.04	2,009.33	1,004.66	3,370.24	1,687.62	0.00	0.00	0.262
5.00	-16.53	-6.87	0.00	-391.14	0.00	391.14	1,990.85	995.43	3,279.75	1,642.31	0.05	-0.09	0.247
10.00	-15.69	-6.57	0.00	-356.78	0.00	356.78	1,971.76	985.88	3,189.37	1,597.06	0.18	-0.17	0.231
15.00	-14.86	-6.26	0.00	-323.95	0.00	323.95	1,952.06	976.03	3,099.16	1,551.88	0.40	-0.25	0.216
20.00	-14.05	-5.96	0.00	-292.64	0.00	292.64	1,931.73	965.87	3,009.15	1,506.81	0.70	-0.32	0.202
25.00	-13.25	-5.67	0.00	-262.82	0.00	262.82	1,910.79	955.40	2,919.43	1,461.88	1.08	-0.40	0.187
30.00	-12.46	-5.36	0.00	-234.49	0.00	234.49	1,889.23	944.62	2,830.03	1,417.12	1.53	-0.47	0.172
35.00	-11.68	-5.06	0.00	-207.68	0.00	207.68	1,867.06	933.53	2,741.01	1,372.54	2.06	-0.53	0.158
40.00	-10.92	-4.74	0.00	-182.40	0.00	182.40	1,844.27	922.13	2,652.43	1,328.19	2.65	-0.59	0.143
45.00	-10.17	-4.49	0.00	-158.70	0.00	158.70	1,820.86	910.43	2,564.34	1,284.08	3.30	-0.65	0.129
47.84	-9.75	-4.33	0.00	-145.93	0.00	145.93	1,807.27	903.63	2,514.48	1,259.11	3.69	-0.68	0.121
50.00	-9.26	-4.17	0.00	-136.60	0.00	136.60	1,796.83	898.42	2,476.80	1,240.24	4.00	-0.70	0.115
52.66	-8.65	-4.00	0.00	-125.52	0.00	125.52	1,181.91	590.96	1,634.83	818.63	4.40	-0.73	0.161
55.00	-8.38	-3.76	0.00	-116.16	0.00	116.16	1,176.68	588.34	1,611.12	806.76	4.76	-0.75	0.151
60.00	-7.79	-3.43	0.00	-97.36	0.00	97.36	1,165.04	582.52	1,560.37	781.35	5.58	-0.80	0.131
65.00	-7.22	-3.09	0.00	-80.22	0.00	80.22	1,152.79	576.40	1,509.51	755.88	6.45	-0.85	0.112
70.00	-6.65	-2.76	0.00	-64.75	0.00	64.75	1,139.92	569.96	1,458.59	730.38	7.37	-0.90	0.095
75.00	-6.09	-2.43	0.00	-50.94	0.00	50.94	1,126.44	563.22	1,407.67	704.88	8.32	-0.93	0.078
80.00	-5.55	-2.13	0.00	-38.81	0.00	38.81	1,112.33	556.17	1,356.80	679.41	9.32	-0.96	0.062
84.00	-5.11	-1.96	0.00	-30.30	0.00	30.30	1,100.61	550.30	1,316.18	659.07	10.13	-0.98	0.051
84.00	-5.11	-1.96	0.00	-30.30	0.00	30.30	1,103.87	551.93	1,356.12	905.48	10.13	-0.98	0.038
85.00	-4.98	-1.77	0.00	-28.34	0.00	28.34	1,103.87	551.93	1,356.12	905.48	10.34	-0.99	0.036
90.00	-3.44	-1.47	0.00	-19.47	0.00	19.47	1,103.87	551.93	1,356.12	905.48	11.38	-1.00	0.025
94.00	-2.97	-1.31	0.00	-13.59	0.00	13.59	1,103.87	551.93	1,356.12	905.48	12.22	-1.01	0.018
94.00	-2.97	-1.31	0.00	-13.59	0.00	13.59	1,103.87	551.93	1,356.12	905.48	12.22	-1.01	0.018
95.00	-2.85	-1.12	0.00	-12.28	0.00	12.28	1,103.87	551.93	1,356.12	905.48	12.43	-1.01	0.016
100.00	-1.91	-0.81	0.00	-6.70	0.00	6.70	1,103.87	551.93	1,356.12	905.48	13.49	-1.01	0.009
104.00	-1.47	-0.65	0.00	-3.44	0.00	3.44	1,103.87	551.93	1,356.12	905.48	14.34	-1.02	0.005
104.00	-1.47	-0.65	0.00	-3.44	0.00	3.44	1,103.87	551.93	1,356.12	905.48	14.34	-1.02	0.005
105.00	-1.36	-0.45	0.00	-2.80	0.00	2.80	1,103.87	551.93	1,356.12	905.48	14.55	-1.02	0.004
110.00	-0.38	-0.14	0.00	-0.55	0.00	0.55	1,103.87	551.93	1,356.12	905.48	15.62	-1.02	0.001
114.00	0.00	-0.13	0.00	0.00	0.00	0.00	1,103.87	551.93	1,356.12	905.48	16.47	-1.02	0.000

Site Number: 27741

Code: ANSI/TIA-222-G

© 2007 - 2018 by ATC IP LLC. All rights reserved.

Site Name: Round Hill CT, Greenwich, CT

Engineering Number: REV01

7/6/2018 10:30:40 AM

Customer: KGI

**Load Case:** 0.9D + 1.6W

100 mph with No Ice (Reduced DL)

22 Iterations

Gust Response Factor : 1.10

Wind Importance Factor : 1.00

Dead Load Factor : 0.90

Wind Load Factor : 1.60

**Applied Segment Forces Summary**

Seg Elev (ft)	Description	Shaft Forces		Discrete Forces			Linear Forces		Sum of Forces				
		Wind FX (lb)	Dead Load (lb)	Wind FX (lb)	Torsion MY (lb-ft)	Moment MZ (lb-ft)	Dead Load (lb)	Wind FX (lb)	Dead Load (lb)	Wind FX (lb)	Dead Load (lb)	Torsion MY (lb-ft)	Moment MZ (lb)
0.00		167.4	0.0					0.0	0.0	167.4	0.0	0.0	0.0
5.00		331.9	490.7					0.0	141.1	331.9	631.8	0.0	0.0
10.00		325.9	482.0					0.0	141.1	325.9	623.1	0.0	0.0
15.00		320.0	473.2					0.0	141.1	320.0	614.3	0.0	0.0
20.00		314.1	464.4					0.0	141.1	314.1	605.5	0.0	0.0
25.00		308.1	455.7					0.0	141.1	308.1	596.8	0.0	0.0
30.00	Appertunance(s)	307.1	446.9	6.8	0.0	0.0	0.5	0.0	141.1	313.9	588.5	0.0	0.0
35.00		312.1	438.1					0.0	140.4	312.1	578.5	0.0	0.0
40.00		317.5	429.3					0.0	140.4	317.5	569.7	0.0	0.0
45.00		251.6	420.6					0.0	140.4	251.6	561.0	0.0	0.0
47.84	Bot - Section 2	162.3	235.3					0.0	79.9	162.3	315.1	0.0	0.0
50.00		157.9	310.6					0.0	60.5	157.9	371.2	0.0	0.0
52.66	Top - Section 1	164.4	379.1					0.0	74.7	164.4	453.8	0.0	0.0
55.00		242.1	142.6					0.0	65.7	242.1	208.3	0.0	0.0
60.00		330.3	299.7					0.0	140.4	330.3	440.1	0.0	0.0
65.00		330.4	293.1					0.0	140.4	330.4	433.5	0.0	0.0
70.00		329.8	286.5					0.0	140.4	329.8	426.9	0.0	0.0
75.00		328.5	280.0					0.0	140.4	328.5	420.4	0.0	0.0
80.00		294.2	273.4					0.0	140.4	294.2	413.8	0.0	0.0
84.00	Top - Section 2	160.7	214.0					0.0	112.3	160.7	326.3	0.0	0.0
85.00		183.5	71.6					0.0	28.1	183.5	99.6	0.0	0.0
90.00	Appertunance(s)	277.5	357.8	0.0	0.0	0.0	665.1	0.0	140.4	277.5	1,163.3	0.0	0.0
94.00	Top - Section 3	155.6	286.2					0.0	67.4	155.6	353.6	0.0	0.0
95.00		189.2	71.6					0.0	16.8	189.2	88.4	0.0	0.0
100.00	Appertunance(s)	285.9	357.8	0.0	0.0	0.0	270.9	0.0	84.2	285.9	712.9	0.0	0.0
104.00	Top - Section 4	160.2	286.2					0.0	44.9	160.2	331.2	0.0	0.0
105.00		194.6	71.6					0.0	11.2	194.6	82.8	0.0	0.0
110.00	Appertunance(s)	293.8	357.8	0.0	0.0	0.0	327.6	0.0	56.2	293.8	741.5	0.0	0.0
114.00		131.4	286.2					0.0	0.0	131.4	286.2	0.0	0.0
<b>Totals:</b>										7,334.64	13,038.3	0.00	0.00

Site Number: 27741

Code: ANSI/TIA-222-G

© 2007 - 2018 by ATC IP LLC. All rights reserved.

Site Name: Round Hill CT, Greenwich, CT

Engineering Number: REV01

7/6/2018 10:30:41 AM

Customer: KGI

**Load Case:** 0.9D + 1.6W

100 mph with No Ice (Reduced DL)

22 Iterations

Gust Response Factor : 1.10

Wind Importance Factor : 1.00

Dead Load Factor : 0.90

Wind Load Factor : 1.60

**Calculated Forces**

Seg Elev (ft)	Pu FY (-) (kips)	Vu FX (-) (kips)	Tu MY (ft-kips)	Mu MZ (ft-kips)	Mu MX (ft-kips)	Resultant Moment (ft-kips)	phi Pn (kips)	phi Vn (kips)	phi Tn (ft-kips)	phi Mn (ft-kips)	Total Deflect (in)	Rotation (deg)	Ratio
0.00	-13.03	-7.18	0.00	-424.68	0.00	424.68	2,009.33	1,004.66	3,370.24	1,687.62	0.00	0.00	0.258
5.00	-12.39	-6.86	0.00	-388.80	0.00	388.80	1,990.85	995.43	3,279.75	1,642.31	0.05	-0.09	0.243
10.00	-11.76	-6.55	0.00	-354.49	0.00	354.49	1,971.76	985.88	3,189.37	1,597.06	0.18	-0.17	0.228
15.00	-11.14	-6.24	0.00	-321.73	0.00	321.73	1,952.06	976.03	3,099.16	1,551.88	0.40	-0.25	0.213
20.00	-10.53	-5.94	0.00	-290.51	0.00	290.51	1,931.73	965.87	3,009.15	1,506.81	0.70	-0.32	0.198
25.00	-9.92	-5.64	0.00	-260.81	0.00	260.81	1,910.79	955.40	2,919.43	1,461.88	1.07	-0.39	0.184
30.00	-9.33	-5.33	0.00	-232.60	0.00	232.60	1,889.23	944.62	2,830.03	1,417.12	1.52	-0.46	0.169
35.00	-8.75	-5.03	0.00	-205.93	0.00	205.93	1,867.06	933.53	2,741.01	1,372.54	2.04	-0.53	0.155
40.00	-8.18	-4.71	0.00	-180.80	0.00	180.80	1,844.27	922.13	2,652.43	1,328.19	2.63	-0.59	0.141
45.00	-7.62	-4.46	0.00	-157.25	0.00	157.25	1,820.86	910.43	2,564.34	1,284.08	3.27	-0.64	0.127
47.84	-7.30	-4.30	0.00	-144.57	0.00	144.57	1,807.27	903.63	2,514.48	1,259.11	3.67	-0.67	0.119
50.00	-6.93	-4.14	0.00	-135.30	0.00	135.30	1,796.83	898.42	2,476.80	1,240.24	3.98	-0.70	0.113
52.66	-6.48	-3.97	0.00	-124.30	0.00	124.30	1,181.91	590.96	1,634.83	818.63	4.37	-0.72	0.157
55.00	-6.27	-3.73	0.00	-115.00	0.00	115.00	1,176.68	588.34	1,611.12	806.76	4.73	-0.74	0.148
60.00	-5.83	-3.40	0.00	-96.36	0.00	96.36	1,165.04	582.52	1,560.37	781.35	5.54	-0.80	0.128
65.00	-5.40	-3.07	0.00	-79.36	0.00	79.36	1,152.79	576.40	1,509.51	755.88	6.40	-0.85	0.110
70.00	-4.98	-2.73	0.00	-64.03	0.00	64.03	1,139.92	569.96	1,458.59	730.38	7.31	-0.89	0.092
75.00	-4.56	-2.40	0.00	-50.36	0.00	50.36	1,126.44	563.22	1,407.67	704.88	8.26	-0.92	0.076
80.00	-4.15	-2.10	0.00	-38.36	0.00	38.36	1,112.33	556.17	1,356.80	679.41	9.25	-0.95	0.060
84.00	-3.83	-1.94	0.00	-29.95	0.00	29.95	1,100.61	550.30	1,316.18	659.07	10.06	-0.97	0.049
84.00	-3.83	-1.94	0.00	-29.95	0.00	29.95	1,103.87	551.93	1,356.12	905.48	10.06	-0.97	0.037
85.00	-3.73	-1.75	0.00	-28.01	0.00	28.01	1,103.87	551.93	1,356.12	905.48	10.26	-0.98	0.034
90.00	-2.57	-1.46	0.00	-19.25	0.00	19.25	1,103.87	551.93	1,356.12	905.48	11.29	-0.99	0.024
94.00	-2.22	-1.29	0.00	-13.43	0.00	13.43	1,103.87	551.93	1,356.12	905.48	12.13	-1.00	0.017
94.00	-2.22	-1.29	0.00	-13.43	0.00	13.43	1,103.87	551.93	1,356.12	905.48	12.13	-1.00	0.017
95.00	-2.14	-1.10	0.00	-12.14	0.00	12.14	1,103.87	551.93	1,356.12	905.48	12.34	-1.00	0.015
100.00	-1.43	-0.80	0.00	-6.62	0.00	6.62	1,103.87	551.93	1,356.12	905.48	13.39	-1.01	0.009
104.00	-1.10	-0.64	0.00	-3.40	0.00	3.40	1,103.87	551.93	1,356.12	905.48	14.23	-1.01	0.005
104.00	-1.10	-0.64	0.00	-3.40	0.00	3.40	1,103.87	551.93	1,356.12	905.48	14.23	-1.01	0.005
105.00	-1.02	-0.44	0.00	-2.76	0.00	2.76	1,103.87	551.93	1,356.12	905.48	14.44	-1.01	0.004
110.00	-0.28	-0.14	0.00	-0.55	0.00	0.55	1,103.87	551.93	1,356.12	905.48	15.50	-1.01	0.001
114.00	0.00	-0.13	0.00	0.00	0.00	0.00	1,103.87	551.93	1,356.12	905.48	16.34	-1.01	0.000

Site Number: 27741

Code: ANSI/TIA-222-G

© 2007 - 2018 by ATC IP LLC. All rights reserved.

Site Name: Round Hill CT, Greenwich, CT

Engineering Number: REV01

7/6/2018 10:30:41 AM

Customer: KGI

<b>Load Case:</b> 1.2D + 1.0Di + 1.0Wi	50 mph with 0.75 in Radial Ice	21 Iterations
Gust Response Factor : 1.10	Ice Dead Load Factor : 1.00	Wind Importance Factor : 1.00
Dead Load Factor : 1.20		Ice Importance Factor : 1.00
Wind Load Factor : 1.00		

**Applied Segment Forces Summary**

Seg Elev (ft)	Description	Shaft Forces		Discrete Forces			Linear Forces		Sum of Forces				
		Wind FX (lb)	Dead Load (lb)	Wind FX (lb)	Torsion MY (lb-ft)	Moment MZ (lb-ft)	Dead Load (lb)	Wind FX (lb)	Dead Load (lb)	Wind FX (lb)	Dead Load (lb)	Torsion MY (lb-ft)	Moment MZ (lb)
0.00		51.1	0.0					0.0	0.0	51.1	0.0	0.0	0.0
5.00		101.6	965.7					0.0	188.2	101.6	1,153.9	0.0	0.0
10.00		100.3	977.9					0.0	188.2	100.3	1,166.0	0.0	0.0
15.00		98.8	976.4					0.0	188.2	98.8	1,164.5	0.0	0.0
20.00		97.3	969.7					0.0	188.2	97.3	1,157.9	0.0	0.0
25.00		95.7	960.3					0.0	188.2	95.7	1,148.4	0.0	0.0
30.00	Appertunance(s)	95.7	949.0	1.9	0.0	0.0	13.6	0.0	188.2	97.5	1,150.7	0.0	0.0
35.00		97.5	936.5					0.0	187.2	97.5	1,123.7	0.0	0.0
40.00		99.4	923.1					0.0	187.2	99.4	1,110.3	0.0	0.0
45.00		78.9	908.9					0.0	187.2	78.9	1,096.1	0.0	0.0
47.84	Bot - Section 2	51.0	511.2					0.0	106.5	51.0	617.7	0.0	0.0
50.00		49.7	565.0					0.0	80.7	49.7	645.7	0.0	0.0
52.66	Top - Section 1	51.8	690.4					0.0	99.5	51.8	789.9	0.0	0.0
55.00		76.4	352.1					0.0	87.7	76.4	439.8	0.0	0.0
60.00		104.4	740.8					0.0	187.2	104.4	928.0	0.0	0.0
65.00		104.7	727.7					0.0	187.2	104.7	914.9	0.0	0.0
70.00		104.8	714.3					0.0	187.2	104.8	901.5	0.0	0.0
75.00		104.7	700.7					0.0	187.2	104.7	887.9	0.0	0.0
80.00		94.0	686.8					0.0	187.2	94.0	874.0	0.0	0.0
84.00	Top - Section 2	52.2	539.9					0.0	149.8	52.2	689.6	0.0	0.0
85.00		63.7	159.2					0.0	37.4	63.7	196.6	0.0	0.0
90.00	Appertunance(s)	96.3	797.0	31.2	0.0	0.0	2,379.2	0.0	187.2	127.5	3,363.5	0.0	0.0
94.00	Top - Section 3	54.0	639.0					0.0	89.9	54.0	728.8	0.0	0.0
95.00		65.7	159.9					0.0	22.5	65.7	182.4	0.0	0.0
100.00	Appertunance(s)	99.3	800.6	97.7	0.0	0.0	1,674.0	0.0	112.3	197.0	2,587.0	0.0	0.0
104.00	Top - Section 4	55.7	641.7					0.0	59.9	55.7	701.6	0.0	0.0
105.00		67.7	160.6					0.0	15.0	67.7	175.6	0.0	0.0
110.00	Appertunance(s)	102.2	804.0	0.0	0.0	0.0	1,757.4	0.0	74.9	102.2	2,636.2	0.0	0.0
114.00		45.7	644.3					0.0	0.0	45.7	644.3	0.0	0.0
<b>Totals:</b>										2,491.28	29,176.4	0.00	0.00



Site Number: 27741

Code: ANSI/TIA-222-G

© 2007 - 2018 by ATC IP LLC. All rights reserved.

Site Name: Round Hill CT, Greenwich, CT

Engineering Number: REV01

7/6/2018 10:30:41 AM

Customer: KGI

**Load Case:** 1.2D + 1.0Di + 1.0Wi

50 mph with 0.75 in Radial Ice

21 Iterations

Gust Response Factor : 1.10

Ice Dead Load Factor : 1.00

Wind Importance Factor : 1.00

Dead Load Factor : 1.20

Ice Importance Factor : 1.00

Wind Load Factor : 1.00

**Calculated Forces**

Seg Elev (ft)	Pu FY (-) (kips)	Vu FX (-) (kips)	Tu MY (ft-kips)	Mu MZ (ft-kips)	Mu MX (ft-kips)	Resultant Moment (ft-kips)	phi Pn (kips)	phi Vn (kips)	phi Tn (ft-kips)	phi Mn (ft-kips)	Total Deflect (in)	Rotation (deg)	Ratio
0.00	-29.18	-2.45	0.00	-157.24	0.00	157.24	2,009.33	1,004.66	3,370.24	1,687.62	0.00	0.00	0.108
5.00	-28.02	-2.36	0.00	-145.01	0.00	145.01	1,990.85	995.43	3,279.75	1,642.31	0.02	-0.03	0.102
10.00	-26.85	-2.27	0.00	-133.20	0.00	133.20	1,971.76	985.88	3,189.37	1,597.06	0.07	-0.06	0.097
15.00	-25.69	-2.19	0.00	-121.83	0.00	121.83	1,952.06	976.03	3,099.16	1,551.88	0.15	-0.09	0.092
20.00	-24.53	-2.10	0.00	-110.90	0.00	110.90	1,931.73	965.87	3,009.15	1,506.81	0.26	-0.12	0.086
25.00	-23.38	-2.01	0.00	-100.41	0.00	100.41	1,910.79	955.40	2,919.43	1,461.88	0.40	-0.15	0.081
30.00	-22.23	-1.92	0.00	-90.35	0.00	90.35	1,889.23	944.62	2,830.03	1,417.12	0.57	-0.18	0.076
35.00	-21.10	-1.83	0.00	-80.75	0.00	80.75	1,867.06	933.53	2,741.01	1,372.54	0.77	-0.20	0.070
40.00	-19.99	-1.73	0.00	-71.61	0.00	71.61	1,844.27	922.13	2,652.43	1,328.19	0.99	-0.22	0.065
45.00	-18.90	-1.66	0.00	-62.94	0.00	62.94	1,820.86	910.43	2,564.34	1,284.08	1.24	-0.25	0.059
47.84	-18.28	-1.60	0.00	-58.23	0.00	58.23	1,807.27	903.63	2,514.48	1,259.11	1.39	-0.26	0.056
50.00	-17.63	-1.56	0.00	-54.77	0.00	54.77	1,796.83	898.42	2,476.80	1,240.24	1.51	-0.27	0.054
52.66	-16.84	-1.50	0.00	-50.64	0.00	50.64	1,181.91	590.96	1,634.83	818.63	1.66	-0.28	0.076
55.00	-16.40	-1.43	0.00	-47.12	0.00	47.12	1,176.68	588.34	1,611.12	806.76	1.80	-0.29	0.072
60.00	-15.48	-1.33	0.00	-39.98	0.00	39.98	1,165.04	582.52	1,560.37	781.35	2.11	-0.31	0.064
65.00	-14.56	-1.22	0.00	-33.35	0.00	33.35	1,152.79	576.40	1,509.51	755.88	2.45	-0.33	0.057
70.00	-13.66	-1.11	0.00	-27.25	0.00	27.25	1,139.92	569.96	1,458.59	730.38	2.80	-0.35	0.049
75.00	-12.77	-1.01	0.00	-21.68	0.00	21.68	1,126.44	563.22	1,407.67	704.88	3.17	-0.36	0.042
80.00	-11.90	-0.91	0.00	-16.64	0.00	16.64	1,112.33	556.17	1,356.80	679.41	3.56	-0.38	0.035
84.00	-11.21	-0.85	0.00	-13.01	0.00	13.01	1,100.61	550.30	1,316.18	659.07	3.88	-0.38	0.030
84.00	-11.21	-0.85	0.00	-13.01	0.00	13.01	1,103.87	551.93	1,356.12	905.48	3.88	-0.38	0.025
85.00	-11.01	-0.79	0.00	-12.15	0.00	12.15	1,103.87	551.93	1,356.12	905.48	3.96	-0.39	0.023
90.00	-7.65	-0.64	0.00	-8.20	0.00	8.20	1,103.87	551.93	1,356.12	905.48	4.37	-0.39	0.016
94.00	-6.92	-0.58	0.00	-5.64	0.00	5.64	1,103.87	551.93	1,356.12	905.48	4.70	-0.39	0.013
94.00	-6.92	-0.58	0.00	-5.64	0.00	5.64	1,103.87	551.93	1,356.12	905.48	4.70	-0.39	0.013
95.00	-6.74	-0.51	0.00	-5.06	0.00	5.06	1,103.87	551.93	1,356.12	905.48	4.78	-0.40	0.012
100.00	-4.16	-0.30	0.00	-2.49	0.00	2.49	1,103.87	551.93	1,356.12	905.48	5.19	-0.40	0.007
104.00	-3.45	-0.24	0.00	-1.29	0.00	1.29	1,103.87	551.93	1,356.12	905.48	5.53	-0.40	0.005
104.00	-3.45	-0.24	0.00	-1.29	0.00	1.29	1,103.87	551.93	1,356.12	905.48	5.53	-0.40	0.005
105.00	-3.28	-0.17	0.00	-1.05	0.00	1.05	1,103.87	551.93	1,356.12	905.48	5.61	-0.40	0.004
110.00	-0.64	-0.05	0.00	-0.20	0.00	0.20	1,103.87	551.93	1,356.12	905.48	6.03	-0.40	0.001
114.00	0.00	-0.05	0.00	0.00	0.00	0.00	1,103.87	551.93	1,356.12	905.48	6.36	-0.40	0.000

Site Number: 27741

Code: ANSI/TIA-222-G

© 2007 - 2018 by ATC IP LLC. All rights reserved.

Site Name: Round Hill CT, Greenwich, CT

Engineering Number: REV01

7/6/2018 10:30:41 AM

Customer: KGI

**Load Case:** 1.0D + 1.0W

Serviceability 60 mph

21 Iterations

Gust Response Factor : 1.10

Wind Importance Factor : 1.00

Dead Load Factor : 1.00

Wind Load Factor : 1.00

**Applied Segment Forces Summary**

Seg Elev (ft)	Description	Shaft Forces		Discrete Forces			Linear Forces		Sum of Forces				
		Wind FX (lb)	Dead Load (lb)	Wind FX (lb)	Torsion MY (lb-ft)	Moment MZ (lb-ft)	Dead Load (lb)	Wind FX (lb)	Dead Load (lb)	Wind FX (lb)	Dead Load (lb)	Torsion MY (lb-ft)	Moment MZ (lb)
0.00		37.7	0.0					0.0	0.0	37.7	0.0	0.0	0.0
5.00		74.7	545.3					0.0	156.8	74.7	702.1	0.0	0.0
10.00		73.3	535.5					0.0	156.8	73.3	692.3	0.0	0.0
15.00		72.0	525.8					0.0	156.8	72.0	682.6	0.0	0.0
20.00		70.7	516.0					0.0	156.8	70.7	672.8	0.0	0.0
25.00		69.3	506.3					0.0	156.8	69.3	663.1	0.0	0.0
30.00	Appertunance(s)	69.1	496.5	1.5	0.0	0.0	0.6	0.0	156.8	70.6	653.9	0.0	0.0
35.00		70.2	486.8					0.0	156.0	70.2	642.8	0.0	0.0
40.00		71.4	477.1					0.0	156.0	71.4	633.1	0.0	0.0
45.00		56.6	467.3					0.0	156.0	56.6	623.3	0.0	0.0
47.84	Bot - Section 2	36.5	261.4					0.0	88.7	36.5	350.2	0.0	0.0
50.00		35.5	345.1					0.0	67.3	35.5	412.4	0.0	0.0
52.66	Top - Section 1	37.0	421.2					0.0	83.0	37.0	504.2	0.0	0.0
55.00		54.5	158.4					0.0	73.0	54.5	231.5	0.0	0.0
60.00		74.3	333.0					0.0	156.0	74.3	489.0	0.0	0.0
65.00		74.3	325.7					0.0	156.0	74.3	481.7	0.0	0.0
70.00		74.2	318.4					0.0	156.0	74.2	474.4	0.0	0.0
75.00		73.9	311.1					0.0	156.0	73.9	467.1	0.0	0.0
80.00		66.2	303.8					0.0	156.0	66.2	459.8	0.0	0.0
84.00	Top - Section 2	36.1	237.7					0.0	124.8	36.1	362.5	0.0	0.0
85.00		41.3	79.5					0.0	31.2	41.3	110.7	0.0	0.0
90.00	Appertunance(s)	62.4	397.5	0.0	0.0	0.0	739.0	0.0	156.0	62.4	1,292.5	0.0	0.0
94.00	Top - Section 3	35.0	318.0					0.0	74.9	35.0	392.9	0.0	0.0
95.00		42.6	79.5					0.0	18.7	42.6	98.2	0.0	0.0
100.00	Appertunance(s)	64.3	397.5	0.0	0.0	0.0	301.0	0.0	93.6	64.3	792.1	0.0	0.0
104.00	Top - Section 4	36.0	318.0					0.0	49.9	36.0	368.0	0.0	0.0
105.00		43.8	79.5					0.0	12.5	43.8	92.0	0.0	0.0
110.00	Appertunance(s)	66.1	397.5	0.0	0.0	0.0	364.0	0.0	62.4	66.1	823.9	0.0	0.0
114.00		29.6	318.0					0.0	0.0	29.6	318.0	0.0	0.0
<b>Totals:</b>										1,650.29	14,487.0	0.00	0.00

Site Number: 27741

Code: ANSI/TIA-222-G

© 2007 - 2018 by ATC IP LLC. All rights reserved.

Site Name: Round Hill CT, Greenwich, CT

Engineering Number: REV01

7/6/2018 10:30:42 AM

Customer: KGI

**Load Case:** 1.0D + 1.0W

Serviceability 60 mph

21 Iterations

Gust Response Factor : 1.10

Wind Importance Factor : 1.00

Dead Load Factor : 1.00

Wind Load Factor : 1.00

**Calculated Forces**

Seg Elev (ft)	Pu FY (-) (kips)	Vu FX (-) (kips)	Tu MY (ft-kips)	Mu MZ (ft-kips)	Mu MX (ft-kips)	Resultant Moment (ft-kips)	phi Pn (kips)	phi Vn (kips)	phi Tn (ft-kips)	phi Mn (ft-kips)	Total Deflect (in)	Rotation (deg)	Ratio
0.00	-14.49	-1.61	0.00	-95.70	0.00	95.70	2,009.33	1,004.66	3,370.24	1,687.62	0.00	0.00	0.064
5.00	-13.78	-1.54	0.00	-87.63	0.00	87.63	1,990.85	995.43	3,279.75	1,642.31	0.01	-0.02	0.060
10.00	-13.09	-1.47	0.00	-79.90	0.00	79.90	1,971.76	985.88	3,189.37	1,597.06	0.04	-0.04	0.057
15.00	-12.41	-1.41	0.00	-72.53	0.00	72.53	1,952.06	976.03	3,099.16	1,551.88	0.09	-0.06	0.053
20.00	-11.74	-1.34	0.00	-65.50	0.00	65.50	1,931.73	965.87	3,009.15	1,506.81	0.16	-0.07	0.050
25.00	-11.07	-1.27	0.00	-58.81	0.00	58.81	1,910.79	955.40	2,919.43	1,461.88	0.24	-0.09	0.046
30.00	-10.42	-1.20	0.00	-52.46	0.00	52.46	1,889.23	944.62	2,830.03	1,417.12	0.34	-0.10	0.043
35.00	-9.77	-1.13	0.00	-46.45	0.00	46.45	1,867.06	933.53	2,741.01	1,372.54	0.46	-0.12	0.039
40.00	-9.14	-1.06	0.00	-40.79	0.00	40.79	1,844.27	922.13	2,652.43	1,328.19	0.59	-0.13	0.036
45.00	-8.52	-1.01	0.00	-35.48	0.00	35.48	1,820.86	910.43	2,564.34	1,284.08	0.74	-0.15	0.032
47.84	-8.17	-0.97	0.00	-32.62	0.00	32.62	1,807.27	903.63	2,514.48	1,259.11	0.83	-0.15	0.030
50.00	-7.76	-0.93	0.00	-30.53	0.00	30.53	1,796.83	898.42	2,476.80	1,240.24	0.90	-0.16	0.029
52.66	-7.25	-0.90	0.00	-28.05	0.00	28.05	1,181.91	590.96	1,634.83	818.63	0.99	-0.16	0.040
55.00	-7.02	-0.84	0.00	-25.95	0.00	25.95	1,176.68	588.34	1,611.12	806.76	1.07	-0.17	0.038
60.00	-6.53	-0.77	0.00	-21.75	0.00	21.75	1,165.04	582.52	1,560.37	781.35	1.25	-0.18	0.033
65.00	-6.05	-0.69	0.00	-17.91	0.00	17.91	1,152.79	576.40	1,509.51	755.88	1.44	-0.19	0.029
70.00	-5.58	-0.62	0.00	-14.45	0.00	14.45	1,139.92	569.96	1,458.59	730.38	1.65	-0.20	0.025
75.00	-5.11	-0.54	0.00	-11.37	0.00	11.37	1,126.44	563.22	1,407.67	704.88	1.86	-0.21	0.021
80.00	-4.65	-0.47	0.00	-8.66	0.00	8.66	1,112.33	556.17	1,356.80	679.41	2.09	-0.22	0.017
84.00	-4.29	-0.44	0.00	-6.76	0.00	6.76	1,100.61	550.30	1,316.18	659.07	2.27	-0.22	0.014
84.00	-4.29	-0.44	0.00	-6.76	0.00	6.76	1,103.87	551.93	1,356.12	905.48	2.27	-0.22	0.011
85.00	-4.18	-0.40	0.00	-6.32	0.00	6.32	1,103.87	551.93	1,356.12	905.48	2.31	-0.22	0.011
90.00	-2.88	-0.33	0.00	-4.35	0.00	4.35	1,103.87	551.93	1,356.12	905.48	2.55	-0.22	0.007
94.00	-2.49	-0.29	0.00	-3.03	0.00	3.03	1,103.87	551.93	1,356.12	905.48	2.73	-0.23	0.006
94.00	-2.49	-0.29	0.00	-3.03	0.00	3.03	1,103.87	551.93	1,356.12	905.48	2.73	-0.23	0.006
95.00	-2.39	-0.25	0.00	-2.74	0.00	2.74	1,103.87	551.93	1,356.12	905.48	2.78	-0.23	0.005
100.00	-1.60	-0.18	0.00	-1.49	0.00	1.49	1,103.87	551.93	1,356.12	905.48	3.02	-0.23	0.003
104.00	-1.23	-0.14	0.00	-0.77	0.00	0.77	1,103.87	551.93	1,356.12	905.48	3.21	-0.23	0.002
104.00	-1.23	-0.14	0.00	-0.77	0.00	0.77	1,103.87	551.93	1,356.12	905.48	3.21	-0.23	0.002
105.00	-1.14	-0.10	0.00	-0.62	0.00	0.62	1,103.87	551.93	1,356.12	905.48	3.26	-0.23	0.002
110.00	-0.32	-0.03	0.00	-0.12	0.00	0.12	1,103.87	551.93	1,356.12	905.48	3.49	-0.23	0.000
114.00	0.00	-0.03	0.00	0.00	0.00	0.00	1,103.87	551.93	1,356.12	905.48	3.69	-0.23	0.000

Site Number: 27741

Code: ANSI/TIA-222-G

© 2007 - 2018 by ATC IP LLC. All rights reserved.

Site Name: Round Hill CT, Greenwich, CT

Engineering Number: REV01

7/6/2018 10:30:42 AM

Customer: KGI

**Equivalent Lateral Forces Method Analysis**

(Based on ASCE7-10 Chapters 11, 12, 15)

Spectral Response Acceleration for Short Period ( $S_s$ ):	0.26
Spectral Response Acceleration at 1.0 Second Period ( $S_1$ ):	0.07
Long-Period Transition Period ( $T_L$ ):	6
Importance Factor ( $I_E$ ):	1.00
Site Coefficient $F_a$ :	1.59
Site Coefficient $F_v$ :	2.40
Response Modification Coefficient (R):	1.50
Design Spectral Response Acceleration at Short Period ( $S_{ds}$ ):	0.28
Design Spectral Response Acceleration at 1.0 Second Period ( $S_{d1}$ ):	0.11
Seismic Response Coefficient ( $C_s$ ):	0.05
Upper Limit $C_s$	0.05
Lower Limit $C_s$	0.03
Period based on Rayleigh Method (sec):	1.48
Redundancy Factor (p):	1.30
Seismic Force Distribution Exponent (k):	1.49
Total Unfactored Dead Load:	14.49 k
Seismic Base Shear (E):	0.96 k

**Load Case (1.2 + 0.2S<sub>ds</sub>) \* DL + E ELM**

**Seismic Equivalent Lateral Forces Method**

Segment	Height Above Base (ft)	Weight (lb)	$W_z$ (lb-ft)	$C_{vx}$	Horizontal Force (lb)	Vertical Force (lb)
28	112.00	318	358	0.054	52	399
27	107.50	460	488	0.073	71	577
26	104.50	92	93	0.014	14	115
25	102.00	368	361	0.054	52	462
24	97.50	491	450	0.068	65	616
23	94.50	98	86	0.013	12	123
22	92.00	393	330	0.050	48	493
21	87.50	554	432	0.065	63	695
20	84.50	111	82	0.012	12	139
19	82.00	363	257	0.039	37	455
18	77.50	460	299	0.045	43	577
17	72.50	467	275	0.041	40	586
16	67.50	474	251	0.038	36	595
15	62.50	482	228	0.034	33	605
14	57.50	489	204	0.031	30	614
13	53.83	231	88	0.013	13	290
12	51.33	504	178	0.027	26	633
11	48.92	412	135	0.020	20	518
10	46.42	350	106	0.016	15	439
9	42.50	623	166	0.025	24	782
8	37.50	633	140	0.021	20	794
7	32.50	643	115	0.017	17	807
6	27.50	653	91	0.014	13	820

Site Number: 27741

Code: ANSI/TIA-222-G

© 2007 - 2018 by ATC IP LLC. All rights reserved.

Site Name: Round Hill CT, Greenwich, CT

Engineering Number: REV01

7/6/2018 10:30:42 AM

Customer: KGI

5	22.50	663	68	0.010	10	832
4	17.50	673	48	0.007	7	844
3	12.50	683	29	0.004	4	857
2	7.50	692	14	0.002	2	869
1	2.50	702	3	0.000	0	881
Flush Mount	110.00	250	274	0.041	40	314
QXW-636X6312XBF-EDIN	110.00	114	125	0.019	18	143
BXA-70063/6CF	100.00	51	49	0.007	7	64
Flush Mount	100.00	250	238	0.036	34	314
QS66512-2	90.00	333	271	0.041	39	418
Flush Mount	90.00	250	203	0.031	29	314
TMA2117F00V1-1	90.00	156	127	0.019	18	196
GPS	30.00	1	0	0.000	0	1
		14,487	6,663	1.000	965	18,181

**Load Case (0.9 - 0.2Sds) \* DL + E ELFM**

**Seismic (Reduced DL) Equivalent Lateral Forces Method**

Segment	Height Above Base (ft)	Weight (lb)	W <sub>z</sub> (lb-ft)	C <sub>vx</sub>	Horizontal Force (lb)	Vertical Force (lb)
28	112.00	318	358	0.054	52	269
27	107.50	460	488	0.073	71	389
26	104.50	92	93	0.014	14	78
25	102.00	368	361	0.054	52	311
24	97.50	491	450	0.068	65	415
23	94.50	98	86	0.013	12	83
22	92.00	393	330	0.050	48	332
21	87.50	554	432	0.065	63	468
20	84.50	111	82	0.012	12	94
19	82.00	363	257	0.039	37	306
18	77.50	460	299	0.045	43	388
17	72.50	467	275	0.041	40	395
16	67.50	474	251	0.038	36	401
15	62.50	482	228	0.034	33	407
14	57.50	489	204	0.031	30	413
13	53.83	231	88	0.013	13	196
12	51.33	504	178	0.027	26	426
11	48.92	412	135	0.020	20	348
10	46.42	350	106	0.016	15	296
9	42.50	623	166	0.025	24	527
8	37.50	633	140	0.021	20	535
7	32.50	643	115	0.017	17	543
6	27.50	653	91	0.014	13	552
5	22.50	663	68	0.010	10	560
4	17.50	673	48	0.007	7	569
3	12.50	683	29	0.004	4	577
2	7.50	692	14	0.002	2	585
1	2.50	702	3	0.000	0	593
Flush Mount	110.00	250	274	0.041	40	211
QXW-636X6312XBF-EDIN	110.00	114	125	0.019	18	96
BXA-70063/6CF	100.00	51	49	0.007	7	43
Flush Mount	100.00	250	238	0.036	34	211
QS66512-2	90.00	333	271	0.041	39	281
Flush Mount	90.00	250	203	0.031	29	211
TMA2117F00V1-1	90.00	156	127	0.019	18	132
GPS	30.00	1	0	0.000	0	1
		14,487	6,663	1.000	965	12,241

---

**Site Number:** 27741

**Code:** ANSI/TIA-222-G

© 2007 - 2018 by ATC IP LLC. All rights reserved.

**Site Name:** Round Hill CT, Greenwich, CT

**Engineering Number:** REV01

**7/6/2018 10:30:42 AM**

**Customer:** KGI

---

Site Number: 27741

Code: ANSI/TIA-222-G

© 2007 - 2018 by ATC IP LLC. All rights reserved.

Site Name: Round Hill CT, Greenwich, CT

Engineering Number: REV01

7/6/2018 10:30:42 AM

Customer: KGI

**Load Case (1.2 + 0.2Sds) \* DL + E ELFM**

**Seismic Equivalent Lateral Forces Method**

**Calculated Forces**

Seg Elev (ft)	Pu FY (-) (kips)	Vu FX (-) (kips)	Tu MY (ft-kips)	Mu MZ (ft-kips)	Mu MX (ft-kips)	Resultant Moment (ft-kips)	phi Pn (kips)	phi Vn (kips)	phi Tn (ft-kips)	phi Mn (ft-kips)	Total Deflect (in)	Rotation (deg)	Ratio
0.00	-17.30	-0.97	0.00	-79.29	0.00	79.29	2,009.33	1,004.66	3,370.24	1,687.62	0.00	0.00	0.056
5.00	-16.43	-0.97	0.00	-74.46	0.00	74.46	1,990.85	995.43	3,279.75	1,642.31	0.01	-0.02	0.054
10.00	-15.57	-0.97	0.00	-69.62	0.00	69.62	1,971.76	985.88	3,189.37	1,597.06	0.03	-0.03	0.051
15.00	-14.73	-0.96	0.00	-64.77	0.00	64.77	1,952.06	976.03	3,099.16	1,551.88	0.08	-0.05	0.049
20.00	-13.90	-0.96	0.00	-59.95	0.00	59.95	1,931.73	965.87	3,009.15	1,506.81	0.13	-0.06	0.047
25.00	-13.08	-0.95	0.00	-55.16	0.00	55.16	1,910.79	955.40	2,919.43	1,461.88	0.21	-0.08	0.045
30.00	-12.27	-0.93	0.00	-50.43	0.00	50.43	1,889.23	944.62	2,830.03	1,417.12	0.30	-0.09	0.042
35.00	-11.47	-0.91	0.00	-45.76	0.00	45.76	1,867.06	933.53	2,741.01	1,372.54	0.40	-0.11	0.039
40.00	-10.69	-0.89	0.00	-41.20	0.00	41.20	1,844.27	922.13	2,652.43	1,328.19	0.52	-0.12	0.037
45.00	-10.25	-0.88	0.00	-36.75	0.00	36.75	1,820.86	910.43	2,564.34	1,284.08	0.66	-0.13	0.034
47.84	-9.73	-0.86	0.00	-34.26	0.00	34.26	1,807.27	903.63	2,514.48	1,259.11	0.74	-0.14	0.033
50.00	-9.10	-0.83	0.00	-32.41	0.00	32.41	1,796.83	898.42	2,476.80	1,240.24	0.80	-0.15	0.031
52.66	-8.81	-0.82	0.00	-30.20	0.00	30.20	1,181.91	590.96	1,634.83	818.63	0.89	-0.15	0.044
55.00	-8.20	-0.79	0.00	-28.29	0.00	28.29	1,176.68	588.34	1,611.12	806.76	0.96	-0.16	0.042
60.00	-7.59	-0.75	0.00	-24.35	0.00	24.35	1,165.04	582.52	1,560.37	781.35	1.13	-0.17	0.038
65.00	-7.00	-0.72	0.00	-20.58	0.00	20.58	1,152.79	576.40	1,509.51	755.88	1.32	-0.18	0.033
70.00	-6.41	-0.68	0.00	-17.00	0.00	17.00	1,139.92	569.96	1,458.59	730.38	1.52	-0.19	0.029
75.00	-5.83	-0.63	0.00	-13.61	0.00	13.61	1,126.44	563.22	1,407.67	704.88	1.73	-0.20	0.024
80.00	-5.38	-0.59	0.00	-10.45	0.00	10.45	1,112.33	556.17	1,356.80	679.41	1.94	-0.21	0.020
84.00	-5.24	-0.58	0.00	-8.07	0.00	8.07	1,100.61	550.30	1,316.18	659.07	2.13	-0.22	0.017
84.00	-5.24	-0.58	0.00	-8.07	0.00	8.07	1,103.87	551.93	1,356.12	905.48	2.13	-0.22	0.014
85.00	-4.55	-0.52	0.00	-7.49	0.00	7.49	1,103.87	551.93	1,356.12	905.48	2.17	-0.22	0.012
90.00	-3.13	-0.38	0.00	-4.91	0.00	4.91	1,103.87	551.93	1,356.12	905.48	2.40	-0.22	0.008
94.00	-3.00	-0.36	0.00	-3.40	0.00	3.40	1,103.87	551.93	1,356.12	905.48	2.59	-0.22	0.006
94.00	-3.00	-0.36	0.00	-3.40	0.00	3.40	1,103.87	551.93	1,356.12	905.48	2.59	-0.22	0.006
95.00	-2.39	-0.30	0.00	-3.03	0.00	3.03	1,103.87	551.93	1,356.12	905.48	2.64	-0.22	0.006
100.00	-1.55	-0.20	0.00	-1.55	0.00	1.55	1,103.87	551.93	1,356.12	905.48	2.87	-0.23	0.003
104.00	-1.43	-0.19	0.00	-0.75	0.00	0.75	1,103.87	551.93	1,356.12	905.48	3.06	-0.23	0.002
104.00	-1.43	-0.19	0.00	-0.75	0.00	0.75	1,103.87	551.93	1,356.12	905.48	3.06	-0.23	0.002
105.00	-0.86	-0.11	0.00	-0.56	0.00	0.56	1,103.87	551.93	1,356.12	905.48	3.11	-0.23	0.001
110.00	0.00	0.00	0.00	0.00	0.00	0.00	1,103.87	551.93	1,356.12	905.48	3.35	-0.23	0.000
114.00	0.00	0.00	0.00	0.00	0.00	0.00	1,103.87	551.93	1,356.12	905.48	3.53	-0.23	0.000

**Load Case (0.9 - 0.2Sds) \* DL + E ELFM**

**Seismic (Reduced DL) Equivalent Lateral Forces Method**

**Calculated Forces**

Seg Elev (ft)	Pu FY (-) (kips)	Vu FX (-) (kips)	Tu MY (ft-kips)	Mu MZ (ft-kips)	Mu MX (ft-kips)	Resultant Moment (ft-kips)	phi Pn (kips)	phi Vn (kips)	phi Tn (ft-kips)	phi Mn (ft-kips)	Total Deflect (in)	Rotation (deg)	Ratio
0.00	-11.65	-0.97	0.00	-78.68	0.00	78.68	2,009.33	1,004.66	3,370.24	1,687.62	0.00	0.00	0.052
5.00	-11.06	-0.97	0.00	-73.85	0.00	73.85	1,990.85	995.43	3,279.75	1,642.31	0.01	-0.02	0.051
10.00	-10.49	-0.96	0.00	-69.02	0.00	69.02	1,971.76	985.88	3,189.37	1,597.06	0.03	-0.03	0.049
15.00	-9.92	-0.96	0.00	-64.19	0.00	64.19	1,952.06	976.03	3,099.16	1,551.88	0.08	-0.05	0.046
20.00	-9.36	-0.95	0.00	-59.39	0.00	59.39	1,931.73	965.87	3,009.15	1,506.81	0.13	-0.06	0.044
25.00	-8.80	-0.94	0.00	-54.63	0.00	54.63	1,910.79	955.40	2,919.43	1,461.88	0.21	-0.08	0.042
30.00	-8.26	-0.93	0.00	-49.93	0.00	49.93	1,889.23	944.62	2,830.03	1,417.12	0.30	-0.09	0.040
35.00	-7.73	-0.91	0.00	-45.30	0.00	45.30	1,867.06	933.53	2,741.01	1,372.54	0.40	-0.11	0.037
40.00	-7.20	-0.88	0.00	-40.78	0.00	40.78	1,844.27	922.13	2,652.43	1,328.19	0.52	-0.12	0.035
45.00	-6.90	-0.87	0.00	-36.36	0.00	36.36	1,820.86	910.43	2,564.34	1,284.08	0.65	-0.13	0.032
47.84	-6.55	-0.85	0.00	-33.90	0.00	33.90	1,807.27	903.63	2,514.48	1,259.11	0.73	-0.14	0.031
50.00	-6.13	-0.82	0.00	-32.07	0.00	32.07	1,796.83	898.42	2,476.80	1,240.24	0.80	-0.14	0.029
52.66	-5.93	-0.81	0.00	-29.88	0.00	29.88	1,181.91	590.96	1,634.83	818.63	0.88	-0.15	0.042
55.00	-5.52	-0.78	0.00	-27.99	0.00	27.99	1,176.68	588.34	1,611.12	806.76	0.95	-0.16	0.039
60.00	-5.11	-0.75	0.00	-24.09	0.00	24.09	1,165.04	582.52	1,560.37	781.35	1.12	-0.17	0.035
65.00	-4.71	-0.71	0.00	-20.36	0.00	20.36	1,152.79	576.40	1,509.51	755.88	1.31	-0.18	0.031
70.00	-4.32	-0.67	0.00	-16.81	0.00	16.81	1,139.92	569.96	1,458.59	730.38	1.50	-0.19	0.027
75.00	-3.93	-0.63	0.00	-13.46	0.00	13.46	1,126.44	563.22	1,407.67	704.88	1.71	-0.20	0.023
80.00	-3.62	-0.59	0.00	-10.34	0.00	10.34	1,112.33	556.17	1,356.80	679.41	1.93	-0.21	0.018
84.00	-3.53	-0.58	0.00	-7.99	0.00	7.99	1,100.61	550.30	1,316.18	659.07	2.11	-0.22	0.015
84.00	-3.53	-0.58	0.00	-7.99	0.00	7.99	1,103.87	551.93	1,356.12	905.48	2.11	-0.22	0.012
85.00	-3.06	-0.51	0.00	-7.41	0.00	7.41	1,103.87	551.93	1,356.12	905.48	2.15	-0.22	0.011
90.00	-2.10	-0.37	0.00	-4.85	0.00	4.85	1,103.87	551.93	1,356.12	905.48	2.38	-0.22	0.007
94.00	-2.02	-0.36	0.00	-3.36	0.00	3.36	1,103.87	551.93	1,356.12	905.48	2.56	-0.22	0.006
94.00	-2.02	-0.36	0.00	-3.36	0.00	3.36	1,103.87	551.93	1,356.12	905.48	2.56	-0.22	0.006
95.00	-1.61	-0.29	0.00	-3.00	0.00	3.00	1,103.87	551.93	1,356.12	905.48	2.61	-0.22	0.005
100.00	-1.04	-0.20	0.00	-1.53	0.00	1.53	1,103.87	551.93	1,356.12	905.48	2.84	-0.22	0.003
104.00	-0.96	-0.18	0.00	-0.74	0.00	0.74	1,103.87	551.93	1,356.12	905.48	3.03	-0.22	0.002
104.00	-0.96	-0.18	0.00	-0.74	0.00	0.74	1,103.87	551.93	1,356.12	905.48	3.03	-0.22	0.002
105.00	-0.58	-0.11	0.00	-0.56	0.00	0.56	1,103.87	551.93	1,356.12	905.48	3.08	-0.22	0.001
110.00	0.00	0.00	0.00	0.00	0.00	0.00	1,103.87	551.93	1,356.12	905.48	3.31	-0.22	0.000
114.00	0.00	0.00	0.00	0.00	0.00	0.00	1,103.87	551.93	1,356.12	905.48	3.50	-0.22	0.000



Site Number: 27741

Code: ANSI/TIA-222-G

© 2007 - 2018 by ATC IP LLC. All rights reserved.

Site Name: Round Hill CT, Greenwich, CT

Engineering Number: REV01

7/6/2018 10:30:42 AM

Customer: KGI

### Equivalent Modal Forces Analysis

(Based on ASCE7-10 Chapters 11, 12 & 15 and ANSI/TIA-G, section 2.7)

Spectral Response Acceleration for Short Period ( $S_s$ ):	0.26
Spectral Response Acceleration at 1.0 Second Period ( $S_1$ ):	0.07
Importance Factor ( $I_E$ ):	1.00
Site Coefficient $F_a$ :	1.59
Site Coefficient $F_v$ :	2.40
Response Modification Coefficient (R):	1.50
Design Spectral Response Acceleration at Short Period ( $S_{ds}$ ):	0.28
Design Spectral Response Acceleration at 1.0 Second Period ( $S_{d1}$ ):	0.11
Period Based on Rayleigh Method (sec):	1.48
Redundancy Factor ( $\rho$ ):	1.30

#### Load Case (1.2 + 0.2Sds) \* DL + E EMAM

#### Seismic Equivalent Modal Analysis Method

Segment	Height Above Base (ft)	Weight (lb)	a	b	c	Saz	Horizontal Force (lb)	Vertical Force (lb)
28	112.00	318	1.824	1.651	1.020	0.471	130	399
27	107.50	460	1.681	1.050	0.785	0.350	139	577
26	104.50	92	1.588	0.742	0.654	0.278	22	115
25	102.00	368	1.513	0.534	0.558	0.225	72	462
24	97.50	491	1.382	0.252	0.414	0.141	60	616
23	94.50	98	1.299	0.119	0.335	0.094	8	123
22	92.00	393	1.231	0.036	0.278	0.061	21	493
21	87.50	554	1.113	-0.062	0.195	0.013	6	695
20	84.50	111	1.038	-0.098	0.151	-0.010	-1	139
19	82.00	363	0.978	-0.115	0.121	-0.024	-7	455
18	77.50	460	0.873	-0.121	0.077	-0.037	-15	577
17	72.50	467	0.764	-0.104	0.044	-0.035	-14	586
16	67.50	474	0.663	-0.075	0.023	-0.020	-8	595
15	62.50	482	0.568	-0.041	0.011	0.003	1	605
14	57.50	489	0.481	-0.009	0.006	0.027	11	614
13	53.83	231	0.421	0.011	0.006	0.042	8	290
12	51.33	504	0.383	0.023	0.007	0.050	22	633
11	48.92	412	0.348	0.033	0.009	0.056	20	518
10	46.42	350	0.313	0.042	0.011	0.061	19	439
9	42.50	623	0.263	0.053	0.016	0.066	36	782
8	37.50	633	0.205	0.062	0.023	0.068	37	794
7	32.50	643	0.154	0.068	0.030	0.067	37	807
6	27.50	653	0.110	0.071	0.036	0.064	37	820
5	22.50	663	0.074	0.072	0.040	0.062	36	832
4	17.50	673	0.045	0.071	0.042	0.059	34	844
3	12.50	683	0.023	0.065	0.039	0.054	32	857
2	7.50	692	0.008	0.052	0.030	0.044	26	869
1	2.50	702	0.001	0.023	0.013	0.021	13	881
Flush Mount	110.00	250	1.760	1.362	0.909	0.415	90	314
QXW-636X6312XBF-EDIN	110.00	114	1.760	1.362	0.909	0.415	41	143
BXA-70063/6CF	100.00	51	1.454	0.395	0.490	0.185	8	64
Flush Mount	100.00	250	1.454	0.395	0.490	0.185	40	314
QS66512-2	90.00	333	1.178	-0.015	0.239	0.038	11	418
Flush Mount	90.00	250	1.178	-0.015	0.239	0.038	8	314

Site Number: 27741

Code: ANSI/TIA-222-G

© 2007 - 2018 by ATC IP LLC. All rights reserved.

Site Name: Round Hill CT, Greenwich, CT

Engineering Number: REV01

7/6/2018 10:30:42 AM

Customer: KGI

TMA2117F00V1-1	90.00	156	1.178	-0.015	0.239	0.038	5	196
GPS	30.00	1	0.131	0.069	0.033	0.066	0	1
		14,487	29.437	7.940	8.522	3.630	985	18,181

**Load Case (0.9 - 0.2Sds) \* DL + E EMAM**

**Seismic (Reduced DL) Equivalent Modal Analysis Method**

Segment	Height Above Base (ft)	Weight (lb)	a	b	c	Saz	Horizontal Force (lb)	Vertical Force (lb)
28	112.00	318	1.824	1.651	1.020	0.471	130	269
27	107.50	460	1.681	1.050	0.785	0.350	139	389
26	104.50	92	1.588	0.742	0.654	0.278	22	78
25	102.00	368	1.513	0.534	0.558	0.225	72	311
24	97.50	491	1.382	0.252	0.414	0.141	60	415
23	94.50	98	1.299	0.119	0.335	0.094	8	83
22	92.00	393	1.231	0.036	0.278	0.061	21	332
21	87.50	554	1.113	-0.062	0.195	0.013	6	468
20	84.50	111	1.038	-0.098	0.151	-0.010	-1	94
19	82.00	363	0.978	-0.115	0.121	-0.024	-7	306
18	77.50	460	0.873	-0.121	0.077	-0.037	-15	388
17	72.50	467	0.764	-0.104	0.044	-0.035	-14	395
16	67.50	474	0.663	-0.075	0.023	-0.020	-8	401
15	62.50	482	0.568	-0.041	0.011	0.003	1	407
14	57.50	489	0.481	-0.009	0.006	0.027	11	413
13	53.83	231	0.421	0.011	0.006	0.042	8	196
12	51.33	504	0.383	0.023	0.007	0.050	22	426
11	48.92	412	0.348	0.033	0.009	0.056	20	348
10	46.42	350	0.313	0.042	0.011	0.061	19	296
9	42.50	623	0.263	0.053	0.016	0.066	36	527
8	37.50	633	0.205	0.062	0.023	0.068	37	535
7	32.50	643	0.154	0.068	0.030	0.067	37	543
6	27.50	653	0.110	0.071	0.036	0.064	37	552
5	22.50	663	0.074	0.072	0.040	0.062	36	560
4	17.50	673	0.045	0.071	0.042	0.059	34	569
3	12.50	683	0.023	0.065	0.039	0.054	32	577
2	7.50	692	0.008	0.052	0.030	0.044	26	585
1	2.50	702	0.001	0.023	0.013	0.021	13	593
Flush Mount	110.00	250	1.760	1.362	0.909	0.415	90	211
QXW-636X6312XBF-EDIN	110.00	114	1.760	1.362	0.909	0.415	41	96
BXA-70063/6CF	100.00	51	1.454	0.395	0.490	0.185	8	43
Flush Mount	100.00	250	1.454	0.395	0.490	0.185	40	211
QS66512-2	90.00	333	1.178	-0.015	0.239	0.038	11	281
Flush Mount	90.00	250	1.178	-0.015	0.239	0.038	8	211
TMA2117F00V1-1	90.00	156	1.178	-0.015	0.239	0.038	5	132
GPS	30.00	1	0.131	0.069	0.033	0.066	0	1
		14,487	29.437	7.940	8.522	3.630	985	12,241

Site Number: 27741

Code: ANSI/TIA-222-G

© 2007 - 2018 by ATC IP LLC. All rights reserved.

Site Name: Round Hill CT, Greenwich, CT

Engineering Number: REV01

7/6/2018 10:30:42 AM

Customer: KGI

**Load Case (1.2 + 0.2Sds) \* DL + E EMAM**

**Seismic Equivalent Modal Analysis Method**

**Calculated Forces**

Seg Elev (ft)	Pu FY (-) (kips)	Vu FX (-) (kips)	Tu MY (ft-kips)	Mu MZ (ft-kips)	Mu MX (ft-kips)	Resultant Moment (ft-kips)	phi Pn (kips)	phi Vn (kips)	phi Tn (ft-kips)	phi Mn (ft-kips)	Total Deflect (in)	Rotation (deg)	Ratio
0.00	-17.30	-0.97	0.00	-77.65	0.00	77.65	2,009.33	1,004.66	3,370.24	1,687.62	0.00	0.00	0.055
5.00	-16.43	-0.95	0.00	-72.78	0.00	72.78	1,990.85	995.43	3,279.75	1,642.31	0.01	-0.02	0.053
10.00	-15.57	-0.92	0.00	-68.02	0.00	68.02	1,971.76	985.88	3,189.37	1,597.06	0.03	-0.03	0.050
15.00	-14.73	-0.89	0.00	-63.40	0.00	63.40	1,952.06	976.03	3,099.16	1,551.88	0.07	-0.05	0.048
20.00	-13.90	-0.86	0.00	-58.93	0.00	58.93	1,931.73	965.87	3,009.15	1,506.81	0.13	-0.06	0.046
25.00	-13.08	-0.83	0.00	-54.63	0.00	54.63	1,910.79	955.40	2,919.43	1,461.88	0.20	-0.08	0.044
30.00	-12.27	-0.79	0.00	-50.50	0.00	50.50	1,889.23	944.62	2,830.03	1,417.12	0.29	-0.09	0.042
35.00	-11.47	-0.76	0.00	-46.55	0.00	46.55	1,867.06	933.53	2,741.01	1,372.54	0.40	-0.11	0.040
40.00	-10.69	-0.72	0.00	-42.77	0.00	42.77	1,844.27	922.13	2,652.43	1,328.19	0.51	-0.12	0.038
45.00	-10.25	-0.70	0.00	-39.17	0.00	39.17	1,820.86	910.43	2,564.34	1,284.08	0.65	-0.13	0.036
47.84	-9.74	-0.68	0.00	-37.17	0.00	37.17	1,807.27	903.63	2,514.48	1,259.11	0.73	-0.14	0.035
50.00	-9.10	-0.66	0.00	-35.70	0.00	35.70	1,796.83	898.42	2,476.80	1,240.24	0.79	-0.15	0.034
52.66	-8.81	-0.65	0.00	-33.95	0.00	33.95	1,181.91	590.96	1,634.83	818.63	0.88	-0.15	0.049
55.00	-8.20	-0.64	0.00	-32.42	0.00	32.42	1,176.68	588.34	1,611.12	806.76	0.95	-0.16	0.047
60.00	-7.59	-0.64	0.00	-29.22	0.00	29.22	1,165.04	582.52	1,560.37	781.35	1.13	-0.18	0.044
65.00	-7.00	-0.65	0.00	-26.02	0.00	26.02	1,152.79	576.40	1,509.51	755.88	1.32	-0.19	0.040
70.00	-6.41	-0.66	0.00	-22.78	0.00	22.78	1,139.92	569.96	1,458.59	730.38	1.53	-0.20	0.037
75.00	-5.83	-0.68	0.00	-19.47	0.00	19.47	1,126.44	563.22	1,407.67	704.88	1.75	-0.22	0.033
80.00	-5.38	-0.68	0.00	-16.10	0.00	16.10	1,112.33	556.17	1,356.80	679.41	1.98	-0.23	0.029
84.00	-5.24	-0.68	0.00	-13.37	0.00	13.37	1,100.61	550.30	1,316.18	659.07	2.18	-0.24	0.025
84.00	-5.24	-0.68	0.00	-13.37	0.00	13.37	1,103.87	551.93	1,356.12	905.48	2.18	-0.24	0.020
85.00	-4.55	-0.67	0.00	-12.69	0.00	12.69	1,103.87	551.93	1,356.12	905.48	2.23	-0.24	0.018
90.00	-3.13	-0.62	0.00	-9.32	0.00	9.32	1,103.87	551.93	1,356.12	905.48	2.49	-0.25	0.013
94.00	-3.00	-0.62	0.00	-6.82	0.00	6.82	1,103.87	551.93	1,356.12	905.48	2.69	-0.25	0.010
94.00	-3.00	-0.62	0.00	-6.82	0.00	6.82	1,103.87	551.93	1,356.12	905.48	2.69	-0.25	0.010
95.00	-2.39	-0.55	0.00	-6.21	0.00	6.21	1,103.87	551.93	1,356.12	905.48	2.75	-0.25	0.009
100.00	-1.55	-0.43	0.00	-3.44	0.00	3.44	1,103.87	551.93	1,356.12	905.48	3.01	-0.25	0.005
104.00	-1.43	-0.41	0.00	-1.73	0.00	1.73	1,103.87	551.93	1,356.12	905.48	3.22	-0.25	0.003
104.00	-1.43	-0.41	0.00	-1.73	0.00	1.73	1,103.87	551.93	1,356.12	905.48	3.22	-0.25	0.003
105.00	-0.85	-0.26	0.00	-1.32	0.00	1.32	1,103.87	551.93	1,356.12	905.48	3.28	-0.25	0.002
110.00	0.00	0.00	0.00	0.00	0.00	0.00	1,103.87	551.93	1,356.12	905.48	3.55	-0.26	0.000
114.00	0.00	0.00	0.00	0.00	0.00	0.00	1,103.87	551.93	1,356.12	905.48	3.76	-0.26	0.000

Site Number: 27741

Code: ANSI/TIA-222-G

© 2007 - 2018 by ATC IP LLC. All rights reserved.

Site Name: Round Hill CT, Greenwich, CT

Engineering Number: REV01

7/6/2018 10:30:42 AM

Customer: KGI

**Load Case (0.9 - 0.2Sds) \* DL + E EMAM**

**Seismic (Reduced DL) Equivalent Modal Analysis Method**

**Calculated Forces**

Seg Elev (ft)	Pu FY (-) (kips)	Vu FX (-) (kips)	Tu MY (ft-kips)	Mu MZ (ft-kips)	Mu MX (ft-kips)	Resultant Moment (ft-kips)	phi Pn (kips)	phi Vn (kips)	phi Tn (ft-kips)	phi Mn (ft-kips)	Total Deflect (in)	Rotation (deg)	Ratio
0.00	-11.65	-0.97	0.00	-77.02	0.00	77.02	2,009.33	1,004.66	3,370.24	1,687.62	0.00	0.00	0.051
5.00	-11.06	-0.95	0.00	-72.15	0.00	72.15	1,990.85	995.43	3,279.75	1,642.31	0.01	-0.02	0.049
10.00	-10.49	-0.92	0.00	-67.40	0.00	67.40	1,971.76	985.88	3,189.37	1,597.06	0.03	-0.03	0.048
15.00	-9.92	-0.89	0.00	-62.80	0.00	62.80	1,952.06	976.03	3,099.16	1,551.88	0.07	-0.05	0.046
20.00	-9.36	-0.85	0.00	-58.36	0.00	58.36	1,931.73	965.87	3,009.15	1,506.81	0.13	-0.06	0.044
25.00	-8.80	-0.82	0.00	-54.08	0.00	54.08	1,910.79	955.40	2,919.43	1,461.88	0.20	-0.08	0.042
30.00	-8.26	-0.78	0.00	-49.99	0.00	49.99	1,889.23	944.62	2,830.03	1,417.12	0.29	-0.09	0.040
35.00	-7.73	-0.75	0.00	-46.07	0.00	46.07	1,867.06	933.53	2,741.01	1,372.54	0.39	-0.10	0.038
40.00	-7.20	-0.71	0.00	-42.33	0.00	42.33	1,844.27	922.13	2,652.43	1,328.19	0.51	-0.12	0.036
45.00	-6.90	-0.69	0.00	-38.77	0.00	38.77	1,820.86	910.43	2,564.34	1,284.08	0.64	-0.13	0.034
47.84	-6.55	-0.67	0.00	-36.79	0.00	36.79	1,807.27	903.63	2,514.48	1,259.11	0.72	-0.14	0.033
50.00	-6.13	-0.65	0.00	-35.34	0.00	35.34	1,796.83	898.42	2,476.80	1,240.24	0.78	-0.14	0.032
52.66	-5.93	-0.64	0.00	-33.60	0.00	33.60	1,181.91	590.96	1,634.83	818.63	0.87	-0.15	0.046
55.00	-5.52	-0.63	0.00	-32.10	0.00	32.10	1,176.68	588.34	1,611.12	806.76	0.94	-0.16	0.044
60.00	-5.11	-0.63	0.00	-28.93	0.00	28.93	1,165.04	582.52	1,560.37	781.35	1.12	-0.17	0.041
65.00	-4.71	-0.64	0.00	-25.78	0.00	25.78	1,152.79	576.40	1,509.51	755.88	1.31	-0.19	0.038
70.00	-4.32	-0.65	0.00	-22.58	0.00	22.58	1,139.92	569.96	1,458.59	730.38	1.51	-0.20	0.035
75.00	-3.93	-0.67	0.00	-19.31	0.00	19.31	1,126.44	563.22	1,407.67	704.88	1.73	-0.22	0.031
80.00	-3.62	-0.67	0.00	-15.97	0.00	15.97	1,112.33	556.17	1,356.80	679.41	1.96	-0.23	0.027
84.00	-3.53	-0.68	0.00	-13.27	0.00	13.27	1,100.61	550.30	1,316.18	659.07	2.16	-0.24	0.023
84.00	-3.53	-0.68	0.00	-13.27	0.00	13.27	1,103.87	551.93	1,356.12	905.48	2.16	-0.24	0.018
85.00	-3.06	-0.67	0.00	-12.60	0.00	12.60	1,103.87	551.93	1,356.12	905.48	2.21	-0.24	0.017
90.00	-2.10	-0.62	0.00	-9.26	0.00	9.26	1,103.87	551.93	1,356.12	905.48	2.46	-0.24	0.012
94.00	-2.02	-0.61	0.00	-6.78	0.00	6.78	1,103.87	551.93	1,356.12	905.48	2.67	-0.25	0.009
94.00	-2.02	-0.61	0.00	-6.78	0.00	6.78	1,103.87	551.93	1,356.12	905.48	2.67	-0.25	0.009
95.00	-1.61	-0.55	0.00	-6.17	0.00	6.17	1,103.87	551.93	1,356.12	905.48	2.72	-0.25	0.008
100.00	-1.04	-0.43	0.00	-3.43	0.00	3.43	1,103.87	551.93	1,356.12	905.48	2.98	-0.25	0.005
104.00	-0.96	-0.40	0.00	-1.72	0.00	1.72	1,103.87	551.93	1,356.12	905.48	3.19	-0.25	0.003
104.00	-0.96	-0.40	0.00	-1.72	0.00	1.72	1,103.87	551.93	1,356.12	905.48	3.19	-0.25	0.003
105.00	-0.58	-0.26	0.00	-1.32	0.00	1.32	1,103.87	551.93	1,356.12	905.48	3.25	-0.25	0.002
110.00	0.00	0.00	0.00	0.00	0.00	0.00	1,103.87	551.93	1,356.12	905.48	3.51	-0.25	0.000
114.00	0.00	0.00	0.00	0.00	0.00	0.00	1,103.87	551.93	1,356.12	905.48	3.72	-0.25	0.000

Site Number: 27741

Code: ANSI/TIA-222-G

© 2007 - 2018 by ATC IP LLC. All rights reserved.

Site Name: Round Hill CT, Greenwich, CT

Engineering Number: REV01

7/6/2018 10:30:42 AM

Customer: KGI

**Analysis Summary**

Load Case	Reactions						Max Usage	
	Shear FX (kips)	Shear FZ (kips)	Axial FY (kips)	Moment MX (ft-kips)	Moment MY (ft-kips)	Moment MZ (ft-kips)	Elev (ft)	Interaction Ratio
1.2D + 1.6W	7.18	0.00	17.38	0.00	0.00	427.04	0.00	0.26
0.9D + 1.6W	7.18	0.00	13.03	0.00	0.00	424.68	0.00	0.26
1.2D + 1.0Di + 1.0Wi	2.45	0.00	29.18	0.00	0.00	157.24	0.00	0.11
(1.2 + 0.2Sds) * DL + E ELFM	0.97	0.00	17.30	0.00	0.00	79.29	0.00	0.06
(1.2 + 0.2Sds) * DL + E EMAM	0.97	0.00	17.30	0.00	0.00	77.65	0.00	0.05
(0.9 - 0.2Sds) * DL + E ELFM	0.97	0.00	11.65	0.00	0.00	78.68	0.00	0.05
(0.9 - 0.2Sds) * DL + E EMAM	0.97	0.00	11.65	0.00	0.00	77.02	0.00	0.05
1.0D + 1.0W	1.61	0.00	14.49	0.00	0.00	95.70	0.00	0.06

Site Number: **27741**  
 Site Name: **Round Hill CT**  
 Job Number: **REV01**  
 Engineer: **CRB**  
 Date: **7/6/2018**

**Base Plate and Bolt Analysis**

Moment: **427.0 k-ft**  
 Shear/Leg: **7.2 k**  
 Compression/Leg: **17.4 k**

TIA-222 Code Revision (F/G): **G**  
 Anchor Bolt Arrangement: **Round**  
 Monopole Shaft Diameter (Across Flats): **41.0 in**  
 Lower Monopole Thickness: **0.250 in**  
 # of Sides of Pole: **18**  
 Monopole Shaft Yield Strength: **65 ksi**  
 Baseplate Diameter / Length: **47.50**  
 Base Plate Thickness: **2.00 in**  
 Base Plate Yield Strength: **60 ksi**  
 Baseplate Detail Type: **D**  
 Include Plate Thickness Beyond Bolt Circle: **Y**  
 Stress Increase: **1.00**  
 Fillet Weld Size: **0.375 in**  
 Weld Type (CJP or F/F): **CJP**  
 Weld Strength: **70 ksi**

**Anchor Bolts**

Anchor Bolt Yield Strength: **75 ksi**  
 Anchor Bolt Ultimate Strength: **100 ksi**  
 Anchor Bolt Diameter: **2.25 in**  
 Anchor Bolt Circle: **49.00 in**  
 # of Anchor Bolts: **4**  
 Minimum Anchor Bolt Separation: **6.00 in**  
 Additional Anchor Bolts Installed: **N**

Failure Mode:	Effective Width (in)	Baseplate Flexural Capacity				Baseplate Shear Capacity			
		Moment (k-in)	S/Z (in <sup>3</sup> )	Capacity (k-in)	Usage	Shear (k)	Area (in <sup>2</sup> )	Capacity (k)	Usage
AA	30.83	435.3	30.8	1665.0	0.26	108.8	61.7	1998.0	0.05
AB	30.83	435.3	30.8	1665.0	0.26	108.8	61.7	1998.0	0.05
BA	29.84	400.9	29.8	1611.4	0.25	108.8	59.7	1933.7	0.06
BB	29.84	400.9	29.8	1611.4	0.25	108.8	59.7	1933.7	0.06

**Anchor Bolt Capacity**

Area of Bolt: **3.25 in<sup>2</sup>**  
 Inertia of Bolt: **0.84 in<sup>4</sup>**  
 Total Bolt Inertia: **3902.2 in<sup>4</sup>**  
 Maximum Bolt Tension: **100.1 k**  
 Maximum Bolt Compression: **108.8 k**  
 Bolt Shear: **1.8 k**  
 Tensile Bolt Capacity: **259.8 k**  
 Compressive Bolt Capacity: **259.8 k**  
 Shear Bolt Capacity: **140.3 k**  
 Interaction Equation: **0.44 Result: OK**

**Base Weld Capacity**

Force / Weld: **3.1 k/in**  
 Weld Capacity: **23.8 k/in**  
 Interaction Equation: **0.13 Result: OK**

SES Base Plate Design Moment: **435.3 k-in**  
 Design Stress: **13.5 ksi**  
 SES Base Plate Allowable Stress / Moment Capacity: **1738.9 ksi / k-in**  
 Usage: **0.25**

Moment Factor: **1.00**  
 Length Factor: **0.96**

Site Name: Round Hill CT  
 Site Number: 27741  
 Engineering Number: REV01  
 Engineer: C. Bateman  
 Date: 07/06/18  
 Tower Type: MP

Program Last Updated: 5/13/2014

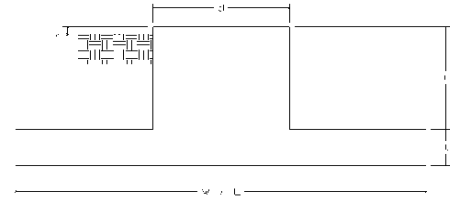

**Design Loads (Factored) - Analysis per TIA-222-G Standards**

Design / Analysis / Mapping:	Analysis		
Compression/Leg:	0.0 k	Concrete Strength ( $f'_c$ ):	4000 psi
Uplift/Leg:	0.0 k	Pad Tension Steel Depth:	32.00 in
Total Shear:	7.2 k	$\phi_{\text{Shear}}$ :	0.75
Moment:	427.0 k-ft	$\phi_{\text{Flexure / Tension}}$ :	0.90
Tower + Appurtenance Weight:	17.4 k	$\phi_{\text{Compression}}$ :	0.65
Depth to Base of Foundation (l + t - h):	5.00 ft	$\beta$ :	0.85
Diameter of Pier (d):	6.00 ft	Bottom Pad Rebar Size #:	8
Height of Pier above Ground (h):	1.00	# of Bottom Pad Rebar:	16
Width of Pad (W):	15.00 ft	Pad Bottom Steel Area:	12.64 in <sup>2</sup>
Length of Pad (L):	15.00 ft	Pad Steel $F_y$ :	60000 psi
Thickness of Pad (t):	3.00 ft	Top Pad Rebar Size #:	8
Tower Leg Center to Center:	0.00 ft	# of Top Pad Rebar:	16
Number of Tower Legs:	1.0 (1 if MP or GT)	Pad Top Steel Area:	12.64 in <sup>2</sup>
Tower Center from Mat Center:	0.00 ft	Pier Rebar Size #:	8
Depth Below Ground Surface to Water Table:	99.00 ft	Pier Steel Area (Single Bar):	0.79 in <sup>2</sup>
Unit Weight of Concrete:	150.0 pcf	# of Pier Rebar:	22
Unit Weight of Soil Above Water Table:	100.0 pcf	Pier Steel $F_y$ :	60000 psi
Unit Weight of Water:	62.4 pcf	Pier Cage Diameter:	64.0 in
Unit Weight of Soil Below Water Table:	50.0 pcf	Rebar Strain Limit:	0.008
Friction Angle of Uplift:	0.0 Degrees	Steel Elastic Modulus:	29000 ksi
Ultimate Coefficient of Shear Friction:	0.35	Tie Rebar Size #:	4
Ultimate Compressive Bearing Pressure:	12000.0 psf	Tie Steel Area (Single Bar):	0.20 in <sup>2</sup>
Ultimate Passive Pressure on Pad Face:	0.0 psf	Tie Spacing:	6 in
$\phi_{\text{Soil and Concrete Weight}}$ :	0.9	Tie Steel $F_y$ :	60000 psi
$\phi_{\text{Soil}}$ :	0.75		

**Overturning Moment Usage**

Design OTM:	470.1 k-ft
OTM Resistance:	1132.7 k-ft
Design OTM / OTM Resistance:	0.42 Result: OK

**Soil Bearing Pressure Usage**

Net Bearing Pressure:	1542 psf
Factored Nominal Bearing Pressure:	9000 psf
Net Bearing Pressure/Factored Nominal Bearing Pressure:	0.17 Result: OK
Load Direction Controlling Design Bearing Pressure:	Diagonal to Pad Edge

**Sliding Factor of Safety**

Total Factored Sliding Resistance:	44.0 k
Sliding Design / Sliding Resistance:	0.16 Result: OK

## One Way Shear, Flexural Capacity, and Punching Shear

Factored One Way Shear ( $V_u$ ):	28.8 k
One Way Shear Capacity ( $\phi V_c$ ):	359.9 k - ACI11.3.1.1
$V_u / \phi V_c$ :	0.08 Result: OK
Load Direction Controlling Shear Capacity:	Diagonal to Pad Edge
Lower Steel Pad Factored Moment ( $M_u$ ):	164.8 k-ft
Lower Steel Pad Moment Capacity ( $\phi M_n$ ):	1736.8 k-ft - ACI10.3
$M_u / \phi M_n$ :	0.09 Result: OK
Load Direction Controlling Flexural Capacity:	Diagonal to Pad Edge
Upper Steel Pad Factored Moment ( $M_u$ ):	76.8 k-ft
Upper Steel Pad Moment Capacity ( $\phi M_n$ ):	1790.2 k-ft
$M_u / \phi M_n$ :	0.04 Result: OK
Lower Pad Flexural Reinforcement Ratio:	0.0022 OK - Minimum Reinforcement Ratio Met - ACI10.5.1
Upper Pad Flexural Reinforcement Ratio:	0.0022 OK - Minimum Reinforcement Ratio Met - ACI10.5.1
Lower Pad Reinforcement Spacing:	11 in - Pad Reinforcing Spacing OK - ACI7.12.2.2 & 10.5.4
Upper Pad Reinforcement Spacing:	11 in - Pad Reinforcing Spacing OK - ACI7.12.2.2 & 10.5.4
Factored Punching Shear ( $V_u$ ):	0.0 k
Nominal Punching Shear Capacity ( $\phi_c V_n$ ):	1983.7 k - ACI11.12.2.1
$V_u / \phi V_c$ :	0.00 Result: OK
Factored Moment in Pier ( $M_u$ ):	448.6 k-ft
Pier Moment Capacity ( $\phi M_n$ ):	2451.3 k-ft
$M_u / \phi M_n$ :	0.18 Result: OK
Factored Shear in Pier ( $V_u$ ):	7.2 k
Pier Shear Capacity ( $\phi V_n$ ):	386.3 k
$V_u / \phi V_c$ :	0.02 Result: OK
Pier Shear Reinforcement Ratio:	0.0005 No Ties Necessary for Shear - ACI11.5.6.1
Factored Tension in Pier ( $T_u$ ):	0.0 k
Pier Tension Capacity ( $\phi T_n$ ):	938.5 k
$T_u / \phi T_n$ :	0.00 Result: OK
Factored Compression in Pier ( $P_u$ ):	0.0 k
Pier Compression Capacity ( $\phi P_n$ ):	7167.7 k - ACI10.3.6.2
$P_u / \phi P_n$ :	0.00 Result: OK
Pier Compression Reinforcement Ratio:	0.004 NG - Increase Pier Steel - ACI10.9.1 & 10.8.4
$M_u / \phi_B M_n + T_u / \phi_T T_n$ :	0.18 Result: OK

Nominal and Design Moment Capacity and Factored Design Loads

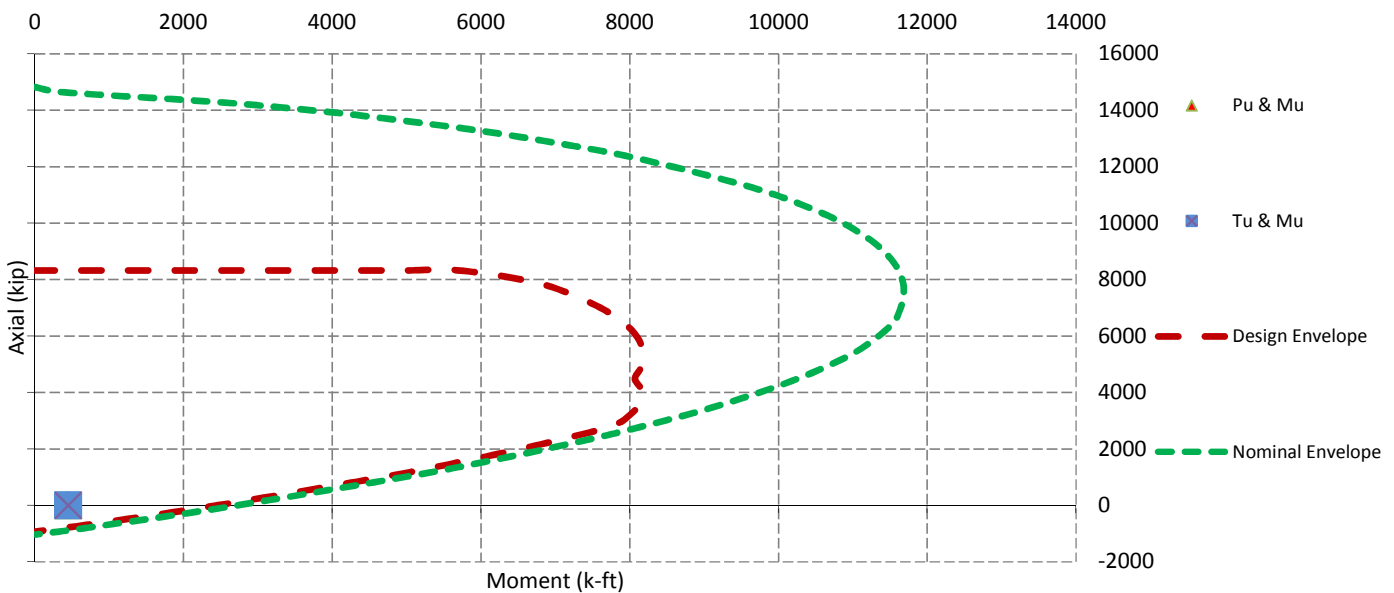





# Radio Frequency Emissions Analysis Report

AT&T Existing Facility

**Site ID: CT2303**

FA#: 10050955

Greenwich Round Hill Rd  
395 Round Hill Road  
Greenwich, CT 6831

**June 13, 2018**

**Centerline Communications Project Number: 950012-118**

Site Compliance Summary	
Compliance Status:	<b>COMPLIANT</b>
Site total MPE% of FCC general population allowable limit:	<b>8.64 %</b>



June 13, 2018

AT&T Mobility – New England  
Attn: John Benedetto, RF Manager  
550 Cochituate Road  
Suite 550 – 13&14  
Framingham, MA 06040

### Emissions Analysis for Site: **CT2303 – Greenwich Round Hill Rd**

Centerline Communications, LLC (“Centerline”) was directed to analyze the proposed AT&T facility located at **395 Round Hill Road, Greenwich, CT**, for the purpose of determining whether the emissions from the Proposed AT&T Antenna Installation located on this property are within specified federal limits.

All information used in this report was analyzed as a percentage of current Maximum Permissible Exposure (% MPE) as listed in the FCC OET Bulletin 65 Edition 97-01 and ANSI/IEEE Std C95.1. The FCC regulates Maximum Permissible Exposure in units of microwatts per square centimeter ( $\mu\text{W}/\text{cm}^2$ ). The number of  $\mu\text{W}/\text{cm}^2$  calculated at each sample point is called the power density. The exposure limit for power density varies depending upon the frequencies being utilized. Wireless Carriers and Paging Services use different frequency bands each with different exposure limits, therefore it is necessary to report results and limits in terms of percent MPE rather than power density.

All results were compared to the FCC (Federal Communications Commission) radio frequency exposure rules, 47 CFR 1.1307(b)(1) – (b)(3), to determine compliance with the Maximum Permissible Exposure (MPE) limits for General Population/Uncontrolled environments as defined below.

General population/uncontrolled exposure limits apply to situations in which the general population may be exposed or in which persons who are exposed as a consequence of their employment may not be made fully aware of the potential for exposure or cannot exercise control over their exposure. Therefore, members of the general population would always be considered under this category when exposure is not employment related, for example, in the case of a telecommunications tower that exposes persons in a nearby residential area.

Population exposure to radio frequencies is regulated and enforced in units of microwatts per square centimeter ( $\mu\text{W}/\text{cm}^2$ ). The general population exposure limits for the 700 and 850 MHz Bands are approximately  $467 \mu\text{W}/\text{cm}^2$  and  $567 \mu\text{W}/\text{cm}^2$  respectively. The general population exposure limit for the 1900 MHz (PCS), 2100 MHz (AWS) and 2300 MHz (WCS) bands is  $1000 \mu\text{W}/\text{cm}^2$ . Because each carrier will be using different frequency bands, and each frequency band has different exposure limits, it is necessary to report percent of MPE rather than power density.



Occupational/controlled exposure limits apply to situations in which persons are exposed as a consequence of their employment and in which those persons who are exposed have been made fully aware of the potential for exposure and can exercise control over their exposure. Occupational/controlled exposure limits also apply where exposure is of a transient nature as a result of incidental passage through a location where exposure levels may be above general population/uncontrolled limits (see below), as long as the exposed person has been made fully aware of the potential for exposure and can exercise control over his or her exposure by leaving the area or by some other appropriate means.

Additional details can be found in FCC OET 65.



## CALCULATIONS

Calculations were performed for the proposed AT&T Wireless antenna facility located at **395 Round Hill Road, Greenwich, CT**, using the equipment information listed below. All calculations were performed per the specifications under FCC OET 65. Since AT&T is proposing highly focused directional panel antennas, which project most of the emitted energy out toward the horizon, all calculations were performed assuming a lobe representing the maximum gain of the antenna per the antenna manufactures supplied specifications, minus 10 dB, was focused at the base of the tower. For this report the sample point is the top of a 6-foot person standing at the base of the tower.

Per FCC OET Bulletin No. 65 - Edition 97-01 recommendations to achieve the maximum anticipated value at each sample point, all power levels emitting from the proposed antenna installation are increased by a factor of 2.56 to account for possible in-phase reflections from the surrounding environment. All power values expressed and analyzed are maximum power levels expected to be used on all radios.

All emissions values for additional carriers were taken from the Connecticut Siting Council (CSC) active MPE database. Values in this database are provided by the individual carriers themselves

For each sector the following channel counts, frequency bands and power levels were utilized as shown in *Table 1*:

Technology	Frequency Band	Channel Count	Transmit Power per Channel (W)
UMTS	850 MHz	2	30
LTE	1900 MHz (PCS)	2	40
LTE	2300 MHz (WCS)	4	30
LTE	700 MHz	2	40

*Table 1: Channel Data Table*



The following antennas listed in *Table 2* were used in the modeling for transmission in the 700 MHz, 850 MHz, 1900 MHz (PCS) and 2300 MHz (WCS) frequency bands. This is based on feedback from the carrier with regards to anticipated antenna selection. Maximum gain values for all antennas are listed in the Inventory and Power Data table below. The maximum gain of the antenna per the antenna manufactures supplied specifications, minus 10 dB, was used for all calculations. This value is a very conservative estimate as gain reductions for these particular antennas are typically much higher in this direction.

Sector	Antenna Number	Antenna Make / Model	Antenna Centerline (ft)
A	1	Quintel QS66512-2	88
B	1	Quintel QS66512-2	88
C	1	Quintel QS66512-2	88

*Table 2: Antenna Data*

All calculations were done with respect to uncontrolled / general population threshold limits.



## RESULTS

Per the calculations completed for the proposed AT&T configurations *Table 3* shows resulting emissions power levels and percentages of the FCC's allowable general population limit.

Antenna ID	Antenna Make / Model	Frequency Bands	Antenna Gain (dBd)	Channel Count	Total TX Power (W)	ERP (W)	MPE %
Antenna A1	Quintel QS66512-2	850 MHz / 1900 MHz (PCS) / 2300 MHz (WCS) / 700 MHz	11.35 / 13.85 / 14.85/10.85	10	340	7,398.89	4.88
Sector A Composite MPE%							<b>4.88</b>
Antenna B1	Quintel QS66512-2	850 MHz / 1900 MHz (PCS) / 2300 MHz (WCS) / 700 MHz	11.35 / 13.85 / 14.85 / 10.85	10	340	7,398.89	4.88
Sector B Composite MPE%							<b>4.88</b>
Antenna C1	Quintel QS66512-2	850 MHz / 1900 MHz (PCS) / 2300 MHz (WCS) / 700 MHz	11.35 / 13.85 / 14.85 / 10.85	10	340	7,398.89	4.88
Sector C Composite MPE%							<b>4.88</b>

*Table 3: AT&T Emissions Levels*



The Following table (*table 4*) shows all additional carriers on site and their MPE% as recorded in the CSC active MPE database for this facility along with the newly calculated maximum AT&T MPE contributions per this report. FCC OET 65 specifies that for carriers utilizing directional antennas that the highest recorded sector value be used for composite site MPE values due to their greatly reduced emissions contributions in the directions of the adjacent sectors. For this site, all three sectors have the same configuration yielding the same results on all three sectors. *Table 5* below shows a summary for each AT&T Sector as well as the composite MPE value for the site.

<b>Site Composite MPE%</b>	
<b>Carrier</b>	<b>MPE%</b>
AT&T – Max Sector Value	<b>4.88 %</b>
Verizon Wireless	3.76 %
<b>Site Total MPE %:</b>	<b>8.64 %</b>

*Table 4: All Carrier MPE Contributions*

AT&T Sector A Total:	4.88 %
AT&T Sector B Total:	4.88 %
AT&T Sector C Total:	4.88 %
<b>Site Total:</b>	<b>8.64 %</b>

*Table 5: Site MPE Summary*



FCC OET 65 specifies that for carriers utilizing directional antennas that the highest recorded sector value be used for composite site MPE values due to their greatly reduced emissions contributions in the directions of the adjacent sectors. *Table 6* below details a breakdown by frequency band and technology for the MPE power values for the maximum calculated AT&T sector(s). For this site, all three sectors have the same configuration yielding the same results on all three sectors.

AT&T _ Frequency Band / Technology Max Power Values (Per Sector)	# Channels	Watts ERP (Per Channel)	Height (feet)	Total Power Density ( $\mu\text{W}/\text{cm}^2$ )	Frequency (MHz)	Allowable MPE ( $\mu\text{W}/\text{cm}^2$ )	Calculated % MPE
AT&T 850 MHz UMTS	2	409.37	88	4.38	850 MHz	567	0.77%
AT&T 1900 MHz (PCS) LTE	2	970.64	88	10.38	1900 MHz (PCS)	1000	1.04%
AT&T 2300 MHz (WCS) LTE	4	916.48	88	19.60	2300 MHz (WCS)	1000	1.96%
AT&T 700 MHz LTE	2	486.47	88	5.20	700 MHz	467	1.11%
						<b>Total:</b>	<b>4.88%</b>

*Table 6: AT&T Maximum Sector MPE Power Values*





## Summary

All calculations performed for this analysis yielded results that were **within** the allowable limits for general population exposure to RF Emissions.

The anticipated maximum composite contributions from the AT&T facility as well as the site composite emissions value with regards to compliance with FCC's allowable limits for general population exposure to RF Emissions are shown here:

AT&T Sector	Power Density Value (%)
Sector A:	4.88 %
Sector B:	4.88 %
Sector C:	4.88 %
AT&T Maximum Total (per sector):	4.88 %
Site Total:	8.64 %
Site Compliance Status:	<b>COMPLIANT</b>

The anticipated composite MPE value for this site assuming all carriers present is **8.64 %** of the allowable FCC established general population limit sampled at the ground level. This is based upon values listed in the Connecticut Siting Council database for existing carrier emissions.

FCC guidelines state that if a site is found to be out of compliance (over allowable thresholds), that carriers over a 5% contribution to the composite value will require measures to bring the site into compliance. For this facility, the composite values calculated were well within the allowable 100% threshold standard per the federal government.

A handwritten signature in black ink, appearing to read 'Scott Heffernan', is positioned above the printed name.

Scott Heffernan  
RF Engineering Director  
**Centerline Communications, LLC**  
95 Ryan Drive, Suite 1  
Raynham, MA 02767

ADMINISTRATIVE INFORMATION

PARCEL NUMBER 10-3689
Parent Parcel Number 10-4013
Property Address ROUND HILL ROAD 0395
Neighborhood 2800 PARKWAY NORTH
Property Class 270 Telecommunications

OWNERSHIP

ROUND HILL COMMUNITY CHURCH INC
MR TIMOTHY PARKS-VERIZON WIRELESS
99 EAST RIVER DR-9TH FLOOR
EAST HARTFORD, CT 06108
LOT NO PT 27 ROUND HILL RD E66

Tax ID 098

TRANSFER OF OWNERSHIP

Printed 06/19/2018 Card No. 1 of 1

Date

COMMERCIAL

TAXING DISTRICT INFORMATION

Jurisdiction 57 Greenwich, CT
Area 001
Corporation 057
District 10
Section & Plat 183
Routing Number 7424E0066

VALUATION RECORD

Table with columns: Assessment Year, Reason for Change, 2010 Reval, 2012 List, 2013 List, 2015 Prelim, 2015 Final, 2016 List, 2017 List. Rows include VALUATION and Market data.

Site Description
Topography:

Public Utilities:
Electric

Street or Road:

Neighborhood:

Zoning: RA-4 Single Family 4
1 Primary Commercial

Legal Acres: 0.2296

LAND DATA AND CALCULATIONS

Table with columns: Rating, Measured, Table, Prod. Factor, Base Rate, Adjusted Rate, Extended Value, Influence Factor, Value. Includes Land Type and various calculation metrics.

DBA: Cell Tower Site. Two 115' monopoles and supporting facilities.
Tenant: Verizon. Users: Verizon PCS, Cingular, T-Mobil, Sprint-Nextel.
GEN: Equip strg bldg partitioned for indiv users and common area.
SPLT: Split from 10-4013 for cellular tower site containing 10,000 sf per P&Z FSP # 2715Site Plan. RCS - 10/7/10.

Supplemental Cards

TRUE TAX VALUE 328100

Permit Number FilingDate Est. Cost Field Visit
Type Est. SqFt

Supplemental Cards
TOTAL LAND VALUE

328100



This map was produced from the Town of Greenwich Geographic Information System. The Town expressly disclaims any liability that may result from the use of this map. Aerial: 4/2/08. Data: 10/1/08. Map: 7/20/09. Copyright © 2005 by the Town of Greenwich.

# TOWN OF GREENWICH TAX MAP 098 VOL 2



**PROJECT INFORMATION**

SCOPE OF WORK: ITEMS TO BE MOUNTED INSIDE EXISTING FLAGPOLE:

- NEW AT&T ANTENNA: (QS66512-2) (TYP. OF 1 PER SECTOR, TOTAL OF 3)
- NEW AT&T TMAs: (TMA2117F00V1-1) (TYP. OF 2 PER SECTOR, TOTAL OF 6)
- NEW AT&T 7/8" COAX CABLES (TYP. OF 2 PER SECTOR, TOTAL OF 6)

ITEMS TO BE MOUNTED INSIDE EXISTING EQUIPMENT SHELTER:

- UPGRADE DUL TO 5216 IN EXISTING LTE RACK
- ADD XMU IN EXISTING LTE RACK.
- DECOM GSM 850 & RXAIT.
- NEW AT&T RRUS: RRUS-12 (PCS) (TYP. OF 1 PER SECTOR, TOTAL OF 3)
- NEW AT&T RRUS: RRUS-32 (WCS) (TYP. OF 1 PER SECTOR, TOTAL OF 3)
- NEW AT&T SURGE ARRESTOR: (APTDC-BDFDM-DB) (TOTAL OF 8)
- NEW AT&T DIPLEXER: (QBC0007F1V51-1) (TYP OF 4 PER SECTOR, TOTAL OF 12).

ITEMS TO REMAIN:

- (3) RRU'S & (6) 7/8" COAX CABLES.

SQUID ALARMING (NOT TO BE DAISY CHAINED):

- THE 1ST SQUID INSTALLED WILL BE ALARMED TO THE LOWEST BAND (OR FIRST INSTALLED RRH/RRU ON THE ALPHA SECTOR, IN THE EVENT THE ALARM CABLE CANNOT BE CONNECTED TO ALPHA IT WILL BE ACCEPTABLE TO ALARM TO THE CLOSEST PHYSICAL SECTOR ON AN EXCEPTION BASIS.
- 2ND SQUID INSTALLED WILL BE ALARMED TO THE LOWEST BAND (OR FIRST INSTALLED) RRH/RRU ON THE BETA SECTOR.
- 3RD SQUID INSTALLED WILL BE ALARMED TO THE LOWEST BAND (OR FIRST INSTALLED) RRH/RRU ON THE GAMMA SECTOR.

SITE ADDRESS: 395 ROUND HILL ROAD  
GREENWICH, CT 06831

PAGE ID: MRCTB022576

LATITUDE: 41.0951081° N 41° 5' 42.39" N  
LONGITUDE: 73.6641931° W 73° 39' 51.09" W

TYPE OF SITE: FLAGPOLE/INDOOR EQUIPMENT

STRUCTURE HEIGHT: 115'-0"± A.G.L  
RAD CENTER: 90'-0"± A.G.L

CURRENT USE: TELECOMMUNICATIONS FACILITY  
PROPOSED USE: TELECOMMUNICATIONS FACILITY



**SITE NUMBER: CT2303**

**SITE NAME: GREENWICH ROUND HILL ROAD**

**FA CODE: 2051A0ACWC**

**PROJECT: LTE 2C 2018 UPGRADE**

**DRAWING INDEX**

SHEET NO.	DESCRIPTION	REV.
T-1	TITLE SHEET	1
GN-1	GENERAL NOTES 	1
A-1	COMPOUND & EQUIPMENT PLAN	1
A-2	ANTENNA LAYOUT & ELEVATION	1
A-3	DETAILS	1
G-1	GROUNDING DETAILS	1
RF-1	RF PLUMBING DIAGRAM	1

**VICINITY MAP**

**DIRECTIONS TO SITE:**

START OUT GOING NORTHEAST ON ENTERPRISE DR TOWARD CAPITOL BLVD. TURN LEFT ONTO CAPITOL BLVD. TURN LEFT ONTO WEST ST. MERGE ONTO I-91 S VIA THE RAMP ON THE LEFT TOWARD NEW HAVEN. MERGE ONTO CT-15 S VIA EXIT 17. TAKE EXIT 29 TOWARD LAKE AVE. KEEP LEFT AT THE FORK TO GO ON OLD MILL RD. TURN RIGHT ONTO ROUND HILL RD. 395 ROUND HILL RD IS ON THE RIGHT.



**GENERAL NOTES**

1. THIS DOCUMENT IS THE CREATION, DESIGN, PROPERTY AND COPYRIGHTED WORK OF AT&T. ANY DUPLICATION OR USE WITHOUT EXPRESS WRITTEN CONSENT IS STRICTLY PROHIBITED. DUPLICATION AND USE BY GOVERNMENT AGENCIES FOR THE PURPOSES OF CONDUCTING THEIR LAWFULLY AUTHORIZED REGULATORY AND ADMINISTRATIVE FUNCTIONS IS SPECIFICALLY ALLOWED.
2. THE FACILITY IS AN UNMANNED PRIVATE AND SECURED EQUIPMENT INSTALLATION. IT IS ONLY ACCESSED BY TRAINED TECHNICIANS FOR PERIODIC ROUTINE MAINTENANCE AND THEREFORE DOES NOT REQUIRE ANY WATER OR SANITARY SEWER SERVICE. THE FACILITY IS NOT GOVERNED BY REGULATIONS REQUIRING PUBLIC ACCESS PER ADA REQUIREMENTS.
3. CONTRACTOR SHALL VERIFY ALL PLANS AND EXISTING DIMENSIONS AND CONDITIONS ON THE JOB SITE AND SHALL IMMEDIATELY NOTIFY THE AT&T MOBILITY REPRESENTATIVE IN WRITING OF DISCREPANCIES BEFORE PROCEEDING WITH THE WORK OR BE RESPONSIBLE FOR SAME.
4. CONSTRUCTION DRAWINGS ARE VALID FOR SIX MONTHS AFTER ENGINEER OF RECORD'S STAMPED AND SIGNED SUBMITTAL DATE LISTED HEREIN.

**72 HOURS**



**CALL BEFORE YOU DIG**

CALL TOLL FREE 1-800-922-4455

OR CALL 811

**UNDERGROUND SERVICE ALERT**

**HGD HUDSON Design Group LLC**  
45 BEECHWOOD DRIVE NORTH ANDOVER, MA 01845  
TEL: (978) 557-5553 FAX: (978) 336-5586

**CENTERLINE COMMUNICATIONS**  
95 RYAN DRIVE RAYNHAM, MA 02767

**SITE NUMBER: CT2303**  
**SITE NAME: GREENWICH ROUND HILL ROAD**  
395 ROUND HILL ROAD  
GREENWICH, CT 06831  
FAIRFIELD COUNTY

**at&t**  
500 ENTERPRISE DRIVE, SUITE 3A  
ROCKY HILL, CT 06067

NO.	DATE	REVISIONS	BY	CHK	APP'D
1	06/12/18	ISSUED FOR CONSTRUCTION	SG	AT	EMC
A	03/06/18	ISSUED FOR REVIEW	GA	AT	DJC

SCALE: AS SHOWN DESIGNED BY: AT DRAWN BY: GA

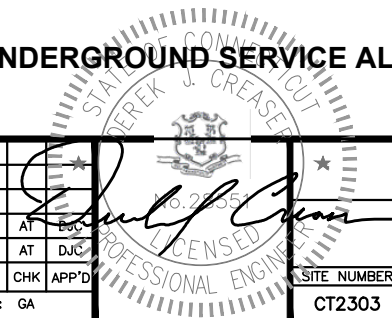

AT&T		
TITLE SHEET (LTE 2C)		
SITE NUMBER	DRAWING NUMBER	REV
CT2303	T-1	1

**GROUNDING NOTES**

1. THE SUBCONTRACTOR SHALL REVIEW AND INSPECT THE EXISTING FACILITY GROUNDING SYSTEM AND LIGHTNING PROTECTION SYSTEM (AS DESIGNED AND INSTALLED) FOR STRICT COMPLIANCE WITH THE NEC (AS ADOPTED BY THE AHJ), THE SITE-SPECIFIC (UL, LPI, OR NFPA) LIGHTING PROTECTION CODE, AND GENERAL COMPLIANCE WITH TELCORDIA AND TIA GROUNDING STANDARDS. THE SUBCONTRACTOR SHALL REPORT ANY VIOLATIONS OR ADVERSE FINDINGS TO THE CONTRACTOR FOR RESOLUTION.
2. ALL GROUND ELECTRODE SYSTEMS (INCLUDING TELECOMMUNICATION, RADIO, LIGHTNING PROTECTION, AND AC POWER GES'S) SHALL BE BONDED TOGETHER, AT OR BELOW GRADE, BY TWO OR MORE COPPER BONDING CONDUCTORS IN ACCORDANCE WITH THE NEC.
3. THE SUBCONTRACTOR SHALL PERFORM IEEE FALL-OF-POTENTIAL RESISTANCE TO EARTH TESTING (PER IEEE 1100 AND 81) FOR NEW GROUND ELECTRODE SYSTEMS. THE SUBCONTRACTOR SHALL FURNISH AND INSTALL SUPPLEMENTAL GROUND ELECTRODES AS NEEDED TO ACHIEVE A TEST RESULT OF 5 OHMS OR LESS.
4. METAL RACEWAY SHALL NOT BE USED AS THE NEC REQUIRED EQUIPMENT GROUND CONDUCTOR. STRANDED COPPER CONDUCTORS WITH GREEN INSULATION, SIZED IN ACCORDANCE WITH THE NEC, SHALL BE FURNISHED AND INSTALLED WITH THE POWER CIRCUITS TO BTS EQUIPMENT.
5. EACH BTS CABINET FRAME SHALL BE DIRECTLY CONNECTED TO THE MASTER GROUND BAR WITH GREEN INSULATED SUPPLEMENTAL EQUIPMENT GROUND WIRES, 6 AWG STRANDED COPPER OR LARGER FOR INDOOR BTS 2 AWG STRANDED COPPER FOR OUTDOOR BTS.
6. EXOTHERMIC WELDS SHALL BE USED FOR ALL GROUNDING CONNECTIONS BELOW GRADE.
7. APPROVED ANTIOXIDANT COATINGS (I.E., CONDUCTIVE GEL OR PASTE) SHALL BE USED ON ALL COMPRESSION AND BOLTED GROUND CONNECTIONS.
8. ICE BRIDGE BONDING CONDUCTORS SHALL BE EXOTHERMICALLY BONDED OR BOLTED TO GROUND BAR.
9. ALUMINUM CONDUCTOR OR COPPER CLAD STEEL CONDUCTOR SHALL NOT BE USED FOR GROUNDING CONNECTIONS.
10. MISCELLANEOUS ELECTRICAL AND NON-ELECTRICAL METAL BOXES, FRAMES AND SUPPORTS SHALL BE BONDED TO THE GROUND RING, IN ACCORDANCE WITH THE NEC.
11. METAL CONDUIT SHALL BE MADE ELECTRICALLY CONTINUOUS WITH LISTED BONDING FITTINGS OR BY BONDING ACROSS THE DISCONTINUITY WITH 6 AWS COPPER WIRE UL APPROVED GROUNDING TYPE CONDUIT CLAMPS.
12. ALL NEW STRUCTURES WITH A FOUNDATION AND/OR FOOTING HAVING 20 FT. OR MORE OF 1/2 IN. OR GREATER ELECTRICALLY CONDUCTIVE REINFORCING STEEL MUST HAVE IT BONDED TO THE GROUND RING USING AN EXOTHERMIC WELD CONNECTION USING #2 AWG SOLID BARE TINNED COPPER GROUND WIRE, PER NEC 250.50

**GENERAL NOTES**

1. FOR THE PURPOSE OF CONSTRUCTION DRAWING, THE FOLLOWING DEFINITIONS SHALL APPLY:  
 CONTRACTOR – CENTERLINE  
 SUBCONTRACTOR – GENERAL CONTRACTOR (CONSTRUCTION)  
 OWNER – AT&T MOBILITY
2. PRIOR TO THE SUBMISSION OF BIDS, THE BIDDING SUBCONTRACTOR SHALL VISIT THE CELL SITE TO FAMILIARIZE WITH THE EXISTING CONDITIONS AND TO CONFIRM THAT THE WORK CAN BE ACCOMPLISHED AS SHOWN ON THE CONSTRUCTION DRAWINGS. ANY DISCREPANCY FOUND SHALL BE BROUGHT TO THE ATTENTION OF CONTRACTOR.
3. ALL MATERIALS FURNISHED AND INSTALLED SHALL BE IN STRICT ACCORDANCE WITH ALL APPLICABLE CODES, REGULATIONS, AND ORDINANCES. SUBCONTRACTOR SHALL ISSUE ALL APPROPRIATE NOTICES AND COMPLY WITH ALL LAWS, ORDINANCES, RULES, REGULATIONS, AND LAWFUL ORDERS OF ANY PUBLIC AUTHORITY REGARDING THE PERFORMANCE OF THE WORK. ALL WORK CARRIED OUT SHALL COMPLY WITH ALL APPLICABLE MUNICIPAL AND UTILITY COMPANY SPECIFICATIONS AND LOCAL JURISDICTIONAL CODES, ORDINANCES AND APPLICABLE REGULATIONS.
4. DRAWINGS PROVIDED HERE ARE NOT TO BE SCALED AND ARE INTENDED TO SHOW OUTLINE ONLY.
5. UNLESS NOTED OTHERWISE, THE WORK SHALL INCLUDE FURNISHING MATERIALS, EQUIPMENT, APPURTENANCES, AND LABOR NECESSARY TO COMPLETE ALL INSTALLATIONS AS INDICATED ON THE DRAWINGS.
6. "KITTING LIST" SUPPLIED WITH THE BID PACKAGE IDENTIFIES ITEMS THAT WILL BE SUPPLIED BY CONTRACTOR. ITEMS NOT INCLUDED IN THE BILL OF MATERIALS AND KITTING LIST SHALL BE SUPPLIED BY THE SUBCONTRACTOR.
7. THE SUBCONTRACTOR SHALL INSTALL ALL EQUIPMENT AND MATERIALS IN ACCORDANCE WITH MANUFACTURER'S RECOMMENDATIONS UNLESS SPECIFICALLY STATED OTHERWISE.
8. IF THE SPECIFIED EQUIPMENT CANNOT BE INSTALLED AS SHOWN ON THESE DRAWINGS, THE SUBCONTRACTOR SHALL PROPOSE AN ALTERNATIVE INSTALLATION SPACE FOR APPROVAL BY THE CONTRACTOR.
9. SUBCONTRACTOR SHALL DETERMINE ACTUAL ROUTING OF CONDUIT, POWER AND T1 CABLES, GROUNDING CABLES AS SHOWN ON THE POWER, GROUNDING AND TELCO PLAN DRAWING. SUBCONTRACTOR SHALL UTILIZE EXISTING TRAYS AND/OR SHALL ADD NEW TRAYS AS NECESSARY. SUBCONTRACTOR SHALL CONFIRM THE ACTUAL ROUTING WITH THE CONTRACTOR.
10. THE SUBCONTRACTOR SHALL PROTECT EXISTING IMPROVEMENTS, PAVEMENTS, CURBS, LANDSCAPING AND STRUCTURES. ANY DAMAGED PART SHALL BE REPAIRED AT SUBCONTRACTOR'S EXPENSE TO THE SATISFACTION OF OWNER.
11. SUBCONTRACTOR SHALL LEGALLY AND PROPERLY DISPOSE OF ALL SCRAP MATERIALS SUCH AS COAXIAL CABLES AND OTHER ITEMS REMOVED FROM THE EXISTING FACILITY. ANTENNAS REMOVED SHALL BE RETURNED TO THE OWNER'S DESIGNATED LOCATION.
12. SUBCONTRACTOR SHALL LEAVE PREMISES IN CLEAN CONDITION.
13. ALL CONCRETE REPAIR WORK SHALL BE DONE IN ACCORDANCE WITH AMERICAN CONCRETE INSTITUTE (ACI) 301.

14. ANY NEW CONCRETE NEEDED FOR THE CONSTRUCTION SHALL BE AIR-ENTRAINED AND SHALL HAVE 4000 PSI STRENGTH AT 28 DAYS. ALL CONCRETE WORK SHALL BE DONE IN ACCORDANCE WITH ACI 318 CODE REQUIREMENTS.
15. ALL STRUCTURAL STEEL WORK SHALL BE DETAILED, FABRICATED AND ERECTED IN ACCORDANCE WITH AISC SPECIFICATIONS. ALL STRUCTURAL STEEL SHALL BE ASTM A36 (Fy = 36 ksi) UNLESS OTHERWISE NOTED. PIPES SHALL BE ASTM A53 TYPE E (Fy = 36 ksi). ALL STEEL EXPOSED TO WEATHER SHALL BE HOT DIPPED GALVANIZED. TOUCHUP ALL SCRATCHES AND OTHER MARKS IN THE FIELD AFTER STEEL IS ERECTED USING A COMPATIBLE ZINC RICH PAINT.
16. CONSTRUCTION SHALL COMPLY WITH LTE SPECIFICATIONS AND "GENERAL CONSTRUCTION SERVICES FOR CONSTRUCTION OF AT&T SITES."
17. SUBCONTRACTOR SHALL VERIFY ALL EXISTING DIMENSIONS AND CONDITIONS PRIOR TO COMMENCING ANY WORK. ALL DIMENSIONS OF EXISTING CONSTRUCTION SHOWN ON THE DRAWINGS MUST BE VERIFIED. SUBCONTRACTOR SHALL NOTIFY THE CONTRACTOR OF ANY DISCREPANCIES PRIOR TO ORDERING MATERIAL OR PROCEEDING WITH CONSTRUCTION.
18. THE EXISTING CELL SITE IS IN FULL COMMERCIAL OPERATION. ANY CONSTRUCTION WORK BY SUBCONTRACTOR SHALL NOT DISRUPT THE EXISTING NORMAL OPERATION. ANY WORK ON EXISTING EQUIPMENT MUST BE COORDINATED WITH CONTRACTOR. ALSO, WORK SHOULD BE SCHEDULED FOR AN APPROPRIATE MAINTENANCE WINDOW USUALLY IN LOW TRAFFIC PERIODS AFTER MIDNIGHT.
19. SINCE THE CELL SITE IS ACTIVE, ALL SAFETY PRECAUTIONS MUST BE TAKEN WHEN WORKING AROUND HIGH LEVELS OF ELECTROMAGNETIC RADIATION. EQUIPMENT SHOULD BE SHUTDOWN PRIOR TO PERFORMING ANY WORK THAT COULD EXPOSE THE WORKERS TO DANGER. PERSONAL RF EXPOSURE MONITORS ARE ADVISED TO BE WORN TO ALERT OF ANY DANGEROUS EXPOSURE LEVELS.
20. APPLICABLE BUILDING CODES:  
 SUBCONTRACTOR'S WORK SHALL COMPLY WITH ALL APPLICABLE NATIONAL, STATE, AND LOCAL CODES AS ADOPTED BY THE LOCAL AUTHORITY HAVING JURISDICTION (AHJ) FOR THE LOCATION. THE EDITION OF THE AHJ ADOPTED CODES AND STANDARDS IN EFFECT ON THE DATE OF CONTRACT AWARD SHALL GOVERN THE DESIGN.  
 BUILDING CODE: IBC 2012 WITH 2016 CT BUILDING CODE AMENDMENTS  
 ELECTRICAL CODE: REFER TO ELECTRICAL DRAWINGS  
 LIGHTENING CODE: REFER TO ELECTRICAL DRAWINGS  
  
 SUBCONTRACTOR'S WORK SHALL COMPLY WITH THE LATEST EDITION OF THE FOLLOWING STANDARDS:  
  
 AMERICAN CONCRETE INSTITUTE (ACI) 318; BUILDING CODE REQUIREMENTS FOR STRUCTURAL CONCRETE;  
  
 AMERICAN INSTITUTE OF STEEL CONSTRUCTION (AISC)  
 MANUAL OF STEEL CONSTRUCTION, ASD, FOURTEENTH EDITION;  
  
 TELECOMMUNICATIONS INDUSTRY ASSOCIATION (TIA) 222-G,  
 STRUCTURAL STANDARDS FOR STEEL  
  
 EQUIPMENT AND ANTENNA SUPPORTING STRUCTURES; REFER TO ELECTRICAL DRAWINGS FOR SPECIFIC ELECTRICAL STANDARDS.  
  
 FOR ANY CONFLICTS BETWEEN SECTIONS OF LISTED CODES AND STANDARDS REGARDING MATERIAL, METHODS OF CONSTRUCTION, OR OTHER REQUIREMENTS, THE MOST RESTRICTIVE REQUIREMENT SHALL GOVERN. WHERE THERE IS CONFLICT BETWEEN A GENERAL REQUIREMENT AND A SPECIFIC REQUIREMENT, THE SPECIFIC REQUIREMENT SHALL GOVERN.

**ABBREVIATIONS**

AGL	ABOVE GRADE LEVEL	EQ	EQUAL	REQ	REQUIRED
AWG	AMERICAN WIRE GAUGE	GC	GENERAL CONTRACTOR	RF	RADIO FREQUENCY
BBU	BATTERY BACKUP UNIT	GRC	GALVANIZED RIGID CONDUIT	TBD	TO BE DETERMINED
BTCW	BARE TINNED SOLID COPPER WIRE	MGB	MASTER GROUND BAR	TBR	TO BE REMOVED
BGR	BURIED GROUND RING	MIN	MINIMUM	TBRR	TO BE REMOVED AND REPLACED
BTS	BASE TRANSCEIVER STATION	P	PROPOSED	TYP	TYPICAL
E	EXISTING	NTS	NOT TO SCALE	UG	UNDER GROUND
EGB	EQUIPMENT GROUND BAR	RAD	RADIATION CENTER LINE (ANTENNA)	VIF	VERIFY IN FIELD
EGR	EQUIPMENT GROUND RING	REF	REFERENCE		



45 BEECHWOOD DRIVE  
NORTH ANDOVER, MA 01845  
TEL: (978) 557-5553  
FAX: (978) 336-5586



95 RYAN DRIVE  
RAYNHAM, MA 02767

**SITE NUMBER: CT2303**  
**SITE NAME: GREENWICH ROUND HILL ROAD**  
 395 ROUND HILL ROAD  
 GREENWICH, CT 06831  
 FAIRFIELD COUNTY



500 ENTERPRISE DRIVE, SUITE 3A  
ROCKY HILL, CT 06067

				AT&T	
				GENERAL NOTES (LTE 2C)	
NO.		DATE		REVISIONS	
1		06/12/18		ISSUED FOR CONSTRUCTION	
A		03/06/18		ISSUED FOR REVIEW	
SCALE:		DESIGNED BY:		DRAWN BY:	
AS SHOWN		AT		GA	
SITE NUMBER		DRAWING NUMBER		REV	
CT2303		GN-1		1	



**NOTE:**  
AN ANALYSIS FOR THE CAPACITY OF THE EXISTING STRUCTURES TO SUPPORT THE PROPOSED EQUIPMENT SHALL BE DETERMINED PRIOR TO CONSTRUCTION.

**NOTE:**  
REFER TO THE FINAL RF DATA SHEET FOR FINAL ANTENNA SETTINGS.

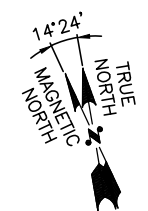
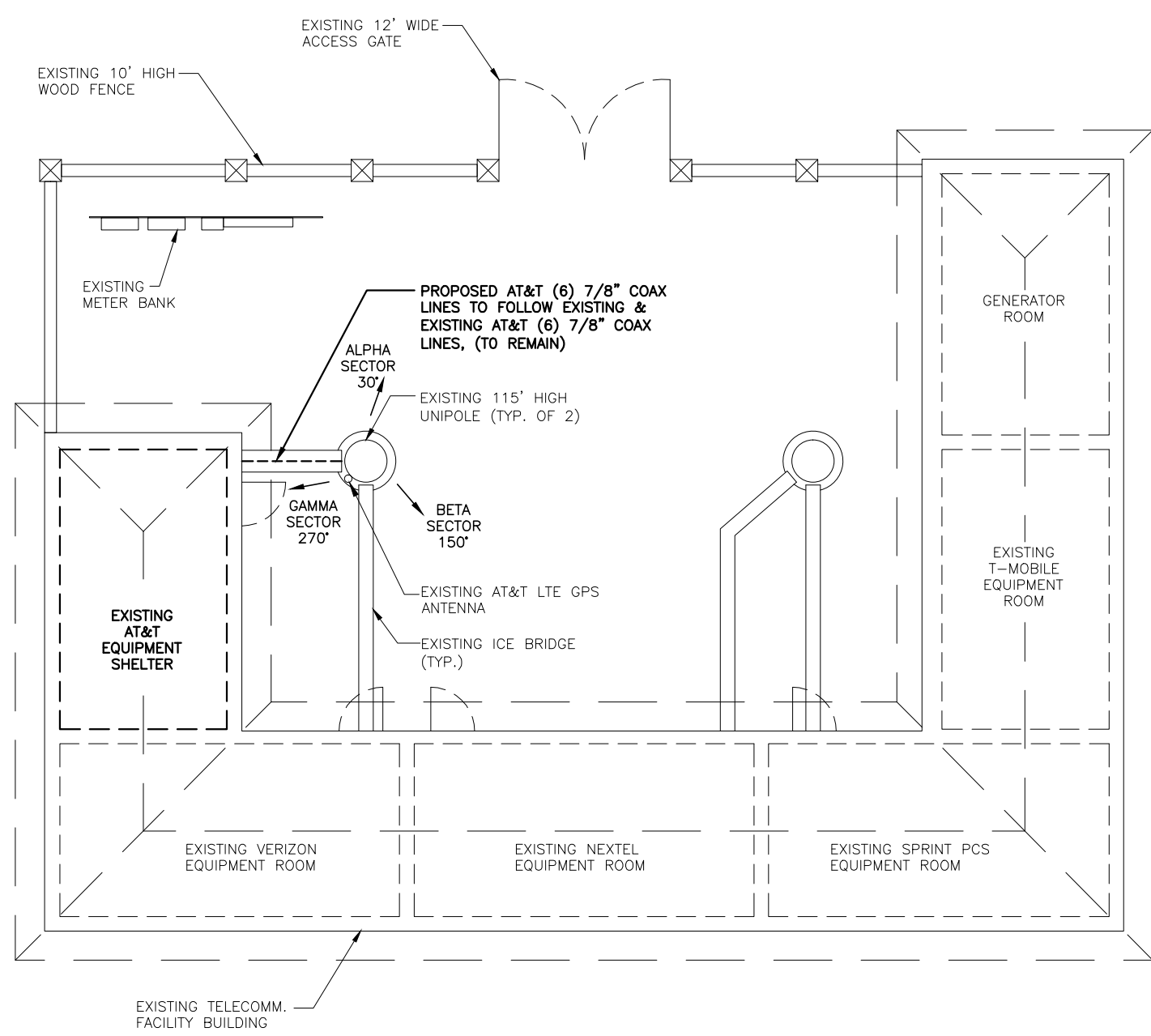

**COMPOUND PLAN**  
22x34 SCALE: 3/16"=1'-0"  
11x17 SCALE: 3/32"=1'-0"  
1 A-1

**NOTE:**  
REPLACE ANY MISSING GROUND BARS WHEN INSTALLING PROPOSED EQUIPMENT GROUNDING.

PROPOSED AT&T RRUS-12 (PCS)  
(TYP. OF 1 PER SECTOR, TOTAL OF 3) ON PROPOSED RACK

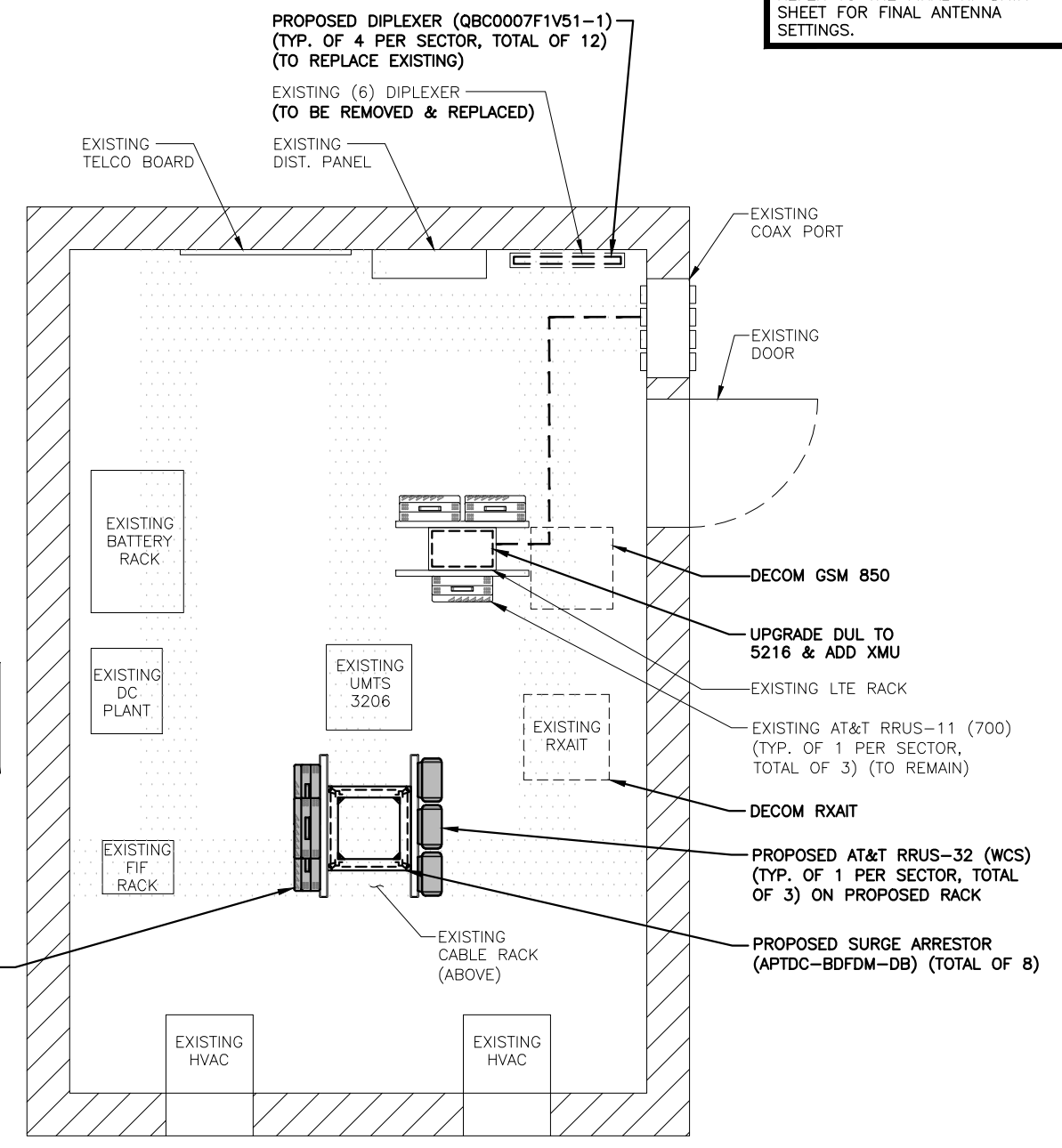

**EQUIPMENT PLAN**  
22x34 SCALE: 1/2"=1'-0"  
11x17 SCALE: 1/4"=1'-0"  
2 A-1

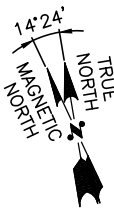
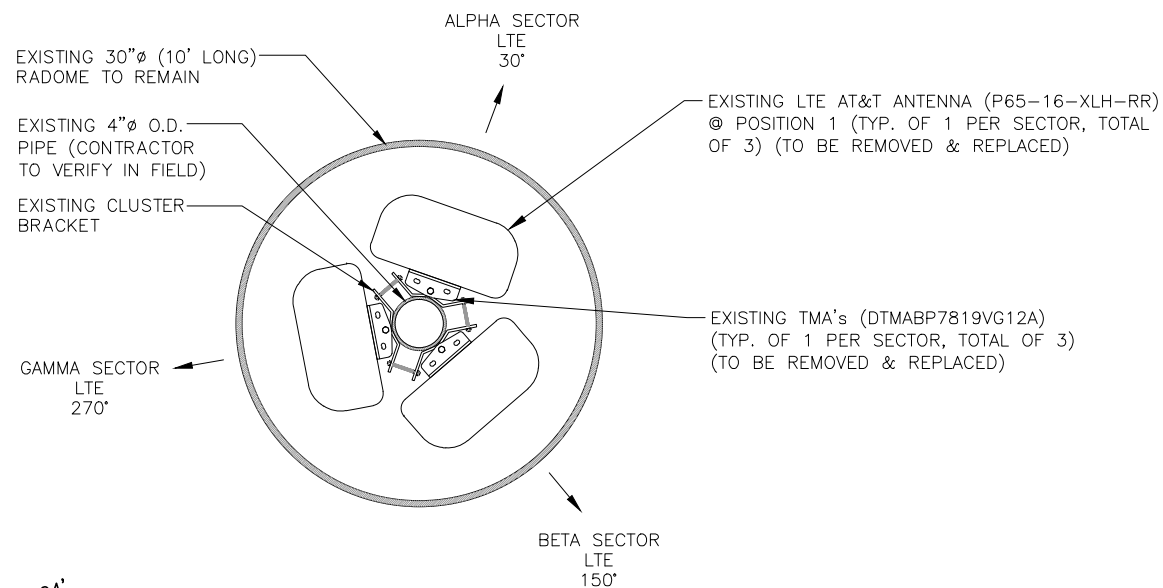

**EXISTING ANTENNA LAYOUT** 1  
SCALE: N.T.S. A-2

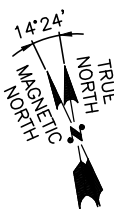
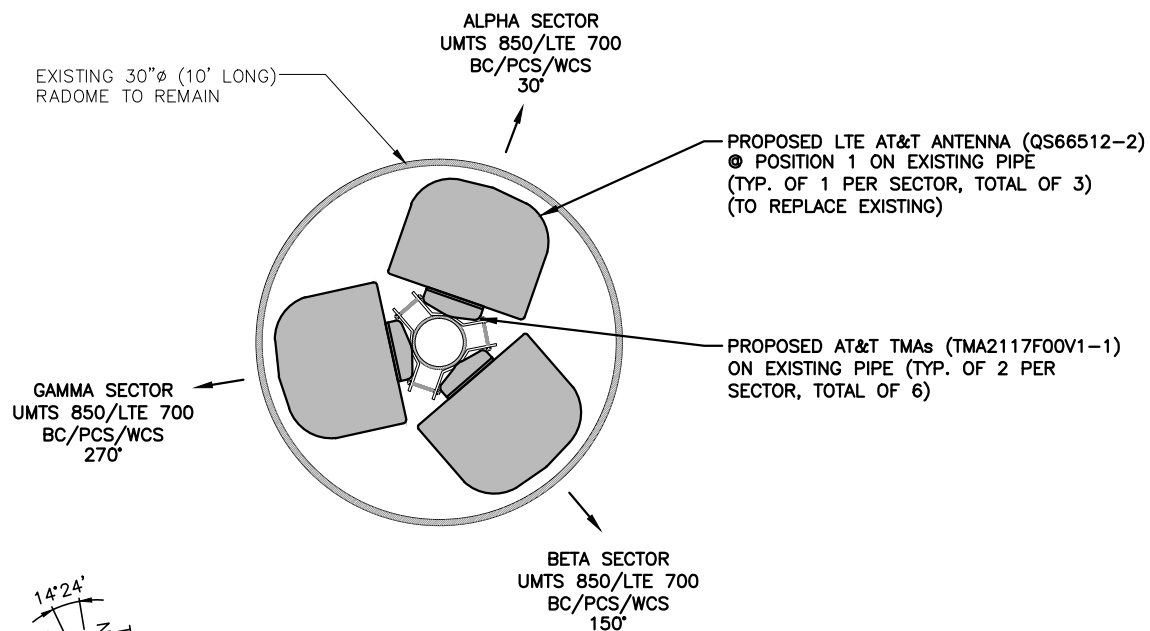

**PROPOSED ANTENNA LAYOUT** 2  
SCALE: N.T.S. A-2

**NOTE:**  
AN ANALYSIS FOR THE CAPACITY OF THE EXISTING STRUCTURES TO SUPPORT THE PROPOSED EQUIPMENT SHALL BE DETERMINED PRIOR TO CONSTRUCTION.

**NOTE:**  
REFER TO THE FINAL RF DATA SHEET FOR FINAL ANTENNA SETTINGS.

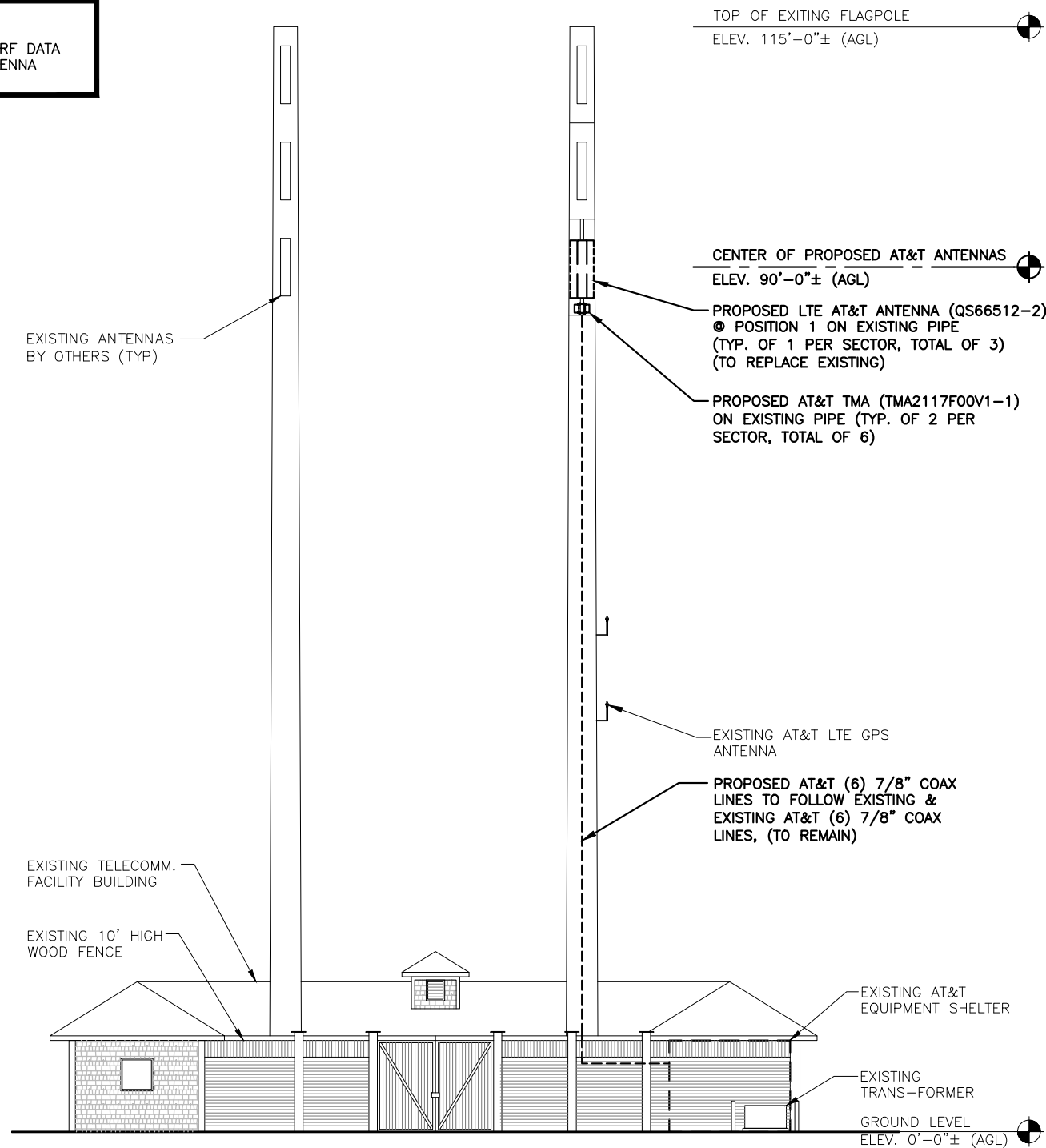

**ELEVATION** 3  
22x34 SCALE: 1/8"=1'-0" A-2  
11x17 SCALE: 1/16"=1'-0"

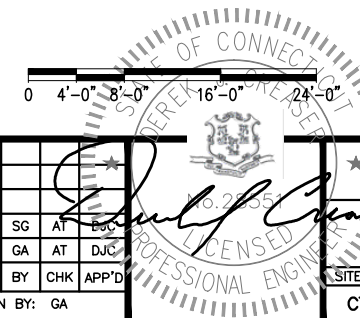

NO.	DATE	REVISIONS	BY	CHK	APP'D
1	06/12/18	ISSUED FOR CONSTRUCTION	SG	AT	EDC
A	03/06/18	ISSUED FOR REVIEW	GA	AT	DJC

SCALE: AS SHOWN DESIGNED BY: AT DRAWN BY: GA

AT&T		
ANTENNA LAYOUT & ELEVATION (LTE 2C)		
SITE NUMBER	DRAWING NUMBER	REV
CT2303	A-2	1

**NOTE:**  
AN ANALYSIS FOR THE CAPACITY OF THE EXISTING STRUCTURES TO SUPPORT THE PROPOSED EQUIPMENT SHALL BE DETERMINED PRIOR TO CONSTRUCTION.

**NOTE:**  
REFER TO THE FINAL RF DATA SHEET FOR FINAL ANTENNA SETTINGS.

ANTENNA SCHEDULE											
SECTOR	EXISTING/PROPOSED	BAND	ANTENNA	SIZE (INCHES) (L x W x D)	ANTENNA $\phi$ HEIGHT	AZIMUTH	TMA/COMBINER	RRU	SIZE (INCHES) (L x W x D)	FEEDER	RAYCAP
A1	PROPOSED	UMTS 850/LTE 700 BC/PCS/WCS	QS66512-2	72X12X9.6	90'-0"±	30°	(P)(2) TMA2117F00V1-1	(E)RRUS-11 (700) (P)RRUS-12 (PCS) (P)RRUS-32 (WCS)	20.4X18.5X7.5 27.2X12.1X7.0	(2)(E) 7/8" (115'±) (2)(P) 7/8" (115'±)	
A2	-	-	-	-	-	-	-	-	-	-	
A3	-	-	-	-	-	-	-	-	-	-	
A4	-	-	-	-	-	-	-	-	-	-	
B1	PROPOSED	UMTS 850/LTE 700 BC/PCS/WCS	QS66512-2	72X12X9.6	90'-0"±	150°	(P)(2) TMA2117F00V1-1	(E)RRUS-11 (700) (P)RRUS-12 (PCS) (P)RRUS-32 (WCS)	20.4X18.5X7.5 27.2X12.1X7.0	(2)(E) 7/8" (115'±) (2)(P) 7/8" (115'±)	
B2	-	-	-	-	-	-	-	-	-	-	
B3	-	-	-	-	-	-	-	-	-	-	
B4	-	-	-	-	-	-	-	-	-	-	
C1	PROPOSED	UMTS 850/LTE 700 BC/PCS/WCS	QS66512-2	72X12X9.6	90'-0"±	270°	(P)(2) TMA2117F00V1-1	(E)RRUS-11 (700) (P)RRUS-12 (PCS) (P)RRUS-32 (WCS)	20.4X18.5X7.5 27.2X12.1X7.0	(2)(E) 7/8" (115'±) (2)(P) 7/8" (115'±)	
C2	-	-	-	-	-	-	-	-	-	-	
C3	-	-	-	-	-	-	-	-	-	-	
C4	-	-	-	-	-	-	-	-	-	-	

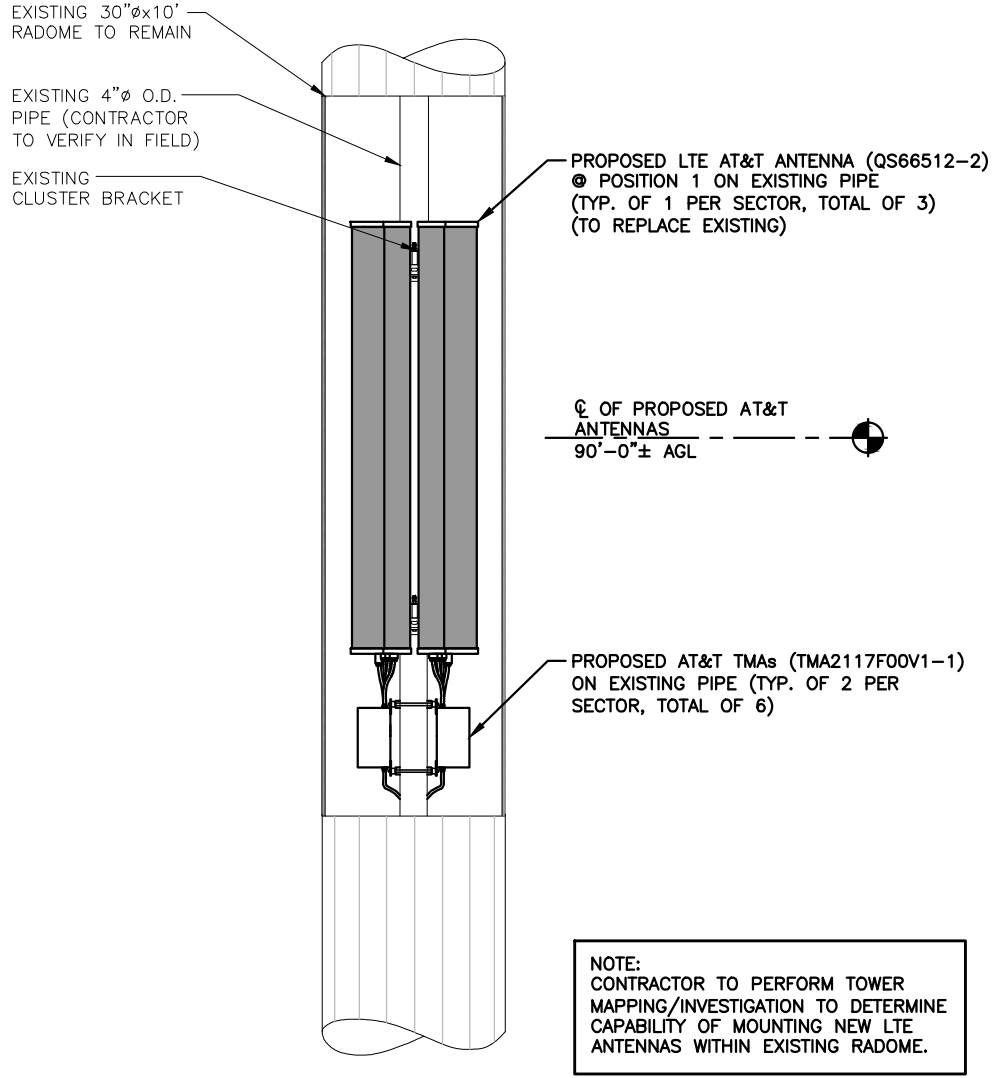

**PROPOSED ANTENNA & RRUS MOUNT DETAIL**  
22x34 SCALE: 3/4"=1'-0"  
11x17 SCALE: 3/8"=1'-0"

**FINAL ANTENNA CONFIGURATION TABLE** 3 A-3

RRU CHART				
QUANTITY	MODEL	L	W	D
3(E)	RRUS-11	19.7"	17.0"	7.2"
3(P)	RRUS-12	20.4"	18.5"	7.5"
3(P)	RRUS-32	27.2"	12.1"	7.0"

**NOTE:**  
MOUNT PER MANUFACTURER'S SPECIFICATIONS

**NOTE:**  
SEE RFDS FOR RRH FREQUENCY AND MODEL NUMBER

PROPOSED RRU REFER TO THE FINAL RFDS AND CHART FOR QUANTITY, MODEL AND DIMENSIONS

**PROPOSED RRUS DETAIL**  
SCALE: N.T.S.

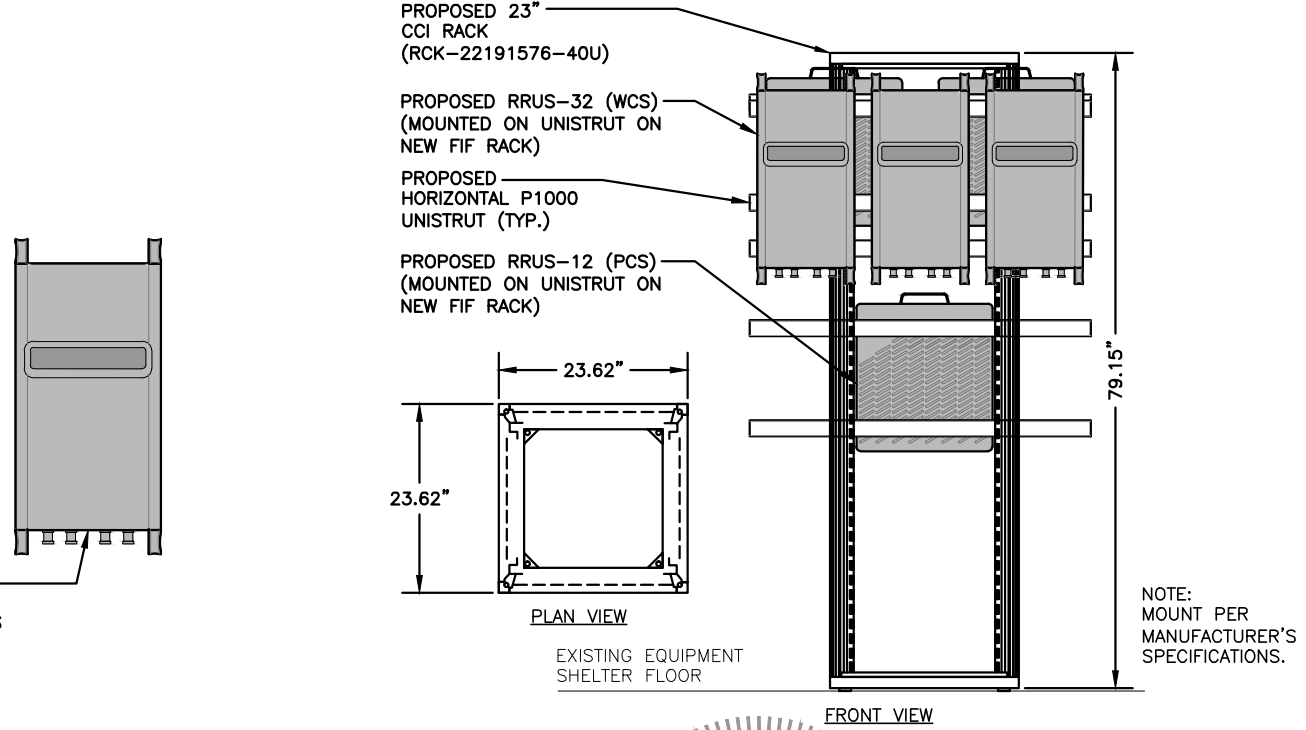

**PROPOSED EQUIPMENT RACK DETAIL** 5 A-3  
SCALE: N.T.S.



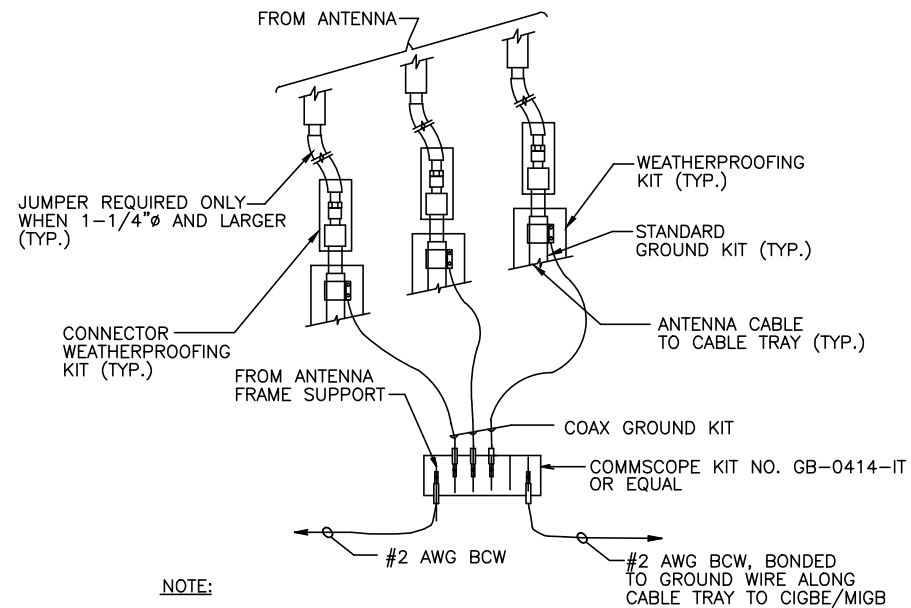

NOTE:  
 1. DO NOT INSTALL CABLE GROUND KIT AT A BEND AND ALWAYS DIRECT GROUND WIRE DOWN TO CIGBE.

**GROUND WIRE TO GROUND BAR CONNECTION DETAIL** 1  
 SCALE: N.T.S. G-1

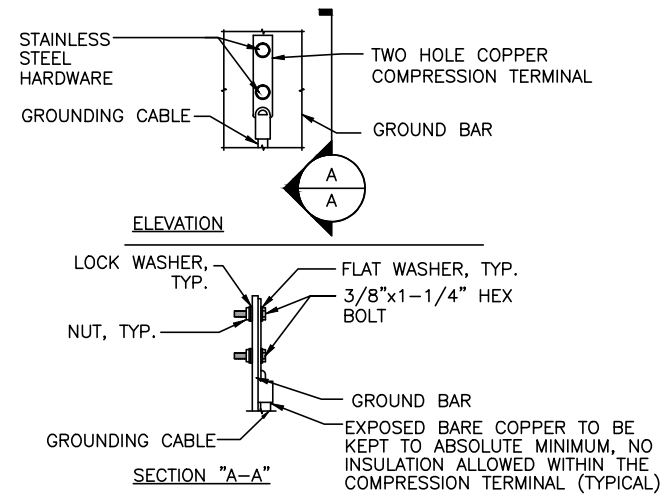

NOTE:  
 1. "DOUBLING UP" OR "STACKING" OF CONNECTION IS NOT PERMITTED.  
 2. OXIDE INHIBITING COMPOUND TO BE USED AT ALL LOCATION.  
 3. CADWELD DOWNLEADS FROM UPPER EGB, LOWER EGB, AND MGB

**TYPICAL GROUND BAR CONNECTION DETAIL** 3  
 SCALE: N.T.S. G-1

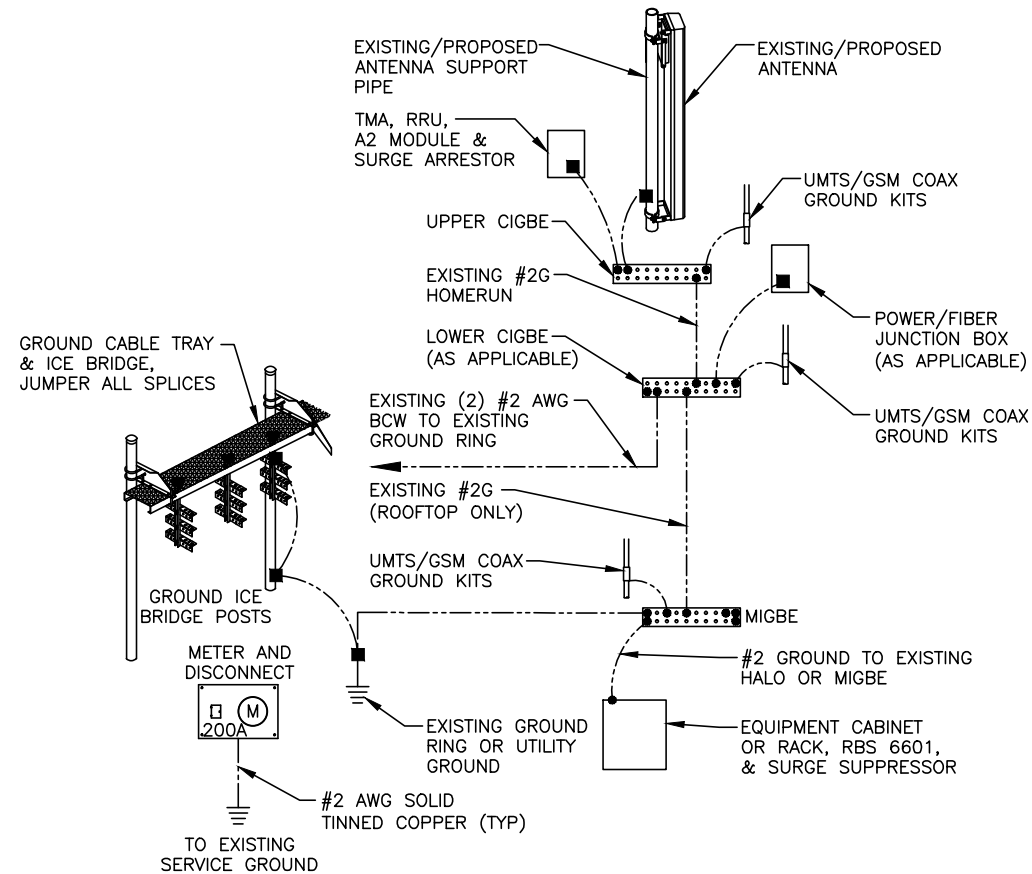

**GROUNDING RISER DIAGRAM** 2  
 SCALE: N.T.S. G-1

EACH GROUND CONDUCTOR TERMINATING ON ANY GROUND BAR SHALL HAVE AN IDENTIFICATION TAG ATTACHED AT EACH END THAT WILL IDENTIFY ITS ORIGIN AND DESTINATION.

**SECTION "P" - SURGE PRODUCERS**

- CABLE ENTRY PORTS (HATCH PLATES) (#2)
- GENERATOR FRAMEWORK (IF AVAILABLE) (#2)
- TELCO GROUND BAR
- COMMERCIAL POWER COMMON NEUTRAL/GROUND BOND (#2)
- +24V POWER SUPPLY RETURN BAR (#2)
- 48V POWER SUPPLY RETURN BAR (#2)
- RECTIFIER FRAMES.

**SECTION "A" - SURGE ABSORBERS**

- INTERIOR GROUND RING (#2)
- EXTERNAL EARTH GROUND FIELD (BURIED GROUND RING) (#2)
- METALLIC COLD WATER PIPE (IF AVAILABLE) (#2)
- BUILDING STEEL (IF AVAILABLE) (#2)

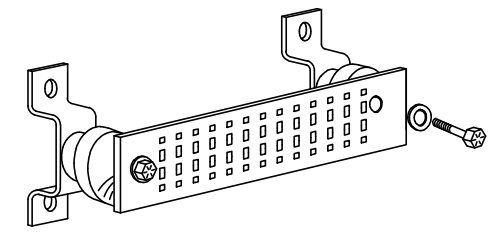

**GROUND BAR - DETAIL** 4  
 SCALE: N.T.S. G-1

1	06/12/18	ISSUED FOR CONSTRUCTION	SG	AT	EMC
A	03/06/18	ISSUED FOR REVIEW	GA	AT	DJC
NO.	DATE	REVISIONS	BY	CHK	APP'D
SCALE: AS SHOWN		DESIGNED BY: AT	DRAWN BY: GA		

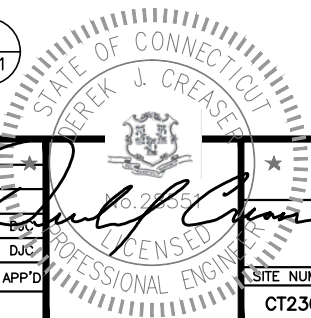

AT&T		
GROUNDING DETAILS (LTE 2C)		
SITE NUMBER	DRAWING NUMBER	REV
CT2303	G-1	1

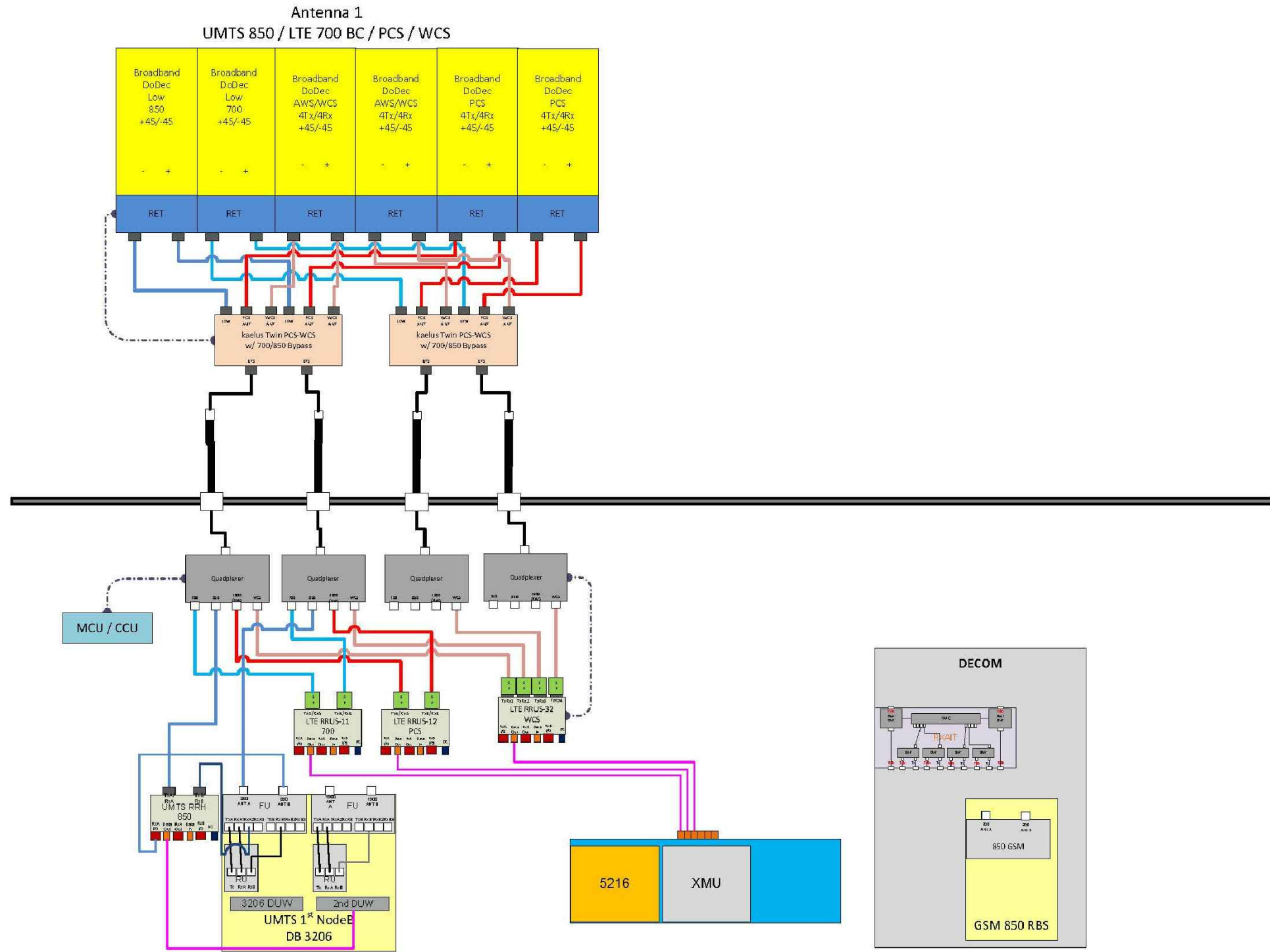

**RF PLUMBING DIAGRAM** 1  
SCALE: N.T.S. RF-1

**NOTE:**  
1. CONTRACTOR TO CONFIRM ALL PARTS.  
2. INSTALL ALL EQUIPMENT TO MANUFACTURER'S RECOMMENDATIONS

**NOTE:**  
REFER TO THE FINAL RF DATA SHEET FOR FINAL ANTENNA SETTINGS.

NO.	DATE	REVISIONS	BY	CHK	APP'D
1	06/12/18	ISSUED FOR CONSTRUCTION	SG	AT	[Signature]
A	03/06/18	ISSUED FOR REVIEW	GA	AT	DJC

SCALE: AS SHOWN    DESIGNED BY: AT    DRAWN BY: GA

