



STATE OF CONNECTICUT

CONNECTICUT SITING COUNCIL

Ten Franklin Square, New Britain, CT 06051

Phone: (860) 827-2935 Fax: (860) 827-2950

E-Mail: siting.council@po.state.ct.us

Web Site: www.ct.gov/csc

March 11, 2004

Kenneth C. Baldwin
Robinson & Cole
280 Trumbull Street
Hartford, CT 06103-3597

RE: **EM-VER-015-035-057-135-158-040219** - Cellco Partnership d/b/a Verizon Wireless notice of intent to modify existing telecommunications facilities located at Butternut Hollow Road, Greenwich; Ledge Road, Darien; Eastover Road, Stamford; 69 Guinea Road, Stamford; 623 Pine Street, Bridgeport; 2 Sunny Lane, Westport; and Post Office Lane, Westport, Connecticut.

Dear Attorney Baldwin:

At a public meeting held on March 4, 2004, the Connecticut Siting Council (Council) acknowledged your notice to modify these telecommunications facilities with the exception of the Bridgeport, 623 Pine Street facility, which the Council tabled to allow the city to review the filing, pursuant to Section 16-50j-73 of the Regulations of Connecticut State Agencies.

The proposed modifications are to be implemented as specified here and in your notice dated February 19, 2004. The modifications are in compliance with the exception criteria in Section 16-50j-72 (b) of the Regulations of Connecticut State Agencies as changes to existing facility sites that would not increase tower heights, extend the boundaries of the tower site, increase noise levels at the tower site boundaries by six decibels, and increase the total radio frequencies electromagnetic radiation power density measured at the tower site boundaries to or above the standard adopted by the State Department of Environmental Protection pursuant to General Statutes § 22a-162. These facilities have also been carefully modeled to ensure that radio frequency emissions are conservatively below State and federal standards applicable to the frequencies now used on these towers.

This decision is under the exclusive jurisdiction of the Council. Any additional change to these facilities will require explicit notice to this agency pursuant to Regulations of Connecticut State Agencies Section 16-50j-73. Such notice shall include all relevant information regarding the proposed change with cumulative worst-case modeling of radio frequency exposure at the closest point of uncontrolled access to the tower base, consistent with Federal Communications Commission, Office of Engineering and Technology, Bulletin 65. Any deviation from this format may result in the Council implementing enforcement proceedings pursuant to General Statutes § 16-50u including, without limitation, imposition of expenses resulting from such failure and of civil penalties in an amount not less than one thousand dollars per day for each day of construction or operation in material violation.

Thank you for your attention and cooperation.

Very truly yours,

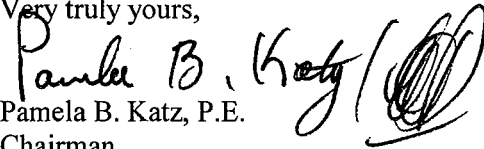
Pamela B. Katz, P.E.
Chairman

PBK/laf

c: See attached list.

Recipient List:

Honorable John Fabrizi, Mayor, City of Bridgeport
Michael P. Nidoh, City Planner, City of Bridgeport
Melanie Howlett, Associate City Attorney, City of Bridgeport
Honorable Evonne M. Klein, First Selectman, Town of Darien
David J. Keating, Zoning Enforcement Office, Town of Darien
Honorable James A. Lash, First Selectman, Town of Greenwich
Diane Fox, Planning and Zoning Director, Town of Greenwich
Honorable Dannel P. Malloy, Mayor, City of Stamford
Robert Stein, Planning and Zoning Director, City of Stamford
Honorable Diane G. Farrell, First Selectwoman, Town of Westport
Katherine Barnard, Director of Planning and Zoning, Town of Westport

280 Trumbull Street
Hartford, CT 06103-3597
Main (860) 275-8200
Fax (860) 275-8299
kbaldwin@rc.com
Direct (860) 275-8345

February 19, 2004

Via Hand Delivery

S. Derek Phelps
Executive Director
Connecticut Siting Council
10 Franklin Square
New Britain, CT 06051

Re: **Notice of Exempt Modification – Antenna Swap**

Butternut – Butternut Hollow Road, Greenwich, CT
Darien – Ledge Road, Darien, CT
North Stamford – Eastover Road, Stamford, CT
Riverbank – 69 Guinea Road, Stamford, CT
Bridgeport SW – 623 Pine Street, Bridgeport, CT
Cranbury – 2 Sunny Lane, Westport, CT
Westport South – Post Office Lane, Westport, CT

RECEIVED
FEB 19 2004

CONNECTICUT
SITING COUNCIL

Dear Mr. Phelps:

Cellco Partnership d/b/a Verizon Wireless (“Cellco”) has established telecommunications facilities at each of the above-referenced tower sites. In each case, Cellco has received approval to install twelve (12) panel-type cellular antennas on the existing tower. Cellco now intends to modify each of these facilities by simply replacing six (6) of the cellular antennas with six (6) PCS antennas.

Please accept this letter as notification pursuant to R.C.S.A. § 16-50j-73, for construction that constitutes an exempt modification pursuant to R.C.S.A. § 16-50j-72(b)(2). In accordance with R.C.S.A. § 16-50j-73, a copy of this letter is being sent to the chief elected officials in each municipality.



Law Offices

BOSTON

HARTFORD

NEW LONDON

STAMFORD

GREENWICH

NEW YORK

www.rc.com

HART1-1159920-1

S. Derek Phelps
February 19, 2004
Page 2

As the Council knows, on May 23, 2003, Cellco acquired, from Northcoast Communications, a license to provide PCS service throughout Connecticut. The proposed modifications to each of the above referenced tower sites will allow Cellco to provide its customers in Connecticut, with enhanced wireless voice and data services. While these modifications are not significant, Cellco feels compelled to present these modifications to the Council for review.

The planned modifications to the above-referenced facilities fall squarely within those activities explicitly provided for in R.C.S.A. § 16-50j-72(b)(2).

1. The proposed modifications will not result in any increase in the overall height of any of the existing tower structures. Cellco's replacement antennas will be mounted at the same level as its existing antennas.
2. The proposed modifications will not affect any ground-mounted equipment and will not require the extension of the site boundaries.
3. The proposed modifications will not increase noise levels at the facility by six decibels or more.
4. The proposed modifications will not result in radio frequency (RF) power density levels at the facilities that exceed the Federal Communications Commission (FCC) adopted safety standard. Attached to this notice are RF Power Density calculations for both the Cellco cellular and PCS antennas at each of the sites identified.

Also attached, behind each power density calculation table, are the specifications for the existing cellular and proposed PCS antennas to be used at each of these sites. Please note that in each case the existing cellular antennas are in fact heavier and have a larger wind area than the proposed PCS antennas. An updated structural analysis is therefore not required for the proposed modifications.



S. Derek Phelps
February 19, 2004
Page 3

For the foregoing reasons, Cellco respectfully submits that the proposed modifications to the above-referenced telecommunications facilities constitute an exempt modification under R.C.S.A. § 16-50j-72(b)(2).

Sincerely,

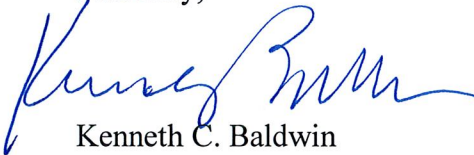

Kenneth C. Baldwin

cc: James Lash, First Selectman, Town of Greenwich
Evonne Klein, First Selectwoman, Town of Darien
Daniel P. Malloy, Mayor, City of Stamford
John M. Fabrizi, Mayor, City of Bridgeport
Diane G. Farrell, First Selectwoman, Town of Westport
Sandy M. Carter, Verizon Wireless



General Power Density

Site Name: Butternut, CT
 Tower Height: 130 Ft. rad center

Operator	Operating Frequency (MHz)	Number of Trans.	ERP Per Trans. (watts)	Total ERP (watts)	Distance to Target (feet)	Calculated Power Density (mW/cm ²)	Maximum Permissible Exposure* (mW/cm ²)	Fraction of MPE (%)
Verizon	880	9	200	1800	130	0.0383	0.56733	6.75%
Verizon	1900	3	285	855	130	0.0182	1	1.82%
Total Percentage of Maximum Permissible Exposure								8.57%

*Guidelines adopted by the FCC on August 1, 1996, 47 CFR Part 1 based on NCRP Report 86, 1986 and generally on ANSI/IEEE C95.1-1992

MHz = Megahertz

mW/cm² = milliwatts per square centimeter

ERP = Effective Radiated Power

Absolute worst case scenario, maximum values used.



DECIBEL
Base Station Antennas

DB844H65E-XY

13.1 dBd, Directed Dipole Antenna
806-896, 870-960 MHz

806-896 MHz
870-960 MHz

- Excellent azimuth roll-off, 15-20% reduction in cell to cell overlap
- Superior front to back ratio
- Low profile, low wind load for easy zoning
- Outstanding field record, with thousands of units deployed, world wide

65°

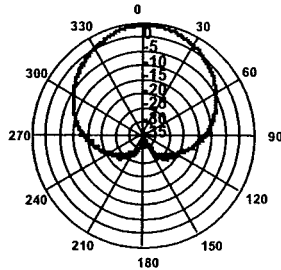

Horizontal 835 MHz (Tilt=0)

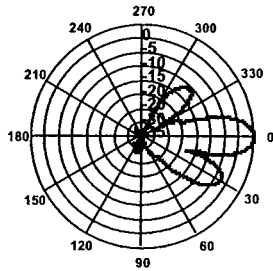

Vertical 835 MHz (Tilt=0)

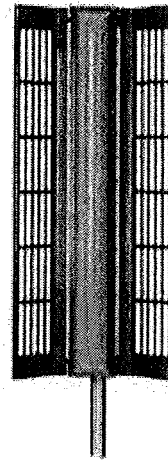

ELECTRICAL

Frequency (MHz):	806-896	870-960
Polarization:	Vertical	Vertical
Gain (dBd/dBi):	13.1/15.2	13.3/15.4
Azimuth BW:	65°	65°
Elevation BW:	15°	15°
Beam Tilt:	0°	0°
USLS* (dB):	>15	>15
Front-to-Back Ratio* (dB):	40	40
VSWR:	<1.5:1	<1.5:1
Impedance:	50 Ohms	50 Ohms
Max Input Power:	500 Watts	500 Watts
Lightning Protection:	DC Ground	DC Ground

MECHANICAL

Weight:	20 lbs (9.1 kg)
Dimensions (LxWxD):	48 X 21 X 8.5 in (1219 X 533 X 216 mm)
Max. Wind Area:	4.7 ft ² (0.44 m ²)
Max. Wind Load (@ 100mph):	186 lbf (827 N)
Max. Wind Speed:	125 mph (201 km/h)
Radiator Material:	Brass
Reflector Material:	Passivated Aluminum
Radome Material:	ABS, UV Resistant
Mounting Hardware Material:	Galvanized Steel
Connector Type:	7-16 DIN - Female (Back)
Alt. Connectors:	N Type - Female
Color:	Light Gray
Standard Mounting Hardware:	DB380 Pipe Mount Kit, Included
Downtilt Mounting Hardware:	DB5083, optional
Opt. Mounting Hardware:	DB5084-AZ Azimuth Wall Mount



Andrew Corporation
8635 Stemmons Freeway
Dallas, Texas U.S.A 75247-3701
Tel: 214.631.0310

Fax: 214.631.4706
Toll Free Tel: 1.800.676.5342
Fax: 1.800.229.4706
www.andrew.com

Date: 1/26/2004
* - Indicates Typical Values

rhstech@andrew.com

DECIBEL
Base Station Antennas

DB844H80E-XY

12.5 dBd, Directed Dipole Antenna
806-896, 870-960 MHz

806-896 MHz
870-960 MHz

- Excellent azimuth roll-off, 15-20% reduction in cell to cell overlap
- Superior front to back ratio
- Low profile, low wind load for easy zoning
- Outstanding field record, with thousands of units deployed, world wide

80°

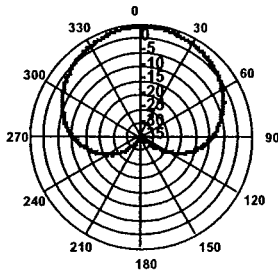

Horizontal 835 MHz (Tilt=0)

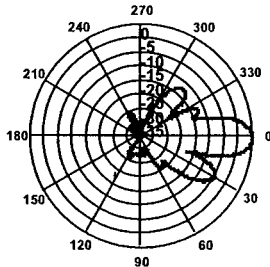

Vertical 835 MHz (Tilt=0)

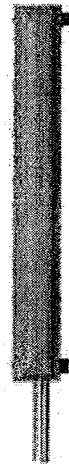

ELECTRICAL			MECHANICAL	
Frequency (MHz):	806-896	870-960	Weight:	14 lbs (6.4 kg)
Polarization:	Vertical	Vertical	Dimensions (LxWxD):	48 X 6.5 X 8 in (1219 X 165 X 203 mm)
Gain (dBd/dBi):	12.5/14.6	12.8/14.9	Max. Wind Area:	2.6 ft ² (0.24 m ²)
Azimuth BW:	80°	80°	Max. Wind Load (@ 100mph):	104 lbf (463 N)
Elevation BW:	15°	15°	Max. Wind Speed:	125 mph (201 km/h)
Beam Tilt:	0°	0°	Radiator Material:	Brass
USLS* (dB):	>15	>15	Reflector Material:	Passivated Aluminum
Front-to-Back Ratio* (dB):	40	40	Radome Material:	ABS, UV Resistant
VSWR:	<1.5:1	<1.5:1	Mounting Hardware Material:	Galvanized Steel
Impedance:	50 Ohms	50 Ohms	Connector Type:	7-16 DIN - Female (Back)
Max Input Power:	500 Watts	500 Watts	Alt. Connectors:	N Type - Female
Lightning Protection:	DC Ground	DC Ground	Color:	Light Gray
Opt Electrical Tilt:	6°	6°	Standard Mounting Hardware:	DB380 Pipe Mount Kit, included
			Downtilt Mounting Hardware:	DB5083, optional
			Opt. Mounting Hardware:	DB5084-AZ Azimuth Wall Mount



Andrew Corporation
8635 Stemmons Freeway
Dallas, Texas U.S.A 75247-3701
Tel: 214.631.0310

Fax: 214.631.4706
Toll Free Tel: 1.800.676.5342
Fax: 1.800.229.4706
www.andrew.com

Date: 1/26/2004
* - Indicates Typical Values

dh1tech@andrew.com

DECIBEL
Base Station Antennas

948F85T2E-M

16.1 dBi, Directed Dipole Antenna
1850-1990 MHz

1850-1990 MHz

dB Director®
MaxFill™

- Exceptional azimuth roll-off reducing soft hand-offs and improving capacity
- Excellent upper side lobe suppression
- Deep null filling below the horizon assures improved signal intensity
- Low profile appearance and low wind loading profile for easier zoning approvals

85°

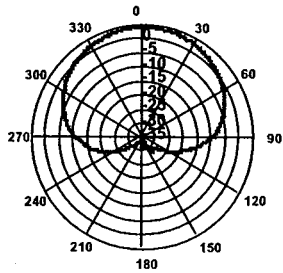

Azimuth 1850 MHz (Tilt=2)

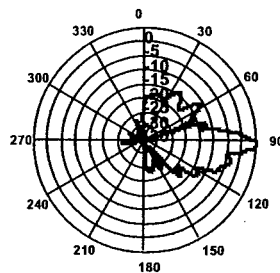

Vertical 1850 MHz (Tilt=2)

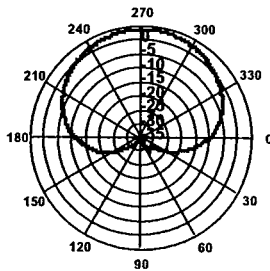

Horizontal 1850 MHz (Tilt=2)



ELECTRICAL

Frequency (MHz):	1850-1990
Polarization:	Vertical
Gain (dBd/dBi):	14/16.1
Azimuth BW:	85°
Elevation BW:	8°
Beam Tilt:	2°
USLS* (dB):	>18
Null Fill* (dB):	15
Front-to-Back Ratio* (dB):	40
VSWR:	<1.33:1
IM Suppression - Two 20 Watt Carriers:	-150
Impedance:	50 Ohms
Max Input Power:	250 Watts
Lightning Protection:	DC Ground
Opt Electrical Tilt:	0°, 4°, 6°

MECHANICAL

Weight:	8.5 lbs (3.9 kg)
Dimensions (LxWxD):	48 X 3.5 X 7 in (1219 X 89 X 178 mm)
Max. Wind Area:	2.3 ft² (0.21 m²)
Max. Wind Load (@ 100mph):	92 lbf (409 N)
Max. Wind Speed:	125 mph (201 km/h)
Radiator Material:	Low Loss Circuit Board
Reflector Material:	Passivated Aluminum
Radome Material:	ABS, UV Resistant
Mounting Hardware Material:	Galvanized Steel
Connector Type:	7-16 DIN - Female (Bottom)
Color:	Light Gray
Standard Mounting Hardware:	DB390 Pipe Mount Kit, included
Downtilt Mounting Hardware:	DB5098, optional
Opt. Mounting Hardware:	DB5094-AZ Azimuth Wall Mount



Andrew Corporation
8635 Stemmons Freeway
Dallas, Texas U.S.A 75247-3701
Tel: 214.631.0310

Fax: 214.631.4706
Toll Free Tel: 1.800.676.5342
Fax: 1.800.229.4706
www.andrew.com

Date: 1/23/2004
* - Indicates Typical Values

dbtech@andrew.com

General Power Density

Site Name: Darien, CT
 Tower Height: 102 Ft. rad center

Operator	Operating Frequency (MHz)	Number of Trans.	ERP Per Trans. (watts)	Total ERP (watts)	Distance to Target (feet)	Calculated Power Density (mW/cm ²)	Maximum Permissible Exposure (mW/cm ²)	Fraction of MPE (%)
Verizon	880	9	200	1800	102	0.0622	0.56733	10.97%
Verizon	1900	3	285	855	102	0.0296	1	2.96%
Total Percentage of Maximum Permissible Exposure								13.92%

*Guidelines adopted by the FCC on August 1, 1996, 47 CFR Part 1 based on NCRP Report 86, 1986 and generally on ANSI/IEEE C95.1-1992

MHz = Megahertz

mW/cm² = milliwatts per square centimeter

ERP = Effective Radiated Power

Absolute worst case scenario, maximum values used.



ALP 9212-N

Log-Periodic Reflector Antenna

92 Degrees 12 dBd

Features:

- Broadbanded. (800-900 MHz)
- Low backlobe radiation. Front-to-back ratio better than 28 dB
- Low Intermodulation Products.
- Low Wind-load.
- Low weight.
- Small size.
- Rugged design.

Please see the following pages including radiation patterns/tables for ALP 9212-N.

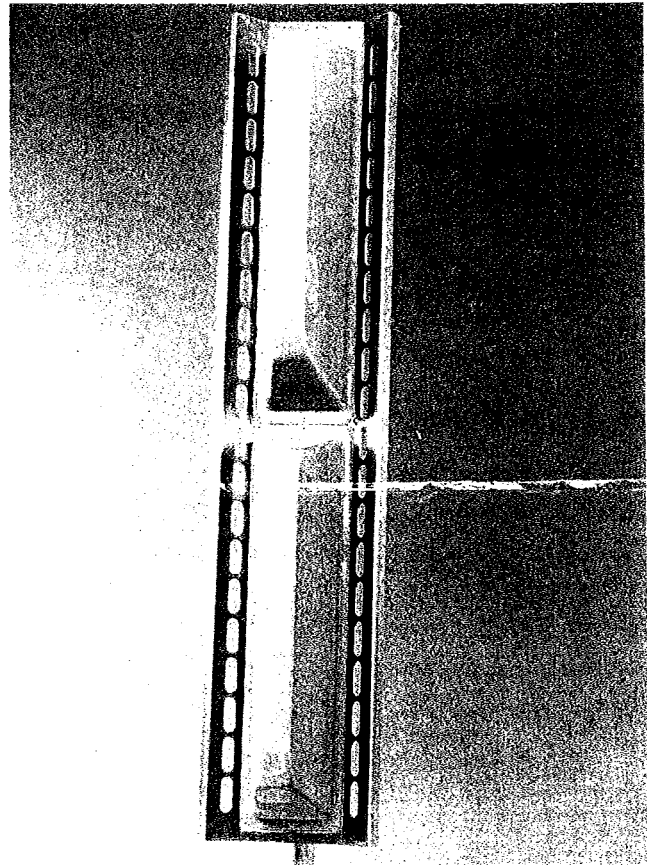

Electrical Specifications:

Frequency range:	806-896 MHz
Impedance:	50 ohm
Connector:	N-female or 7/8" EIA
VSWR:	Typ. 1.3:1 max 1.5:1
Polarization:	Vertical
Gain:	12 dBd
Front to back ratio:	>28 dB
Side-lobe suppression:	>18 dB
Intermodulation: (2x25W):	IM3 >146 dB IM5 >153 dB IM7 & IM9 >163 dB
Power Rating:	500 W
H-Plane:	-3 dB 95 °
E-Plane:	-3 dB 15 °
Lightning Protection:	DC Grounded

Mechanical Specifications:

Overall Height:	52 in	(1320 mm)
Width:	11.4 in	(290 mm)
Depth:	11.4 in	(290 mm)
Weight including brackets:	26.7 lbs	(12 Kg)
Rated wind velocity:	113 mph	(180 Km/h)
Wind Area (CxA/Front):	3.9 sq.ft	(0.36 sq.m)
Lateral thrust at rated wind		
Worst case:	570 N	

Materials:

Radiating elements:	Aluminum
Element housing:	Grey PVC
Back-plate:	Aluminum
Mounting hardware	
clamps:	Hot dip galvanized steel
bolts:	Stainless steel

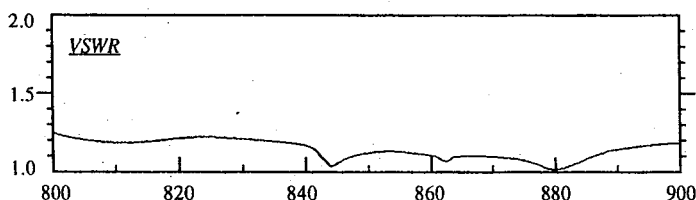

Manufactured by: Allgon System AB

DECIBEL
Base Station Antennas

948F85T2E-M

16.1 dBi, Directed Dipole Antenna
1850-1990 MHz

1850-1990 MHz

**dB Director®
MaxFill™**

- Exceptional azimuth roll-off reducing soft hand-offs and improving capacity
- Excellent upper side lobe suppression
- Deep null filling below the horizon assures improved signal intensity
- Low profile appearance and low wind loading profile for easier zoning approvals

850

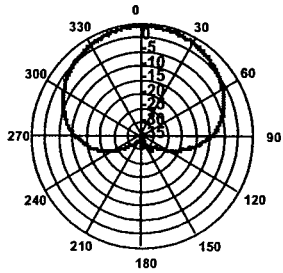

Azimuth 1850 MHz (Tilt=2)

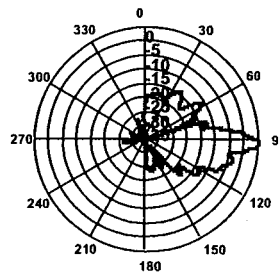

Vertical 1850 MHz (Tilt=2)

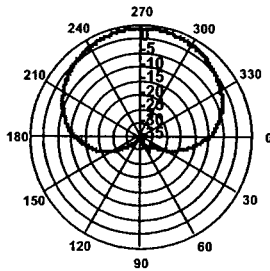

Horizontal 1850 MHz (Tilt=2)



ELECTRICAL

Frequency (MHz):	1850-1990
Polarization:	Vertical
Gain (dBd/dBi):	14/16.1
Azimuth BW:	85°
Elevation BW:	8°
Beam Tilt:	2°
USLS* (dB):	>18
Null Fill* (dB):	15
Front-to-Back Ratio* (dB):	40
VSWR:	<1.33:1
IM Suppression - Two 20 Watt Carriers:	-150
Impedance:	50 Ohms
Max Input Power:	250 Watts
Lightning Protection:	DC Ground
Opt Electrical Tilt:	0°, 4°, 6°

MECHANICAL

Weight:	8.5 lbs (3.9 kg)
Dimensions (LxWxD):	48 X 3.5 X 7 in (1219 X 89 X 178 mm)
Max. Wind Area:	2.3 ft² (0.21 m²)
Max. Wind Load (@ 100mph):	92 lbf (409 N)
Max. Wind Speed:	125 mph (201 km/h)
Radiator Material:	Low Loss Circuit Board
Reflector Material:	Passivated Aluminum
Radome Material:	ABS, UV Resistant
Mounting Hardware Material:	Galvanized Steel
Connector Type:	7-16 DIN - Female (Bottom)
Color:	Light Gray
Standard Mounting Hardware:	DB390 Pipe Mount Kit, included
Downtilt Mounting Hardware:	DB5098, optional
Opt. Mounting Hardware:	DB5094-AZ Azimuth Wall Mount



Andrew Corporation
8635 Stemmons Freeway
Dallas, Texas U.S.A 75247-3701
Tel: 214.631.0310

Fax: 214.631.4706
Toll Free Tel: 1.800.676.5342
Fax: 1.800.229.4706
www.andrew.com

Date: 1/23/2004
* - Indicates Typical Values

dbtech@andrew.com

General Power Density

Site Name: N Stamford, CT
 Tower Height: 147.5 Ft. rad center

Operator	Operating Frequency (MHz)	Number of Trans.	ERP Per Trans. (watts)	Total ERP (watts)	Distance to Target (feet)	Calculated Power Density (mW/cm ²)	Maximum Permissible Exposure (mW/cm ²)	Fraction of MPE (%)
Verizon	880	9	200	1800	147.5	0.0298	0.56733	5.24%
Verizon	1900	3	285	855	147.5	0.0141	1	1.41%
Total Percentage of Maximum Permissible Exposure								6.66%

*Guidelines adopted by the FCC on August 1, 1996, 47 CFR Part 1 based on NCRP Report 86, 1986 and generally on ANSI/IEEE C95.1-1992

MHz = Megahertz
 mW/cm² = milliwatts per square centimeter
 ERP = Effective Radiated Power

Absolute worst case scenario, maximum values used.



SC 9012-Din

Enhanced Log-Periodic Antenna

Features:

- Small Size
- Aesthetically Pleasing
- Suitable For TDMA/CDMA/GSM
- High Return Loss
- Low Intermodulation
- High FTB
- Broadbanded
- Side-lobe Suppression
- Sturdy Design
- Down-Tilt Brackets Incl.

• connector on backplane

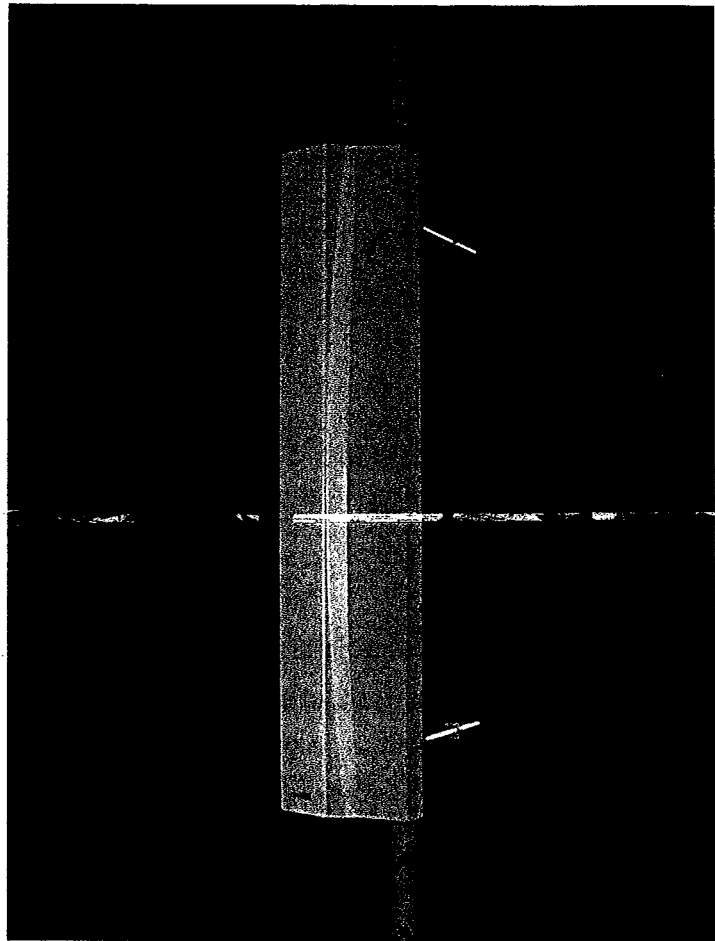

Electrical Specification

Frequency Range:	800-900 MHz
Impedance:	50 ohm
Connector Type:	7/16 Din
Return Loss:	20 dB
Polarization:	Vertical
Gain:	> 11 dBd
Front To Back Ratio:	> 30 dB
Side-Lobe Suppression:	18 dB
Intermodulation (2x25W):	IM3 > 146 dB IM5 > 153 dB IM7/9 > 163 dB
Power Rating:	500 W
H-Plane (-3 dB point):	85 - 92°
V-Plane (-3 dB point):	16 - 18°
Lightning Protection:	DC Grounded

Mechanical Specification

Overall Height:	43 in	[1092 mm]
Width:	6.5 in	[165 mm]
Depth:	8 in	[203 mm]
Weight Including Tilt-Brackets:	20 lbs	[9.1 Kg]
Wind load measured up to:	150 mph	[240 Km/h]
Wind Area (Side of antenna):	2.3 sq. ft.	[0.22 sq.m]
Lateral Thrust At 113 mph/ 180Km/h (Worst Case):	112 lbs	[500 N]

Materials

Radiating Elements:	Aluminum
Extrusion:	Aluminum
Radome:	Grey PVC
Tilt-Bracket:	Hot Dip Galvanized Steel
Antenna Bolts:	Stainless Steel

The SC 9012-Din is made in U.S.A.

DECIBEL®
Base Station Antennas

948F85T2E-M

16.1 dBi, Directed Dipole Antenna
1850-1990 MHz

1850-1990 MHz

dB Director®
MaxFill™

- Exceptional azimuth roll-off reducing soft hand-offs and improving capacity
- Excellent upper side lobe suppression
- Deep null filling below the horizon assures improved signal intensity
- Low profile appearance and low wind loading profile for easier zoning approvals

850

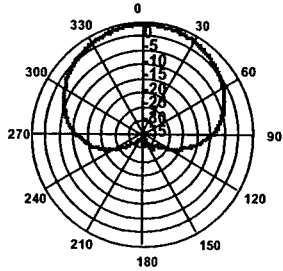

Azimuth 1850 MHz (Tilt=2)

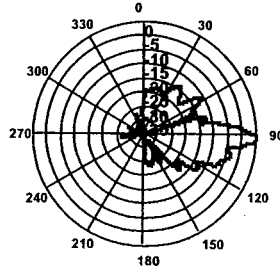

Vertical 1850 MHz (Tilt=2)

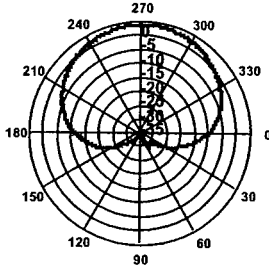

Horizontal 1850 MHz (Tilt=2)



ELECTRICAL

Frequency (MHz):	1850-1990
Polarization:	Vertical
Gain (dBd/dBi):	14/16.1
Azimuth BW:	85°
Elevation BW:	8°
Beam Tilt:	2°
USLS* (dB):	>18
Null Fill* (dB):	15
Front-to-Back Ratio* (dB):	40
VSWR:	<1.33:1
IM Suppression - Two 20 Watt Carriers:	-150
Impedance:	50 Ohms
Max Input Power:	250 Watts
Lightning Protection:	DC Ground
Opt Electrical Tilt:	0°, 4°, 6°

MECHANICAL

Weight:	8.5 lbs (3.9 kg)
Dimensions (LxWxD):	48 X 3.5 X 7 in (1219 X 89 X 178 mm)
Max. Wind Area:	2.3 ft² (0.21 m²)
Max. Wind Load (@ 100mph):	92 lbf (409 N)
Max. Wind Speed:	125 mph (201 km/h)
Radiator Material:	Low Loss Circuit Board
Reflector Material:	Passivated Aluminum
Radome Material:	ABS, UV Resistant
Mounting Hardware Material:	Galvanized Steel
Connector Type:	7-16 DIN - Female (Bottom)
Color:	Light Gray
Standard Mounting Hardware:	DB390 Pipe Mount Kit, included
Downtilt Mounting Hardware:	DB5098, optional
Opt. Mounting Hardware:	DB5094-AZ Azimuth Wall Mount



Andrew Corporation
8635 Stemmons Freeway
Dallas, Texas U.S.A 75247-3701
Tel: 214.631.0310

Fax: 214.631.4706
Toll Free Tel: 1.800.676.5342
Fax: 1.800.229.4706
www.andrew.com

Date: 1/23/2004
* - Indicates Typical Values

dbtech@andrew.com

General Power Density

Site Name: Riverbank, CT
 Tower Height: 141 Ft. rad center

Operator	Operating Frequency (MHz)	Number of Trans.	ERP Per Trans. (watts)	Total ERP (watts)	Distance to Target (feet)	Calculated Power Density (mW/cm ²)	Maximum Permissible Exposure (mW/cm ²)	Fraction of MPE (%)
Verizon	880	9	200	1800	141	0.0326	0.56733	5.74%
Verizon	1900	3	285	855	141	0.0155	1	1.55%
Total Percentage of Maximum Permissible Exposure								7.29%

*Guidelines adopted by the FCC on August 1, 1996, 47 CFR Part 1 based on NCRP Report 86, 1986 and generally on ANSI/IEEE C95.1-1-1992

MHz = Megahertz

mW/cm² = milliwatts per square centimeter

ERP = Effective Radiated Power

Absolute worst case scenario, maximum values used.



ALP-E 9011-Din

Enhanced Log-Periodic Antenna

Features:

- Small Size
- Aesthetically Pleasing
- Suitable For TDMA/CDMA
- High Return Loss
- Low Intermodulation
- High FTB
- Broadbanded
- Side-lobe Suppression
- Sturdy Design
- Down-Tilt Brackets Incl.

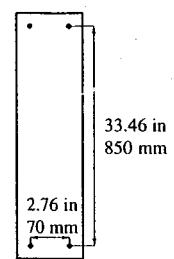
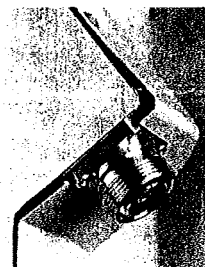
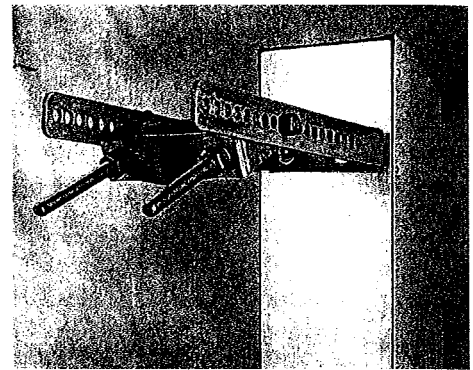
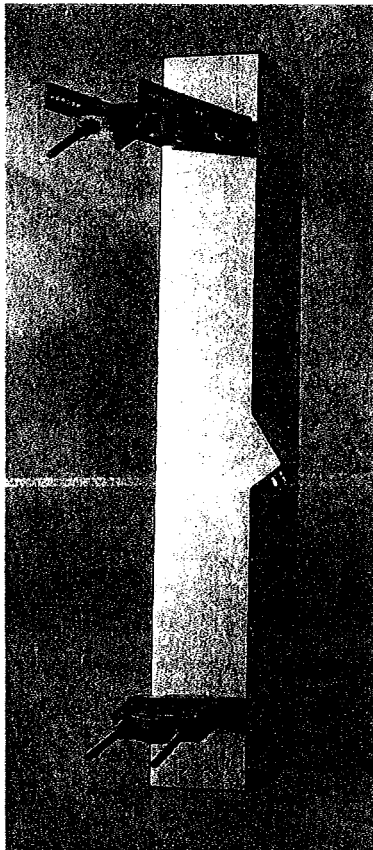

The distance between the center of the bolts (on the back of the antenna) are shown in the drawing above.

Bolt diameter is: 3/8-16
[comes with lock nut].



Frequency Range:	800-900 MHz
Impedance:	50 ohm
Connector Type:	7/16 Din
Return Loss:	20 dB
Polarization:	Vertical
Gain:	> 11 dBd
Front To Back Ratio:	> 30 dB
Side-Lobe Suppression:	18 dB
Intermodulation (2x25W):	IM3 > 146 dB
	IM5 > 153 dB
	IM7/9 > 163 dB
Power Rating:	500 W
H-Plane (-3 dB point):	85 - 92°
V-Plane (-3 dB point):	16 - 18°
Lightning Protection:	DC Grounded

Overall Height:	43 in	[1092 mm]
Width:	6.5 in	[165 mm]
Depth:	8 in	[203 mm]
Weight Including Tilt-Brackets:	20 lbs	[9.1 Kg]
Rated Wind Velocity:	113 mph	[180 Km/h]
Wind Area (CxA/Side):	2.3 sq. ft.	[0.22 sq.m]
Lateral Thrust At Rated Wind Worst Case:	112 lbs	[500 N]



Radiating Elements:	Aluminum
Extrusion:	Aluminum
Radome:	Grey PVC
Tilt-Bracket:	Hot Dip Galvanized Steel
Antenna Bolts:	Stainless Steel

The ALP-E 9011-Din is made in U.S.A.

DECIBEL
Base Station Antennas

948F85T2E-M

16.1 dBi, Directed Dipole Antenna
1850-1990 MHz

1850-1990 MHz

dB Director®
MaxFill™

- Exceptional azimuth roll-off reducing soft hand-offs and improving capacity
- Excellent upper side lobe suppression
- Deep null filling below the horizon assures improved signal intensity
- Low profile appearance and low wind loading profile for easier zoning approvals

850

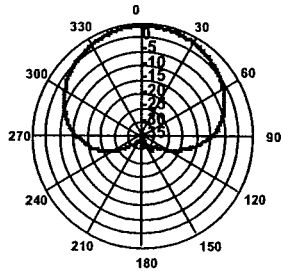

Azimuth 1850 MHz (Tilt=2)

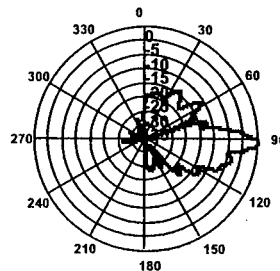

Vertical 1850 MHz (Tilt=2)

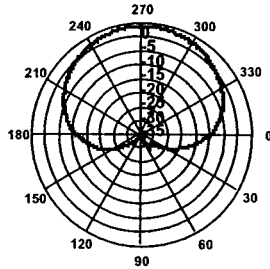

Horizontal 1850 MHz (Tilt=2)



ELECTRICAL

Frequency (MHz):	1850-1990
Polarization:	Vertical
Gain (dBd/dBi):	14/16.1
Azimuth BW:	85°
Elevation BW:	8°
Beam Tilt:	2°
USLS* (dB):	>18
Null Fill* (dB):	15
Front-to-Back Ratio* (dB):	40
VSWR:	<1.33:1
IM Suppression - Two 20 Watt Carriers:	-150
Impedance:	50 Ohms
Max Input Power:	250 Watts
Lightning Protection:	DC Ground
Opt Electrical Tilt:	0°, 4°, 6°

MECHANICAL

Weight:	8.5 lbs (3.9 kg)
Dimensions (LxWxD):	48 X 3.5 X 7 in (1219 X 89 X 178 mm)
Max. Wind Area:	2.3 ft² (0.21 m²)
Max. Wind Load (@ 100mph):	92 lbf (409 N)
Max. Wind Speed:	125 mph (201 km/h)
Radiator Material:	Low Loss Circuit Board
Reflector Material:	Passivated Aluminum
Radome Material:	ABS, UV Resistant
Mounting Hardware Material:	Galvanized Steel
Connector Type:	7-16 DIN - Female (Bottom)
Color:	Light Gray
Standard Mounting Hardware:	DB390 Pipe Mount Kit, included
Downtilt Mounting Hardware:	DB5098, optional
Opt. Mounting Hardware:	DB5094-AZ Azimuth Wall Mount



Andrew Corporation
8635 Stemmons Freeway
Dallas, Texas U.S.A 75247-3701
Tel: 214.631.0310

Fax: 214.631.4706
Toll Free Tel: 1.800.676.5342
Fax: 1.800.229.4706
www.andrew.com

Date: 1/23/2004
* - Indicates Typical Values

dbtech@andrew.com

General Power Density

Site Name: Bridgeport SW, CT
 Tower Height: 110 Ft. rad center

Operator	Operating Frequency (MHz)	Number of Trans.	ERP Per Trans. (watts)	Total ERP (watts)	Distance to Target (feet)	Calculated Power Density (mW/cm ²)	Maximum Permissible Exposure*	Fraction of MPE (%)
Verizon	880	9	200	1800	110	0.0535	0.56733	9.43%
Verizon	1900	3	285	855	110	0.0254	1	2.54%
Total Percentage of Maximum Permissible Exposure								11.97%

*Guidelines adopted by the FCC on August 1, 1996, 47 CFR Part 1 based on NCRP Report 86, 1986 and generally on ANSI/IEEE C95.1-1992

MHz = Megahertz

mW/cm² = milliwatts per square centimeter

ERP = Effective Radiated Power

Absolute worst case scenario, maximum values used.



Maximizer™ Directional Panel Antenna

APL8665* Series

The Celwave Maximizer series is a log periodic dipole array which uses a patented design to achieve a front-to-back ratio of 45 dB, the highest front-to-back ratio in the industry. Maximizers are available to cover ESMR, AMPS, PCS and DCS frequency ranges. They use RFS's patented monolithic CELLite® technology, which eliminates cable and soldered joints to reduce the possibility of inter-modulation products. The CELLite technology assures high reliability and excellent repeatability of electrical characteristics. The cellular Maximizers are available in 65°, 80° and 90° horizontal beamwidths and the PCS/DCS Maximizers are available in 65° and 90° horizontal beamwidths. Patent number 6,133,889.

- **45 dB front-to-back ratio**
Reduces co-channel interference.
- **Monolithic construction**
Reduces IM.
- **No solder joints**
For high reliability.
- **Surface treated components**
To prevent galvanic corrosion.
- **UV stabilized radome**
Assures long life without radome deterioration due to UV exposure.

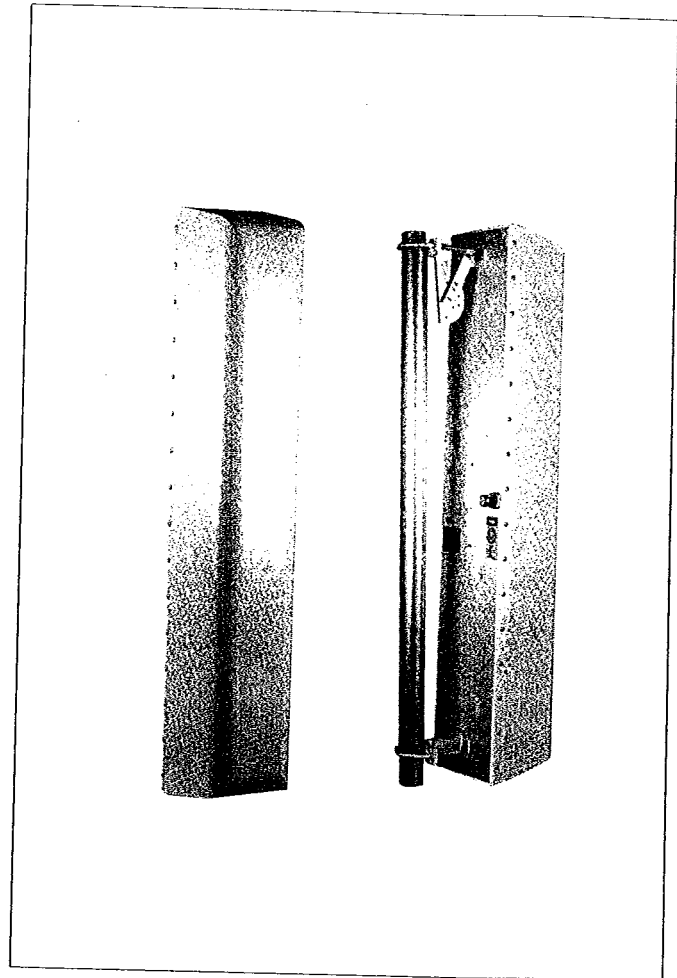

APL8665* Series

ORDERING INFORMATION

Product Number	Frequency Range - MHz
APL866513-12T0	806-894
APL866513-12T6	806-894
APL866513-12T9	806-894
APL866513-14T0	806-894
APL866513-14T6	806-894
APL866513-14T9	806-894
APL866513-42T0	806-894
APL866513-42T6	806-894
APL866513-42T9	806-894
APL866513-44T0	806-894
APL866513-44T6	806-894
APL866513-44T9	806-894
APL866516-12T0	806-894
APL866516-14T0	806-894
APL866516-42T0	806-894
APL866516-44T0	806-894

Maximizer™ Directional Panel Antenna

APL8665* Series

CHARACTERISTICS

Electrical Specifications

	APL866516-12T0	APL866516-14T0	APL866516-42T0	APL866516-44T0
Frequency Range - MHz	806-894	806-894	806-894	806-894
Horizontal Pattern	Directional	Directional	Directional	Directional
Antenna Type	Panel/Log Periodic	Panel/Log Periodic	Panel/Log Periodic	Panel/Log Periodic
Gain dBd (dBi)	16.0 (18.1)	16.0 (18.1)	16.0 (18.1)	16.0 (18.1)
Connector Type	N-Female	N-Female	7-16 DIN-Female	7-16 DIN-Female
Mount Type	downtilt bracket	fixed pipe	downtilt bracket	fixed pipe
Electrical Tilt - Degrees	0	0	0	0
Horizontal Beamwidth, Degrees	65	65	65	65
Mounting Hardware - Supplied	Downtilt Bracket 10228	Fixed: 10238	Downtilt Bracket 10228	Fixed: 10238
Rated Wind Speed - mph (km/hr)	112 (181)	112 (181)	112 (181)	112 (181)
Bandwidth - MHz for 1.5:1 VSWR	88	88	88	88
Vertical Beamwidth, Degrees	8	8	8	8
Upper Sidelobe Suppression - dB Typ.	18	18	18	18
Polarization	Vertical	Vertical	Vertical	Vertical
Front-To-Back Ratio - dB	45	45	45	45
Maximum Power Input - Watts	500	500	500	500
Lightning Protection	Direct Ground	Direct Ground	Direct Ground	Direct Ground
3rd Order IMD @ 16 x 41 dBm: - dBm	-100	-100	-100	-100

Mechanical Specifications

Dimensions - WxDxH - in. (mm)	9.2 x 8.0 x 93.0 (233.7 x 203.2 x 2362)	9.2 x 8.0 x 93.0 (233.7 x 203.2 x 2362)	9.2 x 8.0 x 93.0 (233.7 x 203.2 x 2362)	9.2 x 8.0 x 93.0 (233.7 x 203.2 x 2362)
Weight w/o Mtg. Hardware - lbs. (kg)	31.4 (14.3)	31.4 (14.3)	31.4 (14.3)	31.4 (14.3)
Weight w/ Mtg. Hardware - lbs. (kg)	34.8 (15.8)	34.8 (15.8)	34.8 (15.8)	34.8 (15.8)
Radiating Element Material	Aluminum Alloy	Aluminum Alloy	Aluminum Alloy	Aluminum Alloy
Radome Material	UV Stabilized High Impact ABS	UV Stabilized High Impact ABS	UV Stabilized High Impact ABS	UV Stabilized High Impact ABS
Reflector Material	5052-H32 Aluminum	5052-H32 Aluminum	5052-H32 Aluminum	5052-H32 Aluminum
Max Wind Loading Area (Flat Plate Equivalent) - ft ² (m ²)	7.9 (0.73)	7.9 (0.73)	7.9 (0.73)	7.9 (0.73)
Maximum Thrust @ Rated Wind - lbf (N)	396 (1761)	396 (1761)	396 (1761)	396 (1761)
Side Wind Loading Area (FPE) - ft ² (m ²)	5.17 (0.48)	5.17 (0.48)	5.17 (0.48)	5.17 (0.48)
Side Thrust @ Rated Wind - lbf (N)	259 (1152)	259 (1152)	259 (1152)	259 (1152)
Mounting Hardware - Optional	Downtilt: 10228-25	Downtilt: 10228-25	Downtilt: 10228-25	Downtilt: 10228-25

Shipping Specifications

Weight - lbs. (kg)	36 (16.3)	36 (16.3)	36 (16.3)	36 (16.3)
Dimensions of Antenna - WxDxH - in. (mm)	13.75x14.0x103.5 (350x356x2629)	13.75x14.0x103.5 (350x356x2629)	13.75x14.0x103.5 (350x356x2629)	13.75x14.0x103.5 (350x356x2629)
Dimensions of Accessory	Packed w/antenna	Packed w/antenna	Packed w/antenna	Packed w/antenna
Mode	Common Carrier	Common Carrier	Common Carrier	Common Carrier

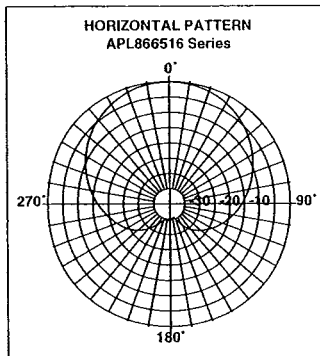
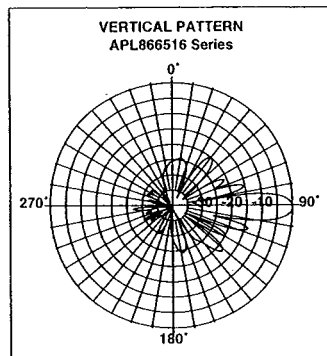

Maximizer® Directional Panel Antenna

APL1965* Series

The Celwave Maximizer series is a log periodic dipole array which uses a patented design to achieve a front-to-back ratio of 45 dB, the highest front-to-back ratio in the industry. Maximizers are available to cover ESMR, AMPS, PCS and DCS frequency ranges. They use Celwave's patented monolithic CELLite® technology, which eliminates cable and soldered joints to reduce the possibility of intermodulation products. The CELLite technology assures high reliability and excellent repeatability of electrical characteristics. The cellular Maximizers are available in 65°, 80° and 90° horizontal beamwidths and the PCS/DCS Maximizers are available in 65° and 90° horizontal beamwidths.

- **45 dB front-to-back ratio**
Reduces co-channel interference.
- **Monolithic construction**
Reduces IM.
- **No solder joints**
For high reliability.
- **Surface treated components**
To prevent galvanic corrosion.
- **UV stabilized radome**
Assures long life without radome deterioration due to UV exposure.

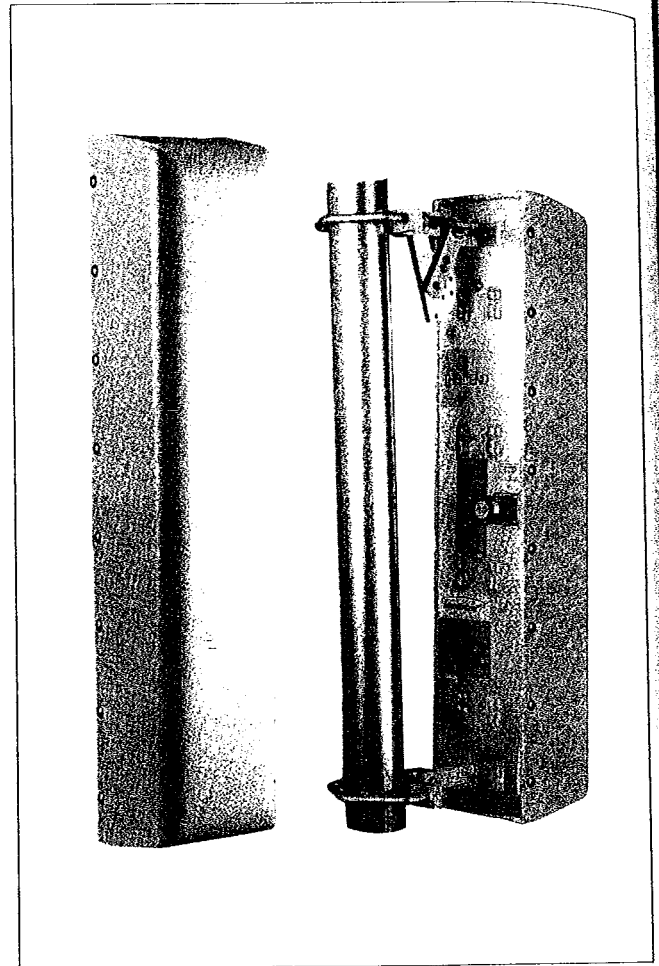

APL1965 Series

ORDERING INFORMATION

Product Number	Frequency Range - MHz
APL196513-42T0	1850-1990
APL196513-42T2	1850-1990
APL196513-44T0	1850-1990
APL196513-44T2	1850-1990
APL196516-42T0	1850-1990
APL196516-42T2	1850-1990
APL196516-42T5	1850-1990
APL196516-44T0	1850-1990
APL196516-44T2	1850-1990
APL196516-44T5	1850-1990

BASE STATION ANTENNAS

C
E
R
H
A
G
C
N
E
T
M
-
F
E
E
L
I
E

Maximizer® Directional Panel Antenna

APL1965* Series

BASE STATION ANTENNAS

CHARACTERISTICS	APL196516-42T0	APL196516-42T2	APL196516-42T5	APL196516-44T0
Electrical Specifications				
Frequency Range - MHz	1850-1990	1850-1990	1850-1990	1850-1990
Horizontal Pattern	Directional	Directional	Directional	Directional
Antenna Type	Panel/Log Periodic	Panel/Log Periodic	Panel/Log Periodic	Panel/Log Periodic
Gain dBd (dBi)	16.0 (18.1)	16.0 (18.1)	16.0 (18.1)	16.0 (18.1)
Connector Type	7-16 DIN-Female	7-16 DIN-Female	7-16 DIN-Female	7-16 DIN-Female
Mount Type	downtilt	downtilt	downtilt	fixed
Electrical Tilt - Degrees	0	-2	-5	0
Horizontal Beamwidth, Degrees	65	65	65	65
Mounting Hardware - Supplied	Downtilt Bracket APM21-5	Downtilt Bracket APM21-5	Downtilt Bracket APM21-5	Fixed Pipe Bracket APM19-2
Rated Wind Speed - mph (km/hr)	125 (201.25)	125 (201.25)	125 (201.25)	125 (201.25)
Bandwidth - MHz for 1.5:1 VSWR	140	140	140	140
Vertical Beamwidth, Degrees	6	6	6	6
Null Fill - dB	> -15	> -15	> -15	> -15
Upper Sidelobe Suppression - dB Typ.	> -18	> -18	> -18	> -18
Polarization	Vertical	Vertical	Vertical	Vertical
Front-To-Back Ratio - dB	45	45	45	45
Maximum Power Input - Watts	250	250	250	250
Lightning Protection	Direct Ground	Direct Ground	Direct Ground	Direct Ground
3rd Order IMD @ 2 x 43 dBm: - dBm	-100	-100	-100	-100
Mechanical Specifications				
Dimensions - WxDxH - in. (mm)	5.0 x 4.0 x 63.0 (127 x 102 x 1600)	5.0 x 4.0 x 63.0 (127 x 102 x 1600)	5.0 x 4.0 x 63.0 (127 x 102 x 1600)	5.0 x 4.0 x 63.0 (127 x 102 x 1600)
Weight w/o Mtg. Hardware - lbs. (kg)	10 (4.54)	10 (4.54)	10 (4.54)	10 (4.54)
Weight w/ Mtg. Hardware - lbs. (kg)	14 (6.35)	14 (6.35)	14 (6.35)	14 (6.35)
Radiating Element Material	Aluminum Alloy	Aluminum Alloy	Aluminum Alloy	Aluminum Alloy
Radome Material	UV-Stabilized High Impact ABS	UV-Stabilized High Impact ABS	UV-Stabilized High Impact ABS	UV-Stabilized High Impact ABS
Reflector Material	5032-H32 Aluminum	5032-H32 Aluminum	5032-H32 Aluminum	5032-H32 Aluminum
Max Wind Loading Area (Flat Plate Equivalent) - ft2 (m2)	2.2 (0.205)	2.2 (0.205)	2.2 (0.205)	2.2 (0.205)
Maximum Thrust @ Rated Wind - lbf (N)	88 (282)	88 (282)	88 (282)	88 (282)
Side Wind Loading Area (FPE) - ft2 (m2)	1.75 (0.163)	1.75 (0.163)	1.75 (0.163)	1.75 (0.163)
Side Thrust @ Rated Wind - lbf (N)	70 (312)	70 (312)	70 (312)	70 (312)
Shipping Specifications				
Weight - lbs. (kg)	18 (8.1)	18 (8.1)	18 (8.1)	18 (8.1)
Dimensions of Antenna - WxDxH - ft. (mm)	10 x 14 x 82 (254 x 356 x 2083)	10 x 14 x 82 (254 x 356 x 2083)	10 x 14 x 82 (254 x 356 x 2083)	10 x 14 x 82 (254 x 356 x 2083)
Dimensions of Accessory - WxDxH - ft. (m)	3 x 9 x 12 (76 x 229 x 305)	3 x 9 x 12 (76 x 229 x 305)	3 x 9 x 12 (76 x 229 x 305)	3 x 9 x 12 (76 x 229 x 305)
Mode	UPS	UPS	UPS	UPS

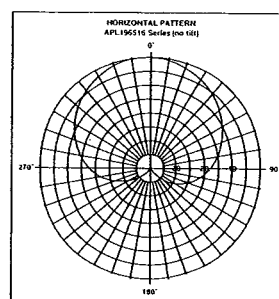
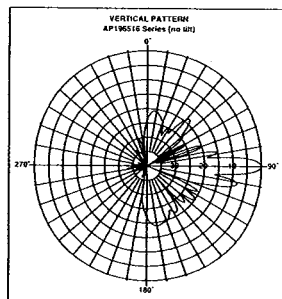

General Power Density

Site Name: Cranbury, CT
 Tower Height: 128 Ft. rad center

Operator	Operating Frequency (MHz)	Number of Trans.	ERP Per Trans. (watts)	Total ERP (watts)	Distance to Target (feet)	Calculated Power Density (mW/cm ²)	Maximum Permissible Exposure* (mW/cm ²)	Fraction of MPE (%)
Verizon	880	9	200	1800	128	0.0395	0.56733	6.96%
Verizon	1900	3	285	855	128	0.0188	1	1.88%
Total Percentage of Maximum Permissible Exposure								8.84%

*Guidelines adopted by the FCC on August 1, 1996, 47 CFR Part 1 based on NCRP Report 86, 1986 and generally on ANSI/IEEE C95.1-1992

MHz = Megahertz

mW/cm² = milliwatts per square centimeter

ERP = Effective Radiated Power

Absolute worst case scenario, maximum values used.

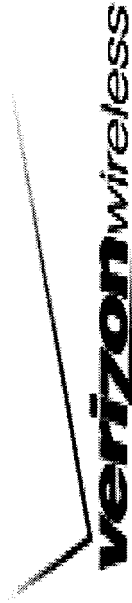

Log-Periodic 80°/13 dBd

LPD-7907/4

Mechanical specifications

Length	1200 mm	47.2 in
Width	130 mm	5.1 in
Depth	375 mm	14.8 in
Weight	12 kg	26.5 lbs
Wind area	0.40 m ²	4.3 ft ²
Wind load at 50m/s	630 N	142 lbs

Mounting

Through three pair of clamps to pipe diameter Ø50-160 mm (2.0-6.3 in).

Antenna consisting of brass and covered by a fiberglass radome.

Mounting Bracket #36110003

Downtilt Bracket #36114002

Electrical specifications

Frequency range	806-960 MHz
Impedance	50Ω
Connector	N, NE, DIN, E-DIN or EIA
VSWR	≤1.25:1
Polarization	Vertical
Gain	13 dBd
Power rating	500 W
Half power angle	
H-plane	80°
E-plane	14°
Lobe fill	1.25°
Null fill	5%
Lightning protection	Direct ground

Radiation-pattern (at mid-band)

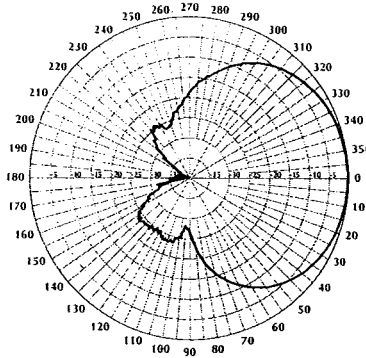

Horizontal

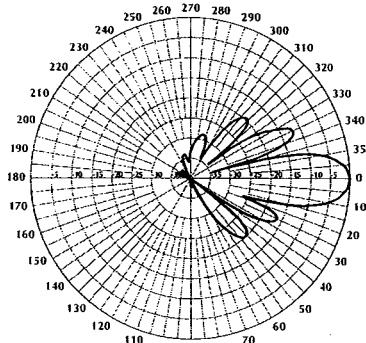

Vertical

Radiation patterns for all Antel antennas are measured with the antenna mounted on a fiberglass pole.

Mounting on a metal pole will typically improve the Front-to-Back Ratio.

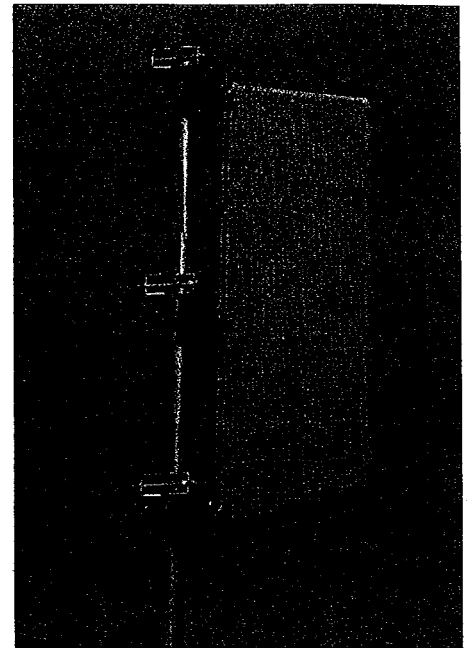

Antel's Exclusive 3T
(True Transmission
Line Technology)
Antenna Design:

- True log-periodic design allows for superior front-to-side characteristics to minimize sector overlap.
- Durable brass feedline design that eliminates the need for solder joints in the signal path.
- A non-collinear system with access to every radiating element for broad bandwidth and superior performance.
- Air as insulation for virtually no internal signal loss.

Every Antel antenna is under a five-year limited warranty for repair or replacement.

For a list of models, including electrical downtilt and/or null fill combinations, see page 137.

Typical values:

- Power Rating limited by Connector only.
- N indicates an elongated N Connector.
- DIN indicates an elongated DIN Connector.
- EIA indicates a 7/16" EIA Flange.
- All dimensions are in millimeters unless otherwise indicated.
- Components of the antenna may be made with stainless steel.

806-960 MHz

815-399-0001 outside the U.S.A. • antel@antelinc.com

Antel
INTERNATIONAL, INC.

Vertically Polarized, Log Periodic 80° / 16 dBi

LPA-185080/8CF ___ 2°

When ordering, replace " ___ " with connector type.

Mechanical specifications

Length	1204 mm	47.4 in
Width	104 mm	4.1 in
Depth	150 mm	5.9 in
⁴⁾ Weight	3.2 kg	7.0 lbs

Wind Area

Front	0.125 m ²	1.35 ft ²
Side	0.144 m ²	1.55 ft ²

Rated Wind Velocity (Safety factor 2.0)

>658 km/hr >409 mph

Wind load @ 100 mph (161 km/hr)

Front	202 N	45 lbs
Side	211 N	47 lbs

Antenna consisting of aluminum alloy with brass feedlines covered by a UV safe fiberglass radome.

Mounting & Downtilting:

Wall mounted or pole tower mount with mounting brackets.

Mounting bracket kit #26799997

Downtilt bracket kit #26799999

The downtilt bracket kit includes the mounting bracket kit.

Electrical specifications

Frequency Range	1850-1990 MHz
Impedance	50Ω
³⁾ Connector	NE, E-DIN
¹⁾ VSWR	≤1.4:1
Polarization	Vertical
¹⁾ Gain	16 dBi
²⁾ Power Rating	250 W
¹⁾ Half Power Angle	
H-Plane	80°
E-Plane	8°
¹⁾ Lobe Tilt	2°
¹⁾ Null Fill	10%
Lightning Protection	Direct Ground

¹⁾ Typical Values

²⁾ Power Rating limited by connector only.

³⁾ NE indicates an elongated N Connector.

E-DIN indicates an elongated DIN Connector.

⁴⁾ The antenna weight listed above does not include the bracket weight.

Improvements to mechanical and/or electrical performance of the antenna may be made without notice.

Radiation-pattern ¹⁾

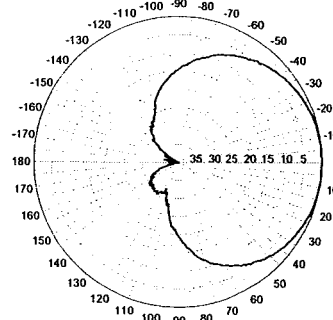

Horizontal

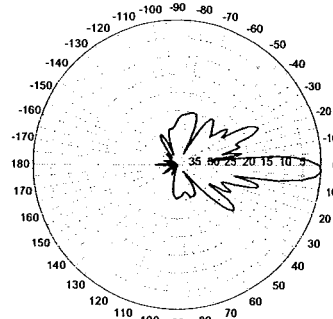

Vertical

Radiation patterns for all antennas are measured with the antenna mounted on a fiberglass pole.

Mounting on a metal pole will typically improve the Front-to-Back Ratio.

CF Denotes a Center-Fed Connector.

1850-1990 MHz

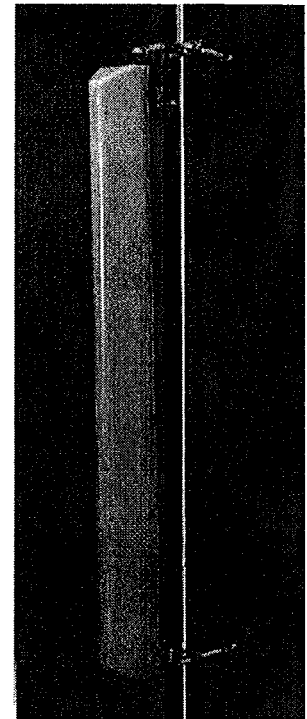

1850-1990 MHz



Amphenol Antel's Exclusive 3T (True Transmission Line Technology) Antenna Design:

- True log-periodic design allows for superior front-to-side characteristics to minimize sector overlap.
- Unique feedline design eliminates the need for conventional solder joints in the signal path.
- A non-collinear system with access to every radiating element for broad bandwidth and superior performance.
- Air as insulation for virtually no internal signal loss.

Every Amphenol Antel antenna is under a five-year limited warranty for repair or replacement.

Antenna available with center-fed connector only.



Revision Date: 12/15/03

Vertically Polarized, Log Periodic 80° / 16 dBi

LPA-185080/8CF ___ 2°

When ordering, replace " ___ " with connector type.

Mechanical specifications

Length	1204 mm	47.4 in
Width	104 mm	4.1 in
Depth	150 mm	5.9 in
⁴⁾ Weight	3.2 kg	7.0 lbs
Wind Area		
Front	0.125 m ²	1.35 ft ²
Side	0.144 m ²	1.55 ft ²
Rated Wind Velocity (Safety factor 2.0)		
	>658 km/hr	>409 mph
Wind load @ 100 mph (161 km/hr)		
Front	202 N	45 lbs
Side	211 N	47 lbs

Antenna consisting of aluminum alloy with brass feedlines covered by a UV safe fiberglass radome.

Mounting & Downtilting:

Wall mounted or pole tower mount with mounting brackets.

Mounting bracket kit #26799997

Downtilt bracket kit #26799999

The downtilt bracket kit includes the mounting bracket kit.

Electrical specifications

Frequency Range	1850-1990 MHz
Impedance	50Ω
³⁾ Connector	NE, E-DIN
¹⁾ VSWR	≤1.4:1
Polarization	Vertical
¹⁾ Gain	16 dBi
²⁾ Power Rating	250 W
¹⁾ Half Power Angle	
H-Plane	80°
E-Plane	8°
¹⁾ Lobe Tilt	2°
¹⁾ Null Fill	10%
Lightning Protection	Direct Ground

¹⁾ Typical Values

²⁾ Power Rating limited by connector only.

³⁾ NE indicates an elongated N Connector.

E-DIN indicates an elongated DIN Connector.

⁴⁾ The antenna weight listed above does not include the bracket weight.

Improvements to mechanical and/or electrical performance of the antenna may be made without notice.

Radiation-pattern ¹⁾

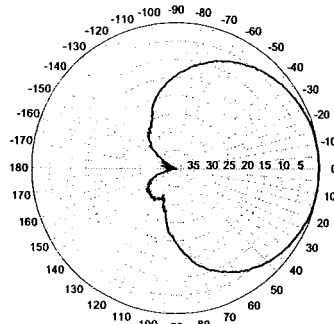

Horizontal

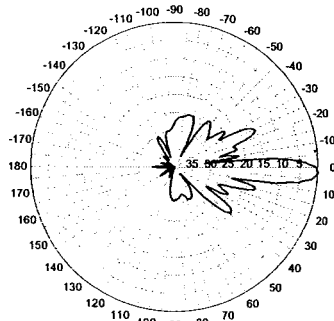

Vertical

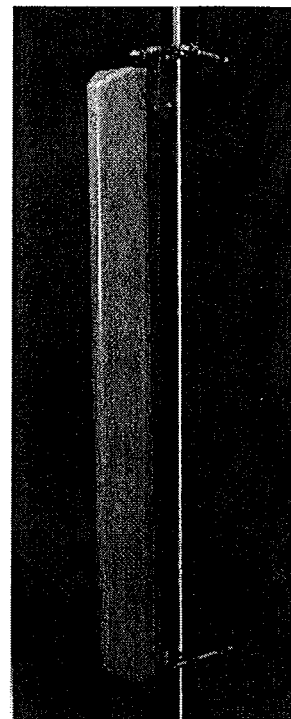

1850-1990 MHz



Amphenol Antel's
Exclusive 3T (True
Transmission Line
Technology)
Antenna Design:

- True log-periodic design allows for superior front-to-side characteristics to minimize sector overlap.
- Unique feedline design eliminates the need for conventional solder joints in the signal path.
- A non-collinear system with access to every radiating element for broad bandwidth and superior performance.
- Air as insulation for virtually no internal signal loss.

Every Amphenol Antel antenna is under a five-year limited warranty for repair or replacement.

Antenna available with center-fed connector only.

CF Denotes a Center-Fed Connector.

1850-1990 MHz

**Amphenol
Antel, Inc.**
The Antenna Technology Company

Revision Date: 12/15/03

General Power Density

Site Name: Westport S, CT
 Tower Height: 100 Ft. rad center

Operator	Operating Frequency (MHz)	Number of Trans.	ERP Per Trans. (watts)	Total ERP (watts)	Distance to Target (feet)	Calculated Power Density (mW/cm ²)	Maximum Permissible Exposure*	Fraction of MPE (%)
Verizon	880	9	200	1800	100	0.0647	0.56733	11.41%
Verizon	1900	3	285	855	100	0.0307	1	3.07%
Total Percentage of Maximum Permissible Exposure								14.48%

*Guidelines adopted by the FCC on August 1, 1996, 47 CFR Part 1 based on NCRP Report 86, 1986 and generally on ANSI/IEEE C95.1-1992

MHz = Megahertz
 mW/cm² = milliwatts per square centimeter
 ERP = Effective Radiated Power

Absolute worst case scenario, maximum values used.



ALP 8013-N

Log-Periodic Reflector Antenna

80 Degrees 13 dBd

Features:

- Broadbanded. (800-900 MHz)
- Low backlobe radiation. Front-to-back ratio better than 30 dB
- Low Intermodulation Products.
- Low Wind-load.
- Low weight.
- Small size.
- Rugged design.

Please see the following pages including radiation patterns/tables for ALP 8013-N.

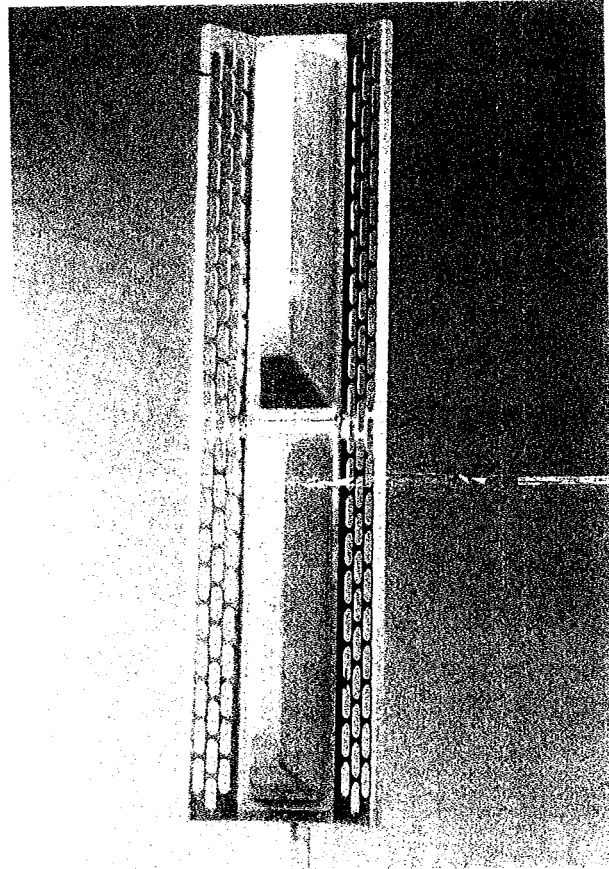

Electrical Specifications:

Frequency range:	806-896 MHz
Impedance:	50 ohm
Connector:	N-female or 7/8" EIA
VSWR:	Typ. 1.3:1 max 1.5:1
Polarization:	Vertical
Gain:	13 dBd
Front to back ratio:	>30 dB
Side-lobe supression:	>18 dB
Intermodulation: (2x25W):	IM3 >146 dB IM5 >153 dB IM7 & IM9 >163 dB
Power Rating:	500 W
H-Plane:	-3 dB 84 °
E-Plane:	-3 dB 15 °
Lightning Protection:	DC Grounded

Mechanical Specifications:

Overall Height:	52 in	(1320 mm)
Width:	13 in	(330 mm)
Depth:	11.4 in	(290 mm)
Weight including brackets:	27.3 lbs	(12.3 Kg)
Rated wind velocity:	113 mph	(180 Km/h)
Wind Area (CxA/Front):	4.5 sq.ft	(0.42 sq.m)
Lateral thrust at rated wind		
Worst case:	650 N	

Materials:

Radiating elements:	Aluminum
Element housing:	Grey PVC
Back-plate:	Aluminum

Mounting hardware	
clamps:	Hot dip galvanized steel
bolts:	Stainless steel

Manufactured by: Allgon System AB

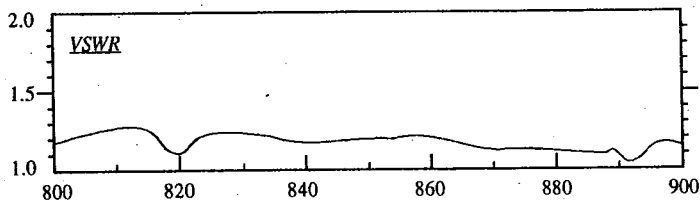

DECIBEL
Base Station Antennas

950F85T2E-M

16.9 dBi, Directed Dipole Antenna
1850-1990 MHz

1850-1990 MHz

dB Director®

- Exceptional azimuth roll-off reducing soft hand-offs and improving capacity
- Excellent upper side lobe suppression
- Deep null filling below the horizon assures improved signal intensity
- Low profile appearance and low wind loading profile for easier zoning approvals

850

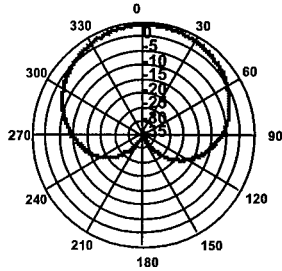

Azimuth 1920 MHz (Tilt=2)

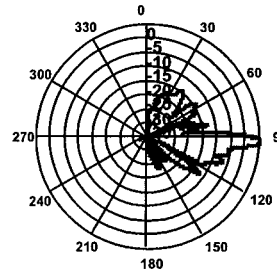

Vertical 1920 MHz (Tilt=2)

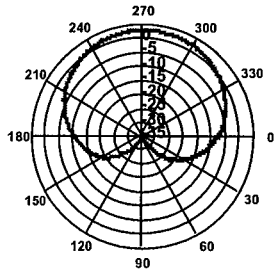

Horizontal 1920 MHz (Tilt=2)



ELECTRICAL

Frequency (MHz):	1850-1990
Polarization:	Vertical
Gain (dBd/dBi):	14.8/16.9
Azimuth BW:	85°
Elevation BW:	6.5°
Beam Tilt:	2°
USLS* (dB):	>16
Null Fill* (dB):	12
Front-to-Back Ratio* (dB):	40
VSWR:	<1.33:1
IM Suppression - Two 20 Watt Carriers:	-150 dBc
Impedance:	50 Ohms
Max Input Power:	250 Watts
Lightning Protection:	DC Ground
Opt Electrical Tilt:	0°, 4°, 6°

MECHANICAL

Weight:	11.5 lbs (5.2 kg)
Dimensions (LxWxD):	60 X 3.5 X 7 in (1524 X 89 X 178 mm)
Max. Wind Area:	2.9 ft² (0.27 m²)
Max. Wind Load (@ 100mph):	116 lbf (516 N)
Max. Wind Speed:	125 mph (201 km/h)
Radiator Material:	Low Loss Circuit Board
Reflector Material:	Passivated Aluminum
Radome Material:	ABS, UV Resistant
Mounting Hardware Material:	Galvanized Steel
Connector Type:	7-16 DIN - Female (Bottom)
Color:	Light Gray
Standard Mounting Hardware:	DB390 Pipe Mount Kit, Included
Downtilt Mounting Hardware:	DB5098, optional
Opt. Mounting Hardware:	DB5094-AZ Azimuth Wall Mount



Andrew Corporation
8635 Stemmons Freeway
Dallas, Texas U.S.A 75247-3701
Tel: 214.631.0310

Fax: 214.631.4706
Toll Free Tel: 1.800.676.5342
Fax: 1.800.229.4706
www.andrew.com

Date: 1/23/2004
* - Indicates Typical Values

dbtech@andrew.com