



Northeast Site Solutions  
Denise Sabo  
420 Main Street, Box 2 Sturbridge MA 01566  
860-209-4690  
[denise@northeastsitesolutions.com](mailto:denise@northeastsitesolutions.com)

May 21, 2018

Members of the Siting Council  
Connecticut Siting Council  
Ten Franklin Square  
New Britain, CT 06051

RE: Exempt Modification Application

150 Butternut Hollow Road, Greenwich CT 06830  
Latitude: 41.096927  
Longitude: -73.68854  
T-Mobile Site#: CT11070B- L700

Dear Ms. Bachman:

T-Mobile is requesting to file an exempt modification for an existing 180-foot lattice tower located at 150 Butternut Hollow Road, Greenwich CT 06830. T-Mobile currently has approval for nine (9) antennas at the 137-foot level of the existing 180-foot tower. The tower and property are owned by CT State Police. The tower structure requires modifications which are shown on SK1-SK5 of the Tower Reinforcement Drawings. T-Mobile now intends to make the following proposed changes.

Planned Modifications:

Remove:  
NONE

Remove and Replace:

(3) AIR21 Antenna – 1900-2100 Mhz (Remove) – (3) (3) AIR32 Antenna – 1900-2100 Mhz (Replace)  
(3) LNX6515 – L700 Mhz (Remove) – (3) RFS – APXAA24 Antenna (Replace)

Install New:

(3)RRU  
(3)Fiber line  
(3) Diplexers

Existing to Remain:

(6) Coax  
(3) RRU  
(3) Twin TMA  
(3) AIR21 Antenna – 1900-2100 Mhz

This facility was first approved by the Connecticut Siting Council. Docket No. 150 – Approved in 1992 to erect telecommunication lattice tower, not to exceed the height of 200-feet Please see attached. The town was not able to provide a parcel map for this site.

Please accept this letter as notification pursuant to Regulations of Connecticut State Agencies § 16- SOj-73, for construction that constitutes an exempt modification pursuant to R.C.S.A. § 16-50j-72(b)(2). In accordance with R.C.S.A. § 16-SOj-73, a copy of this letter is being sent to First Selectman Peter Tesei, Elected Official and Jodi Couture, Planning Director for the Town of Greenwich, as well as the property owner and the tower owner.

The planned modifications to the facility fall squarely within those activities explicitly provided for in R.C.S.A. § 16-50j-72(b)(2).

1. The proposed modifications will not result in an increase in the height of the existing structure.
2. The proposed modifications will not require the extension of the site boundary.
3. The proposed modifications will not increase noise levels at the facility by six decibels or more, or to levels that exceed state and local criteria.
4. The operation of the replacement antennas will not increase radio frequency emissions at the facility to a level at or above the Federal Communications Commission safety standard.
5. The proposed modifications will not cause a change or alteration in the physical or environmental characteristics of the site. ·
6. The existing structure and its foundation can support the proposed loading.

For the foregoing reasons, T-Mobile respectfully submits that the proposed modifications to the above referenced telecommunications facility constitute an exempt modification under R.C.S.A. § 16-50j-72(b)(2).

Sincerely,

Denise Sabo  
Mobile: 860-209-4690  
Fax: 413-521-0558  
Office: 4 Angela's Way, Burlington CT 06013  
Email: denise@northeastsitesolutions.com

Attachments

cc: Peter Tesei, First Selectman- as elected official  
Jodi Couture, Zoning Enforcement Officer  
Brian Bonito - as property& tower owner

# Exhibit A

DOCKET NO. 150 - An application of the State of Connecticut, Department of Public Safety, Division of State Police for a Certificate of Environmental Compatibility and Public Need for the construction, operation, and maintenance of a telecommunications facility located on Butternut Hollow Road, in the Town of Greenwich, Connecticut.

Connecticut

Siting

Council

August 4, 1992

DECISION AND ORDER

Pursuant to the foregoing Findings of Fact and Opinion, the Connecticut Siting Council (Council) finds that the effects associated with the construction, operation, and maintenance of a telecommunications tower, building, and associated equipment at the proposed site in Greenwich, Connecticut, including effects on the natural environment; ecological integrity and balance; public health and safety; scenic, historic, and recreational values; forest and parks; air and water purity; and fish and wildlife are not disproportionate either alone or cumulatively with other effects, are not in conflict with the policies of the State concerning such effects, and are not sufficient reason to deny the application, and therefore directs that a Certificate of Environmental Compatibility and Public Need, as provided by 16-50k of the General Statutes of Connecticut (CGS), be issued to the Connecticut Department of Public Safety, Division of State Police, for the construction, operation, and maintenance of a telecommunications tower, building, and associated equipment at the proposed site on Butternut Hollow Road, in Greenwich, Connecticut.

The facility shall be constructed, operated, and maintained substantially as specified in the Council's record in this proceeding, and subject to the following conditions:

1. The self-supporting, lattice tower shall be designed no taller than necessary to provide the proposed communications, and in no event shall the tower exceed the proposed tower height of 200 feet above ground level, with antennas and all appurtenances, to maintain a clear microwave path from the Butternut Hollow Road site to the Greenwich Hospital rooftop facility.
2. Prior to construction, a Phase I archaeological survey of the facility site shall be conducted by a professional archaeologist with results submitted to the Council. All artifacts shall be made available for inspection by the Connecticut Historic Preservation Office and, if necessary, a Phase II archaeological survey shall be prepared and submitted to the Council.
3. New connecting utility lines to the facility shall be undergrounded along Butternut Hollow Road.

4. The Certificate Holder shall prepare a Development and Management (D&M) Plan for this site in compliance with Sections 16-50j-75 through 16-50j-77 of the Regulations of State agencies. The D&M Plan shall be submitted and approved by the Council prior to the commencement of construction and shall also include:
  - A. Final comprehensive site plans detailing the tower location, tower foundation specifications and profiles, tower height and antenna placements, equipment building specifications and profiles, placement of the propane tank, all grading and cut and fill details showing existing and final contour lines and elevations, the security fence, and landscaping and placement of vegetative screening.
  - B. Detailed plans, including grading, for the final route of the site's access road, designed to minimize tree clearing and excessive cutting of earth.
  - C. Detailed plans for the underground utility line from the nearest existing utility pole on Butternut Hollow Road to the tower site. Such plans are to be developed with review by the Connecticut Light and Power Company and the Town of Greenwich.
  - D. Plans for erosion and sedimentation control consistent with the Connecticut Guidelines for Soil Erosion and Sediment Control, as amended, including measures for the protection of wetlands, watercourses, and Putnam Lake.
  - E. Plans for the final disposal of excess excavated material from trenching activities.
  - F. Plans and procedures for blasting, including explosion protection, and notification to adjacent property owners.
  - G. Final construction schedule.
5. Selective vegetative clearing shall be allowed prior to approval of the D&M plan to permit reconnaissance necessary to prepare the D&M Plan and the Phase I archaeological survey.
6. The Certificate Holder shall comply with existing and future radio frequency (RF) standards promulgated by State or federal regulatory agencies. Upon the establishment of any new governmental RF standards, the facility granted herein shall be brought into compliance with such standards.

7. The Certificate Holder shall provide the Council a recalculated report of electromagnetic radio frequency power density if and when circumstances in operation cause a change in power density above the levels originally calculated and provided in the application.
8. The Certificate Holder shall permit public or private entities to share space on the proposed tower for fair consideration, or shall provide any requesting entity with specific legal, technical, environmental, or economic reasons precluding such tower sharing.
9. The Certificate Holder shall notify the Council of the commencement of construction no less than seven days prior to construction and shall provide a report to the Council upon completion of construction, including the final construction costs and date of commercial operation.
10. If the facility does not initially provide, or permanently ceases to provide telecommunications service following completion of construction, this Decision and Order shall be void, and the tower and all associated equipment shall be dismantled and removed or reapplication for any new use shall be made to the Council before any such new use is made.

Unless otherwise approved by the Council, this Decision and Order shall be void if all construction authorized herein is not completed within five years of the effective date of this Decision and Order or within five years after all appeals to this Decision and Order have been resolved.

Pursuant to CGS Section 16-50p, we hereby directed that a copy of the Findings of Fact, Opinion, and Decision and Order be served on each person listed below, and notice of issuance shall be published in The Greenwich Time and The Greenwich News.

By this Decision and Order, the Council disposes of the legal rights, duties, and privileges of each party named or admitted to the proceeding in accordance with Section 16-50j-17 of the Regulations of State Agencies.

The parties to this proceeding are:

PARTIES

Connecticut State Police

ITS REPRESENTATIVES

L. D. McCallum and  
Stephen R. Sarnoski  
Office of the Attorney  
General  
Mackenzie Hall  
110 Sherman Street  
Hartford, CT 06105  
(203) 566-7570

Town of Greenwich

Attorney John K. Wetmore  
Assistant Town Attorney  
Town of Greenwich  
101 Field Point Road  
Greenwich, CT 06830

Metro Mobile CTS, Inc.

Henry H. Sprague III  
Robinson and Cole  
One Commercial Plaza  
Hartford, CT 06103-3597  
(203) 275-8200

INTERVENOR

Springwich Cellular  
Limited Partnership

ITS REPRESENTATIVES



Peter J. Tyrrell, Esq.  
Springwich Cellular Limited  
Partnership  
227 Church Street  
New Haven, CT 06510  
(203) 771-7381

TEF/bd

6264E

CERTIFICATION

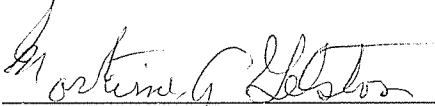
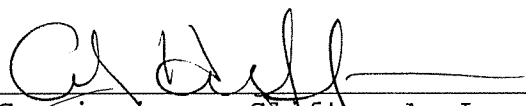
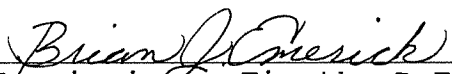
The undersigned members of the Connecticut Siting Council (Council) hereby certify that they have heard this case, or read the record thereof, in DOCKET NO. 150 - An application of the State of Connecticut, Department of Public Safety, Division of State Police for a Certificate of Environmental Compatibility and Public Need for the construction, operation, and maintenance of a telecommunications facility located on Butternut Hollow Road, in the Town of Greenwich, Connecticut, and voted as follows to approve the site:

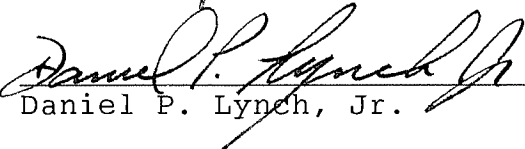
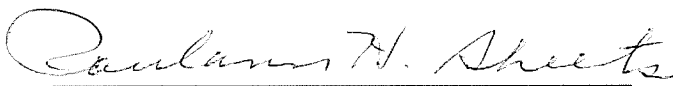
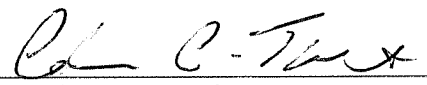
<u>Council Members</u>	<u>Vote Cast</u>
 _____ Mortimer A. Gelston Chairman	YES
 _____ Commissioner Clifton A. Leonhardt Designee: Gerald J. Heffernan	ABSTAIN
 _____ Commissioner Timothy R.E. Keeney Designee: Brian Emerick	YES
 _____ Harry E. Covey	YES
 _____ Daniel P. Lynch, Jr.	YES
_____ Gloria Dibble Pond	ABSENT
 _____ Paulann H. Sheets	YES
_____ William H. Smith	ABSENT
 _____ Colin C. Tait	ABSTAIN

Dated at New Britain, Connecticut, August 4, 1992.



# Exhibit B

ADMINISTRATIVE INFORMATION

PARCEL NUMBER 11-1142

Parent Parcel Number

Property Address BUTTERNUT HOLLOW ROAD 0024

Neighborhood 2800 PARKWAY NORTH

Property Class 430 Hydro Plant

TAXING DISTRICT INFORMATION

Jurisdiction 57 Greenwich, CT

Area 001

Corporation 057

District 11

Section & Plat 259

Routing Number 1067E0011

Site Description

Topography:

Public Utilities: Electric

Street or Road:

Neighborhood:

Zoning: RA-2 Single Family 2 1 Primary Commercial 2 PA-490 Forest 2 3 Open Space AQ 161.9900

OWNERSHIP

AQUARION WATER COMPANY OF CONNECTICUT BRIDGEFORD, CT 06606

LOT NO 37 BUTTERNUT HOLLOW RD E 11

Tax ID 199/018

TRANSFER OF OWNERSHIP

Date

05/21/2002 CONNECTICUT-AMERICAN WATER CO

04/12/1977 NA

Bk/Pg: 3862, 102

Bk/Pg: 1012, 120

UTILITY

VALUATION RECORD

Table with columns: Assessment Year, Reason for Change, 2010 BAA, 2012 List, 2013 List, 2015 Prelim, 2015 Final, 2016 List, 2017 List. Rows include VALUATION Market and VALUATION 70% Assessed.

LAND DATA AND CALCULATIONS

Table with columns: Rating, Measured Soil ID, Actual Frontage, Effective Depth, Prod. Factor, Depth Factor, Base Rate, Adjusted Rate, Extended Value, Influence Factor, Value. Includes rows for RA-2 Single Family 2 and 3 Open Space AQ.

BA10: Reduce unit val on Forest Land (21) frm \$25,600/ac to \$3,000/ac
BP12: 11-1118 (\$521k) instl recycle line frm dwrg bldg to plant wtr
oil tnks, piping. Chg evb frm 2000 to 2005. Remaining is PP.

Permit Number FilingDate Est. Cost Est. Sqft
Type

Supplemental Cards
TRUE TAX VALUE 9672500

Supplemental Cards
TOTAL LAND VALUE 9672500

**PHYSICAL CHARACTERISTICS**

ROOFING					
Built-up					
WALLS					
Frame	B	1	2	U	
Brick		Yes			
Metal					
Guard					
FRAMING					
R Conc	B	1	2	U	
		2592	0	0	
FINISH					
UP	UP	SF	FO	FD	
1	0	0	0	2592	
Total	0	0	0	2592	
HEATING AND AIR CONDITIONING					
Heat	B	1	2	U	
		2592	0	0	

**IMPROVEMENT DATA**

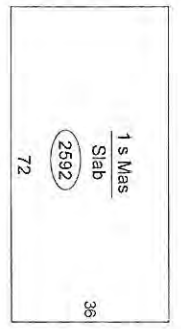

Dewatering Bldg.

- 01
- 02
- 03
- 04

Water Treatment Plant w/ max design capacity of 2.3 MGD

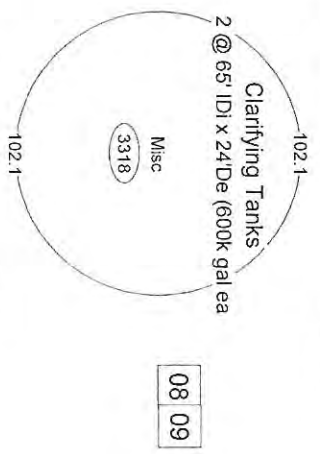

- 1 Thickening Tank samas clarifying tanks 06
- 2-540k gal retention basins 07



**SPECIAL FEATURES**

**SUMMARY OF IMPROVEMENTS**

Description	Value	ID	Use	Styry Hgt	Const Type	Grade	Year Const	Year Cond	Base Rate	Feat-ures	Adj Rate	Size or Area	Computed Value	Phys Obsol	Market Adj	Comp %	Value
C : Remod 2012																	
01 HUTLSTOR	0.00	C		0.00	85		1999	2005	0.00	N	0.00	2592	0	0	150	100	1018400
02 PAVING	1.00			1.00	1		1999	2000	3.45	N	3.38	20000	67600	0	0	100	67600
03 UTILSHED	123.00			1.00	1		1960	1985	44.50	N	66.75	14x 16	14950	13	0	100	13000
04 ELEVATANK	8.00			8.00	51C		1960	1985	3.08	N	4.62	5000000	2310000	3	0	100	2240700
05 FENCECL	0.00			0.00			1970	1990	24.15	N	36.23	1603	58080	11	0	100	51700
06 CLFR. TK	0.00			0.00			1999	2000	0.00	N	0.00	0	0	0	0	100	1100000
07 TIKNG TK	0.00			0.00			1999	2000	0.00	N	0.00	0	0	0	0	100	550000
08 Ret. Bas	0.00			0.00			1999	2000	0.00	N	0.00	0	0	0	0	100	315000
09 Nxtl Bld	0.00			0.00			2007	2007	0.00	N	0.00	0	0	0	0	100	48000
09 FENCECL	6.00			6.00	51C		2007	2007	18.50	N	27.75	132	3660	4	0	100	3500

(LCM: 150.00)

Data Collector/Date: bd 04/19/2012 Appraiser/Date: TOG 10/01/2015  
 Neighborhood: Neigh 2800 AV Supplemental Cards: 5407900  
 TOTAL IMPROVEMENT VALUE

# Exhibit C

Copyright © 2018 Foresite LLC all rights reserved. The details, templates, drawing formats or any portion of this document generated by Foresite LLC may not be duplicated, traced or used otherwise for any profit-driven enterprise.

ANTENNA UPGRADES BY

# T-Mobile

## T-MOBILE NORTHEAST LLC

SITE NUMBER: CT11070B  
 SITE NAME: CONNECTICUT STATE POLICE #2  
 SITE ADDRESS: 150 BUTTERNUT HOLLOW RD (CSP TOWER # 74)  
 GREENWICH, CT 06830  
 (RF CONFIGURATION 67D92DB)

**APPLICANT:**  
  
**T-MOBILE NORTHEAST LLC**  
 35 GRIFFIN ROAD SOUTH  
 BLOOMFIELD, CT 06002  
 860-692-7100

**PROJECT MANAGER**  
  
**NSS NORTHEAST**  
 SITE SOLUTIONS  
*Turnkey Wireless Development*  
 420 MAIN STREET, BLDG 4  
 STURBRIDGE, MA 01566  
 203-275-6669

**CONSULTANT:**  
  
**FORESITE** LLC  
 Architects . Engineers . Surveyors  
 462 WALNUT STREET  
 NEWTON, MA 02460  
 617-212-3123

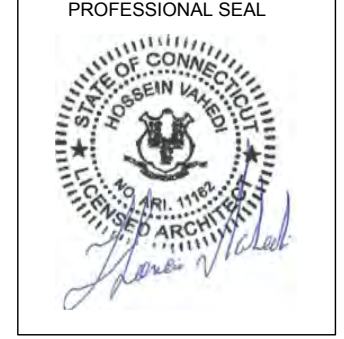

THIS DOCUMENT IS THE DESIGN PROPERTY AND COPYRIGHT OF FORESITE, LLC. AND FOR THE EXCLUSIVE USE BY THE TITLE CLIENT. DUPLICATION OR USE WITHOUT THE EXPRESS WRITTEN CONSENT OF THE CREATOR IS STRICTLY PROHIBITED. DRAWING SCALES ARE INTENDED FOR 11"x17" SIZE PRINTED MEDIA ONLY. ALL OTHER PRINTED SIZES ARE DEEMED "NOT TO SCALE".

REV	DESCRIPTION	DATE
A	PRELIMINARY	04/12/18
0	ISSUED FOR PERMIT	05/21/18

SITE NUMBER: CT11070B  
 SITE NAME: CONNECTICUT STATE POLICE #2  
 SITE ADDRESS: 150 BUTTERNUT HOLLOW RD  
 GREENWICH, CT 06830

SHEET TITLE:  
 T-1: TITLE SHEET

**PROJECT SCOPE:**  
 UPGRADE OF EXISTING WIRELESS FACILITY AS FOLLOWS:  
 REPLACE (6) EXISTING ANTENNAS ON EXISTING TOWER,  
 ADD (3) REMOTE RADIO UNITS AT ANTENNAS,  
 ADD (3) DIPLEXERS AT ANTENNAS,  
 ADD (3) FIBER HYBRID CABLES.

- PROJECT NOTES:**
- THIS IS AN UNMANNED TELECOMMUNICATION FACILITY AND NOT FOR HUMAN HABITATION: HANDICAPPED ACCESS IS NOT REQUIRED. POTABLE WATER OR SANITARY SERVICE IS NOT REQUIRED. NO OUTDOOR STORAGE OR ANY SOLID WASTE RECEPTACLES REQUIRED.
  - CONTRACTOR SHALL VERIFY ALL PLANS, EXISTING DIMENSIONS, AND CONDITIONS ON THE JOB SITE. CONTRACTOR SHALL IMMEDIATELY NOTIFY THE ARCHITECT/ENGINEER IN WRITING OF ANY DISCREPANCIES BEFORE PROCEEDING WITH THE WORK. FAILURE TO NOTIFY THE ARCHITECT/ENGINEER PLACES THE RESPONSIBILITY ON THE CONTRACTOR TO CORRECT THE DISCREPANCIES AT THE CONTRACTOR'S EXPENSE.
  - DEVELOPMENT AND USE OF THE SITE WILL CONFORM TO ALL APPLICABLE CODES, ORDINANCES AND SPECIFICATIONS.
  - REFER TO STRUCTURAL ANALYSIS REPORT TITLED "DETAILED STRUCTURAL ANALYSIS AND MODIFICATION OF AN EXISTING 180' SELF SUPPORTING LATTICE TOWER WITH STACK-N-BOLT SYSTEM AND FOUNDATION FOR PROPOSED ANTENNA ARRANGEMENT, REVISION-1. DATED MARCH 27, 2018, PREPARED BY AECOM.

**APPLICABLE STATE ADOPTION CODES:**  
 2016 CONNECTICUT STATE BUILDING CODE (CSBC). ANS/TIA-222-G-2005 STRUCTURAL STANDARD FOR ANTENNA SUPPORTING STRUCTURES AND ANTENNAS.  
 2014 NATIONAL ELECTRICAL CODE (NFPA 70) FOR POWER AND GROUNDING REQUIREMENTS.

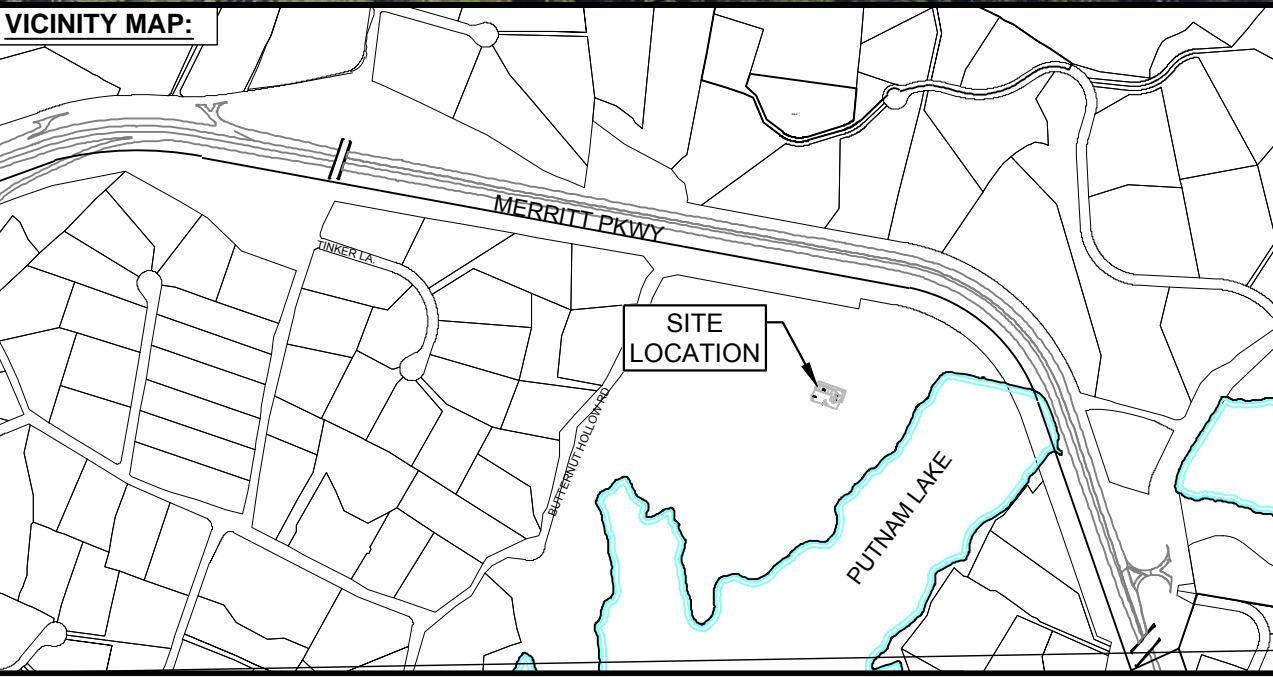

**PROJECT INFORMATION:**  
 ADDRESS: 150 BUTTERNUT HOLLOW RD  
 GREENWICH, CT 06830  
 STRUCTURE TYPE: LATTICE TOWER  
 ZONING DISTRICT: RA-2  
 PARCEL ID: 1111423  
 COORDINATES: N 41.096927 / W -73.638854  
 TOWER HEIGHT: 180'  
 T-MOBILE ANTENNA ELEV: 137'

**PROJECT TEAM:**  
 APPLICANT: T-MOBILE NORTHEAST, LLC.  
 35 GRIFFIN ROAD SOUTH  
 BLOOMFIELD, CT 06002  
 860-692-7100  
 LANDLORD: STATE POLICE  
 PAUL ZITO - PUBLIC SAFETY DIRECTOR OF  
 TELECOMMUNICATIONS CT DEPARTMENT  
 OF EMERGENCY SERVICES AND PUBLIC  
 PROTECTION DIVISION OF STATE POLICE  
 1111 COUNTRY CLUB ROAD  
 MIDDLETOWN, CT 06457  
 OFFICE: 860-685-8280 FAX: 860-6858345  
 24/7 EMERGENCIES : 860-685-8008

PROJECT MANAGER: NORTHEAST SITE SOLUTIONS  
 420 MAIN STREET, BLDG 4  
 STURBRIDGE, MA 01566  
 SHELDON FREINCLE  
 SHELDON@NORTHEASTSITE  
 SOLUTIONS.COM  
 201-776-8521  
 CONSULTANTS: FORESITE LLC  
 462 WALNUT ST  
 NEWTON, MA 02460  
 SAEED MOSSAVAT  
 SMOSSAVAT@FORESITELLC.COM  
 617-212-3123

**SHEET INDEX:**

T-1:	TITLE SHEET
N-1:	GENERAL NOTES
A-1:	PLAN
A-2:	ELEVATION
A-3:	ANTENNA PLAN
A-4:	ANTENNA DETAILS
E-1:	GROUNDING DETAILS

Copyright © 2018 Foresite LLC all rights reserved. The details, templates, drawing formats or any portion of this document generated by Foresite LLC may not be duplicated, traced or used otherwise for any profit-driven enterprise.

**GENERAL NOTES:**

1. THE CONTRACTOR SHALL GIVE ALL NOTICES AND COMPLY WITH ALL LAWS, ORDINANCES, RULES, REGULATIONS AND LAWFUL ORDERS OF ANY PUBLIC AUTHORITY, MUNICIPAL AND UTILITY COMPANY SPECIFICATIONS, AND LOCAL AND STATE JURISDICTIONAL CODES BEARING ON THE PERFORMANCE OF THE WORK. THE WORK PERFORMED ON THE PROJECT AND THE MATERIALS INSTALLED SHALL BE IN STRICT ACCORDANCE WITH ALL APPLICABLE CODES, REGULATIONS, AND ORDINANCES.
2. THE ARCHITECT/ENGINEER HAS MADE EVERY EFFORT TO SET FORTH IN THE CONSTRUCTION AND CONTRACT DOCUMENTS THE COMPLETE SCOPE OF WORK. THE CONTRACTOR BIDDING THE JOB IS NEVERTHELESS CAUTIONED THAT MINOR OMISSIONS OR ERRORS IN THE DRAWINGS AND OR SPECIFICATIONS SHALL NOT EXCUSE SAID CONTRACTOR FROM COMPLETING THE PROJECT AND IMPROVEMENTS IN ACCORDANCE WITH THE INTENT OF THESE DOCUMENTS.
3. THE CONTRACTOR OR BIDDER SHALL BEAR THE RESPONSIBILITY OF NOTIFYING (IN WRITING) THE CLIENT'S REPRESENTATIVE OF ANY CONFLICTS, ERRORS, OR OMISSIONS PRIOR TO THE SUBMISSION OF CONTRACTOR'S PROPOSAL OR PERFORMANCE OF WORK.
5. THE CONTRACTOR SHALL VISIT THE JOB SITE PRIOR TO THE SUBMISSION OF BIDS OR PERFORMING WORK TO FAMILIARIZE HIMSELF WITH THE FIELD CONDITIONS AND TO VERIFY THAT THE PROJECT CAN BE CONSTRUCTED IN ACCORDANCE WITH THE CONSTRUCTION DOCUMENTS.
6. THE CONTRACTOR SHALL INSTALL ALL EQUIPMENT AND MATERIALS ACCORDING TO THE MANUFACTURER'S / VENDOR'S SPECIFICATIONS UNLESS NOTED OTHERWISE OR WHERE LOCAL CODES OR ORDINANCES TAKE PRECEDENCE.
7. THE CONTRACTOR SHALL MAKE NECESSARY PROVISIONS TO PROTECT EXISTING IMPROVEMENTS DURING CONSTRUCTION.
8. THE CONTRACTOR SHALL COMPLY WITH ALL PERTINENT SECTIONS OF THE BASIC STATE BUILDING CODE, LATEST EDITION, AND ALL OSHA REQUIREMENTS AS THEY APPLY TO THIS PROJEC
9. THE CONTRACTOR SHALL NOTIFY THE CLIENT'S REPRESENTATIVE IN WRITING WHERE A CONFLICT OCCURS ON ANY OF THE CONTRACT DOCUMENTS. THE CONTRACTOR IS NOT TO ORDER MATERIAL OR CONSTRUCT ANY PORTION OF THE WORK THAT IS IN CONFLICT UNTIL CONFLICT IS RESOLVED BY THE CLIENT'S REPRESENTATIVE.
10. THE WORK SHALL CONFORM TO THE CODES AND STANDARDS OF THE FOLLOWING AGENCIES AS FURTHER CITED HEREIN:
  - A. ASTM: AMERICAN SOCIETY FOR TESTING AND MATERIALS, AS PUBLISHED IN "COMPILATION OF ASTM STANDARDS BUILDING CODES" OR LATEST EDITION.
  - B. AWS: AMERICAN WELDING SOCIETY INC. AS PUBLISHED IN "STANDARD D1.1-08, STRUCTURAL WELDING CODE" OR LATEST EDITION.
  - C. AISC: AMERICAN INSTITUTE FOR STEEL CONSTRUCTION AS PUBLISHED IN "CODE FOR STANDARD PRACTICE FOR STEEL BUILDINGS AND BRIDGES"; "SPECIFICATIONS FOR THE DESIGN, FABRICATION AND ERECTION OF STRUCTURAL STEEL FOR BUILDINGS" (LATEST EDITION).
11. BOLTING:
  - A. BOLTS SHALL BE CONFORMING TO ASTM A325 HIGH STRENGTH, HOT DIP GALVANIZED WITH ASTM A153 HEAVY HEX TYPE NUTS.
  - B. BOLTS SHALL BE 3/4"Ø MINIMUM (UNLESS OTHERWISE NOTED)
  - C. ALL CONNECTIONS SHALL BE 2 BOLTS MINIMUM.
12. FABRICATION:
  - A. FABRICATION OF STEEL SHALL CONFORM TO THE AISC AND AWS STANDARDS AND CODES (LATEST EDITION).
  - B. ALL STRUCTURAL STEEL SHALL BE HOT-DIP GALVANIZED AFTER FABRICATION IN ACCORDANCE WITH ASTM A123 (LATEST EDITION), UNLESS OTHERWISE NOTED.
13. ERECTION OF STEEL:
  - A. PROVIDE ALL ERECTION EQUIPMENT, BRACING, PLANKING, FIELD BOLTS, NUTS, WASHERS, DRIFT PINS, AND SIMILAR MATERIALS WHICH DO NOT FORM A PART OF THE COMPLETED CONSTRUCTION BUT ARE NECESSARY FOR ITS PROPER ERECTION.
  - B. ERECT AND ANCHOR ALL STRUCTURAL STEEL IN ACCORDANCE WITH AISC REFERENCE STANDARDS. ALL WORK SHALL BE ACCURATELY SET TO ESTABLISHED LINES AND ELEVATIONS AND RIGIDLY FASTENED IN PLACE WITH SUITABLE ATTACHMENTS TO THE CONSTRUCTION OF THE BUILDING.
  - C. TEMPORARY BRACING, GUYING AND SUPPORT SHALL BE PROVIDED TO KEEP THE STRUCTURE SAFE AND ALIGNED AT ALL TIMES DURING CONSTRUCTION, AND TO PREVENT DANGER TO PERSONS AND PROPERTY. CHECK ALL TEMPORARY LOADS AND STAY WITHIN SAFE CAPACITY OF ALL BUILDING COMPONENTS.

14. ANTENNA INSTALLATION:
  - A. INSTALL ANTENNAS AS INDICATED ON DRAWINGS AND CLIENT'S REPRESENTATIVE SPECIFICATIONS.
  - B. INSTALL GALVANIZED STEEL ANTENNA MOUNTS AS INDICATED ON DRAWINGS.
  - C. INSTALL COAXIAL / FIBER CABLES AND TERMINATIONS BETWEEN ANTENNAS AND EQUIPMENT PER MANUFACTURER'S RECOMMENDATIONS. WEATHERPROOF ALL CONNECTORS BETWEEN THE ANTENNA AND EQUIPMENT PER MANUFACTURER'S REQUIREMENTS.
15. ANTENNA AND COAXIAL / FIBER CABLE GROUNDING:
  - A. ALL EXTERIOR #6 GREEN GROUND WIRE "DAISY CHAIN" CONNECTIONS ARE TO BE WEATHER SEALED WITH ANDREWS CONNECTOR/SPLICE WEATHERPROOFING KIT TYPE #221213 OR EQUAL.
  - B. ALL COAXIAL / FIBER CABLE GROUNDING KITS ARE TO BE INSTALLED ON STRAIGHT RUNS OF COAXIAL / FIBER CABLE (NOT WITHIN BENDS).
16. RELATED WORK, FURNISH THE FOLLOWING WORK AS SPECIFIED UNDER CONSTRUCTION DOCUMENTS, BUT COORDINATE WITH OTHER TRADES PRIOR TO BID:
  - A. FLASHING OF OPENING INTO OUTSIDE WALLS
  - B. SEALING AND CAULKING ALL OPENINGS
  - C. PAINTING
  - D. CUTTING AND PATCHING
17. REQUIREMENTS OF REGULATORY AGENCIES:
  - A. FURNISH U.L. LISTED EQUIPMENT WHERE SUCH LABEL IS AVAILABLE. INSTALL IN CONFORMANCE WITH U.L. STANDARDS WHERE APPLICABLE.
  - B. INSTALL ANTENNA, ANTENNA CABLES, GROUNDING SYSTEM IN ACCORDANCE WITH DRAWINGS AND SPECIFICATION IN EFFECT AT PROJECT LOCATION AND RECOMMENDATIONS OF STATE AND LOCAL BUILDING CODES, AND SPECIAL CODES HAVING JURISDICTION OVER SPECIFIC PORTIONS OF WORK. THIS WORK INCLUDES BUT IS NOT LIMITED TO THE FOLLOWING:
    - C. TIA-EIA - 222 (LATEST EDITION). STRUCTURAL STANDARDS FOR STEEL ANTENNA TOWERS AND ANTENNA SUPPORTING STRUCTURES.
    - D. FAA - FEDERAL AVIATION ADMINISTRATION ADVISORY CIRCULAR AC 70/7460-IH, OBSTRUCTION MARKING AND LIGHTING.
    - E. FCC - FEDERAL COMMUNICATIONS COMMISSION RULES AND REGULATIONS FORM 715, OBSTRUCTION MARKING AND LIGHTING SPECIFICATION FOR ANTENNA STRUCTURES AND FORM 715A, HIGH INTENSITY OBSTRUCTION LIGHTING SPECIFICATIONS FOR ANTENNA STRUCTURES.
    - F. AISC - AMERICAN INSTITUTE OF STEEL CONSTRUCTION SPECIFICATION FOR STRUCTURAL JOINTS USING ASTM A325 BOLTS (LATEST EDITION).
    - G. NEC - NATIONAL ELECTRICAL CODE - ON TOWER LIGHTING KITS.
    - H. UL - UNDERWRITER'S LABORATORIES APPROVED ELECTRICAL PRODUCTS.
    - I. IN ALL CASES, PART 77 OF THE FAA RULES AND PARTS 17 AND 22 OF THE FCC RULES ARE APPLICABLE AND IN THE EVENT OF CONFLICT, SUPERSEDE ANY OTHER STANDARDS OR SPECIFICATIONS.
    - J. 2009 LIFE SAFETY CODE NFPA - 101.

**APPLICANT:**  
  
**T-MOBILE NORTHEAST LLC**  
 35 GRIFFIN ROAD SOUTH  
 BLOOMFIELD, CT 06002  
 860-692-7100

**PROJECT MANAGER**  
  
**NSS NORTHEAST**  
Turnkey Wireless Development  
 420 MAIN STREET, BLDG 4  
 STURBRIDGE, MA 01566  
 203-275-6669

**CONSULTANT:**  
  
**Architects . Engineers . Surveyors**  
 462 WALNUT STREET  
 NEWTON, MA 02460  
 617-212-3123

PROFESSIONAL SEAL



THIS DOCUMENT IS THE DESIGN PROPERTY AND COPYRIGHT OF FORESITE, LLC. AND FOR THE EXCLUSIVE USE BY THE TITLE CLIENT. DUPLICATION OR USE WITHOUT THE EXPRESS WRITTEN CONSENT OF THE CREATOR IS STRICTLY PROHIBITED. DRAWING SCALES ARE INTENDED FOR 11"x17" SIZE PRINTED MEDIA ONLY. ALL OTHER PRINTED SIZES ARE DEEMED "NOT TO SCALE".

REV	DESCRIPTION	DATE
A	PRELIMINARY	04/12/18
0	ISSUED FOR PERMIT	05/21/18

SITE NUMBER: CT11070B  
 SITE NAME: CONNECTICUT STATE POLICE #2  
 SITE ADDRESS: 150 BUTTERNUT HOLLOW RD  
 GREENWICH, CT 06830

SHEET TITLE:  
**N-1: NOTES AND DISCLAIMERS**

Copyright © 2018 Foresite LLC all rights reserved. The details, templates, drawing formats or any portion of this document generated by Foresite LLC may not be duplicated, traced or used otherwise for any profit-driven enterprise.

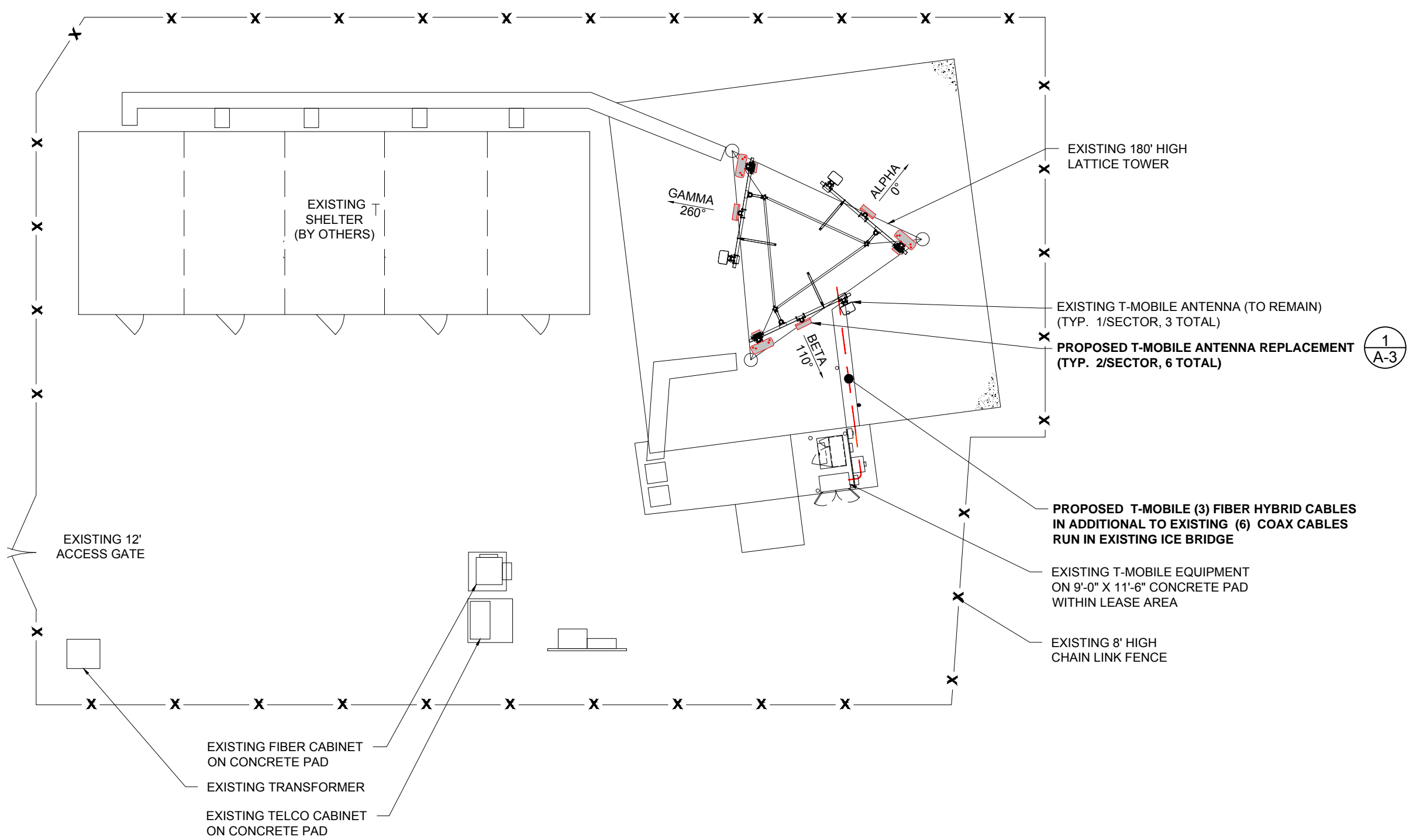
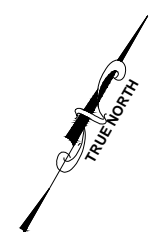

**SITE PLAN**  
 SCALE: 1/16" = 1'-0" 1/A-1

**APPLICANT:**  
**T-Mobile**  
**T-MOBILE NORTHEAST LLC**  
 35 GRIFFIN ROAD SOUTH  
 BLOOMFIELD, CT 06002  
 860-692-7100

**PROJECT MANAGER**  
**NSS NORTHEAST**  
 SITE SOLUTIONS  
*Turkey Wireless Development*  
 420 MAIN STREET, BLDG 4  
 STURBRIDGE, MA 01566  
 203-275-6669

**CONSULTANT:**  
**FORESITE** LLC  
 Architects . Engineers . Surveyors  
 462 WALNUT STREET  
 NEWTON, MA 02460  
 617-212-3123

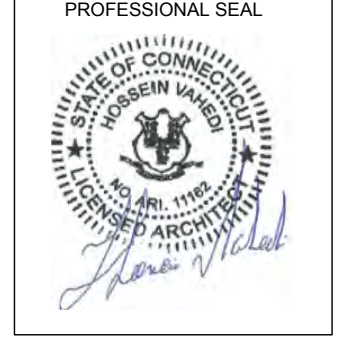

THIS DOCUMENT IS THE DESIGN PROPERTY AND COPYRIGHT OF FORESITE, LLC. AND FOR THE EXCLUSIVE USE BY THE TITLE CLIENT. DUPLICATION OR USE WITHOUT THE EXPRESS WRITTEN CONSENT OF THE CREATOR IS STRICTLY PROHIBITED. DRAWING SCALES ARE INTENDED FOR 11"x17" SIZE PRINTED MEDIA ONLY. ALL OTHER PRINTED SIZES ARE DEEMED "NOT TO SCALE".

REV	DESCRIPTION	DATE
A	PRELIMINARY	04/12/18
0	ISSUED FOR PERMIT	05/21/18

SITE NUMBER: CT11070B  
 SITE NAME: CONNECTICUT STATE POLICE #2  
 SITE ADDRESS: 150 BUTTERNUT HOLLOW RD  
 GREENWICH, CT 06830

SHEET TITLE:  
 A-1: PLAN

Copyright © 2018 Foresite LLC all rights reserved. The details, templates, drawing formats or any portion of this document generated by Foresite LLC may not be duplicated, traced or used otherwise for any profit-driven enterprise.

**STRUCTURAL NOTES:**

PRIOR TO COMMENCING CONSTRUCTION, GC SHALL REFER TO TOWER STRUCTURAL ANALYSIS PROVIDED BY OTHERS TO DETERMINE IF THERE ARE ANY SUPPLEMENTAL OR SPECIAL REQUIREMENTS FOR TOWER TOP EQUIPMENT AND FOR CABLE BUNDLING, SHIELDING, MOUNTING OR RELOCATION ARRANGEMENTS.

**ANTENNA MOUNT STRUCTURAL ASSESSMENT REQUIREMENT:**

NO ASSESSMENTS HAVE BEEN MADE TO DETERMINE THAT THE EXISTING ANTENNA MOUNT IS ADEQUATE TO ACCOMMODATE THE ADDITIONAL EQUIPMENT LOADS. DETAILS SHOWN HEREIN FOR STRUCTURAL MODIFICATIONS OF THE EXISTING ANTENNA MOUNTS ARE PRELIMINARY ONLY AND FINAL CONSTRUCTION DETAILS ARE SUBJECT TO ANTENNA MOUNT STRUCTURAL ASSESEMENT.

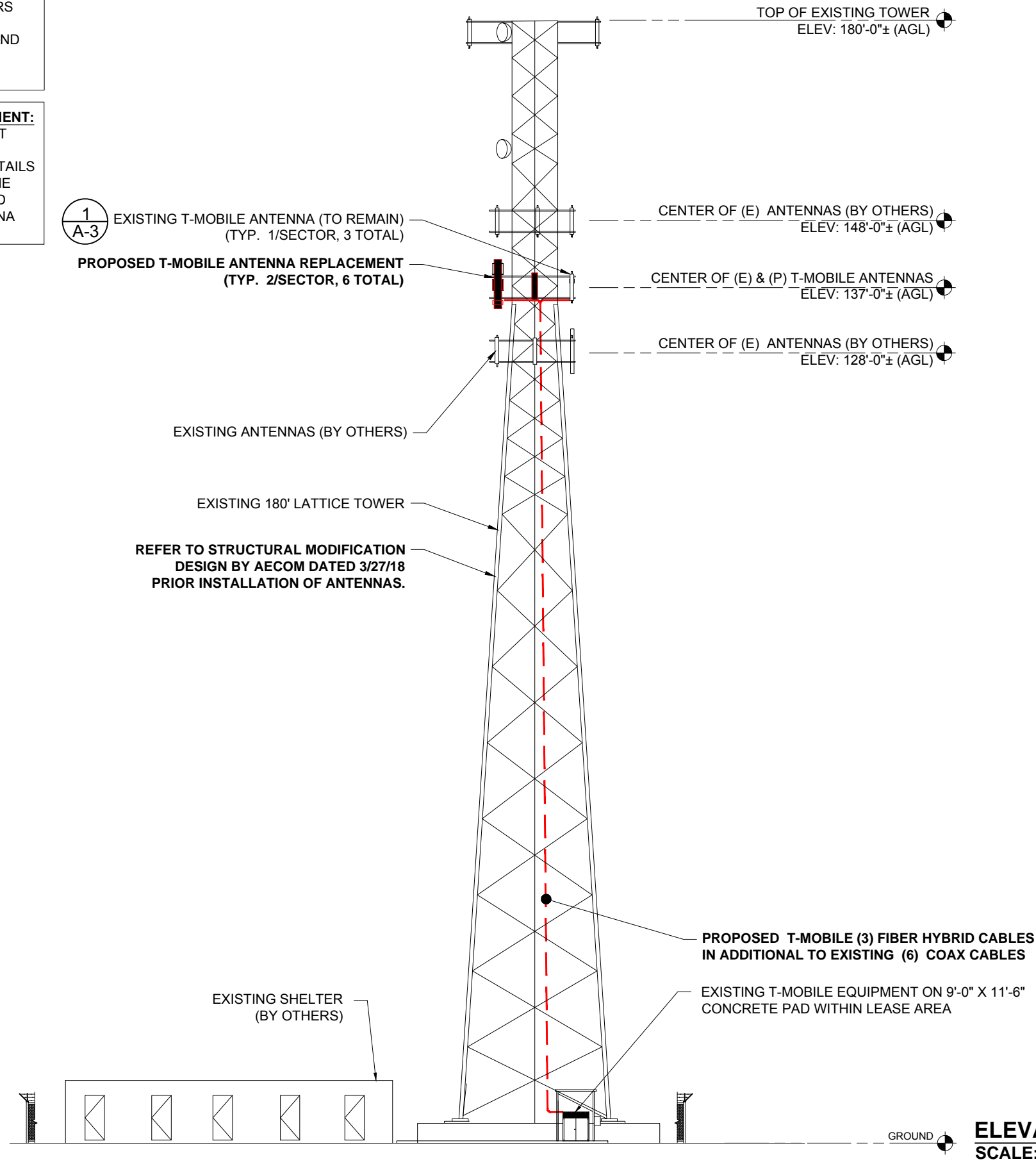

GROUND **ELEVATION**  
SCALE: 1" = 20'-0" 1/A-2

**APPLICANT:**  
**T-Mobile**  
**T-MOBILE NORTHEAST LLC**  
35 GRIFFIN ROAD SOUTH  
BLOOMFIELD, CT 06002  
860-692-7100

**PROJECT MANAGER**  
**NSS NORTHEAST**  
SITE SOLUTIONS  
*Turnkey Wireless Development*  
420 MAIN STREET, BLDG 4  
STURBRIDGE, MA 01566  
203-275-6669

**CONSULTANT:**  
**FORESITE** LLC  
Architects . Engineers . Surveyors  
462 WALNUT STREET  
NEWTON, MA 02460  
617-212-3123

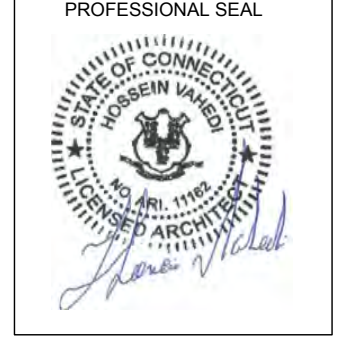

THIS DOCUMENT IS THE DESIGN PROPERTY AND COPYRIGHT OF FORESITE, LLC. AND FOR THE EXCLUSIVE USE BY THE TITLE CLIENT. DUPLICATION OR USE WITHOUT THE EXPRESS WRITTEN CONSENT OF THE CREATOR IS STRICTLY PROHIBITED. DRAWING SCALES ARE INTENDED FOR 11"x17" SIZE PRINTED MEDIA ONLY. ALL OTHER PRINTED SIZES ARE DEEMED "NOT TO SCALE".

REV	DESCRIPTION	DATE
A	PRELIMINARY	04/12/18
0	ISSUED FOR PERMIT	05/21/18

SITE NUMBER: CT11070B  
SITE NAME: CONNECTICUT STATE POLICE #2  
SITE ADDRESS: 150 BUTTERNUT HOLLOW RD  
GREENWICH, CT 06830

SHEET TITLE:  
A-2: ELEVATION



Copyright © 2018 Foresite LLC all rights reserved. The details, templates, drawing formats or any portion of this document generated by Foresite LLC may not be duplicated, traced or used otherwise for any profit-driven enterprise.

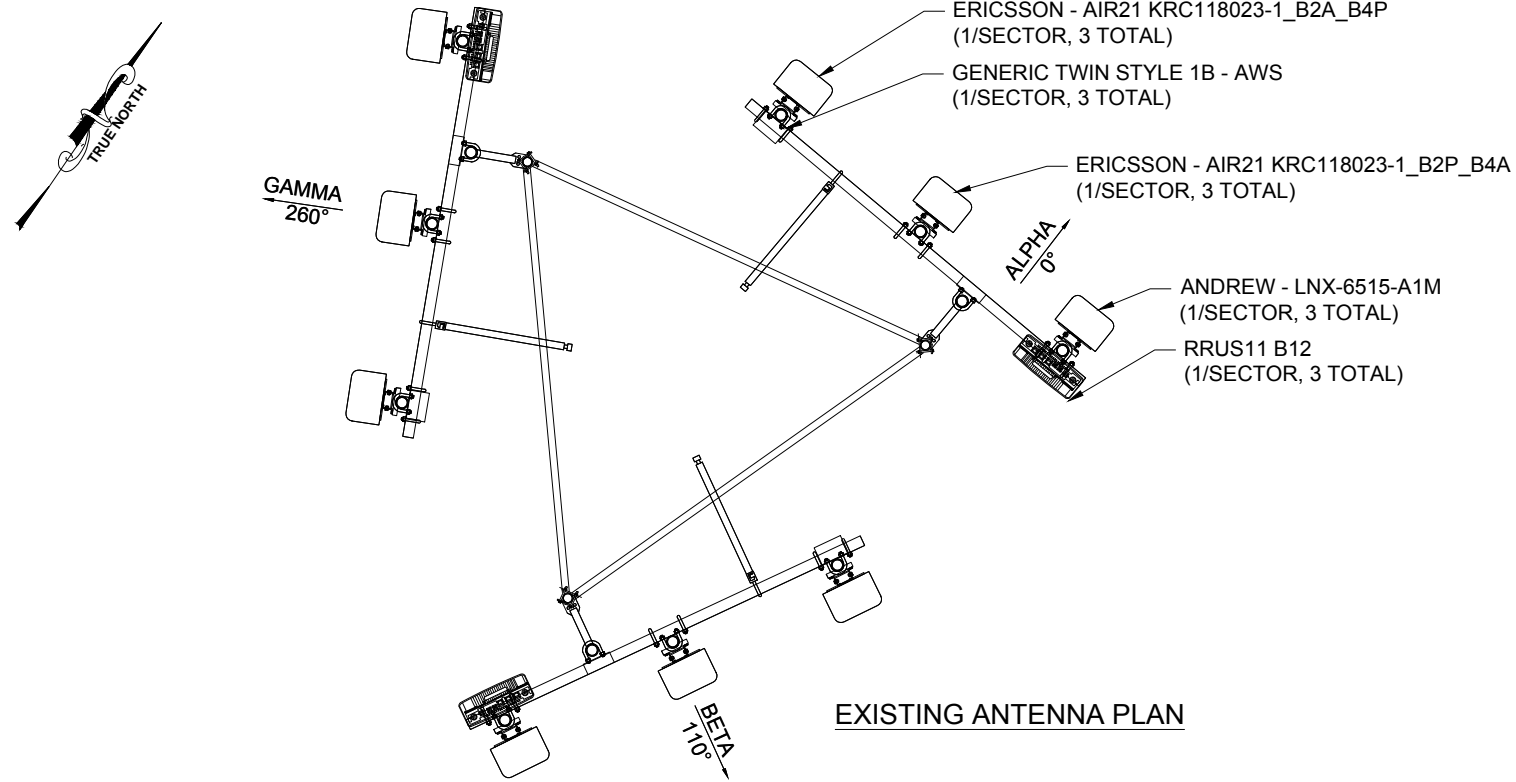

**STRUCTURAL NOTES:**  
 PRIOR TO COMMENCING CONSTRUCTION, GC SHALL REFER TO TOWER STRUCTURAL ANALYSIS PROVIDED BY OTHERS TO DETERMINE IF THERE ARE ANY SUPPLEMENTAL OR SPECIAL REQUIREMENTS FOR TOWER TOP EQUIPMENT AND FOR CABLE BUNDLING, SHIELDING, MOUNTING OR RELOCATION ARRANGEMENTS.

**ANTENNA MOUNT STRUCTURAL ASSESSMENT REQUIREMENT:**  
 NO ASSESSMENTS HAVE BEEN MADE TO DETERMINE THAT THE EXISTING ANTENNA MOUNT IS ADEQUATE TO ACCOMMODATE THE ADDITIONAL EQUIPMENT LOADS. DETAILS SHOWN HEREIN FOR STRUCTURAL MODIFICATIONS OF THE EXISTING ANTENNA MOUNTS ARE PRELIMINARY ONLY AND FINAL CONSTRUCTION DETAILS ARE SUBJECT TO ANTENNA MOUNT STRUCTURAL ASSESEMENT.

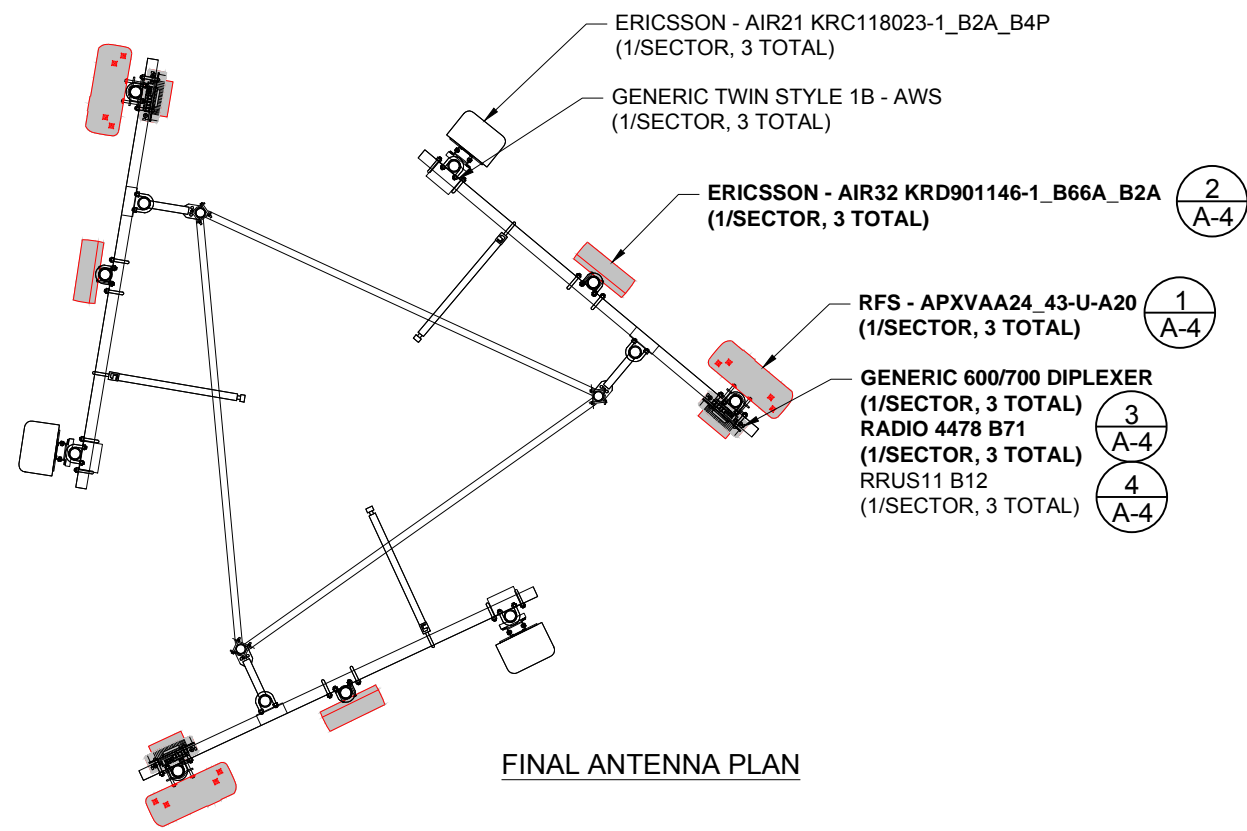

**ANTENNA PLAN**  
 SCALE: NTS

**APPLICANT:**  
**T-Mobile**  
**T-MOBILE NORTHEAST LLC**  
 35 GRIFFIN ROAD SOUTH  
 BLOOMFIELD, CT 06002  
 860-692-7100

**PROJECT MANAGER**  
**NSS NORTHEAST**  
 SITE SOLUTIONS  
*Turnkey Wireless Development*  
 420 MAIN STREET, BLDG 4  
 STURBRIDGE, MA 01566  
 203-275-6669

**CONSULTANT:**  
**FORESITE** LLC  
 Architects . Engineers . Surveyors  
 462 WALNUT STREET  
 NEWTON, MA 02460  
 617-212-3123



THIS DOCUMENT IS THE DESIGN PROPERTY AND COPYRIGHT OF FORESITE, LLC. AND FOR THE EXCLUSIVE USE BY THE TITLE CLIENT. DUPLICATION OR USE WITHOUT THE EXPRESS WRITTEN CONSENT OF THE CREATOR IS STRICTLY PROHIBITED. DRAWING SCALES ARE INTENDED FOR 11"x17" SIZE PRINTED MEDIA ONLY. ALL OTHER PRINTED SIZES ARE DEEMED "NOT TO SCALE".

REV	DESCRIPTION	DATE
A	PRELIMINARY	04/12/18
0	ISSUED FOR PERMIT	05/21/18

SITE NUMBER: CT11070B  
 SITE NAME: CONNECTICUT STATE POLICE #2  
 SITE ADDRESS: 150 BUTTERNUT HOLLOW RD  
 GREENWICH, CT 06830

SHEET TITLE:  
 A-3: ANTENNA PLAN AND DETAILS

Copyright © 2018 Foresite LLC all rights reserved. The details, templates, drawing formats or any portion of this document generated by Foresite LLC may not be duplicated, traced or used otherwise for any profit-driven enterprise.

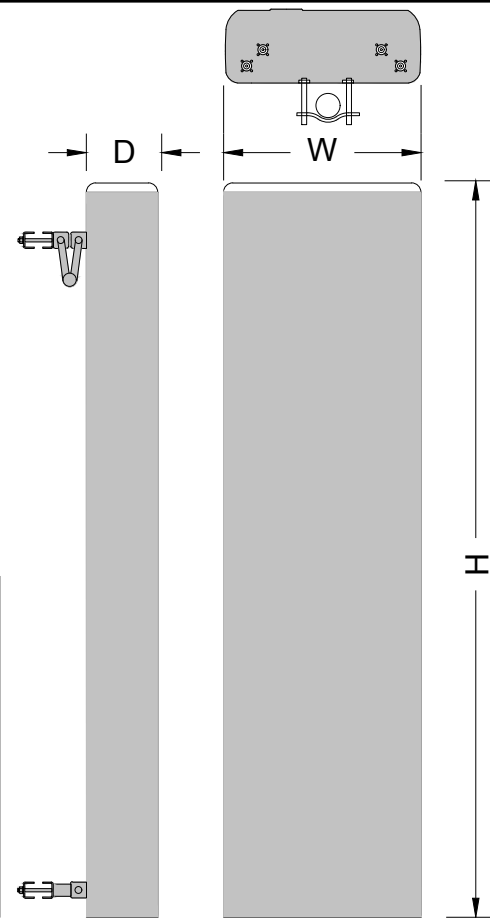

APX ANTENNA SPECIFICATIONS	
MODEL #	APXVAA24_43-U-A20
MANUF.	RFS
HEIGHT	95.9"
WIDTH	24.0"
DEPTH	8.7"
WEIGHT	115.5 LB

**APX ANTENNA**  
N.T.S

1  
A-4

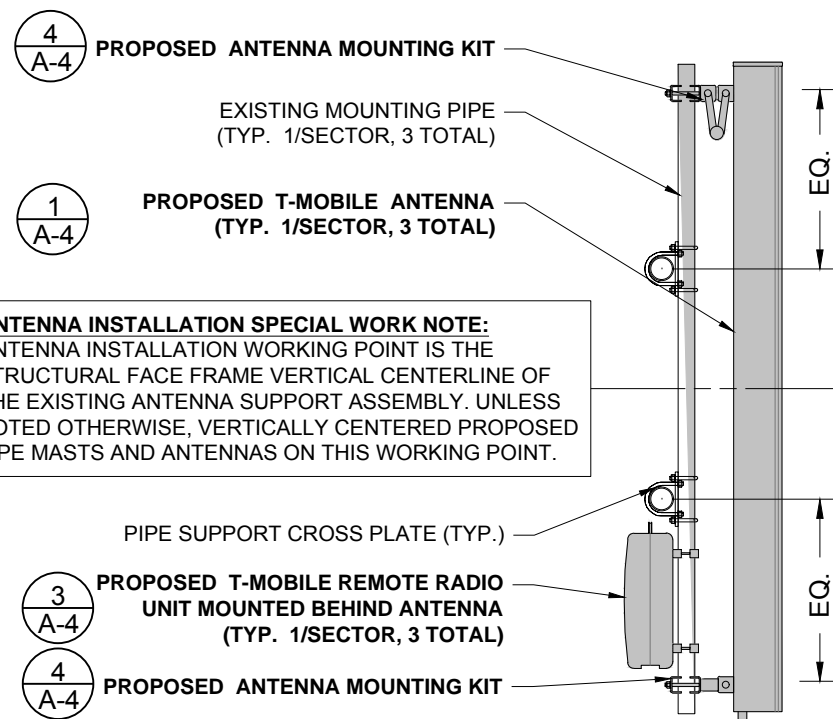

**ANTENNA INSTALLATION SPECIAL WORK NOTE:**  
ANTENNA INSTALLATION WORKING POINT IS THE STRUCTURAL FACE FRAME VERTICAL CENTERLINE OF THE EXISTING ANTENNA SUPPORT ASSEMBLY. UNLESS NOTED OTHERWISE, VERTICALLY CENTERED PROPOSED PIPE MASTS AND ANTENNAS ON THIS WORKING POINT.

- 4  
A-4 PROPOSED ANTENNA MOUNTING KIT
- EXISTING MOUNTING PIPE (TYP. 1/SECTOR, 3 TOTAL)
- 1  
A-4 PROPOSED T-MOBILE ANTENNA (TYP. 1/SECTOR, 3 TOTAL)
- PIPE SUPPORT CROSS PLATE (TYP.)
- 3  
A-4 PROPOSED T-MOBILE REMOTE RADIO UNIT MOUNTED BEHIND ANTENNA (TYP. 1/SECTOR, 3 TOTAL)
- 4  
A-4 PROPOSED ANTENNA MOUNTING KIT

**L600 ANTENNA AND RRU MOUNTING DETAIL**  
N.T.S

5  
A-4

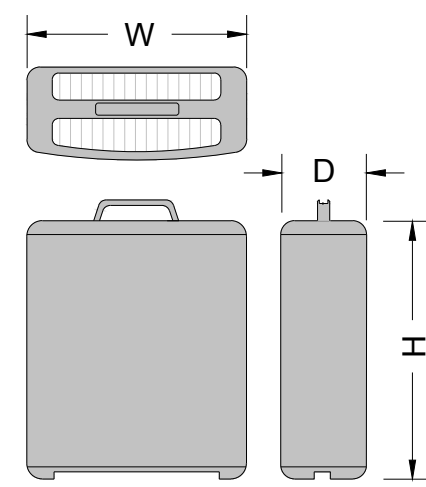

REMOTE RADIO UNIT SPECIFICATIONS	
MODEL #	RADIO 4478 B71
MANUF.	ERICSSON
HEIGHT	18.1"
WIDTH	13.5"
DEPTH	8"
WEIGHT	56.2 LB

**REMOTE RADIO UNIT**  
N.T.S

3  
A-4

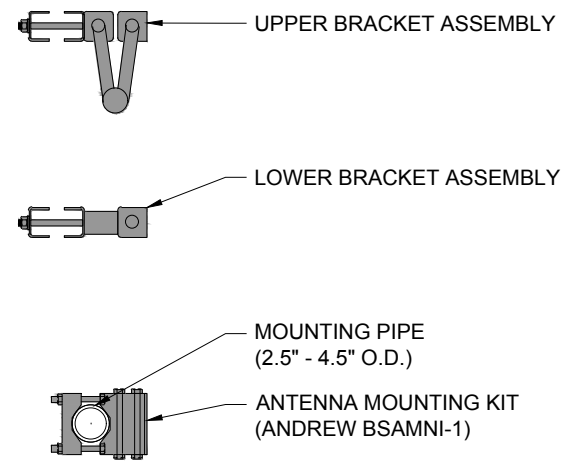

AIR32 ANTENNA SPECIFICATIONS	
MODEL #	AIR32 KDR901146-1 B66A_B2A
MANUF.	ERICSSON
HEIGHT	58.1"
WIDTH	15.7"
DEPTH	9.4"
WEIGHT	180 LB

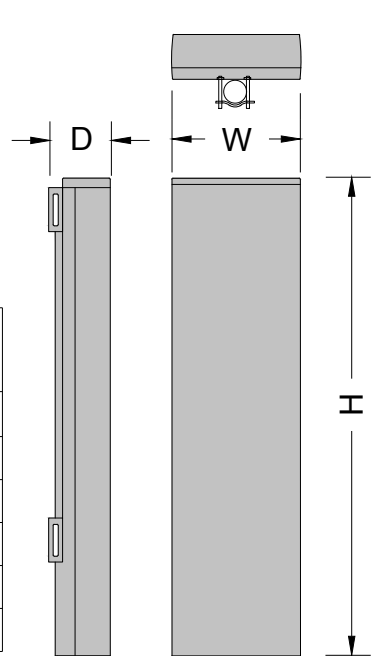

**ANTENNA MOUNTING BRACKET**  
N.T.S

6  
A-4

**AIR32 ANTENNA**  
N.T.S

2  
A-4

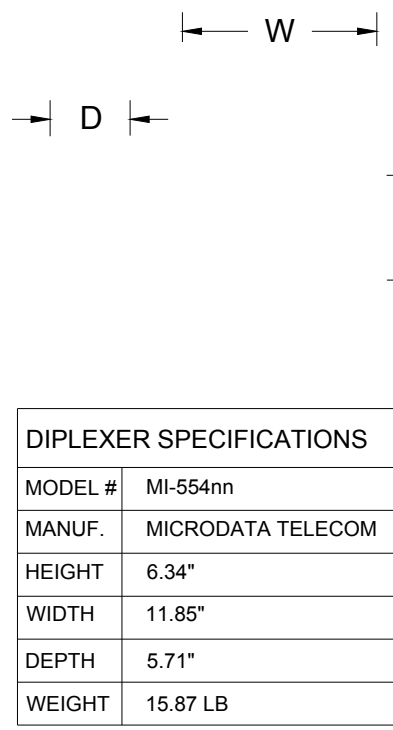

DIPLEXER SPECIFICATIONS	
MODEL #	MI-554nn
MANUF.	MICRODATA TELECOM
HEIGHT	6.34"
WIDTH	11.85"
DEPTH	5.71"
WEIGHT	15.87 LB

**DIPLEXER**  
N.T.S

4  
A-4

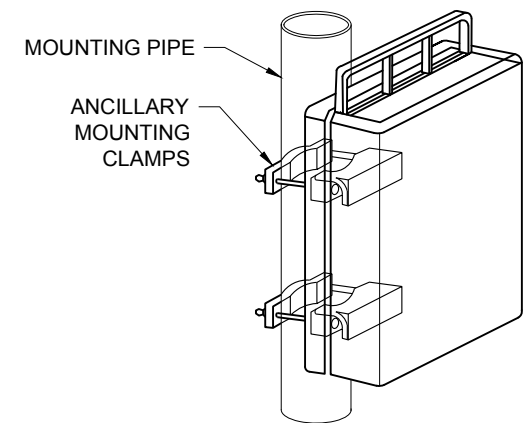

RRU MOUNTING DETAIL

**REMOTE RADIO UNIT MOUNTING DETAIL**  
N.T.S

7  
A-4

**APPLICANT:**  
**T-Mobile**  
**T-MOBILE NORTHEAST LLC**  
35 GRIFFIN ROAD SOUTH  
BLOOMFIELD, CT 06002  
860-692-7100

**PROJECT MANAGER**  
**NSS NORTHEAST**  
SITE SOLUTIONS  
Turnkey Wireless Development  
420 MAIN STREET, BLDG 4  
STURBRIDGE, MA 01566  
203-275-6669

**CONSULTANT:**  
**FORESITE** LLC  
Architects . Engineers . Surveyors  
462 WALNUT STREET  
NEWTON, MA 02460  
617-212-3123

PROFESSIONAL SEAL

THIS DOCUMENT IS THE DESIGN PROPERTY AND COPYRIGHT OF FORESITE, LLC. AND FOR THE EXCLUSIVE USE BY THE TITLE CLIENT. DUPLICATION OR USE WITHOUT THE EXPRESS WRITTEN CONSENT OF THE CREATOR IS STRICTLY PROHIBITED. DRAWING SCALES ARE INTENDED FOR 11"x17" SIZE PRINTED MEDIA ONLY. ALL OTHER PRINTED SIZES ARE DEEMED "NOT TO SCALE".

REV	DESCRIPTION	DATE
A	PRELIMINARY	04/12/18
0	ISSUED FOR PERMIT	05/21/18

SITE NUMBER: CT11070B  
SITE NAME: CONNECTICUT STATE POLICE #2  
SITE ADDRESS: 150 BUTTERNUT HOLLOW RD  
GREENWICH, CT 06830

SHEET TITLE:  
A-4: ANTENNA DETAILS

Copyright © 2018 Foresite LLC all rights reserved. The details, templates, drawing formats or any portion of this document generated by Foresite LLC may not be duplicated, traced or used otherwise for any profit-driven enterprise.

**ELECTRICAL & GROUNDING NOTES**

1. ALL ELECTRICAL WORK SHALL CONFORM TO THE REQUIREMENTS OF THE NATIONAL ELECTRICAL CODE (NEC) AS WELL AS APPLICABLE STATE AND LOCAL CODES.
2. ALL ELECTRICAL ITEMS SHALL BE U.L. APPROVED OR LISTED AND PRODUCED PER SPECIFICATION REQUIREMENTS.
3. THE ELECTRICAL WORK INCLUDES ALL LABOR AND MATERIAL DESCRIBED BY DRAWINGS AND SPECIFICATION INCLUDING INCIDENTAL WORK TO PROVIDE COMPLETE OPERATING AND APPROVED ELECTRICAL SYSTEM.
4. GENERAL CONTRACTOR SHALL PAY FEES FOR PERMITS, AND RESPONSIBLE FOR OBTAINING SAID PERMITS AND COORDINATION OF INSPECTIONS.
5. ELECTRICAL AND TELCO WIRING OUTSIDE A BUILDING AND EXPOSED TO WEATHER SHALL BE IN WATER TIGHT GALVANIZED RIGID STEEL CONDUITS OR SCHEDULE 80 PVC (AS PERMITTED BY CODE) AND WHERE REQUIRED IN LIQUID TIGHT FLEXIBLE METAL OR NONMETALLIC CONDUITS.
6. RIGID STEEL CONDUITS SHALL BE GROUNDED AT BOTH ENDS.
7. ELECTRICAL WIRING SHALL BE COPPER WITH TYPE XHHW, THWN, OR THIN INSULATION.
8. RUN ELECTRICAL CONDUIT OR CABLING BETWEEN ELECTRICAL ROOM AND PROPOSED CELL SITE ARE PEDESTAL AS INDICATED ON THIS DRAWING. PROVIDE FULL LENGTH PULL ROPE. COORDINATE INSTALLATION WITH UTILITY COMPANY.
9. RUN TELCO CONDUIT OR CABLE BETWEEN TELEPHONE UTILITY DEMARCATION POINT AND PROPOSED CELL SITE TELECOM CABINET AND RBS CABINET AS INDICATED ON DRAWING A -1. PROVIDE FULL LENGTH PULL ROPE INSTALLED TELCO CONDUIT. PROVIDE GREENLEE CONDUIT MEASURING TAPE AT EACH END.
10. ALL EQUIPMENT LOCATED OUTSIDE SHALL HAVE NAME 3R ENCLOSURE.
11. GROUNDING SHALL COMPLY WITH NEC ART. 250.
12. GROUNDING COAX CABLE SHIELDS MINIMUM AT BOTH ENDS USING MANUFACTURERS COAX CABLE GROUNDING KITS SUPPLIED BY PROJECT OWNER.
13. USE #6 COPPER STRANDED WIRE WITH GREEN COLOR INSTALLATION FOR ABOVE GRADE GROUNDING (UNLESS OTHERWISE SPECIFIED) AND #2 SOLID TINNED BARE COPPER WIRE FOR BELOW GRADE GROUNDING AS INDICATED ON THE GROUND.
14. ALL GROUND CONNECTIONS TO BE BURNDY HYGROUN COMPRESSION TYPE CONNECTORS OR CADWELD EXOTHERMIC WELD. DO NOT ALLOW BARE COPPER WIRE TO BE IN CONTACT WITH GALVANIZED STEEL.
15. ROUTE GROUNDING CONDUCTORS ALONG THE SHORTEST AND STRAIGHTEST PATH POSSIBLE, EXCEPT AS OTHERWISE INDICATED. GROUNDING LEADS SHOULD NEVER BE BENT AS RIGHT ANGLE. ALWAYS MAKE AT LEAST 12" RADIUS BENDS. #6 WIRE CAN BE BENT AT 6" RADIUS WHEN NECESSARY BOND ANY METER OBJECTS WITHIN 7 FEET OF PROPOSED EQUIPMENT OR CABINET TO MASTER GROUND BAR.
16. CONNECTIONS TO MGB SHALL BE ARRANGED IN THREE MAIN GROUPS: SURGE PROCEDURES (COAXIAL CABLE GROUND KITS, TELCO AND POWER PANEL GROUND); (GROUNDING ELECTRODE RING OR BUILDING STEEL); NON-SURGING OBJECTS (EGB GROUND IN RBS UNIT).
17. CONNECTIONS TO GROUND BARS SHALL BE MADE WITH TWO HOLE COMPRESSION TYPE COPPER LUGS. APPLY OXIDE INHIBITING COMPOUND TO ALL LOCATIONS.
18. APPLY OXIDE INHIBITING COMPOUND TO ALL COMPRESSION TYPE GROUND CONNECTION.
19. BOND ANTENNA MOUNTING BRACKETS, COAXIAL CABLE GROUND KITS, AND ALNA TO EGB PLACED NEAR THE ANTENNA LOCATION.
20. BOND ANTENNA EGB'S AND MGB TO WATER MAIN.
21. TEST COMPLETED GROUND SYSTEM AND RECORD RESULTS FOR PROJECT CLOSE-OUT DOCUMENTATION.
22. BOND ANY METAL OBJECTS WITHIN 7 FEET OF PROPOSED EQUIPMENT OR CABINET TO MASTER GROUND BAR.
23. VERIFY PROPOSED SERVICE UPGRADE WITH LOCAL UTILITY COMPANY PRIOR TO CONSTRUCTION.

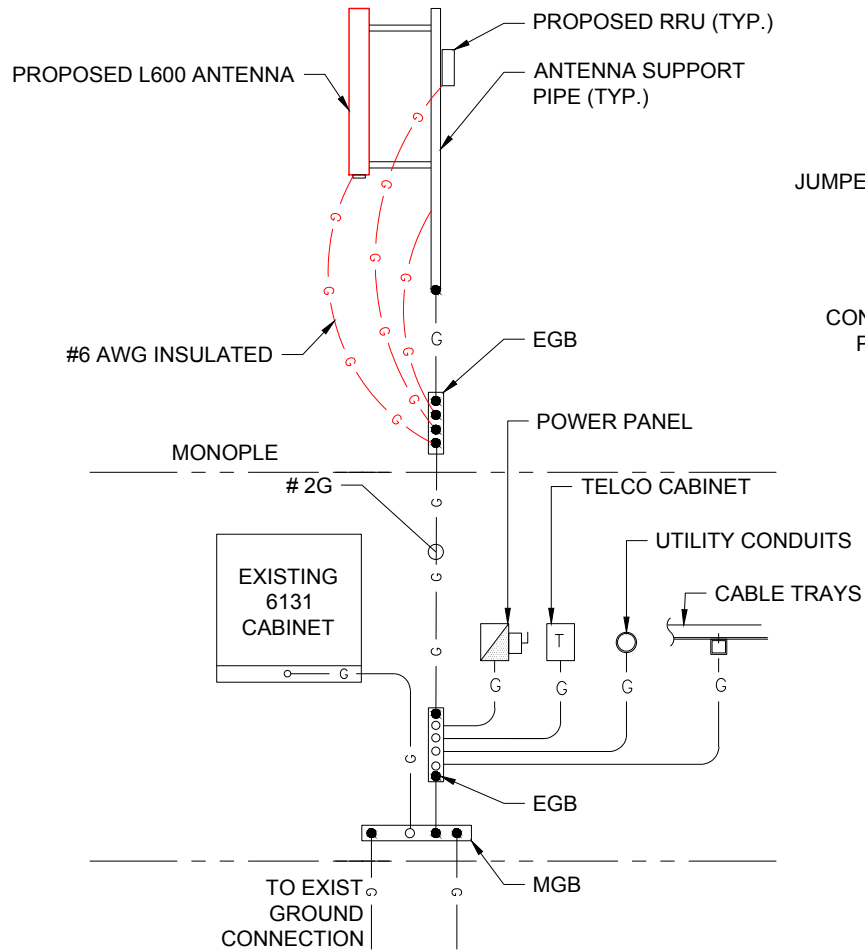

**GROUNDING RISER DIAGRAM** 1  
SCALE: N.T.S. E-1

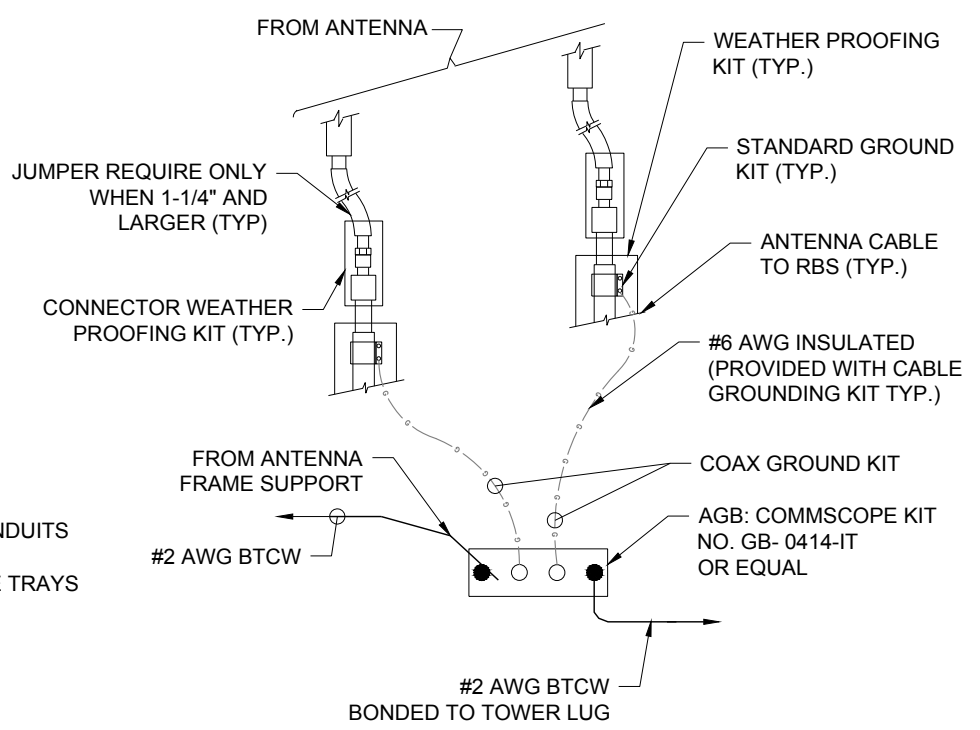

**NOTES:**  
INSTALL CABLE GROUND KIT ABOVE HORIZONTAL BEND AND ALWAYS DIRECT GROUND WIRE DOWN TO AGB/EGB

**TOWER TOP CABLE GROUNDING DETAIL** 2  
SCALE: N.T.S. E-1

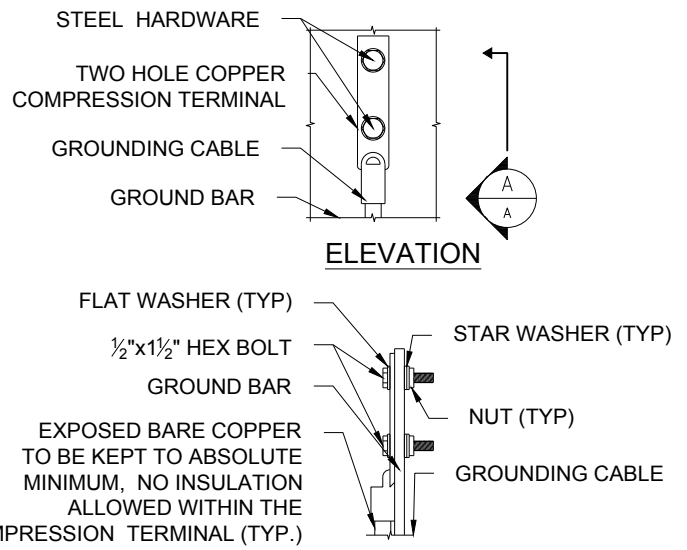

**NOTES:**  
1. "DOUBLING UP" OR "STACKING " OF CONNECTION IS NOT PERMITTED.  
2. OXIDE INHIBITING COMPOUND TO BE USED AT ALL LOCATIONS.

**TYPICAL GROUND BAR CONNECTIOS DETAIL** 3  
SCALE: N.T.S. E-1

**APPLICANT:**  
**T-Mobile**  
**T-MOBILE NORTHEAST LLC**  
35 GRIFFIN ROAD SOUTH  
BLOOMFIELD, CT 06002  
860-692-7100

**PROJECT MANAGER**  
**NSS NORTHEAST**  
SITE SOLUTIONS  
Turnkey Wireless Development  
420 MAIN STREET, BLDG 4  
STURBRIDGE, MA 01566  
203-275-6669

**CONSULTANT:**  
**FORESITE** LLC  
Architects . Engineers . Surveyors  
462 WALNUT STREET  
NEWTON, MA 02460  
617-212-3123

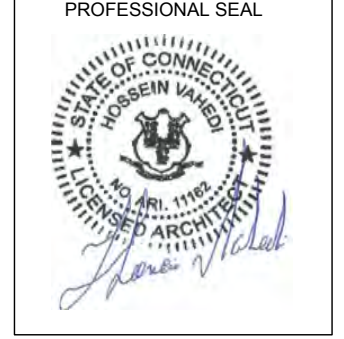

THIS DOCUMENT IS THE DESIGN PROPERTY AND COPYRIGHT OF FORESITE, LLC. AND FOR THE EXCLUSIVE USE BY THE TITLE CLIENT. DUPLICATION OR USE WITHOUT THE EXPRESS WRITTEN CONSENT OF THE CREATOR IS STRICTLY PROHIBITED. DRAWING SCALES ARE INTENDED FOR 11"x17" SIZE PRINTED MEDIA ONLY. ALL OTHER PRINTED SIZES ARE DEEMED "NOT TO SCALE".

REV	DESCRIPTION	DATE
A	PRELIMINARY	04/12/18
0	ISSUED FOR PERMIT	05/21/18

SITE NUMBER: CT11070B  
SITE NAME: CONNECTICUT STATE POLICE #2  
SITE ADDRESS: 150 BUTTERNUT HOLLOW RD  
GREENWICH, CT 06830

SHEET TITLE:  
E-1: GROUNDING AND ELECTRICAL DETAILS

# Exhibit D



Submitted to  
Empire Telecom USA, LLC  
16 Esquire Road  
Billerica, MA 01862

Submitted by  
AECOM  
500 Enterprise Drive,  
Suite 3B  
Rocky Hill, CT 06067  
March 27, 2018

Airosmith Development, Inc.  
32 Clinton Street  
Saratoga Springs, NY 12866

Northeast Site Solutions  
199 Brickyard Road  
Farmington, CT 06032

Verizon Wireless  
20 Alexander Drive, 2<sup>nd</sup> Floor  
Wallingford, CT

# DETAILED STRUCTURAL ANALYSIS AND MODIFICATION OF AN EXISTING 180' SELF SUPPORTING LATTICE TOWER WITH STACK-N-BOLT SYSTEM AND FOUNDATION FOR PROPOSED ANTENNA ARRANGEMENT

AT&T Site No. : CT2129  
Sprint Site No. : CT03XC343  
T-Mobile Site No. : CT11070B  
Verizon Site No. : Butternut, CT

Site Name : Connecticut State Police Tower #74  
Site Address: 150 Butternut Hollow Road  
CSP Tower # 74

60537397  
Revision #1

## **TABLE OF CONTENTS**

- 1. EXECUTIVE SUMMARY**
- 2. INTRODUCTION**
- 3. ANALYSIS METHODOLOGY AND LOADING CONDITIONS**
- 4. FINDINGS AND EVALUATION**
- 5. CONCLUSIONS**
- 6. ANALYSIS DATA**
  - **TOWER REINFORCEMENT DRAWINGS SK-1 THROUGH SK-5**
  - **CALCULATIONS COVER PAGE**
  - **PLS-TOWER INPUT / OUTPUT SUMMARY**
  - **PLS-TOWER NODE LOCATIONS**
  - **PLS-TOWER MEMBER LOCATIONS**
  - **PLS-TOWER DETAILED OUTPUT**
  - **CONNECTION BETWEEN TOWERS EVALUATION**
  - **FOUNDATION EVALUATION**

**1. EXECUTIVE SUMMARY**

This report summarizes the controlling load case structural analysis and evaluation of the 180' dual lattice tower, comprised of an exterior tower and an interior tower, located off of Butternut Hollow Road in Greenwich, Connecticut.

The structural analysis was conducted in accordance with the 2016 Connecticut State Building Code which includes the TIA-222-G<sup>1</sup> Standard, 2012 International Building Code, the 2016 Connecticut State Building Code Amendments, the AISC<sup>2</sup> Load Resistance Factor Design (LRFD), the ASCE 7<sup>3</sup> design Code, and the Connecticut State Police Requirements which include the TIA/EIA-222-F<sup>4</sup>.

The antenna loading considered in the analysis consists of all the existing antennas, transmission lines and ancillary items as outlined in the Introduction Section of this report.

The proposed antenna modifications are listed below:

<b>Proposed Antenna, Mounts &amp; Cables</b>	<b>Carrier</b>	<b>Antenna Center Elevation</b>
<b><u>Remove:</u></b>		
(3) Windload Dishes	<b>CSP (Existing)</b>	<b>@ 180'</b>
(3) Powerwave P65-16-XLH-RR Panel Antennas	<b>AT&amp;T (Existing)</b>	<b>@ 148'</b>
(3) EMS RR90-17-02DP Panel Antennas (3) GSM TMA Units	<b>T-Mobile (Existing)</b>	<b>@ 136'</b>
(3) Swedcom SLCP 2x6014 Panel Antennas (3) Amphenol BXA-171063-8BF Panel Antennas (3) Commscope HBXX6516DS-A2M Panel Antennas (6) Commscope HBXX6517DS-A2M Panel Antennas (6) Diplexer Units (3) ALU 2x60 AWS RRH Units (9) 1-5/8" Coaxial Cables	<b>Verizon (Existing)</b>	<b>@ 126'</b>
<b><u>Install:</u></b>		
(3) CCI OPA-65R-LCUU-H6 Panel Antennas (3) Ericsson RRUS-32 B2 RRH Units	<b>AT&amp;T (Proposed)</b>	<b>@ 148'</b>
(3) Ericsson AIR 21 B2A/B4P Panel Antennas (3) Ericsson AIR 32 B66A/B2A Panel Antennas (3) APXVSAA24_43-U-A20 Panel Antennas (3) (AWS) TMA Units (3) Ericsson 4478 B71 RRH Units (3) Ericsson RRUS-11 RRH Units (3) Generic 600/700 Diplexer Units (3) Ericsson Hybriflex Cable 6x12 Fiber Optic Cables	<b>T-Mobile (Proposed)</b>	<b>@ 136'</b>

Proposed Antenna, Mounts & Cables (Cont.)	Carrier	Antenna Center Elevation
<b>(6) Commscope JAHH-65B-R3B-2DT Panel Antennas</b> <b>(3) BSAMNT-SBS-2-2 (JAHH Panel Antenna) Mounting Brackets</b> <b>(3) Nokia 2x60-700MHz RRH Units</b> <b>(3) Nokia 4x45-AWS RRH Units</b> <b>(3) Nokia 2x80W-850 MHz RRH Units</b> <b>(2) RFS DB-T1-6Z-8AB-OZ Distribution Boxes</b> <b>(2) 1-5/8" O.D. Fiber Optic Cables</b>	<b>Verizon (Proposed)</b>	<b>@ 126'</b>
<b>(3) Commscope DT465B-2XR Panel Antennas</b> <b>(3) 2x50W (800MHz) RRH Units</b> <b>(3) TD-RRH8x20-25 RRH Units w/ Solar Shield</b> <b>(1) Hybrid Cable (1-1/4" O.D. Cable used for Analysis)</b>	<b>Sprint (Proposed)</b>	<b>@ 115'</b>

The results of an initial assessment analysis indicated the existing exterior and interior tower structures did not have enough capacity for the proposed loading conditions. The existing tower structures require modifications shown on SK-1 through SK-5. **Once the modifications indicated on sheets SK-1 through SK-5 are performed, the modified structures are considered structurally adequate with the wind load classification specified with the existing and proposed antenna loading. No installation of proposed antennas shall occur without the required modification being completed.**

The results of the analysis indicate the modified tower's sway (deflection) is 0.67 degrees and the modified tower's twist (rotation) is 0.07 degrees. These figures are within the Connecticut State Police requirements of 0.75 degrees for combined twist (rotation) and sway (deflection) when applying the TIA/EIA-222-F design conditions.

1. TIA = Telecommunications Industry Association Structural Standard for Antenna Supporting Structures and Antennas (Version G)

2. AISC = American Institute of Steel Construction (14<sup>th</sup> Edition)

3. ASCE 7 = American Society of Civil Engineers Standard 7 (2010 Edition)

4. TIA/EIA = Telecommunications Industry Association Structural Standard for Antenna Supporting Structures and Antennas (Version F)



1. **EXECUTIVE SUMMARY** *(continued)*

This analysis is based on:

- 1) The tower structure's theoretical capacity not including any assessment of the condition of the tower.
- 2) Member sizes and tower geometry of the outer tower taken from manufacturers' drawings prepared by Rohn Industries, Inc., file number 28325, dated December 28, 1992.
- 3) Member sizes and tower geometry of the inner tower taken from design calculations and drawings prepared by Towertek Industries Inc., signed and sealed May 9, 2002.
- 4) Foundation modifications taken from drawings prepared by Walker Engineering Incorporated, Job number 0206-237R2, signed and sealed November 26, 2002.
- 5) Tower Mapping and Existing Inventory performed by D&K Nationwide Communications, Inc. on March 31, 2016
- 6) Previous structural analysis performed by AECOM on behalf of the Connecticut State Police, project # 60509756.08 / PNS-608, signed and sealed on September 6, 2016.
- 7) Proposed antenna inventory Radio Frequency Data Sheet (RFDS) and contract drawings provided by AT&T, obtained via e-mail, dated May 5, 2017.
- 8) Proposed antenna inventory RFDS provided by Verizon Wireless, obtained via e-mail, dated August 18, 2017.
- 9) Proposed antenna inventory RFDS provided by Sprint, obtained via e-mail, dated January 8, 2017.
- 10) Proposed antenna inventory RFDS provided by T-Mobile, obtained via e-mail, dated, February 15, 2018, with a revision to proposed inventory obtained via e-mail dated March 26, 2018.
- 11) Antenna inventory as specified in section 2 and 6 of this report.

This report is only valid as per the information and data provided by others for antenna inventory, mounts, tower structure, existing foundation and associated cables. The user of this report shall field verify the antenna, cabling and mount configuration used, as well as the physical condition of the tower members, connections and foundations. Notify the engineer in writing immediately if any of the information in this report is found to be other than specified.

If you should have any questions, please call.

Sincerely,

**AECOM,**

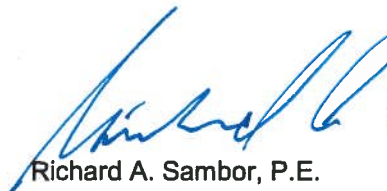
  
Richard A. Sambor, P.E.  
Senior Structural Engineer

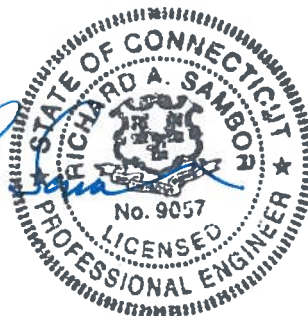

RAS/mcd

Cc: IA, CF/Book – AECOM

## 2. INTRODUCTION

The subject tower is located off of Butternut Hollow Road in Greenwich, Connecticut. The original outer structure is a self-supporting three-legged 180' steel tapered lattice tower manufactured by Rohn Industries. A subsequent inner tower structure, a Stack-N-Bolt system, was installed inside the original tower and was designed by Towertek.

The structural analysis was conducted in accordance with the following:

- TIA-222-G Standard for Standard for a wind velocity of range of 90 mph to 110 mph (3-second gust) and 50 mph (3-second gust) concurrent with 0.75" ice thickness, considered to increase in thickness with height
- 2012 International Building Code with 2016 Connecticut State Building Code Amendments for a wind speed of 101 mph (3-second gust)
- 2010 AISC Load Resistance Factor Design (LRFD)
- 2010 ASCE 7 Minimum Design Loads for Buildings and Other Structures for the ice thickness referenced in the TIA-222-G Standard
- Connecticut State Police Requirements for a wind velocity of 90 mph (fastest mile) and 90 mph (fastest mile) concurrent with 0.5" ice. Twist (rotation) and sway (deflection) were determined in accordance with Connecticut State Police Requirements for a wind velocity of 90 mph (fastest mile) concurrent with 0.5" ice, analyzed under the TIA/EIA-222-F design Standard.

The existing structure supports numerous communication antennas. The inventory is summarized below:

<b>Antenna Type</b>	<b>Carrier</b>	<b>Mount</b>	<b>Centerline Elevation / Leg</b>	<b>Cable</b>
(1) Scala OGT9-806 (inverted) * (1) Sinclair SC479-HF1LDF (inverted) (1) TTA/Junction Box *	#27A,27B,27C CSP 2 *, 4 & 74 * (existing)	3' Stand-Off	175 / B	(2) 1-5/8" (1) 3/8" *
(1) (inverted) Dipole Antenna	#26-A NEU – 20 (existing)	Shared with Above (Omni @ 175')	175 / A	(1) 7/8"
(1) Sinclair SC479-HF1LDF (inverted) (1) Junction Box	#26-B CSP – 67 (existing)	Shared with Above (Omni @ 175')	175 / A	(1) 1-5/8" (1) 1/2"
(1) PD-420 20' Dipole Antenna	#28D NEU – 55 (existing)	3' Stand-Off	174 / C	(1) 7/8"
(1) DB-583 Omni Antenna	#28C TOG – 5 (existing)	Shared with Above	174 / C	(1) 1-5/8"
(1) Scala OGT9-806N * (1) Sinclair SC479-HF1LDF	#28A,28B CSP - 1 * & 3 (existing)	3' Stand-Off	174 / C	(2) 1-5/8"

<b>Antenna Type</b>	<b>Carrier</b>	<b>Mount</b>	<b>Centerline Elevation / Leg</b>	<b>Cable</b>
(1) SC3-W100AC 3' Dish Antenna	#25 Greenwich Police Dep. (existing)	Dish Mount	168 / B	(1) Elliptical Cable
(1) Kathrine 197-501 Panel Antenna (1) TMA	#23 Stamford 64 & 65 (existing)	3' Arm	168 / A	(1) 1-5/8" (1) 1/2"
DB-586-Y	#22 TOG - 6 (existing)	Leg Mounted	165 / A	(1) 7/8"
8' (solid) Dish with Radome	#21 SPD - 9 (existing)	Dish Mount	160 / A	(1) EW90
(3) Sinclair SC-479-HF1LDF (1 upright, 2 inverted) (1) TMA	CSP 70 to 73 (reserve)	3' Stand-Off	160	(3) 1-5/8" (1) 1/2"
(1) Kathrine 197-501 Panel Antenna	#20 Unknown (existing)	3' Arm	159.5 / A	(1) 7/8"
(1) Kathrine 197-501 Panel Antenna	#19 Stamford 63 (existing)	3' Arm	159 / B	(1) 7/8"
<b>(3) OPA-65R-LCUU-H6 Panel Antennas (3) RRUS-32 B2 RRH Units</b>	<b>AT&amp;T (Proposed)</b>	<i>Shared with Below Mounts</i>	<b>147.5 / ABC</b>	<i>See Below Cables</i>
(6) Powerwave 7770 (12) TMAs (6) Ericsson RRU (1) Raycap Surge Suppressor	AT&T (existing)	(3) Side Arm Mounts	147.5' / ABC	(12) 1-5/8" (1) Fiber Optic Cable (2) DC Cables
(1) Celwave PD1142	#15 CSP – 21 (existing)	3' Arm	137 / B	(1) 7/8"
<b>(3) AIR 21 B2A/B4P Panels (3) AIR32 B66A/B2A Panels (3) APXVSA24_43-U-A20 Panel Antennas (3) (AWS) TMA Units (3) 4478 B71 RRH Units (3) RRUS-11 RRH Units (3) Generic Diplexer (600/700)</b>	<b>T-Mobile (Proposed)</b>	<i>Shared with Below Mounts</i>	<b>136 / ABC</b>	<b>(3) 1-1/4" Hybriflex Cables (6x12)</b>

<b>Antenna Type</b>	<b>Carrier</b>	<b>Mount</b>	<b>Centerline Elevation / Leg</b>	<b>Cable</b>
-----	T-Mobile (existing)	Face Mounted	136 / ABC	(6) 1-5/8"
(1) 6' Dipole Antenna	#12 unknown (existing)	3' Arm	135 / C	(1) 7/8"
(1) Kreco CO41AN	#11 NEU – 18 (existing)	Mounted on Below Frame	130 / A	(1) 1-5/8"
<b>(6) JAHH-65B-R3B-2DT Panels (3) Mount Brackets for JAHH Panels (3) 2x60-700 MHz RRH Units (3) 4x45-AWS RRH Units (3) 2x80W-850MHz RRH (2) DB-T1-6Z-8B-OZ</b>	<b>Verizon (Proposed)</b>	<i>Shared with Below Mounts</i>	<b>126 / ABC</b>	<b>(2) 1-5/8" Fiber Optic Cables</b>
(6) Andrew DB844H80-XY Panels (1) Raycap DB-T1-6Z-8AB-0Z Distribution Box (AWS)	Verizon (existing)	(3) Boom Gates (existing)	126 / ABC	(6) 1 5/8" (1) 1-5/8" Fiber Optic Cable
(1) Celwave PD1142	#9 DEP – 54 (existing)	3' Arm	122 / B	(1) 7/8"
(1) Celwave PD1142	#8 CSP – 66 (existing)	Share with (#9) 3' Arm	122 / B	(1) 7/8"
<b>(3) DT465B-2XR Panels (3) 800 MHz RRH Units (3) TD-RRH 8x20-25 RRH Units</b>	<b>Sprint (Proposed)</b>	<i>Shared with below Mount</i>	115 / ABC	<b>(1) Hybriflex Cable</b>
(3) APXVSPP18-C Panel Antennas (3) 800 MHz 2x50W RRH Units (3) 1900 MHz 4x45 RRH Units	Sprint (existing)	(3) 12' T-Arm Mount	115 / ABC	(3) Hybriflex Cables
(1) Celwave PD1142	#7 NEU – 17 (existing)	3' Stand-off	110 / A	(1) 7/8"
(1) Celwave PD1142	#5 NEU – 16 (existing)	6' Arm	82 / C	(1) 1-5/8"
(1) 10' Dipole	#4 DOT – 56 (existing)	3' Arm	65 / C	(1) 7/8"

<b>Antenna Type</b>	<b>Carrier</b>	<b>Mount</b>	<b>Centerline Elevation / Leg</b>	<b>Cable</b>
(1) GPS	#3 Sprint - 69 (existing)	3' Arm	60 / C	(1) 7/8"
(1) 4' Dipole Antenna	#1 Unknown (existing)	3' Arm	56 / A	(1) 7/8"
(1) GPS (TMG-26N)	#2 Verizon - 68 (existing)	3' Arm	54 / B	(1) 7/8"

**Notes:** Antenna elevations and ID numbering obtained from Tower Mapping and Existing Inventory via tower climb, performed by D&K Nationwide Communications, Inc. on March 31, 2016.

“ \* “ indicated future decommissioning of CSP antennas

This structural analysis and evaluation of the communications tower was performed by AECOM on behalf of AT&T, Sprint, T-Mobile and Verizon Wireless (VZW). The purpose of this analysis was to investigate the structural integrity of the modified tower and existing foundation for existing and proposed antenna loads in compliance with the 2016 Connecticut State Building Code. This analysis was conducted to evaluate stress on the tower and the effect forces to the foundation of the tower resulting from existing and proposed antenna arrangements.

### 3. ANALYSIS METHODOLOGY AND LOADING CONDITIONS

The structural analysis was done in accordance with, the TIA-222-G--Structural Standard for Antenna Towers and Antenna Supporting Structures and Antennas, the 2012 International Building Code with 2016 Connecticut State Building Code Amendments and the American Institute of Steel Construction (AISC) Manual of Steel Construction – Load Resistance Factor Design (LRFD)

The analysis was conducted using PLS-Tower (version 10.62) and used the following conditions for this tower review (following the TIA/EIA-222-G Standard):

- Structure Class 3 – (Essential Communications)
  - NOTE: ASCE 7 and CT State Building Code Applied Risk Category 4 for design wind loads (see below)
- Topographic Category 3 – (Tower location on top of hill – rolling wind conditions considered)
  - Crest Height used for analysis: (approximate elevations listed below)
    - Tower Base Elevation = 350 feet
    - High point (2 mile Radius) = 560 feet (Ref. Round Hill – West of Tower Site)
    - Low Point (2 mile Radius) = 212 feet (Ref. Near intersection of Grahampton Lane – South of Tower Site)
    - “H” = (Avg of High/Low) – Base Elevation = 36 feet
- Exposure Class C – (Open Terrain with scattered obstructions)
- Load Conditions:
  - Five load conditions were evaluated as shown which were compared to design stresses according to AISC and TIA-222-G Standard. The load conditions apply TIA-222-G load combinations from Section 2.3.2 (shown at the end of this section)

Basic Wind Speed:

- TIA-222-G:
  - Fairfield County (Wind Speed Range):  $V = 90 \text{ mph} - 110 \text{ mph}$  (3-second gust) [Annex of TIA/EIA-222-G 2006]
- IBC 2012 w/ 2016 CT State Building Code Amendment:
  - (2012) IBC Section 1609.1.1 – Determination of Wind Loads – Exception 5 “Designs using TIA-222” applies for determination of Design Wind Load obtained as “V.ult” are to be converted to “V.asd” when applying the TIA-222-G design Standard (under Section 1609.3) for Basic Wind Speed.
  - (2016) CT State Building Code Amendment to the IBC Section 1609.3 wind loads are obtained from Appendix N of the State Building Code.
    - **V.asd = 101 mph** (3-Second Gust) Wind Design Parameter for the Town of Middlebury, Connecticut for Risk Category four (IV) for essential communications (Connecticut State Police).

Ice thickness used for this analysis is **0.75 inch** (assumed to start at the base of the tower) and is considered to increase in thickness with height. The initial ice thickness for design is referenced in the Annex of TIA-222-G and follows the same design criteria as the ASCE 7 Standard.

The below load condition implements the design requirements of the Connecticut State Police for the tower structures deflection limits with the allowable deflection limit of the combination of the tower’s sway (deflection) and twist (rotation) under the TIA-222-F design Standard. This design limit required the design combined value of sway (deflection) and twist (rotation) to be under 0.75 degrees following the TIA-222-F design Standard.

Load Condition (TIA-222-F) = 90 mph (fastest mile) Wind Load (with ice) + Ice Load + Tower Dead Load

### 3. ANALYSIS METHODOLOGY AND LOADING CONDITIONS (cont.)

Seismic event consideration factors/values for design (and are applied into the PLS-Tower design outputs – see below load combination):

- $S_s = 0.259$  (2016 CT State Building Code – Location Specific Value)
- $S_1 = 0.070$  (2016 CT State Building Code – Location Specific Value)
- Seismic Design Category = “C” – (2012 International Building Code)
- $F_a = 1.6$  (Obtained from TIA-222-G Table 2-12 Considering above conditions)
- $F_v = 2.4$  (Obtained from TIA-222-G Table 2-13 Considering above conditions)

Strength Limit State Load Combinations (TIA-222-G Section 2.3.2):

The structural analysis herein has considered the following load combinations within the analysis:

1. **1.2 Dead Load Tower structure + 1.0 Dead Load Guy Assemblies + 1.6 Wind load without ice**
2. 0.9 Dead Load Tower structure + 1.0 Dead Load Guy Assemblies + 1.6 Wind load without ice
3. 1.2 Dead Load Tower structure + 1.0 Dead Load Guy Assemblies + 1.0 Dead weight of ice due to factored ice thickness + 1.0 Concurrent wind load with factored ice thickness + 1.0 Load effects due to temperature
4. 1.2 Dead Load Tower structure + 1.0 Dead Load Guy Assemblies + 1.0 Earthquake Load
5. 0.9 Dead Load Tower structure + 1.0 Dead Load Guy Assemblies + 1.0 Earthquake Load

NOTE 1: The above **bolded** load combination is considered to create the governing design loads per the results of the analysis.

NOTE 2: The above “Dead Load Guy Assemblies” are not considered as part of the analysis and are considered as a value of zero.

NOTE 3: The “Load effects due to temperature” do not apply for structures that are self-sustaining (from the TIA-222-G Standard)

#### 4. FINDINGS AND EVALUATION

The combined axial and bending stresses on the tower structure were evaluated to compare with the strength design in accordance with AISC (LRFD). The results of an initial analysis indicated that the existing exterior and interior tower structures did not have enough capacity to support the proposed loading conditions. The tower structure requires modifications shown on SK-1 through SK-5. **Once the modifications indicated on sheets SK-1 through SK-5 are performed, the modified structure and existing foundation are considered structurally adequate with the wind load specification and with the existing and proposed antenna loading included herein.**

The existing dual lattice tower's sway (deflection) is 0.67 degrees, and the existing tower's twist (rotation) is 0.07 degrees. The figures combined ARE within the Connecticut State Police requirement of 0.75 degrees for combined twist and sway.

See the below tables for tower capacity and tower deflection (sway) and rotation (twist) figures:

##### Tower Twist & Sway 90 mph concurrent with ice (TIA-222-F Condition):

<b>Component</b>	<b>Allowable</b>	<b>Actual</b>
Twist	0.75°	0.07°
Sway		0.67°

##### Proposed Tower Component Stress vs Capacity Summary (TIA-222-G Condition):

<b>Component</b>	<b>Component Size</b>	<b>Controlling Member</b>	<b>Stress (% Capacity)</b>	<b>Pass/Fail</b>
Rohn Diagonal	L3-1/2x3-1/2x1/4	Rohn-DF42	96.51	Pass
Rohn Leg	Rohn 6 EH (Extra Heavy)	Rohn-LG2P	91.86	Pass
Rohn Horizontal	L1-3/4x1-3/4x3/16	Rohn-H2P	16.33	Pass
Rohn Flange Bolts	(6) 1" Diameter A325 Bolts – Tension	Rohn-LH21	84.81	Pass
Interior Tower Diagonal	L6x6x3/8	SNB-DI42	96.74	Pass
Interior Tower Leg	Pipe 8 SCH 80 (Extra Strong)	SNB-LH2P	99.89	Pass
Interior Tower Horizontal	Pipe 4"x0.494" (Pipe 4 XXS)	SNB-H9cP	3.91	Pass
Interior Flange Bolts	(6) 1" Diameter A325 Bolts – Tension	SNB-LG21	97.45	Pass
Tower-to-Tower Connection	A325 Bolt	3/4" Bolt	64.2	Pass
Foundation	36.5' Square	Overturning Moment Resistance	94.5	Pass
Foundation	36.5' Square	Soil Bearing Resistance	73.6	Pass
Foundation	36.5' Square	Punching Shear Capacity	49.5	Pass
Foundation	36.5' Square	Foundation Flexure Capacity	88.9	Pass



## 5. CONCLUSIONS

The results of an initial assessment analysis indicated the existing Exterior and Interior tower structures did not have enough capacity for the proposed loading conditions. The existing tower structures require modifications shown on SK-1 through SK-5. **Once the modifications indicated on sheets SK-1 through SK-5 are performed, the modified structures are considered structurally adequate with the wind load classification specified with the existing and proposed antenna loading. No installation of proposed antennas shall occur without the required modification being completed.**

The results of the analysis indicate the modified tower's sway (deflection) is 0.67 degrees and the modified tower's twist (rotation) is 0.07 degrees. These figures are within the Connecticut State Police requirements of 0.75 degrees for combined twist (rotation) and sway (deflection) when applying the TIA/EIA-222-F design conditions.

### Limitations/Assumptions:

This report is based on the following:

- A. Tower is properly installed and maintained.
- B. All members and their geometry are as specified in the original manufacturer drawings and are in good condition.
- C. All required members are in place.
- D. All bolts are in place and are properly tightened.
- E. Tower is in plumb condition.
- F. All member protective coatings are in good condition.
- G. All tower members were properly designed, detailed, fabricated, installed, and have been properly maintained since erection.
- H. Foundations are in good condition without defect and were properly constructed to support original design loads as specified in the original design documents.

AECOM is not responsible for any modifications completed prior to or hereafter in which AECOM is not or was not directly involved. Modifications include but are not limited to:

- A. Adding antennas
- B. Removing/replacing antennas
- C. Adding coaxial cables

AECOM hereby states that this document represents the entire report and that it assumes no liability for any factual changes that may occur after the date of this report. All representations, recommendations, and conclusions are based upon information contained and set forth herein. If you are aware of any information which conflicts with that which is contained herein, or you are aware of any defects arising from original design, material, fabrication, or erection deficiencies, you should disregard this report and immediately contact AECOM. AECOM disclaims all liability for any representation, recommendation, or conclusion not expressly stated herein.

**Ongoing and Periodic Inspection and Maintenance:**

After the Contractor has successfully completed the installation and the work has been accepted, the owner will be responsible for the ongoing and periodic inspection and maintenance of the tower.

The owner shall refer to TIA-222-G Section 14.2 for recommendations for maintenance and inspection. The frequency of the inspection and maintenance intervals is to be determined by the owner based upon actual site and environmental conditions. It is recommended that a complete and thorough inspection of the entire tower structural system be performed at least yearly and more frequently as conditions warrant. It is also recommended that the structure be inspected after severe wind and/or ice storms or other extreme loading conditions.

## 6. ANALYSIS DATA

## **TOWER REINFORCEMENT DRAWINGS SK-1 THROUGH SK-5**

## GENERAL CONSTRUCTION NOTES

1. ALL WORK SHALL COMPLY WITH THE CONNECTICUT STATE BUILDING AND LIFE SAFETY CODES, SUPPLEMENTS AND AMENDMENTS.
2. CONTRACTOR IS TO REVIEW ALL DRAWINGS AND NOTES IN THE CONTRACT DOCUMENT SET. CONTRACTOR SHALL COORDINATE ALL WORK SHOWN IN THE SET OF DRAWINGS. THE CONTRACTOR SHALL PROVIDE A COMPLETE SET OF DRAWINGS TO ALL SUB-CONTRACTORS AND ALL RELATED PARTIES. THE SUB-CONTRACTORS SHALL EXAMINE ALL THE DRAWINGS AND SPECIFICATIONS FOR THE INFORMATION THAT AFFECTS THEIR WORK.
3. CONTRACTOR SHALL PROVIDE A COMPLETE BUILD-OUT WITH ALL FINISHES, STRUCTURAL, MECHANICAL, AND ELECTRICAL COMPONENTS AND PROVIDE ALL ITEMS AS SHOWN OR INDICATED ON DRAWINGS OR WRITTEN IN SPECIFICATIONS.
4. CONTRACTOR SHALL FURNISH ALL MATERIAL, LABOR AND EQUIPMENT TO COMPLETE THE WORK AND FURNISH A COMPLETED JOB ALL IN ACCORDANCE WITH LOCAL AND STATE GOVERNING AUTHORITIES AND OTHER AUTHORITIES HAVING LAWFUL JURISDICTION OVER THE WORK.
5. CONTRACTOR SHALL SECURE AND PAY FOR ALL PERMITS AND ALL INSPECTIONS REQUIRED AND SHALL ALSO PAY FEES REQUIRED FOR THE GENERAL CONSTRUCTION AND ELECTRICAL SUB-CONTRACTORS SHALL PAY FOR THEIR PERMITS.
6. CONTRACTOR SHALL MAINTAIN A CURRENT SET OF DRAWINGS ON SITE AT ALL TIMES AND ENSURE THE DISTRIBUTION OF NEW DRAWINGS TO SUB-CONTRACTORS AND OTHER RELEVANT PARTIES AS SOON AS THEY ARE MADE AVAILABLE. ALL OLD DRAWINGS SHALL BE MARKED VOID AND REMOVED FROM THE CONTRACT AREA. CONTRACTOR SHALL FURNISH 'AS-BUILT' SET OF DRAWINGS TO OWNER UPON COMPLETION OF PROJECT.
7. INSTALLATION OF THIS WIRELESS COMMUNICATIONS EQUIPMENT SITE REQUIRES WORK IN THE IMMEDIATE VICINITY OF EXISTING OPERATING TELECOMMUNICATION SYSTEMS. THE CONTRACTOR SHALL PROVIDE AND COORDINATE THE METHODS OF PROTECTION WITH THE VARIOUS TELECOMMUNICATION CARRIERS AND THE TOWER OWNER. THERE SHALL BE NO INTERRUPTION OF OPERATION WITHOUT TIMELY COORDINATION WITH AND APPROVAL BY THE VARIOUS COMMUNICATIONS OPERATORS INCLUDING THE CONNECTICUT STATE POLICE.
8. THE REINFORCEMENT OF PORTIONS OF THIS TOWER STRUCTURE WILL AFFECT CRITICAL CONNECTICUT STATE POLICE ANTENNAS.
9. NO MOVEMENT, ALTERATION, OR DISCONNECTION OF CONNECTICUT STATE POLICE ANTENNAS MAY OCCUR WITHOUT THE NOTIFICATION AND APPROVAL OF THE CONNECTICUT STATE POLICE. CONTACT THE NETWORK CONTROL CENTER AT 860-865-8008.
10. TOWER REINFORCING WORK AFFECTING CRITICAL CONNECTICUT STATE POLICE ANTENNAS MAY BE REQUIRED TO BE CONDUCTED AT TIMES AS DETERMINED BY THE REQUIREMENTS OF THE CONNECTICUT STATE POLICE.
11. ALL EQUIPMENT AND PRODUCTS PURCHASED ARE TO BE REVIEWED BY CONTRACTOR AND ALL APPLICABLE SUB-CONTRACTORS FOR ANY CONDITION PER MFR'S RECOMMENDATIONS. CONTRACTOR TO SUPPLY THESE ITEMS AT NO COST TO OWNER OR ARCHITECT.
12. CONTRACTOR SHALL BE RESPONSIBLE FOR ALL ON-SITE SAFETY FROM THE TIME THE JOB IS AWARDED UNTIL ALL WORK IS COMPLETE AND ACCEPTED BY THE OWNER.
13. CONTRACTOR TO REVIEW ALL SHOP DRAWINGS AND SUBMIT COPY TO ARCHITECT FOR REVIEW. DRAWINGS MUST BEAR THE CHECKER'S INITIALS BEFORE SUBMITTAL TO THE ARCHITECT FOR REVIEW.
14. THE CONTRACTOR SHALL FIELD VERIFY ALL DIMENSIONS, ELEVATIONS, ANGLES, AND EXISTING CONDITIONS AT THE SITE, PRIOR TO FABRICATION AND/OR INSTALLATION OF ANY WORK IN THE CONTRACT AREA. SUBMIT ANY DISCREPANCIES FROM THE DRAWINGS TO THE ARCHITECT.
15. THE CONTRACTOR IS SOLELY RESPONSIBLE TO DETERMINE CONSTRUCTION PROCEDURE AND SEQUENCE, AND TO ENSURE THE SAFETY OF THE EXISTING STRUCTURE AND ITS COMPONENT PARTS DURING CONSTRUCTION. THIS INCLUDES THE ADDITION OF WHATEVER SHORING, BRACING, UNDERPINNING, ETC. THAT MAY BE NECESSARY.
16. CONTRACTOR TO CONTACT "CALL BEFORE YOU DIG" AT 1-800-922-4455 TO VERIFY AND IDENTIFY THE EXACT LOCATIONS OF ALL UNDERGROUND UTILITIES AND OBSTRUCTIONS IDENTIFIED PRIOR TO COMMENCING WORK IN THE CONTRACT AREA.
17. CONTRACTOR SHALL COMPLY WITH OWNER ENVIRONMENTAL ENGINEER ON ALL METHODS AND PROVISIONS FOR ALL EXCAVATION ACTIVITIES INCLUDING SOIL DISPOSAL. ALL BACKFILL MATERIALS TO BE PROVIDED BY THE CONTRACTOR.
18. DIMENSIONS OF EXISTING TOWER ARE BASED ON MANUFACTURER'S DRAWINGS PREPARED BY ROHN INDUSTRIES, INC., DATED DECEMBER 1992, AND ARE NOT GUARANTEED. CONTRACTOR SHALL TAKE FIELD DIMENSIONS AS NECESSARY TO ASSURE PROPER FIT OF ALL FINISHED WORK AND SHALL ASSUME FULL RESPONSIBILITY FOR THEIR ACCURACY. WHEN SHOP DRAWINGS BASED ON FIELD MEASUREMENT ARE SUBMITTED FOR REVIEW, DIMENSIONS ARE PROVIDED FOR THE ENGINEER'S REFERENCE ONLY.
19. TOWER INVENTORY IS BASED ON INFORMATION OBTAINED BY CONNECTICUT STATE POLICE DATED APRIL 12, 2016. TOWER MAPPING AND EXISTING INVENTORY OBTAINED FROM D&K NATIONWIDE COMMUNICATIONS, INC. DATED MARCH 2, 2016.
20. CONTRACTOR TO VERIFY REQUIRED CLEARANCES INCLUDING BUT NOT LIMITED TO EXISTING BUILDINGS, EQUIPMENT PADS AND SHELTERS PRIOR TO COMMENCING WORK.
21. THE CONTRACTOR IS RESPONSIBLE FOR THE STABILITY OF THE STRUCTURE DURING CONSTRUCTION. NO MEMBER OF THE TOWER SHALL BE LEFT DISCONNECTED FOR THE NEXT WORKING DAY. THE CONTRACTOR SHALL BE AWARE OF WEATHER AND WIND CONDITIONS AND NOT PERFORM MEMBER REPLACEMENT IN A WIND.

## STRUCTURAL NOTES

### STRUCTURAL STEEL MATERIAL:

ALL STRUCTURAL STEEL MEMBERS AND HSS TUBING USED FOR REINFORCING SHALL BE MINIMUM 50 KSI WITH THE BELOW EXCEPTIONS:

ANGLE SIZE 2-1/2"x2-1/2"x3/16" AND SMALLER ..... A36  
STRUCTURAL PLATES ..... A36

STRUCTURAL STEEL SHALL CONFORM TO ALL THE REQUIREMENTS OF THE ASTM SPECIFICATION, AS REFERENCED IN THE CODE.

UNLESS OTHERWISE NOTED, ALL STEEL WILL BE GALVANIZED IN ACCORDANCE WITH ASTM 123 AFTER FABRICATION. TOUCH UP ALL DAMAGED GALVANIZED STEEL WITH APPROVED COLD ZINC, "GALVANOX", "DRY GALV", "ZINC-IT", OR APPROVED EQUIVALENT, IN ACCORDANCE WITH MANUFACTURER'S GUIDELINES. TOUCH-UP DAMAGED NON GALVANIZED STEEL WITH SAME PAINT APPLIED IN SHOP OR FIELD.

SHOP AND ERECTION DRAWINGS SHALL BE SUBMITTED FOR ALL STRUCTURAL STEEL WORK IN ACCORDANCE WITH THE CONTRACT DOCUMENTS. SUBMIT 2 SETS OF PRINTS FOR THE ENGINEER REVIEW.

MILL BEARING ENDS OF COLUMNS, STIFFENERS, AND OTHER BEARING SURFACES TO TRANSFER LOAD OVER ENTIRE CROSS SECTION.

THE OMISSION OF ANY MATERIAL THAT WAS SHOWN ON THE CONTRACT DRAWINGS SHALL NOT RELIEVE THE CONTRACTOR OF PROVIDING THE SAME.

### CONNECTIONS / FIELD ASSEMBLY:

BOLTED CONNECTIONS: UNLESS OTHERWISE NOTED, ALL JOINTS ARE SLIP CRITICAL TYPE, REQUIRING 5/8" & 3/4" DIA. A325-N & A490-X BOLTS, A563 NUTS AND F436 WASHERS, ALL GALVANIZED. BEVELED WASHERS SHALL BE USED ON BEAM FLANGES HAVING A SLOPE GREATER THAN 1:20.

STRUCTURE IS DESIGNED TO BE LEVEL AND PLUMB, SELF-SUPPORTING AND STABLE AFTER WORK IS COMPLETED.

COMMENCEMENT OF WORK WITHOUT NOTIFYING THE ENGINEER OF ANY DISCREPANCIES WILL BE CONSIDERED ACCEPTANCE OF PRECEDING WORK.

### INSPECTIONS:

SPECIAL INSPECTIONS ARE REQUIRED PER THE CODE FOR STRUCTURAL STEEL WORK.

OWNER WILL SUPPLY THE SERVICES OF A SPECIAL INSPECTOR AND TESTING AGENTS AS REQUIRED. CONTRACTOR SHALL COORDINATE INSPECTIONS OF FABRICATOR'S AND ERECTOR'S WORK AND MATERIALS TO MEET THE REQUIREMENTS OF THE STATEMENT OF SPECIAL INSPECTIONS FOR THIS PROJECT.

COPIES OF TESTING AND INSPECTION REPORTS WILL BE PROVIDED TO THE OWNER, BUILDING OFFICIAL, ENGINEER OF RECORD AND CONTRACTOR.

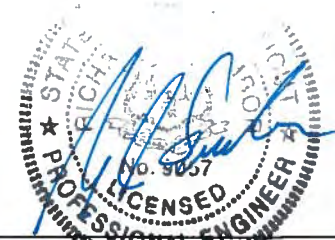

PROJECT NO.  
60537397  
Designed by:  
MCD  
Drawn by:  
GAT  
Checked by:  
ICA  
Approved by:  
RAS

**AECOM**  
500 ENTERPRISE DRIVE  
ROCKY HILL, CONNECTICUT  
(860)-529-8882

AT&T | Sprint | T-Mobile | verizon

SITE ADDRESS: BUTTERNUT HOLLOW ROAD  
GREENWICH, CONNECTICUT 06831

REV.	DATE	DESCRIPTION
1	3/27/18	RE-ISSUE

Scale: AS NOTED    Date: 03/20/18

Job No.    File No.

Dwg. No.  
**SK-1**  
Dwg. 1 of 5

**NOTES:**

1. REFER TO STRUCTURAL NOTES ON SK-1 FOR STEEL GRADE REQUIREMENTS FOR REPLACEMENT MEMBERS
2. REINFORCEMENT OF TOWER IS REQUIRED FOR ALL 3 SIDES OF EXISTING EXTERIOR TOWER STRUCTURE.
3. CONNECTION BOLTS THAT ARE REMOVED DURING MEMBER REPLACEMENT SHALL BE REPLACED IN KIND, UNLESS NOTED OTHERWISE. EXISTING BOLTS SHALL NOT BE RE-USED FOR CONNECTING REPLACEMENT MEMBERS.
4. CONTRACTOR SHALL COORDINATE WITH ROHN INC. FOR INDICATED TOWER REPLACEMENT MEMBERS AS SHOWN.
5. CONTRACTOR SHALL VERIFY INFORMATION SHOWN ON THIS SHEET PRIOR TO ORDERING MATERIALS.
6. THE BOTTOM 2 FEET OF THE TOWER'S LEGS AND DIAGONAL MEMBERS ARE ENCASED IN CONCRETE, PART OF A PREVIOUS FOUNDATION MODIFICATION.

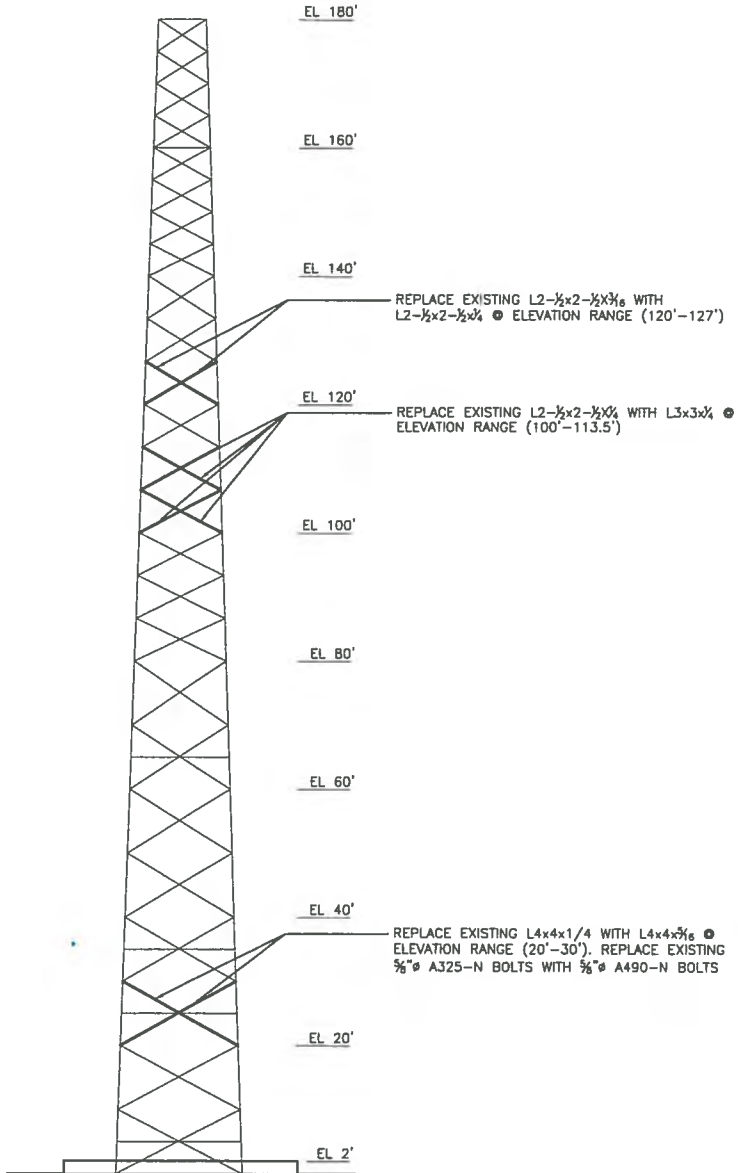

**1** TOWER ELEVATION - EXTERIOR TOWER  
 SK-2 SCALE: 1" = 30'-0" (INTERIOR TOWER NOT SHOWN FOR CLARITY)



PROJECT NO.  
60537397  
 Designed by:  
NCD  
 Drawn by:  
GAT  
 Checked by:  
ICA  
 Approved by:  
RAS

**AECOM**  
 500 ENTERPRISE DRIVE  
 ROCKY HILL, CONNECTICUT  
 (860)-529-8882

AT&T | Sprint | T-Mobile | verizon  
 SITE ADDRESS: BUTTERNUT HOLLOW ROAD  
 GREENWICH, CONNECTICUT 06831

1	3/27/18	RE-ISSUE
REV.	DATE:	DESCRIPTION
Scale: AS NOTED		Date: 03/20/18
Job No.	File No.	Dwg. 2 of 5

Dwg. No.  
**SK-2**

**NOTES:**

1. REFER TO STRUCTURAL NOTES ON SK-1 FOR STEEL GRADE REQUIREMENTS FOR REPLACEMENT MEMBERS
2. REINFORCEMENT OF TOWER IS REQUIRED FOR ALL 3 SIDES OF EXISTING INTERIOR TOWER STRUCTURE.
3. CONNECTION BOLTS THAT ARE REMOVED DURING MEMBER REPLACEMENT SHALL BE REPLACED IN KIND, UNLESS NOTED OTHERWISE. EXISTING BOLTS SHALL NOT BE RE-USED FOR CONNECTING REPLACEMENT MEMBERS.
4. CONTRACTOR SHALL VERIFY INFORMATION SHOWN ON THIS SHEET PRIOR TO ORDERING MATERIALS
5. THE BOTTOM 2 FEET OF THE TOWER'S LEGS AND DIAGONAL MEMBERS ARE ENCASED IN CONCRETE, PART OF A PREVIOUS FOUNDATION MODIFICATION.
6. EXISTING TOWER DIAGONAL MEMBERS AT ELEVATION 0'-2' RANGE ARE ENCASED IN CONCRETE. CONTRACTOR SHALL PROVIDE TEMPORARY SUPPORT OF TOWER STRUCTURE DURING CONSTRUCTION OF PROPOSED DIAGONAL BASE CONNECTIONS. REFER TO SK-5 FOR DETAILS FOR REPLACEMENT OF DIAGONAL MEMBERS.
7. EXISTING DIAGONAL MEMBERS EMBEDDED IN CONCRETE ARE TO BE CUT AFTER REPLACEMENT INSTALLATION OF DIAGONAL BASE ANCHORS, BASEPLATE AND CONNECTION PLATES ARE CONSTRUCTED TO ALLOW REPLACEMENT OF PROPOSED DIAGONAL MEMBERS (AS INDICATED IN NOTE 3 ABOVE AND SK-5).

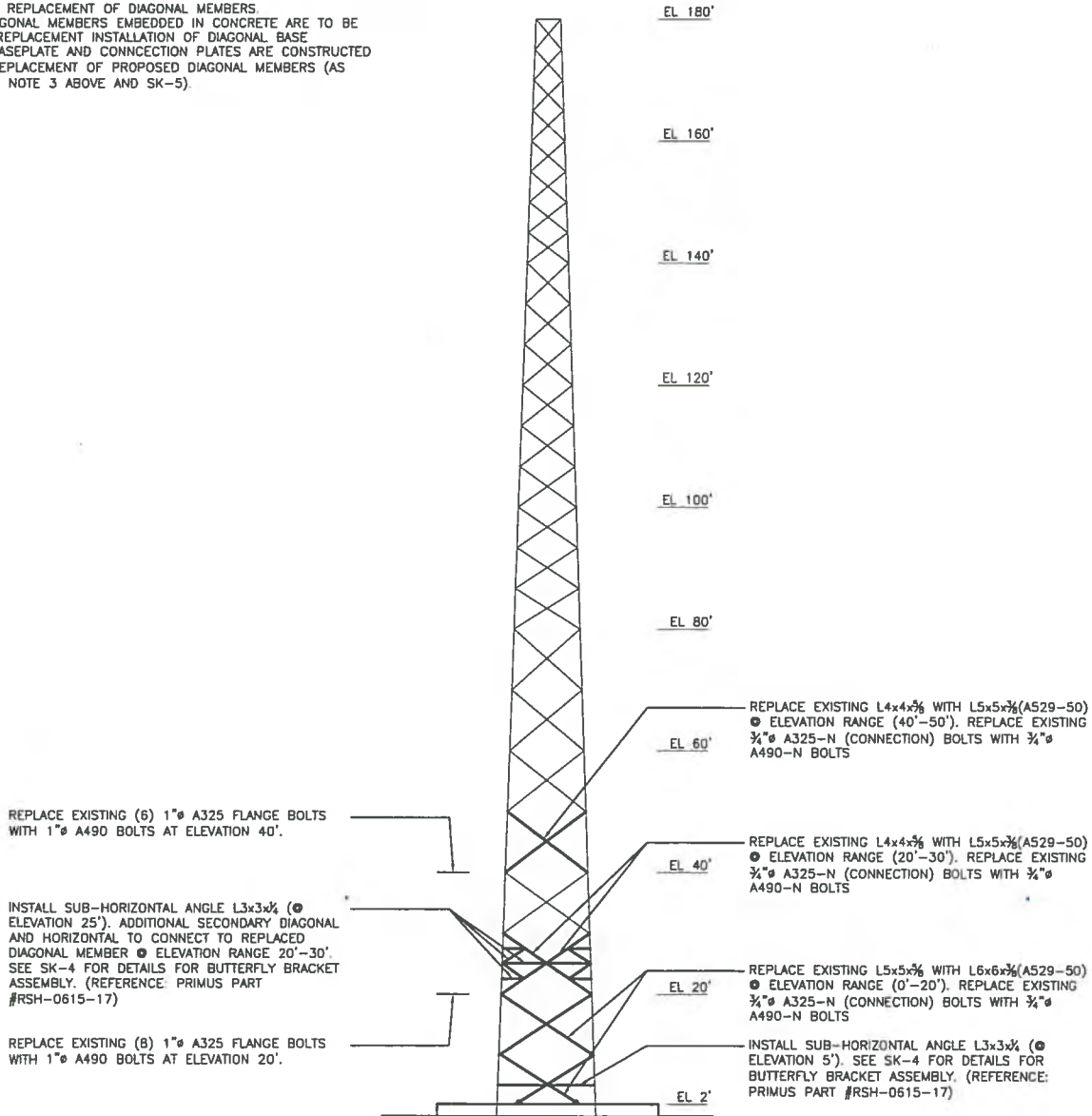

**1 TOWER ELEVATION - INTERIOR TOWER**  
 SK-3 SCALE: 1" = 30'-0" (EXTERIOR TOWER NOT SHOWN FOR CLARITY)

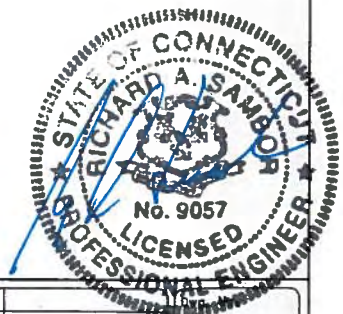

PROJECT NO.  
60537397  
 Designed by:  
MCD  
 Drawn by:  
GAT  
 Checked by:  
ICA  
 Approved by:  
RAS

**AECOM**  
 500 ENTERPRISE DRIVE  
 ROCKY HILL, CONNECTICUT  
 (860)-529-8882

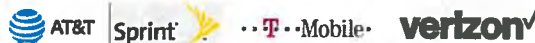

SITE ADDRESS: BUTTERNUT HOLLOW ROAD  
 GREENWICH, CONNECTICUT 06831

1	3/27/18	RE-ISSUE
REV.	DATE:	DESCRIPTION
Scale: AS NOTED		Date: 03/20/18
Job No.	File No.	Dwg. 3 of 5

SK-3

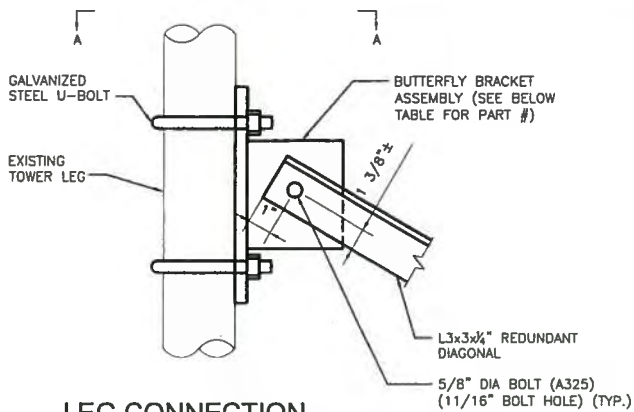

**3**  
SK-4  
**LEG CONNECTION REDUNDANT DIAGONAL**  
SCALE: 1-1/2"=1'-0"

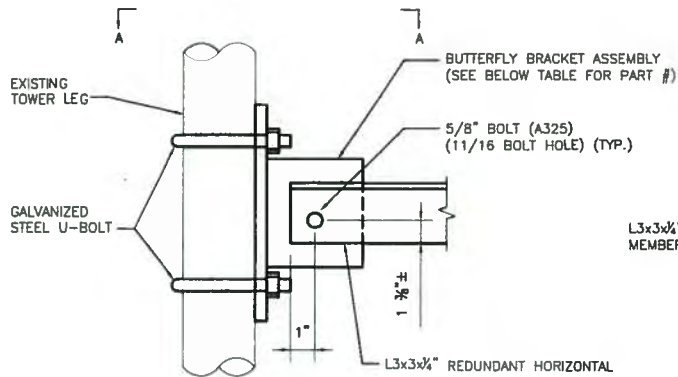

**2**  
SK-4  
**LEG CONNECTION REDUNDANT HORIZONTAL**  
SCALE: 1-1/2"=1'-0"

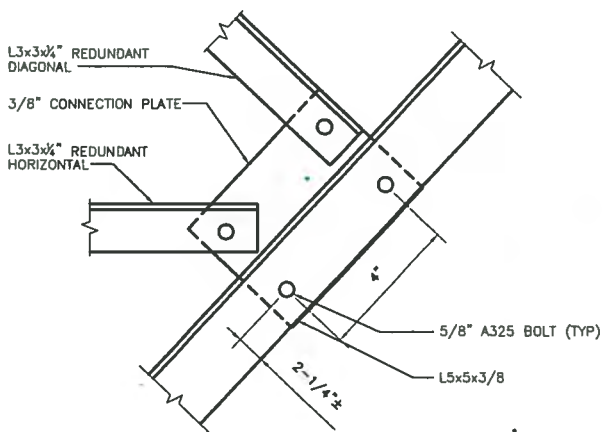

**1**  
SK-4  
**REDUNDANT MEMBER CONNECTION**  
SCALE: 1-1/2"=1'-0"

ELEVATION	LEG BUTTERFLY BRACKET #
2'-10"	RSH-0500-00
20'-30"	RSH-0500-00

NOTE: LEG BUTTERFLY BRACKET ASSEMBLY INFORMATION FROM PRIMUS ELECTRONICS CORPORATION. CONTRACTOR SHALL USE PRODUCTS SIMILAR TO OR EXCEEDING IN QUALITY FOR CONSTRUCTION.

NOTE:  
1. DETAILS 2 & 3 ABOVE INDICATE CONNECTIONS OF DIAGONAL AND HORIZONTAL MEMBERS TO TOWER LEGS. BUTTERFLY BRACKET ASSEMBLIES USED FOR CONNECTION TO EXISTING LEGS SHALL BE INSTALLED AS CLOSE TO EXISTING ADJOINING HORIZONTAL MEMBER AS POSSIBLE.

- NOTES:**
- REFER TO SK-1 FOR STRUCTURAL NOTES COORDINATE SHEET WITH SK-3 FOR SECONDARY HORIZONTAL/DIAGONAL CONNECTION MEMBERS.
  - CONTRACTOR SHALL FIELD VERIFY DIMENSIONS SHOWN PRIOR TO ORDERING SUPPLIES.
  - U-BOLTED CONNECTION ASSEMBLIES CONNECTING THE EXTERIOR AND INTERIOR TOWERS ARE PERMITTED TO BE ADJUSTED ONE UNIT AT A TIME TO ALLOW THE INSTALLATION OF THE PROPOSED BUTTERFLY BRACKET ASSEMBLIES INDICATED HERE AND ON SHEET SK-3.

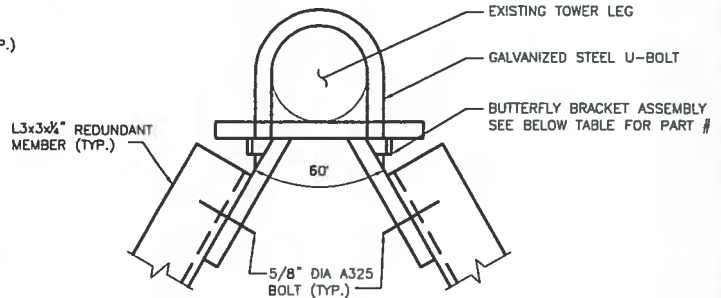

**5**  
SK-4  
**SECTION A**  
SCALE: N.T.S.

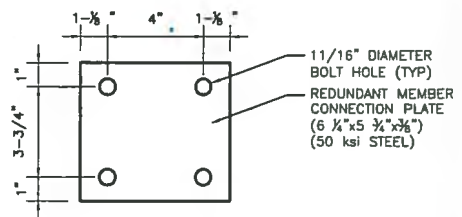

**4**  
SK-4  
**CONNECTION PLATE**  
SCALE: 1-1/2"=1'-0"

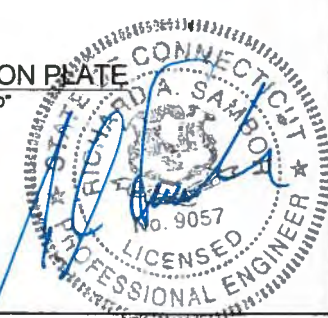

PROJECT NO.  
60537397  
Designed by:  
MCD  
Drawn by:  
GAT  
Checked by:  
ICA  
Approved by:  
RAS

**AECOM**  
500 ENTERPRISE DRIVE  
ROCKY HILL, CONNECTICUT  
(860)-529-8882

AT&T | Sprint | T-Mobile | verizon

SITE ADDRESS:  
BUTTERNUT HOLLOW ROAD  
GREENWICH, CONNECTICUT 06831

REV.	DATE	DESCRIPTION
1	3/27/18	RE-ISSUE

Scale: AS NOTED Date: 03/20/18

Dwg. No.  
**SK-4**  
Job No. File No. Dwg. 4 of 5



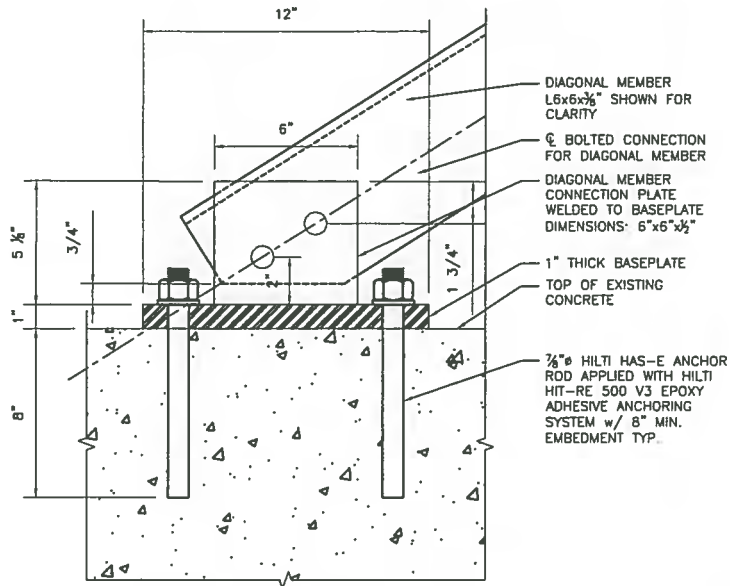

**2** DIAGONAL BASE ANCHOR - ELEVATION VIEW  
SK-5 SCALE: 1-1/2"=1'-0"

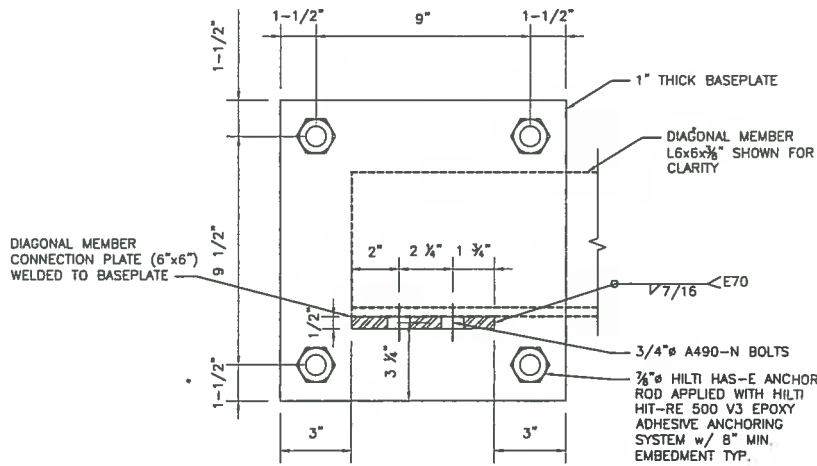

**1** DIAGONAL BASE ANCHOR - PLAN VIEW  
SK-5 SCALE: 1-1/2"=1'-0"

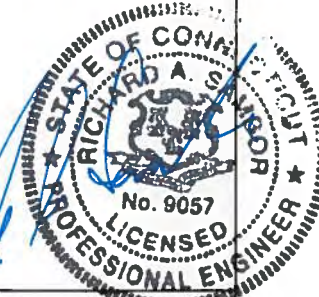

PROJECT NO.  
60537397  
Designed by:  
MCD  
Drawn by:  
GAT  
Checked by:  
ICA  
Approved by:  
RAS

**AECOM**  
500 ENTERPRISE DRIVE  
ROCKY HILL, CONNECTICUT  
(860)-529-8882

AT&T Sprint T-Mobile verizon  
SITE ADDRESS: BUTTERNUT HOLLOW ROAD  
GREENWICH, CONNECTICUT 06831

1	3/27/18	RE-ISSUE
REV.	DATE:	DESCRIPTION
Scale: AS NOTED		Date: 03/20/18
Job No.	File No.	Dwg. No.

Dwg. No.  
**SK-5**  
Dwg. 5 of 5

## **CALCULATIONS COVER PAGE**

## A Note Regarding the Tower Calculations included herein:

The computer program utilized for the structural analysis contained in this report was "PLS-Tower", Version 10.62. This program does not apply multiple wind attack angles to TIA-222-G load cases in order to determine the loading condition that causes the greatest stress. As a result, multiple analyses with different wind attack angles were run in order to arrive at the controlling condition causing the greatest stress. This report includes only the TIA-222-G load case and wind attack angle that cause the greatest stress to the tower members in order to minimize the size of this report. The analyses conducted but not included with this report are available upon request.

## PLS-TOWER INPUT / OUTPUT SUMMARY

Project Name : Multi-Carrier Analysis  
 Project Notes: Butternut Hollow  
 Project File : P:\Projects\Telcom\StructuralsByLocation\Connecticut\GreenwichCSP#74\10-02152018\_Multicarrier MOD\\_PLS\_G\PLS-Tower\_Wind\_0\4-Carir.tow  
 Date run : 5:17:03 PM Monday, March 19, 2018  
 by : Tower Version 10.62  
 Licensed to : URS Connecticut

Successfully performed nonlinear analysis

Unusual number of fixed joints found: 6. Towers normally have from between 1 and 4 fixed joints. ??  
 Linear appurtenance "DNK1-7/8" @ 56`" is included in the face zone (face solidity ratio for Rev. F), but does not contribute to wind load: this is nonsensical ??  
 Linear appurtenance "DNK2-7/8" @ 54`" is included in the face zone (face solidity ratio for Rev. F), but does not contribute to wind load: this is nonsensical ??  
 Linear appurtenance "DNK3-7/8" @ 60`" is included in the face zone (face solidity ratio for Rev. F), but does not contribute to wind load: this is nonsensical ??  
 Linear appurtenance "DNK4-7/8" @ 65`" is included in the face zone (face solidity ratio for Rev. F), but does not contribute to wind load: this is nonsensical ??  
 Linear appurtenance "DNK5-1-5/8" @ 82`" is included in the face zone (face solidity ratio for Rev. F), but does not contribute to wind load: this is nonsensical ??  
 Linear appurtenance "DNK6-Hybriflex Cables @ Sprint" is included in the face zone (face solidity ratio for Rev. F), but does not contribute to wind load: this is nonsensical ??  
 Linear appurtenance "DNK7-7/8" @ 110`" is included in the face zone (face solidity ratio for Rev. F), but does not contribute to wind load: this is nonsensical ??  
 Linear appurtenance "DNK8-7/8" @ 122`" is included in the face zone (face solidity ratio for Rev. F), but does not contribute to wind load: this is nonsensical ??  
 Linear appurtenance "DNK9-7/8" @ 122`" is included in the face zone (face solidity ratio for Rev. F), but does not contribute to wind load: this is nonsensical ??  
 Linear appurtenance "DNK10-1-5/8" @ VZW" is included in the face zone (face solidity ratio for Rev. F), but does not contribute to wind load: this is nonsensical ??  
 Linear appurtenance "DNK11-1-5/8" @ 130`" is included in the face zone (face solidity ratio for Rev. F), but does not contribute to wind load: this is nonsensical ??  
 Linear appurtenance "DNK12-7/8" @ 135`" is included in the face zone (face solidity ratio for Rev. F), but does not contribute to wind load: this is nonsensical ??  
 Linear appurtenance "DNK13,14-1-5/8" @ T-Mobile" is included in the face zone (face solidity ratio for Rev. F), but does not contribute to wind load: this is nonsensical ??  
 Linear appurtenance "DNK15-7/8" @ 137`" is included in the face zone (face solidity ratio for Rev. F), but does not contribute to wind load: this is nonsensical ??  
 Linear appurtenance "DNK16,17,18-1-5/8" @ ATT" is included in the face zone (face solidity ratio for Rev. F), but does not contribute to wind load: this is nonsensical ??  
 Linear appurtenance "DNK16,17,18-Optic Fiber Cable @ ATT" is included in the face zone (face solidity ratio for Rev. F), but does not contribute to wind load: this is nonsensical ??  
 Linear appurtenance "DNK16,17,18-DC Cable @ ATT" is included in the face zone (face solidity ratio for Rev. F), but does not contribute to wind load: this is nonsensical ??  
 Linear appurtenance "DNK19-7/8" @ 159`" is included in the face zone (face solidity ratio for Rev. F), but does not contribute to wind load: this is nonsensical ??  
 Linear appurtenance "DNK20-7/8" @ 159.5`" is included in the face zone (face solidity ratio for Rev. F), but does not contribute to wind load: this is nonsensical ??  
 Linear appurtenance "CSP70,71,72-1-5/8" @ 160` (3)" is included in the face zone (face solidity ratio for Rev. F), but does not contribute to wind load: this is nonsensical ??  
 Linear appurtenance "CSP73-1/2" @ 160`" is included in the face zone (face solidity ratio for Rev. F), but does not contribute to wind load: this is nonsensical ??  
 Linear appurtenance "DNK21-Elliptical @ 160`" is included in the face zone (face solidity ratio for Rev. F), but does not contribute to wind load: this is nonsensical ??  
 Linear appurtenance "DNK22-7/8" @ 165`" is included in the face zone (face solidity ratio for Rev. F), but does not contribute to wind load: this is nonsensical ??  
 Linear appurtenance "DNK23A-1-5/8" @ 168`" is included in the face zone (face solidity ratio for Rev. F), but does not contribute to wind load: this is nonsensical ??  
 Linear appurtenance "DNK23B-1/2" @ 168`" is included in the face zone (face solidity ratio for Rev. F), but does not contribute to wind load: this is nonsensical ??  
 Linear appurtenance "DNK26-B-1-5/8" @ 175`" is included in the face zone (face solidity ratio for Rev. F), but does not contribute to wind load: this is nonsensical ??  
 Linear appurtenance "DNK26A-7/8" @ 175`" is included in the face zone (face solidity ratio for Rev. F), but does not contribute to wind load: this is nonsensical ??  
 Linear appurtenance "DNK26C-1/2" @ 175`" is included in the face zone (face solidity ratio for Rev. F), but does not contribute to wind load: this is nonsensical ??  
 Linear appurtenance "DNK27-B-1-5/8" @ 175`" is included in the face zone (face solidity ratio for Rev. F), but does not contribute to wind load: this is nonsensical ??  
 Linear appurtenance "DNK27A-7/8" @ 175`" is included in the face zone (face solidity ratio for Rev. F), but does not contribute to wind load: this is nonsensical ??  
 Linear appurtenance "DNK27C-3/8" @ 175`" is included in the face zone (face solidity ratio for Rev. F), but does not contribute to wind load: this is nonsensical ??  
 Linear appurtenance "DNK28A-1-5/8" @ 175`" is included in the face zone (face solidity ratio for Rev. F), but does not contribute to wind load: this is nonsensical ??  
 Linear appurtenance "DNK28B-1-5/8" @ 175`" is included in the face zone (face solidity ratio for Rev. F), but does not contribute to wind load: this is nonsensical ??  
 Linear appurtenance "DNK28C-1-5/8" @ 175`" is included in the face zone (face solidity ratio for Rev. F), but does not contribute to wind load: this is nonsensical ??  
 Linear appurtenance "DNK28D-7/8" @ 175`" is included in the face zone (face solidity ratio for Rev. F), but does not contribute to wind load: this is nonsensical ??  
 Linear appurtenance "GRN-1-Elliptical @ 172` (DNK25)" is included in the face zone (face solidity ratio for Rev. F), but does not contribute to wind load: this is nonsensical ??  
 Linear appurtenance "VZW-(3) Hybriflex Cables" is included in the face zone (face solidity ratio for Rev. F), but does not contribute to wind load: this is nonsensical ??  
 Linear appurtenance "Hybriflex 6x12 Cables @ T-Mobile" is included in the face zone (face solidity ratio for Rev. F), but does not contribute to wind load: this is nonsensical ??  
 Linear appurtenance "Hybriflex 9x18 Cables @ T-Mobile" is included in the face zone (face solidity ratio for Rev. F), but does not contribute to wind load: this is nonsensical ??  
 The model has 40 warnings. ??

Member check option: ANSI/TIA 222-G-1  
 Connection rupture check: ANSI/TIA 222-G-1  
 Crossing diagonal check: ANSI/TIA 222-G-1 [Alternate Unsupported RLOUT = 1]  
 Loads from file: p:\projects\telcom\structuralsbylocation\connecticut\greenwichcsp#74\10-02152018\_multicarrier mod\\_pls\_g\pls-tower\_wind\_0\4-carir.eia

\*\*\* Analysis Results:

Maximum element usage is 99.89% for Angle "SNB-LH2P" in load case "1: 1.2D + 1.0Dg + 1.6Wo"

**Summary of Joint Support Reactions For All Load Cases:**

Load Case	Joint Label	Long. Force (kips)	Tran. Force (kips)	Vert. Force (kips)	Shear Force (kips)	Tran. Moment (ft-k)	Long. Moment (ft-k)	Vert. Moment (ft-k)	Bending Moment (ft-k)	Found. Usage %
1: 1.2D + 1.0Dg + 1.6Wo	RohnJP	-29.67	0.11	355.57	29.67	-0.06	-5.55	-0.01	5.55	0.00

1:	1.2D + 1.0Dg + 1.6Wo	SNB-JP	-51.25	0.00	512.04	51.25	0.00	-13.50	0.00	13.50	0.00
1:	1.2D + 1.0Dg + 1.6Wo	RohnJ1	-9.49	-10.04	-147.95	13.81	1.91	-1.42	0.00	2.39	0.00
1:	1.2D + 1.0Dg + 1.6Wo	RohnJ2	-9.70	9.95	-148.25	13.89	-1.86	-1.53	-0.01	2.41	0.00
1:	1.2D + 1.0Dg + 1.6Wo	SNB-J1	-17.54	-18.77	-227.91	25.69	5.44	-2.70	-0.03	6.07	0.00
1:	1.2D + 1.0Dg + 1.6Wo	SNB-J2	-17.56	18.80	-228.39	25.73	-5.44	-2.71	0.03	6.08	0.00
2:	0.9D + 1.0Dg + 1.6Wo	RohnJP	-29.40	0.11	350.14	29.40	-0.06	-5.48	-0.01	5.48	0.00
2:	0.9D + 1.0Dg + 1.6Wo	SNB-JP	-51.11	0.00	506.81	51.11	0.00	-13.37	0.00	13.37	0.00
2:	0.9D + 1.0Dg + 1.6Wo	RohnJ1	-9.63	-10.26	-152.67	14.07	1.97	-1.46	0.00	2.45	0.00
2:	0.9D + 1.0Dg + 1.6Wo	RohnJ2	-9.83	10.17	-153.00	14.15	-1.91	-1.57	-0.01	2.47	0.00
2:	0.9D + 1.0Dg + 1.6Wo	SNB-J1	-17.61	-18.88	-232.22	25.82	5.53	-2.77	-0.03	6.18	0.00
2:	0.9D + 1.0Dg + 1.6Wo	SNB-J2	-17.63	18.92	-232.72	25.86	-5.54	-2.77	0.03	6.19	0.00
4:	1.2D + 1.0Dg + 1.0E	RohnJP	-2.53	0.00	41.68	2.53	-0.00	-0.56	0.00	0.56	0.00
4:	1.2D + 1.0Dg + 1.0E	SNB-JP	-3.06	0.00	49.49	3.06	-0.00	-1.18	-0.00	1.18	0.00
4:	1.2D + 1.0Dg + 1.0E	RohnJ1	0.11	0.32	8.93	0.34	-0.09	0.11	-0.00	0.14	0.00
4:	1.2D + 1.0Dg + 1.0E	RohnJ2	0.10	-0.33	9.02	0.34	0.10	0.10	0.00	0.14	0.00
4:	1.2D + 1.0Dg + 1.0E	SNB-J1	-0.46	-0.55	2.95	0.71	-0.03	0.20	-0.01	0.20	0.00
4:	1.2D + 1.0Dg + 1.0E	SNB-J2	-0.46	0.55	3.05	0.71	0.03	0.20	0.01	0.20	0.00
5:	0.9D + 1.0Dg + 1.0E	RohnJP	-2.27	0.00	36.66	2.27	-0.00	-0.49	0.00	0.49	0.00
5:	0.9D + 1.0Dg + 1.0E	SNB-JP	-2.92	0.00	44.79	2.92	-0.00	-1.06	-0.00	1.06	0.00
5:	0.9D + 1.0Dg + 1.0E	RohnJ1	-0.03	0.09	4.00	0.10	-0.04	0.07	-0.00	0.08	0.00
5:	0.9D + 1.0Dg + 1.0E	RohnJ2	-0.03	-0.10	4.07	0.10	0.04	0.07	0.00	0.08	0.00
5:	0.9D + 1.0Dg + 1.0E	SNB-J1	-0.53	-0.66	-1.63	0.85	0.07	0.14	-0.01	0.16	0.00
5:	0.9D + 1.0Dg + 1.0E	SNB-J2	-0.53	0.66	-1.55	0.85	-0.07	0.14	0.01	0.16	0.00
6:	Service 1.0D + 1.0Dg + 1.0 Wo	RohnJP	-7.32	0.02	91.59	7.32	-0.01	-1.42	-0.00	1.42	0.00
6:	Service 1.0D + 1.0Dg + 1.0 Wo	SNB-JP	-11.85	0.00	125.71	11.85	-0.00	-3.32	-0.00	3.32	0.00
6:	Service 1.0D + 1.0Dg + 1.0 Wo	RohnJ1	-1.79	-1.66	-20.95	2.44	0.29	-0.22	-0.00	0.37	0.00
6:	Service 1.0D + 1.0Dg + 1.0 Wo	RohnJ2	-1.83	1.64	-20.96	2.46	-0.28	-0.24	-0.00	0.37	0.00
6:	Service 1.0D + 1.0Dg + 1.0 Wo	SNB-J1	-3.75	-3.89	-39.71	5.40	0.98	-0.44	-0.01	1.07	0.00
6:	Service 1.0D + 1.0Dg + 1.0 Wo	SNB-J2	-3.75	3.90	-39.75	5.41	-0.98	-0.44	0.01	1.07	0.00
	1.2*DL	RohnJP	-1.07	0.00	19.97	1.07	-0.00	-0.28	-0.00	0.28	0.00
	1.2*DL	SNB-JP	-0.55	0.00	18.61	0.55	-0.00	-0.48	-0.00	0.48	0.00
	1.2*DL	RohnJ1	0.53	0.92	19.79	1.07	-0.24	0.14	-0.00	0.28	0.00
	1.2*DL	RohnJ2	0.54	-0.92	19.88	1.07	0.24	0.14	0.00	0.28	0.00
	1.2*DL	SNB-J1	0.28	0.48	18.39	0.55	-0.41	0.24	-0.00	0.48	0.00
	1.2*DL	SNB-J2	0.28	-0.48	18.49	0.55	0.41	0.24	0.00	0.48	0.00
	0.9DL	RohnJP	-0.80	0.00	14.97	0.80	-0.00	-0.21	-0.00	0.21	0.00
	0.9DL	SNB-JP	-0.41	0.00	13.95	0.41	-0.00	-0.36	-0.00	0.36	0.00
	0.9DL	RohnJ1	0.40	0.69	14.84	0.80	-0.18	0.10	-0.00	0.21	0.00
	0.9DL	RohnJ2	0.40	-0.69	14.91	0.80	0.18	0.10	0.00	0.21	0.00
	0.9DL	SNB-J1	0.21	0.36	13.79	0.41	-0.31	0.18	-0.00	0.36	0.00
	0.9DL	SNB-J2	0.21	-0.36	13.87	0.41	0.31	0.18	0.00	0.36	0.00

Summary of Joint Support Reactions For All Load Cases in Direction of Leg:

Load Case	Support Joint	Origin Joint	Leg Member	Force In Leg Dir. (kips)	Residual Perpendicular (kips)	Shear To Leg (kips)	Residual Shear Horizontal To Leg - Res. (kips)	Residual Shear Horizontal To Leg - Long. (kips)	Residual Shear Horizontal To Leg - Tran. (kips)	Total Force Long. (kips)	Total Force Tran. (kips)	Total Force Vert. (kips)
1: 1.2D + 1.0Dg + 1.6Wo	RohnJP	RohnIaS	Rohn-LI2P	356.461	15.609	15.621	-0.108	15.621	-29.67	0.11	355.57	
1: 1.2D + 1.0Dg + 1.6Wo	SNB-JP	SNB-IaS	SNB-LI2P	513.663	31.080	31.104	-0.002	31.104	-51.25	0.00	512.04	
1: 1.2D + 1.0Dg + 1.6Wo	RohnJ1	RohnIa1	Rohn-LI21	-148.363	8.236	8.241	4.976	6.570	-9.49	-10.04	-147.95	
1: 1.2D + 1.0Dg + 1.6Wo	RohnJ2	RohnIa2	Rohn-LI22	-148.665	8.334	8.340	-4.874	6.767	-9.70	9.95	-148.25	
1: 1.2D + 1.0Dg + 1.6Wo	SNB-J1	SNB-Ia1	SNB-LI21	-228.719	17.063	17.075	11.006	13.055	-17.54	-18.77	-227.91	
1: 1.2D + 1.0Dg + 1.6Wo	SNB-J2	SNB-Ia2	SNB-LI22	-229.194	17.081	17.092	-11.022	13.064	-17.56	18.80	-228.39	
2: 0.9D + 1.0Dg + 1.6Wo	RohnJP	RohnIaS	Rohn-LI2P	351.026	15.554	15.566	-0.108	15.566	-29.40	0.11	350.14	
2: 0.9D + 1.0Dg + 1.6Wo	SNB-JP	SNB-IaS	SNB-LI2P	508.424	31.141	31.166	-0.001	31.166	-51.11	0.00	506.81	
2: 0.9D + 1.0Dg + 1.6Wo	RohnJ1	RohnIa1	Rohn-LI21	-153.095	8.308	8.314	5.041	6.611	-9.63	-10.26	-152.67	
2: 0.9D + 1.0Dg + 1.6Wo	RohnJ2	RohnIa2	Rohn-LI22	-153.419	8.406	8.411	-4.938	6.809	-9.83	10.17	-153.00	
2: 0.9D + 1.0Dg + 1.6Wo	SNB-J1	SNB-Ia1	SNB-LI21	-233.030	17.031	17.043	10.971	13.042	-17.61	-18.88	-232.22	
2: 0.9D + 1.0Dg + 1.6Wo	SNB-J2	SNB-Ia2	SNB-LI22	-233.529	17.047	17.059	-10.986	13.051	-17.63	18.92	-232.72	
4: 1.2D + 1.0Dg + 1.0E	RohnJP	RohnIaS	Rohn-LI2P	41.748	0.887	0.887	-0.003	0.887	-2.53	0.00	41.68	
4: 1.2D + 1.0Dg + 1.0E	SNB-JP	SNB-IaS	SNB-LI2P	49.569	1.108	1.109	-0.001	1.109	-3.06	0.00	49.49	
4: 1.2D + 1.0Dg + 1.0E	RohnJ1	RohnIa1	Rohn-LI21	8.935	0.072	0.072	-0.018	0.069	0.11	0.32	8.93	
4: 1.2D + 1.0Dg + 1.0E	RohnJ2	RohnIa2	Rohn-LI22	9.026	0.077	0.077	0.019	0.074	0.10	-0.33	9.02	
4: 1.2D + 1.0Dg + 1.0E	SNB-J1	SNB-Ia1	SNB-LI21	2.919	0.828	0.828	0.647	0.517	-0.46	-0.55	2.95	
4: 1.2D + 1.0Dg + 1.0E	SNB-J2	SNB-Ia2	SNB-LI22	3.021	0.830	0.831	-0.650	0.517	-0.46	0.55	3.05	
5: 0.9D + 1.0Dg + 1.0E	RohnJP	RohnIaS	Rohn-LI2P	36.719	0.818	0.819	-0.003	0.819	-2.27	0.00	36.66	
5: 0.9D + 1.0Dg + 1.0E	SNB-JP	SNB-IaS	SNB-LI2P	44.870	1.155	1.156	-0.001	1.156	-2.92	0.00	44.79	

5: 0.9D + 1.0Dg + 1.0E	RohnJ1	RohnIa1	Rohn-LI21	4.001	0.114	0.114	0.043	0.105	-0.03	0.09	4.00
5: 0.9D + 1.0Dg + 1.0E	RohnJ2	RohnIa2	Rohn-LI22	4.069	0.118	0.118	-0.042	0.110	-0.03	-0.10	4.07
5: 0.9D + 1.0Dg + 1.0E	SNB-J1	SNB-Ia1	SNB-LI21	-1.660	0.785	0.785	0.609	0.496	-0.53	-0.66	-1.63
5: 0.9D + 1.0Dg + 1.0E	SNB-J2	SNB-Ia2	SNB-LI22	-1.584	0.786	0.787	-0.611	0.496	-0.53	0.66	-1.55
6: Service 1.0D + 1.0Dg + 1.0 Wo	RohnJP	RohnIaS	Rohn-LI2P	91.804	3.699	3.702	-0.025	3.701	-7.32	0.02	91.59
6: Service 1.0D + 1.0Dg + 1.0 Wo	SNB-JP	SNB-IaS	SNB-LI2P	126.076	6.899	6.905	-0.001	6.905	-11.85	0.00	125.71
6: Service 1.0D + 1.0Dg + 1.0 Wo	RohnJ1	RohnIa1	Rohn-LI21	-21.021	1.665	1.666	0.946	1.372	-1.79	-1.66	-20.95
6: Service 1.0D + 1.0Dg + 1.0 Wo	RohnJ2	RohnIa2	Rohn-LI22	-21.033	1.690	1.691	-0.925	1.415	-1.83	1.64	-20.96
6: Service 1.0D + 1.0Dg + 1.0 Wo	SNB-J1	SNB-Ia1	SNB-LI21	-39.885	3.904	3.906	2.537	2.971	-3.75	-3.89	-39.71
6: Service 1.0D + 1.0Dg + 1.0 Wo	SNB-J2	SNB-Ia2	SNB-LI22	-39.927	3.908	3.911	-2.541	2.973	-3.75	3.90	-39.75
1.2*DL	RohnJP	RohnIaS	Rohn-LI2P	19.995	0.281	0.281	-0.001	0.281	-1.07	0.00	19.97
1.2*DL	SNB-JP	SNB-IaS	SNB-LI2P	18.617	0.180	0.180	-0.001	-0.180	-0.55	0.00	18.61
1.2*DL	RohnJ1	RohnIa1	Rohn-LI21	19.812	0.285	0.285	-0.246	-0.143	0.53	0.92	19.79
1.2*DL	RohnJ2	RohnIa2	Rohn-LI22	19.903	0.283	0.283	0.244	-0.143	0.54	-0.92	19.88
1.2*DL	SNB-J1	SNB-Ia1	SNB-LI21	18.395	0.174	0.174	0.151	0.086	0.28	0.48	18.39
1.2*DL	SNB-J2	SNB-Ia2	SNB-LI22	18.497	0.176	0.176	-0.154	0.086	0.28	-0.48	18.49
0.9DL	RohnJP	RohnIaS	Rohn-LI2P	14.995	0.212	0.212	-0.001	0.212	-0.80	0.00	14.97
0.9DL	SNB-JP	SNB-IaS	SNB-LI2P	13.955	0.134	0.134	-0.001	-0.134	-0.41	0.00	13.95
0.9DL	RohnJ1	RohnIa1	Rohn-LI21	14.864	0.214	0.214	-0.186	-0.108	0.40	0.69	14.84
0.9DL	RohnJ2	RohnIa2	Rohn-LI22	14.931	0.213	0.213	0.184	-0.107	0.40	-0.69	14.91
0.9DL	SNB-J1	SNB-Ia1	SNB-LI21	13.797	0.129	0.129	0.113	0.064	0.21	0.36	13.79
0.9DL	SNB-J2	SNB-Ia2	SNB-LI22	13.872	0.131	0.131	-0.115	0.064	0.21	-0.36	13.87

**EIA Sections Information:**

Section Label	Top Z (ft)	Bottom Z (ft)	Joint Count	Member Count	Top Width (ft)	Bottom Width (ft)	Gross Area (ft^2)	Face Adjust Factor	Ar Adjust Factor	Dead Load Factor
A	180.000	160.000	36	111	7.50	8.87	163.75	0.9000	0.9000	1.000
B	160.000	140.000	33	93	8.87	10.23	191.05	0.9000	0.9000	1.000
C	140.000	120.000	27	72	10.23	11.60	218.31	0.9000	0.9000	1.000
D	120.000	100.000	27	72	11.60	12.96	245.54	0.9000	0.9000	1.000
E	100.000	80.000	27	72	12.96	14.32	272.78	0.9000	0.9000	1.000
F	80.000	60.000	21	51	14.32	15.68	300.04	0.9000	0.9000	1.000
G	60.000	40.000	21	51	15.68	17.05	327.29	0.9000	0.9000	1.000
H	40.000	20.000	21	51	17.05	18.41	354.57	0.9000	0.9000	1.000
I	20.000	0.000	18	39	18.41	19.78	381.92	0.9000	0.9000	1.000

Printed capacities do not include the strength factor entered for each load case.  
The Group Summary reports on the member and load case that resulted in maximum usage which may not necessarily be the same as that which produces maximum force.

**Group Summary (Compression Portion):**

Group Label	Group Desc.	Angle Type	Angle Size	Steel Strength (ksi)	Max Usage %	Max Use In Comp. %	Comp. Control Member	Comp. Force (kips)	Comp. Control Load Case	L/R Capacity (kips)	Comp. Conn. Shear Capacity (kips)	Comp. Conn. Bearing Capacity (kips)	RLX	RLY	RLZ	L/R Length (ft)	Length Comp. Member (ft)	Curve No.	No. Of Bolts Comp.
Rohn-D1	Rohn Diagonal 1	SAE	1.75X1.75X0.1875	36.0	39.98	39.98	Rohn-DA61	-1.9291: 1.2D +	4.825	12.433	13.050	0.500	0.500	0.500	170.38	9.740	4	1	
Rohn-D2	Rohn Diagonal 2	SAE	2X2X0.1875	36.0	85.01	85.01	Rohn-DB61	-4.9181: 1.2D +	5.786	12.433	13.050	0.500	0.500	0.500	166.50	10.934	4	1	
Rohn-D3	Rohn Diagonal 3	SAE	2.5X2.5X0.1875	36.0	80.35	80.35	Rohn-DC41	-6.8041: 1.2D +	8.468	12.433	13.050	0.500	0.500	0.500	155.13	12.798	4	1	
Rohn-D4	Rohn Diagonal 4	SAE	2.5X2.5X0.25	36.0	85.88	85.88	Rohn-DD21	-8.3961: 1.2D +	9.776	12.433	17.400	0.500	0.500	0.500	165.83	13.570	4	1	
Rohn-D5	Rohn Diagonal 5	SAE	3X3X0.25	50.0	77.70	77.70	Rohn-DE61	-9.6611: 1.2D +	13.033	12.433	19.500	0.500	0.500	0.500	157.99	15.589	4	1	
Rohn-D6	Rohn Diagonal 6	SAE	3.5X3.5X0.25	50.0	94.19	94.19	Rohn-DF32	-11.7121: 1.2D +	15.227	12.433	19.500	0.500	0.500	0.500	158.34	18.315	4	1	
Rohn-D7	Rohn Diagonal 7	SAE	4X4X0.25	50.0	83.19	83.19	Rohn-DH12	-10.3431: 1.2D +	19.124	12.433	19.500	0.500	0.500	0.500	151.38	20.058	4	1	
Rohn-L1	Rohn Leg 1	Pipe	Pipe3EH	50.0	10.75	10.75	Rohn-LA4P	-11.1821: 1.2D +	103.968	0.000	0.000	1.000	1.000	1.000	52.67	5.004	1	0	
Rohn-L2	Rohn Leg 2	Pipe	Pipe3.5EH	50.0	29.08	29.08	Rohn-LB4P	-38.6001: 1.2D +	132.756	0.000	0.000	1.000	1.000	1.000	45.84	5.004	1	0	
Rohn-L3	Rohn Leg 3	Pipe	Pipe4EH	50.0	50.99	50.99	Rohn-LC3P	-76.7221: 1.2D +	150.478	0.000	0.000	1.000	1.000	1.000	54.04	6.665	1	0	
Rohn-L4	Rohn Leg 4	Pipe	Pipe5STD	50.0	81.28	81.28	Rohn-LD3P	-129.1271: 1.2D +	158.870	0.000	0.000	1.000	1.000	1.000	42.54	6.665	1	0	
Rohn-L5	Rohn Leg 5	Pipe	Pipe5EH	50.0	77.58	77.58	Rohn-LE3P	-174.1791: 1.2D +	224.520	0.000	0.000	1.000	1.000	1.000	43.23	6.665	1	0	
Rohn-L6	Rohn Leg 6	Pipe	Pipe6EHS	50.0	80.00	80.00	Rohn-LF1P	-195.0311: 1.2D +	243.786	0.000	0.000	1.000	1.000	1.000	54.10	10.008	1	0	
Rohn-L7	Rohn Leg 7	Pipe	Pipe6EH	50.0	92.59	92.59	Rohn-LG2P	-264.0551: 1.2D +	285.178	0.000	0.000	1.000	1.000	1.000	54.59	10.008	1	0	
Rohn-L8	Rohn Leg 8	Pipe	Pipe8EHS	50.0	83.60	83.60	Rohn-LI1P	-328.8561: 1.2D +	393.385	0.000	0.000	1.000	1.000	1.000	40.57	10.008	1	0	
Rohn-H1	Rohn Horizontal 1	SAE	1.75X1.75X0.1875	36.0	2.54	2.54	Rohn-H12	-0.2061: 1.2D +	8.108	0.000	0.000	0.500	0.500	0.500	131.28	7.505	4	0	
SNB-D1	SNB Diagonal 1	SAE	2X2X0.3125	36.0	11.97	11.82	SNB-DA72	-1.4701: 1.2D +	19.391	12.433	21.750	0.500	0.500	0.500	111.38	7.240	1	1	





SNB-L6	SNB Leg 6	Pipe	Pipel0XS	36.0	95.26	42.67	SNB-LI22	222.5602: 0.9D +	521.639	0.000	0.000	0.000	10.008	0	0.000	0
Connect	Connect Towers	BIG	0.1X0.1X1	36.0	0.03	0.03	Connect IP	7.1811: 1.2D +	25919.960	0.000	0.000	0.000	2.002	0	0.000	0
SNB-H1	SNB Horizontal 1	Pipe	P3-425	36.0	2.17	1.55	SNB-H4eP	2.0561: 1.2D +	133.002	0.000	0.000	0.000	4.066	0	0.000	0
SNB-H2	SNB Horizontal 2	Pipe	P4-494	36.0	3.94	1.87	SNB-H9bP	3.7551: 1.2D +	201.204	0.000	0.000	0.000	7.472	0	0.000	0
Rohn-D8	Rohn Diagonal 8	SAE	2X2X0.375	36.0	0.00	0.00		0.000	0.000	0.000	0.000	0.000	0.000	0	0.000	0
WLAC-1	Wind Lacing 1	SAE	2X2X0.25	36.0	1.66	1.47	SNB-WL-D3P	0.4471: 1.2D +	30.456	0.000	0.000	0.000	4.066	0	0.000	0
WLAC-2	Wind Lacing 2	SAE	2.5X2.5X0.3125	36.0	3.50	1.45	SNB-WL-I3P	0.6861: 1.2D +	47.304	0.000	0.000	0.000	7.472	0	0.000	0
R-D1-MOD	MODIFICATION - L1.75X1.75x3/16	SAE	1.75X1.75X0.1875	50.0	0.00	0.00		0.000	0.000	0.000	0.000	0.000	0.000	0	0.000	0
R-D2-MOD	MODIFICATION - L2X2x3/16	SAE	2X2X0.1875	50.0	0.00	0.00		0.000	0.000	0.000	0.000	0.000	0.000	0	0.000	0
R-D3-MOD	MODIFICATION - L2.5X2.5x1/4	SAE	2.5X2.5X0.25	50.0	87.77	64.19	Rohn-DC5P	7.9812: 0.9D +	37.225	12.433	19.500	14.625	13.177	1	1.000	0.6875
R-D4-MOD	MODIFICATION - L3x3x1/4	SAE	3X3X0.25	50.0	81.41	78.63	Rohn-DD3P	9.7761: 1.2D +	46.366	12.433	19.500	14.625	13.977	1	1.000	0.6875
R-D5-MOD	MODIFICATION - L3X3x1/4	SAE	3X3X0.25	50.0	0.00	0.00		0.000	0.000	0.000	0.000	0.000	0.000	0	0.000	0
R-D6-MOD	MODIFICATION - L3.5X3.5x5/16	SAE	3.5X3.5X0.3125	50.0	0.00	0.00		0.000	0.000	0.000	0.000	0.000	0.000	0	0.000	0
R-D7-MOD	MODIFICATION - L4X4x5/16	SAE	4X4X0.3125	50.0	80.14	72.20	Rohn-DH4P	11.2222: 0.9D +	79.895	15.542	24.375	18.281	20.653	1	1.000	0.6875
S-D1-MOD	MODIFICATION - L2X2x5/16	SAE	2X2X0.3125	50.0	0.00	0.00		0.000	0.000	0.000	0.000	0.000	0.000	0	0.000	0
S-D2-MOD	MODIFICATION - L2x2x1/4	SAE	2X2X0.25	50.0	0.00	0.00		0.000	0.000	0.000	0.000	0.000	0.000	0	0.000	0
S-D3-MOD	MODIFICATION - L2.5X2.5x5/16	SAE	2.5X2.5X0.3125	50.0	0.00	0.00		0.000	0.000	0.000	0.000	0.000	0.000	0	0.000	0
S-D4-MOD	MODIFICATION - L3.5X3.5x3/8	SAE	3.5X3.5X0.375	50.0	0.00	0.00		0.000	0.000	0.000	0.000	0.000	0.000	0	0.000	0
S-D5-MOD	MODIFICATION - L4X4x0.5	SAE	4X4X0.5	50.0	0.00	0.00		0.000	0.000	0.000	0.000	0.000	0.000	0	0.000	0
S-D6-MOD	MODIFICATION - L5X5x3/8	SAE	5X5X0.375	50.0	67.08	59.60	SNB-DG4P	13.3371: 1.2D +	120.850	22.376	35.100	26.471	16.594	1	1.000	0.8125
S-D7-MOD	MODIFICATION - L6X6x3/8	SAE	6X6X0.375	50.0	91.87	79.57	SNB-DI4P	17.8061: 1.2D +	148.272	22.376	35.100	26.471	18.841	1	1.000	0.8125

\*\*\* Maximum Stress Summary for Each Load Case

**Summary of Maximum Usages by Load Case:**

	Load Case	Maximum Usage %	Element Label	Element Type
1:	1.2D + 1.0Dg + 1.6Wo	99.89	SNB-LH2P	Angle
2:	0.9D + 1.0Dg + 1.6Wo	98.84	SNB-LH2P	Angle
4:	1.2D + 1.0Dg + 1.0E	12.49	Rohn-LD3P	Angle
5:	0.9D + 1.0Dg + 1.0E	11.06	Rohn-LD3P	Angle
6:	Service 1.0D + 1.0Dg + 1.0 Wo	24.51	SNB-LH1P	Angle
	1.2*DL	5.68	Rohn-LD3P	Angle
	0.9DL	4.26	Rohn-LD3P	Angle

\*\*\* Weight of structure (lbs):

Weight of Angles*Section DLF:	61800.0
Weight of Equipment:	12661.2
Total:	74461.2

\*\*\* End of Report

## PLS-TOWER NODE LOCATIONS

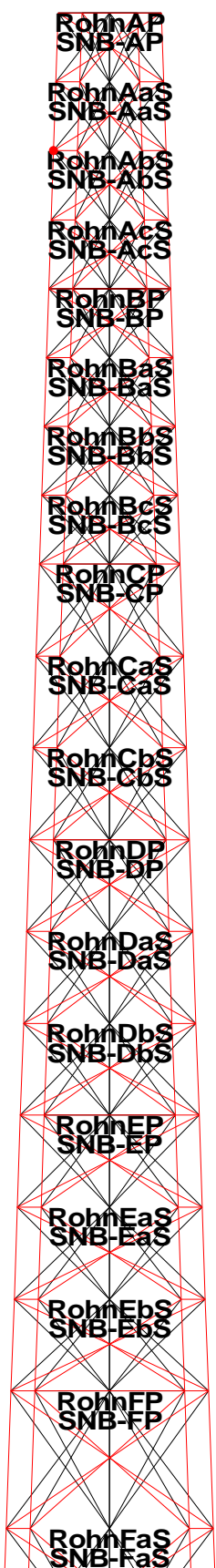

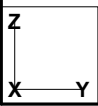
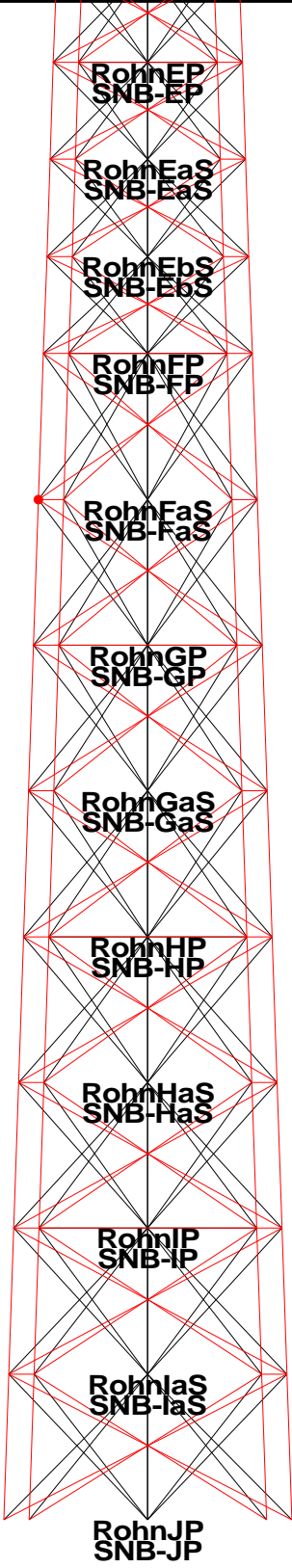

## PLS-TOWER MEMBER LOCATIONS

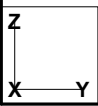
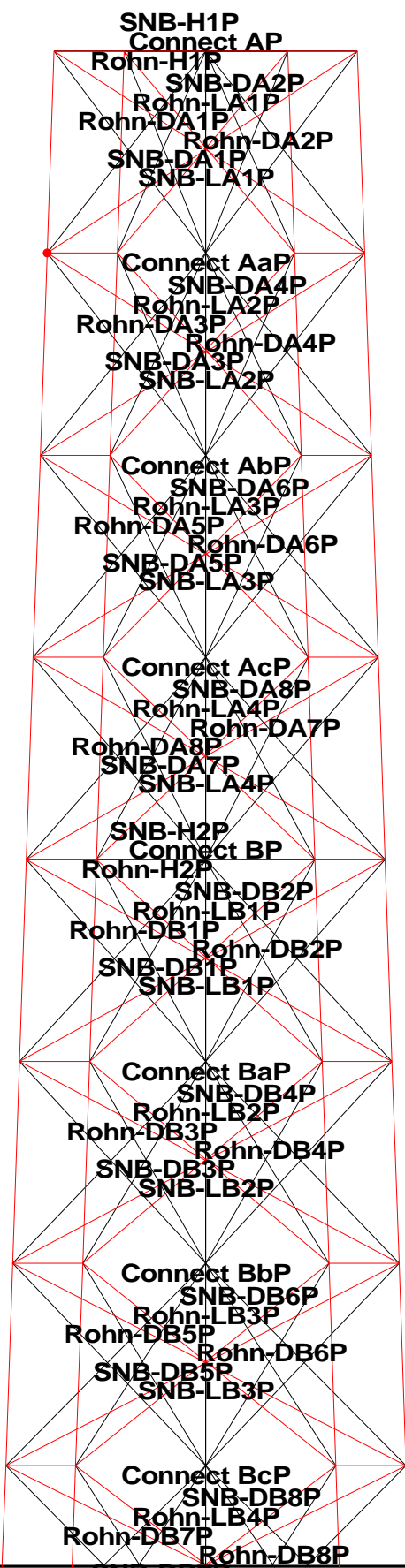

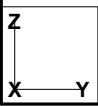
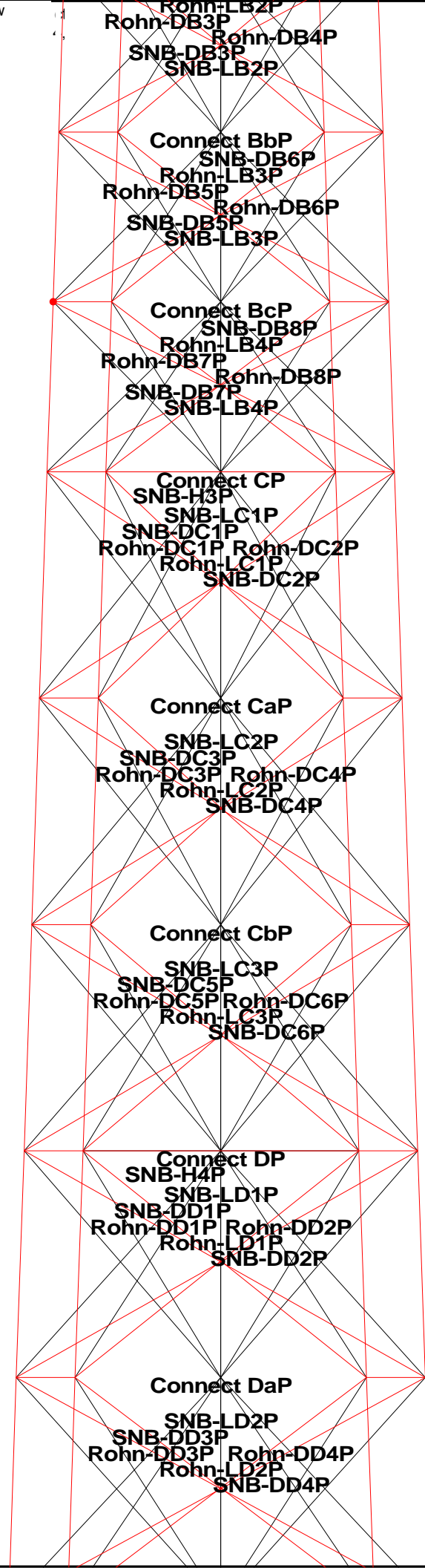

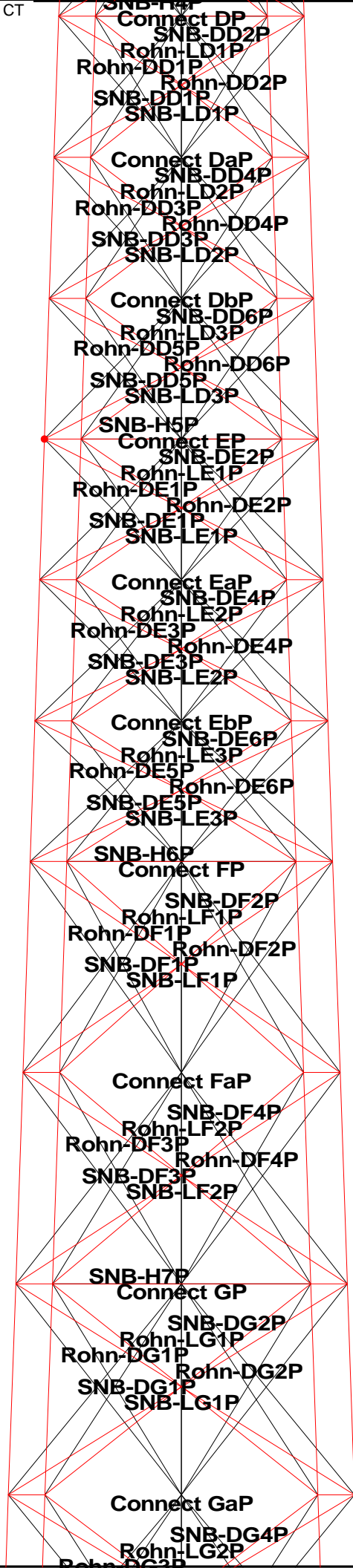



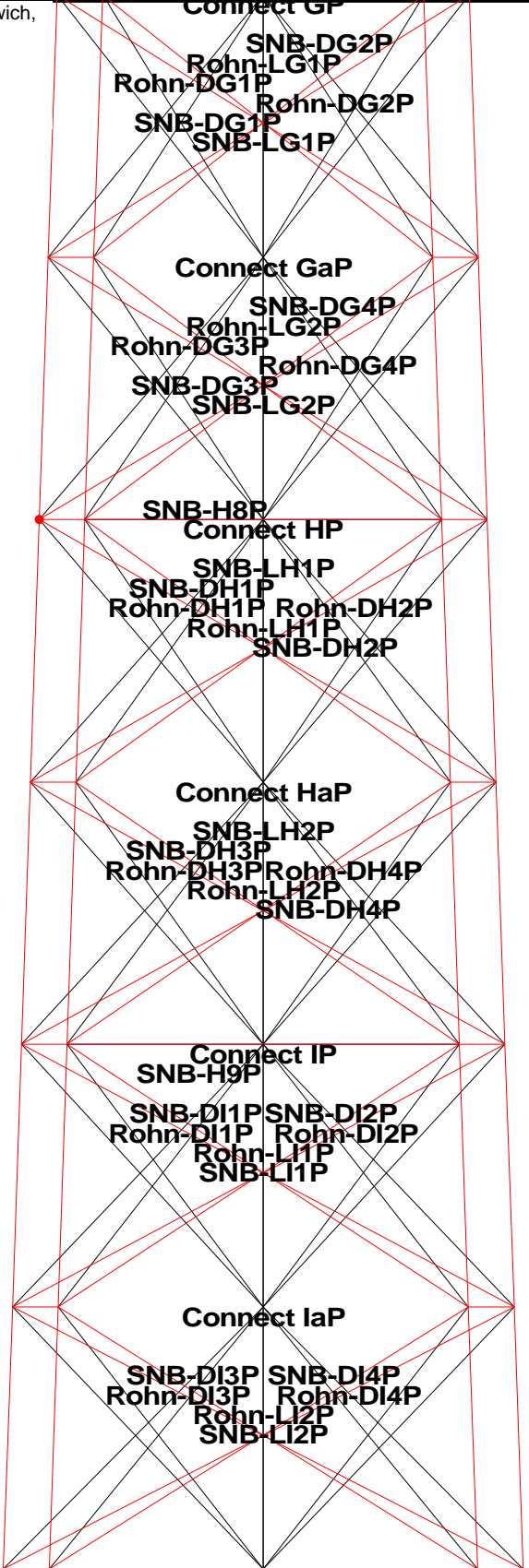

## PLS-TOWER DETAILED OUTPUT

Project Name : Multi-Carrier Analysis  
Project Notes: Butternut Hollow  
Project File : P:\Projects\Telcom\StructuralsByLocation\Connecticut\GreenwichCSP#74\10-02152018\_Multicarrier MOD\\_PLS\_G\PLS-Tower\_Wind\_0\4-Carir.tow  
Date run : 5:17:02 PM Monday, March 19, 2018  
by : Tower Version 10.62  
Licensed to : URS Connecticut

Successfully performed nonlinear analysis

Unusual number of fixed joints found: 6. Towers normally have from between 1 and 4 fixed joints. ??  
Linear appurtenance "DNK1-7/8" @ 56`" is included in the face zone (face solidity ratio for Rev. F), but does not contribute to wind load: this is nonsensical ??  
Linear appurtenance "DNK2-7/8" @ 54`" is included in the face zone (face solidity ratio for Rev. F), but does not contribute to wind load: this is nonsensical ??  
Linear appurtenance "DNK3-7/8" @ 60`" is included in the face zone (face solidity ratio for Rev. F), but does not contribute to wind load: this is nonsensical ??  
Linear appurtenance "DNK4-7/8" @ 65`" is included in the face zone (face solidity ratio for Rev. F), but does not contribute to wind load: this is nonsensical ??  
Linear appurtenance "DNK5-1-5/8" @ 82`" is included in the face zone (face solidity ratio for Rev. F), but does not contribute to wind load: this is nonsensical ??  
Linear appurtenance "DNK6-Hybriflex Cables @ Sprint" is included in the face zone (face solidity ratio for Rev. F), but does not contribute to wind load: this is nonsensical ??  
Linear appurtenance "DNK7-7/8" @ 110`" is included in the face zone (face solidity ratio for Rev. F), but does not contribute to wind load: this is nonsensical ??  
Linear appurtenance "DNK8-7/8" @ 122`" is included in the face zone (face solidity ratio for Rev. F), but does not contribute to wind load: this is nonsensical ??  
Linear appurtenance "DNK9-7/8" @ 122`" is included in the face zone (face solidity ratio for Rev. F), but does not contribute to wind load: this is nonsensical ??  
Linear appurtenance "DNK10-1-5/8" @ VZW" is included in the face zone (face solidity ratio for Rev. F), but does not contribute to wind load: this is nonsensical ??  
Linear appurtenance "DNK11-1-5/8" @ 130`" is included in the face zone (face solidity ratio for Rev. F), but does not contribute to wind load: this is nonsensical ??  
Linear appurtenance "DNK12-7/8" @ 135`" is included in the face zone (face solidity ratio for Rev. F), but does not contribute to wind load: this is nonsensical ??  
Linear appurtenance "DNK13,14-1-5/8" @ T-Mobile" is included in the face zone (face solidity ratio for Rev. F), but does not contribute to wind load: this is nonsensical ??  
Linear appurtenance "DNK15-7/8" @ 137`" is included in the face zone (face solidity ratio for Rev. F), but does not contribute to wind load: this is nonsensical ??  
Linear appurtenance "DNK16,17,18-1-5/8" @ ATT" is included in the face zone (face solidity ratio for Rev. F), but does not contribute to wind load: this is nonsensical ??  
Linear appurtenance "DNK16,17,18-Optic Fiber Cable @ ATT" is included in the face zone (face solidity ratio for Rev. F), but does not contribute to wind load: this is nonsensical ??  
Linear appurtenance "DNK16,17,18-DC Cable @ ATT" is included in the face zone (face solidity ratio for Rev. F), but does not contribute to wind load: this is nonsensical ??  
Linear appurtenance "DNK19-7/8" @ 159`" is included in the face zone (face solidity ratio for Rev. F), but does not contribute to wind load: this is nonsensical ??  
Linear appurtenance "DNK20-7/8" @ 159.5`" is included in the face zone (face solidity ratio for Rev. F), but does not contribute to wind load: this is nonsensical ??  
Linear appurtenance "CSP70,71,72-1-5/8" @ 160` (3)" is included in the face zone (face solidity ratio for Rev. F), but does not contribute to wind load: this is nonsensical ??  
Linear appurtenance "CSP73-1/2" @ 160`" is included in the face zone (face solidity ratio for Rev. F), but does not contribute to wind load: this is nonsensical ??  
Linear appurtenance "DNK21-Elliptical @ 160`" is included in the face zone (face solidity ratio for Rev. F), but does not contribute to wind load: this is nonsensical ??  
Linear appurtenance "DNK22-7/8" @ 165`" is included in the face zone (face solidity ratio for Rev. F), but does not contribute to wind load: this is nonsensical ??  
Linear appurtenance "DNK23A-1-5/8" @ 168`" is included in the face zone (face solidity ratio for Rev. F), but does not contribute to wind load: this is nonsensical ??  
Linear appurtenance "DNK23B-1/2" @ 168`" is included in the face zone (face solidity ratio for Rev. F), but does not contribute to wind load: this is nonsensical ??  
Linear appurtenance "DNK26-B-1-5/8" @ 175`" is included in the face zone (face solidity ratio for Rev. F), but does not contribute to wind load: this is nonsensical ??  
Linear appurtenance "DNK26A-7/8" @ 175`" is included in the face zone (face solidity ratio for Rev. F), but does not contribute to wind load: this is nonsensical ??  
Linear appurtenance "DNK26C-1/2" @ 175`" is included in the face zone (face solidity ratio for Rev. F), but does not contribute to wind load: this is nonsensical ??  
Linear appurtenance "DNK27-B-1-5/8" @ 175`" is included in the face zone (face solidity ratio for Rev. F), but does not contribute to wind load: this is nonsensical ??  
Linear appurtenance "DNK27A-7/8" @ 175`" is included in the face zone (face solidity ratio for Rev. F), but does not contribute to wind load: this is nonsensical ??  
Linear appurtenance "DNK27C-3/8" @ 175`" is included in the face zone (face solidity ratio for Rev. F), but does not contribute to wind load: this is nonsensical ??  
Linear appurtenance "DNK28A-1-5/8" @ 175`" is included in the face zone (face solidity ratio for Rev. F), but does not contribute to wind load: this is nonsensical ??  
Linear appurtenance "DNK28B-1-5/8" @ 175`" is included in the face zone (face solidity ratio for Rev. F), but does not contribute to wind load: this is nonsensical ??  
Linear appurtenance "DNK28C-1-5/8" @ 175`" is included in the face zone (face solidity ratio for Rev. F), but does not contribute to wind load: this is nonsensical ??  
Linear appurtenance "DNK28D-7/8" @ 175`" is included in the face zone (face solidity ratio for Rev. F), but does not contribute to wind load: this is nonsensical ??  
Linear appurtenance "GRN-1-Elliptical @ 172` (DNK25)" is included in the face zone (face solidity ratio for Rev. F), but does not contribute to wind load: this is nonsensical ??  
Linear appurtenance "VZW-(3) Hybriflex Cables" is included in the face zone (face solidity ratio for Rev. F), but does not contribute to wind load: this is nonsensical ??  
Linear appurtenance "Hybriflex 6x12 Cables @ T-Mobile" is included in the face zone (face solidity ratio for Rev. F), but does not contribute to wind load: this is nonsensical ??  
Linear appurtenance "Hybriflex 9x18 Cables @ T-Mobile" is included in the face zone (face solidity ratio for Rev. F), but does not contribute to wind load: this is nonsensical ??  
The model has 40 warnings. ??

Nonlinear convergence parameters: Use Standard Parameters  
Member check option: ANSI/TIA 222-G-1  
Connection rupture check: ANSI/TIA 222-G-1  
Crossing diagonal check: ANSI/TIA 222-G-1 [Alternate Unsupported RLOUT = 1]

**Joints Geometry:**

Joint Label	Symmetry Code	X Coord. (ft)	Y Coord. (ft)	Z Coord. (ft)	X Disp. Rest.	Y Disp. Rest.	Z Disp. Rest.	X Rot. Rest.	Y Rot. Rest.	Z Rot. Rest.
-------------	---------------	---------------	---------------	---------------	---------------	---------------	---------------	--------------	--------------	--------------

RohnAP	Tri-Symmetry	4.333	0	180	Free	Free	Free	Free	Free	Free
RohnBP	Tri-Symmetry	5.121	0	160	Free	Free	Free	Free	Free	Free
RohnCP	Tri-Symmetry	5.909	0	140	Free	Free	Free	Free	Free	Free
RohnDP	Tri-Symmetry	6.695	0	120	Free	Free	Free	Free	Free	Free
RohnEP	Tri-Symmetry	7.481	0	100	Free	Free	Free	Free	Free	Free
RohnFP	Tri-Symmetry	8.268	0	80	Free	Free	Free	Free	Free	Free
RohnGP	Tri-Symmetry	9.055	0	60	Free	Free	Free	Free	Free	Free
RohnHP	Tri-Symmetry	9.841	0	40	Free	Free	Free	Free	Free	Free
RohnIP	Tri-Symmetry	10.63	0	20	Free	Free	Free	Free	Free	Free
RohnJP	Tri-Symmetry	11.42	0	0	Fixed	Fixed	Fixed	Fixed	Fixed	Fixed
SNB-AP	Tri-Symmetry	2.333	0	180	Free	Free	Free	Free	Free	Free
SNB-BP	Tri-Symmetry	3.121	0	160	Free	Free	Free	Free	Free	Free
SNB-CP	Tri-Symmetry	3.908	0	140	Free	Free	Free	Free	Free	Free
SNB-DP	Tri-Symmetry	4.695	0	120	Free	Free	Free	Free	Free	Free
SNB-EP	Tri-Symmetry	5.481	0	100	Free	Free	Free	Free	Free	Free
SNB-FP	Tri-Symmetry	6.268	0	80	Free	Free	Free	Free	Free	Free
SNB-GP	Tri-Symmetry	7.055	0	60	Free	Free	Free	Free	Free	Free
SNB-HP	Tri-Symmetry	7.841	0	40	Free	Free	Free	Free	Free	Free
SNB-IP	Tri-Symmetry	8.628	0	20	Free	Free	Free	Free	Free	Free
SNB-JP	Tri-Symmetry	9.415	0	0	Fixed	Fixed	Fixed	Fixed	Fixed	Fixed
RohnA1	Tri-Gen 1	-2.167	-3.752	180	Free	Free	Free	Free	Free	Free
RohnA2	Tri-Gen 2	-2.167	3.752	180	Free	Free	Free	Free	Free	Free
RohnB1	Tri-Gen 1	-2.561	-4.435	160	Free	Free	Free	Free	Free	Free
RohnB2	Tri-Gen 2	-2.561	4.435	160	Free	Free	Free	Free	Free	Free
RohnC1	Tri-Gen 1	-2.954	-5.117	140	Free	Free	Free	Free	Free	Free
RohnC2	Tri-Gen 2	-2.954	5.117	140	Free	Free	Free	Free	Free	Free
RohnD1	Tri-Gen 1	-3.348	-5.798	120	Free	Free	Free	Free	Free	Free
RohnD2	Tri-Gen 2	-3.348	5.798	120	Free	Free	Free	Free	Free	Free
RohnE1	Tri-Gen 1	-3.741	-6.479	100	Free	Free	Free	Free	Free	Free
RohnE2	Tri-Gen 2	-3.741	6.479	100	Free	Free	Free	Free	Free	Free
RohnF1	Tri-Gen 1	-4.134	-7.16	80	Free	Free	Free	Free	Free	Free
RohnF2	Tri-Gen 2	-4.134	7.16	80	Free	Free	Free	Free	Free	Free
RohnG1	Tri-Gen 1	-4.527	-7.842	60	Free	Free	Free	Free	Free	Free
RohnG2	Tri-Gen 2	-4.527	7.842	60	Free	Free	Free	Free	Free	Free
RohnH1	Tri-Gen 1	-4.921	-8.523	40	Free	Free	Free	Free	Free	Free
RohnH2	Tri-Gen 2	-4.921	8.523	40	Free	Free	Free	Free	Free	Free
RohnI1	Tri-Gen 1	-5.315	-9.206	20	Free	Free	Free	Free	Free	Free
RohnI2	Tri-Gen 2	-5.315	9.206	20	Free	Free	Free	Free	Free	Free
RohnJ1	Tri-Gen 1	-5.71	-9.89	0	Fixed	Fixed	Fixed	Fixed	Fixed	Fixed
RohnJ2	Tri-Gen 2	-5.71	9.89	0	Fixed	Fixed	Fixed	Fixed	Fixed	Fixed
SNB-A1	Tri-Gen 1	-1.167	-2.02	180	Free	Free	Free	Free	Free	Free
SNB-A2	Tri-Gen 2	-1.167	2.02	180	Free	Free	Free	Free	Free	Free
SNB-B1	Tri-Gen 1	-1.561	-2.703	160	Free	Free	Free	Free	Free	Free
SNB-B2	Tri-Gen 2	-1.561	2.703	160	Free	Free	Free	Free	Free	Free
SNB-C1	Tri-Gen 1	-1.954	-3.384	140	Free	Free	Free	Free	Free	Free
SNB-C2	Tri-Gen 2	-1.954	3.384	140	Free	Free	Free	Free	Free	Free
SNB-D1	Tri-Gen 1	-2.348	-4.066	120	Free	Free	Free	Free	Free	Free
SNB-D2	Tri-Gen 2	-2.348	4.066	120	Free	Free	Free	Free	Free	Free
SNB-E1	Tri-Gen 1	-2.74	-4.747	100	Free	Free	Free	Free	Free	Free
SNB-E2	Tri-Gen 2	-2.74	4.747	100	Free	Free	Free	Free	Free	Free
SNB-F1	Tri-Gen 1	-3.134	-5.428	80	Free	Free	Free	Free	Free	Free
SNB-F2	Tri-Gen 2	-3.134	5.428	80	Free	Free	Free	Free	Free	Free
SNB-G1	Tri-Gen 1	-3.528	-6.11	60	Free	Free	Free	Free	Free	Free
SNB-G2	Tri-Gen 2	-3.528	6.11	60	Free	Free	Free	Free	Free	Free
SNB-H1	Tri-Gen 1	-3.921	-6.791	40	Free	Free	Free	Free	Free	Free
SNB-H2	Tri-Gen 2	-3.921	6.791	40	Free	Free	Free	Free	Free	Free
SNB-I1	Tri-Gen 1	-4.314	-7.472	20	Free	Free	Free	Free	Free	Free
SNB-I2	Tri-Gen 2	-4.314	7.472	20	Free	Free	Free	Free	Free	Free
SNB-J1	Tri-Gen 1	-4.708	-8.154	0	Fixed	Fixed	Fixed	Fixed	Fixed	Fixed
SNB-J2	Tri-Gen 2	-4.708	8.154	0	Fixed	Fixed	Fixed	Fixed	Fixed	Fixed

Secondary Joints:

Joint Label	Symmetry Code	Origin Joint	End Joint	Fraction	Elevation	X Disp. Rest.	Y Disp. Rest.	Z Disp. Rest.	X Rot. Rest.	Y Rot. Rest.	Z Rot. Rest.
RohnAaS	Tri-Symmetry	RohnAP	RohnBP	0.25	0	Free	Free	Free	Free	Free	Free
RohnAbS	Tri-Symmetry	RohnAP	RohnBP	0.5	0	Free	Free	Free	Free	Free	Free

RohnAcS	Tri-Symmetry	RohnAP	RohnBP	0.75	0	Free	Free	Free	Free	Free	Free
RohnBaS	Tri-Symmetry	RohnBP	RohnCP	0.25	0	Free	Free	Free	Free	Free	Free
RohnBbS	Tri-Symmetry	RohnBP	RohnCP	0.5	0	Free	Free	Free	Free	Free	Free
RohnBcS	Tri-Symmetry	RohnBP	RohnCP	0.75	0	Free	Free	Free	Free	Free	Free
RohnCaS	Tri-Symmetry	RohnCP	RohnDP	0.333	0	Free	Free	Free	Free	Free	Free
RohnCbS	Tri-Symmetry	RohnCP	RohnDP	0.667	0	Free	Free	Free	Free	Free	Free
RohnDaS	Tri-Symmetry	RohnDP	RohnEP	0.333	0	Free	Free	Free	Free	Free	Free
RohnDbS	Tri-Symmetry	RohnDP	RohnEP	0.667	0	Free	Free	Free	Free	Free	Free
RohnEaS	Tri-Symmetry	RohnEP	RohnFP	0.333	0	Free	Free	Free	Free	Free	Free
RohnEbS	Tri-Symmetry	RohnEP	RohnFP	0.667	0	Free	Free	Free	Free	Free	Free
RohnFaS	Tri-Symmetry	RohnFP	RohnGP	0.5	0	Free	Free	Free	Free	Free	Free
RohnGaS	Tri-Symmetry	RohnGP	RohnHP	0.5	0	Free	Free	Free	Free	Free	Free
RohnHaS	Tri-Symmetry	RohnHP	RohnIP	0.5	0	Free	Free	Free	Free	Free	Free
RohnIaS	Tri-Symmetry	RohnIP	RohnJP	0.5	0	Free	Free	Free	Free	Free	Free
SNB-AaS	Tri-Symmetry	SNB-AP	SNB-BP	0.25	0	Free	Free	Free	Free	Free	Free
SNB-AbS	Tri-Symmetry	SNB-AP	SNB-BP	0.5	0	Free	Free	Free	Free	Free	Free
SNB-AcS	Tri-Symmetry	SNB-AP	SNB-BP	0.75	0	Free	Free	Free	Free	Free	Free
SNB-BaS	Tri-Symmetry	SNB-BP	SNB-CP	0.25	0	Free	Free	Free	Free	Free	Free
SNB-BbS	Tri-Symmetry	SNB-BP	SNB-CP	0.5	0	Free	Free	Free	Free	Free	Free
SNB-BcS	Tri-Symmetry	SNB-BP	SNB-CP	0.75	0	Free	Free	Free	Free	Free	Free
SNB-CaS	Tri-Symmetry	SNB-CP	SNB-DP	0.333	0	Free	Free	Free	Free	Free	Free
SNB-CbS	Tri-Symmetry	SNB-CP	SNB-DP	0.667	0	Free	Free	Free	Free	Free	Free
SNB-DaS	Tri-Symmetry	SNB-DP	SNB-EP	0.333	0	Free	Free	Free	Free	Free	Free
SNB-DbS	Tri-Symmetry	SNB-DP	SNB-EP	0.667	0	Free	Free	Free	Free	Free	Free
SNB-EaS	Tri-Symmetry	SNB-EP	SNB-FP	0.333	0	Free	Free	Free	Free	Free	Free
SNB-EbS	Tri-Symmetry	SNB-EP	SNB-FP	0.667	0	Free	Free	Free	Free	Free	Free
SNB-FaS	Tri-Symmetry	SNB-FP	SNB-GP	0.5	0	Free	Free	Free	Free	Free	Free
SNB-GaS	Tri-Symmetry	SNB-GP	SNB-HP	0.5	0	Free	Free	Free	Free	Free	Free
SNB-HaS	Tri-Symmetry	SNB-HP	SNB-IP	0.5	0	Free	Free	Free	Free	Free	Free
SNB-IaS	Tri-Symmetry	SNB-IP	SNB-JP	0.5	0	Free	Free	Free	Free	Free	Free
SNB-WL-A1S	None	SNB-AP	SNB-A1	0.5	0	Free	Free	Free	Free	Free	Free
SNB-WL-A2S	None	SNB-A1	SNB-A2	0.5	0	Free	Free	Free	Free	Free	Free
SNB-WL-A3S	None	SNB-A2	SNB-AP	0.5	0	Free	Free	Free	Free	Free	Free
SNB-WL-B1S	None	SNB-BP	SNB-B1	0.5	0	Free	Free	Free	Free	Free	Free
SNB-WL-B2S	None	SNB-B1	SNB-B2	0.5	0	Free	Free	Free	Free	Free	Free
SNB-WL-B3S	None	SNB-B2	SNB-BP	0.5	0	Free	Free	Free	Free	Free	Free
SNB-WL-C1S	None	SNB-CP	SNB-C1	0.5	0	Free	Free	Free	Free	Free	Free
SNB-WL-C2S	None	SNB-C1	SNB-C2	0.5	0	Free	Free	Free	Free	Free	Free
SNB-WL-C3S	None	SNB-C2	SNB-CP	0.5	0	Free	Free	Free	Free	Free	Free
SNB-WL-D1S	None	SNB-DP	SNB-D1	0.5	0	Free	Free	Free	Free	Free	Free
SNB-WL-D2S	None	SNB-D1	SNB-D2	0.5	0	Free	Free	Free	Free	Free	Free
SNB-WL-D3S	None	SNB-D2	SNB-DP	0.5	0	Free	Free	Free	Free	Free	Free
SNB-WL-E1S	None	SNB-EP	SNB-E1	0.5	0	Free	Free	Free	Free	Free	Free
SNB-WL-E2S	None	SNB-E1	SNB-E2	0.5	0	Free	Free	Free	Free	Free	Free
SNB-WL-E3S	None	SNB-E2	SNB-EP	0.5	0	Free	Free	Free	Free	Free	Free
SNB-WL-F1S	None	SNB-FP	SNB-F1	0.5	0	Free	Free	Free	Free	Free	Free
SNB-WL-F2S	None	SNB-F1	SNB-F2	0.5	0	Free	Free	Free	Free	Free	Free
SNB-WL-F3S	None	SNB-F2	SNB-FP	0.5	0	Free	Free	Free	Free	Free	Free
SNB-WL-G1S	None	SNB-GP	SNB-G1	0.5	0	Free	Free	Free	Free	Free	Free
SNB-WL-G2S	None	SNB-G1	SNB-G2	0.5	0	Free	Free	Free	Free	Free	Free
SNB-WL-G3S	None	SNB-G2	SNB-GP	0.5	0	Free	Free	Free	Free	Free	Free
SNB-WL-H1S	None	SNB-HP	SNB-H1	0.5	0	Free	Free	Free	Free	Free	Free
SNB-WL-H2S	None	SNB-H1	SNB-H2	0.5	0	Free	Free	Free	Free	Free	Free
SNB-WL-H3S	None	SNB-H2	SNB-HP	0.5	0	Free	Free	Free	Free	Free	Free
SNB-WL-I1S	None	SNB-IP	SNB-I1	0.5	0	Free	Free	Free	Free	Free	Free
SNB-WL-I2S	None	SNB-I1	SNB-I2	0.5	0	Free	Free	Free	Free	Free	Free
SNB-WL-I3S	None	SNB-I2	SNB-IP	0.5	0	Free	Free	Free	Free	Free	Free
RohnAa1	Tri-Gen 1	RohnAP	RohnBP	0.25	0	Free	Free	Free	Free	Free	Free
RohnAa2	Tri-Gen 2	RohnAP	RohnBP	0.25	0	Free	Free	Free	Free	Free	Free
RohnAb1	Tri-Gen 1	RohnAP	RohnBP	0.5	0	Free	Free	Free	Free	Free	Free
RohnAb2	Tri-Gen 2	RohnAP	RohnBP	0.5	0	Free	Free	Free	Free	Free	Free
RohnAc1	Tri-Gen 1	RohnAP	RohnBP	0.75	0	Free	Free	Free	Free	Free	Free
RohnAc2	Tri-Gen 2	RohnAP	RohnBP	0.75	0	Free	Free	Free	Free	Free	Free
RohnBa1	Tri-Gen 1	RohnBP	RohnCP	0.25	0	Free	Free	Free	Free	Free	Free
RohnBa2	Tri-Gen 2	RohnBP	RohnCP	0.25	0	Free	Free	Free	Free	Free	Free
RohnBb1	Tri-Gen 1	RohnBP	RohnCP	0.5	0	Free	Free	Free	Free	Free	Free
RohnBb2	Tri-Gen 2	RohnBP	RohnCP	0.5	0	Free	Free	Free	Free	Free	Free
RohnBc1	Tri-Gen 1	RohnBP	RohnCP	0.75	0	Free	Free	Free	Free	Free	Free
RohnBc2	Tri-Gen 2	RohnBP	RohnCP	0.75	0	Free	Free	Free	Free	Free	Free

RohnCa1	Tri-Gen 1	RohnCP	RohnDP	0.333	0	Free	Free	Free	Free	Free	Free
RohnCa2	Tri-Gen 2	RohnCP	RohnDP	0.333	0	Free	Free	Free	Free	Free	Free
RohnCb1	Tri-Gen 1	RohnCP	RohnDP	0.667	0	Free	Free	Free	Free	Free	Free
RohnCb2	Tri-Gen 2	RohnCP	RohnDP	0.667	0	Free	Free	Free	Free	Free	Free
RohnDa1	Tri-Gen 1	RohnDP	RohnEP	0.333	0	Free	Free	Free	Free	Free	Free
RohnDa2	Tri-Gen 2	RohnDP	RohnEP	0.333	0	Free	Free	Free	Free	Free	Free
RohnDb1	Tri-Gen 1	RohnDP	RohnEP	0.667	0	Free	Free	Free	Free	Free	Free
RohnDb2	Tri-Gen 2	RohnDP	RohnEP	0.667	0	Free	Free	Free	Free	Free	Free
RohnEa1	Tri-Gen 1	RohnEP	RohnFP	0.333	0	Free	Free	Free	Free	Free	Free
RohnEa2	Tri-Gen 2	RohnEP	RohnFP	0.333	0	Free	Free	Free	Free	Free	Free
RohnEb1	Tri-Gen 1	RohnEP	RohnFP	0.667	0	Free	Free	Free	Free	Free	Free
RohnEb2	Tri-Gen 2	RohnEP	RohnFP	0.667	0	Free	Free	Free	Free	Free	Free
RohnFa1	Tri-Gen 1	RohnFP	RohnGP	0.5	0	Free	Free	Free	Free	Free	Free
RohnFa2	Tri-Gen 2	RohnFP	RohnGP	0.5	0	Free	Free	Free	Free	Free	Free
RohnGa1	Tri-Gen 1	RohnGP	RohnHP	0.5	0	Free	Free	Free	Free	Free	Free
RohnGa2	Tri-Gen 2	RohnGP	RohnHP	0.5	0	Free	Free	Free	Free	Free	Free
RohnHa1	Tri-Gen 1	RohnHP	RohnIP	0.5	0	Free	Free	Free	Free	Free	Free
RohnHa2	Tri-Gen 2	RohnHP	RohnIP	0.5	0	Free	Free	Free	Free	Free	Free
RohnIa1	Tri-Gen 1	RohnIP	RohnJP	0.5	0	Free	Free	Free	Free	Free	Free
RohnIa2	Tri-Gen 2	RohnIP	RohnJP	0.5	0	Free	Free	Free	Free	Free	Free
SNB-Aa1	Tri-Gen 1	SNB-AP	SNB-BP	0.25	0	Free	Free	Free	Free	Free	Free
SNB-Aa2	Tri-Gen 2	SNB-AP	SNB-BP	0.25	0	Free	Free	Free	Free	Free	Free
SNB-Ab1	Tri-Gen 1	SNB-AP	SNB-BP	0.5	0	Free	Free	Free	Free	Free	Free
SNB-Ab2	Tri-Gen 2	SNB-AP	SNB-BP	0.5	0	Free	Free	Free	Free	Free	Free
SNB-Ac1	Tri-Gen 1	SNB-AP	SNB-BP	0.75	0	Free	Free	Free	Free	Free	Free
SNB-Ac2	Tri-Gen 2	SNB-AP	SNB-BP	0.75	0	Free	Free	Free	Free	Free	Free
SNB-Ba1	Tri-Gen 1	SNB-BP	SNB-CP	0.25	0	Free	Free	Free	Free	Free	Free
SNB-Ba2	Tri-Gen 2	SNB-BP	SNB-CP	0.25	0	Free	Free	Free	Free	Free	Free
SNB-Bb1	Tri-Gen 1	SNB-BP	SNB-CP	0.5	0	Free	Free	Free	Free	Free	Free
SNB-Bb2	Tri-Gen 2	SNB-BP	SNB-CP	0.5	0	Free	Free	Free	Free	Free	Free
SNB-Bc1	Tri-Gen 1	SNB-BP	SNB-CP	0.75	0	Free	Free	Free	Free	Free	Free
SNB-Bc2	Tri-Gen 2	SNB-BP	SNB-CP	0.75	0	Free	Free	Free	Free	Free	Free
SNB-Ca1	Tri-Gen 1	SNB-CP	SNB-DP	0.333	0	Free	Free	Free	Free	Free	Free
SNB-Ca2	Tri-Gen 2	SNB-CP	SNB-DP	0.333	0	Free	Free	Free	Free	Free	Free
SNB-Cb1	Tri-Gen 1	SNB-CP	SNB-DP	0.667	0	Free	Free	Free	Free	Free	Free
SNB-Cb2	Tri-Gen 2	SNB-CP	SNB-DP	0.667	0	Free	Free	Free	Free	Free	Free
SNB-Da1	Tri-Gen 1	SNB-DP	SNB-EP	0.333	0	Free	Free	Free	Free	Free	Free
SNB-Da2	Tri-Gen 2	SNB-DP	SNB-EP	0.333	0	Free	Free	Free	Free	Free	Free
SNB-Db1	Tri-Gen 1	SNB-DP	SNB-EP	0.667	0	Free	Free	Free	Free	Free	Free
SNB-Db2	Tri-Gen 2	SNB-DP	SNB-EP	0.667	0	Free	Free	Free	Free	Free	Free
SNB-Ea1	Tri-Gen 1	SNB-EP	SNB-FP	0.333	0	Free	Free	Free	Free	Free	Free
SNB-Ea2	Tri-Gen 2	SNB-EP	SNB-FP	0.333	0	Free	Free	Free	Free	Free	Free
SNB-Eb1	Tri-Gen 1	SNB-EP	SNB-FP	0.667	0	Free	Free	Free	Free	Free	Free
SNB-Eb2	Tri-Gen 2	SNB-EP	SNB-FP	0.667	0	Free	Free	Free	Free	Free	Free
SNB-Fa1	Tri-Gen 1	SNB-FP	SNB-GP	0.5	0	Free	Free	Free	Free	Free	Free
SNB-Fa2	Tri-Gen 2	SNB-FP	SNB-GP	0.5	0	Free	Free	Free	Free	Free	Free
SNB-Ga1	Tri-Gen 1	SNB-GP	SNB-HP	0.5	0	Free	Free	Free	Free	Free	Free
SNB-Ga2	Tri-Gen 2	SNB-GP	SNB-HP	0.5	0	Free	Free	Free	Free	Free	Free
SNB-Ha1	Tri-Gen 1	SNB-HP	SNB-IP	0.5	0	Free	Free	Free	Free	Free	Free
SNB-Ha2	Tri-Gen 2	SNB-HP	SNB-IP	0.5	0	Free	Free	Free	Free	Free	Free
SNB-Ia1	Tri-Gen 1	SNB-IP	SNB-JP	0.5	0	Free	Free	Free	Free	Free	Free
SNB-Ia2	Tri-Gen 2	SNB-IP	SNB-JP	0.5	0	Free	Free	Free	Free	Free	Free

The model contains 60 primary and 123 secondary joints for a total of 183 joints.

**Steel Material Properties:**

Steel Material Label	Modulus of Elasticity (ksi)	Yield Stress Fy (ksi)	Ultimate Stress Fu (ksi)	Member All. Stress Hyp. 1 (ksi)	Member All. Stress Hyp. 2 (ksi)	Member Rupture Hyp. 1 (ksi)	Member Rupture Hyp. 2 (ksi)	Member Bearing Hyp. 1 (ksi)	Member Bearing Hyp. 2 (ksi)
A 36	2.9e+004	36	58	0	0	0	0	0	0
A572-50	2.9e+004	50	65	0	0	0	0	0	0

**Bolt Properties:**

Bolt Label	Bolt Diameter	Hole Diameter	Ultimate Shear	Default End	Default Bolt Capacity	Shear Capacity	Shear Capacity
------------	---------------	---------------	----------------	-------------	-----------------------	----------------	----------------

	(in)	(in)	Capacity (kips)	Distance (in)	Spacing (in)	Hyp. 1 (kips)	Hyp. 2 (kips)
5/8 A325-N	0.625	0.6875	16.58	1.125	1.5	0	0
3/4 A325-N	0.75	0.8125	23.87	1.35	1.8	0	0
5/8 A490-N	0.625	0.6875	20.72	1.125	1.5	0	0
3/4 A490-N	0.75	0.8125	29.83	1.35	1.8	0	0

Number Bolts Used By Type:

Bolt Number Type	Bolts
5/8 A325-N	228
5/8 A490-N	6
3/4 A325-N	42
3/4 A490-N	24

Angle Properties:

Angle Type	Angle Size	Long Leg	Short Leg	Thick. (in)	Unit Weight (lbs/ft)	Gross Area (in^2)	w/t Ratio	Radius of Gyration Rx (in)	Radius of Gyration Ry (in)	Radius of Gyration Rz (in)	Number of Angles	Wind Width (in)	Short Edge Dist. (in)	Long Edge Dist. (in)	Optimize Cost Factor	Section Modulus (in^3)
SAE	6X6X0.375	6	6	0.375	14.9	4.36	13.67	1.88	1.88	1.19	1	6	3	0	1.0000	0
SAE	5X5X0.625	5	5	0.625	20	5.86	6.2	1.52	1.52	0.978	1	5	2.5	0	1.0000	0
SAE	5X5X0.375	5	5	0.375	12.3	3.61	11	1.56	1.56	0.99	1	5	2.5	0	1.0000	0
SAE	4X4X0.625	4	4	0.625	15.7	4.61	4.8	1.2	1.2	0.779	1	4	2	0	1.0000	0
SAE	4X4X0.5	4	4	0.5	12.8	3.75	6.25	1.22	1.22	0.782	1	4	2	0	1.0000	0
SAE	4X4X0.3125	4	4	0.3125	8.2	2.4	10.6	1.24	1.24	0.791	1	4	2	0	1.0000	0
SAE	4X4X0.25	4	4	0.25	6.6	1.94	13.5	1.25	1.25	0.795	1	4	2	0	1.0000	0
SAE	3.5X3.5X0.375	3.5	3.5	0.375	8.5	2.48	7.33	1.07	1.07	0.687	1	3.5	1.75	0	1.0000	0
SAE	3.5X3.5X0.3125	3.5	3.5	0.3125	7.2	2.09	9	1.08	1.08	0.69	1	3.5	1.75	0	1.0000	0
SAE	3.5X3.5X0.25	3.5	3.5	0.25	5.8	1.69	11.5	1.09	1.09	0.694	1	3.5	1.75	0	1.0000	0
SAE	3X3X0.5	3	3	0.5	9.4	2.75	4.38	0.898	0.898	0.584	1	3	1.5	0	1.0000	0
SAE	3X3X0.25	3	3	0.25	4.9	1.44	9.75	0.93	0.93	0.592	1	3	1.5	0	1.0000	0
SAE	2.5X2.5X0.3125	2.5	2.5	0.3125	5	1.46	6	0.761	0.761	0.489	1	2.5	1.25	0	1.0000	0
SAE	2.5X2.5X0.25	2.5	2.5	0.25	4.1	1.19	7.75	0.769	0.769	0.491	1	2.5	1.25	0	1.0000	0
SAE	2.5X2.5X0.1875	2.5	2.5	0.1875	3.07	0.902	10.67	0.778	0.778	0.495	1	2.5	1.25	0	1.0000	0
SAE	2X2X0.375	2	2	0.375	4.7	1.36	3	0.594	0.594	0.389	1	2	1	0	1.0000	0
SAE	2X2X0.3125	2	2	0.3125	3.92	1.15	3.8	0.601	0.601	0.39	1	2	1	0	1.0000	0
SAE	2X2X0.25	2	2	0.25	3.19	0.94	5	0.609	0.609	0.391	1	2	1	0	1.0000	0
SAE	2X2X0.1875	2	2	0.1875	2.44	0.71	8	0.617	0.617	0.394	1	2	1	0	1.0000	0
SAE	1.75X1.75X0.1875	1.75	1.75	0.1875	2.12	0.62	6	0.537	0.537	0.343	1	1.75	0.875	0	1.0000	0
BIG	0.1X0.1X1	0.1	0.1	1	0	800	2.17	9.99	9.99	9.99	1	0.1	0.05	0	1.0000	0
Pipe	Pipe3EH	3.5	2.9	0	10.3	2.83	1	1.14	1.14	1.14	1	0	0	0	0.0000	0
Pipe	Pipe4EH	4.5	3.826	0	15	4.14	1	1.48	1.48	1.48	1	0	0	0	0.0000	0
Pipe	Pipe5STD	5.563	5.047	0	14.6	4.03	1	1.88	1.88	1.88	1	0	0	0	0.0000	0
Pipe	Pipe5EH	5.563	4.813	0	20.8	5.72	1	1.85	1.85	1.85	1	0	0	0	0.0000	0
Pipe	Pipe6EH	6.625	5.761	0	28.6	7.88	1	2.2	2.2	2.2	1	0	0	0	0.0000	0
Pipe	Pipe8EHS	8.625	8	0	35.78	9.86	1	2.96	2.96	2.96	1	0	0	0	0.0000	0
Pipe	Pipe3.5EH	4	3.364	0	12.5	3.44	1	1.31	1.31	1.31	1	0	0	0	0.0000	0
Pipe	Pipe6EHS	6.625	5.96	0	24.38	6.71	1	2.22	2.22	2.22	1	0	0	0	0.0000	0
Pipe	P3-437	3.5	2.626	0	15	4.2	1	1.09	1.09	1.09	1	0	0	0	0.0000	0
Pipe	P4-494	4.5	3.512	0	21.4	6.21	1	1.42	1.42	1.42	1	0	0	0	0.0000	0
Pipe	P6-562	6.625	5.5	0	36.6	10.7	1	2.15	2.15	2.15	1	0	0	0	0.0000	0
Pipe	Pipe8XS	8.625	7.625	0	43.39	12.8	1	2.88	2.88	2.88	1	0	0	0	0.0000	0
Pipe	Pipe10XS	10.75	9.75	0	54.74	16.1	1	3.63	3.63	3.63	1	0	0	0	0.0000	0
Pipe	P3-425	3.5	2.65	0	15	4.105	1	1.097	1.097	1.097	1	0	0	0	0.0000	0

Angle Groups:

Group Label	Group Angle Description	Angle Type	Material Type	Element Type	Group Type	Optimize Group	Allow. Angle	Add. Width
							For Optimize	(in)

Rohn-D1	Rohn Diagonal 1	SAE	1.75X1.75X0.1875	A 36	Truss	Other	None	0.000
Rohn-D2	Rohn Diagonal 2	SAE	2X2X0.1875	A 36	Truss	Other	None	0.000
Rohn-D3	Rohn Diagonal 3	SAE	2.5X2.5X0.1875	A 36	Truss	Other	None	0.000
Rohn-D4	Rohn Diagonal 4	SAE	2.5X2.5X0.25	A 36	Truss	Other	None	0.000
Rohn-D5	Rohn Diagonal 5	SAE	3X3X0.25	A572-50	Truss	Other	None	0.000
Rohn-D6	Rohn Diagonal 6	SAE	3.5X3.5X0.25	A572-50	Truss	Other	None	0.000
Rohn-D7	Rohn Diagonal 7	SAE	4X4X0.25	A572-50	Truss	Other	None	0.000
Rohn-L1	Rohn Leg 1	Pipe	Pipe3EH	A572-50	Beam	Leg	None	0.000
Rohn-L2	Rohn Leg 2	Pipe	Pipe3.5EH	A572-50	Beam	Leg	None	0.000
Rohn-L3	Rohn Leg 3	Pipe	Pipe4EH	A572-50	Beam	Leg	None	0.000
Rohn-L4	Rohn Leg 4	Pipe	Pipe5STD	A572-50	Beam	Leg	None	0.000
Rohn-L5	Rohn Leg 5	Pipe	Pipe5EH	A572-50	Beam	Leg	None	0.000
Rohn-L6	Rohn Leg 6	Pipe	Pipe6EHS	A572-50	Beam	Leg	None	0.000
Rohn-L7	Rohn Leg 7	Pipe	Pipe6EH	A572-50	Beam	Leg	None	0.000
Rohn-L8	Rohn Leg 8	Pipe	Pipe8EHS	A572-50	Beam	Leg	None	0.000
Rohn-H1	Rohn Horizontal 1	SAE	1.75X1.75X0.1875	A 36	Beam	Other	None	0.000
SNB-D1	SNB Diagonal 1	SAE	2X2X0.3125	A 36	Truss	Other	None	0.000
SNB-D2	SNB Diagonal 2	SAE	2X2X0.25	A 36	Truss	Other	None	0.000
SNB-D3	SNB Diagonal 3	SAE	2.5X2.5X0.3125	A 36	Truss	Other	None	0.000
SNB-D4	SNB Diagonal 4	SAE	3X3X0.5	A 36	Truss	Other	None	0.000
SNB-D5	SNB Diagonal 5	SAE	4X4X0.5	A 36	Truss	Other	None	0.000
SNB-D6	SNB Diagonal 6	SAE	4X4X0.625	A 36	Truss	Other	None	0.000
SNB-D7	SNB Diagonal 7	SAE	5X5X0.625	A 36	Truss	Other	None	0.000
SNB-L1	SNB Leg 1	Pipe	P3-437	A 36	Beam	Leg	None	0.000
SNB-L2	SNB Leg 2	Pipe	P4-494	A 36	Beam	Leg	None	0.000
SNB-L3	SNB Leg 3	Pipe	Pipe5EH	A 36	Beam	Leg	None	0.000
SNB-L4	SNB Leg 4	Pipe	P6-562	A 36	Beam	Leg	None	0.000
SNB-L5	SNB Leg 5	Pipe	Pipe8XS	A 36	Beam	Leg	None	0.000
SNB-L6	SNB Leg 6	Pipe	Pipe10XS	A 36	Beam	Leg	None	0.000
Connect	Connect Towers	BIG	0.1X0.1X1	A 36		Other	None	0.000
SNB-H1	SNB Horizontal 1	Pipe	P3-425	A 36	Beam	Other	None	0.000
SNB-H2	SNB Horizontal 2	Pipe	P4-494	A 36	Beam	Other	None	0.000
Rohn-D8	Rohn Diagonal 8	SAE	2X2X0.375	A 36	Truss	Other	None	0.000
WLAC-1	Wind Lacing 1	SAE	2X2X0.25	A 36	Truss	Redundant	None	0.000
WLAC-2	Wind Lacing 2	SAE	2.5X2.5X0.3125	A 36	Truss	Redundant	None	0.000
R-D1-MOD	MODIFICATION - L1.75X1.75x3/16	SAE	1.75X1.75X0.1875	A572-50	Truss	Other	None	0.000
R-D2-MOD	MODIFICATION - L2X2x3/16	SAE	2X2X0.1875	A572-50	Truss	Other	None	0.000
R-D3-MOD	MODIFICATION - L2.5X2.5x1/4	SAE	2.5X2.5X0.25	A572-50	Truss	Other	None	0.000
R-D4-MOD	MODIFICATION - L3x3x1/4	SAE	3X3X0.25	A572-50	Truss	Other	None	0.000
R-D5-MOD	MODIFICATION - L3X3x1/4	SAE	3X3X0.25	A572-50	Truss	Other	None	0.000
R-D6-MOD	MODIFICATION - L3.5X3.5x5/16	SAE	3.5X3.5X0.3125	A572-50	Truss	Other	None	0.000
R-D7-MOD	MODIFICATION - L4X4x5/16	SAE	4X4X0.3125	A572-50	Truss	Other	None	0.000
S-D1-MOD	MODIFICATION - L2X2x5/16	SAE	2X2X0.3125	A572-50	Truss	Other	None	0.000
S-D2-MOD	MODIFICATION - L2x2x1/4	SAE	2X2X0.25	A572-50	Truss	Other	None	0.000
S-D3-MOD	MODIFICATION - L2.5X2.5x5/16	SAE	2.5X2.5X0.3125	A572-50	Truss	Other	None	0.000
S-D4-MOD	MODIFICATION - L3.5X3.5x3/8	SAE	3.5X3.5X0.375	A572-50	Truss	Other	None	0.000
S-D5-MOD	MODIFICATION - L4X4x0.5	SAE	4X4X0.5	A572-50	Truss	Other	None	0.000
S-D6-MOD	MODIFICATION - L5X5x3/8	SAE	5X5X0.375	A572-50	Truss	Other	None	0.000
S-D7-MOD	MODIFICATION - L6X6x3/8	SAE	6X6X0.375	A572-50	Truss	Other	None	0.000

**Aggregate Angle Information:**

**Note: Estimate of surface area reported for painting purposes, not wind loading.**

Angle Type	Angle Size	Material Type	Total Length (ft)	Total Surface Area (ft^2)	Total Weight (lbs)
SAE	1.75X1.75X0.1875	A 36	279.43	163.00	592.39
SAE	2X2X0.1875	A 36	258.81	172.54	631.49
SAE	2.5X2.5X0.1875	A 36	151.20	126.00	464.18
SAE	2.5X2.5X0.25	A572-50	79.06	65.89	324.16
SAE	2.5X2.5X0.25	A 36	81.42	67.85	333.83
SAE	3X3X0.25	A572-50	443.36	443.36	2172.46
SAE	3.5X3.5X0.25	A572-50	446.54	520.96	2589.91
SAE	4X4X0.25	A572-50	379.04	505.38	2501.65
SAE	4X4X0.3125	A572-50	123.92	165.23	1016.15
Pipe	Pipe3EH	A572-50	60.05	64.05	618.48



Pipe	Pipe3.5EH	A572-50	60.05	73.70	750.58
Pipe	Pipe4EH	A572-50	60.05	83.32	900.69
Pipe	Pipe5STD	A572-50	60.05	106.18	876.68
Pipe	Pipe5EH	A572-50	60.05	103.84	1248.97
Pipe	Pipe6EHS	A572-50	60.05	125.95	1463.93
Pipe	Pipe6EH	A572-50	120.09	247.91	3434.66
Pipe	Pipe8EHS	A572-50	60.05	166.38	2148.47
SAE	2X2X0.3125	A 36	165.23	110.15	647.69
SAE	2X2X0.25	A 36	225.69	150.46	719.94
SAE	2.5X2.5X0.3125	A 36	470.63	392.19	2353.15
SAE	3X3X0.5	A 36	219.00	219.00	2058.63
SAE	4X4X0.5	A 36	183.26	244.34	2345.69
SAE	4X4X0.625	A 36	199.19	265.58	3127.26
SAE	5X5X0.375	A572-50	205.76	342.94	2530.90
SAE	6X6X0.375	A572-50	222.64	445.29	3317.38
Pipe	P3-437	A 36	60.05	61.31	900.70
Pipe	P4-494	A 36	303.38	405.11	6492.26
Pipe	Pipe5EH	A 36	60.05	103.84	1248.96
Pipe	P6-562	A 36	120.09	242.69	4395.40
Pipe	Pipe8XS	A 36	120.09	325.25	5210.82
Pipe	Pipe10XS	A 36	60.05	205.16	3286.94
BIG	0.1X0.1X1	A 36	150.03	5.00	0.00
Pipe	P3-425	A 36	73.04	74.87	1095.63

**Sections:**

The adjustment factors below only apply to dead load and wind areas that are calculated for members in the model. They do not apply to equipment or to manually input dead load and drag areas.

Section Label	Joint Defining Section Bottom	Dead Load Adjust. Factor	Transverse Drag x Area For Face	Longitudinal Drag x Area For Face	Transverse Area Factor (CD From Code)	Longitudinal Area Factor (CD From Code)	Af Factor For EIA Only	Flat Face For EIA Only	Ar Round Face For EIA Only	Transverse Drag x Area For All	Longitudinal Drag x Area For All	SAPS Drag x Area Factor	Angle Drag x Area Factor	SAPS Round Drag x Area Factor	Force Solid Face
A	RohnBP	1.000	0.000	0.000	0.000	0.000	0.900	0.900	0.000	0.000	0.000	0.000	0.000	0.000	None
B	RohnCP	1.000	0.000	0.000	0.000	0.000	0.900	0.900	0.000	0.000	0.000	0.000	0.000	0.000	None
C	RohnDP	1.000	0.000	0.000	0.000	0.000	0.900	0.900	0.000	0.000	0.000	0.000	0.000	0.000	None
D	RohnEP	1.000	0.000	0.000	0.000	0.000	0.900	0.900	0.000	0.000	0.000	0.000	0.000	0.000	None
E	RohnFP	1.000	0.000	0.000	0.000	0.000	0.900	0.900	0.000	0.000	0.000	0.000	0.000	0.000	None
F	RohnGP	1.000	0.000	0.000	0.000	0.000	0.900	0.900	0.000	0.000	0.000	0.000	0.000	0.000	None
G	RohnHP	1.000	0.000	0.000	0.000	0.000	0.900	0.900	0.000	0.000	0.000	0.000	0.000	0.000	None
H	RohnIP	1.000	0.000	0.000	0.000	0.000	0.900	0.900	0.000	0.000	0.000	0.000	0.000	0.000	None
I	RohnJP	1.000	0.000	0.000	0.000	0.000	0.900	0.900	0.000	0.000	0.000	0.000	0.000	0.000	None

**Angle Member Connectivity:**

Member Label	Group Label	Section Label	Symmetry Code	Origin Joint	End Joint	Ecc. Code	Rest. Code	Ratio RLX	Ratio RLY	Ratio RLZ	Bolt Type	# Bolts	# Holes	# Shear Planes	Connect Leg	Short Edge Dist. (in)	Long Edge Dist. (in)	End Dist. (in)	Bolt Spacing (in)	Rest. Coef.	
Rohn-DA1P	Rohn-D1		Tri-Symmetry	RohnAP	RohnAa1	1	4	0.5	0.5	0.5	5/8	A325-N	1	1	1	Long only	0	0	0	0	0
Rohn-DA11	Rohn-D1		Tri-Gen 1	RohnA1	RohnAa2	1	4	0.5	0.5	0.5	5/8	A325-N	1	1	1	Long only	0	0	0	0	0
Rohn-DA12	Rohn-D1		Tri-Gen 2	RohnA2	RohnAaS	1	4	0.5	0.5	0.5	5/8	A325-N	1	1	1	Long only	0	0	0	0	0
Rohn-DA2P	Rohn-D1		Tri-Symmetry	RohnAP	RohnAa2	1	4	0.5	0.5	0.5	5/8	A325-N	1	1	1	Long only	0	0	0	0	0
Rohn-DA21	Rohn-D1		Tri-Gen 1	RohnA1	RohnAaS	1	4	0.5	0.5	0.5	5/8	A325-N	1	1	1	Long only	0	0	0	0	0
Rohn-DA22	Rohn-D1		Tri-Gen 2	RohnA2	RohnAa1	1	4	0.5	0.5	0.5	5/8	A325-N	1	1	1	Long only	0	0	0	0	0
Rohn-DA3P	Rohn-D1		Tri-Symmetry	RohnAaS	RohnAb1	1	4	0.5	0.5	0.5	5/8	A325-N	1	1	1	Long only	0	0	0	0	0
Rohn-DA31	Rohn-D1		Tri-Gen 1	RohnAa1	RohnAb2	1	4	0.5	0.5	0.5	5/8	A325-N	1	1	1	Long only	0	0	0	0	0
Rohn-DA32	Rohn-D1		Tri-Gen 2	RohnAa2	RohnAbS	1	4	0.5	0.5	0.5	5/8	A325-N	1	1	1	Long only	0	0	0	0	0
Rohn-DA4P	Rohn-D1		Tri-Symmetry	RohnAaS	RohnAb2	1	4	0.5	0.5	0.5	5/8	A325-N	1	1	1	Long only	0	0	0	0	0
Rohn-DA41	Rohn-D1		Tri-Gen 1	RohnAa1	RohnAbS	1	4	0.5	0.5	0.5	5/8	A325-N	1	1	1	Long only	0	0	0	0	0
Rohn-DA42	Rohn-D1		Tri-Gen 2	RohnAa2	RohnAb1	1	4	0.5	0.5	0.5	5/8	A325-N	1	1	1	Long only	0	0	0	0	0
Rohn-DA5P	Rohn-D1		Tri-Symmetry	RohnAbS	RohnAc1	1	4	0.5	0.5	0.5	5/8	A325-N	1	1	1	Long only	0	0	0	0	0
Rohn-DA51	Rohn-D1		Tri-Gen 1	RohnAb1	RohnAc2	1	4	0.5	0.5	0.5	5/8	A325-N	1	1	1	Long only	0	0	0	0	0
Rohn-DA52	Rohn-D1		Tri-Gen 2	RohnAb2	RohnAcS	1	4	0.5	0.5	0.5	5/8	A325-N	1	1	1	Long only	0	0	0	0	0
Rohn-DA6P	Rohn-D1		Tri-Symmetry	RohnAbS	RohnAc2	1	4	0.5	0.5	0.5	5/8	A325-N	1	1	1	Long only	0	0	0	0	0
Rohn-DA61	Rohn-D1		Tri-Gen 1	RohnAb1	RohnAcS	1	4	0.5	0.5	0.5	5/8	A325-N	1	1	1	Long only	0	0	0	0	0
Rohn-DA62	Rohn-D1		Tri-Gen 2	RohnAb2	RohnAc1	1	4	0.5	0.5	0.5	5/8	A325-N	1	1	1	Long only	0	0	0	0	0
Rohn-DA7P	Rohn-D1		Tri-Symmetry	RohnAcS	RohnB2	1	4	0.5	0.5	0.5	5/8	A325-N	1	1	1	Long only	0	0	0	0	0





Rohn-LA31	Rohn-L1	Tri-Gen 1	RohnAb1	RohnAc1	1	4	1	1	1	0	0	0	0	0	0	0	0
Rohn-LA32	Rohn-L1	Tri-Gen 2	RohnAb2	RohnAc2	1	4	1	1	1	0	0	0	0	0	0	0	0
Rohn-LA4P	Rohn-L1	Tri-Symmetry	RohnAcS	RohnBP	1	4	1	1	1	0	0	0	0	0	0	0	0
Rohn-LA41	Rohn-L1	Tri-Gen 1	RohnAc1	RohnB1	1	4	1	1	1	0	0	0	0	0	0	0	0
Rohn-LA42	Rohn-L1	Tri-Gen 2	RohnAc2	RohnB2	1	4	1	1	1	0	0	0	0	0	0	0	0
Rohn-LB1P	Rohn-L2	Tri-Symmetry	RohnBP	RohnBaS	1	4	1	1	1	0	0	0	0	0	0	0	0
Rohn-LB11	Rohn-L2	Tri-Gen 1	RohnB1	RohnBa1	1	4	1	1	1	0	0	0	0	0	0	0	0
Rohn-LB12	Rohn-L2	Tri-Gen 2	RohnB2	RohnBa2	1	4	1	1	1	0	0	0	0	0	0	0	0
Rohn-LB2P	Rohn-L2	Tri-Symmetry	RohnBaS	RohnBbS	1	4	1	1	1	0	0	0	0	0	0	0	0
Rohn-LB21	Rohn-L2	Tri-Gen 1	RohnBa1	RohnBb1	1	4	1	1	1	0	0	0	0	0	0	0	0
Rohn-LB22	Rohn-L2	Tri-Gen 2	RohnBa2	RohnBb2	1	4	1	1	1	0	0	0	0	0	0	0	0
Rohn-LB3P	Rohn-L2	Tri-Symmetry	RohnBbS	RohnBcS	1	4	1	1	1	0	0	0	0	0	0	0	0
Rohn-LB31	Rohn-L2	Tri-Gen 1	RohnBb1	RohnBc1	1	4	1	1	1	0	0	0	0	0	0	0	0
Rohn-LB32	Rohn-L2	Tri-Gen 2	RohnBb2	RohnBc2	1	4	1	1	1	0	0	0	0	0	0	0	0
Rohn-LB4P	Rohn-L2	Tri-Symmetry	RohnBcS	RohnCP	1	4	1	1	1	0	0	0	0	0	0	0	0
Rohn-LB41	Rohn-L2	Tri-Gen 1	RohnBc1	RohnC1	1	4	1	1	1	0	0	0	0	0	0	0	0
Rohn-LB42	Rohn-L2	Tri-Gen 2	RohnBc2	RohnC2	1	4	1	1	1	0	0	0	0	0	0	0	0
Rohn-LC1P	Rohn-L3	Tri-Symmetry	RohnCP	RohnCaS	1	4	1	1	1	0	0	0	0	0	0	0	0
Rohn-LC11	Rohn-L3	Tri-Gen 1	RohnC1	RohnCa1	1	4	1	1	1	0	0	0	0	0	0	0	0
Rohn-LC12	Rohn-L3	Tri-Gen 2	RohnC2	RohnCa2	1	4	1	1	1	0	0	0	0	0	0	0	0
Rohn-LC2P	Rohn-L3	Tri-Symmetry	RohnCaS	RohnCbS	1	4	1	1	1	0	0	0	0	0	0	0	0
Rohn-LC21	Rohn-L3	Tri-Gen 1	RohnCa1	RohnCb1	1	4	1	1	1	0	0	0	0	0	0	0	0
Rohn-LC22	Rohn-L3	Tri-Gen 2	RohnCa2	RohnCb2	1	4	1	1	1	0	0	0	0	0	0	0	0
Rohn-LC3P	Rohn-L3	Tri-Symmetry	RohnCbS	RohnDP	1	4	1	1	1	0	0	0	0	0	0	0	0
Rohn-LC31	Rohn-L3	Tri-Gen 1	RohnCb1	RohnD1	1	4	1	1	1	0	0	0	0	0	0	0	0
Rohn-LC32	Rohn-L3	Tri-Gen 2	RohnCb2	RohnD2	1	4	1	1	1	0	0	0	0	0	0	0	0
Rohn-LD1P	Rohn-L4	Tri-Symmetry	RohnDP	RohnDaS	1	4	1	1	1	0	0	0	0	0	0	0	0
Rohn-LD11	Rohn-L4	Tri-Gen 1	RohnD1	RohnDa1	1	4	1	1	1	0	0	0	0	0	0	0	0
Rohn-LD12	Rohn-L4	Tri-Gen 2	RohnD2	RohnDa2	1	4	1	1	1	0	0	0	0	0	0	0	0
Rohn-LD2P	Rohn-L4	Tri-Symmetry	RohnDaS	RohnDbS	1	4	1	1	1	0	0	0	0	0	0	0	0
Rohn-LD21	Rohn-L4	Tri-Gen 1	RohnDa1	RohnDb1	1	4	1	1	1	0	0	0	0	0	0	0	0
Rohn-LD22	Rohn-L4	Tri-Gen 2	RohnDa2	RohnDb2	1	4	1	1	1	0	0	0	0	0	0	0	0
Rohn-LD3P	Rohn-L4	Tri-Symmetry	RohnDbS	RohnEP	1	4	1	1	1	0	0	0	0	0	0	0	0
Rohn-LD31	Rohn-L4	Tri-Gen 1	RohnDb1	RohnE1	1	4	1	1	1	0	0	0	0	0	0	0	0
Rohn-LD32	Rohn-L4	Tri-Gen 2	RohnDb2	RohnE2	1	4	1	1	1	0	0	0	0	0	0	0	0
Rohn-LE1P	Rohn-L5	Tri-Symmetry	RohnEP	RohnEaS	1	4	1	1	1	0	0	0	0	0	0	0	0
Rohn-LE11	Rohn-L5	Tri-Gen 1	RohnE1	RohnEa1	1	4	1	1	1	0	0	0	0	0	0	0	0
Rohn-LE12	Rohn-L5	Tri-Gen 2	RohnE2	RohnEa2	1	4	1	1	1	0	0	0	0	0	0	0	0
Rohn-LE2P	Rohn-L5	Tri-Symmetry	RohnEaS	RohnEbS	1	4	1	1	1	0	0	0	0	0	0	0	0
Rohn-LE21	Rohn-L5	Tri-Gen 1	RohnEa1	RohnEb1	1	4	1	1	1	0	0	0	0	0	0	0	0
Rohn-LE22	Rohn-L5	Tri-Gen 2	RohnEa2	RohnEb2	1	4	1	1	1	0	0	0	0	0	0	0	0
Rohn-LE3P	Rohn-L5	Tri-Symmetry	RohnEbS	RohnFP	1	4	1	1	1	0	0	0	0	0	0	0	0
Rohn-LE31	Rohn-L5	Tri-Gen 1	RohnEb1	RohnF1	1	4	1	1	1	0	0	0	0	0	0	0	0
Rohn-LE32	Rohn-L5	Tri-Gen 2	RohnEb2	RohnF2	1	4	1	1	1	0	0	0	0	0	0	0	0
Rohn-LF1P	Rohn-L6	Tri-Symmetry	RohnFP	RohnFaS	1	4	1	1	1	0	0	0	0	0	0	0	0
Rohn-LF11	Rohn-L6	Tri-Gen 1	RohnF1	RohnFa1	1	4	1	1	1	0	0	0	0	0	0	0	0
Rohn-LF12	Rohn-L6	Tri-Gen 2	RohnF2	RohnFa2	1	4	1	1	1	0	0	0	0	0	0	0	0
Rohn-LF2P	Rohn-L6	Tri-Symmetry	RohnFaS	RohnGP	1	4	0.5	0.5	0.5	0	0	0	0	0	0	0	0
Rohn-LF21	Rohn-L6	Tri-Gen 1	RohnFa1	RohnG1	1	4	0.5	0.5	0.5	0	0	0	0	0	0	0	0
Rohn-LF22	Rohn-L6	Tri-Gen 2	RohnFa2	RohnG2	1	4	0.5	0.5	0.5	0	0	0	0	0	0	0	0
Rohn-LG1P	Rohn-L7	Tri-Symmetry	RohnGP	RohnGaS	1	4	1	1	1	0	0	0	0	0	0	0	0
Rohn-LG11	Rohn-L7	Tri-Gen 1	RohnG1	RohnGa1	1	4	1	1	1	0	0	0	0	0	0	0	0
Rohn-LG12	Rohn-L7	Tri-Gen 2	RohnG2	RohnGa2	1	4	1	1	1	0	0	0	0	0	0	0	0
Rohn-LG2P	Rohn-L7	Tri-Symmetry	RohnGaS	RohnHP	1	4	1	1	1	0	0	0	0	0	0	0	0
Rohn-LG21	Rohn-L7	Tri-Gen 1	RohnGa1	RohnH1	1	4	1	1	1	0	0	0	0	0	0	0	0
Rohn-LG22	Rohn-L7	Tri-Gen 2	RohnGa2	RohnH2	1	4	1	1	1	0	0	0	0	0	0	0	0
Rohn-LH1P	Rohn-L7	Tri-Symmetry	RohnHP	RohnHaS	1	4	0.5	0.5	0.5	0	0	0	0	0	0	0	0
Rohn-LH11	Rohn-L7	Tri-Gen 1	RohnH1	RohnHa1	1	4	0.5	0.5	0.5	0	0	0	0	0	0	0	0
Rohn-LH12	Rohn-L7	Tri-Gen 2	RohnH2	RohnHa2	1	4	0.5	0.5	0.5	0	0	0	0	0	0	0	0
Rohn-LH2P	Rohn-L7	Tri-Symmetry	RohnHaS	RohnIP	1	4	0.5	0.5	0.5	0	0	0	0	0	0	0	0
Rohn-LH21	Rohn-L7	Tri-Gen 1	RohnHa1	RohnI1	1	4	0.5	0.5	0.5	0	0	0	0	0	0	0	0
Rohn-LH22	Rohn-L7	Tri-Gen 2	RohnHa2	RohnI2	1	4	0.5	0.5	0.5	0	0	0	0	0	0	0	0
Rohn-LI1P	Rohn-L8	Tri-Symmetry	RohnIP	RohnIaS	1	4	1	1	1	0	0	0	0	0	0	0	0
Rohn-LI11	Rohn-L8	Tri-Gen 1	RohnI1	RohnIa1	1	4	1	1	1	0	0	0	0	0	0	0	0
Rohn-LI12	Rohn-L8	Tri-Gen 2	RohnI2	RohnIa2	1	4	1	1	1	0	0	0	0	0	0	0	0
Rohn-LI2P	Rohn-L8	Tri-Symmetry	RohnIaS	RohnJP	1	4	0.5	0.5	0.5	0	0	0	0	0	0	0	0
Rohn-LI21	Rohn-L8	Tri-Gen 1	RohnIa1	RohnJ1	1	4	0.5	0.5	0.5	0	0	0	0	0	0	0	0
Rohn-LI22	Rohn-L8	Tri-Gen 2	RohnIa2	RohnJ2	1	4	0.5	0.5	0.5	0	0	0	0	0	0	0	0
Rohn-H1P	Rohn-H1	Tri-Symmetry	RohnAP	RohnA1	1	4	0.5	0.5	0.5	0	0	0	0	0	0	0	0







SNB-LF11	SNB-L4	Tri-Gen 1	SNB-F1	SNB-Fa1	1	4	1	1	1	0	0	0	0	0	0	0
SNB-LF12	SNB-L4	Tri-Gen 2	SNB-F2	SNB-Fa2	1	4	1	1	1	0	0	0	0	0	0	0
SNB-LF2P	SNB-L4	Tri-Symmetry	SNB-FaS	SNB-GP	1	4	1	1	1	0	0	0	0	0	0	0
SNB-LF21	SNB-L4	Tri-Gen 1	SNB-Fa1	SNB-G1	1	4	1	1	1	0	0	0	0	0	0	0
SNB-LF22	SNB-L4	Tri-Gen 2	SNB-Fa2	SNB-G2	1	4	1	1	1	0	0	0	0	0	0	0
SNB-LG1P	SNB-L5	Tri-Symmetry	SNB-GP	SNB-GaS	1	4	1	1	1	0	0	0	0	0	0	0
SNB-LG11	SNB-L5	Tri-Gen 1	SNB-G1	SNB-Ga1	1	4	1	1	1	0	0	0	0	0	0	0
SNB-LG12	SNB-L5	Tri-Gen 2	SNB-G2	SNB-Ga2	1	4	1	1	1	0	0	0	0	0	0	0
SNB-LG2P	SNB-L5	Tri-Symmetry	SNB-GaS	SNB-HP	1	4	1	1	1	0	0	0	0	0	0	0
SNB-LG21	SNB-L5	Tri-Gen 1	SNB-Ga1	SNB-H1	1	4	1	1	1	0	0	0	0	0	0	0
SNB-LG22	SNB-L5	Tri-Gen 2	SNB-Ga2	SNB-H2	1	4	1	1	1	0	0	0	0	0	0	0
SNB-LH1P	SNB-L5	Tri-Symmetry	SNB-HP	SNB-HaS	1	4	1	1	1	0	0	0	0	0	0	0
SNB-LH11	SNB-L5	Tri-Gen 1	SNB-H1	SNB-Ha1	1	4	1	1	1	0	0	0	0	0	0	0
SNB-LH12	SNB-L5	Tri-Gen 2	SNB-H2	SNB-Ha2	1	4	1	1	1	0	0	0	0	0	0	0
SNB-LH2P	SNB-L5	Tri-Symmetry	SNB-HaS	SNB-IP	1	4	0.25	0.25	0.25	0	0	0	0	0	0	0
SNB-LH21	SNB-L5	Tri-Gen 1	SNB-Ha1	SNB-I1	1	4	0.25	0.25	0.25	0	0	0	0	0	0	0
SNB-LH22	SNB-L5	Tri-Gen 2	SNB-Ha2	SNB-I2	1	4	0.25	0.25	0.25	0	0	0	0	0	0	0
SNB-LI1P	SNB-L6	Tri-Symmetry	SNB-IP	SNB-IaS	1	4	1	1	1	0	0	0	0	0	0	0
SNB-LI11	SNB-L6	Tri-Gen 1	SNB-I1	SNB-Ia1	1	4	1	1	1	0	0	0	0	0	0	0
SNB-LI12	SNB-L6	Tri-Gen 2	SNB-I2	SNB-Ia2	1	4	1	1	1	0	0	0	0	0	0	0
SNB-LI2P	SNB-L6	Tri-Symmetry	SNB-IaS	SNB-JP	1	4	0.5	0.5	0.5	0	0	0	0	0	0	0
SNB-LI21	SNB-L6	Tri-Gen 1	SNB-Ia1	SNB-J1	1	4	0.5	0.5	0.5	0	0	0	0	0	0	0
SNB-LI22	SNB-L6	Tri-Gen 2	SNB-Ia2	SNB-J2	1	4	0.5	0.5	0.5	0	0	0	0	0	0	0
Connect AP	Connect	Tri-Symmetry	RohnAP	SNB-AP	1	4	1	1	1	0	0	0	0	0	0	0
Connect A1	Connect	Tri-Gen 1	RohnA1	SNB-A1	1	4	1	1	1	0	0	0	0	0	0	0
Connect A2	Connect	Tri-Gen 2	RohnA2	SNB-A2	1	4	1	1	1	0	0	0	0	0	0	0
Connect AaP	Connect	Tri-Symmetry	RohnAaS	SNB-AaS	1	4	1	1	1	0	0	0	0	0	0	0
Connect Aa1	Connect	Tri-Gen 1	RohnAa1	SNB-Aa1	1	4	1	1	1	0	0	0	0	0	0	0
Connect Aa2	Connect	Tri-Gen 2	RohnAa2	SNB-Aa2	1	4	1	1	1	0	0	0	0	0	0	0
Connect AbP	Connect	Tri-Symmetry	RohnAbS	SNB-AbS	1	4	1	1	1	0	0	0	0	0	0	0
Connect Ab1	Connect	Tri-Gen 1	RohnAb1	SNB-Ab1	1	4	1	1	1	0	0	0	0	0	0	0
Connect Ab2	Connect	Tri-Gen 2	RohnAb2	SNB-Ab2	1	4	1	1	1	0	0	0	0	0	0	0
Connect AcP	Connect	Tri-Symmetry	RohnAcS	SNB-AcS	1	4	1	1	1	0	0	0	0	0	0	0
Connect Ac1	Connect	Tri-Gen 1	RohnAc1	SNB-Ac1	1	4	1	1	1	0	0	0	0	0	0	0
Connect Ac2	Connect	Tri-Gen 2	RohnAc2	SNB-Ac2	1	4	1	1	1	0	0	0	0	0	0	0
Connect BP	Connect	Tri-Symmetry	RohnBP	SNB-BP	1	4	1	1	1	0	0	0	0	0	0	0
Connect B1	Connect	Tri-Gen 1	RohnB1	SNB-B1	1	4	1	1	1	0	0	0	0	0	0	0
Connect B2	Connect	Tri-Gen 2	RohnB2	SNB-B2	1	4	1	1	1	0	0	0	0	0	0	0
Connect BaP	Connect	Tri-Symmetry	RohnBaS	SNB-BaS	1	4	1	1	1	0	0	0	0	0	0	0
Connect Ba1	Connect	Tri-Gen 1	RohnBa1	SNB-Ba1	1	4	1	1	1	0	0	0	0	0	0	0
Connect Ba2	Connect	Tri-Gen 2	RohnBa2	SNB-Ba2	1	4	1	1	1	0	0	0	0	0	0	0
Connect BbP	Connect	Tri-Symmetry	RohnBbS	SNB-BbS	1	4	1	1	1	0	0	0	0	0	0	0
Connect Bb1	Connect	Tri-Gen 1	RohnBb1	SNB-Bb1	1	4	1	1	1	0	0	0	0	0	0	0
Connect Bb2	Connect	Tri-Gen 2	RohnBb2	SNB-Bb2	1	4	1	1	1	0	0	0	0	0	0	0
Connect BcP	Connect	Tri-Symmetry	RohnBcS	SNB-BcS	1	4	1	1	1	0	0	0	0	0	0	0
Connect Bc1	Connect	Tri-Gen 1	RohnBc1	SNB-Bc1	1	4	1	1	1	0	0	0	0	0	0	0
Connect Bc2	Connect	Tri-Gen 2	RohnBc2	SNB-Bc2	1	4	1	1	1	0	0	0	0	0	0	0
Connect CP	Connect	Tri-Symmetry	RohnCP	SNB-CP	1	4	1	1	1	0	0	0	0	0	0	0
Connect C1	Connect	Tri-Gen 1	RohnC1	SNB-C1	1	4	1	1	1	0	0	0	0	0	0	0
Connect C2	Connect	Tri-Gen 2	RohnC2	SNB-C2	1	4	1	1	1	0	0	0	0	0	0	0
Connect CaP	Connect	Tri-Symmetry	RohnCaS	SNB-CaS	1	4	1	1	1	0	0	0	0	0	0	0
Connect Ca1	Connect	Tri-Gen 1	RohnCa1	SNB-Ca1	1	4	1	1	1	0	0	0	0	0	0	0
Connect Ca2	Connect	Tri-Gen 2	RohnCa2	SNB-Ca2	1	4	1	1	1	0	0	0	0	0	0	0
Connect CbP	Connect	Tri-Symmetry	RohnCbS	SNB-CbS	1	4	1	1	1	0	0	0	0	0	0	0
Connect Cb1	Connect	Tri-Gen 1	RohnCb1	SNB-Cb1	1	4	1	1	1	0	0	0	0	0	0	0
Connect Cb2	Connect	Tri-Gen 2	RohnCb2	SNB-Cb2	1	4	1	1	1	0	0	0	0	0	0	0
Connect DP	Connect	Tri-Symmetry	RohnDP	SNB-DP	1	4	1	1	1	0	0	0	0	0	0	0
Connect D1	Connect	Tri-Gen 1	RohnD1	SNB-D1	1	4	1	1	1	0	0	0	0	0	0	0
Connect D2	Connect	Tri-Gen 2	RohnD2	SNB-D2	1	4	1	1	1	0	0	0	0	0	0	0
Connect DaP	Connect	Tri-Symmetry	RohnDaS	SNB-DaS	1	4	1	1	1	0	0	0	0	0	0	0
Connect Da1	Connect	Tri-Gen 1	RohnDa1	SNB-Da1	1	4	1	1	1	0	0	0	0	0	0	0
Connect Da2	Connect	Tri-Gen 2	RohnDa2	SNB-Da2	1	4	1	1	1	0	0	0	0	0	0	0
Connect DbP	Connect	Tri-Symmetry	RohnDbS	SNB-DbS	1	4	1	1	1	0	0	0	0	0	0	0
Connect Db1	Connect	Tri-Gen 1	RohnDb1	SNB-Db1	1	4	1	1	1	0	0	0	0	0	0	0
Connect Db2	Connect	Tri-Gen 2	RohnDb2	SNB-Db2	1	4	1	1	1	0	0	0	0	0	0	0
Connect EP	Connect	Tri-Symmetry	RohnEP	SNB-EP	1	4	1	1	1	0	0	0	0	0	0	0
Connect E1	Connect	Tri-Gen 1	RohnE1	SNB-E1	1	4	1	1	1	0	0	0	0	0	0	0
Connect E2	Connect	Tri-Gen 2	RohnE2	SNB-E2	1	4	1	1	1	0	0	0	0	0	0	0
Connect EaP	Connect	Tri-Symmetry	RohnEaS	SNB-EaS	1	4	1	1	1	0	0	0	0	0	0	0



Connect Ea1	Connect	Tri-Gen 1	RohnEa1	SNB-Ea1	1	4	1	1	1	0	0	0	0	0	0	0
Connect Ea2	Connect	Tri-Gen 2	RohnEa2	SNB-Ea2	1	4	1	1	1	0	0	0	0	0	0	0
Connect EbP	Connect	Tri-Symmetry	RohnEbS	SNB-EbS	1	4	1	1	1	0	0	0	0	0	0	0
Connect Eb1	Connect	Tri-Gen 1	RohnEb1	SNB-Eb1	1	4	1	1	1	0	0	0	0	0	0	0
Connect Eb2	Connect	Tri-Gen 2	RohnEb2	SNB-Eb2	1	4	1	1	1	0	0	0	0	0	0	0
Connect FP	Connect	Tri-Symmetry	RohnFP	SNB-FP	1	4	1	1	1	0	0	0	0	0	0	0
Connect F1	Connect	Tri-Gen 1	RohnF1	SNB-F1	1	4	1	1	1	0	0	0	0	0	0	0
Connect F2	Connect	Tri-Gen 2	RohnF2	SNB-F2	1	4	1	1	1	0	0	0	0	0	0	0
Connect FaP	Connect	Tri-Symmetry	RohnFaS	SNB-FaS	1	4	1	1	1	0	0	0	0	0	0	0
Connect Fa1	Connect	Tri-Gen 1	RohnFa1	SNB-Fa1	1	4	1	1	1	0	0	0	0	0	0	0
Connect Fa2	Connect	Tri-Gen 2	RohnFa2	SNB-Fa2	1	4	1	1	1	0	0	0	0	0	0	0
Connect GP	Connect	Tri-Symmetry	RohnGP	SNB-GP	1	4	1	1	1	0	0	0	0	0	0	0
Connect G1	Connect	Tri-Gen 1	RohnG1	SNB-G1	1	4	1	1	1	0	0	0	0	0	0	0
Connect G2	Connect	Tri-Gen 2	RohnG2	SNB-G2	1	4	1	1	1	0	0	0	0	0	0	0
Connect GaP	Connect	Tri-Symmetry	RohnGaS	SNB-GaS	1	4	1	1	1	0	0	0	0	0	0	0
Connect Ga1	Connect	Tri-Gen 1	RohnGa1	SNB-Ga1	1	4	1	1	1	0	0	0	0	0	0	0
Connect Ga2	Connect	Tri-Gen 2	RohnGa2	SNB-Ga2	1	4	1	1	1	0	0	0	0	0	0	0
Connect HP	Connect	Tri-Symmetry	RohnHP	SNB-HP	1	4	1	1	1	0	0	0	0	0	0	0
Connect H1	Connect	Tri-Gen 1	RohnH1	SNB-H1	1	4	1	1	1	0	0	0	0	0	0	0
Connect H2	Connect	Tri-Gen 2	RohnH2	SNB-H2	1	4	1	1	1	0	0	0	0	0	0	0
Connect HaP	Connect	Tri-Symmetry	RohnHaS	SNB-HaS	1	4	1	1	1	0	0	0	0	0	0	0
Connect Ha1	Connect	Tri-Gen 1	RohnHa1	SNB-Ha1	1	4	1	1	1	0	0	0	0	0	0	0
Connect Ha2	Connect	Tri-Gen 2	RohnHa2	SNB-Ha2	1	4	1	1	1	0	0	0	0	0	0	0
Connect IP	Connect	Tri-Symmetry	RohnIP	SNB-IP	1	4	1	1	1	0	0	0	0	0	0	0
Connect I1	Connect	Tri-Gen 1	RohnI1	SNB-I1	1	4	1	1	1	0	0	0	0	0	0	0
Connect I2	Connect	Tri-Gen 2	RohnI2	SNB-I2	1	4	1	1	1	0	0	0	0	0	0	0
Connect IaP	Connect	Tri-Symmetry	RohnIaS	SNB-IaS	1	4	1	1	1	0	0	0	0	0	0	0
Connect Ia1	Connect	Tri-Gen 1	RohnIa1	SNB-Ia1	1	4	1	1	1	0	0	0	0	0	0	0
Connect Ia2	Connect	Tri-Gen 2	RohnIa2	SNB-Ia2	1	4	1	1	1	0	0	0	0	0	0	0
SNB-H1aP	SNB-H1	None	SNB-AP	SNB-WL-A1S	1	4	1	1	1	0	0	0	0	0	0	0
SNB-H1bP	SNB-H1	None	SNB-WL-A1S	SNB-A1	1	4	1	1	1	0	0	0	0	0	0	0
SNB-H1cP	SNB-H1	None	SNB-A1	SNB-WL-A2S	1	4	1	1	1	0	0	0	0	0	0	0
SNB-H1dP	SNB-H1	None	SNB-WL-A2S	SNB-A2	1	4	1	1	1	0	0	0	0	0	0	0
SNB-H1eP	SNB-H1	None	SNB-A2	SNB-WL-A3S	1	4	1	1	1	0	0	0	0	0	0	0
SNB-H1fP	SNB-H1	None	SNB-WL-A3S	SNB-AP	1	4	1	1	1	0	0	0	0	0	0	0
SNB-H2aP	SNB-H1	None	SNB-BP	SNB-WL-B1S	1	4	1	1	1	0	0	0	0	0	0	0
SNB-H2bP	SNB-H1	None	SNB-WL-B1S	SNB-B1	1	4	1	1	1	0	0	0	0	0	0	0
SNB-H2cP	SNB-H1	None	SNB-B1	SNB-WL-B2S	1	4	1	1	1	0	0	0	0	0	0	0
SNB-H2dP	SNB-H1	None	SNB-WL-B2S	SNB-B2	1	4	1	1	1	0	0	0	0	0	0	0
SNB-H2eP	SNB-H1	None	SNB-B2	SNB-WL-B3S	1	4	1	1	1	0	0	0	0	0	0	0
SNB-H2fP	SNB-H1	None	SNB-WL-B3S	SNB-BP	1	4	1	1	1	0	0	0	0	0	0	0
SNB-H3aP	SNB-H1	None	SNB-CP	SNB-WL-C1S	1	4	1	1	1	0	0	0	0	0	0	0
SNB-H3bP	SNB-H1	None	SNB-WL-C1S	SNB-C1	1	4	1	1	1	0	0	0	0	0	0	0
SNB-H3cP	SNB-H1	None	SNB-C1	SNB-WL-C2S	1	4	1	1	1	0	0	0	0	0	0	0
SNB-H3dP	SNB-H1	None	SNB-WL-C2S	SNB-C2	1	4	1	1	1	0	0	0	0	0	0	0
SNB-H3eP	SNB-H1	None	SNB-C2	SNB-WL-C3S	1	4	1	1	1	0	0	0	0	0	0	0
SNB-H3fP	SNB-H1	None	SNB-WL-C3S	SNB-CP	1	4	1	1	1	0	0	0	0	0	0	0
SNB-H4aP	SNB-H1	None	SNB-DP	SNB-WL-D1S	1	4	1	1	1	0	0	0	0	0	0	0
SNB-H4bP	SNB-H1	None	SNB-WL-D1S	SNB-D1	1	4	1	1	1	0	0	0	0	0	0	0
SNB-H4cP	SNB-H1	None	SNB-D1	SNB-WL-D2S	1	4	1	1	1	0	0	0	0	0	0	0
SNB-H4dP	SNB-H1	None	SNB-WL-D2S	SNB-D2	1	4	1	1	1	0	0	0	0	0	0	0
SNB-H4eP	SNB-H1	None	SNB-D2	SNB-WL-D3S	1	4	1	1	1	0	0	0	0	0	0	0
SNB-H4fP	SNB-H1	None	SNB-WL-D3S	SNB-DP	1	4	1	1	1	0	0	0	0	0	0	0
SNB-H5aP	SNB-H2	None	SNB-EP	SNB-WL-E1S	1	4	1	1	1	0	0	0	0	0	0	0
SNB-H5bP	SNB-H2	None	SNB-WL-E1S	SNB-E1	1	4	1	1	1	0	0	0	0	0	0	0
SNB-H5cP	SNB-H2	None	SNB-E1	SNB-WL-E2S	1	4	1	1	1	0	0	0	0	0	0	0
SNB-H5dP	SNB-H2	None	SNB-WL-E2S	SNB-E2	1	4	1	1	1	0	0	0	0	0	0	0
SNB-H5eP	SNB-H2	None	SNB-E2	SNB-WL-E3S	1	4	1	1	1	0	0	0	0	0	0	0
SNB-H5fP	SNB-H2	None	SNB-WL-E3S	SNB-EP	1	4	1	1	1	0	0	0	0	0	0	0
SNB-H6aP	SNB-H2	None	SNB-FP	SNB-WL-F1S	1	4	1	1	1	0	0	0	0	0	0	0
SNB-H6bP	SNB-H2	None	SNB-WL-F1S	SNB-F1	1	4	1	1	1	0	0	0	0	0	0	0
SNB-H6cP	SNB-H2	None	SNB-F1	SNB-WL-F2S	1	4	1	1	1	0	0	0	0	0	0	0
SNB-H6dP	SNB-H2	None	SNB-WL-F2S	SNB-F2	1	4	1	1	1	0	0	0	0	0	0	0
SNB-H6eP	SNB-H2	None	SNB-F2	SNB-WL-F3S	1	4	1	1	1	0	0	0	0	0	0	0
SNB-H6fP	SNB-H2	None	SNB-WL-F3S	SNB-FP	1	4	1	1	1	0	0	0	0	0	0	0
SNB-H7aP	SNB-H2	None	SNB-GP	SNB-WL-G1S	1	4	1	1	1	0	0	0	0	0	0	0
SNB-H7bP	SNB-H2	None	SNB-WL-G1S	SNB-G1	1	4	1	1	1	0	0	0	0	0	0	0
SNB-H7cP	SNB-H2	None	SNB-G1	SNB-WL-G2S	1	4	1	1	1	0	0	0	0	0	0	0
SNB-H7dP	SNB-H2	None	SNB-WL-G2S	SNB-G2	1	4	1	1	1	0	0	0	0	0	0	0

SNB-H7eP	SNB-H2	None	SNB-G2	SNB-WL-G3S	1	4	1	1	1	0	0	0	0	0	0	0	0	0	0	0
SNB-H7fP	SNB-H2	None	SNB-WL-G3S	SNB-GP	1	4	1	1	1	0	0	0	0	0	0	0	0	0	0	0
SNB-H8aP	SNB-H2	None	SNB-HP	SNB-WL-H1S	1	4	1	1	1	0	0	0	0	0	0	0	0	0	0	0
SNB-H8bP	SNB-H2	None	SNB-WL-H1S	SNB-H1	1	4	1	1	1	0	0	0	0	0	0	0	0	0	0	0
SNB-H8cP	SNB-H2	None	SNB-H1	SNB-WL-H2S	1	4	1	1	1	0	0	0	0	0	0	0	0	0	0	0
SNB-H8dP	SNB-H2	None	SNB-WL-H2S	SNB-H2	1	4	1	1	1	0	0	0	0	0	0	0	0	0	0	0
SNB-H8eP	SNB-H2	None	SNB-H2	SNB-WL-H3S	1	4	1	1	1	0	0	0	0	0	0	0	0	0	0	0
SNB-H8fP	SNB-H2	None	SNB-WL-H3S	SNB-HP	1	4	1	1	1	0	0	0	0	0	0	0	0	0	0	0
SNB-H9aP	SNB-H2	None	SNB-IP	SNB-WL-I1S	1	4	1	1	1	0	0	0	0	0	0	0	0	0	0	0
SNB-H9bP	SNB-H2	None	SNB-WL-I1S	SNB-I1	1	4	1	1	1	0	0	0	0	0	0	0	0	0	0	0
SNB-H9cP	SNB-H2	None	SNB-I1	SNB-WL-I2S	1	4	1	1	1	0	0	0	0	0	0	0	0	0	0	0
SNB-H9dP	SNB-H2	None	SNB-WL-I2S	SNB-I2	1	4	1	1	1	0	0	0	0	0	0	0	0	0	0	0
SNB-H9eP	SNB-H2	None	SNB-I2	SNB-WL-I3S	1	4	1	1	1	0	0	0	0	0	0	0	0	0	0	0
SNB-H9fP	SNB-H2	None	SNB-WL-I3S	SNB-IP	1	4	1	1	1	0	0	0	0	0	0	0	0	0	0	0
SNB-WL-A1P	WLAC-1	None	SNB-WL-A1S	SNB-WL-A2S	1	4	1	1	1	0	0	0	0	0	0	0	0	0	0	0
SNB-WL-A2P	WLAC-1	None	SNB-WL-A2S	SNB-WL-A3S	1	4	1	1	1	0	0	0	0	0	0	0	0	0	0	0
SNB-WL-A3P	WLAC-1	None	SNB-WL-A3S	SNB-WL-A1S	1	4	1	1	1	0	0	0	0	0	0	0	0	0	0	0
SNB-WL-B1P	WLAC-1	None	SNB-WL-B1S	SNB-WL-B2S	1	4	1	1	1	0	0	0	0	0	0	0	0	0	0	0
SNB-WL-B2P	WLAC-1	None	SNB-WL-B2S	SNB-WL-B3S	1	4	1	1	1	0	0	0	0	0	0	0	0	0	0	0
SNB-WL-B3P	WLAC-1	None	SNB-WL-B3S	SNB-WL-B1S	1	4	1	1	1	0	0	0	0	0	0	0	0	0	0	0
SNB-WL-C1P	WLAC-1	None	SNB-WL-C1S	SNB-WL-C2S	1	4	1	1	1	0	0	0	0	0	0	0	0	0	0	0
SNB-WL-C2P	WLAC-1	None	SNB-WL-C2S	SNB-WL-C3S	1	4	1	1	1	0	0	0	0	0	0	0	0	0	0	0
SNB-WL-C3P	WLAC-1	None	SNB-WL-C3S	SNB-WL-C1S	1	4	1	1	1	0	0	0	0	0	0	0	0	0	0	0
SNB-WL-D1P	WLAC-1	None	SNB-WL-D1S	SNB-WL-D2S	1	4	1	1	1	0	0	0	0	0	0	0	0	0	0	0
SNB-WL-D2P	WLAC-1	None	SNB-WL-D2S	SNB-WL-D3S	1	4	1	1	1	0	0	0	0	0	0	0	0	0	0	0
SNB-WL-D3P	WLAC-1	None	SNB-WL-D3S	SNB-WL-D1S	1	4	1	1	1	0	0	0	0	0	0	0	0	0	0	0
SNB-WL-E1P	WLAC-2	None	SNB-WL-E1S	SNB-WL-E2S	1	4	1	1	1	0	0	0	0	0	0	0	0	0	0	0
SNB-WL-E2P	WLAC-2	None	SNB-WL-E2S	SNB-WL-E3S	1	4	1	1	1	0	0	0	0	0	0	0	0	0	0	0
SNB-WL-E3P	WLAC-2	None	SNB-WL-E3S	SNB-WL-E1S	1	4	1	1	1	0	0	0	0	0	0	0	0	0	0	0
SNB-WL-F1P	WLAC-2	None	SNB-WL-F1S	SNB-WL-F2S	1	4	1	1	1	0	0	0	0	0	0	0	0	0	0	0
SNB-WL-F2P	WLAC-2	None	SNB-WL-F2S	SNB-WL-F3S	1	4	1	1	1	0	0	0	0	0	0	0	0	0	0	0
SNB-WL-F3P	WLAC-2	None	SNB-WL-F3S	SNB-WL-F1S	1	4	1	1	1	0	0	0	0	0	0	0	0	0	0	0
SNB-WL-G1P	WLAC-2	None	SNB-WL-G1S	SNB-WL-G2S	1	4	1	1	1	0	0	0	0	0	0	0	0	0	0	0
SNB-WL-G2P	WLAC-2	None	SNB-WL-G2S	SNB-WL-G3S	1	4	1	1	1	0	0	0	0	0	0	0	0	0	0	0
SNB-WL-G3P	WLAC-2	None	SNB-WL-G3S	SNB-WL-G1S	1	4	1	1	1	0	0	0	0	0	0	0	0	0	0	0
SNB-WL-H1P	WLAC-2	None	SNB-WL-H1S	SNB-WL-H2S	1	4	1	1	1	0	0	0	0	0	0	0	0	0	0	0
SNB-WL-H2P	WLAC-2	None	SNB-WL-H2S	SNB-WL-H3S	1	4	1	1	1	0	0	0	0	0	0	0	0	0	0	0
SNB-WL-H3P	WLAC-2	None	SNB-WL-H3S	SNB-WL-H1S	1	4	1	1	1	0	0	0	0	0	0	0	0	0	0	0
SNB-WL-I1P	WLAC-2	None	SNB-WL-I1S	SNB-WL-I2S	1	4	1	1	1	0	0	0	0	0	0	0	0	0	0	0
SNB-WL-I2P	WLAC-2	None	SNB-WL-I2S	SNB-WL-I3S	1	4	1	1	1	0	0	0	0	0	0	0	0	0	0	0
SNB-WL-I3P	WLAC-2	None	SNB-WL-I3S	SNB-WL-I1S	1	4	1	1	1	0	0	0	0	0	0	0	0	0	0	0

Member Capacities and Overrides:

Warnings	Member Label	Group Label	Design Comp.	Design Control	Tension	Tension Control	L/r	Length (ft)	L/r	Connection Comp.	Connection Shear	Connection Bearing	Net Section Tension Capacity (kips)	Rupture Capacity (kips)	RTE Dist. (kips)	End RTE Dist. (kips)	Edge Capacity (kips)	Override Comp.	Override Control Criterion	Override Capacity (kips)	Override Control Criterion	Override Member ship
	Rohn-DA1P	Rohn-D1	5.454	L/r	7.750	Rupture	160	9.16	5.454	12.433	13.050	16.022	7.750	0.000	0.000	0.000	0.000			0.000		Automatic
	Rohn-DA11	Rohn-D1	5.454	L/r	7.750	Rupture	160	9.16	5.454	12.433	13.050	16.022	7.750	0.000	0.000	0.000	0.000			0.000		Automatic
	Rohn-DA12	Rohn-D1	5.454	L/r	7.750	Rupture	160	9.16	5.454	12.433	13.050	16.022	7.750	0.000	0.000	0.000	0.000			0.000		Automatic
	Rohn-DA2P	Rohn-D1	5.454	L/r	7.750	Rupture	160	9.16	5.454	12.433	13.050	16.022	7.750	0.000	0.000	0.000	0.000			0.000		Automatic
	Rohn-DA21	Rohn-D1	5.454	L/r	7.750	Rupture	160	9.16	5.454	12.433	13.050	16.022	7.750	0.000	0.000	0.000	0.000			0.000		Automatic
	Rohn-DA22	Rohn-D1	5.454	L/r	7.750	Rupture	160	9.16	5.454	12.433	13.050	16.022	7.750	0.000	0.000	0.000	0.000			0.000		Automatic
	Rohn-DA3P	Rohn-D1	5.127	L/r	7.750	Rupture	165	9.45	5.127	12.433	13.050	16.022	7.750	0.000	0.000	0.000	0.000			0.000		Automatic
	Rohn-DA31	Rohn-D1	5.127	L/r	7.750	Rupture	165	9.45	5.127	12.433	13.050	16.022	7.750	0.000	0.000	0.000	0.000			0.000		Automatic
	Rohn-DA32	Rohn-D1	5.127	L/r	7.750	Rupture	165	9.45	5.127	12.433	13.050	16.022	7.750	0.000	0.000	0.000	0.000			0.000		Automatic
	Rohn-DA4P	Rohn-D1	5.127	L/r	7.750	Rupture	165	9.45	5.127	12.433	13.050	16.022	7.750	0.000	0.000	0.000	0.000			0.000		Automatic
	Rohn-DA41	Rohn-D1	5.127	L/r	7.750	Rupture	165	9.45	5.127	12.433	13.050	16.022	7.750	0.000	0.000	0.000	0.000			0.000		Automatic
	Rohn-DA42	Rohn-D1	5.127	L/r	7.750	Rupture	165	9.45	5.127	12.433	13.050	16.022	7.750	0.000	0.000	0.000	0.000			0.000		Automatic
	Rohn-DA5P	Rohn-D1	4.825	L/r	7.750	Rupture	170	9.74	4.825	12.433	13.050	16.022	7.750	0.000	0.000	0.000	0.000			0.000		Automatic
	Rohn-DA51	Rohn-D1	4.825	L/r	7.750	Rupture	170	9.74	4.825	12.433	13.050	16.022	7.750	0.000	0.000	0.000	0.000			0.000		Automatic
	Rohn-DA52	Rohn-D1	4.825	L/r	7.750	Rupture	170	9.74	4.825	12.433	13.050	16.022	7.750	0.000	0.000	0.000	0.000			0.000		Automatic
	Rohn-DA6P	Rohn-D1	4.825	L/r	7.750	Rupture	170	9.74	4.825	12.433	13.050	16.022	7.750	0.000	0.000	0.000	0.000			0.000		Automatic



















SNB-H7bP	SNB-H2	174.858	L/r	201.204	Net Sect	52	6.11	174.858	0.000	0.000	201.204	0.000	0.000	0.000	0.000	0.000	Automatic
SNB-H7cP	SNB-H2	174.858	L/r	201.204	Net Sect	52	6.11	174.858	0.000	0.000	201.204	0.000	0.000	0.000	0.000	0.000	Automatic
SNB-H7dP	SNB-H2	174.858	L/r	201.204	Net Sect	52	6.11	174.858	0.000	0.000	201.204	0.000	0.000	0.000	0.000	0.000	Automatic
SNB-H7eP	SNB-H2	174.858	L/r	201.204	Net Sect	52	6.11	174.858	0.000	0.000	201.204	0.000	0.000	0.000	0.000	0.000	Automatic
SNB-H7fP	SNB-H2	174.858	L/r	201.204	Net Sect	52	6.11	174.858	0.000	0.000	201.204	0.000	0.000	0.000	0.000	0.000	Automatic
SNB-H8aP	SNB-H2	169.180	L/r	201.204	Net Sect	57	6.79	169.180	0.000	0.000	201.204	0.000	0.000	0.000	0.000	0.000	Automatic
SNB-H8bP	SNB-H2	169.180	L/r	201.204	Net Sect	57	6.79	169.180	0.000	0.000	201.204	0.000	0.000	0.000	0.000	0.000	Automatic
SNB-H8cP	SNB-H2	169.180	L/r	201.204	Net Sect	57	6.79	169.180	0.000	0.000	201.204	0.000	0.000	0.000	0.000	0.000	Automatic
SNB-H8dP	SNB-H2	169.180	L/r	201.204	Net Sect	57	6.79	169.180	0.000	0.000	201.204	0.000	0.000	0.000	0.000	0.000	Automatic
SNB-H8eP	SNB-H2	169.180	L/r	201.204	Net Sect	57	6.79	169.180	0.000	0.000	201.204	0.000	0.000	0.000	0.000	0.000	Automatic
SNB-H8fP	SNB-H2	169.180	L/r	201.204	Net Sect	57	6.79	169.180	0.000	0.000	201.204	0.000	0.000	0.000	0.000	0.000	Automatic
SNB-H9aP	SNB-H2	163.108	L/r	201.204	Net Sect	63	7.47	163.108	0.000	0.000	201.204	0.000	0.000	0.000	0.000	0.000	Automatic
SNB-H9bP	SNB-H2	163.108	L/r	201.204	Net Sect	63	7.47	163.108	0.000	0.000	201.204	0.000	0.000	0.000	0.000	0.000	Automatic
SNB-H9cP	SNB-H2	163.108	L/r	201.204	Net Sect	63	7.47	163.108	0.000	0.000	201.204	0.000	0.000	0.000	0.000	0.000	Automatic
SNB-H9dP	SNB-H2	163.108	L/r	201.204	Net Sect	63	7.47	163.108	0.000	0.000	201.204	0.000	0.000	0.000	0.000	0.000	Automatic
SNB-H9eP	SNB-H2	163.108	L/r	201.204	Net Sect	63	7.47	163.108	0.000	0.000	201.204	0.000	0.000	0.000	0.000	0.000	Automatic
SNB-H9fP	SNB-H2	163.108	L/r	201.204	Net Sect	63	7.47	163.108	0.000	0.000	201.204	0.000	0.000	0.000	0.000	0.000	Automatic
SNB-WL-A1P	WLAC-1	24.875	L/r	30.456	Net Sect	62	2.02	24.875	0.000	0.000	30.456	0.000	0.000	0.000	0.000	0.000	Automatic
SNB-WL-A2P	WLAC-1	24.875	L/r	30.456	Net Sect	62	2.02	24.875	0.000	0.000	30.456	0.000	0.000	0.000	0.000	0.000	Automatic
SNB-WL-A3P	WLAC-1	24.875	L/r	30.456	Net Sect	62	2.02	24.875	0.000	0.000	30.456	0.000	0.000	0.000	0.000	0.000	Automatic
SNB-WL-B1P	WLAC-1	21.201	L/r	30.456	Net Sect	83	2.70	21.201	0.000	0.000	30.456	0.000	0.000	0.000	0.000	0.000	Automatic
SNB-WL-B2P	WLAC-1	21.201	L/r	30.456	Net Sect	83	2.70	21.201	0.000	0.000	30.456	0.000	0.000	0.000	0.000	0.000	Automatic
SNB-WL-B3P	WLAC-1	21.201	L/r	30.456	Net Sect	83	2.70	21.201	0.000	0.000	30.456	0.000	0.000	0.000	0.000	0.000	Automatic
SNB-WL-C1P	WLAC-1	17.258	L/r	30.456	Net Sect	104	3.38	17.258	0.000	0.000	30.456	0.000	0.000	0.000	0.000	0.000	Automatic
SNB-WL-C2P	WLAC-1	17.258	L/r	30.456	Net Sect	104	3.38	17.258	0.000	0.000	30.456	0.000	0.000	0.000	0.000	0.000	Automatic
SNB-WL-C3P	WLAC-1	17.258	L/r	30.456	Net Sect	104	3.38	17.258	0.000	0.000	30.456	0.000	0.000	0.000	0.000	0.000	Automatic
SNB-WL-D1P	WLAC-1	13.417	L/r	30.456	Net Sect	125	4.07	13.417	0.000	0.000	30.456	0.000	0.000	0.000	0.000	0.000	Automatic
SNB-WL-D2P	WLAC-1	13.417	L/r	30.456	Net Sect	125	4.07	13.417	0.000	0.000	30.456	0.000	0.000	0.000	0.000	0.000	Automatic
SNB-WL-D3P	WLAC-1	13.417	L/r	30.456	Net Sect	125	4.07	13.417	0.000	0.000	30.456	0.000	0.000	0.000	0.000	0.000	Automatic
SNB-WL-E1P	WLAC-2	23.157	L/r	47.304	Net Sect	116	4.75	23.157	0.000	0.000	47.304	0.000	0.000	0.000	0.000	0.000	Automatic
SNB-WL-E2P	WLAC-2	23.157	L/r	47.304	Net Sect	116	4.75	23.157	0.000	0.000	47.304	0.000	0.000	0.000	0.000	0.000	Automatic
SNB-WL-E3P	WLAC-2	23.157	L/r	47.304	Net Sect	116	4.75	23.157	0.000	0.000	47.304	0.000	0.000	0.000	0.000	0.000	Automatic
SNB-WL-F1P	WLAC-2	18.587	L/r	47.304	Net Sect	133	5.43	18.587	0.000	0.000	47.304	0.000	0.000	0.000	0.000	0.000	Automatic
SNB-WL-F2P	WLAC-2	18.587	L/r	47.304	Net Sect	133	5.43	18.587	0.000	0.000	47.304	0.000	0.000	0.000	0.000	0.000	Automatic
SNB-WL-F3P	WLAC-2	18.587	L/r	47.304	Net Sect	133	5.43	18.587	0.000	0.000	47.304	0.000	0.000	0.000	0.000	0.000	Automatic
SNB-WL-G1P	WLAC-2	14.672	L/r	47.304	Net Sect	150	6.11	14.672	0.000	0.000	47.304	0.000	0.000	0.000	0.000	0.000	Automatic
SNB-WL-G2P	WLAC-2	14.672	L/r	47.304	Net Sect	150	6.11	14.672	0.000	0.000	47.304	0.000	0.000	0.000	0.000	0.000	Automatic
SNB-WL-G3P	WLAC-2	14.672	L/r	47.304	Net Sect	150	6.11	14.672	0.000	0.000	47.304	0.000	0.000	0.000	0.000	0.000	Automatic
SNB-WL-H1P	WLAC-2	11.878	L/r	47.304	Net Sect	167	6.79	11.878	0.000	0.000	47.304	0.000	0.000	0.000	0.000	0.000	Automatic
SNB-WL-H2P	WLAC-2	11.878	L/r	47.304	Net Sect	167	6.79	11.878	0.000	0.000	47.304	0.000	0.000	0.000	0.000	0.000	Automatic
SNB-WL-H3P	WLAC-2	11.878	L/r	47.304	Net Sect	167	6.79	11.878	0.000	0.000	47.304	0.000	0.000	0.000	0.000	0.000	Automatic
SNB-WL-I1P	WLAC-2	9.810	L/r	47.304	Net Sect	183	7.47	9.810	0.000	0.000	47.304	0.000	0.000	0.000	0.000	0.000	Automatic
SNB-WL-I2P	WLAC-2	9.810	L/r	47.304	Net Sect	183	7.47	9.810	0.000	0.000	47.304	0.000	0.000	0.000	0.000	0.000	Automatic
SNB-WL-I3P	WLAC-2	9.810	L/r	47.304	Net Sect	183	7.47	9.810	0.000	0.000	47.304	0.000	0.000	0.000	0.000	0.000	Automatic

The model contains 612 angle members.

**Section Joint Information:**

Section Label	Joint Label	Joint Elevation (ft)
A	RohnAP	180.000
A	RohnAa1	175.000
A	RohnA1	180.000
A	RohnAa2	175.000
A	RohnA2	180.000
A	RohnAaS	175.000
A	RohnAb1	170.000
A	RohnAb2	170.000
A	RohnAbS	170.000
A	RohnAc1	165.000
A	RohnAc2	165.000
A	RohnAcS	165.000
A	RohnB2	160.000
A	RohnBP	160.000
A	RohnB1	160.000
A	SNB-AP	180.000

A	SNB-Aa1	175.000
A	SNB-A1	180.000
A	SNB-Aa2	175.000
A	SNB-A2	180.000
A	SNB-AaS	175.000
A	SNB-Ab1	170.000
A	SNB-Ab2	170.000
A	SNB-AbS	170.000
A	SNB-Ac1	165.000
A	SNB-Ac2	165.000
A	SNB-AcS	165.000
A	SNB-B1	160.000
A	SNB-B2	160.000
A	SNB-BP	160.000
A	SNB-WL-A1S	180.000
A	SNB-WL-A2S	180.000
A	SNB-WL-A3S	180.000
A	SNB-WL-B1S	160.000
A	SNB-WL-B2S	160.000
A	SNB-WL-B3S	160.000
B	RohnBP	160.000
B	RohnBa1	155.000
B	RohnB1	160.000
B	RohnBa2	155.000
B	RohnB2	160.000
B	RohnBaS	155.000
B	RohnBb1	150.000
B	RohnBb2	150.000
B	RohnBbS	150.000
B	RohnBc1	145.000
B	RohnBc2	145.000
B	RohnBcS	145.000
B	RohnC1	140.000
B	RohnC2	140.000
B	RohnCP	140.000
B	SNB-BP	160.000
B	SNB-Ba1	155.000
B	SNB-B1	160.000
B	SNB-Ba2	155.000
B	SNB-B2	160.000
B	SNB-BaS	155.000
B	SNB-Bb1	150.000
B	SNB-Bb2	150.000
B	SNB-BbS	150.000
B	SNB-Bc1	145.000
B	SNB-Bc2	145.000
B	SNB-BcS	145.000
B	SNB-C1	140.000
B	SNB-C2	140.000
B	SNB-CP	140.000
B	SNB-WL-C1S	140.000
B	SNB-WL-C2S	140.000
B	SNB-WL-C3S	140.000
C	RohnCP	140.000
C	RohnCa1	133.340
C	RohnC1	140.000
C	RohnCa2	133.340
C	RohnC2	140.000
C	RohnCaS	133.340
C	RohnCb1	126.660
C	RohnCb2	126.660
C	RohnCbS	126.660
C	RohnD1	120.000
C	RohnD2	120.000
C	RohnDP	120.000
C	SNB-CP	140.000
C	SNB-Ca1	133.340
C	SNB-C1	140.000
C	SNB-Ca2	133.340

C	SNB-C2	140.000
C	SNB-CaS	133.340
C	SNB-Cb1	126.660
C	SNB-Cb2	126.660
C	SNB-CbS	126.660
C	SNB-D1	120.000
C	SNB-D2	120.000
C	SNB-DP	120.000
C	SNB-WL-D1S	120.000
C	SNB-WL-D2S	120.000
C	SNB-WL-D3S	120.000
D	RohnDP	120.000
D	RohnDa1	113.340
D	RohnD1	120.000
D	RohnDa2	113.340
D	RohnD2	120.000
D	RohnDaS	113.340
D	RohnDb1	106.660
D	RohnDb2	106.660
D	RohnDbS	106.660
D	RohnE1	100.000
D	RohnE2	100.000
D	RohnEP	100.000
D	SNB-DP	120.000
D	SNB-Da1	113.340
D	SNB-D1	120.000
D	SNB-Da2	113.340
D	SNB-D2	120.000
D	SNB-DaS	113.340
D	SNB-Db1	106.660
D	SNB-Db2	106.660
D	SNB-DbS	106.660
D	SNB-E1	100.000
D	SNB-E2	100.000
D	SNB-EP	100.000
D	SNB-WL-E1S	100.000
D	SNB-WL-E2S	100.000
D	SNB-WL-E3S	100.000
E	RohnEP	100.000
E	RohnEa1	93.340
E	RohnE1	100.000
E	RohnEa2	93.340
E	RohnE2	100.000
E	RohnEaS	93.340
E	RohnEb1	86.660
E	RohnEb2	86.660
E	RohnEbS	86.660
E	RohnF1	80.000
E	RohnF2	80.000
E	RohnFP	80.000
E	SNB-EP	100.000
E	SNB-Ea1	93.340
E	SNB-E1	100.000
E	SNB-Ea2	93.340
E	SNB-E2	100.000
E	SNB-EaS	93.340
E	SNB-Eb1	86.660
E	SNB-Eb2	86.660
E	SNB-EbS	86.660
E	SNB-F1	80.000
E	SNB-F2	80.000
E	SNB-FP	80.000
E	SNB-WL-F1S	80.000
E	SNB-WL-F2S	80.000
E	SNB-WL-F3S	80.000
F	RohnFP	80.000
F	RohnFa1	70.000
F	RohnF1	80.000
F	RohnFa2	70.000

F	RohnF2	80.000
F	RohnFaS	70.000
F	RohnG1	60.000
F	RohnG2	60.000
F	RohnGP	60.000
F	SNB-FP	80.000
F	SNB-Fa1	70.000
F	SNB-F1	80.000
F	SNB-Fa2	70.000
F	SNB-F2	80.000
F	SNB-FaS	70.000
F	SNB-G1	60.000
F	SNB-G2	60.000
F	SNB-GP	60.000
F	SNB-WL-G1S	60.000
F	SNB-WL-G2S	60.000
F	SNB-WL-G3S	60.000
G	RohnGP	60.000
G	RohnGa1	50.000
G	RohnG1	60.000
G	RohnGa2	50.000
G	RohnG2	60.000
G	RohnGaS	50.000
G	RohnH1	40.000
G	RohnH2	40.000
G	RohnHP	40.000
G	SNB-GP	60.000
G	SNB-Ga1	50.000
G	SNB-G1	60.000
G	SNB-Ga2	50.000
G	SNB-G2	60.000
G	SNB-GaS	50.000
G	SNB-H1	40.000
G	SNB-H2	40.000
G	SNB-HP	40.000
G	SNB-WL-H1S	40.000
G	SNB-WL-H2S	40.000
G	SNB-WL-H3S	40.000
H	RohnHP	40.000
H	RohnHa1	30.000
H	RohnH1	40.000
H	RohnHa2	30.000
H	RohnH2	40.000
H	RohnHaS	30.000
H	RohnI1	20.000
H	RohnI2	20.000
H	RohnIP	20.000
H	SNB-HP	40.000
H	SNB-Ha1	30.000
H	SNB-H1	40.000
H	SNB-Ha2	30.000
H	SNB-H2	40.000
H	SNB-HaS	30.000
H	SNB-I1	20.000
H	SNB-I2	20.000
H	SNB-IP	20.000
H	SNB-WL-I1S	20.000
H	SNB-WL-I2S	20.000
H	SNB-WL-I3S	20.000
I	RohnIP	20.000
I	RohnIa1	10.000
I	RohnI1	20.000
I	RohnIa2	10.000
I	RohnI2	20.000
I	RohnIaS	10.000
I	RohnJ1	0.000
I	RohnJ2	0.000
I	RohnJP	0.000
I	SNB-IP	20.000

I	SNB-Ia1	10.000
I	SNB-I1	20.000
I	SNB-Ia2	10.000
I	SNB-I2	20.000
I	SNB-IaS	10.000
I	SNB-J1	0.000
I	SNB-J2	0.000
I	SNB-JP	0.000

EIA Sections Information:

Section Label	Top Z (ft)	Bottom Z (ft)	Joint Count	Member Count	Top Width (ft)	Bottom Width (ft)	Gross Area (ft^2)	Face Adjust Factor	Af Face Adjust Factor	Ar Face Adjust Factor	Dead Load Factor
A	180.000	160.000	36	111	7.50	8.87	163.75	0.9000	0.9000	1.000	1.000
B	160.000	140.000	33	93	8.87	10.23	191.05	0.9000	0.9000	1.000	1.000
C	140.000	120.000	27	72	10.23	11.60	218.31	0.9000	0.9000	1.000	1.000
D	120.000	100.000	27	72	11.60	12.96	245.54	0.9000	0.9000	1.000	1.000
E	100.000	80.000	27	72	12.96	14.32	272.78	0.9000	0.9000	1.000	1.000
F	80.000	60.000	21	51	14.32	15.68	300.04	0.9000	0.9000	1.000	1.000
G	60.000	40.000	21	51	15.68	17.05	327.29	0.9000	0.9000	1.000	1.000
H	40.000	20.000	21	51	17.05	18.41	354.57	0.9000	0.9000	1.000	1.000
I	20.000	0.000	18	39	18.41	19.78	381.92	0.9000	0.9000	1.000	1.000

Equipment Library:

Equipment Property Label	Stock Number	Weight (lbs)	Wind Area (ft^2)	Ice Area (ft^2)	Shape or EIA Antenna Type	Drag Coef.	Diameter (ft)	Height (ft)
RFS PD1142 w/ ice	Omni	10.0	1.32	0.00	Circle	1.00	0.00	0.00
Andrew DB-583 w/ ice	Omni	6.3	0.54	0.00	Circle	1.00	0.00	0.00
12` T-Arm Mount	Mount	465.0	13.60	0.00	Square	1.00	0.00	0.00
3` Stand-Off Mount	Mount	50.0	2.72	0.00	Square	1.00	0.00	0.00
Dipole Dipole	Dipole	46.0	9.17	0.00	Circle	1.00	0.00	0.00
TMA TMA	TMA	15.0	1.29	0.00	Square	1.00	0.00	0.00
GPS GPS	GPS	10.0	1.00	0.00	Circle	1.00	0.00	0.00
Powerwave 7770 Panel	Panel	35.0	5.88	0.00	Square	1.00	0.00	0.00
Raycap Surge Suppressor	Other	27.0	1.79	0.00	Circle	1.00	0.00	0.00
4` Dipole Dipole	Dipole	40.0	3.70	0.00	Circle	1.00	0.00	0.00
DB586-Y Omni	Omni	8.2	1.01	0.00	Circle	1.00	0.00	0.00
5` Dipole Dipole	Dipole	50.0	3.95	0.00	Circle	1.00	0.00	0.00
8` Omni Omni	Omni	5.0	2.00	0.00	Circle	1.00	0.00	0.00
12` Omni Omni	Omni	55.0	4.00	0.00	Circle	1.00	0.00	0.00
Boom Gate Mount	Mount	471.0	13.60	0.00	Square	1.00	0.00	0.00
Scala OGT9-806 w/ ice	Omni	18.5	2.27	0.00	Circle	1.00	0.00	0.00
Sinclair SC479-HF1LDF w/ ice	Omni	34.0	5.06	0.00	Circle	1.00	0.00	0.00
RFS APXVSP18-C w/ ice	Panel	90.0	8.26	0.00	Square	1.00	0.00	0.00
ALU RRH RRH	RRH	60.0	6.90	0.00	Square	1.00	0.00	0.00
6` Stand-Off Mount	Mount	140.0	10.60	0.00	Square	1.00	0.00	0.00
Decibel DB844H80-XY w/ ice	Panel	10.0	3.97	0.00	Square	1.00	0.00	0.00
Raycap DB-T1-6Z-8AB-0Z Dist. Box	Panel	45.0	5.60	0.00	Square	1.00	0.00	0.00
Ericsson AIR B2A/B4P Panel	Panel	110.0	6.53	0.00	Square	1.00	0.00	0.00
Decibel PD-420 2 bay - Dipole Dipole	Dipole	10.0	1.64	0.00	Square	1.00	0.00	0.00
RRHU-11 RRH Unit RRH	RRH	50.0	2.99	0.00	Square	1.00	0.00	0.00
10` Dipole Dipole	Dipole	46.0	9.17	0.00	Square	1.00	0.00	0.00
4`x1` Panel Panel	Panel	30.0	6.53	0.00	Square	1.00	0.00	0.00
DT465B-2XR-V2 Panel	Panel	88.4	9.65	0.00	Square	1.00	0.00	0.00
800 MHz RRH Unit RRH	RRH	60.0	6.90	0.00	Square	1.00	0.00	0.00
TD-RRH 8x20-25 RRH Unit RRH	RRH	66.1	4.72	0.00	Square	1.00	0.00	0.00
JAHH-65B-R3B Panel Panel	Panel	126.3	9.66	0.00	Square	1.00	0.00	0.00
BSAMNT-SBS-2-2 Mount for JAHH Antenna Mount	Mount	116.0	3.78	0.00	Square	1.00	0.00	0.00
RRH 2x60W (700 MHz) RRH	RRH	60.0	2.12	0.00	Square	1.00	0.00	0.00
RRH 4x45W (AWS) RRH	RRH	60.0	2.96	0.00	Square	1.00	0.00	0.00
RHH 2x80W (850 MHz) RRH	RRH	90.0	2.91	0.00	Square	1.00	0.00	0.00
Ericsson 4478 (B71) RRH Unit RRH	RRH	60.0	1.26	0.00	Square	1.00	0.00	0.00
AIR32 B66/B2A Panel	Panel	132.2	5.84	0.00	Square	1.00	0.00	0.00
APXVAA24_43-U-A20 (RFS) Panel	Panel	150.0	22.38	0.00	Square	1.00	0.00	0.00

Twin TMA Unit - Generic	Other	25.0	1.12	0.00	Square	1.00	0.00	0.00
Diplexer Unit - Generic	Other	25.0	0.72	0.00	Square	1.00	0.00	0.00
TMA Unit (LGP24101)	Other	14.1	1.29	0.00	Square	1.00	0.00	0.00
OPA-65-LCUU-H6 Panel	Panel	64.0	10.12	0.00	Square	1.00	0.00	0.00
RRUS-32 RRH Unit	Other	80.0	3.88	0.00	Square	1.00	0.00	0.00
4` Dish	Dish	120.0	13.10	0.00	EIA Microwave MaxCA	1.00	0.00	0.00
8` Dish with Radome	Dish	560.0	51.32	0.00	EIA Microwave Radome MaxCA	1.00	0.00	0.00

**Equipment Connectivity:**

Equipment Label	Attach Label	Equipment Property Set	EIA Orientation Angle (deg)
DNK-1	RohnGP	5` Dipole	0.00
MT-DNK1	RohnGP	3` Stand-Off	0.00
DNK2-GPS68	RohnG1	GPS	120.00
MT-DNK2	RohnG1	3` Stand-Off	120.00
DNK3-GPS69	RohnG2	GPS	240.00
MT-DNK3	RohnG2	3` Stand-Off	240.00
DNK4-DOT56	RohnG2	10` Dipole	240.00
MT-DNK4	RohnG2	3` Stand-Off	240.00
DNK5-NEU16	RohnF2	8` Omni	240.00
MT-DNK5	RohnF2	6` Stand-Off	240.00
DNK9-DEP54	RohnD1	RFS PD1142 w/ ice	120.00
MT-DNK9	RohnD1	3` Stand-Off	120.00
DNK8-CSP66	RohnD1	RFS PD1142 w/ ice	120.00
DNK7-NEU17	RohnDaS	12` Omni	0.00
MT-DNK7	RohnDaS	3` Stand-Off	0.00
Sprint-A	RohnDaS	12` T-Arm	0.00
Sprint-B	RohnDa1	12` T-Arm	120.00
Sprint-C	RohnDa2	12` T-Arm	240.00
Sprint-1	RohnDaS	RFS APXVSPP18-C w/ ice	0.00
Sprint-2	RohnDaS	ALU RRH	0.00
Sprint-3	RohnDaS	ALU RRH	0.00
Sprint-4	RohnDa1	RFS APXVSPP18-C w/ ice	120.00
Sprint-5	RohnDa1	ALU RRH	120.00
Sprint-6	RohnDa1	ALU RRH	120.00
Sprint-7	RohnDa2	RFS APXVSPP18-C w/ ice	240.00
Sprint-8	RohnDa2	ALU RRH	240.00
Sprint-9	RohnDa2	ALU RRH	240.00
Sprint-10	RohnDaS	DT465B-2XR-V2	0.00
Sprint-11	RohnDa1	DT465B-2XR-V2	120.00
Sprint-12	RohnDa2	DT465B-2XR-V2	240.00
Sprint-13	RohnDaS	800 MHz RRH Unit	0.00
Sprint-14	RohnDa1	800 MHz RRH Unit	120.00
Sprint-15	RohnDa2	800 MHz RRH Unit	240.00
Sprint-16	RohnDaS	TD-RRH 8x20-25 RRH Unit	0.00
Sprint-17	RohnDa1	TD-RRH 8x20-25 RRH Unit	120.00
Sprint-18	RohnDa2	TD-RRH 8x20-25 RRH Unit	240.00
Verizon-A	RohnCbS	Boom Gate	0.00
Verizon-B	RohnCb1	Boom Gate	120.00
Verizon-C	RohnCb2	Boom Gate	240.00
Verizon-1	RohnCbS	Decibel DB844H80-XY w/ ice	0.00
Verizon-2	RohnCbS	Decibel DB844H80-XY w/ ice	0.00
Verizon-3	RohnCb1	Decibel DB844H80-XY w/ ice	120.00
Verizon-4	RohnCb1	Decibel DB844H80-XY w/ ice	120.00
Verizon-5	RohnCb2	Decibel DB844H80-XY w/ ice	240.00
Verizon-6	RohnCb2	Decibel DB844H80-XY w/ ice	240.00
Verizon-7	RohnCbS	JAHH-65B-R3B Panel	0.00
Verizon-8	RohnCbS	JAHH-65B-R3B Panel	0.00
Verizon-9	RohnCb1	JAHH-65B-R3B Panel	120.00
Verizon-10	RohnCb1	JAHH-65B-R3B Panel	120.00
Verizon-11	RohnCb2	JAHH-65B-R3B Panel	240.00
Verizon-12	RohnCb2	JAHH-65B-R3B Panel	240.00
Verizon-D	RohnCbS	BSAMNT-SBS-2-2 Mount for JAHH Antenna	0.00
Verizon-E	RohnCb1	BSAMNT-SBS-2-2 Mount for JAHH Antenna	120.00
Verizon-F	RohnCb2	BSAMNT-SBS-2-2 Mount for JAHH Antenna	240.00



Verizon-13	RohnCbS	RRH 2x60W (700 MHz)	0.00
Verizon-14	RohnCb1	RRH 2x60W (700 MHz)	120.00
Verizon-15	RohnCb2	RRH 2x60W (700 MHz)	240.00
Verizon-16	RohnCbS	RRH 4x45W (AWS)	0.00
Verizon-17	RohnCb1	RRH 4x45W (AWS)	120.00
Verizon-18	RohnCb2	RRH 4x45W (AWS)	240.00
Verizon-19	RohnCbS	RHH 2x80W (850 MHz)	0.00
Verizon-20	RohnCb1	RHH 2x80W (850 MHz)	120.00
Verizon-21	RohnCb2	RHH 2x80W (850 MHz)	240.00
Verizon-22	RohnCbS	Raycap DB-T1-6Z-8AB-0Z Dist. Box	0.00
Verizon-23	RohnCb1	Raycap DB-T1-6Z-8AB-0Z Dist. Box	120.00
Verizon-24	RohnCb2	Raycap DB-T1-6Z-8AB-0Z Dist. Box	240.00
NEU-18	RohnCbS	12` Omni	0.00
DNK15-CSP21	RohnCa1	RFS PD1142 w/ ice	120.00
MT-DNK15	RohnCa1	3` Stand-Off	120.00
DNK-12	RohnCa2	5` Dipole	240.00
MT-DNK12	RohnCa2	3` Stand-Off	240.00
T-Mobile-1	RohnCaS	Ericsson AIR B2A/B4P	0.00
T-Mobile-2	RohnCaS	AIR32 B66/B2A	0.00
T-Mobile-3	RohnCaS	APXVAA24_43-U-A20 (RFS)	0.00
T-Mobile-4	RohnCa1	Ericsson AIR B2A/B4P	120.00
T-Mobile-5	RohnCa1	AIR32 B66/B2A	120.00
T-Mobile-6	RohnCa1	APXVAA24_43-U-A20 (RFS)	120.00
T-Mobile-7	RohnCa2	Ericsson AIR B2A/B4P	240.00
T-Mobile-8	RohnCa2	AIR32 B66/B2A	240.00
T-Mobile-9	RohnCa2	APXVAA24_43-U-A20 (RFS)	240.00
T-Mobile-10	RohnCaS	Twin TMA Unit - Generic	0.00
T-Mobile-11	RohnCa1	Twin TMA Unit - Generic	120.00
T-Mobile-12	RohnCa2	Twin TMA Unit - Generic	240.00
T-Mobile-13	RohnCaS	RRHU-11 RRH Unit	0.00
T-Mobile-14	RohnCa1	RRHU-11 RRH Unit	120.00
T-Mobile-15	RohnCa2	RRHU-11 RRH Unit	240.00
T-Mobile-16	RohnCaS	Ericsson 4478 (B71) RRH Unit	0.00
T-Mobile-17	RohnCa1	Ericsson 4478 (B71) RRH Unit	120.00
T-Mobile-18	RohnCa2	Ericsson 4478 (B71) RRH Unit	240.00
T-Mobile-19	RohnCaS	Diplexer Unit - Generic	0.00
T-Mobile-20	RohnCa1	Diplexer Unit - Generic	120.00
T-Mobile-21	RohnCa2	Diplexer Unit - Generic	240.00
ATT-A	RohnBbS	12` T-Arm	0.00
ATT-B	RohnBb1	12` T-Arm	120.00
ATT-C	RohnBb2	12` T-Arm	240.00
ATT-A1	RohnBbS	Powerwave 7770	0.00
ATT-A2	RohnBbS	Powerwave 7770	0.00
ATT-A3	RohnBbS	RRHU-11 RRH Unit	0.00
ATT-A4	RohnBbS	TMA Unit (LGP24101)	0.00
ATT-A5	RohnBbS	TMA Unit (LGP24101)	0.00
ATT-A6	RohnBbS	Raycap Surge Suppressor	0.00
ATT-A7	RohnBbS	OPA-65-LCUU-H6 Panel	0.00
ATT-A8	RohnBbS	RRUS-32 RRH Unit	0.00
ATT-B1	RohnBb1	RRHU-11 RRH Unit	120.00
ATT-B2	RohnBb1	TMA Unit (LGP24101)	120.00
ATT-B3	RohnBb1	TMA Unit (LGP24101)	120.00
ATT-B4	RohnBb1	OPA-65-LCUU-H6 Panel	120.00
ATT-B5	RohnBb1	RRUS-32 RRH Unit	120.00
ATT-C1	RohnBb2	RRHU-11 RRH Unit	240.00
ATT-C2	RohnBb2	TMA Unit (LGP24101)	240.00
ATT-C3	RohnBb2	TMA Unit (LGP24101)	240.00
ATT-C4	RohnBb2	OPA-65-LCUU-H6 Panel	240.00
ATT-C5	RohnBb2	RRUS-32 RRH Unit	240.00
CSP-70	RohnBP	Sinclair SC479-HF1LDF w/ ice	0.00
CSP-71	RohnB1	Sinclair SC479-HF1LDF w/ ice	120.00
CSP-72	RohnB2	Sinclair SC479-HF1LDF w/ ice	240.00
CSP-73	RohnB2	TMA	240.00
DNK21-SPD9	RohnBP	8` Dish with Radome	0.00
DNK20-UNKNOWN	RohnBP	4`x1` Panel	240.00
DNK19-STAM63	RohnB1	4`x1` Panel	120.00
159-A	RohnBP	3` Stand-Off	0.00
159-B	RohnB1	3` Stand-Off	120.00
160	RohnBP	3` Stand-Off	240.00

DNK22-TOG-6	RohnAcS	DB586-Y	0.00
DNK23-STAM64	RohnAcS	4`x1` Panel	0.00
DNK23-STAM65	RohnAcS	TMA	0.00
GRN-1 (DNK25)	RohnAb1	4` Dish	120.00
DNK26aCSP-67	RohnAaS	Dipole	0.00
DNK26bNEU-20	RohnAa1	4` Dipole	0.00
DNK27A-CSP4	RohnAa2	Sinclair SC479-HF1LDF w/ ice	240.00
DNK27B-CSP2	RohnAa2	Scala OGT9-806 w/ ice	120.00
DNK27C-CSP74	RohnAa1	TMA	120.00
DNK28A-CSP1	RohnAa1	Scala OGT9-806 w/ ice	120.00
DNK28B-CSP3	RohnAa2	Sinclair SC479-HF1LDF w/ ice	240.00
DNK28C-TOG5	RohnAaS	Andrew DB-583 w/ ice	0.00
DNK28D-NEU55	RohnAa2	Decibel PD-420 2 bay - Dipole	240.00
Top-A	RohnAP	6` Stand-Off	0.00
Top-B	RohnA1	6` Stand-Off	120.00
Top-C1	RohnA2	6` Stand-Off	260.00
Top-C2	RohnA2	6` Stand-Off	220.00
ATT-B7	RohnBb1	Powerwave 7770	120.00
ATT-B8	RohnBb1	Powerwave 7770	120.00
ATT-C7	RohnBb2	Powerwave 7770	240.00
ATT-C8	RohnBb2	Powerwave 7770	240.00

**Linear Appurtenances:**

Description	From (ft)	To (ft)	Quantity	Shape	Width or Diameter (in)	Perimeter (in)	Unit Weight (lbs/ft)	In Face Zone	Include in Wind Load
Full Cable Tray 2-150 (wind only)	2	150	2	Flat	24	0	0	Yes	Yes
Full Cable Tray 150-top (wind only)	150	180	1	Flat	24	0	0	Yes	Yes
DNK1-7/8" @ 56`	2	180	1	Round	0	0	1.30128	Yes	No
DNK2-7/8" @ 54`	2	180	1	Round	0	0	1.30128	Yes	No
DNK3-7/8" @ 60`	2	180	1	Round	0	0	1.30128	Yes	No
DNK4-7/8" @ 65`	2	180	1	Round	0	0	1.30128	Yes	No
DNK5-1-5/8" @ 82`	2	180	1	Round	0	0	2.33495	Yes	No
DNK6-Hybriflex Cables @ Sprint	2	180	4	Round	0	0	0.9	Yes	No
DNK7-7/8" @ 110`	2	180	1	Round	0	0	1.30128	Yes	No
DNK8-7/8" @ 122`	2	180	1	Round	0	0	1.30128	Yes	No
DNK9-7/8" @ 122`	2	180	1	Round	0	0	1.30128	Yes	No
DNK10-1-5/8" @ VZW	2	180	6	Round	0	0	2.33495	Yes	No
DNK11-1-5/8" @ 130`	2	180	1	Round	0	0	2.33495	Yes	No
DNK12-7/8" @ 135`	2	180	1	Round	0	0	1.30128	Yes	No
DNK13,14-1-5/8" @ T-Mobile	2	180	6	Round	0	0	2.33495	Yes	No
DNK15-7/8" @ 137`	2	180	1	Round	0	0	1.30128	Yes	No
DNK16,17,18-1-5/8" @ ATT	2	180	12	Round	0	0	2.33495	Yes	No
DNK16,17,18-Optic Fiber Cable @ ATT	2	180	1	Round	0	0	1.3	Yes	No
DNK16,17,18-DC Cable @ ATT	2	180	2	Round	0	0	0.3	Yes	No
DNK19-7/8" @ 159`	2	180	1	Round	0	0	1.30128	Yes	No
DNK20-7/8" @ 159.5`	2	180	1	Round	0	0	1.30128	Yes	No
CSP70,71,72-1-5/8" @ 160` (3)	2	180	3	Round	0	0	2.33495	Yes	No
CSP73-1/2" @ 160`	2	180	1	Round	0	0	0.840278	Yes	No
DNK21-Ellipitical @ 160`	2	180	1	Round	0	0	1.24804	Yes	No
DNK22-7/8" @ 165`	2	180	1	Round	0	0	1.30128	Yes	No
DNK23A-1-5/8" @ 168`	2	180	1	Round	0	0	2.33495	Yes	No
DNK23B-1/2" @ 168`	2	180	1	Round	0	0	0.840278	Yes	No
DNK26-B-1-5/8" @ 175`	2	180	1	Round	0	0	2.33495	Yes	No
DNK26A-7/8" @ 175`	2	180	1	Round	0	0	1.30128	Yes	No
DNK26C-1/2" @ 175`	2	180	1	Round	0	0	0.840278	Yes	No
DNK27-B-1-5/8" @ 175`	2	180	1	Round	0	0	2.33495	Yes	No
DNK27A-7/8" @ 175`	2	180	1	Round	0	0	1.30128	Yes	No
DNK27C-3/8" @ 175`	2	180	1	Round	0	0	0.654213	Yes	No
DNK28A-1-5/8" @ 175`	2	180	1	Round	0	0	2.33495	Yes	No
DNK28B-1-5/8" @ 175`	2	180	1	Round	0	0	2.33495	Yes	No
DNK28C-1-5/8" @ 175`	2	180	1	Round	0	0	2.33495	Yes	No
DNK28D-7/8" @ 175`	2	180	1	Round	0	0	1.30128	Yes	No
GRN-1-Ellipitical @ 172` (DNK25)	2	180	1	Round	0	0	1.24804	Yes	No
VZW-(3) Hybriflex Cables	2	180	3	Round	0	0	1.3	Yes	No
Hybriflex 6x12 Cables @ T-Mobile	2	180	2	Round	0	0	1.7	Yes	No
Hybriflex 9x18 Cables @ T-Mobile	2	180	1	Round	0	0	0.9	Yes	No



\*\*\* Loads Data

Loads from file: p:\projects\telcom\structuralsbylocation\connecticut\greenwichcsp#74\10-02152018\_multicarrier mod\\_pls\_g\pls-tower\_wind\_0\4-carir.eia

Structure Height Summary (used for calculating wind/ice adjust with height):

Structure height above ground 180.00 (ft)  
 Elevation of structure bottom for wind height adjustment: 0.00 (ft)  
 Structure height for structure gust response factor: 180.00 (ft)  
 Structure gust response factor, Gh: 0.8500  
 Mean wind conversion factor, m: 0.6000  
 Wind direction probability factor, Kd, for structures: 0.85, for appurtenances: 0.85  
 Structure fundamental frequency, f1: 2.0198 (Hz)  
 Guy installation temperature: 60.00 (deg F)  
 Tower Type: Triangular Latticed

ANSI/TIA 222-G Load Options:

Structure Class 3  
 Exposure Category C Open terrain  
 Topographic Category 2 (Kzt calculated based on crest height, H, of 36.00 (ft))  
 Spectral Response SDS 0.276  
 Spectral Response SD1 0.112

EIA Rev. G Load Cases:

Load Case Description	Dead Load Factor	Wind Load Factor	Strength Factor	Load Case Type	Basic Wind Speed (mph)	Wind Dir. (Deg)	Mean Wind Start Elevation (ft)	Mean Wind Stop Elevation (ft)	Ice Thick. (in)	Ice Density (lbs/ft^3)	Temperature (deg F)	Point Loads	Joint Displ.
1: 1.2D + 1.0Dg + 1.6Wo	1.2000	1.6000	1.0000	Regular	94.000	0	0.00	0.00	0.0000	0.0000	60.0		
2: 0.9D + 1.0Dg + 1.6Wo	0.9000	1.6000	1.0000	Regular	94.000	0	0.00	0.00	0.0000	0.0000	60.0		
4: 1.2D + 1.0Dg + 1.0E	1.2000	1.0000	1.0000	Earthquake	0.000	0	0.00	0.00	0.0000	0.0000	60.0		
5: 0.9D + 1.0Dg + 1.0E	0.9000	1.0000	1.0000	Earthquake	0.000	0	0.00	0.00	0.0000	0.0000	60.0		
6: Service 1.0D + 1.0Dg + 1.0 Wo	1.0000	1.0000	1.0000	Service	60.000	0	0.00	0.00	0.0000	0.0000	60.0		
1.2*DL	1.2000	1.0000	1.0000	Regular	0.000	0	0.00	0.00	0.0000	0.0000	60.0		
0.9DL	0.9000	1.0000	1.0000	Regular	0.000	0	0.00	0.00	0.0000	0.0000	60.0		

Equipment Load Case Information for "1: 1.2D + 1.0Dg + 1.6Wo":

Equipment Label	Equipment Property Set	Elevation Above Ground (ft)	qzGh (psf)	Ice Thick. (in)	Total Wind Area (ft^2)	Wind Incidence Angle (deg)	222-G CA	222-G CS	222-G CM	Antenna Axial Load (lbs)	Antenna Side Load (lbs)	Antenna Moment (ft-lbs)	Long. Load (lbs)	Trans. Load (lbs)	Vert. Load (lbs)
DNK-1	5` Dipole	60.00	37.91	0.00	3.95	0.00							149.91	0.00	60.00
MT-DNK1	3` Stand-Off	60.00	37.91	0.00	2.72	0.00							103.13	0.00	60.00
DNK2-GPS68	GPS	60.00	37.91	0.00	1.00	120.00							37.91	0.00	12.00
MT-DNK2	3` Stand-Off	60.00	37.91	0.00	2.72	120.00							103.13	0.00	60.00
DNK3-GPS69	GPS	60.00	37.91	0.00	1.00	240.00							37.91	0.00	12.00
MT-DNK3	3` Stand-Off	60.00	37.91	0.00	2.72	240.00							103.13	0.00	60.00
DNK4-DOT56	10` Dipole	60.00	37.91	0.00	9.17	240.00							347.55	0.00	55.20
MT-DNK4	3` Stand-Off	60.00	37.91	0.00	2.72	240.00							103.13	0.00	60.00
DNK5-NEU16	8` Omni	80.00	38.26	0.00	2.00	240.00							76.52	0.00	6.00
MT-DNK5	6` Stand-Off	80.00	38.26	0.00	10.60	240.00							405.54	0.00	168.00
DNK9-DEP54	RFS PD1142 w/ ice	120.00	40.05	0.00	1.32	120.00							52.71	0.00	12.00
MT-DNK9	3` Stand-Off	120.00	40.05	0.00	2.72	120.00							108.95	0.00	60.00
DNK8-CSP66	RFS PD1142 w/ ice	120.00	40.05	0.00	1.32	120.00							52.71	0.00	12.00
DNK7-NEU17	12` Omni	113.34	39.71	0.00	4.00	0.00							158.85	0.00	66.00
MT-DNK7	3` Stand-Off	113.34	39.71	0.00	2.72	0.00							108.02	0.00	60.00
Sprint-A	12` T-Arm	113.34	39.71	0.00	13.60	0.00							540.09	0.00	558.00
Sprint-B	12` T-Arm	113.34	39.71	0.00	13.60	120.00							540.09	0.00	558.00
Sprint-C	12` T-Arm	113.34	39.71	0.00	13.60	240.00							540.09	0.00	558.00
Sprint-1	RFS APXVSP18-C w/ ice	113.34	39.71	0.00	8.26	0.00							328.03	0.00	108.00
Sprint-2	ALU RRH	113.34	39.71	0.00	6.90	0.00							273.89	0.00	72.00
Sprint-3	ALU RRH	113.34	39.71	0.00	6.90	0.00							273.89	0.00	72.00

Sprint-4	RFS APXVSP18-C w/ ice	113.34	39.71	0.00	8.26	120.00	328.03	0.00	108.00
Sprint-5	ALU RRH	113.34	39.71	0.00	6.90	120.00	273.89	0.00	72.00
Sprint-6	ALU RRH	113.34	39.71	0.00	6.90	120.00	273.89	0.00	72.00
Sprint-7	RFS APXVSP18-C w/ ice	113.34	39.71	0.00	8.26	240.00	328.03	0.00	108.00
Sprint-8	ALU RRH	113.34	39.71	0.00	6.90	240.00	273.89	0.00	72.00
Sprint-9	ALU RRH	113.34	39.71	0.00	6.90	240.00	273.89	0.00	72.00
Sprint-10	DT465B-2XR-V2	113.34	39.71	0.00	9.65	0.00	383.09	0.00	106.08
Sprint-11	DT465B-2XR-V2	113.34	39.71	0.00	9.65	120.00	383.09	0.00	106.08
Sprint-12	DT465B-2XR-V2	113.34	39.71	0.00	9.65	240.00	383.09	0.00	106.08
Sprint-13	800 MHz RRH Unit	113.34	39.71	0.00	6.90	0.00	273.89	0.00	72.00
Sprint-14	800 MHz RRH Unit	113.34	39.71	0.00	6.90	120.00	273.89	0.00	72.00
Sprint-15	800 MHz RRH Unit	113.34	39.71	0.00	6.90	240.00	273.89	0.00	72.00
Sprint-16	TD-RRH 8x20-25 RRH Unit	113.34	39.71	0.00	4.72	0.00	187.43	0.00	79.36
Sprint-17	TD-RRH 8x20-25 RRH Unit	113.34	39.71	0.00	4.72	120.00	187.43	0.00	79.36
Sprint-18	TD-RRH 8x20-25 RRH Unit	113.34	39.71	0.00	4.72	240.00	187.43	0.00	79.36
Verizon-A	Boom Gate	126.66	40.40	0.00	13.60	0.00	549.47	0.00	565.20
Verizon-B	Boom Gate	126.66	40.40	0.00	13.60	120.00	549.47	0.00	565.20
Verizon-C	Boom Gate	126.66	40.40	0.00	13.60	240.00	549.47	0.00	565.20
Verizon-1	Decibel DB844H80-XY w/ ice	126.66	40.40	0.00	3.97	0.00	160.26	0.00	12.00
Verizon-2	Decibel DB844H80-XY w/ ice	126.66	40.40	0.00	3.97	0.00	160.26	0.00	12.00
Verizon-3	Decibel DB844H80-XY w/ ice	126.66	40.40	0.00	3.97	120.00	160.26	0.00	12.00
Verizon-4	Decibel DB844H80-XY w/ ice	126.66	40.40	0.00	3.97	120.00	160.26	0.00	12.00
Verizon-5	Decibel DB844H80-XY w/ ice	126.66	40.40	0.00	3.97	240.00	160.26	0.00	12.00
Verizon-6	Decibel DB844H80-XY w/ ice	126.66	40.40	0.00	3.97	240.00	160.26	0.00	12.00
Verizon-7	JAHH-65B-R3B Panel	126.66	40.40	0.00	9.66	0.00	390.28	0.00	151.56
Verizon-8	JAHH-65B-R3B Panel	126.66	40.40	0.00	9.66	0.00	390.28	0.00	151.56
Verizon-9	JAHH-65B-R3B Panel	126.66	40.40	0.00	9.66	120.00	390.28	0.00	151.56
Verizon-10	JAHH-65B-R3B Panel	126.66	40.40	0.00	9.66	120.00	390.28	0.00	151.56
Verizon-11	JAHH-65B-R3B Panel	126.66	40.40	0.00	9.66	240.00	390.28	0.00	151.56
Verizon-12	JAHH-65B-R3B Panel	126.66	40.40	0.00	9.66	240.00	390.28	0.00	151.56
Verizon-D	BSAMNT-SBS-2-2 Mount for JAHH Antenna	126.66	40.40	0.00	3.78	0.00	152.88	0.00	139.20
Verizon-E	BSAMNT-SBS-2-2 Mount for JAHH Antenna	126.66	40.40	0.00	3.78	120.00	152.88	0.00	139.20
Verizon-F	BSAMNT-SBS-2-2 Mount for JAHH Antenna	126.66	40.40	0.00	3.78	240.00	152.88	0.00	139.20
Verizon-13	RRH 2x60W (700 MHz)	126.66	40.40	0.00	2.12	0.00	85.60	0.00	72.00
Verizon-14	RRH 2x60W (700 MHz)	126.66	40.40	0.00	2.12	120.00	85.60	0.00	72.00
Verizon-15	RRH 2x60W (700 MHz)	126.66	40.40	0.00	2.12	240.00	85.60	0.00	72.00
Verizon-16	RRH 4x45W (AWS)	126.66	40.40	0.00	2.96	0.00	119.58	0.00	72.00
Verizon-17	RRH 4x45W (AWS)	126.66	40.40	0.00	2.96	120.00	119.58	0.00	72.00
Verizon-18	RRH 4x45W (AWS)	126.66	40.40	0.00	2.96	240.00	119.58	0.00	72.00
Verizon-19	RHH 2x80W (850 MHz)	126.66	40.40	0.00	2.91	0.00	117.45	0.00	108.00
Verizon-20	RHH 2x80W (850 MHz)	126.66	40.40	0.00	2.91	120.00	117.45	0.00	108.00
Verizon-21	RHH 2x80W (850 MHz)	126.66	40.40	0.00	2.91	240.00	117.45	0.00	108.00
Verizon-22	Raycap DB-T1-6Z-8AB-0Z Dist. Box	126.66	40.40	0.00	5.60	0.00	226.25	0.00	54.00
Verizon-23	Raycap DB-T1-6Z-8AB-0Z Dist. Box	126.66	40.40	0.00	5.60	120.00	226.25	0.00	54.00
Verizon-24	Raycap DB-T1-6Z-8AB-0Z Dist. Box	126.66	40.40	0.00	5.60	240.00	226.25	0.00	54.00
NEU-18	12` Omni	126.66	40.40	0.00	4.00	0.00	161.61	0.00	66.00
DNK15-CSP21	RFS PD1142 w/ ice	133.34	40.75	0.00	1.32	120.00	53.63	0.00	12.00
MT-DNK15	3` Stand-Off	133.34	40.75	0.00	2.72	120.00	110.85	0.00	60.00
DNK-12	5` Dipole	133.34	40.75	0.00	3.95	240.00	161.13	0.00	60.00
MT-DNK12	3` Stand-Off	133.34	40.75	0.00	2.72	240.00	110.85	0.00	60.00
T-Mobile-1	Ericsson AIR B2A/B4P	133.34	40.75	0.00	6.53	0.00	266.25	0.00	132.02
T-Mobile-2	AIR32 B66/B2A	133.34	40.75	0.00	5.84	0.00	238.18	0.00	158.64
T-Mobile-3	APXVAA24_43-U-A20 (RFS)	133.34	40.75	0.00	22.38	0.00	911.91	0.00	180.00
T-Mobile-4	Ericsson AIR B2A/B4P	133.34	40.75	0.00	6.53	120.00	266.25	0.00	132.02
T-Mobile-5	AIR32 B66/B2A	133.34	40.75	0.00	5.84	120.00	238.18	0.00	158.64
T-Mobile-6	APXVAA24_43-U-A20 (RFS)	133.34	40.75	0.00	22.38	120.00	911.91	0.00	180.00
T-Mobile-7	Ericsson AIR B2A/B4P	133.34	40.75	0.00	6.53	240.00	266.25	0.00	132.02
T-Mobile-8	AIR32 B66/B2A	133.34	40.75	0.00	5.84	240.00	238.18	0.00	158.64
T-Mobile-9	APXVAA24_43-U-A20 (RFS)	133.34	40.75	0.00	22.38	240.00	911.91	0.00	180.00
T-Mobile-10	Twin TMA Unit - Generic	133.34	40.75	0.00	1.12	0.00	45.82	0.00	30.00
T-Mobile-11	Twin TMA Unit - Generic	133.34	40.75	0.00	1.12	120.00	45.82	0.00	30.00
T-Mobile-12	Twin TMA Unit - Generic	133.34	40.75	0.00	1.12	240.00	45.82	0.00	30.00
T-Mobile-13	RRHU-11 RRH Unit	133.34	40.75	0.00	2.99	0.00	122.01	0.00	60.00
T-Mobile-14	RRHU-11 RRH Unit	133.34	40.75	0.00	2.99	120.00	122.01	0.00	60.00
T-Mobile-15	RRHU-11 RRH Unit	133.34	40.75	0.00	2.99	240.00	122.01	0.00	60.00
T-Mobile-16	Ericsson 4478 (B71) RRH Unit	133.34	40.75	0.00	1.26	0.00	51.49	0.00	72.00
T-Mobile-17	Ericsson 4478 (B71) RRH Unit	133.34	40.75	0.00	1.26	120.00	51.49	0.00	72.00
T-Mobile-18	Ericsson 4478 (B71) RRH Unit	133.34	40.75	0.00	1.26	240.00	51.49	0.00	72.00
T-Mobile-19	Diplexer Unit - Generic	133.34	40.75	0.00	0.72	0.00	29.54	0.00	30.00



E	100.00	80.00	90.00	38.62	0.00	37.01	40.26	20.85	272.8	0.28	1.00	1.00	0.50	2.34	57.9	5233	80.00	2.00	0.00	0.60	0.00	6180	11412	12042
F	80.00	60.00	70.00	38.01	0.00	37.32	43.90	21.91	300.0	0.27	1.00	1.00	0.49	2.38	59.2	5351	80.00	2.00	0.00	0.60	0.00	6081	11432	12661
G	60.00	40.00	50.00	38.04	0.00	42.28	50.37	25.41	327.3	0.28	1.00	1.00	0.50	2.34	67.7	6031	80.00	2.00	0.00	0.60	0.00	6087	12118	14137
H	40.00	20.00	30.00	39.16	0.00	48.05	50.83	25.47	354.6	0.28	1.00	1.00	0.49	2.35	73.5	6776	80.00	2.00	0.00	0.60	0.00	6265	13042	15046
I	20.00	0.00	10.00	43.43	0.00	59.30	58.17	29.86	381.9	0.31	1.00	1.00	0.51	2.28	89.2	8813	72.00	2.00	0.00	0.60	0.00	6254	15067	15157

Equipment Load Case Information for "2: 0.9D + 1.0Dg + 1.6Wo":

Equipment Label	Equipment Property Set	Elevation Above Ground (ft)	qzGh (psf)	Ice Thick. (in)	Total Wind Area (ft^2)	Wind Incidence Angle (deg)	222-G CA	222-G CS	222-G CM	Antenna Axial Load (lbs)	Antenna Side Load (lbs)	Antenna Moment (ft-lbs)	Long. Load (lbs)	Trans. Load (lbs)	Vert. Load (lbs)
DNK-1	5` Dipole	60.00	37.91	0.00	3.95	0.00							149.91	0.00	45.00
MT-DNK1	3` Stand-Off	60.00	37.91	0.00	2.72	0.00							103.13	0.00	45.00
DNK2-GPS68	GPS	60.00	37.91	0.00	1.00	120.00							37.91	0.00	9.00
MT-DNK2	3` Stand-Off	60.00	37.91	0.00	2.72	120.00							103.13	0.00	45.00
DNK3-GPS69	GPS	60.00	37.91	0.00	1.00	240.00							37.91	0.00	9.00
MT-DNK3	3` Stand-Off	60.00	37.91	0.00	2.72	240.00							103.13	0.00	45.00
DNK4-DOT56	10` Dipole	60.00	37.91	0.00	9.17	240.00							347.55	0.00	41.40
MT-DNK4	3` Stand-Off	60.00	37.91	0.00	2.72	240.00							103.13	0.00	45.00
DNK5-NEU16	8` Omni	80.00	38.26	0.00	2.00	240.00							76.52	0.00	4.50
MT-DNK5	6` Stand-Off	80.00	38.26	0.00	10.60	240.00							405.54	0.00	126.00
DNK9-DEP54	RFS PD1142 w/ ice	120.00	40.05	0.00	1.32	120.00							52.71	0.00	9.00
MT-DNK9	3` Stand-Off	120.00	40.05	0.00	2.72	120.00							108.95	0.00	45.00
DNK8-CSP66	RFS PD1142 w/ ice	120.00	40.05	0.00	1.32	120.00							52.71	0.00	9.00
DNK7-NEU17	12` Omni	113.34	39.71	0.00	4.00	0.00							158.85	0.00	49.50
MT-DNK7	3` Stand-Off	113.34	39.71	0.00	2.72	0.00							108.02	0.00	45.00
Sprint-A	12` T-Arm	113.34	39.71	0.00	13.60	0.00							540.09	0.00	418.50
Sprint-B	12` T-Arm	113.34	39.71	0.00	13.60	120.00							540.09	0.00	418.50
Sprint-C	12` T-Arm	113.34	39.71	0.00	13.60	240.00							540.09	0.00	418.50
Sprint-1	RFS APXVSP18-C w/ ice	113.34	39.71	0.00	8.26	0.00							328.03	0.00	81.00
Sprint-2	ALU RRH	113.34	39.71	0.00	6.90	0.00							273.89	0.00	54.00
Sprint-3	ALU RRH	113.34	39.71	0.00	6.90	0.00							273.89	0.00	54.00
Sprint-4	RFS APXVSP18-C w/ ice	113.34	39.71	0.00	8.26	120.00							328.03	0.00	81.00
Sprint-5	ALU RRH	113.34	39.71	0.00	6.90	120.00							273.89	0.00	54.00
Sprint-6	ALU RRH	113.34	39.71	0.00	6.90	120.00							273.89	0.00	54.00
Sprint-7	RFS APXVSP18-C w/ ice	113.34	39.71	0.00	8.26	240.00							328.03	0.00	81.00
Sprint-8	ALU RRH	113.34	39.71	0.00	6.90	240.00							273.89	0.00	54.00
Sprint-9	ALU RRH	113.34	39.71	0.00	6.90	240.00							273.89	0.00	54.00
Sprint-10	DT465B-2XR-V2	113.34	39.71	0.00	9.65	0.00							383.09	0.00	79.56
Sprint-11	DT465B-2XR-V2	113.34	39.71	0.00	9.65	120.00							383.09	0.00	79.56
Sprint-12	DT465B-2XR-V2	113.34	39.71	0.00	9.65	240.00							383.09	0.00	79.56
Sprint-13	800 MHz RRH Unit	113.34	39.71	0.00	6.90	0.00							273.89	0.00	54.00
Sprint-14	800 MHz RRH Unit	113.34	39.71	0.00	6.90	120.00							273.89	0.00	54.00
Sprint-15	800 MHz RRH Unit	113.34	39.71	0.00	6.90	240.00							273.89	0.00	54.00
Sprint-16	TD-RRH 8x20-25 RRH Unit	113.34	39.71	0.00	4.72	0.00							187.43	0.00	59.52
Sprint-17	TD-RRH 8x20-25 RRH Unit	113.34	39.71	0.00	4.72	120.00							187.43	0.00	59.52
Sprint-18	TD-RRH 8x20-25 RRH Unit	113.34	39.71	0.00	4.72	240.00							187.43	0.00	59.52
Verizon-A	Boom Gate	126.66	40.40	0.00	13.60	0.00							549.47	0.00	423.90
Verizon-B	Boom Gate	126.66	40.40	0.00	13.60	120.00							549.47	0.00	423.90
Verizon-C	Boom Gate	126.66	40.40	0.00	13.60	240.00							549.47	0.00	423.90
Verizon-1	Decibel DB844H80-XY w/ ice	126.66	40.40	0.00	3.97	0.00							160.26	0.00	9.00
Verizon-2	Decibel DB844H80-XY w/ ice	126.66	40.40	0.00	3.97	0.00							160.26	0.00	9.00
Verizon-3	Decibel DB844H80-XY w/ ice	126.66	40.40	0.00	3.97	120.00							160.26	0.00	9.00
Verizon-4	Decibel DB844H80-XY w/ ice	126.66	40.40	0.00	3.97	120.00							160.26	0.00	9.00
Verizon-5	Decibel DB844H80-XY w/ ice	126.66	40.40	0.00	3.97	240.00							160.26	0.00	9.00
Verizon-6	Decibel DB844H80-XY w/ ice	126.66	40.40	0.00	3.97	240.00							160.26	0.00	9.00
Verizon-7	JAHH-65B-R3B Panel	126.66	40.40	0.00	9.66	0.00							390.28	0.00	113.67
Verizon-8	JAHH-65B-R3B Panel	126.66	40.40	0.00	9.66	0.00							390.28	0.00	113.67
Verizon-9	JAHH-65B-R3B Panel	126.66	40.40	0.00	9.66	120.00							390.28	0.00	113.67
Verizon-10	JAHH-65B-R3B Panel	126.66	40.40	0.00	9.66	120.00							390.28	0.00	113.67
Verizon-11	JAHH-65B-R3B Panel	126.66	40.40	0.00	9.66	240.00							390.28	0.00	113.67
Verizon-12	JAHH-65B-R3B Panel	126.66	40.40	0.00	9.66	240.00							390.28	0.00	113.67
Verizon-D	BSAMNT-SBS-2-2 Mount for JAHH Antenna	126.66	40.40	0.00	3.78	0.00							152.88	0.00	104.40
Verizon-E	BSAMNT-SBS-2-2 Mount for JAHH Antenna	126.66	40.40	0.00	3.78	120.00							152.88	0.00	104.40
Verizon-F	BSAMNT-SBS-2-2 Mount for JAHH Antenna	126.66	40.40	0.00	3.78	240.00							152.88	0.00	104.40
Verizon-13	RRH 2x60W (700 MHz)	126.66	40.40	0.00	2.12	0.00							85.60	0.00	54.00
Verizon-14	RRH 2x60W (700 MHz)	126.66	40.40	0.00	2.12	120.00							85.60	0.00	54.00

Verizon-15	RRH 2x60W (700 MHz)	126.66	40.40	0.00	2.12	240.00	85.60	0.00	54.00
Verizon-16	RRH 4x45W (AWS)	126.66	40.40	0.00	2.96	0.00	119.58	0.00	54.00
Verizon-17	RRH 4x45W (AWS)	126.66	40.40	0.00	2.96	120.00	119.58	0.00	54.00
Verizon-18	RRH 4x45W (AWS)	126.66	40.40	0.00	2.96	240.00	119.58	0.00	54.00
Verizon-19	RHH 2x80W (850 MHz)	126.66	40.40	0.00	2.91	0.00	117.45	0.00	81.00
Verizon-20	RHH 2x80W (850 MHz)	126.66	40.40	0.00	2.91	120.00	117.45	0.00	81.00
Verizon-21	RHH 2x80W (850 MHz)	126.66	40.40	0.00	2.91	240.00	117.45	0.00	81.00
Verizon-22	Raycap DB-T1-6Z-8AB-0Z Dist. Box	126.66	40.40	0.00	5.60	0.00	226.25	0.00	40.50
Verizon-23	Raycap DB-T1-6Z-8AB-0Z Dist. Box	126.66	40.40	0.00	5.60	120.00	226.25	0.00	40.50
Verizon-24	Raycap DB-T1-6Z-8AB-0Z Dist. Box	126.66	40.40	0.00	5.60	240.00	226.25	0.00	40.50
NEU-18	12` Omni	126.66	40.40	0.00	4.00	0.00	161.61	0.00	49.50
DNK15-CSP21	RFS PD1142 w/ ice	133.34	40.75	0.00	1.32	120.00	53.63	0.00	9.00
MT-DNK15	3` Stand-Off	133.34	40.75	0.00	2.72	120.00	110.85	0.00	45.00
DNK-12	5` Dipole	133.34	40.75	0.00	3.95	240.00	161.13	0.00	45.00
MT-DNK12	3` Stand-Off	133.34	40.75	0.00	2.72	240.00	110.85	0.00	45.00
T-Mobile-1	Ericsson AIR B2A/B4P	133.34	40.75	0.00	6.53	0.00	266.25	0.00	99.02
T-Mobile-2	AIR32 B66/B2A	133.34	40.75	0.00	5.84	0.00	238.18	0.00	118.98
T-Mobile-3	APXVAA24_43-U-A20 (RFS)	133.34	40.75	0.00	22.38	0.00	911.91	0.00	135.00
T-Mobile-4	Ericsson AIR B2A/B4P	133.34	40.75	0.00	6.53	120.00	266.25	0.00	99.02
T-Mobile-5	AIR32 B66/B2A	133.34	40.75	0.00	5.84	120.00	238.18	0.00	118.98
T-Mobile-6	APXVAA24_43-U-A20 (RFS)	133.34	40.75	0.00	22.38	120.00	911.91	0.00	135.00
T-Mobile-7	Ericsson AIR B2A/B4P	133.34	40.75	0.00	6.53	240.00	266.25	0.00	99.02
T-Mobile-8	AIR32 B66/B2A	133.34	40.75	0.00	5.84	240.00	238.18	0.00	118.98
T-Mobile-9	APXVAA24_43-U-A20 (RFS)	133.34	40.75	0.00	22.38	240.00	911.91	0.00	135.00
T-Mobile-10	Twin TMA Unit - Generic	133.34	40.75	0.00	1.12	0.00	45.82	0.00	22.50
T-Mobile-11	Twin TMA Unit - Generic	133.34	40.75	0.00	1.12	120.00	45.82	0.00	22.50
T-Mobile-12	Twin TMA Unit - Generic	133.34	40.75	0.00	1.12	240.00	45.82	0.00	22.50
T-Mobile-13	RRHU-11 RRH Unit	133.34	40.75	0.00	2.99	0.00	122.01	0.00	45.00
T-Mobile-14	RRHU-11 RRH Unit	133.34	40.75	0.00	2.99	120.00	122.01	0.00	45.00
T-Mobile-15	RRHU-11 RRH Unit	133.34	40.75	0.00	2.99	240.00	122.01	0.00	45.00
T-Mobile-16	Ericsson 4478 (B71) RRH Unit	133.34	40.75	0.00	1.26	0.00	51.49	0.00	54.00
T-Mobile-17	Ericsson 4478 (B71) RRH Unit	133.34	40.75	0.00	1.26	120.00	51.49	0.00	54.00
T-Mobile-18	Ericsson 4478 (B71) RRH Unit	133.34	40.75	0.00	1.26	240.00	51.49	0.00	54.00
T-Mobile-19	Diplexer Unit - Generic	133.34	40.75	0.00	0.72	0.00	29.54	0.00	22.50
T-Mobile-20	Diplexer Unit - Generic	133.34	40.75	0.00	0.72	120.00	29.54	0.00	22.50
T-Mobile-21	Diplexer Unit - Generic	133.34	40.75	0.00	0.72	240.00	29.54	0.00	22.50
ATT-A	12` T-Arm	150.00	41.62	0.00	13.60	0.00	566.06	0.00	418.50
ATT-B	12` T-Arm	150.00	41.62	0.00	13.60	120.00	566.06	0.00	418.50
ATT-C	12` T-Arm	150.00	41.62	0.00	13.60	240.00	566.06	0.00	418.50
ATT-A1	Powerwave 7770	150.00	41.62	0.00	5.88	0.00	244.74	0.00	31.50
ATT-A2	Powerwave 7770	150.00	41.62	0.00	5.88	0.00	244.74	0.00	31.50
ATT-A3	RRHU-11 RRH Unit	150.00	41.62	0.00	2.99	0.00	124.61	0.00	45.00
ATT-A4	TMA Unit (LGP24101)	150.00	41.62	0.00	1.29	0.00	53.61	0.00	12.69
ATT-A5	TMA Unit (LGP24101)	150.00	41.62	0.00	1.29	0.00	53.61	0.00	12.69
ATT-A6	Raycap Surge Suppressor	150.00	41.62	0.00	1.79	0.00	74.37	0.00	24.30
ATT-A7	OPA-65-LCUU-H6 Panel	150.00	41.62	0.00	10.12	0.00	421.31	0.00	57.60
ATT-A8	RRUS-32 RRH Unit	150.00	41.62	0.00	3.88	0.00	161.46	0.00	72.00
ATT-B1	RRHU-11 RRH Unit	150.00	41.62	0.00	2.99	120.00	124.61	0.00	45.00
ATT-B2	TMA Unit (LGP24101)	150.00	41.62	0.00	1.29	120.00	53.61	0.00	12.69
ATT-B3	TMA Unit (LGP24101)	150.00	41.62	0.00	1.29	120.00	53.61	0.00	12.69
ATT-B4	OPA-65-LCUU-H6 Panel	150.00	41.62	0.00	10.12	120.00	421.31	0.00	57.60
ATT-B5	RRUS-32 RRH Unit	150.00	41.62	0.00	3.88	120.00	161.46	0.00	72.00
ATT-C1	RRHU-11 RRH Unit	150.00	41.62	0.00	2.99	240.00	124.61	0.00	45.00
ATT-C2	TMA Unit (LGP24101)	150.00	41.62	0.00	1.29	240.00	53.61	0.00	12.69
ATT-C3	TMA Unit (LGP24101)	150.00	41.62	0.00	1.29	240.00	53.61	0.00	12.69
ATT-C4	OPA-65-LCUU-H6 Panel	150.00	41.62	0.00	10.12	240.00	421.31	0.00	57.60
ATT-C5	RRUS-32 RRH Unit	150.00	41.62	0.00	3.88	240.00	161.46	0.00	72.00
CSP-70	Sinclair SC479-HF1LDF w/ ice	160.00	42.13	0.00	5.06	0.00	213.09	0.00	30.60
CSP-71	Sinclair SC479-HF1LDF w/ ice	160.00	42.13	0.00	5.06	120.00	213.09	0.00	30.60
CSP-72	Sinclair SC479-HF1LDF w/ ice	160.00	42.13	0.00	5.06	240.00	213.09	0.00	30.60
CSP-73	TMA	160.00	42.13	0.00	1.29	240.00	54.27	0.00	13.50
DNK21-SPD9	8` Dish with Radome	160.00	42.13	0.00	51.32	0.00	1866.70	0.00	504.00
DNK20-UNKOWN	4`x1` Panel	160.00	42.13	0.00	6.53	240.00	275.13	0.00	27.00
DNK19-STAM63	4`x1` Panel	160.00	42.13	0.00	6.53	120.00	275.13	0.00	27.00
159-A	3` Stand-Off	160.00	42.13	0.00	2.72	0.00	114.60	0.00	45.00
159-B	3` Stand-Off	160.00	42.13	0.00	2.72	120.00	114.60	0.00	45.00
160	3` Stand-Off	160.00	42.13	0.00	2.72	240.00	114.60	0.00	45.00
DNK22-TOG-6	DB586-Y	165.00	42.38	0.00	1.01	0.00	42.99	0.00	7.42
DNK23-STAM64	4`x1` Panel	165.00	42.38	0.00	6.53	0.00	276.77	0.00	27.00



DNK23-STAM65	TMA	165.00	42.38	0.00	1.29	0.00																54.59	0.00	13.50
GRN-1 (DNK25)	4` Dish	170.00	42.63	0.00	13.10	50.00	1.66410	0.08980	-0.06910	929.39	50.15											929.39	-50.15	108.00
DNK26aCSP-67	Dipole	175.00	42.88	0.00	9.17	0.00																393.05	0.00	41.40
DNK26bNEU-20	4` Dipole	175.00	42.88	0.00	3.70	0.00																158.51	0.00	36.00
DNK27A-CSP4	Sinclair SC479-HF1LDF w/ ice	175.00	42.88	0.00	5.06	240.00																216.86	0.00	30.60
DNK27B-CSP2	Scala OGT9-806 w/ ice	175.00	42.88	0.00	2.27	120.00																97.48	0.00	16.65
DNK27C-CSP74	TMA	175.00	42.88	0.00	1.29	120.00																55.23	0.00	13.50
DNK28A-CSP1	Scala OGT9-806 w/ ice	175.00	42.88	0.00	2.27	120.00																97.48	0.00	16.65
DNK28B-CSP3	Sinclair SC479-HF1LDF w/ ice	175.00	42.88	0.00	5.06	240.00																216.86	0.00	30.60
DNK28C-TOG5	Andrew DB-583 w/ ice	175.00	42.88	0.00	0.54	0.00																23.04	0.00	5.63
DNK28D-NEU55	Decibel PD-420 2 bay - Dipole	175.00	42.88	0.00	1.64	240.00																70.45	0.00	9.00
Top-A	6` Stand-Off	180.00	43.12	0.00	10.60	0.00																457.07	0.00	126.00
Top-B	6` Stand-Off	180.00	43.12	0.00	10.60	120.00																457.07	0.00	126.00
Top-C1	6` Stand-Off	180.00	43.12	0.00	10.60	260.00																457.07	0.00	126.00
Top-C2	6` Stand-Off	180.00	43.12	0.00	10.60	220.00																457.07	0.00	126.00
ATT-B7	Powerwave 7770	150.00	41.62	0.00	5.88	120.00																244.74	0.00	31.50
ATT-B8	Powerwave 7770	150.00	41.62	0.00	5.88	120.00																244.74	0.00	31.50
ATT-C7	Powerwave 7770	150.00	41.62	0.00	5.88	240.00																244.74	0.00	31.50
ATT-C8	Powerwave 7770	150.00	41.62	0.00	5.88	240.00																244.74	0.00	31.50

EIA Section Load Case Information for "2: 0.9D + 1.0Dg + 1.6Wo":

Note: qzGh (adjusted wind pressure) includes: Velocity Pressure Coefficient (Kz), Topographic Factor (Kzt), Gust Effect Factor (Gh), Wind Direction Probability Factor (Kd), Wind Importance Factor (Table 2-3), Wind Load Factor (from Loads/EIA Loads)  
Face RR is the minimum round reduction factor for all round angles and appurtenances in the section

Section Label	Z of Top (ft)	Z of Bottom (ft)	Ave. Elev. Above Gnd. (ft)	qzGh (psf)	Ice Thick. (in)	Face AF (ft^2)	Face AR (ft^2)	Face RR*AR (ft^2)	Face AG (ft^2)	Face e	Face DF	Face DR	Face RR	Face CF	Face AE (ft^2)	Face WF (lbs)	NotF AAF (ft^2)	NotF CAF	NotF AAR (ft^2)	NotF CAR	NotF AAR*CAR (ft^2)	NotF WA (lbs)	Total Wind (lbs)	Total Weight (lbs)
A	180.00	160.00	170.00	42.63	0.00	20.58	21.02	12.12	163.7	0.25	1.00	1.00	0.58	2.43	32.7	3381	40.00	2.00	0.00	0.60	0.00	3411	6792	5078
B	160.00	140.00	150.00	41.62	0.00	22.52	27.30	15.19	191.0	0.26	1.00	1.00	0.55	2.41	37.7	3776	60.00	2.00	0.00	0.60	0.00	4995	8770	5418
C	140.00	120.00	130.00	40.58	0.00	25.73	29.16	15.97	218.3	0.25	1.00	1.00	0.55	2.43	41.7	4118	80.00	2.00	0.00	0.60	0.00	6492	10610	6022
D	120.00	100.00	110.00	39.54	0.00	30.37	36.61	19.25	245.5	0.27	1.00	1.00	0.52	2.37	49.6	4652	80.00	2.00	0.00	0.60	0.00	6327	10979	6643
E	100.00	80.00	90.00	38.62	0.00	37.01	40.26	20.85	272.8	0.28	1.00	1.00	0.50	2.34	57.9	5233	80.00	2.00	0.00	0.60	0.00	6180	11412	9032
F	80.00	60.00	70.00	38.01	0.00	37.32	43.90	21.91	300.0	0.27	1.00	1.00	0.49	2.38	59.2	5351	80.00	2.00	0.00	0.60	0.00	6081	11432	9496
G	60.00	40.00	50.00	38.04	0.00	42.28	50.37	25.41	327.3	0.28	1.00	1.00	0.50	2.34	67.7	6031	80.00	2.00	0.00	0.60	0.00	6087	12118	10603
H	40.00	20.00	30.00	39.16	0.00	48.05	50.83	25.47	354.6	0.28	1.00	1.00	0.49	2.35	73.5	6776	80.00	2.00	0.00	0.60	0.00	6265	13042	11284
I	20.00	0.00	10.00	43.43	0.00	59.30	58.17	29.86	381.9	0.31	1.00	1.00	0.51	2.28	89.2	8813	72.00	2.00	0.00	0.60	0.00	6254	15067	11368

Equipment Load Case Information for "4: 1.2D + 1.0Dg + 1.0E":

Equipment Label	Equipment Property Set	Elevation Above Ground (ft)	qzGh (psf)	Ice Thick. (in)	Total Wind Area (ft^2)	Wind Incidence Angle (deg)	222-G CA	222-G CS	222-G CM	Antenna Axial Load (lbs)	Antenna Side Load (lbs)	Antenna Moment (ft-lbs)	Long. Load (lbs)	Trans. Load (lbs)	Vert. Load (lbs)
DNK-1	5` Dipole	60.00	0.00	0.00	3.95	0.00							0.00	0.00	60.00
MT-DNK1	3` Stand-Off	60.00	0.00	0.00	2.72	0.00							0.00	0.00	60.00
DNK2-GPS68	GPS	60.00	0.00	0.00	1.00	120.00							0.00	0.00	12.00
MT-DNK2	3` Stand-Off	60.00	0.00	0.00	2.72	120.00							0.00	0.00	60.00
DNK3-GPS69	GPS	60.00	0.00	0.00	1.00	240.00							0.00	0.00	12.00
MT-DNK3	3` Stand-Off	60.00	0.00	0.00	2.72	240.00							0.00	0.00	60.00
DNK4-DOT56	10` Dipole	60.00	0.00	0.00	9.17	240.00							0.00	0.00	55.20
MT-DNK4	3` Stand-Off	60.00	0.00	0.00	2.72	240.00							0.00	0.00	60.00
DNK5-NEU16	8` Omni	80.00	0.00	0.00	2.00	240.00							0.00	0.00	6.00
MT-DNK5	6` Stand-Off	80.00	0.00	0.00	10.60	240.00							0.00	0.00	168.00
DNK9-DEP54	RFS PD1142 w/ ice	120.00	0.00	0.00	1.32	120.00							0.00	0.00	12.00
MT-DNK9	3` Stand-Off	120.00	0.00	0.00	2.72	120.00							0.00	0.00	60.00
DNK8-CSP66	RFS PD1142 w/ ice	120.00	0.00	0.00	1.32	120.00							0.00	0.00	12.00
DNK7-NEU17	12` Omni	113.34	0.00	0.00	4.00	0.00							0.00	0.00	66.00
MT-DNK7	3` Stand-Off	113.34	0.00	0.00	2.72	0.00							0.00	0.00	60.00
Sprint-A	12` T-Arm	113.34	0.00	0.00	13.60	0.00							0.00	0.00	558.00
Sprint-B	12` T-Arm	113.34	0.00	0.00	13.60	120.00							0.00	0.00	558.00
Sprint-C	12` T-Arm	113.34	0.00	0.00	13.60	240.00							0.00	0.00	558.00
Sprint-1	RFS APXVSP18-C w/ ice	113.34	0.00	0.00	8.26	0.00							0.00	0.00	108.00
Sprint-2	ALU RRH	113.34	0.00	0.00	6.90	0.00							0.00	0.00	72.00
Sprint-3	ALU RRH	113.34	0.00	0.00	6.90	0.00							0.00	0.00	72.00
Sprint-4	RFS APXVSP18-C w/ ice	113.34	0.00	0.00	8.26	120.00							0.00	0.00	108.00

Sprint-5		ALU RRH	113.34	0.00	0.00	6.90	120.00	0.00	0.00	72.00
Sprint-6		ALU RRH	113.34	0.00	0.00	6.90	120.00	0.00	0.00	72.00
Sprint-7	RFS APXVSP18-C w/ ice		113.34	0.00	0.00	8.26	240.00	0.00	0.00	108.00
Sprint-8		ALU RRH	113.34	0.00	0.00	6.90	240.00	0.00	0.00	72.00
Sprint-9		ALU RRH	113.34	0.00	0.00	6.90	240.00	0.00	0.00	72.00
Sprint-10		DT465B-2XR-V2	113.34	0.00	0.00	9.65	0.00	0.00	0.00	106.08
Sprint-11		DT465B-2XR-V2	113.34	0.00	0.00	9.65	120.00	0.00	0.00	106.08
Sprint-12		DT465B-2XR-V2	113.34	0.00	0.00	9.65	240.00	0.00	0.00	106.08
Sprint-13		800 MHz RRH Unit	113.34	0.00	0.00	6.90	0.00	0.00	0.00	72.00
Sprint-14		800 MHz RRH Unit	113.34	0.00	0.00	6.90	120.00	0.00	0.00	72.00
Sprint-15		800 MHz RRH Unit	113.34	0.00	0.00	6.90	240.00	0.00	0.00	72.00
Sprint-16		TD-RRH 8x20-25 RRH Unit	113.34	0.00	0.00	4.72	0.00	0.00	0.00	79.36
Sprint-17		TD-RRH 8x20-25 RRH Unit	113.34	0.00	0.00	4.72	120.00	0.00	0.00	79.36
Sprint-18		TD-RRH 8x20-25 RRH Unit	113.34	0.00	0.00	4.72	240.00	0.00	0.00	79.36
Verizon-A		Boom Gate	126.66	0.00	0.00	13.60	0.00	0.00	0.00	565.20
Verizon-B		Boom Gate	126.66	0.00	0.00	13.60	120.00	0.00	0.00	565.20
Verizon-C		Boom Gate	126.66	0.00	0.00	13.60	240.00	0.00	0.00	565.20
Verizon-1	Decibel DB844H80-XY w/ ice		126.66	0.00	0.00	3.97	0.00	0.00	0.00	12.00
Verizon-2	Decibel DB844H80-XY w/ ice		126.66	0.00	0.00	3.97	0.00	0.00	0.00	12.00
Verizon-3	Decibel DB844H80-XY w/ ice		126.66	0.00	0.00	3.97	120.00	0.00	0.00	12.00
Verizon-4	Decibel DB844H80-XY w/ ice		126.66	0.00	0.00	3.97	120.00	0.00	0.00	12.00
Verizon-5	Decibel DB844H80-XY w/ ice		126.66	0.00	0.00	3.97	240.00	0.00	0.00	12.00
Verizon-6	Decibel DB844H80-XY w/ ice		126.66	0.00	0.00	3.97	240.00	0.00	0.00	12.00
Verizon-7	JAHH-65B-R3B Panel		126.66	0.00	0.00	9.66	0.00	0.00	0.00	151.56
Verizon-8	JAHH-65B-R3B Panel		126.66	0.00	0.00	9.66	0.00	0.00	0.00	151.56
Verizon-9	JAHH-65B-R3B Panel		126.66	0.00	0.00	9.66	120.00	0.00	0.00	151.56
Verizon-10	JAHH-65B-R3B Panel		126.66	0.00	0.00	9.66	120.00	0.00	0.00	151.56
Verizon-11	JAHH-65B-R3B Panel		126.66	0.00	0.00	9.66	240.00	0.00	0.00	151.56
Verizon-12	JAHH-65B-R3B Panel		126.66	0.00	0.00	9.66	240.00	0.00	0.00	151.56
Verizon-D	BSAMNT-SBS-2-2 Mount for JAHH Antenna		126.66	0.00	0.00	3.78	0.00	0.00	0.00	139.20
Verizon-E	BSAMNT-SBS-2-2 Mount for JAHH Antenna		126.66	0.00	0.00	3.78	120.00	0.00	0.00	139.20
Verizon-F	BSAMNT-SBS-2-2 Mount for JAHH Antenna		126.66	0.00	0.00	3.78	240.00	0.00	0.00	139.20
Verizon-13	RRH 2x60W (700 MHz)		126.66	0.00	0.00	2.12	0.00	0.00	0.00	72.00
Verizon-14	RRH 2x60W (700 MHz)		126.66	0.00	0.00	2.12	120.00	0.00	0.00	72.00
Verizon-15	RRH 2x60W (700 MHz)		126.66	0.00	0.00	2.12	240.00	0.00	0.00	72.00
Verizon-16	RRH 4x45W (AWS)		126.66	0.00	0.00	2.96	0.00	0.00	0.00	72.00
Verizon-17	RRH 4x45W (AWS)		126.66	0.00	0.00	2.96	120.00	0.00	0.00	72.00
Verizon-18	RRH 4x45W (AWS)		126.66	0.00	0.00	2.96	240.00	0.00	0.00	72.00
Verizon-19	RHH 2x80W (850 MHz)		126.66	0.00	0.00	2.91	0.00	0.00	0.00	108.00
Verizon-20	RHH 2x80W (850 MHz)		126.66	0.00	0.00	2.91	120.00	0.00	0.00	108.00
Verizon-21	RHH 2x80W (850 MHz)		126.66	0.00	0.00	2.91	240.00	0.00	0.00	108.00
Verizon-22	Raycap DB-T1-6Z-8AB-0Z Dist. Box		126.66	0.00	0.00	5.60	0.00	0.00	0.00	54.00
Verizon-23	Raycap DB-T1-6Z-8AB-0Z Dist. Box		126.66	0.00	0.00	5.60	120.00	0.00	0.00	54.00
Verizon-24	Raycap DB-T1-6Z-8AB-0Z Dist. Box		126.66	0.00	0.00	5.60	240.00	0.00	0.00	54.00
NEU-18	12` Omni		126.66	0.00	0.00	4.00	0.00	0.00	0.00	66.00
DNK15-CSP21	RFS PD1142 w/ ice		133.34	0.00	0.00	1.32	120.00	0.00	0.00	12.00
MT-DNK15	3` Stand-Off		133.34	0.00	0.00	2.72	120.00	0.00	0.00	60.00
DNK-12	5` Dipole		133.34	0.00	0.00	3.95	240.00	0.00	0.00	60.00
MT-DNK12	3` Stand-Off		133.34	0.00	0.00	2.72	240.00	0.00	0.00	60.00
T-Mobile-1	Ericsson AIR B2A/B4P		133.34	0.00	0.00	6.53	0.00	0.00	0.00	132.02
T-Mobile-2	AIR32 B66/B2A		133.34	0.00	0.00	5.84	0.00	0.00	0.00	158.64
T-Mobile-3	APXVAA24_43-U-A20 (RFS)		133.34	0.00	0.00	22.38	0.00	0.00	0.00	180.00
T-Mobile-4	Ericsson AIR B2A/B4P		133.34	0.00	0.00	6.53	120.00	0.00	0.00	132.02
T-Mobile-5	AIR32 B66/B2A		133.34	0.00	0.00	5.84	120.00	0.00	0.00	158.64
T-Mobile-6	APXVAA24_43-U-A20 (RFS)		133.34	0.00	0.00	22.38	120.00	0.00	0.00	180.00
T-Mobile-7	Ericsson AIR B2A/B4P		133.34	0.00	0.00	6.53	240.00	0.00	0.00	132.02
T-Mobile-8	AIR32 B66/B2A		133.34	0.00	0.00	5.84	240.00	0.00	0.00	158.64
T-Mobile-9	APXVAA24_43-U-A20 (RFS)		133.34	0.00	0.00	22.38	240.00	0.00	0.00	180.00
T-Mobile-10	Twin TMA Unit - Generic		133.34	0.00	0.00	1.12	0.00	0.00	0.00	30.00
T-Mobile-11	Twin TMA Unit - Generic		133.34	0.00	0.00	1.12	120.00	0.00	0.00	30.00
T-Mobile-12	Twin TMA Unit - Generic		133.34	0.00	0.00	1.12	240.00	0.00	0.00	30.00
T-Mobile-13	RRHU-11 RRH Unit		133.34	0.00	0.00	2.99	0.00	0.00	0.00	60.00
T-Mobile-14	RRHU-11 RRH Unit		133.34	0.00	0.00	2.99	120.00	0.00	0.00	60.00
T-Mobile-15	RRHU-11 RRH Unit		133.34	0.00	0.00	2.99	240.00	0.00	0.00	60.00
T-Mobile-16	Ericsson 4478 (B71) RRH Unit		133.34	0.00	0.00	1.26	0.00	0.00	0.00	72.00
T-Mobile-17	Ericsson 4478 (B71) RRH Unit		133.34	0.00	0.00	1.26	120.00	0.00	0.00	72.00
T-Mobile-18	Ericsson 4478 (B71) RRH Unit		133.34	0.00	0.00	1.26	240.00	0.00	0.00	72.00
T-Mobile-19	Diplexer Unit - Generic		133.34	0.00	0.00	0.72	0.00	0.00	0.00	30.00
T-Mobile-20	Diplexer Unit - Generic		133.34	0.00	0.00	0.72	120.00	0.00	0.00	30.00

T-Mobile-21	Diplexer Unit - Generic	133.34	0.00	0.00	0.72	240.00	0.00	0.00	30.00
ATT-A	12` T-Arm	150.00	0.00	0.00	13.60	0.00	0.00	0.00	558.00
ATT-B	12` T-Arm	150.00	0.00	0.00	13.60	120.00	0.00	0.00	558.00
ATT-C	12` T-Arm	150.00	0.00	0.00	13.60	240.00	0.00	0.00	558.00
ATT-A1	Powerwave 7770	150.00	0.00	0.00	5.88	0.00	0.00	0.00	42.00
ATT-A2	Powerwave 7770	150.00	0.00	0.00	5.88	0.00	0.00	0.00	42.00
ATT-A3	RRHU-11 RRH Unit	150.00	0.00	0.00	2.99	0.00	0.00	0.00	60.00
ATT-A4	TMA Unit (LGP24101)	150.00	0.00	0.00	1.29	0.00	0.00	0.00	16.92
ATT-A5	TMA Unit (LGP24101)	150.00	0.00	0.00	1.29	0.00	0.00	0.00	16.92
ATT-A6	Raycap Surge Suppressor	150.00	0.00	0.00	1.79	0.00	0.00	0.00	32.40
ATT-A7	OPA-65-LCUU-H6 Panel	150.00	0.00	0.00	10.12	0.00	0.00	0.00	76.80
ATT-A8	RRUS-32 RRH Unit	150.00	0.00	0.00	3.88	0.00	0.00	0.00	96.00
ATT-B1	RRHU-11 RRH Unit	150.00	0.00	0.00	2.99	120.00	0.00	0.00	60.00
ATT-B2	TMA Unit (LGP24101)	150.00	0.00	0.00	1.29	120.00	0.00	0.00	16.92
ATT-B3	TMA Unit (LGP24101)	150.00	0.00	0.00	1.29	120.00	0.00	0.00	16.92
ATT-B4	OPA-65-LCUU-H6 Panel	150.00	0.00	0.00	10.12	120.00	0.00	0.00	76.80
ATT-B5	RRUS-32 RRH Unit	150.00	0.00	0.00	3.88	120.00	0.00	0.00	96.00
ATT-C1	RRHU-11 RRH Unit	150.00	0.00	0.00	2.99	240.00	0.00	0.00	60.00
ATT-C2	TMA Unit (LGP24101)	150.00	0.00	0.00	1.29	240.00	0.00	0.00	16.92
ATT-C3	TMA Unit (LGP24101)	150.00	0.00	0.00	1.29	240.00	0.00	0.00	16.92
ATT-C4	OPA-65-LCUU-H6 Panel	150.00	0.00	0.00	10.12	240.00	0.00	0.00	76.80
ATT-C5	RRUS-32 RRH Unit	150.00	0.00	0.00	3.88	240.00	0.00	0.00	96.00
CSP-70	Sinclair SC479-HF1LDF w/ ice	160.00	0.00	0.00	5.06	0.00	0.00	0.00	40.80
CSP-71	Sinclair SC479-HF1LDF w/ ice	160.00	0.00	0.00	5.06	120.00	0.00	0.00	40.80
CSP-72	Sinclair SC479-HF1LDF w/ ice	160.00	0.00	0.00	5.06	240.00	0.00	0.00	40.80
CSP-73	TMA	160.00	0.00	0.00	1.29	240.00	0.00	0.00	18.00
DNK21-SPD9	8` Dish with Radome	160.00	0.00	0.00	51.32	0.00	0.86330	0.00	672.00
DNK20-UNKNOWN	4`xl` Panel	160.00	0.00	0.00	6.53	240.00	0.00	0.00	36.00
DNK19-STAM63	4`xl` Panel	160.00	0.00	0.00	6.53	120.00	0.00	0.00	36.00
159-A	3` Stand-Off	160.00	0.00	0.00	2.72	0.00	0.00	0.00	60.00
159-B	3` Stand-Off	160.00	0.00	0.00	2.72	120.00	0.00	0.00	60.00
160	3` Stand-Off	160.00	0.00	0.00	2.72	240.00	0.00	0.00	60.00
DNK22-TOG-6	DB586-Y	165.00	0.00	0.00	1.01	0.00	0.00	0.00	9.90
DNK23-STAM64	4`xl` Panel	165.00	0.00	0.00	6.53	0.00	0.00	0.00	36.00
DNK23-STAM65	TMA	165.00	0.00	0.00	1.29	0.00	0.00	0.00	18.00
GRN-1 (DNK25)	4` Dish	170.00	0.00	0.00	13.10	50.00	1.66410	0.08980	-0.06910
DNK26aCSP-67	Dipole	175.00	0.00	0.00	9.17	0.00	0.00	0.00	55.20
DNK26bNEU-20	4` Dipole	175.00	0.00	0.00	3.70	0.00	0.00	0.00	48.00
DNK27A-CSP4	Sinclair SC479-HF1LDF w/ ice	175.00	0.00	0.00	5.06	240.00	0.00	0.00	40.80
DNK27B-CSP2	Scala OGT9-806 w/ ice	175.00	0.00	0.00	2.27	120.00	0.00	0.00	22.20
DNK27C-CSP74	TMA	175.00	0.00	0.00	1.29	120.00	0.00	0.00	18.00
DNK28A-CSP1	Scala OGT9-806 w/ ice	175.00	0.00	0.00	2.27	120.00	0.00	0.00	22.20
DNK28B-CSP3	Sinclair SC479-HF1LDF w/ ice	175.00	0.00	0.00	5.06	240.00	0.00	0.00	40.80
DNK28C-TOG5	Andrew DB-583 w/ ice	175.00	0.00	0.00	0.54	0.00	0.00	0.00	7.50
DNK28D-NEU55	Decibel PD-420 2 bay - Dipole	175.00	0.00	0.00	1.64	240.00	0.00	0.00	12.00
Top-A	6` Stand-Off	180.00	0.00	0.00	10.60	0.00	0.00	0.00	168.00
Top-B	6` Stand-Off	180.00	0.00	0.00	10.60	120.00	0.00	0.00	168.00
Top-C1	6` Stand-Off	180.00	0.00	0.00	10.60	260.00	0.00	0.00	168.00
Top-C2	6` Stand-Off	180.00	0.00	0.00	10.60	220.00	0.00	0.00	168.00
ATT-B7	Powerwave 7770	150.00	0.00	0.00	5.88	120.00	0.00	0.00	42.00
ATT-B8	Powerwave 7770	150.00	0.00	0.00	5.88	120.00	0.00	0.00	42.00
ATT-C7	Powerwave 7770	150.00	0.00	0.00	5.88	240.00	0.00	0.00	42.00
ATT-C8	Powerwave 7770	150.00	0.00	0.00	5.88	240.00	0.00	0.00	42.00

EIA Section Load Case Information for "4: 1.2D + 1.0Dg + 1.0E":

Note: qzGh (adjusted wind pressure) includes: Velocity Pressure Coefficient (Kz), Topographic Factor (Kzt), Gust Effect Factor (Gh), Wind Direction Probability Factor (Kd), Wind Importance Factor (Table 2-3), Wind Load Factor (from Loads/EIA Loads)  
Face RR is the minimum round reduction factor for all round angles and appurtenances in the section

Section Label	Z of Top (ft)	Z of Bottom (ft)	Ave. Elev. Above Gnd. (ft)	Elev. qzGh (psf)	Ice Thick. (in)	Face AF (ft^2)	Face AR (ft^2)	Face RR*AR (ft^2)	Face AG (ft^2)	Face e (ft^2)	Face DF (ft^2)	Face DR (ft^2)	Face RR (ft^2)	Face CF (ft^2)	Face AE (ft^2)	Face WF (lbs)	NotF AAF (ft^2)	NotF CAF (ft^2)	NotF AAR (ft^2)	NotF CAR (ft^2)	NotF AAR*CAR (ft^2)	NotF WA (lbs)	Total Wind (lbs)	Total Weight (lbs)
A	180.00	160.00	170.00	0.00	0.00	20.58	21.02	12.32	163.7	0.25	1.00	1.00	0.59	2.43	32.9	0	24.00	2.00	0.00	1.20	0.00	0	0	6770
B	160.00	140.00	150.00	0.00	0.00	22.52	27.30	16.04	191.0	0.26	1.00	1.00	0.59	2.41	38.6	0	36.00	2.00	0.00	1.20	0.00	0	0	7224
C	140.00	120.00	130.00	0.00	0.00	25.73	29.16	17.07	218.3	0.25	1.00	1.00	0.59	2.43	42.8	0	48.00	2.00	0.00	1.20	0.00	0	0	8030
D	120.00	100.00	110.00	0.00	0.00	30.37	36.61	21.63	245.5	0.27	1.00	1.00	0.59	2.37	52.0	0	48.00	2.00	0.00	1.20	0.00	0	0	8857
E	100.00	80.00	90.00	0.00	0.00	37.01	40.26	23.91	272.8	0.28	1.00	1.00	0.59	2.34	60.9	0	48.00	2.00	0.00	1.20	0.00	0	0	12042

F	80.00	60.00	70.00	0.00	0.00	37.32	43.90	25.92	300.0	0.27	1.00	1.00	0.59	2.38	63.2	0	48.00	2.00	0.00	1.20	0.00	0	0	12661
G	60.00	40.00	50.00	0.00	0.00	42.28	50.37	29.91	327.3	0.28	1.00	1.00	0.59	2.34	72.2	0	48.00	2.00	0.00	1.20	0.00	0	0	14137
H	40.00	20.00	30.00	0.00	0.00	48.05	50.83	30.12	354.6	0.28	1.00	1.00	0.59	2.35	78.2	0	48.00	2.00	0.00	1.20	0.00	0	0	15046
I	20.00	0.00	10.00	0.00	0.00	59.30	58.17	34.98	381.9	0.31	1.00	1.00	0.60	2.28	94.3	0	43.20	2.00	0.00	1.20	0.00	0	0	15157

Equipment Load Case Information for "5: 0.9D + 1.0Dg + 1.0E":

Equipment Label	Equipment Property Set	Elevation Above Ground (ft)	qzGh (psf)	Ice Thick. (in)	Total Wind Area (ft^2)	Wind Incidence Angle (deg)	222-G CA	222-G CS	222-G CM	Antenna Axial Load (lbs)	Antenna Side Load (lbs)	Antenna Moment (ft-lbs)	Long. Load (lbs)	Trans. Load (lbs)	Vert. Load (lbs)
DNK-1	5` Dipole	60.00	0.00	0.00	3.95	0.00							0.00	0.00	45.00
MT-DNK1	3` Stand-Off	60.00	0.00	0.00	2.72	0.00							0.00	0.00	45.00
DNK2-GPS68	GPS	60.00	0.00	0.00	1.00	120.00							0.00	0.00	9.00
MT-DNK2	3` Stand-Off	60.00	0.00	0.00	2.72	120.00							0.00	0.00	45.00
DNK3-GPS69	GPS	60.00	0.00	0.00	1.00	240.00							0.00	0.00	9.00
MT-DNK3	3` Stand-Off	60.00	0.00	0.00	2.72	240.00							0.00	0.00	45.00
DNK4-DOT56	10` Dipole	60.00	0.00	0.00	9.17	240.00							0.00	0.00	41.40
MT-DNK4	3` Stand-Off	60.00	0.00	0.00	2.72	240.00							0.00	0.00	45.00
DNK5-NEU16	8` Omni	80.00	0.00	0.00	2.00	240.00							0.00	0.00	4.50
MT-DNK5	6` Stand-Off	80.00	0.00	0.00	10.60	240.00							0.00	0.00	126.00
DNK9-DEP54	RFS PD1142 w/ ice	120.00	0.00	0.00	1.32	120.00							0.00	0.00	9.00
MT-DNK9	3` Stand-Off	120.00	0.00	0.00	2.72	120.00							0.00	0.00	45.00
DNK8-CSP66	RFS PD1142 w/ ice	120.00	0.00	0.00	1.32	120.00							0.00	0.00	9.00
DNK7-NEU17	12` Omni	113.34	0.00	0.00	4.00	0.00							0.00	0.00	49.50
MT-DNK7	3` Stand-Off	113.34	0.00	0.00	2.72	0.00							0.00	0.00	45.00
Sprint-A	12` T-Arm	113.34	0.00	0.00	13.60	0.00							0.00	0.00	418.50
Sprint-B	12` T-Arm	113.34	0.00	0.00	13.60	120.00							0.00	0.00	418.50
Sprint-C	12` T-Arm	113.34	0.00	0.00	13.60	240.00							0.00	0.00	418.50
Sprint-1	RFS APXVSP18-C w/ ice	113.34	0.00	0.00	8.26	0.00							0.00	0.00	81.00
Sprint-2	ALU RRH	113.34	0.00	0.00	6.90	0.00							0.00	0.00	54.00
Sprint-3	ALU RRH	113.34	0.00	0.00	6.90	0.00							0.00	0.00	54.00
Sprint-4	RFS APXVSP18-C w/ ice	113.34	0.00	0.00	8.26	120.00							0.00	0.00	81.00
Sprint-5	ALU RRH	113.34	0.00	0.00	6.90	120.00							0.00	0.00	54.00
Sprint-6	ALU RRH	113.34	0.00	0.00	6.90	120.00							0.00	0.00	54.00
Sprint-7	RFS APXVSP18-C w/ ice	113.34	0.00	0.00	8.26	240.00							0.00	0.00	81.00
Sprint-8	ALU RRH	113.34	0.00	0.00	6.90	240.00							0.00	0.00	54.00
Sprint-9	ALU RRH	113.34	0.00	0.00	6.90	240.00							0.00	0.00	54.00
Sprint-10	DT465B-2XR-V2	113.34	0.00	0.00	9.65	0.00							0.00	0.00	79.56
Sprint-11	DT465B-2XR-V2	113.34	0.00	0.00	9.65	120.00							0.00	0.00	79.56
Sprint-12	DT465B-2XR-V2	113.34	0.00	0.00	9.65	240.00							0.00	0.00	79.56
Sprint-13	800 MHz RRH Unit	113.34	0.00	0.00	6.90	0.00							0.00	0.00	54.00
Sprint-14	800 MHz RRH Unit	113.34	0.00	0.00	6.90	120.00							0.00	0.00	54.00
Sprint-15	800 MHz RRH Unit	113.34	0.00	0.00	6.90	240.00							0.00	0.00	54.00
Sprint-16	TD-RRH 8x20-25 RRH Unit	113.34	0.00	0.00	4.72	0.00							0.00	0.00	59.52
Sprint-17	TD-RRH 8x20-25 RRH Unit	113.34	0.00	0.00	4.72	120.00							0.00	0.00	59.52
Sprint-18	TD-RRH 8x20-25 RRH Unit	113.34	0.00	0.00	4.72	240.00							0.00	0.00	59.52
Verizon-A	Boom Gate	126.66	0.00	0.00	13.60	0.00							0.00	0.00	423.90
Verizon-B	Boom Gate	126.66	0.00	0.00	13.60	120.00							0.00	0.00	423.90
Verizon-C	Boom Gate	126.66	0.00	0.00	13.60	240.00							0.00	0.00	423.90
Verizon-1	Decibel DB844H80-XY w/ ice	126.66	0.00	0.00	3.97	0.00							0.00	0.00	9.00
Verizon-2	Decibel DB844H80-XY w/ ice	126.66	0.00	0.00	3.97	0.00							0.00	0.00	9.00
Verizon-3	Decibel DB844H80-XY w/ ice	126.66	0.00	0.00	3.97	120.00							0.00	0.00	9.00
Verizon-4	Decibel DB844H80-XY w/ ice	126.66	0.00	0.00	3.97	120.00							0.00	0.00	9.00
Verizon-5	Decibel DB844H80-XY w/ ice	126.66	0.00	0.00	3.97	240.00							0.00	0.00	9.00
Verizon-6	Decibel DB844H80-XY w/ ice	126.66	0.00	0.00	3.97	240.00							0.00	0.00	9.00
Verizon-7	JAHH-65B-R3B Panel	126.66	0.00	0.00	9.66	0.00							0.00	0.00	113.67
Verizon-8	JAHH-65B-R3B Panel	126.66	0.00	0.00	9.66	0.00							0.00	0.00	113.67
Verizon-9	JAHH-65B-R3B Panel	126.66	0.00	0.00	9.66	120.00							0.00	0.00	113.67
Verizon-10	JAHH-65B-R3B Panel	126.66	0.00	0.00	9.66	120.00							0.00	0.00	113.67
Verizon-11	JAHH-65B-R3B Panel	126.66	0.00	0.00	9.66	240.00							0.00	0.00	113.67
Verizon-12	JAHH-65B-R3B Panel	126.66	0.00	0.00	9.66	240.00							0.00	0.00	113.67
Verizon-D	BSAMNT-SBS-2-2 Mount for JAHH Antenna	126.66	0.00	0.00	3.78	0.00							0.00	0.00	104.40
Verizon-E	BSAMNT-SBS-2-2 Mount for JAHH Antenna	126.66	0.00	0.00	3.78	120.00							0.00	0.00	104.40
Verizon-F	BSAMNT-SBS-2-2 Mount for JAHH Antenna	126.66	0.00	0.00	3.78	240.00							0.00	0.00	104.40
Verizon-13	RRH 2x60W (700 MHz)	126.66	0.00	0.00	2.12	0.00							0.00	0.00	54.00
Verizon-14	RRH 2x60W (700 MHz)	126.66	0.00	0.00	2.12	120.00							0.00	0.00	54.00
Verizon-15	RRH 2x60W (700 MHz)	126.66	0.00	0.00	2.12	240.00							0.00	0.00	54.00

Verizon-16		RRH 4x45W (AWS)	126.66	0.00	0.00	2.96	0.00	0.00	0.00	54.00
Verizon-17		RRH 4x45W (AWS)	126.66	0.00	0.00	2.96	120.00	0.00	0.00	54.00
Verizon-18		RRH 4x45W (AWS)	126.66	0.00	0.00	2.96	240.00	0.00	0.00	54.00
Verizon-19		RHH 2x80W (850 MHz)	126.66	0.00	0.00	2.91	0.00	0.00	0.00	81.00
Verizon-20		RHH 2x80W (850 MHz)	126.66	0.00	0.00	2.91	120.00	0.00	0.00	81.00
Verizon-21		RHH 2x80W (850 MHz)	126.66	0.00	0.00	2.91	240.00	0.00	0.00	81.00
Verizon-22	Raycap	DB-T1-6Z-8AB-0Z Dist. Box	126.66	0.00	0.00	5.60	0.00	0.00	0.00	40.50
Verizon-23	Raycap	DB-T1-6Z-8AB-0Z Dist. Box	126.66	0.00	0.00	5.60	120.00	0.00	0.00	40.50
Verizon-24	Raycap	DB-T1-6Z-8AB-0Z Dist. Box	126.66	0.00	0.00	5.60	240.00	0.00	0.00	40.50
NEU-18		12` Omni	126.66	0.00	0.00	4.00	0.00	0.00	0.00	49.50
DNK15-CSP21		RFS PD1142 w/ ice	133.34	0.00	0.00	1.32	120.00	0.00	0.00	9.00
MT-DNK15		3` Stand-Off	133.34	0.00	0.00	2.72	120.00	0.00	0.00	45.00
DNK-12		5` Dipole	133.34	0.00	0.00	3.95	240.00	0.00	0.00	45.00
MT-DNK12		3` Stand-Off	133.34	0.00	0.00	2.72	240.00	0.00	0.00	45.00
T-Mobile-1		Ericsson AIR B2A/B4P	133.34	0.00	0.00	6.53	0.00	0.00	0.00	99.02
T-Mobile-2		AIR32 B66/B2A	133.34	0.00	0.00	5.84	0.00	0.00	0.00	118.98
T-Mobile-3		APXVAA24_43-U-A20 (RFS)	133.34	0.00	0.00	22.38	0.00	0.00	0.00	135.00
T-Mobile-4		Ericsson AIR B2A/B4P	133.34	0.00	0.00	6.53	120.00	0.00	0.00	99.02
T-Mobile-5		AIR32 B66/B2A	133.34	0.00	0.00	5.84	120.00	0.00	0.00	118.98
T-Mobile-6		APXVAA24_43-U-A20 (RFS)	133.34	0.00	0.00	22.38	120.00	0.00	0.00	135.00
T-Mobile-7		Ericsson AIR B2A/B4P	133.34	0.00	0.00	6.53	240.00	0.00	0.00	99.02
T-Mobile-8		AIR32 B66/B2A	133.34	0.00	0.00	5.84	240.00	0.00	0.00	118.98
T-Mobile-9		APXVAA24_43-U-A20 (RFS)	133.34	0.00	0.00	22.38	240.00	0.00	0.00	135.00
T-Mobile-10		Twin TMA Unit - Generic	133.34	0.00	0.00	1.12	0.00	0.00	0.00	22.50
T-Mobile-11		Twin TMA Unit - Generic	133.34	0.00	0.00	1.12	120.00	0.00	0.00	22.50
T-Mobile-12		Twin TMA Unit - Generic	133.34	0.00	0.00	1.12	240.00	0.00	0.00	22.50
T-Mobile-13		RRHU-11 RRH Unit	133.34	0.00	0.00	2.99	0.00	0.00	0.00	45.00
T-Mobile-14		RRHU-11 RRH Unit	133.34	0.00	0.00	2.99	120.00	0.00	0.00	45.00
T-Mobile-15		RRHU-11 RRH Unit	133.34	0.00	0.00	2.99	240.00	0.00	0.00	45.00
T-Mobile-16		Ericsson 4478 (B71) RRH Unit	133.34	0.00	0.00	1.26	0.00	0.00	0.00	54.00
T-Mobile-17		Ericsson 4478 (B71) RRH Unit	133.34	0.00	0.00	1.26	120.00	0.00	0.00	54.00
T-Mobile-18		Ericsson 4478 (B71) RRH Unit	133.34	0.00	0.00	1.26	240.00	0.00	0.00	54.00
T-Mobile-19		Diplexer Unit - Generic	133.34	0.00	0.00	0.72	0.00	0.00	0.00	22.50
T-Mobile-20		Diplexer Unit - Generic	133.34	0.00	0.00	0.72	120.00	0.00	0.00	22.50
T-Mobile-21		Diplexer Unit - Generic	133.34	0.00	0.00	0.72	240.00	0.00	0.00	22.50
ATT-A		12` T-Arm	150.00	0.00	0.00	13.60	0.00	0.00	0.00	418.50
ATT-B		12` T-Arm	150.00	0.00	0.00	13.60	120.00	0.00	0.00	418.50
ATT-C		12` T-Arm	150.00	0.00	0.00	13.60	240.00	0.00	0.00	418.50
ATT-A1		Powerwave 7770	150.00	0.00	0.00	5.88	0.00	0.00	0.00	31.50
ATT-A2		Powerwave 7770	150.00	0.00	0.00	5.88	0.00	0.00	0.00	31.50
ATT-A3		RRHU-11 RRH Unit	150.00	0.00	0.00	2.99	0.00	0.00	0.00	45.00
ATT-A4		TMA Unit (LGP24101)	150.00	0.00	0.00	1.29	0.00	0.00	0.00	12.69
ATT-A5		TMA Unit (LGP24101)	150.00	0.00	0.00	1.29	0.00	0.00	0.00	12.69
ATT-A6		Raycap Surge Suppressor	150.00	0.00	0.00	1.79	0.00	0.00	0.00	24.30
ATT-A7		OPA-65-LCUU-H6 Panel	150.00	0.00	0.00	10.12	0.00	0.00	0.00	57.60
ATT-A8		RRUS-32 RRH Unit	150.00	0.00	0.00	3.88	0.00	0.00	0.00	72.00
ATT-B1		RRHU-11 RRH Unit	150.00	0.00	0.00	2.99	120.00	0.00	0.00	45.00
ATT-B2		TMA Unit (LGP24101)	150.00	0.00	0.00	1.29	120.00	0.00	0.00	12.69
ATT-B3		TMA Unit (LGP24101)	150.00	0.00	0.00	1.29	120.00	0.00	0.00	12.69
ATT-B4		OPA-65-LCUU-H6 Panel	150.00	0.00	0.00	10.12	120.00	0.00	0.00	57.60
ATT-B5		RRUS-32 RRH Unit	150.00	0.00	0.00	3.88	120.00	0.00	0.00	72.00
ATT-C1		RRHU-11 RRH Unit	150.00	0.00	0.00	2.99	240.00	0.00	0.00	45.00
ATT-C2		TMA Unit (LGP24101)	150.00	0.00	0.00	1.29	240.00	0.00	0.00	12.69
ATT-C3		TMA Unit (LGP24101)	150.00	0.00	0.00	1.29	240.00	0.00	0.00	12.69
ATT-C4		OPA-65-LCUU-H6 Panel	150.00	0.00	0.00	10.12	240.00	0.00	0.00	57.60
ATT-C5		RRUS-32 RRH Unit	150.00	0.00	0.00	3.88	240.00	0.00	0.00	72.00
CSP-70	Sinclair	SC479-HF1LDF w/ ice	160.00	0.00	0.00	5.06	0.00	0.00	0.00	30.60
CSP-71	Sinclair	SC479-HF1LDF w/ ice	160.00	0.00	0.00	5.06	120.00	0.00	0.00	30.60
CSP-72	Sinclair	SC479-HF1LDF w/ ice	160.00	0.00	0.00	5.06	240.00	0.00	0.00	30.60
CSP-73		TMA	160.00	0.00	0.00	1.29	240.00	0.00	0.00	13.50
DNK21-SPD9		8` Dish with Radome	160.00	0.00	0.00	51.32	0.00	0.86330	0.00	504.00
DNK20-UNKNOWN		4`x1` Panel	160.00	0.00	0.00	6.53	240.00	0.00	0.00	27.00
DNK19-STAM63		4`x1` Panel	160.00	0.00	0.00	6.53	120.00	0.00	0.00	27.00
159-A		3` Stand-Off	160.00	0.00	0.00	2.72	0.00	0.00	0.00	45.00
159-B		3` Stand-Off	160.00	0.00	0.00	2.72	120.00	0.00	0.00	45.00
160		3` Stand-Off	160.00	0.00	0.00	2.72	240.00	0.00	0.00	45.00
DNK22-TOG-6		DB586-Y	165.00	0.00	0.00	1.01	0.00	0.00	0.00	7.42
DNK23-STAM64		4`x1` Panel	165.00	0.00	0.00	6.53	0.00	0.00	0.00	27.00
DNK23-STAM65		TMA	165.00	0.00	0.00	1.29	0.00	0.00	0.00	13.50

GRN-1 (DNK25)	4` Dish	170.00	0.00	0.00	13.10	50.00	1.66410	0.08980	-0.06910	0.00	0.00	108.00
DNK26aCSP-67	Dipole	175.00	0.00	0.00	9.17	0.00				0.00	0.00	41.40
DNK26bNEU-20	4` Dipole	175.00	0.00	0.00	3.70	0.00				0.00	0.00	36.00
DNK27A-CSP4	Sinclair SC479-HF1LDF w/ ice	175.00	0.00	0.00	5.06	240.00				0.00	0.00	30.60
DNK27B-CSP2	Scala OGT9-806 w/ ice	175.00	0.00	0.00	2.27	120.00				0.00	0.00	16.65
DNK27C-CSP74	TMA	175.00	0.00	0.00	1.29	120.00				0.00	0.00	13.50
DNK28A-CSP1	Scala OGT9-806 w/ ice	175.00	0.00	0.00	2.27	120.00				0.00	0.00	16.65
DNK28B-CSP3	Sinclair SC479-HF1LDF w/ ice	175.00	0.00	0.00	5.06	240.00				0.00	0.00	30.60
DNK28C-TOG5	Andrew DB-583 w/ ice	175.00	0.00	0.00	0.54	0.00				0.00	0.00	5.63
DNK28D-NEU55	Decibel PD-420 2 bay - Dipole	175.00	0.00	0.00	1.64	240.00				0.00	0.00	9.00
Top-A	6` Stand-Off	180.00	0.00	0.00	10.60	0.00				0.00	0.00	126.00
Top-B	6` Stand-Off	180.00	0.00	0.00	10.60	120.00				0.00	0.00	126.00
Top-C1	6` Stand-Off	180.00	0.00	0.00	10.60	260.00				0.00	0.00	126.00
Top-C2	6` Stand-Off	180.00	0.00	0.00	10.60	220.00				0.00	0.00	126.00
ATT-B7	Powerwave 7770	150.00	0.00	0.00	5.88	120.00				0.00	0.00	31.50
ATT-B8	Powerwave 7770	150.00	0.00	0.00	5.88	120.00				0.00	0.00	31.50
ATT-C7	Powerwave 7770	150.00	0.00	0.00	5.88	240.00				0.00	0.00	31.50
ATT-C8	Powerwave 7770	150.00	0.00	0.00	5.88	240.00				0.00	0.00	31.50

EIA Section Load Case Information for "5: 0.9D + 1.0Dg + 1.0E":

Note: qzGh (adjusted wind pressure) includes: Velocity Pressure Coefficient (Kz), Topographic Factor (Kzt), Gust Effect Factor (Gh), Wind Direction Probability Factor (Kd), Wind Importance Factor (Table 2-3), Wind Load Factor (from Loads/EIA Loads)  
Face RR is the minimum round reduction factor for all round angles and appurtenances in the section

Section Label	Z of Top (ft)	Z of Bottom (ft)	Ave. Elev. Above Gnd. (ft)	qzGh (psf)	Ice Thick. (in)	Face AF (ft^2)	Face AR (ft^2)	Face RR*AR (ft^2)	Face AG (ft^2)	Face e	Face DF	Face DR	Face RR	Face CF	Face AE (ft^2)	Face WF (lbs)	NotF AAF (ft^2)	NotF CAF	NotF AAR (ft^2)	NotF CAR	NotF AAR*CAR (ft^2)	NotF WA (lbs)	Total Wind (lbs)	Total Weight (lbs)
A	180.00	160.00	170.00	0.00	0.00	20.58	21.02	12.32	163.7	0.25	1.00	1.00	0.59	2.43	32.9	0	24.00	2.00	0.00	1.20	0.00	0	0	5078
B	160.00	140.00	150.00	0.00	0.00	22.52	27.30	16.04	191.0	0.26	1.00	1.00	0.59	2.41	38.6	0	36.00	2.00	0.00	1.20	0.00	0	0	5418
C	140.00	120.00	130.00	0.00	0.00	25.73	29.16	17.07	218.3	0.25	1.00	1.00	0.59	2.43	42.8	0	48.00	2.00	0.00	1.20	0.00	0	0	6022
D	120.00	100.00	110.00	0.00	0.00	30.37	36.61	21.63	245.5	0.27	1.00	1.00	0.59	2.37	52.0	0	48.00	2.00	0.00	1.20	0.00	0	0	6643
E	100.00	80.00	90.00	0.00	0.00	37.01	40.26	23.91	272.8	0.28	1.00	1.00	0.59	2.34	60.9	0	48.00	2.00	0.00	1.20	0.00	0	0	9032
F	80.00	60.00	70.00	0.00	0.00	37.32	43.90	25.92	300.0	0.27	1.00	1.00	0.59	2.38	63.2	0	48.00	2.00	0.00	1.20	0.00	0	0	9496
G	60.00	40.00	50.00	0.00	0.00	42.28	50.37	29.91	327.3	0.28	1.00	1.00	0.59	2.34	72.2	0	48.00	2.00	0.00	1.20	0.00	0	0	10603
H	40.00	20.00	30.00	0.00	0.00	48.05	50.83	30.12	354.6	0.28	1.00	1.00	0.59	2.35	78.2	0	48.00	2.00	0.00	1.20	0.00	0	0	11284
I	20.00	0.00	10.00	0.00	0.00	59.30	58.17	34.98	381.9	0.31	1.00	1.00	0.60	2.28	94.3	0	43.20	2.00	0.00	1.20	0.00	0	0	11368

Equipment Load Case Information for "6: Service 1.0D + 1.0Dg + 1.0 Wo":

Equipment Label	Equipment Property Set	Elevation Above Ground (ft)	qzGh (psf)	Ice Thick. (in)	Total Wind Area (ft^2)	Wind Incidence Angle (deg)	222-G CA	222-G CS	222-G CM	Antenna Axial Load (lbs)	Antenna Side Load (lbs)	Antenna Moment (ft-lbs)	Long. Load (lbs)	Trans. Load (lbs)	Vert. Load (lbs)
DNK-1	5` Dipole	60.00	8.40	0.00	3.95	0.00							33.19	0.00	50.00
MT-DNK1	3` Stand-Off	60.00	8.40	0.00	2.72	0.00							22.84	0.00	50.00
DNK2-GPS68	GPS	60.00	8.40	0.00	1.00	120.00							8.40	0.00	10.00
MT-DNK2	3` Stand-Off	60.00	8.40	0.00	2.72	120.00							22.84	0.00	50.00
DNK3-GPS69	GPS	60.00	8.40	0.00	1.00	240.00							8.40	0.00	10.00
MT-DNK3	3` Stand-Off	60.00	8.40	0.00	2.72	240.00							22.84	0.00	50.00
DNK4-DOT56	10` Dipole	60.00	8.40	0.00	9.17	240.00							76.96	0.00	46.00
MT-DNK4	3` Stand-Off	60.00	8.40	0.00	2.72	240.00							22.84	0.00	50.00
DNK5-NEU16	8` Omni	80.00	8.47	0.00	2.00	240.00							16.94	0.00	5.00
MT-DNK5	6` Stand-Off	80.00	8.47	0.00	10.60	240.00							89.80	0.00	140.00
DNK9-DEP54	RFS PD1142 w/ ice	120.00	8.87	0.00	1.32	120.00							11.67	0.00	10.00
MT-DNK9	3` Stand-Off	120.00	8.87	0.00	2.72	120.00							24.12	0.00	50.00
DNK8-CSP66	RFS PD1142 w/ ice	120.00	8.87	0.00	1.32	120.00							11.67	0.00	10.00
DNK7-NEU17	12` Omni	113.34	8.79	0.00	4.00	0.00							35.17	0.00	55.00
MT-DNK7	3` Stand-Off	113.34	8.79	0.00	2.72	0.00							23.92	0.00	50.00
Sprint-A	12` T-Arm	113.34	8.79	0.00	13.60	0.00							119.59	0.00	465.00
Sprint-B	12` T-Arm	113.34	8.79	0.00	13.60	120.00							119.59	0.00	465.00
Sprint-C	12` T-Arm	113.34	8.79	0.00	13.60	240.00							119.59	0.00	465.00
Sprint-1	RFS APXVSP18-C w/ ice	113.34	8.79	0.00	8.26	0.00							72.63	0.00	90.00
Sprint-2	ALU RRH	113.34	8.79	0.00	6.90	0.00							60.65	0.00	60.00
Sprint-3	ALU RRH	113.34	8.79	0.00	6.90	0.00							60.65	0.00	60.00
Sprint-4	RFS APXVSP18-C w/ ice	113.34	8.79	0.00	8.26	120.00							72.63	0.00	90.00
Sprint-5	ALU RRH	113.34	8.79	0.00	6.90	120.00							60.65	0.00	60.00

Sprint-6		ALU RRH	113.34	8.79	0.00	6.90	120.00	60.65	0.00	60.00
Sprint-7	RFS APXVSP18-C w/ ice		113.34	8.79	0.00	8.26	240.00	72.63	0.00	90.00
Sprint-8		ALU RRH	113.34	8.79	0.00	6.90	240.00	60.65	0.00	60.00
Sprint-9		ALU RRH	113.34	8.79	0.00	6.90	240.00	60.65	0.00	60.00
Sprint-10		DT465B-2XR-V2	113.34	8.79	0.00	9.65	0.00	84.83	0.00	88.40
Sprint-11		DT465B-2XR-V2	113.34	8.79	0.00	9.65	120.00	84.83	0.00	88.40
Sprint-12		DT465B-2XR-V2	113.34	8.79	0.00	9.65	240.00	84.83	0.00	88.40
Sprint-13		800 MHz RRH Unit	113.34	8.79	0.00	6.90	0.00	60.65	0.00	60.00
Sprint-14		800 MHz RRH Unit	113.34	8.79	0.00	6.90	120.00	60.65	0.00	60.00
Sprint-15		800 MHz RRH Unit	113.34	8.79	0.00	6.90	240.00	60.65	0.00	60.00
Sprint-16	TD-RRH 8x20-25	RRH Unit	113.34	8.79	0.00	4.72	0.00	41.50	0.00	66.13
Sprint-17	TD-RRH 8x20-25	RRH Unit	113.34	8.79	0.00	4.72	120.00	41.50	0.00	66.13
Sprint-18	TD-RRH 8x20-25	RRH Unit	113.34	8.79	0.00	4.72	240.00	41.50	0.00	66.13
Verizon-A		Boom Gate	126.66	8.95	0.00	13.60	0.00	121.67	0.00	471.00
Verizon-B		Boom Gate	126.66	8.95	0.00	13.60	120.00	121.67	0.00	471.00
Verizon-C		Boom Gate	126.66	8.95	0.00	13.60	240.00	121.67	0.00	471.00
Verizon-1	Decibel DB844H80-XY w/ ice		126.66	8.95	0.00	3.97	0.00	35.49	0.00	10.00
Verizon-2	Decibel DB844H80-XY w/ ice		126.66	8.95	0.00	3.97	0.00	35.49	0.00	10.00
Verizon-3	Decibel DB844H80-XY w/ ice		126.66	8.95	0.00	3.97	120.00	35.49	0.00	10.00
Verizon-4	Decibel DB844H80-XY w/ ice		126.66	8.95	0.00	3.97	120.00	35.49	0.00	10.00
Verizon-5	Decibel DB844H80-XY w/ ice		126.66	8.95	0.00	3.97	240.00	35.49	0.00	10.00
Verizon-6	Decibel DB844H80-XY w/ ice		126.66	8.95	0.00	3.97	240.00	35.49	0.00	10.00
Verizon-7	JAHH-65B-R3B	Panel	126.66	8.95	0.00	9.66	0.00	86.42	0.00	126.30
Verizon-8	JAHH-65B-R3B	Panel	126.66	8.95	0.00	9.66	0.00	86.42	0.00	126.30
Verizon-9	JAHH-65B-R3B	Panel	126.66	8.95	0.00	9.66	120.00	86.42	0.00	126.30
Verizon-10	JAHH-65B-R3B	Panel	126.66	8.95	0.00	9.66	120.00	86.42	0.00	126.30
Verizon-11	JAHH-65B-R3B	Panel	126.66	8.95	0.00	9.66	240.00	86.42	0.00	126.30
Verizon-12	JAHH-65B-R3B	Panel	126.66	8.95	0.00	9.66	240.00	86.42	0.00	126.30
Verizon-D	BSAMNT-SBS-2-2	Mount for JAHH Antenna	126.66	8.95	0.00	3.78	0.00	33.85	0.00	116.00
Verizon-E	BSAMNT-SBS-2-2	Mount for JAHH Antenna	126.66	8.95	0.00	3.78	120.00	33.85	0.00	116.00
Verizon-F	BSAMNT-SBS-2-2	Mount for JAHH Antenna	126.66	8.95	0.00	3.78	240.00	33.85	0.00	116.00
Verizon-13		RRH 2x60W (700 MHz)	126.66	8.95	0.00	2.12	0.00	18.95	0.00	60.00
Verizon-14		RRH 2x60W (700 MHz)	126.66	8.95	0.00	2.12	120.00	18.95	0.00	60.00
Verizon-15		RRH 2x60W (700 MHz)	126.66	8.95	0.00	2.12	240.00	18.95	0.00	60.00
Verizon-16		RRH 4x45W (AWS)	126.66	8.95	0.00	2.96	0.00	26.48	0.00	60.00
Verizon-17		RRH 4x45W (AWS)	126.66	8.95	0.00	2.96	120.00	26.48	0.00	60.00
Verizon-18		RRH 4x45W (AWS)	126.66	8.95	0.00	2.96	240.00	26.48	0.00	60.00
Verizon-19		RHH 2x80W (850 MHz)	126.66	8.95	0.00	2.91	0.00	26.01	0.00	90.00
Verizon-20		RHH 2x80W (850 MHz)	126.66	8.95	0.00	2.91	120.00	26.01	0.00	90.00
Verizon-21		RHH 2x80W (850 MHz)	126.66	8.95	0.00	2.91	240.00	26.01	0.00	90.00
Verizon-22	Raycap DB-T1-6Z-8AB-0Z	Dist. Box	126.66	8.95	0.00	5.60	0.00	50.10	0.00	45.00
Verizon-23	Raycap DB-T1-6Z-8AB-0Z	Dist. Box	126.66	8.95	0.00	5.60	120.00	50.10	0.00	45.00
Verizon-24	Raycap DB-T1-6Z-8AB-0Z	Dist. Box	126.66	8.95	0.00	5.60	240.00	50.10	0.00	45.00
NEU-18		12` Omni	126.66	8.95	0.00	4.00	0.00	35.78	0.00	55.00
DNK15-CSP21	RFS PD1142 w/ ice		133.34	9.02	0.00	1.32	120.00	11.88	0.00	10.00
MT-DNK15		3` Stand-Off	133.34	9.02	0.00	2.72	120.00	24.54	0.00	50.00
DNK-12		5` Dipole	133.34	9.02	0.00	3.95	240.00	35.68	0.00	50.00
MT-DNK12		3` Stand-Off	133.34	9.02	0.00	2.72	240.00	24.54	0.00	50.00
T-Mobile-1		Ericsson AIR B2A/B4P	133.34	9.02	0.00	6.53	0.00	58.95	0.00	110.02
T-Mobile-2		AIR32 B66/B2A	133.34	9.02	0.00	5.84	0.00	52.74	0.00	132.20
T-Mobile-3	APXVAA24_43-U-A20 (RFS)		133.34	9.02	0.00	22.38	0.00	201.92	0.00	150.00
T-Mobile-4		Ericsson AIR B2A/B4P	133.34	9.02	0.00	6.53	120.00	58.95	0.00	110.02
T-Mobile-5		AIR32 B66/B2A	133.34	9.02	0.00	5.84	120.00	52.74	0.00	132.20
T-Mobile-6	APXVAA24_43-U-A20 (RFS)		133.34	9.02	0.00	22.38	120.00	201.92	0.00	150.00
T-Mobile-7		Ericsson AIR B2A/B4P	133.34	9.02	0.00	6.53	240.00	58.95	0.00	110.02
T-Mobile-8		AIR32 B66/B2A	133.34	9.02	0.00	5.84	240.00	52.74	0.00	132.20
T-Mobile-9	APXVAA24_43-U-A20 (RFS)		133.34	9.02	0.00	22.38	240.00	201.92	0.00	150.00
T-Mobile-10		Twin TMA Unit - Generic	133.34	9.02	0.00	1.12	0.00	10.15	0.00	25.00
T-Mobile-11		Twin TMA Unit - Generic	133.34	9.02	0.00	1.12	120.00	10.15	0.00	25.00
T-Mobile-12		Twin TMA Unit - Generic	133.34	9.02	0.00	1.12	240.00	10.15	0.00	25.00
T-Mobile-13		RRHU-11 RRH Unit	133.34	9.02	0.00	2.99	0.00	27.02	0.00	50.00
T-Mobile-14		RRHU-11 RRH Unit	133.34	9.02	0.00	2.99	120.00	27.02	0.00	50.00
T-Mobile-15		RRHU-11 RRH Unit	133.34	9.02	0.00	2.99	240.00	27.02	0.00	50.00
T-Mobile-16	Ericsson 4478 (B71)	RRH Unit	133.34	9.02	0.00	1.26	0.00	11.40	0.00	60.00
T-Mobile-17	Ericsson 4478 (B71)	RRH Unit	133.34	9.02	0.00	1.26	120.00	11.40	0.00	60.00
T-Mobile-18	Ericsson 4478 (B71)	RRH Unit	133.34	9.02	0.00	1.26	240.00	11.40	0.00	60.00
T-Mobile-19		Diplexer Unit - Generic	133.34	9.02	0.00	0.72	0.00	6.54	0.00	25.00
T-Mobile-20		Diplexer Unit - Generic	133.34	9.02	0.00	0.72	120.00	6.54	0.00	25.00
T-Mobile-21		Diplexer Unit - Generic	133.34	9.02	0.00	0.72	240.00	6.54	0.00	25.00





G	60.00	40.00	50.00	8.42	0.00	42.28	50.37	28.32	327.3	0.28	1.00	1.00	0.54	2.34	70.6	1393	80.00	2.00	0.00	0.60	0.00	1348	2741	11781
H	40.00	20.00	30.00	8.67	0.00	48.05	50.83	28.41	354.6	0.28	1.00	1.00	0.54	2.35	76.5	1561	80.00	2.00	0.00	0.60	0.00	1387	2948	12538
I	20.00	0.00	10.00	9.62	0.00	59.30	58.17	30.73	381.9	0.31	1.00	1.00	0.51	2.28	90.0	1970	72.00	2.00	0.00	0.60	0.00	1385	3355	12631

Equipment Load Case Information for "1.2\*DL":

Equipment Label	Equipment Property Set	Elevation Above Ground (ft)	qzGh (psf)	Ice Thick. (in)	Total Wind Area (ft^2)	Wind Incidence Angle (deg)	222-G CA	222-G CS	222-G CM	Antenna Axial Load FAM (lbs)	Antenna Side Load FSM (lbs)	Antenna Moment MM (ft-lbs)	Long. Load (lbs)	Trans. Load (lbs)	Vert. Load (lbs)
DNK-1	5` Dipole	60.00	0.00	0.00	3.95	0.00							0.00	0.00	60.00
MT-DNK1	3` Stand-Off	60.00	0.00	0.00	2.72	0.00							0.00	0.00	60.00
DNK2-GPS68	GPS	60.00	0.00	0.00	1.00	120.00							0.00	0.00	12.00
MT-DNK2	3` Stand-Off	60.00	0.00	0.00	2.72	120.00							0.00	0.00	60.00
DNK3-GPS69	GPS	60.00	0.00	0.00	1.00	240.00							0.00	0.00	12.00
MT-DNK3	3` Stand-Off	60.00	0.00	0.00	2.72	240.00							0.00	0.00	60.00
DNK4-DOT56	10` Dipole	60.00	0.00	0.00	9.17	240.00							0.00	0.00	55.20
MT-DNK4	3` Stand-Off	60.00	0.00	0.00	2.72	240.00							0.00	0.00	60.00
DNK5-NEU16	8` Omni	80.00	0.00	0.00	2.00	240.00							0.00	0.00	6.00
MT-DNK5	6` Stand-Off	80.00	0.00	0.00	10.60	240.00							0.00	0.00	168.00
DNK9-DEP54	RFS PD1142 w/ ice	120.00	0.00	0.00	1.32	120.00							0.00	0.00	12.00
MT-DNK9	3` Stand-Off	120.00	0.00	0.00	2.72	120.00							0.00	0.00	60.00
DNK8-CSP66	RFS PD1142 w/ ice	120.00	0.00	0.00	1.32	120.00							0.00	0.00	12.00
DNK7-NEU17	12` Omni	113.34	0.00	0.00	4.00	0.00							0.00	0.00	66.00
MT-DNK7	3` Stand-Off	113.34	0.00	0.00	2.72	0.00							0.00	0.00	60.00
Sprint-A	12` T-Arm	113.34	0.00	0.00	13.60	0.00							0.00	0.00	558.00
Sprint-B	12` T-Arm	113.34	0.00	0.00	13.60	120.00							0.00	0.00	558.00
Sprint-C	12` T-Arm	113.34	0.00	0.00	13.60	240.00							0.00	0.00	558.00
Sprint-1	RFS APXVSP18-C w/ ice	113.34	0.00	0.00	8.26	0.00							0.00	0.00	108.00
Sprint-2	ALU RRH	113.34	0.00	0.00	6.90	0.00							0.00	0.00	72.00
Sprint-3	ALU RRH	113.34	0.00	0.00	6.90	0.00							0.00	0.00	72.00
Sprint-4	RFS APXVSP18-C w/ ice	113.34	0.00	0.00	8.26	120.00							0.00	0.00	108.00
Sprint-5	ALU RRH	113.34	0.00	0.00	6.90	120.00							0.00	0.00	72.00
Sprint-6	ALU RRH	113.34	0.00	0.00	6.90	120.00							0.00	0.00	72.00
Sprint-7	RFS APXVSP18-C w/ ice	113.34	0.00	0.00	8.26	240.00							0.00	0.00	108.00
Sprint-8	ALU RRH	113.34	0.00	0.00	6.90	240.00							0.00	0.00	72.00
Sprint-9	ALU RRH	113.34	0.00	0.00	6.90	240.00							0.00	0.00	72.00
Sprint-10	DT465B-2XR-V2	113.34	0.00	0.00	9.65	0.00							0.00	0.00	106.08
Sprint-11	DT465B-2XR-V2	113.34	0.00	0.00	9.65	120.00							0.00	0.00	106.08
Sprint-12	DT465B-2XR-V2	113.34	0.00	0.00	9.65	240.00							0.00	0.00	106.08
Sprint-13	800 MHz RRH Unit	113.34	0.00	0.00	6.90	0.00							0.00	0.00	72.00
Sprint-14	800 MHz RRH Unit	113.34	0.00	0.00	6.90	120.00							0.00	0.00	72.00
Sprint-15	800 MHz RRH Unit	113.34	0.00	0.00	6.90	240.00							0.00	0.00	72.00
Sprint-16	TD-RRH 8x20-25 RRH Unit	113.34	0.00	0.00	4.72	0.00							0.00	0.00	79.36
Sprint-17	TD-RRH 8x20-25 RRH Unit	113.34	0.00	0.00	4.72	120.00							0.00	0.00	79.36
Sprint-18	TD-RRH 8x20-25 RRH Unit	113.34	0.00	0.00	4.72	240.00							0.00	0.00	79.36
Verizon-A	Boom Gate	126.66	0.00	0.00	13.60	0.00							0.00	0.00	565.20
Verizon-B	Boom Gate	126.66	0.00	0.00	13.60	120.00							0.00	0.00	565.20
Verizon-C	Boom Gate	126.66	0.00	0.00	13.60	240.00							0.00	0.00	565.20
Verizon-1	Decibel DB844H80-XY w/ ice	126.66	0.00	0.00	3.97	0.00							0.00	0.00	12.00
Verizon-2	Decibel DB844H80-XY w/ ice	126.66	0.00	0.00	3.97	0.00							0.00	0.00	12.00
Verizon-3	Decibel DB844H80-XY w/ ice	126.66	0.00	0.00	3.97	120.00							0.00	0.00	12.00
Verizon-4	Decibel DB844H80-XY w/ ice	126.66	0.00	0.00	3.97	120.00							0.00	0.00	12.00
Verizon-5	Decibel DB844H80-XY w/ ice	126.66	0.00	0.00	3.97	240.00							0.00	0.00	12.00
Verizon-6	Decibel DB844H80-XY w/ ice	126.66	0.00	0.00	3.97	240.00							0.00	0.00	12.00
Verizon-7	JAHH-65B-R3B Panel	126.66	0.00	0.00	9.66	0.00							0.00	0.00	151.56
Verizon-8	JAHH-65B-R3B Panel	126.66	0.00	0.00	9.66	0.00							0.00	0.00	151.56
Verizon-9	JAHH-65B-R3B Panel	126.66	0.00	0.00	9.66	120.00							0.00	0.00	151.56
Verizon-10	JAHH-65B-R3B Panel	126.66	0.00	0.00	9.66	120.00							0.00	0.00	151.56
Verizon-11	JAHH-65B-R3B Panel	126.66	0.00	0.00	9.66	240.00							0.00	0.00	151.56
Verizon-12	JAHH-65B-R3B Panel	126.66	0.00	0.00	9.66	240.00							0.00	0.00	151.56
Verizon-D	BSAMNT-SBS-2-2 Mount for JAHH Antenna	126.66	0.00	0.00	3.78	0.00							0.00	0.00	139.20
Verizon-E	BSAMNT-SBS-2-2 Mount for JAHH Antenna	126.66	0.00	0.00	3.78	120.00							0.00	0.00	139.20
Verizon-F	BSAMNT-SBS-2-2 Mount for JAHH Antenna	126.66	0.00	0.00	3.78	240.00							0.00	0.00	139.20
Verizon-13	RRH 2x60W (700 MHz)	126.66	0.00	0.00	2.12	0.00							0.00	0.00	72.00
Verizon-14	RRH 2x60W (700 MHz)	126.66	0.00	0.00	2.12	120.00							0.00	0.00	72.00
Verizon-15	RRH 2x60W (700 MHz)	126.66	0.00	0.00	2.12	240.00							0.00	0.00	72.00
Verizon-16	RRH 4x45W (AWS)	126.66	0.00	0.00	2.96	0.00							0.00	0.00	72.00

Verizon-17	RRH 4x45W (AWS)	126.66	0.00	0.00	2.96	120.00	0.00	0.00	72.00
Verizon-18	RRH 4x45W (AWS)	126.66	0.00	0.00	2.96	240.00	0.00	0.00	72.00
Verizon-19	RHH 2x80W (850 MHz)	126.66	0.00	0.00	2.91	0.00	0.00	0.00	108.00
Verizon-20	RHH 2x80W (850 MHz)	126.66	0.00	0.00	2.91	120.00	0.00	0.00	108.00
Verizon-21	RHH 2x80W (850 MHz)	126.66	0.00	0.00	2.91	240.00	0.00	0.00	108.00
Verizon-22	Raycap DB-T1-6Z-8AB-0Z Dist. Box	126.66	0.00	0.00	5.60	0.00	0.00	0.00	54.00
Verizon-23	Raycap DB-T1-6Z-8AB-0Z Dist. Box	126.66	0.00	0.00	5.60	120.00	0.00	0.00	54.00
Verizon-24	Raycap DB-T1-6Z-8AB-0Z Dist. Box	126.66	0.00	0.00	5.60	240.00	0.00	0.00	54.00
NEU-18	12` Omni	126.66	0.00	0.00	4.00	0.00	0.00	0.00	66.00
DNK15-CSP21	RFS PD1142 w/ ice	133.34	0.00	0.00	1.32	120.00	0.00	0.00	12.00
MT-DNK15	3` Stand-Off	133.34	0.00	0.00	2.72	120.00	0.00	0.00	60.00
DNK-12	5` Dipole	133.34	0.00	0.00	3.95	240.00	0.00	0.00	60.00
MT-DNK12	3` Stand-Off	133.34	0.00	0.00	2.72	240.00	0.00	0.00	60.00
T-Mobile-1	Ericsson AIR B2A/B4P	133.34	0.00	0.00	6.53	0.00	0.00	0.00	132.02
T-Mobile-2	AIR32 B66/B2A	133.34	0.00	0.00	5.84	0.00	0.00	0.00	158.64
T-Mobile-3	APXVAA24_43-U-A20 (RFS)	133.34	0.00	0.00	22.38	0.00	0.00	0.00	180.00
T-Mobile-4	Ericsson AIR B2A/B4P	133.34	0.00	0.00	6.53	120.00	0.00	0.00	132.02
T-Mobile-5	AIR32 B66/B2A	133.34	0.00	0.00	5.84	120.00	0.00	0.00	158.64
T-Mobile-6	APXVAA24_43-U-A20 (RFS)	133.34	0.00	0.00	22.38	120.00	0.00	0.00	180.00
T-Mobile-7	Ericsson AIR B2A/B4P	133.34	0.00	0.00	6.53	240.00	0.00	0.00	132.02
T-Mobile-8	AIR32 B66/B2A	133.34	0.00	0.00	5.84	240.00	0.00	0.00	158.64
T-Mobile-9	APXVAA24_43-U-A20 (RFS)	133.34	0.00	0.00	22.38	240.00	0.00	0.00	180.00
T-Mobile-10	Twin TMA Unit - Generic	133.34	0.00	0.00	1.12	0.00	0.00	0.00	30.00
T-Mobile-11	Twin TMA Unit - Generic	133.34	0.00	0.00	1.12	120.00	0.00	0.00	30.00
T-Mobile-12	Twin TMA Unit - Generic	133.34	0.00	0.00	1.12	240.00	0.00	0.00	30.00
T-Mobile-13	RRHU-11 RRH Unit	133.34	0.00	0.00	2.99	0.00	0.00	0.00	60.00
T-Mobile-14	RRHU-11 RRH Unit	133.34	0.00	0.00	2.99	120.00	0.00	0.00	60.00
T-Mobile-15	RRHU-11 RRH Unit	133.34	0.00	0.00	2.99	240.00	0.00	0.00	60.00
T-Mobile-16	Ericsson 4478 (B71) RRH Unit	133.34	0.00	0.00	1.26	0.00	0.00	0.00	72.00
T-Mobile-17	Ericsson 4478 (B71) RRH Unit	133.34	0.00	0.00	1.26	120.00	0.00	0.00	72.00
T-Mobile-18	Ericsson 4478 (B71) RRH Unit	133.34	0.00	0.00	1.26	240.00	0.00	0.00	72.00
T-Mobile-19	Diplexer Unit - Generic	133.34	0.00	0.00	0.72	0.00	0.00	0.00	30.00
T-Mobile-20	Diplexer Unit - Generic	133.34	0.00	0.00	0.72	120.00	0.00	0.00	30.00
T-Mobile-21	Diplexer Unit - Generic	133.34	0.00	0.00	0.72	240.00	0.00	0.00	30.00
ATT-A	12` T-Arm	150.00	0.00	0.00	13.60	0.00	0.00	0.00	558.00
ATT-B	12` T-Arm	150.00	0.00	0.00	13.60	120.00	0.00	0.00	558.00
ATT-C	12` T-Arm	150.00	0.00	0.00	13.60	240.00	0.00	0.00	558.00
ATT-A1	Powerwave 7770	150.00	0.00	0.00	5.88	0.00	0.00	0.00	42.00
ATT-A2	Powerwave 7770	150.00	0.00	0.00	5.88	0.00	0.00	0.00	42.00
ATT-A3	RRHU-11 RRH Unit	150.00	0.00	0.00	2.99	0.00	0.00	0.00	60.00
ATT-A4	TMA Unit (LGP24101)	150.00	0.00	0.00	1.29	0.00	0.00	0.00	16.92
ATT-A5	TMA Unit (LGP24101)	150.00	0.00	0.00	1.29	0.00	0.00	0.00	16.92
ATT-A6	Raycap Surge Suppressor	150.00	0.00	0.00	1.79	0.00	0.00	0.00	32.40
ATT-A7	OPA-65-LCUU-H6 Panel	150.00	0.00	0.00	10.12	0.00	0.00	0.00	76.80
ATT-A8	RRUS-32 RRH Unit	150.00	0.00	0.00	3.88	0.00	0.00	0.00	96.00
ATT-B1	RRHU-11 RRH Unit	150.00	0.00	0.00	2.99	120.00	0.00	0.00	60.00
ATT-B2	TMA Unit (LGP24101)	150.00	0.00	0.00	1.29	120.00	0.00	0.00	16.92
ATT-B3	TMA Unit (LGP24101)	150.00	0.00	0.00	1.29	120.00	0.00	0.00	16.92
ATT-B4	OPA-65-LCUU-H6 Panel	150.00	0.00	0.00	10.12	120.00	0.00	0.00	76.80
ATT-B5	RRUS-32 RRH Unit	150.00	0.00	0.00	3.88	120.00	0.00	0.00	96.00
ATT-C1	RRHU-11 RRH Unit	150.00	0.00	0.00	2.99	240.00	0.00	0.00	60.00
ATT-C2	TMA Unit (LGP24101)	150.00	0.00	0.00	1.29	240.00	0.00	0.00	16.92
ATT-C3	TMA Unit (LGP24101)	150.00	0.00	0.00	1.29	240.00	0.00	0.00	16.92
ATT-C4	OPA-65-LCUU-H6 Panel	150.00	0.00	0.00	10.12	240.00	0.00	0.00	76.80
ATT-C5	RRUS-32 RRH Unit	150.00	0.00	0.00	3.88	240.00	0.00	0.00	96.00
CSP-70	Sinclair SC479-HF1LDF w/ ice	160.00	0.00	0.00	5.06	0.00	0.00	0.00	40.80
CSP-71	Sinclair SC479-HF1LDF w/ ice	160.00	0.00	0.00	5.06	120.00	0.00	0.00	40.80
CSP-72	Sinclair SC479-HF1LDF w/ ice	160.00	0.00	0.00	5.06	240.00	0.00	0.00	40.80
CSP-73	TMA	160.00	0.00	0.00	1.29	240.00	0.00	0.00	18.00
DNK21-SPD9	8` Dish with Radome	160.00	0.00	0.00	51.32	0.00	0.86330	0.00	672.00
DNK20-UNKNOWN	4`xl` Panel	160.00	0.00	0.00	6.53	240.00	0.00	0.00	36.00
DNK19-STAM63	4`xl` Panel	160.00	0.00	0.00	6.53	120.00	0.00	0.00	36.00
159-A	3` Stand-Off	160.00	0.00	0.00	2.72	0.00	0.00	0.00	60.00
159-B	3` Stand-Off	160.00	0.00	0.00	2.72	120.00	0.00	0.00	60.00
160	3` Stand-Off	160.00	0.00	0.00	2.72	240.00	0.00	0.00	60.00
DNK22-TOG-6	DB586-Y	165.00	0.00	0.00	1.01	0.00	0.00	0.00	9.90
DNK23-STAM64	4`xl` Panel	165.00	0.00	0.00	6.53	0.00	0.00	0.00	36.00
DNK23-STAM65	TMA	165.00	0.00	0.00	1.29	0.00	0.00	0.00	18.00
GRN-1 (DNK25)	4` Dish	170.00	0.00	0.00	13.10	50.00	1.66410	0.08980	-0.06910

DNK26aCSP-67	Dipole	175.00	0.00	0.00	9.17	0.00	0.00	0.00	55.20
DNK26bNEU-20	4` Dipole	175.00	0.00	0.00	3.70	0.00	0.00	0.00	48.00
DNK27A-CSP4	Sinclair SC479-HF1LDF w/ ice	175.00	0.00	0.00	5.06	240.00	0.00	0.00	40.80
DNK27B-CSP2	Scala OGT9-806 w/ ice	175.00	0.00	0.00	2.27	120.00	0.00	0.00	22.20
DNK27C-CSP74	TMA	175.00	0.00	0.00	1.29	120.00	0.00	0.00	18.00
DNK28A-CSP1	Scala OGT9-806 w/ ice	175.00	0.00	0.00	2.27	120.00	0.00	0.00	22.20
DNK28B-CSP3	Sinclair SC479-HF1LDF w/ ice	175.00	0.00	0.00	5.06	240.00	0.00	0.00	40.80
DNK28C-TOG5	Andrew DB-583 w/ ice	175.00	0.00	0.00	0.54	0.00	0.00	0.00	7.50
DNK28D-NEU55	Decibel PD-420 2 bay - Dipole	175.00	0.00	0.00	1.64	240.00	0.00	0.00	12.00
Top-A	6` Stand-Off	180.00	0.00	0.00	10.60	0.00	0.00	0.00	168.00
Top-B	6` Stand-Off	180.00	0.00	0.00	10.60	120.00	0.00	0.00	168.00
Top-C1	6` Stand-Off	180.00	0.00	0.00	10.60	260.00	0.00	0.00	168.00
Top-C2	6` Stand-Off	180.00	0.00	0.00	10.60	220.00	0.00	0.00	168.00
ATT-B7	Powerwave 7770	150.00	0.00	0.00	5.88	120.00	0.00	0.00	42.00
ATT-B8	Powerwave 7770	150.00	0.00	0.00	5.88	120.00	0.00	0.00	42.00
ATT-C7	Powerwave 7770	150.00	0.00	0.00	5.88	240.00	0.00	0.00	42.00
ATT-C8	Powerwave 7770	150.00	0.00	0.00	5.88	240.00	0.00	0.00	42.00

EIA Section Load Case Information for "1.2\*DL":

Note: qzGh (adjusted wind pressure) includes: Velocity Pressure Coefficient (Kz), Topographic Factor (Kzt), Gust Effect Factor (Gh), Wind Direction Probability Factor (Kd), Wind Importance Factor (Table 2-3), Wind Load Factor (from Loads/EIA Loads)  
Face RR is the minimum round reduction factor for all round angles and appurtenances in the section

Section Label	Z of Top (ft)	Z of Bottom (ft)	Ave. Elev. Above Gnd. (ft)	Elev. qzGh (psf)	Ice Thick. (in)	Face AF (ft^2)	Face AR (ft^2)	Face RR*AR (ft^2)	Face AG (ft^2)	Face e	Face DF	Face DR	Face RR	Face CF	Face AE (ft^2)	Face WF (lbs)	NotF AAF (ft^2)	NotF CAF	NotF AAR (ft^2)	NotF CAR	NotF AAR*CAR (ft^2)	NotF WA (lbs)	Total Wind (lbs)	Total Weight (lbs)
A	180.00	160.00	170.00	0.00	0.00	20.58	21.02	12.32	163.7	0.25	1.00	1.00	0.59	2.43	32.9	0	24.00	2.00	0.00	1.20	0.00	0	0	6770
B	160.00	140.00	150.00	0.00	0.00	22.52	27.30	16.04	191.0	0.26	1.00	1.00	0.59	2.41	38.6	0	36.00	2.00	0.00	1.20	0.00	0	0	7224
C	140.00	120.00	130.00	0.00	0.00	25.73	29.16	17.07	218.3	0.25	1.00	1.00	0.59	2.43	42.8	0	48.00	2.00	0.00	1.20	0.00	0	0	8030
D	120.00	100.00	110.00	0.00	0.00	30.37	36.61	21.63	245.5	0.27	1.00	1.00	0.59	2.37	52.0	0	48.00	2.00	0.00	1.20	0.00	0	0	8857
E	100.00	80.00	90.00	0.00	0.00	37.01	40.26	23.91	272.8	0.28	1.00	1.00	0.59	2.34	60.9	0	48.00	2.00	0.00	1.20	0.00	0	0	12042
F	80.00	60.00	70.00	0.00	0.00	37.32	43.90	25.92	300.0	0.27	1.00	1.00	0.59	2.38	63.2	0	48.00	2.00	0.00	1.20	0.00	0	0	12661
G	60.00	40.00	50.00	0.00	0.00	42.28	50.37	29.91	327.3	0.28	1.00	1.00	0.59	2.34	72.2	0	48.00	2.00	0.00	1.20	0.00	0	0	14137
H	40.00	20.00	30.00	0.00	0.00	48.05	50.83	30.12	354.6	0.28	1.00	1.00	0.59	2.35	78.2	0	48.00	2.00	0.00	1.20	0.00	0	0	15046
I	20.00	0.00	10.00	0.00	0.00	59.30	58.17	34.98	381.9	0.31	1.00	1.00	0.60	2.28	94.3	0	43.20	2.00	0.00	1.20	0.00	0	0	15157

Equipment Load Case Information for "0.9DL":

Equipment Label	Equipment Property Set	Elevation Above Ground (ft)	qzGh (psf)	Ice Thick. (in)	Total Wind Area (ft^2)	Wind Incidence Angle (deg)	222-G CA	222-G CS	222-G CM	Antenna Axial Load FAM (lbs)	Antenna Side Load FSM (lbs)	Antenna Moment MM (ft-lbs)	Long. Load (lbs)	Trans. Load (lbs)	Vert. Load (lbs)
DNK-1	5` Dipole	60.00	0.00	0.00	3.95	0.00							0.00	0.00	45.00
MT-DNK1	3` Stand-Off	60.00	0.00	0.00	2.72	0.00							0.00	0.00	45.00
DNK2-GPS68	GPS	60.00	0.00	0.00	1.00	120.00							0.00	0.00	9.00
MT-DNK2	3` Stand-Off	60.00	0.00	0.00	2.72	120.00							0.00	0.00	45.00
DNK3-GPS69	GPS	60.00	0.00	0.00	1.00	240.00							0.00	0.00	9.00
MT-DNK3	3` Stand-Off	60.00	0.00	0.00	2.72	240.00							0.00	0.00	45.00
DNK4-DOT56	10` Dipole	60.00	0.00	0.00	9.17	240.00							0.00	0.00	41.40
MT-DNK4	3` Stand-Off	60.00	0.00	0.00	2.72	240.00							0.00	0.00	45.00
DNK5-NEU16	8` Omni	80.00	0.00	0.00	2.00	240.00							0.00	0.00	4.50
MT-DNK5	6` Stand-Off	80.00	0.00	0.00	10.60	240.00							0.00	0.00	126.00
DNK9-DEP54	RFS PD1142 w/ ice	120.00	0.00	0.00	1.32	120.00							0.00	0.00	9.00
MT-DNK9	3` Stand-Off	120.00	0.00	0.00	2.72	120.00							0.00	0.00	45.00
DNK8-CSP66	RFS PD1142 w/ ice	120.00	0.00	0.00	1.32	120.00							0.00	0.00	9.00
DNK7-NEU17	12` Omni	113.34	0.00	0.00	4.00	0.00							0.00	0.00	49.50
MT-DNK7	3` Stand-Off	113.34	0.00	0.00	2.72	0.00							0.00	0.00	45.00
Sprint-A	12` T-Arm	113.34	0.00	0.00	13.60	0.00							0.00	0.00	418.50
Sprint-B	12` T-Arm	113.34	0.00	0.00	13.60	120.00							0.00	0.00	418.50
Sprint-C	12` T-Arm	113.34	0.00	0.00	13.60	240.00							0.00	0.00	418.50
Sprint-1	RFS APXVSP18-C w/ ice	113.34	0.00	0.00	8.26	0.00							0.00	0.00	81.00
Sprint-2	ALU RRH	113.34	0.00	0.00	6.90	0.00							0.00	0.00	54.00
Sprint-3	ALU RRH	113.34	0.00	0.00	6.90	0.00							0.00	0.00	54.00
Sprint-4	RFS APXVSP18-C w/ ice	113.34	0.00	0.00	8.26	120.00							0.00	0.00	81.00
Sprint-5	ALU RRH	113.34	0.00	0.00	6.90	120.00							0.00	0.00	54.00
Sprint-6	ALU RRH	113.34	0.00	0.00	6.90	120.00							0.00	0.00	54.00

Sprint-7	RFS APXVSP18-C w/ ice	113.34	0.00	0.00	8.26	240.00	0.00	0.00	81.00
Sprint-8	ALU RRH	113.34	0.00	0.00	6.90	240.00	0.00	0.00	54.00
Sprint-9	ALU RRH	113.34	0.00	0.00	6.90	240.00	0.00	0.00	54.00
Sprint-10	DT465B-2XR-V2	113.34	0.00	0.00	9.65	0.00	0.00	0.00	79.56
Sprint-11	DT465B-2XR-V2	113.34	0.00	0.00	9.65	120.00	0.00	0.00	79.56
Sprint-12	DT465B-2XR-V2	113.34	0.00	0.00	9.65	240.00	0.00	0.00	79.56
Sprint-13	800 MHz RRH Unit	113.34	0.00	0.00	6.90	0.00	0.00	0.00	54.00
Sprint-14	800 MHz RRH Unit	113.34	0.00	0.00	6.90	120.00	0.00	0.00	54.00
Sprint-15	800 MHz RRH Unit	113.34	0.00	0.00	6.90	240.00	0.00	0.00	54.00
Sprint-16	TD-RRH 8x20-25 RRH Unit	113.34	0.00	0.00	4.72	0.00	0.00	0.00	59.52
Sprint-17	TD-RRH 8x20-25 RRH Unit	113.34	0.00	0.00	4.72	120.00	0.00	0.00	59.52
Sprint-18	TD-RRH 8x20-25 RRH Unit	113.34	0.00	0.00	4.72	240.00	0.00	0.00	59.52
Verizon-A	Boom Gate	126.66	0.00	0.00	13.60	0.00	0.00	0.00	423.90
Verizon-B	Boom Gate	126.66	0.00	0.00	13.60	120.00	0.00	0.00	423.90
Verizon-C	Boom Gate	126.66	0.00	0.00	13.60	240.00	0.00	0.00	423.90
Verizon-1	Decibel DB844H80-XY w/ ice	126.66	0.00	0.00	3.97	0.00	0.00	0.00	9.00
Verizon-2	Decibel DB844H80-XY w/ ice	126.66	0.00	0.00	3.97	0.00	0.00	0.00	9.00
Verizon-3	Decibel DB844H80-XY w/ ice	126.66	0.00	0.00	3.97	120.00	0.00	0.00	9.00
Verizon-4	Decibel DB844H80-XY w/ ice	126.66	0.00	0.00	3.97	120.00	0.00	0.00	9.00
Verizon-5	Decibel DB844H80-XY w/ ice	126.66	0.00	0.00	3.97	240.00	0.00	0.00	9.00
Verizon-6	Decibel DB844H80-XY w/ ice	126.66	0.00	0.00	3.97	240.00	0.00	0.00	9.00
Verizon-7	JAHH-65B-R3B Panel	126.66	0.00	0.00	9.66	0.00	0.00	0.00	113.67
Verizon-8	JAHH-65B-R3B Panel	126.66	0.00	0.00	9.66	0.00	0.00	0.00	113.67
Verizon-9	JAHH-65B-R3B Panel	126.66	0.00	0.00	9.66	120.00	0.00	0.00	113.67
Verizon-10	JAHH-65B-R3B Panel	126.66	0.00	0.00	9.66	120.00	0.00	0.00	113.67
Verizon-11	JAHH-65B-R3B Panel	126.66	0.00	0.00	9.66	240.00	0.00	0.00	113.67
Verizon-12	JAHH-65B-R3B Panel	126.66	0.00	0.00	9.66	240.00	0.00	0.00	113.67
Verizon-D	BSAMNT-SBS-2-2 Mount for JAHH Antenna	126.66	0.00	0.00	3.78	0.00	0.00	0.00	104.40
Verizon-E	BSAMNT-SBS-2-2 Mount for JAHH Antenna	126.66	0.00	0.00	3.78	120.00	0.00	0.00	104.40
Verizon-F	BSAMNT-SBS-2-2 Mount for JAHH Antenna	126.66	0.00	0.00	3.78	240.00	0.00	0.00	104.40
Verizon-13	RRH 2x60W (700 MHz)	126.66	0.00	0.00	2.12	0.00	0.00	0.00	54.00
Verizon-14	RRH 2x60W (700 MHz)	126.66	0.00	0.00	2.12	120.00	0.00	0.00	54.00
Verizon-15	RRH 2x60W (700 MHz)	126.66	0.00	0.00	2.12	240.00	0.00	0.00	54.00
Verizon-16	RRH 4x45W (AWS)	126.66	0.00	0.00	2.96	0.00	0.00	0.00	54.00
Verizon-17	RRH 4x45W (AWS)	126.66	0.00	0.00	2.96	120.00	0.00	0.00	54.00
Verizon-18	RRH 4x45W (AWS)	126.66	0.00	0.00	2.96	240.00	0.00	0.00	54.00
Verizon-19	RHH 2x80W (850 MHz)	126.66	0.00	0.00	2.91	0.00	0.00	0.00	81.00
Verizon-20	RHH 2x80W (850 MHz)	126.66	0.00	0.00	2.91	120.00	0.00	0.00	81.00
Verizon-21	RHH 2x80W (850 MHz)	126.66	0.00	0.00	2.91	240.00	0.00	0.00	81.00
Verizon-22	Raycap DB-T1-6Z-8AB-0Z Dist. Box	126.66	0.00	0.00	5.60	0.00	0.00	0.00	40.50
Verizon-23	Raycap DB-T1-6Z-8AB-0Z Dist. Box	126.66	0.00	0.00	5.60	120.00	0.00	0.00	40.50
Verizon-24	Raycap DB-T1-6Z-8AB-0Z Dist. Box	126.66	0.00	0.00	5.60	240.00	0.00	0.00	40.50
NEU-18	12` Omni	126.66	0.00	0.00	4.00	0.00	0.00	0.00	49.50
DNK15-CSP21	RFS PD1142 w/ ice	133.34	0.00	0.00	1.32	120.00	0.00	0.00	9.00
MT-DNK15	3` Stand-Off	133.34	0.00	0.00	2.72	120.00	0.00	0.00	45.00
DNK-12	5` Dipole	133.34	0.00	0.00	3.95	240.00	0.00	0.00	45.00
MT-DNK12	3` Stand-Off	133.34	0.00	0.00	2.72	240.00	0.00	0.00	45.00
T-Mobile-1	Ericsson AIR B2A/B4P	133.34	0.00	0.00	6.53	0.00	0.00	0.00	99.02
T-Mobile-2	AIR32 B66/B2A	133.34	0.00	0.00	5.84	0.00	0.00	0.00	118.98
T-Mobile-3	APXVAA24_43-U-A20 (RFS)	133.34	0.00	0.00	22.38	0.00	0.00	0.00	135.00
T-Mobile-4	Ericsson AIR B2A/B4P	133.34	0.00	0.00	6.53	120.00	0.00	0.00	99.02
T-Mobile-5	AIR32 B66/B2A	133.34	0.00	0.00	5.84	120.00	0.00	0.00	118.98
T-Mobile-6	APXVAA24_43-U-A20 (RFS)	133.34	0.00	0.00	22.38	120.00	0.00	0.00	135.00
T-Mobile-7	Ericsson AIR B2A/B4P	133.34	0.00	0.00	6.53	240.00	0.00	0.00	99.02
T-Mobile-8	AIR32 B66/B2A	133.34	0.00	0.00	5.84	240.00	0.00	0.00	118.98
T-Mobile-9	APXVAA24_43-U-A20 (RFS)	133.34	0.00	0.00	22.38	240.00	0.00	0.00	135.00
T-Mobile-10	Twin TMA Unit - Generic	133.34	0.00	0.00	1.12	0.00	0.00	0.00	22.50
T-Mobile-11	Twin TMA Unit - Generic	133.34	0.00	0.00	1.12	120.00	0.00	0.00	22.50
T-Mobile-12	Twin TMA Unit - Generic	133.34	0.00	0.00	1.12	240.00	0.00	0.00	22.50
T-Mobile-13	RRHU-11 RRH Unit	133.34	0.00	0.00	2.99	0.00	0.00	0.00	45.00
T-Mobile-14	RRHU-11 RRH Unit	133.34	0.00	0.00	2.99	120.00	0.00	0.00	45.00
T-Mobile-15	RRHU-11 RRH Unit	133.34	0.00	0.00	2.99	240.00	0.00	0.00	45.00
T-Mobile-16	Ericsson 4478 (B71) RRH Unit	133.34	0.00	0.00	1.26	0.00	0.00	0.00	54.00
T-Mobile-17	Ericsson 4478 (B71) RRH Unit	133.34	0.00	0.00	1.26	120.00	0.00	0.00	54.00
T-Mobile-18	Ericsson 4478 (B71) RRH Unit	133.34	0.00	0.00	1.26	240.00	0.00	0.00	54.00
T-Mobile-19	Diplexer Unit - Generic	133.34	0.00	0.00	0.72	0.00	0.00	0.00	22.50
T-Mobile-20	Diplexer Unit - Generic	133.34	0.00	0.00	0.72	120.00	0.00	0.00	22.50
T-Mobile-21	Diplexer Unit - Generic	133.34	0.00	0.00	0.72	240.00	0.00	0.00	22.50
ATT-A	12` T-Arm	150.00	0.00	0.00	13.60	0.00	0.00	0.00	418.50

ATT-B	12` T-Arm	150.00	0.00	0.00	13.60	120.00	0.00	0.00	418.50
ATT-C	12` T-Arm	150.00	0.00	0.00	13.60	240.00	0.00	0.00	418.50
ATT-A1	Powerwave 7770	150.00	0.00	0.00	5.88	0.00	0.00	0.00	31.50
ATT-A2	Powerwave 7770	150.00	0.00	0.00	5.88	0.00	0.00	0.00	31.50
ATT-A3	RRHU-11 RRH Unit	150.00	0.00	0.00	2.99	0.00	0.00	0.00	45.00
ATT-A4	TMA Unit (LGP24101)	150.00	0.00	0.00	1.29	0.00	0.00	0.00	12.69
ATT-A5	TMA Unit (LGP24101)	150.00	0.00	0.00	1.29	0.00	0.00	0.00	12.69
ATT-A6	Raycap Surge Suppressor	150.00	0.00	0.00	1.79	0.00	0.00	0.00	24.30
ATT-A7	OPA-65-LCUU-H6 Panel	150.00	0.00	0.00	10.12	0.00	0.00	0.00	57.60
ATT-A8	RRUS-32 RRH Unit	150.00	0.00	0.00	3.88	0.00	0.00	0.00	72.00
ATT-B1	RRHU-11 RRH Unit	150.00	0.00	0.00	2.99	120.00	0.00	0.00	45.00
ATT-B2	TMA Unit (LGP24101)	150.00	0.00	0.00	1.29	120.00	0.00	0.00	12.69
ATT-B3	TMA Unit (LGP24101)	150.00	0.00	0.00	1.29	120.00	0.00	0.00	12.69
ATT-B4	OPA-65-LCUU-H6 Panel	150.00	0.00	0.00	10.12	120.00	0.00	0.00	57.60
ATT-B5	RRUS-32 RRH Unit	150.00	0.00	0.00	3.88	120.00	0.00	0.00	72.00
ATT-C1	RRHU-11 RRH Unit	150.00	0.00	0.00	2.99	240.00	0.00	0.00	45.00
ATT-C2	TMA Unit (LGP24101)	150.00	0.00	0.00	1.29	240.00	0.00	0.00	12.69
ATT-C3	TMA Unit (LGP24101)	150.00	0.00	0.00	1.29	240.00	0.00	0.00	12.69
ATT-C4	OPA-65-LCUU-H6 Panel	150.00	0.00	0.00	10.12	240.00	0.00	0.00	57.60
ATT-C5	RRUS-32 RRH Unit	150.00	0.00	0.00	3.88	240.00	0.00	0.00	72.00
CSP-70	Sinclair SC479-HF1LDF w/ ice	160.00	0.00	0.00	5.06	0.00	0.00	0.00	30.60
CSP-71	Sinclair SC479-HF1LDF w/ ice	160.00	0.00	0.00	5.06	120.00	0.00	0.00	30.60
CSP-72	Sinclair SC479-HF1LDF w/ ice	160.00	0.00	0.00	5.06	240.00	0.00	0.00	30.60
CSP-73	TMA	160.00	0.00	0.00	1.29	240.00	0.00	0.00	13.50
DNK21-SPD9	8` Dish with Radome	160.00	0.00	0.00	51.32	0.00	0.86330	0.00	504.00
DNK20-UNKNOWN	4`xl` Panel	160.00	0.00	0.00	6.53	240.00	0.00	0.00	27.00
DNK19-STAM63	4`xl` Panel	160.00	0.00	0.00	6.53	120.00	0.00	0.00	27.00
159-A	3` Stand-Off	160.00	0.00	0.00	2.72	0.00	0.00	0.00	45.00
159-B	3` Stand-Off	160.00	0.00	0.00	2.72	120.00	0.00	0.00	45.00
160	3` Stand-Off	160.00	0.00	0.00	2.72	240.00	0.00	0.00	45.00
DNK22-TOG-6	DB586-Y	165.00	0.00	0.00	1.01	0.00	0.00	0.00	7.42
DNK23-STAM64	4`xl` Panel	165.00	0.00	0.00	6.53	0.00	0.00	0.00	27.00
DNK23-STAM65	TMA	165.00	0.00	0.00	1.29	0.00	0.00	0.00	13.50
GRN-1 (DNK25)	4` Dish	170.00	0.00	0.00	13.10	50.00	1.66410	0.08980	-0.06910
DNK26aCSP-67	Dipole	175.00	0.00	0.00	9.17	0.00	0.00	0.00	41.40
DNK26bNEU-20	4` Dipole	175.00	0.00	0.00	3.70	0.00	0.00	0.00	36.00
DNK27A-CSP4	Sinclair SC479-HF1LDF w/ ice	175.00	0.00	0.00	5.06	240.00	0.00	0.00	30.60
DNK27B-CSP2	Scala OGT9-806 w/ ice	175.00	0.00	0.00	2.27	120.00	0.00	0.00	16.65
DNK27C-CSP74	TMA	175.00	0.00	0.00	1.29	120.00	0.00	0.00	13.50
DNK28A-CSP1	Scala OGT9-806 w/ ice	175.00	0.00	0.00	2.27	120.00	0.00	0.00	16.65
DNK28B-CSP3	Sinclair SC479-HF1LDF w/ ice	175.00	0.00	0.00	5.06	240.00	0.00	0.00	30.60
DNK28C-TOG5	Andrew DB-583 w/ ice	175.00	0.00	0.00	0.54	0.00	0.00	0.00	5.63
DNK28D-NEU55	Decibel PD-420 2 bay - Dipole	175.00	0.00	0.00	1.64	240.00	0.00	0.00	9.00
Top-A	6` Stand-Off	180.00	0.00	0.00	10.60	0.00	0.00	0.00	126.00
Top-B	6` Stand-Off	180.00	0.00	0.00	10.60	120.00	0.00	0.00	126.00
Top-C1	6` Stand-Off	180.00	0.00	0.00	10.60	260.00	0.00	0.00	126.00
Top-C2	6` Stand-Off	180.00	0.00	0.00	10.60	220.00	0.00	0.00	126.00
ATT-B7	Powerwave 7770	150.00	0.00	0.00	5.88	120.00	0.00	0.00	31.50
ATT-B8	Powerwave 7770	150.00	0.00	0.00	5.88	120.00	0.00	0.00	31.50
ATT-C7	Powerwave 7770	150.00	0.00	0.00	5.88	240.00	0.00	0.00	31.50
ATT-C8	Powerwave 7770	150.00	0.00	0.00	5.88	240.00	0.00	0.00	31.50

EIA Section Load Case Information for "0.9DL":

Note: qzGh (adjusted wind pressure) includes: Velocity Pressure Coefficient (Kz), Topographic Factor (Kzt), Gust Effect Factor (Gh), Wind Direction Probability Factor (Kd), Wind Importance Factor (Table 2-3), Wind Load Factor (from Loads/EIA Loads)  
Face RR is the minimum round reduction factor for all round angles and appurtenances in the section

Section Label	Z of Top (ft)	Z of Bottom (ft)	Ave. Elev. Above Gnd. (ft)	qzGh (psf)	Ice Thick. (in)	Face AF (ft^2)	Face AR (ft^2)	Face RR*AR (ft^2)	Face AG (ft^2)	Face e (ft^2)	Face DF (ft^2)	Face DR (ft^2)	Face RR (ft^2)	Face CF (ft^2)	Face AE (ft^2)	Face WF (lbs)	NotF AAF (ft^2)	NotF CAF (ft^2)	NotF AAR (ft^2)	NotF CAR (ft^2)	NotF AAR*CAR (ft^2)	NotF WA (lbs)	Total Wind (lbs)	Total Weight (lbs)
A	180.00	160.00	170.00	0.00	0.00	20.58	21.02	12.32	163.7	0.25	1.00	1.00	0.59	2.43	32.9	0	24.00	2.00	0.00	1.20	0.00	0	0	5078
B	160.00	140.00	150.00	0.00	0.00	22.52	27.30	16.04	191.0	0.26	1.00	1.00	0.59	2.41	38.6	0	36.00	2.00	0.00	1.20	0.00	0	0	5418
C	140.00	120.00	130.00	0.00	0.00	25.73	29.16	17.07	218.3	0.25	1.00	1.00	0.59	2.43	42.8	0	48.00	2.00	0.00	1.20	0.00	0	0	6022
D	120.00	100.00	110.00	0.00	0.00	30.37	36.61	21.63	245.5	0.27	1.00	1.00	0.59	2.37	52.0	0	48.00	2.00	0.00	1.20	0.00	0	0	6643
E	100.00	80.00	90.00	0.00	0.00	37.01	40.26	23.91	272.8	0.28	1.00	1.00	0.59	2.34	60.9	0	48.00	2.00	0.00	1.20	0.00	0	0	9032
F	80.00	60.00	70.00	0.00	0.00	37.32	43.90	25.92	300.0	0.27	1.00	1.00	0.59	2.38	63.2	0	48.00	2.00	0.00	1.20	0.00	0	0	9496
G	60.00	40.00	50.00	0.00	0.00	42.28	50.37	29.91	327.3	0.28	1.00	1.00	0.59	2.34	72.2	0	48.00	2.00	0.00	1.20	0.00	0	0	10603

H	40.00	20.00	30.00	0.00	0.00	48.05	50.83	30.12	354.6	0.28	1.00	1.00	0.59	2.35	78.2	0	48.00	2.00	0.00	1.20	0.00	0	0	11284
I	20.00	0.00	10.00	0.00	0.00	59.30	58.17	34.98	381.9	0.31	1.00	1.00	0.60	2.28	94.3	0	43.20	2.00	0.00	1.20	0.00	0	0	11368

\*\*\* Analysis Results:

Maximum element usage is 99.89% for Angle "SNB-LH2P" in load case "1: 1.2D + 1.0Dg + 1.6Wo"

Angle Forces For All Load Cases:

Positive for tension - negative for compression

Group Label	Angle Label	Max. Usage For All LC %	Max. Tens. For All LC (kips)	Max. Comp. For All LC (kips)	LC 1 (kips)	LC 2 (kips)	LC 3 (kips)	LC 4 (kips)	LC 5 (kips)	LC 6 (kips)	LC 7 (kips)
Rohn-D1	Rohn-DA1P	11.20	0.868	-0.006	0.867	0.868	0.142	0.145	0.189	-0.006	-0.003
Rohn-D1	Rohn-DA11	1.38	0.107	0.000	0.106	0.107	0.011	0.012	0.025	0.001	0.003
Rohn-D1	Rohn-DA12	25.72	0.000	-1.403	-1.403	-1.396	-0.214	-0.210	-0.315	-0.009	-0.005
Rohn-D1	Rohn-DA2P	12.64	0.980	-0.001	0.980	0.979	0.169	0.171	0.218	-0.001	0.001
Rohn-D1	Rohn-DA21	15.18	0.000	-0.828	-0.828	-0.823	-0.167	-0.164	-0.184	-0.003	-0.000
Rohn-D1	Rohn-DA22	4.71	0.365	-0.011	0.361	0.365	0.031	0.035	0.074	-0.011	-0.006
Rohn-D1	Rohn-DA3P	10.47	0.812	-0.019	0.808	0.812	0.156	0.162	0.169	-0.019	-0.013
Rohn-D1	Rohn-DA31	1.22	0.095	-0.007	0.092	0.095	0.009	0.012	0.017	-0.007	-0.004
Rohn-D1	Rohn-DA32	33.36	0.000	-1.710	-1.710	-1.702	-0.256	-0.251	-0.384	-0.011	-0.006
Rohn-D1	Rohn-DA4P	17.98	1.393	-0.013	1.392	1.393	0.202	0.206	0.301	-0.013	-0.008
Rohn-D1	Rohn-DA41	28.76	0.000	-1.475	-1.475	-1.467	-0.231	-0.226	-0.332	-0.011	-0.006
Rohn-D1	Rohn-DA42	8.92	0.692	-0.013	0.688	0.692	0.040	0.045	0.146	-0.013	-0.008
Rohn-D1	Rohn-DA5P	18.76	1.454	-0.024	1.450	1.454	0.192	0.200	0.308	-0.024	-0.016
Rohn-D1	Rohn-DA51	4.04	0.313	-0.009	0.309	0.313	0.001	0.005	0.064	-0.009	-0.005
Rohn-D1	Rohn-DA52	33.03	0.001	-1.594	-1.594	-1.588	-0.247	-0.245	-0.352	-0.000	0.001
Rohn-D1	Rohn-DA6P	20.90	1.620	-0.024	1.617	1.620	0.215	0.222	0.345	-0.024	-0.016
Rohn-D1	Rohn-DA61	39.98	0.000	-1.929	-1.929	-1.922	-0.243	-0.240	-0.428	-0.003	-0.001
Rohn-D1	Rohn-DA62	0.20	0.016	-0.006	0.003	0.006	0.012	0.016	-0.002	-0.006	-0.003
Rohn-D1	Rohn-DA7P	20.40	1.581	-0.044	1.573	1.581	0.205	0.217	0.323	-0.044	-0.031
Rohn-D1	Rohn-DA71	39.44	0.000	-1.793	-1.793	-1.785	-0.259	-0.255	-0.399	-0.006	-0.002
Rohn-D1	Rohn-DA72	0.41	0.029	-0.019	0.023	0.029	0.007	0.013	-0.005	-0.019	-0.012
Rohn-D1	Rohn-DA8P	23.80	1.845	-0.041	1.837	1.845	0.199	0.211	0.383	-0.041	-0.029
Rohn-D1	Rohn-DA81	2.21	0.171	-0.023	0.164	0.171	-0.010	-0.003	0.023	-0.023	-0.016
Rohn-D1	Rohn-DA82	37.11	0.000	-1.687	-1.687	-1.680	-0.270	-0.267	-0.375	-0.004	-0.001
Rohn-D2	Rohn-DB1P	35.51	3.114	-0.054	3.107	3.114	0.301	0.316	0.657	-0.054	-0.039
Rohn-D2	Rohn-DB11	1.46	0.128	-0.030	0.118	0.128	-0.028	-0.019	0.009	-0.030	-0.021
Rohn-D2	Rohn-DB12	42.51	0.000	-2.754	-2.754	-2.744	-0.367	-0.363	-0.612	-0.004	-0.001
Rohn-D2	Rohn-DB2P	32.09	2.814	-0.056	2.806	2.814	0.305	0.320	0.589	-0.056	-0.040
Rohn-D2	Rohn-DB21	48.68	0.000	-3.154	-3.154	-3.143	-0.367	-0.363	-0.702	-0.007	-0.003
Rohn-D2	Rohn-DB22	4.34	0.000	-0.281	-0.281	-0.273	-0.021	-0.012	-0.077	-0.026	-0.017
Rohn-D2	Rohn-DB3P	30.23	2.651	-0.035	2.648	2.651	0.300	0.310	0.567	-0.035	-0.025
Rohn-D2	Rohn-DB31	9.54	0.836	-0.024	0.830	0.836	0.017	0.024	0.170	-0.024	-0.016
Rohn-D2	Rohn-DB32	49.01	0.004	-2.999	-2.999	-2.990	-0.378	-0.377	-0.662	0.003	0.004
Rohn-D2	Rohn-DB4P	26.10	2.289	-0.037	2.285	2.289	0.300	0.311	0.485	-0.037	-0.027
Rohn-D2	Rohn-DB41	54.54	0.003	-3.338	-3.338	-3.328	-0.376	-0.374	-0.738	0.001	0.003
Rohn-D2	Rohn-DB42	5.34	0.469	-0.021	0.463	0.469	0.023	0.030	0.091	-0.021	-0.014
Rohn-D2	Rohn-DB5P	46.73	4.099	-0.067	4.090	4.099	0.353	0.371	0.867	-0.067	-0.049
Rohn-D2	Rohn-DB51	9.94	0.871	-0.057	0.857	0.871	-0.016	0.000	0.156	-0.057	-0.041
Rohn-D2	Rohn-DB52	79.23	0.000	-4.584	-4.584	-4.561	-0.507	-0.494	-1.041	-0.041	-0.029
Rohn-D2	Rohn-DB6P	42.93	3.765	-0.069	3.756	3.765	0.355	0.373	0.792	-0.069	-0.050
Rohn-D2	Rohn-DB61	85.01	0.000	-4.918	-4.918	-4.895	-0.505	-0.492	-1.116	-0.042	-0.030
Rohn-D2	Rohn-DB62	5.91	0.518	-0.055	0.505	0.518	-0.011	0.005	0.079	-0.055	-0.040
Rohn-D2	Rohn-DB7P	52.18	4.576	-0.069	4.568	4.576	0.382	0.400	0.972	-0.069	-0.050
Rohn-D2	Rohn-DB71	3.79	0.000	-0.207	-0.207	-0.189	-0.081	-0.064	-0.085	-0.064	-0.046
Rohn-D2	Rohn-DB72	74.25	0.000	-4.066	-4.066	-4.041	-0.492	-0.476	-0.933	-0.053	-0.038
Rohn-D2	Rohn-DB8P	48.61	4.263	-0.070	4.255	4.263	0.385	0.403	0.903	-0.070	-0.051
Rohn-D2	Rohn-DB81	80.15	0.000	-4.389	-4.389	-4.364	-0.489	-0.474	-1.004	-0.053	-0.038
Rohn-D2	Rohn-DB82	9.91	0.000	-0.543	-0.543	-0.525	-0.077	-0.060	-0.159	-0.063	-0.045
Rohn-D3	Rohn-DC1P	46.64	4.565	-0.123	4.544	4.565	0.342	0.374	0.935	-0.123	-0.091
Rohn-D3	Rohn-DC11	9.82	0.962	-0.114	0.933	0.962	-0.064	-0.034	0.137	-0.114	-0.084
Rohn-D3	Rohn-DC12	59.50	0.000	-5.365	-5.365	-5.323	-0.629	-0.599	-1.255	-0.107	-0.078
Rohn-D3	Rohn-DC2P	43.19	4.228	-0.124	4.207	4.228	0.344	0.376	0.860	-0.124	-0.091
Rohn-D3	Rohn-DC21	62.82	0.000	-5.664	-5.664	-5.623	-0.625	-0.595	-1.322	-0.107	-0.078
Rohn-D3	Rohn-DC22	6.10	0.597	-0.114	0.568	0.597	-0.061	-0.031	0.057	-0.114	-0.084
Rohn-D3	Rohn-DC3P	57.04	5.583	-0.015	5.583	5.575	0.487	0.491	1.233	-0.015	-0.010
Rohn-D3	Rohn-DC31	13.77	1.348	-0.011	1.347	1.348	0.009	0.013	0.292	-0.011	-0.007
Rohn-D3	Rohn-DC32	78.02	0.000	-6.607	-6.607	-6.590	-0.533	-0.530	-1.467	-0.002	-0.000

Rohn-D3	Rohn-DC4P	54.17	5.301	-0.015	5.301	5.293	0.491	0.495	1.170	-0.015	-0.010
Rohn-D3	Rohn-DC41	80.35	0.000	-6.804	-6.804	-6.787	-0.527	-0.524	-1.511	-0.003	-0.001
Rohn-D3	Rohn-DC42	11.21	1.097	-0.010	1.095	1.097	0.016	0.019	0.237	-0.010	-0.007
R-D3-MOD	Rohn-DC5P	64.19	7.981	-0.245	7.936	7.981	0.359	0.420	1.615	-0.245	-0.182
R-D3-MOD	Rohn-DC51	4.99	0.620	-0.238	0.560	0.620	-0.205	-0.144	-0.024	-0.238	-0.176
R-D3-MOD	Rohn-DC52	84.90	0.000	-8.803	-8.803	-8.724	-0.874	-0.813	-2.093	-0.231	-0.172
R-D3-MOD	Rohn-DC6P	62.69	7.795	-0.246	7.750	7.795	0.364	0.426	1.574	-0.246	-0.183
R-D3-MOD	Rohn-DC61	87.77	0.000	-9.100	-9.100	-9.021	-0.873	-0.811	-2.160	-0.233	-0.173
R-D3-MOD	Rohn-DC62	3.20	0.398	-0.235	0.339	0.398	-0.197	-0.136	-0.071	-0.235	-0.175
Rohn-D4	Rohn-DD1P	54.84	6.818	-0.233	6.773	6.818	0.259	0.318	1.366	-0.233	-0.173
Rohn-D4	Rohn-DD11	9.53	1.185	-0.226	1.129	1.185	-0.161	-0.103	0.113	-0.226	-0.168
Rohn-D4	Rohn-DD12	81.91	0.000	-8.008	-8.008	-7.936	-0.772	-0.716	-1.909	-0.214	-0.159
Rohn-D4	Rohn-DD2P	52.52	6.530	-0.234	6.485	6.530	0.260	0.319	1.301	-0.234	-0.174
Rohn-D4	Rohn-DD21	85.88	0.000	-8.396	-8.396	-8.324	-0.774	-0.717	-1.996	-0.217	-0.161
Rohn-D4	Rohn-DD22	6.38	0.793	-0.222	0.738	0.793	-0.156	-0.099	0.029	-0.222	-0.165
R-D4-MOD	Rohn-DD3P	78.63	9.776	-0.054	9.776	9.771	0.554	0.567	2.149	-0.054	-0.039
R-D4-MOD	Rohn-DD31	3.34	0.416	-0.077	0.402	0.416	-0.077	-0.065	0.058	-0.047	-0.034
R-D4-MOD	Rohn-DD32	78.79	0.000	-9.796	-9.796	-9.768	-0.615	-0.604	-2.197	-0.036	-0.026
R-D4-MOD	Rohn-DD4P	75.66	9.408	-0.056	9.408	9.403	0.553	0.567	2.066	-0.056	-0.041
R-D4-MOD	Rohn-DD41	81.41	0.000	-10.122	-10.122	-10.093	-0.613	-0.602	-2.269	-0.036	-0.026
R-D4-MOD	Rohn-DD42	0.59	0.069	-0.074	0.056	0.069	-0.074	-0.062	-0.018	-0.044	-0.032
R-D4-MOD	Rohn-DD5P	67.98	8.453	-0.312	8.388	8.453	0.187	0.265	1.679	-0.312	-0.233
R-D4-MOD	Rohn-DD51	7.18	0.892	-0.304	0.817	0.892	-0.220	-0.143	-0.009	-0.304	-0.227
R-D4-MOD	Rohn-DD52	77.71	0.000	-9.662	-9.662	-9.570	-0.883	-0.806	-2.325	-0.296	-0.221
R-D4-MOD	Rohn-DD6P	65.45	8.137	-0.312	8.073	8.137	0.188	0.267	1.610	-0.312	-0.233
R-D4-MOD	Rohn-DD61	80.41	0.000	-9.998	-9.998	-9.906	-0.881	-0.804	-2.399	-0.296	-0.220
R-D4-MOD	Rohn-DD62	4.49	0.558	-0.305	0.482	0.558	-0.219	-0.142	-0.084	-0.305	-0.227
Rohn-D5	Rohn-DE1P	54.22	6.741	-0.248	6.688	6.741	0.106	0.168	1.345	-0.248	-0.185
Rohn-D5	Rohn-DE11	6.36	0.791	-0.240	0.731	0.791	-0.198	-0.137	0.015	-0.240	-0.179
Rohn-D5	Rohn-DE12	61.76	0.000	-7.679	-7.679	-7.607	-0.634	-0.573	-1.857	-0.236	-0.176
Rohn-D5	Rohn-DE2P	51.58	6.413	-0.248	6.360	6.413	0.108	0.170	1.274	-0.248	-0.184
Rohn-D5	Rohn-DE21	64.19	0.000	-7.981	-7.981	-7.909	-0.630	-0.570	-1.922	-0.233	-0.173
Rohn-D5	Rohn-DE22	3.83	0.476	-0.244	0.416	0.476	-0.200	-0.138	-0.058	-0.244	-0.182
Rohn-D5	Rohn-DE3P	67.29	8.367	-0.108	8.353	8.367	0.371	0.397	1.804	-0.108	-0.080
Rohn-D5	Rohn-DE31	5.59	0.000	-0.695	-0.695	-0.666	-0.165	-0.139	-0.222	-0.101	-0.075
Rohn-D5	Rohn-DE32	60.59	0.000	-7.534	-7.534	-7.497	-0.517	-0.491	-1.738	-0.101	-0.075
Rohn-D5	Rohn-DE4P	65.07	8.090	-0.105	8.077	8.090	0.375	0.401	1.745	-0.105	-0.078
Rohn-D5	Rohn-DE41	63.33	0.000	-7.874	-7.874	-7.838	-0.512	-0.487	-1.810	-0.097	-0.072
Rohn-D5	Rohn-DE42	8.01	0.000	-0.996	-0.996	-0.965	-0.171	-0.143	-0.294	-0.108	-0.081
Rohn-D5	Rohn-DE5P	70.46	8.761	-0.298	8.698	8.761	0.228	0.303	1.762	-0.298	-0.222
Rohn-D5	Rohn-DE51	3.46	0.430	-0.289	0.359	0.430	-0.268	-0.195	-0.095	-0.289	-0.216
Rohn-D5	Rohn-DE52	76.76	0.000	-9.544	-9.544	-9.455	-0.845	-0.769	-2.307	-0.296	-0.221
Rohn-D5	Rohn-DE6P	67.64	8.410	-0.293	8.348	8.410	0.233	0.306	1.686	-0.293	-0.219
Rohn-D5	Rohn-DE61	77.70	0.000	-9.661	-9.661	-9.574	-0.835	-0.761	-2.329	-0.289	-0.216
Rohn-D5	Rohn-DE62	2.41	0.058	-0.300	-0.016	0.058	-0.279	-0.203	-0.186	-0.300	-0.224
Rohn-D6	Rohn-DF1P	83.46	10.377	-0.264	10.326	10.377	0.319	0.384	2.166	-0.264	-0.198
Rohn-D6	Rohn-DF11	2.09	0.000	-0.260	-0.253	-0.188	-0.260	-0.197	-0.224	-0.251	-0.188
Rohn-D6	Rohn-DF12	87.80	0.000	-10.917	-10.917	-10.837	-0.847	-0.780	-2.598	-0.264	-0.197
Rohn-D6	Rohn-DF2P	82.69	10.281	-0.257	10.232	10.281	0.330	0.393	2.150	-0.257	-0.193
Rohn-D6	Rohn-DF21	87.39	0.000	-10.865	-10.865	-10.788	-0.830	-0.765	-2.580	-0.253	-0.190
Rohn-D6	Rohn-DF22	2.18	0.000	-0.271	-0.169	-0.100	-0.271	-0.203	-0.217	-0.269	-0.201
Rohn-D6	Rohn-DF3P	80.99	10.070	-0.259	10.016	10.070	0.326	0.390	2.085	-0.259	-0.194
Rohn-D6	Rohn-DF31	7.22	0.898	-0.244	0.837	0.898	-0.204	-0.143	0.031	-0.244	-0.183
Rohn-D6	Rohn-DF32	94.19	0.000	-11.712	-11.712	-11.636	-0.890	-0.825	-2.759	-0.256	-0.191
Rohn-D6	Rohn-DF4P	81.20	10.096	-0.249	10.045	10.096	0.342	0.403	2.096	-0.249	-0.187
Rohn-D6	Rohn-DF41	92.93	0.000	-11.555	-11.555	-11.480	-0.877	-0.813	-2.720	-0.249	-0.186
Rohn-D6	Rohn-DF42	6.50	0.808	-0.261	0.743	0.808	-0.216	-0.150	-0.000	-0.261	-0.195
Rohn-D6	Rohn-DG1P	71.61	8.904	-0.243	8.852	8.904	0.213	0.273	1.857	-0.243	-0.183
Rohn-D6	Rohn-DG11	2.02	0.251	-0.231	0.193	0.251	-0.213	-0.155	-0.109	-0.231	-0.173
Rohn-D6	Rohn-DG12	82.66	0.000	-10.277	-10.277	-10.208	-0.725	-0.665	-2.450	-0.239	-0.179
Rohn-D6	Rohn-DG2P	72.96	9.072	-0.237	9.022	9.072	0.226	0.284	1.899	-0.237	-0.177
Rohn-D6	Rohn-DG21	79.45	0.000	-9.879	-9.879	-9.811	-0.710	-0.652	-2.357	-0.233	-0.174
Rohn-D6	Rohn-DG22	5.04	0.626	-0.244	0.565	0.626	-0.218	-0.157	-0.035	-0.244	-0.183
Rohn-D6	Rohn-DG3P	78.65	9.779	-0.218	9.732	9.779	0.305	0.360	2.050	-0.218	-0.164
Rohn-D6	Rohn-DG31	1.68	0.170	-0.209	0.117	0.170	-0.206	-0.154	-0.111	-0.209	-0.157
Rohn-D6	Rohn-DG32	88.50	0.000	-11.004	-11.004	-10.945	-0.751	-0.697	-2.576	-0.214	-0.160
Rohn-D6	Rohn-DG4P	81.58	10.143	-0.212	10.097	10.143	0.319	0.372	2.134	-0.212	-0.159
Rohn-D6	Rohn-DG41	86.16	0.000	-10.713	-10.713	-10.654	-0.741	-0.688	-2.510	-0.210	-0.157
Rohn-D6	Rohn-DG42	3.49	0.434	-0.218	0.378	0.434	-0.209	-0.154	-0.059	-0.218	-0.164



Rohn-D7	Rohn-DH1P	76.15	9.468	-0.240	9.413	9.468	0.202	0.262	1.994	-0.240	-0.181
Rohn-D7	Rohn-DH11	2.29	0.000	-0.285	-0.285	-0.226	-0.237	-0.179	-0.219	-0.233	-0.175
Rohn-D7	Rohn-DH12	83.19	0.000	-10.343	-10.343	-10.280	-0.684	-0.625	-2.465	-0.236	-0.177
Rohn-D7	Rohn-DH2P	78.44	9.753	-0.237	9.699	9.753	0.212	0.271	2.060	-0.237	-0.178
Rohn-D7	Rohn-DH21	80.73	0.000	-10.037	-10.037	-9.975	-0.674	-0.616	-2.396	-0.232	-0.174
Rohn-D7	Rohn-DH22	1.93	0.049	-0.239	-0.012	0.049	-0.237	-0.177	-0.163	-0.239	-0.180
R-D7-MOD	Rohn-DH3P	70.35	10.933	-0.264	10.869	10.933	0.271	0.337	2.284	-0.264	-0.198
R-D7-MOD	Rohn-DH31	2.32	0.361	-0.259	0.294	0.361	-0.255	-0.190	-0.109	-0.259	-0.194
R-D7-MOD	Rohn-DH32	80.14	0.000	-12.455	-12.455	-12.391	-0.809	-0.745	-2.924	-0.260	-0.195
R-D7-MOD	Rohn-DH4P	72.20	11.222	-0.261	11.158	11.222	0.280	0.346	2.350	-0.261	-0.196
R-D7-MOD	Rohn-DH41	78.33	0.000	-12.174	-12.174	-12.109	-0.801	-0.737	-2.860	-0.258	-0.193
R-D7-MOD	Rohn-DH42	4.00	0.622	-0.264	0.553	0.622	-0.253	-0.187	-0.055	-0.264	-0.198
Rohn-D7	Rohn-DI1P	64.26	7.989	-0.184	7.942	7.989	0.150	0.197	1.696	-0.184	-0.138
Rohn-D7	Rohn-DI11	7.97	0.991	-0.180	0.946	0.991	-0.150	-0.105	0.096	-0.180	-0.134
Rohn-D7	Rohn-DI12	79.76	0.000	-9.917	-9.917	-9.873	-0.553	-0.508	-2.337	-0.180	-0.135
Rohn-D7	Rohn-DI2P	66.44	8.260	-0.182	8.213	8.260	0.159	0.205	1.757	-0.182	-0.136
Rohn-D7	Rohn-DI21	77.59	0.000	-9.647	-9.647	-9.603	-0.546	-0.501	-2.276	-0.179	-0.134
Rohn-D7	Rohn-DI22	10.03	1.247	-0.183	1.201	1.247	-0.147	-0.101	0.151	-0.183	-0.137
Rohn-D7	Rohn-DI3P	62.66	7.791	-0.175	7.746	7.791	0.136	0.180	1.642	-0.175	-0.132
Rohn-D7	Rohn-DI31	9.21	1.145	-0.172	1.100	1.145	-0.104	-0.061	0.118	-0.172	-0.129
Rohn-D7	Rohn-DI32	78.62	0.000	-9.776	-9.776	-9.737	-0.561	-0.518	-2.276	-0.173	-0.130
Rohn-D7	Rohn-DI4P	64.60	8.031	-0.174	7.986	8.031	0.142	0.186	1.696	-0.174	-0.131
Rohn-D7	Rohn-DI41	76.69	0.000	-9.536	-9.536	-9.498	-0.554	-0.512	-2.222	-0.171	-0.129
Rohn-D7	Rohn-DI42	11.04	1.373	-0.174	1.327	1.373	-0.100	-0.057	0.167	-0.174	-0.131
Rohn-L1	Rohn-LA1P	1.31	0.000	-1.357	-1.357	-1.268	-0.526	-0.440	-0.519	-0.352	-0.266
Rohn-L1	Rohn-LA11	0.34	0.135	-0.356	0.050	0.135	-0.271	-0.184	-0.210	-0.356	-0.269
Rohn-L1	Rohn-LA12	0.49	0.189	-0.513	0.064	0.189	-0.424	-0.297	-0.304	-0.513	-0.387
Rohn-L1	Rohn-LA2P	3.83	0.000	-3.982	-3.982	-3.826	-1.175	-1.028	-1.249	-0.593	-0.446
Rohn-L1	Rohn-LA21	1.05	1.335	-0.632	1.184	1.335	-0.335	-0.180	-0.129	-0.632	-0.476
Rohn-L1	Rohn-LA22	0.86	1.101	-0.805	0.906	1.101	-0.516	-0.316	-0.299	-0.805	-0.606
Rohn-L1	Rohn-LA3P	7.14	0.000	-7.428	-7.428	-7.221	-1.830	-1.638	-2.120	-0.767	-0.577
Rohn-L1	Rohn-LA31	2.14	2.726	-0.974	2.493	2.726	-0.439	-0.198	-0.051	-0.974	-0.733
Rohn-L1	Rohn-LA32	2.01	2.563	-1.000	2.324	2.563	-0.471	-0.224	-0.105	-1.000	-0.752
Rohn-L1	Rohn-LA4P	10.75	0.000	-11.182	-11.182	-10.913	-2.535	-2.290	-3.082	-0.979	-0.736
Rohn-L1	Rohn-LA41	3.25	4.143	-1.164	3.866	4.143	-0.388	-0.100	0.136	-1.164	-0.875
Rohn-L1	Rohn-LA42	3.33	4.241	-1.195	3.957	4.241	-0.417	-0.122	0.138	-1.195	-0.898
Rohn-L2	Rohn-LB1P	12.81	0.000	-17.010	-17.010	-16.423	-4.369	-3.816	-5.133	-2.207	-1.657
Rohn-L2	Rohn-LB11	3.97	6.149	-1.719	5.740	6.149	-0.638	-0.211	0.209	-1.719	-1.292
Rohn-L2	Rohn-LB12	4.03	6.240	-1.679	5.842	6.240	-0.598	-0.182	0.257	-1.679	-1.261
Rohn-L2	Rohn-LB2P	16.88	0.000	-22.408	-22.408	-21.760	-5.226	-4.624	-6.446	-2.397	-1.799
Rohn-L2	Rohn-LB21	5.51	8.536	-1.967	8.072	8.536	-0.552	-0.064	0.574	-1.967	-1.477
Rohn-L2	Rohn-LB22	5.61	8.691	-1.932	8.235	8.691	-0.516	-0.037	0.632	-1.932	-1.451
Rohn-L2	Rohn-LB3P	22.68	0.000	-30.106	-30.106	-29.168	-7.065	-6.187	-8.829	-3.493	-2.621
Rohn-L2	Rohn-LB31	7.13	11.032	-3.075	10.299	11.032	-1.289	-0.525	0.384	-3.075	-2.309
Rohn-L2	Rohn-LB32	7.23	11.197	-3.044	10.472	11.197	-1.258	-0.501	0.442	-3.044	-2.285
Rohn-L2	Rohn-LB4P	29.08	0.000	-38.600	-38.600	-37.593	-8.089	-7.161	-10.833	-3.688	-2.767
Rohn-L2	Rohn-LB41	9.70	15.011	-3.299	14.232	15.011	-1.097	-0.278	1.120	-3.299	-2.477
Rohn-L2	Rohn-LB42	9.81	15.191	-3.270	14.420	15.191	-1.068	-0.256	1.179	-3.270	-2.454
Rohn-L3	Rohn-LC1P	31.61	0.000	-47.573	-47.573	-46.438	-9.410	-8.373	-13.090	-4.118	-3.090
Rohn-L3	Rohn-LC11	10.17	18.940	-3.755	18.059	18.940	-1.107	-0.176	1.689	-3.755	-2.819
Rohn-L3	Rohn-LC12	10.29	19.165	-3.726	18.291	19.165	-1.078	-0.154	1.758	-3.726	-2.797
Rohn-L3	Rohn-LC2P	40.00	0.000	-60.117	-60.117	-58.690	-11.554	-10.250	-16.528	-5.179	-3.884
Rohn-L3	Rohn-LC21	12.78	23.809	-4.908	22.652	23.809	-1.719	-0.499	1.999	-4.908	-3.683
Rohn-L3	Rohn-LC22	12.91	24.043	-4.928	22.881	24.043	-1.738	-0.514	2.037	-4.928	-3.698
Rohn-L3	Rohn-LC3P	50.99	0.000	-76.722	-76.722	-74.897	-14.175	-12.505	-21.113	-6.634	-4.977
Rohn-L3	Rohn-LC31	16.29	30.351	-6.318	28.859	30.351	-2.546	-0.976	2.510	-6.318	-4.742
Rohn-L3	Rohn-LC32	16.39	30.532	-6.341	29.034	30.532	-2.571	-0.995	2.534	-6.341	-4.759
Rohn-L4	Rohn-LD1P	58.48	0.000	-92.906	-92.906	-90.892	-15.938	-14.107	-25.094	-7.264	-5.449
Rohn-L4	Rohn-LD11	20.72	37.570	-7.052	35.911	37.570	-2.714	-0.962	3.625	-7.052	-5.293
Rohn-L4	Rohn-LD12	20.86	37.831	-6.996	36.186	37.831	-2.659	-0.921	3.721	-6.996	-5.250
Rohn-L4	Rohn-LD2P	70.32	0.000	-111.629	-111.629	-109.159	-18.749	-16.495	-30.294	-8.946	-6.709
Rohn-L4	Rohn-LD21	24.77	44.916	-8.632	42.879	44.916	-3.729	-1.583	4.205	-8.632	-6.477
Rohn-L4	Rohn-LD22	24.95	45.238	-8.580	43.214	45.238	-3.677	-1.543	4.312	-8.580	-6.437
Rohn-L4	Rohn-LD3P	81.28	0.000	-129.127	-129.127	-126.608	-19.838	-17.565	-34.230	-9.019	-6.764
Rohn-L4	Rohn-LD31	29.53	53.554	-8.728	51.508	53.554	-3.317	-1.148	6.068	-8.728	-6.550
Rohn-L4	Rohn-LD32	29.70	53.865	-8.677	51.833	53.865	-3.266	-1.110	6.173	-8.677	-6.511
Rohn-L5	Rohn-LE1P	64.54	0.000	-144.899	-144.899	-142.152	-21.524	-19.043	-38.245	-9.842	-7.382
Rohn-L5	Rohn-LE11	23.45	60.361	-9.573	58.116	60.361	-3.731	-1.352	7.024	-9.573	-7.184
Rohn-L5	Rohn-LE12	23.58	60.687	-9.519	58.456	60.687	-3.677	-1.311	7.134	-9.519	-7.143





SNB-D5	SNB-DF1P	63.53	11.372	0.000	11.372	11.307	0.834	0.784	2.688	0.195	0.146
SNB-D5	SNB-DF11	7.54	1.350	0.000	1.350	1.302	0.289	0.240	0.393	0.192	0.143
SNB-D5	SNB-DF12	68.73	0.207	-12.304	-12.266	-12.304	-0.530	-0.581	-2.595	0.207	0.155
SNB-D5	SNB-DF2P	64.14	11.481	0.000	11.481	11.419	0.828	0.780	2.708	0.188	0.140
SNB-D5	SNB-DF21	68.73	0.199	-12.303	-12.267	-12.303	-0.538	-0.587	-2.601	0.199	0.149
SNB-D5	SNB-DF22	6.93	1.240	0.000	1.240	1.188	0.303	0.251	0.379	0.208	0.155
SNB-D5	SNB-DF3P	63.85	11.430	0.000	11.430	11.358	0.844	0.787	2.713	0.221	0.165
SNB-D5	SNB-DF31	7.15	1.280	0.000	1.280	1.228	0.272	0.219	0.397	0.214	0.160
SNB-D5	SNB-DF32	68.43	0.230	-12.249	-12.208	-12.249	-0.452	-0.509	-2.564	0.230	0.173
SNB-D5	SNB-DF4P	63.83	11.426	0.000	11.426	11.356	0.836	0.781	2.707	0.212	0.159
SNB-D5	SNB-DF41	69.06	0.224	-12.363	-12.323	-12.363	-0.459	-0.515	-2.593	0.224	0.168
SNB-D5	SNB-DF42	7.83	1.402	0.000	1.402	1.346	0.288	0.231	0.433	0.228	0.171
SNB-D6	SNB-DG1P	73.65	13.183	0.000	13.183	13.138	0.820	0.784	3.070	0.140	0.104
SNB-D6	SNB-DG11	12.13	2.171	0.000	2.171	2.136	0.292	0.257	0.542	0.139	0.104
SNB-D6	SNB-DG12	84.51	0.146	-15.128	-15.102	-15.128	-0.688	-0.724	-3.269	0.146	0.109
SNB-D6	SNB-DG2P	74.03	13.252	0.000	13.252	13.208	0.815	0.781	3.082	0.134	0.100
SNB-D6	SNB-DG21	84.34	0.143	-15.098	-15.073	-15.098	-0.690	-0.726	-3.264	0.143	0.107
SNB-D6	SNB-DG22	11.59	2.075	0.000	2.075	2.038	0.299	0.262	0.526	0.147	0.110
S-D6-MOD	SNB-DG3P	59.49	13.312	0.000	13.312	13.255	0.845	0.801	3.114	0.173	0.130
S-D6-MOD	SNB-DG31	7.61	1.703	0.000	1.703	1.662	0.257	0.214	0.467	0.173	0.130
S-D6-MOD	SNB-DG32	65.61	0.179	-14.681	-14.649	-14.681	-0.578	-0.622	-3.151	0.179	0.134
S-D6-MOD	SNB-DG4P	59.60	13.337	0.000	13.337	13.280	0.842	0.799	3.117	0.170	0.128
S-D6-MOD	SNB-DG41	65.81	0.178	-14.727	-14.695	-14.727	-0.580	-0.623	-3.161	0.178	0.134
S-D6-MOD	SNB-DG42	7.73	1.729	0.000	1.729	1.686	0.261	0.217	0.475	0.177	0.133
SNB-D6	SNB-DH1P	76.56	13.706	0.000	13.706	13.663	0.794	0.754	3.214	0.160	0.120
SNB-D6	SNB-DH11	16.10	2.882	0.000	2.882	2.842	0.343	0.303	0.711	0.163	0.122
SNB-D6	SNB-DH12	91.41	0.164	-16.364	-16.326	-16.364	-0.652	-0.693	-3.531	0.164	0.123
SNB-D6	SNB-DH2P	76.59	13.711	0.000	13.711	13.668	0.793	0.753	3.214	0.158	0.119
SNB-D6	SNB-DH21	91.37	0.165	-16.356	-16.318	-16.356	-0.651	-0.692	-3.529	0.165	0.124
SNB-D6	SNB-DH22	16.05	2.873	0.000	2.873	2.831	0.345	0.304	0.710	0.164	0.123
S-D6-MOD	SNB-DH3P	59.29	13.267	0.000	13.267	13.216	0.775	0.730	3.120	0.182	0.137
S-D6-MOD	SNB-DH31	9.23	2.065	0.000	2.065	2.021	0.282	0.236	0.549	0.185	0.139
S-D6-MOD	SNB-DH32	67.08	0.187	-15.010	-14.968	-15.010	-0.505	-0.551	-3.217	0.187	0.140
S-D6-MOD	SNB-DH4P	59.33	13.275	0.000	13.275	13.223	0.775	0.730	3.121	0.182	0.137
S-D6-MOD	SNB-DH41	67.08	0.188	-15.010	-14.967	-15.010	-0.504	-0.550	-3.216	0.188	0.141
S-D6-MOD	SNB-DH42	9.21	2.061	0.000	2.061	2.017	0.282	0.236	0.548	0.185	0.139
S-D7-MOD	SNB-DI1P	76.52	17.122	0.000	17.122	17.103	0.798	0.771	3.951	0.114	0.086
S-D7-MOD	SNB-DI11	5.84	1.307	0.000	1.307	1.277	0.210	0.181	0.344	0.120	0.091
S-D7-MOD	SNB-DI12	82.03	0.119	-18.355	-18.321	-18.355	-0.656	-0.686	-4.013	0.119	0.090
S-D7-MOD	SNB-DI2P	76.55	17.130	0.000	17.130	17.110	0.798	0.771	3.953	0.114	0.087
S-D7-MOD	SNB-DI21	82.00	0.121	-18.349	-18.313	-18.349	-0.654	-0.684	-4.010	0.121	0.092
S-D7-MOD	SNB-DI22	5.79	1.297	0.000	1.297	1.267	0.208	0.179	0.341	0.117	0.089
S-D7-MOD	SNB-DI3P	79.53	17.795	0.000	17.795	17.763	0.836	0.799	4.110	0.146	0.109
S-D7-MOD	SNB-DI31	13.36	2.989	0.000	2.989	2.952	0.315	0.276	0.727	0.151	0.113
S-D7-MOD	SNB-DI32	91.87	0.150	-20.558	-20.514	-20.558	-0.704	-0.743	-4.475	0.150	0.112
S-D7-MOD	SNB-DI4P	79.57	17.806	0.000	17.806	17.772	0.836	0.799	4.113	0.146	0.109
S-D7-MOD	SNB-DI41	91.84	0.152	-20.551	-20.507	-20.551	-0.702	-0.741	-4.473	0.152	0.114
S-D7-MOD	SNB-DI42	13.30	2.976	0.000	2.976	2.940	0.312	0.274	0.723	0.148	0.110
SNB-L1	SNB-LA1P	0.74	0.000	-0.859	-0.859	-0.756	-0.491	-0.388	-0.432	-0.397	-0.295
SNB-L1	SNB-LA11	0.34	0.000	-0.391	-0.240	-0.140	-0.346	-0.245	-0.291	-0.391	-0.290
SNB-L1	SNB-LA12	0.35	0.000	-0.401	-0.208	-0.105	-0.352	-0.249	-0.290	-0.401	-0.298
SNB-L1	SNB-LA2P	2.00	0.000	-2.322	-2.322	-2.167	-0.965	-0.815	-0.872	-0.588	-0.437
SNB-L1	SNB-LA21	0.49	0.539	-0.563	0.397	0.539	-0.372	-0.228	-0.256	-0.563	-0.419
SNB-L1	SNB-LA22	0.50	0.538	-0.583	0.391	0.538	-0.389	-0.239	-0.270	-0.583	-0.434
SNB-L1	SNB-LA3P	4.48	0.000	-5.195	-5.195	-4.978	-1.671	-1.464	-1.648	-0.813	-0.607
SNB-L1	SNB-LA31	1.25	1.699	-0.740	1.517	1.699	-0.310	-0.123	-0.117	-0.740	-0.552
SNB-L1	SNB-LA32	1.26	1.709	-0.758	1.522	1.709	-0.325	-0.134	-0.127	-0.758	-0.565
SNB-L1	SNB-LA4P	7.63	0.000	-8.851	-8.851	-8.572	-2.440	-2.178	-2.589	-1.029	-0.768
SNB-L1	SNB-LA41	2.23	3.041	-0.884	2.827	3.041	-0.184	0.039	0.084	-0.884	-0.660
SNB-L1	SNB-LA42	2.32	3.154	-0.890	2.939	3.154	-0.188	0.037	0.105	-0.890	-0.665
SNB-L2	SNB-LB1P	7.79	0.000	-14.267	-14.267	-13.806	-3.826	-3.394	-4.206	-1.707	-1.277
SNB-L2	SNB-LB11	2.55	5.140	-1.486	4.782	5.140	-0.426	-0.054	0.147	-1.486	-1.112
SNB-L2	SNB-LB12	2.60	5.232	-1.481	4.875	5.232	-0.421	-0.050	0.171	-1.481	-1.109
SNB-L2	SNB-LB2P	11.51	0.000	-21.071	-21.071	-20.523	-4.942	-4.438	-5.887	-1.988	-1.488
SNB-L2	SNB-LB21	4.09	8.230	-1.713	7.824	8.230	-0.235	0.194	0.682	-1.713	-1.282
SNB-L2	SNB-LB22	4.15	8.342	-1.702	7.938	8.342	-0.224	0.202	0.714	-1.702	-1.274
SNB-L2	SNB-LB3P	15.77	0.000	-28.888	-28.888	-28.260	-6.061	-5.495	-7.768	-2.228	-1.668
SNB-L2	SNB-LB31	5.88	11.824	-1.924	11.374	11.824	-0.007	0.473	1.339	-1.924	-1.441
SNB-L2	SNB-LB32	5.95	11.972	-1.910	11.526	11.972	0.007	0.484	1.381	-1.910	-1.430



Connect	Connect	BaP	0.00	0.801	0.000	0.801	0.783	0.089	0.072	0.202	0.046	0.030
Connect	Connect	Ba1	0.00	0.059	-0.317	-0.298	-0.317	0.038	0.019	-0.034	0.059	0.039
Connect	Connect	Ba2	0.00	0.061	-0.365	-0.346	-0.365	0.038	0.018	-0.043	0.061	0.040
Connect	Connect	BbP	0.00	0.811	0.000	0.811	0.788	0.114	0.092	0.217	0.068	0.046
Connect	Connect	Bb1	0.00	0.085	-0.295	-0.270	-0.295	0.064	0.037	-0.011	0.085	0.059
Connect	Connect	Bb2	0.00	0.087	-0.287	-0.261	-0.287	0.066	0.039	-0.007	0.087	0.061
Connect	Connect	BcP	0.00	0.446	0.000	0.446	0.402	0.159	0.116	0.189	0.154	0.110
Connect	Connect	Bc1	0.00	0.165	-0.032	0.014	-0.032	0.162	0.116	0.102	0.165	0.119
Connect	Connect	Bc2	0.00	0.167	-0.035	0.010	-0.035	0.164	0.117	0.102	0.167	0.120
Connect	Connect	CP	0.00	0.592	0.000	0.592	0.525	0.274	0.206	0.283	0.253	0.184
Connect	Connect	C1	0.00	0.254	0.000	0.094	0.025	0.244	0.175	0.174	0.254	0.185
Connect	Connect	C2	0.00	0.255	0.000	0.125	0.056	0.246	0.177	0.182	0.255	0.186
Connect	Connect	CaP	0.01	1.679	0.000	1.679	1.639	0.192	0.153	0.452	0.136	0.098
Connect	Connect	Ca1	0.00	0.138	-0.727	-0.690	-0.727	0.109	0.070	-0.071	0.138	0.099
Connect	Connect	Ca2	0.00	0.135	-0.761	-0.725	-0.761	0.105	0.067	-0.080	0.135	0.097
Connect	Connect	CbP	0.00	0.569	0.000	0.569	0.489	0.255	0.175	0.308	0.305	0.224
Connect	Connect	Cb1	0.00	0.333	0.000	0.221	0.140	0.333	0.252	0.236	0.307	0.225
Connect	Connect	Cb2	0.00	0.330	0.000	0.185	0.105	0.330	0.249	0.227	0.304	0.224
Connect	Connect	DP	0.01	3.639	0.000	3.639	3.457	0.902	0.725	1.226	0.684	0.508
Connect	Connect	D1	0.00	0.674	-1.165	-0.995	-1.165	0.561	0.388	0.191	0.674	0.501
Connect	Connect	D2	0.00	0.675	-1.080	-0.910	-1.080	0.564	0.390	0.210	0.675	0.501
Connect	Connect	DaP	0.00	0.341	0.000	0.155	0.069	0.311	0.222	0.237	0.341	0.252
Connect	Connect	Da1	0.00	0.523	0.000	0.523	0.432	0.361	0.271	0.327	0.343	0.253
Connect	Connect	Da2	0.00	0.464	0.000	0.464	0.373	0.362	0.271	0.315	0.345	0.255
Connect	Connect	DbP	0.01	2.218	0.000	2.218	2.081	0.609	0.476	0.810	0.518	0.385
Connect	Connect	Db1	0.00	0.518	-0.490	-0.359	-0.490	0.472	0.339	0.236	0.518	0.385
Connect	Connect	Db2	0.00	0.522	-0.476	-0.344	-0.476	0.476	0.343	0.242	0.522	0.388
Connect	Connect	EP	0.02	5.358	0.000	5.358	5.141	1.193	0.982	1.698	0.824	0.614
Connect	Connect	E1	0.01	0.824	-1.711	-1.505	-1.711	0.639	0.429	0.178	0.824	0.614
Connect	Connect	E2	0.01	0.829	-1.717	-1.510	-1.717	0.644	0.433	0.179	0.829	0.618
Connect	Connect	EaP	0.00	0.497	-0.953	-0.828	-0.953	0.359	0.231	0.123	0.497	0.369
Connect	Connect	Ea1	0.00	1.144	0.000	1.144	1.014	0.572	0.443	0.562	0.503	0.374
Connect	Connect	Ea2	0.00	1.125	0.000	1.125	0.994	0.577	0.447	0.562	0.509	0.378
Connect	Connect	EbP	0.01	0.592	-1.755	-1.609	-1.755	0.400	0.250	0.008	0.592	0.442
Connect	Connect	Eb1	0.01	1.578	0.000	1.578	1.424	0.691	0.539	0.716	0.596	0.445
Connect	Connect	Eb2	0.01	1.758	0.000	1.758	1.603	0.700	0.546	0.759	0.603	0.449
Connect	Connect	FP	0.00	0.862	0.000	0.684	0.481	0.862	0.655	0.655	0.822	0.615
Connect	Connect	F1	0.00	0.818	0.000	0.809	0.601	0.798	0.592	0.695	0.818	0.612
Connect	Connect	F2	0.00	0.820	0.000	0.523	0.315	0.796	0.589	0.634	0.820	0.613
Connect	Connect	FaP	0.00	0.672	0.000	0.459	0.287	0.614	0.445	0.533	0.672	0.503
Connect	Connect	Fa1	0.00	0.700	0.000	0.581	0.413	0.700	0.531	0.538	0.673	0.504
Connect	Connect	Fa2	0.00	0.887	0.000	0.887	0.719	0.703	0.534	0.604	0.673	0.503
Connect	Connect	GP	0.02	4.412	0.000	4.412	4.236	0.977	0.798	1.420	0.714	0.535
Connect	Connect	G1	0.01	0.714	-1.391	-1.211	-1.391	0.583	0.404	0.193	0.714	0.535
Connect	Connect	G2	0.01	0.706	-1.682	-1.504	-1.682	0.573	0.396	0.124	0.706	0.529
Connect	Connect	GaP	0.00	0.584	-0.676	-0.526	-0.676	0.470	0.323	0.269	0.584	0.438
Connect	Connect	Ga1	0.00	1.005	0.000	1.005	0.860	0.644	0.497	0.577	0.587	0.440
Connect	Connect	Ga2	0.00	1.170	0.000	1.170	1.026	0.640	0.494	0.610	0.582	0.436
Connect	Connect	HP	0.01	2.256	0.000	2.256	2.095	0.813	0.644	0.915	0.676	0.507
Connect	Connect	H1	0.00	0.676	-0.461	-0.289	-0.461	0.607	0.438	0.382	0.676	0.507
Connect	Connect	H2	0.00	0.673	-0.510	-0.339	-0.510	0.603	0.435	0.370	0.673	0.505
Connect	Connect	HaP	0.01	0.655	-2.276	-2.109	-2.276	0.462	0.298	-0.039	0.655	0.492
Connect	Connect	Ha1	0.01	1.985	0.000	1.985	1.823	0.754	0.590	0.837	0.657	0.493
Connect	Connect	Ha2	0.01	1.993	0.000	1.993	1.831	0.751	0.588	0.837	0.655	0.491
Connect	Connect	IP	0.03	7.181	0.000	7.181	7.017	1.016	0.844	2.024	0.690	0.517
Connect	Connect	I1	0.01	0.691	-2.905	-2.728	-2.905	0.527	0.354	-0.157	0.691	0.518
Connect	Connect	I2	0.01	0.689	-2.915	-2.739	-2.915	0.525	0.352	-0.161	0.689	0.516
Connect	Connect	IaP	0.01	2.088	0.000	2.088	1.985	0.439	0.337	0.743	0.409	0.307
Connect	Connect	Ia1	0.00	0.410	-0.592	-0.491	-0.592	0.395	0.293	0.138	0.410	0.308
Connect	Connect	Ia2	0.00	0.409	-0.595	-0.493	-0.595	0.393	0.291	0.137	0.409	0.307
SNB-H1	SNB-H1aP		0.36	0.000	-0.469	-0.468	-0.469	-0.087	-0.089	-0.108	-0.009	-0.011
SNB-H1	SNB-H1bP		0.08	0.000	-0.108	-0.106	-0.108	-0.000	-0.003	-0.036	-0.009	-0.011
SNB-H1	SNB-H1cP		0.16	0.212	-0.009	0.212	0.208	0.048	0.045	0.039	-0.006	-0.009
SNB-H1	SNB-H1dP		0.16	0.213	-0.009	0.213	0.209	0.048	0.045	0.040	-0.006	-0.009
SNB-H1	SNB-H1eP		0.02	0.020	-0.008	0.020	0.017	0.006	0.003	-0.006	-0.005	-0.008
SNB-H1	SNB-H1fP		0.27	0.000	-0.345	-0.343	-0.345	-0.081	-0.084	-0.078	-0.005	-0.008
SNB-H1	SNB-H2aP		0.06	0.086	0.000	0.086	0.076	0.018	0.008	0.034	0.026	0.015
SNB-H1	SNB-H2bP		0.33	0.435	0.000	0.435	0.424	0.068	0.058	0.106	0.026	0.015
SNB-H1	SNB-H2cP		0.23	0.300	0.000	0.300	0.289	0.040	0.030	0.080	0.025	0.015



WLAC-2	SNB-WL-I1P	3.50	0.000	-0.343	-0.343	-0.343	-0.004	-0.004	-0.077	0.000	0.000
WLAC-2	SNB-WL-I2P	3.50	0.000	-0.343	-0.343	-0.343	-0.004	-0.004	-0.077	0.000	0.000
WLAC-2	SNB-WL-I3P	1.45	0.686	0.000	0.686	0.685	0.008	0.008	0.155	0.000	0.000

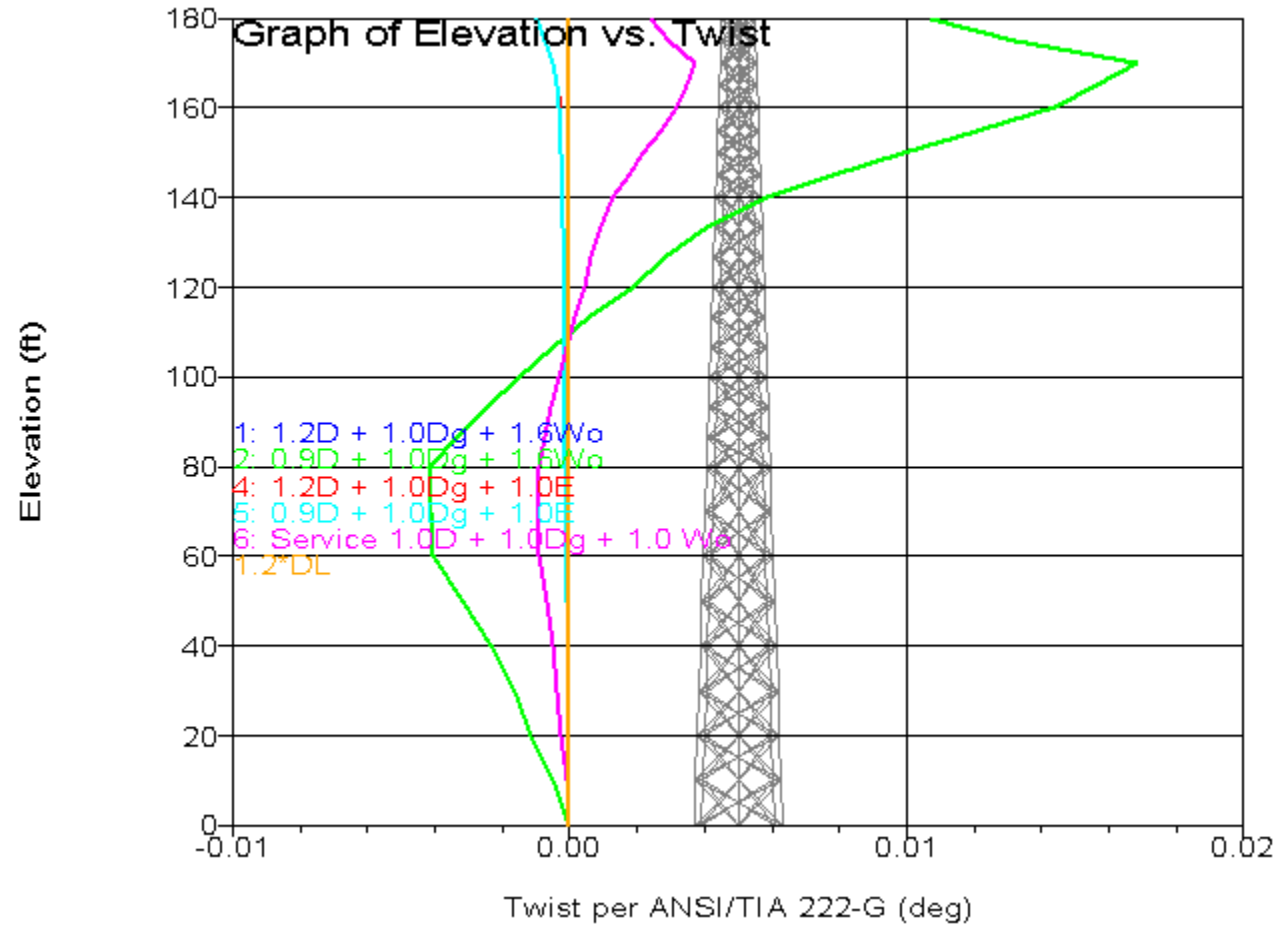



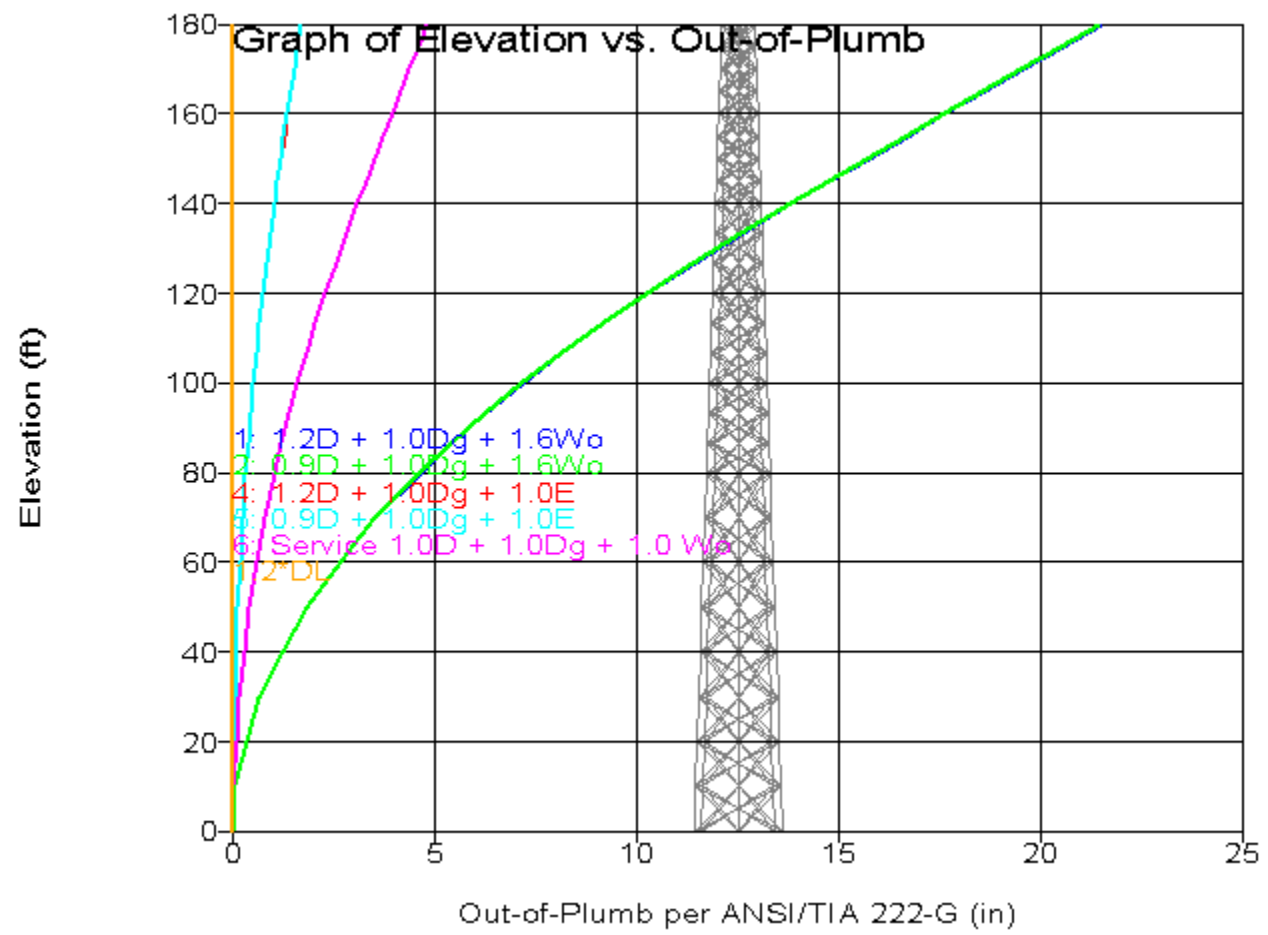
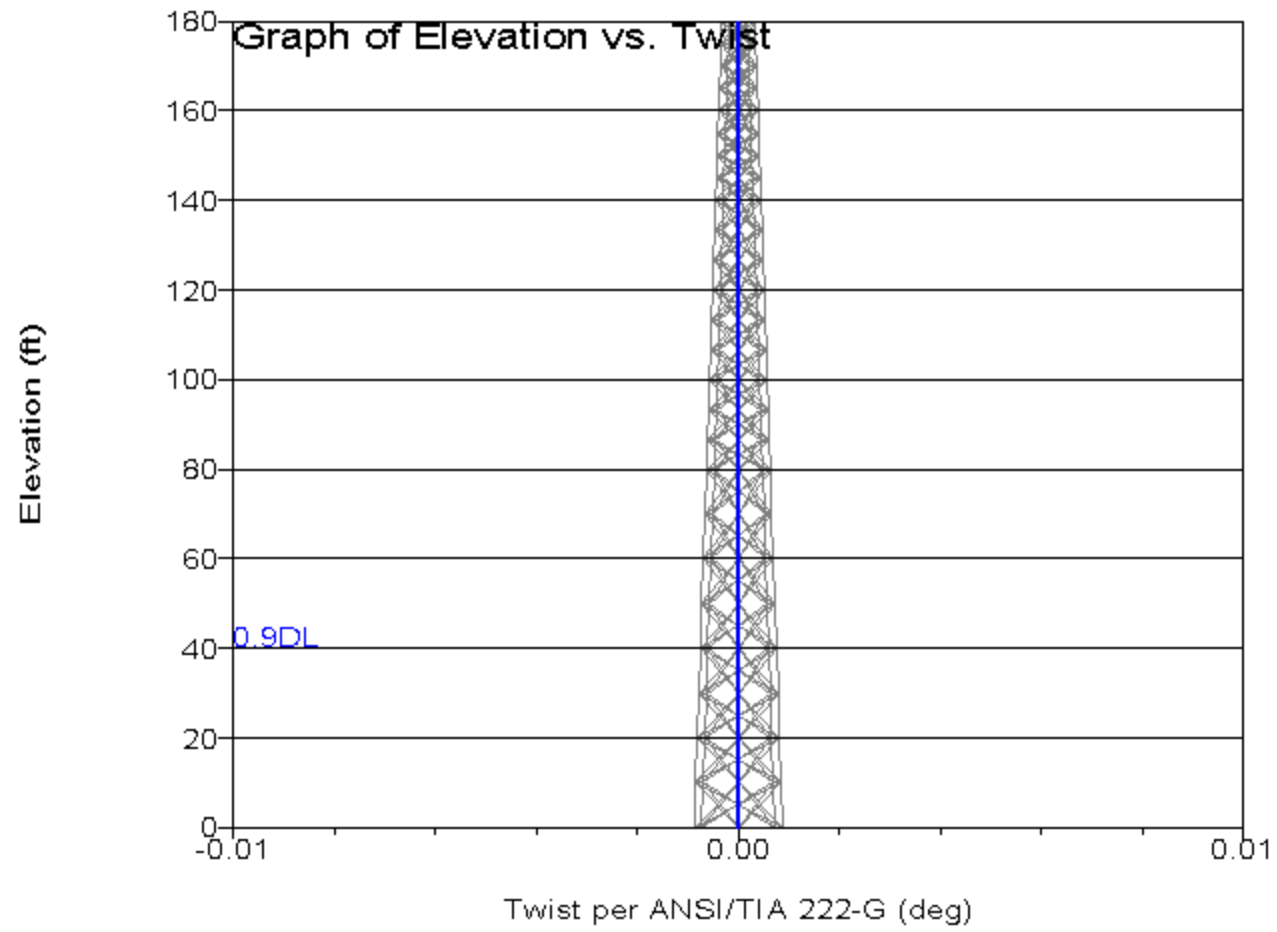

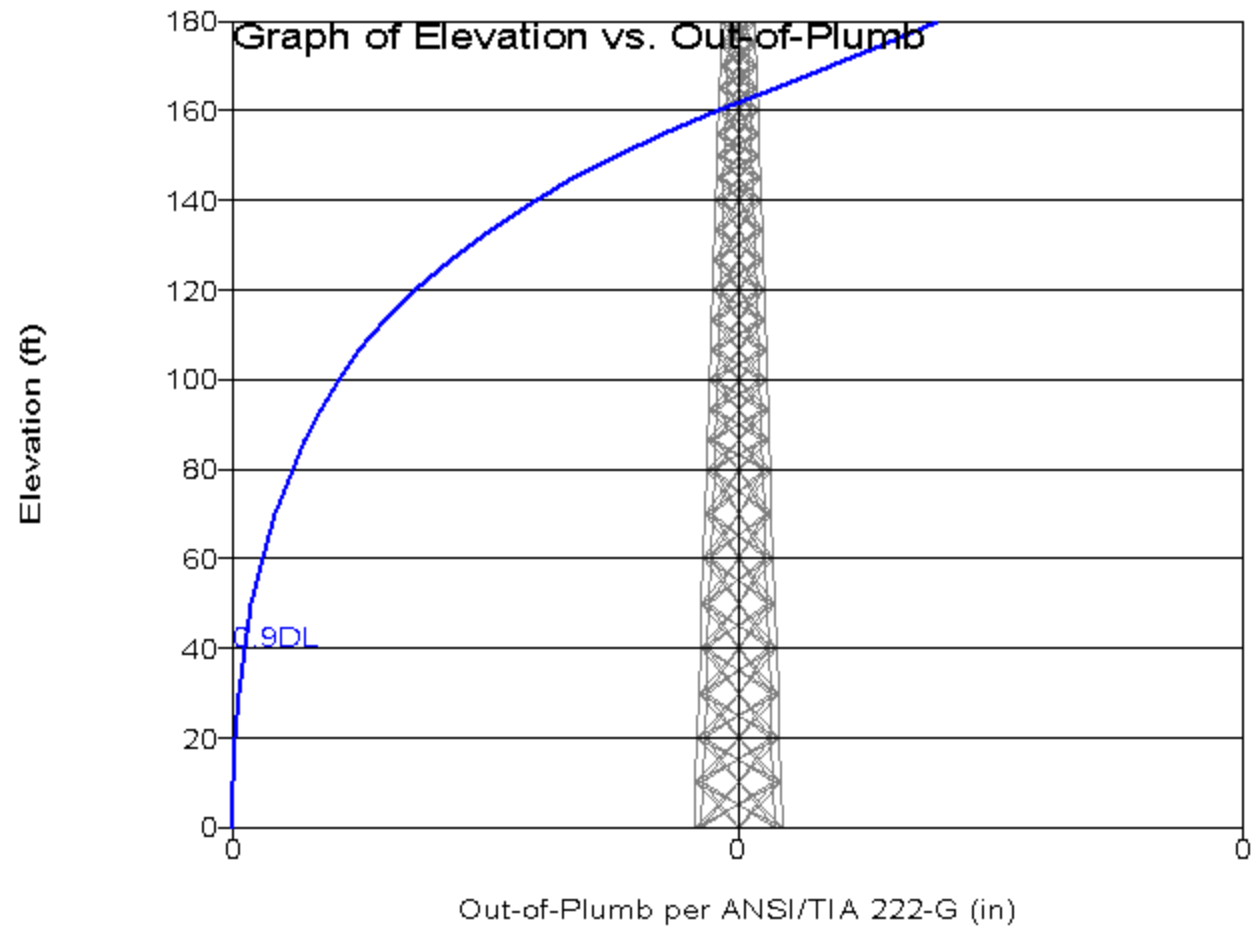

Twist and Out-of-Plumb for "1: 1.2D + 1.0Dg + 1.6Wo":

Elevation (ft)	Twist (deg)	Sway (deg)	Out of Plumb (in)
0.00	0.00	0.00	0.00
10.00	-0.00	0.05	0.06
20.00	-0.00	0.12	0.34
30.00	-0.00	0.16	0.64
40.00	-0.00	0.25	1.21
50.00	-0.00	0.31	1.82
60.00	-0.00	0.38	2.65
70.00	-0.00	0.43	3.52
80.00	-0.00	0.51	4.62
86.66	-0.00	0.56	5.40
93.34	-0.00	0.60	6.25
100.00	-0.00	0.64	7.16
106.66	-0.00	0.69	8.10
113.34	0.00	0.75	9.16
120.00	0.00	0.78	10.25
126.66	0.00	0.83	11.41
133.34	0.00	0.85	12.61
140.00	0.01	0.87	13.81
145.00	0.01	0.90	14.75
150.00	0.01	0.91	15.72
155.00	0.01	0.90	16.66
160.00	0.01	0.92	17.62
165.00	0.02	0.92	18.58
170.00	0.02	0.92	19.55
175.00	0.01	0.92	20.52
180.00	0.01	0.92	21.48

Twist and Out-of-Plumb for "2: 0.9D + 1.0Dg + 1.6Wo":

Elevation (ft)	Twist (deg)	Sway (deg)	Out of Plumb (in)
0.00	0.00	0.00	0.00
10.00	-0.00	0.05	0.06
20.00	-0.00	0.12	0.34
30.00	-0.00	0.16	0.64
40.00	-0.00	0.25	1.21
50.00	-0.00	0.30	1.82
60.00	-0.00	0.38	2.65
70.00	-0.00	0.43	3.52
80.00	-0.00	0.51	4.62
86.66	-0.00	0.56	5.39
93.34	-0.00	0.60	6.24
100.00	-0.00	0.64	7.14
106.66	-0.00	0.69	8.09
113.34	0.00	0.75	9.15
120.00	0.00	0.78	10.23
126.66	0.00	0.82	11.39
133.34	0.00	0.85	12.58
140.00	0.01	0.87	13.79
145.00	0.01	0.89	14.72
150.00	0.01	0.91	15.69
155.00	0.01	0.90	16.62
160.00	0.01	0.92	17.59
165.00	0.02	0.91	18.54
170.00	0.02	0.92	19.51
175.00	0.01	0.92	20.47
180.00	0.01	0.92	21.44

Twist and Out-of-Plumb for "4: 1.2D + 1.0Dg + 1.0E":

Elevation (ft)	Twist (deg)	Sway (deg)	Out of Plumb (in)
0.00	0.00	0.00	0.00
10.00	-0.00	0.00	0.00
20.00	-0.00	0.01	0.02
30.00	-0.00	0.01	0.04
40.00	-0.00	0.02	0.08
50.00	-0.00	0.02	0.12
60.00	-0.00	0.03	0.17
70.00	-0.00	0.03	0.23
80.00	-0.00	0.04	0.31
86.66	-0.00	0.04	0.37
93.34	-0.00	0.04	0.43
100.00	-0.00	0.05	0.50
106.66	-0.00	0.05	0.57
113.34	-0.00	0.06	0.65
120.00	-0.00	0.06	0.73
126.66	-0.00	0.07	0.82
133.34	-0.00	0.07	0.92
140.00	-0.00	0.07	1.02
145.00	-0.00	0.08	1.10
150.00	-0.00	0.08	1.18
155.00	-0.00	0.08	1.26
160.00	-0.00	0.08	1.35
165.00	-0.00	0.08	1.43
170.00	-0.00	0.08	1.51
175.00	-0.00	0.08	1.60
180.00	-0.00	0.08	1.68

Twist and Out-of-Plumb for "5: 0.9D + 1.0Dg + 1.0E":

Elevation (ft)	Twist (deg)	Sway (deg)	Out of Plumb (in)
0.00	0.00	0.00	0.00
10.00	-0.00	0.00	0.00
20.00	-0.00	0.01	0.02
30.00	-0.00	0.01	0.04
40.00	-0.00	0.02	0.08
50.00	-0.00	0.02	0.12
60.00	-0.00	0.03	0.17
70.00	-0.00	0.03	0.23
80.00	-0.00	0.04	0.31
86.66	-0.00	0.04	0.37
93.34	-0.00	0.04	0.43
100.00	-0.00	0.05	0.49
106.66	-0.00	0.05	0.56
113.34	-0.00	0.06	0.64
120.00	-0.00	0.06	0.73
126.66	-0.00	0.07	0.82
133.34	-0.00	0.07	0.92
140.00	-0.00	0.07	1.02
145.00	-0.00	0.07	1.10
150.00	-0.00	0.08	1.18
155.00	-0.00	0.08	1.26
160.00	-0.00	0.08	1.34
165.00	-0.00	0.08	1.42
170.00	-0.00	0.08	1.51
175.00	-0.00	0.08	1.59
180.00	-0.00	0.08	1.68

Twist and Out-of-Plumb for "6: Service 1.0D + 1.0Dg + 1.0 Wo":

Elevation (ft)	Twist (deg)	Sway (deg)	Out of Plumb (in)
0.00	0.00	0.00	0.00
10.00	-0.00	0.01	0.01
20.00	-0.00	0.03	0.08
30.00	-0.00	0.04	0.14
40.00	-0.00	0.06	0.27
50.00	-0.00	0.07	0.41
60.00	-0.00	0.09	0.59
70.00	-0.00	0.10	0.79
80.00	-0.00	0.11	1.03
86.66	-0.00	0.13	1.21
93.34	-0.00	0.13	1.39
100.00	-0.00	0.14	1.60
106.66	-0.00	0.15	1.81
113.34	0.00	0.17	2.05
120.00	0.00	0.17	2.29
126.66	0.00	0.18	2.55
133.34	0.00	0.19	2.81
140.00	0.00	0.19	3.08
145.00	0.00	0.20	3.29
150.00	0.00	0.20	3.51
155.00	0.00	0.20	3.72
160.00	0.00	0.21	3.93
165.00	0.00	0.20	4.15
170.00	0.00	0.21	4.37
175.00	0.00	0.21	4.58
180.00	0.00	0.21	4.80

Twist and Out-of-Plumb for "1.2\*DL":

Elevation (ft)	Twist (deg)	Sway (deg)	Out of Plumb (in)
0.00	0.00	0.00	0.00
10.00	-0.00	0.00	0.00
20.00	-0.00	-0.00	0.00
30.00	-0.00	0.00	0.00
40.00	-0.00	-0.00	0.00
50.00	-0.00	0.00	0.00
60.00	-0.00	-0.00	0.00
70.00	0.00	0.00	0.00
80.00	0.00	-0.00	0.00
86.66	0.00	0.00	0.00
93.34	0.00	0.00	0.00
100.00	0.00	0.00	0.00
106.66	0.00	0.00	0.00
113.34	0.00	0.00	0.00
120.00	0.00	0.00	0.00
126.66	0.00	0.00	0.01
133.34	0.00	0.00	0.01
140.00	0.00	0.00	0.01
145.00	0.00	0.00	0.01
150.00	0.00	0.00	0.01
155.00	0.00	0.00	0.01
160.00	0.00	0.00	0.01
165.00	0.00	0.00	0.01
170.00	0.00	0.00	0.02
175.00	0.00	0.00	0.02
180.00	-0.00	0.00	0.02

Twist and Out-of-Plumb for "0.9DL":

Elevation (ft)	Twist (deg)	Sway (deg)	Out of Plumb (in)
0.00	0.00	0.00	0.00
10.00	-0.00	0.00	0.00
20.00	-0.00	-0.00	0.00
30.00	-0.00	0.00	0.00
40.00	-0.00	-0.00	0.00
50.00	-0.00	0.00	0.00
60.00	-0.00	-0.00	0.00
70.00	0.00	0.00	0.00
80.00	0.00	-0.00	0.00
86.66	0.00	0.00	0.00
93.34	0.00	0.00	0.00
100.00	0.00	0.00	0.00
106.66	0.00	0.00	0.00
113.34	0.00	0.00	0.00
120.00	0.00	0.00	0.00
126.66	0.00	0.00	0.00
133.34	0.00	0.00	0.01
140.00	0.00	0.00	0.01
145.00	0.00	0.00	0.01
150.00	0.00	0.00	0.01
155.00	0.00	0.00	0.01
160.00	0.00	0.00	0.01
165.00	0.00	0.00	0.01
170.00	0.00	0.00	0.01
175.00	0.00	0.00	0.01
180.00	-0.00	0.00	0.01

Equilibrium Joint Positions and Rotations for Load Case "1: 1.2D + 1.0Dg + 1.6Wo":

Joint Label	X-Displ (ft)	Y-Displ (ft)	Z-Displ (ft)	X-Rot (deg)	Y-Rot (deg)	Z-Rot (deg)	X-Pos (ft)	Y-Pos (ft)	Z-Pos (ft)
RohnAP	1.789	-0.0008485	-0.08948	0.0062	0.9185	0.0109	6.122	-0.0008485	179.9
RohnBP	1.468	-4.892e-005	-0.0981	-0.0012	0.9165	0.0107	6.589	-4.892e-005	159.9
RohnCP	1.151	-0.0003176	-0.1026	-0.0007	0.8834	0.0071	7.06	-0.0003176	139.9
RohnDP	0.8548	-0.0004246	-0.1018	-0.0002	0.8028	0.0047	7.55	-0.0004246	119.9
RohnEP	0.596	-0.0005783	-0.09127	-0.0005	0.6622	0.0032	8.077	-0.0005783	99.91
RohnFP	0.3859	-0.0007472	-0.07917	-0.0004	0.5253	0.0020	8.654	-0.0007472	79.92
RohnGP	0.2212	-0.0006766	-0.06367	0.0006	0.3996	0.0014	9.276	-0.0006766	59.94
RohnHP	0.1016	-0.0004485	-0.04581	0.0010	0.2743	0.0009	9.943	-0.0004485	39.95
RohnIP	0.02873	-0.0002241	-0.02253	0.0006	0.1250	0.0003	10.66	-0.0002241	19.98
RohnJP	0	0	0	0.0000	0.0000	0.0000	11.42	0	0
SNB-AP	1.789	-0.001691	-0.05318	0.0020	0.9134	-0.0000	4.122	-0.001691	179.9
SNB-BP	1.468	-0.001288	-0.06255	0.0009	0.9096	-0.0000	4.589	-0.001288	159.9
SNB-CP	1.151	-0.0009147	-0.06969	0.0010	0.8764	0.0000	5.059	-0.0009147	139.9
SNB-DP	0.855	-0.0006052	-0.07209	0.0008	0.7912	-0.0000	5.55	-0.0006052	119.9
SNB-EP	0.5962	-0.0003839	-0.06636	0.0006	0.6467	-0.0000	6.077	-0.0003839	99.93
SNB-FP	0.386	-0.0002356	-0.0614	0.0004	0.5244	0.0000	6.654	-0.0002356	79.94
SNB-GP	0.2212	-0.0001298	-0.05071	0.0002	0.3801	0.0000	7.276	-0.0001298	59.95
SNB-HP	0.1017	-5.559e-005	-0.0376	0.0002	0.2646	0.0000	7.943	-5.559e-005	39.96
SNB-IP	0.02874	-1.468e-005	-0.01905	0.0001	0.1207	0.0000	8.657	-1.468e-005	19.98
SNB-JP	0	0	0	0.0000	0.0000	0.0000	9.415	0	0
RohnA1	1.791	-0.002134	0.01395	0.0009	0.9214	0.0039	-0.3759	-3.755	180
RohnA2	1.789	-0.002045	0.0141	0.0007	0.9204	0.0176	-0.3773	3.75	180
RohnB1	1.47	-0.001967	0.02238	0.0060	0.9231	-0.0005	-1.091	-4.437	160
RohnB2	1.467	-0.001918	0.02259	-0.0016	0.9212	0.0221	-1.093	4.433	160
RohnC1	1.152	-0.000917	0.02921	-0.0013	0.8782	-0.0094	-1.803	-5.118	140
RohnC2	1.151	-0.001524	0.0294	0.0059	0.8747	0.0235	-1.804	5.116	140
RohnD1	0.8549	-0.0001477	0.03335	-0.0019	0.7991	-0.0137	-2.493	-5.798	120
RohnD2	0.8545	-0.001306	0.03352	0.0051	0.7967	0.0230	-2.493	5.797	120
RohnE1	0.5962	-0.0001314	0.03267	-0.0002	0.6613	-0.0134	-3.144	-6.479	100
RohnE2	0.5966	-0.0004369	0.03278	0.0027	0.6588	0.0197	-3.144	6.478	100
RohnF1	0.385	0.0005631	0.03011	0.0109	0.5481	-0.0132	-3.749	-7.16	80.03
RohnF2	0.3861	-0.0003937	0.03018	-0.0095	0.5470	0.0172	-3.748	7.16	80.03
RohnG1	0.2205	0.0003877	0.02519	0.0033	0.4061	-0.0100	-4.307	-7.841	60.03
RohnG2	0.2217	3.042e-005	0.02524	-0.0030	0.4064	0.0128	-4.306	7.842	60.03
RohnH1	0.1009	0.0004299	0.01863	0.0032	0.2808	-0.0074	-4.82	-8.522	40.02
RohnH2	0.1016	-0.0001411	0.01866	-0.0034	0.2816	0.0091	-4.819	8.522	40.02
RohnI1	0.02842	0.0001904	0.009291	0.0059	0.1384	-0.0042	-5.287	-9.206	20.01
RohnI2	0.02878	-1.053e-005	0.00931	-0.0063	0.1392	0.0047	-5.286	9.206	20.01
RohnJ1	0	0	0	0.0000	0.0000	0.0000	-5.71	-9.89	0
RohnJ2	0	0	0	0.0000	0.0000	0.0000	-5.71	9.89	0
SNB-A1	1.79	-0.001696	0.002984	-0.0043	0.9253	-0.0019	0.6232	-2.022	180
SNB-A2	1.79	-0.001689	0.003065	0.0063	0.9247	0.0020	0.6232	2.019	180
SNB-B1	1.469	-0.001297	0.01169	-0.0008	0.9187	-0.0022	-0.09198	-2.704	160
SNB-B2	1.469	-0.001283	0.0118	0.0031	0.9189	0.0024	-0.09199	2.702	160
SNB-C1	1.152	-0.0009084	0.01934	-0.0013	0.8865	-0.0030	-0.8023	-3.385	140
SNB-C2	1.152	-0.0009273	0.01945	0.0033	0.8865	0.0030	-0.8023	3.383	140
SNB-D1	0.8555	-0.00052	0.02437	-0.0038	0.8071	-0.0052	-1.492	-4.067	120
SNB-D2	0.8555	-0.0006917	0.02448	0.0053	0.8071	0.0052	-1.492	4.065	120
SNB-E1	0.5965	-0.0002912	0.02492	-0.0020	0.6569	-0.0041	-2.144	-4.747	100
SNB-E2	0.5965	-0.0004751	0.025	0.0030	0.6568	0.0041	-2.144	4.746	100
SNB-F1	0.3862	-0.0001462	0.02475	0.0027	0.5515	-0.0040	-2.748	-5.428	80.02
SNB-F2	0.3862	-0.00033	0.02482	-0.0020	0.5514	0.0039	-2.748	5.428	80.02
SNB-G1	0.2212	1.735e-005	0.02132	0.0007	0.4108	-0.0048	-3.306	-6.11	60.02
SNB-G2	0.2212	-0.0002826	0.02138	-0.0002	0.4108	0.0048	-3.306	6.11	60.02
SNB-H1	0.1014	0.0001461	0.01625	-0.0045	0.2826	-0.0047	-3.819	-6.79	40.02
SNB-H2	0.1014	-0.0002573	0.01629	0.0048	0.2825	0.0047	-3.819	6.79	40.02
SNB-I1	0.02831	0.0002523	0.008359	0.0016	0.1445	-0.0044	-4.286	-7.472	20.01
SNB-I2	0.02831	-0.0002807	0.008378	-0.0014	0.1445	0.0044	-4.286	7.472	20.01
SNB-J1	0	0	0	0.0000	0.0000	0.0000	-4.708	-8.154	0
SNB-J2	0	0	0	0.0000	0.0000	0.0000	-4.708	8.154	0

RohnAaS	1.709	-0.0004164	-0.09192	0.0014	0.9229	0.0108	6.239	-0.0004164	174.9
RohnAbs	1.628	-0.0003847	-0.0942	0.0027	0.9213	0.0108	6.355	-0.0003847	169.9
RohnAcS	1.548	4.293e-005	-0.09627	0.0021	0.9188	0.0108	6.472	4.293e-005	164.9
RohnBaS	1.388	-6.137e-005	-0.09976	-0.0003	0.9151	0.0098	6.706	-6.137e-005	154.9
RohnBbS	1.308	-0.0001477	-0.1011	-0.0010	0.9086	0.0089	6.823	-0.0001477	149.9
RohnBcS	1.229	-0.0002236	-0.1021	-0.0010	0.9019	0.0080	6.941	-0.0002236	144.9
RohnCaS	1.05	-0.0003454	-0.1032	-0.0002	0.8587	0.0063	7.22	-0.0003454	133.2
RohnCbS	0.9506	-0.0003791	-0.103	-0.0004	0.8386	0.0055	7.384	-0.0003791	126.6
RohnDaS	0.7636	-0.0004423	-0.09949	-0.0004	0.7603	0.0042	7.72	-0.0004423	113.2
RohnDbS	0.6773	-0.0005143	-0.09594	-0.0007	0.7215	0.0037	7.897	-0.0005143	106.6
RohnEaS	0.5221	-0.0006507	-0.08794	-0.0011	0.6143	0.0028	8.265	-0.0006507	93.25
RohnEbS	0.4517	-0.0007636	-0.0839	-0.0003	0.5898	0.0024	8.458	-0.0007636	86.58
RohnFaS	0.2997	-0.0008415	-0.07215	0.0002	0.4739	0.0017	8.961	-0.0008415	69.93
RohnGaS	0.158	-0.0006322	-0.05533	0.0005	0.3419	0.0011	9.606	-0.0006322	49.94
RohnHaS	0.06125	-0.0003231	-0.03479	0.0005	0.2095	0.0006	10.3	-0.0003231	29.97
RohnIaS	0.01097	-0.0001035	-0.0117	0.0008	0.0883	0.0002	11.04	-0.0001035	9.988
SNB-AaS	1.709	-0.001547	-0.05566	0.0005	0.9244	-0.0001	4.239	-0.001547	174.9
SNB-Abs	1.628	-0.001546	-0.05809	0.0012	0.9205	-0.0000	4.355	-0.001546	169.9
SNB-AcS	1.548	-0.001344	-0.06039	0.0017	0.9209	-0.0000	4.472	-0.001344	164.9
SNB-BaS	1.388	-0.001187	-0.06465	0.0012	0.9173	-0.0000	4.706	-0.001187	154.9
SNB-BbS	1.308	-0.001097	-0.06657	0.0010	0.9078	0.0000	4.823	-0.001097	149.9
SNB-BcS	1.229	-0.001001	-0.06825	0.0011	0.9043	0.0000	4.941	-0.001001	144.9
SNB-CaS	1.05	-0.0008039	-0.07112	0.0009	0.8602	0.0000	5.22	-0.0008039	133.3
SNB-CbS	0.9508	-0.0006987	-0.07191	0.0008	0.8417	0.0000	5.384	-0.0006987	126.6
SNB-DaS	0.7638	-0.0005161	-0.07117	0.0007	0.7629	-0.0000	5.721	-0.0005161	113.3
SNB-DbS	0.6775	-0.0004484	-0.0692	0.0005	0.7256	-0.0000	5.897	-0.0004484	106.6
SNB-EaS	0.5222	-0.0003212	-0.06537	0.0004	0.6193	0.0000	6.265	-0.0003212	93.27
SNB-EbS	0.4518	-0.0002829	-0.06367	0.0004	0.5899	0.0000	6.458	-0.0002829	86.6
SNB-FaS	0.2997	-0.0001816	-0.05668	0.0003	0.4798	0.0000	6.961	-0.0001816	69.94
SNB-GaS	0.158	-9.14e-005	-0.04475	0.0002	0.3499	0.0000	7.606	-9.14e-005	49.96
SNB-HaS	0.06126	-2.919e-005	-0.02893	0.0001	0.2137	0.0000	8.296	-2.919e-005	29.97
SNB-IaS	0.01097	-1.793e-006	-0.01008	0.0000	0.0898	0.0000	9.032	-1.793e-006	9.99
SNB-WL-A1S	1.79	-0.001701	-0.02528	-0.0011	0.9191	-0.0040	2.373	-1.012	180
SNB-WL-A2S	1.79	-0.001693	0.002863	0.0008	0.9250	0.0001	0.6233	-0.001693	180
SNB-WL-A3S	1.79	-0.001681	-0.02523	0.0042	0.9191	0.0040	2.373	1.009	180
SNB-WL-B1S	1.468	-0.001299	-0.02569	0.0031	0.9087	-0.0041	2.248	-1.353	160
SNB-WL-B2S	1.469	-0.00129	0.01154	0.0012	0.9188	0.0001	-0.09195	-0.00129	160
SNB-WL-B3S	1.468	-0.001275	-0.02564	-0.0011	0.9088	0.0042	2.248	1.35	160
SNB-WL-C1S	1.151	-0.000936	-0.02568	0.0068	0.8693	-0.0039	2.128	-1.693	140
SNB-WL-C2S	1.152	-0.0009179	0.01897	0.0010	0.8865	0.0000	-0.8022	-0.0009179	140
SNB-WL-C3S	1.151	-0.0008963	-0.02562	-0.0049	0.8692	0.0040	2.128	1.691	140
SNB-WL-D1S	0.8553	-0.0006384	-0.02498	0.0081	0.7825	-0.0040	2.029	-2.034	120
SNB-WL-D2S	0.8557	-0.0006059	0.02342	0.0008	0.8071	0.0000	-1.492	-0.0006059	120
SNB-WL-D3S	0.8553	-0.0005717	-0.02492	-0.0065	0.7825	0.0040	2.029	2.032	120
SNB-WL-E1S	0.5964	-0.0004093	-0.02151	0.0096	0.6340	-0.0029	1.967	-2.374	99.98
SNB-WL-E2S	0.5967	-0.0003831	0.02427	0.0005	0.6569	-0.0000	-2.144	-0.0003831	100
SNB-WL-E3S	0.5964	-0.0003577	-0.02147	-0.0085	0.6340	0.0029	1.967	2.373	99.98
SNB-WL-F1S	0.3861	-0.0002697	-0.02003	0.0090	0.5249	-0.0020	1.953	-2.714	79.98
SNB-WL-F2S	0.3864	-0.0002381	0.02371	0.0004	0.5514	-0.0000	-2.748	-0.0002381	80.02
SNB-WL-F3S	0.3861	-0.0002082	-0.02	-0.0083	0.5249	0.0020	1.953	2.714	79.98
SNB-WL-G1S	0.2213	-0.0001779	-0.01767	0.0037	0.3899	-0.0015	1.985	-3.055	59.98
SNB-WL-G2S	0.2215	-0.0001326	0.01908	0.0002	0.4108	-0.0000	-3.306	-0.0001326	60.02
SNB-WL-G3S	0.2213	-8.91e-005	-0.01765	-0.0032	0.3899	0.0015	1.985	3.055	59.98
SNB-WL-H1S	0.1016	-0.000108	-0.01469	0.0059	0.2596	-0.0014	2.062	-3.395	39.99
SNB-WL-H2S	0.1018	-5.559e-005	0.01246	0.0002	0.2826	-0.0000	-3.819	-5.559e-005	40.01
SNB-WL-H3S	0.1016	-4.614e-006	-0.01467	-0.0055	0.2596	0.0014	2.062	3.395	39.99
SNB-WL-I1S	0.02865	-7.51e-005	-0.01093	0.0078	0.1205	-0.0017	2.186	-3.736	19.99
SNB-WL-I2S	0.02877	-1.421e-005	0.003439	0.0001	0.1445	-0.0000	-4.285	-1.421e-005	20
SNB-WL-I3S	0.02865	4.588e-005	-0.01092	-0.0077	0.1205	0.0016	2.186	3.736	19.99
RohnAa1	1.71	-0.0022	0.01618	-0.0016	0.9145	0.0032	-0.5546	-3.925	175
RohnAa2	1.709	-0.002008	0.01633	-0.0003	0.9242	0.0188	-0.5563	3.921	175
RohnAb1	1.631	-0.002332	0.01832	0.0030	0.9242	0.0017	-0.7329	-4.096	170
RohnAb2	1.628	-0.002121	0.01852	-0.0018	0.9266	0.0201	-0.7356	4.092	170
RohnAc1	1.55	-0.001962	0.02041	0.0019	0.9207	0.0008	-0.9125	-4.266	165
RohnAc2	1.547	-0.00216	0.02061	0.0027	0.9160	0.0207	-0.9147	4.262	165
RohnBa1	1.389	-0.001517	0.02432	-0.0007	0.9107	-0.0025	-1.27	-4.607	155
RohnBa2	1.387	-0.001992	0.02452	0.0065	0.9058	0.0221	-1.272	4.604	155
RohnBb1	1.31	-0.001982	0.02609	0.0026	0.9100	-0.0052	-1.447	-4.778	150
RohnBb2	1.309	-0.001164	0.02629	0.0026	0.9063	0.0231	-1.449	4.775	150

RohnBc1	1.23	-0.001112	0.02778	0.0101	0.9162	-0.0084	-1.626	-4.948	145
RohnBc2	1.229	-0.001678	0.02797	-0.0049	0.9120	0.0244	-1.627	4.945	145
RohnCa1	1.051	-0.001114	0.03096	0.0008	0.8609	-0.0112	-2.034	-5.345	133.4
RohnCa2	1.05	-0.000933	0.03113	0.0030	0.8581	0.0237	-2.035	5.343	133.4
RohnCb1	0.9511	-0.0006891	0.03239	0.0073	0.8471	-0.0133	-2.265	-5.572	126.7
RohnCb2	0.9506	-0.001034	0.03256	-0.0043	0.8458	0.0243	-2.266	5.57	126.7
RohnDa1	0.7638	-0.0004064	0.03373	0.0064	0.7737	-0.0145	-2.715	-6.025	113.4
RohnDa2	0.7637	-0.0007076	0.03387	-0.0033	0.7709	0.0228	-2.715	6.024	113.4
RohnDb1	0.6757	0.0007049	0.03355	0.0012	0.7193	-0.0140	-2.934	-6.251	106.7
RohnDb2	0.6758	-0.001537	0.03368	0.0014	0.7173	0.0213	-2.934	6.251	106.7
RohnEa1	0.5207	0.0006547	0.03222	0.0076	0.6290	-0.0137	-3.351	-6.705	93.37
RohnEa2	0.5213	-0.0009763	0.03232	-0.0055	0.6272	0.0192	-3.35	6.705	93.37
RohnEb1	0.4503	0.0007638	0.03137	-0.0043	0.5786	-0.0127	-3.553	-6.933	86.69
RohnEb2	0.4511	-0.0008507	0.03145	0.0068	0.5756	0.0174	-3.552	6.932	86.69
RohnFa1	0.2943	0.002619	0.0281	-0.0033	0.4666	-0.0110	-4.036	-7.498	70.03
RohnFa2	0.2953	-0.002354	0.02816	0.0041	0.4663	0.0144	-4.035	7.499	70.03
RohnGa1	0.1526	0.002633	0.02226	-0.0003	0.3409	-0.0085	-4.571	-8.18	50.02
RohnGa2	0.1535	-0.002294	0.0223	-0.0001	0.3426	0.0109	-4.571	8.18	50.02
RohnHa1	0.05513	0.002962	0.0143	-0.0019	0.2056	-0.0056	-5.063	-8.861	30.01
RohnHa2	0.05564	-0.002731	0.01433	0.0016	0.2066	0.0067	-5.062	8.861	30.01
RohnIa1	0.00648	0.002092	0.004869	-0.0009	0.0864	-0.0026	-5.506	-9.546	10
RohnIa2	0.006658	-0.002	0.004879	0.0002	0.0878	0.0030	-5.506	9.546	10
SNB-Aa1	1.709	-0.001598	0.005223	0.0030	0.9197	-0.0020	0.4443	-2.193	175
SNB-Aa2	1.709	-0.001612	0.005307	-0.0003	0.9205	0.0022	0.4443	2.189	175
SNB-Ab1	1.629	-0.001472	0.007429	0.0015	0.9235	-0.0022	0.2655	-2.363	170
SNB-Ab2	1.629	-0.001483	0.007527	0.0009	0.9235	0.0024	0.2654	2.36	170
SNB-Ac1	1.548	-0.00133	0.009601	0.0017	0.9191	-0.0022	0.08638	-2.534	165
SNB-Ac2	1.548	-0.001473	0.009699	0.0004	0.9183	0.0023	0.08644	2.531	165
SNB-Ba1	1.388	-0.001102	0.01378	0.0028	0.9163	-0.0027	-0.2705	-2.874	155
SNB-Ba2	1.388	-0.001292	0.01388	-0.0007	0.9162	0.0029	-0.2705	2.872	155
SNB-Bb1	1.309	-0.0009983	0.01576	0.0019	0.9109	-0.0030	-0.4485	-3.045	150
SNB-Bb2	1.309	-0.001201	0.01587	0.0003	0.9109	0.0031	-0.4485	3.042	150
SNB-Bc1	1.23	-0.0008293	0.01762	0.0012	0.8998	-0.0030	-0.6261	-3.215	145
SNB-Bc2	1.23	-0.001185	0.01773	0.0009	0.8997	0.0031	-0.6261	3.213	145
SNB-Ca1	1.049	-0.0002802	0.02138	0.0066	0.8698	-0.0043	-1.036	-3.612	133.4
SNB-Ca2	1.049	-0.001341	0.02149	-0.0048	0.8698	0.0044	-1.036	3.61	133.4
SNB-Cb1	0.9501	-0.0001163	0.02307	-0.0013	0.8300	-0.0044	-1.266	-3.839	126.7
SNB-Cb2	0.9501	-0.001296	0.02318	0.0031	0.8300	0.0044	-1.266	3.838	126.7
SNB-Da1	0.7628	0.0001661	0.02514	0.0114	0.7793	-0.0061	-1.716	-4.292	113.4
SNB-Da2	0.7628	-0.001217	0.02524	-0.0100	0.7792	0.0061	-1.716	4.291	113.4
SNB-Db1	0.6755	0.0007833	0.02532	-0.0041	0.7114	-0.0046	-1.934	-4.519	106.7
SNB-Db2	0.6755	-0.00168	0.02541	0.0053	0.7115	0.0046	-1.934	4.518	106.7
SNB-Ea1	0.5213	0.0002888	0.02526	0.0070	0.6298	-0.0046	-2.35	-4.973	93.37
SNB-Ea2	0.5213	-0.0009416	0.02534	-0.0060	0.6299	0.0045	-2.35	4.973	93.37
SNB-Eb1	0.4508	0.0004305	0.02519	-0.0042	0.5745	-0.0035	-2.552	-5.201	86.69
SNB-Eb2	0.4508	-0.0009784	0.02526	0.0050	0.5745	0.0034	-2.552	5.2	86.69
SNB-Fa1	0.2942	0.002659	0.02345	0.0010	0.4676	-0.0040	-3.037	-5.766	70.02
SNB-Fa2	0.2942	-0.002998	0.02351	-0.0004	0.4676	0.0039	-3.037	5.766	70.02
SNB-Ga1	0.1529	0.002427	0.01915	0.0026	0.3403	-0.0047	-3.571	-6.448	50.02
SNB-Ga2	0.1529	-0.002597	0.0192	-0.0021	0.3403	0.0047	-3.571	6.448	50.02
SNB-Ha1	0.05572	0.002623	0.01266	0.0025	0.2064	-0.0045	-4.062	-7.129	30.01
SNB-Ha2	0.05572	-0.002684	0.01269	-0.0022	0.2064	0.0044	-4.062	7.129	30.01
SNB-Ia1	0.006028	0.002353	0.004474	-0.0002	0.0845	-0.0026	-4.505	-7.81	10
SNB-Ia2	0.006032	-0.002361	0.004484	0.0003	0.0845	0.0026	-4.505	7.81	10

Joint Support Reactions for Load Case "1: 1.2D + 1.0Dg + 1.6Wo":

Joint Label	X Force (kips)	X Usage %	Y Force (kips)	Y Usage %	Z Force (kips)	Z Usage %	Comp. Usage %	Uplift Force (kips)	Result. Force (kips)	Result. Usage % (ft-k)	X Moment (ft-k)	X-M. Usage % (ft-k)	Y Moment (ft-k)	Y-M. Usage % (ft-k)	Z Moment (ft-k)	Z-M. Usage %	Max. Usage %
RohnJP	-29.67	0.0	0.11	0.0	355.57	0.0	0.0	0.0	356.80	0.0	-0.06	0.0	-5.6	0.0	-0.01	0.0	0.0
SNB-JP	-51.25	0.0	0.00	0.0	512.04	0.0	0.0	0.0	514.60	0.0	0.00	0.0	-13.5	0.0	0.00	0.0	0.0
RohnJ1	-9.49	0.0	-10.04	0.0	-147.95	0.0	0.0	0.0	148.59	0.0	1.91	0.0	-1.4	0.0	0.00	0.0	0.0
RohnJ2	-9.70	0.0	9.95	0.0	-148.25	0.0	0.0	0.0	148.90	0.0	-1.86	0.0	-1.5	0.0	-0.01	0.0	0.0
SNB-J1	-17.54	0.0	-18.77	0.0	-227.91	0.0	0.0	0.0	229.35	0.0	5.44	0.0	-2.7	0.0	-0.03	0.0	0.0
SNB-J2	-17.56	0.0	18.80	0.0	-228.39	0.0	0.0	0.0	229.83	0.0	-5.44	0.0	-2.7	0.0	0.03	0.0	0.0



Joint Displacements, Loads and Member Forces on Joints for Load Case "1: 1.2D + 1.0Dg + 1.6Wo":

Joint Label	X External Load (kips)	Y External Load (kips)	Z External Load (kips)	X Member Force (kips)	Y Member Force (kips)	Z Member Force (kips)	X Disp. (ft)	Y Disp. (ft)	Z Disp. (ft)
RohnAP	0.6457	0.0000	-0.3561	-0.6457	-0.0000	0.3561	1.7889	-0.0008	-0.0895
RohnBP	3.0386	0.0000	-1.2758	-3.0386	-0.0000	1.2758	1.4676	-0.0000	-0.0981
RohnCP	0.6587	0.0000	-0.5163	-0.6587	0.0000	0.5163	1.1508	-0.0003	-0.1026
RohnDP	0.7996	0.0000	-0.6254	-0.7996	0.0000	0.6254	0.8548	-0.0004	-0.1018
RohnEP	0.8293	0.0000	-0.7740	-0.8293	0.0000	0.7740	0.5960	-0.0006	-0.0913
RohnFP	0.9670	0.0000	-1.0489	-0.9670	-0.0000	1.0489	0.3859	-0.0007	-0.0792
RohnGP	1.3744	0.0000	-1.3961	-1.3744	-0.0000	1.3961	0.2212	-0.0007	-0.0637
RohnHP	1.1981	0.0000	-1.3896	-1.1981	-0.0000	1.3896	0.1016	-0.0004	-0.0458
RohnIP	1.4581	0.0000	-1.5585	-1.4581	-0.0000	1.5585	0.0287	-0.0002	-0.0225
RohnJP	0.8371	0.0000	-0.8421	28.8289	-0.1081	-354.7247	0.0000	0.0000	0.0000
SNB-AP	0.1887	0.0000	-0.1881	-0.1887	0.0000	0.1881	1.7893	-0.0017	-0.0532
SNB-BP	0.4544	0.0000	-0.4070	-0.4544	0.0000	0.4070	1.4679	-0.0013	-0.0625
SNB-CP	0.6587	0.0000	-0.5163	-0.6587	0.0000	0.5163	1.1511	-0.0009	-0.0697
SNB-DP	0.7996	0.0000	-0.6254	-0.7996	0.0000	0.6254	0.8550	-0.0006	-0.0721
SNB-EP	0.8293	0.0000	-0.7740	-0.8293	0.0000	0.7740	0.5962	-0.0004	-0.0664
SNB-FP	0.9670	0.0000	-1.0489	-0.9670	0.0000	1.0489	0.3860	-0.0002	-0.0614
SNB-GP	1.1214	0.0000	-1.2761	-1.1214	0.0000	1.2761	0.2212	-0.0001	-0.0507
SNB-HP	1.1981	0.0000	-1.3896	-1.1981	0.0000	1.3896	0.1017	-0.0001	-0.0376
SNB-IP	1.4581	0.0000	-1.5585	-1.4581	0.0000	1.5585	0.0287	-0.0000	-0.0190
SNB-JP	0.8371	0.0000	-0.8421	50.4158	-0.0019	-511.2017	0.0000	0.0000	0.0000
RohnA1	0.6457	0.0000	-0.3561	-0.6457	-0.0000	0.3561	1.7906	-0.0021	0.0140
RohnA2	1.1028	0.0000	-0.5241	-1.1028	-0.0000	0.5241	1.7892	-0.0020	0.0141
RohnB1	1.0572	0.0000	-0.5438	-1.0572	-0.0000	0.5438	1.4697	-0.0020	0.0224
RohnB2	0.7218	0.0000	-0.4658	-0.7218	-0.0000	0.4658	1.4675	-0.0019	0.0226
RohnC1	0.6587	0.0000	-0.5163	-0.6587	0.0000	0.5163	1.1518	-0.0009	0.0292
RohnC2	0.6587	0.0000	-0.5163	-0.6587	-0.0000	0.5163	1.1508	-0.0015	0.0294
RohnD1	1.0140	0.0000	-0.7094	-1.0140	0.0000	0.7094	0.8549	-0.0001	0.0334
RohnD2	0.7996	0.0000	-0.6254	-0.7996	-0.0000	0.6254	0.8545	-0.0013	0.0335
RohnE1	0.8293	0.0000	-0.7740	-0.8293	0.0000	0.7740	0.5962	-0.0001	0.0327
RohnE2	0.8293	0.0000	-0.7740	-0.8293	-0.0000	0.7740	0.5966	-0.0004	0.0328
RohnF1	0.9670	0.0000	-1.0489	-0.9670	-0.0000	1.0489	0.3850	0.0006	0.0301
RohnF2	1.4491	0.0000	-1.2229	-1.4491	-0.0000	1.2229	0.3861	-0.0004	0.0302
RohnG1	1.2624	0.0000	-1.3481	-1.2624	0.0000	1.3481	0.2205	0.0004	0.0252
RohnG2	1.7131	0.0000	-1.4633	-1.7131	-0.0000	1.4633	0.2217	0.0000	0.0252
RohnH1	1.1981	0.0000	-1.3896	-1.1981	-0.0000	1.3896	0.1009	0.0004	0.0186
RohnH2	1.1981	0.0000	-1.3896	-1.1981	0.0000	1.3896	0.1016	-0.0001	0.0187
RohnI1	1.4581	0.0000	-1.5585	-1.4581	-0.0000	1.5585	0.0284	0.0002	0.0093
RohnI2	1.4581	0.0000	-1.5585	-1.4581	0.0000	1.5585	0.0288	-0.0000	0.0093
RohnJ1	0.8371	0.0000	-0.8421	8.6546	10.0366	148.7903	0.0000	0.0000	0.0000
RohnJ2	0.8371	0.0000	-0.8421	8.8582	-9.9451	149.0914	0.0000	0.0000	0.0000
SNB-A1	0.1887	0.0000	-0.1881	-0.1887	-0.0000	0.1881	1.7897	-0.0017	0.0030
SNB-A2	0.1887	0.0000	-0.1881	-0.1887	0.0000	0.1881	1.7897	-0.0017	0.0031
SNB-B1	0.4544	0.0000	-0.4070	-0.4544	-0.0000	0.4070	1.4685	-0.0013	0.0117
SNB-B2	0.4544	0.0000	-0.4070	-0.4544	0.0000	0.4070	1.4685	-0.0013	0.0118
SNB-C1	0.6587	0.0000	-0.5163	-0.6587	-0.0000	0.5163	1.1517	-0.0009	0.0193
SNB-C2	0.6587	0.0000	-0.5163	-0.6587	0.0000	0.5163	1.1517	-0.0009	0.0195
SNB-D1	0.7996	0.0000	-0.6254	-0.7996	-0.0000	0.6254	0.8555	-0.0005	0.0244
SNB-D2	0.7996	0.0000	-0.6254	-0.7996	0.0000	0.6254	0.8555	-0.0007	0.0245
SNB-E1	0.8293	0.0000	-0.7740	-0.8293	-0.0000	0.7740	0.5965	-0.0003	0.0249
SNB-E2	0.8293	0.0000	-0.7740	-0.8293	0.0000	0.7740	0.5965	-0.0005	0.0250
SNB-F1	0.9670	0.0000	-1.0489	-0.9670	-0.0000	1.0489	0.3862	-0.0001	0.0248
SNB-F2	0.9670	0.0000	-1.0489	-0.9670	0.0000	1.0489	0.3862	-0.0003	0.0248
SNB-G1	1.1214	0.0000	-1.2761	-1.1214	-0.0000	1.2761	0.2212	0.0000	0.0213
SNB-G2	1.1214	0.0000	-1.2761	-1.1214	0.0000	1.2761	0.2212	-0.0003	0.0214
SNB-H1	1.1981	0.0000	-1.3896	-1.1981	-0.0000	1.3896	0.1014	0.0001	0.0163
SNB-H2	1.1981	0.0000	-1.3896	-1.1981	0.0000	1.3896	0.1014	-0.0003	0.0163
SNB-I1	1.4581	0.0000	-1.5585	-1.4581	-0.0000	1.5585	0.0283	0.0003	0.0084
SNB-I2	1.4581	0.0000	-1.5585	-1.4581	0.0000	1.5585	0.0283	-0.0003	0.0084
SNB-J1	0.8371	0.0000	-0.8421	16.7017	18.7729	228.7534	0.0000	0.0000	0.0000
SNB-J2	0.8371	0.0000	-0.8421	16.7203	-18.8046	229.2273	0.0000	0.0000	0.0000
RohnAaS	0.6047	0.0000	-0.2508	-0.6047	0.0000	0.2508	1.7086	-0.0004	-0.0919
RohnAbS	0.1887	0.0000	-0.1881	-0.1887	0.0000	0.1881	1.6280	-0.0004	-0.0942
RohnAcS	0.5630	0.0000	-0.2520	-0.5630	0.0000	0.2520	1.5478	0.0000	-0.0963

RohnBaS	0.2658	0.0000	-0.2189	-0.2658	0.0000	0.2189	1.3877	-0.0001	-0.0998
RohnBbS	2.2103	0.0000	-1.1599	-2.2103	0.0000	1.1599	1.3080	-0.0001	-0.1011
RohnBcS	0.2658	0.0000	-0.2189	-0.2658	0.0000	0.2189	1.2291	-0.0002	-0.1021
RohnCaS	2.0581	0.0000	-0.9601	-2.0581	0.0000	0.9601	1.0497	-0.0003	-0.1032
RohnCbS	2.9069	0.0000	-1.7009	-2.9069	0.0000	1.7009	0.9506	-0.0004	-0.1030
RohnDaS	2.9338	0.0000	-1.5215	-2.9338	0.0000	1.5215	0.7636	-0.0004	-0.0995
RohnDbS	0.4066	0.0000	-0.3280	-0.4066	0.0000	0.3280	0.6773	-0.0005	-0.0959
RohnEaS	0.4227	0.0000	-0.4460	-0.4227	-0.0000	0.4460	0.5221	-0.0007	-0.0879
RohnEbS	0.4227	0.0000	-0.4460	-0.4227	-0.0000	0.4460	0.4517	-0.0008	-0.0839
RohnFaS	0.5444	0.0000	-0.6029	-0.5444	-0.0000	0.6029	0.2997	-0.0008	-0.0722
RohnGaS	0.5770	0.0000	-0.6732	-0.5770	-0.0000	0.6732	0.1580	-0.0006	-0.0553
RohnHaS	0.6210	0.0000	-0.7165	-0.6210	-0.0000	0.7165	0.0612	-0.0003	-0.0348
RohnIaS	0.8371	0.0000	-0.8421	-0.8371	-0.0000	0.8421	0.0110	-0.0001	-0.0117
SNB-AaS	0.1887	0.0000	-0.1881	-0.1887	-0.0000	0.1881	1.7090	-0.0015	-0.0557
SNB-AbS	0.1887	0.0000	-0.1881	-0.1887	-0.0000	0.1881	1.6284	-0.0015	-0.0581
SNB-AcS	0.1887	0.0000	-0.1881	-0.1887	-0.0000	0.1881	1.5482	-0.0013	-0.0604
SNB-BaS	0.2658	0.0000	-0.2189	-0.2658	-0.0000	0.2189	1.3880	-0.0012	-0.0647
SNB-BbS	0.2658	0.0000	-0.2189	-0.2658	-0.0000	0.2189	1.3083	-0.0011	-0.0666
SNB-BcS	0.2658	0.0000	-0.2189	-0.2658	-0.0000	0.2189	1.2293	-0.0010	-0.0682
SNB-CaS	0.3930	0.0000	-0.2974	-0.3930	-0.0000	0.2974	1.0499	-0.0008	-0.0711
SNB-CbS	0.3930	0.0000	-0.2974	-0.3930	-0.0000	0.2974	0.9508	-0.0007	-0.0719
SNB-DaS	0.4066	0.0000	-0.3280	-0.4066	-0.0000	0.3280	0.7638	-0.0005	-0.0712
SNB-DbS	0.4066	0.0000	-0.3280	-0.4066	-0.0000	0.3280	0.6775	-0.0004	-0.0692
SNB-EaS	0.4227	0.0000	-0.4460	-0.4227	-0.0000	0.4460	0.5222	-0.0003	-0.0654
SNB-EbS	0.4227	0.0000	-0.4460	-0.4227	0.0000	0.4460	0.4518	-0.0003	-0.0637
SNB-FaS	0.5444	0.0000	-0.6029	-0.5444	-0.0000	0.6029	0.2997	-0.0002	-0.0567
SNB-GaS	0.5770	0.0000	-0.6732	-0.5770	-0.0000	0.6732	0.1580	-0.0001	-0.0447
SNB-HaS	0.6210	0.0000	-0.7165	-0.6210	-0.0000	0.7165	0.0613	-0.0000	-0.0289
SNB-IaS	0.8371	0.0000	-0.8421	-0.8371	-0.0000	0.8421	0.0110	-0.0000	-0.0101
SNB-WL-A1S	0.1887	0.0000	-0.1881	-0.1887	0.0000	0.1881	1.7895	-0.0017	-0.0253
SNB-WL-A2S	0.1887	0.0000	-0.1881	-0.1887	0.0000	0.1881	1.7898	-0.0017	0.0029
SNB-WL-A3S	0.1887	0.0000	-0.1881	-0.1887	-0.0000	0.1881	1.7895	-0.0017	-0.0252
SNB-WL-B1S	0.1887	0.0000	-0.1881	-0.1887	0.0000	0.1881	1.4682	-0.0013	-0.0257
SNB-WL-B2S	0.1887	0.0000	-0.1881	-0.1887	-0.0000	0.1881	1.4686	-0.0013	0.0115
SNB-WL-B3S	0.1887	0.0000	-0.1881	-0.1887	-0.0000	0.1881	1.4682	-0.0013	-0.0256
SNB-WL-C1S	0.2658	0.0000	-0.2189	-0.2658	0.0000	0.2189	1.1514	-0.0009	-0.0257
SNB-WL-C2S	0.2658	0.0000	-0.2189	-0.2658	-0.0000	0.2189	1.1518	-0.0009	0.0190
SNB-WL-C3S	0.2658	0.0000	-0.2189	-0.2658	-0.0000	0.2189	1.1514	-0.0009	-0.0256
SNB-WL-D1S	0.3930	0.0000	-0.2974	-0.3930	0.0000	0.2974	0.8553	-0.0006	-0.0250
SNB-WL-D2S	0.3930	0.0000	-0.2974	-0.3930	-0.0000	0.2974	0.8557	-0.0006	0.0234
SNB-WL-D3S	0.3930	0.0000	-0.2974	-0.3930	-0.0000	0.2974	0.8553	-0.0006	-0.0249
SNB-WL-E1S	0.4066	0.0000	-0.3280	-0.4066	0.0000	0.3280	0.5964	-0.0004	-0.0215
SNB-WL-E2S	0.4066	0.0000	-0.3280	-0.4066	-0.0000	0.3280	0.5967	-0.0004	0.0243
SNB-WL-E3S	0.4066	0.0000	-0.3280	-0.4066	-0.0000	0.3280	0.5964	-0.0004	-0.0215
SNB-WL-F1S	0.4227	0.0000	-0.4460	-0.4227	0.0000	0.4460	0.3861	-0.0003	-0.0200
SNB-WL-F2S	0.4227	0.0000	-0.4460	-0.4227	-0.0000	0.4460	0.3864	-0.0002	0.0237
SNB-WL-F3S	0.4227	0.0000	-0.4460	-0.4227	-0.0000	0.4460	0.3861	-0.0002	-0.0200
SNB-WL-G1S	0.5444	0.0000	-0.6029	-0.5444	0.0000	0.6029	0.2213	-0.0002	-0.0177
SNB-WL-G2S	0.5444	0.0000	-0.6029	-0.5444	-0.0000	0.6029	0.2215	-0.0001	0.0191
SNB-WL-G3S	0.5444	0.0000	-0.6029	-0.5444	-0.0000	0.6029	0.2213	-0.0001	-0.0176
SNB-WL-H1S	0.5770	0.0000	-0.6732	-0.5770	0.0000	0.6732	0.1016	-0.0001	-0.0147
SNB-WL-H2S	0.5770	0.0000	-0.6732	-0.5770	-0.0000	0.6732	0.1018	-0.0001	0.0125
SNB-WL-H3S	0.5770	0.0000	-0.6732	-0.5770	-0.0000	0.6732	0.1016	-0.0000	-0.0147
SNB-WL-I1S	0.6210	0.0000	-0.7165	-0.6210	0.0000	0.7165	0.0286	-0.0001	-0.0109
SNB-WL-I2S	0.6210	0.0000	-0.7165	-0.6210	-0.0000	0.7165	0.0288	-0.0000	0.0034
SNB-WL-I3S	0.6210	0.0000	-0.7165	-0.6210	-0.0000	0.7165	0.0286	0.0000	-0.0109
RohnAa1	0.4999	0.0000	-0.2763	-0.4999	0.0000	0.2763	1.7104	-0.0022	0.0162
RohnAa2	0.7903	0.0000	-0.3039	-0.7903	-0.0000	0.3039	1.7087	-0.0020	0.0163
RohnAb1	1.1180	-0.0502	-0.3321	-1.1180	0.0502	0.3321	1.6306	-0.0023	0.0183
RohnAb2	0.1887	0.0000	-0.1881	-0.1887	-0.0000	0.1881	1.6279	-0.0021	0.0185
RohnAc1	0.1887	0.0000	-0.1881	-0.1887	0.0000	0.1881	1.5495	-0.0020	0.0204
RohnAc2	0.1887	0.0000	-0.1881	-0.1887	-0.0000	0.1881	1.5473	-0.0022	0.0206
RohnBa1	0.2658	0.0000	-0.2189	-0.2658	0.0000	0.2189	1.3891	-0.0015	0.0243
RohnBa2	0.2658	0.0000	-0.2189	-0.2658	-0.0000	0.2189	1.3872	-0.0020	0.0245
RohnBb1	2.1359	0.0000	-1.1275	-2.1359	0.0000	1.1275	1.3105	-0.0020	0.0261
RohnBb2	2.1359	0.0000	-1.1275	-2.1359	-0.0000	1.1275	1.3088	-0.0012	0.0263
RohnBc1	0.2658	0.0000	-0.2189	-0.2658	0.0000	0.2189	1.2301	-0.0011	0.0278
RohnBc2	0.2658	0.0000	-0.2189	-0.2658	0.0000	0.2189	1.2287	-0.0017	0.0280
RohnCa1	2.2226	0.0000	-1.0321	-2.2226	0.0000	1.0321	1.0510	-0.0011	0.0310

RohnCa2	2.3301	0.0000	-1.0801	-2.3301	-0.0000	1.0801	1.0502	-0.0009	0.0311
RohnCb1	2.7453	0.0000	-1.6349	-2.7453	0.0000	1.6349	0.9511	-0.0007	0.0324
RohnCb2	2.7453	0.0000	-1.6349	-2.7453	-0.0000	1.6349	0.9506	-0.0010	0.0326
RohnDa1	2.6669	0.0000	-1.3955	-2.6669	0.0000	1.3955	0.7638	-0.0004	0.0337
RohnDa2	2.6669	0.0000	-1.3955	-2.6669	-0.0000	1.3955	0.7637	-0.0007	0.0339
RohnDb1	0.4066	0.0000	-0.3280	-0.4066	0.0000	0.3280	0.6757	0.0007	0.0335
RohnDb2	0.4066	0.0000	-0.3280	-0.4066	-0.0000	0.3280	0.6758	-0.0015	0.0337
RohnEa1	0.4227	0.0000	-0.4460	-0.4227	-0.0000	0.4460	0.5207	0.0007	0.0322
RohnEa2	0.4227	0.0000	-0.4460	-0.4227	0.0000	0.4460	0.5213	-0.0010	0.0323
RohnEb1	0.4227	0.0000	-0.4460	-0.4227	0.0000	0.4460	0.4503	0.0008	0.0314
RohnEb2	0.4227	0.0000	-0.4460	-0.4227	-0.0000	0.4460	0.4511	-0.0009	0.0315
RohnFa1	0.5444	0.0000	-0.6029	-0.5444	0.0000	0.6029	0.2943	0.0026	0.0281
RohnFa2	0.5444	0.0000	-0.6029	-0.5444	-0.0000	0.6029	0.2953	-0.0024	0.0282
RohnGa1	0.5770	0.0000	-0.6732	-0.5770	0.0000	0.6732	0.1526	0.0026	0.0223
RohnGa2	0.5770	0.0000	-0.6732	-0.5770	-0.0000	0.6732	0.1535	-0.0023	0.0223
RohnHa1	0.6210	0.0000	-0.7165	-0.6210	0.0000	0.7165	0.0551	0.0030	0.0143
RohnHa2	0.6210	0.0000	-0.7165	-0.6210	-0.0000	0.7165	0.0556	-0.0027	0.0143
RohnIa1	0.8371	0.0000	-0.8421	-0.8371	0.0000	0.8421	0.0065	0.0021	0.0049
RohnIa2	0.8371	0.0000	-0.8421	-0.8371	-0.0000	0.8421	0.0067	-0.0020	0.0049
SNB-Aa1	0.1887	0.0000	-0.1881	-0.1887	-0.0000	0.1881	1.7093	-0.0016	0.0052
SNB-Aa2	0.1887	0.0000	-0.1881	-0.1887	0.0000	0.1881	1.7093	-0.0016	0.0053
SNB-Ab1	0.1887	0.0000	-0.1881	-0.1887	-0.0000	0.1881	1.6290	-0.0015	0.0074
SNB-Ab2	0.1887	0.0000	-0.1881	-0.1887	0.0000	0.1881	1.6289	-0.0015	0.0075
SNB-Ac1	0.1887	0.0000	-0.1881	-0.1887	-0.0000	0.1881	1.5484	-0.0013	0.0096
SNB-Ac2	0.1887	0.0000	-0.1881	-0.1887	0.0000	0.1881	1.5484	-0.0015	0.0097
SNB-Ba1	0.2658	0.0000	-0.2189	-0.2658	-0.0000	0.2189	1.3883	-0.0011	0.0138
SNB-Ba2	0.2658	0.0000	-0.2189	-0.2658	0.0000	0.2189	1.3883	-0.0013	0.0139
SNB-Bb1	0.2658	0.0000	-0.2189	-0.2658	-0.0000	0.2189	1.3087	-0.0010	0.0158
SNB-Bb2	0.2658	0.0000	-0.2189	-0.2658	0.0000	0.2189	1.3087	-0.0012	0.0159
SNB-Bc1	0.2658	0.0000	-0.2189	-0.2658	-0.0000	0.2189	1.2295	-0.0008	0.0176
SNB-Bc2	0.2658	0.0000	-0.2189	-0.2658	0.0000	0.2189	1.2295	-0.0012	0.0177
SNB-Ca1	0.3930	0.0000	-0.2974	-0.3930	-0.0000	0.2974	1.0495	-0.0003	0.0214
SNB-Ca2	0.3930	0.0000	-0.2974	-0.3930	0.0000	0.2974	1.0495	-0.0013	0.0215
SNB-Cb1	0.3930	0.0000	-0.2974	-0.3930	-0.0000	0.2974	0.9501	-0.0001	0.0231
SNB-Cb2	0.3930	0.0000	-0.2974	-0.3930	0.0000	0.2974	0.9501	-0.0013	0.0232
SNB-Da1	0.4066	0.0000	-0.3280	-0.4066	-0.0000	0.3280	0.7628	0.0002	0.0251
SNB-Da2	0.4066	0.0000	-0.3280	-0.4066	0.0000	0.3280	0.7628	-0.0012	0.0252
SNB-Db1	0.4066	0.0000	-0.3280	-0.4066	-0.0000	0.3280	0.6755	0.0008	0.0253
SNB-Db2	0.4066	0.0000	-0.3280	-0.4066	0.0000	0.3280	0.6755	-0.0017	0.0254
SNB-Ea1	0.4227	0.0000	-0.4460	-0.4227	-0.0000	0.4460	0.5213	0.0003	0.0253
SNB-Ea2	0.4227	0.0000	-0.4460	-0.4227	0.0000	0.4460	0.5213	-0.0009	0.0253
SNB-Eb1	0.4227	0.0000	-0.4460	-0.4227	0.0000	0.4460	0.4508	0.0004	0.0252
SNB-Eb2	0.4227	0.0000	-0.4460	-0.4227	-0.0000	0.4460	0.4508	-0.0010	0.0253
SNB-Fa1	0.5444	0.0000	-0.6029	-0.5444	-0.0000	0.6029	0.2942	0.0027	0.0235
SNB-Fa2	0.5444	0.0000	-0.6029	-0.5444	0.0000	0.6029	0.2942	-0.0030	0.0235
SNB-Ga1	0.5770	0.0000	-0.6732	-0.5770	-0.0000	0.6732	0.1529	0.0024	0.0191
SNB-Ga2	0.5770	0.0000	-0.6732	-0.5770	0.0000	0.6732	0.1529	-0.0026	0.0192
SNB-Ha1	0.6210	0.0000	-0.7165	-0.6210	0.0000	0.7165	0.0557	0.0026	0.0127
SNB-Ha2	0.6210	0.0000	-0.7165	-0.6210	0.0000	0.7165	0.0557	-0.0027	0.0127
SNB-Ia1	0.8371	0.0000	-0.8421	-0.8371	0.0000	0.8421	0.0060	0.0024	0.0045
SNB-Ia2	0.8371	0.0000	-0.8421	-0.8371	-0.0000	0.8421	0.0060	-0.0024	0.0045

**Moments for Angles Modeled as Beams:**

Angle Label	Torsion (ft-lbs)	Origin X Moment (ft-lbs)	Origin Y Moment (ft-lbs)	End X Moment (ft-lbs)	End Y Moment (ft-lbs)	X Shear (lbs)	Y Shear (lbs)
Rohn-LA1P	-0.01	1.03	4.69	26.12	-17.83	5.43	-2.63
Rohn-LA11	2.04	-1.59	2.70	11.26	38.09	1.93	8.15
Rohn-LA12	-2.21	1.17	2.88	6.58	-16.81	1.55	-2.78
Rohn-LA2P	-0.01	-26.12	17.83	-32.87	26.04	-11.79	8.77
Rohn-LA21	2.04	-11.26	-38.09	-35.18	-88.29	-9.28	-25.25
Rohn-LA22	-2.21	-6.58	16.81	1.13	3.90	-1.09	4.14
Rohn-LA3P	-0.01	32.87	-26.04	35.80	-13.21	13.73	-7.85
Rohn-LA31	2.04	35.18	88.29	40.80	105.83	15.18	38.79
Rohn-LA32	-2.21	-1.13	-3.90	-24.26	51.06	-5.07	9.42
Rohn-LA4P	-0.01	-35.80	13.21	-18.82	24.90	-10.92	7.62
Rohn-LA41	2.04	-40.80	-105.83	-62.04	-118.53	-20.55	-44.84

Rohn-LA42	-2.21	24.26	-51.06	46.34	-78.40	14.11	-25.87
Rohn-LB1P	2.93	18.15	-14.14	10.97	-2.53	5.82	-3.33
Rohn-LB11	8.54	60.35	125.13	115.58	227.50	35.16	70.47
Rohn-LB12	-2.58	-43.06	84.20	-109.79	211.91	-30.55	59.17
Rohn-LB2P	2.93	-10.97	2.53	-4.26	56.99	-3.04	11.90
Rohn-LB21	8.53	-115.59	-227.50	-142.98	-222.25	-51.67	-89.87
Rohn-LB22	-2.58	109.79	-211.91	142.29	-216.46	50.37	-85.60
Rohn-LB3P	2.93	4.26	-56.98	4.10	-1.41	1.67	-11.67
Rohn-LB31	8.54	142.98	222.25	79.77	170.13	44.51	78.40
Rohn-LB32	-2.59	-142.29	216.46	-79.85	168.66	-44.39	76.96
Rohn-LB4P	2.93	-4.10	1.41	-6.36	154.56	-2.09	31.18
Rohn-LB41	8.53	-79.77	-170.12	15.05	144.54	-12.93	-5.11
Rohn-LB42	-2.57	79.85	-168.66	-9.99	141.34	13.96	-5.46
Rohn-LC1P	2.93	6.36	-154.56	1.81	81.47	1.23	-10.97
Rohn-LC11	8.52	-15.05	-144.54	-35.17	20.14	-7.53	-18.66
Rohn-LC12	-2.57	9.98	-141.34	37.37	16.57	7.10	-18.72
Rohn-LC2P	2.93	-1.81	-81.47	1.28	110.24	-0.08	4.31
Rohn-LC21	8.53	35.17	-20.14	-27.02	110.60	1.22	13.53
Rohn-LC22	-2.57	-37.37	-16.57	31.97	100.76	-0.81	12.59
Rohn-LC3P	2.93	-1.29	-110.24	-3.23	232.74	-0.68	18.39
Rohn-LC31	8.54	27.02	-110.60	114.78	347.58	21.27	35.55
Rohn-LC32	-2.58	-31.97	-100.76	-121.91	369.41	-23.08	40.30
Rohn-LD1P	2.93	3.23	-232.74	6.74	404.68	1.50	25.82
Rohn-LD11	8.49	-114.78	-347.58	-239.48	34.36	-53.13	-46.98
Rohn-LD12	-2.53	121.91	-369.41	247.35	16.88	55.38	-52.87
Rohn-LD2P	2.93	-6.74	-404.68	-2.04	176.43	-1.31	-34.17
Rohn-LD21	8.60	239.48	-34.36	318.82	780.54	83.48	111.57
Rohn-LD22	-2.65	-247.35	-16.88	-319.05	786.47	-84.69	115.08
Rohn-LD3P	2.93	2.04	-176.43	-0.66	714.27	0.21	80.78
Rohn-LD31	8.42	-318.79	-780.55	-297.06	90.50	-92.36	-103.48
Rohn-LD32	-2.47	319.02	-786.48	298.71	92.42	92.64	-104.09
Rohn-LE1P	2.94	0.66	-714.26	12.29	275.54	1.94	-65.88
Rohn-LE11	8.57	297.06	-90.49	134.72	575.66	64.76	72.77
Rohn-LE12	-2.61	-298.71	-92.41	-129.88	561.52	-64.28	70.36
Rohn-LE2P	2.93	-12.30	-275.54	-26.83	229.54	-5.86	-6.89
Rohn-LE21	8.52	-134.71	-575.66	111.65	461.01	-3.45	-17.14
Rohn-LE22	-2.57	129.87	-561.53	-124.38	500.52	0.82	-9.12
Rohn-LE3P	2.94	26.83	-229.54	27.81	1102.36	8.21	131.09
Rohn-LE31	8.46	-111.64	-461.01	-424.80	169.13	-80.45	-43.77
Rohn-LE32	-2.50	124.37	-500.52	461.03	89.62	87.79	-61.62
Rohn-LF1P	2.92	-27.82	-1102.36	-39.96	91.10	-6.78	-101.15
Rohn-LF11	8.73	424.79	-169.12	756.23	1723.89	117.96	155.29
Rohn-LF12	-2.79	-461.03	-89.61	-778.89	1785.62	-123.85	169.40
Rohn-LF2P	2.95	39.96	-91.10	29.77	1633.52	6.98	154.30
Rohn-LF21	8.19	-756.15	-1723.93	-909.11	-317.87	-166.32	-203.92
Rohn-LF22	-2.22	778.80	-1785.67	942.96	-391.78	171.96	-217.47
Rohn-LG1P	2.92	-29.78	-1633.52	-26.59	-86.87	-5.64	-172.09
Rohn-LG11	8.89	909.10	317.88	1008.37	2064.68	191.52	237.97
Rohn-LG12	-2.95	-942.95	391.80	-1020.95	2100.21	-196.15	248.90
Rohn-LG2P	2.94	26.59	86.87	13.32	1897.98	3.99	198.56
Rohn-LG21	8.16	-1008.28	-2064.73	-1102.41	-455.16	-210.80	-251.67
Rohn-LG22	-2.20	1020.84	-2100.26	1107.29	-466.13	212.55	-256.32
Rohn-LH1P	2.93	-13.33	-1897.98	0.31	-162.28	-1.30	-206.12
Rohn-LH11	8.88	1102.39	455.18	1239.51	2470.52	233.89	292.19
Rohn-LH12	-2.93	-1107.28	466.15	-1242.57	2478.73	-234.68	294.10
Rohn-LH2P	2.93	-0.31	162.28	-2.08	2426.38	-0.24	259.01
Rohn-LH21	7.82	-1239.37	-2470.59	-1446.63	-669.11	-268.24	-313.55
Rohn-LH22	-1.86	1242.41	-2478.80	1451.47	-674.10	269.03	-314.87
Rohn-LI1P	2.93	2.07	-2426.38	-9.39	-196.92	-0.73	-262.43
Rohn-LI11	8.75	1446.62	669.13	1862.01	3821.78	330.45	448.52
Rohn-LI12	-2.80	-1451.46	674.12	-1848.24	3798.88	-329.55	446.74
Rohn-LI2P	2.94	9.39	196.92	58.37	5552.55	6.78	575.20
Rohn-LI21	7.40	-1861.83	-3821.87	-1913.25	1425.52	-377.02	-239.33
Rohn-LI22	-1.46	1848.04	-3798.98	1858.27	1529.19	370.15	-226.69
Rohn-H1P	0.20	2.23	0.13	3.08	-1.05	0.71	-0.12
Rohn-H11	-0.06	0.07	-1.05	0.00	1.24	0.01	0.02
Rohn-H12	0.38	-3.09	1.04	-3.29	-0.07	-0.85	0.13
Rohn-H2P	-0.53	6.64	-1.88	6.93	-3.47	1.53	-0.60
Rohn-H21	-0.11	1.19	-3.21	0.07	-0.03	0.14	-0.36

Rohn-H22	0.15	-6.71	0.53	-6.17	-1.09	-1.45	-0.06
SNB-LA1P	-0.03	4.02	66.88	14.57	-9.81	3.71	11.41
SNB-LA11	0.27	67.64	-23.57	16.63	16.17	16.84	-1.48
SNB-LA12	-0.28	-71.83	-36.36	-25.14	-6.99	-19.38	-8.66
SNB-LA2P	-0.03	-14.57	9.81	-19.75	36.89	-6.86	9.33
SNB-LA21	0.27	-16.63	-16.17	-6.35	-43.37	-4.59	-11.90
SNB-LA22	-0.28	25.14	6.99	16.85	-14.12	8.39	-1.42
SNB-LA3P	-0.03	19.75	-36.89	16.24	-39.47	7.19	-15.26
SNB-LA31	0.27	6.35	43.37	4.82	74.79	2.23	23.61
SNB-LA32	-0.28	-16.85	14.12	-13.52	50.78	-6.07	12.97
SNB-LA4P	-0.03	-16.24	39.47	-10.46	118.22	-5.34	31.51
SNB-LA41	0.27	-4.82	-74.79	12.91	-72.15	1.62	-29.36
SNB-LA42	-0.28	13.52	-50.78	-5.71	-55.24	1.56	-21.19
SNB-LB1P	-0.06	9.62	182.01	4.67	46.51	2.86	45.67
SNB-LB11	3.24	114.33	60.84	50.05	101.89	32.85	32.52
SNB-LB12	-3.03	-119.96	47.39	-53.29	94.82	-34.62	28.42
SNB-LB2P	-0.06	-4.67	-46.51	-2.69	120.81	-1.47	14.85
SNB-LB21	3.23	-50.05	-101.89	-33.72	-6.40	-16.74	-21.64
SNB-LB22	-3.02	53.29	-94.82	35.96	-2.05	17.84	-19.36
SNB-LB3P	-0.06	2.69	-120.81	2.22	-59.10	0.98	-35.96
SNB-LB31	3.24	33.72	6.40	45.81	201.52	15.89	41.55
SNB-LB32	-3.03	-35.96	2.05	-46.07	198.88	-16.39	40.15
SNB-LB4P	-0.06	-2.22	59.10	-0.19	550.97	-0.48	121.95
SNB-LB41	3.23	-45.81	-201.52	-1.10	32.61	-9.37	-33.75
SNB-LB42	-3.02	46.07	-198.88	3.87	34.23	9.98	-32.90
SNB-LC1P	0.03	0.18	-36.35	0.29	177.70	0.07	21.21
SNB-LC11	8.39	183.20	-39.93	78.04	179.17	39.19	20.89
SNB-LC12	-8.31	-185.22	-41.24	-77.89	178.93	-39.47	20.66
SNB-LC2P	0.03	-0.29	-177.70	0.98	64.98	0.10	-16.87
SNB-LC21	8.36	-78.04	-179.17	27.31	345.21	-7.59	24.83
SNB-LC22	-8.29	77.89	-178.93	-27.70	343.88	7.51	24.67
SNB-LC3P	0.03	-0.98	-64.98	-0.37	602.37	-0.20	80.66
SNB-LC31	8.37	-27.31	-345.21	5.95	-44.26	-3.20	-58.42
SNB-LC32	-8.30	27.70	-343.88	-1.61	-41.40	3.91	-57.79
SNB-LD1P	-0.02	0.46	128.22	3.01	711.56	0.52	126.07
SNB-LD11	10.65	327.18	-36.73	13.71	538.72	51.14	75.30
SNB-LD12	-10.49	-331.69	-40.05	-14.65	534.71	-51.95	74.20
SNB-LD2P	-0.02	-3.01	-711.56	-0.15	57.42	-0.47	-97.92
SNB-LD21	10.64	-13.71	-538.72	305.61	856.96	43.65	47.59
SNB-LD22	-10.48	14.64	-534.71	-302.81	858.76	-43.10	48.46
SNB-LD3P	-0.02	0.15	-57.42	-0.81	1570.99	-0.10	227.28
SNB-LD31	10.49	-305.59	-856.97	-347.49	268.92	-97.95	-88.19
SNB-LD32	-10.33	302.79	-858.77	349.77	270.91	97.87	-88.17
SNB-LE1P	-0.30	1.44	-338.70	10.17	1093.35	1.74	113.28
SNB-LE11	22.08	696.88	-224.42	227.80	1186.85	138.71	144.36
SNB-LE12	-21.69	-699.57	-227.79	-229.05	1174.45	-139.30	142.00
SNB-LE2P	-0.31	-10.17	-1093.35	-6.77	432.46	-2.53	-98.92
SNB-LE21	21.99	-227.79	-1186.85	360.00	1690.76	19.78	75.36
SNB-LE22	-21.59	229.04	-1174.45	-345.47	1706.77	-17.42	79.60
SNB-LE3P	-0.30	6.77	-432.46	4.95	2988.35	1.76	383.73
SNB-LE31	21.87	-359.97	-1690.77	-720.47	-489.83	-162.05	-327.06
SNB-LE32	-21.47	345.45	-1706.78	707.23	-503.24	157.89	-331.47
SNB-LF1P	-0.03	-4.82	-1735.75	-1.72	-185.81	-0.65	-192.16
SNB-LF11	38.65	1515.33	285.38	1575.40	3196.45	308.74	347.79
SNB-LF12	-38.65	-1503.28	297.88	-1560.22	3207.04	-306.02	350.09
SNB-LF2P	-0.03	1.72	185.81	3.40	3648.48	0.51	383.47
SNB-LF21	37.40	-1575.28	-3196.52	-1565.48	-1225.53	-313.72	-441.68
SNB-LF22	-37.41	1560.09	-3207.11	1553.88	-1235.98	311.04	-443.78
SNB-LG1P	0.28	-3.31	-2117.35	-0.54	133.86	-0.39	-198.36
SNB-LG11	63.79	2889.59	620.00	2754.85	5878.91	563.83	649.14
SNB-LG12	-64.20	-2878.03	630.40	-2740.25	5887.69	-561.21	651.06
SNB-LG2P	0.28	0.54	-133.86	2.31	6230.47	0.29	609.75
SNB-LG21	61.93	-2754.64	-5879.03	-2224.12	-1579.30	-497.29	-744.94
SNB-LG22	-62.34	2740.03	-5887.81	2221.94	-1582.97	495.62	-746.19
SNB-LH1P	0.08	-2.16	-4019.91	3.70	-230.62	0.15	-425.16
SNB-LH11	61.58	3785.17	834.80	3264.89	6512.28	704.17	733.80
SNB-LH12	-61.83	-3783.96	837.81	-3260.06	6510.59	-703.56	733.93
SNB-LH2P	0.07	-3.70	230.62	-1.78	7169.49	-0.55	740.26
SNB-LH21	58.75	-3264.61	-6512.45	-3197.80	-1899.10	-645.43	-840.08

SNB-LH22	-59.00	3259.77	-6510.76	3200.84	-1895.09	645.25	-839.51
SNB-LI1P	-0.03	1.88	-4717.49	7.90	-117.30	0.98	-483.57
SNB-LI11	19.21	5134.76	955.92	5408.73	9901.18	1053.09	1084.40
SNB-LI12	-19.43	-5137.92	951.82	-5403.86	9894.56	-1052.92	1083.33
SNB-LI2P	-0.04	-7.90	117.30	-1.59	13504.53	-0.95	1362.56
SNB-LI21	14.82	-5408.21	-9901.47	-5435.21	2698.72	-1083.00	-719.38
SNB-LI22	-15.04	5403.35	-9894.85	5442.94	2706.33	1083.28	-717.96
SNB-H1aP	-1.75	40.80	68.90	151.28	-0.30	95.07	33.95
SNB-H1bP	-1.75	-151.28	0.31	-30.54	35.96	-89.99	17.95
SNB-H1cP	-2.05	50.86	-36.76	139.00	-1.43	93.97	-18.90
SNB-H1dP	-2.05	-138.99	1.43	-44.86	36.25	-90.99	18.65
SNB-H1eP	6.25	43.17	-35.80	144.82	-2.11	93.04	-18.76
SNB-H1fP	6.25	-144.82	2.11	-41.05	-68.72	-91.99	-32.97
SNB-H2aP	-7.61	177.59	54.94	152.84	2.67	122.25	21.31
SNB-H2bP	-7.61	-152.84	-2.66	-16.74	20.91	-62.74	6.75
SNB-H2cP	0.64	112.21	-25.98	137.46	3.85	92.37	-8.19
SNB-H2dP	0.63	-137.45	-3.85	-112.89	25.57	-92.62	8.04
SNB-H2eP	6.76	13.73	-20.63	154.41	1.36	62.21	-7.13
SNB-H2fP	6.76	-154.41	-1.37	-177.39	-54.94	-122.76	-20.83
SNB-H3aP	-6.19	300.61	36.01	206.98	-3.72	149.98	9.54
SNB-H3bP	-6.18	-206.98	3.73	-12.08	11.88	-64.73	4.61
SNB-H3cP	0.03	170.58	-20.35	193.36	11.01	107.53	-2.76
SNB-H3dP	0.02	-193.36	-11.01	-170.06	20.23	-107.38	2.72
SNB-H3eP	6.10	11.75	-11.63	207.08	-3.71	64.65	-4.53
SNB-H3fP	6.11	-207.07	3.70	-300.74	-36.10	-150.04	-9.57
SNB-H4aP	-6.61	425.62	18.76	330.26	-14.98	185.90	0.93
SNB-H4bP	-6.60	-330.26	14.97	-97.30	3.76	-105.15	4.61
SNB-H4cP	-0.09	278.74	-9.78	317.34	35.02	146.61	6.21
SNB-H4dP	-0.11	-317.34	-35.02	-278.68	9.63	-146.59	-6.25
SNB-H4eP	6.68	97.64	-3.70	330.04	-15.16	105.18	-4.64
SNB-H4fP	6.69	-330.03	15.16	-425.68	-18.70	-185.86	-0.87
SNB-H5aP	-10.31	717.18	28.68	429.73	-24.28	241.62	0.93
SNB-H5bP	-10.30	-429.73	24.28	44.69	-0.15	-81.12	5.08
SNB-H5cP	-0.35	362.48	-19.61	407.79	57.26	162.28	7.93
SNB-H5dP	-0.37	-407.79	-57.26	-362.13	19.38	-162.21	-7.98
SNB-H5eP	10.64	-43.75	0.11	428.94	-24.36	81.15	-5.11
SNB-H5fP	10.64	-428.94	24.36	-717.84	-28.37	-241.59	-0.84
SNB-H6aP	-48.52	751.22	9.30	688.61	-23.91	265.25	-2.67
SNB-H6bP	-48.51	-688.61	23.88	-264.47	-9.49	-175.58	2.64
SNB-H6cP	-0.13	620.37	-15.12	582.34	48.16	221.57	6.09
SNB-H6dP	-0.15	-582.34	-48.16	-621.03	15.25	-221.69	-6.06
SNB-H6eP	48.64	265.29	9.75	688.43	-22.49	175.69	-2.37
SNB-H6fP	48.65	-688.43	22.52	-751.27	-9.58	-265.22	2.40
SNB-H7aP	-43.79	909.17	-8.85	1006.84	-31.15	313.59	-6.52
SNB-H7bP	-43.77	-1006.84	31.11	-724.69	-17.85	-283.40	2.15
SNB-H7cP	0.04	923.70	-12.17	916.48	56.70	301.19	7.29
SNB-H7dP	-0.01	-916.48	-56.70	-923.68	12.32	-301.19	-7.26
SNB-H7eP	43.76	724.81	18.09	1007.08	-29.91	283.46	-1.96
SNB-H7fP	43.78	-1007.07	29.95	-909.39	8.55	-313.67	6.32
SNB-H8aP	-12.29	1283.35	-15.34	1191.06	-34.07	364.39	-7.27
SNB-H8bP	-12.26	-1191.06	34.06	-866.04	-9.11	-302.93	3.67
SNB-H8cP	-0.08	1117.82	6.35	1178.65	67.67	338.20	10.90
SNB-H8dP	-0.13	-1178.65	-67.67	-1118.39	-6.42	-338.28	-10.91
SNB-H8eP	12.38	866.62	9.03	1190.90	-33.85	302.99	-3.66
SNB-H8fP	12.41	-1190.90	33.86	-1283.43	15.55	-364.38	7.28
SNB-H9aP	-29.91	1432.89	-20.86	1385.50	-40.37	377.18	-8.17
SNB-H9bP	-29.88	-1385.50	40.33	-1103.97	8.03	-333.16	6.45
SNB-H9cP	0.01	1360.30	28.38	1342.57	79.77	361.74	14.47
SNB-H9dP	-0.06	-1342.57	-79.77	-1360.34	-28.39	-361.75	-14.48
SNB-H9eP	29.93	1104.04	-8.05	1385.46	-40.31	333.17	-6.49
SNB-H9fP	29.95	-1385.46	40.35	-1432.99	20.97	-377.19	8.23

Equilibrium Joint Positions and Rotations for Load Case "2: 0.9D + 1.0Dg + 1.6Wo":

Joint Label	X-Displ (ft)	Y-Displ (ft)	Z-Displ (ft)	X-Rot (deg)	Y-Rot (deg)	Z-Rot (deg)	X-Pos (ft)	Y-Pos (ft)	Z-Pos (ft)
RohnAP	1.785	-0.0008879	-0.08694	0.0063	0.9165	0.0109	6.118	-0.0008879	179.9
RohnBP	1.465	-8.464e-005	-0.09558	-0.0012	0.9145	0.0107	6.586	-8.464e-005	159.9
RohnCP	1.149	-0.0003504	-0.1003	-0.0007	0.8814	0.0071	7.058	-0.0003504	139.9
RohnDP	0.8533	-0.000453	-0.09969	-0.0002	0.8012	0.0047	7.548	-0.000453	119.9
RohnEP	0.595	-0.000601	-0.08951	-0.0005	0.6610	0.0032	8.076	-0.000601	99.91
RohnFP	0.3853	-0.0007622	-0.07775	-0.0003	0.5247	0.0020	8.653	-0.0007622	79.92
RohnGP	0.2208	-0.0006844	-0.06259	0.0006	0.3991	0.0014	9.276	-0.0006844	59.94
RohnHP	0.1015	-0.0004514	-0.04507	0.0010	0.2740	0.0009	9.943	-0.0004514	39.95
RohnIP	0.02871	-0.0002246	-0.02217	0.0006	0.1251	0.0003	10.66	-0.0002246	19.98
RohnJP	0	0	0	0.0000	0.0000	0.0000	11.42	0	0
SNB-AP	1.786	-0.001731	-0.05192	0.0020	0.9130	-0.0000	4.119	-0.001731	179.9
SNB-BP	1.465	-0.001324	-0.06131	0.0009	0.9087	-0.0000	4.586	-0.001324	159.9
SNB-CP	1.149	-0.0009474	-0.0685	0.0010	0.8757	0.0000	5.057	-0.0009474	139.9
SNB-DP	0.8535	-0.0006334	-0.071	0.0008	0.7916	-0.0000	5.549	-0.0006334	119.9
SNB-EP	0.5952	-0.0004058	-0.06544	0.0006	0.6467	-0.0000	6.076	-0.0004058	99.93
SNB-FP	0.3854	-0.0002498	-0.0606	0.0004	0.5254	0.0000	6.653	-0.0002498	79.94
SNB-GP	0.2209	-0.0001371	-0.05009	0.0003	0.3820	0.0000	7.276	-0.0001371	59.95
SNB-HP	0.1015	-5.824e-005	-0.03716	0.0002	0.2663	0.0000	7.943	-5.824e-005	39.96
SNB-IP	0.02871	-1.507e-005	-0.01884	0.0001	0.1223	0.0000	8.657	-1.507e-005	19.98
SNB-JP	0	0	0	0.0000	0.0000	0.0000	9.415	0	0
RohnA1	1.787	-0.002176	0.01625	0.0011	0.9192	0.0039	-0.3795	-3.755	180
RohnA2	1.786	-0.002083	0.0164	0.0006	0.9182	0.0176	-0.3809	3.75	180
RohnB1	1.467	-0.002004	0.02461	0.0060	0.9209	-0.0004	-1.094	-4.437	160
RohnB2	1.465	-0.001951	0.02482	-0.0016	0.9190	0.0221	-1.096	4.433	160
RohnC1	1.15	-0.0009512	0.03129	-0.0013	0.8762	-0.0094	-1.805	-5.118	140
RohnC2	1.149	-0.001555	0.03148	0.0059	0.8727	0.0235	-1.806	5.116	140
RohnD1	0.8534	-0.0001758	0.03522	-0.0018	0.7974	-0.0136	-2.494	-5.798	120
RohnD2	0.853	-0.001334	0.03538	0.0050	0.7949	0.0230	-2.495	5.797	120
RohnE1	0.5953	-0.0001523	0.03419	-0.0002	0.6600	-0.0134	-3.145	-6.479	100
RohnE2	0.5956	-0.0004605	0.0343	0.0027	0.6576	0.0197	-3.145	6.478	100
RohnF1	0.3844	0.0005505	0.03133	0.0112	0.5469	-0.0131	-3.75	-7.16	80.03
RohnF2	0.3855	-0.0004105	0.0314	-0.0098	0.5458	0.0172	-3.748	7.16	80.03
RohnG1	0.2202	0.0003814	0.02612	0.0034	0.4054	-0.0100	-4.307	-7.841	60.03
RohnG2	0.2214	2.14e-005	0.02618	-0.0031	0.4056	0.0128	-4.306	7.842	60.03
RohnH1	0.1008	0.0004287	0.01927	0.0033	0.2803	-0.0074	-4.82	-8.522	40.02
RohnH2	0.1015	-0.0001457	0.01931	-0.0035	0.2812	0.0091	-4.819	8.522	40.02
RohnI1	0.02839	0.0001912	0.009598	0.0061	0.1381	-0.0042	-5.287	-9.206	20.01
RohnI2	0.02875	-1.236e-005	0.009618	-0.0065	0.1389	0.0047	-5.286	9.206	20.01
RohnJ1	0	0	0	0.0000	0.0000	0.0000	-5.71	-9.89	0
RohnJ2	0	0	0	0.0000	0.0000	0.0000	-5.71	9.89	0
SNB-A1	1.786	-0.001736	0.004104	-0.0028	0.9223	-0.0019	0.6196	-2.022	180
SNB-A2	1.786	-0.001728	0.004187	0.0049	0.9217	0.0020	0.6196	2.019	180
SNB-B1	1.466	-0.001332	0.01276	0.0002	0.9160	-0.0022	-0.09484	-2.704	160
SNB-B2	1.466	-0.001319	0.01287	0.0021	0.9162	0.0023	-0.09485	2.702	160
SNB-C1	1.15	-0.0009397	0.02033	-0.0002	0.8839	-0.0030	-0.8044	-3.385	140
SNB-C2	1.15	-0.000961	0.02045	0.0022	0.8839	0.0030	-0.8044	3.383	140
SNB-D1	0.854	-0.0005453	0.02526	-0.0020	0.8044	-0.0051	-1.493	-4.067	120
SNB-D2	0.854	-0.000723	0.02537	0.0036	0.8044	0.0051	-1.493	4.065	120
SNB-E1	0.5955	-0.0003113	0.02566	-0.0009	0.6550	-0.0041	-2.145	-4.747	100
SNB-E2	0.5955	-0.0004998	0.02575	0.0019	0.6549	0.0041	-2.145	4.746	100
SNB-F1	0.3856	-0.0001579	0.02539	0.0044	0.5495	-0.0039	-2.748	-5.428	80.03
SNB-F2	0.3856	-0.000348	0.02546	-0.0036	0.5494	0.0039	-2.748	5.428	80.03
SNB-G1	0.2209	1.027e-005	0.02182	0.0029	0.4089	-0.0048	-3.307	-6.11	60.02
SNB-G2	0.2209	-0.0002913	0.02188	-0.0024	0.4089	0.0047	-3.307	6.11	60.02
SNB-H1	0.1013	0.000144	0.01661	-0.0026	0.2811	-0.0047	-3.819	-6.79	40.02
SNB-H2	0.1013	-0.0002615	0.01665	0.0029	0.2810	0.0047	-3.819	6.79	40.02
SNB-I1	0.02828	0.0002523	0.008532	0.0031	0.1435	-0.0043	-4.286	-7.472	20.01
SNB-I2	0.02828	-0.0002821	0.008552	-0.0030	0.1435	0.0043	-4.286	7.472	20.01
SNB-J1	0	0	0	0.0000	0.0000	0.0000	-4.708	-8.154	0
SNB-J2	0	0	0	0.0000	0.0000	0.0000	-4.708	8.154	0

RohnAaS	1.705	-0.0004528	-0.08938	0.0014	0.9207	0.0108	6.235	-0.0004528	174.9
RohnAbS	1.625	-0.0004209	-0.09167	0.0027	0.9192	0.0108	6.352	-0.0004209	169.9
RohnAcS	1.545	6.646e-006	-0.09374	0.0021	0.9166	0.0108	6.469	6.646e-006	164.9
RohnBaS	1.385	-9.677e-005	-0.09727	-0.0003	0.9130	0.0098	6.703	-9.677e-005	154.9
RohnBbS	1.306	-0.0001822	-0.09867	-0.0010	0.9065	0.0089	6.821	-0.0001822	149.9
RohnBcS	1.227	-0.0002574	-0.09969	-0.0010	0.8999	0.0080	6.939	-0.0002574	144.9
RohnCaS	1.048	-0.0003768	-0.1009	-0.0001	0.8571	0.0063	7.218	-0.0003768	133.2
RohnCbS	0.9489	-0.0004088	-0.1008	-0.0004	0.8367	0.0055	7.382	-0.0004088	126.6
RohnDaS	0.7623	-0.0004693	-0.09746	-0.0004	0.7591	0.0042	7.719	-0.0004693	113.2
RohnDbS	0.6762	-0.0005392	-0.09404	-0.0007	0.7199	0.0037	7.895	-0.0005392	106.6
RohnEaS	0.5212	-0.0006709	-0.08629	-0.0010	0.6134	0.0028	8.264	-0.0006709	93.25
RohnEbS	0.451	-0.0007812	-0.08237	-0.0003	0.5884	0.0024	8.457	-0.0007812	86.58
RohnFaS	0.2992	-0.000852	-0.0709	0.0002	0.4730	0.0017	8.961	-0.000852	69.93
RohnGaS	0.1577	-0.0006367	-0.05441	0.0005	0.3414	0.0011	9.606	-0.0006367	49.95
RohnHaS	0.06109	-0.0003244	-0.03424	0.0005	0.2092	0.0006	10.3	-0.0003244	29.97
RohnIaS	0.01089	-0.0001034	-0.01152	0.0008	0.0882	0.0002	11.04	-0.0001034	9.988
SNB-AaS	1.706	-0.001585	-0.05441	0.0005	0.9217	-0.0001	4.236	-0.001585	174.9
SNB-AbS	1.625	-0.001583	-0.05684	0.0012	0.9186	-0.0000	4.352	-0.001583	169.9
SNB-AcS	1.545	-0.001381	-0.05915	0.0017	0.9184	-0.0000	4.469	-0.001381	164.9
SNB-BaS	1.385	-0.001222	-0.06342	0.0012	0.9149	-0.0000	4.703	-0.001222	154.9
SNB-BbS	1.306	-0.001132	-0.06535	0.0010	0.9060	-0.0000	4.82	-0.001132	149.9
SNB-BcS	1.227	-0.001035	-0.06704	0.0011	0.9019	0.0000	4.938	-0.001035	144.9
SNB-CaS	1.048	-0.0008353	-0.06996	0.0010	0.8583	0.0000	5.218	-0.0008353	133.3
SNB-CbS	0.9491	-0.0007286	-0.07078	0.0009	0.8393	0.0000	5.382	-0.0007286	126.6
SNB-DaS	0.7624	-0.0005426	-0.07013	0.0007	0.7613	-0.0000	5.719	-0.0005426	113.3
SNB-DbS	0.6763	-0.0004727	-0.06822	0.0006	0.7237	-0.0000	5.896	-0.0004727	106.6
SNB-EaS	0.5213	-0.0003407	-0.06449	0.0004	0.6181	0.0000	6.264	-0.0003407	93.28
SNB-EbS	0.4511	-0.0002997	-0.06283	0.0004	0.5882	0.0000	6.457	-0.0002997	86.6
SNB-FaS	0.2992	-0.0001919	-0.05598	0.0003	0.4778	0.0000	6.961	-0.0001919	69.94
SNB-GaS	0.1577	-9.586e-005	-0.04422	0.0002	0.3482	0.0000	7.606	-9.586e-005	49.96
SNB-HaS	0.0611	-3.023e-005	-0.02861	0.0001	0.2125	0.0000	8.296	-3.023e-005	29.97
SNB-IaS	0.01089	-1.678e-006	-0.009975	0.0000	0.0894	0.0000	9.032	-1.678e-006	9.99
SNB-WL-A1S	1.786	-0.00174	-0.02405	-0.0003	0.9174	-0.0040	2.369	-1.012	180
SNB-WL-A2S	1.786	-0.001732	0.004027	0.0008	0.9220	0.0001	0.6196	-0.001732	180
SNB-WL-A3S	1.786	-0.001721	-0.024	0.0035	0.9174	0.0040	2.369	1.008	180
SNB-WL-B1S	1.465	-0.001335	-0.02447	0.0036	0.9069	-0.0041	2.246	-1.353	160
SNB-WL-B2S	1.466	-0.001325	0.01267	0.0012	0.9161	0.0001	-0.09481	-0.001325	160
SNB-WL-B3S	1.465	-0.001311	-0.02442	-0.0016	0.9070	0.0042	2.246	1.35	160
SNB-WL-C1S	1.149	-0.0009685	-0.02446	0.0073	0.8676	-0.0039	2.126	-1.693	140
SNB-WL-C2S	1.15	-0.0009503	0.02009	0.0010	0.8839	0.0000	-0.8043	-0.0009503	140
SNB-WL-C3S	1.149	-0.000929	-0.02441	-0.0054	0.8676	0.0040	2.126	1.691	140
SNB-WL-D1S	0.8538	-0.0006666	-0.02371	0.0090	0.7814	-0.0040	2.028	-2.034	120
SNB-WL-D2S	0.8542	-0.0006341	0.02459	0.0008	0.8044	0.0000	-1.493	-0.0006341	120
SNB-WL-D3S	0.8538	-0.0006	-0.02366	-0.0074	0.7814	0.0040	2.028	2.032	120
SNB-WL-E1S	0.5954	-0.0004314	-0.02049	0.0101	0.6331	-0.0029	1.966	-2.374	99.98
SNB-WL-E2S	0.5957	-0.0004056	0.02521	0.0005	0.6550	0.0000	-2.145	-0.0004056	100
SNB-WL-E3S	0.5954	-0.00038	-0.02044	-0.0090	0.6331	0.0029	1.966	2.373	99.98
SNB-WL-F1S	0.3855	-0.0002842	-0.01894	0.0099	0.5245	-0.0020	1.953	-2.714	79.98
SNB-WL-F2S	0.3858	-0.000253	0.02473	0.0004	0.5495	-0.0000	-2.748	-0.000253	80.02
SNB-WL-F3S	0.3855	-0.0002228	-0.0189	-0.0091	0.5244	0.0020	1.953	2.714	79.98
SNB-WL-G1S	0.2209	-0.0001854	-0.01642	0.0048	0.3899	-0.0015	1.985	-3.055	59.98
SNB-WL-G2S	0.2212	-0.0001405	0.02027	0.0003	0.4089	-0.0000	-3.306	-0.0001405	60.02
SNB-WL-G3S	0.2209	-9.672e-005	-0.0164	-0.0043	0.3899	0.0015	1.985	3.055	59.98
SNB-WL-H1S	0.1015	-0.0001109	-0.01331	0.0068	0.2598	-0.0015	2.062	-3.395	39.99
SNB-WL-H2S	0.1017	-5.874e-005	0.01381	0.0002	0.2811	-0.0000	-3.819	-5.874e-005	40.01
SNB-WL-H3S	0.1015	-7.568e-006	-0.01328	-0.0065	0.2598	0.0015	2.062	3.395	39.99
SNB-WL-I1S	0.02862	-7.561e-005	-0.009398	0.0086	0.1208	-0.0017	2.186	-3.736	19.99
SNB-WL-I2S	0.02874	-1.487e-005	0.004974	0.0001	0.1435	-0.0000	-4.285	-1.487e-005	20
SNB-WL-I3S	0.02862	4.533e-005	-0.009388	-0.0084	0.1208	0.0017	2.186	3.736	19.99
RohnAa1	1.707	-0.002233	0.01846	-0.0016	0.9123	0.0032	-0.558	-3.925	175
RohnAa2	1.705	-0.002051	0.01862	-0.0003	0.9220	0.0188	-0.5597	3.921	175
RohnAb1	1.627	-0.002369	0.02059	0.0031	0.9220	0.0017	-0.7362	-4.096	170
RohnAb2	1.625	-0.002157	0.02079	-0.0018	0.9244	0.0201	-0.7388	4.092	170
RohnAc1	1.547	-0.00199	0.02266	0.0019	0.9186	0.0008	-0.9155	-4.266	165
RohnAc2	1.544	-0.002204	0.02286	0.0027	0.9138	0.0207	-0.9177	4.262	165
RohnBa1	1.386	-0.001544	0.02651	-0.0007	0.9086	-0.0024	-1.273	-4.607	155
RohnBa2	1.385	-0.002035	0.02672	0.0065	0.9037	0.0221	-1.274	4.603	155
RohnBb1	1.308	-0.002016	0.02826	0.0026	0.9079	-0.0052	-1.45	-4.778	150
RohnBb2	1.306	-0.001199	0.02846	0.0026	0.9042	0.0231	-1.451	4.775	150



RohnBc1	1.228	-0.001136	0.0299	0.0101	0.9141	-0.0084	-1.628	-4.948	145
RohnBc2	1.226	-0.001721	0.0301	-0.0049	0.9100	0.0243	-1.63	4.945	145
RohnCa1	1.049	-0.001129	0.03298	0.0010	0.8589	-0.0112	-2.036	-5.345	133.4
RohnCa2	1.048	-0.0009811	0.03316	0.0028	0.8561	0.0237	-2.037	5.343	133.4
RohnCb1	0.9495	-0.0006969	0.03434	0.0071	0.8454	-0.0132	-2.267	-5.572	126.7
RohnCb2	0.9489	-0.001085	0.03451	-0.0041	0.8441	0.0242	-2.268	5.57	126.7
RohnDa1	0.7625	-0.0004042	0.03549	0.0067	0.7720	-0.0145	-2.716	-6.025	113.4
RohnDa2	0.7624	-0.0007628	0.03563	-0.0035	0.7692	0.0228	-2.716	6.024	113.4
RohnDb1	0.6746	0.00071	0.03518	0.0010	0.7180	-0.0140	-2.935	-6.251	106.7
RohnDb2	0.6747	-0.001591	0.03532	0.0017	0.7160	0.0213	-2.935	6.25	106.7
RohnEa1	0.5199	0.0006557	0.03364	0.0078	0.6277	-0.0137	-3.352	-6.705	93.37
RohnEa2	0.5204	-0.001017	0.03375	-0.0056	0.6259	0.0192	-3.351	6.705	93.37
RohnEb1	0.4496	0.0007604	0.03269	-0.0045	0.5777	-0.0127	-3.553	-6.933	86.69
RohnEb2	0.4504	-0.0008819	0.03278	0.0071	0.5747	0.0174	-3.553	6.932	86.69
RohnFa1	0.2939	0.002673	0.02917	-0.0033	0.4659	-0.0109	-4.037	-7.498	70.03
RohnFa2	0.2949	-0.002429	0.02924	0.0042	0.4656	0.0144	-4.036	7.499	70.03
RohnGa1	0.1524	0.002688	0.02304	-0.0003	0.3403	-0.0085	-4.572	-8.18	50.02
RohnGa2	0.1533	-0.002359	0.02309	-0.0001	0.3421	0.0108	-4.571	8.18	50.02
RohnHa1	0.05512	0.003028	0.01478	-0.0019	0.2053	-0.0056	-5.063	-8.861	30.01
RohnHa2	0.05563	-0.0028	0.01481	0.0016	0.2063	0.0067	-5.062	8.861	30.01
RohnIa1	0.006518	0.002152	0.005023	-0.0009	0.0864	-0.0026	-5.506	-9.546	10.01
RohnIa2	0.006697	-0.00206	0.005034	0.0002	0.0877	0.0030	-5.506	9.546	10.01
SNB-Aa1	1.706	-0.001629	0.006332	0.0026	0.9178	-0.0020	0.4409	-2.193	175
SNB-Aa2	1.706	-0.001657	0.006417	0.0001	0.9186	0.0022	0.4409	2.189	175
SNB-Ab1	1.626	-0.001508	0.008526	0.0017	0.9213	-0.0022	0.2623	-2.363	170
SNB-Ab2	1.626	-0.00152	0.008625	0.0007	0.9212	0.0024	0.2622	2.36	170
SNB-Ac1	1.545	-0.001358	0.01068	0.0014	0.9171	-0.0021	0.08334	-2.534	165
SNB-Ac2	1.545	-0.001517	0.01078	0.0007	0.9163	0.0023	0.08339	2.531	165
SNB-Ba1	1.386	-0.001126	0.01483	0.0026	0.9144	-0.0027	-0.2732	-2.874	155
SNB-Ba2	1.386	-0.001338	0.01493	-0.0004	0.9143	0.0028	-0.2732	2.872	155
SNB-Bb1	1.306	-0.00103	0.01679	0.0021	0.9087	-0.0029	-0.451	-3.045	150
SNB-Bb2	1.306	-0.001238	0.0169	0.0002	0.9088	0.0030	-0.451	3.042	150
SNB-Bc1	1.227	-0.0008504	0.01863	0.0009	0.8980	-0.0030	-0.6284	-3.215	145
SNB-Bc2	1.227	-0.001231	0.01875	0.0012	0.8979	0.0031	-0.6284	3.213	145
SNB-Ca1	1.048	-0.0002937	0.02234	0.0067	0.8679	-0.0043	-1.037	-3.612	133.4
SNB-Ca2	1.048	-0.001389	0.02246	-0.0048	0.8679	0.0043	-1.037	3.61	133.4
SNB-Cb1	0.9484	-0.0001237	0.024	-0.0018	0.8285	-0.0043	-1.268	-3.839	126.7
SNB-Cb2	0.9484	-0.001348	0.02411	0.0037	0.8286	0.0043	-1.268	3.838	126.7
SNB-Da1	0.7615	0.0001682	0.02599	0.0112	0.7777	-0.0060	-1.717	-4.292	113.4
SNB-Da2	0.7615	-0.001273	0.02609	-0.0098	0.7777	0.0060	-1.717	4.291	113.4
SNB-Db1	0.6744	0.0007894	0.02611	-0.0044	0.7103	-0.0045	-1.935	-4.519	106.7
SNB-Db2	0.6744	-0.001735	0.0262	0.0057	0.7104	0.0045	-1.935	4.518	106.7
SNB-Ea1	0.5205	0.000291	0.02597	0.0070	0.6287	-0.0045	-2.351	-4.973	93.37
SNB-Ea2	0.5205	-0.0009839	0.02605	-0.0060	0.6287	0.0045	-2.351	4.973	93.37
SNB-Eb1	0.4501	0.000428	0.02586	-0.0047	0.5738	-0.0034	-2.553	-5.201	86.69
SNB-Eb2	0.4501	-0.001011	0.02594	0.0055	0.5738	0.0034	-2.553	5.2	86.69
SNB-Fa1	0.2938	0.002712	0.02402	0.0001	0.4674	-0.0039	-3.037	-5.766	70.02
SNB-Fa2	0.2938	-0.003074	0.02408	0.0006	0.4674	0.0039	-3.037	5.766	70.02
SNB-Ga1	0.1528	0.002482	0.01957	0.0016	0.3403	-0.0047	-3.571	-6.448	50.02
SNB-Ga2	0.1528	-0.002663	0.01962	-0.0011	0.3403	0.0046	-3.571	6.447	50.02
SNB-Ha1	0.0557	0.00269	0.01292	0.0016	0.2066	-0.0044	-4.062	-7.129	30.01
SNB-Ha2	0.05571	-0.002755	0.01295	-0.0014	0.2066	0.0044	-4.062	7.129	30.01
SNB-Ia1	0.006065	0.002414	0.00456	-0.0006	0.0846	-0.0026	-4.505	-7.81	10
SNB-Ia2	0.006068	-0.002422	0.00457	0.0007	0.0847	0.0026	-4.505	7.81	10

Joint Support Reactions for Load Case "2: 0.9D + 1.0Dg + 1.6Wo":

Joint Label	X Force (kips)	X Usage %	Y Force (kips)	Y Usage %	Z Force (kips)	Z Usage %	Comp. Usage %	Uplift Usage %	Result. Force (kips)	Result. Usage %	X Moment (ft-k)	X-M. Usage %	Y Moment (ft-k)	Y-M. Usage %	Z Moment (ft-k)	Z-M. Usage %	Max. Usage %
RohnJP	-29.40	0.0	0.11	0.0	350.14	0.0	0.0	0.0	351.37	0.0	-0.06	0.0	-5.5	0.0	-0.01	0.0	0.0
SNB-JP	-51.11	0.0	0.00	0.0	506.81	0.0	0.0	0.0	509.38	0.0	0.00	0.0	-13.4	0.0	0.00	0.0	0.0
RohnJ1	-9.63	0.0	-10.26	0.0	-152.67	0.0	0.0	0.0	153.32	0.0	1.97	0.0	-1.5	0.0	0.00	0.0	0.0
RohnJ2	-9.83	0.0	10.17	0.0	-153.00	0.0	0.0	0.0	153.65	0.0	-1.91	0.0	-1.6	0.0	-0.01	0.0	0.0
SNB-J1	-17.61	0.0	-18.88	0.0	-232.22	0.0	0.0	0.0	233.65	0.0	5.53	0.0	-2.8	0.0	-0.03	0.0	0.0
SNB-J2	-17.63	0.0	18.92	0.0	-232.72	0.0	0.0	0.0	234.15	0.0	-5.54	0.0	-2.8	0.0	0.03	0.0	0.0

Joint Displacements, Loads and Member Forces on Joints for Load Case "2: 0.9D + 1.0Dg + 1.6Wo":

Joint Label	X External Load (kips)	Y External Load (kips)	Z External Load (kips)	X Member Force (kips)	Y Member Force (kips)	Z Member Force (kips)	X Disp. (ft)	Y Disp. (ft)	Z Disp. (ft)
RohnAP	0.6457	0.0000	-0.2670	-0.6457	-0.0000	0.2670	1.7854	-0.0009	-0.0869
RohnBP	3.0386	0.0000	-0.9568	-3.0386	-0.0000	0.9568	1.4648	-0.0001	-0.0956
RohnCP	0.6587	0.0000	-0.3872	-0.6587	0.0000	0.3872	1.1487	-0.0004	-0.1003
RohnDP	0.7996	0.0000	-0.4691	-0.7996	0.0000	0.4691	0.8533	-0.0005	-0.0997
RohnEP	0.8293	0.0000	-0.5805	-0.8293	-0.0000	0.5805	0.5950	-0.0006	-0.0895
RohnFP	0.9670	0.0000	-0.7867	-0.9670	-0.0000	0.7867	0.3853	-0.0008	-0.0777
RohnGP	1.3744	0.0000	-1.0471	-1.3744	-0.0000	1.0471	0.2208	-0.0007	-0.0626
RohnHP	1.1981	0.0000	-1.0422	-1.1981	-0.0000	1.0422	0.1015	-0.0005	-0.0451
RohnIP	1.4581	0.0000	-1.1689	-1.4581	-0.0000	1.1689	0.0287	-0.0002	-0.0222
RohnJP	0.8371	0.0000	-0.6316	28.5592	-0.1080	-349.5072	0.0000	0.0000	0.0000
SNB-AP	0.1887	0.0000	-0.1410	-0.1887	0.0000	0.1410	1.7857	-0.0017	-0.0519
SNB-BP	0.4544	0.0000	-0.3052	-0.4544	0.0000	0.3052	1.4651	-0.0013	-0.0613
SNB-CP	0.6587	0.0000	-0.3872	-0.6587	0.0000	0.3872	1.1490	-0.0009	-0.0685
SNB-DP	0.7996	0.0000	-0.4691	-0.7996	0.0000	0.4691	0.8535	-0.0006	-0.0710
SNB-EP	0.8293	0.0000	-0.5805	-0.8293	0.0000	0.5805	0.5952	-0.0004	-0.0654
SNB-FP	0.9670	0.0000	-0.7867	-0.9670	0.0000	0.7867	0.3854	-0.0002	-0.0606
SNB-GP	1.1214	0.0000	-0.9571	-1.1214	0.0000	0.9571	0.2209	-0.0001	-0.0501
SNB-HP	1.1981	0.0000	-1.0422	-1.1981	0.0000	1.0422	0.1015	-0.0001	-0.0372
SNB-IP	1.4581	0.0000	-1.1689	-1.4581	0.0000	1.1689	0.0287	-0.0000	-0.0188
SNB-JP	0.8371	0.0000	-0.6316	50.2713	-0.0014	-506.1743	0.0000	0.0000	0.0000
RohnA1	0.6457	0.0000	-0.2670	-0.6457	-0.0000	0.2670	1.7870	-0.0022	0.0163
RohnA2	1.1028	0.0000	-0.3930	-1.1028	-0.0000	0.3930	1.7856	-0.0021	0.0164
RohnB1	1.0572	0.0000	-0.4078	-1.0572	-0.0000	0.4078	1.4669	-0.0020	0.0246
RohnB2	0.7218	0.0000	-0.3493	-0.7218	-0.0000	0.3493	1.4646	-0.0020	0.0248
RohnC1	0.6587	0.0000	-0.3872	-0.6587	0.0000	0.3872	1.1497	-0.0010	0.0313
RohnC2	0.6587	0.0000	-0.3872	-0.6587	-0.0000	0.3872	1.1486	-0.0016	0.0315
RohnD1	1.0140	0.0000	-0.5321	-1.0140	0.0000	0.5321	0.8534	-0.0002	0.0352
RohnD2	0.7996	0.0000	-0.4691	-0.7996	-0.0000	0.4691	0.8530	-0.0013	0.0354
RohnE1	0.8293	0.0000	-0.5805	-0.8293	0.0000	0.5805	0.5953	-0.0002	0.0342
RohnE2	0.8293	0.0000	-0.5805	-0.8293	-0.0000	0.5805	0.5956	-0.0005	0.0343
RohnF1	0.9670	0.0000	-0.7867	-0.9670	-0.0000	0.7867	0.3844	0.0006	0.0313
RohnF2	1.4491	0.0000	-0.9172	-1.4491	-0.0000	0.9172	0.3855	-0.0004	0.0314
RohnG1	1.2624	0.0000	-1.0111	-1.2624	0.0000	1.0111	0.2202	0.0004	0.0261
RohnG2	1.7131	0.0000	-1.0975	-1.7131	-0.0000	1.0975	0.2214	0.0000	0.0262
RohnH1	1.1981	0.0000	-1.0422	-1.1981	-0.0000	1.0422	0.1008	0.0004	0.0193
RohnH2	1.1981	0.0000	-1.0422	-1.1981	0.0000	1.0422	0.1015	-0.0001	0.0193
RohnI1	1.4581	0.0000	-1.1689	-1.4581	-0.0000	1.1689	0.0284	0.0002	0.0096
RohnI2	1.4581	0.0000	-1.1689	-1.4581	-0.0000	1.1689	0.0288	-0.0000	0.0096
RohnJ1	0.8371	0.0000	-0.6316	8.7896	10.2633	153.3044	0.0000	0.0000	0.0000
RohnJ2	0.8371	0.0000	-0.6316	8.9937	-10.1720	153.6277	0.0000	0.0000	0.0000
SNB-A1	0.1887	0.0000	-0.1410	-0.1887	-0.0000	0.1410	1.7861	-0.0017	0.0041
SNB-A2	0.1887	0.0000	-0.1410	-0.1887	0.0000	0.1411	1.7861	-0.0017	0.0042
SNB-B1	0.4544	0.0000	-0.3052	-0.4544	-0.0000	0.3052	1.4657	-0.0013	0.0128
SNB-B2	0.4544	0.0000	-0.3052	-0.4544	0.0000	0.3052	1.4657	-0.0013	0.0129
SNB-C1	0.6587	0.0000	-0.3872	-0.6587	-0.0000	0.3872	1.1496	-0.0009	0.0203
SNB-C2	0.6587	0.0000	-0.3872	-0.6587	0.0000	0.3872	1.1496	-0.0010	0.0204
SNB-D1	0.7996	0.0000	-0.4691	-0.7996	-0.0000	0.4691	0.8540	-0.0005	0.0253
SNB-D2	0.7996	0.0000	-0.4691	-0.7996	0.0000	0.4691	0.8540	-0.0007	0.0254
SNB-E1	0.8293	0.0000	-0.5805	-0.8293	-0.0000	0.5805	0.5955	-0.0003	0.0257
SNB-E2	0.8293	0.0000	-0.5805	-0.8293	0.0000	0.5805	0.5955	-0.0005	0.0257
SNB-F1	0.9670	0.0000	-0.7867	-0.9670	-0.0000	0.7867	0.3856	-0.0002	0.0254
SNB-F2	0.9670	0.0000	-0.7867	-0.9670	0.0000	0.7867	0.3856	-0.0003	0.0255
SNB-G1	1.1214	0.0000	-0.9571	-1.1214	-0.0000	0.9571	0.2209	0.0000	0.0218
SNB-G2	1.1214	0.0000	-0.9571	-1.1214	0.0000	0.9571	0.2209	-0.0003	0.0219
SNB-H1	1.1981	0.0000	-1.0422	-1.1981	-0.0000	1.0422	0.1013	0.0001	0.0166
SNB-H2	1.1981	0.0000	-1.0422	-1.1981	0.0000	1.0422	0.1013	-0.0003	0.0166
SNB-I1	1.4581	0.0000	-1.1689	-1.4581	-0.0000	1.1689	0.0283	0.0003	0.0085
SNB-I2	1.4581	0.0000	-1.1689	-1.4581	0.0000	1.1689	0.0283	-0.0003	0.0086
SNB-J1	0.8371	0.0000	-0.6316	16.7736	18.8845	232.8515	0.0000	0.0000	0.0000
SNB-J2	0.8371	0.0000	-0.6316	16.7923	-18.9166	233.3501	0.0000	0.0000	0.0000
RohnAaS	0.6047	0.0000	-0.1881	-0.6047	0.0000	0.1881	1.7052	-0.0005	-0.0894
RohnAbS	0.1887	0.0000	-0.1410	-0.1887	0.0000	0.1410	1.6248	-0.0004	-0.0917
RohnAcS	0.5630	0.0000	-0.1890	-0.5630	0.0000	0.1890	1.5448	0.0000	-0.0937

RohnBaS	0.2658	0.0000	-0.1642	-0.2658	0.0000	0.1642	1.3850	-0.0001	-0.0973
RohnBbS	2.2103	0.0000	-0.8700	-2.2103	0.0000	0.8700	1.3055	-0.0002	-0.0987
RohnBcS	0.2658	0.0000	-0.1642	-0.2658	0.0000	0.1642	1.2268	-0.0003	-0.0997
RohnCaS	2.0581	0.0000	-0.7200	-2.0581	0.0000	0.7200	1.0477	-0.0004	-0.1009
RohnCbS	2.9069	0.0000	-1.2757	-2.9069	0.0000	1.2757	0.9489	-0.0004	-0.1008
RohnDaS	2.9338	0.0000	-1.1411	-2.9338	0.0000	1.1411	0.7623	-0.0005	-0.0975
RohnDbS	0.4066	0.0000	-0.2460	-0.4066	0.0000	0.2460	0.6762	-0.0005	-0.0940
RohnEaS	0.4227	0.0000	-0.3345	-0.4227	-0.0000	0.3345	0.5212	-0.0007	-0.0863
RohnEbS	0.4227	0.0000	-0.3345	-0.4227	-0.0000	0.3345	0.4510	-0.0008	-0.0824
RohnFaS	0.5444	0.0000	-0.4522	-0.5444	-0.0000	0.4522	0.2992	-0.0009	-0.0709
RohnGaS	0.5770	0.0000	-0.5049	-0.5770	-0.0000	0.5049	0.1577	-0.0006	-0.0544
RohnHaS	0.6210	0.0000	-0.5373	-0.6210	-0.0000	0.5373	0.0611	-0.0003	-0.0342
RohnIaS	0.8371	0.0000	-0.6316	-0.8371	-0.0000	0.6316	0.0109	-0.0001	-0.0115
SNB-AaS	0.1887	0.0000	-0.1410	-0.1887	-0.0000	0.1410	1.7055	-0.0016	-0.0544
SNB-AbS	0.1887	0.0000	-0.1410	-0.1887	-0.0000	0.1410	1.6251	-0.0016	-0.0568
SNB-AcS	0.1887	0.0000	-0.1410	-0.1887	-0.0000	0.1410	1.5451	-0.0014	-0.0591
SNB-BaS	0.2658	0.0000	-0.1642	-0.2658	-0.0000	0.1642	1.3853	-0.0012	-0.0634
SNB-BbS	0.2658	0.0000	-0.1642	-0.2658	-0.0000	0.1642	1.3058	-0.0011	-0.0654
SNB-BcS	0.2658	0.0000	-0.1642	-0.2658	-0.0000	0.1642	1.2270	-0.0010	-0.0670
SNB-CaS	0.3930	0.0000	-0.2230	-0.3930	-0.0000	0.2230	1.0480	-0.0008	-0.0700
SNB-CbS	0.3930	0.0000	-0.2230	-0.3930	-0.0000	0.2230	0.9491	-0.0007	-0.0708
SNB-DaS	0.4066	0.0000	-0.2460	-0.4066	-0.0000	0.2460	0.7624	-0.0005	-0.0701
SNB-DbS	0.4066	0.0000	-0.2460	-0.4066	-0.0000	0.2460	0.6763	-0.0005	-0.0682
SNB-EaS	0.4227	0.0000	-0.3345	-0.4227	-0.0000	0.3345	0.5213	-0.0003	-0.0645
SNB-EbS	0.4227	0.0000	-0.3345	-0.4227	0.0000	0.3345	0.4511	-0.0003	-0.0628
SNB-FaS	0.5444	0.0000	-0.4522	-0.5444	-0.0000	0.4522	0.2992	-0.0002	-0.0560
SNB-GaS	0.5770	0.0000	-0.5049	-0.5770	-0.0000	0.5049	0.1577	-0.0001	-0.0442
SNB-HaS	0.6210	0.0000	-0.5373	-0.6210	-0.0000	0.5373	0.0611	-0.0000	-0.0286
SNB-IaS	0.8371	0.0000	-0.6316	-0.8371	-0.0000	0.6316	0.0109	-0.0000	-0.0100
SNB-WL-A1S	0.1887	0.0000	-0.1410	-0.1887	0.0000	0.1410	1.7859	-0.0017	-0.0241
SNB-WL-A2S	0.1887	0.0000	-0.1410	-0.1887	-0.0000	0.1410	1.7861	-0.0017	0.0040
SNB-WL-A3S	0.1887	0.0000	-0.1410	-0.1887	-0.0000	0.1410	1.7859	-0.0017	-0.0240
SNB-WL-B1S	0.1887	0.0000	-0.1410	-0.1887	0.0000	0.1410	1.4654	-0.0013	-0.0245
SNB-WL-B2S	0.1887	0.0000	-0.1410	-0.1887	-0.0000	0.1410	1.4657	-0.0013	0.0127
SNB-WL-B3S	0.1887	0.0000	-0.1410	-0.1887	-0.0000	0.1410	1.4654	-0.0013	-0.0244
SNB-WL-C1S	0.2658	0.0000	-0.1642	-0.2658	0.0000	0.1642	1.1493	-0.0010	-0.0245
SNB-WL-C2S	0.2658	0.0000	-0.1642	-0.2658	-0.0000	0.1642	1.1497	-0.0010	0.0201
SNB-WL-C3S	0.2658	0.0000	-0.1642	-0.2658	-0.0000	0.1642	1.1493	-0.0009	-0.0244
SNB-WL-D1S	0.3930	0.0000	-0.2230	-0.3930	0.0000	0.2230	0.8538	-0.0007	-0.0237
SNB-WL-D2S	0.3930	0.0000	-0.2230	-0.3930	-0.0000	0.2230	0.8542	-0.0006	0.0246
SNB-WL-D3S	0.3930	0.0000	-0.2230	-0.3930	-0.0000	0.2230	0.8538	-0.0006	-0.0237
SNB-WL-E1S	0.4066	0.0000	-0.2460	-0.4066	0.0000	0.2460	0.5954	-0.0004	-0.0205
SNB-WL-E2S	0.4066	0.0000	-0.2460	-0.4066	-0.0000	0.2460	0.5957	-0.0004	0.0252
SNB-WL-E3S	0.4066	0.0000	-0.2460	-0.4066	-0.0000	0.2460	0.5954	-0.0004	-0.0204
SNB-WL-F1S	0.4227	0.0000	-0.3345	-0.4227	0.0000	0.3345	0.3855	-0.0003	-0.0189
SNB-WL-F2S	0.4227	0.0000	-0.3345	-0.4227	-0.0000	0.3345	0.3858	-0.0003	0.0247
SNB-WL-F3S	0.4227	0.0000	-0.3345	-0.4227	-0.0000	0.3345	0.3855	-0.0002	-0.0189
SNB-WL-G1S	0.5444	0.0000	-0.4522	-0.5444	0.0000	0.4522	0.2209	-0.0002	-0.0164
SNB-WL-G2S	0.5444	0.0000	-0.4522	-0.5444	-0.0000	0.4522	0.2212	-0.0001	0.0203
SNB-WL-G3S	0.5444	0.0000	-0.4522	-0.5444	-0.0000	0.4522	0.2209	-0.0001	-0.0164
SNB-WL-H1S	0.5770	0.0000	-0.5049	-0.5770	0.0000	0.5049	0.1015	-0.0001	-0.0133
SNB-WL-H2S	0.5770	0.0000	-0.5049	-0.5770	0.0000	0.5049	0.1017	-0.0001	0.0138
SNB-WL-H3S	0.5770	0.0000	-0.5049	-0.5770	-0.0000	0.5049	0.1015	-0.0000	-0.0133
SNB-WL-I1S	0.6210	0.0000	-0.5373	-0.6210	0.0000	0.5373	0.0286	-0.0001	-0.0094
SNB-WL-I2S	0.6210	0.0000	-0.5373	-0.6210	-0.0000	0.5373	0.0287	-0.0000	0.0050
SNB-WL-I3S	0.6210	0.0000	-0.5373	-0.6210	-0.0000	0.5373	0.0286	0.0000	-0.0094
RohnAa1	0.4999	0.0000	-0.2072	-0.4999	0.0000	0.2072	1.7070	-0.0022	0.0185
RohnAa2	0.7903	0.0000	-0.2279	-0.7903	-0.0000	0.2279	1.7053	-0.0021	0.0186
RohnAb1	1.1180	-0.0502	-0.2490	-1.1180	0.0502	0.2490	1.6273	-0.0024	0.0206
RohnAb2	0.1887	0.0000	-0.1410	-0.1887	-0.0000	0.1410	1.6247	-0.0022	0.0208
RohnAc1	0.1887	0.0000	-0.1410	-0.1887	0.0000	0.1410	1.5465	-0.0020	0.0227
RohnAc2	0.1887	0.0000	-0.1410	-0.1887	-0.0000	0.1410	1.5443	-0.0022	0.0229
RohnBa1	0.2658	0.0000	-0.1642	-0.2658	0.0000	0.1642	1.3865	-0.0015	0.0265
RohnBa2	0.2658	0.0000	-0.1642	-0.2658	-0.0000	0.1642	1.3845	-0.0020	0.0267
RohnBb1	2.1359	0.0000	-0.8457	-2.1359	0.0000	0.8457	1.3080	-0.0020	0.0283
RohnBb2	2.1359	0.0000	-0.8457	-2.1359	-0.0000	0.8457	1.3064	-0.0012	0.0285
RohnBc1	0.2658	0.0000	-0.1642	-0.2658	0.0000	0.1642	1.2278	-0.0011	0.0299
RohnBc2	0.2658	0.0000	-0.1642	-0.2658	0.0000	0.1642	1.2265	-0.0017	0.0301
RohnCa1	2.2226	0.0000	-0.7740	-2.2226	0.0000	0.7740	1.0491	-0.0011	0.0330

RohnCa2	2.3301	0.0000	-0.8100	-2.3301	-0.0000	0.8100	1.0483	-0.0010	0.0332
RohnCb1	2.7453	0.0000	-1.2262	-2.7453	0.0000	1.2262	0.9495	-0.0007	0.0343
RohnCb2	2.7453	0.0000	-1.2262	-2.7453	-0.0000	1.2262	0.9489	-0.0011	0.0345
RohnDa1	2.6669	0.0000	-1.0466	-2.6669	0.0000	1.0466	0.7625	-0.0004	0.0355
RohnDa2	2.6669	0.0000	-1.0466	-2.6669	-0.0000	1.0466	0.7624	-0.0008	0.0356
RohnDb1	0.4066	0.0000	-0.2460	-0.4066	0.0000	0.2460	0.6746	0.0007	0.0352
RohnDb2	0.4066	0.0000	-0.2460	-0.4066	-0.0000	0.2460	0.6747	-0.0016	0.0353
RohnEa1	0.4227	0.0000	-0.3345	-0.4227	-0.0000	0.3345	0.5199	0.0007	0.0336
RohnEa2	0.4227	0.0000	-0.3345	-0.4227	0.0000	0.3345	0.5204	-0.0010	0.0337
RohnEb1	0.4227	0.0000	-0.3345	-0.4227	0.0000	0.3345	0.4496	0.0008	0.0327
RohnEb2	0.4227	0.0000	-0.3345	-0.4227	-0.0000	0.3345	0.4504	-0.0009	0.0328
RohnFa1	0.5444	0.0000	-0.4522	-0.5444	0.0000	0.4522	0.2939	0.0027	0.0292
RohnFa2	0.5444	0.0000	-0.4522	-0.5444	-0.0000	0.4522	0.2949	-0.0024	0.0292
RohnGa1	0.5770	0.0000	-0.5049	-0.5770	-0.0000	0.5049	0.1524	0.0027	0.0230
RohnGa2	0.5770	0.0000	-0.5049	-0.5770	-0.0000	0.5049	0.1533	-0.0024	0.0231
RohnHa1	0.6210	0.0000	-0.5373	-0.6210	0.0000	0.5373	0.0551	0.0030	0.0148
RohnHa2	0.6210	0.0000	-0.5373	-0.6210	-0.0000	0.5373	0.0556	-0.0028	0.0148
RohnIa1	0.8371	0.0000	-0.6316	-0.8371	0.0000	0.6316	0.0065	0.0022	0.0050
RohnIa2	0.8371	0.0000	-0.6316	-0.8371	-0.0000	0.6316	0.0067	-0.0021	0.0050
SNB-Aa1	0.1887	0.0000	-0.1410	-0.1887	-0.0000	0.1410	1.7059	-0.0016	0.0063
SNB-Aa2	0.1887	0.0000	-0.1410	-0.1887	0.0000	0.1410	1.7059	-0.0017	0.0064
SNB-Ab1	0.1887	0.0000	-0.1410	-0.1887	-0.0000	0.1410	1.6258	-0.0015	0.0085
SNB-Ab2	0.1887	0.0000	-0.1410	-0.1887	0.0000	0.1410	1.6257	-0.0015	0.0086
SNB-Ac1	0.1887	0.0000	-0.1410	-0.1887	-0.0000	0.1410	1.5453	-0.0014	0.0107
SNB-Ac2	0.1887	0.0000	-0.1410	-0.1887	0.0000	0.1410	1.5454	-0.0015	0.0108
SNB-Ba1	0.2658	0.0000	-0.1642	-0.2658	-0.0000	0.1642	1.3857	-0.0011	0.0148
SNB-Ba2	0.2658	0.0000	-0.1642	-0.2658	0.0000	0.1642	1.3857	-0.0013	0.0149
SNB-Bb1	0.2658	0.0000	-0.1642	-0.2658	-0.0000	0.1642	1.3062	-0.0010	0.0168
SNB-Bb2	0.2658	0.0000	-0.1642	-0.2658	0.0000	0.1642	1.3062	-0.0012	0.0169
SNB-Bc1	0.2658	0.0000	-0.1642	-0.2658	-0.0000	0.1642	1.2272	-0.0009	0.0186
SNB-Bc2	0.2658	0.0000	-0.1642	-0.2658	0.0000	0.1642	1.2272	-0.0012	0.0187
SNB-Ca1	0.3930	0.0000	-0.2230	-0.3930	-0.0000	0.2230	1.0476	-0.0003	0.0223
SNB-Ca2	0.3930	0.0000	-0.2230	-0.3930	0.0000	0.2230	1.0476	-0.0014	0.0225
SNB-Cb1	0.3930	0.0000	-0.2230	-0.3930	-0.0000	0.2230	0.9484	-0.0001	0.0240
SNB-Cb2	0.3930	0.0000	-0.2230	-0.3930	0.0000	0.2230	0.9484	-0.0013	0.0241
SNB-Da1	0.4066	0.0000	-0.2460	-0.4066	-0.0000	0.2460	0.7615	0.0002	0.0260
SNB-Da2	0.4066	0.0000	-0.2460	-0.4066	0.0000	0.2460	0.7615	-0.0013	0.0261
SNB-Db1	0.4066	0.0000	-0.2460	-0.4066	-0.0000	0.2460	0.6744	0.0008	0.0261
SNB-Db2	0.4066	0.0000	-0.2460	-0.4066	0.0000	0.2460	0.6744	-0.0017	0.0262
SNB-Ea1	0.4227	0.0000	-0.3345	-0.4227	-0.0000	0.3345	0.5205	0.0003	0.0260
SNB-Ea2	0.4227	0.0000	-0.3345	-0.4227	0.0000	0.3345	0.5205	-0.0010	0.0260
SNB-Eb1	0.4227	0.0000	-0.3345	-0.4227	0.0000	0.3345	0.4501	0.0004	0.0259
SNB-Eb2	0.4227	0.0000	-0.3345	-0.4227	-0.0000	0.3345	0.4501	-0.0010	0.0259
SNB-Fa1	0.5444	0.0000	-0.4522	-0.5444	-0.0000	0.4522	0.2938	0.0027	0.0240
SNB-Fa2	0.5444	0.0000	-0.4522	-0.5444	0.0000	0.4522	0.2938	-0.0031	0.0241
SNB-Ga1	0.5770	0.0000	-0.5049	-0.5770	-0.0000	0.5049	0.1528	0.0025	0.0196
SNB-Ga2	0.5770	0.0000	-0.5049	-0.5770	0.0000	0.5049	0.1528	-0.0027	0.0196
SNB-Ha1	0.6210	0.0000	-0.5373	-0.6210	0.0000	0.5373	0.0557	0.0027	0.0129
SNB-Ha2	0.6210	0.0000	-0.5373	-0.6210	-0.0000	0.5373	0.0557	-0.0028	0.0129
SNB-Ia1	0.8371	0.0000	-0.6316	-0.8371	0.0000	0.6316	0.0061	0.0024	0.0046
SNB-Ia2	0.8371	0.0000	-0.6316	-0.8371	-0.0000	0.6316	0.0061	-0.0024	0.0046

**Moments for Angles Modeled as Beams:**

Angle Label	Torsion (ft-lbs)	Origin X Moment (ft-lbs)	Origin Y Moment (ft-lbs)	End X Moment (ft-lbs)	End Y Moment (ft-lbs)	X Shear (lbs)	Y Shear (lbs)
Rohn-LA1P	-0.01	1.03	4.71	26.24	-16.83	5.45	-2.42
Rohn-LA11	2.04	-1.56	2.68	12.16	37.68	2.12	8.07
Rohn-LA12	-2.20	1.13	2.85	5.77	-17.28	1.38	-2.88
Rohn-LA2P	-0.01	-26.24	16.83	-32.88	24.65	-11.82	8.29
Rohn-LA21	2.04	-12.16	-37.68	-36.36	-87.58	-9.70	-25.03
Rohn-LA22	-2.20	-5.77	17.28	2.33	4.58	-0.69	4.37
Rohn-LA3P	-0.01	32.88	-24.65	35.77	-11.41	13.72	-7.21
Rohn-LA31	2.04	36.36	87.58	42.32	104.89	15.72	38.46
Rohn-LA32	-2.20	-2.33	-4.58	-25.79	50.17	-5.62	9.11
Rohn-LA4P	-0.01	-35.77	11.41	-18.78	22.33	-10.90	6.74
Rohn-LA41	2.04	-42.32	-104.89	-63.95	-117.14	-21.24	-44.37

Rohn-LA42	-2.20	25.79	-50.17	48.28	-77.06	14.80	-25.43
Rohn-LB1P	2.93	18.11	-11.53	10.92	0.56	5.80	-2.19
Rohn-LB11	8.53	62.28	123.72	117.85	225.05	36.00	69.70
Rohn-LB12	-2.57	-45.01	82.85	-112.09	209.51	-31.40	58.42
Rohn-LB2P	2.93	-10.92	-0.56	-4.24	53.30	-3.03	10.54
Rohn-LB21	8.52	-117.85	-225.05	-145.41	-220.04	-52.61	-88.94
Rohn-LB22	-2.57	112.09	-209.51	144.71	-214.27	51.32	-84.68
Rohn-LB3P	2.93	4.24	-53.30	4.08	2.06	1.66	-10.24
Rohn-LB31	8.53	145.41	220.04	82.52	167.72	45.55	77.48
Rohn-LB32	-2.57	-144.71	214.27	-82.61	166.27	-45.42	76.04
Rohn-LB4P	2.93	-4.08	-2.06	-6.36	150.60	-2.09	29.70
Rohn-LB41	8.52	-82.52	-167.72	12.17	145.93	-14.06	-4.35
Rohn-LB42	-2.56	82.61	-166.27	-7.12	142.72	15.08	-4.71
Rohn-LC1P	2.93	6.36	-150.60	1.79	82.19	1.22	-10.27
Rohn-LC11	8.51	-12.17	-145.93	-34.31	19.23	-6.97	-19.01
Rohn-LC12	-2.55	7.12	-142.72	36.49	15.69	6.54	-19.06
Rohn-LC2P	2.93	-1.79	-82.19	1.31	112.76	-0.07	4.57
Rohn-LC21	8.51	34.31	-19.23	-24.36	108.88	1.49	13.41
Rohn-LC22	-2.56	-36.49	-15.69	29.32	99.02	-1.07	12.46
Rohn-LC3P	2.93	-1.31	-112.76	-3.23	226.40	-0.68	17.06
Rohn-LC31	8.52	24.36	-108.88	109.59	349.34	20.09	36.07
Rohn-LC32	-2.57	-29.32	-99.02	-116.75	371.13	-21.91	40.82
Rohn-LD1P	2.93	3.23	-226.40	6.66	406.03	1.49	26.97
Rohn-LD11	8.48	-109.59	-349.34	-236.60	32.93	-51.92	-47.46
Rohn-LD12	-2.52	116.74	-371.14	244.41	15.51	54.17	-53.34
Rohn-LD2P	2.93	-6.66	-406.03	-2.03	181.59	-1.30	-33.60
Rohn-LD21	8.59	236.59	-32.93	322.69	775.39	83.63	111.02
Rohn-LD22	-2.63	-244.41	-15.51	-322.96	781.28	-84.84	114.50
Rohn-LD3P	2.93	2.03	-181.59	-0.69	702.81	0.20	78.29
Rohn-LD31	8.41	-322.67	-775.40	-304.38	95.26	-94.04	-102.00
Rohn-LD32	-2.45	322.94	-781.29	306.01	97.19	94.32	-102.59
Rohn-LE1P	2.93	0.68	-702.81	12.27	280.63	1.95	-63.40
Rohn-LE11	8.56	304.38	-95.25	139.28	571.29	66.54	71.40
Rohn-LE12	-2.60	-306.01	-97.18	-134.46	557.17	-66.06	68.99
Rohn-LE2P	2.93	-12.27	-280.63	-26.78	232.78	-5.85	-7.16
Rohn-LE21	8.51	-139.27	-571.29	114.43	457.66	-3.71	-16.99
Rohn-LE22	-2.55	134.45	-557.18	-127.19	497.09	1.09	-8.98
Rohn-LE3P	2.94	26.78	-232.78	27.69	1082.58	8.18	127.63
Rohn-LE31	8.44	-114.43	-457.67	-438.09	178.08	-82.86	-41.93
Rohn-LE32	-2.48	127.18	-497.10	474.33	98.76	90.21	-59.74
Rohn-LF1P	2.92	-27.69	-1082.58	-39.72	119.47	-6.74	-96.33
Rohn-LF11	8.73	438.09	-178.07	778.16	1704.89	121.48	152.50
Rohn-LF12	-2.78	-474.33	-98.75	-800.73	1766.39	-127.35	166.56
Rohn-LF2P	2.95	39.72	-119.47	29.60	1597.36	6.94	147.84
Rohn-LF21	8.17	-778.09	-1704.93	-933.95	-299.56	-170.99	-200.20
Rohn-LF22	-2.20	800.64	-1766.43	967.84	-373.23	176.63	-213.70
Rohn-LG1P	2.92	-29.61	-1597.36	-26.34	-51.51	-5.60	-164.93
Rohn-LG11	8.89	933.93	299.58	1035.09	2041.47	196.66	233.82
Rohn-LG12	-2.94	-967.83	373.25	-1047.53	2076.77	-201.29	244.70
Rohn-LG2P	2.94	26.34	51.51	13.22	1856.50	3.96	190.87
Rohn-LG21	8.14	-1034.99	-2041.52	-1131.25	-433.80	-216.35	-247.22
Rohn-LG22	-2.18	1047.42	-2076.83	1136.21	-444.62	218.09	-251.82
Rohn-LH1P	2.93	-13.22	-1856.50	0.43	-120.19	-1.28	-197.76
Rohn-LH11	8.88	1131.23	433.82	1271.60	2443.80	239.97	287.38
Rohn-LH12	-2.93	-1136.20	444.64	-1274.58	2451.90	-240.76	289.27
Rohn-LH2P	2.93	-0.44	120.19	-2.11	2371.96	-0.25	249.35
Rohn-LH21	7.79	-1271.46	-2443.88	-1485.56	-641.02	-275.33	-308.07
Rohn-LH22	-1.84	1274.43	-2451.98	1490.51	-645.91	276.12	-309.37
Rohn-LI1P	2.93	2.11	-2371.96	-9.19	-129.00	-0.71	-250.18
Rohn-LI11	8.75	1485.55	641.05	1915.90	3778.26	339.71	441.37
Rohn-LI12	-2.80	-1490.50	645.94	-1901.96	3755.21	-338.81	439.55
Rohn-LI2P	2.94	9.19	129.00	58.25	5479.26	6.75	561.06
Rohn-LI21	7.36	-1915.72	-3778.36	-1968.09	1465.14	-387.87	-231.02
Rohn-LI22	-1.42	1901.77	-3755.31	1913.10	1569.01	380.99	-218.35
Rohn-H1P	0.20	2.24	0.12	3.05	-1.05	0.70	-0.12
Rohn-H11	-0.06	0.09	-1.05	-0.03	1.23	0.01	0.02
Rohn-H12	0.38	-3.06	1.04	-3.30	-0.07	-0.85	0.13
Rohn-H2P	-0.52	6.66	-1.88	6.92	-3.47	1.53	-0.60
Rohn-H21	-0.11	1.20	-3.20	0.06	-0.03	0.14	-0.36

Rohn-H22	0.15	-6.70	0.53	-6.19	-1.09	-1.45	-0.06
SNB-LA1P	-0.03	4.04	48.03	14.57	-13.24	3.72	6.95
SNB-LA11	0.27	51.33	-14.14	13.64	17.90	12.98	0.75
SNB-LA12	-0.28	-55.45	-26.89	-22.07	-5.22	-15.49	-6.42
SNB-LA2P	-0.03	-14.57	13.24	-19.71	35.41	-6.85	9.72
SNB-LA21	0.27	-13.64	-17.90	-7.53	-42.53	-4.23	-12.08
SNB-LA22	-0.28	22.07	5.22	18.05	-13.32	8.02	-1.62
SNB-LA3P	-0.03	19.71	-35.41	16.23	-33.86	7.18	-13.84
SNB-LA31	0.27	7.53	42.53	9.47	71.81	3.40	22.85
SNB-LA32	-0.28	-18.05	13.32	-18.14	47.83	-7.23	12.22
SNB-LA4P	-0.03	-16.23	33.86	-10.45	101.59	-5.33	27.07
SNB-LA41	0.27	-9.47	-71.81	-0.93	-63.96	-2.08	-27.13
SNB-LA42	-0.28	18.14	-47.83	8.09	-47.08	5.24	-18.97
SNB-LB1P	-0.06	9.61	154.39	4.65	44.94	2.85	39.84
SNB-LB11	3.20	90.47	74.14	48.67	101.83	27.81	35.17
SNB-LB12	-3.00	-96.15	60.69	-51.95	94.77	-29.60	31.07
SNB-LB2P	-0.06	-4.65	-44.94	-2.70	112.78	-1.47	13.56
SNB-LB21	3.19	-48.67	-101.83	-39.82	-2.81	-17.68	-20.91
SNB-LB22	-3.00	51.95	-94.77	42.04	1.53	18.78	-18.63
SNB-LB3P	-0.06	2.70	-112.78	2.20	-42.34	0.98	-31.00
SNB-LB31	3.20	39.82	2.81	59.98	192.18	19.94	38.96
SNB-LB32	-3.00	-42.04	-1.53	-60.26	189.55	-20.44	37.57
SNB-LB4P	-0.06	-2.20	42.34	-0.18	504.74	-0.48	109.35
SNB-LB41	3.19	-59.98	-192.18	-39.55	54.85	-19.89	-27.44
SNB-LB42	-2.99	60.26	-189.55	42.29	56.46	20.49	-26.59
SNB-LC1P	0.03	0.18	-61.20	0.29	167.69	0.07	15.98
SNB-LC11	8.32	160.68	-27.16	69.56	183.16	34.54	23.40
SNB-LC12	-8.25	-162.68	-28.45	-69.41	182.93	-34.82	23.17
SNB-LC2P	0.03	-0.29	-167.69	0.97	82.71	0.10	-12.72
SNB-LC21	8.30	-69.56	-183.16	42.90	335.10	-3.99	22.72
SNB-LC22	-8.23	69.41	-182.93	-43.29	333.78	3.91	22.56
SNB-LC3P	0.03	-0.97	-82.71	-0.36	547.53	-0.20	69.77
SNB-LC31	8.30	-42.89	-335.10	-40.28	-17.55	-12.48	-52.90
SNB-LC32	-8.23	43.28	-333.78	44.57	-14.72	13.18	-52.28
SNB-LD1P	-0.03	0.46	65.31	2.96	691.63	0.51	113.63
SNB-LD11	10.69	271.57	-5.08	-1.93	546.09	40.45	81.15
SNB-LD12	-10.54	-276.05	-8.36	0.95	542.11	-41.27	80.06
SNB-LD2P	-0.03	-2.96	-691.63	-0.17	81.59	-0.47	-91.32
SNB-LD21	10.70	1.94	-546.09	325.87	842.27	49.02	44.29
SNB-LD22	-10.55	-0.96	-542.11	-323.14	844.05	-48.47	45.15
SNB-LD3P	-0.03	0.17	-81.59	-0.81	1507.88	-0.10	214.17
SNB-LD31	10.52	-325.85	-842.28	-397.78	298.04	-108.53	-81.62
SNB-LD32	-10.38	323.12	-844.06	400.04	300.06	108.46	-81.59
SNB-LE1P	-0.31	1.46	-427.59	10.09	1066.09	1.73	95.85
SNB-LE11	21.96	616.40	-178.64	205.61	1196.11	123.30	152.62
SNB-LE12	-21.58	-619.01	-181.99	-206.90	1183.78	-123.89	150.27
SNB-LE2P	-0.31	-10.09	-1066.09	-6.72	485.86	-2.52	-86.85
SNB-LE21	21.89	-205.60	-1196.12	406.40	1659.28	30.03	69.26
SNB-LE22	-21.51	206.89	-1183.78	-391.98	1675.19	-27.68	73.49
SNB-LE3P	-0.31	6.72	-485.86	4.90	2794.31	1.74	346.58
SNB-LE31	21.73	-406.37	-1659.29	-881.09	-394.68	-193.10	-308.07
SNB-LE32	-21.35	391.95	-1675.19	868.04	-407.92	188.98	-312.44
SNB-LF1P	-0.02	-4.76	-1779.46	-1.57	-127.91	-0.63	-190.74
SNB-LF11	38.58	1469.44	308.70	1620.74	3160.55	308.69	346.53
SNB-LF12	-38.57	-1457.45	321.08	-1605.52	3170.99	-305.97	348.81
SNB-LF2P	-0.02	1.57	127.91	3.34	3458.83	0.49	358.71
SNB-LF21	37.29	-1620.62	-3160.63	-1718.85	-1131.55	-333.56	-428.71
SNB-LF22	-37.28	1605.40	-3171.07	1707.50	-1141.80	330.91	-430.77
SNB-LG1P	0.28	-3.26	-2297.65	-0.18	218.40	-0.34	-207.93
SNB-LG11	63.81	2720.13	711.20	2820.54	5824.21	553.46	652.78
SNB-LG12	-64.18	-2708.75	721.43	-2805.71	5832.74	-550.84	654.66
SNB-LG2P	0.29	0.18	-218.39	2.18	5888.70	0.24	567.11
SNB-LG21	61.92	-2820.33	-5824.33	-2504.78	-1410.30	-531.88	-722.59
SNB-LG22	-62.29	2805.51	-5832.86	2502.89	-1413.69	530.21	-723.78
SNB-LH1P	0.09	-2.04	-4149.55	4.08	-135.98	0.20	-428.65
SNB-LH11	61.82	3654.09	901.48	3337.52	6452.98	698.32	734.53
SNB-LH12	-62.04	-3653.15	904.22	-3332.48	6451.02	-697.73	734.60
SNB-LH2P	0.09	-4.08	135.98	-1.94	6862.23	-0.60	700.05
SNB-LH21	58.96	-3337.24	-6453.15	-3446.70	-1747.48	-677.53	-819.00

SNB-LH22	-59.17	3332.20	-6451.19	3450.01	-1743.19	677.36	-818.38
SNB-LI1P	-0.01	2.02	-4969.97	8.44	-57.94	1.05	-502.88
SNB-LI11	19.85	4892.31	1084.59	5449.26	9853.02	1032.91	1092.44
SNB-LI12	-20.02	-4895.75	1080.19	-5444.04	9846.09	-1032.73	1091.30
SNB-LI2P	-0.01	-8.44	57.94	-1.99	13374.31	-1.04	1343.58
SNB-LI21	15.55	-5448.75	-9853.31	-5528.39	2766.64	-1096.34	-707.78
SNB-LI22	-15.71	5443.53	-9846.37	5536.31	2774.40	1096.61	-706.31
SNB-H1aP	-1.75	29.89	68.89	114.67	-0.09	71.55	34.05
SNB-H1bP	-1.75	-114.68	0.10	-19.67	36.01	-66.49	17.87
SNB-H1cP	-2.05	39.98	-36.80	102.43	-1.98	70.49	-19.19
SNB-H1dP	-2.05	-102.42	1.98	-33.93	36.29	-67.49	18.94
SNB-H1eP	6.23	32.24	-35.85	108.23	-1.88	69.52	-18.68
SNB-H1fP	6.24	-108.23	1.88	-30.18	-68.70	-68.50	-33.08
SNB-H2aP	-7.57	152.04	54.90	114.51	2.79	98.62	21.34
SNB-H2bP	-7.57	-114.52	-2.78	8.05	21.07	-39.39	6.77
SNB-H2cP	0.64	86.92	-26.10	99.21	3.29	68.86	-8.44
SNB-H2dP	0.63	-99.21	-3.29	-87.67	25.69	-69.14	8.29
SNB-H2eP	6.72	-11.04	-20.78	116.09	1.48	38.87	-7.14
SNB-H2fP	6.72	-116.09	-1.49	-151.81	-54.90	-99.12	-20.86
SNB-H3aP	-6.18	259.55	35.85	155.19	-3.80	122.54	9.47
SNB-H3bP	-6.17	-155.19	3.80	28.30	12.37	-37.49	4.78
SNB-H3cP	0.03	129.78	-20.80	141.54	10.06	80.17	-3.17
SNB-H3dP	0.03	-141.54	-10.06	-129.27	20.68	-80.02	3.14
SNB-H3eP	6.10	-28.65	-12.12	155.29	-3.78	37.42	-4.70
SNB-H3fP	6.10	-155.29	3.78	-259.69	-35.94	-122.62	-9.50
SNB-H4aP	-6.61	357.64	18.54	247.33	-15.19	148.79	0.83
SNB-H4bP	-6.60	-247.33	15.19	-30.01	4.62	-68.21	4.87
SNB-H4cP	-0.09	210.50	-10.74	233.83	33.41	109.28	5.58
SNB-H4dP	-0.10	-233.83	-33.41	-210.46	10.59	-109.27	-5.61
SNB-H4eP	6.68	30.34	-4.56	247.12	-15.38	68.24	-4.91
SNB-H4fP	6.69	-247.12	15.38	-357.69	-18.48	-148.75	-0.76
SNB-H5aP	-10.31	629.42	28.17	322.70	-24.77	200.58	0.72
SNB-H5bP	-10.30	-322.70	24.77	131.09	1.11	-40.37	5.45
SNB-H5cP	-0.35	274.86	-20.70	300.21	55.37	121.15	7.31
SNB-H5dP	-0.36	-300.21	-55.37	-274.47	20.46	-121.07	-7.36
SNB-H5eP	10.64	-130.18	-1.15	321.92	-24.84	40.39	-5.48
SNB-H5fP	10.64	-321.92	24.84	-630.10	-27.87	-200.56	-0.63
SNB-H6aP	-48.43	613.88	9.06	523.96	-24.25	209.61	-2.78
SNB-H6bP	-48.42	-523.96	24.23	-127.79	-8.21	-120.06	2.95
SNB-H6cP	-0.13	482.20	-16.45	416.89	46.00	165.63	5.44
SNB-H6dP	-0.15	-416.89	-46.00	-482.76	16.56	-165.74	-5.42
SNB-H6eP	48.56	128.54	8.46	523.74	-22.85	120.16	-2.66
SNB-H6fP	48.56	-523.74	22.87	-613.96	-9.34	-209.59	2.51
SNB-H7aP	-43.72	695.55	-8.29	761.68	-30.76	238.51	-6.37
SNB-H7bP	-43.71	-761.68	30.73	-511.05	-17.26	-208.31	2.19
SNB-H7cP	0.03	707.64	-12.87	669.14	55.19	225.34	6.93
SNB-H7dP	-0.01	-669.14	-55.19	-707.57	13.01	-225.33	-6.90
SNB-H7eP	43.70	511.12	17.49	761.86	-29.53	208.35	-1.99
SNB-H7fP	43.72	-761.86	29.56	-695.75	7.99	-238.57	6.16
SNB-H8aP	-12.31	1011.21	-14.94	894.48	-33.81	280.64	-7.17
SNB-H8bP	-12.29	-894.48	33.80	-594.16	-8.59	-219.22	3.71
SNB-H8cP	-0.08	841.88	5.68	878.02	66.36	253.29	10.61
SNB-H8dP	-0.13	-878.02	-66.36	-842.44	-5.76	-253.37	-10.62
SNB-H8eP	12.41	594.72	8.50	894.30	-33.59	219.28	-3.70
SNB-H8fP	12.43	-894.30	33.60	-1011.27	15.15	-280.62	7.19
SNB-H9aP	-29.91	1109.73	-20.63	1044.06	-40.20	288.24	-8.12
SNB-H9bP	-29.89	-1044.06	40.17	-780.57	8.26	-244.19	6.47
SNB-H9cP	-0.00	1030.52	27.85	994.63	78.91	271.04	14.29
SNB-H9dP	-0.05	-994.63	-78.91	-1030.58	-27.87	-271.05	-14.29
SNB-H9eP	29.93	780.66	-8.29	1044.02	-40.15	244.19	-6.50
SNB-H9fP	29.95	-1044.01	40.18	-1109.82	20.73	-288.25	8.17

Equilibrium Joint Positions and Rotations for Load Case "4: 1.2D + 1.0Dg + 1.0E":

Joint Label	X-Displ (ft)	Y-Displ (ft)	Z-Displ (ft)	X-Rot (deg)	Y-Rot (deg)	Z-Rot (deg)	X-Pos (ft)	Y-Pos (ft)	Z-Pos (ft)
RohnAP	0.1402	0.0001	-0.01542	0.0000	0.0801	-0.0008	4.473	0.0001	180
RohnBP	0.1121	0.0001227	-0.01614	0.0000	0.0791	-0.0004	5.233	0.0001227	160
RohnCP	0.08512	0.0001146	-0.01595	-0.0000	0.0735	-0.0003	5.994	0.0001146	140
RohnDP	0.06112	9.869e-005	-0.01492	-0.0000	0.0625	-0.0002	6.756	9.869e-005	120
RohnEP	0.04136	7.468e-005	-0.01257	-0.0001	0.0488	-0.0001	7.522	7.468e-005	99.99
RohnFP	0.02609	4.385e-005	-0.01041	-0.0001	0.0359	-0.0001	8.294	4.385e-005	79.99
RohnGP	0.01451	1.717e-005	-0.008082	-0.0001	0.0272	-0.0001	9.07	1.717e-005	59.99
RohnHP	0.00642	2.553e-006	-0.005639	-0.0000	0.0178	-0.0000	9.847	2.553e-006	39.99
RohnIP	0.001686	-2.973e-006	-0.002709	-0.0000	0.0067	-0.0000	10.63	-2.973e-006	20
RohnJP	0	0	0	0.0000	0.0000	0.0000	11.42	0	0
SNB-AP	0.1403	0.0001679	-0.007814	-0.0000	0.0737	-0.0000	2.473	0.0001679	180
SNB-BP	0.1121	0.0001507	-0.008672	-0.0000	0.0743	-0.0000	3.233	0.0001507	160
SNB-CP	0.08513	0.0001365	-0.009107	-0.0001	0.0684	-0.0000	3.993	0.0001365	140
SNB-DP	0.06113	0.0001173	-0.008871	-0.0001	0.0545	-0.0000	4.756	0.0001173	120
SNB-EP	0.04137	9.182e-005	-0.007711	-0.0001	0.0432	-0.0000	5.522	9.182e-005	99.99
SNB-FP	0.0261	6.015e-005	-0.006871	-0.0001	0.0301	-0.0000	6.294	6.015e-005	79.99
SNB-GP	0.01451	3.151e-005	-0.005485	-0.0001	0.0168	-0.0000	7.07	3.151e-005	59.99
SNB-HP	0.006421	1.221e-005	-0.003942	-0.0000	0.0094	-0.0000	7.847	1.221e-005	40
SNB-IP	0.001686	2.297e-006	-0.001938	-0.0000	0.0009	-0.0000	8.63	2.297e-006	20
SNB-JP	0	0	0	0.0000	0.0000	0.0000	9.415	0	0
RohnA1	0.1402	0.0002079	-0.006409	-0.0007	0.0806	-0.0012	-2.026	-3.752	180
RohnA2	0.1403	0.000206	-0.006434	0.0003	0.0810	-0.0004	-2.026	3.753	180
RohnB1	0.1121	0.0001694	-0.005748	-0.0000	0.0802	-0.0012	-2.448	-4.435	160
RohnB2	0.1122	0.000158	-0.005749	-0.0001	0.0803	0.0004	-2.448	4.435	160
RohnC1	0.08505	0.0001777	-0.005017	-0.0002	0.0733	-0.0015	-2.869	-5.117	140
RohnC2	0.08509	0.0001181	-0.005026	0.0001	0.0733	0.0010	-2.869	5.117	140
RohnD1	0.06101	0.0001649	-0.004231	-0.0005	0.0632	-0.0015	-3.286	-5.798	120
RohnD2	0.06104	8.737e-005	-0.00424	0.0004	0.0632	0.0011	-3.286	5.798	120
RohnE1	0.04129	0.0001197	-0.003274	-0.0002	0.0489	-0.0012	-3.699	-6.479	100
RohnE2	0.04132	8.265e-005	-0.003295	0.0000	0.0489	0.0010	-3.699	6.479	100
RohnF1	0.02598	0.0001043	-0.002505	-0.0006	0.0398	-0.0011	-4.108	-7.16	80
RohnF2	0.02601	3.55e-005	-0.002535	0.0004	0.0398	0.0009	-4.108	7.16	80
RohnG1	0.01445	6.272e-005	-0.001836	-0.0002	0.0281	-0.0008	-4.513	-7.842	60
RohnG2	0.01447	1.545e-005	-0.001861	0.0001	0.0281	0.0007	-4.513	7.842	60
RohnH1	0.006352	4.33e-005	-0.001223	-0.0002	0.0187	-0.0005	-4.914	-8.523	40
RohnH2	0.006367	-9.692e-006	-0.001238	0.0001	0.0188	0.0005	-4.914	8.523	40
RohnI1	0.001635	2.455e-005	-0.0005824	-0.0005	0.0092	-0.0003	-5.313	-9.206	20
RohnI2	0.001642	-1.518e-005	-0.0005889	0.0005	0.0092	0.0003	-5.313	9.206	20
RohnJ1	0	0	0	0.0000	0.0000	0.0000	-5.71	-9.89	0
RohnJ2	0	0	0	0.0000	0.0000	0.0000	-5.71	9.89	0
SNB-A1	0.1403	0.0001674	-0.002891	-0.0060	0.0841	-0.0001	-1.026	-2.02	180
SNB-A2	0.1403	0.000169	-0.002896	0.0058	0.0841	0.0001	-1.026	2.021	180
SNB-B1	0.1122	0.0001501	-0.002267	-0.0038	0.0818	-0.0001	-1.448	-2.703	160
SNB-B2	0.1122	0.0001519	-0.002271	0.0038	0.0818	0.0001	-1.448	2.703	160
SNB-C1	0.08512	0.0001347	-0.001704	-0.0042	0.0761	-0.0002	-1.869	-3.384	140
SNB-C2	0.08512	0.0001389	-0.00171	0.0041	0.0761	0.0002	-1.869	3.385	140
SNB-D1	0.0611	0.0001146	-0.001251	-0.0070	0.0673	-0.0003	-2.286	-4.066	120
SNB-D2	0.0611	0.0001206	-0.00126	0.0068	0.0673	0.0003	-2.286	4.066	120
SNB-E1	0.04134	9.168e-005	-0.0009261	-0.0043	0.0509	-0.0003	-2.699	-4.747	100
SNB-E2	0.04134	9.245e-005	-0.0009396	0.0041	0.0509	0.0003	-2.699	4.747	100
SNB-F1	0.02606	5.681e-005	-0.0006791	-0.0062	0.0430	-0.0002	-3.108	-5.428	80
SNB-F2	0.02606	6.38e-005	-0.0006946	0.0060	0.0431	0.0002	-3.108	5.428	80
SNB-G1	0.01449	3.969e-005	-0.0004792	-0.0082	0.0330	-0.0003	-3.513	-6.11	60
SNB-G2	0.01449	2.359e-005	-0.0004929	0.0080	0.0330	0.0003	-3.513	6.11	60
SNB-H1	0.006387	2.259e-005	-0.0003088	-0.0075	0.0228	-0.0003	-3.914	-6.79	40
SNB-H2	0.006387	2.141e-006	-0.0003184	0.0074	0.0228	0.0003	-3.914	6.791	40
SNB-I1	0.001648	1.666e-005	-0.000148	-0.0057	0.0123	-0.0002	-4.312	-7.472	20
SNB-I2	0.001648	-1.185e-005	-0.0001524	0.0057	0.0123	0.0002	-4.312	7.472	20
SNB-J1	0	0	0	0.0000	0.0000	0.0000	-4.708	-8.154	0
SNB-J2	0	0	0	0.0000	0.0000	0.0000	-4.708	8.154	0



RohnAaS	0.1332	0.0001007	-0.01566	0.0000	0.0810	-0.0007	4.663	0.0001007	175
RohnAbS	0.1261	0.0001073	-0.01587	0.0002	0.0805	-0.0006	4.853	0.0001073	170
RohnAcS	0.1192	0.0001233	-0.01602	0.0001	0.0804	-0.0005	5.043	0.0001233	165
RohnBaS	0.1053	0.0001237	-0.01619	0.0000	0.0788	-0.0004	5.423	0.0001237	155
RohnBbS	0.09839	0.0001207	-0.01619	-0.0000	0.0774	-0.0003	5.613	0.0001207	150
RohnBcS	0.09174	0.000118	-0.01609	-0.0000	0.0761	-0.0003	5.804	0.000118	145
RohnCaS	0.07685	0.0001098	-0.01574	-0.0000	0.0693	-0.0002	6.248	0.0001098	133.3
RohnCbS	0.06884	0.0001038	-0.01541	-0.0000	0.0680	-0.0002	6.502	0.0001038	126.6
RohnDaS	0.05415	9.338e-005	-0.01428	-0.0001	0.0573	-0.0002	7.011	9.338e-005	113.3
RohnDbS	0.04758	8.406e-005	-0.01346	-0.0001	0.0553	-0.0001	7.267	8.406e-005	106.6
RohnEaS	0.03602	6.432e-005	-0.01191	-0.0001	0.0440	-0.0001	7.779	6.432e-005	93.33
RohnEbS	0.03088	5.348e-005	-0.01119	-0.0001	0.0435	-0.0001	8.037	5.348e-005	86.65
RohnFaS	0.02029	2.666e-005	-0.009298	-0.0001	0.0335	-0.0001	8.682	2.666e-005	69.99
RohnGaS	0.01049	6.567e-006	-0.006898	-0.0000	0.0231	-0.0000	9.458	6.567e-006	49.99
RohnHaS	0.004088	-1.584e-006	-0.004209	-0.0000	0.0137	-0.0000	10.24	-1.584e-006	30
RohnIaS	0.0008943	-2.634e-006	-0.001378	0.0000	0.0051	-0.0000	11.03	-2.634e-006	9.999
SNB-AaS	0.1332	0.000163	-0.008065	-0.0001	0.0828	-0.0000	2.663	0.000163	175
SNB-AbS	0.1262	0.0001552	-0.008299	-0.0000	0.0798	-0.0000	2.853	0.0001552	170
SNB-AcS	0.1192	0.0001545	-0.008501	-0.0000	0.0818	-0.0000	3.043	0.0001545	165
SNB-BaS	0.1053	0.0001479	-0.008831	-0.0000	0.0802	-0.0000	3.423	0.0001479	155
SNB-BbS	0.09841	0.0001445	-0.00896	-0.0000	0.0767	-0.0000	3.613	0.0001445	150
SNB-BcS	0.09175	0.0001409	-0.009049	-0.0000	0.0777	-0.0000	3.803	0.0001409	145
SNB-CaS	0.07686	0.0001305	-0.009103	-0.0001	0.0702	-0.0000	4.247	0.0001305	133.3
SNB-CbS	0.06885	0.0001241	-0.009013	-0.0001	0.0700	-0.0000	4.502	0.0001241	126.7
SNB-DaS	0.05416	0.0001101	-0.008577	-0.0001	0.0592	-0.0000	5.011	0.0001101	113.3
SNB-DbS	0.04759	0.0001013	-0.008173	-0.0001	0.0565	-0.0000	5.267	0.0001013	106.7
SNB-EaS	0.03603	8.173e-005	-0.007486	-0.0001	0.0453	-0.0000	5.779	8.173e-005	93.33
SNB-EbS	0.03088	7.077e-005	-0.007197	-0.0001	0.0448	-0.0000	6.037	7.077e-005	86.65
SNB-FaS	0.0203	4.412e-005	-0.006217	-0.0001	0.0377	-0.0000	6.682	4.412e-005	69.99
SNB-GaS	0.01049	1.991e-005	-0.004747	-0.0001	0.0279	-0.0000	7.458	1.991e-005	50
SNB-HaS	0.004089	5.349e-006	-0.002971	-0.0000	0.0174	-0.0000	8.239	5.349e-006	30
SNB-IaS	0.0008943	-1.31e-007	-0.0009932	-0.0000	0.0066	-0.0000	9.022	-1.31e-007	9.999
SNB-WL-A1S	0.1403	0.0001661	-0.005527	-0.0030	0.0789	0.0000	0.7235	-1.01	180
SNB-WL-A2S	0.1403	0.0001682	-0.003066	-0.0001	0.0841	-0.0000	-1.026	0.0001682	180
SNB-WL-A3S	0.1403	0.0001701	-0.005529	0.0029	0.0789	-0.0000	0.7235	1.01	180
SNB-WL-B1S	0.1122	0.0001493	-0.005729	-0.0014	0.0772	-0.0000	0.8924	-1.351	160
SNB-WL-B2S	0.1122	0.000151	-0.00252	-0.0000	0.0818	-0.0000	-1.448	0.000151	160
SNB-WL-B3S	0.1122	0.0001525	-0.005731	0.0014	0.0772	-0.0000	0.8924	1.352	160
SNB-WL-C1S	0.08513	0.0001353	-0.005898	-0.0014	0.0710	-0.0000	1.062	-1.692	140
SNB-WL-C2S	0.08513	0.0001368	-0.002193	-0.0000	0.0761	-0.0000	-1.869	0.0001368	140
SNB-WL-C3S	0.08513	0.0001381	-0.005901	0.0013	0.0710	0.0000	1.062	1.692	140
SNB-WL-D1S	0.06111	0.0001159	-0.006168	-0.0029	0.0599	-0.0001	1.235	-2.033	120
SNB-WL-D2S	0.06112	0.0001176	-0.002349	-0.0001	0.0673	-0.0000	-2.286	0.0001176	120
SNB-WL-D3S	0.06111	0.000119	-0.006172	0.0028	0.0599	0.0001	1.235	2.033	120
SNB-WL-E1S	0.04135	9.092e-005	-0.00509	-0.0015	0.0459	-0.0001	1.412	-2.373	99.99
SNB-WL-E2S	0.04136	9.206e-005	-0.001697	-0.0001	0.0509	-0.0000	-2.699	9.206e-005	100
SNB-WL-E3S	0.04135	9.297e-005	-0.005097	0.0014	0.0459	0.0001	1.412	2.373	99.99
SNB-WL-F1S	0.02608	5.889e-005	-0.005307	-0.0027	0.0358	-0.0001	1.593	-2.714	79.99
SNB-WL-F2S	0.02608	6.03e-005	-0.002172	-0.0001	0.0430	-0.0000	-3.108	6.03e-005	80
SNB-WL-F3S	0.02608	6.151e-005	-0.005315	0.0025	0.0359	0.0001	1.593	2.714	79.99
SNB-WL-G1S	0.0145	3.018e-005	-0.005761	-0.0040	0.0247	-0.0001	1.778	-3.055	59.99
SNB-WL-G2S	0.01451	3.164e-005	-0.003217	-0.0001	0.0330	-0.0000	-3.513	3.164e-005	60
SNB-WL-G3S	0.0145	3.294e-005	-0.005768	0.0039	0.0247	0.0001	1.778	3.055	59.99
SNB-WL-H1S	0.006407	1.123e-005	-0.006092	-0.0034	0.0155	-0.0001	1.967	-3.395	39.99
SNB-WL-H2S	0.006409	1.236e-005	-0.004272	-0.0000	0.0228	-0.0000	-3.914	1.236e-005	40
SNB-WL-H3S	0.006407	1.339e-005	-0.006097	0.0033	0.0155	0.0001	1.967	3.395	39.99
SNB-WL-I1S	0.001671	1.665e-006	-0.006432	-0.0027	0.0062	-0.0001	2.159	-3.736	19.99
SNB-WL-I2S	0.001672	2.405e-006	-0.005503	-0.0000	0.0123	0.0000	-4.312	2.405e-006	19.99
SNB-WL-I3S	0.001671	3.088e-006	-0.006434	0.0026	0.0062	0.0001	2.159	3.736	19.99
RohnAa1	0.1332	0.0001616	-0.006248	-0.0002	0.0805	-0.0012	-2.132	-3.923	175
RohnAa2	0.1333	0.0002177	-0.006263	-0.0003	0.0810	-0.0002	-2.132	3.923	175
RohnAb1	0.1261	0.000172	-0.006084	-0.0001	0.0810	-0.0012	-2.237	-4.094	170
RohnAb2	0.1262	0.0001778	-0.006089	-0.0002	0.0813	0.0000	-2.237	4.094	170
RohnAc1	0.1191	0.0001516	-0.005912	-0.0000	0.0801	-0.0012	-2.343	-4.264	165
RohnAc2	0.1191	0.0001881	-0.005915	-0.0001	0.0802	0.0002	-2.343	4.264	165
RohnBa1	0.1051	0.0001517	-0.005573	-0.0003	0.0785	-0.0013	-2.554	-4.605	155
RohnBa2	0.1052	0.00017	-0.005576	0.0002	0.0785	0.0006	-2.554	4.606	155
RohnBb1	0.09839	0.00014	-0.005407	-0.0001	0.0776	-0.0014	-2.659	-4.776	150
RohnBb2	0.09844	0.0001741	-0.005413	0.0000	0.0776	0.0007	-2.659	4.776	150

RohnBc1	0.09158	0.0001449	-0.005204	0.0003	0.0769	-0.0015	-2.764	-4.947	145
RohnBc2	0.09162	0.0001606	-0.005211	-0.0005	0.0769	0.0009	-2.764	4.947	145
RohnCa1	0.07665	0.0001068	-0.004783	-0.0007	0.0711	-0.0015	-3.009	-5.344	133.3
RohnCa2	0.07669	0.0001757	-0.004794	0.0005	0.0712	0.0011	-3.009	5.344	133.3
RohnCb1	0.06856	0.0001017	-0.004523	0.0006	0.0671	-0.0015	-3.148	-5.571	126.7
RohnCb2	0.06859	0.000165	-0.004533	-0.0007	0.0672	0.0011	-3.148	5.572	126.7
RohnDa1	0.05382	6.377e-005	-0.003927	-0.0007	0.0601	-0.0015	-3.425	-6.025	113.3
RohnDa2	0.05385	0.0001744	-0.00394	0.0005	0.0601	0.0011	-3.425	6.025	113.3
RohnDb1	0.04716	7.987e-005	-0.00358	0.0004	0.0534	-0.0013	-3.562	-6.252	106.7
RohnDb2	0.04719	0.0001414	-0.003597	-0.0006	0.0535	0.0010	-3.562	6.252	106.7
RohnEa1	0.03571	7.567e-005	-0.003011	-0.0003	0.0462	-0.0012	-3.836	-6.706	93.34
RohnEa2	0.03574	0.0001065	-0.003034	0.0001	0.0462	0.0010	-3.836	6.706	93.34
RohnEb1	0.03063	8.77e-005	-0.002751	0.0003	0.0412	-0.0011	-3.972	-6.933	86.66
RohnEb2	0.03066	7.35e-005	-0.002777	-0.0005	0.0412	0.0009	-3.972	6.933	86.66
RohnFa1	0.01941	-1.817e-005	-0.00215	-0.0001	0.0326	-0.0009	-4.311	-7.501	70
RohnFa2	0.01944	0.0001246	-0.002177	-0.0001	0.0326	0.0007	-4.311	7.501	70
RohnGa1	0.00967	-4.116e-005	-0.001516	-0.0001	0.0231	-0.0006	-4.714	-8.182	50
RohnGa2	0.009688	9.42e-005	-0.001536	-0.0001	0.0231	0.0006	-4.714	8.182	50
RohnHa1	0.003196	-7.738e-005	-0.0008881	0.0000	0.0133	-0.0004	-5.115	-8.864	30
RohnHa2	0.003206	9.655e-005	-0.0008987	-0.0001	0.0133	0.0003	-5.115	8.864	30
RohnIa1	0.000166	-9.913e-005	-0.000284	-0.0001	0.0048	-0.0001	-5.512	-9.548	10
RohnIa2	0.0001693	0.0001023	-0.0002872	0.0000	0.0048	0.0001	-5.512	9.548	10
SNB-Aa1	0.1332	0.0001388	-0.002732	0.0015	0.0799	-0.0002	-1.132	-2.191	175
SNB-Aa2	0.1332	0.0001845	-0.002736	-0.0017	0.0799	0.0002	-1.132	2.191	175
SNB-Ab1	0.1262	0.0001565	-0.002573	-0.0006	0.0815	-0.0002	-1.237	-2.361	170
SNB-Ab2	0.1262	0.0001584	-0.002577	0.0006	0.0815	0.0002	-1.237	2.362	170
SNB-Ac1	0.1191	0.0001397	-0.002416	0.0011	0.0795	-0.0002	-1.343	-2.532	165
SNB-Ac2	0.1191	0.0001668	-0.00242	-0.0011	0.0795	0.0002	-1.343	2.532	165
SNB-Ba1	0.1052	0.0001232	-0.002112	0.0011	0.0785	-0.0002	-1.554	-2.873	155
SNB-Ba2	0.1052	0.0001728	-0.002117	-0.0012	0.0785	0.0002	-1.554	2.873	155
SNB-Bb1	0.09837	0.000152	-0.001968	-0.0005	0.0781	-0.0002	-1.659	-3.043	150
SNB-Bb2	0.09837	0.0001376	-0.001973	0.0005	0.0781	0.0002	-1.659	3.044	150
SNB-Bc1	0.09162	0.0001223	-0.00183	0.0010	0.0753	-0.0002	-1.764	-3.214	145
SNB-Bc2	0.09162	0.0001599	-0.001835	-0.0011	0.0753	0.0002	-1.764	3.214	145
SNB-Ca1	0.07661	0.0001258	-0.001535	0.0005	0.0715	-0.0003	-2.008	-3.611	133.3
SNB-Ca2	0.07661	0.0001351	-0.001542	-0.0006	0.0715	0.0003	-2.008	3.612	133.3
SNB-Cb1	0.06855	0.0001056	-0.001377	0.0015	0.0652	-0.0003	-2.148	-3.839	126.7
SNB-Cb2	0.06855	0.0001425	-0.001385	-0.0017	0.0652	0.0003	-2.148	3.839	126.7
SNB-Da1	0.05379	7.808e-005	-0.001117	0.0013	0.0600	-0.0004	-2.425	-4.293	113.3
SNB-Da2	0.05379	0.000142	-0.001128	-0.0015	0.0600	0.0004	-2.425	4.293	113.3
SNB-Db1	0.04714	8.8e-005	-0.001	0.0008	0.0525	-0.0003	-2.562	-4.52	106.7
SNB-Db2	0.04714	0.0001153	-0.001012	-0.0010	0.0525	0.0003	-2.562	4.52	106.7
SNB-Ea1	0.03575	4.89e-005	-0.0008264	0.0005	0.0460	-0.0003	-2.836	-4.974	93.34
SNB-Ea2	0.03575	0.000115	-0.0008408	-0.0007	0.0460	0.0003	-2.836	4.974	93.34
SNB-Eb1	0.03066	6.842e-005	-0.0007416	0.0014	0.0402	-0.0002	-2.972	-5.201	86.66
SNB-Eb2	0.03066	7.421e-005	-0.0007568	-0.0016	0.0402	0.0002	-2.972	5.201	86.66
SNB-Fa1	0.01938	2.428e-006	-0.000555	0.0035	0.0307	-0.0002	-3.311	-5.769	70
SNB-Fa2	0.01937	8.803e-005	-0.0005701	-0.0037	0.0307	0.0002	-3.311	5.769	70
SNB-Ga1	0.009669	-4.124e-005	-0.0003733	0.0038	0.0209	-0.0003	-3.714	-6.45	50
SNB-Ga2	0.009669	8.304e-005	-0.0003851	-0.0039	0.0209	0.0003	-3.714	6.45	50
SNB-Ha1	0.003211	-8.647e-005	-0.0002078	0.0032	0.0116	-0.0002	-4.114	-7.131	30
SNB-Ha2	0.003211	9.903e-005	-0.0002149	-0.0033	0.0116	0.0002	-4.114	7.131	30
SNB-Ia1	0.0001501	-8.991e-005	-5.823e-005	0.0013	0.0040	-0.0001	-4.511	-7.813	10
SNB-Ia2	0.0001495	9.082e-005	-6.042e-005	-0.0013	0.0040	0.0001	-4.511	7.813	10

Joint Support Reactions for Load Case "4: 1.2D + 1.0Dg + 1.0E":

Joint Label	X Force (kips)	X Usage % (kips)	Y Force (kips)	Y Usage % (kips)	Z Comp. Force (kips)	Z Usage % (kips)	Uplift Usage %	Result. Force (kips)	Result. Usage % (ft-k)	X Moment Usage % (ft-k)	X-M. Moment Usage % (ft-k)	Y Moment Usage % (ft-k)	Y-M. Moment Usage % (ft-k)	Z Moment Usage % (ft-k)	Z-M. Moment Usage % (ft-k)	Max. Usage %
RohnJP	-2.53	0.0	0.00	0.0	41.68	0.0	0.0	41.76	0.0	-0.00	0.0	-0.6	0.0	0.00	0.0	0.0
SNB-JP	-3.06	0.0	0.00	0.0	49.49	0.0	0.0	49.58	0.0	-0.00	0.0	-1.2	0.0	-0.00	0.0	0.0
RohnJ1	0.11	0.0	0.32	0.0	8.93	0.0	0.0	8.94	0.0	-0.09	0.0	0.1	0.0	-0.00	0.0	0.0
RohnJ2	0.10	0.0	-0.33	0.0	9.02	0.0	0.0	9.03	0.0	0.10	0.0	0.1	0.0	0.00	0.0	0.0
SNB-J1	-0.46	0.0	-0.55	0.0	2.95	0.0	0.0	3.03	0.0	-0.03	0.0	0.2	0.0	-0.01	0.0	0.0
SNB-J2	-0.46	0.0	0.55	0.0	3.05	0.0	0.0	3.13	0.0	0.03	0.0	0.2	0.0	0.01	0.0	0.0

Joint Displacements, Loads and Member Forces on Joints for Load Case "4: 1.2D + 1.0Dg + 1.0E":

Joint Label	X External Load (kips)	Y External Load (kips)	Z External Load (kips)	X Member Force (kips)	Y Member Force (kips)	Z Member Force (kips)	X Disp. (ft)	Y Disp. (ft)	Z Disp. (ft)
RohnAP	0.0989	0.0000	-0.3561	-0.0989	0.0000	0.3561	0.1402	0.0001	-0.0154
RohnBP	0.1987	0.0000	-1.2758	-0.1987	0.0000	1.2758	0.1121	0.0001	-0.0161
RohnCP	0.0458	0.0000	-0.5163	-0.0458	0.0000	0.5163	0.0851	0.0001	-0.0159
RohnDP	0.0374	0.0000	-0.6254	-0.0374	0.0000	0.6254	0.0611	0.0001	-0.0149
RohnEP	0.0371	0.0000	-0.7740	-0.0371	0.0000	0.7740	0.0414	0.0001	-0.0126
RohnFP	0.0405	0.0000	-1.0489	-0.0405	0.0000	1.0489	0.0261	0.0000	-0.0104
RohnGP	0.0390	0.0000	-1.3961	-0.0390	0.0000	1.3961	0.0145	0.0000	-0.0081
RohnHP	0.0254	0.0000	-1.3896	-0.0254	0.0000	1.3896	0.0064	0.0000	-0.0056
RohnIP	0.0173	0.0000	-1.5585	-0.0173	0.0000	1.5585	0.0017	-0.0000	-0.0027
RohnJP	0.0000	0.0000	-0.8421	2.5337	-0.0032	-40.8381	0.0000	0.0000	0.0000
SNB-AP	0.0522	0.0000	-0.1881	-0.0522	0.0000	0.1881	0.1403	0.0002	-0.0078
SNB-BP	0.0634	0.0000	-0.4070	-0.0634	0.0000	0.4070	0.1121	0.0002	-0.0087
SNB-CP	0.0458	0.0000	-0.5163	-0.0458	0.0000	0.5163	0.0851	0.0001	-0.0091
SNB-DP	0.0374	0.0000	-0.6254	-0.0374	0.0000	0.6254	0.0611	0.0001	-0.0089
SNB-EP	0.0371	0.0000	-0.7740	-0.0371	0.0000	0.7740	0.0414	0.0001	-0.0077
SNB-FP	0.0405	0.0000	-1.0489	-0.0405	0.0000	1.0489	0.0261	0.0001	-0.0069
SNB-GP	0.0357	0.0000	-1.2761	-0.0357	0.0000	1.2761	0.0145	0.0000	-0.0055
SNB-HP	0.0254	0.0000	-1.3896	-0.0254	0.0000	1.3896	0.0064	0.0000	-0.0039
SNB-IP	0.0173	0.0000	-1.5585	-0.0173	-0.0000	1.5585	0.0017	0.0000	-0.0019
SNB-JP	0.0000	0.0000	-0.8421	3.0562	-0.0012	-48.6449	0.0000	0.0000	0.0000
RohnA1	0.0989	0.0000	-0.3561	-0.0989	0.0000	0.3561	0.1402	0.0002	-0.0064
RohnA2	0.1455	0.0000	-0.5241	-0.1455	-0.0000	0.5241	0.1403	0.0002	-0.0064
RohnB1	0.0847	0.0000	-0.5438	-0.0847	0.0000	0.5438	0.1121	0.0002	-0.0057
RohnB2	0.0726	0.0000	-0.4658	-0.0726	-0.0000	0.4658	0.1122	0.0002	-0.0057
RohnC1	0.0458	0.0000	-0.5163	-0.0458	0.0000	0.5163	0.0851	0.0002	-0.0050
RohnC2	0.0458	0.0000	-0.5163	-0.0458	-0.0000	0.5163	0.0851	0.0001	-0.0050
RohnD1	0.0424	0.0000	-0.7094	-0.0424	0.0000	0.7094	0.0610	0.0002	-0.0042
RohnD2	0.0374	0.0000	-0.6254	-0.0374	-0.0000	0.6254	0.0610	0.0001	-0.0042
RohnE1	0.0371	0.0000	-0.7740	-0.0371	0.0000	0.7740	0.0413	0.0001	-0.0033
RohnE2	0.0371	0.0000	-0.7740	-0.0371	-0.0000	0.7740	0.0413	0.0001	-0.0033
RohnF1	0.0405	0.0000	-1.0489	-0.0405	0.0000	1.0489	0.0260	0.0001	-0.0025
RohnF2	0.0473	0.0000	-1.2229	-0.0473	-0.0000	1.2229	0.0260	0.0000	-0.0025
RohnG1	0.0377	0.0000	-1.3481	-0.0377	0.0000	1.3481	0.0144	0.0001	-0.0018
RohnG2	0.0409	0.0000	-1.4633	-0.0409	-0.0000	1.4633	0.0145	0.0000	-0.0019
RohnH1	0.0254	0.0000	-1.3896	-0.0254	0.0000	1.3896	0.0064	0.0000	-0.0012
RohnH2	0.0254	0.0000	-1.3896	-0.0254	-0.0000	1.3896	0.0064	-0.0000	-0.0012
RohnI1	0.0173	0.0000	-1.5585	-0.0173	0.0000	1.5585	0.0016	0.0000	-0.0006
RohnI2	0.0173	0.0000	-1.5585	-0.0173	0.0000	1.5585	0.0016	-0.0000	-0.0006
RohnJ1	0.0000	0.0000	-0.8421	-0.1069	-0.3239	-8.0868	0.0000	0.0000	0.0000
RohnJ2	0.0000	0.0000	-0.8421	-0.1039	0.3275	-8.1779	0.0000	0.0000	0.0000
SNB-A1	0.0522	0.0000	-0.1881	-0.0522	-0.0000	0.1881	0.1403	0.0002	-0.0029
SNB-A2	0.0522	0.0000	-0.1881	-0.0522	0.0000	0.1881	0.1403	0.0002	-0.0029
SNB-B1	0.0634	0.0000	-0.4070	-0.0634	-0.0000	0.4070	0.1122	0.0002	-0.0023
SNB-B2	0.0634	0.0000	-0.4070	-0.0634	0.0000	0.4070	0.1122	0.0002	-0.0023
SNB-C1	0.0458	0.0000	-0.5163	-0.0458	-0.0000	0.5163	0.0851	0.0001	-0.0017
SNB-C2	0.0458	0.0000	-0.5163	-0.0458	0.0000	0.5163	0.0851	0.0001	-0.0017
SNB-D1	0.0374	0.0000	-0.6254	-0.0374	-0.0000	0.6254	0.0611	0.0001	-0.0013
SNB-D2	0.0374	0.0000	-0.6254	-0.0374	0.0000	0.6254	0.0611	0.0001	-0.0013
SNB-E1	0.0371	0.0000	-0.7740	-0.0371	-0.0000	0.7740	0.0413	0.0001	-0.0009
SNB-E2	0.0371	0.0000	-0.7740	-0.0371	0.0000	0.7740	0.0413	0.0001	-0.0009
SNB-F1	0.0405	0.0000	-1.0489	-0.0405	-0.0000	1.0489	0.0261	0.0001	-0.0007
SNB-F2	0.0405	0.0000	-1.0489	-0.0405	0.0000	1.0489	0.0261	0.0001	-0.0007
SNB-G1	0.0357	0.0000	-1.2761	-0.0357	-0.0000	1.2761	0.0145	0.0000	-0.0005
SNB-G2	0.0357	0.0000	-1.2761	-0.0357	0.0000	1.2761	0.0145	0.0000	-0.0005
SNB-H1	0.0254	0.0000	-1.3896	-0.0254	-0.0000	1.3896	0.0064	0.0000	-0.0003
SNB-H2	0.0254	0.0000	-1.3896	-0.0254	0.0000	1.3896	0.0064	0.0000	-0.0003
SNB-I1	0.0173	0.0000	-1.5585	-0.0173	-0.0000	1.5585	0.0016	0.0000	-0.0001
SNB-I2	0.0173	0.0000	-1.5585	-0.0173	-0.0000	1.5585	0.0016	-0.0000	-0.0002
SNB-J1	0.0000	0.0000	-0.8421	0.4589	0.5467	-2.1073	0.0000	0.0000	0.0000
SNB-J2	0.0000	0.0000	-0.8421	0.4572	-0.5458	-2.2091	0.0000	0.0000	0.0000
RohnAaS	0.0606	0.0000	-0.2508	-0.0606	0.0000	0.2508	0.1332	0.0001	-0.0157
RohnAbS	0.0393	0.0000	-0.1881	-0.0393	0.0000	0.1881	0.1261	0.0001	-0.0159
RohnAcS	0.0455	0.0000	-0.2520	-0.0455	0.0000	0.2520	0.1192	0.0001	-0.0160

RohnBaS	0.0294	0.0000	-0.2189	-0.0294	0.0000	0.2189	0.1053	0.0001	-0.0162
RohnBbS	0.1348	0.0000	-1.1599	-0.1348	0.0000	1.1599	0.0984	0.0001	-0.0162
RohnBcS	0.0221	0.0000	-0.2189	-0.0221	0.0000	0.2189	0.0917	0.0001	-0.0161
RohnCaS	0.0728	0.0000	-0.9601	-0.0728	0.0000	0.9601	0.0769	0.0001	-0.0157
RohnCbS	0.1131	0.0000	-1.7009	-0.1131	0.0000	1.7009	0.0688	0.0001	-0.0154
RohnDaS	0.0835	0.0000	-1.5215	-0.0835	0.0000	1.5215	0.0542	0.0001	-0.0143
RohnDbS	0.0168	0.0000	-0.3280	-0.0168	0.0000	0.3280	0.0476	0.0001	-0.0135
RohnEaS	0.0201	0.0000	-0.4460	-0.0201	0.0000	0.4460	0.0360	0.0001	-0.0119
RohnEbS	0.0187	0.0000	-0.4460	-0.0187	0.0000	0.4460	0.0309	0.0001	-0.0112
RohnFaS	0.0201	0.0000	-0.6029	-0.0201	0.0000	0.6029	0.0203	0.0000	-0.0093
RohnGaS	0.0154	0.0000	-0.6732	-0.0154	0.0000	0.6732	0.0105	0.0000	-0.0069
RohnHaS	0.0104	0.0000	-0.7165	-0.0104	0.0000	0.7165	0.0041	-0.0000	-0.0042
RohnIaS	0.0059	0.0000	-0.8421	-0.0059	0.0000	0.8421	0.0009	-0.0000	-0.0014
SNB-AaS	0.0454	0.0000	-0.1881	-0.0454	0.0000	0.1881	0.1332	0.0002	-0.0081
SNB-AbS	0.0393	0.0000	-0.1881	-0.0393	0.0000	0.1881	0.1262	0.0002	-0.0083
SNB-AcS	0.0340	0.0000	-0.1881	-0.0340	0.0000	0.1881	0.1192	0.0002	-0.0085
SNB-BaS	0.0294	0.0000	-0.2189	-0.0294	0.0000	0.2189	0.1053	0.0001	-0.0088
SNB-BbS	0.0254	0.0000	-0.2189	-0.0254	0.0000	0.2189	0.0984	0.0001	-0.0090
SNB-BcS	0.0221	0.0000	-0.2189	-0.0221	0.0000	0.2189	0.0918	0.0001	-0.0090
SNB-CaS	0.0226	0.0000	-0.2974	-0.0226	0.0000	0.2974	0.0769	0.0001	-0.0091
SNB-CbS	0.0198	0.0000	-0.2974	-0.0198	0.0000	0.2974	0.0688	0.0001	-0.0090
SNB-DaS	0.0180	0.0000	-0.3280	-0.0180	0.0000	0.3280	0.0542	0.0001	-0.0086
SNB-DbS	0.0168	0.0000	-0.3280	-0.0168	0.0000	0.3280	0.0476	0.0001	-0.0082
SNB-EaS	0.0201	0.0000	-0.4460	-0.0201	0.0000	0.4460	0.0360	0.0001	-0.0075
SNB-EbS	0.0187	0.0000	-0.4460	-0.0187	0.0000	0.4460	0.0309	0.0001	-0.0072
SNB-FaS	0.0201	0.0000	-0.6029	-0.0201	0.0000	0.6029	0.0203	0.0000	-0.0062
SNB-GaS	0.0154	0.0000	-0.6732	-0.0154	0.0000	0.6732	0.0105	0.0000	-0.0047
SNB-HaS	0.0104	0.0000	-0.7165	-0.0104	0.0000	0.7165	0.0041	0.0000	-0.0030
SNB-IaS	0.0059	0.0000	-0.8421	-0.0059	0.0000	0.8421	0.0009	-0.0000	-0.0010
SNB-WL-A1S	0.0522	0.0000	-0.1881	-0.0522	0.0000	0.1881	0.1403	0.0002	-0.0055
SNB-WL-A2S	0.0522	0.0000	-0.1881	-0.0522	0.0000	0.1881	0.1403	0.0002	-0.0031
SNB-WL-A3S	0.0522	0.0000	-0.1881	-0.0522	-0.0000	0.1881	0.1403	0.0002	-0.0055
SNB-WL-B1S	0.0293	0.0000	-0.1881	-0.0293	0.0000	0.1881	0.1122	0.0001	-0.0057
SNB-WL-B2S	0.0293	0.0000	-0.1881	-0.0293	0.0000	0.1881	0.1122	0.0002	-0.0025
SNB-WL-B3S	0.0293	0.0000	-0.1881	-0.0293	-0.0000	0.1881	0.1122	0.0002	-0.0057
SNB-WL-C1S	0.0194	0.0000	-0.2189	-0.0194	0.0000	0.2189	0.0851	0.0001	-0.0059
SNB-WL-C2S	0.0194	0.0000	-0.2189	-0.0194	0.0000	0.2189	0.0851	0.0001	-0.0022
SNB-WL-C3S	0.0194	0.0000	-0.2189	-0.0194	-0.0000	0.2189	0.0851	0.0001	-0.0059
SNB-WL-D1S	0.0178	0.0000	-0.2974	-0.0178	0.0000	0.2974	0.0611	0.0001	-0.0062
SNB-WL-D2S	0.0178	0.0000	-0.2974	-0.0178	0.0000	0.2974	0.0611	0.0001	-0.0023
SNB-WL-D3S	0.0178	0.0000	-0.2974	-0.0178	-0.0000	0.2974	0.0611	0.0001	-0.0062
SNB-WL-E1S	0.0157	0.0000	-0.3280	-0.0157	0.0000	0.3280	0.0414	0.0001	-0.0051
SNB-WL-E2S	0.0157	0.0000	-0.3280	-0.0157	0.0000	0.3280	0.0414	0.0001	-0.0017
SNB-WL-E3S	0.0157	0.0000	-0.3280	-0.0157	-0.0000	0.3280	0.0414	0.0001	-0.0051
SNB-WL-F1S	0.0172	0.0000	-0.4460	-0.0172	0.0000	0.4460	0.0261	0.0001	-0.0053
SNB-WL-F2S	0.0172	0.0000	-0.4460	-0.0172	0.0000	0.4460	0.0261	0.0001	-0.0022
SNB-WL-F3S	0.0172	0.0000	-0.4460	-0.0172	-0.0000	0.4460	0.0261	0.0001	-0.0053
SNB-WL-G1S	0.0169	0.0000	-0.6029	-0.0169	0.0000	0.6029	0.0145	0.0000	-0.0058
SNB-WL-G2S	0.0169	0.0000	-0.6029	-0.0169	0.0000	0.6029	0.0145	0.0000	-0.0032
SNB-WL-G3S	0.0169	0.0000	-0.6029	-0.0169	-0.0000	0.6029	0.0145	0.0000	-0.0058
SNB-WL-H1S	0.0123	0.0000	-0.6732	-0.0123	0.0000	0.6732	0.0064	0.0000	-0.0061
SNB-WL-H2S	0.0123	0.0000	-0.6732	-0.0123	0.0000	0.6732	0.0064	0.0000	-0.0043
SNB-WL-H3S	0.0123	0.0000	-0.6732	-0.0123	-0.0000	0.6732	0.0064	0.0000	-0.0061
SNB-WL-I1S	0.0080	0.0000	-0.7165	-0.0080	0.0000	0.7165	0.0017	0.0000	-0.0064
SNB-WL-I2S	0.0080	0.0000	-0.7165	-0.0080	0.0000	0.7165	0.0017	0.0000	-0.0055
SNB-WL-I3S	0.0080	0.0000	-0.7165	-0.0080	-0.0000	0.7165	0.0017	0.0000	-0.0064
RohnAa1	0.0667	0.0000	-0.2763	-0.0667	0.0000	0.2763	0.1332	0.0002	-0.0062
RohnAa2	0.0734	0.0000	-0.3039	-0.0734	-0.0000	0.3039	0.1333	0.0002	-0.0063
RohnAb1	0.0695	0.0000	-0.3321	-0.0695	0.0000	0.3321	0.1261	0.0002	-0.0061
RohnAb2	0.0393	0.0000	-0.1881	-0.0393	-0.0000	0.1881	0.1262	0.0002	-0.0061
RohnAc1	0.0340	0.0000	-0.1881	-0.0340	0.0000	0.1881	0.1191	0.0002	-0.0059
RohnAc2	0.0340	0.0000	-0.1881	-0.0340	-0.0000	0.1881	0.1191	0.0002	-0.0059
RohnBa1	0.0294	0.0000	-0.2189	-0.0294	0.0000	0.2189	0.1051	0.0002	-0.0056
RohnBa2	0.0294	0.0000	-0.2189	-0.0294	-0.0000	0.2189	0.1052	0.0002	-0.0056
RohnBb1	0.1310	0.0000	-1.1275	-0.1310	0.0000	1.1275	0.0984	0.0001	-0.0054
RohnBb2	0.1310	0.0000	-1.1275	-0.1310	-0.0000	1.1275	0.0984	0.0002	-0.0054
RohnBc1	0.0221	0.0000	-0.2189	-0.0221	0.0000	0.2189	0.0916	0.0001	-0.0052
RohnBc2	0.0221	0.0000	-0.2189	-0.0221	-0.0000	0.2189	0.0916	0.0002	-0.0052
RohnCa1	0.0783	0.0000	-1.0321	-0.0783	0.0000	1.0321	0.0766	0.0001	-0.0048

RohnCa2	0.0819	0.0000	-1.0801	-0.0819	-0.0000	1.0801	0.0767	0.0002	-0.0048
RohnCb1	0.1087	0.0000	-1.6349	-0.1087	0.0000	1.6349	0.0686	0.0001	-0.0045
RohnCb2	0.1087	0.0000	-1.6349	-0.1087	-0.0000	1.6349	0.0686	0.0002	-0.0045
RohnDa1	0.0766	0.0000	-1.3955	-0.0766	0.0000	1.3955	0.0538	0.0001	-0.0039
RohnDa2	0.0766	0.0000	-1.3955	-0.0766	-0.0000	1.3955	0.0539	0.0002	-0.0039
RohnDb1	0.0168	0.0000	-0.3280	-0.0168	0.0000	0.3280	0.0472	0.0001	-0.0036
RohnDb2	0.0168	0.0000	-0.3280	-0.0168	-0.0000	0.3280	0.0472	0.0001	-0.0036
RohnEa1	0.0201	0.0000	-0.4460	-0.0201	0.0000	0.4460	0.0357	0.0001	-0.0030
RohnEa2	0.0201	0.0000	-0.4460	-0.0201	-0.0000	0.4460	0.0357	0.0001	-0.0030
RohnEb1	0.0187	0.0000	-0.4460	-0.0187	0.0000	0.4460	0.0306	0.0001	-0.0028
RohnEb2	0.0187	0.0000	-0.4460	-0.0187	-0.0000	0.4460	0.0307	0.0001	-0.0028
RohnFa1	0.0201	0.0000	-0.6029	-0.0201	0.0000	0.6029	0.0194	-0.0000	-0.0022
RohnFa2	0.0201	0.0000	-0.6029	-0.0201	-0.0000	0.6029	0.0194	0.0001	-0.0022
RohnGa1	0.0154	0.0000	-0.6732	-0.0154	0.0000	0.6732	0.0097	-0.0000	-0.0015
RohnGa2	0.0154	0.0000	-0.6732	-0.0154	-0.0000	0.6732	0.0097	0.0001	-0.0015
RohnHa1	0.0104	0.0000	-0.7165	-0.0104	0.0000	0.7165	0.0032	-0.0001	-0.0009
RohnHa2	0.0104	0.0000	-0.7165	-0.0104	-0.0000	0.7165	0.0032	0.0001	-0.0009
RohnIa1	0.0059	0.0000	-0.8421	-0.0059	0.0000	0.8421	0.0002	-0.0001	-0.0003
RohnIa2	0.0059	0.0000	-0.8421	-0.0059	0.0000	0.8421	0.0002	0.0001	-0.0003
SNB-Aa1	0.0454	0.0000	-0.1881	-0.0454	-0.0000	0.1881	0.1332	0.0001	-0.0027
SNB-Aa2	0.0454	0.0000	-0.1881	-0.0454	0.0000	0.1881	0.1332	0.0002	-0.0027
SNB-Ab1	0.0393	0.0000	-0.1881	-0.0393	-0.0000	0.1881	0.1262	0.0002	-0.0026
SNB-Ab2	0.0393	0.0000	-0.1881	-0.0393	0.0000	0.1881	0.1262	0.0002	-0.0026
SNB-Ac1	0.0340	0.0000	-0.1881	-0.0340	-0.0000	0.1881	0.1191	0.0001	-0.0024
SNB-Ac2	0.0340	0.0000	-0.1881	-0.0340	0.0000	0.1881	0.1191	0.0002	-0.0024
SNB-Ba1	0.0294	0.0000	-0.2189	-0.0294	-0.0000	0.2189	0.1052	0.0001	-0.0021
SNB-Ba2	0.0294	0.0000	-0.2189	-0.0294	0.0000	0.2189	0.1052	0.0002	-0.0021
SNB-Bb1	0.0254	0.0000	-0.2189	-0.0254	-0.0000	0.2189	0.0984	0.0002	-0.0020
SNB-Bb2	0.0254	0.0000	-0.2189	-0.0254	0.0000	0.2189	0.0984	0.0001	-0.0020
SNB-Bc1	0.0221	0.0000	-0.2189	-0.0221	-0.0000	0.2189	0.0916	0.0001	-0.0018
SNB-Bc2	0.0221	0.0000	-0.2189	-0.0221	0.0000	0.2189	0.0916	0.0002	-0.0018
SNB-Ca1	0.0226	0.0000	-0.2974	-0.0226	-0.0000	0.2974	0.0766	0.0001	-0.0015
SNB-Ca2	0.0226	0.0000	-0.2974	-0.0226	0.0000	0.2974	0.0766	0.0001	-0.0015
SNB-Cb1	0.0198	0.0000	-0.2974	-0.0198	-0.0000	0.2974	0.0685	0.0001	-0.0014
SNB-Cb2	0.0198	0.0000	-0.2974	-0.0198	0.0000	0.2974	0.0685	0.0001	-0.0014
SNB-Da1	0.0180	0.0000	-0.3280	-0.0180	-0.0000	0.3280	0.0538	0.0001	-0.0011
SNB-Da2	0.0180	0.0000	-0.3280	-0.0180	0.0000	0.3280	0.0538	0.0001	-0.0011
SNB-Db1	0.0168	0.0000	-0.3280	-0.0168	-0.0000	0.3280	0.0471	0.0001	-0.0010
SNB-Db2	0.0168	0.0000	-0.3280	-0.0168	0.0000	0.3280	0.0471	0.0001	-0.0010
SNB-Ea1	0.0201	0.0000	-0.4460	-0.0201	-0.0000	0.4460	0.0358	0.0000	-0.0008
SNB-Ea2	0.0201	0.0000	-0.4460	-0.0201	0.0000	0.4460	0.0358	0.0001	-0.0008
SNB-Eb1	0.0187	0.0000	-0.4460	-0.0187	-0.0000	0.4460	0.0307	0.0001	-0.0007
SNB-Eb2	0.0187	0.0000	-0.4460	-0.0187	0.0000	0.4460	0.0307	0.0001	-0.0008
SNB-Fa1	0.0201	0.0000	-0.6029	-0.0201	-0.0000	0.6029	0.0194	0.0000	-0.0006
SNB-Fa2	0.0201	0.0000	-0.6029	-0.0201	0.0000	0.6029	0.0194	0.0001	-0.0006
SNB-Ga1	0.0154	0.0000	-0.6732	-0.0154	-0.0000	0.6732	0.0097	-0.0000	-0.0004
SNB-Ga2	0.0154	0.0000	-0.6732	-0.0154	0.0000	0.6732	0.0097	0.0001	-0.0004
SNB-Ha1	0.0104	0.0000	-0.7165	-0.0104	-0.0000	0.7165	0.0032	-0.0001	-0.0002
SNB-Ha2	0.0104	0.0000	-0.7165	-0.0104	0.0000	0.7165	0.0032	0.0001	-0.0002
SNB-Ia1	0.0059	0.0000	-0.8421	-0.0059	-0.0000	0.8421	0.0002	-0.0001	-0.0001
SNB-Ia2	0.0059	0.0000	-0.8421	-0.0059	0.0000	0.8421	0.0001	0.0001	-0.0001

**Moments for Angles Modeled as Beams:**

Angle Label	Torsion (ft-lbs)	Origin X Moment (ft-lbs)	Origin Y Moment (ft-lbs)	End X Moment (ft-lbs)	End Y Moment (ft-lbs)	X Shear (lbs)	Y Shear (lbs)
Rohn-LA1P	-0.19	0.10	0.79	-0.08	-4.20	0.00	-0.68
Rohn-LA11	0.01	-0.40	0.44	-3.35	1.39	-0.75	0.36
Rohn-LA12	-0.41	0.38	0.63	3.35	0.59	0.74	0.24
Rohn-LA2P	-0.19	0.08	4.20	-0.64	6.78	-0.11	2.19
Rohn-LA21	0.01	3.35	-1.39	2.99	-4.31	1.27	-1.14
Rohn-LA22	-0.41	-3.35	-0.59	-3.96	-1.82	-1.46	-0.48
Rohn-LA3P	-0.19	0.64	-6.78	1.01	-6.19	0.33	-2.59
Rohn-LA31	0.01	-2.99	4.31	-3.18	9.21	-1.23	2.70
Rohn-LA32	-0.41	3.96	1.82	3.66	7.48	1.52	1.86
Rohn-LA4P	-0.19	-1.01	6.19	-0.48	12.85	-0.30	3.80
Rohn-LA41	0.01	3.18	-9.21	3.01	-9.81	1.24	-3.80

Rohn-LA42	-0.41	-3.66	-7.48	-3.59	-8.27	-1.45	-3.15
Rohn-LB1P	-0.11	0.49	-11.64	0.44	-9.13	0.19	-4.15
Rohn-LB11	0.41	-3.42	10.56	-1.36	24.38	-0.95	6.98
Rohn-LB12	-0.63	3.95	9.04	1.61	23.71	1.11	6.55
Rohn-LB2P	-0.11	-0.44	9.13	-0.16	21.19	-0.12	6.06
Rohn-LB21	0.41	1.36	-24.38	0.30	-16.70	0.33	-8.21
Rohn-LB22	-0.63	-1.61	-23.71	-0.30	-16.44	-0.38	-8.03
Rohn-LB3P	-0.11	0.16	-21.19	0.10	-10.86	0.05	-6.41
Rohn-LB31	0.41	-0.30	16.70	-4.22	22.44	-0.90	7.82
Rohn-LB32	-0.63	0.30	16.44	4.29	22.30	0.92	7.74
Rohn-LB4P	-0.11	-0.10	10.86	-0.03	32.36	-0.03	8.64
Rohn-LB41	0.41	4.22	-22.44	8.64	7.57	2.57	-2.97
Rohn-LB42	-0.63	-4.29	-22.30	-8.67	7.81	-2.59	-2.90
Rohn-LC1P	-0.11	0.03	-32.36	0.09	8.49	0.02	-3.58
Rohn-LC11	0.41	-8.64	-7.57	-4.29	12.78	-1.94	0.78
Rohn-LC12	-0.63	8.67	-7.81	4.47	12.39	1.97	0.69
Rohn-LC2P	-0.11	-0.09	-8.49	-0.05	3.11	-0.02	-0.80
Rohn-LC21	0.41	4.29	-12.78	-7.37	25.65	-0.46	1.93
Rohn-LC22	-0.63	-4.47	-12.39	7.25	25.80	0.42	2.00
Rohn-LC3P	-0.11	0.05	-3.11	-0.06	49.58	-0.00	6.97
Rohn-LC31	0.41	7.37	-25.65	17.52	12.21	3.73	-2.02
Rohn-LC32	-0.63	-7.25	-25.80	-17.54	12.61	-3.72	-1.98
Rohn-LD1P	-0.11	0.06	-49.58	0.43	28.66	0.07	-3.14
Rohn-LD11	0.41	-17.52	-12.21	-15.05	33.36	-4.89	3.17
Rohn-LD12	-0.63	17.54	-12.61	15.28	32.96	4.92	3.05
Rohn-LD2P	-0.11	-0.43	-28.66	-0.13	1.57	-0.08	-4.05
Rohn-LD21	0.41	15.05	-33.36	-1.51	66.54	2.03	4.96
Rohn-LD22	-0.63	-15.28	-32.96	1.63	66.76	-2.04	5.06
Rohn-LD3P	-0.11	0.13	-1.57	0.12	95.68	0.04	14.12
Rohn-LD31	0.41	1.51	-66.54	11.59	1.10	1.96	-9.82
Rohn-LD32	-0.63	-1.63	-66.76	-11.50	1.01	-1.97	-9.86
Rohn-LE1P	-0.11	-0.12	-95.68	0.11	3.45	-0.00	-13.84
Rohn-LE11	0.41	-11.59	-1.10	-9.25	56.36	-3.13	8.29
Rohn-LE12	-0.63	11.50	-1.01	9.33	56.24	3.12	8.29
Rohn-LE2P	-0.11	-0.11	-3.45	-0.33	7.40	-0.07	0.59
Rohn-LE21	0.41	9.25	-56.36	-4.05	45.67	0.78	-1.60
Rohn-LE22	-0.63	-9.33	-56.24	4.04	46.20	-0.79	-1.50
Rohn-LE3P	-0.11	0.33	-7.40	0.59	149.92	0.14	21.39
Rohn-LE31	0.41	4.05	-45.67	23.15	-15.95	4.08	-9.25
Rohn-LE32	-0.63	-4.04	-46.20	-22.94	-17.22	-4.05	-9.52
Rohn-LF1P	-0.11	-0.59	-149.92	-1.07	-95.48	-0.17	-24.52
Rohn-LF11	0.41	-23.15	15.95	-35.69	182.59	-5.88	19.84
Rohn-LF12	-0.63	22.94	17.22	35.17	183.79	5.81	20.09
Rohn-LF2P	-0.11	1.07	95.48	0.63	242.99	0.17	33.83
Rohn-LF21	0.41	35.70	-182.59	39.15	-77.07	7.48	-25.95
Rohn-LF22	-0.63	-35.17	-183.78	-39.24	-78.30	-7.43	-26.19
Rohn-LG1P	-0.11	-0.63	-242.99	-1.00	-132.26	-0.16	-37.50
Rohn-LG11	0.41	-39.15	77.07	-43.20	209.66	-8.23	28.65
Rohn-LG12	-0.63	39.24	78.30	42.66	210.58	8.18	28.87
Rohn-LG2P	-0.11	1.00	132.26	0.37	272.65	0.14	40.46
Rohn-LG21	0.42	43.21	-209.66	47.99	-92.36	9.11	-30.18
Rohn-LG22	-0.64	-42.66	-210.58	-48.34	-92.90	-9.09	-30.33
Rohn-LH1P	-0.11	-0.37	-272.65	-0.41	-161.91	-0.08	-43.43
Rohn-LH11	0.40	-47.99	92.36	-54.66	237.35	-10.26	32.95
Rohn-LH12	-0.63	48.34	92.90	54.31	237.85	10.26	33.05
Rohn-LH2P	-0.11	0.41	161.91	0.03	348.58	0.04	51.02
Rohn-LH21	0.41	54.66	-237.35	69.49	-126.60	12.41	-36.37
Rohn-LH22	-0.63	-54.31	-237.85	-69.88	-127.09	-12.41	-36.47
Rohn-LI1P	-0.11	-0.03	-348.58	-1.07	-249.72	-0.11	-59.79
Rohn-LI11	0.40	-69.49	126.60	-98.15	395.14	-16.75	52.13
Rohn-LI12	-0.62	69.88	127.09	97.79	395.20	16.75	52.19
Rohn-LI2P	-0.11	1.07	249.72	1.89	558.49	0.30	80.77
Rohn-LI21	0.41	98.15	-395.14	94.80	-105.77	19.28	-50.05
Rohn-LI22	-0.63	-97.79	-395.20	-96.20	-104.08	-19.38	-49.89
Rohn-H1P	0.02	0.40	0.01	0.54	-0.06	0.13	-0.01
Rohn-H11	0.02	-0.11	0.05	0.06	0.18	-0.01	0.03
Rohn-H12	0.02	-0.68	0.24	-0.51	0.18	-0.16	0.06
Rohn-H2P	-0.03	0.71	-0.14	0.84	-0.26	0.18	-0.04
Rohn-H21	0.01	-0.02	-0.17	-0.03	0.07	-0.01	-0.01

Rohn-H22	0.04	-0.86	0.17	-0.72	0.06	-0.18	0.03
SNB-LA1P	-0.00	0.08	77.18	0.35	13.46	0.09	18.11
SNB-LA11	0.02	65.39	-36.23	12.84	-6.38	15.63	-8.52
SNB-LA12	-0.02	-65.81	-36.58	-13.28	-7.04	-15.80	-8.72
SNB-LA2P	-0.00	-0.35	-13.46	-0.62	7.88	-0.20	-1.11
SNB-LA21	0.02	-12.84	6.38	2.43	-4.94	-2.08	0.29
SNB-LA22	-0.02	13.28	7.04	-2.23	-4.10	2.21	0.59
SNB-LA3P	-0.00	0.62	-7.88	0.42	-22.33	0.21	-6.04
SNB-LA31	0.02	-2.43	4.94	-14.30	18.65	-3.34	4.71
SNB-LA32	-0.02	2.23	4.10	13.94	17.97	3.23	4.41
SNB-LA4P	-0.00	-0.42	22.33	-0.26	74.79	-0.14	19.41
SNB-LA41	0.02	14.30	-18.65	48.62	-34.37	12.57	-10.60
SNB-LA42	-0.02	-13.94	-17.97	-48.28	-33.86	-12.43	-10.36
SNB-LB1P	-0.00	0.29	119.98	0.19	16.19	0.10	27.21
SNB-LB11	0.42	98.61	-40.82	11.79	16.90	22.06	-4.78
SNB-LB12	-0.42	-98.65	-41.18	-11.79	16.69	-22.07	-4.89
SNB-LB2P	-0.00	-0.19	-16.19	-0.06	45.36	-0.05	5.83
SNB-LB21	0.42	-11.79	-16.90	16.78	-10.16	1.00	-5.41
SNB-LB22	-0.42	11.79	-16.68	-16.62	-10.00	-0.96	-5.33
SNB-LB3P	-0.00	0.06	-45.36	0.14	-61.95	0.04	-21.45
SNB-LB31	0.42	-16.78	10.16	-44.19	60.19	-12.18	14.06
SNB-LB32	-0.42	16.62	10.00	44.27	60.08	12.17	14.01
SNB-LB4P	-0.00	-0.14	61.95	-0.02	225.64	-0.03	57.48
SNB-LB41	0.43	44.19	-60.19	136.50	-75.42	36.11	-27.10
SNB-LB42	-0.42	-44.27	-60.08	-136.40	-75.33	-36.11	-27.06
SNB-LC1P	-0.00	0.01	81.08	0.03	57.34	0.01	20.77
SNB-LC11	0.86	101.49	-52.27	39.37	9.54	21.13	-6.41
SNB-LC12	-0.86	-101.63	-52.37	-39.40	9.49	-21.16	-6.43
SNB-LC2P	-0.00	-0.03	-57.34	0.03	-54.52	0.00	-16.73
SNB-LC21	0.86	-39.37	-9.54	-53.36	72.27	-13.87	9.38
SNB-LC22	-0.86	39.40	-9.49	53.34	72.22	13.87	9.38
SNB-LC3P	-0.00	-0.03	54.52	-0.01	258.54	-0.01	46.97
SNB-LC31	0.86	53.36	-72.27	165.71	-100.01	32.87	-25.85
SNB-LC32	-0.86	-53.34	-72.22	-165.50	-99.88	-32.83	-25.82
SNB-LD1P	-0.00	0.03	228.03	0.21	130.83	0.04	53.85
SNB-LD11	1.13	237.78	-125.32	66.08	26.99	45.59	-14.75
SNB-LD12	-1.13	-237.94	-125.44	-65.97	26.81	-45.60	-14.80
SNB-LD2P	-0.00	-0.21	-130.83	0.03	-73.87	-0.03	-30.62
SNB-LD21	1.12	-66.08	-26.99	-55.03	125.93	-18.12	14.80
SNB-LD22	-1.12	65.97	-26.81	55.32	126.06	18.14	14.85
SNB-LD3P	-0.00	-0.03	73.87	0.05	347.77	0.00	63.27
SNB-LD31	1.13	55.03	-125.93	159.88	-91.49	32.24	-32.62
SNB-LD32	-1.13	-55.32	-126.06	-159.88	-91.54	-32.29	-32.65
SNB-LE1P	-0.01	-0.09	295.92	0.31	184.59	0.03	72.10
SNB-LE11	1.91	353.58	-189.73	102.84	61.77	68.48	-19.20
SNB-LE12	-1.91	-353.85	-189.78	-102.70	61.49	-68.50	-19.25
SNB-LE2P	-0.01	-0.31	-184.59	-0.22	-158.98	-0.08	-51.40
SNB-LE21	1.90	-102.84	-61.77	-149.80	241.84	-37.79	26.94
SNB-LE22	-1.90	102.70	-61.49	150.26	242.36	37.84	27.05
SNB-LE3P	-0.01	0.22	158.98	0.18	926.38	0.06	162.85
SNB-LE31	1.92	149.80	-241.84	548.95	-390.81	104.84	-94.92
SNB-LE32	-1.92	-150.26	-242.36	-549.83	-391.52	-105.04	-95.10
SNB-LF1P	0.01	-0.29	41.33	-0.64	-222.63	-0.09	-18.12
SNB-LF11	2.75	275.99	-69.32	-60.88	358.33	21.49	28.88
SNB-LF12	-2.76	-275.60	-68.76	60.78	359.01	-21.46	29.00
SNB-LF2P	0.01	0.64	222.63	0.22	949.91	0.09	117.17
SNB-LF21	2.76	60.88	-358.33	466.22	-435.70	52.67	-79.34
SNB-LF22	-2.77	-60.79	-359.01	-467.25	-436.54	-52.76	-79.49
SNB-LG1P	0.02	-0.27	533.43	-1.42	-292.03	-0.17	24.12
SNB-LG11	4.45	825.19	-301.71	-66.53	597.85	75.81	29.59
SNB-LG12	-4.48	-824.30	-300.89	65.62	598.95	-75.81	29.78
SNB-LG2P	0.02	1.42	292.03	0.44	1667.94	0.19	195.86
SNB-LG21	4.45	66.53	-597.85	907.50	-739.37	97.33	-133.62
SNB-LG22	-4.48	-65.62	-598.95	-908.64	-740.52	-97.35	-133.84
SNB-LH1P	0.01	-0.45	240.20	-1.46	-353.13	-0.19	-11.29
SNB-LH11	4.16	729.11	-198.76	-69.98	634.62	65.86	43.55
SNB-LH12	-4.18	-728.01	-197.61	69.10	635.78	-65.84	43.78
SNB-LH2P	0.01	1.46	353.13	0.55	1583.36	0.20	193.52
SNB-LH21	4.15	69.98	-634.62	738.32	-686.38	80.77	-132.00

SNB-LH22	-4.18	-69.10	-635.78	-739.38	-687.61	-80.79	-132.24
SNB-LI1P	0.00	-0.54	674.72	-2.04	-187.14	-0.26	48.73
SNB-LI11	2.26	1215.66	-434.91	164.97	799.11	137.96	36.39
SNB-LI12	-2.28	-1214.53	-433.63	-166.52	800.56	-138.00	36.66
SNB-LI2P	0.00	2.04	187.14	1.17	1177.76	0.32	136.40
SNB-LI21	2.23	-164.96	-799.11	31.09	-198.92	-13.38	-99.73
SNB-LI22	-2.25	166.52	-800.56	-31.39	-200.35	13.50	-100.01
SNB-H1aP	-0.30	44.73	-2.73	146.52	-2.04	94.66	-2.36
SNB-H1bP	-0.30	-146.52	2.04	-42.06	-1.21	-93.34	0.41
SNB-H1cP	-0.07	44.12	1.13	145.68	3.80	93.94	2.44
SNB-H1dP	-0.07	-145.68	-3.80	-44.33	-1.14	-94.04	-2.44
SNB-H1eP	0.37	42.34	1.21	146.36	-2.13	93.40	-0.45
SNB-H1fP	0.37	-146.36	2.13	-44.77	2.73	-94.60	2.40
SNB-H2aP	-1.06	113.01	-0.55	153.89	-0.54	98.75	-0.40
SNB-H2bP	-1.06	-153.89	0.54	-87.37	-1.31	-89.26	-0.28
SNB-H2cP	0.01	102.65	0.57	151.55	2.45	94.05	1.12
SNB-H2dP	0.01	-151.55	-2.45	-102.43	-0.57	-93.97	-1.12
SNB-H2eP	1.04	87.23	1.31	153.92	-0.59	89.22	0.26
SNB-H2fP	1.04	-153.92	0.59	-113.10	0.56	-98.79	0.43
SNB-H3aP	-0.53	177.40	0.93	207.74	0.49	113.80	0.42
SNB-H3bP	-0.53	-207.74	-0.49	-147.67	-2.07	-105.01	-0.76
SNB-H3cP	0.00	163.73	1.30	206.60	3.32	109.42	1.37
SNB-H3dP	0.00	-206.60	-3.32	-163.77	-1.30	-109.43	-1.36
SNB-H3eP	0.53	147.68	2.07	207.74	0.49	105.02	0.76
SNB-H3fP	0.53	-207.74	-0.49	-177.38	-0.93	-113.79	-0.42
SNB-H4aP	-0.70	281.31	2.16	333.09	1.17	151.11	0.82
SNB-H4bP	-0.70	-333.09	-1.17	-260.45	-3.17	-145.98	-1.07
SNB-H4cP	-0.00	272.73	2.64	331.74	5.63	148.67	2.03
SNB-H4dP	-0.00	-331.74	-5.63	-272.69	-2.64	-148.65	-2.03
SNB-H4eP	0.71	260.43	3.17	333.08	1.16	145.97	1.06
SNB-H4fP	0.71	-333.08	-1.16	-281.35	-2.15	-151.11	-0.81
SNB-H5aP	-0.76	372.12	3.25	429.49	1.47	168.88	1.00
SNB-H5bP	-0.76	-429.49	-1.47	-325.00	-4.66	-158.95	-1.29
SNB-H5cP	-0.00	350.39	3.35	427.98	8.33	163.98	2.46
SNB-H5dP	-0.00	-427.98	-8.33	-350.59	-3.35	-164.02	-2.46
SNB-H5eP	0.77	325.10	4.66	429.48	1.47	158.97	1.29
SNB-H5fP	0.77	-429.48	-1.47	-372.03	-3.25	-168.86	-1.00
SNB-H6aP	-3.65	560.92	3.11	662.57	1.92	225.39	0.93
SNB-H6bP	-3.65	-662.57	-1.92	-533.11	-4.79	-220.27	-1.24
SNB-H6cP	0.01	555.37	3.41	654.72	7.47	222.93	2.00
SNB-H6dP	0.01	-654.72	-7.47	-555.77	-3.40	-223.00	-2.00
SNB-H6eP	3.64	533.30	4.80	662.58	1.94	220.31	1.24
SNB-H6fP	3.64	-662.58	-1.94	-560.70	-3.12	-225.36	-0.93
SNB-H7aP	-2.95	858.15	0.33	985.53	-0.73	301.76	-0.06
SNB-H7bP	-2.95	-985.53	0.73	-852.73	-2.25	-300.87	-0.25
SNB-H7cP	0.01	862.70	0.28	979.60	4.34	301.53	0.76
SNB-H7dP	0.01	-979.60	-4.34	-862.84	-0.27	-301.55	-0.76
SNB-H7eP	2.94	852.77	2.26	985.55	-0.72	300.88	0.25
SNB-H7fP	2.95	-985.55	0.72	-858.07	-0.34	-301.75	0.06
SNB-H8aP	-0.59	1102.01	0.53	1191.76	-0.76	337.79	-0.03
SNB-H8bP	-0.59	-1191.76	0.76	-1082.94	-1.30	-334.98	-0.08
SNB-H8cP	0.00	1094.96	1.32	1191.60	4.70	336.73	0.89
SNB-H8dP	0.00	-1191.60	-4.70	-1094.99	-1.32	-336.73	-0.89
SNB-H8eP	0.59	1082.95	1.29	1191.76	-0.77	334.98	0.08
SNB-H8fP	0.59	-1191.76	0.77	-1101.99	-0.53	-337.79	0.04
SNB-H9aP	-1.73	1304.69	0.36	1375.01	-1.09	358.63	-0.10
SNB-H9bP	-1.73	-1375.01	1.09	-1294.90	-0.13	-357.32	0.13
SNB-H9cP	0.00	1305.45	1.77	1372.88	4.46	358.45	0.83
SNB-H9dP	0.00	-1372.88	-4.46	-1305.40	-1.77	-358.44	-0.83
SNB-H9eP	1.72	1294.87	0.13	1375.02	-1.10	357.31	-0.13
SNB-H9fP	1.73	-1375.02	1.10	-1304.71	-0.35	-358.63	0.10



Equilibrium Joint Positions and Rotations for Load Case "5: 0.9D + 1.0Dg + 1.0E":

Joint Label	X-Displ (ft)	Y-Displ (ft)	Z-Displ (ft)	X-Rot (deg)	Y-Rot (deg)	Z-Rot (deg)	X-Pos (ft)	Y-Pos (ft)	Z-Pos (ft)
RohnAP	0.1396	5.719e-005	-0.01305	0.0001	0.0797	-0.0008	4.473	5.719e-005	180
RohnBP	0.1117	8.475e-005	-0.0138	0.0000	0.0787	-0.0004	5.233	8.475e-005	160
RohnCP	0.0848	8.008e-005	-0.01375	-0.0000	0.0732	-0.0003	5.994	8.008e-005	140
RohnDP	0.06092	6.915e-005	-0.01294	-0.0000	0.0624	-0.0002	6.756	6.915e-005	120
RohnEP	0.04124	5.136e-005	-0.01096	-0.0001	0.0487	-0.0001	7.522	5.136e-005	99.99
RohnFP	0.02602	2.851e-005	-0.009112	-0.0001	0.0362	-0.0001	8.294	2.851e-005	79.99
RohnGP	0.01447	9.294e-006	-0.007089	-0.0000	0.0272	-0.0001	9.069	9.294e-006	59.99
RohnHP	0.006404	-4.012e-007	-0.004956	-0.0000	0.0179	-0.0000	9.847	-4.012e-007	40
RohnIP	0.001682	-3.447e-006	-0.002382	0.0000	0.0070	-0.0000	10.63	-3.447e-006	20
RohnJP	0	0	0	0.0000	0.0000	0.0000	11.42	0	0
SNB-AP	0.1396	0.0001254	-0.006676	-0.0000	0.0750	-0.0000	2.473	0.0001254	180
SNB-BP	0.1117	0.0001128	-0.007558	-0.0000	0.0750	-0.0000	3.233	0.0001128	160
SNB-CP	0.08481	0.0001022	-0.008046	-0.0000	0.0693	-0.0000	3.993	0.0001022	140
SNB-DP	0.06092	8.784e-005	-0.007904	-0.0000	0.0563	-0.0000	4.756	8.784e-005	120
SNB-EP	0.04124	6.878e-005	-0.006898	-0.0001	0.0443	-0.0000	5.522	6.878e-005	99.99
SNB-FP	0.02602	4.505e-005	-0.006171	-0.0001	0.0320	-0.0000	6.294	4.505e-005	79.99
SNB-GP	0.01447	2.36e-005	-0.004937	-0.0001	0.0192	-0.0000	7.069	2.36e-005	60
SNB-HP	0.006405	9.147e-006	-0.003555	-0.0000	0.0115	-0.0000	7.847	9.147e-006	40
SNB-IP	0.001682	1.721e-006	-0.001748	-0.0000	0.0026	-0.0000	8.63	1.721e-006	20
SNB-JP	0	0	0	0.0000	0.0000	0.0000	9.415	0	0
RohnA1	0.1396	0.0001631	-0.004095	-0.0006	0.0801	-0.0012	-2.027	-3.752	180
RohnA2	0.1397	0.0001657	-0.004113	0.0002	0.0805	-0.0004	-2.027	3.753	180
RohnB1	0.1117	0.0001296	-0.003484	0.0001	0.0796	-0.0012	-2.449	-4.435	160
RohnB2	0.1117	0.0001221	-0.003485	-0.0002	0.0797	0.0004	-2.449	4.435	160
RohnC1	0.08474	0.0001422	-0.002882	-0.0002	0.0729	-0.0015	-2.87	-5.117	140
RohnC2	0.08478	8.492e-005	-0.002889	0.0001	0.0729	0.0010	-2.87	5.117	140
RohnD1	0.06081	0.0001369	-0.002306	-0.0004	0.0628	-0.0015	-3.287	-5.798	120
RohnD2	0.06084	5.655e-005	-0.002313	0.0003	0.0628	0.0011	-3.287	5.798	120
RohnE1	0.04117	9.794e-005	-0.001698	-0.0002	0.0488	-0.0012	-3.699	-6.479	100
RohnE2	0.0412	5.823e-005	-0.001713	0.0000	0.0488	0.0010	-3.699	6.479	100
RohnF1	0.02591	9.156e-005	-0.001232	-0.0002	0.0394	-0.0011	-4.108	-7.16	80
RohnF2	0.02594	1.787e-005	-0.001255	0.0001	0.0395	0.0009	-4.108	7.16	80
RohnG1	0.01441	5.527e-005	-0.0008646	-0.0001	0.0279	-0.0008	-4.513	-7.842	60
RohnG2	0.01444	7.069e-006	-0.0008837	-0.0000	0.0280	0.0007	-4.513	7.842	60
RohnH1	0.006338	4.108e-005	-0.0005548	-0.0001	0.0186	-0.0005	-4.914	-8.523	40
RohnH2	0.006353	-1.359e-005	-0.0005662	0.0001	0.0187	0.0005	-4.914	8.523	40
RohnI1	0.001632	2.458e-005	-0.000262	-0.0003	0.0090	-0.0003	-5.313	-9.206	20
RohnI2	0.00164	-1.634e-005	-0.0002668	0.0003	0.0091	0.0003	-5.313	9.206	20
RohnJ1	0	0	0	0.0000	0.0000	0.0000	-5.71	-9.89	0
RohnJ2	0	0	0	0.0000	0.0000	0.0000	-5.71	9.89	0
SNB-A1	0.1396	0.0001249	-0.001784	-0.0045	0.0828	-0.0001	-1.027	-2.02	180
SNB-A2	0.1396	0.0001264	-0.001787	0.0044	0.0828	0.0001	-1.027	2.021	180
SNB-B1	0.1117	0.0001124	-0.001191	-0.0028	0.0807	-0.0001	-1.449	-2.703	160
SNB-B2	0.1117	0.0001137	-0.001194	0.0028	0.0807	0.0001	-1.449	2.703	160
SNB-C1	0.0848	0.0001015	-0.0006813	-0.0031	0.0751	-0.0002	-1.869	-3.384	140
SNB-C2	0.0848	0.0001033	-0.0006857	0.0031	0.0751	0.0002	-1.869	3.385	140
SNB-D1	0.06089	8.825e-005	-0.0003188	-0.0052	0.0660	-0.0003	-2.287	-4.066	120
SNB-D2	0.06089	8.787e-005	-0.0003255	0.0051	0.0660	0.0003	-2.287	4.066	120
SNB-E1	0.04121	7.103e-005	-0.0001403	-0.0032	0.0501	-0.0003	-2.699	-4.747	100
SNB-E2	0.04121	6.687e-005	-0.0001504	0.0030	0.0501	0.0003	-2.699	4.747	100
SNB-F1	0.02599	4.48e-005	-1.776e-006	-0.0045	0.0419	-0.0002	-3.108	-5.428	80
SNB-F2	0.02599	4.55e-005	-1.344e-005	0.0044	0.0419	0.0002	-3.108	5.428	80
SNB-G1	0.01445	3.247e-005	5.189e-005	-0.0060	0.0316	-0.0003	-3.513	-6.11	60
SNB-G2	0.01445	1.49e-005	4.163e-005	0.0059	0.0316	0.0003	-3.513	6.11	60
SNB-H1	0.006373	2.044e-005	6.75e-005	-0.0056	0.0216	-0.0003	-3.914	-6.79	40
SNB-H2	0.006373	-1.912e-006	6.029e-005	0.0055	0.0216	0.0003	-3.914	6.791	40
SNB-I1	0.001646	1.668e-005	3.655e-005	-0.0042	0.0114	-0.0002	-4.312	-7.472	20
SNB-I2	0.001646	-1.308e-005	3.327e-005	0.0042	0.0114	0.0002	-4.312	7.472	20
SNB-J1	0	0	0	0.0000	0.0000	0.0000	-4.708	-8.154	0
SNB-J2	0	0	0	0.0000	0.0000	0.0000	-4.708	8.154	0

RohnAaS	0.1326	6.122e-005	-0.0133	0.0001	0.0805	-0.0007	4.663	6.122e-005	175
RohnAbS	0.1256	6.83e-005	-0.0135	0.0002	0.0801	-0.0006	4.853	6.83e-005	170
RohnAcS	0.1186	8.466e-005	-0.01367	0.0001	0.0799	-0.0005	5.043	8.466e-005	165
RohnBaS	0.1048	8.623e-005	-0.01388	0.0000	0.0784	-0.0004	5.423	8.623e-005	155
RohnBbS	0.09801	8.413e-005	-0.01391	-0.0000	0.0770	-0.0003	5.613	8.413e-005	150
RohnBcS	0.09138	8.244e-005	-0.01386	-0.0000	0.0757	-0.0003	5.803	8.244e-005	145
RohnCaS	0.07655	7.691e-005	-0.0136	-0.0000	0.0692	-0.0002	6.247	7.691e-005	133.3
RohnCbS	0.06857	7.287e-005	-0.01334	-0.0000	0.0676	-0.0002	6.502	7.287e-005	126.6
RohnDaS	0.05394	6.547e-005	-0.01241	-0.0000	0.0574	-0.0002	7.011	6.547e-005	113.3
RohnDbS	0.04739	5.838e-005	-0.01172	-0.0001	0.0549	-0.0001	7.267	5.838e-005	106.6
RohnEaS	0.03589	4.36e-005	-0.0104	-0.0001	0.0441	-0.0001	7.779	4.36e-005	93.33
RohnEbS	0.03077	3.537e-005	-0.009781	-0.0001	0.0431	-0.0001	8.037	3.537e-005	86.65
RohnFaS	0.02016	1.567e-005	-0.008149	-0.0001	0.0334	-0.0001	8.682	1.567e-005	69.99
RohnGaS	0.01038	1.844e-006	-0.006059	-0.0000	0.0230	-0.0000	9.458	1.844e-006	49.99
RohnHaS	0.003994	-2.898e-006	-0.003704	-0.0000	0.0136	-0.0000	10.24	-2.898e-006	30
RohnIaS	0.0008181	-2.563e-006	-0.001214	0.0000	0.0051	-0.0000	11.03	-2.563e-006	9.999
SNB-AaS	0.1326	0.0001222	-0.00693	-0.0001	0.0818	-0.0000	2.663	0.0001222	175
SNB-AbS	0.1256	0.0001158	-0.007169	-0.0000	0.0795	-0.0000	2.853	0.0001158	170
SNB-AcS	0.1186	0.000116	-0.007378	-0.0000	0.0810	-0.0000	3.043	0.000116	165
SNB-BaS	0.1048	0.0001108	-0.007728	-0.0000	0.0795	-0.0000	3.423	0.0001108	155
SNB-BbS	0.09801	0.0001081	-0.007868	-0.0000	0.0765	-0.0000	3.613	0.0001081	150
SNB-BcS	0.09138	0.0001055	-0.007972	-0.0000	0.0769	-0.0000	3.803	0.0001055	145
SNB-CaS	0.07656	9.772e-005	-0.008069	-0.0000	0.0699	-0.0000	4.247	9.772e-005	133.3
SNB-CbS	0.06858	9.293e-005	-0.008013	-0.0000	0.0690	-0.0000	4.502	9.293e-005	126.7
SNB-DaS	0.05395	8.249e-005	-0.007657	-0.0001	0.0588	-0.0000	5.011	8.249e-005	113.3
SNB-DbS	0.0474	7.587e-005	-0.007307	-0.0001	0.0558	-0.0000	5.267	7.587e-005	106.7
SNB-EaS	0.03589	6.123e-005	-0.006709	-0.0001	0.0451	-0.0000	5.779	6.123e-005	93.33
SNB-EbS	0.03078	5.299e-005	-0.006459	-0.0001	0.0441	-0.0000	6.037	5.299e-005	86.65
SNB-FaS	0.02016	3.302e-005	-0.005593	-0.0001	0.0365	-0.0000	6.682	3.302e-005	69.99
SNB-GaS	0.01038	1.49e-005	-0.00428	-0.0000	0.0267	-0.0000	7.458	1.49e-005	50
SNB-HaS	0.003994	4.006e-006	-0.002683	-0.0000	0.0164	-0.0000	8.238	4.006e-006	30
SNB-IaS	0.0008181	-9.78e-008	-0.000899	-0.0000	0.0062	-0.0000	9.022	-9.78e-008	9.999
SNB-WL-A1S	0.1396	0.0001236	-0.004361	-0.0022	0.0788	0.0000	0.7229	-1.01	180
SNB-WL-A2S	0.1396	0.0001256	-0.001915	-0.0000	0.0828	-0.0000	-1.027	0.0001256	180
SNB-WL-A3S	0.1396	0.0001276	-0.004362	0.0021	0.0788	-0.0000	0.7229	1.01	180
SNB-WL-B1S	0.1117	0.0001114	-0.004569	-0.0009	0.0770	-0.0000	0.8919	-1.351	160
SNB-WL-B2S	0.1117	0.0001131	-0.001379	-0.0000	0.0807	-0.0000	-1.449	0.0001131	160
SNB-WL-B3S	0.1117	0.0001146	-0.004571	0.0009	0.0770	-0.0000	0.8919	1.352	160
SNB-WL-C1S	0.08481	0.000101	-0.004734	-0.0009	0.0709	-0.0000	1.062	-1.692	140
SNB-WL-C2S	0.08481	0.0001024	-0.001047	-0.0000	0.0751	-0.0000	-1.869	0.0001024	140
SNB-WL-C3S	0.08481	0.0001037	-0.004736	0.0008	0.0709	0.0000	1.062	1.692	140
SNB-WL-D1S	0.06091	8.645e-005	-0.004943	-0.0020	0.0601	-0.0001	1.235	-2.033	120
SNB-WL-D2S	0.06091	8.806e-005	-0.001141	-0.0000	0.0660	-0.0000	-2.287	8.806e-005	120
SNB-WL-D3S	0.06091	8.948e-005	-0.004946	0.0019	0.0601	0.0001	1.235	2.033	120
SNB-WL-E1S	0.04123	6.787e-005	-0.004098	-0.0010	0.0461	-0.0001	1.411	-2.373	100
SNB-WL-E2S	0.04123	6.895e-005	-0.000717	-0.0001	0.0501	-0.0000	-2.699	6.895e-005	100
SNB-WL-E3S	0.04123	6.986e-005	-0.004103	0.0009	0.0461	0.0001	1.411	2.373	100
SNB-WL-F1S	0.026	4.379e-005	-0.00424	-0.0018	0.0362	-0.0001	1.593	-2.714	80
SNB-WL-F2S	0.02601	4.515e-005	-0.001114	-0.0001	0.0419	-0.0000	-3.108	4.515e-005	80
SNB-WL-F3S	0.026	4.635e-005	-0.004246	0.0017	0.0362	0.0001	1.593	2.714	80
SNB-WL-G1S	0.01447	2.225e-005	-0.00453	-0.0029	0.0253	-0.0001	1.778	-3.055	60
SNB-WL-G2S	0.01447	2.368e-005	-0.001994	-0.0000	0.0316	-0.0000	-3.513	2.368e-005	60
SNB-WL-G3S	0.01447	2.499e-005	-0.004536	0.0028	0.0253	0.0001	1.778	3.055	60
SNB-WL-H1S	0.006392	8.148e-006	-0.00472	-0.0024	0.0160	-0.0001	1.967	-3.395	40
SNB-WL-H2S	0.006394	9.26e-006	-0.002903	-0.0000	0.0216	-0.0000	-3.914	9.26e-006	40
SNB-WL-H3S	0.006392	1.029e-005	-0.004724	0.0024	0.0160	0.0001	1.967	3.395	40
SNB-WL-I1S	0.001668	1.074e-006	-0.004901	-0.0019	0.0066	-0.0001	2.159	-3.736	20
SNB-WL-I2S	0.00167	1.801e-006	-0.003973	-0.0000	0.0114	0.0000	-4.312	1.801e-006	20
SNB-WL-I3S	0.001668	2.487e-006	-0.004903	0.0019	0.0066	0.0001	2.159	3.736	20
RohnAa1	0.1326	0.000126	-0.00394	-0.0002	0.0800	-0.0012	-2.132	-3.923	175
RohnAa2	0.1327	0.0001725	-0.003952	-0.0002	0.0806	-0.0002	-2.132	3.923	175
RohnAb1	0.1256	0.000132	-0.003787	-0.0000	0.0805	-0.0012	-2.238	-4.094	170
RohnAb2	0.1256	0.0001392	-0.00379	-0.0002	0.0808	0.0000	-2.238	4.094	170
RohnAc1	0.1186	0.0001206	-0.003631	-0.0001	0.0796	-0.0012	-2.343	-4.264	165
RohnAc2	0.1186	0.0001421	-0.003633	-0.0001	0.0797	0.0002	-2.343	4.264	165
RohnBa1	0.1047	0.0001231	-0.003332	-0.0003	0.0781	-0.0013	-2.554	-4.605	155
RohnBa2	0.1048	0.0001241	-0.003335	0.0002	0.0781	0.0005	-2.554	4.606	155
RohnBb1	0.09801	0.0001036	-0.003192	-0.0001	0.0771	-0.0014	-2.659	-4.776	150
RohnBb2	0.09805	0.0001377	-0.003196	0.0000	0.0772	0.0007	-2.659	4.776	150

RohnBc1	0.09124	0.00012	-0.003028	0.0003	0.0765	-0.0015	-2.765	-4.947	145
RohnBc2	0.09128	0.0001145	-0.003033	-0.0004	0.0765	0.0009	-2.765	4.947	145
RohnCa1	0.07638	9.131e-005	-0.002701	-0.0004	0.0707	-0.0015	-3.009	-5.344	133.3
RohnCa2	0.07642	0.0001257	-0.00271	0.0003	0.0707	0.0011	-3.009	5.344	133.3
RohnCb1	0.06833	9.311e-005	-0.002511	0.0004	0.0669	-0.0015	-3.148	-5.571	126.7
RohnCb2	0.06837	0.0001115	-0.002518	-0.0005	0.0670	0.0011	-3.148	5.571	126.7
RohnDa1	0.05366	6.545e-005	-0.002104	-0.0004	0.0597	-0.0014	-3.425	-6.025	113.3
RohnDa2	0.0537	0.0001175	-0.002114	0.0003	0.0597	0.0011	-3.425	6.025	113.3
RohnDb1	0.04703	8.706e-005	-0.001881	0.0003	0.0534	-0.0013	-3.563	-6.252	106.7
RohnDb2	0.04706	8.324e-005	-0.001893	-0.0004	0.0534	0.0010	-3.563	6.252	106.7
RohnEa1	0.03562	7.79e-005	-0.001531	-0.0001	0.0459	-0.0012	-3.836	-6.706	93.34
RohnEa2	0.03565	6.317e-005	-0.001549	-0.0000	0.0459	0.0010	-3.836	6.706	93.34
RohnEb1	0.03055	8.558e-005	-0.001373	0.0001	0.0412	-0.0011	-3.972	-6.933	86.66
RohnEb2	0.03058	3.977e-005	-0.001393	-0.0003	0.0412	0.0009	-3.972	6.933	86.66
RohnFa1	0.0194	4.138e-005	-0.001027	-0.0001	0.0325	-0.0009	-4.311	-7.501	70
RohnFa2	0.01943	4.253e-005	-0.001048	-0.0000	0.0326	0.0007	-4.311	7.501	70
RohnGa1	0.009685	1.978e-005	-0.0006952	-0.0000	0.0230	-0.0006	-4.714	-8.182	50
RohnGa2	0.009704	2.296e-005	-0.0007102	-0.0001	0.0231	0.0006	-4.714	8.182	50
RohnHa1	0.003232	-4.479e-006	-0.0003932	-0.0000	0.0133	-0.0004	-5.115	-8.864	30
RohnHa2	0.003243	2.055e-005	-0.0004012	-0.0000	0.0133	0.0003	-5.115	8.864	30
RohnIa1	0.0002036	-3.457e-005	-0.000123	-0.0001	0.0048	-0.0001	-5.512	-9.548	10
RohnIa2	0.0002071	3.751e-005	-0.0001254	0.0000	0.0048	0.0001	-5.512	9.548	10
SNB-Aa1	0.1326	0.0001047	-0.00163	0.0011	0.0796	-0.0002	-1.132	-2.191	175
SNB-Aa2	0.1326	0.000137	-0.001633	-0.0012	0.0797	0.0002	-1.132	2.191	175
SNB-Ab1	0.1256	0.0001179	-0.001478	-0.0004	0.0809	-0.0002	-1.238	-2.362	170
SNB-Ab2	0.1256	0.000118	-0.001481	0.0004	0.0809	0.0002	-1.238	2.362	170
SNB-Ac1	0.1186	0.0001096	-0.00133	0.0008	0.0792	-0.0002	-1.343	-2.532	165
SNB-Ac2	0.1186	0.0001197	-0.001332	-0.0008	0.0792	0.0002	-1.343	2.532	165
SNB-Ba1	0.1048	9.764e-005	-0.001048	0.0008	0.0782	-0.0002	-1.554	-2.873	155
SNB-Ba2	0.1048	0.0001239	-0.001051	-0.0009	0.0782	0.0002	-1.554	2.873	155
SNB-Bb1	0.09798	0.0001179	-0.000916	-0.0004	0.0776	-0.0002	-1.659	-3.044	150
SNB-Bb2	0.09798	9.892e-005	-0.0009194	0.0003	0.0776	0.0002	-1.659	3.044	150
SNB-Bc1	0.09127	9.976e-005	-0.000792	0.0007	0.0751	-0.0002	-1.764	-3.214	145
SNB-Bc2	0.09127	0.0001115	-0.0007959	-0.0008	0.0751	0.0002	-1.764	3.214	145
SNB-Ca1	0.07634	0.000112	-0.0005392	0.0005	0.0711	-0.0003	-2.009	-3.611	133.3
SNB-Ca2	0.07634	8.329e-005	-0.0005444	-0.0006	0.0711	0.0003	-2.009	3.611	133.3
SNB-Cb1	0.06832	9.835e-005	-0.000414	0.0010	0.0653	-0.0003	-2.148	-3.839	126.7
SNB-Cb2	0.06832	8.745e-005	-0.0004199	-0.0011	0.0653	0.0003	-2.148	3.839	126.7
SNB-Da1	0.05363	8.086e-005	-0.0002305	0.0012	0.0598	-0.0004	-2.425	-4.293	113.3
SNB-Da2	0.05364	8.396e-005	-0.0002383	-0.0013	0.0598	0.0004	-2.425	4.293	113.3
SNB-Db1	0.04701	9.638e-005	-0.0001654	0.0004	0.0526	-0.0003	-2.563	-4.52	106.7
SNB-Db2	0.04701	5.587e-005	-0.0001744	-0.0006	0.0526	0.0003	-2.563	4.52	106.7
SNB-Ea1	0.03566	5.208e-005	-7.508e-005	0.0005	0.0459	-0.0003	-2.836	-4.974	93.34
SNB-Ea2	0.03566	7.068e-005	-8.592e-005	-0.0007	0.0459	0.0003	-2.836	4.974	93.34
SNB-Eb1	0.03058	6.714e-005	-2.757e-005	0.0009	0.0404	-0.0002	-2.972	-5.201	86.66
SNB-Eb2	0.03058	3.971e-005	-3.896e-005	-0.0011	0.0404	0.0002	-2.972	5.201	86.66
SNB-Fa1	0.01937	6.217e-005	4.842e-005	0.0026	0.0312	-0.0002	-3.311	-5.769	70
SNB-Fa2	0.01936	5.603e-006	3.71e-005	-0.0027	0.0312	0.0002	-3.311	5.769	70
SNB-Ga1	0.009684	1.982e-005	7.978e-005	0.0028	0.0214	-0.0003	-3.714	-6.45	50
SNB-Ga2	0.009684	1.149e-005	7.089e-005	-0.0029	0.0214	0.0003	-3.714	6.45	50
SNB-Ha1	0.003248	-1.351e-005	7.171e-005	0.0024	0.0121	-0.0002	-4.114	-7.131	30
SNB-Ha2	0.003247	2.291e-005	6.642e-005	-0.0025	0.0121	0.0002	-4.114	7.131	30
SNB-Ia1	0.0001876	-2.529e-005	3.345e-005	0.0010	0.0042	-0.0001	-4.511	-7.813	10
SNB-Ia2	0.0001871	2.597e-005	3.181e-005	-0.0010	0.0042	0.0001	-4.511	7.813	10

Joint Support Reactions for Load Case "5: 0.9D + 1.0Dg + 1.0E":

Joint Label	X Force (kips)	X Usage % (kips)	Y Force (kips)	Y Usage % (kips)	Z Comp. Force (kips)	Z Usage % (kips)	Uplift Usage %	Result. Force (kips)	Result. Usage % (ft-k)	X Moment Usage % (ft-k)	X-M. Moment Usage % (ft-k)	Y Moment Usage % (ft-k)	Y-M. Moment Usage % (ft-k)	Z Moment Usage % (ft-k)	Z-M. Moment Usage % (ft-k)	Max. Usage %
RohnJP	-2.27	0.0	0.00	0.0	36.66	0.0	0.0	36.73	0.0	-0.00	0.0	-0.5	0.0	0.00	0.0	0.0
SNB-JP	-2.92	0.0	0.00	0.0	44.79	0.0	0.0	44.88	0.0	-0.00	0.0	-1.1	0.0	-0.00	0.0	0.0
RohnJ1	-0.03	0.0	0.09	0.0	4.00	0.0	0.0	4.00	0.0	-0.04	0.0	0.1	0.0	-0.00	0.0	0.0
RohnJ2	-0.03	0.0	-0.10	0.0	4.07	0.0	0.0	4.07	0.0	0.04	0.0	0.1	0.0	0.00	0.0	0.0
SNB-J1	-0.53	0.0	-0.66	0.0	-1.63	0.0	0.0	1.84	0.0	0.07	0.0	0.1	0.0	-0.01	0.0	0.0
SNB-J2	-0.53	0.0	0.66	0.0	-1.55	0.0	0.0	1.77	0.0	-0.07	0.0	0.1	0.0	0.01	0.0	0.0

Joint Displacements, Loads and Member Forces on Joints for Load Case "5: 0.9D + 1.0Dg + 1.0E":

Joint Label	X External Load (kips)	Y External Load (kips)	Z External Load (kips)	X Member Force (kips)	Y Member Force (kips)	Z Member Force (kips)	X Disp. (ft)	Y Disp. (ft)	Z Disp. (ft)
RohnAP	0.0989	0.0000	-0.2670	-0.0989	0.0000	0.2670	0.1396	0.0001	-0.0131
RohnBP	0.1987	0.0000	-0.9568	-0.1987	0.0000	0.9568	0.1117	0.0001	-0.0138
RohnCP	0.0458	0.0000	-0.3872	-0.0458	0.0000	0.3872	0.0848	0.0001	-0.0138
RohnDP	0.0374	0.0000	-0.4691	-0.0374	0.0000	0.4691	0.0609	0.0001	-0.0129
RohnEP	0.0371	0.0000	-0.5805	-0.0371	0.0000	0.5805	0.0412	0.0001	-0.0110
RohnFP	0.0405	0.0000	-0.7867	-0.0405	0.0000	0.7867	0.0260	0.0000	-0.0091
RohnGP	0.0390	0.0000	-1.0471	-0.0390	0.0000	1.0471	0.0145	0.0000	-0.0071
RohnHP	0.0254	0.0000	-1.0422	-0.0254	0.0000	1.0422	0.0064	-0.0000	-0.0050
RohnIP	0.0173	0.0000	-1.1689	-0.0173	-0.0000	1.1689	0.0017	-0.0000	-0.0024
RohnJP	0.0000	0.0000	-0.6316	2.2667	-0.0031	-36.0266	0.0000	0.0000	0.0000
SNB-AP	0.0522	0.0000	-0.1410	-0.0522	0.0000	0.1410	0.1396	0.0001	-0.0067
SNB-BP	0.0634	0.0000	-0.3052	-0.0634	0.0000	0.3052	0.1117	0.0001	-0.0076
SNB-CP	0.0458	0.0000	-0.3872	-0.0458	0.0000	0.3872	0.0848	0.0001	-0.0080
SNB-DP	0.0374	0.0000	-0.4691	-0.0374	0.0000	0.4691	0.0609	0.0001	-0.0079
SNB-EP	0.0371	0.0000	-0.5805	-0.0371	0.0000	0.5805	0.0412	0.0001	-0.0069
SNB-FP	0.0405	0.0000	-0.7867	-0.0405	0.0000	0.7867	0.0260	0.0000	-0.0062
SNB-GP	0.0357	0.0000	-0.9571	-0.0357	0.0000	0.9571	0.0145	0.0000	-0.0049
SNB-HP	0.0254	0.0000	-1.0422	-0.0254	0.0000	1.0422	0.0064	0.0000	-0.0036
SNB-IP	0.0173	0.0000	-1.1689	-0.0173	0.0000	1.1689	0.0017	0.0000	-0.0017
SNB-JP	0.0000	0.0000	-0.6316	2.9185	-0.0009	-44.1580	0.0000	0.0000	0.0000
RohnA1	0.0989	0.0000	-0.2670	-0.0989	0.0000	0.2670	0.1396	0.0002	-0.0041
RohnA2	0.1455	0.0000	-0.3930	-0.1455	-0.0000	0.3930	0.1397	0.0002	-0.0041
RohnB1	0.0847	0.0000	-0.4078	-0.0847	0.0000	0.4078	0.1117	0.0001	-0.0035
RohnB2	0.0726	0.0000	-0.3493	-0.0726	-0.0000	0.3493	0.1117	0.0001	-0.0035
RohnC1	0.0458	0.0000	-0.3872	-0.0458	0.0000	0.3872	0.0847	0.0001	-0.0029
RohnC2	0.0458	0.0000	-0.3872	-0.0458	-0.0000	0.3872	0.0848	0.0001	-0.0029
RohnD1	0.0424	0.0000	-0.5321	-0.0424	0.0000	0.5321	0.0608	0.0001	-0.0023
RohnD2	0.0374	0.0000	-0.4691	-0.0374	-0.0000	0.4691	0.0608	0.0001	-0.0023
RohnE1	0.0371	0.0000	-0.5805	-0.0371	0.0000	0.5805	0.0412	0.0001	-0.0017
RohnE2	0.0371	0.0000	-0.5805	-0.0371	-0.0000	0.5805	0.0412	0.0001	-0.0017
RohnF1	0.0405	0.0000	-0.7867	-0.0405	0.0000	0.7867	0.0259	0.0001	-0.0012
RohnF2	0.0473	0.0000	-0.9172	-0.0473	-0.0000	0.9172	0.0259	0.0000	-0.0013
RohnG1	0.0377	0.0000	-1.0111	-0.0377	-0.0000	1.0111	0.0144	0.0001	-0.0009
RohnG2	0.0409	0.0000	-1.0975	-0.0409	-0.0000	1.0975	0.0144	0.0000	-0.0009
RohnH1	0.0254	0.0000	-1.0422	-0.0254	0.0000	1.0422	0.0063	0.0000	-0.0006
RohnH2	0.0254	0.0000	-1.0422	-0.0254	-0.0000	1.0422	0.0064	-0.0000	-0.0006
RohnI1	0.0173	0.0000	-1.1689	-0.0173	-0.0000	1.1689	0.0016	0.0000	-0.0003
RohnI2	0.0173	0.0000	-1.1689	-0.0173	-0.0000	1.1689	0.0016	-0.0000	-0.0003
RohnJ1	0.0000	0.0000	-0.6316	0.0262	-0.0940	-3.3696	0.0000	0.0000	0.0000
RohnJ2	0.0000	0.0000	-0.6316	0.0296	0.0974	-3.4379	0.0000	0.0000	0.0000
SNB-A1	0.0522	0.0000	-0.1410	-0.0522	-0.0000	0.1410	0.1396	0.0001	-0.0018
SNB-A2	0.0522	0.0000	-0.1410	-0.0522	0.0000	0.1410	0.1396	0.0001	-0.0018
SNB-B1	0.0634	0.0000	-0.3052	-0.0634	-0.0000	0.3052	0.1117	0.0001	-0.0012
SNB-B2	0.0634	0.0000	-0.3052	-0.0634	0.0000	0.3052	0.1117	0.0001	-0.0012
SNB-C1	0.0458	0.0000	-0.3872	-0.0458	-0.0000	0.3872	0.0848	0.0001	-0.0007
SNB-C2	0.0458	0.0000	-0.3872	-0.0458	0.0000	0.3872	0.0848	0.0001	-0.0007
SNB-D1	0.0374	0.0000	-0.4691	-0.0374	-0.0000	0.4691	0.0609	0.0001	-0.0003
SNB-D2	0.0374	0.0000	-0.4691	-0.0374	0.0000	0.4691	0.0609	0.0001	-0.0003
SNB-E1	0.0371	0.0000	-0.5805	-0.0371	-0.0000	0.5805	0.0412	0.0001	-0.0001
SNB-E2	0.0371	0.0000	-0.5805	-0.0371	0.0000	0.5805	0.0412	0.0001	-0.0002
SNB-F1	0.0405	0.0000	-0.7867	-0.0405	-0.0000	0.7867	0.0260	0.0000	-0.0000
SNB-F2	0.0405	0.0000	-0.7867	-0.0405	0.0000	0.7867	0.0260	0.0000	-0.0000
SNB-G1	0.0357	0.0000	-0.9571	-0.0357	-0.0000	0.9571	0.0145	0.0000	0.0001
SNB-G2	0.0357	0.0000	-0.9571	-0.0357	0.0000	0.9571	0.0145	0.0000	0.0000
SNB-H1	0.0254	0.0000	-1.0422	-0.0254	-0.0000	1.0422	0.0064	0.0000	0.0001
SNB-H2	0.0254	0.0000	-1.0422	-0.0254	0.0000	1.0422	0.0064	-0.0000	0.0001
SNB-I1	0.0173	0.0000	-1.1689	-0.0173	0.0000	1.1689	0.0016	0.0000	0.0000
SNB-I2	0.0173	0.0000	-1.1689	-0.0173	-0.0000	1.1689	0.0016	-0.0000	0.0000
SNB-J1	0.0000	0.0000	-0.6316	0.5278	0.6643	2.2602	0.0000	0.0000	0.0000
SNB-J2	0.0000	0.0000	-0.6316	0.5265	-0.6637	2.1840	0.0000	0.0000	0.0000
RohnAaS	0.0606	0.0000	-0.1881	-0.0606	0.0000	0.1881	0.1326	0.0001	-0.0133
RohnAbS	0.0393	0.0000	-0.1410	-0.0393	0.0000	0.1410	0.1256	0.0001	-0.0135
RohnAcS	0.0455	0.0000	-0.1890	-0.0455	0.0000	0.1890	0.1186	0.0001	-0.0137

RohnBaS	0.0294	0.0000	-0.1642	-0.0294	0.0000	0.1642	0.1048	0.0001	-0.0139
RohnBbS	0.1348	0.0000	-0.8700	-0.1348	0.0000	0.8700	0.0980	0.0001	-0.0139
RohnBcS	0.0221	0.0000	-0.1642	-0.0221	0.0000	0.1642	0.0914	0.0001	-0.0139
RohnCaS	0.0728	0.0000	-0.7200	-0.0728	0.0000	0.7200	0.0766	0.0001	-0.0136
RohnCbS	0.1131	0.0000	-1.2757	-0.1131	0.0000	1.2757	0.0686	0.0001	-0.0133
RohnDaS	0.0835	0.0000	-1.1411	-0.0835	0.0000	1.1411	0.0539	0.0001	-0.0124
RohnDbS	0.0168	0.0000	-0.2460	-0.0168	0.0000	0.2460	0.0474	0.0001	-0.0117
RohnEaS	0.0201	0.0000	-0.3345	-0.0201	0.0000	0.3345	0.0359	0.0000	-0.0104
RohnEbS	0.0187	0.0000	-0.3345	-0.0187	0.0000	0.3345	0.0308	0.0000	-0.0098
RohnFaS	0.0201	0.0000	-0.4522	-0.0201	0.0000	0.4522	0.0202	0.0000	-0.0081
RohnGaS	0.0154	0.0000	-0.5049	-0.0154	0.0000	0.5049	0.0104	0.0000	-0.0061
RohnHaS	0.0104	0.0000	-0.5373	-0.0104	0.0000	0.5373	0.0040	-0.0000	-0.0037
RohnIaS	0.0059	0.0000	-0.6316	-0.0059	0.0000	0.6316	0.0008	-0.0000	-0.0012
SNB-AaS	0.0454	0.0000	-0.1410	-0.0454	0.0000	0.1410	0.1326	0.0001	-0.0069
SNB-AbS	0.0393	0.0000	-0.1410	-0.0393	0.0000	0.1410	0.1256	0.0001	-0.0072
SNB-AcS	0.0340	0.0000	-0.1410	-0.0340	0.0000	0.1410	0.1186	0.0001	-0.0074
SNB-BaS	0.0294	0.0000	-0.1642	-0.0294	0.0000	0.1642	0.1048	0.0001	-0.0077
SNB-BbS	0.0254	0.0000	-0.1642	-0.0254	0.0000	0.1642	0.0980	0.0001	-0.0079
SNB-BcS	0.0221	0.0000	-0.1642	-0.0221	0.0000	0.1642	0.0914	0.0001	-0.0080
SNB-CaS	0.0226	0.0000	-0.2230	-0.0226	0.0000	0.2230	0.0766	0.0001	-0.0081
SNB-CbS	0.0198	0.0000	-0.2230	-0.0198	0.0000	0.2230	0.0686	0.0001	-0.0080
SNB-DaS	0.0180	0.0000	-0.2460	-0.0180	0.0000	0.2460	0.0539	0.0001	-0.0077
SNB-DbS	0.0168	0.0000	-0.2460	-0.0168	0.0000	0.2460	0.0474	0.0001	-0.0073
SNB-EaS	0.0201	0.0000	-0.3345	-0.0201	0.0000	0.3345	0.0359	0.0001	-0.0067
SNB-EbS	0.0187	0.0000	-0.3345	-0.0187	0.0000	0.3345	0.0308	0.0001	-0.0065
SNB-FaS	0.0201	0.0000	-0.4522	-0.0201	0.0000	0.4522	0.0202	0.0000	-0.0056
SNB-GaS	0.0154	0.0000	-0.5049	-0.0154	0.0000	0.5049	0.0104	0.0000	-0.0043
SNB-HaS	0.0104	0.0000	-0.5373	-0.0104	0.0000	0.5373	0.0040	0.0000	-0.0027
SNB-IaS	0.0059	0.0000	-0.6316	-0.0059	0.0000	0.6316	0.0008	-0.0000	-0.0009
SNB-WL-A1S	0.0522	0.0000	-0.1410	-0.0522	0.0000	0.1410	0.1396	0.0001	-0.0044
SNB-WL-A2S	0.0522	0.0000	-0.1410	-0.0522	0.0000	0.1410	0.1396	0.0001	-0.0019
SNB-WL-A3S	0.0522	0.0000	-0.1410	-0.0522	-0.0000	0.1410	0.1396	0.0001	-0.0044
SNB-WL-B1S	0.0293	0.0000	-0.1410	-0.0293	0.0000	0.1410	0.1117	0.0001	-0.0046
SNB-WL-B2S	0.0293	0.0000	-0.1410	-0.0293	0.0000	0.1410	0.1117	0.0001	-0.0014
SNB-WL-B3S	0.0293	0.0000	-0.1410	-0.0293	-0.0000	0.1410	0.1117	0.0001	-0.0046
SNB-WL-C1S	0.0194	0.0000	-0.1642	-0.0194	0.0000	0.1642	0.0848	0.0001	-0.0047
SNB-WL-C2S	0.0194	0.0000	-0.1642	-0.0194	0.0000	0.1642	0.0848	0.0001	-0.0010
SNB-WL-C3S	0.0194	0.0000	-0.1642	-0.0194	-0.0000	0.1642	0.0848	0.0001	-0.0047
SNB-WL-D1S	0.0178	0.0000	-0.2230	-0.0178	0.0000	0.2230	0.0609	0.0001	-0.0049
SNB-WL-D2S	0.0178	0.0000	-0.2230	-0.0178	0.0000	0.2230	0.0609	0.0001	-0.0011
SNB-WL-D3S	0.0178	0.0000	-0.2230	-0.0178	-0.0000	0.2230	0.0609	0.0001	-0.0049
SNB-WL-E1S	0.0157	0.0000	-0.2460	-0.0157	0.0000	0.2460	0.0412	0.0001	-0.0041
SNB-WL-E2S	0.0157	0.0000	-0.2460	-0.0157	0.0000	0.2460	0.0412	0.0001	-0.0007
SNB-WL-E3S	0.0157	0.0000	-0.2460	-0.0157	-0.0000	0.2460	0.0412	0.0001	-0.0041
SNB-WL-F1S	0.0172	0.0000	-0.3345	-0.0172	0.0000	0.3345	0.0260	0.0000	-0.0042
SNB-WL-F2S	0.0172	0.0000	-0.3345	-0.0172	0.0000	0.3345	0.0260	0.0000	-0.0011
SNB-WL-F3S	0.0172	0.0000	-0.3345	-0.0172	-0.0000	0.3345	0.0260	0.0000	-0.0042
SNB-WL-G1S	0.0169	0.0000	-0.4522	-0.0169	0.0000	0.4522	0.0145	0.0000	-0.0045
SNB-WL-G2S	0.0169	0.0000	-0.4522	-0.0169	0.0000	0.4522	0.0145	0.0000	-0.0020
SNB-WL-G3S	0.0169	0.0000	-0.4522	-0.0169	-0.0000	0.4522	0.0145	0.0000	-0.0045
SNB-WL-H1S	0.0123	0.0000	-0.5049	-0.0123	0.0000	0.5049	0.0064	0.0000	-0.0047
SNB-WL-H2S	0.0123	0.0000	-0.5049	-0.0123	0.0000	0.5049	0.0064	0.0000	-0.0029
SNB-WL-H3S	0.0123	0.0000	-0.5049	-0.0123	-0.0000	0.5049	0.0064	0.0000	-0.0047
SNB-WL-I1S	0.0080	0.0000	-0.5373	-0.0080	0.0000	0.5373	0.0017	0.0000	-0.0049
SNB-WL-I2S	0.0080	0.0000	-0.5373	-0.0080	-0.0000	0.5373	0.0017	0.0000	-0.0040
SNB-WL-I3S	0.0080	0.0000	-0.5373	-0.0080	-0.0000	0.5373	0.0017	0.0000	-0.0049
RohnAa1	0.0667	0.0000	-0.2072	-0.0667	0.0000	0.2072	0.1326	0.0001	-0.0039
RohnAa2	0.0734	0.0000	-0.2279	-0.0734	-0.0000	0.2279	0.1327	0.0002	-0.0040
RohnAb1	0.0695	0.0000	-0.2490	-0.0695	0.0000	0.2490	0.1256	0.0001	-0.0038
RohnAb2	0.0393	0.0000	-0.1410	-0.0393	-0.0000	0.1410	0.1256	0.0001	-0.0038
RohnAc1	0.0340	0.0000	-0.1410	-0.0340	0.0000	0.1410	0.1186	0.0001	-0.0036
RohnAc2	0.0340	0.0000	-0.1410	-0.0340	-0.0000	0.1410	0.1186	0.0001	-0.0036
RohnBa1	0.0294	0.0000	-0.1642	-0.0294	0.0000	0.1642	0.1047	0.0001	-0.0033
RohnBa2	0.0294	0.0000	-0.1642	-0.0294	-0.0000	0.1642	0.1048	0.0001	-0.0033
RohnBb1	0.1310	0.0000	-0.8457	-0.1310	0.0000	0.8457	0.0980	0.0001	-0.0032
RohnBb2	0.1310	0.0000	-0.8457	-0.1310	-0.0000	0.8457	0.0980	0.0001	-0.0032
RohnBc1	0.0221	0.0000	-0.1642	-0.0221	0.0000	0.1642	0.0912	0.0001	-0.0030
RohnBc2	0.0221	0.0000	-0.1642	-0.0221	-0.0000	0.1642	0.0913	0.0001	-0.0030
RohnCa1	0.0783	0.0000	-0.7740	-0.0783	0.0000	0.7740	0.0764	0.0001	-0.0027

RohnCa2	0.0819	0.0000	-0.8100	-0.0819	-0.0000	0.8100	0.0764	0.0001	-0.0027
RohnCb1	0.1087	0.0000	-1.2262	-0.1087	0.0000	1.2262	0.0683	0.0001	-0.0025
RohnCb2	0.1087	0.0000	-1.2262	-0.1087	-0.0000	1.2262	0.0684	0.0001	-0.0025
RohnDa1	0.0766	0.0000	-1.0466	-0.0766	0.0000	1.0466	0.0537	0.0001	-0.0021
RohnDa2	0.0766	0.0000	-1.0466	-0.0766	-0.0000	1.0466	0.0537	0.0001	-0.0021
RohnDb1	0.0168	0.0000	-0.2460	-0.0168	0.0000	0.2460	0.0470	0.0001	-0.0019
RohnDb2	0.0168	0.0000	-0.2460	-0.0168	-0.0000	0.2460	0.0471	0.0001	-0.0019
RohnEa1	0.0201	0.0000	-0.3345	-0.0201	0.0000	0.3345	0.0356	0.0001	-0.0015
RohnEa2	0.0201	0.0000	-0.3345	-0.0201	-0.0000	0.3345	0.0357	0.0001	-0.0015
RohnEb1	0.0187	0.0000	-0.3345	-0.0187	0.0000	0.3345	0.0305	0.0001	-0.0014
RohnEb2	0.0187	0.0000	-0.3345	-0.0187	-0.0000	0.3345	0.0306	0.0000	-0.0014
RohnFa1	0.0201	0.0000	-0.4522	-0.0201	0.0000	0.4522	0.0194	0.0000	-0.0010
RohnFa2	0.0201	0.0000	-0.4522	-0.0201	0.0000	0.4522	0.0194	0.0000	-0.0010
RohnGa1	0.0154	0.0000	-0.5049	-0.0154	0.0000	0.5049	0.0097	0.0000	-0.0007
RohnGa2	0.0154	0.0000	-0.5049	-0.0154	-0.0000	0.5049	0.0097	0.0000	-0.0007
RohnHa1	0.0104	0.0000	-0.5373	-0.0104	0.0000	0.5373	0.0032	-0.0000	-0.0004
RohnHa2	0.0104	0.0000	-0.5373	-0.0104	0.0000	0.5373	0.0032	0.0000	-0.0004
RohnIa1	0.0059	0.0000	-0.6316	-0.0059	0.0000	0.6316	0.0002	-0.0000	-0.0001
RohnIa2	0.0059	0.0000	-0.6316	-0.0059	0.0000	0.6316	0.0002	0.0000	-0.0001
SNB-Aa1	0.0454	0.0000	-0.1410	-0.0454	-0.0000	0.1410	0.1326	0.0001	-0.0016
SNB-Aa2	0.0454	0.0000	-0.1410	-0.0454	0.0000	0.1410	0.1326	0.0001	-0.0016
SNB-Ab1	0.0393	0.0000	-0.1410	-0.0393	-0.0000	0.1410	0.1256	0.0001	-0.0015
SNB-Ab2	0.0393	0.0000	-0.1410	-0.0393	0.0000	0.1410	0.1256	0.0001	-0.0015
SNB-Ac1	0.0340	0.0000	-0.1410	-0.0340	-0.0000	0.1410	0.1186	0.0001	-0.0013
SNB-Ac2	0.0340	0.0000	-0.1410	-0.0340	0.0000	0.1410	0.1186	0.0001	-0.0013
SNB-Ba1	0.0294	0.0000	-0.1642	-0.0294	-0.0000	0.1642	0.1048	0.0001	-0.0010
SNB-Ba2	0.0294	0.0000	-0.1642	-0.0294	0.0000	0.1642	0.1048	0.0001	-0.0011
SNB-Bb1	0.0254	0.0000	-0.1642	-0.0254	-0.0000	0.1642	0.0980	0.0001	-0.0009
SNB-Bb2	0.0254	0.0000	-0.1642	-0.0254	0.0000	0.1642	0.0980	0.0001	-0.0009
SNB-Bc1	0.0221	0.0000	-0.1642	-0.0221	-0.0000	0.1642	0.0913	0.0001	-0.0008
SNB-Bc2	0.0221	0.0000	-0.1642	-0.0221	0.0000	0.1642	0.0913	0.0001	-0.0008
SNB-Ca1	0.0226	0.0000	-0.2230	-0.0226	-0.0000	0.2230	0.0763	0.0001	-0.0005
SNB-Ca2	0.0226	0.0000	-0.2230	-0.0226	0.0000	0.2230	0.0763	0.0001	-0.0005
SNB-Cb1	0.0198	0.0000	-0.2230	-0.0198	-0.0000	0.2230	0.0683	0.0001	-0.0004
SNB-Cb2	0.0198	0.0000	-0.2230	-0.0198	0.0000	0.2230	0.0683	0.0001	-0.0004
SNB-Da1	0.0180	0.0000	-0.2460	-0.0180	-0.0000	0.2460	0.0536	0.0001	-0.0002
SNB-Da2	0.0180	0.0000	-0.2460	-0.0180	0.0000	0.2460	0.0536	0.0001	-0.0002
SNB-Db1	0.0168	0.0000	-0.2460	-0.0168	-0.0000	0.2460	0.0470	0.0001	-0.0002
SNB-Db2	0.0168	0.0000	-0.2460	-0.0168	0.0000	0.2460	0.0470	0.0001	-0.0002
SNB-Ea1	0.0201	0.0000	-0.3345	-0.0201	-0.0000	0.3345	0.0357	0.0001	-0.0001
SNB-Ea2	0.0201	0.0000	-0.3345	-0.0201	0.0000	0.3345	0.0357	0.0001	-0.0001
SNB-Eb1	0.0187	0.0000	-0.3345	-0.0187	-0.0000	0.3345	0.0306	0.0001	-0.0000
SNB-Eb2	0.0187	0.0000	-0.3345	-0.0187	0.0000	0.3345	0.0306	0.0000	-0.0000
SNB-Fa1	0.0201	0.0000	-0.4522	-0.0201	-0.0000	0.4522	0.0194	0.0001	0.0000
SNB-Fa2	0.0201	0.0000	-0.4522	-0.0201	-0.0000	0.4522	0.0194	0.0000	0.0000
SNB-Ga1	0.0154	0.0000	-0.5049	-0.0154	-0.0000	0.5049	0.0097	0.0000	0.0001
SNB-Ga2	0.0154	0.0000	-0.5049	-0.0154	0.0000	0.5049	0.0097	0.0000	0.0001
SNB-Ha1	0.0104	0.0000	-0.5373	-0.0104	-0.0000	0.5373	0.0032	-0.0000	0.0001
SNB-Ha2	0.0104	0.0000	-0.5373	-0.0104	-0.0000	0.5373	0.0032	0.0000	0.0001
SNB-Ia1	0.0059	0.0000	-0.6316	-0.0059	-0.0000	0.6316	0.0002	-0.0000	0.0000
SNB-Ia2	0.0059	0.0000	-0.6316	-0.0059	-0.0000	0.6316	0.0002	0.0000	0.0000

**Moments for Angles Modeled as Beams:**

Angle Label	Torsion (ft-lbs)	Origin X Moment (ft-lbs)	Origin Y Moment (ft-lbs)	End X Moment (ft-lbs)	End Y Moment (ft-lbs)	X Shear (lbs)	Y Shear (lbs)
Rohn-LA1P	-0.19	0.10	0.82	0.06	-3.21	0.03	-0.48
Rohn-LA11	0.01	-0.37	0.42	-2.44	0.99	-0.56	0.28
Rohn-LA12	-0.41	0.33	0.60	2.53	0.09	0.57	0.14
Rohn-LA2P	-0.19	-0.06	3.21	-0.67	5.41	-0.15	1.72
Rohn-LA21	0.01	2.44	-0.99	1.77	-3.66	0.84	-0.93
Rohn-LA22	-0.41	-2.53	-0.09	-2.74	-1.14	-1.05	-0.25
Rohn-LA3P	-0.19	0.67	-5.41	1.00	-4.38	0.33	-1.96
Rohn-LA31	0.01	-1.77	3.66	-1.59	8.39	-0.67	2.41
Rohn-LA32	-0.41	2.74	1.14	2.08	6.68	0.96	1.56
Rohn-LA4P	-0.19	-1.00	4.38	-0.46	10.30	-0.29	2.93
Rohn-LA41	0.01	1.59	-8.39	0.95	-8.60	0.51	-3.39

Rohn-LA42	-0.41	-2.08	-6.68	-1.52	-7.08	-0.72	-2.75
Rohn-LB1P	-0.11	0.47	-9.03	0.41	-6.02	0.18	-3.01
Rohn-LB11	0.41	-1.35	9.35	1.19	22.39	-0.03	6.34
Rohn-LB12	-0.63	1.89	7.86	-0.96	21.75	0.19	5.92
Rohn-LB2P	-0.11	-0.41	6.02	-0.16	17.63	-0.11	4.73
Rohn-LB21	0.41	-1.19	-22.39	-2.49	-14.94	-0.74	-7.46
Rohn-LB22	-0.63	0.96	-21.75	2.47	-14.70	0.69	-7.28
Rohn-LB3P	-0.11	0.16	-17.63	0.10	-7.37	0.05	-5.00
Rohn-LB31	0.41	2.49	14.94	-1.23	20.43	0.25	7.07
Rohn-LB32	-0.63	-2.47	14.70	1.29	20.29	-0.24	6.99
Rohn-LB4P	-0.11	-0.10	7.37	-0.04	28.72	-0.03	7.21
Rohn-LB41	0.41	1.23	-20.43	5.70	9.21	1.38	-2.24
Rohn-LB42	-0.63	-1.29	-20.29	-5.75	9.45	-1.41	-2.17
Rohn-LC1P	-0.11	0.04	-28.72	0.07	9.42	0.02	-2.89
Rohn-LC11	0.41	-5.70	-9.21	-3.42	12.05	-1.37	0.43
Rohn-LC12	-0.63	5.75	-9.45	3.59	11.68	1.40	0.34
Rohn-LC2P	-0.11	-0.07	-9.42	-0.02	5.92	-0.01	-0.52
Rohn-LC21	0.41	3.42	-12.05	-4.78	24.10	-0.20	1.80
Rohn-LC22	-0.63	-3.59	-11.68	4.68	24.22	0.16	1.88
Rohn-LC3P	-0.11	0.02	-5.92	-0.07	43.70	-0.01	5.67
Rohn-LC31	0.41	4.78	-24.10	12.56	14.82	2.60	-1.39
Rohn-LC32	-0.63	-4.68	-24.22	-12.62	15.22	-2.59	-1.35
Rohn-LD1P	-0.11	0.07	-43.69	0.37	31.00	0.07	-1.91
Rohn-LD11	0.41	-12.56	-14.82	-12.74	31.90	-3.80	2.56
Rohn-LD12	-0.63	12.62	-15.22	12.93	31.54	3.83	2.45
Rohn-LD2P	-0.11	-0.37	-31.00	-0.12	7.08	-0.07	-3.58
Rohn-LD21	0.41	12.74	-31.90	3.27	63.27	2.40	4.69
Rohn-LD22	-0.63	-12.93	-31.54	-3.18	63.47	-2.41	4.78
Rohn-LD3P	-0.11	0.12	-7.08	0.09	85.72	0.03	11.80
Rohn-LD31	0.41	-3.27	-63.27	3.37	5.82	0.02	-8.62
Rohn-LD32	-0.63	3.18	-63.47	-3.31	5.75	-0.02	-8.66
Rohn-LE1P	-0.11	-0.09	-85.72	0.12	9.09	0.00	-11.50
Rohn-LE11	0.41	-3.37	-5.82	-4.29	53.23	-1.15	7.11
Rohn-LE12	-0.63	3.31	-5.75	4.36	53.10	1.15	7.10
Rohn-LE2P	-0.11	-0.12	-9.09	-0.34	11.09	-0.07	0.30
Rohn-LE21	0.41	4.29	-53.23	-0.82	43.51	0.52	-1.45
Rohn-LE22	-0.63	-4.36	-53.10	0.77	44.04	-0.54	-1.36
Rohn-LE3P	-0.11	0.34	-11.09	0.54	132.29	0.13	18.19
Rohn-LE31	0.41	0.82	-43.51	8.39	-7.37	1.38	-7.63
Rohn-LE32	-0.63	-0.77	-44.04	-8.14	-8.54	-1.34	-7.89
Rohn-LF1P	-0.11	-0.54	-132.29	-0.91	-67.06	-0.14	-19.92
Rohn-LF11	0.41	-8.39	7.37	-11.30	167.82	-1.97	17.51
Rohn-LF12	-0.63	8.14	8.54	10.85	168.88	1.90	17.73
Rohn-LF2P	-0.11	0.91	67.06	0.54	209.98	0.15	27.69
Rohn-LF21	0.41	11.31	-167.82	11.36	-60.71	2.26	-22.84
Rohn-LF22	-0.63	-10.85	-168.88	-11.36	-61.78	-2.22	-23.05
Rohn-LG1P	-0.11	-0.54	-209.98	-0.81	-97.30	-0.13	-30.71
Rohn-LG11	0.41	-11.36	60.71	-13.25	191.63	-2.46	25.21
Rohn-LG12	-0.63	11.36	61.78	12.82	192.38	2.42	25.40
Rohn-LG2P	-0.11	0.81	97.30	0.30	234.57	0.11	33.17
Rohn-LG21	0.41	13.25	-191.63	15.79	-73.40	2.90	-26.48
Rohn-LG22	-0.63	-12.82	-192.38	-16.05	-73.82	-2.88	-26.60
Rohn-LH1P	-0.11	-0.30	-234.57	-0.30	-120.42	-0.06	-35.48
Rohn-LH11	0.40	-15.79	73.40	-19.08	216.06	-3.48	28.92
Rohn-LH12	-0.62	16.05	73.82	18.80	216.48	3.48	29.01
Rohn-LH2P	-0.11	0.30	120.42	0.01	298.08	0.03	41.82
Rohn-LH21	0.40	19.08	-216.06	26.62	-101.40	4.57	-31.72
Rohn-LH22	-0.62	-18.80	-216.48	-26.89	-101.80	-4.57	-31.80
Rohn-LI1P	-0.11	-0.01	-298.08	-0.87	-181.57	-0.09	-47.93
Rohn-LI11	0.40	-26.62	101.40	-39.47	360.10	-6.60	46.12
Rohn-LI12	-0.62	26.89	101.80	39.27	360.03	6.61	46.15
Rohn-LI2P	-0.11	0.87	181.57	1.76	488.78	0.26	66.99
Rohn-LI21	0.40	39.47	-360.10	35.27	-70.64	7.47	-43.04
Rohn-LI22	-0.62	-39.28	-360.03	-36.66	-68.78	-7.59	-42.85
Rohn-H1P	0.02	0.42	0.01	0.52	-0.06	0.13	-0.01
Rohn-H11	0.02	-0.09	0.05	0.03	0.18	-0.01	0.03
Rohn-H12	0.02	-0.64	0.24	-0.53	0.18	-0.16	0.06
Rohn-H2P	-0.03	0.74	-0.14	0.85	-0.25	0.18	-0.04
Rohn-H21	0.01	-0.00	-0.16	-0.04	0.07	-0.00	-0.01

Rohn-H22	0.04	-0.87	0.17	-0.76	0.06	-0.18	0.03
SNB-LA1P	-0.00	0.10	58.32	0.37	10.02	0.09	13.66
SNB-LA11	0.02	49.09	-26.81	9.87	-4.65	11.78	-6.29
SNB-LA12	-0.02	-49.42	-27.12	-10.23	-5.28	-11.92	-6.48
SNB-LA2P	-0.00	-0.37	-10.02	-0.59	6.42	-0.19	-0.72
SNB-LA21	0.02	-9.87	4.65	1.21	-4.13	-1.73	0.10
SNB-LA22	-0.02	10.23	5.28	-0.99	-3.32	1.85	0.39
SNB-LA3P	-0.00	0.59	-6.42	0.42	-16.73	0.20	-4.63
SNB-LA31	0.02	-1.21	4.13	-9.58	15.78	-2.16	3.98
SNB-LA32	-0.02	0.99	3.32	9.24	15.10	2.05	3.68
SNB-LA4P	-0.00	-0.42	16.73	-0.27	58.24	-0.14	14.98
SNB-LA41	0.02	9.58	-15.78	34.65	-26.25	8.84	-8.40
SNB-LA42	-0.02	-9.24	-15.10	-34.34	-25.76	-8.71	-8.17
SNB-LB1P	-0.00	0.28	92.49	0.17	14.69	0.09	21.42
SNB-LB11	0.41	74.83	-27.31	10.58	17.09	17.07	-2.04
SNB-LB12	-0.41	-74.91	-27.68	-10.61	16.87	-17.09	-2.16
SNB-LB2P	-0.00	-0.17	-14.69	-0.07	37.58	-0.05	4.58
SNB-LB21	0.41	-10.58	-17.09	10.47	-6.59	-0.02	-4.73
SNB-LB22	-0.41	10.61	-16.87	-10.34	-6.43	0.06	-4.66
SNB-LB3P	-0.00	0.07	-37.58	0.12	-45.21	0.04	-16.54
SNB-LB31	0.41	-10.47	6.59	-29.71	51.27	-8.03	11.56
SNB-LB32	-0.41	10.34	6.43	29.77	51.16	8.01	11.51
SNB-LB4P	-0.00	-0.12	45.21	-0.02	180.25	-0.03	45.06
SNB-LB41	0.42	29.71	-51.27	97.66	-52.91	25.45	-20.82
SNB-LB42	-0.41	-29.77	-51.16	-97.57	-52.83	-25.45	-20.78
SNB-LC1P	-0.00	0.01	55.87	0.02	47.64	0.01	15.53
SNB-LC11	0.85	79.22	-39.48	31.00	13.99	16.54	-3.83
SNB-LC12	-0.85	-79.34	-39.57	-31.03	13.95	-16.56	-3.84
SNB-LC2P	-0.00	-0.02	-47.64	0.02	-36.43	0.00	-12.58
SNB-LC21	0.85	-31.00	-13.99	-37.59	62.86	-10.26	7.31
SNB-LC22	-0.85	31.03	-13.95	37.57	62.82	10.26	7.31
SNB-LC3P	-0.00	-0.02	36.43	-0.00	204.43	-0.00	36.14
SNB-LC31	0.85	37.59	-62.86	119.21	-73.10	23.53	-20.40
SNB-LC32	-0.85	-37.57	-62.82	-119.04	-73.00	-23.50	-20.38
SNB-LD1P	-0.00	0.02	164.66	0.17	112.34	0.03	41.56
SNB-LD11	1.13	182.50	-93.47	50.30	35.57	34.93	-8.69
SNB-LD12	-1.13	-182.64	-93.58	-50.23	35.42	-34.94	-8.73
SNB-LD2P	-0.00	-0.17	-112.34	0.02	-49.40	-0.02	-24.20
SNB-LD21	1.12	-50.30	-35.57	-33.84	113.10	-12.59	11.60
SNB-LD22	-1.12	50.23	-35.42	34.06	113.21	12.61	11.64
SNB-LD3P	-0.00	-0.02	49.40	0.04	287.41	0.00	50.54
SNB-LD31	1.13	33.84	-113.10	108.35	-61.68	21.33	-26.22
SNB-LD32	-1.13	-34.06	-113.21	-108.35	-61.72	-21.37	-26.24
SNB-LE1P	-0.01	-0.06	205.11	0.26	159.19	0.03	54.66
SNB-LE11	1.90	274.24	-143.96	81.06	73.57	53.31	-10.56
SNB-LE12	-1.90	-274.45	-144.00	-80.97	73.33	-53.32	-10.60
SNB-LE2P	-0.01	-0.26	-159.19	-0.19	-104.24	-0.07	-39.41
SNB-LE21	1.89	-81.06	-73.57	-102.26	213.63	-27.42	20.95
SNB-LE22	-1.89	80.97	-73.33	102.64	214.07	27.47	21.05
SNB-LE3P	-0.01	0.19	104.24	0.15	736.55	0.05	126.16
SNB-LE31	1.90	102.26	-213.63	385.63	-296.09	73.20	-76.47
SNB-LE32	-1.90	-102.64	-214.07	-386.34	-296.67	-73.36	-76.63
SNB-LF1P	0.00	-0.24	-6.72	-0.49	-165.15	-0.07	-17.18
SNB-LF11	2.74	233.22	-45.01	-11.70	328.58	22.13	28.34
SNB-LF12	-2.75	-232.88	-44.54	11.67	329.13	-22.10	28.44
SNB-LF2P	0.00	0.49	165.15	0.18	765.90	0.07	93.04
SNB-LF21	2.75	11.70	-328.58	308.41	-343.77	31.99	-67.18
SNB-LF22	-2.76	-11.67	-329.13	-309.21	-344.43	-32.06	-67.30
SNB-LG1P	0.01	-0.21	346.21	-1.07	-207.80	-0.13	13.83
SNB-LG11	4.45	661.31	-207.86	5.69	554.12	66.65	34.60
SNB-LG12	-4.47	-660.62	-207.21	-6.35	554.97	-66.64	34.75
SNB-LG2P	0.01	1.07	207.80	0.34	1334.49	0.14	154.12
SNB-LG21	4.44	-5.69	-554.12	620.71	-572.82	61.45	-112.61
SNB-LG22	-4.47	6.35	-554.97	-621.57	-573.70	-61.47	-112.78
SNB-LH1P	0.01	-0.34	100.50	-1.10	-259.84	-0.14	-15.92
SNB-LH11	4.17	605.95	-128.58	9.94	586.58	61.54	45.76
SNB-LH12	-4.19	-605.11	-127.71	-10.60	587.46	-61.52	45.94
SNB-LH2P	0.01	1.10	259.84	0.41	1285.46	0.15	154.43
SNB-LH21	4.17	-9.94	-586.58	482.41	-537.67	47.21	-112.34



SNB-LH22	-4.18	10.60	-587.46	-483.20	-538.59	-47.22	-112.52
SNB-LI1P	0.00	-0.41	409.41	-1.53	-128.04	-0.19	28.12
SNB-LI11	2.30	983.41	-301.79	215.33	767.52	119.78	46.54
SNB-LI12	-2.32	-982.56	-300.84	-216.49	768.60	-119.81	46.74
SNB-LI2P	0.00	1.53	128.04	0.87	1056.82	0.24	118.41
SNB-LI21	2.27	-215.33	-767.52	-71.65	-138.09	-28.68	-90.49
SNB-LI22	-2.28	216.49	-768.60	71.42	-139.17	28.77	-90.71
SNB-H1aP	-0.29	33.83	-2.74	109.91	-2.07	71.14	-2.38
SNB-H1bP	-0.29	-109.91	2.07	-31.18	-1.15	-69.83	0.45
SNB-H1cP	-0.07	33.25	1.08	109.08	3.71	70.45	2.37
SNB-H1dP	-0.07	-109.08	-3.71	-33.40	-1.09	-70.52	-2.37
SNB-H1eP	0.37	31.43	1.15	109.75	-2.14	69.88	-0.49
SNB-H1fP	0.37	-109.75	2.14	-33.90	2.74	-71.10	2.42
SNB-H2aP	-1.04	87.60	-0.64	115.55	-0.63	75.16	-0.47
SNB-H2bP	-1.04	-115.55	0.63	-62.41	-1.18	-65.84	-0.20
SNB-H2cP	0.02	77.39	0.46	113.24	2.30	70.53	1.02
SNB-H2dP	0.02	-113.24	-2.30	-77.23	-0.46	-70.47	-1.02
SNB-H2eP	1.02	62.29	1.18	115.59	-0.68	65.81	0.19
SNB-H2fP	1.02	-115.59	0.68	-87.65	0.64	-75.19	0.49
SNB-H3aP	-0.53	136.64	0.59	155.93	0.16	86.44	0.22
SNB-H3bP	-0.53	-155.93	-0.16	-106.93	-1.69	-77.67	-0.54
SNB-H3cP	0.00	122.98	0.92	154.77	2.89	82.07	1.13
SNB-H3dP	0.00	-154.77	-2.89	-123.01	-0.92	-82.08	-1.12
SNB-H3eP	0.53	106.95	1.69	155.93	0.15	77.67	0.54
SNB-H3fP	0.53	-155.93	-0.15	-136.62	-0.59	-86.44	-0.22
SNB-H4aP	-0.70	213.49	1.52	249.99	0.53	113.99	0.50
SNB-H4bP	-0.70	-249.99	-0.53	-192.64	-2.47	-108.86	-0.74
SNB-H4cP	-0.00	204.84	1.93	248.58	4.87	111.52	1.67
SNB-H4dP	-0.00	-248.58	-4.87	-204.81	-1.93	-111.51	-1.67
SNB-H4eP	0.70	192.63	2.47	249.98	0.52	108.86	0.74
SNB-H4fP	0.70	-249.98	-0.52	-213.52	-1.52	-113.99	-0.50
SNB-H5aP	-0.76	284.83	2.35	322.29	0.56	127.90	0.61
SNB-H5bP	-0.76	-322.29	-0.56	-237.78	-3.68	-117.99	-0.89
SNB-H5cP	-0.00	263.10	2.38	320.72	7.29	123.00	2.04
SNB-H5dP	-0.00	-320.72	-7.29	-263.26	-2.38	-123.03	-2.04
SNB-H5eP	0.77	237.86	3.68	322.28	0.56	118.01	0.89
SNB-H5fP	0.77	-322.28	-0.56	-284.76	-2.34	-127.89	-0.61
SNB-H6aP	-3.63	423.54	2.21	497.66	1.01	169.70	0.59
SNB-H6bP	-3.63	-497.66	-1.01	-395.74	-3.81	-164.58	-0.89
SNB-H6cP	0.01	417.93	2.42	489.75	6.41	167.21	1.63
SNB-H6dP	0.00	-489.75	-6.41	-418.23	-2.41	-167.27	-1.63
SNB-H6eP	3.63	395.88	3.82	497.67	1.03	164.61	0.89
SNB-H6fP	3.63	-497.67	-1.03	-423.38	-2.22	-169.68	-0.60
SNB-H7aP	-2.95	643.81	0.14	739.71	-0.94	226.44	-0.13
SNB-H7bP	-2.95	-739.71	0.93	-638.33	-1.98	-225.55	-0.17
SNB-H7cP	0.01	648.16	0.00	733.62	4.00	226.16	0.66
SNB-H7dP	0.01	-733.62	-4.00	-648.26	0.00	-226.17	-0.65
SNB-H7eP	2.94	638.37	1.99	739.73	-0.92	225.55	0.17
SNB-H7fP	2.94	-739.73	0.92	-643.74	-0.15	-226.43	0.13
SNB-H8aP	-0.60	828.84	0.32	893.99	-0.98	253.71	-0.10
SNB-H8bP	-0.59	-893.99	0.98	-809.76	-1.02	-250.90	-0.01
SNB-H8cP	0.00	821.50	1.04	893.52	4.37	252.56	0.80
SNB-H8dP	0.00	-893.52	-4.37	-821.53	-1.04	-252.57	-0.80
SNB-H8eP	0.59	809.77	1.02	893.99	-0.99	250.90	0.00
SNB-H8fP	0.60	-893.99	0.99	-828.83	-0.31	-253.71	0.10
SNB-H9aP	-1.73	979.52	0.21	1031.65	-1.25	269.16	-0.14
SNB-H9bP	-1.73	-1031.65	1.24	-969.67	0.04	-267.84	0.17
SNB-H9cP	0.00	979.81	1.57	1029.08	4.24	268.85	0.78
SNB-H9dP	0.00	-1029.08	-4.24	-979.77	-1.57	-268.85	-0.78
SNB-H9eP	1.72	969.65	-0.05	1031.65	-1.25	267.84	-0.17
SNB-H9fP	1.73	-1031.65	1.25	-979.54	-0.20	-269.16	0.14

Equilibrium Joint Positions and Rotations for Load Case "6: Service 1.0D + 1.0Dg + 1.0 Wo":

Joint Label	X-Displ (ft)	Y-Displ (ft)	Z-Displ (ft)	X-Rot (deg)	Y-Rot (deg)	Z-Rot (deg)	X-Pos (ft)	Y-Pos (ft)	Z-Pos (ft)
RohnAP	0.3996	-8.386e-005	-0.02377	0.0012	0.2049	0.0024	4.733	-8.386e-005	180
RohnBP	0.3278	8.155e-005	-0.02604	-0.0003	0.2046	0.0024	5.449	8.155e-005	160
RohnCP	0.257	1.393e-005	-0.02714	-0.0002	0.1972	0.0016	6.166	1.393e-005	140
RohnDP	0.191	-2.184e-005	-0.0268	-0.0001	0.1789	0.0010	6.886	-2.184e-005	120
RohnEP	0.1332	-7.096e-005	-0.02387	-0.0002	0.1477	0.0007	7.614	-7.096e-005	99.98
RohnFP	0.08628	-0.0001278	-0.02061	-0.0001	0.1163	0.0005	8.354	-0.0001278	79.98
RohnGP	0.04946	-0.0001305	-0.01653	0.0001	0.0890	0.0003	9.104	-0.0001305	59.98
RohnHP	0.02275	-9.193e-005	-0.01186	0.0002	0.0610	0.0002	9.864	-9.193e-005	39.99
RohnIP	0.006436	-4.826e-005	-0.00582	0.0001	0.0273	0.0001	10.64	-4.826e-005	19.99
RohnJP	0	0	0	0.0000	0.0000	0.0000	11.42	0	0
SNB-AP	0.3996	-0.0002722	-0.01265	0.0004	0.1999	-0.0000	2.733	-0.0002722	180
SNB-BP	0.3278	-0.0001939	-0.01512	0.0002	0.2003	-0.0000	3.449	-0.0001939	160
SNB-CP	0.2571	-0.0001194	-0.01701	0.0002	0.1925	-0.0000	4.165	-0.0001194	140
SNB-DP	0.191	-6.242e-005	-0.0177	0.0001	0.1715	-0.0000	4.886	-6.242e-005	120
SNB-EP	0.1332	-2.867e-005	-0.01635	0.0001	0.1413	-0.0000	5.614	-2.867e-005	99.98
SNB-FP	0.08629	-1.503e-005	-0.01517	0.0000	0.1122	0.0000	6.354	-1.503e-005	79.98
SNB-GP	0.04947	-9.162e-006	-0.01255	0.0000	0.0787	0.0000	7.104	-9.162e-006	59.99
SNB-HP	0.02275	-4.633e-006	-0.009301	0.0000	0.0538	0.0000	7.864	-4.633e-006	39.99
SNB-IP	0.006437	-1.737e-006	-0.004708	0.0000	0.0226	0.0000	8.634	-1.737e-006	20
SNB-JP	0	0	0	0.0000	0.0000	0.0000	9.415	0	0
RohnA1	0.3998	-0.0003673	-0.0006454	-0.0003	0.2060	0.0013	-1.767	-3.753	180
RohnA2	0.3995	-0.000353	-0.0006311	0.0004	0.2058	0.0034	-1.767	3.752	180
RohnB1	0.3281	-0.0003423	0.0009104	0.0010	0.2065	0.0003	-2.232	-4.435	160
RohnB2	0.3276	-0.000335	0.0009501	-0.0002	0.2060	0.0045	-2.233	4.435	160
RohnC1	0.2571	-0.0001192	0.002313	-0.0004	0.1960	-0.0018	-2.697	-5.117	140
RohnC2	0.2569	-0.0002545	0.002346	0.0013	0.1953	0.0050	-2.698	5.117	140
RohnD1	0.1908	3.464e-005	0.003375	-0.0008	0.1785	-0.0029	-3.157	-5.798	120
RohnD2	0.1907	-0.000213	0.003404	0.0013	0.1779	0.0050	-3.157	5.798	120
RohnE1	0.1331	2.218e-005	0.003799	-0.0002	0.1476	-0.0029	-3.607	-6.479	100
RohnE2	0.1332	-3.514e-005	0.003812	0.0006	0.1471	0.0043	-3.607	6.479	100
RohnF1	0.08598	0.0001534	0.003787	0.0016	0.1229	-0.0028	-4.048	-7.16	80
RohnF2	0.08623	-4.14e-005	0.003786	-0.0014	0.1227	0.0038	-4.048	7.16	80
RohnG1	0.04928	9.807e-005	0.003323	0.0005	0.0909	-0.0022	-4.478	-7.842	60
RohnG2	0.04955	3.366e-005	0.00332	-0.0006	0.0909	0.0028	-4.478	7.842	60
RohnH1	0.02257	9.348e-005	0.002543	0.0005	0.0629	-0.0016	-4.898	-8.522	40
RohnH2	0.02273	-1.435e-005	0.002542	-0.0006	0.0631	0.0020	-4.898	8.523	40
RohnI1	0.006365	3.425e-005	0.001292	0.0008	0.0314	-0.0009	-5.309	-9.206	20
RohnI2	0.006445	8.531e-006	0.001292	-0.0009	0.0316	0.0010	-5.309	9.206	20
RohnJ1	0	0	0	0.0000	0.0000	0.0000	-5.71	-9.89	0
RohnJ2	0	0	0	0.0000	0.0000	0.0000	-5.71	9.89	0
SNB-A1	0.3996	-0.0002726	-9.798e-005	-0.0046	0.2089	-0.0002	-0.7669	-2.021	180
SNB-A2	0.3996	-0.0002713	-8.274e-005	0.0050	0.2087	0.0002	-0.7669	2.02	180
SNB-B1	0.3278	-0.0001953	0.001466	-0.0027	0.2067	-0.0002	-1.233	-2.703	160
SNB-B2	0.3278	-0.0001917	0.001487	0.0032	0.2067	0.0003	-1.233	2.703	160
SNB-C1	0.2571	-0.0001204	0.002864	-0.0030	0.1994	-0.0005	-1.697	-3.385	140
SNB-C2	0.2571	-0.0001187	0.002886	0.0034	0.1994	0.0005	-1.697	3.384	140
SNB-D1	0.191	-5.098e-005	0.00383	-0.0053	0.1826	-0.0010	-2.157	-4.066	120
SNB-D2	0.191	-7.337e-005	0.003848	0.0056	0.1826	0.0010	-2.157	4.066	120
SNB-E1	0.1332	-1.419e-005	0.004024	-0.0032	0.1481	-0.0008	-2.607	-4.747	100
SNB-E2	0.1332	-4.244e-005	0.004034	0.0033	0.1481	0.0008	-2.607	4.747	100
SNB-F1	0.08625	-3.77e-006	0.004066	-0.0036	0.1255	-0.0008	-3.048	-5.428	80
SNB-F2	0.08625	-2.72e-005	0.004072	0.0037	0.1255	0.0008	-3.048	5.428	80
SNB-G1	0.04942	1.969e-005	0.003545	-0.0052	0.0949	-0.0010	-3.478	-6.11	60
SNB-G2	0.04942	-3.91e-005	0.003549	0.0052	0.0949	0.0010	-3.478	6.11	60
SNB-H1	0.02267	3.52e-005	0.002734	-0.0057	0.0658	-0.0010	-3.898	-6.79	40
SNB-H2	0.02268	-4.434e-005	0.002737	0.0057	0.0658	0.0010	-3.898	6.79	40
SNB-I1	0.006332	5.323e-005	0.001419	-0.0034	0.0345	-0.0010	-4.308	-7.472	20
SNB-I2	0.006332	-5.642e-005	0.001421	0.0034	0.0345	0.0010	-4.308	7.472	20
SNB-J1	0	0	0	0.0000	0.0000	0.0000	-4.708	-8.154	0
SNB-J2	0	0	0	0.0000	0.0000	0.0000	-4.708	8.154	0

RohnAaS	0.3817	3.67e-006	-0.02441	0.0002	0.2063	0.0024	4.912	3.67e-006	175
RohnAbS	0.3636	9.71e-006	-0.02501	0.0006	0.2058	0.0024	5.091	9.71e-006	170
RohnAcS	0.3457	0.0001034	-0.02556	0.0004	0.2054	0.0024	5.27	0.0001034	165
RohnBaS	0.31	7.764e-005	-0.02646	-0.0002	0.2044	0.0022	5.628	7.764e-005	155
RohnBbS	0.2921	5.64e-005	-0.0268	-0.0003	0.2028	0.0020	5.807	5.64e-005	150
RohnBcS	0.2745	3.709e-005	-0.02702	-0.0003	0.2013	0.0018	5.987	3.709e-005	145
RohnCaS	0.2345	3.634e-006	-0.02726	-0.0001	0.1911	0.0014	6.405	3.634e-006	133.3
RohnCbS	0.2124	-8.389e-006	-0.02717	-0.0002	0.1875	0.0012	6.646	-8.389e-006	126.6
RohnDaS	0.1707	-2.978e-005	-0.02614	-0.0002	0.1689	0.0009	7.127	-2.978e-005	113.3
RohnDbS	0.1514	-5.105e-005	-0.02513	-0.0002	0.1616	0.0008	7.371	-5.105e-005	106.6
RohnEaS	0.1168	-9.33e-005	-0.02296	-0.0003	0.1366	0.0006	7.86	-9.33e-005	93.32
RohnEbS	0.101	-0.0001244	-0.02187	-0.0001	0.1323	0.0005	8.107	-0.0001244	86.64
RohnFaS	0.06722	-0.0001588	-0.01874	-0.0000	0.1060	0.0004	8.729	-0.0001588	69.98
RohnGaS	0.03553	-0.0001278	-0.01433	0.0001	0.0764	0.0002	9.484	-0.0001278	49.99
RohnHaS	0.01393	-6.814e-005	-0.008979	0.0001	0.0469	0.0001	10.25	-6.814e-005	29.99
RohnIaS	0.002645	-2.304e-005	-0.00301	0.0002	0.0198	0.0000	11.03	-2.304e-005	9.997
SNB-AaS	0.3817	-0.0002443	-0.01331	0.0001	0.2077	-0.0000	2.912	-0.0002443	175
SNB-AbS	0.3637	-0.0002475	-0.01395	0.0002	0.2051	-0.0000	3.091	-0.0002475	170
SNB-AcS	0.3458	-0.0002048	-0.01455	0.0004	0.2067	-0.0000	3.27	-0.0002048	165
SNB-BaS	0.31	-0.0001732	-0.01567	0.0002	0.2057	-0.0000	3.628	-0.0001732	155
SNB-BbS	0.2922	-0.0001551	-0.01618	0.0002	0.2023	-0.0000	3.807	-0.0001551	150
SNB-BcS	0.2746	-0.0001359	-0.01663	0.0002	0.2028	-0.0000	3.986	-0.0001359	145
SNB-CaS	0.2345	-9.848e-005	-0.0174	0.0002	0.1919	-0.0000	4.405	-9.848e-005	133.3
SNB-CbS	0.2124	-7.898e-005	-0.01762	0.0002	0.1894	-0.0000	4.645	-7.898e-005	126.6
SNB-DaS	0.1707	-4.703e-005	-0.01749	0.0001	0.1706	-0.0000	5.127	-4.703e-005	113.3
SNB-DbS	0.1515	-3.718e-005	-0.01702	0.0001	0.1630	-0.0000	5.371	-3.718e-005	106.6
SNB-EaS	0.1168	-2.099e-005	-0.01612	0.0000	0.1383	0.0000	5.86	-2.099e-005	93.32
SNB-EbS	0.101	-1.901e-005	-0.01571	0.0000	0.1332	0.0000	6.107	-1.901e-005	86.64
SNB-FaS	0.06722	-1.282e-005	-0.014	0.0000	0.1098	0.0000	6.729	-1.282e-005	69.99
SNB-GaS	0.03554	-7.769e-006	-0.01106	0.0000	0.0809	0.0000	7.484	-7.769e-006	49.99
SNB-HaS	0.01393	-3.068e-006	-0.007142	0.0000	0.0501	0.0000	8.248	-3.068e-006	29.99
SNB-IaS	0.002645	-4.577e-007	-0.002478	0.0000	0.0211	0.0000	9.024	-4.577e-007	9.998
SNB-WL-A1S	0.3996	-0.0002736	-0.006522	-0.0021	0.2043	-0.0001	0.9829	-1.01	180
SNB-WL-A2S	0.3996	-0.000272	-0.0002332	0.0002	0.2088	0.0000	-0.7669	-0.000272	180
SNB-WL-A3S	0.3996	-0.0002701	-0.006511	0.0027	0.2042	0.0001	0.9829	1.01	180
SNB-WL-B1S	0.3278	-0.0001958	-0.007043	-0.0005	0.2022	-0.0002	1.108	-1.352	160
SNB-WL-B2S	0.3279	-0.0001935	0.001273	0.0002	0.2067	0.0000	-1.233	-0.0001935	160
SNB-WL-B3S	0.3278	-0.0001909	-0.007034	0.0009	0.2022	0.0002	1.108	1.351	160
SNB-WL-C1S	0.2571	-0.0001237	-0.007488	0.0002	0.1932	-0.0002	1.234	-1.692	140
SNB-WL-C2S	0.2571	-0.0001196	0.002478	0.0002	0.1994	0.0000	-1.697	-0.0001196	140
SNB-WL-C3S	0.2571	-0.0001152	-0.007478	0.0002	0.1932	0.0002	1.234	1.692	140
SNB-WL-D1S	0.191	-6.955e-005	-0.007862	-0.0004	0.1733	-0.0003	1.365	-2.033	120
SNB-WL-D2S	0.191	-6.217e-005	0.002937	0.0001	0.1826	0.0000	-2.156	-6.217e-005	120
SNB-WL-D3S	0.191	-5.484e-005	-0.007853	0.0007	0.1733	0.0003	1.365	2.033	120
SNB-WL-E1S	0.1332	-3.423e-005	-0.006812	0.0008	0.1407	-0.0003	1.503	-2.373	99.99
SNB-WL-E2S	0.1332	-2.831e-005	0.003403	0.0001	0.1481	-0.0000	-2.607	-2.831e-005	100
SNB-WL-E3S	0.1332	-2.276e-005	-0.006806	-0.0006	0.1407	0.0003	1.503	2.373	99.99
SNB-WL-F1S	0.08628	-2.266e-005	-0.006864	-0.0001	0.1159	-0.0002	1.653	-2.714	79.99
SNB-WL-F2S	0.0863	-1.548e-005	0.0029	0.0000	0.1255	-0.0000	-3.048	-1.548e-005	80
SNB-WL-F3S	0.08628	-8.774e-006	-0.006861	0.0001	0.1159	0.0002	1.653	2.714	79.99
SNB-WL-G1S	0.04946	-2.001e-005	-0.006855	-0.0018	0.0855	-0.0002	1.813	-3.055	59.99
SNB-WL-G2S	0.04948	-9.706e-006	0.001353	0.0000	0.0949	-0.0000	-3.478	-9.706e-006	60
SNB-WL-G3S	0.04946	1.41e-007	-0.006854	0.0019	0.0855	0.0002	1.813	3.055	59.99
SNB-WL-H1S	0.02273	-1.645e-005	-0.006602	-0.0010	0.0567	-0.0002	1.983	-3.395	39.99
SNB-WL-H2S	0.02276	-4.565e-006	-0.0005345	0.0000	0.0658	-0.0000	-3.898	-4.565e-006	40
SNB-WL-H3S	0.02273	6.955e-006	-0.006601	0.0010	0.0567	0.0002	1.983	3.395	39.99
SNB-WL-I1S	0.006412	-1.538e-005	-0.006175	-0.0001	0.0259	-0.0003	2.163	-3.736	19.99
SNB-WL-I2S	0.006436	-1.596e-006	-0.002959	0.0000	0.0345	-0.0000	-4.308	-1.596e-006	20
SNB-WL-I3S	0.006412	1.2e-005	-0.006175	0.0001	0.0259	0.0003	2.163	3.736	19.99
RohnAa1	0.3819	-0.0004027	-0.0002461	-0.0004	0.2043	0.0011	-1.883	-3.923	175
RohnAa2	0.3815	-0.0003347	-0.000225	-0.0001	0.2065	0.0037	-1.883	3.923	175
RohnAb1	0.364	-0.0004226	0.0001456	0.0004	0.2066	0.0008	-1.999	-4.094	170
RohnAb2	0.3634	-0.0003738	0.0001802	-0.0003	0.2071	0.0040	-2	4.093	170
RohnAc1	0.3459	-0.0003608	0.0005364	0.0004	0.2057	0.0006	-2.116	-4.265	165
RohnAc2	0.3454	-0.0003658	0.0005743	0.0005	0.2047	0.0042	-2.117	4.264	165
RohnBa1	0.3101	-0.000268	0.001285	-0.0004	0.2035	-0.0002	-2.349	-4.606	155
RohnBa2	0.3096	-0.000329	0.001324	0.0014	0.2024	0.0046	-2.349	4.605	155
RohnBb1	0.2925	-0.0003534	0.001636	0.0003	0.2033	-0.0009	-2.465	-4.776	150
RohnBb2	0.2921	-0.0001672	0.001672	0.0006	0.2024	0.0048	-2.465	4.776	150

RohnBc1	0.2745	-0.0001872	0.001997	0.0021	0.2046	-0.0016	-2.581	-4.947	145
RohnBc2	0.2743	-0.0002588	0.002032	-0.0011	0.2036	0.0051	-2.582	4.946	145
RohnCa1	0.2346	-0.0002112	0.002703	-0.0004	0.1924	-0.0023	-2.851	-5.344	133.3
RohnCa2	0.2344	-8.311e-005	0.002733	0.0011	0.1918	0.0051	-2.851	5.344	133.3
RohnCb1	0.2123	-0.0001332	0.003064	0.0019	0.1888	-0.0027	-3.004	-5.572	126.7
RohnCb2	0.2122	-9.733e-005	0.003093	-0.0014	0.1886	0.0052	-3.004	5.571	126.7
RohnDa1	0.1705	-9.683e-005	0.003604	0.0007	0.1731	-0.0031	-3.308	-6.025	113.3
RohnDa2	0.1704	-1.513e-005	0.003628	-0.0001	0.1725	0.0049	-3.308	6.025	113.3
RohnDb1	0.1508	0.0001398	0.00377	0.0007	0.1602	-0.0030	-3.459	-6.252	106.7
RohnDb2	0.1508	-0.0001997	0.003789	-0.0002	0.1598	0.0046	-3.459	6.252	106.7
RohnEa1	0.1162	0.0001399	0.003866	0.0012	0.1407	-0.0029	-3.755	-6.706	93.34
RohnEa2	0.1164	-0.0001105	0.003875	-0.0009	0.1403	0.0042	-3.755	6.706	93.34
RohnEb1	0.1005	0.0001753	0.003865	-0.0005	0.1288	-0.0027	-3.902	-6.933	86.66
RohnEb2	0.1007	-0.0001068	0.003869	0.0010	0.1281	0.0038	-3.902	6.933	86.66
RohnFa1	0.06563	0.0004437	0.003641	-0.0007	0.1040	-0.0024	-4.265	-7.501	70
RohnFa2	0.06585	-0.0003294	0.003639	0.0007	0.1040	0.0031	-4.265	7.501	70
RohnGa1	0.03399	0.0004475	0.003	-0.0001	0.0761	-0.0019	-4.69	-8.182	50
RohnGa2	0.03418	-0.0003469	0.002998	-0.0000	0.0765	0.0024	-4.69	8.182	50
RohnHa1	0.0122	0.0004942	0.001988	-0.0004	0.0459	-0.0012	-5.106	-8.864	30
RohnHa2	0.01232	-0.0004353	0.001988	0.0003	0.0461	0.0015	-5.105	8.864	30
RohnIa1	0.001344	0.0003184	0.0006923	-0.0001	0.0193	-0.0006	-5.511	-9.548	10
RohnIa2	0.001383	-0.0002973	0.0006926	-0.0000	0.0196	0.0006	-5.511	9.548	10
SNB-Aa1	0.3817	-0.0002695	0.0003007	0.0016	0.2049	-0.0002	-0.8833	-2.191	175
SNB-Aa2	0.3817	-0.0002442	0.0003166	-0.0011	0.2051	0.0002	-0.8833	2.191	175
SNB-Ab1	0.3637	-0.0002322	0.0006954	-0.0002	0.2067	-0.0002	-0.9998	-2.362	170
SNB-Ab2	0.3637	-0.000231	0.0007144	0.0007	0.2067	0.0003	-0.9998	2.361	170
SNB-Ac1	0.3457	-0.0002199	0.001088	0.0011	0.2050	-0.0002	-1.116	-2.532	165
SNB-Ac2	0.3457	-0.0002137	0.001107	-0.0006	0.2048	0.0003	-1.116	2.532	165
SNB-Ba1	0.3099	-0.0001802	0.001847	0.0012	0.2043	-0.0004	-1.349	-2.873	155
SNB-Ba2	0.3099	-0.0001691	0.001868	-0.0008	0.2043	0.0004	-1.349	2.873	155
SNB-Bb1	0.2921	-0.0001378	0.002208	-0.0000	0.2037	-0.0004	-1.465	-3.044	150
SNB-Bb2	0.2921	-0.0001722	0.00223	0.0005	0.2037	0.0005	-1.465	3.043	150
SNB-Bc1	0.2744	-0.0001273	0.00255	0.0009	0.2005	-0.0005	-1.581	-3.214	145
SNB-Bc2	0.2744	-0.0001462	0.002571	-0.0005	0.2005	0.0005	-1.581	3.214	145
SNB-Ca1	0.2342	-2.768e-005	0.00325	0.0013	0.1942	-0.0008	-1.851	-3.611	133.3
SNB-Ca2	0.2342	-0.0001714	0.003271	-0.0010	0.1942	0.0008	-1.851	3.611	133.3
SNB-Cb1	0.2121	-7.119e-006	0.003578	0.0009	0.1844	-0.0008	-2.004	-3.839	126.7
SNB-Cb2	0.2121	-0.0001535	0.003598	-0.0006	0.1845	0.0008	-2.004	3.839	126.7
SNB-Da1	0.1702	2.995e-005	0.004003	0.0028	0.1737	-0.0012	-2.308	-4.293	113.3
SNB-Da2	0.1702	-0.0001277	0.004019	-0.0026	0.1737	0.0012	-2.308	4.293	113.3
SNB-Db1	0.1508	0.0001556	0.004071	-0.0000	0.1582	-0.0009	-2.459	-4.52	106.7
SNB-Db2	0.1508	-0.0002294	0.004084	0.0002	0.1582	0.0009	-2.459	4.52	106.7
SNB-Ea1	0.1164	5.683e-005	0.004112	0.0016	0.1406	-0.0009	-2.755	-4.974	93.34
SNB-Ea2	0.1164	-0.0001007	0.004121	-0.0015	0.1406	0.0009	-2.755	4.974	93.34
SNB-Eb1	0.1007	0.0001001	0.004125	0.0003	0.1275	-0.0007	-2.902	-5.201	86.66
SNB-Eb2	0.1007	-0.0001337	0.004132	-0.0002	0.1275	0.0007	-2.902	5.201	86.66
SNB-Fa1	0.06561	0.0004501	0.003886	0.0025	0.1031	-0.0008	-3.265	-5.769	70
SNB-Fa2	0.06561	-0.0004695	0.003891	-0.0024	0.1031	0.0008	-3.265	5.769	70
SNB-Ga1	0.03408	0.0003968	0.003213	0.0029	0.0746	-0.0010	-3.69	-6.45	50
SNB-Ga2	0.03408	-0.0004087	0.003216	-0.0029	0.0746	0.0010	-3.69	6.45	50
SNB-Ha1	0.01234	0.0004138	0.002151	0.0025	0.0450	-0.0010	-4.105	-7.131	30
SNB-Ha2	0.01234	-0.0004195	0.002153	-0.0025	0.0450	0.0009	-4.105	7.131	30
SNB-Ia1	0.001249	0.0003732	0.0007752	0.0008	0.0184	-0.0006	-4.51	-7.812	10
SNB-Ia2	0.001249	-0.0003744	0.000776	-0.0008	0.0184	0.0006	-4.51	7.812	10

Joint Support Reactions for Load Case "6: Service 1.0D + 1.0Dg + 1.0 Wo":

Joint Label	X Force (kips)	X Usage % (kips)	Y Force (kips)	Y Usage % (kips)	Z Comp. Force (kips)	Z Usage % (kips)	Uplift Usage %	Result. Force (kips)	Result. Usage % (ft-k)	X Moment (ft-k)	X-M. Usage % (ft-k)	Y Moment (ft-k)	Y-M. Usage % (ft-k)	Z Moment (ft-k)	Z-M. Usage %	Max. Usage %
RohnJP	-7.32	0.0	0.02	0.0	91.59	0.0	0.0	91.88	0.0	-0.01	0.0	-1.4	0.0	-0.00	0.0	0.0
SNB-JP	-11.85	0.0	0.00	0.0	125.71	0.0	0.0	126.27	0.0	-0.00	0.0	-3.3	0.0	-0.00	0.0	0.0
RohnJ1	-1.79	0.0	-1.66	0.0	-20.95	0.0	0.0	21.09	0.0	0.29	0.0	-0.2	0.0	-0.00	0.0	0.0
RohnJ2	-1.83	0.0	1.64	0.0	-20.96	0.0	0.0	21.10	0.0	-0.28	0.0	-0.2	0.0	-0.00	0.0	0.0
SNB-J1	-3.75	0.0	-3.89	0.0	-39.71	0.0	0.0	40.08	0.0	0.98	0.0	-0.4	0.0	-0.01	0.0	0.0
SNB-J2	-3.75	0.0	3.90	0.0	-39.75	0.0	0.0	40.12	0.0	-0.98	0.0	-0.4	0.0	0.01	0.0	0.0

Joint Displacements, Loads and Member Forces on Joints for Load Case "6: Service 1.0D + 1.0Dg + 1.0 Wo":

Joint Label	X External Load (kips)	Y External Load (kips)	Z External Load (kips)	X Member Force (kips)	Y Member Force (kips)	Z Member Force (kips)	X Disp. (ft)	Y Disp. (ft)	Z Disp. (ft)
RohnAP	0.1431	0.0000	-0.2967	-0.1431	-0.0000	0.2967	0.3996	-0.0001	-0.0238
RohnBP	0.6735	0.0000	-1.0631	-0.6735	-0.0000	1.0631	0.3278	0.0001	-0.0260
RohnCP	0.1473	0.0000	-0.4302	-0.1473	-0.0000	0.4302	0.2570	0.0000	-0.0271
RohnDP	0.1798	0.0000	-0.5212	-0.1798	0.0000	0.5212	0.1910	-0.0000	-0.0268
RohnEP	0.1875	0.0000	-0.6450	-0.1875	-0.0000	0.6450	0.1332	-0.0001	-0.0239
RohnFP	0.2194	0.0000	-0.8741	-0.2194	-0.0000	0.8741	0.0863	-0.0001	-0.0206
RohnGP	0.3103	0.0000	-1.1634	-0.3103	-0.0000	1.1634	0.0495	-0.0001	-0.0165
RohnHP	0.2709	0.0000	-1.1580	-0.2709	-0.0000	1.1580	0.0227	-0.0001	-0.0119
RohnIP	0.3268	0.0000	-1.2988	-0.3268	-0.0000	1.2988	0.0064	-0.0000	-0.0058
RohnJP	0.1864	0.0000	-0.7017	7.1327	-0.0248	-90.8845	0.0000	0.0000	0.0000
SNB-AP	0.0419	0.0000	-0.1567	-0.0419	0.0000	0.1567	0.3996	-0.0003	-0.0126
SNB-BP	0.1013	0.0000	-0.3391	-0.1013	0.0000	0.3391	0.3278	-0.0002	-0.0151
SNB-CP	0.1473	0.0000	-0.4302	-0.1473	0.0000	0.4302	0.2571	-0.0001	-0.0170
SNB-DP	0.1798	0.0000	-0.5212	-0.1798	0.0000	0.5212	0.1910	-0.0001	-0.0177
SNB-EP	0.1875	0.0000	-0.6450	-0.1875	0.0000	0.6450	0.1332	-0.0000	-0.0164
SNB-FP	0.2194	0.0000	-0.8741	-0.2194	-0.0000	0.8741	0.0863	-0.0000	-0.0152
SNB-GP	0.2543	0.0000	-1.0634	-0.2543	-0.0000	1.0634	0.0495	-0.0000	-0.0125
SNB-HP	0.2709	0.0000	-1.1580	-0.2709	-0.0000	1.1580	0.0228	-0.0000	-0.0093
SNB-IP	0.3268	0.0000	-1.2988	-0.3268	-0.0000	1.2988	0.0064	-0.0000	-0.0047
SNB-JP	0.1864	0.0000	-0.7017	11.6649	-0.0011	-125.0059	0.0000	0.0000	0.0000
RohnA1	0.1431	0.0000	-0.2967	-0.1431	0.0000	0.2967	0.3998	-0.0004	-0.0006
RohnA2	0.2443	0.0000	-0.4367	-0.2443	-0.0000	0.4367	0.3995	-0.0004	-0.0006
RohnB1	0.2348	0.0000	-0.4531	-0.2348	0.0000	0.4531	0.3281	-0.0003	0.0009
RohnB2	0.1605	0.0000	-0.3881	-0.1605	-0.0000	0.3881	0.3276	-0.0003	0.0010
RohnC1	0.1473	0.0000	-0.4302	-0.1473	0.0000	0.4302	0.2571	-0.0001	0.0023
RohnC2	0.1473	0.0000	-0.4302	-0.1473	-0.0000	0.4302	0.2569	-0.0003	0.0023
RohnD1	0.2272	0.0000	-0.5912	-0.2272	0.0000	0.5912	0.1908	0.0000	0.0034
RohnD2	0.1798	0.0000	-0.5212	-0.1798	-0.0000	0.5212	0.1907	-0.0002	0.0034
RohnE1	0.1875	0.0000	-0.6450	-0.1875	0.0000	0.6450	0.1331	0.0000	0.0038
RohnE2	0.1875	0.0000	-0.6450	-0.1875	-0.0000	0.6450	0.1332	-0.0000	0.0038
RohnF1	0.2194	0.0000	-0.8741	-0.2194	0.0000	0.8741	0.0860	0.0002	0.0038
RohnF2	0.3261	0.0000	-1.0191	-0.3261	-0.0000	1.0191	0.0862	-0.0000	0.0038
RohnG1	0.2855	0.0000	-1.1234	-0.2855	0.0000	1.1234	0.0493	0.0001	0.0033
RohnG2	0.3853	0.0000	-1.2194	-0.3853	-0.0000	1.2194	0.0495	0.0000	0.0033
RohnH1	0.2709	0.0000	-1.1580	-0.2709	0.0000	1.1580	0.0226	0.0001	0.0025
RohnH2	0.2709	0.0000	-1.1580	-0.2709	-0.0000	1.1580	0.0227	-0.0000	0.0025
RohnI1	0.3268	0.0000	-1.2988	-0.3268	-0.0000	1.2988	0.0064	0.0000	0.0013
RohnI2	0.3268	0.0000	-1.2988	-0.3268	-0.0000	1.2988	0.0064	0.0000	0.0013
RohnJ1	0.1864	0.0000	-0.7017	1.5993	1.6623	21.6469	0.0000	0.0000	0.0000
RohnJ2	0.1864	0.0000	-0.7017	1.6430	-1.6414	21.6590	0.0000	0.0000	0.0000
SNB-A1	0.0419	0.0000	-0.1567	-0.0419	-0.0000	0.1567	0.3996	-0.0003	-0.0001
SNB-A2	0.0419	0.0000	-0.1567	-0.0419	0.0000	0.1567	0.3996	-0.0003	-0.0001
SNB-B1	0.1013	0.0000	-0.3391	-0.1013	-0.0000	0.3391	0.3278	-0.0002	0.0015
SNB-B2	0.1013	0.0000	-0.3391	-0.1013	0.0000	0.3391	0.3278	-0.0002	0.0015
SNB-C1	0.1473	0.0000	-0.4302	-0.1473	-0.0000	0.4302	0.2571	-0.0001	0.0029
SNB-C2	0.1473	0.0000	-0.4302	-0.1473	0.0000	0.4302	0.2571	-0.0001	0.0029
SNB-D1	0.1798	0.0000	-0.5212	-0.1798	-0.0000	0.5212	0.1910	-0.0001	0.0038
SNB-D2	0.1798	0.0000	-0.5212	-0.1798	0.0000	0.5212	0.1910	-0.0001	0.0038
SNB-E1	0.1875	0.0000	-0.6450	-0.1875	-0.0000	0.6450	0.1332	-0.0000	0.0040
SNB-E2	0.1875	0.0000	-0.6450	-0.1875	0.0000	0.6450	0.1332	-0.0000	0.0040
SNB-F1	0.2194	0.0000	-0.8741	-0.2194	-0.0000	0.8741	0.0863	-0.0000	0.0041
SNB-F2	0.2194	0.0000	-0.8741	-0.2194	0.0000	0.8741	0.0863	-0.0000	0.0041
SNB-G1	0.2543	0.0000	-1.0634	-0.2543	-0.0000	1.0634	0.0494	0.0000	0.0035
SNB-G2	0.2543	0.0000	-1.0634	-0.2543	0.0000	1.0634	0.0494	-0.0000	0.0035
SNB-H1	0.2709	0.0000	-1.1580	-0.2709	-0.0000	1.1580	0.0227	0.0000	0.0027
SNB-H2	0.2709	0.0000	-1.1580	-0.2709	0.0000	1.1580	0.0227	-0.0000	0.0027
SNB-I1	0.3268	0.0000	-1.2988	-0.3268	-0.0000	1.2988	0.0063	0.0001	0.0014
SNB-I2	0.3268	0.0000	-1.2988	-0.3268	0.0000	1.2988	0.0063	-0.0001	0.0014
SNB-J1	0.1864	0.0000	-0.7017	3.5657	3.8898	40.4116	0.0000	0.0000	0.0000
SNB-J2	0.1864	0.0000	-0.7017	3.5685	-3.8960	40.4528	0.0000	0.0000	0.0000
RohnAaS	0.1340	0.0000	-0.2090	-0.1340	0.0000	0.2090	0.3817	0.0000	-0.0244
RohnAbS	0.0419	0.0000	-0.1567	-0.0419	-0.0000	0.1567	0.3636	0.0000	-0.0250
RohnAcS	0.1248	0.0000	-0.2100	-0.1248	-0.0000	0.2100	0.3457	0.0001	-0.0256

RohnBaS	0.0594	0.0000	-0.1824	-0.0594	-0.0000	0.1824	0.3100	0.0001	-0.0265
RohnBbS	0.4900	0.0000	-0.9666	-0.4900	0.0000	0.9666	0.2921	0.0001	-0.0268
RohnBcS	0.0594	0.0000	-0.1824	-0.0594	0.0000	0.1824	0.2745	0.0000	-0.0270
RohnCaS	0.4566	0.0000	-0.8000	-0.4566	-0.0000	0.8000	0.2345	0.0000	-0.0273
RohnCbS	0.6445	0.0000	-1.4174	-0.6445	-0.0000	1.4174	0.2124	-0.0000	-0.0272
RohnDaS	0.6515	0.0000	-1.2679	-0.6515	-0.0000	1.2679	0.1707	-0.0000	-0.0261
RohnDbS	0.0919	0.0000	-0.2734	-0.0919	-0.0000	0.2734	0.1514	-0.0001	-0.0251
RohnEaS	0.0956	0.0000	-0.3717	-0.0956	-0.0000	0.3717	0.1168	-0.0001	-0.0230
RohnEbS	0.0956	0.0000	-0.3717	-0.0956	-0.0000	0.3717	0.1010	-0.0001	-0.0219
RohnFaS	0.1238	0.0000	-0.5024	-0.1238	-0.0000	0.5024	0.0672	-0.0002	-0.0187
RohnGaS	0.1305	0.0000	-0.5610	-0.1305	-0.0000	0.5610	0.0355	-0.0001	-0.0143
RohnHaS	0.1404	0.0000	-0.5970	-0.1404	-0.0000	0.5970	0.0139	-0.0001	-0.0090
RohnIaS	0.1864	0.0000	-0.7017	-0.1864	-0.0000	0.7017	0.0026	-0.0000	-0.0030
SNB-AaS	0.0419	0.0000	-0.1567	-0.0419	0.0000	0.1567	0.3817	-0.0002	-0.0133
SNB-AbS	0.0419	0.0000	-0.1567	-0.0419	-0.0000	0.1567	0.3637	-0.0002	-0.0139
SNB-AcS	0.0419	0.0000	-0.1567	-0.0419	-0.0000	0.1567	0.3458	-0.0002	-0.0146
SNB-BaS	0.0594	0.0000	-0.1824	-0.0594	-0.0000	0.1824	0.3100	-0.0002	-0.0157
SNB-BbS	0.0594	0.0000	-0.1824	-0.0594	-0.0000	0.1824	0.2922	-0.0002	-0.0162
SNB-BcS	0.0594	0.0000	-0.1824	-0.0594	-0.0000	0.1824	0.2746	-0.0001	-0.0166
SNB-CaS	0.0879	0.0000	-0.2478	-0.0879	-0.0000	0.2478	0.2345	-0.0001	-0.0174
SNB-CbS	0.0879	0.0000	-0.2478	-0.0879	-0.0000	0.2478	0.2124	-0.0001	-0.0176
SNB-DaS	0.0919	0.0000	-0.2734	-0.0919	-0.0000	0.2734	0.1707	-0.0000	-0.0175
SNB-DbS	0.0919	0.0000	-0.2734	-0.0919	-0.0000	0.2734	0.1515	-0.0000	-0.0170
SNB-EaS	0.0956	0.0000	-0.3717	-0.0956	-0.0000	0.3717	0.1168	-0.0000	-0.0161
SNB-EbS	0.0956	0.0000	-0.3717	-0.0956	-0.0000	0.3717	0.1010	-0.0000	-0.0157
SNB-FaS	0.1238	0.0000	-0.5024	-0.1237	-0.0000	0.5024	0.0672	-0.0000	-0.0140
SNB-GaS	0.1305	0.0000	-0.5610	-0.1305	-0.0000	0.5610	0.0355	-0.0000	-0.0111
SNB-HaS	0.1404	0.0000	-0.5970	-0.1404	-0.0000	0.5970	0.0139	-0.0000	-0.0071
SNB-IaS	0.1864	0.0000	-0.7017	-0.1864	-0.0000	0.7017	0.0026	-0.0000	-0.0025
SNB-WL-A1S	0.0419	0.0000	-0.1567	-0.0419	0.0000	0.1567	0.3996	-0.0003	-0.0065
SNB-WL-A2S	0.0419	0.0000	-0.1567	-0.0419	-0.0000	0.1567	0.3996	-0.0003	-0.0002
SNB-WL-A3S	0.0419	0.0000	-0.1567	-0.0419	-0.0000	0.1567	0.3996	-0.0003	-0.0065
SNB-WL-B1S	0.0419	0.0000	-0.1567	-0.0419	0.0000	0.1567	0.3278	-0.0002	-0.0070
SNB-WL-B2S	0.0419	0.0000	-0.1567	-0.0419	-0.0000	0.1567	0.3279	-0.0002	0.0013
SNB-WL-B3S	0.0419	0.0000	-0.1567	-0.0419	-0.0000	0.1567	0.3278	-0.0002	-0.0070
SNB-WL-C1S	0.0594	0.0000	-0.1824	-0.0594	0.0000	0.1824	0.2571	-0.0001	-0.0075
SNB-WL-C2S	0.0594	0.0000	-0.1824	-0.0594	-0.0000	0.1824	0.2571	-0.0001	0.0025
SNB-WL-C3S	0.0594	0.0000	-0.1824	-0.0594	-0.0000	0.1824	0.2571	-0.0001	-0.0075
SNB-WL-D1S	0.0879	0.0000	-0.2478	-0.0879	0.0000	0.2478	0.1910	-0.0001	-0.0079
SNB-WL-D2S	0.0879	0.0000	-0.2478	-0.0879	-0.0000	0.2478	0.1910	-0.0001	0.0029
SNB-WL-D3S	0.0879	0.0000	-0.2478	-0.0879	-0.0000	0.2478	0.1910	-0.0001	-0.0079
SNB-WL-E1S	0.0919	0.0000	-0.2734	-0.0919	0.0000	0.2734	0.1332	-0.0000	-0.0068
SNB-WL-E2S	0.0919	0.0000	-0.2734	-0.0919	-0.0000	0.2734	0.1332	-0.0000	0.0034
SNB-WL-E3S	0.0919	0.0000	-0.2734	-0.0919	-0.0000	0.2734	0.1332	-0.0000	-0.0068
SNB-WL-F1S	0.0956	0.0000	-0.3717	-0.0956	0.0000	0.3717	0.0863	-0.0000	-0.0069
SNB-WL-F2S	0.0956	0.0000	-0.3717	-0.0956	-0.0000	0.3717	0.0863	-0.0000	0.0029
SNB-WL-F3S	0.0956	0.0000	-0.3717	-0.0956	-0.0000	0.3717	0.0863	-0.0000	-0.0069
SNB-WL-G1S	0.1238	0.0000	-0.5024	-0.1237	0.0000	0.5024	0.0495	-0.0000	-0.0069
SNB-WL-G2S	0.1238	0.0000	-0.5024	-0.1237	-0.0000	0.5024	0.0495	-0.0000	0.0014
SNB-WL-G3S	0.1238	0.0000	-0.5024	-0.1237	-0.0000	0.5024	0.0495	0.0000	-0.0069
SNB-WL-H1S	0.1305	0.0000	-0.5610	-0.1305	0.0000	0.5610	0.0227	-0.0000	-0.0066
SNB-WL-H2S	0.1305	0.0000	-0.5610	-0.1305	-0.0000	0.5610	0.0228	-0.0000	-0.0005
SNB-WL-H3S	0.1305	0.0000	-0.5610	-0.1305	-0.0000	0.5610	0.0227	0.0000	-0.0066
SNB-WL-I1S	0.1404	0.0000	-0.5970	-0.1404	0.0000	0.5970	0.0064	-0.0000	-0.0062
SNB-WL-I2S	0.1404	0.0000	-0.5970	-0.1404	-0.0000	0.5970	0.0064	-0.0000	-0.0030
SNB-WL-I3S	0.1404	0.0000	-0.5970	-0.1404	-0.0000	0.5970	0.0064	0.0000	-0.0062
RohnAa1	0.1108	0.0000	-0.2302	-0.1108	0.0000	0.2302	0.3819	-0.0004	-0.0002
RohnAa2	0.1751	0.0000	-0.2532	-0.1751	-0.0000	0.2532	0.3815	-0.0003	-0.0002
RohnAb1	0.2477	-0.0111	-0.2767	-0.2477	0.0111	0.2767	0.3640	-0.0004	0.0001
RohnAb2	0.0419	0.0000	-0.1567	-0.0419	-0.0000	0.1567	0.3634	-0.0004	0.0002
RohnAc1	0.0419	0.0000	-0.1567	-0.0419	0.0000	0.1567	0.3459	-0.0004	0.0005
RohnAc2	0.0419	0.0000	-0.1567	-0.0419	-0.0000	0.1567	0.3454	-0.0004	0.0006
RohnBa1	0.0594	0.0000	-0.1824	-0.0594	0.0000	0.1824	0.3101	-0.0003	0.0013
RohnBa2	0.0594	0.0000	-0.1824	-0.0594	-0.0000	0.1824	0.3096	-0.0003	0.0013
RohnBb1	0.4735	0.0000	-0.9396	-0.4735	0.0000	0.9396	0.2925	-0.0004	0.0016
RohnBb2	0.4735	0.0000	-0.9396	-0.4735	-0.0000	0.9396	0.2921	-0.0002	0.0017
RohnBc1	0.0594	0.0000	-0.1824	-0.0594	0.0000	0.1824	0.2745	-0.0002	0.0020
RohnBc2	0.0594	0.0000	-0.1824	-0.0594	-0.0000	0.1824	0.2743	-0.0003	0.0020
RohnCa1	0.4930	0.0000	-0.8600	-0.4930	0.0000	0.8600	0.2346	-0.0002	0.0027

RohnCa2	0.5168	0.0000	-0.9000	-0.5168	-0.0000	0.9000	0.2344	-0.0001	0.0027
RohnCb1	0.6088	0.0000	-1.3624	-0.6088	0.0000	1.3624	0.2123	-0.0001	0.0031
RohnCb2	0.6088	0.0000	-1.3624	-0.6088	-0.0000	1.3624	0.2122	-0.0001	0.0031
RohnDa1	0.5924	0.0000	-1.1629	-0.5924	0.0000	1.1629	0.1705	-0.0001	0.0036
RohnDa2	0.5924	0.0000	-1.1629	-0.5924	-0.0000	1.1629	0.1704	-0.0000	0.0036
RohnDb1	0.0919	0.0000	-0.2734	-0.0919	0.0000	0.2734	0.1508	0.0001	0.0038
RohnDb2	0.0919	0.0000	-0.2734	-0.0919	-0.0000	0.2734	0.1508	-0.0002	0.0038
RohnEa1	0.0956	0.0000	-0.3717	-0.0956	0.0000	0.3717	0.1162	0.0001	0.0039
RohnEa2	0.0956	0.0000	-0.3717	-0.0956	-0.0000	0.3717	0.1164	-0.0001	0.0039
RohnEb1	0.0956	0.0000	-0.3717	-0.0956	0.0000	0.3717	0.1005	0.0002	0.0039
RohnEb2	0.0956	0.0000	-0.3717	-0.0956	-0.0000	0.3717	0.1007	-0.0001	0.0039
RohnFa1	0.1238	0.0000	-0.5024	-0.1237	0.0000	0.5024	0.0656	0.0004	0.0036
RohnFa2	0.1238	0.0000	-0.5024	-0.1237	-0.0000	0.5024	0.0659	-0.0003	0.0036
RohnGa1	0.1305	0.0000	-0.5610	-0.1305	0.0000	0.5610	0.0340	0.0004	0.0030
RohnGa2	0.1305	0.0000	-0.5610	-0.1305	-0.0000	0.5610	0.0342	-0.0003	0.0030
RohnHa1	0.1404	0.0000	-0.5970	-0.1404	0.0000	0.5970	0.0122	0.0005	0.0020
RohnHa2	0.1404	0.0000	-0.5970	-0.1404	-0.0000	0.5970	0.0123	-0.0004	0.0020
RohnIa1	0.1864	0.0000	-0.7017	-0.1864	0.0000	0.7017	0.0013	0.0003	0.0007
RohnIa2	0.1864	0.0000	-0.7017	-0.1864	-0.0000	0.7017	0.0014	-0.0003	0.0007
SNB-Aa1	0.0419	0.0000	-0.1567	-0.0419	-0.0000	0.1567	0.3817	-0.0003	0.0003
SNB-Aa2	0.0419	0.0000	-0.1567	-0.0419	0.0000	0.1567	0.3817	-0.0002	0.0003
SNB-Ab1	0.0419	0.0000	-0.1567	-0.0419	-0.0000	0.1567	0.3637	-0.0002	0.0007
SNB-Ab2	0.0419	0.0000	-0.1567	-0.0419	0.0000	0.1567	0.3637	-0.0002	0.0007
SNB-Ac1	0.0419	0.0000	-0.1567	-0.0419	-0.0000	0.1567	0.3457	-0.0002	0.0011
SNB-Ac2	0.0419	0.0000	-0.1567	-0.0419	0.0000	0.1567	0.3457	-0.0002	0.0011
SNB-Ba1	0.0594	0.0000	-0.1824	-0.0594	-0.0000	0.1824	0.3099	-0.0002	0.0018
SNB-Ba2	0.0594	0.0000	-0.1824	-0.0594	0.0000	0.1824	0.3099	-0.0002	0.0019
SNB-Bb1	0.0594	0.0000	-0.1824	-0.0594	-0.0000	0.1824	0.2921	-0.0001	0.0022
SNB-Bb2	0.0594	0.0000	-0.1824	-0.0594	0.0000	0.1824	0.2921	-0.0002	0.0022
SNB-Bc1	0.0594	0.0000	-0.1824	-0.0594	-0.0000	0.1824	0.2744	-0.0001	0.0025
SNB-Bc2	0.0594	0.0000	-0.1824	-0.0594	0.0000	0.1824	0.2744	-0.0001	0.0026
SNB-Ca1	0.0879	0.0000	-0.2478	-0.0879	-0.0000	0.2478	0.2342	-0.0000	0.0032
SNB-Ca2	0.0879	0.0000	-0.2478	-0.0879	0.0000	0.2478	0.2342	-0.0002	0.0033
SNB-Cb1	0.0879	0.0000	-0.2478	-0.0879	-0.0000	0.2478	0.2121	-0.0000	0.0036
SNB-Cb2	0.0879	0.0000	-0.2478	-0.0879	0.0000	0.2478	0.2121	-0.0002	0.0036
SNB-Da1	0.0919	0.0000	-0.2734	-0.0919	-0.0000	0.2734	0.1702	0.0000	0.0040
SNB-Da2	0.0919	0.0000	-0.2734	-0.0919	0.0000	0.2734	0.1702	-0.0001	0.0040
SNB-Db1	0.0919	0.0000	-0.2734	-0.0919	-0.0000	0.2734	0.1508	0.0002	0.0041
SNB-Db2	0.0919	0.0000	-0.2734	-0.0919	0.0000	0.2734	0.1508	-0.0002	0.0041
SNB-Ea1	0.0956	0.0000	-0.3717	-0.0956	-0.0000	0.3717	0.1164	0.0001	0.0041
SNB-Ea2	0.0956	0.0000	-0.3717	-0.0956	0.0000	0.3717	0.1164	-0.0001	0.0041
SNB-Eb1	0.0956	0.0000	-0.3717	-0.0956	-0.0000	0.3717	0.1007	0.0001	0.0041
SNB-Eb2	0.0956	0.0000	-0.3717	-0.0956	0.0000	0.3717	0.1007	-0.0001	0.0041
SNB-Fa1	0.1238	0.0000	-0.5024	-0.1237	-0.0000	0.5024	0.0656	0.0005	0.0039
SNB-Fa2	0.1238	0.0000	-0.5024	-0.1237	0.0000	0.5024	0.0656	-0.0005	0.0039
SNB-Ga1	0.1305	0.0000	-0.5610	-0.1305	-0.0000	0.5610	0.0341	0.0004	0.0032
SNB-Ga2	0.1305	0.0000	-0.5610	-0.1305	0.0000	0.5610	0.0341	-0.0004	0.0032
SNB-Ha1	0.1404	0.0000	-0.5970	-0.1404	-0.0000	0.5970	0.0123	0.0004	0.0022
SNB-Ha2	0.1404	0.0000	-0.5970	-0.1404	0.0000	0.5970	0.0123	-0.0004	0.0022
SNB-Ia1	0.1864	0.0000	-0.7017	-0.1864	-0.0000	0.7017	0.0012	0.0004	0.0008
SNB-Ia2	0.1864	0.0000	-0.7017	-0.1864	0.0000	0.7017	0.0012	-0.0004	0.0008

**Moments for Angles Modeled as Beams:**

Angle Label	Torsion (ft-lbs)	Origin		End		X Shear (lbs)	Y Shear (lbs)
		X Moment (ft-lbs)	Y Moment (ft-lbs)	X Moment (ft-lbs)	Y Moment (ft-lbs)		
Rohn-LA1P	-0.00	0.27	1.02	5.45	-6.11	1.14	-1.02
Rohn-LA11	0.50	-0.45	0.63	0.45	9.29	0.00	1.98
Rohn-LA12	-0.53	0.39	0.76	3.24	-2.60	0.72	-0.37
Rohn-LA2P	-0.00	-5.45	6.11	-7.18	8.83	-2.53	2.99
Rohn-LA21	0.50	-0.45	-9.29	-5.05	-21.02	-1.10	-6.06
Rohn-LA22	-0.53	-3.24	2.60	-2.44	-0.68	-1.13	0.38
Rohn-LA3P	-0.00	7.18	-8.83	7.88	-7.06	3.01	-3.17
Rohn-LA31	0.50	5.05	21.02	5.31	25.31	2.07	9.26
Rohn-LA32	-0.53	2.44	0.68	-1.79	13.14	0.13	2.76
Rohn-LA4P	-0.00	-7.88	7.06	-3.97	11.41	-2.37	3.69
Rohn-LA41	0.50	-5.31	-25.31	-8.69	-29.08	-2.80	-10.87

Rohn-LA42	-0.53	1.79	-13.14	5.67	-20.15	1.49	-6.65
Rohn-LB1P	0.65	3.78	-9.09	2.41	-7.76	1.24	-3.37
Rohn-LB11	2.01	8.19	30.60	19.61	55.14	5.55	17.13
Rohn-LB12	-0.68	-4.96	21.43	-18.48	51.61	-4.68	14.60
Rohn-LB2P	0.65	-2.41	7.77	-0.94	20.93	-0.67	5.74
Rohn-LB21	2.01	-19.61	-55.13	-25.31	-53.42	-8.98	-21.69
Rohn-LB22	-0.68	18.48	-51.61	25.18	-52.13	8.72	-20.73
Rohn-LB3P	0.65	0.94	-20.93	0.88	-8.45	0.36	-5.87
Rohn-LB31	2.01	25.31	53.42	10.71	42.36	7.20	19.14
Rohn-LB32	-0.68	-25.18	52.13	-10.73	42.07	-7.18	18.82
Rohn-LB4P	0.65	-0.88	8.45	-1.47	42.70	-0.47	10.22
Rohn-LB41	2.01	-10.71	-42.36	9.93	28.19	-0.16	-2.83
Rohn-LB42	-0.68	10.73	-42.07	-9.00	27.46	0.35	-2.92
Rohn-LC1P	0.65	1.47	-42.70	0.43	15.92	0.29	-4.02
Rohn-LC11	2.00	-9.93	-28.19	-9.81	6.06	-2.96	-3.32
Rohn-LC12	-0.68	9.00	-27.45	10.31	5.23	2.90	-3.33
Rohn-LC2P	0.65	-0.43	-15.92	0.18	17.58	-0.04	0.25
Rohn-LC21	2.00	9.81	-6.06	-12.44	28.15	-0.39	3.30
Rohn-LC22	-0.68	-10.31	-5.23	13.46	26.03	0.47	3.11
Rohn-LC3P	0.65	-0.18	-17.58	-0.75	65.61	-0.14	7.21
Rohn-LC31	2.00	12.44	-28.15	37.63	71.07	7.51	6.44
Rohn-LC32	-0.68	-13.46	-26.03	-39.30	75.92	-7.92	7.49
Rohn-LD1P	0.65	0.75	-65.61	1.59	84.32	0.35	2.81
Rohn-LD11	2.00	-37.63	-71.07	-59.60	9.82	-14.59	-9.19
Rohn-LD12	-0.68	39.30	-75.92	61.44	5.85	15.11	-10.51
Rohn-LD2P	0.65	-1.59	-84.32	-0.48	25.25	-0.31	-8.84
Rohn-LD21	2.01	59.60	-9.82	60.04	182.60	17.90	25.84
Rohn-LD22	-0.68	-61.44	-5.85	-60.07	183.97	-18.18	26.64
Rohn-LD3P	0.65	0.48	-25.25	-0.12	182.67	0.05	23.62
Rohn-LD31	2.00	-60.04	-182.60	-46.86	6.97	-16.04	-26.35
Rohn-LD32	-0.68	60.07	-183.97	47.20	7.35	16.09	-26.50
Rohn-LE1P	0.65	0.12	-182.66	2.62	47.48	0.41	-20.29
Rohn-LE11	2.00	46.86	-6.97	17.83	135.56	9.71	19.29
Rohn-LE12	-0.68	-47.20	-7.35	-16.78	132.47	-9.60	18.77
Rohn-LE2P	0.65	-2.62	-47.47	-5.79	41.43	-1.26	-0.90
Rohn-LE21	2.00	-17.83	-135.55	18.06	109.11	0.04	-3.96
Rohn-LE22	-0.68	16.78	-132.47	-20.82	117.91	-0.60	-2.18
Rohn-LE3P	0.65	5.79	-41.43	6.06	288.54	1.78	37.08
Rohn-LE31	2.00	-18.06	-109.11	-61.25	12.27	-11.90	-14.53
Rohn-LE32	-0.68	20.82	-117.91	69.11	-5.60	13.49	-18.53
Rohn-LF1P	0.65	-6.06	-288.54	-9.02	-50.26	-1.51	-33.86
Rohn-LF11	2.01	61.25	-12.27	113.04	426.12	17.41	41.35
Rohn-LF12	-0.69	-69.11	5.60	-118.28	440.16	-18.72	44.54
Rohn-LF2P	0.65	9.02	50.26	6.55	444.97	1.56	49.50
Rohn-LF21	1.99	-113.03	-426.13	-140.60	-119.99	-25.34	-54.57
Rohn-LF22	-0.67	118.27	-440.16	147.88	-136.74	26.59	-57.64
Rohn-LG1P	0.65	-6.55	-444.97	-6.17	-106.08	-1.27	-55.08
Rohn-LG11	2.02	140.60	119.99	158.94	514.38	29.93	63.38
Rohn-LG12	-0.70	-147.88	136.74	-162.03	522.61	-30.97	65.88
Rohn-LG2P	0.65	6.17	106.08	2.97	516.95	0.91	62.27
Rohn-LG21	2.00	-158.93	-514.38	-175.62	-159.83	-33.43	-67.36
Rohn-LG22	-0.67	162.02	-522.61	176.47	-162.51	33.82	-68.45
Rohn-LH1P	0.65	-2.97	-516.95	-0.19	-139.05	-0.32	-65.57
Rohn-LH11	1.99	175.62	159.83	198.94	615.68	37.42	77.48
Rohn-LH12	-0.67	-176.47	162.51	-199.81	617.70	-37.60	77.96
Rohn-LH2P	0.65	0.19	139.05	-0.39	666.13	-0.02	80.48
Rohn-LH21	1.96	-198.93	-615.68	-229.15	-226.31	-42.77	-84.13
Rohn-LH22	-0.63	199.80	-617.71	229.95	-227.66	42.94	-84.46
Rohn-LI1P	0.65	0.39	-666.13	-2.60	-213.83	-0.22	-87.95
Rohn-LI11	1.98	229.15	226.31	284.60	955.92	51.33	118.12
Rohn-LI12	-0.65	-229.95	227.66	-281.96	951.23	-51.15	117.79
Rohn-LI2P	0.65	2.60	213.83	13.23	1415.31	1.58	162.84
Rohn-LI21	1.93	-284.59	-955.93	-292.58	218.63	-57.67	-73.67
Rohn-LI22	-0.61	281.94	-951.23	280.35	241.14	56.18	-70.95
Rohn-H1P	0.05	0.43	-0.17	0.72	-0.35	0.15	-0.07
Rohn-H11	-0.01	-0.06	-0.15	0.05	0.20	-0.00	0.01
Rohn-H12	0.08	-0.82	0.35	-0.76	0.18	-0.21	0.07
Rohn-H2P	-0.12	1.47	-0.59	1.61	-0.89	0.35	-0.17
Rohn-H21	-0.02	0.17	-0.66	-0.01	-0.06	0.02	-0.08



Rohn-H22	0.03	-1.48	0.24	-1.29	-0.07	-0.31	0.02
SNB-LA1P	-0.00	1.08	61.97	3.25	6.85	0.86	13.75
SNB-LA11	0.08	54.70	-28.32	11.21	-0.83	13.17	-5.83
SNB-LA12	-0.08	-56.29	-30.77	-13.40	-5.91	-13.93	-7.33
SNB-LA2P	-0.00	-3.25	-6.85	-4.46	11.30	-1.54	0.89
SNB-LA21	0.08	-11.21	0.83	1.23	-11.36	-1.99	-2.11
SNB-LA22	-0.08	13.40	5.91	1.07	-4.87	2.89	0.21
SNB-LA3P	-0.00	4.46	-11.30	3.59	-22.17	1.61	-6.69
SNB-LA31	0.08	-1.22	11.37	-10.14	23.31	-2.27	6.93
SNB-LA32	-0.08	-1.07	4.87	8.12	17.99	1.41	4.57
SNB-LA4P	-0.00	-3.59	22.17	-2.31	66.70	-1.18	17.76
SNB-LA41	0.08	10.14	-23.31	36.64	-35.34	9.35	-11.72
SNB-LA42	-0.08	-8.12	-17.99	-34.88	-31.62	-8.59	-9.92
SNB-LB1P	-0.02	2.12	109.67	1.06	15.13	0.64	24.94
SNB-LB11	0.77	83.76	-19.44	14.74	21.78	19.68	0.47
SNB-LB12	-0.74	-84.78	-22.44	-15.35	20.21	-20.01	-0.45
SNB-LB2P	-0.02	-1.06	-15.13	-0.57	44.94	-0.33	5.96
SNB-LB21	0.77	-14.74	-21.78	7.15	-9.90	-1.52	-6.33
SNB-LB22	-0.74	15.35	-20.21	-6.59	-8.91	1.75	-5.82
SNB-LB3P	-0.02	0.57	-44.94	0.55	-53.53	0.22	-19.68
SNB-LB31	0.77	-7.15	9.90	-24.63	66.10	-6.35	15.19
SNB-LB32	-0.74	6.59	8.91	24.65	65.50	6.24	14.87
SNB-LB4P	-0.02	-0.55	53.53	-0.03	233.42	-0.12	57.35
SNB-LB41	0.77	24.63	-66.10	94.61	-47.61	23.83	-22.72
SNB-LB42	-0.74	-24.65	-65.50	-93.99	-47.23	-23.71	-22.53
SNB-LC1P	0.00	0.03	55.27	0.07	63.65	0.02	17.84
SNB-LC11	1.94	95.24	-40.19	37.74	28.55	19.95	-1.75
SNB-LC12	-1.93	-95.73	-40.51	-37.70	28.49	-20.02	-1.80
SNB-LC2P	0.00	-0.07	-63.65	0.25	-30.15	0.03	-14.03
SNB-LC21	1.93	-37.74	-28.55	-32.58	99.72	-10.52	10.65
SNB-LC22	-1.93	37.70	-28.49	32.49	99.39	10.50	10.61
SNB-LC3P	0.00	-0.25	30.15	-0.09	266.43	-0.05	44.50
SNB-LC31	1.94	32.58	-99.72	115.18	-76.00	22.17	-26.36
SNB-LC32	-1.93	-32.49	-99.39	-114.15	-75.30	-22.00	-26.21
SNB-LD1P	-0.01	0.13	185.64	0.76	203.91	0.13	58.45
SNB-LD11	2.52	208.38	-86.12	41.08	97.50	37.43	1.71
SNB-LD12	-2.49	-209.44	-86.89	-41.18	96.56	-37.60	1.45
SNB-LD2P	-0.01	-0.76	-203.91	0.02	-47.96	-0.11	-37.68
SNB-LD21	2.51	-41.08	-97.50	16.76	222.72	-3.64	18.73
SNB-LD22	-2.48	41.18	-96.56	-15.99	223.15	3.77	18.94
SNB-LD3P	-0.01	-0.02	47.96	-0.14	496.77	-0.02	81.74
SNB-LD31	2.51	-16.76	-222.72	48.02	-14.78	4.69	-35.63
SNB-LD32	-2.49	15.98	-223.15	-47.52	-14.36	-4.73	-35.63
SNB-LE1P	-0.07	0.26	149.26	2.35	305.64	0.39	68.26
SNB-LE11	5.08	350.02	-160.48	103.32	233.63	68.01	10.97
SNB-LE12	-5.00	-350.80	-161.24	-103.47	230.83	-68.15	10.44
SNB-LE2P	-0.07	-2.35	-305.64	-1.54	-39.88	-0.58	-51.69
SNB-LE21	5.07	-103.31	-233.63	-34.81	446.46	-20.66	31.83
SNB-LE22	-4.99	103.47	-230.83	38.19	450.17	21.19	32.81
SNB-LE3P	-0.07	1.54	39.88	1.16	1131.63	0.41	175.80
SNB-LE31	5.08	34.82	-446.46	236.44	-344.99	40.70	-118.74
SNB-LE32	-5.00	-38.19	-450.17	-239.75	-348.26	-41.70	-119.78
SNB-LF1P	-0.00	-1.21	-267.76	-0.73	-183.45	-0.19	-45.09
SNB-LF11	8.67	444.66	8.96	233.82	788.95	67.79	79.72
SNB-LF12	-8.68	-441.91	11.95	-230.65	791.60	-67.20	80.29
SNB-LF2P	-0.00	0.73	183.45	0.85	1264.05	0.16	144.67
SNB-LF21	8.64	-233.81	-788.95	31.62	-504.92	-20.20	-129.28
SNB-LF22	-8.64	230.64	-791.61	-34.68	-507.66	19.58	-129.82
SNB-LG1P	0.07	-0.87	-13.06	-0.96	-179.40	-0.18	-19.23
SNB-LG11	14.35	1050.12	-83.93	446.16	1425.41	149.50	134.04
SNB-LG12	-14.45	-1047.15	-81.21	-443.59	1427.97	-148.95	134.56
SNB-LG2P	0.07	0.96	179.40	0.78	2206.89	0.17	238.50
SNB-LG21	14.28	-446.15	-1425.42	193.46	-771.33	-25.25	-219.49
SNB-LG22	-14.38	443.58	-1427.97	-194.56	-772.83	24.88	-219.89
SNB-LH1P	0.02	-0.75	-556.03	-0.11	-283.37	-0.09	-83.90
SNB-LH11	13.83	1156.14	26.67	545.76	1582.23	170.05	160.75
SNB-LH12	-13.89	-1155.27	28.02	-545.28	1582.60	-169.91	160.92
SNB-LH2P	0.02	0.11	283.37	-0.01	2331.70	0.01	261.38
SNB-LH21	13.71	-545.75	-1582.24	-104.00	-803.59	-64.92	-238.38

SNB-LH22	-13.77	545.26	-1582.60	104.06	-803.51	64.88	-238.41
SNB-LI1P	-0.00	0.03	-407.03	0.44	-178.71	0.05	-58.54
SNB-LI11	4.50	1727.78	-95.32	1101.21	2306.95	282.66	220.98
SNB-LI12	-4.56	-1727.81	-95.40	-1101.08	2306.44	-282.65	220.92
SNB-LI2P	-0.00	-0.44	178.71	0.37	3323.63	-0.01	350.05
SNB-LI21	4.24	-1101.18	-2306.96	-978.30	438.36	-207.77	-186.70
SNB-LI22	-4.29	1101.05	-2306.46	979.75	439.08	207.90	-186.58
SNB-H1aP	-0.53	35.82	1.04	123.43	-1.37	78.82	-0.16
SNB-H1bP	-0.53	-123.43	1.38	-33.67	0.91	-77.75	1.13
SNB-H1cP	-0.59	37.41	-1.10	120.72	2.20	78.27	0.55
SNB-H1dP	-0.59	-120.72	-2.20	-37.46	1.03	-78.29	-0.58
SNB-H1eP	1.24	35.54	-0.89	122.02	-1.78	77.99	-1.33
SNB-H1fP	1.24	-122.02	1.78	-36.76	-0.99	-78.59	0.39
SNB-H2aP	-1.66	102.79	1.75	128.17	-0.26	85.45	0.55
SNB-H2bP	-1.66	-128.17	0.26	-64.02	-0.94	-71.11	-0.25
SNB-H2cP	0.15	86.95	-0.26	124.77	3.26	78.33	1.11
SNB-H2dP	0.15	-124.77	-3.26	-86.64	0.22	-78.22	-1.12
SNB-H2eP	1.50	63.44	0.95	128.50	-0.57	71.02	0.14
SNB-H2fP	1.50	-128.50	0.57	-102.69	-1.74	-85.54	-0.44
SNB-H3aP	-1.29	167.41	1.04	173.52	-0.73	100.73	0.09
SNB-H3bP	-1.29	-173.52	0.73	-102.08	-2.27	-81.43	-0.45
SNB-H3cP	0.01	137.70	0.36	170.67	5.13	91.12	1.62
SNB-H3dP	0.01	-170.67	-5.13	-137.62	-0.35	-91.09	-1.62
SNB-H3eP	1.28	102.02	2.29	173.54	-0.73	81.42	0.46
SNB-H3fP	1.28	-173.54	0.73	-167.42	-1.07	-100.74	-0.10
SNB-H4aP	-1.39	261.79	0.52	277.87	-2.19	132.72	-0.41
SNB-H4bP	-1.39	-277.87	2.19	-187.90	-3.57	-114.55	-0.34
SNB-H4cP	-0.02	228.46	2.16	275.12	10.66	123.85	3.15
SNB-H4dP	-0.02	-275.12	-10.66	-228.44	-2.17	-123.85	-3.15
SNB-H4eP	1.41	187.95	3.57	277.82	-2.23	114.55	0.33
SNB-H4fP	1.41	-277.82	2.23	-261.83	-0.51	-132.72	0.42
SNB-H5aP	-2.17	374.21	1.17	358.81	-3.78	154.43	-0.55
SNB-H5bP	-2.16	-358.81	3.78	-203.66	-6.31	-118.50	-0.53
SNB-H5cP	-0.08	294.33	1.89	354.17	16.90	136.62	3.96
SNB-H5dP	-0.08	-354.17	-16.90	-294.43	-1.92	-136.64	-3.96
SNB-H5eP	2.24	203.91	6.28	358.64	-3.80	118.51	0.52
SNB-H5fP	2.24	-358.63	3.80	-374.31	-1.10	-154.41	0.57
SNB-H6aP	-10.86	505.10	0.25	557.63	-2.89	195.78	-0.48
SNB-H6bP	-10.86	-557.63	2.89	-394.18	-7.05	-175.34	-0.77
SNB-H6cP	-0.02	474.65	1.56	533.81	14.28	185.78	2.92
SNB-H6dP	-0.03	-533.81	-14.28	-475.05	-1.52	-185.85	-2.91
SNB-H6eP	10.89	394.46	7.10	557.60	-2.58	175.39	0.83
SNB-H6fP	10.89	-557.60	2.59	-504.98	-0.32	-195.75	0.42
SNB-H7aP	-9.91	727.99	-3.27	826.20	-6.01	254.38	-1.51
SNB-H7bP	-9.91	-826.20	6.00	-685.41	-6.04	-247.41	-0.01
SNB-H7cP	0.01	730.56	-0.79	805.52	13.72	251.41	2.12
SNB-H7dP	0.01	-805.52	-13.72	-730.63	0.83	-251.42	-2.11
SNB-H7eP	9.90	685.46	6.09	826.26	-5.73	247.42	0.05
SNB-H7fP	9.90	-826.26	5.74	-727.97	3.19	-254.38	1.47
SNB-H8aP	-2.81	954.75	-3.46	994.07	-6.68	286.99	-1.49
SNB-H8bP	-2.80	-994.07	6.68	-860.94	-3.33	-273.18	0.49
SNB-H8cP	-0.02	916.98	2.65	990.55	15.81	280.91	2.72
SNB-H8dP	-0.03	-990.55	-15.81	-917.13	-2.66	-280.94	-2.72
SNB-H8eP	2.83	861.06	3.31	994.03	-6.64	273.19	-0.49
SNB-H8fP	2.83	-994.03	6.64	-954.75	3.51	-286.99	1.50
SNB-H9aP	-6.79	1115.11	-4.17	1148.70	-8.24	302.97	-1.66
SNB-H9bP	-6.78	-1148.70	8.24	-1040.89	1.02	-293.04	1.23
SNB-H9cP	0.00	1097.94	6.98	1138.04	18.25	299.25	3.38
SNB-H9dP	-0.01	-1138.04	-18.25	-1097.92	-6.98	-299.24	-3.38
SNB-H9eP	6.79	1040.89	-1.02	1148.69	-8.24	293.03	-1.24
SNB-H9fP	6.80	-1148.69	8.24	-1115.15	4.20	-302.97	1.67

Service Loads Check:

Joint Label	Elevation (ft)	Actual Twist (deg)	Allowable Twist (deg)	Twist Usage %	Actual Sway (deg)	Allowable Sway (deg)	Sway Usage %	Actual Disp. (ft)	Allowable Disp. (ft)	Disp. Usage %	Max. Usage %
SNB-A2	180.00	0.00	4.00	0.1	0.21	4.00	5.1	0.40	5.40	7.4	7.4

SNB-A1	180.00	0.00	4.00	0.1	0.21	4.00	5.1	0.40	5.40	7.4	7.4
SNB-WL-A2S	180.00	0.00	4.00	0.1	0.21	4.00	5.1	0.40	5.40	7.4	7.4
RohnA2	180.00	0.00	4.00	0.1	0.21	4.00	5.1	0.40	5.40	7.4	7.4
RohnA1	180.00	0.00	4.00	0.1	0.21	4.00	5.1	0.40	5.40	7.4	7.4
SNB-WL-A3S	179.99	0.00	4.00	0.1	0.21	4.00	5.1	0.40	5.40	7.4	7.4
SNB-WL-A1S	179.99	0.00	4.00	0.1	0.21	4.00	5.1	0.40	5.40	7.4	7.4
SNB-AP	179.99	0.00	4.00	0.1	0.21	4.00	5.1	0.40	5.40	7.4	7.4
RohnAP	179.98	0.00	4.00	0.1	0.21	4.00	5.1	0.40	5.40	7.4	7.4
SNB-Aa2	175.00	0.00	4.00	0.1	0.21	4.00	5.1	0.38	5.40	7.1	7.1
SNB-Aa1	175.00	0.00	4.00	0.1	0.21	4.00	5.1	0.38	5.40	7.1	7.1
RohnAa2	175.00	0.00	4.00	0.1	0.21	4.00	5.1	0.38	5.40	7.1	7.1
RohnAa1	175.00	0.00	4.00	0.1	0.21	4.00	5.1	0.38	5.40	7.1	7.1
SNB-AaS	174.99	0.00	4.00	0.1	0.21	4.00	5.1	0.38	5.40	7.1	7.1
RohnAaS	174.98	0.00	4.00	0.1	0.21	4.00	5.1	0.38	5.40	7.1	7.1
SNB-Ab2	170.00	0.00	4.00	0.1	0.21	4.00	5.1	0.36	5.40	6.7	6.7
SNB-Ab1	170.00	0.00	4.00	0.1	0.21	4.00	5.1	0.36	5.40	6.7	6.7
RohnAb2	170.00	0.00	4.00	0.1	0.21	4.00	5.1	0.36	5.40	6.7	6.7
RohnAb1	170.00	0.00	4.00	0.1	0.21	4.00	5.1	0.36	5.40	6.7	6.7
SNB-AbS	169.99	0.00	4.00	0.1	0.21	4.00	5.1	0.36	5.40	6.7	6.7
RohnAbS	169.97	0.00	4.00	0.1	0.21	4.00	5.1	0.36	5.40	6.7	6.7
SNB-Ac2	165.00	0.00	4.00	0.1	0.21	4.00	5.1	0.35	5.40	6.4	6.4
SNB-Ac1	165.00	0.00	4.00	0.1	0.21	4.00	5.1	0.35	5.40	6.4	6.4
RohnAc2	165.00	0.00	4.00	0.1	0.21	4.00	5.1	0.35	5.40	6.4	6.4
RohnAc1	165.00	0.00	4.00	0.1	0.21	4.00	5.1	0.35	5.40	6.4	6.4
SNB-AcS	164.99	0.00	4.00	0.1	0.21	4.00	5.1	0.35	5.40	6.4	6.4
RohnAcS	164.97	0.00	4.00	0.1	0.21	4.00	5.1	0.35	5.40	6.4	6.4
SNB-B2	160.00	0.00	4.00	0.1	0.21	4.00	5.1	0.33	5.40	6.1	6.1
SNB-B1	160.00	0.00	4.00	0.1	0.21	4.00	5.1	0.33	5.40	6.1	6.1
SNB-WL-B2S	160.00	0.00	4.00	0.1	0.21	4.00	5.1	0.33	5.40	6.1	6.1
RohnB2	160.00	0.00	4.00	0.1	0.21	4.00	5.1	0.33	5.40	6.1	6.1
RohnB1	160.00	0.00	4.00	0.1	0.21	4.00	5.1	0.33	5.40	6.1	6.1
SNB-WL-B3S	159.99	0.00	4.00	0.1	0.21	4.00	5.1	0.33	5.40	6.1	6.1
SNB-WL-B1S	159.99	0.00	4.00	0.1	0.21	4.00	5.1	0.33	5.40	6.1	6.1
SNB-BP	159.98	0.00	4.00	0.1	0.21	4.00	5.1	0.33	5.40	6.1	6.1
RohnBP	159.97	0.00	4.00	0.1	0.21	4.00	5.1	0.33	5.40	6.1	6.1
SNB-Ba2	155.00	0.00	4.00	0.1	0.21	4.00	5.1	0.31	5.40	5.7	5.7
SNB-Ba1	155.00	0.00	4.00	0.1	0.21	4.00	5.1	0.31	5.40	5.7	5.7
RohnBa2	155.00	0.00	4.00	0.1	0.21	4.00	5.1	0.31	5.40	5.7	5.7
RohnBa1	155.00	0.00	4.00	0.1	0.21	4.00	5.1	0.31	5.40	5.7	5.7
SNB-BaS	154.98	0.00	4.00	0.1	0.21	4.00	5.1	0.31	5.40	5.7	5.7
RohnBaS	154.97	0.00	4.00	0.1	0.21	4.00	5.1	0.31	5.40	5.7	5.7
SNB-Bb2	150.00	0.00	4.00	0.1	0.21	4.00	5.1	0.29	5.40	5.4	5.4
SNB-Bb1	150.00	0.00	4.00	0.1	0.21	4.00	5.1	0.29	5.40	5.4	5.4
RohnBb2	150.00	0.00	4.00	0.1	0.21	4.00	5.1	0.29	5.40	5.4	5.4
RohnBb1	150.00	0.00	4.00	0.1	0.21	4.00	5.1	0.29	5.40	5.4	5.4
SNB-BbS	149.98	0.00	4.00	0.1	0.21	4.00	5.1	0.29	5.40	5.4	5.4
RohnBbS	149.97	0.00	4.00	0.1	0.21	4.00	5.1	0.29	5.40	5.4	5.4
SNB-Bc2	145.00	0.00	4.00	0.1	0.21	4.00	5.1	0.27	5.40	5.1	5.1
SNB-Bc1	145.00	0.00	4.00	0.1	0.21	4.00	5.1	0.27	5.40	5.1	5.1
RohnBc2	145.00	0.00	4.00	0.1	0.21	4.00	5.1	0.27	5.40	5.1	5.1
RohnBc1	145.00	0.00	4.00	0.1	0.21	4.00	5.1	0.27	5.40	5.1	5.1
SNB-BcS	144.98	0.00	4.00	0.1	0.21	4.00	5.1	0.27	5.40	5.1	5.1
RohnBcS	144.97	0.00	4.00	0.1	0.21	4.00	5.1	0.27	5.40	5.1	5.1
SNB-C2	140.00	0.00	4.00	0.1	0.21	4.00	5.1	0.26	5.40	4.8	5.1
SNB-C1	140.00	0.00	4.00	0.1	0.21	4.00	5.1	0.26	5.40	4.8	5.1
SNB-WL-C2S	140.00	0.00	4.00	0.1	0.21	4.00	5.1	0.26	5.40	4.8	5.1
RohnC2	140.00	0.00	4.00	0.1	0.21	4.00	5.1	0.26	5.40	4.8	5.1
RohnC1	140.00	0.00	4.00	0.1	0.21	4.00	5.1	0.26	5.40	4.8	5.1
SNB-WL-C3S	139.99	0.00	4.00	0.1	0.21	4.00	5.1	0.26	5.40	4.8	5.1
SNB-WL-C1S	139.99	0.00	4.00	0.1	0.21	4.00	5.1	0.26	5.40	4.8	5.1
SNB-CP	139.98	0.00	4.00	0.1	0.21	4.00	5.1	0.26	5.40	4.8	5.1
RohnCP	139.97	0.00	4.00	0.1	0.21	4.00	5.1	0.26	5.40	4.8	5.1
SNB-Ca2	133.34	0.00	4.00	0.1	0.21	4.00	5.1	0.23	5.40	4.3	5.1
SNB-Ca1	133.34	0.00	4.00	0.1	0.21	4.00	5.1	0.23	5.40	4.3	5.1
RohnCa2	133.34	0.00	4.00	0.1	0.21	4.00	5.1	0.23	5.40	4.3	5.1
RohnCa1	133.34	0.00	4.00	0.1	0.21	4.00	5.1	0.23	5.40	4.3	5.1
SNB-CaS	133.32	0.00	4.00	0.1	0.21	4.00	5.1	0.23	5.40	4.3	5.1
RohnCaS	133.31	0.00	4.00	0.1	0.21	4.00	5.1	0.23	5.40	4.3	5.1
SNB-Cb2	126.66	0.00	4.00	0.1	0.21	4.00	5.1	0.21	5.40	3.9	5.1

SNB-Cb1	126.66	0.00	4.00	0.1	0.21	4.00	5.1	0.21	5.40	3.9	5.1
RohnCb2	126.66	0.00	4.00	0.1	0.21	4.00	5.1	0.21	5.40	3.9	5.1
RohnCb1	126.66	0.00	4.00	0.1	0.21	4.00	5.1	0.21	5.40	3.9	5.1
SNB-CbS	126.64	0.00	4.00	0.1	0.21	4.00	5.1	0.21	5.40	3.9	5.1
RohnCbS	126.63	0.00	4.00	0.1	0.21	4.00	5.1	0.21	5.40	3.9	5.1
SNB-D2	120.00	0.00	4.00	0.1	0.21	4.00	5.1	0.19	5.40	3.5	5.1
SNB-D1	120.00	0.00	4.00	0.1	0.21	4.00	5.1	0.19	5.40	3.5	5.1
RohnD2	120.00	0.00	4.00	0.1	0.21	4.00	5.1	0.19	5.40	3.5	5.1
RohnD1	120.00	0.00	4.00	0.1	0.21	4.00	5.1	0.19	5.40	3.5	5.1
SNB-WL-D2S	120.00	0.00	4.00	0.1	0.21	4.00	5.1	0.19	5.40	3.5	5.1
SNB-WL-D3S	119.99	0.00	4.00	0.1	0.21	4.00	5.1	0.19	5.40	3.5	5.1
SNB-WL-D1S	119.99	0.00	4.00	0.1	0.21	4.00	5.1	0.19	5.40	3.5	5.1
SNB-DP	119.98	0.00	4.00	0.1	0.21	4.00	5.1	0.19	5.40	3.5	5.1
RohnDP	119.97	0.00	4.00	0.1	0.21	4.00	5.1	0.19	5.40	3.5	5.1
SNB-Da2	113.34	0.00	4.00	0.1	0.21	4.00	5.1	0.17	5.40	3.2	5.1
SNB-Da1	113.34	0.00	4.00	0.1	0.21	4.00	5.1	0.17	5.40	3.2	5.1
RohnDa2	113.34	0.00	4.00	0.1	0.21	4.00	5.1	0.17	5.40	3.2	5.1
RohnDa1	113.34	0.00	4.00	0.1	0.21	4.00	5.1	0.17	5.40	3.2	5.1
SNB-DaS	113.32	0.00	4.00	0.1	0.21	4.00	5.1	0.17	5.40	3.2	5.1
RohnDaS	113.31	0.00	4.00	0.1	0.21	4.00	5.1	0.17	5.40	3.2	5.1
SNB-Db2	106.66	0.00	4.00	0.1	0.21	4.00	5.1	0.15	5.40	2.8	5.1
SNB-Db1	106.66	0.00	4.00	0.1	0.21	4.00	5.1	0.15	5.40	2.8	5.1
RohnDb2	106.66	0.00	4.00	0.1	0.21	4.00	5.1	0.15	5.40	2.8	5.1
RohnDb1	106.66	0.00	4.00	0.1	0.21	4.00	5.1	0.15	5.40	2.8	5.1
SNB-DbS	106.64	0.00	4.00	0.1	0.21	4.00	5.1	0.15	5.40	2.8	5.1
RohnDbS	106.63	0.00	4.00	0.1	0.21	4.00	5.1	0.15	5.40	2.8	5.1
SNB-E2	100.00	0.00	4.00	0.1	0.21	4.00	5.1	0.13	5.40	2.5	5.1
SNB-E1	100.00	0.00	4.00	0.1	0.21	4.00	5.1	0.13	5.40	2.5	5.1
RohnE2	100.00	0.00	4.00	0.1	0.21	4.00	5.1	0.13	5.40	2.5	5.1
RohnE1	100.00	0.00	4.00	0.1	0.21	4.00	5.1	0.13	5.40	2.5	5.1
SNB-WL-E2S	100.00	0.00	4.00	0.1	0.21	4.00	5.1	0.13	5.40	2.5	5.1
SNB-WL-E3S	99.99	0.00	4.00	0.1	0.21	4.00	5.1	0.13	5.40	2.5	5.1
SNB-WL-E1S	99.99	0.00	4.00	0.1	0.21	4.00	5.1	0.13	5.40	2.5	5.1
SNB-EP	99.98	0.00	4.00	0.1	0.21	4.00	5.1	0.13	5.40	2.5	5.1
RohnEP	99.98	0.00	4.00	0.1	0.21	4.00	5.1	0.13	5.40	2.5	5.1
SNB-Ea2	93.34	0.00	4.00	0.1	0.21	4.00	5.1	0.12	5.40	2.2	5.1
SNB-Ea1	93.34	0.00	4.00	0.1	0.21	4.00	5.1	0.12	5.40	2.2	5.1
RohnEa2	93.34	0.00	4.00	0.1	0.21	4.00	5.1	0.12	5.40	2.2	5.1
RohnEa1	93.34	0.00	4.00	0.1	0.21	4.00	5.1	0.12	5.40	2.2	5.1
SNB-EaS	93.32	0.00	4.00	0.1	0.21	4.00	5.1	0.12	5.40	2.2	5.1
RohnEaS	93.32	0.00	4.00	0.1	0.21	4.00	5.1	0.12	5.40	2.2	5.1
SNB-Eb2	86.66	0.00	4.00	0.1	0.21	4.00	5.2	0.10	5.40	1.9	5.2
SNB-Eb1	86.66	0.00	4.00	0.1	0.21	4.00	5.2	0.10	5.40	1.9	5.2
RohnEb2	86.66	0.00	4.00	0.1	0.21	4.00	5.2	0.10	5.40	1.9	5.2
RohnEb1	86.66	0.00	4.00	0.1	0.21	4.00	5.2	0.10	5.40	1.9	5.2
SNB-EbS	86.64	0.00	4.00	0.1	0.21	4.00	5.2	0.10	5.40	1.9	5.2
RohnEbS	86.64	0.00	4.00	0.1	0.21	4.00	5.2	0.10	5.40	1.9	5.2
SNB-F2	80.00	0.00	4.00	0.1	0.21	4.00	5.1	0.09	5.40	1.6	5.1
SNB-F1	80.00	0.00	4.00	0.1	0.21	4.00	5.1	0.09	5.40	1.6	5.1
RohnF1	80.00	0.00	4.00	0.1	0.21	4.00	5.1	0.09	5.40	1.6	5.1
RohnF2	80.00	0.00	4.00	0.1	0.21	4.00	5.1	0.09	5.40	1.6	5.1
SNB-WL-F2S	80.00	0.00	4.00	0.1	0.21	4.00	5.1	0.09	5.40	1.6	5.1
SNB-WL-F3S	79.99	0.00	4.00	0.1	0.20	4.00	5.0	0.09	5.40	1.6	5.0
SNB-WL-F1S	79.99	0.00	4.00	0.1	0.20	4.00	5.0	0.09	5.40	1.6	5.0
SNB-FP	79.98	0.00	4.00	0.1	0.20	4.00	5.0	0.09	5.40	1.6	5.0
RohnFP	79.98	0.00	4.00	0.1	0.20	4.00	5.0	0.09	5.40	1.6	5.0
SNB-Fa2	70.00	0.00	4.00	0.0	0.19	4.00	4.8	0.07	5.40	1.2	4.8
SNB-Fa1	70.00	0.00	4.00	0.0	0.19	4.00	4.8	0.07	5.40	1.2	4.8
RohnFa1	70.00	0.00	4.00	0.0	0.19	4.00	4.8	0.07	5.40	1.2	4.8
RohnFa2	70.00	0.00	4.00	0.0	0.19	4.00	4.8	0.07	5.40	1.2	4.8
SNB-FaS	69.99	0.00	4.00	0.0	0.19	4.00	4.8	0.07	5.40	1.2	4.8
RohnFaS	69.98	0.00	4.00	0.0	0.19	4.00	4.8	0.07	5.40	1.2	4.8
SNB-G2	60.00	0.00	4.00	0.0	0.17	4.00	4.4	0.05	5.40	0.9	4.4
SNB-G1	60.00	0.00	4.00	0.0	0.17	4.00	4.4	0.05	5.40	0.9	4.4
RohnG1	60.00	0.00	4.00	0.0	0.17	4.00	4.4	0.05	5.40	0.9	4.4
RohnG2	60.00	0.00	4.00	0.0	0.17	4.00	4.4	0.05	5.40	0.9	4.4
SNB-WL-G2S	60.00	0.00	4.00	0.0	0.17	4.00	4.4	0.05	5.40	0.9	4.4
SNB-WL-G3S	59.99	0.00	4.00	0.0	0.17	4.00	4.2	0.05	5.40	0.9	4.2
SNB-WL-G1S	59.99	0.00	4.00	0.0	0.17	4.00	4.2	0.05	5.40	0.9	4.2

SNB-GP	59.99	0.00	4.00	0.0	0.17	4.00	4.2	0.05	5.40	0.9	4.2
RohnGP	59.98	0.00	4.00	0.0	0.17	4.00	4.2	0.05	5.40	0.9	4.2
SNB-Ga2	50.00	-0.00	4.00	0.0	0.14	4.00	3.6	0.03	5.40	0.6	3.6
SNB-Ga1	50.00	-0.00	4.00	0.0	0.14	4.00	3.6	0.03	5.40	0.6	3.6
RohnGa1	50.00	-0.00	4.00	0.0	0.14	4.00	3.6	0.03	5.40	0.6	3.6
RohnGa2	50.00	-0.00	4.00	0.0	0.14	4.00	3.6	0.03	5.40	0.6	3.6
SNB-GaS	49.99	-0.00	4.00	0.0	0.13	4.00	3.4	0.04	5.40	0.7	3.4
RohnGaS	49.99	-0.00	4.00	0.0	0.13	4.00	3.4	0.04	5.40	0.7	3.4
SNB-H2	40.00	-0.00	4.00	0.0	0.11	4.00	2.9	0.02	5.40	0.4	2.9
SNB-H1	40.00	-0.00	4.00	0.0	0.11	4.00	2.9	0.02	5.40	0.4	2.9
RohnH1	40.00	-0.00	4.00	0.0	0.11	4.00	2.9	0.02	5.40	0.4	2.9
RohnH2	40.00	-0.00	4.00	0.0	0.11	4.00	2.9	0.02	5.40	0.4	2.9
SNB-WL-H2S	40.00	-0.00	4.00	0.0	0.10	4.00	2.4	0.02	5.40	0.4	2.4
SNB-WL-H3S	39.99	-0.00	4.00	0.0	0.10	4.00	2.4	0.02	5.40	0.4	2.4
SNB-WL-H1S	39.99	-0.00	4.00	0.0	0.10	4.00	2.4	0.02	5.40	0.4	2.4
SNB-HP	39.99	-0.00	4.00	0.0	0.10	4.00	2.4	0.02	5.40	0.4	2.4
RohnHP	39.99	-0.00	4.00	0.0	0.10	4.00	2.4	0.02	5.40	0.4	2.4
SNB-Ha2	30.00	-0.00	4.00	0.0	0.09	4.00	2.1	0.01	5.40	0.2	2.1
SNB-Ha1	30.00	-0.00	4.00	0.0	0.09	4.00	2.1	0.01	5.40	0.2	2.1
RohnHa2	30.00	-0.00	4.00	0.0	0.09	4.00	2.1	0.01	5.40	0.2	2.1
RohnHa1	30.00	-0.00	4.00	0.0	0.09	4.00	2.1	0.01	5.40	0.2	2.1
SNB-HaS	29.99	-0.00	4.00	0.0	0.07	4.00	1.7	0.01	5.40	0.3	1.7
RohnHaS	29.99	-0.00	4.00	0.0	0.07	4.00	1.7	0.01	5.40	0.3	1.7
SNB-I2	20.00	-0.00	4.00	0.0	0.06	4.00	1.4	0.01	5.40	0.1	1.4
SNB-I1	20.00	-0.00	4.00	0.0	0.06	4.00	1.4	0.01	5.40	0.1	1.4
RohnI2	20.00	-0.00	4.00	0.0	0.06	4.00	1.4	0.01	5.40	0.1	1.4
RohnI1	20.00	-0.00	4.00	0.0	0.06	4.00	1.4	0.01	5.40	0.1	1.4
SNB-WL-I2S	20.00	-0.00	4.00	0.0	0.04	4.00	0.9	0.01	5.40	0.1	0.9
SNB-IP	20.00	-0.00	4.00	0.0	0.04	4.00	0.9	0.01	5.40	0.1	0.9
RohnIP	19.99	-0.00	4.00	0.0	0.04	4.00	0.9	0.01	5.40	0.1	0.9
SNB-WL-I3S	19.99	-0.00	4.00	0.0	0.04	4.00	0.9	0.01	5.40	0.1	0.9
SNB-WL-I1S	19.99	-0.00	4.00	0.0	0.04	4.00	0.9	0.01	5.40	0.1	0.9
SNB-Ia2	10.00	-0.00	4.00	0.0	0.03	4.00	0.7	0.00	5.40	0.0	0.7
SNB-Ia1	10.00	-0.00	4.00	0.0	0.03	4.00	0.7	0.00	5.40	0.0	0.7
RohnIa2	10.00	-0.00	4.00	0.0	0.03	4.00	0.7	0.00	5.40	0.0	0.7
RohnIa1	10.00	-0.00	4.00	0.0	0.03	4.00	0.7	0.00	5.40	0.0	0.7
SNB-IaS	10.00	-0.00	4.00	0.0	0.01	4.00	0.3	0.00	5.40	0.0	0.3
RohnIaS	10.00	-0.00	4.00	0.0	0.01	4.00	0.3	0.00	5.40	0.0	0.3

Equilibrium Joint Positions and Rotations for Load Case "1.2\*DL":

Joint Label	X-Displ (ft)	Y-Displ (ft)	Z-Displ (ft)	X-Rot (deg)	Y-Rot (deg)	Z-Rot (deg)	X-Pos (ft)	Y-Pos (ft)	Z-Pos (ft)
RohnAP	0.00157	0.0001689	-0.009451	-0.0002	0.0008	0.0000	4.335	0.0001689	180
RohnBP	0.001079	0.0001497	-0.009306	-0.0000	0.0010	0.0000	5.122	0.0001497	160
RohnCP	0.0006778	0.0001364	-0.00873	-0.0001	0.0009	0.0000	5.91	0.0001364	140
RohnDP	0.0004134	0.0001169	-0.007855	-0.0000	0.0002	-0.0000	6.695	0.0001169	120
RohnEP	0.0002353	9.238e-005	-0.00642	-0.0001	0.0003	-0.0000	7.481	9.238e-005	99.99
RohnFP	0.0001377	6.085e-005	-0.005179	-0.0001	-0.0014	-0.0000	8.268	6.085e-005	79.99
RohnGP	6.404e-005	3.119e-005	-0.003947	-0.0001	-0.0002	-0.0000	9.055	3.119e-005	60
RohnHP	2.832e-005	1.168e-005	-0.002714	-0.0000	-0.0003	-0.0000	9.841	1.168e-005	40
RohnIP	8.848e-006	1.85e-006	-0.0013	-0.0000	-0.0011	-0.0000	10.63	1.85e-006	20
RohnJP	0	0	0	0.0000	0.0000	0.0000	11.42	0	0
SNB-AP	0.001576	0.0001676	-0.004517	-0.0001	-0.0055	-0.0000	2.335	0.0001676	180
SNB-BP	0.001085	0.0001498	-0.00442	-0.0000	-0.0034	-0.0000	3.122	0.0001498	160
SNB-CP	0.0006829	0.000136	-0.004203	-0.0001	-0.0040	-0.0000	3.909	0.000136	140
SNB-DP	0.0004174	0.0001169	-0.003825	-0.0001	-0.0076	0.0000	4.695	0.0001169	120
SNB-EP	0.0002378	9.164e-005	-0.003216	-0.0001	-0.0046	-0.0000	5.481	9.164e-005	100
SNB-FP	0.0001391	6.012e-005	-0.002769	-0.0001	-0.0076	-0.0000	6.268	6.012e-005	80
SNB-GP	6.477e-005	3.151e-005	-0.002168	-0.0001	-0.0099	-0.0000	7.055	3.151e-005	60
SNB-HP	2.861e-005	1.223e-005	-0.001534	-0.0000	-0.0087	-0.0000	7.841	1.223e-005	40
SNB-IP	8.864e-006	2.321e-006	-0.0007509	-0.0000	-0.0071	-0.0000	8.628	2.321e-006	20
SNB-JP	0	0	0	0.0000	0.0000	0.0000	9.415	0	0
RohnA1	0.001578	0.0001734	-0.009287	-0.0006	0.0016	-0.0000	-2.165	-3.752	180
RohnA2	0.001579	0.0001626	-0.00931	0.0004	0.0017	0.0000	-2.165	3.753	180
RohnB1	0.001087	0.0001539	-0.009085	-0.0003	0.0017	-0.0000	-2.559	-4.435	160
RohnB2	0.001087	0.0001456	-0.009086	0.0002	0.0017	0.0000	-2.559	4.435	160
RohnC1	0.0006737	0.0001372	-0.008572	-0.0001	0.0009	-0.0000	-2.954	-5.117	140
RohnC2	0.0006741	0.0001349	-0.008581	-0.0000	0.0009	0.0000	-2.954	5.117	140
RohnD1	0.0003949	0.0001084	-0.007732	-0.0005	0.0009	-0.0000	-3.347	-5.798	120
RohnD2	0.0003949	0.0001253	-0.007741	0.0003	0.0009	0.0000	-3.347	5.798	120
RohnE1	0.0002197	8.498e-005	-0.006333	-0.0002	0.0004	-0.0000	-3.74	-6.479	99.99
RohnE2	0.0002203	9.866e-005	-0.006353	0.0000	0.0004	0.0000	-3.74	6.479	99.99
RohnF1	0.000116	4.932e-005	-0.005115	-0.0015	0.0010	0.0000	-4.134	-7.16	79.99
RohnF2	0.0001166	7.128e-005	-0.005145	0.0013	0.0010	0.0000	-4.134	7.16	79.99
RohnG1	5.877e-005	2.886e-005	-0.0039	-0.0004	0.0003	0.0000	-4.527	-7.842	60
RohnG2	5.848e-005	3.401e-005	-0.003925	0.0003	0.0003	0.0000	-4.527	7.842	60
RohnH1	2.041e-005	7.963e-006	-0.002685	-0.0004	0.0003	0.0000	-4.92	-8.523	40
RohnH2	1.987e-005	1.632e-005	-0.0027	0.0003	0.0003	0.0000	-4.92	8.523	40
RohnI1	2.016e-006	-1.229e-006	-0.001287	-0.0010	0.0006	0.0000	-5.315	-9.206	20
RohnI2	1.545e-006	5.744e-006	-0.001293	0.0010	0.0006	0.0000	-5.315	9.206	20
RohnJ1	0	0	0	0.0000	0.0000	0.0000	-5.71	-9.89	0
RohnJ2	0	0	0	0.0000	0.0000	0.0000	-5.71	9.89	0
SNB-A1	0.001576	0.0001678	-0.004429	-0.0060	0.0048	0.0000	-1.165	-2.02	180
SNB-A2	0.001576	0.0001676	-0.004434	0.0059	0.0048	0.0000	-1.165	2.021	180
SNB-B1	0.001084	0.0001492	-0.004313	-0.0041	0.0037	-0.0000	-1.559	-2.703	160
SNB-B2	0.001084	0.0001503	-0.004317	0.0040	0.0037	0.0000	-1.559	2.703	160
SNB-C1	0.0006742	0.0001312	-0.004103	-0.0044	0.0034	-0.0000	-1.953	-3.384	140
SNB-C2	0.0006742	0.0001407	-0.004108	0.0043	0.0034	0.0000	-1.953	3.385	140
SNB-D1	0.0003945	0.0001041	-0.003742	-0.0072	0.0048	-0.0000	-2.347	-4.066	120
SNB-D2	0.0003945	0.0001296	-0.00375	0.0071	0.0048	0.0000	-2.347	4.066	120
SNB-E1	0.0002203	8.179e-005	-0.003157	-0.0044	0.0028	-0.0000	-2.74	-4.747	100
SNB-E2	0.0002203	0.0001015	-0.00317	0.0042	0.0028	0.0000	-2.74	4.747	100
SNB-F1	0.0001166	4.74e-005	-0.002722	-0.0069	0.0042	-0.0000	-3.134	-5.428	80
SNB-F2	0.0001166	7.285e-005	-0.002737	0.0067	0.0042	0.0000	-3.134	5.428	80
SNB-G1	5.86e-005	2.813e-005	-0.002134	-0.0088	0.0052	-0.0000	-3.527	-6.11	60
SNB-G2	5.859e-005	3.491e-005	-0.002148	0.0087	0.0052	0.0000	-3.527	6.11	60
SNB-H1	2.035e-005	7.664e-006	-0.001512	-0.0076	0.0045	-0.0000	-3.92	-6.79	40
SNB-H2	2.029e-005	1.69e-005	-0.001522	0.0076	0.0045	0.0000	-3.92	6.791	40
SNB-I1	2.194e-006	-1.349e-006	-0.0007414	-0.0062	0.0036	-0.0000	-4.314	-7.472	20
SNB-I2	2.131e-006	6.101e-006	-0.0007457	0.0061	0.0036	0.0000	-4.314	7.472	20
SNB-J1	0	0	0	0.0000	0.0000	0.0000	-4.708	-8.154	0
SNB-J2	0	0	0	0.0000	0.0000	0.0000	-4.708	8.154	0

RohnAaS	0.001477	0.0001556	-0.009433	-0.0001	0.0015	0.0000	4.531	0.0001556	175
RohnAbS	0.001331	0.0001539	-0.009403	-0.0000	0.0012	0.0000	4.728	0.0001539	170
RohnAcS	0.001241	0.0001522	-0.00936	-0.0000	0.0016	0.0000	4.925	0.0001522	165
RohnBaS	0.001015	0.0001478	-0.009198	-0.0000	0.0012	0.0000	5.319	0.0001478	155
RohnBbS	0.0008653	0.0001443	-0.009084	-0.0000	0.0010	0.0000	5.516	0.0001443	150
RohnBcS	0.0008179	0.0001405	-0.00891	-0.0000	0.0010	0.0000	5.713	0.0001405	145
RohnCaS	0.0006594	0.0001299	-0.008502	-0.0001	-0.0001	-0.0000	6.171	0.0001299	133.3
RohnCbS	0.0005901	0.0001225	-0.008217	-0.0001	0.0014	-0.0000	6.434	0.0001225	126.7
RohnDaS	0.0004717	0.0001105	-0.007438	-0.0001	-0.0007	-0.0000	6.957	0.0001105	113.3
RohnDbS	0.0004305	0.0001017	-0.006928	-0.0001	0.0014	-0.0000	7.22	0.0001017	106.7
RohnEaS	0.0002956	8.214e-005	-0.006022	-0.0001	-0.0005	-0.0000	7.743	8.214e-005	93.33
RohnEbS	0.000229	7.181e-005	-0.005605	-0.0001	0.0013	-0.0000	8.006	7.181e-005	86.65
RohnFaS	0.0004209	4.361e-005	-0.004566	-0.0001	0.0005	-0.0000	8.662	4.361e-005	70
RohnGaS	0.0003483	1.871e-005	-0.003334	-0.0001	0.0001	-0.0000	9.448	1.871e-005	50
RohnHaS	0.0003583	5.183e-006	-0.002009	-0.0000	0.0002	-0.0000	10.24	5.183e-006	30
RohnIaS	0.0003016	-2.9e-007	-0.0006531	-0.0000	0.0001	-0.0000	11.03	-2.9e-007	9.999
SNB-AaS	0.001483	0.0001611	-0.004504	-0.0001	0.0033	-0.0000	2.531	0.0001611	175
SNB-AbS	0.001337	0.0001555	-0.004486	-0.0000	0.0005	-0.0000	2.728	0.0001555	170
SNB-AcS	0.001247	0.0001523	-0.004456	-0.0000	0.0028	-0.0000	2.925	0.0001523	165
SNB-BaS	0.00102	0.0001471	-0.004375	-0.0000	0.0025	-0.0000	3.319	0.0001471	155
SNB-BbS	0.000871	0.0001439	-0.004325	-0.0000	0.0004	-0.0000	3.515	0.0001439	150
SNB-BcS	0.0008233	0.0001403	-0.004265	-0.0000	0.0025	-0.0000	3.712	0.0001403	145
SNB-CaS	0.0006642	0.0001301	-0.004091	-0.0001	0.0007	0.0000	4.171	0.0001301	133.3
SNB-CbS	0.0005946	0.0001237	-0.003957	-0.0001	0.0032	0.0000	4.434	0.0001237	126.7
SNB-DaS	0.0004752	0.0001097	-0.003637	-0.0001	0.0011	0.0000	4.957	0.0001097	113.3
SNB-DbS	0.0004335	0.0001012	-0.003422	-0.0001	0.0023	-0.0000	5.22	0.0001012	106.7
SNB-EaS	0.0002977	8.152e-005	-0.003074	-0.0001	0.0004	-0.0000	5.743	8.152e-005	93.34
SNB-EbS	0.0002308	7.076e-005	-0.00292	-0.0001	0.0027	-0.0000	6.006	7.076e-005	86.66
SNB-FaS	0.000422	4.421e-005	-0.002465	-0.0001	0.0046	-0.0000	6.662	4.421e-005	70
SNB-GaS	0.0003488	1.998e-005	-0.001848	-0.0001	0.0046	-0.0000	7.448	1.998e-005	50
SNB-HaS	0.0003585	5.388e-006	-0.001139	-0.0000	0.0038	-0.0000	8.235	5.388e-006	30
SNB-IaS	0.0003016	-1.139e-007	-0.0003731	-0.0000	0.0016	-0.0000	9.022	-1.139e-007	10
SNB-WL-A1S	0.001576	0.0001677	-0.004647	-0.0030	-0.0003	-0.0000	0.5848	-1.01	180
SNB-WL-A2S	0.001576	0.0001677	-0.004606	-0.0001	0.0048	0.0000	-1.165	0.0001677	180
SNB-WL-A3S	0.001576	0.0001677	-0.004649	0.0029	-0.0003	-0.0000	0.5848	1.01	180
SNB-WL-B1S	0.001084	0.0001498	-0.004623	-0.0020	0.0001	0.0000	0.7813	-1.351	160
SNB-WL-B2S	0.001084	0.0001498	-0.004571	-0.0000	0.0037	0.0000	-1.559	0.0001498	160
SNB-WL-B3S	0.001084	0.0001498	-0.004625	0.0020	0.0001	-0.0000	0.7813	1.352	160
SNB-WL-C1S	0.0006772	0.0001359	-0.004644	-0.0022	-0.0003	-0.0000	0.9777	-1.692	140
SNB-WL-C2S	0.0006771	0.000136	-0.004596	-0.0000	0.0034	-0.0000	-1.953	0.000136	140
SNB-WL-C3S	0.0006772	0.000136	-0.004646	0.0021	-0.0003	0.0000	0.9777	1.692	140
SNB-WL-D1S	0.0004024	0.0001167	-0.004886	-0.0036	-0.0014	-0.0000	1.174	-2.033	120
SNB-WL-D2S	0.0004022	0.0001169	-0.004849	-0.0001	0.0048	-0.0000	-2.347	0.0001169	120
SNB-WL-D3S	0.0004024	0.000117	-0.004891	0.0035	-0.0014	0.0000	1.174	2.033	120
SNB-WL-E1S	0.0002263	9.154e-005	-0.003955	-0.0022	-0.0009	-0.0000	1.37	-2.373	100
SNB-WL-E2S	0.0002261	9.164e-005	-0.003932	-0.0001	0.0028	-0.0000	-2.74	9.164e-005	100
SNB-WL-E3S	0.0002263	9.174e-005	-0.003962	0.0021	-0.0009	0.0000	1.37	2.373	100
SNB-WL-F1S	0.0001242	6.002e-005	-0.004262	-0.0035	-0.0017	-0.0000	1.567	-2.714	80
SNB-WL-F2S	0.000124	6.012e-005	-0.004246	-0.0001	0.0042	-0.0000	-3.134	6.012e-005	80
SNB-WL-F3S	0.0001242	6.022e-005	-0.00427	0.0033	-0.0017	0.0000	1.567	2.714	80
SNB-WL-G1S	6.071e-005	3.149e-005	-0.004914	-0.0044	-0.0024	-0.0000	1.764	-3.055	60
SNB-WL-G2S	6.067e-005	3.152e-005	-0.004904	-0.0001	0.0052	-0.0000	-3.527	3.152e-005	60
SNB-WL-G3S	6.071e-005	3.154e-005	-0.004921	0.0043	-0.0024	0.0000	1.764	3.055	60
SNB-WL-H1S	2.314e-005	1.225e-005	-0.005487	-0.0038	-0.0021	-0.0000	1.96	-3.395	39.99
SNB-WL-H2S	2.31e-005	1.228e-005	-0.005481	-0.0000	0.0045	0.0000	-3.92	1.228e-005	39.99
SNB-WL-H3S	2.314e-005	1.231e-005	-0.005492	0.0038	-0.0021	0.0000	1.96	3.395	39.99
SNB-WL-I1S	4.445e-006	2.356e-006	-0.006123	-0.0031	-0.0017	-0.0000	2.157	-3.736	19.99
SNB-WL-I2S	4.412e-006	2.374e-006	-0.00612	-0.0000	0.0036	0.0000	-4.314	2.374e-006	19.99
SNB-WL-I3S	4.445e-006	2.392e-006	-0.006125	0.0031	-0.0017	0.0000	2.157	3.736	19.99
RohnAa1	0.001448	0.000139	-0.009261	0.0000	0.0013	-0.0000	-2.264	-3.923	175
RohnAa2	0.001444	0.0001797	-0.009275	-0.0002	0.0013	0.0000	-2.264	3.923	175
RohnAb1	0.001337	0.0001548	-0.009221	-0.0002	0.0015	-0.0000	-2.362	-4.094	170
RohnAb2	0.001335	0.0001557	-0.009225	0.0001	0.0015	0.0000	-2.362	4.094	170
RohnAc1	0.001197	0.0001209	-0.009158	0.0001	0.0014	-0.0000	-2.461	-4.264	165
RohnAc2	0.001197	0.0001838	-0.00916	-0.0001	0.0014	0.0000	-2.461	4.264	165
RohnBa1	0.0009373	0.0001112	-0.008995	-0.0000	0.0013	-0.0000	-2.658	-4.605	155
RohnBa2	0.000938	0.0001833	-0.008998	-0.0000	0.0013	0.0000	-2.658	4.606	155
RohnBb1	0.0008548	0.0001416	-0.008895	-0.0002	0.0012	-0.0000	-2.757	-4.776	150
RohnBb2	0.0008551	0.0001464	-0.008901	0.0001	0.0012	0.0000	-2.757	4.776	150

RohnBc1	0.0007334	9.65e-005	-0.008737	-0.0001	0.0011	-0.0000	-2.855	-4.947	145
RohnBc2	0.0007337	0.0001841	-0.008744	-0.0000	0.0011	0.0000	-2.855	4.947	145
RohnCa1	0.0005285	5.896e-005	-0.008358	-0.0009	0.0013	-0.0000	-3.085	-5.344	133.3
RohnCa2	0.0005286	0.0002005	-0.008368	0.0008	0.0013	0.0000	-3.085	5.344	133.3
RohnCb1	0.0004276	3.184e-005	-0.008081	0.0005	0.0004	-0.0000	-3.216	-5.571	126.7
RohnCb2	0.0004269	0.0002144	-0.008091	-0.0006	0.0004	0.0000	-3.216	5.572	126.7
RohnDa1	0.0002616	-8.648e-006	-0.007323	-0.0012	0.0012	-0.0000	-3.478	-6.025	113.3
RohnDa2	0.0002624	0.0002281	-0.007336	0.0010	0.0012	0.0000	-3.478	6.025	113.3
RohnDb1	0.0001929	-3.133e-005	-0.006827	0.0007	-0.0000	-0.0000	-3.609	-6.252	106.7
RohnDb2	0.0001934	0.0002339	-0.006843	-0.0009	-0.0000	0.0000	-3.609	6.252	106.7
RohnEa1	0.0001306	-1.089e-005	-0.005943	-0.0008	0.0007	-0.0000	-3.871	-6.706	93.33
RohnEa2	0.0001311	0.0001743	-0.005966	0.0006	0.0007	0.0000	-3.871	6.706	93.33
RohnEb1	0.000113	6.69e-006	-0.005534	0.0008	-0.0002	0.0000	-4.003	-6.933	86.65
RohnEb2	0.0001137	0.0001358	-0.005556	-0.0010	-0.0002	0.0000	-4.003	6.933	86.65
RohnFa1	-7.812e-005	-0.0002405	-0.004511	0.0002	0.0000	0.0000	-4.331	-7.501	70
RohnFa2	-7.951e-005	0.0003302	-0.004538	-0.0004	0.0000	0.0000	-4.331	7.501	70
RohnGa1	-0.0001152	-0.0002455	-0.003296	-0.0001	0.0001	0.0000	-4.724	-8.182	50
RohnGa2	-0.0001172	0.0002863	-0.003316	-0.0000	0.0001	0.0000	-4.724	8.182	50
RohnHa1	-0.0001619	-0.0002927	-0.001988	0.0001	-0.0000	0.0000	-5.118	-8.864	30
RohnHa2	-0.0001631	0.000305	-0.001998	-0.0002	-0.0000	0.0000	-5.118	8.865	30
RohnIa1	-0.0001498	-0.0002591	-0.0006467	0.0001	-0.0000	0.0000	-5.513	-9.548	9.999
RohnIa2	-0.0001506	0.0002599	-0.0006499	-0.0001	-0.0000	-0.0000	-5.513	9.548	9.999
SNB-Aa1	0.00144	0.0001367	-0.004409	0.0016	0.0005	0.0000	-1.264	-2.191	175
SNB-Aa2	0.001441	0.0001847	-0.004414	-0.0017	0.0005	0.0000	-1.264	2.191	175
SNB-Ab1	0.001329	0.0001527	-0.004385	-0.0008	0.0019	-0.0000	-1.362	-2.361	170
SNB-Ab2	0.001329	0.0001587	-0.004389	0.0007	0.0019	0.0000	-1.362	2.362	170
SNB-Ac1	0.001186	0.0001209	-0.00435	0.0012	0.0007	-0.0000	-1.461	-2.532	165
SNB-Ac2	0.001186	0.0001838	-0.004354	-0.0012	0.0007	0.0000	-1.461	2.532	165
SNB-Ba1	0.0009405	0.0001029	-0.004267	0.0010	0.0007	-0.0000	-1.658	-2.873	155
SNB-Ba2	0.0009405	0.0001912	-0.004271	-0.0011	0.0007	0.0000	-1.658	2.873	155
SNB-Bb1	0.0008547	0.0001354	-0.004219	-0.0007	0.0015	-0.0000	-1.756	-3.044	150
SNB-Bb2	0.0008547	0.0001525	-0.004224	0.0006	0.0015	0.0000	-1.756	3.044	150
SNB-Bc1	0.0007331	9.063e-005	-0.004162	0.0012	0.0003	-0.0000	-1.855	-3.214	145
SNB-Bc2	0.0007332	0.0001898	-0.004167	-0.0013	0.0003	0.0000	-1.855	3.214	145
SNB-Ca1	0.000526	5.491e-005	-0.003995	-0.0001	0.0009	-0.0000	-2.085	-3.611	133.3
SNB-Ca2	0.0005263	0.0002047	-0.004002	0.0000	0.0009	0.0000	-2.085	3.612	133.3
SNB-Cb1	0.0004239	2.886e-005	-0.003867	0.0021	-0.0005	-0.0000	-2.216	-3.839	126.7
SNB-Cb2	0.0004243	0.000218	-0.003875	-0.0022	-0.0005	0.0000	-2.216	3.839	126.7
SNB-Da1	0.0002591	-1.128e-005	-0.003561	0.0004	0.0003	-0.0000	-2.478	-4.293	113.3
SNB-Da2	0.0002593	0.0002303	-0.003571	-0.0006	0.0003	0.0000	-2.478	4.293	113.3
SNB-Db1	0.0001922	-3.435e-005	-0.003354	0.0015	-0.0005	-0.0000	-2.609	-4.52	106.7
SNB-Db2	0.0001922	0.0002367	-0.003366	-0.0016	-0.0005	0.0000	-2.609	4.52	106.7
SNB-Ea1	0.0001305	-1.326e-005	-0.003019	0.0000	0.0003	-0.0000	-2.871	-4.974	93.34
SNB-Ea2	0.0001305	0.0001764	-0.003033	-0.0002	0.0003	0.0000	-2.871	4.974	93.34
SNB-Eb1	0.0001134	4.477e-006	-0.002869	0.0020	-0.0010	-0.0000	-3.003	-5.201	86.66
SNB-Eb2	0.0001131	0.0001375	-0.002884	-0.0022	-0.0010	0.0000	-3.003	5.201	86.66
SNB-Fa1	-7.987e-005	-0.0002407	-0.002425	0.0037	-0.0020	-0.0000	-3.331	-5.769	70
SNB-Fa2	-8.075e-005	0.0003307	-0.00244	-0.0039	-0.0020	0.0000	-3.331	5.769	70
SNB-Ga1	-0.0001163	-0.0002454	-0.001821	0.0039	-0.0022	-0.0000	-3.724	-6.45	50
SNB-Ga2	-0.0001172	0.0002869	-0.001833	-0.0040	-0.0022	0.0000	-3.724	6.45	50
SNB-Ha1	-0.0001623	-0.0002926	-0.001123	0.0033	-0.0018	-0.0000	-4.117	-7.132	30
SNB-Ha2	-0.0001633	0.000305	-0.00113	-0.0033	-0.0018	0.0000	-4.117	7.132	30
SNB-Ia1	-0.0001498	-0.0002591	-0.0003683	0.0014	-0.0008	-0.0000	-4.511	-7.813	10
SNB-Ia2	-0.0001505	0.00026	-0.0003705	-0.0014	-0.0008	0.0000	-4.511	7.813	10

Joint Support Reactions for Load Case "1.2\*DL":

Joint Label	X Force (kips)	X Usage % (kips)	Y Force (kips)	Y Usage % (kips)	Z Comp. Force (kips)	Z Usage % (kips)	Uplift Usage %	Result. Force (kips)	Result. Usage % (ft-k)	X Moment Usage % (ft-k)	X-M. Moment Usage % (ft-k)	Y Moment Usage % (ft-k)	Y-M. Moment Usage % (ft-k)	Z Moment Usage % (ft-k)	Z-M. Moment Usage % (ft-k)	Max. Usage %
RohnJP	-1.07	0.0	0.00	0.0	19.97	0.0	0.0	20.00	0.0	-0.00	0.0	-0.3	0.0	-0.00	0.0	0.0
SNB-JP	-0.55	0.0	0.00	0.0	18.61	0.0	0.0	18.62	0.0	-0.00	0.0	-0.5	0.0	-0.00	0.0	0.0
RohnJ1	0.53	0.0	0.92	0.0	19.79	0.0	0.0	19.81	0.0	-0.24	0.0	0.1	0.0	-0.00	0.0	0.0
RohnJ2	0.54	0.0	-0.92	0.0	19.88	0.0	0.0	19.91	0.0	0.24	0.0	0.1	0.0	0.00	0.0	0.0
SNB-J1	0.28	0.0	0.48	0.0	18.39	0.0	0.0	18.40	0.0	-0.41	0.0	0.2	0.0	-0.00	0.0	0.0
SNB-J2	0.28	0.0	-0.48	0.0	18.49	0.0	0.0	18.50	0.0	0.41	0.0	0.2	0.0	0.00	0.0	0.0



Joint Displacements, Loads and Member Forces on Joints for Load Case "1.2\*DL":

Joint Label	X External Load (kips)	Y External Load (kips)	Z External Load (kips)	X Member Force (kips)	Y Member Force (kips)	Z Member Force (kips)	X Disp. (ft)	Y Disp. (ft)	Z Disp. (ft)
RohnAP	0.0000	0.0000	-0.3561	0.0000	0.0000	0.3561	0.0016	0.0002	-0.0095
RohnBP	0.0000	0.0000	-1.2758	0.0000	0.0000	1.2758	0.0011	0.0001	-0.0093
RohnCP	0.0000	0.0000	-0.5163	0.0000	0.0000	0.5163	0.0007	0.0001	-0.0087
RohnDP	0.0000	0.0000	-0.6254	0.0000	0.0000	0.6254	0.0004	0.0001	-0.0079
RohnEP	0.0000	0.0000	-0.7740	0.0000	0.0000	0.7740	0.0002	0.0001	-0.0064
RohnFP	0.0000	0.0000	-1.0489	0.0000	0.0000	1.0489	0.0001	0.0001	-0.0052
RohnGP	0.0000	0.0000	-1.3961	0.0000	0.0000	1.3961	0.0001	0.0000	-0.0039
RohnHP	0.0000	0.0000	-1.3896	0.0000	0.0000	1.3896	0.0000	0.0000	-0.0027
RohnIP	0.0000	0.0000	-1.5585	0.0000	0.0000	1.5585	0.0000	0.0000	-0.0013
RohnJP	0.0000	0.0000	-0.8421	1.0702	-0.0007	-19.1260	0.0000	0.0000	0.0000
SNB-AP	0.0000	0.0000	-0.1881	0.0000	0.0000	0.1881	0.0016	0.0002	-0.0045
SNB-BP	0.0000	0.0000	-0.4070	0.0000	0.0000	0.4070	0.0011	0.0001	-0.0044
SNB-CP	0.0000	0.0000	-0.5163	0.0000	0.0000	0.5163	0.0007	0.0001	-0.0042
SNB-DP	0.0000	0.0000	-0.6254	0.0000	0.0000	0.6254	0.0004	0.0001	-0.0038
SNB-EP	0.0000	0.0000	-0.7740	0.0000	0.0000	0.7740	0.0002	0.0001	-0.0032
SNB-FP	0.0000	0.0000	-1.0489	0.0000	0.0000	1.0489	0.0001	0.0001	-0.0028
SNB-GP	0.0000	0.0000	-1.2761	0.0000	0.0000	1.2761	0.0001	0.0000	-0.0022
SNB-HP	0.0000	0.0000	-1.3896	0.0000	0.0000	1.3896	0.0000	0.0000	-0.0015
SNB-IP	0.0000	0.0000	-1.5585	0.0000	0.0000	1.5585	0.0000	0.0000	-0.0008
SNB-JP	0.0000	0.0000	-0.8421	0.5525	-0.0012	-17.7672	0.0000	0.0000	0.0000
RohnA1	0.0000	0.0000	-0.3561	0.0000	0.0000	0.3561	0.0016	0.0002	-0.0093
RohnA2	0.0000	0.0000	-0.5241	0.0000	0.0000	0.5241	0.0016	0.0002	-0.0093
RohnB1	0.0000	0.0000	-0.5438	0.0000	0.0000	0.5438	0.0011	0.0002	-0.0091
RohnB2	0.0000	0.0000	-0.4658	0.0000	0.0000	0.4658	0.0011	0.0001	-0.0091
RohnC1	0.0000	0.0000	-0.5163	0.0000	0.0000	0.5163	0.0007	0.0001	-0.0086
RohnC2	0.0000	0.0000	-0.5163	0.0000	0.0000	0.5163	0.0007	0.0001	-0.0086
RohnD1	0.0000	0.0000	-0.7094	0.0000	0.0000	0.7094	0.0004	0.0001	-0.0077
RohnD2	0.0000	0.0000	-0.6254	0.0000	0.0000	0.6254	0.0004	0.0001	-0.0077
RohnE1	0.0000	0.0000	-0.7740	0.0000	0.0000	0.7740	0.0002	0.0001	-0.0063
RohnE2	0.0000	0.0000	-0.7740	0.0000	0.0000	0.7740	0.0002	0.0001	-0.0064
RohnF1	0.0000	0.0000	-1.0489	0.0000	0.0000	1.0489	0.0001	0.0000	-0.0051
RohnF2	0.0000	0.0000	-1.2229	0.0000	0.0000	1.2229	0.0001	0.0001	-0.0051
RohnG1	0.0000	0.0000	-1.3481	0.0000	0.0000	1.3481	0.0001	0.0000	-0.0039
RohnG2	0.0000	0.0000	-1.4633	0.0000	0.0000	1.4633	0.0001	0.0000	-0.0039
RohnH1	0.0000	0.0000	-1.3896	0.0000	0.0000	1.3896	0.0000	0.0000	-0.0027
RohnH2	0.0000	0.0000	-1.3896	0.0000	0.0000	1.3896	0.0000	0.0000	-0.0027
RohnI1	0.0000	0.0000	-1.5585	0.0000	0.0000	1.5585	0.0000	-0.0000	-0.0013
RohnI2	0.0000	0.0000	-1.5585	0.0000	0.0000	1.5585	0.0000	0.0000	-0.0013
RohnJ1	0.0000	0.0000	-0.8421	-0.5338	-0.9233	-18.9435	0.0000	0.0000	0.0000
RohnJ2	0.0000	0.0000	-0.8421	-0.5352	0.9243	-19.0343	0.0000	0.0000	0.0000
SNB-A1	0.0000	0.0000	-0.1881	0.0000	0.0000	0.1881	0.0016	0.0002	-0.0044
SNB-A2	0.0000	0.0000	-0.1881	0.0000	0.0000	0.1881	0.0016	0.0002	-0.0044
SNB-B1	0.0000	0.0000	-0.4070	0.0000	0.0000	0.4070	0.0011	0.0001	-0.0043
SNB-B2	0.0000	0.0000	-0.4070	0.0000	0.0000	0.4070	0.0011	0.0002	-0.0043
SNB-C1	0.0000	0.0000	-0.5163	0.0000	0.0000	0.5163	0.0007	0.0001	-0.0041
SNB-C2	0.0000	0.0000	-0.5163	0.0000	0.0000	0.5163	0.0007	0.0001	-0.0041
SNB-D1	0.0000	0.0000	-0.6254	0.0000	0.0000	0.6254	0.0004	0.0001	-0.0037
SNB-D2	0.0000	0.0000	-0.6254	0.0000	0.0000	0.6254	0.0004	0.0001	-0.0038
SNB-E1	0.0000	0.0000	-0.7740	0.0000	0.0000	0.7740	0.0002	0.0001	-0.0032
SNB-E2	0.0000	0.0000	-0.7740	0.0000	0.0000	0.7740	0.0002	0.0001	-0.0032
SNB-F1	0.0000	0.0000	-1.0489	0.0000	0.0000	1.0489	0.0001	0.0000	-0.0027
SNB-F2	0.0000	0.0000	-1.0489	0.0000	0.0000	1.0489	0.0001	0.0001	-0.0027
SNB-G1	0.0000	0.0000	-1.2761	0.0000	0.0000	1.2761	0.0001	0.0000	-0.0021
SNB-G2	0.0000	0.0000	-1.2761	0.0000	0.0000	1.2761	0.0001	0.0000	-0.0021
SNB-H1	0.0000	0.0000	-1.3896	0.0000	0.0000	1.3896	0.0000	0.0000	-0.0015
SNB-H2	0.0000	0.0000	-1.3896	0.0000	0.0000	1.3896	0.0000	0.0000	-0.0015
SNB-I1	0.0000	0.0000	-1.5585	0.0000	-0.0000	1.5585	0.0000	-0.0000	-0.0007
SNB-I2	0.0000	0.0000	-1.5585	0.0000	0.0000	1.5585	0.0000	0.0000	-0.0007
SNB-J1	0.0000	0.0000	-0.8421	-0.2761	-0.4754	-17.5458	0.0000	0.0000	0.0000
SNB-J2	0.0000	0.0000	-0.8421	-0.2779	0.4761	-17.6472	0.0000	0.0000	0.0000
RohnAaS	0.0000	0.0000	-0.2508	0.0000	0.0000	0.2508	0.0015	0.0002	-0.0094
RohnAbS	0.0000	0.0000	-0.1881	0.0000	0.0000	0.1881	0.0013	0.0002	-0.0094
RohnAcS	0.0000	0.0000	-0.2520	0.0000	0.0000	0.2520	0.0012	0.0002	-0.0094

RohnBaS	0.0000	0.0000	-0.2189	0.0000	0.0000	0.2189	0.0010	0.0001	-0.0092
RohnBbS	0.0000	0.0000	-1.1599	0.0000	0.0000	1.1599	0.0009	0.0001	-0.0091
RohnBcS	0.0000	0.0000	-0.2189	0.0000	0.0000	0.2189	0.0008	0.0001	-0.0089
RohnCaS	0.0000	0.0000	-0.9601	0.0000	0.0000	0.9601	0.0007	0.0001	-0.0085
RohnCbS	0.0000	0.0000	-1.7009	0.0000	0.0000	1.7009	0.0006	0.0001	-0.0082
RohnDaS	0.0000	0.0000	-1.5215	0.0000	0.0000	1.5215	0.0005	0.0001	-0.0074
RohnDbS	0.0000	0.0000	-0.3280	0.0000	0.0000	0.3280	0.0004	0.0001	-0.0069
RohnEaS	0.0000	0.0000	-0.4460	0.0000	0.0000	0.4460	0.0003	0.0001	-0.0060
RohnEbS	0.0000	0.0000	-0.4460	0.0000	0.0000	0.4460	0.0002	0.0001	-0.0056
RohnFaS	0.0000	0.0000	-0.6029	0.0000	0.0000	0.6029	0.0004	0.0000	-0.0046
RohnGaS	0.0000	0.0000	-0.6732	0.0000	0.0000	0.6732	0.0003	0.0000	-0.0033
RohnHaS	0.0000	0.0000	-0.7165	0.0000	0.0000	0.7165	0.0004	0.0000	-0.0020
RohnIaS	0.0000	0.0000	-0.8421	0.0000	0.0000	0.8421	0.0003	-0.0000	-0.0007
SNB-AaS	0.0000	0.0000	-0.1881	0.0000	0.0000	0.1881	0.0015	0.0002	-0.0045
SNB-AbS	0.0000	0.0000	-0.1881	0.0000	0.0000	0.1881	0.0013	0.0002	-0.0045
SNB-AcS	0.0000	0.0000	-0.1881	0.0000	0.0000	0.1881	0.0012	0.0002	-0.0045
SNB-BaS	0.0000	0.0000	-0.2189	0.0000	0.0000	0.2189	0.0010	0.0001	-0.0044
SNB-BbS	0.0000	0.0000	-0.2189	0.0000	0.0000	0.2189	0.0009	0.0001	-0.0043
SNB-BcS	0.0000	0.0000	-0.2189	0.0000	0.0000	0.2189	0.0008	0.0001	-0.0043
SNB-CaS	0.0000	0.0000	-0.2974	0.0000	0.0000	0.2974	0.0007	0.0001	-0.0041
SNB-CbS	0.0000	0.0000	-0.2974	0.0000	0.0000	0.2974	0.0006	0.0001	-0.0040
SNB-DaS	0.0000	0.0000	-0.3280	0.0000	0.0000	0.3280	0.0005	0.0001	-0.0036
SNB-DbS	0.0000	0.0000	-0.3280	0.0000	0.0000	0.3280	0.0004	0.0001	-0.0034
SNB-EaS	0.0000	0.0000	-0.4460	0.0000	0.0000	0.4460	0.0003	0.0001	-0.0031
SNB-EbS	0.0000	0.0000	-0.4460	0.0000	0.0000	0.4460	0.0002	0.0001	-0.0029
SNB-FaS	0.0000	0.0000	-0.6029	0.0000	0.0000	0.6029	0.0004	0.0000	-0.0025
SNB-GaS	0.0000	0.0000	-0.6732	0.0000	0.0000	0.6732	0.0003	0.0000	-0.0018
SNB-HaS	0.0000	0.0000	-0.7165	0.0000	0.0000	0.7165	0.0004	0.0000	-0.0011
SNB-IaS	0.0000	0.0000	-0.8421	0.0000	0.0000	0.8421	0.0003	-0.0000	-0.0004
SNB-WL-A1S	0.0000	0.0000	-0.1881	0.0000	0.0000	0.1881	0.0016	0.0002	-0.0046
SNB-WL-A2S	0.0000	0.0000	-0.1881	0.0000	0.0000	0.1881	0.0016	0.0002	-0.0046
SNB-WL-A3S	0.0000	0.0000	-0.1881	0.0000	0.0000	0.1881	0.0016	0.0002	-0.0046
SNB-WL-B1S	0.0000	0.0000	-0.1881	0.0000	0.0000	0.1881	0.0011	0.0001	-0.0046
SNB-WL-B2S	0.0000	0.0000	-0.1881	0.0000	0.0000	0.1881	0.0011	0.0001	-0.0046
SNB-WL-B3S	0.0000	0.0000	-0.1881	0.0000	0.0000	0.1881	0.0011	0.0001	-0.0046
SNB-WL-C1S	0.0000	0.0000	-0.2189	0.0000	0.0000	0.2189	0.0007	0.0001	-0.0046
SNB-WL-C2S	0.0000	0.0000	-0.2189	0.0000	0.0000	0.2189	0.0007	0.0001	-0.0046
SNB-WL-C3S	0.0000	0.0000	-0.2189	0.0000	0.0000	0.2189	0.0007	0.0001	-0.0046
SNB-WL-D1S	0.0000	0.0000	-0.2974	0.0000	0.0000	0.2974	0.0004	0.0001	-0.0049
SNB-WL-D2S	0.0000	0.0000	-0.2974	0.0000	0.0000	0.2974	0.0004	0.0001	-0.0048
SNB-WL-D3S	0.0000	0.0000	-0.2974	0.0000	0.0000	0.2974	0.0004	0.0001	-0.0049
SNB-WL-E1S	0.0000	0.0000	-0.3280	0.0000	0.0000	0.3280	0.0002	0.0001	-0.0040
SNB-WL-E2S	0.0000	0.0000	-0.3280	0.0000	0.0000	0.3280	0.0002	0.0001	-0.0039
SNB-WL-E3S	0.0000	0.0000	-0.3280	0.0000	0.0000	0.3280	0.0002	0.0001	-0.0040
SNB-WL-F1S	0.0000	0.0000	-0.4460	0.0000	0.0000	0.4460	0.0001	0.0001	-0.0043
SNB-WL-F2S	0.0000	0.0000	-0.4460	0.0000	0.0000	0.4460	0.0001	0.0001	-0.0042
SNB-WL-F3S	0.0000	0.0000	-0.4460	0.0000	0.0000	0.4460	0.0001	0.0001	-0.0043
SNB-WL-G1S	0.0000	0.0000	-0.6029	0.0000	0.0000	0.6029	0.0001	0.0000	-0.0049
SNB-WL-G2S	0.0000	0.0000	-0.6029	0.0000	0.0000	0.6029	0.0001	0.0000	-0.0049
SNB-WL-G3S	0.0000	0.0000	-0.6029	0.0000	0.0000	0.6029	0.0001	0.0000	-0.0049
SNB-WL-H1S	0.0000	0.0000	-0.6732	0.0000	0.0000	0.6732	0.0000	0.0000	-0.0055
SNB-WL-H2S	0.0000	0.0000	-0.6732	0.0000	0.0000	0.6732	0.0000	0.0000	-0.0055
SNB-WL-H3S	0.0000	0.0000	-0.6732	0.0000	0.0000	0.6732	0.0000	0.0000	-0.0055
SNB-WL-I1S	0.0000	0.0000	-0.7165	0.0000	0.0000	0.7165	0.0000	0.0000	-0.0061
SNB-WL-I2S	0.0000	0.0000	-0.7165	0.0000	0.0000	0.7165	0.0000	0.0000	-0.0061
SNB-WL-I3S	0.0000	0.0000	-0.7165	0.0000	-0.0000	0.7165	0.0000	0.0000	-0.0061
RohnAa1	0.0000	0.0000	-0.2763	0.0000	0.0000	0.2763	0.0014	0.0001	-0.0093
RohnAa2	0.0000	0.0000	-0.3039	0.0000	0.0000	0.3039	0.0014	0.0002	-0.0093
RohnAb1	0.0000	0.0000	-0.3321	0.0000	0.0000	0.3321	0.0013	0.0002	-0.0092
RohnAb2	0.0000	0.0000	-0.1881	0.0000	0.0000	0.1881	0.0013	0.0002	-0.0092
RohnAc1	0.0000	0.0000	-0.1881	0.0000	0.0000	0.1881	0.0012	0.0001	-0.0092
RohnAc2	0.0000	0.0000	-0.1881	0.0000	0.0000	0.1881	0.0012	0.0002	-0.0092
RohnBa1	0.0000	0.0000	-0.2189	0.0000	0.0000	0.2189	0.0009	0.0001	-0.0090
RohnBa2	0.0000	0.0000	-0.2189	0.0000	0.0000	0.2189	0.0009	0.0002	-0.0090
RohnBb1	0.0000	0.0000	-1.1275	0.0000	0.0000	1.1275	0.0009	0.0001	-0.0089
RohnBb2	0.0000	0.0000	-1.1275	0.0000	0.0000	1.1275	0.0009	0.0001	-0.0089
RohnBc1	0.0000	0.0000	-0.2189	0.0000	0.0000	0.2189	0.0007	0.0001	-0.0087
RohnBc2	0.0000	0.0000	-0.2189	0.0000	0.0000	0.2189	0.0007	0.0002	-0.0087
RohnCa1	0.0000	0.0000	-1.0321	0.0000	0.0000	1.0321	0.0005	0.0001	-0.0084

RohnCa2	0.0000	0.0000	-1.0801	0.0000	0.0000	1.0801	0.0005	0.0002	-0.0084
RohnCb1	0.0000	0.0000	-1.6349	0.0000	0.0000	1.6349	0.0004	0.0000	-0.0081
RohnCb2	0.0000	0.0000	-1.6349	0.0000	0.0000	1.6349	0.0004	0.0002	-0.0081
RohnDa1	0.0000	0.0000	-1.3955	0.0000	0.0000	1.3955	0.0003	-0.0000	-0.0073
RohnDa2	0.0000	0.0000	-1.3955	0.0000	0.0000	1.3955	0.0003	0.0002	-0.0073
RohnDb1	0.0000	0.0000	-0.3280	0.0000	0.0000	0.3280	0.0002	-0.0000	-0.0068
RohnDb2	0.0000	0.0000	-0.3280	0.0000	0.0000	0.3280	0.0002	0.0002	-0.0068
RohnEa1	0.0000	0.0000	-0.4460	0.0000	0.0000	0.4460	0.0001	-0.0000	-0.0059
RohnEa2	0.0000	0.0000	-0.4460	0.0000	0.0000	0.4460	0.0001	0.0002	-0.0060
RohnEb1	0.0000	0.0000	-0.4460	0.0000	0.0000	0.4460	0.0001	0.0000	-0.0055
RohnEb2	0.0000	0.0000	-0.4460	0.0000	0.0000	0.4460	0.0001	0.0001	-0.0056
RohnFa1	0.0000	0.0000	-0.6029	0.0000	0.0000	0.6029	-0.0001	-0.0002	-0.0045
RohnFa2	0.0000	0.0000	-0.6029	0.0000	0.0000	0.6029	-0.0001	0.0003	-0.0045
RohnGa1	0.0000	0.0000	-0.6732	0.0000	0.0000	0.6732	-0.0001	-0.0002	-0.0033
RohnGa2	0.0000	0.0000	-0.6732	0.0000	0.0000	0.6732	-0.0001	0.0003	-0.0033
RohnHa1	0.0000	0.0000	-0.7165	0.0000	0.0000	0.7165	-0.0002	-0.0003	-0.0020
RohnHa2	0.0000	0.0000	-0.7165	0.0000	0.0000	0.7165	-0.0002	0.0003	-0.0020
RohnIa1	0.0000	0.0000	-0.8421	0.0000	0.0000	0.8421	-0.0001	-0.0003	-0.0006
RohnIa2	0.0000	0.0000	-0.8421	0.0000	0.0000	0.8421	-0.0002	0.0003	-0.0006
SNB-Aa1	0.0000	0.0000	-0.1881	0.0000	0.0000	0.1881	0.0014	0.0001	-0.0044
SNB-Aa2	0.0000	0.0000	-0.1881	0.0000	0.0000	0.1881	0.0014	0.0002	-0.0044
SNB-Ab1	0.0000	0.0000	-0.1881	0.0000	0.0000	0.1881	0.0013	0.0002	-0.0044
SNB-Ab2	0.0000	0.0000	-0.1881	0.0000	0.0000	0.1881	0.0013	0.0002	-0.0044
SNB-Ac1	0.0000	0.0000	-0.1881	0.0000	0.0000	0.1881	0.0012	0.0001	-0.0044
SNB-Ac2	0.0000	0.0000	-0.1881	0.0000	0.0000	0.1881	0.0012	0.0002	-0.0044
SNB-Ba1	0.0000	0.0000	-0.2189	0.0000	0.0000	0.2189	0.0009	0.0001	-0.0043
SNB-Ba2	0.0000	0.0000	-0.2189	0.0000	0.0000	0.2189	0.0009	0.0002	-0.0043
SNB-Bb1	0.0000	0.0000	-0.2189	0.0000	0.0000	0.2189	0.0009	0.0001	-0.0042
SNB-Bb2	0.0000	0.0000	-0.2189	0.0000	0.0000	0.2189	0.0009	0.0002	-0.0042
SNB-Bc1	0.0000	0.0000	-0.2189	0.0000	0.0000	0.2189	0.0007	0.0001	-0.0042
SNB-Bc2	0.0000	0.0000	-0.2189	0.0000	0.0000	0.2189	0.0007	0.0002	-0.0042
SNB-Ca1	0.0000	0.0000	-0.2974	0.0000	0.0000	0.2974	0.0005	0.0001	-0.0040
SNB-Ca2	0.0000	0.0000	-0.2974	0.0000	0.0000	0.2974	0.0005	0.0002	-0.0040
SNB-Cb1	0.0000	0.0000	-0.2974	0.0000	0.0000	0.2974	0.0004	0.0000	-0.0039
SNB-Cb2	0.0000	0.0000	-0.2974	0.0000	0.0000	0.2974	0.0004	0.0002	-0.0039
SNB-Da1	0.0000	0.0000	-0.3280	0.0000	0.0000	0.3280	0.0003	-0.0000	-0.0036
SNB-Da2	0.0000	0.0000	-0.3280	0.0000	0.0000	0.3280	0.0003	0.0002	-0.0036
SNB-Db1	0.0000	0.0000	-0.3280	0.0000	0.0000	0.3280	0.0002	-0.0000	-0.0034
SNB-Db2	0.0000	0.0000	-0.3280	0.0000	0.0000	0.3280	0.0002	0.0002	-0.0034
SNB-Ea1	0.0000	0.0000	-0.4460	0.0000	0.0000	0.4460	0.0001	-0.0000	-0.0030
SNB-Ea2	0.0000	0.0000	-0.4460	0.0000	0.0000	0.4460	0.0001	0.0002	-0.0030
SNB-Eb1	0.0000	0.0000	-0.4460	0.0000	0.0000	0.4460	0.0001	0.0000	-0.0029
SNB-Eb2	0.0000	0.0000	-0.4460	0.0000	0.0000	0.4460	0.0001	0.0001	-0.0029
SNB-Fa1	0.0000	0.0000	-0.6029	0.0000	0.0000	0.6029	-0.0001	-0.0002	-0.0024
SNB-Fa2	0.0000	0.0000	-0.6029	0.0000	0.0000	0.6029	-0.0001	0.0003	-0.0024
SNB-Ga1	0.0000	0.0000	-0.6732	0.0000	0.0000	0.6732	-0.0001	-0.0002	-0.0018
SNB-Ga2	0.0000	0.0000	-0.6732	0.0000	0.0000	0.6732	-0.0001	0.0003	-0.0018
SNB-Ha1	0.0000	0.0000	-0.7165	0.0000	0.0000	0.7165	-0.0002	-0.0003	-0.0011
SNB-Ha2	0.0000	0.0000	-0.7165	0.0000	0.0000	0.7165	-0.0002	0.0003	-0.0011
SNB-Ia1	0.0000	0.0000	-0.8421	0.0000	-0.0000	0.8421	-0.0001	-0.0003	-0.0004
SNB-Ia2	0.0000	0.0000	-0.8421	0.0000	0.0000	0.8421	-0.0002	0.0003	-0.0004

**Moments for Angles Modeled as Beams:**

Angle Label	Torsion (ft-lbs)	Origin X Moment (ft-lbs)	Origin Y Moment (ft-lbs)	End X Moment (ft-lbs)	End Y Moment (ft-lbs)	X Shear (lbs)	Y Shear (lbs)
Rohn-LA1P	0.00	0.00	-0.11	-0.55	-3.62	-0.11	-0.75
Rohn-LA11	0.00	-0.08	0.05	-3.35	1.43	-0.69	0.30
Rohn-LA12	-0.00	0.17	0.10	2.96	1.84	0.63	0.39
Rohn-LA2P	0.00	0.54	3.63	0.13	5.10	0.13	1.74
Rohn-LA21	0.00	3.35	-1.43	4.56	-2.39	1.58	-0.76
Rohn-LA22	-0.00	-2.96	-1.84	-4.54	-2.52	-1.50	-0.87
Rohn-LA3P	0.00	-0.13	-5.10	0.03	-6.82	-0.02	-2.38
Rohn-LA31	0.00	-4.56	2.39	-6.03	3.01	-2.12	1.08
Rohn-LA32	-0.00	4.54	2.52	5.99	2.96	2.10	1.10
Rohn-LA4P	0.00	-0.03	6.82	-0.07	9.68	-0.02	3.30
Rohn-LA41	0.00	6.03	-3.01	7.85	-4.52	2.77	-1.50

Rohn-LA42	-0.00	-5.99	-2.96	-7.86	-4.44	-2.77	-1.48
Rohn-LB1P	0.00	0.07	-9.91	0.14	-11.84	0.04	-4.35
Rohn-LB11	0.01	-7.88	4.50	-9.78	7.49	-3.53	2.39
Rohn-LB12	-0.01	7.86	4.41	9.87	7.38	3.54	2.36
Rohn-LB2P	0.00	-0.14	11.84	-0.02	13.63	-0.03	5.09
Rohn-LB21	0.01	9.78	-7.49	10.77	-6.57	4.11	-2.81
Rohn-LB22	-0.01	-9.87	-7.38	-10.73	-6.52	-4.12	-2.78
Rohn-LB3P	0.00	0.02	-13.63	0.02	-13.38	0.01	-5.40
Rohn-LB31	0.01	-10.77	6.57	-11.54	7.58	-4.46	2.83
Rohn-LB32	-0.01	10.73	6.52	11.58	7.57	4.46	2.82
Rohn-LB4P	0.00	-0.02	13.38	0.04	13.95	0.00	5.46
Rohn-LB41	0.01	11.54	-7.58	11.36	-6.39	4.58	-2.79
Rohn-LB42	-0.01	-11.58	-7.57	-11.30	-6.40	-4.57	-2.79
Rohn-LC1P	0.00	-0.04	-13.95	0.08	-3.64	0.01	-2.64
Rohn-LC11	0.01	-11.36	6.39	-3.29	2.76	-2.20	1.37
Rohn-LC12	-0.01	11.30	6.40	3.33	2.69	2.19	1.36
Rohn-LC2P	0.00	-0.08	3.64	-0.15	-11.21	-0.03	-1.13
Rohn-LC21	0.01	3.29	-2.76	-10.21	6.00	-1.03	0.48
Rohn-LC22	-0.01	-3.33	-2.69	10.12	6.12	1.02	0.51
Rohn-LC3P	0.00	0.14	11.21	0.07	23.00	0.03	5.13
Rohn-LC31	0.01	10.21	-6.00	19.48	-10.54	4.46	-2.48
Rohn-LC32	-0.01	-10.12	-6.12	-19.34	-10.53	-4.42	-2.50
Rohn-LD1P	0.00	-0.07	-23.00	0.22	-9.41	0.02	-4.86
Rohn-LD11	0.01	-19.48	10.54	-8.84	5.61	-4.25	2.42
Rohn-LD12	-0.01	19.34	10.54	9.01	5.46	4.25	2.40
Rohn-LD2P	0.00	-0.22	9.41	-0.03	-22.13	-0.04	-1.90
Rohn-LD21	0.01	8.84	-5.61	-19.30	12.41	-1.56	1.02
Rohn-LD22	-0.01	-9.01	-5.46	19.44	12.53	1.56	1.06
Rohn-LD3P	0.00	0.03	22.13	0.12	39.05	0.02	9.18
Rohn-LD31	0.01	19.30	-12.41	32.92	-18.76	7.83	-4.68
Rohn-LD32	-0.01	-19.44	-12.53	-32.83	-18.84	-7.84	-4.71
Rohn-LE1P	0.00	-0.12	-39.05	-0.03	-22.62	-0.02	-9.25
Rohn-LE11	0.01	-32.92	18.76	-19.83	12.03	-7.91	4.62
Rohn-LE12	-0.01	32.83	18.84	19.86	12.09	7.91	4.64
Rohn-LE2P	0.00	0.03	22.62	0.05	-14.78	0.01	1.17
Rohn-LE21	0.01	19.83	-12.03	-12.97	8.12	1.03	-0.58
Rohn-LE22	-0.01	-19.86	-12.09	13.13	8.16	-1.01	-0.59
Rohn-LE3P	0.00	-0.05	14.78	0.20	69.46	0.02	12.64
Rohn-LE31	0.01	12.97	-8.12	59.23	-34.03	10.83	-6.32
Rohn-LE32	-0.01	-13.13	-8.16	-59.41	-34.37	-10.89	-6.38
Rohn-LF1P	0.00	-0.20	-69.46	-0.62	-113.16	-0.08	-18.25
Rohn-LF11	0.01	-59.23	34.03	-97.93	57.34	-15.71	9.13
Rohn-LF12	-0.01	59.41	34.37	97.65	57.89	15.69	9.22
Rohn-LF2P	0.00	0.62	113.16	0.35	130.31	0.10	24.33
Rohn-LF21	0.01	97.93	-57.34	111.56	-64.47	20.93	-12.17
Rohn-LF22	-0.01	-97.65	-57.89	-111.91	-65.07	-20.94	-12.29
Rohn-LG1P	0.00	-0.35	-130.31	-0.77	-138.85	-0.11	-26.90
Rohn-LG11	0.01	-111.56	64.47	-120.14	69.99	-23.15	13.44
Rohn-LG12	-0.01	111.91	65.07	119.70	70.63	23.14	13.56
Rohn-LG2P	0.00	0.77	138.85	0.24	150.21	0.10	28.89
Rohn-LG21	0.01	120.14	-69.99	128.98	-74.59	24.90	-14.45
Rohn-LG22	-0.01	-119.70	-70.62	-129.34	-75.07	-24.89	-14.56
Rohn-LH1P	0.00	-0.24	-150.21	-0.44	-164.61	-0.07	-31.46
Rohn-LH11	0.01	-128.98	74.59	-142.39	82.84	-27.12	15.73
Rohn-LH12	-0.01	129.34	75.07	142.12	83.19	27.13	15.81
Rohn-LH2P	0.00	0.44	164.61	0.08	199.37	0.05	36.37
Rohn-LH21	0.01	142.39	-82.84	171.49	-99.22	31.37	-18.19
Rohn-LH22	-0.01	-142.12	-83.19	-171.95	-99.58	-31.39	-18.26
Rohn-LI1P	0.00	-0.08	-199.37	-0.78	-271.33	-0.09	-47.04
Rohn-LI11	0.01	-171.49	99.22	-234.99	136.78	-40.62	23.58
Rohn-LI12	-0.01	171.95	99.58	234.36	137.32	40.60	23.67
Rohn-LI2P	0.00	0.78	271.33	0.54	276.72	0.13	54.77
Rohn-LI21	0.01	234.99	-136.78	238.65	-138.50	47.33	-27.51
Rohn-LI22	-0.01	-234.36	-137.32	-238.70	-139.15	-47.27	-27.63
Rohn-H1P	-0.00	-0.08	-0.00	0.07	-0.00	-0.00	-0.00
Rohn-H11	0.01	-0.05	0.00	0.11	0.00	0.01	0.00
Rohn-H12	-0.00	-0.11	-0.00	0.06	-0.00	-0.01	-0.00
Rohn-H2P	-0.01	-0.13	-0.00	-0.03	-0.01	-0.02	-0.00
Rohn-H21	-0.00	-0.04	-0.00	0.03	0.00	-0.00	-0.00

Rohn-H22	0.01	0.04	0.01	0.14	0.00	0.02	0.00
SNB-LA1P	-0.00	-0.07	75.75	-0.05	14.30	-0.02	18.00
SNB-LA11	0.00	65.50	-37.86	12.35	-7.18	15.56	-9.00
SNB-LA12	-0.00	-65.83	-37.98	-12.65	-7.30	-15.68	-9.05
SNB-LA2P	-0.00	0.05	-14.30	-0.12	5.27	-0.02	-1.80
SNB-LA21	0.00	-12.35	7.18	4.38	-2.93	-1.59	0.85
SNB-LA22	-0.00	12.65	7.30	-4.49	-2.84	1.63	0.89
SNB-LA3P	-0.00	0.12	-5.27	-0.01	-21.83	0.02	-5.42
SNB-LA31	0.00	-4.38	2.93	-18.40	11.16	-4.55	2.82
SNB-LA32	-0.00	4.49	2.84	18.30	11.12	4.55	2.79
SNB-LA4P	-0.00	0.01	21.83	0.03	65.40	0.01	17.43
SNB-LA41	0.00	18.40	-11.16	55.25	-32.05	14.72	-8.63
SNB-LA42	-0.00	-18.30	-11.12	-55.13	-32.00	-14.67	-8.62
SNB-LB1P	-0.00	0.04	110.81	0.06	7.22	0.02	23.59
SNB-LB11	0.03	95.90	-54.61	5.85	-1.45	20.34	-11.20
SNB-LB12	-0.03	-95.74	-54.57	-5.72	-1.45	-20.28	-11.19
SNB-LB2P	-0.00	-0.06	-7.22	0.04	29.82	-0.00	4.52
SNB-LB21	0.03	-5.85	1.46	24.27	-13.67	3.68	-2.44
SNB-LB22	-0.03	5.72	1.45	-24.16	-13.66	-3.69	-2.44
SNB-LB3P	-0.00	-0.04	-29.81	0.08	-65.78	0.01	-19.10
SNB-LB31	0.03	-24.27	13.67	-56.99	34.93	-16.24	9.71
SNB-LB32	-0.03	24.16	13.66	57.11	34.90	16.24	9.70
SNB-LB4P	-0.00	-0.08	65.78	-0.01	180.32	-0.02	49.18
SNB-LB41	0.03	56.99	-34.93	154.74	-89.70	42.31	-24.91
SNB-LB42	-0.03	-57.11	-34.90	-154.69	-89.66	-42.33	-24.89
SNB-LC1P	-0.00	0.00	101.79	0.02	38.96	0.00	21.12
SNB-LC11	0.02	89.65	-51.56	33.66	-18.14	18.50	-10.46
SNB-LC12	-0.02	-89.75	-51.62	-33.66	-18.16	-18.52	-10.47
SNB-LC2P	-0.00	-0.02	-38.96	0.04	-72.29	0.00	-16.64
SNB-LC21	0.02	-33.66	18.14	-62.98	37.29	-14.46	8.29
SNB-LC22	-0.02	33.66	18.16	62.98	37.24	14.46	8.29
SNB-LC3P	-0.00	-0.04	72.29	-0.01	215.76	-0.01	43.22
SNB-LC31	0.02	62.98	-37.29	185.77	-107.52	37.32	-21.73
SNB-LC32	-0.02	-62.98	-37.24	-185.62	-107.42	-37.30	-21.70
SNB-LD1P	-0.00	0.03	254.37	0.17	73.89	0.03	49.25
SNB-LD11	0.02	221.51	-127.80	63.51	-34.99	42.76	-24.42
SNB-LD12	-0.02	-221.59	-127.87	-63.32	-35.08	-42.75	-24.45
SNB-LD2P	-0.00	-0.17	-73.89	0.08	-97.88	-0.01	-25.69
SNB-LD21	0.02	-63.51	34.99	-84.97	50.63	-22.21	12.81
SNB-LD22	-0.02	63.32	35.08	85.23	50.69	22.22	12.83
SNB-LD3P	-0.00	-0.08	97.88	0.04	240.12	-0.01	50.71
SNB-LD31	0.02	84.97	-50.63	206.20	-119.24	43.69	-25.49
SNB-LD32	-0.02	-85.23	-50.69	-206.18	-119.28	-43.72	-25.50
SNB-LE1P	-0.00	-0.09	364.57	0.21	101.35	0.02	69.91
SNB-LE11	0.03	317.47	-183.40	87.30	-48.29	60.73	-34.76
SNB-LE12	-0.02	-317.73	-183.45	-87.10	-48.42	-60.74	-34.79
SNB-LE2P	-0.00	-0.21	-101.35	-0.11	-219.21	-0.05	-47.95
SNB-LE21	0.03	-87.30	48.29	-190.39	111.59	-41.54	23.92
SNB-LE22	-0.02	87.10	48.43	190.69	111.89	41.55	23.98
SNB-LE3P	-0.00	0.11	219.21	0.11	757.48	0.03	146.54
SNB-LE31	0.03	190.39	-111.59	653.78	-378.47	126.66	-73.53
SNB-LE32	-0.02	-190.69	-111.89	-654.46	-379.00	-126.80	-73.65
SNB-LF1P	0.01	-0.23	194.54	-0.58	-228.82	-0.08	-3.43
SNB-LF11	0.01	170.78	-98.07	-197.21	116.43	-2.64	1.84
SNB-LF12	-0.02	-170.56	-97.68	196.98	116.96	2.64	1.93
SNB-LF2P	0.01	0.57	228.82	0.15	732.96	0.07	96.11
SNB-LF21	0.01	197.21	-116.43	631.68	-366.38	82.83	-48.25
SNB-LF22	-0.02	-196.98	-116.96	-632.59	-367.08	-82.90	-48.37
SNB-LG1P	0.02	-0.21	752.69	-1.35	-334.65	-0.16	41.77
SNB-LG11	0.02	654.92	-377.10	-289.17	170.14	36.55	-20.68
SNB-LG12	-0.03	-654.15	-376.41	288.17	171.12	-36.57	-20.51
SNB-LG2P	0.02	1.35	334.65	0.39	1328.61	0.17	166.20
SNB-LG21	0.02	289.17	-170.14	1147.04	-664.07	143.51	-83.36
SNB-LG22	-0.03	-288.17	-171.12	-1148.13	-665.16	-143.52	-83.57
SNB-LH1P	0.01	-0.40	564.95	-1.43	-369.53	-0.18	19.53
SNB-LH11	0.01	492.63	-283.37	-319.28	186.86	17.32	-9.64
SNB-LH12	-0.02	-491.56	-282.29	318.39	188.00	-17.30	-9.42
SNB-LH2P	0.01	1.43	369.53	0.54	1185.09	0.20	155.35
SNB-LH21	0.01	319.28	-186.86	1022.86	-592.08	134.12	-77.84

SNB-LH22	-0.02	-318.39	-188.00	-1023.90	-593.30	-134.13	-78.07
SNB-LI1P	0.01	-0.53	1069.34	-2.03	-232.90	-0.26	83.58
SNB-LI11	0.00	929.36	-535.93	-201.51	119.31	72.73	-41.63
SNB-LI12	-0.01	-928.24	-534.68	199.96	120.75	-72.77	-41.36
SNB-LI2P	0.01	2.03	232.90	1.14	478.36	0.32	71.07
SNB-LI21	0.00	201.51	-119.31	411.63	-239.56	61.27	-35.86
SNB-LI22	-0.01	-199.96	-120.75	-411.90	-241.02	-61.14	-36.15
SNB-H1aP	-0.01	43.81	-0.08	146.23	-0.04	94.06	-0.06
SNB-H1bP	-0.01	-146.23	0.04	-43.70	0.07	-94.01	0.06
SNB-H1cP	-0.00	43.65	-0.08	146.20	-0.07	93.97	-0.07
SNB-H1dP	0.00	-146.20	0.07	-43.92	0.07	-94.10	0.07
SNB-H1eP	0.01	43.84	-0.07	146.23	-0.09	94.07	-0.08
SNB-H1fP	0.01	-146.23	0.09	-43.68	0.08	-93.99	0.08
SNB-H2aP	-0.05	101.70	0.27	153.27	0.27	94.33	0.20
SNB-H2bP	-0.05	-153.27	-0.27	-100.04	-0.29	-93.72	-0.21
SNB-H2cP	-0.00	101.12	0.24	153.15	0.26	94.07	0.19
SNB-H2dP	-0.00	-153.14	-0.26	-100.88	-0.24	-93.98	-0.19
SNB-H2eP	0.06	99.94	0.29	153.26	0.26	93.68	0.20
SNB-H2fP	0.06	-153.26	-0.26	-101.83	-0.26	-94.38	-0.19
SNB-H3aP	0.00	162.88	1.42	207.39	1.41	109.40	0.84
SNB-H3bP	0.00	-207.39	-1.41	-163.02	-1.42	-109.44	-0.84
SNB-H3cP	-0.00	162.93	1.43	207.39	1.47	109.42	0.86
SNB-H3dP	-0.00	-207.39	-1.47	-162.97	-1.43	-109.43	-0.86
SNB-H3eP	-0.00	163.04	1.42	207.39	1.41	109.45	0.84
SNB-H3fP	-0.00	-207.39	-1.41	-162.87	-1.42	-109.40	-0.84
SNB-H4aP	-0.01	271.42	2.67	332.68	2.65	148.57	1.31
SNB-H4bP	-0.01	-332.68	-2.65	-271.57	-2.67	-148.61	-1.31
SNB-H4cP	-0.00	271.56	2.67	332.65	2.73	148.60	1.33
SNB-H4dP	-0.00	-332.65	-2.73	-271.50	-2.67	-148.59	-1.33
SNB-H4eP	0.01	271.54	2.67	332.67	2.65	148.60	1.31
SNB-H4fP	0.01	-332.67	-2.65	-271.45	-2.67	-148.58	-1.31
SNB-H5aP	-0.00	349.17	3.75	429.01	3.74	163.94	1.58
SNB-H5bP	-0.00	-429.01	-3.74	-349.26	-3.76	-163.96	-1.58
SNB-H5cP	0.00	349.13	3.75	429.00	3.81	163.93	1.59
SNB-H5dP	0.00	-429.00	-3.81	-349.33	-3.75	-163.97	-1.59
SNB-H5eP	0.00	349.36	3.76	429.01	3.74	163.98	1.58
SNB-H5fP	0.00	-429.01	-3.74	-349.07	-3.76	-163.92	-1.58
SNB-H6aP	-0.03	549.77	3.78	659.99	3.77	222.86	1.39
SNB-H6bP	-0.03	-659.99	-3.77	-549.95	-3.78	-222.90	-1.39
SNB-H6cP	0.01	549.72	3.80	659.95	3.84	222.85	1.41
SNB-H6dP	0.01	-659.95	-3.84	-550.11	-3.79	-222.92	-1.41
SNB-H6eP	0.02	550.13	3.79	660.01	3.78	222.93	1.39
SNB-H6fP	0.02	-660.01	-3.78	-549.56	-3.79	-222.83	-1.39
SNB-H7aP	-0.01	857.79	0.96	983.57	0.97	301.38	0.32
SNB-H7bP	-0.01	-983.57	-0.97	-857.99	-0.97	-301.41	-0.32
SNB-H7cP	0.01	857.84	0.97	983.57	1.00	301.39	0.32
SNB-H7dP	0.01	-983.57	-1.00	-857.97	-0.96	-301.41	-0.32
SNB-H7eP	0.00	858.04	0.97	983.59	0.97	301.42	0.32
SNB-H7fP	0.00	-983.59	-0.97	-857.70	-0.97	-301.37	-0.32
SNB-H8aP	0.00	1093.25	1.06	1191.71	1.06	336.49	0.31
SNB-H8bP	0.00	-1191.71	-1.06	-1093.38	-1.05	-336.51	-0.31
SNB-H8cP	0.00	1093.30	1.06	1191.72	1.08	336.50	0.32
SNB-H8dP	0.00	-1191.72	-1.08	-1093.32	-1.06	-336.51	-0.32
SNB-H8eP	-0.01	1093.39	1.05	1191.71	1.05	336.51	0.31
SNB-H8fP	-0.01	-1191.71	-1.05	-1093.23	-1.05	-336.49	-0.31
SNB-H9aP	-0.00	1301.59	0.76	1374.30	0.76	358.12	0.20
SNB-H9bP	-0.00	-1374.30	-0.76	-1301.76	-0.75	-358.14	-0.20
SNB-H9cP	0.00	1301.71	0.76	1374.31	0.77	358.14	0.21
SNB-H9dP	0.00	-1374.31	-0.77	-1301.65	-0.76	-358.13	-0.21
SNB-H9eP	0.00	1301.72	0.75	1374.31	0.75	358.14	0.20
SNB-H9fP	0.00	-1374.31	-0.75	-1301.61	-0.75	-358.12	-0.20

Equilibrium Joint Positions and Rotations for Load Case "0.9DL":

Joint Label	X-Displ (ft)	Y-Displ (ft)	Z-Displ (ft)	X-Rot (deg)	Y-Rot (deg)	Z-Rot (deg)	X-Pos (ft)	Y-Pos (ft)	Z-Pos (ft)
RohnAP	0.001153	0.0001228	-0.00709	-0.0001	0.0006	0.0000	4.334	0.0001228	180
RohnBP	0.0007897	0.0001092	-0.006981	-0.0000	0.0007	0.0000	5.122	0.0001092	160
RohnCP	0.000494	0.0001	-0.006548	-0.0000	0.0007	0.0000	5.909	0.0001	140
RohnDP	0.0003	8.602e-005	-0.005891	-0.0000	0.0001	-0.0000	6.695	8.602e-005	120
RohnEP	0.0001697	6.817e-005	-0.004815	-0.0001	0.0002	-0.0000	7.481	6.817e-005	100
RohnFP	9.909e-005	4.494e-005	-0.003884	-0.0001	-0.0010	-0.0000	8.268	4.494e-005	80
RohnGP	4.585e-005	2.301e-005	-0.00296	-0.0001	-0.0002	-0.0000	9.055	2.301e-005	60
RohnHP	2.049e-005	8.594e-006	-0.002036	-0.0000	-0.0003	-0.0000	9.841	8.594e-006	40
RohnIP	6.735e-006	1.348e-006	-0.0009747	-0.0000	-0.0008	-0.0000	10.63	1.348e-006	20
RohnJP	0	0	0	0.0000	0.0000	0.0000	11.42	0	0
SNB-AP	0.001156	0.0001219	-0.003385	-0.0001	-0.0041	-0.0000	2.334	0.0001219	180
SNB-BP	0.0007931	0.0001092	-0.003312	-0.0000	-0.0025	-0.0000	3.122	0.0001092	160
SNB-CP	0.0004968	9.966e-005	-0.00315	-0.0000	-0.0031	-0.0000	3.908	9.966e-005	140
SNB-DP	0.0003022	8.599e-005	-0.002867	-0.0000	-0.0057	0.0000	4.695	8.599e-005	120
SNB-EP	0.0001711	6.762e-005	-0.00241	-0.0001	-0.0035	-0.0000	5.481	6.762e-005	100
SNB-FP	9.985e-005	4.44e-005	-0.002075	-0.0001	-0.0057	-0.0000	6.268	4.44e-005	80
SNB-GP	4.625e-005	2.325e-005	-0.001625	-0.0001	-0.0075	-0.0000	7.055	2.325e-005	60
SNB-HP	2.064e-005	9.007e-006	-0.00115	-0.0000	-0.0065	-0.0000	7.841	9.007e-006	40
SNB-IP	6.733e-006	1.7e-006	-0.0005629	-0.0000	-0.0053	-0.0000	8.628	1.7e-006	20
SNB-JP	0	0	0	0.0000	0.0000	0.0000	9.415	0	0
RohnA1	0.001158	0.0001253	-0.006968	-0.0004	0.0012	-0.0000	-2.165	-3.752	180
RohnA2	0.001158	0.000119	-0.006986	0.0003	0.0012	0.0000	-2.165	3.753	180
RohnB1	0.0007944	0.0001115	-0.006817	-0.0002	0.0012	-0.0000	-2.56	-4.435	160
RohnB2	0.0007943	0.000107	-0.006818	0.0002	0.0012	0.0000	-2.56	4.435	160
RohnC1	0.0004895	9.981e-005	-0.006431	-0.0000	0.0007	-0.0000	-2.954	-5.117	140
RohnC2	0.0004898	9.968e-005	-0.006438	-0.0000	0.0007	0.0000	-2.954	5.117	140
RohnD1	0.000285	7.904e-005	-0.005801	-0.0003	0.0006	-0.0000	-3.347	-5.798	120
RohnD2	0.000285	9.295e-005	-0.005808	0.0003	0.0006	0.0000	-3.347	5.798	120
RohnE1	0.0001573	6.222e-005	-0.004752	-0.0001	0.0003	-0.0000	-3.74	-6.479	100
RohnE2	0.0001578	7.328e-005	-0.004766	0.0000	0.0003	0.0000	-3.74	6.479	100
RohnF1	8.235e-005	3.602e-005	-0.003838	-0.0011	0.0008	0.0000	-4.134	-7.16	80
RohnF2	8.283e-005	5.304e-005	-0.00386	0.0010	0.0008	0.0000	-4.134	7.16	80
RohnG1	4.148e-005	2.102e-005	-0.002926	-0.0003	0.0002	0.0000	-4.527	-7.842	60
RohnG2	4.127e-005	2.538e-005	-0.002945	0.0002	0.0002	0.0000	-4.527	7.842	60
RohnH1	1.409e-005	5.532e-006	-0.002014	-0.0003	0.0002	0.0000	-4.92	-8.523	40
RohnH2	1.369e-005	1.236e-005	-0.002025	0.0002	0.0002	0.0000	-4.92	8.523	40
RohnI1	1.068e-006	-1.286e-006	-0.0009655	-0.0007	0.0004	0.0000	-5.315	-9.206	20
RohnI2	7.159e-007	4.59e-006	-0.0009702	0.0007	0.0004	0.0000	-5.315	9.206	20
RohnJ1	0	0	0	0.0000	0.0000	0.0000	-5.71	-9.89	0
RohnJ2	0	0	0	0.0000	0.0000	0.0000	-5.71	9.89	0
SNB-A1	0.001157	0.0001221	-0.00332	-0.0045	0.0036	0.0000	-1.165	-2.02	180
SNB-A2	0.001157	0.0001218	-0.003324	0.0044	0.0036	0.0000	-1.165	2.021	180
SNB-B1	0.0007925	0.0001089	-0.003234	-0.0031	0.0028	-0.0000	-1.56	-2.703	160
SNB-B2	0.0007925	0.0001096	-0.003236	0.0030	0.0028	0.0000	-1.56	2.703	160
SNB-C1	0.0004903	9.612e-005	-0.003076	-0.0033	0.0026	-0.0000	-1.954	-3.384	140
SNB-C2	0.0004903	0.0001032	-0.00308	0.0032	0.0026	0.0000	-1.954	3.385	140
SNB-D1	0.0002851	7.644e-005	-0.002806	-0.0054	0.0036	-0.0000	-2.347	-4.066	120
SNB-D2	0.0002851	9.553e-005	-0.002812	0.0053	0.0036	0.0000	-2.347	4.066	120
SNB-E1	0.000158	6.024e-005	-0.002367	-0.0033	0.0021	-0.0000	-2.74	-4.747	100
SNB-E2	0.000158	7.499e-005	-0.002377	0.0032	0.0021	0.0000	-2.74	4.747	100
SNB-F1	8.293e-005	3.482e-005	-0.002041	-0.0052	0.0031	-0.0000	-3.134	-5.428	80
SNB-F2	8.293e-005	5.397e-005	-0.002053	0.0050	0.0031	0.0000	-3.134	5.428	80
SNB-G1	4.143e-005	2.059e-005	-0.001601	-0.0066	0.0039	-0.0000	-3.527	-6.11	60
SNB-G2	4.142e-005	2.592e-005	-0.001611	0.0065	0.0039	0.0000	-3.527	6.11	60
SNB-H1	1.408e-005	5.366e-006	-0.001134	-0.0057	0.0033	-0.0000	-3.92	-6.79	40
SNB-H2	1.403e-005	1.273e-005	-0.001141	0.0057	0.0033	0.0000	-3.92	6.791	40
SNB-I1	1.205e-006	-1.362e-006	-0.000556	-0.0046	0.0027	-0.0000	-4.314	-7.472	20
SNB-I2	1.158e-006	4.843e-006	-0.0005592	0.0046	0.0027	0.0000	-4.314	7.472	20
SNB-J1	0	0	0	0.0000	0.0000	0.0000	-4.708	-8.154	0
SNB-J2	0	0	0	0.0000	0.0000	0.0000	-4.708	8.154	0

RohnAaS	0.001084	0.000113	-0.007076	-0.0001	0.0011	0.0000	4.531	0.000113	175
RohnAbS	0.0009759	0.000112	-0.007053	0.0000	0.0009	0.0000	4.728	0.000112	170
RohnAcS	0.0009092	0.0001109	-0.007021	-0.0000	0.0012	0.0000	4.925	0.0001109	165
RohnBaS	0.0007422	0.000108	-0.006899	-0.0000	0.0009	0.0000	5.319	0.000108	155
RohnBbS	0.000632	0.0001055	-0.006813	-0.0000	0.0008	0.0000	5.516	0.0001055	150
RohnBcS	0.0005972	0.0001029	-0.006683	-0.0000	0.0007	0.0000	5.713	0.0001029	145
RohnCaS	0.0004812	9.532e-005	-0.006377	-0.0000	-0.0001	-0.0000	6.171	9.532e-005	133.3
RohnCbS	0.0004307	9e-005	-0.006163	-0.0000	0.0010	-0.0000	6.434	9e-005	126.7
RohnDaS	0.0003444	8.14e-005	-0.005579	-0.0000	-0.0006	-0.0000	6.957	8.14e-005	113.3
RohnDbS	0.0003147	7.5e-005	-0.005196	-0.0001	0.0010	-0.0000	7.22	7.5e-005	106.7
RohnEaS	0.0002156	6.065e-005	-0.004517	-0.0001	-0.0004	-0.0000	7.743	6.065e-005	93.34
RohnEbS	0.0001666	5.304e-005	-0.004204	-0.0001	0.0009	-0.0000	8.006	5.304e-005	86.66
RohnFaS	0.0003122	3.219e-005	-0.003425	-0.0001	0.0004	-0.0000	8.662	3.219e-005	70
RohnGaS	0.0002594	1.378e-005	-0.0025	-0.0000	0.0001	-0.0000	9.448	1.378e-005	50
RohnHaS	0.0002678	3.806e-006	-0.001507	-0.0000	0.0001	-0.0000	10.24	3.806e-006	30
RohnIaS	0.0002259	-2.216e-007	-0.0004898	-0.0000	0.0001	-0.0000	11.03	-2.216e-007	10
SNB-AaS	0.001087	0.0001171	-0.003375	-0.0001	0.0024	-0.0000	2.531	0.0001171	175
SNB-AbS	0.0009793	0.0001132	-0.003362	-0.0000	0.0003	-0.0000	2.728	0.0001132	170
SNB-AcS	0.0009126	0.000111	-0.003339	-0.0000	0.0021	-0.0000	2.925	0.000111	165
SNB-BaS	0.0007455	0.0001074	-0.003279	-0.0000	0.0019	-0.0000	3.318	0.0001074	155
SNB-BbS	0.0006352	0.0001053	-0.003242	-0.0000	0.0003	-0.0000	3.515	0.0001053	150
SNB-BcS	0.0006003	0.0001027	-0.003197	-0.0000	0.0018	-0.0000	3.712	0.0001027	145
SNB-CaS	0.0004839	9.545e-005	-0.003066	-0.0000	0.0005	0.0000	4.171	9.545e-005	133.3
SNB-CbS	0.0004332	9.092e-005	-0.002966	-0.0000	0.0024	0.0000	4.433	9.092e-005	126.7
SNB-DaS	0.0003465	8.084e-005	-0.002726	-0.0000	0.0008	0.0000	4.957	8.084e-005	113.3
SNB-DbS	0.0003164	7.46e-005	-0.002565	-0.0001	0.0017	-0.0000	5.22	7.46e-005	106.7
SNB-EaS	0.0002168	6.018e-005	-0.002304	-0.0001	0.0003	-0.0000	5.743	6.018e-005	93.34
SNB-EbS	0.0001676	5.225e-005	-0.002189	-0.0001	0.0020	-0.0000	6.006	5.225e-005	86.66
SNB-FaS	0.0003128	3.264e-005	-0.001848	-0.0001	0.0034	-0.0000	6.662	3.264e-005	70
SNB-GaS	0.0002597	1.473e-005	-0.001386	-0.0000	0.0035	-0.0000	7.448	1.473e-005	50
SNB-HaS	0.0002679	3.959e-006	-0.0008538	-0.0000	0.0029	-0.0000	8.235	3.959e-006	30
SNB-IaS	0.0002259	-8.927e-008	-0.0002796	-0.0000	0.0012	-0.0000	9.022	-8.927e-008	10
SNB-WL-A1S	0.001156	0.0001219	-0.003483	-0.0023	-0.0003	-0.0000	0.5844	-1.01	180
SNB-WL-A2S	0.001156	0.0001219	-0.003452	-0.0000	0.0036	0.0000	-1.165	0.0001219	180
SNB-WL-A3S	0.001156	0.0001219	-0.003485	0.0022	-0.0003	-0.0000	0.5844	1.01	180
SNB-WL-B1S	0.0007927	0.0001093	-0.003466	-0.0015	0.0001	0.0000	0.781	-1.351	160
SNB-WL-B2S	0.0007927	0.0001093	-0.003427	-0.0000	0.0028	0.0000	-1.56	0.0001093	160
SNB-WL-B3S	0.0007927	0.0001093	-0.003467	0.0015	0.0001	-0.0000	0.781	1.352	160
SNB-WL-C1S	0.0004926	9.962e-005	-0.003481	-0.0017	-0.0002	-0.0000	0.9775	-1.692	140
SNB-WL-C2S	0.0004925	9.966e-005	-0.003447	-0.0000	0.0026	-0.0000	-1.954	9.966e-005	140
SNB-WL-C3S	0.0004926	9.97e-005	-0.003483	0.0016	-0.0002	0.0000	0.9775	1.692	140
SNB-WL-D1S	0.0002909	8.59e-005	-0.003664	-0.0027	-0.0011	-0.0000	1.174	-2.033	120
SNB-WL-D2S	0.0002908	8.599e-005	-0.003636	-0.0000	0.0036	-0.0000	-2.347	8.599e-005	120
SNB-WL-D3S	0.0002909	8.607e-005	-0.003667	0.0026	-0.0011	0.0000	1.174	2.033	120
SNB-WL-E1S	0.0001625	6.754e-005	-0.002965	-0.0017	-0.0007	-0.0000	1.37	-2.373	100
SNB-WL-E2S	0.0001623	6.762e-005	-0.002949	-0.0001	0.0021	-0.0000	-2.74	6.762e-005	100
SNB-WL-E3S	0.0001625	6.769e-005	-0.00297	0.0016	-0.0007	0.0000	1.37	2.373	100
SNB-WL-F1S	8.867e-005	4.432e-005	-0.003196	-0.0026	-0.0013	-0.0000	1.567	-2.714	80
SNB-WL-F2S	8.853e-005	4.44e-005	-0.003185	-0.0001	0.0031	-0.0000	-3.134	4.44e-005	80
SNB-WL-F3S	8.867e-005	4.447e-005	-0.003202	0.0025	-0.0013	0.0000	1.567	2.714	80
SNB-WL-G1S	4.307e-005	2.324e-005	-0.003685	-0.0033	-0.0018	-0.0000	1.764	-3.055	60
SNB-WL-G2S	4.304e-005	2.326e-005	-0.003678	-0.0000	0.0039	-0.0000	-3.527	2.326e-005	60
SNB-WL-G3S	4.308e-005	2.328e-005	-0.00369	0.0032	-0.0018	0.0000	1.764	3.055	60
SNB-WL-H1S	1.629e-005	9.026e-006	-0.004115	-0.0029	-0.0016	-0.0000	1.96	-3.395	40
SNB-WL-H2S	1.626e-005	9.046e-006	-0.004111	-0.0000	0.0033	0.0000	-3.92	9.046e-006	40
SNB-WL-H3S	1.629e-005	9.066e-006	-0.004119	0.0028	-0.0016	0.0000	1.96	3.395	40
SNB-WL-I1S	3.068e-006	1.725e-006	-0.004592	-0.0023	-0.0013	-0.0000	2.157	-3.736	20
SNB-WL-I2S	3.042e-006	1.74e-006	-0.004591	-0.0000	0.0027	0.0000	-4.314	1.74e-006	20
SNB-WL-I3S	3.068e-006	1.754e-006	-0.004594	0.0023	-0.0013	0.0000	2.157	3.736	20
RohnAa1	0.001062	0.0001003	-0.006949	0.0000	0.0010	-0.0000	-2.264	-3.923	175
RohnAa2	0.001058	0.0001314	-0.00696	-0.0001	0.0010	0.0000	-2.264	3.923	175
RohnAb1	0.0009793	0.0001118	-0.006919	-0.0002	0.0011	-0.0000	-2.363	-4.094	170
RohnAb2	0.0009781	0.0001141	-0.006922	0.0001	0.0011	0.0000	-2.363	4.094	170
RohnAc1	0.0008761	8.704e-005	-0.006871	0.0001	0.0010	-0.0000	-2.461	-4.264	165
RohnAc2	0.000876	0.0001349	-0.006873	-0.0001	0.0010	0.0000	-2.461	4.264	165
RohnBa1	0.0006838	8.023e-005	-0.006749	-0.0000	0.0010	-0.0000	-2.658	-4.605	155
RohnBa2	0.0006842	0.0001349	-0.006751	-0.0000	0.0010	0.0000	-2.658	4.606	155
RohnBb1	0.0006229	0.0001028	-0.006674	-0.0001	0.0009	-0.0000	-2.757	-4.776	150
RohnBb2	0.0006231	0.0001078	-0.006678	0.0001	0.0009	0.0000	-2.757	4.776	150



RohnBc1	0.0005334	6.961e-005	-0.006556	-0.0001	0.0008	-0.0000	-2.855	-4.947	145
RohnBc2	0.0005336	0.0001358	-0.006561	-0.0000	0.0008	0.0000	-2.855	4.947	145
RohnCa1	0.0003824	4.175e-005	-0.006271	-0.0007	0.0010	-0.0000	-3.085	-5.344	133.3
RohnCa2	0.0003825	0.0001487	-0.006279	0.0006	0.0010	0.0000	-3.085	5.344	133.3
RohnCb1	0.0003083	2.17e-005	-0.006063	0.0004	0.0003	-0.0000	-3.216	-5.571	126.7
RohnCb2	0.0003077	0.0001592	-0.006071	-0.0005	0.0003	0.0000	-3.216	5.572	126.7
RohnDa1	0.0001865	-8.158e-006	-0.005494	-0.0009	0.0009	-0.0000	-3.478	-6.025	113.3
RohnDa2	0.0001872	0.0001698	-0.005504	0.0008	0.0009	0.0000	-3.478	6.025	113.3
RohnDb1	0.0001362	-2.5e-005	-0.005122	0.0005	-0.0000	-0.0000	-3.609	-6.252	106.7
RohnDb2	0.0001366	0.0001744	-0.005134	-0.0007	-0.0000	0.0000	-3.609	6.252	106.7
RohnEa1	9.164e-005	-9.329e-006	-0.004459	-0.0006	0.0005	-0.0000	-3.871	-6.706	93.34
RohnEa2	9.201e-005	0.00013	-0.004476	0.0005	0.0005	0.0000	-3.871	6.706	93.34
RohnEb1	7.932e-005	4.021e-006	-0.004152	0.0006	-0.0002	0.0000	-4.003	-6.933	86.66
RohnEb2	7.983e-005	0.0001012	-0.004171	-0.0007	-0.0002	0.0000	-4.003	6.933	86.66
RohnFa1	-6.192e-005	-0.0001809	-0.003385	0.0001	0.0000	0.0000	-4.331	-7.501	70
RohnFa2	-6.295e-005	0.0002471	-0.003405	-0.0003	0.0000	0.0000	-4.331	7.501	70
RohnGa1	-8.796e-005	-0.0001842	-0.002473	-0.0001	0.0001	0.0000	-4.724	-8.182	50
RohnGa2	-8.945e-005	0.0002144	-0.002488	-0.0000	0.0001	0.0000	-4.724	8.182	50
RohnHa1	-0.0001219	-0.0002194	-0.001491	0.0001	-0.0000	0.0000	-5.118	-8.864	30
RohnHa2	-0.0001227	0.0002284	-0.001499	-0.0001	-0.0000	0.0000	-5.118	8.864	30
RohnIa1	-0.0001123	-0.0001942	-0.0004852	0.0000	-0.0000	0.0000	-5.513	-9.548	10
RohnIa2	-0.0001129	0.0001948	-0.0004875	-0.0001	-0.0000	-0.0000	-5.513	9.548	10
SNB-Aa1	0.001056	9.958e-005	-0.003306	0.0012	0.0003	0.0000	-1.264	-2.191	175
SNB-Aa2	0.001057	0.0001342	-0.003309	-0.0013	0.0003	0.0000	-1.264	2.191	175
SNB-Ab1	0.0009738	0.0001112	-0.003287	-0.0006	0.0014	-0.0000	-1.363	-2.362	170
SNB-Ab2	0.0009737	0.0001154	-0.00329	0.0006	0.0014	0.0000	-1.363	2.362	170
SNB-Ac1	0.0008679	8.798e-005	-0.003262	0.0009	0.0005	-0.0000	-1.461	-2.532	165
SNB-Ac2	0.0008679	0.000134	-0.003264	-0.0009	0.0005	0.0000	-1.461	2.532	165
SNB-Ba1	0.0006866	7.495e-005	-0.003199	0.0008	0.0005	-0.0000	-1.658	-2.873	155
SNB-Ba2	0.0006866	0.0001399	-0.003202	-0.0008	0.0005	0.0000	-1.658	2.873	155
SNB-Bb1	0.0006233	9.903e-005	-0.003163	-0.0005	0.0011	-0.0000	-1.757	-3.044	150
SNB-Bb2	0.0006233	0.0001115	-0.003167	0.0005	0.0011	0.0000	-1.757	3.044	150
SNB-Bc1	0.0005336	6.605e-005	-0.00312	0.0009	0.0002	-0.0000	-1.855	-3.214	145
SNB-Bc2	0.0005337	0.0001393	-0.003124	-0.0010	0.0002	0.0000	-1.855	3.214	145
SNB-Ca1	0.000381	3.949e-005	-0.002996	-0.0001	0.0007	-0.0000	-2.085	-3.611	133.3
SNB-Ca2	0.0003812	0.000151	-0.003001	0.0000	0.0007	0.0000	-2.085	3.611	133.3
SNB-Cb1	0.000306	2.019e-005	-0.0029	0.0016	-0.0004	-0.0000	-2.216	-3.839	126.7
SNB-Cb2	0.0003062	0.0001612	-0.002906	-0.0016	-0.0004	0.0000	-2.216	3.839	126.7
SNB-Da1	0.000185	-9.558e-006	-0.00267	0.0003	0.0002	-0.0000	-2.478	-4.293	113.3
SNB-Da2	0.0001852	0.0001709	-0.002678	-0.0004	0.0002	0.0000	-2.478	4.293	113.3
SNB-Db1	0.000136	-2.677e-005	-0.002516	0.0011	-0.0004	-0.0000	-2.609	-4.52	106.7
SNB-Db2	0.000136	0.000176	-0.002524	-0.0012	-0.0004	0.0000	-2.609	4.52	106.7
SNB-Ea1	9.176e-005	-1.075e-005	-0.002264	0.0000	0.0002	-0.0000	-2.871	-4.974	93.34
SNB-Ea2	9.173e-005	0.0001312	-0.002274	-0.0002	0.0002	0.0000	-2.871	4.974	93.34
SNB-Eb1	7.977e-005	2.65e-006	-0.002152	0.0015	-0.0007	-0.0000	-3.003	-5.201	86.66
SNB-Eb2	7.959e-005	0.0001022	-0.002163	-0.0016	-0.0007	0.0000	-3.003	5.201	86.66
SNB-Fa1	-6.312e-005	-0.0001809	-0.001819	0.0028	-0.0015	-0.0000	-3.331	-5.769	70
SNB-Fa2	-6.377e-005	0.0002473	-0.00183	-0.0029	-0.0015	0.0000	-3.331	5.769	70
SNB-Ga1	-8.874e-005	-0.0001841	-0.001366	0.0029	-0.0016	-0.0000	-3.724	-6.45	50
SNB-Ga2	-8.941e-005	0.0002147	-0.001374	-0.0030	-0.0016	0.0000	-3.724	6.45	50
SNB-Ha1	-0.0001221	-0.0002193	-0.0008425	0.0024	-0.0014	-0.0000	-4.117	-7.132	30
SNB-Ha2	-0.0001228	0.0002284	-0.0008477	-0.0025	-0.0014	0.0000	-4.117	7.132	30
SNB-Ia1	-0.0001123	-0.0001942	-0.0002762	0.0011	-0.0006	-0.0000	-4.511	-7.813	10
SNB-Ia2	-0.0001128	0.0001948	-0.0002778	-0.0011	-0.0006	0.0000	-4.511	7.813	10

Joint Support Reactions for Load Case "0.9DL":

Joint Label	X Force (kips)	X Usage % (kips)	Y Force (kips)	Y Usage % (kips)	Z Comp. Force (kips)	Z Usage % (kips)	Uplift Usage %	Result. Force (kips)	Result. Usage % (ft-k)	X Moment Usage % (ft-k)	X-M. Moment Usage % (ft-k)	Y Moment Usage % (ft-k)	Y-M. Moment Usage % (ft-k)	Z Moment Usage % (ft-k)	Z-M. Moment Usage % (ft-k)	Max. Usage %
RohnJP	-0.80	0.0	0.00	0.0	14.97	0.0	0.0	15.00	0.0	-0.00	0.0	-0.2	0.0	-0.00	0.0	0.0
SNB-JP	-0.41	0.0	0.00	0.0	13.95	0.0	0.0	13.96	0.0	-0.00	0.0	-0.4	0.0	-0.00	0.0	0.0
RohnJ1	0.40	0.0	0.69	0.0	14.84	0.0	0.0	14.87	0.0	-0.18	0.0	0.1	0.0	-0.00	0.0	0.0
RohnJ2	0.40	0.0	-0.69	0.0	14.91	0.0	0.0	14.93	0.0	0.18	0.0	0.1	0.0	0.00	0.0	0.0
SNB-J1	0.21	0.0	0.36	0.0	13.79	0.0	0.0	13.80	0.0	-0.31	0.0	0.2	0.0	-0.00	0.0	0.0
SNB-J2	0.21	0.0	-0.36	0.0	13.87	0.0	0.0	13.87	0.0	0.31	0.0	0.2	0.0	0.00	0.0	0.0

Joint Displacements, Loads and Member Forces on Joints for Load Case "0.9DL":

Joint Label	X External Load (kips)	Y External Load (kips)	Z External Load (kips)	X Member Force (kips)	Y Member Force (kips)	Z Member Force (kips)	X Disp. (ft)	Y Disp. (ft)	Z Disp. (ft)
RohnAP	0.0000	0.0000	-0.2670	0.0000	0.0000	0.2670	0.0012	0.0001	-0.0071
RohnBP	0.0000	0.0000	-0.9568	0.0000	0.0000	0.9568	0.0008	0.0001	-0.0070
RohnCP	0.0000	0.0000	-0.3872	0.0000	0.0000	0.3872	0.0005	0.0001	-0.0065
RohnDP	0.0000	0.0000	-0.4691	0.0000	0.0000	0.4691	0.0003	0.0001	-0.0059
RohnEP	0.0000	0.0000	-0.5805	0.0000	0.0000	0.5805	0.0002	0.0001	-0.0048
RohnFP	0.0000	0.0000	-0.7867	0.0000	0.0000	0.7867	0.0001	0.0000	-0.0039
RohnGP	0.0000	0.0000	-1.0471	0.0000	0.0000	1.0471	0.0000	0.0000	-0.0030
RohnHP	0.0000	0.0000	-1.0422	0.0000	0.0000	1.0422	0.0000	0.0000	-0.0020
RohnIP	0.0000	0.0000	-1.1689	0.0000	0.0000	1.1689	0.0000	0.0000	-0.0010
RohnJP	0.0000	0.0000	-0.6316	0.8033	-0.0005	-14.3432	0.0000	0.0000	0.0000
SNB-AP	0.0000	0.0000	-0.1410	0.0000	0.0000	0.1410	0.0012	0.0001	-0.0034
SNB-BP	0.0000	0.0000	-0.3052	0.0000	0.0000	0.3052	0.0008	0.0001	-0.0033
SNB-CP	0.0000	0.0000	-0.3872	0.0000	0.0000	0.3872	0.0005	0.0001	-0.0032
SNB-DP	0.0000	0.0000	-0.4691	0.0000	0.0000	0.4691	0.0003	0.0001	-0.0029
SNB-EP	0.0000	0.0000	-0.5805	0.0000	0.0000	0.5805	0.0002	0.0001	-0.0024
SNB-FP	0.0000	0.0000	-0.7867	0.0000	0.0000	0.7867	0.0001	0.0000	-0.0021
SNB-GP	0.0000	0.0000	-0.9571	0.0000	0.0000	0.9571	0.0000	0.0000	-0.0016
SNB-HP	0.0000	0.0000	-1.0422	0.0000	0.0000	1.0422	0.0000	0.0000	-0.0011
SNB-IP	0.0000	0.0000	-1.1689	0.0000	0.0000	1.1689	0.0000	0.0000	-0.0006
SNB-JP	0.0000	0.0000	-0.6316	0.4149	-0.0009	-13.3178	0.0000	0.0000	0.0000
RohnA1	0.0000	0.0000	-0.2670	0.0000	0.0000	0.2670	0.0012	0.0001	-0.0070
RohnA2	0.0000	0.0000	-0.3930	0.0000	0.0000	0.3930	0.0012	0.0001	-0.0070
RohnB1	0.0000	0.0000	-0.4078	0.0000	0.0000	0.4078	0.0008	0.0001	-0.0068
RohnB2	0.0000	0.0000	-0.3493	0.0000	0.0000	0.3493	0.0008	0.0001	-0.0068
RohnC1	0.0000	0.0000	-0.3872	0.0000	0.0000	0.3872	0.0005	0.0001	-0.0064
RohnC2	0.0000	0.0000	-0.3872	0.0000	0.0000	0.3872	0.0005	0.0001	-0.0064
RohnD1	0.0000	0.0000	-0.5321	0.0000	0.0000	0.5321	0.0003	0.0001	-0.0058
RohnD2	0.0000	0.0000	-0.4691	0.0000	0.0000	0.4691	0.0003	0.0001	-0.0058
RohnE1	0.0000	0.0000	-0.5805	0.0000	0.0000	0.5805	0.0002	0.0001	-0.0048
RohnE2	0.0000	0.0000	-0.5805	0.0000	0.0000	0.5805	0.0002	0.0001	-0.0048
RohnF1	0.0000	0.0000	-0.7867	0.0000	0.0000	0.7867	0.0001	0.0000	-0.0038
RohnF2	0.0000	0.0000	-0.9172	0.0000	0.0000	0.9172	0.0001	0.0001	-0.0039
RohnG1	0.0000	0.0000	-1.0111	0.0000	0.0000	1.0111	0.0000	0.0000	-0.0029
RohnG2	0.0000	0.0000	-1.0975	0.0000	0.0000	1.0975	0.0000	0.0000	-0.0029
RohnH1	0.0000	0.0000	-1.0422	0.0000	0.0000	1.0422	0.0000	0.0000	-0.0020
RohnH2	0.0000	0.0000	-1.0422	0.0000	0.0000	1.0422	0.0000	0.0000	-0.0020
RohnI1	0.0000	0.0000	-1.1689	0.0000	0.0000	1.1689	0.0000	-0.0000	-0.0010
RohnI2	0.0000	0.0000	-1.1689	0.0000	0.0000	1.1689	0.0000	0.0000	-0.0010
RohnJ1	0.0000	0.0000	-0.6316	-0.4008	-0.6933	-14.2124	0.0000	0.0000	0.0000
RohnJ2	0.0000	0.0000	-0.6316	-0.4018	0.6940	-14.2795	0.0000	0.0000	0.0000
SNB-A1	0.0000	0.0000	-0.1410	0.0000	0.0000	0.1410	0.0012	0.0001	-0.0033
SNB-A2	0.0000	0.0000	-0.1410	0.0000	0.0000	0.1410	0.0012	0.0001	-0.0033
SNB-B1	0.0000	0.0000	-0.3052	0.0000	-0.0000	0.3052	0.0008	0.0001	-0.0032
SNB-B2	0.0000	0.0000	-0.3052	0.0000	0.0000	0.3052	0.0008	0.0001	-0.0032
SNB-C1	0.0000	0.0000	-0.3872	0.0000	-0.0000	0.3872	0.0005	0.0001	-0.0031
SNB-C2	0.0000	0.0000	-0.3872	0.0000	0.0000	0.3872	0.0005	0.0001	-0.0031
SNB-D1	0.0000	0.0000	-0.4691	0.0000	-0.0000	0.4691	0.0003	0.0001	-0.0028
SNB-D2	0.0000	0.0000	-0.4691	0.0000	0.0000	0.4691	0.0003	0.0001	-0.0028
SNB-E1	0.0000	0.0000	-0.5805	0.0000	-0.0000	0.5805	0.0002	0.0001	-0.0024
SNB-E2	0.0000	0.0000	-0.5805	0.0000	0.0000	0.5805	0.0002	0.0001	-0.0024
SNB-F1	0.0000	0.0000	-0.7867	0.0000	0.0000	0.7867	0.0001	0.0000	-0.0020
SNB-F2	0.0000	0.0000	-0.7867	0.0000	0.0000	0.7867	0.0001	0.0001	-0.0021
SNB-G1	0.0000	0.0000	-0.9571	0.0000	0.0000	0.9571	0.0000	0.0000	-0.0016
SNB-G2	0.0000	0.0000	-0.9571	0.0000	0.0000	0.9571	0.0000	0.0000	-0.0016
SNB-H1	0.0000	0.0000	-1.0422	0.0000	0.0000	1.0422	0.0000	0.0000	-0.0011
SNB-H2	0.0000	0.0000	-1.0422	0.0000	0.0000	1.0422	0.0000	0.0000	-0.0011
SNB-I1	0.0000	0.0000	-1.1689	0.0000	0.0000	1.1689	0.0000	-0.0000	-0.0006
SNB-I2	0.0000	0.0000	-1.1689	0.0000	0.0000	1.1689	0.0000	0.0000	-0.0006
SNB-J1	0.0000	0.0000	-0.6316	-0.2076	-0.3575	-13.1602	0.0000	0.0000	0.0000
SNB-J2	0.0000	0.0000	-0.6316	-0.2089	0.3580	-13.2349	0.0000	0.0000	0.0000
RohnAaS	0.0000	0.0000	-0.1881	0.0000	0.0000	0.1881	0.0011	0.0001	-0.0071
RohnAbS	0.0000	0.0000	-0.1410	0.0000	0.0000	0.1410	0.0010	0.0001	-0.0071
RohnAcS	0.0000	0.0000	-0.1890	0.0000	0.0000	0.1890	0.0009	0.0001	-0.0070

RohnBaS	0.0000	0.0000	-0.1642	0.0000	0.0000	0.1642	0.0007	0.0001	-0.0069
RohnBbS	0.0000	0.0000	-0.8700	0.0000	0.0000	0.8700	0.0006	0.0001	-0.0068
RohnBcS	0.0000	0.0000	-0.1642	0.0000	0.0000	0.1642	0.0006	0.0001	-0.0067
RohnCaS	0.0000	0.0000	-0.7200	0.0000	0.0000	0.7200	0.0005	0.0001	-0.0064
RohnCbS	0.0000	0.0000	-1.2757	0.0000	0.0000	1.2757	0.0004	0.0001	-0.0062
RohnDaS	0.0000	0.0000	-1.1411	0.0000	0.0000	1.1411	0.0003	0.0001	-0.0056
RohnDbS	0.0000	0.0000	-0.2460	0.0000	0.0000	0.2460	0.0003	0.0001	-0.0052
RohnEaS	0.0000	0.0000	-0.3345	0.0000	0.0000	0.3345	0.0002	0.0001	-0.0045
RohnEbS	0.0000	0.0000	-0.3345	0.0000	0.0000	0.3345	0.0002	0.0001	-0.0042
RohnFaS	0.0000	0.0000	-0.4522	0.0000	0.0000	0.4522	0.0003	0.0000	-0.0034
RohnGaS	0.0000	0.0000	-0.5049	0.0000	0.0000	0.5049	0.0003	0.0000	-0.0025
RohnHaS	0.0000	0.0000	-0.5373	0.0000	0.0000	0.5373	0.0003	0.0000	-0.0015
RohnIaS	0.0000	0.0000	-0.6316	0.0000	0.0000	0.6316	0.0002	-0.0000	-0.0005
SNB-AaS	0.0000	0.0000	-0.1410	0.0000	0.0000	0.1410	0.0011	0.0001	-0.0034
SNB-AbS	0.0000	0.0000	-0.1410	0.0000	0.0000	0.1410	0.0010	0.0001	-0.0034
SNB-AcS	0.0000	0.0000	-0.1410	0.0000	0.0000	0.1410	0.0009	0.0001	-0.0033
SNB-BaS	0.0000	0.0000	-0.1642	0.0000	0.0000	0.1642	0.0007	0.0001	-0.0033
SNB-BbS	0.0000	0.0000	-0.1642	0.0000	0.0000	0.1642	0.0006	0.0001	-0.0032
SNB-BcS	0.0000	0.0000	-0.1642	0.0000	0.0000	0.1642	0.0006	0.0001	-0.0032
SNB-CaS	0.0000	0.0000	-0.2230	0.0000	0.0000	0.2230	0.0005	0.0001	-0.0031
SNB-CbS	0.0000	0.0000	-0.2230	0.0000	0.0000	0.2230	0.0004	0.0001	-0.0030
SNB-DaS	0.0000	0.0000	-0.2460	0.0000	0.0000	0.2460	0.0003	0.0001	-0.0027
SNB-DbS	0.0000	0.0000	-0.2460	0.0000	0.0000	0.2460	0.0003	0.0001	-0.0026
SNB-EaS	0.0000	0.0000	-0.3345	0.0000	0.0000	0.3345	0.0002	0.0001	-0.0023
SNB-EbS	0.0000	0.0000	-0.3345	0.0000	0.0000	0.3345	0.0002	0.0001	-0.0022
SNB-FaS	0.0000	0.0000	-0.4522	0.0000	0.0000	0.4522	0.0003	0.0000	-0.0018
SNB-GaS	0.0000	0.0000	-0.5049	0.0000	0.0000	0.5049	0.0003	0.0000	-0.0014
SNB-HaS	0.0000	0.0000	-0.5373	0.0000	0.0000	0.5373	0.0003	0.0000	-0.0009
SNB-IaS	0.0000	0.0000	-0.6316	0.0000	0.0000	0.6316	0.0002	-0.0000	-0.0003
SNB-WL-A1S	0.0000	0.0000	-0.1410	0.0000	0.0000	0.1410	0.0012	0.0001	-0.0035
SNB-WL-A2S	0.0000	0.0000	-0.1410	0.0000	0.0000	0.1410	0.0012	0.0001	-0.0035
SNB-WL-A3S	0.0000	0.0000	-0.1410	0.0000	0.0000	0.1410	0.0012	0.0001	-0.0035
SNB-WL-B1S	0.0000	0.0000	-0.1410	0.0000	0.0000	0.1410	0.0008	0.0001	-0.0035
SNB-WL-B2S	0.0000	0.0000	-0.1410	0.0000	0.0000	0.1410	0.0008	0.0001	-0.0034
SNB-WL-B3S	0.0000	0.0000	-0.1410	0.0000	0.0000	0.1410	0.0008	0.0001	-0.0035
SNB-WL-C1S	0.0000	0.0000	-0.1642	0.0000	0.0000	0.1642	0.0005	0.0001	-0.0035
SNB-WL-C2S	0.0000	0.0000	-0.1642	0.0000	0.0000	0.1642	0.0005	0.0001	-0.0034
SNB-WL-C3S	0.0000	0.0000	-0.1642	0.0000	0.0000	0.1642	0.0005	0.0001	-0.0035
SNB-WL-D1S	0.0000	0.0000	-0.2230	0.0000	0.0000	0.2230	0.0003	0.0001	-0.0037
SNB-WL-D2S	0.0000	0.0000	-0.2230	0.0000	0.0000	0.2230	0.0003	0.0001	-0.0036
SNB-WL-D3S	0.0000	0.0000	-0.2230	0.0000	0.0000	0.2230	0.0003	0.0001	-0.0037
SNB-WL-E1S	0.0000	0.0000	-0.2460	0.0000	0.0000	0.2460	0.0002	0.0001	-0.0030
SNB-WL-E2S	0.0000	0.0000	-0.2460	0.0000	0.0000	0.2460	0.0002	0.0001	-0.0029
SNB-WL-E3S	0.0000	0.0000	-0.2460	0.0000	0.0000	0.2460	0.0002	0.0001	-0.0030
SNB-WL-F1S	0.0000	0.0000	-0.3345	0.0000	0.0000	0.3345	0.0001	0.0000	-0.0032
SNB-WL-F2S	0.0000	0.0000	-0.3345	0.0000	0.0000	0.3345	0.0001	0.0000	-0.0032
SNB-WL-F3S	0.0000	0.0000	-0.3345	0.0000	0.0000	0.3345	0.0001	0.0000	-0.0032
SNB-WL-G1S	0.0000	0.0000	-0.4522	0.0000	0.0000	0.4522	0.0000	0.0000	-0.0037
SNB-WL-G2S	0.0000	0.0000	-0.4522	0.0000	0.0000	0.4522	0.0000	0.0000	-0.0037
SNB-WL-G3S	0.0000	0.0000	-0.4522	0.0000	0.0000	0.4522	0.0000	0.0000	-0.0037
SNB-WL-H1S	0.0000	0.0000	-0.5049	0.0000	0.0000	0.5049	0.0000	0.0000	-0.0041
SNB-WL-H2S	0.0000	0.0000	-0.5049	0.0000	0.0000	0.5049	0.0000	0.0000	-0.0041
SNB-WL-H3S	0.0000	0.0000	-0.5049	0.0000	0.0000	0.5049	0.0000	0.0000	-0.0041
SNB-WL-I1S	0.0000	0.0000	-0.5373	0.0000	0.0000	0.5373	0.0000	0.0000	-0.0046
SNB-WL-I2S	0.0000	0.0000	-0.5373	0.0000	0.0000	0.5373	0.0000	0.0000	-0.0046
SNB-WL-I3S	0.0000	0.0000	-0.5373	0.0000	0.0000	0.5373	0.0000	0.0000	-0.0046
RohnAa1	0.0000	0.0000	-0.2072	0.0000	0.0000	0.2072	0.0011	0.0001	-0.0069
RohnAa2	0.0000	0.0000	-0.2279	0.0000	0.0000	0.2279	0.0011	0.0001	-0.0070
RohnAb1	0.0000	0.0000	-0.2490	0.0000	0.0000	0.2490	0.0010	0.0001	-0.0069
RohnAb2	0.0000	0.0000	-0.1410	0.0000	0.0000	0.1410	0.0010	0.0001	-0.0069
RohnAc1	0.0000	0.0000	-0.1410	0.0000	0.0000	0.1410	0.0009	0.0001	-0.0069
RohnAc2	0.0000	0.0000	-0.1410	0.0000	0.0000	0.1410	0.0009	0.0001	-0.0069
RohnBa1	0.0000	0.0000	-0.1642	0.0000	0.0000	0.1642	0.0007	0.0001	-0.0067
RohnBa2	0.0000	0.0000	-0.1642	0.0000	0.0000	0.1642	0.0007	0.0001	-0.0068
RohnBb1	0.0000	0.0000	-0.8457	0.0000	0.0000	0.8457	0.0006	0.0001	-0.0067
RohnBb2	0.0000	0.0000	-0.8457	0.0000	0.0000	0.8457	0.0006	0.0001	-0.0067
RohnBc1	0.0000	0.0000	-0.1642	0.0000	0.0000	0.1642	0.0005	0.0001	-0.0066
RohnBc2	0.0000	0.0000	-0.1642	0.0000	0.0000	0.1642	0.0005	0.0001	-0.0066
RohnCa1	0.0000	0.0000	-0.7740	0.0000	0.0000	0.7740	0.0004	0.0000	-0.0063

RohnCa2	0.0000	0.0000	-0.8100	0.0000	0.0000	0.8100	0.0004	0.0001	-0.0063
RohnCb1	0.0000	0.0000	-1.2262	0.0000	0.0000	1.2262	0.0003	0.0000	-0.0061
RohnCb2	0.0000	0.0000	-1.2262	0.0000	0.0000	1.2262	0.0003	0.0002	-0.0061
RohnDa1	0.0000	0.0000	-1.0466	0.0000	0.0000	1.0466	0.0002	-0.0000	-0.0055
RohnDa2	0.0000	0.0000	-1.0466	0.0000	0.0000	1.0466	0.0002	0.0002	-0.0055
RohnDb1	0.0000	0.0000	-0.2460	0.0000	0.0000	0.2460	0.0001	-0.0000	-0.0051
RohnDb2	0.0000	0.0000	-0.2460	0.0000	0.0000	0.2460	0.0001	0.0002	-0.0051
RohnEa1	0.0000	0.0000	-0.3345	0.0000	0.0000	0.3345	0.0001	-0.0000	-0.0045
RohnEa2	0.0000	0.0000	-0.3345	0.0000	0.0000	0.3345	0.0001	0.0001	-0.0045
RohnEb1	0.0000	0.0000	-0.3345	0.0000	0.0000	0.3345	0.0001	0.0000	-0.0042
RohnEb2	0.0000	0.0000	-0.3345	0.0000	0.0000	0.3345	0.0001	0.0001	-0.0042
RohnFa1	0.0000	0.0000	-0.4522	0.0000	0.0000	0.4522	-0.0001	-0.0002	-0.0034
RohnFa2	0.0000	0.0000	-0.4522	0.0000	0.0000	0.4522	-0.0001	0.0002	-0.0034
RohnGa1	0.0000	0.0000	-0.5049	0.0000	0.0000	0.5049	-0.0001	-0.0002	-0.0025
RohnGa2	0.0000	0.0000	-0.5049	0.0000	0.0000	0.5049	-0.0001	0.0002	-0.0025
RohnHa1	0.0000	0.0000	-0.5373	0.0000	0.0000	0.5373	-0.0001	-0.0002	-0.0015
RohnHa2	0.0000	0.0000	-0.5373	0.0000	0.0000	0.5373	-0.0001	0.0002	-0.0015
RohnIa1	0.0000	0.0000	-0.6316	0.0000	0.0000	0.6316	-0.0001	-0.0002	-0.0005
RohnIa2	0.0000	0.0000	-0.6316	0.0000	-0.0000	0.6316	-0.0001	0.0002	-0.0005
SNB-Aa1	0.0000	0.0000	-0.1410	0.0000	-0.0000	0.1410	0.0011	0.0001	-0.0033
SNB-Aa2	0.0000	0.0000	-0.1410	0.0000	0.0000	0.1410	0.0011	0.0001	-0.0033
SNB-Ab1	0.0000	0.0000	-0.1410	0.0000	-0.0000	0.1410	0.0010	0.0001	-0.0033
SNB-Ab2	0.0000	0.0000	-0.1410	0.0000	0.0000	0.1410	0.0010	0.0001	-0.0033
SNB-Ac1	0.0000	0.0000	-0.1410	0.0000	-0.0000	0.1410	0.0009	0.0001	-0.0033
SNB-Ac2	0.0000	0.0000	-0.1410	0.0000	0.0000	0.1410	0.0009	0.0001	-0.0033
SNB-Ba1	0.0000	0.0000	-0.1642	0.0000	-0.0000	0.1642	0.0007	0.0001	-0.0032
SNB-Ba2	0.0000	0.0000	-0.1642	0.0000	0.0000	0.1642	0.0007	0.0001	-0.0032
SNB-Bb1	0.0000	0.0000	-0.1642	0.0000	-0.0000	0.1642	0.0006	0.0001	-0.0032
SNB-Bb2	0.0000	0.0000	-0.1642	0.0000	0.0000	0.1642	0.0006	0.0001	-0.0032
SNB-Bc1	0.0000	0.0000	-0.1642	0.0000	-0.0000	0.1642	0.0005	0.0001	-0.0031
SNB-Bc2	0.0000	0.0000	-0.1642	0.0000	0.0000	0.1642	0.0005	0.0001	-0.0031
SNB-Ca1	0.0000	0.0000	-0.2230	0.0000	-0.0000	0.2230	0.0004	0.0000	-0.0030
SNB-Ca2	0.0000	0.0000	-0.2230	0.0000	0.0000	0.2230	0.0004	0.0002	-0.0030
SNB-Cb1	0.0000	0.0000	-0.2230	0.0000	-0.0000	0.2230	0.0003	0.0000	-0.0029
SNB-Cb2	0.0000	0.0000	-0.2230	0.0000	0.0000	0.2230	0.0003	0.0002	-0.0029
SNB-Da1	0.0000	0.0000	-0.2460	0.0000	-0.0000	0.2460	0.0002	-0.0000	-0.0027
SNB-Da2	0.0000	0.0000	-0.2460	0.0000	0.0000	0.2460	0.0002	0.0002	-0.0027
SNB-Db1	0.0000	0.0000	-0.2460	0.0000	-0.0000	0.2460	0.0001	-0.0000	-0.0025
SNB-Db2	0.0000	0.0000	-0.2460	0.0000	0.0000	0.2460	0.0001	0.0002	-0.0025
SNB-Ea1	0.0000	0.0000	-0.3345	0.0000	-0.0000	0.3345	0.0001	-0.0000	-0.0023
SNB-Ea2	0.0000	0.0000	-0.3345	0.0000	0.0000	0.3345	0.0001	0.0001	-0.0023
SNB-Eb1	0.0000	0.0000	-0.3345	0.0000	-0.0000	0.3345	0.0001	0.0000	-0.0022
SNB-Eb2	0.0000	0.0000	-0.3345	0.0000	0.0000	0.3345	0.0001	0.0001	-0.0022
SNB-Fa1	0.0000	0.0000	-0.4522	0.0000	0.0000	0.4522	-0.0001	-0.0002	-0.0018
SNB-Fa2	0.0000	0.0000	-0.4522	0.0000	0.0000	0.4522	-0.0001	0.0002	-0.0018
SNB-Ga1	0.0000	0.0000	-0.5049	0.0000	0.0000	0.5049	-0.0001	-0.0002	-0.0014
SNB-Ga2	0.0000	0.0000	-0.5049	0.0000	0.0000	0.5049	-0.0001	0.0002	-0.0014
SNB-Ha1	0.0000	0.0000	-0.5373	0.0000	0.0000	0.5373	-0.0001	-0.0002	-0.0008
SNB-Ha2	0.0000	0.0000	-0.5373	0.0000	0.0000	0.5373	-0.0001	0.0002	-0.0008
SNB-Ia1	0.0000	0.0000	-0.6316	0.0000	0.0000	0.6316	-0.0001	-0.0002	-0.0003
SNB-Ia2	0.0000	0.0000	-0.6316	0.0000	0.0000	0.6316	-0.0001	0.0002	-0.0003

**Moments for Angles Modeled as Beams:**

Angle Label	Torsion (ft-lbs)	Origin X Moment (ft-lbs)	Origin Y Moment (ft-lbs)	End X Moment (ft-lbs)	End Y Moment (ft-lbs)	X Shear (lbs)	Y Shear (lbs)
Rohn-LA1P	0.00	0.00	-0.08	-0.41	-2.63	-0.08	-0.54
Rohn-LA11	0.00	-0.06	0.04	-2.44	1.04	-0.50	0.21
Rohn-LA12	-0.00	0.13	0.07	2.15	1.34	0.45	0.28
Rohn-LA2P	0.00	0.41	2.64	0.10	3.73	0.10	1.27
Rohn-LA21	0.00	2.44	-1.03	3.34	-1.74	1.16	-0.55
Rohn-LA22	-0.00	-2.15	-1.33	-3.32	-1.84	-1.09	-0.63
Rohn-LA3P	0.00	-0.10	-3.73	0.02	-5.01	-0.02	-1.75
Rohn-LA31	0.00	-3.34	1.74	-4.43	2.21	-1.55	0.79
Rohn-LA32	-0.00	3.32	1.84	4.40	2.17	1.54	0.80
Rohn-LA4P	0.00	-0.02	5.01	-0.05	7.13	-0.01	2.43
Rohn-LA41	0.00	4.43	-2.20	5.78	-3.32	2.04	-1.10

Rohn-LA42	-0.00	-4.40	-2.16	-5.79	-3.27	-2.04	-1.09
Rohn-LB1P	0.00	0.05	-7.31	0.10	-8.73	0.03	-3.20
Rohn-LB11	0.01	-5.80	3.31	-7.20	5.54	-2.60	1.77
Rohn-LB12	-0.01	5.79	3.24	7.27	5.46	2.61	1.74
Rohn-LB2P	0.00	-0.10	8.73	-0.02	10.07	-0.02	3.76
Rohn-LB21	0.01	7.20	-5.54	7.95	-4.85	3.03	-2.08
Rohn-LB22	-0.01	-7.27	-5.46	-7.92	-4.81	-3.04	-2.05
Rohn-LB3P	0.00	0.02	-10.07	0.02	-9.89	0.01	-3.99
Rohn-LB31	0.01	-7.95	4.85	-8.53	5.61	-3.29	2.09
Rohn-LB32	-0.01	7.92	4.82	8.56	5.61	3.29	2.08
Rohn-LB4P	0.00	-0.02	9.89	0.03	10.34	0.00	4.04
Rohn-LB41	0.01	8.53	-5.61	8.42	-4.74	3.39	-2.07
Rohn-LB42	-0.01	-8.56	-5.60	-8.37	-4.74	-3.38	-2.07
Rohn-LC1P	0.00	-0.03	-10.34	0.06	-2.69	0.00	-1.95
Rohn-LC11	0.01	-8.42	4.74	-2.43	2.05	-1.63	1.02
Rohn-LC12	-0.01	8.37	4.74	2.45	2.00	1.62	1.01
Rohn-LC2P	0.00	-0.06	2.69	-0.11	-8.37	-0.02	-0.85
Rohn-LC21	0.01	2.43	-2.05	-7.62	4.48	-0.78	0.36
Rohn-LC22	-0.01	-2.46	-1.99	7.56	4.56	0.76	0.38
Rohn-LC3P	0.00	0.11	8.37	0.05	17.15	0.02	3.83
Rohn-LC31	0.01	7.62	-4.48	14.53	-7.86	3.32	-1.85
Rohn-LC32	-0.01	-7.56	-4.56	-14.43	-7.86	-3.30	-1.86
Rohn-LD1P	0.00	-0.05	-17.15	0.16	-7.00	0.02	-3.62
Rohn-LD11	0.01	-14.53	7.87	-6.57	4.17	-3.17	1.81
Rohn-LD12	-0.01	14.43	7.86	6.70	4.06	3.17	1.79
Rohn-LD2P	0.00	-0.16	7.00	-0.02	-16.58	-0.03	-1.43
Rohn-LD21	0.01	6.57	-4.17	-14.46	9.29	-1.18	0.77
Rohn-LD22	-0.01	-6.70	-4.06	14.56	9.37	1.18	0.80
Rohn-LD3P	0.00	0.02	16.58	0.09	29.21	0.02	6.87
Rohn-LD31	0.01	14.46	-9.29	24.64	-14.04	5.87	-3.50
Rohn-LD32	-0.01	-14.56	-9.37	-24.57	-14.10	-5.87	-3.52
Rohn-LE1P	0.00	-0.09	-29.21	-0.02	-16.93	-0.02	-6.92
Rohn-LE11	0.01	-24.64	14.04	-14.84	8.99	-5.92	3.46
Rohn-LE12	-0.01	24.56	14.10	14.86	9.04	5.92	3.47
Rohn-LE2P	0.00	0.02	16.93	0.04	-11.06	0.01	0.88
Rohn-LE21	0.01	14.84	-8.99	-9.70	6.07	0.77	-0.44
Rohn-LE22	-0.01	-14.86	-9.04	9.82	6.10	-0.75	-0.44
Rohn-LE3P	0.00	-0.04	11.06	0.15	51.99	0.02	9.46
Rohn-LE31	0.01	9.70	-6.07	44.36	-25.49	8.11	-4.73
Rohn-LE32	-0.01	-9.83	-6.09	-44.49	-25.74	-8.15	-4.78
Rohn-LF1P	0.00	-0.15	-51.99	-0.46	-84.74	-0.06	-13.66
Rohn-LF11	0.01	-44.36	25.49	-73.34	42.92	-11.76	6.84
Rohn-LF12	-0.01	44.49	25.74	73.13	43.33	11.75	6.90
Rohn-LF2P	0.00	0.46	84.74	0.26	97.54	0.07	18.22
Rohn-LF21	0.01	73.34	-42.92	83.54	-48.27	15.68	-9.11
Rohn-LF22	-0.01	-73.13	-43.33	-83.80	-48.71	-15.68	-9.20
Rohn-LG1P	0.00	-0.26	-97.54	-0.57	-103.93	-0.08	-20.13
Rohn-LG11	0.01	-83.54	48.27	-89.94	52.36	-17.34	10.06
Rohn-LG12	-0.01	83.80	48.71	89.61	52.84	17.33	10.15
Rohn-LG2P	0.00	0.57	103.93	0.18	112.38	0.07	21.62
Rohn-LG21	0.01	89.94	-52.36	96.54	-55.81	18.63	-10.81
Rohn-LG22	-0.01	-89.61	-52.83	-96.80	-56.17	-18.63	-10.89
Rohn-LH1P	0.00	-0.18	-112.38	-0.33	-123.16	-0.05	-23.54
Rohn-LH11	0.01	-96.54	55.82	-106.55	61.96	-20.29	11.77
Rohn-LH12	-0.01	96.80	56.17	106.35	62.22	20.30	11.83
Rohn-LH2P	0.00	0.33	123.16	0.06	149.15	0.04	27.21
Rohn-LH21	0.01	106.55	-61.96	128.34	-74.24	23.47	-13.61
Rohn-LH22	-0.01	-106.35	-62.22	-128.68	-74.50	-23.49	-13.66
Rohn-LI1P	0.00	-0.06	-149.15	-0.58	-203.16	-0.06	-35.21
Rohn-LI11	0.01	-128.34	74.24	-175.97	102.38	-30.41	17.65
Rohn-LI12	-0.01	128.68	74.50	175.50	102.77	30.40	17.71
Rohn-LI2P	0.00	0.58	203.16	0.40	207.23	0.10	41.01
Rohn-LI21	0.01	175.97	-102.38	178.79	-103.75	35.45	-20.60
Rohn-LI22	-0.01	-175.50	-102.77	-178.81	-104.22	-35.41	-20.68
Rohn-H1P	-0.00	-0.06	-0.00	0.05	-0.00	-0.00	-0.00
Rohn-H11	0.00	-0.04	0.00	0.08	0.00	0.01	0.00
Rohn-H12	-0.00	-0.08	-0.00	0.04	-0.00	-0.01	-0.00
Rohn-H2P	-0.00	-0.10	-0.00	-0.02	-0.00	-0.01	-0.00
Rohn-H21	-0.00	-0.03	-0.00	0.02	0.00	-0.00	-0.00

Rohn-H22	0.00	0.03	0.00	0.10	0.00	0.02	0.00
SNB-LA1P	-0.00	-0.05	56.90	-0.04	10.86	-0.02	13.54
SNB-LA11	0.00	49.20	-28.44	9.38	-5.45	11.71	-6.77
SNB-LA12	-0.00	-49.45	-28.53	-9.60	-5.54	-11.80	-6.81
SNB-LA2P	-0.00	0.04	-10.86	-0.09	3.81	-0.01	-1.41
SNB-LA21	0.00	-9.38	5.45	3.17	-2.12	-1.24	0.67
SNB-LA22	-0.00	9.60	5.54	-3.25	-2.06	1.27	0.70
SNB-LA3P	-0.00	0.09	-3.81	-0.01	-16.22	0.02	-4.00
SNB-LA31	0.00	-3.17	2.13	-13.67	8.30	-3.36	2.08
SNB-LA32	-0.00	3.25	2.06	13.60	8.26	3.37	2.06
SNB-LA4P	-0.00	0.01	16.22	0.02	48.86	0.01	13.01
SNB-LA41	0.00	13.67	-8.29	41.28	-23.94	10.98	-6.44
SNB-LA42	-0.00	-13.60	-8.26	-41.18	-23.91	-10.95	-6.43
SNB-LB1P	-0.00	0.03	83.34	0.05	5.72	0.02	17.80
SNB-LB11	0.02	72.13	-41.08	4.65	-1.25	15.34	-8.46
SNB-LB12	-0.02	-72.01	-41.04	-4.55	-1.24	-15.30	-8.45
SNB-LB2P	-0.00	-0.05	-5.72	0.03	22.06	-0.00	3.27
SNB-LB21	0.02	-4.65	1.25	17.95	-10.10	2.66	-1.77
SNB-LB22	-0.02	4.55	1.24	-17.86	-10.09	-2.66	-1.77
SNB-LB3P	-0.00	-0.03	-22.06	0.06	-49.03	0.01	-14.21
SNB-LB31	0.02	-17.95	10.11	-42.48	26.04	-12.08	7.22
SNB-LB32	-0.02	17.86	10.09	42.57	26.02	12.08	7.22
SNB-LB4P	-0.00	-0.06	49.04	-0.01	135.01	-0.01	36.78
SNB-LB41	0.02	42.48	-26.04	115.87	-67.16	31.65	-18.63
SNB-LB42	-0.02	-42.57	-26.02	-115.83	-67.13	-31.66	-18.62
SNB-LC1P	-0.00	0.00	76.55	0.02	29.29	0.00	15.88
SNB-LC11	0.02	67.41	-38.77	25.31	-13.64	13.91	-7.86
SNB-LC12	-0.02	-67.48	-38.81	-25.31	-13.66	-13.92	-7.87
SNB-LC2P	-0.00	-0.02	-29.29	0.03	-54.17	0.00	-12.49
SNB-LC21	0.02	-25.31	13.65	-47.20	27.94	-10.85	6.22
SNB-LC22	-0.01	25.31	13.66	47.20	27.90	10.85	6.22
SNB-LC3P	-0.00	-0.03	54.18	-0.01	161.71	-0.01	32.39
SNB-LC31	0.02	47.20	-27.93	139.25	-80.59	27.97	-16.28
SNB-LC32	-0.01	-47.20	-27.90	-139.13	-80.52	-27.96	-16.27
SNB-LD1P	-0.00	0.02	190.95	0.13	55.51	0.02	36.98
SNB-LD11	0.01	166.27	-95.93	47.72	-26.31	32.11	-18.34
SNB-LD12	-0.01	-166.33	-95.99	-47.58	-26.38	-32.09	-18.36
SNB-LD2P	-0.00	-0.13	-55.51	0.06	-73.39	-0.01	-19.28
SNB-LD21	0.01	-47.72	26.31	-63.71	37.94	-16.67	9.61
SNB-LD22	-0.01	47.58	26.38	63.91	37.99	16.68	9.63
SNB-LD3P	-0.00	-0.06	73.39	0.03	179.97	-0.00	38.01
SNB-LD31	0.01	63.71	-37.94	154.57	-89.39	32.75	-19.10
SNB-LD32	-0.01	-63.91	-37.98	-154.55	-89.41	-32.78	-19.11
SNB-LE1P	-0.00	-0.07	273.59	0.16	76.09	0.01	52.47
SNB-LE11	0.02	238.22	-137.62	65.56	-36.29	45.58	-26.09
SNB-LE12	-0.02	-238.42	-137.66	-65.41	-36.39	-45.59	-26.11
SNB-LE2P	-0.00	-0.16	-76.09	-0.08	-164.37	-0.04	-35.97
SNB-LE21	0.02	-65.56	36.29	-142.75	83.64	-31.16	17.94
SNB-LE22	-0.02	65.41	36.39	142.98	83.87	31.17	17.99
SNB-LE3P	-0.00	0.08	164.37	0.08	567.96	0.02	109.88
SNB-LE31	0.02	142.75	-83.64	490.26	-283.80	94.97	-55.13
SNB-LE32	-0.02	-142.98	-83.86	-490.76	-284.18	-95.08	-55.22
SNB-LF1P	0.00	-0.17	146.16	-0.42	-171.39	-0.06	-2.52
SNB-LF11	0.01	128.25	-73.66	-147.73	87.17	-1.95	1.35
SNB-LF12	-0.01	-128.10	-73.38	147.56	87.56	1.95	1.42
SNB-LF2P	0.01	0.42	171.39	0.11	549.38	0.05	72.02
SNB-LF21	0.01	147.73	-87.17	473.53	-274.63	62.08	-36.15
SNB-LF22	-0.01	-147.56	-87.56	-474.21	-275.14	-62.13	-36.24
SNB-LG1P	0.01	-0.15	564.93	-1.00	-250.45	-0.11	31.42
SNB-LG11	0.01	491.48	-283.02	-216.44	127.26	27.48	-15.56
SNB-LG12	-0.02	-490.91	-282.52	215.70	127.98	-27.50	-15.44
SNB-LG2P	0.01	1.00	250.45	0.29	995.76	0.13	124.53
SNB-LG21	0.01	216.44	-127.26	859.78	-497.73	107.54	-62.45
SNB-LG22	-0.02	-215.70	-127.98	-860.59	-498.53	-107.55	-62.60
SNB-LH1P	0.01	-0.30	424.51	-1.06	-276.34	-0.14	14.81
SNB-LH11	0.01	370.06	-212.90	-238.81	139.67	13.12	-7.32
SNB-LH12	-0.02	-369.27	-212.11	238.14	140.51	-13.10	-7.15
SNB-LH2P	0.01	1.06	276.35	0.40	887.86	0.15	116.33
SNB-LH21	0.01	238.81	-139.67	766.43	-443.60	100.45	-58.28

SNB-LH22	-0.02	-238.14	-140.51	-767.20	-444.51	-100.46	-58.46
SNB-LI1P	0.01	-0.39	803.09	-1.50	-173.81	-0.19	62.88
SNB-LI11	0.00	697.84	-402.47	-150.43	88.94	54.70	-31.33
SNB-LI12	-0.01	-697.01	-401.54	149.28	90.00	-54.73	-31.13
SNB-LI2P	0.01	1.50	173.82	0.85	358.00	0.23	53.14
SNB-LI21	0.00	150.43	-88.94	308.22	-179.34	45.83	-26.81
SNB-LI22	-0.01	-149.28	-90.00	-308.41	-180.42	-45.73	-27.02
SNB-H1aP	-0.01	32.90	-0.12	109.62	-0.09	70.54	-0.10
SNB-H1bP	-0.01	-109.62	0.09	-32.83	0.12	-70.51	0.10
SNB-H1cP	-0.00	32.79	-0.12	109.60	-0.12	70.47	-0.12
SNB-H1dP	0.00	-109.60	0.12	-32.99	0.11	-70.57	0.11
SNB-H1eP	0.01	32.93	-0.11	109.62	-0.13	70.55	-0.12
SNB-H1fP	0.01	-109.62	0.13	-32.80	0.12	-70.49	0.12
SNB-H2aP	-0.04	76.30	0.16	114.93	0.16	70.75	0.12
SNB-H2bP	-0.04	-114.93	-0.16	-75.06	-0.17	-70.29	-0.12
SNB-H2cP	-0.00	75.86	0.14	114.84	0.15	70.55	0.11
SNB-H2dP	-0.00	-114.84	-0.15	-75.69	-0.14	-70.49	-0.11
SNB-H2eP	0.04	74.98	0.17	114.92	0.16	70.26	0.12
SNB-H2fP	0.04	-114.92	-0.16	-76.39	-0.16	-70.78	-0.12
SNB-H3aP	0.00	122.15	1.06	155.57	1.04	82.06	0.62
SNB-H3bP	0.00	-155.57	-1.04	-122.26	-1.05	-82.09	-0.62
SNB-H3cP	-0.00	122.19	1.06	155.57	1.09	82.07	0.64
SNB-H3dP	0.00	-155.57	-1.09	-122.21	-1.06	-82.08	-0.64
SNB-H3eP	-0.00	122.27	1.06	155.57	1.04	82.09	0.62
SNB-H3fP	-0.00	-155.57	-1.04	-122.14	-1.06	-82.05	-0.62
SNB-H4aP	-0.01	203.60	1.99	249.55	1.97	111.45	0.97
SNB-H4bP	-0.01	-249.55	-1.97	-203.72	-1.99	-111.48	-0.97
SNB-H4cP	-0.00	203.71	1.99	249.53	2.03	111.47	0.99
SNB-H4dP	-0.00	-249.53	-2.03	-203.66	-1.99	-111.46	-0.99
SNB-H4eP	0.01	203.70	1.99	249.55	1.97	111.47	0.97
SNB-H4fP	0.01	-249.54	-1.97	-203.62	-1.99	-111.45	-0.97
SNB-H5aP	-0.00	261.90	2.80	321.78	2.79	122.97	1.18
SNB-H5bP	-0.00	-321.78	-2.79	-261.98	-2.81	-122.98	-1.18
SNB-H5cP	-0.00	261.88	2.80	321.78	2.84	122.96	1.19
SNB-H5dP	0.00	-321.78	-2.84	-262.02	-2.80	-122.99	-1.19
SNB-H5eP	0.00	262.05	2.81	321.78	2.79	123.00	1.18
SNB-H5fP	0.00	-321.78	-2.79	-261.83	-2.81	-122.95	-1.18
SNB-H6aP	-0.02	412.39	2.83	495.06	2.82	167.17	1.04
SNB-H6bP	-0.02	-495.06	-2.82	-412.53	-2.83	-167.20	-1.04
SNB-H6cP	0.01	412.35	2.84	495.02	2.87	167.16	1.05
SNB-H6dP	0.01	-495.02	-2.87	-412.64	-2.83	-167.21	-1.05
SNB-H6eP	0.02	412.66	2.83	495.07	2.82	167.22	1.04
SNB-H6fP	0.02	-495.07	-2.82	-412.23	-2.84	-167.14	-1.04
SNB-H7aP	-0.01	643.38	0.71	737.70	0.72	226.04	0.23
SNB-H7bP	-0.01	-737.70	-0.72	-643.54	-0.72	-226.07	-0.24
SNB-H7cP	0.01	643.42	0.72	737.70	0.74	226.05	0.24
SNB-H7dP	0.01	-737.70	-0.74	-643.52	-0.72	-226.06	-0.24
SNB-H7eP	0.00	643.57	0.72	737.72	0.72	226.08	0.24
SNB-H7fP	0.00	-737.72	-0.72	-643.32	-0.72	-226.04	-0.24
SNB-H8aP	0.00	820.00	0.80	893.83	0.80	252.39	0.24
SNB-H8bP	0.00	-893.84	-0.80	-820.10	-0.80	-252.40	-0.23
SNB-H8cP	0.00	820.03	0.80	893.85	0.81	252.39	0.24
SNB-H8dP	0.00	-893.85	-0.81	-820.05	-0.80	-252.40	-0.24
SNB-H8eP	-0.00	820.10	0.79	893.84	0.79	252.40	0.23
SNB-H8fP	-0.00	-893.84	-0.79	-819.98	-0.80	-252.38	-0.23
SNB-H9aP	-0.00	976.26	0.58	1030.80	0.58	268.61	0.16
SNB-H9bP	-0.00	-1030.80	-0.58	-976.39	-0.58	-268.63	-0.16
SNB-H9cP	0.00	976.36	0.58	1030.80	0.59	268.62	0.16
SNB-H9dP	0.00	-1030.80	-0.59	-976.31	-0.59	-268.62	-0.16
SNB-H9eP	0.00	976.37	0.58	1030.80	0.57	268.62	0.15
SNB-H9fP	0.00	-1030.80	-0.57	-976.28	-0.58	-268.61	-0.15







1.2*DL	5.68	Rohn-LD3P	Angle
0.9DL	4.26	Rohn-LD3P	Angle

\*\*\* Weight of structure (lbs):  
Weight of Angles\*Section DLF: 61800.0  
Weight of Equipment: 12661.2  
Total: 74461.2

\*\*\* End of Report

"0 DEG" "+60 DEG" "-60 DEG" "+90 DEG" "-90 DEG" "180 DEG" Max Tension  
(Kips)

		0	60	-60	90	-90	180			Bolt Tension Factored Tensile		Cap Percentage	
		(Kips)						Capacity	Capacity				
								# Bolts	Dia	Bolt LFRD			
Rohn-L1	Rohn-LA1P	0	0	0	0	0	0.723	0.723					
Rohn-L1	Rohn-LA11	0.135	0.542	0	0.455	0	0	0.542					
Rohn-L1	Rohn-LA12	0.189	0	0.679	0	0.538	0	0.679					
Rohn-L1	Rohn-LA2P	0	0	0	0	0	2.865	2.865					
Rohn-L1	Rohn-LA21	1.335	3.056	0	2.619	0	0	3.056					
Rohn-L1	Rohn-LA22	1.101	0	2.767	0	2.375	0	2.767					
Rohn-L1	Rohn-LA3P	0	0	0	0	0	5.91	5.91					
Rohn-L1	Rohn-LA31	2.726	6.006	0	5.17	0	0	6.006					
Rohn-L1	Rohn-LA32	2.563	0	5.742	0	4.956	0	5.742					
Rohn-L1	Rohn-LA4P	0	0	0	0	0	9.191	9.191					
Rohn-L1	Rohn-LA41	4.143	8.709	0	7.47	0	0	8.709					
Rohn-L1	Rohn-LA42	4.241	0	8.802	0	7.517	0	8.802					
Rohn-L2	Rohn-LB1P	0	0	0	0	0	12.809	12.809	4	0.75	29.8	119.2 OK	11%
Rohn-L2	Rohn-LB11	6.149	13.059	0	11.24	0	0	13.059	4	0.75	29.8	119.2 OK	11%
Rohn-L2	Rohn-LB12	6.24	0	13.057	0	11.201	0	13.057	4	0.75	29.8	119.2 OK	11%
Rohn-L2	Rohn-LB2P	0	0	0	0	0	17.68	17.68	4	0.75	29.8	119.2 OK	15%
Rohn-L2	Rohn-LB21	8.536	18.044	0	15.636	0	0	18.044	4	0.75	29.8	119.2 OK	15%
Rohn-L2	Rohn-LB22	8.691	0	18.084	0	15.608	0	18.084	4	0.75	29.8	119.2 OK	15%
Rohn-L2	Rohn-LB3P	0	0	0	0	0	23.313	23.313	4	0.75	29.8	119.2 OK	20%
Rohn-L2	Rohn-LB31	11.032	23.606	0	20.381	0	0	23.606	4	0.75	29.8	119.2 OK	20%
Rohn-L2	Rohn-LB32	11.197	0	23.63	0	20.326	0	23.63	4	0.75	29.8	119.2 OK	20%
Rohn-L2	Rohn-LB4P	0	0	0	0	0	31.258	31.258	4	0.75	29.8	119.2 OK	26%
Rohn-L2	Rohn-LB41	15.011	31.546	0	27.281	0	0	31.546	4	0.75	29.8	119.2 OK	26%
Rohn-L2	Rohn-LB42	15.191	0	31.562	0	27.207	0	31.562	4	0.75	29.8	119.2 OK	26%
Rohn-L3	Rohn-LC1P	0	0	0	0	0	39.195	39.195	4	0.875	40.6	162.4 OK	24%
Rohn-L3	Rohn-LC11	18.94	39.529	0	34.228	0	0	39.529	4	0.875	40.6	162.4 OK	24%
Rohn-L3	Rohn-LC12	19.165	0	39.574	0	34.163	0	39.574	4	0.875	40.6	162.4 OK	24%
Rohn-L3	Rohn-LC2P	0	0	0	0	0	49.556	49.556	4	0.875	40.6	162.4 OK	31%
Rohn-L3	Rohn-LC21	23.809	49.743	0	43.048	0	0	49.743	4	0.875	40.6	162.4 OK	31%
Rohn-L3	Rohn-LC22	24.043	0	49.77	0	42.94	0	49.77	4	0.875	40.6	162.4 OK	31%
Rohn-L3	Rohn-LC3P	0	0	0	0	0	63.308	63.308	4	0.875	40.6	162.4 OK	39%
Rohn-L3	Rohn-LC31	30.351	63.531	0	54.93	0	0	63.531	4	0.875	40.6	162.4 OK	39%
Rohn-L3	Rohn-LC32	30.532	0	63.466	0	54.746	0	63.466	4	0.875	40.6	162.4 OK	39%

Rohn-L4 Rohn-LD1P	0	0	0	0	0	77.954	77.954	4	1	53	212 OK	37%
Rohn-L4 Rohn-LD11	37.57	78.112	0	67.583	0	0	78.112	4	1	53	212 OK	37%
Rohn-L4 Rohn-LD12	37.831	0	78.114	0	67.453	0	78.114	4	1	53	212 OK	37%
Rohn-L4 Rohn-LD2P	0	0	0	0	0	93.356	93.356	4	1	53	212 OK	44%
Rohn-L4 Rohn-LD21	44.916	93.504	0	80.85	0	0	93.504	4	1	53	212 OK	44%
Rohn-L4 Rohn-LD22	45.238	0	93.556	0	80.737	0	93.556	4	1	53	212 OK	44%
Rohn-L4 Rohn-LD3P	0	0	0	0	0	110.249	110.249	4	1	53	212 OK	52%
Rohn-L4 Rohn-LD31	53.554	110.499	0	95.658	0	0	110.499	4	1	53	212 OK	52%
Rohn-L4 Rohn-LD32	53.865	0	110.526	0	95.522	0	110.526	4	1	53	212 OK	52%
Rohn-L5 Rohn-LE1P	0	0	0	0	0	124.1	124.1	4	1	53	212 OK	59%
Rohn-L5 Rohn-LE11	60.361	124.292	0	107.615	0	0	124.292	4	1	53	212 OK	59%
Rohn-L5 Rohn-LE12	60.687	0	124.33	0	107.481	0	124.33	4	1	53	212 OK	59%
Rohn-L5 Rohn-LE2P	0	0	0	0	0	137.464	137.464	4	1	53	212 OK	65%
Rohn-L5 Rohn-LE21	67.027	137.654	0	119.211	0	0	137.654	4	1	53	212 OK	65%
Rohn-L5 Rohn-LE22	67.329	0	137.659	0	119.052	0	137.659	4	1	53	212 OK	65%
Rohn-L5 Rohn-LE3P	0	0	0	0	0	150.975	150.975	4	1	53	212 OK	71%
Rohn-L5 Rohn-LE31	73.859	151.151	0	131.002	0	0	151.151	4	1	53	212 OK	71%
Rohn-L5 Rohn-LE32	74.28	0	151.275	0	130.914	0	151.275	4	1	53	212 OK	71%
Rohn-L6 Rohn-LF1P	0	0	0	0	0	169.572	169.572	6	1	53	318 OK	53%
Rohn-L6 Rohn-LF11	83.028	169.747	0	147.112	0	0	169.747	6	1	53	318 OK	53%
Rohn-L6 Rohn-LF12	83.308	0	169.718	0	146.879	0	169.718	6	1	53	318 OK	53%
Rohn-L6 Rohn-LF2P	0	0	0	0	0	191.452	191.452	6	1	53	318 OK	60%
Rohn-L6 Rohn-LF21	94.146	191.584	0	166.138	0	0	191.584	6	1	53	318 OK	60%
Rohn-L6 Rohn-LF22	94.457	0	191.57	0	165.913	0	191.57	6	1	53	318 OK	60%
Rohn-L7 Rohn-LG1P	0	0	0	0	0	211.72	211.72	6	1	53	318 OK	67%
Rohn-L7 Rohn-LG11	104.132	211.874	0	183.753	0	0	211.874	6	1	53	318 OK	67%
Rohn-L7 Rohn-LG12	104.434	0	211.843	0	183.486	0	211.843	6	1	53	318 OK	67%
Rohn-L7 Rohn-LG2P	0	0	0	0	0	231.228	231.228	6	1	53	318 OK	73%
Rohn-L7 Rohn-LG21	114.061	231.404	0	200.743	0	0	231.404	6	1	53	318 OK	73%
Rohn-L7 Rohn-LG22	114.267	0	231.253	0	200.4	0	231.253	6	1	53	318 OK	73%
Rohn-L7 Rohn-LH1P	0	0	0	0	0	250.073	250.073	6	1	53	318 OK	79%
Rohn-L7 Rohn-LH11	123.343	250.229	0	217.095	0	0	250.229	6	1	53	318 OK	79%
Rohn-L7 Rohn-LH12	123.615	0	250.136	0	216.788	0	250.136	6	1	53	318 OK	79%
Rohn-L7 Rohn-LH2P	0	0	0	0	0	269.55	269.55	6	1	53	318 OK	85%
Rohn-L7 Rohn-LH21	133.239	269.699	0	234.075	0	0	269.699	6	1	53	318 OK	85%
Rohn-L7 Rohn-LH22	133.525	0	269.609	0	233.766	0	269.609	6	1	53	318 OK	85%
Rohn-L8 Rohn-LI1P	0	0	0	0	0	286.761	286.761	8	1	53	424 OK	68%
Rohn-L8 Rohn-LI11	141.703	286.903	0	249.018	0	0	286.903	8	1	53	424 OK	68%
Rohn-L8 Rohn-LI12	142.009	0	286.823	0	248.712	0	286.823	8	1	53	424 OK	68%
Rohn-L8 Rohn-LI2P	0	0	0	0	0	301.836	301.836	8	1	53	424 OK	71%
Rohn-L8 Rohn-LI21	149.245	301.973	0	262.135	0	0	301.973	8	1	53	424 OK	71%
Rohn-L8 Rohn-LI22	149.563	0	301.897	0	261.829	0	301.897	8	1	53	424 OK	71%

SNB-L1	SNB-LA1P	0	0	0	0	0	0.172	0.172						
SNB-L1	SNB-LA11	0	0	0	0	0	0	0						
SNB-L1	SNB-LA12	0	0	0.203	0	0.172	0	0.203						
SNB-L1	SNB-LA2P	0	0	0	0	0	1.261	1.261						
SNB-L1	SNB-LA21	0.539	1.357	0	1.111	0	0	1.357						
SNB-L1	SNB-LA22	0.538	0	1.259	0	0.985	0	1.259						
SNB-L1	SNB-LA3P	0	0	0	0	0	3.657	3.657						
SNB-L1	SNB-LA31	1.699	3.836	0	3.291	0	0	3.836						
SNB-L1	SNB-LA32	1.709	0	3.633	0	3.039	0	3.633						
SNB-L1	SNB-LA4P	0	0	0	0	0	6.827	6.827						
SNB-L1	SNB-LA41	3.041	6.716	0	5.853	0	0	6.716						
SNB-L1	SNB-LA42	3.154	0	6.942	0	6.041	0	6.942						
SNB-L2	SNB-LB1P	0	0	0	0	0	10.908	10.908	4	0.75	29.8	119.2 OK	9%	
SNB-L2	SNB-LB11	5.14	11.135	0	9.639	0	0	11.135	4	0.75	29.8	119.2 OK	9%	
SNB-L2	SNB-LB12	5.232	0	11.129	0	9.575	0	11.129	4	0.75	29.8	119.2 OK	9%	
SNB-L2	SNB-LB2P	0	0	0	0	0	17.009	17.009	4	0.75	29.8	119.2 OK	14%	
SNB-L2	SNB-LB21	8.23	17.157	0	14.843	0	0	17.157	4	0.75	29.8	119.2 OK	14%	
SNB-L2	SNB-LB22	8.342	0	17.15	0	14.768	0	17.15	4	0.75	29.8	119.2 OK	14%	
SNB-L2	SNB-LB3P	0	0	0	0	0	24.181	24.181	4	0.75	29.8	119.2 OK	20%	
SNB-L2	SNB-LB31	11.824	24.345	0	21.112	0	0	24.345	4	0.75	29.8	119.2 OK	20%	
SNB-L2	SNB-LB32	11.972	0	24.339	0	21.02	0	24.339	4	0.75	29.8	119.2 OK	20%	
SNB-L2	SNB-LB4P	0	0	0	0	0	31.634	31.634	4	0.75	29.8	119.2 OK	27%	
SNB-L2	SNB-LB41	15.595	31.866	0	27.668	0	0	31.866	4	0.75	29.8	119.2 OK	27%	
SNB-L2	SNB-LB42	15.78	0	31.873	0	27.571	0	31.873	4	0.75	29.8	119.2 OK	27%	
SNB-L2	SNB-LC1P	0	0	0	0	0	41.402	41.402	4	0.875	40.6	162.4 OK	25%	
SNB-L2	SNB-LC11	20.443	41.676	0	36.158	0	0	41.676	4	0.875	40.6	162.4 OK	26%	
SNB-L2	SNB-LC12	20.642	0	41.688	0	36.06	0	41.688	4	0.875	40.6	162.4 OK	26%	
SNB-L2	SNB-LC2P	0	0	0	0	0	55.867	55.867	4	0.875	40.6	162.4 OK	34%	
SNB-L2	SNB-LC21	27.595	56.08	0	48.678	0	0	56.08	4	0.875	40.6	162.4 OK	35%	
SNB-L2	SNB-LC22	27.823	0	56.085	0	48.555	0	56.085	4	0.875	40.6	162.4 OK	35%	
SNB-L2	SNB-LC3P	0	0	0	0	0	69.396	69.396	4	0.875	40.6	162.4 OK	43%	
SNB-L2	SNB-LC31	34.439	69.509	0	60.405	0	0	69.509	4	0.875	40.6	162.4 OK	43%	
SNB-L2	SNB-LC32	34.722	0	69.523	0	60.263	0	69.523	4	0.875	40.6	162.4 OK	43%	
SNB-L3	SNB-LD1P	0	0	0	0	0	85.811	85.811	4	1	53	212 OK	40%	
SNB-L3	SNB-LD11	42.54	85.941	0	74.652	0	0	85.941	4	1	53	212 OK	41%	
SNB-L3	SNB-LD12	42.854	0	85.972	0	74.512	0	85.972	4	1	53	212 OK	41%	
SNB-L3	SNB-LD2P	0	0	0	0	0	106.703	106.703	4	1	53	212 OK	50%	
SNB-L3	SNB-LD21	52.963	106.897	0	92.846	0	0	106.897	4	1	53	212 OK	50%	
SNB-L3	SNB-LD22	53.285	0	106.909	0	92.682	0	106.909	4	1	53	212 OK	50%	
SNB-L3	SNB-LD3P	0	0	0	0	0	124.794	124.794	4	1	53	212 OK	59%	
SNB-L3	SNB-LD31	62.291	125.041	0	108.661	0	0	125.041	4	1	53	212 OK	59%	
SNB-L3	SNB-LD32	62.629	0	125.048	0	108.48	0	125.048	4	1	53	212 OK	59%	

SNB-L4	SNB-LE1P	0	0	0	0	0	146.711	146.711	4	1	53	212 OK	69%
SNB-L4	SNB-LE11	73.115	146.919	0	127.652	0	0	146.919	4	1	53	212 OK	69%
SNB-L4	SNB-LE12	73.497	0	146.951	0	127.473	0	146.951	4	1	53	212 OK	69%
SNB-L4	SNB-LE2P	0	0	0	0	0	172.478	172.478	4	1	53	212 OK	81%
SNB-L4	SNB-LE21	86.068	172.686	0	150.06	0	0	172.686	4	1	53	212 OK	81%
SNB-L4	SNB-LE22	86.466	0	172.694	0	149.838	0	172.694	4	1	53	212 OK	81%
SNB-L4	SNB-LE3P	0	0	0	0	0	192.415	192.415	4	1	53	212 OK	91%
SNB-L4	SNB-LE31	96.392	192.618	0	167.45	0	0	192.618	4	1	53	212 OK	91%
SNB-L4	SNB-LE32	96.736	0	192.57	0	167.19	0	192.57	4	1	53	212 OK	91%
SNB-L4	SNB-LF1P	0	0	0	0	0	217.388	217.388	6	1	53	318 OK	68%
SNB-L4	SNB-LF11	108.509	217.589	0	189.059	0	0	217.589	6	1	53	318 OK	68%
SNB-L4	SNB-LF12	108.874	0	217.538	0	188.773	0	217.538	6	1	53	318 OK	68%
SNB-L4	SNB-LF2P	0	0	0	0	0	246.909	246.909	6	1	53	318 OK	78%
SNB-L4	SNB-LF21	123.558	247.115	0	214.812	0	0	247.115	6	1	53	318 OK	78%
SNB-L4	SNB-LF22	123.922	0	247.039	0	214.488	0	247.039	6	1	53	318 OK	78%
SNB-L5	SNB-LG1P	0	0	0	0	0	276.774	276.774	6	1	53	318 OK	87%
SNB-L5	SNB-LG11	138.416	276.973	0	240.752	0	0	276.973	6	1	53	318 OK	87%
SNB-L5	SNB-LG12	138.783	0	276.894	0	240.418	0	276.894	6	1	53	318 OK	87%
SNB-L5	SNB-LG2P	0	0	0	0	0	309.704	309.704	6	1	53	318 OK	97%
SNB-L5	SNB-LG21	155.244	309.891	0	269.502	0	0	309.891	6	1	53	318 OK	97%
SNB-L5	SNB-LG22	155.674	0	309.828	0	269.146	0	309.828	6	1	53	318 OK	97%
SNB-L5	SNB-LH1P	0	0	0	0	0	340.682	340.682	6	1	53	318 No Good - Replace Bolt	107%
SNB-L5	SNB-LH11	170.602	340.861	0	296.401	0	0	340.861	6	1	53	318 No Good - Replace Bolt	107%
SNB-L5	SNB-LH12	171.042	0	340.801	0	296.043	0	340.801	6	1	53	318 No Good - Replace Bolt	107%
SNB-L5	SNB-LH2P	0	0	0	0	0	372.685	372.685	6	1	53	318 No Good - Replace Bolt	117%
SNB-L5	SNB-LH21	187.034	372.86	0	324.355	0	0	372.86	6	1	53	318 No Good - Replace Bolt	117%
SNB-L5	SNB-LH22	187.486	0	372.791	0	323.979	0	372.791	6	1	53	318 No Good - Replace Bolt	117%
SNB-L6	SNB-LI1P	0	0	0	0	0	405.171	405.171	8	1	53	424 OK	96%
SNB-L6	SNB-LI11	203.278	405.338	0	352.624	0	0	405.338	8	1	53	424 OK	96%
SNB-L6	SNB-LI12	203.746	0	405.269	0	352.242	0	405.269	8	1	53	424 OK	96%
SNB-L6	SNB-LI2P	0	0	0	0	0	441.619	441.619	8	1	53	424 No Good - Replace Bolt	104%
SNB-L6	SNB-LI21	222.073	441.779	0	384.497	0	0	441.779	8	1	53	424 No Good - Replace Bolt	104%
SNB-L6	SNB-LI22	222.56	0	441.711	0	384.107	0	441.711	8	1	53	424 No Good - Replace Bolt	104%

### Replaced Existing A325 Bolts with A490 Bolts

		Bolt Tension										Cap Percentage		
										Capacity		Factored Tensile Capacity		
										# Bolts Dia Bolt LRFD				
SNB-L5	SNB-LH1P	0	0	0	0	0	340.682	340.682	6	1	66.6	399.6 OK	85%	
SNB-L5	SNB-LH11	170.602	340.861	0	296.401	0	0	340.861	6	1	66.6	399.6 OK	85%	
SNB-L5	SNB-LH12	171.042	0	340.801	0	296.043	0	340.801	6	1	66.6	399.6 OK	85%	
SNB-L5	SNB-LH2P	0	0	0	0	0	372.685	372.685	6	1	66.6	399.6 OK	93%	
SNB-L5	SNB-LH21	187.034	372.86	0	324.355	0	0	372.86	6	1	66.6	399.6 OK	93%	
SNB-L5	SNB-LH22	187.486	0	372.791	0	323.979	0	372.791	6	1	66.6	399.6 OK	93%	
SNB-L6	SNB-LI1P	0	0	0	0	0	405.171	405.171	8	1	66.6	532.8 OK	76%	
SNB-L6	SNB-LI11	203.278	405.338	0	352.624	0	0	405.338	8	1	66.6	532.8 OK	76%	
SNB-L6	SNB-LI12	203.746	0	405.269	0	352.242	0	405.269	8	1	66.6	532.8 OK	76%	
SNB-L6	SNB-LI2P	0	0	0	0	0	441.619	441.619	8	1	66.6	532.8 OK	83%	
SNB-L6	SNB-LI21	222.073	441.779	0	384.497	0	0	441.779	8	1	66.6	532.8 OK	83%	
SNB-L6	SNB-LI22	222.56	0	441.711	0	384.107	0	441.711	8	1	66.6	532.8 OK	83%	

## CONNECTION BETWEEN TOWERS EVALUATION



Job 180' ROHN SSV Tower w/ SNB Reinf. - Greenwich Project No. \_\_\_\_\_ Page \_\_\_\_\_ of \_\_\_\_\_  
Description Tower to Tower Connection Force Computed by MCD Sheet \_\_\_\_\_ of \_\_\_\_\_  
TIA-222-G All Load Cases and with Ice Forces Checked by \_\_\_\_\_ Date 03/19/18  
Date \_\_\_\_\_

## **SUMMARY OF CONNECTION FORCES FOR ALL WIND ANGLES AND LOAD COMBINATIONS**

Loads Without Ice (V.asd wind Speed = 101 MPH)

Wind Angle	Force @ "Connection"
0 Deg	7.1811 kips
+60 Deg	3.5851 kips
-60 Deg	3.5911 kips
+90 Deg	6.0601 kips
-90 Deg	6.0631 kips

Loads With Design Ice 2.5 inch ("V" wind Speed = 50 MPH)

Wind Angle	Force @ "Connection"
0 Deg	8.5193 kips
+60 Deg	7.7883 kips
-60 Deg	7.7893 kips
+90 Deg	8.3143 kips
-90 Deg	8.3183 kips



Job 180' ROHN SSV Tower w/ SNB Reinf. - Greenwich Project No. \_\_\_\_\_ Sheet 1 of 1  
 Description Tower Connection - TIA-222-G Loads on Conection Computed by MCD Date 03/19/18  
 \_\_\_\_\_ Checked by \_\_\_\_\_ Date \_\_\_\_\_

Bolt Diameter	$\text{Dia}_{\text{bolt}} := \frac{3}{4} \text{ in}$	
Bolt Shear Capacity	$\text{Capacity}_{\text{bolt}} := 6.64 \text{ kip}$	Per AISC 15th Edition p. 7-24 for 3/4" A325 slip critical bolt (Considered as Long Slotted Hole) - LRFD
Shear Plane Area	$\text{Area}_{\text{plate}} := \frac{3}{8} \text{ in} \cdot \left( \frac{3}{4} \text{ in} + 1 \text{ in} \right)$	$\text{Area}_{\text{plate}} = 0.6563 \text{ in}^2$
Yield Strength of Plate	$F_{y\text{plate}} := 36 \text{ ksi}$	$\phi := 1.0$ LRFD Reduction Factor - AISC Chapter J
Plate Capacity	$\text{Capacity}_{\text{plate}} := 0.6 \text{ Area}_{\text{plate}} \cdot F_{y\text{plate}} \cdot \phi$	$\text{Capacity}_{\text{plate}} = 14.175 \text{ kip}$
U-Bolt Size	$\text{Dia}_{\text{ubolt}} := \frac{1}{2} \text{ in}$	
U-Bolt Area	$\text{Area}_{\text{ubolt}} := 2 \cdot \pi \left( \frac{\text{Dia}_{\text{ubolt}}}{2} \right)^2$	$\text{Area}_{\text{ubolt}} = 0.3927 \text{ in}^2$
	$F_{y\text{ubolt}} := 58 \text{ ksi}$	
	$\phi := 0.75$	LRFD Reduction Factor - AISC Chapter J
	$\text{Capacity}_{\text{ubolt}} := (0.75 \text{ Area}_{\text{ubolt}} \cdot F_{y\text{ubolt}}) \cdot \phi$	$\text{Capacity}_{\text{ubolt}} = 12.8118 \text{ kip}$
Connection Capacity	$\text{Capacity}_{\text{connection}} := \min(\text{Capacity}_{\text{bolt}}, \text{Capacity}_{\text{plate}}, \text{Capacity}_{\text{ubolt}})$	
	$\text{Capacity}_{\text{connection}} = 6.64 \text{ kip}$	
Max Connection Spacing	$\text{Spacing} := 5 \text{ ft}$	
Connection Capacity per Foot	$\text{Capacity}_{\text{LF}} := \frac{\text{Capacity}_{\text{connection}}}{\text{Spacing}}$	$\text{Capacity}_{\text{LF}} = 1.328 \frac{\text{kip}}{\text{ft}}$
Max Connection Force (Tension):	$F_{\text{max}} := 8.5193 \text{ kip}$	NOTE: Force obtained from TIA-222-G Load Combination #3 (PLS-TOWER program)
Connection Spacing in PLS-Tower	$\text{Spacing}_{\text{PLS.Tower}} := 10 \text{ ft}$	
Connection Force per Foot	$\text{Force}_{\text{LF}} := \frac{F_{\text{max}}}{\text{Spacing}_{\text{PLS.Tower}}}$	$\text{Force}_{\text{LF}} = 0.8519 \cdot \text{kip}$
Percent Capacity	$\text{Percent}_{\text{capacity}} := \frac{\text{Force}_{\text{LF}}}{\text{Capacity}_{\text{LF}}}$	$\text{Percent}_{\text{capacity}} = 64.2\%$

# FOUNDATION EVALUATION



From PLS-Tower Output Summary

Summary of Joint Support Reactions For All Load Cases:

Load Case	Joint Label	Long. Force (kips)	Tran. Force (kips)	Vert. Force (kips)	Shear Force (kips)	Tran. Moment (ft-k)	Long. Moment (ft-k)	Vert. Moment (ft-k)	Bending Moment (ft-k)	Found. Usage %
"-90"	1: 1.2D + 1.0Dg + 1.6Wo RohnJP	-0.91	3.86	19.69	3.96	-0.33	-0.28	0.01	0.43	0
	1: 1.2D + 1.0Dg + 1.6Wo SNB-JP	-0.4	6.41	18.36	6.43	0.68	-0.5	0.05	0.84	0
	1: 1.2D + 1.0Dg + 1.6Wo RohnJ1	11.15	22.46	303.01	25.08	-4.01	2.48	0.01	4.71	0
	1: 1.2D + 1.0Dg + 1.6Wo RohnJ2	-10.18	20.85	-263.32	23.2	-3.68	-2	0.02	4.19	0
	1: 1.2D + 1.0Dg + 1.6Wo SNB-J1	18.74	38.86	434.47	43.15	-9.64	6.16	-0.03	11.44	0
"-60"	1: 1.2D + 1.0Dg + 1.6Wo SNB-J2	-18.35	38.17	-397.08	42.36	-9.04	-5.43	-0.02	10.54	0
	1: 1.2D + 1.0Dg + 1.6Wo RohnJP	-14.67	3.32	181.76	15.04	-0.18	-2.82	0.01	2.82	0
	1: 1.2D + 1.0Dg + 1.6Wo SNB-JP	-24.73	5.47	256.28	25.33	0.76	-6.75	0.05	6.8	0
	1: 1.2D + 1.0Dg + 1.6Wo RohnJ1	4.9	14.14	181.97	14.96	-2.4	1.49	0	2.82	0
	1: 1.2D + 1.0Dg + 1.6Wo RohnJ2	-13.51	22.88	-304.36	26.57	-4.11	-2.53	0.01	4.83	0
"0"	1: 1.2D + 1.0Dg + 1.6Wo SNB-J1	7.66	24.18	256.63	25.36	-5.47	4.05	-0.05	6.81	0
	1: 1.2D + 1.0Dg + 1.6Wo SNB-J2	-24.15	41.83	-457.17	48.3	-10.5	-6.07	0	12.13	0
	1: 1.2D + 1.0Dg + 1.6Wo RohnJP	-29.67	0.11	355.57	29.67	-0.06	-5.55	-0.01	5.55	0
	1: 1.2D + 1.0Dg + 1.6Wo SNB-JP	-51.25	0	512.04	51.25	0	-13.5	0	13.5	0
	1: 1.2D + 1.0Dg + 1.6Wo RohnJ1	-9.49	-10.04	-147.95	13.81	1.91	-1.42	0	2.39	0
"60"	1: 1.2D + 1.0Dg + 1.6Wo RohnJ2	-9.7	9.95	-148.25	13.89	-1.86	-1.53	-0.01	2.41	0
	1: 1.2D + 1.0Dg + 1.6Wo SNB-J1	-17.54	-18.77	-227.91	25.69	5.44	-2.7	-0.03	6.07	0
	1: 1.2D + 1.0Dg + 1.6Wo SNB-J2	-17.56	18.8	-228.39	25.73	-5.44	-2.71	0.03	6.08	0
	1: 1.2D + 1.0Dg + 1.6Wo RohnJP	-14.7	-3.21	182.17	15.04	0.12	-2.82	-0.02	2.82	0
	1: 1.2D + 1.0Dg + 1.6Wo SNB-JP	-24.77	-5.47	256.83	25.36	-0.76	-6.76	-0.05	6.81	0
"90"	1: 1.2D + 1.0Dg + 1.6Wo RohnJ1	-13.41	-22.94	-304.46	26.57	4.14	-2.48	-0.01	4.83	0
	1: 1.2D + 1.0Dg + 1.6Wo RohnJ2	4.79	-14.17	181.66	14.96	2.42	1.44	-0.01	2.82	0
	1: 1.2D + 1.0Dg + 1.6Wo SNB-J1	-24.15	-41.83	-457.27	48.3	10.51	-6.06	0	12.13	0
	1: 1.2D + 1.0Dg + 1.6Wo SNB-J2	7.64	-24.15	256.17	25.33	5.46	4.05	0.05	6.8	0
	1: 1.2D + 1.0Dg + 1.6Wo RohnJP	-0.94	-3.86	20.17	3.97	0.33	-0.29	-0.01	0.44	0
"1.2*DL"	1: 1.2D + 1.0Dg + 1.6Wo SNB-JP	-0.44	-6.41	18.99	6.43	-0.68	-0.51	-0.05	0.85	0
	1: 1.2D + 1.0Dg + 1.6Wo RohnJ1	-10.19	-20.86	-263.65	23.22	3.68	-2	-0.02	4.19	0
	1: 1.2D + 1.0Dg + 1.6Wo RohnJ2	11.15	-22.45	302.86	25.07	4	2.48	-0.01	4.71	0
	1: 1.2D + 1.0Dg + 1.6Wo SNB-J1	-18.36	-38.19	-397.5	42.38	9.05	-5.43	0.02	10.55	0
	1: 1.2D + 1.0Dg + 1.6Wo SNB-J2	18.74	-38.84	434.25	43.13	9.63	6.16	0.03	11.43	0
"1.2*DL"	1.2*DL RohnJP	-1.07	0	19.97	1.07	0	-0.28	0	0.28	0
	1.2*DL SNB-JP	-0.55	0	18.61	0.55	0	-0.48	0	0.48	0
	1.2*DL RohnJ1	0.53	0.92	19.79	1.07	-0.24	0.14	0	0.28	0
	1.2*DL RohnJ2	0.54	-0.92	19.88	1.07	0.24	0.14	0	0.28	0
	1.2*DL SNB-J1	0.28	0.48	18.39	0.55	-0.41	0.24	0	0.48	0
1.2*DL SNB-J2	0.28	-0.48	18.49	0.55	0.41	0.24	0	0.48	0	

Load Case	Joint Label	Vert. Tower Forces (k)	Leg Moment Arm (ft)	Moment (ft-k)	Total Moment (ft-k)	Shear (k)	Total Shear (k)
-90 deg	RohnJP	-0.28	0.00	0.00	14302.7	3.96	144.2
-90 deg	SNB-JP	-0.25	0.00	0.00		6.43	
-90 deg	RohnJ1	283.22	11.42	3234.37		25.08	
-90 deg	RohnJ2	-283.2	-11.42	3234.14		23.20	
-90 deg	SNB-J1	416.08	9.42	3919.47		43.15	
-90 deg	SNB-J2	-415.57	-9.42	3914.67		42.36	
-60 deg	RohnJP	161.79	6.60	1067.81	14175.8	15.04	155.6
-60 deg	SNB-JP	237.67	5.44	1292.92		25.33	
-60 deg	RohnJ1	162.18	6.60	1070.39		14.96	
-60 deg	RohnJ2	-324.24	-13.18	4273.48		26.57	
-60 deg	SNB-J1	238.24	5.44	1296.03		25.36	
-60 deg	SNB-J2	-475.66	-10.88	5175.18		48.30	
0 deg	RohnJP	335.6	13.18	4423.21	14691.4	29.67	160.0
0 deg	SNB-JP	493.43	10.88	5368.52		51.25	
0 deg	RohnJ1	-167.74	-6.60	1107.08		13.81	
0 deg	RohnJ2	-168.13	-6.60	1109.66		13.89	
0 deg	SNB-J1	-246.3	-5.44	1339.87		25.69	
0 deg	SNB-J2	-246.88	-5.44	1343.03		25.73	
+60 deg	RohnJP	162.2	6.60	1070.52	14176.0	15.04	155.6
+60 deg	SNB-JP	238.22	5.44	1295.92		25.36	
+60 deg	RohnJ1	-324.25	-13.18	4273.62		26.57	
+60 deg	RohnJ2	161.78	6.60	1067.75		14.96	
+60 deg	SNB-J1	-475.66	-10.88	5175.18		48.30	
+60 deg	SNB-J2	237.68	5.44	1292.98		25.33	
+90 deg	RohnJP	0.2	0.00	0.00	14302.7	3.97	144.2
+90 deg	SNB-JP	0.38	0.00	0.00		6.43	
+90 deg	RohnJ1	-283.44	-11.42	3236.88		23.22	
+90 deg	RohnJ2	282.98	11.42	3231.63		25.07	
+90 deg	SNB-J1	-415.89	-9.42	3917.68		42.38	
+90 deg	SNB-J2	415.76	9.42	3916.46		43.13	

Forces taken from PLS-Tower output with 1.2\*DL Only load case subtracted from Vertical Tower Forces

Dimensions taken from CAD drawing

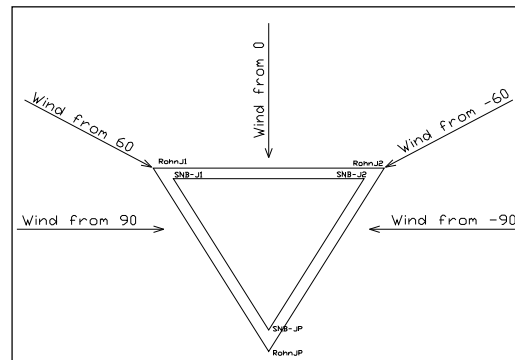



Job	180' ROHN SSV Tower w/ SNB Reinf. - Greenwich	Project No.	Page	_____	of	_____
Description	Overturing Moment Calculation	Computed by	Sheet	_____	of	_____
	TIA-222-G Load Case #2	Checked by	Date	_____	_____	_____
			Date	_____	_____	_____

From PLS-Tower Output Summary

Summary of Joint Support Reactions For All Load Cases:

Load Case	Joint Label	Long. Force (kips)	Tran. Force (kips)	Vert. Force (kips)	Shear Force (kips)	Tran. Moment (ft-k)	Long. Moment (ft-k)	Vert. Moment (ft-k)	Bending Moment (ft-k)	Found. Usage %
"-90"	2: 0.9D + 1.0Dg + 1.6Wo RohnJP	-0.64	3.86	14.7	3.92	-0.34	-0.21	0.01	0.4	0
	2: 0.9D + 1.0Dg + 1.6Wo SNB-JP	-0.26	6.42	13.7	6.42	0.66	-0.38	0.05	0.76	0
	2: 0.9D + 1.0Dg + 1.6Wo RohnJ1	11.02	22.23	297.69	24.81	-3.95	2.44	0.01	4.64	0
	2: 0.9D + 1.0Dg + 1.6Wo RohnJ2	-10.32	21.08	-267.92	23.47	-3.73	-2.03	0.02	4.25	0
	2: 0.9D + 1.0Dg + 1.6Wo SNB-J1	18.67	38.74	429.38	43	-9.53	6.09	-0.03	11.31	0
"-60"	2: 0.9D + 1.0Dg + 1.6Wo SNB-J2	-18.41	38.29	-401.21	42.49	-9.14	-5.48	-0.02	10.65	0
	2: 0.9D + 1.0Dg + 1.6Wo RohnJP	-14.4	3.33	176.56	14.78	-0.19	-2.75	0.01	2.75	0
	2: 0.9D + 1.0Dg + 1.6Wo SNB-JP	-24.59	5.48	251.34	25.19	0.75	-6.63	0.05	6.67	0
	2: 0.9D + 1.0Dg + 1.6Wo RohnJ1	4.76	13.91	176.82	14.7	-2.34	1.44	0	2.75	0
	2: 0.9D + 1.0Dg + 1.6Wo RohnJ2	-13.64	23.11	-308.9	26.84	-4.17	-2.56	0.01	4.9	0
"0"	2: 0.9D + 1.0Dg + 1.6Wo SNB-J1	7.58	24.06	251.75	25.23	-5.37	3.97	-0.05	6.68	0
	2: 0.9D + 1.0Dg + 1.6Wo SNB-J2	-24.22	41.94	-461.23	48.43	-10.6	-6.12	0	12.24	0
	2: 0.9D + 1.0Dg + 1.6Wo RohnJP	-29.4	0.11	350.14	29.4	-0.06	-5.48	-0.01	5.48	0
	2: 0.9D + 1.0Dg + 1.6Wo SNB-JP	-51.11	0	506.81	51.11	0	-13.37	0	13.37	0
	2: 0.9D + 1.0Dg + 1.6Wo RohnJ1	-9.63	-10.26	-152.67	14.07	1.97	-1.46	0	2.45	0
"60"	2: 0.9D + 1.0Dg + 1.6Wo RohnJ2	-9.83	10.17	-153	14.15	-1.91	-1.57	-0.01	2.47	0
	2: 0.9D + 1.0Dg + 1.6Wo SNB-J1	-17.61	-18.88	-232.22	25.82	5.53	-2.77	-0.03	6.18	0
	2: 0.9D + 1.0Dg + 1.6Wo SNB-J2	-17.63	18.92	-232.72	25.86	-5.54	-2.77	0.03	6.19	0
	2: 0.9D + 1.0Dg + 1.6Wo RohnJP	-14.43	-3.22	176.97	14.78	0.13	-2.75	-0.02	2.75	0
	2: 0.9D + 1.0Dg + 1.6Wo SNB-JP	-24.63	-5.47	251.9	25.23	-0.75	-6.64	-0.05	6.68	0
"90"	2: 0.9D + 1.0Dg + 1.6Wo RohnJ1	-13.54	-23.17	-308.98	26.84	4.2	-2.51	-0.01	4.89	0
	2: 0.9D + 1.0Dg + 1.6Wo RohnJ2	4.66	-13.94	176.48	14.7	2.37	1.39	-0.01	2.75	0
	2: 0.9D + 1.0Dg + 1.6Wo SNB-J1	-24.22	-41.94	-461.3	48.43	10.6	-6.12	0	12.24	0
	2: 0.9D + 1.0Dg + 1.6Wo SNB-J2	7.56	-24.03	251.27	25.19	5.36	3.97	0.05	6.67	0
	2: 0.9D + 1.0Dg + 1.6Wo RohnJP	-0.67	-3.86	15.18	3.92	0.34	-0.22	-0.01	0.4	0
"0.9*DL"	2: 0.9D + 1.0Dg + 1.6Wo SNB-JP	-0.3	-6.42	14.33	6.42	-0.67	-0.39	-0.05	0.77	0
	2: 0.9D + 1.0Dg + 1.6Wo RohnJ1	-10.32	-21.09	-268.22	23.48	3.74	-2.03	-0.02	4.26	0
	2: 0.9D + 1.0Dg + 1.6Wo RohnJ2	11.01	-22.22	297.52	24.8	3.94	2.44	-0.01	4.64	0
	2: 0.9D + 1.0Dg + 1.6Wo SNB-J1	-18.43	-38.31	-401.61	42.51	9.15	-5.48	0.02	10.66	0
	2: 0.9D + 1.0Dg + 1.6Wo SNB-J2	18.66	-38.72	429.13	42.98	9.53	6.09	0.03	11.31	0
"0.9*DL"	0.9DL RohnJP	-0.8	0	14.97	0.8	0	-0.21	0	0.21	0
	0.9DL SNB-JP	-0.41	0	13.95	0.41	0	-0.36	0	0.36	0
	0.9DL RohnJ1	0.4	0.69	14.84	0.8	-0.18	0.1	0	0.21	0
	0.9DL RohnJ2	0.4	-0.69	14.91	0.8	0.18	0.1	0	0.21	0
	0.9DL SNB-J1	0.21	0.36	13.79	0.41	-0.31	0.18	0	0.36	0
0.9DL SNB-J2	0.21	-0.36	13.87	0.41	0.31	0.18	0	0.36	0	



Job 180' ROHN SSV Tower w/ SNB Reinf. - Greenwich  
 Description Overtuning Moment Calculation  
TIA-222-G Load Case #2

Project No. \_\_\_\_\_  
 Computed by MCD  
 Checked by \_\_\_\_\_

Page \_\_\_\_\_ of \_\_\_\_\_  
 Sheet \_\_\_\_\_ of \_\_\_\_\_  
 Date 03/19/18  
 Date \_\_\_\_\_

Load Case	Joint Label	Vert. Tower Forces (k)	Leg Moment Arm (ft)	Moment (ft-k)	Total Moment (ft-k)	Shear (k)	Total Shear (k)
-90 deg	RohnJP	-0.27	0.00	0.00	14285.0	3.92	144.1
-90 deg	SNB-JP	-0.25	0.00	0.00		6.42	
-90 deg	RohnJ1	282.85	11.42	3230.15		24.81	
-90 deg	RohnJ2	-282.83	-11.42	3229.92		23.47	
-90 deg	SNB-J1	415.59	9.42	3914.86		43.00	
-90 deg	SNB-J2	-415.08	-9.42	3910.05		42.49	
-60 deg	RohnJP	161.59	6.60	1066.49	14158.4	14.78	155.2
-60 deg	SNB-JP	237.39	5.44	1291.40		25.19	
-60 deg	RohnJ1	161.98	6.60	1069.07		14.70	
-60 deg	RohnJ2	-323.81	-13.18	4267.82		26.84	
-60 deg	SNB-J1	237.96	5.44	1294.50		25.23	
-60 deg	SNB-J2	-475.1	-10.88	5169.09		48.43	
0 deg	RohnJP	335.17	13.18	4417.54	14673.4	29.40	160.4
0 deg	SNB-JP	492.86	10.88	5362.32		51.11	
0 deg	RohnJ1	-167.51	-6.60	1105.57		14.07	
0 deg	RohnJ2	-167.91	-6.60	1108.21		14.15	
0 deg	SNB-J1	-246.01	-5.44	1338.29		25.82	
0 deg	SNB-J2	-246.59	-5.44	1341.45		25.86	
+60 deg	RohnJP	162	6.60	1069.20	14158.4	14.78	155.2
+60 deg	SNB-JP	237.95	5.44	1294.45		25.23	
+60 deg	RohnJ1	-323.82	-13.18	4267.95		26.84	
+60 deg	RohnJ2	161.57	6.60	1066.36		14.70	
+60 deg	SNB-J1	-475.09	-10.88	5168.98		48.43	
+60 deg	SNB-J2	237.4	5.44	1291.46		25.19	
+90 deg	RohnJP	0.21	0.00	0.00	14284.8	3.92	144.1
+90 deg	SNB-JP	0.38	0.00	0.00		6.42	
+90 deg	RohnJ1	-283.06	-11.42	3232.55		23.48	
+90 deg	RohnJ2	282.61	11.42	3227.41		24.80	
+90 deg	SNB-J1	-415.4	-9.42	3913.07		42.51	
+90 deg	SNB-J2	415.26	9.42	3911.75		42.98	

Forces taken from PLS-Tower output with 0.9\*DL Only load case subtracted from Vertical Tower Forces

Dimensions taken from CAD drawing

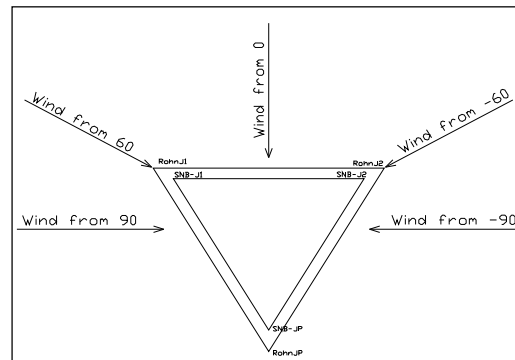



Job 180' ROHN SSV Tower w/ SNB Reinf. - Greenwich  
 Description Overturning Moment Calculation  
TIA-222-G Load Case #3

Project No. \_\_\_\_\_  
 Computed by MCD  
 Checked by \_\_\_\_\_

Page \_\_\_\_\_ of \_\_\_\_\_  
 Sheet \_\_\_\_\_ of \_\_\_\_\_  
 Date 03/19/18  
 Date \_\_\_\_\_

From PLS-Tower Output Summary

Summary of Joint Support Reactions For All Load Cases:

Load Case	Joint Label	Long. Force (kips)	Tran. Force (kips)	Vert. Force (kips)	Shear Force (kips)	Tran. Moment (ft-k)	Long. Moment (ft-k)	Vert. Moment (ft-k)	Bending Moment (ft-k)	Found. Usage %
"-90"	3: 1.2D + 1.0Dg + 1.0 Di + 1.0 Wi + 1.0 Ti RohnJP	0.09	1.4	160.75	1.4	0.05	1.67	0.01	1.67	0
	3: 1.2D + 1.0Dg + 1.0 Di + 1.0 Wi + 1.0 Ti SNB-JP	3.79	1.95	183.19	4.26	0.47	4.44	0.02	4.47	0
	3: 1.2D + 1.0Dg + 1.0 Di + 1.0 Wi + 1.0 Ti RohnJ1	3.9	8.07	263.34	8.97	0.15	-0.02	0	0.16	0
	3: 1.2D + 1.0Dg + 1.0 Di + 1.0 Wi + 1.0 Ti RohnJ2	-3.99	8.22	58.05	9.14	-2.75	-1.62	0	3.2	0
	3: 1.2D + 1.0Dg + 1.0 Di + 1.0 Wi + 1.0 Ti SNB-J1	4.44	9.63	330.92	10.61	0.71	-0.11	-0.01	0.72	0
"-60"	3: 1.2D + 1.0Dg + 1.0 Di + 1.0 Wi + 1.0 Ti SNB-J2	-8.23	16.19	35.31	18.16	-7.02	-4.3	-0.01	8.23	0
	3: 1.2D + 1.0Dg + 1.0 Di + 1.0 Wi + 1.0 Ti RohnJP	-5.11	1.2	220.03	5.25	0.06	0.79	0.01	0.79	0
	3: 1.2D + 1.0Dg + 1.0 Di + 1.0 Wi + 1.0 Ti SNB-JP	-4.48	1.68	268.51	4.78	0.44	2.27	0.02	2.31	0
	3: 1.2D + 1.0Dg + 1.0 Di + 1.0 Wi + 1.0 Ti RohnJ1	1.55	5.01	219.89	5.24	0.72	-0.32	0	0.79	0
	3: 1.2D + 1.0Dg + 1.0 Di + 1.0 Wi + 1.0 Ti RohnJ2	-5.26	9.08	42.22	10.49	-2.97	-1.72	0	3.43	0
"0"	3: 1.2D + 1.0Dg + 1.0 Di + 1.0 Wi + 1.0 Ti SNB-J1	0.79	4.72	268.35	4.78	2.18	-0.75	-0.02	2.31	0
	3: 1.2D + 1.0Dg + 1.0 Di + 1.0 Wi + 1.0 Ti SNB-J2	-10.16	17.6	12.56	20.33	-7.63	-4.4	0	8.81	0
	3: 1.2D + 1.0Dg + 1.0 Di + 1.0 Wi + 1.0 Ti RohnJP	-10.41	-0.01	279.7	10.41	0	-0.1	0	0.1	0
	3: 1.2D + 1.0Dg + 1.0 Di + 1.0 Wi + 1.0 Ti SNB-JP	-12.89	0	354.5	12.89	0	0.07	0	0.07	0
	3: 1.2D + 1.0Dg + 1.0 Di + 1.0 Wi + 1.0 Ti RohnJ1	-3.72	-4.02	101.16	5.47	2.23	-1.25	0	2.55	0
"60"	3: 1.2D + 1.0Dg + 1.0 Di + 1.0 Wi + 1.0 Ti RohnJ2	-3.7	4.03	101.28	5.47	-2.23	-1.24	0	2.55	0
	3: 1.2D + 1.0Dg + 1.0 Di + 1.0 Wi + 1.0 Ti SNB-J1	-7.55	-9.65	97.41	12.25	5.94	-2.99	-0.02	6.65	0
	3: 1.2D + 1.0Dg + 1.0 Di + 1.0 Wi + 1.0 Ti SNB-J2	-7.54	9.65	97.52	12.25	-5.94	-2.98	0.02	6.65	0
	3: 1.2D + 1.0Dg + 1.0 Di + 1.0 Wi + 1.0 Ti RohnJP	-5.12	-1.21	220.1	5.26	-0.06	0.79	-0.01	0.79	0
	3: 1.2D + 1.0Dg + 1.0 Di + 1.0 Wi + 1.0 Ti SNB-JP	-4.48	-1.68	268.61	4.79	-0.44	2.26	-0.02	2.31	0
"90"	3: 1.2D + 1.0Dg + 1.0 Di + 1.0 Wi + 1.0 Ti RohnJ1	-5.27	-9.07	42.03	10.49	2.96	-1.73	0	3.43	0
	3: 1.2D + 1.0Dg + 1.0 Di + 1.0 Wi + 1.0 Ti RohnJ2	1.56	-5	220.01	5.24	-0.73	-0.32	0	0.79	0
	3: 1.2D + 1.0Dg + 1.0 Di + 1.0 Wi + 1.0 Ti SNB-J1	-10.17	-17.6	12.35	20.33	7.63	-4.41	0	8.81	0
	3: 1.2D + 1.0Dg + 1.0 Di + 1.0 Wi + 1.0 Ti SNB-J2	0.79	-4.71	268.46	4.78	-2.19	-0.75	0.02	2.31	0
	3: 1.2D + 1.0Dg + 1.0 Di + 1.0 Wi + 1.0 Ti RohnJP	0.09	-1.39	160.84	1.4	-0.06	1.66	-0.01	1.67	0
"1.2*DL"	3: 1.2D + 1.0Dg + 1.0 Di + 1.0 Wi + 1.0 Ti SNB-JP	3.78	-1.95	183.29	4.26	-0.48	4.44	-0.02	4.47	0
	3: 1.2D + 1.0Dg + 1.0 Di + 1.0 Wi + 1.0 Ti RohnJ1	-3.99	-8.23	57.82	9.14	2.75	-1.63	0	3.2	0
	3: 1.2D + 1.0Dg + 1.0 Di + 1.0 Wi + 1.0 Ti RohnJ2	3.91	-8.07	263.49	8.97	-0.15	-0.02	0	0.16	0
	3: 1.2D + 1.0Dg + 1.0 Di + 1.0 Wi + 1.0 Ti SNB-J1	-8.23	-16.2	35.05	18.17	7.02	-4.3	0.01	8.23	0
	3: 1.2D + 1.0Dg + 1.0 Di + 1.0 Wi + 1.0 Ti SNB-J2	4.44	-9.63	331.08	10.61	-0.71	-0.1	0.01	0.72	0
1.2*DL	RohnJP	-1.07	0	19.97	1.07	0	-0.28	0	0.28	0
1.2*DL	SNB-JP	-0.55	0	18.61	0.55	0	-0.48	0	0.48	0
1.2*DL	RohnJ1	0.53	0.92	19.79	1.07	-0.24	0.14	0	0.28	0
1.2*DL	RohnJ2	0.54	-0.92	19.88	1.07	0.24	0.14	0	0.28	0
1.2*DL	SNB-J1	0.28	0.48	18.39	0.55	-0.41	0.24	0	0.48	0
1.2*DL	SNB-J2	0.28	-0.48	18.49	0.55	0.41	0.24	0	0.48	0



Job 180' ROHN SSV Tower w/ SNB Reinf. - Greenwich  
 Description Overtuning Moment Calculation  
TIA-222-G Load Case #3

Project No. \_\_\_\_\_  
 Computed by MCD  
 Checked by \_\_\_\_\_

Page \_\_\_\_\_ of \_\_\_\_\_  
 Sheet \_\_\_\_\_ of \_\_\_\_\_  
 Date 03/19/18  
 Date \_\_\_\_\_

Load Case	Joint Label	Vert. Tower Forces (k)	Leg Moment Arm (ft)	Moment (ft-k)	Total Moment (ft-k)	Shear (k)	Total Shear (k)
-90 deg	RohnJP	140.78	0.00	0.00	5131.0	1.40	52.5
-90 deg	SNB-JP	164.58	0.00	0.00		4.26	
-90 deg	RohnJ1	243.55	11.42	2781.34		8.97	
-90 deg	RohnJ2	38.17	-11.42	-435.90		9.14	
-90 deg	SNB-J1	312.53	9.42	2944.03		10.61	
-90 deg	SNB-J2	16.82	-9.42	-158.44		18.16	
-60 deg	RohnJP	200.06	6.60	1320.40	5130.4	5.25	50.9
-60 deg	SNB-JP	249.9	5.44	1359.46		4.78	
-60 deg	RohnJ1	200.1	6.60	1320.66		5.24	
-60 deg	RohnJ2	22.34	-13.18	-294.44		10.49	
-60 deg	SNB-J1	249.96	5.44	1359.78		4.78	
-60 deg	SNB-J2	-5.93	-10.88	64.52		20.33	
0 deg	RohnJP	259.73	13.18	3423.24	5143.7	10.41	58.7
0 deg	SNB-JP	335.89	10.88	3654.48		12.89	
0 deg	RohnJ1	81.37	-6.60	-537.04		5.47	
0 deg	RohnJ2	81.4	-6.60	-537.24		5.47	
0 deg	SNB-J1	79.02	-5.44	-429.87		12.25	
0 deg	SNB-J2	79.03	-5.44	-429.92		12.25	
+60 deg	RohnJP	200.13	6.60	1320.86	5134.1	5.26	50.9
+60 deg	SNB-JP	250	5.44	1360.00		4.79	
+60 deg	RohnJ1	22.24	-13.18	-293.12		10.49	
+60 deg	RohnJ2	200.13	6.60	1320.86		5.24	
+60 deg	SNB-J1	-6.04	-10.88	65.72		20.33	
+60 deg	SNB-J2	249.97	5.44	1359.84		4.78	
+90 deg	RohnJP	140.87	0.00	0.00	5135.4	1.40	52.6
+90 deg	SNB-JP	164.68	0.00	0.00		4.26	
+90 deg	RohnJ1	38.03	-11.42	-434.30		9.14	
+90 deg	RohnJ2	243.61	11.42	2782.03		8.97	
+90 deg	SNB-J1	16.66	-9.42	-156.94		18.17	
+90 deg	SNB-J2	312.59	9.42	2944.60		10.61	

Forces taken from PLS-Tower output with 1.2\*DL Only load case subtracted from Vertical Tower Forces

Dimensions taken from CAD drawing

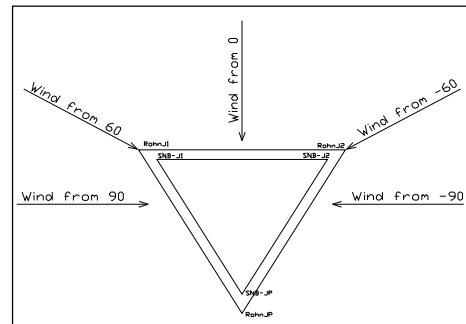





From PLS-Tower Output Summary

Summary of Joint Support Reactions For All Load Cases:

Load Case	Joint Label	Long. Force (kips)	Tran. Force (kips)	Vert. Force (kips)	Shear Force (kips)	Tran. Moment (ft-k)	Long. Moment (ft-k)	Vert. Moment (ft-k)	Bending Moment (ft-k)	Found. Usage %	
"-90"	4: 1.2D + 1.0Dg + 1.0E	RohnJP	-1.07	0.1	19.97	1.07	0.04	-0.28	0	0.28	0
	4: 1.2D + 1.0Dg + 1.0E	SNB-JP	-0.55	0.15	18.61	0.57	0.18	-0.48	0.01	0.51	0
	4: 1.2D + 1.0Dg + 1.0E	RohnJ1	1.14	2.03	38.59	2.33	-0.43	0.29	0	0.52	0
	4: 1.2D + 1.0Dg + 1.0E	RohnJ2	-0.07	0.19	1.07	0.2	0.04	-0.01	0	0.04	0
	4: 1.2D + 1.0Dg + 1.0E	SNB-J1	1.3	2.39	45.12	2.72	-0.89	0.62	0	1.09	0
"-60"	4: 1.2D + 1.0Dg + 1.0E	SNB-J2	-0.74	1.44	-8.25	1.62	-0.07	-0.14	0	0.16	0
	4: 1.2D + 1.0Dg + 1.0E	RohnJP	-1.8	0.09	30.82	1.8	0.04	-0.42	0	0.42	0
	4: 1.2D + 1.0Dg + 1.0E	SNB-JP	-1.8	0.13	34.05	1.81	0.16	-0.83	0.01	0.84	0
	4: 1.2D + 1.0Dg + 1.0E	RohnJ1	0.85	1.59	30.64	1.8	-0.34	0.25	0	0.42	0
	4: 1.2D + 1.0Dg + 1.0E	RohnJ2	-0.21	0.34	-1.83	0.4	0	-0.01	0	0.01	0
"0"	4: 1.2D + 1.0Dg + 1.0E	SNB-J1	0.79	1.62	33.82	1.81	-0.64	0.55	-0.01	0.84	0
	4: 1.2D + 1.0Dg + 1.0E	SNB-J2	-0.97	1.69	-12.38	1.95	-0.19	-0.11	0	0.22	0
	4: 1.2D + 1.0Dg + 1.0E	RohnJP	-2.53	0	41.68	2.53	0	-0.56	0	0.56	0
	4: 1.2D + 1.0Dg + 1.0E	SNB-JP	-3.06	0	49.49	3.06	0	-1.18	0	1.18	0
	4: 1.2D + 1.0Dg + 1.0E	RohnJ1	0.11	0.32	8.93	0.34	-0.09	0.11	0	0.14	0
"60"	4: 1.2D + 1.0Dg + 1.0E	RohnJ2	0.1	-0.33	9.02	0.34	0.1	0.1	0	0.14	0
	4: 1.2D + 1.0Dg + 1.0E	SNB-J1	-0.46	-0.55	2.95	0.71	-0.03	0.2	-0.01	0.2	0
	4: 1.2D + 1.0Dg + 1.0E	SNB-J2	-0.46	0.55	3.05	0.71	0.03	0.2	0.01	0.2	0
	4: 1.2D + 1.0Dg + 1.0E	RohnJP	-1.8	-0.08	30.82	1.8	-0.04	-0.42	0	0.42	0
	4: 1.2D + 1.0Dg + 1.0E	SNB-JP	-1.8	-0.12	34.05	1.81	-0.16	-0.83	-0.01	0.84	0
"90"	4: 1.2D + 1.0Dg + 1.0E	RohnJ1	-0.21	-0.34	-1.92	0.4	0	-0.01	0	0.01	0
	4: 1.2D + 1.0Dg + 1.0E	RohnJ2	0.85	-1.59	30.73	1.8	0.34	0.25	0	0.42	0
	4: 1.2D + 1.0Dg + 1.0E	SNB-J1	-0.98	-1.69	-12.49	1.95	0.19	-0.11	0	0.22	0
	4: 1.2D + 1.0Dg + 1.0E	SNB-J2	0.79	-1.62	33.93	1.81	0.64	0.55	0.01	0.84	0
	4: 1.2D + 1.0Dg + 1.0E	RohnJP	-1.07	-0.1	19.97	1.07	-0.04	-0.28	0	0.28	0
"1.2*DL"	4: 1.2D + 1.0Dg + 1.0E	SNB-JP	-0.55	-0.14	18.61	0.57	-0.18	-0.48	-0.01	0.51	0
	4: 1.2D + 1.0Dg + 1.0E	RohnJ1	-0.08	-0.19	0.98	0.2	-0.04	-0.01	0	0.04	0
	4: 1.2D + 1.0Dg + 1.0E	RohnJ2	1.14	-2.04	38.68	2.34	0.43	0.29	0	0.52	0
	4: 1.2D + 1.0Dg + 1.0E	SNB-J1	-0.75	-1.44	-8.35	1.62	0.07	-0.14	0	0.16	0
	4: 1.2D + 1.0Dg + 1.0E	SNB-J2	1.3	-2.39	45.23	2.72	0.89	0.62	0	1.09	0
	1.2*DL	RohnJP	-1.07	0	19.97	1.07	0	-0.28	0	0.28	0
1.2*DL	SNB-JP	-0.55	0	18.61	0.55	0	-0.48	0	0.48	0	
1.2*DL	RohnJ1	0.53	0.92	19.79	1.07	-0.24	0.14	0	0.28	0	
1.2*DL	RohnJ2	0.54	-0.92	19.88	1.07	0.24	0.14	0	0.28	0	
1.2*DL	SNB-J1	0.28	0.48	18.39	0.55	-0.41	0.24	0	0.48	0	
1.2*DL	SNB-J2	0.28	-0.48	18.49	0.55	0.41	0.24	0	0.48	0	



Job 180' ROHN SSV Tower w/ SNB Reinf. - Greenwich  
 Description Overtuning Moment Calculation  
TIA-222-G Load Case #4

Project No. \_\_\_\_\_  
 Computed by MCD  
 Checked by \_\_\_\_\_

Page \_\_\_\_\_ of \_\_\_\_\_  
 Sheet \_\_\_\_\_ of \_\_\_\_\_  
 Date 03/19/18  
 Date \_\_\_\_\_

Load Case	Joint Label	Vert. Tower Forces (k)	Leg Moment Arm (ft)	Moment (ft-k)	Total Moment (ft-k)	Shear (k)	Total Shear (k)
-90 deg	RohnJP	0	0.00	0.00	933.2	1.07	8.5
-90 deg	SNB-JP	0	0.00	0.00		0.57	
-90 deg	RohnJ1	18.8	11.42	214.70		2.33	
-90 deg	RohnJ2	-18.81	-11.42	214.81		0.20	
-90 deg	SNB-J1	26.73	9.42	251.80		2.72	
-90 deg	SNB-J2	-26.74	-9.42	251.89		1.62	
-60 deg	RohnJP	10.85	6.60	71.61	933.2	1.80	9.6
-60 deg	SNB-JP	15.44	5.44	83.99		1.81	
-60 deg	RohnJ1	10.85	6.60	71.61		1.80	
-60 deg	RohnJ2	-21.71	-13.18	286.14		0.40	
-60 deg	SNB-J1	15.43	5.44	83.94		1.81	
-60 deg	SNB-J2	-30.87	-10.88	335.87		1.95	
0 deg	RohnJP	21.71	13.18	286.14	933.5	2.53	7.7
0 deg	SNB-JP	30.88	10.88	335.97		3.06	
0 deg	RohnJ1	-10.86	-6.60	71.68		0.34	
0 deg	RohnJ2	-10.86	-6.60	71.68		0.34	
0 deg	SNB-J1	-15.44	-5.44	83.99		0.71	
0 deg	SNB-J2	-15.44	-5.44	83.99		0.71	
+60 deg	RohnJP	10.85	6.60	71.61	933.3	1.80	9.6
+60 deg	SNB-JP	15.44	5.44	83.99		1.81	
+60 deg	RohnJ1	-21.71	-13.18	286.14		0.40	
+60 deg	RohnJ2	10.85	6.60	71.61		1.80	
+60 deg	SNB-J1	-30.88	-10.88	335.97		1.95	
+60 deg	SNB-J2	15.44	5.44	83.99		1.81	
+90 deg	RohnJP	0	0.00	0.00	933.3	1.07	8.5
+90 deg	SNB-JP	0	0.00	0.00		0.57	
+90 deg	RohnJ1	-18.81	-11.42	214.81		0.20	
+90 deg	RohnJ2	18.8	11.42	214.70		2.34	
+90 deg	SNB-J1	-26.74	-9.42	251.89		1.62	
+90 deg	SNB-J2	26.74	9.42	251.89		2.72	

Forces taken from PLS-Tower output with 1.2\*DL Only load case subtracted from Vertical Tower Forces

Dimensions taken from CAD drawing

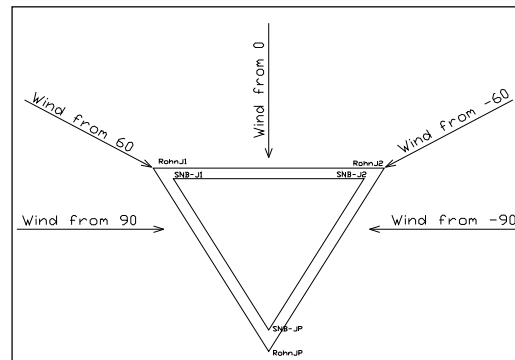



From PLS-Tower Output Summary

Summary of Joint Support Reactions For All Load Cases:

Load Case	Joint Label	Long. Force (kips)	Tran. Force (kips)	Vert. Force (kips)	Shear Force (kips)	Tran. Moment (ft-k)	Long. Moment (ft-k)	Vert. Moment (ft-k)	Bending Moment (ft-k)	Found. Usage %	
"-90"	5: 0.9D + 1.0Dg + 1.0E	RohnJP	-0.8	0.1	14.98	0.81	0.04	-0.21	0	0.21	0
	5: 0.9D + 1.0Dg + 1.0E	SNB-JP	-0.41	0.15	13.96	0.44	0.18	-0.36	0.01	0.4	0
	5: 0.9D + 1.0Dg + 1.0E	RohnJ1	1.01	1.8	33.61	2.07	-0.37	0.25	0	0.45	0
	5: 0.9D + 1.0Dg + 1.0E	RohnJ2	-0.21	0.42	-3.86	0.47	-0.02	-0.04	0	0.05	0
	5: 0.9D + 1.0Dg + 1.0E	SNB-J1	1.23	2.27	40.49	2.58	-0.79	0.56	0	0.97	0
"-60"	5: 0.9D + 1.0Dg + 1.0E	SNB-J2	-0.81	1.56	-12.84	1.76	-0.17	-0.2	0	0.26	0
	5: 0.9D + 1.0Dg + 1.0E	RohnJP	-1.53	0.09	25.82	1.54	0.04	-0.35	0	0.35	0
	5: 0.9D + 1.0Dg + 1.0E	SNB-JP	-1.67	0.13	29.37	1.67	0.15	-0.71	0.01	0.72	0
	5: 0.9D + 1.0Dg + 1.0E	RohnJ1	0.71	1.36	25.68	1.53	-0.28	0.22	0	0.35	0
	5: 0.9D + 1.0Dg + 1.0E	RohnJ2	-0.34	0.57	-6.77	0.66	-0.06	-0.04	0	0.07	0
"0"	5: 0.9D + 1.0Dg + 1.0E	SNB-J1	0.72	1.5	29.2	1.67	-0.53	0.49	-0.01	0.72	0
	5: 0.9D + 1.0Dg + 1.0E	SNB-J2	-1.04	1.81	-16.97	2.09	-0.3	-0.17	0	0.34	0
	5: 0.9D + 1.0Dg + 1.0E	RohnJP	-2.27	0	36.66	2.27	0	-0.49	0	0.49	0
	5: 0.9D + 1.0Dg + 1.0E	SNB-JP	-2.92	0	44.79	2.92	0	-1.06	0	1.06	0
	5: 0.9D + 1.0Dg + 1.0E	RohnJ1	-0.03	0.09	4	0.1	-0.04	0.07	0	0.08	0
"60"	5: 0.9D + 1.0Dg + 1.0E	RohnJ2	-0.03	-0.1	4.07	0.1	0.04	0.07	0	0.08	0
	5: 0.9D + 1.0Dg + 1.0E	SNB-J1	-0.53	-0.66	-1.63	0.85	0.07	0.14	-0.01	0.16	0
	5: 0.9D + 1.0Dg + 1.0E	SNB-J2	-0.53	0.66	-1.55	0.85	-0.07	0.14	0.01	0.16	0
	5: 0.9D + 1.0Dg + 1.0E	RohnJP	-1.53	-0.08	25.82	1.54	-0.04	-0.35	0	0.35	0
	5: 0.9D + 1.0Dg + 1.0E	SNB-JP	-1.67	-0.13	29.37	1.67	-0.16	-0.71	-0.01	0.72	0
"90"	5: 0.9D + 1.0Dg + 1.0E	RohnJ1	-0.34	-0.57	-6.84	0.66	0.06	-0.04	0	0.08	0
	5: 0.9D + 1.0Dg + 1.0E	RohnJ2	0.71	-1.36	25.75	1.53	0.28	0.22	0	0.35	0
	5: 0.9D + 1.0Dg + 1.0E	SNB-J1	-1.04	-1.81	-17.04	2.09	0.3	-0.17	0	0.34	0
	5: 0.9D + 1.0Dg + 1.0E	SNB-J2	0.73	-1.5	29.28	1.67	0.53	0.49	0.01	0.72	0
	5: 0.9D + 1.0Dg + 1.0E	RohnJP	-0.8	-0.1	14.98	0.81	-0.04	-0.21	0	0.21	0
"0.9*DL"	5: 0.9D + 1.0Dg + 1.0E	SNB-JP	-0.41	-0.15	13.96	0.44	-0.18	-0.36	-0.01	0.4	0
	5: 0.9D + 1.0Dg + 1.0E	RohnJ1	-0.21	-0.42	-3.93	0.47	0.02	-0.05	0	0.05	0
	5: 0.9D + 1.0Dg + 1.0E	RohnJ2	1.01	-1.81	33.68	2.07	0.37	0.25	0	0.45	0
	5: 0.9D + 1.0Dg + 1.0E	SNB-J1	-0.81	-1.56	-12.91	1.76	0.17	-0.2	0	0.26	0
	5: 0.9D + 1.0Dg + 1.0E	SNB-J2	1.23	-2.27	40.56	2.58	0.79	0.56	0	0.97	0
"0.9*DL"	0.9DL	RohnJP	-0.8	0	14.97	0.8	0	-0.21	0	0.21	0
	0.9DL	SNB-JP	-0.41	0	13.95	0.41	0	-0.36	0	0.36	0
	0.9DL	RohnJ1	0.4	0.69	14.84	0.8	-0.18	0.1	0	0.21	0
	0.9DL	RohnJ2	0.4	-0.69	14.91	0.8	0.18	0.1	0	0.21	0
	0.9DL	SNB-J1	0.21	0.36	13.79	0.41	-0.31	0.18	0	0.36	0
0.9DL	SNB-J2	0.21	-0.36	13.87	0.41	0.31	0.18	0	0.36	0	



Job 180' ROHN SSV Tower w/ SNB Reinf. - Greenwich  
 Description Overtuning Moment Calculation  
TIA-222-G Load Case #5

Project No. \_\_\_\_\_  
 Computed by MCD  
 Checked by \_\_\_\_\_

Page \_\_\_\_\_ of \_\_\_\_\_  
 Sheet \_\_\_\_\_ of \_\_\_\_\_  
 Date 03/19/18  
 Date \_\_\_\_\_

Load Case	Joint Label	Vert. Tower Forces (k)	Leg Moment Arm (ft)	Moment (ft-k)	Total Moment (ft-k)	Shear (k)	Total Shear (k)
-90 deg	RohnJP	0.01	0.00	0.00	931.8	0.81	8.1
-90 deg	SNB-JP	0.01	0.00	0.00		0.44	
-90 deg	RohnJ1	18.77	11.42	214.35		2.07	
-90 deg	RohnJ2	-18.77	-11.42	214.35		0.47	
-90 deg	SNB-J1	26.7	9.42	251.51		2.58	
-90 deg	SNB-J2	-26.71	-9.42	251.61		1.76	
-60 deg	RohnJP	10.85	6.60	71.61	932.2	1.54	9.2
-60 deg	SNB-JP	15.42	5.44	83.88		1.67	
-60 deg	RohnJ1	10.84	6.60	71.54		1.53	
-60 deg	RohnJ2	-21.68	-13.18	285.74		0.66	
-60 deg	SNB-J1	15.41	5.44	83.83		1.67	
-60 deg	SNB-J2	-30.84	-10.88	335.54		2.09	
0 deg	RohnJP	21.69	13.18	285.87	932.3	2.27	7.1
0 deg	SNB-JP	30.84	10.88	335.54		2.92	
0 deg	RohnJ1	-10.84	-6.60	71.54		0.10	
0 deg	RohnJ2	-10.84	-6.60	71.54		0.10	
0 deg	SNB-J1	-15.42	-5.44	83.88		0.85	
0 deg	SNB-J2	-15.42	-5.44	83.88		0.85	
+60 deg	RohnJP	10.85	6.60	71.61	932.0	1.54	9.2
+60 deg	SNB-JP	15.42	5.44	83.88		1.67	
+60 deg	RohnJ1	-21.68	-13.18	285.74		0.66	
+60 deg	RohnJ2	10.84	6.60	71.54		1.53	
+60 deg	SNB-J1	-30.83	-10.88	335.43		2.09	
+60 deg	SNB-J2	15.41	5.44	83.83		1.67	
+90 deg	RohnJP	0.01	0.00	0.00	931.6	0.81	8.1
+90 deg	SNB-JP	0.01	0.00	0.00		0.44	
+90 deg	RohnJ1	-18.77	-11.42	214.35		0.47	
+90 deg	RohnJ2	18.77	11.42	214.35		2.07	
+90 deg	SNB-J1	-26.7	-9.42	251.51		1.76	
+90 deg	SNB-J2	26.69	9.42	251.42		2.58	

Forces taken from PLS-Tower output with 0.9\*DL Only load case subtracted from Vertical Tower Forces

Dimensions taken from CAD drawing

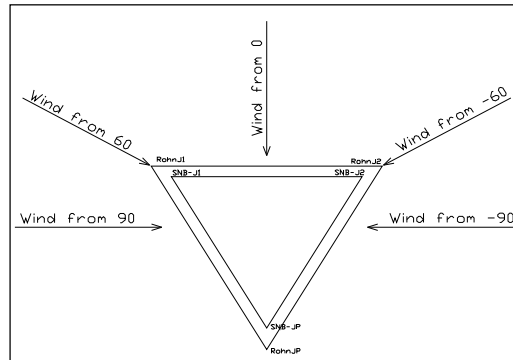



Load Case	Load Case 1	Load Case 1	Load Case 2	Load Case 2	Load Case 3	Load Case 3	Load Case 4	Load Case 4	Load Case 5	Load Case 5
Load Case	Total Moment (ft-k)	Total Shear (k)	Total Moment (ft-k)	Total Shear (k)	Total Moment (ft-k)	Total Shear (k)	Total Moment (ft-k)	Total Shear (k)	Total Moment (ft-k)	Total Shear (k)
Wo -90 deg	14303	144.2	14285	144.1	5131	52.5	933.2	8.5	931.8	8.1
Wo -60 deg	14176	155.6	14158.4	155.2	5131	51	933.2	9.6	932.2	9.2
Wo 0 deg	14691	160	14673.4	160.4	5143.7	58.7	933.5	7.7	932.3	7.1
Wo 60 deg	14176	155.6	14158.4	155.2	5134	51	933.3	9.6	932	9.2
Wo 90 deg	14303	144.2	14284.8	144.1	5135	52.6	933.3	8.5	932.6	8.1

Maximum Moment = 14691 kip\*ft

Maximum Shear = 160.4 kip

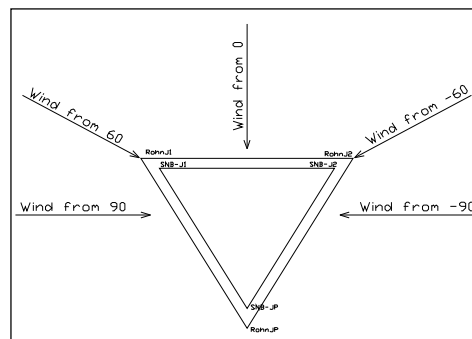

Job	<u>180' ROHN SSV Tower w/ SNB Reinf. - Greenwich</u>	Project No.	_____	Sheet	<u>1</u> of <u>7</u>
Description	<u>Foundation Analysis (TIA-222-G)</u>	Computed by	<u>MCD</u>	Date	<u>03/19/18</u>
	_____	Checked by	_____	Date	_____

## PIER AND MAT FOUNDATION ANALYSIS - 3 PIERS

### TOWER FORCES:

Moment Caused by Tower  $M_t := 14691 \text{ kip}\cdot\text{ft}$   
 Shear at Base of Tower  $S_t := 160.4 \text{ kip}$   
 Max Compressive Force  $C_t := 510.6 \text{ kip}$   
 Max Uplift  $U_t := 459.67 \text{ kip}$   
 Height of Tower  $H_t := 180 \text{ ft}$   
 Width of Tower at Base  $W_t := 22.833 \text{ ft}$   
 Weight of Tower  $WT_{t,0.9} := 86.21 \text{ kip}$   
 $WT_{t,1.2} := 114.95 \text{ kip}$

### FOOTING DIMENSIONS:

Width of Footing  $W_f := 36.5 \text{ ft}$   
 Overall Depth of Footing  $D_f := 3.5 \text{ ft}$   
 Thickness of Footing  $T_f := 6.0 \text{ ft}$   
 Reinforcement Cover:  $C_{vr} := 3 \text{ in}$

NOTE: Information for "Weight of Tower" obtained from Load Combination Calculation Excel Sheets Summation of Factored DL.

### MATERIAL PROPERTIES:

Compressive Strength of Concrete	$f_c := 3000 \text{ psi}$	Unit Weight of Soil	$\gamma_s := 130 \text{ pcf}$
Yield Strength of Steel Reinforcement	$f_y := 60000 \text{ psi}$	Unit Weight of Concrete	$\gamma_c := 150 \text{ pcf}$
Internal Friction Angle of Soil	$\phi_s := 36 \text{ deg}$	Depth to Neglect	$n := 0 \text{ ft}$
Allowable Bearing Capacity	$q_s := 4000 \text{ psf}$	Cohesion of Clay Type Soil	$c_w := 0 \text{ ksf}$
Ultimate Bearing Capacity	$R_s := 2 \cdot q_s$	Note: Use 0 for Sandy Soil	
Coefficient of Lateral Soil Pressure	$K_p := \frac{1 + \sin(\phi_s)}{1 - \sin(\phi_s)}$	$K_p = 3.8518$	

What is Position of Center of Tower with respect to Center of Pad? 1=Offset  
2=Not Offset  $Pos_{tower} := 2$

### STEEL REINFORCING:

#### PAD REINFORCEMENT:

Bar Size	$BS_{pad} := 7$	Bar Diameter	$d_{bpad} := 0.875 \text{ in}$
Number of Bars	$NB_{pad} := 37$	Bar Area	$A_{bpad} := 0.60 \text{ in}^2$

Job 180' ROHN SSV Tower w/ SNB Reinf. - Greenwich  
 Description Foundation Analysis (TIA-222-G)

Project No.                       
 Computed by MCD  
 Checked by                     

Sheet 2 of 7  
 Date 03/19/18  
 Date                     

**FOUNDATION OVERVIEW**

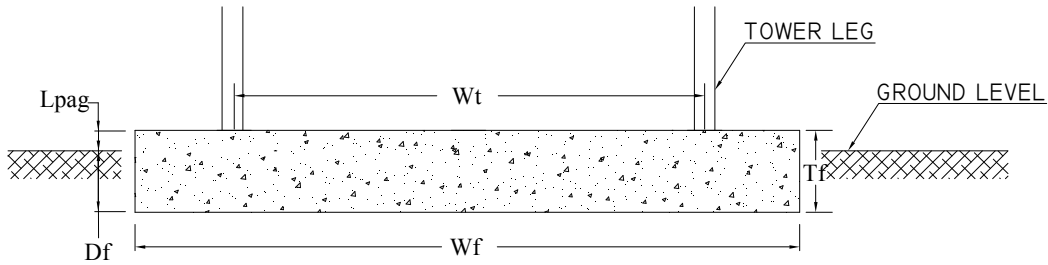

**ELEVATION**

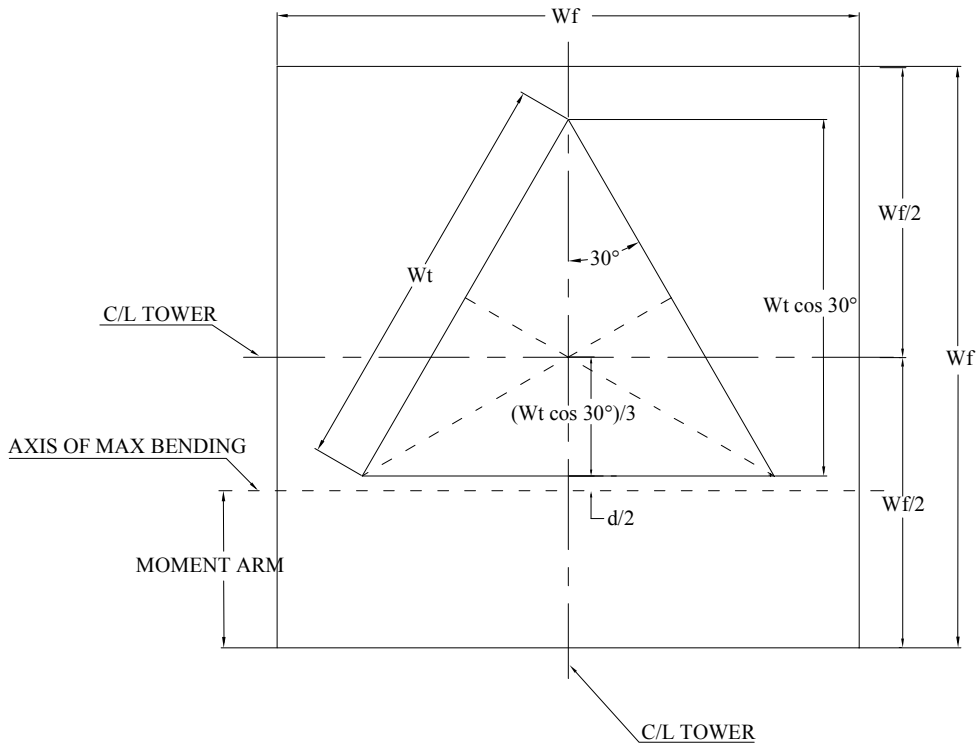

**PLAN**

## STABILITY OF FOOTING

NOTE: Reduction factor is implemented as 0.75 for pull-out/uplift of foundation. Reduction factor shall be applied to Overturning Moment in this case

Passive Pressure:	$P_{pn} := K_p \cdot \gamma_s \cdot n + c \cdot 2 \cdot \sqrt{K_p}$ $P_{pt} := K_p \cdot \gamma_s \cdot (D_f - T_f) + c \cdot 2 \cdot \sqrt{K_p}$ $P_{top} := \text{if}[n < (D_f - T_f), P_{pt}, P_{pn}]$ $P_{bot} := K_p \cdot \gamma_s \cdot D_f + c \cdot 2 \cdot \sqrt{K_p}$ $P_{ave} := \frac{P_{top} + P_{bot}}{2}$	$P_{pn} = 0 \cdot \text{ksf}$ $P_{pt} = -1.2518 \cdot \text{ksf}$ $P_{top} = 0 \cdot \text{ksf}$ $P_{bot} = 1.7526 \cdot \text{ksf}$ $P_{ave} = 0.8763 \cdot \text{ksf}$
Shear:	$T_{pp} := \text{if}[n < (D_f - T_f), T_f, (D_f - n)]$ $A_{pp} := W_f \cdot T_{pp}$	$T_{pp} = 3.5 \cdot \text{ft}$ $A_{pp} = 127.75 \cdot \text{ft}^2$
Ultimate Shear:	$S_u := P_{ave} \cdot A_{pp}$	$S_u = 111.9465 \cdot \text{kip}$
Weight of Concrete Pad:	$WT_c := (W_f^2 \cdot T_f) \cdot \gamma_c$	$WT_c = 1199.025 \cdot \text{kip}$
Weight of Soil above Footing:	$WT_{s1} := 0$	$WT_{s1} = 0 \cdot \text{kip}$
Weight of Soil Wedge at back face:	$WT_{s2} := \left[ \frac{(D_f - n)^2 \cdot \tan(\phi_s)}{2} \cdot W_f \right] \cdot \gamma_s$	$WT_{s2} = 21.1156 \cdot \text{kip}$
Distance to center of Tower Leg from Edge of Footing:	$X_{t1} := \frac{W_f}{2} - \frac{W_t \cdot \cos(30\text{-deg})}{2}$ $X_t := \text{if}(\text{Pos}_{tower} = 1, X_{t1}, X_{t2})$	$X_{t2} := \frac{W_f}{2} - \frac{W_t \cdot \cos(30\text{-deg})}{3}$ $X_t = 11.6587 \cdot \text{ft}$
Additional Offset of Footing:	$X_{off1} := \frac{W_f}{2} - \left( \frac{W_t \cdot \cos(30\text{-deg})}{3} + X_t \right)$ $X_{off} := \text{if}(\text{Pos}_{tower} = 1, X_{off1}, X_{off2})$	$X_{off2} := 0$ $X_{off} = 0 \cdot \text{ft}$
Resisting Moment:	$M_r := \left[ 0.9(WT_c + WT_{s1}) \right] \cdot \frac{W_f}{2} + \left[ WT_{t\_0.9} \cdot 0.9 \cdot \left( \frac{W_f}{2} - X_{off} \right) \right] + 0.90 \cdot \left( S_u \cdot \frac{T_{pp}}{3} \right) \dots$ $+ WT_{s2} \cdot 0.90 \cdot \left( W_f + \frac{T_{pp} \cdot \tan(\phi_s)}{3} \right)$	$M_r = 22094.6177 \cdot \text{kip} \cdot \text{ft}$
	$\Phi_{OT} := 0.75$ <b>ANSI/TIA-222-G REDUCTION FACTOR</b>	
Overturning Moment:	$M_{ot} := M_t + S_t \cdot (T_f) + WT_{t\_1.2} \cdot X_{off}$	$M_{ot} = 15653.4 \cdot \text{kip} \cdot \text{ft}$
Factor of Safety:	$\text{RatioStability} := \frac{M_r \cdot \Phi_{OT}}{M_{ot}}$ $\text{StabilityCheck} := \text{if}(M_r \cdot \Phi_{OT} > M_{ot}, \text{"Okay"}, \text{"No Good"})$	$\text{RatioStability} = 0.945$ $\text{StabilityCheck} = \text{"Okay"}$



Job	<u>180' ROHN SSV Tower w/ SNB Reinf. - Greenwich</u>	Project No.	_____	Sheet	<u>4</u>	of	<u>7</u>
Description	<u>Foundation Analysis (TIA-222-G)</u>	Computed by	<u>MCD</u>	Date	<u>03/19/18</u>		
		Checked by	_____	Date	_____		

**BEARING PRESSURE CHECK:**

$$\text{LOAD}_{\text{tot}} := (\text{WT}_{\text{c}} + \text{WT}_{\text{sl}}) \cdot 0.9 + \text{WT}_{\text{t}_0.9} \quad \text{LOAD}_{\text{tot}} = 1165.3325 \cdot \text{kip}$$

$$A_{\text{mat}} := W_{\text{f}}^2 \quad A_{\text{mat}} = 1332.25 \cdot \text{ft}^2$$

$$S := \frac{W_{\text{f}}^3}{6} \quad S = 8104.5208 \cdot \text{ft}^3$$

$$P_{\text{max}} := \frac{\text{LOAD}_{\text{tot}}}{A_{\text{mat}}} + \frac{M_{\text{ot}}}{S} \quad P_{\text{max}} = 2.8062 \cdot \text{ksf}$$

$$P_{\text{min}} := \frac{\text{LOAD}_{\text{tot}}}{A_{\text{mat}}} - \frac{M_{\text{ot}}}{S} \quad P_{\text{min}} = -1.0567 \cdot \text{ksf}$$

$$\text{MaxPressure} := \text{if}(P_{\text{max}} < 0.75R_{\text{s}}, \text{"Okay"}, \text{"No Good"}) \quad \text{MaxPressure} = \text{"Okay"}$$

$$\text{MinPressure} := \text{if}[(P_{\text{min}} \geq 0) \cdot (P_{\text{min}} < 0.75 \cdot R_{\text{s}}), \text{"Okay"}, \text{"No Good"}] \quad \text{MinPressure} = \text{"No Good"}$$

Distance to Resultant of Pressure Distribution:

$$X_{\text{p}} := \frac{P_{\text{max}}}{\frac{P_{\text{max}} - P_{\text{min}}}{W_{\text{f}}}} \cdot \frac{1}{3} \quad X_{\text{p}} = 8.8384 \cdot \text{ft}$$

Distance to Kern:

$$X_{\text{k}} := \frac{W_{\text{f}}}{3} \quad X_{\text{k}} = 12.1667 \cdot \text{ft}$$

Since Resultant Force is Not in Kern, Area to which Pressure is Applied Must be Reduced.

$$\text{Eccentricity: } e := \frac{M_{\text{ot}}}{\text{LOAD}_{\text{tot}}} \quad e = 13.4326$$

$$\text{Adjusted Soil Pressure: } q_{\text{a}} := \frac{2 \cdot \text{LOAD}_{\text{tot}}}{3 \cdot W_{\text{f}} \cdot \left( \frac{W_{\text{f}}}{2} - e \right)} \quad q_{\text{a}} = 4.4182 \cdot \text{ksf}$$

$$\text{Revised Maximum: } q_{\text{max}} := \text{if}(X_{\text{p}} < X_{\text{k}}, q_{\text{a}}, P_{\text{max}}) \quad q_{\text{max}} = 4.4182 \cdot \text{ksf}$$

$$\text{PressureCheck} := \text{if}(q_{\text{max}} < 0.75 \cdot R_{\text{s}}, \text{"Okay"}, \text{"No Good"}) \quad \text{PressureCheck} = \text{"Okay"}$$

**CHECK PUNCHING AND BEAM SHEAR:**

**Beam Shear:** (Critical section located at a distance d from the face of Pier) (ACI 11.3.1.1)

$$\phi_c := 0.75 \quad (\text{ACI 9.3.2.3})$$

$$T_f := 4\text{ft} \quad \leftarrow \text{OVERRIDE - Original Footing Thickness}$$

$$d := T_f - C_{vr} - .5\text{in} \quad d = 44.5\text{in}$$

Factored load:  $FL := \frac{C_t}{W_f^2}$  FL = 0.3833·ksf

$$V_{req} := \frac{FL \cdot (X_t - d) \cdot W_f}{\phi_c} \quad V_{req} = 148.2903 \cdot \text{kip}$$

ACI 11.3.1.1  $V_{Avail} := 2 \cdot \sqrt{f'_c \cdot \text{psi}} \cdot W_f \cdot d$  V<sub>Avail</sub> = 2135.1321·kip

$$\text{BeamShearCheck} := \text{if}(V_{req} < V_{Avail}, \text{"Okay"}, \text{"No Good"}) \quad \text{BeamShearCheck} = \text{"Okay"}$$

**Punching Shear:** (Critical Section Located at a distance of d/2 from the face of pier) (ACI 11.12.2.1)

$$b_o := (d) \cdot \pi \quad b_o = 11.6501 \cdot \text{ft}$$

$$V_{req} := FL \cdot \frac{W_f^2 - (d)^2 \cdot \frac{\pi}{4}}{\phi_c} \quad V_{req} = 675.2807 \cdot \text{kip}$$

$$V_{Avail} := 4 \cdot \sqrt{f'_c \cdot \text{psi}} \cdot b_o \cdot d \quad V_{Avail} = 1362.9832 \cdot \text{kip}$$

$$\text{PunchingShearCheck} := \text{if}(V_{req} < V_{Avail}, \text{"Okay"}, \text{"No Good"}) \quad \text{PunchingShearCheck} = \text{"Okay"}$$

Job	180' ROHN SSV Tower w/ SNB Reinf. - Greenwich	Project No.		Sheet	6 of 7
Description	Foundation Analysis (TIA-222-G)	Computed by	MCD	Date	03/19/18
		Checked by		Date	

**TENSILE REINFORCEMENT IN PAD:**  $\phi_m := 0.90$  per ACI 9.3.2.2

**Applied Moments:** *NOTE: Existing 2 feet of concrete over original foundation considered in uplift reduction for design calculations shown below*

$$0.9 \cdot \frac{\gamma_c \cdot (2\text{ft} \cdot 32.5\text{ft} \cdot 32.5\text{ft})}{3} = 95.0625 \cdot \text{kip}$$

$$M_{nT} := [(U_t - 95\text{kip}) \cdot (W_t \cdot \sin(60 \cdot \text{deg})) + S_t \cdot (D_f)] - WT_t \cdot 1.2 \cdot X_{\text{off}}$$

$$M_{nS} := -1 \cdot \left[ \frac{1}{2} \cdot \left( \frac{W_f}{2} + \frac{W_t}{3} \cdot \cos(30 \cdot \text{deg}) \right)^2 \cdot 0.9 W_t \cdot [\gamma_s \cdot (T_{pp} - T_f)] + 0.9 WT_{s2} \cdot \left[ \left( \frac{W_f}{2} + \frac{W_t}{3} \cdot \cos(30 \cdot \text{deg}) \right) + (D_f - n) \cdot \tan(\phi_s) \right] \right]$$

$$M_{nC} := -1 \cdot \left[ \frac{1}{2} \cdot \left( \frac{W_f}{2} + \frac{W_t}{3} \cdot \cos(30 \cdot \text{deg}) \right)^2 \cdot 0.9 \cdot W_t \cdot (\gamma_c \cdot T_f) \right]$$

Design Moment:  $M_n := \frac{M_{nT} + M_{nS} + M_{nC}}{\phi_m}$   $M_n = 4288.6455 \cdot \text{kips} \cdot \text{ft}$

**Required Reinforcement:**

ACI 10.2.7.3  $\beta := \text{if} \left[ f_c \leq 4000 \cdot \text{psi}, .85, \text{if} \left[ f_c \geq 8000 \cdot \text{psi}, .65, .85 - \left( \frac{\frac{f_c}{\text{psi}} - 4000}{1000} \right) \cdot .05 \right] \right]$   $\beta = 0.85$

Effective Width:  $b_{\text{eff}} := W_t \cdot \cos(30 \cdot \text{deg}) + 0$   $b_{\text{eff}} = 237.2875 \cdot \text{in}$

$$A_s := \frac{M_n}{\phi_m \cdot f_y \cdot d}$$

$A_s = 21.4165 \cdot \text{in}^2$

$$a := \frac{A_s \cdot f_y}{\beta \cdot f_c \cdot b_{\text{eff}}}$$

$a = 2.1237 \cdot \text{in}$

$$A_{s_{\text{min}}} := \frac{M_n}{f_y \cdot \left( d - \frac{a}{2} \right)}$$

$A_s = 19.746 \cdot \text{in}^2$

$$\rho := \frac{A_s}{b_{\text{eff}} \cdot d}$$

$\rho = 0.0019$

**Temperature and Shrinkage:**  $\rho_{\text{sh}} := \text{if}(f_y \geq 60000 \cdot \text{psi}, 0.0018, 0.0020)$   $\rho_{\text{sh}} = 0.0018$   
(ACI 7.12.2.1b)

Area Required:  $A_s := \text{if} \left( \rho \geq \rho_{\text{sh}}, A_s, \rho_{\text{sh}} \cdot \frac{b_{\text{eff}}}{2} \cdot d \right)$   $A_s = 19.746 \cdot \text{in}^2$

Area Provided:  $A_{s_{\text{prov}}} := A_{\text{bpad}} \cdot \text{NB}_{\text{pad}}$   $A_{s_{\text{prov}}} = 22.2 \cdot \text{in}^2$

PadReinforcement := if( $A_{s_{\text{prov}}} > A_s$ , "Okay", "No Good") **PadReinforcement = "Okay"**

Job	<u>180' ROHN SSV Tower w/ SNB Reinf. - Greenwich</u>	Project No.	_____	Sheet	<u>7</u>	of	<u>7</u>
Description	<u>Foundation Analysis (TIA-222-G)</u>	Computed by	<u>MCD</u>	Date	<u>03/19/18</u>		
	_____	Checked by	_____	Date	_____		

**DEVELOPMENT LENGTH OF PAD REINFORCEMENT:**

**TENSION (ACI 12.2.3)**

Bar Spacing:  $B_{sPad} := \frac{W_f - 2 \cdot C_{vr} - N B_{pad} \cdot d_{bpad}}{N B_{pad} - 1}$   $B_{sPad} = 11.1007 \cdot in$

- Development Length Factors:
- Reinforcement Location Factor  $\alpha := 1.0$
  - Coating Factor  $\beta := 1.0$
  - Concrete strength Factor  $\lambda := 1.0$
  - Reinforcement Size Factor  $\gamma := 1.0$

Spacing or Cover Dimension:  $c := \text{if} \left( C_{vr} < \frac{B_{sPad}}{2}, C_{vr}, \frac{B_{sPad}}{2} \right)$   $c = 3 \cdot in$

Transverse Reinforcement IndeAs allowed by ACI 12.2.4  $k_{tr} := 0$

Development Length:  $L_{dbt} := \frac{3}{40} \cdot \frac{f_y}{\sqrt{f_c \cdot psi}} \cdot \frac{\alpha \cdot \beta \cdot \gamma \cdot \lambda}{c + k_{tr}} \cdot d_{bpad}$   $L_{dbt} = 20.9675 \cdot in$

$L_{dbmin} := 12 \cdot in$

Minimum Development Length:  $L_{dbtCheck} := \text{if} (L_{dbt} \geq L_{dbmin}, "Use L.dbt", "Use L.dbmin")$   $L_{dbtCheck} = "Use L.dbt"$   
 (ACI 12.2.1)

Available Length in Pad:  $L_{Pad} := \frac{W_f}{2} - \frac{W_t}{2} - C_{vr}$   $L_{Pad} = 79.002 \cdot in$

$L_{padTension} := \text{if} (L_{Pad} > L_{dbt}, "Okay", "No Good")$   $L_{padTension} = "Okay"$

**X** Diagonal Members SNB-D7

Compression force = 21,647 kips (C)

Tension force = 21,317 kips (T)

• Convert to "XY" plane forces 

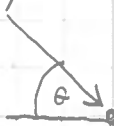
21,647   $\theta = 32.06^\circ$  (CAD Measured from PLS-TOWER  
• P & F model)

$$21,647 (C) \sin 32.06^\circ = 11,490.4 \text{ kips}$$

$$21,647 (C) \cos 32.06^\circ = 18,345.7 \text{ kips}$$

• For conservative considerations, assume 18,345.7 kips is controlling compression force

• Tension/Uplift force

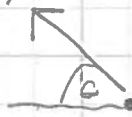
21,317   $21,317 (T) \sin 32.06^\circ = 11,315.2 \text{ kips}$

$$21,317 (T) \cos 32.06^\circ = 18,066.0 \text{ kips}$$

• For conservative considerations, assume 18,066.0 kips is controlling tension/uplift force.

Prior to Modification

$\frac{3}{4}$ " Anchor Shear cap. = 17.9 kips LRF D x 2 = 35.8 kips > 18,345 kips  
∴ connection OK

• For Anchorage Design, the following shall apply:

$$V = 11.4904 \text{ kips} / 4 \text{ anchors} = \underline{2.8726 \text{ kips}}$$

$$\uparrow (Uplift) = 18.0660 \text{ kips} / 4 \text{ anchors} = \underline{4.5165 \text{ kips}}$$

Apply (4) HILTI HIT-RE500 VS Epoxy Anchoring System

- Consider "Cracked Concrete"

• For 7/8" diameter Anchor @ 7/8" effective embedment & 5' concrete (Hilti: table 26)

$$\begin{aligned} \rightarrow \text{Tension capacity/anchor} &= 13,375 \text{ lbf} \quad (\text{Prior to Red. Factor}) \\ \rightarrow \text{Shear capacity/anchor} &= 28,810 \text{ lbf} \quad (\text{Prior to Reduction Factor}) \end{aligned}$$

• Apply "HAS-E" Anchor Bolts (table 29)

$$\begin{aligned} \text{Tension capacity/anchor} &= \underline{21,755 \text{ lbf}} \quad (\text{LRFD Capacity}) \\ \text{Shear capacity/anchor} &= \underline{12,050 \text{ lbf}} \quad (\text{LRFD Capacity}) \end{aligned}$$

NOTE: EPOXY Anchors Based on Application of Concrete Reduction Factors:

(Apply table 39 for cracked concrete & "s" = 6 in):

$$\begin{aligned} \text{Tension capacity/anchor} &= 13,375 \times 0.61 = \underline{8,158 \text{ lbf/anchor}} \\ \text{Shear capacity/anchor} &= 28,810 \times 0.55 = \underline{15,845 \text{ lbf/anchor}} \end{aligned}$$

Apply 4 anchors & consider interaction EQ (HILTI Sect. 5.1.6.7)

$$\frac{N_u}{\phi N_n} + \frac{V_u}{\phi V_n} = \left( \frac{4.5165}{8.158} \right) + \left( \frac{2.8726}{12.050} \right) = 0.79 \leq 1.2 \therefore \text{OK}$$

Tension/Compression force applied to Baseplate = 22 kips.

Per Design sketch SK-5 - Determine Plastic Bending Capacity of Baseplate.

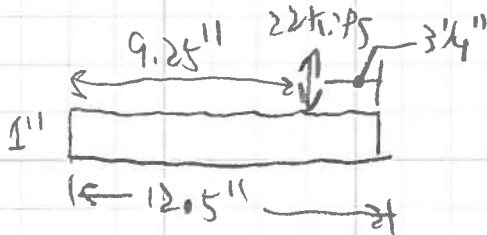

$$M_{\text{applied}} = \frac{Pab}{l} = \frac{22 \text{ kips} \times 9.25'' \times 3.25''}{12.5''} = \underline{52.91 \text{ k.in}}$$

Plate Plastic Capacity =  $M_p = \sigma_z$

$$= 0.9 \times 50 \text{ ksi} \times \frac{bd^2}{4} = 0.9 \times 50 \text{ ksi} \times \frac{(12.5 \text{ in})(1 \text{ in})^2}{4}$$

$$M_p = \underline{140.625 \text{ k.in}}$$

• NOTE: LTB is not considered for Plate "minor" axis bending.

$$\frac{52.91 \text{ k.in}}{140.625 \text{ k.in}} = 37.7\% \therefore \text{OK}$$

### 3.2.4 HIT-RE 500 V3 Epoxy Adhesive Anchoring System

**Table 26 - Hilti HIT-RE 500 V3 adhesive design strength with concrete / bond failure for threaded rod in cracked concrete<sup>1,2,3,4,5,6,7,8,9,11</sup>**

Nominal anchor diameter In.	Effective embedment In. (mm)	Tension — $\Phi_N$				Shear — $\Phi_V$			
		$f'_c = 2,500$ psi (17.2 MPa) lb (kN)	$f'_c = 3,000$ psi (20.7 MPa) lb (kN)	$f'_c = 4,000$ psi (27.6 MPa) lb (kN)	$f'_c = 6,000$ psi (41.4 MPa) lb (kN)	$f'_c = 2,500$ psi (17.2 MPa) lb (kN)	$f'_c = 3,000$ psi (20.7 MPa) lb (kN)	$f'_c = 4,000$ psi (27.6 MPa) lb (kN)	$f'_c = 6,000$ psi (41.4 MPa) lb (kN)
3/8	2-3/8 (60)	2,020 (9.0)	2,215 (9.9)	2,500 (11.1)	2,655 (11.8)	2,180 (9.7)	2,385 (10.6)	2,690 (12.0)	2,860 (12.7)
	3-3/8 (86)	3,310 (14.7)	3,400 (15.1)	3,550 (15.8)	3,770 (16.8)	7,125 (31.7)	7,325 (32.6)	7,645 (34.0)	8,125 (36.1)
	4-1/2 (114)	4,410 (19.6)	4,535 (20.2)	4,735 (21.1)	5,030 (22.4)	9,500 (42.3)	9,765 (43.4)	10,195 (45.3)	10,835 (48.2)
	7-1/2 (191)	7,350 (32.7)	7,555 (33.6)	7,890 (35.1)	8,385 (37.3)	15,835 (70.4)	16,275 (72.4)	16,990 (75.6)	18,055 (80.3)
1/2	2-3/4 (70)	2,520 (11.2)	2,760 (12.3)	3,185 (14.2)	3,905 (17.4)	5,425 (24.1)	5,945 (26.4)	6,865 (30.5)	8,405 (37.4)
	4-1/2 (114)	5,275 (23.5)	5,780 (25.7)	6,260 (27.8)	6,655 (29.8)	11,360 (50.5)	12,445 (55.4)	13,485 (60.0)	14,330 (63.7)
	6 (152)	7,780 (34.6)	7,995 (35.6)	8,350 (37.1)	8,770 (39.5)	16,755 (74.5)	17,220 (76.6)	17,980 (80.0)	19,110 (85.0)
	10 (254)	12,965 (57.7)	13,325 (59.3)	13,915 (61.9)	14,785 (65.8)	27,930 (124.2)	28,705 (127.7)	29,970 (133.3)	31,850 (141.7)
5/8	3-1/8 (79)	3,050 (13.6)	3,345 (14.9)	3,860 (17.2)	4,730 (21.0)	6,575 (29.2)	7,200 (32.0)	8,315 (37.0)	10,185 (45.3)
	5-5/8 (143)	7,370 (32.8)	8,075 (35.9)	9,325 (41.5)	10,315 (45.9)	15,875 (70.6)	17,390 (77.4)	20,080 (89.3)	22,215 (98.8)
	7-1/2 (191)	11,350 (50.5)	12,395 (55.1)	12,940 (57.6)	13,755 (61.2)	24,440 (108.7)	26,695 (118.7)	27,875 (124.0)	29,620 (131.8)
	12-1/2 (318)	20,100 (89.4)	20,660 (91.9)	21,570 (95.9)	22,920 (102.0)	43,295 (192.6)	44,495 (197.9)	46,460 (206.7)	49,370 (219.6)
3/4 <sup>10</sup>	3-1/2 (89)	3,620 (16.1)	3,965 (17.6)	4,575 (20.4)	5,605 (24.9)	7,790 (34.7)	8,535 (38.0)	9,855 (43.8)	12,070 (53.7)
	6-3/4 (171)	9,690 (43.1)	10,615 (47.2)	12,255 (54.5)	14,735 (65.5)	20,870 (92.8)	22,860 (101.7)	26,395 (117.4)	31,740 (141.2)
	9 (229)	14,920 (66.4)	16,340 (72.7)	18,490 (82.2)	19,650 (87.4)	32,130 (142.9)	35,195 (156.6)	39,820 (177.1)	42,320 (188.2)
	15 (381)	28,715 (127.7)	29,510 (131.3)	30,815 (137.1)	32,745 (145.7)	61,850 (275.1)	63,565 (282.7)	66,370 (295.2)	70,530 (313.7)
7/8 <sup>10</sup>	3-1/2 (89)	3,620 (16.1)	3,965 (17.6)	4,575 (20.4)	5,605 (24.9)	7,790 (34.7)	8,535 (38.0)	9,855 (43.8)	12,070 (53.7)
	7-7/8 (200)	12,210 (54.3)	13,375 (59.5)	15,445 (68.7)	18,915 (84.1)	26,300 (117.0)	28,810 (128.2)	33,265 (148.0)	40,740 (181.2)
	10-1/2 (267)	18,800 (83.6)	20,590 (91.6)	23,780 (105.8)	26,530 (118.0)	40,490 (180.1)	44,355 (197.3)	51,215 (227.8)	57,140 (254.2)
	17-1/2 (445)	38,775 (172.5)	39,850 (177.3)	41,605 (185.1)	44,215 (196.7)	83,510 (371.5)	85,825 (381.8)	89,610 (398.6)	95,230 (423.6)
1	4 (102)	4,420 (19.7)	4,840 (21.5)	5,590 (24.9)	6,845 (30.4)	9,520 (42.3)	10,430 (46.4)	12,040 (53.6)	14,750 (65.6)
	9 (229)	14,920 (66.4)	16,340 (72.7)	18,870 (83.9)	23,110 (102.8)	32,130 (142.9)	35,195 (156.6)	40,640 (180.8)	48,775 (217.4)
	12 (305)	22,965 (102.2)	25,160 (111.9)	29,050 (129.2)	34,650 (154.1)	49,465 (220.0)	54,190 (241.0)	62,570 (278.3)	74,630 (332.0)
	20 (508)	49,415 (219.8)	52,045 (231.5)	54,340 (241.7)	57,750 (256.9)	106,435 (473.4)	112,100 (498.6)	117,045 (520.6)	124,385 (553.3)
1-1/4 <sup>10</sup>	5 (127)	6,175 (27.5)	6,765 (30.1)	7,815 (34.8)	9,570 (42.6)	13,305 (59.2)	14,575 (64.8)	16,830 (74.9)	20,610 (91.7)
	11-1/4 (286)	22,850 (92.7)	22,840 (101.6)	26,370 (117.3)	32,295 (143.7)	44,905 (199.7)	49,190 (218.8)	56,800 (252.7)	69,565 (309.4)
	15 (381)	32,095 (142.8)	35,160 (156.4)	40,600 (180.6)	49,725 (221.2)	69,135 (307.5)	75,730 (336.9)	87,445 (389.0)	107,100 (476.4)
	25 (635)	69,060 (307.2)	75,655 (336.5)	80,800 (359.4)	85,865 (381.9)	148,750 (661.7)	162,945 (724.8)	174,030 (774.1)	184,945 (822.7)

1 See Section 3.1.8 for explanation on development of load values.  
 2 See Section 3.1.8.6 to convert design strength value to ASD value.  
 3 Linear interpolation between embedment depths and concrete compressive strengths is not permitted.  
 4 Apply spacing, edge distance, and concrete thickness factors in tables 30-41 as necessary to the above values. Compare to the steel values in table 29. The lesser of the values is to be used for the design.  
 5 Data is for temperature range A: Max. short term temperature = 130°F (55°C), max. long term temperature = 110°F (43°C).  
 For temperature range B: Max. short term temperature = 176°F (80°C), max. long term temperature = 110°F (43°C) multiply above values by 0.89.  
 Short term elevated concrete temperatures are those that occur over brief intervals, e.g., as a result of diurnal cycling. Long term concrete temperatures are roughly constant over significant periods of time.  
 6 Tabular values are for dry or water saturated concrete conditions.  
 For water-filled drilled holes multiply design strength by 0.51.  
 For submerged (under water) applications multiply design strength by 0.44.  
 7 Tabular values are for short term loads only. For sustained loads including overhead use, see Section 3.1.8.8.  
 8 Tabular values are for normal-weight concrete only. For lightweight concrete multiply design strength by  $\lambda_c$  as follows:  
 For sand-lightweight,  $\lambda_c = 0.51$ . For all-lightweight,  $\lambda_c = 0.45$ .  
 9 Tabular values are for holes drilled in concrete with carbide tipped hammer drill bit. Diamond core drilling is not permitted in cracked concrete conditions except as indicated in note 10.  
 10 Diamond core drilling with Hilti TE-YRT roughening tool is permitted for 3/4", 7/8", and 1 1/4" diameter anchors for dry and water-saturated concrete conditions. See Table 28  
 11 Tabular values are for static loads only. For seismic loads, multiply cracked concrete tabular values in tension and shear by  $\alpha_{sm}$  indicated below.  
 See section 3.1.8.7 for additional information on seismic applications.  
 3/8-in. diameter -  $\alpha_{sm} = 0.69$   
 1/2-in. diameter -  $\alpha_{sm} = 0.70$   
 5/8-in. diameter -  $\alpha_{sm} = 0.71$   
 3/4-in. diameter and larger -  $\alpha_{sm} = 0.75$



**HIT-RE 500 V3 Epoxy Adhesive Anchoring System 3.2.4**

**Table 38 - Load adjustment factors for 7/8-in. diameter threaded rods in uncracked concrete<sup>1,2,3</sup>**

7/8-in. uncracked concrete	Spacing factor in tension $f_{AN}$				Edge distance factor in tension $f_{RN}$				Spacing factor in shear <sup>4</sup> $f_{SV}$				Edge distance in shear				Concrete thickness factor in shear <sup>5</sup> $f_{TV}$							
													⊥ Toward edge $f_{RV}$		∥ To and away from edge $f_{RV}$									
	Embedment $h_{ef}$ (mm)	3-1/2 (89)	7-7/8 (200)	10-1/2 (267)	17-1/2 (445)	3-1/2 (89)	7-7/8 (200)	10-1/2 (267)	17-1/2 (445)	3-1/2 (89)	7-7/8 (200)	10-1/2 (267)	17-1/2 (445)	3-1/2 (89)	7-7/8 (200)	10-1/2 (267)	17-1/2 (445)	3-1/2 (89)	7-7/8 (200)	10-1/2 (267)	17-1/2 (445)			
1-3/4 (44)	n/a	n/a	n/a	n/a	0.39	0.24	0.18	0.10	n/a	n/a	n/a	n/a	0.09	0.03	0.02	0.01	0.18	0.05	0.04	0.02	n/a	n/a	n/a	n/a
4-3/8 (111)	0.58	0.58	0.57	0.54	0.53	0.31	0.23	0.13	0.58	0.54	0.53	0.52	0.35	0.11	0.07	0.03	0.63	0.22	0.14	0.07	n/a	n/a	n/a	n/a
5 (127)	0.59	0.59	0.58	0.55	0.56	0.33	0.24	0.13	0.59	0.54	0.53	0.52	0.43	0.13	0.09	0.04	0.70	0.27	0.17	0.08	n/a	n/a	n/a	n/a
5-1/2 (140)	0.60	0.60	0.59	0.55	0.58	0.34	0.25	0.14	0.60	0.55	0.54	0.52	0.50	0.15	0.10	0.05	0.76	0.31	0.20	0.09	0.65	n/a	n/a	n/a
6 (152)	0.61	0.61	0.60	0.56	0.61	0.36	0.26	0.15	0.61	0.55	0.54	0.52	0.57	0.17	0.11	0.05	0.83	0.35	0.23	0.11	0.68	n/a	n/a	n/a
7 (178)	0.63	0.63	0.61	0.57	0.65	0.39	0.28	0.16	0.63	0.56	0.55	0.53	0.71	0.22	0.14	0.07	0.97	0.39	0.29	0.13	0.73	n/a	n/a	n/a
8 (203)	0.65	0.65	0.63	0.58	0.71	0.42	0.31	0.17	0.65	0.57	0.55	0.53	0.87	0.27	0.17	0.08	1.00	0.42	0.33	0.16	0.78	n/a	n/a	n/a
9 (229)	0.67	0.67	0.64	0.59	0.76	0.45	0.33	0.18	0.67	0.58	0.56	0.54	1.00	0.32	0.21	0.10		0.45	0.35	0.19	0.83	n/a	n/a	n/a
9-7/8 (251)	0.69	0.69	0.66	0.59	0.80	0.48	0.35	0.19	0.69	0.59	0.56	0.54		0.37	0.24	0.11		0.48	0.37	0.22	0.87	0.59	n/a	n/a
10 (254)	0.69	0.69	0.66	0.60	0.81	0.49	0.35	0.19	0.69	0.59	0.57	0.54		0.38	0.24	0.11		0.49	0.37	0.23	0.87	0.59	n/a	n/a
11 (279)	0.71	0.71	0.67	0.60	0.87	0.52	0.38	0.21	0.71	0.60	0.57	0.54		0.43	0.28	0.13		0.52	0.40	0.26	0.91	0.62	n/a	n/a
12 (305)	0.73	0.73	0.69	0.61	0.92	0.56	0.40	0.22	0.73	0.60	0.58	0.55		0.49	0.32	0.15		0.56	0.42	0.29	0.95	0.65	n/a	n/a
12-1/2 (318)	0.74	0.74	0.70	0.62	0.95	0.59	0.41	0.23	0.74	0.61	0.58	0.55		0.52	0.34	0.16		0.59	0.43	0.29	0.97	0.66	0.57	n/a
14 (356)	0.76	0.76	0.72	0.63	1.00	0.66	0.46	0.25	0.77	0.62	0.59	0.55		0.62	0.40	0.19		0.66	0.47	0.31	1.00	0.70	0.60	n/a
16 (406)	0.80	0.80	0.75	0.65		0.75	0.52	0.29	0.80	0.64	0.60	0.56		0.76	0.49	0.23		0.75	0.52	0.34		0.75	0.65	n/a
18 (457)	0.84	0.84	0.79	0.67		0.84	0.59	0.32	0.84	0.66	0.62	0.57		0.91	0.59	0.27		0.84	0.59	0.36		0.79	0.68	n/a
19-1/2 (495)	0.87	0.87	0.81	0.69		0.92	0.64	0.35	0.87	0.67	0.63	0.58		1.00	0.66	0.31		0.92	0.64	0.38		0.82	0.71	0.55
20 (508)	0.88	0.88	0.82	0.69		0.94	0.65	0.36	0.88	0.67	0.63	0.58			0.69	0.32		0.94	0.65	0.39		0.83	0.72	0.56
22 (559)	0.91	0.91	0.85	0.71		1.00	0.72	0.40	0.92	0.69	0.64	0.59			0.80	0.37		1.00	0.72	0.41		0.87	0.76	0.59
24 (610)	0.95	0.95	0.88	0.73			0.78	0.43	0.96	0.71	0.66	0.59			0.91	0.42			0.78	0.44		0.91	0.79	0.61
26 (660)	0.99	0.99	0.91	0.75			0.85	0.47	0.99	0.73	0.67	0.60			1.00	0.48			0.85	0.47		0.95	0.82	0.64
28 (711)	1.00	1.00	0.94	0.77			0.91	0.50	1.00	0.74	0.68	0.61				0.53			0.91	0.50		0.99	0.85	0.66
30 (762)			0.98	0.79			0.98	0.54		0.76	0.70	0.62				0.59			0.98	0.54		1.00	0.88	0.68
36 (914)			1.00	0.84			1.00	0.65		0.81	0.73	0.64				0.77			1.00	0.65		1.00	0.97	0.75
> 48 (1219)				0.96			0.86			0.92	0.81	0.69				1.00				0.86			1.00	0.87

3.2.4

**Table 39 - Load adjustment factors for 7/8-in. diameter threaded rods in cracked concrete<sup>1,2,3</sup>**

7/8-in. cracked concrete	Spacing factor in tension $f_{AN}$				Edge distance factor in tension $f_{RN}$				Spacing factor in shear <sup>4</sup> $f_{SV}$				Edge distance in shear				Concrete thickness factor in shear <sup>5</sup> $f_{TV}$								
													⊥ Toward edge $f_{RV}$		∥ To and away from edge $f_{RV}$										
	Embedment $h_{ef}$ (mm)	3-1/2 (89)	7-7/8 (200)	10-1/2 (267)	17-1/2 (445)	3-1/2 (89)	7-7/8 (200)	10-1/2 (267)	17-1/2 (445)	3-1/2 (89)	7-7/8 (200)	10-1/2 (267)	17-1/2 (445)	3-1/2 (89)	7-7/8 (200)	10-1/2 (267)	17-1/2 (445)	3-1/2 (89)	7-7/8 (200)	10-1/2 (267)	17-1/2 (445)				
1-3/4 (44)	n/a	n/a	n/a	n/a	0.42	0.42	0.41	0.38	n/a	n/a	n/a	n/a	0.09	0.03	0.02	0.01	0.18	0.06	0.04	0.02	n/a	n/a	n/a	n/a	
4-3/8 (111)	0.58	0.58	0.57	0.54	0.53	0.53	0.50	0.44	0.58	0.54	0.53	0.52	0.36	0.11	0.07	0.03	0.71	0.22	0.14	0.07	n/a	n/a	n/a	n/a	
5 (127)	0.59	0.59	0.58	0.55	0.56	0.56	0.52	0.45	0.60	0.54	0.53	0.52	0.43	0.13	0.09	0.04	0.87	0.27	0.17	0.08	n/a	n/a	n/a	n/a	
5-1/2 (140)	0.60	0.60	0.59	0.55	0.58	0.58	0.54	0.46	0.61	0.55	0.54	0.52	0.50	0.15	0.10	0.05	1.00	0.31	0.20	0.10	0.65	n/a	n/a	n/a	
6 (152)	0.61	0.61	0.60	0.56	0.61	0.61	0.56	0.47	0.61	0.55	0.54	0.52	0.57	0.18	0.11	0.06		0.35	0.23	0.11	0.68	n/a	n/a	n/a	
7 (178)	0.63	0.63	0.61	0.57	0.65	0.65	0.60	0.49	0.63	0.56	0.55	0.53	0.72	0.22	0.14	0.07		0.44	0.29	0.14	0.73	n/a	n/a	n/a	
8 (203)	0.65	0.65	0.63	0.58	0.71	0.71	0.64	0.52	0.65	0.57	0.55	0.53	0.88	0.27	0.18	0.09		0.54	0.35	0.17	0.78	n/a	n/a	n/a	
9 (229)	0.67	0.67	0.64	0.59	0.76	0.76	0.68	0.54	0.67	0.58	0.56	0.54	1.00	0.32	0.21	0.10		0.65	0.42	0.20	0.83	n/a	n/a	n/a	
9-7/8 (251)	0.69	0.69	0.66	0.59	0.80	0.80	0.72	0.56	0.69	0.59	0.56	0.54		0.37	0.24	0.12		0.74	0.48	0.23	0.87	0.59	n/a	n/a	
10 (254)	0.69	0.69	0.66	0.60	0.81	0.81	0.73	0.56	0.69	0.59	0.57	0.54		0.38	0.25	0.12		0.76	0.49	0.24	0.87	0.59	n/a	n/a	
11 (279)	0.71	0.71	0.67	0.60	0.87	0.87	0.77	0.59	0.71	0.60	0.57	0.54		0.44	0.28	0.14		0.87	0.57	0.28	0.92	0.62	n/a	n/a	
12 (305)	0.73	0.73	0.69	0.61	0.92	0.92	0.82	0.61	0.73	0.60	0.58	0.55		0.50	0.32	0.16		1.00	0.65	0.31	0.96	0.65	n/a	n/a	
12-1/2 (318)	0.74	0.74	0.70	0.62	0.95	0.95	0.84	0.62	0.74	0.61	0.58	0.55		0.53	0.34	0.17			0.69	0.33	0.98	0.66	0.57	n/a	
14 (356)	0.76	0.76	0.72	0.63	1.00	1.00	0.91	0.66	0.77	0.62	0.59	0.56		0.63	0.41	0.20			0.82	0.40	1.00	0.70	0.61	n/a	
16 (406)	0.80	0.80	0.75	0.65			1.00	0.71	0.81	0.64	0.60	0.56		0.77	0.50	0.24				1.00	0.48		0.75	0.65	n/a
18 (457)	0.84	0.84	0.79	0.67				0.76	0.84	0.66	0.62	0.57		0.91	0.59	0.29					0.58		0.79	0.69	n/a
19-1/2 (495)	0.87	0.87	0.81	0.69				0.80	0.87	0.67	0.63	0.58		1.00	0.67	0.32					0.65		0.82	0.71	0.56
20 (508)	0.88	0.88	0.82	0.69				0.82	0.88	0.67	0.63	0.58			0.70	0.34					0.67		0.84	0.72	0.57
22 (559)	0.91	0.91	0.85	0.71				0.87	0.92	0.69	0.64	0.59			0.80	0.39					0.78		0.88	0.76	0.60
24 (610)	0.95	0.95	0.88	0.73				0.93	0.96	0.71	0.66	0.60			0.91	0.44					0.89		0.92	0.79	0.62
26 (660)	0.99	0.99	0.91	0.75				0.99	1.00	0.73	0.67	0.61			1.00	0.50					0.99		0.95	0.82	0.65
28 (711)	1.00	1.00	0.94	0.77				1.00		0.74	0.68	0.61				0.56					1.00		0.99	0.86	0.67
30 (762)			0.98	0.79						0.76	0.70	0.62				0.62							1.00	0.89	0.70
36 (914)			1.00	0.84						0.81	0.74	0.65				0.81								0.97	0.76
> 48 (1219)				0.96						0.92	0.81	0.69				1.00								1.00	0.88

- 1 Linear interpolation not permitted.
- 2 Shaded area with reduced edge distance is permitted provided the installation torque is reduced to 0.30 T<sub>max</sub> for 5d ≤ s ≤ 16-in. and to 0.5 T<sub>max</sub> for s > 16-in.
- 3 When combining multiple load adjustment factors (e.g. for a 4 anchor pattern in a corner with a thin concrete member) the design can become very conservative. To optimize the design, use Hilti PROFIS Anchor Design software or perform anchor calculation using the design equations from ACI 318 Chapter 17.
- 4 Spacing factor reduction in shear,  $f_{SV}$ , assumes an influence of a nearby edge. If no edge exists, then  $f_{SV} = f_{SV}^*$ .
- 5 Concrete thickness reduction factor in shear,  $f_{TV}$ , assumes an influence of a nearby edge. If no edge exists, then  $f_{TV} = 1.0$ .

### 3.2.4 HIT-RE 500 V3 Epoxy Adhesive Anchoring System

**Table 29 - Steel design strength for Hilti HIT-V and HAS threaded rods<sup>1</sup>**

Nominal anchor diameter in.	HIT-V ASTM A307 Grade A <sup>2</sup>			HAS-E ISO 898 Class 5.8 <sup>2</sup>			HAS-E-B ASTM A193 B7 <sup>3</sup>			HAS-R stainless steel ASTM F593 - AISI 304/316 SS <sup>2</sup>		
	Tensile <sup>4</sup> $\phi N_{sa}$ lb (kN)	Shear <sup>5</sup> $\phi V_{sa}$ lb (kN)	Seismic Shear <sup>6</sup> $\phi V_{sa,eq}$ lb (kN)	Tensile <sup>4</sup> $\phi N_{sa}$ lb (kN)	Shear <sup>5</sup> $\phi V_{sa}$ lb (kN)	Seismic Shear <sup>6</sup> $\phi V_{sa,eq}$ lb (kN)	Tensile <sup>4</sup> $\phi N_{sa}$ lb (kN)	Shear <sup>5</sup> $\phi V_{sa}$ lb (kN)	Seismic Shear <sup>6</sup> $\phi V_{sa,eq}$ lb (kN)	Tensile <sup>4</sup> $\phi N_{sa}$ lb (kN)	Shear <sup>5</sup> $\phi V_{sa}$ lb (kN)	Seismic Shear <sup>6</sup> $\phi V_{sa,eq}$ lb (kN)
3/8	3,025 (13.5)	1,675 (7.5)	1,175 (5.2)	3,655 (16.3)	2,020 (9.0)	1,415 (6.3)	7,265 (32.3)	3,775 (16.8)	2,645 (11.8)	5,040 (22.4)	2,790 (12.4)	1,955 (8.7)
1/2	5,535 (24.6)	3,065 (13.6)	2,145 (9.5)	6,690 (29.8)	3,705 (16.5)	2,595 (11.5)	13,300 (59.2)	6,915 (30.8)	4,840 (21.5)	9,225 (41.0)	5,110 (22.7)	3,575 (15.9)
5/8	8,815 (39.2)	4,880 (21.7)	3,415 (15.2)	10,650 (47.4)	5,900 (26.2)	4,130 (18.4)	21,190 (94.3)	11,020 (49.0)	7,715 (34.3)	14,690 (65.3)	8,135 (36.2)	5,695 (25.3)
3/4	13,045 (58.0)	7,225 (32.1)	5,060 (22.5)	15,765 (70.1)	8,730 (38.8)	6,110 (27.2)	31,360 (139.5)	16,305 (72.5)	11,415 (50.8)	18,480 (82.2)	10,235 (45.5)	7,165 (31.9)
7/8	-	-	-	21,755 (96.8)	12,050 (53.6)	8,435 (37.5)	43,285 (192.5)	22,505 (100.1)	15,755 (70.1)	25,510 (113.5)	14,125 (62.8)	9,890 (44.0)
1	23,620 (105.1)	13,085 (58.2)	9,160 (40.7)	28,540 (127.0)	15,865 (70.3)	11,865 (49.2)	56,785 (252.6)	29,525 (131.3)	20,670 (91.9)	33,465 (148.9)	18,535 (82.4)	12,975 (57.7)
1-1/4	-	-	-	45,670 (203.1)	25,295 (112.5)	17,705 (78.8)	90,850 (404.1)	47,240 (210.1)	33,070 (147.1)	53,540 (238.2)	29,655 (131.9)	20,760 (92.3)

1 See Section 3.1.8.6 to convert design strength value to ASD value.

2 HIT-V, HAS-E, and HAS-R threaded rods are considered brittle steel elements. HIT-V does not comply with % elongation requirements of ASTM A307 Grade A steel. HAS-E does not comply with % elongation requirements of ISO 898-1.

3 HAS-E-B7 rods are considered ductile steel elements.

4 Tensile =  $\phi A_{sa} N_{sa}$  as noted in ACI 318 Chapter 17.

5 Shear =  $\phi 0.60 A_{sa} V_{sa}$  as noted in ACI 318 Chapter 17.

6 Seismic Shear =  $\alpha_{V_{sa,eq}} \phi V_{sa}$  : Reduction for seismic shear only. See section 3.1.8.7 for additional information on seismic applications.

$L=15' \pm$ ; to be field

ver. field

**\* Tapered Self-Support Tower Sub-Horizontals**

- Designed to strengthen tower legs by reducing their KL/r value
- Complete kits contain (6) Angles, (3) Brackets, (3) Center Plates, (6) 5/8" U-bolts, (27) 5/8" Bolts
- All material is minimum A36, Hardware is A325X, Hot-Dip Galvanized
- Connections use Squirter® F959 DTI washers to ensure proper installed bolt tension
- Double bolted angle connections at both ends
- Brackets center themselves on legs with the welded solid rods on backside
- Specify leg butterfly bracket kit + angle / center plate kit [Qty: (3) per Kit]

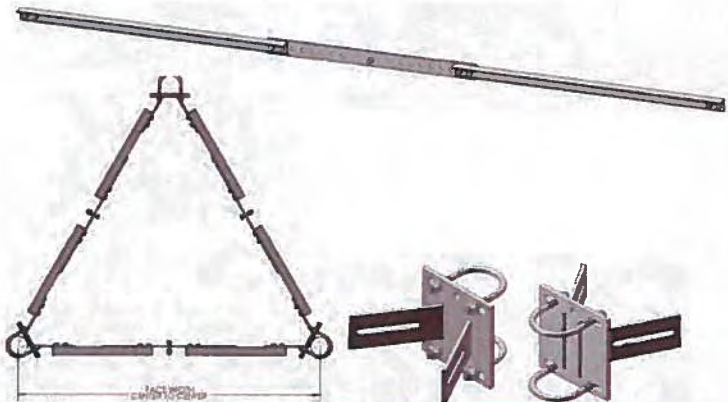

Sub Horizontal Angle & Center Plate						
Mfr	Tower Face Width Range (ft)	Center Plate Size	Sub-Horizontal Size	Φ Pn (kips)	Leg Pu* (kips)	Kit #
Structural Components	5 - 6	3/8" x 3"	2" x 2" x 3/16"	20.00	800	RSH-0605-06
	6 - 7	3/8" x 3"	2" x 2" x 3/16"	18.00	720	RSH-0606-07
	7 - 9	3/8" x 3"	2" x 2" x 1/4"	13.75	550	RSH-0607-09
	9 - 11	3/8" x 3"	2" x 2" x 1/4"	9.50	380	RSH-0609-11
	11 - 13	3/8" x 3"	2-1/2" x 2-1/2" x 1/4"	12.13	485	RSH-0611-13
	13 - 15	1/2" x 4"	2-1/2" x 2-1/2" x 1/4"	8.50	340	RSH-0613-15
	15 - 17	1/2" x 4"	3" x 3" x 1/4"	16.50	660	RSH-0615-17
	17 - 19	1/2" x 4"	3" x 3" x 1/4"	12.50	500	RSH-0617-19
	19 - 21	5/8" x 4"	3-1/2" x 3-1/2" x 1/4"	16.00	640	RSH-0619-21
	21 - 23	5/8" x 4"	3-1/2" x 3-1/2" x 1/4"	12.88	515	RSH-0621-23
	23 - 25	5/8" x 4"	4" x 4" x 1/4"	15.88	635	RSH-0623-25

Leg Butterfly Bracket		
Leg Ø Range (O.D.) (in)	U-Bolt Size	Kit #
1.5 - 2.5	5/8" x 2-9/16"	RSH-0515-25
2.5 - 3.5	5/8" x 3-9/16"	RSH-0525-35
3.5 - 4.5	5/8" x 4-9/16"	RSH-0535-45
4.5 - 6.75	5/8" x 6-13/16"	RSH-0545-68
6.75 - 8.625	5/8" x 8-11/16"	RSH-0568-86
8.625 - 10.75	5/8" x 10-13/16"	RSH-0586-00

\*CAPACITY BASED ON FULLY LOADING HORIZONTAL WITH 2.5% OF LEG COMPRESSION  
NOTE: Order (1) RSH-05###-### kit and (1) RSH-06###-### kit for (1) full sub-horizontal assembly

**Guyed Tower Torque Arm**

- Designed to provide torsion resistance to guyed towers when needed
- Kits contain all materials to bolt torque arm onto tower
- All material is minimum A572-50, Hardware is A325X, Hot-Dip Galvanized
- Connections use Squirter F959 DTI washers to ensure proper installed bolt tension
- Fits guyed towers with 1.25" - 3.5" OD Legs
- Add split pipe sleeve kit if tower leg is 2" SCH 40, 2.5" SCH 40 or 3" SCH 40 [Qty: (3) per kit]
- Use split pipe sleeves to avoid crimping thin wall pipe legs

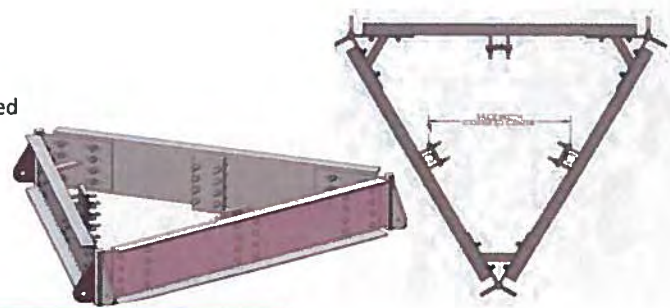

Mfr	Face Width (C-C) (in)	EHS WIRE SIZE									
		< 5/16"	3/8"	7/16"	1/2"	9/16"	5/8"	11/16"	3/4"	7/8"	1"
Structural Components	18	RTA-1135-18			RTA-1235-18						
	24	RTA-1135-24			RTA-1235-24						RTA-1335-24
	30	RTA-1135-30			RTA-1235-30					RTA-1335-30	
	33	RTA-1135-33			RTA-1235-33				RTA-1335-33		
	36	RTA-1235-36						RTA-1335-36			
	39	RTA-1235-39					RTA-1335-39				
	41	RTA-1235-41					RTA-1335-41				
	42	RTA-1235-42					RTA-1335-42				
	45	RTA-1235-45				RTA-1335-45					
	48	RTA-1235-48				RTA-1335-48					
	54	RTA-1235-54				RTA-1335-54					
	57	RTA-1235-57				RTA-1335-57					
	60	RTA-1235-60				RTA-1335-60					
	72	RTA-1235-72			RTA-1335-72						



Towers with SCH 40 Pipe Legs: Split Pipe Sleeves	
Leg OD	Kit #
2.375"	RGA-1000-23
2.875"	RGA-1000-28
3.5"	RGA-1000-35

LIGHT      MEDIUM      HEAVY

## About AECOM

AECOM (NYSE: ACM) is a global provider of professional technical and management support services to a broad range of markets, including transportation, facilities, environmental, energy, water and government. With approximately 45,000 employees around the world, AECOM is a leader in all of the key markets that it serves. AECOM provides a blend of global reach, local knowledge, innovation, and collaborative technical excellence in delivering solutions that enhance and sustain the world's built, natural, and social environments. A Fortune 500 company, AECOM serves clients in more than 100 countries and has annual revenue in excess of \$6 billion.

More information on AECOM and its services can be found at [www.aecom.com](http://www.aecom.com).

500 Enterprise Drive, Suite 3B  
Rocky Hill, CT 06067  
860-529-8882  
Fax: 860-529-3991

# Exhibit E



## RADIO FREQUENCY EMISSIONS ANALYSIS REPORT EVALUATION OF HUMAN EXPOSURE POTENTIAL TO NON-IONIZING EMISSIONS

T-Mobile Existing Facility

Site ID: CT11070B

CT State Police\_2  
150 Butternut Hollow Road  
Greenwich, CT 06830

**April 19, 2018**

**EBC Project Number: 6218002986**

Site Compliance Summary	
Compliance Status:	<b>COMPLIANT</b>
Site total MPE% of FCC general population allowable limit:	<b>10.53 %</b>



April 19, 2018

T-Mobile USA  
Attn: Jason Overbey, RF Manager  
35 Griffin Road South  
Bloomfield, CT 06002

## Emissions Analysis for Site: **CT11070B – CT State Police\_2**

EBI Consulting was directed to analyze the proposed T-Mobile facility located at **150 Butternut Hollow Road, Greenwich, CT**, for the purpose of determining whether the emissions from the Proposed T-Mobile Antenna Installation located on this property are within specified federal limits.

All information used in this report was analyzed as a percentage of current Maximum Permissible Exposure (% MPE) as listed in the FCC OET Bulletin 65 Edition 97-01 and ANSI/IEEE Std C95.1. The FCC regulates Maximum Permissible Exposure in units of microwatts per square centimeter ( $\mu\text{W}/\text{cm}^2$ ). The number of  $\mu\text{W}/\text{cm}^2$  calculated at each sample point is called the power density. The exposure limit for power density varies depending upon the frequencies being utilized. Wireless Carriers and Paging Services use different frequency bands each with different exposure limits, therefore it is necessary to report results and limits in terms of percent MPE rather than power density.

All results were compared to the FCC (Federal Communications Commission) radio frequency exposure rules, 47 CFR 1.1307(b)(1) – (b)(3), to determine compliance with the Maximum Permissible Exposure (MPE) limits for General Population/Uncontrolled environments as defined below.

General population/uncontrolled exposure limits apply to situations in which the general population may be exposed or in which persons who are exposed as a consequence of their employment may not be made fully aware of the potential for exposure or cannot exercise control over their exposure. Therefore, members of the general population would always be considered under this category when exposure is not employment related, for example, in the case of a telecommunications tower that exposes persons in a nearby residential area.

Public exposure to radio frequencies is regulated and enforced in units of microwatts per square centimeter ( $\mu\text{W}/\text{cm}^2$ ). The general population exposure limit for the 600 MHz and 700 MHz Band is approximately  $400 \mu\text{W}/\text{cm}^2$  and  $467 \mu\text{W}/\text{cm}^2$  respectively, and the general population exposure limit for the 1900 MHz (PCS) and 2100 MHz (AWS) bands is  $1000 \mu\text{W}/\text{cm}^2$ . Because each carrier will be using different frequency bands, and each frequency band has different exposure limits, it is necessary to report percent of MPE rather than power density.



Occupational/controlled exposure limits apply to situations in which persons are exposed as a consequence of their employment and in which those persons who are exposed have been made fully aware of the potential for exposure and can exercise control over their exposure. Occupational/controlled exposure limits also apply where exposure is of a transient nature as a result of incidental passage through a location where exposure levels may be above general population/uncontrolled limits (see below), as long as the exposed person has been made fully aware of the potential for exposure and can exercise control over his or her exposure by leaving the area or by some other appropriate means.

Additional details can be found in FCC OET 65.

## CALCULATIONS

Calculations were done for the proposed T-Mobile Wireless antenna facility located at **150 Butternut Hollow Road, Greenwich, CT**, using the equipment information listed below. All calculations were performed per the specifications under FCC OET 65. Since T-Mobile is proposing highly focused directional panel antennas, which project most of the emitted energy out toward the horizon, all calculations were performed assuming a lobe representing the maximum gain of the antenna per the antenna manufactures supplied specifications, minus 10 dB, was focused at the base of the tower. For this report the sample point is the top of a 6-foot person standing at the base of the tower.

For all calculations, all equipment was calculated using the following assumptions:

- 1) 2 GSM channels (PCS Band - 1900 MHz) were considered for each sector of the proposed installation. These Channels have a transmit power of 30 Watts per Channel.
- 2) 2 UMTS channels (PCS Band - 1900 MHz) were considered for each sector of the proposed installation. These Channels have a transmit power of 30 Watts per Channel.
- 3) 2 UMTS channels (AWS Band – 2100 MHz) were considered for each sector of the proposed installation. These Channels have a transmit power of 30 Watts per Channel.
- 4) 2 LTE channels (PCS Band - 1900 MHz) were considered for each sector of the proposed installation. These Channels have a transmit power of 60 Watts per Channel.
- 5) 2 LTE channels (AWS Band – 2100 MHz) were considered for each sector of the proposed installation. These Channels have a transmit power of 60 Watts per Channel.
- 6) 2 LTE channels (600 MHz Band) were considered for each sector of the proposed installation. These Channels have a transmit power of 30 Watts.





- 7) 2 LTE channels (700 MHz Band) were considered for each sector of the proposed installation. These Channels have a transmit power of 30 Watts.
- 8) All radios at the proposed installation were considered to be running at full power and were uncombined in their RF transmissions paths per carrier prescribed configuration. Per FCC OET Bulletin No. 65 - Edition 97-01 recommendations to achieve the maximum anticipated value at each sample point, all power levels emitting from the proposed antenna installation are increased by a factor of 2.56 to account for possible in-phase reflections from the surrounding environment. This is rarely the case, and if so, is never continuous.
- 9) For the following calculations the sample point was the top of a 6-foot person standing at the base of the tower. The maximum gain of the antenna per the antenna manufactures supplied specifications minus 10 dB was used in this direction. This value is a very conservative estimate as gain reductions for these particular antennas are typically much higher in this direction.
- 10) The antennas used in this modeling are the **Ericsson AIR32 B66A/B2A & Ericsson AIR21 B2A/B4P** for 1900 MHz (PCS) and 2100 MHz (AWS) channels and the **RFS APXVAA24-43-U-A20** for 600 MHz and 700 MHz channels. This is based on feedback from the carrier with regards to anticipated antenna selection. The **Ericsson AIR32 B66A/B2A** has a maximum gain of **15.9 dBd** at its main lobe at 1900 MHz and 2100 MHz. The **Ericsson AIR21 B2A/B4P** has a maximum gain of **15.9 dBd** at its main lobe at 1900 MHz and 2100 MHz. The **RFS APXVAA24-43-U-A20** has a maximum gain of **13.15/ 13.55 dBd** at its main lobe at 600 MHz and 700 MHz respectively. The maximum gain of the antenna per the antenna manufactures supplied specifications, minus 10 dB, was used for all calculations. This value is a very conservative estimate as gain reductions for these particular antennas are typically much higher in this direction.
- 11) The antenna mounting height centerline of the proposed antennas is **137 feet** above ground level (AGL).
- 12) Emissions values for additional carriers were taken from the Connecticut Siting Council active database. Values in this database are provided by the individual carriers themselves.
- 13) All calculations were done with respect to uncontrolled / general population threshold limits.



## T-Mobile Site Inventory and Power Data

Sector:	A	Sector:	B	Sector:	C
Antenna #:	1	Antenna #:	1	Antenna #:	1
Make / Model:	Ericsson AIR32 B66A/B2A	Make / Model:	Ericsson AIR32 B66A/B2A	Make / Model:	Ericsson AIR32 B66A/B2A
Gain:	15.9 dBd	Gain:	15.9 dBd	Gain:	15.9 dBd
Height (AGL):	137	Height (AGL):	137	Height (AGL):	137
Frequency Bands	1900 MHz (PCS) / 2100 MHz (AWS)	Frequency Bands	1900 MHz (PCS) / 2100 MHz (AWS)	Frequency Bands	1900 MHz (PCS) / 2100 MHz (AWS)
Channel Count	4	Channel Count	4	Channel Count	4
Total TX Power(W):	240	Total TX Power(W):	240	Total TX Power(W):	240
ERP (W):	9,337.08	ERP (W):	9,337.08	ERP (W):	9,337.08
Antenna A1 MPE%	1.96	Antenna B1 MPE%	1.96	Antenna C1 MPE%	1.96
Antenna #:	2	Antenna #:	2	Antenna #:	2
Make / Model:	Ericsson AIR21 B2A/B4P	Make / Model:	Ericsson AIR21 B2A/B4P	Make / Model:	Ericsson AIR21 B2A/B4P
Gain:	15.9 dBd	Gain:	15.9 dBd	Gain:	15.9 dBd
Height (AGL):	137	Height (AGL):	137	Height (AGL):	137
Frequency Bands	1900 MHz (PCS) / 2100 MHz (AWS)	Frequency Bands	1900 MHz (PCS) / 2100 MHz (AWS)	Frequency Bands	1900 MHz (PCS) / 2100 MHz (AWS)
Channel Count	6	Channel Count	6	Channel Count	6
Total TX Power(W):	180	Total TX Power(W):	180	Total TX Power(W):	180
ERP (W):	7,002.81	ERP (W):	7,002.81	ERP (W):	7,002.81
Antenna A2 MPE%	1.46	Antenna B2 MPE%	1.46	Antenna C2 MPE%	1.46
Antenna #:	3	Antenna #:	3	Antenna #:	3
Make / Model:	RFS APXVAA24-43-U-A20	Make / Model:	RFS APXVAA24-43-U-A20	Make / Model:	RFS APXVAA24-43-U-A20
Gain:	13.15/ 13.55 dBd	Gain:	13.15/ 13.55 dBd	Gain:	13.15/ 13.55 dBd
Height (AGL):	137	Height (AGL):	137	Height (AGL):	137
Frequency Bands	600 MHz / 700 MHz	Frequency Bands	600 MHz / 700 MHz	Frequency Bands	600 MHz / 700 MHz
Channel Count	4	Channel Count	4	Channel Count	4
Total TX Power(W):	120	Total TX Power(W):	120	Total TX Power(W):	120
ERP (W):	2,598.01	ERP (W):	2,598.01	ERP (W):	2,598.01
Antenna A3 MPE%	1.26	Antenna B3 MPE%	1.26	Antenna C3 MPE%	1.26

Site Composite MPE%	
Carrier	MPE%
T-Mobile (Per Sector Max)	4.68 %
State Police	0.42 %
Greenwich	0.26 %
DOT	0.06 %
NU	1.04 %
Sprint	0.61 %
AT&T	1.42 %
Verizon Wireless	2.04 %
<b>Site Total MPE %:</b>	<b>10.53 %</b>

T-Mobile Sector A Total:	4.68 %
T-Mobile Sector B Total:	4.68 %
T-Mobile Sector C Total:	4.68 %
<b>Site Total:</b>	<b>10.53 %</b>



## T-Mobile Max Power Values (Per Sector)

T-Mobile_Max Power Values per sector	# Channels	Watts ERP (Per Channel)	Height (feet)	Total Power Density ( $\mu\text{W}/\text{cm}^2$ )	Frequency (MHz)	Allowable MPE ( $\mu\text{W}/\text{cm}^2$ )	Calculated % MPE
T-Mobile AWS - 2100 MHz LTE	2	2,334.27	137	9.78	AWS - 2100 MHz	1000	0.98%
T-Mobile PCS - 1900 MHz LTE	2	2,334.27	137	9.78	PCS - 1900 MHz	1000	0.98%
T-Mobile AWS - 2100 MHz UMTS	2	1,167.14	137	4.89	AWS - 2100 MHz	1000	0.49%
T-Mobile PCS - 1900 MHz UMTS	2	1,167.14	137	4.89	PCS - 1900 MHz	1000	0.49%
T-Mobile PCS - 1900 MHz GSM	2	1,167.14	137	4.89	PCS - 1900 MHz	1000	0.49%
T-Mobile 600 MHz LTE	2	619.61	137	2.60	600 MHz	400	0.65%
T-Mobile 700 MHz LTE	2	679.39	137	2.85	700 MHz	467	0.61%
						<b>Total*:</b>	<b>4.68%</b>

\*NOTE: Totals may vary by 0.01% due to summing of remainders



## Summary

All calculations performed for this analysis yielded results that were **within** the allowable limits for general population exposure to RF Emissions.

The anticipated maximum composite contributions from the T-Mobile facility as well as the site composite emissions value with regards to compliance with FCC's allowable limits for general population exposure to RF Emissions are shown here:

T-Mobile Sector	Power Density Value (%)
Sector A:	4.68 %
Sector B:	4.68 %
Sector C:	4.68 %
T-Mobile Per Sector Maximum:	4.68 %
Site Total:	10.53 %
Site Compliance Status:	<b>COMPLIANT</b>

The anticipated composite MPE value for this site assuming all carriers present is **10.53%** of the allowable FCC established general population limit sampled at the ground level. This is based upon values listed in the Connecticut Siting Council database for existing carrier emissions.

FCC guidelines state that if a site is found to be out of compliance (over allowable thresholds), that carriers over a 5% contribution to the composite value will require measures to bring the site into compliance. For this facility, the composite values calculated were well within the allowable 100% threshold standard per the federal government.

# Exhibit F

**UPS Internet Shipping: View/Print Label**

1. **Ensure there are no other shipping or tracking labels attached to your package.** Select the Print button on the print dialog box that appears. Note: If your browser does not support this function select Print from the File menu to print the label.
2. **Fold the printed label at the solid line below.** Place the label in a UPS Shipping Pouch. If you do not have a pouch, affix the folded label using clear plastic shipping tape over the entire label.
3. **GETTING YOUR SHIPMENT TO UPS**  
**Customers with a Daily Pickup**  
Your driver will pickup your shipment(s) as usual.

**Customers without a Daily Pickup**

Take your package to any location of The UPS Store®, UPS Access Point(TM) location, UPS Drop Box, UPS Customer Center, Staples® or Authorized Shipping Outlet near you. Items sent via UPS Return Services(SM) (including via Ground) are also accepted at Drop Boxes. To find the location nearest you, please visit the 'Find Locations' Quick link at ups.com.



Schedule a same day or future day Pickup to have a UPS driver pickup all of your Internet Shipping packages. Hand the package to any UPS driver in your area.

UPS Access Point™  
THE UPS STORE  
542 HOPMEADOW ST  
SIMSBURY ,CT 06070

UPS Access Point™  
HAV-MOR MARKET  
24 S ELM ST  
WINDSOR LOCKS ,CT 06096

UPS Access Point™  
THE UPS STORE  
41 CROSSROADS PLZ  
WEST HARTFORD ,CT 06117

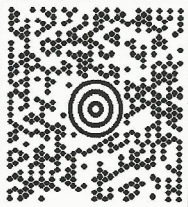
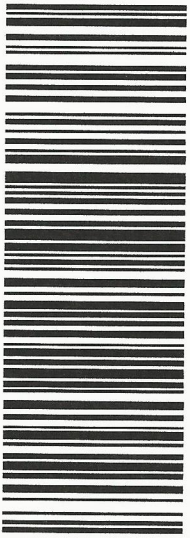
FOLD HERE

DEBORAH CHASE 860-490-8839 T- MOBILE/NSS 35 GRIFFIN RD SOUTH BLOOMFIELD CT 06002	2 LBS PAK 1 OF 1
<b>SHIP TO:</b> BRIAN BENITO 860-685-8297 STATE OF CT, DEPT EMERGENCY SERVICES MIDDLETOWN CT'S UNIT 1111 COUNTRY CLUB ROAD MIDDLETOWN CT 06457-2389	<b>CT 061 9-01</b> 
	<b>UPS 2ND DAY AIR</b> TRACKING #: 1Z 8X7 15X 02 9224 7102 <b>2</b>
	
BILLING: P/P	
Reference# 1: GT11070B-L700 ZAP Reference# 2: ZONING COPY FOR STATE POLICE <small>UPS 2D 042 WNTNY050 99.CA. 04/2018</small>	
	

**UPS Internet Shipping: View/Print Label**

1. **Ensure there are no other shipping or tracking labels attached to your package.** Select the Print button on the print dialog box that appears. Note: If your browser does not support this function select Print from the File menu to print the label.
2. **Fold the printed label at the solid line below.** Place the label in a UPS Shipping Pouch. If you do not have a pouch, affix the folded label using clear plastic shipping tape over the entire label.
3. **GETTING YOUR SHIPMENT TO UPS**  
**Customers with a Daily Pickup**  
Your driver will pickup your shipment(s) as usual.

**Customers without a Daily Pickup**



Take your package to any location of The UPS Store®, UPS Access Point™ location, UPS Drop Box, UPS Customer Center, Staples® or Authorized Shipping Outlet near you. Items sent via UPS Return Services(SM) (including via Ground) are also accepted at Drop Boxes. To find the location nearest you, please visit the 'Find Locations' Quick link at ups.com.  
Schedule a same day or future day Pickup to have a UPS driver pickup all of your Internet Shipping packages. Hand the package to any UPS driver in your area.

UPS Access Point™  
THE UPS STORE  
542 HOPMEADOW ST  
SIMSBURY ,CT 06070

UPS Access Point™  
HAV-MOR MARKET  
24 S ELM ST  
WINDSOR LOCKS ,CT 06096

UPS Access Point™  
THE UPS STORE  
41 CROSSROADS PLZ  
WEST HARTFORD ,CT 06117

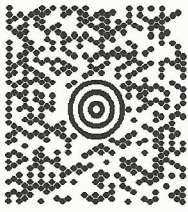
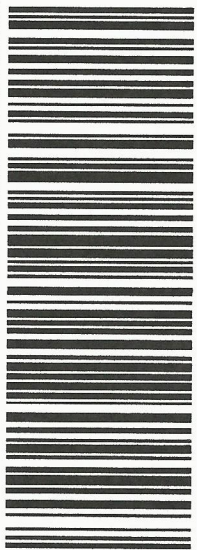
FOLD HERE

DEBORAH CHASE 860-490-8839 T. MOBILE/MS 33 GRIFFIN RD SOUTH BLOOMFIELD CT 06002	2 LBS    PAK    1 OF 1
<b>SHIP TO:</b> PETER TESEI- FIRST SELECTMAN 203-622-7700 GREENWICH TOWN HALL 101 FIELD POINT ROAD <b>GREENWICH CT 06830-6463</b>	<b>CT 069 9-01</b> 
	<b>UPS 2ND DAY AIR</b> TRACKING #: 1Z 8X7 15X 02 9349 6716
	
BILLING: P/P	
Reference#1: CTI1070B-L700 ZAP Reference#2: ZONING APPLICATION- TOWN OFFICIAL <small>UPS 20.0.4z. WINTNSO 99.04.04/2018</small>	
	

**UPS Internet Shipping: View/Print Label**

1. **Ensure there are no other shipping or tracking labels attached to your package.** Select the Print button on the print dialog box that appears. Note: If your browser does not support this function select Print from the File menu to print the label.
2. **Fold the printed label at the solid line below.** Place the label in a UPS Shipping Pouch. If you do not have a pouch, affix the folded label using clear plastic shipping tape over the entire label.
3. **GETTING YOUR SHIPMENT TO UPS**  
**Customers with a Daily Pickup**  
Your driver will pickup your shipment(s) as usual.

**Customers without a Daily Pickup**

Take your package to any location of The UPS Store®, UPS Access Point(TM) location, UPS Drop Box, UPS Customer Center, Staples® or Authorized Shipping Outlet near you. Items sent via UPS Return Services(SM) (including via Ground) are also accepted at Drop Boxes. To find the location nearest you, please visit the 'Find Locations' Quick link at ups.com.



Schedule a same day or future day Pickup to have a UPS driver pickup all of your Internet Shipping packages. Hand the package to any UPS driver in your area.

UPS Access Point™  
THE UPS STORE  
542 HOPMEADOW ST  
SIMSBURY ,CT 06070

UPS Access Point™  
HAV-MOR MARKET  
24 S ELM ST  
WINDSOR LOCKS ,CT 06096

UPS Access Point™  
THE UPS STORE  
41 CROSSROADS PLZ  
WEST HARTFORD ,CT 06117

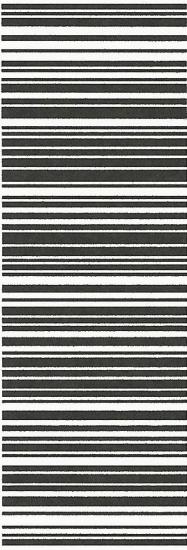
FOLD HERE

DEBORAH CHASE 860-490-8839 T- MOBILE/NSB 35 GRIFFIN RD SOUTH BLOOMFIELD CT 06002	2 LBS PAK 1 OF 1	<b>SHIP TO:</b> JODI COUTURE 203-622-7700 GREENWICH TOWN HALL 101 FIELD POINT ROAD GREENWICH CT 06830-6463	<b>CT 069 9-01</b> 	<b>UPS 2ND DAY AIR</b> TRACKING #: 1Z 8X7 15X 02 9423 9322 <b>2</b>		BILLING: P/P	 Reference#1: CT11070B-L700 ZAP Reference#2: ZONING APPLICATION-ZONING OFFICIAL LUS 20.0-42. WINTHVS0 99.0A 0-4/2018
--	------------------------	---	---	---	---	--------------	--