

7018 2290 0000 8504 6910

U.S. Postal Service™
CERTIFIED MAIL® RECEIPT
 Domestic Mail Only

For delivery information, visit our website at www.usps.com®.

GREENWICH, CT 06830

OFFICIAL USE

Certified Mail Fee	\$3.45	0867
Extra Services & Fees (check box, add fee as appropriate)	\$2.75	77
<input type="checkbox"/> Return Receipt (hardcopy)	\$0.00	
<input type="checkbox"/> Return Receipt (electronic)	\$0.00	
<input type="checkbox"/> Certified Mail Restricted Delivery	\$0.00	
<input type="checkbox"/> Adult Signature Required	\$0.00	
<input type="checkbox"/> Adult Signature Restricted Delivery	\$0.00	
Postage	\$0.50	
Total Postage and Fees	\$6.70	10/22/2018

Postmark Here

Sent To: Mark DeLuca CT03X343
 Street and Apt. No., or PO Box No.
101 Field Point Rd
 City, State, ZIP+4®
Greenwich CT 06830

PS Form 3800, April 2015 PSN 7530-02-000-9047 See Reverse for Instructions

7018 2290 0000 8504 6897

U.S. Postal Service™
CERTIFIED MAIL® RECEIPT
 Domestic Mail Only

For delivery information, visit our website at www.usps.com®.

GREENWICH, CT 06830

OFFICIAL USE

Certified Mail Fee	\$3.45	0867
Extra Services & Fees (check box, add fee as appropriate)	\$2.75	77
<input type="checkbox"/> Return Receipt (hardcopy)	\$0.00	
<input type="checkbox"/> Return Receipt (electronic)	\$0.00	
<input type="checkbox"/> Certified Mail Restricted Delivery	\$0.00	
<input type="checkbox"/> Adult Signature Required	\$0.00	
<input type="checkbox"/> Adult Signature Restricted Delivery	\$0.00	
Postage	\$0.50	
Total Postage and Fees	\$6.70	10/22/2018

Postmark Here

Sent To: Peter Tseu CT03X343
 Street and Apt. No., or PO Box No.
101 Field Point Rd
 City, State, ZIP+4®
Greenwich CT 06830

PS Form 3800, April 2015 PSN 7530-02-000-9047 See Reverse for Instructions

7018 2290 0000 8504 6903

U.S. Postal Service™
CERTIFIED MAIL® RECEIPT
 Domestic Mail Only

For delivery information, visit our website at www.usps.com®.

MIDDLETOWN, CT 06457

OFFICIAL USE

Certified Mail Fee	\$3.45	0867
Extra Services & Fees (check box, add fee as appropriate)	\$2.75	77
<input type="checkbox"/> Return Receipt (hardcopy)	\$0.00	
<input type="checkbox"/> Return Receipt (electronic)	\$0.00	
<input type="checkbox"/> Certified Mail Restricted Delivery	\$0.00	
<input type="checkbox"/> Adult Signature Required	\$0.00	
<input type="checkbox"/> Adult Signature Restricted Delivery	\$0.00	
Postage	\$0.50	
Total Postage and Fees	\$6.70	10/22/2018

Postmark Here

Sent To: Brian Benito CT03X343
 Street and Apt. No., or PO Box No.
111 Courtsy Club Rd
 City, State, ZIP+4®
Middletown CT 06457

PS Form 3800, April 2015 PSN 7530-02-000-9047 See Reverse for Instructions

7018 2290 0000 8504 6927

U.S. Postal Service™
CERTIFIED MAIL® RECEIPT
 Domestic Mail Only

For delivery information, visit our website at www.usps.com®.

HARTFORD, CT 06106

OFFICIAL USE

Certified Mail Fee	\$3.45	0867
Extra Services & Fees (check box, add fee as appropriate)	\$2.75	77
<input type="checkbox"/> Return Receipt (hardcopy)	\$0.00	
<input type="checkbox"/> Return Receipt (electronic)	\$0.00	
<input type="checkbox"/> Certified Mail Restricted Delivery	\$0.00	
<input type="checkbox"/> Adult Signature Required	\$0.00	
<input type="checkbox"/> Adult Signature Restricted Delivery	\$0.00	
Postage	\$0.50	
Total Postage and Fees	\$6.70	10/22/2018

Postmark Here

Sent To: Gov Donald Miller CT03X343
 Street and Apt. No., or PO Box No.
450 Capitol Ave
 City, State, ZIP+4®
Hartford CT 06106

PS Form 3800, April 2015 PSN 7530-02-000-9047 See Reverse for Instructions



October 22nd, 2018

Melanie Bachman, Executive Director
Connecticut Siting Council
10 Franklin Square
New Britain, CT 06051

RE: Notice of Exempt Modification – Antenna Swap for wireless facility located at 45 BUTTERNUT HOLLOW ROAD, GREENWICH, CONNECTICUT – CT03XC343 (lat. 41° 05' 49.0698" N, long. - 73° 38' 19.4274" W)

Dear Ms. Bachman:

Sprint Spectrum, LP ("Sprint") currently maintains wireless telecommunications antennas at the (115-foot level) on an existing (180-foot self-support tower) at the above-referenced address. The property is owned by the STATE OF CONNECTICUT and the tower is owned by STATE OF CONNECTICUT DEPARTMENT OF PUBLIC SAFETY DIVISION OF STATE POLICE

Sprint's proposed work involves antenna replacement and tower work. Sprint intends to add three (3) new antennas and add six (6) new RRHs onto the tower. All the proposed work is contained within the existing fenced area. Please refer to the attached drawings for site plans prepared by Infinigy Engineering.

Please accept this letter as notification pursuant to R.C.S.A. § 16-50j-73, for construction that constitutes an exempt modification pursuant to R.C.S.A. § 16-50j-72(b). In accordance with R.C.S.A. § 16-50j-73, a copy of this letter is being sent to PETER TESEI, FIRST SELECTMAN and KATIE DELUCA, DIRECTOR OF PLANNING AND ZONING of the City of GREENWICH. A copy of this letter is also being sent to Brian Benito the tower manager for STATE OF CONNECTICUT DEPARTMENT OF PUBLIC SAFETY DIVISION OF STATE POLICE, and STATE OF CONNECTICUT who owns the land.

The planned modifications to the facility fall squarely within those activities explicitly provided for in R.C.S.A. § 16-50j-72(b).

1. The proposed modifications will not result in an increase in the height of the existing tower.
2. The antennas work is a one-for-one replacement of facility components.



3. The proposed modifications will include the addition of ground base equipment as depicted on the attached drawings; however, the proposed equipment will not require an extension of the site boundaries.
4. The proposed modifications will not increase noise levels at the facility by six decibels or more.
5. The additional ground based equipment will not increase radio frequency (RF) emissions at the facility to a level at or above the Federal Communications Commission (FCC) adopted safety standard.

For the foregoing reasons, Sprint respectfully submits that the proposed modifications to the above referenced telecommunications facility constitutes an exempt modification under R.C.S.A. § 16-50j-72(b).

If you have any questions or require any additional information regarding this request, please do not hesitate to give me a call at (518) 350-4222 or email me to aperkowski@airosmithdevelopment.com

Kind Regards,

A handwritten signature in black ink, appearing to read 'A. Perkowski', is written over a large, light blue oval-shaped background.

Arthur Perkowski
Airosmith Development Inc.
32 Clinton Street
Saratoga Springs, NY 12866
518-306-1711 desk & fax
518-871-3707 cell
aperkowski@airosmithdevelopment.com

Attachment

CC: PETER TESEI (FIRST SELECTMAN / Greenwich, CT)
BRIAN BENITO (Manager, CT State Police Towers)
KATIE DELUCA (DIRECTOR OF PLANNING AND ZONING / Greenwich, CT)
STATE OF CONNECTICUT (Land Owner)



Add notes here ...



RADIO FREQUENCY EMISSIONS ANALYSIS REPORT EVALUATION OF HUMAN EXPOSURE POTENTIAL TO NON-IONIZING EMISSIONS

SPRINT Existing Facility

Site ID: CT03XC343

(R2E) CT4072 to CT03XC343 CLP (Merritt 3)
45 Butternut Hollow Road
Greenwich, CT 06830

October 31, 2018

EBI Project Number: 6218006879

Site Compliance Summary	
Compliance Status:	COMPLIANT
Site total MPE% of FCC general population allowable limit:	13.44 %



October 31, 2018

SPRINT

Attn: RF Engineering Manager
1 International Boulevard, Suite 800
Mahwah, NJ 07495

Emissions Analysis for Site: **CT03XC343 – (R2E) CT4072 to CT03XC343 CLP (Merritt 3)**

EBI Consulting was directed to analyze the proposed SPRINT facility located at **45 Butternut Hollow Road, Greenwich, CT**, for the purpose of determining whether the emissions from the Proposed SPRINT Antenna Installation located on this property are within specified federal limits.

All information used in this report was analyzed as a percentage of current Maximum Permissible Exposure (% MPE) as listed in the FCC OET Bulletin 65 Edition 97-01 and ANSI/IEEE Std C95.1. The FCC regulates Maximum Permissible Exposure in units of microwatts per square centimeter ($\mu\text{W}/\text{cm}^2$). The number of $\mu\text{W}/\text{cm}^2$ calculated at each sample point is called the power density. The exposure limit for power density varies depending upon the frequencies being utilized. Wireless Carriers and Paging Services use different frequency bands each with different exposure limits, therefore it is necessary to report results and limits in terms of percent MPE rather than power density.

All results were compared to the FCC (Federal Communications Commission) radio frequency exposure rules, 47 CFR 1.1307(b)(1) – (b)(3), to determine compliance with the Maximum Permissible Exposure (MPE) limits for General Population/Uncontrolled environments as defined below.

General population/uncontrolled exposure limits apply to situations in which the general population may be exposed or in which persons who are exposed as a consequence of their employment may not be made fully aware of the potential for exposure or cannot exercise control over their exposure. Therefore, members of the general population would always be considered under this category when exposure is not employment related, for example, in the case of a telecommunications tower that exposes persons in a nearby residential area.

General population exposure to radio frequencies is regulated and enforced in units of microwatts per square centimeter ($\mu\text{W}/\text{cm}^2$). The general population exposure limits for the 850 MHz Band is approximately $567 \mu\text{W}/\text{cm}^2$. The general population exposure limit for the 1900 MHz (PCS) and 2500 MHz (BRS) bands is $1000 \mu\text{W}/\text{cm}^2$. Because each carrier will be using different frequency bands, and each frequency band has different exposure limits, it is necessary to report percent of MPE rather than power density.



Occupational/controlled exposure limits apply to situations in which persons are exposed as a consequence of their employment and in which those persons who are exposed have been made fully aware of the potential for exposure and can exercise control over their exposure. Occupational/controlled exposure limits also apply where exposure is of a transient nature as a result of incidental passage through a location where exposure levels may be above general population/uncontrolled limits (see below), as long as the exposed person has been made fully aware of the potential for exposure and can exercise control over his or her exposure by leaving the area or by some other appropriate means.

Additional details can be found in FCC OET 65.

CALCULATIONS

Calculations were done for the proposed SPRINT Wireless antenna facility located at **45 Butternut Hollow Road, Greenwich, CT**, using the equipment information listed below. All calculations were performed per the specifications under FCC OET 65. Since SPRINT is proposing highly focused directional panel antennas, which project most of the emitted energy out toward the horizon, all calculations were performed assuming a lobe representing the maximum gain of the antenna per the antenna manufactures supplied specifications, minus 10 dB for directional panel antennas, was focused at the base of the tower. For this report the sample point is the top of a 6-foot person standing at the base of the tower.

For all calculations, all equipment was calculated using the following assumptions:

- 1) 1 CDMA channels (850 MHz) were considered for each sector of the proposed installation. These Channels have a transmit power of 20 Watts per Channel.
- 2) 2 LTE channels (850 MHz) were considered for each sector of the proposed installation. These Channels have a transmit power of 50 Watts per Channel.
- 3) 5 CDMA channels (1900 MHz (PCS)) were considered for each sector of the proposed installation. These Channels have a transmit power of 16 Watts per Channel.
- 4) 2 LTE channels (1900 MHz (PCS)) were considered for each sector of the proposed installation. These Channels have a transmit power of 40 Watts per Channel.
- 5) 8 LTE channels (2500 MHz (BRS)) were considered for each sector of the proposed installation. These Channels have a transmit power of 20 Watts per Channel.



- 6) All radios at the proposed installation were considered to be running at full power and were uncombined in their RF transmissions paths per carrier prescribed configuration. Per FCC OET Bulletin No. 65 - Edition 97-01 recommendations to achieve the maximum anticipated value at each sample point, all power levels emitting from the proposed antenna installation are increased by a factor of 2.56 to account for possible in-phase reflections from the surrounding environment. This is rarely the case, and if so, is never continuous.
- 7) For the following calculations, the sample point was the top of a 6-foot person standing at the base of the tower. The maximum gain of the antenna per the antenna manufactures supplied specifications, minus 10 dB for directional panel antennas, was used in this direction. This value is a very conservative estimate as gain reductions for these particular antennas are typically much higher in this direction.
- 8) The antennas used in this modeling are the **RFS APXVSP18-C-A20 and the Commscope DT465B-2XR** for transmission in the 850 MHz, 1900 MHz (PCS) and 2500 MHz (BRS) frequency bands. This is based on feedback from the carrier with regards to anticipated antenna selection. Maximum gain values for all antennas are listed in the Inventory and Power Data table below. The maximum gain of the antenna per the antenna manufactures supplied specifications, minus 10 dB for directional panel antennas, was used for all calculations. This value is a very conservative estimate as gain reductions for these particular antennas are typically much higher in this direction.
- 9) The antenna mounting height centerlines of the proposed panel antennas are **115 feet** above ground level (AGL) for **Sector A**, **115 feet** above ground level (AGL) for **Sector B** and **115 feet** above ground level (AGL) for Sector C.
- 10) Emissions values for additional carriers were taken from the Connecticut Siting Council active database. Values in this database are provided by the individual carriers themselves.

All calculations were done with respect to uncontrolled / general population threshold limits.



SPRINT Site Inventory and Power Data by Antenna

Sector:	A	Sector:	B	Sector:	C
Antenna #:	1	Antenna #:	1	Antenna #:	1
Make / Model:	RFS APXVSPP18-C-A20	Make / Model:	RFS APXVSPP18-C-A20	Make / Model:	RFS APXVSPP18-C-A20
Gain:	13.4 / 15.9 dBd	Gain:	13.4 / 15.9 dBd	Gain:	13.4 / 15.9 dBd
Height (AGL):	115 feet	Height (AGL):	115 feet	Height (AGL):	115 feet
Frequency Bands	850 MHz / 1900 MHz (PCS)	Frequency Bands	850 MHz / 1900 MHz (PCS)	Frequency Bands	850 MHz / 1900 MHz (PCS)
Channel Count	8	Channel Count	8	Channel Count	8
Total TX Power(W):	180 Watts	Total TX Power(W):	180 Watts	Total TX Power(W):	180 Watts
ERP (W):	6,662.27	ERP (W):	6,662.27	ERP (W):	6,662.27
Antenna A1 MPE%	2.12 %	Antenna B1 MPE%	2.12 %	Antenna C1 MPE%	2.12 %
Antenna #:	2	Antenna #:	2	Antenna #:	2
Make / Model:	Commscope DT465B-2XR	Make / Model:	Commscope DT465B-2XR	Make / Model:	Commscope DT465B-2XR
Gain:	15.05 dBd	Gain:	15.05 dBd	Gain:	15.05 dBd
Height (AGL):	115 feet	Height (AGL):	115 feet	Height (AGL):	115 feet
Frequency Bands	2500 MHz (BRS) / 850 MHz	Frequency Bands	2500 MHz (BRS) / 850 MHz	Frequency Bands	2500 MHz (BRS) / 850 MHz
Channel Count	10	Channel Count	10	Channel Count	10
Total TX Power(W):	260 Watts	Total TX Power(W):	260 Watts	Total TX Power(W):	260 Watts
ERP (W):	7,280.95	ERP (W):	7,280.95	ERP (W):	7,280.95
Antenna A2 MPE%	2.70 %	Antenna B2 MPE%	2.70 %	Antenna C2 MPE%	2.70 %

Site Composite MPE%	
Carrier	MPE%
SPRINT – Max per sector	4.82 %
State Police	0.42 %
Greenwich	0.26 %
DOT	0.06 %
NU	1.04 %
T-Mobile	3.38 %
AT&T	1.42 %
Verizon Wireless	2.04 %
Site Total MPE %:	13.44 %

SPRINT Sector A Total:	4.82 %
SPRINT Sector B Total:	4.82 %
SPRINT Sector C Total:	4.82 %
Site Total:	13.44 %

SPRINT _ Frequency Band / Technology (Per Sector)	# Channels	Watts ERP (Per Channel)	Height (feet)	Total Power Density ($\mu\text{W}/\text{cm}^2$)	Frequency (MHz)	Allowable MPE ($\mu\text{W}/\text{cm}^2$)	Calculated % MPE
Sprint 850 MHz CDMA	1	437.55	115	1.32	850 MHz	567	0.24%
Sprint 1900 MHz (PCS) CDMA	5	622.47	115	9.42	1900 MHz (PCS)	1000	0.94%
Sprint 1900 MHz (PCS) LTE	2	1,556.18	115	9.42	1900 MHz (PCS)	1000	0.94%
Sprint 2500 MHz (BRS) LTE	8	639.78	115	15.49	2500 MHz (BRS)	1000	1.55%
Sprint 850 MHz LTE	2	1,081.36	115	6.54	850 MHz	567	1.15%
						Total:	4.82%



Summary

All calculations performed for this analysis yielded results that were **within** the allowable limits for general population exposure to RF Emissions.

The anticipated maximum composite contributions from the SPRINT facility as well as the site composite emissions value with regards to compliance with FCC's allowable limits for general population exposure to RF Emissions are shown here:

SPRINT Sector	Power Density Value (%)
Sector A:	4.82 %
Sector B:	4.82 %
Sector C:	4.82 %
SPRINT Maximum MPE % (per sector):	4.82 %
Site Total:	13.44 %
Site Compliance Status:	COMPLIANT

The anticipated composite MPE value for this site assuming all carriers present is **13.44 %** of the allowable FCC established general population limit sampled at the ground level. This is based upon values listed in the Connecticut Siting Council database for existing carrier emissions.

FCC guidelines state that if a site is found to be out of compliance (over allowable thresholds), that carriers over a 5% contribution to the composite value will require measures to bring the site into compliance. For this facility, the composite values calculated were well within the allowable 100% threshold standard per the federal government.

Sprint



PROJECT: DO MACRO UPGRADE
 SITE NAME: (R2E) CT4072 TO CT03XC343 CLP (MERRITT 3)
 SITE CASCADE: CT03XC343
 SITE ADDRESS: 45 BUTTERNUT HOLLOW RD GREENWICH, CT 06830
 SITE TYPE: SELF SUPPORT TOWER
 MARKET: SOUTHERN CONNECTICUT

PLANS PREPARED FOR:



PLANS PREPARED BY:

INFINIGY
 FROM ZERO TO INFINIGY
 the solutions are endless
 1033 Watervliet Shaker Rd | Albany, NY 12205
 Phone: 518-690-0790 | Fax: 518-690-0793
 www.infinigy.com
 JOB NUMBER 526-104

PROJECT MANAGER:

AIROSMITH
 DEVELOPMENT
 32 CLINTON ST.
 SARATOGA SPRINGS, NY 12868
 OFFICE: (518) 308-3740

ENGINEERING LICENSE:



DRAWING NOTICE:

THESE DOCUMENTS ARE CONFIDENTIAL AND ARE THE SOLE PROPERTY OF SPRINT AND MAY NOT BE REPRODUCED, DISSEMINATED OR REDISTRIBUTED WITHOUT THE EXPRESS WRITTEN CONSENT OF SPRINT.

REVISIONS:

DESCRIPTION	DATE	BY	REV.
REVISED/ISSUED FOR PERMIT	07/24/18	ETC	1
ISSUED FOR PERMIT	02/12/18	ETC	0

SITE NAME:
 (R2E) CT4072 TO CT03XC343 CLP (MERRITT 3)

SITE NUMBER:
 CT03XC343

SITE ADDRESS:
 45 BUTTERNUT HOLLOW RD GREENWICH, CT 06830

SHEET DESCRIPTION:
 TITLE SHEET & PROJECT DATA

SHEET NUMBER:
 T-1

SITE INFORMATION

TOWER OWNER:
 STATE OF CONNECTICUT
 DEPARTMENT OF PUBLIC SAFETY
 DIVISION OF STATE POLICE
 1111 COUNTRY CLUB ROAD
 MIDDLETOWN, CT 06457

LATITUDE (NAD83):
 41° 5' 49.0698" N
 41.0969638°

LONGITUDE (NAD83):
 73° 38' 19.4274" W
 -73.6387305°

COUNTY:
 FAIRFIELD

ZONING JURISDICTION:
 CONNECTICUT SITING COUNCIL

ZONING DISTRICT:
 TBD

POWER COMPANY:
 CL&P
 PHONE: (800) 286-2000

AAV PROVIDER:
 VERIZON
 PHONE: (800) 331-0500

PROJECT MANAGER:
 AIROSMITH DEVELOPMENT
 TERRI BURKHOLDER
 (315) 719-2928
 TBURKHOLDER@AIROSMITHDEVELOPMENT.COM

AREA MAP

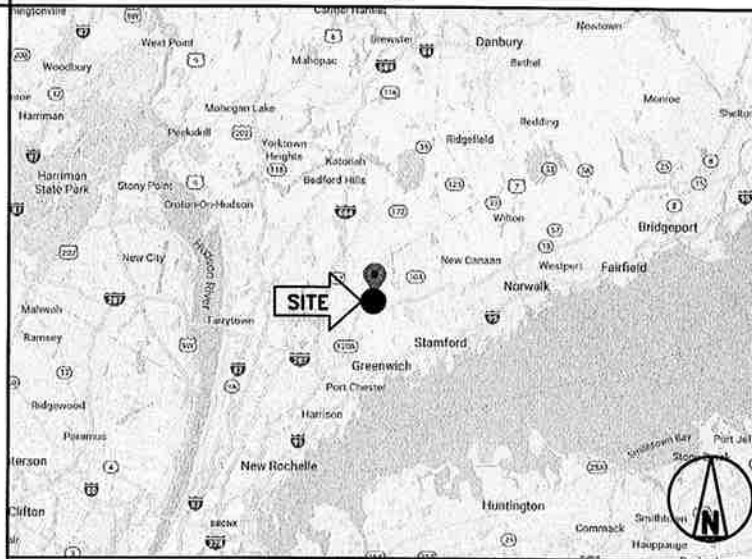

LOCATION MAP

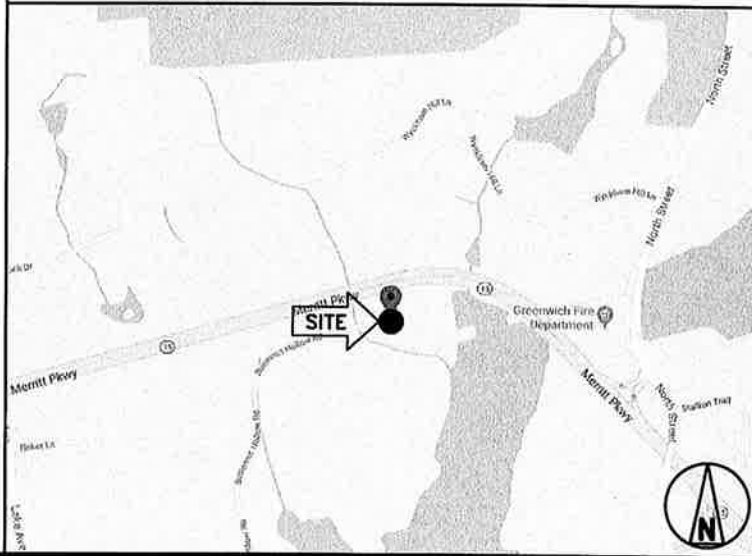

PROJECT DESCRIPTION

- SPRINT PROPOSES TO MODIFY AN EXISTING UNMANNED TELECOMMUNICATIONS FACILITY.
- INSTALL (3) PANEL ANTENNAS
 - INSTALL (3) 2.5 GHz RRH'S & (3) 800 MHz RRH'S BEHIND ANTENNAS
 - INSTALL (30) JUMPER CABLES
 - INSTALL (1) HYBRID CABLE
 - INSTALL 2.5 EQUIPMENT INSIDE EXISTING N.V. MMBS CABINET

THESE PLANS HAVE BEEN DEVELOPED FOR THE MODIFICATION OF AN EXISTING UNMANNED TELECOMMUNICATIONS FACILITY OWNED OR LEASED BY SPRINT IN ACCORDANCE WITH THE SCOPE OF WORK PROVIDED BY SPRINT. INFINIGY HAS INCORPORATED THIS SCOPE OF WORK IN THE PLANS. THESE PLANS ARE NOT FOR CONSTRUCTION UNLESS ACCOMPANIED BY A PASSING STRUCTURAL STABILITY ANALYSIS PREPARED BY A LICENSED STRUCTURAL ENGINEER. STRUCTURAL ANALYSIS MUST INCLUDE BOTH TOWER AND MOUNT.

APPLICABLE CODES

ALL WORK SHALL BE PERFORMED AND MATERIALS INSTALL IN ACCORDANCE WITH THE CURRENT EDITIONS OF THE FOLLOWING CODES AS ADOPTED BY THE LOCAL GOVERNING AUTHORITIES. NOTHING IN THESE PLANS IS TO BE CONSTRUED TO PERMIT WORK NOT CONFORMING TO THESE CODES.

1. INTERNATIONAL BUILDING CODE (2015 IBC)
2. TIA-222-G OR LATEST EDITION
3. NFPA 780 - LIGHTNING PROTECTION CODE
4. 2011 NATIONAL ELECTRIC CODE OR LATEST EDITION
5. ANY OTHER NATIONAL OR LOCAL APPLICABLE CODES, MOST RECENT EDITIONS
6. CT BUILDING CODE
7. LOCAL BUILDING CODE
8. CITY/COUNTY ORDINANCES

DRAWING INDEX

SHEET NO.	SHEET TITLE	REV.
T-1	TITLE SHEET & PROJECT DATA	1
SP-1	SPRINT SPECIFICATIONS	1
SP-2	SPRINT SPECIFICATIONS	1
SP-3	SPRINT SPECIFICATIONS	1
A-1	SITE PLAN	1
A-2	TOWER ELEVATION	1
A-3	ANTENNA LAYOUT & MOUNTING DETAILS	1
A-4	EQUIPMENT & MOUNTING DETAILS	1
A-5	CIVIL DETAILS	1
A-6	PLUMBING DIAGRAM	1
E-1	ELECTRICAL & GROUNDING PLAN	1
E-2	ELECTRICAL & GROUNDING DETAILS	1
SK-1	TOWER MODIFICATION DETAILS	3
SK-2	TOWER MODIFICATION DETAILS	3
SK-3	TOWER MODIFICATION DETAILS	3
SK-4	TOWER MODIFICATION DETAILS	3
SK-5	TOWER MODIFICATION DETAILS	3



Know what's below.
 Call before you dig.
 www.call811.com

THESE OUTLINE SPECIFICATIONS IN CONJUNCTION WITH THE SPRINT STANDARD CONSTRUCTION SPECIFICATIONS, INCLUDING CONTRACT DOCUMENTS AND THE CONSTRUCTION DRAWINGS DESCRIBE THE WORK TO BE PERFORMED BY THE CONTRACTOR.

SECTION 01 100 – SCOPE OF WORK

PART 1 – GENERAL

- 1.1 THE WORK: THESE STANDARD CONSTRUCTION SPECIFICATIONS IN CONJUNCTION WITH THE SPRINT CONSTRUCTION STANDARDS FOR WIRELESS SITES, CONTRACT DOCUMENTS AND THE CONSTRUCTION DRAWINGS DESCRIBE THE WORK TO BE PERFORMED BY THE CONTRACTOR.
- 1.2 RELATED DOCUMENTS:
 - A. THE REQUIREMENTS OF THIS SECTION APPLY TO ALL SECTIONS IN THIS SPECIFICATION.
 - B. SPRINT 'STANDARD CONSTRUCTION DETAILS FOR WIRELESS SITES' ARE INCLUDED IN AND MADE A PART OF THESE SPECIFICATIONS HEREWITH.
- 1.3 PRECEDENCE: SHOULD CONFLICTS OCCUR BETWEEN THE STANDARD CONSTRUCTION SPECIFICATIONS FOR WIRELESS SITES INCLUDING THE STANDARD CONSTRUCTION DETAILS FOR WIRELESS SITES AND THE CONSTRUCTION DRAWINGS, INFORMATION ON THE CONSTRUCTION DRAWINGS SHALL TAKE PRECEDENCE. NOTIFY SPRINT CONSTRUCTION MANAGER IF THIS OCCURS.
- 1.4 NATIONALLY RECOGNIZED CODES AND STANDARDS:
 - A. THE WORK SHALL COMPLY WITH APPLICABLE NATIONAL AND LOCAL CODES AND STANDARDS, LATEST EDITION, AND PORTIONS THEREOF, INCLUDED BUT NOT LIMITED TO THE FOLLOWING:
 - 1. GR-63-CORE NEBS REQUIREMENTS: PHYSICAL PROTECTION
 - 5. GR-78-CORE GENERIC REQUIREMENTS FOR THE PHYSICAL DESIGN AND MANUFACTURE OF TELECOMMUNICATIONS EQUIPMENT.
 - 3. GR-1089 CORE, ELECTROMAGNETIC COMPATIBILITY AND ELECTRICAL SAFETY –GENERIC CRITERIA FOR NETWORK TELECOMMUNICATIONS EQUIPMENT.
 - 4. NATIONAL FIRE PROTECTION ASSOCIATION CODES AND STANDARDS (NFPA) INCLUDING NFPA 70 (NATIONAL ELECTRICAL CODE – 'NEC') AND NFPA 101 (LIFE SAFETY CODE).
 - 5. AMERICAN SOCIETY FOR TESTING OF MATERIALS (ASTM)
 - 6. INSTITUTE OF ELECTRONIC AND ELECTRICAL ENGINEERS (IEEE)
 - 7. AMERICAN CONCRETE INSTITUTE (ACI)
 - 8. AMERICAN WIRE PRODUCERS ASSOCIATION (AWPA)
 - 9. CONCRETE REINFORCING STEEL INSTITUTE (CRSI)
 - 10. AMERICAN ASSOCIATION OF STATE HIGHWAY AND TRANSPORTATION OFFICIALS (AASHTO)
 - 11. PORTLAND CEMENT ASSOCIATION (PCA)
 - 12. NATIONAL CONCRETE MASONRY ASSOCIATION (NCMA)
 - 13. BRICK INDUSTRY ASSOCIATION (BIA)
 - 14. AMERICAN WELDING SOCIETY (AWS)
 - 15. NATIONAL ROOFING CONTRACTORS ASSOCIATION (NRCA)
 - 16. SHEET METAL AND AIR CONDITIONING CONTRACTORS' NATIONAL ASSOCIATION (SMACNA)
 - 17. DOOR AND HARDWARE INSTITUTE (DHI)
 - 18. OCCUPATIONAL SAFETY AND HEALTH ACT (OSHA)
 - 19. APPLICABLE BUILDING CODES INCLUDING UNIFORM BUILDING CODE, SOUTHERN BUILDING CODE, BOCA, AND THE INTERNATIONAL BUILDING CODE.

1.5 DEFINITIONS:

- A. WORK: THE SUM OF TASKS AND RESPONSIBILITIES IDENTIFIED IN THE CONTRACT DOCUMENTS.
- B. COMPANY: SPRINT CORPORATION
- C. ENGINEER: SYNONYMOUS WITH ARCHITECT & ENGINEER AND 'A&E'. THE DESIGN PROFESSIONAL HAVING PROFESSIONAL RESPONSIBILITY FOR DESIGN OF THE PROJECT.
- D. CONTRACTOR: CONSTRUCTION CONTRACTOR; CONSTRUCTION VENDOR; INDIVIDUAL OR ENTITY WHO AFTER EXECUTION OF A CONTRACT IS BOUND TO ACCOMPLISH THE WORK.
- E. THIRD PARTY VENDOR OR AGENCY: A VENDOR OR AGENCY ENGAGED SEPARATELY BY THE COMPANY, A&E, OR CONTRACTOR TO PROVIDE MATERIALS OR TO ACCOMPLISH SPECIFIC TASKS RELATED TO BUT NOT INCLUDED IN THE WORK.
- F. OFCI: OWNER FURNISHED, CONTRACTOR INSTALLED EQUIPMENT.
- G. CONSTRUCTION MANAGER – ALL PROJECTS RELATED COMMUNICATION TO FLOW THROUGH SPRINT REPRESENTATIVE IN CHARGE OF PROJECT...

- 1.6 SITE FAMILIARITY: CONTRACTOR SHALL BE RESPONSIBLE FOR FAMILIARIZING HIMSELF WITH ALL CONTRACT DOCUMENTS, FIELD CONDITIONS AND DIMENSIONS PRIOR TO PROCEEDING WITH CONSTRUCTION. ANY DISCREPANCIES SHALL BE BROUGHT TO THE ATTENTION OF THE SPRINT CONSTRUCTION MANAGER PRIOR TO THE COMMENCEMENT OF WORK. NO COMPENSATION WILL BE AWARDED BASED ON CLAIM OF LACK OF KNOWLEDGE OR FIELD CONDITIONS.
- 1.7 POINT OF CONTACT: COMMUNICATION BETWEEN SPRINT AND THE CONTRACTOR SHALL FLOW THROUGH THE SINGLE SPRINT CONSTRUCTION MANAGER APPOINTED TO MANAGE THE PROJECT FOR SPRINT.
- 1.8 ON-SITE SUPERVISION: THE CONTRACTOR SHALL SUPERVISE AND DIRECT THE WORK AND SHALL BE RESPONSIBLE FOR CONSTRUCTION MEANS, METHODS, TECHNIQUES, SEQUENCES, AND PROCEDURES IN ACCORDANCE WITH THE CONTRACT DOCUMENTS. THE CONTRACTOR SHALL EMPLOY A COMPETENT SUPERINTENDENT WHO SHALL BE IN ATTENDANCE AT THE SITE AT ALL TIMES DURING PERFORMANCE OF THE WORK.
- 1.9 DRAWINGS, SPECIFICATIONS AND DETAILS REQUIRED AT JOBSITE: THE CONSTRUCTION CONTRACTOR SHALL MAINTAIN A FULL SET OF THE CONSTRUCTION DRAWINGS, STANDARD CONSTRUCTION DETAILS FOR WIRELESS SITES AND THE STANDARD CONSTRUCTION SPECIFICATIONS FOR WIRELESS SITES AT THE JOBSITE FROM MOBILIZATION THROUGH CONSTRUCTION COMPLETION.
 - A. THE JOBSITE DRAWINGS, SPECIFICATIONS AND DETAILS SHALL BE CLEARLY MARKED DAILY IN RED PENCIL WITH ANY CHANGES IN CONSTRUCTION OVER WHAT IS DEPICTED IN THE DOCUMENTS. AT CONSTRUCTION COMPLETION, THIS JOBSITE MARKUP SET SHALL BE DELIVERED TO THE COMPANY OR COMPANY'S DESIGNATED REPRESENTATIVE TO BE FORWARDED TO THE COMPANY'S A&E VENDOR FOR PRODUCTION OF 'AS-BUILT' DRAWINGS.
 - B. DETAILS ARE INTENDED TO SHOW DESIGN INTENT. MODIFICATIONS MAY BE REQUIRED TO SUIT JOB DIMENSIONS OR CONDITIONS, AND SUCH MODIFICATIONS SHALL BE INCLUDED AS PART OF THE WORK. CONTRACTOR SHALL NOTIFY SPRINT CONSTRUCTION MANAGER OF ANY VARIATIONS PRIOR TO PROCEEDING WITH THE WORK.
 - C. DIMENSIONS SHOWN ARE TO FINISH SURFACES UNLESS NOTED OTHERWISE. SPACING BETWEEN EQUIPMENT IS THE REQUIRED CLEARANCE. SHOULD THERE BE ANY QUESTIONS REGARDING THE CONTRACT DOCUMENTS, EXISTING CONDITIONS AND/OR DESIGN INTENT, THE CONTRACTOR SHALL BE RESPONSIBLE FOR OBTAINING A CLARIFICATION FROM THE SPRINT CONSTRUCTION MANAGER PRIOR TO PROCEEDING WITH THE WORK.
- 1.10 USE OF JOB SITE: THE CONTRACTOR SHALL CONFINE ALL CONSTRUCTION AND RELATED OPERATIONS INCLUDING STAGING AND STORAGE OF MATERIALS AND EQUIPMENT, PARKING, TEMPORARY FACILITIES, AND WASTE STORAGE TO THE LEASE PARCEL UNLESS OTHERWISE PERMITTED BY THE CONTRACT DOCUMENTS.
- 1.11 UTILITIES SERVICES: WHERE NECESSARY TO CUT EXISTING PIPES, ELECTRICAL WIRES, CONDUITS, CABLES, ETC., OF UTILITY SERVICES, OR OF FIRE PROTECTION OR COMMUNICATIONS SYSTEMS, THEY SHALL BE CUT AND CAPPED AT SUITABLE PLACES OR WHERE SHOWN. ALL SUCH ACTIONS SHALL BE COORDINATED WITH THE UTILITY COMPANY INVOLVED.
- 1.12 PERMITS / FEES: WHEN REQUIRED THAT A PERMIT OR CONNECTION FEE BE PAID TO A PUBLIC UTILITY PROVIDER FOR NEW SERVICE TO THE CONSTRUCTION PROJECT, PAYMENT OF SUCH FEE SHALL BE THE RESPONSIBILITY OF THE CONTRACTOR.
- 1.13 CONTRACTOR SHALL TAKE ALL MEASURES AND PROVIDE ALL MATERIAL NECESSARY FOR PROTECTING EXISTING EQUIPMENT AND PROPERTY.
- 1.14 METHODS OF PROCEDURE (MOPS) FOR CONSTRUCTION: CONTRACTOR SHALL PERFORM WORK AS DESCRIBED IN THE FOLLOWING INSTALLATION AND COMMISSIONING MOPS.

NOTE: IN SHORT-FORM SPECIFICATIONS ON THE DRAWINGS, A/E TO INSERT LIST OF APPLICABLE MOPS INCLUDING EN-2012-001, EN-2013-002, EL-0568, AND TS-0193
- 1.15 USE OF ELECTRONIC PROJECT MANAGEMENT SYSTEMS:

PART 2 – PRODUCTS (NOT USED)

PART 3 – EXECUTION

- 3.1 TEMPORARY UTILITIES AND FACILITIES: THE CONTRACTOR SHALL BE RESPONSIBLE FOR ALL TEMPORARY UTILITIES AND FACILITIES NECESSARY EXCEPT AS OTHERWISE INDICATED IN THE CONSTRUCTION DOCUMENTS. TEMPORARY UTILITIES AND FACILITIES INCLUDE POTABLE WATER, HEAT, HVAC, ELECTRICITY, SANITARY FACILITIES, WASTE DISPOSAL FACILITIES, AND TELEPHONE/COMMUNICATION SERVICES. PROVIDE TEMPORARY UTILITIES AND FACILITIES IN ACCORDANCE WITH OSHA AND THE AUTHORITY HAVING JURISDICTION. CONTRACTOR MAY UTILIZE THE COMPANY ELECTRICAL SERVICE IN THE COMPLETION OF THE WORK WHEN IT BECOMES AVAILABLE. USE OF THE LESSORS OR SITE OWNER'S UTILITIES OR FACILITIES IS EXPRESSLY FORBIDDEN EXCEPT AS OTHERWISE ALLOWED IN THE CONTRACT DOCUMENTS.
- 3.2 ACCESS TO WORK: THE CONTRACTOR SHALL PROVIDE ACCESS TO THE JOB SITE FOR AUTHORIZED COMPANY PERSONNEL AND AUTHORIZED REPRESENTATIVES OF THE ARCHITECT/ENGINEER DURING ALL PHASES OF THE WORK.
- 3.3 TESTING: REQUIREMENTS FOR TESTING BY THIS CONTRACTOR SHALL BE AS INDICATED HEREWITH, ON THE CONSTRUCTION DRAWINGS, AND IN THE INDIVIDUAL SECTIONS OF THESE SPECIFICATIONS. SHOULD COMPANY CHOOSE TO ENGAGE ANY THIRD-PARTY TO CONDUCT ADDITIONAL TESTING, THE CONTRACTOR SHALL COOPERATE WITH AND PROVIDE A WORK AREA FOR COMPANY'S TEST AGENCY.
- 3.4 DIMENSIONS: VERIFY DIMENSIONS INDICATED ON DRAWINGS WITH FIELD DIMENSIONS BEFORE FABRICATION OR ORDERING OF MATERIALS. DO NOT SCALE DRAWINGS.

3.5 EXISTING CONDITIONS: NOTIFY THE SPRINT CONSTRUCTION MANAGER OF EXISTING CONDITIONS DIFFERING FROM THOSE INDICATED ON THE DRAWINGS. DO NOT REMOVE OR ALTER STRUCTURAL COMPONENTS WITHOUT PRIOR WRITTEN APPROVAL FROM THE ARCHITECT AND ENGINEER.

SECTION 01 200 – COMPANY FURNISHED MATERIAL AND EQUIPMENT

PART 1 – GENERAL

- 1.1 THE WORK: THESE STANDARD CONSTRUCTION SPECIFICATIONS IN CONJUNCTION WITH THE OTHER CONTRACT DOCUMENTS AND THE CONSTRUCTION DRAWINGS DESCRIBE THE WORK TO BE PERFORMED BY THE CONTRACTOR.
- 1.2 RELATED DOCUMENTS:
 - A. THE REQUIREMENTS OF THIS SECTION APPLY TO ALL SECTIONS IN THIS SPECIFICATION.
 - B. SPRINT 'STANDARD CONSTRUCTION DETAILS FOR WIRELESS SITES' ARE INCLUDED IN AND MADE A PART OF THESE SPECIFICATIONS HEREWITH.

PART 2 – PRODUCTS (NOT USED)

PART 3 – EXECUTION

- 3.1 RECEIPT OF MATERIAL AND EQUIPMENT:
 - A. A COMPANY FURNISHED MATERIAL AND EQUIPMENT IS IDENTIFIED ON THE RF DATA SHEET IN THE CONSTRUCTION DOCUMENTS.
 - B. THE CONTRACTOR IS RESPONSIBLE FOR SPRINT PROVIDED MATERIAL AND EQUIPMENT AND UPON RECEIPT SHALL:
 - 1. ACCEPT DELIVERIES AS SHIPPED AND TAKE RECEIPT.
 - 2. VERIFY COMPLETENESS AND CONDITION OF ALL DELIVERIES.
 - 3. TAKE RESPONSIBILITY FOR EQUIPMENT AND PROVIDE INSURANCE PROTECTION AS REQUIRED IN AGREEMENT.
 - 4. RECORD ANY DEFECTS OR DAMAGES AND WITHIN TWENTY-FOUR HOURS AFTER RECEIPT, REPORT TO SPRINT OR ITS DESIGNATED PROJECT REPRESENTATIVE OF SUCH.
 - 5. PROVIDE SECURE AND NECESSARY WEATHER PROTECTED WAREHOUSING.
 - 6. COORDINATE SAFE AND SECURE TRANSPORTATION OF MATERIAL AND EQUIPMENT, DELIVERING AND OFF-LOADING FROM CONTRACTOR'S WAREHOUSE TO SITE.
- 3.2 DELIVERABLES:
 - A. COMPLETE SHIPPING AND RECEIPT DOCUMENTATION IN ACCORDANCE WITH COMPANY PRACTICE.
 - B. IF APPLICABLE, COMPLETE LOST/STOLEN/DAMAGED DOCUMENTATION REPORT AS NECESSARY IN ACCORDANCE WITH COMPANY PRACTICE, AND AS DIRECTED BY COMPANY.
 - C. UPLOAD DOCUMENTATION INTO SPRINT SITE MANAGEMENT SYSTEM (SMS) AND/OR PROVIDE HARD COPY DOCUMENTATION AS REQUESTED.

SECTION 01 300 – CELL SITE CONSTRUCTION CO.

PART 1 – GENERAL

- 1.1 THE WORK: THESE STANDARD CONSTRUCTION SPECIFICATIONS IN CONJUNCTION WITH THE OTHER CONTRACT DOCUMENTS AND THE CONSTRUCTION DRAWINGS DESCRIBE THE WORK TO BE PERFORMED BY THE CONTRACTOR.
- 1.2 RELATED DOCUMENTS:
 - A. THE REQUIREMENTS OF THIS SECTION APPLY TO ALL SECTIONS IN THIS SPECIFICATION.
 - B. SPRINT 'STANDARD CONSTRUCTION DETAILS FOR WIRELESS SITES' ARE INCLUDED IN AND MADE A PART OF THESE SPECIFICATIONS HEREWITH.
- 1.3 NOTICE TO PROCEED
 - A. NO WORK SHALL COMMENCE PRIOR TO COMPANY'S WRITTEN NOTICE TO PROCEED AND THE ISSUANCE OF THE WORK ORDER.
 - B. UPON RECEIVING NOTICE TO PROCEED, CONTRACTOR SHALL FULLY PERFORM ALL WORK NECESSARY TO PROVIDE SPRINT WITH AN OPERATIONAL WIRELESS FACILITY.

PART 2 – PRODUCTS (NOT USED)

PART 3 – EXECUTION

- 3.1 FUNCTIONAL REQUIREMENTS:
 - A. THE ACTIVITIES DESCRIBED IN THIS PARAGRAPH REPRESENT MINIMUM ACTIONS AND PROCESSES REQUIRED TO SUCCESSFULLY COMPLETE THE WORK. THE ACTIVITIES DESCRIBED ARE NOT EXHAUSTIVE, AND CONTRACTOR SHALL TAKE ANY AND ALL ACTIONS AS NECESSARY TO SUCCESSFULLY COMPLETE THE CONSTRUCTION OF A FULLY FUNCTIONING WIRELESS FACILITY AT THE SITE IN ACCORDANCE WITH COMPANY PROCESSES.
 - B. SUBMIT SPECIFIC DOCUMENTATION AS INDICATED HEREIN, AND OBTAIN REQUIRED APPROVALS WHILE THE WORK IS BEING PERFORMED.
 - C. MANAGE AND CONDUCT ALL FIELD CONSTRUCTION SERVICE RELATED ACTIVITIES
 - D. PROVIDE CONSTRUCTION ACTIVITIES TO THE EXTENT REQUIRED BY THE CONTRACT DOCUMENTS, INCLUDING BUT NOT LIMITED TO THE FOLLOWING:

PLANS PREPARED FOR:



PLANS PREPARED BY:

INFINIGY
FROM ZERO TO INFINIGY
the solutions are endless
1033 Watervliet Shaker Rd | Albany, NY 12205
Phone: 518-690-0790 | Fax: 518-690-0793
www.infinigy.com
JOB NUMBER 526-104

PROJECT MANAGER:

AIROSMITH
DEVELOPMENT
32 CLINTON ST.
SARATOGA SPRINGS, NY 12868
OFFICE# (518) 306-3740

ENGINEERING LICENSE:



DRAWING NOTICE:

THESE DOCUMENTS ARE CONFIDENTIAL AND ARE THE SOLE PROPERTY OF SPRINT AND MAY NOT BE REPRODUCED, DISSEMINATED OR REDISTRIBUTED WITHOUT THE EXPRESS WRITTEN CONSENT OF SPRINT.

REVISIONS:	DESCRIPTION	DATE	BY	REV
REVISED/ISSUED FOR PERMIT		07/24/16	ETC	1
ISSUED FOR PERMIT		02/12/16	ETC	0

SITE NAME:
**(R2E) CT4072 TO
CT03XC343 CLP
(MERRITT 3)**

SITE NUMBER:
CT03XC343

SITE ADDRESS:
**45 BUTTERNUT HOLLOW RD
GREENWICH, CT 06830**

SHEET DESCRIPTION:
SPRINT SPECIFICATIONS

SHEET NUMBER:
SP-1

CONTINUE FROM SP-1

1. PERFORM ANY REQUIRED SITE ENVIRONMENTAL MITIGATION.
2. PREPARE GROUND SITES; PROVIDE DE-GRUBBING; AND ROUGH AND FINAL GRADING, AND COMPOUND SURFACE TREATMENTS.
3. MANAGE AND CONDUCT ALL ACTIVITIES FOR INSTALLATION OF UTILITIES INCLUDING ELECTRICAL AND TELCO BACKHAUL.
4. INSTALL UNDERGROUND FACILITIES INCLUDING UNDERGROUND POWER AND COMMUNICATIONS CONDUITS, AND UNDERGROUND GROUNDING SYSTEM.
5. INSTALL ABOVE GROUND GROUNDING SYSTEMS.
6. PROVIDE NEW HVAC INSTALLATIONS AND MODIFICATIONS.
7. INSTALL "H-FRAMES", CABINETS AND SHELTERS AS INDICATED.
8. INSTALL ROADS, ACCESS WAYS, CURBS AND DRAINS AS INDICATED.
9. ACCOMPLISH REQUIRED MODIFICATION OF EXISTING FACILITIES.
10. PROVIDE ANTENNA SUPPORT STRUCTURE FOUNDATIONS.
11. PROVIDE SLABS AND EQUIPMENT PLATFORMS.
12. INSTALL COMPOUND FENCING, SIGHT SHIELDING, LANDSCAPING AND ACCESS BARRIERS.
13. PERFORM INSPECTION AND MATERIAL TESTING AS REQUIRED HEREINAFTER.
14. CONDUCT SITE RESISTANCE TO EARTH TESTING AS REQUIRED HEREINAFTER.
15. INSTALL FIXED GENERATOR SETS AND OTHER STANDBY POWER SOLUTIONS.
16. INSTALL TOWERS, ANTENNA SUPPORT STRUCTURES AND PLATFORMS ON EXISTING TOWERS AS REQUIRED.
17. INSTALL CELL SITE RADIOS, MICROWAVE, GPS, COAXIAL MAINLINE, ANTENNAS, CROSS BAND COUPLERS, TOWER TOP AMPLIFIERS, LOW NOISE AMPLIFIERS AND RELATED EQUIPMENT.
18. PERFORM, DOCUMENT, AND CLOSE OUT ANY CONSTRUCTION CONTROL DOCUMENTS THAT MAY BE REQUIRED BY GOVERNMENT AGENCIES AND LANDLORDS.
19. PERFORM ANTENNA AND COAX SWEEP TESTING AND MAKE ANY AND ALL NECESSARY CORRECTIONS.
20. REMAIN ON SITE MOBILIZED THROUGHOUT HAND-OFF AND INTEGRATION TO ASSIST AS NEEDED UNTIL SITE IS DEEMED SUBSTANTIALLY COMPLETE AND PLACED "ON AIR."

3.2 GENERAL REQUIREMENTS FOR CIVIL CONSTRUCTION:

- A. CONTRACTOR SHALL KEEP THE SITE FREE FROM ACCUMULATING WASTE MATERIAL, DEBRIS, AND TRASH. AT THE COMPLETION OF THE WORK, CONTRACTOR SHALL REMOVE FROM THE SITE ALL REMAINING RUBBISH, IMPLEMENTS, TEMPORARY FACILITIES, AND SURPLUS MATERIALS.
- B. EQUIPMENT ROOMS SHALL AT ALL TIMES BE MAINTAINED "BROOM CLEAN" AND CLEAR OF DEBRIS.
- C. CONTRACTOR SHALL TAKE ALL REASONABLE PRECAUTIONS TO DISCOVER AND LOCATE ANY HAZARDOUS CONDITION.
 1. IN THE EVENT CONTRACTOR ENCOUNTERS ANY HAZARDOUS CONDITION WHICH HAS NOT BEEN ABATED OR OTHERWISE MITIGATED, CONTRACTOR AND ALL OTHER PERSONS SHALL IMMEDIATELY STOP WORK IN THE AFFECTED AREA AND NOTIFY COMPANY IN WRITING. THE WORK IN THE AFFECTED AREA SHALL NOT BE RESUMED EXCEPT BY WRITTEN NOTIFICATION BY COMPANY.
 2. CONTRACTOR AGREES TO USE CARE WHILE ON THE SITE AND SHALL NOT TAKE ANY ACTION THAT WILL OR MAY RESULT IN OR CAUSE THE HAZARDOUS CONDITION TO BE FURTHER RELEASED IN THE ENVIRONMENT, OR TO FURTHER EXPOSE INDIVIDUALS TO THE HAZARD.

D. CONTRACTOR'S ACTIVITIES SHALL BE RESTRICTED TO THE PROJECT LIMITS. SHOULD AREAS OUTSIDE THE PROJECT LIMITS BE AFFECTED BY CONTRACTOR'S ACTIVITIES, CONTRACTOR SHALL IMMEDIATELY RETURN THEM TO ORIGINAL CONDITION

E. CONDUCT TESTING AS REQUIRED HEREIN.

3.3 DELIVERABLES:

- A. CONTRACTOR SHALL REVIEW, APPROVE, AND SUBMIT TO SPRINT SHOP DRAWINGS, PRODUCT DATA, SAMPLES, AND SIMILAR SUBMITTALS AS REQUIRED HEREINAFTER
- B. PROVIDE DOCUMENTATION INCLUDING, BUT NOT LIMITED TO, THE FOLLOWING. DOCUMENTATION SHALL BE FORWARDED IN ORIGINAL FORMAT AND/OR UPLOADED INTO SMS.
 1. ALL CORRESPONDENCE AND PRELIMINARY CONSTRUCTION REPORTS.
 2. PROJECT PROGRESS REPORTS.
 3. CIVIL CONSTRUCTION START DATE (POPULATE FIELD IN SMS AND/OR FORWARD NOTIFICATION).
 4. ELECTRICAL SERVICE COMPLETION DATE (POPULATE FIELD IN SMS AND/OR FORWARD NOTIFICATION).

5. LINES AND ANTENNA INSTALL DATE (POPULATE FIELD IN SMS AND/OR FORWARD NOTIFICATION).
6. POWER INSTALL DATE (POPULATE FIELD IN SMS AND/OR FORWARD NOTIFICATION).
7. TELCO READY DATE (POPULATE FIELD IN SMS AND/OR FORWARD NOTIFICATION).
8. PPC (OR SHELTER) INSTALL DATE (POPULATE FIELD IN SMS AND/OR FORWARD NOTIFICATION).
9. TOWER CONSTRUCTION START DATE (POPULATE FIELD IN SMS AND/OR FORWARD NOTIFICATION).
10. TOWER CONSTRUCTION COMPLETE DATE (POPULATE FIELD IN SMS AND/OR FORWARD NOTIFICATION).
11. BTS AND RADIO EQUIPMENT DELIVERED AT SITE DATE (POPULATE FIELD IN SMS AND/OR FORWARD NOTIFICATION).
12. NETWORK OPERATIONS HANDOFF CHECKLIST (HOC WALK) COMPLETE (UPLOAD FORM IN SMS)
13. CIVIL CONSTRUCTION COMPLETE DATE (POPULATE FIELD IN SMS AND/OR FORWARD NOTIFICATION).
14. SITE CONSTRUCTION PROGRESS PHOTOS UNLOADED INTO SMS.

SECTION 01 400 - SUBMITTALS & TESTS

PART 1 - GENERAL

1.1 THE WORK: THESE STANDARD CONSTRUCTION SPECIFICATIONS IN CONJUNCTION WITH THE OTHER CONTRACT DOCUMENTS AND THE CONSTRUCTION DRAWINGS DESCRIBE THE WORK TO BE PERFORMED BY THE CONTRACTOR.

1.2 RELATED DOCUMENTS:

- A. THE REQUIREMENTS OF THIS SECTION APPLY TO ALL SECTIONS IN THIS SPECIFICATION.
- B. SPRINT "STANDARD CONSTRUCTION DETAILS FOR WIRELESS SITES" ARE INCLUDED IN AND MADE A PART OF THESE SPECIFICATIONS HERewith.

1.3 SUBMITTALS:

- A. THE WORK IN ALL ASPECTS SHALL COMPLY WITH THE CONSTRUCTION DRAWINGS AND THESE SPECIFICATIONS.
- B. SUBMIT THE FOLLOWING TO COMPANY REPRESENTATIVE FOR APPROVAL.
 1. CONCRETE MIX-DESIGNS FOR TOWER FOUNDATIONS, ANCHORS PIERS, AND CONCRETE PAVING.
 2. CONCRETE BREAK TESTS AS SPECIFIED HEREIN.
 3. SPECIAL FINISHES FOR INTERIOR SPACES, IF ANY.
 4. ALL EQUIPMENT AND MATERIALS SO IDENTIFIED ON THE CONSTRUCTION DRAWINGS.
 5. CHEMICAL GROUNDING DESIGN
- D. ALTERNATES: AT THE COMPANY'S REQUEST, ANY ALTERNATIVES TO THE MATERIALS OR METHODS SPECIFIED SHALL BE SUBMITTED TO SPRINT'S CONSTRUCTION MANAGER FOR APPROVAL PRIOR TO BEING SHIPPED TO SITE. SPRINT WILL REVIEW AND APPROVE ONLY THOSE REQUESTS MADE IN WRITING. NO VERBAL APPROVALS WILL BE CONSIDERED. SUBMITTAL FOR APPROVAL SHALL INCLUDE A STATEMENT OF COST REDUCTION PROPOSED FOR USE OF ALTERNATE PRODUCT.

1.4 TESTS AND INSPECTIONS:

- A. THE CONTRACTOR SHALL BE RESPONSIBLE FOR ALL CONSTRUCTION TESTS, INSPECTIONS AND PROJECT DOCUMENTATION.
- B. CONTRACTOR SHALL ACCOMPLISH TESTING INCLUDING BUT NOT LIMITED TO THE FOLLOWING:
 1. COAX SWEEPS AND FIBER TESTS PER TS-0200 REV 4 ANTENNA LINE ACCEPTANCE STANDARDS.
 2. AGL, AZIMUTH AND DOWNTILT USING ELECTRONIC COMMERCIAL MADE-FOR-THE-PURPOSE ANTENNA ALIGNMENT TOOL.
 3. CONTRACTOR SHALL BE RESPONSIBLE FOR ANY AND ALL CORRECTIONS TO ANY WORK IDENTIFIED AS UNACCEPTABLE IN SITE INSPECTION ACTIVITIES AND/OR AS A RESULT OF TESTING.
- C. REQUIRED CLOSEOUT DOCUMENTATION INCLUDES, BUT IS NOT LIMITED TO THE FOLLOWING:
 1. AZIMUTH, DOWNTILT, AGL - UPLOAD REPORT FROM ANTENNA ALIGNMENT TOOL TO SITERRA TASK 465. INSTALLED AZIMUTH, DOWNTILT, AND AGL MUST CONFORM TO THE RF DATA SHEETS. SWEEP AND FIBER TESTS
 2. SCANABLE BARCODE PHOTOGRAPHS OF TOWER TOP AND INACCESSIBLE SERIALIZED EQUIPMENT
 3. ALL AVAILABLE JURISDICTIONAL INFORMATION
 4. PDF SCAN OF REDLINES PRODUCED IN FIELD

5. ELECTRONIC AS-BUILT DRAWINGS IN AUTOCAD AND PDF FORMATS. ANY FIELD CHANGE MUST BE REFLECTED BY MODIFYING THE PLANS, ELEVATIONS, AND DETAILS IN THE DRAWING SETS. GENERAL NOTES INDICATING MODIFICATIONS WILL NOT BE ACCEPTED. CHANGES SHALL BE HIGHLIGHTED AS "CLOUDS" IDENTIFIED AS THE "AS-BUILT" CONDITION.
6. LIEN WAIVERS
7. FINAL PAYMENT APPLICATION
8. REQUIRED FINAL CONSTRUCTION PHOTOS
9. CONSTRUCTION AND COMMISSIONING CHECKLIST COMPLETE WITH NO DEFICIENT ITEMS
10. ALL POST NTP TASKS INCLUDING DOCUMENT UPLOADS COMPLETED IN SITERRA (SPRINTS DOCUMENT REPOSITORY OF RECORD).

- 1.5 COMMISSIONING: PERFORM ALL COMMISSIONING AS REQUIRED BY APPLICABLE MOPs
- 1.6 INTEGRATION: PERFORM ALL INTEGRATION ACTIVITIES AS REQUIRED BY APPLICABLE MOPs

PART 2 - PRODUCTS (NOT USED)

PART 3 - EXECUTION

3.1 REQUIREMENTS FOR TESTING:

A. THIRD PARTY TESTING AGENCY:

1. WHEN THE USE OF A THIRD PARTY INDEPENDENT TESTING AGENCY IS REQUIRED, THE AGENCY THAT IS SELECTED MUST PERFORM SUCH WORK ON A REGULAR BASIS IN THE STATE WHERE THE PROJECT IS LOCATED AND HAVE A THOROUGH UNDERSTANDING OF LOCAL AVAILABLE MATERIALS, INCLUDING THE SOIL, ROCK, AND GROUNDWATER CONDITIONS.
2. THE THIRD PARTY TESTING AGENCY IS TO BE FAMILIAR WITH THE APPLICABLE REQUIREMENTS FOR THE TESTS TO BE DONE, EQUIPMENT TO BE USED, AND ASSOCIATED HEALTH AND SAFETY ISSUES.
3. EXPERIENCE IN SOILS, CONCRETE, MASONRY, AGGREGATE, AND ASPHALT TESTING USING ASTM, AASHTO, AND OTHER METHODS IS NEEDED.
4. EXPERIENCE IN SOILS, CONCRETE, MASONRY, AGGREGATE, AND ASPHALT TESTING USING ASTM, AASHTO, AND OTHER METHODS IS NEEDED.

3.2 REQUIRED TESTS:

- A. CONTRACTOR SHALL ACCOMPLISH TESTING INCLUDING BUT NOT LIMITED TO THE FOLLOWING:
 1. CONCRETE CYLINDER BREAK TESTS FOR THE TOWER AND ANCHOR FOUNDATIONS AS SPECIFIED IN SECTION: PORTLAND CEMENT CONCRETE PAVING.
 2. ASPHALT ROADWAY COMPACTED THICKNESS, SURFACE SMOOTHNESS, AND COMPACTED DENSITY TESTING AS SPECIFIED IN SECTION: HOT MIX ASPHALT PAVING.
 3. FIELD QUALITY CONTROL TESTING AS SPECIFIED IN SECTION: PORTLAND CEMENT CONCRETE PAVING.
 4. TESTING REQUIRED UNDER SECTION: AGGREGATE BASE FOR ACCESS ROADS, PADS AND ANCHOR LOCATIONS
 5. STRUCTURAL BACKFILL COMPACTION TESTS FOR THE TOWER FOUNDATION.
 6. SITE RESISTANCE TO EARTH TESTING PER EXHIBIT: CELL SITE GROUNDING SYSTEM DESIGN.
 7. ANTENNA AND COAX SWEEP TESTS PER EXHIBIT: ANTENNA TRANSMISSION LINE ACCEPTANCE STANDARDS.
 8. GROUNDING AT ANTENNA MASTS FOR GPS AND ANTENNAS
 9. ALL OTHER TESTS REQUIRED BY COMPANY OR JURISDICTION.

3.3 REQUIRED INSPECTIONS

- A. SCHEDULE INSPECTIONS WITH COMPANY REPRESENTATIVE.
- B. CONDUCT INSPECTIONS INCLUDING BUT NOT LIMITED TO THE FOLLOWING:
 1. GROUNDING SYSTEM INSTALLATION PRIOR TO EARTH CONCEALMENT DOCUMENTED WITH DIGITAL PHOTOGRAPHS BY CONTRACTOR, APPROVED BY A&E OR SPRINT REPRESENTATIVE.
 2. FORMING FOR CONCRETE AND REBAR PLACEMENT PRIOR TO POUR DOCUMENTED WITH DIGITAL PHOTOGRAPHS BY CONTRACTOR, APPROVED BY A&E OR SPRINT REPRESENTATIVE.
 3. COMPACTION OF BACKFILL MATERIALS; AGGREGATE BASE FOR ROADS, PADS, AND ANCHORS; ASPHALT PAVING; AND SHAFT BACKFILL FOR CONCRETE AND WOOD POLES, BY INDEPENDENT THIRD PARTY AGENCY.
 4. PRE- AND POST-CONSTRUCTION ROOFTOP AND STRUCTURAL INSPECTIONS ON EXISTING FACILITIES.
 5. TOWER ERECTION SECTION STACKING AND PLATFORM ATTACHMENT DOCUMENTED BY DIGITAL PHOTOGRAPHS BY THIRD PARTY AGENCY.
 6. ANTENNA AZIMUTH, DOWN TILT AND PER SUNLIGHT TOOL SUNSIGHT INSTRUMENTS - ANTENNALIGN ALIGNMENT TOOL (AAT)

PLANS PREPARED FOR:



PLANS PREPARED BY:

INFINIGY
FROM ZERO TO INFINIGY
the solutions are endless
1033 Watervliet Shaker Rd | Albany, NY 12205
Phone: 518-690-0790 | Fax: 518-690-0793
www.infinigy.com
JOB NUMBER 526-104

PROJECT MANAGER:

AIRSMITH
DEVELOPMENT
32 CLINTON ST.
SARATOGA SPRINGS, NY 12866
OFFICE# (518) 308-3740

ENGINEERING LICENSE:



DRAWING NOTICE:

THESE DOCUMENTS ARE CONFIDENTIAL AND ARE THE SOLE PROPERTY OF SPRINT AND MAY NOT BE REPRODUCED, DISSEMINATED OR REDISTRIBUTED WITHOUT THE EXPRESS WRITTEN CONSENT OF SPRINT.

REVISIONS:	DESCRIPTION	DATE	BY	REV.
REVISED/ISSUED FOR PERMIT		07/24/18	ETC	1
ISSUED FOR PERMIT		02/12/18	ETC	0

SITE NAME:
(R2E) CT4072 TO CT03XC343 CLP (MERRITT 3)

SITE NUMBER:
CT03XC343

SITE ADDRESS:
45 BUTTERNUT HOLLOW RD GREENWICH, CT 06830

SHEET DESCRIPTION:
SPRINT SPECIFICATIONS

SHEET NUMBER:
SP-2

DRAWING NOTICE:

THESE DOCUMENTS ARE CONFIDENTIAL AND ARE THE SOLE PROPERTY OF SPRINT AND MAY NOT BE REPRODUCED, DISSEMINATED OR REDISTRIBUTED WITHOUT THE EXPRESS WRITTEN CONSENT OF SPRINT.

REVISIONS:	DESCRIPTION	DATE	BY	REV.
REVISED/ISSUED FOR PERMIT		07/24/18	ETC	1
ISSUED FOR PERMIT		02/12/18	ETC	0

SITE NAME:

(R2E) CT4072 TO CT03XC343 CLP (MERRITT 3)

SITE NUMBER:

CT03XC343

SITE ADDRESS:

45 BUTTERNUT HOLLOW RD
GREENWICH, CT 06830

SHEET DESCRIPTION:

SITE PLAN

SHEET NUMBER:

A-1

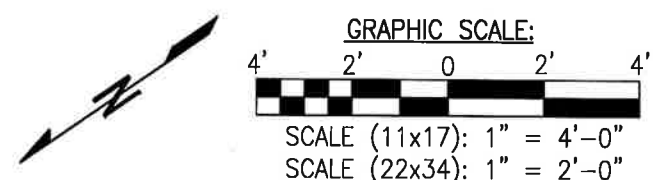
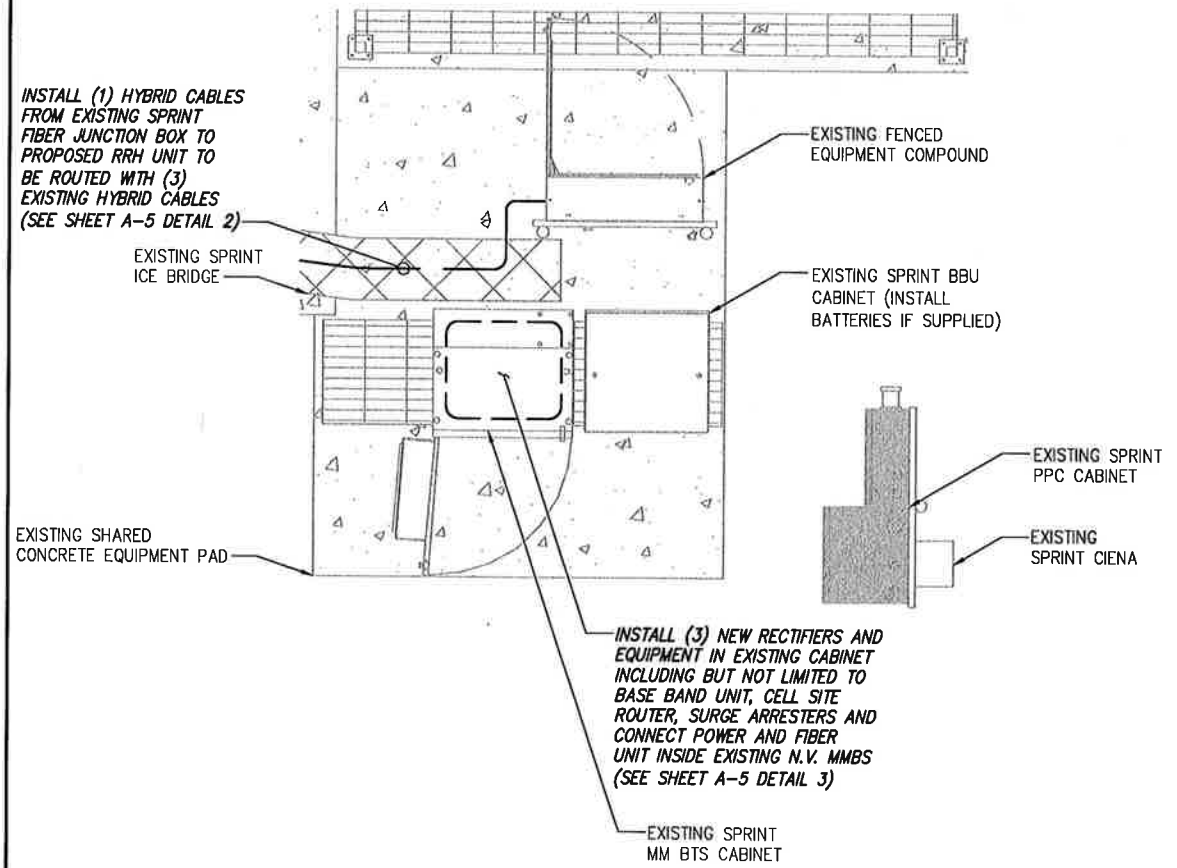
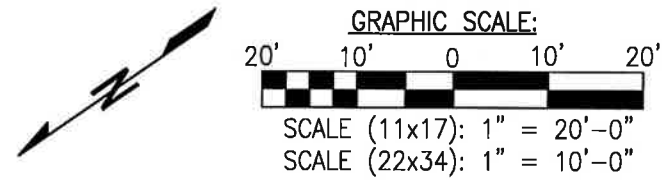
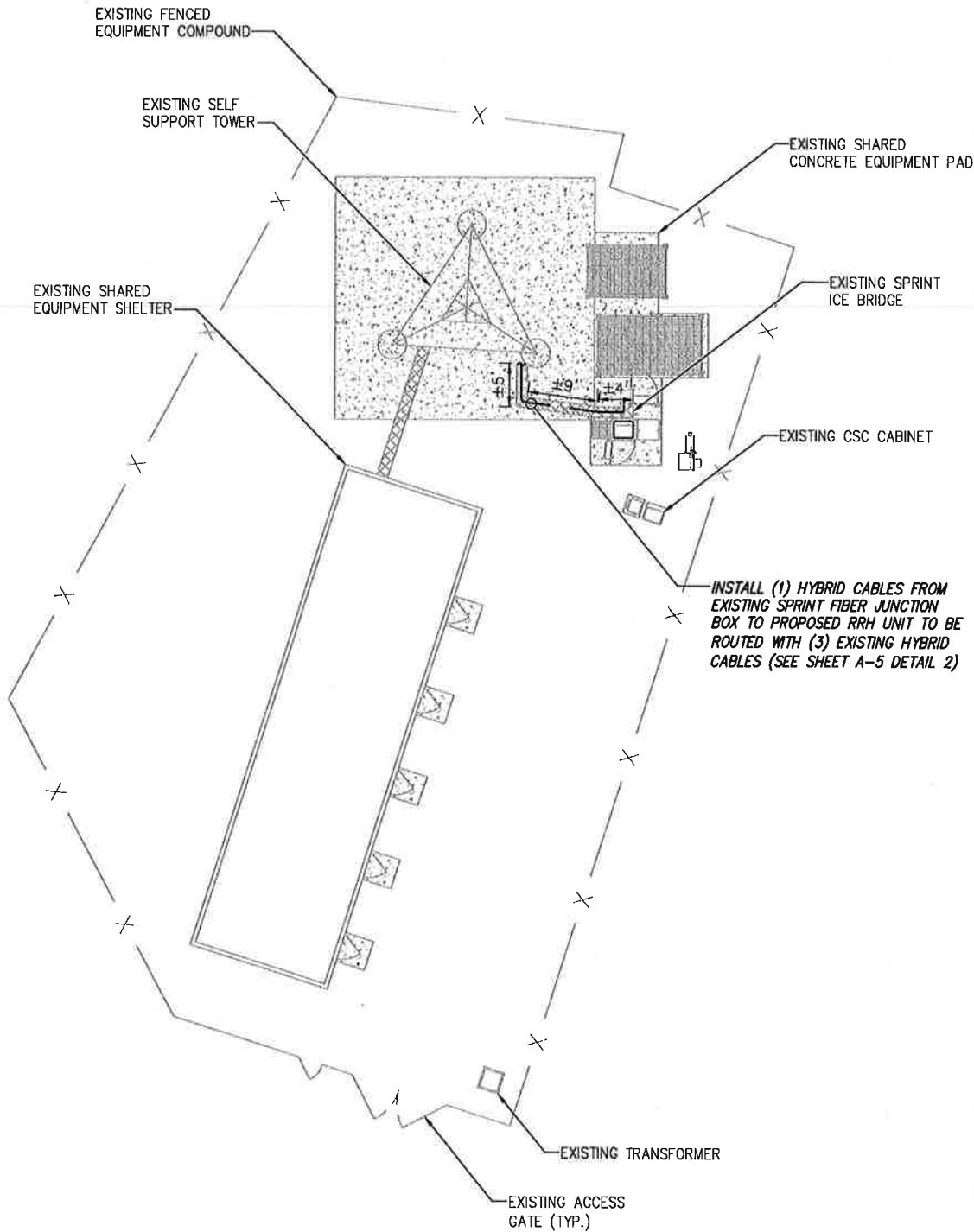

INFORMATION CONTAINED WITHIN DRAWINGS ARE BASED ON PROVIDED INFORMATION AND ARE NOT THE RESULT OF A FIELD SURVEY.

NOTE:
 INFINIGY ENGINEERING HAS NOT EVALUATED THE EXISTING STRUCTURE FOR THIS SITE, AND ASSUMES NO RESPONSIBILITY FOR ITS STRUCTURAL INTEGRITY. REFER TO STRUCTURAL ANALYSIS BY OTHERS PRIOR TO ANY CONSTRUCTION.

NOTE:
 SEE DETAIL 2 ON A-3 FOR ANTENNA LAYOUT

TOP OF TOWER
 ELEV. = 180'-0" A.G.L.

⊕ OF EXISTING/TO BE INSTALLED SPRINT ANTENNAS
 ELEV. = 115'-0" A.G.L.

NOTE:
 * STRUCTURAL ANALYSIS COMPLETED BY AECOM. FOR ADDITIONAL INFORMATION SEE REPORT TITLED: "DETAILED STRUCTURAL ANALYSIS AND MODIFICATION OF AN EXISTING 160' SELF SUPPORTING LATTICE TOWER AND FOUNDATION FOR PROPOSED ANTENNA ARRANGEMENT, CARRIER SITE NUMBER: CT03XC343", DATED: "OCTOBER 11, 2018". ACCORDING TO RESULTS OF STRUCTURAL MODIFICATION REPORT, THE STRUCTURE HAS SUFFICIENT CAPACITY TO SUPPORT THE PROPOSED LOADING CONTINGENT OF THE FOLLOWING MODIFICATIONS: ONCE THE MODIFICATION INDICATED ON SHEETS SK-1 THROUGH SK-5 ARE PERFORMED, THE MODIFIED STRUCTURES ARE CONSIDERED STRUCTURALLY ADEQUATE WITH THE WIND LOAD CLASSIFICATION SPECIFIED WITH THE EXISTING AND PROPOSED ANTENNA LOADING. NO INSTALLATION OF PROPOSED ANTENNAS SHALL OCCUR WITHOUT THE REQUIRED MODIFICATION BEING COMPLETED.

* ANTENNA AND RRH SUPPORT EVALUATION COMPLETED BY INFINIGY. FOR ADDITIONAL INFORMATION SEE REPORT TITLED: "SPRINT DO MACRO PROJECT MOUNT ANALYSIS", DATED: "JULY 5, 2018". ACCORDING TO THE RESULTS OF REVIEW, THE ANTENNA AND RRH SUPPORTS WILL BE ADEQUATE TO SUPPORT THE PROPOSED LOADING CONTINGENT ON THE FOLLOWING INSTALLATION: CONTRACTOR TO INSTALL (3) SITEPRO1 STK-U STIFF ARM ON UNBRACED END OF MOUNT, ATTACH TO OPPOSITE TOWER LEG.

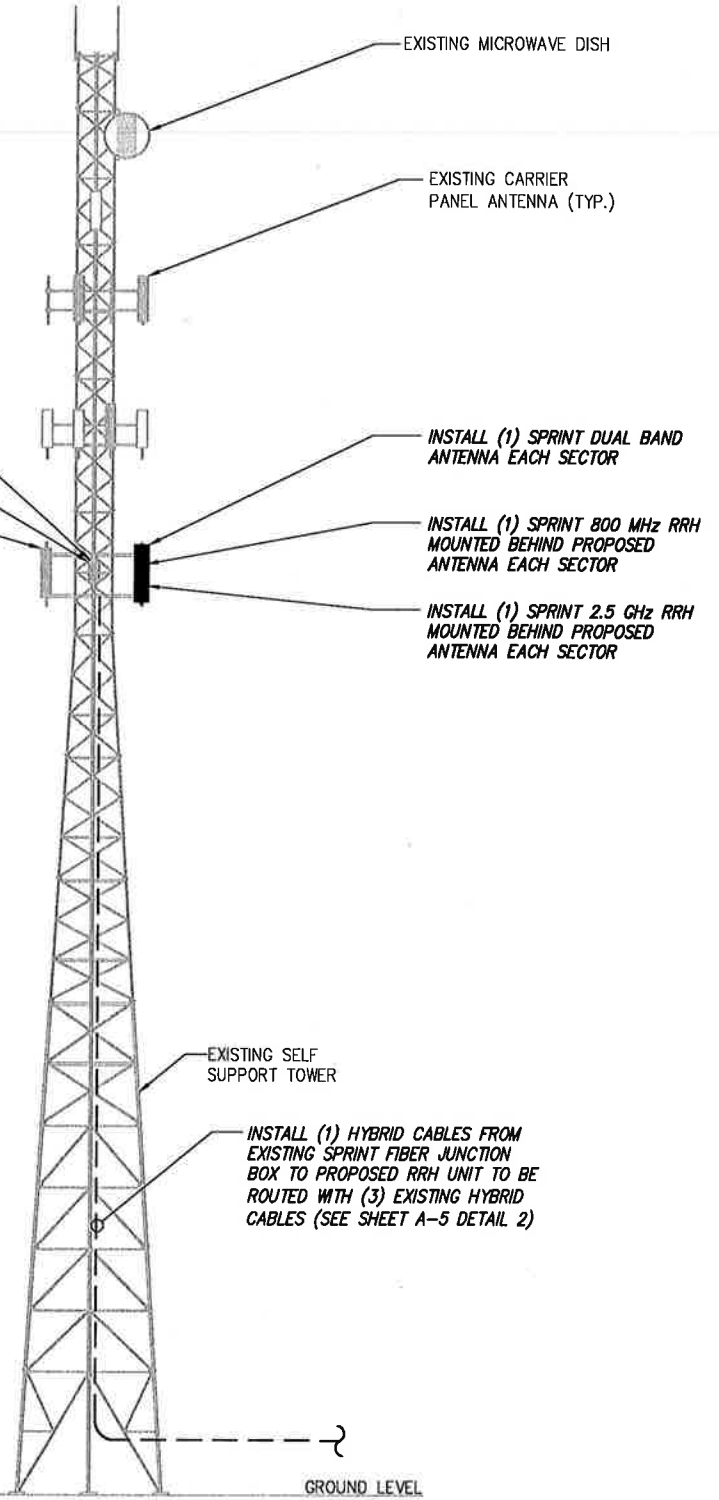

TOWER ELEVATION

NO SCALE

1

SITE LOADING CHART

SECTOR	EXISTING/PROPOSED	ANTENNA MODEL #	VENDOR	AZIMUTH	QTY.	REMAIN/REMOVED	RRH (QTY/MODEL)	CABLE	CABLE LENGTH	RAD CENTER
ALPHA	PROPOSED	DT465B-2XR	COMM-SCOPE	20°	1	-	(2) 800 MHZ 2X50W RRH W/ FILTER	SEE SHEET A-5 DETAIL 1	±115' AGL	±115' AGL
	EXISTING	APXVSPP18-C-A20	RFS	20°	1	REMAIN	(1) TD-RRHBX20-25 W/ SOLAR SHIELD (1) 1900 MHZ 4X45 RRH	EXISTING COAX		
BETA	PROPOSED	DT465B-2XR	COMM-SCOPE	140°	1	-	(2) 800 MHZ 2X50W RRH W/ FILTER	SEE SHEET A-5 DETAIL 1	±134*	±115' AGL
	EXISTING	APXVSPP18-C-A20	RFS	140°	1	REMAIN	(1) TD-RRHBX20-25 W/ SOLAR SHIELD (1) 1900 MHZ 4X45 RRH	EXISTING COAX		
GAMMA	PROPOSED	DT465B-2XR	COMM-SCOPE	220°	1	-	(2) 800 MHZ 2X50W RRH W/ FILTER	SEE SHEET A-5 DETAIL 1	±115' AGL	±115' AGL
	EXISTING	APXVSPP18-C-A20	RFS	220°	1	REMAIN	(1) TD-RRHBX20-25 W/ SOLAR SHIELD (1) 1900 MHZ 4X45 RRH	EXISTING COAX		

PROJECT SCOPE:

INSTALL: (3) PANEL ANTENNAS AND (6) RRH'S

* PROPOSED CABLE LENGTH WAS DETERMINED USING THE SUM OF THE RAD CENTER OF ANTENNAS, AND DISTANCE FROM EXISTING EQUIPMENT AREA TO TOWER BASE WITH AN ADDITIONAL 20' BUFFER. LENGTH TO BE VERIFIED IN FIELD PRIOR TO ORDERING MATERIALS.

SITE LOADING CHART

NO SCALE

2

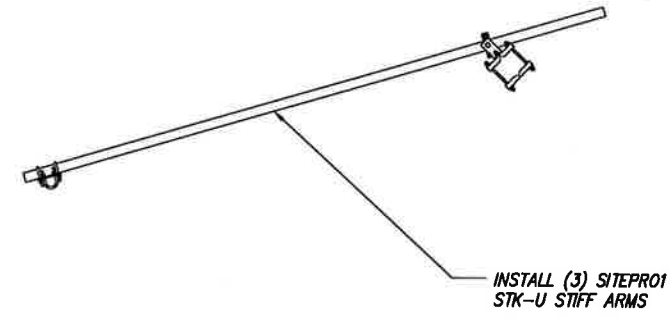

STIFF ARM DETAIL

NO SCALE

3

PLANS PREPARED FOR:

PLANS PREPARED BY:

FROM ZERO TO INFINIGY
 the solutions are endless

1033 Watervliet Shaker Rd | Albany, NY 12205
 Phone: 518-690-0790 | Fax: 518-690-0793
 www.infinigy.com
 JOB NUMBER 526-104

PROJECT MANAGER:

32 CLINTON ST.
 SARATOGA SPRINGS, NY 12888
 OFFICE# (518) 306-3740

ENGINEERING LICENSE:

DRAWING NOTICE:
 THESE DOCUMENTS ARE CONFIDENTIAL AND ARE THE SOLE PROPERTY OF SPRINT AND MAY NOT BE REPRODUCED, DISSEMINATED OR REDISTRIBUTED WITHOUT THE EXPRESS WRITTEN CONSENT OF SPRINT.

REVISIONS:	DESCRIPTION	DATE	BY	REV.
REVISED/ISSUED FOR PERMIT		07/24/18	ETC	1
ISSUED FOR PERMIT		02/12/18	ETC	0

SITE NAME:
 (R2E) CT4072 TO CT03XC343 CLP (MERRITT 3)

SITE NUMBER:
 CT03XC343

SITE ADDRESS:
 45 BUTTERNUT HOLLOW RD
 GREENWICH, CT 06830

SHEET DESCRIPTION:
 TOWER ELEVATION

SHEET NUMBER:
 A-2

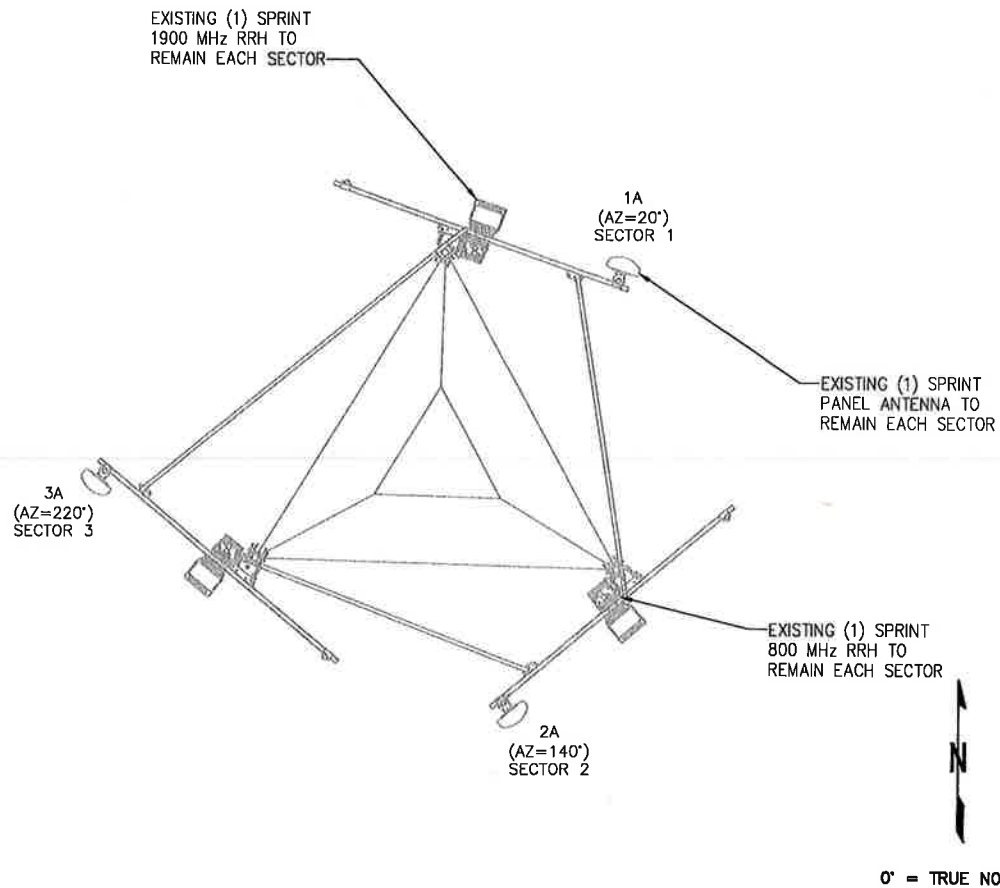

EXISTING ANTENNA & LAYOUT

NO SCALE

1

THE CONFIGURATION PLANS ARE BASED ON PROVIDED INFORMATION AND ARE FOR CONCEPTUAL PURPOSES ONLY. CONTRACTOR TO VERIFY FIELD CONDITIONS PRIOR TO CONSTRUCTION.

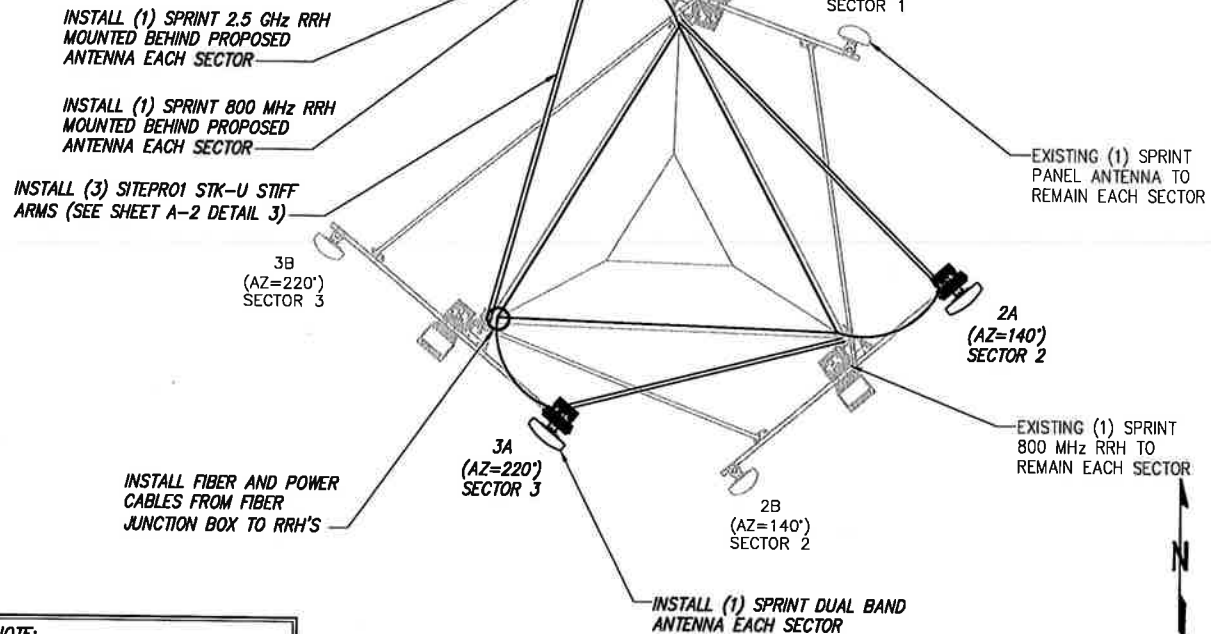

FINAL ANTENNA & RRH LAYOUT

NO SCALE

2

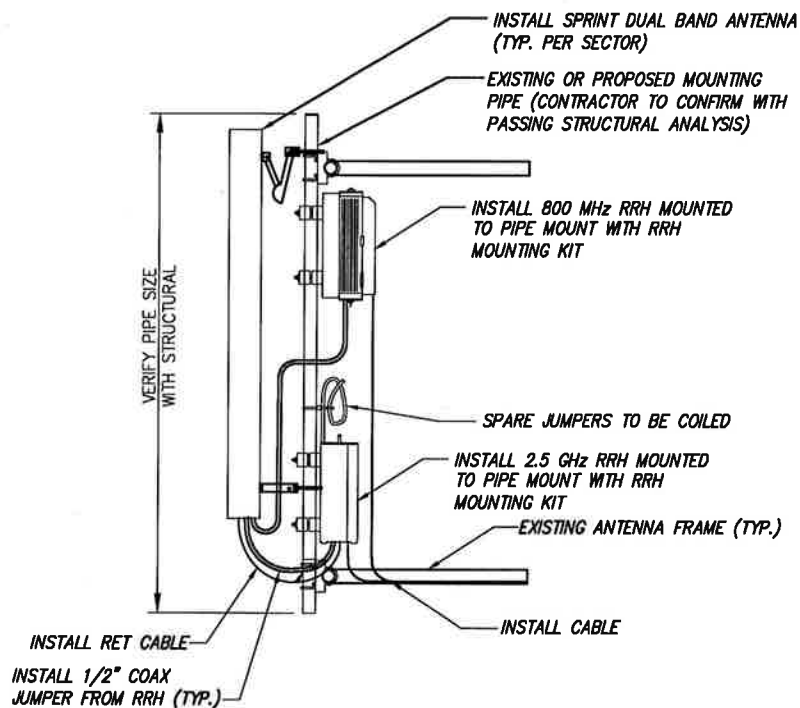

TYPICAL ANTENNA & RRH MOUNTING DETAILS

NO SCALE

3

NOTE: CONTRACTOR TO POSITION RRH ON MOUNT BEHIND ANTENNA SUCH THAT THE RRH DOES NOT INTERFERE WITH THE EXISTING PLATFORM/T-ARM MOUNTING HARDWARE.

NOTE: THE DIAGRAM IS FOR CONCEPTUAL PURPOSES ONLY. CONTRACTOR IS TO REFER TO PASSING STRUCTURAL ANALYSIS FOR ANTENNA AND RRH MOUNTING DETAILS

NOTES:

1. CUT DC CONDUCTORS TO LENGTH.
2. COIL FIBER CABLE AND SECURE AT SIDE OF RRH.
3. DO NOT EXCEED BEND RADIUS.

DETAIL NOT USED

NO SCALE

4

PLANS PREPARED FOR:

PLANS PREPARED BY:

FROM ZERO TO INFINIGY
the solutions are endless

1033 Watervliet Shaker Rd | Albany, NY 12205
Phone: 518-690-0790 | Fax: 518-690-0793
www.infinigy.com
JOB NUMBER 526-104

PROJECT MANAGER:

32 CLINTON ST.
SARATOGA SPRINGS, NY 12866
OFFICE# (518) 306-3740

ENGINEERING LICENSE:

DRAWING NOTICE:

THESE DOCUMENTS ARE CONFIDENTIAL AND ARE THE SOLE PROPERTY OF SPRINT AND MAY NOT BE REPRODUCED, DISSEMINATED OR REDISTRIBUTED WITHOUT THE EXPRESS WRITTEN CONSENT OF SPRINT.

REVISIONS:

DESCRIPTION	DATE	BY	REV.
REMOVED/ISSUED FOR PERMIT	07/24/18	ETC	1
ISSUED FOR PERMIT	02/12/18	ETC	0

SITE NAME:
(R2E) CT4072 TO CT03XC343 CLP (MERRITT 3)

SITE NUMBER:
CT03XC343

SITE ADDRESS:
45 BUTTERNUT HOLLOW RD GREENWICH, CT 06830

SHEET DESCRIPTION:
ANTENNA LAYOUT & MOUNTING DETAILS

SHEET NUMBER:
A-3

RRH: ALCATEL LUCENT TD-RRH8X20

COLOR: LIGHT GREY
WEIGHT: 70 LBS.

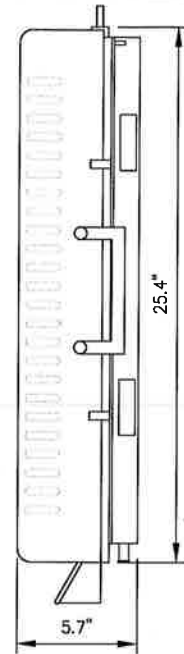

SIDE VIEW

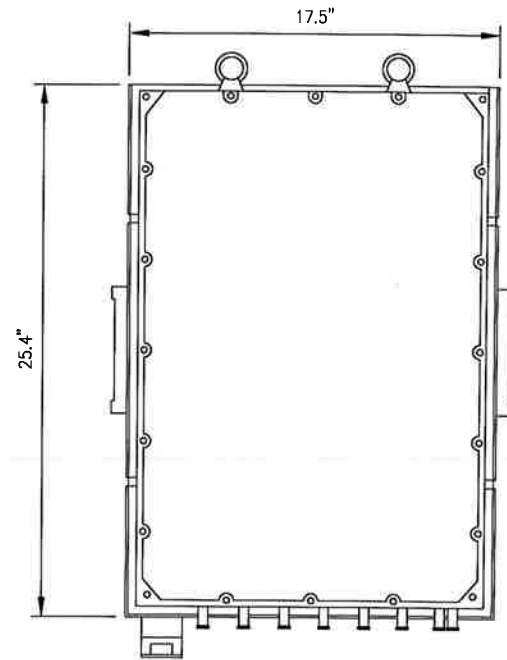

FRONT VIEW

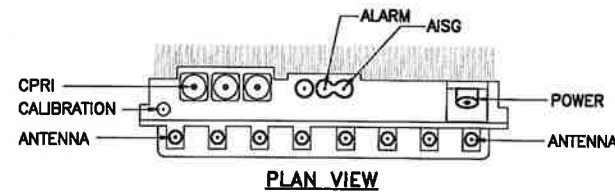

PLAN VIEW

NOTES

COMPLY WITH MANUFACTURERS INSTRUCTIONS TO ENSURE THAT ALL RRH'S RECEIVE ELECTRICAL POWER WITHIN 24 HOURS OF BEING REMOVED FROM THE MANUFACTURER'S PACKAGING. DO NOT OPEN RRH PACKAGES IN THE RAIN.

2.5 RRH'S

NO SCALE

1

RRH: ALCATEL LUCENT 1900 MHz

COLOR: LIGHT GREY
WEIGHT: 70 LBS.
(INCLUDING OPTIONAL SOLAR SHIELD)

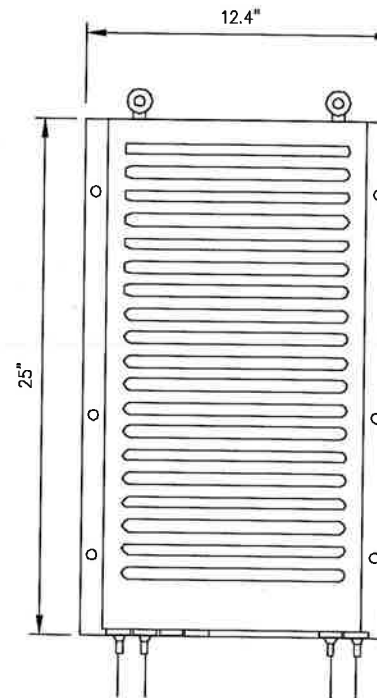

FRONT VIEW

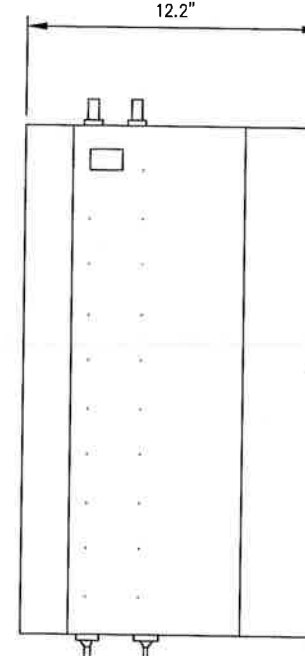

SIDE VIEW

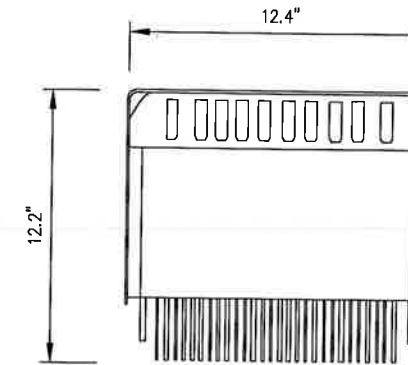

TOP VIEW

EXISTING 1900 MHz RRH

NO SCALE

2

PLANS PREPARED FOR:



PLANS PREPARED BY:

INFINIGY
FROM ZERO TO INFINIGY

the solutions are endless

1033 Watervliet Shaker Rd | Albany, NY 12205
Phone: 518-690-0790 | Fax: 518-690-0793
www.infinigy.com
JOB NUMBER 526-104

PROJECT MANAGER:

AIRSMITH
DEVELOPMENT

32 CLINTON ST.
SARATOGA SPRINGS, NY 12868
OFFICE# (518) 308-3740

ENGINEERING LICENSE:



DRAWING NOTICE:

THESE DOCUMENTS ARE CONFIDENTIAL AND ARE THE SOLE PROPERTY OF SPRINT AND MAY NOT BE REPRODUCED, DISSEMINATED OR REDISTRIBUTED WITHOUT THE EXPRESS WRITTEN CONSENT OF SPRINT.

REVISIONS:

DESCRIPTION	DATE	BY	REV.
REVISED/ISSUED FOR PERMIT	07/24/18	ETC	1
ISSUED FOR PERMIT	02/12/18	ETC	0

SITE NAME:

(R2E) CT4072 TO
CT03XC343 CLP
(MERRITT 3)

SITE NUMBER:

CT03XC343

SITE ADDRESS:

45 BUTTERNUT HOLLOW RD
GREENWICH, CT 06830

SHEET DESCRIPTION:

EQUIPMENT &
MOUNTING DETAILS

SHEET NUMBER:

A-4

ANTENNA COMMSCOPE DT465B-2XR

RADOME MATERIAL: FIBERGLASS
RADOME COLOR: LIGHT GREY
DIMENSIONS, HxWxD.in(mim): 71.9"x13.8"x8.2" (1825x350x209mm)
WEIGHT: 58 lbs
CONNECTORS: (2) 7/16" DIN FEMALE
(8) 4.1/9.5 DIN FEMALE

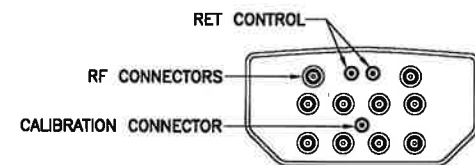

PLAN VIEW



SIDE VIEW

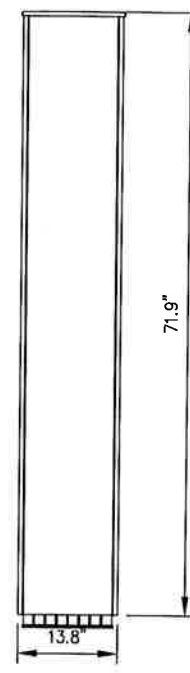

FRONT VIEW

DUAL BAND ANTENNA

NO SCALE

3

RRH: ALCATEL LUCENT RRH 800 MHz 2x50W

COLOR: LIGHT GREY
WEIGHT: 53 LBS.

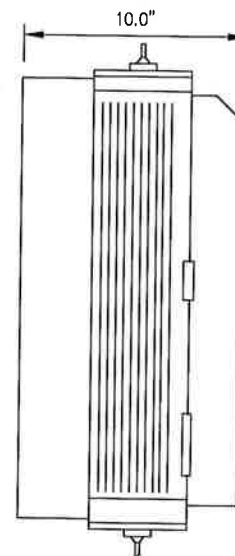

SIDE VIEW

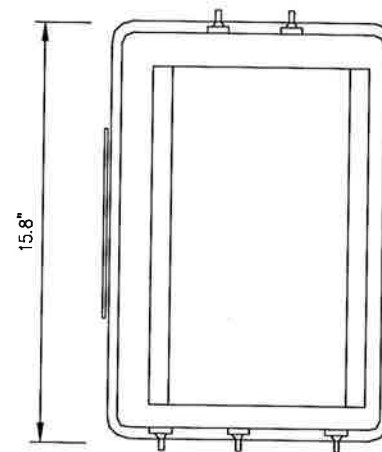

FRONT VIEW

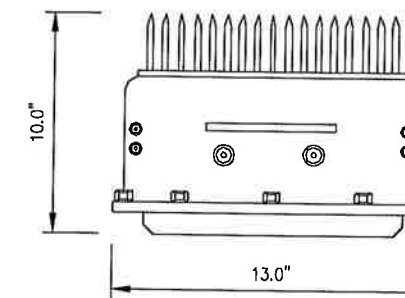

PLAN VIEW

NOTES

COMPLY WITH MANUFACTURERS INSTRUCTIONS TO ENSURE THAT ALL RRH'S RECEIVE ELECTRICAL POWER WITHIN 24 HOURS OF BEING REMOVED FROM THE MANUFACTURER'S PACKAGING. DO NOT OPEN RRH PACKAGES IN THE RAIN.

800 MHz RRH

NO SCALE

4

RFS HYBRIFLEX RISER CABLE SCHEDULE

Fiber Only (Existing DC Power)	Hybrid cable MN: HB058-M12-050F 12x multi-mode fiber pairs, Top: Outdoor protected connectors, Bottom: LC Connectors, 5/8 cable, 50 ft	50 ft
	MN: HB058-M12-075F	75 ft
	MN: HB058-M12-100F	100 ft
	MN: HB058-M12-125F	125 ft
	MN: HB058-M12-150F	150 ft
	MN: HB058-M12-175F	175 ft
MN: HB058-M12-200F	200 ft	

8 AWG Power	Hybrid cable MN: HB114-08U3M12-050F 3x 8 AWG power pairs, 12x multi-mode fiber pairs, Outdoor rated connectors & LC Connectors, 1 1/4 cable, 50 ft	50 ft
	MN: HB114-08U3M12-075F	75 ft
	MN: HB114-08U3M12-100F	100 ft
	MN: HB114-08U3M12-125F	125 ft
	MN: HB114-08U3M12-150F	150 ft
	MN: HB114-08U3M12-175F	175 ft
MN: HB114-08U3M12-200F	200 ft	

6 AWG Power	Hybrid cable MN: HB114-13U3M12-225F 3x 6 AWG power pair, 12x multi-mode fiber pairs, Outdoor rated connectors & LC Connectors, 1 1/4 cable, 225 ft	225 ft
	MN: HB114-13U3M12-250F	250 ft
	MN: HB114-13U3M12-300F	300 ft

4 AWG Power	Hybrid cable MN: HB114-21U3M12-325F 3x 4 AWG power pair, 12x multi-mode fiber pairs, Outdoor rated connectors & LC Connectors, 1 1/4 cable, 325 ft	325 ft
	MN: HB114-21U3M12-350F	350 ft
	MN: HB114-21U3M12-375F	375 ft

RFS HYBRIFLEX JUMPER CABLE SCHEDULE

Fiber Only	Hybrid Jumper cable MN: HBF012-M3-5F1 5 ft, 3x multi-mode fiber pairs, Outdoor & LC connectors, 1/2 cable	5 ft
	MN: HBF012-M3-10F1	10 ft
	MN: HBF012-M3-15F1	15 ft
	MN: HBF012-M3-20F1	20 ft
	MN: HBF012-M3-25F1	25 ft
	MN: HBF012-M3-30F1	30 ft

8 AWG Power	Hybrid Jumper cable MN: HBF058-08U1M3-5F1 5 ft, 1x 8 AWG power pair, 3x multi-mode fiber pairs, Outdoor & LC Connectors, 5/8 cable	5 ft
	MN: HBF058-08U1M3-10F1	10 ft
	MN: HBF058-08U1M3-15F1	15 ft
	MN: HBF058-08U1M3-20F1	20 ft
	MN: HBF058-08U1M3-25F1	25 ft
	MN: HBF058-08U1M3-30F1	30 ft

6 AWG Power	Hybrid Jumper cable MN: HBF058-13U1M3-5F1 5 ft, 1x 6 AWG power pair, 3x multi-mode fiber pairs, Outdoor & LC Connectors, 5/8 cable	5 ft
	MN: HBF058-13U1M3-10F1	10 ft
	MN: HBF058-13U1M3-15F1	15 ft
	MN: HBF058-13U1M3-20F1	20 ft
	MN: HBF058-13U1M3-25F1	25 ft
	MN: HBF058-13U1M3-30F1	30 ft

4 AWG Power	Hybrid Jumper cable MN: HBF078-21U1M3-5F1 5 ft, 1x 4 AWG power pair, 3x multi-mode fiber pairs, Outdoor & LC Connectors, 7/8 cable	5 ft
	MN: HBF078-21U1M3-10F1	10 ft
	MN: HBF078-21U1M3-15F1	15 ft
	MN: HBF078-21U1M3-20F1	20 ft
	MN: HBF078-21U1M3-25F1	25 ft
	MN: HBF078-21U1M3-30F1	30 ft

* PROPOSED CABLE LENGTH WAS DETERMINED USING THE SUM OF THE RAD CENTER OF ANTENNAS, AND DISTANCE FROM EXISTING EQUIPMENT AREA TO TOWER BASE WITH AN ADDITIONAL 20' BUFFER. LENGTH TO BE VERIFIED IN FIELD PRIOR TO ORDERING MATERIALS.

NOTE:
SPRINT CM TO CONFIRM HYBRID OR FIBER RISER CABLE AND HYBRID OR FIBER JUMPER CABLE MODEL NUMBERS IF HYBRID CABLES ARE REQUIRED BEFORE PREPARING BOM.

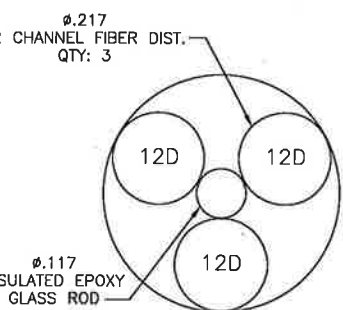
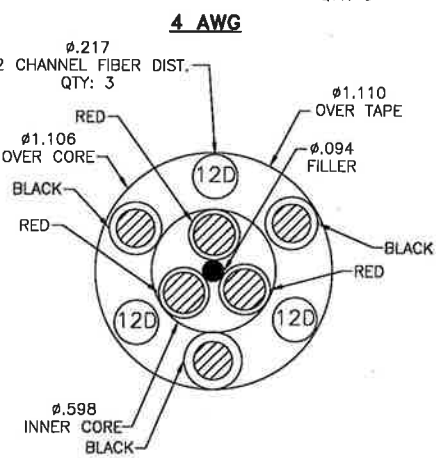
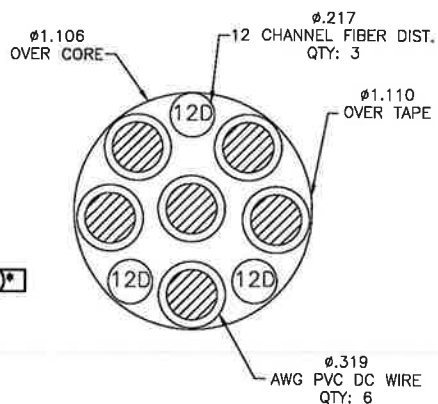

FIBER ONLY

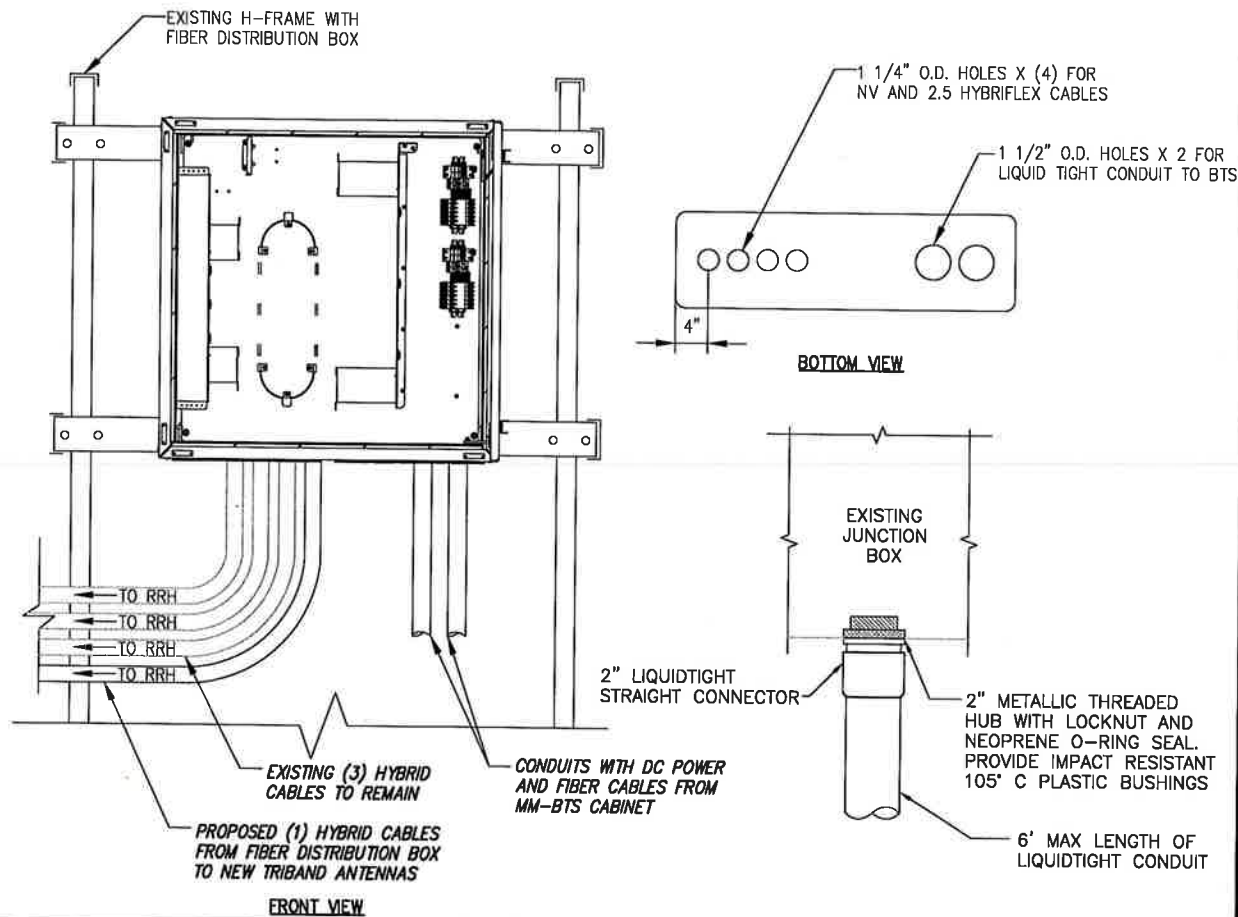

FIBER JUNCTION BOX & PENETRATION

NO SCALE

2

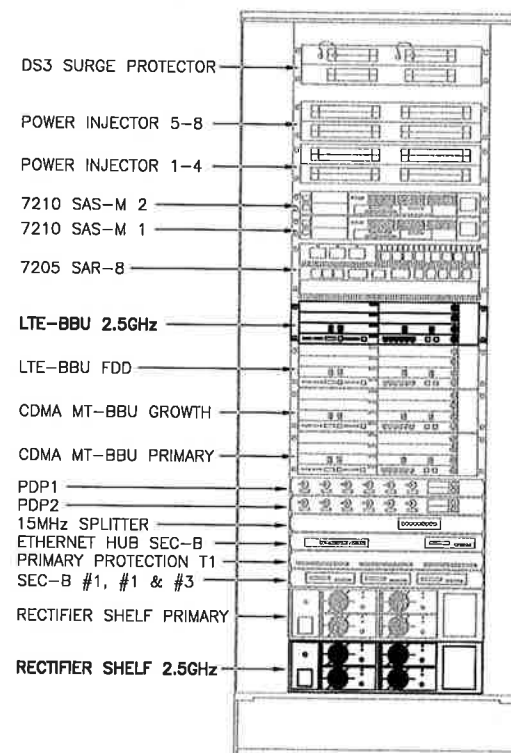

FRONT VIEW

NEW EQUIPMENT IN EXISTING CABINET

NO SCALE

3

2.5 CABLE CROSS SECTION DATA

NO SCALE

1

PLANS PREPARED FOR:



PLANS PREPARED BY:

INFINIGY
FROM ZERO TO INFINIGY
the solutions are endless
1033 Watervliet Shaker Rd | Albany, NY 12203
Phone: 518-690-0790 | Fax: 518-690-0793
www.infinigy.com
JOB NUMBER 526-104

PROJECT MANAGER:

AIROSMITH
DEVELOPMENT
32 CLINTON ST.
SARATOGA SPRINGS, NY 12888
OFFICE: (518) 308-3740

ENGINEERING LICENSE:

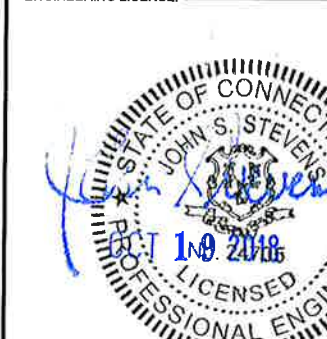

DRAWING NOTICE:

THESE DOCUMENTS ARE CONFIDENTIAL AND ARE THE SOLE PROPERTY OF SPRINT AND MAY NOT BE REPRODUCED, DISSEMINATED OR REDISTRIBUTED WITHOUT THE EXPRESS WRITTEN CONSENT OF SPRINT.

REVISIONS:

DESCRIPTION	DATE	BY	REV.
REMOVED/ISSUED FOR PERMIT	07/24/18	ETC	1
ISSUED FOR PERMIT	02/12/18	ETC	0

SITE NAME:

(R2E) CT4072 TO CT03XC343 CLP (MERRITT 3)

SITE NUMBER:

CT03XC343

SITE ADDRESS:

45 BUTTERNUT HOLLOW RD GREENWICH, CT 06830

SHEET DESCRIPTION:

CIVIL DETAILS

SHEET NUMBER:

A-5

ALU 211 DT465B-2XR & APXVSP18-C-A20 wo Filters

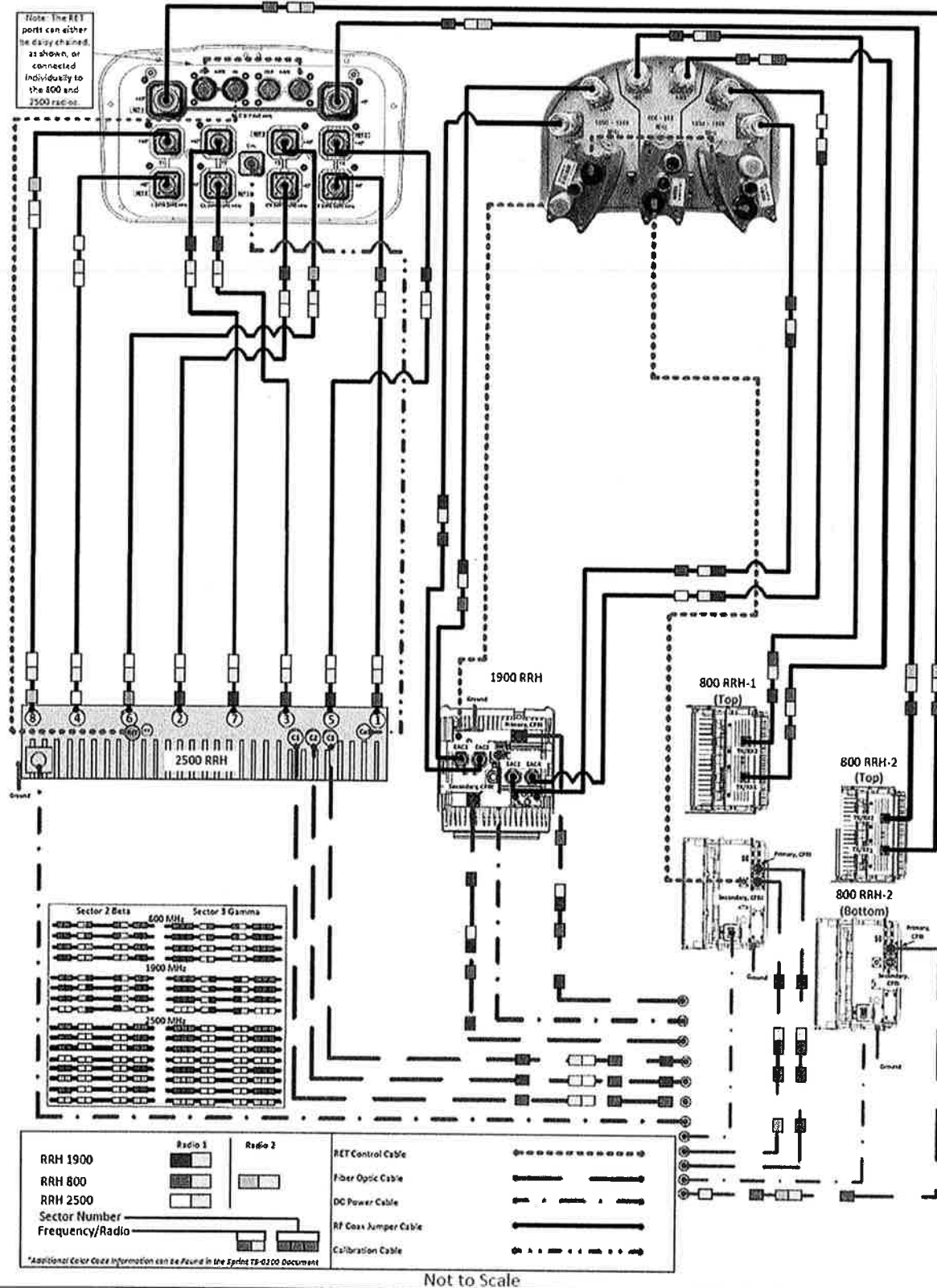

PLUMBING DIAGRAM

NO SCALE

1

PLANS PREPARED FOR:



PLANS PREPARED BY:

INFINIGY
FROM ZERO TO INFINIGY

the solutions are endless

1033 Watervliet Shaker Rd | Albany, NY 12205
Phone: 518-690-0790 | Fax: 518-690-0793
www.infinigy.com
JOB NUMBER 526-104

PROJECT MANAGER:

AIRSMITH
DEVELOPMENT

32 CLINTON ST.
SARATOGA SPRINGS, NY 12866
OFFICE# (518) 308-3740

ENGINEERING LICENSE:



DRAWING NOTICE:

THESE DOCUMENTS ARE CONFIDENTIAL AND ARE THE SOLE PROPERTY OF SPRINT AND MAY NOT BE REPRODUCED, DISSEMINATED OR REDISTRIBUTED WITHOUT THE EXPRESS WRITTEN CONSENT OF SPRINT.

REVISIONS:

DESCRIPTION	DATE	BY	REV.
REVISED/ISSUED FOR PERMIT	07/24/18	ETC	1
ISSUED FOR PERMIT	02/12/18	ETC	0

SITE NAME:

(R2E) CT4072 TO
CT03XC343 CLP
(MERRITT 3)

SITE NUMBER:

CT03XC343

SITE ADDRESS:

45 BUTTERNUT HOLLOW RD
GREENWICH, CT 06830

SHEET DESCRIPTION:

PLUMBING DIAGRAM

SHEET NUMBER:

A-6

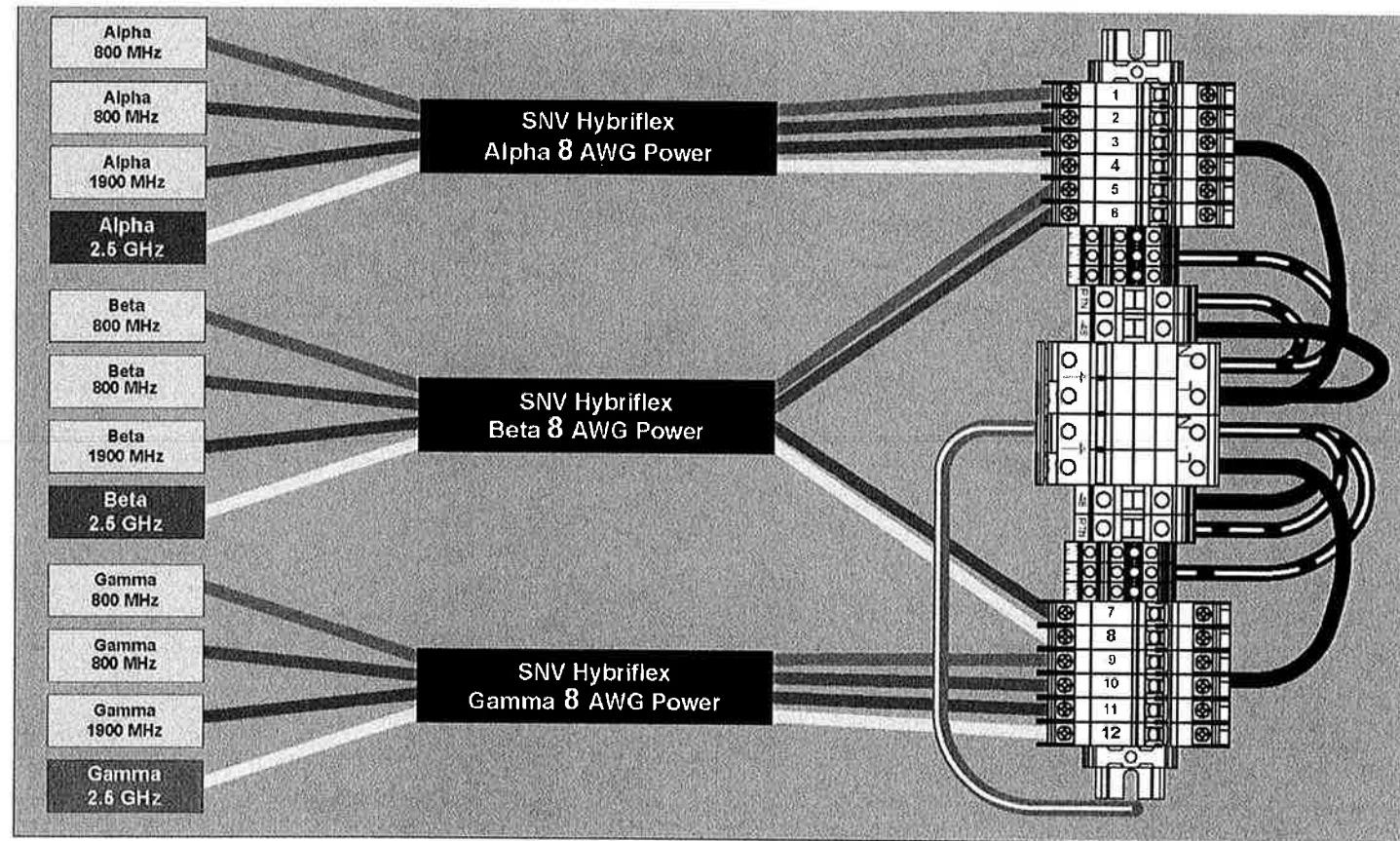

RRH TO DISTRIBUTION BOX POWER CONNECTIVITY

NO SCALE

1

LEGEND:

- EXISTING GROUND RING
- CADWELD CONNECTION (EXOTHERMIC WELD)
- ▲ MECHANICAL CONNECTION
- ⊗ GROUND ROD
- CABLE GROUND KIT

BOND INSTALL ANTENNA TO SECTOR GROUND BAR PER MANUFACTURER'S SPECIFICATIONS

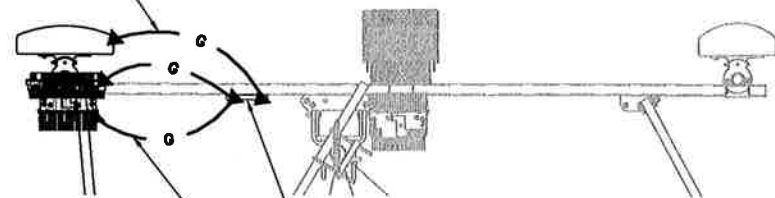

EXISTING SPRINT TOWER GROUND BAR (CONTRACTOR TO VERIFY)

BOND RRH'S TO SECTOR BAR PER MANUFACTURER'S SPECIFICATIONS

TYPICAL ANTENNA GROUNDING PLAN

NO SCALE

2

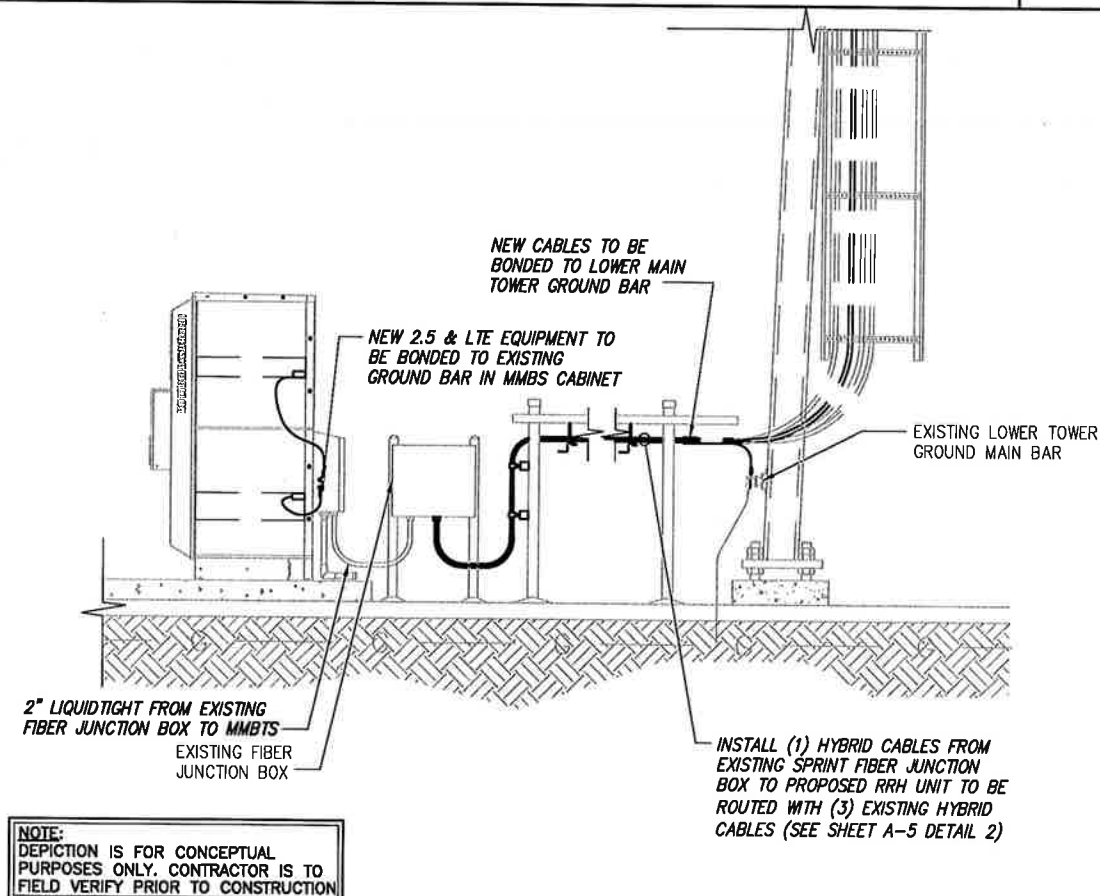

NOTE:
DEPICTION IS FOR CONCEPTUAL PURPOSES ONLY. CONTRACTOR IS TO FIELD VERIFY PRIOR TO CONSTRUCTION

TYPICAL EQUIPMENT GROUNDING PLAN (ELEVATION)

NO SCALE

3

PLANS PREPARED FOR:



PLANS PREPARED BY:



FROM ZERO TO INFINIGY
the solutions are endless

1033 Watervliet Shaker Rd | Albany, NY 12205
Phone: 518-690-0790 | Fax: 518-690-0793
www.infinigy.com
JOB NUMBER 526-104

PROJECT MANAGER:



32 CLINTON ST.
SARATOGA SPRINGS, NY 12866
OFFICE# (518) 308-3740

ENGINEERING LICENSE:

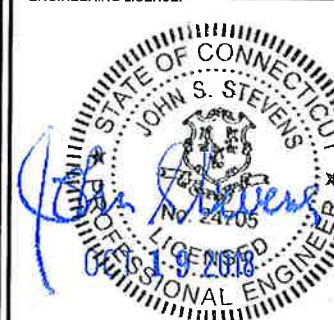

DRAWING NOTICE:

THESE DOCUMENTS ARE CONFIDENTIAL AND ARE THE SOLE PROPERTY OF SPRINT AND MAY NOT BE REPRODUCED, DISSEMINATED OR REDISTRIBUTED WITHOUT THE EXPRESS WRITTEN CONSENT OF SPRINT.

REVISIONS:

DESCRIPTION	DATE	BY	REV.
REVISED/ISSUED FOR PERMIT	07/24/15	ETC	1
ISSUED FOR PERMIT	02/12/18	ETC	0

SITE NAME:
(R2E) CT4072 TO CT03XC343 CLP (MERRITT 3)

SITE NUMBER:
CT03XC343

SITE ADDRESS:
45 BUTTERNUT HOLLOW RD GREENWICH, CT 06830

SHEET DESCRIPTION:
ELECTRICAL & GROUNDING PLAN

SHEET NUMBER:
E-1

NOTES
 CG SHALL REFERENCE ALL SPECS FOR "CONNECTING THE POWER SUPPLY" OF THE NEW INSTALLATION DOCUMENTS, FOR ALL CONNECTION SPECIFICATIONS.

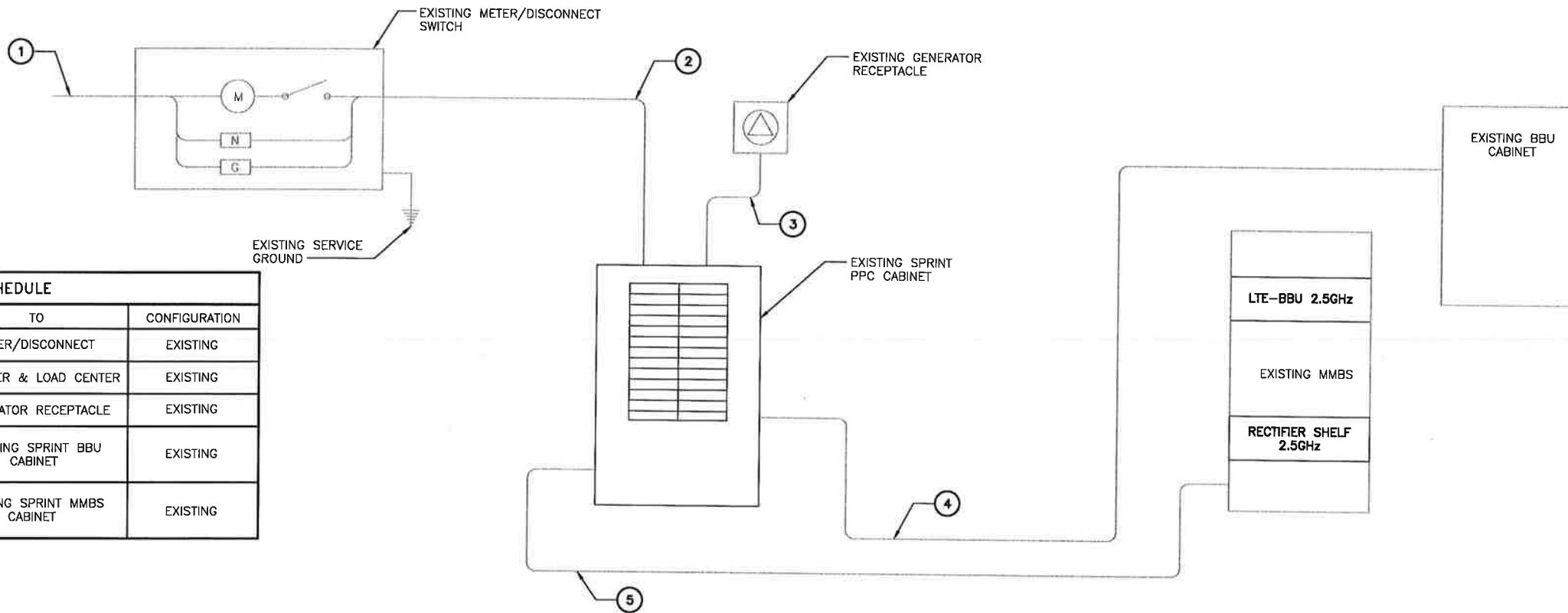

CIRCUIT SCHEDULE			
NO	FROM	TO	CONFIGURATION
①	UTILITY SOURCE	METER/DISCONNECT	EXISTING
②	METER/DISCONNECT	TRANSFER & LOAD CENTER	EXISTING
③	TRANSFER & LOAD CENTER	GENERATOR RECEPTACLE	EXISTING
④	TRANSFER & LOAD CENTER	EXISTING SPRINT BBU CABINET	EXISTING
⑤	TRANSFER & LOAD CENTER	EXISTING SPRINT MMBS CABINET	EXISTING

ELECTRICAL ONE-LINE DIAGRAM

NO SCALE 1

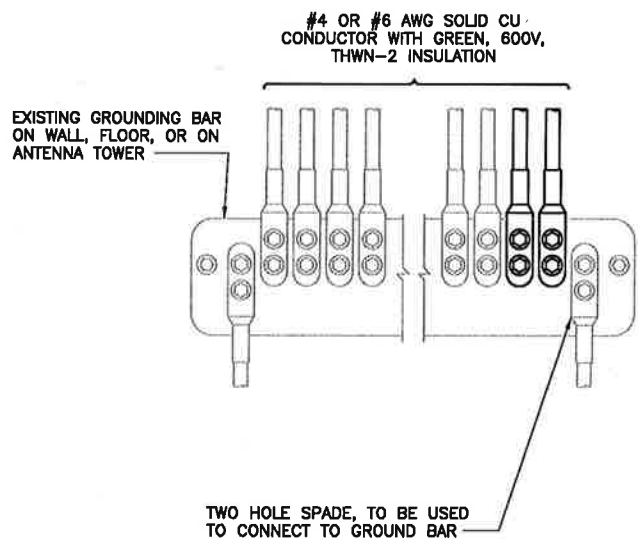

NOTES
 1. APPLY NO-OX TO LUG AND BAR CONTACT SURFACE. DO NOT COAT INLINE LUG.
 2. IF STOLEN GROUND BARS ARE ENCOUNTERED, CONTACT SPRINT CM FOR REPLACEMENT THREADED ROD KIT.

INSTALLATION OF GROUNDING CONDUCTOR TO GROUNDING BAR

NO SCALE

2

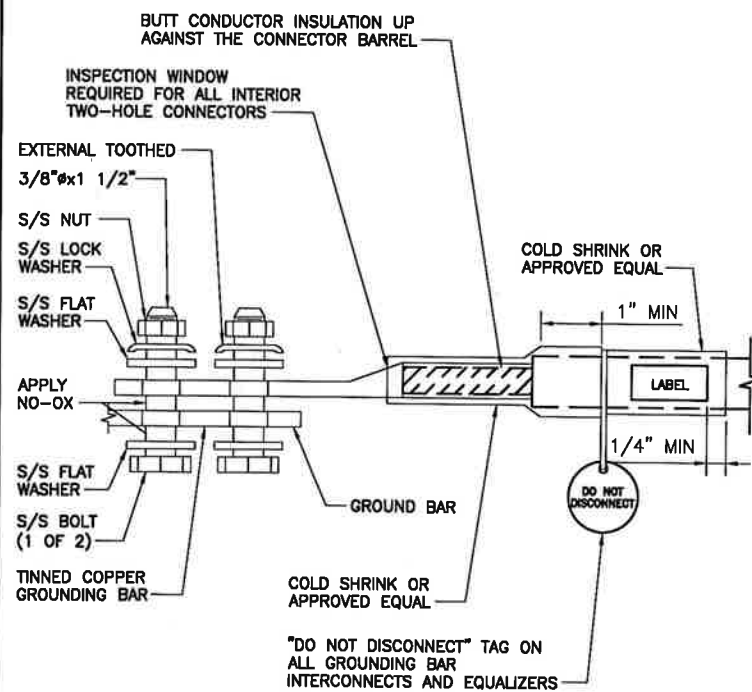

"DO NOT DISCONNECT" TAG ON ALL GROUNDING BAR INTERCONNECTS AND EQUALIZERS

TWO HOLE LUG

NO SCALE

3

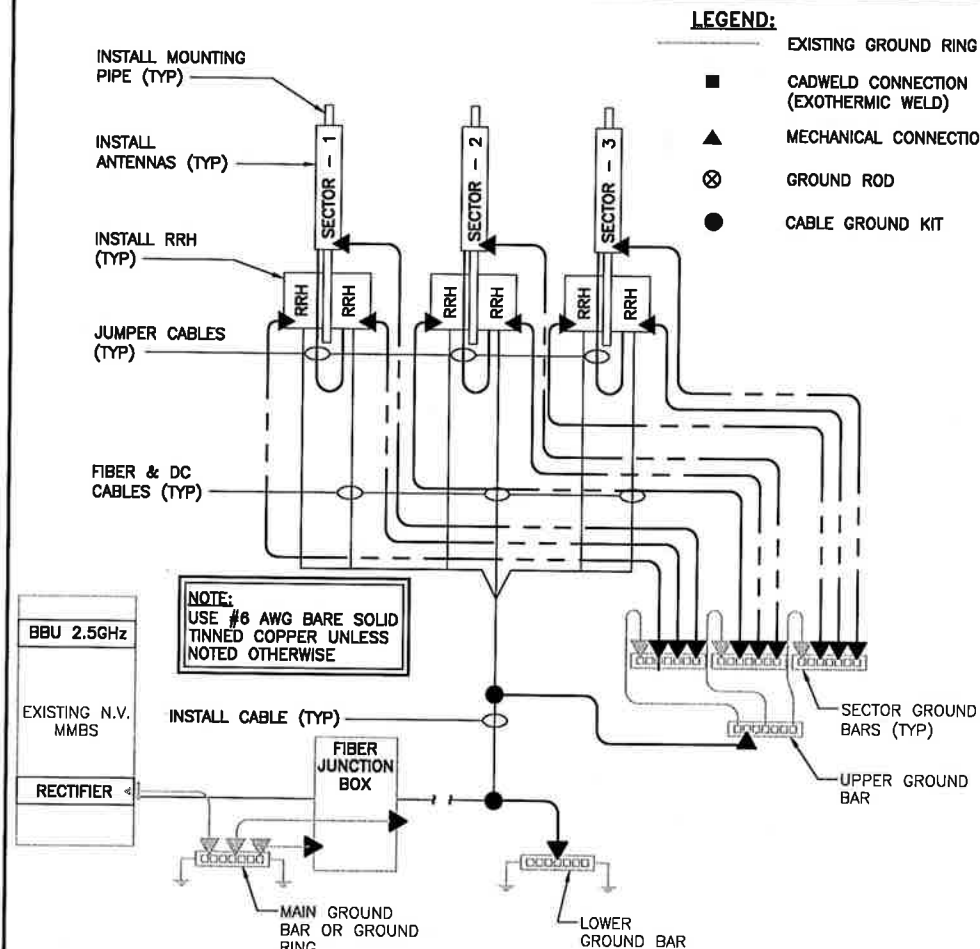

LEGEND:

- EXISTING GROUND RING
- ▲ CADWELDED CONNECTION (EXOTHERMIC WELD)
- ⊗ MECHANICAL CONNECTION
- ⊙ GROUND ROD
- CABLE GROUND KIT

NOTE:
 USE #8 AWG BARE SOLID TINNED COPPER UNLESS NOTED OTHERWISE

GROUNDING RISER DIAGRAM

NO SCALE

4

PLANS PREPARED FOR:



PLANS PREPARED BY:

INFINIGY
 FROM ZERO TO INFINIGY
 the solutions are endless
 1033 Watervliet Shaker Rd | Albany, NY 12205
 Phone: 518-690-0790 | Fax: 518-690-0793
 www.infinigy.com
 JOB NUMBER 526-104

PROJECT MANAGER:

AIRSMITH DEVELOPMENT
 32 CLINTON ST.
 SARATOGA SPRINGS, NY 12866
 OFFICE# (518) 308-3740

ENGINEERING LICENSE:



DRAWING NOTICE:

THESE DOCUMENTS ARE CONFIDENTIAL AND ARE THE SOLE PROPERTY OF SPRINT AND MAY NOT BE REPRODUCED, DISSEMINATED OR REDISTRIBUTED WITHOUT THE EXPRESS WRITTEN CONSENT OF SPRINT.

REVISIONS:

DESCRIPTION	DATE	BY	REV.
REMOVED/ISSUED FOR PERMIT	07/24/18	ETC	1
ISSUED FOR PERMIT	02/12/18	ETC	0

SITE NAME:
 (R2E) CT4072 TO CT03XC343 CLP (MERRITT 3)

SITE NUMBER:
 CT03XC343

SITE ADDRESS:
 45 BUTTERNUT HOLLOW RD
 GREENWICH, CT 06830

SHEET DESCRIPTION:
 ELECTRICAL & GROUNDING DETAILS

SHEET NUMBER:
 E-2

GENERAL CONSTRUCTION NOTES

- ALL WORK SHALL COMPLY WITH THE CONNECTICUT STATE BUILDING AND LIFE SAFETY CODES, SUPPLEMENTS AND AMENDMENTS.
- CONTRACTOR IS TO REVIEW ALL DRAWINGS AND NOTES IN THE CONTRACT DOCUMENT SET. CONTRACTOR SHALL COORDINATE ALL WORK SHOWN IN THE SET OF DRAWINGS. THE CONTRACTOR SHALL PROVIDE A COMPLETE SET OF DRAWINGS TO ALL SUB-CONTRACTORS AND ALL RELATED PARTIES. THE SUB-CONTRACTORS SHALL EXAMINE ALL THE DRAWINGS AND SPECIFICATIONS FOR THE INFORMATION THAT AFFECTS THEIR WORK.
- CONTRACTOR SHALL PROVIDE A COMPLETE BUILD-OUT WITH ALL FINISHES, STRUCTURAL, MECHANICAL, AND ELECTRICAL COMPONENTS AND PROVIDE ALL ITEMS AS SHOWN OR INDICATED ON DRAWINGS OR WRITTEN IN SPECIFICATIONS.
- CONTRACTOR SHALL FURNISH ALL MATERIAL, LABOR AND EQUIPMENT TO COMPLETE THE WORK AND FURNISH A COMPLETED JOB ALL IN ACCORDANCE WITH LOCAL AND STATE GOVERNING AUTHORITIES AND OTHER AUTHORITIES HAVING LAWFUL JURISDICTION OVER THE WORK.
- CONTRACTOR SHALL SECURE AND PAY FOR ALL PERMITS AND ALL INSPECTIONS REQUIRED AND SHALL ALSO PAY FEES REQUIRED FOR THE GENERAL CONSTRUCTION AND ELECTRICAL SUB-CONTRACTORS SHALL PAY FOR THEIR PERMITS.
- CONTRACTOR SHALL MAINTAIN A CURRENT SET OF DRAWINGS ON SITE AT ALL TIMES AND ENSURE THE DISTRIBUTION OF NEW DRAWINGS TO SUB-CONTRACTORS AND OTHER RELEVANT PARTIES AS SOON AS THEY ARE MADE AVAILABLE. ALL OLD DRAWINGS SHALL BE MARKED VOID AND REMOVED FROM THE CONTRACT AREA. CONTRACTOR SHALL FURNISH 'AS-BUILT' SET OF DRAWINGS TO OWNER UPON COMPLETION OF PROJECT.
- INSTALLATION OF THIS WIRELESS COMMUNICATIONS EQUIPMENT SITE REQUIRES WORK IN THE IMMEDIATE VICINITY OF EXISTING OPERATING TELECOMMUNICATION SYSTEMS. THE CONTRACTOR SHALL PROVIDE AND COORDINATE THE METHODS OF PROTECTION WITH THE VARIOUS TELECOMMUNICATION CARRIERS AND THE TOWER OWNER. THERE SHALL BE NO INTERRUPTION OF OPERATION WITHOUT TIMELY COORDINATION WITH AND APPROVAL BY THE VARIOUS COMMUNICATIONS OPERATORS INCLUDING THE CONNECTICUT STATE POLICE.
- THE REINFORCEMENT OF PORTIONS OF THIS TOWER STRUCTURE WILL AFFECT CRITICAL CONNECTICUT STATE POLICE ANTENNAS.
- NO MOVEMENT, ALTERATION, OR DISCONNECTION OF CONNECTICUT STATE POLICE ANTENNAS MAY OCCUR WITHOUT THE NOTIFICATION AND APPROVAL OF THE CONNECTICUT STATE POLICE. CONTACT THE NETWORK CONTROL CENTER AT 860-865-8008.
- TOWER REINFORCING WORK AFFECTING CRITICAL CONNECTICUT STATE POLICE ANTENNAS MAY BE REQUIRED TO BE CONDUCTED AT TIMES AS DETERMINED BY THE REQUIREMENTS OF THE CONNECTICUT STATE POLICE.
- ALL EQUIPMENT AND PRODUCTS PURCHASED ARE TO BE REVIEWED BY CONTRACTOR AND ALL APPLICABLE SUB-CONTRACTORS FOR ANY CONDITION PER MFR'S RECOMMENDATIONS. CONTRACTOR TO SUPPLY THESE ITEMS AT NO COST TO OWNER OR ARCHITECT.
- CONTRACTOR SHALL BE RESPONSIBLE FOR ALL ON-SITE SAFETY FROM THE TIME THE JOB IS AWARDED UNTIL ALL WORK IS COMPLETE AND ACCEPTED BY THE OWNER.
- CONTRACTOR TO REVIEW ALL SHOP DRAWINGS AND SUBMIT COPY TO ARCHITECT FOR REVIEW. DRAWINGS MUST BEAR THE CHECKER'S INITIALS BEFORE SUBMITTAL TO THE ARCHITECT FOR REVIEW.
- THE CONTRACTOR SHALL FIELD VERIFY ALL DIMENSIONS, ELEVATIONS, ANGLES, AND EXISTING CONDITIONS AT THE SITE, PRIOR TO FABRICATION AND/OR INSTALLATION OF ANY WORK IN THE CONTRACT AREA. SUBMIT ANY DISCREPANCIES FROM THE DRAWINGS TO THE ARCHITECT.
- THE CONTRACTOR IS SOLELY RESPONSIBLE TO DETERMINE CONSTRUCTION PROCEDURE AND SEQUENCE, AND TO ENSURE THE SAFETY OF THE EXISTING STRUCTURE AND ITS COMPONENT PARTS DURING CONSTRUCTION. THIS INCLUDES THE ADDITION OF WHATEVER SHORING, BRACING, UNDERPINNING, ETC. THAT MAY BE NECESSARY.
- CONTRACTOR TO CONTACT "CALL BEFORE YOU DIG" AT 1-800-922-4455 TO VERIFY AND IDENTIFY THE EXACT LOCATIONS OF ALL UNDERGROUND UTILITIES AND OBSTRUCTIONS IDENTIFIED PRIOR TO COMMENCING WORK IN THE CONTRACT AREA.
- CONTRACTOR SHALL COMPLY WITH OWNER ENVIRONMENTAL ENGINEER ON ALL METHODS AND PROVISIONS FOR ALL EXCAVATION ACTIVITIES INCLUDING SOIL DISPOSAL. ALL BACKFILL MATERIALS TO BE PROVIDED BY THE CONTRACTOR.
- DIMENSIONS OF EXISTING TOWER ARE BASED ON MANUFACTURER'S DRAWINGS PREPARED BY ROHN INDUSTRIES, INC., DATED DECEMBER 1992, AND ARE NOT GUARANTEED. CONTRACTOR SHALL TAKE FIELD DIMENSIONS AS NECESSARY TO ASSURE PROPER FIT OF ALL FINISHED WORK AND SHALL ASSUME FULL RESPONSIBILITY FOR THEIR ACCURACY. WHEN SHOP DRAWINGS BASED ON FIELD MEASUREMENT ARE SUBMITTED FOR REVIEW, DIMENSIONS ARE PROVIDED FOR THE ENGINEER'S REFERENCE ONLY.
- TOWER INVENTORY IS BASED ON INFORMATION OBTAINED BY CONNECTICUT STATE POLICE DATED APRIL 12, 2016. TOWER MAPPING AND EXISTING INVENTORY OBTAINED FROM D&K NATIONWIDE COMMUNICATIONS, INC. DATED MARCH 2, 2016.
- CONTRACTOR TO VERIFY REQUIRED CLEARANCES INCLUDING BUT NOT LIMITED TO EXISTING BUILDINGS, EQUIPMENT PADS AND SHELTERS PRIOR TO COMMENCING WORK.
- THE CONTRACTOR IS RESPONSIBLE FOR THE STABILITY OF THE STRUCTURE DURING CONSTRUCTION. NO MEMBER OF THE TOWER SHALL BE LEFT DISCONNECTED FOR THE NEXT WORKING DAY. THE CONTRACTOR SHALL BE AWARE OF WEATHER AND WIND CONDITIONS AND NOT PERFORM MEMBER REPLACEMENT IN A WIND.

STRUCTURAL NOTES

STRUCTURAL STEEL MATERIAL:

ALL STRUCTURAL STEEL MEMBERS AND HSS TUBING USED FOR REINFORCING SHALL BE MINIMUM 50 KSI WITH THE BELOW EXCEPTIONS:
 ANGLE SIZE 2-1/2"x2-1/2"x3/16" AND SMALLER A36
 STRUCTURAL PLATES A36

STRUCTURAL STEEL SHALL CONFORM TO ALL THE REQUIREMENTS OF THE ASTM SPECIFICATION, AS REFERENCED IN THE CODE.

UNLESS OTHERWISE NOTED, ALL STEEL WILL BE GALVANIZED IN ACCORDANCE WITH ASTM 123 AFTER FABRICATION. TOUCH UP ALL DAMAGED GALVANIZED STEEL WITH APPROVED COLD ZINC, "GALVANOX", "DRY GALV", "ZINC-IT", OR APPROVED EQUIVALENT, IN ACCORDANCE WITH MANUFACTURERS GUIDELINES. TOUCH-UP DAMAGED NON GALVANIZED STEEL WITH SAME PAINT APPLIED IN SHOP OR FIELD.

SHOP AND ERECTION DRAWINGS SHALL BE SUBMITTED FOR ALL STRUCTURAL STEEL WORK IN ACCORDANCE WITH THE CONTRACT DOCUMENTS. SUBMIT 2 SETS OF PRINTS FOR THE ENGINEER REVIEW.

MILL BEARING ENDS OF COLUMNS, STIFFENERS, AND OTHER BEARING SURFACES TO TRANSFER LOAD OVER ENTIRE CROSS SECTION.

THE OMISSION OF ANY MATERIAL THAT WAS SHOWN ON THE CONTRACT DRAWINGS SHALL NOT RELIEVE THE CONTRACTOR OF PROVIDING THE SAME.

CONNECTIONS / FIELD ASSEMBLY:

BOLTED CONNECTIONS: UNLESS OTHERWISE NOTED, ALL JOINTS ARE SLIP CRITICAL TYPE, REQUIRING 5/8" & 3/4" DIA. A325-N & A490-X BOLTS, A563 NUTS AND F436 WASHERS, ALL GALVANIZED. BEVELED WASHERS SHALL BE USED ON BEAM FLANGES HAVING A SLOPE GREATER THAN 1:20.

STRUCTURE IS DESIGNED TO BE LEVEL AND PLUMB, SELF-SUPPORTING AND STABLE AFTER WORK IS COMPLETED.

COMMENCEMENT OF WORK WITHOUT NOTIFYING THE ENGINEER OF ANY DISCREPANCIES WILL BE CONSIDERED ACCEPTANCE OF PRECEDING WORK.

INSPECTIONS:

SPECIAL INSPECTIONS ARE REQUIRED PER THE CODE FOR STRUCTURAL STEEL WORK.

OWNER WILL SUPPLY THE SERVICES OF A SPECIAL INSPECTOR AND TESTING AGENTS AS REQUIRED. CONTRACTOR SHALL COORDINATE INSPECTIONS OF FABRICATOR'S AND ERECTOR'S WORK AND MATERIALS TO MEET THE REQUIREMENTS OF THE STATEMENT OF SPECIAL INSPECTIONS FOR THIS PROJECT.

COPIES OF TESTING AND INSPECTION REPORTS WILL BE PROVIDED TO THE OWNER, BUILDING OFFICIAL, ENGINEER OF RECORD AND CONTRACTOR.



PROJECT NO.
60537397
Designed by:
MCD
Drawn by:
GAT
Checked by:
ICA
Approved by:
RAS

AECOM
500 ENTERPRISE DRIVE
ROCKY HILL, CONNECTICUT
(860)-529-8882



SITE ADDRESS: BUTTERNUT HOLLOW ROAD
GREENWICH, CONNECTICUT 06831

REV.	DATE:	DESCRIPTION
3	10/11/18	RE-ISSUED
2	10/03/18	RE-ISSUED
1	3/27/18	RE-ISSUE

Scale: AS NOTED Date: 03/20/18

Job No.

File No.

Dwg. No.

SK-1

Dwg. 1 of 5

NOTES:

1. REFER TO STRUCTURAL NOTES ON SK-1 FOR STEEL GRADE REQUIREMENTS FOR REPLACEMENT MEMBERS.
2. REINFORCEMENT OF TOWER IS REQUIRED FOR ALL 3 SIDES OF EXISTING EXTERIOR TOWER STRUCTURE.
3. CONNECTION BOLTS THAT ARE REMOVED DURING MEMBER REPLACEMENT SHALL BE REPLACED IN KIND, UNLESS NOTED OTHERWISE. EXISTING BOLTS SHALL NOT BE RE-USED FOR CONNECTING REPLACEMENT MEMBERS.
4. CONTRACTOR SHALL COORDINATE WITH ROHN INC. FOR INDICATED TOWER REPLACEMENT MEMBERS AS SHOWN.
5. CONTRACTOR SHALL VERIFY INFORMATION SHOWN ON THIS SHEET PRIOR TO ORDERING MATERIALS.
6. THE BOTTOM 2 FEET OF THE TOWER'S LEGS AND DIAGONAL MEMBERS ARE ENCASED IN CONCRETE, PART OF A PREVIOUS FOUNDATION MODIFICATION.

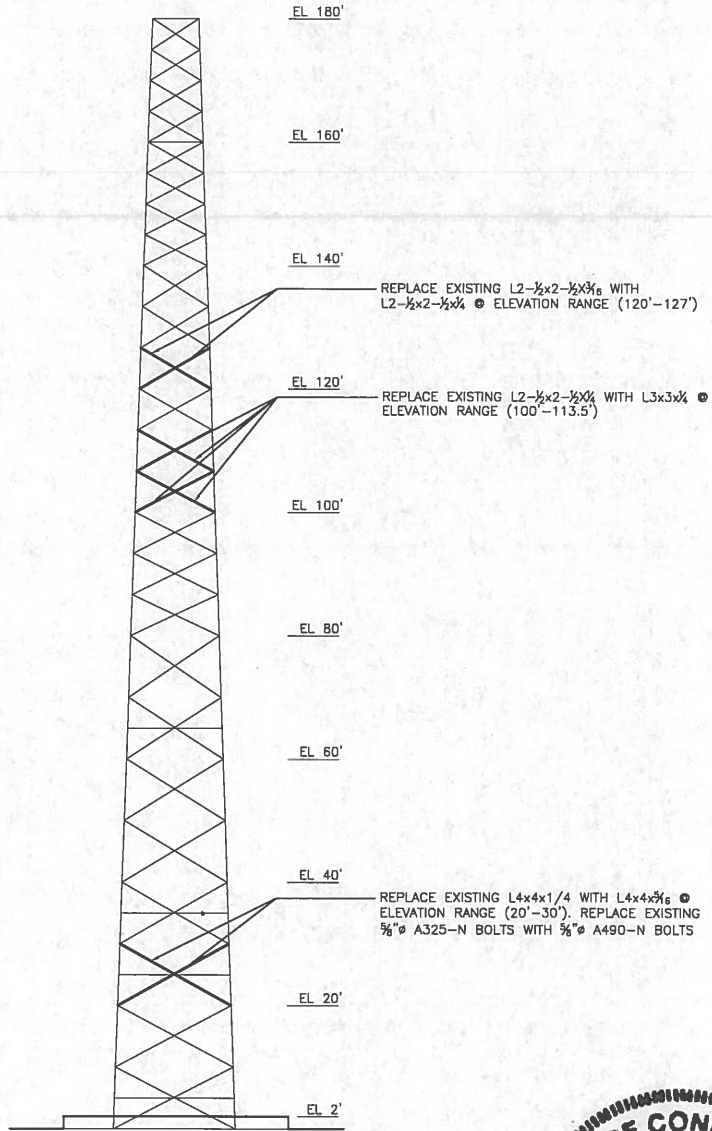

1 TOWER ELEVATION - EXTERIOR TOWER
 SK-2 SCALE: 1" = 30'-0" (INTERIOR TOWER NOT SHOWN FOR CLARITY)



PROJECT NO. 60537397 Designed by: MCD Drawn by: GAT Checked by: ICA Approved by: RAS	AECOM 500 ENTERPRISE DRIVE ROCKY HILL, CONNECTICUT (860)-529-8882		<table border="1" style="width: 100%; border-collapse: collapse;"> <tr><td>3</td><td>10/11/18</td><td>RE-ISSUED</td></tr> <tr><td>2</td><td>10/03/18</td><td>RE-ISSUED</td></tr> <tr><td>1</td><td>3/27/18</td><td>RE-ISSUE</td></tr> <tr><td>REV.</td><td>DATE:</td><td>DESCRIPTION</td></tr> </table>	3	10/11/18	RE-ISSUED	2	10/03/18	RE-ISSUED	1	3/27/18	RE-ISSUE	REV.	DATE:	DESCRIPTION	Dwg. No. SK-2 Dwg. 2 of 5
3	10/11/18	RE-ISSUED														
2	10/03/18	RE-ISSUED														
1	3/27/18	RE-ISSUE														
REV.	DATE:	DESCRIPTION														
SITE ADDRESS: BUTTERNUT HOLLOW ROAD GREENWICH, CONNECTICUT 06831			Scale: AS NOTED Date: 03/20/18	Job No. File No. Dwg. 2 of 5												

NOTES:

1. REFER TO STRUCTURAL NOTES ON SK-1 FOR STEEL GRADE REQUIREMENTS FOR REPLACEMENT MEMBERS.
2. REINFORCEMENT OF TOWER IS REQUIRED FOR ALL 3 SIDES OF EXISTING INTERIOR TOWER STRUCTURE.
3. CONNECTION BOLTS THAT ARE REMOVED DURING MEMBER REPLACEMENT SHALL BE REPLACED IN KIND, UNLESS NOTED OTHERWISE. EXISTING BOLTS SHALL NOT BE RE-USED FOR CONNECTING REPLACEMENT MEMBERS.
4. CONTRACTOR SHALL VERIFY INFORMATION SHOWN ON THIS SHEET PRIOR TO ORDERING MATERIALS.
5. THE BOTTOM 2 FEET OF THE TOWER'S LEGS AND DIAGONAL MEMBERS ARE ENCASED IN CONCRETE, PART OF A PREVIOUS FOUNDATION MODIFICATION.
6. EXISTING TOWER DIAGONAL MEMBERS AT ELEVATION 0'-2' RANGE ARE ENCASED IN CONCRETE. CONTRACTOR SHALL PROVIDE TEMPORARY SUPPORT OF TOWER STRUCTURE DURING CONSTRUCTION OF PROPOSED DIAGONAL BASE CONNECTIONS. REFER TO SK-5 FOR DETAILS FOR REPLACEMENT OF DIAGONAL MEMBERS.
7. EXISTING DIAGONAL MEMBERS EMBEDDED IN CONCRETE ARE TO BE CUT AFTER REPLACEMENT INSTALLATION OF DIAGONAL BASE ANCHORS, BASEPLATE AND CONNECTION PLATES ARE CONSTRUCTED TO ALLOW REPLACEMENT OF PROPOSED DIAGONAL MEMBERS (AS INDICATED IN NOTE 3 ABOVE AND SK-5).

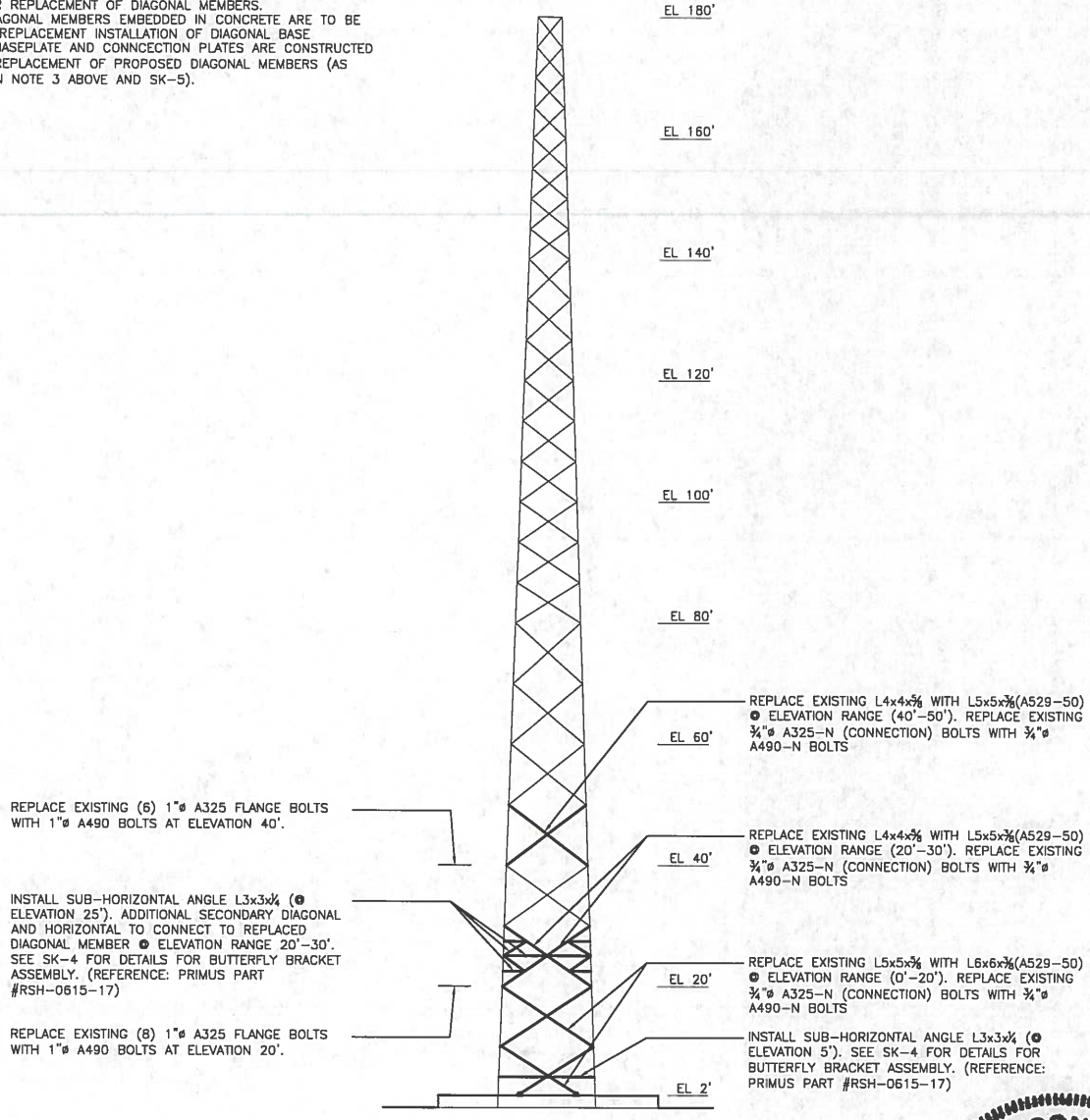

1 TOWER ELEVATION - INTERIOR TOWER
 SK-3 SCALE: 1" = 30'-0" (EXTERIOR TOWER NOT SHOWN FOR CLARITY)



PROJECT NO.
60537397

Designed by:
MCD

Drawn by:
GAT

Checked by:
ICA

Approved by:
RAS

AECOM

500 ENTERPRISE DRIVE
 ROCKY HILL, CONNECTICUT
 (860)-529-8882

AT&T | Sprint | T-Mobile | verizon

SITE ADDRESS: BUTTERNUT HOLLOW ROAD
 GREENWICH, CONNECTICUT 06831

3	10/11/18	RE-ISSUED
2	10/03/18	RE-ISSUED
1	3/27/18	RE-ISSUE
REV.	DATE	DESCRIPTION
Scale: AS NOTED		Date: 03/20/18
Job No.	File No.	Dwg. 3 of 5

Dwg. No.
SK-3

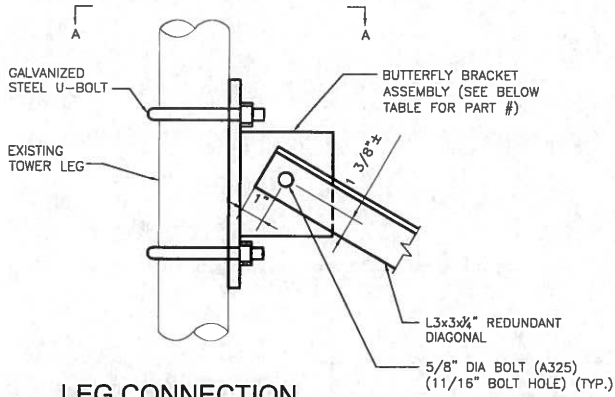

3
SK-4 **LEG CONNECTION REDUNDANT DIAGONAL**
SCALE: 1-1/2"=1'-0"

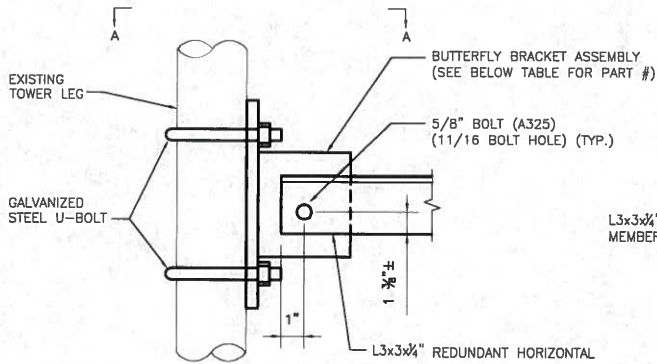

2
SK-4 **LEG CONNECTION REDUNDANT HORIZONTAL**
SCALE: 1-1/2"=1'-0"

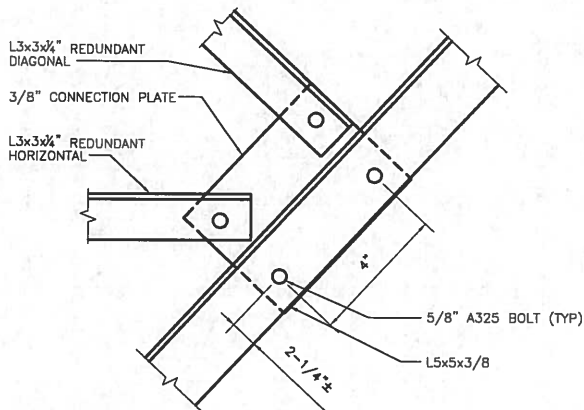

1
SK-4 **REDUNDANT MEMBER CONNECTION**
SCALE: 1-1/2"=1'-0"

ELEVATION	LEG BUTTERFLY BRACKET #
2'-10"	RSH-0500-00
20'-30"	RSH-0500-00

NOTE: LEG BUTTERFLY BRACKET ASSEMBLY INFORMATION FROM PRIMUS ELECTRONICS CORPORATION. CONTRACTOR SHALL USE PRODUCTS SIMILAR TO OR EXCEEDING IN QUALITY FOR CONSTRUCTION.

NOTE:

1. DETAILS 2 & 3 ABOVE INDICATE CONNECTIONS OF DIAGONAL AND HORIZONTAL MEMBERS TO TOWER LEGS. BUTTERFLY BRACKET ASSEMBLIES USED FOR CONNECTION TO EXISTING LEGS SHALL BE INSTALLED AS CLOSE TO EXISTING ADJOINING HORIZONTAL MEMBER AS POSSIBLE.

NOTES:

- REFER TO SK-1 FOR STRUCTURAL NOTES. COORDINATE SHEET WITH SK-3 FOR SECONDARY HORIZONTAL/DIAGONAL CONNECTION MEMBERS.
- CONTRACTOR SHALL FIELD VERIFY DIMENSIONS SHOWN PRIOR TO ORDERING SUPPLIES.
- U-BOLTED CONNECTION ASSEMBLIES CONNECTING THE EXTERIOR AND INTERIOR TOWERS ARE PERMITTED TO BE ADJUSTED ONE UNIT AT A TIME TO ALLOW THE INSTALLATION OF THE PROPOSED BUTTERFLY BRACKET ASSEMBLIES INDICATED HERE AND ON SHEET SK-3.

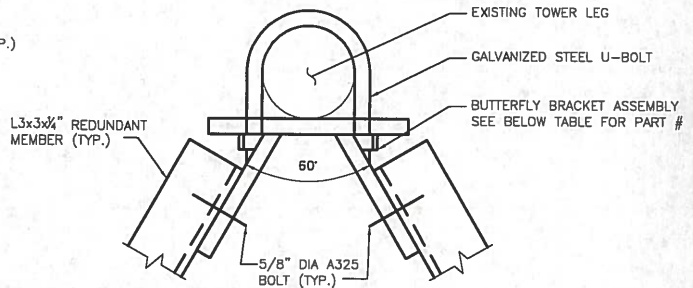

5
SK-4 **SECTION A**
SCALE: N.T.S.

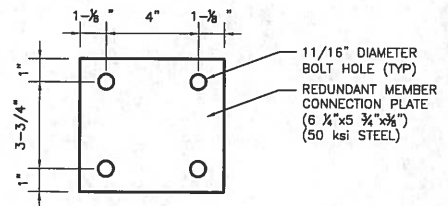

4
SK-4 **CONNECTION PLATE**
SCALE: 1-1/2"=1'-0"

PROJECT NO.
60537397
Designed by:
MCD
Drawn by:
GAT
Checked by:
ICA
Approved by:
RAS

AECOM
500 ENTERPRISE DRIVE
ROCKY HILL, CONNECTICUT
(860)-529-8882

AT&T | Sprint | T-Mobile | verizon
SITE ADDRESS: BUTTERNUT HOLLOW ROAD
GREENWICH, CONNECTICUT 06831

3	10/11/18	RE-ISSUED
2	10/03/18	RE-ISSUED
1	3/27/18	RE-ISSUE
REV.	DATE:	DESCRIPTION
Scale: AS NOTED		Date: 03/20/18
Job No.	File No.	Dwg. 4 of 5

Dwg. No.
SK-4

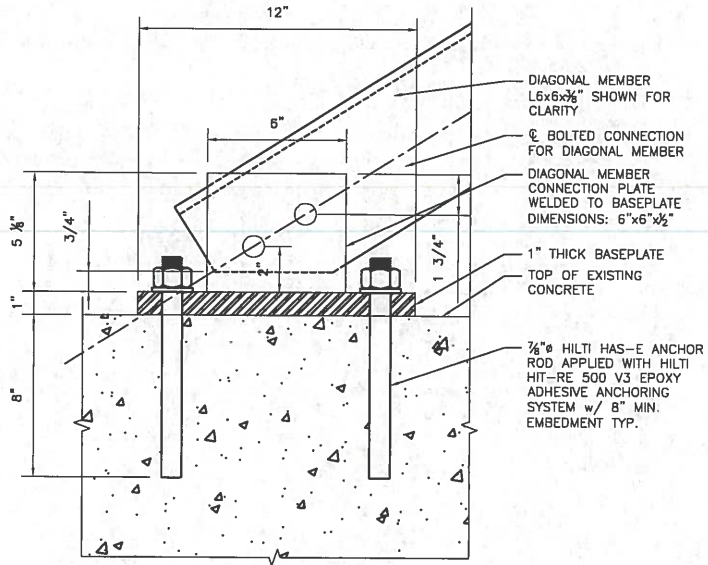

2 DIAGONAL BASE ANCHOR - ELEVATION VIEW
 SK-5 SCALE: 1-1/2"=1'-0"

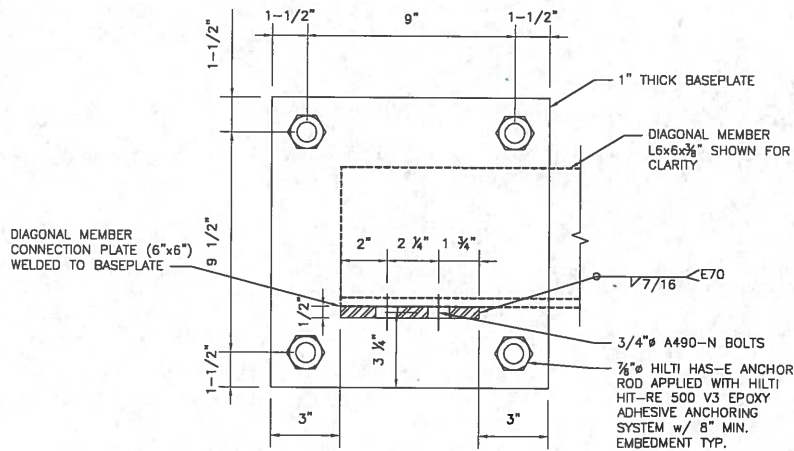

1 DIAGONAL BASE ANCHOR - PLAN VIEW
 SK-5 SCALE: 1-1/2"=1'-0"



PROJECT NO.
60537397
 Designed by:
MCD
 Drawn by:
GAT
 Checked by:
ICA
 Approved by:
RAS

AECOM
 500 ENTERPRISE DRIVE
 ROCKY HILL, CONNECTICUT
 (860)-529-8882

AT&T | Sprint | T-Mobile | verizon
 SITE ADDRESS: BUTTERNUT HOLLOW ROAD
 GREENWICH, CONNECTICUT 06831

3	10/11/18	RE-ISSUED
2	10/03/18	RE-ISSUED
1	3/27/18	RE-ISSUE
REV.	DATE:	DESCRIPTION
Scale: AS NOTED		Date: 03/20/18
Job No.	File No.	Dwg. No.

Dwg. No.
SK-5
 Dwg. 5 of 5



Submitted to
Empire Telecom USA, LLC
16 Esquire Road
Billerica, MA 01862

Submitted by
AECOM
500 Enterprise Drive,
Suite 3B
Rocky Hill, CT 06067
October 11, 2018

Airosmith Development, Inc.
32 Clinton Street
Saratoga Springs, NY 12866

Northeast Site Solutions
199 Brickyard Road
Farmington, CT 06032

Verizon Wireless
20 Alexander Drive, 2nd Floor
Wallingford, CT

DETAILED STRUCTURAL ANALYSIS AND MODIFICATION OF AN EXISTING 180' SELF SUPPORTING LATTICE TOWER WITH STACK-N-BOLT SYSTEM AND FOUNDATION FOR PROPOSED ANTENNA ARRANGEMENT

AT&T Site No. : CT2129
Sprint Site No. : CT03XC343
T-Mobile Site No. : CT11070B
Verizon Site No. : Butternut, CT

Site Name : Connecticut State Police Tower #74
Site Address: 150 Butternut Hollow Road
CSP Tower # 74

60537397
Revision #3

TABLE OF CONTENTS

- 1. EXECUTIVE SUMMARY**
- 2. INTRODUCTION**
- 3. ANALYSIS METHODOLOGY AND LOADING CONDITIONS**
- 4. FINDINGS AND EVALUATION**
- 5. CONCLUSIONS**
- 6. ANALYSIS DATA**
 - **TOWER REINFORCEMENT DRAWINGS SK-1 THROUGH SK-5**
 - **CALCULATIONS COVER PAGE**
 - **PLS-TOWER INPUT / OUTPUT SUMMARY**
 - **PLS-TOWER NODE LOCATIONS**
 - **PLS-TOWER MEMBER LOCATIONS**
 - **PLS-TOWER DETAILED OUTPUT**
 - **CONNECTION BETWEEN TOWERS EVALUATION**
 - **FOUNDATION EVALUATION**

1. EXECUTIVE SUMMARY

This report summarizes the controlling load case structural analysis and evaluation of the 180' dual lattice tower, comprised of an exterior tower and an interior tower, located off of Butternut Hollow Road in Greenwich, Connecticut.

The structural analysis was conducted in accordance with the 2016 Connecticut State Building Code which includes the TIA-222-G¹ Standard, 2012 International Building Code, the 2016 Connecticut State Building Code Amendments, the AISC² Load Resistance Factor Design (LRFD), the ASCE 7³ design Code, and the Connecticut State Police Requirements which include the TIA/EIA-222-F⁴.

The antenna loading considered in the analysis consists of all the existing antennas, transmission lines and ancillary items as outlined in the Introduction Section of this report.

The proposed antenna modifications are listed below:

Proposed Antenna, Mounts & Cables	Carrier	Antenna Center Elevation
<u>Remove:</u>		
(3) Windload Dishes	CSP (Existing)	@ 180'
(3) Powerwave P65-16-XLH-RR Panel Antennas	AT&T (Existing)	@ 148'
(3) EMS RR90-17-02DP Panel Antennas (3) GSM TMA Units	T-Mobile (Existing)	@ 136'
(3) Swedcom SLCP 2x6014 Panel Antennas (3) Amphenol BXA-171063-8BF Panel Antennas (3) Commscope HBXX6516DS-A2M Panel Antennas (6) Commscope HBXX6517DS-A2M Panel Antennas (6) Diplexer Units (3) ALU 2x60 AWS RRH Units (9) 1-5/8" Coaxial Cables	Verizon (Existing)	@ 126'
<u>Install:</u>		
(3) CCI OPA-65R-LCUU-H6 Panel Antennas (3) Ericsson RRUS-32 B2 RRH Units	AT&T (Proposed)	@ 148'
(3) Ericsson AIR 21 B2A/B4P Panel Antennas (3) Ericsson AIR 32 B66A/B2A Panel Antennas (3) APXVSAA24_43-U-A20 Panel Antennas (3) (AWS) TMA Units (3) Ericsson 4478 B71 RRH Units (3) Ericsson RRUS-11 RRH Units (3) Generic 600/700 Diplexer Units (3) Ericsson Hybriflex Cable 6x12 Fiber Optic Cables	T-Mobile (Proposed)	@ 136'

Proposed Antenna, Mounts & Cables (Cont.)	Carrier	Antenna Center Elevation
(6) Commscope JAHH-65B-R3B-2DT Panel Antennas (3) BSAMNT-SBS-2-2 (JAHH Panel Antenna) Mounting Brackets (3) Nokia 2x60-700MHz RRH Units (3) Nokia 4x45-AWS RRH Units (3) Nokia 2x80W-850 MHz RRH Units (2) RFS DB-T1-6Z-8AB-OZ Distribution Boxes (2) 1-5/8" O.D. Fiber Optic Cables (3) Commscope DT465B-2XR Panel Antennas (3) 2x50W (800MHz) RRH Units (3) TD-RRH8x20-25 RRH Units w/ Solar Shield (1) Hybrid Cable (1-1/4" O.D. Cable used for Analysis) (3) Stiff-Arm Mount Support Attachments (1 per Sector) (SitePro1 Part # STK-U)	Verizon (Proposed)	@ 126'
	Sprint (Proposed)	@ 115'

The results of an initial assessment analysis indicated the existing exterior and interior tower structures did not have enough capacity for the proposed loading conditions. The existing tower structures require modifications shown on SK-1 through SK-5. **Once the modifications indicated on sheets SK-1 through SK-5 are performed, the modified structures are considered structurally adequate with the wind load classification specified with the existing and proposed antenna loading. No installation of proposed antennas shall occur without the required modification being completed.**

The results of the analysis indicate the modified tower's sway (deflection) is 0.67 degrees and the modified tower's twist (rotation) is 0.07 degrees. These figures are within the Connecticut State Police requirements of 0.75 degrees for combined twist (rotation) and sway (deflection) when applying the TIA/EIA-222-F design conditions.

1. TIA = Telecommunications Industry Association Structural Standard for Antenna Supporting Structures and Antennas (Version G)

2. AISC = American Institute of Steel Construction (14th Edition)

3. ASCE 7 = American Society of Civil Engineers Standard 7 (2010 Edition)

4. TIA/EIA = Telecommunications Industry Association Structural Standard for Antenna Supporting Structures and Antennas (Version F)

1. **EXECUTIVE SUMMARY** *(continued)*

This analysis is based on:

- 1) The tower structure's theoretical capacity not including any assessment of the condition of the tower.
- 2) Member sizes and tower geometry of the outer tower taken from manufacturers' drawings prepared by Rohn Industries, Inc., file number 28325, dated December 28, 1992.
- 3) Member sizes and tower geometry of the inner tower taken from design calculations and drawings prepared by Towertek Industries Inc., signed and sealed May 9, 2002.
- 4) Foundation modifications taken from drawings prepared by Walker Engineering Incorporated, Job number 0206-237R2, signed and sealed November 26, 2002.
- 5) Tower Mapping and Existing Inventory performed by D&K Nationwide Communications, Inc. on March 31, 2016
- 6) Previous structural analysis performed by AECOM on behalf of the Connecticut State Police, project # 60509756.08 / PNS-608, signed and sealed on September 6, 2016.
- 7) Proposed antenna inventory Radio Frequency Data Sheet (RFDS) and contract drawings provided by AT&T, obtained via e-mail, dated May 5, 2017.
- 8) Proposed antenna inventory RFDS provided by Verizon Wireless, obtained via e-mail, dated August 18, 2017.
- 9) Proposed antenna inventory RFDS provided by Sprint, obtained via e-mail, dated January 8, 2017.
- 10) Proposed antenna inventory RFDS provided by T-Mobile, obtained via e-mail, dated, February 15, 2018, with a revision to proposed inventory obtained via e-mail dated March 26, 2018.
- 11) Antenna inventory as specified in section 2 and 6 of this report.

This report is only valid as per the information and data provided by others for antenna inventory, mounts, tower structure, existing foundation and associated cables. The user of this report shall field verify the antenna, cabling and mount configuration used, as well as the physical condition of the tower members, connections and foundations. Notify the engineer in writing immediately if any of the information in this report is found to be other than specified.

If you should have any questions, please call.

Sincerely,
AECOM,

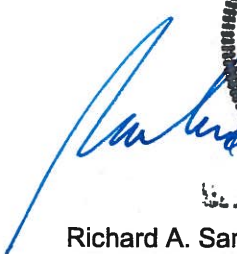

The seal is circular with a double border. The outer border contains the text "STATE OF CONNECTICUT" at the top and "PROFESSIONAL ENGINEER" at the bottom, separated by two stars. The inner border contains the name "RICHARD A. SAMBOR" at the top and "No. 8057" at the bottom. In the center is the state seal of Connecticut, featuring a shield with a ship and a plow, topped by a crest with a star.

Richard A. Sambor, P.E.
Senior Structural Engineer

RAS/mcd
Cc: IA, CF/Book – AECOM

2. INTRODUCTION

The subject tower is located off of Butternut Hollow Road in Greenwich, Connecticut. The original outer structure is a self-supporting three-legged 180' steel tapered lattice tower manufactured by Rohn Industries. A subsequent inner tower structure, a Stack-N-Bolt system, was installed inside the original tower and was designed by Towertek.

The structural analysis was conducted in accordance with the following:

- TIA-222-G Standard for Standard for a wind velocity of range of 90 mph to 110 mph (3-second gust) and 50 mph (3-second gust) concurrent with 0.75" ice thickness, considered to increase in thickness with height
- 2012 International Building Code with 2016 Connecticut State Building Code Amendments for a wind speed of 101 mph (3-second gust)
- 2010 AISC Load Resistance Factor Design (LRFD)
- 2010 ASCE 7 Minimum Design Loads for Buildings and Other Structures for the ice thickness referenced in the TIA-222-G Standard
- Connecticut State Police Requirements for a wind velocity of 90 mph (fastest mile) and 90 mph (fastest mile) concurrent with 0.5" ice. Twist (rotation) and sway (deflection) were determined in accordance with Connecticut State Police Requirements for a wind velocity of 90 mph (fastest mile) concurrent with 0.5" ice, analyzed under the TIA/EIA-222-F design Standard.

The existing structure supports numerous communication antennas. The inventory is summarized below:

Antenna Type	Carrier	Mount	Centerline Elevation / Leg	Cable
(1) Scala OGT9-806 (inverted) * (1) Sinclair SC479-HF1LDF (inverted) (1) TTA/Junction Box *	#27A,27B,27C CSP 2 *, 4 & 74 * (existing)	3' Stand-Off	175 / B	(2) 1-5/8" (1) 3/8" *
(1) (inverted) Dipole Antenna	#26-A NEU – 20 (existing)	Shared with Above (Omni @ 175')	175 / A	(1) 7/8"
(1) Sinclair SC479-HF1LDF (inverted) (1) Junction Box	#26-B CSP – 67 (existing)	Shared with Above (Omni @ 175')	175 / A	(1) 1-5/8" (1) 1/2"
(1) PD-420 20' Dipole Antenna	#28D NEU – 55 (existing)	3' Stand-Off	174 / C	(1) 7/8"
(1) DB-583 Omni Antenna	#28C TOG – 5 (existing)	Shared with Above	174 / C	(1) 1-5/8"
(1) Scala OGT9-806N * (1) Sinclair SC479-HF1LDF	#28A,28B CSP - 1 * & 3 (existing)	3' Stand-Off	174 / C	(2) 1-5/8"

Antenna Type	Carrier	Mount	Centerline Elevation / Leg	Cable
(1) SC3-W100AC 3' Dish Antenna	#25 Greenwich Police Dep. (existing)	Dish Mount	168 / B	(1) Elliptical Cable
(1) Kathrine 197-501 Panel Antenna (1) TMA	#23 Stamford 64 & 65 (existing)	3' Arm	168 / A	(1) 1-5/8" (1) 1/2"
DB-586-Y	#22 TOG - 6 (existing)	Leg Mounted	165 / A	(1) 7/8"
8' (solid) Dish with Radome	#21 SPD - 9 (existing)	Dish Mount	160 / A	(1) EW90
(3) Sinclair SC-479-HF1LDF (1 upright, 2 inverted) (1) TMA	CSP 70 to 73 (reserve)	3' Stand-Off	160	(3) 1-5/8" (1) 1/2"
(1) Kathrine 197-501 Panel Antenna	#20 Unknown (existing)	3' Arm	159.5 / A	(1) 7/8"
(1) Kathrine 197-501 Panel Antenna	#19 Stamford 63 (existing)	3' Arm	159 / B	(1) 7/8"
(3) OPA-65R-LCUU-H6 Panel Antennas (3) RRUS-32 B2 RRH Units	AT&T (Proposed)	<i>Shared with Below Mounts</i>	147.5 / ABC	<i>See Below Cables</i>
(6) Powerwave 7770 (12) TMAs (6) Ericsson RRU (1) Raycap Surge Suppressor	AT&T (existing)	(3) Side Arm Mounts	147.5' / ABC	(12) 1-5/8" (1) Fiber Optic Cable (2) DC Cables
(1) Celwave PD1142	#15 CSP – 21 (existing)	3' Arm	137 / B	(1) 7/8"
(3) AIR 21 B2A/B4P Panels (3) AIR32 B66A/B2A Panels (3) APXVSA24_43-U-A20 Panel Antennas (3) (AWS) TMA Units (3) 4478 B71 RRH Units (3) RRUS-11 RRH Units (3) Generic Diplexer (600/700)	T-Mobile (Proposed)	<i>Shared with Below Mounts</i>	136 / ABC	(3) 1-1/4" Hybriflex Cables (6x12)

Antenna Type	Carrier	Mount	Centerline Elevation / Leg	Cable
-----	T-Mobile (existing)	Face Mounted	136 / ABC	(6) 1-5/8"
(1) 6' Dipole Antenna	#12 unknown (existing)	3' Arm	135 / C	(1) 7/8"
(1) Kreco CO41AN	#11 NEU – 18 (existing)	Mounted on Below Frame	130 / A	(1) 1-5/8"
(6) JAHH-65B-R3B-2DT Panels (3) Mount Brackets for JAHH Panels (3) 2x60-700 MHz RRH Units (3) 4x45-AWS RRH Units (3) 2x80W-850MHz RRH (2) DB-T1-6Z-8B-OZ	Verizon (Proposed)	<i>Shared with Below Mounts</i>	126 / ABC	(2) 1-5/8" Fiber Optic Cables
(6) Andrew DB844H80-XY Panels (1) Raycap DB-T1-6Z-8AB-0Z Distribution Box (AWS)	Verizon (existing)	(3) Boom Gates (existing)	126 / ABC	(6) 1 5/8" (1) 1-5/8" Fiber Optic Cable
(1) Celwave PD1142	#9 DEP – 54 (existing)	3' Arm	122 / B	(1) 7/8"
(1) Celwave PD1142	#8 CSP – 66 (existing)	Share with (#9) 3' Arm	122 / B	(1) 7/8"
(3) DT465B-2XR Panels (3) 800 MHz RRH Units (3) TD-RRH 8x20-25 RRH Units	Sprint (Proposed)	(3) STK-U Stiff Arm Support to Below Mount	115 / ABC	(1) Hybriflex Cable
(3) APXVSP18-C Panel Antennas (3) 800 MHz 2x50W RRH Units (3) 1900 MHz 4x45 RRH Units	Sprint (existing)	(3) 12' T-Arm Mount	115 / ABC	(3) Hybriflex Cables
(1) Celwave PD1142	#7 NEU – 17 (existing)	3' Stand-off	110 / A	(1) 7/8"
(1) Celwave PD1142	#5 NEU – 16 (existing)	6' Arm	82 / C	(1) 1-5/8"
(1) 10' Dipole	#4 DOT – 56 (existing)	3' Arm	65 / C	(1) 7/8"

<i>Antenna Type</i>	<i>Carrier</i>	<i>Mount</i>	<i>Centerline Elevation / Leg</i>	<i>Cable</i>
(1) GPS	#3 Sprint - 69 (existing)	3' Arm	60 / C	(1) 7/8"
(1) 4' Dipole Antenna	#1 Unknown (existing)	3' Arm	56 / A	(1) 7/8"
(1) GPS (TMG-26N)	#2 Verizon - 68 (existing)	3' Arm	54 / B	(1) 7/8"

Notes: Antenna elevations and ID numbering obtained from Tower Mapping and Existing Inventory via tower climb, performed by D&K Nationwide Communications, Inc. on March 31, 2016.

“ * “ indicated future decommissioning of CSP antennas

This structural analysis and evaluation of the communications tower was performed by AECOM on behalf of AT&T, Sprint, T-Mobile and Verizon Wireless (VZW). The purpose of this analysis was to investigate the structural integrity of the modified tower and existing foundation for existing and proposed antenna loads in compliance with the 2016 Connecticut State Building Code. This analysis was conducted to evaluate stress on the tower and the effect forces to the foundation of the tower resulting from existing and proposed antenna arrangements.

3. ANALYSIS METHODOLOGY AND LOADING CONDITIONS

The structural analysis was done in accordance with, the TIA-222-G--Structural Standard for Antenna Towers and Antenna Supporting Structures and Antennas, the 2012 International Building Code with 2016 Connecticut State Building Code Amendments and the American Institute of Steel Construction (AISC) Manual of Steel Construction – Load Resistance Factor Design (LRFD)

The analysis was conducted using PLS-Tower (version 10.62) and used the following conditions for this tower review (following the TIA/EIA-222-G Standard):

- Structure Class 3 – (Essential Communications)
 - NOTE: ASCE 7 and CT State Building Code Applied Risk Category 4 for design wind loads (see below)
- Topographic Category 3 – (Tower location on top of hill – rolling wind conditions considered)
 - Crest Height used for analysis: (approximate elevations listed below)
 - Tower Base Elevation = 350 feet
 - High point (2 mile Radius) = 560 feet (Ref. Round Hill – West of Tower Site)
 - Low Point (2 mile Radius) = 212 feet (Ref. Near intersection of Grahampton Lane – South of Tower Site)
 - “H” = (Avg of High/Low) – Base Elevation = 36 feet
- Exposure Class C – (Open Terrain with scattered obstructions)
- Load Conditions:
 - Five load conditions were evaluated as shown which were compared to design stresses according to AISC and TIA-222-G Standard. The load conditions apply TIA-222-G load combinations from Section 2.3.2 (shown at the end of this section)

Basic Wind Speed:

- TIA-222-G:
 - Fairfield County (Wind Speed Range): V = 90 mph - 110 mph (3-second gust) [Annex of TIA/EIA-222-G 2006]
- IBC 2012 w/ 2016 CT State Building Code Amendment:
 - (2012) IBC Section 1609.1.1 – Determination of Wind Loads – Exception 5 “Designs using TIA-222” applies for determination of Design Wind Load obtained as “V.ult” are to be converted to “V.asd” when applying the TIA-222-G design Standard (under Section 1609.3) for Basic Wind Speed.
 - (2016) CT State Building Code Amendment to the IBC Section 1609.3 wind loads are obtained from Appendix N of the State Building Code.
 - **V.asd = 101 mph** (3-Second Gust) Wind Design Parameter for the Town of Middlebury, Connecticut for Risk Category four (IV) for essential communications (Connecticut State Police).

Ice thickness used for this analysis is **0.75 inch** (assumed to start at the base of the tower) and is considered to increase in thickness with height. The initial ice thickness for design is referenced in the Annex of TIA-222-G and follows the same design criteria as the ASCE 7 Standard.

The below load condition implements the design requirements of the Connecticut State Police for the tower structures deflection limits with the allowable deflection limit of the combination of the tower’s sway (deflection) and twist (rotation) under the TIA-222-F design Standard. This design limit required the design combined value of sway (deflection) and twist (rotation) to be under 0.75 degrees following the TIA-222-F design Standard.

Load Condition (TIA-222-F) = 90 mph (fastest mile) Wind Load (with ice) + Ice Load + Tower Dead Load

3. ANALYSIS METHODOLOGY AND LOADING CONDITIONS (cont.)

Seismic event consideration factors/values for design (and are applied into the PLS-Tower design outputs – see below load combination):

- $S_s = 0.259$ (2016 CT State Building Code – Location Specific Value)
- $S_1 = 0.070$ (2016 CT State Building Code – Location Specific Value)
- Seismic Design Category = “C” – (2012 International Building Code)
- $F_a = 1.6$ (Obtained from TIA-222-G Table 2-12 Considering above conditions)
- $F_v = 2.4$ (Obtained from TIA-222-G Table 2-13 Considering above conditions)

Strength Limit State Load Combinations (TIA-222-G Section 2.3.2):

The structural analysis herein has considered the following load combinations within the analysis:

1. **1.2 Dead Load Tower structure + 1.0 Dead Load Guy Assemblies + 1.6 Wind load without ice**
2. 0.9 Dead Load Tower structure + 1.0 Dead Load Guy Assemblies + 1.6 Wind load without ice
3. 1.2 Dead Load Tower structure + 1.0 Dead Load Guy Assemblies + 1.0 Dead weight of ice due to factored ice thickness + 1.0 Concurrent wind load with factored ice thickness + 1.0 Load effects due to temperature
4. 1.2 Dead Load Tower structure + 1.0 Dead Load Guy Assemblies + 1.0 Earthquake Load
5. 0.9 Dead Load Tower structure + 1.0 Dead Load Guy Assemblies + 1.0 Earthquake Load

NOTE 1: The above **bolded** load combination is considered to create the governing design loads per the results of the analysis.

NOTE 2: The above “Dead Load Guy Assemblies” are not considered as part of the analysis and are considered as a value of zero.

NOTE 3: The “Load effects due to temperature” do not apply for structures that are self-sustaining (from the TIA-222-G Standard)

4. FINDINGS AND EVALUATION

The combined axial and bending stresses on the tower structure were evaluated to compare with the strength design in accordance with AISC (LRFD). The results of an initial analysis indicated that the existing exterior and interior tower structures did not have enough capacity to support the proposed loading conditions. The tower structure requires modifications shown on SK-1 through SK-5. **Once the modifications indicated on sheets SK-1 through SK-5 are performed, the modified structure and existing foundation are considered structurally adequate with the wind load specification and with the existing and proposed antenna loading included herein.**

The existing dual lattice tower's sway (deflection) is 0.67 degrees, and the existing tower's twist (rotation) is 0.07 degrees. The figures combined ARE within the Connecticut State Police requirement of 0.75 degrees for combined twist and sway.

See the below tables for tower capacity and tower deflection (sway) and rotation (twist) figures:

Tower Twist & Sway 90 mph concurrent with ice (TIA-222-F Condition):

Component	Allowable	Actual
Twist	0.75°	0.07°
Sway		0.67°

Proposed Tower Component Stress vs Capacity Summary (TIA-222-G Condition):

Component	Component Size	Controlling Member	Stress (% Capacity)	Pass/Fail
Rohn Diagonal	L3-1/2x3-1/2x1/4	Rohn-DF42	96.51	Pass
Rohn Leg	Rohn 6 EH (Extra Heavy)	Rohn-LG2P	91.86	Pass
Rohn Horizontal	L1-3/4x1-3/4x3/16	Rohn-H2P	16.33	Pass
Rohn Flange Bolts	(6) 1" Diameter A325 Bolts – Tension	Rohn-LH21	84.81	Pass
Interior Tower Diagonal	L6x6x3/8	SNB-DI42	96.74	Pass
Interior Tower Leg	Pipe 8 SCH 80 (Extra Strong)	SNB-LH2P	99.89	Pass
Interior Tower Horizontal	Pipe 4"x0.494" (Pipe 4 XXS)	SNB-H9cP	3.91	Pass
Interior Flange Bolts	(6) 1" Diameter A325 Bolts – Tension	SNB-LG21	97.45	Pass
Tower-to-Tower Connection	A325 Bolt	3/4" Bolt	64.2	Pass
Foundation	36.5' Square	Overturning Moment Resistance	94.5	Pass
Foundation	36.5' Square	Soil Bearing Resistance	73.6	Pass
Foundation	36.5' Square	Punching Shear Capacity	49.5	Pass
Foundation	36.5' Square	Foundation Flexure Capacity	88.9	Pass

Structure Rating (Maximum from all components) =	99.89 %	Pass
--	---------	------

5. CONCLUSIONS

The results of an initial assessment analysis indicated the existing Exterior and Interior tower structures did not have enough capacity for the proposed loading conditions. The existing tower structures require modifications shown on SK-1 through SK-5. **Once the modifications indicated on sheets SK-1 through SK-5 are performed, the modified structures are considered structurally adequate with the wind load classification specified with the existing and proposed antenna loading. No installation of proposed antennas shall occur without the required modification being completed.**

The results of the analysis indicate the modified tower's sway (deflection) is 0.67 degrees and the modified tower's twist (rotation) is 0.07 degrees. These figures are within the Connecticut State Police requirements of 0.75 degrees for combined twist (rotation) and sway (deflection) when applying the TIA/EIA-222-F design conditions.

Limitations/Assumptions:

This report is based on the following:

- A. Tower is properly installed and maintained.
- B. All members and their geometry are as specified in the original manufacturer drawings and are in good condition.
- C. All required members are in place.
- D. All bolts are in place and are properly tightened.
- E. Tower is in plumb condition.
- F. All member protective coatings are in good condition.
- G. All tower members were properly designed, detailed, fabricated, installed, and have been properly maintained since erection.
- H. Foundations are in good condition without defect and were properly constructed to support original design loads as specified in the original design documents.

AECOM is not responsible for any modifications completed prior to or hereafter in which AECOM is not or was not directly involved. Modifications include but are not limited to:

- A. Adding antennas
- B. Removing/replacing antennas
- C. Adding coaxial cables

AECOM hereby states that this document represents the entire report and that it assumes no liability for any factual changes that may occur after the date of this report. All representations, recommendations, and conclusions are based upon information contained and set forth herein. If you are aware of any information which conflicts with that which is contained herein, or you are aware of any defects arising from original design, material, fabrication, or erection deficiencies, you should disregard this report and immediately contact AECOM. AECOM disclaims all liability for any representation, recommendation, or conclusion not expressly stated herein.

Ongoing and Periodic Inspection and Maintenance:

After the Contractor has successfully completed the installation and the work has been accepted, the owner will be responsible for the ongoing and periodic inspection and maintenance of the tower.

The owner shall refer to TIA-222-G Section 14.2 for recommendations for maintenance and inspection. The frequency of the inspection and maintenance intervals is to be determined by the owner based upon actual site and environmental conditions. It is recommended that a complete and thorough inspection of the entire tower structural system be performed at least yearly and more frequently as conditions warrant. It is also recommended that the structure be inspected after severe wind and/or ice storms or other extreme loading conditions.

6. ANALYSIS DATA

TOWER REINFORCEMENT DRAWINGS SK-1 THROUGH SK-5

GENERAL CONSTRUCTION NOTES

- ALL WORK SHALL COMPLY WITH THE CONNECTICUT STATE BUILDING AND LIFE SAFETY CODES, SUPPLEMENTS AND AMENDMENTS.
- CONTRACTOR IS TO REVIEW ALL DRAWINGS AND NOTES IN THE CONTRACT DOCUMENT SET. CONTRACTOR SHALL COORDINATE ALL WORK SHOWN IN THE SET OF DRAWINGS. THE CONTRACTOR SHALL PROVIDE A COMPLETE SET OF DRAWINGS TO ALL SUB-CONTRACTORS AND ALL RELATED PARTIES. THE SUB-CONTRACTORS SHALL EXAMINE ALL THE DRAWINGS AND SPECIFICATIONS FOR THE INFORMATION THAT AFFECTS THEIR WORK.
- CONTRACTOR SHALL PROVIDE A COMPLETE BUILD-OUT WITH ALL FINISHES, STRUCTURAL, MECHANICAL, AND ELECTRICAL COMPONENTS AND PROVIDE ALL ITEMS AS SHOWN OR INDICATED ON DRAWINGS OR WRITTEN IN SPECIFICATIONS.
- CONTRACTOR SHALL FURNISH ALL MATERIAL, LABOR AND EQUIPMENT TO COMPLETE THE WORK AND FURNISH A COMPLETED JOB ALL IN ACCORDANCE WITH LOCAL AND STATE GOVERNING AUTHORITIES AND OTHER AUTHORITIES HAVING LAWFUL JURISDICTION OVER THE WORK.
- CONTRACTOR SHALL SECURE AND PAY FOR ALL PERMITS AND ALL INSPECTIONS REQUIRED AND SHALL ALSO PAY FEES REQUIRED FOR THE GENERAL CONSTRUCTION AND ELECTRICAL SUB-CONTRACTORS SHALL PAY FOR THEIR PERMITS.
- CONTRACTOR SHALL MAINTAIN A CURRENT SET OF DRAWINGS ON SITE AT ALL TIMES AND ENSURE THE DISTRIBUTION OF NEW DRAWINGS TO SUB-CONTRACTORS AND OTHER RELEVANT PARTIES AS SOON AS THEY ARE MADE AVAILABLE. ALL OLD DRAWINGS SHALL BE MARKED VOID AND REMOVED FROM THE CONTRACT AREA. CONTRACTOR SHALL FURNISH 'AS-BUILT' SET OF DRAWINGS TO OWNER UPON COMPLETION OF PROJECT.
- INSTALLATION OF THIS WIRELESS COMMUNICATIONS EQUIPMENT SITE REQUIRES WORK IN THE IMMEDIATE VICINITY OF EXISTING OPERATING TELECOMMUNICATION SYSTEMS. THE CONTRACTOR SHALL PROVIDE AND COORDINATE THE METHODS OF PROTECTION WITH THE VARIOUS TELECOMMUNICATION CARRIERS AND THE TOWER OWNER. THERE SHALL BE NO INTERRUPTION OF OPERATION WITHOUT TIMELY COORDINATION WITH AND APPROVAL BY THE VARIOUS COMMUNICATIONS OPERATORS INCLUDING THE CONNECTICUT STATE POLICE.
- THE REINFORCEMENT OF PORTIONS OF THIS TOWER STRUCTURE WILL AFFECT CRITICAL CONNECTICUT STATE POLICE ANTENNAS.
- NO MOVEMENT, ALTERATION, OR DISCONNECTION OF CONNECTICUT STATE POLICE ANTENNAS MAY OCCUR WITHOUT THE NOTIFICATION AND APPROVAL OF THE CONNECTICUT STATE POLICE. CONTACT THE NETWORK CONTROL CENTER AT 860-865-8008.
- TOWER REINFORCING WORK AFFECTING CRITICAL CONNECTICUT STATE POLICE ANTENNAS MAY BE REQUIRED TO BE CONDUCTED AT TIMES AS DETERMINED BY THE REQUIREMENTS OF THE CONNECTICUT STATE POLICE.
- ALL EQUIPMENT AND PRODUCTS PURCHASED ARE TO BE REVIEWED BY CONTRACTOR AND ALL APPLICABLE SUB-CONTRACTORS FOR ANY CONDITION PER MFR'S RECOMMENDATIONS. CONTRACTOR TO SUPPLY THESE ITEMS AT NO COST TO OWNER OR ARCHITECT.
- CONTRACTOR SHALL BE RESPONSIBLE FOR ALL ON-SITE SAFETY FROM THE TIME THE JOB IS AWARDED UNTIL ALL WORK IS COMPLETE AND ACCEPTED BY THE OWNER.
- CONTRACTOR TO REVIEW ALL SHOP DRAWINGS AND SUBMIT COPY TO ARCHITECT FOR REVIEW. DRAWINGS MUST BEAR THE CHECKER'S INITIALS BEFORE SUBMITTAL TO THE ARCHITECT FOR REVIEW.
- THE CONTRACTOR SHALL FIELD VERIFY ALL DIMENSIONS, ELEVATIONS, ANGLES, AND EXISTING CONDITIONS AT THE SITE, PRIOR TO FABRICATION AND/OR INSTALLATION OF ANY WORK IN THE CONTRACT AREA. SUBMIT ANY DISCREPANCIES FROM THE DRAWINGS TO THE ARCHITECT.
- THE CONTRACTOR IS SOLELY RESPONSIBLE TO DETERMINE CONSTRUCTION PROCEDURE AND SEQUENCE, AND TO ENSURE THE SAFETY OF THE EXISTING STRUCTURE AND ITS COMPONENT PARTS DURING CONSTRUCTION. THIS INCLUDES THE ADDITION OF WHATEVER SHORING, BRACING, UNDERPINNING, ETC. THAT MAY BE NECESSARY.
- CONTRACTOR TO CONTACT "CALL BEFORE YOU DIG" AT 1-800-922-4455 TO VERIFY AND IDENTIFY THE EXACT LOCATIONS OF ALL UNDERGROUND UTILITIES AND OBSTRUCTIONS IDENTIFIED PRIOR TO COMMENCING WORK IN THE CONTRACT AREA.
- CONTRACTOR SHALL COMPLY WITH OWNER ENVIRONMENTAL ENGINEER ON ALL METHODS AND PROVISIONS FOR ALL EXCAVATION ACTIVITIES INCLUDING SOIL DISPOSAL. ALL BACKFILL MATERIALS TO BE PROVIDED BY THE CONTRACTOR.
- DIMENSIONS OF EXISTING TOWER ARE BASED ON MANUFACTURER'S DRAWINGS PREPARED BY ROHN INDUSTRIES, INC., DATED DECEMBER 1992, AND ARE NOT GUARANTEED. CONTRACTOR SHALL TAKE FIELD DIMENSIONS AS NECESSARY TO ASSURE PROPER FIT OF ALL FINISHED WORK AND SHALL ASSUME FULL RESPONSIBILITY FOR THEIR ACCURACY. WHEN SHOP DRAWINGS BASED ON FIELD MEASUREMENT ARE SUBMITTED FOR REVIEW, DIMENSIONS ARE PROVIDED FOR THE ENGINEER'S REFERENCE ONLY.
- TOWER INVENTORY IS BASED ON INFORMATION OBTAINED BY CONNECTICUT STATE POLICE DATED APRIL 12, 2016. TOWER MAPPING AND EXISTING INVENTORY OBTAINED FROM D&K NATIONWIDE COMMUNICATIONS, INC. DATED MARCH 2, 2016.
- CONTRACTOR TO VERIFY REQUIRED CLEARANCES INCLUDING BUT NOT LIMITED TO EXISTING BUILDINGS, EQUIPMENT PADS AND SHELTERS PRIOR TO COMMENCING WORK.
- THE CONTRACTOR IS RESPONSIBLE FOR THE STABILITY OF THE STRUCTURE DURING CONSTRUCTION. NO MEMBER OF THE TOWER SHALL BE LEFT DISCONNECTED FOR THE NEXT WORKING DAY. THE CONTRACTOR SHALL BE AWARE OF WEATHER AND WIND CONDITIONS AND NOT PERFORM MEMBER REPLACEMENT IN A WIND.

STRUCTURAL NOTES

STRUCTURAL STEEL MATERIAL:

ALL STRUCTURAL STEEL MEMBERS AND HSS TUBING USED FOR REINFORCING SHALL BE MINIMUM 50 KSI WITH THE BELOW EXCEPTIONS:
 ANGLE SIZE 2-1/2"x2-1/2"x3/16" AND SMALLER A36
 STRUCTURAL PLATES A36

STRUCTURAL STEEL SHALL CONFORM TO ALL THE REQUIREMENTS OF THE ASTM SPECIFICATION, AS REFERENCED IN THE CODE.

UNLESS OTHERWISE NOTED, ALL STEEL WILL BE GALVANIZED IN ACCORDANCE WITH ASTM 123 AFTER FABRICATION. TOUCH UP ALL DAMAGED GALVANIZED STEEL WITH APPROVED COLD ZINC, "GALVANOX", "DRY GALV", "ZINC-IT", OR APPROVED EQUIVALENT, IN ACCORDANCE WITH MANUFACTURERS GUIDELINES. TOUCH-UP DAMAGED NON GALVANIZED STEEL WITH SAME PAINT APPLIED IN SHOP OR FIELD.

SHOP AND ERECTION DRAWINGS SHALL BE SUBMITTED FOR ALL STRUCTURAL STEEL WORK IN ACCORDANCE WITH THE CONTRACT DOCUMENTS. SUBMIT 2 SETS OF PRINTS FOR THE ENGINEER REVIEW.

MILL BEARING ENDS OF COLUMNS, STIFFENERS, AND OTHER BEARING SURFACES TO TRANSFER LOAD OVER ENTIRE CROSS SECTION.

THE OMISSION OF ANY MATERIAL THAT WAS SHOWN ON THE CONTRACT DRAWINGS SHALL NOT RELIEVE THE CONTRACTOR OF PROVIDING THE SAME.

CONNECTIONS / FIELD ASSEMBLY:

BOLTED CONNECTIONS: UNLESS OTHERWISE NOTED, ALL JOINTS ARE SLIP CRITICAL TYPE, REQUIRING 5/8" & 3/4" DIA. A325-N & A490-X BOLTS, A563 NUTS AND F436 WASHERS, ALL GALVANIZED. BEVELED WASHERS SHALL BE USED ON BEAM FLANGES HAVING A SLOPE GREATER THAN 1:20.

STRUCTURE IS DESIGNED TO BE LEVEL AND PLUMB, SELF-SUPPORTING AND STABLE AFTER WORK IS COMPLETED.

COMMENCEMENT OF WORK WITHOUT NOTIFYING THE ENGINEER OF ANY DISCREPANCIES WILL BE CONSIDERED ACCEPTANCE OF PRECEDING WORK.

INSPECTIONS:

SPECIAL INSPECTIONS ARE REQUIRED PER THE CODE FOR STRUCTURAL STEEL WORK.

OWNER WILL SUPPLY THE SERVICES OF A SPECIAL INSPECTOR AND TESTING AGENTS AS REQUIRED. CONTRACTOR SHALL COORDINATE INSPECTIONS OF FABRICATOR'S AND ERECTOR'S WORK AND MATERIALS TO MEET THE REQUIREMENTS OF THE STATEMENT OF SPECIAL INSPECTIONS FOR THIS PROJECT.

COPIES OF TESTING AND INSPECTION REPORTS WILL BE PROVIDED TO THE OWNER, BUILDING OFFICIAL, ENGINEER OF RECORD AND CONTRACTOR.



PROJECT NO.
60537397
Designed by:
MCD
Drawn by:
GAT
Checked by:
ICA
Approved by:
RAS

AECOM
500 ENTERPRISE DRIVE
ROCKY HILL, CONNECTICUT
(860)-529-8882



SITE ADDRESS: BUTTERNUT HOLLOW ROAD
GREENWICH, CONNECTICUT 06831

REV.	DATE:	DESCRIPTION
3	10/11/18	RE-ISSUED
2	10/03/18	RE-ISSUED
1	3/27/18	RE-ISSUE

Scale: AS NOTED Date: 03/20/18

Job No.

File No.

Dwg. No.

SK-1

Dwg. 1 of 5

NOTES:

1. REFER TO STRUCTURAL NOTES ON SK-1 FOR STEEL GRADE REQUIREMENTS FOR REPLACEMENT MEMBERS.
2. REINFORCEMENT OF TOWER IS REQUIRED FOR ALL 3 SIDES OF EXISTING EXTERIOR TOWER STRUCTURE.
3. CONNECTION BOLTS THAT ARE REMOVED DURING MEMBER REPLACEMENT SHALL BE REPLACED IN KIND, UNLESS NOTED OTHERWISE. EXISTING BOLTS SHALL NOT BE RE-USED FOR CONNECTING REPLACEMENT MEMBERS.
4. CONTRACTOR SHALL COORDINATE WITH ROHN INC. FOR INDICATED TOWER REPLACEMENT MEMBERS AS SHOWN.
5. CONTRACTOR SHALL VERIFY INFORMATION SHOWN ON THIS SHEET PRIOR TO ORDERING MATERIALS.
6. THE BOTTOM 2 FEET OF THE TOWER'S LEGS AND DIAGONAL MEMBERS ARE ENCASED IN CONCRETE, PART OF A PREVIOUS FOUNDATION MODIFICATION.

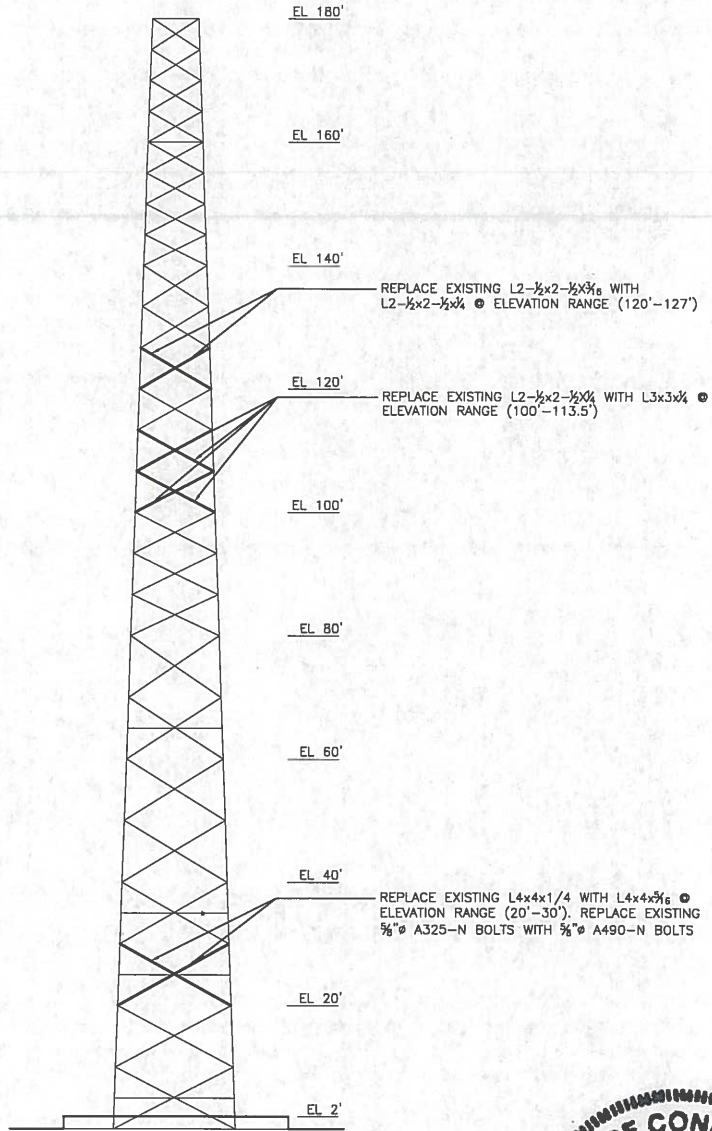

1 TOWER ELEVATION - EXTERIOR TOWER
 SK-2 SCALE: 1" = 30'-0" (INTERIOR TOWER NOT SHOWN FOR CLARITY)



PROJECT NO. 60537397 Designed by: MCD Drawn by: GAT Checked by: ICA Approved by: RAS	AECOM 500 ENTERPRISE DRIVE ROCKY HILL, CONNECTICUT (860)-529-8882		<table border="1" style="width: 100%; border-collapse: collapse;"> <tr><td>3</td><td>10/11/18</td><td>RE-ISSUED</td></tr> <tr><td>2</td><td>10/03/18</td><td>RE-ISSUED</td></tr> <tr><td>1</td><td>3/27/18</td><td>RE-ISSUE</td></tr> <tr><td>REV.</td><td>DATE:</td><td>DESCRIPTION</td></tr> </table>	3	10/11/18	RE-ISSUED	2	10/03/18	RE-ISSUED	1	3/27/18	RE-ISSUE	REV.	DATE:	DESCRIPTION	Dwg. No. SK-2 Dwg. 2 of 5
3	10/11/18	RE-ISSUED														
2	10/03/18	RE-ISSUED														
1	3/27/18	RE-ISSUE														
REV.	DATE:	DESCRIPTION														
SITE ADDRESS: BUTTERNUT HOLLOW ROAD GREENWICH, CONNECTICUT 06831			Scale: AS NOTED Date: 03/20/18	Job No. File No.												

NOTES:

1. REFER TO STRUCTURAL NOTES ON SK-1 FOR STEEL GRADE REQUIREMENTS FOR REPLACEMENT MEMBERS.
2. REINFORCEMENT OF TOWER IS REQUIRED FOR ALL 3 SIDES OF EXISTING INTERIOR TOWER STRUCTURE.
3. CONNECTION BOLTS THAT ARE REMOVED DURING MEMBER REPLACEMENT SHALL BE REPLACED IN KIND, UNLESS NOTED OTHERWISE. EXISTING BOLTS SHALL NOT BE RE-USED FOR CONNECTING REPLACEMENT MEMBERS.
4. CONTRACTOR SHALL VERIFY INFORMATION SHOWN ON THIS SHEET PRIOR TO ORDERING MATERIALS.
5. THE BOTTOM 2 FEET OF THE TOWER'S LEGS AND DIAGONAL MEMBERS ARE ENCASED IN CONCRETE, PART OF A PREVIOUS FOUNDATION MODIFICATION.
6. EXISTING TOWER DIAGONAL MEMBERS AT ELEVATION 0'-2' RANGE ARE ENCASED IN CONCRETE. CONTRACTOR SHALL PROVIDE TEMPORARY SUPPORT OF TOWER STRUCTURE DURING CONSTRUCTION OF PROPOSED DIAGONAL BASE CONNECTIONS. REFER TO SK-5 FOR DETAILS FOR REPLACEMENT OF DIAGONAL MEMBERS.
7. EXISTING DIAGONAL MEMBERS EMBEDDED IN CONCRETE ARE TO BE CUT AFTER REPLACEMENT INSTALLATION OF DIAGONAL BASE ANCHORS, BASEPLATE AND CONNECTION PLATES ARE CONSTRUCTED TO ALLOW REPLACEMENT OF PROPOSED DIAGONAL MEMBERS (AS INDICATED IN NOTE 3 ABOVE AND SK-5).

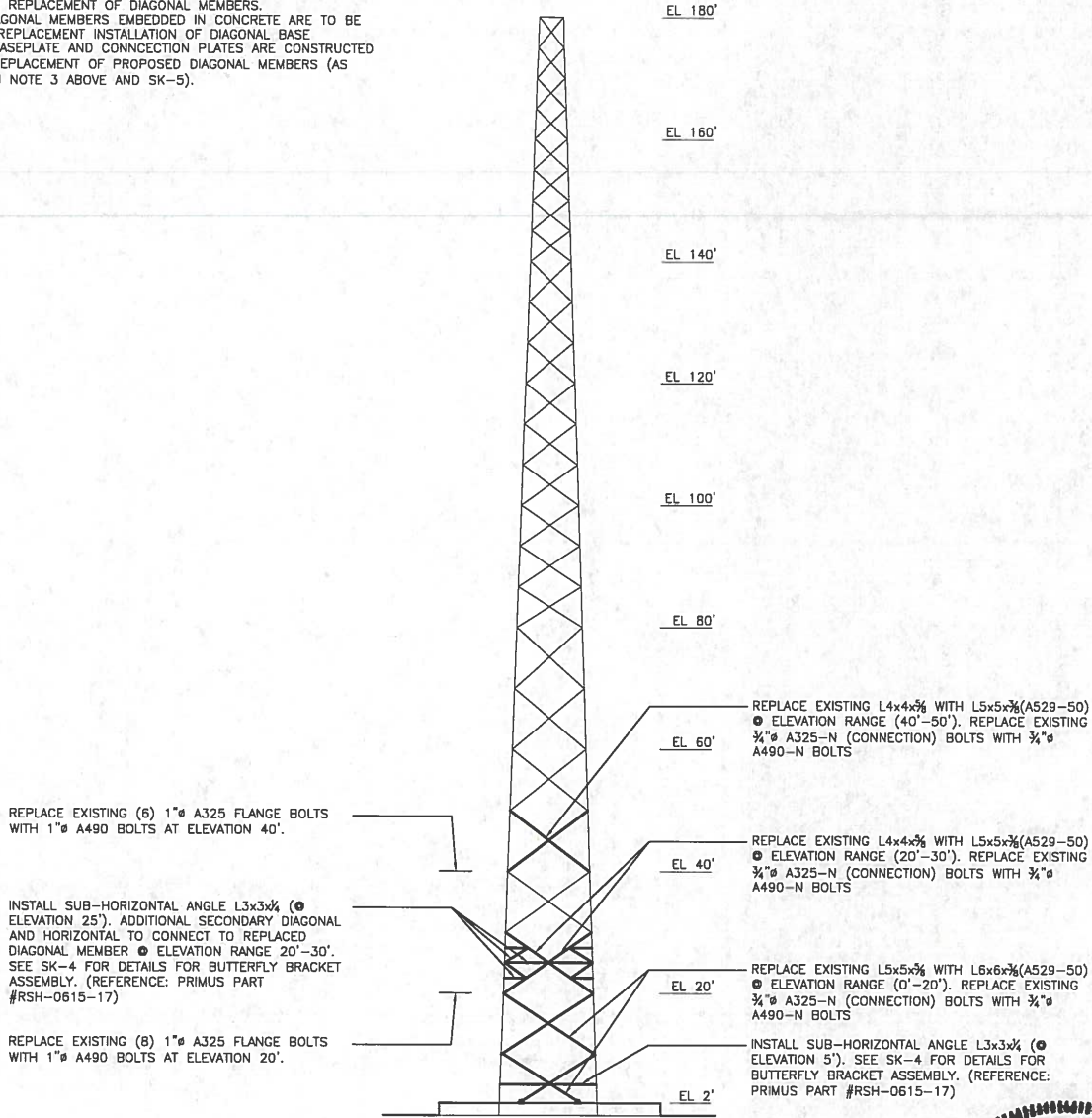

1 TOWER ELEVATION - INTERIOR TOWER
 SK-3 SCALE: 1" = 30'-0" (EXTERIOR TOWER NOT SHOWN FOR CLARITY)



PROJECT NO.
60537397

Designed by:
MCD

Drawn by:
GAT

Checked by:
ICA

Approved by:
RAS

AECOM

500 ENTERPRISE DRIVE
 ROCKY HILL, CONNECTICUT
 (860)-529-8882

AT&T | Sprint | T-Mobile | verizon

SITE ADDRESS: BUTTERNUT HOLLOW ROAD
 GREENWICH, CONNECTICUT 06831

3	10/11/18	RE-ISSUED
2	10/03/18	RE-ISSUED
1	3/27/18	RE-ISSUE
REV.	DATE	DESCRIPTION
Scale: AS NOTED		Date: 03/20/18
Job No.	File No.	Dwg. 3 of 5

Dwg. No.
SK-3

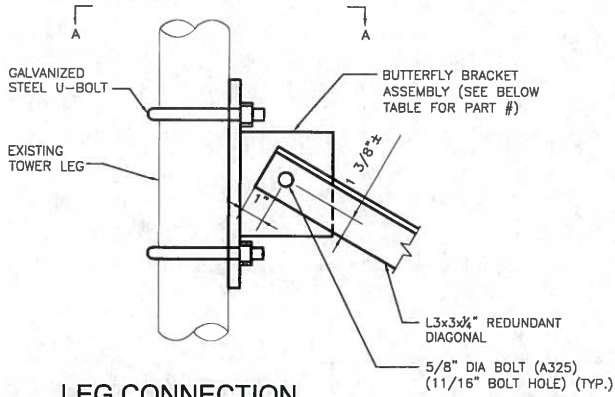

3
SK-4 **LEG CONNECTION REDUNDANT DIAGONAL**
SCALE: 1-1/2"=1'-0"

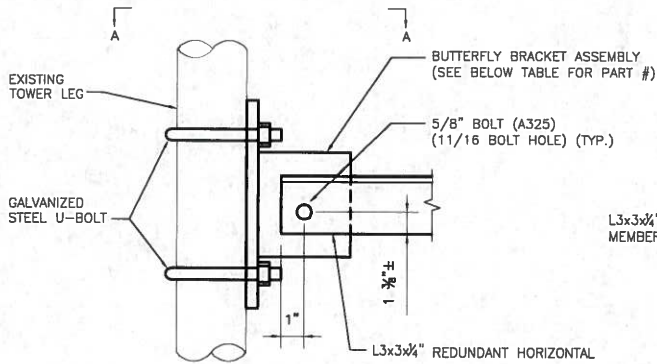

2
SK-4 **LEG CONNECTION REDUNDANT HORIZONTAL**
SCALE: 1-1/2"=1'-0"

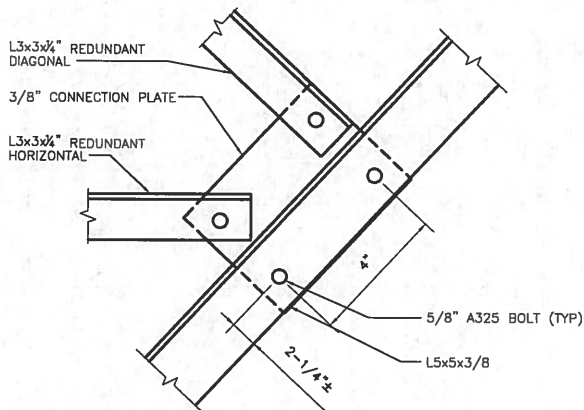

1
SK-4 **REDUNDANT MEMBER CONNECTION**
SCALE: 1-1/2"=1'-0"

ELEVATION	LEG BUTTERFLY BRACKET #	NOTE: LEG BUTTERFLY BRACKET ASSEMBLY INFORMATION FROM PRIMUS ELECTRONICS CORPORATION. CONTRACTOR SHALL USE PRODUCTS SIMILAR TO OR EXCEEDING IN QUALITY FOR CONSTRUCTION.
2'-10"	RSH-0500-00	
20'-30"	RSH-0500-00	

NOTE:

1. DETAILS 2 & 3 ABOVE INDICATE CONNECTIONS OF DIAGONAL AND HORIZONTAL MEMBERS TO TOWER LEGS. BUTTERFLY BRACKET ASSEMBLIES USED FOR CONNECTION TO EXISTING LEGS SHALL BE INSTALLED AS CLOSE TO EXISTING ADJOINING HORIZONTAL MEMBER AS POSSIBLE.

NOTES:

- REFER TO SK-1 FOR STRUCTURAL NOTES. COORDINATE SHEET WITH SK-3 FOR SECONDARY HORIZONTAL/DIAGONAL CONNECTION MEMBERS.
- CONTRACTOR SHALL FIELD VERIFY DIMENSIONS SHOWN PRIOR TO ORDERING SUPPLIES.
- U-BOLTED CONNECTION ASSEMBLIES CONNECTING THE EXTERIOR AND INTERIOR TOWERS ARE PERMITTED TO BE ADJUSTED ONE UNIT AT A TIME TO ALLOW THE INSTALLATION OF THE PROPOSED BUTTERFLY BRACKET ASSEMBLIES INDICATED HERE AND ON SHEET SK-3.

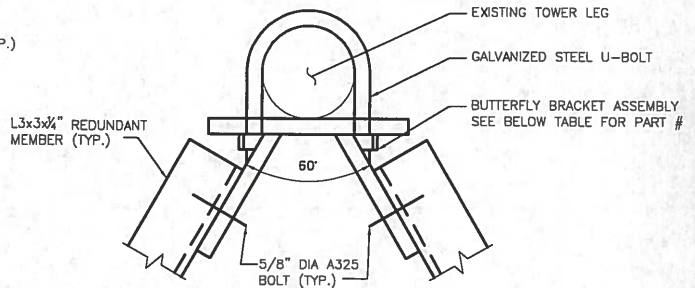

5
SK-4 **SECTION A**
SCALE: N.T.S.

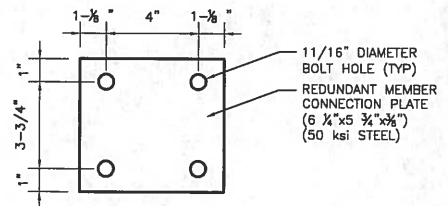

4
SK-4 **CONNECTION PLATE**
SCALE: 1-1/2"=1'-0"

PROJECT NO.
60537397
Designed by:
MCD
Drawn by:
GAT
Checked by:
ICA
Approved by:
RAS

AECOM
500 ENTERPRISE DRIVE
ROCKY HILL, CONNECTICUT
(860)-529-8882

AT&T | Sprint | T-Mobile | verizon
SITE ADDRESS: BUTTERNUT HOLLOW ROAD
GREENWICH, CONNECTICUT 06831

3	10/11/18	RE-ISSUED
2	10/03/18	RE-ISSUED
1	3/27/18	RE-ISSUE
REV.	DATE:	DESCRIPTION
Scale: AS NOTED		Date: 03/20/18
Job No.	File No.	Dwg. 4 of 5

Dwg. No.
SK-4

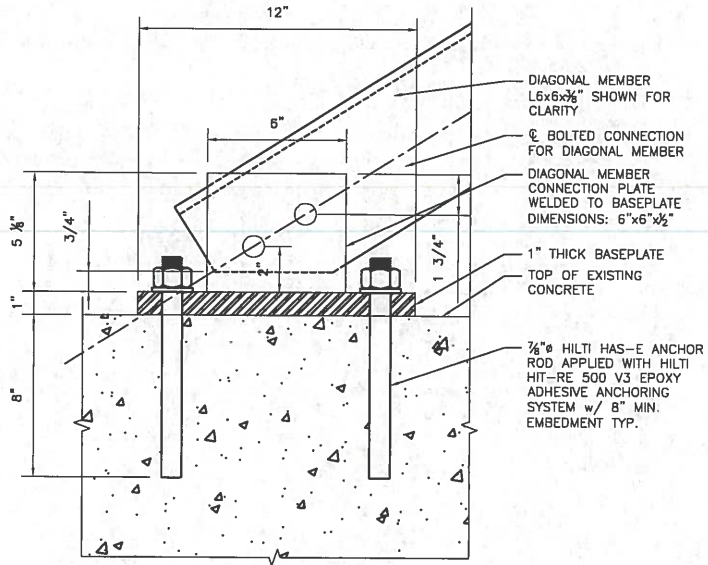

2 DIAGONAL BASE ANCHOR - ELEVATION VIEW
 SK-5 SCALE: 1-1/2"=1'-0"

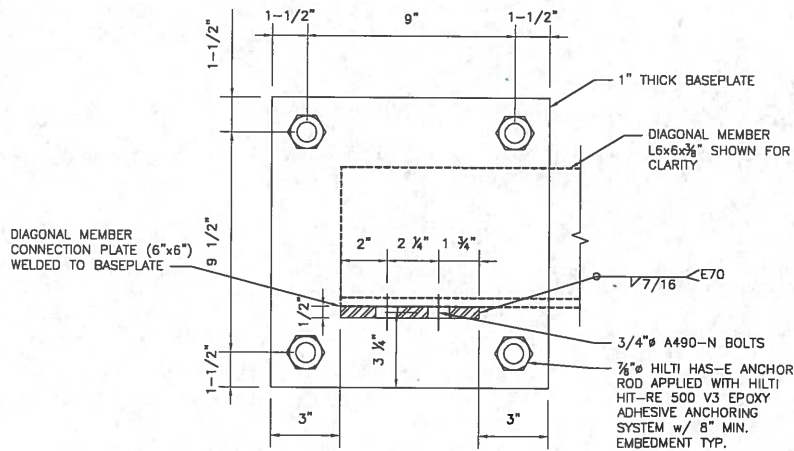

1 DIAGONAL BASE ANCHOR - PLAN VIEW
 SK-5 SCALE: 1-1/2"=1'-0"



PROJECT NO.
60537397
 Designed by:
MCD
 Drawn by:
GAT
 Checked by:
ICA
 Approved by:
RAS

AECOM
 500 ENTERPRISE DRIVE
 ROCKY HILL, CONNECTICUT
 (860)-529-8882

AT&T | Sprint | T-Mobile | verizon

SITE ADDRESS: BUTTERNUT HOLLOW ROAD
 GREENWICH, CONNECTICUT 06831

3	10/11/18	RE-ISSUED
2	10/03/18	RE-ISSUED
1	3/27/18	RE-ISSUE
REV.	DATE:	DESCRIPTION
Scale: AS NOTED		Date: 03/20/18
Job No.	File No.	Dwg. No.

Dwg. No.
SK-5
 Dwg. 5 of 5

CALCULATIONS COVER PAGE

A Note Regarding the Tower Calculations included herein:

The computer program utilized for the structural analysis contained in this report was “PLS-Tower”, Version 10.62. This program does not apply multiple wind attack angles to greatest stress. As a result, multiple analyses with different wind attack angles were run in order to arrive at the controlling condition causing the greatest stress. This report includes only the TIA-222-G load case and wind attack angle that causes the greatest stress to the tower members in order to minimize the size of this report. The analyses conducted but not included with this report are available upon request.

PLS-TOWER INPUT / OUTPUT SUMMARY

Project Name : Multi-Carrier Analysis
 Project Notes: Butternut Hollow
 Project File : P:\Projects\Telcom\StructuralsByLocation\Connecticut\GreenwichCSP#74\13-10102018 - Re-issue_Multicarrier_PLS_G\PLS-Tower_Wind_0\4-Carir.tow
 Date run : 5:44:33 PM Thursday, October 11, 2018
 by : Tower Version 10.62
 Licensed to : URS Connecticut

Successfully performed nonlinear analysis

Unusual number of fixed joints found: 6. Towers normally have from between 1 and 4 fixed joints. ??
 Linear appurtenance "DNK1-7/8" @ 56" is included in the face zone (face solidity ratio for Rev. F), but does not contribute to wind load: this is nonsensical ??
 Linear appurtenance "DNK2-7/8" @ 54" is included in the face zone (face solidity ratio for Rev. F), but does not contribute to wind load: this is nonsensical ??
 Linear appurtenance "DNK3-7/8" @ 60" is included in the face zone (face solidity ratio for Rev. F), but does not contribute to wind load: this is nonsensical ??
 Linear appurtenance "DNK4-7/8" @ 65" is included in the face zone (face solidity ratio for Rev. F), but does not contribute to wind load: this is nonsensical ??
 Linear appurtenance "DNK5-1-5/8" @ 82" is included in the face zone (face solidity ratio for Rev. F), but does not contribute to wind load: this is nonsensical ??
 Linear appurtenance "DNK6-Hybriflex Cables @ Sprint" is included in the face zone (face solidity ratio for Rev. F), but does not contribute to wind load: this is nonsensical ??
 Linear appurtenance "DNK7-7/8" @ 110" is included in the face zone (face solidity ratio for Rev. F), but does not contribute to wind load: this is nonsensical ??
 Linear appurtenance "DNK8-7/8" @ 122" is included in the face zone (face solidity ratio for Rev. F), but does not contribute to wind load: this is nonsensical ??
 Linear appurtenance "DNK9-7/8" @ 122" is included in the face zone (face solidity ratio for Rev. F), but does not contribute to wind load: this is nonsensical ??
 Linear appurtenance "DNK10-1-5/8" @ VZW" is included in the face zone (face solidity ratio for Rev. F), but does not contribute to wind load: this is nonsensical ??
 Linear appurtenance "DNK11-1-5/8" @ 130" is included in the face zone (face solidity ratio for Rev. F), but does not contribute to wind load: this is nonsensical ??
 Linear appurtenance "DNK12-7/8" @ 135" is included in the face zone (face solidity ratio for Rev. F), but does not contribute to wind load: this is nonsensical ??
 Linear appurtenance "DNK13,14-1-5/8" @ T-Mobile" is included in the face zone (face solidity ratio for Rev. F), but does not contribute to wind load: this is nonsensical ??
 Linear appurtenance "DNK15-7/8" @ 137" is included in the face zone (face solidity ratio for Rev. F), but does not contribute to wind load: this is nonsensical ??
 Linear appurtenance "DNK16,17,18-1-5/8" @ ATT" is included in the face zone (face solidity ratio for Rev. F), but does not contribute to wind load: this is nonsensical ??
 Linear appurtenance "DNK16,17,18-Optic Fiber Cable @ ATT" is included in the face zone (face solidity ratio for Rev. F), but does not contribute to wind load: this is nonsensical ??
 Linear appurtenance "DNK16,17,18-DC Cable @ ATT" is included in the face zone (face solidity ratio for Rev. F), but does not contribute to wind load: this is nonsensical ??
 Linear appurtenance "DNK19-7/8" @ 159" is included in the face zone (face solidity ratio for Rev. F), but does not contribute to wind load: this is nonsensical ??
 Linear appurtenance "DNK20-7/8" @ 159.5" is included in the face zone (face solidity ratio for Rev. F), but does not contribute to wind load: this is nonsensical ??
 Linear appurtenance "CSP70,71,72-1-5/8" @ 160(3)" is included in the face zone (face solidity ratio for Rev. F), but does not contribute to wind load: this is nonsensical ??
 Linear appurtenance "CSP73-1/2" @ 160" is included in the face zone (face solidity ratio for Rev. F), but does not contribute to wind load: this is nonsensical ??
 Linear appurtenance "DNK21-Elliptical @ 160" is included in the face zone (face solidity ratio for Rev. F), but does not contribute to wind load: this is nonsensical ??
 Linear appurtenance "DNK22-7/8" @ 165" is included in the face zone (face solidity ratio for Rev. F), but does not contribute to wind load: this is nonsensical ??
 Linear appurtenance "DNK23A-1-5/8" @ 168" is included in the face zone (face solidity ratio for Rev. F), but does not contribute to wind load: this is nonsensical ??
 Linear appurtenance "DNK23B-1/2" @ 168" is included in the face zone (face solidity ratio for Rev. F), but does not contribute to wind load: this is nonsensical ??
 Linear appurtenance "DNK26-B-1-5/8" @ 175" is included in the face zone (face solidity ratio for Rev. F), but does not contribute to wind load: this is nonsensical ??
 Linear appurtenance "DNK26A-7/8" @ 175" is included in the face zone (face solidity ratio for Rev. F), but does not contribute to wind load: this is nonsensical ??
 Linear appurtenance "DNK26C-1/2" @ 175" is included in the face zone (face solidity ratio for Rev. F), but does not contribute to wind load: this is nonsensical ??
 Linear appurtenance "DNK27-B-1-5/8" @ 175" is included in the face zone (face solidity ratio for Rev. F), but does not contribute to wind load: this is nonsensical ??
 Linear appurtenance "DNK27A-7/8" @ 175" is included in the face zone (face solidity ratio for Rev. F), but does not contribute to wind load: this is nonsensical ??
 Linear appurtenance "DNK27C-3/8" @ 175" is included in the face zone (face solidity ratio for Rev. F), but does not contribute to wind load: this is nonsensical ??
 Linear appurtenance "DNK28A-1-5/8" @ 175" is included in the face zone (face solidity ratio for Rev. F), but does not contribute to wind load: this is nonsensical ??
 Linear appurtenance "DNK28B-1-5/8" @ 175" is included in the face zone (face solidity ratio for Rev. F), but does not contribute to wind load: this is nonsensical ??
 Linear appurtenance "DNK28C-1-5/8" @ 175" is included in the face zone (face solidity ratio for Rev. F), but does not contribute to wind load: this is nonsensical ??
 Linear appurtenance "DNK28D-7/8" @ 175" is included in the face zone (face solidity ratio for Rev. F), but does not contribute to wind load: this is nonsensical ??
 Linear appurtenance "GRN-1-Elliptical @ 172 (DNK25)" is included in the face zone (face solidity ratio for Rev. F), but does not contribute to wind load: this is nonsensical ??
 Linear appurtenance "VZW-(3) Hybriflex Cables" is included in the face zone (face solidity ratio for Rev. F), but does not contribute to wind load: this is nonsensical ??
 Linear appurtenance "Hybriflex 6x12 Cables @ T-Mobile" is included in the face zone (face solidity ratio for Rev. F), but does not contribute to wind load: this is nonsensical ??
 Linear appurtenance "Hybriflex 9x18 Cables @ T-Mobile" is included in the face zone (face solidity ratio for Rev. F), but does not contribute to wind load: this is nonsensical ??
 The model has 40 warnings. ??

Member check option: ANSI/TIA 222-G-1
 Connection rapture check: ANSI/TIA 222-G-1
 Crossing diagonal check: ANSI/TIA 222-G-1 [Alternate Unsupported RLOUT = 1]
 Loads from file: p:\projects\telcom\structuralsbylocation\connecticut\greenwichcsp#74\13-10102018 - re-issue_multicarrier_pls_g\pls-tower_wind_0\4-carir.eia

*** Analysis Results:

Maximum element usage is 99.89% for Angle "SNB-LH2P" in load case "1: 1.2D + 1.0Dg + 1.6Wo"

Summary of Joint Support Reactions For All Load Cases:

Load Case	Joint Label	Long. Force (kips)	Tran. Force (kips)	Vert. Force (kips)	Shear Force (kips)	Tran. Moment (ft-k)	Long. Moment (ft-k)	Vert. Moment (ft-k)	Bending Moment (ft-k)	Found. Usage %
1: 1.2D + 1.0Dg + 1.6Wo	RohnJP	-29.67	0.11	355.57	29.67	-0.06	-5.55	-0.01	5.55	0.00

1:	1.2D + 1.0Dg + 1.6Wo	SNB-JP	-51.25	0.00	512.04	51.25	0.00	-13.50	0.00	13.50	0.00
1:	1.2D + 1.0Dg + 1.6Wo	RohnJ1	-9.49	-10.04	-147.95	13.81	1.91	-1.42	0.00	2.39	0.00
1:	1.2D + 1.0Dg + 1.6Wo	RohnJ2	-9.70	9.95	-148.25	13.89	-1.86	-1.53	-0.01	2.41	0.00
1:	1.2D + 1.0Dg + 1.6Wo	SNB-J1	-17.54	-18.77	-227.91	25.69	5.44	-2.70	-0.03	6.07	0.00
1:	1.2D + 1.0Dg + 1.6Wo	SNB-J2	-17.56	18.80	-228.39	25.73	-5.44	-2.71	0.03	6.08	0.00
2:	0.9D + 1.0Dg + 1.6Wo	RohnJP	-29.40	0.11	350.14	29.40	-0.06	-5.48	-0.01	5.48	0.00
2:	0.9D + 1.0Dg + 1.6Wo	SNB-JP	-51.11	0.00	506.81	51.11	0.00	-13.37	0.00	13.37	0.00
2:	0.9D + 1.0Dg + 1.6Wo	RohnJ1	-9.63	-10.26	-152.67	14.07	1.97	-1.46	0.00	2.45	0.00
2:	0.9D + 1.0Dg + 1.6Wo	RohnJ2	-9.83	10.17	-153.00	14.15	-1.91	-1.57	-0.01	2.47	0.00
2:	0.9D + 1.0Dg + 1.6Wo	SNB-J1	-17.61	-18.88	-232.22	25.82	5.53	-2.77	-0.03	6.18	0.00
2:	0.9D + 1.0Dg + 1.6Wo	SNB-J2	-17.63	18.92	-232.72	25.86	-5.54	-2.77	0.03	6.19	0.00
4:	1.2D + 1.0Dg + 1.0E	RohnJP	-2.53	0.00	41.68	2.53	-0.00	-0.56	0.00	0.56	0.00
4:	1.2D + 1.0Dg + 1.0E	SNB-JP	-3.06	0.00	49.49	3.06	-0.00	-1.18	-0.00	1.18	0.00
4:	1.2D + 1.0Dg + 1.0E	RohnJ1	0.11	0.32	8.93	0.34	-0.09	0.11	-0.00	0.14	0.00
4:	1.2D + 1.0Dg + 1.0E	RohnJ2	0.10	-0.33	9.02	0.34	0.10	0.10	0.00	0.14	0.00
4:	1.2D + 1.0Dg + 1.0E	SNB-J1	-0.46	-0.55	2.95	0.71	-0.03	0.20	-0.01	0.20	0.00
4:	1.2D + 1.0Dg + 1.0E	SNB-J2	-0.46	0.55	3.05	0.71	0.03	0.20	0.01	0.20	0.00
5:	0.9D + 1.0Dg + 1.0E	RohnJP	-2.27	0.00	36.66	2.27	-0.00	-0.49	0.00	0.49	0.00
5:	0.9D + 1.0Dg + 1.0E	SNB-JP	-2.92	0.00	44.79	2.92	-0.00	-1.06	-0.00	1.06	0.00
5:	0.9D + 1.0Dg + 1.0E	RohnJ1	-0.03	0.09	4.00	0.10	-0.04	0.07	-0.00	0.08	0.00
5:	0.9D + 1.0Dg + 1.0E	RohnJ2	-0.03	-0.10	4.07	0.10	0.04	0.07	0.00	0.08	0.00
5:	0.9D + 1.0Dg + 1.0E	SNB-J1	-0.53	-0.66	-1.63	0.85	0.07	0.14	-0.01	0.16	0.00
5:	0.9D + 1.0Dg + 1.0E	SNB-J2	-0.53	0.66	-1.55	0.85	-0.07	0.14	0.01	0.16	0.00
6:	Service 1.0D + 1.0Dg + 1.0 Wo	RohnJP	-7.32	0.02	91.59	7.32	-0.01	-1.42	-0.00	1.42	0.00
6:	Service 1.0D + 1.0Dg + 1.0 Wo	SNB-JP	-11.85	0.00	125.71	11.85	-0.00	-3.32	-0.00	3.32	0.00
6:	Service 1.0D + 1.0Dg + 1.0 Wo	RohnJ1	-1.79	-1.66	-20.95	2.44	0.29	-0.22	-0.00	0.37	0.00
6:	Service 1.0D + 1.0Dg + 1.0 Wo	RohnJ2	-1.83	1.64	-20.96	2.46	-0.28	-0.24	-0.00	0.37	0.00
6:	Service 1.0D + 1.0Dg + 1.0 Wo	SNB-J1	-3.75	-3.89	-39.71	5.40	0.98	-0.44	-0.01	1.07	0.00
6:	Service 1.0D + 1.0Dg + 1.0 Wo	SNB-J2	-3.75	3.90	-39.75	5.41	-0.98	-0.44	0.01	1.07	0.00
	1.2*DL	RohnJP	-1.07	0.00	19.97	1.07	-0.00	-0.28	-0.00	0.28	0.00
	1.2*DL	SNB-JP	-0.55	0.00	18.61	0.55	-0.00	-0.48	-0.00	0.48	0.00
	1.2*DL	RohnJ1	0.53	0.92	19.79	1.07	-0.24	0.14	-0.00	0.28	0.00
	1.2*DL	RohnJ2	0.54	-0.92	19.88	1.07	0.24	0.14	0.00	0.28	0.00
	1.2*DL	SNB-J1	0.28	0.48	18.39	0.55	-0.41	0.24	-0.00	0.48	0.00
	1.2*DL	SNB-J2	0.28	-0.48	18.49	0.55	0.41	0.24	0.00	0.48	0.00
	0.9DL	RohnJP	-0.80	0.00	14.97	0.80	-0.00	-0.21	-0.00	0.21	0.00
	0.9DL	SNB-JP	-0.41	0.00	13.95	0.41	-0.00	-0.36	-0.00	0.36	0.00
	0.9DL	RohnJ1	0.40	0.69	14.84	0.80	-0.18	0.10	-0.00	0.21	0.00
	0.9DL	RohnJ2	0.40	-0.69	14.91	0.80	0.18	0.10	0.00	0.21	0.00
	0.9DL	SNB-J1	0.21	0.36	13.79	0.41	-0.31	0.18	-0.00	0.36	0.00
	0.9DL	SNB-J2	0.21	-0.36	13.87	0.41	0.31	0.18	0.00	0.36	0.00

Summary of Joint Support Reactions For All Load Cases in Direction of Leg:

Load Case	Support Joint	Origin Joint	Leg Member	Force In Leg Dir.	Residual Perpendicular	Residual Shear		Residual Shear		Total Long.	Total Tran.	Total Vert.
						To Leg	Horizontal	To Leg - Res.	Horizontal			
					(kips)	(kips)	(kips)	(kips)	(kips)	(kips)	(kips)	(kips)
1:	1.2D + 1.0Dg + 1.6Wo	RohnJP	RohnIaS	Rohn-LI2P	356.461	15.609	15.621	-0.108	15.621	-29.67	0.11	355.57
1:	1.2D + 1.0Dg + 1.6Wo	SNB-JP	SNB-IaS	SNB-LI2P	513.663	31.080	31.104	-0.002	31.104	-51.25	0.00	512.04
1:	1.2D + 1.0Dg + 1.6Wo	RohnJ1	RohnIa1	Rohn-LI21	-148.363	8.236	8.241	4.976	6.570	-9.49	-10.04	-147.95
1:	1.2D + 1.0Dg + 1.6Wo	RohnJ2	RohnIa2	Rohn-LI22	-148.665	8.334	8.340	-4.874	6.767	-9.70	9.95	-148.25
1:	1.2D + 1.0Dg + 1.6Wo	SNB-J1	SNB-Ia1	SNB-LI21	-228.719	17.063	17.075	17.075	13.055	-17.54	-18.77	-227.91
1:	1.2D + 1.0Dg + 1.6Wo	SNB-J2	SNB-Ia2	SNB-LI22	-229.194	17.081	17.092	-11.022	13.064	-17.56	18.80	-228.39
2:	0.9D + 1.0Dg + 1.6Wo	RohnJP	RohnIaS	Rohn-LI2P	351.026	15.554	15.566	-0.108	15.566	-29.40	0.11	350.14
2:	0.9D + 1.0Dg + 1.6Wo	SNB-JP	SNB-IaS	SNB-LI2P	508.424	31.141	31.166	-0.001	31.166	-51.11	0.00	506.81
2:	0.9D + 1.0Dg + 1.6Wo	RohnJ1	RohnIa1	Rohn-LI21	-153.095	8.308	8.314	5.041	6.611	-9.63	-10.26	-152.67
2:	0.9D + 1.0Dg + 1.6Wo	RohnJ2	RohnIa2	Rohn-LI22	-153.419	8.406	8.411	-4.938	6.809	-9.83	10.17	-153.00
2:	0.9D + 1.0Dg + 1.6Wo	SNB-J1	SNB-Ia1	SNB-LI21	-233.030	17.031	17.043	10.971	13.042	-17.61	-18.88	-232.22
2:	0.9D + 1.0Dg + 1.6Wo	SNB-J2	SNB-Ia2	SNB-LI22	-233.529	17.047	17.059	-10.986	13.051	-17.63	18.92	-232.72
4:	1.2D + 1.0Dg + 1.0E	RohnJP	RohnIaS	Rohn-LI2P	41.748	0.887	0.887	-0.003	0.887	-2.53	0.00	41.68
4:	1.2D + 1.0Dg + 1.0E	SNB-JP	SNB-IaS	SNB-LI2P	49.569	1.108	1.109	-0.001	1.109	-3.06	0.00	49.49
4:	1.2D + 1.0Dg + 1.0E	RohnJ1	RohnIa1	Rohn-LI21	8.935	0.072	0.072	-0.018	0.069	0.11	0.32	8.93
4:	1.2D + 1.0Dg + 1.0E	RohnJ2	RohnIa2	Rohn-LI22	9.026	0.077	0.077	0.019	0.074	0.10	-0.33	9.02
4:	1.2D + 1.0Dg + 1.0E	SNB-J1	SNB-Ia1	SNB-LI21	2.919	0.828	0.828	0.647	0.517	-0.46	-0.55	2.95
4:	1.2D + 1.0Dg + 1.0E	SNB-J2	SNB-Ia2	SNB-LI22	3.021	0.830	0.831	-0.650	0.517	-0.46	0.55	3.05
5:	0.9D + 1.0Dg + 1.0E	RohnJP	RohnIaS	Rohn-LI2P	36.719	0.818	0.819	-0.003	0.819	-2.27	0.00	36.66
5:	0.9D + 1.0Dg + 1.0E	SNB-JP	SNB-IaS	SNB-LI2P	44.870	1.155	1.156	-0.001	1.156	-2.92	0.00	44.79

5: 0.9D + 1.0Dg + 1.0E	RohnJ1	RohnIa1	Rohn-LI21	4.001	0.114	0.114	0.043	0.105	-0.03	0.09	4.00
5: 0.9D + 1.0Dg + 1.0E	RohnJ2	RohnIa2	Rohn-LI22	4.069	0.118	0.118	-0.042	0.110	-0.03	-0.10	4.07
5: 0.9D + 1.0Dg + 1.0E	SNB-J1	SNB-Ia1	SNB-LI21	-1.660	0.785	0.785	0.609	0.496	-0.53	-0.66	-1.63
5: 0.9D + 1.0Dg + 1.0E	SNB-J2	SNB-Ia2	SNB-LI22	-1.584	0.786	0.787	-0.611	0.496	-0.53	0.66	-1.55
6: Service 1.0D + 1.0Dg + 1.0 Wo	RohnJP	RohnIaS	Rohn-LI2P	91.804	3.699	3.702	-0.025	3.701	-7.32	0.02	91.59
6: Service 1.0D + 1.0Dg + 1.0 Wo	SNB-JP	SNB-IaS	SNB-LI2P	126.076	6.899	6.905	-0.001	6.905	-11.85	0.00	125.71
6: Service 1.0D + 1.0Dg + 1.0 Wo	RohnJ1	RohnIa1	Rohn-LI21	-21.021	1.665	1.666	0.946	1.372	-1.79	-1.66	-20.95
6: Service 1.0D + 1.0Dg + 1.0 Wo	RohnJ2	RohnIa2	Rohn-LI22	-21.033	1.690	1.691	-0.925	1.415	-1.83	1.64	-20.96
6: Service 1.0D + 1.0Dg + 1.0 Wo	SNB-J1	SNB-Ia1	SNB-LI21	-39.885	3.904	3.906	2.537	2.971	-3.75	-3.89	-39.71
6: Service 1.0D + 1.0Dg + 1.0 Wo	SNB-J2	SNB-Ia2	SNB-LI22	-39.927	3.908	3.911	-2.541	2.973	-3.75	3.90	-39.75
1.2*DL	RohnJP	RohnIaS	Rohn-LI2P	19.995	0.281	0.281	-0.001	0.281	-1.07	0.00	19.97
1.2*DL	SNB-JP	SNB-IaS	SNB-LI2P	18.617	0.180	0.180	-0.001	-0.180	-0.55	0.00	18.61
1.2*DL	RohnJ1	RohnIa1	Rohn-LI21	19.812	0.285	0.285	-0.246	-0.143	0.53	0.92	19.79
1.2*DL	RohnJ2	RohnIa2	Rohn-LI22	19.903	0.283	0.283	0.244	-0.143	0.54	-0.92	19.88
1.2*DL	SNB-J1	SNB-Ia1	SNB-LI21	18.395	0.174	0.174	0.151	0.086	0.28	0.48	18.39
1.2*DL	SNB-J2	SNB-Ia2	SNB-LI22	18.497	0.176	0.176	-0.154	0.086	0.28	-0.48	18.49
0.9DL	RohnJP	RohnIaS	Rohn-LI2P	14.995	0.212	0.212	-0.001	0.212	-0.80	0.00	14.97
0.9DL	SNB-JP	SNB-IaS	SNB-LI2P	13.955	0.134	0.134	-0.001	-0.134	-0.41	0.00	13.95
0.9DL	RohnJ1	RohnIa1	Rohn-LI21	14.864	0.214	0.214	-0.186	-0.108	0.40	0.69	14.84
0.9DL	RohnJ2	RohnIa2	Rohn-LI22	14.931	0.213	0.213	0.184	-0.107	0.40	-0.69	14.91
0.9DL	SNB-J1	SNB-Ia1	SNB-LI21	13.797	0.129	0.129	0.113	0.064	0.21	0.36	13.79
0.9DL	SNB-J2	SNB-Ia2	SNB-LI22	13.872	0.131	0.131	-0.115	0.064	0.21	-0.36	13.87

EIA Sections Information:

Section Label	Top Z (ft)	Bottom Z (ft)	Joint Count	Member Count	Top Width (ft)	Bottom Width (ft)	Gross Area (ft^2)	Face Adjust Factor	Face Adjust Factor	Dead Load
A	180.000	160.000	36	111	7.50	8.87	163.75	0.9000	0.9000	1.000
B	160.000	140.000	33	93	8.87	10.23	191.05	0.9000	0.9000	1.000
C	140.000	120.000	27	72	10.23	11.60	218.31	0.9000	0.9000	1.000
D	120.000	100.000	27	72	11.60	12.96	245.54	0.9000	0.9000	1.000
E	100.000	80.000	27	72	12.96	14.32	272.78	0.9000	0.9000	1.000
F	80.000	60.000	21	51	14.32	15.68	300.04	0.9000	0.9000	1.000
G	60.000	40.000	21	51	15.68	17.05	327.29	0.9000	0.9000	1.000
H	40.000	20.000	21	51	17.05	18.41	354.57	0.9000	0.9000	1.000
I	20.000	0.000	18	39	18.41	19.78	381.92	0.9000	0.9000	1.000

Printed capacities do not include the strength factor entered for each load case.
The Group Summary reports on the member and load case that resulted in maximum usage which may not necessarily be the same as that which produces maximum force.

Group Summary (Compression Portion):

Group Label	Group Desc.	Angle Type	Angle Size	Steel Strength (ksi)	Max Usage %	Max In Comp. %	Comp. Control Member	Comp. Force (kips)	Comp. Control Case	L/R Capacity (kips)	Comp. Shear Capacity (kips)	Comp. Conn. Bearing Capacity (kips)	RLX	RLY	RLZ	L/R Length (ft)	Comp. Member	Curve No.	No. Of Bolts Comp.
Rohn-D1	Rohn Diagonal 1	SAE	1.75X1.75X0.1875	36.0	39.98	39.98	Rohn-DA61	-1.9291: 1.2D +		4.825	12.433	13.050	0.500	0.500	0.500	170.38	9.740	4	1
Rohn-D2	Rohn Diagonal 2	SAE	2X2X0.1875	36.0	85.01	85.01	Rohn-DB61	-4.9181: 1.2D +		5.786	12.433	13.050	0.500	0.500	0.500	166.50	10.934	4	1
Rohn-D3	Rohn Diagonal 3	SAE	2.5X2.5X0.1875	36.0	80.35	80.35	Rohn-DC41	-6.8041: 1.2D +		8.468	12.433	13.050	0.500	0.500	0.500	155.13	12.798	4	1
Rohn-D4	Rohn Diagonal 4	SAE	2.5X2.5X0.25	36.0	85.88	85.88	Rohn-DD21	-8.3961: 1.2D +		9.776	12.433	17.400	0.500	0.500	0.500	165.83	13.570	4	1
Rohn-D5	Rohn Diagonal 5	SAE	3X3X0.25	50.0	77.70	77.70	Rohn-DE61	-9.6611: 1.2D +		13.033	12.433	19.500	0.500	0.500	0.500	157.99	15.589	4	1
Rohn-D6	Rohn Diagonal 6	SAE	3.5X3.5X0.25	50.0	94.19	94.19	Rohn-DF32	-11.7121: 1.2D +		15.227	12.433	19.500	0.500	0.500	0.500	158.34	18.315	4	1
Rohn-D7	Rohn Diagonal 7	SAE	4X4X0.25	50.0	83.19	83.19	Rohn-DH12	-10.3431: 1.2D +		19.124	12.433	19.500	0.500	0.500	0.500	151.38	20.058	4	1
Rohn-L1	Rohn Leg 1	Pipe	Pipe3EH	50.0	10.75	10.75	Rohn-LA4P	-11.1821: 1.2D +		103.968	0.000	0.000	1.000	1.000	1.000	52.67	5.004	1	0
Rohn-L2	Rohn Leg 2	Pipe	Pipe3.5EH	50.0	29.08	29.08	Rohn-LB4P	-38.6001: 1.2D +		132.756	0.000	0.000	1.000	1.000	1.000	45.84	5.004	1	0
Rohn-L3	Rohn Leg 3	Pipe	Pipe4EH	50.0	50.99	50.99	Rohn-LC3P	-76.7221: 1.2D +		150.478	0.000	0.000	1.000	1.000	1.000	54.04	6.665	1	0
Rohn-L4	Rohn Leg 4	Pipe	Pipe5STD	50.0	81.28	81.28	Rohn-LD3P	-129.1271: 1.2D +		158.870	0.000	0.000	1.000	1.000	1.000	42.54	6.665	1	0
Rohn-L5	Rohn Leg 5	Pipe	Pipe5EH	50.0	77.58	77.58	Rohn-LE3P	-174.1791: 1.2D +		224.520	0.000	0.000	1.000	1.000	1.000	43.23	6.665	1	0
Rohn-L6	Rohn Leg 6	Pipe	Pipe6EHS	50.0	80.00	80.00	Rohn-LF1P	-195.0311: 1.2D +		243.786	0.000	0.000	1.000	1.000	1.000	54.10	10.008	1	0
Rohn-L7	Rohn Leg 7	Pipe	Pipe6EH	50.0	92.59	92.59	Rohn-LG2P	-264.0551: 1.2D +		285.178	0.000	0.000	1.000	1.000	1.000	54.59	10.008	1	0
Rohn-L8	Rohn Leg 8	Pipe	Pipe8EHS	50.0	83.60	83.60	Rohn-LI1P	-328.8561: 1.2D +		393.385	0.000	0.000	1.000	1.000	1.000	40.57	10.008	1	0
Rohn-H1	Rohn Horizontal 1	SAE	1.75X1.75X0.1875	36.0	2.54	2.54	Rohn-H12	-0.2061: 1.2D +		8.108	0.000	0.000	0.500	0.500	0.500	131.28	7.505	4	0
SNB-D1	SNB Diagonal 1	SAE	2X2X0.3125	36.0	11.97	11.82	SNB-DA72	-1.4701: 1.2D +		19.391	12.433	21.750	0.500	0.500	0.500	111.38	7.240	1	1

SNB-D2	SNB Diagonal	2	SAE	2X2X0.25	36.0	28.60	28.60	SNB-DB72	-3.5561: 1.2D +	13.020	12.433	17.400	0.500	0.500	0.500	127.05	8.279	4	1
SNB-D3	SNB Diagonal	3	SAE	2.5X2.5X0.3125	36.0	76.71	76.71	SNB-DD61	-9.5371: 1.2D +	16.821	12.433	21.750	0.500	0.500	0.500	140.03	11.412	4	1
SNB-D4	SNB Diagonal	4	SAE	3X3X0.5	36.0	71.30	71.30	SNB-DE12	-12.7631: 1.2D +	41.188	17.901	41.760	0.500	0.500	0.500	121.07	11.784	4	1
SNB-D5	SNB Diagonal	5	SAE	4X4X0.5	36.0	69.06	69.06	SNB-DF41	-12.3632: 0.9D +	57.545	17.901	41.760	0.500	0.500	0.500	119.15	15.529	1	1
SNB-D6	SNB Diagonal	6	SAE	4X4X0.625	36.0	91.41	91.41	SNB-DH12	-16.3642: 0.9D +	59.660	17.901	52.200	0.500	0.500	0.500	132.03	17.142	4	1
SNB-D7	SNB Diagonal	7	SAE	5X5X0.625	36.0	0.00	0.00		0.000	0.000	0.000	0.000	0.000	0.000	0.00	0.000	0	0	
SNB-L1	SNB Leg	1	Pipe	P3-437	36.0	7.63	7.63	SNB-LA4P	-8.8511: 1.2D +	115.987	0.000	0.000	1.000	1.000	0.000	55.09	5.004	1	0
SNB-L2	SNB Leg	2	Pipe	P4-494	36.0	45.88	45.88	SNB-LC3P	-78.1191: 1.2D +	170.256	0.000	0.000	1.000	1.000	1.000	56.33	6.665	1	0
SNB-L3	SNB Leg	3	Pipe	Pipe5EH	36.0	82.04	82.04	SNB-LD3P	-137.7931: 1.2D +	167.960	0.000	0.000	1.000	1.000	1.000	43.23	6.665	1	0
SNB-L4	SNB Leg	4	Pipe	P6-562	36.0	92.27	92.27	SNB-LF2P	-271.4381: 1.2D +	294.167	0.000	0.000	1.000	1.000	1.000	55.86	10.008	1	0
SNB-L5	SNB Leg	5	Pipe	Pipe8XS	36.0	99.89	99.89	SNB-LH2P	-411.9051: 1.2D +	412.353	0.000	0.000	1.000	1.000	1.000	10.42	10.008	1	0
SNB-L6	SNB Leg	6	Pipe	Pipe10XS	36.0	95.26	95.26	SNB-LI2P	-489.8271: 1.2D +	514.179	0.000	0.000	0.500	0.500	0.500	16.54	10.008	1	0
Connect	Connect Towers	BIG		0.1X0.1X1	36.0	0.03	0.01	Connect I2	-2.9152: 0.9D +	25912.070	0.000	0.000	1.000	1.000	1.000	2.40	2.002	1	0
SNB-H1	SNB Horizontal	1	Pipe	P3-425	36.0	2.17	2.17	SNB-H4cP	-2.5992: 0.9D +	119.859	0.000	0.000	1.000	1.000	1.000	44.46	4.066	1	0
SNB-H2	SNB Horizontal	2	Pipe	P4-494	36.0	3.94	3.94	SNB-H9cP	-6.4192: 0.9D +	163.108	0.000	0.000	1.000	1.000	1.000	63.14	7.472	1	0
Rohn-D8	Rohn Diagonal	8	SAE	2X2X0.375	36.0	0.00	0.00		0.000	0.000	0.000	0.000	0.000	0.000	0.00	0.000	0	0	
WLAC-1	Wind Lacing	1	SAE	2X2X0.25	36.0	1.66	1.66	SNB-WL-D2P	-0.2222: 0.9D +	13.417	0.000	0.000	1.000	1.000	1.000	124.79	4.066	4	0
WLAC-2	Wind Lacing	2	SAE	2.5X2.5X0.3125	36.0	3.50	3.50	SNB-WL-I2P	-0.3431: 1.2D +	9.810	0.000	0.000	1.000	1.000	1.000	183.36	7.472	4	0
R-D1-MOD	MODIFICATION - L1.75X1.75x3/16	SAE	1.75X1.75X0.1875	50.0	0.00	0.00		0.000	0.000	0.000	0.000	0.000	0.000	0.000	0.00	0.000	0	0	
R-D2-MOD	MODIFICATION - L2X2x3/16	SAE	2X2X0.1875	50.0	0.00	0.00		0.000	0.000	0.000	0.000	0.000	0.000	0.000	0.00	0.000	0	0	
R-D3-MOD	MODIFICATION - L2.5X2.5x1/4	SAE	2.5X2.5X0.25	50.0	87.77	87.77	Rohn-DC61	-9.1001: 1.2D +	10.368	12.433	19.500	0.500	0.500	0.500	161.02	13.177	4	1	
R-D4-MOD	MODIFICATION - L3x3x1/4	SAE	3X3X0.25	50.0	81.41	81.41	Rohn-DD41	-10.1221: 1.2D +	16.211	12.433	19.500	0.500	0.500	0.500	141.66	13.977	4	1	
R-D5-MOD	MODIFICATION - L3X3x1/4	SAE	3X3X0.25	50.0	0.00	0.00		0.000	0.000	0.000	0.000	0.000	0.000	0.000	0.00	0.000	0	0	
R-D6-MOD	MODIFICATION - L3.5X3.5x5/16	SAE	3.5X3.5X0.3125	50.0	0.00	0.00		0.000	0.000	0.000	0.000	0.000	0.000	0.000	0.00	0.000	0	0	
R-D7-MOD	MODIFICATION - L4X4x5/16	SAE	4X4X0.3125	50.0	80.14	80.14	Rohn-DH32	-12.4551: 1.2D +	22.091	15.542	24.375	0.500	0.500	0.500	156.66	20.653	4	1	
S-D1-MOD	MODIFICATION - L2X2x5/16	SAE	2X2X0.3125	50.0	0.00	0.00		0.000	0.000	0.000	0.000	0.000	0.000	0.000	0.00	0.000	0	0	
S-D2-MOD	MODIFICATION - L2x2x1/4	SAE	2X2X0.25	50.0	0.00	0.00		0.000	0.000	0.000	0.000	0.000	0.000	0.000	0.00	0.000	0	0	
S-D3-MOD	MODIFICATION - L2.5X2.5x5/16	SAE	2.5X2.5X0.3125	50.0	0.00	0.00		0.000	0.000	0.000	0.000	0.000	0.000	0.000	0.00	0.000	0	0	
S-D4-MOD	MODIFICATION - L3.5X3.5x3/8	SAE	3.5X3.5X0.375	50.0	0.00	0.00		0.000	0.000	0.000	0.000	0.000	0.000	0.000	0.00	0.000	0	0	
S-D5-MOD	MODIFICATION - L4X4x0.5	SAE	4X4X0.5	50.0	0.00	0.00		0.000	0.000	0.000	0.000	0.000	0.000	0.000	0.00	0.000	0	0	
S-D6-MOD	MODIFICATION - L5X5x3/8	SAE	5X5X0.375	50.0	67.08	67.08	SNB-DH32	-15.0102: 0.9D +	70.032	22.376	35.100	0.500	0.500	0.500	107.27	17.700	1	1	
S-D7-MOD	MODIFICATION - L6X6x3/8	SAE	6X6X0.375	50.0	91.87	91.87	SNB-DI32	-20.5582: 0.9D +	95.638	22.376	35.100	0.500	0.500	0.500	94.99	18.841	1	1	

Group Summary (Tension Portion):

Group Label	Group Desc.	Angle Type	Angle Size	Steel Strength (ksi)	Max Usage %	Max Use In Tens. %	Tension Control Member	Tension Force (kips)	Tension Control Load Case	Net Section Capacity (kips)	Tens. Capacity (kips)	Conn. Shear Capacity (kips)	Tens. Capacity (kips)	Conn. Rupture Capacity (kips)	Length Tens. Member (ft)	No. Of Bolts Tens.	No. Of Holes	Hole Diameter (in)
Rohn-D1	Rohn Diagonal	1	SAE 1.75X1.75X0.1875	36.0	39.98	23.80	Rohn-DA8P	1.8452: 0.9D +	16.022	12.433	12.433	13.050	7.750	10.034	1	1.000	0.6875	
Rohn-D2	Rohn Diagonal	2	SAE 2X2X0.1875	36.0	85.01	52.18	Rohn-DB7P	4.5762: 0.9D +	18.958	12.433	12.433	13.050	8.770	11.238	1	1.000	0.6875	
Rohn-D3	Rohn Diagonal	3	SAE 2.5X2.5X0.1875	36.0	80.35	57.04	Rohn-DC3P	5.5831: 1.2D +	25.222	12.433	12.433	13.050	9.787	12.798	1	1.000	0.6875	
Rohn-D4	Rohn Diagonal	4	SAE 2.5X2.5X0.25	36.0	85.88	54.84	Rohn-DD1P	6.8182: 0.9D +	33.216	12.433	12.433	17.400	13.050	13.570	1	1.000	0.6875	
Rohn-D5	Rohn Diagonal	5	SAE 3X3X0.25	50.0	77.70	70.46	Rohn-DE5P	8.7612: 0.9D +	46.366	12.433	12.433	19.500	14.625	15.589	1	1.000	0.6875	
Rohn-D6	Rohn Diagonal	6	SAE 3.5X3.5X0.25	50.0	94.19	83.46	Rohn-DF1P	10.3772: 0.9D +	55.506	12.433	12.433	19.500	14.625	17.748	1	1.000	0.6875	
Rohn-D7	Rohn Diagonal	7	SAE 4X4X0.25	50.0	83.19	78.44	Rohn-DH2P	9.7532: 0.9D +	64.647	12.433	12.433	19.500	14.625	20.058	1	1.000	0.6875	
Rohn-L1	Rohn Leg	1	Pipe Pipe3.5EH	50.0	10.75	3.33	Rohn-LA42	4.2412: 0.9D +	127.350	0.000	0.000	0.000	0.000	5.004	0	0.000	0	
Rohn-L2	Rohn Leg	2	Pipe Pipe3.5EH	50.0	29.08	9.81	Rohn-LB42	15.1912: 0.9D +	154.800	0.000	0.000	0.000	0.000	5.004	0	0.000	0	
Rohn-L3	Rohn Leg	3	Pipe Pipe4EH	50.0	50.99	16.39	Rohn-LC32	30.5322: 0.9D +	186.300	0.000	0.000	0.000	0.000	6.665	0	0.000	0	
Rohn-L4	Rohn Leg	4	Pipe Pipe5TD	50.0	81.28	29.70	Rohn-LD32	53.8652: 0.9D +	181.350	0.000	0.000	0.000	0.000	6.665	0	0.000	0	
Rohn-L5	Rohn Leg	5	Pipe Pipe5EH	50.0	77.58	28.86	Rohn-LE32	74.2802: 0.9D +	257.400	0.000	0.000	0.000	0.000	6.665	0	0.000	0	
Rohn-L6	Rohn Leg	6	Pipe Pipe6EHS	50.0	80.00	31.28	Rohn-LF22	94.4572: 0.9D +	301.950	0.000	0.000	0.000	0.000	10.008	0	0.000	0	
Rohn-L7	Rohn Leg	7	Pipe Pipe6EH	50.0	92.59	37.66	Rohn-LH22	133.5252: 0.9D +	354.599	0.000	0.000	0.000	0.000	10.008	0	0.000	0	
Rohn-L8	Rohn Leg	8	Pipe Pipe8EHS	50.0	83.60	33.71	Rohn-LI22	149.5632: 0.9D +	443.699	0.000	0.000	0.000	0.000	10.008	0	0.000	0	
Rohn-H1	Rohn Horizontal	1	SAE 1.75X1.75X0.1875	36.0	2.54	1.11	Rohn-H11	0.2242: 0.9D +	20.088	0.000	0.000	0.000	0.000	7.505	0	0.000	0	
SNB-D1	SNB Diagonal	1	SAE 2X2X0.3125	36.0	11.97	11.97	SNB-DA7P	1.4891: 1.2D +	30.509	12.433	12.433	21.750	14.616	7.240	1	1.000	0.6875	
SNB-D2	SNB Diagonal	2	SAE 2X2X0.25	36.0	28.60	28.25	SNB-DB6P	3.3031: 1.2D +	25.060	12.433	12.433	17.400	11.693	8.011	1	1.000	0.6875	
SNB-D3	SNB Diagonal	3	SAE 2.5X2.5X0.3125	36.0	76.71	72.64	SNB-DD3P	9.0311: 1.2D +	40.623	12.433	12.433	21.750	16.312	11.059	1	1.000	0.6875	
SNB-D4	SNB Diagonal	4	SAE 3X3X0.5	36.0	71.30	66.08	SNB-DE4P	11.8291: 1.2D +	76.465	17.901	17.901	41.760	31.494	12.172	1	1.000	0.8125	
SNB-D5	SNB Diagonal	5	SAE 4X4X0.5	36.0	69.06	64.14	SNB-DF2P	11.4811: 1.2D +	109.090	17.901	17.901	41.760	31.494	15.014	1	1.000	0.8125	
SNB-D6	SNB Diagonal	6	SAE 4X4X0.625	36.0	91.41	76.59	SNB-DH2P	13.7111: 1.2D +	133.834	17.901	17.901	52.200	39.367	17.142	1	1.000	0.8125	
SNB-D7	SNB Diagonal	7	SAE 5X5X0.625	36.0	0.00	0.00		0.000	0.000	0.000	0.000	0.000	0.000	0.000	0	0.000	0	
SNB-L1	SNB Leg	1	Pipe P3-437	36.0	7.63	2.32	SNB-LA42	3.1542: 0.9D +	136.080	0.000	0.000	0.000	0.000	5.004	0	0.000	0	
SNB-L2	SNB Leg	2	Pipe P4-494	36.0	45.88	17.26	SNB-LC32	34.7222: 0.9D +	201.204	0.000	0.000	0.000	0.000	6.665	0	0.000	0	
SNB-L3	SNB Leg	3	Pipe Pipe5EH	36.0	82.04	33.79	SNB-LD32	62.6292: 0.9D +	185.328	0.000	0.000	0.000	0.000	6.665	0	0.000	0	
SNB-L4	SNB Leg	4	Pipe P6-562	36.0	92.27	35.75	SNB-LF22	123.9222: 0.9D +	346.679	0.000	0.000	0.000	0.000	10.008	0	0.000	0	
SNB-L5	SNB Leg	5	Pipe Pipe8XS	36.0	99.89	45.21	SNB-LH22	187.4862: 0.9D +	414.719	0.000	0.000	0.000	0.000	10.008	0	0.000	0	

SNB-L6	SNB Leg 6	Pipe	Pipe10XS	36.0	95.26	42.67	SNB-LI22	222.5602: 0.9D +	521.639	0.000	0.000	0.000	10.008	0	0.000	0
Connect	Connect Towers	BIG	0.1X0.1X1	36.0	0.03	0.03	Connect IP	7.1811: 1.2D +	25919.960	0.000	0.000	0.000	2.002	0	0.000	0
SNB-H1	SNB Horizontal 1	Pipe	P3-425	36.0	2.17	1.55	SNB-H4eP	2.0561: 1.2D +	133.002	0.000	0.000	0.000	4.066	0	0.000	0
SNB-H2	SNB Horizontal 2	Pipe	P4-494	36.0	3.94	1.87	SNB-H9bP	3.7551: 1.2D +	201.204	0.000	0.000	0.000	7.472	0	0.000	0
Rohn-D8	Rohn Diagonal 8	SAE	2X2X0.375	36.0	0.00	0.00		0.000	0.000	0.000	0.000	0.000	0.000	0	0.000	0
WLAC-1	Wind Lacing 1	SAE	2X2X0.25	36.0	1.66	1.47	SNB-WL-D3P	0.4471: 1.2D +	30.456	0.000	0.000	0.000	4.066	0	0.000	0
WLAC-2	Wind Lacing 2	SAE	2.5X2.5X0.3125	36.0	3.50	1.45	SNB-WL-I3P	0.6861: 1.2D +	47.304	0.000	0.000	0.000	7.472	0	0.000	0
R-D1-MOD	MODIFICATION - L1.75X1.75x3/16	SAE	1.75X1.75X0.1875	50.0	0.00	0.00		0.000	0.000	0.000	0.000	0.000	0.000	0	0.000	0
R-D2-MOD	MODIFICATION - L2X2x3/16	SAE	2X2X0.1875	50.0	0.00	0.00		0.000	0.000	0.000	0.000	0.000	0.000	0	0.000	0
R-D3-MOD	MODIFICATION - L2.5X2.5x1/4	SAE	2.5X2.5X0.25	50.0	87.77	64.19	Rohn-DC5P	7.9812: 0.9D +	37.225	12.433	19.500	14.625	13.177	1	1.000	0.6875
R-D4-MOD	MODIFICATION - L3x3x1/4	SAE	3X3X0.25	50.0	81.41	78.63	Rohn-DD3P	9.7761: 1.2D +	46.366	12.433	19.500	14.625	13.977	1	1.000	0.6875
R-D5-MOD	MODIFICATION - L3X3x1/4	SAE	3X3X0.25	50.0	0.00	0.00		0.000	0.000	0.000	0.000	0.000	0.000	0	0.000	0
R-D6-MOD	MODIFICATION - L3.5X3.5x5/16	SAE	3.5X3.5X0.3125	50.0	0.00	0.00		0.000	0.000	0.000	0.000	0.000	0.000	0	0.000	0
R-D7-MOD	MODIFICATION - L4X4x5/16	SAE	4X4X0.3125	50.0	80.14	72.20	Rohn-DH4P	11.2222: 0.9D +	79.895	15.542	24.375	18.281	20.653	1	1.000	0.6875
S-D1-MOD	MODIFICATION - L2X2x5/16	SAE	2X2X0.3125	50.0	0.00	0.00		0.000	0.000	0.000	0.000	0.000	0.000	0	0.000	0
S-D2-MOD	MODIFICATION - L2x2x1/4	SAE	2X2X0.25	50.0	0.00	0.00		0.000	0.000	0.000	0.000	0.000	0.000	0	0.000	0
S-D3-MOD	MODIFICATION - L2.5X2.5x5/16	SAE	2.5X2.5X0.3125	50.0	0.00	0.00		0.000	0.000	0.000	0.000	0.000	0.000	0	0.000	0
S-D4-MOD	MODIFICATION - L3.5X3.5x3/8	SAE	3.5X3.5X0.375	50.0	0.00	0.00		0.000	0.000	0.000	0.000	0.000	0.000	0	0.000	0
S-D5-MOD	MODIFICATION - L4X4x0.5	SAE	4X4X0.5	50.0	0.00	0.00		0.000	0.000	0.000	0.000	0.000	0.000	0	0.000	0
S-D6-MOD	MODIFICATION - L5X5x3/8	SAE	5X5X0.375	50.0	67.08	59.60	SNB-DG4P	13.3371: 1.2D +	120.850	22.376	35.100	26.471	16.594	1	1.000	0.8125
S-D7-MOD	MODIFICATION - L6X6x3/8	SAE	6X6X0.375	50.0	91.87	79.57	SNB-DI4P	17.8061: 1.2D +	148.272	22.376	35.100	26.471	18.841	1	1.000	0.8125

*** Maximum Stress Summary for Each Load Case

Summary of Maximum Usages by Load Case:

Load Case	Maximum Usage %	Element Label	Element Type
1: 1.2D + 1.0Dg + 1.6Wo	99.89	SNB-LH2P	Angle
2: 0.9D + 1.0Dg + 1.6Wo	98.84	SNB-LH2P	Angle
4: 1.2D + 1.0Dg + 1.0E	12.49	Rohn-LD3P	Angle
5: 0.9D + 1.0Dg + 1.0E	11.06	Rohn-LD3P	Angle
6: Service 1.0D + 1.0Dg + 1.0 Wo	24.51	SNB-LH1P	Angle
1.2*DL	5.68	Rohn-LD3P	Angle
0.9DL	4.26	Rohn-LD3P	Angle

*** Weight of structure (lbs):

Weight of Angles*Section DLF:	61800.0
Weight of Equipment:	12661.2
Total:	74461.2

*** End of Report

PLS-TOWER NODE LOCATIONS

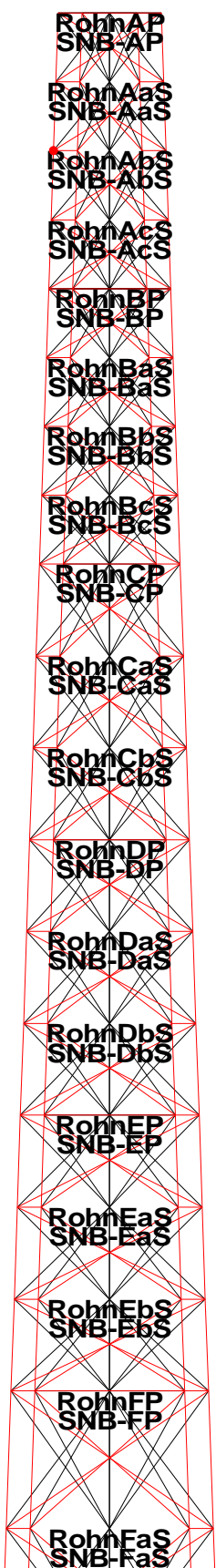

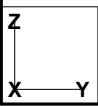
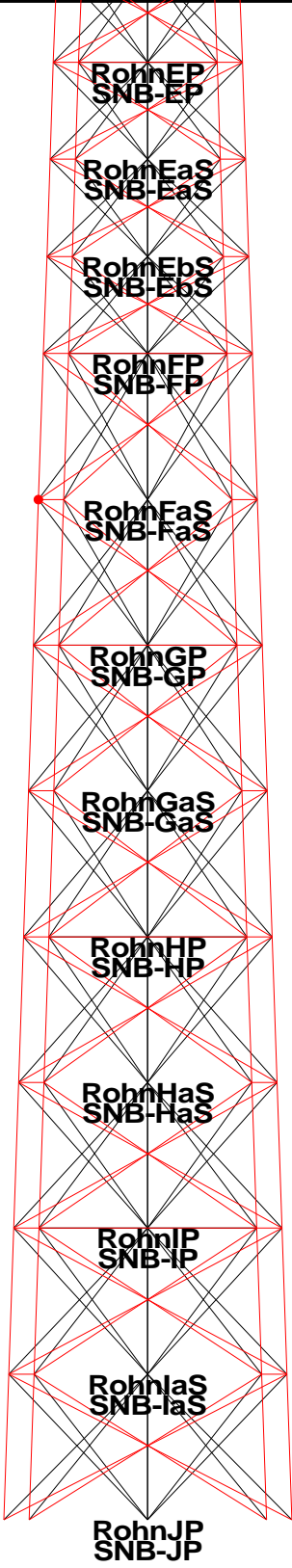

PLS-TOWER MEMBER LOCATIONS

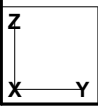
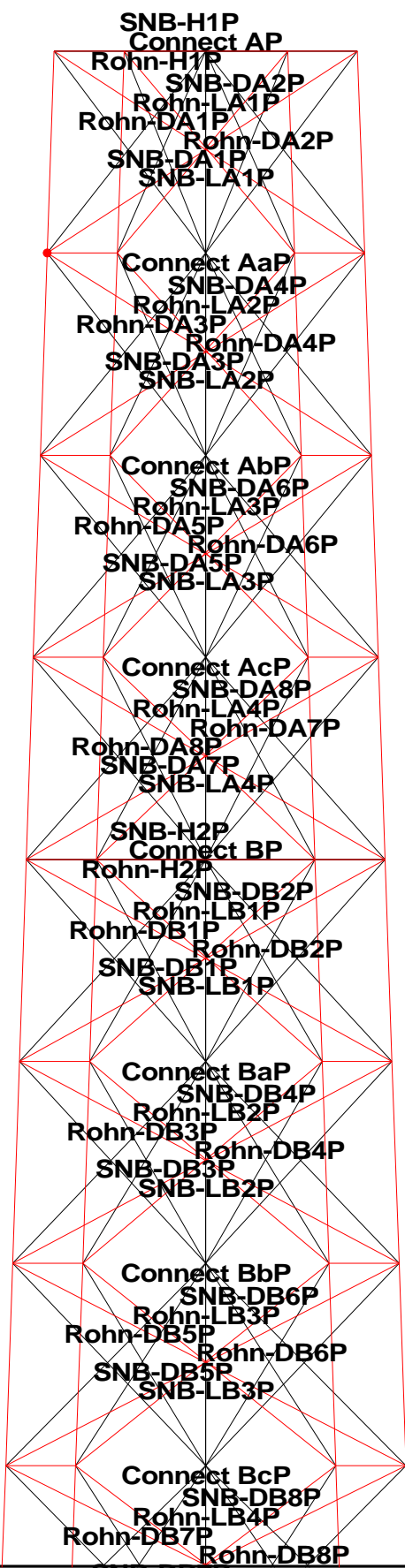

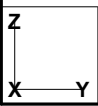
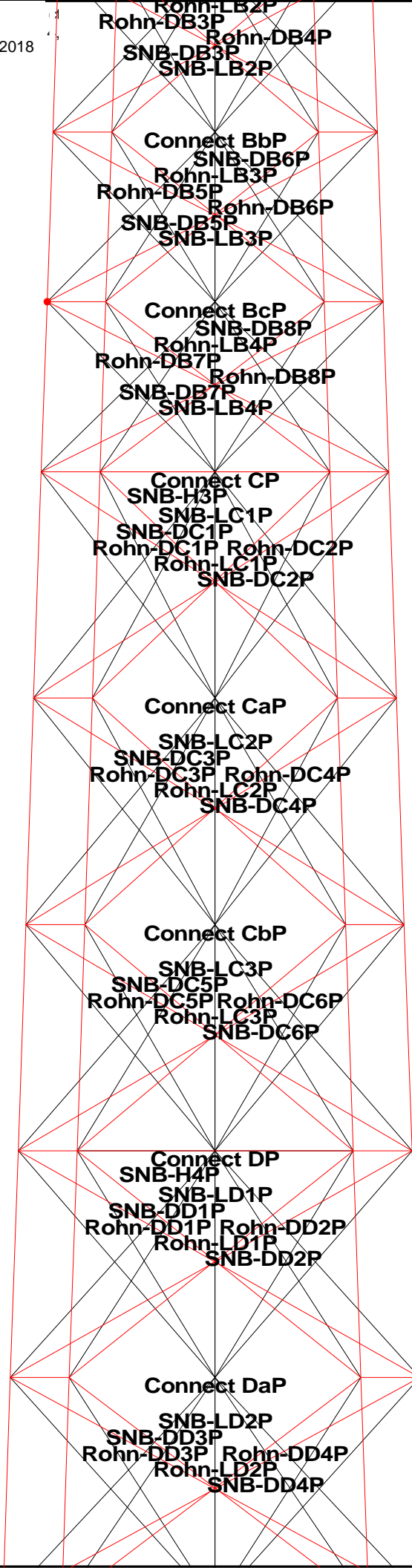

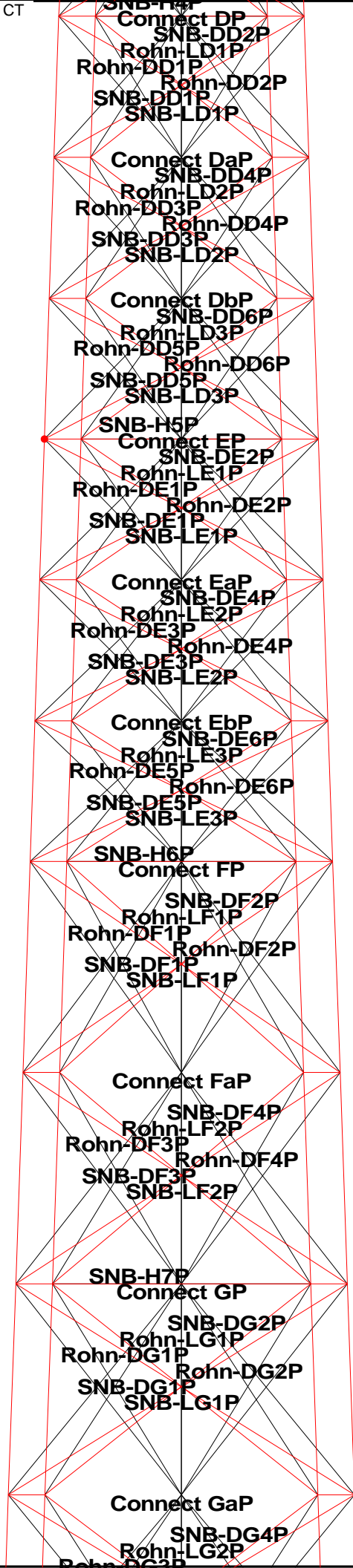

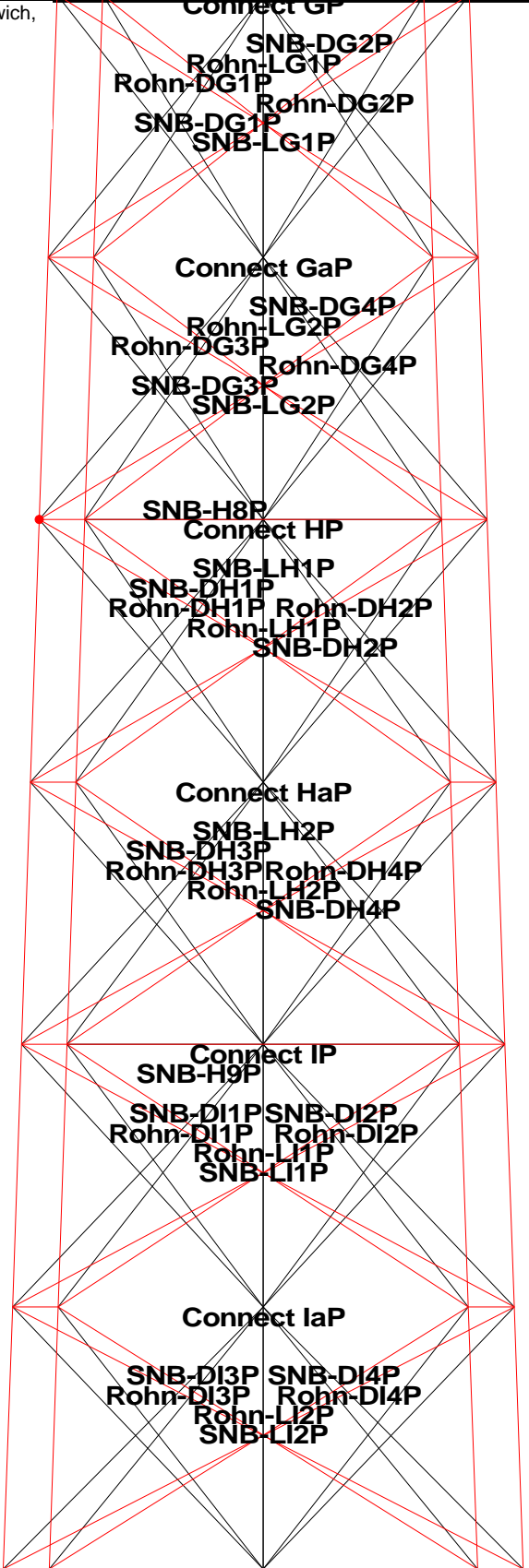

PLS-TOWER DETAILED OUTPUT

Project Name : Multi-Carrier Analysis
 Project Notes: Butternut Hollow
 Project File : P:\Projects\Telcom\StructuralsByLocation\Connecticut\GreenwichCSP#74\13-10102018 - Re-issue_Multicarrier_PLS_G\PLS-Tower_Wind_0\4-Carir.tow
 Date run : 5:49:08 PM Thursday, October 11, 2018
 by : Tower Version 10.62
 Licensed to : URS Connecticut

Successfully performed nonlinear analysis

Unusual number of fixed joints found: 6. Towers normally have from between 1 and 4 fixed joints. ??
 Linear appurtenance "DNK1-7/8" @ 56" is included in the face zone (face solidity ratio for Rev. F), but does not contribute to wind load: this is nonsensical ??
 Linear appurtenance "DNK2-7/8" @ 54" is included in the face zone (face solidity ratio for Rev. F), but does not contribute to wind load: this is nonsensical ??
 Linear appurtenance "DNK3-7/8" @ 60" is included in the face zone (face solidity ratio for Rev. F), but does not contribute to wind load: this is nonsensical ??
 Linear appurtenance "DNK4-7/8" @ 65" is included in the face zone (face solidity ratio for Rev. F), but does not contribute to wind load: this is nonsensical ??
 Linear appurtenance "DNK5-1-5/8" @ 82" is included in the face zone (face solidity ratio for Rev. F), but does not contribute to wind load: this is nonsensical ??
 Linear appurtenance "DNK6-Hybriflex Cables @ Sprint" is included in the face zone (face solidity ratio for Rev. F), but does not contribute to wind load: this is nonsensical ??
 Linear appurtenance "DNK7-7/8" @ 110" is included in the face zone (face solidity ratio for Rev. F), but does not contribute to wind load: this is nonsensical ??
 Linear appurtenance "DNK8-7/8" @ 122" is included in the face zone (face solidity ratio for Rev. F), but does not contribute to wind load: this is nonsensical ??
 Linear appurtenance "DNK9-7/8" @ 122" is included in the face zone (face solidity ratio for Rev. F), but does not contribute to wind load: this is nonsensical ??
 Linear appurtenance "DNK10-1-5/8" @ VZW" is included in the face zone (face solidity ratio for Rev. F), but does not contribute to wind load: this is nonsensical ??
 Linear appurtenance "DNK11-1-5/8" @ 130" is included in the face zone (face solidity ratio for Rev. F), but does not contribute to wind load: this is nonsensical ??
 Linear appurtenance "DNK12-7/8" @ 135" is included in the face zone (face solidity ratio for Rev. F), but does not contribute to wind load: this is nonsensical ??
 Linear appurtenance "DNK13,14-1-5/8" @ T-Mobile" is included in the face zone (face solidity ratio for Rev. F), but does not contribute to wind load: this is nonsensical ??
 Linear appurtenance "DNK15-7/8" @ 137" is included in the face zone (face solidity ratio for Rev. F), but does not contribute to wind load: this is nonsensical ??
 Linear appurtenance "DNK16,17,18-1-5/8" @ ATT" is included in the face zone (face solidity ratio for Rev. F), but does not contribute to wind load: this is nonsensical ??
 Linear appurtenance "DNK16,17,18-Optic Fiber Cable @ ATT" is included in the face zone (face solidity ratio for Rev. F), but does not contribute to wind load: this is nonsensical ??
 Linear appurtenance "DNK16,17,18-DC Cable @ ATT" is included in the face zone (face solidity ratio for Rev. F), but does not contribute to wind load: this is nonsensical ??
 Linear appurtenance "DNK19-7/8" @ 159" is included in the face zone (face solidity ratio for Rev. F), but does not contribute to wind load: this is nonsensical ??
 Linear appurtenance "DNK20-7/8" @ 159.5" is included in the face zone (face solidity ratio for Rev. F), but does not contribute to wind load: this is nonsensical ??
 Linear appurtenance "CSP70,71,72-1-5/8" @ 160(3)" is included in the face zone (face solidity ratio for Rev. F), but does not contribute to wind load: this is nonsensical ??
 Linear appurtenance "CSP73-1/2" @ 160" is included in the face zone (face solidity ratio for Rev. F), but does not contribute to wind load: this is nonsensical ??
 Linear appurtenance "DNK21-Elliptical @ 160" is included in the face zone (face solidity ratio for Rev. F), but does not contribute to wind load: this is nonsensical ??
 Linear appurtenance "DNK22-7/8" @ 165" is included in the face zone (face solidity ratio for Rev. F), but does not contribute to wind load: this is nonsensical ??
 Linear appurtenance "DNK23A-1-5/8" @ 168" is included in the face zone (face solidity ratio for Rev. F), but does not contribute to wind load: this is nonsensical ??
 Linear appurtenance "DNK23B-1/2" @ 168" is included in the face zone (face solidity ratio for Rev. F), but does not contribute to wind load: this is nonsensical ??
 Linear appurtenance "DNK26-B-1-5/8" @ 175" is included in the face zone (face solidity ratio for Rev. F), but does not contribute to wind load: this is nonsensical ??
 Linear appurtenance "DNK26A-7/8" @ 175" is included in the face zone (face solidity ratio for Rev. F), but does not contribute to wind load: this is nonsensical ??
 Linear appurtenance "DNK26C-1/2" @ 175" is included in the face zone (face solidity ratio for Rev. F), but does not contribute to wind load: this is nonsensical ??
 Linear appurtenance "DNK27-B-1-5/8" @ 175" is included in the face zone (face solidity ratio for Rev. F), but does not contribute to wind load: this is nonsensical ??
 Linear appurtenance "DNK27A-7/8" @ 175" is included in the face zone (face solidity ratio for Rev. F), but does not contribute to wind load: this is nonsensical ??
 Linear appurtenance "DNK27C-3/8" @ 175" is included in the face zone (face solidity ratio for Rev. F), but does not contribute to wind load: this is nonsensical ??
 Linear appurtenance "DNK28A-1-5/8" @ 175" is included in the face zone (face solidity ratio for Rev. F), but does not contribute to wind load: this is nonsensical ??
 Linear appurtenance "DNK28B-1-5/8" @ 175" is included in the face zone (face solidity ratio for Rev. F), but does not contribute to wind load: this is nonsensical ??
 Linear appurtenance "DNK28C-1-5/8" @ 175" is included in the face zone (face solidity ratio for Rev. F), but does not contribute to wind load: this is nonsensical ??
 Linear appurtenance "DNK28D-7/8" @ 175" is included in the face zone (face solidity ratio for Rev. F), but does not contribute to wind load: this is nonsensical ??
 Linear appurtenance "GRN-1-Elliptical @ 172 (DNK25)" is included in the face zone (face solidity ratio for Rev. F), but does not contribute to wind load: this is nonsensical ??
 Linear appurtenance "VZW-(3) Hybriflex Cables" is included in the face zone (face solidity ratio for Rev. F), but does not contribute to wind load: this is nonsensical ??
 Linear appurtenance "Hybriflex 6x12 Cables @ T-Mobile" is included in the face zone (face solidity ratio for Rev. F), but does not contribute to wind load: this is nonsensical ??
 Linear appurtenance "Hybriflex 9x18 Cables @ T-Mobile" is included in the face zone (face solidity ratio for Rev. F), but does not contribute to wind load: this is nonsensical ??
 The model has 40 warnings. ??

Nonlinear convergence parameters: Use Standard Parameters
 Member check option: ANSI/TIA 222-G-1
 Connection rupture check: ANSI/TIA 222-G-1
 Crossing diagonal check: ANSI/TIA 222-G-1 [Alternate Unsupported RLOUT = 1]

Joints Geometry:

Joint Label	Symmetry Code	X Coord. (ft)	Y Coord. (ft)	Z Coord. (ft)	X Disp. Rest.	Y Disp. Rest.	Z Disp. Rest.	X Rot. Rest.	Y Rot. Rest.	Z Rot. Rest.

RohnAP	Tri-Symmetry	4.333	0	180	Free	Free	Free	Free	Free	Free	Free
RohnBP	Tri-Symmetry	5.121	0	160	Free	Free	Free	Free	Free	Free	Free
RohnCP	Tri-Symmetry	5.909	0	140	Free	Free	Free	Free	Free	Free	Free
RohnDP	Tri-Symmetry	6.695	0	120	Free	Free	Free	Free	Free	Free	Free
RohnEP	Tri-Symmetry	7.481	0	100	Free	Free	Free	Free	Free	Free	Free
RohnFP	Tri-Symmetry	8.268	0	80	Free	Free	Free	Free	Free	Free	Free
RohnGP	Tri-Symmetry	9.055	0	60	Free	Free	Free	Free	Free	Free	Free
RohnHP	Tri-Symmetry	9.841	0	40	Free	Free	Free	Free	Free	Free	Free
RohnIP	Tri-Symmetry	10.63	0	20	Free	Free	Free	Free	Free	Free	Free
RohnJP	Tri-Symmetry	11.42	0	0	Fixed	Fixed	Fixed	Fixed	Fixed	Fixed	Fixed
SNB-AP	Tri-Symmetry	2.333	0	180	Free	Free	Free	Free	Free	Free	Free
SNB-BP	Tri-Symmetry	3.121	0	160	Free	Free	Free	Free	Free	Free	Free
SNB-CP	Tri-Symmetry	3.908	0	140	Free	Free	Free	Free	Free	Free	Free
SNB-DP	Tri-Symmetry	4.695	0	120	Free	Free	Free	Free	Free	Free	Free
SNB-EP	Tri-Symmetry	5.481	0	100	Free	Free	Free	Free	Free	Free	Free
SNB-FP	Tri-Symmetry	6.268	0	80	Free	Free	Free	Free	Free	Free	Free
SNB-GP	Tri-Symmetry	7.055	0	60	Free	Free	Free	Free	Free	Free	Free
SNB-HP	Tri-Symmetry	7.841	0	40	Free	Free	Free	Free	Free	Free	Free
SNB-IP	Tri-Symmetry	8.628	0	20	Free	Free	Free	Free	Free	Free	Free
SNB-JP	Tri-Symmetry	9.415	0	0	Fixed	Fixed	Fixed	Fixed	Fixed	Fixed	Fixed
RohnA1	Tri-Gen 1	-2.167	-3.752	180	Free	Free	Free	Free	Free	Free	Free
RohnA2	Tri-Gen 2	-2.167	3.752	180	Free	Free	Free	Free	Free	Free	Free
RohnB1	Tri-Gen 1	-2.561	-4.435	160	Free	Free	Free	Free	Free	Free	Free
RohnB2	Tri-Gen 2	-2.561	4.435	160	Free	Free	Free	Free	Free	Free	Free
RohnC1	Tri-Gen 1	-2.954	-5.117	140	Free	Free	Free	Free	Free	Free	Free
RohnC2	Tri-Gen 2	-2.954	5.117	140	Free	Free	Free	Free	Free	Free	Free
RohnD1	Tri-Gen 1	-3.348	-5.798	120	Free	Free	Free	Free	Free	Free	Free
RohnD2	Tri-Gen 2	-3.348	5.798	120	Free	Free	Free	Free	Free	Free	Free
RohnE1	Tri-Gen 1	-3.741	-6.479	100	Free	Free	Free	Free	Free	Free	Free
RohnE2	Tri-Gen 2	-3.741	6.479	100	Free	Free	Free	Free	Free	Free	Free
RohnF1	Tri-Gen 1	-4.134	-7.16	80	Free	Free	Free	Free	Free	Free	Free
RohnF2	Tri-Gen 2	-4.134	7.16	80	Free	Free	Free	Free	Free	Free	Free
RohnG1	Tri-Gen 1	-4.527	-7.842	60	Free	Free	Free	Free	Free	Free	Free
RohnG2	Tri-Gen 2	-4.527	7.842	60	Free	Free	Free	Free	Free	Free	Free
RohnH1	Tri-Gen 1	-4.921	-8.523	40	Free	Free	Free	Free	Free	Free	Free
RohnH2	Tri-Gen 2	-4.921	8.523	40	Free	Free	Free	Free	Free	Free	Free
RohnI1	Tri-Gen 1	-5.315	-9.206	20	Free	Free	Free	Free	Free	Free	Free
RohnI2	Tri-Gen 2	-5.315	9.206	20	Free	Free	Free	Free	Free	Free	Free
RohnJ1	Tri-Gen 1	-5.71	-9.89	0	Fixed	Fixed	Fixed	Fixed	Fixed	Fixed	Fixed
RohnJ2	Tri-Gen 2	-5.71	9.89	0	Fixed	Fixed	Fixed	Fixed	Fixed	Fixed	Fixed
SNB-A1	Tri-Gen 1	-1.167	-2.02	180	Free	Free	Free	Free	Free	Free	Free
SNB-A2	Tri-Gen 2	-1.167	2.02	180	Free	Free	Free	Free	Free	Free	Free
SNB-B1	Tri-Gen 1	-1.561	-2.703	160	Free	Free	Free	Free	Free	Free	Free
SNB-B2	Tri-Gen 2	-1.561	2.703	160	Free	Free	Free	Free	Free	Free	Free
SNB-C1	Tri-Gen 1	-1.954	-3.384	140	Free	Free	Free	Free	Free	Free	Free
SNB-C2	Tri-Gen 2	-1.954	3.384	140	Free	Free	Free	Free	Free	Free	Free
SNB-D1	Tri-Gen 1	-2.348	-4.066	120	Free	Free	Free	Free	Free	Free	Free
SNB-D2	Tri-Gen 2	-2.348	4.066	120	Free	Free	Free	Free	Free	Free	Free
SNB-E1	Tri-Gen 1	-2.74	-4.747	100	Free	Free	Free	Free	Free	Free	Free
SNB-E2	Tri-Gen 2	-2.74	4.747	100	Free	Free	Free	Free	Free	Free	Free
SNB-F1	Tri-Gen 1	-3.134	-5.428	80	Free	Free	Free	Free	Free	Free	Free
SNB-F2	Tri-Gen 2	-3.134	5.428	80	Free	Free	Free	Free	Free	Free	Free
SNB-G1	Tri-Gen 1	-3.528	-6.11	60	Free	Free	Free	Free	Free	Free	Free
SNB-G2	Tri-Gen 2	-3.528	6.11	60	Free	Free	Free	Free	Free	Free	Free
SNB-H1	Tri-Gen 1	-3.921	-6.791	40	Free	Free	Free	Free	Free	Free	Free
SNB-H2	Tri-Gen 2	-3.921	6.791	40	Free	Free	Free	Free	Free	Free	Free
SNB-I1	Tri-Gen 1	-4.314	-7.472	20	Free	Free	Free	Free	Free	Free	Free
SNB-I2	Tri-Gen 2	-4.314	7.472	20	Free	Free	Free	Free	Free	Free	Free
SNB-J1	Tri-Gen 1	-4.708	-8.154	0	Fixed	Fixed	Fixed	Fixed	Fixed	Fixed	Fixed
SNB-J2	Tri-Gen 2	-4.708	8.154	0	Fixed	Fixed	Fixed	Fixed	Fixed	Fixed	Fixed

Secondary Joints:

Joint Label	Symmetry Code	Origin Joint	End Joint	Fraction	Elevation	X Disp. Rest.	Y Disp. Rest.	Z Disp. Rest.	X Rot. Rest.	Y Rot. Rest.	Z Rot. Rest.
(ft)											
RohnAaS	Tri-Symmetry	RohnAP	RohnBP	0.25	0	Free	Free	Free	Free	Free	Free
RohnAbs	Tri-Symmetry	RohnAP	RohnBP	0.5	0	Free	Free	Free	Free	Free	Free

RohnAcS	Tri-Symmetry	RohnAP	RohnBP	0.75	0	Free	Free	Free	Free	Free	Free	Free
RohnBaS	Tri-Symmetry	RohnBP	RohnCP	0.25	0	Free	Free	Free	Free	Free	Free	Free
RohnBbS	Tri-Symmetry	RohnBP	RohnCP	0.5	0	Free	Free	Free	Free	Free	Free	Free
RohnBcS	Tri-Symmetry	RohnBP	RohnCP	0.75	0	Free	Free	Free	Free	Free	Free	Free
RohnCaS	Tri-Symmetry	RohnCP	RohnDP	0.333	0	Free	Free	Free	Free	Free	Free	Free
RohnCbS	Tri-Symmetry	RohnCP	RohnDP	0.667	0	Free	Free	Free	Free	Free	Free	Free
RohnDaS	Tri-Symmetry	RohnDP	RohnEP	0.333	0	Free	Free	Free	Free	Free	Free	Free
RohnDbS	Tri-Symmetry	RohnDP	RohnEP	0.667	0	Free	Free	Free	Free	Free	Free	Free
RohnEaS	Tri-Symmetry	RohnEP	RohnFP	0.333	0	Free	Free	Free	Free	Free	Free	Free
RohnEbS	Tri-Symmetry	RohnEP	RohnFP	0.667	0	Free	Free	Free	Free	Free	Free	Free
RohnFaS	Tri-Symmetry	RohnFP	RohnGP	0.5	0	Free	Free	Free	Free	Free	Free	Free
RohnGaS	Tri-Symmetry	RohnGP	RohnHP	0.5	0	Free	Free	Free	Free	Free	Free	Free
RohnHaS	Tri-Symmetry	RohnHP	RohnIP	0.5	0	Free	Free	Free	Free	Free	Free	Free
RohnIaS	Tri-Symmetry	RohnIP	RohnJP	0.5	0	Free	Free	Free	Free	Free	Free	Free
SNB-AaS	Tri-Symmetry	SNB-AP	SNB-BP	0.25	0	Free	Free	Free	Free	Free	Free	Free
SNB-AbS	Tri-Symmetry	SNB-AP	SNB-BP	0.5	0	Free	Free	Free	Free	Free	Free	Free
SNB-AcS	Tri-Symmetry	SNB-AP	SNB-BP	0.75	0	Free	Free	Free	Free	Free	Free	Free
SNB-BaS	Tri-Symmetry	SNB-BP	SNB-CP	0.25	0	Free	Free	Free	Free	Free	Free	Free
SNB-BbS	Tri-Symmetry	SNB-BP	SNB-CP	0.5	0	Free	Free	Free	Free	Free	Free	Free
SNB-BcS	Tri-Symmetry	SNB-BP	SNB-CP	0.75	0	Free	Free	Free	Free	Free	Free	Free
SNB-CaS	Tri-Symmetry	SNB-CP	SNB-DP	0.333	0	Free	Free	Free	Free	Free	Free	Free
SNB-CbS	Tri-Symmetry	SNB-CP	SNB-DP	0.667	0	Free	Free	Free	Free	Free	Free	Free
SNB-DaS	Tri-Symmetry	SNB-DP	SNB-EP	0.333	0	Free	Free	Free	Free	Free	Free	Free
SNB-DbS	Tri-Symmetry	SNB-DP	SNB-EP	0.667	0	Free	Free	Free	Free	Free	Free	Free
SNB-EaS	Tri-Symmetry	SNB-EP	SNB-FP	0.333	0	Free	Free	Free	Free	Free	Free	Free
SNB-EbS	Tri-Symmetry	SNB-EP	SNB-FP	0.667	0	Free	Free	Free	Free	Free	Free	Free
SNB-FaS	Tri-Symmetry	SNB-FP	SNB-GP	0.5	0	Free	Free	Free	Free	Free	Free	Free
SNB-GaS	Tri-Symmetry	SNB-GP	SNB-HP	0.5	0	Free	Free	Free	Free	Free	Free	Free
SNB-HaS	Tri-Symmetry	SNB-HP	SNB-IP	0.5	0	Free	Free	Free	Free	Free	Free	Free
SNB-IaS	Tri-Symmetry	SNB-IP	SNB-JP	0.5	0	Free	Free	Free	Free	Free	Free	Free
SNB-WL-A1S	None	SNB-AP	SNB-A1	0.5	0	Free	Free	Free	Free	Free	Free	Free
SNB-WL-A2S	None	SNB-A1	SNB-A2	0.5	0	Free	Free	Free	Free	Free	Free	Free
SNB-WL-A3S	None	SNB-A2	SNB-AP	0.5	0	Free	Free	Free	Free	Free	Free	Free
SNB-WL-B1S	None	SNB-BP	SNB-B1	0.5	0	Free	Free	Free	Free	Free	Free	Free
SNB-WL-B2S	None	SNB-B1	SNB-B2	0.5	0	Free	Free	Free	Free	Free	Free	Free
SNB-WL-B3S	None	SNB-B2	SNB-BP	0.5	0	Free	Free	Free	Free	Free	Free	Free
SNB-WL-C1S	None	SNB-CP	SNB-C1	0.5	0	Free	Free	Free	Free	Free	Free	Free
SNB-WL-C2S	None	SNB-C1	SNB-C2	0.5	0	Free	Free	Free	Free	Free	Free	Free
SNB-WL-C3S	None	SNB-C2	SNB-CP	0.5	0	Free	Free	Free	Free	Free	Free	Free
SNB-WL-D1S	None	SNB-DP	SNB-D1	0.5	0	Free	Free	Free	Free	Free	Free	Free
SNB-WL-D2S	None	SNB-D1	SNB-D2	0.5	0	Free	Free	Free	Free	Free	Free	Free
SNB-WL-D3S	None	SNB-D2	SNB-DP	0.5	0	Free	Free	Free	Free	Free	Free	Free
SNB-WL-E1S	None	SNB-EP	SNB-E1	0.5	0	Free	Free	Free	Free	Free	Free	Free
SNB-WL-E2S	None	SNB-E1	SNB-E2	0.5	0	Free	Free	Free	Free	Free	Free	Free
SNB-WL-E3S	None	SNB-E2	SNB-EP	0.5	0	Free	Free	Free	Free	Free	Free	Free
SNB-WL-F1S	None	SNB-FP	SNB-F1	0.5	0	Free	Free	Free	Free	Free	Free	Free
SNB-WL-F2S	None	SNB-F1	SNB-F2	0.5	0	Free	Free	Free	Free	Free	Free	Free
SNB-WL-F3S	None	SNB-F2	SNB-FP	0.5	0	Free	Free	Free	Free	Free	Free	Free
SNB-WL-G1S	None	SNB-GP	SNB-G1	0.5	0	Free	Free	Free	Free	Free	Free	Free
SNB-WL-G2S	None	SNB-G1	SNB-G2	0.5	0	Free	Free	Free	Free	Free	Free	Free
SNB-WL-G3S	None	SNB-G2	SNB-GP	0.5	0	Free	Free	Free	Free	Free	Free	Free
SNB-WL-H1S	None	SNB-HP	SNB-H1	0.5	0	Free	Free	Free	Free	Free	Free	Free
SNB-WL-H2S	None	SNB-H1	SNB-H2	0.5	0	Free	Free	Free	Free	Free	Free	Free
SNB-WL-H3S	None	SNB-H2	SNB-HP	0.5	0	Free	Free	Free	Free	Free	Free	Free
SNB-WL-I1S	None	SNB-IP	SNB-I1	0.5	0	Free	Free	Free	Free	Free	Free	Free
SNB-WL-I2S	None	SNB-I1	SNB-I2	0.5	0	Free	Free	Free	Free	Free	Free	Free
SNB-WL-I3S	None	SNB-I2	SNB-IP	0.5	0	Free	Free	Free	Free	Free	Free	Free
RohnAa1	Tri-Gen 1	RohnAP	RohnBP	0.25	0	Free	Free	Free	Free	Free	Free	Free
RohnAa2	Tri-Gen 2	RohnAP	RohnBP	0.25	0	Free	Free	Free	Free	Free	Free	Free
RohnAb1	Tri-Gen 1	RohnAP	RohnBP	0.5	0	Free	Free	Free	Free	Free	Free	Free
RohnAb2	Tri-Gen 2	RohnAP	RohnBP	0.5	0	Free	Free	Free	Free	Free	Free	Free
RohnAc1	Tri-Gen 1	RohnAP	RohnBP	0.75	0	Free	Free	Free	Free	Free	Free	Free
RohnAc2	Tri-Gen 2	RohnAP	RohnBP	0.75	0	Free	Free	Free	Free	Free	Free	Free
RohnBa1	Tri-Gen 1	RohnBP	RohnCP	0.25	0	Free	Free	Free	Free	Free	Free	Free
RohnBa2	Tri-Gen 2	RohnBP	RohnCP	0.25	0	Free	Free	Free	Free	Free	Free	Free
RohnBb1	Tri-Gen 1	RohnBP	RohnCP	0.5	0	Free	Free	Free	Free	Free	Free	Free
RohnBb2	Tri-Gen 2	RohnBP	RohnCP	0.5	0	Free	Free	Free	Free	Free	Free	Free
RohnBc1	Tri-Gen 1	RohnBP	RohnCP	0.75	0	Free	Free	Free	Free	Free	Free	Free
RohnBc2	Tri-Gen 2	RohnBP	RohnCP	0.75	0	Free	Free	Free	Free	Free	Free	Free

RohnCa1	Tri-Gen 1	RohnCP	RohnDP	0.333	0	Free	Free	Free	Free	Free	Free
RohnCa2	Tri-Gen 2	RohnCP	RohnDP	0.333	0	Free	Free	Free	Free	Free	Free
RohnCb1	Tri-Gen 1	RohnCP	RohnDP	0.667	0	Free	Free	Free	Free	Free	Free
RohnCb2	Tri-Gen 2	RohnCP	RohnDP	0.667	0	Free	Free	Free	Free	Free	Free
RohnDa1	Tri-Gen 1	RohnDP	RohnEP	0.333	0	Free	Free	Free	Free	Free	Free
RohnDa2	Tri-Gen 2	RohnDP	RohnEP	0.333	0	Free	Free	Free	Free	Free	Free
RohnDb1	Tri-Gen 1	RohnDP	RohnEP	0.667	0	Free	Free	Free	Free	Free	Free
RohnDb2	Tri-Gen 2	RohnDP	RohnEP	0.667	0	Free	Free	Free	Free	Free	Free
RohnEa1	Tri-Gen 1	RohnEP	RohnFP	0.333	0	Free	Free	Free	Free	Free	Free
RohnEa2	Tri-Gen 2	RohnEP	RohnFP	0.333	0	Free	Free	Free	Free	Free	Free
RohnEb1	Tri-Gen 1	RohnEP	RohnFP	0.667	0	Free	Free	Free	Free	Free	Free
RohnEb2	Tri-Gen 2	RohnEP	RohnFP	0.667	0	Free	Free	Free	Free	Free	Free
RohnFa1	Tri-Gen 1	RohnFP	RohnGP	0.5	0	Free	Free	Free	Free	Free	Free
RohnFa2	Tri-Gen 2	RohnFP	RohnGP	0.5	0	Free	Free	Free	Free	Free	Free
RohnGa1	Tri-Gen 1	RohnGP	RohnHP	0.5	0	Free	Free	Free	Free	Free	Free
RohnGa2	Tri-Gen 2	RohnGP	RohnHP	0.5	0	Free	Free	Free	Free	Free	Free
RohnHa1	Tri-Gen 1	RohnHP	RohnIP	0.5	0	Free	Free	Free	Free	Free	Free
RohnHa2	Tri-Gen 2	RohnHP	RohnIP	0.5	0	Free	Free	Free	Free	Free	Free
RohnIa1	Tri-Gen 1	RohnIP	RohnJP	0.5	0	Free	Free	Free	Free	Free	Free
RohnIa2	Tri-Gen 2	RohnIP	RohnJP	0.5	0	Free	Free	Free	Free	Free	Free
SNB-Aa1	Tri-Gen 1	SNB-AP	SNB-BP	0.25	0	Free	Free	Free	Free	Free	Free
SNB-Aa2	Tri-Gen 2	SNB-AP	SNB-BP	0.25	0	Free	Free	Free	Free	Free	Free
SNB-Ab1	Tri-Gen 1	SNB-AP	SNB-BP	0.5	0	Free	Free	Free	Free	Free	Free
SNB-Ab2	Tri-Gen 2	SNB-AP	SNB-BP	0.5	0	Free	Free	Free	Free	Free	Free
SNB-Ac1	Tri-Gen 1	SNB-AP	SNB-BP	0.75	0	Free	Free	Free	Free	Free	Free
SNB-Ac2	Tri-Gen 2	SNB-AP	SNB-BP	0.75	0	Free	Free	Free	Free	Free	Free
SNB-Ba1	Tri-Gen 1	SNB-BP	SNB-CP	0.25	0	Free	Free	Free	Free	Free	Free
SNB-Ba2	Tri-Gen 2	SNB-BP	SNB-CP	0.25	0	Free	Free	Free	Free	Free	Free
SNB-Bb1	Tri-Gen 1	SNB-BP	SNB-CP	0.5	0	Free	Free	Free	Free	Free	Free
SNB-Bb2	Tri-Gen 2	SNB-BP	SNB-CP	0.5	0	Free	Free	Free	Free	Free	Free
SNB-Bc1	Tri-Gen 1	SNB-BP	SNB-CP	0.75	0	Free	Free	Free	Free	Free	Free
SNB-Bc2	Tri-Gen 2	SNB-BP	SNB-CP	0.75	0	Free	Free	Free	Free	Free	Free
SNB-Ca1	Tri-Gen 1	SNB-CP	SNB-DP	0.333	0	Free	Free	Free	Free	Free	Free
SNB-Ca2	Tri-Gen 2	SNB-CP	SNB-DP	0.333	0	Free	Free	Free	Free	Free	Free
SNB-Cb1	Tri-Gen 1	SNB-CP	SNB-DP	0.667	0	Free	Free	Free	Free	Free	Free
SNB-Cb2	Tri-Gen 2	SNB-CP	SNB-DP	0.667	0	Free	Free	Free	Free	Free	Free
SNB-Da1	Tri-Gen 1	SNB-DP	SNB-EP	0.333	0	Free	Free	Free	Free	Free	Free
SNB-Da2	Tri-Gen 2	SNB-DP	SNB-EP	0.333	0	Free	Free	Free	Free	Free	Free
SNB-Db1	Tri-Gen 1	SNB-DP	SNB-EP	0.667	0	Free	Free	Free	Free	Free	Free
SNB-Db2	Tri-Gen 2	SNB-DP	SNB-EP	0.667	0	Free	Free	Free	Free	Free	Free
SNB-Ea1	Tri-Gen 1	SNB-EP	SNB-FP	0.333	0	Free	Free	Free	Free	Free	Free
SNB-Ea2	Tri-Gen 2	SNB-EP	SNB-FP	0.333	0	Free	Free	Free	Free	Free	Free
SNB-Eb1	Tri-Gen 1	SNB-EP	SNB-FP	0.667	0	Free	Free	Free	Free	Free	Free
SNB-Eb2	Tri-Gen 2	SNB-EP	SNB-FP	0.667	0	Free	Free	Free	Free	Free	Free
SNB-Fa1	Tri-Gen 1	SNB-FP	SNB-GP	0.5	0	Free	Free	Free	Free	Free	Free
SNB-Fa2	Tri-Gen 2	SNB-FP	SNB-GP	0.5	0	Free	Free	Free	Free	Free	Free
SNB-Ga1	Tri-Gen 1	SNB-GP	SNB-HP	0.5	0	Free	Free	Free	Free	Free	Free
SNB-Ga2	Tri-Gen 2	SNB-GP	SNB-HP	0.5	0	Free	Free	Free	Free	Free	Free
SNB-Ha1	Tri-Gen 1	SNB-HP	SNB-IP	0.5	0	Free	Free	Free	Free	Free	Free
SNB-Ha2	Tri-Gen 2	SNB-HP	SNB-IP	0.5	0	Free	Free	Free	Free	Free	Free
SNB-Ia1	Tri-Gen 1	SNB-IP	SNB-JP	0.5	0	Free	Free	Free	Free	Free	Free
SNB-Ia2	Tri-Gen 2	SNB-IP	SNB-JP	0.5	0	Free	Free	Free	Free	Free	Free

The model contains 60 primary and 123 secondary joints for a total of 183 joints.

Steel Material Properties:

Steel Material Label	Modulus of Elasticity (ksi)	Yield Stress Fy (ksi)	Ultimate Stress Fu (ksi)	Member All. Hyp. 1	Member All. Hyp. 2	Member Rupture Hyp. 1	Member Rupture Hyp. 2	Member Bearing Hyp. 1	Member Bearing Hyp. 2
A 36	2.9e+004	36	58	0	0	0	0	0	0
A572-50	2.9e+004	50	65	0	0	0	0	0	0

Bolt Properties:

Bolt Label	Bolt Diameter	Hole Diameter	Ultimate Shear	Default End	Default Bolt Capacity	Shear Capacity	Shear Capacity
------------	---------------	---------------	----------------	-------------	-----------------------	----------------	----------------

	(in)	(in)	Capacity (kips)	Distance (in)	Spacing (in)	Hyp. 1 (kips)	Hyp. 2 (kips)
5/8 A325-N	0.625	0.6875	16.58	1.125	1.5	0	0
3/4 A325-N	0.75	0.8125	23.87	1.35	1.8	0	0
5/8 A490-N	0.625	0.6875	20.72	1.125	1.5	0	0
3/4 A490-N	0.75	0.8125	29.83	1.35	1.8	0	0

Number Bolts Used By Type:

Bolt Number Type	Bolts
5/8 A325-N	228
5/8 A490-N	6
3/4 A325-N	42
3/4 A490-N	24

Angle Properties:

Angle Type	Angle Size	Long Leg	Short Leg	Thick. (in)	Unit Weight (lbs/ft)	Gross Area (in^2)	w/t Ratio	Radius of Gyration Rx (in)	Radius of Gyration Ry (in)	Radius of Gyration Rz (in)	Number of Angles	Wind Width (in)	Short Edge Dist. (in)	Long Edge Dist. (in)	Optimize Cost Factor	Section Modulus (in^3)
SAE	6X6X0.375	6	6	0.375	14.9	4.36	13.67	1.88	1.88	1.19	1	6	3	0	1.0000	0
SAE	5X5X0.625	5	5	0.625	20	5.86	6.2	1.52	1.52	0.978	1	5	2.5	0	1.0000	0
SAE	5X5X0.375	5	5	0.375	12.3	3.61	11	1.56	1.56	0.99	1	5	2.5	0	1.0000	0
SAE	4X4X0.625	4	4	0.625	15.7	4.61	4.8	1.2	1.2	0.779	1	4	2	0	1.0000	0
SAE	4X4X0.5	4	4	0.5	12.8	3.75	6.25	1.22	1.22	0.782	1	4	2	0	1.0000	0
SAE	4X4X0.3125	4	4	0.3125	8.2	2.4	10.6	1.24	1.24	0.791	1	4	2	0	1.0000	0
SAE	4X4X0.25	4	4	0.25	6.6	1.94	13.5	1.25	1.25	0.795	1	4	2	0	1.0000	0
SAE	3.5X3.5X0.375	3.5	3.5	0.375	8.5	2.48	7.33	1.07	1.07	0.687	1	3.5	1.75	0	1.0000	0
SAE	3.5X3.5X0.3125	3.5	3.5	0.3125	7.2	2.09	9	1.08	1.08	0.69	1	3.5	1.75	0	1.0000	0
SAE	3.5X3.5X0.25	3.5	3.5	0.25	5.8	1.69	11.5	1.09	1.09	0.694	1	3.5	1.75	0	1.0000	0
SAE	3X3X0.5	3	3	0.5	9.4	2.75	4.38	0.898	0.898	0.584	1	3	1.5	0	1.0000	0
SAE	3X3X0.25	3	3	0.25	4.9	1.44	9.75	0.93	0.93	0.592	1	3	1.5	0	1.0000	0
SAE	2.5X2.5X0.3125	2.5	2.5	0.3125	5	1.46	6	0.761	0.761	0.489	1	2.5	1.25	0	1.0000	0
SAE	2.5X2.5X0.25	2.5	2.5	0.25	4.1	1.19	7.75	0.769	0.769	0.491	1	2.5	1.25	0	1.0000	0
SAE	2.5X2.5X0.1875	2.5	2.5	0.1875	3.07	0.902	10.67	0.778	0.778	0.495	1	2.5	1.25	0	1.0000	0
SAE	2X2X0.375	2	2	0.375	4.7	1.36	3	0.594	0.594	0.389	1	2	1	0	1.0000	0
SAE	2X2X0.3125	2	2	0.3125	3.92	1.15	3.8	0.601	0.601	0.39	1	2	1	0	1.0000	0
SAE	2X2X0.25	2	2	0.25	3.19	0.94	5	0.609	0.609	0.391	1	2	1	0	1.0000	0
SAE	2X2X0.1875	2	2	0.1875	2.44	0.71	8	0.617	0.617	0.394	1	2	1	0	1.0000	0
SAE	1.75X1.75X0.1875	1.75	1.75	0.1875	2.12	0.62	6	0.537	0.537	0.343	1	1.75	0.875	0	1.0000	0
BIG	0.1X0.1X1	0.1	0.1	1	0	800	2.17	9.99	9.99	9.99	1	0.1	0.05	0	1.0000	0
Pipe	Pipe3EH	3.5	2.9	0	10.3	2.83	1	1.14	1.14	1.14	1	0	0	0	0.0000	0
Pipe	Pipe4EH	4.5	3.826	0	15	4.14	1	1.48	1.48	1.48	1	0	0	0	0.0000	0
Pipe	Pipe5STD	5.563	5.047	0	14.6	4.03	1	1.88	1.88	1.88	1	0	0	0	0.0000	0
Pipe	Pipe5EH	5.563	4.813	0	20.8	5.72	1	1.85	1.85	1.85	1	0	0	0	0.0000	0
Pipe	Pipe6EH	6.625	5.761	0	28.6	7.88	1	2.2	2.2	2.2	1	0	0	0	0.0000	0
Pipe	Pipe8EHS	8.625	8	0	35.78	9.86	1	2.96	2.96	2.96	1	0	0	0	0.0000	0
Pipe	Pipe3.5EH	4	3.364	0	12.5	3.44	1	1.31	1.31	1.31	1	0	0	0	0.0000	0
Pipe	Pipe6EHS	6.625	5.96	0	24.38	6.71	1	2.22	2.22	2.22	1	0	0	0	0.0000	0
Pipe	P3-437	3.5	2.626	0	15	4.2	1	1.09	1.09	1.09	1	0	0	0	0.0000	0
Pipe	P4-494	4.5	3.512	0	21.4	6.21	1	1.42	1.42	1.42	1	0	0	0	0.0000	0
Pipe	P6-562	6.625	5.5	0	36.6	10.7	1	2.15	2.15	2.15	1	0	0	0	0.0000	0
Pipe	Pipe8XS	8.625	7.625	0	43.39	12.8	1	2.88	2.88	2.88	1	0	0	0	0.0000	0
Pipe	Pipe10XS	10.75	9.75	0	54.74	16.1	1	3.63	3.63	3.63	1	0	0	0	0.0000	0
Pipe	P3-425	3.5	2.65	0	15	4.105	1	1.097	1.097	1.097	1	0	0	0	0.0000	0

Angle Groups:

Group Label	Group Angle Description Type	Angle Size	Material Type	Element Type	Group Type	Optimize Group	Allow. Angle Width	Add. For Optimize (in)
----------------	---------------------------------	---------------	------------------	-----------------	---------------	-------------------	--------------------------	---------------------------------

Rohn-D1	Rohn Diagonal 1	SAE	1.75X1.75X0.1875	A 36	Truss	Other	None	0.000
Rohn-D2	Rohn Diagonal 2	SAE	2X2X0.1875	A 36	Truss	Other	None	0.000
Rohn-D3	Rohn Diagonal 3	SAE	2.5X2.5X0.1875	A 36	Truss	Other	None	0.000
Rohn-D4	Rohn Diagonal 4	SAE	2.5X2.5X0.25	A 36	Truss	Other	None	0.000
Rohn-D5	Rohn Diagonal 5	SAE	3X3X0.25	A572-50	Truss	Other	None	0.000
Rohn-D6	Rohn Diagonal 6	SAE	3.5X3.5X0.25	A572-50	Truss	Other	None	0.000
Rohn-D7	Rohn Diagonal 7	SAE	4X4X0.25	A572-50	Truss	Other	None	0.000
Rohn-L1	Rohn Leg 1	Pipe	Pipe3EH	A572-50	Beam	Leg	None	0.000
Rohn-L2	Rohn Leg 2	Pipe	Pipe3.5EH	A572-50	Beam	Leg	None	0.000
Rohn-L3	Rohn Leg 3	Pipe	Pipe4EH	A572-50	Beam	Leg	None	0.000
Rohn-L4	Rohn Leg 4	Pipe	Pipe5STD	A572-50	Beam	Leg	None	0.000
Rohn-L5	Rohn Leg 5	Pipe	Pipe5EH	A572-50	Beam	Leg	None	0.000
Rohn-L6	Rohn Leg 6	Pipe	Pipe6EHS	A572-50	Beam	Leg	None	0.000
Rohn-L7	Rohn Leg 7	Pipe	Pipe6EH	A572-50	Beam	Leg	None	0.000
Rohn-L8	Rohn Leg 8	Pipe	Pipe8EHS	A572-50	Beam	Leg	None	0.000
Rohn-H1	Rohn Horizontal 1	SAE	1.75X1.75X0.1875	A 36	Beam	Other	None	0.000
SNB-D1	SNB Diagonal 1	SAE	2X2X0.3125	A 36	Truss	Other	None	0.000
SNB-D2	SNB Diagonal 2	SAE	2X2X0.25	A 36	Truss	Other	None	0.000
SNB-D3	SNB Diagonal 3	SAE	2.5X2.5X0.3125	A 36	Truss	Other	None	0.000
SNB-D4	SNB Diagonal 4	SAE	3X3X0.5	A 36	Truss	Other	None	0.000
SNB-D5	SNB Diagonal 5	SAE	4X4X0.5	A 36	Truss	Other	None	0.000
SNB-D6	SNB Diagonal 6	SAE	4X4X0.625	A 36	Truss	Other	None	0.000
SNB-D7	SNB Diagonal 7	SAE	5X5X0.625	A 36	Truss	Other	None	0.000
SNB-L1	SNB Leg 1	Pipe	P3-437	A 36	Beam	Leg	None	0.000
SNB-L2	SNB Leg 2	Pipe	P4-494	A 36	Beam	Leg	None	0.000
SNB-L3	SNB Leg 3	Pipe	Pipe5EH	A 36	Beam	Leg	None	0.000
SNB-L4	SNB Leg 4	Pipe	P6-562	A 36	Beam	Leg	None	0.000
SNB-L5	SNB Leg 5	Pipe	Pipe8XS	A 36	Beam	Leg	None	0.000
SNB-L6	SNB Leg 6	Pipe	Pipe10XS	A 36	Beam	Leg	None	0.000
Connect	Connect Towers	BIG	0.1X0.1X1	A 36	Other	None	None	0.000
SNB-H1	SNB Horizontal 1	Pipe	P3-425	A 36	Beam	Other	None	0.000
SNB-H2	SNB Horizontal 2	Pipe	P4-494	A 36	Beam	Other	None	0.000
Rohn-D8	Rohn Diagonal 8	SAE	2X2X0.375	A 36	Truss	Other	None	0.000
WLAC-1	Wind Lacing 1	SAE	2X2X0.25	A 36	Truss	Redundant	None	0.000
WLAC-2	Wind Lacing 2	SAE	2.5X2.5X0.3125	A 36	Truss	Redundant	None	0.000
R-D1-MOD	MODIFICATION - L1.75X1.75x3/16	SAE	1.75X1.75X0.1875	A572-50	Truss	Other	None	0.000
R-D2-MOD	MODIFICATION - L2X2x3/16	SAE	2X2X0.1875	A572-50	Truss	Other	None	0.000
R-D3-MOD	MODIFICATION - L2.5X2.5x1/4	SAE	2.5X2.5X0.25	A572-50	Truss	Other	None	0.000
R-D4-MOD	MODIFICATION - L3x3x1/4	SAE	3X3X0.25	A572-50	Truss	Other	None	0.000
R-D5-MOD	MODIFICATION - L3X3x1/4	SAE	3X3X0.25	A572-50	Truss	Other	None	0.000
R-D6-MOD	MODIFICATION - L3.5X3.5x5/16	SAE	3.5X3.5X0.3125	A572-50	Truss	Other	None	0.000
R-D7-MOD	MODIFICATION - L4X4x5/16	SAE	4X4X0.3125	A572-50	Truss	Other	None	0.000
S-D1-MOD	MODIFICATION - L2X2x5/16	SAE	2X2X0.3125	A572-50	Truss	Other	None	0.000
S-D2-MOD	MODIFICATION - L2x2x1/4	SAE	2X2X0.25	A572-50	Truss	Other	None	0.000
S-D3-MOD	MODIFICATION - L2.5X2.5x5/16	SAE	2.5X2.5X0.3125	A572-50	Truss	Other	None	0.000
S-D4-MOD	MODIFICATION - L3.5X3.5x3/8	SAE	3.5X3.5X0.375	A572-50	Truss	Other	None	0.000
S-D5-MOD	MODIFICATION - L4X4x0.5	SAE	4X4X0.5	A572-50	Truss	Other	None	0.000
S-D6-MOD	MODIFICATION - L5X5x3/8	SAE	5X5X0.375	A572-50	Truss	Other	None	0.000
S-D7-MOD	MODIFICATION - L6X6x3/8	SAE	6X6X0.375	A572-50	Truss	Other	None	0.000

Aggregate Angle Information:

Note: Estimate of surface area reported for painting purposes, not wind loading.

Angle Type	Angle Size	Material Type	Total Length (ft)	Total Surface Area (ft^2)	Total Weight (lbs)
SAE	1.75X1.75X0.1875	A 36	279.43	163.00	592.39
SAE	2X2X0.1875	A 36	258.81	172.54	631.49
SAE	2.5X2.5X0.1875	A 36	151.20	126.00	464.18
SAE	2.5X2.5X0.25	A572-50	79.06	65.89	324.16
SAE	2.5X2.5X0.25	A 36	81.42	67.85	333.83
SAE	3X3X0.25	A572-50	443.36	443.36	2172.46
SAE	3.5X3.5X0.25	A572-50	446.54	520.96	2589.91
SAE	4X4X0.25	A572-50	379.04	505.38	2501.65
SAE	4X4X0.3125	A572-50	123.92	165.23	1016.15
Pipe	Pipe3EH	A572-50	60.05	64.05	618.48

Pipe	Pipe3.5EH	A572-50	60.05	73.70	750.58
Pipe	Pipe4EH	A572-50	60.05	83.32	900.69
Pipe	Pipe5STD	A572-50	60.05	106.18	876.68
Pipe	Pipe5EH	A572-50	60.05	103.84	1248.97
Pipe	Pipe6EHS	A572-50	60.05	125.95	1463.93
Pipe	Pipe6EH	A572-50	120.09	247.91	3434.66
Pipe	Pipe8EHS	A572-50	60.05	166.38	2148.47
SAE	2X2X0.3125	A 36	165.23	110.15	647.69
SAE	2X2X0.25	A 36	225.69	150.46	719.94
SAE	2.5X2.5X0.3125	A 36	470.63	392.19	2353.15
SAE	3X3X0.5	A 36	219.00	219.00	2058.63
SAE	4X4X0.5	A 36	183.26	244.34	2345.69
SAE	4X4X0.625	A 36	199.19	265.58	3127.26
SAE	5X5X0.375	A572-50	205.76	342.94	2530.90
SAE	6X6X0.375	A572-50	222.64	445.29	3317.38
Pipe	P3-437	A 36	60.05	61.31	900.70
Pipe	P4-494	A 36	303.38	405.11	6492.26
Pipe	Pipe5EH	A 36	60.05	103.84	1248.96
Pipe	P6-562	A 36	120.09	242.69	4395.40
Pipe	Pipe8XS	A 36	120.09	325.25	5210.82
Pipe	Pipe10XS	A 36	60.05	205.16	3286.94
BIG	0.1X0.1X1	A 36	150.03	5.00	0.00
Pipe	P3-425	A 36	73.04	74.87	1095.63

Sections:
The adjustment factors below only apply to dead load and wind areas that are calculated for members in the model.
They do not apply to equipment or to manually input dead load and drag areas.

Section Label	Joint Defining Section	Dead Load Adjust. Factor	Transverse Drag x Area For Face	Longitudinal Drag x Area For Face	Transverse Area Factor (CD From Code)	Longitudinal Area Factor (CD From Code)	Af For EIA Only	Flat For EIA Only	Ar For EIA Only	Round Factor For Face	Transverse Drag x Area For All	Longitudinal Drag x Area For All	SAPS Drag x Area Factor	Angle Factor	SAPS Drag x Area Factor	Round Force Solid Face
A	RohnBP	1.000	0.000	0.000	0.000	0.000	0.900	0.900	0.900	0.000	0.000	0.000	0.000	0.000	0.000	None
B	RohnCP	1.000	0.000	0.000	0.000	0.000	0.900	0.900	0.900	0.000	0.000	0.000	0.000	0.000	0.000	None
C	RohnDP	1.000	0.000	0.000	0.000	0.000	0.900	0.900	0.900	0.000	0.000	0.000	0.000	0.000	0.000	None
D	RohnEP	1.000	0.000	0.000	0.000	0.000	0.900	0.900	0.900	0.000	0.000	0.000	0.000	0.000	0.000	None
E	RohnFP	1.000	0.000	0.000	0.000	0.000	0.900	0.900	0.900	0.000	0.000	0.000	0.000	0.000	0.000	None
F	RohnGP	1.000	0.000	0.000	0.000	0.000	0.900	0.900	0.900	0.000	0.000	0.000	0.000	0.000	0.000	None
G	RohnHP	1.000	0.000	0.000	0.000	0.000	0.900	0.900	0.900	0.000	0.000	0.000	0.000	0.000	0.000	None
H	RohnIP	1.000	0.000	0.000	0.000	0.000	0.900	0.900	0.900	0.000	0.000	0.000	0.000	0.000	0.000	None
I	RohnJP	1.000	0.000	0.000	0.000	0.000	0.900	0.900	0.900	0.000	0.000	0.000	0.000	0.000	0.000	None

Angle Member Connectivity:

Member Label	Group Label	Section Label	Symmetry Code	Origin Joint	End Joint	Ecc. Code	Rest. Code	Ratio RLY	Ratio RLZ	Bolt Type	# Bolts	# Holes	# Shear Planes	Connect Leg	Short Edge Dist. (in)	Long Edge Dist. (in)	End Dist. (in)	Bolt Spacing (in)	Rest. Coef.		
Rohn-DA1P	Rohn-D1	Tri-Symmetry		RohnAP	RohnAa1	1	4	0.5	0.5	0.5	5/8	A325-N	1	1	1	Long only	0	0	0	0	0
Rohn-DA11	Rohn-D1	Tri-Gen 1		RohnA1	RohnAa2	1	4	0.5	0.5	0.5	5/8	A325-N	1	1	1	Long only	0	0	0	0	0
Rohn-DA12	Rohn-D1	Tri-Gen 2		RohnA2	RohnAa3	1	4	0.5	0.5	0.5	5/8	A325-N	1	1	1	Long only	0	0	0	0	0
Rohn-DA2P	Rohn-D1	Tri-Symmetry		RohnAP	RohnAa2	1	4	0.5	0.5	0.5	5/8	A325-N	1	1	1	Long only	0	0	0	0	0
Rohn-DA21	Rohn-D1	Tri-Gen 1		RohnA1	RohnAa3	1	4	0.5	0.5	0.5	5/8	A325-N	1	1	1	Long only	0	0	0	0	0
Rohn-DA22	Rohn-D1	Tri-Gen 2		RohnA2	RohnAa1	1	4	0.5	0.5	0.5	5/8	A325-N	1	1	1	Long only	0	0	0	0	0
Rohn-DA3P	Rohn-D1	Tri-Symmetry		RohnAaS	RohnAb1	1	4	0.5	0.5	0.5	5/8	A325-N	1	1	1	Long only	0	0	0	0	0
Rohn-DA31	Rohn-D1	Tri-Gen 1		RohnAa1	RohnAb2	1	4	0.5	0.5	0.5	5/8	A325-N	1	1	1	Long only	0	0	0	0	0
Rohn-DA32	Rohn-D1	Tri-Gen 2		RohnAa2	RohnAbS	1	4	0.5	0.5	0.5	5/8	A325-N	1	1	1	Long only	0	0	0	0	0
Rohn-DA4P	Rohn-D1	Tri-Symmetry		RohnAaS	RohnAb2	1	4	0.5	0.5	0.5	5/8	A325-N	1	1	1	Long only	0	0	0	0	0
Rohn-DA41	Rohn-D1	Tri-Gen 1		RohnAa1	RohnAbS	1	4	0.5	0.5	0.5	5/8	A325-N	1	1	1	Long only	0	0	0	0	0
Rohn-DA42	Rohn-D1	Tri-Gen 2		RohnAa2	RohnAb1	1	4	0.5	0.5	0.5	5/8	A325-N	1	1	1	Long only	0	0	0	0	0
Rohn-DA5P	Rohn-D1	Tri-Symmetry		RohnAbS	RohnAc1	1	4	0.5	0.5	0.5	5/8	A325-N	1	1	1	Long only	0	0	0	0	0
Rohn-DA51	Rohn-D1	Tri-Gen 1		RohnAb1	RohnAc2	1	4	0.5	0.5	0.5	5/8	A325-N	1	1	1	Long only	0	0	0	0	0
Rohn-DA52	Rohn-D1	Tri-Gen 2		RohnAb2	RohnAcS	1	4	0.5	0.5	0.5	5/8	A325-N	1	1	1	Long only	0	0	0	0	0
Rohn-DA6P	Rohn-D1	Tri-Symmetry		RohnAbS	RohnAc2	1	4	0.5	0.5	0.5	5/8	A325-N	1	1	1	Long only	0	0	0	0	0
Rohn-DA61	Rohn-D1	Tri-Gen 1		RohnAb1	RohnAcS	1	4	0.5	0.5	0.5	5/8	A325-N	1	1	1	Long only	0	0	0	0	0
Rohn-DA62	Rohn-D1	Tri-Gen 2		RohnAb2	RohnAc1	1	4	0.5	0.5	0.5	5/8	A325-N	1	1	1	Long only	0	0	0	0	0
Rohn-DA7P	Rohn-D1	Tri-Symmetry		RohnAcS	RohnB2	1	4	0.5	0.5	0.5	5/8	A325-N	1	1	1	Long only	0	0	0	0	0

Rohn-LA31	Rohn-L1	Tri-Gen 1	RohnAb1	RohnAc1	1	4	1	1	1	0	0	0	0	0	0	0	0	0
Rohn-LA32	Rohn-L1	Tri-Gen 2	RohnAb2	RohnAc2	1	4	1	1	1	0	0	0	0	0	0	0	0	0
Rohn-LA4P	Rohn-L1	Tri-Symmetry	RohnAcS	RohnBP	1	4	1	1	1	0	0	0	0	0	0	0	0	0
Rohn-LA41	Rohn-L1	Tri-Gen 1	RohnAc1	RohnB1	1	4	1	1	1	0	0	0	0	0	0	0	0	0
Rohn-LA42	Rohn-L1	Tri-Gen 2	RohnAc2	RohnB2	1	4	1	1	1	0	0	0	0	0	0	0	0	0
Rohn-LB1P	Rohn-L2	Tri-Symmetry	RohnBP	RohnBaS	1	4	1	1	1	0	0	0	0	0	0	0	0	0
Rohn-LB11	Rohn-L2	Tri-Gen 1	RohnB1	RohnBa1	1	4	1	1	1	0	0	0	0	0	0	0	0	0
Rohn-LB12	Rohn-L2	Tri-Gen 2	RohnB2	RohnBa2	1	4	1	1	1	0	0	0	0	0	0	0	0	0
Rohn-LB2P	Rohn-L2	Tri-Symmetry	RohnBaS	RohnBbS	1	4	1	1	1	0	0	0	0	0	0	0	0	0
Rohn-LB21	Rohn-L2	Tri-Gen 1	RohnBa1	RohnBb1	1	4	1	1	1	0	0	0	0	0	0	0	0	0
Rohn-LB22	Rohn-L2	Tri-Gen 2	RohnBa2	RohnBb2	1	4	1	1	1	0	0	0	0	0	0	0	0	0
Rohn-LB3P	Rohn-L2	Tri-Symmetry	RohnBbS	RohnBcS	1	4	1	1	1	0	0	0	0	0	0	0	0	0
Rohn-LB31	Rohn-L2	Tri-Gen 1	RohnBb1	RohnBc1	1	4	1	1	1	0	0	0	0	0	0	0	0	0
Rohn-LB32	Rohn-L2	Tri-Gen 2	RohnBb2	RohnBc2	1	4	1	1	1	0	0	0	0	0	0	0	0	0
Rohn-LB4P	Rohn-L2	Tri-Symmetry	RohnBcS	RohnCP	1	4	1	1	1	0	0	0	0	0	0	0	0	0
Rohn-LB41	Rohn-L2	Tri-Gen 1	RohnBc1	RohnC1	1	4	1	1	1	0	0	0	0	0	0	0	0	0
Rohn-LB42	Rohn-L2	Tri-Gen 2	RohnBc2	RohnC2	1	4	1	1	1	0	0	0	0	0	0	0	0	0
Rohn-LC1P	Rohn-L3	Tri-Symmetry	RohnCP	RohnCaS	1	4	1	1	1	0	0	0	0	0	0	0	0	0
Rohn-LC11	Rohn-L3	Tri-Gen 1	RohnC1	RohnCa1	1	4	1	1	1	0	0	0	0	0	0	0	0	0
Rohn-LC12	Rohn-L3	Tri-Gen 2	RohnC2	RohnCa2	1	4	1	1	1	0	0	0	0	0	0	0	0	0
Rohn-LC2P	Rohn-L3	Tri-Symmetry	RohnCaS	RohnCbS	1	4	1	1	1	0	0	0	0	0	0	0	0	0
Rohn-LC21	Rohn-L3	Tri-Gen 1	RohnCa1	RohnCb1	1	4	1	1	1	0	0	0	0	0	0	0	0	0
Rohn-LC22	Rohn-L3	Tri-Gen 2	RohnCa2	RohnCb2	1	4	1	1	1	0	0	0	0	0	0	0	0	0
Rohn-LC3P	Rohn-L3	Tri-Symmetry	RohnCbS	RohnDP	1	4	1	1	1	0	0	0	0	0	0	0	0	0
Rohn-LC31	Rohn-L3	Tri-Gen 1	RohnCb1	RohnD1	1	4	1	1	1	0	0	0	0	0	0	0	0	0
Rohn-LC32	Rohn-L3	Tri-Gen 2	RohnCb2	RohnD2	1	4	1	1	1	0	0	0	0	0	0	0	0	0
Rohn-LD1P	Rohn-L4	Tri-Symmetry	RohnDP	RohnDaS	1	4	1	1	1	0	0	0	0	0	0	0	0	0
Rohn-LD11	Rohn-L4	Tri-Gen 1	RohnD1	RohnDa1	1	4	1	1	1	0	0	0	0	0	0	0	0	0
Rohn-LD12	Rohn-L4	Tri-Gen 2	RohnD2	RohnDa2	1	4	1	1	1	0	0	0	0	0	0	0	0	0
Rohn-LD2P	Rohn-L4	Tri-Symmetry	RohnDaS	RohnDbS	1	4	1	1	1	0	0	0	0	0	0	0	0	0
Rohn-LD21	Rohn-L4	Tri-Gen 1	RohnDa1	RohnDb1	1	4	1	1	1	0	0	0	0	0	0	0	0	0
Rohn-LD22	Rohn-L4	Tri-Gen 2	RohnDa2	RohnDb2	1	4	1	1	1	0	0	0	0	0	0	0	0	0
Rohn-LD3P	Rohn-L4	Tri-Symmetry	RohnDbS	RohnEP	1	4	1	1	1	0	0	0	0	0	0	0	0	0
Rohn-LD31	Rohn-L4	Tri-Gen 1	RohnDb1	RohnE1	1	4	1	1	1	0	0	0	0	0	0	0	0	0
Rohn-LD32	Rohn-L4	Tri-Gen 2	RohnDb2	RohnE2	1	4	1	1	1	0	0	0	0	0	0	0	0	0
Rohn-LE1P	Rohn-L5	Tri-Symmetry	RohnEP	RohnEaS	1	4	1	1	1	0	0	0	0	0	0	0	0	0
Rohn-LE11	Rohn-L5	Tri-Gen 1	RohnE1	RohnEa1	1	4	1	1	1	0	0	0	0	0	0	0	0	0
Rohn-LE12	Rohn-L5	Tri-Gen 2	RohnE2	RohnEa2	1	4	1	1	1	0	0	0	0	0	0	0	0	0
Rohn-LE2P	Rohn-L5	Tri-Symmetry	RohnEaS	RohnEbS	1	4	1	1	1	0	0	0	0	0	0	0	0	0
Rohn-LE21	Rohn-L5	Tri-Gen 1	RohnEa1	RohnEb1	1	4	1	1	1	0	0	0	0	0	0	0	0	0
Rohn-LE22	Rohn-L5	Tri-Gen 2	RohnEa2	RohnEb2	1	4	1	1	1	0	0	0	0	0	0	0	0	0
Rohn-LE3P	Rohn-L5	Tri-Symmetry	RohnEbS	RohnFP	1	4	1	1	1	0	0	0	0	0	0	0	0	0
Rohn-LE31	Rohn-L5	Tri-Gen 1	RohnEb1	RohnF1	1	4	1	1	1	0	0	0	0	0	0	0	0	0
Rohn-LE32	Rohn-L5	Tri-Gen 2	RohnEb2	RohnF2	1	4	1	1	1	0	0	0	0	0	0	0	0	0
Rohn-LF1P	Rohn-L6	Tri-Symmetry	RohnFP	RohnFaS	1	4	1	1	1	0	0	0	0	0	0	0	0	0
Rohn-LF11	Rohn-L6	Tri-Gen 1	RohnF1	RohnFa1	1	4	1	1	1	0	0	0	0	0	0	0	0	0
Rohn-LF12	Rohn-L6	Tri-Gen 2	RohnF2	RohnFa2	1	4	1	1	1	0	0	0	0	0	0	0	0	0
Rohn-LF2P	Rohn-L6	Tri-Symmetry	RohnFaS	RohnGP	1	4	0.5	0.5	0.5	0	0	0	0	0	0	0	0	0
Rohn-LF21	Rohn-L6	Tri-Gen 1	RohnFa1	RohnG1	1	4	0.5	0.5	0.5	0	0	0	0	0	0	0	0	0
Rohn-LF22	Rohn-L6	Tri-Gen 2	RohnFa2	RohnG2	1	4	0.5	0.5	0.5	0	0	0	0	0	0	0	0	0
Rohn-LG1P	Rohn-L7	Tri-Symmetry	RohnGP	RohnGaS	1	4	1	1	1	0	0	0	0	0	0	0	0	0
Rohn-LG11	Rohn-L7	Tri-Gen 1	RohnG1	RohnGa1	1	4	1	1	1	0	0	0	0	0	0	0	0	0
Rohn-LG12	Rohn-L7	Tri-Gen 2	RohnG2	RohnGa2	1	4	1	1	1	0	0	0	0	0	0	0	0	0
Rohn-LG2P	Rohn-L7	Tri-Symmetry	RohnGaS	RohnHP	1	4	1	1	1	0	0	0	0	0	0	0	0	0
Rohn-LG21	Rohn-L7	Tri-Gen 1	RohnGa1	RohnH1	1	4	1	1	1	0	0	0	0	0	0	0	0	0
Rohn-LG22	Rohn-L7	Tri-Gen 2	RohnGa2	RohnH2	1	4	1	1	1	0	0	0	0	0	0	0	0	0
Rohn-LH1P	Rohn-L7	Tri-Symmetry	RohnHP	RohnHaS	1	4	0.5	0.5	0.5	0	0	0	0	0	0	0	0	0
Rohn-LH11	Rohn-L7	Tri-Gen 1	RohnH1	RohnHa1	1	4	0.5	0.5	0.5	0	0	0	0	0	0	0	0	0
Rohn-LH12	Rohn-L7	Tri-Gen 2	RohnH2	RohnHa2	1	4	0.5	0.5	0.5	0	0	0	0	0	0	0	0	0
Rohn-LH2P	Rohn-L7	Tri-Symmetry	RohnHaS	RohnIP	1	4	0.5	0.5	0.5	0	0	0	0	0	0	0	0	0
Rohn-LH21	Rohn-L7	Tri-Gen 1	RohnHa1	RohnI1	1	4	0.5	0.5	0.5	0	0	0	0	0	0	0	0	0
Rohn-LH22	Rohn-L7	Tri-Gen 2	RohnHa2	RohnI2	1	4	0.5	0.5	0.5	0	0	0	0	0	0	0	0	0
Rohn-LI1P	Rohn-L8	Tri-Symmetry	RohnIP	RohnIaS	1	4	1	1	1	0	0	0	0	0	0	0	0	0
Rohn-LI11	Rohn-L8	Tri-Gen 1	RohnI1	RohnIa1	1	4	1	1	1	0	0	0	0	0	0	0	0	0
Rohn-LI12	Rohn-L8	Tri-Gen 2	RohnI2	RohnIa2	1	4	1	1	1	0	0	0	0	0	0	0	0	0
Rohn-LI2P	Rohn-L8	Tri-Symmetry	RohnIaS	RohnJP	1	4	0.5	0.5	0.5	0	0	0	0	0	0	0	0	0
Rohn-LI21	Rohn-L8	Tri-Gen 1	RohnIa1	RohnJ1	1	4	0.5	0.5	0.5	0	0	0	0	0	0	0	0	0
Rohn-LI22	Rohn-L8	Tri-Gen 2	RohnIa2	RohnJ2	1	4	0.5	0.5	0.5	0	0	0	0	0	0	0	0	0
Rohn-H1P	Rohn-H1	Tri-Symmetry	RohnAP	RohnA1	1	4	0.5	0.5	0.5	0	0	0	0	0	0	0	0	0

SNB-DH31	S-D6-MOD	Tri-Gen 1	SNB-Ha1	SNB-I2	1	4	0.5	0.5	0.5	3/4	A490-N	1	1	1	Long only	0	0	0	0	0	0
SNB-DH32	S-D6-MOD	Tri-Gen 2	SNB-Ha2	SNB-I2	1	4	0.5	0.5	0.5	3/4	A490-N	1	1	1	Long only	0	0	0	0	0	0
SNB-DH4P	S-D6-MOD	Tri-Symmetry	SNB-HaS	SNB-I2	1	4	0.5	0.5	0.5	3/4	A490-N	1	1	1	Long only	0	0	0	0	0	0
SNB-DH41	S-D6-MOD	Tri-Gen 1	SNB-Ha1	SNB-IP	1	4	0.5	0.5	0.5	3/4	A490-N	1	1	1	Long only	0	0	0	0	0	0
SNB-DH42	S-D6-MOD	Tri-Gen 2	SNB-Ha2	SNB-I1	1	4	0.5	0.5	0.5	3/4	A490-N	1	1	1	Long only	0	0	0	0	0	0
SNB-DI1P	S-D7-MOD	Tri-Symmetry	SNB-IP	SNB-Ia1	1	4	0.5	0.5	0.5	3/4	A490-N	1	1	1	Long only	0	0	0	0	0	0
SNB-DI11	S-D7-MOD	Tri-Gen 1	SNB-I1	SNB-Ia2	1	4	0.5	0.5	0.5	3/4	A490-N	1	1	1	Long only	0	0	0	0	0	0
SNB-DI12	S-D7-MOD	Tri-Gen 2	SNB-I2	SNB-IaS	1	4	0.5	0.5	0.5	3/4	A490-N	1	1	1	Long only	0	0	0	0	0	0
SNB-DI2P	S-D7-MOD	Tri-Symmetry	SNB-IP	SNB-Ia2	1	4	0.5	0.5	0.5	3/4	A490-N	1	1	1	Long only	0	0	0	0	0	0
SNB-DI21	S-D7-MOD	Tri-Gen 1	SNB-I1	SNB-IaS	1	4	0.5	0.5	0.5	3/4	A490-N	1	1	1	Long only	0	0	0	0	0	0
SNB-DI22	S-D7-MOD	Tri-Gen 2	SNB-I2	SNB-Ia1	1	4	0.5	0.5	0.5	3/4	A490-N	1	1	1	Long only	0	0	0	0	0	0
SNB-DI3P	S-D7-MOD	Tri-Symmetry	SNB-IaS	SNB-J1	1	4	0.5	0.5	0.5	3/4	A490-N	1	1	1	Long only	0	0	0	0	0	0
SNB-DI31	S-D7-MOD	Tri-Gen 1	SNB-Ia1	SNB-J2	1	4	0.5	0.5	0.5	3/4	A490-N	1	1	1	Long only	0	0	0	0	0	0
SNB-DI32	S-D7-MOD	Tri-Gen 2	SNB-Ia2	SNB-JP	1	4	0.5	0.5	0.5	3/4	A490-N	1	1	1	Long only	0	0	0	0	0	0
SNB-DI4P	S-D7-MOD	Tri-Symmetry	SNB-IaS	SNB-J2	1	4	0.5	0.5	0.5	3/4	A490-N	1	1	1	Long only	0	0	0	0	0	0
SNB-DI41	S-D7-MOD	Tri-Gen 1	SNB-Ia1	SNB-JP	1	4	0.5	0.5	0.5	3/4	A490-N	1	1	1	Long only	0	0	0	0	0	0
SNB-DI42	S-D7-MOD	Tri-Gen 2	SNB-Ia2	SNB-J1	1	4	0.5	0.5	0.5	3/4	A490-N	1	1	1	Long only	0	0	0	0	0	0
SNB-LA1P	SNB-L1	Tri-Symmetry	SNB-AP	SNB-AaS	1	4	1	1	1			0	0	0	0	0	0	0	0	0	
SNB-LA11	SNB-L1	Tri-Gen 1	SNB-A1	SNB-Aa1	1	4	1	1	1			0	0	0	0	0	0	0	0	0	
SNB-LA12	SNB-L1	Tri-Gen 2	SNB-A2	SNB-Aa2	1	4	1	1	1			0	0	0	0	0	0	0	0	0	
SNB-LA2P	SNB-L1	Tri-Symmetry	SNB-AaS	SNB-AbS	1	4	1	1	1			0	0	0	0	0	0	0	0	0	
SNB-LA21	SNB-L1	Tri-Gen 1	SNB-Aa1	SNB-Ab1	1	4	1	1	1			0	0	0	0	0	0	0	0	0	
SNB-LA22	SNB-L1	Tri-Gen 2	SNB-Aa2	SNB-Ab2	1	4	1	1	1			0	0	0	0	0	0	0	0	0	
SNB-LA3P	SNB-L1	Tri-Symmetry	SNB-AbS	SNB-AcS	1	4	1	1	1			0	0	0	0	0	0	0	0	0	
SNB-LA31	SNB-L1	Tri-Gen 1	SNB-Ab1	SNB-Ac1	1	4	1	1	1			0	0	0	0	0	0	0	0	0	
SNB-LA32	SNB-L1	Tri-Gen 2	SNB-Ab2	SNB-Ac2	1	4	1	1	1			0	0	0	0	0	0	0	0	0	
SNB-LA4P	SNB-L1	Tri-Symmetry	SNB-AcS	SNB-BP	1	4	1	1	1			0	0	0	0	0	0	0	0	0	
SNB-LA41	SNB-L1	Tri-Gen 1	SNB-Ac1	SNB-B1	1	4	1	1	1			0	0	0	0	0	0	0	0	0	
SNB-LA42	SNB-L1	Tri-Gen 2	SNB-Ac2	SNB-B2	1	4	1	1	1			0	0	0	0	0	0	0	0	0	
SNB-LB1P	SNB-L2	Tri-Symmetry	SNB-BP	SNB-BaS	1	4	1	1	1			0	0	0	0	0	0	0	0	0	
SNB-LB11	SNB-L2	Tri-Gen 1	SNB-B1	SNB-Ba1	1	4	1	1	1			0	0	0	0	0	0	0	0	0	
SNB-LB12	SNB-L2	Tri-Gen 2	SNB-B2	SNB-Ba2	1	4	1	1	1			0	0	0	0	0	0	0	0	0	
SNB-LB2P	SNB-L2	Tri-Symmetry	SNB-BaS	SNB-BbS	1	4	1	1	1			0	0	0	0	0	0	0	0	0	
SNB-LB21	SNB-L2	Tri-Gen 1	SNB-Ba1	SNB-Bb1	1	4	1	1	1			0	0	0	0	0	0	0	0	0	
SNB-LB22	SNB-L2	Tri-Gen 2	SNB-Ba2	SNB-Bb2	1	4	1	1	1			0	0	0	0	0	0	0	0	0	
SNB-LB3P	SNB-L2	Tri-Symmetry	SNB-BbS	SNB-BcS	1	4	1	1	1			0	0	0	0	0	0	0	0	0	
SNB-LB31	SNB-L2	Tri-Gen 1	SNB-Bb1	SNB-Bc1	1	4	1	1	1			0	0	0	0	0	0	0	0	0	
SNB-LB32	SNB-L2	Tri-Gen 2	SNB-Bb2	SNB-Bc2	1	4	1	1	1			0	0	0	0	0	0	0	0	0	
SNB-LB4P	SNB-L2	Tri-Symmetry	SNB-BcS	SNB-CP	1	4	1	1	1			0	0	0	0	0	0	0	0	0	
SNB-LB41	SNB-L2	Tri-Gen 1	SNB-Bc1	SNB-C1	1	4	1	1	1			0	0	0	0	0	0	0	0	0	
SNB-LB42	SNB-L2	Tri-Gen 2	SNB-Bc2	SNB-C2	1	4	1	1	1			0	0	0	0	0	0	0	0	0	
SNB-LC1P	SNB-L2	Tri-Symmetry	SNB-CP	SNB-CaS	1	4	1	1	1			0	0	0	0	0	0	0	0	0	
SNB-LC11	SNB-L2	Tri-Gen 1	SNB-C1	SNB-Ca1	1	4	1	1	1			0	0	0	0	0	0	0	0	0	
SNB-LC12	SNB-L2	Tri-Gen 2	SNB-C2	SNB-Ca2	1	4	1	1	1			0	0	0	0	0	0	0	0	0	
SNB-LC2P	SNB-L2	Tri-Symmetry	SNB-CaS	SNB-CbS	1	4	1	1	1			0	0	0	0	0	0	0	0	0	
SNB-LC21	SNB-L2	Tri-Gen 1	SNB-Ca1	SNB-Cb1	1	4	1	1	1			0	0	0	0	0	0	0	0	0	
SNB-LC22	SNB-L2	Tri-Gen 2	SNB-Ca2	SNB-Cb2	1	4	1	1	1			0	0	0	0	0	0	0	0	0	
SNB-LC3P	SNB-L2	Tri-Symmetry	SNB-CbS	SNB-DP	1	4	1	1	1			0	0	0	0	0	0	0	0	0	
SNB-LC31	SNB-L2	Tri-Gen 1	SNB-Cb1	SNB-D1	1	4	1	1	1			0	0	0	0	0	0	0	0	0	
SNB-LC32	SNB-L2	Tri-Gen 2	SNB-Cb2	SNB-D2	1	4	1	1	1			0	0	0	0	0	0	0	0	0	
SNB-LD1P	SNB-L3	Tri-Symmetry	SNB-DP	SNB-DaS	1	4	1	1	1			0	0	0	0	0	0	0	0	0	
SNB-LD11	SNB-L3	Tri-Gen 1	SNB-D1	SNB-Da1	1	4	1	1	1			0	0	0	0	0	0	0	0	0	
SNB-LD12	SNB-L3	Tri-Gen 2	SNB-D2	SNB-Da2	1	4	1	1	1			0	0	0	0	0	0	0	0	0	
SNB-LD2P	SNB-L3	Tri-Symmetry	SNB-DaS	SNB-DbS	1	4	1	1	1			0	0	0	0	0	0	0	0	0	
SNB-LD21	SNB-L3	Tri-Gen 1	SNB-Da1	SNB-Db1	1	4	1	1	1			0	0	0	0	0	0	0	0	0	
SNB-LD22	SNB-L3	Tri-Gen 2	SNB-Da2	SNB-Db2	1	4	1	1	1			0	0	0	0	0	0	0	0	0	
SNB-LD3P	SNB-L3	Tri-Symmetry	SNB-DbS	SNB-EP	1	4	1	1	1			0	0	0	0	0	0	0	0	0	
SNB-LD31	SNB-L3	Tri-Gen 1	SNB-Db1	SNB-E1	1	4	1	1	1			0	0	0	0	0	0	0	0	0	
SNB-LD32	SNB-L3	Tri-Gen 2	SNB-Db2	SNB-E2	1	4	1	1	1			0	0	0	0	0	0	0	0	0	
SNB-LE1P	SNB-L4	Tri-Symmetry	SNB-EP	SNB-EaS	1	4	1	1	1			0	0	0	0	0	0	0	0	0	
SNB-LE11	SNB-L4	Tri-Gen 1	SNB-E1	SNB-Ea1	1	4	1	1	1			0	0	0	0	0	0	0	0	0	
SNB-LE12	SNB-L4	Tri-Gen 2	SNB-E2	SNB-Ea2	1	4	1	1	1			0	0	0	0	0	0	0	0	0	
SNB-LE2P	SNB-L4	Tri-Symmetry	SNB-EaS	SNB-EbS	1	4	1	1	1			0	0	0	0	0	0	0	0	0	
SNB-LE21	SNB-L4	Tri-Gen 1	SNB-Ea1	SNB-Eb1	1	4	1	1	1			0	0	0	0	0	0	0	0	0	
SNB-LE22	SNB-L4	Tri-Gen 2	SNB-Ea2	SNB-Eb2	1	4	1	1	1			0	0	0	0	0	0	0	0	0	
SNB-LE3P	SNB-L4	Tri-Symmetry	SNB-EbS	SNB-FP	1	4	1	1	1			0	0	0	0	0	0	0	0	0	
SNB-LE31	SNB-L4	Tri-Gen 1	SNB-Eb1	SNB-F1	1	4	1	1	1			0	0	0	0	0	0	0	0	0	
SNB-LE32	SNB-L4	Tri-Gen 2	SNB-Eb2	SNB-F2	1	4	1	1	1			0	0	0	0	0	0	0	0	0	
SNB-LF1P	SNB-L4	Tri-Symmetry	SNB-FP	SNB-FaS	1	4	1	1	1			0	0	0	0	0	0	0	0	0	

SNB-LF11	SNB-L4	Tri-Gen 1	SNB-F1	SNB-Fa1	1	4	1	1	1	0	0	0	0	0	0	0	0	0	0
SNB-LF12	SNB-L4	Tri-Gen 2	SNB-F2	SNB-Fa2	1	4	1	1	1	0	0	0	0	0	0	0	0	0	0
SNB-LF2P	SNB-L4	Tri-Symmetry	SNB-FaS	SNB-GP	1	4	1	1	1	0	0	0	0	0	0	0	0	0	0
SNB-LF21	SNB-L4	Tri-Gen 1	SNB-Fal	SNB-G1	1	4	1	1	1	0	0	0	0	0	0	0	0	0	0
SNB-LF22	SNB-L4	Tri-Gen 2	SNB-Fa2	SNB-G2	1	4	1	1	1	0	0	0	0	0	0	0	0	0	0
SNB-LG1P	SNB-L5	Tri-Symmetry	SNB-GP	SNB-GaS	1	4	1	1	1	0	0	0	0	0	0	0	0	0	0
SNB-LG11	SNB-L5	Tri-Gen 1	SNB-G1	SNB-Gal	1	4	1	1	1	0	0	0	0	0	0	0	0	0	0
SNB-LG12	SNB-L5	Tri-Gen 2	SNB-G2	SNB-Ga2	1	4	1	1	1	0	0	0	0	0	0	0	0	0	0
SNB-LG2P	SNB-L5	Tri-Symmetry	SNB-GaS	SNB-HP	1	4	1	1	1	0	0	0	0	0	0	0	0	0	0
SNB-LG21	SNB-L5	Tri-Gen 1	SNB-Gal	SNB-H1	1	4	1	1	1	0	0	0	0	0	0	0	0	0	0
SNB-LG22	SNB-L5	Tri-Gen 2	SNB-Ga2	SNB-H2	1	4	1	1	1	0	0	0	0	0	0	0	0	0	0
SNB-LH1P	SNB-L5	Tri-Symmetry	SNB-HP	SNB-HaS	1	4	1	1	1	0	0	0	0	0	0	0	0	0	0
SNB-LH11	SNB-L5	Tri-Gen 1	SNB-H1	SNB-Hal	1	4	1	1	1	0	0	0	0	0	0	0	0	0	0
SNB-LH12	SNB-L5	Tri-Gen 2	SNB-H2	SNB-Ha2	1	4	1	1	1	0	0	0	0	0	0	0	0	0	0
SNB-LH2P	SNB-L5	Tri-Symmetry	SNB-HaS	SNB-IP	1	4	0.25	0.25	0.25	0	0	0	0	0	0	0	0	0	0
SNB-LH21	SNB-L5	Tri-Gen 1	SNB-Hal	SNB-I1	1	4	0.25	0.25	0.25	0	0	0	0	0	0	0	0	0	0
SNB-LH22	SNB-L5	Tri-Gen 2	SNB-Ha2	SNB-I2	1	4	0.25	0.25	0.25	0	0	0	0	0	0	0	0	0	0
SNB-LI1P	SNB-L6	Tri-Symmetry	SNB-IP	SNB-IaS	1	4	1	1	1	0	0	0	0	0	0	0	0	0	0
SNB-LI11	SNB-L6	Tri-Gen 1	SNB-I1	SNB-Ia1	1	4	1	1	1	0	0	0	0	0	0	0	0	0	0
SNB-LI12	SNB-L6	Tri-Gen 2	SNB-I2	SNB-Ia2	1	4	1	1	1	0	0	0	0	0	0	0	0	0	0
SNB-LI2P	SNB-L6	Tri-Symmetry	SNB-JP	SNB-JB	1	4	0.5	0.5	0.5	0	0	0	0	0	0	0	0	0	0
SNB-LI21	SNB-L6	Tri-Gen 1	SNB-Ia1	SNB-J1	1	4	0.5	0.5	0.5	0	0	0	0	0	0	0	0	0	0
SNB-LI22	SNB-L6	Tri-Gen 2	SNB-Ia2	SNB-J2	1	4	0.5	0.5	0.5	0	0	0	0	0	0	0	0	0	0
Connect AP	Connect	Tri-Symmetry	RohnAP	SNB-AP	1	4	1	1	1	0	0	0	0	0	0	0	0	0	0
Connect A1	Connect	Tri-Gen 1	RohnA1	SNB-A1	1	4	1	1	1	0	0	0	0	0	0	0	0	0	0
Connect A2	Connect	Tri-Gen 2	RohnA2	SNB-A2	1	4	1	1	1	0	0	0	0	0	0	0	0	0	0
Connect AaP	Connect	Tri-Symmetry	RohnAaS	SNB-AaS	1	4	1	1	1	0	0	0	0	0	0	0	0	0	0
Connect Aa1	Connect	Tri-Gen 1	RohnAa1	SNB-Aa1	1	4	1	1	1	0	0	0	0	0	0	0	0	0	0
Connect Aa2	Connect	Tri-Gen 2	RohnAa2	SNB-Aa2	1	4	1	1	1	0	0	0	0	0	0	0	0	0	0
Connect AbP	Connect	Tri-Symmetry	RohnAbs	SNB-AbS	1	4	1	1	1	0	0	0	0	0	0	0	0	0	0
Connect Ab1	Connect	Tri-Gen 1	RohnAb1	SNB-Ab1	1	4	1	1	1	0	0	0	0	0	0	0	0	0	0
Connect Ab2	Connect	Tri-Gen 2	RohnAb2	SNB-Ab2	1	4	1	1	1	0	0	0	0	0	0	0	0	0	0
Connect AcP	Connect	Tri-Symmetry	RohnAcS	SNB-AcS	1	4	1	1	1	0	0	0	0	0	0	0	0	0	0
Connect Ac1	Connect	Tri-Gen 1	RohnAc1	SNB-Ac1	1	4	1	1	1	0	0	0	0	0	0	0	0	0	0
Connect Ac2	Connect	Tri-Gen 2	RohnAc2	SNB-Ac2	1	4	1	1	1	0	0	0	0	0	0	0	0	0	0
Connect BP	Connect	Tri-Symmetry	RohnBP	SNB-BP	1	4	1	1	1	0	0	0	0	0	0	0	0	0	0
Connect B1	Connect	Tri-Gen 1	RohnB1	SNB-B1	1	4	1	1	1	0	0	0	0	0	0	0	0	0	0
Connect B2	Connect	Tri-Gen 2	RohnB2	SNB-B2	1	4	1	1	1	0	0	0	0	0	0	0	0	0	0
Connect BaP	Connect	Tri-Symmetry	RohnBaS	SNB-BaS	1	4	1	1	1	0	0	0	0	0	0	0	0	0	0
Connect Ba1	Connect	Tri-Gen 1	RohnBa1	SNB-Ba1	1	4	1	1	1	0	0	0	0	0	0	0	0	0	0
Connect Ba2	Connect	Tri-Gen 2	RohnBa2	SNB-Ba2	1	4	1	1	1	0	0	0	0	0	0	0	0	0	0
Connect BbP	Connect	Tri-Symmetry	RohnBbS	SNB-BbS	1	4	1	1	1	0	0	0	0	0	0	0	0	0	0
Connect Bb1	Connect	Tri-Gen 1	RohnBb1	SNB-Bb1	1	4	1	1	1	0	0	0	0	0	0	0	0	0	0
Connect Bb2	Connect	Tri-Gen 2	RohnBb2	SNB-Bb2	1	4	1	1	1	0	0	0	0	0	0	0	0	0	0
Connect BcP	Connect	Tri-Symmetry	RohnBcS	SNB-BcS	1	4	1	1	1	0	0	0	0	0	0	0	0	0	0
Connect Bc1	Connect	Tri-Gen 1	RohnBc1	SNB-Bc1	1	4	1	1	1	0	0	0	0	0	0	0	0	0	0
Connect Bc2	Connect	Tri-Gen 2	RohnBc2	SNB-Bc2	1	4	1	1	1	0	0	0	0	0	0	0	0	0	0
Connect CP	Connect	Tri-Symmetry	RohnCP	SNB-CP	1	4	1	1	1	0	0	0	0	0	0	0	0	0	0
Connect C1	Connect	Tri-Gen 1	RohnC1	SNB-C1	1	4	1	1	1	0	0	0	0	0	0	0	0	0	0
Connect C2	Connect	Tri-Gen 2	RohnC2	SNB-C2	1	4	1	1	1	0	0	0	0	0	0	0	0	0	0
Connect CaP	Connect	Tri-Symmetry	RohnCaS	SNB-CaS	1	4	1	1	1	0	0	0	0	0	0	0	0	0	0
Connect Ca1	Connect	Tri-Gen 1	RohnCa1	SNB-Ca1	1	4	1	1	1	0	0	0	0	0	0	0	0	0	0
Connect Ca2	Connect	Tri-Gen 2	RohnCa2	SNB-Ca2	1	4	1	1	1	0	0	0	0	0	0	0	0	0	0
Connect CbP	Connect	Tri-Symmetry	RohnCbS	SNB-CbS	1	4	1	1	1	0	0	0	0	0	0	0	0	0	0
Connect Cb1	Connect	Tri-Gen 1	RohnCb1	SNB-Cb1	1	4	1	1	1	0	0	0	0	0	0	0	0	0	0
Connect Cb2	Connect	Tri-Gen 2	RohnCb2	SNB-Cb2	1	4	1	1	1	0	0	0	0	0	0	0	0	0	0
Connect Dp	Connect	Tri-Symmetry	RohnDP	SNB-DP	1	4	1	1	1	0	0	0	0	0	0	0	0	0	0
Connect D1	Connect	Tri-Gen 1	RohnD1	SNB-D1	1	4	1	1	1	0	0	0	0	0	0	0	0	0	0
Connect D2	Connect	Tri-Gen 2	RohnD2	SNB-D2	1	4	1	1	1	0	0	0	0	0	0	0	0	0	0
Connect DaP	Connect	Tri-Symmetry	RohnDaS	SNB-DaS	1	4	1	1	1	0	0	0	0	0	0	0	0	0	0
Connect Da1	Connect	Tri-Gen 1	RohnDa1	SNB-Da1	1	4	1	1	1	0	0	0	0	0	0	0	0	0	0
Connect Da2	Connect	Tri-Gen 2	RohnDa2	SNB-Da2	1	4	1	1	1	0	0	0	0	0	0	0	0	0	0
Connect DbP	Connect	Tri-Symmetry	RohnDbS	SNB-DbS	1	4	1	1	1	0	0	0	0	0	0	0	0	0	0
Connect Db1	Connect	Tri-Gen 1	RohnDb1	SNB-Db1	1	4	1	1	1	0	0	0	0	0	0	0	0	0	0
Connect Db2	Connect	Tri-Gen 2	RohnDb2	SNB-Db2	1	4	1	1	1	0	0	0	0	0	0	0	0	0	0
Connect EP	Connect	Tri-Symmetry	RohnEP	SNB-EP	1	4	1	1	1	0	0	0	0	0	0	0	0	0	0
Connect E1	Connect	Tri-Gen 1	RohnE1	SNB-E1	1	4	1	1	1	0	0	0	0	0	0	0	0	0	0
Connect E2	Connect	Tri-Gen 2	RohnE2	SNB-E2	1	4	1	1	1	0	0	0	0	0	0	0	0	0	0
Connect EaP	Connect	Tri-Symmetry	RohnEaS	SNB-EaS	1	4	1	1	1	0	0	0	0	0	0	0	0	0	0

Connect Ea1	Connect	Tri-Gen 1	RohnEa1	SNB-Ea1	1	4	1	1	1	0	0	0	0	0	0	0	0
Connect Ea2	Connect	Tri-Gen 2	RohnEa2	SNB-Ea2	1	4	1	1	1	0	0	0	0	0	0	0	0
Connect EbP	Connect	Tri-Symmetry	RohnEbS	SNB-EbS	1	4	1	1	1	0	0	0	0	0	0	0	0
Connect Eb1	Connect	Tri-Gen 1	RohnEb1	SNB-Eb1	1	4	1	1	1	0	0	0	0	0	0	0	0
Connect Eb2	Connect	Tri-Gen 2	RohnEb2	SNB-Eb2	1	4	1	1	1	0	0	0	0	0	0	0	0
Connect FP	Connect	Tri-Symmetry	RohnFP	SNB-FP	1	4	1	1	1	0	0	0	0	0	0	0	0
Connect F1	Connect	Tri-Gen 1	RohnF1	SNB-F1	1	4	1	1	1	0	0	0	0	0	0	0	0
Connect F2	Connect	Tri-Gen 2	RohnF2	SNB-F2	1	4	1	1	1	0	0	0	0	0	0	0	0
Connect FaP	Connect	Tri-Symmetry	RohnFaS	SNB-FaS	1	4	1	1	1	0	0	0	0	0	0	0	0
Connect Fa1	Connect	Tri-Gen 1	RohnFa1	SNB-Fa1	1	4	1	1	1	0	0	0	0	0	0	0	0
Connect Fa2	Connect	Tri-Gen 2	RohnFa2	SNB-Fa2	1	4	1	1	1	0	0	0	0	0	0	0	0
Connect GP	Connect	Tri-Symmetry	RohnGP	SNB-GP	1	4	1	1	1	0	0	0	0	0	0	0	0
Connect G1	Connect	Tri-Gen 1	RohnG1	SNB-G1	1	4	1	1	1	0	0	0	0	0	0	0	0
Connect G2	Connect	Tri-Gen 2	RohnG2	SNB-G2	1	4	1	1	1	0	0	0	0	0	0	0	0
Connect GaP	Connect	Tri-Symmetry	RohnGaS	SNB-GaS	1	4	1	1	1	0	0	0	0	0	0	0	0
Connect Ga1	Connect	Tri-Gen 1	RohnGa1	SNB-Ga1	1	4	1	1	1	0	0	0	0	0	0	0	0
Connect Ga2	Connect	Tri-Gen 2	RohnGa2	SNB-Ga2	1	4	1	1	1	0	0	0	0	0	0	0	0
Connect HP	Connect	Tri-Symmetry	RohnHP	SNB-HP	1	4	1	1	1	0	0	0	0	0	0	0	0
Connect H1	Connect	Tri-Gen 1	RohnH1	SNB-H1	1	4	1	1	1	0	0	0	0	0	0	0	0
Connect H2	Connect	Tri-Gen 2	RohnH2	SNB-H2	1	4	1	1	1	0	0	0	0	0	0	0	0
Connect HaP	Connect	Tri-Symmetry	RohnHaS	SNB-HaS	1	4	1	1	1	0	0	0	0	0	0	0	0
Connect Ha1	Connect	Tri-Gen 1	RohnHa1	SNB-Ha1	1	4	1	1	1	0	0	0	0	0	0	0	0
Connect Ha2	Connect	Tri-Gen 2	RohnHa2	SNB-Ha2	1	4	1	1	1	0	0	0	0	0	0	0	0
Connect IP	Connect	Tri-Symmetry	RohnIP	SNB-IP	1	4	1	1	1	0	0	0	0	0	0	0	0
Connect I1	Connect	Tri-Gen 1	RohnI1	SNB-I1	1	4	1	1	1	0	0	0	0	0	0	0	0
Connect I2	Connect	Tri-Gen 2	RohnI2	SNB-I2	1	4	1	1	1	0	0	0	0	0	0	0	0
Connect IaP	Connect	Tri-Symmetry	RohnIaS	SNB-IaS	1	4	1	1	1	0	0	0	0	0	0	0	0
Connect Ia1	Connect	Tri-Gen 1	RohnIa1	SNB-Ia1	1	4	1	1	1	0	0	0	0	0	0	0	0
Connect Ia2	Connect	Tri-Gen 2	RohnIa2	SNB-Ia2	1	4	1	1	1	0	0	0	0	0	0	0	0
SNB-H1aP	SNB-H1	None	SNB-AP	SNB-WL-A1S	1	4	1	1	1	0	0	0	0	0	0	0	0
SNB-H1bP	SNB-H1	None	SNB-WL-A1S	SNB-A1	1	4	1	1	1	0	0	0	0	0	0	0	0
SNB-H1cP	SNB-H1	None	SNB-A1	SNB-WL-A2S	1	4	1	1	1	0	0	0	0	0	0	0	0
SNB-H1dP	SNB-H1	None	SNB-WL-A2S	SNB-A2	1	4	1	1	1	0	0	0	0	0	0	0	0
SNB-H1eP	SNB-H1	None	SNB-A2	SNB-WL-A3S	1	4	1	1	1	0	0	0	0	0	0	0	0
SNB-H1fP	SNB-H1	None	SNB-WL-A3S	SNB-AP	1	4	1	1	1	0	0	0	0	0	0	0	0
SNB-H2aP	SNB-H1	None	SNB-BP	SNB-WL-B1S	1	4	1	1	1	0	0	0	0	0	0	0	0
SNB-H2bP	SNB-H1	None	SNB-WL-B1S	SNB-B1	1	4	1	1	1	0	0	0	0	0	0	0	0
SNB-H2cP	SNB-H1	None	SNB-B1	SNB-WL-B2S	1	4	1	1	1	0	0	0	0	0	0	0	0
SNB-H2dP	SNB-H1	None	SNB-WL-B2S	SNB-B2	1	4	1	1	1	0	0	0	0	0	0	0	0
SNB-H2eP	SNB-H1	None	SNB-B2	SNB-WL-B3S	1	4	1	1	1	0	0	0	0	0	0	0	0
SNB-H2fP	SNB-H1	None	SNB-WL-B3S	SNB-BP	1	4	1	1	1	0	0	0	0	0	0	0	0
SNB-H3aP	SNB-H1	None	SNB-CP	SNB-WL-C1S	1	4	1	1	1	0	0	0	0	0	0	0	0
SNB-H3bP	SNB-H1	None	SNB-WL-C1S	SNB-C1	1	4	1	1	1	0	0	0	0	0	0	0	0
SNB-H3cP	SNB-H1	None	SNB-C1	SNB-WL-C2S	1	4	1	1	1	0	0	0	0	0	0	0	0
SNB-H3dP	SNB-H1	None	SNB-WL-C2S	SNB-C2	1	4	1	1	1	0	0	0	0	0	0	0	0
SNB-H3eP	SNB-H1	None	SNB-C2	SNB-WL-C3S	1	4	1	1	1	0	0	0	0	0	0	0	0
SNB-H3fP	SNB-H1	None	SNB-WL-C3S	SNB-CP	1	4	1	1	1	0	0	0	0	0	0	0	0
SNB-H4aP	SNB-H1	None	SNB-DP	SNB-WL-D1S	1	4	1	1	1	0	0	0	0	0	0	0	0
SNB-H4bP	SNB-H1	None	SNB-WL-D1S	SNB-D1	1	4	1	1	1	0	0	0	0	0	0	0	0
SNB-H4cP	SNB-H1	None	SNB-D1	SNB-WL-D2S	1	4	1	1	1	0	0	0	0	0	0	0	0
SNB-H4dP	SNB-H1	None	SNB-WL-D2S	SNB-D2	1	4	1	1	1	0	0	0	0	0	0	0	0
SNB-H4eP	SNB-H1	None	SNB-D2	SNB-WL-D3S	1	4	1	1	1	0	0	0	0	0	0	0	0
SNB-H4fP	SNB-H1	None	SNB-WL-D3S	SNB-DP	1	4	1	1	1	0	0	0	0	0	0	0	0
SNB-H5aP	SNB-H2	None	SNB-EP	SNB-WL-E1S	1	4	1	1	1	0	0	0	0	0	0	0	0
SNB-H5bP	SNB-H2	None	SNB-WL-E1S	SNB-E1	1	4	1	1	1	0	0	0	0	0	0	0	0
SNB-H5cP	SNB-H2	None	SNB-E1	SNB-WL-E2S	1	4	1	1	1	0	0	0	0	0	0	0	0
SNB-H5dP	SNB-H2	None	SNB-WL-E2S	SNB-E2	1	4	1	1	1	0	0	0	0	0	0	0	0
SNB-H5eP	SNB-H2	None	SNB-E2	SNB-WL-E3S	1	4	1	1	1	0	0	0	0	0	0	0	0
SNB-H5fP	SNB-H2	None	SNB-WL-E3S	SNB-EP	1	4	1	1	1	0	0	0	0	0	0	0	0
SNB-H6aP	SNB-H2	None	SNB-FP	SNB-WL-F1S	1	4	1	1	1	0	0	0	0	0	0	0	0
SNB-H6bP	SNB-H2	None	SNB-WL-F1S	SNB-F1	1	4	1	1	1	0	0	0	0	0	0	0	0
SNB-H6cP	SNB-H2	None	SNB-F1	SNB-WL-F2S	1	4	1	1	1	0	0	0	0	0	0	0	0
SNB-H6dP	SNB-H2	None	SNB-WL-F2S	SNB-F2	1	4	1	1	1	0	0	0	0	0	0	0	0
SNB-H6eP	SNB-H2	None	SNB-F2	SNB-WL-F3S	1	4	1	1	1	0	0	0	0	0	0	0	0
SNB-H6fP	SNB-H2	None	SNB-WL-F3S	SNB-FP	1	4	1	1	1	0	0	0	0	0	0	0	0
SNB-H7aP	SNB-H2	None	SNB-GP	SNB-WL-G1S	1	4	1	1	1	0	0	0	0	0	0	0	0
SNB-H7bP	SNB-H2	None	SNB-WL-G1S	SNB-G1	1	4	1	1	1	0	0	0	0	0	0	0	0
SNB-H7cP	SNB-H2	None	SNB-G1	SNB-WL-G2S	1	4	1	1	1	0	0	0	0	0	0	0	0
SNB-H7dP	SNB-H2	None	SNB-WL-G2S	SNB-G2	1	4	1	1	1	0	0	0	0	0	0	0	0

SNB-H7eP	SNB-H2	None	SNB-G2	SNB-WL-G3S	1	4	1	1	1	0	0	0	0	0	0	0	0	0	0
SNB-H7fP	SNB-H2	None	SNB-WL-G3S	SNB-GP	1	4	1	1	1	0	0	0	0	0	0	0	0	0	0
SNB-H8aP	SNB-H2	None	SNB-HP	SNB-WL-H1S	1	4	1	1	1	0	0	0	0	0	0	0	0	0	0
SNB-H8bP	SNB-H2	None	SNB-WL-H1S	SNB-H1	1	4	1	1	1	0	0	0	0	0	0	0	0	0	0
SNB-H8cP	SNB-H2	None	SNB-H1	SNB-WL-H2S	1	4	1	1	1	0	0	0	0	0	0	0	0	0	0
SNB-H8dP	SNB-H2	None	SNB-WL-H2S	SNB-H2	1	4	1	1	1	0	0	0	0	0	0	0	0	0	0
SNB-H8eP	SNB-H2	None	SNB-H2	SNB-WL-H3S	1	4	1	1	1	0	0	0	0	0	0	0	0	0	0
SNB-H8fP	SNB-H2	None	SNB-WL-H3S	SNB-HP	1	4	1	1	1	0	0	0	0	0	0	0	0	0	0
SNB-H9aP	SNB-H2	None	SNB-IP	SNB-WL-I1S	1	4	1	1	1	0	0	0	0	0	0	0	0	0	0
SNB-H9bP	SNB-H2	None	SNB-WL-I1S	SNB-I1	1	4	1	1	1	0	0	0	0	0	0	0	0	0	0
SNB-H9cP	SNB-H2	None	SNB-I1	SNB-WL-I2S	1	4	1	1	1	0	0	0	0	0	0	0	0	0	0
SNB-H9dP	SNB-H2	None	SNB-WL-I2S	SNB-I2	1	4	1	1	1	0	0	0	0	0	0	0	0	0	0
SNB-H9eP	SNB-H2	None	SNB-I2	SNB-WL-I3S	1	4	1	1	1	0	0	0	0	0	0	0	0	0	0
SNB-H9fP	SNB-H2	None	SNB-WL-I3S	SNB-IP	1	4	1	1	1	0	0	0	0	0	0	0	0	0	0
SNB-WL-A1P	WLAC-1	None	SNB-WL-A1S	SNB-WL-A2S	1	4	1	1	1	0	0	0	0	0	0	0	0	0	0
SNB-WL-A2P	WLAC-1	None	SNB-WL-A2S	SNB-WL-A3S	1	4	1	1	1	0	0	0	0	0	0	0	0	0	0
SNB-WL-A3P	WLAC-1	None	SNB-WL-A3S	SNB-WL-A1S	1	4	1	1	1	0	0	0	0	0	0	0	0	0	0
SNB-WL-B1P	WLAC-1	None	SNB-WL-B1S	SNB-WL-B2S	1	4	1	1	1	0	0	0	0	0	0	0	0	0	0
SNB-WL-B2P	WLAC-1	None	SNB-WL-B2S	SNB-WL-B3S	1	4	1	1	1	0	0	0	0	0	0	0	0	0	0
SNB-WL-B3P	WLAC-1	None	SNB-WL-B3S	SNB-WL-B1S	1	4	1	1	1	0	0	0	0	0	0	0	0	0	0
SNB-WL-C1P	WLAC-1	None	SNB-WL-C1S	SNB-WL-C2S	1	4	1	1	1	0	0	0	0	0	0	0	0	0	0
SNB-WL-C2P	WLAC-1	None	SNB-WL-C2S	SNB-WL-C3S	1	4	1	1	1	0	0	0	0	0	0	0	0	0	0
SNB-WL-C3P	WLAC-1	None	SNB-WL-C3S	SNB-WL-C1S	1	4	1	1	1	0	0	0	0	0	0	0	0	0	0
SNB-WL-D1P	WLAC-1	None	SNB-WL-D1S	SNB-WL-D2S	1	4	1	1	1	0	0	0	0	0	0	0	0	0	0
SNB-WL-D2P	WLAC-1	None	SNB-WL-D2S	SNB-WL-D3S	1	4	1	1	1	0	0	0	0	0	0	0	0	0	0
SNB-WL-D3P	WLAC-1	None	SNB-WL-D3S	SNB-WL-D1S	1	4	1	1	1	0	0	0	0	0	0	0	0	0	0
SNB-WL-E1P	WLAC-2	None	SNB-WL-E1S	SNB-WL-E2S	1	4	1	1	1	0	0	0	0	0	0	0	0	0	0
SNB-WL-E2P	WLAC-2	None	SNB-WL-E2S	SNB-WL-E3S	1	4	1	1	1	0	0	0	0	0	0	0	0	0	0
SNB-WL-E3P	WLAC-2	None	SNB-WL-E3S	SNB-WL-E1S	1	4	1	1	1	0	0	0	0	0	0	0	0	0	0
SNB-WL-F1P	WLAC-2	None	SNB-WL-F1S	SNB-WL-F2S	1	4	1	1	1	0	0	0	0	0	0	0	0	0	0
SNB-WL-F2P	WLAC-2	None	SNB-WL-F2S	SNB-WL-F3S	1	4	1	1	1	0	0	0	0	0	0	0	0	0	0
SNB-WL-F3P	WLAC-2	None	SNB-WL-F3S	SNB-WL-F1S	1	4	1	1	1	0	0	0	0	0	0	0	0	0	0
SNB-WL-G1P	WLAC-2	None	SNB-WL-G1S	SNB-WL-G2S	1	4	1	1	1	0	0	0	0	0	0	0	0	0	0
SNB-WL-G2P	WLAC-2	None	SNB-WL-G2S	SNB-WL-G3S	1	4	1	1	1	0	0	0	0	0	0	0	0	0	0
SNB-WL-G3P	WLAC-2	None	SNB-WL-G3S	SNB-WL-G1S	1	4	1	1	1	0	0	0	0	0	0	0	0	0	0
SNB-WL-H1P	WLAC-2	None	SNB-WL-H1S	SNB-WL-H2S	1	4	1	1	1	0	0	0	0	0	0	0	0	0	0
SNB-WL-H2P	WLAC-2	None	SNB-WL-H2S	SNB-WL-H3S	1	4	1	1	1	0	0	0	0	0	0	0	0	0	0
SNB-WL-H3P	WLAC-2	None	SNB-WL-H3S	SNB-WL-H1S	1	4	1	1	1	0	0	0	0	0	0	0	0	0	0
SNB-WL-I1P	WLAC-2	None	SNB-WL-I1S	SNB-WL-I2S	1	4	1	1	1	0	0	0	0	0	0	0	0	0	0
SNB-WL-I2P	WLAC-2	None	SNB-WL-I2S	SNB-WL-I3S	1	4	1	1	1	0	0	0	0	0	0	0	0	0	0
SNB-WL-I3P	WLAC-2	None	SNB-WL-I3S	SNB-WL-I1S	1	4	1	1	1	0	0	0	0	0	0	0	0	0	0

Member Capacities and Overrides:

Member	Group	Design	Comp.	Design	Tension	L/r	Length	L/r	Connection	Connection	Net	Rupture	RTE	End	RTE	Edge	Override	Override	Override	Override	Override
Warnings	Label	Label	Comp.	Control	Tension	Control		Comp.	Shear	Bearing	Section	Tension	Dist.	Dist.	Comp.	Comp.	Tension	Tension	Face	or	
Errors			Capacity	Criterion	Capacity	Criterion		Capacity	Capacity	Capacity	Tension	Capacity	Tension	Tension	Capacity	Control	Capacity	Control	Member	ship	
			(kips)		(kips)		(ft)	(kips)	(kips)	(kips)	(kips)	(kips)	(kips)	(kips)	(kips)	(kips)	(kips)	(kips)			
--																					
Rohn-DA1P	Rohn-D1	5.454	L/r	7.750	Rupture	160	9.16	5.454	12.433	13.050	16.022	7.750	0.000	0.000	0.000		0.000		Automatic		
Rohn-DA11	Rohn-D1	5.454	L/r	7.750	Rupture	160	9.16	5.454	12.433	13.050	16.022	7.750	0.000	0.000	0.000		0.000		Automatic		
Rohn-DA12	Rohn-D1	5.454	L/r	7.750	Rupture	160	9.16	5.454	12.433	13.050	16.022	7.750	0.000	0.000	0.000		0.000		Automatic		
Rohn-DA2P	Rohn-D1	5.454	L/r	7.750	Rupture	160	9.16	5.454	12.433	13.050	16.022	7.750	0.000	0.000	0.000		0.000		Automatic		
Rohn-DA21	Rohn-D1	5.454	L/r	7.750	Rupture	160	9.16	5.454	12.433	13.050	16.022	7.750	0.000	0.000	0.000		0.000		Automatic		
Rohn-DA22	Rohn-D1	5.454	L/r	7.750	Rupture	160	9.16	5.454	12.433	13.050	16.022	7.750	0.000	0.000	0.000		0.000		Automatic		
Rohn-DA3P	Rohn-D1	5.127	L/r	7.750	Rupture	165	9.45	5.127	12.433	13.050	16.022	7.750	0.000	0.000	0.000		0.000		Automatic		
Rohn-DA31	Rohn-D1	5.127	L/r	7.750	Rupture	165	9.45	5.127	12.433	13.050	16.022	7.750	0.000	0.000	0.000		0.000		Automatic		
Rohn-DA32	Rohn-D1	5.127	L/r	7.750	Rupture	165	9.45	5.127	12.433	13.050	16.022	7.750	0.000	0.000	0.000		0.000		Automatic		
Rohn-DA4P	Rohn-D1	5.127	L/r	7.750	Rupture	165	9.45	5.127	12.433	13.050	16.022	7.750	0.000	0.000	0.000		0.000		Automatic		
Rohn-DA41	Rohn-D1	5.127	L/r	7.750	Rupture	165	9.45	5.127	12.433	13.050	16.022	7.750	0.000	0.000	0.000		0.000		Automatic		
Rohn-DA42	Rohn-D1	5.127	L/r	7.750	Rupture	165	9.45	5.127	12.433	13.050	16.022	7.750	0.000	0.000	0.000		0.000		Automatic		
Rohn-DA5P	Rohn-D1	4.825	L/r	7.750	Rupture	170	9.74	4.825	12.433	13.050	16.022	7.750	0.000	0.000	0.000		0.000		Automatic		
Rohn-DA51	Rohn-D1	4.825	L/r	7.750	Rupture	170	9.74	4.825	12.433	13.050	16.022	7.750	0.000	0.000	0.000		0.000		Automatic		
Rohn-DA52	Rohn-D1	4.825	L/r	7.750	Rupture	170	9.74	4.825	12.433	13.050	16.022	7.750	0.000	0.000	0.000		0.000		Automatic		
Rohn-DA6P	Rohn-D1	4.825	L/r	7.750	Rupture	170	9.74	4.825	12.433	13.050	16.022	7.750	0.000	0.000	0.000		0.000		Automatic		

SNB-H7bP	SNB-H2	174.858	L/r	201.204	Net Sect	52	6.11	174.858	0.000	0.000	201.204	0.000	0.000	0.000	0.000	0.000	Automatic
SNB-H7cP	SNB-H2	174.858	L/r	201.204	Net Sect	52	6.11	174.858	0.000	0.000	201.204	0.000	0.000	0.000	0.000	0.000	Automatic
SNB-H7dP	SNB-H2	174.858	L/r	201.204	Net Sect	52	6.11	174.858	0.000	0.000	201.204	0.000	0.000	0.000	0.000	0.000	Automatic
SNB-H7eP	SNB-H2	174.858	L/r	201.204	Net Sect	52	6.11	174.858	0.000	0.000	201.204	0.000	0.000	0.000	0.000	0.000	Automatic
SNB-H7fP	SNB-H2	174.858	L/r	201.204	Net Sect	52	6.11	174.858	0.000	0.000	201.204	0.000	0.000	0.000	0.000	0.000	Automatic
SNB-H8aP	SNB-H2	169.180	L/r	201.204	Net Sect	57	6.79	169.180	0.000	0.000	201.204	0.000	0.000	0.000	0.000	0.000	Automatic
SNB-H8bP	SNB-H2	169.180	L/r	201.204	Net Sect	57	6.79	169.180	0.000	0.000	201.204	0.000	0.000	0.000	0.000	0.000	Automatic
SNB-H8cP	SNB-H2	169.180	L/r	201.204	Net Sect	57	6.79	169.180	0.000	0.000	201.204	0.000	0.000	0.000	0.000	0.000	Automatic
SNB-H8dP	SNB-H2	169.180	L/r	201.204	Net Sect	57	6.79	169.180	0.000	0.000	201.204	0.000	0.000	0.000	0.000	0.000	Automatic
SNB-H8eP	SNB-H2	169.180	L/r	201.204	Net Sect	57	6.79	169.180	0.000	0.000	201.204	0.000	0.000	0.000	0.000	0.000	Automatic
SNB-H8fP	SNB-H2	169.180	L/r	201.204	Net Sect	57	6.79	169.180	0.000	0.000	201.204	0.000	0.000	0.000	0.000	0.000	Automatic
SNB-H9aP	SNB-H2	163.108	L/r	201.204	Net Sect	63	7.47	163.108	0.000	0.000	201.204	0.000	0.000	0.000	0.000	0.000	Automatic
SNB-H9bP	SNB-H2	163.108	L/r	201.204	Net Sect	63	7.47	163.108	0.000	0.000	201.204	0.000	0.000	0.000	0.000	0.000	Automatic
SNB-H9cP	SNB-H2	163.108	L/r	201.204	Net Sect	63	7.47	163.108	0.000	0.000	201.204	0.000	0.000	0.000	0.000	0.000	Automatic
SNB-H9dP	SNB-H2	163.108	L/r	201.204	Net Sect	63	7.47	163.108	0.000	0.000	201.204	0.000	0.000	0.000	0.000	0.000	Automatic
SNB-H9eP	SNB-H2	163.108	L/r	201.204	Net Sect	63	7.47	163.108	0.000	0.000	201.204	0.000	0.000	0.000	0.000	0.000	Automatic
SNB-H9fP	SNB-H2	163.108	L/r	201.204	Net Sect	63	7.47	163.108	0.000	0.000	201.204	0.000	0.000	0.000	0.000	0.000	Automatic
SNB-WL-A1P	WLAC-1	24.875	L/r	30.456	Net Sect	62	2.02	24.875	0.000	0.000	30.456	0.000	0.000	0.000	0.000	0.000	Automatic
SNB-WL-A2P	WLAC-1	24.875	L/r	30.456	Net Sect	62	2.02	24.875	0.000	0.000	30.456	0.000	0.000	0.000	0.000	0.000	Automatic
SNB-WL-A3P	WLAC-1	24.875	L/r	30.456	Net Sect	62	2.02	24.875	0.000	0.000	30.456	0.000	0.000	0.000	0.000	0.000	Automatic
SNB-WL-B1P	WLAC-1	21.201	L/r	30.456	Net Sect	83	2.70	21.201	0.000	0.000	30.456	0.000	0.000	0.000	0.000	0.000	Automatic
SNB-WL-B2P	WLAC-1	21.201	L/r	30.456	Net Sect	83	2.70	21.201	0.000	0.000	30.456	0.000	0.000	0.000	0.000	0.000	Automatic
SNB-WL-B3P	WLAC-1	21.201	L/r	30.456	Net Sect	83	2.70	21.201	0.000	0.000	30.456	0.000	0.000	0.000	0.000	0.000	Automatic
SNB-WL-C1P	WLAC-1	17.258	L/r	30.456	Net Sect	104	3.38	17.258	0.000	0.000	30.456	0.000	0.000	0.000	0.000	0.000	Automatic
SNB-WL-C2P	WLAC-1	17.258	L/r	30.456	Net Sect	104	3.38	17.258	0.000	0.000	30.456	0.000	0.000	0.000	0.000	0.000	Automatic
SNB-WL-C3P	WLAC-1	17.258	L/r	30.456	Net Sect	104	3.38	17.258	0.000	0.000	30.456	0.000	0.000	0.000	0.000	0.000	Automatic
SNB-WL-D1P	WLAC-1	13.417	L/r	30.456	Net Sect	125	4.07	13.417	0.000	0.000	30.456	0.000	0.000	0.000	0.000	0.000	Automatic
SNB-WL-D2P	WLAC-1	13.417	L/r	30.456	Net Sect	125	4.07	13.417	0.000	0.000	30.456	0.000	0.000	0.000	0.000	0.000	Automatic
SNB-WL-D3P	WLAC-1	13.417	L/r	30.456	Net Sect	125	4.07	13.417	0.000	0.000	30.456	0.000	0.000	0.000	0.000	0.000	Automatic
SNB-WL-E1P	WLAC-2	23.157	L/r	47.304	Net Sect	116	4.75	23.157	0.000	0.000	47.304	0.000	0.000	0.000	0.000	0.000	Automatic
SNB-WL-E2P	WLAC-2	23.157	L/r	47.304	Net Sect	116	4.75	23.157	0.000	0.000	47.304	0.000	0.000	0.000	0.000	0.000	Automatic
SNB-WL-E3P	WLAC-2	23.157	L/r	47.304	Net Sect	116	4.75	23.157	0.000	0.000	47.304	0.000	0.000	0.000	0.000	0.000	Automatic
SNB-WL-F1P	WLAC-2	18.587	L/r	47.304	Net Sect	133	5.43	18.587	0.000	0.000	47.304	0.000	0.000	0.000	0.000	0.000	Automatic
SNB-WL-F2P	WLAC-2	18.587	L/r	47.304	Net Sect	133	5.43	18.587	0.000	0.000	47.304	0.000	0.000	0.000	0.000	0.000	Automatic
SNB-WL-F3P	WLAC-2	18.587	L/r	47.304	Net Sect	133	5.43	18.587	0.000	0.000	47.304	0.000	0.000	0.000	0.000	0.000	Automatic
SNB-WL-G1P	WLAC-2	14.672	L/r	47.304	Net Sect	150	6.11	14.672	0.000	0.000	47.304	0.000	0.000	0.000	0.000	0.000	Automatic
SNB-WL-G2P	WLAC-2	14.672	L/r	47.304	Net Sect	150	6.11	14.672	0.000	0.000	47.304	0.000	0.000	0.000	0.000	0.000	Automatic
SNB-WL-G3P	WLAC-2	14.672	L/r	47.304	Net Sect	150	6.11	14.672	0.000	0.000	47.304	0.000	0.000	0.000	0.000	0.000	Automatic
SNB-WL-H1P	WLAC-2	11.878	L/r	47.304	Net Sect	167	6.79	11.878	0.000	0.000	47.304	0.000	0.000	0.000	0.000	0.000	Automatic
SNB-WL-H2P	WLAC-2	11.878	L/r	47.304	Net Sect	167	6.79	11.878	0.000	0.000	47.304	0.000	0.000	0.000	0.000	0.000	Automatic
SNB-WL-H3P	WLAC-2	11.878	L/r	47.304	Net Sect	167	6.79	11.878	0.000	0.000	47.304	0.000	0.000	0.000	0.000	0.000	Automatic
SNB-WL-I1P	WLAC-2	9.810	L/r	47.304	Net Sect	183	7.47	9.810	0.000	0.000	47.304	0.000	0.000	0.000	0.000	0.000	Automatic
SNB-WL-I2P	WLAC-2	9.810	L/r	47.304	Net Sect	183	7.47	9.810	0.000	0.000	47.304	0.000	0.000	0.000	0.000	0.000	Automatic
SNB-WL-I3P	WLAC-2	9.810	L/r	47.304	Net Sect	183	7.47	9.810	0.000	0.000	47.304	0.000	0.000	0.000	0.000	0.000	Automatic

The model contains 612 angle members.

Section Joint Information:

Section Label	Joint Label	Joint Elevation (ft)
A	RohnAP	180.000
A	RohnAa1	175.000
A	RohnA1	180.000
A	RohnAa2	175.000
A	RohnA2	180.000
A	RohnAaS	175.000
A	RohnAb1	170.000
A	RohnAb2	170.000
A	RohnAbS	170.000
A	RohnAc1	165.000
A	RohnAc2	165.000
A	RohnAcS	165.000
A	RohnB2	160.000
A	RohnBP	160.000
A	RohnB1	160.000
A	SNB-AP	180.000

A	SNB-Aa1	175.000
A	SNB-A1	180.000
A	SNB-Aa2	175.000
A	SNB-A2	180.000
A	SNB-AaS	175.000
A	SNB-Ab1	170.000
A	SNB-Ab2	170.000
A	SNB-AbS	170.000
A	SNB-Ac1	165.000
A	SNB-Ac2	165.000
A	SNB-AcS	165.000
A	SNB-B1	160.000
A	SNB-B2	160.000
A	SNB-BP	160.000
A	SNB-WL-A1S	180.000
A	SNB-WL-A2S	180.000
A	SNB-WL-A3S	180.000
A	SNB-WL-B1S	160.000
A	SNB-WL-B2S	160.000
A	SNB-WL-B3S	160.000
B	RohnBP	160.000
B	RohnBa1	155.000
B	RohnB1	160.000
B	RohnBa2	155.000
B	RohnB2	160.000
B	RohnBaS	155.000
B	RohnBb1	150.000
B	RohnBb2	150.000
B	RohnBbS	150.000
B	RohnBc1	145.000
B	RohnBc2	145.000
B	RohnBcS	145.000
B	RohnC1	140.000
B	RohnC2	140.000
B	RohnCP	140.000
B	SNB-BP	160.000
B	SNB-Ba1	155.000
B	SNB-B1	160.000
B	SNB-Ba2	155.000
B	SNB-B2	160.000
B	SNB-BaS	155.000
B	SNB-Bb1	150.000
B	SNB-Bb2	150.000
B	SNB-BbS	150.000
B	SNB-Bc1	145.000
B	SNB-Bc2	145.000
B	SNB-BcS	145.000
B	SNB-C1	140.000
B	SNB-C2	140.000
B	SNB-CP	140.000
B	SNB-WL-C1S	140.000
B	SNB-WL-C2S	140.000
B	SNB-WL-C3S	140.000
C	RohnCP	140.000
C	RohnCa1	133.340
C	RohnC1	140.000
C	RohnCa2	133.340
C	RohnC2	140.000
C	RohnCaS	133.340
C	RohnCb1	126.660
C	RohnCb2	126.660
C	RohnCbS	126.660
C	RohnD1	120.000
C	RohnD2	120.000
C	RohnDP	120.000
C	SNB-CP	140.000
C	SNB-Ca1	133.340
C	SNB-C1	140.000
C	SNB-Ca2	133.340

C	SNB-C2	140.000
C	SNB-CaS	133.340
C	SNB-Cb1	126.660
C	SNB-Cb2	126.660
C	SNB-CbS	126.660
C	SNB-D1	120.000
C	SNB-D2	120.000
C	SNB-DP	120.000
C	SNB-WL-D1S	120.000
C	SNB-WL-D2S	120.000
C	SNB-WL-D3S	120.000
D	RohnDP	120.000
D	RohnDa1	113.340
D	RohnD1	120.000
D	RohnDa2	113.340
D	RohnD2	120.000
D	RohnDaS	113.340
D	RohnDb1	106.660
D	RohnDb2	106.660
D	RohnDbS	106.660
D	RohnE1	100.000
D	RohnE2	100.000
D	RohnEP	100.000
D	SNB-DP	120.000
D	SNB-Da1	113.340
D	SNB-D1	120.000
D	SNB-Da2	113.340
D	SNB-D2	120.000
D	SNB-DaS	113.340
D	SNB-Db1	106.660
D	SNB-Db2	106.660
D	SNB-DbS	106.660
D	SNB-E1	100.000
D	SNB-E2	100.000
D	SNB-EP	100.000
D	SNB-WL-E1S	100.000
D	SNB-WL-E2S	100.000
D	SNB-WL-E3S	100.000
E	RohnEP	100.000
E	RohnEa1	93.340
E	RohnE1	100.000
E	RohnEa2	93.340
E	RohnE2	100.000
E	RohnEaS	93.340
E	RohnEb1	86.660
E	RohnEb2	86.660
E	RohnEbS	86.660
E	RohnF1	80.000
E	RohnF2	80.000
E	RohnFP	80.000
E	SNB-EP	100.000
E	SNB-Ea1	93.340
E	SNB-E1	100.000
E	SNB-Ea2	93.340
E	SNB-E2	100.000
E	SNB-EaS	93.340
E	SNB-Eb1	86.660
E	SNB-Eb2	86.660
E	SNB-EbS	86.660
E	SNB-F1	80.000
E	SNB-F2	80.000
E	SNB-FP	80.000
E	SNB-WL-F1S	80.000
E	SNB-WL-F2S	80.000
E	SNB-WL-F3S	80.000
F	RohnFP	80.000
F	RohnFa1	70.000
F	RohnF1	80.000
F	RohnFa2	70.000

F	RohnF2	80.000
F	RohnFaS	70.000
F	RohnG1	60.000
F	RohnG2	60.000
F	RohnGP	60.000
F	SNB-FP	80.000
F	SNB-Fa1	70.000
F	SNB-F1	80.000
F	SNB-Fa2	70.000
F	SNB-F2	80.000
F	SNB-FaS	70.000
F	SNB-G1	60.000
F	SNB-G2	60.000
F	SNB-GP	60.000
F	SNB-WL-G1S	60.000
F	SNB-WL-G2S	60.000
F	SNB-WL-G3S	60.000
G	RohnGP	60.000
G	RohnGa1	50.000
G	RohnG1	60.000
G	RohnGa2	50.000
G	RohnG2	60.000
G	RohnGaS	50.000
G	RohnH1	40.000
G	RohnH2	40.000
G	RohnHP	40.000
G	SNB-GP	60.000
G	SNB-Ga1	50.000
G	SNB-G1	60.000
G	SNB-Ga2	50.000
G	SNB-G2	60.000
G	SNB-GaS	50.000
G	SNB-H1	40.000
G	SNB-H2	40.000
G	SNB-HP	40.000
G	SNB-WL-H1S	40.000
G	SNB-WL-H2S	40.000
G	SNB-WL-H3S	40.000
H	RohnHP	40.000
H	RohnHa1	30.000
H	RohnH1	40.000
H	RohnHa2	30.000
H	RohnH2	40.000
H	RohnHaS	30.000
H	RohnI1	20.000
H	RohnI2	20.000
H	RohnIP	20.000
H	SNB-HP	40.000
H	SNB-Ha1	30.000
H	SNB-H1	40.000
H	SNB-Ha2	30.000
H	SNB-H2	40.000
H	SNB-HaS	30.000
H	SNB-I1	20.000
H	SNB-I2	20.000
H	SNB-IP	20.000
H	SNB-WL-I1S	20.000
H	SNB-WL-I2S	20.000
H	SNB-WL-I3S	20.000
I	RohnIP	20.000
I	RohnIa1	10.000
I	RohnI1	20.000
I	RohnIa2	10.000
I	RohnI2	20.000
I	RohnIaS	10.000
I	RohnJ1	0.000
I	RohnJ2	0.000
I	RohnJP	0.000
I	SNB-IP	20.000

I	SNB-Ia1	10.000
I	SNB-I1	20.000
I	SNB-Ia2	10.000
I	SNB-I2	20.000
I	SNB-IaS	10.000
I	SNB-J1	0.000
I	SNB-J2	0.000
I	SNB-JP	0.000

EIA Sections Information:

Section Label	Top Z (ft)	Bottom Z (ft)	Joint Z Count	Member Count	Top Width (ft)	Bottom Width (ft)	Gross Area (ft^2)	Face Adj Factor	Face Ar Adj Factor	Dead Load
A	180.000	160.000	36	111	7.50	8.87	163.75	0.9000	0.9000	1.000
B	160.000	140.000	33	93	8.87	10.23	191.05	0.9000	0.9000	1.000
C	140.000	120.000	27	72	10.23	11.60	218.31	0.9000	0.9000	1.000
D	120.000	100.000	27	72	11.60	12.96	245.54	0.9000	0.9000	1.000
E	100.000	80.000	27	72	12.96	14.32	272.78	0.9000	0.9000	1.000
F	80.000	60.000	21	51	14.32	15.68	300.04	0.9000	0.9000	1.000
G	60.000	40.000	21	51	15.68	17.05	327.29	0.9000	0.9000	1.000
H	40.000	20.000	21	51	17.05	18.41	354.57	0.9000	0.9000	1.000
I	20.000	0.000	18	39	18.41	19.78	381.92	0.9000	0.9000	1.000

Equipment Library:

Equipment Property Label	Stock Number	Weight (lbs)	Wind Area (ft^2)	Ice Area (ft^2)	Shape or EIA Antenna Type	Drag Coef.	Diameter (ft)	Height (ft)
RFS PD1142 w/ ice	Omni	10.0	1.32	0.00	Circle	1.00	0.00	0.00
Andrew DB-583 w/ ice	Omni	6.3	0.54	0.00	Circle	1.00	0.00	0.00
12` T-Arm Mount	Mount	465.0	13.60	0.00	Square	1.00	0.00	0.00
3` Stand-Off Mount	Mount	50.0	2.72	0.00	Square	1.00	0.00	0.00
Dipole Dipole	Dipole	46.0	9.17	0.00	Circle	1.00	0.00	0.00
TMA TMA	TMA	15.0	1.29	0.00	Square	1.00	0.00	0.00
GPS GPS	GPS	10.0	1.00	0.00	Circle	1.00	0.00	0.00
Powerwave 7770 Panel	Panel	35.0	5.88	0.00	Square	1.00	0.00	0.00
Raycap Surge Suppressor Other	Other	27.0	1.79	0.00	Circle	1.00	0.00	0.00
4` Dipole Dipole	Dipole	40.0	3.70	0.00	Circle	1.00	0.00	0.00
DB586-Y Omni	Omni	8.2	1.01	0.00	Circle	1.00	0.00	0.00
5` Dipole Dipole	Dipole	50.0	3.95	0.00	Circle	1.00	0.00	0.00
8` Omni Omni	Omni	5.0	2.00	0.00	Circle	1.00	0.00	0.00
12` Omni Omni	Omni	55.0	4.00	0.00	Circle	1.00	0.00	0.00
Boom Gate Mount	Mount	471.0	13.60	0.00	Square	1.00	0.00	0.00
Scala OGT9-806 w/ ice	Omni	18.5	2.27	0.00	Circle	1.00	0.00	0.00
Sinclair SC479-HF1LDF w/ ice	Omni	34.0	5.06	0.00	Circle	1.00	0.00	0.00
RFS APXVSP18-C w/ ice	Panel	90.0	8.26	0.00	Square	1.00	0.00	0.00
ALU RRH	RRH	60.0	6.90	0.00	Square	1.00	0.00	0.00
6` Stand-Off Mount	Mount	140.0	10.60	0.00	Square	1.00	0.00	0.00
Decibel DB844H80-XY w/ ice	Panel	10.0	3.97	0.00	Square	1.00	0.00	0.00
Raycap DB-T1-6Z-8AB-0Z Dist. Box	Panel	45.0	5.60	0.00	Square	1.00	0.00	0.00
Ericsson AIR B2A/B4P	Panel	110.0	6.53	0.00	Square	1.00	0.00	0.00
Decibel PD-420 2 bay - Dipole	Dipole	10.0	1.64	0.00	Square	1.00	0.00	0.00
RRHU-11 RRH Unit	RRH	50.0	2.99	0.00	Square	1.00	0.00	0.00
10` Dipole Dipole	Dipole	46.0	9.17	0.00	Square	1.00	0.00	0.00
4`x1` Panel	Panel	30.0	6.53	0.00	Square	1.00	0.00	0.00
DT465B-2XR-V2	Panel	88.4	9.65	0.00	Square	1.00	0.00	0.00
800 MHz RRH Unit	RRH	60.0	6.90	0.00	Square	1.00	0.00	0.00
TD-RRH 8x20-25 RRH Unit	RRH	66.1	4.72	0.00	Square	1.00	0.00	0.00
JAHH-65B-R3B Panel	Panel	126.3	9.66	0.00	Square	1.00	0.00	0.00
BSAMNT-SBS-2-2 Mount for JAHH Antenna	Mount	116.0	3.78	0.00	Square	1.00	0.00	0.00
RRH 2x60W (700 MHz)	RRH	60.0	2.12	0.00	Square	1.00	0.00	0.00
RRH 4x45W (AWS)	RRH	60.0	2.96	0.00	Square	1.00	0.00	0.00
RHH 2x80W (850 MHz)	RRH	90.0	2.91	0.00	Square	1.00	0.00	0.00
Ericsson 4478 (B71) RRH Unit	RRH	60.0	1.26	0.00	Square	1.00	0.00	0.00
AIR32 B66/B2A	Panel	132.2	5.84	0.00	Square	1.00	0.00	0.00
APXVAA24_43-U-A20 (RFS)	Panel	150.0	22.38	0.00	Square	1.00	0.00	0.00

Twin TMA Unit - Generic	Other	25.0	1.12	0.00	Square	1.00	0.00	0.00
Diplexer Unit - Generic	Other	25.0	0.72	0.00	Square	1.00	0.00	0.00
TMA Unit (LGP24101)	Other	14.1	1.29	0.00	Square	1.00	0.00	0.00
OPA-65-LCUU-H6 Panel	Panel	64.0	10.12	0.00	Square	1.00	0.00	0.00
RRUS-32 RRH Unit	Other	80.0	3.88	0.00	Square	1.00	0.00	0.00
4` Dish	Dish	120.0	13.10	0.00	EIA Microwave MaxCA	1.00	0.00	0.00
8` Dish with Radome	Dish	560.0	51.32	0.00	EIA Microwave Radome MaxCA	1.00	0.00	0.00

Equipment Connectivity:

Equipment Label	Attach Label	Equipment Property	EIA Antenna Orientation Set	Angle (deg)
DNK-1	RohnGP	5` Dipole		0.00
MT-DNK1	RohnGP	3` Stand-Off		0.00
DNK2-GPS68	RohnG1	GPS		120.00
MT-DNK2	RohnG1	3` Stand-Off		120.00
DNK3-GPS69	RohnG2	GPS		240.00
MT-DNK3	RohnG2	3` Stand-Off		240.00
DNK4-DOT56	RohnG2	10` Dipole		240.00
MT-DNK4	RohnG2	3` Stand-Off		240.00
DNK5-NEU16	RohnF2	8` Omni		240.00
MT-DNK5	RohnF2	6` Stand-Off		240.00
DNK9-DEP54	RohnD1	RFS PD1142 w/ ice		120.00
MT-DNK9	RohnD1	3` Stand-Off		120.00
DNK8-CSP66	RohnD1	RFS PD1142 w/ ice		120.00
DNK7-NEU17	RohnDaS	12` Omni		0.00
MT-DNK7	RohnDaS	3` Stand-Off		0.00
Sprint-A	RohnDaS	12` T-Arm		0.00
Sprint-B	RohnDa1	12` T-Arm		120.00
Sprint-C	RohnDa2	12` T-Arm		240.00
Sprint-1	RohnDaS	RFS APXVSP18-C w/ ice		0.00
Sprint-2	RohnDaS	ALU RRH		0.00
Sprint-3	RohnDaS	ALU RRH		0.00
Sprint-4	RohnDa1	RFS APXVSP18-C w/ ice		120.00
Sprint-5	RohnDa1	ALU RRH		120.00
Sprint-6	RohnDa1	ALU RRH		120.00
Sprint-7	RohnDa2	RFS APXVSP18-C w/ ice		240.00
Sprint-8	RohnDa2	ALU RRH		240.00
Sprint-9	RohnDa2	ALU RRH		240.00
Sprint-10	RohnDaS	DT465B-2XR-V2		0.00
Sprint-11	RohnDa1	DT465B-2XR-V2		120.00
Sprint-12	RohnDa2	DT465B-2XR-V2		240.00
Sprint-13	RohnDaS	800 MHz RRH Unit		0.00
Sprint-14	RohnDa1	800 MHz RRH Unit		120.00
Sprint-15	RohnDa2	800 MHz RRH Unit		240.00
Sprint-16	RohnDaS	TD-RRH 8x20-25 RRH Unit		0.00
Sprint-17	RohnDa1	TD-RRH 8x20-25 RRH Unit		120.00
Sprint-18	RohnDa2	TD-RRH 8x20-25 RRH Unit		240.00
Verizon-A	RohnCbS	Boom Gate		0.00
Verizon-B	RohnCb1	Boom Gate		120.00
Verizon-C	RohnCb2	Boom Gate		240.00
Verizon-1	RohnCbS	Decibel DB844H80-XY w/ ice		0.00
Verizon-2	RohnCbS	Decibel DB844H80-XY w/ ice		0.00
Verizon-3	RohnCb1	Decibel DB844H80-XY w/ ice		120.00
Verizon-4	RohnCb1	Decibel DB844H80-XY w/ ice		120.00
Verizon-5	RohnCb2	Decibel DB844H80-XY w/ ice		240.00
Verizon-6	RohnCb2	Decibel DB844H80-XY w/ ice		240.00
Verizon-7	RohnCbS	JAHH-65B-R3B Panel		0.00
Verizon-8	RohnCbS	JAHH-65B-R3B Panel		0.00
Verizon-9	RohnCb1	JAHH-65B-R3B Panel		120.00
Verizon-10	RohnCb1	JAHH-65B-R3B Panel		120.00
Verizon-11	RohnCb2	JAHH-65B-R3B Panel		240.00
Verizon-12	RohnCb2	JAHH-65B-R3B Panel		240.00
Verizon-D	RohnCbS	BSAMNT-SBS-2-2 Mount for JAHH Antenna		0.00
Verizon-E	RohnCb1	BSAMNT-SBS-2-2 Mount for JAHH Antenna		120.00
Verizon-F	RohnCb2	BSAMNT-SBS-2-2 Mount for JAHH Antenna		240.00

Verizon-13	RohnCbS	RRH 2x60W (700 MHz)	0.00
Verizon-14	RohnCb1	RRH 2x60W (700 MHz)	120.00
Verizon-15	RohnCb2	RRH 2x60W (700 MHz)	240.00
Verizon-16	RohnCbS	RRH 4x45W (AWS)	0.00
Verizon-17	RohnCb1	RRH 4x45W (AWS)	120.00
Verizon-18	RohnCb2	RRH 4x45W (AWS)	240.00
Verizon-19	RohnCbS	RHH 2x80W (850 MHz)	0.00
Verizon-20	RohnCb1	RHH 2x80W (850 MHz)	120.00
Verizon-21	RohnCb2	RHH 2x80W (850 MHz)	240.00
Verizon-22	RohnCbS	Raycap DB-T1-6Z-8AB-0Z Dist. Box	0.00
Verizon-23	RohnCb1	Raycap DB-T1-6Z-8AB-0Z Dist. Box	120.00
Verizon-24	RohnCb2	Raycap DB-T1-6Z-8AB-0Z Dist. Box	240.00
NEU-18	RohnCbS	12` Omni	0.00
DNK15-CSP21	RohnCa1	RFS PD1142 w/ ice	120.00
MT-DNK15	RohnCa1	3` Stand-Off	120.00
DNK-12	RohnCa2	5` Dipole	240.00
MT-DNK12	RohnCa2	3` Stand-Off	240.00
T-Mobile-1	RohnCaS	Ericsson AIR B2A/B4P	0.00
T-Mobile-2	RohnCaS	AIR32 B66/B2A	0.00
T-Mobile-3	RohnCaS	APXVAA24_43-U-A20 (RFS)	0.00
T-Mobile-4	RohnCa1	Ericsson AIR B2A/B4P	120.00
T-Mobile-5	RohnCa1	AIR32 B66/B2A	120.00
T-Mobile-6	RohnCa1	APXVAA24_43-U-A20 (RFS)	120.00
T-Mobile-7	RohnCa2	Ericsson AIR B2A/B4P	240.00
T-Mobile-8	RohnCa2	AIR32 B66/B2A	240.00
T-Mobile-9	RohnCa2	APXVAA24_43-U-A20 (RFS)	240.00
T-Mobile-10	RohnCaS	Twin TMA Unit - Generic	0.00
T-Mobile-11	RohnCa1	Twin TMA Unit - Generic	120.00
T-Mobile-12	RohnCa2	Twin TMA Unit - Generic	240.00
T-Mobile-13	RohnCaS	RRHU-11 RRH Unit	0.00
T-Mobile-14	RohnCa1	RRHU-11 RRH Unit	120.00
T-Mobile-15	RohnCa2	RRHU-11 RRH Unit	240.00
T-Mobile-16	RohnCaS	Ericsson 4478 (B71) RRH Unit	0.00
T-Mobile-17	RohnCa1	Ericsson 4478 (B71) RRH Unit	120.00
T-Mobile-18	RohnCa2	Ericsson 4478 (B71) RRH Unit	240.00
T-Mobile-19	RohnCaS	Diplexer Unit - Generic	0.00
T-Mobile-20	RohnCa1	Diplexer Unit - Generic	120.00
T-Mobile-21	RohnCa2	Diplexer Unit - Generic	240.00
ATT-A	RohnBbS	12` T-Arm	0.00
ATT-B	RohnBb1	12` T-Arm	120.00
ATT-C	RohnBb2	12` T-Arm	240.00
ATT-A1	RohnBbS	Powerwave 7770	0.00
ATT-A2	RohnBbS	Powerwave 7770	0.00
ATT-A3	RohnBbS	RRHU-11 RRH Unit	0.00
ATT-A4	RohnBbS	TMA Unit (LGP24101)	0.00
ATT-A5	RohnBbS	TMA Unit (LGP24101)	0.00
ATT-A6	RohnBbS	Raycap Surge Suppressor	0.00
ATT-A7	RohnBbS	OPA-65-LCUU-H6 Panel	0.00
ATT-A8	RohnBbS	RRUS-32 RRH Unit	0.00
ATT-B1	RohnBb1	RRHU-11 RRH Unit	120.00
ATT-B2	RohnBb1	TMA Unit (LGP24101)	120.00
ATT-B3	RohnBb1	TMA Unit (LGP24101)	120.00
ATT-B4	RohnBb1	OPA-65-LCUU-H6 Panel	120.00
ATT-B5	RohnBb1	RRUS-32 RRH Unit	120.00
ATT-C1	RohnBb2	RRHU-11 RRH Unit	240.00
ATT-C2	RohnBb2	TMA Unit (LGP24101)	240.00
ATT-C3	RohnBb2	TMA Unit (LGP24101)	240.00
ATT-C4	RohnBb2	OPA-65-LCUU-H6 Panel	240.00
ATT-C5	RohnBb2	RRUS-32 RRH Unit	240.00
CSP-70	RohnBP	Sinclair SC479-HF1LDF w/ ice	0.00
CSP-71	RohnB1	Sinclair SC479-HF1LDF w/ ice	120.00
CSP-72	RohnB2	Sinclair SC479-HF1LDF w/ ice	240.00
CSP-73	RohnB2	TMA	240.00
DNK21-SPD9	RohnBP	8` Dish with Radome	0.00
DNK20-UNKNOWN	RohnBP	4`x1` Panel	240.00
DNK19-STAM63	RohnB1	4`x1` Panel	120.00
159-A	RohnBP	3` Stand-Off	0.00
159-B	RohnB1	3` Stand-Off	120.00
160	RohnBP	3` Stand-Off	240.00

DNK22-TOG-6	RohnAcS	DB586-Y	0.00
DNK23-STAM64	RohnAcS	4`x1` Panel	0.00
DNK23-STAM65	RohnAcS	TMA	0.00
GRN-1 (DNK25)	RohnAbl	4` Dish	120.00
DNK26aCSP-67	RohnAaS	Dipole	0.00
DNK26bNEU-20	RohnAa1	4` Dipole	0.00
DNK27A-CSP4	RohnAa2	Sinclair SC479-HFLLDF w/ ice	240.00
DNK27B-CSP2	RohnAa2	Scala OGT9-806 w/ ice	120.00
DNK27C-CSP74	RohnAa1	TMA	120.00
DNK28A-CSP1	RohnAa1	Scala OGT9-806 w/ ice	120.00
DNK28B-CSP3	RohnAa2	Sinclair SC479-HFLLDF w/ ice	240.00
DNK28C-TOG5	RohnAaS	Andrew DB-583 w/ ice	0.00
DNK28D-NEU55	RohnAa2	Decibel PD-420 2 bay - Dipole	240.00
Top-A	RohnAP	6` Stand-Off	0.00
Top-B	RohnA1	6` Stand-Off	120.00
Top-C1	RohnA2	6` Stand-Off	260.00
Top-C2	RohnA2	6` Stand-Off	220.00
ATT-B7	RohnBb1	Powerwave 7770	120.00
ATT-B8	RohnBb1	Powerwave 7770	120.00
ATT-C7	RohnBb2	Powerwave 7770	240.00
ATT-C8	RohnBb2	Powerwave 7770	240.00

Linear Appurtenances:

Description	From	To	Quantity	Shape	Width or Perimeter	Unit	In	Include	In
	(ft)	(ft)			Diameter	Weight	Face	Wind	Load
					(in)	(lbs/ft)	Zone		
Full Cable Tray 2-150 (wind only)	2	150	2	Flat	24	0	0	Yes	Yes
Full Cable Tray 150-top (wind only)	150	180	1	Flat	24	0	0	Yes	Yes
DNK1-7/8" @ 56`	2	180	1	Round	0	0	1.30128	Yes	No
DNK2-7/8" @ 54`	2	180	1	Round	0	0	1.30128	Yes	No
DNK3-7/8" @ 60`	2	180	1	Round	0	0	1.30128	Yes	No
DNK4-7/8" @ 65`	2	180	1	Round	0	0	1.30128	Yes	No
DNK5-1-5/8" @ 82`	2	180	1	Round	0	0	2.33495	Yes	No
DNK6-Hybriflex Cables @ Sprint	2	180	4	Round	0	0	0.9	Yes	No
DNK7-7/8" @ 110`	2	180	1	Round	0	0	1.30128	Yes	No
DNK8-7/8" @ 122`	2	180	1	Round	0	0	1.30128	Yes	No
DNK9-7/8" @ 122`	2	180	1	Round	0	0	1.30128	Yes	No
DNK10-1-5/8" @ VZW	2	180	6	Round	0	0	2.33495	Yes	No
DNK11-1-5/8" @ 130`	2	180	1	Round	0	0	2.33495	Yes	No
DNK12-7/8" @ 135`	2	180	1	Round	0	0	1.30128	Yes	No
DNK13,14-1-5/8" @ T-Mobile	2	180	6	Round	0	0	2.33495	Yes	No
DNK15-7/8" @ 137`	2	180	1	Round	0	0	1.30128	Yes	No
DNK16,17,18-1-5/8" @ ATT	2	180	12	Round	0	0	2.33495	Yes	No
DNK16,17,18-Optic Fiber Cable @ ATT	2	180	1	Round	0	0	1.3	Yes	No
DNK16,17,18-DC Cable @ ATT	2	180	2	Round	0	0	0.3	Yes	No
DNK19-7/8" @ 159`	2	180	1	Round	0	0	1.30128	Yes	No
DNK20-7/8" @ 159.5`	2	180	1	Round	0	0	1.30128	Yes	No
CSP70,71,72-1-5/8" @ 160` (3)	2	180	3	Round	0	0	2.33495	Yes	No
CSP73-1/2" @ 160`	2	180	1	Round	0	0	0.840278	Yes	No
DNK21-Elliptical @ 160`	2	180	1	Round	0	0	1.24804	Yes	No
DNK22-7/8" @ 165`	2	180	1	Round	0	0	1.30128	Yes	No
DNK23A-1-5/8" @ 168`	2	180	1	Round	0	0	2.33495	Yes	No
DNK23B-1/2" @ 168`	2	180	1	Round	0	0	0.840278	Yes	No
DNK26-B-1-5/8" @ 175`	2	180	1	Round	0	0	2.33495	Yes	No
DNK26A-7/8" @ 175`	2	180	1	Round	0	0	1.30128	Yes	No
DNK26C-1/2" @ 175`	2	180	1	Round	0	0	0.840278	Yes	No
DNK27-B-1-5/8" @ 175`	2	180	1	Round	0	0	2.33495	Yes	No
DNK27A-7/8" @ 175`	2	180	1	Round	0	0	1.30128	Yes	No
DNK27C-3/8" @ 175`	2	180	1	Round	0	0	0.654213	Yes	No
DNK28A-1-5/8" @ 175`	2	180	1	Round	0	0	2.33495	Yes	No
DNK28B-1-5/8" @ 175`	2	180	1	Round	0	0	2.33495	Yes	No
DNK28C-1-5/8" @ 175`	2	180	1	Round	0	0	2.33495	Yes	No
DNK28D-7/8" @ 175`	2	180	1	Round	0	0	1.30128	Yes	No
GRN-1-Elliptical @ 172` (DNK25)	2	180	1	Round	0	0	1.24804	Yes	No
VZW-(3) Hybriflex Cables	2	180	3	Round	0	0	1.3	Yes	No
Hybriflex 6x12 Cables @ T-Mobile	2	180	2	Round	0	0	1.7	Yes	No
Hybriflex 9x18 Cables @ T-Mobile	2	180	1	Round	0	0	0.9	Yes	No

*** Loads Data

Loads from file: p:\projects\telcom\structuralsbylocation\connecticut\greenwichcsp#74\13-10102018 - re-issue_multicarrier_pls_g\pls-tower_wind_0\4-carir.eia

Structure Height Summary (used for calculating wind/ice adjust with height):

Structure height above ground 180.00 (ft)
 Elevation of structure bottom for wind height adjustment: 0.00 (ft)
 Structure height for structure gust response factor: 180.00 (ft)
 Structure gust response factor, Gh: 0.8500
 Mean wind conversion factor, m: 0.6000
 Wind direction probability factor, Kd, for structures: 0.85, for appurtenances: 0.85
 Structure fundamental frequency, f1: 2.0198 (Hz)
 Guy installation temperature: 60.00 (deg F)
 Tower Type: Triangular Latticed

ANSI/TIA 222-G Load Options:

Structure Class 3
 Exposure Category C Open terrain
 Topographic Category 2 (Kzt calculated based on crest height, H, of 36.00 (ft))
 Spectral Response SDS 0.276
 Spectral Response SD1 0.112

EIA Rev. G Load Cases:

Load Case Description	Dead Load Factor	Wind Load Factor	Strength Factor	Load Case Type	Basic Wind Speed (mph)	Wind Dir. (Deg)	Mean Wind Start Elevation (ft)	Mean Wind Stop Elevation (ft)	Ice Thick. (in)	Ice Density (lbs/ft^3)	Temperature (deg F)	Point Loads	Joint Displ.
1: 1.2D + 1.0Dg + 1.6Wo	1.2000	1.6000	1.0000	Regular	94.000	0	0.00	0.00	0.0000	0.0000	60.0		
2: 0.9D + 1.0Dg + 1.6Wo	0.9000	1.6000	1.0000	Regular	94.000	0	0.00	0.00	0.0000	0.0000	60.0		
4: 1.2D + 1.0Dg + 1.0E	1.2000	1.0000	1.0000	Earthquake	0.000	0	0.00	0.00	0.0000	0.0000	60.0		
5: 0.9D + 1.0Dg + 1.0E	0.9000	1.0000	1.0000	Earthquake	0.000	0	0.00	0.00	0.0000	0.0000	60.0		
6: Service 1.0D + 1.0Dg + 1.0 Wo	1.0000	1.0000	1.0000	Service	60.000	0	0.00	0.00	0.0000	0.0000	60.0		
1.2*DL	1.2000	1.0000	1.0000	Regular	0.000	0	0.00	0.00	0.0000	0.0000	60.0		
0.9DL	0.9000	1.0000	1.0000	Regular	0.000	0	0.00	0.00	0.0000	0.0000	60.0		

Equipment Load Case Information for "1: 1.2D + 1.0Dg + 1.6Wo":

Equipment Label	Equipment Property Set	Elevation Above Ground (ft)	qzGh (psf)	Ice Thick. (in)	Total Wind Area (ft^2)	Wind Incidence Angle (deg)	222-G CA	222-G CS	222-G CM	Antenna Axial Load (lbs)	Antenna Side Load (lbs)	Antenna Moment (ft-lbs)	Long. Load (lbs)	Trans. Load (lbs)	Vert. Load (lbs)
DNK-1	5` Dipole	60.00	37.91	0.00	3.95	0.00							149.91	0.00	60.00
MT-DNK1	3` Stand-Off	60.00	37.91	0.00	2.72	0.00							103.13	0.00	60.00
DNK2-GPS68	GPS	60.00	37.91	0.00	1.00	120.00							37.91	0.00	12.00
MT-DNK2	3` Stand-Off	60.00	37.91	0.00	2.72	120.00							103.13	0.00	60.00
DNK3-GPS69	GPS	60.00	37.91	0.00	1.00	240.00							37.91	0.00	12.00
MT-DNK3	3` Stand-Off	60.00	37.91	0.00	2.72	240.00							103.13	0.00	60.00
DNK4-DOT56	10` Dipole	60.00	37.91	0.00	9.17	240.00							347.55	0.00	55.20
MT-DNK4	3` Stand-Off	60.00	37.91	0.00	2.72	240.00							103.13	0.00	60.00
DNK5-NEU16	8` Omni	80.00	38.26	0.00	2.00	240.00							76.52	0.00	6.00
MT-DNK5	6` Stand-Off	80.00	38.26	0.00	10.60	240.00							405.54	0.00	168.00
DNK9-DEP54	RFS PD1142 w/ ice	120.00	40.05	0.00	1.32	120.00							52.71	0.00	12.00
MT-DNK9	3` Stand-Off	120.00	40.05	0.00	2.72	120.00							108.95	0.00	60.00
DNK8-CSP66	RFS PD1142 w/ ice	120.00	40.05	0.00	1.32	120.00							52.71	0.00	12.00
DNK7-NEU17	12` Omni	113.34	39.71	0.00	4.00	0.00							158.85	0.00	66.00
MT-DNK7	3` Stand-Off	113.34	39.71	0.00	2.72	0.00							108.02	0.00	60.00
Sprint-A	12` T-Arm	113.34	39.71	0.00	13.60	0.00							540.09	0.00	558.00
Sprint-B	12` T-Arm	113.34	39.71	0.00	13.60	120.00							540.09	0.00	558.00
Sprint-C	12` T-Arm	113.34	39.71	0.00	13.60	240.00							540.09	0.00	558.00
Sprint-1	RFS APXVSP18-C w/ ice	113.34	39.71	0.00	8.26	0.00							328.03	0.00	108.00
Sprint-2	ALU RRH	113.34	39.71	0.00	6.90	0.00							273.89	0.00	72.00
Sprint-3	ALU RRH	113.34	39.71	0.00	6.90	0.00							273.89	0.00	72.00

Sprint-4	RFS APXVSP18-C w/ ice	113.34	39.71	0.00	8.26	120.00	328.03	0.00	108.00
Sprint-5	ALU RRH	113.34	39.71	0.00	6.90	120.00	273.89	0.00	72.00
Sprint-6	ALU RRH	113.34	39.71	0.00	6.90	120.00	273.89	0.00	72.00
Sprint-7	RFS APXVSP18-C w/ ice	113.34	39.71	0.00	8.26	240.00	328.03	0.00	108.00
Sprint-8	ALU RRH	113.34	39.71	0.00	6.90	240.00	273.89	0.00	72.00
Sprint-9	ALU RRH	113.34	39.71	0.00	6.90	240.00	273.89	0.00	72.00
Sprint-10	DT465B-2XR-V2	113.34	39.71	0.00	9.65	0.00	383.09	0.00	106.08
Sprint-11	DT465B-2XR-V2	113.34	39.71	0.00	9.65	120.00	383.09	0.00	106.08
Sprint-12	DT465B-2XR-V2	113.34	39.71	0.00	9.65	240.00	383.09	0.00	106.08
Sprint-13	800 MHz RRH Unit	113.34	39.71	0.00	6.90	0.00	273.89	0.00	72.00
Sprint-14	800 MHz RRH Unit	113.34	39.71	0.00	6.90	120.00	273.89	0.00	72.00
Sprint-15	800 MHz RRH Unit	113.34	39.71	0.00	6.90	240.00	273.89	0.00	72.00
Sprint-16	TD-RRH 8x20-25 RRH Unit	113.34	39.71	0.00	4.72	0.00	187.43	0.00	79.36
Sprint-17	TD-RRH 8x20-25 RRH Unit	113.34	39.71	0.00	4.72	120.00	187.43	0.00	79.36
Sprint-18	TD-RRH 8x20-25 RRH Unit	113.34	39.71	0.00	4.72	240.00	187.43	0.00	79.36
Verizon-A	Boom Gate	126.66	40.40	0.00	13.60	0.00	549.47	0.00	565.20
Verizon-B	Boom Gate	126.66	40.40	0.00	13.60	120.00	549.47	0.00	565.20
Verizon-C	Boom Gate	126.66	40.40	0.00	13.60	240.00	549.47	0.00	565.20
Verizon-1	Decibel DB844H80-XY w/ ice	126.66	40.40	0.00	3.97	0.00	160.26	0.00	12.00
Verizon-2	Decibel DB844H80-XY w/ ice	126.66	40.40	0.00	3.97	0.00	160.26	0.00	12.00
Verizon-3	Decibel DB844H80-XY w/ ice	126.66	40.40	0.00	3.97	120.00	160.26	0.00	12.00
Verizon-4	Decibel DB844H80-XY w/ ice	126.66	40.40	0.00	3.97	120.00	160.26	0.00	12.00
Verizon-5	Decibel DB844H80-XY w/ ice	126.66	40.40	0.00	3.97	240.00	160.26	0.00	12.00
Verizon-6	Decibel DB844H80-XY w/ ice	126.66	40.40	0.00	3.97	240.00	160.26	0.00	12.00
Verizon-7	JAHH-65B-R3B Panel	126.66	40.40	0.00	9.66	0.00	390.28	0.00	151.56
Verizon-8	JAHH-65B-R3B Panel	126.66	40.40	0.00	9.66	0.00	390.28	0.00	151.56
Verizon-9	JAHH-65B-R3B Panel	126.66	40.40	0.00	9.66	120.00	390.28	0.00	151.56
Verizon-10	JAHH-65B-R3B Panel	126.66	40.40	0.00	9.66	120.00	390.28	0.00	151.56
Verizon-11	JAHH-65B-R3B Panel	126.66	40.40	0.00	9.66	240.00	390.28	0.00	151.56
Verizon-12	JAHH-65B-R3B Panel	126.66	40.40	0.00	9.66	240.00	390.28	0.00	151.56
Verizon-D	BSAMNT-SBS-2-2 Mount for JAHH Antenna	126.66	40.40	0.00	3.78	0.00	152.88	0.00	139.20
Verizon-E	BSAMNT-SBS-2-2 Mount for JAHH Antenna	126.66	40.40	0.00	3.78	120.00	152.88	0.00	139.20
Verizon-F	BSAMNT-SBS-2-2 Mount for JAHH Antenna	126.66	40.40	0.00	3.78	240.00	152.88	0.00	139.20
Verizon-13	RRH 2x60W (700 MHz)	126.66	40.40	0.00	2.12	0.00	85.60	0.00	72.00
Verizon-14	RRH 2x60W (700 MHz)	126.66	40.40	0.00	2.12	120.00	85.60	0.00	72.00
Verizon-15	RRH 2x60W (700 MHz)	126.66	40.40	0.00	2.12	240.00	85.60	0.00	72.00
Verizon-16	RRH 4x45W (AWS)	126.66	40.40	0.00	2.96	0.00	119.58	0.00	72.00
Verizon-17	RRH 4x45W (AWS)	126.66	40.40	0.00	2.96	120.00	119.58	0.00	72.00
Verizon-18	RRH 4x45W (AWS)	126.66	40.40	0.00	2.96	240.00	119.58	0.00	72.00
Verizon-19	RHH 2x80W (850 MHz)	126.66	40.40	0.00	2.91	0.00	117.45	0.00	108.00
Verizon-20	RHH 2x80W (850 MHz)	126.66	40.40	0.00	2.91	120.00	117.45	0.00	108.00
Verizon-21	RHH 2x80W (850 MHz)	126.66	40.40	0.00	2.91	240.00	117.45	0.00	108.00
Verizon-22	Raycap DB-T1-6Z-8AB-0Z Dist. Box	126.66	40.40	0.00	5.60	0.00	226.25	0.00	54.00
Verizon-23	Raycap DB-T1-6Z-8AB-0Z Dist. Box	126.66	40.40	0.00	5.60	120.00	226.25	0.00	54.00
Verizon-24	Raycap DB-T1-6Z-8AB-0Z Dist. Box	126.66	40.40	0.00	5.60	240.00	226.25	0.00	54.00
NEU-18	12` Omni	126.66	40.40	0.00	4.00	0.00	161.61	0.00	66.00
DNK15-CSP21	RFS PD1142 w/ ice	133.34	40.75	0.00	1.32	120.00	53.63	0.00	12.00
MT-DNK15	3` Stand-Off	133.34	40.75	0.00	2.72	120.00	110.85	0.00	60.00
DNK-12	5` Dipole	133.34	40.75	0.00	3.95	240.00	161.13	0.00	60.00
MT-DNK12	3` Stand-Off	133.34	40.75	0.00	2.72	240.00	110.85	0.00	60.00
T-Mobile-1	Ericsson AIR B2A/B4P	133.34	40.75	0.00	6.53	0.00	266.25	0.00	132.02
T-Mobile-2	AIR32 B66/B2A	133.34	40.75	0.00	5.84	0.00	238.18	0.00	158.64
T-Mobile-3	APXVAA24_43-U-A20 (RFS)	133.34	40.75	0.00	22.38	0.00	911.91	0.00	180.00
T-Mobile-4	Ericsson AIR B2A/B4P	133.34	40.75	0.00	6.53	120.00	266.25	0.00	132.02
T-Mobile-5	AIR32 B66/B2A	133.34	40.75	0.00	5.84	120.00	238.18	0.00	158.64
T-Mobile-6	APXVAA24_43-U-A20 (RFS)	133.34	40.75	0.00	22.38	120.00	911.91	0.00	180.00
T-Mobile-7	Ericsson AIR B2A/B4P	133.34	40.75	0.00	6.53	240.00	266.25	0.00	132.02
T-Mobile-8	AIR32 B66/B2A	133.34	40.75	0.00	5.84	240.00	238.18	0.00	158.64
T-Mobile-9	APXVAA24_43-U-A20 (RFS)	133.34	40.75	0.00	22.38	240.00	911.91	0.00	180.00
T-Mobile-10	Twin TMA Unit - Generic	133.34	40.75	0.00	1.12	0.00	45.82	0.00	30.00
T-Mobile-11	Twin TMA Unit - Generic	133.34	40.75	0.00	1.12	120.00	45.82	0.00	30.00
T-Mobile-12	Twin TMA Unit - Generic	133.34	40.75	0.00	1.12	240.00	45.82	0.00	30.00
T-Mobile-13	RRHU-11 RRH Unit	133.34	40.75	0.00	2.99	0.00	122.01	0.00	60.00
T-Mobile-14	RRHU-11 RRH Unit	133.34	40.75	0.00	2.99	120.00	122.01	0.00	60.00
T-Mobile-15	RRHU-11 RRH Unit	133.34	40.75	0.00	2.99	240.00	122.01	0.00	60.00
T-Mobile-16	Ericsson 4478 (B71) RRH Unit	133.34	40.75	0.00	1.26	0.00	51.49	0.00	72.00
T-Mobile-17	Ericsson 4478 (B71) RRH Unit	133.34	40.75	0.00	1.26	120.00	51.49	0.00	72.00
T-Mobile-18	Ericsson 4478 (B71) RRH Unit	133.34	40.75	0.00	1.26	240.00	51.49	0.00	72.00
T-Mobile-19	Diplexer Unit - Generic	133.34	40.75	0.00	0.72	0.00	29.54	0.00	30.00

T-Mobile-20	Diplexer Unit - Generic	133.34	40.75	0.00	0.72	120.00															29.54	0.00	30.00
T-Mobile-21	Diplexer Unit - Generic	133.34	40.75	0.00	0.72	240.00															29.54	0.00	30.00
ATT-A	12` T-Arm	150.00	41.62	0.00	13.60	0.00															566.06	0.00	558.00
ATT-B	12` T-Arm	150.00	41.62	0.00	13.60	120.00															566.06	0.00	558.00
ATT-C	12` T-Arm	150.00	41.62	0.00	13.60	240.00															566.06	0.00	558.00
ATT-A1	Powerwave 7770	150.00	41.62	0.00	5.88	0.00															244.74	0.00	42.00
ATT-A2	Powerwave 7770	150.00	41.62	0.00	5.88	0.00															244.74	0.00	42.00
ATT-A3	RRHU-11 RRH Unit	150.00	41.62	0.00	2.99	0.00															124.61	0.00	60.00
ATT-A4	TMA Unit (LGP24101)	150.00	41.62	0.00	1.29	0.00															53.61	0.00	16.92
ATT-A5	TMA Unit (LGP24101)	150.00	41.62	0.00	1.29	0.00															53.61	0.00	16.92
ATT-A6	Raycap Surge Suppressor	150.00	41.62	0.00	1.79	0.00															74.37	0.00	32.40
ATT-A7	OPA-65-LCUU-H6 Panel	150.00	41.62	0.00	10.12	0.00															421.31	0.00	76.80
ATT-A8	RRUS-32 RRH Unit	150.00	41.62	0.00	3.88	0.00															161.46	0.00	96.00
ATT-B1	RRHU-11 RRH Unit	150.00	41.62	0.00	2.99	120.00															124.61	0.00	60.00
ATT-B2	TMA Unit (LGP24101)	150.00	41.62	0.00	1.29	120.00															53.61	0.00	16.92
ATT-B3	TMA Unit (LGP24101)	150.00	41.62	0.00	1.29	120.00															53.61	0.00	16.92
ATT-B4	OPA-65-LCUU-H6 Panel	150.00	41.62	0.00	10.12	120.00															421.31	0.00	76.80
ATT-B5	RRUS-32 RRH Unit	150.00	41.62	0.00	3.88	120.00															161.46	0.00	96.00
ATT-C1	RRHU-11 RRH Unit	150.00	41.62	0.00	2.99	240.00															124.61	0.00	60.00
ATT-C2	TMA Unit (LGP24101)	150.00	41.62	0.00	1.29	240.00															53.61	0.00	16.92
ATT-C3	TMA Unit (LGP24101)	150.00	41.62	0.00	1.29	240.00															53.61	0.00	16.92
ATT-C4	OPA-65-LCUU-H6 Panel	150.00	41.62	0.00	10.12	240.00															421.31	0.00	76.80
ATT-C5	RRUS-32 RRH Unit	150.00	41.62	0.00	3.88	240.00															161.46	0.00	96.00
CSP-70	Sinclair SC479-HF1LDF w/ ice	160.00	42.13	0.00	5.06	0.00															213.09	0.00	40.80
CSP-71	Sinclair SC479-HF1LDF w/ ice	160.00	42.13	0.00	5.06	120.00															213.09	0.00	40.80
CSP-72	Sinclair SC479-HF1LDF w/ ice	160.00	42.13	0.00	5.06	240.00															213.09	0.00	40.80
CSP-73	TMA	160.00	42.13	0.00	1.29	240.00															54.27	0.00	18.00
DNK21-SPD9	8` Dish with Radome	160.00	42.13	0.00	51.32	0.00	0.86330														1866.70	0.00	672.00
DNK20-UNKNOWN	4`xl` Panel	160.00	42.13	0.00	6.53	240.00															275.13	0.00	36.00
DNK19-STAM63	4`xl` Panel	160.00	42.13	0.00	6.53	120.00															275.13	0.00	36.00
159-A	3` Stand-Off	160.00	42.13	0.00	2.72	0.00															114.60	0.00	60.00
159-B	3` Stand-Off	160.00	42.13	0.00	2.72	120.00															114.60	0.00	60.00
160	3` Stand-Off	160.00	42.13	0.00	2.72	240.00															114.60	0.00	60.00
DNK22-TOG-6	DB586-Y	165.00	42.38	0.00	1.01	0.00															42.99	0.00	9.90
DNK23-STAM64	4`xl` Panel	165.00	42.38	0.00	6.53	0.00															276.77	0.00	36.00
DNK23-STAM65	TMA	165.00	42.38	0.00	1.29	0.00															54.59	0.00	18.00
GRN-1 (DNK25)	4` Dish	170.00	42.63	0.00	13.10	50.00	1.66410	0.08980	-0.06910	929.39	50.15									929.39	-50.15	144.00	
DNK26aCSP-67	Dipole	175.00	42.88	0.00	9.17	0.00															393.05	0.00	55.20
DNK26bNEU-20	4` Dipole	175.00	42.88	0.00	3.70	0.00															158.51	0.00	48.00
DNK27A-CSP4	Sinclair SC479-HF1LDF w/ ice	175.00	42.88	0.00	5.06	240.00															216.86	0.00	40.80
DNK27B-CSP2	Scala OGT9-806 w/ ice	175.00	42.88	0.00	2.27	120.00															97.48	0.00	22.20
DNK27C-CSP74	TMA	175.00	42.88	0.00	1.29	120.00															55.23	0.00	18.00
DNK28A-CSP1	Scala OGT9-806 w/ ice	175.00	42.88	0.00	2.27	120.00															97.48	0.00	22.20
DNK28B-CSP3	Sinclair SC479-HF1LDF w/ ice	175.00	42.88	0.00	5.06	240.00															216.86	0.00	40.80
DNK28C-TOG5	Andrew DB-583 w/ ice	175.00	42.88	0.00	0.54	0.00															23.04	0.00	7.50
DNK28D-NEU55	Decibel PD-420 2 bay - Dipole	175.00	42.88	0.00	1.64	240.00															70.45	0.00	12.00
Top-A	6` Stand-Off	180.00	43.12	0.00	10.60	0.00															457.07	0.00	168.00
Top-B	6` Stand-Off	180.00	43.12	0.00	10.60	120.00															457.07	0.00	168.00
Top-C1	6` Stand-Off	180.00	43.12	0.00	10.60	260.00															457.07	0.00	168.00
Top-C2	6` Stand-Off	180.00	43.12	0.00	10.60	220.00															457.07	0.00	168.00
ATT-B7	Powerwave 7770	150.00	41.62	0.00	5.88	120.00															244.74	0.00	42.00
ATT-B8	Powerwave 7770	150.00	41.62	0.00	5.88	120.00															244.74	0.00	42.00
ATT-C7	Powerwave 7770	150.00	41.62	0.00	5.88	240.00															244.74	0.00	42.00
ATT-C8	Powerwave 7770	150.00	41.62	0.00	5.88	240.00															244.74	0.00	42.00

EIA Section Load Case Information for "1: 1.2D + 1.0Dg + 1.6Wo":

Note: qzGh (adjusted wind pressure) includes: Velocity Pressure Coefficient (Kz), Topographic Factor (Kzt), Gust Effect Factor (Gh), Wind Direction Probability Factor (Kd), Wind Importance Factor (Table 2-3), Wind Load Factor (from Loads/EIA Loads)
Face RR is the minimum round reduction factor for all round angles and appurtenances in the section

Section Label	Z of Top (ft)	Z of Bottom (ft)	Z of Ave. Above Gnd. (ft)	Elev. (ft)	qzGh (psf)	Ice Thick. (in)	Face AF (ft^2)	Face AR (ft^2)	Face RR*AR (ft^2)	Face AG (ft^2)	Face e	Face DF	Face DR	Face RR	Face CF	Face AE (ft^2)	Face WF (lbs)	NotF AAF (ft^2)	NotF CAF	NotF AAR (ft^2)	NotF CAR	NotF AAR*CAR (ft^2)	Total WA (lbs)	Total Wind (lbs)	Total Weight (lbs)
A	180.00	160.00	170.00	42.63	0.00	20.58	21.02	12.12	163.7	0.25	1.00	1.00	0.58	2.43	32.7	3381	40.00	2.00	0.00	0.60	0.00	3411	6792	6770	
B	160.00	140.00	150.00	41.62	0.00	22.52	27.30	15.19	191.0	0.26	1.00	1.00	0.55	2.41	37.7	3776	60.00	2.00	0.00	0.60	0.00	4995	8770	7224	
C	140.00	120.00	130.00	40.58	0.00	25.73	29.16	15.97	218.3	0.25	1.00	1.00	0.55	2.43	41.7	4118	80.00	2.00	0.00	0.60	0.00	6492	10610	8030	
D	120.00	100.00	110.00	39.54	0.00	30.37	36.61	19.25	245.5	0.27	1.00	1.00	0.52	2.37	49.6	4652	80.00	2.00	0.00	0.60	0.00	6327	10979	8857	

E	100.00	80.00	90.00	38.62	0.00	37.01	40.26	20.85	272.8	0.28	1.00	1.00	0.50	2.34	57.9	5233	80.00	2.00	0.00	0.60	0.00	6180	11412	12042
F	80.00	60.00	70.00	38.01	0.00	37.32	43.90	21.91	300.0	0.27	1.00	1.00	0.49	2.38	59.2	5351	80.00	2.00	0.00	0.60	0.00	6081	11432	12661
G	60.00	40.00	50.00	38.04	0.00	42.28	50.37	25.41	327.3	0.28	1.00	1.00	0.50	2.34	67.7	6031	80.00	2.00	0.00	0.60	0.00	6087	12118	14137
H	40.00	20.00	30.00	39.16	0.00	48.05	50.83	25.47	354.6	0.28	1.00	1.00	0.49	2.35	73.5	6776	80.00	2.00	0.00	0.60	0.00	6265	13042	15046
I	20.00	0.00	10.00	43.43	0.00	59.30	58.17	29.86	381.9	0.31	1.00	1.00	0.51	2.28	89.2	8813	72.00	2.00	0.00	0.60	0.00	6254	15067	15157

Equipment Load Case Information for "2: 0.9D + 1.0Dg + 1.6Wo":

Equipment Label	Equipment Property Set	Elevation Above Ground (ft)	qzGh (psf)	Ice Thick. (in)	Total Wind Area (ft^2)	Wind Incidence Angle (deg)	222-G CA	222-G CS	222-G CM	Antenna Axial Load (lbs)	Antenna Side Load (lbs)	Antenna Moment (ft-lbs)	Long. Load (lbs)	Trans. Load (lbs)	Vert. Load (lbs)
DNK-1	5` Dipole	60.00	37.91	0.00	3.95	0.00							149.91	0.00	45.00
MT-DNK1	3` Stand-Off	60.00	37.91	0.00	2.72	0.00							103.13	0.00	45.00
DNK2-GPS68	GPS	60.00	37.91	0.00	1.00	120.00							37.91	0.00	9.00
MT-DNK2	3` Stand-Off	60.00	37.91	0.00	2.72	120.00							103.13	0.00	45.00
DNK3-GPS69	GPS	60.00	37.91	0.00	1.00	240.00							37.91	0.00	9.00
MT-DNK3	3` Stand-Off	60.00	37.91	0.00	2.72	240.00							103.13	0.00	45.00
DNK4-DOT56	10` Dipole	60.00	37.91	0.00	9.17	240.00							347.55	0.00	41.40
MT-DNK4	3` Stand-Off	60.00	37.91	0.00	2.72	240.00							103.13	0.00	45.00
DNK5-NEU16	8` Omni	80.00	38.26	0.00	2.00	240.00							76.52	0.00	4.50
MT-DNK5	6` Stand-Off	80.00	38.26	0.00	10.60	240.00							405.54	0.00	126.00
DNK9-DEP54	RFS PD1142 w/ ice	120.00	40.05	0.00	1.32	120.00							52.71	0.00	9.00
MT-DNK9	3` Stand-Off	120.00	40.05	0.00	2.72	120.00							108.95	0.00	45.00
DNK8-CSP66	RFS PD1142 w/ ice	120.00	40.05	0.00	1.32	120.00							52.71	0.00	9.00
DNK7-NEU17	12` Omni	113.34	39.71	0.00	4.00	0.00							158.85	0.00	49.50
MT-DNK7	3` Stand-Off	113.34	39.71	0.00	2.72	0.00							108.02	0.00	45.00
Sprint-A	12` T-Arm	113.34	39.71	0.00	13.60	0.00							540.09	0.00	418.50
Sprint-B	12` T-Arm	113.34	39.71	0.00	13.60	120.00							540.09	0.00	418.50
Sprint-C	12` T-Arm	113.34	39.71	0.00	13.60	240.00							540.09	0.00	418.50
Sprint-1	RFS APXVSP18-C w/ ice	113.34	39.71	0.00	8.26	0.00							328.03	0.00	81.00
Sprint-2	ALU RRH	113.34	39.71	0.00	6.90	0.00							273.89	0.00	54.00
Sprint-3	ALU RRH	113.34	39.71	0.00	6.90	0.00							273.89	0.00	54.00
Sprint-4	RFS APXVSP18-C w/ ice	113.34	39.71	0.00	8.26	120.00							328.03	0.00	81.00
Sprint-5	ALU RRH	113.34	39.71	0.00	6.90	120.00							273.89	0.00	54.00
Sprint-6	ALU RRH	113.34	39.71	0.00	6.90	120.00							273.89	0.00	54.00
Sprint-7	RFS APXVSP18-C w/ ice	113.34	39.71	0.00	8.26	240.00							328.03	0.00	81.00
Sprint-8	ALU RRH	113.34	39.71	0.00	6.90	240.00							273.89	0.00	54.00
Sprint-9	ALU RRH	113.34	39.71	0.00	6.90	240.00							273.89	0.00	54.00
Sprint-10	DT465B-2XR-V2	113.34	39.71	0.00	9.65	0.00							383.09	0.00	79.56
Sprint-11	DT465B-2XR-V2	113.34	39.71	0.00	9.65	120.00							383.09	0.00	79.56
Sprint-12	DT465B-2XR-V2	113.34	39.71	0.00	9.65	240.00							383.09	0.00	79.56
Sprint-13	800 MHz RRH Unit	113.34	39.71	0.00	6.90	0.00							273.89	0.00	54.00
Sprint-14	800 MHz RRH Unit	113.34	39.71	0.00	6.90	120.00							273.89	0.00	54.00
Sprint-15	800 MHz RRH Unit	113.34	39.71	0.00	6.90	240.00							273.89	0.00	54.00
Sprint-16	TD-RRH 8x20-25 RRH Unit	113.34	39.71	0.00	4.72	0.00							187.43	0.00	59.52
Sprint-17	TD-RRH 8x20-25 RRH Unit	113.34	39.71	0.00	4.72	120.00							187.43	0.00	59.52
Sprint-18	TD-RRH 8x20-25 RRH Unit	113.34	39.71	0.00	4.72	240.00							187.43	0.00	59.52
Verizon-A	Boom Gate	126.66	40.40	0.00	13.60	0.00							549.47	0.00	423.90
Verizon-B	Boom Gate	126.66	40.40	0.00	13.60	120.00							549.47	0.00	423.90
Verizon-C	Boom Gate	126.66	40.40	0.00	13.60	240.00							549.47	0.00	423.90
Verizon-1	Decibel DB844H80-XY w/ ice	126.66	40.40	0.00	3.97	0.00							160.26	0.00	9.00
Verizon-2	Decibel DB844H80-XY w/ ice	126.66	40.40	0.00	3.97	0.00							160.26	0.00	9.00
Verizon-3	Decibel DB844H80-XY w/ ice	126.66	40.40	0.00	3.97	120.00							160.26	0.00	9.00
Verizon-4	Decibel DB844H80-XY w/ ice	126.66	40.40	0.00	3.97	120.00							160.26	0.00	9.00
Verizon-5	Decibel DB844H80-XY w/ ice	126.66	40.40	0.00	3.97	240.00							160.26	0.00	9.00
Verizon-6	Decibel DB844H80-XY w/ ice	126.66	40.40	0.00	3.97	240.00							160.26	0.00	9.00
Verizon-7	JAHH-65B-R3B Panel	126.66	40.40	0.00	9.66	0.00							390.28	0.00	113.67
Verizon-8	JAHH-65B-R3B Panel	126.66	40.40	0.00	9.66	0.00							390.28	0.00	113.67
Verizon-9	JAHH-65B-R3B Panel	126.66	40.40	0.00	9.66	120.00							390.28	0.00	113.67
Verizon-10	JAHH-65B-R3B Panel	126.66	40.40	0.00	9.66	120.00							390.28	0.00	113.67
Verizon-11	JAHH-65B-R3B Panel	126.66	40.40	0.00	9.66	240.00							390.28	0.00	113.67
Verizon-12	JAHH-65B-R3B Panel	126.66	40.40	0.00	9.66	240.00							390.28	0.00	113.67
Verizon-D	BSAMNT-SBS-2-2 Mount for JAHH Antenna	126.66	40.40	0.00	3.78	0.00							152.88	0.00	104.40
Verizon-E	BSAMNT-SBS-2-2 Mount for JAHH Antenna	126.66	40.40	0.00	3.78	120.00							152.88	0.00	104.40
Verizon-F	BSAMNT-SBS-2-2 Mount for JAHH Antenna	126.66	40.40	0.00	3.78	240.00							152.88	0.00	104.40
Verizon-13	RRH 2x60W (700 MHz)	126.66	40.40	0.00	2.12	0.00							85.60	0.00	54.00
Verizon-14	RRH 2x60W (700 MHz)	126.66	40.40	0.00	2.12	120.00							85.60	0.00	54.00

Verizon-15	RRH 2x60W (700 MHz)	126.66	40.40	0.00	2.12	240.00		85.60	0.00	54.00
Verizon-16	RRH 4x45W (AWS)	126.66	40.40	0.00	2.96	0.00		119.58	0.00	54.00
Verizon-17	RRH 4x45W (AWS)	126.66	40.40	0.00	2.96	120.00		119.58	0.00	54.00
Verizon-18	RRH 4x45W (AWS)	126.66	40.40	0.00	2.96	240.00		119.58	0.00	54.00
Verizon-19	RHH 2x80W (850 MHz)	126.66	40.40	0.00	2.91	0.00		117.45	0.00	81.00
Verizon-20	RHH 2x80W (850 MHz)	126.66	40.40	0.00	2.91	120.00		117.45	0.00	81.00
Verizon-21	RHH 2x80W (850 MHz)	126.66	40.40	0.00	2.91	240.00		117.45	0.00	81.00
Verizon-22	Raycap DB-T1-6Z-8AB-0Z Dist. Box	126.66	40.40	0.00	5.60	0.00		226.25	0.00	40.50
Verizon-23	Raycap DB-T1-6Z-8AB-0Z Dist. Box	126.66	40.40	0.00	5.60	120.00		226.25	0.00	40.50
Verizon-24	Raycap DB-T1-6Z-8AB-0Z Dist. Box	126.66	40.40	0.00	5.60	240.00		226.25	0.00	40.50
NEU-18	12` Omni	126.66	40.40	0.00	4.00	0.00		161.61	0.00	49.50
DNK15-CSP21	RFS PD1142 w/ ice	133.34	40.75	0.00	1.32	120.00		53.63	0.00	9.00
MT-DNK15	3` Stand-Off	133.34	40.75	0.00	2.72	120.00		110.85	0.00	45.00
DNK-12	5` Dipole	133.34	40.75	0.00	3.95	240.00		161.13	0.00	45.00
MT-DNK12	3` Stand-Off	133.34	40.75	0.00	2.72	240.00		110.85	0.00	45.00
T-Mobile-1	Ericsson AIR B2A/B4P	133.34	40.75	0.00	6.53	0.00		266.25	0.00	99.02
T-Mobile-2	AIR32 B66/B2A	133.34	40.75	0.00	5.84	0.00		238.18	0.00	118.98
T-Mobile-3	APXVAA24_43-U-A20 (RFS)	133.34	40.75	0.00	22.38	0.00		911.91	0.00	135.00
T-Mobile-4	Ericsson AIR B2A/B4P	133.34	40.75	0.00	6.53	120.00		266.25	0.00	99.02
T-Mobile-5	AIR32 B66/B2A	133.34	40.75	0.00	5.84	120.00		238.18	0.00	118.98
T-Mobile-6	APXVAA24_43-U-A20 (RFS)	133.34	40.75	0.00	22.38	120.00		911.91	0.00	135.00
T-Mobile-7	Ericsson AIR B2A/B4P	133.34	40.75	0.00	6.53	240.00		266.25	0.00	99.02
T-Mobile-8	AIR32 B66/B2A	133.34	40.75	0.00	5.84	240.00		238.18	0.00	118.98
T-Mobile-9	APXVAA24_43-U-A20 (RFS)	133.34	40.75	0.00	22.38	240.00		911.91	0.00	135.00
T-Mobile-10	Twin TMA Unit - Generic	133.34	40.75	0.00	1.12	0.00		45.82	0.00	22.50
T-Mobile-11	Twin TMA Unit - Generic	133.34	40.75	0.00	1.12	120.00		45.82	0.00	22.50
T-Mobile-12	Twin TMA Unit - Generic	133.34	40.75	0.00	1.12	240.00		45.82	0.00	22.50
T-Mobile-13	RRHU-11 RRH Unit	133.34	40.75	0.00	2.99	0.00		122.01	0.00	45.00
T-Mobile-14	RRHU-11 RRH Unit	133.34	40.75	0.00	2.99	120.00		122.01	0.00	45.00
T-Mobile-15	RRHU-11 RRH Unit	133.34	40.75	0.00	2.99	240.00		122.01	0.00	45.00
T-Mobile-16	Ericsson 4478 (B71) RRH Unit	133.34	40.75	0.00	1.26	0.00		51.49	0.00	54.00
T-Mobile-17	Ericsson 4478 (B71) RRH Unit	133.34	40.75	0.00	1.26	120.00		51.49	0.00	54.00
T-Mobile-18	Ericsson 4478 (B71) RRH Unit	133.34	40.75	0.00	1.26	240.00		51.49	0.00	54.00
T-Mobile-19	Diplexer Unit - Generic	133.34	40.75	0.00	0.72	0.00		29.54	0.00	22.50
T-Mobile-20	Diplexer Unit - Generic	133.34	40.75	0.00	0.72	120.00		29.54	0.00	22.50
T-Mobile-21	Diplexer Unit - Generic	133.34	40.75	0.00	0.72	240.00		29.54	0.00	22.50
ATT-A	12` T-Arm	150.00	41.62	0.00	13.60	0.00		566.06	0.00	418.50
ATT-B	12` T-Arm	150.00	41.62	0.00	13.60	120.00		566.06	0.00	418.50
ATT-C	12` T-Arm	150.00	41.62	0.00	13.60	240.00		566.06	0.00	418.50
ATT-A1	Powerwave 7770	150.00	41.62	0.00	5.88	0.00		244.74	0.00	31.50
ATT-A2	Powerwave 7770	150.00	41.62	0.00	5.88	0.00		244.74	0.00	31.50
ATT-A3	RRHU-11 RRH Unit	150.00	41.62	0.00	2.99	0.00		124.61	0.00	45.00
ATT-A4	TMA Unit (LGP24101)	150.00	41.62	0.00	1.29	0.00		53.61	0.00	12.69
ATT-A5	TMA Unit (LGP24101)	150.00	41.62	0.00	1.29	0.00		53.61	0.00	12.69
ATT-A6	Raycap Surge Suppressor	150.00	41.62	0.00	1.79	0.00		74.37	0.00	24.30
ATT-A7	OPA-65-LCUU-H6 Panel	150.00	41.62	0.00	10.12	0.00		421.31	0.00	57.60
ATT-A8	RRUS-32 RRH Unit	150.00	41.62	0.00	3.88	0.00		161.46	0.00	72.00
ATT-B1	RRHU-11 RRH Unit	150.00	41.62	0.00	2.99	120.00		124.61	0.00	45.00
ATT-B2	TMA Unit (LGP24101)	150.00	41.62	0.00	1.29	120.00		53.61	0.00	12.69
ATT-B3	TMA Unit (LGP24101)	150.00	41.62	0.00	1.29	120.00		53.61	0.00	12.69
ATT-B4	OPA-65-LCUU-H6 Panel	150.00	41.62	0.00	10.12	120.00		421.31	0.00	57.60
ATT-B5	RRUS-32 RRH Unit	150.00	41.62	0.00	3.88	120.00		161.46	0.00	72.00
ATT-C1	RRHU-11 RRH Unit	150.00	41.62	0.00	2.99	240.00		124.61	0.00	45.00
ATT-C2	TMA Unit (LGP24101)	150.00	41.62	0.00	1.29	240.00		53.61	0.00	12.69
ATT-C3	TMA Unit (LGP24101)	150.00	41.62	0.00	1.29	240.00		53.61	0.00	12.69
ATT-C4	OPA-65-LCUU-H6 Panel	150.00	41.62	0.00	10.12	240.00		421.31	0.00	57.60
ATT-C5	RRUS-32 RRH Unit	150.00	41.62	0.00	3.88	240.00		161.46	0.00	72.00
CSP-70	Sinclair SC479-HF1LDF w/ ice	160.00	42.13	0.00	5.06	0.00		213.09	0.00	30.60
CSP-71	Sinclair SC479-HF1LDF w/ ice	160.00	42.13	0.00	5.06	120.00		213.09	0.00	30.60
CSP-72	Sinclair SC479-HF1LDF w/ ice	160.00	42.13	0.00	5.06	240.00		213.09	0.00	30.60
CSP-73	TMA	160.00	42.13	0.00	1.29	240.00		54.27	0.00	13.50
DNK21-SPD9	8` Dish with Radome	160.00	42.13	0.00	51.32	0.00	0.86330		1866.70	1866.70
DNK20-UNKNOWN	4`x1` Panel	160.00	42.13	0.00	6.53	240.00		275.13	0.00	27.00
DNK19-STAM63	4`x1` Panel	160.00	42.13	0.00	6.53	120.00		275.13	0.00	27.00
159-A	3` Stand-Off	160.00	42.13	0.00	2.72	0.00		114.60	0.00	45.00
159-B	3` Stand-Off	160.00	42.13	0.00	2.72	120.00		114.60	0.00	45.00
160	3` Stand-Off	160.00	42.13	0.00	2.72	240.00		114.60	0.00	45.00
DNK22-TOG-6	DB586-Y	165.00	42.38	0.00	1.01	0.00		42.99	0.00	7.42
DNK23-STAM64	4`x1` Panel	165.00	42.38	0.00	6.53	0.00		276.77	0.00	27.00

DNK23-STAM65		TMA	165.00	42.38	0.00	1.29	0.00														54.59	0.00	13.50
GRN-1 (DNK25)	4`	Dish	170.00	42.63	0.00	13.10	50.00	1.66410	0.08980	-0.06910	929.39	50.15									929.39	-50.15	108.00
DNK26aCSP-67		Dipole	175.00	42.88	0.00	9.17	0.00														393.05	0.00	41.40
DNK26bNEU-20	4`	Dipole	175.00	42.88	0.00	3.70	0.00														158.51	0.00	36.00
DNK27A-CSP4		Sinclair SC479-HF1LDF w/ ice	175.00	42.88	0.00	5.06	240.00														216.86	0.00	30.60
DNK27B-CSP2		Scala OGT9-806 w/ ice	175.00	42.88	0.00	2.27	120.00														97.48	0.00	16.65
DNK27C-CSP74		TMA	175.00	42.88	0.00	1.29	120.00														55.23	0.00	13.50
DNK28A-CSP1		Scala OGT9-806 w/ ice	175.00	42.88	0.00	2.27	120.00														97.48	0.00	16.65
DNK28B-CSP3		Sinclair SC479-HF1LDF w/ ice	175.00	42.88	0.00	5.06	240.00														216.86	0.00	30.60
DNK28C-TOG5		Andrew DB-583 w/ ice	175.00	42.88	0.00	0.54	0.00														23.04	0.00	5.63
DNK28D-NEU55		Decibel PD-420 2 bay - Dipole	175.00	42.88	0.00	1.64	240.00														70.45	0.00	9.00
Top-A		6` Stand-Off	180.00	43.12	0.00	10.60	0.00														457.07	0.00	126.00
Top-B		6` Stand-Off	180.00	43.12	0.00	10.60	120.00														457.07	0.00	126.00
Top-C1		6` Stand-Off	180.00	43.12	0.00	10.60	260.00														457.07	0.00	126.00
Top-C2		6` Stand-Off	180.00	43.12	0.00	10.60	220.00														457.07	0.00	126.00
ATT-B7		Powerwave 7770	150.00	41.62	0.00	5.88	120.00														244.74	0.00	31.50
ATT-B8		Powerwave 7770	150.00	41.62	0.00	5.88	120.00														244.74	0.00	31.50
ATT-C7		Powerwave 7770	150.00	41.62	0.00	5.88	240.00														244.74	0.00	31.50
ATT-C8		Powerwave 7770	150.00	41.62	0.00	5.88	240.00														244.74	0.00	31.50

EIA Section Load Case Information for "2: 0.9D + 1.0Dg + 1.6Wo":

Note: qzGh (adjusted wind pressure) includes: Velocity Pressure Coefficient (Kz), Topographic Factor (Kzt), Gust Effect Factor (Gh), Wind Direction Probability Factor (Kd), Wind Importance Factor (Table 2-3), Wind Load Factor (from Loads/EIA Loads)
 Face RR is the minimum round reduction factor for all round angles and appurtenances in the section

Section Label	Z of Top (ft)	Z of Ave. Bottom (ft)	Elev. Above Gnd. (ft)	qzGh (psf)	Ice Thick. (in)	Face AF (ft^2)	Face AR (ft^2)	Face RR*AR (ft^2)	Face AG (ft^2)	Face e	Face DF	Face DR	Face RR	Face CF	Face AE (ft^2)	Face WF (lbs)	NotF AAF (ft^2)	NotF CAF	NotF AAR (ft^2)	NotF CAR	NotF AAR*CAR (ft^2)	NotF WA (lbs)	Total Weight (lbs)	
A	180.00	160.00	170.00	42.63	0.00	20.58	21.02	12.12	163.7	0.25	1.00	1.00	0.58	2.43	32.7	3381	40.00	2.00	0.00	0.60	0.00	3411	6792	5078
B	160.00	140.00	150.00	41.62	0.00	22.52	27.30	15.19	191.0	0.26	1.00	1.00	0.55	2.41	37.7	3776	60.00	2.00	0.00	0.60	0.00	4995	8770	5418
C	140.00	120.00	130.00	40.58	0.00	25.73	29.16	15.97	218.3	0.25	1.00	1.00	0.55	2.43	41.7	4118	80.00	2.00	0.00	0.60	0.00	6492	10610	6022
D	120.00	100.00	110.00	39.54	0.00	30.37	36.61	19.25	245.5	0.27	1.00	1.00	0.52	2.37	49.6	4652	80.00	2.00	0.00	0.60	0.00	6327	10979	6643
E	100.00	80.00	90.00	38.62	0.00	37.01	40.26	20.85	272.8	0.28	1.00	1.00	0.50	2.34	57.9	5233	80.00	2.00	0.00	0.60	0.00	6180	11412	9032
F	80.00	60.00	70.00	38.01	0.00	37.32	43.90	21.91	300.0	0.27	1.00	1.00	0.49	2.38	59.2	5351	80.00	2.00	0.00	0.60	0.00	6081	11432	9496
G	60.00	40.00	50.00	38.04	0.00	42.28	50.37	25.41	327.3	0.28	1.00	1.00	0.50	2.34	67.7	6031	80.00	2.00	0.00	0.60	0.00	6087	12118	10603
H	40.00	20.00	30.00	39.16	0.00	48.05	50.83	25.47	354.6	0.28	1.00	1.00	0.49	2.35	73.5	6776	80.00	2.00	0.00	0.60	0.00	6265	13042	11284
I	20.00	0.00	10.00	43.43	0.00	59.30	58.17	29.86	381.9	0.31	1.00	1.00	0.51	2.28	89.2	8813	72.00	2.00	0.00	0.60	0.00	6254	15067	11368

Equipment Load Case Information for "4: 1.2D + 1.0Dg + 1.0E":

Equipment Label	Equipment Property Set	Elevation Above Ground (ft)	qzGh (psf)	Ice Thick. (in)	Total Wind Area (ft^2)	Wind Incidence Angle (deg)	222-G CA	222-G CS	222-G CM	Antenna Axial Load (lbs)	Antenna Side Load (lbs)	Antenna Moment (ft-lbs)	Long. Load (lbs)	Trans. Load (lbs)	Vert. Load (lbs)
DNK-1	5` Dipole	60.00	0.00	0.00	3.95	0.00							0.00	0.00	60.00
MT-DNK1	3` Stand-Off	60.00	0.00	0.00	2.72	0.00							0.00	0.00	60.00
DNK2-GPS68	GPS	60.00	0.00	0.00	1.00	120.00							0.00	0.00	12.00
MT-DNK2	3` Stand-Off	60.00	0.00	0.00	2.72	120.00							0.00	0.00	60.00
DNK3-GPS69	GPS	60.00	0.00	0.00	1.00	240.00							0.00	0.00	12.00
MT-DNK3	3` Stand-Off	60.00	0.00	0.00	2.72	240.00							0.00	0.00	60.00
DNK4-DOT56	10` Dipole	60.00	0.00	0.00	9.17	240.00							0.00	0.00	55.20
MT-DNK4	3` Stand-Off	60.00	0.00	0.00	2.72	240.00							0.00	0.00	60.00
DNK5-NEU16	8` Omni	80.00	0.00	0.00	2.00	240.00							0.00	0.00	6.00
MT-DNK5	6` Stand-Off	80.00	0.00	0.00	10.60	240.00							0.00	0.00	168.00
DNK9-DEP54	RFS PD1142 w/ ice	120.00	0.00	0.00	1.32	120.00							0.00	0.00	12.00
MT-DNK9	3` Stand-Off	120.00	0.00	0.00	2.72	120.00							0.00	0.00	60.00
DNK8-CSP66	RFS PD1142 w/ ice	120.00	0.00	0.00	1.32	120.00							0.00	0.00	12.00
DNK7-NEU17	12` Omni	113.34	0.00	0.00	4.00	0.00							0.00	0.00	66.00
MT-DNK7	3` Stand-Off	113.34	0.00	0.00	2.72	0.00							0.00	0.00	60.00
Sprint-A	12` T-Arm	113.34	0.00	0.00	13.60	0.00							0.00	0.00	558.00
Sprint-B	12` T-Arm	113.34	0.00	0.00	13.60	120.00							0.00	0.00	558.00
Sprint-C	12` T-Arm	113.34	0.00	0.00	13.60	240.00							0.00	0.00	558.00
Sprint-1	RFS APXVSP18-C w/ ice	113.34	0.00	0.00	8.26	0.00							0.00	0.00	108.00
Sprint-2	ALU RRH	113.34	0.00	0.00	6.90	0.00							0.00	0.00	72.00
Sprint-3	ALU RRH	113.34	0.00	0.00	6.90	0.00							0.00	0.00	72.00
Sprint-4	RFS APXVSP18-C w/ ice	113.34	0.00	0.00	8.26	120.00							0.00	0.00	108.00

Sprint-5	ALU RRH	113.34	0.00	0.00	6.90	120.00	0.00	0.00	72.00
Sprint-6	ALU RRH	113.34	0.00	0.00	6.90	120.00	0.00	0.00	72.00
Sprint-7	RFS APXVSP18-C w/ ice	113.34	0.00	0.00	8.26	240.00	0.00	0.00	108.00
Sprint-8	ALU RRH	113.34	0.00	0.00	6.90	240.00	0.00	0.00	72.00
Sprint-9	ALU RRH	113.34	0.00	0.00	6.90	240.00	0.00	0.00	72.00
Sprint-10	DT465B-2XR-V2	113.34	0.00	0.00	9.65	0.00	0.00	0.00	106.08
Sprint-11	DT465B-2XR-V2	113.34	0.00	0.00	9.65	120.00	0.00	0.00	106.08
Sprint-12	DT465B-2XR-V2	113.34	0.00	0.00	9.65	240.00	0.00	0.00	106.08
Sprint-13	800 MHz RRH Unit	113.34	0.00	0.00	6.90	0.00	0.00	0.00	72.00
Sprint-14	800 MHz RRH Unit	113.34	0.00	0.00	6.90	120.00	0.00	0.00	72.00
Sprint-15	800 MHz RRH Unit	113.34	0.00	0.00	6.90	240.00	0.00	0.00	72.00
Sprint-16	TD-RRH 8x20-25 RRH Unit	113.34	0.00	0.00	4.72	0.00	0.00	0.00	79.36
Sprint-17	TD-RRH 8x20-25 RRH Unit	113.34	0.00	0.00	4.72	120.00	0.00	0.00	79.36
Sprint-18	TD-RRH 8x20-25 RRH Unit	113.34	0.00	0.00	4.72	240.00	0.00	0.00	79.36
Verizon-A	Boom Gate	126.66	0.00	0.00	13.60	0.00	0.00	0.00	565.20
Verizon-B	Boom Gate	126.66	0.00	0.00	13.60	120.00	0.00	0.00	565.20
Verizon-C	Boom Gate	126.66	0.00	0.00	13.60	240.00	0.00	0.00	565.20
Verizon-1	Decibel DB844H80-XY w/ ice	126.66	0.00	0.00	3.97	0.00	0.00	0.00	12.00
Verizon-2	Decibel DB844H80-XY w/ ice	126.66	0.00	0.00	3.97	0.00	0.00	0.00	12.00
Verizon-3	Decibel DB844H80-XY w/ ice	126.66	0.00	0.00	3.97	120.00	0.00	0.00	12.00
Verizon-4	Decibel DB844H80-XY w/ ice	126.66	0.00	0.00	3.97	120.00	0.00	0.00	12.00
Verizon-5	Decibel DB844H80-XY w/ ice	126.66	0.00	0.00	3.97	240.00	0.00	0.00	12.00
Verizon-6	Decibel DB844H80-XY w/ ice	126.66	0.00	0.00	3.97	240.00	0.00	0.00	12.00
Verizon-7	JAHH-65B-R3B Panel	126.66	0.00	0.00	9.66	0.00	0.00	0.00	151.56
Verizon-8	JAHH-65B-R3B Panel	126.66	0.00	0.00	9.66	0.00	0.00	0.00	151.56
Verizon-9	JAHH-65B-R3B Panel	126.66	0.00	0.00	9.66	120.00	0.00	0.00	151.56
Verizon-10	JAHH-65B-R3B Panel	126.66	0.00	0.00	9.66	120.00	0.00	0.00	151.56
Verizon-11	JAHH-65B-R3B Panel	126.66	0.00	0.00	9.66	240.00	0.00	0.00	151.56
Verizon-12	JAHH-65B-R3B Panel	126.66	0.00	0.00	9.66	240.00	0.00	0.00	151.56
Verizon-D	BSAMNT-SBS-2-2 Mount for JAHH Antenna	126.66	0.00	0.00	3.78	0.00	0.00	0.00	139.20
Verizon-E	BSAMNT-SBS-2-2 Mount for JAHH Antenna	126.66	0.00	0.00	3.78	120.00	0.00	0.00	139.20
Verizon-F	BSAMNT-SBS-2-2 Mount for JAHH Antenna	126.66	0.00	0.00	3.78	240.00	0.00	0.00	139.20
Verizon-13	RRH 2x60W (700 MHz)	126.66	0.00	0.00	2.12	0.00	0.00	0.00	72.00
Verizon-14	RRH 2x60W (700 MHz)	126.66	0.00	0.00	2.12	120.00	0.00	0.00	72.00
Verizon-15	RRH 2x60W (700 MHz)	126.66	0.00	0.00	2.12	240.00	0.00	0.00	72.00
Verizon-16	RRH 4x45W (AWS)	126.66	0.00	0.00	2.96	0.00	0.00	0.00	72.00
Verizon-17	RRH 4x45W (AWS)	126.66	0.00	0.00	2.96	120.00	0.00	0.00	72.00
Verizon-18	RRH 4x45W (AWS)	126.66	0.00	0.00	2.96	240.00	0.00	0.00	72.00
Verizon-19	RHH 2x80W (850 MHz)	126.66	0.00	0.00	2.91	0.00	0.00	0.00	108.00
Verizon-20	RHH 2x80W (850 MHz)	126.66	0.00	0.00	2.91	120.00	0.00	0.00	108.00
Verizon-21	RHH 2x80W (850 MHz)	126.66	0.00	0.00	2.91	240.00	0.00	0.00	108.00
Verizon-22	Raycap DB-T1-6Z-8AB-0Z Dist. Box	126.66	0.00	0.00	5.60	0.00	0.00	0.00	54.00
Verizon-23	Raycap DB-T1-6Z-8AB-0Z Dist. Box	126.66	0.00	0.00	5.60	120.00	0.00	0.00	54.00
Verizon-24	Raycap DB-T1-6Z-8AB-0Z Dist. Box	126.66	0.00	0.00	5.60	240.00	0.00	0.00	54.00
NEU-18	12` Omni	126.66	0.00	0.00	4.00	0.00	0.00	0.00	66.00
DNK15-CSP21	RFS PD1142 w/ ice	133.34	0.00	0.00	1.32	120.00	0.00	0.00	12.00
MT-DNK15	3` Stand-Off	133.34	0.00	0.00	2.72	120.00	0.00	0.00	60.00
DNK-12	5` Dipole	133.34	0.00	0.00	3.95	240.00	0.00	0.00	60.00
MT-DNK12	3` Stand-Off	133.34	0.00	0.00	2.72	240.00	0.00	0.00	60.00
T-Mobile-1	Ericsson AIR B2A/B4P	133.34	0.00	0.00	6.53	0.00	0.00	0.00	132.02
T-Mobile-2	AIR32 B66/B2A	133.34	0.00	0.00	5.84	0.00	0.00	0.00	158.64
T-Mobile-3	APXVAA24_43-U-A20 (RFS)	133.34	0.00	0.00	22.38	0.00	0.00	0.00	180.00
T-Mobile-4	Ericsson AIR B2A/B4P	133.34	0.00	0.00	6.53	120.00	0.00	0.00	132.02
T-Mobile-5	AIR32 B66/B2A	133.34	0.00	0.00	5.84	120.00	0.00	0.00	158.64
T-Mobile-6	APXVAA24_43-U-A20 (RFS)	133.34	0.00	0.00	22.38	120.00	0.00	0.00	180.00
T-Mobile-7	Ericsson AIR B2A/B4P	133.34	0.00	0.00	6.53	240.00	0.00	0.00	132.02
T-Mobile-8	AIR32 B66/B2A	133.34	0.00	0.00	5.84	240.00	0.00	0.00	158.64
T-Mobile-9	APXVAA24_43-U-A20 (RFS)	133.34	0.00	0.00	22.38	240.00	0.00	0.00	180.00
T-Mobile-10	Twin TMA Unit - Generic	133.34	0.00	0.00	1.12	0.00	0.00	0.00	30.00
T-Mobile-11	Twin TMA Unit - Generic	133.34	0.00	0.00	1.12	120.00	0.00	0.00	30.00
T-Mobile-12	Twin TMA Unit - Generic	133.34	0.00	0.00	1.12	240.00	0.00	0.00	30.00
T-Mobile-13	RRHU-11 RRH Unit	133.34	0.00	0.00	2.99	0.00	0.00	0.00	60.00
T-Mobile-14	RRHU-11 RRH Unit	133.34	0.00	0.00	2.99	120.00	0.00	0.00	60.00
T-Mobile-15	RRHU-11 RRH Unit	133.34	0.00	0.00	2.99	240.00	0.00	0.00	60.00
T-Mobile-16	Ericsson 4478 (B71) RRH Unit	133.34	0.00	0.00	1.26	0.00	0.00	0.00	72.00
T-Mobile-17	Ericsson 4478 (B71) RRH Unit	133.34	0.00	0.00	1.26	120.00	0.00	0.00	72.00
T-Mobile-18	Ericsson 4478 (B71) RRH Unit	133.34	0.00	0.00	1.26	240.00	0.00	0.00	72.00
T-Mobile-19	Diplexer Unit - Generic	133.34	0.00	0.00	0.72	0.00	0.00	0.00	30.00
T-Mobile-20	Diplexer Unit - Generic	133.34	0.00	0.00	0.72	120.00	0.00	0.00	30.00

T-Mobile-21	Diplexer Unit - Generic	133.34	0.00	0.00	0.72	240.00													0.00	0.00	30.00
ATT-A	12` T-Arm	150.00	0.00	0.00	13.60	0.00													0.00	0.00	558.00
ATT-B	12` T-Arm	150.00	0.00	0.00	13.60	120.00													0.00	0.00	558.00
ATT-C	12` T-Arm	150.00	0.00	0.00	13.60	240.00													0.00	0.00	558.00
ATT-A1	Powerwave 7770	150.00	0.00	0.00	5.88	0.00													0.00	0.00	42.00
ATT-A2	Powerwave 7770	150.00	0.00	0.00	5.88	0.00													0.00	0.00	42.00
ATT-A3	RRHU-11 RRH Unit	150.00	0.00	0.00	2.99	0.00													0.00	0.00	60.00
ATT-A4	TMA Unit (LGP24101)	150.00	0.00	0.00	1.29	0.00													0.00	0.00	16.92
ATT-A5	TMA Unit (LGP24101)	150.00	0.00	0.00	1.29	0.00													0.00	0.00	16.92
ATT-A6	Raycap Surge Suppressor	150.00	0.00	0.00	1.79	0.00													0.00	0.00	32.40
ATT-A7	OPA-65-LCUU-H6 Panel	150.00	0.00	0.00	10.12	0.00													0.00	0.00	76.80
ATT-A8	RRUS-32 RRH Unit	150.00	0.00	0.00	3.88	0.00													0.00	0.00	96.00
ATT-B1	RRHU-11 RRH Unit	150.00	0.00	0.00	2.99	120.00													0.00	0.00	60.00
ATT-B2	TMA Unit (LGP24101)	150.00	0.00	0.00	1.29	120.00													0.00	0.00	16.92
ATT-B3	TMA Unit (LGP24101)	150.00	0.00	0.00	1.29	120.00													0.00	0.00	16.92
ATT-B4	OPA-65-LCUU-H6 Panel	150.00	0.00	0.00	10.12	120.00													0.00	0.00	76.80
ATT-B5	RRUS-32 RRH Unit	150.00	0.00	0.00	3.88	120.00													0.00	0.00	96.00
ATT-C1	RRHU-11 RRH Unit	150.00	0.00	0.00	2.99	240.00													0.00	0.00	60.00
ATT-C2	TMA Unit (LGP24101)	150.00	0.00	0.00	1.29	240.00													0.00	0.00	16.92
ATT-C3	TMA Unit (LGP24101)	150.00	0.00	0.00	1.29	240.00													0.00	0.00	16.92
ATT-C4	OPA-65-LCUU-H6 Panel	150.00	0.00	0.00	10.12	240.00													0.00	0.00	76.80
ATT-C5	RRUS-32 RRH Unit	150.00	0.00	0.00	3.88	240.00													0.00	0.00	96.00
CSP-70	Sinclair SC479-HF1LDF w/ ice	160.00	0.00	0.00	5.06	0.00													0.00	0.00	40.80
CSP-71	Sinclair SC479-HF1LDF w/ ice	160.00	0.00	0.00	5.06	120.00													0.00	0.00	40.80
CSP-72	Sinclair SC479-HF1LDF w/ ice	160.00	0.00	0.00	5.06	240.00													0.00	0.00	40.80
CSP-73	TMA	160.00	0.00	0.00	1.29	240.00													0.00	0.00	18.00
DNK21-SPD9	8` Dish with Radome	160.00	0.00	0.00	51.32	0.00	0.86330												0.00	0.00	672.00
DNK20-UNKNOWN	4`xl` Panel	160.00	0.00	0.00	6.53	240.00													0.00	0.00	36.00
DNK19-STAM63	4`xl` Panel	160.00	0.00	0.00	6.53	120.00													0.00	0.00	36.00
159-A	3` Stand-Off	160.00	0.00	0.00	2.72	0.00													0.00	0.00	60.00
159-B	3` Stand-Off	160.00	0.00	0.00	2.72	120.00													0.00	0.00	60.00
160	3` Stand-Off	160.00	0.00	0.00	2.72	240.00													0.00	0.00	60.00
DNK22-TOG-6	DB586-Y	165.00	0.00	0.00	1.01	0.00													0.00	0.00	9.90
DNK23-STAM64	4`xl` Panel	165.00	0.00	0.00	6.53	0.00													0.00	0.00	36.00
DNK23-STAM65	TMA	165.00	0.00	0.00	1.29	0.00													0.00	0.00	18.00
GRN-1 (DNK25)	4` Dish	170.00	0.00	0.00	13.10	50.00	1.66410	0.08980	-0.06910										0.00	0.00	144.00
DNK26aCSP-67	Dipole	175.00	0.00	0.00	9.17	0.00													0.00	0.00	55.20
DNK26bNEU-20	4` Dipole	175.00	0.00	0.00	3.70	0.00													0.00	0.00	48.00
DNK27A-CSP4	Sinclair SC479-HF1LDF w/ ice	175.00	0.00	0.00	5.06	240.00													0.00	0.00	40.80
DNK27B-CSP2	Scala OGT9-806 w/ ice	175.00	0.00	0.00	2.27	120.00													0.00	0.00	22.20
DNK27C-CSP74	TMA	175.00	0.00	0.00	1.29	120.00													0.00	0.00	18.00
DNK28A-CSP1	Scala OGT9-806 w/ ice	175.00	0.00	0.00	2.27	120.00													0.00	0.00	22.20
DNK28B-CSP3	Sinclair SC479-HF1LDF w/ ice	175.00	0.00	0.00	5.06	240.00													0.00	0.00	40.80
DNK28C-TOG5	Andrew DB-583 w/ ice	175.00	0.00	0.00	0.54	0.00													0.00	0.00	7.50
DNK28D-NEU55	Decibel PD-420 2 bay - Dipole	175.00	0.00	0.00	1.64	240.00													0.00	0.00	12.00
Top-A	6` Stand-Off	180.00	0.00	0.00	10.60	0.00													0.00	0.00	168.00
Top-B	6` Stand-Off	180.00	0.00	0.00	10.60	120.00													0.00	0.00	168.00
Top-C1	6` Stand-Off	180.00	0.00	0.00	10.60	260.00													0.00	0.00	168.00
Top-C2	6` Stand-Off	180.00	0.00	0.00	10.60	220.00													0.00	0.00	168.00
ATT-B7	Powerwave 7770	150.00	0.00	0.00	5.88	120.00													0.00	0.00	42.00
ATT-B8	Powerwave 7770	150.00	0.00	0.00	5.88	120.00													0.00	0.00	42.00
ATT-C7	Powerwave 7770	150.00	0.00	0.00	5.88	240.00													0.00	0.00	42.00
ATT-C8	Powerwave 7770	150.00	0.00	0.00	5.88	240.00													0.00	0.00	42.00

EIA Section Load Case Information for "4: 1.2D + 1.0Dg + 1.0E":

Note: qzGh (adjusted wind pressure) includes: Velocity Pressure Coefficient (Kz), Topographic Factor (Kzt), Gust Effect Factor (Gh), Wind Direction Probability Factor (Kd), Wind Importance Factor (Table 2-3), Wind Load Factor (from Loads/EIA Loads)
Face RR is the minimum round reduction factor for all round angles and appurtenances in the section

Section Label	Z of Top (ft)	Z of Ave. Bottom (ft)	Elev. Above Gnd. (ft)	qzGh (psf)	Ice Thick. (in)	Face AF (ft^2)	Face AR (ft^2)	Face RR (ft^2)	Face AR (ft^2)	Face AG (ft^2)	Face e (ft^2)	Face DF (ft^2)	Face DR (ft^2)	Face RR (ft^2)	Face CF (ft^2)	Face AE (ft^2)	Face WF (ft^2)	NotF AAF (ft^2)	NotF CAF (ft^2)	NotF AAR (ft^2)	NotF CAR (ft^2)	NotF AAR*CAR (ft^2)	NotF WA (lbs)	Total Wind (lbs)	Total Weight (lbs)
A	180.00	160.00	170.00	0.00	0.00	20.58	21.02	12.32	163.7	0.25	1.00	1.00	0.59	2.43	32.9	0	24.00	2.00	0.00	1.20	0.00	0	0	6770	
B	160.00	140.00	150.00	0.00	0.00	22.52	27.30	16.04	191.0	0.26	1.00	1.00	0.59	2.41	38.6	0	36.00	2.00	0.00	1.20	0.00	0	0	7224	
C	140.00	120.00	130.00	0.00	0.00	25.73	29.16	17.07	218.3	0.25	1.00	1.00	0.59	2.43	42.8	0	48.00	2.00	0.00	1.20	0.00	0	0	8030	
D	120.00	100.00	110.00	0.00	0.00	30.37	36.61	21.63	245.5	0.27	1.00	1.00	0.59	2.37	52.0	0	48.00	2.00	0.00	1.20	0.00	0	0	8857	
E	100.00	80.00	90.00	0.00	0.00	37.01	40.26	23.91	272.8	0.28	1.00	1.00	0.59	2.34	60.9	0	48.00	2.00	0.00	1.20	0.00	0	0	12042	

F	80.00	60.00	70.00	0.00	0.00	37.32	43.90	25.92	300.0	0.27	1.00	1.00	0.59	2.38	63.2	0	48.00	2.00	0.00	1.20	0.00	0	0	12661
G	60.00	40.00	50.00	0.00	0.00	42.28	50.37	29.91	327.3	0.28	1.00	1.00	0.59	2.34	72.2	0	48.00	2.00	0.00	1.20	0.00	0	0	14137
H	40.00	20.00	30.00	0.00	0.00	48.05	50.83	30.12	354.6	0.28	1.00	1.00	0.59	2.35	78.2	0	48.00	2.00	0.00	1.20	0.00	0	0	15046
I	20.00	0.00	10.00	0.00	0.00	59.30	58.17	34.98	381.9	0.31	1.00	1.00	0.60	2.28	94.3	0	43.20	2.00	0.00	1.20	0.00	0	0	15157

Equipment Load Case Information for "5: 0.9D + 1.0Dg + 1.0E":

Equipment Label	Equipment Property Set	Elevation Above Ground (ft)	qzGh (psf)	Ice Thick. (in)	Total Wind Area (ft^2)	Wind Incidence Angle (deg)	222-G CA	222-G CS	222-G CM	Antenna Load FAM (lbs)	Antenna Side Load FSM (lbs)	Antenna Moment MM (ft-lbs)	Long. Load (lbs)	Trans. Load (lbs)	Vert. Load (lbs)
DNK-1	5` Dipole	60.00	0.00	0.00	3.95	0.00							0.00	0.00	45.00
MT-DNK1	3` Stand-Off	60.00	0.00	0.00	2.72	0.00							0.00	0.00	45.00
DNK2-GPS68	GPS	60.00	0.00	0.00	1.00	120.00							0.00	0.00	9.00
MT-DNK2	3` Stand-Off	60.00	0.00	0.00	2.72	120.00							0.00	0.00	45.00
DNK3-GPS69	GPS	60.00	0.00	0.00	1.00	240.00							0.00	0.00	9.00
MT-DNK3	3` Stand-Off	60.00	0.00	0.00	2.72	240.00							0.00	0.00	45.00
DNK4-DOT56	10` Dipole	60.00	0.00	0.00	9.17	240.00							0.00	0.00	41.40
MT-DNK4	3` Stand-Off	60.00	0.00	0.00	2.72	240.00							0.00	0.00	45.00
DNK5-NEU16	8` Omni	80.00	0.00	0.00	2.00	240.00							0.00	0.00	4.50
MT-DNK5	6` Stand-Off	80.00	0.00	0.00	10.60	240.00							0.00	0.00	126.00
DNK9-DEP54	RFS PD1142 w/ ice	120.00	0.00	0.00	1.32	120.00							0.00	0.00	9.00
MT-DNK9	3` Stand-Off	120.00	0.00	0.00	2.72	120.00							0.00	0.00	45.00
DNK8-CSP66	RFS PD1142 w/ ice	120.00	0.00	0.00	1.32	120.00							0.00	0.00	9.00
DNK7-NEU17	12` Omni	113.34	0.00	0.00	4.00	0.00							0.00	0.00	49.50
MT-DNK7	3` Stand-Off	113.34	0.00	0.00	2.72	0.00							0.00	0.00	45.00
Sprint-A	12` T-Arm	113.34	0.00	0.00	13.60	0.00							0.00	0.00	418.50
Sprint-B	12` T-Arm	113.34	0.00	0.00	13.60	120.00							0.00	0.00	418.50
Sprint-C	12` T-Arm	113.34	0.00	0.00	13.60	240.00							0.00	0.00	418.50
Sprint-1	RFS APXVSP18-C w/ ice	113.34	0.00	0.00	8.26	0.00							0.00	0.00	81.00
Sprint-2	ALU RRH	113.34	0.00	0.00	6.90	0.00							0.00	0.00	54.00
Sprint-3	ALU RRH	113.34	0.00	0.00	6.90	0.00							0.00	0.00	54.00
Sprint-4	RFS APXVSP18-C w/ ice	113.34	0.00	0.00	8.26	120.00							0.00	0.00	81.00
Sprint-5	ALU RRH	113.34	0.00	0.00	6.90	120.00							0.00	0.00	54.00
Sprint-6	ALU RRH	113.34	0.00	0.00	6.90	120.00							0.00	0.00	54.00
Sprint-7	RFS APXVSP18-C w/ ice	113.34	0.00	0.00	8.26	240.00							0.00	0.00	81.00
Sprint-8	ALU RRH	113.34	0.00	0.00	6.90	240.00							0.00	0.00	54.00
Sprint-9	ALU RRH	113.34	0.00	0.00	6.90	240.00							0.00	0.00	54.00
Sprint-10	DT465B-2XR-V2	113.34	0.00	0.00	9.65	0.00							0.00	0.00	79.56
Sprint-11	DT465B-2XR-V2	113.34	0.00	0.00	9.65	120.00							0.00	0.00	79.56
Sprint-12	DT465B-2XR-V2	113.34	0.00	0.00	9.65	240.00							0.00	0.00	79.56
Sprint-13	800 MHz RRH Unit	113.34	0.00	0.00	6.90	0.00							0.00	0.00	54.00
Sprint-14	800 MHz RRH Unit	113.34	0.00	0.00	6.90	120.00							0.00	0.00	54.00
Sprint-15	800 MHz RRH Unit	113.34	0.00	0.00	6.90	240.00							0.00	0.00	54.00
Sprint-16	TD-RRH 8x20-25 RRH Unit	113.34	0.00	0.00	4.72	0.00							0.00	0.00	59.52
Sprint-17	TD-RRH 8x20-25 RRH Unit	113.34	0.00	0.00	4.72	120.00							0.00	0.00	59.52
Sprint-18	TD-RRH 8x20-25 RRH Unit	113.34	0.00	0.00	4.72	240.00							0.00	0.00	59.52
Verizon-A	Boom Gate	126.66	0.00	0.00	13.60	0.00							0.00	0.00	423.90
Verizon-B	Boom Gate	126.66	0.00	0.00	13.60	120.00							0.00	0.00	423.90
Verizon-C	Boom Gate	126.66	0.00	0.00	13.60	240.00							0.00	0.00	423.90
Verizon-1	Decibel DB844H80-XY w/ ice	126.66	0.00	0.00	3.97	0.00							0.00	0.00	9.00
Verizon-2	Decibel DB844H80-XY w/ ice	126.66	0.00	0.00	3.97	0.00							0.00	0.00	9.00
Verizon-3	Decibel DB844H80-XY w/ ice	126.66	0.00	0.00	3.97	120.00							0.00	0.00	9.00
Verizon-4	Decibel DB844H80-XY w/ ice	126.66	0.00	0.00	3.97	120.00							0.00	0.00	9.00
Verizon-5	Decibel DB844H80-XY w/ ice	126.66	0.00	0.00	3.97	240.00							0.00	0.00	9.00
Verizon-6	Decibel DB844H80-XY w/ ice	126.66	0.00	0.00	3.97	240.00							0.00	0.00	9.00
Verizon-7	JAHH-65B-R3B Panel	126.66	0.00	0.00	9.66	0.00							0.00	0.00	113.67
Verizon-8	JAHH-65B-R3B Panel	126.66	0.00	0.00	9.66	0.00							0.00	0.00	113.67
Verizon-9	JAHH-65B-R3B Panel	126.66	0.00	0.00	9.66	120.00							0.00	0.00	113.67
Verizon-10	JAHH-65B-R3B Panel	126.66	0.00	0.00	9.66	120.00							0.00	0.00	113.67
Verizon-11	JAHH-65B-R3B Panel	126.66	0.00	0.00	9.66	240.00							0.00	0.00	113.67
Verizon-12	JAHH-65B-R3B Panel	126.66	0.00	0.00	9.66	240.00							0.00	0.00	113.67
Verizon-D	BSAMNT-SBS-2-2 Mount for JAHH Antenna	126.66	0.00	0.00	3.78	0.00							0.00	0.00	104.40
Verizon-E	BSAMNT-SBS-2-2 Mount for JAHH Antenna	126.66	0.00	0.00	3.78	120.00							0.00	0.00	104.40
Verizon-F	BSAMNT-SBS-2-2 Mount for JAHH Antenna	126.66	0.00	0.00	3.78	240.00							0.00	0.00	104.40
Verizon-13	RRH 2x60W (700 MHz)	126.66	0.00	0.00	2.12	0.00							0.00	0.00	54.00
Verizon-14	RRH 2x60W (700 MHz)	126.66	0.00	0.00	2.12	120.00							0.00	0.00	54.00
Verizon-15	RRH 2x60W (700 MHz)	126.66	0.00	0.00	2.12	240.00							0.00	0.00	54.00

Verizon-16	RRH 4x45W (AWS)	126.66	0.00	0.00	2.96	0.00	0.00	0.00	54.00
Verizon-17	RRH 4x45W (AWS)	126.66	0.00	0.00	2.96	120.00	0.00	0.00	54.00
Verizon-18	RRH 4x45W (AWS)	126.66	0.00	0.00	2.96	240.00	0.00	0.00	54.00
Verizon-19	RHH 2x80W (850 MHz)	126.66	0.00	0.00	2.91	0.00	0.00	0.00	81.00
Verizon-20	RHH 2x80W (850 MHz)	126.66	0.00	0.00	2.91	120.00	0.00	0.00	81.00
Verizon-21	RHH 2x80W (850 MHz)	126.66	0.00	0.00	2.91	240.00	0.00	0.00	81.00
Verizon-22	Raycap DB-T1-6Z-8AB-0Z Dist. Box	126.66	0.00	0.00	5.60	0.00	0.00	0.00	40.50
Verizon-23	Raycap DB-T1-6Z-8AB-0Z Dist. Box	126.66	0.00	0.00	5.60	120.00	0.00	0.00	40.50
Verizon-24	Raycap DB-T1-6Z-8AB-0Z Dist. Box	126.66	0.00	0.00	5.60	240.00	0.00	0.00	40.50
NEU-18	12` Omni	126.66	0.00	0.00	4.00	0.00	0.00	0.00	49.50
DNK15-CSP21	RFS PD1142 w/ ice	133.34	0.00	0.00	1.32	120.00	0.00	0.00	9.00
MT-DNK15	3` Stand-Off	133.34	0.00	0.00	2.72	120.00	0.00	0.00	45.00
DNK-12	5` Dipole	133.34	0.00	0.00	3.95	240.00	0.00	0.00	45.00
MT-DNK12	3` Stand-Off	133.34	0.00	0.00	2.72	240.00	0.00	0.00	45.00
T-Mobile-1	Ericsson AIR B2A/B4P	133.34	0.00	0.00	6.53	0.00	0.00	0.00	99.02
T-Mobile-2	AIR32 B66/B2A	133.34	0.00	0.00	5.84	0.00	0.00	0.00	118.98
T-Mobile-3	APXVAA24_43-U-A20 (RFS)	133.34	0.00	0.00	22.38	0.00	0.00	0.00	135.00
T-Mobile-4	Ericsson AIR B2A/B4P	133.34	0.00	0.00	6.53	120.00	0.00	0.00	99.02
T-Mobile-5	AIR32 B66/B2A	133.34	0.00	0.00	5.84	120.00	0.00	0.00	118.98
T-Mobile-6	APXVAA24_43-U-A20 (RFS)	133.34	0.00	0.00	22.38	120.00	0.00	0.00	135.00
T-Mobile-7	Ericsson AIR B2A/B4P	133.34	0.00	0.00	6.53	240.00	0.00	0.00	99.02
T-Mobile-8	AIR32 B66/B2A	133.34	0.00	0.00	5.84	240.00	0.00	0.00	118.98
T-Mobile-9	APXVAA24_43-U-A20 (RFS)	133.34	0.00	0.00	22.38	240.00	0.00	0.00	135.00
T-Mobile-10	Twin TMA Unit - Generic	133.34	0.00	0.00	1.12	0.00	0.00	0.00	22.50
T-Mobile-11	Twin TMA Unit - Generic	133.34	0.00	0.00	1.12	120.00	0.00	0.00	22.50
T-Mobile-12	Twin TMA Unit - Generic	133.34	0.00	0.00	1.12	240.00	0.00	0.00	22.50
T-Mobile-13	RRHU-11 RRH Unit	133.34	0.00	0.00	2.99	0.00	0.00	0.00	45.00
T-Mobile-14	RRHU-11 RRH Unit	133.34	0.00	0.00	2.99	120.00	0.00	0.00	45.00
T-Mobile-15	RRHU-11 RRH Unit	133.34	0.00	0.00	2.99	240.00	0.00	0.00	45.00
T-Mobile-16	Ericsson 4478 (B71) RRH Unit	133.34	0.00	0.00	1.26	0.00	0.00	0.00	54.00
T-Mobile-17	Ericsson 4478 (B71) RRH Unit	133.34	0.00	0.00	1.26	120.00	0.00	0.00	54.00
T-Mobile-18	Ericsson 4478 (B71) RRH Unit	133.34	0.00	0.00	1.26	240.00	0.00	0.00	54.00
T-Mobile-19	Diplexer Unit - Generic	133.34	0.00	0.00	0.72	0.00	0.00	0.00	22.50
T-Mobile-20	Diplexer Unit - Generic	133.34	0.00	0.00	0.72	120.00	0.00	0.00	22.50
T-Mobile-21	Diplexer Unit - Generic	133.34	0.00	0.00	0.72	240.00	0.00	0.00	22.50
ATT-A	12` T-Arm	150.00	0.00	0.00	13.60	0.00	0.00	0.00	418.50
ATT-B	12` T-Arm	150.00	0.00	0.00	13.60	120.00	0.00	0.00	418.50
ATT-C	12` T-Arm	150.00	0.00	0.00	13.60	240.00	0.00	0.00	418.50
ATT-A1	Powerwave 7770	150.00	0.00	0.00	5.88	0.00	0.00	0.00	31.50
ATT-A2	Powerwave 7770	150.00	0.00	0.00	5.88	0.00	0.00	0.00	31.50
ATT-A3	RRHU-11 RRH Unit	150.00	0.00	0.00	2.99	0.00	0.00	0.00	45.00
ATT-A4	TMA Unit (LGP24101)	150.00	0.00	0.00	1.29	0.00	0.00	0.00	12.69
ATT-A5	TMA Unit (LGP24101)	150.00	0.00	0.00	1.29	0.00	0.00	0.00	12.69
ATT-A6	Raycap Surge Suppressor	150.00	0.00	0.00	1.79	0.00	0.00	0.00	24.30
ATT-A7	OPA-65-LCUU-H6 Panel	150.00	0.00	0.00	10.12	0.00	0.00	0.00	57.60
ATT-A8	RRUS-32 RRH Unit	150.00	0.00	0.00	3.88	0.00	0.00	0.00	72.00
ATT-B1	RRHU-11 RRH Unit	150.00	0.00	0.00	2.99	120.00	0.00	0.00	45.00
ATT-B2	TMA Unit (LGP24101)	150.00	0.00	0.00	1.29	120.00	0.00	0.00	12.69
ATT-B3	TMA Unit (LGP24101)	150.00	0.00	0.00	1.29	120.00	0.00	0.00	12.69
ATT-B4	OPA-65-LCUU-H6 Panel	150.00	0.00	0.00	10.12	120.00	0.00	0.00	57.60
ATT-B5	RRUS-32 RRH Unit	150.00	0.00	0.00	3.88	120.00	0.00	0.00	72.00
ATT-C1	RRHU-11 RRH Unit	150.00	0.00	0.00	2.99	240.00	0.00	0.00	45.00
ATT-C2	TMA Unit (LGP24101)	150.00	0.00	0.00	1.29	240.00	0.00	0.00	12.69
ATT-C3	TMA Unit (LGP24101)	150.00	0.00	0.00	1.29	240.00	0.00	0.00	12.69
ATT-C4	OPA-65-LCUU-H6 Panel	150.00	0.00	0.00	10.12	240.00	0.00	0.00	57.60
ATT-C5	RRUS-32 RRH Unit	150.00	0.00	0.00	3.88	240.00	0.00	0.00	72.00
CSP-70	Sinclair SC479-HF1LDF w/ ice	160.00	0.00	0.00	5.06	0.00	0.00	0.00	30.60
CSP-71	Sinclair SC479-HF1LDF w/ ice	160.00	0.00	0.00	5.06	120.00	0.00	0.00	30.60
CSP-72	Sinclair SC479-HF1LDF w/ ice	160.00	0.00	0.00	5.06	240.00	0.00	0.00	30.60
CSP-73	TMA	160.00	0.00	0.00	1.29	240.00	0.00	0.00	13.50
DNK21-SPD9	8` Dish with Radome	160.00	0.00	0.00	51.32	0.00	0.86330	0.00	504.00
DNK20-UNKNOWN	4`xl` Panel	160.00	0.00	0.00	6.53	240.00	0.00	0.00	27.00
DNK19-STAM63	4`xl` Panel	160.00	0.00	0.00	6.53	120.00	0.00	0.00	27.00
159-A	3` Stand-Off	160.00	0.00	0.00	2.72	0.00	0.00	0.00	45.00
159-B	3` Stand-Off	160.00	0.00	0.00	2.72	120.00	0.00	0.00	45.00
160	3` Stand-Off	160.00	0.00	0.00	2.72	240.00	0.00	0.00	45.00
DNK22-TOG-6	DB586-Y	165.00	0.00	0.00	1.01	0.00	0.00	0.00	7.42
DNK23-STAM64	4`xl` Panel	165.00	0.00	0.00	6.53	0.00	0.00	0.00	27.00
DNK23-STAM65	TMA	165.00	0.00	0.00	1.29	0.00	0.00	0.00	13.50

GRN-1 (DNK25)	4` Dish	170.00	0.00	0.00	13.10	50.00	1.66410	0.08980	-0.06910	0.00	0.00	108.00
DNK26aCSP-67	Dipole	175.00	0.00	0.00	9.17	0.00				0.00	0.00	41.40
DNK26bNEU-20	4` Dipole	175.00	0.00	0.00	3.70	0.00				0.00	0.00	36.00
DNK27A-CSP4	Sinclair SC479-HF1LDF w/ ice	175.00	0.00	0.00	5.06	240.00				0.00	0.00	30.60
DNK27B-CSP2	Scala OGT9-806 w/ ice	175.00	0.00	0.00	2.27	120.00				0.00	0.00	16.65
DNK27C-CSP74	TMA	175.00	0.00	0.00	1.29	120.00				0.00	0.00	13.50
DNK28A-CSP1	Scala OGT9-806 w/ ice	175.00	0.00	0.00	2.27	120.00				0.00	0.00	16.65
DNK28B-CSP3	Sinclair SC479-HF1LDF w/ ice	175.00	0.00	0.00	5.06	240.00				0.00	0.00	30.60
DNK28C-TOG5	Andrew DB-583 w/ ice	175.00	0.00	0.00	0.54	0.00				0.00	0.00	5.63
DNK28D-NEU55	Decibel PD-420 2 bay - Dipole	175.00	0.00	0.00	1.64	240.00				0.00	0.00	9.00
Top-A	6` Stand-Off	180.00	0.00	0.00	10.60	0.00				0.00	0.00	126.00
Top-B	6` Stand-Off	180.00	0.00	0.00	10.60	120.00				0.00	0.00	126.00
Top-C1	6` Stand-Off	180.00	0.00	0.00	10.60	260.00				0.00	0.00	126.00
Top-C2	6` Stand-Off	180.00	0.00	0.00	10.60	220.00				0.00	0.00	126.00
ATT-B7	Powerwave 7770	150.00	0.00	0.00	5.88	120.00				0.00	0.00	31.50
ATT-B8	Powerwave 7770	150.00	0.00	0.00	5.88	120.00				0.00	0.00	31.50
ATT-C7	Powerwave 7770	150.00	0.00	0.00	5.88	240.00				0.00	0.00	31.50
ATT-C8	Powerwave 7770	150.00	0.00	0.00	5.88	240.00				0.00	0.00	31.50

EIA Section Load Case Information for "5: 0.9D + 1.0Dg + 1.0E":

Note: qzGh (adjusted wind pressure) includes: Velocity Pressure Coefficient (Kz), Topographic Factor (Kzt), Gust Effect Factor (Gh), Wind Direction Probability Factor (Kd), Wind Importance Factor (Table 2-3), Wind Load Factor (from Loads/EIA Loads) Face RR is the minimum round reduction factor for all round angles and appurtenances in the section

Section Label	Z of Top (ft)	Z of Bottom (ft)	Ave. Above Gnd. (ft)	Elev. (ft)	qzGh (psf)	Ice Thick. (in)	Face AF (ft^2)	Face AR (ft^2)	Face RR*AR (ft^2)	Face AG (ft^2)	Face e	Face DF	Face DR	Face RR	Face CF	Face AE (ft^2)	Face WF (lbs)	NotF AAF (ft^2)	NotF CAF	NotF AAR (ft^2)	NotF CAR	NotF AAR*CAR (ft^2)	NotF WA (lbs)	Total Wind (lbs)	Total Weight (lbs)
A	180.00	160.00	170.00	0.00	0.00	20.58	21.02	12.32	163.7	0.25	1.00	1.00	0.59	2.43	32.9	0	24.00	2.00	0.00	1.20	0.00	0	0	5078	
B	160.00	140.00	150.00	0.00	0.00	22.52	27.30	16.04	191.0	0.26	1.00	1.00	0.59	2.41	38.6	0	36.00	2.00	0.00	1.20	0.00	0	0	5418	
C	140.00	120.00	130.00	0.00	0.00	25.73	29.16	17.07	218.3	0.25	1.00	1.00	0.59	2.43	42.8	0	48.00	2.00	0.00	1.20	0.00	0	0	6022	
D	120.00	100.00	110.00	0.00	0.00	30.37	36.61	21.63	245.5	0.27	1.00	1.00	0.59	2.37	52.0	0	48.00	2.00	0.00	1.20	0.00	0	0	6643	
E	100.00	80.00	90.00	0.00	0.00	37.01	40.26	23.91	272.8	0.28	1.00	1.00	0.59	2.34	60.9	0	48.00	2.00	0.00	1.20	0.00	0	0	9032	
F	80.00	60.00	70.00	0.00	0.00	37.32	43.90	25.92	300.0	0.27	1.00	1.00	0.59	2.38	63.2	0	48.00	2.00	0.00	1.20	0.00	0	0	9496	
G	60.00	40.00	50.00	0.00	0.00	42.28	50.37	29.91	327.3	0.28	1.00	1.00	0.59	2.34	72.2	0	48.00	2.00	0.00	1.20	0.00	0	0	10603	
H	40.00	20.00	30.00	0.00	0.00	48.05	50.83	30.12	354.6	0.28	1.00	1.00	0.59	2.35	78.2	0	48.00	2.00	0.00	1.20	0.00	0	0	11284	
I	20.00	0.00	10.00	0.00	0.00	59.30	58.17	34.98	381.9	0.31	1.00	1.00	0.60	2.28	94.3	0	43.20	2.00	0.00	1.20	0.00	0	0	11368	

Equipment Load Case Information for "6: Service 1.0D + 1.0Dg + 1.0 Wo":

Equipment Label	Equipment Property Set	Elevation Above Ground (ft)	qzGh (psf)	Ice Thick. (in)	Total Wind Area (ft^2)	Wind Incidence Angle (deg)	222-G CA	222-G CS	222-G CM	Antenna Axial Load (lbs)	Antenna Side Load (lbs)	Antenna Moment (ft-lbs)	Long. Load (lbs)	Trans. Load (lbs)	Vert. Load (lbs)
DNK-1	5` Dipole	60.00	8.40	0.00	3.95	0.00							33.19	0.00	50.00
MT-DNK1	3` Stand-Off	60.00	8.40	0.00	2.72	0.00							22.84	0.00	50.00
DNK2-GPS68	GPS	60.00	8.40	0.00	1.00	120.00							8.40	0.00	10.00
MT-DNK2	3` Stand-Off	60.00	8.40	0.00	2.72	120.00							22.84	0.00	50.00
DNK3-GPS69	GPS	60.00	8.40	0.00	1.00	240.00							8.40	0.00	10.00
MT-DNK3	3` Stand-Off	60.00	8.40	0.00	2.72	240.00							22.84	0.00	50.00
DNK4-DOT56	10` Dipole	60.00	8.40	0.00	9.17	240.00							76.96	0.00	46.00
MT-DNK4	3` Stand-Off	60.00	8.40	0.00	2.72	240.00							22.84	0.00	50.00
DNK5-NEU16	8` Omni	80.00	8.47	0.00	2.00	240.00							16.94	0.00	5.00
MT-DNK5	6` Stand-Off	80.00	8.47	0.00	10.60	240.00							89.80	0.00	140.00
DNK9-DEP54	RFS PD1142 w/ ice	120.00	8.87	0.00	1.32	120.00							11.67	0.00	10.00
MT-DNK9	3` Stand-Off	120.00	8.87	0.00	2.72	120.00							24.12	0.00	50.00
DNK8-CSP66	RFS PD1142 w/ ice	120.00	8.87	0.00	1.32	120.00							11.67	0.00	10.00
DNK7-NEU17	12` Omni	113.34	8.79	0.00	4.00	0.00							35.17	0.00	55.00
MT-DNK7	3` Stand-Off	113.34	8.79	0.00	2.72	0.00							23.92	0.00	50.00
Sprint-A	12` T-Arm	113.34	8.79	0.00	13.60	0.00							119.59	0.00	465.00
Sprint-B	12` T-Arm	113.34	8.79	0.00	13.60	120.00							119.59	0.00	465.00
Sprint-C	12` T-Arm	113.34	8.79	0.00	13.60	240.00							119.59	0.00	465.00
Sprint-1	RFS APXVSP18-C w/ ice	113.34	8.79	0.00	8.26	0.00							72.63	0.00	90.00
Sprint-2	ALU RRH	113.34	8.79	0.00	6.90	0.00							60.65	0.00	60.00
Sprint-3	ALU RRH	113.34	8.79	0.00	6.90	0.00							60.65	0.00	60.00
Sprint-4	RFS APXVSP18-C w/ ice	113.34	8.79	0.00	8.26	120.00							72.63	0.00	90.00
Sprint-5	ALU RRH	113.34	8.79	0.00	6.90	120.00							60.65	0.00	60.00

Sprint-6		ALU RRH	113.34	8.79	0.00	6.90	120.00	60.65	0.00	60.00
Sprint-7	RFS	APXVSP18-C w/ ice	113.34	8.79	0.00	8.26	240.00	72.63	0.00	90.00
Sprint-8		ALU RRH	113.34	8.79	0.00	6.90	240.00	60.65	0.00	60.00
Sprint-9		ALU RRH	113.34	8.79	0.00	6.90	240.00	60.65	0.00	60.00
Sprint-10		DT465B-2XR-V2	113.34	8.79	0.00	9.65	0.00	84.83	0.00	88.40
Sprint-11		DT465B-2XR-V2	113.34	8.79	0.00	9.65	120.00	84.83	0.00	88.40
Sprint-12		DT465B-2XR-V2	113.34	8.79	0.00	9.65	240.00	84.83	0.00	88.40
Sprint-13		800 MHz RRH Unit	113.34	8.79	0.00	6.90	0.00	60.65	0.00	60.00
Sprint-14		800 MHz RRH Unit	113.34	8.79	0.00	6.90	120.00	60.65	0.00	60.00
Sprint-15		800 MHz RRH Unit	113.34	8.79	0.00	6.90	240.00	60.65	0.00	60.00
Sprint-16	TD-RRH	8x20-25 RRH Unit	113.34	8.79	0.00	4.72	0.00	41.50	0.00	66.13
Sprint-17	TD-RRH	8x20-25 RRH Unit	113.34	8.79	0.00	4.72	120.00	41.50	0.00	66.13
Sprint-18	TD-RRH	8x20-25 RRH Unit	113.34	8.79	0.00	4.72	240.00	41.50	0.00	66.13
Verizon-A		Boom Gate	126.66	8.95	0.00	13.60	0.00	121.67	0.00	471.00
Verizon-B		Boom Gate	126.66	8.95	0.00	13.60	120.00	121.67	0.00	471.00
Verizon-C		Boom Gate	126.66	8.95	0.00	13.60	240.00	121.67	0.00	471.00
Verizon-1	Decibel	DB844H80-XY w/ ice	126.66	8.95	0.00	3.97	0.00	35.49	0.00	10.00
Verizon-2	Decibel	DB844H80-XY w/ ice	126.66	8.95	0.00	3.97	0.00	35.49	0.00	10.00
Verizon-3	Decibel	DB844H80-XY w/ ice	126.66	8.95	0.00	3.97	120.00	35.49	0.00	10.00
Verizon-4	Decibel	DB844H80-XY w/ ice	126.66	8.95	0.00	3.97	240.00	35.49	0.00	10.00
Verizon-5	Decibel	DB844H80-XY w/ ice	126.66	8.95	0.00	3.97	240.00	35.49	0.00	10.00
Verizon-6	Decibel	DB844H80-XY w/ ice	126.66	8.95	0.00	3.97	240.00	35.49	0.00	10.00
Verizon-7		JAHH-65B-R3B Panel	126.66	8.95	0.00	9.66	0.00	86.42	0.00	126.30
Verizon-8		JAHH-65B-R3B Panel	126.66	8.95	0.00	9.66	0.00	86.42	0.00	126.30
Verizon-9		JAHH-65B-R3B Panel	126.66	8.95	0.00	9.66	120.00	86.42	0.00	126.30
Verizon-10		JAHH-65B-R3B Panel	126.66	8.95	0.00	9.66	120.00	86.42	0.00	126.30
Verizon-11		JAHH-65B-R3B Panel	126.66	8.95	0.00	9.66	240.00	86.42	0.00	126.30
Verizon-12		JAHH-65B-R3B Panel	126.66	8.95	0.00	9.66	240.00	86.42	0.00	126.30
Verizon-D	BSAMNT-SBS-2-2	Mount for JAHH Antenna	126.66	8.95	0.00	3.78	0.00	33.85	0.00	116.00
Verizon-E	BSAMNT-SBS-2-2	Mount for JAHH Antenna	126.66	8.95	0.00	3.78	120.00	33.85	0.00	116.00
Verizon-F	BSAMNT-SBS-2-2	Mount for JAHH Antenna	126.66	8.95	0.00	3.78	240.00	33.85	0.00	116.00
Verizon-13		RRH 2x60W (700 MHz)	126.66	8.95	0.00	2.12	0.00	18.95	0.00	60.00
Verizon-14		RRH 2x60W (700 MHz)	126.66	8.95	0.00	2.12	120.00	18.95	0.00	60.00
Verizon-15		RRH 2x60W (700 MHz)	126.66	8.95	0.00	2.12	240.00	18.95	0.00	60.00
Verizon-16		RRH 4x45W (AWS)	126.66	8.95	0.00	2.96	0.00	26.48	0.00	60.00
Verizon-17		RRH 4x45W (AWS)	126.66	8.95	0.00	2.96	120.00	26.48	0.00	60.00
Verizon-18		RRH 4x45W (AWS)	126.66	8.95	0.00	2.96	240.00	26.48	0.00	60.00
Verizon-19		RHH 2x80W (850 MHz)	126.66	8.95	0.00	2.91	0.00	26.01	0.00	90.00
Verizon-20		RHH 2x80W (850 MHz)	126.66	8.95	0.00	2.91	120.00	26.01	0.00	90.00
Verizon-21		RHH 2x80W (850 MHz)	126.66	8.95	0.00	2.91	240.00	26.01	0.00	90.00
Verizon-22	Raycap	DB-T1-6Z-8AB-0Z Dist. Box	126.66	8.95	0.00	5.60	0.00	50.10	0.00	45.00
Verizon-23	Raycap	DB-T1-6Z-8AB-0Z Dist. Box	126.66	8.95	0.00	5.60	120.00	50.10	0.00	45.00
Verizon-24	Raycap	DB-T1-6Z-8AB-0Z Dist. Box	126.66	8.95	0.00	5.60	240.00	50.10	0.00	45.00
NEU-18		12` Omni	126.66	8.95	0.00	4.00	0.00	35.78	0.00	55.00
DNK15-CSP21	RFS	PD1142 w/ ice	133.34	9.02	0.00	1.32	120.00	11.88	0.00	10.00
MT-DNK15		3` Stand-Off	133.34	9.02	0.00	2.72	120.00	24.54	0.00	50.00
DNK-12		5` Dipole	133.34	9.02	0.00	3.95	240.00	35.68	0.00	50.00
MT-DNK12		3` Stand-Off	133.34	9.02	0.00	2.72	240.00	24.54	0.00	50.00
T-Mobile-1	Ericsson	AIR B2A/B4P	133.34	9.02	0.00	6.53	0.00	58.95	0.00	110.02
T-Mobile-2		AIR32 B66/B2A	133.34	9.02	0.00	5.84	0.00	52.74	0.00	132.20
T-Mobile-3	APXVAA24_43-U-A20	(RFS)	133.34	9.02	0.00	22.38	0.00	201.92	0.00	150.00
T-Mobile-4	Ericsson	AIR B2A/B4P	133.34	9.02	0.00	6.53	120.00	58.95	0.00	110.02
T-Mobile-5		AIR32 B66/B2A	133.34	9.02	0.00	5.84	120.00	52.74	0.00	132.20
T-Mobile-6	APXVAA24_43-U-A20	(RFS)	133.34	9.02	0.00	22.38	120.00	201.92	0.00	150.00
T-Mobile-7	Ericsson	AIR B2A/B4P	133.34	9.02	0.00	6.53	240.00	58.95	0.00	110.02
T-Mobile-8		AIR32 B66/B2A	133.34	9.02	0.00	5.84	240.00	52.74	0.00	132.20
T-Mobile-9	APXVAA24_43-U-A20	(RFS)	133.34	9.02	0.00	22.38	240.00	201.92	0.00	150.00
T-Mobile-10	Twin TMA Unit - Generic		133.34	9.02	0.00	1.12	0.00	10.15	0.00	25.00
T-Mobile-11	Twin TMA Unit - Generic		133.34	9.02	0.00	1.12	120.00	10.15	0.00	25.00
T-Mobile-12	Twin TMA Unit - Generic		133.34	9.02	0.00	1.12	240.00	10.15	0.00	25.00
T-Mobile-13		RRHU-11 RRH Unit	133.34	9.02	0.00	2.99	0.00	27.02	0.00	50.00
T-Mobile-14		RRHU-11 RRH Unit	133.34	9.02	0.00	2.99	120.00	27.02	0.00	50.00
T-Mobile-15		RRHU-11 RRH Unit	133.34	9.02	0.00	2.99	240.00	27.02	0.00	50.00
T-Mobile-16	Ericsson	4478 (B71) RRH Unit	133.34	9.02	0.00	1.26	0.00	11.40	0.00	60.00
T-Mobile-17	Ericsson	4478 (B71) RRH Unit	133.34	9.02	0.00	1.26	120.00	11.40	0.00	60.00
T-Mobile-18	Ericsson	4478 (B71) RRH Unit	133.34	9.02	0.00	1.26	240.00	11.40	0.00	60.00
T-Mobile-19		Diplexer Unit - Generic	133.34	9.02	0.00	0.72	0.00	6.54	0.00	25.00
T-Mobile-20		Diplexer Unit - Generic	133.34	9.02	0.00	0.72	120.00	6.54	0.00	25.00
T-Mobile-21		Diplexer Unit - Generic	133.34	9.02	0.00	0.72	240.00	6.54	0.00	25.00

ATT-A	12` T-Arm	150.00	9.22	0.00	13.60	0.00											125.34	0.00	465.00
ATT-B	12` T-Arm	150.00	9.22	0.00	13.60	120.00											125.34	0.00	465.00
ATT-C	12` T-Arm	150.00	9.22	0.00	13.60	240.00											125.34	0.00	465.00
ATT-A1	Powerwave 7770	150.00	9.22	0.00	5.88	0.00											54.19	0.00	35.00
ATT-A2	Powerwave 7770	150.00	9.22	0.00	5.88	0.00											54.19	0.00	35.00
ATT-A3	RRHU-11 RRH Unit	150.00	9.22	0.00	2.99	0.00											27.59	0.00	50.00
ATT-A4	TMA Unit (LGP24101)	150.00	9.22	0.00	1.29	0.00											11.87	0.00	14.10
ATT-A5	TMA Unit (LGP24101)	150.00	9.22	0.00	1.29	0.00											11.87	0.00	14.10
ATT-A6	Raycap Surge Suppressor	150.00	9.22	0.00	1.79	0.00											16.47	0.00	27.00
ATT-A7	OPA-65-LCUU-H6 Panel	150.00	9.22	0.00	10.12	0.00											93.29	0.00	64.00
ATT-A8	RRUS-32 RRH Unit	150.00	9.22	0.00	3.88	0.00											35.75	0.00	80.00
ATT-B1	RRHU-11 RRH Unit	150.00	9.22	0.00	2.99	120.00											27.59	0.00	50.00
ATT-B2	TMA Unit (LGP24101)	150.00	9.22	0.00	1.29	120.00											11.87	0.00	14.10
ATT-B3	TMA Unit (LGP24101)	150.00	9.22	0.00	1.29	120.00											11.87	0.00	14.10
ATT-B4	OPA-65-LCUU-H6 Panel	150.00	9.22	0.00	10.12	120.00											93.29	0.00	64.00
ATT-B5	RRUS-32 RRH Unit	150.00	9.22	0.00	3.88	120.00											35.75	0.00	80.00
ATT-C1	RRHU-11 RRH Unit	150.00	9.22	0.00	2.99	240.00											27.59	0.00	50.00
ATT-C2	TMA Unit (LGP24101)	150.00	9.22	0.00	1.29	240.00											11.87	0.00	14.10
ATT-C3	TMA Unit (LGP24101)	150.00	9.22	0.00	1.29	240.00											11.87	0.00	14.10
ATT-C4	OPA-65-LCUU-H6 Panel	150.00	9.22	0.00	10.12	240.00											93.29	0.00	64.00
ATT-C5	RRUS-32 RRH Unit	150.00	9.22	0.00	3.88	240.00											35.75	0.00	80.00
CSP-70	Sinclair SC479-HF1LDF w/ ice	160.00	9.33	0.00	5.06	0.00											47.18	0.00	34.00
CSP-71	Sinclair SC479-HF1LDF w/ ice	160.00	9.33	0.00	5.06	120.00											47.18	0.00	34.00
CSP-72	Sinclair SC479-HF1LDF w/ ice	160.00	9.33	0.00	5.06	240.00											47.18	0.00	34.00
CSP-73	TMA	160.00	9.33	0.00	1.29	240.00											12.02	0.00	15.00
DNK21-SPD9	8` Dish with Radome	160.00	9.33	0.00	51.32	0.00	0.86330			413.34							413.34	0.00	560.00
DNK20-UNKNOWN	4`xl` Panel	160.00	9.33	0.00	6.53	240.00											60.92	0.00	30.00
DNK19-STAM63	4`xl` Panel	160.00	9.33	0.00	6.53	120.00											60.92	0.00	30.00
159-A	3` Stand-Off	160.00	9.33	0.00	2.72	0.00											25.38	0.00	50.00
159-B	3` Stand-Off	160.00	9.33	0.00	2.72	120.00											25.38	0.00	50.00
160	3` Stand-Off	160.00	9.33	0.00	2.72	240.00											25.38	0.00	50.00
DNK22-TOG-6	DB586-Y	165.00	9.39	0.00	1.01	0.00											9.52	0.00	8.25
DNK23-STAM64	4`xl` Panel	165.00	9.39	0.00	6.53	0.00											61.28	0.00	30.00
DNK23-STAM65	TMA	165.00	9.39	0.00	1.29	0.00											12.09	0.00	15.00
GRN-1 (DNK25)	4` Dish	170.00	9.44	0.00	13.10	50.00	1.66410	0.08980	-0.06910	205.79		11.11				205.79	-11.11	120.00	
DNK26aCSP-67	Dipole	175.00	9.49	0.00	9.17	0.00											87.03	0.00	46.00
DNK26bNEU-20	4` Dipole	175.00	9.49	0.00	3.70	0.00											35.10	0.00	40.00
DNK27A-CSP4	Sinclair SC479-HF1LDF w/ ice	175.00	9.49	0.00	5.06	240.00											48.02	0.00	34.00
DNK27B-CSP2	Scala OGT9-806 w/ ice	175.00	9.49	0.00	2.27	120.00											21.58	0.00	18.50
DNK27C-CSP74	TMA	175.00	9.49	0.00	1.29	120.00											12.23	0.00	15.00
DNK28A-CSP1	Scala OGT9-806 w/ ice	175.00	9.49	0.00	2.27	120.00											21.58	0.00	18.50
DNK28B-CSP3	Sinclair SC479-HF1LDF w/ ice	175.00	9.49	0.00	5.06	240.00											48.02	0.00	34.00
DNK28C-TOG5	Andrew DB-583 w/ ice	175.00	9.49	0.00	0.54	0.00											5.10	0.00	6.25
DNK28D-NEU55	Decibel PD-420 2 bay - Dipole	175.00	9.49	0.00	1.64	240.00											15.60	0.00	10.00
Top-A	6` Stand-Off	180.00	9.55	0.00	10.60	0.00											101.21	0.00	140.00
Top-B	6` Stand-Off	180.00	9.55	0.00	10.60	120.00											101.21	0.00	140.00
Top-C1	6` Stand-Off	180.00	9.55	0.00	10.60	260.00											101.21	0.00	140.00
Top-C2	6` Stand-Off	180.00	9.55	0.00	10.60	220.00											101.21	0.00	140.00
ATT-B7	Powerwave 7770	150.00	9.22	0.00	5.88	120.00											54.19	0.00	35.00
ATT-B8	Powerwave 7770	150.00	9.22	0.00	5.88	120.00											54.19	0.00	35.00
ATT-C7	Powerwave 7770	150.00	9.22	0.00	5.88	240.00											54.19	0.00	35.00
ATT-C8	Powerwave 7770	150.00	9.22	0.00	5.88	240.00											54.19	0.00	35.00

EIA Section Load Case Information for "6: Service 1.0D + 1.0Dg + 1.0 Wo":

Note: qzGh (adjusted wind pressure) includes: Velocity Pressure Coefficient (Kz), Topographic Factor (Kzt), Gust Effect Factor (Gh), Wind Direction Probability Factor (Kd), Wind Importance Factor (Table 2-3), Wind Load Factor (from Loads/EIA Loads)
Face RR is the minimum round reduction factor for all round angles and appurtenances in the section

Section Label	Z of Top (ft)	Z of Bottom (ft)	Ave. Elev. Above Gnd. (ft)	Elev. qzGh (psf)	Ice Thick. (in)	Face AF (ft^2)	Face AR (ft^2)	Face RR*AR (ft^2)	Face AG (ft^2)	Face e	Face DF	Face DR	Face RR	Face CF (ft^2)	Face AE (lbs)	Face WF (lbs)	NotF AAF (ft^2)	NotF CAF (ft^2)	NotF AAR (ft^2)	NotF CAR (ft^2)	NotF AAR*CAR (ft^2)	NotF WA (lbs)	Total Total (lbs)	Total Wind Weight (lbs)
A	180.00	160.00	170.00	9.44	0.00	20.58	21.02	12.32	163.7	0.25	1.00	1.00	0.59	2.43	32.9	753	40.00	2.00	0.00	0.60	0.00	755	1508	5642
B	160.00	140.00	150.00	9.22	0.00	22.52	27.30	16.04	191.0	0.26	1.00	1.00	0.59	2.41	38.6	855	60.00	2.00	0.00	0.60	0.00	1106	1961	6020
C	140.00	120.00	130.00	8.98	0.00	25.73	29.16	17.07	218.3	0.25	1.00	1.00	0.59	2.43	42.8	936	80.00	2.00	0.00	0.60	0.00	1438	2373	6691
D	120.00	100.00	110.00	8.76	0.00	30.37	36.61	21.63	245.5	0.27	1.00	1.00	0.59	2.37	52.0	1080	80.00	2.00	0.00	0.60	0.00	1401	2481	7381
E	100.00	80.00	90.00	8.55	0.00	37.01	40.26	23.59	272.8	0.28	1.00	1.00	0.58	2.34	60.6	1213	80.00	2.00	0.00	0.60	0.00	1368	2582	10035
F	80.00	60.00	70.00	8.42	0.00	37.32	43.90	25.29	300.0	0.27	1.00	1.00	0.57	2.38	62.6	1252	80.00	2.00	0.00	0.60	0.00	1346	2599	10551

G	60.00	40.00	50.00	8.42	0.00	42.28	50.37	28.32	327.3	0.28	1.00	1.00	0.54	2.34	70.6	1393	80.00	2.00	0.00	0.60	0.00	1348	2741	11781
H	40.00	20.00	30.00	8.67	0.00	48.05	50.83	28.41	354.6	0.28	1.00	1.00	0.54	2.35	76.5	1561	80.00	2.00	0.00	0.60	0.00	1387	2948	12538
I	20.00	0.00	10.00	9.62	0.00	59.30	58.17	30.73	381.9	0.31	1.00	1.00	0.51	2.28	90.0	1970	72.00	2.00	0.00	0.60	0.00	1385	3355	12631

Equipment Load Case Information for "1.2*DL":

Equipment Label	Equipment Property Set	Elevation Above Ground (ft)	qzGh (psf)	Ice Thick. (in)	Total Wind Area (ft^2)	Wind Incidence Angle (deg)	222-G CA	222-G CS	222-G CM	Antenna Axial Load (lbs)	Antenna Side Load (lbs)	Antenna Moment (ft-lbs)	Long. Load (lbs)	Trans. Load (lbs)	Vert. Load (lbs)
DNK-1	5` Dipole	60.00	0.00	0.00	3.95	0.00							0.00	0.00	60.00
MT-DNK1	3` Stand-Off	60.00	0.00	0.00	2.72	0.00							0.00	0.00	60.00
DNK2-GPS68	GPS	60.00	0.00	0.00	1.00	120.00							0.00	0.00	12.00
MT-DNK2	3` Stand-Off	60.00	0.00	0.00	2.72	120.00							0.00	0.00	60.00
DNK3-GPS69	GPS	60.00	0.00	0.00	1.00	240.00							0.00	0.00	12.00
MT-DNK3	3` Stand-Off	60.00	0.00	0.00	2.72	240.00							0.00	0.00	60.00
DNK4-DOT56	10` Dipole	60.00	0.00	0.00	9.17	240.00							0.00	0.00	55.20
MT-DNK4	3` Stand-Off	60.00	0.00	0.00	2.72	240.00							0.00	0.00	60.00
DNK5-NEU16	8` Omni	80.00	0.00	0.00	2.00	240.00							0.00	0.00	6.00
MT-DNK5	6` Stand-Off	80.00	0.00	0.00	10.60	240.00							0.00	0.00	168.00
DNK9-DEP54	RFS PDL142 w/ ice	120.00	0.00	0.00	1.32	120.00							0.00	0.00	12.00
MT-DNK9	3` Stand-Off	120.00	0.00	0.00	2.72	120.00							0.00	0.00	60.00
DNK8-CSP66	RFS PDL142 w/ ice	120.00	0.00	0.00	1.32	120.00							0.00	0.00	12.00
DNK7-NEU17	12` Omni	113.34	0.00	0.00	4.00	0.00							0.00	0.00	66.00
MT-DNK7	3` Stand-Off	113.34	0.00	0.00	2.72	0.00							0.00	0.00	60.00
Sprint-A	12` T-Arm	113.34	0.00	0.00	13.60	0.00							0.00	0.00	558.00
Sprint-B	12` T-Arm	113.34	0.00	0.00	13.60	120.00							0.00	0.00	558.00
Sprint-C	12` T-Arm	113.34	0.00	0.00	13.60	240.00							0.00	0.00	558.00
Sprint-1	RFS APXVSP18-C w/ ice	113.34	0.00	0.00	8.26	0.00							0.00	0.00	108.00
Sprint-2	ALU RRH	113.34	0.00	0.00	6.90	0.00							0.00	0.00	72.00
Sprint-3	ALU RRH	113.34	0.00	0.00	6.90	0.00							0.00	0.00	72.00
Sprint-4	RFS APXVSP18-C w/ ice	113.34	0.00	0.00	8.26	120.00							0.00	0.00	108.00
Sprint-5	ALU RRH	113.34	0.00	0.00	6.90	120.00							0.00	0.00	72.00
Sprint-6	ALU RRH	113.34	0.00	0.00	6.90	120.00							0.00	0.00	72.00
Sprint-7	RFS APXVSP18-C w/ ice	113.34	0.00	0.00	8.26	240.00							0.00	0.00	108.00
Sprint-8	ALU RRH	113.34	0.00	0.00	6.90	240.00							0.00	0.00	72.00
Sprint-9	ALU RRH	113.34	0.00	0.00	6.90	240.00							0.00	0.00	72.00
Sprint-10	DT465B-2XR-V2	113.34	0.00	0.00	9.65	0.00							0.00	0.00	106.08
Sprint-11	DT465B-2XR-V2	113.34	0.00	0.00	9.65	120.00							0.00	0.00	106.08
Sprint-12	DT465B-2XR-V2	113.34	0.00	0.00	9.65	240.00							0.00	0.00	106.08
Sprint-13	800 MHz RRH Unit	113.34	0.00	0.00	6.90	0.00							0.00	0.00	72.00
Sprint-14	800 MHz RRH Unit	113.34	0.00	0.00	6.90	120.00							0.00	0.00	72.00
Sprint-15	800 MHz RRH Unit	113.34	0.00	0.00	6.90	240.00							0.00	0.00	72.00
Sprint-16	TD-RRH 8x20-25 RRH Unit	113.34	0.00	0.00	4.72	0.00							0.00	0.00	79.36
Sprint-17	TD-RRH 8x20-25 RRH Unit	113.34	0.00	0.00	4.72	120.00							0.00	0.00	79.36
Sprint-18	TD-RRH 8x20-25 RRH Unit	113.34	0.00	0.00	4.72	240.00							0.00	0.00	79.36
Verizon-A	Boom Gate	126.66	0.00	0.00	13.60	0.00							0.00	0.00	565.20
Verizon-B	Boom Gate	126.66	0.00	0.00	13.60	120.00							0.00	0.00	565.20
Verizon-C	Boom Gate	126.66	0.00	0.00	13.60	240.00							0.00	0.00	565.20
Verizon-1	Decibel DB844H80-XY w/ ice	126.66	0.00	0.00	3.97	0.00							0.00	0.00	12.00
Verizon-2	Decibel DB844H80-XY w/ ice	126.66	0.00	0.00	3.97	0.00							0.00	0.00	12.00
Verizon-3	Decibel DB844H80-XY w/ ice	126.66	0.00	0.00	3.97	120.00							0.00	0.00	12.00
Verizon-4	Decibel DB844H80-XY w/ ice	126.66	0.00	0.00	3.97	120.00							0.00	0.00	12.00
Verizon-5	Decibel DB844H80-XY w/ ice	126.66	0.00	0.00	3.97	240.00							0.00	0.00	12.00
Verizon-6	Decibel DB844H80-XY w/ ice	126.66	0.00	0.00	3.97	240.00							0.00	0.00	12.00
Verizon-7	JAHH-65B-R3B Panel	126.66	0.00	0.00	9.66	0.00							0.00	0.00	151.56
Verizon-8	JAHH-65B-R3B Panel	126.66	0.00	0.00	9.66	0.00							0.00	0.00	151.56
Verizon-9	JAHH-65B-R3B Panel	126.66	0.00	0.00	9.66	120.00							0.00	0.00	151.56
Verizon-10	JAHH-65B-R3B Panel	126.66	0.00	0.00	9.66	120.00							0.00	0.00	151.56
Verizon-11	JAHH-65B-R3B Panel	126.66	0.00	0.00	9.66	240.00							0.00	0.00	151.56
Verizon-12	JAHH-65B-R3B Panel	126.66	0.00	0.00	9.66	240.00							0.00	0.00	151.56
Verizon-D	BSAMNT-SBS-2-2 Mount for JAHH Antenna	126.66	0.00	0.00	3.78	0.00							0.00	0.00	139.20
Verizon-E	BSAMNT-SBS-2-2 Mount for JAHH Antenna	126.66	0.00	0.00	3.78	120.00							0.00	0.00	139.20
Verizon-F	BSAMNT-SBS-2-2 Mount for JAHH Antenna	126.66	0.00	0.00	3.78	240.00							0.00	0.00	139.20
Verizon-13	RRH 2x60W (700 MHz)	126.66	0.00	0.00	2.12	0.00							0.00	0.00	72.00
Verizon-14	RRH 2x60W (700 MHz)	126.66	0.00	0.00	2.12	120.00							0.00	0.00	72.00
Verizon-15	RRH 2x60W (700 MHz)	126.66	0.00	0.00	2.12	240.00							0.00	0.00	72.00
Verizon-16	RRH 4x45W (AWS)	126.66	0.00	0.00	2.96	0.00							0.00	0.00	72.00

Verizon-17	RRH 4x45W (AWS)	126.66	0.00	0.00	2.96	120.00	0.00	0.00	72.00
Verizon-18	RRH 4x45W (AWS)	126.66	0.00	0.00	2.96	240.00	0.00	0.00	72.00
Verizon-19	RHH 2x80W (850 MHz)	126.66	0.00	0.00	2.91	0.00	0.00	0.00	108.00
Verizon-20	RHH 2x80W (850 MHz)	126.66	0.00	0.00	2.91	120.00	0.00	0.00	108.00
Verizon-21	RHH 2x80W (850 MHz)	126.66	0.00	0.00	2.91	240.00	0.00	0.00	108.00
Verizon-22	Raycap DB-T1-6Z-8AB-OZ Dist. Box	126.66	0.00	0.00	5.60	0.00	0.00	0.00	54.00
Verizon-23	Raycap DB-T1-6Z-8AB-OZ Dist. Box	126.66	0.00	0.00	5.60	120.00	0.00	0.00	54.00
Verizon-24	Raycap DB-T1-6Z-8AB-OZ Dist. Box	126.66	0.00	0.00	5.60	240.00	0.00	0.00	54.00
NEU-18	12` Omni	126.66	0.00	0.00	4.00	0.00	0.00	0.00	66.00
DNK15-CSP21	RFS PD1142 w/ ice	133.34	0.00	0.00	1.32	120.00	0.00	0.00	12.00
MT-DNK15	3` Stand-Off	133.34	0.00	0.00	2.72	120.00	0.00	0.00	60.00
DNK-12	5` Dipole	133.34	0.00	0.00	3.95	240.00	0.00	0.00	60.00
MT-DNK12	3` Stand-Off	133.34	0.00	0.00	2.72	240.00	0.00	0.00	60.00
T-Mobile-1	Ericsson AIR B2A/B4P	133.34	0.00	0.00	6.53	0.00	0.00	0.00	132.02
T-Mobile-2	AIR32 B66/B2A	133.34	0.00	0.00	5.84	0.00	0.00	0.00	158.64
T-Mobile-3	APXVAA24_43-U-A20 (RFS)	133.34	0.00	0.00	22.38	0.00	0.00	0.00	180.00
T-Mobile-4	Ericsson AIR B2A/B4P	133.34	0.00	0.00	6.53	120.00	0.00	0.00	132.02
T-Mobile-5	AIR32 B66/B2A	133.34	0.00	0.00	5.84	120.00	0.00	0.00	158.64
T-Mobile-6	APXVAA24_43-U-A20 (RFS)	133.34	0.00	0.00	22.38	120.00	0.00	0.00	180.00
T-Mobile-7	Ericsson AIR B2A/B4P	133.34	0.00	0.00	6.53	240.00	0.00	0.00	132.02
T-Mobile-8	AIR32 B66/B2A	133.34	0.00	0.00	5.84	240.00	0.00	0.00	158.64
T-Mobile-9	APXVAA24_43-U-A20 (RFS)	133.34	0.00	0.00	22.38	240.00	0.00	0.00	180.00
T-Mobile-10	Twin TMA Unit - Generic	133.34	0.00	0.00	1.12	0.00	0.00	0.00	30.00
T-Mobile-11	Twin TMA Unit - Generic	133.34	0.00	0.00	1.12	120.00	0.00	0.00	30.00
T-Mobile-12	Twin TMA Unit - Generic	133.34	0.00	0.00	1.12	240.00	0.00	0.00	30.00
T-Mobile-13	RRHU-11 RRH Unit	133.34	0.00	0.00	2.99	0.00	0.00	0.00	60.00
T-Mobile-14	RRHU-11 RRH Unit	133.34	0.00	0.00	2.99	120.00	0.00	0.00	60.00
T-Mobile-15	RRHU-11 RRH Unit	133.34	0.00	0.00	2.99	240.00	0.00	0.00	60.00
T-Mobile-16	Ericsson 4478 (B71) RRH Unit	133.34	0.00	0.00	1.26	0.00	0.00	0.00	72.00
T-Mobile-17	Ericsson 4478 (B71) RRH Unit	133.34	0.00	0.00	1.26	120.00	0.00	0.00	72.00
T-Mobile-18	Ericsson 4478 (B71) RRH Unit	133.34	0.00	0.00	1.26	240.00	0.00	0.00	72.00
T-Mobile-19	Diplexer Unit - Generic	133.34	0.00	0.00	0.72	0.00	0.00	0.00	30.00
T-Mobile-20	Diplexer Unit - Generic	133.34	0.00	0.00	0.72	120.00	0.00	0.00	30.00
T-Mobile-21	Diplexer Unit - Generic	133.34	0.00	0.00	0.72	240.00	0.00	0.00	30.00
ATT-A	12` T-Arm	150.00	0.00	0.00	13.60	0.00	0.00	0.00	558.00
ATT-B	12` T-Arm	150.00	0.00	0.00	13.60	120.00	0.00	0.00	558.00
ATT-C	12` T-Arm	150.00	0.00	0.00	13.60	240.00	0.00	0.00	558.00
ATT-A1	Powerwave 7770	150.00	0.00	0.00	5.88	0.00	0.00	0.00	42.00
ATT-A2	Powerwave 7770	150.00	0.00	0.00	5.88	0.00	0.00	0.00	42.00
ATT-A3	RRHU-11 RRH Unit	150.00	0.00	0.00	2.99	0.00	0.00	0.00	60.00
ATT-A4	TMA Unit (LGP24101)	150.00	0.00	0.00	1.29	0.00	0.00	0.00	16.92
ATT-A5	TMA Unit (LGP24101)	150.00	0.00	0.00	1.29	0.00	0.00	0.00	16.92
ATT-A6	Raycap Surge Suppressor	150.00	0.00	0.00	1.79	0.00	0.00	0.00	32.40
ATT-A7	OPA-65-LCUU-H6 Panel	150.00	0.00	0.00	10.12	0.00	0.00	0.00	76.80
ATT-A8	RRUS-32 RRH Unit	150.00	0.00	0.00	3.88	0.00	0.00	0.00	96.00
ATT-B1	RRHU-11 RRH Unit	150.00	0.00	0.00	2.99	120.00	0.00	0.00	60.00
ATT-B2	TMA Unit (LGP24101)	150.00	0.00	0.00	1.29	120.00	0.00	0.00	16.92
ATT-B3	TMA Unit (LGP24101)	150.00	0.00	0.00	1.29	120.00	0.00	0.00	16.92
ATT-B4	OPA-65-LCUU-H6 Panel	150.00	0.00	0.00	10.12	120.00	0.00	0.00	76.80
ATT-B5	RRUS-32 RRH Unit	150.00	0.00	0.00	3.88	120.00	0.00	0.00	96.00
ATT-C1	RRHU-11 RRH Unit	150.00	0.00	0.00	2.99	240.00	0.00	0.00	60.00
ATT-C2	TMA Unit (LGP24101)	150.00	0.00	0.00	1.29	240.00	0.00	0.00	16.92
ATT-C3	TMA Unit (LGP24101)	150.00	0.00	0.00	1.29	240.00	0.00	0.00	16.92
ATT-C4	OPA-65-LCUU-H6 Panel	150.00	0.00	0.00	10.12	240.00	0.00	0.00	76.80
ATT-C5	RRUS-32 RRH Unit	150.00	0.00	0.00	3.88	240.00	0.00	0.00	96.00
CSP-70	Sinclair SC479-HF1LDF w/ ice	160.00	0.00	0.00	5.06	0.00	0.00	0.00	40.80
CSP-71	Sinclair SC479-HF1LDF w/ ice	160.00	0.00	0.00	5.06	120.00	0.00	0.00	40.80
CSP-72	Sinclair SC479-HF1LDF w/ ice	160.00	0.00	0.00	5.06	240.00	0.00	0.00	40.80
CSP-73	TMA	160.00	0.00	0.00	1.29	240.00	0.00	0.00	18.00
DNK21-SPD9	8` Dish with Radome	160.00	0.00	0.00	51.32	0.00	0.86330	0.00	672.00
DNK20-UNKNOWN	4`x1` Panel	160.00	0.00	0.00	6.53	240.00	0.00	0.00	36.00
DNK19-STAM63	4`x1` Panel	160.00	0.00	0.00	6.53	120.00	0.00	0.00	36.00
159-A	3` Stand-Off	160.00	0.00	0.00	2.72	0.00	0.00	0.00	60.00
159-B	3` Stand-Off	160.00	0.00	0.00	2.72	120.00	0.00	0.00	60.00
160	3` Stand-Off	160.00	0.00	0.00	2.72	240.00	0.00	0.00	60.00
DNK22-TOG-6	DB586-Y	165.00	0.00	0.00	1.01	0.00	0.00	0.00	9.90
DNK23-STAM64	4`x1` Panel	165.00	0.00	0.00	6.53	0.00	0.00	0.00	36.00
DNK23-STAM65	TMA	165.00	0.00	0.00	1.29	0.00	0.00	0.00	18.00
GRN-1 (DNK25)	4` Dish	170.00	0.00	0.00	13.10	50.00	1.66410	0.08980	-0.06910

DNK26aCSP-67	Dipole	175.00	0.00	0.00	9.17	0.00	0.00	0.00	0.00	0.00	0.00	0.00	0.00	0.00	0.00	0.00	0.00	0.00	0.00	55.20
DNK26bNEU-20	4` Dipole	175.00	0.00	0.00	3.70	0.00	0.00	0.00	0.00	0.00	0.00	0.00	0.00	0.00	0.00	0.00	0.00	0.00	0.00	48.00
DNK27A-CSP4	Sinclair SC479-HF1LDF w/ ice	175.00	0.00	0.00	5.06	240.00	0.00	0.00	0.00	0.00	0.00	0.00	0.00	0.00	0.00	0.00	0.00	0.00	0.00	40.80
DNK27B-CSP2	Scala OGT9-806 w/ ice	175.00	0.00	0.00	2.27	120.00	0.00	0.00	0.00	0.00	0.00	0.00	0.00	0.00	0.00	0.00	0.00	0.00	0.00	22.20
DNK27C-CSP74	TMA	175.00	0.00	0.00	1.29	120.00	0.00	0.00	0.00	0.00	0.00	0.00	0.00	0.00	0.00	0.00	0.00	0.00	0.00	18.00
DNK28A-CSP1	Scala OGT9-806 w/ ice	175.00	0.00	0.00	2.27	120.00	0.00	0.00	0.00	0.00	0.00	0.00	0.00	0.00	0.00	0.00	0.00	0.00	0.00	22.20
DNK28B-CSP3	Sinclair SC479-HF1LDF w/ ice	175.00	0.00	0.00	5.06	240.00	0.00	0.00	0.00	0.00	0.00	0.00	0.00	0.00	0.00	0.00	0.00	0.00	0.00	40.80
DNK28C-TOG5	Andrew DB-583 w/ ice	175.00	0.00	0.00	0.54	0.00	0.00	0.00	0.00	0.00	0.00	0.00	0.00	0.00	0.00	0.00	0.00	0.00	0.00	7.50
DNK28D-NEU55	Decibel PD-420 2 bay - Dipole	175.00	0.00	0.00	1.64	240.00	0.00	0.00	0.00	0.00	0.00	0.00	0.00	0.00	0.00	0.00	0.00	0.00	0.00	12.00
Top-A	6` Stand-Off	180.00	0.00	0.00	10.60	0.00	0.00	0.00	0.00	0.00	0.00	0.00	0.00	0.00	0.00	0.00	0.00	0.00	0.00	168.00
Top-B	6` Stand-Off	180.00	0.00	0.00	10.60	120.00	0.00	0.00	0.00	0.00	0.00	0.00	0.00	0.00	0.00	0.00	0.00	0.00	0.00	168.00
Top-C1	6` Stand-Off	180.00	0.00	0.00	10.60	260.00	0.00	0.00	0.00	0.00	0.00	0.00	0.00	0.00	0.00	0.00	0.00	0.00	0.00	168.00
Top-C2	6` Stand-Off	180.00	0.00	0.00	10.60	220.00	0.00	0.00	0.00	0.00	0.00	0.00	0.00	0.00	0.00	0.00	0.00	0.00	0.00	168.00
ATT-B7	Powerwave 7770	150.00	0.00	0.00	5.88	120.00	0.00	0.00	0.00	0.00	0.00	0.00	0.00	0.00	0.00	0.00	0.00	0.00	0.00	42.00
ATT-B8	Powerwave 7770	150.00	0.00	0.00	5.88	120.00	0.00	0.00	0.00	0.00	0.00	0.00	0.00	0.00	0.00	0.00	0.00	0.00	0.00	42.00
ATT-C7	Powerwave 7770	150.00	0.00	0.00	5.88	240.00	0.00	0.00	0.00	0.00	0.00	0.00	0.00	0.00	0.00	0.00	0.00	0.00	0.00	42.00
ATT-C8	Powerwave 7770	150.00	0.00	0.00	5.88	240.00	0.00	0.00	0.00	0.00	0.00	0.00	0.00	0.00	0.00	0.00	0.00	0.00	0.00	42.00

EIA Section Load Case Information for "1.2*DL":

Note: qzGh (adjusted wind pressure) includes: Velocity Pressure Coefficient (Kz), Topographic Factor (Kzt), Gust Effect Factor (Gh), Wind Direction Probability Factor (Kd), Wind Importance Factor (Table 2-3), Wind Load Factor (from Loads/EIA Loads)
Face RR is the minimum round reduction factor for all round angles and appurtenances in the section

Section Label	Z of Top (ft)	Z of Bottom (ft)	Ave. Elev. (ft)	Elev. Above Gnd. (psf)	qzGh (psf)	Ice Thick. (in)	Face AF (ft^2)	Face AR (ft^2)	Face RR*AR (ft^2)	Face AG (ft^2)	Face e	Face DF	Face DR	Face RR	Face CF	Face AE (ft^2)	Face WF (lbs)	NotF AAF (ft^2)	NotF CAF	NotF AAR (ft^2)	NotF CAR	NotF AAR*CAR (ft^2)	NotF WA (lbs)	Total Wind (lbs)	Total Weight (lbs)
A	180.00	160.00	170.00	0.00	0.00	20.58	21.02	12.32	163.7	0.25	1.00	1.00	0.59	2.43	32.9	0	24.00	2.00	0.00	1.20	0.00	0	0	6770	
B	160.00	140.00	150.00	0.00	0.00	22.52	27.30	16.04	191.0	0.26	1.00	1.00	0.59	2.41	38.6	0	36.00	2.00	0.00	1.20	0.00	0	0	7224	
C	140.00	120.00	130.00	0.00	0.00	25.73	29.16	17.07	218.3	0.25	1.00	1.00	0.59	2.43	42.8	0	48.00	2.00	0.00	1.20	0.00	0	0	8030	
D	120.00	100.00	110.00	0.00	0.00	30.37	36.61	21.63	245.5	0.27	1.00	1.00	0.59	2.37	52.0	0	48.00	2.00	0.00	1.20	0.00	0	0	8857	
E	100.00	80.00	90.00	0.00	0.00	37.01	40.26	23.91	272.8	0.28	1.00	1.00	0.59	2.34	60.9	0	48.00	2.00	0.00	1.20	0.00	0	0	12042	
F	80.00	60.00	70.00	0.00	0.00	37.32	43.90	25.92	300.0	0.27	1.00	1.00	0.59	2.38	63.2	0	48.00	2.00	0.00	1.20	0.00	0	0	12661	
G	60.00	40.00	50.00	0.00	0.00	42.28	50.37	29.91	327.3	0.28	1.00	1.00	0.59	2.34	72.2	0	48.00	2.00	0.00	1.20	0.00	0	0	14137	
H	40.00	20.00	30.00	0.00	0.00	48.05	50.83	30.12	354.6	0.28	1.00	1.00	0.59	2.35	78.2	0	48.00	2.00	0.00	1.20	0.00	0	0	15046	
I	20.00	0.00	10.00	0.00	0.00	59.30	58.17	34.98	381.9	0.31	1.00	1.00	0.60	2.28	94.3	0	43.20	2.00	0.00	1.20	0.00	0	0	15157	

Equipment Load Case Information for "0.9DL":

Equipment Label	Equipment Property Set	Elevation Above Ground (ft)	qzGh (psf)	Ice Thick. (in)	Total Wind Area (ft^2)	Wind Incidence Angle (deg)	222-G CA	222-G CS	222-G CM	Antenna Axial Load (lbs)	Antenna Side Load (lbs)	Antenna Moment (ft-lbs)	Long. Load (lbs)	Trans. Load (lbs)	Vert. Load (lbs)
DNK-1	5` Dipole	60.00	0.00	0.00	3.95	0.00							0.00	0.00	45.00
MT-DNK1	3` Stand-Off	60.00	0.00	0.00	2.72	0.00							0.00	0.00	45.00
DNK2-GPS68	GPS	60.00	0.00	0.00	1.00	120.00							0.00	0.00	9.00
MT-DNK2	3` Stand-Off	60.00	0.00	0.00	2.72	120.00							0.00	0.00	45.00
DNK3-GPS69	GPS	60.00	0.00	0.00	1.00	240.00							0.00	0.00	9.00
MT-DNK3	3` Stand-Off	60.00	0.00	0.00	2.72	240.00							0.00	0.00	45.00
DNK4-DOT56	10` Dipole	60.00	0.00	0.00	9.17	240.00							0.00	0.00	41.40
MT-DNK4	3` Stand-Off	60.00	0.00	0.00	2.72	240.00							0.00	0.00	45.00
DNK5-NEU16	8` Omni	80.00	0.00	0.00	2.00	240.00							0.00	0.00	4.50
MT-DNK5	6` Stand-Off	80.00	0.00	0.00	10.60	240.00							0.00	0.00	126.00
DNK9-DEP54	RFS PD1142 w/ ice	120.00	0.00	0.00	1.32	120.00							0.00	0.00	9.00
MT-DNK9	3` Stand-Off	120.00	0.00	0.00	2.72	120.00							0.00	0.00	45.00
DNK8-CSP66	RFS PD1142 w/ ice	120.00	0.00	0.00	1.32	120.00							0.00	0.00	9.00
DNK7-NEU17	12` Omni	113.34	0.00	0.00	4.00	0.00							0.00	0.00	49.50
MT-DNK7	3` Stand-Off	113.34	0.00	0.00	2.72	0.00							0.00	0.00	45.00
Sprint-A	12` T-Arm	113.34	0.00	0.00	13.60	0.00							0.00	0.00	418.50
Sprint-B	12` T-Arm	113.34	0.00	0.00	13.60	120.00							0.00	0.00	418.50
Sprint-C	12` T-Arm	113.34	0.00	0.00	13.60	240.00							0.00	0.00	418.50
Sprint-1	RFS APXVSP18-C w/ ice	113.34	0.00	0.00	8.26	0.00							0.00	0.00	81.00
Sprint-2	ALU RRH	113.34	0.00	0.00	6.90	0.00							0.00	0.00	54.00
Sprint-3	ALU RRH	113.34	0.00	0.00	6.90	0.00							0.00	0.00	54.00
Sprint-4	RFS APXVSP18-C w/ ice	113.34	0.00	0.00	8.26	120.00							0.00	0.00	81.00
Sprint-5	ALU RRH	113.34	0.00	0.00	6.90	120.00							0.00	0.00	54.00
Sprint-6	ALU RRH	113.34	0.00	0.00	6.90	120.00							0.00	0.00	54.00

Sprint-7	RFS APXVSP18-C w/ ice	113.34	0.00	0.00	8.26	240.00	0.00	0.00	81.00
Sprint-8	ALU RRH	113.34	0.00	0.00	6.90	240.00	0.00	0.00	54.00
Sprint-9	ALU RRH	113.34	0.00	0.00	6.90	240.00	0.00	0.00	54.00
Sprint-10	DT465B-2XR-V2	113.34	0.00	0.00	9.65	0.00	0.00	0.00	79.56
Sprint-11	DT465B-2XR-V2	113.34	0.00	0.00	9.65	120.00	0.00	0.00	79.56
Sprint-12	DT465B-2XR-V2	113.34	0.00	0.00	9.65	240.00	0.00	0.00	79.56
Sprint-13	800 MHz RRH Unit	113.34	0.00	0.00	6.90	0.00	0.00	0.00	54.00
Sprint-14	800 MHz RRH Unit	113.34	0.00	0.00	6.90	120.00	0.00	0.00	54.00
Sprint-15	800 MHz RRH Unit	113.34	0.00	0.00	6.90	240.00	0.00	0.00	54.00
Sprint-16	TD-RRH 8x20-25 RRH Unit	113.34	0.00	0.00	4.72	0.00	0.00	0.00	59.52
Sprint-17	TD-RRH 8x20-25 RRH Unit	113.34	0.00	0.00	4.72	120.00	0.00	0.00	59.52
Sprint-18	TD-RRH 8x20-25 RRH Unit	113.34	0.00	0.00	4.72	240.00	0.00	0.00	59.52
Verizon-A	Boom Gate	126.66	0.00	0.00	13.60	0.00	0.00	0.00	423.90
Verizon-B	Boom Gate	126.66	0.00	0.00	13.60	120.00	0.00	0.00	423.90
Verizon-C	Boom Gate	126.66	0.00	0.00	13.60	240.00	0.00	0.00	423.90
Verizon-1	Decibel DB844H80-XY w/ ice	126.66	0.00	0.00	3.97	0.00	0.00	0.00	9.00
Verizon-2	Decibel DB844H80-XY w/ ice	126.66	0.00	0.00	3.97	0.00	0.00	0.00	9.00
Verizon-3	Decibel DB844H80-XY w/ ice	126.66	0.00	0.00	3.97	120.00	0.00	0.00	9.00
Verizon-4	Decibel DB844H80-XY w/ ice	126.66	0.00	0.00	3.97	120.00	0.00	0.00	9.00
Verizon-5	Decibel DB844H80-XY w/ ice	126.66	0.00	0.00	3.97	240.00	0.00	0.00	9.00
Verizon-6	Decibel DB844H80-XY w/ ice	126.66	0.00	0.00	3.97	240.00	0.00	0.00	9.00
Verizon-7	JAHH-65B-R3B Panel	126.66	0.00	0.00	9.66	0.00	0.00	0.00	113.67
Verizon-8	JAHH-65B-R3B Panel	126.66	0.00	0.00	9.66	0.00	0.00	0.00	113.67
Verizon-9	JAHH-65B-R3B Panel	126.66	0.00	0.00	9.66	120.00	0.00	0.00	113.67
Verizon-10	JAHH-65B-R3B Panel	126.66	0.00	0.00	9.66	240.00	0.00	0.00	113.67
Verizon-11	JAHH-65B-R3B Panel	126.66	0.00	0.00	9.66	240.00	0.00	0.00	113.67
Verizon-12	JAHH-65B-R3B Panel	126.66	0.00	0.00	9.66	240.00	0.00	0.00	113.67
Verizon-D	BSAMNT-SBS-2-2 Mount for JAHH Antenna	126.66	0.00	0.00	3.78	0.00	0.00	0.00	104.40
Verizon-E	BSAMNT-SBS-2-2 Mount for JAHH Antenna	126.66	0.00	0.00	3.78	120.00	0.00	0.00	104.40
Verizon-F	BSAMNT-SBS-2-2 Mount for JAHH Antenna	126.66	0.00	0.00	3.78	240.00	0.00	0.00	104.40
Verizon-13	RRH 2x60W (700 MHz)	126.66	0.00	0.00	2.12	0.00	0.00	0.00	54.00
Verizon-14	RRH 2x60W (700 MHz)	126.66	0.00	0.00	2.12	120.00	0.00	0.00	54.00
Verizon-15	RRH 2x60W (700 MHz)	126.66	0.00	0.00	2.12	240.00	0.00	0.00	54.00
Verizon-16	RRH 4x45W (AWS)	126.66	0.00	0.00	2.96	0.00	0.00	0.00	54.00
Verizon-17	RRH 4x45W (AWS)	126.66	0.00	0.00	2.96	120.00	0.00	0.00	54.00
Verizon-18	RRH 4x45W (AWS)	126.66	0.00	0.00	2.96	240.00	0.00	0.00	54.00
Verizon-19	RHH 2x80W (850 MHz)	126.66	0.00	0.00	2.91	0.00	0.00	0.00	81.00
Verizon-20	RHH 2x80W (850 MHz)	126.66	0.00	0.00	2.91	120.00	0.00	0.00	81.00
Verizon-21	RHH 2x80W (850 MHz)	126.66	0.00	0.00	2.91	240.00	0.00	0.00	81.00
Verizon-22	Raycap DB-T1-6Z-8AB-0Z Dist. Box	126.66	0.00	0.00	5.60	0.00	0.00	0.00	40.50
Verizon-23	Raycap DB-T1-6Z-8AB-0Z Dist. Box	126.66	0.00	0.00	5.60	120.00	0.00	0.00	40.50
Verizon-24	Raycap DB-T1-6Z-8AB-0Z Dist. Box	126.66	0.00	0.00	5.60	240.00	0.00	0.00	40.50
Verizon-18	12` Omni	126.66	0.00	0.00	4.00	0.00	0.00	0.00	49.50
DNK15-CSP21	RFS PD1142 w/ ice	133.34	0.00	0.00	1.32	120.00	0.00	0.00	9.00
MT-DNK15	3` Stand-Off	133.34	0.00	0.00	2.72	120.00	0.00	0.00	45.00
DNK-12	5` Dipole	133.34	0.00	0.00	3.95	240.00	0.00	0.00	45.00
MT-DNK12	3` Stand-Off	133.34	0.00	0.00	2.72	240.00	0.00	0.00	45.00
T-Mobile-1	Ericsson AIR B2A/B4P	133.34	0.00	0.00	6.53	0.00	0.00	0.00	99.02
T-Mobile-2	AIR32 B66/B2A	133.34	0.00	0.00	5.84	0.00	0.00	0.00	118.98
T-Mobile-3	APXVAA24_43-U-A20 (RFS)	133.34	0.00	0.00	22.38	0.00	0.00	0.00	135.00
T-Mobile-4	Ericsson AIR B2A/B4P	133.34	0.00	0.00	6.53	120.00	0.00	0.00	99.02
T-Mobile-5	AIR32 B66/B2A	133.34	0.00	0.00	5.84	120.00	0.00	0.00	118.98
T-Mobile-6	APXVAA24_43-U-A20 (RFS)	133.34	0.00	0.00	22.38	120.00	0.00	0.00	135.00
T-Mobile-7	Ericsson AIR B2A/B4P	133.34	0.00	0.00	6.53	240.00	0.00	0.00	99.02
T-Mobile-8	AIR32 B66/B2A	133.34	0.00	0.00	5.84	240.00	0.00	0.00	118.98
T-Mobile-9	APXVAA24_43-U-A20 (RFS)	133.34	0.00	0.00	22.38	240.00	0.00	0.00	135.00
T-Mobile-10	Twin TMA Unit - Generic	133.34	0.00	0.00	1.12	0.00	0.00	0.00	22.50
T-Mobile-11	Twin TMA Unit - Generic	133.34	0.00	0.00	1.12	120.00	0.00	0.00	22.50
T-Mobile-12	Twin TMA Unit - Generic	133.34	0.00	0.00	1.12	240.00	0.00	0.00	22.50
T-Mobile-13	RRHU-11 RRH Unit	133.34	0.00	0.00	2.99	0.00	0.00	0.00	45.00
T-Mobile-14	RRHU-11 RRH Unit	133.34	0.00	0.00	2.99	120.00	0.00	0.00	45.00
T-Mobile-15	RRHU-11 RRH Unit	133.34	0.00	0.00	2.99	240.00	0.00	0.00	45.00
T-Mobile-16	Ericsson 4478 (B71) RRH Unit	133.34	0.00	0.00	1.26	0.00	0.00	0.00	54.00
T-Mobile-17	Ericsson 4478 (B71) RRH Unit	133.34	0.00	0.00	1.26	120.00	0.00	0.00	54.00
T-Mobile-18	Ericsson 4478 (B71) RRH Unit	133.34	0.00	0.00	1.26	240.00	0.00	0.00	54.00
T-Mobile-19	Diplexer Unit - Generic	133.34	0.00	0.00	0.72	0.00	0.00	0.00	22.50
T-Mobile-20	Diplexer Unit - Generic	133.34	0.00	0.00	0.72	120.00	0.00	0.00	22.50
T-Mobile-21	Diplexer Unit - Generic	133.34	0.00	0.00	0.72	240.00	0.00	0.00	22.50
ATT-A	12` T-Arm	150.00	0.00	0.00	13.60	0.00	0.00	0.00	418.50

ATT-B	12` T-Arm	150.00	0.00	0.00	13.60	120.00														0.00	0.00	418.50	
ATT-C	12` T-Arm	150.00	0.00	0.00	13.60	240.00															0.00	0.00	418.50
ATT-A1	Powerwave 7770	150.00	0.00	0.00	5.88	0.00															0.00	0.00	31.50
ATT-A2	Powerwave 7770	150.00	0.00	0.00	5.88	0.00															0.00	0.00	31.50
ATT-A3	RRHU-11 RRH Unit	150.00	0.00	0.00	2.99	0.00															0.00	0.00	45.00
ATT-A4	TMA Unit (LGP24101)	150.00	0.00	0.00	1.29	0.00															0.00	0.00	12.69
ATT-A5	TMA Unit (LGP24101)	150.00	0.00	0.00	1.29	0.00															0.00	0.00	12.69
ATT-A6	Raycap Surge Suppressor	150.00	0.00	0.00	1.79	0.00															0.00	0.00	24.30
ATT-A7	OPA-65-LCUU-H6 Panel	150.00	0.00	0.00	10.12	0.00															0.00	0.00	57.60
ATT-A8	RRUS-32 RRH Unit	150.00	0.00	0.00	3.88	0.00															0.00	0.00	72.00
ATT-B1	RRHU-11 RRH Unit	150.00	0.00	0.00	2.99	120.00															0.00	0.00	45.00
ATT-B2	TMA Unit (LGP24101)	150.00	0.00	0.00	1.29	120.00															0.00	0.00	12.69
ATT-B3	TMA Unit (LGP24101)	150.00	0.00	0.00	1.29	120.00															0.00	0.00	12.69
ATT-B4	OPA-65-LCUU-H6 Panel	150.00	0.00	0.00	10.12	120.00															0.00	0.00	57.60
ATT-B5	RRUS-32 RRH Unit	150.00	0.00	0.00	3.88	120.00															0.00	0.00	72.00
ATT-C1	RRHU-11 RRH Unit	150.00	0.00	0.00	2.99	240.00															0.00	0.00	45.00
ATT-C2	TMA Unit (LGP24101)	150.00	0.00	0.00	1.29	240.00															0.00	0.00	12.69
ATT-C3	TMA Unit (LGP24101)	150.00	0.00	0.00	1.29	240.00															0.00	0.00	12.69
ATT-C4	OPA-65-LCUU-H6 Panel	150.00	0.00	0.00	10.12	240.00															0.00	0.00	57.60
ATT-C5	RRUS-32 RRH Unit	150.00	0.00	0.00	3.88	240.00															0.00	0.00	72.00
CSP-70	Sinclair SC479-HF1LDF w/ ice	160.00	0.00	0.00	5.06	0.00															0.00	0.00	30.60
CSP-71	Sinclair SC479-HF1LDF w/ ice	160.00	0.00	0.00	5.06	120.00															0.00	0.00	30.60
CSP-72	Sinclair SC479-HF1LDF w/ ice	160.00	0.00	0.00	5.06	240.00															0.00	0.00	30.60
CSP-73	TMA	160.00	0.00	0.00	1.29	240.00															0.00	0.00	13.50
DNK21-SPD9	8` Dish with Radome	160.00	0.00	0.00	51.32	0.00	0.86330														0.00	0.00	504.00
DNK20-UNKNOWN	4`x1` Panel	160.00	0.00	0.00	6.53	240.00															0.00	0.00	27.00
DNK19-STAM63	4`x1` Panel	160.00	0.00	0.00	6.53	120.00															0.00	0.00	27.00
159-A	3` Stand-Off	160.00	0.00	0.00	2.72	0.00															0.00	0.00	45.00
159-B	3` Stand-Off	160.00	0.00	0.00	2.72	120.00															0.00	0.00	45.00
160	3` Stand-Off	160.00	0.00	0.00	2.72	240.00															0.00	0.00	45.00
DNK22-TOG-6	DB586-Y	165.00	0.00	0.00	1.01	0.00															0.00	0.00	7.42
DNK23-STAM64	4`x1` Panel	165.00	0.00	0.00	6.53	0.00															0.00	0.00	27.00
DNK23-STAM65	TMA	165.00	0.00	0.00	1.29	0.00															0.00	0.00	13.50
GRN-1 (DNK25)	4` Dish	170.00	0.00	0.00	13.10	50.00	1.66410	0.08980	-0.06910												0.00	0.00	108.00
DNK26aCSP-67	Dipole	175.00	0.00	0.00	9.17	0.00															0.00	0.00	41.40
DNK26bNEU-20	4` Dipole	175.00	0.00	0.00	3.70	0.00															0.00	0.00	36.00
DNK27A-CSP4	Sinclair SC479-HF1LDF w/ ice	175.00	0.00	0.00	5.06	240.00															0.00	0.00	30.60
DNK27B-CSP2	Scala OGT9-806 w/ ice	175.00	0.00	0.00	2.27	120.00															0.00	0.00	16.65
DNK27C-CSP74	TMA	175.00	0.00	0.00	1.29	120.00															0.00	0.00	13.50
DNK28A-CSP1	Scala OGT9-806 w/ ice	175.00	0.00	0.00	2.27	120.00															0.00	0.00	16.65
DNK28B-CSP3	Sinclair SC479-HF1LDF w/ ice	175.00	0.00	0.00	5.06	240.00															0.00	0.00	30.60
DNK28C-TOG5	Andrew DB-583 w/ ice	175.00	0.00	0.00	0.54	0.00															0.00	0.00	5.63
DNK28D-NEU55	Decibel PD-420 2 bay - Dipole	175.00	0.00	0.00	1.64	240.00															0.00	0.00	9.00
Top-A	6` Stand-Off	180.00	0.00	0.00	10.60	0.00															0.00	0.00	126.00
Top-B	6` Stand-Off	180.00	0.00	0.00	10.60	120.00															0.00	0.00	126.00
Top-C1	6` Stand-Off	180.00	0.00	0.00	10.60	260.00															0.00	0.00	126.00
Top-C2	6` Stand-Off	180.00	0.00	0.00	10.60	220.00															0.00	0.00	126.00
ATT-B7	Powerwave 7770	150.00	0.00	0.00	5.88	120.00															0.00	0.00	31.50
ATT-B8	Powerwave 7770	150.00	0.00	0.00	5.88	120.00															0.00	0.00	31.50
ATT-C7	Powerwave 7770	150.00	0.00	0.00	5.88	240.00															0.00	0.00	31.50
ATT-C8	Powerwave 7770	150.00	0.00	0.00	5.88	240.00															0.00	0.00	31.50

EIA Section Load Case Information for "0.9DL":

Note: qzGh (adjusted wind pressure) includes: Velocity Pressure Coefficient (Kz), Topographic Factor (Kzt), Gust Effect Factor (Gh), Wind Direction Probability Factor (Kd), Wind Importance Factor (Table 2-3), Wind Load Factor (from Loads/EIA Loads)
Face RR is the minimum round reduction factor for all round angles and appurtenances in the section

Section Label	Z of Top (ft)	Z of Bottom (ft)	Ave. Elev. Above Gnd. (ft)	Elev. qzGh (psf)	Ice Thick. (in)	Face AF (ft^2)	Face AR (ft^2)	Face RR*AR (ft^2)	Face AG (ft^2)	Face e	Face DF	Face DR	Face RR	Face CF	Face AE (ft^2)	Face WF (lbs)	NotF AAF (ft^2)	NotF CAF	NotF AAR (ft^2)	NotF CAR	NotF AAR*CAR (ft^2)	NotF WA (lbs)	Total Wind (lbs)	Total Weight (lbs)
A	180.00	160.00	170.00	0.00	0.00	20.58	21.02	12.32	163.7	0.25	1.00	1.00	0.59	2.43	32.9	0	24.00	2.00	0.00	1.20	0.00	0	0	5078
B	160.00	140.00	150.00	0.00	0.00	22.52	27.30	16.04	191.0	0.26	1.00	1.00	0.59	2.41	38.6	0	36.00	2.00	0.00	1.20	0.00	0	0	5418
C	140.00	120.00	130.00	0.00	0.00	25.73	29.16	17.07	218.3	0.25	1.00	1.00	0.59	2.43	42.8	0	48.00	2.00	0.00	1.20	0.00	0	0	6022
D	120.00	100.00	110.00	0.00	0.00	30.37	36.61	21.63	245.5	0.27	1.00	1.00	0.59	2.37	52.0	0	48.00	2.00	0.00	1.20	0.00	0	0	6643
E	100.00	80.00	90.00	0.00	0.00	37.01	40.26	23.91	272.8	0.28	1.00	1.00	0.59	2.34	60.9	0	48.00	2.00	0.00	1.20	0.00	0	0	9032
F	80.00	60.00	70.00	0.00	0.00	37.32	43.90	25.92	300.0	0.27	1.00	1.00	0.59	2.38	63.2	0	48.00	2.00	0.00	1.20	0.00	0	0	9496
G	60.00	40.00	50.00	0.00	0.00	42.28	50.37	29.91	327.3	0.28	1.00	1.00	0.59	2.34	72.2	0	48.00	2.00	0.00	1.20	0.00	0	0	10603

H	40.00	20.00	30.00	0.00	0.00	48.05	50.83	30.12	354.6	0.28	1.00	1.00	0.59	2.35	78.2	0	48.00	2.00	0.00	1.20	0.00	0	0	11284
I	20.00	0.00	10.00	0.00	0.00	59.30	58.17	34.98	381.9	0.31	1.00	1.00	0.60	2.28	94.3	0	43.20	2.00	0.00	1.20	0.00	0	0	11368

*** Analysis Results:

Maximum element usage is 99.89% for Angle "SNB-LH2P" in load case "1: 1.2D + 1.0Dg + 1.6Wo"

Angle Forces For All Load Cases:

Positive for tension - negative for compression

Group Label	Angle Label	Max. Usage For All LC %	Max. Tens. For All LC (kips)	Max. Comp. For All LC (kips)	LC 1 (kips)	LC 2 (kips)	LC 3 (kips)	LC 4 (kips)	LC 5 (kips)	LC 6 (kips)	LC 7 (kips)
Rohn-D1	Rohn-DA1P	11.20	0.868	-0.006	0.867	0.868	0.142	0.145	0.189	-0.006	-0.003
Rohn-D1	Rohn-DA11	1.38	0.107	0.000	0.106	0.107	0.011	0.012	0.025	0.001	0.003
Rohn-D1	Rohn-DA12	25.72	0.000	-1.403	-1.403	-1.396	-0.214	-0.210	-0.315	-0.009	-0.005
Rohn-D1	Rohn-DA2P	12.64	0.980	-0.001	0.980	0.979	0.169	0.171	0.218	-0.001	0.001
Rohn-D1	Rohn-DA21	15.18	0.000	-0.828	-0.828	-0.823	-0.167	-0.164	-0.184	-0.003	-0.000
Rohn-D1	Rohn-DA22	4.71	0.365	-0.011	0.361	0.365	0.031	0.035	0.074	-0.011	-0.006
Rohn-D1	Rohn-DA3P	10.47	0.812	-0.019	0.808	0.812	0.156	0.162	0.169	-0.019	-0.013
Rohn-D1	Rohn-DA31	1.22	0.095	-0.007	0.092	0.095	0.009	0.012	0.017	-0.007	-0.004
Rohn-D1	Rohn-DA32	33.36	0.000	-1.710	-1.710	-1.710	-0.256	-0.251	-0.384	-0.011	-0.006
Rohn-D1	Rohn-DA4P	17.98	1.393	-0.013	1.392	1.393	0.202	0.206	0.301	-0.013	-0.008
Rohn-D1	Rohn-DA41	28.76	0.000	-1.475	-1.475	-1.467	-0.231	-0.226	-0.332	-0.011	-0.006
Rohn-D1	Rohn-DA42	8.92	0.692	-0.013	0.688	0.692	0.040	0.045	0.146	-0.013	-0.008
Rohn-D1	Rohn-DA5P	18.76	1.454	-0.024	1.450	1.454	0.192	0.200	0.308	-0.024	-0.016
Rohn-D1	Rohn-DA51	4.04	0.313	-0.009	0.309	0.313	0.001	0.005	0.064	-0.009	-0.005
Rohn-D1	Rohn-DA52	33.03	0.001	-1.594	-1.594	-1.588	-0.247	-0.245	-0.352	-0.000	0.001
Rohn-D1	Rohn-DA6P	20.90	1.620	-0.024	1.617	1.620	0.215	0.222	0.345	-0.024	-0.016
Rohn-D1	Rohn-DA61	39.98	0.000	-1.929	-1.929	-1.922	-0.243	-0.240	-0.428	-0.003	-0.001
Rohn-D1	Rohn-DA62	0.20	0.016	-0.006	0.003	0.006	0.012	0.016	-0.002	-0.006	-0.003
Rohn-D1	Rohn-DA7P	20.40	1.581	-0.044	1.573	1.581	0.205	0.217	0.323	-0.044	-0.031
Rohn-D1	Rohn-DA71	39.44	0.000	-1.793	-1.793	-1.785	-0.259	-0.255	-0.399	-0.006	-0.002
Rohn-D1	Rohn-DA72	0.41	0.029	-0.019	0.023	0.029	0.007	0.013	-0.005	-0.019	-0.012
Rohn-D1	Rohn-DA8P	23.80	1.845	-0.041	1.837	1.845	0.199	0.211	0.383	-0.041	-0.029
Rohn-D1	Rohn-DA81	2.21	0.171	-0.023	0.164	0.171	-0.010	-0.003	0.023	-0.023	-0.016
Rohn-D1	Rohn-DA82	37.11	0.000	-1.687	-1.687	-1.680	-0.270	-0.267	-0.375	-0.004	-0.001
Rohn-D2	Rohn-DB1P	35.51	3.114	-0.054	3.107	3.114	0.301	0.316	0.657	-0.054	-0.039
Rohn-D2	Rohn-DB11	1.46	0.128	-0.030	0.118	0.128	-0.028	-0.019	0.009	-0.030	-0.021
Rohn-D2	Rohn-DB12	42.51	0.000	-2.754	-2.754	-2.744	-0.367	-0.363	-0.612	-0.004	-0.001
Rohn-D2	Rohn-DB2P	32.09	2.814	-0.056	2.806	2.814	0.305	0.320	0.589	-0.056	-0.040
Rohn-D2	Rohn-DB21	48.68	0.000	-3.154	-3.154	-3.143	-0.367	-0.363	-0.702	-0.007	-0.003
Rohn-D2	Rohn-DB22	4.34	0.000	-0.281	-0.281	-0.273	-0.021	-0.012	-0.077	-0.026	-0.017
Rohn-D2	Rohn-DB3P	30.23	2.651	-0.035	2.648	2.651	0.300	0.310	0.567	-0.035	-0.025
Rohn-D2	Rohn-DB31	9.54	0.836	-0.024	0.830	0.836	0.017	0.024	0.170	-0.024	-0.016
Rohn-D2	Rohn-DB32	49.01	0.004	-2.999	-2.999	-2.990	-0.378	-0.377	-0.662	0.003	0.004
Rohn-D2	Rohn-DB4P	26.10	2.289	-0.037	2.285	2.289	0.300	0.311	0.485	-0.037	-0.027
Rohn-D2	Rohn-DB41	54.54	0.003	-3.338	-3.338	-3.328	-0.376	-0.374	-0.738	0.001	0.003
Rohn-D2	Rohn-DB42	5.34	0.469	-0.021	0.463	0.469	0.023	0.030	0.091	-0.021	-0.014
Rohn-D2	Rohn-DB5P	46.73	4.099	-0.067	4.090	4.099	0.353	0.371	0.867	-0.067	-0.049
Rohn-D2	Rohn-DB51	9.94	0.871	-0.057	0.857	0.871	-0.016	0.000	0.156	-0.057	-0.041
Rohn-D2	Rohn-DB52	79.23	0.000	-4.584	-4.584	-4.561	-0.507	-0.494	-1.041	-0.041	-0.029
Rohn-D2	Rohn-DB6P	42.93	3.765	-0.069	3.756	3.765	0.355	0.373	0.792	-0.069	-0.050
Rohn-D2	Rohn-DB61	85.01	0.000	-4.918	-4.918	-4.895	-0.505	-0.492	-1.116	-0.042	-0.030
Rohn-D2	Rohn-DB62	5.91	0.518	-0.055	0.505	0.518	-0.011	0.005	0.079	-0.055	-0.040
Rohn-D2	Rohn-DB7P	52.18	4.576	-0.069	4.568	4.576	0.382	0.400	0.972	-0.069	-0.050
Rohn-D2	Rohn-DB71	3.79	0.000	-0.207	-0.207	-0.189	-0.081	-0.064	-0.085	-0.064	-0.046
Rohn-D2	Rohn-DB72	74.25	0.000	-4.066	-4.066	-4.041	-0.492	-0.476	-0.933	-0.053	-0.038
Rohn-D2	Rohn-DB8P	48.61	4.263	-0.070	4.255	4.263	0.385	0.403	0.903	-0.070	-0.051
Rohn-D2	Rohn-DB81	80.15	0.000	-4.389	-4.389	-4.364	-0.489	-0.474	-1.004	-0.053	-0.038
Rohn-D2	Rohn-DB82	9.91	0.000	-0.543	-0.543	-0.525	-0.077	-0.060	-0.159	-0.063	-0.045
Rohn-D3	Rohn-DC1P	46.64	4.565	-0.123	4.544	4.565	0.342	0.374	0.935	-0.123	-0.091
Rohn-D3	Rohn-DC11	9.82	0.962	-0.114	0.933	0.962	-0.064	-0.034	0.137	-0.114	-0.084
Rohn-D3	Rohn-DC12	59.50	0.000	-5.365	-5.365	-5.323	-0.629	-0.599	-1.255	-0.107	-0.078
Rohn-D3	Rohn-DC2P	43.19	4.228	-0.124	4.207	4.228	0.344	0.376	0.860	-0.124	-0.091
Rohn-D3	Rohn-DC21	62.82	0.000	-5.664	-5.664	-5.623	-0.625	-0.595	-1.322	-0.107	-0.078
Rohn-D3	Rohn-DC22	6.10	0.597	-0.114	0.568	0.597	-0.061	-0.031	0.057	-0.114	-0.084
Rohn-D3	Rohn-DC3P	57.04	5.583	-0.015	5.583	5.575	0.487	0.491	1.233	-0.015	-0.010
Rohn-D3	Rohn-DC31	13.77	1.348	-0.011	1.347	1.348	0.009	0.013	0.292	-0.011	-0.007
Rohn-D3	Rohn-DC32	78.02	0.000	-6.607	-6.607	-6.590	-0.533	-0.530	-1.467	-0.002	-0.000

Rohn-D3	Rohn-DC4P	54.17	5.301	-0.015	5.301	5.293	0.491	0.495	1.170	-0.015	-0.010
Rohn-D3	Rohn-DC41	80.35	0.000	-6.804	-6.804	-6.787	-0.527	-0.524	-1.511	-0.003	-0.001
Rohn-D3	Rohn-DC42	11.21	1.097	-0.010	1.095	1.097	0.016	0.019	0.237	-0.010	-0.007
R-D3-MOD	Rohn-DC5P	64.19	7.981	-0.245	7.936	7.981	0.359	0.420	1.615	-0.245	-0.182
R-D3-MOD	Rohn-DC51	4.99	0.620	-0.238	0.560	0.620	-0.205	-0.144	-0.024	-0.238	-0.176
R-D3-MOD	Rohn-DC52	84.90	0.000	-8.803	-8.803	-8.724	-0.874	-0.813	-2.093	-0.231	-0.172
R-D3-MOD	Rohn-DC6P	62.69	7.795	-0.246	7.750	7.795	0.364	0.426	1.574	-0.246	-0.183
R-D3-MOD	Rohn-DC61	87.77	0.000	-9.100	-9.100	-9.021	-0.873	-0.811	-2.160	-0.233	-0.173
R-D3-MOD	Rohn-DC62	3.20	0.398	-0.235	0.339	0.398	-0.197	-0.136	-0.071	-0.235	-0.175
Rohn-D4	Rohn-DD1P	54.84	6.818	-0.233	6.773	6.818	0.259	0.318	1.366	-0.233	-0.173
Rohn-D4	Rohn-DD11	9.53	1.185	-0.226	1.129	1.185	-0.161	-0.103	0.113	-0.226	-0.168
Rohn-D4	Rohn-DD12	81.91	0.000	-8.008	-8.008	-7.936	-0.772	-0.716	-1.909	-0.214	-0.159
Rohn-D4	Rohn-DD2P	52.52	6.530	-0.234	6.485	6.530	0.260	0.319	1.301	-0.234	-0.174
Rohn-D4	Rohn-DD21	85.88	0.000	-8.396	-8.396	-8.324	-0.774	-0.717	-1.996	-0.217	-0.161
Rohn-D4	Rohn-DD22	6.38	0.793	-0.222	0.738	0.793	-0.156	-0.099	0.029	-0.222	-0.165
R-D4-MOD	Rohn-DD3P	78.63	9.776	-0.054	9.776	9.771	0.554	0.567	2.149	-0.054	-0.039
R-D4-MOD	Rohn-DD31	3.34	0.416	-0.077	0.402	0.416	-0.077	-0.065	0.058	-0.047	-0.034
R-D4-MOD	Rohn-DD32	78.79	0.000	-9.796	-9.796	-9.768	-0.615	-0.604	-2.197	-0.036	-0.026
R-D4-MOD	Rohn-DD4P	75.66	9.408	-0.056	9.408	9.403	0.553	0.567	2.066	-0.056	-0.041
R-D4-MOD	Rohn-DD41	81.41	0.000	-10.122	-10.122	-10.093	-0.613	-0.602	-2.269	-0.036	-0.026
R-D4-MOD	Rohn-DD42	0.59	0.069	-0.074	0.056	0.069	-0.074	-0.062	-0.018	-0.044	-0.032
R-D4-MOD	Rohn-DD5P	67.98	8.453	-0.312	8.388	8.453	0.187	0.265	1.679	-0.312	-0.233
R-D4-MOD	Rohn-DD51	7.18	0.892	-0.304	0.817	0.892	-0.220	-0.143	-0.009	-0.304	-0.227
R-D4-MOD	Rohn-DD52	77.71	0.000	-9.662	-9.662	-9.570	-0.883	-0.806	-2.325	-0.296	-0.221
R-D4-MOD	Rohn-DD6P	65.45	8.137	-0.312	8.073	8.137	0.188	0.267	1.610	-0.312	-0.233
R-D4-MOD	Rohn-DD61	80.41	0.000	-9.998	-9.998	-9.906	-0.881	-0.804	-2.399	-0.296	-0.220
R-D4-MOD	Rohn-DD62	4.49	0.558	-0.305	0.482	0.558	-0.219	-0.142	-0.084	-0.305	-0.227
Rohn-D5	Rohn-DE1P	54.22	6.741	-0.248	6.688	6.741	0.106	0.168	1.345	-0.248	-0.185
Rohn-D5	Rohn-DE11	6.36	0.791	-0.240	0.731	0.791	-0.198	-0.137	0.015	-0.240	-0.179
Rohn-D5	Rohn-DE12	61.76	0.000	-7.679	-7.679	-7.607	-0.634	-0.573	-1.857	-0.236	-0.176
Rohn-D5	Rohn-DE2P	51.58	6.413	-0.248	6.360	6.413	0.108	0.170	1.274	-0.248	-0.184
Rohn-D5	Rohn-DE21	64.19	0.000	-7.981	-7.981	-7.909	-0.630	-0.570	-1.922	-0.233	-0.173
Rohn-D5	Rohn-DE22	3.83	0.476	-0.244	0.416	0.476	-0.200	-0.138	-0.058	-0.244	-0.182
Rohn-D5	Rohn-DE3P	67.29	8.367	-0.108	8.353	8.367	0.371	0.397	1.804	-0.108	-0.080
Rohn-D5	Rohn-DE31	5.59	0.000	-0.695	-0.695	-0.666	-0.165	-0.139	-0.222	-0.101	-0.075
Rohn-D5	Rohn-DE32	60.59	0.000	-7.534	-7.534	-7.497	-0.517	-0.491	-1.738	-0.101	-0.075
Rohn-D5	Rohn-DE4P	65.07	8.090	-0.105	8.077	8.090	0.375	0.401	1.745	-0.105	-0.078
Rohn-D5	Rohn-DE41	63.33	0.000	-7.874	-7.874	-7.838	-0.512	-0.487	-1.810	-0.097	-0.072
Rohn-D5	Rohn-DE42	8.01	0.000	-0.996	-0.996	-0.965	-0.171	-0.143	-0.294	-0.108	-0.081
Rohn-D5	Rohn-DE5P	70.46	8.761	-0.298	8.698	8.761	0.228	0.303	1.762	-0.298	-0.222
Rohn-D5	Rohn-DE51	3.46	0.430	-0.289	0.359	0.430	-0.268	-0.195	-0.095	-0.289	-0.216
Rohn-D5	Rohn-DE52	76.76	0.000	-9.544	-9.544	-9.455	-0.845	-0.769	-2.307	-0.296	-0.221
Rohn-D5	Rohn-DE6P	67.64	8.410	-0.293	8.348	8.410	0.233	0.306	1.686	-0.293	-0.219
Rohn-D5	Rohn-DE61	77.70	0.000	-9.661	-9.661	-9.574	-0.835	-0.761	-2.329	-0.289	-0.216
Rohn-D5	Rohn-DE62	2.41	0.058	-0.300	-0.016	0.058	-0.279	-0.203	-0.186	-0.300	-0.224
Rohn-D6	Rohn-DF1P	83.46	10.377	-0.264	10.326	10.377	0.319	0.384	2.166	-0.264	-0.198
Rohn-D6	Rohn-DF11	2.09	0.000	-0.260	-0.253	-0.188	-0.260	-0.197	-0.224	-0.251	-0.188
Rohn-D6	Rohn-DF12	87.80	0.000	-10.917	-10.917	-10.837	-0.847	-0.780	-2.598	-0.264	-0.197
Rohn-D6	Rohn-DF2P	82.69	10.281	-0.257	10.232	10.281	0.330	0.393	2.150	-0.257	-0.193
Rohn-D6	Rohn-DF21	87.39	0.000	-10.865	-10.865	-10.788	-0.830	-0.765	-2.580	-0.253	-0.190
Rohn-D6	Rohn-DF22	2.18	0.000	-0.271	-0.169	-0.100	-0.271	-0.203	-0.217	-0.269	-0.201
Rohn-D6	Rohn-DF3P	80.99	10.070	-0.259	10.016	10.070	0.326	0.390	2.085	-0.259	-0.194
Rohn-D6	Rohn-DF31	7.22	0.898	-0.244	0.837	0.898	-0.204	-0.143	0.031	-0.244	-0.183
Rohn-D6	Rohn-DF32	94.19	0.000	-11.712	-11.712	-11.636	-0.890	-0.825	-2.759	-0.256	-0.191
Rohn-D6	Rohn-DF4P	81.20	10.096	-0.249	10.045	10.096	0.342	0.403	2.096	-0.249	-0.187
Rohn-D6	Rohn-DF41	92.93	0.000	-11.555	-11.555	-11.480	-0.877	-0.813	-2.720	-0.249	-0.186
Rohn-D6	Rohn-DF42	6.50	0.808	-0.261	0.743	0.808	-0.216	-0.150	-0.000	-0.261	-0.195
Rohn-D6	Rohn-DG1P	71.61	8.904	-0.243	8.852	8.904	0.213	0.273	1.857	-0.243	-0.183
Rohn-D6	Rohn-DG11	2.02	0.251	-0.231	0.193	0.251	-0.213	-0.155	-0.109	-0.231	-0.173
Rohn-D6	Rohn-DG12	82.66	0.000	-10.277	-10.277	-10.208	-0.725	-0.665	-2.450	-0.239	-0.179
Rohn-D6	Rohn-DG2P	72.96	9.072	-0.237	9.022	9.072	0.226	0.284	1.899	-0.237	-0.177
Rohn-D6	Rohn-DG21	79.45	0.000	-9.879	-9.879	-9.811	-0.710	-0.652	-2.357	-0.233	-0.174
Rohn-D6	Rohn-DG22	5.04	0.626	-0.244	0.565	0.626	-0.218	-0.157	-0.035	-0.244	-0.183
Rohn-D6	Rohn-DG3P	78.65	9.779	-0.218	9.732	9.779	0.305	0.360	2.050	-0.218	-0.164
Rohn-D6	Rohn-DG31	1.68	0.170	-0.209	0.117	0.170	-0.206	-0.154	-0.111	-0.209	-0.157
Rohn-D6	Rohn-DG32	88.50	0.000	-11.004	-11.004	-10.945	-0.751	-0.697	-2.576	-0.214	-0.160
Rohn-D6	Rohn-DG4P	81.58	10.143	-0.212	10.097	10.143	0.319	0.372	2.134	-0.212	-0.159
Rohn-D6	Rohn-DG41	86.16	0.000	-10.713	-10.713	-10.654	-0.741	-0.688	-2.510	-0.210	-0.157
Rohn-D6	Rohn-DG42	3.49	0.434	-0.218	0.378	0.434	-0.209	-0.154	-0.059	-0.218	-0.164

Rohn-D7	Rohn-DH1P	76.15	9.468	-0.240	9.413	9.468	0.202	0.262	1.994	-0.240	-0.181
Rohn-D7	Rohn-DH11	2.29	0.000	-0.285	-0.285	-0.226	-0.237	-0.179	-0.219	-0.233	-0.175
Rohn-D7	Rohn-DH12	83.19	0.000	-10.343	-10.343	-10.280	-0.684	-0.625	-2.465	-0.236	-0.177
Rohn-D7	Rohn-DH2P	78.44	9.753	-0.237	9.699	9.753	0.212	0.271	2.060	-0.237	-0.178
Rohn-D7	Rohn-DH21	80.73	0.000	-10.037	-10.037	-9.975	-0.674	-0.616	-2.396	-0.232	-0.174
Rohn-D7	Rohn-DH22	1.93	0.049	-0.239	-0.012	0.049	-0.237	-0.177	-0.163	-0.239	-0.180
R-D7-MOD	Rohn-DH3P	70.35	10.933	-0.264	10.869	10.933	0.271	0.337	2.284	-0.264	-0.198
R-D7-MOD	Rohn-DH31	2.32	0.361	-0.259	0.294	0.361	-0.255	-0.190	-0.109	-0.259	-0.194
R-D7-MOD	Rohn-DH32	80.14	0.000	-12.455	-12.455	-12.391	-0.809	-0.745	-2.924	-0.260	-0.195
R-D7-MOD	Rohn-DH4P	72.20	11.222	-0.261	11.158	11.222	0.280	0.346	2.350	-0.261	-0.196
R-D7-MOD	Rohn-DH41	78.33	0.000	-12.174	-12.174	-12.109	-0.801	-0.737	-2.860	-0.258	-0.193
R-D7-MOD	Rohn-DH42	4.00	0.622	-0.264	0.553	0.622	-0.253	-0.187	-0.055	-0.264	-0.198
Rohn-D7	Rohn-DI1P	64.26	7.989	-0.184	7.942	7.989	0.150	0.197	1.696	-0.184	-0.138
Rohn-D7	Rohn-DI11	7.97	0.991	-0.180	0.946	0.991	-0.150	-0.105	0.096	-0.180	-0.134
Rohn-D7	Rohn-DI12	79.76	0.000	-9.917	-9.917	-9.873	-0.553	-0.508	-2.337	-0.180	-0.135
Rohn-D7	Rohn-DI2P	66.44	8.260	-0.182	8.213	8.260	0.159	0.205	1.757	-0.182	-0.136
Rohn-D7	Rohn-DI21	77.59	0.000	-9.647	-9.647	-9.603	-0.546	-0.501	-2.276	-0.179	-0.134
Rohn-D7	Rohn-DI22	10.03	1.247	-0.183	1.201	1.247	-0.147	-0.101	0.151	-0.183	-0.137
Rohn-D7	Rohn-DI3P	62.66	7.791	-0.175	7.746	7.791	0.136	0.180	1.642	-0.175	-0.132
Rohn-D7	Rohn-DI31	9.21	1.145	-0.172	1.100	1.145	-0.104	-0.061	0.118	-0.172	-0.129
Rohn-D7	Rohn-DI32	78.62	0.000	-9.776	-9.776	-9.737	-0.561	-0.518	-2.276	-0.173	-0.130
Rohn-D7	Rohn-DI4P	64.60	8.031	-0.174	7.986	8.031	0.142	0.186	1.696	-0.174	-0.131
Rohn-D7	Rohn-DI41	76.69	0.000	-9.536	-9.536	-9.498	-0.554	-0.512	-2.222	-0.171	-0.129
Rohn-D7	Rohn-DI42	11.04	1.373	-0.174	1.327	1.373	-0.100	-0.057	0.167	-0.174	-0.131
Rohn-L1	Rohn-LA1P	1.31	0.000	-1.357	-1.357	-1.268	-0.526	-0.440	-0.519	-0.352	-0.266
Rohn-L1	Rohn-LA11	0.34	0.135	-0.356	0.050	0.135	-0.271	-0.184	-0.210	-0.356	-0.269
Rohn-L1	Rohn-LA12	0.49	0.189	-0.513	0.064	0.189	-0.424	-0.297	-0.304	-0.513	-0.387
Rohn-L1	Rohn-LA2P	3.83	0.000	-3.982	-3.982	-3.826	-1.175	-1.028	-1.249	-0.593	-0.446
Rohn-L1	Rohn-LA21	1.05	1.335	-0.632	1.184	1.335	-0.335	-0.180	-0.129	-0.632	-0.476
Rohn-L1	Rohn-LA22	0.86	1.101	-0.805	0.906	1.101	-0.516	-0.316	-0.299	-0.805	-0.606
Rohn-L1	Rohn-LA3P	7.14	0.000	-7.428	-7.428	-7.221	-1.830	-1.638	-2.120	-0.767	-0.577
Rohn-L1	Rohn-LA31	2.14	2.726	-0.974	2.493	2.726	-0.439	-0.198	-0.051	-0.974	-0.733
Rohn-L1	Rohn-LA32	2.01	2.563	-1.000	2.324	2.563	-0.471	-0.224	-0.105	-1.000	-0.752
Rohn-L1	Rohn-LA4P	10.75	0.000	-11.182	-11.182	-10.913	-2.535	-2.290	-3.082	-0.979	-0.736
Rohn-L1	Rohn-LA41	3.25	4.143	-1.164	3.866	4.143	-0.388	-0.100	0.136	-1.164	-0.875
Rohn-L1	Rohn-LA42	3.33	4.241	-1.195	3.957	4.241	-0.417	-0.122	0.138	-1.195	-0.898
Rohn-L2	Rohn-LB1P	12.81	0.000	-17.010	-17.010	-16.423	-4.369	-3.816	-5.133	-2.207	-1.657
Rohn-L2	Rohn-LB11	3.97	6.149	-1.719	5.740	6.149	-0.638	-0.211	0.209	-1.719	-1.292
Rohn-L2	Rohn-LB12	4.03	6.240	-1.679	5.842	6.240	-0.598	-0.182	0.257	-1.679	-1.261
Rohn-L2	Rohn-LB2P	16.88	0.000	-22.408	-22.408	-21.760	-5.226	-4.624	-6.446	-2.397	-1.799
Rohn-L2	Rohn-LB21	5.51	8.536	-1.967	8.072	8.536	-0.552	-0.064	0.574	-1.967	-1.477
Rohn-L2	Rohn-LB22	5.61	8.691	-1.932	8.235	8.691	-0.516	-0.037	0.632	-1.932	-1.451
Rohn-L2	Rohn-LB3P	22.68	0.000	-30.106	-30.106	-29.168	-7.065	-6.187	-8.829	-3.493	-2.621
Rohn-L2	Rohn-LB31	7.13	11.032	-3.075	10.299	11.032	-1.289	-0.525	0.384	-3.075	-2.309
Rohn-L2	Rohn-LB32	7.23	11.197	-3.044	10.472	11.197	-1.258	-0.501	0.442	-3.044	-2.285
Rohn-L2	Rohn-LB4P	29.08	0.000	-38.600	-38.600	-37.593	-8.089	-7.161	-10.833	-3.688	-2.767
Rohn-L2	Rohn-LB41	9.70	15.011	-3.299	14.232	15.011	-1.097	-0.278	1.120	-3.299	-2.477
Rohn-L2	Rohn-LB42	9.81	15.191	-3.270	14.420	15.191	-1.068	-0.256	1.179	-3.270	-2.454
Rohn-L3	Rohn-LC1P	31.61	0.000	-47.573	-47.573	-46.438	-9.410	-8.373	-13.090	-4.118	-3.090
Rohn-L3	Rohn-LC11	10.17	18.940	-3.755	18.059	18.940	-1.107	-0.176	1.689	-3.755	-2.819
Rohn-L3	Rohn-LC12	10.29	19.165	-3.726	18.291	19.165	-1.078	-0.154	1.758	-3.726	-2.797
Rohn-L3	Rohn-LC2P	40.00	0.000	-60.117	-60.117	-58.690	-11.554	-10.250	-16.528	-5.179	-3.884
Rohn-L3	Rohn-LC21	12.78	23.809	-4.908	22.652	23.809	-1.719	-0.499	1.999	-4.908	-3.683
Rohn-L3	Rohn-LC22	12.91	24.043	-4.928	22.881	24.043	-1.738	-0.514	2.037	-4.928	-3.698
Rohn-L3	Rohn-LC3P	50.99	0.000	-76.722	-76.722	-74.897	-14.175	-12.505	-21.113	-6.634	-4.977
Rohn-L3	Rohn-LC31	16.29	30.351	-6.318	28.859	30.351	-2.546	-0.976	2.510	-6.318	-4.742
Rohn-L3	Rohn-LC32	16.39	30.532	-6.341	29.034	30.532	-2.571	-0.995	2.534	-6.341	-4.759
Rohn-L4	Rohn-LD1P	58.48	0.000	-92.906	-92.906	-90.892	-15.938	-14.107	-25.094	-7.264	-5.449
Rohn-L4	Rohn-LD11	20.72	37.570	-7.052	35.911	37.570	-2.714	-0.962	3.625	-7.052	-5.293
Rohn-L4	Rohn-LD12	20.86	37.831	-6.996	36.186	37.831	-2.659	-0.921	3.721	-6.996	-5.250
Rohn-L4	Rohn-LD2P	70.32	0.000	-111.629	-111.629	-109.159	-18.749	-16.495	-30.294	-8.946	-6.709
Rohn-L4	Rohn-LD21	24.77	44.916	-8.632	42.879	44.916	-3.729	-1.583	4.205	-8.632	-6.477
Rohn-L4	Rohn-LD22	24.95	45.238	-8.580	43.214	45.238	-3.677	-1.543	4.312	-8.580	-6.437
Rohn-L4	Rohn-LD3P	81.28	0.000	-129.127	-129.127	-126.608	-19.838	-17.565	-34.230	-9.019	-6.764
Rohn-L4	Rohn-LD31	29.53	53.554	-8.728	51.508	53.554	-3.317	-1.148	6.068	-8.728	-6.550
Rohn-L4	Rohn-LD32	29.70	53.865	-8.677	51.833	53.865	-3.266	-1.110	6.173	-8.677	-6.511
Rohn-L5	Rohn-LE1P	64.54	0.000	-144.899	-144.899	-142.152	-21.524	-19.043	-38.245	-9.842	-7.382
Rohn-L5	Rohn-LE11	23.45	60.361	-9.573	58.116	60.361	-3.731	-1.352	7.024	-9.573	-7.184
Rohn-L5	Rohn-LE12	23.58	60.687	-9.519	58.456	60.687	-3.677	-1.311	7.134	-9.519	-7.143

Rohn-L5	Rohn-LE2P	71.17	0.000	-159.651	-159.651	-156.739	-22.869	-20.245	-41.884	-10.406	-7.804
Rohn-L5	Rohn-LE21	26.04	67.027	-10.155	64.647	67.027	-3.921	-1.397	8.127	-10.155	-7.620
Rohn-L5	Rohn-LE22	26.16	67.329	-10.093	64.965	67.329	-3.860	-1.352	8.238	-10.093	-7.573
Rohn-L5	Rohn-LE3P	77.58	0.000	-174.179	-174.179	-171.177	-23.966	-21.271	-45.294	-10.687	-8.015
Rohn-L5	Rohn-LE31	28.69	73.859	-10.449	71.417	73.859	-3.808	-1.212	9.457	-10.449	-7.841
Rohn-L5	Rohn-LE32	28.86	74.280	-10.375	71.856	74.280	-3.733	-1.155	9.603	-10.375	-7.785
Rohn-L6	Rohn-LF1P	80.00	0.000	-195.031	-195.031	-191.748	-26.097	-23.149	-50.582	-11.690	-8.767
Rohn-L6	Rohn-LF11	27.50	83.028	-11.467	80.345	83.028	-4.263	-1.413	10.838	-11.467	-8.605
Rohn-L6	Rohn-LF12	27.59	83.308	-11.545	80.607	83.308	-4.340	-1.470	10.852	-11.545	-8.662
Rohn-L6	Rohn-LF2P	76.48	0.000	-218.900	-218.900	-215.436	-28.012	-24.908	-56.292	-12.309	-9.231
Rohn-L6	Rohn-LF21	31.18	94.146	-12.103	91.318	94.146	-4.250	-1.241	12.903	-12.103	-9.081
Rohn-L6	Rohn-LF22	31.28	94.457	-12.153	91.617	94.457	-4.301	-1.280	12.942	-12.153	-9.118
Rohn-L7	Rohn-LG1P	85.03	0.000	-242.483	-242.483	-238.642	-30.604	-27.143	-62.436	-13.725	-10.293
Rohn-L7	Rohn-LG11	29.37	104.132	-13.488	100.969	104.132	-5.047	-1.693	14.225	-13.488	-10.120
Rohn-L7	Rohn-LG12	29.45	104.434	-13.628	101.237	104.434	-5.188	-1.799	14.201	-13.628	-10.225
Rohn-L7	Rohn-LG2P	92.59	0.000	-264.055	-264.055	-260.021	-32.361	-28.724	-67.699	-14.429	-10.821
Rohn-L7	Rohn-LG21	32.17	114.061	-14.206	110.727	114.061	-5.239	-1.706	15.975	-14.206	-10.659
Rohn-L7	Rohn-LG22	32.22	114.267	-14.329	110.902	114.267	-5.363	-1.799	15.942	-14.329	-10.751
Rohn-L7	Rohn-LH1P	85.21	0.000	-286.152	-286.152	-281.765	-34.722	-30.742	-73.491	-15.797	-11.846
Rohn-L7	Rohn-LH11	34.78	123.343	-15.587	119.669	123.343	-6.123	-2.245	17.145	-15.587	-11.694
Rohn-L7	Rohn-LH12	34.86	123.615	-15.697	119.914	123.615	-6.233	-2.328	17.133	-15.697	-11.776
Rohn-L7	Rohn-LH2P	91.65	0.000	-307.747	-307.747	-303.179	-36.388	-32.233	-78.765	-16.495	-12.370
Rohn-L7	Rohn-LH21	37.57	133.239	-16.295	129.392	133.239	-6.347	-2.293	18.899	-16.295	-12.226
Rohn-L7	Rohn-LH22	37.66	133.525	-16.397	129.653	133.525	-6.450	-2.370	18.896	-16.397	-12.301
Rohn-L8	Rohn-LI1P	83.60	0.000	-328.856	-328.856	-323.881	-38.869	-34.306	-84.488	-18.130	-13.597
Rohn-L8	Rohn-LI11	31.94	141.703	-17.939	137.445	141.703	-7.568	-3.103	19.706	-17.939	-13.459
Rohn-L8	Rohn-LI12	32.01	142.009	-18.035	137.727	142.009	-7.664	-3.175	19.711	-18.035	-13.530
Rohn-L8	Rohn-LI2P	80.40	0.000	-346.163	-346.163	-340.976	-40.363	-35.586	-88.902	-18.985	-14.237
Rohn-L8	Rohn-LI21	33.64	149.245	-18.801	144.768	149.245	-8.111	-3.430	20.836	-18.801	-14.105
Rohn-L8	Rohn-LI22	33.71	149.563	-18.893	145.064	149.563	-8.204	-3.499	20.846	-18.893	-14.173
Rohn-H1	Rohn-H1P	1.22	0.000	-0.099	-0.099	-0.089	-0.025	-0.015	-0.033	-0.023	-0.013
Rohn-H1	Rohn-H11	1.11	0.224	-0.026	0.213	0.224	-0.004	0.006	0.034	-0.026	-0.015
Rohn-H1	Rohn-H12	2.54	0.000	-0.206	-0.206	-0.195	-0.048	-0.037	-0.059	-0.027	-0.016
Rohn-H1	Rohn-H2P	1.90	0.000	-0.110	-0.110	-0.103	-0.016	-0.008	-0.034	-0.019	-0.011
Rohn-H1	Rohn-H21	0.54	0.108	-0.023	0.100	0.108	-0.023	-0.015	0.015	-0.017	-0.009
Rohn-H1	Rohn-H22	0.31	0.045	-0.018	0.037	0.045	-0.010	-0.002	-0.001	-0.018	-0.010
SNB-D1	SNB-DA1P	3.36	0.418	0.000	0.418	0.412	0.078	0.072	0.101	0.016	0.010
SNB-D1	SNB-DA11	0.72	0.014	-0.090	-0.086	-0.090	0.014	0.011	-0.016	0.007	0.003
SNB-D1	SNB-DA12	1.70	0.014	-0.212	-0.207	-0.212	-0.055	-0.061	-0.038	0.014	0.009
SNB-D1	SNB-DA2P	1.75	0.218	0.000	0.218	0.213	0.069	0.064	0.053	0.010	0.005
SNB-D1	SNB-DA21	0.70	0.011	-0.087	-0.083	-0.087	-0.054	-0.059	-0.013	0.011	0.007
SNB-D1	SNB-DA22	0.19	0.023	-0.012	-0.006	-0.012	0.023	0.017	0.007	0.016	0.010
SNB-D1	SNB-DA3P	5.17	0.643	0.000	0.643	0.635	0.137	0.130	0.151	0.017	0.010
SNB-D1	SNB-DA31	0.90	0.112	0.000	0.112	0.107	0.026	0.023	0.027	0.006	0.002
SNB-D1	SNB-DA32	6.79	0.004	-0.845	-0.844	-0.845	-0.141	-0.144	-0.186	0.004	0.001
SNB-D1	SNB-DA4P	6.29	0.782	0.000	0.782	0.775	0.138	0.132	0.180	0.014	0.008
SNB-D1	SNB-DA41	6.41	0.006	-0.797	-0.795	-0.797	-0.139	-0.143	-0.174	0.006	0.002
SNB-D1	SNB-DA42	0.65	0.023	-0.081	-0.077	-0.081	0.023	0.019	-0.014	0.007	0.003
SNB-D1	SNB-DA5P	8.28	1.030	0.000	1.030	1.018	0.217	0.207	0.245	0.030	0.021
SNB-D1	SNB-DA51	0.96	0.009	-0.119	-0.115	-0.119	0.002	-0.003	-0.021	0.009	0.005
SNB-D1	SNB-DA52	7.72	0.000	-0.960	-0.960	-0.959	-0.184	-0.185	-0.216	-0.003	-0.004
SNB-D1	SNB-DA6P	8.32	1.035	0.000	1.035	1.022	0.217	0.207	0.247	0.032	0.022
SNB-D1	SNB-DA61	9.03	0.001	-1.122	-1.122	-1.122	-0.186	-0.188	-0.250	0.001	-0.002
SNB-D1	SNB-DA62	0.35	0.044	-0.000	0.044	0.041	0.003	-0.000	0.011	0.004	0.001
SNB-D1	SNB-DA7P	11.97	1.489	0.000	1.489	1.480	0.228	0.222	0.338	0.016	0.010
SNB-D1	SNB-DA71	1.63	0.203	-0.004	0.203	0.201	0.029	0.028	0.042	-0.003	-0.004
SNB-D1	SNB-DA72	11.82	0.000	-1.470	-1.470	-1.461	-0.267	-0.261	-0.346	-0.031	-0.025
SNB-D1	SNB-DA8P	11.05	1.374	0.000	1.374	1.365	0.227	0.220	0.315	0.019	0.012
SNB-D1	SNB-DA81	10.11	0.000	-1.257	-1.257	-1.249	-0.258	-0.253	-0.296	-0.027	-0.022
SNB-D1	SNB-DA82	0.84	0.104	-0.009	0.104	0.104	0.021	0.021	0.016	-0.009	-0.009
SNB-D2	SNB-DB1P	18.48	2.161	0.000	2.161	2.147	0.312	0.302	0.496	0.030	0.021
SNB-D2	SNB-DB11	0.79	0.092	0.000	0.092	0.085	0.040	0.034	0.031	0.019	0.013
SNB-D2	SNB-DB12	17.69	0.000	-2.199	-2.199	-2.194	-0.307	-0.307	-0.491	-0.004	-0.005
SNB-D2	SNB-DB2P	18.42	2.154	0.000	2.154	2.139	0.314	0.303	0.496	0.032	0.022
SNB-D2	SNB-DB21	17.72	0.000	-2.203	-2.203	-2.198	-0.306	-0.306	-0.491	-0.003	-0.004
SNB-D2	SNB-DB22	0.85	0.100	0.000	0.100	0.094	0.038	0.032	0.030	0.015	0.010
SNB-D2	SNB-DB3P	24.13	2.821	0.000	2.821	2.801	0.377	0.363	0.651	0.044	0.031
SNB-D2	SNB-DB31	0.32	0.038	-0.027	-0.015	-0.027	0.037	0.025	0.019	0.038	0.026
SNB-D2	SNB-DB32	21.76	0.021	-2.706	-2.705	-2.706	-0.311	-0.317	-0.588	0.021	0.014

SNB-D2	SNB-DB4P	24.18	2.827	0.000	2.827	2.807	0.379	0.365	0.654	0.046	0.032
SNB-D2	SNB-DB41	21.61	0.022	-2.686	-2.686	-2.686	-0.309	-0.316	-0.583	0.022	0.015
SNB-D2	SNB-DB42	0.44	0.035	-0.055	-0.044	-0.055	0.034	0.023	0.011	0.035	0.024
SNB-D2	SNB-DB5P	28.15	3.292	0.000	3.292	3.272	0.400	0.387	0.753	0.039	0.028
SNB-D2	SNB-DB51	0.51	0.039	-0.063	-0.052	-0.063	0.029	0.018	0.011	0.039	0.027
SNB-D2	SNB-DB52	25.03	0.032	-3.112	-3.110	-3.112	-0.318	-0.327	-0.671	0.032	0.022
SNB-D2	SNB-DB6P	28.25	3.303	0.000	3.303	3.283	0.401	0.388	0.756	0.040	0.028
SNB-D2	SNB-DB61	24.98	0.032	-3.106	-3.105	-3.106	-0.318	-0.327	-0.670	0.032	0.022
SNB-D2	SNB-DB62	0.66	0.038	-0.082	-0.071	-0.082	0.028	0.017	0.007	0.038	0.027
SNB-D2	SNB-DB7P	27.96	3.269	0.000	3.269	3.253	0.362	0.354	0.739	0.025	0.017
SNB-D2	SNB-DB71	2.97	0.347	0.000	0.347	0.338	0.068	0.059	0.093	0.028	0.020
SNB-D2	SNB-DB72	28.60	0.026	-3.556	-3.556	-3.555	-0.353	-0.360	-0.773	0.026	0.018
SNB-D2	SNB-DB8P	28.02	3.277	0.000	3.277	3.261	0.362	0.354	0.741	0.025	0.017
SNB-D2	SNB-DB81	28.53	0.025	-3.547	-3.547	-3.546	-0.353	-0.360	-0.771	0.025	0.017
SNB-D2	SNB-DB82	2.79	0.327	0.000	0.327	0.318	0.068	0.059	0.089	0.028	0.020
SNB-D3	SNB-DC1P	35.27	4.386	-0.068	4.380	4.386	0.342	0.357	0.931	-0.068	-0.052
SNB-D3	SNB-DC11	4.67	0.581	-0.061	0.569	0.581	0.034	0.048	0.087	-0.061	-0.047
SNB-D3	SNB-DC12	42.02	0.000	-5.225	-5.225	-5.198	-0.572	-0.556	-1.201	-0.065	-0.050
SNB-D3	SNB-DC2P	35.26	4.384	-0.068	4.378	4.384	0.341	0.356	0.930	-0.068	-0.052
SNB-D3	SNB-DC21	42.06	0.000	-5.229	-5.229	-5.201	-0.573	-0.556	-1.202	-0.065	-0.050
SNB-D3	SNB-DC22	4.69	0.583	-0.060	0.571	0.583	0.035	0.049	0.088	-0.060	-0.047
SNB-D3	SNB-DC3P	51.03	6.344	0.000	6.344	6.283	0.703	0.655	1.521	0.182	0.134
SNB-D3	SNB-DC31	5.85	0.179	-0.728	-0.683	-0.728	0.092	0.045	-0.044	0.179	0.132
SNB-D3	SNB-DC32	41.78	0.184	-5.195	-5.159	-5.195	-0.252	-0.299	-1.032	0.184	0.136
SNB-D3	SNB-DC4P	50.99	6.339	0.000	6.339	6.278	0.703	0.654	1.520	0.181	0.134
SNB-D3	SNB-DC41	41.59	0.185	-5.171	-5.135	-5.171	-0.250	-0.297	-1.026	0.185	0.137
SNB-D3	SNB-DC42	6.04	0.178	-0.751	-0.707	-0.751	0.090	0.044	-0.050	0.178	0.131
SNB-D3	SNB-DC5P	42.77	5.318	-0.000	5.318	5.305	0.376	0.373	1.181	0.001	-0.000
SNB-D3	SNB-DC51	9.39	1.168	0.000	1.168	1.162	0.134	0.130	0.263	0.009	0.006
SNB-D3	SNB-DC52	51.65	0.004	-6.422	-6.422	-6.410	-0.493	-0.494	-1.420	0.004	0.002
SNB-D3	SNB-DC6P	42.95	5.341	0.000	5.341	5.327	0.377	0.375	1.187	0.003	0.001
SNB-D3	SNB-DC61	51.49	0.006	-6.402	-6.402	-6.390	-0.491	-0.493	-1.415	0.006	0.003
SNB-D3	SNB-DC62	9.01	1.120	0.000	1.120	1.115	0.130	0.127	0.251	0.006	0.003
SNB-D3	SNB-DD1P	59.01	7.337	-0.028	7.337	7.328	0.460	0.465	1.616	-0.028	-0.022
SNB-D3	SNB-DD11	14.29	1.776	-0.023	1.776	1.776	0.145	0.150	0.381	-0.023	-0.018
SNB-D3	SNB-DD12	73.79	0.000	-9.174	-9.174	-9.148	-0.686	-0.678	-2.058	-0.031	-0.024
SNB-D3	SNB-DD2P	58.87	7.320	-0.026	7.320	7.310	0.461	0.465	1.614	-0.026	-0.021
SNB-D3	SNB-DD21	73.81	0.000	-9.178	-9.178	-9.151	-0.686	-0.678	-2.058	-0.031	-0.024
SNB-D3	SNB-DD22	14.42	1.794	-0.025	1.793	1.794	0.144	0.149	0.384	-0.025	-0.020
SNB-D3	SNB-DD3P	72.64	9.031	0.000	9.031	8.934	0.921	0.839	2.205	0.313	0.233
SNB-D3	SNB-DD31	8.35	0.310	-1.038	-0.962	-1.038	0.181	0.102	-0.029	0.310	0.231
SNB-D3	SNB-DD32	58.15	0.312	-7.230	-7.164	-7.230	-0.167	-0.245	-1.395	0.312	0.232
SNB-D3	SNB-DD4P	72.62	9.030	0.000	9.030	8.932	0.921	0.840	2.205	0.314	0.234
SNB-D3	SNB-DD41	57.97	0.312	-7.207	-7.142	-7.207	-0.167	-0.245	-1.390	0.312	0.232
SNB-D3	SNB-DD42	8.55	0.310	-1.063	-0.988	-1.063	0.181	0.102	-0.035	0.310	0.230
SNB-D3	SNB-DD5P	65.92	8.196	0.000	8.196	8.178	0.515	0.512	1.831	0.006	0.004
SNB-D3	SNB-DD51	10.28	1.278	0.000	1.278	1.273	0.134	0.131	0.283	0.009	0.006
SNB-D3	SNB-DD52	76.62	0.007	-9.527	-9.527	-9.511	-0.628	-0.629	-2.106	0.007	0.005
SNB-D3	SNB-DD6P	66.08	8.216	0.000	8.216	8.198	0.515	0.512	1.835	0.006	0.004
SNB-D3	SNB-DD61	76.71	0.005	-9.537	-9.537	-9.521	-0.630	-0.631	-2.109	0.005	0.003
SNB-D3	SNB-DD62	10.17	1.265	0.000	1.265	1.259	0.137	0.133	0.282	0.012	0.008
SNB-D4	SNB-DE1P	60.59	10.846	0.000	10.846	10.812	0.743	0.725	2.457	0.060	0.044
SNB-D4	SNB-DE11	11.42	2.044	0.000	2.044	2.023	0.233	0.216	0.491	0.062	0.046
SNB-D4	SNB-DE12	71.30	0.063	-12.763	-12.763	-12.756	-0.791	-0.806	-2.799	0.063	0.047
SNB-D4	SNB-DE2P	60.52	10.834	0.000	10.834	10.800	0.740	0.724	2.453	0.058	0.043
SNB-D4	SNB-DE21	71.16	0.059	-12.738	-12.738	-12.730	-0.794	-0.808	-2.796	0.059	0.044
SNB-D4	SNB-DE22	11.33	2.028	0.000	2.028	2.006	0.239	0.221	0.492	0.068	0.050
SNB-D4	SNB-DE3P	65.90	11.797	0.000	11.797	11.688	1.076	0.986	2.851	0.348	0.259
SNB-D4	SNB-DE31	4.01	0.344	-0.717	-0.633	-0.717	0.256	0.169	0.063	0.344	0.257
SNB-D4	SNB-DE32	57.40	0.357	-10.275	-10.202	-10.275	-0.285	-0.374	-2.047	0.357	0.266
SNB-D4	SNB-DE4P	66.08	11.829	0.000	11.829	11.721	1.073	0.984	2.856	0.344	0.256
SNB-D4	SNB-DE41	57.43	0.350	-10.281	-10.210	-10.281	-0.291	-0.379	-2.052	0.350	0.262
SNB-D4	SNB-DE42	4.17	0.354	-0.747	-0.661	-0.747	0.266	0.176	0.063	0.354	0.264
SNB-D4	SNB-DE5P	47.18	8.445	-0.077	8.439	8.445	0.399	0.417	1.843	-0.077	-0.058
SNB-D4	SNB-DE51	13.99	2.504	-0.077	2.490	2.504	0.127	0.146	0.505	-0.077	-0.059
SNB-D4	SNB-DE52	62.72	0.000	-11.227	-11.227	-11.192	-0.747	-0.730	-2.536	-0.065	-0.049
SNB-D4	SNB-DE6P	47.09	8.429	-0.083	8.422	8.429	0.393	0.412	1.835	-0.083	-0.063
SNB-D4	SNB-DE61	63.15	0.000	-11.305	-11.305	-11.268	-0.755	-0.736	-2.558	-0.072	-0.054
SNB-D4	SNB-DE62	14.49	2.594	-0.064	2.584	2.594	0.142	0.157	0.534	-0.064	-0.048

SNB-D5	SNB-DF1P	63.53	11.372	0.000	11.372	11.307	0.834	0.784	2.688	0.195	0.146
SNB-D5	SNB-DF11	7.54	1.350	0.000	1.350	1.302	0.289	0.240	0.393	0.192	0.143
SNB-D5	SNB-DF12	68.73	0.207	-12.304	-12.266	-12.304	-0.530	-0.581	-2.595	0.207	0.155
SNB-D5	SNB-DF2P	64.14	11.481	0.000	11.481	11.419	0.828	0.780	2.708	0.188	0.140
SNB-D5	SNB-DF21	68.73	0.199	-12.303	-12.267	-12.303	-0.538	-0.587	-2.601	0.199	0.149
SNB-D5	SNB-DF22	6.93	1.240	0.000	1.240	1.188	0.303	0.251	0.379	0.208	0.155
SNB-D5	SNB-DF3P	63.85	11.430	0.000	11.430	11.358	0.844	0.787	2.713	0.221	0.165
SNB-D5	SNB-DF31	7.15	1.280	0.000	1.280	1.228	0.272	0.219	0.397	0.214	0.160
SNB-D5	SNB-DF32	68.43	0.230	-12.249	-12.208	-12.249	-0.452	-0.509	-2.564	0.230	0.173
SNB-D5	SNB-DF4P	63.83	11.426	0.000	11.426	11.356	0.836	0.781	2.707	0.212	0.159
SNB-D5	SNB-DF41	69.06	0.224	-12.363	-12.323	-12.363	-0.459	-0.515	-2.593	0.224	0.168
SNB-D5	SNB-DF42	7.83	1.402	0.000	1.402	1.346	0.288	0.231	0.433	0.228	0.171
SNB-D6	SNB-DG1P	73.65	13.183	0.000	13.183	13.138	0.820	0.784	3.070	0.140	0.104
SNB-D6	SNB-DG11	12.13	2.171	0.000	2.171	2.136	0.292	0.257	0.542	0.139	0.104
SNB-D6	SNB-DG12	84.51	0.146	-15.128	-15.102	-15.128	-0.688	-0.724	-3.269	0.146	0.109
SNB-D6	SNB-DG2P	74.03	13.252	0.000	13.252	13.208	0.815	0.781	3.082	0.134	0.100
SNB-D6	SNB-DG21	84.34	0.143	-15.098	-15.073	-15.098	-0.690	-0.726	-3.264	0.143	0.107
SNB-D6	SNB-DG22	11.59	2.075	0.000	2.075	2.038	0.299	0.262	0.526	0.147	0.110
S-D6-MOD	SNB-DG3P	59.49	13.312	0.000	13.312	13.255	0.845	0.801	3.114	0.173	0.130
S-D6-MOD	SNB-DG31	7.61	1.703	0.000	1.703	1.662	0.257	0.214	0.467	0.173	0.130
S-D6-MOD	SNB-DG32	65.61	0.179	-14.681	-14.649	-14.681	-0.578	-0.622	-3.151	0.179	0.134
S-D6-MOD	SNB-DG4P	59.60	13.337	0.000	13.337	13.280	0.842	0.799	3.117	0.170	0.128
S-D6-MOD	SNB-DG41	65.81	0.178	-14.727	-14.695	-14.727	-0.580	-0.623	-3.161	0.178	0.134
S-D6-MOD	SNB-DG42	7.73	1.729	0.000	1.729	1.686	0.261	0.217	0.475	0.177	0.133
SNB-D6	SNB-DH1P	76.56	13.706	0.000	13.706	13.663	0.794	0.754	3.214	0.160	0.120
SNB-D6	SNB-DH11	16.10	2.882	0.000	2.882	2.842	0.343	0.303	0.711	0.163	0.122
SNB-D6	SNB-DH12	91.41	0.164	-16.364	-16.326	-16.364	-0.652	-0.693	-3.531	0.164	0.123
SNB-D6	SNB-DH2P	76.59	13.711	0.000	13.711	13.668	0.793	0.753	3.214	0.158	0.119
SNB-D6	SNB-DH21	91.37	0.165	-16.356	-16.318	-16.356	-0.651	-0.692	-3.529	0.165	0.124
SNB-D6	SNB-DH22	16.05	2.873	0.000	2.873	2.831	0.345	0.304	0.710	0.164	0.123
S-D6-MOD	SNB-DH3P	59.29	13.267	0.000	13.267	13.216	0.775	0.730	3.120	0.182	0.137
S-D6-MOD	SNB-DH31	9.23	2.065	0.000	2.065	2.021	0.282	0.236	0.549	0.185	0.139
S-D6-MOD	SNB-DH32	67.08	0.187	-15.010	-14.968	-15.010	-0.505	-0.551	-3.217	0.187	0.140
S-D6-MOD	SNB-DH4P	59.33	13.275	0.000	13.275	13.223	0.775	0.730	3.121	0.182	0.137
S-D6-MOD	SNB-DH41	67.08	0.188	-15.010	-14.967	-15.010	-0.504	-0.550	-3.216	0.188	0.141
S-D6-MOD	SNB-DH42	9.21	2.061	0.000	2.061	2.017	0.282	0.236	0.548	0.185	0.139
S-D7-MOD	SNB-DI1P	76.52	17.122	0.000	17.122	17.103	0.798	0.771	3.951	0.114	0.086
S-D7-MOD	SNB-DI11	5.84	1.307	0.000	1.307	1.277	0.210	0.181	0.344	0.120	0.091
S-D7-MOD	SNB-DI12	82.03	0.119	-18.355	-18.321	-18.355	-0.656	-0.686	-4.013	0.119	0.090
S-D7-MOD	SNB-DI2P	76.55	17.130	0.000	17.130	17.110	0.798	0.771	3.953	0.114	0.087
S-D7-MOD	SNB-DI21	82.00	0.121	-18.349	-18.313	-18.349	-0.654	-0.684	-4.010	0.121	0.092
S-D7-MOD	SNB-DI22	5.79	1.297	0.000	1.297	1.267	0.208	0.179	0.341	0.117	0.089
S-D7-MOD	SNB-DI3P	79.53	17.795	0.000	17.795	17.763	0.836	0.799	4.110	0.146	0.109
S-D7-MOD	SNB-DI31	13.36	2.989	0.000	2.989	2.952	0.315	0.276	0.727	0.151	0.113
S-D7-MOD	SNB-DI32	91.87	0.150	-20.558	-20.514	-20.558	-0.704	-0.743	-4.475	0.150	0.112
S-D7-MOD	SNB-DI4P	79.57	17.806	0.000	17.806	17.772	0.836	0.799	4.113	0.146	0.109
S-D7-MOD	SNB-DI41	91.84	0.152	-20.551	-20.507	-20.551	-0.702	-0.741	-4.473	0.152	0.114
S-D7-MOD	SNB-DI42	13.30	2.976	0.000	2.976	2.940	0.312	0.274	0.723	0.148	0.110
SNB-L1	SNB-LA1P	0.74	0.000	-0.859	-0.859	-0.756	-0.491	-0.388	-0.432	-0.397	-0.295
SNB-L1	SNB-LA11	0.34	0.000	-0.391	-0.240	-0.140	-0.346	-0.245	-0.291	-0.391	-0.290
SNB-L1	SNB-LA12	0.35	0.000	-0.401	-0.208	-0.105	-0.352	-0.249	-0.290	-0.401	-0.298
SNB-L1	SNB-LA2P	2.00	0.000	-2.322	-2.322	-2.167	-0.965	-0.815	-0.872	-0.588	-0.437
SNB-L1	SNB-LA21	0.49	0.539	-0.563	0.397	0.539	-0.372	-0.228	-0.256	-0.563	-0.419
SNB-L1	SNB-LA22	0.50	0.538	-0.583	0.391	0.538	-0.389	-0.239	-0.270	-0.583	-0.434
SNB-L1	SNB-LA3P	4.48	0.000	-5.195	-5.195	-4.978	-1.671	-1.464	-1.648	-0.813	-0.607
SNB-L1	SNB-LA31	1.25	1.699	-0.740	1.517	1.699	-0.310	-0.123	-0.117	-0.740	-0.552
SNB-L1	SNB-LA32	1.26	1.709	-0.758	1.522	1.709	-0.325	-0.134	-0.127	-0.758	-0.565
SNB-L1	SNB-LA4P	7.63	0.000	-8.851	-8.851	-8.572	-2.440	-2.178	-2.589	-1.029	-0.768
SNB-L1	SNB-LA41	2.23	3.041	-0.884	2.827	3.041	-0.184	0.039	0.084	-0.884	-0.660
SNB-L1	SNB-LA42	2.32	3.154	-0.890	2.939	3.154	-0.188	0.037	0.105	-0.890	-0.665
SNB-L2	SNB-LB1P	7.79	0.000	-14.267	-14.267	-13.806	-3.826	-3.394	-4.206	-1.707	-1.277
SNB-L2	SNB-LB11	2.55	5.140	-1.486	4.782	5.140	-0.426	-0.054	0.147	-1.486	-1.112
SNB-L2	SNB-LB12	2.60	5.232	-1.481	4.875	5.232	-0.421	-0.050	0.171	-1.481	-1.109
SNB-L2	SNB-LB2P	11.51	0.000	-21.071	-21.071	-20.523	-4.942	-4.438	-5.887	-1.988	-1.488
SNB-L2	SNB-LB21	4.09	8.230	-1.713	7.824	8.230	-0.235	0.194	0.682	-1.713	-1.282
SNB-L2	SNB-LB22	4.15	8.342	-1.702	7.938	8.342	-0.224	0.202	0.714	-1.702	-1.274
SNB-L2	SNB-LB3P	15.77	0.000	-28.888	-28.888	-28.260	-6.061	-5.495	-7.768	-2.228	-1.668
SNB-L2	SNB-LB31	5.88	11.824	-1.924	11.374	11.824	-0.007	0.473	1.339	-1.924	-1.441
SNB-L2	SNB-LB32	5.95	11.972	-1.910	11.526	11.972	0.007	0.484	1.381	-1.910	-1.430

SNB-L2	SNB-LB4P	20.18	0.000	-36.948	-36.948	-36.248	-7.118	-6.498	-9.686	-2.440	-1.827
SNB-L2	SNB-LB4I	7.75	15.595	-2.130	15.104	15.595	0.210	0.741	2.039	-2.130	-1.596
SNB-L2	SNB-LB42	7.84	15.780	-2.115	15.293	15.780	0.225	0.752	2.090	-2.115	-1.584
SNB-L2	SNB-LC1P	28.25	0.000	-48.090	-48.090	-47.212	-8.759	-7.984	-12.534	-3.051	-2.285
SNB-L2	SNB-LC11	10.16	20.443	-2.746	19.812	20.443	0.111	0.795	2.705	-2.746	-2.058
SNB-L2	SNB-LC12	10.26	20.642	-2.732	20.013	20.642	0.125	0.805	2.759	-2.732	-2.047
SNB-L2	SNB-LC2P	37.67	0.000	-64.071	-64.071	-62.997	-10.785	-9.849	-16.470	-3.680	-2.755
SNB-L2	SNB-LC21	13.72	27.595	-3.374	26.824	27.595	0.180	1.021	3.877	-3.374	-2.528
SNB-L2	SNB-LC22	13.83	27.823	-3.359	27.055	27.823	0.194	1.031	3.937	-3.359	-2.516
SNB-L2	SNB-LC3P	45.88	0.000	-78.119	-78.119	-77.001	-11.906	-10.954	-19.623	-3.737	-2.799
SNB-L2	SNB-LC31	17.12	34.439	-3.444	33.666	34.439	0.640	1.496	5.352	-3.444	-2.582
SNB-L2	SNB-LC32	17.26	34.722	-3.426	33.954	34.722	0.658	1.509	5.427	-3.426	-2.568
SNB-L3	SNB-LD1P	57.47	0.000	-96.526	-96.526	-95.149	-14.045	-12.869	-24.254	-4.622	-3.462
SNB-L3	SNB-LD11	22.95	42.540	-4.330	41.565	42.540	0.381	1.457	6.561	-4.330	-3.247
SNB-L3	SNB-LD12	23.12	42.854	-4.308	41.885	42.854	0.404	1.474	6.645	-4.308	-3.230
SNB-L3	SNB-LD2P	71.02	0.000	-119.212	-119.212	-117.602	-16.340	-14.973	-29.757	-5.366	-4.019
SNB-L3	SNB-LD21	28.58	52.963	-5.065	51.827	52.963	0.423	1.681	8.393	-5.065	-3.797
SNB-L3	SNB-LD22	28.75	53.285	-5.040	52.155	53.285	0.447	1.699	8.481	-5.040	-3.778
SNB-L3	SNB-LD3P	82.04	0.000	-137.793	-137.793	-136.156	-17.476	-16.118	-33.861	-5.328	-3.992
SNB-L3	SNB-LD31	33.61	62.291	-5.029	61.182	62.291	1.047	2.294	10.497	-5.029	-3.771
SNB-L3	SNB-LD32	33.79	62.629	-5.007	61.527	62.629	1.069	2.310	10.587	-5.007	-3.754
SNB-L4	SNB-LE1P	50.40	0.000	-162.456	-162.456	-160.483	-20.165	-18.512	-40.057	-6.493	-4.864
SNB-L4	SNB-LE11	21.09	73.115	-6.192	71.739	73.115	0.645	2.182	12.132	-6.192	-4.643
SNB-L4	SNB-LE12	21.20	73.497	-6.177	72.125	73.497	0.660	2.193	12.226	-6.177	-4.632
SNB-L4	SNB-LE2P	59.07	0.000	-190.299	-190.299	-188.089	-22.684	-20.838	-46.724	-7.245	-5.428
SNB-L4	SNB-LE21	24.83	86.068	-6.943	84.527	86.068	0.777	2.500	14.523	-6.943	-5.206
SNB-L4	SNB-LE22	24.94	86.466	-6.942	84.926	86.466	0.778	2.501	14.612	-6.942	-5.205
SNB-L4	SNB-LE3P	65.44	0.000	-210.940	-210.940	-208.702	-23.876	-22.034	-51.310	-7.227	-5.415
SNB-L4	SNB-LE31	27.80	96.392	-6.933	94.870	96.392	1.393	3.111	16.835	-6.933	-5.200
SNB-L4	SNB-LE32	27.90	96.736	-6.951	95.210	96.736	1.375	3.098	16.901	-6.951	-5.212
SNB-L4	SNB-LF1P	81.49	0.000	-239.714	-239.714	-236.982	-27.277	-24.977	-58.873	-9.046	-6.778
SNB-L4	SNB-LF11	31.30	108.509	-8.760	106.551	108.509	0.358	2.532	18.335	-8.760	-6.569
SNB-L4	SNB-LF12	31.40	108.874	-8.804	106.905	108.874	0.313	2.498	18.387	-8.804	-6.602
SNB-L4	SNB-LF2P	92.27	0.000	-271.438	-271.438	-268.511	-29.681	-27.223	-66.340	-9.662	-7.240
SNB-L4	SNB-LF21	35.64	123.558	-9.382	121.465	123.558	0.629	2.957	21.290	-9.382	-7.036
SNB-L4	SNB-LF22	35.75	123.922	-9.455	121.812	123.922	0.555	2.902	21.323	-9.455	-7.050
SNB-L5	SNB-LG1P	80.76	0.000	-305.628	-305.628	-302.227	-33.166	-30.267	-75.067	-11.419	-8.998
SNB-L5	SNB-LG11	33.38	138.416	-11.147	135.898	138.416	-0.273	2.496	23.449	-11.147	-8.360
SNB-L5	SNB-LG12	33.46	138.783	-11.241	136.243	138.783	-0.367	2.425	23.468	-11.241	-8.430
SNB-L5	SNB-LG2P	90.17	0.000	-341.233	-341.233	-337.625	-35.724	-32.647	-83.469	-12.125	-9.087
SNB-L5	SNB-LG21	37.43	155.244	-11.859	152.565	155.244	-0.059	2.886	26.751	-11.859	-8.895
SNB-L5	SNB-LG22	37.54	155.674	-11.964	152.968	155.674	-0.164	2.807	26.777	-11.964	-8.973
SNB-L5	SNB-LH1P	99.63	0.000	-377.051	-377.051	-372.916	-39.409	-35.823	-92.752	-14.154	-10.609
SNB-L5	SNB-LH11	41.14	170.602	-13.899	167.422	170.602	-1.271	2.184	28.847	-13.899	-10.425
SNB-L5	SNB-LH12	41.24	171.042	-14.008	167.835	171.042	-1.381	2.102	28.872	-14.008	-10.505
SNB-L5	SNB-LH2P	99.89	0.000	-411.905	-411.905	-407.576	-41.771	-38.002	-101.014	-14.891	-11.161
SNB-L5	SNB-LH21	45.10	187.034	-14.643	183.673	187.034	-1.202	2.438	32.047	-14.643	-10.983
SNB-L5	SNB-LH22	45.21	187.486	-14.753	184.098	187.486	-1.312	2.356	32.073	-14.753	-11.064
SNB-L6	SNB-LI1P	91.36	0.000	-449.902	-449.902	-445.031	-45.489	-41.174	-110.879	-17.078	-12.803
SNB-L6	SNB-LI11	38.97	203.278	-16.842	199.367	203.278	-2.636	1.553	34.234	-16.842	-12.633
SNB-L6	SNB-LI12	39.06	203.746	-16.949	199.808	203.746	-2.744	1.473	34.265	-16.949	-12.712
SNB-L6	SNB-LI2P	95.26	0.000	-489.827	-489.827	-484.748	-47.941	-43.408	-120.362	-17.944	-13.450
SNB-L6	SNB-LI21	42.57	222.073	-17.718	217.934	222.073	-2.720	1.691	37.880	-17.718	-13.289
SNB-L6	SNB-LI22	42.67	222.560	-17.822	218.396	222.560	-2.824	1.614	37.918	-17.822	-13.365
Connect	Connect AP	0.00	0.036	-0.481	-0.465	-0.481	-0.082	-0.100	-0.089	0.036	0.017
Connect	Connect A1	0.00	0.100	0.000	0.100	0.082	0.078	0.060	0.033	0.030	0.012
Connect	Connect A2	0.00	0.191	0.000	0.191	0.170	0.088	0.068	0.060	0.041	0.021
Connect	Connect AaP	0.00	0.520	0.000	0.520	0.510	0.050	0.040	0.124	0.020	0.010
Connect	Connect Aa1	0.00	0.012	-0.110	-0.103	-0.110	-0.003	-0.011	-0.019	0.012	0.004
Connect	Connect Aa2	0.00	0.003	-0.416	-0.411	-0.416	-0.017	-0.022	-0.093	0.003	-0.003
Connect	Connect AbP	0.00	0.166	0.000	0.166	0.149	0.078	0.061	0.063	0.049	0.031
Connect	Connect Ab1	0.00	0.023	-0.377	-0.367	-0.377	-0.002	-0.013	-0.071	0.023	0.012
Connect	Connect Ab2	0.00	0.035	-0.006	0.035	0.027	0.003	-0.006	0.014	0.016	0.007
Connect	Connect AcP	0.00	0.496	0.000	0.496	0.478	0.077	0.059	0.138	0.052	0.034
Connect	Connect Ac1	0.00	0.075	0.000	0.075	0.063	0.027	0.014	0.032	0.031	0.018
Connect	Connect Ac2	0.00	0.028	-0.244	-0.232	-0.244	0.014	0.002	-0.038	0.028	0.016
Connect	Connect BP	0.00	1.081	0.000	1.081	1.049	0.101	0.069	0.280	0.081	0.050
Connect	Connect B1	0.00	0.440	0.000	0.440	0.406	0.130	0.096	0.144	0.089	0.055
Connect	Connect B2	0.00	0.567	0.000	0.567	0.533	0.136	0.102	0.174	0.092	0.057

Connect	Connect	BaP	0.00	0.801	0.000	0.801	0.783	0.089	0.072	0.202	0.046	0.030
Connect	Connect	Ba1	0.00	0.059	-0.317	-0.298	-0.317	0.038	0.019	-0.034	0.059	0.039
Connect	Connect	Ba2	0.00	0.061	-0.365	-0.346	-0.365	0.038	0.018	-0.043	0.061	0.040
Connect	Connect	BbP	0.00	0.811	0.000	0.811	0.788	0.114	0.092	0.217	0.068	0.046
Connect	Connect	Bb1	0.00	0.085	-0.295	-0.270	-0.295	0.064	0.037	-0.011	0.085	0.059
Connect	Connect	Bb2	0.00	0.087	-0.287	-0.261	-0.287	0.066	0.039	-0.007	0.087	0.061
Connect	Connect	BcP	0.00	0.446	0.000	0.446	0.402	0.159	0.116	0.189	0.154	0.110
Connect	Connect	Bc1	0.00	0.165	-0.032	0.014	-0.032	0.162	0.116	0.102	0.165	0.119
Connect	Connect	Bc2	0.00	0.167	-0.035	0.010	-0.035	0.164	0.117	0.102	0.167	0.120
Connect	Connect	CP	0.00	0.592	0.000	0.592	0.525	0.274	0.206	0.283	0.253	0.184
Connect	Connect	C1	0.00	0.254	0.000	0.094	0.025	0.244	0.175	0.174	0.254	0.185
Connect	Connect	C2	0.00	0.255	0.000	0.125	0.056	0.246	0.177	0.182	0.255	0.186
Connect	Connect	CaP	0.01	1.679	0.000	1.679	1.639	0.192	0.153	0.452	0.136	0.098
Connect	Connect	Ca1	0.00	0.138	-0.727	-0.690	-0.727	0.109	0.070	-0.071	0.138	0.099
Connect	Connect	Ca2	0.00	0.135	-0.761	-0.725	-0.761	0.105	0.067	-0.080	0.135	0.097
Connect	Connect	CbP	0.00	0.569	0.000	0.569	0.489	0.255	0.175	0.308	0.305	0.224
Connect	Connect	Cb1	0.00	0.333	0.000	0.221	0.140	0.333	0.252	0.236	0.307	0.225
Connect	Connect	Cb2	0.00	0.330	0.000	0.185	0.105	0.330	0.249	0.227	0.304	0.224
Connect	Connect	DP	0.01	3.639	0.000	3.639	3.457	0.902	0.725	1.226	0.684	0.508
Connect	Connect	D1	0.00	0.674	-1.165	-0.995	-1.165	0.561	0.388	0.191	0.674	0.501
Connect	Connect	D2	0.00	0.675	-1.080	-0.910	-1.080	0.564	0.390	0.210	0.675	0.501
Connect	Connect	DaP	0.00	0.341	0.000	0.155	0.069	0.311	0.222	0.237	0.341	0.252
Connect	Connect	Da1	0.00	0.523	0.000	0.523	0.432	0.361	0.271	0.327	0.343	0.253
Connect	Connect	Da2	0.00	0.464	0.000	0.464	0.373	0.362	0.271	0.315	0.345	0.255
Connect	Connect	DbP	0.01	2.218	0.000	2.218	2.081	0.609	0.476	0.810	0.518	0.385
Connect	Connect	Db1	0.00	0.518	-0.490	-0.359	-0.490	0.472	0.339	0.236	0.518	0.385
Connect	Connect	Db2	0.00	0.522	-0.476	-0.344	-0.476	0.476	0.343	0.242	0.522	0.388
Connect	Connect	EP	0.02	5.358	0.000	5.358	5.141	1.193	0.982	1.698	0.824	0.614
Connect	Connect	E1	0.01	0.824	-1.711	-1.505	-1.711	0.639	0.429	0.178	0.824	0.614
Connect	Connect	E2	0.01	0.829	-1.717	-1.510	-1.717	0.644	0.433	-0.179	0.829	0.618
Connect	Connect	EaP	0.00	0.497	-0.953	-0.828	-0.953	0.359	0.231	0.123	0.497	0.369
Connect	Connect	Ea1	0.00	1.144	0.000	1.144	1.014	0.572	0.443	0.562	0.503	0.374
Connect	Connect	Ea2	0.00	1.125	0.000	1.125	0.994	0.577	0.447	0.562	0.509	0.378
Connect	Connect	EbP	0.01	0.592	-1.755	-1.609	-1.755	0.400	0.250	0.008	0.592	0.442
Connect	Connect	Eb1	0.01	1.578	0.000	1.578	1.424	0.691	0.539	0.716	0.596	0.445
Connect	Connect	Eb2	0.01	1.758	0.000	1.758	1.603	0.700	0.546	0.759	0.603	0.449
Connect	Connect	FP	0.00	0.862	0.000	0.684	0.481	0.862	0.655	0.655	0.822	0.615
Connect	Connect	F1	0.00	0.818	0.000	0.809	0.601	0.798	0.592	0.695	0.818	0.612
Connect	Connect	F2	0.00	0.820	0.000	0.523	0.315	0.796	0.589	0.634	0.820	0.613
Connect	Connect	FaP	0.00	0.672	0.000	0.459	0.287	0.614	0.445	0.533	0.672	0.503
Connect	Connect	Fa1	0.00	0.700	0.000	0.581	0.413	0.700	0.531	0.538	0.673	0.504
Connect	Connect	Fa2	0.00	0.887	0.000	0.887	0.719	0.703	0.534	0.604	0.673	0.503
Connect	Connect	GP	0.02	4.412	0.000	4.412	4.236	0.977	0.798	1.420	0.714	0.535
Connect	Connect	G1	0.01	0.714	-1.391	-1.211	-1.391	0.583	0.404	0.193	0.714	0.535
Connect	Connect	G2	0.01	0.706	-1.682	-1.504	-1.682	0.573	0.396	0.124	0.706	0.529
Connect	Connect	GaP	0.00	0.584	-0.676	-0.526	-0.676	0.470	0.323	0.269	0.584	0.438
Connect	Connect	Ga1	0.00	1.005	0.000	1.005	0.860	0.644	0.497	0.577	0.587	0.440
Connect	Connect	Ga2	0.00	1.170	0.000	1.170	1.026	0.640	0.494	0.610	0.582	0.436
Connect	Connect	HP	0.01	2.256	0.000	2.256	2.095	0.813	0.644	0.915	0.676	0.507
Connect	Connect	H1	0.00	0.676	-0.461	-0.289	-0.461	0.607	0.438	0.382	0.676	0.507
Connect	Connect	H2	0.00	0.673	-0.510	-0.339	-0.510	0.603	0.435	0.370	0.673	0.505
Connect	Connect	HaP	0.01	0.655	-2.276	-2.109	-2.276	0.462	0.298	-0.039	0.655	0.492
Connect	Connect	Ha1	0.01	1.985	0.000	1.985	1.823	0.754	0.590	0.837	0.657	0.493
Connect	Connect	Ha2	0.01	1.993	0.000	1.993	1.831	0.751	0.588	0.837	0.655	0.491
Connect	Connect	IP	0.03	7.181	0.000	7.181	7.017	1.016	0.844	2.024	0.690	0.517
Connect	Connect	I1	0.01	0.691	-2.905	-2.728	-2.905	0.527	0.354	-0.157	0.691	0.518
Connect	Connect	I2	0.01	0.689	-2.915	-2.739	-2.915	0.525	0.352	-0.161	0.689	0.516
Connect	Connect	IaP	0.01	2.088	0.000	2.088	1.985	0.439	0.337	0.743	0.409	0.307
Connect	Connect	Ia1	0.00	0.410	-0.592	-0.491	-0.592	0.395	0.293	0.138	0.410	0.308
Connect	Connect	Ia2	0.00	0.409	-0.595	-0.493	-0.595	0.393	0.291	0.137	0.409	0.307
SNB-H1	SNB-H1aP		0.36	0.000	-0.469	-0.468	-0.469	-0.087	-0.089	-0.108	-0.009	-0.011
SNB-H1	SNB-H1bP		0.08	0.000	-0.108	-0.106	-0.108	-0.000	-0.003	-0.036	-0.009	-0.011
SNB-H1	SNB-H1cP		0.16	0.212	-0.009	0.212	0.208	0.048	0.045	0.039	-0.006	-0.009
SNB-H1	SNB-H1dP		0.16	0.213	-0.009	0.213	0.209	0.048	0.045	0.040	-0.006	-0.009
SNB-H1	SNB-H1eP		0.02	0.020	-0.008	0.020	0.017	0.006	0.003	-0.006	-0.005	-0.008
SNB-H1	SNB-H1fP		0.27	0.000	-0.345	-0.343	-0.345	-0.081	-0.084	-0.078	-0.005	-0.008
SNB-H1	SNB-H2aP		0.06	0.086	0.000	0.086	0.076	0.018	0.008	0.034	0.026	0.015
SNB-H1	SNB-H2bP		0.33	0.435	0.000	0.435	0.424	0.068	0.058	0.106	0.026	0.015
SNB-H1	SNB-H2cP		0.23	0.300	0.000	0.300	0.289	0.040	0.030	0.080	0.025	0.015

SNB-H1	SNB-H2dP	0.23	0.300	0.000	0.300	0.289	0.040	0.030	0.080	0.025	0.015
SNB-H1	SNB-H2eP	0.43	0.572	0.000	0.572	0.561	0.073	0.063	0.137	0.026	0.016
SNB-H1	SNB-H2fP	0.17	0.222	0.000	0.222	0.212	0.023	0.013	0.065	0.026	0.016
SNB-H1	SNB-H3aP	0.17	0.230	0.000	0.230	0.185	0.207	0.162	0.160	0.176	0.131
SNB-H1	SNB-H3bP	0.53	0.702	0.000	0.702	0.656	0.241	0.195	0.263	0.176	0.131
SNB-H1	SNB-H3cP	0.30	0.169	-0.374	-0.332	-0.374	0.076	0.033	0.031	0.169	0.125
SNB-H1	SNB-H3dP	0.30	0.169	-0.374	-0.332	-0.374	0.076	0.033	0.031	0.169	0.125
SNB-H1	SNB-H3eP	0.53	0.710	0.000	0.710	0.664	0.241	0.196	0.264	0.176	0.131
SNB-H1	SNB-H3fP	0.18	0.238	0.000	0.238	0.193	0.208	0.163	0.162	0.176	0.131
SNB-H1	SNB-H4aP	1.02	1.350	0.000	1.350	1.249	0.512	0.414	0.538	0.388	0.290
SNB-H1	SNB-H4bP	1.53	2.028	0.000	2.028	1.927	0.542	0.444	0.688	0.388	0.290
SNB-H1	SNB-H4cP	2.17	0.378	-2.599	-2.510	-2.599	0.092	-0.003	-0.325	0.378	0.282
SNB-H1	SNB-H4dP	2.17	0.378	-2.599	-2.510	-2.599	0.092	-0.003	-0.325	0.378	0.282
SNB-H1	SNB-H4eP	1.55	2.056	0.000	2.056	1.954	0.543	0.444	0.694	0.388	0.290
SNB-H1	SNB-H4fP	1.04	1.377	0.000	1.377	1.277	0.513	0.414	0.544	0.388	0.290
SNB-H2	SNB-H5aP	0.95	1.919	0.000	1.919	1.819	0.550	0.453	0.666	0.383	0.287
SNB-H2	SNB-H5bP	1.30	2.618	0.000	2.618	2.517	0.576	0.479	0.822	0.383	0.286
SNB-H2	SNB-H5cP	1.93	0.376	-3.575	-3.487	-3.575	0.017	-0.078	-0.534	0.376	0.281
SNB-H2	SNB-H5dP	1.93	0.376	-3.575	-3.487	-3.575	0.017	-0.078	-0.534	0.376	0.281
SNB-H2	SNB-H5eP	1.30	2.617	0.000	2.617	2.517	0.576	0.479	0.822	0.383	0.286
SNB-H2	SNB-H5fP	0.95	1.918	0.000	1.918	1.819	0.550	0.453	0.666	0.383	0.286
SNB-H2	SNB-H6aP	0.86	1.724	0.000	1.724	1.614	0.574	0.465	0.649	0.436	0.327
SNB-H2	SNB-H6bP	1.22	2.454	0.000	2.454	2.343	0.603	0.494	0.813	0.436	0.327
SNB-H2	SNB-H6cP	1.75	0.429	-3.151	-3.046	-3.151	0.123	0.015	-0.384	0.429	0.322
SNB-H2	SNB-H6dP	1.75	0.429	-3.151	-3.046	-3.151	0.123	0.015	-0.384	0.429	0.322
SNB-H2	SNB-H6eP	1.15	2.310	0.000	2.310	2.199	0.601	0.492	0.782	0.436	0.327
SNB-H2	SNB-H6fP	0.79	1.581	0.000	1.581	1.471	0.572	0.463	0.618	0.436	0.327
SNB-H2	SNB-H7aP	0.90	1.813	0.000	1.813	1.784	0.276	0.246	0.474	0.122	0.092
SNB-H2	SNB-H7bP	1.37	2.750	0.000	2.750	2.720	0.305	0.275	0.686	0.122	0.092
SNB-H2	SNB-H7cP	2.54	0.118	-4.438	-4.407	-4.438	-0.219	-0.249	-0.855	0.118	0.089
SNB-H2	SNB-H7dP	2.54	0.118	-4.438	-4.407	-4.438	-0.219	-0.249	-0.855	0.118	0.089
SNB-H2	SNB-H7eP	1.30	2.612	0.000	2.612	2.583	0.304	0.274	0.656	0.122	0.092
SNB-H2	SNB-H7fP	0.83	1.676	0.000	1.676	1.647	0.275	0.245	0.443	0.122	0.092
SNB-H2	SNB-H8aP	1.11	2.232	0.000	2.232	2.195	0.342	0.303	0.594	0.156	0.117
SNB-H2	SNB-H8bP	1.60	3.218	0.000	3.218	3.180	0.362	0.323	0.817	0.156	0.117
SNB-H2	SNB-H8cP	3.17	0.153	-5.362	-5.322	-5.362	-0.241	-0.279	-1.034	0.153	0.115
SNB-H2	SNB-H8dP	3.17	0.153	-5.362	-5.322	-5.362	-0.241	-0.279	-1.034	0.153	0.115
SNB-H2	SNB-H8eP	1.58	3.179	0.000	3.179	3.140	0.363	0.324	0.809	0.157	0.118
SNB-H2	SNB-H8fP	1.09	2.192	0.000	2.192	2.155	0.343	0.304	0.586	0.157	0.118
SNB-H2	SNB-H9aP	1.34	2.701	0.000	2.701	2.667	0.348	0.312	0.689	0.138	0.102
SNB-H2	SNB-H9bP	1.87	3.755	0.000	3.755	3.720	0.361	0.325	0.927	0.138	0.102
SNB-H2	SNB-H9cP	3.94	0.136	-6.419	-6.383	-6.419	-0.297	-0.333	-1.290	0.136	0.101
SNB-H2	SNB-H9dP	3.94	0.136	-6.419	-6.383	-6.419	-0.297	-0.333	-1.290	0.136	0.101
SNB-H2	SNB-H9eP	1.86	3.747	0.000	3.747	3.711	0.362	0.326	0.926	0.140	0.103
SNB-H2	SNB-H9fP	1.34	2.693	0.000	2.693	2.658	0.349	0.313	0.688	0.140	0.103
WLAC-1	SNB-WL-A1P	0.53	0.000	-0.131	-0.131	-0.131	-0.027	-0.027	-0.024	-0.000	-0.000
WLAC-1	SNB-WL-A2P	0.54	0.000	-0.133	-0.133	-0.133	-0.028	-0.028	-0.024	-0.000	-0.000
WLAC-1	SNB-WL-A3P	0.86	0.260	-0.000	0.260	0.260	0.055	0.054	0.047	-0.000	-0.000
WLAC-1	SNB-WL-B1P	0.56	0.000	-0.120	-0.120	-0.119	-0.016	-0.016	-0.023	0.000	0.000
WLAC-1	SNB-WL-B2P	0.57	0.000	-0.121	-0.121	-0.120	-0.016	-0.016	-0.023	0.000	0.000
WLAC-1	SNB-WL-B3P	0.81	0.247	0.000	0.247	0.246	0.033	0.033	0.049	0.000	0.000
WLAC-1	SNB-WL-C1P	0.92	0.001	-0.159	-0.159	-0.159	-0.010	-0.010	-0.033	0.001	0.001
WLAC-1	SNB-WL-C2P	0.92	0.001	-0.158	-0.158	-0.158	-0.010	-0.010	-0.033	0.001	0.001
WLAC-1	SNB-WL-C3P	1.05	0.320	0.000	0.320	0.319	0.023	0.022	0.068	0.001	0.001
WLAC-1	SNB-WL-D1P	1.66	0.002	-0.222	-0.222	-0.222	-0.008	-0.008	-0.048	0.002	0.001
WLAC-1	SNB-WL-D2P	1.66	0.002	-0.222	-0.222	-0.222	-0.008	-0.008	-0.048	0.002	0.001
WLAC-1	SNB-WL-D3P	1.47	0.447	0.000	0.447	0.446	0.021	0.020	0.099	0.001	0.001
WLAC-2	SNB-WL-E1P	0.98	0.002	-0.228	-0.228	-0.228	-0.006	-0.007	-0.049	0.002	0.001
WLAC-2	SNB-WL-E2P	0.99	0.002	-0.228	-0.228	-0.228	-0.006	-0.007	-0.049	0.002	0.001
WLAC-2	SNB-WL-E3P	0.97	0.460	0.000	0.460	0.459	0.018	0.018	0.102	0.002	0.001
WLAC-2	SNB-WL-F1P	1.29	0.002	-0.240	-0.240	-0.240	-0.008	-0.008	-0.052	0.002	0.001
WLAC-2	SNB-WL-F2P	1.29	0.002	-0.239	-0.239	-0.239	-0.008	-0.008	-0.052	0.002	0.001
WLAC-2	SNB-WL-F3P	1.02	0.480	0.000	0.480	0.479	0.020	0.020	0.108	0.002	0.001
WLAC-2	SNB-WL-G1P	2.11	0.000	-0.309	-0.309	-0.309	-0.009	-0.009	-0.070	0.000	0.000
WLAC-2	SNB-WL-G2P	2.10	0.000	-0.308	-0.308	-0.308	-0.009	-0.009	-0.069	0.000	0.000
WLAC-2	SNB-WL-G3P	1.30	0.615	0.000	0.615	0.615	0.019	0.019	0.140	0.000	0.000
WLAC-2	SNB-WL-H1P	2.72	0.000	-0.323	-0.323	-0.323	-0.006	-0.006	-0.073	0.000	0.000
WLAC-2	SNB-WL-H2P	2.72	0.000	-0.323	-0.323	-0.323	-0.006	-0.006	-0.073	0.000	0.000
WLAC-2	SNB-WL-H3P	1.36	0.645	0.000	0.645	0.644	0.013	0.013	0.146	0.000	0.000

WLAC-2	SNB-WL-I1P	3.50	0.000	-0.343	-0.343	-0.343	-0.004	-0.004	-0.077	0.000	0.000
WLAC-2	SNB-WL-I2P	3.50	0.000	-0.343	-0.343	-0.343	-0.004	-0.004	-0.077	0.000	0.000
WLAC-2	SNB-WL-I3P	1.45	0.686	0.000	0.686	0.685	0.008	0.008	0.155	0.000	0.000

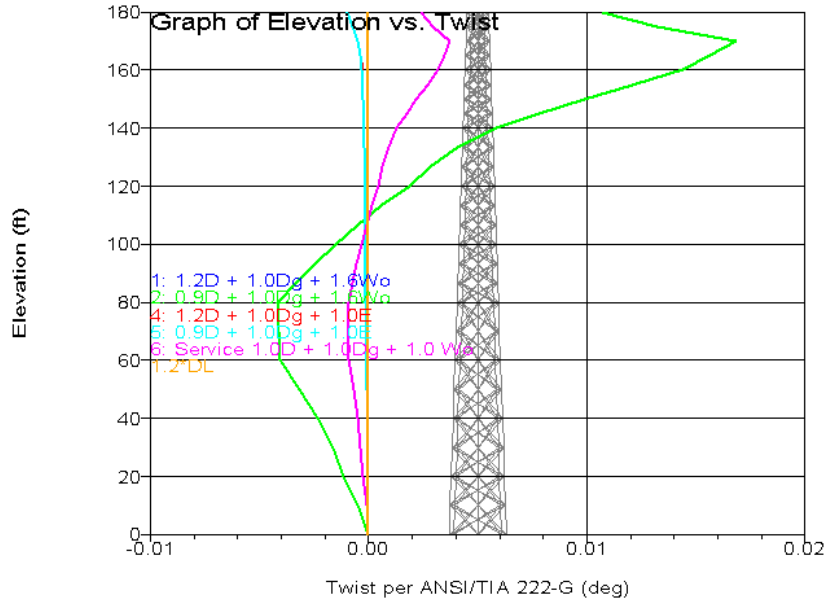

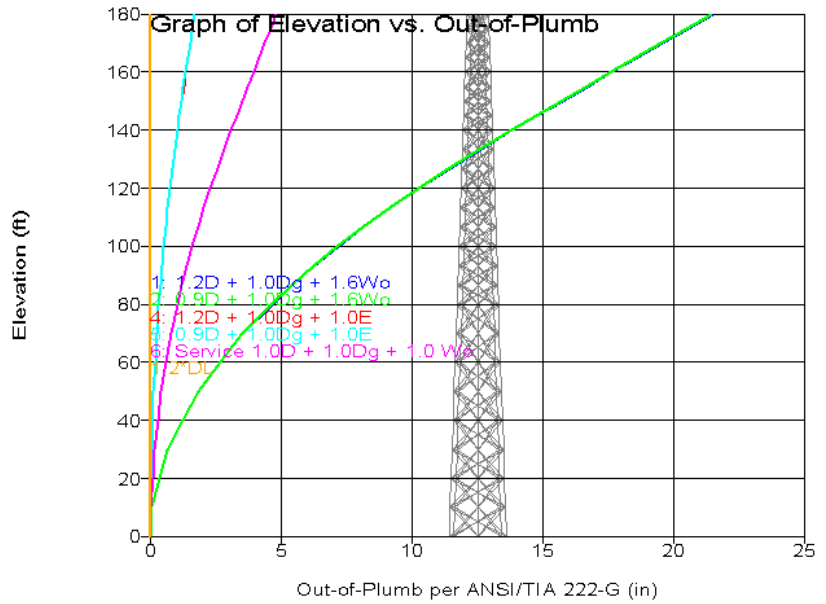
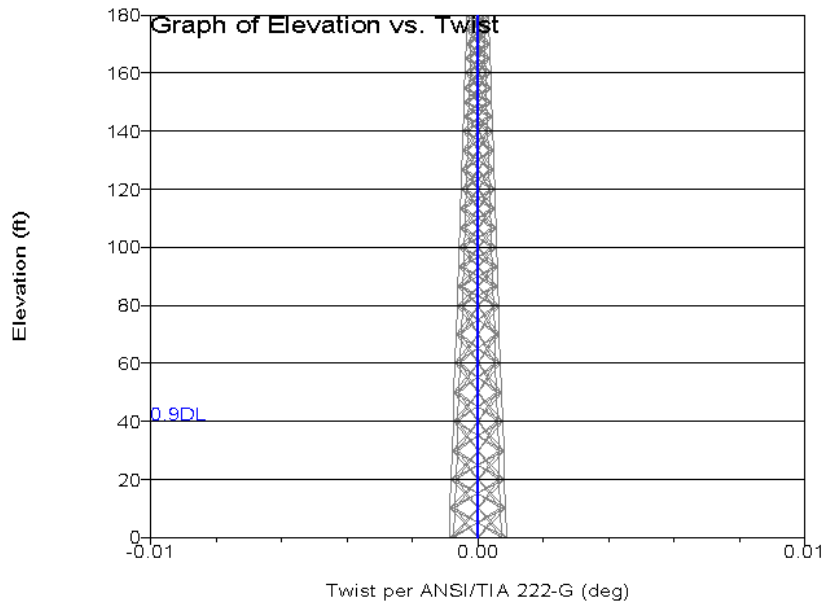

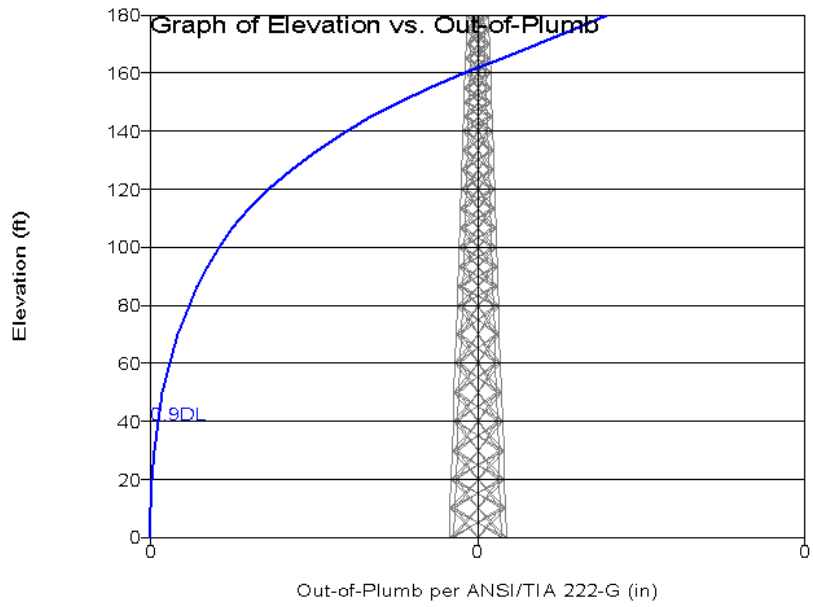

Twist and Out-of-Plumb for "1: 1.2D + 1.0Dg + 1.6Wo":

Elevation (ft)	Twist (deg)	Sway (deg)	Out of Plumb (in)
0.00	0.00	0.00	0.00
10.00	-0.00	0.05	0.06
20.00	-0.00	0.12	0.34
30.00	-0.00	0.16	0.64
40.00	-0.00	0.25	1.21
50.00	-0.00	0.31	1.82
60.00	-0.00	0.38	2.65
70.00	-0.00	0.43	3.52
80.00	-0.00	0.51	4.62
86.66	-0.00	0.56	5.40
93.34	-0.00	0.60	6.25
100.00	-0.00	0.64	7.16
106.66	-0.00	0.69	8.10
113.34	0.00	0.75	9.16
120.00	0.00	0.78	10.25
126.66	0.00	0.83	11.41
133.34	0.00	0.85	12.61
140.00	0.01	0.87	13.81
145.00	0.01	0.90	14.75
150.00	0.01	0.91	15.72
155.00	0.01	0.90	16.66
160.00	0.01	0.92	17.62
165.00	0.02	0.92	18.58
170.00	0.02	0.92	19.55
175.00	0.01	0.92	20.52
180.00	0.01	0.92	21.48

Twist and Out-of-Plumb for "2: 0.9D + 1.0Dg + 1.6Wo":

Elevation (ft)	Twist (deg)	Sway (deg)	Out of Plumb (in)
0.00	0.00	0.00	0.00
10.00	-0.00	0.05	0.06
20.00	-0.00	0.12	0.34
30.00	-0.00	0.16	0.64
40.00	-0.00	0.25	1.21
50.00	-0.00	0.30	1.82
60.00	-0.00	0.38	2.65
70.00	-0.00	0.43	3.52
80.00	-0.00	0.51	4.62
86.66	-0.00	0.56	5.39
93.34	-0.00	0.60	6.24
100.00	-0.00	0.64	7.14
106.66	-0.00	0.69	8.09
113.34	0.00	0.75	9.15
120.00	0.00	0.78	10.23
126.66	0.00	0.82	11.39
133.34	0.00	0.85	12.58
140.00	0.01	0.87	13.79
145.00	0.01	0.89	14.72
150.00	0.01	0.91	15.69
155.00	0.01	0.90	16.62
160.00	0.01	0.92	17.59
165.00	0.02	0.91	18.54
170.00	0.02	0.92	19.51
175.00	0.01	0.92	20.47
180.00	0.01	0.92	21.44

Twist and Out-of-Plumb for "4: 1.2D + 1.0Dg + 1.0E":

Elevation (ft)	Twist (deg)	Sway (deg)	Out of Plumb (in)
0.00	0.00	0.00	0.00
10.00	-0.00	0.00	0.00
20.00	-0.00	0.01	0.02
30.00	-0.00	0.01	0.04
40.00	-0.00	0.02	0.08
50.00	-0.00	0.02	0.12
60.00	-0.00	0.03	0.17
70.00	-0.00	0.03	0.23
80.00	-0.00	0.04	0.31
86.66	-0.00	0.04	0.37
93.34	-0.00	0.04	0.43
100.00	-0.00	0.05	0.50
106.66	-0.00	0.05	0.57
113.34	-0.00	0.06	0.65
120.00	-0.00	0.06	0.73
126.66	-0.00	0.07	0.82
133.34	-0.00	0.07	0.92
140.00	-0.00	0.07	1.02
145.00	-0.00	0.08	1.10
150.00	-0.00	0.08	1.18
155.00	-0.00	0.08	1.26
160.00	-0.00	0.08	1.35
165.00	-0.00	0.08	1.43
170.00	-0.00	0.08	1.51
175.00	-0.00	0.08	1.60
180.00	-0.00	0.08	1.68

Twist and Out-of-Plumb for "5: 0.9D + 1.0Dg + 1.0E":

Elevation (ft)	Twist (deg)	Sway (deg)	Out of Plumb (in)
0.00	0.00	0.00	0.00
10.00	-0.00	0.00	0.00
20.00	-0.00	0.01	0.02
30.00	-0.00	0.01	0.04
40.00	-0.00	0.02	0.08
50.00	-0.00	0.02	0.12
60.00	-0.00	0.03	0.17
70.00	-0.00	0.03	0.23
80.00	-0.00	0.04	0.31
86.66	-0.00	0.04	0.37
93.34	-0.00	0.04	0.43
100.00	-0.00	0.05	0.49
106.66	-0.00	0.05	0.56
113.34	-0.00	0.06	0.64
120.00	-0.00	0.06	0.73
126.66	-0.00	0.07	0.82
133.34	-0.00	0.07	0.92
140.00	-0.00	0.07	1.02
145.00	-0.00	0.07	1.10
150.00	-0.00	0.08	1.18
155.00	-0.00	0.08	1.26
160.00	-0.00	0.08	1.34
165.00	-0.00	0.08	1.42
170.00	-0.00	0.08	1.51
175.00	-0.00	0.08	1.59
180.00	-0.00	0.08	1.68

Twist and Out-of-Plumb for "6: Service 1.0D + 1.0Dg + 1.0 Wo":

Elevation (ft)	Twist (deg)	Sway (deg)	Out of Plumb (in)
0.00	0.00	0.00	0.00
10.00	-0.00	0.01	0.01
20.00	-0.00	0.03	0.08
30.00	-0.00	0.04	0.14
40.00	-0.00	0.06	0.27
50.00	-0.00	0.07	0.41
60.00	-0.00	0.09	0.59
70.00	-0.00	0.10	0.79
80.00	-0.00	0.11	1.03
86.66	-0.00	0.13	1.21
93.34	-0.00	0.13	1.39
100.00	-0.00	0.14	1.60
106.66	-0.00	0.15	1.81
113.34	0.00	0.17	2.05
120.00	0.00	0.17	2.29
126.66	0.00	0.18	2.55
133.34	0.00	0.19	2.81
140.00	0.00	0.19	3.08
145.00	0.00	0.20	3.29
150.00	0.00	0.20	3.51
155.00	0.00	0.20	3.72
160.00	0.00	0.21	3.93
165.00	0.00	0.20	4.15
170.00	0.00	0.21	4.37
175.00	0.00	0.21	4.58
180.00	0.00	0.21	4.80

Twist and Out-of-Plumb for "1.2*DL":

Elevation (ft)	Twist (deg)	Sway (deg)	Out of Plumb (in)
0.00	0.00	0.00	0.00
10.00	-0.00	0.00	0.00
20.00	-0.00	-0.00	0.00
30.00	-0.00	0.00	0.00
40.00	-0.00	-0.00	0.00
50.00	-0.00	0.00	0.00
60.00	-0.00	-0.00	0.00
70.00	0.00	0.00	0.00
80.00	0.00	-0.00	0.00
86.66	0.00	0.00	0.00
93.34	0.00	0.00	0.00
100.00	0.00	0.00	0.00
106.66	0.00	0.00	0.00
113.34	0.00	0.00	0.00
120.00	0.00	0.00	0.00
126.66	0.00	0.00	0.01
133.34	0.00	0.00	0.01
140.00	0.00	0.00	0.01
145.00	0.00	0.00	0.01
150.00	0.00	0.00	0.01
155.00	0.00	0.00	0.01
160.00	0.00	0.00	0.01
165.00	0.00	0.00	0.01
170.00	0.00	0.00	0.02
175.00	0.00	0.00	0.02
180.00	-0.00	0.00	0.02

Twist and Out-of-Plumb for "0.9DL":

Elevation (ft)	Twist (deg)	Sway (deg)	Out of Plumb (in)
0.00	0.00	0.00	0.00
10.00	-0.00	0.00	0.00
20.00	-0.00	-0.00	0.00
30.00	-0.00	0.00	0.00
40.00	-0.00	-0.00	0.00
50.00	-0.00	0.00	0.00
60.00	-0.00	-0.00	0.00
70.00	0.00	0.00	0.00
80.00	0.00	-0.00	0.00
86.66	0.00	0.00	0.00
93.34	0.00	0.00	0.00
100.00	0.00	0.00	0.00
106.66	0.00	0.00	0.00
113.34	0.00	0.00	0.00
120.00	0.00	0.00	0.00
126.66	0.00	0.00	0.00
133.34	0.00	0.00	0.01
140.00	0.00	0.00	0.01
145.00	0.00	0.00	0.01
150.00	0.00	0.00	0.01
155.00	0.00	0.00	0.01
160.00	0.00	0.00	0.01
165.00	0.00	0.00	0.01
170.00	0.00	0.00	0.01
175.00	0.00	0.00	0.01
180.00	-0.00	0.00	0.01

Equilibrium Joint Positions and Rotations for Load Case "1: 1.2D + 1.0Dg + 1.6Wo":

Joint Label	X-Displ (ft)	Y-Displ (ft)	Z-Displ (ft)	X-Rot (deg)	Y-Rot (deg)	Z-Rot (deg)	X-Pos (ft)	Y-Pos (ft)	Z-Pos (ft)
RohnAP	1.789	-0.0008485	-0.08948	0.0062	0.9185	0.0109	6.122	-0.0008485	179.9
RohnBP	1.468	-4.892e-005	-0.0981	-0.0012	0.9165	0.0107	6.589	-4.892e-005	159.9
RohnCP	1.151	-0.0003176	-0.1026	-0.0007	0.8834	0.0071	7.06	-0.0003176	139.9
RohnDP	0.8548	-0.0004246	-0.1018	-0.0002	0.8028	0.0047	7.55	-0.0004246	119.9
RohnEP	0.596	-0.0005783	-0.09127	-0.0005	0.6622	0.0032	8.077	-0.0005783	99.91
RohnFP	0.3859	-0.0007472	-0.07917	-0.0004	0.5253	0.0020	8.654	-0.0007472	79.92
RohnGP	0.2212	-0.0006766	-0.06367	0.0006	0.3996	0.0014	9.276	-0.0006766	59.94
RohnHP	0.1016	-0.0004485	-0.04581	0.0010	0.2743	0.0009	9.943	-0.0004485	39.95
RohnIP	0.02873	-0.0002241	-0.02253	0.0006	0.1250	0.0003	10.66	-0.0002241	19.98
RohnJP	0	0	0	0.0000	0.0000	0.0000	11.42	0	0
SNB-AP	1.789	-0.001691	-0.05318	0.0020	0.9134	-0.0000	4.122	-0.001691	179.9
SNB-BP	1.468	-0.001288	-0.06255	0.0009	0.9096	-0.0000	4.589	-0.001288	159.9
SNB-CP	1.151	-0.0009147	-0.06969	0.0010	0.8764	0.0000	5.059	-0.0009147	139.9
SNB-DP	0.855	-0.0006052	-0.07209	0.0008	0.7912	-0.0000	5.55	-0.0006052	119.9
SNB-EP	0.5962	-0.0003839	-0.06636	0.0006	0.6467	-0.0000	6.077	-0.0003839	99.93
SNB-FP	0.386	-0.0002356	-0.0614	0.0004	0.5244	0.0000	6.654	-0.0002356	79.94
SNB-GP	0.2212	-0.0001298	-0.05071	0.0002	0.3801	0.0000	7.276	-0.0001298	59.95
SNB-HP	0.1017	-5.559e-005	-0.0376	0.0002	0.2646	0.0000	7.943	-5.559e-005	39.96
SNB-IP	0.02874	-1.468e-005	-0.01905	0.0001	0.1207	0.0000	8.657	-1.468e-005	19.98
SNB-JP	0	0	0	0.0000	0.0000	0.0000	9.415	0	0
RohnA1	1.791	-0.002134	0.01395	0.0009	0.9214	0.0039	-0.3759	-3.755	180
RohnA2	1.789	-0.002045	0.0141	0.0007	0.9204	0.0176	-0.3773	3.75	180
RohnB1	1.47	-0.001967	0.02238	0.0060	0.9231	-0.0005	-1.091	-4.437	160
RohnB2	1.467	-0.001918	0.02259	-0.0016	0.9212	0.0221	-1.093	4.433	160
RohnC1	1.152	-0.000917	0.02921	-0.0013	0.8782	-0.0094	-1.803	-5.118	140
RohnC2	1.151	-0.001524	0.0294	0.0059	0.8747	0.0235	-1.804	5.116	140
RohnD1	0.8549	-0.0001477	0.03335	-0.0019	0.7991	-0.0137	-2.493	-5.798	120
RohnD2	0.8545	-0.001306	0.03352	0.0051	0.7967	0.0230	-2.493	5.797	120
RohnE1	0.5962	-0.0001314	0.03267	-0.0002	0.6613	-0.0134	-3.144	-6.479	100
RohnE2	0.5966	-0.0004369	0.03278	0.0027	0.6588	0.0197	-3.144	6.478	100
RohnF1	0.385	0.0005631	0.03011	0.0109	0.5481	-0.0132	-3.749	-7.16	80.03
RohnF2	0.3861	-0.0003937	0.03018	-0.0095	0.5470	0.0172	-3.748	7.16	80.03
RohnG1	0.2205	0.0003877	0.02519	0.0033	0.4061	-0.0100	-4.307	-7.841	60.03
RohnG2	0.2217	3.042e-005	0.02524	-0.0030	0.4064	0.0128	-4.306	7.842	60.03
RohnH1	0.1009	0.0004299	0.01863	0.0032	0.2808	-0.0074	-4.82	-8.522	40.02
RohnH2	0.1016	-0.0001411	0.01866	-0.0034	0.2816	0.0091	-4.819	8.522	40.02
RohnI1	0.02842	0.0001904	0.009291	0.0059	0.1384	-0.0042	-5.287	-9.206	20.01
RohnI2	0.02878	-1.053e-005	0.00931	-0.0063	0.1392	0.0047	-5.286	9.206	20.01
RohnJ1	0	0	0	0.0000	0.0000	0.0000	-5.71	-9.89	0
RohnJ2	0	0	0	0.0000	0.0000	0.0000	-5.71	9.89	0
SNB-A1	1.79	-0.001696	0.002984	-0.0043	0.9253	-0.0019	0.6232	-2.022	180
SNB-A2	1.79	-0.001689	0.003065	0.0063	0.9247	0.0020	0.6232	2.019	180
SNB-B1	1.469	-0.001297	0.01169	-0.0008	0.9187	-0.0022	-0.09198	-2.704	160
SNB-B2	1.469	-0.001283	0.0118	0.0031	0.9189	0.0024	-0.09199	2.702	160
SNB-C1	1.152	-0.0009084	0.01934	-0.0013	0.8865	-0.0030	-0.8023	-3.385	140
SNB-C2	1.152	-0.0009273	0.01945	0.0033	0.8865	0.0030	-0.8023	3.383	140
SNB-D1	0.8555	-0.00052	0.02437	-0.0038	0.8071	-0.0052	-1.492	-4.067	120
SNB-D2	0.8555	-0.0006917	0.02448	0.0053	0.8071	0.0052	-1.492	4.065	120
SNB-E1	0.5965	-0.0002912	0.02492	-0.0020	0.6569	-0.0041	-2.144	-4.747	100
SNB-E2	0.5965	-0.0004751	0.025	0.0030	0.6568	0.0041	-2.144	4.746	100
SNB-F1	0.3862	-0.0001462	0.02475	0.0027	0.5515	-0.0040	-2.748	-5.428	80.02
SNB-F2	0.3862	-0.00033	0.02482	-0.0020	0.5514	0.0039	-2.748	5.428	80.02
SNB-G1	0.2212	1.735e-005	0.02132	0.0007	0.4108	-0.0048	-3.306	-6.11	60.02
SNB-G2	0.2212	-0.0002826	0.02138	-0.0002	0.4108	0.0048	-3.306	6.11	60.02
SNB-H1	0.1014	0.0001461	0.01625	-0.0045	0.2826	-0.0047	-3.819	-6.79	40.02
SNB-H2	0.1014	-0.0002573	0.01629	0.0048	0.2825	0.0047	-3.819	6.79	40.02
SNB-I1	0.02831	0.0002523	0.008359	0.0016	0.1445	-0.0044	-4.286	-7.472	20.01
SNB-I2	0.02831	-0.0002807	0.008378	-0.0014	0.1445	0.0044	-4.286	7.472	20.01
SNB-J1	0	0	0	0.0000	0.0000	0.0000	-4.708	-8.154	0
SNB-J2	0	0	0	0.0000	0.0000	0.0000	-4.708	8.154	0

RohnAaS	1.709	-0.0004164	-0.09192	0.0014	0.9229	0.0108	6.239	-0.0004164	174.9
RohnAbS	1.628	-0.0003847	-0.0942	0.0027	0.9213	0.0108	6.355	-0.0003847	169.9
RohnAcS	1.548	4.293e-005	-0.09627	0.0021	0.9188	0.0108	6.472	4.293e-005	164.9
RohnBaS	1.388	-6.137e-005	-0.09976	-0.0003	0.9151	0.0098	6.706	-6.137e-005	154.9
RohnBbS	1.308	-0.0001477	-0.1011	-0.0010	0.9086	0.0089	6.823	-0.0001477	149.9
RohnBcS	1.229	-0.0002236	-0.1021	-0.0010	0.9019	0.0080	6.941	-0.0002236	144.9
RohnCaS	1.05	-0.0003454	-0.1032	-0.0002	0.8587	0.0063	7.22	-0.0003454	133.2
RohnCbS	0.9506	-0.0003791	-0.103	-0.0004	0.8386	0.0055	7.384	-0.0003791	126.6
RohnDaS	0.7636	-0.0004423	-0.09949	-0.0004	0.7603	0.0042	7.72	-0.0004423	113.2
RohnDbS	0.6773	-0.0005143	-0.09594	-0.0007	0.7215	0.0037	7.897	-0.0005143	106.6
RohnEaS	0.5221	-0.0006507	-0.08794	-0.0011	0.6143	0.0028	8.265	-0.0006507	93.25
RohnEbS	0.4517	-0.0007636	-0.0839	-0.0003	0.5898	0.0024	8.458	-0.0007636	86.58
RohnFaS	0.2997	-0.0008415	-0.07215	0.0002	0.4739	0.0017	8.961	-0.0008415	69.93
RohnGaS	0.158	-0.0006322	-0.05533	0.0005	0.3419	0.0011	9.606	-0.0006322	49.94
RohnHaS	0.06125	-0.0003231	-0.03479	0.0005	0.2095	0.0006	10.3	-0.0003231	29.97
RohnIaS	0.01097	-0.0001035	-0.0117	0.0008	0.0883	0.0002	11.04	-0.0001035	9.988
SNB-AaS	1.709	-0.001547	-0.05566	0.0005	0.9244	-0.0001	4.239	-0.001547	174.9
SNB-AbS	1.628	-0.001546	-0.05809	0.0012	0.9205	-0.0000	4.355	-0.001546	169.9
SNB-AcS	1.548	-0.001344	-0.06039	0.0017	0.9209	-0.0000	4.472	-0.001344	164.9
SNB-BaS	1.388	-0.001187	-0.06465	0.0012	0.9173	-0.0000	4.706	-0.001187	154.9
SNB-BbS	1.308	-0.001097	-0.06657	0.0010	0.9078	0.0000	4.823	-0.001097	149.9
SNB-BcS	1.229	-0.001001	-0.06825	0.0011	0.9043	0.0000	4.941	-0.001001	144.9
SNB-CaS	1.05	-0.0008039	-0.07112	0.0009	0.8602	0.0000	5.22	-0.0008039	133.3
SNB-CbS	0.9508	-0.0006987	-0.07191	0.0008	0.8417	0.0000	5.384	-0.0006987	126.6
SNB-DaS	0.7638	-0.0005161	-0.07117	0.0007	0.7629	-0.0000	5.721	-0.0005161	113.3
SNB-DbS	0.6775	-0.0004484	-0.0692	0.0005	0.7256	-0.0000	5.897	-0.0004484	106.6
SNB-EaS	0.5222	-0.0003212	-0.06537	0.0004	0.6193	0.0000	6.265	-0.0003212	93.27
SNB-EbS	0.4518	-0.0002829	-0.06367	0.0004	0.5899	0.0000	6.458	-0.0002829	86.6
SNB-FaS	0.2997	-0.0001816	-0.05668	0.0003	0.4798	0.0000	6.961	-0.0001816	69.94
SNB-GaS	0.158	-9.14e-005	-0.04475	0.0002	0.3499	0.0000	7.606	-9.14e-005	49.96
SNB-HaS	0.06126	-2.919e-005	-0.02893	0.0001	0.2137	0.0000	8.296	-2.919e-005	29.97
SNB-IaS	0.01097	-1.793e-006	-0.01008	0.0000	0.0898	0.0000	9.032	-1.793e-006	9.99
SNB-WL-A1S	1.79	-0.001701	-0.02528	-0.0011	0.9191	-0.0040	2.373	-1.012	180
SNB-WL-A2S	1.79	-0.001693	0.002863	0.0008	0.9250	0.0001	0.6233	-0.001693	180
SNB-WL-A3S	1.79	-0.001681	-0.02523	0.0042	0.9191	0.0040	2.373	1.009	180
SNB-WL-B1S	1.468	-0.001299	-0.02569	0.0031	0.9087	-0.0041	2.248	-1.353	160
SNB-WL-B2S	1.469	-0.00129	0.01154	0.0012	0.9188	0.0001	-0.09195	-0.00129	160
SNB-WL-B3S	1.468	-0.001275	-0.02564	-0.0011	0.9088	0.0042	2.248	1.35	160
SNB-WL-C1S	1.151	-0.000936	-0.02568	0.0068	0.8693	-0.0039	2.128	-1.693	140
SNB-WL-C2S	1.152	-0.0009179	0.01897	0.0010	0.8865	0.0000	-0.8022	-0.0009179	140
SNB-WL-C3S	1.151	-0.0008963	-0.02562	-0.0049	0.8692	0.0040	2.128	1.691	140
SNB-WL-D1S	0.8553	-0.0006384	-0.02498	0.0081	0.7825	-0.0040	2.029	-2.034	120
SNB-WL-D2S	0.8557	-0.0006059	0.02342	0.0008	0.8071	0.0000	-1.492	-0.0006059	120
SNB-WL-D3S	0.8553	-0.0005717	-0.02492	-0.0065	0.7825	0.0040	2.029	2.032	120
SNB-WL-E1S	0.5964	-0.0004093	-0.02151	0.0096	0.6340	-0.0029	1.967	-2.374	99.98
SNB-WL-E2S	0.5967	-0.0003831	0.02427	0.0005	0.6569	-0.0000	-2.144	-0.0003831	100
SNB-WL-E3S	0.5964	-0.0003577	-0.02147	-0.0085	0.6340	0.0029	1.967	2.373	99.98
SNB-WL-F1S	0.3861	-0.0002697	-0.02003	0.0090	0.5249	-0.0020	1.953	-2.714	79.98
SNB-WL-F2S	0.3864	-0.0002381	0.02371	0.0004	0.5514	-0.0000	-2.748	-0.0002381	80.02
SNB-WL-F3S	0.3861	-0.0002082	-0.02	-0.0083	0.5249	0.0020	1.953	2.714	79.98
SNB-WL-G1S	0.2213	-0.0001779	-0.01767	0.0037	0.3899	-0.0015	1.985	-3.055	59.98
SNB-WL-G2S	0.2215	-0.0001326	0.01908	0.0002	0.4108	-0.0000	-3.306	-0.0001326	60.02
SNB-WL-G3S	0.2213	-8.91e-005	-0.01765	-0.0032	0.3899	0.0015	1.985	3.055	59.98
SNB-WL-H1S	0.1016	-0.000108	-0.01469	0.0059	0.2596	-0.0014	2.062	-3.395	39.99
SNB-WL-H2S	0.1018	-5.559e-005	0.01246	0.0002	0.2826	-0.0000	-3.819	-5.559e-005	40.01
SNB-WL-H3S	0.1016	-4.614e-006	-0.01467	-0.0055	0.2596	0.0014	2.062	3.395	39.99
SNB-WL-I1S	0.02865	-7.51e-005	-0.01093	0.0078	0.1205	-0.0017	2.186	-3.736	19.99
SNB-WL-I2S	0.02877	-1.421e-005	0.003439	0.0001	0.1445	-0.0000	-4.285	-1.421e-005	20
SNB-WL-I3S	0.02865	4.588e-005	-0.01092	-0.0077	0.1205	0.0016	2.186	3.736	19.99
RohnAa1	1.71	-0.0022	0.01618	-0.0016	0.9145	0.0032	-0.5546	-3.925	175
RohnAa2	1.709	-0.002008	0.01633	-0.0003	0.9242	0.0188	-0.5563	3.921	175
RohnAb1	1.631	-0.002332	0.01832	0.0030	0.9242	0.0017	-0.7329	-4.096	170
RohnAb2	1.628	-0.002121	0.01852	-0.0018	0.9266	0.0201	-0.7356	4.092	170
RohnAc1	1.55	-0.001962	0.02041	0.0019	0.9207	0.0008	-0.9125	-4.266	165
RohnAc2	1.547	-0.00216	0.02061	0.0027	0.9160	0.0207	-0.9147	4.262	165
RohnBa1	1.389	-0.001517	0.02432	-0.0007	0.9107	-0.0025	-1.27	-4.607	155
RohnBa2	1.387	-0.001992	0.02452	0.0065	0.9058	0.0221	-1.272	4.604	155
RohnBb1	1.31	-0.001982	0.02609	0.0026	0.9100	-0.0052	-1.447	-4.778	150
RohnBb2	1.309	-0.001164	0.02629	0.0026	0.9063	0.0231	-1.449	4.775	150

RohnBc1	1.23	-0.001112	0.02778	0.0101	0.9162	-0.0084	-1.626	-4.948	145
RohnBc2	1.229	-0.001678	0.02797	-0.0049	0.9120	0.0244	-1.627	4.945	145
RohnCa1	1.051	-0.001114	0.03096	0.0008	0.8609	-0.0112	-2.034	-5.345	133.4
RohnCa2	1.05	-0.000933	0.03113	0.0030	0.8581	0.0237	-2.035	5.343	133.4
RohnCb1	0.9511	-0.0006891	0.03239	0.0073	0.8471	-0.0133	-2.265	-5.572	126.7
RohnCb2	0.9506	-0.001034	0.03256	-0.0043	0.8458	0.0243	-2.266	5.57	126.7
RohnDa1	0.7638	-0.0004064	0.03373	0.0064	0.7737	-0.0145	-2.715	-6.025	113.4
RohnDa2	0.7637	-0.0007076	0.03387	-0.0033	0.7709	0.0228	-2.715	6.024	113.4
RohnDb1	0.6757	0.0007049	0.03355	0.0012	0.7193	-0.0140	-2.934	-6.251	106.7
RohnDb2	0.6758	-0.001537	0.03368	0.0014	0.7173	0.0213	-2.934	6.251	106.7
RohnEa1	0.5207	0.0006547	0.03222	0.0076	0.6290	-0.0137	-3.351	-6.705	93.37
RohnEa2	0.5213	-0.0009763	0.03232	-0.0055	0.6272	0.0192	-3.35	6.705	93.37
RohnEb1	0.4503	0.0007638	0.03137	-0.0043	0.5786	-0.0127	-3.553	-6.933	86.69
RohnEb2	0.4511	-0.0008507	0.03145	0.0068	0.5756	0.0174	-3.552	6.932	86.69
RohnFa1	0.2943	0.002619	0.0281	-0.0033	0.4666	-0.0110	-4.036	-7.498	70.03
RohnFa2	0.2953	-0.002354	0.02816	0.0041	0.4663	0.0144	-4.035	7.499	70.03
RohnGa1	0.1526	0.002633	0.02226	-0.0003	0.3409	-0.0085	-4.571	-8.18	50.02
RohnGa2	0.1535	-0.002294	0.0223	-0.0001	0.3426	0.0109	-4.571	8.18	50.02
RohnHa1	0.05513	0.002962	0.0143	-0.0019	0.2056	-0.0056	-5.063	-8.861	30.01
RohnHa2	0.05564	-0.002731	0.01433	0.0016	0.2066	0.0067	-5.062	8.861	30.01
RohnIa1	0.00648	0.002092	0.004869	-0.0009	0.0864	-0.0026	-5.506	-9.546	10
RohnIa2	0.006658	-0.002	0.004879	0.0002	0.0878	0.0030	-5.506	9.546	10
SNB-Aa1	1.709	-0.001598	0.005223	0.0030	0.9197	-0.0020	0.4443	-2.193	175
SNB-Aa2	1.709	-0.001612	0.005307	-0.0003	0.9205	0.0022	0.4443	2.189	175
SNB-Ab1	1.629	-0.001472	0.007429	0.0015	0.9235	-0.0022	0.2655	-2.363	170
SNB-Ab2	1.629	-0.001483	0.007527	0.0009	0.9235	0.0024	0.2654	2.36	170
SNB-Ac1	1.548	-0.00133	0.009601	0.0017	0.9191	-0.0022	0.08638	-2.534	165
SNB-Ac2	1.548	-0.001473	0.009699	0.0004	0.9183	0.0023	0.08644	2.531	165
SNB-Ba1	1.388	-0.001102	0.01378	0.0028	0.9163	-0.0027	-0.2705	-2.874	155
SNB-Ba2	1.388	-0.001292	0.01388	-0.0007	0.9162	0.0029	-0.2705	2.872	155
SNB-Bb1	1.309	-0.0009983	0.01576	0.0019	0.9109	-0.0030	-0.4485	-3.045	150
SNB-Bb2	1.309	-0.001201	0.01587	0.0003	0.9109	0.0031	-0.4485	3.042	150
SNB-Bc1	1.23	-0.0008293	0.01762	0.0012	0.8998	-0.0030	-0.6261	-3.215	145
SNB-Bc2	1.23	-0.001185	0.01773	0.0009	0.8997	0.0031	-0.6261	3.213	145
SNB-Ca1	1.049	-0.0002802	0.02138	0.0066	0.8698	-0.0043	-1.036	-3.612	133.4
SNB-Ca2	1.049	-0.001341	0.02149	-0.0048	0.8698	0.0044	-1.036	3.61	133.4
SNB-Cb1	0.9501	-0.0001163	0.02307	-0.0013	0.8300	-0.0044	-1.266	-3.839	126.7
SNB-Cb2	0.9501	-0.001296	0.02318	0.0031	0.8300	0.0044	-1.266	3.838	126.7
SNB-Da1	0.7628	0.0001661	0.02514	0.0114	0.7793	-0.0061	-1.716	-4.292	113.4
SNB-Da2	0.7628	-0.001217	0.02524	-0.0100	0.7792	0.0061	-1.716	4.291	113.4
SNB-Db1	0.6755	0.0007833	0.02532	-0.0041	0.7114	-0.0046	-1.934	-4.519	106.7
SNB-Db2	0.6755	-0.00168	0.02541	0.0053	0.7115	0.0046	-1.934	4.518	106.7
SNB-Ea1	0.5213	0.0002888	0.02526	0.0070	0.6298	-0.0046	-2.35	-4.973	93.37
SNB-Ea2	0.5213	-0.0009416	0.02534	-0.0060	0.6299	0.0045	-2.35	4.973	93.37
SNB-Eb1	0.4508	0.0004305	0.02519	-0.0042	0.5745	-0.0035	-2.552	-5.201	86.69
SNB-Eb2	0.4508	-0.0009784	0.02526	0.0050	0.5745	0.0034	-2.552	5.2	86.69
SNB-Fa1	0.2942	0.002659	0.02345	0.0010	0.4676	-0.0040	-3.037	-5.766	70.02
SNB-Fa2	0.2942	-0.002998	0.02351	-0.0004	0.4676	0.0039	-3.037	5.766	70.02
SNB-Ga1	0.1529	0.002427	0.01915	0.0026	0.3403	-0.0047	-3.571	-6.448	50.02
SNB-Ga2	0.1529	-0.002597	0.0192	-0.0021	0.3403	0.0047	-3.571	6.448	50.02
SNB-Ha1	0.05572	0.002623	0.01266	0.0025	0.2064	-0.0045	-4.062	-7.129	30.01
SNB-Ha2	0.05572	-0.002684	0.01269	-0.0022	0.2064	0.0044	-4.062	7.129	30.01
SNB-Ia1	0.006028	0.002353	0.004474	-0.0002	0.0845	-0.0026	-4.505	-7.81	10
SNB-Ia2	0.006032	-0.002361	0.004484	0.0003	0.0845	0.0026	-4.505	7.81	10

Joint Support Reactions for Load Case "1: 1.2D + 1.0Dg + 1.6Wo":

Joint Label	X Force (kips)	X Usage %	Y Force (kips)	Y Usage %	Z Force (kips)	Z Usage %	Comp. Usage %	Uplift Usage %	Result. Force (kips)	Result. Usage %	X Moment (ft-k)	X-M. Usage %	Y Moment (ft-k)	Y-M. Usage %	Z Moment (ft-k)	Z-M. Usage %	Max. Usage %
RohnJP	-29.67	0.0	0.11	0.0	355.57	0.0	0.0	0.0	356.80	0.0	-0.06	0.0	-5.6	0.0	-0.01	0.0	0.0
SNB-JP	-51.25	0.0	0.00	0.0	512.04	0.0	0.0	0.0	514.60	0.0	0.00	0.0	-13.5	0.0	0.00	0.0	0.0
RohnJ1	-9.49	0.0	-10.04	0.0	-147.95	0.0	0.0	0.0	148.59	0.0	1.91	0.0	-1.4	0.0	0.00	0.0	0.0
RohnJ2	-9.70	0.0	9.95	0.0	-148.25	0.0	0.0	0.0	148.90	0.0	-1.86	0.0	-1.5	0.0	-0.01	0.0	0.0
SNB-J1	-17.54	0.0	-18.77	0.0	-227.91	0.0	0.0	0.0	229.35	0.0	5.44	0.0	-2.7	0.0	-0.03	0.0	0.0
SNB-J2	-17.56	0.0	18.80	0.0	-228.39	0.0	0.0	0.0	229.83	0.0	-5.44	0.0	-2.7	0.0	0.03	0.0	0.0

Joint Displacements, Loads and Member Forces on Joints for Load Case "1: 1.2D + 1.0Dg + 1.6Wo":

Joint Label	X External Load (kips)	Y External Load (kips)	Z External Load (kips)	X Member Force (kips)	Y Member Force (kips)	Z Member Force (kips)	X Disp. (ft)	Y Disp. (ft)	Z Disp. (ft)
RohnAP	0.6457	0.0000	-0.3561	-0.6457	-0.0000	0.3561	1.7889	-0.0008	-0.0895
RohnBP	3.0386	0.0000	-1.2758	-3.0386	-0.0000	1.2758	1.4676	-0.0000	-0.0981
RohnCP	0.6587	0.0000	-0.5163	-0.6587	0.0000	0.5163	1.1508	-0.0003	-0.1026
RohnDP	0.7996	0.0000	-0.6254	-0.7996	0.0000	0.6254	0.8548	-0.0004	-0.1018
RohnEP	0.8293	0.0000	-0.7740	-0.8293	0.0000	0.7740	0.5960	-0.0006	-0.0913
RohnFP	0.9670	0.0000	-1.0489	-0.9670	-0.0000	1.0489	0.3859	-0.0007	-0.0792
RohnGP	1.3744	0.0000	-1.3961	-1.3744	-0.0000	1.3961	0.2212	-0.0007	-0.0637
RohnHP	1.1981	0.0000	-1.3896	-1.1981	-0.0000	1.3896	0.1016	-0.0004	-0.0458
RohnIP	1.4581	0.0000	-1.5585	-1.4581	-0.0000	1.5585	0.0287	-0.0002	-0.0225
RohnJP	0.8371	0.0000	-0.8421	28.8289	-0.1081	-354.7247	0.0000	0.0000	0.0000
SNB-AP	0.1887	0.0000	-0.1881	-0.1887	0.0000	0.1881	1.7893	-0.0017	-0.0532
SNB-BP	0.4544	0.0000	-0.4070	-0.4544	0.0000	0.4070	1.4679	-0.0013	-0.0625
SNB-CP	0.6587	0.0000	-0.5163	-0.6587	0.0000	0.5163	1.1511	-0.0009	-0.0697
SNB-DP	0.7996	0.0000	-0.6254	-0.7996	0.0000	0.6254	0.8550	-0.0006	-0.0721
SNB-EP	0.8293	0.0000	-0.7740	-0.8293	0.0000	0.7740	0.5962	-0.0004	-0.0664
SNB-FP	0.9670	0.0000	-1.0489	-0.9670	0.0000	1.0489	0.3860	-0.0002	-0.0614
SNB-GP	1.1214	0.0000	-1.2761	-1.1214	0.0000	1.2761	0.2212	-0.0001	-0.0507
SNB-HP	1.1981	0.0000	-1.3896	-1.1981	0.0000	1.3896	0.1017	-0.0001	-0.0376
SNB-IP	1.4581	0.0000	-1.5585	-1.4581	0.0000	1.5585	0.0287	-0.0000	-0.0190
SNB-JP	0.8371	0.0000	-0.8421	50.4158	-0.0019	-511.2017	0.0000	0.0000	0.0000
RohnA1	0.6457	0.0000	-0.3561	-0.6457	-0.0000	0.3561	1.7906	-0.0021	0.0140
RohnA2	1.1028	0.0000	-0.5241	-1.1028	-0.0000	0.5241	1.7892	-0.0020	0.0141
RohnB1	1.0572	0.0000	-0.5438	-1.0572	-0.0000	0.5438	1.4697	-0.0020	0.0224
RohnB2	0.7218	0.0000	-0.4658	-0.7218	-0.0000	0.4658	1.4675	-0.0019	0.0226
RohnC1	0.6587	0.0000	-0.5163	-0.6587	0.0000	0.5163	1.1518	-0.0009	0.0292
RohnC2	0.6587	0.0000	-0.5163	-0.6587	-0.0000	0.5163	1.1508	-0.0015	0.0294
RohnD1	1.0140	0.0000	-0.7094	-1.0140	0.0000	0.7094	0.8549	-0.0001	0.0334
RohnD2	0.7996	0.0000	-0.6254	-0.7996	-0.0000	0.6254	0.8545	-0.0013	0.0335
RohnE1	0.8293	0.0000	-0.7740	-0.8293	0.0000	0.7740	0.5962	-0.0001	0.0327
RohnE2	0.8293	0.0000	-0.7740	-0.8293	-0.0000	0.7740	0.5966	-0.0004	0.0328
RohnF1	0.9670	0.0000	-1.0489	-0.9670	-0.0000	1.0489	0.3850	0.0006	0.0301
RohnF2	1.4491	0.0000	-1.2229	-1.4491	-0.0000	1.2229	0.3861	-0.0004	0.0302
RohnG1	1.2624	0.0000	-1.3481	-1.2624	0.0000	1.3481	0.2205	0.0004	0.0252
RohnG2	1.7131	0.0000	-1.4633	-1.7131	-0.0000	1.4633	0.2217	0.0000	0.0252
RohnH1	1.1981	0.0000	-1.3896	-1.1981	-0.0000	1.3896	0.1009	0.0004	0.0186
RohnH2	1.1981	0.0000	-1.3896	-1.1981	0.0000	1.3896	0.1016	-0.0001	0.0187
RohnI1	1.4581	0.0000	-1.5585	-1.4581	-0.0000	1.5585	0.0284	0.0002	0.0093
RohnI2	1.4581	0.0000	-1.5585	-1.4581	0.0000	1.5585	0.0288	-0.0000	0.0093
RohnJ1	0.8371	0.0000	-0.8421	8.6546	10.0366	148.7903	0.0000	0.0000	0.0000
RohnJ2	0.8371	0.0000	-0.8421	8.8582	-9.9451	149.0914	0.0000	0.0000	0.0000
SNB-A1	0.1887	0.0000	-0.1881	-0.1887	-0.0000	0.1881	1.7897	-0.0017	0.0030
SNB-A2	0.1887	0.0000	-0.1881	-0.1887	0.0000	0.1881	1.7897	-0.0017	0.0031
SNB-B1	0.4544	0.0000	-0.4070	-0.4544	-0.0000	0.4070	1.4685	-0.0013	0.0117
SNB-B2	0.4544	0.0000	-0.4070	-0.4544	0.0000	0.4070	1.4685	-0.0013	0.0118
SNB-C1	0.6587	0.0000	-0.5163	-0.6587	-0.0000	0.5163	1.1517	-0.0009	0.0193
SNB-C2	0.6587	0.0000	-0.5163	-0.6587	0.0000	0.5163	1.1517	-0.0009	0.0195
SNB-D1	0.7996	0.0000	-0.6254	-0.7996	-0.0000	0.6254	0.8555	-0.0005	0.0244
SNB-D2	0.7996	0.0000	-0.6254	-0.7996	0.0000	0.6254	0.8555	-0.0007	0.0245
SNB-E1	0.8293	0.0000	-0.7740	-0.8293	-0.0000	0.7740	0.5965	-0.0003	0.0249
SNB-E2	0.8293	0.0000	-0.7740	-0.8293	0.0000	0.7740	0.5965	-0.0005	0.0250
SNB-F1	0.9670	0.0000	-1.0489	-0.9670	-0.0000	1.0489	0.3862	-0.0001	0.0248
SNB-F2	0.9670	0.0000	-1.0489	-0.9670	0.0000	1.0489	0.3862	-0.0003	0.0248
SNB-G1	1.1214	0.0000	-1.2761	-1.1214	-0.0000	1.2761	0.2212	0.0000	0.0213
SNB-G2	1.1214	0.0000	-1.2761	-1.1214	0.0000	1.2761	0.2212	-0.0003	0.0214
SNB-H1	1.1981	0.0000	-1.3896	-1.1981	-0.0000	1.3896	0.1014	0.0001	0.0163
SNB-H2	1.1981	0.0000	-1.3896	-1.1981	0.0000	1.3896	0.1014	-0.0003	0.0163
SNB-I1	1.4581	0.0000	-1.5585	-1.4581	-0.0000	1.5585	0.0283	0.0003	0.0084
SNB-I2	1.4581	0.0000	-1.5585	-1.4581	0.0000	1.5585	0.0283	-0.0003	0.0084
SNB-J1	0.8371	0.0000	-0.8421	16.7017	18.7729	228.7534	0.0000	0.0000	0.0000
SNB-J2	0.8371	0.0000	-0.8421	16.7203	-18.8046	229.2273	0.0000	0.0000	0.0000
RohnAaS	0.6047	0.0000	-0.2508	-0.6047	0.0000	0.2508	1.7086	-0.0004	-0.0919
RohnAbs	0.1887	0.0000	-0.1881	-0.1887	0.0000	0.1881	1.6280	-0.0004	-0.0942
RohnAcS	0.5630	0.0000	-0.2520	-0.5630	0.0000	0.2520	1.5478	0.0000	-0.0963

RohnBaS	0.2658	0.0000	-0.2189	-0.2658	0.0000	0.2189	1.3877	-0.0001	-0.0998
RohnBbS	2.2103	0.0000	-1.1599	-2.2103	0.0000	1.1599	1.3080	-0.0001	-0.1011
RohnBcS	0.2658	0.0000	-0.2189	-0.2658	0.0000	0.2189	1.2291	-0.0002	-0.1021
RohnCaS	2.0581	0.0000	-0.9601	-2.0581	0.0000	0.9601	1.0497	-0.0003	-0.1032
RohnCbS	2.9069	0.0000	-1.7009	-2.9069	0.0000	1.7009	0.9506	-0.0004	-0.1030
RohnDaS	2.9338	0.0000	-1.5215	-2.9338	0.0000	1.5215	0.7636	-0.0004	-0.0995
RohnDbS	0.4066	0.0000	-0.3280	-0.4066	0.0000	0.3280	0.6773	-0.0005	-0.0959
RohnEaS	0.4227	0.0000	-0.4460	-0.4227	-0.0000	0.4460	0.5221	-0.0007	-0.0879
RohnEbS	0.4227	0.0000	-0.4460	-0.4227	-0.0000	0.4460	0.4517	-0.0008	-0.0839
RohnFaS	0.5444	0.0000	-0.6029	-0.5444	-0.0000	0.6029	0.2997	-0.0008	-0.0722
RohnGaS	0.5770	0.0000	-0.6732	-0.5770	-0.0000	0.6732	0.1580	-0.0006	-0.0553
RohnHaS	0.6210	0.0000	-0.7165	-0.6210	-0.0000	0.7165	0.0612	-0.0003	-0.0348
RohnIaS	0.8371	0.0000	-0.8421	-0.8371	-0.0000	0.8421	0.0110	-0.0001	-0.0117
SNB-AaS	0.1887	0.0000	-0.1881	-0.1887	-0.0000	0.1881	1.7090	-0.0015	-0.0557
SNB-AbS	0.1887	0.0000	-0.1881	-0.1887	-0.0000	0.1881	1.6284	-0.0015	-0.0581
SNB-AcS	0.1887	0.0000	-0.1881	-0.1887	-0.0000	0.1881	1.5482	-0.0013	-0.0604
SNB-BaS	0.2658	0.0000	-0.2189	-0.2658	-0.0000	0.2189	1.3880	-0.0012	-0.0647
SNB-BbS	0.2658	0.0000	-0.2189	-0.2658	-0.0000	0.2189	1.3083	-0.0011	-0.0666
SNB-BcS	0.2658	0.0000	-0.2189	-0.2658	-0.0000	0.2189	1.2293	-0.0010	-0.0682
SNB-CaS	0.3930	0.0000	-0.2974	-0.3930	-0.0000	0.2974	1.0499	-0.0008	-0.0711
SNB-CbS	0.3930	0.0000	-0.2974	-0.3930	-0.0000	0.2974	0.9508	-0.0007	-0.0719
SNB-DaS	0.4066	0.0000	-0.3280	-0.4066	-0.0000	0.3280	0.7638	-0.0005	-0.0712
SNB-DbS	0.4066	0.0000	-0.3280	-0.4066	-0.0000	0.3280	0.6775	-0.0004	-0.0692
SNB-EaS	0.4227	0.0000	-0.4460	-0.4227	-0.0000	0.4460	0.5222	-0.0003	-0.0654
SNB-EbS	0.4227	0.0000	-0.4460	-0.4227	0.0000	0.4460	0.4518	-0.0003	-0.0637
SNB-FaS	0.5444	0.0000	-0.6029	-0.5444	-0.0000	0.6029	0.2997	-0.0002	-0.0567
SNB-GaS	0.5770	0.0000	-0.6732	-0.5770	-0.0000	0.6732	0.1580	-0.0001	-0.0447
SNB-HaS	0.6210	0.0000	-0.7165	-0.6210	-0.0000	0.7165	0.0613	-0.0000	-0.0289
SNB-IaS	0.8371	0.0000	-0.8421	-0.8371	-0.0000	0.8421	0.0110	-0.0000	-0.0101
SNB-WL-A1S	0.1887	0.0000	-0.1881	-0.1887	0.0000	0.1881	1.7895	-0.0017	-0.0253
SNB-WL-A2S	0.1887	0.0000	-0.1881	-0.1887	0.0000	0.1881	1.7898	-0.0017	0.0029
SNB-WL-A3S	0.1887	0.0000	-0.1881	-0.1887	-0.0000	0.1881	1.7895	-0.0017	-0.0252
SNB-WL-B1S	0.1887	0.0000	-0.1881	-0.1887	0.0000	0.1881	1.4682	-0.0013	-0.0257
SNB-WL-B2S	0.1887	0.0000	-0.1881	-0.1887	-0.0000	0.1881	1.4686	-0.0013	0.0115
SNB-WL-B3S	0.1887	0.0000	-0.1881	-0.1887	-0.0000	0.1881	1.4682	-0.0013	-0.0256
SNB-WL-C1S	0.2658	0.0000	-0.2189	-0.2658	0.0000	0.2189	1.1514	-0.0009	-0.0257
SNB-WL-C2S	0.2658	0.0000	-0.2189	-0.2658	-0.0000	0.2189	1.1518	-0.0009	0.0190
SNB-WL-C3S	0.2658	0.0000	-0.2189	-0.2658	-0.0000	0.2189	1.1514	-0.0009	-0.0256
SNB-WL-D1S	0.3930	0.0000	-0.2974	-0.3930	0.0000	0.2974	0.8553	-0.0006	-0.0250
SNB-WL-D2S	0.3930	0.0000	-0.2974	-0.3930	-0.0000	0.2974	0.8557	-0.0006	0.0234
SNB-WL-D3S	0.3930	0.0000	-0.2974	-0.3930	-0.0000	0.2974	0.8553	-0.0006	-0.0249
SNB-WL-E1S	0.4066	0.0000	-0.3280	-0.4066	0.0000	0.3280	0.5964	-0.0004	-0.0215
SNB-WL-E2S	0.4066	0.0000	-0.3280	-0.4066	-0.0000	0.3280	0.5967	-0.0004	0.0243
SNB-WL-E3S	0.4066	0.0000	-0.3280	-0.4066	-0.0000	0.3280	0.5964	-0.0004	-0.0215
SNB-WL-F1S	0.4227	0.0000	-0.4460	-0.4227	0.0000	0.4460	0.3861	-0.0003	-0.0200
SNB-WL-F2S	0.4227	0.0000	-0.4460	-0.4227	-0.0000	0.4460	0.3864	-0.0002	0.0237
SNB-WL-F3S	0.4227	0.0000	-0.4460	-0.4227	-0.0000	0.4460	0.3861	-0.0002	-0.0200
SNB-WL-G1S	0.5444	0.0000	-0.6029	-0.5444	0.0000	0.6029	0.2213	-0.0002	-0.0177
SNB-WL-G2S	0.5444	0.0000	-0.6029	-0.5444	-0.0000	0.6029	0.2215	-0.0001	0.0191
SNB-WL-G3S	0.5444	0.0000	-0.6029	-0.5444	-0.0000	0.6029	0.2213	-0.0001	-0.0176
SNB-WL-H1S	0.5770	0.0000	-0.6732	-0.5770	0.0000	0.6732	0.1016	-0.0001	-0.0147
SNB-WL-H2S	0.5770	0.0000	-0.6732	-0.5770	-0.0000	0.6732	0.1018	-0.0001	0.0125
SNB-WL-H3S	0.5770	0.0000	-0.6732	-0.5770	-0.0000	0.6732	0.1016	-0.0000	-0.0147
SNB-WL-I1S	0.6210	0.0000	-0.7165	-0.6210	0.0000	0.7165	0.0286	-0.0001	-0.0109
SNB-WL-I2S	0.6210	0.0000	-0.7165	-0.6210	-0.0000	0.7165	0.0288	-0.0000	0.0034
SNB-WL-I3S	0.6210	0.0000	-0.7165	-0.6210	-0.0000	0.7165	0.0286	0.0000	-0.0109
RohnAa1	0.4999	0.0000	-0.2763	-0.4999	0.0000	0.2763	1.7104	-0.0022	0.0162
RohnAa2	0.7903	0.0000	-0.3039	-0.7903	-0.0000	0.3039	1.7087	-0.0020	0.0163
RohnAb1	1.1180	-0.0502	-0.3321	-1.1180	0.0502	0.3321	1.6306	-0.0023	0.0183
RohnAb2	0.1887	0.0000	-0.1881	-0.1887	-0.0000	0.1881	1.6279	-0.0021	0.0185
RohnAc1	0.1887	0.0000	-0.1881	-0.1887	0.0000	0.1881	1.5495	-0.0020	0.0204
RohnAc2	0.1887	0.0000	-0.1881	-0.1887	-0.0000	0.1881	1.5473	-0.0022	0.0206
RohnBa1	0.2658	0.0000	-0.2189	-0.2658	0.0000	0.2189	1.3891	-0.0015	0.0243
RohnBa2	0.2658	0.0000	-0.2189	-0.2658	-0.0000	0.2189	1.3872	-0.0020	0.0245
RohnBb1	2.1359	0.0000	-1.1275	-2.1359	0.0000	1.1275	1.3105	-0.0020	0.0261
RohnBb2	2.1359	0.0000	-1.1275	-2.1359	-0.0000	1.1275	1.3088	-0.0012	0.0263
RohnBc1	0.2658	0.0000	-0.2189	-0.2658	0.0000	0.2189	1.2301	-0.0011	0.0278
RohnBc2	0.2658	0.0000	-0.2189	-0.2658	0.0000	0.2189	1.2287	-0.0017	0.0280
RohnCa1	2.2226	0.0000	-1.0321	-2.2226	0.0000	1.0321	1.0510	-0.0011	0.0310

RohnCa2	2.3301	0.0000	-1.0801	-2.3301	-0.0000	1.0801	1.0502	-0.0009	0.0311
RohnCb1	2.7453	0.0000	-1.6349	-2.7453	0.0000	1.6349	0.9511	-0.0007	0.0324
RohnCb2	2.7453	0.0000	-1.6349	-2.7453	-0.0000	1.6349	0.9506	-0.0010	0.0326
RohnDa1	2.6669	0.0000	-1.3955	-2.6669	0.0000	1.3955	0.7638	-0.0004	0.0337
RohnDa2	2.6669	0.0000	-1.3955	-2.6669	-0.0000	1.3955	0.7637	-0.0007	0.0339
RohnDb1	0.4066	0.0000	-0.3280	-0.4066	0.0000	0.3280	0.6757	0.0007	0.0335
RohnDb2	0.4066	0.0000	-0.3280	-0.4066	-0.0000	0.3280	0.6758	-0.0015	0.0337
RohnEa1	0.4227	0.0000	-0.4460	-0.4227	-0.0000	0.4460	0.5207	0.0007	0.0322
RohnEa2	0.4227	0.0000	-0.4460	-0.4227	0.0000	0.4460	0.5213	-0.0010	0.0323
RohnEb1	0.4227	0.0000	-0.4460	-0.4227	0.0000	0.4460	0.4503	0.0008	0.0314
RohnEb2	0.4227	0.0000	-0.4460	-0.4227	-0.0000	0.4460	0.4511	-0.0009	0.0315
RohnFa1	0.5444	0.0000	-0.6029	-0.5444	0.0000	0.6029	0.2943	0.0026	0.0281
RohnFa2	0.5444	0.0000	-0.6029	-0.5444	-0.0000	0.6029	0.2953	-0.0024	0.0282
RohnGa1	0.5770	0.0000	-0.6732	-0.5770	0.0000	0.6732	0.1526	0.0026	0.0223
RohnGa2	0.5770	0.0000	-0.6732	-0.5770	-0.0000	0.6732	0.1535	-0.0023	0.0223
RohnHa1	0.6210	0.0000	-0.7165	-0.6210	0.0000	0.7165	0.0551	0.0030	0.0143
RohnHa2	0.6210	0.0000	-0.7165	-0.6210	-0.0000	0.7165	0.0556	-0.0027	0.0143
RohnIa1	0.8371	0.0000	-0.8421	-0.8371	0.0000	0.8421	0.0065	0.0021	0.0049
RohnIa2	0.8371	0.0000	-0.8421	-0.8371	-0.0000	0.8421	0.0067	-0.0020	0.0049
SNB-Aa1	0.1887	0.0000	-0.1881	-0.1887	-0.0000	0.1881	1.7093	-0.0016	0.0052
SNB-Aa2	0.1887	0.0000	-0.1881	-0.1887	0.0000	0.1881	1.7093	-0.0016	0.0053
SNB-Ab1	0.1887	0.0000	-0.1881	-0.1887	-0.0000	0.1881	1.6290	-0.0015	0.0074
SNB-Ab2	0.1887	0.0000	-0.1881	-0.1887	0.0000	0.1881	1.6289	-0.0015	0.0075
SNB-Ac1	0.1887	0.0000	-0.1881	-0.1887	-0.0000	0.1881	1.5484	-0.0013	0.0096
SNB-Ac2	0.1887	0.0000	-0.1881	-0.1887	0.0000	0.1881	1.5484	-0.0015	0.0097
SNB-Ba1	0.2658	0.0000	-0.2189	-0.2658	-0.0000	0.2189	1.3883	-0.0011	0.0138
SNB-Ba2	0.2658	0.0000	-0.2189	-0.2658	0.0000	0.2189	1.3883	-0.0013	0.0139
SNB-Bb1	0.2658	0.0000	-0.2189	-0.2658	-0.0000	0.2189	1.3087	-0.0010	0.0158
SNB-Bb2	0.2658	0.0000	-0.2189	-0.2658	0.0000	0.2189	1.3087	-0.0012	0.0159
SNB-Bc1	0.2658	0.0000	-0.2189	-0.2658	-0.0000	0.2189	1.2295	-0.0008	0.0176
SNB-Bc2	0.2658	0.0000	-0.2189	-0.2658	0.0000	0.2189	1.2295	-0.0012	0.0177
SNB-Ca1	0.3930	0.0000	-0.2974	-0.3930	-0.0000	0.2974	1.0495	-0.0003	0.0214
SNB-Ca2	0.3930	0.0000	-0.2974	-0.3930	0.0000	0.2974	1.0495	-0.0013	0.0215
SNB-Cb1	0.3930	0.0000	-0.2974	-0.3930	-0.0000	0.2974	0.9501	-0.0001	0.0231
SNB-Cb2	0.3930	0.0000	-0.2974	-0.3930	0.0000	0.2974	0.9501	-0.0013	0.0232
SNB-Da1	0.4066	0.0000	-0.3280	-0.4066	-0.0000	0.3280	0.7628	0.0002	0.0251
SNB-Da2	0.4066	0.0000	-0.3280	-0.4066	0.0000	0.3280	0.7628	-0.0012	0.0252
SNB-Db1	0.4066	0.0000	-0.3280	-0.4066	-0.0000	0.3280	0.6755	0.0008	0.0253
SNB-Db2	0.4066	0.0000	-0.3280	-0.4066	0.0000	0.3280	0.6755	-0.0017	0.0254
SNB-Ea1	0.4227	0.0000	-0.4460	-0.4227	-0.0000	0.4460	0.5213	0.0003	0.0253
SNB-Ea2	0.4227	0.0000	-0.4460	-0.4227	0.0000	0.4460	0.5213	-0.0009	0.0253
SNB-Eb1	0.4227	0.0000	-0.4460	-0.4227	0.0000	0.4460	0.4508	0.0004	0.0252
SNB-Eb2	0.4227	0.0000	-0.4460	-0.4227	-0.0000	0.4460	0.4508	-0.0010	0.0253
SNB-Fa1	0.5444	0.0000	-0.6029	-0.5444	-0.0000	0.6029	0.2942	0.0027	0.0235
SNB-Fa2	0.5444	0.0000	-0.6029	-0.5444	0.0000	0.6029	0.2942	-0.0030	0.0235
SNB-Ga1	0.5770	0.0000	-0.6732	-0.5770	-0.0000	0.6732	0.1529	0.0024	0.0191
SNB-Ga2	0.5770	0.0000	-0.6732	-0.5770	0.0000	0.6732	0.1529	-0.0026	0.0192
SNB-Ha1	0.6210	0.0000	-0.7165	-0.6210	0.0000	0.7165	0.0557	0.0026	0.0127
SNB-Ha2	0.6210	0.0000	-0.7165	-0.6210	0.0000	0.7165	0.0557	-0.0027	0.0127
SNB-Ia1	0.8371	0.0000	-0.8421	-0.8371	0.0000	0.8421	0.0060	0.0024	0.0045
SNB-Ia2	0.8371	0.0000	-0.8421	-0.8371	-0.0000	0.8421	0.0060	-0.0024	0.0045

Moments for Angles Modeled as Beams:

Angle Torsion	Origin	Origin	End	End	X	Y	
Label	X Moment	Y Moment	X Moment	Y Moment	Shear	Shear	
	(ft-lbs)	(ft-lbs)	(ft-lbs)	(ft-lbs)	(lbs)	(lbs)	
Rohn-LA1P	-0.01	1.03	4.69	26.12	-17.83	5.43	-2.63
Rohn-LA11	2.04	-1.59	2.70	11.26	38.09	1.93	8.15
Rohn-LA12	-2.21	1.17	2.88	6.58	-16.81	1.55	-2.78
Rohn-LA2P	-0.01	-26.12	17.83	-32.87	26.04	-11.79	8.77
Rohn-LA21	2.04	-11.26	-38.09	-35.18	-88.29	-9.28	-25.25
Rohn-LA22	-2.21	-6.58	16.81	1.13	3.90	-1.09	4.14
Rohn-LA3P	-0.01	32.87	-26.04	35.80	-13.21	13.73	-7.85
Rohn-LA31	2.04	35.18	88.29	40.80	105.83	15.18	38.79
Rohn-LA32	-2.21	-1.13	-3.90	-24.26	51.06	-5.07	9.42
Rohn-LA4P	-0.01	-35.80	13.21	-18.82	24.90	-10.92	7.62
Rohn-LA41	2.04	-40.80	-105.83	-62.04	-118.53	-20.55	-44.84

Rohn-LA42	-2.21	24.26	-51.06	46.34	-78.40	14.11	-25.87
Rohn-LB1P	2.93	18.15	-14.14	10.97	-2.53	5.82	-3.33
Rohn-LB11	8.54	60.35	125.13	115.58	227.50	35.16	70.47
Rohn-LB12	-2.58	-43.06	84.20	-109.79	211.91	-30.55	59.17
Rohn-LB2P	2.93	-10.97	2.53	-4.26	56.99	-3.04	11.90
Rohn-LB21	8.53	-115.59	-227.50	-142.98	-222.25	-51.67	-89.87
Rohn-LB22	-2.58	109.79	-211.91	142.29	-216.46	50.37	-85.60
Rohn-LB3P	2.93	4.26	-56.98	4.10	-1.41	1.67	-11.67
Rohn-LB31	8.54	142.98	222.25	79.77	170.13	44.51	78.40
Rohn-LB32	-2.59	-142.29	216.46	-79.85	168.66	-44.39	76.96
Rohn-LB4P	2.93	-4.10	1.41	-6.36	154.56	-2.09	31.18
Rohn-LB41	8.53	-79.77	-170.12	15.05	144.54	-12.93	-5.11
Rohn-LB42	-2.57	79.85	-168.66	-9.99	141.34	13.96	-5.46
Rohn-LC1P	2.93	6.36	-154.56	1.81	81.47	1.23	-10.97
Rohn-LC11	8.52	-15.05	-144.54	-35.17	20.14	-7.53	-18.66
Rohn-LC12	-2.57	9.98	-141.34	37.37	16.57	7.10	-18.72
Rohn-LC2P	2.93	-1.81	-81.47	1.28	110.24	-0.08	4.31
Rohn-LC21	8.53	35.17	-20.14	-27.02	110.60	1.22	13.53
Rohn-LC22	-2.57	-37.37	-16.57	31.97	100.76	-0.81	12.59
Rohn-LC3P	2.93	-1.29	-110.24	-3.23	232.74	-0.68	18.39
Rohn-LC31	8.54	27.02	-110.60	114.78	347.58	21.27	35.55
Rohn-LC32	-2.58	-31.97	-100.76	-121.91	369.41	-23.08	40.30
Rohn-LD1P	2.93	3.23	-232.74	6.74	404.68	1.50	25.82
Rohn-LD11	8.49	-114.78	-347.58	-239.48	34.36	-53.13	-46.98
Rohn-LD12	-2.53	121.91	-369.41	247.35	16.88	55.38	-52.87
Rohn-LD2P	2.93	-6.74	-404.68	-2.04	176.43	-1.31	-34.17
Rohn-LD21	8.60	239.48	-34.36	318.82	780.54	83.48	111.57
Rohn-LD22	-2.65	-247.35	-16.88	-319.05	786.47	-84.69	115.08
Rohn-LD3P	2.93	2.04	-176.43	-0.66	714.27	0.21	80.78
Rohn-LD31	8.42	-318.79	-780.55	-297.06	90.50	-92.36	-103.48
Rohn-LD32	-2.47	319.02	-786.48	298.71	92.42	92.64	-104.09
Rohn-LE1P	2.94	0.66	-714.26	12.29	275.54	1.94	-65.88
Rohn-LE11	8.57	297.06	-90.49	134.72	575.66	64.76	72.77
Rohn-LE12	-2.61	-298.71	-92.41	-129.88	561.52	-64.28	70.36
Rohn-LE2P	2.93	-12.30	-275.54	-26.83	229.54	-5.86	-6.89
Rohn-LE21	8.52	-134.71	-575.66	111.65	461.01	-3.45	-17.14
Rohn-LE22	-2.57	129.87	-561.53	-124.38	500.52	0.82	-9.12
Rohn-LE3P	2.94	26.83	-229.54	27.81	1102.36	8.21	131.09
Rohn-LE31	8.46	-111.64	-461.01	-424.80	169.13	-80.45	-43.77
Rohn-LE32	-2.50	124.37	-500.52	461.03	89.62	87.79	-61.62
Rohn-LF1P	2.92	-27.82	-1102.36	-39.96	91.10	-6.78	-101.15
Rohn-LF11	8.73	424.79	-169.12	756.23	1723.89	117.96	155.29
Rohn-LF12	-2.79	-461.03	-89.61	-778.89	1785.62	-123.85	169.40
Rohn-LF2P	2.95	39.96	-91.10	29.77	1633.52	6.98	154.30
Rohn-LF21	8.19	-756.15	-1723.93	-909.11	-317.87	-166.32	-203.92
Rohn-LF22	-2.22	778.80	-1785.67	942.96	-391.78	171.96	-217.47
Rohn-LG1P	2.92	-29.78	-1633.52	-26.59	-86.87	-5.64	-172.09
Rohn-LG11	8.89	909.10	317.88	1008.37	2064.68	191.52	237.97
Rohn-LG12	-2.95	-942.95	391.80	-1020.95	2100.21	-196.15	248.90
Rohn-LG2P	2.94	26.59	86.87	13.32	1897.98	3.99	198.56
Rohn-LG21	8.16	-1008.28	-2064.73	-1102.41	-455.16	-210.80	-251.67
Rohn-LG22	-2.20	1020.84	-2100.26	1107.29	-466.13	212.55	-256.32
Rohn-LH1P	2.93	-13.33	-1897.98	0.31	-162.28	-1.30	-206.12
Rohn-LH11	8.88	1102.39	455.18	1239.51	2470.52	233.89	292.19
Rohn-LH12	-2.93	-1107.28	466.15	-1242.57	2478.73	-234.68	294.10
Rohn-LH2P	2.93	-0.31	162.28	-2.08	2426.38	-0.24	259.01
Rohn-LH21	7.82	-1239.37	-2470.59	-1446.63	-669.11	-268.24	-313.55
Rohn-LH22	-1.86	1242.41	-2478.80	1451.47	-674.10	269.03	-314.87
Rohn-LI1P	2.93	2.07	-2426.38	-9.39	-196.92	-0.73	-262.43
Rohn-LI11	8.75	1446.62	669.13	1862.01	3821.78	330.45	448.52
Rohn-LI12	-2.80	-1451.46	674.12	-1848.24	3798.88	-329.55	446.74
Rohn-LI2P	2.94	9.39	196.92	58.37	5552.55	6.78	575.20
Rohn-LI21	7.40	-1861.83	-3821.87	-1913.25	1425.52	-377.02	-239.33
Rohn-LI22	-1.46	1848.04	-3798.98	1858.27	1529.19	370.15	-226.69
Rohn-H1P	0.20	2.23	0.13	3.08	-1.05	0.71	-0.12
Rohn-H11	-0.06	0.07	-1.05	0.00	1.24	0.01	0.02
Rohn-H12	0.38	-3.09	1.04	-3.29	-0.07	-0.85	0.13
Rohn-H2P	-0.53	6.64	-1.88	6.93	-3.47	1.53	-0.60
Rohn-H21	-0.11	1.19	-3.21	0.07	-0.03	0.14	-0.36

Rohn-H22	0.15	-6.71	0.53	-6.17	-1.09	-1.45	-0.06
SNB-LA1P	-0.03	4.02	66.88	14.57	-9.81	3.71	11.41
SNB-LA11	0.27	67.64	-23.57	16.63	16.17	16.84	-1.48
SNB-LA12	-0.28	-71.83	-36.36	-25.14	-6.99	-19.38	-8.66
SNB-LA2P	-0.03	-14.57	9.81	-19.75	36.89	-6.86	9.33
SNB-LA21	0.27	-16.63	-16.17	-6.35	-43.37	-4.59	-11.90
SNB-LA22	-0.28	25.14	6.99	16.85	-14.12	8.39	-1.42
SNB-LA3P	-0.03	19.75	-36.89	16.24	-39.47	7.19	-15.26
SNB-LA31	0.27	6.35	43.37	4.82	74.79	2.23	23.61
SNB-LA32	-0.28	-16.85	14.12	-13.52	50.78	-6.07	12.97
SNB-LA4P	-0.03	-16.24	39.47	-10.46	118.22	-5.34	31.51
SNB-LA41	0.27	-4.82	-74.79	12.91	-72.15	1.62	-29.36
SNB-LA42	-0.28	13.52	-50.78	-5.71	-55.24	1.56	-21.19
SNB-LB1P	-0.06	9.62	182.01	4.67	46.51	2.86	45.67
SNB-LB11	3.24	114.33	60.84	50.05	101.89	32.85	32.52
SNB-LB12	-3.03	-119.96	47.39	-53.29	94.82	-34.62	28.42
SNB-LB2P	-0.06	-4.67	-46.51	-2.69	120.81	-1.47	14.85
SNB-LB21	3.23	-50.05	-101.89	-33.72	-6.40	-16.74	-21.64
SNB-LB22	-3.02	53.29	-94.82	35.96	-2.05	17.84	-19.36
SNB-LB3P	-0.06	2.69	-120.81	2.22	-59.10	0.98	-35.96
SNB-LB31	3.24	33.72	6.40	45.81	201.52	15.89	41.55
SNB-LB32	-3.03	-35.96	2.05	-46.07	198.88	-16.39	40.15
SNB-LB4P	-0.06	-2.22	59.10	-0.19	550.97	-0.48	121.95
SNB-LB41	3.23	-45.81	-201.52	-1.10	32.61	-9.37	-33.75
SNB-LB42	-3.02	46.07	-198.88	3.87	34.23	9.98	-32.90
SNB-LC1P	0.03	0.18	-36.35	0.29	177.70	0.07	21.21
SNB-LC11	8.39	183.20	-39.93	78.04	179.17	39.19	20.89
SNB-LC12	-8.31	-185.22	-41.24	-77.89	178.93	-39.47	20.66
SNB-LC2P	0.03	-0.29	-177.70	0.98	64.98	0.10	-16.87
SNB-LC21	8.36	-78.04	-179.17	27.31	345.21	-7.59	24.83
SNB-LC22	-8.29	77.89	-178.93	-27.70	343.88	7.51	24.67
SNB-LC3P	0.03	-0.98	-64.98	-0.37	602.37	-0.20	80.66
SNB-LC31	8.37	-27.31	-345.21	5.95	-44.26	-3.20	-58.42
SNB-LC32	-8.30	27.70	-343.88	-1.61	-41.40	3.91	-57.79
SNB-LD1P	-0.02	0.46	128.22	3.01	711.56	0.52	126.07
SNB-LD11	10.65	327.18	-36.73	13.71	538.72	51.14	75.30
SNB-LD12	-10.49	-331.69	-40.05	-14.65	534.71	-51.95	74.20
SNB-LD2P	-0.02	-3.01	-711.56	-0.15	57.42	-0.47	-97.92
SNB-LD21	10.64	-13.71	-538.72	305.61	856.96	43.65	47.59
SNB-LD22	-10.48	14.64	-534.71	-302.81	858.76	-43.10	48.46
SNB-LD3P	-0.02	0.15	-57.42	-0.81	1570.99	-0.10	227.28
SNB-LD31	10.49	-305.59	-856.97	-347.49	268.92	-97.95	-88.19
SNB-LD32	-10.33	302.79	-858.77	349.77	270.91	97.87	-88.17
SNB-LE1P	-0.30	1.44	-338.70	10.17	1093.35	1.74	113.28
SNB-LE11	22.08	696.88	-224.42	227.80	1186.85	138.71	144.36
SNB-LE12	-21.69	-699.57	-227.79	-229.05	1174.45	-139.30	142.00
SNB-LE2P	-0.31	-10.17	-1093.35	-6.77	432.46	-2.53	-98.92
SNB-LE21	21.99	-227.79	-1186.85	360.00	1690.76	19.78	75.36
SNB-LE22	-21.59	229.04	-1174.45	-345.47	1706.77	-17.42	79.60
SNB-LE3P	-0.30	6.77	-432.46	4.95	2988.35	1.76	383.73
SNB-LE31	21.87	-359.97	-1690.77	-720.47	-489.83	-162.05	-327.06
SNB-LE32	-21.47	345.45	-1706.78	707.23	-503.24	157.89	-331.47
SNB-LF1P	-0.03	-4.82	-1735.75	-1.72	-185.81	-0.65	-192.16
SNB-LF11	38.65	1515.33	285.38	1575.40	3196.45	308.74	347.79
SNB-LF12	-38.65	-1503.28	297.88	-1560.22	3207.04	-306.02	350.09
SNB-LF2P	-0.03	1.72	185.81	3.40	3648.48	0.51	383.47
SNB-LF21	37.40	-1575.28	-3196.52	-1565.48	-1225.53	-313.72	-441.68
SNB-LF22	-37.41	1560.09	-3207.11	1553.88	-1235.98	311.04	-443.78
SNB-LG1P	0.28	-3.31	-2117.35	-0.54	133.86	-0.39	-198.36
SNB-LG11	63.79	2889.59	620.00	2754.85	5878.91	563.83	649.14
SNB-LG12	-64.20	-2878.03	630.40	-2740.25	5887.69	-561.21	651.06
SNB-LG2P	0.28	0.54	-133.86	2.31	6230.47	0.29	609.75
SNB-LG21	61.93	-2754.64	-5879.03	-2224.12	-1579.30	-497.29	-744.94
SNB-LG22	-62.34	2740.03	-5887.81	2221.94	-1582.97	495.62	-746.19
SNB-LH1P	0.08	-2.16	-4019.91	3.70	-230.62	0.15	-425.16
SNB-LH11	61.58	3785.17	834.80	3264.89	6512.28	704.17	733.80
SNB-LH12	-61.83	-3783.96	837.81	-3260.06	6510.59	-703.56	733.93
SNB-LH2P	0.07	-3.70	230.62	-1.78	7169.49	-0.55	740.26
SNB-LH21	58.75	-3264.61	-6512.45	-3197.80	-1899.10	-645.43	-840.08

SNB-LH22	-59.00	3259.77	-6510.76	3200.84	-1895.09	645.25	-839.51
SNB-LI1P	-0.03		1.88	-4717.49	7.90	-117.30	0.98
SNB-LI11	19.21	5134.76	955.92	5408.73	9901.18	1053.09	1084.40
SNB-LI12	-19.43	-5137.92	951.82	-5403.86	9894.56	-1052.92	1083.33
SNB-LI2P	-0.04	-7.90	117.30	-1.59	13504.53	-0.95	1362.56
SNB-LI21	14.82	-5408.21	-9901.47	-5435.21	2698.72	-1083.00	-719.38
SNB-LI22	-15.04	5403.35	-9894.85	5442.94	2706.33	1083.28	-717.96
SNB-H1aP	-1.75	40.80	68.90	151.28	-0.30	95.07	33.95
SNB-H1bP	-1.75	-151.28	0.31	-30.54	35.96	-89.99	17.95
SNB-H1cP	-2.05	50.86	-36.76	139.00	-1.43	93.97	-18.90
SNB-H1dP	-2.05	-138.99	1.43	-44.86	36.25	-90.99	18.65
SNB-H1eP	6.25	43.17	-35.80	144.82	-2.11	93.04	-18.76
SNB-H1fP	6.25	-144.82	2.11	-41.05	-68.72	-91.99	-32.97
SNB-H2aP	-7.61	177.59	54.94	152.84	2.67	122.25	21.31
SNB-H2bP	-7.61	-152.84	-2.66	-16.74	20.91	-62.74	6.75
SNB-H2cP	0.64	112.21	-25.98	137.46	3.85	92.37	-8.19
SNB-H2dP	0.63	-137.45	-3.85	-112.89	25.57	-92.62	8.04
SNB-H2eP	6.76	13.73	-20.63	154.41	1.36	62.21	-7.13
SNB-H2fP	6.76	-154.41	-1.37	-177.39	-54.94	-122.76	-20.83
SNB-H3aP	-6.19	300.61	36.01	206.98	-3.72	149.98	9.54
SNB-H3bP	-6.18	-206.98	3.73	-12.08	11.88	-64.73	4.61
SNB-H3cP	0.03	170.58	-20.35	193.36	11.01	107.53	-2.76
SNB-H3dP	0.02	-193.36	-11.01	-170.06	20.23	-107.38	2.72
SNB-H3eP	6.10	11.75	-11.63	207.08	-3.71	64.65	-4.53
SNB-H3fP	6.11	-207.07	3.70	-300.74	-36.10	-150.04	-9.57
SNB-H4aP	-6.61	425.62	18.76	330.26	-14.98	185.90	0.93
SNB-H4bP	-6.60	-330.26	14.97	-97.30	3.76	-105.15	4.61
SNB-H4cP	-0.09	278.74	-9.78	317.34	35.02	146.61	6.21
SNB-H4dP	-0.11	-317.34	-35.02	-278.68	9.63	-146.59	-6.25
SNB-H4eP	6.68	97.64	-3.70	330.04	-15.16	105.18	-4.64
SNB-H4fP	6.69	-330.03	15.16	-425.68	-18.70	-185.86	-0.87
SNB-H5aP	-10.31	717.18	28.68	429.73	-24.28	241.62	0.93
SNB-H5bP	-10.30	-429.73	24.28	44.69	-0.15	-81.12	5.08
SNB-H5cP	-0.35	362.48	-19.61	407.79	57.26	162.28	7.93
SNB-H5dP	-0.37	-407.79	-57.26	-362.13	19.38	-162.21	-7.98
SNB-H5eP	10.64	-43.75	0.11	428.94	-24.36	81.15	-5.11
SNB-H5fP	10.64	-428.94	24.36	-717.84	-28.37	-241.59	-0.84
SNB-H6aP	-48.52	751.22	9.30	688.61	-23.91	265.25	-2.67
SNB-H6bP	-48.51	-688.61	23.88	-264.47	-9.49	-175.58	2.64
SNB-H6cP	-0.13	620.37	-15.12	582.34	48.16	221.57	6.09
SNB-H6dP	-0.15	-582.34	-48.16	-621.03	15.25	-221.69	-6.06
SNB-H6eP	48.64	265.29	9.75	688.43	-22.49	175.69	-2.37
SNB-H6fP	48.65	-688.43	22.52	-751.27	-9.58	-265.22	2.40
SNB-H7aP	-43.79	909.17	-8.85	1006.84	-31.15	313.59	-6.52
SNB-H7bP	-43.77	-1006.84	31.11	-724.69	-17.85	-283.40	2.15
SNB-H7cP	0.04	923.70	-12.17	916.48	56.70	301.19	7.29
SNB-H7dP	-0.01	-916.48	-56.70	-923.68	12.32	-301.19	-7.26
SNB-H7eP	43.76	724.81	18.09	1007.08	-29.91	283.46	-1.96
SNB-H7fP	43.78	-1007.07	29.95	-909.39	8.55	-313.67	6.32
SNB-H8aP	-12.29	1283.35	-15.34	1191.06	-34.07	364.39	-7.27
SNB-H8bP	-12.26	-1191.06	34.06	-866.04	-9.11	-302.93	3.67
SNB-H8cP	-0.08	1117.82	6.35	1178.65	67.67	338.20	10.90
SNB-H8dP	-0.13	-1117.82	-67.67	-1118.39	-6.42	-338.28	-10.91
SNB-H8eP	12.38	866.62	9.03	1190.90	-33.85	302.99	-3.66
SNB-H8fP	12.41	-1190.90	33.86	-1283.43	15.55	-364.38	7.28
SNB-H9aP	-29.91	1432.89	-20.86	1385.50	-40.37	377.18	-8.17
SNB-H9bP	-29.88	-1385.50	40.33	-1103.97	8.03	-333.16	6.45
SNB-H9cP	0.01	1360.30	28.38	1342.57	79.77	361.74	14.47
SNB-H9dP	-0.06	-1342.57	-79.77	-1360.34	-28.39	-361.75	-14.48
SNB-H9eP	29.93	1104.04	-8.05	1385.46	-40.31	333.17	-6.49
SNB-H9fP	29.95	-1385.46	40.35	-1432.99	20.97	-377.19	8.23

Equilibrium Joint Positions and Rotations for Load Case "2: 0.9D + 1.0Dg + 1.6Wo":

Joint Label	X-Displ (ft)	Y-Displ (ft)	Z-Displ (ft)	X-Rot (deg)	Y-Rot (deg)	Z-Rot (deg)	X-Pos (ft)	Y-Pos (ft)	Z-Pos (ft)
RohnAP	1.785	-0.0008879	-0.08694	0.0063	0.9165	0.0109	6.118	-0.0008879	179.9
RohnBP	1.465	-8.464e-005	-0.09558	-0.0012	0.9145	0.0107	6.586	-8.464e-005	159.9
RohnCP	1.149	-0.0003504	-0.1003	-0.0007	0.8814	0.0071	7.058	-0.0003504	139.9
RohnDP	0.8533	-0.000453	-0.09969	-0.0002	0.8012	0.0047	7.548	-0.000453	119.9
RohnEP	0.595	-0.000601	-0.08951	-0.0005	0.6610	0.0032	8.076	-0.000601	99.91
RohnFP	0.3853	-0.0007622	-0.07775	-0.0003	0.5247	0.0020	8.653	-0.0007622	79.92
RohnGP	0.2208	-0.0006844	-0.06259	0.0006	0.3991	0.0014	9.276	-0.0006844	59.94
RohnHP	0.1015	-0.0004514	-0.04507	0.0010	0.2740	0.0009	9.943	-0.0004514	39.95
RohnIP	0.02871	-0.0002246	-0.02217	0.0006	0.1251	0.0003	10.66	-0.0002246	19.98
RohnJP	0	0	0	0.0000	0.0000	0.0000	11.42	0	0
SNB-AP	1.786	-0.001731	-0.05192	0.0020	0.9130	-0.0000	4.119	-0.001731	179.9
SNB-BP	1.465	-0.001324	-0.06131	0.0009	0.9087	-0.0000	4.586	-0.001324	159.9
SNB-CP	1.149	-0.0009474	-0.0685	0.0010	0.8757	0.0000	5.057	-0.0009474	139.9
SNB-DP	0.8535	-0.0006334	-0.071	0.0008	0.7916	-0.0000	5.549	-0.0006334	119.9
SNB-EP	0.5952	-0.0004058	-0.06544	0.0006	0.6467	-0.0000	6.076	-0.0004058	99.93
SNB-FP	0.3854	-0.0002498	-0.0606	0.0004	0.5254	0.0000	6.653	-0.0002498	79.94
SNB-GP	0.2209	-0.0001371	-0.05009	0.0003	0.3820	0.0000	7.276	-0.0001371	59.95
SNB-HP	0.1015	-5.824e-005	-0.03716	0.0002	0.2663	0.0000	7.943	-5.824e-005	39.96
SNB-IP	0.02871	-1.507e-005	-0.01884	0.0001	0.1223	0.0000	8.657	-1.507e-005	19.98
SNB-JP	0	0	0	0.0000	0.0000	0.0000	9.415	0	0
RohnA1	1.787	-0.002176	0.01625	0.0011	0.9192	0.0039	-0.3795	-3.755	180
RohnA2	1.786	-0.002083	0.0164	0.0006	0.9182	0.0176	-0.3809	3.75	180
RohnB1	1.467	-0.002004	0.02461	0.0060	0.9209	-0.0004	-1.094	-4.437	160
RohnB2	1.465	-0.001951	0.02482	-0.0016	0.9190	0.0221	-1.096	4.433	160
RohnC1	1.15	-0.0009512	0.03129	-0.0013	0.8762	-0.0094	-1.805	-5.118	140
RohnC2	1.149	-0.001555	0.03148	0.0059	0.8727	0.0235	-1.806	5.116	140
RohnD1	0.8534	-0.0001758	0.03522	-0.0018	0.7974	-0.0136	-2.494	-5.798	120
RohnD2	0.853	-0.001334	0.03538	0.0050	0.7949	0.0230	-2.495	5.797	120
RohnE1	0.5953	-0.0001523	0.03419	-0.0002	0.6600	-0.0134	-3.145	-6.479	100
RohnE2	0.5956	-0.0004605	0.0343	0.0027	0.6576	0.0197	-3.145	6.478	100
RohnF1	0.3844	0.0005505	0.03133	0.0112	0.5469	-0.0131	-3.75	-7.16	80.03
RohnF2	0.3855	-0.0004105	0.0314	-0.0098	0.5458	0.0172	-3.748	7.16	80.03
RohnG1	0.2202	0.0003814	0.02612	0.0034	0.4054	-0.0100	-4.307	-7.841	60.03
RohnG2	0.2214	2.14e-005	0.02618	-0.0031	0.4056	0.0128	-4.306	7.842	60.03
RohnH1	0.1008	0.0004287	0.01927	0.0033	0.2803	-0.0074	-4.82	-8.522	40.02
RohnH2	0.1015	-0.0001457	0.01931	-0.0035	0.2812	0.0091	-4.819	8.522	40.02
RohnI1	0.02839	0.0001912	0.009598	0.0061	0.1381	-0.0042	-5.287	-9.206	20.01
RohnI2	0.02875	-1.236e-005	0.009618	-0.0065	0.1389	0.0047	-5.286	9.206	20.01
RohnJ1	0	0	0	0.0000	0.0000	0.0000	-5.71	-9.89	0
RohnJ2	0	0	0	0.0000	0.0000	0.0000	-5.71	9.89	0
SNB-A1	1.786	-0.001736	0.004104	-0.0028	0.9223	-0.0019	0.6196	-2.022	180
SNB-A2	1.786	-0.001728	0.004187	0.0049	0.9217	0.0020	0.6196	2.019	180
SNB-B1	1.466	-0.001332	0.01276	0.0002	0.9160	-0.0022	-0.09484	-2.704	160
SNB-B2	1.466	-0.001319	0.01287	0.0021	0.9162	0.0023	-0.09485	2.702	160
SNB-C1	1.15	-0.0009397	0.02033	-0.0002	0.8839	-0.0030	-0.8044	-3.385	140
SNB-C2	1.15	-0.000961	0.02045	0.0022	0.8839	0.0030	-0.8044	3.383	140
SNB-D1	0.854	-0.0005453	0.02526	-0.0020	0.8044	-0.0051	-1.493	-4.067	120
SNB-D2	0.854	-0.000723	0.02537	0.0036	0.8044	0.0051	-1.493	4.065	120
SNB-E1	0.5955	-0.0003113	0.02566	-0.0009	0.6550	-0.0041	-2.145	-4.747	100
SNB-E2	0.5955	-0.0004998	0.02575	0.0019	0.6549	0.0041	-2.145	4.746	100
SNB-F1	0.3856	-0.0001579	0.02539	0.0044	0.5495	-0.0039	-2.748	-5.428	80.03
SNB-F2	0.3856	-0.000348	0.02546	-0.0036	0.5494	0.0039	-2.748	5.428	80.03
SNB-G1	0.2209	1.027e-005	0.02182	0.0029	0.4089	-0.0048	-3.307	-6.11	60.02
SNB-G2	0.2209	-0.0002913	0.02188	-0.0024	0.4089	0.0047	-3.307	6.11	60.02
SNB-H1	0.1013	0.000144	0.01661	-0.0026	0.2811	-0.0047	-3.819	-6.79	40.02
SNB-H2	0.1013	-0.0002615	0.01665	0.0029	0.2810	0.0047	-3.819	6.79	40.02
SNB-I1	0.02828	0.0002523	0.008532	0.0031	0.1435	-0.0043	-4.286	-7.472	20.01
SNB-I2	0.02828	-0.0002821	0.008552	-0.0030	0.1435	0.0043	-4.286	7.472	20.01
SNB-J1	0	0	0	0.0000	0.0000	0.0000	-4.708	-8.154	0
SNB-J2	0	0	0	0.0000	0.0000	0.0000	-4.708	8.154	0

RohnAaS	1.705	-0.0004528	-0.08938	0.0014	0.9207	0.0108	6.235	-0.0004528	174.9
RohnAbS	1.625	-0.0004209	-0.09167	0.0027	0.9192	0.0108	6.352	-0.0004209	169.9
RohnAcS	1.545	6.646e-006	-0.09374	0.0021	0.9166	0.0108	6.469	6.646e-006	164.9
RohnBaS	1.385	-9.677e-005	-0.09727	-0.0003	0.9130	0.0098	6.703	-9.677e-005	154.9
RohnBbS	1.306	-0.0001822	-0.09867	-0.0010	0.9065	0.0089	6.821	-0.0001822	149.9
RohnBcS	1.227	-0.0002574	-0.09969	-0.0010	0.8999	0.0080	6.939	-0.0002574	144.9
RohnCaS	1.048	-0.0003768	-0.1009	-0.0001	0.8571	0.0063	7.218	-0.0003768	133.2
RohnCbS	0.9489	-0.0004088	-0.1008	-0.0004	0.8367	0.0055	7.382	-0.0004088	126.6
RohnDaS	0.7623	-0.0004693	-0.09746	-0.0004	0.7591	0.0042	7.719	-0.0004693	113.2
RohnDbS	0.6762	-0.0005392	-0.09404	-0.0007	0.7199	0.0037	7.895	-0.0005392	106.6
RohnEaS	0.5212	-0.0006709	-0.08629	-0.0010	0.6134	0.0028	8.264	-0.0006709	93.25
RohnEbS	0.451	-0.0007812	-0.08237	-0.0003	0.5884	0.0024	8.457	-0.0007812	86.58
RohnFaS	0.2992	-0.000852	-0.0709	0.0002	0.4730	0.0017	8.961	-0.000852	69.93
RohnGaS	0.1577	-0.0006367	-0.05441	0.0005	0.3414	0.0011	9.606	-0.0006367	49.95
RohnHaS	0.06109	-0.0003244	-0.03424	0.0005	0.2092	0.0006	10.3	-0.0003244	29.97
RohnIaS	0.01089	-0.0001034	-0.01152	0.0008	0.0882	0.0002	11.04	-0.0001034	9.988
SNB-AaS	1.706	-0.001585	-0.05441	0.0005	0.9217	-0.0001	4.236	-0.001585	174.9
SNB-AbS	1.625	-0.001583	-0.05684	0.0012	0.9186	-0.0000	4.352	-0.001583	169.9
SNB-AcS	1.545	-0.001381	-0.05915	0.0017	0.9184	-0.0000	4.469	-0.001381	164.9
SNB-BaS	1.385	-0.001222	-0.06342	0.0012	0.9149	-0.0000	4.703	-0.001222	154.9
SNB-BbS	1.306	-0.001132	-0.06535	0.0010	0.9060	-0.0000	4.82	-0.001132	149.9
SNB-BcS	1.227	-0.001035	-0.06704	0.0011	0.9019	0.0000	4.938	-0.001035	144.9
SNB-CaS	1.048	-0.0008353	-0.06996	0.0010	0.8583	0.0000	5.218	-0.0008353	133.3
SNB-CbS	0.9491	-0.0007286	-0.07078	0.0009	0.8393	0.0000	5.382	-0.0007286	126.6
SNB-DaS	0.7624	-0.0005426	-0.07013	0.0007	0.7613	-0.0000	5.719	-0.0005426	113.3
SNB-DbS	0.6763	-0.0004727	-0.06822	0.0006	0.7237	-0.0000	5.896	-0.0004727	106.6
SNB-EaS	0.5213	-0.0003407	-0.06449	0.0004	0.6181	0.0000	6.264	-0.0003407	93.28
SNB-EbS	0.4511	-0.0002997	-0.06283	0.0004	0.5882	0.0000	6.457	-0.0002997	86.6
SNB-FaS	0.2992	-0.0001919	-0.05598	0.0003	0.4778	0.0000	6.961	-0.0001919	69.94
SNB-GaS	0.1577	-9.586e-005	-0.04422	0.0002	0.3482	0.0000	7.606	-9.586e-005	49.96
SNB-HaS	0.0611	-3.023e-005	-0.02861	0.0001	0.2125	0.0000	8.296	-3.023e-005	29.97
SNB-IaS	0.01089	-1.678e-006	-0.009975	0.0000	0.0894	0.0000	9.032	-1.678e-006	9.99
SNB-WL-A1S	1.786	-0.00174	-0.02405	-0.0003	0.9174	-0.0040	2.369	-1.012	180
SNB-WL-A2S	1.786	-0.001732	0.004027	0.0008	0.9220	0.0001	0.6196	-0.001732	180
SNB-WL-A3S	1.786	-0.001721	-0.024	0.0035	0.9174	0.0040	2.369	-1.008	180
SNB-WL-B1S	1.465	-0.001335	-0.02447	0.0036	0.9069	-0.0041	2.246	-1.353	160
SNB-WL-B2S	1.466	-0.001325	0.01267	0.0012	0.9161	0.0001	-0.09481	-0.001325	160
SNB-WL-B3S	1.465	-0.001311	-0.02442	-0.0016	0.9070	0.0042	2.246	-1.35	160
SNB-WL-C1S	1.149	-0.0009685	-0.02446	0.0073	0.8676	-0.0039	2.126	-1.693	140
SNB-WL-C2S	1.15	-0.0009503	0.02009	0.0010	0.8839	0.0000	-0.8043	-0.0009503	140
SNB-WL-C3S	1.149	-0.000929	-0.02441	-0.0054	0.8676	0.0040	2.126	-1.691	140
SNB-WL-D1S	0.8538	-0.0006666	-0.02371	0.0090	0.7814	-0.0040	2.028	-2.034	120
SNB-WL-D2S	0.8542	-0.0006341	0.02459	0.0008	0.8044	0.0000	-1.493	-0.0006341	120
SNB-WL-D3S	0.8538	-0.0006	-0.02366	-0.0074	0.7814	0.0040	2.028	-2.032	120
SNB-WL-E1S	0.5954	-0.0004314	-0.02049	0.0101	0.6331	-0.0029	1.966	-2.374	99.98
SNB-WL-E2S	0.5957	-0.0004056	0.02521	0.0005	0.6550	0.0000	-2.145	-0.0004056	100
SNB-WL-E3S	0.5954	-0.00038	-0.02044	-0.0090	0.6331	0.0029	1.966	-2.373	99.98
SNB-WL-F1S	0.3855	-0.0002842	-0.01894	0.0099	0.5245	-0.0020	1.953	-2.714	79.98
SNB-WL-F2S	0.3858	-0.000253	0.02473	0.0004	0.5495	-0.0000	-2.748	-0.000253	80.02
SNB-WL-F3S	0.3855	-0.0002228	-0.0189	-0.0091	0.5244	0.0020	1.953	-2.714	79.98
SNB-WL-G1S	0.2209	-0.0001854	-0.01642	0.0048	0.3899	-0.0015	1.985	-3.055	59.98
SNB-WL-G2S	0.2212	-0.0001405	0.02027	0.0003	0.4089	-0.0000	-3.306	-0.0001405	60.02
SNB-WL-G3S	0.2209	-9.672e-005	-0.0164	-0.0043	0.3899	0.0015	1.985	-3.055	59.98
SNB-WL-H1S	0.1015	-0.0001109	-0.01331	0.0068	0.2598	-0.0015	2.062	-3.395	39.99
SNB-WL-H2S	0.1017	-5.874e-005	0.01381	0.0002	0.2811	-0.0000	-3.819	-5.874e-005	40.01
SNB-WL-H3S	0.1015	-7.568e-006	-0.01328	-0.0065	0.2598	0.0015	2.062	-3.395	39.99
SNB-WL-I1S	0.02862	-7.561e-005	-0.009398	0.0086	0.1208	-0.0017	2.186	-3.736	19.99
SNB-WL-I2S	0.02874	-1.487e-005	0.004974	0.0001	0.1435	-0.0000	-4.285	-1.487e-005	20
SNB-WL-I3S	0.02862	4.533e-005	-0.009388	-0.0084	0.1208	0.0017	2.186	-3.736	19.99
RohnAa1	1.707	-0.002233	0.01846	-0.0016	0.9123	0.0032	-0.558	-3.925	175
RohnAa2	1.705	-0.002051	0.01862	-0.0003	0.9220	0.0188	-0.5597	-3.921	175
RohnAb1	1.627	-0.002369	0.02059	0.0031	0.9220	0.0017	-0.7362	-4.096	170
RohnAb2	1.625	-0.002157	0.02079	-0.0018	0.9244	0.0201	-0.7388	-4.092	170
RohnAc1	1.547	-0.00199	0.02266	0.0019	0.9186	0.0008	-0.9155	-4.266	165
RohnAc2	1.544	-0.002204	0.02286	0.0027	0.9138	0.0207	-0.9177	-4.262	165
RohnBa1	1.386	-0.001544	0.02651	-0.0007	0.9086	-0.0024	-1.273	-4.607	155
RohnBa2	1.385	-0.002035	0.02672	0.0065	0.9037	0.0221	-1.274	-4.603	155
RohnBb1	1.308	-0.002016	0.02826	0.0026	0.9079	-0.0052	-1.45	-4.778	150
RohnBb2	1.306	-0.001199	0.02846	0.0026	0.9042	0.0231	-1.451	-4.775	150

RohnBc1	1.228	-0.001136	0.0299	0.0101	0.9141	-0.0084	-1.628	-4.948	145
RohnBc2	1.226	-0.001721	0.0301	-0.0049	0.9100	0.0243	-1.63	4.945	145
RohnCa1	1.049	-0.001129	0.03298	0.0010	0.8589	-0.0112	-2.036	-5.345	133.4
RohnCa2	1.048	-0.0009811	0.03316	0.0028	0.8561	0.0237	-2.037	5.343	133.4
RohnCb1	0.9495	-0.0006969	0.03434	0.0071	0.8454	-0.0132	-2.267	-5.572	126.7
RohnCb2	0.9489	-0.001085	0.03451	-0.0041	0.8441	0.0242	-2.268	5.57	126.7
RohnDa1	0.7625	-0.0004042	0.03549	0.0067	0.7720	-0.0145	-2.716	-6.025	113.4
RohnDa2	0.7624	-0.0007628	0.03563	-0.0035	0.7692	0.0228	-2.716	6.024	113.4
RohnDb1	0.6746	0.00071	0.03518	0.0010	0.7180	-0.0140	-2.935	-6.251	106.7
RohnDb2	0.6747	-0.001591	0.03532	0.0017	0.7160	0.0213	-2.935	6.25	106.7
RohnEa1	0.5199	0.0006557	0.03364	0.0078	0.6277	-0.0137	-3.352	-6.705	93.37
RohnEa2	0.5204	-0.001017	0.03375	-0.0056	0.6259	0.0192	-3.351	6.705	93.37
RohnEb1	0.4496	0.0007604	0.03269	-0.0045	0.5777	-0.0127	-3.553	-6.933	86.69
RohnEb2	0.4504	-0.0008819	0.03278	0.0071	0.5747	0.0174	-3.553	6.932	86.69
RohnFa1	0.2939	0.002673	0.02917	-0.0033	0.4659	-0.0109	-4.037	-7.498	70.03
RohnFa2	0.2949	-0.002429	0.02924	0.0042	0.4656	0.0144	-4.036	7.499	70.03
RohnGa1	0.1524	0.002688	0.02304	-0.0003	0.3403	-0.0085	-4.572	-8.18	50.02
RohnGa2	0.1533	-0.002359	0.02309	-0.0001	0.3421	0.0108	-4.571	8.18	50.02
RohnHa1	0.05512	0.003028	0.01478	-0.0019	0.2053	-0.0056	-5.063	-8.861	30.01
RohnHa2	0.05563	-0.0028	0.01481	0.0016	0.2063	0.0067	-5.062	8.861	30.01
RohnIa1	0.006518	0.002152	0.005023	-0.0009	0.0864	-0.0026	-5.506	-9.546	10.01
RohnIa2	0.006697	-0.00206	0.005034	0.0002	0.0877	0.0030	-5.506	9.546	10.01
SNB-Aa1	1.706	-0.001629	0.006332	0.0026	0.9178	-0.0020	0.4409	-2.193	175
SNB-Aa2	1.706	-0.001657	0.006417	0.0001	0.9186	0.0022	0.4409	2.189	175
SNB-Ab1	1.626	-0.001508	0.008526	0.0017	0.9213	-0.0022	0.2623	-2.363	170
SNB-Ab2	1.626	-0.00152	0.008625	0.0007	0.9212	0.0024	0.2622	2.36	170
SNB-Ac1	1.545	-0.001358	0.01068	0.0014	0.9171	-0.0021	0.08334	-2.534	165
SNB-Ac2	1.545	-0.001517	0.01078	0.0007	0.9163	0.0023	0.08339	2.531	165
SNB-Ba1	1.386	-0.001126	0.01483	0.0026	0.9144	-0.0027	-0.2732	-2.874	155
SNB-Ba2	1.386	-0.001338	0.01493	-0.0004	0.9143	0.0028	-0.2732	2.872	155
SNB-Bb1	1.306	-0.00103	0.01679	0.0021	0.9087	-0.0029	-0.451	-3.045	150
SNB-Bb2	1.306	-0.001238	0.0169	0.0002	0.9088	0.0030	-0.451	3.042	150
SNB-Bc1	1.227	-0.0008504	0.01863	0.0009	0.8980	-0.0030	-0.6284	-3.215	145
SNB-Bc2	1.227	-0.001231	0.01875	0.0012	0.8979	0.0031	-0.6284	3.213	145
SNB-Ca1	1.048	-0.0002937	0.02234	0.0067	0.8679	-0.0043	-1.037	-3.612	133.4
SNB-Ca2	1.048	-0.001389	0.02246	-0.0048	0.8679	0.0043	-1.037	3.61	133.4
SNB-Cb1	0.9484	-0.0001237	0.024	-0.0018	0.8285	-0.0043	-1.268	-3.839	126.7
SNB-Cb2	0.9484	-0.001348	0.02411	0.0037	0.8286	0.0043	-1.268	3.838	126.7
SNB-Da1	0.7615	0.0001682	0.02599	0.0112	0.7777	-0.0060	-1.717	-4.292	113.4
SNB-Da2	0.7615	-0.001273	0.02609	-0.0098	0.7777	0.0060	-1.717	4.291	113.4
SNB-Db1	0.6744	0.0007894	0.02611	-0.0044	0.7103	-0.0045	-1.935	-4.519	106.7
SNB-Db2	0.6744	-0.001735	0.0262	0.0057	0.7104	0.0045	-1.935	4.518	106.7
SNB-Ea1	0.5205	0.000291	0.02597	0.0070	0.6287	-0.0045	-2.351	-4.973	93.37
SNB-Ea2	0.5205	-0.0009839	0.02605	-0.0060	0.6287	0.0045	-2.351	4.973	93.37
SNB-Eb1	0.4501	0.000428	0.02586	-0.0047	0.5738	-0.0034	-2.553	-5.201	86.69
SNB-Eb2	0.4501	-0.001011	0.02594	0.0055	0.5738	0.0034	-2.553	5.2	86.69
SNB-Fa1	0.2938	0.002712	0.02402	0.0001	0.4674	-0.0039	-3.037	-5.766	70.02
SNB-Fa2	0.2938	-0.003074	0.02408	0.0006	0.4674	0.0039	-3.037	5.766	70.02
SNB-Ga1	0.1528	0.002482	0.01957	0.0016	0.3403	-0.0047	-3.571	-6.448	50.02
SNB-Ga2	0.1528	-0.002663	0.01962	-0.0011	0.3403	0.0046	-3.571	6.447	50.02
SNB-Ha1	0.0557	0.00269	0.01292	0.0016	0.2066	-0.0044	-4.062	-7.129	30.01
SNB-Ha2	0.05571	-0.002755	0.01295	-0.0014	0.2066	0.0044	-4.062	7.129	30.01
SNB-Ia1	0.006065	0.002414	0.00456	-0.0006	0.0846	-0.0026	-4.505	-7.81	10
SNB-Ia2	0.006068	-0.002422	0.00457	0.0007	0.0847	0.0026	-4.505	7.81	10

Joint Support Reactions for Load Case "2: 0.9D + 1.0Dg + 1.6Wo":

Joint Label	X Force (kips)	X Usage %	Y Force (kips)	Y Usage %	Z Force (kips)	Z Usage %	Comp. Usage %	Uplift Result. %	Result. Force (kips)	Result. Usage %	X Moment (ft-k)	X-M. Usage %	Y Moment (ft-k)	Y-M. Usage %	Z Moment (ft-k)	Z-M. Usage %	Max. Usage %
RohnJP	-29.40	0.0	0.11	0.0	350.14	0.0	0.0	0.0	351.37	0.0	-0.06	0.0	-5.5	0.0	-0.01	0.0	0.0
SNB-JP	-51.11	0.0	0.00	0.0	506.81	0.0	0.0	0.0	509.38	0.0	0.00	0.0	-13.4	0.0	0.00	0.0	0.0
RohnJ1	-9.63	0.0	-10.26	0.0	-152.67	0.0	0.0	0.0	153.32	0.0	1.97	0.0	-1.5	0.0	0.00	0.0	0.0
RohnJ2	-9.83	0.0	10.17	0.0	-153.00	0.0	0.0	0.0	153.65	0.0	-1.91	0.0	-1.6	0.0	-0.01	0.0	0.0
SNB-J1	-17.61	0.0	-18.88	0.0	-232.22	0.0	0.0	0.0	233.65	0.0	5.53	0.0	-2.8	0.0	-0.03	0.0	0.0
SNB-J2	-17.63	0.0	18.92	0.0	-232.72	0.0	0.0	0.0	234.15	0.0	-5.54	0.0	-2.8	0.0	0.03	0.0	0.0

Joint Displacements, Loads and Member Forces on Joints for Load Case "2: 0.9D + 1.0Dg + 1.6Wo":

Joint Label	X External Load (kips)	Y External Load (kips)	Z External Load (kips)	X Member Force (kips)	Y Member Force (kips)	Z Member Force (kips)	X Disp. (ft)	Y Disp. (ft)	Z Disp. (ft)
RohnAP	0.6457	0.0000	-0.2670	-0.6457	-0.0000	0.2670	1.7854	-0.0009	-0.0869
RohnBP	3.0386	0.0000	-0.9568	-3.0386	-0.0000	0.9568	1.4648	-0.0001	-0.0956
RohnCP	0.6587	0.0000	-0.3872	-0.6587	0.0000	0.3872	1.1487	-0.0004	-0.1003
RohnDP	0.7996	0.0000	-0.4691	-0.7996	0.0000	0.4691	0.8533	-0.0005	-0.0997
RohnEP	0.8293	0.0000	-0.5805	-0.8293	-0.0000	0.5805	0.5950	-0.0006	-0.0895
RohnFP	0.9670	0.0000	-0.7867	-0.9670	-0.0000	0.7867	0.3853	-0.0008	-0.0777
RohnGP	1.3744	0.0000	-1.0471	-1.3744	-0.0000	1.0471	0.2208	-0.0007	-0.0626
RohnHP	1.1981	0.0000	-1.0422	-1.1981	-0.0000	1.0422	0.1015	-0.0005	-0.0451
RohnIP	1.4581	0.0000	-1.1689	-1.4581	-0.0000	1.1689	0.0287	-0.0002	-0.0222
RohnJP	0.8371	0.0000	-0.6316	28.5592	-0.1080	-349.5072	0.0000	0.0000	0.0000
SNB-AP	0.1887	0.0000	-0.1410	-0.1887	0.0000	0.1410	1.7857	-0.0017	-0.0519
SNB-BP	0.4544	0.0000	-0.3052	-0.4544	0.0000	0.3052	1.4651	-0.0013	-0.0613
SNB-CP	0.6587	0.0000	-0.3872	-0.6587	0.0000	0.3872	1.1490	-0.0009	-0.0685
SNB-DP	0.7996	0.0000	-0.4691	-0.7996	0.0000	0.4691	0.8535	-0.0006	-0.0710
SNB-EP	0.8293	0.0000	-0.5805	-0.8293	0.0000	0.5805	0.5952	-0.0004	-0.0654
SNB-FP	0.9670	0.0000	-0.7867	-0.9670	0.0000	0.7867	0.3854	-0.0002	-0.0606
SNB-GP	1.1214	0.0000	-0.9571	-1.1214	0.0000	0.9571	0.2209	-0.0001	-0.0501
SNB-HP	1.1981	0.0000	-1.0422	-1.1981	0.0000	1.0422	0.1015	-0.0001	-0.0372
SNB-IP	1.4581	0.0000	-1.1689	-1.4581	0.0000	1.1689	0.0287	-0.0000	-0.0188
SNB-JP	0.8371	0.0000	-0.6316	50.2713	-0.0014	-506.1743	0.0000	0.0000	0.0000
RohnA1	0.6457	0.0000	-0.2670	-0.6457	-0.0000	0.2670	1.7870	-0.0022	0.0163
RohnA2	1.1028	0.0000	-0.3930	-1.1028	-0.0000	0.3930	1.7856	-0.0021	0.0164
RohnB1	1.0572	0.0000	-0.4078	-1.0572	-0.0000	0.4078	1.4669	-0.0020	0.0246
RohnB2	0.7218	0.0000	-0.3493	-0.7218	-0.0000	0.3493	1.4646	-0.0020	0.0248
RohnC1	0.6587	0.0000	-0.3872	-0.6587	0.0000	0.3872	1.1497	-0.0010	0.0313
RohnC2	0.6587	0.0000	-0.3872	-0.6587	-0.0000	0.3872	1.1486	-0.0016	0.0315
RohnD1	1.0140	0.0000	-0.5321	-1.0140	0.0000	0.5321	0.8534	-0.0002	0.0352
RohnD2	0.7996	0.0000	-0.4691	-0.7996	-0.0000	0.4691	0.8530	-0.0013	0.0354
RohnE1	0.8293	0.0000	-0.5805	-0.8293	0.0000	0.5805	0.5953	-0.0002	0.0342
RohnE2	0.8293	0.0000	-0.5805	-0.8293	-0.0000	0.5805	0.5956	-0.0005	0.0343
RohnF1	0.9670	0.0000	-0.7867	-0.9670	-0.0000	0.7867	0.3844	0.0006	0.0313
RohnF2	1.4491	0.0000	-0.9172	-1.4491	-0.0000	0.9172	0.3855	-0.0004	0.0314
RohnG1	1.2624	0.0000	-1.0111	-1.2624	0.0000	1.0111	0.2202	0.0004	0.0261
RohnG2	1.7131	0.0000	-1.0975	-1.7131	-0.0000	1.0975	0.2214	0.0000	0.0262
RohnH1	1.1981	0.0000	-1.0422	-1.1981	-0.0000	1.0422	0.1008	0.0004	0.0193
RohnH2	1.1981	0.0000	-1.0422	-1.1981	0.0000	1.0422	0.1015	-0.0001	0.0193
RohnI1	1.4581	0.0000	-1.1689	-1.4581	-0.0000	1.1689	0.0284	0.0002	0.0096
RohnI2	1.4581	0.0000	-1.1689	-1.4581	-0.0000	1.1689	0.0288	-0.0000	0.0096
RohnJ1	0.8371	0.0000	-0.6316	8.7896	10.2633	153.3044	0.0000	0.0000	0.0000
RohnJ2	0.8371	0.0000	-0.6316	8.9937	-10.1720	153.6277	0.0000	0.0000	0.0000
SNB-A1	0.1887	0.0000	-0.1410	-0.1887	-0.0000	0.1410	1.7861	-0.0017	0.0041
SNB-A2	0.1887	0.0000	-0.1410	-0.1887	0.0000	0.1411	1.7861	-0.0017	0.0042
SNB-B1	0.4544	0.0000	-0.3052	-0.4544	-0.0000	0.3052	1.4657	-0.0013	0.0128
SNB-B2	0.4544	0.0000	-0.3052	-0.4544	0.0000	0.3052	1.4657	-0.0013	0.0129
SNB-C1	0.6587	0.0000	-0.3872	-0.6587	-0.0000	0.3872	1.1496	-0.0009	0.0203
SNB-C2	0.6587	0.0000	-0.3872	-0.6587	0.0000	0.3872	1.1496	-0.0010	0.0204
SNB-D1	0.7996	0.0000	-0.4691	-0.7996	-0.0000	0.4691	0.8540	-0.0005	0.0253
SNB-D2	0.7996	0.0000	-0.4691	-0.7996	0.0000	0.4691	0.8540	-0.0007	0.0254
SNB-E1	0.8293	0.0000	-0.5805	-0.8293	-0.0000	0.5805	0.5955	-0.0003	0.0257
SNB-E2	0.8293	0.0000	-0.5805	-0.8293	0.0000	0.5805	0.5955	-0.0005	0.0257
SNB-F1	0.9670	0.0000	-0.7867	-0.9670	-0.0000	0.7867	0.3856	-0.0002	0.0254
SNB-F2	0.9670	0.0000	-0.7867	-0.9670	0.0000	0.7867	0.3856	-0.0003	0.0255
SNB-G1	1.1214	0.0000	-0.9571	-1.1214	-0.0000	0.9571	0.2209	0.0000	0.0218
SNB-G2	1.1214	0.0000	-0.9571	-1.1214	0.0000	0.9571	0.2209	-0.0003	0.0219
SNB-H1	1.1981	0.0000	-1.0422	-1.1981	-0.0000	1.0422	0.1013	0.0001	0.0166
SNB-H2	1.1981	0.0000	-1.0422	-1.1981	0.0000	1.0422	0.1013	-0.0003	0.0166
SNB-I1	1.4581	0.0000	-1.1689	-1.4581	-0.0000	1.1689	0.0283	0.0003	0.0085
SNB-I2	1.4581	0.0000	-1.1689	-1.4581	0.0000	1.1689	0.0283	-0.0003	0.0086
SNB-J1	0.8371	0.0000	-0.6316	16.7736	18.8845	232.8515	0.0000	0.0000	0.0000
SNB-J2	0.8371	0.0000	-0.6316	16.7923	-18.9166	233.3501	0.0000	0.0000	0.0000
RohnAaS	0.6047	0.0000	-0.1881	-0.6047	0.0000	0.1881	1.7052	-0.0005	-0.0894
RohnAbS	0.1887	0.0000	-0.1410	-0.1887	0.0000	0.1410	1.6248	-0.0004	-0.0917
RohnAcS	0.5630	0.0000	-0.1890	-0.5630	0.0000	0.1890	1.5448	0.0000	-0.0937

RohnBaS	0.2658	0.0000	-0.1642	-0.2658	0.0000	0.1642	1.3850	-0.0001	-0.0973
RohnBbS	2.2103	0.0000	-0.8700	-2.2103	0.0000	0.8700	1.3055	-0.0002	-0.0987
RohnBcS	0.2658	0.0000	-0.1642	-0.2658	0.0000	0.1642	1.2268	-0.0003	-0.0997
RohnCaS	2.0581	0.0000	-0.7200	-2.0581	0.0000	0.7200	1.0477	-0.0004	-0.1009
RohnCbS	2.9069	0.0000	-1.2757	-2.9069	0.0000	1.2757	0.9489	-0.0004	-0.1008
RohnDaS	2.9338	0.0000	-1.1411	-2.9338	0.0000	1.1411	0.7623	-0.0005	-0.0975
RohnDbS	0.4066	0.0000	-0.2460	-0.4066	0.0000	0.2460	0.6762	-0.0005	-0.0940
RohnEaS	0.4227	0.0000	-0.3345	-0.4227	-0.0000	0.3345	0.5212	-0.0007	-0.0863
RohnEbS	0.4227	0.0000	-0.3345	-0.4227	-0.0000	0.3345	0.4510	-0.0008	-0.0824
RohnFaS	0.5444	0.0000	-0.4522	-0.5444	-0.0000	0.4522	0.2992	-0.0009	-0.0709
RohnGaS	0.5770	0.0000	-0.5049	-0.5770	-0.0000	0.5049	0.1577	-0.0006	-0.0544
RohnHaS	0.6210	0.0000	-0.5373	-0.6210	-0.0000	0.5373	0.0611	-0.0003	-0.0342
RohnIaS	0.8371	0.0000	-0.6316	-0.8371	-0.0000	0.6316	0.0109	-0.0001	-0.0115
SNB-AaS	0.1887	0.0000	-0.1410	-0.1887	-0.0000	0.1410	1.7055	-0.0016	-0.0544
SNB-AbS	0.1887	0.0000	-0.1410	-0.1887	-0.0000	0.1410	1.6251	-0.0016	-0.0568
SNB-AcS	0.1887	0.0000	-0.1410	-0.1887	-0.0000	0.1410	1.5451	-0.0014	-0.0591
SNB-BaS	0.2658	0.0000	-0.1642	-0.2658	-0.0000	0.1642	1.3853	-0.0012	-0.0634
SNB-BbS	0.2658	0.0000	-0.1642	-0.2658	-0.0000	0.1642	1.3058	-0.0011	-0.0654
SNB-BcS	0.2658	0.0000	-0.1642	-0.2658	-0.0000	0.1642	1.2270	-0.0010	-0.0670
SNB-CaS	0.3930	0.0000	-0.2230	-0.3930	-0.0000	0.2230	1.0480	-0.0008	-0.0700
SNB-CbS	0.3930	0.0000	-0.2230	-0.3930	-0.0000	0.2230	0.9491	-0.0007	-0.0708
SNB-DaS	0.4066	0.0000	-0.2460	-0.4066	-0.0000	0.2460	0.7624	-0.0005	-0.0701
SNB-DbS	0.4066	0.0000	-0.2460	-0.4066	-0.0000	0.2460	0.6763	-0.0005	-0.0682
SNB-EaS	0.4227	0.0000	-0.3345	-0.4227	-0.0000	0.3345	0.5213	-0.0003	-0.0645
SNB-EbS	0.4227	0.0000	-0.3345	-0.4227	0.0000	0.3345	0.4511	-0.0003	-0.0628
SNB-FaS	0.5444	0.0000	-0.4522	-0.5444	-0.0000	0.4522	0.2992	-0.0002	-0.0560
SNB-GaS	0.5770	0.0000	-0.5049	-0.5770	-0.0000	0.5049	0.1577	-0.0001	-0.0442
SNB-HaS	0.6210	0.0000	-0.5373	-0.6210	-0.0000	0.5373	0.0611	-0.0000	-0.0286
SNB-IaS	0.8371	0.0000	-0.6316	-0.8371	-0.0000	0.6316	0.0109	-0.0000	-0.0100
SNB-WL-A1S	0.1887	0.0000	-0.1410	-0.1887	0.0000	0.1410	1.7859	-0.0017	-0.0241
SNB-WL-A2S	0.1887	0.0000	-0.1410	-0.1887	-0.0000	0.1410	1.7861	-0.0017	0.0040
SNB-WL-A3S	0.1887	0.0000	-0.1410	-0.1887	-0.0000	0.1410	1.7859	-0.0017	-0.0240
SNB-WL-B1S	0.1887	0.0000	-0.1410	-0.1887	0.0000	0.1410	1.4654	-0.0013	-0.0245
SNB-WL-B2S	0.1887	0.0000	-0.1410	-0.1887	-0.0000	0.1410	1.4657	-0.0013	0.0127
SNB-WL-B3S	0.1887	0.0000	-0.1410	-0.1887	-0.0000	0.1410	1.4654	-0.0013	-0.0244
SNB-WL-C1S	0.2658	0.0000	-0.1642	-0.2658	0.0000	0.1642	1.1493	-0.0010	-0.0245
SNB-WL-C2S	0.2658	0.0000	-0.1642	-0.2658	-0.0000	0.1642	1.1497	-0.0010	0.0201
SNB-WL-C3S	0.2658	0.0000	-0.1642	-0.2658	-0.0000	0.1642	1.1493	-0.0009	-0.0244
SNB-WL-D1S	0.3930	0.0000	-0.2230	-0.3930	0.0000	0.2230	0.8538	-0.0007	-0.0237
SNB-WL-D2S	0.3930	0.0000	-0.2230	-0.3930	-0.0000	0.2230	0.8542	-0.0006	0.0246
SNB-WL-D3S	0.3930	0.0000	-0.2230	-0.3930	-0.0000	0.2230	0.8538	-0.0006	-0.0237
SNB-WL-E1S	0.4066	0.0000	-0.2460	-0.4066	0.0000	0.2460	0.5954	-0.0004	-0.0205
SNB-WL-E2S	0.4066	0.0000	-0.2460	-0.4066	-0.0000	0.2460	0.5957	-0.0004	0.0252
SNB-WL-E3S	0.4066	0.0000	-0.2460	-0.4066	-0.0000	0.2460	0.5954	-0.0004	-0.0204
SNB-WL-F1S	0.4227	0.0000	-0.3345	-0.4227	0.0000	0.3345	0.3855	-0.0003	-0.0189
SNB-WL-F2S	0.4227	0.0000	-0.3345	-0.4227	-0.0000	0.3345	0.3858	-0.0003	0.0247
SNB-WL-F3S	0.4227	0.0000	-0.3345	-0.4227	-0.0000	0.3345	0.3855	-0.0002	-0.0189
SNB-WL-G1S	0.5444	0.0000	-0.4522	-0.5444	0.0000	0.4522	0.2209	-0.0002	-0.0164
SNB-WL-G2S	0.5444	0.0000	-0.4522	-0.5444	-0.0000	0.4522	0.2212	-0.0001	0.0203
SNB-WL-G3S	0.5444	0.0000	-0.4522	-0.5444	-0.0000	0.4522	0.2209	-0.0001	-0.0164
SNB-WL-H1S	0.5770	0.0000	-0.5049	-0.5770	0.0000	0.5049	0.1015	-0.0001	-0.0133
SNB-WL-H2S	0.5770	0.0000	-0.5049	-0.5770	0.0000	0.5049	0.1017	-0.0001	0.0138
SNB-WL-H3S	0.5770	0.0000	-0.5049	-0.5770	-0.0000	0.5049	0.1015	-0.0000	-0.0133
SNB-WL-I1S	0.6210	0.0000	-0.5373	-0.6210	0.0000	0.5373	0.0286	-0.0001	-0.0094
SNB-WL-I2S	0.6210	0.0000	-0.5373	-0.6210	-0.0000	0.5373	0.0287	-0.0000	0.0050
SNB-WL-I3S	0.6210	0.0000	-0.5373	-0.6210	-0.0000	0.5373	0.0286	0.0000	-0.0094
RohnAa1	0.4999	0.0000	-0.2072	-0.4999	0.0000	0.2072	1.7070	-0.0022	0.0185
RohnAa2	0.7903	0.0000	-0.2279	-0.7903	-0.0000	0.2279	1.7053	-0.0021	0.0186
RohnAb1	1.1180	-0.0502	-0.2490	-1.1180	0.0502	0.2490	1.6273	-0.0024	0.0206
RohnAb2	0.1887	0.0000	-0.1410	-0.1887	-0.0000	0.1410	1.6247	-0.0022	0.0208
RohnAc1	0.1887	0.0000	-0.1410	-0.1887	0.0000	0.1410	1.5465	-0.0020	0.0227
RohnAc2	0.1887	0.0000	-0.1410	-0.1887	-0.0000	0.1410	1.5443	-0.0022	0.0229
RohnBa1	0.2658	0.0000	-0.1642	-0.2658	0.0000	0.1642	1.3865	-0.0015	0.0265
RohnBa2	0.2658	0.0000	-0.1642	-0.2658	-0.0000	0.1642	1.3845	-0.0020	0.0267
RohnBb1	2.1359	0.0000	-0.8457	-2.1359	0.0000	0.8457	1.3080	-0.0020	0.0283
RohnBb2	2.1359	0.0000	-0.8457	-2.1359	-0.0000	0.8457	1.3064	-0.0012	0.0285
RohnBc1	0.2658	0.0000	-0.1642	-0.2658	0.0000	0.1642	1.2278	-0.0011	0.0299
RohnBc2	0.2658	0.0000	-0.1642	-0.2658	0.0000	0.1642	1.2265	-0.0017	0.0301
RohnCa1	2.2226	0.0000	-0.7740	-2.2226	0.0000	0.7740	1.0491	-0.0011	0.0330

RohnCa2	2.3301	0.0000	-0.8100	-2.3301	-0.0000	0.8100	1.0483	-0.0010	0.0332
RohnCb1	2.7453	0.0000	-1.2262	-2.7453	0.0000	1.2262	0.9495	-0.0007	0.0343
RohnCb2	2.7453	0.0000	-1.2262	-2.7453	-0.0000	1.2262	0.9489	-0.0011	0.0345
RohnDa1	2.6669	0.0000	-1.0466	-2.6669	0.0000	1.0466	0.7625	-0.0004	0.0355
RohnDa2	2.6669	0.0000	-1.0466	-2.6669	-0.0000	1.0466	0.7624	-0.0008	0.0356
RohnDb1	0.4066	0.0000	-0.2460	-0.4066	0.0000	0.2460	0.6746	0.0007	0.0352
RohnDb2	0.4066	0.0000	-0.2460	-0.4066	-0.0000	0.2460	0.6747	-0.0016	0.0353
RohnEa1	0.4227	0.0000	-0.3345	-0.4227	-0.0000	0.3345	0.5199	0.0007	0.0336
RohnEa2	0.4227	0.0000	-0.3345	-0.4227	0.0000	0.3345	0.5204	-0.0010	0.0337
RohnEb1	0.4227	0.0000	-0.3345	-0.4227	0.0000	0.3345	0.4496	0.0008	0.0327
RohnEb2	0.4227	0.0000	-0.3345	-0.4227	-0.0000	0.3345	0.4504	-0.0009	0.0328
RohnFa1	0.5444	0.0000	-0.4522	-0.5444	0.0000	0.4522	0.2939	0.0027	0.0292
RohnFa2	0.5444	0.0000	-0.4522	-0.5444	-0.0000	0.4522	0.2949	-0.0024	0.0292
RohnGa1	0.5770	0.0000	-0.5049	-0.5770	-0.0000	0.5049	0.1524	0.0027	0.0230
RohnGa2	0.5770	0.0000	-0.5049	-0.5770	0.0000	0.5049	0.1533	-0.0024	0.0231
RohnHa1	0.6210	0.0000	-0.5373	-0.6210	0.0000	0.5373	0.0551	0.0030	0.0148
RohnHa2	0.6210	0.0000	-0.5373	-0.6210	-0.0000	0.5373	0.0556	-0.0028	0.0148
RohnIa1	0.8371	0.0000	-0.6316	-0.8371	0.0000	0.6316	0.0065	0.0022	0.0050
RohnIa2	0.8371	0.0000	-0.6316	-0.8371	-0.0000	0.6316	0.0067	-0.0021	0.0050
SNB-Aa1	0.1887	0.0000	-0.1410	-0.1887	-0.0000	0.1410	1.7059	-0.0016	0.0063
SNB-Aa2	0.1887	0.0000	-0.1410	-0.1887	0.0000	0.1410	1.7059	-0.0017	0.0064
SNB-Ab1	0.1887	0.0000	-0.1410	-0.1887	-0.0000	0.1410	1.6258	-0.0015	0.0085
SNB-Ab2	0.1887	0.0000	-0.1410	-0.1887	0.0000	0.1410	1.6257	-0.0015	0.0086
SNB-Ac1	0.1887	0.0000	-0.1410	-0.1887	-0.0000	0.1410	1.5453	-0.0014	0.0107
SNB-Ac2	0.1887	0.0000	-0.1410	-0.1887	0.0000	0.1410	1.5454	-0.0015	0.0108
SNB-Ba1	0.2658	0.0000	-0.1642	-0.2658	-0.0000	0.1642	1.3857	-0.0011	0.0148
SNB-Ba2	0.2658	0.0000	-0.1642	-0.2658	0.0000	0.1642	1.3857	-0.0013	0.0149
SNB-Bb1	0.2658	0.0000	-0.1642	-0.2658	-0.0000	0.1642	1.3062	-0.0010	0.0168
SNB-Bb2	0.2658	0.0000	-0.1642	-0.2658	0.0000	0.1642	1.3062	-0.0012	0.0169
SNB-Bc1	0.2658	0.0000	-0.1642	-0.2658	-0.0000	0.1642	1.2272	-0.0009	0.0186
SNB-Bc2	0.2658	0.0000	-0.1642	-0.2658	0.0000	0.1642	1.2272	-0.0012	0.0187
SNB-Ca1	0.3930	0.0000	-0.2230	-0.3930	-0.0000	0.2230	1.0476	-0.0003	0.0223
SNB-Ca2	0.3930	0.0000	-0.2230	-0.3930	0.0000	0.2230	1.0476	-0.0014	0.0225
SNB-Cb1	0.3930	0.0000	-0.2230	-0.3930	-0.0000	0.2230	0.9484	-0.0001	0.0240
SNB-Cb2	0.3930	0.0000	-0.2230	-0.3930	0.0000	0.2230	0.9484	-0.0013	0.0241
SNB-Da1	0.4066	0.0000	-0.2460	-0.4066	-0.0000	0.2460	0.7615	0.0002	0.0260
SNB-Da2	0.4066	0.0000	-0.2460	-0.4066	0.0000	0.2460	0.7615	-0.0013	0.0261
SNB-Db1	0.4066	0.0000	-0.2460	-0.4066	-0.0000	0.2460	0.6744	0.0008	0.0261
SNB-Db2	0.4066	0.0000	-0.2460	-0.4066	0.0000	0.2460	0.6744	-0.0017	0.0262
SNB-Ea1	0.4227	0.0000	-0.3345	-0.4227	-0.0000	0.3345	0.5205	0.0003	0.0260
SNB-Ea2	0.4227	0.0000	-0.3345	-0.4227	0.0000	0.3345	0.5205	-0.0010	0.0260
SNB-Eb1	0.4227	0.0000	-0.3345	-0.4227	0.0000	0.3345	0.4501	0.0004	0.0259
SNB-Eb2	0.4227	0.0000	-0.3345	-0.4227	-0.0000	0.3345	0.4501	-0.0010	0.0259
SNB-Fa1	0.5444	0.0000	-0.4522	-0.5444	-0.0000	0.4522	0.2938	0.0027	0.0240
SNB-Fa2	0.5444	0.0000	-0.4522	-0.5444	0.0000	0.4522	0.2938	-0.0031	0.0241
SNB-Ga1	0.5770	0.0000	-0.5049	-0.5770	-0.0000	0.5049	0.1528	0.0025	0.0196
SNB-Ga2	0.5770	0.0000	-0.5049	-0.5770	0.0000	0.5049	0.1528	-0.0027	0.0196
SNB-Ha1	0.6210	0.0000	-0.5373	-0.6210	0.0000	0.5373	0.0557	0.0027	0.0129
SNB-Ha2	0.6210	0.0000	-0.5373	-0.6210	-0.0000	0.5373	0.0557	-0.0028	0.0129
SNB-Ia1	0.8371	0.0000	-0.6316	-0.8371	0.0000	0.6316	0.0061	0.0024	0.0046
SNB-Ia2	0.8371	0.0000	-0.6316	-0.8371	-0.0000	0.6316	0.0061	-0.0024	0.0046

Moments for Angles Modeled as Beams:

Angle Torsion	Origin	Origin	End	End	X	Y	
Label	X Moment	Y Moment	X Moment	Y Moment	Shear	Shear	
(ft-lbs)	(ft-lbs)	(ft-lbs)	(ft-lbs)	(ft-lbs)	(lbs)	(lbs)	
Rohn-LA1P	-0.01	1.03	4.71	26.24	-16.83	5.45	-2.42
Rohn-LA11	2.04	-1.56	2.68	12.16	37.68	2.12	8.07
Rohn-LA12	-2.20	1.13	2.85	5.77	-17.28	1.38	-2.88
Rohn-LA2P	-0.01	-26.24	16.83	-32.88	24.65	-11.82	8.29
Rohn-LA21	2.04	-12.16	-37.68	-36.36	-87.58	-9.70	-25.03
Rohn-LA22	-2.20	-5.77	17.28	2.33	4.58	-0.69	4.37
Rohn-LA3P	-0.01	32.88	-24.65	35.77	-11.41	13.72	-7.21
Rohn-LA31	2.04	36.36	87.58	42.32	104.89	15.72	38.46
Rohn-LA32	-2.20	-2.33	-4.58	-25.79	50.17	-5.62	9.11
Rohn-LA4P	-0.01	-35.77	11.41	-18.78	22.33	-10.90	6.74
Rohn-LA41	2.04	-42.32	-104.89	-63.95	-117.14	-21.24	-44.37

Rohn-LA42	-2.20	25.79	-50.17	48.28	-77.06	14.80	-25.43
Rohn-LB1P	2.93	18.11	-11.53	10.92	0.56	5.80	-2.19
Rohn-LB11	8.53	62.28	123.72	117.85	225.05	36.00	69.70
Rohn-LB12	-2.57	-45.01	82.85	-112.09	209.51	-31.40	58.42
Rohn-LB2P	2.93	-10.92	-0.56	-4.24	53.30	-3.03	10.54
Rohn-LB21	8.52	-117.85	-225.05	-145.41	-220.04	-52.61	-88.94
Rohn-LB22	-2.57	112.09	-209.51	144.71	-214.27	51.32	-84.68
Rohn-LB3P	2.93	4.24	-53.30	4.08	2.06	1.66	-10.24
Rohn-LB31	8.53	145.41	220.04	82.52	167.72	45.55	77.48
Rohn-LB32	-2.57	-144.71	214.27	-82.61	166.27	-45.42	76.04
Rohn-LB4P	2.93	-4.08	-2.06	-6.36	150.60	-2.09	29.70
Rohn-LB41	8.52	-82.52	-167.72	12.17	145.93	-14.06	-4.35
Rohn-LB42	-2.56	82.61	-166.27	-7.12	142.72	15.08	-4.71
Rohn-LC1P	2.93	6.36	-150.60	1.79	82.19	1.22	-10.27
Rohn-LC11	8.51	-12.17	-145.93	-34.31	19.23	-6.97	-19.01
Rohn-LC12	-2.55	7.12	-142.72	36.49	15.69	6.54	-19.06
Rohn-LC2P	2.93	-1.79	-82.19	1.31	112.76	-0.07	4.57
Rohn-LC21	8.51	34.31	-19.23	-24.36	108.88	1.49	13.41
Rohn-LC22	-2.56	-36.49	-15.69	29.32	99.02	-1.07	12.46
Rohn-LC3P	2.93	-1.31	-112.76	-3.23	226.40	-0.68	17.06
Rohn-LC31	8.52	24.36	-108.88	109.59	349.34	20.09	36.07
Rohn-LC32	-2.57	-29.32	-99.02	-116.75	371.13	-21.91	40.82
Rohn-LD1P	2.93	3.23	-226.40	6.66	406.03	1.49	26.97
Rohn-LD11	8.48	-109.59	-349.34	-236.60	32.93	-51.92	-47.46
Rohn-LD12	-2.52	116.74	-371.14	244.41	15.51	54.17	-53.34
Rohn-LD2P	2.93	-6.66	-406.03	-2.03	181.59	-1.30	-33.60
Rohn-LD21	8.59	236.59	-32.93	322.69	775.39	83.63	111.02
Rohn-LD22	-2.63	-244.41	-15.51	-322.96	781.28	-84.84	114.50
Rohn-LD3P	2.93	2.03	-181.59	-0.69	702.81	0.20	78.29
Rohn-LD31	8.41	-322.67	-775.40	-304.38	95.26	-94.04	-102.00
Rohn-LD32	-2.45	322.94	-781.29	306.01	97.19	94.32	-102.59
Rohn-LE1P	2.93	0.68	-702.81	12.27	280.63	1.95	-63.40
Rohn-LE11	8.56	304.38	-95.25	139.28	571.29	66.54	71.40
Rohn-LE12	-2.60	-306.01	-97.18	-134.46	557.17	-66.06	68.99
Rohn-LE2P	2.93	-12.27	-280.63	-26.78	232.78	-5.85	-7.16
Rohn-LE21	8.51	-139.27	-571.29	114.43	457.66	-3.71	-16.99
Rohn-LE22	-2.55	134.45	-557.18	-127.19	497.09	1.09	-8.98
Rohn-LE3P	2.94	26.78	-232.78	27.69	1082.58	8.18	127.63
Rohn-LE31	8.44	-114.43	-457.67	-438.09	178.08	-82.86	-41.93
Rohn-LE32	-2.48	127.18	-497.10	474.33	98.76	90.21	-59.74
Rohn-LF1P	2.92	-27.69	-1082.58	-39.72	119.47	-6.74	-96.33
Rohn-LF11	8.73	438.09	-178.07	778.16	1704.89	121.48	152.50
Rohn-LF12	-2.78	-474.33	-98.75	-800.73	1766.39	-127.35	166.56
Rohn-LF2P	2.95	39.72	-119.47	29.60	1597.36	6.94	147.84
Rohn-LF21	8.17	-778.09	-1704.93	-933.95	-299.56	-170.99	-200.20
Rohn-LF22	-2.20	800.64	-1766.43	967.84	-373.23	176.63	-213.70
Rohn-LG1P	2.92	-29.61	-1597.36	-26.34	-51.51	-5.60	-164.93
Rohn-LG11	8.89	933.93	299.58	1035.09	2041.47	196.66	233.82
Rohn-LG12	-2.94	-967.83	373.25	-1047.53	2076.77	-201.29	244.70
Rohn-LG2P	2.94	26.34	51.51	13.22	1856.50	3.96	190.87
Rohn-LG21	8.14	-1034.99	-2041.52	-1131.25	-433.80	-216.35	-247.22
Rohn-LG22	-2.18	1047.42	-2076.83	1136.21	-444.62	218.09	-251.82
Rohn-LH1P	2.93	-13.22	-1856.50	0.43	-120.19	-1.28	-197.76
Rohn-LH11	8.88	1131.23	433.82	1271.60	2443.80	239.97	287.38
Rohn-LH12	-2.93	-1136.20	444.64	-1274.58	2451.90	-240.76	289.27
Rohn-LH2P	2.93	-0.44	120.19	-2.11	2371.96	-0.25	249.35
Rohn-LH21	7.79	-1271.46	-2443.88	-1485.56	-641.02	-275.33	-308.07
Rohn-LH22	-1.84	1274.43	-2451.98	1490.51	-645.91	276.12	-309.37
Rohn-LI1P	2.93	2.11	-2371.96	-9.19	-129.00	-0.71	-250.18
Rohn-LI11	8.75	1485.55	641.05	1915.90	3778.26	339.71	441.37
Rohn-LI12	-2.80	-1490.50	645.94	-1901.96	3755.21	-338.81	439.55
Rohn-LI2P	2.94	9.19	129.00	58.25	5479.26	6.75	561.06
Rohn-LI21	7.36	-1915.72	-3778.36	-1968.09	1465.14	-387.87	-231.02
Rohn-LI22	-1.42	1901.77	-3755.31	1913.10	1569.01	380.99	-218.35
Rohn-H1P	0.20	2.24	0.12	3.05	-1.05	0.70	-0.12
Rohn-H11	-0.06	0.09	-1.05	-0.03	1.23	0.01	0.02
Rohn-H12	0.38	-3.06	1.04	-3.30	-0.07	-0.85	0.13
Rohn-H2P	-0.52	6.66	-1.88	6.92	-3.47	1.53	-0.60
Rohn-H21	-0.11	1.20	-3.20	0.06	-0.03	0.14	-0.36

Rohn-H22	0.15	-6.70	0.53	-6.19	-1.09	-1.45	-0.06
SNB-LA1P	-0.03	4.04	48.03	14.57	-13.24	3.72	6.95
SNB-LA11	0.27	51.33	-14.14	13.64	17.90	12.98	0.75
SNB-LA12	-0.28	-55.45	-26.89	-22.07	-5.22	-15.49	-6.42
SNB-LA2P	-0.03	-14.57	13.24	-19.71	35.41	-6.85	9.72
SNB-LA21	0.27	-13.64	-17.90	-7.53	-42.53	-4.23	-12.08
SNB-LA22	-0.28	22.07	5.22	18.05	-13.32	8.02	-1.62
SNB-LA3P	-0.03	19.71	-35.41	16.23	-33.86	7.18	-13.84
SNB-LA31	0.27	7.53	42.53	9.47	71.81	3.40	22.85
SNB-LA32	-0.28	-18.05	13.32	-18.14	47.83	-7.23	12.22
SNB-LA4P	-0.03	-16.23	33.86	-10.45	101.59	-5.33	27.07
SNB-LA41	0.27	-9.47	-71.81	-0.93	-63.96	-2.08	-27.13
SNB-LA42	-0.28	18.14	-47.83	8.09	-47.08	5.24	-18.97
SNB-LB1P	-0.06	9.61	154.39	4.65	44.94	2.85	39.84
SNB-LB11	3.20	90.47	74.14	48.67	101.83	27.81	35.17
SNB-LB12	-3.00	-96.15	60.69	-51.95	94.77	-29.60	31.07
SNB-LB2P	-0.06	-4.65	-44.94	-2.70	112.78	-1.47	13.56
SNB-LB21	3.19	-48.67	-101.83	-39.82	-2.81	-17.68	-20.91
SNB-LB22	-3.00	51.95	-94.77	42.04	1.53	18.78	-18.63
SNB-LB3P	-0.06	2.70	-112.78	2.20	-42.34	0.98	-31.00
SNB-LB31	3.20	39.82	2.81	59.98	192.18	19.94	38.96
SNB-LB32	-3.00	-42.04	-1.53	-60.26	189.55	-20.44	37.57
SNB-LB4P	-0.06	-2.20	42.34	-0.18	504.74	-0.48	109.35
SNB-LB41	3.19	-59.98	-192.18	-39.55	54.85	-19.89	-27.44
SNB-LB42	-2.99	60.26	-189.55	42.29	56.46	20.49	-26.59
SNB-LC1P	0.03	0.18	-61.20	0.29	167.69	0.07	15.98
SNB-LC11	8.32	160.68	-27.16	69.56	183.16	34.54	23.40
SNB-LC12	-8.25	-162.68	-28.45	-69.41	182.93	-34.82	23.17
SNB-LC2P	0.03	-0.29	-167.69	0.97	82.71	0.10	-12.72
SNB-LC21	8.30	-69.56	-183.16	42.90	335.10	-3.99	22.72
SNB-LC22	-8.23	69.41	-182.93	-43.29	333.78	3.91	22.56
SNB-LC3P	0.03	-0.97	-82.71	-0.36	547.53	-0.20	69.77
SNB-LC31	8.30	-42.89	-335.10	-40.28	-17.55	-12.48	-52.90
SNB-LC32	-8.23	43.28	-333.78	44.57	-14.72	13.18	-52.28
SNB-LD1P	-0.03	0.46	65.31	2.96	691.63	0.51	113.63
SNB-LD11	10.69	271.57	-5.08	-1.93	546.09	40.45	81.15
SNB-LD12	-10.54	-276.05	-8.36	0.95	542.11	-41.27	80.06
SNB-LD2P	-0.03	-2.96	-691.63	-0.17	81.59	-0.47	-91.32
SNB-LD21	10.70	1.94	-546.09	325.87	842.27	49.02	44.29
SNB-LD22	-10.55	-0.96	-542.11	-323.14	844.05	-48.47	45.15
SNB-LD3P	-0.03	0.17	-81.59	-0.81	1507.88	-0.10	214.17
SNB-LD31	10.52	-325.85	-842.28	-397.78	298.04	-108.53	-81.62
SNB-LD32	-10.38	323.12	-844.06	400.04	300.06	108.46	-81.59
SNB-LE1P	-0.31	1.46	-427.59	10.09	1066.09	1.73	95.85
SNB-LE11	21.96	616.40	-178.64	205.61	1196.11	123.30	152.62
SNB-LE12	-21.58	-619.01	-181.99	-206.90	1183.78	-123.89	150.27
SNB-LE2P	-0.31	-10.09	-1066.09	-6.72	485.86	-2.52	-86.85
SNB-LE21	21.89	-205.60	-1196.12	406.40	1659.28	30.03	69.26
SNB-LE22	-21.51	206.89	-1183.78	-391.98	1675.19	-27.68	73.49
SNB-LE3P	-0.31	6.72	-485.86	4.90	2794.31	1.74	346.58
SNB-LE31	21.73	-406.37	-1659.29	-881.09	-394.68	-193.10	-308.07
SNB-LE32	-21.35	391.95	-1675.19	868.04	-407.92	188.98	-312.44
SNB-LF1P	-0.02	-4.76	-1779.46	-1.57	-127.91	-0.63	-190.74
SNB-LF11	38.58	1469.44	308.70	1620.74	3160.55	308.69	346.53
SNB-LF12	-38.57	-1457.45	321.08	-1605.52	3170.99	-305.97	348.81
SNB-LF2P	-0.02	1.57	127.91	3.34	3458.83	0.49	358.71
SNB-LF21	37.29	-1620.62	-3160.63	-1718.85	-1131.55	-333.56	-428.71
SNB-LF22	-37.28	1605.40	-3171.07	1707.50	-1141.80	330.91	-430.77
SNB-LG1P	0.28	-3.26	-2297.65	-0.18	218.40	-0.34	-207.93
SNB-LG11	63.81	2720.13	711.20	2820.54	5824.21	553.46	652.78
SNB-LG12	-64.18	-2708.75	721.43	-2805.71	5832.74	-550.84	654.66
SNB-LG2P	0.29	0.18	-218.39	2.18	5888.70	0.24	567.11
SNB-LG21	61.92	-2820.33	-5824.33	-2504.78	-1410.30	-531.88	-722.59
SNB-LG22	-62.29	2805.51	-5832.86	2502.89	-1413.69	530.21	-723.78
SNB-LH1P	0.09	-2.04	-4149.55	4.08	-135.98	0.20	-428.65
SNB-LH11	61.82	3654.09	901.48	3337.52	6452.98	698.32	734.53
SNB-LH12	-62.04	-3653.15	904.22	-3332.48	6451.02	-697.73	734.60
SNB-LH2P	0.09	-4.08	135.98	-1.94	6862.23	-0.60	700.05
SNB-LH21	58.96	-3337.24	-6453.15	-3446.70	-1747.48	-677.53	-819.00

SNB-LH22	-59.17	3332.20	-6451.19	3450.01	-1743.19	677.36	-818.38
SNB-LI1P	-0.01	2.02	-4969.97	8.44	-57.94	1.05	-502.88
SNB-LI11	19.85	4892.31	1084.59	5449.26	9853.02	1032.91	1092.44
SNB-LI12	-20.02	-4895.75	1080.19	-5444.04	9846.09	-1032.73	1091.30
SNB-LI2P	-0.01	-8.44	57.94	-1.99	13374.31	-1.04	1343.58
SNB-LI21	15.55	-5448.75	-9853.31	-5528.39	2766.64	-1096.34	-707.78
SNB-LI22	-15.71	5443.53	-9846.37	5536.31	2774.40	1096.61	-706.31
SNB-H1aP	-1.75	29.89	68.89	114.67	-0.09	71.55	34.05
SNB-H1bP	-1.75	-114.68	0.10	-19.67	36.01	-66.49	17.87
SNB-H1cP	-2.05	39.98	-36.80	102.43	-1.98	70.49	-19.19
SNB-H1dP	-2.05	-102.42	1.98	-33.93	36.29	-67.49	18.94
SNB-H1eP	6.23	32.24	-35.85	108.23	-1.88	69.52	-18.68
SNB-H1fP	6.24	-108.23	1.88	-30.18	-68.70	-68.50	-33.08
SNB-H2aP	-7.57	152.04	54.90	114.51	2.79	98.62	21.34
SNB-H2bP	-7.57	-114.52	-2.78	8.05	21.07	-39.39	6.77
SNB-H2cP	0.64	86.92	-26.10	99.21	3.29	68.86	-8.44
SNB-H2dP	0.63	-99.21	-3.29	-87.67	25.69	-69.14	8.29
SNB-H2eP	6.72	-11.04	-20.78	116.09	1.48	38.87	-7.14
SNB-H2fP	6.72	-116.09	-1.49	-151.81	-54.90	-99.12	-20.86
SNB-H3aP	-6.18	259.55	35.85	155.19	-3.80	122.54	9.47
SNB-H3bP	-6.17	-155.19	3.80	28.30	12.37	-37.49	4.78
SNB-H3cP	0.03	129.78	-20.80	141.54	10.06	80.17	-3.17
SNB-H3dP	0.03	-141.54	-10.06	-129.27	20.68	-80.02	3.14
SNB-H3eP	6.10	-28.65	-12.12	155.29	-3.78	37.42	-4.70
SNB-H3fP	6.10	-155.29	3.78	-259.69	-35.94	-122.62	-9.50
SNB-H4aP	-6.61	357.64	18.54	247.33	-15.19	148.79	0.83
SNB-H4bP	-6.60	-247.33	15.19	-30.01	4.62	-68.21	4.87
SNB-H4cP	-0.09	210.50	-10.74	233.83	33.41	109.28	5.58
SNB-H4dP	-0.10	-233.83	-33.41	-210.46	10.59	-109.27	-5.61
SNB-H4eP	6.68	30.34	-4.56	247.12	-15.38	68.24	-4.91
SNB-H4fP	6.69	-247.12	15.38	-357.69	-18.48	-148.75	-0.76
SNB-H5aP	-10.31	629.42	28.17	322.70	-24.77	200.58	0.72
SNB-H5bP	-10.30	-322.70	24.77	131.09	1.11	-40.37	5.45
SNB-H5cP	-0.35	274.86	-20.70	300.21	55.37	121.15	7.31
SNB-H5dP	-0.36	-300.21	-55.37	-274.47	20.46	-121.07	-7.36
SNB-H5eP	10.64	-130.18	-1.15	321.92	-24.84	40.39	-5.48
SNB-H5fP	10.64	-321.92	24.84	-630.10	-27.87	-200.56	-0.63
SNB-H6aP	-48.43	613.88	9.06	523.96	-24.25	209.61	-2.78
SNB-H6bP	-48.42	-523.96	24.23	-127.79	-8.21	-120.06	2.95
SNB-H6cP	-0.13	482.20	-16.45	416.89	46.00	165.63	5.44
SNB-H6dP	-0.15	-416.89	-46.00	-482.76	16.56	-165.74	-5.42
SNB-H6eP	48.56	128.54	8.46	523.74	-22.85	120.16	-2.66
SNB-H6fP	48.56	-523.74	22.87	-613.96	-9.34	-209.59	2.51
SNB-H7aP	-43.72	695.55	-8.29	761.68	-30.76	238.51	-6.37
SNB-H7bP	-43.71	-761.68	30.73	-511.05	-17.26	-208.31	2.19
SNB-H7cP	0.03	707.64	-12.87	669.14	55.19	225.34	6.93
SNB-H7dP	-0.01	-669.14	-55.19	-707.57	13.01	-225.33	-6.90
SNB-H7eP	43.70	511.12	17.49	761.86	-29.53	208.35	-1.99
SNB-H7fP	43.72	-761.86	29.56	-695.75	7.99	-238.57	6.16
SNB-H8aP	-12.31	1011.21	-14.94	894.48	-33.81	280.64	-7.17
SNB-H8bP	-12.29	-894.48	33.80	-594.16	-8.59	-219.22	3.71
SNB-H8cP	-0.08	841.88	5.68	878.02	66.36	253.29	10.61
SNB-H8dP	-0.13	-878.02	-66.36	-842.44	-5.76	-253.37	-10.62
SNB-H8eP	12.41	594.72	8.50	894.30	-33.59	219.28	-3.70
SNB-H8fP	12.43	-894.30	33.60	-1011.27	15.15	-280.62	7.19
SNB-H9aP	-29.91	1109.73	-20.63	1044.06	-40.20	288.24	-8.12
SNB-H9bP	-29.89	-1044.06	40.17	-780.57	8.26	-244.19	6.47
SNB-H9cP	-0.00	1030.52	27.85	994.63	78.91	271.04	14.29
SNB-H9dP	-0.05	-994.63	-27.85	-1030.58	-27.87	-271.05	-14.29
SNB-H9eP	29.93	780.66	-8.29	1044.02	-40.15	244.19	-6.50
SNB-H9fP	29.95	-1044.01	40.18	-1109.82	20.73	-288.25	8.17

Equilibrium Joint Positions and Rotations for Load Case "4: 1.2D + 1.0Dg + 1.0E":

Joint Label	X-Displ (ft)	Y-Displ (ft)	Z-Displ (ft)	X-Rot (deg)	Y-Rot (deg)	Z-Rot (deg)	X-Pos (ft)	Y-Pos (ft)	Z-Pos (ft)
RohnAP	0.1402	0.0001	-0.01542	0.0000	0.0801	-0.0008	4.473	0.0001	180
RohnBP	0.1121	0.0001227	-0.01614	0.0000	0.0791	-0.0004	5.233	0.0001227	160
RohnCP	0.08512	0.0001146	-0.01595	-0.0000	0.0735	-0.0003	5.994	0.0001146	140
RohnDP	0.06112	9.869e-005	-0.01492	-0.0000	0.0625	-0.0002	6.756	9.869e-005	120
RohnEP	0.04136	7.468e-005	-0.01257	-0.0001	0.0488	-0.0001	7.522	7.468e-005	99.99
RohnFP	0.02609	4.385e-005	-0.01041	-0.0001	0.0359	-0.0001	8.294	4.385e-005	79.99
RohnGP	0.01451	1.717e-005	-0.008082	-0.0001	0.0272	-0.0001	9.07	1.717e-005	59.99
RohnHP	0.00642	2.553e-006	-0.005639	-0.0000	0.0178	-0.0000	9.847	2.553e-006	39.99
RohnIP	0.001686	-2.973e-006	-0.002709	-0.0000	0.0067	-0.0000	10.63	-2.973e-006	20
RohnJP	0	0	0	0.0000	0.0000	0.0000	11.42	0	0
SNB-AP	0.1403	0.0001679	-0.007814	-0.0000	0.0737	-0.0000	2.473	0.0001679	180
SNB-BP	0.1121	0.0001507	-0.008672	-0.0000	0.0743	-0.0000	3.233	0.0001507	160
SNB-CP	0.08513	0.0001365	-0.009107	-0.0001	0.0684	-0.0000	3.993	0.0001365	140
SNB-DP	0.06113	0.0001173	-0.008871	-0.0001	0.0545	-0.0000	4.756	0.0001173	120
SNB-EP	0.04137	9.182e-005	-0.007711	-0.0001	0.0432	-0.0000	5.522	9.182e-005	99.99
SNB-FP	0.0261	6.015e-005	-0.006871	-0.0001	0.0301	-0.0000	6.294	6.015e-005	79.99
SNB-GP	0.01451	3.151e-005	-0.005485	-0.0001	0.0168	-0.0000	7.07	3.151e-005	59.99
SNB-HP	0.006421	1.221e-005	-0.003942	-0.0000	0.0094	-0.0000	7.847	1.221e-005	40
SNB-IP	0.001686	2.297e-006	-0.001938	-0.0000	0.0009	-0.0000	8.63	2.297e-006	20
SNB-JP	0	0	0	0.0000	0.0000	0.0000	9.415	0	0
RohnA1	0.1402	0.0002079	-0.006409	-0.0007	0.0806	-0.0012	-2.026	-3.752	180
RohnA2	0.1403	0.000206	-0.006434	0.0003	0.0810	-0.0004	-2.026	3.753	180
RohnB1	0.1121	0.0001694	-0.005748	-0.0000	0.0802	-0.0012	-2.448	-4.435	160
RohnB2	0.1122	0.000158	-0.005749	-0.0001	0.0803	0.0004	-2.448	4.435	160
RohnC1	0.08505	0.0001777	-0.005017	-0.0002	0.0733	-0.0015	-2.869	-5.117	140
RohnC2	0.08509	0.0001181	-0.005026	0.0001	0.0733	0.0010	-2.869	5.117	140
RohnD1	0.06101	0.0001649	-0.004231	-0.0005	0.0632	-0.0015	-3.286	-5.798	120
RohnD2	0.06104	8.737e-005	-0.00424	0.0004	0.0632	0.0011	-3.286	5.798	120
RohnE1	0.04129	0.0001197	-0.003274	-0.0002	0.0489	-0.0012	-3.699	-6.479	100
RohnE2	0.04132	8.265e-005	-0.003295	0.0000	0.0489	0.0010	-3.699	6.479	100
RohnF1	0.02598	0.0001043	-0.002505	-0.0006	0.0398	-0.0011	-4.108	-7.16	80
RohnF2	0.02601	3.55e-005	-0.002535	0.0004	0.0398	0.0009	-4.108	7.16	80
RohnG1	0.01445	6.272e-005	-0.001836	-0.0002	0.0281	-0.0008	-4.513	-7.842	60
RohnG2	0.01447	1.545e-005	-0.001861	0.0001	0.0281	0.0007	-4.513	7.842	60
RohnH1	0.006352	4.33e-005	-0.001223	-0.0002	0.0187	-0.0005	-4.914	-8.523	40
RohnH2	0.006367	-9.692e-006	-0.001238	0.0001	0.0188	0.0005	-4.914	8.523	40
RohnI1	0.001635	2.455e-005	-0.0005824	-0.0005	0.0092	-0.0003	-5.313	-9.206	20
RohnI2	0.001642	-1.518e-005	-0.0005889	0.0005	0.0092	0.0003	-5.313	9.206	20
RohnJ1	0	0	0	0.0000	0.0000	0.0000	-5.71	-9.89	0
RohnJ2	0	0	0	0.0000	0.0000	0.0000	-5.71	9.89	0
SNB-A1	0.1403	0.0001674	-0.002891	-0.0060	0.0841	-0.0001	-1.026	-2.02	180
SNB-A2	0.1403	0.000169	-0.002896	0.0058	0.0841	0.0001	-1.026	2.021	180
SNB-B1	0.1122	0.0001501	-0.002267	-0.0038	0.0818	-0.0001	-1.448	-2.703	160
SNB-B2	0.1122	0.0001519	-0.002271	0.0038	0.0818	0.0001	-1.448	2.703	160
SNB-C1	0.08512	0.0001347	-0.001704	-0.0042	0.0761	-0.0002	-1.869	-3.384	140
SNB-C2	0.08512	0.0001389	-0.00171	0.0041	0.0761	0.0002	-1.869	3.385	140
SNB-D1	0.0611	0.0001146	-0.001251	-0.0070	0.0673	-0.0003	-2.286	-4.066	120
SNB-D2	0.0611	0.0001206	-0.00126	0.0068	0.0673	0.0003	-2.286	4.066	120
SNB-E1	0.04134	9.168e-005	-0.0009261	-0.0043	0.0509	-0.0003	-2.699	-4.747	100
SNB-E2	0.04134	9.245e-005	-0.0009396	0.0041	0.0509	0.0003	-2.699	4.747	100
SNB-F1	0.02606	5.681e-005	-0.0006791	-0.0062	0.0430	-0.0002	-3.108	-5.428	80
SNB-F2	0.02606	6.38e-005	-0.0006946	0.0060	0.0431	0.0002	-3.108	5.428	80
SNB-G1	0.01449	3.969e-005	-0.0004792	-0.0082	0.0330	-0.0003	-3.513	-6.11	60
SNB-G2	0.01449	2.359e-005	-0.0004929	0.0080	0.0330	0.0003	-3.513	6.11	60
SNB-H1	0.006387	2.259e-005	-0.0003088	-0.0075	0.0228	-0.0003	-3.914	-6.79	40
SNB-H2	0.006387	2.141e-006	-0.0003184	0.0074	0.0228	0.0003	-3.914	6.791	40
SNB-I1	0.001648	1.666e-005	-0.000148	-0.0057	0.0123	-0.0002	-4.312	-7.472	20
SNB-I2	0.001648	-1.185e-005	-0.0001524	0.0057	0.0123	0.0002	-4.312	7.472	20
SNB-J1	0	0	0	0.0000	0.0000	0.0000	-4.708	-8.154	0
SNB-J2	0	0	0	0.0000	0.0000	0.0000	-4.708	8.154	0

RohnAaS	0.1332	0.0001007	-0.01566	0.0000	0.0810	-0.0007	4.663	0.0001007	175
RohnAbS	0.1261	0.0001073	-0.01587	0.0002	0.0805	-0.0006	4.853	0.0001073	170
RohnAcS	0.1192	0.0001233	-0.01602	0.0001	0.0804	-0.0005	5.043	0.0001233	165
RohnBaS	0.1053	0.0001237	-0.01619	0.0000	0.0788	-0.0004	5.423	0.0001237	155
RohnBbS	0.09839	0.0001207	-0.01619	-0.0000	0.0774	-0.0003	5.613	0.0001207	150
RohnBcS	0.09174	0.000118	-0.01609	-0.0000	0.0761	-0.0003	5.804	0.000118	145
RohnCaS	0.07685	0.0001098	-0.01574	-0.0000	0.0693	-0.0002	6.248	0.0001098	133.3
RohnCbS	0.06884	0.0001038	-0.01541	-0.0000	0.0680	-0.0002	6.502	0.0001038	126.6
RohnDaS	0.05415	9.338e-005	-0.01428	-0.0001	0.0573	-0.0002	7.011	9.338e-005	113.3
RohnDbS	0.04758	8.406e-005	-0.01346	-0.0001	0.0553	-0.0001	7.267	8.406e-005	106.6
RohnEaS	0.03602	6.432e-005	-0.01191	-0.0001	0.0440	-0.0001	7.779	6.432e-005	93.33
RohnEbS	0.03088	5.348e-005	-0.01119	-0.0001	0.0435	-0.0001	8.037	5.348e-005	86.65
RohnFaS	0.02029	2.666e-005	-0.009298	-0.0001	0.0335	-0.0001	8.682	2.666e-005	69.99
RohnGaS	0.01049	6.567e-006	-0.006898	-0.0000	0.0231	-0.0000	9.458	6.567e-006	49.99
RohnHaS	0.004088	-1.584e-006	-0.004209	-0.0000	0.0137	-0.0000	10.24	-1.584e-006	30
RohnIaS	0.0008943	-2.634e-006	-0.001378	0.0000	0.0051	-0.0000	11.03	-2.634e-006	9.999
SNB-AaS	0.1332	0.000163	-0.008065	-0.0001	0.0828	-0.0000	2.663	0.000163	175
SNB-AbS	0.1262	0.0001552	-0.008299	-0.0000	0.0798	-0.0000	2.853	0.0001552	170
SNB-AcS	0.1192	0.0001545	-0.008501	-0.0000	0.0818	-0.0000	3.043	0.0001545	165
SNB-BaS	0.1053	0.0001479	-0.008831	-0.0000	0.0802	-0.0000	3.423	0.0001479	155
SNB-BbS	0.09841	0.0001445	-0.008896	-0.0000	0.0767	-0.0000	3.613	0.0001445	150
SNB-BcS	0.09175	0.0001409	-0.009049	-0.0000	0.0777	-0.0000	3.803	0.0001409	145
SNB-CaS	0.07686	0.0001305	-0.009103	-0.0001	0.0702	-0.0000	4.247	0.0001305	133.3
SNB-CbS	0.06885	0.0001241	-0.009013	-0.0001	0.0700	-0.0000	4.502	0.0001241	126.7
SNB-DaS	0.05416	0.0001101	-0.008577	-0.0001	0.0592	-0.0000	5.011	0.0001101	113.3
SNB-DbS	0.04759	0.0001013	-0.008173	-0.0001	0.0565	-0.0000	5.267	0.0001013	106.7
SNB-EaS	0.03603	8.173e-005	-0.007486	-0.0001	0.0453	-0.0000	5.779	8.173e-005	93.33
SNB-EbS	0.03088	7.077e-005	-0.007197	-0.0001	0.0448	-0.0000	6.037	7.077e-005	86.65
SNB-FaS	0.0203	4.412e-005	-0.006217	-0.0001	0.0377	-0.0000	6.682	4.412e-005	69.99
SNB-GaS	0.01049	1.991e-005	-0.004747	-0.0001	0.0279	-0.0000	7.458	1.991e-005	50
SNB-HaS	0.004089	5.349e-006	-0.002971	-0.0000	0.0174	-0.0000	8.239	5.349e-006	30
SNB-IaS	0.0008943	-1.31e-007	-0.0009932	-0.0000	0.0066	-0.0000	9.022	-1.31e-007	9.999
SNB-WL-A1S	0.1403	0.0001661	-0.005527	-0.0030	0.0789	0.0000	0.7235	-1.01	180
SNB-WL-A2S	0.1403	0.0001682	-0.003066	-0.0001	0.0841	-0.0000	-1.026	0.0001682	180
SNB-WL-A3S	0.1403	0.0001701	-0.005529	0.0029	0.0789	-0.0000	0.7235	1.01	180
SNB-WL-B1S	0.1122	0.0001493	-0.005729	-0.0014	0.0772	-0.0000	0.8924	-1.351	160
SNB-WL-B2S	0.1122	0.000151	-0.00252	-0.0000	0.0818	-0.0000	-1.448	0.000151	160
SNB-WL-B3S	0.1122	0.0001525	-0.005731	0.0014	0.0772	-0.0000	0.8924	1.352	160
SNB-WL-C1S	0.08513	0.0001353	-0.005898	-0.0014	0.0710	-0.0000	1.062	-1.692	140
SNB-WL-C2S	0.08513	0.0001368	-0.002193	-0.0000	0.0761	-0.0000	-1.869	0.0001368	140
SNB-WL-C3S	0.08513	0.0001381	-0.005901	0.0013	0.0710	0.0000	1.062	1.692	140
SNB-WL-D1S	0.06111	0.0001159	-0.006168	-0.0029	0.0599	-0.0001	1.235	-2.033	120
SNB-WL-D2S	0.06112	0.0001176	-0.002349	-0.0001	0.0673	-0.0000	-2.286	0.0001176	120
SNB-WL-D3S	0.06111	0.000119	-0.006172	0.0028	0.0599	0.0001	1.235	2.033	120
SNB-WL-E1S	0.04135	9.092e-005	-0.00509	-0.0015	0.0459	-0.0001	1.412	-2.373	99.99
SNB-WL-E2S	0.04136	9.206e-005	-0.001697	-0.0001	0.0509	-0.0000	-2.699	9.206e-005	100
SNB-WL-E3S	0.04135	9.297e-005	-0.005097	0.0014	0.0459	0.0001	1.412	2.373	99.99
SNB-WL-F1S	0.02608	5.889e-005	-0.005307	-0.0027	0.0358	-0.0001	1.593	-2.714	79.99
SNB-WL-F2S	0.02608	6.03e-005	-0.002172	-0.0001	0.0430	-0.0000	-3.108	6.03e-005	80
SNB-WL-F3S	0.02608	6.151e-005	-0.005315	0.0025	0.0359	0.0001	1.593	2.714	79.99
SNB-WL-G1S	0.0145	3.018e-005	-0.005761	-0.0040	0.0247	-0.0001	1.778	-3.055	59.99
SNB-WL-G2S	0.01451	3.164e-005	-0.003217	-0.0001	0.0330	-0.0000	-3.513	3.164e-005	60
SNB-WL-G3S	0.0145	3.294e-005	-0.005768	0.0039	0.0247	0.0001	1.778	3.055	59.99
SNB-WL-H1S	0.006407	1.123e-005	-0.006092	-0.0034	0.0155	-0.0001	1.967	-3.395	39.99
SNB-WL-H2S	0.006409	1.236e-005	-0.004272	-0.0000	0.0228	-0.0000	-3.914	1.236e-005	40
SNB-WL-H3S	0.006407	1.339e-005	-0.006097	0.0033	0.0155	0.0001	1.967	3.395	39.99
SNB-WL-I1S	0.001671	1.665e-006	-0.006432	-0.0027	0.0062	-0.0001	2.159	-3.736	19.99
SNB-WL-I2S	0.001672	2.405e-006	-0.005503	-0.0000	0.0123	0.0000	-4.312	2.405e-006	19.99
SNB-WL-I3S	0.001671	3.088e-006	-0.006434	0.0026	0.0062	0.0001	2.159	3.736	19.99
RohnAa1	0.1332	0.0001616	-0.006248	-0.0002	0.0805	-0.0012	-2.132	-3.923	175
RohnAa2	0.1333	0.0002177	-0.006263	-0.0003	0.0810	-0.0002	-2.132	3.923	175
RohnAb1	0.1261	0.000172	-0.006084	-0.0001	0.0810	-0.0012	-2.237	-4.094	170
RohnAb2	0.1262	0.0001778	-0.006089	-0.0002	0.0813	0.0000	-2.237	4.094	170
RohnAc1	0.1191	0.0001516	-0.005912	-0.0000	0.0801	-0.0012	-2.343	-4.264	165
RohnAc2	0.1191	0.0001881	-0.005915	-0.0001	0.0802	0.0002	-2.343	4.264	165
RohnBa1	0.1051	0.0001517	-0.005573	-0.0003	0.0785	-0.0013	-2.554	-4.605	155
RohnBa2	0.1052	0.00017	-0.005576	0.0002	0.0785	0.0006	-2.554	4.606	155
RohnBb1	0.09839	0.00014	-0.005407	-0.0001	0.0776	-0.0014	-2.659	-4.776	150
RohnBb2	0.09844	0.0001741	-0.005413	0.0000	0.0776	0.0007	-2.659	4.776	150

RohnBc1	0.09158	0.0001449	-0.005204	0.0003	0.0769	-0.0015	-2.764	-4.947	145
RohnBc2	0.09162	0.0001606	-0.005211	-0.0005	0.0769	0.0009	-2.764	4.947	145
RohnCa1	0.07665	0.0001068	-0.004783	-0.0007	0.0711	-0.0015	-3.009	-5.344	133.3
RohnCa2	0.07669	0.0001757	-0.004794	0.0005	0.0712	0.0011	-3.009	5.344	133.3
RohnCb1	0.06856	0.0001017	-0.004523	0.0006	0.0671	-0.0015	-3.148	-5.571	126.7
RohnCb2	0.06859	0.000165	-0.004533	-0.0007	0.0672	0.0011	-3.148	5.572	126.7
RohnDa1	0.05382	6.377e-005	-0.003927	-0.0007	0.0601	-0.0015	-3.425	-6.025	113.3
RohnDa2	0.05385	0.0001744	-0.00394	0.0005	0.0601	0.0011	-3.425	6.025	113.3
RohnDb1	0.04716	7.987e-005	-0.00358	0.0004	0.0534	-0.0013	-3.562	-6.252	106.7
RohnDb2	0.04719	0.0001414	-0.003597	-0.0006	0.0535	0.0010	-3.562	6.252	106.7
RohnEa1	0.03571	7.567e-005	-0.003011	-0.0003	0.0462	-0.0012	-3.836	-6.706	93.34
RohnEa2	0.03574	0.0001065	-0.003034	0.0001	0.0462	0.0010	-3.836	6.706	93.34
RohnEb1	0.03063	8.77e-005	-0.002751	0.0003	0.0412	-0.0011	-3.972	-6.933	86.66
RohnEb2	0.03066	7.35e-005	-0.002777	-0.0005	0.0412	0.0009	-3.972	6.933	86.66
RohnFa1	0.01941	-1.817e-005	-0.00215	-0.0001	0.0326	-0.0009	-4.311	-7.501	70
RohnFa2	0.01944	0.0001246	-0.002177	-0.0001	0.0326	0.0007	-4.311	7.501	70
RohnGa1	0.00967	-4.116e-005	-0.001516	-0.0001	0.0231	-0.0006	-4.714	-8.182	50
RohnGa2	0.009688	9.42e-005	-0.001536	-0.0001	0.0231	0.0006	-4.714	8.182	50
RohnHa1	0.003196	-7.738e-005	-0.0008881	0.0000	0.0133	-0.0004	-5.115	-8.864	30
RohnHa2	0.003206	9.655e-005	-0.0008987	-0.0001	0.0133	0.0003	-5.115	8.864	30
RohnIa1	0.000166	-9.913e-005	-0.000284	-0.0001	0.0048	-0.0001	-5.512	-9.548	10
RohnIa2	0.0001693	0.0001023	-0.0002872	0.0000	0.0048	0.0001	-5.512	9.548	10
SNB-Aa1	0.1332	0.0001388	-0.002732	0.0015	0.0799	-0.0002	-1.132	-2.191	175
SNB-Aa2	0.1332	0.0001845	-0.002736	-0.0017	0.0799	0.0002	-1.132	2.191	175
SNB-Ab1	0.1262	0.0001565	-0.002573	-0.0006	0.0815	-0.0002	-1.237	-2.361	170
SNB-Ab2	0.1262	0.0001584	-0.002577	0.0006	0.0815	0.0002	-1.237	2.362	170
SNB-Ac1	0.1191	0.0001397	-0.002416	0.0011	0.0795	-0.0002	-1.343	-2.532	165
SNB-Ac2	0.1191	0.0001668	-0.00242	-0.0011	0.0795	0.0002	-1.343	2.532	165
SNB-Ba1	0.1052	0.0001232	-0.002112	0.0011	0.0785	-0.0002	-1.554	-2.873	155
SNB-Ba2	0.1052	0.0001728	-0.002117	-0.0012	0.0785	0.0002	-1.554	2.873	155
SNB-Bb1	0.09837	0.000152	-0.001968	-0.0005	0.0781	-0.0002	-1.659	-3.043	150
SNB-Bb2	0.09837	0.0001376	-0.001973	0.0005	0.0781	0.0002	-1.659	3.044	150
SNB-Bc1	0.09162	0.0001223	-0.00183	0.0010	0.0753	-0.0002	-1.764	-3.214	145
SNB-Bc2	0.09162	0.0001599	-0.001835	-0.0011	0.0753	0.0002	-1.764	3.214	145
SNB-Ca1	0.07661	0.0001258	-0.001535	0.0005	0.0715	-0.0003	-2.008	-3.611	133.3
SNB-Ca2	0.07661	0.0001351	-0.001542	-0.0006	0.0715	0.0003	-2.008	3.612	133.3
SNB-Cb1	0.06855	0.0001056	-0.001377	0.0015	0.0652	-0.0003	-2.148	-3.839	126.7
SNB-Cb2	0.06855	0.0001425	-0.001385	-0.0017	0.0652	0.0003	-2.148	3.839	126.7
SNB-Da1	0.05379	7.808e-005	-0.001117	0.0013	0.0600	-0.0004	-2.425	-4.293	113.3
SNB-Da2	0.05379	0.000142	-0.001128	-0.0015	0.0600	0.0004	-2.425	4.293	113.3
SNB-Db1	0.04714	8.8e-005	-0.001	0.0008	0.0525	-0.0003	-2.562	-4.52	106.7
SNB-Db2	0.04714	0.0001153	-0.001012	-0.0010	0.0525	0.0003	-2.562	4.52	106.7
SNB-Ea1	0.03575	4.89e-005	-0.0008264	0.0005	0.0460	-0.0003	-2.836	-4.974	93.34
SNB-Ea2	0.03575	0.000115	-0.0008408	-0.0007	0.0460	0.0003	-2.836	4.974	93.34
SNB-Eb1	0.03066	6.842e-005	-0.0007416	0.0014	0.0402	-0.0002	-2.972	-5.201	86.66
SNB-Eb2	0.03066	7.421e-005	-0.0007568	-0.0016	0.0402	0.0002	-2.972	5.201	86.66
SNB-Fa1	0.01938	2.428e-006	-0.000555	0.0035	0.0307	-0.0002	-3.311	-5.769	70
SNB-Fa2	0.01937	8.803e-005	-0.0005701	-0.0037	0.0307	0.0002	-3.311	5.769	70
SNB-Ga1	0.009669	-4.124e-005	-0.0003733	0.0038	0.0209	-0.0003	-3.714	-6.45	50
SNB-Ga2	0.009669	8.304e-005	-0.0003851	-0.0039	0.0209	0.0003	-3.714	6.45	50
SNB-Ha1	0.003211	-8.647e-005	-0.0002078	0.0032	0.0116	-0.0002	-4.114	-7.131	30
SNB-Ha2	0.003211	9.903e-005	-0.0002149	-0.0033	0.0116	0.0002	-4.114	7.131	30
SNB-Ia1	0.0001501	-8.991e-005	-5.823e-005	0.0013	0.0040	-0.0001	-4.511	-7.813	10
SNB-Ia2	0.0001495	9.082e-005	-6.042e-005	-0.0013	0.0040	0.0001	-4.511	7.813	10

Joint Support Reactions for Load Case "4: 1.2D + 1.0Dg + 1.0E":

Joint Label	X Force (kips)	X Usage %	Y Force (kips)	Y Usage %	Z Force (kips)	Z Usage %	Comp. Usage %	Uplift Result. (kips)	Uplift Usage %	Result. Usage (ft-k)	X Moment Usage (ft-k)	X-M. Moment Usage (ft-k)	Y Moment Usage (ft-k)	Y-M. Moment Usage (ft-k)	Z Moment Usage (ft-k)	Z-M. Moment Usage (ft-k)	Max. Usage %
RohnJP	-2.53	0.0	0.00	0.0	41.68	0.0	0.0	41.76	0.0	-0.00	0.0	-0.6	0.0	0.00	0.0	0.0	0.0
SNB-JP	-3.06	0.0	0.00	0.0	49.49	0.0	0.0	49.58	0.0	-0.00	0.0	-1.2	0.0	-0.00	0.0	0.0	0.0
RohnJ1	0.11	0.0	0.32	0.0	8.93	0.0	0.0	8.94	0.0	-0.09	0.0	0.1	0.0	-0.00	0.0	0.0	0.0
RohnJ2	0.10	0.0	-0.33	0.0	9.02	0.0	0.0	9.03	0.0	0.10	0.0	0.1	0.0	0.00	0.0	0.0	0.0
SNB-J1	-0.46	0.0	-0.55	0.0	2.95	0.0	0.0	3.03	0.0	-0.03	0.0	0.2	0.0	-0.01	0.0	0.0	0.0
SNB-J2	-0.46	0.0	0.55	0.0	3.05	0.0	0.0	3.13	0.0	0.03	0.0	0.2	0.0	0.01	0.0	0.0	0.0

Joint Displacements, Loads and Member Forces on Joints for Load Case "4: 1.2D + 1.0Dg + 1.0E":

Joint Label	X External Load (kips)	Y External Load (kips)	Z External Load (kips)	X Member Force (kips)	Y Member Force (kips)	Z Member Force (kips)	X Disp. (ft)	Y Disp. (ft)	Z Disp. (ft)
RohnAP	0.0989	0.0000	-0.3561	-0.0989	0.0000	0.3561	0.1402	0.0001	-0.0154
RohnBP	0.1987	0.0000	-1.2758	-0.1987	0.0000	1.2758	0.1121	0.0001	-0.0161
RohnCP	0.0458	0.0000	-0.5163	-0.0458	0.0000	0.5163	0.0851	0.0001	-0.0159
RohnDP	0.0374	0.0000	-0.6254	-0.0374	0.0000	0.6254	0.0611	0.0001	-0.0149
RohnEP	0.0371	0.0000	-0.7740	-0.0371	0.0000	0.7740	0.0414	0.0001	-0.0126
RohnFP	0.0405	0.0000	-1.0489	-0.0405	0.0000	1.0489	0.0261	0.0000	-0.0104
RohnGP	0.0390	0.0000	-1.3961	-0.0390	0.0000	1.3961	0.0145	0.0000	-0.0081
RohnHP	0.0254	0.0000	-1.3896	-0.0254	0.0000	1.3896	0.0064	0.0000	-0.0056
RohnIP	0.0173	0.0000	-1.5585	-0.0173	0.0000	1.5585	0.0017	-0.0000	-0.0027
RohnJP	0.0000	0.0000	-0.8421	2.5337	-0.0032	-40.8381	0.0000	0.0000	0.0000
SNB-AP	0.0522	0.0000	-0.1881	-0.0522	0.0000	0.1881	0.1403	0.0002	-0.0078
SNB-BP	0.0634	0.0000	-0.4070	-0.0634	0.0000	0.4070	0.1121	0.0002	-0.0087
SNB-CP	0.0458	0.0000	-0.5163	-0.0458	0.0000	0.5163	0.0851	0.0001	-0.0091
SNB-DP	0.0374	0.0000	-0.6254	-0.0374	0.0000	0.6254	0.0611	0.0001	-0.0089
SNB-EP	0.0371	0.0000	-0.7740	-0.0371	0.0000	0.7740	0.0414	0.0001	-0.0077
SNB-FP	0.0405	0.0000	-1.0489	-0.0405	0.0000	1.0489	0.0261	0.0001	-0.0069
SNB-GP	0.0357	0.0000	-1.2761	-0.0357	0.0000	1.2761	0.0145	0.0000	-0.0055
SNB-HP	0.0254	0.0000	-1.3896	-0.0254	0.0000	1.3896	0.0064	0.0000	-0.0039
SNB-IP	0.0173	0.0000	-1.5585	-0.0173	-0.0000	1.5585	0.0017	0.0000	-0.0019
SNB-JP	0.0000	0.0000	-0.8421	3.0562	-0.0012	-48.6449	0.0000	0.0000	0.0000
RohnA1	0.0989	0.0000	-0.3561	-0.0989	0.0000	0.3561	0.1402	0.0002	-0.0064
RohnA2	0.1455	0.0000	-0.5241	-0.1455	-0.0000	0.5241	0.1403	0.0002	-0.0064
RohnB1	0.0847	0.0000	-0.5438	-0.0847	0.0000	0.5438	0.1121	0.0002	-0.0057
RohnB2	0.0726	0.0000	-0.4658	-0.0726	-0.0000	0.4658	0.1122	0.0002	-0.0057
RohnC1	0.0458	0.0000	-0.5163	-0.0458	0.0000	0.5163	0.0851	0.0002	-0.0050
RohnC2	0.0458	0.0000	-0.5163	-0.0458	-0.0000	0.5163	0.0851	0.0001	-0.0050
RohnD1	0.0424	0.0000	-0.7094	-0.0424	0.0000	0.7094	0.0610	0.0002	-0.0042
RohnD2	0.0374	0.0000	-0.6254	-0.0374	-0.0000	0.6254	0.0610	0.0001	-0.0042
RohnE1	0.0371	0.0000	-0.7740	-0.0371	0.0000	0.7740	0.0413	0.0001	-0.0033
RohnE2	0.0371	0.0000	-0.7740	-0.0371	-0.0000	0.7740	0.0413	0.0001	-0.0033
RohnF1	0.0405	0.0000	-1.0489	-0.0405	0.0000	1.0489	0.0260	0.0001	-0.0025
RohnF2	0.0473	0.0000	-1.2229	-0.0473	-0.0000	1.2229	0.0260	0.0000	-0.0025
RohnG1	0.0377	0.0000	-1.3481	-0.0377	0.0000	1.3481	0.0144	0.0001	-0.0018
RohnG2	0.0409	0.0000	-1.4633	-0.0409	-0.0000	1.4633	0.0145	0.0000	-0.0019
RohnH1	0.0254	0.0000	-1.3896	-0.0254	0.0000	1.3896	0.0064	0.0000	-0.0012
RohnH2	0.0254	0.0000	-1.3896	-0.0254	-0.0000	1.3896	0.0064	-0.0000	-0.0012
RohnI1	0.0173	0.0000	-1.5585	-0.0173	0.0000	1.5585	0.0016	0.0000	-0.0006
RohnI2	0.0173	0.0000	-1.5585	-0.0173	0.0000	1.5585	0.0016	-0.0000	-0.0006
RohnJ1	0.0000	0.0000	-0.8421	-0.1069	-0.3239	-8.0868	0.0000	0.0000	0.0000
RohnJ2	0.0000	0.0000	-0.8421	-0.1039	0.3275	-8.1779	0.0000	0.0000	0.0000
SNB-A1	0.0522	0.0000	-0.1881	-0.0522	-0.0000	0.1881	0.1403	0.0002	-0.0029
SNB-A2	0.0522	0.0000	-0.1881	-0.0522	0.0000	0.1881	0.1403	0.0002	-0.0029
SNB-B1	0.0634	0.0000	-0.4070	-0.0634	-0.0000	0.4070	0.1122	0.0002	-0.0023
SNB-B2	0.0634	0.0000	-0.4070	-0.0634	0.0000	0.4070	0.1122	0.0002	-0.0023
SNB-C1	0.0458	0.0000	-0.5163	-0.0458	-0.0000	0.5163	0.0851	0.0001	-0.0017
SNB-C2	0.0458	0.0000	-0.5163	-0.0458	0.0000	0.5163	0.0851	0.0001	-0.0017
SNB-D1	0.0374	0.0000	-0.6254	-0.0374	-0.0000	0.6254	0.0611	0.0001	-0.0013
SNB-D2	0.0374	0.0000	-0.6254	-0.0374	0.0000	0.6254	0.0611	0.0001	-0.0013
SNB-E1	0.0371	0.0000	-0.7740	-0.0371	-0.0000	0.7740	0.0413	0.0001	-0.0009
SNB-E2	0.0371	0.0000	-0.7740	-0.0371	0.0000	0.7740	0.0413	0.0001	-0.0009
SNB-F1	0.0405	0.0000	-1.0489	-0.0405	-0.0000	1.0489	0.0261	0.0001	-0.0007
SNB-F2	0.0405	0.0000	-1.0489	-0.0405	0.0000	1.0489	0.0261	0.0001	-0.0007
SNB-G1	0.0357	0.0000	-1.2761	-0.0357	-0.0000	1.2761	0.0145	0.0000	-0.0005
SNB-G2	0.0357	0.0000	-1.2761	-0.0357	0.0000	1.2761	0.0145	0.0000	-0.0005
SNB-H1	0.0254	0.0000	-1.3896	-0.0254	-0.0000	1.3896	0.0064	0.0000	-0.0003
SNB-H2	0.0254	0.0000	-1.3896	-0.0254	0.0000	1.3896	0.0064	0.0000	-0.0003
SNB-I1	0.0173	0.0000	-1.5585	-0.0173	-0.0000	1.5585	0.0016	0.0000	-0.0001
SNB-I2	0.0173	0.0000	-1.5585	-0.0173	-0.0000	1.5585	0.0016	-0.0000	-0.0002
SNB-J1	0.0000	0.0000	-0.8421	0.4589	0.5467	-2.1073	0.0000	0.0000	0.0000
SNB-J2	0.0000	0.0000	-0.8421	0.4572	-0.5458	-2.2091	0.0000	0.0000	0.0000
RohnAaS	0.0606	0.0000	-0.2508	-0.0606	0.0000	0.2508	0.1332	0.0001	-0.0157
RohnAbs	0.0393	0.0000	-0.1881	-0.0393	0.0000	0.1881	0.1261	0.0001	-0.0159
RohnAcS	0.0455	0.0000	-0.2520	-0.0455	0.0000	0.2520	0.1192	0.0001	-0.0160

RohnBaS	0.0294	0.0000	-0.2189	-0.0294	0.0000	0.2189	0.1053	0.0001	-0.0162
RohnBbS	0.1348	0.0000	-1.1599	-0.1348	0.0000	1.1599	0.0984	0.0001	-0.0162
RohnBcS	0.0221	0.0000	-0.2189	-0.0221	0.0000	0.2189	0.0917	0.0001	-0.0161
RohnCaS	0.0728	0.0000	-0.9601	-0.0728	0.0000	0.9601	0.0769	0.0001	-0.0157
RohnCbS	0.1131	0.0000	-1.7009	-0.1131	0.0000	1.7009	0.0688	0.0001	-0.0154
RohnDaS	0.0835	0.0000	-1.5215	-0.0835	0.0000	1.5215	0.0542	0.0001	-0.0143
RohnDbS	0.0168	0.0000	-0.3280	-0.0168	0.0000	0.3280	0.0476	0.0001	-0.0135
RohnEaS	0.0201	0.0000	-0.4460	-0.0201	0.0000	0.4460	0.0360	0.0001	-0.0119
RohnEbS	0.0187	0.0000	-0.4460	-0.0187	0.0000	0.4460	0.0309	0.0001	-0.0112
RohnFaS	0.0201	0.0000	-0.6029	-0.0201	0.0000	0.6029	0.0203	0.0000	-0.0093
RohnGaS	0.0154	0.0000	-0.6732	-0.0154	0.0000	0.6732	0.0105	0.0000	-0.0069
RohnHaS	0.0104	0.0000	-0.7165	-0.0104	0.0000	0.7165	0.0041	-0.0000	-0.0042
RohnIaS	0.0059	0.0000	-0.8421	-0.0059	0.0000	0.8421	0.0009	-0.0000	-0.0014
SNB-AaS	0.0454	0.0000	-0.1881	-0.0454	0.0000	0.1881	0.1332	0.0002	-0.0081
SNB-AbS	0.0393	0.0000	-0.1881	-0.0393	0.0000	0.1881	0.1262	0.0002	-0.0083
SNB-AcS	0.0340	0.0000	-0.1881	-0.0340	0.0000	0.1881	0.1192	0.0002	-0.0085
SNB-BaS	0.0294	0.0000	-0.2189	-0.0294	0.0000	0.2189	0.1053	0.0001	-0.0088
SNB-BbS	0.0254	0.0000	-0.2189	-0.0254	0.0000	0.2189	0.0984	0.0001	-0.0090
SNB-BcS	0.0221	0.0000	-0.2189	-0.0221	0.0000	0.2189	0.0918	0.0001	-0.0090
SNB-CaS	0.0226	0.0000	-0.2974	-0.0226	0.0000	0.2974	0.0769	0.0001	-0.0091
SNB-CbS	0.0198	0.0000	-0.2974	-0.0198	0.0000	0.2974	0.0688	0.0001	-0.0090
SNB-DS	0.0180	0.0000	-0.3280	-0.0180	0.0000	0.3280	0.0542	0.0001	-0.0086
SNB-DbS	0.0168	0.0000	-0.3280	-0.0168	0.0000	0.3280	0.0476	0.0001	-0.0082
SNB-EaS	0.0201	0.0000	-0.4460	-0.0201	0.0000	0.4460	0.0360	0.0001	-0.0075
SNB-EbS	0.0187	0.0000	-0.4460	-0.0187	0.0000	0.4460	0.0309	0.0001	-0.0072
SNB-FaS	0.0201	0.0000	-0.6029	-0.0201	0.0000	0.6029	0.0203	0.0000	-0.0062
SNB-GaS	0.0154	0.0000	-0.6732	-0.0154	0.0000	0.6732	0.0105	0.0000	-0.0047
SNB-HaS	0.0104	0.0000	-0.7165	-0.0104	0.0000	0.7165	0.0041	0.0000	-0.0030
SNB-IaS	0.0059	0.0000	-0.8421	-0.0059	0.0000	0.8421	0.0009	-0.0000	-0.0010
SNB-WL-A1S	0.0522	0.0000	-0.1881	-0.0522	0.0000	0.1881	0.1403	0.0002	-0.0055
SNB-WL-A2S	0.0522	0.0000	-0.1881	-0.0522	0.0000	0.1881	0.1403	0.0002	-0.0031
SNB-WL-A3S	0.0522	0.0000	-0.1881	-0.0522	-0.0000	0.1881	0.1403	0.0002	-0.0055
SNB-WL-B1S	0.0293	0.0000	-0.1881	-0.0293	0.0000	0.1881	0.1122	0.0001	-0.0057
SNB-WL-B2S	0.0293	0.0000	-0.1881	-0.0293	0.0000	0.1881	0.1122	0.0002	-0.0025
SNB-WL-B3S	0.0293	0.0000	-0.1881	-0.0293	-0.0000	0.1881	0.1122	0.0002	-0.0057
SNB-WL-C1S	0.0194	0.0000	-0.2189	-0.0194	0.0000	0.2189	0.0851	0.0001	-0.0059
SNB-WL-C2S	0.0194	0.0000	-0.2189	-0.0194	0.0000	0.2189	0.0851	0.0001	-0.0022
SNB-WL-C3S	0.0194	0.0000	-0.2189	-0.0194	-0.0000	0.2189	0.0851	0.0001	-0.0059
SNB-WL-D1S	0.0178	0.0000	-0.2974	-0.0178	0.0000	0.2974	0.0611	0.0001	-0.0062
SNB-WL-D2S	0.0178	0.0000	-0.2974	-0.0178	0.0000	0.2974	0.0611	0.0001	-0.0023
SNB-WL-D3S	0.0178	0.0000	-0.2974	-0.0178	-0.0000	0.2974	0.0611	0.0001	-0.0062
SNB-WL-E1S	0.0157	0.0000	-0.3280	-0.0157	0.0000	0.3280	0.0414	0.0001	-0.0051
SNB-WL-E2S	0.0157	0.0000	-0.3280	-0.0157	0.0000	0.3280	0.0414	0.0001	-0.0017
SNB-WL-E3S	0.0157	0.0000	-0.3280	-0.0157	-0.0000	0.3280	0.0414	0.0001	-0.0051
SNB-WL-F1S	0.0172	0.0000	-0.4460	-0.0172	0.0000	0.4460	0.0261	0.0001	-0.0053
SNB-WL-F2S	0.0172	0.0000	-0.4460	-0.0172	0.0000	0.4460	0.0261	0.0001	-0.0022
SNB-WL-F3S	0.0172	0.0000	-0.4460	-0.0172	-0.0000	0.4460	0.0261	0.0001	-0.0053
SNB-WL-G1S	0.0169	0.0000	-0.6029	-0.0169	0.0000	0.6029	0.0145	0.0000	-0.0058
SNB-WL-G2S	0.0169	0.0000	-0.6029	-0.0169	0.0000	0.6029	0.0145	0.0000	-0.0032
SNB-WL-G3S	0.0169	0.0000	-0.6029	-0.0169	-0.0000	0.6029	0.0145	0.0000	-0.0058
SNB-WL-H1S	0.0123	0.0000	-0.6732	-0.0123	0.0000	0.6732	0.0064	0.0000	-0.0061
SNB-WL-H2S	0.0123	0.0000	-0.6732	-0.0123	0.0000	0.6732	0.0064	0.0000	-0.0043
SNB-WL-H3S	0.0123	0.0000	-0.6732	-0.0123	-0.0000	0.6732	0.0064	0.0000	-0.0061
SNB-WL-I1S	0.0080	0.0000	-0.7165	-0.0080	0.0000	0.7165	0.0017	0.0000	-0.0064
SNB-WL-I2S	0.0080	0.0000	-0.7165	-0.0080	0.0000	0.7165	0.0017	0.0000	-0.0055
SNB-WL-I3S	0.0080	0.0000	-0.7165	-0.0080	-0.0000	0.7165	0.0017	0.0000	-0.0064
RohnAa1	0.0667	0.0000	-0.2763	-0.0667	0.0000	0.2763	0.1332	0.0002	-0.0062
RohnAa2	0.0734	0.0000	-0.3039	-0.0734	-0.0000	0.3039	0.1333	0.0002	-0.0063
RohnAb1	0.0695	0.0000	-0.3321	-0.0695	0.0000	0.3321	0.1261	0.0002	-0.0061
RohnAb2	0.0393	0.0000	-0.1881	-0.0393	-0.0000	0.1881	0.1262	0.0002	-0.0061
RohnAc1	0.0340	0.0000	-0.1881	-0.0340	0.0000	0.1881	0.1191	0.0002	-0.0059
RohnAc2	0.0340	0.0000	-0.1881	-0.0340	-0.0000	0.1881	0.1191	0.0002	-0.0059
RohnBa1	0.0294	0.0000	-0.2189	-0.0294	0.0000	0.2189	0.1051	0.0002	-0.0056
RohnBa2	0.0294	0.0000	-0.2189	-0.0294	-0.0000	0.2189	0.1052	0.0002	-0.0056
RohnBb1	0.1310	0.0000	-1.1275	-0.1310	0.0000	1.1275	0.0984	0.0001	-0.0054
RohnBb2	0.1310	0.0000	-1.1275	-0.1310	-0.0000	1.1275	0.0984	0.0002	-0.0054
RohnBc1	0.0221	0.0000	-0.2189	-0.0221	0.0000	0.2189	0.0916	0.0001	-0.0052
RohnBc2	0.0221	0.0000	-0.2189	-0.0221	-0.0000	0.2189	0.0916	0.0002	-0.0052
RohnCa1	0.0783	0.0000	-1.0321	-0.0783	0.0000	1.0321	0.0766	0.0001	-0.0048

RohnCa2	0.0819	0.0000	-1.0801	-0.0819	-0.0000	1.0801	0.0767	0.0002	-0.0048
RohnCb1	0.1087	0.0000	-1.6349	-0.1087	0.0000	1.6349	0.0686	0.0001	-0.0045
RohnCb2	0.1087	0.0000	-1.6349	-0.1087	-0.0000	1.6349	0.0686	0.0002	-0.0045
RohnDa1	0.0766	0.0000	-1.3955	-0.0766	0.0000	1.3955	0.0538	0.0001	-0.0039
RohnDa2	0.0766	0.0000	-1.3955	-0.0766	-0.0000	1.3955	0.0539	0.0002	-0.0039
RohnDb1	0.0168	0.0000	-0.3280	-0.0168	0.0000	0.3280	0.0472	0.0001	-0.0036
RohnDb2	0.0168	0.0000	-0.3280	-0.0168	-0.0000	0.3280	0.0472	0.0001	-0.0036
RohnEa1	0.0201	0.0000	-0.4460	-0.0201	0.0000	0.4460	0.0357	0.0001	-0.0030
RohnEa2	0.0201	0.0000	-0.4460	-0.0201	-0.0000	0.4460	0.0357	0.0001	-0.0030
RohnEb1	0.0187	0.0000	-0.4460	-0.0187	0.0000	0.4460	0.0306	0.0001	-0.0028
RohnEb2	0.0187	0.0000	-0.4460	-0.0187	-0.0000	0.4460	0.0307	0.0001	-0.0028
RohnFa1	0.0201	0.0000	-0.6029	-0.0201	0.0000	0.6029	0.0194	-0.0000	-0.0022
RohnFa2	0.0201	0.0000	-0.6029	-0.0201	-0.0000	0.6029	0.0194	0.0001	-0.0022
RohnGa1	0.0154	0.0000	-0.6732	-0.0154	0.0000	0.6732	0.0097	-0.0000	-0.0015
RohnGa2	0.0154	0.0000	-0.6732	-0.0154	-0.0000	0.6732	0.0097	0.0001	-0.0015
RohnHa1	0.0104	0.0000	-0.7165	-0.0104	0.0000	0.7165	0.0032	-0.0001	-0.0009
RohnHa2	0.0104	0.0000	-0.7165	-0.0104	-0.0000	0.7165	0.0032	0.0001	-0.0009
RohnIa1	0.0059	0.0000	-0.8421	-0.0059	0.0000	0.8421	0.0002	-0.0001	-0.0003
RohnIa2	0.0059	0.0000	-0.8421	-0.0059	0.0000	0.8421	0.0002	0.0001	-0.0003
SNB-Aa1	0.0454	0.0000	-0.1881	-0.0454	-0.0000	0.1881	0.1332	0.0001	-0.0027
SNB-Aa2	0.0454	0.0000	-0.1881	-0.0454	0.0000	0.1881	0.1332	0.0002	-0.0027
SNB-Ab1	0.0393	0.0000	-0.1881	-0.0393	-0.0000	0.1881	0.1262	0.0002	-0.0026
SNB-Ab2	0.0393	0.0000	-0.1881	-0.0393	0.0000	0.1881	0.1262	0.0002	-0.0026
SNB-Ac1	0.0340	0.0000	-0.1881	-0.0340	-0.0000	0.1881	0.1191	0.0001	-0.0024
SNB-Ac2	0.0340	0.0000	-0.1881	-0.0340	0.0000	0.1881	0.1191	0.0002	-0.0024
SNB-Ba1	0.0294	0.0000	-0.2189	-0.0294	-0.0000	0.2189	0.1052	0.0001	-0.0021
SNB-Ba2	0.0294	0.0000	-0.2189	-0.0294	0.0000	0.2189	0.1052	0.0002	-0.0021
SNB-Bb1	0.0254	0.0000	-0.2189	-0.0254	-0.0000	0.2189	0.0984	0.0002	-0.0020
SNB-Bb2	0.0254	0.0000	-0.2189	-0.0254	0.0000	0.2189	0.0984	0.0001	-0.0020
SNB-Bc1	0.0221	0.0000	-0.2189	-0.0221	-0.0000	0.2189	0.0916	0.0001	-0.0018
SNB-Bc2	0.0221	0.0000	-0.2189	-0.0221	0.0000	0.2189	0.0916	0.0002	-0.0018
SNB-Ca1	0.0226	0.0000	-0.2974	-0.0226	-0.0000	0.2974	0.0766	0.0001	-0.0015
SNB-Ca2	0.0226	0.0000	-0.2974	-0.0226	0.0000	0.2974	0.0766	0.0001	-0.0015
SNB-Cb1	0.0198	0.0000	-0.2974	-0.0198	-0.0000	0.2974	0.0685	0.0001	-0.0014
SNB-Cb2	0.0198	0.0000	-0.2974	-0.0198	0.0000	0.2974	0.0685	0.0001	-0.0014
SNB-Da1	0.0180	0.0000	-0.3280	-0.0180	-0.0000	0.3280	0.0538	0.0001	-0.0011
SNB-Da2	0.0180	0.0000	-0.3280	-0.0180	0.0000	0.3280	0.0538	0.0001	-0.0011
SNB-Db1	0.0168	0.0000	-0.3280	-0.0168	-0.0000	0.3280	0.0471	0.0001	-0.0010
SNB-Db2	0.0168	0.0000	-0.3280	-0.0168	0.0000	0.3280	0.0471	0.0001	-0.0010
SNB-Ea1	0.0201	0.0000	-0.4460	-0.0201	-0.0000	0.4460	0.0358	0.0000	-0.0008
SNB-Ea2	0.0201	0.0000	-0.4460	-0.0201	0.0000	0.4460	0.0358	0.0001	-0.0008
SNB-Eb1	0.0187	0.0000	-0.4460	-0.0187	-0.0000	0.4460	0.0307	0.0001	-0.0007
SNB-Eb2	0.0187	0.0000	-0.4460	-0.0187	0.0000	0.4460	0.0307	0.0001	-0.0008
SNB-Fa1	0.0201	0.0000	-0.6029	-0.0201	-0.0000	0.6029	0.0194	0.0000	-0.0006
SNB-Fa2	0.0201	0.0000	-0.6029	-0.0201	0.0000	0.6029	0.0194	0.0001	-0.0006
SNB-Ga1	0.0154	0.0000	-0.6732	-0.0154	-0.0000	0.6732	0.0097	-0.0000	-0.0004
SNB-Ga2	0.0154	0.0000	-0.6732	-0.0154	0.0000	0.6732	0.0097	0.0001	-0.0004
SNB-Ha1	0.0104	0.0000	-0.7165	-0.0104	-0.0000	0.7165	0.0032	-0.0001	-0.0002
SNB-Ha2	0.0104	0.0000	-0.7165	-0.0104	0.0000	0.7165	0.0032	0.0001	-0.0002
SNB-Ia1	0.0059	0.0000	-0.8421	-0.0059	-0.0000	0.8421	0.0002	-0.0001	-0.0001
SNB-Ia2	0.0059	0.0000	-0.8421	-0.0059	0.0000	0.8421	0.0001	0.0001	-0.0001

Moments for Angles Modeled as Beams:

Angle Label	Torsion (ft-lbs)	Origin X (ft-lbs)	Origin Y (ft-lbs)	Origin Moment (ft-lbs)	End X (ft-lbs)	End Y (ft-lbs)	End Moment (ft-lbs)	X Shear (lbs)	Y Shear (lbs)
Rohn-LA1P	-0.19	0.10	0.79	-0.08	-4.20	0.00	-0.68		
Rohn-LA11	0.01	-0.40	0.44	-3.35	1.39	-0.75	0.36		
Rohn-LA12	-0.41	0.38	0.63	3.35	0.59	0.74	0.24		
Rohn-LA2P	-0.19	0.08	4.20	-0.64	6.78	-0.11	2.19		
Rohn-LA21	0.01	3.35	-1.39	2.99	-4.31	1.27	-1.14		
Rohn-LA22	-0.41	-3.35	-0.59	-3.96	-1.82	-1.46	-0.48		
Rohn-LA3P	-0.19	0.64	-6.78	1.01	-6.19	0.33	-2.59		
Rohn-LA31	0.01	-2.99	4.31	-3.18	9.21	-1.23	2.70		
Rohn-LA32	-0.41	3.96	1.82	3.66	7.48	1.52	1.86		
Rohn-LA4P	-0.19	-1.01	6.19	-0.48	12.85	-0.30	3.80		
Rohn-LA41	0.01	3.18	-9.21	3.01	-9.81	1.24	-3.80		

Rohn-LA22	-0.41	-3.66	-7.48	-3.59	-8.27	-1.45	-3.15
Rohn-LB1P	-0.11	0.49	-11.64	0.44	-9.13	0.19	-4.15
Rohn-LB11	0.41	-3.42	10.56	-1.36	24.38	-0.95	6.98
Rohn-LB12	-0.63	3.95	9.04	1.61	23.71	1.11	6.55
Rohn-LB2P	-0.11	-0.44	9.13	-0.16	21.19	-0.12	6.06
Rohn-LB21	0.41	1.36	-24.38	0.30	-16.70	0.33	-8.21
Rohn-LB22	-0.63	-1.61	-23.71	-0.30	-16.44	-0.38	-8.03
Rohn-LB3P	-0.11	0.16	-21.19	0.10	-10.86	0.05	-6.41
Rohn-LB31	0.41	-0.30	16.70	-4.22	22.44	-0.90	7.82
Rohn-LB32	-0.63	0.30	16.44	4.29	22.30	0.92	7.74
Rohn-LB4P	-0.11	-0.10	10.86	-0.03	32.36	-0.03	8.64
Rohn-LB41	0.41	4.22	-22.44	8.64	7.57	2.57	-2.97
Rohn-LB42	-0.63	-4.29	-22.30	-8.67	7.81	-2.59	-2.90
Rohn-LC1P	-0.11	0.03	-32.36	0.09	8.49	0.02	-3.58
Rohn-LC11	0.41	-8.64	-7.57	-4.29	12.78	-1.94	0.78
Rohn-LC12	-0.63	8.67	-7.81	4.47	12.39	1.97	0.69
Rohn-LC2P	-0.11	-0.09	-8.49	-0.05	3.11	-0.02	-0.80
Rohn-LC21	0.41	4.29	-12.78	-7.37	25.65	-0.46	1.93
Rohn-LC22	-0.63	-4.47	-12.39	7.25	25.80	0.42	2.00
Rohn-LC3P	-0.11	0.05	-3.11	-0.06	49.58	-0.00	6.97
Rohn-LC31	0.41	7.37	-25.65	17.52	12.21	3.73	-2.02
Rohn-LC32	-0.63	-7.25	-25.80	-17.54	12.61	-3.72	-1.98
Rohn-LD1P	-0.11	0.06	-49.58	0.43	28.66	0.07	-3.14
Rohn-LD11	0.41	-17.52	-12.21	-15.05	33.36	-4.89	3.17
Rohn-LD12	-0.63	17.54	-12.61	15.28	32.96	4.92	3.05
Rohn-LD2P	-0.11	-0.43	-28.66	-0.13	1.57	-0.08	-4.05
Rohn-LD21	0.41	15.05	-33.36	-1.51	66.54	2.03	4.96
Rohn-LD22	-0.63	-15.28	-32.96	1.63	66.76	-2.04	5.06
Rohn-LD3P	-0.11	0.13	-1.57	0.12	95.68	0.04	14.12
Rohn-LD31	0.41	1.51	-66.54	11.59	1.10	1.96	-9.82
Rohn-LD32	-0.63	-1.63	-66.76	-11.50	1.01	-1.97	-9.86
Rohn-LE1P	-0.11	-0.12	-95.68	0.11	3.45	-0.00	-13.84
Rohn-LE11	0.41	-11.59	-1.10	-9.25	56.36	-3.13	8.29
Rohn-LE12	-0.63	11.50	-1.01	9.33	56.24	3.12	8.29
Rohn-LE2P	-0.11	-0.11	-3.45	-0.33	7.40	-0.07	0.59
Rohn-LE21	0.41	9.25	-56.36	-4.05	45.67	0.78	-1.60
Rohn-LE22	-0.63	-9.33	-56.24	4.04	46.20	-0.79	-1.50
Rohn-LE3P	-0.11	0.33	-7.40	0.59	149.92	0.14	21.39
Rohn-LE31	0.41	4.05	-45.67	23.15	-15.95	4.08	-9.25
Rohn-LE32	-0.63	-4.04	-46.20	-22.94	-17.22	-4.05	-9.52
Rohn-LF1P	-0.11	-0.59	-149.92	-1.07	-95.48	-0.17	-24.52
Rohn-LF11	0.41	-23.15	15.95	-35.69	182.59	-5.88	19.84
Rohn-LF12	-0.63	22.94	17.22	35.17	183.79	5.81	20.09
Rohn-LF2P	-0.11	1.07	95.48	0.63	242.99	0.17	33.83
Rohn-LF21	0.41	35.70	-182.59	39.15	-77.07	7.48	-25.95
Rohn-LF22	-0.63	-35.17	-183.78	-39.24	-78.30	-7.43	-26.19
Rohn-LG1P	-0.11	-0.63	-242.99	-1.00	-132.26	-0.16	-37.50
Rohn-LG11	0.41	-39.15	77.07	-43.20	209.66	-8.23	28.65
Rohn-LG12	-0.63	39.24	78.30	42.66	210.58	8.18	28.87
Rohn-LG2P	-0.11	1.00	132.26	0.37	272.65	0.14	40.46
Rohn-LG21	0.42	43.21	-209.66	47.99	-92.36	9.11	-30.18
Rohn-LG22	-0.64	-42.66	-210.58	-48.34	-92.90	-9.09	-30.33
Rohn-LH1P	-0.11	-0.37	-272.65	-0.41	-161.91	-0.08	-43.43
Rohn-LH11	0.40	-47.99	92.36	-54.66	237.35	-10.26	32.95
Rohn-LH12	-0.63	48.34	92.90	54.31	237.85	10.26	33.05
Rohn-LH2P	-0.11	0.41	161.91	0.03	348.58	0.04	51.02
Rohn-LH21	0.41	54.66	-237.35	69.49	-126.60	12.41	-36.37
Rohn-LH22	-0.63	-54.31	-237.85	-69.88	-127.09	-12.41	-36.47
Rohn-LI1P	-0.11	-0.03	-348.58	-1.07	-249.72	-0.11	-59.79
Rohn-LI11	0.40	-69.49	126.60	-98.15	395.14	-16.75	52.13
Rohn-LI12	-0.62	69.88	127.09	97.79	395.20	16.75	52.19
Rohn-LI2P	-0.11	1.07	249.72	1.89	558.49	0.30	80.77
Rohn-LI21	0.41	98.15	-395.14	94.80	-105.77	19.28	-50.05
Rohn-LI22	-0.63	-97.79	-395.20	-96.20	-104.08	-19.38	-49.89
Rohn-H1P	0.02	0.40	0.01	0.54	-0.06	0.13	-0.01
Rohn-H11	0.02	-0.11	0.05	0.06	0.18	-0.01	0.03
Rohn-H12	0.02	-0.68	0.24	-0.51	0.18	-0.16	0.06
Rohn-H2P	-0.03	0.71	-0.14	0.84	-0.26	0.18	-0.04
Rohn-H21	0.01	-0.02	-0.17	-0.03	0.07	-0.01	-0.01

Rohn-H22	0.04	-0.86	0.17	-0.72	0.06	-0.18	0.03
SNB-LA1P	-0.00	0.08	77.18	0.35	13.46	0.09	18.11
SNB-LA11	0.02	65.39	-36.23	12.84	-6.38	15.63	-8.52
SNB-LA12	-0.02	-65.81	-36.58	-13.28	-7.04	-15.80	-8.72
SNB-LA2P	-0.00	-0.35	-13.46	-0.62	7.88	-0.20	-1.11
SNB-LA21	0.02	-12.84	6.38	2.43	-4.94	-2.08	0.29
SNB-LA22	-0.02	13.28	7.04	-2.23	-4.10	2.21	0.59
SNB-LA3P	-0.00	0.62	-7.88	0.42	-22.33	0.21	-6.04
SNB-LA31	0.02	-2.43	4.94	-14.30	18.65	-3.34	4.71
SNB-LA32	-0.02	2.23	4.10	13.94	17.97	3.23	4.41
SNB-LA4P	-0.00	-0.42	22.33	-0.26	74.79	-0.14	19.41
SNB-LA41	0.02	14.30	-18.65	48.62	-34.37	12.57	-10.60
SNB-LA42	-0.02	-13.94	-17.97	-48.28	-33.86	-12.43	-10.36
SNB-LB1P	-0.00	0.29	119.98	0.19	16.19	0.10	27.21
SNB-LB11	0.42	98.61	-40.82	11.79	16.90	22.06	-4.78
SNB-LB12	-0.42	-98.65	-41.18	-11.79	16.69	-22.07	-4.89
SNB-LB2P	-0.00	-0.19	-16.19	-0.06	45.36	-0.05	5.83
SNB-LB21	0.42	-11.79	-16.90	16.78	-10.16	1.00	-5.41
SNB-LB22	-0.42	11.79	-16.68	-16.62	-10.00	-0.96	-5.33
SNB-LB3P	-0.00	0.06	-45.36	0.14	-61.95	0.04	-21.45
SNB-LB31	0.42	-16.78	10.16	-44.19	60.19	-12.18	14.06
SNB-LB32	-0.42	16.62	10.00	44.27	60.08	12.17	14.01
SNB-LB4P	-0.00	-0.14	61.95	-0.02	225.64	-0.03	57.48
SNB-LB41	0.43	44.19	-60.19	136.50	-75.42	36.11	-27.10
SNB-LB42	-0.42	-44.27	-60.08	-136.40	-75.33	-36.11	-27.06
SNB-LC1P	-0.00	0.01	81.08	0.03	57.34	0.01	20.77
SNB-LC11	0.86	101.49	-52.27	39.37	9.54	21.13	-6.41
SNB-LC12	-0.86	-101.63	-52.37	-39.40	9.49	-21.16	-6.43
SNB-LC2P	-0.00	-0.03	-57.34	0.03	-54.52	0.00	-16.73
SNB-LC21	0.86	-39.37	-9.54	-53.36	72.27	-13.87	9.38
SNB-LC22	-0.86	39.40	-9.49	53.34	72.22	13.87	9.38
SNB-LC3P	-0.00	-0.03	54.52	-0.01	258.54	-0.01	46.97
SNB-LC31	0.86	53.36	-72.27	165.71	-100.01	32.87	-25.85
SNB-LC32	-0.86	-53.34	-72.22	-165.50	-99.88	-32.83	-25.82
SNB-LD1P	-0.00	0.03	228.03	0.21	130.83	0.04	53.85
SNB-LD11	1.13	237.78	-125.32	66.08	26.99	45.59	-14.75
SNB-LD12	-1.13	-237.94	-125.44	-65.97	26.81	-45.60	-14.80
SNB-LD2P	-0.00	-0.21	-130.83	0.03	-73.87	-0.03	-30.62
SNB-LD21	1.12	-66.08	-26.99	-55.03	125.93	-18.12	14.80
SNB-LD22	-1.12	65.97	-26.81	55.32	126.06	18.14	14.85
SNB-LD3P	-0.00	-0.03	73.87	0.05	347.77	0.00	63.27
SNB-LD31	1.13	55.03	-125.93	159.88	-91.49	32.24	-32.62
SNB-LD32	-1.13	-55.32	-126.06	-159.88	-91.54	-32.29	-32.65
SNB-LE1P	-0.01	-0.09	295.92	0.31	184.59	0.03	72.10
SNB-LE11	1.91	353.58	-189.73	102.84	61.77	68.48	-19.20
SNB-LE12	-1.91	-353.85	-189.78	-102.70	61.49	-68.50	-19.25
SNB-LE2P	-0.01	-0.31	-184.59	-0.22	-158.98	-0.08	-51.40
SNB-LE21	1.90	-102.84	-61.77	-149.80	241.84	-37.79	26.94
SNB-LE22	-1.90	102.70	-61.49	150.26	242.36	37.84	27.05
SNB-LE3P	-0.01	0.22	158.98	0.18	926.38	0.06	162.85
SNB-LE31	1.92	149.80	-241.84	548.95	-390.81	104.84	-94.92
SNB-LE32	-1.92	-150.26	-242.36	-549.83	-391.52	-105.04	-95.10
SNB-LF1P	0.01	-0.29	41.33	-0.64	-222.63	-0.09	-18.12
SNB-LF11	2.75	275.99	-69.32	-60.88	358.33	21.49	28.88
SNB-LF12	-2.76	-275.60	-68.76	60.78	359.01	-21.46	29.00
SNB-LF2P	0.01	0.64	222.63	0.22	949.91	0.09	117.17
SNB-LF21	2.76	60.88	-358.33	466.22	-435.70	52.67	-79.34
SNB-LF22	-2.77	-60.79	-359.01	-467.25	-436.54	-52.76	-79.49
SNB-LG1P	0.02	-0.27	533.43	-1.42	-292.03	-0.17	24.12
SNB-LG11	4.45	825.19	-301.71	-66.53	597.85	75.81	29.59
SNB-LG12	-4.48	-824.30	-300.89	65.62	598.95	-75.81	29.78
SNB-LG2P	0.02	1.42	292.03	0.44	1667.94	0.19	195.86
SNB-LG21	4.45	66.53	-597.85	907.50	-739.37	97.33	-133.62
SNB-LG22	-4.48	-65.62	-598.95	-908.64	-740.52	-97.35	-133.84
SNB-LH1P	0.01	-0.45	240.20	-1.46	-353.13	-0.19	-11.29
SNB-LH11	4.16	729.11	-198.76	-69.98	634.62	65.86	43.55
SNB-LH12	-4.18	-728.01	-197.61	69.10	635.78	-65.84	43.78
SNB-LH2P	0.01	1.46	353.13	0.55	1583.36	0.20	193.52
SNB-LH21	4.15	69.98	-634.62	738.32	-686.38	80.77	-132.00

SNB-LH22	-4.18	-69.10	-635.78	-739.38	-687.61	-80.79	-132.24
SNB-LI1P	0.00	-0.54	674.72	-2.04	-187.14	-0.26	48.73
SNB-LI11	2.26	1215.66	-434.91	164.97	799.11	137.96	36.39
SNB-LI12	-2.28	-1214.53	-433.63	-166.52	800.56	-138.00	36.66
SNB-LI2P	0.00	2.04	187.14	1.17	1177.76	0.32	136.40
SNB-LI21	2.23	-164.96	-799.11	31.09	-198.92	-13.38	-99.73
SNB-LI22	-2.25	166.52	-800.56	-31.39	-200.35	13.50	-100.01
SNB-H1aP	-0.30	44.73	-2.73	146.52	-2.04	94.66	-2.36
SNB-H1bP	-0.30	-146.52	2.04	-42.06	-1.21	-93.34	0.41
SNB-H1cP	-0.07	44.12	1.13	145.68	3.80	93.94	2.44
SNB-H1dP	-0.07	-145.68	-3.80	-44.33	-1.14	-94.04	-2.44
SNB-H1eP	0.37	42.34	1.21	146.36	-2.13	93.40	-0.45
SNB-H1fP	0.37	-146.36	2.13	-44.77	2.73	-94.60	2.40
SNB-H2aP	-1.06	113.01	-0.55	153.89	-0.54	98.75	-0.40
SNB-H2bP	-1.06	-153.89	0.54	-87.37	-1.31	-89.26	-0.28
SNB-H2cP	0.01	102.65	0.57	151.55	2.45	94.05	1.12
SNB-H2dP	0.01	-151.55	-2.45	-102.43	-0.57	-93.97	-1.12
SNB-H2eP	1.04	87.23	1.31	153.92	-0.59	89.22	0.26
SNB-H2fP	1.04	-153.92	0.59	-113.10	0.56	-98.79	0.43
SNB-H3aP	-0.53	177.40	0.93	207.74	0.49	113.80	0.42
SNB-H3bP	-0.53	-207.74	-0.49	-147.67	-2.07	-105.01	-0.76
SNB-H3cP	0.00	163.73	1.30	206.60	3.32	109.42	1.37
SNB-H3dP	0.00	-206.60	-3.32	-163.77	-1.30	-109.43	-1.36
SNB-H3eP	0.53	147.68	2.07	207.74	0.49	105.02	0.76
SNB-H3fP	0.53	-207.74	-0.49	-177.38	-0.93	-113.79	-0.42
SNB-H4aP	-0.70	281.31	2.16	333.09	1.17	151.11	0.82
SNB-H4bP	-0.70	-333.09	-1.17	-260.45	-3.17	-145.98	-1.07
SNB-H4cP	-0.00	272.73	2.64	331.74	5.63	148.67	2.03
SNB-H4dP	-0.00	-331.74	-5.63	-272.69	-2.64	-148.65	-2.03
SNB-H4eP	0.71	260.43	3.17	333.08	1.16	145.97	1.06
SNB-H4fP	0.71	-333.08	-1.16	-281.35	-2.15	-151.11	-0.81
SNB-H5aP	-0.76	372.12	3.25	429.49	1.47	168.88	1.00
SNB-H5bP	-0.76	-429.49	-1.47	-325.00	-4.66	-158.95	-1.29
SNB-H5cP	-0.00	350.39	3.35	427.98	8.33	163.98	2.46
SNB-H5dP	-0.00	-427.98	-8.33	-350.59	-3.35	-164.02	-2.46
SNB-H5eP	0.77	325.10	4.66	429.48	1.47	158.97	1.29
SNB-H5fP	0.77	-429.48	-1.47	-372.03	-3.25	-168.86	-1.00
SNB-H6aP	-3.65	560.92	3.11	662.57	1.92	225.39	0.93
SNB-H6bP	-3.65	-662.57	-1.92	-533.11	-4.79	-220.27	-1.24
SNB-H6cP	0.01	555.37	3.41	654.72	7.47	222.93	2.00
SNB-H6dP	0.01	-654.72	-7.47	-555.77	-3.40	-223.00	-2.00
SNB-H6eP	3.64	533.30	4.80	662.58	1.94	220.31	1.24
SNB-H6fP	3.64	-662.58	-1.94	-560.70	-3.12	-225.36	-0.93
SNB-H7aP	-2.95	858.15	0.33	985.53	-0.73	301.76	-0.06
SNB-H7bP	-2.95	-985.53	0.73	-852.73	-2.25	-300.87	-0.25
SNB-H7cP	0.01	862.70	0.28	979.60	4.34	301.53	0.76
SNB-H7dP	0.01	-979.60	-4.34	-862.84	-0.27	-301.55	-0.76
SNB-H7eP	2.94	852.77	2.26	985.55	-0.72	300.88	0.25
SNB-H7fP	2.95	-985.55	0.72	-858.07	-0.34	-301.75	0.06
SNB-H8aP	-0.59	1102.01	0.53	1191.76	-0.76	337.79	-0.03
SNB-H8bP	-0.59	-1191.76	0.76	-1082.94	-1.30	-334.98	-0.08
SNB-H8cP	0.00	1094.96	1.32	1191.60	4.70	336.73	0.89
SNB-H8dP	0.00	-1191.60	-4.70	-1094.99	-1.32	-336.73	-0.89
SNB-H8eP	0.59	1082.95	1.29	1191.76	-0.77	334.98	0.08
SNB-H8fP	0.59	-1191.76	0.77	-1101.99	-0.53	-337.79	0.04
SNB-H9aP	-1.73	1304.69	0.36	1375.01	-1.09	358.63	-0.10
SNB-H9bP	-1.73	-1375.01	1.09	-1294.90	-0.13	-357.32	0.13
SNB-H9cP	0.00	1305.45	1.77	1372.88	4.46	358.45	0.83
SNB-H9dP	0.00	-1372.88	-4.46	-1305.40	-1.77	-358.44	-0.83
SNB-H9eP	1.72	1294.87	0.13	1375.02	-1.10	357.31	-0.13
SNB-H9fP	1.73	-1375.02	1.10	-1304.71	-0.35	-358.63	0.10

Equilibrium Joint Positions and Rotations for Load Case "5: 0.9D + 1.0Dg + 1.0E":

Joint Label	X-Displ (ft)	Y-Displ (ft)	Z-Displ (ft)	X-Rot (deg)	Y-Rot (deg)	Z-Rot (deg)	X-Pos (ft)	Y-Pos (ft)	Z-Pos (ft)
RohnAP	0.1396	5.719e-005	-0.01305	0.0001	0.0797	-0.0008	4.473	5.719e-005	180
RohnBP	0.1117	8.475e-005	-0.0138	0.0000	0.0787	-0.0004	5.233	8.475e-005	160
RohnCP	0.0848	8.008e-005	-0.01375	-0.0000	0.0732	-0.0003	5.994	8.008e-005	140
RohnDP	0.06092	6.915e-005	-0.01294	-0.0000	0.0624	-0.0002	6.756	6.915e-005	120
RohnEP	0.04124	5.136e-005	-0.01096	-0.0001	0.0487	-0.0001	7.522	5.136e-005	99.99
RohnFP	0.02602	2.851e-005	-0.009112	-0.0001	0.0362	-0.0001	8.294	2.851e-005	79.99
RohnGP	0.01447	9.294e-006	-0.007089	-0.0000	0.0272	-0.0001	9.069	9.294e-006	59.99
RohnHP	0.006404	-4.012e-007	-0.004956	-0.0000	0.0179	-0.0000	9.847	-4.012e-007	40
RohnIP	0.001682	-3.447e-006	-0.002382	0.0000	0.0070	-0.0000	10.63	-3.447e-006	20
RohnJP	0	0	0	0.0000	0.0000	0.0000	11.42	0	0
SNB-AP	0.1396	0.0001254	-0.006676	-0.0000	0.0750	-0.0000	2.473	0.0001254	180
SNB-BP	0.1117	0.0001128	-0.007558	-0.0000	0.0750	-0.0000	3.233	0.0001128	160
SNB-CP	0.08481	0.0001022	-0.008046	-0.0000	0.0693	-0.0000	3.993	0.0001022	140
SNB-DP	0.06092	8.784e-005	-0.007904	-0.0000	0.0563	-0.0000	4.756	8.784e-005	120
SNB-EP	0.04124	6.878e-005	-0.006898	-0.0001	0.0443	-0.0000	5.522	6.878e-005	99.99
SNB-FP	0.02602	4.505e-005	-0.006171	-0.0001	0.0320	-0.0000	6.294	4.505e-005	79.99
SNB-GP	0.01447	2.36e-005	-0.004937	-0.0001	0.0192	-0.0000	7.069	2.36e-005	60
SNB-HP	0.006405	9.147e-006	-0.003555	-0.0000	0.0115	-0.0000	7.847	9.147e-006	40
SNB-IP	0.001682	1.721e-006	-0.001748	-0.0000	0.0026	-0.0000	8.63	1.721e-006	20
SNB-JP	0	0	0	0.0000	0.0000	0.0000	9.415	0	0
RohnA1	0.1396	0.0001631	-0.004095	-0.0006	0.0801	-0.0012	-2.027	-3.752	180
RohnA2	0.1397	0.0001657	-0.004113	0.0002	0.0805	-0.0004	-2.027	3.753	180
RohnB1	0.1117	0.0001296	-0.003484	0.0001	0.0796	-0.0012	-2.449	-4.435	160
RohnB2	0.1117	0.0001221	-0.003485	-0.0002	0.0797	0.0004	-2.449	4.435	160
RohnC1	0.08474	0.0001422	-0.002882	-0.0002	0.0729	-0.0015	-2.87	-5.117	140
RohnC2	0.08478	8.492e-005	-0.002889	0.0001	0.0729	0.0010	-2.87	5.117	140
RohnD1	0.06081	0.0001369	-0.002306	-0.0004	0.0628	-0.0015	-3.287	-5.798	120
RohnD2	0.06084	5.655e-005	-0.002313	0.0003	0.0628	0.0011	-3.287	5.798	120
RohnE1	0.04117	9.794e-005	-0.001698	-0.0002	0.0488	-0.0012	-3.699	-6.479	100
RohnE2	0.0412	5.823e-005	-0.001713	0.0000	0.0488	0.0010	-3.699	6.479	100
RohnF1	0.02591	9.156e-005	-0.001232	-0.0002	0.0394	-0.0011	-4.108	-7.16	80
RohnF2	0.02594	1.787e-005	-0.001255	0.0001	0.0395	0.0009	-4.108	7.16	80
RohnG1	0.01441	5.527e-005	-0.0008646	-0.0001	0.0279	-0.0008	-4.513	-7.842	60
RohnG2	0.01444	7.069e-006	-0.0008837	-0.0000	0.0280	0.0007	-4.513	7.842	60
RohnH1	0.006338	4.108e-005	-0.0005548	-0.0001	0.0186	-0.0005	-4.914	-8.523	40
RohnH2	0.006353	-1.359e-005	-0.0005662	0.0001	0.0187	0.0005	-4.914	8.523	40
RohnI1	0.001632	2.458e-005	-0.000262	-0.0003	0.0090	-0.0003	-5.313	-9.206	20
RohnI2	0.00164	-1.634e-005	-0.0002668	0.0003	0.0091	0.0003	-5.313	9.206	20
RohnJ1	0	0	0	0.0000	0.0000	0.0000	-5.71	-9.89	0
RohnJ2	0	0	0	0.0000	0.0000	0.0000	-5.71	9.89	0
SNB-A1	0.1396	0.0001249	-0.001784	-0.0045	0.0828	-0.0001	-1.027	-2.02	180
SNB-A2	0.1396	0.0001264	-0.001787	0.0044	0.0828	0.0001	-1.027	2.021	180
SNB-B1	0.1117	0.0001124	-0.001191	-0.0028	0.0807	-0.0001	-1.449	-2.703	160
SNB-B2	0.1117	0.0001137	-0.001194	0.0028	0.0807	0.0001	-1.449	2.703	160
SNB-C1	0.0848	0.0001015	-0.0006813	-0.0031	0.0751	-0.0002	-1.869	-3.384	140
SNB-C2	0.0848	0.0001033	-0.0006857	0.0031	0.0751	0.0002	-1.869	3.385	140
SNB-D1	0.06089	8.825e-005	-0.0003188	-0.0052	0.0660	-0.0003	-2.287	-4.066	120
SNB-D2	0.06089	8.787e-005	-0.0003255	0.0051	0.0660	0.0003	-2.287	4.066	120
SNB-E1	0.04121	7.103e-005	-0.0001403	-0.0032	0.0501	-0.0003	-2.699	-4.747	100
SNB-E2	0.04121	6.687e-005	-0.0001504	0.0030	0.0501	0.0003	-2.699	4.747	100
SNB-F1	0.02599	4.48e-005	-1.776e-006	-0.0045	0.0419	-0.0002	-3.108	-5.428	80
SNB-F2	0.02599	4.55e-005	-1.344e-005	0.0044	0.0419	0.0002	-3.108	5.428	80
SNB-G1	0.01445	3.247e-005	5.189e-005	-0.0060	0.0316	-0.0003	-3.513	-6.11	60
SNB-G2	0.01445	1.49e-005	4.163e-005	0.0059	0.0316	0.0003	-3.513	6.11	60
SNB-H1	0.006373	2.044e-005	6.75e-005	-0.0056	0.0216	-0.0003	-3.914	-6.79	40
SNB-H2	0.006373	-1.912e-006	6.029e-005	0.0055	0.0216	0.0003	-3.914	6.791	40
SNB-I1	0.001646	1.668e-005	3.655e-005	-0.0042	0.0114	-0.0002	-4.312	-7.472	20
SNB-I2	0.001646	-1.308e-005	3.327e-005	0.0042	0.0114	0.0002	-4.312	7.472	20
SNB-J1	0	0	0	0.0000	0.0000	0.0000	-4.708	-8.154	0
SNB-J2	0	0	0	0.0000	0.0000	0.0000	-4.708	8.154	0

RohnAaS	0.1326	6.122e-005	-0.0133	0.0001	0.0805	-0.0007	4.663	6.122e-005	175
RohnAbS	0.1256	6.83e-005	-0.0135	0.0002	0.0801	-0.0006	4.853	6.83e-005	170
RohnAcS	0.1186	8.466e-005	-0.01367	0.0001	0.0799	-0.0005	5.043	8.466e-005	165
RohnBaS	0.1048	8.623e-005	-0.01388	0.0000	0.0784	-0.0004	5.423	8.623e-005	155
RohnBbS	0.09801	8.413e-005	-0.01391	-0.0000	0.0770	-0.0003	5.613	8.413e-005	150
RohnBcS	0.09138	8.244e-005	-0.01386	-0.0000	0.0757	-0.0003	5.803	8.244e-005	145
RohnCaS	0.07655	7.691e-005	-0.0136	-0.0000	0.0692	-0.0002	6.247	7.691e-005	133.3
RohnCbS	0.06857	7.287e-005	-0.01334	-0.0000	0.0676	-0.0002	6.502	7.287e-005	126.6
RohnDaS	0.05394	6.547e-005	-0.01241	-0.0000	0.0574	-0.0002	7.011	6.547e-005	113.3
RohnDbS	0.04739	5.838e-005	-0.01172	-0.0001	0.0549	-0.0001	7.267	5.838e-005	106.6
RohnEaS	0.03589	4.36e-005	-0.0104	-0.0001	0.0441	-0.0001	7.779	4.36e-005	93.33
RohnEbS	0.03077	3.537e-005	-0.009781	-0.0001	0.0431	-0.0001	8.037	3.537e-005	86.65
RohnFaS	0.02016	1.567e-005	-0.008149	-0.0001	0.0334	-0.0001	8.682	1.567e-005	69.99
RohnGaS	0.01038	1.844e-006	-0.006059	-0.0000	0.0230	-0.0000	9.458	1.844e-006	49.99
RohnHaS	0.003994	-2.898e-006	-0.003704	-0.0000	0.0136	-0.0000	10.24	-2.898e-006	30
RohnIaS	0.0008181	-2.563e-006	-0.001214	0.0000	0.0051	-0.0000	11.03	-2.563e-006	9.999
SNB-AaS	0.1326	0.0001222	-0.00693	-0.0001	0.0818	-0.0000	2.663	0.0001222	175
SNB-AbS	0.1256	0.0001158	-0.007169	-0.0000	0.0795	-0.0000	2.853	0.0001158	170
SNB-AcS	0.1186	0.000116	-0.007378	-0.0000	0.0810	-0.0000	3.043	0.000116	165
SNB-BaS	0.1048	0.0001108	-0.007728	-0.0000	0.0795	-0.0000	3.423	0.0001108	155
SNB-BbS	0.09801	0.0001081	-0.007868	-0.0000	0.0765	-0.0000	3.613	0.0001081	150
SNB-BcS	0.09138	0.0001055	-0.007972	-0.0000	0.0769	-0.0000	3.803	0.0001055	145
SNB-CaS	0.07656	9.772e-005	-0.008069	-0.0000	0.0699	-0.0000	4.247	9.772e-005	133.3
SNB-CbS	0.06858	9.293e-005	-0.008013	-0.0000	0.0690	-0.0000	4.502	9.293e-005	126.7
SNB-DaS	0.05395	8.249e-005	-0.007657	-0.0001	0.0588	-0.0000	5.011	8.249e-005	113.3
SNB-DbS	0.0474	7.587e-005	-0.007307	-0.0001	0.0558	-0.0000	5.267	7.587e-005	106.7
SNB-EaS	0.03589	6.123e-005	-0.006709	-0.0001	0.0451	-0.0000	5.779	6.123e-005	93.33
SNB-EbS	0.03078	5.299e-005	-0.006459	-0.0001	0.0441	-0.0000	6.037	5.299e-005	86.65
SNB-FaS	0.02016	3.302e-005	-0.005593	-0.0001	0.0365	-0.0000	6.682	3.302e-005	69.99
SNB-GaS	0.01038	1.49e-005	-0.00428	-0.0000	0.0267	-0.0000	7.458	1.49e-005	50
SNB-HaS	0.003994	4.006e-006	-0.002683	-0.0000	0.0164	-0.0000	8.238	4.006e-006	30
SNB-IaS	0.0008181	-9.78e-008	-0.000899	-0.0000	0.0062	-0.0000	9.022	-9.78e-008	9.999
SNB-WL-A1S	0.1396	0.0001236	-0.004361	-0.0022	0.0788	0.0000	0.7229	-1.01	180
SNB-WL-A2S	0.1396	0.0001256	-0.001915	-0.0000	0.0828	-0.0000	-1.027	0.0001256	180
SNB-WL-A3S	0.1396	0.0001276	-0.004362	0.0021	0.0788	-0.0000	0.7229	1.01	180
SNB-WL-B1S	0.1117	0.0001114	-0.004569	-0.0009	0.0770	-0.0000	0.8919	-1.351	160
SNB-WL-B2S	0.1117	0.0001131	-0.001379	-0.0000	0.0807	-0.0000	-1.449	0.0001131	160
SNB-WL-B3S	0.1117	0.0001146	-0.004571	0.0009	0.0770	-0.0000	0.8919	1.352	160
SNB-WL-C1S	0.08481	0.000101	-0.004734	-0.0009	0.0709	-0.0000	1.062	-1.692	140
SNB-WL-C2S	0.08481	0.0001024	-0.001047	-0.0000	0.0751	-0.0000	-1.869	0.0001024	140
SNB-WL-C3S	0.08481	0.0001037	-0.004736	0.0008	0.0709	0.0000	1.062	1.692	140
SNB-WL-D1S	0.06091	8.645e-005	-0.004943	-0.0020	0.0601	-0.0001	1.235	-2.033	120
SNB-WL-D2S	0.06091	8.806e-005	-0.001141	-0.0000	0.0660	-0.0000	-2.287	8.806e-005	120
SNB-WL-D3S	0.06091	8.948e-005	-0.004946	0.0019	0.0601	0.0001	1.235	2.033	120
SNB-WL-E1S	0.04123	6.787e-005	-0.004098	-0.0010	0.0461	-0.0001	1.411	-2.373	100
SNB-WL-E2S	0.04123	6.895e-005	-0.000717	-0.0001	0.0501	-0.0000	-2.699	6.895e-005	100
SNB-WL-E3S	0.04123	6.986e-005	-0.004103	0.0009	0.0461	0.0001	1.411	2.373	100
SNB-WL-F1S	0.026	4.379e-005	-0.00424	-0.0018	0.0362	-0.0001	1.593	-2.714	80
SNB-WL-F2S	0.02601	4.515e-005	-0.001114	-0.0001	0.0419	-0.0000	-3.108	4.515e-005	80
SNB-WL-F3S	0.026	4.635e-005	-0.004246	0.0017	0.0362	0.0001	1.593	2.714	80
SNB-WL-G1S	0.01447	2.225e-005	-0.00453	-0.0029	0.0253	-0.0001	1.778	-3.055	60
SNB-WL-G2S	0.01447	2.368e-005	-0.001994	-0.0000	0.0316	-0.0000	-3.513	2.368e-005	60
SNB-WL-G3S	0.01447	2.499e-005	-0.004536	0.0028	0.0253	0.0001	1.778	3.055	60
SNB-WL-H1S	0.006392	8.148e-006	-0.00472	-0.0024	0.0160	-0.0001	1.967	-3.395	40
SNB-WL-H2S	0.006394	9.26e-006	-0.002903	-0.0000	0.0216	-0.0000	-3.914	9.26e-006	40
SNB-WL-H3S	0.006392	1.029e-005	-0.004724	0.0024	0.0160	0.0001	1.967	3.395	40
SNB-WL-I1S	0.001668	1.074e-006	-0.004901	-0.0019	0.0066	-0.0001	2.159	-3.736	20
SNB-WL-I2S	0.00167	1.801e-006	-0.003973	-0.0000	0.0114	0.0000	-4.312	1.801e-006	20
SNB-WL-I3S	0.001668	2.487e-006	-0.004903	0.0019	0.0066	0.0001	2.159	3.736	20
RohnAa1	0.1326	0.000126	-0.00394	-0.0002	0.0800	-0.0012	-2.132	-3.923	175
RohnAa2	0.1327	0.0001725	-0.003952	-0.0002	0.0806	-0.0002	-2.132	3.923	175
RohnAb1	0.1256	0.000132	-0.003787	-0.0000	0.0805	-0.0012	-2.238	-4.094	170
RohnAb2	0.1256	0.0001392	-0.00379	-0.0002	0.0808	0.0000	-2.238	4.094	170
RohnAc1	0.1186	0.0001206	-0.003631	-0.0001	0.0796	-0.0012	-2.343	-4.264	165
RohnAc2	0.1186	0.0001421	-0.003633	-0.0001	0.0797	0.0002	-2.343	4.264	165
RohnBa1	0.1047	0.0001231	-0.003332	-0.0003	0.0781	-0.0013	-2.554	-4.605	155
RohnBa2	0.1048	0.0001241	-0.003335	0.0002	0.0781	0.0005	-2.554	4.606	155
RohnBb1	0.09801	0.0001036	-0.003192	-0.0001	0.0771	-0.0014	-2.659	-4.776	150
RohnBb2	0.09805	0.0001377	-0.003196	0.0000	0.0772	0.0007	-2.659	4.776	150

RohnBc1	0.09124	0.00012	-0.003028	0.0003	0.0765	-0.0015	-2.765	-4.947	145
RohnBc2	0.09128	0.0001145	-0.003033	-0.0004	0.0765	0.0009	-2.765	4.947	145
RohnCa1	0.07638	9.131e-005	-0.002701	-0.0004	0.0707	-0.0015	-3.009	-5.344	133.3
RohnCa2	0.07642	0.0001257	-0.00271	0.0003	0.0707	0.0011	-3.009	5.344	133.3
RohnCb1	0.06833	9.311e-005	-0.002511	0.0004	0.0669	-0.0015	-3.148	-5.571	126.7
RohnCb2	0.06837	0.0001115	-0.002518	-0.0005	0.0670	0.0011	-3.148	5.571	126.7
RohnDa1	0.05366	6.545e-005	-0.002104	-0.0004	0.0597	-0.0014	-3.425	-6.025	113.3
RohnDa2	0.0537	0.0001175	-0.002114	0.0003	0.0597	0.0011	-3.425	6.025	113.3
RohnDb1	0.04703	8.706e-005	-0.001881	0.0003	0.0534	-0.0013	-3.563	-6.252	106.7
RohnDb2	0.04706	8.324e-005	-0.001893	-0.0004	0.0534	0.0010	-3.563	6.252	106.7
RohnEa1	0.03562	7.79e-005	-0.001531	-0.0001	0.0459	-0.0012	-3.836	-6.706	93.34
RohnEa2	0.03565	6.317e-005	-0.001549	-0.0000	0.0459	0.0010	-3.836	6.706	93.34
RohnEb1	0.03055	8.558e-005	-0.001373	0.0001	0.0412	-0.0011	-3.972	-6.933	86.66
RohnEb2	0.03058	3.977e-005	-0.001393	-0.0003	0.0412	0.0009	-3.972	6.933	86.66
RohnFa1	0.0194	4.138e-005	-0.001027	-0.0001	0.0325	-0.0009	-4.311	-7.501	70
RohnFa2	0.01943	4.253e-005	-0.001048	-0.0000	0.0326	0.0007	-4.311	7.501	70
RohnGa1	0.009685	1.978e-005	-0.0006952	-0.0000	0.0230	-0.0006	-4.714	-8.182	50
RohnGa2	0.009704	2.296e-005	-0.0007102	-0.0001	0.0231	0.0006	-4.714	8.182	50
RohnHa1	0.003232	-4.479e-006	-0.0003932	-0.0000	0.0133	-0.0004	-5.115	-8.864	30
RohnHa2	0.003243	2.055e-005	-0.0004012	-0.0000	0.0133	0.0003	-5.115	8.864	30
RohnIa1	0.0002036	-3.457e-005	-0.000123	-0.0001	0.0048	-0.0001	-5.512	-9.548	10
RohnIa2	0.0002071	3.751e-005	-0.0001254	0.0000	0.0048	0.0001	-5.512	9.548	10
SNB-Aa1	0.1326	0.0001047	-0.00163	0.0011	0.0796	-0.0002	-1.132	-2.191	175
SNB-Aa2	0.1326	0.000137	-0.001633	-0.0012	0.0797	0.0002	-1.132	2.191	175
SNB-Ab1	0.1256	0.0001179	-0.001478	-0.0004	0.0809	-0.0002	-1.238	-2.362	170
SNB-Ab2	0.1256	0.000118	-0.001481	0.0004	0.0809	0.0002	-1.238	2.362	170
SNB-Ac1	0.1186	0.0001096	-0.00133	0.0008	0.0792	-0.0002	-1.343	-2.532	165
SNB-Ac2	0.1186	0.0001197	-0.001332	-0.0008	0.0792	0.0002	-1.343	2.532	165
SNB-Ba1	0.1048	9.764e-005	-0.001048	0.0008	0.0782	-0.0002	-1.554	-2.873	155
SNB-Ba2	0.1048	0.0001239	-0.001051	-0.0009	0.0782	0.0002	-1.554	2.873	155
SNB-Bb1	0.09798	0.0001179	-0.000916	-0.0004	0.0776	-0.0002	-1.659	-3.044	150
SNB-Bb2	0.09798	9.892e-005	-0.0009194	0.0003	0.0776	0.0002	-1.659	3.044	150
SNB-Bc1	0.09127	9.976e-005	-0.000792	0.0007	0.0751	-0.0002	-1.764	-3.214	145
SNB-Bc2	0.09127	0.0001115	-0.0007959	-0.0008	0.0751	0.0002	-1.764	3.214	145
SNB-Ca1	0.07634	0.000112	-0.0005392	0.0005	0.0711	-0.0003	-2.009	-3.611	133.3
SNB-Ca2	0.07634	8.329e-005	-0.0005444	-0.0006	0.0711	0.0003	-2.009	3.611	133.3
SNB-Cb1	0.06832	9.835e-005	-0.000414	0.0010	0.0653	-0.0003	-2.148	-3.839	126.7
SNB-Cb2	0.06832	8.745e-005	-0.0004199	-0.0011	0.0653	0.0003	-2.148	3.839	126.7
SNB-Da1	0.05363	8.086e-005	-0.0002305	0.0012	0.0598	-0.0004	-2.425	-4.293	113.3
SNB-Da2	0.05364	8.396e-005	-0.0002383	-0.0013	0.0598	0.0004	-2.425	4.293	113.3
SNB-Db1	0.04701	9.638e-005	-0.0001654	0.0004	0.0526	-0.0003	-2.563	-4.52	106.7
SNB-Db2	0.04701	5.587e-005	-0.0001744	-0.0006	0.0526	0.0003	-2.563	4.52	106.7
SNB-Ea1	0.03566	5.208e-005	-7.508e-005	0.0005	0.0459	-0.0003	-2.836	-4.974	93.34
SNB-Ea2	0.03566	7.068e-005	-8.592e-005	-0.0007	0.0459	0.0003	-2.836	4.974	93.34
SNB-Eb1	0.03058	6.714e-005	-2.757e-005	0.0009	0.0404	-0.0002	-2.972	-5.201	86.66
SNB-Eb2	0.03058	3.971e-005	-3.896e-005	-0.0011	0.0404	0.0002	-2.972	5.201	86.66
SNB-Fa1	0.01937	6.217e-005	4.842e-005	0.0026	0.0312	-0.0002	-3.311	-5.769	70
SNB-Fa2	0.01936	5.603e-006	3.71e-005	-0.0027	0.0312	0.0002	-3.311	5.769	70
SNB-Ga1	0.009684	1.982e-005	7.978e-005	0.0028	0.0214	-0.0003	-3.714	-6.45	50
SNB-Ga2	0.009684	1.149e-005	7.089e-005	-0.0029	0.0214	0.0003	-3.714	6.45	50
SNB-Ha1	0.003248	-1.351e-005	7.171e-005	0.0024	0.0121	-0.0002	-4.114	-7.131	30
SNB-Ha2	0.003247	2.291e-005	6.642e-005	-0.0025	0.0121	0.0002	-4.114	7.131	30
SNB-Ia1	0.0001876	-2.529e-005	3.345e-005	0.0010	0.0042	-0.0001	-4.511	-7.813	10
SNB-Ia2	0.0001871	2.597e-005	3.181e-005	-0.0010	0.0042	0.0001	-4.511	7.813	10

Joint Support Reactions for Load Case "5: 0.9D + 1.0Dg + 1.0E":

Joint Label	X Force (kips)	X Usage %	Y Force (kips)	Y Usage %	Z Force (kips)	Z Usage %	Comp. Usage %	Uplift Result (kips)	Result. Usage %	X Moment (ft-k)	X-M. Usage %	Y Moment (ft-k)	Y-M. Usage %	Z Moment (ft-k)	Z-M. Usage %	Max. Usage %
RohnJP	-2.27	0.0	0.00	0.0	36.66	0.0	0.0	36.73	0.0	-0.00	0.0	-0.5	0.0	0.00	0.0	0.0
SNB-JP	-2.92	0.0	0.00	0.0	44.79	0.0	0.0	44.88	0.0	-0.00	0.0	-1.1	0.0	-0.00	0.0	0.0
RohnJ1	-0.03	0.0	0.09	0.0	4.00	0.0	0.0	4.00	0.0	-0.04	0.0	0.1	0.0	-0.00	0.0	0.0
RohnJ2	-0.03	0.0	-0.10	0.0	4.07	0.0	0.0	4.07	0.0	0.04	0.0	0.1	0.0	0.00	0.0	0.0
SNB-J1	-0.53	0.0	-0.66	0.0	-1.63	0.0	0.0	1.84	0.0	0.07	0.0	0.1	0.0	-0.01	0.0	0.0
SNB-J2	-0.53	0.0	0.66	0.0	-1.55	0.0	0.0	1.77	0.0	-0.07	0.0	0.1	0.0	0.01	0.0	0.0

Joint Displacements, Loads and Member Forces on Joints for Load Case "5: 0.9D + 1.0Dg + 1.0E":

Joint Label	X External Load (kips)	Y External Load (kips)	Z External Load (kips)	X Member Force (kips)	Y Member Force (kips)	Z Member Force (kips)	X Disp. (ft)	Y Disp. (ft)	Z Disp. (ft)
RohnAP	0.0989	0.0000	-0.2670	-0.0989	0.0000	0.2670	0.1396	0.0001	-0.0131
RohnBP	0.1987	0.0000	-0.9568	-0.1987	0.0000	0.9568	0.1117	0.0001	-0.0138
RohnCP	0.0458	0.0000	-0.3872	-0.0458	0.0000	0.3872	0.0848	0.0001	-0.0138
RohnDP	0.0374	0.0000	-0.4691	-0.0374	0.0000	0.4691	0.0609	0.0001	-0.0129
RohnEP	0.0371	0.0000	-0.5805	-0.0371	0.0000	0.5805	0.0412	0.0001	-0.0110
RohnFP	0.0405	0.0000	-0.7867	-0.0405	0.0000	0.7867	0.0260	0.0000	-0.0091
RohnGP	0.0390	0.0000	-1.0471	-0.0390	0.0000	1.0471	0.0145	0.0000	-0.0071
RohnHP	0.0254	0.0000	-1.0422	-0.0254	0.0000	1.0422	0.0064	-0.0000	-0.0050
RohnIP	0.0173	0.0000	-1.1689	-0.0173	-0.0000	1.1689	0.0017	-0.0000	-0.0024
RohnJP	0.0000	0.0000	-0.6316	2.2667	-0.0031	-36.0266	0.0000	0.0000	0.0000
SNB-AP	0.0522	0.0000	-0.1410	-0.0522	0.0000	0.1410	0.1396	0.0001	-0.0067
SNB-BP	0.0634	0.0000	-0.3052	-0.0634	0.0000	0.3052	0.1117	0.0001	-0.0076
SNB-CP	0.0458	0.0000	-0.3872	-0.0458	0.0000	0.3872	0.0848	0.0001	-0.0080
SNB-DP	0.0374	0.0000	-0.4691	-0.0374	0.0000	0.4691	0.0609	0.0001	-0.0079
SNB-EP	0.0371	0.0000	-0.5805	-0.0371	0.0000	0.5805	0.0412	0.0001	-0.0069
SNB-FP	0.0405	0.0000	-0.7867	-0.0405	0.0000	0.7867	0.0260	0.0000	-0.0062
SNB-GP	0.0357	0.0000	-0.9571	-0.0357	0.0000	0.9571	0.0145	0.0000	-0.0049
SNB-HP	0.0254	0.0000	-1.0422	-0.0254	0.0000	1.0422	0.0064	0.0000	-0.0036
SNB-IP	0.0173	0.0000	-1.1689	-0.0173	0.0000	1.1689	0.0017	0.0000	-0.0017
SNB-JP	0.0000	0.0000	-0.6316	2.9185	-0.0009	-44.1580	0.0000	0.0000	0.0000
RohnA1	0.0989	0.0000	-0.2670	-0.0989	0.0000	0.2670	0.1396	0.0002	-0.0041
RohnA2	0.1455	0.0000	-0.3930	-0.1455	-0.0000	0.3930	0.1397	0.0002	-0.0041
RohnB1	0.0847	0.0000	-0.4078	-0.0847	0.0000	0.4078	0.1117	0.0001	-0.0035
RohnB2	0.0726	0.0000	-0.3493	-0.0726	-0.0000	0.3493	0.1117	0.0001	-0.0035
RohnC1	0.0458	0.0000	-0.3872	-0.0458	0.0000	0.3872	0.0847	0.0001	-0.0029
RohnC2	0.0458	0.0000	-0.3872	-0.0458	-0.0000	0.3872	0.0848	0.0001	-0.0029
RohnD1	0.0424	0.0000	-0.5321	-0.0424	0.0000	0.5321	0.0608	0.0001	-0.0023
RohnD2	0.0374	0.0000	-0.4691	-0.0374	-0.0000	0.4691	0.0608	0.0001	-0.0023
RohnE1	0.0371	0.0000	-0.5805	-0.0371	0.0000	0.5805	0.0412	0.0001	-0.0017
RohnE2	0.0371	0.0000	-0.5805	-0.0371	-0.0000	0.5805	0.0412	0.0001	-0.0017
RohnF1	0.0405	0.0000	-0.7867	-0.0405	0.0000	0.7867	0.0259	0.0001	-0.0012
RohnF2	0.0473	0.0000	-0.9172	-0.0473	-0.0000	0.9172	0.0259	0.0000	-0.0013
RohnG1	0.0377	0.0000	-1.0111	-0.0377	-0.0000	1.0111	0.0144	0.0001	-0.0009
RohnG2	0.0409	0.0000	-1.0975	-0.0409	-0.0000	1.0975	0.0144	0.0000	-0.0009
RohnH1	0.0254	0.0000	-1.0422	-0.0254	0.0000	1.0422	0.0063	0.0000	-0.0006
RohnH2	0.0254	0.0000	-1.0422	-0.0254	-0.0000	1.0422	0.0064	-0.0000	-0.0006
RohnI1	0.0173	0.0000	-1.1689	-0.0173	-0.0000	1.1689	0.0016	0.0000	-0.0003
RohnI2	0.0173	0.0000	-1.1689	-0.0173	-0.0000	1.1689	0.0016	-0.0000	-0.0003
RohnJ1	0.0000	0.0000	-0.6316	0.0262	-0.0940	-3.3696	0.0000	0.0000	0.0000
RohnJ2	0.0000	0.0000	-0.6316	0.0296	0.0974	-3.4379	0.0000	0.0000	0.0000
SNB-A1	0.0522	0.0000	-0.1410	-0.0522	-0.0000	0.1410	0.1396	0.0001	-0.0018
SNB-A2	0.0522	0.0000	-0.1410	-0.0522	0.0000	0.1410	0.1396	0.0001	-0.0018
SNB-B1	0.0634	0.0000	-0.3052	-0.0634	-0.0000	0.3052	0.1117	0.0001	-0.0012
SNB-B2	0.0634	0.0000	-0.3052	-0.0634	0.0000	0.3052	0.1117	0.0001	-0.0012
SNB-C1	0.0458	0.0000	-0.3872	-0.0458	-0.0000	0.3872	0.0848	0.0001	-0.0007
SNB-C2	0.0458	0.0000	-0.3872	-0.0458	0.0000	0.3872	0.0848	0.0001	-0.0007
SNB-D1	0.0374	0.0000	-0.4691	-0.0374	-0.0000	0.4691	0.0609	0.0001	-0.0003
SNB-D2	0.0374	0.0000	-0.4691	-0.0374	0.0000	0.4691	0.0609	0.0001	-0.0003
SNB-E1	0.0371	0.0000	-0.5805	-0.0371	-0.0000	0.5805	0.0412	0.0001	-0.0001
SNB-E2	0.0371	0.0000	-0.5805	-0.0371	0.0000	0.5805	0.0412	0.0001	-0.0002
SNB-F1	0.0405	0.0000	-0.7867	-0.0405	-0.0000	0.7867	0.0260	0.0000	-0.0000
SNB-F2	0.0405	0.0000	-0.7867	-0.0405	0.0000	0.7867	0.0260	0.0000	-0.0000
SNB-G1	0.0357	0.0000	-0.9571	-0.0357	-0.0000	0.9571	0.0145	0.0000	0.0001
SNB-G2	0.0357	0.0000	-0.9571	-0.0357	0.0000	0.9571	0.0145	0.0000	0.0000
SNB-H1	0.0254	0.0000	-1.0422	-0.0254	-0.0000	1.0422	0.0064	0.0000	0.0001
SNB-H2	0.0254	0.0000	-1.0422	-0.0254	0.0000	1.0422	0.0064	-0.0000	0.0001
SNB-I1	0.0173	0.0000	-1.1689	-0.0173	0.0000	1.1689	0.0016	0.0000	0.0000
SNB-I2	0.0173	0.0000	-1.1689	-0.0173	-0.0000	1.1689	0.0016	-0.0000	0.0000
SNB-J1	0.0000	0.0000	-0.6316	0.5278	0.6643	2.2602	0.0000	0.0000	0.0000
SNB-J2	0.0000	0.0000	-0.6316	0.5265	-0.6637	2.1840	0.0000	0.0000	0.0000
RohnAaS	0.0606	0.0000	-0.1881	-0.0606	0.0000	0.1881	0.1326	0.0001	-0.0133
RohnAbs	0.0393	0.0000	-0.1410	-0.0393	0.0000	0.1410	0.1256	0.0001	-0.0135
RohnAcS	0.0455	0.0000	-0.1890	-0.0455	0.0000	0.1890	0.1186	0.0001	-0.0137

RohnBaS	0.0294	0.0000	-0.1642	-0.0294	0.0000	0.1642	0.1048	0.0001	-0.0139
RohnBbS	0.1348	0.0000	-0.8700	-0.1348	0.0000	0.8700	0.0980	0.0001	-0.0139
RohnBcS	0.0221	0.0000	-0.1642	-0.0221	0.0000	0.1642	0.0914	0.0001	-0.0139
RohnCaS	0.0728	0.0000	-0.7200	-0.0728	0.0000	0.7200	0.0766	0.0001	-0.0136
RohnCbS	0.1131	0.0000	-1.2757	-0.1131	0.0000	1.2757	0.0686	0.0001	-0.0133
RohnDaS	0.0835	0.0000	-1.1411	-0.0835	0.0000	1.1411	0.0539	0.0001	-0.0124
RohnDbS	0.0168	0.0000	-0.2460	-0.0168	0.0000	0.2460	0.0474	0.0001	-0.0117
RohnEaS	0.0201	0.0000	-0.3345	-0.0201	0.0000	0.3345	0.0359	0.0000	-0.0104
RohnEbS	0.0187	0.0000	-0.3345	-0.0187	0.0000	0.3345	0.0308	0.0000	-0.0098
RohnFaS	0.0201	0.0000	-0.4522	-0.0201	0.0000	0.4522	0.0202	0.0000	-0.0081
RohnGaS	0.0154	0.0000	-0.5049	-0.0154	0.0000	0.5049	0.0104	0.0000	-0.0061
RohnHaS	0.0104	0.0000	-0.5373	-0.0104	0.0000	0.5373	0.0040	-0.0000	-0.0037
RohnIaS	0.0059	0.0000	-0.6316	-0.0059	0.0000	0.6316	0.0008	-0.0000	-0.0012
SNB-AaS	0.0454	0.0000	-0.1410	-0.0454	0.0000	0.1410	0.1326	0.0001	-0.0069
SNB-AbS	0.0393	0.0000	-0.1410	-0.0393	0.0000	0.1410	0.1256	0.0001	-0.0072
SNB-AcS	0.0340	0.0000	-0.1410	-0.0340	0.0000	0.1410	0.1186	0.0001	-0.0074
SNB-BaS	0.0294	0.0000	-0.1642	-0.0294	0.0000	0.1642	0.1048	0.0001	-0.0077
SNB-BbS	0.0254	0.0000	-0.1642	-0.0254	0.0000	0.1642	0.0980	0.0001	-0.0079
SNB-BcS	0.0221	0.0000	-0.1642	-0.0221	0.0000	0.1642	0.0914	0.0001	-0.0080
SNB-CaS	0.0226	0.0000	-0.2230	-0.0226	0.0000	0.2230	0.0766	0.0001	-0.0081
SNB-CbS	0.0198	0.0000	-0.2230	-0.0198	0.0000	0.2230	0.0686	0.0001	-0.0080
SNB-DS	0.0180	0.0000	-0.2460	-0.0180	0.0000	0.2460	0.0539	0.0001	-0.0077
SNB-DbS	0.0168	0.0000	-0.2460	-0.0168	0.0000	0.2460	0.0474	0.0001	-0.0073
SNB-EaS	0.0201	0.0000	-0.3345	-0.0201	0.0000	0.3345	0.0359	0.0001	-0.0067
SNB-EbS	0.0187	0.0000	-0.3345	-0.0187	0.0000	0.3345	0.0308	0.0001	-0.0065
SNB-FaS	0.0201	0.0000	-0.4522	-0.0201	0.0000	0.4522	0.0202	0.0000	-0.0056
SNB-GaS	0.0154	0.0000	-0.5049	-0.0154	0.0000	0.5049	0.0104	0.0000	-0.0043
SNB-HaS	0.0104	0.0000	-0.5373	-0.0104	0.0000	0.5373	0.0040	0.0000	-0.0027
SNB-IaS	0.0059	0.0000	-0.6316	-0.0059	0.0000	0.6316	0.0008	-0.0000	-0.0009
SNB-WL-A1S	0.0522	0.0000	-0.1410	-0.0522	0.0000	0.1410	0.1396	0.0001	-0.0044
SNB-WL-A2S	0.0522	0.0000	-0.1410	-0.0522	0.0000	0.1410	0.1396	0.0001	-0.0019
SNB-WL-A3S	0.0522	0.0000	-0.1410	-0.0522	-0.0000	0.1410	0.1396	0.0001	-0.0044
SNB-WL-B1S	0.0293	0.0000	-0.1410	-0.0293	0.0000	0.1410	0.1117	0.0001	-0.0046
SNB-WL-B2S	0.0293	0.0000	-0.1410	-0.0293	0.0000	0.1410	0.1117	0.0001	-0.0014
SNB-WL-B3S	0.0293	0.0000	-0.1410	-0.0293	-0.0000	0.1410	0.1117	0.0001	-0.0046
SNB-WL-C1S	0.0194	0.0000	-0.1642	-0.0194	0.0000	0.1642	0.0848	0.0001	-0.0047
SNB-WL-C2S	0.0194	0.0000	-0.1642	-0.0194	0.0000	0.1642	0.0848	0.0001	-0.0010
SNB-WL-C3S	0.0194	0.0000	-0.1642	-0.0194	-0.0000	0.1642	0.0848	0.0001	-0.0047
SNB-WL-D1S	0.0178	0.0000	-0.2230	-0.0178	0.0000	0.2230	0.0609	0.0001	-0.0049
SNB-WL-D2S	0.0178	0.0000	-0.2230	-0.0178	0.0000	0.2230	0.0609	0.0001	-0.0011
SNB-WL-D3S	0.0178	0.0000	-0.2230	-0.0178	-0.0000	0.2230	0.0609	0.0001	-0.0049
SNB-WL-E1S	0.0157	0.0000	-0.2460	-0.0157	0.0000	0.2460	0.0412	0.0001	-0.0041
SNB-WL-E2S	0.0157	0.0000	-0.2460	-0.0157	0.0000	0.2460	0.0412	0.0001	-0.0007
SNB-WL-E3S	0.0157	0.0000	-0.2460	-0.0157	-0.0000	0.2460	0.0412	0.0001	-0.0041
SNB-WL-F1S	0.0172	0.0000	-0.3345	-0.0172	0.0000	0.3345	0.0260	0.0000	-0.0042
SNB-WL-F2S	0.0172	0.0000	-0.3345	-0.0172	0.0000	0.3345	0.0260	0.0000	-0.0011
SNB-WL-F3S	0.0172	0.0000	-0.3345	-0.0172	-0.0000	0.3345	0.0260	0.0000	-0.0042
SNB-WL-G1S	0.0169	0.0000	-0.4522	-0.0169	0.0000	0.4522	0.0145	0.0000	-0.0045
SNB-WL-G2S	0.0169	0.0000	-0.4522	-0.0169	0.0000	0.4522	0.0145	0.0000	-0.0020
SNB-WL-G3S	0.0169	0.0000	-0.4522	-0.0169	-0.0000	0.4522	0.0145	0.0000	-0.0045
SNB-WL-H1S	0.0123	0.0000	-0.5049	-0.0123	0.0000	0.5049	0.0064	0.0000	-0.0047
SNB-WL-H2S	0.0123	0.0000	-0.5049	-0.0123	0.0000	0.5049	0.0064	0.0000	-0.0029
SNB-WL-H3S	0.0123	0.0000	-0.5049	-0.0123	-0.0000	0.5049	0.0064	0.0000	-0.0047
SNB-WL-I1S	0.0080	0.0000	-0.5373	-0.0080	0.0000	0.5373	0.0017	0.0000	-0.0049
SNB-WL-I2S	0.0080	0.0000	-0.5373	-0.0080	-0.0000	0.5373	0.0017	0.0000	-0.0040
SNB-WL-I3S	0.0080	0.0000	-0.5373	-0.0080	-0.0000	0.5373	0.0017	0.0000	-0.0049
RohnAa1	0.0667	0.0000	-0.2072	-0.0667	0.0000	0.2072	0.1326	0.0001	-0.0039
RohnAa2	0.0734	0.0000	-0.2279	-0.0734	-0.0000	0.2279	0.1327	0.0002	-0.0040
RohnAb1	0.0695	0.0000	-0.2490	-0.0695	0.0000	0.2490	0.1256	0.0001	-0.0038
RohnAb2	0.0393	0.0000	-0.1410	-0.0393	-0.0000	0.1410	0.1256	0.0001	-0.0038
RohnAc1	0.0340	0.0000	-0.1410	-0.0340	0.0000	0.1410	0.1186	0.0001	-0.0036
RohnAc2	0.0340	0.0000	-0.1410	-0.0340	-0.0000	0.1410	0.1186	0.0001	-0.0036
RohnBa1	0.0294	0.0000	-0.1642	-0.0294	0.0000	0.1642	0.1047	0.0001	-0.0033
RohnBa2	0.0294	0.0000	-0.1642	-0.0294	-0.0000	0.1642	0.1048	0.0001	-0.0033
RohnBb1	0.1310	0.0000	-0.8457	-0.1310	0.0000	0.8457	0.0980	0.0001	-0.0032
RohnBb2	0.1310	0.0000	-0.8457	-0.1310	-0.0000	0.8457	0.0980	0.0001	-0.0032
RohnBc1	0.0221	0.0000	-0.1642	-0.0221	0.0000	0.1642	0.0912	0.0001	-0.0030
RohnBc2	0.0221	0.0000	-0.1642	-0.0221	-0.0000	0.1642	0.0913	0.0001	-0.0030
RohnCa1	0.0783	0.0000	-0.7740	-0.0783	0.0000	0.7740	0.0764	0.0001	-0.0027

RohnCa2	0.0819	0.0000	-0.8100	-0.0819	-0.0000	0.8100	0.0764	0.0001	-0.0027
RohnCb1	0.1087	0.0000	-1.2262	-0.1087	0.0000	1.2262	0.0683	0.0001	-0.0025
RohnCb2	0.1087	0.0000	-1.2262	-0.1087	-0.0000	1.2262	0.0684	0.0001	-0.0025
RohnDa1	0.0766	0.0000	-1.0466	-0.0766	0.0000	1.0466	0.0537	0.0001	-0.0021
RohnDa2	0.0766	0.0000	-1.0466	-0.0766	-0.0000	1.0466	0.0537	0.0001	-0.0021
RohnDb1	0.0168	0.0000	-0.2460	-0.0168	0.0000	0.2460	0.0470	0.0001	-0.0019
RohnDb2	0.0168	0.0000	-0.2460	-0.0168	-0.0000	0.2460	0.0471	0.0001	-0.0019
RohnEa1	0.0201	0.0000	-0.3345	-0.0201	0.0000	0.3345	0.0356	0.0001	-0.0015
RohnEa2	0.0201	0.0000	-0.3345	-0.0201	-0.0000	0.3345	0.0357	0.0001	-0.0015
RohnEb1	0.0187	0.0000	-0.3345	-0.0187	0.0000	0.3345	0.0305	0.0001	-0.0014
RohnEb2	0.0187	0.0000	-0.3345	-0.0187	-0.0000	0.3345	0.0306	0.0000	-0.0014
RohnFa1	0.0201	0.0000	-0.4522	-0.0201	0.0000	0.4522	0.0194	0.0000	-0.0010
RohnFa2	0.0201	0.0000	-0.4522	-0.0201	0.0000	0.4522	0.0194	0.0000	-0.0010
RohnGa1	0.0154	0.0000	-0.5049	-0.0154	0.0000	0.5049	0.0097	0.0000	-0.0007
RohnGa2	0.0154	0.0000	-0.5049	-0.0154	-0.0000	0.5049	0.0097	0.0000	-0.0007
RohnHa1	0.0104	0.0000	-0.5373	-0.0104	0.0000	0.5373	0.0032	-0.0000	-0.0004
RohnHa2	0.0104	0.0000	-0.5373	-0.0104	0.0000	0.5373	0.0032	0.0000	-0.0004
RohnIa1	0.0059	0.0000	-0.6316	-0.0059	0.0000	0.6316	0.0002	-0.0000	-0.0001
RohnIa2	0.0059	0.0000	-0.6316	-0.0059	0.0000	0.6316	0.0002	0.0000	-0.0001
SNB-Aa1	0.0454	0.0000	-0.1410	-0.0454	-0.0000	0.1410	0.1326	0.0001	-0.0016
SNB-Aa2	0.0454	0.0000	-0.1410	-0.0454	0.0000	0.1410	0.1326	0.0001	-0.0016
SNB-Ab1	0.0393	0.0000	-0.1410	-0.0393	-0.0000	0.1410	0.1256	0.0001	-0.0015
SNB-Ab2	0.0393	0.0000	-0.1410	-0.0393	0.0000	0.1410	0.1256	0.0001	-0.0015
SNB-Ac1	0.0340	0.0000	-0.1410	-0.0340	-0.0000	0.1410	0.1186	0.0001	-0.0013
SNB-Ac2	0.0340	0.0000	-0.1410	-0.0340	0.0000	0.1410	0.1186	0.0001	-0.0013
SNB-Ba1	0.0294	0.0000	-0.1642	-0.0294	-0.0000	0.1642	0.1048	0.0001	-0.0010
SNB-Ba2	0.0294	0.0000	-0.1642	-0.0294	0.0000	0.1642	0.1048	0.0001	-0.0011
SNB-Bb1	0.0254	0.0000	-0.1642	-0.0254	-0.0000	0.1642	0.0980	0.0001	-0.0009
SNB-Bb2	0.0254	0.0000	-0.1642	-0.0254	0.0000	0.1642	0.0980	0.0001	-0.0009
SNB-Bc1	0.0221	0.0000	-0.1642	-0.0221	-0.0000	0.1642	0.0913	0.0001	-0.0008
SNB-Bc2	0.0221	0.0000	-0.1642	-0.0221	0.0000	0.1642	0.0913	0.0001	-0.0008
SNB-Ca1	0.0226	0.0000	-0.2230	-0.0226	-0.0000	0.2230	0.0763	0.0001	-0.0005
SNB-Ca2	0.0226	0.0000	-0.2230	-0.0226	0.0000	0.2230	0.0763	0.0001	-0.0005
SNB-Cb1	0.0198	0.0000	-0.2230	-0.0198	-0.0000	0.2230	0.0683	0.0001	-0.0004
SNB-Cb2	0.0198	0.0000	-0.2230	-0.0198	0.0000	0.2230	0.0683	0.0001	-0.0004
SNB-Da1	0.0180	0.0000	-0.2460	-0.0180	-0.0000	0.2460	0.0536	0.0001	-0.0002
SNB-Da2	0.0180	0.0000	-0.2460	-0.0180	0.0000	0.2460	0.0536	0.0001	-0.0002
SNB-Db1	0.0168	0.0000	-0.2460	-0.0168	-0.0000	0.2460	0.0470	0.0001	-0.0002
SNB-Db2	0.0168	0.0000	-0.2460	-0.0168	0.0000	0.2460	0.0470	0.0001	-0.0002
SNB-Ea1	0.0201	0.0000	-0.3345	-0.0201	-0.0000	0.3345	0.0357	0.0001	-0.0001
SNB-Ea2	0.0201	0.0000	-0.3345	-0.0201	0.0000	0.3345	0.0357	0.0001	-0.0001
SNB-Eb1	0.0187	0.0000	-0.3345	-0.0187	-0.0000	0.3345	0.0306	0.0001	-0.0000
SNB-Eb2	0.0187	0.0000	-0.3345	-0.0187	0.0000	0.3345	0.0306	0.0000	-0.0000
SNB-Fa1	0.0201	0.0000	-0.4522	-0.0201	-0.0000	0.4522	0.0194	0.0001	0.0000
SNB-Fa2	0.0201	0.0000	-0.4522	-0.0201	-0.0000	0.4522	0.0194	0.0000	0.0000
SNB-Ga1	0.0154	0.0000	-0.5049	-0.0154	-0.0000	0.5049	0.0097	0.0000	0.0001
SNB-Ga2	0.0154	0.0000	-0.5049	-0.0154	0.0000	0.5049	0.0097	0.0000	0.0001
SNB-Ha1	0.0104	0.0000	-0.5373	-0.0104	-0.0000	0.5373	0.0032	-0.0000	0.0001
SNB-Ha2	0.0104	0.0000	-0.5373	-0.0104	-0.0000	0.5373	0.0032	0.0000	0.0001
SNB-Ia1	0.0059	0.0000	-0.6316	-0.0059	-0.0000	0.6316	0.0002	-0.0000	0.0000
SNB-Ia2	0.0059	0.0000	-0.6316	-0.0059	-0.0000	0.6316	0.0002	0.0000	0.0000

Moments for Angles Modeled as Beams:

Angle Label	Torsion (ft-lbs)	Origin X Moment (ft-lbs)	Origin Y Moment (ft-lbs)	End X Moment (ft-lbs)	End Y Moment (ft-lbs)	X Shear (lbs)	Y Shear (lbs)
Rohn-LA1P	-0.19	0.10	0.82	0.06	-3.21	0.03	-0.48
Rohn-LA11	0.01	-0.37	0.42	-2.44	0.99	-0.56	0.28
Rohn-LA12	-0.41	0.33	0.60	2.53	0.09	0.57	0.14
Rohn-LA2P	-0.19	-0.06	3.21	-0.67	5.41	-0.15	1.72
Rohn-LA21	0.01	2.44	-0.99	1.77	-3.66	0.84	-0.93
Rohn-LA22	-0.41	-2.53	-0.09	-2.74	-1.14	-1.05	-0.25
Rohn-LA3P	-0.19	0.67	-5.41	1.00	-4.38	0.33	-1.96
Rohn-LA31	0.01	-1.77	3.66	-1.59	8.39	-0.67	2.41
Rohn-LA32	-0.41	2.74	1.14	2.08	6.68	0.96	1.56
Rohn-LA4P	-0.19	-1.00	4.38	-0.46	10.30	-0.29	2.93
Rohn-LA41	0.01	1.59	-8.39	0.95	-8.60	0.51	-3.39

Rohn-LA22	-0.41	-2.08	-6.68	-1.52	-7.08	-0.72	-2.75
Rohn-LB1P	-0.11	0.47	-9.03	0.41	-6.02	0.18	-3.01
Rohn-LB11	0.41	-1.35	9.35	1.19	22.39	-0.03	6.34
Rohn-LB12	-0.63	1.89	7.86	-0.96	21.75	0.19	5.92
Rohn-LB2P	-0.11	-0.41	6.02	-0.16	17.63	-0.11	4.73
Rohn-LB21	0.41	-1.19	-22.39	-2.49	-14.94	-0.74	-7.46
Rohn-LB22	-0.63	0.96	-21.75	2.47	-14.70	0.69	-7.28
Rohn-LB3P	-0.11	0.16	-17.63	0.10	-7.37	0.05	-5.00
Rohn-LB31	0.41	2.49	14.94	-1.23	20.43	0.25	7.07
Rohn-LB32	-0.63	-2.47	14.70	1.29	20.29	-0.24	6.99
Rohn-LB4P	-0.11	-0.10	7.37	-0.04	28.72	-0.03	7.21
Rohn-LB41	0.41	1.23	-20.43	5.70	9.21	1.38	-2.24
Rohn-LB42	-0.63	-1.29	-20.29	-5.75	9.45	-1.41	-2.17
Rohn-LC1P	-0.11	0.04	-28.72	0.07	9.42	0.02	-2.89
Rohn-LC11	0.41	-5.70	-9.21	-3.42	12.05	-1.37	0.43
Rohn-LC12	-0.63	5.75	-9.45	3.59	11.68	1.40	0.34
Rohn-LC2P	-0.11	-0.07	-9.42	-0.02	5.92	-0.01	-0.52
Rohn-LC21	0.41	3.42	-12.05	-4.78	24.10	-0.20	1.80
Rohn-LC22	-0.63	-3.59	-11.68	4.68	24.22	0.16	1.88
Rohn-LC3P	-0.11	0.02	-5.92	-0.07	43.70	-0.01	5.67
Rohn-LC31	0.41	4.78	-24.10	12.56	14.82	2.60	-1.39
Rohn-LC32	-0.63	-4.68	-24.22	-12.62	15.22	-2.59	-1.35
Rohn-LD1P	-0.11	0.07	-43.69	0.37	31.00	0.07	-1.91
Rohn-LD11	0.41	-12.56	-14.82	-12.74	31.90	-3.80	2.56
Rohn-LD12	-0.63	12.62	-15.22	12.93	31.54	3.83	2.45
Rohn-LD2P	-0.11	-0.37	-31.00	-0.12	7.08	-0.07	-3.58
Rohn-LD21	0.41	12.74	-31.90	3.27	63.27	2.40	4.69
Rohn-LD22	-0.63	-12.93	-31.54	-3.18	63.47	-2.41	4.78
Rohn-LD3P	-0.11	0.12	-7.08	0.09	85.72	0.03	11.80
Rohn-LD31	0.41	-3.27	-63.27	3.37	5.82	0.02	-8.62
Rohn-LD32	-0.63	3.18	-63.47	-3.31	5.75	-0.02	-8.66
Rohn-LE1P	-0.11	-0.09	-85.72	0.12	9.09	0.00	-11.50
Rohn-LE11	0.41	-3.37	-5.82	-4.29	53.23	-1.15	7.11
Rohn-LE12	-0.63	3.31	-5.75	4.36	53.10	1.15	7.10
Rohn-LE2P	-0.11	-0.12	-9.09	-0.34	11.09	-0.07	0.30
Rohn-LE21	0.41	4.29	-53.23	-0.82	43.51	0.52	-1.45
Rohn-LE22	-0.63	-4.36	-53.10	0.77	44.04	-0.54	-1.36
Rohn-LE3P	-0.11	0.34	-11.09	0.54	132.29	0.13	18.19
Rohn-LE31	0.41	0.82	-43.51	8.39	-7.37	1.38	-7.63
Rohn-LE32	-0.63	-0.77	-44.04	-8.14	-8.54	-1.34	-7.89
Rohn-LF1P	-0.11	-0.54	-132.29	-0.91	-67.06	-0.14	-19.92
Rohn-LF11	0.41	-8.39	7.37	-11.30	167.82	-1.97	17.51
Rohn-LF12	-0.63	8.14	8.54	10.85	168.88	1.90	17.73
Rohn-LF2P	-0.11	0.91	67.06	0.54	209.98	0.15	27.69
Rohn-LF21	0.41	11.31	-167.82	11.36	-60.71	2.26	-22.84
Rohn-LF22	-0.63	-10.85	-168.88	-11.36	-61.78	-2.22	-23.05
Rohn-LG1P	-0.11	-0.54	-209.98	-0.81	-97.30	-0.13	-30.71
Rohn-LG11	0.41	-11.36	60.71	-13.25	191.63	-2.46	25.21
Rohn-LG12	-0.63	11.36	61.78	12.82	192.38	2.42	25.40
Rohn-LG2P	-0.11	0.81	97.30	0.30	234.57	0.11	33.17
Rohn-LG21	0.41	13.25	-191.63	15.79	-73.40	2.90	-26.48
Rohn-LG22	-0.63	-12.82	-192.38	-16.05	-73.82	-2.88	-26.60
Rohn-LH1P	-0.11	-0.30	-234.57	-0.30	-120.42	-0.06	-35.48
Rohn-LH11	0.40	-15.79	73.40	-19.08	216.06	-3.48	28.92
Rohn-LH12	-0.62	16.05	73.82	18.80	216.48	3.48	29.01
Rohn-LH2P	-0.11	0.30	120.42	0.01	298.08	0.03	41.82
Rohn-LH21	0.40	19.08	-216.06	26.62	-101.40	4.57	-31.72
Rohn-LH22	-0.62	-18.80	-216.48	-26.89	-101.80	-4.57	-31.80
Rohn-LI1P	-0.11	-0.01	-298.08	-0.87	-181.57	-0.09	-47.93
Rohn-LI11	0.40	-26.62	101.40	-39.47	360.10	-6.60	46.12
Rohn-LI12	-0.62	26.89	101.80	39.27	360.03	6.61	46.15
Rohn-LI2P	-0.11	0.87	181.57	1.76	488.78	0.26	66.99
Rohn-LI21	0.40	39.47	-360.10	35.27	-70.64	7.47	-43.04
Rohn-LI22	-0.62	-39.28	-360.03	-36.66	-68.78	-7.59	-42.85
Rohn-H1P	0.02	0.42	0.01	0.52	-0.06	0.13	-0.01
Rohn-H11	0.02	-0.09	0.05	0.03	0.18	-0.01	0.03
Rohn-H12	0.02	-0.64	0.24	-0.53	0.18	-0.16	0.06
Rohn-H2P	-0.03	0.74	-0.14	0.85	-0.25	0.18	-0.04
Rohn-H21	0.01	-0.00	-0.16	-0.04	0.07	-0.00	-0.01

Rohn-H22	0.04	-0.87	0.17	-0.76	0.06	-0.18	0.03
SNB-LA1P	-0.00	0.10	58.32	0.37	10.02	0.09	13.66
SNB-LA11	0.02	49.09	-26.81	9.87	-4.65	11.78	-6.29
SNB-LA12	-0.02	-49.42	-27.12	-10.23	-5.28	-11.92	-6.48
SNB-LA2P	-0.00	-0.37	-10.02	-0.59	6.42	-0.19	-0.72
SNB-LA21	0.02	-9.87	4.65	1.21	-4.13	-1.73	0.10
SNB-LA22	-0.02	10.23	5.28	-0.99	-3.32	1.85	0.39
SNB-LA3P	-0.00	0.59	-6.42	0.42	-16.73	0.20	-4.63
SNB-LA31	0.02	-1.21	4.13	-9.58	15.78	-2.16	3.98
SNB-LA32	-0.02	0.99	3.32	9.24	15.10	2.05	3.68
SNB-LA4P	-0.00	-0.42	16.73	-0.27	58.24	-0.14	14.98
SNB-LA41	0.02	9.58	-15.78	34.65	-26.25	8.84	-8.40
SNB-LA42	-0.02	-9.24	-15.10	-34.34	-25.76	-8.71	-8.17
SNB-LB1P	-0.00	0.28	92.49	0.17	14.69	0.09	21.42
SNB-LB11	0.41	74.83	-27.31	10.58	17.09	17.07	-2.04
SNB-LB12	-0.41	-74.91	-27.68	-10.61	16.87	-17.09	-2.16
SNB-LB2P	-0.00	-0.17	-14.69	-0.07	37.58	-0.05	4.58
SNB-LB21	0.41	-10.58	-17.09	10.47	-6.59	-0.02	-4.73
SNB-LB22	-0.41	10.61	-16.87	-10.34	-6.43	0.06	-4.66
SNB-LB3P	-0.00	0.07	-37.58	0.12	-45.21	0.04	-16.54
SNB-LB31	0.41	-10.47	6.59	-29.71	51.27	-8.03	11.56
SNB-LB32	-0.41	10.34	6.43	29.77	51.16	8.01	11.51
SNB-LB4P	-0.00	-0.12	45.21	-0.02	180.25	-0.03	45.06
SNB-LB41	0.42	29.71	-51.27	97.66	-52.91	25.45	-20.82
SNB-LB42	-0.41	-29.77	-51.16	-97.57	-52.83	-25.45	-20.78
SNB-LC1P	-0.00	0.01	55.87	0.02	47.64	0.01	15.53
SNB-LC11	0.85	79.22	-39.48	31.00	13.99	16.54	-3.83
SNB-LC12	-0.85	-79.34	-39.57	-31.03	13.95	-16.56	-3.84
SNB-LC2P	-0.00	-0.02	-47.64	0.02	-36.43	0.00	-12.58
SNB-LC21	0.85	-31.00	-13.99	-37.59	62.86	-10.26	7.31
SNB-LC22	-0.85	31.03	-13.95	37.57	62.82	10.26	7.31
SNB-LC3P	-0.00	-0.02	36.43	-0.00	204.43	-0.00	36.14
SNB-LC31	0.85	37.59	-62.86	119.21	-73.10	23.53	-20.40
SNB-LC32	-0.85	-37.57	-62.82	-119.04	-73.00	-23.50	-20.38
SNB-LD1P	-0.00	0.02	164.66	0.17	112.34	0.03	41.56
SNB-LD11	1.13	182.50	-93.47	50.30	35.57	34.93	-8.69
SNB-LD12	-1.13	-182.64	-93.58	-50.23	35.42	-34.94	-8.73
SNB-LD2P	-0.00	-0.17	-112.34	0.02	-49.40	-0.02	-24.20
SNB-LD21	1.12	-50.30	-35.57	-33.84	113.10	-12.59	11.60
SNB-LD22	-1.12	50.23	-35.42	34.06	113.21	12.61	11.64
SNB-LD3P	-0.00	-0.02	49.40	0.04	287.41	0.00	50.54
SNB-LD31	1.13	33.84	-113.10	108.35	-61.68	21.33	-26.22
SNB-LD32	-1.13	-34.06	-113.21	-108.35	-61.72	-21.37	-26.24
SNB-LE1P	-0.01	-0.06	205.11	0.26	159.19	0.03	54.66
SNB-LE11	1.90	274.24	-143.96	81.06	73.57	53.31	-10.56
SNB-LE12	-1.90	-274.45	-144.00	-80.97	73.33	-53.32	-10.60
SNB-LE2P	-0.01	-0.26	-159.19	-0.19	-104.24	-0.07	-39.41
SNB-LE21	1.89	-81.06	-73.57	-102.26	213.63	-27.42	20.95
SNB-LE22	-1.89	80.97	-73.33	102.64	214.07	27.47	21.05
SNB-LE3P	-0.01	0.19	104.24	0.15	736.55	0.05	126.16
SNB-LE31	1.90	102.26	-213.63	385.63	-296.09	73.20	-76.47
SNB-LE32	-1.90	-102.64	-214.07	-386.34	-296.67	-73.36	-76.63
SNB-LF1P	0.00	-0.24	-6.72	-0.49	-165.15	-0.07	-17.18
SNB-LF11	2.74	233.22	-45.01	-11.70	328.58	22.13	28.34
SNB-LF12	-2.75	-232.88	-44.54	11.67	329.13	-22.10	28.44
SNB-LF2P	0.00	0.49	165.15	0.18	765.90	0.07	93.04
SNB-LF21	2.75	11.70	-328.58	308.41	-343.77	31.99	-67.18
SNB-LF22	-2.76	-11.67	-329.13	-309.21	-344.43	-32.06	-67.30
SNB-LG1P	0.01	-0.21	346.21	-1.07	-207.80	-0.13	13.83
SNB-LG11	4.45	661.31	-207.86	5.69	554.12	66.65	34.60
SNB-LG12	-4.47	-660.62	-207.21	-6.35	554.97	-66.64	34.75
SNB-LG2P	0.01	1.07	207.80	0.34	1334.49	0.14	154.12
SNB-LG21	4.44	-5.69	-554.12	620.71	-572.82	61.45	-112.61
SNB-LG22	-4.47	6.35	-554.97	-621.57	-573.70	-61.47	-112.78
SNB-LH1P	0.01	-0.34	100.50	-1.10	-259.84	-0.14	-15.92
SNB-LH11	4.17	605.95	-128.58	9.94	586.58	61.54	45.76
SNB-LH12	-4.19	-605.11	-127.71	-10.60	587.46	-61.52	45.94
SNB-LH2P	0.01	1.10	259.84	0.41	1285.46	0.15	154.43
SNB-LH21	4.17	-9.94	-586.58	482.41	-537.67	47.21	-112.34

SNB-LH22	-4.18	10.60	-587.46	-483.20	-538.59	-47.22	-112.52
SNB-LI1P	0.00	-0.41	409.41	-1.53	-128.04	-0.19	28.12
SNB-LI11	2.30	983.41	-301.79	215.33	767.52	119.78	46.54
SNB-LI12	-2.32	-982.56	-300.84	-216.49	768.60	-119.81	46.74
SNB-LI2P	0.00	1.53	128.04	0.87	1056.82	0.24	118.41
SNB-LI21	2.27	-215.33	-767.52	-71.65	-138.09	-28.68	-90.49
SNB-LI22	-2.28	216.49	-768.60	71.42	-139.17	28.77	-90.71
SNB-H1aP	-0.29	33.83	-2.74	109.91	-2.07	71.14	-2.38
SNB-H1bP	-0.29	-109.91	2.07	-31.18	-1.15	-69.83	0.45
SNB-H1cP	-0.07	33.25	1.08	109.08	3.71	70.45	2.37
SNB-H1dP	-0.07	-109.08	-3.71	-33.40	-1.09	-70.52	-2.37
SNB-H1eP	0.37	31.43	1.15	109.75	-2.14	69.88	-0.49
SNB-H1fP	0.37	-109.75	2.14	-33.90	2.74	-71.10	2.42
SNB-H2aP	-1.04	87.60	-0.64	115.55	-0.63	75.16	-0.47
SNB-H2bP	-1.04	-115.55	0.63	-62.41	-1.18	-65.84	-0.20
SNB-H2cP	0.02	77.39	0.46	113.24	2.30	70.53	1.02
SNB-H2dP	0.02	-113.24	-2.30	-77.23	-0.46	-70.47	-1.02
SNB-H2eP	1.02	62.29	1.18	115.59	-0.68	65.81	0.19
SNB-H2fP	1.02	-115.59	0.68	-87.65	0.64	-75.19	0.49
SNB-H3aP	-0.53	136.64	0.59	155.93	0.16	86.44	0.22
SNB-H3bP	-0.53	-155.93	-0.16	-106.93	-1.69	-77.67	-0.54
SNB-H3cP	0.00	122.98	0.92	154.77	2.89	82.07	1.13
SNB-H3dP	0.00	-154.77	-2.89	-123.01	-0.92	-82.08	-1.12
SNB-H3eP	0.53	106.95	1.69	155.93	0.15	77.67	0.54
SNB-H3fP	0.53	-155.93	-0.15	-136.62	-0.59	-86.44	-0.22
SNB-H4aP	-0.70	213.49	1.52	249.99	0.53	113.99	0.50
SNB-H4bP	-0.70	-249.99	-0.53	-192.64	-2.47	-108.86	-0.74
SNB-H4cP	-0.00	204.84	1.93	248.58	4.87	111.52	1.67
SNB-H4dP	-0.00	-248.58	-4.87	-204.81	-1.93	-111.51	-1.67
SNB-H4eP	0.70	192.63	2.47	249.98	0.52	108.86	0.74
SNB-H4fP	0.70	-249.98	-0.52	-213.52	-1.52	-113.99	-0.50
SNB-H5aP	-0.76	284.83	2.35	322.29	0.56	127.90	0.61
SNB-H5bP	-0.76	-322.29	-0.56	-237.78	-3.68	-117.99	-0.89
SNB-H5cP	-0.00	263.10	2.38	320.72	7.29	123.00	2.04
SNB-H5dP	-0.00	-320.72	-7.29	-263.26	-2.38	-123.03	-2.04
SNB-H5eP	0.77	237.86	3.68	322.28	0.56	118.01	0.89
SNB-H5fP	0.77	-322.28	-0.56	-284.76	-2.34	-127.89	-0.61
SNB-H6aP	-3.63	423.54	2.21	497.66	1.01	169.70	0.59
SNB-H6bP	-3.63	-497.66	-1.01	-395.74	-3.81	-164.58	-0.89
SNB-H6cP	0.01	417.93	2.42	489.75	6.41	167.21	1.63
SNB-H6dP	0.00	-489.75	-6.41	-418.23	-2.41	-167.27	-1.63
SNB-H6eP	3.63	395.88	3.82	497.67	1.03	164.61	0.89
SNB-H6fP	3.63	-497.67	-1.03	-423.38	-2.22	-169.68	-0.60
SNB-H7aP	-2.95	643.81	0.14	739.71	-0.94	226.44	-0.13
SNB-H7bP	-2.95	-739.71	0.93	-638.33	-1.98	-225.55	-0.17
SNB-H7cP	0.01	648.16	0.00	733.62	4.00	226.16	0.66
SNB-H7dP	0.01	-733.62	-4.00	-648.26	0.00	-226.17	-0.65
SNB-H7eP	2.94	638.37	1.99	739.73	-0.92	225.55	0.17
SNB-H7fP	2.94	-739.73	0.92	-643.74	-0.15	-226.43	0.13
SNB-H8aP	-0.60	828.84	0.32	893.99	-0.98	253.71	-0.10
SNB-H8bP	-0.59	-893.99	0.98	-809.76	-1.02	-250.90	-0.01
SNB-H8cP	0.00	821.50	1.04	893.52	4.37	252.56	0.80
SNB-H8dP	0.00	-893.52	-4.37	-821.53	-1.04	-252.57	-0.80
SNB-H8eP	0.59	809.77	1.02	893.99	-0.99	250.90	0.00
SNB-H8fP	0.60	-893.99	0.99	-828.83	-0.31	-253.71	0.10
SNB-H9aP	-1.73	979.52	0.21	1031.65	-1.25	269.16	-0.14
SNB-H9bP	-1.73	-1031.65	1.24	-969.67	0.04	-267.84	0.17
SNB-H9cP	0.00	979.81	1.57	1029.08	4.24	268.85	0.78
SNB-H9dP	0.00	-1029.08	-4.24	-979.77	-1.57	-268.85	-0.78
SNB-H9eP	1.72	969.65	-0.05	1031.65	-1.25	267.84	-0.17
SNB-H9fP	1.73	-1031.65	1.25	-979.54	-0.20	-269.16	0.14

Equilibrium Joint Positions and Rotations for Load Case "6: Service 1.0D + 1.0Dg + 1.0 Wo":

Joint Label	X-Displ (ft)	Y-Displ (ft)	Z-Displ (ft)	X-Rot (deg)	Y-Rot (deg)	Z-Rot (deg)	X-Pos (ft)	Y-Pos (ft)	Z-Pos (ft)
RohnAP	0.3996	-8.386e-005	-0.02377	0.0012	0.2049	0.0024	4.733	-8.386e-005	180
RohnBP	0.3278	8.155e-005	-0.02604	-0.0003	0.2046	0.0024	5.449	8.155e-005	160
RohnCP	0.257	1.393e-005	-0.02714	-0.0002	0.1972	0.0016	6.166	1.393e-005	140
RohnDP	0.191	-2.184e-005	-0.0268	-0.0001	0.1789	0.0010	6.886	-2.184e-005	120
RohnEP	0.1332	-7.096e-005	-0.02387	-0.0002	0.1477	0.0007	7.614	-7.096e-005	99.98
RohnFP	0.08628	-0.0001278	-0.02061	-0.0001	0.1163	0.0005	8.354	-0.0001278	79.98
RohnGP	0.04946	-0.0001305	-0.01653	0.0001	0.0890	0.0003	9.104	-0.0001305	59.98
RohnHP	0.02275	-9.193e-005	-0.01186	0.0002	0.0610	0.0002	9.864	-9.193e-005	39.99
RohnIP	0.006436	-4.826e-005	-0.00582	0.0001	0.0273	0.0001	10.64	-4.826e-005	19.99
RohnJP	0	0	0	0.0000	0.0000	0.0000	11.42	0	0
SNB-AP	0.3996	-0.0002722	-0.01265	0.0004	0.1999	-0.0000	2.733	-0.0002722	180
SNB-BP	0.3278	-0.0001939	-0.01512	0.0002	0.2003	-0.0000	3.449	-0.0001939	160
SNB-CP	0.2571	-0.0001194	-0.01701	0.0002	0.1925	-0.0000	4.165	-0.0001194	140
SNB-DP	0.191	-6.242e-005	-0.0177	0.0001	0.1715	-0.0000	4.886	-6.242e-005	120
SNB-EP	0.1332	-2.867e-005	-0.01635	0.0001	0.1413	-0.0000	5.614	-2.867e-005	99.98
SNB-FP	0.08629	-1.503e-005	-0.01517	0.0000	0.1122	0.0000	6.354	-1.503e-005	79.98
SNB-GP	0.04947	-9.162e-006	-0.01255	0.0000	0.0787	0.0000	7.104	-9.162e-006	59.99
SNB-HP	0.02275	-4.633e-006	-0.009301	0.0000	0.0538	0.0000	7.864	-4.633e-006	39.99
SNB-IP	0.006437	-1.737e-006	-0.004708	0.0000	0.0226	0.0000	8.634	-1.737e-006	20
SNB-JP	0	0	0	0.0000	0.0000	0.0000	9.415	0	0
RohnA1	0.3998	-0.0003673	-0.0006454	-0.0003	0.2060	0.0013	-1.767	-3.753	180
RohnA2	0.3995	-0.000353	-0.0006311	0.0004	0.2058	0.0034	-1.767	3.752	180
RohnB1	0.3281	-0.0003423	0.0009104	0.0010	0.2065	0.0003	-2.232	-4.435	160
RohnB2	0.3276	-0.000335	0.0009501	-0.0002	0.2060	0.0045	-2.233	4.435	160
RohnC1	0.2571	-0.0001192	0.002313	-0.0004	0.1960	-0.0018	-2.697	-5.117	140
RohnC2	0.2569	-0.0002545	0.002346	0.0013	0.1953	0.0050	-2.698	5.117	140
RohnD1	0.1908	3.464e-005	0.003375	-0.0008	0.1785	-0.0029	-3.157	-5.798	120
RohnD2	0.1907	-0.000213	0.003404	0.0013	0.1779	0.0050	-3.157	5.798	120
RohnE1	0.1331	2.218e-005	0.003799	-0.0002	0.1476	-0.0029	-3.607	-6.479	100
RohnE2	0.1332	-3.514e-005	0.003812	0.0006	0.1471	0.0043	-3.607	6.479	100
RohnF1	0.08598	0.0001534	0.003787	0.0016	0.1229	-0.0028	-4.048	-7.16	80
RohnF2	0.08623	-4.14e-005	0.003786	-0.0014	0.1227	0.0038	-4.048	7.16	80
RohnG1	0.04928	9.807e-005	0.003323	0.0005	0.0909	-0.0022	-4.478	-7.842	60
RohnG2	0.04955	3.366e-005	0.00332	-0.0006	0.0909	0.0028	-4.478	7.842	60
RohnH1	0.02257	9.348e-005	0.002543	0.0005	0.0629	-0.0016	-4.898	-8.522	40
RohnH2	0.02273	-1.435e-005	0.002542	-0.0006	0.0631	0.0020	-4.898	8.523	40
RohnI1	0.006365	3.425e-005	0.001292	0.0008	0.0314	-0.0009	-5.309	-9.206	20
RohnI2	0.006445	8.531e-006	0.001292	-0.0009	0.0316	0.0010	-5.309	9.206	20
RohnJ1	0	0	0	0.0000	0.0000	0.0000	-5.71	-9.89	0
RohnJ2	0	0	0	0.0000	0.0000	0.0000	-5.71	9.89	0
SNB-A1	0.3996	-0.0002726	-9.798e-005	-0.0046	0.2089	-0.0002	-0.7669	-2.021	180
SNB-A2	0.3996	-0.0002713	-8.274e-005	0.0050	0.2087	0.0002	-0.7669	2.02	180
SNB-B1	0.3278	-0.0001953	0.001466	-0.0027	0.2067	-0.0002	-1.233	-2.703	160
SNB-B2	0.3278	-0.0001917	0.001487	0.0032	0.2067	0.0003	-1.233	2.703	160
SNB-C1	0.2571	-0.0001204	0.002864	-0.0030	0.1994	-0.0005	-1.697	-3.385	140
SNB-C2	0.2571	-0.0001187	0.002886	0.0034	0.1994	0.0005	-1.697	3.384	140
SNB-D1	0.191	-5.098e-005	0.00383	-0.0053	0.1826	-0.0010	-2.157	-4.066	120
SNB-D2	0.191	-7.337e-005	0.003848	0.0056	0.1826	0.0010	-2.157	4.066	120
SNB-E1	0.1332	-1.419e-005	0.004024	-0.0032	0.1481	-0.0008	-2.607	-4.747	100
SNB-E2	0.1332	-4.244e-005	0.004034	0.0033	0.1481	0.0008	-2.607	4.747	100
SNB-F1	0.08625	-3.77e-006	0.004066	-0.0036	0.1255	-0.0008	-3.048	-5.428	80
SNB-F2	0.08625	-2.72e-005	0.004072	0.0037	0.1255	0.0008	-3.048	5.428	80
SNB-G1	0.04942	1.969e-005	0.003545	-0.0052	0.0949	-0.0010	-3.478	-6.11	60
SNB-G2	0.04942	-3.91e-005	0.003549	0.0052	0.0949	0.0010	-3.478	6.11	60
SNB-H1	0.02267	3.52e-005	0.002734	-0.0057	0.0658	-0.0010	-3.898	-6.79	40
SNB-H2	0.02268	-4.434e-005	0.002737	0.0057	0.0658	0.0010	-3.898	6.79	40
SNB-I1	0.006332	5.323e-005	0.001419	-0.0034	0.0345	-0.0010	-4.308	-7.472	20
SNB-I2	0.006332	-5.642e-005	0.001421	0.0034	0.0345	0.0010	-4.308	7.472	20
SNB-J1	0	0	0	0.0000	0.0000	0.0000	-4.708	-8.154	0
SNB-J2	0	0	0	0.0000	0.0000	0.0000	-4.708	8.154	0

RohnAaS	0.3817	3.67e-006	-0.02441	0.0002	0.2063	0.0024	4.912	3.67e-006	175
RohnAbs	0.3636	9.71e-006	-0.02501	0.0006	0.2058	0.0024	5.091	9.71e-006	170
RohnAcS	0.3457	0.0001034	-0.02556	0.0004	0.2054	0.0024	5.27	0.0001034	165
RohnBaS	0.31	7.764e-005	-0.02646	-0.0002	0.2044	0.0022	5.628	7.764e-005	155
RohnBbS	0.2921	5.64e-005	-0.0268	-0.0003	0.2028	0.0020	5.807	5.64e-005	150
RohnBcS	0.2745	3.709e-005	-0.02702	-0.0003	0.2013	0.0018	5.987	3.709e-005	145
RohnCaS	0.2345	3.634e-006	-0.02726	-0.0001	0.1911	0.0014	6.405	3.634e-006	133.3
RohnCbS	0.2124	-8.389e-006	-0.02717	-0.0002	0.1875	0.0012	6.646	-8.389e-006	126.6
RohnDaS	0.1707	-2.978e-005	-0.02614	-0.0002	0.1689	0.0009	7.127	-2.978e-005	113.3
RohnDbS	0.1514	-5.105e-005	-0.02513	-0.0002	0.1616	0.0008	7.371	-5.105e-005	106.6
RohnEaS	0.1168	-9.33e-005	-0.02296	-0.0003	0.1366	0.0006	7.86	-9.33e-005	93.32
RohnEbS	0.101	-0.0001244	-0.02187	-0.0001	0.1323	0.0005	8.107	-0.0001244	86.64
RohnFaS	0.06722	-0.0001588	-0.01874	-0.0000	0.1060	0.0004	8.729	-0.0001588	69.98
RohnGaS	0.03553	-0.0001278	-0.01433	0.0001	0.0764	0.0002	9.484	-0.0001278	49.99
RohnHaS	0.01393	-6.814e-005	-0.008979	0.0001	0.0469	0.0001	10.25	-6.814e-005	29.99
RohnIaS	0.002645	-2.304e-005	-0.00301	0.0002	0.0198	0.0000	11.03	-2.304e-005	9.997
SNB-AaS	0.3817	-0.0002443	-0.01331	0.0001	0.2077	-0.0000	2.912	-0.0002443	175
SNB-AbS	0.3637	-0.0002475	-0.01395	0.0002	0.2051	-0.0000	3.091	-0.0002475	170
SNB-AcS	0.3458	-0.0002048	-0.01455	0.0004	0.2067	-0.0000	3.27	-0.0002048	165
SNB-BaS	0.31	-0.0001732	-0.01567	0.0002	0.2057	-0.0000	3.628	-0.0001732	155
SNB-BbS	0.2922	-0.0001551	-0.01618	0.0002	0.2023	-0.0000	3.807	-0.0001551	150
SNB-BcS	0.2746	-0.0001359	-0.01663	0.0002	0.2028	-0.0000	3.986	-0.0001359	145
SNB-CaS	0.2345	-9.848e-005	-0.0174	0.0002	0.1919	-0.0000	4.405	-9.848e-005	133.3
SNB-CbS	0.2124	-7.898e-005	-0.01762	0.0002	0.1894	-0.0000	4.645	-7.898e-005	126.6
SNB-DaS	0.1707	-4.703e-005	-0.01749	0.0001	0.1706	-0.0000	5.127	-4.703e-005	113.3
SNB-DbS	0.1515	-3.718e-005	-0.01702	0.0001	0.1630	-0.0000	5.371	-3.718e-005	106.6
SNB-EaS	0.1168	-2.099e-005	-0.01612	0.0000	0.1383	0.0000	5.86	-2.099e-005	93.32
SNB-EbS	0.101	-1.901e-005	-0.01571	0.0000	0.1332	0.0000	6.107	-1.901e-005	86.64
SNB-FaS	0.06722	-1.282e-005	-0.014	0.0000	0.1098	0.0000	6.729	-1.282e-005	69.99
SNB-GaS	0.03554	-7.769e-006	-0.01106	0.0000	0.0809	0.0000	7.484	-7.769e-006	49.99
SNB-HaS	0.01393	-3.068e-006	-0.007142	0.0000	0.0501	0.0000	8.248	-3.068e-006	29.99
SNB-IaS	0.002645	-4.577e-007	-0.002478	0.0000	0.0211	0.0000	9.024	-4.577e-007	9.998
SNB-WL-A1S	0.3996	-0.0002736	-0.006522	-0.0021	0.2043	-0.0001	0.9829	-1.01	180
SNB-WL-A2S	0.3996	-0.000272	-0.0002332	0.0002	0.2088	0.0000	-0.7669	-0.000272	180
SNB-WL-A3S	0.3996	-0.0002701	-0.006511	0.0027	0.2042	0.0001	0.9829	1.01	180
SNB-WL-B1S	0.3278	-0.0001958	-0.007043	-0.0005	0.2022	-0.0002	1.108	-1.352	160
SNB-WL-B2S	0.3279	-0.0001935	0.001273	0.0002	0.2067	0.0000	-1.233	-0.0001935	160
SNB-WL-B3S	0.3278	-0.0001909	-0.007034	0.0009	0.2022	0.0002	1.108	1.351	160
SNB-WL-C1S	0.2571	-0.0001237	-0.007488	0.0002	0.1932	-0.0002	1.234	-1.692	140
SNB-WL-C2S	0.2571	-0.0001196	0.002478	0.0002	0.1994	0.0000	-1.697	-0.0001196	140
SNB-WL-C3S	0.2571	-0.0001152	-0.007478	0.0002	0.1932	0.0002	1.234	1.692	140
SNB-WL-D1S	0.191	-6.955e-005	-0.007862	-0.0004	0.1733	-0.0003	1.365	-2.033	120
SNB-WL-D2S	0.191	-6.217e-005	0.002937	0.0001	0.1826	0.0000	-2.156	-6.217e-005	120
SNB-WL-D3S	0.191	-5.484e-005	-0.007853	0.0007	0.1733	0.0003	1.365	2.033	120
SNB-WL-E1S	0.1332	-3.423e-005	-0.006812	0.0008	0.1407	-0.0003	1.503	-2.373	99.99
SNB-WL-E2S	0.1332	-2.831e-005	0.003403	0.0001	0.1481	-0.0000	-2.607	-2.831e-005	100
SNB-WL-E3S	0.1332	-2.276e-005	-0.006806	-0.0006	0.1407	0.0003	1.503	2.373	99.99
SNB-WL-F1S	0.08628	-2.266e-005	-0.006864	-0.0001	0.1159	-0.0002	1.653	-2.714	79.99
SNB-WL-F2S	0.0863	-1.548e-005	0.0029	0.0000	0.1255	-0.0000	-3.048	-1.548e-005	80
SNB-WL-F3S	0.08628	-8.774e-006	-0.006861	0.0001	0.1159	0.0002	1.653	2.714	79.99
SNB-WL-G1S	0.04946	-2.001e-005	-0.006855	-0.0018	0.0855	-0.0002	1.813	-3.055	59.99
SNB-WL-G2S	0.04948	-9.706e-006	0.001353	0.0000	0.0949	-0.0000	-3.478	-9.706e-006	60
SNB-WL-G3S	0.04946	1.41e-007	-0.006854	0.0019	0.0855	0.0002	1.813	3.055	59.99
SNB-WL-H1S	0.02273	-1.645e-005	-0.006602	-0.0010	0.0567	-0.0002	1.983	-3.395	39.99
SNB-WL-H2S	0.02276	-4.565e-006	-0.0005345	0.0000	0.0658	-0.0000	-3.898	-4.565e-006	40
SNB-WL-H3S	0.02273	6.955e-006	-0.006601	0.0010	0.0567	0.0002	1.983	3.395	39.99
SNB-WL-I1S	0.006412	-1.538e-005	-0.006175	-0.0001	0.0259	-0.0003	2.163	-3.736	19.99
SNB-WL-I2S	0.006436	-1.596e-006	-0.002959	0.0000	0.0345	-0.0000	-4.308	-1.596e-006	20
SNB-WL-I3S	0.006412	1.2e-005	-0.006175	0.0001	0.0259	0.0003	2.163	3.736	19.99
RohnAa1	0.3819	-0.0004027	-0.0002461	-0.0004	0.2043	0.0011	-1.883	-3.923	175
RohnAa2	0.3815	-0.0003347	-0.000225	-0.0001	0.2065	0.0037	-1.883	3.923	175
RohnAb1	0.364	-0.0004226	0.0001456	0.0004	0.2066	0.0008	-1.999	-4.094	170
RohnAb2	0.3634	-0.0003738	0.0001802	-0.0003	0.2071	0.0040	-2	4.093	170
RohnAc1	0.3459	-0.0003608	0.0005364	0.0004	0.2057	0.0006	-2.116	-4.265	165
RohnAc2	0.3454	-0.0003658	0.0005743	0.0005	0.2047	0.0042	-2.117	4.264	165
RohnBa1	0.3101	-0.000268	0.001285	-0.0004	0.2035	-0.0002	-2.349	-4.606	155
RohnBa2	0.3096	-0.000329	0.001324	0.0014	0.2024	0.0046	-2.349	4.605	155
RohnBb1	0.2925	-0.0003534	0.001636	0.0003	0.2033	-0.0009	-2.465	-4.776	150
RohnBb2	0.2921	-0.0001672	0.001672	0.0006	0.2024	0.0048	-2.465	4.776	150

RohnBc1	0.2745	-0.0001872	0.001997	0.0021	0.2046	-0.0016	-2.581	-4.947	145
RohnBc2	0.2743	-0.0002588	0.002032	-0.0011	0.2036	0.0051	-2.582	4.946	145
RohnCa1	0.2346	-0.0002112	0.002703	-0.0004	0.1924	-0.0023	-2.851	-5.344	133.3
RohnCa2	0.2344	-8.311e-005	0.002733	0.0011	0.1918	0.0051	-2.851	5.344	133.3
RohnCb1	0.2123	-0.0001332	0.003064	0.0019	0.1888	-0.0027	-3.004	-5.572	126.7
RohnCb2	0.2122	-9.733e-005	0.003093	-0.0014	0.1886	0.0052	-3.004	5.571	126.7
RohnDa1	0.1705	-9.683e-005	0.003604	0.0007	0.1731	-0.0031	-3.308	-6.025	113.3
RohnDa2	0.1704	-1.513e-005	0.003628	-0.0001	0.1725	0.0049	-3.308	6.025	113.3
RohnDb1	0.1508	0.0001398	0.00377	0.0007	0.1602	-0.0030	-3.459	-6.252	106.7
RohnDb2	0.1508	-0.0001997	0.003789	-0.0002	0.1598	0.0046	-3.459	6.252	106.7
RohnEa1	0.1162	0.0001399	0.003866	0.0012	0.1407	-0.0029	-3.755	-6.706	93.34
RohnEa2	0.1164	-0.0001105	0.003875	-0.0009	0.1403	0.0042	-3.755	6.706	93.34
RohnEb1	0.1005	0.0001753	0.003865	-0.0005	0.1288	-0.0027	-3.902	-6.933	86.66
RohnEb2	0.1007	-0.0001068	0.003869	0.0010	0.1281	0.0038	-3.902	6.933	86.66
RohnFa1	0.06563	0.0004437	0.003641	-0.0007	0.1040	-0.0024	-4.265	-7.501	70
RohnFa2	0.06585	-0.0003294	0.003639	0.0007	0.1040	0.0031	-4.265	7.501	70
RohnGa1	0.03399	0.0004475	0.003	-0.0001	0.0761	-0.0019	-4.69	-8.182	50
RohnGa2	0.03418	-0.0003469	0.002998	-0.0000	0.0765	0.0024	-4.69	8.182	50
RohnHa1	0.0122	0.0004942	0.001988	-0.0004	0.0459	-0.0012	-5.106	-8.864	30
RohnHa2	0.01232	-0.0004353	0.001988	0.0003	0.0461	0.0015	-5.105	8.864	30
RohnIa1	0.001344	0.0003184	0.0006923	-0.0001	0.0193	-0.0006	-5.511	-9.548	10
RohnIa2	0.001383	-0.0002973	0.0006926	-0.0000	0.0196	0.0006	-5.511	9.548	10
SNB-Aa1	0.3817	-0.0002695	0.0003007	0.0016	0.2049	-0.0002	-0.8833	-2.191	175
SNB-Aa2	0.3817	-0.0002442	0.0003166	-0.0011	0.2051	0.0002	-0.8833	2.191	175
SNB-Ab1	0.3637	-0.0002322	0.0006954	-0.0002	0.2067	-0.0002	-0.9998	-2.362	170
SNB-Ab2	0.3637	-0.000231	0.0007144	0.0007	0.2067	0.0003	-0.9998	2.361	170
SNB-Ac1	0.3457	-0.0002199	0.001088	0.0011	0.2050	-0.0002	-1.116	-2.532	165
SNB-Ac2	0.3457	-0.0002137	0.001107	-0.0006	0.2048	0.0003	-1.116	2.532	165
SNB-Ba1	0.3099	-0.0001802	0.001847	0.0012	0.2043	-0.0004	-1.349	-2.873	155
SNB-Ba2	0.3099	-0.0001691	0.001868	-0.0008	0.2043	0.0004	-1.349	2.873	155
SNB-Bb1	0.2921	-0.0001378	0.002208	-0.0000	0.2037	-0.0004	-1.465	-3.044	150
SNB-Bb2	0.2921	-0.0001722	0.00223	0.0005	0.2037	0.0005	-1.465	3.043	150
SNB-Bc1	0.2744	-0.0001273	0.00255	0.0009	0.2005	-0.0005	-1.581	-3.214	145
SNB-Bc2	0.2744	-0.0001462	0.002571	-0.0005	0.2005	0.0005	-1.581	3.214	145
SNB-Ca1	0.2342	-2.768e-005	0.00325	0.0013	0.1942	-0.0008	-1.851	-3.611	133.3
SNB-Ca2	0.2342	-0.0001714	0.003271	-0.0010	0.1942	0.0008	-1.851	3.611	133.3
SNB-Cb1	0.2121	-7.119e-006	0.003578	0.0009	0.1844	-0.0008	-2.004	-3.839	126.7
SNB-Cb2	0.2121	-0.0001535	0.003598	-0.0006	0.1845	0.0008	-2.004	3.839	126.7
SNB-Da1	0.1702	2.995e-005	0.004003	0.0028	0.1737	-0.0012	-2.308	-4.293	113.3
SNB-Da2	0.1702	-0.0001277	0.004019	-0.0026	0.1737	0.0012	-2.308	4.293	113.3
SNB-Db1	0.1508	0.0001556	0.004071	-0.0000	0.1582	-0.0009	-2.459	-4.52	106.7
SNB-Db2	0.1508	-0.0002294	0.004084	0.0002	0.1582	0.0009	-2.459	4.52	106.7
SNB-Ea1	0.1164	5.683e-005	0.004112	0.0016	0.1406	-0.0009	-2.755	-4.974	93.34
SNB-Ea2	0.1164	-0.0001007	0.004121	-0.0015	0.1406	0.0009	-2.755	4.974	93.34
SNB-Eb1	0.1007	0.0001001	0.004125	0.0003	0.1275	-0.0007	-2.902	-5.201	86.66
SNB-Eb2	0.1007	-0.0001337	0.004132	-0.0002	0.1275	0.0007	-2.902	5.201	86.66
SNB-Fa1	0.06561	0.0004501	0.003886	0.0025	0.1031	-0.0008	-3.265	-5.769	70
SNB-Fa2	0.06561	-0.0004695	0.003891	-0.0024	0.1031	0.0008	-3.265	5.769	70
SNB-Ga1	0.03408	0.0003968	0.003213	0.0029	0.0746	-0.0010	-3.69	-6.45	50
SNB-Ga2	0.03408	-0.0004087	0.003216	-0.0029	0.0746	0.0010	-3.69	6.45	50
SNB-Ha1	0.01234	0.0004138	0.002151	0.0025	0.0450	-0.0010	-4.105	-7.131	30
SNB-Ha2	0.01234	-0.0004195	0.002153	-0.0025	0.0450	0.0009	-4.105	7.131	30
SNB-Ia1	0.001249	0.0003732	0.0007752	0.0008	0.0184	-0.0006	-4.51	-7.812	10
SNB-Ia2	0.001249	-0.0003744	0.000776	-0.0008	0.0184	0.0006	-4.51	7.812	10

Joint Support Reactions for Load Case "6: Service 1.0D + 1.0Dg + 1.0 Wo":

Joint Label	X Force (kips)	X Usage % (kips)	Y Force (kips)	Y Usage % (kips)	Z Force (kips)	Z Usage % (kips)	Uplift Usage %	Result. Force (kips)	Result. Usage % (ft-k)	X Moment Usage % (ft-k)	X-M. Moment Usage % (ft-k)	Y Moment Usage % (ft-k)	Y-M. Moment Usage % (ft-k)	Z Moment Usage %	Z-M. Usage %	Max. Usage %
RohnJP	-7.32	0.0	0.02	0.0	91.59	0.0	0.0	91.88	0.0	-0.01	0.0	-1.4	0.0	-0.00	0.0	0.0
SNB-JP	-11.85	0.0	0.00	0.0	125.71	0.0	0.0	126.27	0.0	-0.00	0.0	-3.3	0.0	-0.00	0.0	0.0
RohnJ1	-1.79	0.0	-1.66	0.0	-20.95	0.0	0.0	21.09	0.0	0.29	0.0	-0.2	0.0	-0.00	0.0	0.0
RohnJ2	-1.83	0.0	1.64	0.0	-20.96	0.0	0.0	21.10	0.0	-0.28	0.0	-0.2	0.0	-0.00	0.0	0.0
SNB-J1	-3.75	0.0	-3.89	0.0	-39.71	0.0	0.0	40.08	0.0	0.98	0.0	-0.4	0.0	-0.01	0.0	0.0
SNB-J2	-3.75	0.0	3.90	0.0	-39.75	0.0	0.0	40.12	0.0	-0.98	0.0	-0.4	0.0	0.01	0.0	0.0

Joint Displacements, Loads and Member Forces on Joints for Load Case "6: Service 1.0D + 1.0Dg + 1.0 Wo":

Joint Label	X External Load (kips)	Y External Load (kips)	Z External Load (kips)	X Member Force (kips)	Y Member Force (kips)	Z Member Force (kips)	X Disp. (ft)	Y Disp. (ft)	Z Disp. (ft)
RohnAP	0.1431	0.0000	-0.2967	-0.1431	-0.0000	0.2967	0.3996	-0.0001	-0.0238
RohnBP	0.6735	0.0000	-1.0631	-0.6735	-0.0000	1.0631	0.3278	0.0001	-0.0260
RohnCP	0.1473	0.0000	-0.4302	-0.1473	-0.0000	0.4302	0.2570	0.0000	-0.0271
RohnDP	0.1798	0.0000	-0.5212	-0.1798	0.0000	0.5212	0.1910	-0.0000	-0.0268
RohnEP	0.1875	0.0000	-0.6450	-0.1875	-0.0000	0.6450	0.1332	-0.0001	-0.0239
RohnFP	0.2194	0.0000	-0.8741	-0.2194	-0.0000	0.8741	0.0863	-0.0001	-0.0206
RohnGP	0.3103	0.0000	-1.1634	-0.3103	-0.0000	1.1634	0.0495	-0.0001	-0.0165
RohnHP	0.2709	0.0000	-1.1580	-0.2709	-0.0000	1.1580	0.0227	-0.0001	-0.0119
RohnIP	0.3268	0.0000	-1.2988	-0.3268	-0.0000	1.2988	0.0064	-0.0000	-0.0058
RohnJP	0.1864	0.0000	-0.7017	7.1327	-0.0248	-90.8845	0.0000	0.0000	0.0000
SNB-AP	0.0419	0.0000	-0.1567	-0.0419	0.0000	0.1567	0.3996	-0.0003	-0.0126
SNB-BP	0.1013	0.0000	-0.3391	-0.1013	0.0000	0.3391	0.3278	-0.0002	-0.0151
SNB-CP	0.1473	0.0000	-0.4302	-0.1473	0.0000	0.4302	0.2571	-0.0001	-0.0170
SNB-DP	0.1798	0.0000	-0.5212	-0.1798	0.0000	0.5212	0.1910	-0.0001	-0.0177
SNB-EP	0.1875	0.0000	-0.6450	-0.1875	0.0000	0.6450	0.1332	-0.0000	-0.0164
SNB-FP	0.2194	0.0000	-0.8741	-0.2194	-0.0000	0.8741	0.0863	-0.0000	-0.0152
SNB-GP	0.2543	0.0000	-1.0634	-0.2543	-0.0000	1.0634	0.0495	-0.0000	-0.0125
SNB-HP	0.2709	0.0000	-1.1580	-0.2709	-0.0000	1.1580	0.0228	-0.0000	-0.0093
SNB-IP	0.3268	0.0000	-1.2988	-0.3268	-0.0000	1.2988	0.0064	-0.0000	-0.0047
SNB-JP	0.1864	0.0000	-0.7017	11.6649	-0.0011	-125.0059	0.0000	0.0000	0.0000
RohnA1	0.1431	0.0000	-0.2967	-0.1431	0.0000	0.2967	0.3998	-0.0004	-0.0006
RohnA2	0.2443	0.0000	-0.4367	-0.2443	-0.0000	0.4367	0.3995	-0.0004	-0.0006
RohnB1	0.2348	0.0000	-0.4531	-0.2348	0.0000	0.4531	0.3281	-0.0003	0.0009
RohnB2	0.1605	0.0000	-0.3881	-0.1605	-0.0000	0.3881	0.3276	-0.0003	0.0010
RohnC1	0.1473	0.0000	-0.4302	-0.1473	0.0000	0.4302	0.2571	-0.0001	0.0023
RohnC2	0.1473	0.0000	-0.4302	-0.1473	-0.0000	0.4302	0.2569	-0.0003	0.0023
RohnD1	0.2272	0.0000	-0.5912	-0.2272	0.0000	0.5912	0.1908	0.0000	0.0034
RohnD2	0.1798	0.0000	-0.5212	-0.1798	-0.0000	0.5212	0.1907	-0.0002	0.0034
RohnE1	0.1875	0.0000	-0.6450	-0.1875	0.0000	0.6450	0.1331	0.0000	0.0038
RohnE2	0.1875	0.0000	-0.6450	-0.1875	-0.0000	0.6450	0.1332	-0.0000	0.0038
RohnF1	0.2194	0.0000	-0.8741	-0.2194	0.0000	0.8741	0.0860	0.0002	0.0038
RohnF2	0.3261	0.0000	-1.0191	-0.3261	-0.0000	1.0191	0.0862	-0.0000	0.0038
RohnG1	0.2855	0.0000	-1.1234	-0.2855	0.0000	1.1234	0.0493	0.0001	0.0033
RohnG2	0.3853	0.0000	-1.2194	-0.3853	-0.0000	1.2194	0.0495	0.0000	0.0033
RohnH1	0.2709	0.0000	-1.1580	-0.2709	0.0000	1.1580	0.0226	0.0001	0.0025
RohnH2	0.2709	0.0000	-1.1580	-0.2709	-0.0000	1.1580	0.0227	-0.0000	0.0025
RohnI1	0.3268	0.0000	-1.2988	-0.3268	-0.0000	1.2988	0.0064	0.0000	0.0013
RohnI2	0.3268	0.0000	-1.2988	-0.3268	-0.0000	1.2988	0.0064	0.0000	0.0013
RohnJ1	0.1864	0.0000	-0.7017	1.5993	1.6623	21.6469	0.0000	0.0000	0.0000
RohnJ2	0.1864	0.0000	-0.7017	1.6430	-1.6414	21.6590	0.0000	0.0000	0.0000
SNB-A1	0.0419	0.0000	-0.1567	-0.0419	-0.0000	0.1567	0.3996	-0.0003	-0.0001
SNB-A2	0.0419	0.0000	-0.1567	-0.0419	0.0000	0.1567	0.3996	-0.0003	-0.0001
SNB-B1	0.1013	0.0000	-0.3391	-0.1013	-0.0000	0.3391	0.3278	-0.0002	0.0015
SNB-B2	0.1013	0.0000	-0.3391	-0.1013	0.0000	0.3391	0.3278	-0.0002	0.0015
SNB-C1	0.1473	0.0000	-0.4302	-0.1473	-0.0000	0.4302	0.2571	-0.0001	0.0029
SNB-C2	0.1473	0.0000	-0.4302	-0.1473	0.0000	0.4302	0.2571	-0.0001	0.0029
SNB-D1	0.1798	0.0000	-0.5212	-0.1798	-0.0000	0.5212	0.1910	-0.0001	0.0038
SNB-D2	0.1798	0.0000	-0.5212	-0.1798	0.0000	0.5212	0.1910	-0.0001	0.0038
SNB-E1	0.1875	0.0000	-0.6450	-0.1875	-0.0000	0.6450	0.1332	-0.0000	0.0040
SNB-E2	0.1875	0.0000	-0.6450	-0.1875	0.0000	0.6450	0.1332	-0.0000	0.0040
SNB-F1	0.2194	0.0000	-0.8741	-0.2194	-0.0000	0.8741	0.0863	-0.0000	0.0041
SNB-F2	0.2194	0.0000	-0.8741	-0.2194	0.0000	0.8741	0.0863	-0.0000	0.0041
SNB-G1	0.2543	0.0000	-1.0634	-0.2543	-0.0000	1.0634	0.0494	0.0000	0.0035
SNB-G2	0.2543	0.0000	-1.0634	-0.2543	0.0000	1.0634	0.0494	-0.0000	0.0035
SNB-H1	0.2709	0.0000	-1.1580	-0.2709	-0.0000	1.1580	0.0227	0.0000	0.0027
SNB-H2	0.2709	0.0000	-1.1580	-0.2709	0.0000	1.1580	0.0227	-0.0000	0.0027
SNB-I1	0.3268	0.0000	-1.2988	-0.3268	-0.0000	1.2988	0.0063	0.0001	0.0014
SNB-I2	0.3268	0.0000	-1.2988	-0.3268	0.0000	1.2988	0.0063	-0.0001	0.0014
SNB-J1	0.1864	0.0000	-0.7017	3.5657	3.8898	40.4116	0.0000	0.0000	0.0000
SNB-J2	0.1864	0.0000	-0.7017	3.5685	-3.8960	40.4528	0.0000	0.0000	0.0000
RohnAaS	0.1340	0.0000	-0.2090	-0.1340	0.0000	0.2090	0.3817	0.0000	-0.0244
RohnAbs	0.0419	0.0000	-0.1567	-0.0419	-0.0000	0.1567	0.3636	0.0000	-0.0250
RohnAcS	0.1248	0.0000	-0.2100	-0.1248	-0.0000	0.2100	0.3457	0.0001	-0.0256

RohnBaS	0.0594	0.0000	-0.1824	-0.0594	-0.0000	0.1824	0.3100	0.0001	-0.0265
RohnBbS	0.4900	0.0000	-0.9666	-0.4900	0.0000	0.9666	0.2921	0.0001	-0.0268
RohnBcS	0.0594	0.0000	-0.1824	-0.0594	0.0000	0.1824	0.2745	0.0000	-0.0270
RohnCaS	0.4566	0.0000	-0.8000	-0.4566	-0.0000	0.8000	0.2345	0.0000	-0.0273
RohnCbS	0.6445	0.0000	-1.4174	-0.6445	-0.0000	1.4174	0.2124	-0.0000	-0.0272
RohnDaS	0.6515	0.0000	-1.2679	-0.6515	-0.0000	1.2679	0.1707	-0.0000	-0.0261
RohnDbS	0.0919	0.0000	-0.2734	-0.0919	-0.0000	0.2734	0.1514	-0.0001	-0.0251
RohnEaS	0.0956	0.0000	-0.3717	-0.0956	-0.0000	0.3717	0.1168	-0.0001	-0.0230
RohnEbS	0.0956	0.0000	-0.3717	-0.0956	-0.0000	0.3717	0.1010	-0.0001	-0.0219
RohnFaS	0.1238	0.0000	-0.5024	-0.1238	-0.0000	0.5024	0.0672	-0.0002	-0.0187
RohnGaS	0.1305	0.0000	-0.5610	-0.1305	-0.0000	0.5610	0.0355	-0.0001	-0.0143
RohnHaS	0.1404	0.0000	-0.5970	-0.1404	-0.0000	0.5970	0.0139	-0.0001	-0.0090
RohnIaS	0.1864	0.0000	-0.7017	-0.1864	-0.0000	0.7017	0.0026	-0.0000	-0.0030
SNB-AaS	0.0419	0.0000	-0.1567	-0.0419	0.0000	0.1567	0.3817	-0.0002	-0.0133
SNB-AbS	0.0419	0.0000	-0.1567	-0.0419	-0.0000	0.1567	0.3637	-0.0002	-0.0139
SNB-AcS	0.0419	0.0000	-0.1567	-0.0419	-0.0000	0.1567	0.3458	-0.0002	-0.0146
SNB-BaS	0.0594	0.0000	-0.1824	-0.0594	-0.0000	0.1824	0.3100	-0.0002	-0.0157
SNB-BbS	0.0594	0.0000	-0.1824	-0.0594	-0.0000	0.1824	0.2922	-0.0002	-0.0162
SNB-BcS	0.0594	0.0000	-0.1824	-0.0594	-0.0000	0.1824	0.2746	-0.0001	-0.0166
SNB-CaS	0.0879	0.0000	-0.2478	-0.0879	-0.0000	0.2478	0.2345	-0.0001	-0.0174
SNB-CbS	0.0879	0.0000	-0.2478	-0.0879	-0.0000	0.2478	0.2124	-0.0001	-0.0176
SNB-DaS	0.0919	0.0000	-0.2734	-0.0919	-0.0000	0.2734	0.1707	-0.0000	-0.0175
SNB-DbS	0.0919	0.0000	-0.2734	-0.0919	-0.0000	0.2734	0.1515	-0.0000	-0.0170
SNB-EaS	0.0956	0.0000	-0.3717	-0.0956	-0.0000	0.3717	0.1168	-0.0000	-0.0161
SNB-EbS	0.0956	0.0000	-0.3717	-0.0956	-0.0000	0.3717	0.1010	-0.0000	-0.0157
SNB-FaS	0.1238	0.0000	-0.5024	-0.1237	-0.0000	0.5024	0.0672	-0.0000	-0.0140
SNB-GaS	0.1305	0.0000	-0.5610	-0.1305	-0.0000	0.5610	0.0355	-0.0000	-0.0111
SNB-HaS	0.1404	0.0000	-0.5970	-0.1404	-0.0000	0.5970	0.0139	-0.0000	-0.0071
SNB-IaS	0.1864	0.0000	-0.7017	-0.1864	-0.0000	0.7017	0.0026	-0.0000	-0.0025
SNB-WL-A1S	0.0419	0.0000	-0.1567	-0.0419	0.0000	0.1567	0.3996	-0.0003	-0.0065
SNB-WL-A2S	0.0419	0.0000	-0.1567	-0.0419	-0.0000	0.1567	0.3996	-0.0003	-0.0002
SNB-WL-A3S	0.0419	0.0000	-0.1567	-0.0419	-0.0000	0.1567	0.3996	-0.0003	-0.0065
SNB-WL-B1S	0.0419	0.0000	-0.1567	-0.0419	0.0000	0.1567	0.3278	-0.0002	-0.0070
SNB-WL-B2S	0.0419	0.0000	-0.1567	-0.0419	-0.0000	0.1567	0.3279	-0.0002	0.0013
SNB-WL-B3S	0.0419	0.0000	-0.1567	-0.0419	-0.0000	0.1567	0.3278	-0.0002	-0.0070
SNB-WL-C1S	0.0594	0.0000	-0.1824	-0.0594	0.0000	0.1824	0.2571	-0.0001	-0.0075
SNB-WL-C2S	0.0594	0.0000	-0.1824	-0.0594	-0.0000	0.1824	0.2571	-0.0001	0.0025
SNB-WL-C3S	0.0594	0.0000	-0.1824	-0.0594	-0.0000	0.1824	0.2571	-0.0001	-0.0075
SNB-WL-D1S	0.0879	0.0000	-0.2478	-0.0879	0.0000	0.2478	0.1910	-0.0001	-0.0079
SNB-WL-D2S	0.0879	0.0000	-0.2478	-0.0879	-0.0000	0.2478	0.1910	-0.0001	0.0029
SNB-WL-D3S	0.0879	0.0000	-0.2478	-0.0879	-0.0000	0.2478	0.1910	-0.0001	-0.0079
SNB-WL-E1S	0.0919	0.0000	-0.2734	-0.0919	0.0000	0.2734	0.1332	-0.0000	-0.0068
SNB-WL-E2S	0.0919	0.0000	-0.2734	-0.0919	-0.0000	0.2734	0.1332	-0.0000	0.0034
SNB-WL-E3S	0.0919	0.0000	-0.2734	-0.0919	-0.0000	0.2734	0.1332	-0.0000	-0.0068
SNB-WL-F1S	0.0956	0.0000	-0.3717	-0.0956	0.0000	0.3717	0.0863	-0.0000	-0.0069
SNB-WL-F2S	0.0956	0.0000	-0.3717	-0.0956	-0.0000	0.3717	0.0863	-0.0000	0.0029
SNB-WL-F3S	0.0956	0.0000	-0.3717	-0.0956	-0.0000	0.3717	0.0863	-0.0000	-0.0069
SNB-WL-G1S	0.1238	0.0000	-0.5024	-0.1237	0.0000	0.5024	0.0495	-0.0000	-0.0069
SNB-WL-G2S	0.1238	0.0000	-0.5024	-0.1237	-0.0000	0.5024	0.0495	-0.0000	0.0014
SNB-WL-G3S	0.1238	0.0000	-0.5024	-0.1237	-0.0000	0.5024	0.0495	0.0000	-0.0069
SNB-WL-H1S	0.1305	0.0000	-0.5610	-0.1305	0.0000	0.5610	0.0227	-0.0000	-0.0066
SNB-WL-H2S	0.1305	0.0000	-0.5610	-0.1305	-0.0000	0.5610	0.0228	-0.0000	-0.0005
SNB-WL-H3S	0.1305	0.0000	-0.5610	-0.1305	-0.0000	0.5610	0.0227	0.0000	-0.0066
SNB-WL-I1S	0.1404	0.0000	-0.5970	-0.1404	0.0000	0.5970	0.0064	-0.0000	-0.0062
SNB-WL-I2S	0.1404	0.0000	-0.5970	-0.1404	-0.0000	0.5970	0.0064	-0.0000	-0.0030
SNB-WL-I3S	0.1404	0.0000	-0.5970	-0.1404	-0.0000	0.5970	0.0064	0.0000	-0.0062
RohnAa1	0.1108	0.0000	-0.2302	-0.1108	0.0000	0.2302	0.3819	-0.0004	-0.0002
RohnAa2	0.1751	0.0000	-0.2532	-0.1751	-0.0000	0.2532	0.3815	-0.0003	-0.0002
RohnAb1	0.2477	-0.0111	-0.2767	-0.2477	0.0111	0.2767	0.3640	-0.0004	0.0001
RohnAb2	0.0419	0.0000	-0.1567	-0.0419	-0.0000	0.1567	0.3634	-0.0004	0.0002
RohnAc1	0.0419	0.0000	-0.1567	-0.0419	0.0000	0.1567	0.3459	-0.0004	0.0005
RohnAc2	0.0419	0.0000	-0.1567	-0.0419	-0.0000	0.1567	0.3454	-0.0004	0.0006
RohnBa1	0.0594	0.0000	-0.1824	-0.0594	0.0000	0.1824	0.3101	-0.0003	0.0013
RohnBa2	0.0594	0.0000	-0.1824	-0.0594	-0.0000	0.1824	0.3096	-0.0003	0.0013
RohnBb1	0.4735	0.0000	-0.9396	-0.4735	0.0000	0.9396	0.2925	-0.0004	0.0016
RohnBb2	0.4735	0.0000	-0.9396	-0.4735	-0.0000	0.9396	0.2921	-0.0002	0.0017
RohnBc1	0.0594	0.0000	-0.1824	-0.0594	0.0000	0.1824	0.2745	-0.0002	0.0020
RohnBc2	0.0594	0.0000	-0.1824	-0.0594	-0.0000	0.1824	0.2743	-0.0003	0.0020
RohnCa1	0.4930	0.0000	-0.8600	-0.4930	0.0000	0.8600	0.2346	-0.0002	0.0027

RohnCa2	0.5168	0.0000	-0.9000	-0.5168	-0.0000	0.9000	0.2344	-0.0001	0.0027
RohnCb1	0.6088	0.0000	-1.3624	-0.6088	0.0000	1.3624	0.2123	-0.0001	0.0031
RohnCb2	0.6088	0.0000	-1.3624	-0.6088	-0.0000	1.3624	0.2122	-0.0001	0.0031
RohnDa1	0.5924	0.0000	-1.1629	-0.5924	0.0000	1.1629	0.1705	-0.0001	0.0036
RohnDa2	0.5924	0.0000	-1.1629	-0.5924	-0.0000	1.1629	0.1704	-0.0000	0.0036
RohnDb1	0.0919	0.0000	-0.2734	-0.0919	0.0000	0.2734	0.1508	0.0001	0.0038
RohnDb2	0.0919	0.0000	-0.2734	-0.0919	-0.0000	0.2734	0.1508	-0.0002	0.0038
RohnEa1	0.0956	0.0000	-0.3717	-0.0956	0.0000	0.3717	0.1162	0.0001	0.0039
RohnEa2	0.0956	0.0000	-0.3717	-0.0956	-0.0000	0.3717	0.1164	-0.0001	0.0039
RohnEb1	0.0956	0.0000	-0.3717	-0.0956	0.0000	0.3717	0.1005	0.0002	0.0039
RohnEb2	0.0956	0.0000	-0.3717	-0.0956	-0.0000	0.3717	0.1007	-0.0001	0.0039
RohnFa1	0.1238	0.0000	-0.5024	-0.1237	0.0000	0.5024	0.0656	0.0004	0.0036
RohnFa2	0.1238	0.0000	-0.5024	-0.1237	-0.0000	0.5024	0.0659	-0.0003	0.0036
RohnGa1	0.1305	0.0000	-0.5610	-0.1305	0.0000	0.5610	0.0340	0.0004	0.0030
RohnGa2	0.1305	0.0000	-0.5610	-0.1305	-0.0000	0.5610	0.0342	-0.0003	0.0030
RohnHa1	0.1404	0.0000	-0.5970	-0.1404	0.0000	0.5970	0.0122	0.0005	0.0020
RohnHa2	0.1404	0.0000	-0.5970	-0.1404	-0.0000	0.5970	0.0123	-0.0004	0.0020
RohnIa1	0.1864	0.0000	-0.7017	-0.1864	0.0000	0.7017	0.0013	0.0003	0.0007
RohnIa2	0.1864	0.0000	-0.7017	-0.1864	-0.0000	0.7017	0.0014	-0.0003	0.0007
SNB-Aa1	0.0419	0.0000	-0.1567	-0.0419	-0.0000	0.1567	0.3817	-0.0003	0.0003
SNB-Aa2	0.0419	0.0000	-0.1567	-0.0419	0.0000	0.1567	0.3817	-0.0002	0.0003
SNB-Ab1	0.0419	0.0000	-0.1567	-0.0419	-0.0000	0.1567	0.3637	-0.0002	0.0007
SNB-Ab2	0.0419	0.0000	-0.1567	-0.0419	0.0000	0.1567	0.3637	-0.0002	0.0007
SNB-Ac1	0.0419	0.0000	-0.1567	-0.0419	-0.0000	0.1567	0.3457	-0.0002	0.0011
SNB-Ac2	0.0419	0.0000	-0.1567	-0.0419	0.0000	0.1567	0.3457	-0.0002	0.0011
SNB-Ba1	0.0594	0.0000	-0.1824	-0.0594	-0.0000	0.1824	0.3099	-0.0002	0.0018
SNB-Ba2	0.0594	0.0000	-0.1824	-0.0594	0.0000	0.1824	0.3099	-0.0002	0.0019
SNB-Bb1	0.0594	0.0000	-0.1824	-0.0594	-0.0000	0.1824	0.2921	-0.0001	0.0022
SNB-Bb2	0.0594	0.0000	-0.1824	-0.0594	0.0000	0.1824	0.2921	-0.0002	0.0022
SNB-Bc1	0.0594	0.0000	-0.1824	-0.0594	-0.0000	0.1824	0.2744	-0.0001	0.0025
SNB-Bc2	0.0594	0.0000	-0.1824	-0.0594	0.0000	0.1824	0.2744	-0.0001	0.0026
SNB-Ca1	0.0879	0.0000	-0.2478	-0.0879	-0.0000	0.2478	0.2342	-0.0000	0.0032
SNB-Ca2	0.0879	0.0000	-0.2478	-0.0879	0.0000	0.2478	0.2342	-0.0002	0.0033
SNB-Cb1	0.0879	0.0000	-0.2478	-0.0879	-0.0000	0.2478	0.2121	-0.0000	0.0036
SNB-Cb2	0.0879	0.0000	-0.2478	-0.0879	0.0000	0.2478	0.2121	-0.0002	0.0036
SNB-Da1	0.0919	0.0000	-0.2734	-0.0919	-0.0000	0.2734	0.1702	0.0000	0.0040
SNB-Da2	0.0919	0.0000	-0.2734	-0.0919	0.0000	0.2734	0.1702	-0.0001	0.0040
SNB-Db1	0.0919	0.0000	-0.2734	-0.0919	-0.0000	0.2734	0.1508	0.0002	0.0041
SNB-Db2	0.0919	0.0000	-0.2734	-0.0919	0.0000	0.2734	0.1508	-0.0002	0.0041
SNB-Ea1	0.0956	0.0000	-0.3717	-0.0956	-0.0000	0.3717	0.1164	0.0001	0.0041
SNB-Ea2	0.0956	0.0000	-0.3717	-0.0956	0.0000	0.3717	0.1164	-0.0001	0.0041
SNB-Eb1	0.0956	0.0000	-0.3717	-0.0956	-0.0000	0.3717	0.1007	0.0001	0.0041
SNB-Eb2	0.0956	0.0000	-0.3717	-0.0956	0.0000	0.3717	0.1007	-0.0001	0.0041
SNB-Fa1	0.1238	0.0000	-0.5024	-0.1237	-0.0000	0.5024	0.0656	0.0005	0.0039
SNB-Fa2	0.1238	0.0000	-0.5024	-0.1237	0.0000	0.5024	0.0656	-0.0005	0.0039
SNB-Ga1	0.1305	0.0000	-0.5610	-0.1305	-0.0000	0.5610	0.0341	0.0004	0.0032
SNB-Ga2	0.1305	0.0000	-0.5610	-0.1305	0.0000	0.5610	0.0341	-0.0004	0.0032
SNB-Ha1	0.1404	0.0000	-0.5970	-0.1404	-0.0000	0.5970	0.0123	0.0004	0.0022
SNB-Ha2	0.1404	0.0000	-0.5970	-0.1404	0.0000	0.5970	0.0123	-0.0004	0.0022
SNB-Ia1	0.1864	0.0000	-0.7017	-0.1864	-0.0000	0.7017	0.0012	0.0004	0.0008
SNB-Ia2	0.1864	0.0000	-0.7017	-0.1864	0.0000	0.7017	0.0012	-0.0004	0.0008

Moments for Angles Modeled as Beams:

Angle Torsion Label	Origin X (ft-lbs)	Origin Y (ft-lbs)	Origin Moment (ft-lbs)	End X (ft-lbs)	End Y (ft-lbs)	End Moment (ft-lbs)	X Shear (lbs)	Y Shear (lbs)
Rohn-LA1P	-0.00	0.27	1.02	5.45	-6.11	1.14	-1.02	
Rohn-LA11	0.50	-0.45	0.63	0.45	9.29	0.00	1.98	
Rohn-LA12	-0.53	0.39	0.76	3.24	-2.60	0.72	-0.37	
Rohn-LA2P	-0.00	-5.45	6.11	-7.18	8.83	-2.53	2.99	
Rohn-LA21	0.50	-0.45	-9.29	-5.05	-21.02	-1.10	-6.06	
Rohn-LA22	-0.53	-3.24	2.60	-2.44	-0.68	-1.13	0.38	
Rohn-LA3P	-0.00	7.18	-8.83	7.88	-7.06	3.01	-3.17	
Rohn-LA31	0.50	5.05	21.02	5.31	25.31	2.07	9.26	
Rohn-LA32	-0.53	2.44	0.68	-1.79	13.14	0.13	2.76	
Rohn-LA4P	-0.00	-7.88	7.06	-3.97	11.41	-2.37	3.69	
Rohn-LA41	0.50	-5.31	-25.31	-8.69	-29.08	-2.80	-10.87	

Rohn-LA22	-0.53	1.79	-13.14	5.67	-20.15	1.49	-6.65
Rohn-LB1P	0.65	3.78	-9.09	2.41	-7.76	1.24	-3.37
Rohn-LB11	2.01	8.19	30.60	19.61	55.14	5.55	17.13
Rohn-LB12	-0.68	-4.96	21.43	-18.48	51.61	-4.68	14.60
Rohn-LB2P	0.65	-2.41	7.77	-0.94	20.93	-0.67	5.74
Rohn-LB21	2.01	-19.61	-55.13	-25.31	-53.42	-8.98	-21.69
Rohn-LB22	-0.68	18.48	-51.61	25.18	-52.13	8.72	-20.73
Rohn-LB3P	0.65	0.94	-20.93	0.88	-8.45	0.36	-5.87
Rohn-LB31	2.01	25.31	53.42	10.71	42.36	7.20	19.14
Rohn-LB32	-0.68	-25.18	52.13	-10.73	42.07	-7.18	18.82
Rohn-LB4P	0.65	-0.88	8.45	-1.47	42.70	-0.47	10.22
Rohn-LB41	2.01	-10.71	-42.36	9.93	28.19	-0.16	-2.83
Rohn-LB42	-0.68	10.73	-42.07	-9.00	27.46	0.35	-2.92
Rohn-LC1P	0.65	1.47	-42.70	0.43	15.92	0.29	-4.02
Rohn-LC11	2.00	-9.93	-28.19	-9.81	6.06	-2.96	-3.32
Rohn-LC12	-0.68	9.00	-27.45	10.31	5.23	2.90	-3.33
Rohn-LC2P	0.65	-0.43	-15.92	0.18	17.58	-0.04	0.25
Rohn-LC21	2.00	9.81	-6.06	-12.44	28.15	-0.39	3.30
Rohn-LC22	-0.68	-10.31	-5.23	13.46	26.03	0.47	3.11
Rohn-LC3P	0.65	-0.18	-17.58	-0.75	65.61	-0.14	7.21
Rohn-LC31	2.00	12.44	-28.15	37.63	71.07	7.51	6.44
Rohn-LC32	-0.68	-13.46	-26.03	-39.30	75.92	-7.92	7.49
Rohn-LD1P	0.65	0.75	-65.61	1.59	84.32	0.35	2.81
Rohn-LD11	2.00	-37.63	-71.07	-59.60	9.82	-14.59	-9.19
Rohn-LD12	-0.68	39.30	-75.92	61.44	5.85	15.11	-10.51
Rohn-LD2P	0.65	-1.59	-84.32	-0.48	25.25	-0.31	-8.84
Rohn-LD21	2.01	59.60	-9.82	60.04	182.60	17.90	25.84
Rohn-LD22	-0.68	-61.44	-5.85	-60.07	183.97	-18.18	26.64
Rohn-LD3P	0.65	0.48	-25.25	-0.12	182.67	0.05	23.62
Rohn-LD31	2.00	-60.04	-182.60	-46.86	6.97	-16.04	-26.35
Rohn-LD32	-0.68	60.07	-183.97	47.20	7.35	16.09	-26.50
Rohn-LE1P	0.65	0.12	-182.66	2.62	47.48	0.41	-20.29
Rohn-LE11	2.00	46.86	-6.97	17.83	135.56	9.71	19.29
Rohn-LE12	-0.68	-47.20	-7.35	-16.78	132.47	-9.60	18.77
Rohn-LE2P	0.65	-2.62	-47.47	-5.79	41.43	-1.26	-0.90
Rohn-LE21	2.00	-17.83	-135.55	18.06	109.11	0.04	-3.96
Rohn-LE22	-0.68	16.78	-132.47	-20.82	117.91	-0.60	-2.18
Rohn-LE3P	0.65	5.79	-41.43	6.06	288.54	1.78	37.08
Rohn-LE31	2.00	-18.06	-109.11	-61.25	12.27	-11.90	-14.53
Rohn-LE32	-0.68	20.82	-117.91	69.11	-5.60	13.49	-18.53
Rohn-LF1P	0.65	-6.06	-288.54	-9.02	-50.26	-1.51	-33.86
Rohn-LF11	2.01	61.25	-12.27	113.04	426.12	17.41	41.35
Rohn-LF12	-0.69	-69.11	5.60	-118.28	440.16	-18.72	44.54
Rohn-LF2P	0.65	9.02	50.26	6.55	444.97	1.56	49.50
Rohn-LF21	1.99	-113.03	-426.13	-140.60	-119.99	-25.34	-54.57
Rohn-LF22	-0.67	118.27	-440.16	147.88	-136.74	26.59	-57.64
Rohn-LG1P	0.65	-6.55	-444.97	-6.17	-106.08	-1.27	-55.08
Rohn-LG11	2.02	140.60	119.99	158.94	514.38	29.93	63.38
Rohn-LG12	-0.70	-147.88	136.74	-162.03	522.61	-30.97	65.88
Rohn-LG2P	0.65	6.17	106.08	2.97	516.95	0.91	62.27
Rohn-LG21	2.00	-158.93	-514.38	-175.62	-159.83	-33.43	-67.36
Rohn-LG22	-0.67	162.02	-522.61	176.47	-162.51	33.82	-68.45
Rohn-LH1P	0.65	-2.97	-516.95	-0.19	-139.05	-0.32	-65.57
Rohn-LH11	1.99	175.62	159.83	198.94	615.68	37.42	77.48
Rohn-LH12	-0.67	-176.47	162.51	-199.81	617.70	-37.60	77.96
Rohn-LH2P	0.65	0.19	139.05	-0.39	666.13	-0.02	80.48
Rohn-LH21	1.96	-198.93	-615.68	-229.15	-226.31	-42.77	-84.13
Rohn-LH22	-0.63	199.80	-617.71	229.95	-227.66	42.94	-84.46
Rohn-LI1P	0.65	0.39	-666.13	-2.60	-213.83	-0.22	-87.95
Rohn-LI11	1.98	229.15	226.31	284.60	955.92	51.33	118.12
Rohn-LI12	-0.65	-229.95	227.66	-281.96	951.23	-51.15	117.79
Rohn-LI2P	0.65	2.60	213.83	13.23	1415.31	1.58	162.84
Rohn-LI21	1.93	-284.59	-955.93	-292.58	218.63	-57.67	-73.67
Rohn-LI22	-0.61	281.94	-951.23	280.35	241.14	56.18	-70.95
Rohn-H1P	0.05	0.43	-0.17	0.72	-0.35	0.15	-0.07
Rohn-H11	-0.01	-0.06	-0.15	0.05	0.20	-0.00	0.01
Rohn-H12	0.08	-0.82	0.35	-0.76	0.18	-0.21	0.07
Rohn-H2P	-0.12	1.47	-0.59	1.61	-0.89	0.35	-0.17
Rohn-H21	-0.02	0.17	-0.66	-0.01	-0.06	0.02	-0.08

Rohn-H22	0.03	-1.48	0.24	-1.29	-0.07	-0.31	0.02
SNB-LA1P	-0.00	1.08	61.97	3.25	6.85	0.86	13.75
SNB-LA11	0.08	54.70	-28.32	11.21	-0.83	13.17	-5.83
SNB-LA12	-0.08	-56.29	-30.77	-13.40	-5.91	-13.93	-7.33
SNB-LA2P	-0.00	-3.25	-6.85	-4.46	11.30	-1.54	0.89
SNB-LA21	0.08	-11.21	0.83	1.23	-11.36	-1.99	-2.11
SNB-LA22	-0.08	13.40	5.91	1.07	-4.87	2.89	0.21
SNB-LA3P	-0.00	4.46	-11.30	3.59	-22.17	1.61	-6.69
SNB-LA31	0.08	-1.22	11.37	-10.14	23.31	-2.27	6.93
SNB-LA32	-0.08	-1.07	4.87	8.12	17.99	1.41	4.57
SNB-LA4P	-0.00	-3.59	22.17	-2.31	66.70	-1.18	17.76
SNB-LA41	0.08	10.14	-23.31	36.64	-35.34	9.35	-11.72
SNB-LA42	-0.08	-8.12	-17.99	-34.88	-31.62	-8.59	-9.92
SNB-LB1P	-0.02	2.12	109.67	1.06	15.13	0.64	24.94
SNB-LB11	0.77	83.76	-19.44	14.74	21.78	19.68	0.47
SNB-LB12	-0.74	-84.78	-22.44	-15.35	20.21	-20.01	-0.45
SNB-LB2P	-0.02	-1.06	-15.13	-0.57	44.94	-0.33	5.96
SNB-LB21	0.77	-14.74	-21.78	7.15	-9.90	-1.52	-6.33
SNB-LB22	-0.74	15.35	-20.21	-6.59	-8.91	1.75	-5.82
SNB-LB3P	-0.02	0.57	-44.94	0.55	-53.53	0.22	-19.68
SNB-LB31	0.77	-7.15	9.90	-24.63	66.10	-6.35	15.19
SNB-LB32	-0.74	6.59	8.91	24.65	65.50	6.24	14.87
SNB-LB4P	-0.02	-0.55	53.53	-0.03	233.42	-0.12	57.35
SNB-LB41	0.77	24.63	-66.10	94.61	-47.61	23.83	-22.72
SNB-LB42	-0.74	-24.65	-65.50	-93.99	-47.23	-23.71	-22.53
SNB-LC1P	0.00	0.03	55.27	0.07	63.65	0.02	17.84
SNB-LC11	1.94	95.24	-40.19	37.74	28.55	19.95	-1.75
SNB-LC12	-1.93	-95.73	-40.51	-37.70	28.49	-20.02	-1.80
SNB-LC2P	0.00	-0.07	-63.65	0.25	-30.15	0.03	-14.03
SNB-LC21	1.93	-37.74	-28.55	-32.58	99.72	-10.52	10.65
SNB-LC22	-1.93	37.70	-28.49	32.49	99.39	10.50	10.61
SNB-LC3P	0.00	-0.25	30.15	-0.09	266.43	-0.05	44.50
SNB-LC31	1.94	32.58	-99.72	115.18	-76.00	22.17	-26.36
SNB-LC32	-1.93	-32.49	-99.39	-114.15	-75.30	-22.00	-26.21
SNB-LD1P	-0.01	0.13	185.64	0.76	203.91	0.13	58.45
SNB-LD11	2.52	208.38	-86.12	41.08	97.50	37.43	1.71
SNB-LD12	-2.49	-209.44	-86.89	-41.18	96.56	-37.60	1.45
SNB-LD2P	-0.01	-0.76	-203.91	0.02	-47.96	-0.11	-37.68
SNB-LD21	2.51	-41.08	-97.50	16.76	222.72	-3.64	18.73
SNB-LD22	-2.48	41.18	-96.56	-15.99	223.15	3.77	18.94
SNB-LD3P	-0.01	-0.02	47.96	-0.14	496.77	-0.02	81.74
SNB-LD31	2.51	-16.76	-222.72	48.02	-14.78	4.69	-35.63
SNB-LD32	-2.49	15.98	-223.15	-47.52	-14.36	-4.73	-35.63
SNB-LE1P	-0.07	0.26	149.26	2.35	305.64	0.39	68.26
SNB-LE11	5.08	350.02	-160.48	103.32	233.63	68.01	10.97
SNB-LE12	-5.00	-350.80	-161.24	-103.47	230.83	-68.15	10.44
SNB-LE2P	-0.07	-2.35	-305.64	-1.54	-39.88	-0.58	-51.69
SNB-LE21	5.07	-103.31	-233.63	-34.81	446.46	-20.66	31.83
SNB-LE22	-4.99	103.47	-230.83	38.19	450.17	21.19	32.81
SNB-LE3P	-0.07	1.54	39.88	1.16	1131.63	0.41	175.80
SNB-LE31	5.08	34.82	-446.46	236.44	-344.99	40.70	-118.74
SNB-LE32	-5.00	-38.19	-450.17	-239.75	-348.26	-41.70	-119.78
SNB-LF1P	-0.00	-1.21	-267.76	-0.73	-183.45	-0.19	-45.09
SNB-LF11	8.67	444.66	8.96	233.82	788.95	67.79	79.72
SNB-LF12	-8.68	-441.91	11.95	-230.65	791.60	-67.20	80.29
SNB-LF2P	-0.00	0.73	183.45	0.85	1264.05	0.16	144.67
SNB-LF21	8.64	-233.81	-788.95	31.62	-504.92	-20.20	-129.28
SNB-LF22	-8.64	230.64	-791.61	-34.68	-507.66	19.58	-129.82
SNB-LG1P	0.07	-0.87	-13.06	-0.96	-179.40	-0.18	-19.23
SNB-LG11	14.35	1050.12	-83.93	446.16	1425.41	149.50	134.04
SNB-LG12	-14.45	-1047.15	-81.21	-443.59	1427.97	-148.95	134.56
SNB-LG2P	0.07	0.96	179.40	0.78	2206.89	0.17	238.50
SNB-LG21	14.28	-446.15	-1425.42	193.46	-771.33	-25.25	-219.49
SNB-LG22	-14.38	443.58	-1427.97	-194.56	-772.83	24.88	-219.89
SNB-LH1P	0.02	-0.75	-556.03	-0.11	-283.37	-0.09	-83.90
SNB-LH11	13.83	1156.14	26.67	545.76	1582.23	170.05	160.75
SNB-LH12	-13.89	-1155.27	28.02	-545.28	1582.60	-169.91	160.92
SNB-LH2P	0.02	0.11	283.37	-0.01	2331.70	0.01	261.38
SNB-LH21	13.71	-545.75	-1582.24	-104.00	-803.59	-64.92	-238.38

SNB-LH22	-13.77	545.26	-1582.60	104.06	-803.51	64.88	-238.41
SNB-LI1P	-0.00	0.03	-407.03	0.44	-178.71	0.05	-58.54
SNB-LI11	4.50	1727.78	-95.32	1101.21	2306.95	282.66	220.98
SNB-LI12	-4.56	-1727.81	-95.40	-1101.08	2306.44	-282.65	220.92
SNB-LI2P	-0.00	-0.44	178.71	0.37	3323.63	-0.01	350.05
SNB-LI21	4.24	-1101.18	-2306.96	-978.30	438.36	-207.77	-186.70
SNB-LI22	-4.29	1101.05	-2306.46	979.75	439.08	207.90	-186.58
SNB-H1aP	-0.53	35.82	1.04	123.43	-1.37	78.82	-0.16
SNB-H1bP	-0.53	-123.43	1.38	-33.67	0.91	-77.75	1.13
SNB-H1cP	-0.59	37.41	-1.10	120.72	2.20	78.27	0.55
SNB-H1dP	-0.59	-120.72	-2.20	-37.46	1.03	-78.29	-0.58
SNB-H1eP	1.24	35.54	-0.89	122.02	-1.78	77.99	-1.33
SNB-H1fP	1.24	-122.02	1.78	-36.76	-0.99	-78.59	0.39
SNB-H2aP	-1.66	102.79	1.75	128.17	-0.26	85.45	0.55
SNB-H2bP	-1.66	-128.17	0.26	-64.02	-0.94	-71.11	-0.25
SNB-H2cP	0.15	86.95	-0.26	124.77	3.26	78.33	1.11
SNB-H2dP	0.15	-124.77	-3.26	-86.64	0.22	-78.22	-1.12
SNB-H2eP	1.50	63.44	0.95	128.50	-0.57	71.02	0.14
SNB-H2fP	1.50	-128.50	0.57	-102.69	-1.74	-85.54	-0.44
SNB-H3aP	-1.29	167.41	1.04	173.52	-0.73	100.73	0.09
SNB-H3bP	-1.29	-173.52	0.73	-102.08	-2.27	-81.43	-0.45
SNB-H3cP	0.01	137.70	0.36	170.67	5.13	91.12	1.62
SNB-H3dP	0.01	-170.67	-5.13	-137.62	-0.35	-91.09	-1.62
SNB-H3eP	1.28	102.02	2.29	173.54	-0.73	81.42	0.46
SNB-H3fP	1.28	-173.54	0.73	-167.42	-1.07	-100.74	-0.10
SNB-H4aP	-1.39	261.79	0.52	277.87	-2.19	132.72	-0.41
SNB-H4bP	-1.39	-277.87	2.19	-187.90	-3.57	-114.55	-0.34
SNB-H4cP	-0.02	228.46	2.16	275.12	10.66	123.85	3.15
SNB-H4dP	-0.02	-275.12	-10.66	-228.44	-2.17	-123.85	-3.15
SNB-H4eP	1.41	187.95	3.57	277.82	-2.23	114.55	0.33
SNB-H4fP	1.41	-277.82	2.23	-261.83	-0.51	-132.72	0.42
SNB-H5aP	-2.17	374.21	1.17	358.81	-3.78	154.43	-0.55
SNB-H5bP	-2.16	-358.81	3.78	-203.66	-6.31	-118.50	-0.53
SNB-H5cP	-0.08	294.33	1.89	354.17	16.90	136.62	3.96
SNB-H5dP	-0.08	-354.17	-16.90	-294.43	-1.92	-136.64	-3.96
SNB-H5eP	2.24	203.91	6.28	358.64	-3.80	118.51	0.52
SNB-H5fP	2.24	-358.63	3.80	-374.31	-1.10	-154.41	0.57
SNB-H6aP	-10.86	505.10	0.25	557.63	-2.89	195.78	-0.48
SNB-H6bP	-10.86	-557.63	2.89	-394.18	-7.05	-175.34	-0.77
SNB-H6cP	-0.02	474.65	1.56	533.81	14.28	185.78	2.92
SNB-H6dP	-0.03	-533.81	-14.28	-475.05	-1.52	-185.85	-2.91
SNB-H6eP	10.89	394.46	7.10	557.60	-2.58	175.39	0.83
SNB-H6fP	10.89	-557.60	2.59	-504.98	-0.32	-195.75	0.42
SNB-H7aP	-9.91	727.99	-3.27	826.20	-6.01	254.38	-1.51
SNB-H7bP	-9.91	-826.20	6.00	-685.41	-6.04	-247.41	-0.01
SNB-H7cP	0.01	730.56	-0.79	805.52	13.72	251.41	2.12
SNB-H7dP	0.01	-805.52	-13.72	-730.63	0.83	-251.42	-2.11
SNB-H7eP	9.90	685.46	6.09	826.26	-5.73	247.42	0.05
SNB-H7fP	9.90	-826.26	5.74	-727.97	3.19	-254.38	1.47
SNB-H8aP	-2.81	954.75	-3.46	994.07	-6.68	286.99	-1.49
SNB-H8bP	-2.80	-994.07	6.68	-860.94	-3.33	-273.18	0.49
SNB-H8cP	-0.02	916.98	2.65	990.55	15.81	280.91	2.72
SNB-H8dP	-0.03	-990.55	-15.81	-917.13	-2.66	-280.94	-2.72
SNB-H8eP	2.83	861.06	3.31	994.03	-6.64	273.19	-0.49
SNB-H8fP	2.83	-994.03	6.64	-954.75	3.51	-286.99	1.50
SNB-H9aP	-6.79	1115.11	-4.17	1148.70	-8.24	302.97	-1.66
SNB-H9bP	-6.78	-1148.70	8.24	-1040.89	1.02	-293.04	1.23
SNB-H9cP	0.00	1097.94	6.98	1138.04	18.25	299.25	3.38
SNB-H9dP	-0.01	-1138.04	-18.25	-1097.92	-6.98	-299.24	-3.38
SNB-H9eP	6.79	1040.89	-1.02	1148.69	-8.24	293.03	-1.24
SNB-H9fP	6.80	-1148.69	8.24	-1115.15	4.20	-302.97	1.67

Service Loads Check:

Joint Label	Elevation (ft)	Actual Twist (deg)	Allowable Twist (deg)	Twist Usage %	Actual Sway (deg)	Allowable Sway (deg)	Sway Usage %	Actual Disp. (ft)	Allowable Disp. (ft)	Disp. Usage %	Max. Usage %
SNB-A2	180.00	0.00	4.00	0.1	0.21	4.00	5.1	0.40	5.40	7.4	7.4

SNB-A1	180.00	0.00	4.00	0.1	0.21	4.00	5.1	0.40	5.40	7.4	7.4
SNB-WL-A2S	180.00	0.00	4.00	0.1	0.21	4.00	5.1	0.40	5.40	7.4	7.4
RohnA2	180.00	0.00	4.00	0.1	0.21	4.00	5.1	0.40	5.40	7.4	7.4
RohnA1	180.00	0.00	4.00	0.1	0.21	4.00	5.1	0.40	5.40	7.4	7.4
SNB-WL-A3S	179.99	0.00	4.00	0.1	0.21	4.00	5.1	0.40	5.40	7.4	7.4
SNB-WL-A1S	179.99	0.00	4.00	0.1	0.21	4.00	5.1	0.40	5.40	7.4	7.4
SNB-AP	179.99	0.00	4.00	0.1	0.21	4.00	5.1	0.40	5.40	7.4	7.4
RohnAP	179.98	0.00	4.00	0.1	0.21	4.00	5.1	0.40	5.40	7.4	7.4
SNB-Aa2	175.00	0.00	4.00	0.1	0.21	4.00	5.1	0.38	5.40	7.1	7.1
SNB-Aa1	175.00	0.00	4.00	0.1	0.21	4.00	5.1	0.38	5.40	7.1	7.1
RohnAa2	175.00	0.00	4.00	0.1	0.21	4.00	5.1	0.38	5.40	7.1	7.1
RohnAa1	175.00	0.00	4.00	0.1	0.21	4.00	5.1	0.38	5.40	7.1	7.1
SNB-AaS	174.99	0.00	4.00	0.1	0.21	4.00	5.1	0.38	5.40	7.1	7.1
RohnAaS	174.98	0.00	4.00	0.1	0.21	4.00	5.1	0.38	5.40	7.1	7.1
SNB-Ab2	170.00	0.00	4.00	0.1	0.21	4.00	5.1	0.36	5.40	6.7	6.7
SNB-Ab1	170.00	0.00	4.00	0.1	0.21	4.00	5.1	0.36	5.40	6.7	6.7
RohnAb2	170.00	0.00	4.00	0.1	0.21	4.00	5.1	0.36	5.40	6.7	6.7
RohnAb1	170.00	0.00	4.00	0.1	0.21	4.00	5.1	0.36	5.40	6.7	6.7
SNB-AbS	169.99	0.00	4.00	0.1	0.21	4.00	5.1	0.36	5.40	6.7	6.7
RohnAbS	169.97	0.00	4.00	0.1	0.21	4.00	5.1	0.36	5.40	6.7	6.7
SNB-Ac2	165.00	0.00	4.00	0.1	0.21	4.00	5.1	0.35	5.40	6.4	6.4
SNB-Ac1	165.00	0.00	4.00	0.1	0.21	4.00	5.1	0.35	5.40	6.4	6.4
RohnAc2	165.00	0.00	4.00	0.1	0.21	4.00	5.1	0.35	5.40	6.4	6.4
RohnAc1	165.00	0.00	4.00	0.1	0.21	4.00	5.1	0.35	5.40	6.4	6.4
SNB-AcS	164.99	0.00	4.00	0.1	0.21	4.00	5.1	0.35	5.40	6.4	6.4
RohnAcS	164.97	0.00	4.00	0.1	0.21	4.00	5.1	0.35	5.40	6.4	6.4
SNB-B2	160.00	0.00	4.00	0.1	0.21	4.00	5.1	0.33	5.40	6.1	6.1
SNB-B1	160.00	0.00	4.00	0.1	0.21	4.00	5.1	0.33	5.40	6.1	6.1
SNB-WL-B2S	160.00	0.00	4.00	0.1	0.21	4.00	5.1	0.33	5.40	6.1	6.1
RohnB2	160.00	0.00	4.00	0.1	0.21	4.00	5.1	0.33	5.40	6.1	6.1
RohnB1	160.00	0.00	4.00	0.1	0.21	4.00	5.1	0.33	5.40	6.1	6.1
SNB-WL-B3S	159.99	0.00	4.00	0.1	0.21	4.00	5.1	0.33	5.40	6.1	6.1
SNB-WL-B1S	159.99	0.00	4.00	0.1	0.21	4.00	5.1	0.33	5.40	6.1	6.1
SNB-BP	159.98	0.00	4.00	0.1	0.21	4.00	5.1	0.33	5.40	6.1	6.1
RohnBP	159.97	0.00	4.00	0.1	0.21	4.00	5.1	0.33	5.40	6.1	6.1
SNB-Ba2	155.00	0.00	4.00	0.1	0.21	4.00	5.1	0.31	5.40	5.7	5.7
SNB-Ba1	155.00	0.00	4.00	0.1	0.21	4.00	5.1	0.31	5.40	5.7	5.7
RohnBa2	155.00	0.00	4.00	0.1	0.21	4.00	5.1	0.31	5.40	5.7	5.7
RohnBa1	155.00	0.00	4.00	0.1	0.21	4.00	5.1	0.31	5.40	5.7	5.7
SNB-BaS	154.98	0.00	4.00	0.1	0.21	4.00	5.1	0.31	5.40	5.7	5.7
RohnBaS	154.97	0.00	4.00	0.1	0.21	4.00	5.1	0.31	5.40	5.7	5.7
SNB-Bb2	150.00	0.00	4.00	0.1	0.21	4.00	5.1	0.29	5.40	5.4	5.4
SNB-Bb1	150.00	0.00	4.00	0.1	0.21	4.00	5.1	0.29	5.40	5.4	5.4
RohnBb2	150.00	0.00	4.00	0.1	0.21	4.00	5.1	0.29	5.40	5.4	5.4
RohnBb1	150.00	0.00	4.00	0.1	0.21	4.00	5.1	0.29	5.40	5.4	5.4
SNB-BbS	149.98	0.00	4.00	0.1	0.21	4.00	5.1	0.29	5.40	5.4	5.4
RohnBbS	149.97	0.00	4.00	0.1	0.21	4.00	5.1	0.29	5.40	5.4	5.4
SNB-Bc2	145.00	0.00	4.00	0.1	0.21	4.00	5.1	0.27	5.40	5.1	5.1
SNB-Bc1	145.00	0.00	4.00	0.1	0.21	4.00	5.1	0.27	5.40	5.1	5.1
RohnBc2	145.00	0.00	4.00	0.1	0.21	4.00	5.1	0.27	5.40	5.1	5.1
RohnBc1	145.00	0.00	4.00	0.1	0.21	4.00	5.1	0.27	5.40	5.1	5.1
SNB-BcS	144.98	0.00	4.00	0.1	0.21	4.00	5.1	0.27	5.40	5.1	5.1
RohnBcS	144.97	0.00	4.00	0.1	0.21	4.00	5.1	0.27	5.40	5.1	5.1
SNB-C2	140.00	0.00	4.00	0.1	0.21	4.00	5.1	0.26	5.40	4.8	5.1
SNB-C1	140.00	0.00	4.00	0.1	0.21	4.00	5.1	0.26	5.40	4.8	5.1
SNB-WL-C2S	140.00	0.00	4.00	0.1	0.21	4.00	5.1	0.26	5.40	4.8	5.1
RohnC2	140.00	0.00	4.00	0.1	0.21	4.00	5.1	0.26	5.40	4.8	5.1
RohnC1	140.00	0.00	4.00	0.1	0.21	4.00	5.1	0.26	5.40	4.8	5.1
SNB-WL-C3S	139.99	0.00	4.00	0.1	0.21	4.00	5.1	0.26	5.40	4.8	5.1
SNB-WL-C1S	139.99	0.00	4.00	0.1	0.21	4.00	5.1	0.26	5.40	4.8	5.1
SNB-CP	139.98	0.00	4.00	0.1	0.21	4.00	5.1	0.26	5.40	4.8	5.1
RohnCP	139.97	0.00	4.00	0.1	0.21	4.00	5.1	0.26	5.40	4.8	5.1
SNB-Ca2	133.34	0.00	4.00	0.1	0.21	4.00	5.1	0.23	5.40	4.3	5.1
SNB-Ca1	133.34	0.00	4.00	0.1	0.21	4.00	5.1	0.23	5.40	4.3	5.1
RohnCa2	133.34	0.00	4.00	0.1	0.21	4.00	5.1	0.23	5.40	4.3	5.1
RohnCa1	133.34	0.00	4.00	0.1	0.21	4.00	5.1	0.23	5.40	4.3	5.1
SNB-CaS	133.32	0.00	4.00	0.1	0.21	4.00	5.1	0.23	5.40	4.3	5.1
RohnCaS	133.31	0.00	4.00	0.1	0.21	4.00	5.1	0.23	5.40	4.3	5.1
SNB-Cb2	126.66	0.00	4.00	0.1	0.21	4.00	5.1	0.21	5.40	3.9	5.1

SNB-Cb1	126.66	0.00	4.00	0.1	0.21	4.00	5.1	0.21	5.40	3.9	5.1
RohnCb2	126.66	0.00	4.00	0.1	0.21	4.00	5.1	0.21	5.40	3.9	5.1
RohnCb1	126.66	0.00	4.00	0.1	0.21	4.00	5.1	0.21	5.40	3.9	5.1
SNB-CbS	126.64	0.00	4.00	0.1	0.21	4.00	5.1	0.21	5.40	3.9	5.1
RohnCbS	126.63	0.00	4.00	0.1	0.21	4.00	5.1	0.21	5.40	3.9	5.1
SNB-D2	120.00	0.00	4.00	0.1	0.21	4.00	5.1	0.19	5.40	3.5	5.1
SNB-D1	120.00	0.00	4.00	0.1	0.21	4.00	5.1	0.19	5.40	3.5	5.1
RohnD2	120.00	0.00	4.00	0.1	0.21	4.00	5.1	0.19	5.40	3.5	5.1
RohnD1	120.00	0.00	4.00	0.1	0.21	4.00	5.1	0.19	5.40	3.5	5.1
SNB-WL-D2S	120.00	0.00	4.00	0.1	0.21	4.00	5.1	0.19	5.40	3.5	5.1
SNB-WL-D3S	119.99	0.00	4.00	0.1	0.21	4.00	5.1	0.19	5.40	3.5	5.1
SNB-WL-D1S	119.99	0.00	4.00	0.1	0.21	4.00	5.1	0.19	5.40	3.5	5.1
SNB-DP	119.98	0.00	4.00	0.1	0.21	4.00	5.1	0.19	5.40	3.5	5.1
RohnDP	119.97	0.00	4.00	0.1	0.21	4.00	5.1	0.19	5.40	3.5	5.1
SNB-Da2	113.34	0.00	4.00	0.1	0.21	4.00	5.1	0.17	5.40	3.2	5.1
SNB-Da1	113.34	0.00	4.00	0.1	0.21	4.00	5.1	0.17	5.40	3.2	5.1
RohnDa2	113.34	0.00	4.00	0.1	0.21	4.00	5.1	0.17	5.40	3.2	5.1
RohnDa1	113.34	0.00	4.00	0.1	0.21	4.00	5.1	0.17	5.40	3.2	5.1
SNB-DaS	113.32	0.00	4.00	0.1	0.21	4.00	5.1	0.17	5.40	3.2	5.1
RohnDaS	113.31	0.00	4.00	0.1	0.21	4.00	5.1	0.17	5.40	3.2	5.1
SNB-Db2	106.66	0.00	4.00	0.1	0.21	4.00	5.1	0.15	5.40	2.8	5.1
SNB-Db1	106.66	0.00	4.00	0.1	0.21	4.00	5.1	0.15	5.40	2.8	5.1
RohnDb2	106.66	0.00	4.00	0.1	0.21	4.00	5.1	0.15	5.40	2.8	5.1
RohnDb1	106.66	0.00	4.00	0.1	0.21	4.00	5.1	0.15	5.40	2.8	5.1
SNB-DbS	106.64	0.00	4.00	0.1	0.21	4.00	5.1	0.15	5.40	2.8	5.1
RohnDbS	106.63	0.00	4.00	0.1	0.21	4.00	5.1	0.15	5.40	2.8	5.1
SNB-E2	100.00	0.00	4.00	0.1	0.21	4.00	5.1	0.13	5.40	2.5	5.1
SNB-E1	100.00	0.00	4.00	0.1	0.21	4.00	5.1	0.13	5.40	2.5	5.1
RohnE2	100.00	0.00	4.00	0.1	0.21	4.00	5.1	0.13	5.40	2.5	5.1
RohnE1	100.00	0.00	4.00	0.1	0.21	4.00	5.1	0.13	5.40	2.5	5.1
SNB-WL-E2S	100.00	0.00	4.00	0.1	0.21	4.00	5.1	0.13	5.40	2.5	5.1
SNB-WL-E3S	99.99	0.00	4.00	0.1	0.21	4.00	5.1	0.13	5.40	2.5	5.1
SNB-WL-E1S	99.99	0.00	4.00	0.1	0.21	4.00	5.1	0.13	5.40	2.5	5.1
SNB-EP	99.98	0.00	4.00	0.1	0.21	4.00	5.1	0.13	5.40	2.5	5.1
RohnEP	99.98	0.00	4.00	0.1	0.21	4.00	5.1	0.13	5.40	2.5	5.1
SNB-Ea2	93.34	0.00	4.00	0.1	0.21	4.00	5.1	0.12	5.40	2.2	5.1
SNB-Ea1	93.34	0.00	4.00	0.1	0.21	4.00	5.1	0.12	5.40	2.2	5.1
RohnEa2	93.34	0.00	4.00	0.1	0.21	4.00	5.1	0.12	5.40	2.2	5.1
RohnEa1	93.34	0.00	4.00	0.1	0.21	4.00	5.1	0.12	5.40	2.2	5.1
SNB-EaS	93.32	0.00	4.00	0.1	0.21	4.00	5.1	0.12	5.40	2.2	5.1
RohnEaS	93.32	0.00	4.00	0.1	0.21	4.00	5.1	0.12	5.40	2.2	5.1
SNB-Eb2	86.66	0.00	4.00	0.1	0.21	4.00	5.2	0.10	5.40	1.9	5.2
SNB-Eb1	86.66	0.00	4.00	0.1	0.21	4.00	5.2	0.10	5.40	1.9	5.2
RohnEb2	86.66	0.00	4.00	0.1	0.21	4.00	5.2	0.10	5.40	1.9	5.2
RohnEb1	86.66	0.00	4.00	0.1	0.21	4.00	5.2	0.10	5.40	1.9	5.2
SNB-EbS	86.64	0.00	4.00	0.1	0.21	4.00	5.2	0.10	5.40	1.9	5.2
RohnEbS	86.64	0.00	4.00	0.1	0.21	4.00	5.2	0.10	5.40	1.9	5.2
SNB-F2	80.00	0.00	4.00	0.1	0.21	4.00	5.1	0.09	5.40	1.6	5.1
SNB-F1	80.00	0.00	4.00	0.1	0.21	4.00	5.1	0.09	5.40	1.6	5.1
RohnF2	80.00	0.00	4.00	0.1	0.21	4.00	5.1	0.09	5.40	1.6	5.1
RohnF1	80.00	0.00	4.00	0.1	0.21	4.00	5.1	0.09	5.40	1.6	5.1
SNB-WL-F2S	80.00	0.00	4.00	0.1	0.21	4.00	5.1	0.09	5.40	1.6	5.1
SNB-WL-F3S	79.99	0.00	4.00	0.1	0.20	4.00	5.0	0.09	5.40	1.6	5.0
SNB-WL-F1S	79.99	0.00	4.00	0.1	0.20	4.00	5.0	0.09	5.40	1.6	5.0
SNB-FP	79.98	0.00	4.00	0.1	0.20	4.00	5.0	0.09	5.40	1.6	5.0
RohnFP	79.98	0.00	4.00	0.1	0.20	4.00	5.0	0.09	5.40	1.6	5.0
SNB-Fa2	70.00	0.00	4.00	0.0	0.19	4.00	4.8	0.07	5.40	1.2	4.8
SNB-Fa1	70.00	0.00	4.00	0.0	0.19	4.00	4.8	0.07	5.40	1.2	4.8
RohnFa1	70.00	0.00	4.00	0.0	0.19	4.00	4.8	0.07	5.40	1.2	4.8
RohnFa2	70.00	0.00	4.00	0.0	0.19	4.00	4.8	0.07	5.40	1.2	4.8
SNB-FaS	69.99	0.00	4.00	0.0	0.19	4.00	4.8	0.07	5.40	1.2	4.8
RohnFaS	69.98	0.00	4.00	0.0	0.19	4.00	4.8	0.07	5.40	1.2	4.8
SNB-G2	60.00	0.00	4.00	0.0	0.17	4.00	4.4	0.05	5.40	0.9	4.4
SNB-G1	60.00	0.00	4.00	0.0	0.17	4.00	4.4	0.05	5.40	0.9	4.4
RohnG1	60.00	0.00	4.00	0.0	0.17	4.00	4.4	0.05	5.40	0.9	4.4
RohnG2	60.00	0.00	4.00	0.0	0.17	4.00	4.4	0.05	5.40	0.9	4.4
SNB-WL-G2S	60.00	0.00	4.00	0.0	0.17	4.00	4.4	0.05	5.40	0.9	4.4
SNB-WL-G3S	59.99	0.00	4.00	0.0	0.17	4.00	4.2	0.05	5.40	0.9	4.2
SNB-WL-G1S	59.99	0.00	4.00	0.0	0.17	4.00	4.2	0.05	5.40	0.9	4.2

SNB-GP	59.99	0.00	4.00	0.0	0.17	4.00	4.2	0.05	5.40	0.9	4.2
RohnGP	59.98	0.00	4.00	0.0	0.17	4.00	4.2	0.05	5.40	0.9	4.2
SNB-Ga2	50.00	-0.00	4.00	0.0	0.14	4.00	3.6	0.03	5.40	0.6	3.6
SNB-Ga1	50.00	-0.00	4.00	0.0	0.14	4.00	3.6	0.03	5.40	0.6	3.6
RohnGa1	50.00	-0.00	4.00	0.0	0.14	4.00	3.6	0.03	5.40	0.6	3.6
RohnGa2	50.00	-0.00	4.00	0.0	0.14	4.00	3.6	0.03	5.40	0.6	3.6
SNB-GaS	49.99	-0.00	4.00	0.0	0.13	4.00	3.4	0.04	5.40	0.7	3.4
RohnGaS	49.99	-0.00	4.00	0.0	0.13	4.00	3.4	0.04	5.40	0.7	3.4
SNB-H2	40.00	-0.00	4.00	0.0	0.11	4.00	2.9	0.02	5.40	0.4	2.9
SNB-H1	40.00	-0.00	4.00	0.0	0.11	4.00	2.9	0.02	5.40	0.4	2.9
RohnH1	40.00	-0.00	4.00	0.0	0.11	4.00	2.9	0.02	5.40	0.4	2.9
RohnH2	40.00	-0.00	4.00	0.0	0.11	4.00	2.9	0.02	5.40	0.4	2.9
SNB-WL-H2S	40.00	-0.00	4.00	0.0	0.10	4.00	2.4	0.02	5.40	0.4	2.4
SNB-WL-H3S	39.99	-0.00	4.00	0.0	0.10	4.00	2.4	0.02	5.40	0.4	2.4
SNB-WL-H1S	39.99	-0.00	4.00	0.0	0.10	4.00	2.4	0.02	5.40	0.4	2.4
SNB-HP	39.99	-0.00	4.00	0.0	0.10	4.00	2.4	0.02	5.40	0.4	2.4
RohnHP	39.99	-0.00	4.00	0.0	0.10	4.00	2.4	0.02	5.40	0.4	2.4
SNB-Ha2	30.00	-0.00	4.00	0.0	0.09	4.00	2.1	0.01	5.40	0.2	2.1
SNB-Ha1	30.00	-0.00	4.00	0.0	0.09	4.00	2.1	0.01	5.40	0.2	2.1
RohnHa2	30.00	-0.00	4.00	0.0	0.09	4.00	2.1	0.01	5.40	0.2	2.1
RohnHa1	30.00	-0.00	4.00	0.0	0.09	4.00	2.1	0.01	5.40	0.2	2.1
SNB-HaS	29.99	-0.00	4.00	0.0	0.07	4.00	1.7	0.01	5.40	0.3	1.7
RohnHaS	29.99	-0.00	4.00	0.0	0.07	4.00	1.7	0.01	5.40	0.3	1.7
SNB-I2	20.00	-0.00	4.00	0.0	0.06	4.00	1.4	0.01	5.40	0.1	1.4
SNB-I1	20.00	-0.00	4.00	0.0	0.06	4.00	1.4	0.01	5.40	0.1	1.4
RohnI2	20.00	-0.00	4.00	0.0	0.06	4.00	1.4	0.01	5.40	0.1	1.4
RohnI1	20.00	-0.00	4.00	0.0	0.06	4.00	1.4	0.01	5.40	0.1	1.4
SNB-WL-I2S	20.00	-0.00	4.00	0.0	0.04	4.00	0.9	0.01	5.40	0.1	0.9
SNB-IP	20.00	-0.00	4.00	0.0	0.04	4.00	0.9	0.01	5.40	0.1	0.9
RohnIP	19.99	-0.00	4.00	0.0	0.04	4.00	0.9	0.01	5.40	0.1	0.9
SNB-WL-I3S	19.99	-0.00	4.00	0.0	0.04	4.00	0.9	0.01	5.40	0.1	0.9
SNB-WL-I1S	19.99	-0.00	4.00	0.0	0.04	4.00	0.9	0.01	5.40	0.1	0.9
SNB-Ia2	10.00	-0.00	4.00	0.0	0.03	4.00	0.7	0.00	5.40	0.0	0.7
SNB-Ia1	10.00	-0.00	4.00	0.0	0.03	4.00	0.7	0.00	5.40	0.0	0.7
RohnIa2	10.00	-0.00	4.00	0.0	0.03	4.00	0.7	0.00	5.40	0.0	0.7
RohnIa1	10.00	-0.00	4.00	0.0	0.03	4.00	0.7	0.00	5.40	0.0	0.7
SNB-IaS	10.00	-0.00	4.00	0.0	0.01	4.00	0.3	0.00	5.40	0.0	0.3
RohnIaS	10.00	-0.00	4.00	0.0	0.01	4.00	0.3	0.00	5.40	0.0	0.3

Equilibrium Joint Positions and Rotations for Load Case "1.2*DL":

Joint Label	X-Displ (ft)	Y-Displ (ft)	Z-Displ (ft)	X-Rot (deg)	Y-Rot (deg)	Z-Rot (deg)	X-Pos (ft)	Y-Pos (ft)	Z-Pos (ft)
RohnAP	0.00157	0.0001689	-0.009451	-0.0002	0.0008	0.0000	4.335	0.0001689	180
RohnBP	0.001079	0.0001497	-0.009306	-0.0000	0.0010	0.0000	5.122	0.0001497	160
RohnCP	0.0006778	0.0001364	-0.00873	-0.0001	0.0009	0.0000	5.91	0.0001364	140
RohnDP	0.0004134	0.0001169	-0.007855	-0.0000	0.0002	-0.0000	6.695	0.0001169	120
RohnEP	0.0002353	9.238e-005	-0.00642	-0.0001	0.0003	-0.0000	7.481	9.238e-005	99.99
RohnFP	0.0001377	6.085e-005	-0.005179	-0.0001	-0.0014	-0.0000	8.268	6.085e-005	79.99
RohnGP	6.404e-005	3.119e-005	-0.003947	-0.0001	-0.0002	-0.0000	9.055	3.119e-005	60
RohnHP	2.832e-005	1.168e-005	-0.002714	-0.0000	-0.0003	-0.0000	9.841	1.168e-005	40
RohnIP	8.848e-006	1.85e-006	-0.0013	-0.0000	-0.0011	-0.0000	10.63	1.85e-006	20
RohnJP	0	0	0	0.0000	0.0000	0.0000	11.42	0	0
SNB-AP	0.001576	0.0001676	-0.004517	-0.0001	-0.0055	-0.0000	2.335	0.0001676	180
SNB-BP	0.001085	0.0001498	-0.00442	-0.0000	-0.0034	-0.0000	3.122	0.0001498	160
SNB-CP	0.0006829	0.000136	-0.004203	-0.0001	-0.0040	-0.0000	3.909	0.000136	140
SNB-DP	0.0004174	0.0001169	-0.003825	-0.0001	-0.0076	0.0000	4.695	0.0001169	120
SNB-EP	0.0002378	9.164e-005	-0.003216	-0.0001	-0.0046	-0.0000	5.481	9.164e-005	100
SNB-FP	0.0001391	6.012e-005	-0.002769	-0.0001	-0.0076	-0.0000	6.268	6.012e-005	80
SNB-GP	6.477e-005	3.151e-005	-0.002168	-0.0001	-0.0099	-0.0000	7.055	3.151e-005	60
SNB-HP	2.861e-005	1.223e-005	-0.001534	-0.0000	-0.0087	-0.0000	7.841	1.223e-005	40
SNB-IP	8.864e-006	2.321e-006	-0.0007509	-0.0000	-0.0071	-0.0000	8.628	2.321e-006	20
SNB-JP	0	0	0	0.0000	0.0000	0.0000	9.415	0	0
RohnA1	0.001578	0.0001734	-0.009287	-0.0006	0.0016	-0.0000	-2.165	-3.752	180
RohnA2	0.001579	0.0001626	-0.00931	0.0004	0.0017	0.0000	-2.165	3.753	180
RohnB1	0.001087	0.0001539	-0.009085	-0.0003	0.0017	-0.0000	-2.559	-4.435	160
RohnB2	0.001087	0.0001456	-0.009086	0.0002	0.0017	0.0000	-2.559	4.435	160
RohnC1	0.0006737	0.0001372	-0.008572	-0.0001	0.0009	-0.0000	-2.954	-5.117	140
RohnC2	0.0006741	0.0001349	-0.008581	-0.0000	0.0009	0.0000	-2.954	5.117	140
RohnD1	0.0003949	0.0001084	-0.007732	-0.0005	0.0009	-0.0000	-3.347	-5.798	120
RohnD2	0.0003949	0.0001253	-0.007741	0.0003	0.0009	0.0000	-3.347	5.798	120
RohnE1	0.0002197	8.498e-005	-0.006333	-0.0002	0.0004	-0.0000	-3.74	-6.479	99.99
RohnE2	0.0002203	9.866e-005	-0.006353	0.0000	0.0004	0.0000	-3.74	6.479	99.99
RohnF1	0.000116	4.932e-005	-0.005115	-0.0015	0.0010	0.0000	-4.134	-7.16	79.99
RohnF2	0.0001166	7.128e-005	-0.005145	0.0013	0.0010	0.0000	-4.134	7.16	79.99
RohnG1	5.877e-005	2.886e-005	-0.0039	-0.0004	0.0003	0.0000	-4.527	-7.842	60
RohnG2	5.848e-005	3.401e-005	-0.003925	0.0003	0.0003	0.0000	-4.527	7.842	60
RohnH1	2.041e-005	7.963e-006	-0.002685	-0.0004	0.0003	0.0000	-4.92	-8.523	40
RohnH2	1.987e-005	1.632e-005	-0.0027	0.0003	0.0003	0.0000	-4.92	8.523	40
RohnI1	2.016e-006	-1.229e-006	-0.001287	-0.0010	0.0006	0.0000	-5.315	-9.206	20
RohnI2	1.545e-006	5.744e-006	-0.001293	0.0010	0.0006	0.0000	-5.315	9.206	20
RohnJ1	0	0	0	0.0000	0.0000	0.0000	-5.71	-9.89	0
RohnJ2	0	0	0	0.0000	0.0000	0.0000	-5.71	9.89	0
SNB-A1	0.001576	0.0001678	-0.004429	-0.0060	0.0048	0.0000	-1.165	-2.02	180
SNB-A2	0.001576	0.0001676	-0.004434	0.0059	0.0048	0.0000	-1.165	2.021	180
SNB-B1	0.001084	0.0001492	-0.004313	-0.0041	0.0037	-0.0000	-1.559	-2.703	160
SNB-B2	0.001084	0.0001503	-0.004317	0.0040	0.0037	0.0000	-1.559	2.703	160
SNB-C1	0.0006742	0.0001312	-0.004103	-0.0044	0.0034	-0.0000	-1.953	-3.384	140
SNB-C2	0.0006742	0.0001407	-0.004108	0.0043	0.0034	0.0000	-1.953	3.385	140
SNB-D1	0.0003945	0.0001041	-0.003742	-0.0072	0.0048	-0.0000	-2.347	-4.066	120
SNB-D2	0.0003945	0.0001296	-0.00375	0.0071	0.0048	0.0000	-2.347	4.066	120
SNB-E1	0.0002203	8.179e-005	-0.003157	-0.0044	0.0028	-0.0000	-2.74	-4.747	100
SNB-E2	0.0002203	0.0001015	-0.00317	0.0042	0.0028	0.0000	-2.74	4.747	100
SNB-F1	0.0001166	4.74e-005	-0.002722	-0.0069	0.0042	-0.0000	-3.134	-5.428	80
SNB-F2	0.0001166	7.285e-005	-0.002737	0.0067	0.0042	0.0000	-3.134	5.428	80
SNB-G1	5.86e-005	2.813e-005	-0.002134	-0.0088	0.0052	-0.0000	-3.527	-6.11	60
SNB-G2	5.859e-005	3.491e-005	-0.002148	0.0087	0.0052	0.0000	-3.527	6.11	60
SNB-H1	2.035e-005	7.664e-006	-0.001512	-0.0076	0.0045	-0.0000	-3.92	-6.79	40
SNB-H2	2.029e-005	1.69e-005	-0.001522	0.0076	0.0045	0.0000	-3.92	6.791	40
SNB-I1	2.194e-006	-1.349e-006	-0.0007414	-0.0062	0.0036	-0.0000	-4.314	-7.472	20
SNB-I2	2.131e-006	6.101e-006	-0.0007457	0.0061	0.0036	0.0000	-4.314	7.472	20
SNB-J1	0	0	0	0.0000	0.0000	0.0000	-4.708	-8.154	0
SNB-J2	0	0	0	0.0000	0.0000	0.0000	-4.708	8.154	0

RohnAaS	0.001477	0.0001556	-0.009433	-0.0001	0.0015	0.0000	4.531	0.0001556	175
RohnAbS	0.001331	0.0001539	-0.009403	-0.0000	0.0012	0.0000	4.728	0.0001539	170
RohnAcS	0.001241	0.0001522	-0.00936	-0.0000	0.0016	0.0000	4.925	0.0001522	165
RohnBaS	0.001015	0.0001478	-0.009198	-0.0000	0.0012	0.0000	5.319	0.0001478	155
RohnBbS	0.0008653	0.0001443	-0.009084	-0.0000	0.0010	0.0000	5.516	0.0001443	150
RohnBcS	0.0008179	0.0001405	-0.00891	-0.0000	0.0010	0.0000	5.713	0.0001405	145
RohnCaS	0.0006594	0.0001299	-0.008502	-0.0001	-0.0001	-0.0000	6.171	0.0001299	133.3
RohnCbS	0.0005901	0.0001225	-0.008217	-0.0001	0.0014	-0.0000	6.434	0.0001225	126.7
RohnDaS	0.0004717	0.0001105	-0.007438	-0.0001	-0.0007	-0.0000	6.957	0.0001105	113.3
RohnDbS	0.0004305	0.0001017	-0.006928	-0.0001	0.0014	-0.0000	7.22	0.0001017	106.7
RohnEaS	0.0002956	8.214e-005	-0.006022	-0.0001	-0.0005	-0.0000	7.743	8.214e-005	93.33
RohnEbS	0.000229	7.181e-005	-0.005605	-0.0001	0.0013	-0.0000	8.006	7.181e-005	86.65
RohnFaS	0.0004209	4.361e-005	-0.004566	-0.0001	0.0005	-0.0000	8.662	4.361e-005	70
RohnGaS	0.0003483	1.871e-005	-0.003334	-0.0001	0.0001	-0.0000	9.448	1.871e-005	50
RohnHaS	0.0003583	5.183e-006	-0.002009	-0.0000	0.0002	-0.0000	10.24	5.183e-006	30
RohnIaS	0.0003016	-2.9e-007	-0.0006531	-0.0000	0.0001	-0.0000	11.03	-2.9e-007	9.999
SNB-AaS	0.001483	0.0001611	-0.004504	-0.0001	0.0033	-0.0000	2.531	0.0001611	175
SNB-AbS	0.001337	0.0001555	-0.004486	-0.0000	0.0005	-0.0000	2.728	0.0001555	170
SNB-AcS	0.001247	0.0001523	-0.004456	-0.0000	0.0028	-0.0000	2.925	0.0001523	165
SNB-BaS	0.00102	0.0001471	-0.004375	-0.0000	0.0025	-0.0000	3.319	0.0001471	155
SNB-BbS	0.000871	0.0001439	-0.004325	-0.0000	0.0004	-0.0000	3.515	0.0001439	150
SNB-BcS	0.0008233	0.0001403	-0.004265	-0.0000	0.0025	-0.0000	3.712	0.0001403	145
SNB-CaS	0.0006642	0.0001301	-0.004091	-0.0001	0.0007	0.0000	4.171	0.0001301	133.3
SNB-CbS	0.0005946	0.0001237	-0.003957	-0.0001	0.0032	0.0000	4.434	0.0001237	126.7
SNB-DaS	0.0004752	0.0001097	-0.003637	-0.0001	0.0011	0.0000	4.957	0.0001097	113.3
SNB-DbS	0.0004335	0.0001012	-0.003422	-0.0001	0.0023	-0.0000	5.22	0.0001012	106.7
SNB-EaS	0.0002977	8.152e-005	-0.003074	-0.0001	0.0004	-0.0000	5.743	8.152e-005	93.34
SNB-EbS	0.0002308	7.076e-005	-0.00292	-0.0001	0.0027	-0.0000	6.006	7.076e-005	86.66
SNB-FaS	0.000422	4.421e-005	-0.002465	-0.0001	0.0046	-0.0000	6.662	4.421e-005	70
SNB-GaS	0.0003488	1.998e-005	-0.001848	-0.0001	0.0046	-0.0000	7.448	1.998e-005	50
SNB-HaS	0.0003585	5.388e-006	-0.001139	-0.0000	0.0038	-0.0000	8.235	5.388e-006	30
SNB-IaS	0.0003016	-1.139e-007	-0.0003731	-0.0000	0.0016	-0.0000	9.022	-1.139e-007	10
SNB-WL-A1S	0.001576	0.0001677	-0.004647	-0.0030	-0.0003	-0.0000	0.5848	-1.01	180
SNB-WL-A2S	0.001576	0.0001677	-0.004606	-0.0001	0.0048	0.0000	-1.165	0.0001677	180
SNB-WL-A3S	0.001576	0.0001677	-0.004649	0.0029	-0.0003	-0.0000	0.5848	1.01	180
SNB-WL-B1S	0.001084	0.0001498	-0.004623	-0.0020	0.0001	0.0000	0.7813	-1.351	160
SNB-WL-B2S	0.001084	0.0001498	-0.004571	-0.0000	0.0037	0.0000	-1.559	0.0001498	160
SNB-WL-B3S	0.001084	0.0001498	-0.004625	0.0020	0.0001	-0.0000	0.7813	1.352	160
SNB-WL-C1S	0.0006772	0.0001359	-0.004644	-0.0022	-0.0003	-0.0000	0.9777	-1.692	140
SNB-WL-C2S	0.0006771	0.000136	-0.004596	-0.0000	0.0034	-0.0000	-1.953	0.000136	140
SNB-WL-C3S	0.0006772	0.000136	-0.004646	0.0021	-0.0003	0.0000	0.9777	1.692	140
SNB-WL-D1S	0.0004024	0.0001167	-0.004886	-0.0036	-0.0014	-0.0000	1.174	-2.033	120
SNB-WL-D2S	0.0004022	0.0001169	-0.004849	-0.0001	0.0048	-0.0000	-2.347	0.0001169	120
SNB-WL-D3S	0.0004024	0.000117	-0.004891	0.0035	-0.0014	0.0000	1.174	2.033	120
SNB-WL-E1S	0.0002263	9.154e-005	-0.003955	-0.0022	-0.0009	-0.0000	1.37	-2.373	100
SNB-WL-E2S	0.0002261	9.164e-005	-0.003932	-0.0001	0.0028	-0.0000	-2.74	9.164e-005	100
SNB-WL-E3S	0.0002263	9.174e-005	-0.003962	0.0021	-0.0009	0.0000	1.37	2.373	100
SNB-WL-F1S	0.0001242	6.002e-005	-0.004262	-0.0035	-0.0017	-0.0000	1.567	-2.714	80
SNB-WL-F2S	0.000124	6.012e-005	-0.004246	-0.0001	0.0042	-0.0000	-3.134	6.012e-005	80
SNB-WL-F3S	0.0001242	6.022e-005	-0.00427	0.0033	-0.0017	0.0000	1.567	2.714	80
SNB-WL-G1S	6.071e-005	3.149e-005	-0.004914	-0.0044	-0.0024	-0.0000	1.764	-3.055	60
SNB-WL-G2S	6.067e-005	3.152e-005	-0.004904	-0.0001	0.0052	-0.0000	-3.527	3.152e-005	60
SNB-WL-G3S	6.071e-005	3.154e-005	-0.004921	0.0043	-0.0024	0.0000	1.764	3.055	60
SNB-WL-H1S	2.314e-005	1.225e-005	-0.005487	-0.0038	-0.0021	-0.0000	1.96	-3.395	39.99
SNB-WL-H2S	2.31e-005	1.228e-005	-0.005481	-0.0000	0.0045	0.0000	-3.92	1.228e-005	39.99
SNB-WL-H3S	2.314e-005	1.231e-005	-0.005492	0.0038	-0.0021	0.0000	1.96	3.395	39.99
SNB-WL-I1S	4.445e-006	2.356e-006	-0.006123	-0.0031	-0.0017	-0.0000	2.157	-3.736	19.99
SNB-WL-I2S	4.412e-006	2.374e-006	-0.00612	-0.0000	0.0036	0.0000	-4.314	2.374e-006	19.99
SNB-WL-I3S	4.445e-006	2.392e-006	-0.006125	0.0031	-0.0017	0.0000	2.157	3.736	19.99
RohnAa1	0.001448	0.000139	-0.009261	0.0000	0.0013	-0.0000	-2.264	-3.923	175
RohnAa2	0.001444	0.0001797	-0.009275	-0.0002	0.0013	0.0000	-2.264	3.923	175
RohnAb1	0.001337	0.0001548	-0.009221	-0.0002	0.0015	-0.0000	-2.362	-4.094	170
RohnAb2	0.001335	0.0001557	-0.009225	0.0001	0.0015	0.0000	-2.362	4.094	170
RohnAc1	0.001197	0.0001209	-0.009158	0.0001	0.0014	-0.0000	-2.461	-4.264	165
RohnAc2	0.001197	0.0001838	-0.00916	-0.0001	0.0014	0.0000	-2.461	4.264	165
RohnBa1	0.0009373	0.0001112	-0.008995	-0.0000	0.0013	-0.0000	-2.658	-4.605	155
RohnBa2	0.000938	0.0001833	-0.008998	-0.0000	0.0013	0.0000	-2.658	4.606	155
RohnBb1	0.0008548	0.0001416	-0.008895	-0.0002	0.0012	-0.0000	-2.757	-4.776	150
RohnBb2	0.0008551	0.0001464	-0.008901	0.0001	0.0012	0.0000	-2.757	4.776	150

RohnBc1	0.0007334	9.65e-005	-0.008737	-0.0001	0.0011	-0.0000	-2.855	-4.947	145
RohnBc2	0.0007337	0.0001841	-0.008744	-0.0000	0.0011	0.0000	-2.855	4.947	145
RohnCa1	0.0005285	5.896e-005	-0.008358	-0.0009	0.0013	-0.0000	-3.085	-5.344	133.3
RohnCa2	0.0005286	0.0002005	-0.008368	0.0008	0.0013	0.0000	-3.085	5.344	133.3
RohnCb1	0.0004276	3.184e-005	-0.008081	0.0005	0.0004	-0.0000	-3.216	-5.571	126.7
RohnCb2	0.0004269	0.0002144	-0.008091	-0.0006	0.0004	0.0000	-3.216	5.572	126.7
RohnDa1	0.0002616	-8.648e-006	-0.007323	-0.0012	0.0012	-0.0000	-3.478	-6.025	113.3
RohnDa2	0.0002624	0.0002281	-0.007336	0.0010	0.0012	0.0000	-3.478	6.025	113.3
RohnDb1	0.0001929	-3.133e-005	-0.006827	0.0007	-0.0000	-0.0000	-3.609	-6.252	106.7
RohnDb2	0.0001934	0.0002339	-0.006843	-0.0009	-0.0000	0.0000	-3.609	6.252	106.7
RohnEa1	0.0001306	-1.089e-005	-0.005943	-0.0008	0.0007	-0.0000	-3.871	-6.706	93.33
RohnEa2	0.0001311	0.0001743	-0.005966	0.0006	0.0007	0.0000	-3.871	6.706	93.33
RohnEb1	0.000113	6.69e-006	-0.005534	0.0008	-0.0002	0.0000	-4.003	-6.933	86.65
RohnEb2	0.0001137	0.0001358	-0.005556	-0.0010	-0.0002	0.0000	-4.003	6.933	86.65
RohnFa1	-7.812e-005	-0.0002405	-0.004511	0.0002	0.0000	0.0000	-4.331	-7.501	70
RohnFa2	-7.951e-005	0.0003302	-0.004538	-0.0004	0.0000	0.0000	-4.331	7.501	70
RohnGa1	-0.0001152	-0.0002455	-0.003296	-0.0001	0.0001	0.0000	-4.724	-8.182	50
RohnGa2	-0.0001172	0.0002863	-0.003316	-0.0000	0.0001	0.0000	-4.724	8.182	50
RohnHa1	-0.0001619	-0.0002927	-0.001988	0.0001	-0.0000	0.0000	-5.118	-8.864	30
RohnHa2	-0.0001631	0.000305	-0.001998	-0.0002	-0.0000	0.0000	-5.118	8.865	30
RohnIa1	-0.0001498	-0.0002591	-0.0006467	0.0001	-0.0000	0.0000	-5.513	-9.548	9.999
RohnIa2	-0.0001506	0.0002599	-0.0006499	-0.0001	-0.0000	-0.0000	-5.513	9.548	9.999
SNB-Aa1	0.00144	0.0001367	-0.004409	0.0016	0.0005	0.0000	-1.264	-2.191	175
SNB-Aa2	0.001441	0.0001847	-0.004414	-0.0017	0.0005	0.0000	-1.264	2.191	175
SNB-Ab1	0.001329	0.0001527	-0.004385	-0.0008	0.0019	-0.0000	-1.362	-2.361	170
SNB-Ab2	0.001329	0.0001587	-0.004389	0.0007	0.0019	0.0000	-1.362	2.362	170
SNB-Ac1	0.001186	0.0001209	-0.00435	0.0012	0.0007	-0.0000	-1.461	-2.532	165
SNB-Ac2	0.001186	0.0001838	-0.004354	-0.0012	0.0007	0.0000	-1.461	2.532	165
SNB-Ba1	0.0009405	0.0001029	-0.004267	0.0010	0.0007	-0.0000	-1.658	-2.873	155
SNB-Ba2	0.0009405	0.0001912	-0.004271	-0.0011	0.0007	0.0000	-1.658	2.873	155
SNB-Bb1	0.0008547	0.0001354	-0.004219	-0.0007	0.0015	-0.0000	-1.756	-3.044	150
SNB-Bb2	0.0008547	0.0001525	-0.004224	0.0006	0.0015	0.0000	-1.756	3.044	150
SNB-Bc1	0.0007331	9.063e-005	-0.004162	0.0012	0.0003	-0.0000	-1.855	-3.214	145
SNB-Bc2	0.0007332	0.0001898	-0.004167	-0.0013	0.0003	0.0000	-1.855	3.214	145
SNB-Ca1	0.000526	5.491e-005	-0.003995	-0.0001	0.0009	-0.0000	-2.085	-3.611	133.3
SNB-Ca2	0.0005263	0.0002047	-0.004002	0.0000	0.0009	0.0000	-2.085	3.612	133.3
SNB-Cb1	0.0004239	2.886e-005	-0.003867	0.0021	-0.0005	-0.0000	-2.216	-3.839	126.7
SNB-Cb2	0.0004243	0.000218	-0.003875	-0.0022	-0.0005	0.0000	-2.216	3.839	126.7
SNB-Da1	0.0002591	-1.128e-005	-0.003561	0.0004	0.0003	-0.0000	-2.478	-4.293	113.3
SNB-Da2	0.0002593	0.0002303	-0.003571	-0.0006	0.0003	0.0000	-2.478	4.293	113.3
SNB-Db1	0.0001922	-3.435e-005	-0.003354	0.0015	-0.0005	-0.0000	-2.609	-4.52	106.7
SNB-Db2	0.0001922	0.0002367	-0.003366	-0.0016	-0.0005	0.0000	-2.609	4.52	106.7
SNB-Ea1	0.0001305	-1.326e-005	-0.003019	0.0000	0.0003	-0.0000	-2.871	-4.974	93.34
SNB-Ea2	0.0001305	0.0001764	-0.003033	-0.0002	0.0003	0.0000	-2.871	4.974	93.34
SNB-Eb1	0.0001134	4.477e-006	-0.002869	0.0020	-0.0010	-0.0000	-3.003	-5.201	86.66
SNB-Eb2	0.0001131	0.0001375	-0.002884	-0.0022	-0.0010	0.0000	-3.003	5.201	86.66
SNB-Fa1	-7.987e-005	-0.0002407	-0.002425	0.0037	-0.0020	-0.0000	-3.331	-5.769	70
SNB-Fa2	-8.075e-005	0.0003307	-0.00244	-0.0039	-0.0020	0.0000	-3.331	5.769	70
SNB-Ga1	-0.0001163	-0.0002454	-0.001821	0.0039	-0.0022	-0.0000	-3.724	-6.45	50
SNB-Ga2	-0.0001172	0.0002869	-0.001833	-0.0040	-0.0022	0.0000	-3.724	6.45	50
SNB-Ha1	-0.0001623	-0.0002926	-0.001123	0.0033	-0.0018	-0.0000	-4.117	-7.132	30
SNB-Ha2	-0.0001633	0.000305	-0.00113	-0.0033	-0.0018	0.0000	-4.117	7.132	30
SNB-Ia1	-0.0001498	-0.0002591	-0.0003683	0.0014	-0.0008	-0.0000	-4.511	-7.813	10
SNB-Ia2	-0.0001505	0.00026	-0.0003705	-0.0014	-0.0008	0.0000	-4.511	7.813	10

Joint Support Reactions for Load Case "1.2*DL":

Joint Label	X Force (kips)	X Usage %	Y Force (kips)	Y Usage %	Z Force (kips)	Z Usage %	Comp. Usage %	Uplift Usage %	Result. Force (kips)	Result. Usage % (ft-k)	X Moment Usage % (ft-k)	X-M. Moment Usage % (ft-k)	Y Moment Usage % (ft-k)	Y-M. Moment Usage % (ft-k)	Z Moment Usage % (ft-k)	Z-M. Moment Usage % (ft-k)	Max. Usage %
RohnJP	-1.07	0.0	0.00	0.0	19.97	0.0	0.0	0.0	20.00	0.0	-0.00	0.0	-0.3	0.0	-0.00	0.0	0.0
SNB-JP	-0.55	0.0	0.00	0.0	18.61	0.0	0.0	0.0	18.62	0.0	-0.00	0.0	-0.5	0.0	-0.00	0.0	0.0
RohnJ1	0.53	0.0	0.92	0.0	19.79	0.0	0.0	0.0	19.81	0.0	-0.24	0.0	0.1	0.0	-0.00	0.0	0.0
RohnJ2	0.54	0.0	-0.92	0.0	19.88	0.0	0.0	0.0	19.91	0.0	0.24	0.0	0.1	0.0	0.00	0.0	0.0
SNB-J1	0.28	0.0	0.48	0.0	18.39	0.0	0.0	0.0	18.40	0.0	-0.41	0.0	0.2	0.0	-0.00	0.0	0.0
SNB-J2	0.28	0.0	-0.48	0.0	18.49	0.0	0.0	0.0	18.50	0.0	0.41	0.0	0.2	0.0	0.00	0.0	0.0

Joint Displacements, Loads and Member Forces on Joints for Load Case "1.2*DL":

Joint Label	X External Load (kips)	Y External Load (kips)	Z External Load (kips)	X Member Force (kips)	Y Member Force (kips)	Z Member Force (kips)	X Disp. (ft)	Y Disp. (ft)	Z Disp. (ft)
RohnAP	0.0000	0.0000	-0.3561	0.0000	0.0000	0.3561	0.0016	0.0002	-0.0095
RohnBP	0.0000	0.0000	-1.2758	0.0000	0.0000	1.2758	0.0011	0.0001	-0.0093
RohnCP	0.0000	0.0000	-0.5163	0.0000	0.0000	0.5163	0.0007	0.0001	-0.0087
RohnDP	0.0000	0.0000	-0.6254	0.0000	0.0000	0.6254	0.0004	0.0001	-0.0079
RohnEP	0.0000	0.0000	-0.7740	0.0000	0.0000	0.7740	0.0002	0.0001	-0.0064
RohnFP	0.0000	0.0000	-1.0489	0.0000	0.0000	1.0489	0.0001	0.0001	-0.0052
RohnGP	0.0000	0.0000	-1.3961	0.0000	0.0000	1.3961	0.0001	0.0000	-0.0039
RohnHP	0.0000	0.0000	-1.3896	0.0000	0.0000	1.3896	0.0000	0.0000	-0.0027
RohnIP	0.0000	0.0000	-1.5585	0.0000	0.0000	1.5585	0.0000	0.0000	-0.0013
RohnJP	0.0000	0.0000	-0.8421	1.0702	-0.0007	-19.1260	0.0000	0.0000	0.0000
SNB-AP	0.0000	0.0000	-0.1881	0.0000	0.0000	0.1881	0.0016	0.0002	-0.0045
SNB-BP	0.0000	0.0000	-0.4070	0.0000	0.0000	0.4070	0.0011	0.0001	-0.0044
SNB-CP	0.0000	0.0000	-0.5163	0.0000	0.0000	0.5163	0.0007	0.0001	-0.0042
SNB-DP	0.0000	0.0000	-0.6254	0.0000	0.0000	0.6254	0.0004	0.0001	-0.0038
SNB-EP	0.0000	0.0000	-0.7740	0.0000	0.0000	0.7740	0.0002	0.0001	-0.0032
SNB-FP	0.0000	0.0000	-1.0489	0.0000	0.0000	1.0489	0.0001	0.0001	-0.0028
SNB-GP	0.0000	0.0000	-1.2761	0.0000	0.0000	1.2761	0.0001	0.0000	-0.0022
SNB-HP	0.0000	0.0000	-1.3896	0.0000	0.0000	1.3896	0.0000	0.0000	-0.0015
SNB-IP	0.0000	0.0000	-1.5585	0.0000	0.0000	1.5585	0.0000	0.0000	-0.0008
SNB-JP	0.0000	0.0000	-0.8421	0.5525	-0.0012	-17.7672	0.0000	0.0000	0.0000
RohnA1	0.0000	0.0000	-0.3561	0.0000	0.0000	0.3561	0.0016	0.0002	-0.0093
RohnA2	0.0000	0.0000	-0.5241	0.0000	0.0000	0.5241	0.0016	0.0002	-0.0093
RohnB1	0.0000	0.0000	-0.5438	0.0000	0.0000	0.5438	0.0011	0.0002	-0.0091
RohnB2	0.0000	0.0000	-0.4658	0.0000	0.0000	0.4658	0.0011	0.0001	-0.0091
RohnC1	0.0000	0.0000	-0.5163	0.0000	0.0000	0.5163	0.0007	0.0001	-0.0086
RohnC2	0.0000	0.0000	-0.5163	0.0000	0.0000	0.5163	0.0007	0.0001	-0.0086
RohnD1	0.0000	0.0000	-0.7094	0.0000	0.0000	0.7094	0.0004	0.0001	-0.0077
RohnD2	0.0000	0.0000	-0.6254	0.0000	0.0000	0.6254	0.0004	0.0001	-0.0077
RohnE1	0.0000	0.0000	-0.7740	0.0000	0.0000	0.7740	0.0002	0.0001	-0.0063
RohnE2	0.0000	0.0000	-0.7740	0.0000	0.0000	0.7740	0.0002	0.0001	-0.0064
RohnF1	0.0000	0.0000	-1.0489	0.0000	0.0000	1.0489	0.0001	0.0000	-0.0051
RohnF2	0.0000	0.0000	-1.2229	0.0000	0.0000	1.2229	0.0001	0.0001	-0.0051
RohnG1	0.0000	0.0000	-1.3481	0.0000	0.0000	1.3481	0.0001	0.0000	-0.0039
RohnG2	0.0000	0.0000	-1.4633	0.0000	0.0000	1.4633	0.0001	0.0000	-0.0039
RohnH1	0.0000	0.0000	-1.3896	0.0000	0.0000	1.3896	0.0000	0.0000	-0.0027
RohnH2	0.0000	0.0000	-1.3896	0.0000	0.0000	1.3896	0.0000	0.0000	-0.0027
RohnI1	0.0000	0.0000	-1.5585	0.0000	0.0000	1.5585	0.0000	-0.0000	-0.0013
RohnI2	0.0000	0.0000	-1.5585	0.0000	0.0000	1.5585	0.0000	0.0000	-0.0013
RohnJ1	0.0000	0.0000	-0.8421	-0.5338	-0.9233	-18.9435	0.0000	0.0000	0.0000
RohnJ2	0.0000	0.0000	-0.8421	-0.5352	0.9243	-19.0343	0.0000	0.0000	0.0000
SNB-A1	0.0000	0.0000	-0.1881	0.0000	0.0000	0.1881	0.0016	0.0002	-0.0044
SNB-A2	0.0000	0.0000	-0.1881	0.0000	0.0000	0.1881	0.0016	0.0002	-0.0044
SNB-B1	0.0000	0.0000	-0.4070	0.0000	0.0000	0.4070	0.0011	0.0001	-0.0043
SNB-B2	0.0000	0.0000	-0.4070	0.0000	0.0000	0.4070	0.0011	0.0002	-0.0043
SNB-C1	0.0000	0.0000	-0.5163	0.0000	0.0000	0.5163	0.0007	0.0001	-0.0041
SNB-C2	0.0000	0.0000	-0.5163	0.0000	0.0000	0.5163	0.0007	0.0001	-0.0041
SNB-D1	0.0000	0.0000	-0.6254	0.0000	0.0000	0.6254	0.0004	0.0001	-0.0037
SNB-D2	0.0000	0.0000	-0.6254	0.0000	0.0000	0.6254	0.0004	0.0001	-0.0038
SNB-E1	0.0000	0.0000	-0.7740	0.0000	0.0000	0.7740	0.0002	0.0001	-0.0032
SNB-E2	0.0000	0.0000	-0.7740	0.0000	0.0000	0.7740	0.0002	0.0001	-0.0032
SNB-F1	0.0000	0.0000	-1.0489	0.0000	0.0000	1.0489	0.0001	0.0000	-0.0027
SNB-F2	0.0000	0.0000	-1.0489	0.0000	0.0000	1.0489	0.0001	0.0001	-0.0027
SNB-G1	0.0000	0.0000	-1.2761	0.0000	0.0000	1.2761	0.0001	0.0000	-0.0021
SNB-G2	0.0000	0.0000	-1.2761	0.0000	0.0000	1.2761	0.0001	0.0000	-0.0021
SNB-H1	0.0000	0.0000	-1.3896	0.0000	0.0000	1.3896	0.0000	0.0000	-0.0015
SNB-H2	0.0000	0.0000	-1.3896	0.0000	0.0000	1.3896	0.0000	0.0000	-0.0015
SNB-I1	0.0000	0.0000	-1.5585	0.0000	-0.0000	1.5585	0.0000	-0.0000	-0.0007
SNB-I2	0.0000	0.0000	-1.5585	0.0000	0.0000	1.5585	0.0000	0.0000	-0.0007
SNB-J1	0.0000	0.0000	-0.8421	-0.2761	-0.4754	-17.5458	0.0000	0.0000	0.0000
SNB-J2	0.0000	0.0000	-0.8421	-0.2779	0.4761	-17.6472	0.0000	0.0000	0.0000
RohnAaS	0.0000	0.0000	-0.2508	0.0000	0.0000	0.2508	0.0015	0.0002	-0.0094
RohnAbs	0.0000	0.0000	-0.1881	0.0000	0.0000	0.1881	0.0013	0.0002	-0.0094
RohnAcS	0.0000	0.0000	-0.2520	0.0000	0.0000	0.2520	0.0012	0.0002	-0.0094

RohnBaS	0.0000	0.0000	-0.2189	0.0000	0.0000	0.2189	0.0010	0.0001	-0.0092
RohnBbS	0.0000	0.0000	-1.1599	0.0000	0.0000	1.1599	0.0009	0.0001	-0.0091
RohnBcS	0.0000	0.0000	-0.2189	0.0000	0.0000	0.2189	0.0008	0.0001	-0.0089
RohnCaS	0.0000	0.0000	-0.9601	0.0000	0.0000	0.9601	0.0007	0.0001	-0.0085
RohnCbS	0.0000	0.0000	-1.7009	0.0000	0.0000	1.7009	0.0006	0.0001	-0.0082
RohnDaS	0.0000	0.0000	-1.5215	0.0000	0.0000	1.5215	0.0005	0.0001	-0.0074
RohnDbS	0.0000	0.0000	-0.3280	0.0000	0.0000	0.3280	0.0004	0.0001	-0.0069
RohnEaS	0.0000	0.0000	-0.4460	0.0000	0.0000	0.4460	0.0003	0.0001	-0.0060
RohnEbS	0.0000	0.0000	-0.4460	0.0000	0.0000	0.4460	0.0002	0.0001	-0.0056
RohnFaS	0.0000	0.0000	-0.6029	0.0000	0.0000	0.6029	0.0004	0.0000	-0.0046
RohnGaS	0.0000	0.0000	-0.6732	0.0000	0.0000	0.6732	0.0003	0.0000	-0.0033
RohnHaS	0.0000	0.0000	-0.7165	0.0000	0.0000	0.7165	0.0004	0.0000	-0.0020
RohnIaS	0.0000	0.0000	-0.8421	0.0000	0.0000	0.8421	0.0003	-0.0000	-0.0007
SNB-AaS	0.0000	0.0000	-0.1881	0.0000	0.0000	0.1881	0.0015	0.0002	-0.0045
SNB-AbS	0.0000	0.0000	-0.1881	0.0000	0.0000	0.1881	0.0013	0.0002	-0.0045
SNB-AcS	0.0000	0.0000	-0.1881	0.0000	0.0000	0.1881	0.0012	0.0002	-0.0045
SNB-BaS	0.0000	0.0000	-0.2189	0.0000	0.0000	0.2189	0.0010	0.0001	-0.0044
SNB-BbS	0.0000	0.0000	-0.2189	0.0000	0.0000	0.2189	0.0009	0.0001	-0.0043
SNB-BcS	0.0000	0.0000	-0.2189	0.0000	0.0000	0.2189	0.0008	0.0001	-0.0043
SNB-CaS	0.0000	0.0000	-0.2974	0.0000	0.0000	0.2974	0.0007	0.0001	-0.0041
SNB-CbS	0.0000	0.0000	-0.2974	0.0000	0.0000	0.2974	0.0006	0.0001	-0.0040
SNB-DoS	0.0000	0.0000	-0.3280	0.0000	0.0000	0.3280	0.0005	0.0001	-0.0036
SNB-DbS	0.0000	0.0000	-0.3280	0.0000	0.0000	0.3280	0.0004	0.0001	-0.0034
SNB-EaS	0.0000	0.0000	-0.4460	0.0000	0.0000	0.4460	0.0003	0.0001	-0.0031
SNB-EbS	0.0000	0.0000	-0.4460	0.0000	0.0000	0.4460	0.0002	0.0001	-0.0029
SNB-FaS	0.0000	0.0000	-0.6029	0.0000	0.0000	0.6029	0.0004	0.0000	-0.0025
SNB-GaS	0.0000	0.0000	-0.6732	0.0000	0.0000	0.6732	0.0003	0.0000	-0.0018
SNB-HaS	0.0000	0.0000	-0.7165	0.0000	0.0000	0.7165	0.0004	0.0000	-0.0011
SNB-IaS	0.0000	0.0000	-0.8421	0.0000	0.0000	0.8421	0.0003	-0.0000	-0.0004
SNB-WL-A1S	0.0000	0.0000	-0.1881	0.0000	0.0000	0.1881	0.0016	0.0002	-0.0046
SNB-WL-A2S	0.0000	0.0000	-0.1881	0.0000	0.0000	0.1881	0.0016	0.0002	-0.0046
SNB-WL-A3S	0.0000	0.0000	-0.1881	0.0000	0.0000	0.1881	0.0016	0.0002	-0.0046
SNB-WL-B1S	0.0000	0.0000	-0.1881	0.0000	0.0000	0.1881	0.0011	0.0001	-0.0046
SNB-WL-B2S	0.0000	0.0000	-0.1881	0.0000	0.0000	0.1881	0.0011	0.0001	-0.0046
SNB-WL-B3S	0.0000	0.0000	-0.1881	0.0000	0.0000	0.1881	0.0011	0.0001	-0.0046
SNB-WL-C1S	0.0000	0.0000	-0.2189	0.0000	0.0000	0.2189	0.0007	0.0001	-0.0046
SNB-WL-C2S	0.0000	0.0000	-0.2189	0.0000	0.0000	0.2189	0.0007	0.0001	-0.0046
SNB-WL-C3S	0.0000	0.0000	-0.2189	0.0000	0.0000	0.2189	0.0007	0.0001	-0.0046
SNB-WL-D1S	0.0000	0.0000	-0.2974	0.0000	0.0000	0.2974	0.0004	0.0001	-0.0049
SNB-WL-D2S	0.0000	0.0000	-0.2974	0.0000	0.0000	0.2974	0.0004	0.0001	-0.0048
SNB-WL-D3S	0.0000	0.0000	-0.2974	0.0000	0.0000	0.2974	0.0004	0.0001	-0.0049
SNB-WL-E1S	0.0000	0.0000	-0.3280	0.0000	0.0000	0.3280	0.0002	0.0001	-0.0040
SNB-WL-E2S	0.0000	0.0000	-0.3280	0.0000	0.0000	0.3280	0.0002	0.0001	-0.0039
SNB-WL-E3S	0.0000	0.0000	-0.3280	0.0000	0.0000	0.3280	0.0002	0.0001	-0.0040
SNB-WL-F1S	0.0000	0.0000	-0.4460	0.0000	0.0000	0.4460	0.0001	0.0001	-0.0043
SNB-WL-F2S	0.0000	0.0000	-0.4460	0.0000	0.0000	0.4460	0.0001	0.0001	-0.0042
SNB-WL-F3S	0.0000	0.0000	-0.4460	0.0000	0.0000	0.4460	0.0001	0.0001	-0.0043
SNB-WL-G1S	0.0000	0.0000	-0.6029	0.0000	0.0000	0.6029	0.0001	0.0000	-0.0049
SNB-WL-G2S	0.0000	0.0000	-0.6029	0.0000	0.0000	0.6029	0.0001	0.0000	-0.0049
SNB-WL-G3S	0.0000	0.0000	-0.6029	0.0000	0.0000	0.6029	0.0001	0.0000	-0.0049
SNB-WL-H1S	0.0000	0.0000	-0.6732	0.0000	0.0000	0.6732	0.0000	0.0000	-0.0055
SNB-WL-H2S	0.0000	0.0000	-0.6732	0.0000	0.0000	0.6732	0.0000	0.0000	-0.0055
SNB-WL-H3S	0.0000	0.0000	-0.6732	0.0000	0.0000	0.6732	0.0000	0.0000	-0.0055
SNB-WL-I1S	0.0000	0.0000	-0.7165	0.0000	0.0000	0.7165	0.0000	0.0000	-0.0061
SNB-WL-I2S	0.0000	0.0000	-0.7165	0.0000	0.0000	0.7165	0.0000	0.0000	-0.0061
SNB-WL-I3S	0.0000	0.0000	-0.7165	0.0000	-0.0000	0.7165	0.0000	0.0000	-0.0061
RohnAa1	0.0000	0.0000	-0.2763	0.0000	0.0000	0.2763	0.0014	0.0001	-0.0093
RohnAa2	0.0000	0.0000	-0.3039	0.0000	0.0000	0.3039	0.0014	0.0002	-0.0093
RohnAb1	0.0000	0.0000	-0.3321	0.0000	0.0000	0.3321	0.0013	0.0002	-0.0092
RohnAb2	0.0000	0.0000	-0.1881	0.0000	0.0000	0.1881	0.0013	0.0002	-0.0092
RohnAc1	0.0000	0.0000	-0.1881	0.0000	0.0000	0.1881	0.0012	0.0001	-0.0092
RohnAc2	0.0000	0.0000	-0.1881	0.0000	0.0000	0.1881	0.0012	0.0002	-0.0092
RohnBa1	0.0000	0.0000	-0.2189	0.0000	0.0000	0.2189	0.0009	0.0001	-0.0090
RohnBa2	0.0000	0.0000	-0.2189	0.0000	0.0000	0.2189	0.0009	0.0002	-0.0090
RohnBb1	0.0000	0.0000	-1.1275	0.0000	0.0000	1.1275	0.0009	0.0001	-0.0089
RohnBb2	0.0000	0.0000	-1.1275	0.0000	0.0000	1.1275	0.0009	0.0001	-0.0089
RohnBc1	0.0000	0.0000	-0.2189	0.0000	0.0000	0.2189	0.0007	0.0001	-0.0087
RohnBc2	0.0000	0.0000	-0.2189	0.0000	0.0000	0.2189	0.0007	0.0002	-0.0087
RohnCa1	0.0000	0.0000	-1.0321	0.0000	0.0000	1.0321	0.0005	0.0001	-0.0084

RohnCa2	0.0000	0.0000	-1.0801	0.0000	0.0000	1.0801	0.0005	0.0002	-0.0084
RohnCb1	0.0000	0.0000	-1.6349	0.0000	0.0000	1.6349	0.0004	0.0000	-0.0081
RohnCb2	0.0000	0.0000	-1.6349	0.0000	0.0000	1.6349	0.0004	0.0002	-0.0081
RohnDa1	0.0000	0.0000	-1.3955	0.0000	0.0000	1.3955	0.0003	-0.0000	-0.0073
RohnDa2	0.0000	0.0000	-1.3955	0.0000	0.0000	1.3955	0.0003	0.0002	-0.0073
RohnDb1	0.0000	0.0000	-0.3280	0.0000	0.0000	0.3280	0.0002	-0.0000	-0.0068
RohnDb2	0.0000	0.0000	-0.3280	0.0000	0.0000	0.3280	0.0002	0.0002	-0.0068
RohnEa1	0.0000	0.0000	-0.4460	0.0000	0.0000	0.4460	0.0001	-0.0000	-0.0059
RohnEa2	0.0000	0.0000	-0.4460	0.0000	0.0000	0.4460	0.0001	0.0002	-0.0060
RohnEb1	0.0000	0.0000	-0.4460	0.0000	0.0000	0.4460	0.0001	0.0000	-0.0055
RohnEb2	0.0000	0.0000	-0.4460	0.0000	0.0000	0.4460	0.0001	0.0001	-0.0056
RohnFa1	0.0000	0.0000	-0.6029	0.0000	0.0000	0.6029	-0.0001	-0.0002	-0.0045
RohnFa2	0.0000	0.0000	-0.6029	0.0000	0.0000	0.6029	-0.0001	0.0003	-0.0045
RohnGa1	0.0000	0.0000	-0.6732	0.0000	0.0000	0.6732	-0.0001	-0.0002	-0.0033
RohnGa2	0.0000	0.0000	-0.6732	0.0000	0.0000	0.6732	-0.0001	0.0003	-0.0033
RohnHa1	0.0000	0.0000	-0.7165	0.0000	0.0000	0.7165	-0.0002	-0.0003	-0.0020
RohnHa2	0.0000	0.0000	-0.7165	0.0000	0.0000	0.7165	-0.0002	0.0003	-0.0020
RohnIa1	0.0000	0.0000	-0.8421	0.0000	0.0000	0.8421	-0.0001	-0.0003	-0.0006
RohnIa2	0.0000	0.0000	-0.8421	0.0000	0.0000	0.8421	-0.0002	0.0003	-0.0006
SNB-Aa1	0.0000	0.0000	-0.1881	0.0000	0.0000	0.1881	0.0014	0.0001	-0.0044
SNB-Aa2	0.0000	0.0000	-0.1881	0.0000	0.0000	0.1881	0.0014	0.0002	-0.0044
SNB-Ab1	0.0000	0.0000	-0.1881	0.0000	0.0000	0.1881	0.0013	0.0002	-0.0044
SNB-Ab2	0.0000	0.0000	-0.1881	0.0000	0.0000	0.1881	0.0013	0.0002	-0.0044
SNB-Ac1	0.0000	0.0000	-0.1881	0.0000	0.0000	0.1881	0.0012	0.0001	-0.0044
SNB-Ac2	0.0000	0.0000	-0.1881	0.0000	0.0000	0.1881	0.0012	0.0002	-0.0044
SNB-Ba1	0.0000	0.0000	-0.2189	0.0000	0.0000	0.2189	0.0009	0.0001	-0.0043
SNB-Ba2	0.0000	0.0000	-0.2189	0.0000	0.0000	0.2189	0.0009	0.0002	-0.0043
SNB-Bb1	0.0000	0.0000	-0.2189	0.0000	0.0000	0.2189	0.0009	0.0001	-0.0042
SNB-Bb2	0.0000	0.0000	-0.2189	0.0000	0.0000	0.2189	0.0009	0.0002	-0.0042
SNB-Bc1	0.0000	0.0000	-0.2189	0.0000	0.0000	0.2189	0.0007	0.0001	-0.0042
SNB-Bc2	0.0000	0.0000	-0.2189	0.0000	0.0000	0.2189	0.0007	0.0002	-0.0042
SNB-Ca1	0.0000	0.0000	-0.2974	0.0000	0.0000	0.2974	0.0005	0.0001	-0.0040
SNB-Ca2	0.0000	0.0000	-0.2974	0.0000	0.0000	0.2974	0.0005	0.0002	-0.0040
SNB-Cb1	0.0000	0.0000	-0.2974	0.0000	0.0000	0.2974	0.0004	0.0000	-0.0039
SNB-Cb2	0.0000	0.0000	-0.2974	0.0000	0.0000	0.2974	0.0004	0.0002	-0.0039
SNB-Da1	0.0000	0.0000	-0.3280	0.0000	0.0000	0.3280	0.0003	-0.0000	-0.0036
SNB-Da2	0.0000	0.0000	-0.3280	0.0000	0.0000	0.3280	0.0003	0.0002	-0.0036
SNB-Db1	0.0000	0.0000	-0.3280	0.0000	0.0000	0.3280	0.0002	-0.0000	-0.0034
SNB-Db2	0.0000	0.0000	-0.3280	0.0000	0.0000	0.3280	0.0002	0.0002	-0.0034
SNB-Ea1	0.0000	0.0000	-0.4460	0.0000	0.0000	0.4460	0.0001	-0.0000	-0.0030
SNB-Ea2	0.0000	0.0000	-0.4460	0.0000	0.0000	0.4460	0.0001	0.0002	-0.0030
SNB-Eb1	0.0000	0.0000	-0.4460	0.0000	0.0000	0.4460	0.0001	0.0000	-0.0029
SNB-Eb2	0.0000	0.0000	-0.4460	0.0000	0.0000	0.4460	0.0001	0.0001	-0.0029
SNB-Fa1	0.0000	0.0000	-0.6029	0.0000	0.0000	0.6029	-0.0001	-0.0002	-0.0024
SNB-Fa2	0.0000	0.0000	-0.6029	0.0000	0.0000	0.6029	-0.0001	0.0003	-0.0024
SNB-Ga1	0.0000	0.0000	-0.6732	0.0000	0.0000	0.6732	-0.0001	-0.0002	-0.0018
SNB-Ga2	0.0000	0.0000	-0.6732	0.0000	0.0000	0.6732	-0.0001	0.0003	-0.0018
SNB-Ha1	0.0000	0.0000	-0.7165	0.0000	0.0000	0.7165	-0.0002	-0.0003	-0.0011
SNB-Ha2	0.0000	0.0000	-0.7165	0.0000	0.0000	0.7165	-0.0002	0.0003	-0.0011
SNB-Ia1	0.0000	0.0000	-0.8421	0.0000	-0.0000	0.8421	-0.0001	-0.0003	-0.0004
SNB-Ia2	0.0000	0.0000	-0.8421	0.0000	0.0000	0.8421	-0.0002	0.0003	-0.0004

Moments for Angles Modeled as Beams:

Angle Torsion	Origin	Origin	End	End	X	Y	
Label	X Moment	Y Moment	X Moment	Y Moment	Shear	Shear	
	(ft-lbs)	(ft-lbs)	(ft-lbs)	(ft-lbs)	(lbs)	(lbs)	
Rohn-LA1P	0.00	0.00	-0.11	-0.55	-3.62	-0.11	-0.75
Rohn-LA11	0.00	-0.08	0.05	-3.35	1.43	-0.69	0.30
Rohn-LA12	-0.00	0.17	0.10	2.96	1.84	0.63	0.39
Rohn-LA2P	0.00	0.54	3.63	0.13	5.10	0.13	1.74
Rohn-LA21	0.00	3.35	-1.43	4.56	-2.39	1.58	-0.76
Rohn-LA22	-0.00	-2.96	-1.84	-4.54	-2.52	-1.50	-0.87
Rohn-LA3P	0.00	-0.13	-5.10	0.03	-6.82	-0.02	-2.38
Rohn-LA31	0.00	-4.56	2.39	-6.03	3.01	-2.12	1.08
Rohn-LA32	-0.00	4.54	2.52	5.99	2.96	2.10	1.10
Rohn-LA4P	0.00	-0.03	6.82	-0.07	9.68	-0.02	3.30
Rohn-LA41	0.00	6.03	-3.01	7.85	-4.52	2.77	-1.50

Rohn-LA42	-0.00	-5.99	-2.96	-7.86	-4.44	-2.77	-1.48
Rohn-LB1P	0.00	0.07	-9.91	0.14	-11.84	0.04	-4.35
Rohn-LB11	0.01	-7.88	4.50	-9.78	7.49	-3.53	2.39
Rohn-LB12	-0.01	7.86	4.41	9.87	7.38	3.54	2.36
Rohn-LB2P	0.00	-0.14	11.84	-0.02	13.63	-0.03	5.09
Rohn-LB21	0.01	9.78	-7.49	10.77	-6.57	4.11	-2.81
Rohn-LB22	-0.01	-9.87	-7.38	-10.73	-6.52	-4.12	-2.78
Rohn-LB3P	0.00	0.02	-13.63	0.02	-13.38	0.01	-5.40
Rohn-LB31	0.01	-10.77	6.57	-11.54	7.58	-4.46	2.83
Rohn-LB32	-0.01	10.73	6.52	11.58	7.57	4.46	2.82
Rohn-LB4P	0.00	-0.02	13.38	0.04	13.95	0.00	5.46
Rohn-LB41	0.01	11.54	-7.58	11.36	-6.39	4.58	-2.79
Rohn-LB42	-0.01	-11.58	-7.57	-11.30	-6.40	-4.57	-2.79
Rohn-LC1P	0.00	-0.04	-13.95	0.08	-3.64	0.01	-2.64
Rohn-LC11	0.01	-11.36	6.39	-3.29	2.76	-2.20	1.37
Rohn-LC12	-0.01	11.30	6.40	3.33	2.69	2.19	1.36
Rohn-LC2P	0.00	-0.08	3.64	-0.15	-11.21	-0.03	-1.13
Rohn-LC21	0.01	3.29	-2.76	-10.21	6.00	-1.03	0.48
Rohn-LC22	-0.01	-3.33	-2.69	10.12	6.12	1.02	0.51
Rohn-LC3P	0.00	0.14	11.21	0.07	23.00	0.03	5.13
Rohn-LC31	0.01	10.21	-6.00	19.48	-10.54	4.46	-2.48
Rohn-LC32	-0.01	-10.12	-6.12	-19.34	-10.53	-4.42	-2.50
Rohn-LD1P	0.00	-0.07	-23.00	0.22	-9.41	0.02	-4.86
Rohn-LD11	0.01	-19.48	10.54	-8.84	5.61	-4.25	2.42
Rohn-LD12	-0.01	19.34	10.54	9.01	5.46	4.25	2.40
Rohn-LD2P	0.00	-0.22	9.41	-0.03	-22.13	-0.04	-1.90
Rohn-LD21	0.01	8.84	-5.61	-19.30	12.41	-1.56	1.02
Rohn-LD22	-0.01	-9.01	-5.46	19.44	12.53	1.56	1.06
Rohn-LD3P	0.00	0.03	22.13	0.12	39.05	0.02	9.18
Rohn-LD31	0.01	19.30	-12.41	32.92	-18.76	7.83	-4.68
Rohn-LD32	-0.01	-19.44	-12.53	-32.83	-18.84	-7.84	-4.71
Rohn-LE1P	0.00	-0.12	-39.05	-0.03	-22.62	-0.02	-9.25
Rohn-LE11	0.01	-32.92	18.76	-19.83	12.03	-7.91	4.62
Rohn-LE12	-0.01	32.83	18.84	19.86	12.09	7.91	4.64
Rohn-LE2P	0.00	0.03	22.62	0.05	-14.78	0.01	1.17
Rohn-LE21	0.01	19.83	-12.03	-12.97	8.12	1.03	-0.58
Rohn-LE22	-0.01	-19.86	-12.09	13.13	8.16	-1.01	-0.59
Rohn-LE3P	0.00	-0.05	14.78	0.20	69.46	0.02	12.64
Rohn-LE31	0.01	12.97	-8.12	59.23	-34.03	10.83	-6.32
Rohn-LE32	-0.01	-13.13	-8.16	-59.41	-34.37	-10.89	-6.38
Rohn-LF1P	0.00	-0.20	-69.46	-0.62	-113.16	-0.08	-18.25
Rohn-LF11	0.01	-59.23	34.03	-97.93	57.34	-15.71	9.13
Rohn-LF12	-0.01	59.41	34.37	97.65	57.89	15.69	9.22
Rohn-LF2P	0.00	0.62	113.16	0.35	130.31	0.10	24.33
Rohn-LF21	0.01	97.93	-57.34	111.56	-64.47	20.93	-12.17
Rohn-LF22	-0.01	-97.65	-57.89	-111.91	-65.07	-20.94	-12.29
Rohn-LG1P	0.00	-0.35	-130.31	-0.77	-138.85	-0.11	-26.90
Rohn-LG11	0.01	-111.56	64.47	-120.14	69.99	-23.15	13.44
Rohn-LG12	-0.01	111.91	65.07	119.70	70.63	23.14	13.56
Rohn-LG2P	0.00	0.77	138.85	0.24	150.21	0.10	28.89
Rohn-LG21	0.01	120.14	-69.99	128.98	-74.59	24.90	-14.45
Rohn-LG22	-0.01	-119.70	-70.62	-129.34	-75.07	-24.89	-14.56
Rohn-LH1P	0.00	-0.24	-150.21	-0.44	-164.61	-0.07	-31.46
Rohn-LH11	0.01	-128.98	74.59	-142.39	82.84	-27.12	15.73
Rohn-LH12	-0.01	129.34	75.07	142.12	83.19	27.13	15.81
Rohn-LH2P	0.00	0.44	164.61	0.08	199.37	0.05	36.37
Rohn-LH21	0.01	142.39	-82.84	171.49	-99.22	31.37	-18.19
Rohn-LH22	-0.01	-142.12	-83.19	-171.95	-99.58	-31.39	-18.26
Rohn-LI1P	0.00	-0.08	-199.37	-0.78	-271.33	-0.09	-47.04
Rohn-LI11	0.01	-171.49	99.22	-234.99	136.78	-40.62	23.58
Rohn-LI12	-0.01	171.95	99.58	234.36	137.32	40.60	23.67
Rohn-LI2P	0.00	0.78	271.33	0.54	276.72	0.13	54.77
Rohn-LI21	0.01	234.99	-136.78	238.65	-138.50	47.33	-27.51
Rohn-LI22	-0.01	-234.36	-137.32	-238.70	-139.15	-47.27	-27.63
Rohn-H1P	-0.00	-0.08	-0.00	0.07	-0.00	-0.00	-0.00
Rohn-H11	0.01	-0.05	0.00	0.11	0.00	0.01	0.00
Rohn-H12	-0.00	-0.11	-0.00	0.06	-0.00	-0.01	-0.00
Rohn-H2P	-0.01	-0.13	-0.00	-0.03	-0.01	-0.02	-0.00
Rohn-H21	-0.00	-0.04	-0.00	0.03	0.00	-0.00	-0.00

Rohn-H22	0.01	0.04	0.01	0.14	0.00	0.02	0.00
SNB-LA1P	-0.00	-0.07	75.75	-0.05	14.30	-0.02	18.00
SNB-LA11	0.00	65.50	-37.86	12.35	-7.18	15.56	-9.00
SNB-LA12	-0.00	-65.83	-37.98	-12.65	-7.30	-15.68	-9.05
SNB-LA2P	-0.00	0.05	-14.30	-0.12	5.27	-0.02	-1.80
SNB-LA21	0.00	-12.35	7.18	4.38	-2.93	-1.59	0.85
SNB-LA22	-0.00	12.65	7.30	-4.49	-2.84	1.63	0.89
SNB-LA3P	-0.00	0.12	-5.27	-0.01	-21.83	0.02	-5.42
SNB-LA31	0.00	-4.38	2.93	-18.40	11.16	-4.55	2.82
SNB-LA32	-0.00	4.49	2.84	18.30	11.12	4.55	2.79
SNB-LA4P	-0.00	0.01	21.83	0.03	65.40	0.01	17.43
SNB-LA41	0.00	18.40	-11.16	55.25	-32.05	14.72	-8.63
SNB-LA42	-0.00	-18.30	-11.12	-55.13	-32.00	-14.67	-8.62
SNB-LB1P	-0.00	0.04	110.81	0.06	7.22	0.02	23.59
SNB-LB11	0.03	95.90	-54.61	5.85	-1.45	20.34	-11.20
SNB-LB12	-0.03	-95.74	-54.57	-5.72	-1.45	-20.28	-11.19
SNB-LB2P	-0.00	-0.06	-7.22	0.04	29.82	-0.00	4.52
SNB-LB21	0.03	-5.85	1.46	24.27	-13.67	3.68	-2.44
SNB-LB22	-0.03	5.72	1.45	-24.16	-13.66	-3.69	-2.44
SNB-LB3P	-0.00	-0.04	-29.81	0.08	-65.78	0.01	-19.10
SNB-LB31	0.03	-24.27	13.67	-56.99	34.93	-16.24	9.71
SNB-LB32	-0.03	24.16	13.66	57.11	34.90	16.24	9.70
SNB-LB4P	-0.00	-0.08	65.78	-0.01	180.32	-0.02	49.18
SNB-LB41	0.03	56.99	-34.93	154.74	-89.70	42.31	-24.91
SNB-LB42	-0.03	-57.11	-34.90	-154.69	-89.66	-42.33	-24.89
SNB-LC1P	-0.00	0.00	101.79	0.02	38.96	0.00	21.12
SNB-LC11	0.02	89.65	-51.56	33.66	-18.14	18.50	-10.46
SNB-LC12	-0.02	-89.75	-51.62	-33.66	-18.16	-18.52	-10.47
SNB-LC2P	-0.00	-0.02	-38.96	0.04	-72.29	0.00	-16.64
SNB-LC21	0.02	-33.66	18.14	-62.98	37.29	-14.46	8.29
SNB-LC22	-0.02	33.66	18.16	62.98	37.24	14.46	8.29
SNB-LC3P	-0.00	-0.04	72.29	-0.01	215.76	-0.01	43.22
SNB-LC31	0.02	62.98	-37.29	185.77	-107.52	37.32	-21.73
SNB-LC32	-0.02	-62.98	-37.24	-185.62	-107.42	-37.30	-21.70
SNB-LD1P	-0.00	0.03	254.37	0.17	73.89	0.03	49.25
SNB-LD11	0.02	221.51	-127.80	63.51	-34.99	42.76	-24.42
SNB-LD12	-0.02	-221.59	-127.87	-63.32	-35.08	-42.75	-24.45
SNB-LD2P	-0.00	-0.17	-73.89	0.08	-97.88	-0.01	-25.69
SNB-LD21	0.02	-63.51	34.99	-84.97	50.63	-22.21	12.81
SNB-LD22	-0.02	63.32	35.08	85.23	50.69	22.22	12.83
SNB-LD3P	-0.00	-0.08	97.88	0.04	240.12	-0.01	50.71
SNB-LD31	0.02	84.97	-50.63	206.20	-119.24	43.69	-25.49
SNB-LD32	-0.02	-85.23	-50.69	-206.18	-119.28	-43.72	-25.50
SNB-LE1P	-0.00	-0.09	364.57	0.21	101.35	0.02	69.91
SNB-LE11	0.03	317.47	-183.40	87.30	-48.29	60.73	-34.76
SNB-LE12	-0.02	-317.73	-183.45	-87.10	-48.42	-60.74	-34.79
SNB-LE2P	-0.00	-0.21	-101.35	-0.11	-219.21	-0.05	-47.95
SNB-LE21	0.03	-87.30	48.29	-190.39	111.59	-41.54	23.92
SNB-LE22	-0.02	87.10	48.43	190.69	111.89	41.55	23.98
SNB-LE3P	-0.00	0.11	219.21	0.11	757.48	0.03	146.54
SNB-LE31	0.03	190.39	-111.59	653.78	-378.47	126.66	-73.53
SNB-LE32	-0.02	-190.69	-111.89	-654.46	-379.00	-126.80	-73.65
SNB-LF1P	0.01	-0.23	194.54	-0.58	-228.82	-0.08	-3.43
SNB-LF11	0.01	170.78	-98.07	-197.21	116.43	-2.64	1.84
SNB-LF12	-0.02	-170.56	-97.68	196.98	116.96	2.64	1.93
SNB-LF2P	0.01	0.57	228.82	0.15	732.96	0.07	96.11
SNB-LF21	0.01	197.21	-116.43	631.68	-366.38	82.83	-48.25
SNB-LF22	-0.02	-196.98	-116.96	-632.59	-367.08	-82.90	-48.37
SNB-LG1P	0.02	-0.21	752.69	-1.35	-334.65	-0.16	41.77
SNB-LG11	0.02	654.92	-377.10	-289.17	170.14	36.55	-20.68
SNB-LG12	-0.03	-654.15	-376.41	288.17	171.12	-36.57	-20.51
SNB-LG2P	0.02	1.35	334.65	0.39	1328.61	0.17	166.20
SNB-LG21	0.02	289.17	-170.14	1147.04	-664.07	143.51	-83.36
SNB-LG22	-0.03	-288.17	-171.12	-1148.13	-665.16	-143.52	-83.57
SNB-LH1P	0.01	-0.40	564.95	-1.43	-369.53	-0.18	19.53
SNB-LH11	0.01	492.63	-283.37	-319.28	186.86	17.32	-9.64
SNB-LH12	-0.02	-491.56	-282.29	318.39	188.00	-17.30	-9.42
SNB-LH2P	0.01	1.43	369.53	0.54	1185.09	0.20	155.35
SNB-LH21	0.01	319.28	-186.86	1022.86	-592.08	134.12	-77.84

SNB-LH22	-0.02	-318.39	-188.00	-1023.90	-593.30	-134.13	-78.07
SNB-LI1P	0.01	-0.53	1069.34	-2.03	-232.90	-0.26	83.58
SNB-LI11	0.00	929.36	-535.93	-201.51	119.31	72.73	-41.63
SNB-LI12	-0.01	-928.24	-534.68	199.96	120.75	-72.77	-41.36
SNB-LI2P	0.01	2.03	232.90	1.14	478.36	0.32	71.07
SNB-LI21	0.00	201.51	-119.31	411.63	-239.56	61.27	-35.86
SNB-LI22	-0.01	-199.96	-120.75	-411.90	-241.02	-61.14	-36.15
SNB-H1aP	-0.01	43.81	-0.08	146.23	-0.04	94.06	-0.06
SNB-H1bP	-0.01	-146.23	0.04	-43.70	0.07	-94.01	0.06
SNB-H1cP	-0.00	43.65	-0.08	146.20	-0.07	93.97	-0.07
SNB-H1dP	0.00	-146.20	0.07	-43.92	0.07	-94.10	0.07
SNB-H1eP	0.01	43.84	-0.07	146.23	-0.09	94.07	-0.08
SNB-H1fP	0.01	-146.23	0.09	-43.68	0.08	-93.99	0.08
SNB-H2aP	-0.05	101.70	0.27	153.27	0.27	94.33	0.20
SNB-H2bP	-0.05	-153.27	-0.27	-100.04	-0.29	-93.72	-0.21
SNB-H2cP	-0.00	101.12	0.24	153.15	0.26	94.07	0.19
SNB-H2dP	-0.00	-153.14	-0.26	-100.88	-0.24	-93.98	-0.19
SNB-H2eP	0.06	99.94	0.29	153.26	0.26	93.68	0.20
SNB-H2fP	0.06	-153.26	-0.26	-101.83	-0.26	-94.38	-0.19
SNB-H3aP	0.00	162.88	1.42	207.39	1.41	109.40	0.84
SNB-H3bP	0.00	-207.39	-1.41	-163.02	-1.42	-109.44	-0.84
SNB-H3cP	-0.00	162.93	1.43	207.39	1.47	109.42	0.86
SNB-H3dP	-0.00	-207.39	-1.47	-162.97	-1.43	-109.43	-0.86
SNB-H3eP	-0.00	163.04	1.42	207.39	1.41	109.45	0.84
SNB-H3fP	-0.00	-207.39	-1.41	-162.87	-1.42	-109.40	-0.84
SNB-H4aP	-0.01	271.42	2.67	332.68	2.65	148.57	1.31
SNB-H4bP	-0.01	-332.68	-2.65	-271.57	-2.67	-148.61	-1.31
SNB-H4cP	-0.00	271.56	2.67	332.65	2.73	148.60	1.33
SNB-H4dP	-0.00	-332.65	-2.73	-271.50	-2.67	-148.59	-1.33
SNB-H4eP	0.01	271.54	2.67	332.67	2.65	148.60	1.31
SNB-H4fP	0.01	-332.67	-2.65	-271.45	-2.67	-148.58	-1.31
SNB-H5aP	-0.00	349.17	3.75	429.01	3.74	163.94	1.58
SNB-H5bP	-0.00	-429.01	-3.74	-349.26	-3.76	-163.96	-1.58
SNB-H5cP	0.00	349.13	3.75	429.00	3.81	163.93	1.59
SNB-H5dP	0.00	-429.00	-3.81	-349.33	-3.75	-163.97	-1.59
SNB-H5eP	0.00	349.36	3.76	429.01	3.74	163.98	1.58
SNB-H5fP	0.00	-429.01	-3.74	-349.07	-3.76	-163.92	-1.58
SNB-H6aP	-0.03	549.77	3.78	659.99	3.77	222.86	1.39
SNB-H6bP	-0.03	-659.99	-3.77	-549.95	-3.78	-222.90	-1.39
SNB-H6cP	0.01	549.72	3.80	659.95	3.84	222.85	1.41
SNB-H6dP	0.01	-659.95	-3.84	-550.11	-3.79	-222.92	-1.41
SNB-H6eP	0.02	550.13	3.79	660.01	3.78	222.93	1.39
SNB-H6fP	0.02	-660.01	-3.78	-549.56	-3.79	-222.83	-1.39
SNB-H7aP	-0.01	857.79	0.96	983.57	0.97	301.38	0.32
SNB-H7bP	-0.01	-983.57	-0.97	-857.99	-0.97	-301.41	-0.32
SNB-H7cP	0.01	857.84	0.97	983.57	1.00	301.39	0.32
SNB-H7dP	0.01	-983.57	-1.00	-857.97	-0.96	-301.41	-0.32
SNB-H7eP	0.00	858.04	0.97	983.59	0.97	301.42	0.32
SNB-H7fP	0.00	-983.59	-0.97	-857.70	-0.97	-301.37	-0.32
SNB-H8aP	0.00	1093.25	1.06	1191.71	1.06	336.49	0.31
SNB-H8bP	0.00	-1191.71	-1.06	-1093.38	-1.05	-336.51	-0.31
SNB-H8cP	0.00	1093.30	1.06	1191.72	1.08	336.50	0.32
SNB-H8dP	0.00	-1191.72	-1.08	-1093.32	-1.06	-336.51	-0.32
SNB-H8eP	-0.01	1093.39	1.05	1191.71	1.05	336.51	0.31
SNB-H8fP	-0.01	-1191.71	-1.05	-1093.23	-1.05	-336.49	-0.31
SNB-H9aP	-0.00	1301.59	0.76	1374.30	0.76	358.12	0.20
SNB-H9bP	-0.00	-1374.30	-0.76	-1301.76	-0.75	-358.14	-0.20
SNB-H9cP	0.00	1301.71	0.76	1374.31	0.77	358.14	0.21
SNB-H9dP	0.00	-1374.31	-0.77	-1301.65	-0.76	-358.13	-0.21
SNB-H9eP	0.00	1301.72	0.75	1374.31	0.75	358.14	0.20
SNB-H9fP	0.00	-1374.31	-0.75	-1301.61	-0.75	-358.12	-0.20

Equilibrium Joint Positions and Rotations for Load Case "0.9DL":

Joint Label	X-Displ (ft)	Y-Displ (ft)	Z-Displ (ft)	X-Rot (deg)	Y-Rot (deg)	Z-Rot (deg)	X-Pos (ft)	Y-Pos (ft)	Z-Pos (ft)
RohnAP	0.001153	0.0001228	-0.00709	-0.0001	0.0006	0.0000	4.334	0.0001228	180
RohnBP	0.0007897	0.0001092	-0.006981	-0.0000	0.0007	0.0000	5.122	0.0001092	160
RohnCP	0.000494	0.0001	-0.006548	-0.0000	0.0007	0.0000	5.909	0.0001	140
RohnDP	0.0003	8.602e-005	-0.005891	-0.0000	0.0001	-0.0000	6.695	8.602e-005	120
RohnEP	0.0001697	6.817e-005	-0.004815	-0.0001	0.0002	-0.0000	7.481	6.817e-005	100
RohnFP	9.909e-005	4.494e-005	-0.003884	-0.0001	-0.0010	-0.0000	8.268	4.494e-005	80
RohnGP	4.585e-005	2.301e-005	-0.00296	-0.0001	-0.0002	-0.0000	9.055	2.301e-005	60
RohnHP	2.049e-005	8.594e-006	-0.002036	-0.0000	-0.0003	-0.0000	9.841	8.594e-006	40
RohnIP	6.735e-006	1.348e-006	-0.0009747	-0.0000	-0.0008	-0.0000	10.63	1.348e-006	20
RohnJP	0	0	0	0.0000	0.0000	0.0000	11.42	0	0
SNB-AP	0.001156	0.0001219	-0.003385	-0.0001	-0.0041	-0.0000	2.334	0.0001219	180
SNB-BP	0.0007931	0.0001092	-0.003312	-0.0000	-0.0025	-0.0000	3.122	0.0001092	160
SNB-CP	0.0004968	9.966e-005	-0.00315	-0.0000	-0.0031	-0.0000	3.908	9.966e-005	140
SNB-DP	0.0003022	8.599e-005	-0.002867	-0.0000	-0.0057	0.0000	4.695	8.599e-005	120
SNB-EP	0.0001711	6.762e-005	-0.00241	-0.0001	-0.0035	-0.0000	5.481	6.762e-005	100
SNB-FP	9.985e-005	4.44e-005	-0.002075	-0.0001	-0.0057	-0.0000	6.268	4.44e-005	80
SNB-GP	4.625e-005	2.325e-005	-0.001625	-0.0001	-0.0075	-0.0000	7.055	2.325e-005	60
SNB-HP	2.064e-005	9.007e-006	-0.00115	-0.0000	-0.0065	-0.0000	7.841	9.007e-006	40
SNB-IP	6.733e-006	1.7e-006	-0.0005629	-0.0000	-0.0053	-0.0000	8.628	1.7e-006	20
SNB-JP	0	0	0	0.0000	0.0000	0.0000	9.415	0	0
RohnA1	0.001158	0.0001253	-0.006968	-0.0004	0.0012	-0.0000	-2.165	-3.752	180
RohnA2	0.001158	0.000119	-0.006986	0.0003	0.0012	0.0000	-2.165	3.753	180
RohnB1	0.0007944	0.0001115	-0.006817	-0.0002	0.0012	-0.0000	-2.56	-4.435	160
RohnB2	0.0007943	0.000107	-0.006818	0.0002	0.0012	0.0000	-2.56	4.435	160
RohnC1	0.0004895	9.981e-005	-0.006431	-0.0000	0.0007	-0.0000	-2.954	-5.117	140
RohnC2	0.0004898	9.968e-005	-0.006438	-0.0000	0.0007	0.0000	-2.954	5.117	140
RohnD1	0.000285	7.904e-005	-0.005801	-0.0003	0.0006	-0.0000	-3.347	-5.798	120
RohnD2	0.000285	9.295e-005	-0.005808	0.0003	0.0006	0.0000	-3.347	5.798	120
RohnE1	0.0001573	6.222e-005	-0.004752	-0.0001	0.0003	-0.0000	-3.74	-6.479	100
RohnE2	0.0001578	7.328e-005	-0.004766	0.0000	0.0003	0.0000	-3.74	6.479	100
RohnF1	8.235e-005	3.602e-005	-0.003838	-0.0011	0.0008	0.0000	-4.134	-7.16	80
RohnF2	8.283e-005	5.304e-005	-0.00386	0.0010	0.0008	0.0000	-4.134	7.16	80
RohnG1	4.148e-005	2.102e-005	-0.002926	-0.0003	0.0002	0.0000	-4.527	-7.842	60
RohnG2	4.127e-005	2.538e-005	-0.002945	0.0002	0.0002	0.0000	-4.527	7.842	60
RohnH1	1.409e-005	5.532e-006	-0.002014	-0.0003	0.0002	0.0000	-4.92	-8.523	40
RohnH2	1.369e-005	1.236e-005	-0.002025	0.0002	0.0002	0.0000	-4.92	8.523	40
RohnI1	1.068e-006	-1.286e-006	-0.0009655	-0.0007	0.0004	0.0000	-5.315	-9.206	20
RohnI2	7.159e-007	4.59e-006	-0.0009702	0.0007	0.0004	0.0000	-5.315	9.206	20
RohnJ1	0	0	0	0.0000	0.0000	0.0000	-5.71	-9.89	0
RohnJ2	0	0	0	0.0000	0.0000	0.0000	-5.71	9.89	0
SNB-A1	0.001157	0.0001221	-0.00332	-0.0045	0.0036	0.0000	-1.165	-2.02	180
SNB-A2	0.001157	0.0001218	-0.003324	0.0044	0.0036	0.0000	-1.165	2.021	180
SNB-B1	0.0007925	0.0001089	-0.003234	-0.0031	0.0028	-0.0000	-1.56	-2.703	160
SNB-B2	0.0007925	0.0001096	-0.003236	0.0030	0.0028	0.0000	-1.56	2.703	160
SNB-C1	0.0004903	9.612e-005	-0.003076	-0.0033	0.0026	-0.0000	-1.954	-3.384	140
SNB-C2	0.0004903	0.0001032	-0.00308	0.0032	0.0026	0.0000	-1.954	3.385	140
SNB-D1	0.0002851	7.644e-005	-0.002806	-0.0054	0.0036	-0.0000	-2.347	-4.066	120
SNB-D2	0.0002851	9.553e-005	-0.002812	0.0053	0.0036	0.0000	-2.347	4.066	120
SNB-E1	0.000158	6.024e-005	-0.002367	-0.0033	0.0021	-0.0000	-2.74	-4.747	100
SNB-E2	0.000158	7.499e-005	-0.002377	0.0032	0.0021	0.0000	-2.74	4.747	100
SNB-F1	8.293e-005	3.482e-005	-0.002041	-0.0052	0.0031	-0.0000	-3.134	-5.428	80
SNB-F2	8.293e-005	5.397e-005	-0.002053	0.0050	0.0031	0.0000	-3.134	5.428	80
SNB-G1	4.143e-005	2.059e-005	-0.001601	-0.0066	0.0039	-0.0000	-3.527	-6.11	60
SNB-G2	4.142e-005	2.592e-005	-0.001611	0.0065	0.0039	0.0000	-3.527	6.11	60
SNB-H1	1.408e-005	5.366e-006	-0.001134	-0.0057	0.0033	-0.0000	-3.92	-6.79	40
SNB-H2	1.403e-005	1.273e-005	-0.001141	0.0057	0.0033	0.0000	-3.92	6.791	40
SNB-I1	1.205e-006	-1.362e-006	-0.000556	-0.0046	0.0027	-0.0000	-4.314	-7.472	20
SNB-I2	1.158e-006	4.843e-006	-0.0005592	0.0046	0.0027	0.0000	-4.314	7.472	20
SNB-J1	0	0	0	0.0000	0.0000	0.0000	-4.708	-8.154	0
SNB-J2	0	0	0	0.0000	0.0000	0.0000	-4.708	8.154	0

RohnAaS	0.001084	0.000113	-0.007076	-0.0001	0.0011	0.0000	4.531	0.000113	175
RohnAbS	0.0009759	0.000112	-0.007053	0.0000	0.0009	0.0000	4.728	0.000112	170
RohnAcS	0.0009092	0.0001109	-0.007021	-0.0000	0.0012	0.0000	4.925	0.0001109	165
RohnBaS	0.0007422	0.000108	-0.006899	-0.0000	0.0009	0.0000	5.319	0.000108	155
RohnBbS	0.000632	0.0001055	-0.006813	-0.0000	0.0008	0.0000	5.516	0.0001055	150
RohnBcS	0.0005972	0.0001029	-0.006683	-0.0000	0.0007	0.0000	5.713	0.0001029	145
RohnCaS	0.0004812	9.532e-005	-0.006377	-0.0000	-0.0001	-0.0000	6.171	9.532e-005	133.3
RohnCbS	0.0004307	9e-005	-0.006163	-0.0000	0.0010	-0.0000	6.434	9e-005	126.7
RohnDaS	0.0003444	8.14e-005	-0.005579	-0.0000	-0.0006	-0.0000	6.957	8.14e-005	113.3
RohnDbS	0.0003147	7.5e-005	-0.005196	-0.0001	0.0010	-0.0000	7.22	7.5e-005	106.7
RohnEaS	0.0002156	6.065e-005	-0.004517	-0.0001	-0.0004	-0.0000	7.743	6.065e-005	93.34
RohnEbS	0.0001666	5.304e-005	-0.004204	-0.0001	0.0009	-0.0000	8.006	5.304e-005	86.66
RohnFaS	0.0003122	3.219e-005	-0.003425	-0.0001	0.0004	-0.0000	8.662	3.219e-005	70
RohnGaS	0.0002594	1.378e-005	-0.0025	-0.0000	0.0001	-0.0000	9.448	1.378e-005	50
RohnHaS	0.0002678	3.806e-006	-0.001507	-0.0000	0.0001	-0.0000	10.24	3.806e-006	30
RohnIaS	0.0002259	-2.216e-007	-0.0004898	-0.0000	0.0001	-0.0000	11.03	-2.216e-007	10
SNB-AaS	0.001087	0.0001171	-0.003375	-0.0001	0.0024	-0.0000	2.531	0.0001171	175
SNB-AbS	0.0009793	0.0001132	-0.003362	-0.0000	0.0003	-0.0000	2.728	0.0001132	170
SNB-AcS	0.0009126	0.000111	-0.003339	-0.0000	0.0021	-0.0000	2.925	0.000111	165
SNB-BaS	0.0007455	0.0001074	-0.003279	-0.0000	0.0019	-0.0000	3.318	0.0001074	155
SNB-BbS	0.0006352	0.0001053	-0.003242	-0.0000	0.0003	-0.0000	3.515	0.0001053	150
SNB-BcS	0.0006003	0.0001027	-0.003197	-0.0000	0.0018	-0.0000	3.712	0.0001027	145
SNB-CaS	0.0004839	9.545e-005	-0.003066	-0.0000	0.0005	0.0000	4.171	9.545e-005	133.3
SNB-CbS	0.0004332	9.092e-005	-0.002966	-0.0000	0.0024	0.0000	4.433	9.092e-005	126.7
SNB-DaS	0.0003465	8.084e-005	-0.002726	-0.0000	0.0008	0.0000	4.957	8.084e-005	113.3
SNB-DbS	0.0003164	7.46e-005	-0.002565	-0.0001	0.0017	-0.0000	5.22	7.46e-005	106.7
SNB-EaS	0.0002168	6.018e-005	-0.002304	-0.0001	0.0003	-0.0000	5.743	6.018e-005	93.34
SNB-EbS	0.0001676	5.225e-005	-0.002189	-0.0001	0.0020	-0.0000	6.006	5.225e-005	86.66
SNB-FaS	0.0003128	3.264e-005	-0.001848	-0.0001	0.0034	-0.0000	6.662	3.264e-005	70
SNB-GaS	0.0002597	1.473e-005	-0.001386	-0.0000	0.0035	-0.0000	7.448	1.473e-005	50
SNB-HaS	0.0002679	3.959e-006	-0.0008538	-0.0000	0.0029	-0.0000	8.235	3.959e-006	30
SNB-IaS	0.0002259	-8.927e-008	-0.0002796	-0.0000	0.0012	-0.0000	9.022	-8.927e-008	10
SNB-WL-A1S	0.001156	0.0001219	-0.003483	-0.0023	-0.0003	-0.0000	0.5844	-1.01	180
SNB-WL-A2S	0.001156	0.0001219	-0.003452	-0.0000	0.0036	0.0000	-1.165	0.0001219	180
SNB-WL-A3S	0.001156	0.0001219	-0.003485	0.0022	-0.0003	-0.0000	0.5844	1.01	180
SNB-WL-B1S	0.0007927	0.0001093	-0.003466	-0.0015	0.0001	0.0000	0.781	-1.351	160
SNB-WL-B2S	0.0007927	0.0001093	-0.003427	-0.0000	0.0028	0.0000	-1.56	0.0001093	160
SNB-WL-B3S	0.0007927	0.0001093	-0.003467	0.0015	0.0001	-0.0000	0.781	1.352	160
SNB-WL-C1S	0.0004926	9.962e-005	-0.003481	-0.0017	-0.0002	-0.0000	0.9775	-1.692	140
SNB-WL-C2S	0.0004925	9.966e-005	-0.003447	-0.0000	0.0026	-0.0000	-1.954	9.966e-005	140
SNB-WL-C3S	0.0004926	9.97e-005	-0.003483	0.0016	-0.0002	0.0000	0.9775	1.692	140
SNB-WL-D1S	0.0002909	8.59e-005	-0.003664	-0.0027	-0.0011	-0.0000	1.174	-2.033	120
SNB-WL-D2S	0.0002908	8.599e-005	-0.003636	-0.0000	0.0036	-0.0000	-2.347	8.599e-005	120
SNB-WL-D3S	0.0002909	8.607e-005	-0.003667	0.0026	-0.0011	0.0000	1.174	2.033	120
SNB-WL-E1S	0.0001625	6.754e-005	-0.002965	-0.0017	-0.0007	-0.0000	1.37	-2.373	100
SNB-WL-E2S	0.0001623	6.762e-005	-0.002949	-0.0001	0.0021	-0.0000	-2.74	6.762e-005	100
SNB-WL-E3S	0.0001625	6.769e-005	-0.00297	0.0016	-0.0007	0.0000	1.37	2.373	100
SNB-WL-F1S	8.867e-005	4.432e-005	-0.003196	-0.0026	-0.0013	-0.0000	1.567	-2.714	80
SNB-WL-F2S	8.853e-005	4.44e-005	-0.003185	-0.0001	0.0031	-0.0000	-3.134	4.44e-005	80
SNB-WL-F3S	8.867e-005	4.447e-005	-0.003202	0.0025	-0.0013	0.0000	1.567	2.714	80
SNB-WL-G1S	4.307e-005	2.324e-005	-0.003685	-0.0033	-0.0018	-0.0000	1.764	-3.055	60
SNB-WL-G2S	4.304e-005	2.326e-005	-0.003678	-0.0000	0.0039	-0.0000	-3.527	2.326e-005	60
SNB-WL-G3S	4.308e-005	2.328e-005	-0.00369	0.0032	-0.0018	0.0000	1.764	3.055	60
SNB-WL-H1S	1.629e-005	9.026e-006	-0.004115	-0.0029	-0.0016	-0.0000	1.96	-3.395	40
SNB-WL-H2S	1.626e-005	9.046e-006	-0.004111	-0.0000	0.0033	0.0000	-3.92	9.046e-006	40
SNB-WL-H3S	1.629e-005	9.066e-006	-0.004119	0.0028	-0.0016	0.0000	1.96	3.395	40
SNB-WL-I1S	3.068e-006	1.725e-006	-0.004592	-0.0023	-0.0013	-0.0000	2.157	-3.736	20
SNB-WL-I2S	3.042e-006	1.74e-006	-0.004591	-0.0000	0.0027	0.0000	-4.314	1.74e-006	20
SNB-WL-I3S	3.068e-006	1.754e-006	-0.004594	0.0023	-0.0013	0.0000	2.157	3.736	20
RohnAa1	0.001062	0.0001003	-0.006949	0.0000	0.0010	-0.0000	-2.264	-3.923	175
RohnAa2	0.001058	0.0001314	-0.00696	-0.0001	0.0010	0.0000	-2.264	3.923	175
RohnAb1	0.0009793	0.0001118	-0.006919	-0.0002	0.0011	-0.0000	-2.363	-4.094	170
RohnAb2	0.0009781	0.0001141	-0.006922	0.0001	0.0011	0.0000	-2.363	4.094	170
RohnAc1	0.0008761	8.704e-005	-0.006871	0.0001	0.0010	-0.0000	-2.461	-4.264	165
RohnAc2	0.000876	0.0001349	-0.006873	-0.0001	0.0010	0.0000	-2.461	4.264	165
RohnBa1	0.0006838	8.023e-005	-0.006749	-0.0000	0.0010	-0.0000	-2.658	-4.605	155
RohnBa2	0.0006842	0.0001349	-0.006751	-0.0000	0.0010	0.0000	-2.658	4.606	155
RohnBb1	0.0006229	0.0001028	-0.006674	-0.0001	0.0009	-0.0000	-2.757	-4.776	150
RohnBb2	0.0006231	0.0001078	-0.006678	0.0001	0.0009	0.0000	-2.757	4.776	150

RohnBc1	0.0005334	6.961e-005	-0.006556	-0.0001	0.0008	-0.0000	-2.855	-4.947	145
RohnBc2	0.0005336	0.0001358	-0.006561	-0.0000	0.0008	0.0000	-2.855	4.947	145
RohnCa1	0.0003824	4.175e-005	-0.006271	-0.0007	0.0010	-0.0000	-3.085	-5.344	133.3
RohnCa2	0.0003825	0.0001487	-0.006279	0.0006	0.0010	0.0000	-3.085	5.344	133.3
RohnCb1	0.0003083	2.17e-005	-0.006063	0.0004	0.0003	-0.0000	-3.216	-5.571	126.7
RohnCb2	0.0003077	0.0001592	-0.006071	-0.0005	0.0003	0.0000	-3.216	5.572	126.7
RohnDa1	0.0001865	-8.158e-006	-0.005494	-0.0009	0.0009	-0.0000	-3.478	-6.025	113.3
RohnDa2	0.0001872	0.0001698	-0.005504	0.0008	0.0009	0.0000	-3.478	6.025	113.3
RohnDb1	0.0001362	-2.5e-005	-0.005122	0.0005	-0.0000	-0.0000	-3.609	-6.252	106.7
RohnDb2	0.0001366	0.0001744	-0.005134	-0.0007	-0.0000	0.0000	-3.609	6.252	106.7
RohnEa1	9.164e-005	-9.329e-006	-0.004459	-0.0006	0.0005	-0.0000	-3.871	-6.706	93.34
RohnEa2	9.201e-005	0.00013	-0.004476	0.0005	0.0005	0.0000	-3.871	6.706	93.34
RohnEb1	7.932e-005	4.021e-006	-0.004152	0.0006	-0.0002	0.0000	-4.003	-6.933	86.66
RohnEb2	7.983e-005	0.0001012	-0.004171	-0.0007	-0.0002	0.0000	-4.003	6.933	86.66
RohnFa1	-6.192e-005	-0.0001809	-0.003385	0.0001	0.0000	0.0000	-4.331	-7.501	70
RohnFa2	-6.295e-005	0.0002471	-0.003405	-0.0003	0.0000	0.0000	-4.331	7.501	70
RohnGa1	-8.796e-005	-0.0001842	-0.002473	-0.0001	0.0001	0.0000	-4.724	-8.182	50
RohnGa2	-8.945e-005	0.0002144	-0.002488	-0.0000	0.0001	0.0000	-4.724	8.182	50
RohnHa1	-0.0001219	-0.0002194	-0.001491	0.0001	-0.0000	0.0000	-5.118	-8.864	30
RohnHa2	-0.0001227	0.0002284	-0.001499	-0.0001	-0.0000	0.0000	-5.118	8.864	30
RohnIa1	-0.0001123	-0.0001942	-0.0004852	0.0000	-0.0000	0.0000	-5.513	-9.548	10
RohnIa2	-0.0001129	0.0001948	-0.0004875	-0.0001	-0.0000	-0.0000	-5.513	9.548	10
SNB-Aa1	0.001056	9.958e-005	-0.003306	0.0012	0.0003	0.0000	-1.264	-2.191	175
SNB-Aa2	0.001057	0.0001342	-0.003309	-0.0013	0.0003	0.0000	-1.264	2.191	175
SNB-Ab1	0.0009738	0.0001112	-0.003287	-0.0006	0.0014	-0.0000	-1.363	-2.362	170
SNB-Ab2	0.0009737	0.0001154	-0.00329	0.0006	0.0014	0.0000	-1.363	2.362	170
SNB-Ac1	0.0008679	8.798e-005	-0.003262	0.0009	0.0005	-0.0000	-1.461	-2.532	165
SNB-Ac2	0.0008679	0.000134	-0.003264	-0.0009	0.0005	0.0000	-1.461	2.532	165
SNB-Ba1	0.0006866	7.495e-005	-0.003199	0.0008	0.0005	-0.0000	-1.658	-2.873	155
SNB-Ba2	0.0006866	0.0001399	-0.003202	-0.0008	0.0005	0.0000	-1.658	2.873	155
SNB-Bb1	0.0006233	9.903e-005	-0.003163	-0.0005	0.0011	-0.0000	-1.757	-3.044	150
SNB-Bb2	0.0006233	0.0001115	-0.003167	0.0005	0.0011	0.0000	-1.757	3.044	150
SNB-Bc1	0.0005336	6.605e-005	-0.00312	0.0009	0.0002	-0.0000	-1.855	-3.214	145
SNB-Bc2	0.0005337	0.0001393	-0.003124	-0.0010	0.0002	0.0000	-1.855	3.214	145
SNB-Ca1	0.000381	3.949e-005	-0.002996	-0.0001	0.0007	-0.0000	-2.085	-3.611	133.3
SNB-Ca2	0.0003812	0.000151	-0.003001	0.0000	0.0007	0.0000	-2.085	3.612	133.3
SNB-Cb1	0.000306	2.019e-005	-0.0029	0.0016	-0.0004	-0.0000	-2.216	-3.839	126.7
SNB-Cb2	0.0003062	0.0001612	-0.002906	-0.0016	-0.0004	0.0000	-2.216	3.839	126.7
SNB-Da1	0.000185	-9.558e-006	-0.00267	0.0003	0.0002	-0.0000	-2.478	-4.293	113.3
SNB-Da2	0.0001852	0.0001709	-0.002678	-0.0004	0.0002	0.0000	-2.478	4.293	113.3
SNB-Db1	0.000136	-2.677e-005	-0.002516	0.0011	-0.0004	-0.0000	-2.609	-4.52	106.7
SNB-Db2	0.000136	0.000176	-0.002524	-0.0012	-0.0004	0.0000	-2.609	4.52	106.7
SNB-Ea1	9.176e-005	-1.075e-005	-0.002264	0.0000	0.0002	-0.0000	-2.871	-4.974	93.34
SNB-Ea2	9.173e-005	0.0001312	-0.002274	-0.0002	0.0002	0.0000	-2.871	4.974	93.34
SNB-Eb1	7.977e-005	2.65e-006	-0.002152	0.0015	-0.0007	-0.0000	-3.003	-5.201	86.66
SNB-Eb2	7.959e-005	0.0001022	-0.002163	-0.0016	-0.0007	0.0000	-3.003	5.201	86.66
SNB-Fa1	-6.312e-005	-0.0001809	-0.001819	0.0028	-0.0015	-0.0000	-3.331	-5.769	70
SNB-Fa2	-6.377e-005	0.0002473	-0.00183	-0.0029	-0.0015	0.0000	-3.331	5.769	70
SNB-Ga1	-8.874e-005	-0.0001841	-0.001366	0.0029	-0.0016	-0.0000	-3.724	-6.45	50
SNB-Ga2	-8.941e-005	0.0002147	-0.001374	-0.0030	-0.0016	0.0000	-3.724	6.45	50
SNB-Ha1	-0.0001221	-0.0002193	-0.0008425	0.0024	-0.0014	-0.0000	-4.117	-7.132	30
SNB-Ha2	-0.0001228	0.0002284	-0.0008477	-0.0025	-0.0014	0.0000	-4.117	7.132	30
SNB-Ia1	-0.0001123	-0.0001942	-0.0002762	0.0011	-0.0006	-0.0000	-4.511	-7.813	10
SNB-Ia2	-0.0001128	0.0001948	-0.0002778	-0.0011	-0.0006	0.0000	-4.511	7.813	10

Joint Support Reactions for Load Case "0.9DL":

Joint Label	X Force (kips)	X Usage %	Y Force (kips)	Y Usage %	Z Force (kips)	Z Usage %	Comp. Usage %	Uplift Usage %	Result. Force (kips)	Result. Usage % (ft-k)	X Moment Usage % (ft-k)	X-M. Moment Usage % (ft-k)	Y Moment Usage % (ft-k)	Y-M. Moment Usage % (ft-k)	Z Moment Usage % (ft-k)	Z-M. Moment Usage % (ft-k)	Max. Usage %
RohnJP	-0.80	0.0	0.00	0.0	14.97	0.0	0.0	0.0	15.00	0.0	-0.00	0.0	-0.2	0.0	-0.00	0.0	0.0
SNB-JP	-0.41	0.0	0.00	0.0	13.95	0.0	0.0	0.0	13.96	0.0	-0.00	0.0	-0.4	0.0	-0.00	0.0	0.0
RohnJ1	0.40	0.0	0.69	0.0	14.84	0.0	0.0	0.0	14.87	0.0	-0.18	0.0	0.1	0.0	-0.00	0.0	0.0
RohnJ2	0.40	0.0	-0.69	0.0	14.91	0.0	0.0	0.0	14.93	0.0	0.18	0.0	0.1	0.0	0.00	0.0	0.0
SNB-J1	0.21	0.0	0.36	0.0	13.79	0.0	0.0	0.0	13.80	0.0	-0.31	0.0	0.2	0.0	-0.00	0.0	0.0
SNB-J2	0.21	0.0	-0.36	0.0	13.87	0.0	0.0	0.0	13.87	0.0	0.31	0.0	0.2	0.0	0.00	0.0	0.0

Joint Displacements, Loads and Member Forces on Joints for Load Case "0.9DL":

Joint Label	X External Load (kips)	Y External Load (kips)	Z External Load (kips)	X Member Force (kips)	Y Member Force (kips)	Z Member Force (kips)	X Disp. (ft)	Y Disp. (ft)	Z Disp. (ft)
RohnAP	0.0000	0.0000	-0.2670	0.0000	0.0000	0.2670	0.0012	0.0001	-0.0071
RohnBP	0.0000	0.0000	-0.9568	0.0000	0.0000	0.9568	0.0008	0.0001	-0.0070
RohnCP	0.0000	0.0000	-0.3872	0.0000	0.0000	0.3872	0.0005	0.0001	-0.0065
RohnDP	0.0000	0.0000	-0.4691	0.0000	0.0000	0.4691	0.0003	0.0001	-0.0059
RohnEP	0.0000	0.0000	-0.5805	0.0000	0.0000	0.5805	0.0002	0.0001	-0.0048
RohnFP	0.0000	0.0000	-0.7867	0.0000	0.0000	0.7867	0.0001	0.0000	-0.0039
RohnGP	0.0000	0.0000	-1.0471	0.0000	0.0000	1.0471	0.0000	0.0000	-0.0030
RohnHP	0.0000	0.0000	-1.0422	0.0000	0.0000	1.0422	0.0000	0.0000	-0.0020
RohnIP	0.0000	0.0000	-1.1689	0.0000	0.0000	1.1689	0.0000	0.0000	-0.0010
RohnJP	0.0000	0.0000	-0.6316	0.8033	-0.0005	-14.3432	0.0000	0.0000	0.0000
SNB-AP	0.0000	0.0000	-0.1410	0.0000	0.0000	0.1410	0.0012	0.0001	-0.0034
SNB-BP	0.0000	0.0000	-0.3052	0.0000	0.0000	0.3052	0.0008	0.0001	-0.0033
SNB-CP	0.0000	0.0000	-0.3872	0.0000	0.0000	0.3872	0.0005	0.0001	-0.0032
SNB-DP	0.0000	0.0000	-0.4691	0.0000	0.0000	0.4691	0.0003	0.0001	-0.0029
SNB-EP	0.0000	0.0000	-0.5805	0.0000	0.0000	0.5805	0.0002	0.0001	-0.0024
SNB-FP	0.0000	0.0000	-0.7867	0.0000	0.0000	0.7867	0.0001	0.0000	-0.0021
SNB-GP	0.0000	0.0000	-0.9571	0.0000	0.0000	0.9571	0.0000	0.0000	-0.0016
SNB-HP	0.0000	0.0000	-1.0422	0.0000	0.0000	1.0422	0.0000	0.0000	-0.0011
SNB-IP	0.0000	0.0000	-1.1689	0.0000	0.0000	1.1689	0.0000	0.0000	-0.0006
SNB-JP	0.0000	0.0000	-0.6316	0.4149	-0.0009	-13.3178	0.0000	0.0000	0.0000
RohnA1	0.0000	0.0000	-0.2670	0.0000	0.0000	0.2670	0.0012	0.0001	-0.0070
RohnA2	0.0000	0.0000	-0.3930	0.0000	0.0000	0.3930	0.0012	0.0001	-0.0070
RohnB1	0.0000	0.0000	-0.4078	0.0000	0.0000	0.4078	0.0008	0.0001	-0.0068
RohnB2	0.0000	0.0000	-0.3493	0.0000	0.0000	0.3493	0.0008	0.0001	-0.0068
RohnC1	0.0000	0.0000	-0.3872	0.0000	0.0000	0.3872	0.0005	0.0001	-0.0064
RohnC2	0.0000	0.0000	-0.3872	0.0000	0.0000	0.3872	0.0005	0.0001	-0.0064
RohnD1	0.0000	0.0000	-0.5321	0.0000	0.0000	0.5321	0.0003	0.0001	-0.0058
RohnD2	0.0000	0.0000	-0.4691	0.0000	0.0000	0.4691	0.0003	0.0001	-0.0058
RohnE1	0.0000	0.0000	-0.5805	0.0000	0.0000	0.5805	0.0002	0.0001	-0.0048
RohnE2	0.0000	0.0000	-0.5805	0.0000	0.0000	0.5805	0.0002	0.0001	-0.0048
RohnF1	0.0000	0.0000	-0.7867	0.0000	0.0000	0.7867	0.0001	0.0000	-0.0038
RohnF2	0.0000	0.0000	-0.9172	0.0000	0.0000	0.9172	0.0001	0.0001	-0.0039
RohnG1	0.0000	0.0000	-1.0111	0.0000	0.0000	1.0111	0.0000	0.0000	-0.0029
RohnG2	0.0000	0.0000	-1.0975	0.0000	0.0000	1.0975	0.0000	0.0000	-0.0029
RohnH1	0.0000	0.0000	-1.0422	0.0000	0.0000	1.0422	0.0000	0.0000	-0.0020
RohnH2	0.0000	0.0000	-1.0422	0.0000	0.0000	1.0422	0.0000	0.0000	-0.0020
RohnI1	0.0000	0.0000	-1.1689	0.0000	0.0000	1.1689	0.0000	-0.0000	-0.0010
RohnI2	0.0000	0.0000	-1.1689	0.0000	0.0000	1.1689	0.0000	0.0000	-0.0010
RohnJ1	0.0000	0.0000	-0.6316	-0.4008	-0.6933	-14.2124	0.0000	0.0000	0.0000
RohnJ2	0.0000	0.0000	-0.6316	-0.4018	0.6940	-14.2795	0.0000	0.0000	0.0000
SNB-A1	0.0000	0.0000	-0.1410	0.0000	0.0000	0.1410	0.0012	0.0001	-0.0033
SNB-A2	0.0000	0.0000	-0.1410	0.0000	0.0000	0.1410	0.0012	0.0001	-0.0033
SNB-B1	0.0000	0.0000	-0.3052	0.0000	-0.0000	0.3052	0.0008	0.0001	-0.0032
SNB-B2	0.0000	0.0000	-0.3052	0.0000	0.0000	0.3052	0.0008	0.0001	-0.0032
SNB-C1	0.0000	0.0000	-0.3872	0.0000	-0.0000	0.3872	0.0005	0.0001	-0.0031
SNB-C2	0.0000	0.0000	-0.3872	0.0000	0.0000	0.3872	0.0005	0.0001	-0.0031
SNB-D1	0.0000	0.0000	-0.4691	0.0000	-0.0000	0.4691	0.0003	0.0001	-0.0028
SNB-D2	0.0000	0.0000	-0.4691	0.0000	0.0000	0.4691	0.0003	0.0001	-0.0028
SNB-E1	0.0000	0.0000	-0.5805	0.0000	-0.0000	0.5805	0.0002	0.0001	-0.0024
SNB-E2	0.0000	0.0000	-0.5805	0.0000	0.0000	0.5805	0.0002	0.0001	-0.0024
SNB-F1	0.0000	0.0000	-0.7867	0.0000	0.0000	0.7867	0.0001	0.0000	-0.0020
SNB-F2	0.0000	0.0000	-0.7867	0.0000	0.0000	0.7867	0.0001	0.0001	-0.0021
SNB-G1	0.0000	0.0000	-0.9571	0.0000	0.0000	0.9571	0.0000	0.0000	-0.0016
SNB-G2	0.0000	0.0000	-0.9571	0.0000	0.0000	0.9571	0.0000	0.0000	-0.0016
SNB-H1	0.0000	0.0000	-1.0422	0.0000	0.0000	1.0422	0.0000	0.0000	-0.0011
SNB-H2	0.0000	0.0000	-1.0422	0.0000	0.0000	1.0422	0.0000	0.0000	-0.0011
SNB-I1	0.0000	0.0000	-1.1689	0.0000	0.0000	1.1689	0.0000	-0.0000	-0.0006
SNB-I2	0.0000	0.0000	-1.1689	0.0000	0.0000	1.1689	0.0000	0.0000	-0.0006
SNB-J1	0.0000	0.0000	-0.6316	-0.2076	-0.3575	-13.1602	0.0000	0.0000	0.0000
SNB-J2	0.0000	0.0000	-0.6316	-0.2089	0.3580	-13.2349	0.0000	0.0000	0.0000
RohnAaS	0.0000	0.0000	-0.1881	0.0000	0.0000	0.1881	0.0011	0.0001	-0.0071
RohnAbS	0.0000	0.0000	-0.1410	0.0000	0.0000	0.1410	0.0010	0.0001	-0.0071
RohnAcS	0.0000	0.0000	-0.1890	0.0000	0.0000	0.1890	0.0009	0.0001	-0.0070

RohnBaS	0.0000	0.0000	-0.1642	0.0000	0.0000	0.1642	0.0007	0.0001	-0.0069
RohnBbS	0.0000	0.0000	-0.8700	0.0000	0.0000	0.8700	0.0006	0.0001	-0.0068
RohnBcS	0.0000	0.0000	-0.1642	0.0000	0.0000	0.1642	0.0006	0.0001	-0.0067
RohnCaS	0.0000	0.0000	-0.7200	0.0000	0.0000	0.7200	0.0005	0.0001	-0.0064
RohnCbS	0.0000	0.0000	-1.2757	0.0000	0.0000	1.2757	0.0004	0.0001	-0.0062
RohnDaS	0.0000	0.0000	-1.1411	0.0000	0.0000	1.1411	0.0003	0.0001	-0.0056
RohnDbS	0.0000	0.0000	-0.2460	0.0000	0.0000	0.2460	0.0003	0.0001	-0.0052
RohnEaS	0.0000	0.0000	-0.3345	0.0000	0.0000	0.3345	0.0002	0.0001	-0.0045
RohnEbS	0.0000	0.0000	-0.3345	0.0000	0.0000	0.3345	0.0002	0.0001	-0.0042
RohnFaS	0.0000	0.0000	-0.4522	0.0000	0.0000	0.4522	0.0003	0.0000	-0.0034
RohnGaS	0.0000	0.0000	-0.5049	0.0000	0.0000	0.5049	0.0003	0.0000	-0.0025
RohnHaS	0.0000	0.0000	-0.5373	0.0000	0.0000	0.5373	0.0003	0.0000	-0.0015
RohnIaS	0.0000	0.0000	-0.6316	0.0000	0.0000	0.6316	0.0002	-0.0000	-0.0005
SNB-AaS	0.0000	0.0000	-0.1410	0.0000	0.0000	0.1410	0.0011	0.0001	-0.0034
SNB-AbS	0.0000	0.0000	-0.1410	0.0000	0.0000	0.1410	0.0010	0.0001	-0.0034
SNB-AcS	0.0000	0.0000	-0.1410	0.0000	0.0000	0.1410	0.0009	0.0001	-0.0033
SNB-BaS	0.0000	0.0000	-0.1642	0.0000	0.0000	0.1642	0.0007	0.0001	-0.0033
SNB-BbS	0.0000	0.0000	-0.1642	0.0000	0.0000	0.1642	0.0006	0.0001	-0.0032
SNB-BcS	0.0000	0.0000	-0.1642	0.0000	0.0000	0.1642	0.0006	0.0001	-0.0032
SNB-CaS	0.0000	0.0000	-0.2230	0.0000	0.0000	0.2230	0.0005	0.0001	-0.0031
SNB-CbS	0.0000	0.0000	-0.2230	0.0000	0.0000	0.2230	0.0004	0.0001	-0.0030
SNB-DS	0.0000	0.0000	-0.2460	0.0000	0.0000	0.2460	0.0003	0.0001	-0.0027
SNB-DbS	0.0000	0.0000	-0.2460	0.0000	0.0000	0.2460	0.0003	0.0001	-0.0026
SNB-EaS	0.0000	0.0000	-0.3345	0.0000	0.0000	0.3345	0.0002	0.0001	-0.0023
SNB-EbS	0.0000	0.0000	-0.3345	0.0000	0.0000	0.3345	0.0002	0.0001	-0.0022
SNB-FaS	0.0000	0.0000	-0.4522	0.0000	0.0000	0.4522	0.0003	0.0000	-0.0018
SNB-GaS	0.0000	0.0000	-0.5049	0.0000	0.0000	0.5049	0.0003	0.0000	-0.0014
SNB-HaS	0.0000	0.0000	-0.5373	0.0000	0.0000	0.5373	0.0003	0.0000	-0.0009
SNB-IaS	0.0000	0.0000	-0.6316	0.0000	0.0000	0.6316	0.0002	-0.0000	-0.0003
SNB-WL-A1S	0.0000	0.0000	-0.1410	0.0000	0.0000	0.1410	0.0012	0.0001	-0.0035
SNB-WL-A2S	0.0000	0.0000	-0.1410	0.0000	0.0000	0.1410	0.0012	0.0001	-0.0035
SNB-WL-A3S	0.0000	0.0000	-0.1410	0.0000	0.0000	0.1410	0.0012	0.0001	-0.0035
SNB-WL-B1S	0.0000	0.0000	-0.1410	0.0000	0.0000	0.1410	0.0008	0.0001	-0.0035
SNB-WL-B2S	0.0000	0.0000	-0.1410	0.0000	0.0000	0.1410	0.0008	0.0001	-0.0034
SNB-WL-B3S	0.0000	0.0000	-0.1410	0.0000	0.0000	0.1410	0.0008	0.0001	-0.0035
SNB-WL-C1S	0.0000	0.0000	-0.1642	0.0000	0.0000	0.1642	0.0005	0.0001	-0.0035
SNB-WL-C2S	0.0000	0.0000	-0.1642	0.0000	0.0000	0.1642	0.0005	0.0001	-0.0034
SNB-WL-C3S	0.0000	0.0000	-0.1642	0.0000	0.0000	0.1642	0.0005	0.0001	-0.0035
SNB-WL-D1S	0.0000	0.0000	-0.2230	0.0000	0.0000	0.2230	0.0003	0.0001	-0.0037
SNB-WL-D2S	0.0000	0.0000	-0.2230	0.0000	0.0000	0.2230	0.0003	0.0001	-0.0036
SNB-WL-D3S	0.0000	0.0000	-0.2230	0.0000	0.0000	0.2230	0.0003	0.0001	-0.0037
SNB-WL-E1S	0.0000	0.0000	-0.2460	0.0000	0.0000	0.2460	0.0002	0.0001	-0.0030
SNB-WL-E2S	0.0000	0.0000	-0.2460	0.0000	0.0000	0.2460	0.0002	0.0001	-0.0029
SNB-WL-E3S	0.0000	0.0000	-0.2460	0.0000	0.0000	0.2460	0.0002	0.0001	-0.0030
SNB-WL-F1S	0.0000	0.0000	-0.3345	0.0000	0.0000	0.3345	0.0001	0.0000	-0.0032
SNB-WL-F2S	0.0000	0.0000	-0.3345	0.0000	0.0000	0.3345	0.0001	0.0000	-0.0032
SNB-WL-F3S	0.0000	0.0000	-0.3345	0.0000	0.0000	0.3345	0.0001	0.0000	-0.0032
SNB-WL-G1S	0.0000	0.0000	-0.4522	0.0000	0.0000	0.4522	0.0000	0.0000	-0.0037
SNB-WL-G2S	0.0000	0.0000	-0.4522	0.0000	0.0000	0.4522	0.0000	0.0000	-0.0037
SNB-WL-G3S	0.0000	0.0000	-0.4522	0.0000	0.0000	0.4522	0.0000	0.0000	-0.0037
SNB-WL-H1S	0.0000	0.0000	-0.5049	0.0000	0.0000	0.5049	0.0000	0.0000	-0.0041
SNB-WL-H2S	0.0000	0.0000	-0.5049	0.0000	0.0000	0.5049	0.0000	0.0000	-0.0041
SNB-WL-H3S	0.0000	0.0000	-0.5049	0.0000	0.0000	0.5049	0.0000	0.0000	-0.0041
SNB-WL-I1S	0.0000	0.0000	-0.5373	0.0000	0.0000	0.5373	0.0000	0.0000	-0.0046
SNB-WL-I2S	0.0000	0.0000	-0.5373	0.0000	0.0000	0.5373	0.0000	0.0000	-0.0046
SNB-WL-I3S	0.0000	0.0000	-0.5373	0.0000	0.0000	0.5373	0.0000	0.0000	-0.0046
RohnAa1	0.0000	0.0000	-0.2072	0.0000	0.0000	0.2072	0.0011	0.0001	-0.0069
RohnAa2	0.0000	0.0000	-0.2279	0.0000	0.0000	0.2279	0.0011	0.0001	-0.0070
RohnAb1	0.0000	0.0000	-0.2490	0.0000	0.0000	0.2490	0.0010	0.0001	-0.0069
RohnAb2	0.0000	0.0000	-0.1410	0.0000	0.0000	0.1410	0.0010	0.0001	-0.0069
RohnAc1	0.0000	0.0000	-0.1410	0.0000	0.0000	0.1410	0.0009	0.0001	-0.0069
RohnAc2	0.0000	0.0000	-0.1410	0.0000	0.0000	0.1410	0.0009	0.0001	-0.0069
RohnBa1	0.0000	0.0000	-0.1642	0.0000	0.0000	0.1642	0.0007	0.0001	-0.0067
RohnBa2	0.0000	0.0000	-0.1642	0.0000	0.0000	0.1642	0.0007	0.0001	-0.0068
RohnBb1	0.0000	0.0000	-0.8457	0.0000	0.0000	0.8457	0.0006	0.0001	-0.0067
RohnBb2	0.0000	0.0000	-0.8457	0.0000	0.0000	0.8457	0.0006	0.0001	-0.0067
RohnBc1	0.0000	0.0000	-0.1642	0.0000	0.0000	0.1642	0.0005	0.0001	-0.0066
RohnBc2	0.0000	0.0000	-0.1642	0.0000	0.0000	0.1642	0.0005	0.0001	-0.0066
RohnCa1	0.0000	0.0000	-0.7740	0.0000	0.0000	0.7740	0.0004	0.0000	-0.0063

RohnCa2	0.0000	0.0000	-0.8100	0.0000	0.0000	0.8100	0.0004	0.0001	-0.0063
RohnCb1	0.0000	0.0000	-1.2262	0.0000	0.0000	1.2262	0.0003	0.0000	-0.0061
RohnCb2	0.0000	0.0000	-1.2262	0.0000	0.0000	1.2262	0.0003	0.0002	-0.0061
RohnDa1	0.0000	0.0000	-1.0466	0.0000	0.0000	1.0466	0.0002	-0.0000	-0.0055
RohnDa2	0.0000	0.0000	-1.0466	0.0000	0.0000	1.0466	0.0002	0.0002	-0.0055
RohnDb1	0.0000	0.0000	-0.2460	0.0000	0.0000	0.2460	0.0001	-0.0000	-0.0051
RohnDb2	0.0000	0.0000	-0.2460	0.0000	0.0000	0.2460	0.0001	0.0002	-0.0051
RohnEa1	0.0000	0.0000	-0.3345	0.0000	0.0000	0.3345	0.0001	-0.0000	-0.0045
RohnEa2	0.0000	0.0000	-0.3345	0.0000	0.0000	0.3345	0.0001	0.0001	-0.0045
RohnEb1	0.0000	0.0000	-0.3345	0.0000	0.0000	0.3345	0.0001	0.0000	-0.0042
RohnEb2	0.0000	0.0000	-0.3345	0.0000	0.0000	0.3345	0.0001	0.0001	-0.0042
RohnFa1	0.0000	0.0000	-0.4522	0.0000	0.0000	0.4522	-0.0001	-0.0002	-0.0034
RohnFa2	0.0000	0.0000	-0.4522	0.0000	0.0000	0.4522	-0.0001	0.0002	-0.0034
RohnGa1	0.0000	0.0000	-0.5049	0.0000	0.0000	0.5049	-0.0001	-0.0002	-0.0025
RohnGa2	0.0000	0.0000	-0.5049	0.0000	0.0000	0.5049	-0.0001	0.0002	-0.0025
RohnHa1	0.0000	0.0000	-0.5373	0.0000	0.0000	0.5373	-0.0001	-0.0002	-0.0015
RohnHa2	0.0000	0.0000	-0.5373	0.0000	0.0000	0.5373	-0.0001	0.0002	-0.0015
RohnIa1	0.0000	0.0000	-0.6316	0.0000	0.0000	0.6316	-0.0001	-0.0002	-0.0005
RohnIa2	0.0000	0.0000	-0.6316	0.0000	-0.0000	0.6316	-0.0001	0.0002	-0.0005
SNB-Aa1	0.0000	0.0000	-0.1410	0.0000	-0.0000	0.1410	0.0011	0.0001	-0.0033
SNB-Aa2	0.0000	0.0000	-0.1410	0.0000	0.0000	0.1410	0.0011	0.0001	-0.0033
SNB-Ab1	0.0000	0.0000	-0.1410	0.0000	-0.0000	0.1410	0.0010	0.0001	-0.0033
SNB-Ab2	0.0000	0.0000	-0.1410	0.0000	0.0000	0.1410	0.0010	0.0001	-0.0033
SNB-Ac1	0.0000	0.0000	-0.1410	0.0000	-0.0000	0.1410	0.0009	0.0001	-0.0033
SNB-Ac2	0.0000	0.0000	-0.1410	0.0000	0.0000	0.1410	0.0009	0.0001	-0.0033
SNB-Ba1	0.0000	0.0000	-0.1642	0.0000	-0.0000	0.1642	0.0007	0.0001	-0.0032
SNB-Ba2	0.0000	0.0000	-0.1642	0.0000	0.0000	0.1642	0.0007	0.0001	-0.0032
SNB-Bb1	0.0000	0.0000	-0.1642	0.0000	-0.0000	0.1642	0.0006	0.0001	-0.0032
SNB-Bb2	0.0000	0.0000	-0.1642	0.0000	0.0000	0.1642	0.0006	0.0001	-0.0032
SNB-Bc1	0.0000	0.0000	-0.1642	0.0000	-0.0000	0.1642	0.0005	0.0001	-0.0031
SNB-Bc2	0.0000	0.0000	-0.1642	0.0000	0.0000	0.1642	0.0005	0.0001	-0.0031
SNB-Ca1	0.0000	0.0000	-0.2230	0.0000	-0.0000	0.2230	0.0004	0.0000	-0.0030
SNB-Ca2	0.0000	0.0000	-0.2230	0.0000	0.0000	0.2230	0.0004	0.0002	-0.0030
SNB-Cb1	0.0000	0.0000	-0.2230	0.0000	-0.0000	0.2230	0.0003	0.0000	-0.0029
SNB-Cb2	0.0000	0.0000	-0.2230	0.0000	0.0000	0.2230	0.0003	0.0002	-0.0029
SNB-Da1	0.0000	0.0000	-0.2460	0.0000	-0.0000	0.2460	0.0002	-0.0000	-0.0027
SNB-Da2	0.0000	0.0000	-0.2460	0.0000	0.0000	0.2460	0.0002	0.0002	-0.0027
SNB-Db1	0.0000	0.0000	-0.2460	0.0000	-0.0000	0.2460	0.0001	-0.0000	-0.0025
SNB-Db2	0.0000	0.0000	-0.2460	0.0000	0.0000	0.2460	0.0001	0.0002	-0.0025
SNB-Ea1	0.0000	0.0000	-0.3345	0.0000	-0.0000	0.3345	0.0001	-0.0000	-0.0023
SNB-Ea2	0.0000	0.0000	-0.3345	0.0000	0.0000	0.3345	0.0001	0.0001	-0.0023
SNB-Eb1	0.0000	0.0000	-0.3345	0.0000	-0.0000	0.3345	0.0001	0.0000	-0.0022
SNB-Eb2	0.0000	0.0000	-0.3345	0.0000	0.0000	0.3345	0.0001	0.0001	-0.0022
SNB-Fa1	0.0000	0.0000	-0.4522	0.0000	0.0000	0.4522	-0.0001	-0.0002	-0.0018
SNB-Fa2	0.0000	0.0000	-0.4522	0.0000	0.0000	0.4522	-0.0001	0.0002	-0.0018
SNB-Ga1	0.0000	0.0000	-0.5049	0.0000	0.0000	0.5049	-0.0001	-0.0002	-0.0014
SNB-Ga2	0.0000	0.0000	-0.5049	0.0000	0.0000	0.5049	-0.0001	0.0002	-0.0014
SNB-Ha1	0.0000	0.0000	-0.5373	0.0000	0.0000	0.5373	-0.0001	-0.0002	-0.0008
SNB-Ha2	0.0000	0.0000	-0.5373	0.0000	0.0000	0.5373	-0.0001	0.0002	-0.0008
SNB-Ia1	0.0000	0.0000	-0.6316	0.0000	0.0000	0.6316	-0.0001	-0.0002	-0.0003
SNB-Ia2	0.0000	0.0000	-0.6316	0.0000	0.0000	0.6316	-0.0001	0.0002	-0.0003

Moments for Angles Modeled as Beams:

Angle Torsion Label	Origin X (ft-lbs)	Origin Y (ft-lbs)	Origin Moment (ft-lbs)	End X (ft-lbs)	End Y (ft-lbs)	X Shear (lbs)	Y Shear (lbs)
Rohn-LA1P	0.00	0.00	-0.08	-0.41	-2.63	-0.08	-0.54
Rohn-LA11	0.00	-0.06	0.04	-2.44	1.04	-0.50	0.21
Rohn-LA12	-0.00	0.13	0.07	2.15	1.34	0.45	0.28
Rohn-LA2P	0.00	0.41	2.64	0.10	3.73	0.10	1.27
Rohn-LA21	0.00	2.44	-1.03	3.34	-1.74	1.16	-0.55
Rohn-LA22	-0.00	-2.15	-1.33	-3.32	-1.84	-1.09	-0.63
Rohn-LA3P	0.00	-0.10	-3.73	0.02	-5.01	-0.02	-1.75
Rohn-LA31	0.00	-3.34	1.74	-4.43	2.21	-1.55	0.79
Rohn-LA32	-0.00	3.32	1.84	4.40	2.17	1.54	0.80
Rohn-LA4P	0.00	-0.02	5.01	-0.05	7.13	-0.01	2.43
Rohn-LA41	0.00	4.43	-2.20	5.78	-3.32	2.04	-1.10

Rohn-LA42	-0.00	-4.40	-2.16	-5.79	-3.27	-2.04	-1.09
Rohn-LB1P	0.00	0.05	0.05	-7.31	0.10	-8.73	0.03
Rohn-LB11	0.01	-5.80	3.31	-7.20	5.54	-2.60	1.77
Rohn-LB12	-0.01	5.79	3.24	7.27	5.46	2.61	1.74
Rohn-LB2P	0.00	-0.10	8.73	-0.02	10.07	-0.02	3.76
Rohn-LB21	0.01	7.20	-5.54	7.95	-4.85	3.03	-2.08
Rohn-LB22	-0.01	-7.27	-5.46	-7.92	-4.81	-3.04	-2.05
Rohn-LB3P	0.00	0.02	-10.07	0.02	-9.89	0.01	-3.99
Rohn-LB31	0.01	-7.95	4.85	-8.53	5.61	-3.29	2.09
Rohn-LB32	-0.01	7.92	4.82	8.56	5.61	3.29	2.08
Rohn-LB4P	0.00	-0.02	9.89	0.03	10.34	0.00	4.04
Rohn-LB41	0.01	8.53	-5.61	8.42	-4.74	3.39	-2.07
Rohn-LB42	-0.01	-8.56	-5.60	-8.37	-4.74	-3.38	-2.07
Rohn-LC1P	0.00	-0.03	-10.34	0.06	-2.69	0.00	-1.95
Rohn-LC11	0.01	-8.42	4.74	-2.43	2.05	-1.63	1.02
Rohn-LC12	-0.01	8.37	4.74	2.45	2.00	1.62	1.01
Rohn-LC2P	0.00	-0.06	2.69	-0.11	-8.37	-0.02	-0.85
Rohn-LC21	0.01	2.43	-2.05	-7.62	4.48	-0.78	0.36
Rohn-LC22	-0.01	-2.46	-1.99	7.56	4.56	0.76	0.38
Rohn-LC3P	0.00	0.11	8.37	0.05	17.15	0.02	3.83
Rohn-LC31	0.01	7.62	-4.48	14.53	-7.86	3.32	-1.85
Rohn-LC32	-0.01	-7.56	-4.56	-14.43	-7.86	-3.30	-1.86
Rohn-LD1P	0.00	-0.05	-17.15	0.16	-7.00	0.02	-3.62
Rohn-LD11	0.01	-14.53	7.87	-6.57	4.17	-3.17	1.81
Rohn-LD12	-0.01	14.43	7.86	6.70	4.06	3.17	1.79
Rohn-LD2P	0.00	-0.16	7.00	-0.02	-16.58	-0.03	-1.43
Rohn-LD21	0.01	6.57	-4.17	-14.46	9.29	-1.18	0.77
Rohn-LD22	-0.01	-6.70	-4.06	14.56	9.37	1.18	0.80
Rohn-LD3P	0.00	0.02	16.58	0.09	29.21	0.02	6.87
Rohn-LD31	0.01	14.46	-9.29	24.64	-14.04	5.87	-3.50
Rohn-LD32	-0.01	-14.56	-9.37	-24.57	-14.10	-5.87	-3.52
Rohn-LE1P	0.00	-0.09	-29.21	-0.02	-16.93	-0.02	-6.92
Rohn-LE11	0.01	-24.64	14.04	-14.84	8.99	-5.92	3.46
Rohn-LE12	-0.01	24.56	14.10	14.86	9.04	5.92	3.47
Rohn-LE2P	0.00	0.02	16.93	0.04	-11.06	0.01	0.88
Rohn-LE21	0.01	14.84	-8.99	-9.70	6.07	0.77	-0.44
Rohn-LE22	-0.01	-14.86	-9.04	9.82	6.10	-0.75	-0.44
Rohn-LE3P	0.00	-0.04	11.06	0.15	51.99	0.02	9.46
Rohn-LE31	0.01	9.70	-6.07	44.36	-25.49	8.11	-4.73
Rohn-LE32	-0.01	-9.83	-6.09	-44.49	-25.74	-8.15	-4.78
Rohn-LF1P	0.00	-0.15	-51.99	-0.46	-84.74	-0.06	-13.66
Rohn-LF11	0.01	-44.36	25.49	-73.34	42.92	-11.76	6.84
Rohn-LF12	-0.01	44.49	25.74	73.13	43.33	11.75	6.90
Rohn-LF2P	0.00	0.46	84.74	0.26	97.54	0.07	18.22
Rohn-LF21	0.01	73.34	-42.92	83.54	-48.27	15.68	-9.11
Rohn-LF22	-0.01	-73.13	-43.33	-83.80	-48.71	-15.68	-9.20
Rohn-LG1P	0.00	-0.26	-97.54	-0.57	-103.93	-0.08	-20.13
Rohn-LG11	0.01	-83.54	48.27	-89.94	52.36	-17.34	10.06
Rohn-LG12	-0.01	83.80	48.71	89.61	52.84	17.33	10.15
Rohn-LG2P	0.00	0.57	103.93	0.18	112.38	0.07	21.62
Rohn-LG21	0.01	89.94	-52.36	96.54	-55.81	18.63	-10.81
Rohn-LG22	-0.01	-89.61	-52.83	-96.80	-56.17	-18.63	-10.89
Rohn-LH1P	0.00	-0.18	-112.38	-0.33	-123.16	-0.05	-23.54
Rohn-LH11	0.01	-96.54	55.82	-106.55	61.96	-20.29	11.77
Rohn-LH12	-0.01	96.80	56.17	106.35	62.22	20.30	11.83
Rohn-LH2P	0.00	0.33	123.16	0.06	149.15	0.04	27.21
Rohn-LH21	0.01	106.55	-61.96	128.34	-74.24	23.47	-13.61
Rohn-LH22	-0.01	-106.35	-62.22	-128.68	-74.50	-23.49	-13.66
Rohn-LI1P	0.00	-0.06	-149.15	-0.58	-203.16	-0.06	-35.21
Rohn-LI11	0.01	-128.34	74.24	-175.97	102.38	-30.41	17.65
Rohn-LI12	-0.01	128.68	74.50	175.50	102.77	30.40	17.71
Rohn-LI2P	0.00	0.58	203.16	0.40	207.23	0.10	41.01
Rohn-LI21	0.01	175.97	-102.38	178.79	-103.75	35.45	-20.60
Rohn-LI22	-0.01	-175.50	-102.77	-178.81	-104.22	-35.41	-20.68
Rohn-H1P	-0.00	-0.06	-0.00	0.05	-0.00	-0.00	-0.00
Rohn-H11	0.00	-0.04	0.00	0.08	0.00	0.01	0.00
Rohn-H12	-0.00	-0.08	-0.00	0.04	-0.00	-0.01	-0.00
Rohn-H2P	-0.00	-0.10	-0.00	-0.02	-0.00	-0.01	-0.00
Rohn-H21	-0.00	-0.03	-0.00	0.02	0.00	-0.00	-0.00

Rohn-H22	0.00	0.03	0.00	0.10	0.00	0.02	0.00
SNB-LA1P	-0.00	-0.05	56.90	-0.04	10.86	-0.02	13.54
SNB-LA11	0.00	49.20	-28.44	9.38	-5.45	11.71	-6.77
SNB-LA12	-0.00	-49.45	-28.53	-9.60	-5.54	-11.80	-6.81
SNB-LA2P	-0.00	0.04	-10.86	-0.09	3.81	-0.01	-1.41
SNB-LA21	0.00	-9.38	5.45	3.17	-2.12	-1.24	0.67
SNB-LA22	-0.00	9.60	5.54	-3.25	-2.06	1.27	0.70
SNB-LA3P	-0.00	0.09	-3.81	-0.01	-16.22	0.02	-4.00
SNB-LA31	0.00	-3.17	2.13	-13.67	8.30	-3.36	2.08
SNB-LA32	-0.00	3.25	2.06	13.60	8.26	3.37	2.06
SNB-LA4P	-0.00	0.01	16.22	0.02	48.86	0.01	13.01
SNB-LA41	0.00	13.67	-8.29	41.28	-23.94	10.98	-6.44
SNB-LA42	-0.00	-13.60	-8.26	-41.18	-23.91	-10.95	-6.43
SNB-LB1P	-0.00	0.03	83.34	0.05	5.72	0.02	17.80
SNB-LB11	0.02	72.13	-41.08	4.65	-1.25	15.34	-8.46
SNB-LB12	-0.02	-72.01	-41.04	-4.55	-1.24	-15.30	-8.45
SNB-LB2P	-0.00	-0.05	-5.72	0.03	22.06	-0.00	3.27
SNB-LB21	0.02	-4.65	1.25	17.95	-10.10	2.66	-1.77
SNB-LB22	-0.02	4.55	1.24	-17.86	-10.09	-2.66	-1.77
SNB-LB3P	-0.00	-0.03	-22.06	0.06	-49.03	0.01	-14.21
SNB-LB31	0.02	-17.95	10.11	-42.48	26.04	-12.08	7.22
SNB-LB32	-0.02	17.86	10.09	42.57	26.02	12.08	7.22
SNB-LB4P	-0.00	-0.06	49.04	-0.01	135.01	-0.01	36.78
SNB-LB41	0.02	42.48	-26.04	115.87	-67.16	31.65	-18.63
SNB-LB42	-0.02	-42.57	-26.02	-115.83	-67.13	-31.66	-18.62
SNB-LC1P	-0.00	0.00	76.55	0.02	29.29	0.00	15.88
SNB-LC11	0.02	67.41	-38.77	25.31	-13.64	13.91	-7.86
SNB-LC12	-0.02	-67.48	-38.81	-25.31	-13.66	-13.92	-7.87
SNB-LC2P	-0.00	-0.02	-29.29	0.03	-54.17	0.00	-12.49
SNB-LC21	0.02	-25.31	13.65	-47.20	27.94	-10.85	6.22
SNB-LC22	-0.01	25.31	13.66	47.20	27.90	10.85	6.22
SNB-LC3P	-0.00	-0.03	54.18	-0.01	161.71	-0.01	32.39
SNB-LC31	0.02	47.20	-27.93	139.25	-80.59	27.97	-16.28
SNB-LC32	-0.01	-47.20	-27.90	-139.13	-80.52	-27.96	-16.27
SNB-LD1P	-0.00	0.02	190.95	0.13	55.51	0.02	36.98
SNB-LD11	0.01	166.27	-95.93	47.72	-26.31	32.11	-18.34
SNB-LD12	-0.01	-166.33	-95.99	-47.58	-26.38	-32.09	-18.36
SNB-LD2P	-0.00	-0.13	-55.51	0.06	-73.39	-0.01	-19.28
SNB-LD21	0.01	-47.72	26.31	-63.71	37.94	-16.67	9.61
SNB-LD22	-0.01	47.58	26.38	63.91	37.99	16.68	9.63
SNB-LD3P	-0.00	-0.06	73.39	0.03	179.97	-0.00	38.01
SNB-LD31	0.01	63.71	-37.94	154.57	-89.39	32.75	-19.10
SNB-LD32	-0.01	-63.91	-37.98	-154.55	-89.41	-32.78	-19.11
SNB-LE1P	-0.00	-0.07	273.59	0.16	76.09	0.01	52.47
SNB-LE11	0.02	238.22	-137.62	65.56	-36.29	45.58	-26.09
SNB-LE12	-0.02	-238.42	-137.66	-65.41	-36.39	-45.59	-26.11
SNB-LE2P	-0.00	-0.16	-76.09	-0.08	-164.37	-0.04	-35.97
SNB-LE21	0.02	-65.56	36.29	-142.75	83.64	-31.16	17.94
SNB-LE22	-0.02	65.41	36.39	142.98	83.87	31.17	17.99
SNB-LE3P	-0.00	0.08	164.37	0.08	567.96	0.02	109.88
SNB-LE31	0.02	142.75	-83.64	490.26	-283.80	94.97	-55.13
SNB-LE32	-0.02	-142.98	-83.86	-490.76	-284.18	-95.08	-55.22
SNB-LF1P	0.00	-0.17	146.16	-0.42	-171.39	-0.06	-2.52
SNB-LF11	0.01	128.25	-73.66	-147.73	87.17	-1.95	1.35
SNB-LF12	-0.01	-128.10	-73.38	147.56	87.56	1.95	1.42
SNB-LF2P	0.01	0.42	171.39	0.11	549.38	0.05	72.02
SNB-LF21	0.01	147.73	-87.17	473.53	-274.63	62.08	-36.15
SNB-LF22	-0.01	-147.56	-87.56	-474.21	-275.14	-62.13	-36.24
SNB-LG1P	0.01	-0.15	564.93	-1.00	-250.45	-0.11	31.42
SNB-LG11	0.01	491.48	-283.02	-216.44	127.26	27.48	-15.56
SNB-LG12	-0.02	-490.91	-282.52	215.70	127.98	-27.50	-15.44
SNB-LG2P	0.01	1.00	250.45	0.29	995.76	0.13	124.53
SNB-LG21	0.01	216.44	-127.26	859.78	-497.73	107.54	-62.45
SNB-LG22	-0.02	-215.70	-127.98	-860.59	-498.53	-107.55	-62.60
SNB-LH1P	0.01	-0.30	424.51	-1.06	-276.34	-0.14	14.81
SNB-LH11	0.01	370.06	-212.90	-238.81	139.67	13.12	-7.32
SNB-LH12	-0.02	-369.27	-212.11	238.14	140.51	-13.10	-7.15
SNB-LH2P	0.01	1.06	276.35	0.40	887.86	0.15	116.33
SNB-LH21	0.01	238.81	-139.67	766.43	-443.60	100.45	-58.28

SNB-LH22	-0.02	-238.14	-140.51	-767.20	-444.51	-100.46	-58.46
SNB-LI1P	0.01	-0.39	803.09	-1.50	-173.81	-0.19	62.88
SNB-LI11	0.00	697.84	-402.47	-150.43	88.94	54.70	-31.33
SNB-LI12	-0.01	-697.01	-401.54	149.28	90.00	-54.73	-31.13
SNB-LI2P	0.01	1.50	173.82	0.85	358.00	0.23	53.14
SNB-LI21	0.00	150.43	-88.94	308.22	-179.34	45.83	-26.81
SNB-LI22	-0.01	-149.28	-90.00	-308.41	-180.42	-45.73	-27.02
SNB-H1aP	-0.01	32.90	-0.12	109.62	-0.09	70.54	-0.10
SNB-H1bP	-0.01	-109.62	0.09	-32.83	0.12	-70.51	0.10
SNB-H1cP	-0.00	32.79	-0.12	109.60	-0.12	70.47	-0.12
SNB-H1dP	0.00	-109.60	0.12	-32.99	0.11	-70.57	0.11
SNB-H1eP	0.01	32.93	-0.11	109.62	-0.13	70.55	-0.12
SNB-H1fP	0.01	-109.62	0.13	-32.80	0.12	-70.49	0.12
SNB-H2aP	-0.04	76.30	0.16	114.93	0.16	70.75	0.12
SNB-H2bP	-0.04	-114.93	-0.16	-75.06	-0.17	-70.29	-0.12
SNB-H2cP	-0.00	75.86	0.14	114.84	0.15	70.55	0.11
SNB-H2dP	-0.00	-114.84	-0.15	-75.69	-0.14	-70.49	-0.11
SNB-H2eP	0.04	74.98	0.17	114.92	0.16	70.26	0.12
SNB-H2fP	0.04	-114.92	-0.16	-76.39	-0.16	-70.78	-0.12
SNB-H3aP	0.00	122.15	1.06	155.57	1.04	82.06	0.62
SNB-H3bP	0.00	-155.57	-1.04	-122.26	-1.05	-82.09	-0.62
SNB-H3cP	-0.00	122.19	1.06	155.57	1.09	82.07	0.64
SNB-H3dP	0.00	-155.57	-1.09	-122.21	-1.06	-82.08	-0.64
SNB-H3eP	-0.00	122.27	1.06	155.57	1.04	82.09	0.62
SNB-H3fP	-0.00	-155.57	-1.04	-122.14	-1.06	-82.05	-0.62
SNB-H4aP	-0.01	203.60	1.99	249.55	1.97	111.45	0.97
SNB-H4bP	-0.01	-249.55	-1.97	-203.72	-1.99	-111.48	-0.97
SNB-H4cP	-0.00	203.71	1.99	249.53	2.03	111.47	0.99
SNB-H4dP	-0.00	-249.53	-2.03	-203.66	-1.99	-111.46	-0.99
SNB-H4eP	0.01	203.70	1.99	249.55	1.97	111.47	0.97
SNB-H4fP	0.01	-249.54	-1.97	-203.62	-1.99	-111.45	-0.97
SNB-H5aP	-0.00	261.90	2.80	321.78	2.79	122.97	1.18
SNB-H5bP	-0.00	-321.78	-2.79	-261.98	-2.81	-122.98	-1.18
SNB-H5cP	-0.00	261.88	2.80	321.78	2.84	122.96	1.19
SNB-H5dP	0.00	-321.78	-2.84	-262.02	-2.80	-122.99	-1.19
SNB-H5eP	0.00	262.05	2.81	321.78	2.79	123.00	1.18
SNB-H5fP	0.00	-321.78	-2.79	-261.83	-2.81	-122.95	-1.18
SNB-H6aP	-0.02	412.39	2.83	495.06	2.82	167.17	1.04
SNB-H6bP	-0.02	-495.06	-2.82	-412.53	-2.83	-167.20	-1.04
SNB-H6cP	0.01	412.35	2.84	495.02	2.87	167.16	1.05
SNB-H6dP	0.01	-495.02	-2.87	-412.64	-2.83	-167.21	-1.05
SNB-H6eP	0.02	412.66	2.83	495.07	2.82	167.22	1.04
SNB-H6fP	0.02	-495.07	-2.82	-412.23	-2.84	-167.14	-1.04
SNB-H7aP	-0.01	643.38	0.71	737.70	0.72	226.04	0.23
SNB-H7bP	-0.01	-737.70	-0.72	-643.54	-0.72	-226.07	-0.24
SNB-H7cP	0.01	643.42	0.72	737.70	0.74	226.05	0.24
SNB-H7dP	0.01	-737.70	-0.74	-643.52	-0.72	-226.06	-0.24
SNB-H7eP	0.00	643.57	0.72	737.72	0.72	226.08	0.24
SNB-H7fP	0.00	-737.72	-0.72	-643.32	-0.72	-226.04	-0.24
SNB-H8aP	0.00	820.00	0.80	893.83	0.80	252.39	0.24
SNB-H8bP	0.00	-893.84	-0.80	-820.10	-0.80	-252.40	-0.23
SNB-H8cP	0.00	820.03	0.80	893.85	0.81	252.39	0.24
SNB-H8dP	0.00	-893.85	-0.81	-820.05	-0.80	-252.40	-0.24
SNB-H8eP	-0.00	820.10	0.79	893.84	0.79	252.40	0.23
SNB-H8fP	-0.00	-893.84	-0.79	-819.98	-0.80	-252.38	-0.23
SNB-H9aP	-0.00	976.26	0.58	1030.80	0.58	268.61	0.16
SNB-H9bP	-0.00	-1030.80	-0.58	-976.39	-0.58	-268.63	-0.16
SNB-H9cP	0.00	976.36	0.58	1030.80	0.59	268.62	0.16
SNB-H9dP	0.00	-1030.80	-0.59	-976.31	-0.59	-268.62	-0.16
SNB-H9eP	0.00	976.37	0.58	1030.80	0.57	268.62	0.15
SNB-H9fP	0.00	-1030.80	-0.57	-976.28	-0.58	-268.61	-0.15

Printed capacities do not include the strength factor entered for each load case.
 The Group Summary reports on the member and load case that resulted in maximum usage
 which may not necessarily be the same as that which produces maximum force.

Group Summary (Compression Portion):

Group Label	Group Desc.	Angle Type	Angle Size	Steel Strength (ksi)	Max Usage %	Max Use In Comp. %	Comp. Control Member	Comp. Force (kips)	Comp. Control Load Case	L/R Capacity (kips)	Comp. Shear Capacity (kips)	Comp. Bearing Capacity (kips)	RLX	RLY	RLZ	L/R Length (ft)	Curve No.	No. Of Bolts Comp.
Rohn-D1	Rohn Diagonal 1	SAE	1.75X1.75X0.1875	36.0	39.98	39.98	Rohn-DA61	-1.9291: 1.2D +		4.825	12.433	13.050	0.500	0.500	0.500	170.38	9.740	4 1
Rohn-D2	Rohn Diagonal 2	SAE	2X2X0.1875	36.0	85.01	85.01	Rohn-DB61	-4.9181: 1.2D +		5.786	12.433	13.050	0.500	0.500	0.500	166.50	10.934	4 1
Rohn-D3	Rohn Diagonal 3	SAE	2.5X2.5X0.1875	36.0	80.35	80.35	Rohn-DC41	-6.8041: 1.2D +		8.468	12.433	13.050	0.500	0.500	0.500	155.13	12.798	4 1
Rohn-D4	Rohn Diagonal 4	SAE	2.5X2.5X0.25	36.0	85.88	85.88	Rohn-DD21	-8.3961: 1.2D +		9.776	12.433	17.400	0.500	0.500	0.500	165.83	13.570	4 1
Rohn-D5	Rohn Diagonal 5	SAE	3X3X0.25	50.0	77.70	77.70	Rohn-DE61	-9.6611: 1.2D +		13.033	12.433	19.500	0.500	0.500	0.500	157.99	15.589	4 1
Rohn-D6	Rohn Diagonal 6	SAE	3.5X3.5X0.25	50.0	94.19	94.19	Rohn-DF32	-11.7121: 1.2D +		15.227	12.433	19.500	0.500	0.500	0.500	158.34	18.315	4 1
Rohn-D7	Rohn Diagonal 7	SAE	4X4X0.25	50.0	83.19	83.19	Rohn-DH12	-10.3431: 1.2D +		19.124	12.433	19.500	0.500	0.500	0.500	151.38	20.058	4 1
Rohn-L1	Rohn Leg 1	Pipe	Pipe3EH	50.0	10.75	10.75	Rohn-LA4P	-11.1821: 1.2D +		103.968	0.000	0.000	1.000	1.000	1.000	52.67	5.004	1 0
Rohn-L2	Rohn Leg 2	Pipe	Pipe3.5EH	50.0	29.08	29.08	Rohn-LB4P	-38.6001: 1.2D +		132.756	0.000	0.000	1.000	1.000	1.000	45.84	5.004	1 0
Rohn-L3	Rohn Leg 3	Pipe	Pipe4EH	50.0	50.99	50.99	Rohn-LC3P	-76.7221: 1.2D +		150.478	0.000	0.000	1.000	1.000	1.000	54.04	6.665	1 0
Rohn-L4	Rohn Leg 4	Pipe	Pipe5STD	50.0	81.28	81.28	Rohn-LD3P	-129.1271: 1.2D +		158.870	0.000	0.000	1.000	1.000	1.000	42.54	6.665	1 0
Rohn-L5	Rohn Leg 5	Pipe	Pipe5EH	50.0	77.58	77.58	Rohn-LE3P	-174.1791: 1.2D +		224.520	0.000	0.000	1.000	1.000	1.000	43.23	6.665	1 0
Rohn-L6	Rohn Leg 6	Pipe	Pipe6EHS	50.0	80.00	80.00	Rohn-LF1P	-195.0311: 1.2D +		243.786	0.000	0.000	1.000	1.000	1.000	54.10	10.008	1 0
Rohn-L7	Rohn Leg 7	Pipe	Pipe6EH	50.0	92.59	92.59	Rohn-LG2P	-264.0551: 1.2D +		285.178	0.000	0.000	1.000	1.000	1.000	54.59	10.008	1 0
Rohn-L8	Rohn Leg 8	Pipe	Pipe8EHS	50.0	83.60	83.60	Rohn-LI1P	-328.8561: 1.2D +		393.385	0.000	0.000	1.000	1.000	1.000	40.57	10.008	1 0
Rohn-H1	Rohn Horizontal 1	SAE	1.75X1.75X0.1875	36.0	2.54	2.54	Rohn-H12	-0.2061: 1.2D +		8.108	0.000	0.000	0.500	0.500	0.500	131.28	7.505	4 0
SNB-D1	SNB Diagonal 1	SAE	2X2X0.3125	36.0	11.97	11.82	SNB-DA72	-1.4701: 1.2D +		19.391	12.433	21.750	0.500	0.500	0.500	111.38	7.240	1 1
SNB-D2	SNB Diagonal 2	SAE	2X2X0.25	36.0	28.60	28.60	SNB-DB72	-3.5561: 1.2D +		13.020	12.433	17.400	0.500	0.500	0.500	127.05	8.279	4 1
SNB-D3	SNB Diagonal 3	SAE	2.5X2.5X0.3125	36.0	76.71	76.71	SNB-DD61	-9.5371: 1.2D +		16.821	12.433	21.750	0.500	0.500	0.500	140.03	11.412	4 1
SNB-D4	SNB Diagonal 4	SAE	3X3X0.5	36.0	71.30	71.30	SNB-DE12	-12.7631: 1.2D +		41.188	17.901	41.760	0.500	0.500	0.500	121.07	11.784	4 1
SNB-D5	SNB Diagonal 5	SAE	4X4X0.5	36.0	69.06	69.06	SNB-DF41	-12.3632: 0.9D +		57.545	17.901	41.760	0.500	0.500	0.500	119.15	15.529	1 1
SNB-D6	SNB Diagonal 6	SAE	4X4X0.625	36.0	91.41	91.41	SNB-DH12	-16.3642: 0.9D +		59.660	17.901	52.200	0.500	0.500	0.500	132.03	17.142	4 1
SNB-D7	SNB Diagonal 7	SAE	5X5X0.625	36.0	0.00	0.00		0.000		0.000	0.000	0.000	0.000	0.000	0.00	0.000	0 0	
SNB-L1	SNB Leg 1	Pipe	P3-437	36.0	7.63	7.63	SNB-LA4P	-8.8511: 1.2D +		115.987	0.000	0.000	1.000	1.000	1.000	55.09	5.004	1 0
SNB-L2	SNB Leg 2	Pipe	P4-494	36.0	45.88	45.88	SNB-LC3P	-78.1191: 1.2D +		170.256	0.000	0.000	1.000	1.000	1.000	56.33	6.665	1 0
SNB-L3	SNB Leg 3	Pipe	Pipe5EH	36.0	82.04	82.04	SNB-LD3P	-137.7931: 1.2D +		167.960	0.000	0.000	1.000	1.000	1.000	43.23	6.665	1 0
SNB-L4	SNB Leg 4	Pipe	P6-562	36.0	92.27	92.27	SNB-LF2P	-271.4381: 1.2D +		294.167	0.000	0.000	1.000	1.000	1.000	55.86	10.008	1 0
SNB-L5	SNB Leg 5	Pipe	Pipe8XS	36.0	99.89	99.89	SNB-LH2P	-411.9051: 1.2D +		412.353	0.000	0.000	0.250	0.250	0.250	10.42	10.008	1 0
SNB-L6	SNB Leg 6	Pipe	Pipe10XS	36.0	95.26	95.26	SNB-LI2P	-489.8271: 1.2D +		514.179	0.000	0.000	0.500	0.500	0.500	16.54	10.008	1 0
Connect	Connect Towers	BIG	0.1X0.1X1	36.0	0.03	0.01	Connect I2	-2.9152: 0.9D +		25912.070	0.000	0.000	1.000	1.000	1.000	2.40	2.002	1 0
SNB-H1	SNB Horizontal 1	Pipe	P3-425	36.0	2.17	2.17	SNB-H4cP	-2.5992: 0.9D +		119.859	0.000	0.000	1.000	1.000	1.000	44.46	4.066	1 0
SNB-H2	SNB Horizontal 2	Pipe	P4-494	36.0	3.94	3.94	SNB-H9cP	-6.4192: 0.9D +		163.108	0.000	0.000	1.000	1.000	1.000	63.14	7.472	1 0
Rohn-D8	Rohn Diagonal 8	SAE	2X2X0.375	36.0	0.00	0.00		0.000		0.000	0.000	0.000	0.000	0.000	0.00	0.000	0 0	
WLAC-1	Wind Lacing 1	SAE	2X2X0.25	36.0	1.66	1.66	SNB-WL-D2P	-0.2222: 0.9D +		13.417	0.000	0.000	1.000	1.000	1.000	124.79	4.066	4 0
WLAC-2	Wind Lacing 2	SAE	2.5X2.5X0.3125	36.0	3.50	3.50	SNB-WL-I2P	-0.3431: 1.2D +		9.810	0.000	0.000	1.000	1.000	1.000	183.36	7.472	4 0
R-D1-MOD	MODIFICATION - L1.75X1.75x3/16	SAE	1.75X1.75X0.1875	50.0	0.00	0.00		0.000		0.000	0.000	0.000	0.000	0.000	0.00	0.000	0 0	
R-D2-MOD	MODIFICATION - L2X2x3/16	SAE	2X2X0.1875	50.0	0.00	0.00		0.000		0.000	0.000	0.000	0.000	0.000	0.00	0.000	0 0	
R-D3-MOD	MODIFICATION - L2.5X2.5x1/4	SAE	2.5X2.5X0.25	50.0	87.77	87.77	Rohn-DC61	-9.1001: 1.2D +		10.368	12.433	19.500	0.500	0.500	0.500	161.02	13.177	4 1
R-D4-MOD	MODIFICATION - L3x3x1/4	SAE	3X3X0.25	50.0	81.41	81.41	Rohn-DD41	-10.1221: 1.2D +		16.211	12.433	19.500	0.500	0.500	0.500	141.66	13.977	4 1
R-D5-MOD	MODIFICATION - L3X3x1/4	SAE	3X3X0.25	50.0	0.00	0.00		0.000		0.000	0.000	0.000	0.000	0.000	0.00	0.000	0 0	
R-D6-MOD	MODIFICATION - L3.5X3.5x5/16	SAE	3.5X3.5X0.3125	50.0	0.00	0.00		0.000		0.000	0.000	0.000	0.000	0.000	0.00	0.000	0 0	
R-D7-MOD	MODIFICATION - L4X4x5/16	SAE	4X4X0.3125	50.0	80.14	80.14	Rohn-DH32	-12.4551: 1.2D +		22.091	15.542	24.375	0.500	0.500	0.500	156.66	20.653	4 1
S-D1-MOD	MODIFICATION - L2X2x5/16	SAE	2X2X0.3125	50.0	0.00	0.00		0.000		0.000	0.000	0.000	0.000	0.000	0.00	0.000	0 0	
S-D2-MOD	MODIFICATION - L2x2x1/4	SAE	2X2X0.25	50.0	0.00	0.00		0.000		0.000	0.000	0.000	0.000	0.000	0.00	0.000	0 0	
S-D3-MOD	MODIFICATION - L2.5X2.5x5/16	SAE	2.5X2.5X0.3125	50.0	0.00	0.00		0.000		0.000	0.000	0.000	0.000	0.000	0.00	0.000	0 0	
S-D4-MOD	MODIFICATION - L3.5X3.5x3/8	SAE	3.5X3.5X0.375	50.0	0.00	0.00		0.000		0.000	0.000	0.000	0.000	0.000	0.00	0.000	0 0	
S-D5-MOD	MODIFICATION - L4X4x0.5	SAE	4X4X0.5	50.0	0.00	0.00		0.000		0.000	0.000	0.000	0.000	0.000	0.00	0.000	0 0	
S-D6-MOD	MODIFICATION - L5X5x3/8	SAE	5X5X0.375	50.0	67.08	67.08	SNB-DH32	-15.0102: 0.9D +		70.032	22.376	35.100	0.500	0.500	0.500	107.27	17.700	1 1
S-D7-MOD	MODIFICATION - L6X6x3/8	SAE	6X6X0.375	50.0	91.87	91.87	SNB-DI32	-20.5582: 0.9D +		95.638	22.376	35.100	0.500	0.500	0.500	94.99	18.841	1 1

Group Summary (Tension Portion):

Group	Group Angle	Angle	Steel	Max	Max	Tension	Tension	Tension	Net Tens.	Conn. Tens.	Conn. Tens.	Conn. Tens.	Conn. Tens.	Length	No. Of	No. Of	Hole
-------	-------------	-------	-------	-----	-----	---------	---------	---------	-----------	-------------	-------------	-------------	-------------	--------	--------	--------	------

Label	Desc.	Type	Size	Strength	Usage	Use In	Control	Force	Control	Section	Shear	Bearing	Rupture	Tens.	Bolts	Holes	Diameter
				(ksi)	%	Tens.	Member	(kips)	Load Case	Capacity	Capacity	Capacity	Capacity	Member	Tens.		(in)
						%				(kips)	(kips)	(kips)	(kips)	(ft)			
Rohn-D1	Rohn Diagonal	1	SAE 1.75X1.75X0.1875	36.0	39.98	23.80	Rohn-DA8P	1.8452:	0.9D +	16.022	12.433	13.050	7.750	10.034	1	1.000	0.6875
Rohn-D2	Rohn Diagonal	2	SAE 2X2X0.1875	36.0	85.01	52.18	Rohn-DB7P	4.5762:	0.9D +	18.958	12.433	13.050	8.770	11.238	1	1.000	0.6875
Rohn-D3	Rohn Diagonal	3	SAE 2.5X2.5X0.1875	36.0	80.35	57.04	Rohn-DC3P	5.5831:	1.2D +	25.222	12.433	13.050	9.787	12.798	1	1.000	0.6875
Rohn-D4	Rohn Diagonal	4	SAE 2.5X2.5X0.25	36.0	85.88	54.84	Rohn-DD1P	6.8182:	0.9D +	33.216	12.433	17.400	13.050	13.570	1	1.000	0.6875
Rohn-D5	Rohn Diagonal	5	SAE 3X3X0.25	50.0	77.70	70.46	Rohn-DE5P	8.7612:	0.9D +	46.366	12.433	19.500	14.625	15.589	1	1.000	0.6875
Rohn-D6	Rohn Diagonal	6	SAE 3.5X3.5X0.25	50.0	94.19	83.46	Rohn-DF1P	10.3772:	0.9D +	55.506	12.433	19.500	14.625	17.748	1	1.000	0.6875
Rohn-D7	Rohn Diagonal	7	SAE 4X4X0.25	50.0	83.19	78.44	Rohn-DH2P	9.7532:	0.9D +	64.647	12.433	19.500	14.625	20.058	1	1.000	0.6875
Rohn-L1	Rohn Leg	1	Pipe Pipe3EH	50.0	10.75	3.33	Rohn-LA42	4.2412:	0.9D +	127.350	0.000	0.000	0.000	5.004	0	0.000	0
Rohn-L2	Rohn Leg	2	Pipe Pipe3.5EH	50.0	29.08	9.81	Rohn-LB42	15.1912:	0.9D +	154.800	0.000	0.000	0.000	5.004	0	0.000	0
Rohn-L3	Rohn Leg	3	Pipe Pipe4EH	50.0	50.99	16.39	Rohn-LC32	30.5322:	0.9D +	186.300	0.000	0.000	0.000	6.665	0	0.000	0
Rohn-L4	Rohn Leg	4	Pipe Pipe5TD	50.0	81.28	29.70	Rohn-LD32	53.8652:	0.9D +	181.350	0.000	0.000	0.000	6.665	0	0.000	0
Rohn-L5	Rohn Leg	5	Pipe Pipe5EH	50.0	77.58	28.86	Rohn-LE32	74.2802:	0.9D +	257.400	0.000	0.000	0.000	6.665	0	0.000	0
Rohn-L6	Rohn Leg	6	Pipe Pipe6EHS	50.0	80.00	31.28	Rohn-LF22	94.4572:	0.9D +	301.950	0.000	0.000	0.000	10.008	0	0.000	0
Rohn-L7	Rohn Leg	7	Pipe Pipe6EH	50.0	92.59	37.66	Rohn-LH22	133.5252:	0.9D +	354.599	0.000	0.000	0.000	10.008	0	0.000	0
Rohn-L8	Rohn Leg	8	Pipe Pipe8EHS	50.0	83.60	33.71	Rohn-LI22	149.5632:	0.9D +	443.699	0.000	0.000	0.000	10.008	0	0.000	0
Rohn-H1	Rohn Horizontal	1	SAE 1.75X1.75X0.1875	36.0	2.54	1.11	Rohn-H11	0.2242:	0.9D +	20.088	0.000	0.000	0.000	7.505	0	0.000	0
SNB-D1	SNB Diagonal	1	SAE 2X2X0.3125	36.0	11.97	11.97	SNB-DA7P	1.4891:	1.2D +	30.509	12.433	21.750	14.616	7.240	1	1.000	0.6875
SNB-D2	SNB Diagonal	2	SAE 2X2X0.25	36.0	28.60	28.25	SNB-DB6P	3.3031:	1.2D +	25.060	12.433	17.400	11.693	8.011	1	1.000	0.6875
SNB-D3	SNB Diagonal	3	SAE 2.5X2.5X0.3125	36.0	76.71	72.64	SNB-DD3P	9.0311:	1.2D +	40.623	12.433	21.750	16.312	11.059	1	1.000	0.6875
SNB-D4	SNB Diagonal	4	SAE 3X3X0.5	36.0	71.30	66.08	SNB-DE4P	11.8291:	1.2D +	76.465	17.901	41.760	31.494	12.172	1	1.000	0.8125
SNB-D5	SNB Diagonal	5	SAE 4X4X0.5	36.0	69.06	64.14	SNB-DF2P	11.4811:	1.2D +	109.090	17.901	41.760	31.494	15.014	1	1.000	0.8125
SNB-D6	SNB Diagonal	6	SAE 4X4X0.625	36.0	91.41	76.59	SNB-DH2P	13.7111:	1.2D +	133.834	17.901	52.200	39.367	17.142	1	1.000	0.8125
SNB-D7	SNB Diagonal	7	SAE 5X5X0.625	36.0	0.00	0.00		0.000		0.000	0.000	0.000	0.000	0.000	0	0.000	0
SNB-L1	SNB Leg	1	Pipe P3-437	36.0	7.63	2.32	SNB-LA42	3.1542:	0.9D +	136.080	0.000	0.000	0.000	5.004	0	0.000	0
SNB-L2	SNB Leg	2	Pipe P4-494	36.0	45.88	17.26	SNB-LC32	34.7222:	0.9D +	201.204	0.000	0.000	0.000	6.665	0	0.000	0
SNB-L3	SNB Leg	3	Pipe Pipe5EH	36.0	82.04	33.79	SNB-LD32	62.6292:	0.9D +	185.328	0.000	0.000	0.000	6.665	0	0.000	0
SNB-L4	SNB Leg	4	Pipe P6-562	36.0	92.27	35.75	SNB-LF22	123.9222:	0.9D +	346.679	0.000	0.000	0.000	10.008	0	0.000	0
SNB-L5	SNB Leg	5	Pipe Pipe8XS	36.0	99.89	45.21	SNB-LH22	187.4862:	0.9D +	414.719	0.000	0.000	0.000	10.008	0	0.000	0
SNB-L6	SNB Leg	6	Pipe Pipe10XS	36.0	95.26	42.67	SNB-LI22	222.5602:	0.9D +	521.639	0.000	0.000	0.000	10.008	0	0.000	0
Connect	Connect Towers	BIG	0.1X0.1X1	36.0	0.03	0.03	Connect IP	7.1811:	1.2D +	25919.960	0.000	0.000	0.000	2.002	0	0.000	0
SNB-H1	SNB Horizontal	1	Pipe P3-425	36.0	2.17	1.55	SNB-H4eP	2.0561:	1.2D +	133.002	0.000	0.000	0.000	4.066	0	0.000	0
SNB-H2	SNB Horizontal	2	Pipe P4-494	36.0	3.94	1.87	SNB-H9bP	3.7551:	1.2D +	201.204	0.000	0.000	0.000	7.472	0	0.000	0
Rohn-D8	Rohn Diagonal	8	SAE 2X2X0.375	36.0	0.00	0.00		0.000		0.000	0.000	0.000	0.000	0.000	0	0.000	0
WLAC-1	Wind Lacing	1	SAE 2X2X0.25	36.0	1.66	1.47	SNB-WL-D3P	0.4471:	1.2D +	30.456	0.000	0.000	0.000	4.066	0	0.000	0
WLAC-2	Wind Lacing	2	SAE 2.5X2.5X0.3125	36.0	3.50	1.45	SNB-WL-I3P	0.6861:	1.2D +	47.304	0.000	0.000	0.000	7.472	0	0.000	0
R-D1-MOD	MODIFICATION - L1.75X1.75x3/16	SAE	1.75X1.75X0.1875	50.0	0.00	0.00		0.000		0.000	0.000	0.000	0.000	0.000	0	0.000	0
R-D2-MOD	MODIFICATION - L2X2x3/16	SAE	2X2X0.1875	50.0	0.00	0.00		0.000		0.000	0.000	0.000	0.000	0.000	0	0.000	0
R-D3-MOD	MODIFICATION - L2.5X2.5x1/4	SAE	2.5X2.5X0.25	50.0	87.77	64.19	Rohn-DC5P	7.9812:	0.9D +	37.225	12.433	19.500	14.625	13.177	1	1.000	0.6875
R-D4-MOD	MODIFICATION - L3x3x1/4	SAE	3X3X0.25	50.0	81.41	78.63	Rohn-DD3P	9.7761:	1.2D +	46.366	12.433	19.500	14.625	13.977	1	1.000	0.6875
R-D5-MOD	MODIFICATION - L3X3x1/4	SAE	3X3X0.25	50.0	0.00	0.00		0.000		0.000	0.000	0.000	0.000	0.000	0	0.000	0
R-D6-MOD	MODIFICATION - L3.5X3.5x5/16	SAE	3.5X3.5X0.3125	50.0	0.00	0.00		0.000		0.000	0.000	0.000	0.000	0.000	0	0.000	0
R-D7-MOD	MODIFICATION - L4X4x5/16	SAE	4X4X0.3125	50.0	80.14	72.20	Rohn-DH4P	11.2222:	0.9D +	79.895	15.542	24.375	18.281	20.653	1	1.000	0.6875
S-D1-MOD	MODIFICATION - L2X2x5/16	SAE	2X2X0.3125	50.0	0.00	0.00		0.000		0.000	0.000	0.000	0.000	0.000	0	0.000	0
S-D2-MOD	MODIFICATION - L2x2x1/4	SAE	2X2X0.25	50.0	0.00	0.00		0.000		0.000	0.000	0.000	0.000	0.000	0	0.000	0
S-D3-MOD	MODIFICATION - L2.5X2.5x5/16	SAE	2.5X2.5X0.3125	50.0	0.00	0.00		0.000		0.000	0.000	0.000	0.000	0.000	0	0.000	0
S-D4-MOD	MODIFICATION - L3.5X3.5x3/8	SAE	3.5X3.5X0.375	50.0	0.00	0.00		0.000		0.000	0.000	0.000	0.000	0.000	0	0.000	0
S-D5-MOD	MODIFICATION - L4X4x0.5	SAE	4X4X0.5	50.0	0.00	0.00		0.000		0.000	0.000	0.000	0.000	0.000	0	0.000	0
S-D6-MOD	MODIFICATION - L5X5x3/8	SAE	5X5X0.375	50.0	67.08	59.60	SNB-DG4P	13.3371:	1.2D +	120.850	22.376	35.100	26.471	16.594	1	1.000	0.8125
S-D7-MOD	MODIFICATION - L6X6x3/8	SAE	6X6X0.375	50.0	91.87	79.57	SNB-DI4P	17.8061:	1.2D +	148.272	22.376	35.100	26.471	18.841	1	1.000	0.8125

*** Maximum Stress Summary for Each Load Case

Summary of Maximum Usages by Load Case:

Load Case	Maximum Usage %	Element Label	Element Type
1: 1.2D + 1.0Dg + 1.6Wo	99.89	SNB-LH2P	Angle
2: 0.9D + 1.0Dg + 1.6Wo	98.84	SNB-LH2P	Angle
4: 1.2D + 1.0Dg + 1.0E	12.49	Rohn-LD3P	Angle
5: 0.9D + 1.0Dg + 1.0E	11.06	Rohn-LD3P	Angle
6: Service 1.0D + 1.0Dg + 1.0 Wo	24.51	SNB-LH1P	Angle

1.2*DL	5.68 Rohn-LD3P	Angle
0.9DL	4.26 Rohn-LD3P	Angle

*** Weight of structure (lbs):
Weight of Angles*Section DLF: 61800.0
Weight of Equipment: 12661.2
Total: 74461.2

*** End of Report

"0 DEG" "+60 DEG" "-60 DEG" "+90 DEG" "-90 DEG" "180 DEG" Max Tension
(Kips)

		"0 DEG"	"+60 DEG"	"-60 DEG"	"+90 DEG"	"-90 DEG"	"180 DEG"	Max Tension (Kips)					Cap Percentage	
									# Bolts	Dia	Bolt Capacity	Factored Tensile Capacity	LRFD	
Rohn-L1	Rohn-LA1P	0	0	0	0	0	0.723	0.723						
Rohn-L1	Rohn-LA11	0.135	0.542	0	0.455	0	0	0.542						
Rohn-L1	Rohn-LA12	0.189	0	0.679	0	0.538	0	0.679						
Rohn-L1	Rohn-LA2P	0	0	0	0	0	2.865	2.865						
Rohn-L1	Rohn-LA21	1.335	3.056	0	2.619	0	0	3.056						
Rohn-L1	Rohn-LA22	1.101	0	2.767	0	2.375	0	2.767						
Rohn-L1	Rohn-LA3P	0	0	0	0	0	5.91	5.91						
Rohn-L1	Rohn-LA31	2.726	6.006	0	5.17	0	0	6.006						
Rohn-L1	Rohn-LA32	2.563	0	5.742	0	4.956	0	5.742						
Rohn-L1	Rohn-LA4P	0	0	0	0	0	9.191	9.191						
Rohn-L1	Rohn-LA41	4.143	8.709	0	7.47	0	0	8.709						
Rohn-L1	Rohn-LA42	4.241	0	8.802	0	7.517	0	8.802						
Rohn-L2	Rohn-LB1P	0	0	0	0	0	12.809	12.809	4	0.75	29.8	119.2	OK	11%
Rohn-L2	Rohn-LB11	6.149	13.059	0	11.24	0	0	13.059	4	0.75	29.8	119.2	OK	11%
Rohn-L2	Rohn-LB12	6.24	0	13.057	0	11.201	0	13.057	4	0.75	29.8	119.2	OK	11%
Rohn-L2	Rohn-LB2P	0	0	0	0	0	17.68	17.68	4	0.75	29.8	119.2	OK	15%
Rohn-L2	Rohn-LB21	8.536	18.044	0	15.636	0	0	18.044	4	0.75	29.8	119.2	OK	15%
Rohn-L2	Rohn-LB22	8.691	0	18.084	0	15.608	0	18.084	4	0.75	29.8	119.2	OK	15%
Rohn-L2	Rohn-LB3P	0	0	0	0	0	23.313	23.313	4	0.75	29.8	119.2	OK	20%
Rohn-L2	Rohn-LB31	11.032	23.606	0	20.381	0	0	23.606	4	0.75	29.8	119.2	OK	20%
Rohn-L2	Rohn-LB32	11.197	0	23.63	0	20.326	0	23.63	4	0.75	29.8	119.2	OK	20%
Rohn-L2	Rohn-LB4P	0	0	0	0	0	31.258	31.258	4	0.75	29.8	119.2	OK	26%
Rohn-L2	Rohn-LB41	15.011	31.546	0	27.281	0	0	31.546	4	0.75	29.8	119.2	OK	26%
Rohn-L2	Rohn-LB42	15.191	0	31.562	0	27.207	0	31.562	4	0.75	29.8	119.2	OK	26%
Rohn-L3	Rohn-LC1P	0	0	0	0	0	39.195	39.195	4	0.875	40.6	162.4	OK	24%
Rohn-L3	Rohn-LC11	18.94	39.529	0	34.228	0	0	39.529	4	0.875	40.6	162.4	OK	24%
Rohn-L3	Rohn-LC12	19.165	0	39.574	0	34.163	0	39.574	4	0.875	40.6	162.4	OK	24%
Rohn-L3	Rohn-LC2P	0	0	0	0	0	49.556	49.556	4	0.875	40.6	162.4	OK	31%
Rohn-L3	Rohn-LC21	23.809	49.743	0	43.048	0	0	49.743	4	0.875	40.6	162.4	OK	31%
Rohn-L3	Rohn-LC22	24.043	0	49.77	0	42.94	0	49.77	4	0.875	40.6	162.4	OK	31%
Rohn-L3	Rohn-LC3P	0	0	0	0	0	63.308	63.308	4	0.875	40.6	162.4	OK	39%
Rohn-L3	Rohn-LC31	30.351	63.531	0	54.93	0	0	63.531	4	0.875	40.6	162.4	OK	39%
Rohn-L3	Rohn-LC32	30.532	0	63.466	0	54.746	0	63.466	4	0.875	40.6	162.4	OK	39%

Rohn-L4 Rohn-LD1P	0	0	0	0	0	77.954	77.954	4	1	53	212 OK	37%
Rohn-L4 Rohn-LD11	37.57	78.112	0	67.583	0	0	78.112	4	1	53	212 OK	37%
Rohn-L4 Rohn-LD12	37.831	0	78.114	0	67.453	0	78.114	4	1	53	212 OK	37%
Rohn-L4 Rohn-LD2P	0	0	0	0	0	93.356	93.356	4	1	53	212 OK	44%
Rohn-L4 Rohn-LD21	44.916	93.504	0	80.85	0	0	93.504	4	1	53	212 OK	44%
Rohn-L4 Rohn-LD22	45.238	0	93.556	0	80.737	0	93.556	4	1	53	212 OK	44%
Rohn-L4 Rohn-LD3P	0	0	0	0	0	110.249	110.249	4	1	53	212 OK	52%
Rohn-L4 Rohn-LD31	53.554	110.499	0	95.658	0	0	110.499	4	1	53	212 OK	52%
Rohn-L4 Rohn-LD32	53.865	0	110.526	0	95.522	0	110.526	4	1	53	212 OK	52%
Rohn-L5 Rohn-LE1P	0	0	0	0	0	124.1	124.1	4	1	53	212 OK	59%
Rohn-L5 Rohn-LE11	60.361	124.292	0	107.615	0	0	124.292	4	1	53	212 OK	59%
Rohn-L5 Rohn-LE12	60.687	0	124.33	0	107.481	0	124.33	4	1	53	212 OK	59%
Rohn-L5 Rohn-LE2P	0	0	0	0	0	137.464	137.464	4	1	53	212 OK	65%
Rohn-L5 Rohn-LE21	67.027	137.654	0	119.211	0	0	137.654	4	1	53	212 OK	65%
Rohn-L5 Rohn-LE22	67.329	0	137.659	0	119.052	0	137.659	4	1	53	212 OK	65%
Rohn-L5 Rohn-LE3P	0	0	0	0	0	150.975	150.975	4	1	53	212 OK	71%
Rohn-L5 Rohn-LE31	73.859	151.151	0	131.002	0	0	151.151	4	1	53	212 OK	71%
Rohn-L5 Rohn-LE32	74.28	0	151.275	0	130.914	0	151.275	4	1	53	212 OK	71%
Rohn-L6 Rohn-LF1P	0	0	0	0	0	169.572	169.572	6	1	53	318 OK	53%
Rohn-L6 Rohn-LF11	83.028	169.747	0	147.112	0	0	169.747	6	1	53	318 OK	53%
Rohn-L6 Rohn-LF12	83.308	0	169.718	0	146.879	0	169.718	6	1	53	318 OK	53%
Rohn-L6 Rohn-LF2P	0	0	0	0	0	191.452	191.452	6	1	53	318 OK	60%
Rohn-L6 Rohn-LF21	94.146	191.584	0	166.138	0	0	191.584	6	1	53	318 OK	60%
Rohn-L6 Rohn-LF22	94.457	0	191.57	0	165.913	0	191.57	6	1	53	318 OK	60%
Rohn-L7 Rohn-LG1P	0	0	0	0	0	211.72	211.72	6	1	53	318 OK	67%
Rohn-L7 Rohn-LG11	104.132	211.874	0	183.753	0	0	211.874	6	1	53	318 OK	67%
Rohn-L7 Rohn-LG12	104.434	0	211.843	0	183.486	0	211.843	6	1	53	318 OK	67%
Rohn-L7 Rohn-LG2P	0	0	0	0	0	231.228	231.228	6	1	53	318 OK	73%
Rohn-L7 Rohn-LG21	114.061	231.404	0	200.743	0	0	231.404	6	1	53	318 OK	73%
Rohn-L7 Rohn-LG22	114.267	0	231.253	0	200.4	0	231.253	6	1	53	318 OK	73%
Rohn-L7 Rohn-LH1P	0	0	0	0	0	250.073	250.073	6	1	53	318 OK	79%
Rohn-L7 Rohn-LH11	123.343	250.229	0	217.095	0	0	250.229	6	1	53	318 OK	79%
Rohn-L7 Rohn-LH12	123.615	0	250.136	0	216.788	0	250.136	6	1	53	318 OK	79%
Rohn-L7 Rohn-LH2P	0	0	0	0	0	269.55	269.55	6	1	53	318 OK	85%
Rohn-L7 Rohn-LH21	133.239	269.699	0	234.075	0	0	269.699	6	1	53	318 OK	85%
Rohn-L7 Rohn-LH22	133.525	0	269.609	0	233.766	0	269.609	6	1	53	318 OK	85%
Rohn-L8 Rohn-LI1P	0	0	0	0	0	286.761	286.761	8	1	53	424 OK	68%
Rohn-L8 Rohn-LI11	141.703	286.903	0	249.018	0	0	286.903	8	1	53	424 OK	68%
Rohn-L8 Rohn-LI12	142.009	0	286.823	0	248.712	0	286.823	8	1	53	424 OK	68%
Rohn-L8 Rohn-LI2P	0	0	0	0	0	301.836	301.836	8	1	53	424 OK	71%
Rohn-L8 Rohn-LI21	149.245	301.973	0	262.135	0	0	301.973	8	1	53	424 OK	71%
Rohn-L8 Rohn-LI22	149.563	0	301.897	0	261.829	0	301.897	8	1	53	424 OK	71%

SNB-L1	SNB-LA1P	0	0	0	0	0	0.172	0.172						
SNB-L1	SNB-LA11	0	0	0	0	0	0	0						
SNB-L1	SNB-LA12	0	0	0.203	0	0.172	0	0.203						
SNB-L1	SNB-LA2P	0	0	0	0	0	1.261	1.261						
SNB-L1	SNB-LA21	0.539	1.357	0	1.111	0	0	1.357						
SNB-L1	SNB-LA22	0.538	0	1.259	0	0.985	0	1.259						
SNB-L1	SNB-LA3P	0	0	0	0	0	3.657	3.657						
SNB-L1	SNB-LA31	1.699	3.836	0	3.291	0	0	3.836						
SNB-L1	SNB-LA32	1.709	0	3.633	0	3.039	0	3.633						
SNB-L1	SNB-LA4P	0	0	0	0	0	6.827	6.827						
SNB-L1	SNB-LA41	3.041	6.716	0	5.853	0	0	6.716						
SNB-L1	SNB-LA42	3.154	0	6.942	0	6.041	0	6.942						
SNB-L2	SNB-LB1P	0	0	0	0	0	10.908	10.908	4	0.75	29.8	119.2 OK	9%	
SNB-L2	SNB-LB11	5.14	11.135	0	9.639	0	0	11.135	4	0.75	29.8	119.2 OK	9%	
SNB-L2	SNB-LB12	5.232	0	11.129	0	9.575	0	11.129	4	0.75	29.8	119.2 OK	9%	
SNB-L2	SNB-LB2P	0	0	0	0	0	17.009	17.009	4	0.75	29.8	119.2 OK	14%	
SNB-L2	SNB-LB21	8.23	17.157	0	14.843	0	0	17.157	4	0.75	29.8	119.2 OK	14%	
SNB-L2	SNB-LB22	8.342	0	17.15	0	14.768	0	17.15	4	0.75	29.8	119.2 OK	14%	
SNB-L2	SNB-LB3P	0	0	0	0	0	24.181	24.181	4	0.75	29.8	119.2 OK	20%	
SNB-L2	SNB-LB31	11.824	24.345	0	21.112	0	0	24.345	4	0.75	29.8	119.2 OK	20%	
SNB-L2	SNB-LB32	11.972	0	24.339	0	21.02	0	24.339	4	0.75	29.8	119.2 OK	20%	
SNB-L2	SNB-LB4P	0	0	0	0	0	31.634	31.634	4	0.75	29.8	119.2 OK	27%	
SNB-L2	SNB-LB41	15.595	31.866	0	27.668	0	0	31.866	4	0.75	29.8	119.2 OK	27%	
SNB-L2	SNB-LB42	15.78	0	31.873	0	27.571	0	31.873	4	0.75	29.8	119.2 OK	27%	
SNB-L2	SNB-LC1P	0	0	0	0	0	41.402	41.402	4	0.875	40.6	162.4 OK	25%	
SNB-L2	SNB-LC11	20.443	41.676	0	36.158	0	0	41.676	4	0.875	40.6	162.4 OK	26%	
SNB-L2	SNB-LC12	20.642	0	41.688	0	36.06	0	41.688	4	0.875	40.6	162.4 OK	26%	
SNB-L2	SNB-LC2P	0	0	0	0	0	55.867	55.867	4	0.875	40.6	162.4 OK	34%	
SNB-L2	SNB-LC21	27.595	56.08	0	48.678	0	0	56.08	4	0.875	40.6	162.4 OK	35%	
SNB-L2	SNB-LC22	27.823	0	56.085	0	48.555	0	56.085	4	0.875	40.6	162.4 OK	35%	
SNB-L2	SNB-LC3P	0	0	0	0	0	69.396	69.396	4	0.875	40.6	162.4 OK	43%	
SNB-L2	SNB-LC31	34.439	69.509	0	60.405	0	0	69.509	4	0.875	40.6	162.4 OK	43%	
SNB-L2	SNB-LC32	34.722	0	69.523	0	60.263	0	69.523	4	0.875	40.6	162.4 OK	43%	
SNB-L3	SNB-LD1P	0	0	0	0	0	85.811	85.811	4	1	53	212 OK	40%	
SNB-L3	SNB-LD11	42.54	85.941	0	74.652	0	0	85.941	4	1	53	212 OK	41%	
SNB-L3	SNB-LD12	42.854	0	85.972	0	74.512	0	85.972	4	1	53	212 OK	41%	
SNB-L3	SNB-LD2P	0	0	0	0	0	106.703	106.703	4	1	53	212 OK	50%	
SNB-L3	SNB-LD21	52.963	106.897	0	92.846	0	0	106.897	4	1	53	212 OK	50%	
SNB-L3	SNB-LD22	53.285	0	106.909	0	92.682	0	106.909	4	1	53	212 OK	50%	
SNB-L3	SNB-LD3P	0	0	0	0	0	124.794	124.794	4	1	53	212 OK	59%	
SNB-L3	SNB-LD31	62.291	125.041	0	108.661	0	0	125.041	4	1	53	212 OK	59%	
SNB-L3	SNB-LD32	62.629	0	125.048	0	108.48	0	125.048	4	1	53	212 OK	59%	

SNB-L4	SNB-LE1P	0	0	0	0	0	146.711	146.711	4	1	53	212 OK	69%
SNB-L4	SNB-LE11	73.115	146.919	0	127.652	0	0	146.919	4	1	53	212 OK	69%
SNB-L4	SNB-LE12	73.497	0	146.951	0	127.473	0	146.951	4	1	53	212 OK	69%
SNB-L4	SNB-LE2P	0	0	0	0	0	172.478	172.478	4	1	53	212 OK	81%
SNB-L4	SNB-LE21	86.068	172.686	0	150.06	0	0	172.686	4	1	53	212 OK	81%
SNB-L4	SNB-LE22	86.466	0	172.694	0	149.838	0	172.694	4	1	53	212 OK	81%
SNB-L4	SNB-LE3P	0	0	0	0	0	192.415	192.415	4	1	53	212 OK	91%
SNB-L4	SNB-LE31	96.392	192.618	0	167.45	0	0	192.618	4	1	53	212 OK	91%
SNB-L4	SNB-LE32	96.736	0	192.57	0	167.19	0	192.57	4	1	53	212 OK	91%
SNB-L4	SNB-LF1P	0	0	0	0	0	217.388	217.388	6	1	53	318 OK	68%
SNB-L4	SNB-LF11	108.509	217.589	0	189.059	0	0	217.589	6	1	53	318 OK	68%
SNB-L4	SNB-LF12	108.874	0	217.538	0	188.773	0	217.538	6	1	53	318 OK	68%
SNB-L4	SNB-LF2P	0	0	0	0	0	246.909	246.909	6	1	53	318 OK	78%
SNB-L4	SNB-LF21	123.558	247.115	0	214.812	0	0	247.115	6	1	53	318 OK	78%
SNB-L4	SNB-LF22	123.922	0	247.039	0	214.488	0	247.039	6	1	53	318 OK	78%
SNB-L5	SNB-LG1P	0	0	0	0	0	276.774	276.774	6	1	53	318 OK	87%
SNB-L5	SNB-LG11	138.416	276.973	0	240.752	0	0	276.973	6	1	53	318 OK	87%
SNB-L5	SNB-LG12	138.783	0	276.894	0	240.418	0	276.894	6	1	53	318 OK	87%
SNB-L5	SNB-LG2P	0	0	0	0	0	309.704	309.704	6	1	53	318 OK	97%
SNB-L5	SNB-LG21	155.244	309.891	0	269.502	0	0	309.891	6	1	53	318 OK	97%
SNB-L5	SNB-LG22	155.674	0	309.828	0	269.146	0	309.828	6	1	53	318 OK	97%
SNB-L5	SNB-LH1P	0	0	0	0	0	340.682	340.682	6	1	53	318 No Good - Replace Bolt	107%
SNB-L5	SNB-LH11	170.602	340.861	0	296.401	0	0	340.861	6	1	53	318 No Good - Replace Bolt	107%
SNB-L5	SNB-LH12	171.042	0	340.801	0	296.043	0	340.801	6	1	53	318 No Good - Replace Bolt	107%
SNB-L5	SNB-LH2P	0	0	0	0	0	372.685	372.685	6	1	53	318 No Good - Replace Bolt	117%
SNB-L5	SNB-LH21	187.034	372.86	0	324.355	0	0	372.86	6	1	53	318 No Good - Replace Bolt	117%
SNB-L5	SNB-LH22	187.486	0	372.791	0	323.979	0	372.791	6	1	53	318 No Good - Replace Bolt	117%
SNB-L6	SNB-LI1P	0	0	0	0	0	405.171	405.171	8	1	53	424 OK	96%
SNB-L6	SNB-LI11	203.278	405.338	0	352.624	0	0	405.338	8	1	53	424 OK	96%
SNB-L6	SNB-LI12	203.746	0	405.269	0	352.242	0	405.269	8	1	53	424 OK	96%
SNB-L6	SNB-LI2P	0	0	0	0	0	441.619	441.619	8	1	53	424 No Good - Replace Bolt	104%
SNB-L6	SNB-LI21	222.073	441.779	0	384.497	0	0	441.779	8	1	53	424 No Good - Replace Bolt	104%
SNB-L6	SNB-LI22	222.56	0	441.711	0	384.107	0	441.711	8	1	53	424 No Good - Replace Bolt	104%

Replaced Existing A325 Bolts with A490 Bolts

		Bolt Tension										Cap Percentage		
										Capacity		Factored Tensile Capacity		
										# Bolts Dia Bolt LRFD				
SNB-L5	SNB-LH1P	0	0	0	0	0	340.682	340.682	6	1	66.6	399.6 OK	85%	
SNB-L5	SNB-LH11	170.602	340.861	0	296.401	0	0	340.861	6	1	66.6	399.6 OK	85%	
SNB-L5	SNB-LH12	171.042	0	340.801	0	296.043	0	340.801	6	1	66.6	399.6 OK	85%	
SNB-L5	SNB-LH2P	0	0	0	0	0	372.685	372.685	6	1	66.6	399.6 OK	93%	
SNB-L5	SNB-LH21	187.034	372.86	0	324.355	0	0	372.86	6	1	66.6	399.6 OK	93%	
SNB-L5	SNB-LH22	187.486	0	372.791	0	323.979	0	372.791	6	1	66.6	399.6 OK	93%	
SNB-L6	SNB-LI1P	0	0	0	0	0	405.171	405.171	8	1	66.6	532.8 OK	76%	
SNB-L6	SNB-LI11	203.278	405.338	0	352.624	0	0	405.338	8	1	66.6	532.8 OK	76%	
SNB-L6	SNB-LI12	203.746	0	405.269	0	352.242	0	405.269	8	1	66.6	532.8 OK	76%	
SNB-L6	SNB-LI2P	0	0	0	0	0	441.619	441.619	8	1	66.6	532.8 OK	83%	
SNB-L6	SNB-LI21	222.073	441.779	0	384.497	0	0	441.779	8	1	66.6	532.8 OK	83%	
SNB-L6	SNB-LI22	222.56	0	441.711	0	384.107	0	441.711	8	1	66.6	532.8 OK	83%	

CONNECTION BETWEEN TOWERS EVALUATION



SUMMARY OF CONNECTION FORCES FOR ALL WIND ANGLES AND LOAD COMBINATIONS

Loads Without Ice (V.asd wind Speed = 101 MPH)

Wind Angle	Force @ "Connection"
0 Deg	7.1811 kips
+60 Deg	3.5851 kips
-60 Deg	3.5911 kips
+90 Deg	6.0601 kips
-90 Deg	6.0631 kips

Loads With Design Ice 2.5 inch ("V" wind Speed = 50 MPH)

Wind Angle	Force @ "Connection"
0 Deg	8.5193 kips
+60 Deg	7.7883 kips
-60 Deg	7.7893 kips
+90 Deg	8.3143 kips
-90 Deg	8.3183 kips

Job	<u>180' ROHN SSV Tower w/ SNB Reinf. - Greenwich</u>	Project No.	<u>Revision 3</u>	Sheet	<u>1</u> of <u>1</u>
Description	<u>Tower Connection - TIA-222-G Loads on Conection</u>	Computed by	<u>MCD</u>	Date	<u>10/11/18</u>
		Checked by		Date	

Bolt Diameter	$\text{Dia}_{\text{bolt}} := \frac{3}{4} \text{ in}$	
Bolt Shear Capacity	$\text{Capacity}_{\text{bolt}} := 6.64 \text{ kip}$	Per AISC 15th Edition p. 7-24 for 3/4" A325 slip critical bolt (Considered as Long Slotted Hole) - LRFD
Shear Plane Area	$\text{Area}_{\text{plate}} := \frac{3}{8} \text{ in} \cdot \left(\frac{3}{4} \text{ in} + 1 \text{ in} \right)$	$\text{Area}_{\text{plate}} = 0.6563 \text{ in}^2$
Yield Strength of Plate	$F_{y\text{plate}} := 36 \text{ ksi}$	$\phi := 1.0$ LRFD Reduction Factor - AISC Chapter J
Plate Capacity	$\text{Capacity}_{\text{plate}} := 0.6 \text{ Area}_{\text{plate}} \cdot F_{y\text{plate}} \cdot \phi$	$\text{Capacity}_{\text{plate}} = 14.175 \text{ kip}$
U-Bolt Size	$\text{Dia}_{\text{ubolt}} := \frac{1}{2} \text{ in}$	
U-Bolt Area	$\text{Area}_{\text{ubolt}} := 2 \cdot \pi \left(\frac{\text{Dia}_{\text{ubolt}}}{2} \right)^2$	$\text{Area}_{\text{ubolt}} = 0.3927 \text{ in}^2$
	$F_{y\text{ubolt}} := 58 \text{ ksi}$	
	$\phi := 0.75$	LRFD Reduction Factor - AISC Chapter J
	$\text{Capacity}_{\text{ubolt}} := (0.75 \text{ Area}_{\text{ubolt}} \cdot F_{y\text{ubolt}}) \cdot \phi$	$\text{Capacity}_{\text{ubolt}} = 12.8118 \text{ kip}$
Connection Capacity	$\text{Capacity}_{\text{connection}} := \min(\text{Capacity}_{\text{bolt}}, \text{Capacity}_{\text{plate}}, \text{Capacity}_{\text{ubolt}})$	
	$\text{Capacity}_{\text{connection}} = 6.64 \text{ kip}$	
Max Connection Spacing	$\text{Spacing} := 5 \text{ ft}$	
Connection Capacity per Foot	$\text{Capacity}_{\text{LF}} := \frac{\text{Capacity}_{\text{connection}}}{\text{Spacing}}$	$\text{Capacity}_{\text{LF}} = 1.328 \frac{\text{kip}}{\text{ft}}$
Max Connection Force (Tension):	$F_{\text{max}} := 8.5193 \text{ kip}$	NOTE: Force obtained from TIA-222-G Load Combination #3 (PLS-TOWER program)
Connection Spacing in PLS-Tower	$\text{Spacing}_{\text{PLS.Tower}} := 10 \text{ ft}$	
Connection Force per Foot	$\text{Force}_{\text{LF}} := \frac{F_{\text{max}}}{\text{Spacing}_{\text{PLS.Tower}}}$	$\text{Force}_{\text{LF}} = 0.8519 \cdot \text{kip}$
Percent Capacity	$\text{Percent}_{\text{capacity}} := \frac{\text{Force}_{\text{LF}}}{\text{Capacity}_{\text{LF}}}$	$\text{Percent}_{\text{capacity}} = 64.2\%$

FOUNDATION EVALUATION



Job	180' ROHN SSV Tower w/ SNB Reinf. - Greenwich	Project No.	Revision 3	Page	_____	of	_____
Description	Overturing Moment Calculation	Computed by	MCD	Sheet	_____	of	_____
	TIA-222-G Load Case #1	Checked by		Date	_____	10/11/18	_____
				Date	_____		_____

From PLS-Tower Output Summary

Summary of Joint Support Reactions For All Load Cases:

Load Case	Joint Label	Long. Force (kips)	Tran. Force (kips)	Vert. Force (kips)	Shear Force (kips)	Tran. Moment (ft-k)	Long. Moment (ft-k)	Vert. Moment (ft-k)	Bending Moment (ft-k)	Found. Usage %
"-90"	1: 1.2D + 1.0Dg + 1.6Wo RohnJP	-0.91	3.86	19.69	3.96	-0.33	-0.28	0.01	0.43	0
	1: 1.2D + 1.0Dg + 1.6Wo SNB-JP	-0.4	6.41	18.36	6.43	0.68	-0.5	0.05	0.84	0
	1: 1.2D + 1.0Dg + 1.6Wo RohnJ1	11.15	22.46	303.01	25.08	-4.01	2.48	0.01	4.71	0
	1: 1.2D + 1.0Dg + 1.6Wo RohnJ2	-10.18	20.85	-263.32	23.2	-3.68	-2	0.02	4.19	0
	1: 1.2D + 1.0Dg + 1.6Wo SNB-J1	18.74	38.86	434.47	43.15	-9.64	6.16	-0.03	11.44	0
"-60"	1: 1.2D + 1.0Dg + 1.6Wo SNB-J2	-18.35	38.17	-397.08	42.36	-9.04	-5.43	-0.02	10.54	0
	1: 1.2D + 1.0Dg + 1.6Wo RohnJP	-14.67	3.32	181.76	15.04	-0.18	-2.82	0.01	2.82	0
	1: 1.2D + 1.0Dg + 1.6Wo SNB-JP	-24.73	5.47	256.28	25.33	0.76	-6.75	0.05	6.8	0
	1: 1.2D + 1.0Dg + 1.6Wo RohnJ1	4.9	14.14	181.97	14.96	-2.4	1.49	0	2.82	0
	1: 1.2D + 1.0Dg + 1.6Wo RohnJ2	-13.51	22.88	-304.36	26.57	-4.11	-2.53	0.01	4.83	0
"0"	1: 1.2D + 1.0Dg + 1.6Wo SNB-J1	7.66	24.18	256.63	25.36	-5.47	4.05	-0.05	6.81	0
	1: 1.2D + 1.0Dg + 1.6Wo SNB-J2	-24.15	41.83	-457.17	48.3	-10.5	-6.07	0	12.13	0
	1: 1.2D + 1.0Dg + 1.6Wo RohnJP	-29.67	0.11	355.57	29.67	-0.06	-5.55	-0.01	5.55	0
	1: 1.2D + 1.0Dg + 1.6Wo SNB-JP	-51.25	0	512.04	51.25	0	-13.5	0	13.5	0
	1: 1.2D + 1.0Dg + 1.6Wo RohnJ1	-9.49	-10.04	-147.95	13.81	1.91	-1.42	0	2.39	0
"60"	1: 1.2D + 1.0Dg + 1.6Wo RohnJ2	-9.7	9.95	-148.25	13.89	-1.86	-1.53	-0.01	2.41	0
	1: 1.2D + 1.0Dg + 1.6Wo SNB-J1	-17.54	-18.77	-227.91	25.69	5.44	-2.7	-0.03	6.07	0
	1: 1.2D + 1.0Dg + 1.6Wo SNB-J2	-17.56	18.8	-228.39	25.73	-5.44	-2.71	0.03	6.08	0
	1: 1.2D + 1.0Dg + 1.6Wo RohnJP	-14.7	-3.21	182.17	15.04	0.12	-2.82	-0.02	2.82	0
	1: 1.2D + 1.0Dg + 1.6Wo SNB-JP	-24.77	-5.47	256.83	25.36	-0.76	-6.76	-0.05	6.81	0
"90"	1: 1.2D + 1.0Dg + 1.6Wo RohnJ1	-13.41	-22.94	-304.46	26.57	4.14	-2.48	-0.01	4.83	0
	1: 1.2D + 1.0Dg + 1.6Wo RohnJ2	4.79	-14.17	181.66	14.96	2.42	1.44	-0.01	2.82	0
	1: 1.2D + 1.0Dg + 1.6Wo SNB-J1	-24.15	-41.83	-457.27	48.3	10.51	-6.06	0	12.13	0
	1: 1.2D + 1.0Dg + 1.6Wo SNB-J2	7.64	-24.15	256.17	25.33	5.46	4.05	0.05	6.8	0
	1: 1.2D + 1.0Dg + 1.6Wo RohnJP	-0.94	-3.86	20.17	3.97	0.33	-0.29	-0.01	0.44	0
"1.2*DL"	1: 1.2D + 1.0Dg + 1.6Wo SNB-JP	-0.44	-6.41	18.99	6.43	-0.68	-0.51	-0.05	0.85	0
	1: 1.2D + 1.0Dg + 1.6Wo RohnJ1	-10.19	-20.86	-263.65	23.22	3.68	-2	-0.02	4.19	0
	1: 1.2D + 1.0Dg + 1.6Wo RohnJ2	11.15	-22.45	302.86	25.07	4	2.48	-0.01	4.71	0
	1: 1.2D + 1.0Dg + 1.6Wo SNB-J1	-18.36	-38.19	-397.5	42.38	9.05	-5.43	0.02	10.55	0
	1: 1.2D + 1.0Dg + 1.6Wo SNB-J2	18.74	-38.84	434.25	43.13	9.63	6.16	0.03	11.43	0
"1.2*DL"	1.2*DL RohnJP	-1.07	0	19.97	1.07	0	-0.28	0	0.28	0
	1.2*DL SNB-JP	-0.55	0	18.61	0.55	0	-0.48	0	0.48	0
	1.2*DL RohnJ1	0.53	0.92	19.79	1.07	-0.24	0.14	0	0.28	0
	1.2*DL RohnJ2	0.54	-0.92	19.88	1.07	0.24	0.14	0	0.28	0
	1.2*DL SNB-J1	0.28	0.48	18.39	0.55	-0.41	0.24	0	0.48	0
1.2*DL SNB-J2	0.28	-0.48	18.49	0.55	0.41	0.24	0	0.48	0	

Load Case	Joint Label	Vert. Tower Forces (k)	Leg Moment Arm (ft)	Moment (ft-k)	Total Moment (ft-k)	Shear (k)	Total Shear (k)
-90 deg	RohnJP	-0.28	0.00	0.00	14302.7	3.96	144.2
-90 deg	SNB-JP	-0.25	0.00	0.00		6.43	
-90 deg	RohnJ1	283.22	11.42	3234.37		25.08	
-90 deg	RohnJ2	-283.2	-11.42	3234.14		23.20	
-90 deg	SNB-J1	416.08	9.42	3919.47		43.15	
-90 deg	SNB-J2	-415.57	-9.42	3914.67		42.36	
-60 deg	RohnJP	161.79	6.60	1067.81	14175.8	15.04	155.6
-60 deg	SNB-JP	237.67	5.44	1292.92		25.33	
-60 deg	RohnJ1	162.18	6.60	1070.39		14.96	
-60 deg	RohnJ2	-324.24	-13.18	4273.48		26.57	
-60 deg	SNB-J1	238.24	5.44	1296.03		25.36	
-60 deg	SNB-J2	-475.66	-10.88	5175.18		48.30	
0 deg	RohnJP	335.6	13.18	4423.21	14691.4	29.67	160.0
0 deg	SNB-JP	493.43	10.88	5368.52		51.25	
0 deg	RohnJ1	-167.74	-6.60	1107.08		13.81	
0 deg	RohnJ2	-168.13	-6.60	1109.66		13.89	
0 deg	SNB-J1	-246.3	-5.44	1339.87		25.69	
0 deg	SNB-J2	-246.88	-5.44	1343.03		25.73	
+60 deg	RohnJP	162.2	6.60	1070.52	14176.0	15.04	155.6
+60 deg	SNB-JP	238.22	5.44	1295.92		25.36	
+60 deg	RohnJ1	-324.25	-13.18	4273.62		26.57	
+60 deg	RohnJ2	161.78	6.60	1067.75		14.96	
+60 deg	SNB-J1	-475.66	-10.88	5175.18		48.30	
+60 deg	SNB-J2	237.68	5.44	1292.98		25.33	
+90 deg	RohnJP	0.2	0.00	0.00	14302.7	3.97	144.2
+90 deg	SNB-JP	0.38	0.00	0.00		6.43	
+90 deg	RohnJ1	-283.44	-11.42	3236.88		23.22	
+90 deg	RohnJ2	282.98	11.42	3231.63		25.07	
+90 deg	SNB-J1	-415.89	-9.42	3917.68		42.38	
+90 deg	SNB-J2	415.76	9.42	3916.46		43.13	

Forces taken from PLS-Tower output with 1.2*DL Only load case subtracted from Vertical Tower Forces

Dimensions taken from CAD drawing

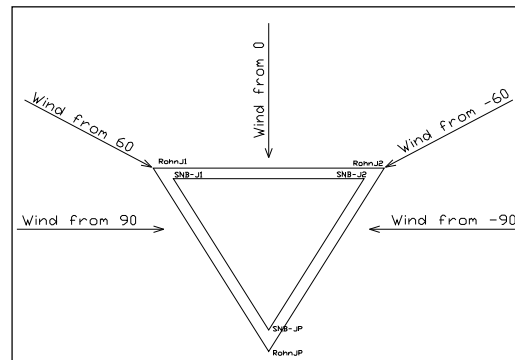



Job	180' ROHN SSV Tower w/ SNB Reinf. - Greenwich	Project No.	Revision 3	Page	_____	of	_____
Description	Overturing Moment Calculation	Computed by	MCD	Sheet	_____	of	_____
	TIA-222-G Load Case #2	Checked by		Date	_____	10/11/18	_____

From PLS-Tower Output Summary

Summary of Joint Support Reactions For All Load Cases:

Load Case	Joint Label	Long. Force (kips)	Tran. Force (kips)	Vert. Force (kips)	Shear Force (kips)	Tran. Moment (ft-k)	Long. Moment (ft-k)	Vert. Moment (ft-k)	Bending Moment (ft-k)	Found. Usage %
"-90"	2: 0.9D + 1.0Dg + 1.6Wo RohnJP	-0.64	3.86	14.7	3.92	-0.34	-0.21	0.01	0.4	0
	2: 0.9D + 1.0Dg + 1.6Wo SNB-JP	-0.26	6.42	13.7	6.42	0.66	-0.38	0.05	0.76	0
	2: 0.9D + 1.0Dg + 1.6Wo RohnJ1	11.02	22.23	297.69	24.81	-3.95	2.44	0.01	4.64	0
	2: 0.9D + 1.0Dg + 1.6Wo RohnJ2	-10.32	21.08	-267.92	23.47	-3.73	-2.03	0.02	4.25	0
	2: 0.9D + 1.0Dg + 1.6Wo SNB-J1	18.67	38.74	429.38	43	-9.53	6.09	-0.03	11.31	0
"-60"	2: 0.9D + 1.0Dg + 1.6Wo SNB-J2	-18.41	38.29	-401.21	42.49	-9.14	-5.48	-0.02	10.65	0
	2: 0.9D + 1.0Dg + 1.6Wo RohnJP	-14.4	3.33	176.56	14.78	-0.19	-2.75	0.01	2.75	0
	2: 0.9D + 1.0Dg + 1.6Wo SNB-JP	-24.59	5.48	251.34	25.19	0.75	-6.63	0.05	6.67	0
	2: 0.9D + 1.0Dg + 1.6Wo RohnJ1	4.76	13.91	176.82	14.7	-2.34	1.44	0	2.75	0
	2: 0.9D + 1.0Dg + 1.6Wo RohnJ2	-13.64	23.11	-308.9	26.84	-4.17	-2.56	0.01	4.9	0
"0"	2: 0.9D + 1.0Dg + 1.6Wo SNB-J1	7.58	24.06	251.75	25.23	-5.37	3.97	-0.05	6.68	0
	2: 0.9D + 1.0Dg + 1.6Wo SNB-J2	-24.22	41.94	-461.23	48.43	-10.6	-6.12	0	12.24	0
	2: 0.9D + 1.0Dg + 1.6Wo RohnJP	-29.4	0.11	350.14	29.4	-0.06	-5.48	-0.01	5.48	0
	2: 0.9D + 1.0Dg + 1.6Wo SNB-JP	-51.11	0	506.81	51.11	0	-13.37	0	13.37	0
	2: 0.9D + 1.0Dg + 1.6Wo RohnJ1	-9.63	-10.26	-152.67	14.07	1.97	-1.46	0	2.45	0
"60"	2: 0.9D + 1.0Dg + 1.6Wo RohnJ2	-9.83	10.17	-153	14.15	-1.91	-1.57	-0.01	2.47	0
	2: 0.9D + 1.0Dg + 1.6Wo SNB-J1	-17.61	-18.88	-232.22	25.82	5.53	-2.77	-0.03	6.18	0
	2: 0.9D + 1.0Dg + 1.6Wo SNB-J2	-17.63	18.92	-232.72	25.86	-5.54	-2.77	0.03	6.19	0
	2: 0.9D + 1.0Dg + 1.6Wo RohnJP	-14.43	-3.22	176.97	14.78	0.13	-2.75	-0.02	2.75	0
	2: 0.9D + 1.0Dg + 1.6Wo SNB-JP	-24.63	-5.47	251.9	25.23	-0.75	-6.64	-0.05	6.68	0
"90"	2: 0.9D + 1.0Dg + 1.6Wo RohnJ1	-13.54	-23.17	-308.98	26.84	4.2	-2.51	-0.01	4.89	0
	2: 0.9D + 1.0Dg + 1.6Wo RohnJ2	4.66	-13.94	176.48	14.7	2.37	1.39	-0.01	2.75	0
	2: 0.9D + 1.0Dg + 1.6Wo SNB-J1	-24.22	-41.94	-461.3	48.43	10.6	-6.12	0	12.24	0
	2: 0.9D + 1.0Dg + 1.6Wo SNB-J2	7.56	-24.03	251.27	25.19	5.36	3.97	0.05	6.67	0
	2: 0.9D + 1.0Dg + 1.6Wo RohnJP	-0.67	-3.86	15.18	3.92	0.34	-0.22	-0.01	0.4	0
"0.9*DL"	2: 0.9D + 1.0Dg + 1.6Wo SNB-JP	-0.3	-6.42	14.33	6.42	-0.67	-0.39	-0.05	0.77	0
	2: 0.9D + 1.0Dg + 1.6Wo RohnJ1	-10.32	-21.09	-268.22	23.48	3.74	-2.03	-0.02	4.26	0
	2: 0.9D + 1.0Dg + 1.6Wo RohnJ2	11.01	-22.22	297.52	24.8	3.94	2.44	-0.01	4.64	0
	2: 0.9D + 1.0Dg + 1.6Wo SNB-J1	-18.43	-38.31	-401.61	42.51	9.15	-5.48	0.02	10.66	0
	2: 0.9D + 1.0Dg + 1.6Wo SNB-J2	18.66	-38.72	429.13	42.98	9.53	6.09	0.03	11.31	0
"0.9*DL"	0.9DL RohnJP	-0.8	0	14.97	0.8	0	-0.21	0	0.21	0
	0.9DL SNB-JP	-0.41	0	13.95	0.41	0	-0.36	0	0.36	0
	0.9DL RohnJ1	0.4	0.69	14.84	0.8	-0.18	0.1	0	0.21	0
	0.9DL RohnJ2	0.4	-0.69	14.91	0.8	0.18	0.1	0	0.21	0
	0.9DL SNB-J1	0.21	0.36	13.79	0.41	-0.31	0.18	0	0.36	0
0.9DL SNB-J2	0.21	-0.36	13.87	0.41	0.31	0.18	0	0.36	0	

Load Case	Joint Label	Vert. Tower Forces (k)	Leg Moment Arm (ft)	Moment (ft-k)	Total Moment (ft-k)	Shear (k)	Total Shear (k)
-90 deg	RohnJP	-0.27	0.00	0.00	14285.0	3.92	144.1
-90 deg	SNB-JP	-0.25	0.00	0.00		6.42	
-90 deg	RohnJ1	282.85	11.42	3230.15		24.81	
-90 deg	RohnJ2	-282.83	-11.42	3229.92		23.47	
-90 deg	SNB-J1	415.59	9.42	3914.86		43.00	
-90 deg	SNB-J2	-415.08	-9.42	3910.05		42.49	
-60 deg	RohnJP	161.59	6.60	1066.49	14158.4	14.78	155.2
-60 deg	SNB-JP	237.39	5.44	1291.40		25.19	
-60 deg	RohnJ1	161.98	6.60	1069.07		14.70	
-60 deg	RohnJ2	-323.81	-13.18	4267.82		26.84	
-60 deg	SNB-J1	237.96	5.44	1294.50		25.23	
-60 deg	SNB-J2	-475.1	-10.88	5169.09		48.43	
0 deg	RohnJP	335.17	13.18	4417.54	14673.4	29.40	160.4
0 deg	SNB-JP	492.86	10.88	5362.32		51.11	
0 deg	RohnJ1	-167.51	-6.60	1105.57		14.07	
0 deg	RohnJ2	-167.91	-6.60	1108.21		14.15	
0 deg	SNB-J1	-246.01	-5.44	1338.29		25.82	
0 deg	SNB-J2	-246.59	-5.44	1341.45		25.86	
+60 deg	RohnJP	162	6.60	1069.20	14158.4	14.78	155.2
+60 deg	SNB-JP	237.95	5.44	1294.45		25.23	
+60 deg	RohnJ1	-323.82	-13.18	4267.95		26.84	
+60 deg	RohnJ2	161.57	6.60	1066.36		14.70	
+60 deg	SNB-J1	-475.09	-10.88	5168.98		48.43	
+60 deg	SNB-J2	237.4	5.44	1291.46		25.19	
+90 deg	RohnJP	0.21	0.00	0.00	14284.8	3.92	144.1
+90 deg	SNB-JP	0.38	0.00	0.00		6.42	
+90 deg	RohnJ1	-283.06	-11.42	3232.55		23.48	
+90 deg	RohnJ2	282.61	11.42	3227.41		24.80	
+90 deg	SNB-J1	-415.4	-9.42	3913.07		42.51	
+90 deg	SNB-J2	415.26	9.42	3911.75		42.98	

Forces taken from PLS-Tower output with 0.9*DL Only load case subtracted from Vertical Tower Forces

Dimensions taken from CAD drawing

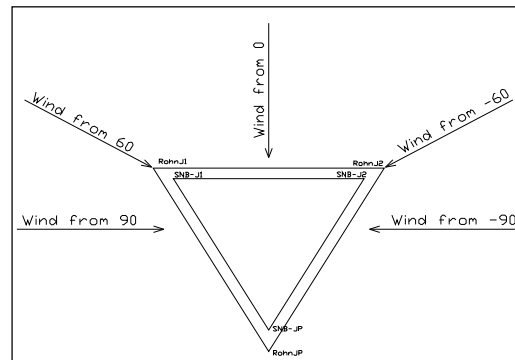



Job	180' ROHN SSV Tower w/ SNB Reinf. - Greenwich	Project No.	Revision 3	Page	_____ of _____
Description	Overturing Moment Calculation	Computed by	MCD	Sheet	_____ of _____
	TIA-222-G Load Case #3	Checked by		Date	10/11/18

From PLS-Tower Output Summary

Summary of Joint Support Reactions For All Load Cases:

Load Case	Joint Label	Long. Force (kips)	Tran. Force (kips)	Vert. Force (kips)	Shear Force (kips)	Tran. Moment (ft-k)	Long. Moment (ft-k)	Vert. Moment (ft-k)	Bending Moment (ft-k)	Found. Usage %
"-90"	3: 1.2D + 1.0Dg + 1.0 Di + 1.0 Wi + 1.0 Ti RohnJP	0.09	1.4	160.75	1.4	0.05	1.67	0.01	1.67	0
	3: 1.2D + 1.0Dg + 1.0 Di + 1.0 Wi + 1.0 Ti SNB-JP	3.79	1.95	183.19	4.26	0.47	4.44	0.02	4.47	0
	3: 1.2D + 1.0Dg + 1.0 Di + 1.0 Wi + 1.0 Ti RohnJ1	3.9	8.07	263.34	8.97	0.15	-0.02	0	0.16	0
	3: 1.2D + 1.0Dg + 1.0 Di + 1.0 Wi + 1.0 Ti RohnJ2	-3.99	8.22	58.05	9.14	-2.75	-1.62	0	3.2	0
	3: 1.2D + 1.0Dg + 1.0 Di + 1.0 Wi + 1.0 Ti SNB-J1	4.44	9.63	330.92	10.61	0.71	-0.11	-0.01	0.72	0
"-60"	3: 1.2D + 1.0Dg + 1.0 Di + 1.0 Wi + 1.0 Ti SNB-J2	-8.23	16.19	35.31	18.16	-7.02	-4.3	-0.01	8.23	0
	3: 1.2D + 1.0Dg + 1.0 Di + 1.0 Wi + 1.0 Ti RohnJP	-5.11	1.2	220.03	5.25	0.06	0.79	0.01	0.79	0
	3: 1.2D + 1.0Dg + 1.0 Di + 1.0 Wi + 1.0 Ti SNB-JP	-4.48	1.68	268.51	4.78	0.44	2.27	0.02	2.31	0
	3: 1.2D + 1.0Dg + 1.0 Di + 1.0 Wi + 1.0 Ti RohnJ1	1.55	5.01	219.89	5.24	0.72	-0.32	0	0.79	0
	3: 1.2D + 1.0Dg + 1.0 Di + 1.0 Wi + 1.0 Ti RohnJ2	-5.26	9.08	42.22	10.49	-2.97	-1.72	0	3.43	0
"0"	3: 1.2D + 1.0Dg + 1.0 Di + 1.0 Wi + 1.0 Ti SNB-J1	0.79	4.72	268.35	4.78	2.18	-0.75	-0.02	2.31	0
	3: 1.2D + 1.0Dg + 1.0 Di + 1.0 Wi + 1.0 Ti SNB-J2	-10.16	17.6	12.56	20.33	-7.63	-4.4	0	8.81	0
	3: 1.2D + 1.0Dg + 1.0 Di + 1.0 Wi + 1.0 Ti RohnJP	-10.41	-0.01	279.7	10.41	0	-0.1	0	0.1	0
	3: 1.2D + 1.0Dg + 1.0 Di + 1.0 Wi + 1.0 Ti SNB-JP	-12.89	0	354.5	12.89	0	0.07	0	0.07	0
	3: 1.2D + 1.0Dg + 1.0 Di + 1.0 Wi + 1.0 Ti RohnJ1	-3.72	-4.02	101.16	5.47	2.23	-1.25	0	2.55	0
"60"	3: 1.2D + 1.0Dg + 1.0 Di + 1.0 Wi + 1.0 Ti RohnJ2	-3.7	4.03	101.28	5.47	-2.23	-1.24	0	2.55	0
	3: 1.2D + 1.0Dg + 1.0 Di + 1.0 Wi + 1.0 Ti SNB-J1	-7.55	-9.65	97.41	12.25	5.94	-2.99	-0.02	6.65	0
	3: 1.2D + 1.0Dg + 1.0 Di + 1.0 Wi + 1.0 Ti SNB-J2	-7.54	9.65	97.52	12.25	-5.94	-2.98	0.02	6.65	0
	3: 1.2D + 1.0Dg + 1.0 Di + 1.0 Wi + 1.0 Ti RohnJP	-5.12	-1.21	220.1	5.26	-0.06	0.79	-0.01	0.79	0
	3: 1.2D + 1.0Dg + 1.0 Di + 1.0 Wi + 1.0 Ti SNB-JP	-4.48	-1.68	268.61	4.79	-0.44	2.26	-0.02	2.31	0
"90"	3: 1.2D + 1.0Dg + 1.0 Di + 1.0 Wi + 1.0 Ti RohnJ1	-5.27	-9.07	42.03	10.49	2.96	-1.73	0	3.43	0
	3: 1.2D + 1.0Dg + 1.0 Di + 1.0 Wi + 1.0 Ti RohnJ2	1.56	-5	220.01	5.24	-0.73	-0.32	0	0.79	0
	3: 1.2D + 1.0Dg + 1.0 Di + 1.0 Wi + 1.0 Ti SNB-J1	-10.17	-17.6	12.35	20.33	7.63	-4.41	0	8.81	0
	3: 1.2D + 1.0Dg + 1.0 Di + 1.0 Wi + 1.0 Ti SNB-J2	0.79	-4.71	268.46	4.78	-2.19	-0.75	0.02	2.31	0
	3: 1.2D + 1.0Dg + 1.0 Di + 1.0 Wi + 1.0 Ti RohnJP	0.09	-1.39	160.84	1.4	-0.06	1.66	-0.01	1.67	0
"1.2*DL"	3: 1.2D + 1.0Dg + 1.0 Di + 1.0 Wi + 1.0 Ti SNB-JP	3.78	-1.95	183.29	4.26	-0.48	4.44	-0.02	4.47	0
	3: 1.2D + 1.0Dg + 1.0 Di + 1.0 Wi + 1.0 Ti RohnJ1	-3.99	-8.23	57.82	9.14	2.75	-1.63	0	3.2	0
	3: 1.2D + 1.0Dg + 1.0 Di + 1.0 Wi + 1.0 Ti RohnJ2	3.91	-8.07	263.49	8.97	-0.15	-0.02	0	0.16	0
	3: 1.2D + 1.0Dg + 1.0 Di + 1.0 Wi + 1.0 Ti SNB-J1	-8.23	-16.2	35.05	18.17	7.02	-4.3	0.01	8.23	0
	3: 1.2D + 1.0Dg + 1.0 Di + 1.0 Wi + 1.0 Ti SNB-J2	4.44	-9.63	331.08	10.61	-0.71	-0.1	0.01	0.72	0
1.2*DL	RohnJP	-1.07	0	19.97	1.07	0	-0.28	0	0.28	0
1.2*DL	SNB-JP	-0.55	0	18.61	0.55	0	-0.48	0	0.48	0
1.2*DL	RohnJ1	0.53	0.92	19.79	1.07	-0.24	0.14	0	0.28	0
1.2*DL	RohnJ2	0.54	-0.92	19.88	1.07	0.24	0.14	0	0.28	0
1.2*DL	SNB-J1	0.28	0.48	18.39	0.55	-0.41	0.24	0	0.48	0
1.2*DL	SNB-J2	0.28	-0.48	18.49	0.55	0.41	0.24	0	0.48	0

Load Case	Joint Label	Vert. Tower Forces (k)	Leg Moment Arm (ft)	Moment (ft-k)	Total Moment (ft-k)	Shear (k)	Total Shear (k)
-90 deg	RohnJP	140.78	0.00	0.00	5131.0	1.40	52.5
-90 deg	SNB-JP	164.58	0.00	0.00		4.26	
-90 deg	RohnJ1	243.55	11.42	2781.34		8.97	
-90 deg	RohnJ2	38.17	-11.42	-435.90		9.14	
-90 deg	SNB-J1	312.53	9.42	2944.03		10.61	
-90 deg	SNB-J2	16.82	-9.42	-158.44		18.16	
-60 deg	RohnJP	200.06	6.60	1320.40	5130.4	5.25	50.9
-60 deg	SNB-JP	249.9	5.44	1359.46		4.78	
-60 deg	RohnJ1	200.1	6.60	1320.66		5.24	
-60 deg	RohnJ2	22.34	-13.18	-294.44		10.49	
-60 deg	SNB-J1	249.96	5.44	1359.78		4.78	
-60 deg	SNB-J2	-5.93	-10.88	64.52		20.33	
0 deg	RohnJP	259.73	13.18	3423.24	5143.7	10.41	58.7
0 deg	SNB-JP	335.89	10.88	3654.48		12.89	
0 deg	RohnJ1	81.37	-6.60	-537.04		5.47	
0 deg	RohnJ2	81.4	-6.60	-537.24		5.47	
0 deg	SNB-J1	79.02	-5.44	-429.87		12.25	
0 deg	SNB-J2	79.03	-5.44	-429.92		12.25	
+60 deg	RohnJP	200.13	6.60	1320.86	5134.1	5.26	50.9
+60 deg	SNB-JP	250	5.44	1360.00		4.79	
+60 deg	RohnJ1	22.24	-13.18	-293.12		10.49	
+60 deg	RohnJ2	200.13	6.60	1320.86		5.24	
+60 deg	SNB-J1	-6.04	-10.88	65.72		20.33	
+60 deg	SNB-J2	249.97	5.44	1359.84		4.78	
+90 deg	RohnJP	140.87	0.00	0.00	5135.4	1.40	52.6
+90 deg	SNB-JP	164.68	0.00	0.00		4.26	
+90 deg	RohnJ1	38.03	-11.42	-434.30		9.14	
+90 deg	RohnJ2	243.61	11.42	2782.03		8.97	
+90 deg	SNB-J1	16.66	-9.42	-156.94		18.17	
+90 deg	SNB-J2	312.59	9.42	2944.60		10.61	

Forces taken from PLS-Tower output with 1.2*DL Only load case subtracted from Vertical Tower Forces

Dimensions taken from CAD drawing

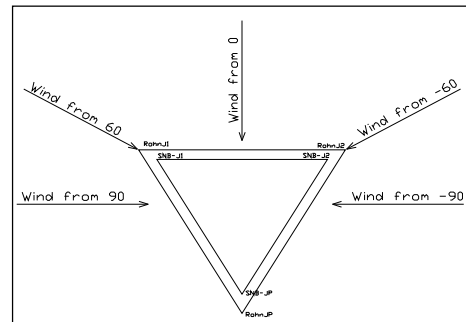



Job	180' ROHN SSV Tower w/ SNB Reinf. - Greenwich	Project No.	Revision 3	Page	_____	of	_____
Description	Overturing Moment Calculation	Computed by	MCD	Sheet	_____	of	_____
	TIA-222-G Load Case #4	Checked by		Date	_____	10/11/18	_____

From PLS-Tower Output Summary

Summary of Joint Support Reactions For All Load Cases:

Load Case	Joint Label	Long. Force (kips)	Tran. Force (kips)	Vert. Force (kips)	Shear Force (kips)	Tran. Moment (ft-k)	Long. Moment (ft-k)	Vert. Moment (ft-k)	Bending Moment (ft-k)	Found. Usage %	
"-90"	4: 1.2D + 1.0Dg + 1.0E	RohnJP	-1.07	0.1	19.97	1.07	0.04	-0.28	0	0.28	0
	4: 1.2D + 1.0Dg + 1.0E	SNB-JP	-0.55	0.15	18.61	0.57	0.18	-0.48	0.01	0.51	0
	4: 1.2D + 1.0Dg + 1.0E	RohnJ1	1.14	2.03	38.59	2.33	-0.43	0.29	0	0.52	0
	4: 1.2D + 1.0Dg + 1.0E	RohnJ2	-0.07	0.19	1.07	0.2	0.04	-0.01	0	0.04	0
	4: 1.2D + 1.0Dg + 1.0E	SNB-J1	1.3	2.39	45.12	2.72	-0.89	0.62	0	1.09	0
"-60"	4: 1.2D + 1.0Dg + 1.0E	SNB-J2	-0.74	1.44	-8.25	1.62	-0.07	-0.14	0	0.16	0
	4: 1.2D + 1.0Dg + 1.0E	RohnJP	-1.8	0.09	30.82	1.8	0.04	-0.42	0	0.42	0
	4: 1.2D + 1.0Dg + 1.0E	SNB-JP	-1.8	0.13	34.05	1.81	0.16	-0.83	0.01	0.84	0
	4: 1.2D + 1.0Dg + 1.0E	RohnJ1	0.85	1.59	30.64	1.8	-0.34	0.25	0	0.42	0
	4: 1.2D + 1.0Dg + 1.0E	RohnJ2	-0.21	0.34	-1.83	0.4	0	-0.01	0	0.01	0
"0"	4: 1.2D + 1.0Dg + 1.0E	SNB-J1	0.79	1.62	33.82	1.81	-0.64	0.55	-0.01	0.84	0
	4: 1.2D + 1.0Dg + 1.0E	SNB-J2	-0.97	1.69	-12.38	1.95	-0.19	-0.11	0	0.22	0
	4: 1.2D + 1.0Dg + 1.0E	RohnJP	-2.53	0	41.68	2.53	0	-0.56	0	0.56	0
	4: 1.2D + 1.0Dg + 1.0E	SNB-JP	-3.06	0	49.49	3.06	0	-1.18	0	1.18	0
	4: 1.2D + 1.0Dg + 1.0E	RohnJ1	0.11	0.32	8.93	0.34	-0.09	0.11	0	0.14	0
"60"	4: 1.2D + 1.0Dg + 1.0E	RohnJ2	0.1	-0.33	9.02	0.34	0.1	0.1	0	0.14	0
	4: 1.2D + 1.0Dg + 1.0E	SNB-J1	-0.46	-0.55	2.95	0.71	-0.03	0.2	-0.01	0.2	0
	4: 1.2D + 1.0Dg + 1.0E	SNB-J2	-0.46	0.55	3.05	0.71	0.03	0.2	0.01	0.2	0
	4: 1.2D + 1.0Dg + 1.0E	RohnJP	-1.8	-0.08	30.82	1.8	-0.04	-0.42	0	0.42	0
	4: 1.2D + 1.0Dg + 1.0E	SNB-JP	-1.8	-0.12	34.05	1.81	-0.16	-0.83	-0.01	0.84	0
"90"	4: 1.2D + 1.0Dg + 1.0E	RohnJ1	-0.21	-0.34	-1.92	0.4	0	-0.01	0	0.01	0
	4: 1.2D + 1.0Dg + 1.0E	RohnJ2	0.85	-1.59	30.73	1.8	0.34	0.25	0	0.42	0
	4: 1.2D + 1.0Dg + 1.0E	SNB-J1	-0.98	-1.69	-12.49	1.95	0.19	-0.11	0	0.22	0
	4: 1.2D + 1.0Dg + 1.0E	SNB-J2	0.79	-1.62	33.93	1.81	0.64	0.55	0.01	0.84	0
	4: 1.2D + 1.0Dg + 1.0E	RohnJP	-1.07	-0.1	19.97	1.07	-0.04	-0.28	0	0.28	0
"1.2*DL"	4: 1.2D + 1.0Dg + 1.0E	SNB-JP	-0.55	-0.14	18.61	0.57	-0.18	-0.48	-0.01	0.51	0
	4: 1.2D + 1.0Dg + 1.0E	RohnJ1	-0.08	-0.19	0.98	0.2	-0.04	-0.01	0	0.04	0
	4: 1.2D + 1.0Dg + 1.0E	RohnJ2	1.14	-2.04	38.68	2.34	0.43	0.29	0	0.52	0
	4: 1.2D + 1.0Dg + 1.0E	SNB-J1	-0.75	-1.44	-8.35	1.62	0.07	-0.14	0	0.16	0
	4: 1.2D + 1.0Dg + 1.0E	SNB-J2	1.3	-2.39	45.23	2.72	0.89	0.62	0	1.09	0
	1.2*DL	RohnJP	-1.07	0	19.97	1.07	0	-0.28	0	0.28	0
1.2*DL	SNB-JP	-0.55	0	18.61	0.55	0	-0.48	0	0.48	0	
1.2*DL	RohnJ1	0.53	0.92	19.79	1.07	-0.24	0.14	0	0.28	0	
1.2*DL	RohnJ2	0.54	-0.92	19.88	1.07	0.24	0.14	0	0.28	0	
1.2*DL	SNB-J1	0.28	0.48	18.39	0.55	-0.41	0.24	0	0.48	0	
1.2*DL	SNB-J2	0.28	-0.48	18.49	0.55	0.41	0.24	0	0.48	0	

Load Case	Joint Label	Vert. Tower Forces (k)	Leg Moment Arm (ft)	Moment (ft-k)	Total Moment (ft-k)	Shear (k)	Total Shear (k)
-90 deg	RohnJP	0	0.00	0.00	933.2	1.07	8.5
-90 deg	SNB-JP	0	0.00	0.00		0.57	
-90 deg	RohnJ1	18.8	11.42	214.70		2.33	
-90 deg	RohnJ2	-18.81	-11.42	214.81		0.20	
-90 deg	SNB-J1	26.73	9.42	251.80		2.72	
-90 deg	SNB-J2	-26.74	-9.42	251.89		1.62	
-60 deg	RohnJP	10.85	6.60	71.61	933.2	1.80	9.6
-60 deg	SNB-JP	15.44	5.44	83.99		1.81	
-60 deg	RohnJ1	10.85	6.60	71.61		1.80	
-60 deg	RohnJ2	-21.71	-13.18	286.14		0.40	
-60 deg	SNB-J1	15.43	5.44	83.94		1.81	
-60 deg	SNB-J2	-30.87	-10.88	335.87		1.95	
0 deg	RohnJP	21.71	13.18	286.14	933.5	2.53	7.7
0 deg	SNB-JP	30.88	10.88	335.97		3.06	
0 deg	RohnJ1	-10.86	-6.60	71.68		0.34	
0 deg	RohnJ2	-10.86	-6.60	71.68		0.34	
0 deg	SNB-J1	-15.44	-5.44	83.99		0.71	
0 deg	SNB-J2	-15.44	-5.44	83.99		0.71	
+60 deg	RohnJP	10.85	6.60	71.61	933.3	1.80	9.6
+60 deg	SNB-JP	15.44	5.44	83.99		1.81	
+60 deg	RohnJ1	-21.71	-13.18	286.14		0.40	
+60 deg	RohnJ2	10.85	6.60	71.61		1.80	
+60 deg	SNB-J1	-30.88	-10.88	335.97		1.95	
+60 deg	SNB-J2	15.44	5.44	83.99		1.81	
+90 deg	RohnJP	0	0.00	0.00	933.3	1.07	8.5
+90 deg	SNB-JP	0	0.00	0.00		0.57	
+90 deg	RohnJ1	-18.81	-11.42	214.81		0.20	
+90 deg	RohnJ2	18.8	11.42	214.70		2.34	
+90 deg	SNB-J1	-26.74	-9.42	251.89		1.62	
+90 deg	SNB-J2	26.74	9.42	251.89		2.72	

Forces taken from PLS-Tower output with 1.2*DL Only load case subtracted from Vertical Tower Forces

Dimensions taken from CAD drawing

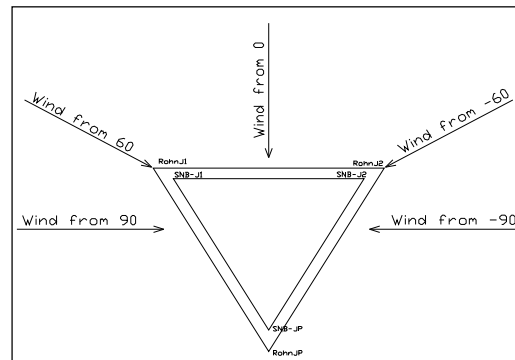



Job	180' ROHN SSV Tower w/ SNB Reinf. - Greenwich	Project No.	Revision 3	Page	_____	of	_____
Description	Overturing Moment Calculation	Computed by	MCD	Sheet	_____	of	_____
	TIA-222-G Load Case #5	Checked by		Date	_____	10/11/18	_____

From PLS-Tower Output Summary

Summary of Joint Support Reactions For All Load Cases:

Load Case	Joint Label	Long. Force (kips)	Tran. Force (kips)	Vert. Force (kips)	Shear Force (kips)	Tran. Moment (ft-k)	Long. Moment (ft-k)	Vert. Moment (ft-k)	Bending Moment (ft-k)	Found. Usage %	
"-90"	5: 0.9D + 1.0Dg + 1.0E	RohnJP	-0.8	0.1	14.98	0.81	0.04	-0.21	0	0.21	0
	5: 0.9D + 1.0Dg + 1.0E	SNB-JP	-0.41	0.15	13.96	0.44	0.18	-0.36	0.01	0.4	0
	5: 0.9D + 1.0Dg + 1.0E	RohnJ1	1.01	1.8	33.61	2.07	-0.37	0.25	0	0.45	0
	5: 0.9D + 1.0Dg + 1.0E	RohnJ2	-0.21	0.42	-3.86	0.47	-0.02	-0.04	0	0.05	0
	5: 0.9D + 1.0Dg + 1.0E	SNB-J1	1.23	2.27	40.49	2.58	-0.79	0.56	0	0.97	0
"-60"	5: 0.9D + 1.0Dg + 1.0E	SNB-J2	-0.81	1.56	-12.84	1.76	-0.17	-0.2	0	0.26	0
	5: 0.9D + 1.0Dg + 1.0E	RohnJP	-1.53	0.09	25.82	1.54	0.04	-0.35	0	0.35	0
	5: 0.9D + 1.0Dg + 1.0E	SNB-JP	-1.67	0.13	29.37	1.67	0.15	-0.71	0.01	0.72	0
	5: 0.9D + 1.0Dg + 1.0E	RohnJ1	0.71	1.36	25.68	1.53	-0.28	0.22	0	0.35	0
	5: 0.9D + 1.0Dg + 1.0E	RohnJ2	-0.34	0.57	-6.77	0.66	-0.06	-0.04	0	0.07	0
"0"	5: 0.9D + 1.0Dg + 1.0E	SNB-J1	0.72	1.5	29.2	1.67	-0.53	0.49	-0.01	0.72	0
	5: 0.9D + 1.0Dg + 1.0E	SNB-J2	-1.04	1.81	-16.97	2.09	-0.3	-0.17	0	0.34	0
	5: 0.9D + 1.0Dg + 1.0E	RohnJP	-2.27	0	36.66	2.27	0	-0.49	0	0.49	0
	5: 0.9D + 1.0Dg + 1.0E	SNB-JP	-2.92	0	44.79	2.92	0	-1.06	0	1.06	0
	5: 0.9D + 1.0Dg + 1.0E	RohnJ1	-0.03	0.09	4	0.1	-0.04	0.07	0	0.08	0
"60"	5: 0.9D + 1.0Dg + 1.0E	RohnJ2	-0.03	-0.1	4.07	0.1	0.04	0.07	0	0.08	0
	5: 0.9D + 1.0Dg + 1.0E	SNB-J1	-0.53	-0.66	-1.63	0.85	0.07	0.14	-0.01	0.16	0
	5: 0.9D + 1.0Dg + 1.0E	SNB-J2	-0.53	0.66	-1.55	0.85	-0.07	0.14	0.01	0.16	0
	5: 0.9D + 1.0Dg + 1.0E	RohnJP	-1.53	-0.08	25.82	1.54	-0.04	-0.35	0	0.35	0
	5: 0.9D + 1.0Dg + 1.0E	SNB-JP	-1.67	-0.13	29.37	1.67	-0.16	-0.71	-0.01	0.72	0
"90"	5: 0.9D + 1.0Dg + 1.0E	RohnJ1	-0.34	-0.57	-6.84	0.66	0.06	-0.04	0	0.08	0
	5: 0.9D + 1.0Dg + 1.0E	RohnJ2	0.71	-1.36	25.75	1.53	0.28	0.22	0	0.35	0
	5: 0.9D + 1.0Dg + 1.0E	SNB-J1	-1.04	-1.81	-17.04	2.09	0.3	-0.17	0	0.34	0
	5: 0.9D + 1.0Dg + 1.0E	SNB-J2	0.73	-1.5	29.28	1.67	0.53	0.49	0.01	0.72	0
	5: 0.9D + 1.0Dg + 1.0E	RohnJP	-0.8	-0.1	14.98	0.81	-0.04	-0.21	0	0.21	0
"0.9*DL"	5: 0.9D + 1.0Dg + 1.0E	SNB-JP	-0.41	-0.15	13.96	0.44	-0.18	-0.36	-0.01	0.4	0
	5: 0.9D + 1.0Dg + 1.0E	RohnJ1	-0.21	-0.42	-3.93	0.47	0.02	-0.05	0	0.05	0
	5: 0.9D + 1.0Dg + 1.0E	RohnJ2	1.01	-1.81	33.68	2.07	0.37	0.25	0	0.45	0
	5: 0.9D + 1.0Dg + 1.0E	SNB-J1	-0.81	-1.56	-12.91	1.76	0.17	-0.2	0	0.26	0
	5: 0.9D + 1.0Dg + 1.0E	SNB-J2	1.23	-2.27	40.56	2.58	0.79	0.56	0	0.97	0
"0.9*DL"	0.9DL	RohnJP	-0.8	0	14.97	0.8	0	-0.21	0	0.21	0
	0.9DL	SNB-JP	-0.41	0	13.95	0.41	0	-0.36	0	0.36	0
	0.9DL	RohnJ1	0.4	0.69	14.84	0.8	-0.18	0.1	0	0.21	0
	0.9DL	RohnJ2	0.4	-0.69	14.91	0.8	0.18	0.1	0	0.21	0
	0.9DL	SNB-J1	0.21	0.36	13.79	0.41	-0.31	0.18	0	0.36	0
0.9DL	SNB-J2	0.21	-0.36	13.87	0.41	0.31	0.18	0	0.36	0	

Load Case	Joint Label	Vert. Tower Forces (k)	Leg Moment Arm (ft)	Moment (ft-k)	Total Moment (ft-k)	Shear (k)	Total Shear (k)
-90 deg	RohnJP	0.01	0.00	0.00	931.8	0.81	8.1
-90 deg	SNB-JP	0.01	0.00	0.00		0.44	
-90 deg	RohnJ1	18.77	11.42	214.35		2.07	
-90 deg	RohnJ2	-18.77	-11.42	214.35		0.47	
-90 deg	SNB-J1	26.7	9.42	251.51		2.58	
-90 deg	SNB-J2	-26.71	-9.42	251.61		1.76	
-60 deg	RohnJP	10.85	6.60	71.61	932.2	1.54	9.2
-60 deg	SNB-JP	15.42	5.44	83.88		1.67	
-60 deg	RohnJ1	10.84	6.60	71.54		1.53	
-60 deg	RohnJ2	-21.68	-13.18	285.74		0.66	
-60 deg	SNB-J1	15.41	5.44	83.83		1.67	
-60 deg	SNB-J2	-30.84	-10.88	335.54		2.09	
0 deg	RohnJP	21.69	13.18	285.87	932.3	2.27	7.1
0 deg	SNB-JP	30.84	10.88	335.54		2.92	
0 deg	RohnJ1	-10.84	-6.60	71.54		0.10	
0 deg	RohnJ2	-10.84	-6.60	71.54		0.10	
0 deg	SNB-J1	-15.42	-5.44	83.88		0.85	
0 deg	SNB-J2	-15.42	-5.44	83.88		0.85	
+60 deg	RohnJP	10.85	6.60	71.61	932.0	1.54	9.2
+60 deg	SNB-JP	15.42	5.44	83.88		1.67	
+60 deg	RohnJ1	-21.68	-13.18	285.74		0.66	
+60 deg	RohnJ2	10.84	6.60	71.54		1.53	
+60 deg	SNB-J1	-30.83	-10.88	335.43		2.09	
+60 deg	SNB-J2	15.41	5.44	83.83		1.67	
+90 deg	RohnJP	0.01	0.00	0.00	931.6	0.81	8.1
+90 deg	SNB-JP	0.01	0.00	0.00		0.44	
+90 deg	RohnJ1	-18.77	-11.42	214.35		0.47	
+90 deg	RohnJ2	18.77	11.42	214.35		2.07	
+90 deg	SNB-J1	-26.7	-9.42	251.51		1.76	
+90 deg	SNB-J2	26.69	9.42	251.42		2.58	

Forces taken from PLS-Tower output with 0.9*DL Only load case subtracted from Vertical Tower Forces

Dimensions taken from CAD drawing

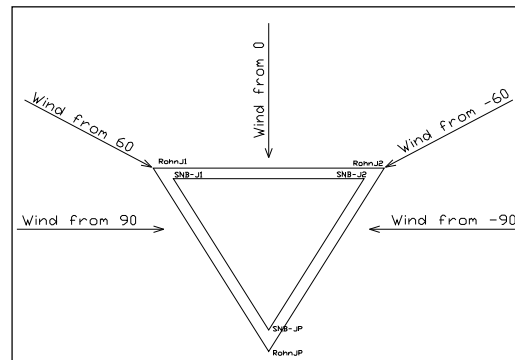



Load Case	Load Case 1	Load Case 1	Load Case 2	Load Case 2	Load Case 3	Load Case 3	Load Case 4	Load Case 4	Load Case 5	Load Case 5
Load Case	Total Moment (ft-k)	Total Shear (k)	Total Moment (ft-k)	Total Shear (k)	Total Moment (ft-k)	Total Shear (k)	Total Moment (ft-k)	Total Shear (k)	Total Moment (ft-k)	Total Shear (k)
Wo -90 deg	14303	144.2	14285	144.1	5131	52.5	933.2	8.5	931.8	8.1
Wo -60 deg	14176	155.6	14158.4	155.2	5131	51	933.2	9.6	932.2	9.2
Wo 0 deg	14691	160	14673.4	160.4	5143.7	58.7	933.5	7.7	932.3	7.1
Wo 60 deg	14176	155.6	14158.4	155.2	5134	51	933.3	9.6	932	9.2
Wo 90 deg	14303	144.2	14284.8	144.1	5135	52.6	933.3	8.5	932.6	8.1

Maximum Moment = 14691 kip*ft

Maximum Shear = 160.4 kip

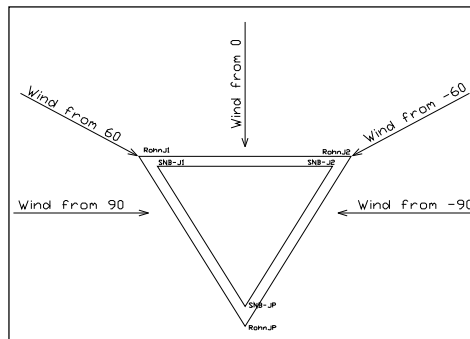

Job 180' ROHN SSV Tower w/ SNB Reinf. - Greenwich
 Description Foundation Analysis (TIA-222-G)

Project No. Revision 3
 Computed by MCD
 Checked by

Sheet 2 of 7
 Date 10/11/18
 Date

FOUNDATION OVERVIEW

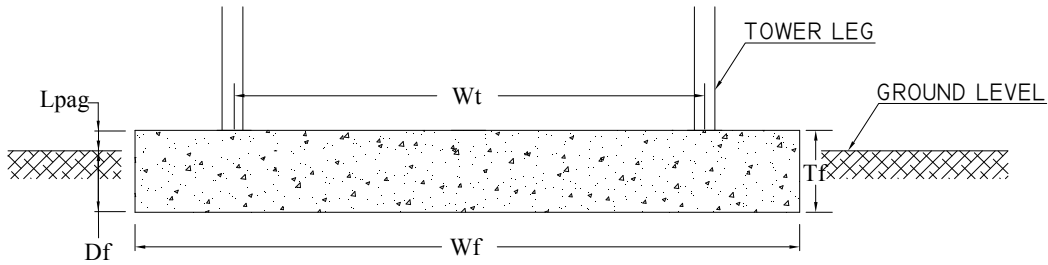

ELEVATION

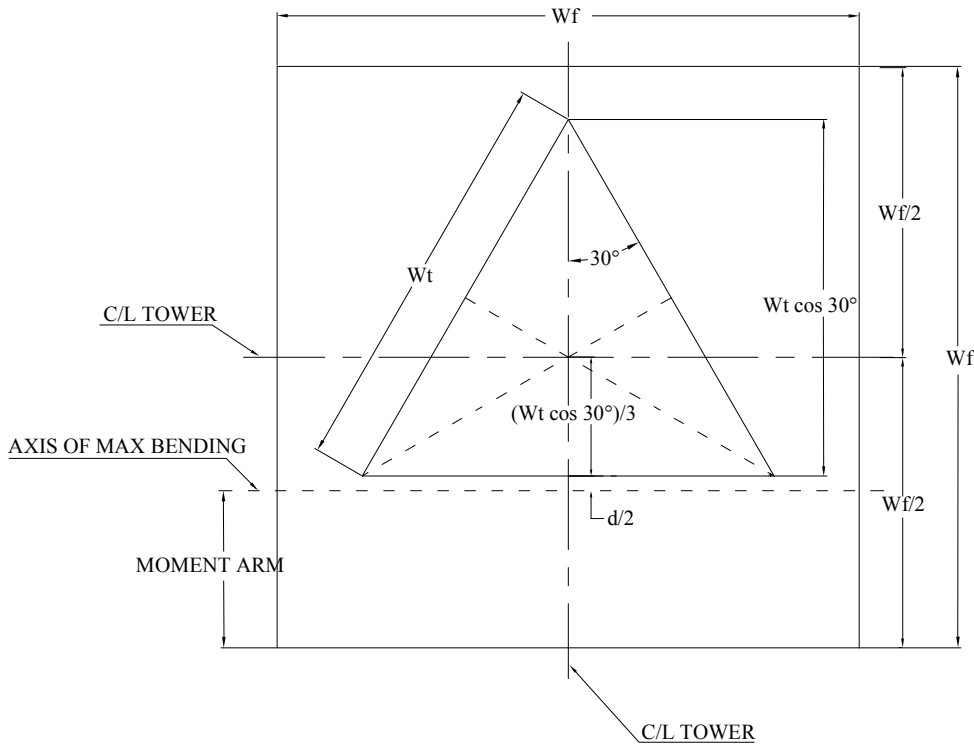

PLAN

Job	<u>180' ROHN SSV Tower w/ SNB Reinf. - Greenwich</u>	Project No.	<u>Revision 3</u>	Sheet	<u>4</u> of <u>7</u>
Description	<u>Foundation Analysis (TIA-222-G)</u>	Computed by	<u>MCD</u>	Date	<u>10/11/18</u>
		Checked by		Date	

BEARING PRESSURE CHECK:

$$\text{LOAD}_{\text{tot}} := (\text{WT}_{\text{c}} + \text{WT}_{\text{sl}}) \cdot 0.9 + \text{WT}_{\text{t}_0.9} \quad \text{LOAD}_{\text{tot}} = 1165.3325 \cdot \text{kip}$$

$$A_{\text{mat}} := W_{\text{f}}^2 \quad A_{\text{mat}} = 1332.25 \cdot \text{ft}^2$$

$$S := \frac{W_{\text{f}}^3}{6} \quad S = 8104.5208 \cdot \text{ft}^3$$

$$P_{\text{max}} := \frac{\text{LOAD}_{\text{tot}}}{A_{\text{mat}}} + \frac{M_{\text{ot}}}{S} \quad P_{\text{max}} = 2.8062 \cdot \text{ksf}$$

$$P_{\text{min}} := \frac{\text{LOAD}_{\text{tot}}}{A_{\text{mat}}} - \frac{M_{\text{ot}}}{S} \quad P_{\text{min}} = -1.0567 \cdot \text{ksf}$$

$$\text{MaxPressure} := \text{if}(P_{\text{max}} < 0.75R_{\text{s}}, \text{"Okay"}, \text{"No Good"}) \quad \text{MaxPressure} = \text{"Okay"}$$

$$\text{MinPressure} := \text{if}[(P_{\text{min}} \geq 0) \cdot (P_{\text{min}} < 0.75 \cdot R_{\text{s}}), \text{"Okay"}, \text{"No Good"}] \quad \text{MinPressure} = \text{"No Good"}$$

Distance to Resultant of Pressure Distribution:

$$X_{\text{p}} := \frac{P_{\text{max}}}{\frac{P_{\text{max}} - P_{\text{min}}}{W_{\text{f}}}} \cdot \frac{1}{3} \quad X_{\text{p}} = 8.8384 \cdot \text{ft}$$

Distance to Kern:

$$X_{\text{k}} := \frac{W_{\text{f}}}{3} \quad X_{\text{k}} = 12.1667 \cdot \text{ft}$$

Since Resultant Force is Not in Kern, Area to which Pressure is Applied Must be Reduced.

Eccentricity:

$$e := \frac{M_{\text{ot}}}{\text{LOAD}_{\text{tot}}} \quad e = 13.4326$$

Adjusted Soil Pressure:

$$q_{\text{a}} := \frac{2 \cdot \text{LOAD}_{\text{tot}}}{3 \cdot W_{\text{f}} \cdot \left(\frac{W_{\text{f}}}{2} - e \right)} \quad q_{\text{a}} = 4.4182 \cdot \text{ksf}$$

Revised Maximum:

$$q_{\text{max}} := \text{if}(X_{\text{p}} < X_{\text{k}}, q_{\text{a}}, P_{\text{max}}) \quad q_{\text{max}} = 4.4182 \cdot \text{ksf}$$

$$\text{PressureCheck} := \text{if}(q_{\text{max}} < 0.75 \cdot R_{\text{s}}, \text{"Okay"}, \text{"No Good"}) \quad \text{PressureCheck} = \text{"Okay"}$$

Job	180' ROHN SSV Tower w/ SNB Reinf. - Greenwich	Project No.	Revision 3	Sheet	5 of 7
Description	Foundation Analysis (TIA-222-G)	Computed by	MCD	Date	10/11/18
		Checked by		Date	

CHECK PUNCHING AND BEAM SHEAR:

Beam Shear: (Critical section located at a distance d from the face of Pier) (ACI 11.3.1.1)

$$\phi_c := 0.75 \quad (\text{ACI 9.3.2.3})$$

$$T_f := 4\text{ft} \quad \leftarrow \text{OVERRIDE - Original Footing Thickness}$$

$$d := T_f - C_{vr} - .5\text{in} \quad d = 44.5\text{in}$$

Factored load:

$$FL := \frac{C_t}{W_f^2} \quad FL = 0.3833\text{ksf}$$

$$V_{req} := \frac{FL \cdot (X_t - d) \cdot W_f}{\phi_c} \quad V_{req} = 148.2903\text{kip}$$

ACI 11.3.1.1

$$V_{Avail} := 2 \cdot \sqrt{f'_c \cdot \text{psi}} \cdot W_f \cdot d \quad V_{Avail} = 2135.1321\text{kip}$$

$$\text{BeamShearCheck} := \text{if}(V_{req} < V_{Avail}, \text{"Okay"}, \text{"No Good"}) \quad \text{BeamShearCheck} = \text{"Okay"}$$

Punching Shear: (Critical Section Located at a distance of d/2 from the face of pier) (ACI 11.12.2.1)

$$b_o := (d) \cdot \pi \quad b_o = 11.6501\text{ft}$$

$$V_{req} := FL \cdot \frac{W_f^2 - (d)^2 \cdot \frac{\pi}{4}}{\phi_c} \quad V_{req} = 675.2807\text{kip}$$

$$V_{Avail} := 4 \cdot \sqrt{f'_c \cdot \text{psi}} \cdot b_o \cdot d \quad V_{Avail} = 1362.9832\text{kip}$$

$$\text{PunchingShearCheck} := \text{if}(V_{req} < V_{Avail}, \text{"Okay"}, \text{"No Good"}) \quad \text{PunchingShearCheck} = \text{"Okay"}$$

Job	180' ROHN SSV Tower w/ SNB Reinf. - Greenwich	Project No.	Revision 3	Sheet	6 of 7
Description	Foundation Analysis (TIA-222-G)	Computed by	MCD	Date	10/11/18
		Checked by		Date	

TENSILE REINFORCEMENT IN PAD: $\phi_m := 0.90$ per ACI 9.3.2.2

Applied Moments: *NOTE: Existing 2 feet of concrete over original foundation considered in uplift reduction for design calculations shown below*

$$0.9 \cdot \frac{\gamma_c \cdot (2\text{ft} \cdot 32.5\text{ft} \cdot 32.5\text{ft})}{3} = 95.0625 \cdot \text{kip}$$

$$M_{nT} := [(U_t - 95\text{kip}) \cdot (W_t \cdot \sin(60 \cdot \text{deg})) + S_t \cdot (D_f)] - W_{T_t} \cdot 1.2 \cdot X_{\text{off}}$$

$$M_{nS} := -1 \cdot \left[\frac{1}{2} \cdot \left(\frac{W_f}{2} + \frac{W_t}{3} \cdot \cos(30 \cdot \text{deg}) \right)^2 \cdot 0.9 W_t \cdot [\gamma_s \cdot (T_{pp} - T_f)] + 0.9 W_{T_s2} \cdot \left[\left(\frac{W_f}{2} + \frac{W_t}{3} \cdot \cos(30 \cdot \text{deg}) \right) + (D_f - n) \cdot \tan(\phi_s) \right] \right]$$

$$M_{nC} := -1 \cdot \left[\frac{1}{2} \cdot \left(\frac{W_f}{2} + \frac{W_t}{3} \cdot \cos(30 \cdot \text{deg}) \right)^2 \cdot 0.9 \cdot W_t \cdot (\gamma_c \cdot T_f) \right]$$

Design Moment: $M_n := \frac{M_{nT} + M_{nS} + M_{nC}}{\phi_m} \quad M_n = 4288.6455 \cdot \text{kips} \cdot \text{ft}$

Required Reinforcement:

ACI 10.2.7.3 $\beta := \text{if} \left[f_c \leq 4000 \cdot \text{psi}, .85, \text{if} \left[f_c \geq 8000 \cdot \text{psi}, .65, .85 - \left(\frac{\frac{f_c}{\text{psi}} - 4000}{1000} \right) \cdot .05 \right] \right] \quad \beta = 0.85$

Effective Width: $b_{\text{eff}} := W_t \cdot \cos(30 \cdot \text{deg}) + 0 \quad b_{\text{eff}} = 237.2875 \cdot \text{in}$

$$A_s := \frac{M_n}{\phi_m \cdot f_y \cdot d} \quad A_s = 21.4165 \cdot \text{in}^2$$

$$a := \frac{A_s \cdot f_y}{\beta \cdot f_c \cdot b_{\text{eff}}} \quad a = 2.1237 \cdot \text{in}$$

$$A_{s_{\text{min}}} := \frac{M_n}{f_y \cdot \left(d - \frac{a}{2} \right)} \quad A_s = 19.746 \cdot \text{in}^2$$

$$\rho := \frac{A_s}{b_{\text{eff}} \cdot d} \quad \rho = 0.0019$$

Temperature and Shrinkage: $\rho_{sh} := \text{if}(f_y \geq 60000 \cdot \text{psi}, 0.0018, 0.0020) \quad \rho_{sh} = 0.0018$
(ACI 7.12.2.1b)

Area Required: $A_s := \text{if} \left(\rho \geq \rho_{sh}, A_s, \rho_{sh} \cdot \frac{b_{\text{eff}}}{2} \cdot d \right) \quad A_s = 19.746 \cdot \text{in}^2$

Area Provided: $A_{s_{\text{prov}}} := A_{\text{bpad}} \cdot \text{NB}_{\text{pad}} \quad A_{s_{\text{prov}}} = 22.2 \cdot \text{in}^2$

PadReinforcement := if($A_{s_{\text{prov}}} > A_s$, "Okay", "No Good") **PadReinforcement = "Okay"**

Job	<u>180' ROHN SSV Tower w/ SNB Reinf. - Greenwich</u>	Project No.	<u>Revision 3</u>	Sheet	<u>7</u> of <u>7</u>
Description	<u>Foundation Analysis (TIA-222-G)</u>	Computed by	<u>MCD</u>	Date	<u>10/11/18</u>
		Checked by		Date	

DEVELOPMENT LENGTH OF PAD REINFORCEMENT:

TENSION (ACI 12.2.3)

Bar Spacing: $B_{sPad} := \frac{W_f - 2 \cdot C_{vr} - N B_{pad} \cdot d_{bpad}}{N B_{pad} - 1}$ $B_{sPad} = 11.1007 \cdot \text{in}$

Development Length Factors:

Reinforcement Location Factor	$\alpha := 1.0$
Coating Factor	$\beta := 1.0$
Concrete strength Factor	$\lambda := 1.0$
Reinforcement Size Factor	$\gamma := 1.0$

Spacing or Cover Dimension: $c := \text{if} \left(C_{vr} < \frac{B_{sPad}}{2}, C_{vr}, \frac{B_{sPad}}{2} \right)$ $c = 3 \cdot \text{in}$

Transverse Reinforcement IndeAs allowed by ACI 12.2.4 $k_{tr} := 0$

Development Length: $L_{dbt} := \frac{3}{40} \cdot \frac{f_y}{\sqrt{f_c \cdot \text{psi}}} \cdot \frac{\alpha \cdot \beta \cdot \gamma \cdot \lambda}{c + k_{tr}} \cdot d_{bpad}$ $L_{dbt} = 20.9675 \cdot \text{in}$
 $L_{dbmin} := 12 \cdot \text{in}$

Minimum Development Length: $L_{dbtCheck} := \text{if} (L_{dbt} \geq L_{dbmin}, \text{"Use L.dbt"}, \text{"Use L.dbmin"})$ $L_{dbtCheck} = \text{"Use L.dbt"}$
 (ACI 12.2.1)

Available Length in Pad: $L_{Pad} := \frac{W_f}{2} - \frac{W_t}{2} - C_{vr}$ $L_{Pad} = 79.002 \cdot \text{in}$

$L_{padTension} := \text{if} (L_{Pad} > L_{dbt}, \text{"Okay"}, \text{"No Good"})$ $L_{padTension} = \text{"Okay"}$

X Diagonal Members SNB-D7

Compression force = 21,647 kips (C)
 Tension force = 21,317 kips (T)

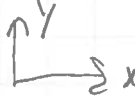
• Convert to "XY" plane forces 

21,647  $\theta = 32.06^\circ$ (CAD Measured from PLS-TOWER
 • P & F model)

$21,647 (C) \sin 32.06^\circ = 11,4904 \text{ kips}$

$21,647 (C) \cos 32.06^\circ = 18,3457 \text{ kips}$

• For conservative considerations, assume 18,3457 kips is controlling compression force

• Tension/Uplift force

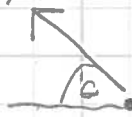
21,317  $21,317 (T) \sin 32.06^\circ = 11,3152 \text{ kips}$

$21,317 (T) \cos 32.06^\circ = 18,0660 \text{ kips}$

• For conservative considerations, assume 18,0660 kips is controlling tension/uplift force.

Prior to Mod. Evaluation

$\frac{3}{4}$ " Anchor Shear cap. = 17.9 kips LRF D x 2 = 35.8 kips > 18.345 kips
 ∴ connection OK

• For Anchorage Design, the following shall apply:

$$V = 11.4904 \text{ kips} / 4 \text{ anchors} = \underline{2.8726 \text{ kips}}$$

$$\uparrow (Uplift) = 18.0660 \text{ kips} / 4 \text{ anchors} = \underline{4.5165 \text{ kips}}$$

Apply (4) HILTI HIT-RE500 VS Epoxy Anchoring System

- Consider "Cracked Concrete"

• For 7/8" diameter Anchor @ 7/8" effective embedment & 5' concrete (Hilti: table 26)

$$\begin{aligned} \rightarrow \text{Tension capacity/anchor} &= 13,375 \text{ lbf} \quad (\text{Prior to Red. Factor}) \\ \rightarrow \text{Shear capacity/anchor} &= 28,810 \text{ lbf} \quad (\text{Prior to Reduction Factor}) \end{aligned}$$

(epoxy)

• Apply "HAS-E" Anchor Bolts (table 29)

$$\begin{aligned} \text{Tension capacity/anchor} &= \underline{21,755 \text{ lbf}} \quad (\text{LRFD Capacity}) \\ \text{Shear capacity/anchor} &= \underline{12,050 \text{ lbf}} \quad (\text{LRFD Capacity}) \end{aligned}$$

NOTE: EPOXY Anchors Based on Application of Concrete Reduction Factors:

(Apply table 39 for cracked concrete & "s" = 6 in):

$$\begin{aligned} \text{Tension capacity/anchor} &= 13,375 \times 0.61 = \underline{8,158 \text{ lbf/anchor}} \\ \text{Shear capacity/anchor} &= 28,810 \times 0.55 = \underline{15,845 \text{ lbf/anchor}} \end{aligned}$$

Apply 4 anchors & consider interaction EQ (HILTI Sect. 5.1.6.7)

$$\frac{N_u}{\phi N_n} + \frac{V_u}{\phi V_n} = \left(\frac{4.5165}{8.158} \right) + \left(\frac{2.8726}{12.050} \right) = 0.79 \leq 1.2 \therefore \text{OK}$$

Tension/Compression force applied to Baseplate = 22 kips.

Per Design sketch SK-5 - Determine Plastic Bending Capacity of Baseplate.

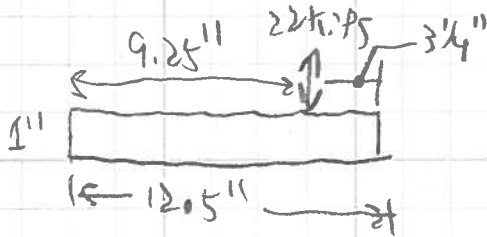

$$M_{\text{applied}} = \frac{Pab}{l} = \frac{22 \text{ kips} \times 9.25'' \times 3.25''}{12.5''} = 52.91 \text{ k.in}$$

Plate Plastic Capacity = $M_p = \sigma Z$

$$= 0.9 \times 50 \text{ ksi} \times \frac{bd^2}{4} = 0.9 \times 50 \text{ ksi} \times \frac{(12.5 \text{ in})(1 \text{ in})^2}{4}$$

$$M_p = 140.625 \text{ k.in}$$

• NOTE: LTB is not considered for Plate "minor" axis bending.

$$\frac{52.91 \text{ k.in}}{140.625 \text{ k.in}} = 37.7\% \therefore \text{OK}$$

3.2.4 HIT-RE 500 V3 Epoxy Adhesive Anchoring System

Table 26 - Hilti HIT-RE 500 V3 adhesive design strength with concrete / bond failure for threaded rod in cracked concrete^{1,2,3,4,5,6,7,8,9,11}

Nominal anchor diameter In.	Effective embedment In. (mm)	Tension — Φ_N				Shear — Φ_V			
		$f'_c = 2,500$ psi (17.2 MPa) lb (kN)	$f'_c = 3,000$ psi (20.7 MPa) lb (kN)	$f'_c = 4,000$ psi (27.6 MPa) lb (kN)	$f'_c = 6,000$ psi (41.4 MPa) lb (kN)	$f'_c = 2,500$ psi (17.2 MPa) lb (kN)	$f'_c = 3,000$ psi (20.7 MPa) lb (kN)	$f'_c = 4,000$ psi (27.6 MPa) lb (kN)	$f'_c = 6,000$ psi (41.4 MPa) lb (kN)
3/8	2-3/8 (60)	2,020 (9.0)	2,215 (9.9)	2,500 (11.1)	2,655 (11.8)	2,180 (9.7)	2,385 (10.6)	2,690 (12.0)	2,860 (12.7)
	3-3/8 (86)	3,310 (14.7)	3,400 (15.1)	3,550 (15.8)	3,770 (16.8)	7,125 (31.7)	7,325 (32.6)	7,645 (34.0)	8,125 (36.1)
	4-1/2 (114)	4,410 (19.6)	4,535 (20.2)	4,735 (21.1)	5,030 (22.4)	9,500 (42.3)	9,765 (43.4)	10,195 (45.3)	10,835 (48.2)
	7-1/2 (191)	7,350 (32.7)	7,555 (33.6)	7,890 (35.1)	8,385 (37.3)	15,835 (70.4)	16,275 (72.4)	16,990 (75.6)	18,055 (80.3)
1/2	2-3/4 (70)	2,520 (11.2)	2,760 (12.3)	3,185 (14.2)	3,905 (17.4)	5,425 (24.1)	5,945 (26.4)	6,865 (30.5)	8,405 (37.4)
	4-1/2 (114)	5,275 (23.5)	5,780 (25.7)	6,260 (27.8)	6,655 (29.8)	11,360 (50.5)	12,445 (55.4)	13,485 (60.0)	14,330 (63.7)
	6 (152)	7,780 (34.6)	7,995 (35.6)	8,350 (37.1)	8,775 (39.5)	16,755 (74.5)	17,220 (76.6)	17,980 (80.0)	19,110 (85.0)
	10 (254)	12,965 (57.7)	13,325 (59.3)	13,915 (61.9)	14,785 (65.8)	27,930 (124.2)	28,705 (127.7)	29,970 (133.3)	31,850 (141.7)
5/8	3-1/8 (79)	3,050 (13.6)	3,345 (14.9)	3,860 (17.2)	4,730 (21.0)	6,575 (29.2)	7,200 (32.0)	8,315 (37.0)	10,185 (45.3)
	5-5/8 (143)	7,370 (32.8)	8,075 (35.9)	9,325 (41.5)	10,315 (45.9)	15,875 (70.6)	17,390 (77.4)	20,080 (89.3)	22,215 (98.8)
	7-1/2 (191)	11,350 (50.5)	12,395 (55.1)	12,940 (57.6)	13,755 (61.2)	24,440 (108.7)	26,695 (118.7)	27,875 (124.0)	29,620 (131.8)
	12-1/2 (318)	20,100 (89.4)	20,660 (91.9)	21,570 (95.9)	22,920 (102.0)	43,295 (192.6)	44,495 (197.9)	46,460 (206.7)	49,370 (219.6)
3/4 ¹⁰	3-1/2 (89)	3,620 (16.1)	3,965 (17.6)	4,575 (20.4)	5,605 (24.9)	7,790 (34.7)	8,535 (38.0)	9,855 (43.8)	12,070 (53.7)
	6-3/4 (171)	9,690 (43.1)	10,615 (47.2)	12,255 (54.5)	14,735 (65.5)	20,870 (92.8)	22,860 (101.7)	26,395 (117.4)	31,740 (141.2)
	9 (229)	14,920 (66.4)	16,340 (72.7)	18,490 (82.2)	19,650 (87.4)	32,130 (142.9)	35,195 (156.6)	39,820 (177.1)	42,320 (188.2)
	15 (381)	28,715 (127.7)	29,510 (131.3)	30,815 (137.1)	32,745 (145.7)	61,850 (275.1)	63,565 (282.7)	66,370 (295.2)	70,530 (313.7)
7/8 ¹⁰	3-1/2 (89)	3,620 (16.1)	3,965 (17.6)	4,575 (20.4)	5,605 (24.9)	7,790 (34.7)	8,535 (38.0)	9,855 (43.8)	12,070 (53.7)
	7-7/8 (200)	12,210 (54.3)	13,375 (59.5)	15,445 (68.7)	18,915 (84.1)	26,300 (117.0)	28,810 (128.2)	33,265 (148.0)	40,740 (181.2)
	10-1/2 (267)	18,800 (83.6)	20,590 (91.6)	23,780 (105.8)	26,530 (118.0)	40,490 (180.1)	44,355 (197.3)	51,215 (227.8)	57,140 (254.2)
	17-1/2 (445)	38,775 (172.5)	39,850 (177.3)	41,605 (185.1)	44,215 (196.7)	83,510 (371.5)	85,825 (381.8)	89,610 (398.6)	95,230 (423.6)
1	4 (102)	4,420 (19.7)	4,840 (21.5)	5,590 (24.9)	6,845 (30.4)	9,520 (42.3)	10,430 (46.4)	12,040 (53.6)	14,750 (65.6)
	9 (229)	14,920 (66.4)	16,340 (72.7)	18,770 (83.9)	23,110 (102.8)	32,130 (142.9)	35,195 (156.6)	40,640 (180.8)	48,775 (217.4)
	12 (305)	22,965 (102.2)	25,160 (111.9)	29,050 (129.2)	34,650 (154.1)	49,465 (220.0)	54,190 (241.0)	62,570 (278.3)	74,630 (332.0)
	20 (508)	49,415 (219.8)	52,045 (231.5)	54,340 (241.7)	57,750 (256.9)	106,435 (473.4)	112,100 (498.6)	117,045 (520.6)	124,385 (553.3)
1-1/4 ¹⁰	5 (127)	6,175 (27.5)	6,765 (30.1)	7,815 (34.8)	9,570 (42.6)	13,305 (59.2)	14,575 (64.8)	16,830 (74.9)	20,610 (91.7)
	11-1/4 (286)	22,850 (92.7)	22,840 (101.6)	26,370 (117.3)	32,295 (143.7)	44,905 (199.7)	49,190 (218.8)	56,800 (252.7)	69,565 (309.4)
	15 (381)	32,095 (142.8)	35,160 (156.4)	40,600 (180.6)	49,725 (221.2)	69,135 (307.5)	75,730 (336.9)	87,445 (389.0)	107,100 (476.4)
	25 (635)	69,060 (307.2)	75,655 (336.5)	80,800 (359.4)	85,865 (381.9)	148,750 (661.7)	162,945 (724.8)	174,030 (774.1)	184,945 (822.7)

1 See Section 3.1.8 for explanation on development of load values.
 2 See Section 3.1.8.6 to convert design strength value to ASD value.
 3 Linear interpolation between embedment depths and concrete compressive strengths is not permitted.
 4 Apply spacing, edge distance, and concrete thickness factors in tables 30-41 as necessary to the above values. Compare to the steel values in table 29. The lesser of the values is to be used for the design.
 5 Data is for temperature range A: Max. short term temperature = 130°F (55°C), max. long term temperature = 110°F (43°C).
 For temperature range B: Max. short term temperature = 176°F (80°C), max. long term temperature = 110°F (43°C) multiply above values by 0.89.
 Short term elevated concrete temperatures are those that occur over brief intervals, e.g., as a result of diurnal cycling. Long term concrete temperatures are roughly constant over significant periods of time.
 6 Tabular values are for dry or water saturated concrete conditions.
 For water-filled drilled holes multiply design strength by 0.51.
 For submerged (under water) applications multiply design strength by 0.44.
 7 Tabular values are for short term loads only. For sustained loads including overhead use, see Section 3.1.8.8.
 8 Tabular values are for normal-weight concrete only. For lightweight concrete multiply design strength by λ_c as follows:
 For sand-lightweight, $\lambda_c = 0.51$. For all-lightweight, $\lambda_c = 0.45$.
 9 Tabular values are for holes drilled in concrete with carbide tipped hammer drill bit. Diamond core drilling is not permitted in cracked concrete conditions except as indicated in note 10.
 10 Diamond core drilling with Hilti TE-YRT roughening tool is permitted for 3/4", 7/8", and 1 1/4" diameter anchors for dry and water-saturated concrete conditions. See Table 28
 11 Tabular values are for static loads only. For seismic loads, multiply cracked concrete tabular values in tension and shear by α_{sm} indicated below.
 See section 3.1.8.7 for additional information on seismic applications.
 3/8-in. diameter - $\alpha_{sm} = 0.69$
 1/2-in. diameter - $\alpha_{sm} = 0.70$
 5/8-in. diameter - $\alpha_{sm} = 0.71$
 3/4-in. diameter and larger - $\alpha_{sm} = 0.75$

HIT-RE 500 V3 Epoxy Adhesive Anchoring System 3.2.4

Table 38 - Load adjustment factors for 7/8-in. diameter threaded rods in uncracked concrete^{1,2,3}

7/8-in. uncracked concrete	Spacing factor in tension f_{AN}				Edge distance factor in tension f_{RN}				Spacing factor in shear ⁴ f_{AV}				Edge distance in shear								Concrete thickness factor in shear ⁵ f_{HV}			
													⊥ Toward edge f_{RV}				∥ To and away from edge f_{RV}							
	Embedment h_e (mm)	3-1/2 (89)	7-7/8 (200)	10-1/2 (267)	17-1/2 (445)	3-1/2 (89)	7-7/8 (200)	10-1/2 (267)	17-1/2 (445)	3-1/2 (89)	7-7/8 (200)	10-1/2 (267)	17-1/2 (445)	3-1/2 (89)	7-7/8 (200)	10-1/2 (267)	17-1/2 (445)	3-1/2 (89)	7-7/8 (200)	10-1/2 (267)	17-1/2 (445)	3-1/2 (89)	7-7/8 (200)	10-1/2 (267)
1-3/4 (44)	n/a	n/a	n/a	n/a	0.39	0.24	0.18	0.10	n/a	n/a	n/a	n/a	0.09	0.03	0.02	0.01	0.18	0.05	0.04	0.02	n/a	n/a	n/a	n/a
4-3/8 (111)	0.58	0.58	0.57	0.54	0.53	0.31	0.23	0.13	0.58	0.54	0.53	0.52	0.35	0.11	0.07	0.03	0.63	0.22	0.14	0.07	n/a	n/a	n/a	n/a
5 (127)	0.59	0.59	0.58	0.55	0.56	0.33	0.24	0.13	0.59	0.54	0.53	0.52	0.43	0.13	0.09	0.04	0.70	0.27	0.17	0.08	n/a	n/a	n/a	n/a
5-1/2 (140)	0.60	0.60	0.59	0.55	0.58	0.34	0.25	0.14	0.60	0.55	0.54	0.52	0.50	0.15	0.10	0.05	0.76	0.31	0.20	0.09	0.65	n/a	n/a	n/a
6 (152)	0.61	0.61	0.60	0.56	0.61	0.36	0.26	0.15	0.61	0.55	0.54	0.52	0.57	0.17	0.11	0.05	0.83	0.35	0.23	0.11	0.68	n/a	n/a	n/a
7 (178)	0.63	0.63	0.61	0.57	0.65	0.39	0.28	0.16	0.63	0.56	0.55	0.53	0.71	0.22	0.14	0.07	0.97	0.39	0.29	0.13	0.73	n/a	n/a	n/a
8 (203)	0.65	0.65	0.63	0.58	0.71	0.42	0.31	0.17	0.65	0.57	0.55	0.53	0.87	0.27	0.17	0.08	1.00	0.42	0.33	0.16	0.78	n/a	n/a	n/a
9 (229)	0.67	0.67	0.64	0.59	0.76	0.45	0.33	0.18	0.67	0.58	0.56	0.54	1.00	0.32	0.21	0.10		0.45	0.35	0.19	0.83	n/a	n/a	n/a
9-7/8 (251)	0.69	0.69	0.66	0.59	0.80	0.48	0.35	0.19	0.69	0.59	0.56	0.54		0.37	0.24	0.11		0.48	0.37	0.22	0.87	0.59	n/a	n/a
10 (254)	0.69	0.69	0.66	0.60	0.81	0.49	0.35	0.19	0.69	0.59	0.57	0.54		0.38	0.24	0.11		0.49	0.37	0.23	0.87	0.59	n/a	n/a
11 (279)	0.71	0.71	0.67	0.60	0.87	0.52	0.38	0.21	0.71	0.60	0.57	0.54		0.43	0.28	0.13		0.52	0.40	0.26	0.91	0.62	n/a	n/a
12 (305)	0.73	0.73	0.69	0.61	0.92	0.56	0.40	0.22	0.73	0.60	0.58	0.55		0.49	0.32	0.15		0.56	0.42	0.29	0.95	0.65	n/a	n/a
12-1/2 (318)	0.74	0.74	0.70	0.62	0.95	0.59	0.41	0.23	0.74	0.61	0.58	0.55		0.52	0.34	0.16		0.59	0.43	0.29	0.97	0.66	0.57	n/a
14 (356)	0.76	0.76	0.72	0.63	1.00	0.66	0.46	0.25	0.77	0.62	0.59	0.55		0.62	0.40	0.19		0.66	0.47	0.31	1.00	0.70	0.60	n/a
16 (406)	0.80	0.80	0.75	0.65		0.75	0.52	0.29	0.80	0.64	0.60	0.56		0.76	0.49	0.23		0.75	0.52	0.34		0.75	0.65	n/a
18 (457)	0.84	0.84	0.79	0.67		0.84	0.59	0.32	0.84	0.66	0.62	0.57		0.91	0.59	0.27		0.84	0.59	0.36		0.79	0.68	n/a
19-1/2 (495)	0.87	0.87	0.81	0.69		0.92	0.64	0.35	0.87	0.67	0.63	0.58		1.00	0.66	0.31		0.92	0.64	0.38		0.82	0.71	0.55
20 (508)	0.88	0.88	0.82	0.69		0.94	0.65	0.36	0.88	0.67	0.63	0.58			0.69	0.32		0.94	0.65	0.39		0.83	0.72	0.56
22 (559)	0.91	0.91	0.85	0.71		1.00	0.72	0.40	0.92	0.69	0.64	0.59			0.80	0.37		1.00	0.72	0.41		0.87	0.76	0.59
24 (610)	0.95	0.95	0.88	0.73			0.78	0.43	0.96	0.71	0.66	0.59			0.91	0.42			0.78	0.44		0.91	0.79	0.61
26 (660)	0.99	0.99	0.91	0.75			0.85	0.47	0.99	0.73	0.67	0.60			1.00	0.48			0.85	0.47		0.95	0.82	0.64
28 (711)	1.00	1.00	0.94	0.77			0.91	0.50	1.00	0.74	0.68	0.61				0.53			0.91	0.50		0.99	0.85	0.66
30 (762)			0.98	0.79			0.98	0.54		0.76	0.70	0.62				0.59			0.98	0.54		1.00	0.88	0.68
36 (914)			1.00	0.84			1.00	0.65		0.81	0.73	0.64				0.77			1.00	0.65			0.97	0.75
> 48 (1219)				0.96			0.86			0.92	0.81	0.69				1.00				0.86			1.00	0.87

3.2.4

Table 39 - Load adjustment factors for 7/8-in. diameter threaded rods in cracked concrete^{1,2,3}

7/8-in. cracked concrete	Spacing factor in tension f_{AN}				Edge distance factor in tension f_{RN}				Spacing factor in shear ⁴ f_{AV}				Edge distance in shear								Concrete thickness factor in shear ⁵ f_{HV}			
													⊥ Toward edge f_{RV}				∥ To and away from edge f_{RV}							
	Embedment h_e (mm)	3-1/2 (89)	7-7/8 (200)	10-1/2 (267)	17-1/2 (445)	3-1/2 (89)	7-7/8 (200)	10-1/2 (267)	17-1/2 (445)	3-1/2 (89)	7-7/8 (200)	10-1/2 (267)	17-1/2 (445)	3-1/2 (89)	7-7/8 (200)	10-1/2 (267)	17-1/2 (445)	3-1/2 (89)	7-7/8 (200)	10-1/2 (267)	17-1/2 (445)	3-1/2 (89)	7-7/8 (200)	10-1/2 (267)
1-3/4 (44)	n/a	n/a	n/a	n/a	0.42	0.42	0.41	0.38	n/a	n/a	n/a	n/a	0.09	0.03	0.02	0.01	0.18	0.06	0.04	0.02	n/a	n/a	n/a	n/a
4-3/8 (111)	0.58	0.58	0.57	0.54	0.53	0.53	0.50	0.44	0.58	0.54	0.53	0.52	0.36	0.11	0.07	0.03	0.71	0.22	0.14	0.07	n/a	n/a	n/a	n/a
5 (127)	0.59	0.59	0.58	0.55	0.56	0.56	0.52	0.45	0.60	0.54	0.53	0.52	0.43	0.13	0.09	0.04	0.87	0.27	0.17	0.08	n/a	n/a	n/a	n/a
5-1/2 (140)	0.60	0.60	0.59	0.55	0.58	0.58	0.54	0.46	0.61	0.55	0.54	0.52	0.50	0.15	0.10	0.05	1.00	0.31	0.20	0.10	0.65	n/a	n/a	n/a
6 (152)	0.61	0.61	0.60	0.56	0.61	0.61	0.56	0.47	0.61	0.55	0.54	0.52	0.57	0.18	0.11	0.06		0.35	0.23	0.11	0.68	n/a	n/a	n/a
7 (178)	0.63	0.63	0.61	0.57	0.65	0.65	0.60	0.49	0.63	0.56	0.55	0.53	0.72	0.22	0.14	0.07		0.44	0.29	0.14	0.73	n/a	n/a	n/a
8 (203)	0.65	0.65	0.63	0.58	0.71	0.71	0.64	0.52	0.65	0.57	0.55	0.53	0.88	0.27	0.18	0.09		0.54	0.35	0.17	0.78	n/a	n/a	n/a
9 (229)	0.67	0.67	0.64	0.59	0.76	0.76	0.68	0.54	0.67	0.58	0.56	0.54	1.00	0.32	0.21	0.10		0.65	0.42	0.20	0.83	n/a	n/a	n/a
9-7/8 (251)	0.69	0.69	0.66	0.59	0.80	0.80	0.72	0.56	0.69	0.59	0.56	0.54		0.37	0.24	0.12		0.74	0.48	0.23	0.87	0.59	n/a	n/a
10 (254)	0.69	0.69	0.66	0.60	0.81	0.81	0.73	0.58	0.69	0.59	0.57	0.54		0.38	0.25	0.12		0.76	0.49	0.24	0.87	0.59	n/a	n/a
11 (279)	0.71	0.71	0.67	0.60	0.87	0.87	0.77	0.59	0.71	0.60	0.57	0.54		0.44	0.28	0.14		0.87	0.57	0.28	0.92	0.62	n/a	n/a
12 (305)	0.73	0.73	0.69	0.61	0.92	0.92	0.82	0.61	0.73	0.60	0.58	0.55		0.50	0.32	0.16		1.00	0.65	0.31	0.96	0.65	n/a	n/a
12-1/2 (318)	0.74	0.74	0.70	0.62	0.95	0.95	0.84	0.62	0.74	0.61	0.58	0.55		0.53	0.34	0.17			0.69	0.33	0.98	0.66	0.57	n/a
14 (356)	0.76	0.76	0.72	0.63	1.00	1.00	0.91	0.66	0.77	0.62	0.59	0.56		0.63	0.41	0.20			0.82	0.40	1.00	0.70	0.61	n/a
16 (406)	0.80	0.80	0.75	0.65			1.00	0.71	0.81	0.64	0.60	0.56		0.77	0.50	0.24			1.00	0.48		0.75	0.65	n/a
18 (457)	0.84	0.84	0.79	0.67			0.76	0.62	0.84	0.66	0.62	0.57		0.91	0.59	0.29				0.58		0.79	0.69	n/a
19-1/2 (495)	0.87	0.87	0.81	0.69			0.80	0.67	0.87	0.67	0.63	0.58		1.00	0.67	0.32				0.65		0.82	0.71	0.56
20 (508)	0.88	0.88	0.82	0.69			0.82	0.68	0.88	0.67	0.63	0.58			0.70	0.34				0.67		0.84	0.72	0.57
22 (559)	0.91	0.91	0.85	0.71			0.87	0.72	0.92	0.69	0.64	0.59			0.80	0.39				0.78		0.88	0.76	0.60
24 (610)	0.95	0.95	0.88	0.73			0.93	0.76	0.96	0.71	0.66	0.60			0.91	0.44				0.89		0.92	0.79	0.62
26 (660)	0.99	0.99	0.91	0.75			0.99	0.80	1.00	0.73	0.67	0.61			1.00	0.50				0.99		0.95	0.82	0.65
28 (711)	1.00	1.00	0.94	0.77			1.00	0.85		0.74	0.68	0.61				0.56				1.00		0.99	0.86	0.67
30 (762)			0.98	0.79				0.98		0.76	0.70	0.62				0.62						1.00	0.89	0.70
36 (914)			1.00	0.84				1.00		0.81	0.74	0.65				0.81							0.97	0.76
> 48 (1219)				0.96				0.96		0.92	0.81	0.69				1.00							1.00	0.88

1 Linear interpolation not permitted.
 2 Shaded area with reduced edge distance is permitted provided the installation torque is reduced to 0.30 T_{max} for 5d ≤ s ≤ 16-in. and to 0.5 T_{max} for s > 16-in.
 3 When combining multiple load adjustment factors (e.g. for a 4 anchor pattern in a corner with a thin concrete member) the design can become very conservative. To optimize the design, use Hilti PROFIS Anchor Design software or perform anchor calculation using the design equations from ACI 318 Chapter 17.
 4 Spacing factor reduction in shear, f_{AV} , assumes an influence of a nearby edge. If no edge exists, then $f_{AV} = f_{AN}$.
 5 Concrete thickness reduction factor in shear, f_{HV} , assumes an influence of a nearby edge. If no edge exists, then $f_{HV} = 1.0$.

3.2.4 HIT-RE 500 V3 Epoxy Adhesive Anchoring System

Table 29 - Steel design strength for Hilti HIT-V and HAS threaded rods¹

Nominal anchor diameter in.	HIT-V ASTM A307 Grade A ²			HAS-E ISO 898 Class 5.8 ²			HAS-E-B ASTM A193 B7 ³			HAS-R stainless steel ASTM F593 - AISI 304/316 SS ²		
	Tensile ⁴ ϕN_{sa} lb (kN)	Shear ⁵ ϕV_{sa} lb (kN)	Seismic Shear ⁶ $\phi V_{sa,eq}$ lb (kN)	Tensile ⁴ ϕN_{sa} lb (kN)	Shear ⁵ ϕV_{sa} lb (kN)	Seismic Shear ⁶ $\phi V_{sa,eq}$ lb (kN)	Tensile ⁴ ϕN_{sa} lb (kN)	Shear ⁵ ϕV_{sa} lb (kN)	Seismic Shear ⁶ $\phi V_{sa,eq}$ lb (kN)	Tensile ⁴ ϕN_{sa} lb (kN)	Shear ⁵ ϕV_{sa} lb (kN)	Seismic Shear ⁶ $\phi V_{sa,eq}$ lb (kN)
3/8	3,025 (13.5)	1,675 (7.5)	1,175 (5.2)	3,655 (16.3)	2,020 (9.0)	1,415 (6.3)	7,265 (32.3)	3,775 (16.8)	2,645 (11.8)	5,040 (22.4)	2,790 (12.4)	1,955 (8.7)
1/2	5,535 (24.6)	3,065 (13.6)	2,145 (9.5)	6,690 (29.8)	3,705 (16.5)	2,595 (11.5)	13,300 (59.2)	6,915 (30.8)	4,840 (21.5)	9,225 (41.0)	5,110 (22.7)	3,575 (15.9)
5/8	8,815 (39.2)	4,880 (21.7)	3,415 (15.2)	10,650 (47.4)	5,900 (26.2)	4,130 (18.4)	21,190 (94.3)	11,020 (49.0)	7,715 (34.3)	14,690 (65.3)	8,135 (36.2)	5,695 (25.3)
3/4	13,045 (58.0)	7,225 (32.1)	5,060 (22.5)	15,765 (70.1)	8,730 (38.8)	6,110 (27.2)	31,360 (139.5)	16,305 (72.5)	11,415 (50.8)	18,480 (82.2)	10,235 (45.5)	7,165 (31.9)
7/8	-	-	-	21,755 (96.8)	12,050 (53.6)	8,435 (37.5)	43,285 (192.5)	22,505 (100.1)	15,755 (70.1)	25,510 (113.5)	14,125 (62.8)	9,890 (44.0)
1	23,620 (105.1)	13,085 (58.2)	9,160 (40.7)	28,540 (127.0)	15,865 (70.3)	11,865 (49.2)	56,785 (252.6)	29,525 (131.3)	20,670 (91.9)	33,465 (148.9)	18,535 (82.4)	12,975 (57.7)
1-1/4	-	-	-	45,670 (203.1)	25,295 (112.5)	17,705 (78.8)	90,850 (404.1)	47,240 (210.1)	33,070 (147.1)	53,540 (238.2)	29,655 (131.9)	20,760 (92.3)

1 See Section 3.1.8.6 to convert design strength value to ASD value.

2 HIT-V, HAS-E, and HAS-R threaded rods are considered brittle steel elements. HIT-V does not comply with % elongation requirements of ASTM A307 Grade A steel. HAS-E does not comply with % elongation requirements of ISO 898-1.

3 HAS-E-B7 rods are considered ductile steel elements.

4 Tensile = $\phi A_{sa} N_{sa}$ as noted in ACI 318 Chapter 17.

5 Shear = $\phi 0.60 A_{sa} V_{sa}$ as noted in ACI 318 Chapter 17.

6 Seismic Shear = $\alpha_{V_{sa,eq}} \phi V_{sa}$: Reduction for seismic shear only. See section 3.1.8.7 for additional information on seismic applications.

$L=15' \pm$; to be field

*** Tapered Self-Support Tower Sub-Horizontals**

- Designed to strengthen tower legs by reducing their KL/r value
- Complete kits contain (6) Angles, (3) Brackets, (3) Center Plates, (6) 5/8" U-bolts, (27) 5/8" Bolts
- All material is minimum A36, Hardware is A325X, Hot-Dip Galvanized
- Connections use Squirter® F959 DTI washers to ensure proper installed bolt tension
- Double bolted angle connections at both ends
- Brackets center themselves on legs with the welded solid rods on backside
- Specify leg butterfly bracket kit + angle / center plate kit [Qty: (3) per Kit]

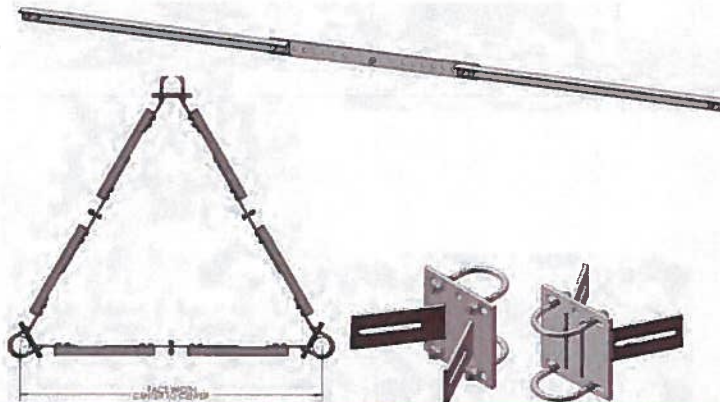

Mfr	Sub Horizontal Angle & Center Plate					
	Tower Face Width Range (ft)	Center Plate Size	Sub-Horizontal Size	Φ Pn (kips)	Leg Pu* (kips)	Kit #
Structural Components	5 - 6	3/8" x 3"	2" x 2" x 3/16"	20.00	800	RSH-0605-06
	6 - 7	3/8" x 3"	2" x 2" x 3/16"	18.00	720	RSH-0606-07
	7 - 9	3/8" x 3"	2" x 2" x 1/4"	13.75	550	RSH-0607-09
	9 - 11	3/8" x 3"	2" x 2" x 1/4"	9.50	380	RSH-0609-11
	11 - 13	3/8" x 3"	2-1/2" x 2-1/2" x 1/4"	12.13	485	RSH-0611-13
	13 - 15	1/2" x 4"	2-1/2" x 2-1/2" x 1/4"	8.50	340	RSH-0613-15
	15 - 17	1/2" x 4"	3" x 3" x 1/4"	16.50	660	RSH-0615-17
	17 - 19	1/2" x 4"	3" x 3" x 1/4"	12.50	500	RSH-0617-19
	19 - 21	5/8" x 4"	3-1/2" x 3-1/2" x 1/4"	16.00	640	RSH-0619-21
	21 - 23	5/8" x 4"	3-1/2" x 3-1/2" x 1/4"	12.88	515	RSH-0621-23
	23 - 25	5/8" x 4"	4" x 4" x 1/4"	15.88	635	RSH-0623-25

Leg Butterfly Bracket		
Leg Ø Range (O.D.) (in)	U-Bolt Size	Kit #
1.5 - 2.5	5/8" x 2-9/16"	RSH-0515-25
2.5 - 3.5	5/8" x 3-9/16"	RSH-0525-35
3.5 - 4.5	5/8" x 4-9/16"	RSH-0535-45
4.5 - 6.75	5/8" x 6-13/16"	RSH-0545-68
6.75 - 8.625	5/8" x 8-11/16"	RSH-0568-86
8.625 - 10.75	5/8" x 10-13/16"	RSH-0586-00

*CAPACITY BASED ON FULLY LOADING HORIZONTAL WITH 2.5% OF LEG COMPRESSION

NOTE: Order (1) RSH-05###-### kit and (1) RSH-06###-### kit for (1) full sub-horizontal assembly

Guyed Tower Torque Arm

- Designed to provide torsion resistance to guyed towers when needed
- Kits contain all materials to bolt torque arm onto tower
- All material is minimum A572-50, Hardware is A325X, Hot-Dip Galvanized
- Connections use Squirter F959 DTI washers to ensure proper installed bolt tension
- Fits guyed towers with 1.25" - 3.5" OD Legs
- Add split pipe sleeve kit if tower leg is 2" SCH 40, 2.5" SCH 40 or 3" SCH 40 [Qty: (3) per kit]
- Use split pipe sleeves to avoid crimping thin wall pipe legs

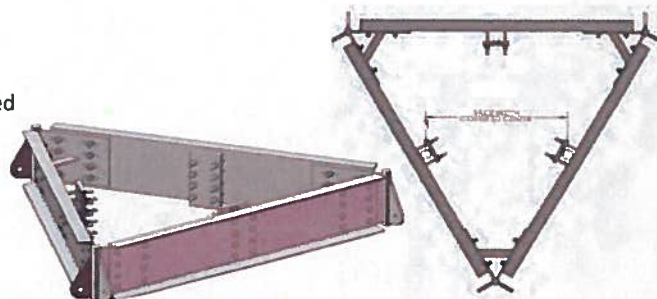

Mfr	Face Width (C-C) (in)	EHS WIRE SIZE									
		< 5/16"	3/8"	7/16"	1/2"	9/16"	5/8"	11/16"	3/4"	7/8"	1"
Structural Components	18	RTA-1135-18			RTA-1235-18						
	24	RTA-1135-24			RTA-1235-24			RTA-1335-24			
	30	RTA-1135-30			RTA-1235-30			RTA-1335-30			
	33	RTA-1135-33			RTA-1235-33			RTA-1335-33			
	36	RTA-1235-36						RTA-1335-36			
	39	RTA-1235-39						RTA-1335-39			
	41	RTA-1235-41						RTA-1335-41			
	42	RTA-1235-42						RTA-1335-42			
	45	RTA-1235-45						RTA-1335-45			
	48	RTA-1235-48						RTA-1335-48			
	54	RTA-1235-54						RTA-1335-54			
	57	RTA-1235-57						RTA-1335-57			
	60	RTA-1235-60						RTA-1335-60			
	72	RTA-1235-72						RTA-1335-72			



Towers with SCH 40 Pipe Legs: Split Pipe Sleeves

Leg OD	Kit #
2.375"	RGA-1000-23
2.875"	RGA-1000-28
3.5"	RGA-1000-35

LIGHT MEDIUM HEAVY

About AECOM

AECOM (NYSE: ACM) is a global provider of professional technical and management support services to a broad range of markets, including transportation, facilities, environmental, energy, water and government. With approximately 45,000 employees around the world, AECOM is a leader in all of the key markets that it serves. AECOM provides a blend of global reach, local knowledge, innovation, and collaborative technical excellence in delivering solutions that enhance and sustain the world's built, natural, and social environments. A Fortune 500 company, AECOM serves clients in more than 100 countries and has annual revenue in excess of \$6 billion.

More information on AECOM and its services can be found at www.aecom.com.

500 Enterprise Drive, Suite 3B
Rocky Hill, CT 06067
860-529-8882
Fax: 860-529-3991



**UNITED STATES
POSTAL SERVICE®**

Click-N-Ship®

P

usps.com 9407 8036 9930 0042 8546 45 0162 0000 0020 6051
US POSTAGE \$16.20
 MD Flat Rate Box
 Signature Confirmation



11/06/2018 Mailed from 12866 062S0000001309

PRIORITY MAIL 1-DAY™

Expected Delivery Date: 11/07/18
 Ref#: CT03XC169
0024

RAY A PERRY
 AIROSMITH DEVELOPMENT
 32 CLINTON ST
 SARATOGA SPGS NY 12866-2110

SIGNATURE REQUIRED

C006

SHIP TO: MELANIE A BACHMAN
 CONNECTICUT SITING COUNCIL
 10 FRANKLIN SQ
 NEW BRITAIN CT 06051-2655

USPS SIGNATURE TRACKING #

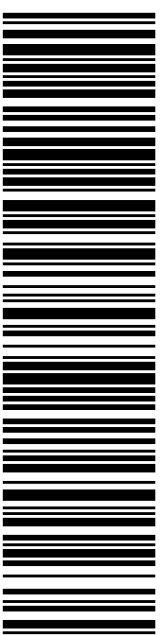

9407 8036 9930 0042 8546 45

Electronic Rate Approved #038555749



Cut on dotted line.

Instructions

1. Each Click-N-Ship® label is unique. Labels are to be used as printed and used only once. DO NOT PHOTO COPY OR ALTER LABEL.
2. Place your label so it does not wrap around the edge of the package.
3. Adhere your label to the package. A self-adhesive label is recommended. If tape or glue is used, DO NOT TAPE OVER BARCODE. Be sure all edges are secure.
4. To mail your package with PC Postage®, you may schedule a Package Pickup online, hand to your letter carrier, take to a Post Office™, or drop in a USPS collection box.
5. Mail your package on the "Ship Date" you selected when creating this label.

Click-N-Ship® Label Record

**Signature Confirmation™ / Insurance Number:
 9407 8036 9930 0042 8546 45**

Trans. #:	448080951	Priority Mail® Postage:	\$13.65
Print Date:	11/06/2018	Insurance Fee	\$0.00
Ship Date:	11/06/2018	Signature Confirmation (Electronic Rate)	\$2.55
Expected Delivery Date:	11/07/2018	Total	\$16.20
Insured Value:	\$50.00		

From: RAY A PERRY
 AIROSMITH DEVELOPMENT
 32 CLINTON ST
 SARATOGA SPGS NY 12866-2110

Ref#: CT03XC169

To: MELANIE A BACHMAN
 CONNECTICUT SITING COUNCIL
 10 FRANKLIN SQ
 NEW BRITAIN CT 06051-2655

* Retail Pricing Priority Mail rates apply. There is no fee for USPS Tracking® service on Priority Mail service with use of this electronic rate shipping label. Refunds for unused postage paid labels can be requested online 30 days from the print date.



Thank you for shipping with the United States Postal Service!
 Check the status of your shipment on the USPS Tracking® page at usps.com