



# STATE OF CONNECTICUT

## CONNECTICUT SITING COUNCIL

Ten Franklin Square, New Britain, CT 06051

Phone: (860) 827-2935 Fax: (860) 827-2950

E-Mail: [siting.council@ct.gov](mailto:siting.council@ct.gov)

[www.ct.gov/csc](http://www.ct.gov/csc)

June 20, 2011

Douglas L. Culp, Real Estate Consultant  
New Cingular Wireless PCS, LLC  
500 Enterprise Drive  
Rocky Hill, CT 06067-3900

RE: **EM-CING-051-110527** - New Cingular Wireless PCS, LLC notice of intent to modify an existing telecommunications facility located at 281 Wood House Road, Fairfield, Connecticut

Dear Mr. Culp:

The Connecticut Siting Council (Council) hereby acknowledges your notice to modify this existing telecommunications facility, pursuant to Section 16-50j-73 of the Regulations of Connecticut State Agencies with the following conditions:

- Any deviation from the proposed modification as specified in this notice and supporting materials with Council shall render this acknowledgement invalid;
- Any material changes to this modification as proposed shall require the filing of a new notice with the Council;
- Not less than 45 days after completion of construction, the Council shall be notified in writing that construction has been completed;
- The validity of this action shall expire one year from the date of this letter; and
- The applicant may file a request for an extension of time beyond the one year deadline provided that such request is submitted to the Council not less than 60 days prior to the expiration;

The proposed modifications including the placement of all necessary equipment and shelters within the tower compound are to be implemented as specified here and in your notice dated May 27, 2011. The modifications are in compliance with the exception criteria in Section 16-50j-72 (b) of the Regulations of Connecticut State Agencies as changes to an existing facility site that would not increase tower height, extend the boundaries of the tower site, increase noise levels at the tower site boundary by six decibels, and increase the total radio frequencies electromagnetic radiation power density measured at the tower site boundary to or above the standard adopted by the State Department of Environmental Protection pursuant to General Statutes § 22a-162. This facility has also been carefully modeled to ensure that radio frequency emissions are conservatively below State and federal standards applicable to the frequencies now used on this tower.

This decision is under the exclusive jurisdiction of the Council. Please be advised that the validity of this action shall expire one year from the date of this letter. Any additional change to this facility will require explicit notice to this agency pursuant to Regulations of Connecticut State Agencies Section 16-50j-73. Such notice shall include all relevant information regarding the proposed change with cumulative worst-case modeling of radio frequency exposure at the closest point of uncontrolled access to the tower base, consistent with Federal Communications Commission, Office of Engineering and Technology, Bulletin 65. Thank you for your attention and cooperation.

Very truly yours,

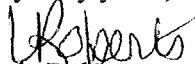
  
Linda Roberts  
Executive Director

LR/CDM/laf

c: The Honorable Kenneth A. Flatto, First Selectman, Town of Fairfield  
Joseph E. Devonshuk, Town Planner, Town of Fairfield  
Crown Castle USA, Inc.





New Cingular Wireless PCS, LLC  
500 Enterprise Drive  
Rocky Hill, Connecticut 06067-3900  
Phone: (860) 463-5511  
Fax: (860) 513-7190

**Douglas L. Culp**  
Real Estate Consultant

HAND DELIVERED

May 27, 2011

Ms. Linda Roberts  
Executive Director  
Connecticut Siting Council  
10 Franklin Square  
New Britain, Connecticut 06051

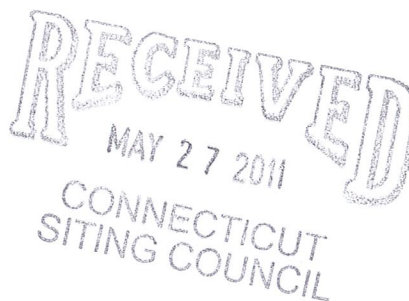

Re: New Cingular Wireless PCS, LLC notice of intent to modify an existing tele-communications facility located at 281 Wood House Fairfield, CT (owner Crown Castle)

Dear Ms. Roberts:

In order to accommodate technological changes, implement Uniform Mobile Telecommunications System (“UMTS”) and/or Long Term Evolution (“LTE”) capabilities, and enhance system performance in the State of Connecticut, New Cingular Wireless PCS, LLC (“AT&T”) plans to modify the equipment configurations at many of its existing cell sites. Please accept this letter and attachments as notification, pursuant to R.C.S.A. Section 16-50j-73, of construction which constitutes an exempt modification pursuant to R.C.S.A. Section 16-50j-72(b)(2). In compliance with R.C.S.A. Section 16-50j-73, a copy of this letter and attachments is being sent to the chief elected official of the municipality in which the affected cell site is located.

UMTS technology offers services to mobile computer and phone users anywhere in the world. Based on the Global System for Mobile (“GSM”) communication standard, UMTS is the planned worldwide standard for mobile users. UMTS, fully implemented, gives computer and phone users high-speed access to the Internet as they travel. They have the same capabilities even when they roam, through both terrestrial wireless and satellite transmissions.

LTE is a new high-performance air interface for cellular mobile communications. It is designed to increase the capacity and speed of mobile telephone networks.

Attached is a summary of the planned modifications, including power density calculations reflecting the change in AT&T’s operations at the site. Also included is documentation of the structural sufficiency of the tower to accommodate the revised antenna configuration.

The changes to the facility do not constitute modifications as defined in Connecticut General Statutes ("C.G.S.") Section 16-50i(d) because the general physical characteristics of the facility will not be significantly changed or altered. Rather, the planned changes to the facility fall squarely within those activities explicitly provided for in R.C.S.A. Section 16-50j-72(b)(2).

1. The height of the overall structure will be unaffected.
2. The proposed changes will not extend the site boundaries. There will be no effect on the site compound other than some enlarged equipment pads as may be noted in the attachments.
3. The proposed changes will not increase the noise level at the existing facility by six decibels or more.
4. Radio frequency power density may increase due to use of one or more GSM channel for UMTS transmissions. Moreover, LTE will utilize additional radio frequencies newly-licensed by the FCC for cellular mobile communications. However, the changes will not increase the calculated "worst case" power density for the combined operations at the site to a level at or above the applicable standard for uncontrolled environments as calculated for a mixed frequency site.

For the foregoing reasons, New Cingular Wireless respectfully submits that the proposed changes at the referenced site constitute exempt modifications under R.C.S.A. Section 16-50j-72(b)(2).

Please feel free to call me at (860) 463-5511 with questions concerning this matter. Thank you for your consideration.

Sincerely,

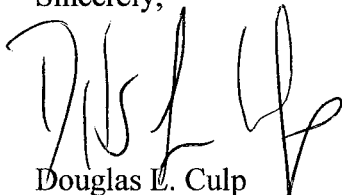
A handwritten signature in black ink, appearing to read 'D. L. Culp', written over a printed name.

Douglas L. Culp  
Real Estate Consultant

Attachments

**NEW CINGULAR WIRELESS PCS, LLC  
Equipment Modification**

281 Wood House Road Fairfield, CT  
Site Number CT2105  
Exempt Mod

**Tower Owner/Manager:** Crown Castle

**Equipment configuration:** Monopole

**Current and/or approved:** Six PowerWave antennas @ 150 ft  
Twelve PowerWave TMA's @ 150 ft  
Twelve runs 1 1/4 inch coax to 150 ft  
Equipment Shelter

**Planned Modifications:** Retain existing PowerWave Antenna's, TMA's at 150 ft  
Retain all Coax Cabling  
Install three PowerWave P65-16 antennas or equivalent @ 150 ft  
Install six remote radio heads and surge arrestor @ 150 ft  
Install one fiber and two DC power cables to 150 ft

**Power Density:**

Worst-case calculations for existing wireless operations at the site, using standard parameters for other carriers, indicate a radio frequency electromagnetic radiation power density, measured at ground level beside the Tower, of 51.3% of the standard adopted by the FCC. As depicted in the second table below, the total radio frequency electromagnetic radiation power density following proposed modifications would be approximately 52.5% of the standard.

**Existing**

Company	Centerline Ht (feet)	Frequency (MHz)	Number of Channels	Power Per Channel (Watts)	Power Density (mW/cm <sup>2</sup> )	Standard Limits (mW/cm <sup>2</sup> )	Percent of Limit
Other Users							37.69
AT&T UMTS	150	1900 Band	1	500	0.0080	1.0000	0.80
AT&T UMTS	150	800 Band	2	500	0.0160	0.5867	2.72
AT&T GSM	150	800Band	10	296	0.0473	0.5867	8.06
AT&T UMTS	150	1900 Band	3	427	0.0205	1.0000	2.05
<b>Total</b>							<b>51.3%</b>

\* Data for other users are from Siting Council records.

## Proposed

Company	Centerline Ht (feet)	Frequency (MHz)	Number of Channels	Power Per Channel (Watts)	Power Density (mW/cm <sup>2</sup> )	Standard Limits (mW/cm <sup>2</sup> )	Percent of Limit
Other Users							37.69
AT&T UMTS	150	800 Band	1	500	0.0080	0.5867	1.36
AT&T UMTS	150	1900 Band	2	500	0.0160	1.0000	1.60
AT&T GSM	150	880 - 894	10	296	0.0473	0.5867	8.06
AT&T GSM	150	1900 Band	3	427	0.0205	1.0000	2.05
AT&T LTE	150	740 - 746	1	500	0.0080	0.4933	1.62
<b>Total</b>							<b>52.4%</b>

\* Data for other users are from Siting Council records.

### Structural information:

The attached structural analysis demonstrates that the monopole and foundation have adequate structural capacity to accommodate the proposed modifications. (Crown Castle, dated 4-21-11).



# WIRELESS COMMUNICATIONS FACILITY CT2105 FAIRFIELD WOODHOUSE 281 WOOD HOUSE ROAD FAIRFIELD, CT 06824

SITE DIRECTIONS	
FROM	TO: AT&T WIRELESS FACILITY FAIRFIELD, CT 06824
1. Beach Elmwoods Dr. heading South Blvd	0.2 mi.
2. Turn left onto Chapel Blvd	0.2 mi.
3. Turn left onto West 331 South	0.2 mi.
4. At exit 17, take ramp right for SR-15 South / Weber Cross Hwy toward E. Main St.	37.7 mi.
5. Turn left onto E. Main St. and then immediately turn right onto SR-35 / Beach Rock Turn	0.2 mi.
6. Turn left onto Longwood Rd.	0.2 mi.
7. Turn right onto Wood House Rd.	0.1 mi.
8. Turn right onto Wood House Rd.	0.1 mi.
9. Turn right onto Wood House Rd.	0.1 mi.
10. Turn right onto Wood House Rd.	0.1 mi.
11. Arrive at 281 Wood House Rd, Fairfield, CT 06824-1823 on the left	

GENERAL NOTES	
1. ALL WORK SHALL BE IN ACCORDANCE WITH THE 2005 INTERNATIONAL BUILDING CODE AS AMENDED BY THE 2006 CONNECTICUT SUPPLEMENT, 2006 CONSTRUCTION CODE AND 2006 AMENDMENTS, 2006 CONNECTICUT FIRE SAFETY CODE AND 2006 AMENDMENTS, 2005 ELECTRICAL CODE AND LOCAL CODES.	
2. CONCRETE REINFORCING SHALL BE SUBJECT TO THE DEVIATION POINT USE PROVIDED BY SITE OWNER, AS BUILT BY THE CONTRACTOR. SHOULD ANY FIELD CONDITIONS PRELUDE IMMEDIATELY NOTIFY THE ENGINEER AND SHALL NOT PROCEED WITH ANY AFFECTED WORK.	
3. CONTRACTOR SHALL REVIEW ALL DRAWINGS AND SPECIFICATIONS IN ALL WORK SHOWN ON THE SET OF DRAWINGS. THE CONTRACTOR SHALL PROVIDE A COMPLETE SET OF DRAWINGS TO ALL SUBCONTRACTORS. CONTRACTOR SHALL EXAMINE ALL THE DRAWINGS AND SPECIFICATIONS FOR THE INFORMATION THAT AFFECTS THEIR WORK.	
4. CONTRACTOR SHALL PROVIDE A COMPLETE BUILD-OUT WITH ALL MATERIALS, LABOR AND EQUIPMENT. CONTRACTOR SHALL PROVIDE ALL MATERIALS, LABOR AND EQUIPMENT AND PROVIDE ALL PERMITS AND INSURANCE REQUIRED FOR THE DRAWINGS AND SPECIFICATIONS.	
5. CONTRACTOR SHALL FURNISH ALL MATERIAL, LABOR AND EQUIPMENT TO COMPLETE THE WORK AND FURNISH A COMPLETED JOB ALL IN ACCORDANCE WITH ALL APPLICABLE SUBCONTRACTORS FOR ANY OTHER AUTHORITIES HAVING LEGAL JURISDICTION OVER THE WORK.	
6. CONTRACTOR SHALL SECURE AND PAY FOR ALL PERMITS AND ALL INSPECTIONS REQUIRED AND SHALL ALSO PAY FEES REQUIRED FOR PERMITS SHALL BE PAID FOR BY THE RESPECTIVE SUBCONTRACTORS.	
7. CONTRACTOR SHALL MAINTAIN A CURRENT SET OF DRAWINGS AND SPECIFICATIONS ON SITE AT ALL TIMES AND INSURE DISTRIBUTION OF NEW DRAWINGS TO SUBCONTRACTORS AND OTHER RELEVANT PARTIES AS REQUIRED. CONTRACTOR SHALL BE RESPONSIBLE FOR ALL WORK MARKED VOID AND REMOVED FROM THE CONTRACT AREA. THE CONTRACTOR SHALL FURNISH AN AS-BUILT SET OF DRAWINGS TO OWNER UPON COMPLETION OF PROJECT.	
8. UNACCEPTABLE WORK SHALL BE REJECTED BY OFFICES THAT IS DETERMINED BY THE CONTRACTOR. THE CONTRACTOR SHALL DETERMINE AND WORK OF THE SUBCONTRACTORS.	
9. THE CONTRACTOR IS SOLELY RESPONSIBLE TO OBTAIN THE CONSTRUCTION PERMITS AND SEQUENCE, AND TO ENSURE THE SAFETY OF THE EXISTING STRUCTURE AND ADJACENT AREAS DURING CONSTRUCTION. THIS INCLUDES THE OBTAINING OF ALL NECESSARY CONSTRUCTION PERMITS THAT MAY BE NECESSARY. MAINTAIN EXISTING BUILDINGS/PROPERTY, ETC. OPERATIONS. COORDINATE WORK WITH BUILDING/PROPERTY OWNER.	
10. DRAWINGS INDICATE THE MINIMUM STANDARDS, BUT IF ANY WORK SHOULD BE INDICATED TO BE SUBSTANDARD TO ANY ORDINANCES, THE CONTRACTOR SHALL OBTAIN ALL NECESSARY PERMITS AND SHALL BE RESPONSIBLE FOR THE WORK CORRECTLY IN ACCORDANCE WITH SUCH ORDINANCES, LAWS, CODES, RULES OR REGULATIONS WITH NO INCREASE IN COSTS.	
11. ALL UTILITY WORK SHALL BE IN ACCORDANCE WITH LOCAL UTILITY REGULATIONS AND SPECIFICATIONS. ALL UTILITY WORK SHALL BE PERFORMED BY THE CONTRACTOR AND ALL APPLICABLE SUBCONTRACTORS FOR ANY CONDITION PER MFR'S RECOMMENDATIONS. CONTRACTOR TO SUPPLY ALL MATERIALS AND LABOR AND SHALL BE RESPONSIBLE FOR THE WORK CORRECTLY IN ACCORDANCE WITH SUCH ORDINANCES, LAWS, CODES, RULES OR REGULATIONS WITH NO INCREASE IN COSTS.	
12. ALL CONSTRUCTION SHALL BE IN ACCORDANCE WITH THE 2005 INTERNATIONAL BUILDING CODE AS AMENDED BY THE 2006 CONNECTICUT SUPPLEMENT, 2006 CONSTRUCTION CODE AND 2006 AMENDMENTS, 2006 CONNECTICUT FIRE SAFETY CODE AND 2006 AMENDMENTS, 2005 ELECTRICAL CODE AND LOCAL CODES.	
13. ALL CONSTRUCTION SHALL BE IN ACCORDANCE WITH THE 2005 INTERNATIONAL BUILDING CODE AS AMENDED BY THE 2006 CONNECTICUT SUPPLEMENT, 2006 CONSTRUCTION CODE AND 2006 AMENDMENTS, 2006 CONNECTICUT FIRE SAFETY CODE AND 2006 AMENDMENTS, 2005 ELECTRICAL CODE AND LOCAL CODES.	
14. CONTRACTOR SHALL BE RESPONSIBLE FOR ALL ON-SITE SAFETY FROM THE TIME THE JOB IS AWARDED UNTIL ALL WORK IS COMPLETE AND ACCEPTED BY THE OWNER.	
15. CHECKERS' INITIALS BEFORE SUBMITTING TO THE CONSTRUCTION MANAGER FOR REVIEW.	
16. CONTRACTOR SHALL VERIFY ALL DIMENSIONS, ELEVATIONS, ANGLES AND DISTANCES PRIOR TO CONSTRUCTION. CONTRACTOR SHALL BE RESPONSIBLE FOR THE FABRICATION AND/OR INSTALLATION OF ANY WORK IN THE CONTRACT AREA.	
17. COORDINATION, LAYOUT, FURNISHING AND INSTALLATION OF CONDUIT SHALL BE THE RESPONSIBILITY OF THE CONTRACTOR. CONTRACTOR SHALL BE RESPONSIBLE FOR THE ELECTRICAL AND TELECOMMUNICATION SERVICE SHALL BE THE SOLE RESPONSIBILITY OF THE CONTRACTOR.	
18. ALL EQUIPMENT AND PRODUCTS PURCHASED ARE TO BE INSTALLED IN ACCORDANCE WITH THE MANUFACTURER'S RECOMMENDATIONS. CONTRACTOR TO SUPPLY THESE ITEMS AT NO COST TO OWNER OR CONSTRUCTION MANAGER.	
19. CONTRACTOR SHALL BE RESPONSIBLE FOR THE PROTECTION OF EXISTING UTILITIES. CONTRACTOR SHALL BE RESPONSIBLE FOR ALL REPAIRS REQUIRED FOR EXISTING STRUCTURES IF DAMAGED DURING CONSTRUCTION ACTIVITIES.	
20. THE CONTRACTOR SHALL CONTACT "CALL BEFORE YOU DIG" AT LEAST 14 DAYS PRIOR TO ANY EXCAVATION WORK. CONTRACTOR SHALL MAINTAIN AND PROTECT EXISTING UTILITIES. CONTRACTOR SHALL BE RESPONSIBLE FOR THE PROTECTION OF EXISTING UTILITIES. CONTRACTOR SHALL BE RESPONSIBLE FOR ALL REPAIRS REQUIRED FOR EXISTING STRUCTURES IF DAMAGED DURING CONSTRUCTION ACTIVITIES.	
21. CONTRACTOR SHALL OBTAIN ALL NECESSARY CONSTRUCTION PERMITS AND SEQUENCE, AND TO ENSURE THE SAFETY OF THE EXISTING STRUCTURE AND ADJACENT AREAS DURING CONSTRUCTION. THIS INCLUDES THE OBTAINING OF ALL NECESSARY CONSTRUCTION PERMITS THAT MAY BE NECESSARY. MAINTAIN EXISTING BUILDINGS/PROPERTY, ETC. OPERATIONS. COORDINATE WORK WITH BUILDING/PROPERTY OWNER.	

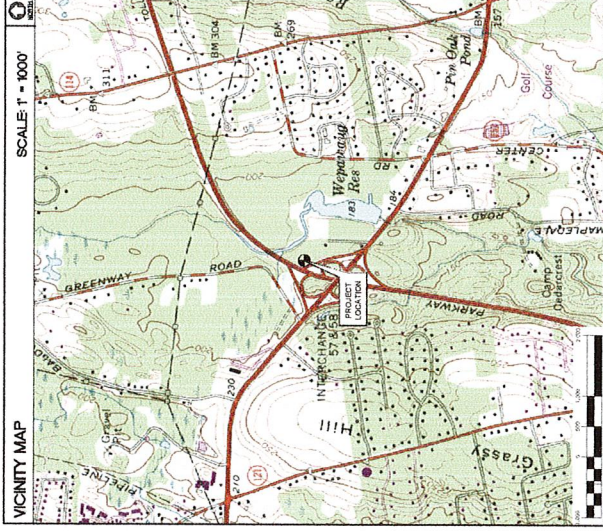

PROJECT SUMMARY	
1. THE PRINCIPAL SCOPE OF WORK GENERALLY CONSISTS OF THE INSTALLATION OF ONE (1) LITE ANTENNA PER SECTOR FOR EACH OF THE (3) LITE ANTENNAS TO THE EXISTING AT&T ANTENNA FACILITY. THE ANTENNAS WILL BE INSTALLED WITHIN THE EXISTING AT&T EQUIPMENT SHELTER.	
2. ADDITIONALLY, (2) REMOTE RADIO UNITS (RRUs) PER SECTOR WILL BE INSTALLED. SURGE ARRESTORS WILL BE INSTALLED AT EACH ANTENNA LOCATION. THE CONTRACTOR SHALL BE RESPONSIBLE FOR OBTAINING ALL NECESSARY PERMITS AND SEQUENCE, AND TO ENSURE THE SAFETY OF THE EXISTING STRUCTURE AND ADJACENT AREAS DURING CONSTRUCTION. THIS INCLUDES THE OBTAINING OF ALL NECESSARY CONSTRUCTION PERMITS THAT MAY BE NECESSARY. MAINTAIN EXISTING BUILDINGS/PROPERTY, ETC. OPERATIONS. COORDINATE WORK WITH BUILDING/PROPERTY OWNER.	

PROJECT INFORMATION	
AT&T SITE NUMBER:	CT2105
AT&T SITE NAME:	FAIRFIELD WOODHOUSE
SITE ADDRESS:	281 WOOD HOUSE ROAD FAIRFIELD, CT 06824
LESSEE/APPLICANT:	AT&T MOBILITY SERVICES, SUITE 3A ROCKY HILL, CT 06067
ENGINEER:	CENTEK ENGINEERING, INC. 63-2 NORTH BRANFORD RD. BRANFORD, CT 06405
PROJECT COORDINATOR:	LATITUDE: 41°-11'-45.3" N LONGITUDE: 72°-52'-56.5" W GROUND ELEVATION: 220' AMSL

SHEET INDEX		
SHT. NO.	DESCRIPTION	REV.
T-1	TITLE SHEET	1
N-1	NOTES AND SPECIFICATIONS	1
C-1	PLANS AND ELEVATION	1
C-2	LITE SYSTEM EQUIPMENT PLANS & DETAILS	1
E-1	ELECTRICAL DETAILS AND NOTES	1
E-2	ELECTRICAL DETAILS	1

DESIGNED BY:	CTE
DRAWN BY:	CEB
CHECKED BY:	CTE
DATE:	12/11/11
REV:	1 02/22/11
REV:	2 3/7/11
REV:	3 3/7/11
SCALE:	AS NOTED
JOB NO.:	110212001

PROFESSIONAL LICENSEE SEAL	
DATE:	3/7/11
CONSTRUCTION:	CLIENT REVIEW

TITLE SHEET
AT&T MOBILITY
WIRELESS COMMUNICATIONS FACILITY
SITE NAME: FAIRFIELD WOODHOUSE
SITE NUMBER: CT2105

Sheet No. 1 of 5







REV	DATE	ISSUED BY	CHK'D BY	DESCRIPTION
1	02/24/11	RJD	CRJ	CONSTRUCTION - CLIENT REVIEW
2	3/1/11	RJD	CRJ	CONSTRUCTION - CLIENT REVIEW

PROFESSIONAL	DATE	EXPIRES	STATUS
000 483430	05/08/11	05/08/14	Active
000 483430	05/08/11	05/08/14	Active

at&t

SAI

CENITEK

DATE: 3/1/11  
SCALE: AS NOTED  
JOB NO.: 1102.L0011

AT&T MOBILITY  
WESTER COMMUNICATIONS FACILITY  
SITE NAME: FAIRFIELD  
WOODHOUSE  
SITE NUMBER: CT105  
FAIRFIELD, CT 06424

DATE: 3/1/11  
SCALE: AS NOTED  
JOB NO.: 1102.L0011

LTE SYSTEM  
EQUIPMENT PLANS  
AND DETAILS

C-2  
Sheet No. 3 of 8

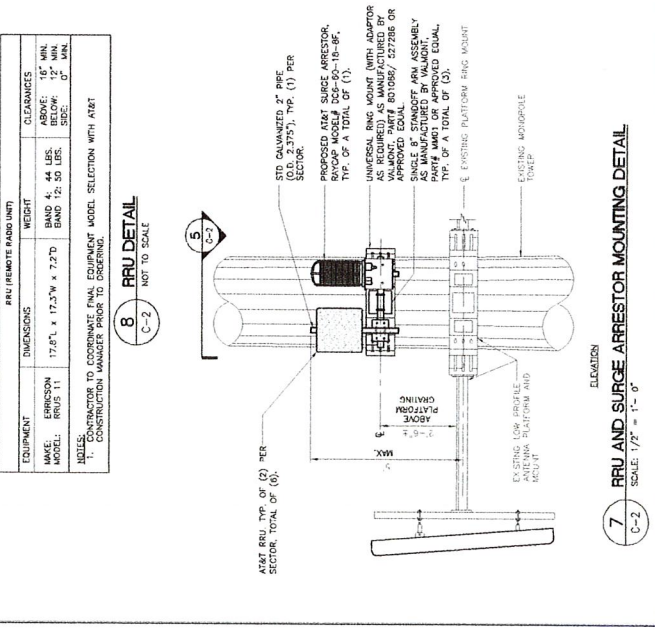
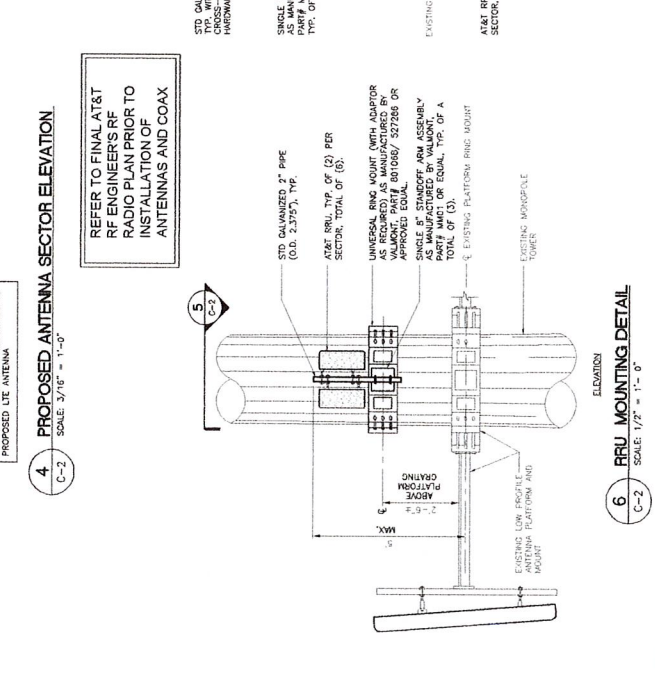
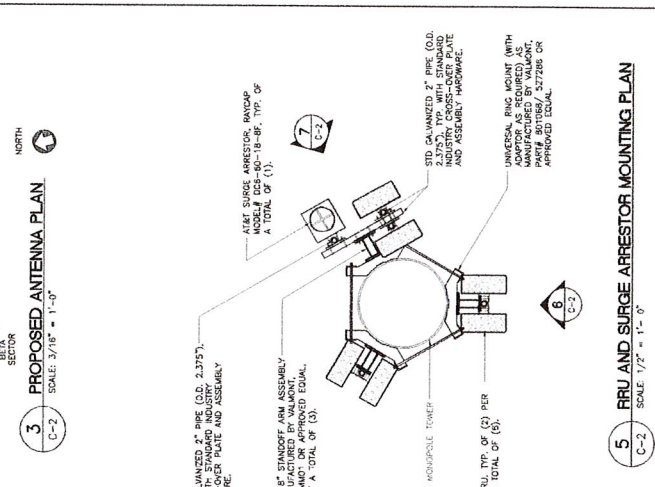
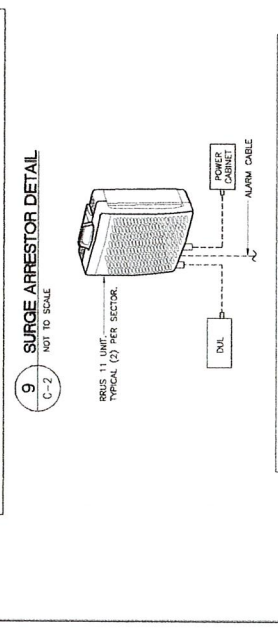
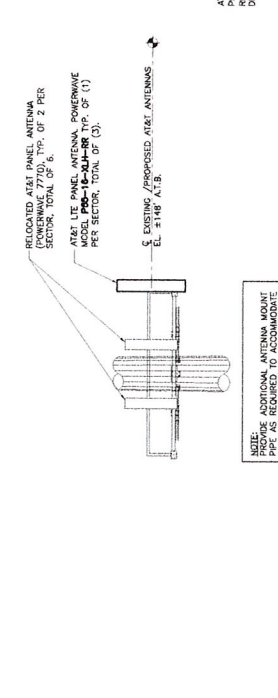
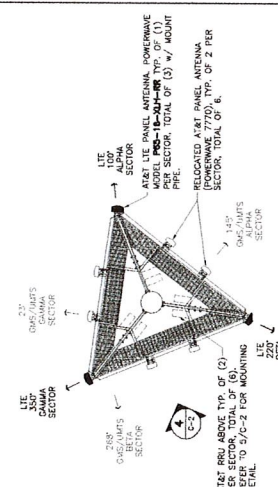
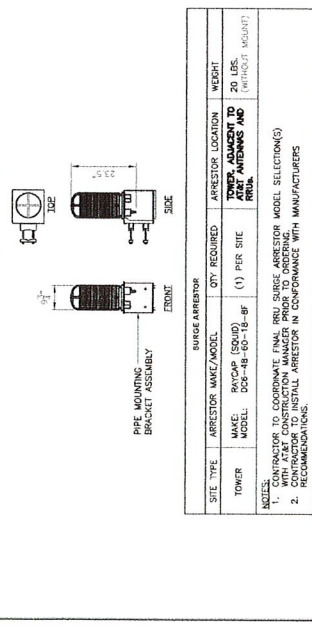
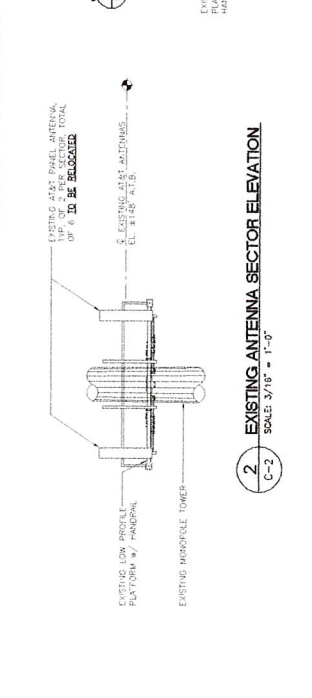
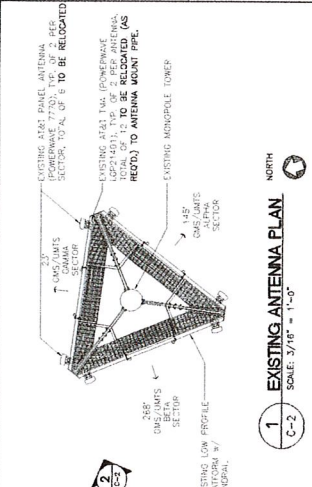

DESIGNED BY:	DAD
DRAWN BY:	LAB
CHECKED BY:	LAB
DATE:	03/24/11
DESCRIPTION:	CONSTRUCTION - CLIENT REVIEW
PROJECT:	CONSTRUCTION - CLIENT REVIEW

DATE:	03/24/11	REV:	1
DESCRIPTION:	CONSTRUCTION - CLIENT REVIEW	BY:	DAD
PROJECT:	CONSTRUCTION - CLIENT REVIEW	CHKD BY:	LAB

AT&T MOBILITY  
WIRELESS COMMUNICATIONS FACILITY  
SITE NAME: FAIRFIELD  
SITE NUMBER: CT1210  
WOODHOUSE

DATE: 3/7/11  
SCALE: AS NOTED  
JOB NO.: 11021.001

ELECTRICAL DETAILS AND NOTES

E-1  
Sheet No. 5 of 5

### ELECTRICAL NOTES

- BEFORE START OF CONSTRUCTION, CONTRACTORS SHALL COORDINATE WITH OWNER FOR ALL CONSTRUCTION STANDARDS AND SPECIFICATIONS, AND ALL MANUFACTURER DOCUMENTATION FOR ALL EQUIPMENT TO BE INSTALLED.
- INSTALL ALL EQUIPMENT IN ACCORDANCE WITH LOCAL BUILDING CODE, NATIONAL ELECTRIC CODE, OWNER AND MANUFACTURER'S SPECIFICATIONS.
- CONNECT ALL NEW EQUIPMENT TO EXISTING TELCO AS REQUIRED BY MANUFACTURER.
- MAINTAIN ALL CLEARANCES REQUIRED BY NEC AND EQUIPMENT MANUFACTURER.
- PRIOR TO INSTALLATION CONTRACTOR SHALL MEASURE EXISTING ELECTRICAL LOAD AND VERIFY EXISTING AVAILABLE CAPACITY FOR PROPOSED INSTALLATION. IF EXISTING AVAILABLE CAPACITY IS INSUFFICIENT, CONTRACTOR SHALL CONSULT WITH LOCAL ELECTRIC UTILITY COMPANY TO UPGRADE EXISTING ELECTRIC SERVICE WITH LOCAL ELECTRICAL ENGINEER'S SIGNATURE AND SEAL.
- CONTRACTOR SHALL INSPECT EXISTING GROUNDING AND LIGHTNING PROTECTION SYSTEM AND ENSURE THAT IT IS IN COMPLIANCE WITH NEC, AND SITE OWNER'S SPECIFICATIONS. ALL DEFICIENCIES SHALL BE CORRECTED AND APPROVED BY THE OWNER'S REPRESENTATIVE AND ANY DEFICIENCIES SHALL BE CORRECTED.
- ALL TRANSMISSION TOWER SITES CONTAIN AN EXTENSIVE BURIED GROUNDING SYSTEM. ALL GROUNDING WORK MUST BE COORDINATED WITH, AND APPROVED BY, THE TOWER ENGINEER. WHATEVER ALL OF THE TOWER OWNER'S SPECIFICATIONS MUST BE STRICTLY FOLLOWED.
- PROVIDE AND INSTALL GROUND KITS FOR ALL NON COAXIAL CABLES AND BOND TO EXISTING GROUNDING SYSTEM PER OWNER'S SPECIFICATIONS AND NEC.
- ALL CONDUCTORS SHALL BE TYPE THWN (UNT. APPLICATION) AND XHHW (EXT. APPLICATION), 75 DEGREE C, 600 VOLT INSULATION, SOFT ANNEALED STRANDED COPPER. ALL CONDUCTORS SHALL BE BONDING TYPE. ALL CONDUCTORS SHALL BE SOLDERLESS PRESSURE CONNECTORS. #6 AWG AND LARGER SHALL BE SPLICED USING SOLDERLESS PRESSURE CONNECTORS. #12 AWG SHALL BE THE MINIMUM SIZE CONDUCTOR FOR ALL WIRE CONNECTORS. #12 AWG SHALL BE THE MINIMUM SIZE CONDUCTOR FOR BRANCH CIRCUIT CONDUCTOR SIZES. CONDUCTORS SHALL BE COLOR CODED FOR CONSISTENT PHASE IDENTIFICATION.
- MAINTAIN MINIMUM CLEARANCES FOR CONDUCTORS SHALL BE 12 TIMES THE LARGEST CONDUCTOR SIZE.
- THE OWNER ELECTRICAL INSTALLATION SHALL BE MADE IN STRICT ACCORDANCE WITH ALL LOCAL, STATE AND NATIONAL CODES AND REGULATIONS WHICH MAY APPLY AND INDICATED IN THE DRAWINGS. OPERATIONS SHALL BE INTERRUPTED AS AN NECESSARY.
- THE ELECTRICAL CONTRACTOR IS TO BE RESPONSIBLE FOR THE COMPLETE INSTALLATION AND COORDINATION OF THE ENTIRE ELECTRICAL SERVICE. ALL ACTIVITIES ARE TO BE COORDINATED THROUGH OWNER'S REPRESENTATIVE. DESIGN APPROVALS AND SIGNATURES SHALL BE OBTAINED FROM THE OWNER'S REPRESENTATIVE PRIOR TO THE START OF WORK.
- ALL FEES AS MAY BE REQUIRED FOR THE ELECTRICAL WORK AND FOR SCHEDULING OF THE CONTRACTOR SHALL BE REQUIRED BY THE LOCAL AUTHORITY.
- THE CONTRACTOR SHALL BE RESPONSIBLE FOR COORDINATION WITH THE SITE AND/OR BUILDING OWNER FOR NEW AND/OR REMEDIATION WORK INVOLVED.
- THE CONTRACTOR SHALL GUARANTEE ALL NEW WORK FOR A PERIOD OF ONE YEAR FROM THE DATE OF COMPLETION OF THE WORK. THE CONTRACTOR SHALL BE RESPONSIBLE FOR OBTAINING WARRANTIES FROM ALL EQUIPMENT MANUFACTURERS FOR SUBMISSION TO THE OWNER.
- CONTRACTOR SHALL OBTAIN APPROVEMENT OF WORK INCLUDED IN CONTRACT DOCUMENTS FROM THE LOCAL AUTHORITY PRIOR TO THE START OF WORK. THE CONTRACTOR SHALL PREVENT CONFLICT WITH WORK OF OTHER TRADES AND FOR THE VERY SPACE AND TYPE OF EXISTING CONDITIONS IN WHICH WORK WILL BE DONE. PRIOR TO SUBMITTAL OF BID.
- ALL NON-CURRENT CARRYING PARTS OF THE ELECTRICAL AND TELEPHONE CONDUIT SYSTEM SHALL BE GROUNDED TO THE EQUIPMENT GROUNDING SYSTEM. PROVIDE AN INDEPENDENT RETURN PATH TO THE EQUIPMENT GROUNDING SOURCES.
- GROUNDING SYSTEM WILL BE IN ACCORDANCE WITH THE LATEST ACCEPTABLE EDITION OF THE NATIONAL ELECTRICAL CODE AND REQUIREMENTS PER LOCAL INSPECTOR.
- EACH ELECTRICAL GROUNDING CONDUCTOR SHALL BE SIZED IN ACCORDANCE WITH THE N.E.C. ARTICLE 250-122 (MIN. #12 AWG).
- CONTRACTOR SHALL PROVIDE A CELLULAR GROUNDING SYSTEM WITH THE MAXIMUM AC RESISTANCE TO GROUND OF 5 OHM BETWEEN ANY POINT ON THE GROUNDING SYSTEM AS MEASURED BY 3-POINT GROUNDING TEST. (REFER TO SECTION 19940).

### TESTS BY INDEPENDENT ELECTRICAL TESTING FIRM

- CONTRACTOR SHALL RETAIN THE SERVICES OF A LOCAL INDEPENDENT ELECTRICAL TESTING FIRM (WITH MINIMUM 5 YEARS COMMERCIAL EXPERIENCE IN THE ELECTRICAL TESTING INDUSTRY) AS SPECIFIED BY OWNER TO PERFORM:
  - RESISTANCE TO GROUND TEST ON THE CELLULAR GROUNDING SYSTEM.
  - TESTING FIRM SHALL INCLUDE THE FOLLOWING INFORMATION WITH THE REPORT:
    - TESTING PROCEDURE INCLUDING THE MAKE AND MODEL OF TEST EQUIPMENT.
    - IDENTIFICATION OF TESTING EQUIPMENT CALIBRATION WITHIN SIX (6) MONTHS OF TESTING DATE. TEST REPORT SHALL INCLUDE IDENTIFICATION TAG ADDRESS AND TELEPHONE NUMBER.
    - GRAPHICAL DESCRIPTION OF TESTING METHOD ACTUALLY IMPLEMENTED.
- OWNER SHALL VERIFY THE RESULTS OF THE TESTING AND SHALL BE NOTIFIED AND DATED BY THE CONSTRUCTION AND INCLUDED WITH THE WRITTEN REPORT/ANALYSIS.
- THE CONTRACTOR SHALL FORWARD SIX (6) COPIES OF THE INDEPENDENT TESTING REPORT TO THE OWNER PRIOR TO THE START OF WORK. THE CONTRACTOR SHALL PROVIDE A MINIMUM OF TEN (10) WORKING DAYS PRIOR TO THE JOB TURNOVER.
- CONTRACTOR TO PROVIDE A MINIMUM OF ONE (1) WEEK NOTICE TO OWNER AND ENGINEER FOR ALL TESTS REQUIRING WITNESSING.

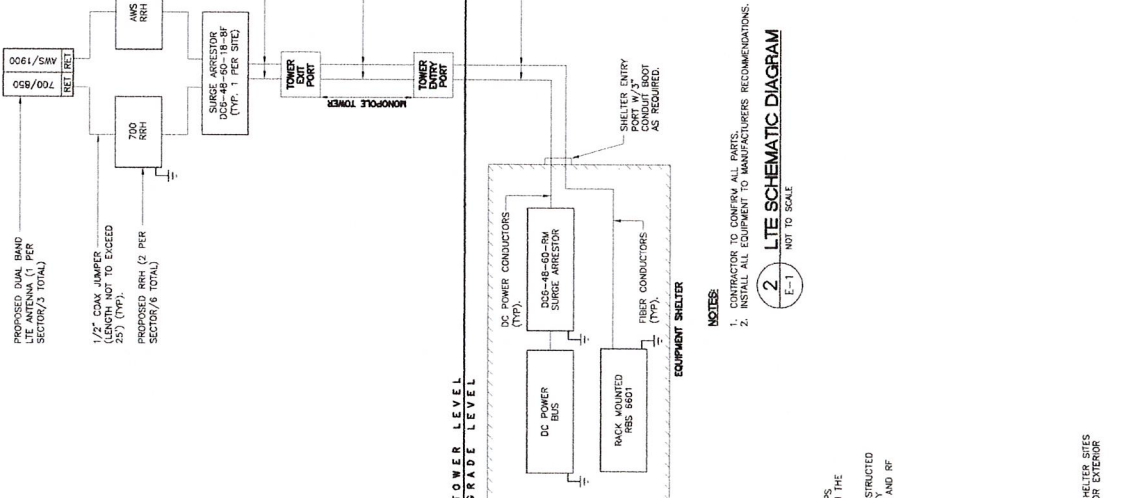

- CONTRACTOR TO VERIFY ALL PARTS, INSTALL ALL EQUIPMENT TO MANUFACTURER'S RECOMMENDATIONS.

2. LTE SCHEMATIC DIAGRAM  
NOT TO SCALE

### 1. TYPICAL ANTENNA GROUNDING DETAIL

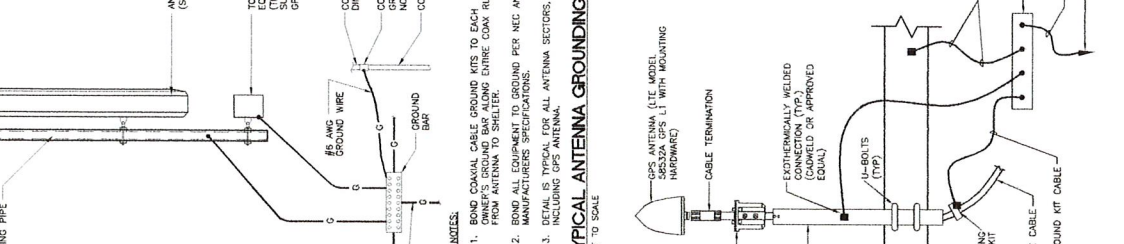

- DETAIL IS TYPICAL FOR ALL ANTENNA SECTORS, INCLUDING GPS ANTENNA.

### 3. GPS MOUNTED TO CABLE TRAY / ICE BRIDGE

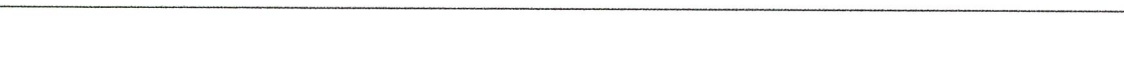

- THE ELEVATION AND LOCATION OF THE GPS ANTENNA SHALL BE IN ACCORDANCE WITH THE FINAL RF REPORT.
- ANTENNA MUST BE INSTALLED WITH UNOBSTRUCTED EXPOSURE TO SOUTHWESTERN SKY. VERIFY EXPOSURE TO SOUTHWESTERN SKY AND RF ENGINEER PRIOR TO INSTALLATION.

DESIGNED BY:	DOB
DRAWN BY:	TAB
CHECKED BY:	DOB
DATE:	03/22/11
CONTRACTOR:	AT&T MOBILITY
CONTRACT:	WIRELESS COMMUNICATIONS FACILITY
PROJECT:	281 WOOD HOUSE ROAD FAIRFIELD, CT 06424
SITE NAME:	WOODHOUSE
SITE NUMBER:	CT12105
DATE:	3/7/11
SCALE:	AS NOTED
JOB NO.:	11021.001
ELECTRICAL DETAILS	
<b>E-2</b>	
Sheet No. 5 of 8	

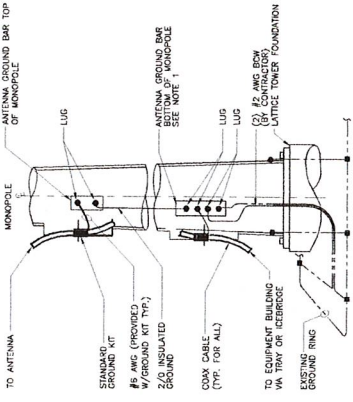
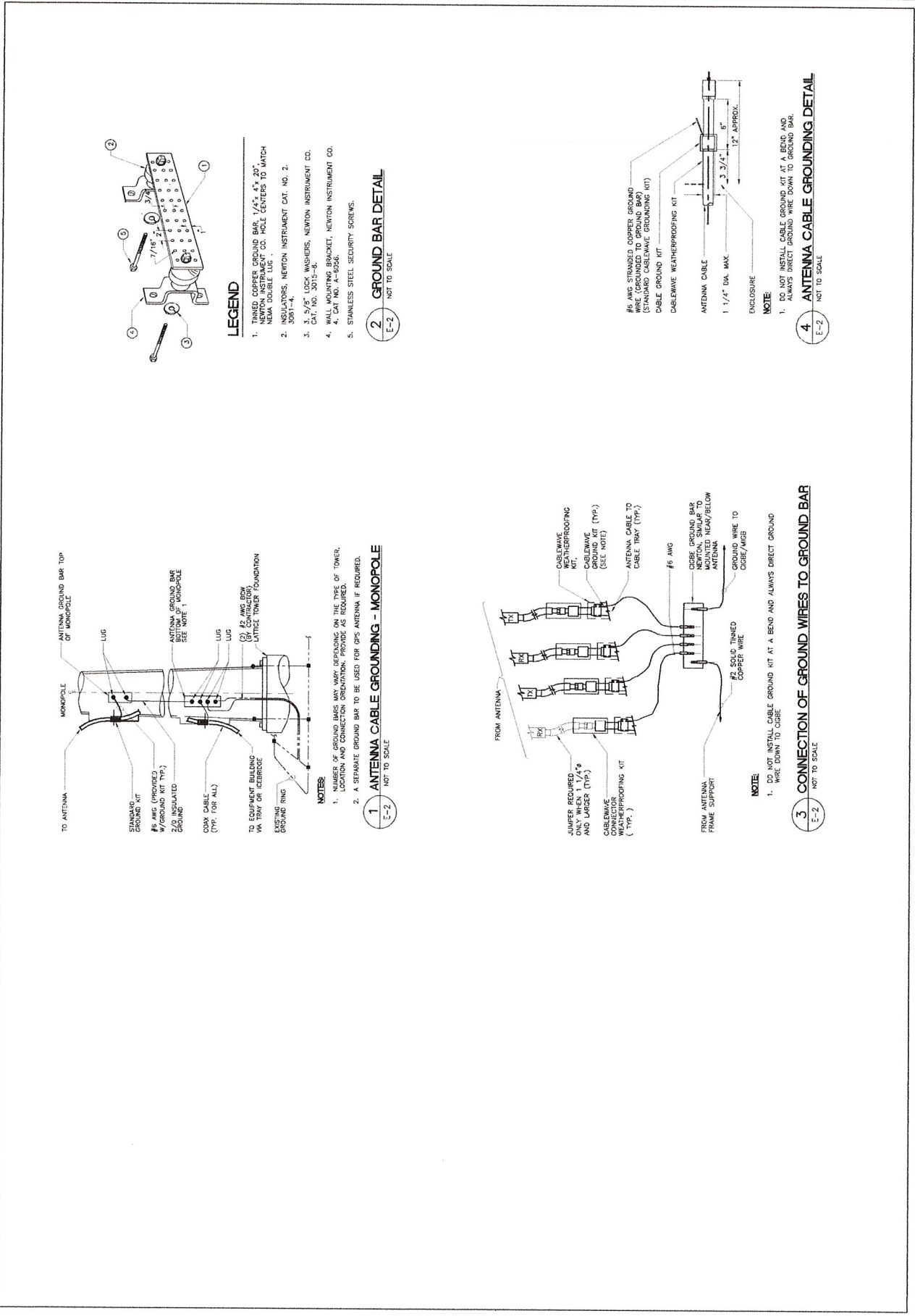

**NOTES:**

- JUMPER OR DIRECT GROUNDING MAY BE USED FOR GPS ANTENNA IF REQUIRED.
- A SEPARATE GROUND BAR TO BE USED FOR GPS ANTENNA IF REQUIRED.

**1 ANTENNA CABLE GROUNDING - MONOPOLE**  
E-2 NOT TO SCALE

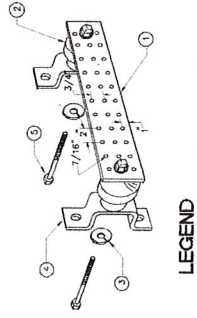

**LEGEND**

- TINNED COPPER GROUND BAR, 1/4" x 4" x .20", NEWBERRY METAL PRODUCTS CO., HOLE CENTERS TO MATCH NEMA DOUBLE LUG.
- INSULATORS, NEWTON INSTRUMENT CO. CAT. NO. 3081-4.
- 3, 5/8" x 1/8" LOCK WASHERS, NEWTON INSTRUMENT CO. CAT. NO. 3015-8.
- WALL MOUNTING BRACKET, NEWTON INSTRUMENT CO. CAT. NO. A-5056.
- STAINLESS STEEL SECURITY SCREWS.

**2 GROUND BAR DETAIL**  
E-2 NOT TO SCALE

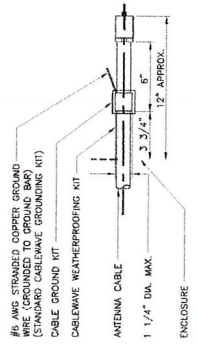

**NOTE:**

- DO NOT INSTALL CABLE GROUND KIT AT A BEND AND ALWAYS DIRECT GROUND WIRE DOWN TO GROUND BAR.

**4 ANTENNA CABLE GROUNDING DETAIL**  
E-2 NOT TO SCALE

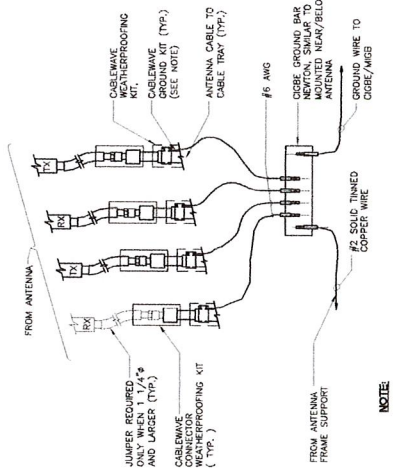

**NOTE:**

- DO NOT INSTALL CABLE GROUND KIT AT A BEND AND ALWAYS DIRECT GROUND WIRE DOWN TO GROUND BAR.

**3 CONNECTION OF GROUND WIRES TO GROUND BAR**  
E-2 NOT TO SCALE

Date: April 21, 2011

Veronica Harris  
Crown Castle  
1200 McArthur Blvd  
Mahwah, NJ 07430



Crown Castle  
2000 Corporate Dr.  
Canonsburg, PA 15317  
(724) 416-2000

**Subject: Structural Analysis Report**

**Carrier Designation:** AT&T Mobility Co-Locate  
Carrier Site Number: 2105  
Carrier Site Name: Fairfield-Woodhouse Road

**Crown Castle Designation:** Crown Castle BU Number: 806355  
Crown Castle Site Name: BRG 126 943086  
Crown Castle JDE Job Number: 154916  
Crown Castle Work Order Number: 402472

**Engineering Firm Designation:** Crown Castle Project Number: 402472

**Site Data:** 281 WOODHOUSE ROAD, FAIRFIELD, Fairfield County, CT  
Latitude 41° 11' 45.3", Longitude -73° 16' 52.9"  
171 Foot - Monopole Tower

Dear Veronica Harris,

Crown Castle is pleased to submit this "Structural Analysis Report" to determine the structural integrity of the above mentioned tower. This analysis has been performed in accordance with the Crown Castle Structural 'Statement of Work' and the terms of Crown Castle Purchase Order Number 402472, in accordance with application 121276, revision 1.

The purpose of the analysis is to determine acceptability of the tower stress level. Based on our analysis we have determined the tower stress level for the structure and foundation, under the following load case, to be:

LC1: Existing + Reserved + Proposed Equipment

**Sufficient Capacity**

Note: See Table I and Table II for the proposed and existing/reserved loading, respectively.

The analysis has been performed in accordance with the TIA/EIA-222-F standard and local code requirements based upon a wind speed of 85 mph fastest mile.

All modifications and equipment proposed in this report shall be installed in accordance with the attached drawings for the determined available structural capacity to be effective.

We at Crown Castle appreciate the opportunity of providing our continuing professional services to you and Crown Castle. If you have any questions or need further assistance on this or any other projects please give us a call.

Structural analysis prepared by: Alex Mrkajic / CSV

Respectfully submitted by:

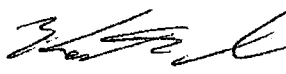
  
Kenton C. Weber, P.E.  
Engineering Supervisor

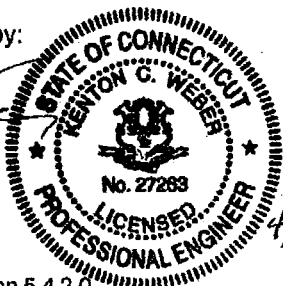

4/21/11

## TABLE OF CONTENTS

### 1) INTRODUCTION

### 2) ANALYSIS CRITERIA

Table 1 - Proposed Antenna and Cable Information

Table 2 - Existing and Reserved Antenna and Cable Information

Table 3 - Design Antenna and Cable Information

### 3) ANALYSIS PROCEDURE

Table 4 - Documents Provided

3.1) Analysis Method

3.2) Assumptions

### 4) ANALYSIS RESULTS

Table 5 – Section Capacity (Summary)

Table 6 - Tower Component Stresses vs. Capacity

4.1) Recommendations

### 5) APPENDIX A

RISATower Output

### 6) APPENDIX B

Base Level Drawing

### 7) APPENDIX C

Additional Calculations

## 1) INTRODUCTION

This tower is a 171 ft Monopole tower designed by EEI, Inc. in May of 1998. The tower was originally designed for a wind speed of 85 mph per TIA/EIA-222-E & F.

## 2) ANALYSIS CRITERIA

The structural analysis was performed for this tower in accordance with the requirements of TIA/EIA-222-F Structural Standards for Steel Antenna Towers and Antenna Supporting Structures using a fastest mile wind speed of 85 mph with no ice, 37.6 mph with 0.75 inch ice thickness and 50 mph under service loads.

**Table 1 - Proposed Antenna and Cable Information**

Mounting Level (ft)	Center Line Elevation (ft)	Number of Antennas	Antenna Manufacturer	Antenna Model	Number of Feed Lines	Feed Line Size (in)	Note
146	148	6	ericsson	RRUS-11	2 1	3/8 5/8	-
		6	powerwave technologies	LGP2140X			
		3	powerwave technologies	P65-16-XLH-RR w/ Mount Pipe			
		1	raycap	DC6-48-60-18-8F			

**Table 2 - Existing and Reserved Antenna and Cable Information**

Mounting Level (ft)	Center Line Elevation (ft)	Number of Antennas	Antenna Manufacturer	Antenna Model	Number of Feed Lines	Feed Line Size (in)	Note
166	167	3	ems wireless	RV90-17-02DP	-	-	2
	166	1	tower mounts	Pipe Mount [PM 601-3]	-	-	
		3	andrew	LNX-6514DS-T4M w/ Mount Pipe	-	-	1
155	158	6	decibel	DB844G65ZAXY w/ Mount Pipe	12	1 5/8	3
		6	rfs celwave	FD9R6004/2C-3L			
		3	rymsa wireless	MG D3-800TV w/ Mount Pipe	-	-	1
	155	1	tower mounts	Platform Mount [LP 602-1]	-	-	
146	148	6	powerwave technologies	7770.00 w/ Mount Pipe	12	1 5/8	1
		6	powerwave technologies	LGP2140X			
	146	-	-	-	1	1/2	4
	146	1	tower mounts	Platform Mount [LP 602-1]	-	-	1
		3	ems wireless	DR65-18-02DP w/ Mount Pipe	-	-	
138	140	3	rfs celwave	APX16DWW-16DWW-S-E-A20 w/ Mount Pipe	12	1 5/8	1
		3	rfs celwave	ATMAA1412D-1A20			
		3	rfs celwave	ATMPP1412D-1CWA			

Mounting Level (ft)	Center Line Elevation (ft)	Number of Antennas	Antenna Manufacturer	Antenna Model	Number of Feed Lines	Feed Line Size (in)	Note
	138	1	tower mounts	Platform Mount [LP 602-1]			
		1	andrew	VHLP800-11			
128	128	3	kathrein	840 10054 w/ Mount Pipe	3	5/16	1
		1	tower mounts	Side Arm Mount [SO 101-3]	1	1/2	
		1	tower mounts	Side Arm Mount [SO 301-1]	3	1/4	
118	118	1	tower mounts	Side Arm Mount [SO 301-1]			
		2	tower mounts	Side Arm Mount [SO 701-1]	-	-	2
		1	tower mounts	T-Arm Mount [TA 602-1]			

Notes:

- 1) Existing Equipment
- 2) Abandoned Equipment, considered in this analysis
- 3) Reserved Equipment
- 4) Equipment to be Removed

**Table 3 - Design Antenna and Cable Information**

Mounting Level (ft)	Center Line Elevation (ft)	Number of Antennas	Antenna Manufacturer	Antenna Model	Number of Feed Lines	Feed Line Size (in)
160	160	12	Allgon	ALP 9212	-	-
148	148	12	Allgon	ALP 11011	-	-
138	138	6	Celwave	APN 199015	-	-
128	128	12	Allgon	ALP 9212	-	-
118	118	12	Allgon	ALP 9212	-	-

**3) ANALYSIS PROCEDURE**

**Table 4 - Documents Provided**

Document	Remarks	Reference	Source
4-GEOTECHNICAL REPORTS	Clarence Welti Assoc., Inc.	1099974	CCISITES
4-TOWER FOUNDATION DRAWINGS/DESIGN/SPECS	EEL, Inc.	1098364	CCISITES
4-TOWER MANUFACTURER DRAWINGS	EEL, Inc.	653293	CCISITES

**3.1) Analysis Method**

RISATower (version 5.4.2.0), a commercially available analysis software package, was used to create a three-dimensional model of the tower and calculate member stresses for various loading cases. Selected output from the analysis is included in Appendix A.

**3.2) Assumptions**

- 1) Tower and structures were built in accordance with the manufacturer's specifications.
- 2) The tower and structures have been maintained in accordance with the manufacturer's specification.
- 3) The configuration of antennas, transmission cables, mounts and other appurtenances are as specified in Tables 1 and 2 and the referenced drawings.
- 4) When applicable, transmission cables are considered as structural components for calculating wind loads as allowed by TIA/EIA-222-F.

This analysis may be affected if any assumptions are not valid or have been made in error. Crown Castle should be notified to determine the effect on the structural integrity of the tower.

**4) ANALYSIS RESULTS**

**Table 5 - Section Capacity (Summary)**

Section No.	Elevation (ft)	Component Type	Size	Critical Element	P (K)	SF*P_allow (K)	% Capacity	Pass / Fail	
L1	171 - 156.5	Pole	TP10.75x10.75x0.365	1	-0.70	333.35	13.9	Pass	
L2	156.5 - 156	Pole	TP19.5x10.75x0.365	2	-0.70	625.46	8.2	Pass	
L3	156 - 132.669	Pole	TP24.79x19.5x0.1875	3	-6.58	735.45	64.7	Pass	
L4	132.669 - 87.0859	Pole	TP34.63x23.5836x0.375	4	-14.55	2052.54	85.4	Pass	
L5	87.0859 - 43	Pole	TP43.75x32.7959x0.4375	5	-25.02	3029.76	89.0	Pass	
L6	43 - 0	Pole	TP52.5x41.5315x0.5	6	-37.50	4081.19	83.2	Pass	
							Summary		
							Pole (L5)	89.0	Pass
							Rating =	89.0	Pass

**Table 6 - Tower Component Stresses vs. Capacity - LC1**

Notes	Component	Elevation (ft)	% Capacity	Pass / Fail
1	Anchor Rods	0	74.8	Pass
1	Base Plate	0	90.6	Pass
1	Base Foundation	0	87.0	Pass
1	Exterior Flange bolts	156	1.7	Pass
1	Exterior Flange plate	156	2.4	Pass

<b>Structure Rating (max from all components) =</b>	<b>90.6%</b>
-----------------------------------------------------	--------------

Notes:

- 1) See additional documentation in "Appendix C – Additional Calculations" for calculations supporting the % capacity consumed.

**4.1) Recommendations**

The tower and its foundation have sufficient capacity to carry the existing, reserved, and proposed loads. No modifications are required at this time.



**APPENDIX A**  
**RISA TOWER OUTPUT**

Section	1	2	3	4	5	6	
Length (ft)	146"	6"	233'-31/32"	48'3"	48'11'-1/32"	49'	
Number of Sides	1	18	18	18	18	18	
Thickness (in)	0.3650	0.3650	0.1875	0.3750	0.4375	0.5000	
Socket Length (ft)			38'-1/32"	49'-31/32"	6'		
Top Dia (in)	10.7500	10.7500	19.5000	23.5636	32.7959	41.5315	
Bot Dia (in)	10.7500	19.5000	24.7600	34.6300	43.7500	52.5000	
Grade	A53-B-35			A572-65			
Weight (K)	0.6	0.0	1.0	5.7	8.7	12.3	28.4

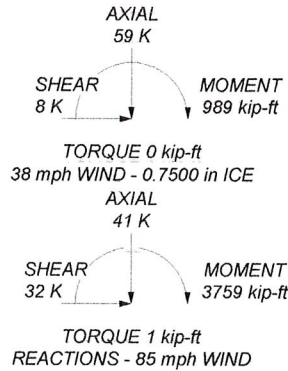
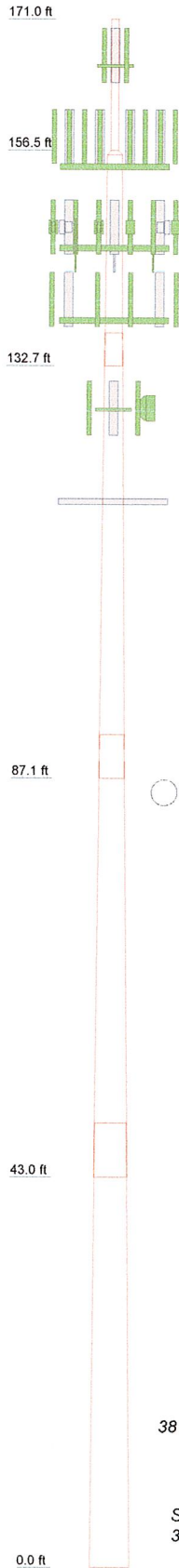

### DESIGNED APPURTENANCE LOADING

TYPE	ELEVATION	TYPE	ELEVATION
RV90-17-02DP	166	6' x 2" Mount Pipe	146
RV90-17-02DP	166	Platform Mount [LP 602-1]	146
RV90-17-02DP	166	APX16DWV-16DWV-S-E-A20 w/Mount Pipe	138
Pipe Mount [PM 601-3]	166	DR65-18-02DP w/ Mount Pipe	138
LNX-6514DS-T4M w/ Mount Pipe	155	ATMAA1412D-1A20	138
(2) DB844G65ZAXY w/ Mount Pipe	155	ATMPP1412D-1CWA	138
MG D3-800TV w/ Mount Pipe	155	APX16DWV-16DWV-S-E-A20 w/Mount Pipe	138
(2) FD9R6004/2C-3L	155	DR65-18-02DP w/ Mount Pipe	138
LNX-6514DS-T4M w/ Mount Pipe	155	ATMAA1412D-1A20	138
(2) DB844G65ZAXY w/ Mount Pipe	155	ATMPP1412D-1CWA	138
MG D3-800TV w/ Mount Pipe	155	DR65-18-02DP w/ Mount Pipe	138
(2) FD9R6004/2C-3L	155	ATMAA1412D-1A20	138
LNX-6514DS-T4M w/ Mount Pipe	155	ATMPP1412D-1CWA	138
(2) DB844G65ZAXY w/ Mount Pipe	155	APX16DWV-16DWV-S-E-A20 w/Mount Pipe	138
MG D3-800TV w/ Mount Pipe	155	6' x 2" Mount Pipe	138
(2) FD9R6004/2C-3L	155	6' x 2" Mount Pipe	138
Platform Mount [LP 602-1]	155	6' x 2" Mount Pipe	138
P65-16-XLH-RR w/ Mount Pipe	146	Platform Mount [LP 602-1]	138
(2) RRUUS-11	146	840 10054 w/ Mount Pipe	128
(2) LGP2140X	146	840 10054 w/ Mount Pipe	128
P65-16-XLH-RR w/ Mount Pipe	146	840 10054 w/ Mount Pipe	128
(2) RRUUS-11	146	6' x 2" Mount Pipe	128
(2) LGP2140X	146	Side Arm Mount [SO 101-3]	128
P65-16-XLH-RR w/ Mount Pipe	146	VHLP800-11	128
(2) RRUUS-11	146	Side Arm Mount [SO 301-1]	118
DC6-48-60-18-8F	146	Side Arm Mount [SO 701-1]	118
(2) LGP2140X	146	Side Arm Mount [SO 701-1]	118
(2) 7770.00 w/ Mount Pipe	146	(3) 6' x 2" Mount Pipe	118
(2) LGP2140X	146	6' x 2" Mount Pipe	118
(2) 7770.00 w/ Mount Pipe	146	6' x 2" Mount Pipe	118
(2) LGP2140X	146	T-Arm Mount [TA 602-1]	118
6' x 2" Mount Pipe	146		
6' x 2" Mount Pipe	146		

### MATERIAL STRENGTH

GRADE	Fy	Fu	GRADE	Fy	Fu
A53-B-35	35 ksi	63 ksi	A572-65	65 ksi	80 ksi

### TOWER DESIGN NOTES

1. Tower is located in Fairfield County, Connecticut.
2. Tower designed for a 85 mph basic wind in accordance with the TIA/EIA-222-F Standard.
3. Tower is also designed for a 38 mph basic wind with 0.75 in ice. Ice is considered to increase in thickness with height.
4. Deflections are based upon a 50 mph wind.
5. TOWER RATING: 89%

<p><b>Crown Castle</b> 2000 Corporate Dr. Canonsburg, PA 15317 We Are Solutions Phone: (724) 416-2000 FAX: (724) 416-2254</p>	<p>Job: <b>BU# 806355</b></p>
	<p>Project: _____</p> <p>Client: Crown Castle Drawn by: cvolk App'd: _____</p> <p>Code: TIA/EIA-222-F Date: 04/21/11 Scale: NTS</p> <p>Path: R:\SA Models - Letters\Work Area\AM\kajic\806355_402472\806355.dwg Dwg No. E-1</p>

<b>RISATower</b>  <b>Crown Castle</b> 2000 Corporate Dr. Canonsburg, PA 15317 Phone: (724) 416-2000 FAX: (724) 416-2254	<b>Job</b>  BU# 806355	<b>Page</b>  1 of 18
	<b>Project</b>	<b>Date</b> 11:39:29 04/21/11
	<b>Client</b>  Crown Castle	<b>Designed by</b> cvolk

## Tower Input Data

There is a pole section.

This tower is designed using the TIA/EIA-222-F standard.

The following design criteria apply:

Tower is located in Fairfield County, Connecticut.

Basic wind speed of 85 mph.

Nominal ice thickness of 0.7500 in.

Ice thickness is considered to increase with height.

Ice density of 56.00 pcf.

A wind speed of 38 mph is used in combination with ice.

Temperature drop of 50 °F.

Deflections calculated using a wind speed of 50 mph.

A non-linear (P-delta) analysis was used.

Pressures are calculated at each section.

Stress ratio used in pole design is 1.333.

Local bending stresses due to climbing loads, feedline supports, and appurtenance mounts are not considered.

## Options

<ul style="list-style-type: none"> <li>Consider Moments - Legs</li> <li>Consider Moments - Horizontals</li> <li>Consider Moments - Diagonals</li> <li>Use Moment Magnification</li> <li>√ Use Code Stress Ratios</li> <li>√ Use Code Safety Factors - Guys</li> <li>√ Escalate Ice</li> <li>Always Use Max Kz</li> <li>Use Special Wind Profile</li> <li>Include Bolts In Member Capacity</li> <li>Leg Bolts Are At Top Of Section</li> <li>Secondary Horizontal Braces Leg</li> <li>Use Diamond Inner Bracing (4 Sided)</li> <li>Add IBC .6D+W Combination</li> </ul>	<ul style="list-style-type: none"> <li>Distribute Leg Loads As Uniform</li> <li>Assume Legs Pinned</li> <li>√ Assume Rigid Index Plate</li> <li>√ Use Clear Spans For Wind Area</li> <li>Use Clear Spans For KL/r</li> <li>Retension Guys To Initial Tension</li> <li>√ Bypass Mast Stability Checks</li> <li>√ Use Azimuth Dish Coefficients</li> <li>√ Project Wind Area of Appurt.</li> <li>Autocalc Torque Arm Areas</li> <li>SR Members Have Cut Ends</li> <li>Sort Capacity Reports By Component</li> <li>Triangulate Diamond Inner Bracing</li> </ul>	<ul style="list-style-type: none"> <li>Treat Feedline Bundles As Cylinder</li> <li>Use ASCE 10 X-Brace Ly Rules</li> <li>Calculate Redundant Bracing Forces</li> <li>Ignore Redundant Members in FEA</li> <li>SR Leg Bolts Resist Compression</li> <li>All Leg Panels Have Same Allowable</li> <li>Offset Girt At Foundation</li> <li>√ Consider Feedline Torque</li> <li>Include Angle Block Shear Check Poles</li> <li>√ Include Shear-Torsion Interaction</li> <li>Always Use Sub-Critical Flow</li> <li>Use Top Mounted Sockets</li> </ul>
------------------------------------------------------------------------------------------------------------------------------------------------------------------------------------------------------------------------------------------------------------------------------------------------------------------------------------------------------------------------------------------------------------------------------------------------------------------------------------------------------------------------------------------------------------------------	--------------------------------------------------------------------------------------------------------------------------------------------------------------------------------------------------------------------------------------------------------------------------------------------------------------------------------------------------------------------------------------------------------------------------------------------------------------------------------------------------------------------------------------------------------------	------------------------------------------------------------------------------------------------------------------------------------------------------------------------------------------------------------------------------------------------------------------------------------------------------------------------------------------------------------------------------------------------------------------------------------------------------------------------------------------------------------------------------------------------

## Tapered Pole Section Geometry

Section	Elevation ft	Section Length ft	Splice Length ft	Number of Sides	Top Diameter in	Bottom Diameter in	Wall Thickness in	Bend Radius in	Pole Grade
L1	171'-156'6"	14'6"	0'	Round	10.7500	10.7500	0.3650		A53-B-35 (35 ksi)
L2	156'6"-156'	6"	0'	18	10.7500	19.5000	0.3650	1.4600	A572-65 (65 ksi)
L3	156'-132'8-1/32"	23'3-31/32"	3'8-1/32"	18	19.5000	24.7900	0.1875	0.7500	A572-65 (65 ksi)
L4	132'8-1/32"-87'1-3/32"	49'3"	4'9-31/32"	18	23.5836	34.6300	0.3750	1.5000	A572-65 (65 ksi)
L5	87'1-3/32"-43'	48'11-1/32"	6'	18	32.7959	43.7500	0.4375	1.7500	A572-65 (65 ksi)

<b>RISATower</b>  <b>Crown Castle</b> 2000 Corporate Dr. Canonsburg, PA 15317 Phone: (724) 416-2000 FAX: (724) 416-2254	<b>Job</b> BU# 806355	<b>Page</b> 2 of 18
	<b>Project</b>	<b>Date</b> 11:39:29 04/21/11
	<b>Client</b> Crown Castle	<b>Designed by</b> cvolk

Section	Elevation ft	Section Length ft	Splice Length ft	Number of Sides	Top Diameter in	Bottom Diameter in	Wall Thickness in	Bend Radius in	Pole Grade
L6	43'-0"	49'		18	41.5315	52.5000	0.5000	2.0000	A572-65 (65 ksi)

### Tapered Pole Properties

Section	Tip Dia. in	Area in <sup>2</sup>	I in <sup>4</sup>	r in	C in	I/C in <sup>3</sup>	J in <sup>4</sup>	I/Q in <sup>2</sup>	w in	w/t
L1	10.7500	11.9083	160.6589	3.6763	5.3750	29.8900	320.8802	5.9506	0.0000	0
L2	10.9158	12.0311	163.9294	3.6867	5.4610	30.0182	328.0744	6.0167	1.2496	3.424
L3	19.8008	22.1681	1025.4692	6.7929	9.9060	103.5200	2052.2878	11.0862	2.7896	7.643
L4	19.8008	11.4934	541.5782	6.8559	9.9060	54.6717	1083.8689	5.7478	3.1020	16.544
L5	24.7825	27.6241	1879.8522	8.2391	11.9805	156.9096	3762.1780	13.8147	3.4907	9.309
L6	35.1642	40.7720	6044.3215	12.1605	17.5920	343.5828	12096.5963	20.3899	5.4349	14.493
L5	34.4008	44.9337	5944.0771	11.4872	16.6603	356.7803	11895.9756	22.4711	5.0021	11.433
L6	44.4249	60.1448	14254.8347	15.3759	22.2250	641.3874	28528.4263	30.0781	6.9300	15.84
L6	43.5360	65.1169	13850.5059	14.5662	21.0980	656.4847	27719.2367	32.5647	6.4295	12.859
L6	53.3099	82.5240	28191.9040	18.4600	26.6700	1057.0643	56420.9036	41.2698	8.3600	16.72

Tower Elevation ft	Gusset Area (per face) ft <sup>2</sup>	Gusset Thickness in	Gusset Grade	Adjust. Factor A <sub>f</sub>	Adjust. Factor A <sub>r</sub>	Weight Mult.	Double Angle Stitch Bolt Spacing Diagonals in	Double Angle Stitch Bolt Spacing Horizontal in
L1 171'-156'6"				1	1	1		
L2 156'6"-156'				1	1	1		
L3 156'-132'8-1/3 2"				1	1	1		
L4 132'8-1/32"-87' 1-3/32"				1	1	1		
L5 87'1-3/32"-43'				1	1	1		
L6 43'-0'				1	1	1		

### Feed Line/Linear Appurtenances - Entered As Area

Description	Face or Leg	Allow Shield	Component Type	Placement ft	Face Offset in	Lateral Offset (Frac FW)	#	C <sub>A</sub> A <sub>A</sub> ft <sup>2</sup> /ft	Weight klf
***									
561(1-5/8")	C	No	Inside Pole	155' - 0'	0.0000	0	12	No Ice 0.00 1/2" Ice 0.00 1" Ice 0.00 2" Ice 0.00 4" Ice 0.00	0.00 0.00 0.00 0.00 0.00
FB-L98B-002-75000(3/8")	C	No	Inside Pole	146' - 0'	0.0000	0	2	No Ice 0.00 1/2" Ice 0.00 1" Ice 0.00 2" Ice 0.00	0.00 0.00 0.00 0.00

<b>RISATower</b>  <b>Crown Castle</b> 2000 Corporate Dr. Canonsburg, PA 15317 Phone: (724) 416-2000 FAX: (724) 416-2254	<b>Job</b> BU# 806355	<b>Page</b> 3 of 18
	<b>Project</b>	<b>Date</b> 11:39:29 04/21/11
	<b>Client</b> Crown Castle	<b>Designed by</b> cvolk

Description	Face or Leg	Allow Shield	Component Type	Placement ft	Face Offset in	Lateral Offset (Frac FW)	#	C <sub>A</sub> A <sub>A</sub> ft <sup>2</sup> /ft	Weight klf	
WR-VG82ST-BRDA( 5/8")	C	No	Inside Pole	146' - 0'	0.0000	0	1	4" Ice	0.00	0.00
								No Ice	0.00	0.00
								1/2" Ice	0.00	0.00
								1" Ice	0.00	0.00
								2" Ice	0.00	0.00
CR 50 1873PE(1-5/8")	C	No	Inside Pole	146' - 0'	0.0000	0	12	4" Ice	0.00	0.00
								No Ice	0.00	0.00
								1/2" Ice	0.00	0.00
								1" Ice	0.00	0.00
								2" Ice	0.00	0.00
LCF158-50JA -A0(1 5/8")	C	No	Inside Pole	138' - 0'	0.0000	0	6	4" Ice	0.00	0.00
								No Ice	0.00	0.00
								1/2" Ice	0.00	0.00
								1" Ice	0.00	0.00
								2" Ice	0.00	0.00
LCF158-50JA -A0(1 5/8")	C	No	CaAa (Out Of Face)	138' - 0'	1.0000	0	1	4" Ice	0.00	0.00
								No Ice	0.20	0.00
								1/2" Ice	0.30	0.00
								1" Ice	0.40	0.00
								2" Ice	0.60	0.01
LCF158-50JA -A0(1 5/8")	C	No	CaAa (Out Of Face)	138' - 0'	1.0000	0	5	4" Ice	1.00	0.03
								No Ice	0.00	0.00
								1/2" Ice	0.00	0.00
								1" Ice	0.00	0.00
								2" Ice	0.00	0.01
7983A(1/2")	C	No	CaAa (Out Of Face)	128' - 0'	1.0000	0	1	4" Ice	0.00	0.00
								No Ice	0.00	0.00
								1/2" Ice	0.00	0.00
								1" Ice	0.00	0.00
								2" Ice	0.00	0.01
9207(5/16")	C	No	CaAa (Out Of Face)	128' - 0'	1.0000	0	3	4" Ice	0.00	0.02
								No Ice	0.00	0.00
								1/2" Ice	0.00	0.00
								1" Ice	0.00	0.00
								2" Ice	0.00	0.01
9258(1/4")	C	No	CaAa (Out Of Face)	128' - 0'	1.0000	0	3	4" Ice	0.00	0.02
								No Ice	0.00	0.00
								1/2" Ice	0.00	0.00
								1" Ice	0.00	0.00
								2" Ice	0.00	0.01
2" Rigid Conduit	C	No	CaAa (Out Of Face)	128' - 0'	1.0000	0	1	4" Ice	0.00	0.02
								No Ice	0.00	0.00
								1/2" Ice	0.00	0.00
								1" Ice	0.00	0.01
								2" Ice	0.00	0.01
2" Rigid Conduit	C	No	CaAa (Out Of Face)	128' - 0'	1.0000	0	1	4" Ice	0.00	0.03
								No Ice	0.20	0.00
								1/2" Ice	0.30	0.00
								1" Ice	0.40	0.01
								2" Ice	0.60	0.01
* Climbing Ladder ( Flat)	C	No	CaAa (Out Of Face)	155' - 147'	48.0000	0	1	4" Ice	1.00	0.03
								No Ice	0.58	0.00
								1/2" Ice	1.03	0.01
								1" Ice	1.48	0.01
								2" Ice	2.37	0.02
Climbing Ladder ( Flat)	C	No	CaAa (Out Of Face)	146' - 138'	48.0000	0	1	4" Ice	4.15	0.05
								No Ice	0.58	0.00
								1/2" Ice	1.03	0.01
								1" Ice	1.48	0.01
								2" Ice	2.37	0.02

<b>RISATower</b>  <b>Crown Castle</b> 2000 Corporate Dr. Canonsburg, PA 15317 Phone: (724) 416-2000 FAX: (724) 416-2254	<b>Job</b> BU# 806355	<b>Page</b> 4 of 18
	<b>Project</b>	<b>Date</b> 11:39:29 04/21/11
	<b>Client</b> Crown Castle	<b>Designed by</b> cvolk

Description	Face or Leg	Allow Shield	Component Type	Placement ft	Face Offset in	Lateral Offset (Frac FW)	#	C <sub>A</sub> A <sub>A</sub> ft <sup>2</sup> /ft	Weight klf	
Climbing Ladder ( Flat)	C	No	CaAa (Out Of Face)	138' - 130'	48.0000	0	1	4" Ice	4.15	0.05
								No Ice	0.58	0.00
								1/2" Ice	1.03	0.01
								1" Ice	1.48	0.01
								2" Ice	2.37	0.02
4" Ice	4.15	0.05								

### Feed Line/Linear Appurtenances Section Areas

Tower Section	Tower Elevation ft	Face	A <sub>R</sub> ft <sup>2</sup>	A <sub>F</sub> ft <sup>2</sup>	C <sub>A</sub> A <sub>A</sub> In Face ft <sup>2</sup>	C <sub>A</sub> A <sub>A</sub> Out Face ft <sup>2</sup>	Weight K
L1	171'-156'6"	A	0.000	0.000	0.000	0.000	0.00
		B	0.000	0.000	0.000	0.000	0.00
		C	0.000	0.000	0.000	0.000	0.00
L2	156'6"-156'	A	0.000	0.000	0.000	0.000	0.00
		B	0.000	0.000	0.000	0.000	0.00
		C	0.000	0.000	0.000	0.000	0.00
L3	156'-132'8-1/32"	A	0.000	0.000	0.000	0.000	0.00
		B	0.000	0.000	0.000	0.000	0.00
		C	0.000	0.000	0.000	0.000	0.00
L4	132'8-1/32"-87'1-3/32"	A	0.000	0.000	0.000	13.521	0.61
		B	0.000	0.000	0.000	0.000	0.00
		C	0.000	0.000	0.000	18.768	1.58
L5	87'1-3/32"-43'	A	0.000	0.000	0.000	0.000	0.00
		B	0.000	0.000	0.000	0.000	0.00
		C	0.000	0.000	0.000	17.546	1.55
L6	43'-0'	A	0.000	0.000	0.000	0.000	0.00
		B	0.000	0.000	0.000	0.000	0.00
		C	0.000	0.000	0.000	17.114	1.51

### Feed Line/Linear Appurtenances Section Areas - With Ice

Tower Section	Tower Elevation ft	Face or Leg	Ice Thickness in	A <sub>R</sub> ft <sup>2</sup>	A <sub>F</sub> ft <sup>2</sup>	C <sub>A</sub> A <sub>A</sub> In Face ft <sup>2</sup>	C <sub>A</sub> A <sub>A</sub> Out Face ft <sup>2</sup>	Weight K
L1	171'-156'6"	A	0.909	0.000	0.000	0.000	0.000	0.00
		B		0.000	0.000	0.000	0.000	0.00
		C		0.000	0.000	0.000	0.000	0.00
L2	156'6"-156'	A	0.904	0.000	0.000	0.000	0.000	0.00
		B		0.000	0.000	0.000	0.000	0.00
		C		0.000	0.000	0.000	0.000	0.00
L3	156'-132'8-1/32"	A	0.895	0.000	0.000	0.000	0.000	0.00
		B		0.000	0.000	0.000	0.000	0.00
		C		0.000	0.000	0.000	0.000	0.00
L4	132'8-1/32"-87'1-3/32"	A	0.866	0.000	0.000	0.000	31.495	0.81
		B		0.000	0.000	0.000	0.000	0.00
		C		0.000	0.000	0.000	36.380	3.11
L5	87'1-3/32"-43'	A	0.813	0.000	0.000	0.000	0.000	0.00
		B		0.000	0.000	0.000	0.000	0.00
		C		0.000	0.000	0.000	32.809	3.03
L6	43'-0'	A	0.750	0.000	0.000	0.000	0.000	0.00
		B		0.000	0.000	0.000	0.000	0.00
		C		0.000	0.000	0.000	31.098	2.83

<b>RISATower</b>  <b>Crown Castle</b> 2000 Corporate Dr. Canonsburg, PA 15317 Phone: (724) 416-2000 FAX: (724) 416-2254	<b>Job</b> BU# 806355	<b>Page</b> 5 of 18
	<b>Project</b>	<b>Date</b> 11:39:29 04/21/11
	<b>Client</b> Crown Castle	<b>Designed by</b> cvolk

### Feed Line Center of Pressure

Section	Elevation	CP <sub>x</sub>	CP <sub>z</sub>	CP <sub>x</sub> Ice	CP <sub>z</sub> Ice
	ft	in	in	in	in
L1	171'-156'6"	0.0000	0.0000	0.0000	0.0000
L2	156'6"-156'	0.0000	0.0000	0.0000	0.0000
L3	156'-132'8"-1/32"	-0.5804	0.3351	-0.9791	0.5653
L4	132'8"-1/32"-87'1-3/32"	-0.4555	0.2630	-0.7418	0.4283
L5	87'1-3/32"-43'	-0.4604	0.2658	-0.7584	0.4379
L6	43'-0'	-0.4700	0.2713	-0.7725	0.4460

### Discrete Tower Loads

Description	Face or Leg	Offset Type	Offsets: Horz Lateral Vert ft ft ft	Azimuth Adjustment °	Placement ft	C <sub>A</sub> A <sub>Front</sub> ft <sup>2</sup>	C <sub>A</sub> A <sub>Side</sub> ft <sup>2</sup>	Weight K	
**									
RV90-17-02DP	A	From Leg	1.00 0' 1'	0.000	166'	No Ice 1/2" Ice 1" Ice 2" Ice 4" Ice	4.36 4.77 5.20 6.08 7.95	1.97 2.31 2.66 3.37 4.89	0.02 0.04 0.07 0.14 0.33
RV90-17-02DP	B	From Leg	1.00 0' 1'	0.000	166'	No Ice 1/2" Ice 1" Ice 2" Ice 4" Ice	4.36 4.77 5.20 6.08 7.95	1.97 2.31 2.66 3.37 4.89	0.02 0.04 0.07 0.14 0.33
RV90-17-02DP	C	From Leg	1.00 0' 1'	0.000	166'	No Ice 1/2" Ice 1" Ice 2" Ice 4" Ice	4.36 4.77 5.20 6.08 7.95	1.97 2.31 2.66 3.37 4.89	0.02 0.04 0.07 0.14 0.33
Pipe Mount [PM 601-3]	C	None		0.000	166'	No Ice 1/2" Ice 1" Ice 2" Ice 4" Ice	4.39 5.48 6.57 8.75 13.11	4.39 5.48 6.57 8.75 13.11	0.20 0.24 0.28 0.36 0.53
*									
LNx-6514DS-T4M w/ Mount Pipe	A	From Leg	4.00 0' 3'	0.000	155'	No Ice 1/2" Ice 1" Ice 2" Ice 4" Ice	8.57 9.22 9.84 11.10 13.75	7.00 8.19 9.08 10.90 14.93	0.06 0.12 0.20 0.38 0.89
(2) DB844G65ZAXY w/ Mount Pipe	A	From Leg	4.00 0' 3'	0.000	155'	No Ice 1/2" Ice 1" Ice 2" Ice 4" Ice	4.90 5.35 5.80 6.73 8.73	4.92 5.60 6.28 7.71 10.83	0.03 0.08 0.13 0.26 0.62
MG D3-800TV w/ Mount Pipe	A	From Leg	4.00 0'	0.000	155'	No Ice 1/2" Ice	3.57 3.98	3.42 4.12	0.04 0.07

<b>RISATower</b>  <b>Crown Castle</b> 2000 Corporate Dr. Canonsburg, PA 15317 Phone: (724) 416-2000 FAX: (724) 416-2254	Job	BU# 806355	Page	6 of 18
	Project		Date	11:39:29 04/21/11
	Client	Crown Castle	Designed by	cvolk

Description	Face or Leg	Offset Type	Offsets: Horz Lateral Vert ft ft ft	Azimuth Adjustment °	Placement ft	C <sub>A</sub> A <sub>1</sub> Front ft <sup>2</sup>	C <sub>A</sub> A <sub>1</sub> Side ft <sup>2</sup>	Weight K
			3'			1" Ice 4.39	4.78	0.11
						2" Ice 5.33	6.16	0.21
						4" Ice 7.34	9.18	0.52
(2) FD9R6004/2C-3L	A	From Leg	4.00	0.000	155'	No Ice 0.37	0.08	0.00
			0'			1/2" Ice 0.45	0.14	0.01
			3'			1" Ice 0.54	0.20	0.01
						2" Ice 0.75	0.34	0.02
						4" Ice 1.28	0.74	0.06
LNx-6514DS-T4M w/ Mount Pipe	B	From Leg	4.00	0.000	155'	No Ice 8.57	7.00	0.06
			0'			1/2" Ice 9.22	8.19	0.12
			3'			1" Ice 9.84	9.08	0.20
						2" Ice 11.10	10.90	0.38
						4" Ice 13.75	14.93	0.89
(2) DB844G65ZAXY w/ Mount Pipe	B	From Leg	4.00	0.000	155'	No Ice 4.90	4.92	0.03
			0'			1/2" Ice 5.35	5.60	0.08
			3'			1" Ice 5.80	6.28	0.13
						2" Ice 6.73	7.71	0.26
						4" Ice 8.73	10.83	0.62
MG D3-800TV w/ Mount Pipe	B	From Leg	4.00	0.000	155'	No Ice 3.57	3.42	0.04
			0'			1/2" Ice 3.98	4.12	0.07
			3'			1" Ice 4.39	4.78	0.11
						2" Ice 5.33	6.16	0.21
						4" Ice 7.34	9.18	0.52
(2) FD9R6004/2C-3L	B	From Leg	4.00	0.000	155'	No Ice 0.37	0.08	0.00
			0'			1/2" Ice 0.45	0.14	0.01
			3'			1" Ice 0.54	0.20	0.01
						2" Ice 0.75	0.34	0.02
						4" Ice 1.28	0.74	0.06
LNx-6514DS-T4M w/ Mount Pipe	C	From Leg	4.00	0.000	155'	No Ice 8.57	7.00	0.06
			0'			1/2" Ice 9.22	8.19	0.12
			3'			1" Ice 9.84	9.08	0.20
						2" Ice 11.10	10.90	0.38
						4" Ice 13.75	14.93	0.89
(2) DB844G65ZAXY w/ Mount Pipe	C	From Leg	4.00	0.000	155'	No Ice 4.90	4.92	0.03
			0'			1/2" Ice 5.35	5.60	0.08
			3'			1" Ice 5.80	6.28	0.13
						2" Ice 6.73	7.71	0.26
						4" Ice 8.73	10.83	0.62
MG D3-800TV w/ Mount Pipe	C	From Leg	4.00	0.000	155'	No Ice 3.57	3.42	0.04
			0'			1/2" Ice 3.98	4.12	0.07
			3'			1" Ice 4.39	4.78	0.11
						2" Ice 5.33	6.16	0.21
						4" Ice 7.34	9.18	0.52
(2) FD9R6004/2C-3L	C	From Leg	4.00	0.000	155'	No Ice 0.37	0.08	0.00
			0'			1/2" Ice 0.45	0.14	0.01
			3'			1" Ice 0.54	0.20	0.01
						2" Ice 0.75	0.34	0.02
						4" Ice 1.28	0.74	0.06
Platform Mount [LP 602-1]	C	None		0.000	155'	No Ice 32.03	32.03	1.34
						1/2" Ice 38.71	38.71	1.80
						1" Ice 45.39	45.39	2.26
						2" Ice 58.75	58.75	3.17
						4" Ice 85.47	85.47	5.00
*								
P65-16-XLH-RR w/ Mount Pipe	A	From Leg	4.00	0.000	146'	No Ice 8.64	6.36	0.08
			0'			1/2" Ice 9.29	7.54	0.14
			2'			1" Ice 9.91	8.43	0.22



<b>RISA Tower</b>  <b>Crown Castle</b> 2000 Corporate Dr. Canonsburg, PA 15317 Phone: (724) 416-2000 FAX: (724) 416-2254	<b>Job</b> BU# 806355	<b>Page</b> 7 of 18
	<b>Project</b>	<b>Date</b> 11:39:29 04/21/11
	<b>Client</b> Crown Castle	<b>Designed by</b> cvolk

Description	Face or Leg	Offset Type	Offsets:		Azimuth Adjustment	Placement	C <sub>A</sub> A <sub>1</sub> Front	C <sub>A</sub> A <sub>1</sub> Side	Weight	
			Horz	Lateral						Vert
(2) RRUS-11	A	From Leg	4.00	0'	0.000	146'	2" Ice	11.18	10.24	0.39
							4" Ice	13.83	14.10	0.89
							No Ice	4.42	1.19	0.06
							1/2" Ice	4.71	1.35	0.08
							1" Ice	5.00	1.53	0.11
							2" Ice	5.61	1.90	0.18
(2) LGP2140X	A	From Leg	4.00	0'	0.000	146'	4" Ice	6.94	2.75	0.37
							No Ice	1.26	0.38	0.02
							1/2" Ice	1.42	0.49	0.03
							1" Ice	1.58	0.62	0.04
							2" Ice	1.94	0.89	0.06
							4" Ice	2.75	1.54	0.14
P65-16-XLH-RR w/ Mount Pipe	B	From Leg	4.00	0'	0.000	146'	No Ice	8.64	6.36	0.08
							1/2" Ice	9.29	7.54	0.14
							1" Ice	9.91	8.43	0.22
							2" Ice	11.18	10.24	0.39
							4" Ice	13.83	14.10	0.89
							No Ice	4.42	1.19	0.06
(2) RRUS-11	B	From Leg	4.00	0'	0.000	146'	1/2" Ice	4.71	1.35	0.08
							1" Ice	5.00	1.53	0.11
							2" Ice	5.61	1.90	0.18
							4" Ice	6.94	2.75	0.37
							No Ice	1.26	0.38	0.02
							1/2" Ice	1.42	0.49	0.03
(2) LGP2140X	B	From Leg	4.00	0'	0.000	146'	1" Ice	1.58	0.62	0.04
							2" Ice	1.94	0.89	0.06
							4" Ice	2.75	1.54	0.14
							No Ice	8.64	6.36	0.08
							1/2" Ice	9.29	7.54	0.14
							1" Ice	9.91	8.43	0.22
P65-16-XLH-RR w/ Mount Pipe	C	From Leg	4.00	0'	0.000	146'	2" Ice	11.18	10.24	0.39
							4" Ice	13.83	14.10	0.89
							No Ice	4.42	1.19	0.06
							1/2" Ice	4.71	1.35	0.08
							1" Ice	5.00	1.53	0.11
							2" Ice	5.61	1.90	0.18
(2) RRUS-11	C	From Leg	4.00	0'	0.000	146'	4" Ice	6.94	2.75	0.37
							No Ice	1.26	0.38	0.02
							1/2" Ice	1.42	0.49	0.03
							1" Ice	1.58	0.62	0.04
							2" Ice	1.94	0.89	0.06
							4" Ice	2.75	1.54	0.14
DC6-48-60-18-8F	C	From Leg	4.00	0'	0.000	146'	No Ice	1.27	1.27	0.02
							1/2" Ice	1.46	1.46	0.04
							1" Ice	1.66	1.66	0.05
							2" Ice	2.09	2.09	0.10
							4" Ice	3.10	3.10	0.21
							No Ice	1.26	0.38	0.02
(2) LGP2140X	C	From Leg	4.00	0'	0.000	146'	1/2" Ice	1.42	0.49	0.03
							1" Ice	1.58	0.62	0.04
							2" Ice	1.94	0.89	0.06
							4" Ice	2.75	1.54	0.14
							No Ice	6.12	4.25	0.06
							1/2" Ice	6.63	5.01	0.10
(2) 7770.00 w/ Mount Pipe	A	From Leg	4.00	0'	0.000	146'	1" Ice	7.13	5.71	0.16
							2" Ice	8.16	7.16	0.29
							4" Ice	10.36	10.41	0.66
							No Ice	1.26	0.38	0.02
							1/2" Ice	1.42	0.49	0.03
							1" Ice	1.58	0.62	0.04
(2) LGP2140X	A	From Leg	4.00	0'	0.000	146'	2" Ice	1.94	0.89	0.06
							4" Ice	2.75	1.54	0.14
							No Ice	1.26	0.38	0.02
							1/2" Ice	1.42	0.49	0.03
							1" Ice	1.58	0.62	0.04
							2" Ice	1.94	0.89	0.06

<b>RISA Tower</b>  <b>Crown Castle</b> 2000 Corporate Dr. Canonsburg, PA 15317 Phone: (724) 416-2000 FAX: (724) 416-2254	<b>Job</b>	BU# 806355	<b>Page</b>	8 of 18
	<b>Project</b>		<b>Date</b>	11:39:29 04/21/11
	<b>Client</b>	Crown Castle	<b>Designed by</b>	cvolk

Description	Face or Leg	Offset Type	Offsets:		Azimuth Adjustment	Placement	C <sub>AA</sub> <sub>Front</sub>	C <sub>AA</sub> <sub>Side</sub>	Weight
			Horz	Vert					
			ft	ft	°	ft	ft <sup>2</sup>	ft <sup>2</sup>	K
(2) 7770.00 w/ Mount Pipe	B	From Leg	4.00	0.000	146'	No Ice	6.12	4.25	0.06
			0'			1/2" Ice	6.63	5.01	0.10
			2'			1" Ice	7.13	5.71	0.16
						2" Ice	8.16	7.16	0.29
						4" Ice	10.36	10.41	0.66
(2) LGP2140X	B	From Leg	4.00	0.000	146'	No Ice	1.26	0.38	0.02
			0'			1/2" Ice	1.42	0.49	0.03
			2'			1" Ice	1.58	0.62	0.04
						2" Ice	1.94	0.89	0.06
						4" Ice	2.75	1.54	0.14
(2) 7770.00 w/ Mount Pipe	C	From Leg	4.00	0.000	146'	No Ice	6.12	4.25	0.06
			0'			1/2" Ice	6.63	5.01	0.10
			2'			1" Ice	7.13	5.71	0.16
						2" Ice	8.16	7.16	0.29
						4" Ice	10.36	10.41	0.66
(2) LGP2140X	C	From Leg	4.00	0.000	146'	No Ice	1.26	0.38	0.02
			0'			1/2" Ice	1.42	0.49	0.03
			2'			1" Ice	1.58	0.62	0.04
						2" Ice	1.94	0.89	0.06
						4" Ice	2.75	1.54	0.14
6' x 2" Mount Pipe	A	From Leg	4.00	0.000	146'	No Ice	1.43	1.43	0.02
			0'			1/2" Ice	1.92	1.92	0.03
			0'			1" Ice	2.29	2.29	0.05
						2" Ice	3.06	3.06	0.09
						4" Ice	4.70	4.70	0.23
6' x 2" Mount Pipe	B	From Leg	4.00	0.000	146'	No Ice	1.43	1.43	0.02
			0'			1/2" Ice	1.92	1.92	0.03
			0'			1" Ice	2.29	2.29	0.05
						2" Ice	3.06	3.06	0.09
						4" Ice	4.70	4.70	0.23
6' x 2" Mount Pipe	C	From Leg	4.00	0.000	146'	No Ice	1.43	1.43	0.02
			0'			1/2" Ice	1.92	1.92	0.03
			0'			1" Ice	2.29	2.29	0.05
						2" Ice	3.06	3.06	0.09
						4" Ice	4.70	4.70	0.23
Platform Mount [LP 602-1]	C	None		0.000	146'	No Ice	32.03	32.03	1.34
						1/2" Ice	38.71	38.71	1.80
						1" Ice	45.39	45.39	2.26
						2" Ice	58.75	58.75	3.17
						4" Ice	85.47	85.47	5.00
* APX16DWV-16DWV-S-E-A 20 w/Mount Pipe	A	From Leg	4.00	0.000	138'	No Ice	7.27	3.29	0.06
			0'			1/2" Ice	7.73	3.92	0.10
			2'			1" Ice	8.21	4.57	0.16
						2" Ice	9.18	5.92	0.28
						4" Ice	11.23	8.88	0.65
DR65-18-02DP w/ Mount Pipe	A	From Leg	4.00	0.000	138'	No Ice	10.40	6.73	0.07
			0'			1/2" Ice	11.19	8.86	0.14
			2'			1" Ice	11.99	11.02	0.22
						2" Ice	13.55	14.26	0.42
						4" Ice	16.72	19.69	1.02
ATMAA1412D-1A20	A	From Leg	4.00	0.000	138'	No Ice	1.17	0.47	0.01
			0'			1/2" Ice	1.31	0.57	0.02
			2'			1" Ice	1.47	0.69	0.03
						2" Ice	1.81	0.95	0.06
						4" Ice	2.58	1.57	0.14
ATMPP1412D-1CWA	A	From Leg	4.00	0.000	138'	No Ice	1.17	0.42	0.01

<b>RISATower</b>  <b>Crown Castle</b> 2000 Corporate Dr. Canonsburg, PA 15317 Phone: (724) 416-2000 FAX: (724) 416-2254	<b>Job</b> BU# 806355	<b>Page</b> 9 of 18
	<b>Project</b>	<b>Date</b> 11:39:29 04/21/11
	<b>Client</b> Crown Castle	<b>Designed by</b> cvolk

Description	Face or Leg	Offset Type	Offsets:		Azimuth Adjustment °	Placement ft	C <sub>A</sub> A <sub>1</sub> Front ft <sup>2</sup>	C <sub>A</sub> A <sub>1</sub> Side ft <sup>2</sup>	Weight K
			Horz Lateral ft	Vert ft					
				0'		1/2" Ice	1.32	0.53	0.02
				2'		1" Ice	1.48	0.65	0.03
						2" Ice	1.82	0.92	0.05
						4" Ice	2.61	1.57	0.13
APX16DWV-16DWV-S-E-A 20 w/Mount Pipe	B	From Leg	4.00	0.000	138'	No Ice	7.27	3.29	0.06
			0'			1/2" Ice	7.73	3.92	0.10
			2'			1" Ice	8.21	4.57	0.16
						2" Ice	9.18	5.92	0.28
						4" Ice	11.23	8.88	0.65
DR65-18-02DP w/ Mount Pipe	B	From Leg	4.00	0.000	138'	No Ice	10.40	6.73	0.07
			0'			1/2" Ice	11.19	8.86	0.14
			2'			1" Ice	11.99	11.02	0.22
						2" Ice	13.55	14.26	0.42
						4" Ice	16.72	19.69	1.02
ATMAA1412D-1A20	B	From Leg	4.00	0.000	138'	No Ice	1.17	0.47	0.01
			0'			1/2" Ice	1.31	0.57	0.02
			2'			1" Ice	1.47	0.69	0.03
						2" Ice	1.81	0.95	0.06
						4" Ice	2.58	1.57	0.14
ATMPP1412D-1CWA	B	From Leg	4.00	0.000	138'	No Ice	1.17	0.42	0.01
			0'			1/2" Ice	1.32	0.53	0.02
			2'			1" Ice	1.48	0.65	0.03
						2" Ice	1.82	0.92	0.05
						4" Ice	2.61	1.57	0.13
DR65-18-02DP w/ Mount Pipe	C	From Leg	4.00	0.000	138'	No Ice	10.40	6.73	0.07
			0'			1/2" Ice	11.19	8.86	0.14
			2'			1" Ice	11.99	11.02	0.22
						2" Ice	13.55	14.26	0.42
						4" Ice	16.72	19.69	1.02
ATMAA1412D-1A20	C	From Leg	4.00	0.000	138'	No Ice	1.17	0.47	0.01
			0'			1/2" Ice	1.31	0.57	0.02
			2'			1" Ice	1.47	0.69	0.03
						2" Ice	1.81	0.95	0.06
						4" Ice	2.58	1.57	0.14
ATMPP1412D-1CWA	C	From Leg	4.00	0.000	138'	No Ice	1.17	0.42	0.01
			0'			1/2" Ice	1.32	0.53	0.02
			2'			1" Ice	1.48	0.65	0.03
						2" Ice	1.82	0.92	0.05
						4" Ice	2.61	1.57	0.13
APX16DWV-16DWV-S-E-A 20 w/Mount Pipe	C	From Leg	4.00	0.000	138'	No Ice	7.27	3.29	0.06
			0'			1/2" Ice	7.73	3.92	0.10
			2'			1" Ice	8.21	4.57	0.16
						2" Ice	9.18	5.92	0.28
						4" Ice	11.23	8.88	0.65
6' x 2" Mount Pipe	A	From Leg	4.00	0.000	138'	No Ice	1.43	1.43	0.02
			0'			1/2" Ice	1.92	1.92	0.03
			0'			1" Ice	2.29	2.29	0.05
						2" Ice	3.06	3.06	0.09
						4" Ice	4.70	4.70	0.23
6' x 2" Mount Pipe	B	From Leg	4.00	0.000	138'	No Ice	1.43	1.43	0.02
			0'			1/2" Ice	1.92	1.92	0.03
			0'			1" Ice	2.29	2.29	0.05
						2" Ice	3.06	3.06	0.09
						4" Ice	4.70	4.70	0.23
6' x 2" Mount Pipe	C	From Leg	4.00	0.000	138'	No Ice	1.43	1.43	0.02
			0'			1/2" Ice	1.92	1.92	0.03
			0'			1" Ice	2.29	2.29	0.05

<b>RISATower</b>  <b>Crown Castle</b> 2000 Corporate Dr. Canonsburg, PA 15317 Phone: (724) 416-2000 FAX: (724) 416-2254	<b>Job</b>	BU# 806355	<b>Page</b>	10 of 18
	<b>Project</b>		<b>Date</b>	11:39:29 04/21/11
	<b>Client</b>	Crown Castle	<b>Designed by</b>	cvolk

Description	Face or Leg	Offset Type	Offsets:		Azimuth Adjustment	Placement	C <sub>v</sub> A <sub>A</sub> Front	C <sub>v</sub> A <sub>A</sub> Side	Weight
			Horz	Lateral Vert					
Platform Mount [LP 602-1]	C	None	0.000	138'	2" Ice	3.06	3.06	0.09	
					4" Ice	4.70	4.70	0.23	
					No Ice	32.03	32.03	1.34	
					1/2" Ice	38.71	38.71	1.80	
					1" Ice	45.39	45.39	2.26	
					2" Ice	58.75	58.75	3.17	
				4" Ice	85.47	85.47	5.00		
* 840 10054 w/ Mount Pipe	A	From Leg	2.00 0' 0'	0.000	128'	No Ice	5.41	2.39	0.05
						1/2" Ice	5.83	2.92	0.09
						1" Ice	6.26	3.47	0.13
						2" Ice	7.16	4.61	0.23
						4" Ice	9.09	7.32	0.53
840 10054 w/ Mount Pipe	B	From Leg	2.00 0' 0'	0.000	128'	No Ice	5.41	2.39	0.05
						1/2" Ice	5.83	2.92	0.09
						1" Ice	6.26	3.47	0.13
						2" Ice	7.16	4.61	0.23
						4" Ice	9.09	7.32	0.53
840 10054 w/ Mount Pipe	C	From Leg	2.00 0' 0'	0.000	128'	No Ice	5.41	2.39	0.05
						1/2" Ice	5.83	2.92	0.09
						1" Ice	6.26	3.47	0.13
						2" Ice	7.16	4.61	0.23
						4" Ice	9.09	7.32	0.53
6' x 2" Mount Pipe	B	From Leg	2.00 0' 0'	0.000	128'	No Ice	1.43	1.43	0.02
						1/2" Ice	1.92	1.92	0.03
						1" Ice	2.29	2.29	0.05
						2" Ice	3.06	3.06	0.09
						4" Ice	4.70	4.70	0.23
Side Arm Mount [SO 101-3]	C	None	0.000	128'	No Ice	7.50	7.50	0.25	
						1/2" Ice	8.90	8.90	0.33
						1" Ice	10.30	10.30	0.41
						2" Ice	13.10	13.10	0.58
						4" Ice	18.70	18.70	0.90
* T-Arm Mount [TA 602-1]	A	From Leg	3.00 0' 0'	0.000	118'	No Ice	7.28	3.02	0.26
						1/2" Ice	9.52	4.20	0.33
						1" Ice	11.76	5.38	0.40
						2" Ice	16.24	7.74	0.55
						4" Ice	25.20	12.46	0.83
Side Arm Mount [SO 301-1]	B	From Leg	3.00 0' 0'	0.000	118'	No Ice	1.00	0.90	0.02
						1/2" Ice	1.39	1.42	0.03
						1" Ice	1.78	1.94	0.04
						2" Ice	2.56	2.98	0.06
						4" Ice	4.12	5.06	0.10
Side Arm Mount [SO 701-1]	B	From Leg	3.00 0' 0'	0.000	118'	No Ice	0.85	1.67	0.07
						1/2" Ice	1.14	2.34	0.08
						1" Ice	1.43	3.01	0.09
						2" Ice	2.01	4.35	0.12
						4" Ice	3.17	7.03	0.18
Side Arm Mount [SO 701-1]	C	From Leg	3.00 0' 0'	0.000	118'	No Ice	0.85	1.67	0.07
						1/2" Ice	1.14	2.34	0.08
						1" Ice	1.43	3.01	0.09
						2" Ice	2.01	4.35	0.12
						4" Ice	3.17	7.03	0.18
(3) 6' x 2" Mount Pipe	A	From Leg	3.00 0' 0'	0.000	118'	No Ice	1.43	1.43	0.02
						1/2" Ice	1.92	1.92	0.03
						1" Ice	2.29	2.29	0.05

<b>RISA Tower</b>  <b>Crown Castle</b> 2000 Corporate Dr. Canonsburg, PA 15317 Phone: (724) 416-2000 FAX: (724) 416-2254	<b>Job</b> BU# 806355	<b>Page</b> 11 of 18
	<b>Project</b>	<b>Date</b> 11:39:29 04/21/11
	<b>Client</b> Crown Castle	<b>Designed by</b> cvolk

Description	Face or Leg	Offset Type	Offsets:		Azimuth Adjustment	Placement	C <sub>A</sub> A <sub>1</sub> Front	C <sub>A</sub> A <sub>1</sub> Side	Weight
			Horz	Lateral					
6' x 2" Mount Pipe	B	From Leg	3.00	0.000	118'	2" Ice	3.06	3.06	0.09
						4" Ice	4.70	4.70	0.23
						No Ice	1.43	1.43	0.02
						1/2" Ice	1.92	1.92	0.03
						1" Ice	2.29	2.29	0.05
6' x 2" Mount Pipe	C	From Leg	3.00	0.000	118'	2" Ice	3.06	3.06	0.09
						4" Ice	4.70	4.70	0.23
						No Ice	1.43	1.43	0.02
						1/2" Ice	1.92	1.92	0.03
						1" Ice	2.29	2.29	0.05
						2" Ice	3.06	3.06	0.09
						4" Ice	4.70	4.70	0.23

### Dishes

Description	Face or Leg	Dish Type	Offset Type	Offsets:		Azimuth Adjustment	3 dB Beam Width	Elevation	Outside Diameter	Aperture Area	Weight
				Horz	Lateral						
VHLP800-11	B	Paraboloid w/Shroud (HP)	From Leg	2.00	-61.000	128'	2.92	No Ice	6.68	0.02	
								1/2" Ice	7.07	0.03	
								1" Ice	7.46	0.03	
								2" Ice	8.23	0.07	
								4" Ice	9.78	0.23	

### Load Combinations

Comb. No.	Description
1	Dead Only
2	Dead+Wind 0 deg - No Ice
3	Dead+Wind 30 deg - No Ice
4	Dead+Wind 60 deg - No Ice
5	Dead+Wind 90 deg - No Ice
6	Dead+Wind 120 deg - No Ice
7	Dead+Wind 150 deg - No Ice
8	Dead+Wind 180 deg - No Ice
9	Dead+Wind 210 deg - No Ice
10	Dead+Wind 240 deg - No Ice
11	Dead+Wind 270 deg - No Ice
12	Dead+Wind 300 deg - No Ice
13	Dead+Wind 330 deg - No Ice
14	Dead+Ice+Temp
15	Dead+Wind 0 deg+Ice+Temp
16	Dead+Wind 30 deg+Ice+Temp
17	Dead+Wind 60 deg+Ice+Temp
18	Dead+Wind 90 deg+Ice+Temp

<b>RISATower</b>  <b>Crown Castle</b> 2000 Corporate Dr. Canonsburg, PA 15317 Phone: (724) 416-2000 FAX: (724) 416-2254	Job	BU# 806355	Page	12 of 18
	Project		Date	11:39:29 04/21/11
	Client	Crown Castle	Designed by	cvolk

Comb. No.	Description
19	Dead+Wind 120 deg+Ice+Temp
20	Dead+Wind 150 deg+Ice+Temp
21	Dead+Wind 180 deg+Ice+Temp
22	Dead+Wind 210 deg+Ice+Temp
23	Dead+Wind 240 deg+Ice+Temp
24	Dead+Wind 270 deg+Ice+Temp
25	Dead+Wind 300 deg+Ice+Temp
26	Dead+Wind 330 deg+Ice+Temp
27	Dead+Wind 0 deg - Service
28	Dead+Wind 30 deg - Service
29	Dead+Wind 60 deg - Service
30	Dead+Wind 90 deg - Service
31	Dead+Wind 120 deg - Service
32	Dead+Wind 150 deg - Service
33	Dead+Wind 180 deg - Service
34	Dead+Wind 210 deg - Service
35	Dead+Wind 240 deg - Service
36	Dead+Wind 270 deg - Service
37	Dead+Wind 300 deg - Service
38	Dead+Wind 330 deg - Service

### Maximum Member Forces

Section No.	Elevation ft	Component Type	Condition	Gov. Load Comb.	Force K	Major Axis Moment kip-ft	Minor Axis Moment kip-ft
L1	171 - 156.5	Pole	Max Tension	8	0.00	-0.00	0.00
			Max. Compression	14	-1.24	0.00	-0.00
			Max. Mx	11	-0.70	10.53	-0.00
			Max. My	8	-0.70	0.00	-10.53
			Max. Vy	11	-1.16	10.53	-0.00
			Max. Vx	8	1.16	0.00	-10.53
			Max. Torque	8			0.00
L2	156.5 - 156	Pole	Max Tension	1	0.00	0.00	0.00
			Max. Compression	14	-1.27	0.00	-0.00
			Max. Mx	11	-0.73	11.11	-0.00
			Max. My	8	-0.73	0.01	-11.11
			Max. Vy	11	-1.19	11.11	-0.00
			Max. Vx	8	1.19	0.01	-11.11
			Max. Torque	8			0.00
L3	156 - 132.669	Pole	Max Tension	1	0.00	0.00	0.00
			Max. Compression	14	-15.46	0.47	-0.25
			Max. Mx	11	-6.59	228.63	-0.13
			Max. My	8	-6.59	0.17	-228.57
			Max. Vy	11	-17.85	228.63	-0.13
			Max. Vx	8	17.85	0.17	-228.57
			Max. Torque	13			0.38
L4	132.669 - 87.0859	Pole	Max Tension	1	0.00	0.00	0.00
			Max. Compression	14	-26.80	2.14	0.04
			Max. Mx	11	-14.57	1177.04	-4.21
			Max. My	2	-14.56	-4.30	1178.64
			Max. Vy	11	-23.90	1177.04	-4.21
			Max. Vx	8	24.02	7.74	-1178.24
			Max. Torque	11			1.25
L5	87.0859 - 43	Pole	Max Tension	1	0.00	0.00	0.00
			Max. Compression	14	-39.80	4.69	-1.40
			Max. Mx	11	-25.03	2286.91	-10.10
			Max. My	8	-25.02	16.84	-2293.06

<b>RISATower</b>  <b>Crown Castle</b> 2000 Corporate Dr. Canonsburg, PA 15317 Phone: (724) 416-2000 FAX: (724) 416-2254	<b>Job</b> BU# 806355	<b>Page</b> 13 of 18
	<b>Project</b>	<b>Date</b> 11:39:29 04/21/11
	<b>Client</b> Crown Castle	<b>Designed by</b> cvolk

Section No.	Elevation ft	Component Type	Condition	Gov. Load Comb.	Force K	Major Axis Moment kip-ft	Minor Axis Moment kip-ft
L6	43 - 0	Pole	Max. Vy	11	-27.70	2286.91	-10.10
			Max. Vx	8	27.82	16.84	-2293.06
			Max. Torque	9			0.77
			Max Tension	1	0.00	0.00	0.00
			Max. Compression	14	-59.00	7.91	-3.26
			Max. Mx	11	-41.19	3738.20	-16.77
			Max. My	8	-41.19	27.19	-3749.93
			Max. Vy	11	-31.44	3738.20	-16.77
			Max. Vx	8	31.56	27.19	-3749.93
			Max. Torque	11			0.84

### Maximum Reactions

Location	Condition	Gov. Load Comb.	Vertical K	Horizontal, X K	Horizontal, Z K
Pole	Max. Vert	22	59.00	3.93	-6.81
	Max. H <sub>x</sub>	11	41.21	31.41	-0.13
	Max. H <sub>z</sub>	2	41.21	-0.12	31.51
	Max. M <sub>x</sub>	2	3747.14	-0.12	31.51
	Max. M <sub>z</sub>	5	3725.28	-31.34	0.10
	Max. Torsion	11	0.84	31.41	-0.13
	Min. Vert	1	41.21	0.00	0.00
	Min. H <sub>x</sub>	5	41.21	-31.34	0.10
	Min. H <sub>z</sub>	8	41.21	0.19	-31.53
	Min. M <sub>x</sub>	8	-3749.93	0.19	-31.53
	Min. M <sub>z</sub>	11	-3738.20	31.41	-0.13
	Min. Torsion	5	-0.56	-31.34	0.10

### Tower Mast Reaction Summary

Load Combination	Vertical K	Shear <sub>x</sub> K	Shear <sub>z</sub> K	Overturning Moment, M <sub>x</sub> kip-ft	Overturning Moment, M <sub>z</sub> kip-ft	Torque kip-ft
Dead Only	41.21	0.00	0.00	0.09	1.45	0.00
Dead+Wind 0 deg - No Ice	41.21	0.12	-31.51	-3747.14	-14.69	0.37
Dead+Wind 30 deg - No Ice	41.21	15.75	-27.29	-3245.11	-1872.92	0.44
Dead+Wind 60 deg - No Ice	41.21	27.16	-15.80	-1879.24	-3229.28	0.51
Dead+Wind 90 deg - No Ice	41.21	31.34	-0.10	-13.40	-3725.28	0.56
Dead+Wind 120 deg - No Ice	41.21	27.15	15.65	1859.93	-3227.56	0.45
Dead+Wind 150 deg - No Ice	41.21	15.65	27.25	3239.55	-1859.03	0.08
Dead+Wind 180 deg - No Ice	41.21	-0.19	31.53	3749.93	27.19	-0.44
Dead+Wind 210 deg - No Ice	41.21	-15.81	27.34	3252.52	1883.69	-0.58
Dead+Wind 240 deg - No Ice	41.21	-27.23	15.84	1884.55	3240.90	-0.71
Dead+Wind 270 deg - No Ice	41.21	-31.41	0.13	16.77	3738.20	-0.84
Dead+Wind 300 deg - No Ice	41.21	-27.20	-15.60	-1852.68	3236.92	-0.76
Dead+Wind 330 deg - No Ice	41.21	-15.59	-27.28	-3243.75	1854.93	0.08
Dead+Ice+Temp	59.00	-0.00	0.00	3.26	7.91	-0.00
Dead+Wind 0 deg+Ice+Temp	59.00	0.03	-7.85	-977.01	4.34	0.02
Dead+Wind 30 deg+Ice+Temp	59.00	3.92	-6.80	-845.73	-481.25	0.05
Dead+Wind 60 deg+Ice+Temp	59.00	6.76	-3.94	-488.21	-835.81	0.10
Dead+Wind 90 deg+Ice+Temp	59.00	7.79	-0.02	0.21	-965.44	0.15
Dead+Wind 120 deg+Ice+Temp	59.00	6.75	3.90	490.32	-835.31	0.15

<b>RISATower</b>  <b>Crown Castle</b> 2000 Corporate Dr. Canonsburg, PA 15317 Phone: (724) 416-2000 FAX: (724) 416-2254	<b>Job</b> BU# 806355	<b>Page</b> 14 of 18
	<b>Project</b>	<b>Date</b> 11:39:29 04/21/11
	<b>Client</b> Crown Castle	<b>Designed by</b> cvolk

Load Combination	Vertical K	Shear <sub>x</sub> K	Shear <sub>z</sub> K	Overturning Moment, M <sub>x</sub> kip-ft	Overturning Moment, M <sub>z</sub> kip-ft	Torque kip-ft
Dead+Wind 150 deg+Ice+Temp	59.00	3.89	6.79	850.96	-477.97	0.09
Dead+Wind 180 deg+Ice+Temp	59.00	-0.04	7.85	984.21	13.84	-0.03
Dead+Wind 210 deg+Ice+Temp	59.00	-3.93	6.81	853.96	499.04	-0.08
Dead+Wind 240 deg+Ice+Temp	59.00	-6.77	3.94	495.97	853.80	-0.14
Dead+Wind 270 deg+Ice+Temp	59.00	-7.81	0.03	7.12	983.71	-0.21
Dead+Wind 300 deg+Ice+Temp	59.00	-6.76	-3.89	-482.13	852.79	-0.22
Dead+Wind 330 deg+Ice+Temp	59.00	-3.88	-6.80	-845.31	492.47	-0.05
Dead+Wind 0 deg - Service	41.21	0.04	-10.93	-1302.72	-4.11	0.13
Dead+Wind 30 deg - Service	41.21	5.46	-9.46	-1128.18	-650.18	0.16
Dead+Wind 60 deg - Service	41.21	9.42	-5.48	-653.30	-1121.75	0.18
Dead+Wind 90 deg - Service	41.21	10.87	-0.04	-4.60	-1294.19	0.20
Dead+Wind 120 deg - Service	41.21	9.41	5.43	646.68	-1121.15	0.16
Dead+Wind 150 deg - Service	41.21	5.43	9.45	1126.33	-645.36	0.03
Dead+Wind 180 deg - Service	41.21	-0.07	10.93	1303.77	10.40	-0.16
Dead+Wind 210 deg - Service	41.21	-5.48	9.48	1130.84	655.88	-0.20
Dead+Wind 240 deg - Service	41.21	-9.44	5.49	655.23	1127.75	-0.25
Dead+Wind 270 deg - Service	41.21	-10.89	0.04	5.85	1300.64	-0.29
Dead+Wind 300 deg - Service	41.21	-9.43	-5.41	-644.09	1126.35	-0.27
Dead+Wind 330 deg - Service	41.21	-5.41	-9.46	-1127.70	645.90	0.03

## Solution Summary

Load Comb.	Sum of Applied Forces			Sum of Reactions			% Error
	PX K	PY K	PZ K	PX K	PY K	PZ K	
1	0.00	-41.21	0.00	0.00	41.21	0.00	0.000%
2	0.12	-41.21	-31.51	-0.12	41.21	31.51	0.000%
3	15.75	-41.21	-27.29	-15.75	41.21	27.29	0.000%
4	27.16	-41.21	-15.80	-27.16	41.21	15.80	0.000%
5	31.34	-41.21	-0.10	-31.34	41.21	0.10	0.000%
6	27.15	-41.21	15.65	-27.15	41.21	-15.65	0.000%
7	15.65	-41.21	27.25	-15.65	41.21	-27.25	0.000%
8	-0.19	-41.21	31.53	0.19	41.21	-31.53	0.000%
9	-15.81	-41.21	27.34	15.81	41.21	-27.34	0.000%
10	-27.23	-41.21	15.84	27.23	41.21	-15.84	0.000%
11	-31.41	-41.21	0.13	31.41	41.21	-0.13	0.000%
12	-27.20	-41.21	-15.60	27.20	41.21	15.60	0.000%
13	-15.59	-41.21	-27.28	15.59	41.21	27.28	0.000%
14	0.00	-59.00	0.00	0.00	59.00	-0.00	0.000%
15	0.03	-59.00	-7.85	-0.03	59.00	7.85	0.000%
16	3.92	-59.00	-6.80	-3.92	59.00	6.80	0.000%
17	6.76	-59.00	-3.94	-6.76	59.00	3.94	0.000%
18	7.79	-59.00	-0.02	-7.79	59.00	0.02	0.000%
19	6.75	-59.00	3.90	-6.75	59.00	-3.90	0.000%
20	3.89	-59.00	6.79	-3.89	59.00	-6.79	0.000%
21	-0.04	-59.00	7.85	0.04	59.00	-7.85	0.000%
22	-3.93	-59.00	6.81	3.93	59.00	-6.81	0.000%
23	-6.77	-59.00	3.94	6.77	59.00	-3.94	0.000%
24	-7.81	-59.00	0.03	7.81	59.00	-0.03	0.000%
25	-6.76	-59.00	-3.89	6.76	59.00	3.89	0.000%
26	-3.88	-59.00	-6.80	3.88	59.00	6.80	0.000%
27	0.04	-41.21	-10.93	-0.04	41.21	10.93	0.000%
28	5.46	-41.21	-9.46	-5.46	41.21	9.46	0.000%
29	9.42	-41.21	-5.48	-9.42	41.21	5.48	0.000%
30	10.87	-41.21	-0.04	-10.87	41.21	0.04	0.000%
31	9.41	-41.21	5.43	-9.41	41.21	-5.43	0.000%
32	5.43	-41.21	9.45	-5.43	41.21	-9.45	0.000%
33	-0.07	-41.21	10.93	0.07	41.21	-10.93	0.000%



<b>RISATower</b>  <b>Crown Castle</b> 2000 Corporate Dr. Canonsburg, PA 15317 Phone: (724) 416-2000 FAX: (724) 416-2254	<b>Job</b> BU# 806355	<b>Page</b> 15 of 18
	<b>Project</b>	<b>Date</b> 11:39:29 04/21/11
	<b>Client</b> Crown Castle	<b>Designed by</b> cvolk

Load Comb.	Sum of Applied Forces			Sum of Reactions			% Error
	PX K	PY K	PZ K	PX K	PY K	PZ K	
34	-5.48	-41.21	9.48	5.48	41.21	-9.48	0.000%
35	-9.44	-41.21	5.49	9.44	41.21	-5.49	0.000%
36	-10.89	-41.21	0.04	10.89	41.21	-0.04	0.000%
37	-9.43	-41.21	-5.41	9.43	41.21	5.41	0.000%
38	-5.41	-41.21	-9.46	5.41	41.21	9.46	0.000%

### Non-Linear Convergence Results

Load Combination	Converged?	Number of Cycles	Displacement Tolerance	Force Tolerance
1	Yes	4	0.0000001	0.0000001
2	Yes	5	0.0000001	0.00004457
3	Yes	6	0.0000001	0.00008801
4	Yes	6	0.0000001	0.00008647
5	Yes	4	0.0000001	0.00035367
6	Yes	6	0.0000001	0.00008759
7	Yes	6	0.0000001	0.00008690
8	Yes	4	0.0000001	0.00059813
9	Yes	6	0.0000001	0.00008662
10	Yes	6	0.0000001	0.00008861
11	Yes	5	0.0000001	0.00006950
12	Yes	6	0.0000001	0.00008584
13	Yes	6	0.0000001	0.00008680
14	Yes	4	0.0000001	0.00003004
15	Yes	5	0.0000001	0.00028196
16	Yes	5	0.0000001	0.00055540
17	Yes	5	0.0000001	0.00055118
18	Yes	5	0.0000001	0.00027910
19	Yes	5	0.0000001	0.00055617
20	Yes	5	0.0000001	0.00055100
21	Yes	5	0.0000001	0.00028336
22	Yes	5	0.0000001	0.00057094
23	Yes	5	0.0000001	0.00057432
24	Yes	5	0.0000001	0.00028435
25	Yes	5	0.0000001	0.00055545
26	Yes	5	0.0000001	0.00056423
27	Yes	4	0.0000001	0.00015997
28	Yes	5	0.0000001	0.00022107
29	Yes	5	0.0000001	0.00021449
30	Yes	4	0.0000001	0.00013738
31	Yes	5	0.0000001	0.00021751
32	Yes	5	0.0000001	0.00021502
33	Yes	4	0.0000001	0.00009679
34	Yes	5	0.0000001	0.00021669
35	Yes	5	0.0000001	0.00022399
36	Yes	4	0.0000001	0.00026700
37	Yes	5	0.0000001	0.00021146
38	Yes	5	0.0000001	0.00021605

### Maximum Tower Deflections - Service Wind

<b>RISATower</b>  <b>Crown Castle</b> 2000 Corporate Dr. Canonsburg, PA 15317 Phone: (724) 416-2000 FAX: (724) 416-2254	<b>Job</b>	BU# 806355	<b>Page</b>	16 of 18
	<b>Project</b>		<b>Date</b>	11:39:29 04/21/11
	<b>Client</b>	Crown Castle	<b>Designed by</b>	cvolk

Section No.	Elevation ft	Horz. Deflection in	Gov. Load Comb.	Tilt °	Twist °
L1	171 - 156.5	48.552	34	2.529	0.001
L2	156.5 - 156	40.901	34	2.495	0.001
L3	156 - 132.669	40.639	34	2.495	0.001
L4	136.336 - 87.0859	30.725	34	2.257	0.001
L5	91.9193 - 43	13.172	34	1.440	0.001
L6	49 - 0	3.549	34	0.677	0.000

**Critical Deflections and Radius of Curvature - Service Wind**

Elevation ft	Appurtenance	Gov. Load Comb.	Deflection in	Tilt °	Twist °	Radius of Curvature ft
166'	RV90-17-02DP	34	45.902	2.515	0.002	32524
155'	LNx-6514DS-T4M w/ Mount Pipe	34	40.118	2.493	0.002	10510
146'	P65-16-XLH-RR w/ Mount Pipe	34	35.488	2.414	0.002	5272
138'	APX16DWV-16DWV-S-E-A20 w/Mount Pipe	34	31.525	2.286	0.002	3614
128'	VHLP800-11	34	26.869	2.108	0.002	3289
118'	T-Arm Mount [TA 602-1]	34	22.578	1.925	0.001	3211

**Maximum Tower Deflections - Design Wind**

Section No.	Elevation ft	Horz. Deflection in	Gov. Load Comb.	Tilt °	Twist °
L1	171 - 156.5	138.947	9	7.241	0.004
L2	156.5 - 156	117.124	9	7.148	0.004
L3	156 - 132.669	116.379	9	7.147	0.004
L4	136.336 - 87.0859	88.070	9	6.472	0.004
L5	91.9193 - 43	37.815	9	4.134	0.001
L6	49 - 0	10.199	9	1.945	0.000

**Critical Deflections and Radius of Curvature - Design Wind**

Elevation ft	Appurtenance	Gov. Load Comb.	Deflection in	Tilt °	Twist °	Radius of Curvature ft
166'	RV90-17-02DP	9	131.391	7.201	0.007	12135
155'	LNx-6514DS-T4M w/ Mount Pipe	9	114.891	7.141	0.007	3865
146'	P65-16-XLH-RR w/ Mount Pipe	9	101.676	6.918	0.006	1906
138'	APX16DWV-16DWV-S-E-A20 w/Mount Pipe	9	90.355	6.556	0.006	1299
128'	VHLP800-11	9	77.045	6.047	0.005	1176
118'	T-Arm Mount [TA 602-1]	9	64.768	5.526	0.004	1144

<b>RISATower</b>  <b>Crown Castle</b> 2000 Corporate Dr. Canonsburg, PA 15317 Phone: (724) 416-2000 FAX: (724) 416-2254	<b>Job</b> BU# 806355	<b>Page</b> 17 of 18
	<b>Project</b>	<b>Date</b> 11:39:29 04/21/11
	<b>Client</b> Crown Castle	<b>Designed by</b> cvolk

## Compression Checks

## Pole Design Data

Section No.	Elevation <i>ft</i>	Size	<i>L</i> <i>ft</i>	<i>L<sub>u</sub></i> <i>ft</i>	<i>Kl/r</i>	<i>F<sub>a</sub></i> <i>ksi</i>	<i>A</i> <i>in<sup>2</sup></i>	Actual <i>P</i> <i>K</i>	Allow. <i>P<sub>a</sub></i> <i>K</i>	Ratio <i>P</i> <i>P<sub>a</sub></i>
L1	171 - 156.5 (1)	TP10.75x10.75x0.365	14'6"	0'	0.0	21.00	11.9083	-0.70	250.07	0.003
L2	156.5 - 156 (2)	TP19.5x10.75x0.365	6"	0'	0.0	39.00	12.0311	-0.70	469.21	0.001
L3	156 - 132.669 (3)	TP24.79x19.5x0.1875	23'3"-31/3"	0'	0.0	39.00	14.1468	-6.58	551.73	0.012
L4	132.669 - 87.0859 (4)	TP34.63x23.5836x0.375	49'3"	0'	0.0	39.00	39.4817	-14.55	1539.79	0.009
L5	87.0859 - 43 (5)	TP43.75x32.7959x0.4375	48'11"-1/3"	0'	0.0	39.00	58.2792	-25.02	2272.89	0.011
L6	43 - 0 (6)	TP52.5x41.5315x0.5	49'	0'	0.0	39.00	78.5041	-37.50	3061.66	0.012

## Pole Bending Design Data

Section No.	Elevation <i>ft</i>	Size	Actual <i>M<sub>x</sub></i> <i>kip-ft</i>	Actual <i>f<sub>bx</sub></i> <i>ksi</i>	Allow. <i>F<sub>bx</sub></i> <i>ksi</i>	Ratio <i>f<sub>bx</sub></i> <i>F<sub>bx</sub></i>	Actual <i>M<sub>y</sub></i> <i>kip-ft</i>	Actual <i>f<sub>by</sub></i> <i>ksi</i>	Allow. <i>F<sub>by</sub></i> <i>ksi</i>	Ratio <i>f<sub>by</sub></i> <i>F<sub>by</sub></i>
L1	171 - 156.5 (1)	TP10.75x10.75x0.365	10.53	4.23	23.10	0.183	0.00	0.00	23.10	0.000
L2	156.5 - 156 (2)	TP19.5x10.75x0.365	10.53	4.21	39.00	0.108	0.00	0.00	39.00	0.000
L3	156 - 132.669 (3)	TP24.79x19.5x0.1875	228.66	33.07	39.00	0.848	0.00	0.00	39.00	0.000
L4	132.669 - 87.0859 (4)	TP34.63x23.5836x0.375	1181.17	44.01	39.00	1.128	0.00	0.00	39.00	0.000
L5	87.0859 - 43 (5)	TP43.75x32.7959x0.4375	2298.68	45.82	39.00	1.175	0.00	0.00	39.00	0.000
L6	43 - 0 (6)	TP52.5x41.5315x0.5	3405.82	42.75	39.00	1.096	0.00	0.00	39.00	0.000

## Pole Shear Design Data

Section No.	Elevation <i>ft</i>	Size	Actual <i>V</i> <i>K</i>	Actual <i>f<sub>v</sub></i> <i>ksi</i>	Allow. <i>F<sub>v</sub></i> <i>ksi</i>	Ratio <i>f<sub>v</sub></i> <i>F<sub>v</sub></i>	Actual <i>T</i> <i>kip-ft</i>	Actual <i>f<sub>vt</sub></i> <i>ksi</i>	Allow. <i>F<sub>vt</sub></i> <i>ksi</i>	Ratio <i>f<sub>vt</sub></i> <i>F<sub>vt</sub></i>
L1	171 - 156.5 (1)	TP10.75x10.75x0.365	1.16	0.10	14.00	0.014	0.00	0.00	14.00	0.000
L2	156.5 - 156 (2)	TP19.5x10.75x0.365	1.19	0.10	26.00	0.004	0.00	0.00	26.00	0.000
L3	156 - 132.669 (3)	TP24.79x19.5x0.1875	17.85	1.26	26.00	0.097	0.19	0.01	26.00	0.001
L4	132.669 - 87.0859 (4)	TP34.63x23.5836x0.375	24.08	0.61	26.00	0.047	0.78	0.01	26.00	0.001
L5	87.0859 - 43 (5)	TP43.75x32.7959x0.4375	27.88	0.48	26.00	0.037	0.69	0.01	26.00	0.000
L6	43 - 0 (6)	TP52.5x41.5315x0.5	30.94	0.39	26.00	0.030	0.61	0.00	26.00	0.000

<b>RISATower</b>  <b>Crown Castle</b> 2000 Corporate Dr. Canonsburg, PA 15317 Phone: (724) 416-2000 FAX: (724) 416-2254	<b>Job</b> BU# 806355	<b>Page</b> 18 of 18
	<b>Project</b>	<b>Date</b> 11:39:29 04/21/11
	<b>Client</b> Crown Castle	<b>Designed by</b> cvolk

**Pole Interaction Design Data**

Section No.	Elevation ft	Ratio P	Ratio $f_{bx}$	Ratio $f_{by}$	Ratio $f_v$	Ratio $f_{vt}$	Comb. Stress Ratio	Allow. Stress Ratio	Criteria
		$P_a$	$F_{bx}$	$F_{by}$	$F_v$	$F_{vt}$			
L1	171 - 156.5 (1)	0.003	0.183	0.000	0.014	0.000	0.186	1.333	H1-3+VT ✓
L2	156.5 - 156 (2)	0.001	0.108	0.000	0.004	0.000	0.109	1.333	H1-3+VT ✓
L3	156 - 132.669 (3)	0.012	0.848	0.000	0.097	0.001	0.862	1.333	H1-3+VT ✓
L4	132.669 - 87.0859 (4)	0.009	1.128	0.000	0.047	0.001	1.138	1.333	H1-3+VT ✓
L5	87.0859 - 43 (5)	0.011	1.175	0.000	0.037	0.000	1.186	1.333	H1-3+VT ✓
L6	43 - 0 (6)	0.012	1.096	0.000	0.030	0.000	1.109	1.333	H1-3+VT ✓

**Section Capacity Table**

Section No.	Elevation ft	Component Type	Size	Critical Element	P K	SF* $P_{allow}$ K	% Capacity	Pass Fail	
L1	171 - 156.5	Pole	TP10.75x10.75x0.365	1	-0.70	333.35	13.9	Pass	
L2	156.5 - 156	Pole	TP19.5x10.75x0.365	2	-0.70	625.46	8.2	Pass	
L3	156 - 132.669	Pole	TP24.79x19.5x0.1875	3	-6.58	735.45	64.7	Pass	
L4	132.669 - 87.0859	Pole	TP34.63x23.5836x0.375	4	-14.55	2052.54	85.4	Pass	
L5	87.0859 - 43	Pole	TP43.75x32.7959x0.4375	5	-25.02	3029.76	89.0	Pass	
L6	43 - 0	Pole	TP52.5x41.5315x0.5	6	-37.50	4081.19	83.2	Pass	
							Summary		
							Pole (L5)	89.0	Pass
							<b>RATING =</b>	<b>89.0</b>	<b>Pass</b>

**APPENDIX B**  
**BASE LEVEL DRAWING**

(PROPOSED—IN ADDITION TO INSTALLED)  
(2) 3/8" TO 146 FT LEVEL  
(1) 5/8" TO 146 FT LEVEL  
(INSTALLED)  
(12) 1-5/8" TO 146 FT LEVEL  
(INSTALLED—TO BE REMOVED)  
(1) 1/2" TO GPS AT 146 FT LEVEL

(RESERVED)  
(12) 1-5/8" TO 155 FT LEVEL

(INSTALLED)  
(12) 1-5/8" TO 138 FT LEVEL

(INSTALLED)  
(1) 1/2" TO 128 FT LEVEL  
(INSTALLED—BUNDLED IN (2) 2" CONDUIT)  
(3) 1/4" TO 128 FT LEVEL  
(3) 5/16" TO 128 FT LEVEL

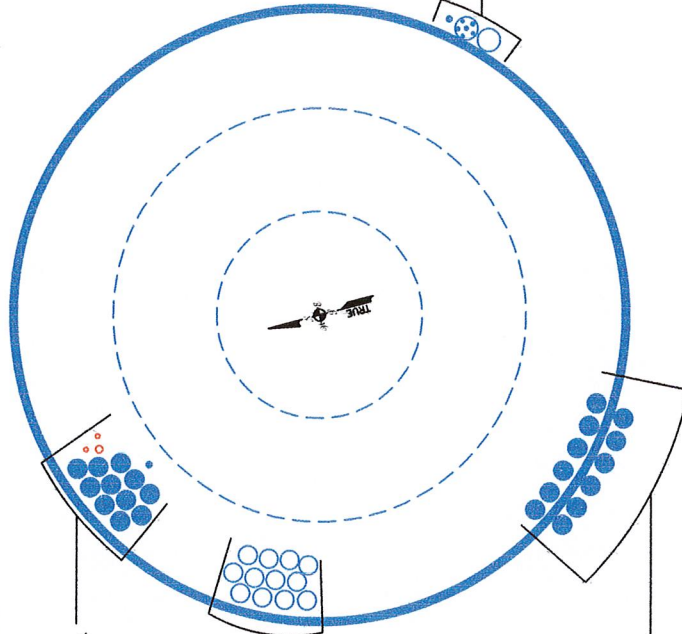

**APPENDIX C**  
**ADDITIONAL CALCULATIONS**

# Stiffened or Unstiffened, Exterior Flange Plate - Any Bolt Material TIA Rev F

## Site Data

BU#:	806355
Site Name:	BRG 126 943086
App #:	121276
Connection Type:	Butt
Pole Manufacturer:	Other

Reactions		
Moment:	10.53	ft-kips
Axial:	0.7	kips
Shear:	1.19	kips
Elevation:	156	feet

## Bolt Data

Qty:	24		
Diameter (in.):	1	Bolt Fu:	120
Bolt Material:	A325	Bolt Fy:	92
N/A:	75	<-- Disregard	Bolt Fty:
N/A:	55	<-- Disregard	44.00
Circle (in.):	25.75		

If No stiffeners, Criteria: **AISC ASD** <-Only Applicable to Unstiffened Cases

## Flange Bolt Results

Bolt Tension Capacity, B:	46.07 kips
Max Bolt directly applied T:	0.79 Kips
Min. PL "tc" for B cap. w/o Pry:	2.177 in
Min PL "treq" for actual T w/ Pry:	0.226 in
Min PL "t1" for actual T w/o Pry:	0.285 in
T allowable with Prying:	31.95 kips
Prying Force, Q:	0.00 kips
Total Bolt Tension=T+Q:	0.79 kips
Prying Bolt Stress Ratio=(T+Q)/(B):	1.7% <b>Pass</b>

<b>Rigid</b>
Service, ASD
Fty*ASIF

## Plate Data

Diam:	28.5	in
Thick, t:	1.5	in
Grade (Fy):	60	ksi
Strength, Fu:	75	ksi
Single-Rod B-eff:	2.58	in

<b>Exterior Flange Plate Results</b>	Flexural Check
Compression Side Plate Stress:	1.4 ksi
Allowable Plate Stress:	60.0 ksi
Compression Plate Stress Ratio:	2.4% <b>Pass</b>
<b>No Prying</b>	
Tension Side Stress Ratio, (treq/t)^2:	2.3% <b>Pass</b>

<b>Rigid</b>
Service ASD
0.75*Fy*ASIF
Comp. Y.L. Length:
16.82

## Stiffener Data (Welding at Both Sides)

Config:	0	*
Weld Type:		
Groove Depth:		in **
Groove Angle:		degrees
Fillet H. Weld:		<-- Disregard
Fillet V. Weld:		in
Width:		in
Height:		in
Thick:		in
Notch:		in
Grade:		ksi
Weld str.:		ksi

n/a

## Stiffener Results

Horizontal Weld :	n/a
Vertical Weld:	n/a
Plate Flex+Shear, fb/Fb+(fv/Fv)^2:	n/a
Plate Tension+Shear, ft/Ft+(fv/Fv)^2:	n/a
Plate Comp. (AISC Bracket):	n/a

## Pole Results

Pole Punching Shear Check:	n/a
----------------------------	-----

## Pole Data

Diam:	19.5	in
Thick:	0.365	in
Grade:	65	ksi
# of Sides:	18	"0" IF Round
Fu	80	ksi
Reinf. Fillet Weld	0	"0" if None

## Stress Increase Factor

ASIF:	1.333
-------	-------

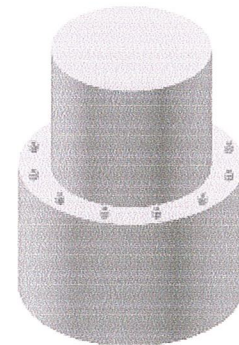
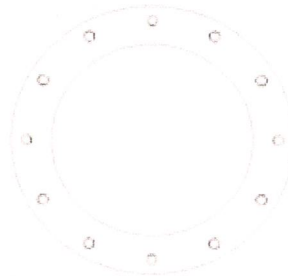

\* 0 = none, 1 = every bolt, 2 = every 2 bolts, 3 = 2 per bolt

\*\* Note: for complete joint penetration groove welds the groove depth must be exactly 1/2 the stiffener thickness for calculation purposes



# Stiffened or Unstiffened, UngROUTED, Circular Base Plate - Any Rod Material

## TIA Rev F

### Site Data

BU#: 806355
Site Name: BRG 126 943086
App #: 121276 Rev. 1
Pole Manufacturer: <i>Other</i>

Reactions		
Moment:	3759	ft-kips
Axial:	41	kips
Shear:	32	kips

### Anchor Rod Data

Qty:	20	
Diam:	2.25	in
Rod Material:	A615-J	
Strength (Fu):	100	ksi
Yield (Fy):	75	ksi
Bolt Circle:	61	in

If No stiffeners, Criteria: **AISC ASD** <-Only Applicable to Unstiffened Cases

### Anchor Rod Results

Maximum Rod Tension: 145.8 Kips  
 Allowable Tension: 195.0 Kips  
 Anchor Rod Stress Ratio: 74.8% **Pass**

Rigid
Service, ASD
Fty*ASIF

### Plate Data

Diam:	67	in
Thick:	2.25	in
Grade:	60	ksi
Single-Rod B-eff:	8.33	in

### Base Plate Results

Base Plate Stress: 54.3 ksi  
 Allowable Plate Stress: 60.0 ksi  
 Base Plate Stress Ratio: 90.6% **Pass**

Flexural Check

Rigid
Service ASD
0.75*Fy*ASIF
Y.L. Length: 31.06

### Stiffener Data (Welding at both sides)

Config:	0	*
Weld Type:		
Groove Depth:		in **
Groove Angle:		degrees
Fillet H. Weld:		<-- Disregard
Fillet V. Weld:		in
Width:		in
Height:		in
Thick:		in
Notch:		in
Grade:		ksi
Weld str.:		ksi

n/a

### Stiffener Results

Horizontal Weld : n/a  
 Vertical Weld: n/a  
 Plate Flex+Shear, fb/Fb+(fv/Fv)^2: n/a  
 Plate Tension+Shear, ft/Ft+(fv/Fv)^2: n/a  
 Plate Comp. (AISC Bracket): n/a

### Pole Results

Pole Punching Shear Check: n/a

### Pole Data

Diam:	52.5	in
Thick:	0.5	in
Grade:	65	ksi
# of Sides:	18	"0" IF Round
Fu	80	ksi
Reinf. Fillet Weld	0	"0" if None

### Stress Increase Factor

ASIF:	1.333
-------	-------

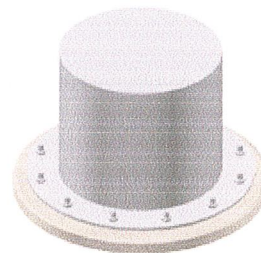
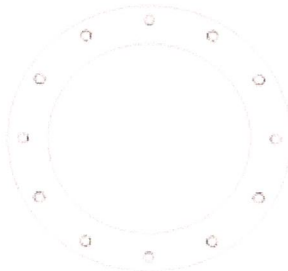

\* 0 = none, 1 = every bolt, 2 = every 2 bolts, 3 = 2 per bolt

\*\* Note: for complete joint penetration groove welds the groove depth must be exactly 1/2 the stiffener thickness for calculation purposes

# Monopole Pier and Pad Foundation

BU #: 806355  
 Site Name: BRG 126 943086  
 App. Number: 121276



Design Reactions		
Shear, S:	32	kips
Moment, M:	3759	ft-kips
Tower Height, H:	171	ft
Tower Weight, Wt:	41	kips
Base Diameter, BD:	4.375	ft

Foundation Dimensions		
Depth, D:	9	ft
Pad Width, W:	22	ft
Neglected Depth, N:	4	ft
Thickness, T:	3.00	ft
Pier Diameter, Pd:	7.00	ft
Ext. Above Grade, E:	1.00	ft
Clear Cover, Cc:	3.0	in

Soil Properties		
Soil Unit Weight, Y:	0.125	kcf
Bearing Capacity, Bc:	12.0	kcf
Angle of Friction, Φ:	36	deg
Cohesion, Co:	0.000	kcf
Passive Pressure, Pp:	0.000	kcf
Base Friction, μ:	0.60	

Material Properties		
Rebar Yield Strength, Fy:	60000	psi
Concrete Strength, Fc:	4000	psi
Concrete Unit Weight, Cc:	0.150	kcf
Seismic Zone, z:	1	

Rebar Properties		
Pier Rebar Size, Sp:	8	
Pier Rebar Quantity, mp:	46	36
Pad Rebar Size, Spad:	8	
Pad Rebar Quantity, mpad:	36	26
Pier Tie Size, St:	4	3
Tie Quantity, mt:	7	8

Design Checks				
	Capacity/Availability	Demand/Limits	Check	
Req'd Pier Diam. (ft)	7	5.375	OK	
Overturning (ft-kips)	5997.72	4079.00	OK	
Shear Capacity (kips)	238.86	32.00	OK	
Bearing (ksf)	12.00	4.11	OK	
Pad Shear - 1-way (kips)	1085.29	794.46	OK	
Pad Shear - 2-way (kips)	3009.19	1242.18	OK	
Pier Rebar Area (in <sup>2</sup> )	36.34	27.71	OK	
Pad Rebar Area (in <sup>2</sup> )	28.44	19.82	OK	
Pier Moment Capacity (k-ft)	4577.56	3983.00	OK	
Pier-Bar Spacing (in)	4.33	18 > s > 2	OK	
Pad Bar Spacing (in)	6.34	18 > s > 2	OK	
Pier Development Length (in)	81	28.21	OK	
Pad Development Length (in)	33	28.21	OK	
Hook Development Length (in)	129.00	13.28	OK	
Rebar Hook Length (in)	90.00	16.00	OK	

Modification Checks				
	Capacity/Availability	Demand/Limits	Check	
Sleeve Rebar Area (in <sup>2</sup> ):	15.8	0.00	Not Used	
Sleeve Moment Capacity (k-ft):	4577.56	3983.00	Not Run	
Sleeve Rebar Spacing (in):	N/A	18 > s > 2	Not Used	
Sleeve Tie Spacing (in):	N/A	9 > s > 4.5	Not Used	
Minimum Extra Thickness (in):	0	0	Not Used	
Pad Rebar Area-short (in <sup>2</sup> ):	0.44	0.00	Not Used	
Pad Rebar Area-long (in <sup>2</sup> ):	0.44	0.00	Not Used	
Pad Rebar Spacing-short (in):	85.5	18 > s > 2	Not Used	
Pad Rebar Spacing-long (in):	85.5	18 > s > 2	Not Used	
End Cap Width (ft):	0	0	Not Used	
End Cap Rebar Area (in <sup>2</sup> ):	3.16	0	Not Used	
Rebar Spacing (in):	-3.00	18 > s > 2	Not Used	
Tie Spacing (in):	17.93	258 > s > 4.5	Not Used	
Dowel Area (in <sup>2</sup> ):	2.2	0.00	Not Used	
Dowel Embedment (in):	9	6	Not Used	
Cone Shear Strength (kips):	25.15	23.76	Not Used	
Dowel Edge Dist (in):	12.00	4.78	Not Used	
Dowel Spacing (in):	60.00	18.00	Not Used	
Dowel Edge Dist (vert) (in):	18.00	4.78	Not Used	
Dowel Devel. Length (in):	-3.00	13.32	Not Used	

Modifications				
	Capacity/Availability	Demand/Limits	Check	
Pier Sleeve, ds	0	in	End Cap Width, Wec:	0
Revised Pier Diameter, dx:	7	ft	Revised Width, Wx:	22
PS Rebar Size, Ss:	8		EC Rebar Size, Sec:	8
Rebar Quantity, ms:	20	0	Rebar Quantity, mec:	4
Tie Size, Sst:	3		EC Tie Size, Seet:	4
Tie Quantity, mst:	9	12	Tie Quantity, meet:	15
Pad Thickness, Te:	0	in	EC Dowel Size, Secd:	6
Revised Pier Thickness, Tx:	3.00	ft	Dowel Quantity, mecd:	5
Rebar Size, Se:	3		Rows of Dowels, Nd:	1
Rebar Quantity (long), me:	4	0	Dowel Depth, decd:	9
Rebar Quantity (short), mex:	4	0	Edge Distance, eecd:	12
Dowel Size, Sed:	3			
Dowel Quantity, med:	0	0		

## P65-15-XLH-RR

## Dual Broadband Antennas

POLARIZATION: Dual linear +/-45°  
 FREQUENCY RANGE: 500-300, 500-600  
 HORIZONTAL BEAM WIDTH (°): 65-65  
 GAIN (dB): 14.7/14.3, 14.7/14.5  
 VSWR: <1.5/1  
 LENGTH: 51"

## ELECTRICAL SPECIFICATIONS\*

Frequency range (MHz)	500-300		500-600		1710-1000	1710-2170	
	500-300	500-600	1710-1000	1710-2170		1710-1000	1710-2170
Frequency band (MHz)	500-300	500-600	1710-1000	1710-2170	1710-1000	1710-2170	1710-2170
Gain (dB@dBi)	14.7/14.3	14.7/14.5	14.7/14.3	14.7/14.5	14.7/14.3	14.7/14.5	14.7/14.5
Polarization	Dual Linear +/- 45				Dual Linear +/- 45		
Nominal Impedance (Ohm)	50						50
VSWR	< 1.5:1						< 1.5:1
Horizontal beam width, -3 dB (°)	73	65	65	65	65	65	
Vertical beam width, -3 dB (°)	17						7.5
Elevation down 10 (°)	0-10						0-9
Side lobe suppression, vertical 1st upper (dB)	> 14						> 20
Isolation between inputs (dB)	> 30						> 30
Intra band Isolation (dB)	> 40						> 40
Tracking, horizontal plane ±60° (dB)	< 2						< 2
Vertical beam squint (°)	< 1.25						< 0.5
Front to back ratio (dB) 180°±30° copolar	> 25						> 25
Front to back ratio (dB) 180°±30° total power	> 25						> 25
Cross polar discrimination (XPD) 0° (dB)	> 15						> 15
Cross polar discrimination (XPD) ±60° (dB)	> 10						> 10
IM3, 2xTx @ 13dBm (dBc)	< -153						< -153
Power handling, average per input (W)	500						300
Power handling, average total (W)	1000						600

## MECHANICAL SPECIFICATIONS\*

Connector	4 X 7/16 DIN Female, IP67
Connector position	Bottom
Dimensions, HxWxD, in (mm)	51" x 12" x 6" (1285 x 305 x 152)
Mounting	Pre-mounted Tri Brackets
Weight, with brackets, lbs (kg)	41 (19)
Weight, without brackets, lbs (kg)	30 (14)
Wind load, non-rotational, see 42 m/s (Cat 1 0/2)	630
Maximum operational wind speed, mph (m/s)	100 (45)
Survival wind speed, mph (m/s)	130 (57)
Lightning protection	DC Ground
Operating Temperature	-40°C to +60°C
Roaming material	PVC, IP65
Packet size, HxWxD, in (mm)	60" x 16" x 10" (1524 x 400 x 254)
Roaming colour	Light Grey
Shipping weight, lbs (kg)	52 (24)
RET	(RET A)SQv1 1, MET and AISCv2.0
Bracket	7256 00, 7459 00



\*All specifications subject to change without notice. Please contact your Powerwave representative for complete performance data.

## ANTENNA PATTERNS\*

For detailed patterns visit <http://www.powerwave.com/pa/>

# POWER

## DC6-48-60-18-8F

### DC Surge Suppression Solution

The DC6-48-60-18 is a dual chambered, DC surge suppression system for use in multi-circuit, Distributed Antenna Systems. The system will protect up to 6 Remote Radio Heads from voltage surges and lightning, and connect up to 18 fiber pairs. The system is enclosed in a NEMA 4 rated, waterproof enclosure.

#### FEATURES

- Protects up to 6 Remote Radio Heads, each with its own protection circuit.
- Flexible design allows for installation at the top of a tower for Remote Radio Head protection.
- Includes fiber connections for up to 18 pairs of fiber.
- LED indicators on individual circuits provide visual indication of suppressor status.
- Form 'C' relays allow for remote monitoring of the suppressor status.
- Patented Strikesorb technology provides over 60 kA of surge current capacity per circuit.
- Strikesorb suppression modules are fully recognized to UL 1449-3rd Edition Safety Standard, meeting all intermediate and high current fault requirements to facilitate use in OEM applications.
- Raycap recommends that DC protection system be installed within 2 meters or 6 feet of the radio.
- Dome design is lightweight and aerodynamic providing maximum flexibility for installation on top of towers.

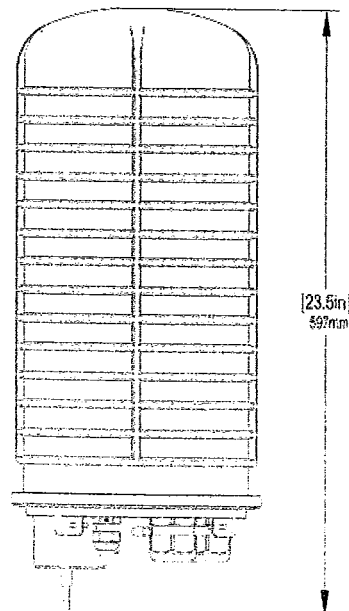
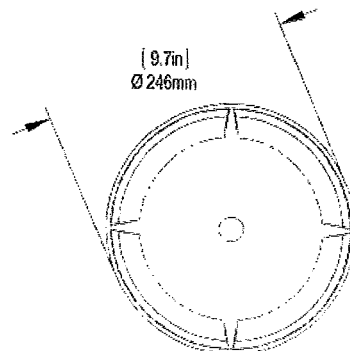

# DC6-48-60-18-8F

## DC Power Surge Protection

Electrical Specifications	
Model Number	DC6-48-60-18-8F
Nominal Operating Voltage	48 VDC
Nominal Discharge Current ( $I_n$ )	20 kA 8/20 $\mu$ s
Maximum Discharge Current ( $I_{max}$ ) per NEMA LS-1	60 kA 8/20 $\mu$ s
Maximum Continuous Operating Voltage ( $U_c$ )	75 VDC
Voltage Protection Rating	400 V

Mechanical Specifications	
Suppression Connection Method	Compression lug, #2-#14 AWG Copper, #2-#12 Aluminum
Fiber Connection Method	LC-LC Single mode duplex
Environmental Rating	IP 68, 7m 72hrs
Operating Temperature	-40° C to + 80° C
Storage Temperature	-70° C to + 80° C
Cold Temperature Cycling	IEC 61300-2-22e -30° C to + 60° C 200 hrs @ 5 psi
Resistance to Aggressive Materials	CEI IEC 61073-2 including acids and bases
UV Protection	ISO 4892-2 Method A Xenon-Arc 2160 hrs
Weight	20 lbs without Mounting Bracket

### STANDARDS

Strikesorb modules are compliant to the following Surge Protection Device (SPD) Standards:

- ANSI/UL 1449 - 3rd Edition
- IEEE C62.41
- NEMA LS-1, IEC 61643-1:2005 2nd Edition:2005
- IEC 61643-12
- EN 61643-11:2002 (including A11:2007)

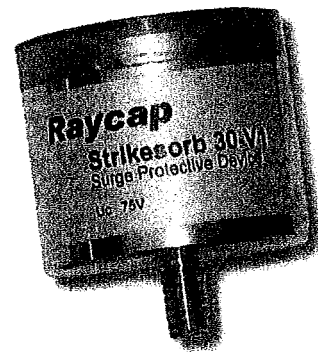

**Raycap**

G02-00-068 REV 050610



GS-07F-0435V



Certified to  
ISO 9001:2000



TUV Rheinland  
of North America

# RRUS 11 – Dual PA RRU.

## Technical Data



RBS6000

- > Multi standard
- > RF: 2x30 Watts
- > Carrier BW: 1.4 – 20 MHz
- > Alarms: 2
- > Dimensions (with sunshield):
  - Width: 17.0 in
  - Height: 17.8 in
  - Depth: 7.2 in
  - Weight: 55 lbs (Band 12)  
50 lbs (Band 4)
  - Weight: 50 lbs (Band 4)
- > Temperature: -40 to +131 F
- > Cooling: Self convection
- > Power: -48 VDC
- > Rec. fuse size 20 Amp
  - Rec. DC cable:
    - 6 mm<sup>2</sup> up to 60 meters
    - 10 mm<sup>2</sup> over 60 meters
- > Power Cons: 200 Watts typ.  
Shielded

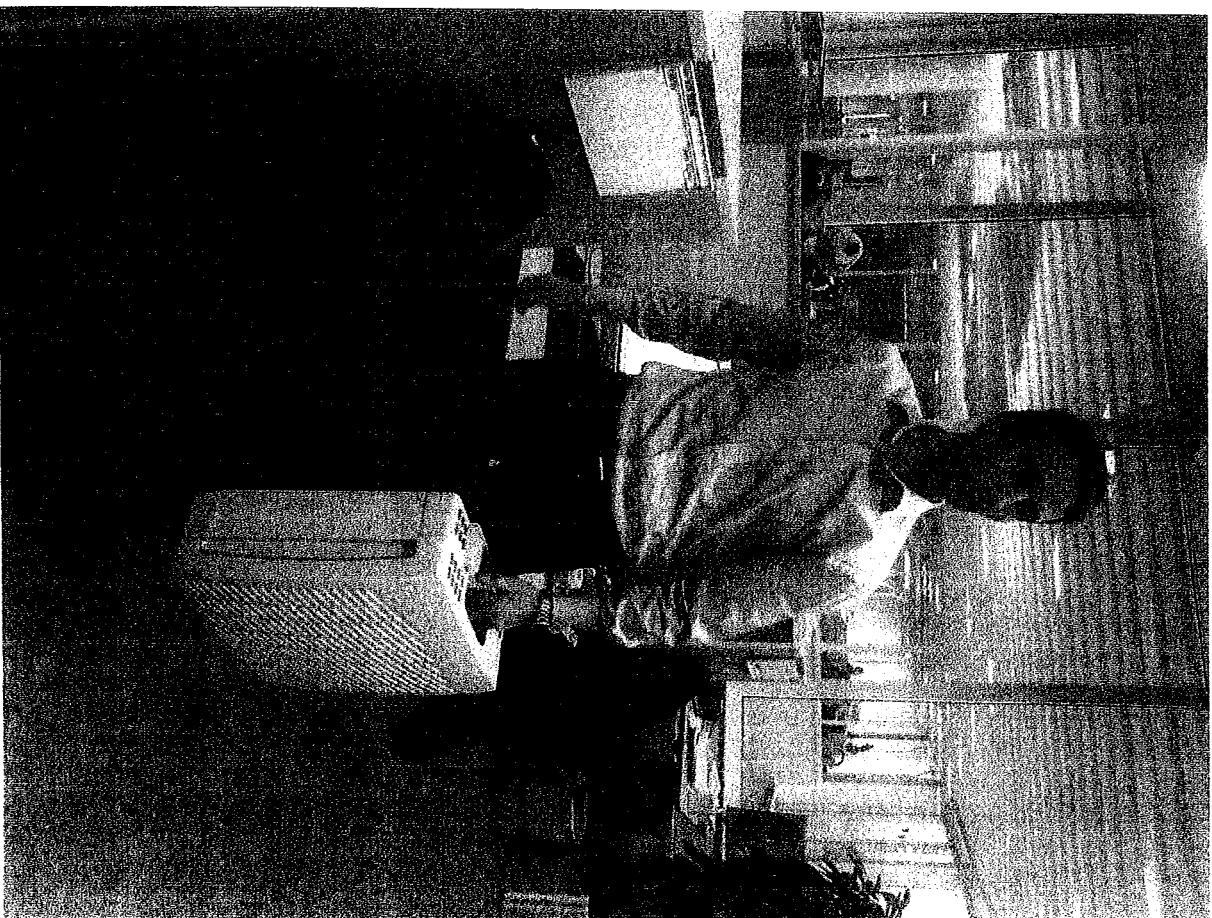

# RRUS-11 I/F



RBS6000

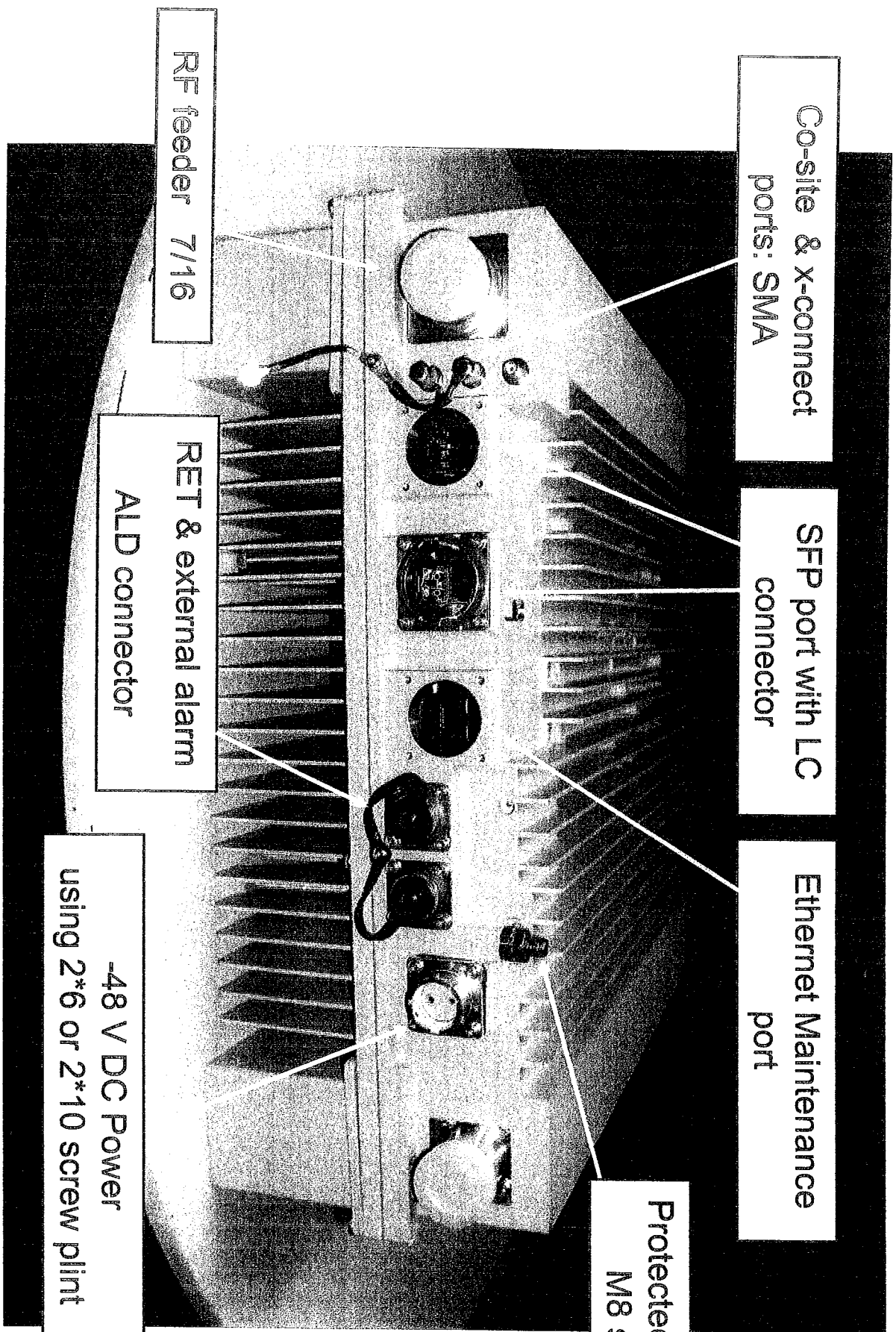

Co-site & x-connect ports: SMA

SFP port with LC connector

Ethernet Maintenance port

Protected ground M8 stud

-48 V DC Power using 2\*6 or 2\*10 screw plint

RET & external alarm ALD connector

RF feeder 7/16