



STATE OF CONNECTICUT

CONNECTICUT SITING COUNCIL

Ten Franklin Square, New Britain, CT 06051

Phone: (860) 827-2935 Fax: (860) 827-2950

E-Mail: siting.council@ct.gov

www.ct.gov/csc

July 18, 2011

Douglas L. Culp, Real Estate Consultant
New Cingular Wireless PCS, LLC
500 Enterprise Drive
Rocky Hill, CT 06067-3900

RE: **EM-CING-051-110629** - New Cingular Wireless PCS, LLC notice of intent to modify an existing telecommunications facility located at 55 Walls Drive, Fairfield, Connecticut.

Dear Mr. Culp:

The Connecticut Siting Council (Council) hereby acknowledges your notice to modify this existing telecommunications facility, pursuant to Section 16-50j-73 of the Regulations of Connecticut State Agencies with the following conditions:

- Any deviation from the proposed modification as specified in this notice and supporting materials with Council shall render this acknowledgement invalid;
- Any material changes to this modification as proposed shall require the filing of a new notice with the Council;
- Not less than 45 days after completion of construction, the Council shall be notified in writing that construction has been completed;
- The validity of this action shall expire one year from the date of this letter; and
- The applicant may file a request for an extension of time beyond the one year deadline provided that such request is submitted to the Council not less than 60 days prior to the expiration;

The proposed modifications including the placement of all necessary equipment and shelters within the tower compound are to be implemented as specified here and in your notice dated June 30, 2011. The modifications are in compliance with the exception criteria in Section 16-50j-72 (b) of the Regulations of Connecticut State Agencies as changes to an existing facility site that would not increase tower height, extend the boundaries of the tower site, increase noise levels at the tower site boundary by six decibels, and increase the total radio frequencies electromagnetic radiation power density measured at the tower site boundary to or above the standard adopted by the State Department of Environmental Protection pursuant to General Statutes § 22a-162. This facility has also been carefully modeled to ensure that radio frequency emissions are conservatively below State and federal standards applicable to the frequencies now used on this tower.

This decision is under the exclusive jurisdiction of the Council. Please be advised that the validity of this action shall expire one year from the date of this letter. Any additional change to this facility will require explicit notice to this agency pursuant to Regulations of Connecticut State Agencies Section 16-50j-73. Such notice shall include all relevant information regarding the proposed change with cumulative worst-case modeling of radio frequency exposure at the closest point of uncontrolled access to the tower base, consistent with Federal Communications Commission, Office of Engineering and Technology, Bulletin 65. Thank you for your attention and cooperation.

Very truly yours,

Linda Roberts
Executive Director

LR/CDM/laf

c: The Honorable Kenneth A. Flatto, First Selectman, Town of Fairfield
Joseph E. Devonshuk, Town Planner, Town of Fairfield
Robert D. Scinto





New Cingular Wireless PCS, LLC
500 Enterprise Drive
Rocky Hill, Connecticut 06067-3900
Phone: (860) 463-5511
Fax: (860) 513-7190

Douglas L. Culp
Real Estate Consultant

HAND DELIVERED

June 30, 2011

Ms. Linda Roberts
Executive Director
Connecticut Siting Council
10 Franklin Square
New Britain, Connecticut 06051

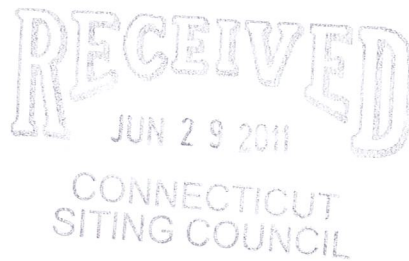

Re: New Cingular Wireless PCS, LLC notice of intent to modify an existing tele-communications facility located 55 Walls Drive Fairfield, CT (Robert D. Scinto).

Dear Ms. Roberts:

In order to accommodate technological changes, implement Uniform Mobile Telecommunications System (“UMTS”) and/or Long Term Evolution (“LTE”) capabilities, and enhance system performance in the State of Connecticut, New Cingular Wireless PCS, LLC (“AT&T”) plans to modify the equipment configurations at many of its existing cell sites. Please accept this letter and attachments as notification, pursuant to R.C.S.A. Section 16-50j-73, of construction which constitutes an exempt modification pursuant to R.C.S.A. Section 16-50j-72(b)(2). In compliance with R.C.S.A. Section 16-50j-73, a copy of this letter and attachments is being sent to the chief elected official of the municipality in which the affected cell site is located.

UMTS technology offers services to mobile computer and phone users anywhere in the world. Based on the Global System for Mobile (“GSM”) communication standard, UMTS is the planned worldwide standard for mobile users. UMTS, fully implemented, gives computer and phone users high-speed access to the Internet as they travel. They have the same capabilities even when they roam, through both terrestrial wireless and satellite transmissions.

LTE is a new high-performance air interface for cellular mobile communications. It is designed to increase the capacity and speed of mobile telephone networks.

Attached is a summary of the planned modifications, including power density calculations reflecting the change in AT&T’s operations at the site. Also included is documentation of the structural sufficiency of the tower to accommodate the revised antenna configuration.

The changes to the facility do not constitute modifications as defined in Connecticut General

Statutes ("C.G.S.") Section 16-50i(d) because the general physical characteristics of the facility will not be significantly changed or altered. Rather, the planned changes to the facility fall squarely within those activities explicitly provided for in R.C.S.A. Section 16-50j-72(b)(2).

1. The height of the overall structure will be unaffected.
2. The proposed changes will not extend the site boundaries. There will be no effect on the site compound other than some enlarged equipment pads as may be noted in the attachments.
3. The proposed changes will not increase the noise level at the existing facility by six decibels or more.
4. Radio frequency power density may increase due to use of one or more GSM channel for UMTS transmissions. Moreover, LTE will utilize additional radio frequencies newly-licensed by the FCC for cellular mobile communications. However, the changes will not increase the calculated "worst case" power density for the combined operations at the site to a level at or above the applicable standard for uncontrolled environments as calculated for a mixed frequency site.

For the foregoing reasons, New Cingular Wireless respectfully submits that the proposed changes at the referenced site constitute exempt modifications under R.C.S.A. Section 16-50j-72(b)(2).

Please feel free to call me at (860) 463-5511 with questions concerning this matter. Thank you for your consideration.

Sincerely,

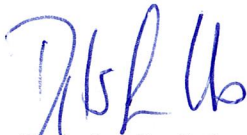

Douglas L. Culp
Real Estate Consultant

Attachments

**NEW CINGULAR WIRELESS PCS, LLC
Equipment Modification**

55 Walls Drive Fairfield, CT
Site Number CT2120
Exempt Mod

Tower Owner/Manager: Robert D. Scinto

Equipment configuration: Lattice Structure on Rooftop

Current and/or approved: Six PowerWave antennas @ 70 ft
Twelve PowerWave TMA's @ 70 ft
Twelve runs 1 1/4 inch coax to 70 ft
Equipment Shelter

Planned Modifications: Retain existing PowerWave Antenna's, TMA's at 70 ft
Retain all Coax Cabling
Install three PowerWave P65-16 antennas or equivalent @ 70 ft
Install six remote radio heads and surge arrestor @ 66 ft
Install one fiber and two DC power cables to 66 ft

Power Density:

Worst-case calculations for existing wireless operations at the site, using standard parameters for other carriers, indicate a radio frequency electromagnetic radiation power density, measured at ground level beside the Tower, of 57.3% of the standard adopted by the FCC. As depicted in the second table below, the total radio frequency electromagnetic radiation power density following proposed modifications would be approximately 62.2% of the standard.

Existing

Company	Centerline Ht (feet)	Frequency (MHz)	Number of Channels	Power Per Channel (Watts)	Power Density (mW/cm ²)	Standard Limits (mW/cm ²)	Percent of Limit
Other Users							0.99
AT&T UMTS	70	1900 Band	1	500	0.0367	1.0000	3.67
AT&T UMTS	70	800 Band	2	500	0.0734	0.5867	12.51
AT&T GSM	70	800Band	10	296	0.2172	0.5867	37.02
AT&T GSM	70	1900 Band	1	427	0.0313	1.0000	3.13
Total							57.3%

* Data for other users are from Siting Council records.

Proposed

Company	Centerline Ht (feet)	Frequency (MHz)	Number of Channels	Power Per Channel (Watts)	Power Density (mW/cm ²)	Standard Limits (mW/cm ²)	Percent of Limit
Other Users							0.99
AT&T UMTS	70	800 Band	1	500	0.0367	0.5867	6.25
AT&T UMTS	70	1900 Band	2	500	0.0734	1.0000	7.34
AT&T GSM	70	880 - 894	10	296	0.2172	0.5867	37.02
AT&T GSM	70	1900 Band	1	427	0.0313	1.0000	3.13
AT&T LTE	70	740 - 746	1	500	0.0367	0.4933	7.44
Total							62.2%

* Data for other users are from Siting Council records.

Structural information:

The attached structural analysis demonstrates that the monopole and foundation have adequate structural capacity to accommodate the proposed modifications. (Hudson Design Group dated 6-24-11).

PROJECT INFORMATION

SCOPE OF WORK: UNMANNED TELECOMMUNICATIONS FACILITY MODIFICATIONS
 SITE ADDRESS: 55 WALLS DR FAIRFIELD, CT 06824
 LATITUDE: 41.147825° N 41° 08' 52.17" N
 LONGITUDE: -73.251471° W -73° 15' 05.30" W
 JURISDICTION: NATIONAL, STATE & LOCAL CODES OR ORDINANCES
 CURRENT USE: TELECOMMUNICATIONS FACILITY
 PROPOSED USE: TELECOMMUNICATIONS FACILITY
 NOC#: 866-915-5600



SITE NUMBER: CT2120
SITE NAME: FAIRFIELD - CENTRAL

DRAWING INDEX

	REV
T-1 TITLE SHEET	2
GN-1 GENERAL NOTES	2
A-1 ROOF & EQUIPMENT PLAN	2
A-2 ANTENNA LAYOUT AND ELEVATION	2
A-3 DETAILS	2
G-1 PLUMBING DIAGRAM & DETAILS	2

VICINITY MAP

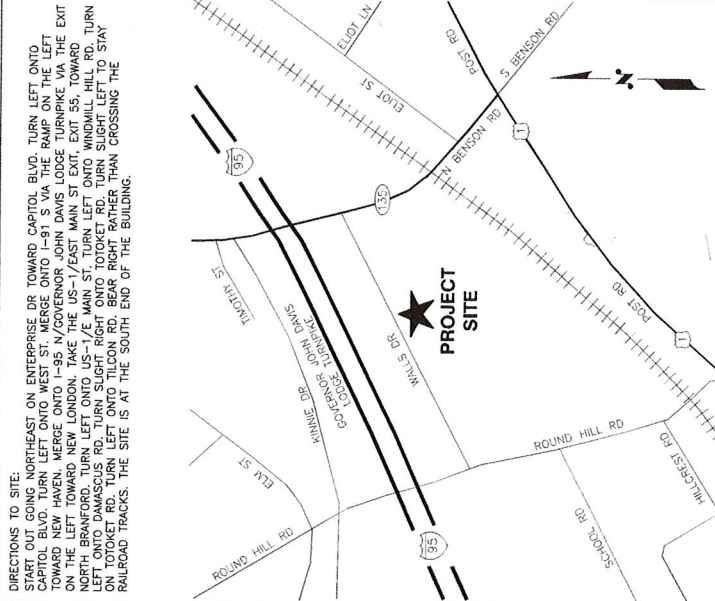

GENERAL NOTES

- THIS DOCUMENT IS THE CREATION, DESIGN, PROPERTY AND COPYRIGHTED WORK OF AT&T. ANY DUPLICATION OR USE WITHOUT EXPRESS WRITTEN PERMISSION OF AT&T IS PROHIBITED. THEIR LAWFULLY AUTHORIZED REGULATORY AND ADMINISTRATIVE FUNCTIONS IS SPECIFICALLY ALLOWED.
- THE FACILITY IS AN UNMANNED PRIVATE AND SECURED EQUIPMENT INSTALLATION. IT IS ONLY TO BE USED BY TRAINED TECHNICIANS FOR PERIODIC ROUTINE MAINTENANCE AND THEREFORE DOES NOT REQUIRE PERIODIC INSPECTION. THE FACILITY IS NOT GOVERNED BY REGULATIONS REQUIRING PUBLIC ACCESS PER ADA REQUIREMENTS.
- CONTRACTOR SHALL VERIFY ALL PLANS AND EXISTING DIMENSIONS AND CONDITIONS ON THE JOB SITE AND SHALL IMMEDIATELY NOTIFY THE AT&T REPRESENTATIVE IN WRITING OF DISCREPANCIES BEFORE PROCEEDING WITH THE WORK OR BE RESPONSIBLE FOR SAME.

CALL
BEFORE YOU DIG
 CALL TOLL FREE 800-922-4455



UNDERGROUND SERVICE ALERT

Hudson Design Group
 150 WASHINGTON STREET
 SALEM, NH 03079
 TEL: (603) 882-5200
 FAX: (603) 882-5206

22 KEENAXON DRIVE
 SALEM, NH 03079

500 ENTERPRISE DRIVE, SUITE 3A
 ROCKY HILL, CT 06867

NO. DATE	BY	REVISIONS	SCALE
0 02/10/11	DC	ISSUED FOR REVIEW	AS SHOWN
1 02/09/11	DC	ISSUED FOR CONSTRUCTION	DESIGNED BY: DC
2 06/15/11	DC	CONSTRUCTION REVISED	DRAWN BY: HC

AT&T
 TITLE SHEET (LIE)
 DRAWING NUMBER
 2120.01
 REV 2

GROUNDING NOTES

1. THE SUBCONTRACTOR SHALL REVIEW AND INSPECT THE EXISTING FACILITY GROUNDING SYSTEM AND LIGHTNING PROTECTION SYSTEM (AS DESIGNED AND INSTALLED) FOR STRICT COMPLIANCE WITH THE NEC (AS ADOPTED BY THE AHJ), THE SITE-SPECIFIC (UL, LPL, OR NFPA) LIGHTNING PROTECTION CODE, AND GENERAL COMPLIANCE WITH TELCORDIA AND TIA GROUNDING STANDARDS. THE SUBCONTRACTOR SHALL REPORT ANY VIOLATIONS OR ADVERSE FINDINGS TO THE CONTRACTOR FOR RESOLUTION.
2. ALL GROUND ELECTRODE SYSTEMS (INCLUDING TELECOMMUNICATION, RADIO, LIGHTNING PROTECTION, AND AC POWER GE'S) SHALL BE BONDED TOGETHER, AT OR BELOW GRADE, BY TWO OR MORE COPPER BONDING CONDUCTORS IN ACCORDANCE WITH THE NEC.
3. THE SUBCONTRACTOR SHALL PERFORM IEEE 110D AND 81) FOR NEW GROUND ELECTRODE SYSTEMS. THE SUBCONTRACTOR SHALL FURNISH AND INSTALL SUPPLEMENTAL GROUND ELECTRODES AS NECESSARY TO ACHIEVE A TEST RESULT OF 5 OHMS OR LESS.
4. METAL RACEWAY SHALL NOT BE USED AS THE NEC REQUIRED EQUIPMENT GROUND CONDUCTOR. STRANDED COPPER CONDUCTORS WITH GREEN INSULATION, SIZED IN ACCORDANCE WITH THE NEC, SHALL BE FURNISHED AND INSTALLED WITH THE POWER CIRCUITS TO ITS EQUIPMENT.
5. EACH BITS CABINET FRAME SHALL BE DIRECTLY CONNECTED TO THE MASTER GROUND BAR WITH GREEN INSULATED SUPPLEMENTAL EQUIPMENT GROUND WIRES, 6 AWG STRANDED COPPER OR LARGER FOR INDOOR BITS 2 AWG STRANDED COPPER FOR OUTDOOR BITS.
6. EXOTHERMIC WELDS SHALL BE USED FOR ALL GROUNDING CONNECTIONS BELOW GRADE.
7. APPROVED ANTI-OXIDANT COATINGS (I.E., CONDUCTIVE GEL OR PASTE) SHALL BE USED ON ALL COMPRESSION AND BOLTED GROUND CONNECTIONS.
8. ICE BRIDGE BONDING CONDUCTORS SHALL BE EXOTHERMICALLY BONDED OR BOLTED TO THE BRIDGE AND THE TOWER GROUND BAR.
9. ALUMINUM CONDUCTOR OR COPPER CLAD STEEL CONDUCTOR SHALL NOT BE USED FOR GROUNDING CONNECTIONS.
10. MISCELLANEOUS ELECTRICAL AND NON-ELECTRICAL METAL BOXES, FRAMES AND SUPPORTS SHALL BE BONDED TO THE GROUND RING, IN ACCORDANCE WITH THE NEC.
11. METAL CONDUIT SHALL BE MADE ELECTRICALLY CONTINUOUS WITH LISTED BONDING FITTINGS OR BY BONDING ACROSS THE DISCONTINUITY WITH 6 AWG COPPER WIRE UL APPROVED GROUNDING TYPE CONDUIT CLAMPS.
12. ALL NEW STRUCTURES WITH A FOUNDATION AND/OR FOOTING HAVING 20 FT. OR MORE OF 1/2 IN. OR GREATER ELECTRICALLY CONDUCTIVE REINFORCING STEEL MUST HAVE IT BONDED TO THE GROUND RING USING AN EXOTHERMIC WELD CONNECTION. THE GROUND RING SHALL BE BARE TINNED COPPER GROUND WIRE, PER NEC 250.50

GENERAL NOTES

1. FOR THE PURPOSE OF CONSTRUCTION DRAWING, THE FOLLOWING DEFINITIONS SHALL APPLY:
CONTRACTOR - SA
SUBCONTRACTOR - GENERAL CONTRACTOR (CONSTRUCTION) OWNER - AT&T MOBILITY
2. PRIOR TO THE SUBMISSION OF BIDS, THE BIDDING SUBCONTRACTOR SHALL VISIT THE CELL SITE TO FAMILIARIZE WITH THE EXISTING CONDITIONS AND TO CONSTRUCTION DRAWINGS. ANY DISCREPANCY FOUND SHALL BE BROUGHT TO THE ATTENTION OF CONTRACTOR.
3. ALL MATERIALS FURNISHED AND INSTALLED SHALL BE IN STRICT ACCORDANCE WITH THE SPECIFICATIONS, STANDARDS, AND CODES. THE SUBCONTRACTOR SHALL ISSUE ALL APPROPRIATE NOTICES AND COMPLY WITH ALL LAWS, ORDINANCES, RULES, REGULATIONS, AND LAWFUL ORDERS OF ANY PUBLIC AUTHORITY REGARDING THE PERFORMANCE OF THE WORK. ALL WORK SHALL BE IN ACCORDANCE WITH ALL APPLICABLE MUNICIPAL AND UTILITY COMPANY SPECIFICATIONS AND LOCAL JURISDICTIONAL CODES, ORDINANCES AND APPLICABLE REGULATIONS.
4. DRAWINGS PROVIDED HERE ARE NOT TO BE SCALED AND ARE INTENDED TO SHOW OUTLINE ONLY.
5. UNLESS NOTED OTHERWISE, THE WORK SHALL INCLUDE FURNISHING MATERIALS, EQUIPMENT, APPURTENANCES, AND LABOR NECESSARY TO COMPLETE ALL INSTALLATIONS AS INDICATED ON THE DRAWINGS.
6. "KITTING LIST" SUPPLIED WITH THE BID PACKAGE IDENTIFIES ITEMS THAT WILL BE SUPPLIED BY CONTRACTOR. ITEMS NOT INCLUDED IN THE BILL OF MATERIALS AND KITTING LIST SHALL BE SUPPLIED BY THE SUBCONTRACTOR.
7. THE SUBCONTRACTOR SHALL INSTALL ALL EQUIPMENT AND MATERIALS IN ACCORDANCE WITH MANUFACTURER'S RECOMMENDATIONS UNLESS SPECIFICALLY STATED OTHERWISE.
8. IF THE SPECIFIED EQUIPMENT CANNOT BE INSTALLED AS SHOWN ON THESE DRAWINGS, THE SUBCONTRACTOR SHALL PROPOSE AN ALTERNATIVE INSTALLATION SPACE FOR APPROVAL BY THE CONTRACTOR.
9. SUBCONTRACTOR SHALL DETERMINE ACTUAL ROUTING OF CONDUIT, POWER AND T1 CABLES, GROUNDING CABLES AS SHOWN ON THE POWER, GROUNDING AND/OR SHIELDING DRAWINGS. THE SUBCONTRACTOR SHALL UTILIZE EXISTING TRAYS AND/OR SHALL ADD NEW TRAYS AS NECESSARY. THE CONTRACTOR SHALL CONFIRM THE ACTUAL ROUTING WITH THE CONTRACTOR.
10. THE SUBCONTRACTOR SHALL PROTECT EXISTING IMPROVEMENTS, UTILITIES, CABLES, LANDSCAPING AND STRUCTURES. ANY DAMAGED PART SHALL BE REPAIRED AT SUBCONTRACTOR'S EXPENSE TO THE SATISFACTION OF OWNER.
11. SUBCONTRACTOR SHALL LEGALLY AND PROPERLY DISPOSE OF ALL SCRAP MATERIALS, INCLUDING ASBESTOS, CABLES AND OTHER ITEMS REMOVED FROM THE EXISTING FACILITY. DEBRIS REMOVED SHALL BE RETURNED TO THE OWNER'S DESIGNATED LOCATION.
12. SUBCONTRACTOR SHALL LEAVE PREMISES IN CLEAN CONDITION.
13. ALL CONCRETE REPAIR WORK SHALL BE DONE IN ACCORDANCE WITH AMERICAN CONCRETE INSTITUTE (ACI) 301.
14. ANY NEW CONCRETE NEEDED FOR THE CONSTRUCTION SHALL BE AIR-ENTRAINED AND SHALL HAVE 4000 PSI STRENGTH AT 28 DAYS. ALL CONCRETE REPAIR WORK SHALL BE DONE IN ACCORDANCE WITH ACI 318 CODE REQUIREMENTS.

15. ALL STRUCTURAL STEEL WORK SHALL BE DETAILED, FABRICATED AND ERECTED IN ACCORDANCE WITH AISC SPECIFICATIONS. ALL STRUCTURAL STEEL SHALL BE ASTM A36 (Fy = 36 ksi) UNLESS OTHERWISE NOTED. PIPES SHALL BE ASTM A53 TYPE E (Fy = 36 ksi). ALL STEEL EXPOSED TO WEATHER SHALL BE HOT-DIPPED GALVANIZED. TOUCHUP ALL SCRATCHES AND DENTS WITH FIELD AFTER STEEL IS ERECTED USING A COMPATIBLE ZINC-RICH PAINT.
 16. CONSTRUCTION SHALL COMPLY WITH UMITS SPECIFICATIONS AND "GENERAL CONSTRUCTION SERVICES FOR CONSTRUCTION OF AT&T MOBILITY SITES".
 17. SUBCONTRACTOR SHALL VERIFY ALL EXISTING DIMENSIONS AND CONDITIONS PRIOR TO COMMENCING ANY WORK. ALL DIMENSIONS OF EXISTING CONSTRUCTION SHOWN ON THE DRAWINGS MUST BE VERIFIED. SUBCONTRACTOR SHALL NOTIFY THE CONTRACTOR OF ANY DISCREPANCIES PRIOR TO ORDERING MATERIAL OR PROCEEDING WITH CONSTRUCTION.
 18. THE EXISTING CELL SITE IS IN FULL COMMERCIAL OPERATION. ANY CONSTRUCTION WORK BY SUBCONTRACTOR SHALL NOT DISRUPT THE EXISTING OPERATION. ALL CONSTRUCTION SHALL BE COORDINATED WITH CONTRACTOR AND SCHEDULED FOR AN APPROPRIATE MAINTENANCE WINDOW USUALLY IN LOW TRAFFIC PERIODS AFTER MIDNIGHT.
 19. SINCE THE CELL SITE IS ACTIVE, ALL SAFETY PRECAUTIONS MUST BE TAKEN WHEN WORKING AROUND HIGH LEVELS OF ELECTROMAGNETIC RADIATION. EQUIPMENT SHOULD BE SHUTDOWN PRIOR TO PERFORMING ANY WORK THAT COULD EXPOSE THE WORKERS TO DANGER. PERSONAL RF EXPOSURE MONITORS ARE ADVISED TO BE WORN TO ALERT OF ANY DANGEROUS EXPOSURE LEVELS.
 20. APPLICABLE BUILDING CODES:
SUBCONTRACTOR'S WORK SHALL COMPLY WITH ALL APPLICABLE NATIONAL, STATE, AND LOCAL CODES AS ADOPTED BY THE LOCAL AUTHORITY HAVING JURISDICTION FOR THE LOCATION. THE EDITION OF THE AHJ ADOPTED CODES AND STANDARDS SHALL BE THE EFFECT ON THE DATE OF CONTRACT AWARD SHALL GOVERN THE DESIGN.
BUILDING CODE: 2003 IBC WITH 2005 CT SUPPLEMENT & 2009 CT AMENDMENTS
CODE: REFER TO ELECTRICAL DRAWINGS
LIGHTNING CODE: REFER TO ELECTRICAL DRAWINGS
- SUBCONTRACTOR'S WORK SHALL COMPLY WITH THE LATEST EDITION OF THE FOLLOWING STANDARDS:
- AMERICAN CONCRETE INSTITUTE (ACI) 318: BUILDING CODE REQUIREMENTS FOR STRUCTURAL CONCRETE.
 - AMERICAN INSTITUTE OF STEEL CONSTRUCTION (AISC)
 - MANUAL OF STEEL CONSTRUCTION, ASD, NINTH EDITION;
 - TELECOMMUNICATIONS INDUSTRY ASSOCIATION (TIA) 222-F, STRUCTURAL STANDARDS FOR STEEL
 - ANTENNA TOWER AND ANTENNA SUPPORTING STRUCTURES, REFER TO ELECTRICAL DRAWINGS FOR SPECIFIC ELECTRICAL STANDARDS.
- FOR ANY CONFLICTS BETWEEN SECTIONS OF LISTED CODES AND STANDARDS REGARDING MATERIAL, METHODS OF CONSTRUCTION, OR OTHER REQUIREMENTS, THE CONTRACTOR SHALL REFER TO THE SPECIFICATIONS WHERE THERE IS CONFLICT BETWEEN A GENERAL REQUIREMENT AND A SPECIFIC REQUIREMENT, THE SPECIFIC REQUIREMENT SHALL GOVERN.

ABBREVIATIONS

ACL	ABOVE GRADE LEVEL	C.C.	GENERAL CONTRACTOR	RF	RADIO FREQUENCY
AWG	AMERICAN WIRE GAUGE	MGB	MASTER GROUND BUS	TBD	TO BE DETERMINED
BCW	BARE COPPER WIRE	MIN	MINIMUM	TBR	TO BE REMOVED
BTS	BASE TRANSCEIVER STATION	PROPOSED	NEW	TBR	TO BE REMOVED
EXISTING	EXISTING	N.T.S.	NOT TO SCALE	TBR	TO BE REMOVED
EG	EQUIPMENT GROUND	REF	REFERENCE	TYP	TYPICAL
EGR	EQUIPMENT GROUND RING	REQ	REQUIRED		

NO.	DATE	ISSUED FOR	REVISIONS	DESIGNED BY	DC	CHECKED BY	HC	DATE	REVISION NUMBER	REV
1	06/15/11	CONSTRUCTION REVISED								
2	03/09/11	ISSUED FOR CONSTRUCTION								
3	02/09/11	ISSUED FOR REVIEW								

SCALE: AS SHOWN	DESIGNED BY: DC	CHECKED BY: HC
-----------------	-----------------	----------------



500 ENTERPRISE DRIVE SUITE 3A
ROCKY HILL, CT 06867

SITE NUMBER: CT2120
SITE NAME: FAIRFIELD-CENTRAL

55 WALLS DR
FAIRFIELD, CT 06824
FAIRFIELD COUNTY

22 KEEMAYON DRIVE
SALEM, NH 03079



SAIT COMMUNICATIONS



Hudson Design Group

NEWTON, MASSACHUSETTS 02459
N. ANDOVER, MA 01860
TEL: 781-552-3333
FAX: 781-552-3338

GENERAL NOTES	AT&T
GENERAL NOTES (LITE)	
DATE NUMBER	2/2/2011
DATE	GN-1
REV	2

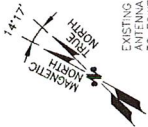
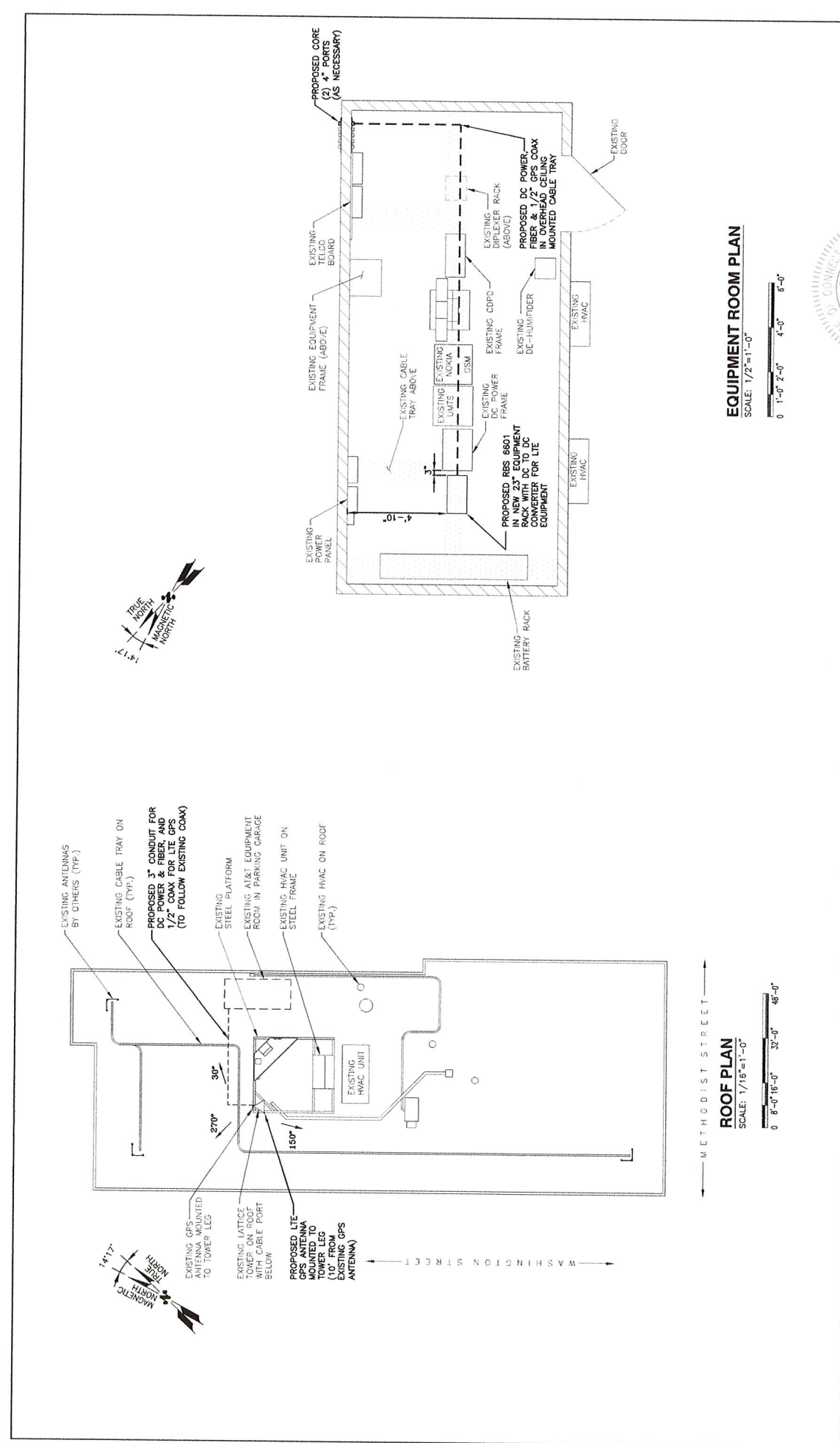

ROOF PLAN
SCALE: 1/16"=1'-0"

0 1'-0" 2'-0" 4'-0" 6'-0"

EQUIPMENT ROOM PLAN
SCALE: 1/2"=1'-0"

0 1'-0" 2'-0" 4'-0" 6'-0"

Hudson Design Group
1400 ASHLEY AVENUE
MIDDLETOWN, CONNECTICUT 06457
TEL: (860) 336-5533
FAX: (860) 336-5526

ISAT Communications

SITE NUMBER: CT2120
SITE NAME: FAIRFIELD - CENTRAL
55 WALLS DR
FAIRFIELD, CT 06424
FAIRFIELD COUNTY

500 ENTERPRISE DRIVE, SUITE 3A
ROCKY HILL, CT 06867

NO.	DATE	ISSUED FOR REVIEW	REVISIONS	DESIGNED BY: DC	DRAWN BY: HC	SCALE
2	06/15/11	CONSTRUCTION REVISED				
1	03/09/11	ISSUED FOR CONSTRUCTION				
0	02/19/11	ISSUED FOR REVIEW				

BY: CHM/BJP
DATE: 2/12/01

AT&T
ROOF & EQUIPMENT PLAN (LIE)

JOB NUMBER: 2120.01
DRAWING NUMBER: A-1

REV: 2

***NOTE:**
REFER TO THE FINAL RF DATA SHEET FOR FINAL ANTENNA CONFIGURATION.

NOTE:
AN ANALYSIS FOR THE CAPACITY OF THE EXISTING STRUCTURE TO SUPPORT THE PROPOSED EQUIPMENT SHALL BE DETERMINED PRIOR TO CONSTRUCTION.

- PROPOSED (3) NEW LTE ANTENNAS MOUNTED TO PROPOSED MOUNTING PIPE (TYP. 1 PER SECTOR)
- EXISTING (6) UMTS/GSM ANTENNAS TO REMAIN (TYP. 2 PER SECTOR)
- PROPOSED LTE GPS ANTENNA MOUNTED TO TOWER LEG (10' FROM EXISTING GPS ANTENNA)
- PROPOSED SURGE ARRESTOR DC8-48-60-18-8F MOUNTED TO EXISTING TOWER LEG
- PROPOSED RRH MOUNTED TO ANTENNA PLATFORM (TYP. OF 2 PER SECTOR)
- PROPOSED (2) DC POWER (1) FIBER LINE TO FOLLOW EXISTING COAX MOUNTED TO TOWER LEG
- EXISTING GPS ANTENNA MOUNTED TO TOWER LEG

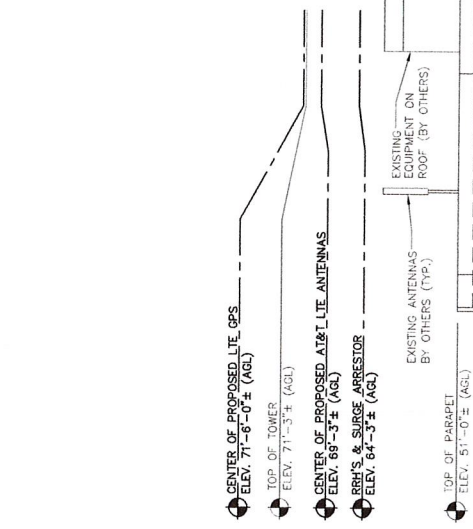

NORTHWEST ELEVATION
SCALE: 1/8"=1'-0"
0 4'-0" 8'-0" 16'-0" 24'-0"

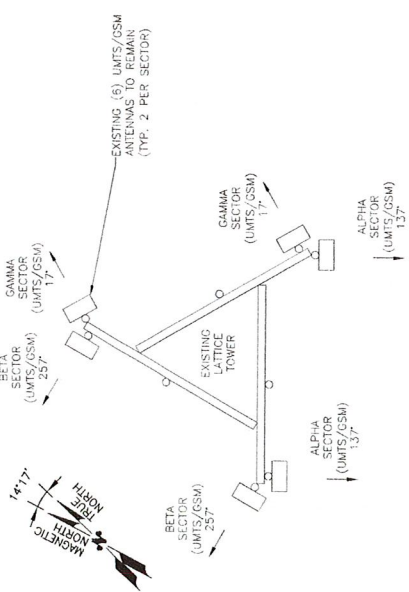

EXISTING GSM/UMTS ANTENNA PLAN
SCALE: N.T.S.

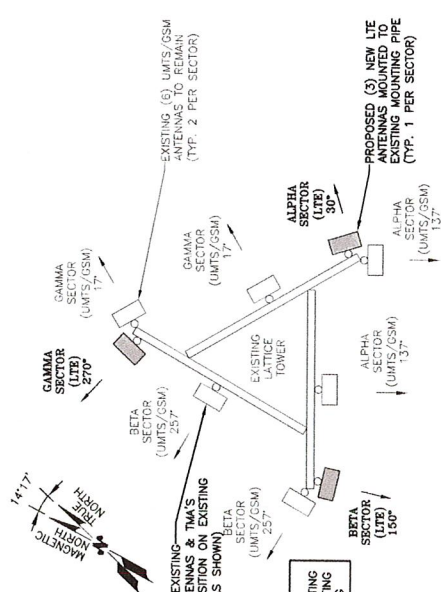

PROPOSED LTE ANTENNA PLAN
SCALE: N.T.S.

Hudson Design Group
1000 WASHINGTON STREET
SUITE 200 NORTH BURLINGTON
N. ANDOVER, MA 01861
TEL: (978) 867-5533
FAX: (978) 867-5536



SITE NUMBER: CT2120
SITE NAME: FAIRFIELD - CENTRAL
55 WALLS DR
FAIRFIELD, CT 06424
FAIRFIELD COUNTY

22 KEENEYDON DRIVE
SALEM, NH 03079



500 ENTERPRISE DRIVE, SUITE 3A
ROCKY HILL, CT 06067

NO.	DATE	BY	CHK'D BY	REVISIONS	DESIGNED BY: DC	DRAWN BY: HC	SCALE: AS SHOWN
2	06/19/11	CONSTRUCTION REVISED	DC	DC	DC	DC	DC
1	03/09/11	ISSUED FOR CONSTRUCTION	DC	DC	DC	DC	DC
0	02/07/11	ISSUED FOR REVIEW	DC	DC	DC	DC	DC
SCALE: AS SHOWN DESIGNED BY: DC DRAWN BY: HC CHECKED BY: <i>David P. Haman</i> DATE: 06/19/11 PROJECT: AT&T ANTENNA LAYOUT AND ELEVATION (LIE)							DRAWING NUMBER: A-2 JOB NUMBER: Z720.01 REV: 2

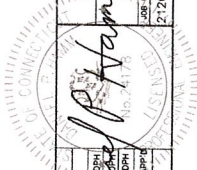

AT&T

NOTE:
AN ANALYSIS FOR THE CAPACITY OF THE EXISTING TOWER LEGS TO SUPPORT THE PROPOSED EQUIPMENT SHALL BE DETERMINED PRIOR TO CONSTRUCTION.

***NOTE:**
REFER TO THE FINAL RF DATA SHEET FOR FINAL ANTENNA CONFIGURATION

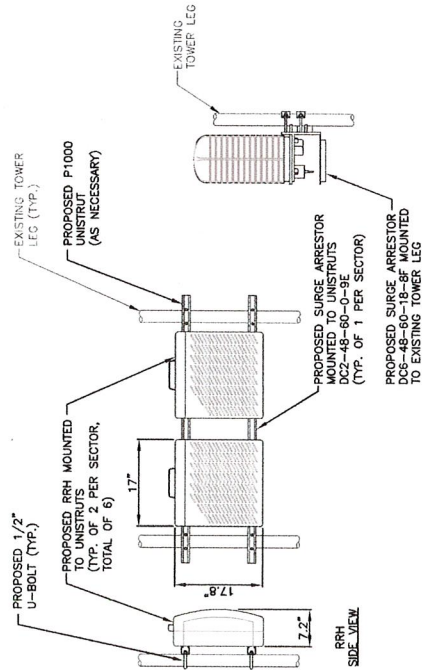

PROPOSED RRH & SURGE ARRESTOR MOUNTING DETAIL

SCALE: N.T.S.

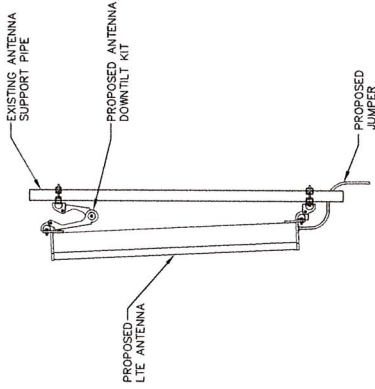

PROPOSED LTE ANTENNA DETAIL

SCALE: N.T.S.

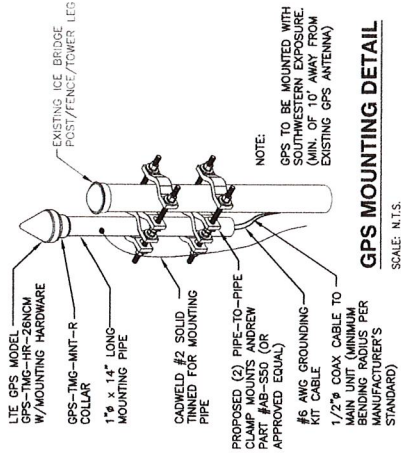

GPS MOUNTING DETAIL

SCALE: N.T.S.

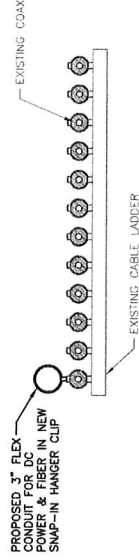

CABLE MOUNTING DETAIL

SCALE: N.T.S.

SITE NUMBER: CT2120
SITE NAME: FAIRFIELD - CENTRAL
55 WALLS DR
FAIRFIELD, CT 06424
FAIRFIELD COUNTY

500 ENTERPRISE DRIVE, SUITE 3A
ROCKY HILL, CT 06067

NO.	DATE	REVISIONS	BY	CHK	APP'D
2	06/15/11	CONSTRUCTION REVISED	DC	DC	DC
1	03/09/11	ISSUED FOR CONSTRUCTION	DC	DC	DC
0	02/10/11	ISSUED FOR REVIEW	DC	DC	DC

DESIGNED BY: DC
DRAWN BY: HC
SCALE: AS SHOWN

DATE: 2/20/01
JOB NUMBER: A-3
DRAWING NUMBER: A-3

DETAILS (LITE)

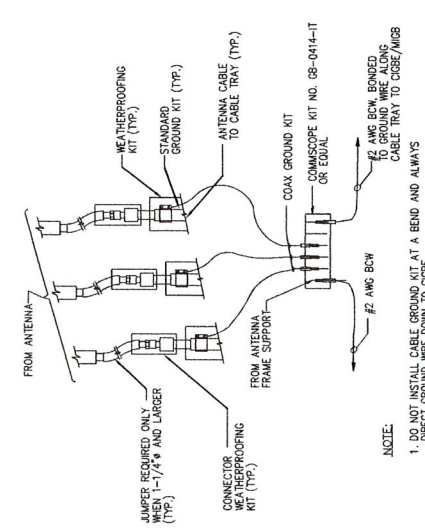

GROUND WIRE TO GROUND BAR CONNECTION DETAIL

1 N.T.S.

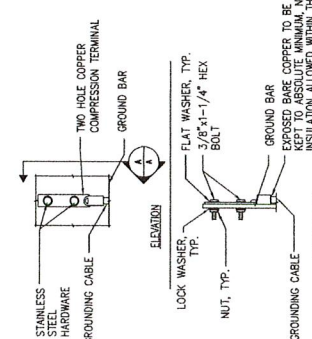

TYPICAL GROUND BAR CONNECTION DETAIL

4 N.T.S.

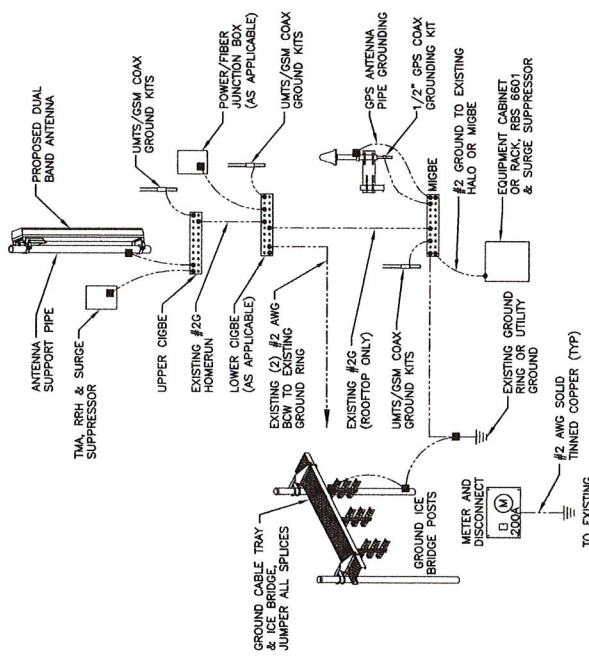

GROUNDING RISER DIAGRAM

2 N.T.S.

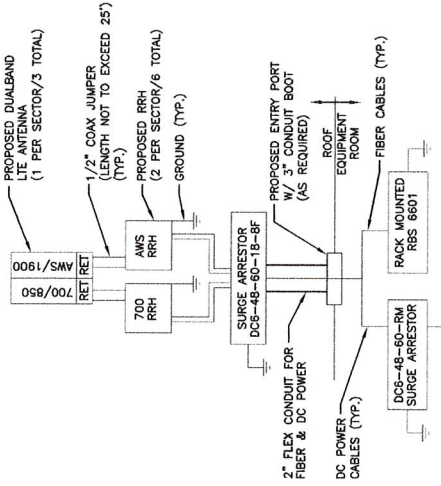

PLUMBING DIAGRAM

3 N.T.S.

- NOTES:
1. CONTRACTOR TO CONFIRM ALL PARTS.
2. INSTALL ALL EQUIPMENT TO MANUFACTURER'S RECOMMENDATIONS.

WIRELESS SOLUTIONS INC.	
NO.	DESCRIPTION
1	HILGB-0420-IS SOLID CHD. BAR (20" x 4" x 1/4")
2	WALL MTC. BRKT.
3	INSULATORS
4	5/8" - 11x1" H.H.C.S.
5	5/8 LOCKWASHER

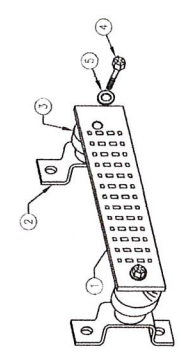

GROUND BAR - DETAIL

5 N.T.S.

EACH GROUND CONDUCTOR TERMINATING ON ANY GROUND BAR SHALL HAVE AN IDENTIFICATION TAG ATTACHED AT EACH END THAT WILL IDENTIFY ITS ORIGIN AND DESTINATION.

SECTION "P" - SURGE PRODUCERS

- CABLE ENTRY PORTS (HATCH PLATES) (#2)
- GENERATOR FRAMEWORK (IF AVAILABLE) (#2)
- TELECOM GROUND BAR
- COMMERCIAL POWER COMMON NEUTRAL/GROUND BOND (#2)
- 48V POWER SUPPLY RETURN BAR (#2)
- RECTIFIER FRAMES.

SECTION "A" - SURGE ABSORBERS

- INTERIOR GROUND RING (#2)
- EXTERNAL EARTH GROUND FIELD (BURIED GROUND RING) (#2)
- METALLIC COLD WATER PIPE (IF AVAILABLE) (#2)
- BUILDING STEEL (IF AVAILABLE) (#2)

1800 COLLEGE STREET
NANDORR MA 01845
TEL: 978 542 5553
FAX: 978 542 5555

at&t

500 ENTERPRISE DRIVE, SUITE 3A
ROCKY HILL, CT 06867

NO.	DATE	REVISIONS	DESIGNED BY: DC	DRAWN BY: HC
1	02/09/11	ISSUED FOR REVIEW	HC	DC/DPH
2	08/15/11	CONSTRUCTION REVISED	HC	DC/DPH

SCALE: AS SHOWN

JOB NUMBER: 27120.01
DRAWING NUMBER: G-1

AT&T PLUMBING DIAGRAM & DETAILS (LTE)

STRUCTURAL ANALYSIS REPORT

For

CT 2120 (LTE)

Fairfield - Central

55 Walls Drive

Fairfield, Connecticut 06824

**Equipment Room in the Basement; Antennas Mounted to Tower
on the Roof**



Prepared for:



500 Enterprise Drive, Suite 3A
Rock Hill, CT 06067

Dated:

June 24, 2011

Prepared by:

HUDSON DESIGN GROUP, LLC.

1600 Osgood Street Building 20 North, Suite 2-101

North Andover, MA 01845

Phone: (978) 557-5553

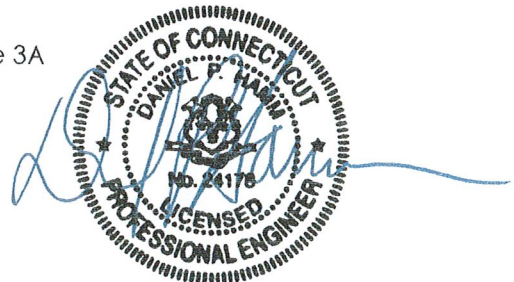



SCOPE OF WORK:

Hudson Design Group LLC (HDG) has been authorized by AT&T to conduct a structural evaluation of the 20' tower supporting the proposed AT&T antennas located at elevation 69.25' above the ground level.

This report represents this office's findings, conclusions and recommendations pertaining to the support of AT&T's existing and proposed antennas listed below.

HDG visited the site and climbed the tower on May 11, 2011 to record dimensional properties of the existing tower and its appurtenances.

CONCLUSION SUMMARY:

Based on our evaluation, we have determined that, in general, structural design and construction can be accomplished per the proposed HDG construction drawings with **NO STRUCTURAL UPGRADES REQUIRED** to the existing tower and steel support frame.

The proposed RBS 6601 Indoor 19" rack will be located inside the existing equipment room, supported by the concrete slab on grade at the garage level below the building.

A summary of the proposed antennas are as follows:

Antennas	Elev.	Mount
Omni 27'	82.25'	Tower Leg
(6)7770.00 Antennas	69.25'	(3)Side Mount Standoff
(12)Powerwave TMAs	68.25'	(3)Side Mount Standoff
(3)P65-16-XLH-RR Antennas	69.25'	(3)Side Mount Standoff
(6)RRUS	67.0'	(3)Tower Face
Surge Arrestor DC6-48-60-18-8f	67.0'	Tower Leg
GPS	60.0'	Tower Leg

*Proposed AT&T Appurtenances shown in Bold.



DESIGN CRITERIA:

1. EIA/TIA-222-F Structural Standards for Steel Antenna Towers and Antenna Supporting Structures

County: Fairfield
Wind Load: 85 mph (fastest mile)
Ice Thickness: 1/2 inch

2. Approximate height above grade to proposed antennas: 69'-3"

Calculations and referenced documents are attached.

ASSUMPTIONS:

1. The tower and steel support frame are properly constructed and maintained.
2. All structural members and their connections are assumed to be in good condition and free of defects with no deterioration to its member capacities.
3. All prior structural modifications, if any, are assumed to be as per data supplied, and to have been properly installed and to be fully effective.



Photo 1: existing antennas mounted to the tower



Photo 2: Existing equipment room in the parking garage below the building



PROPOSED DRAWINGS



CALCULATIONS

DESIGNED APPURTENANCE LOADING

TYPE	ELEVATION	TYPE	ELEVATION
27' whip antenna	71.25	Pirot 4' Side Mount Standoff (1)	69
Powerwave 7770.00 w/mount pipe	69.25	(2) Powerwave tma	68.25
Powerwave 7770.00 w/mount pipe	69.25	(2) Powerwave tma	68.25
Powerwave 7770.00 w/mount pipe	69.25	(2) Powerwave tma	68.25
Powerwave 7770.00 w/mount pipe	69.25	(2) Powerwave tma	68.25
Powerwave 7770.00 w/mount pipe	69.25	(2) Powerwave tma	68.25
Powerwave 7770.00 w/mount pipe	69.25	(2) Powerwave tma	68.25
Powerwave P65-16-XLH-RR	69.25	(2) Ericsson RRU w/support frame	67
Powerwave P65-16-XLH-RR	69.25	(2) Ericsson RRU w/support frame	67
Powerwave P65-16-XLH-RR	69.25	(2) Ericsson RRU w/support frame	67
Pirot 4' Side Mount Standoff (1)	69	Surge Arrestor (DC6-48-60-18-8F)	67
Pirot 4' Side Mount Standoff (1)	69	GPS	60

SYMBOL LIST

MARK	SIZE	MARK	SIZE
A	L2 1/2x2 1/2x1/4		

MATERIAL STRENGTH

GRADE	Fy	Fu	GRADE	Fy	Fu
A36	36 ksi	58 ksi			

TOWER DESIGN NOTES

1. Tower is located in Fairfield County, Connecticut.
2. Tower designed for a 85 mph basic wind in accordance with the TIA/EIA-222-F Standard.
3. Tower is also designed for a 74 mph basic wind with 0.50 in ice.
4. Deflections are based upon a 60 mph wind.
5. TOWER RATING: 42%

Section	T1	T2	T3	14	T5
Legs					
Leg Grade			bent plate (1/4")		
Diagonals			A36		
Diagonal Grade			L2x2x1/4		
Top Girts			A36		
Face Width (ft)			N.A.		
# Panels @ (ft)			4		
Weight (lb)			3 @ 5		
	218.0	201.2	201.2	201.2	192.5
	71.3 ft	68.8 ft	63.8 ft	58.8 ft	53.8 ft
					51.3 ft

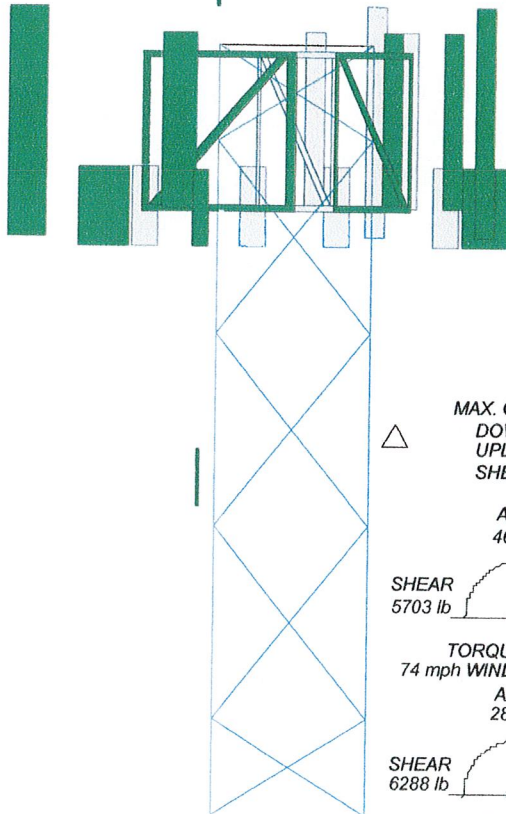

MAX. CORNER REACTIONS AT BASE:

DOWN: 26294 lb
 UPLIFT: -23398 lb
 SHEAR: 3472 lb

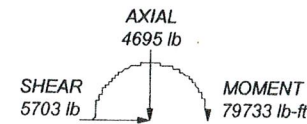

TORQUE 697 lb-ft
 74 mph WIND - 0.5000 in ICE

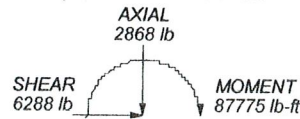

TORQUE 902 lb-ft
 REACTIONS - 85 mph WIND

Hudson Design Group		Job: CT2120	
1600 Osgood Street, Building 20 North, Suite 2-101		Project: 50 walls Street, Fairfield, CT 06824	
North Andover, MA 01845		Client: at&t	Drawn by: kw
Phone: (978)557-5553		Code: TIA/EIA-222-F	Date: 06/27/11
FAX: (978)336-5586		Path: R:\STRUCTURAL DEPT\Analysis Software\RSA1\own\RSA Projects\AT&T CT2120\02120.dwg	App'd: NTS
		Dwg No. E-1	

RISATower Hudson Design Group 1600 Osgood Street, Building 20 North, Suite 2-101 North Andover, MA 01845 Phone: (978)557-5553 FAX: (978)336-5586	Job	CT2120	Page	1 of 18
	Project	50 walls Street, Fairfield, CT 06824	Date	12:16:55 06/27/11
	Client	at&t	Designed by	kw

Tower Input Data

The main tower is a 3x free standing tower with an overall height of 71.25 ft above the ground line.
The base of the tower is set at an elevation of 51.25 ft above the ground line.
The face width of the tower is 4.00 ft at the top and 4.00 ft at the base.
This tower is designed using the TIA/EIA-222-F standard.
The following design criteria apply:

- Tower is located in Fairfield County, Connecticut.
- Basic wind speed of 85 mph.
- Nominal ice thickness of 0.5000 in.
- Ice density of 56 pcf.
- A wind speed of 74 mph is used in combination with ice.
- Temperature drop of 50 °F.
- Deflections calculated using a wind speed of 60 mph.
- A non-linear (P-delta) analysis was used.
- Pressures are calculated at each section.
- Stress ratio used in tower member design is 1.333.
- Local bending stresses due to climbing loads, feedline supports, and appurtenance mounts are not considered.

Options

- | | | |
|--|--|---|
| <ul style="list-style-type: none"> Consider Moments - Legs Consider Moments - Horizontals Consider Moments - Diagonals Use Moment Magnification √ Use Code Stress Ratios √ Use Code Safety Factors - Guys Escalate Ice Always Use Max Kz Use Special Wind Profile √ Include Bolts In Member Capacity Leg Bolts Are At Top Of Section Secondary Horizontal Braces Leg Use Diamond Inner Bracing (4 Sided) Add IBC .6D+W Combination | <ul style="list-style-type: none"> Distribute Leg Loads As Uniform Assume Legs Pinned √ Assume Rigid Index Plate √ Use Clear Spans For Wind Area Use Clear Spans For KL/r Retension Guys To Initial Tension Bypass Mast Stability Checks √ Use Azimuth Dish Coefficients √ Project Wind Area of Appurt. √ Autocalc Torque Arm Areas SR Members Have Cut Ends Sort Capacity Reports By Component Triangulate Diamond Inner Bracing | <ul style="list-style-type: none"> √ Treat Feedline Bundles As Cylinder Use ASCE 10 X-Brace Ly Rules √ Calculate Redundant Bracing Forces Ignore Redundant Members in FEA √ SR Leg Bolts Resist Compression √ All Leg Panels Have Same Allowable Offset Girt At Foundation √ Consider Feedline Torque √ Include Angle Block Shear Check <li style="padding-left: 20px;">Poles Include Shear-Torsion Interaction Always Use Sub-Critical Flow Use Top Mounted Sockets |
|--|--|---|

RISATower Hudson Design Group 1600 Osgood Street, Building 20 North, Suite 2-101 North Andover, MA 01845 Phone: (978)557-5553 FAX: (978)336-5586	Job CT2120	Page 2 of 18
	Project 50 walls Street, Fairfield, CT 06824	Date 12:16:55 06/27/11
	Client at&t	Designed by kw

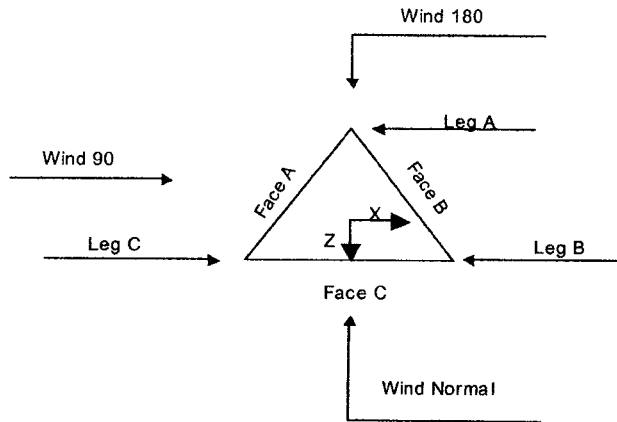

Triangular Tower

Tower Section Geometry

Tower Section	Tower Elevation	Assembly Database	Description	Section Width	Number of Sections	Section Length
	<i>ft</i>			<i>ft</i>		<i>ft</i>
T1	71.25-68.75			4.00	1	2.50
T2	68.75-63.75			4.00	1	5.00
T3	63.75-58.75			4.00	1	5.00
T4	58.75-53.75			4.00	1	5.00
T5	53.75-51.25			4.00	1	2.50

Tower Section Geometry (cont'd)

Tower Section	Tower Elevation	Diagonal Spacing	Bracing Type	Has K Brace End Panels	Has Horizontals	Top Girt Offset	Bottom Girt Offset
	<i>ft</i>	<i>ft</i>				<i>in</i>	<i>in</i>
T1	71.25-68.75	2.50	X Brace	No	No	0.0000	0.0000
T2	68.75-63.75	5.00	X Brace	No	No	0.0000	0.0000
T3	63.75-58.75	5.00	X Brace	No	No	0.0000	0.0000
T4	58.75-53.75	5.00	X Brace	No	No	0.0000	0.0000
T5	53.75-51.25	2.50	X Brace	No	No	0.0000	0.0000

Tower Section Geometry (cont'd)

RISATower Hudson Design Group 1600 Osgood Street, Building 20 North, Suite 2-101 North Andover, MA 01845 Phone: (978)557-5553 FAX: (978)336-5586	Job	CT2120	Page	3 of 18
	Project	50 walls Street, Fairfield, CT 06824	Date	12:16:55 06/27/11
	Client	at&t	Designed by	kw

Tower Elevation ft	Leg Type	Leg Size	Leg Grade	Diagonal Type	Diagonal Size	Diagonal Grade
T1 71.25-68.75	Arbitrary Shape	bent plate (1/4")	A36 (36 ksi)	Single Angle	L2x2x1/4	A36 (36 ksi)
T2 68.75-63.75	Arbitrary Shape	bent plate (1/4")	A36 (36 ksi)	Single Angle	L2x2x1/4	A36 (36 ksi)
T3 63.75-58.75	Arbitrary Shape	bent plate (1/4")	A36 (36 ksi)	Single Angle	L2x2x1/4	A36 (36 ksi)
T4 58.75-53.75	Arbitrary Shape	bent plate (1/4")	A36 (36 ksi)	Single Angle	L2x2x1/4	A36 (36 ksi)
T5 53.75-51.25	Arbitrary Shape	bent plate (1/4")	A36 (36 ksi)	Single Angle	L2x2x1/4	A36 (36 ksi)

Tower Section Geometry (cont'd)

Tower Elevation ft	Top Girt Type	Top Girt Size	Top Girt Grade	Bottom Girt Type	Bottom Girt Size	Bottom Girt Grade
T1 71.25-68.75	Single Angle	L2 1/2x2 1/2x1/4	A36 (36 ksi)	Pipe		A36 (36 ksi)

Feed Line/Linear Appurtenances - Entered As Round Or Flat

Description	Face or Leg	Allow Shield	Component Type	Placement ft	Face Offset in	Lateral Offset (Frac FW)	#	# Per Row	Clear Spacing in	Width or Diameter in	Perimeter in	Weight plf
1 5/8 Climbing Ladder	B	No	Ar (Leg)	67.25 - 51.25	0.0000	0	12	2	1.9800	1.9800		1.04
3" conduit	A	No	Af (Leg)	71.25 - 51.25	0.0000	0	1	1	0.2500	0.0000	0.0000	7.90
1/2	A	No	Ar (CaAa)	67.25 - 51.25	0.0000	0.1	1	1	3.5000	3.5000		3.00
	A	No	Ar (CaAa)	67.25 - 51.25	0.0000	0	1	1	0.5800	0.5800		0.25

Feed Line/Linear Appurtenances Section Areas

Tower Section	Tower Elevation ft	Face	A _R ft ²	A _F ft ²	C _A A _A In Face ft ²	C _A A _A Out Face ft ²	Weight lb
T1	71.25-68.75	A	0.000	0.000	0.000	0.000	19.75
		B	0.000	0.000	0.000	0.000	0.00
		C	0.000	0.000	0.000	0.000	0.00
T2	68.75-63.75	A	0.000	0.000	1.428	0.000	50.88
		B	6.467	0.000	0.000	0.000	43.68
		C	6.467	0.000	0.000	0.000	0.00
T3	63.75-58.75	A	0.000	0.000	2.040	0.000	55.75
		B	9.238	0.000	0.000	0.000	62.40
		C	9.238	0.000	0.000	0.000	0.00
T4	58.75-53.75	A	0.000	0.000	2.040	0.000	55.75
		B	9.238	0.000	0.000	0.000	62.40

RISATower Hudson Design Group 1600 Osgood Street, Building 20 North, Suite 2-101 North Andover, MA 01845 Phone: (978)557-5553 FAX: (978)336-5586	Job	CT2120	Page	4 of 18
	Project	50 walls Street, Fairfield, CT 06824	Date	12:16:55 06/27/11
	Client	at&t	Designed by	kw

Tower Section	Tower Elevation ft	Face	A_R ft ²	A_F ft ²	C_{AA} In Face ft ²	C_{AA} Out Face ft ²	Weight lb
T5	53.75-51.25	C	9.238	0.000	0.000	0.000	0.00
		A	0.000	0.000	1.020	0.000	27.88
		B	4.619	0.000	0.000	0.000	31.20
		C	4.619	0.000	0.000	0.000	0.00

Feed Line/Linear Appurtenances Section Areas - With Ice

Tower Section	Tower Elevation ft	Face or Leg	Ice Thickness in	A_R ft ²	A_F ft ²	C_{AA} In Face ft ²	C_{AA} Out Face ft ²	Weight lb
T1	71.25-68.75	A	0.500	0.000	0.139	0.000	0.000	20.67
		B		0.000	0.139	0.000	0.000	0.00
		C		0.000	0.000	0.000	0.000	0.00
T2	68.75-63.75	A	0.500	0.000	0.278	2.128	0.000	63.58
		B		6.759	0.278	0.000	0.000	107.31
		C		6.759	0.000	0.000	0.000	0.00
T3	63.75-58.75	A	0.500	0.000	0.278	3.040	0.000	73.11
		B		9.655	0.278	0.000	0.000	153.30
		C		9.655	0.000	0.000	0.000	0.00
T4	58.75-53.75	A	0.500	0.000	0.278	3.040	0.000	73.11
		B		9.655	0.278	0.000	0.000	153.30
		C		9.655	0.000	0.000	0.000	0.00
T5	53.75-51.25	A	0.500	0.000	0.139	1.520	0.000	36.55
		B		4.828	0.139	0.000	0.000	76.65
		C		4.828	0.000	0.000	0.000	0.00

Feed Line Center of Pressure

Section	Elevation ft	CP_x in	CP_z in	CP_x Ice in	CP_z Ice in
T1	71.25-68.75	0.0000	0.0000	0.0000	-0.2068
T2	68.75-63.75	3.5036	1.8518	2.8534	1.3076
T3	63.75-58.75	4.1666	2.2022	3.4102	1.6198
T4	58.75-53.75	4.1666	2.2022	3.4102	1.6198
T5	53.75-51.25	3.9303	2.0773	3.1740	1.5076

Discrete Tower Loads

Description	Face or Leg	Offset Type	Offsets: Horz Lateral Vert ft ft ft	Azimuth Adjustment °	Placement ft	C_{AA} Front ft ²	C_{AA} Side ft ²	Weight lb	
27' whip antenna	C	From Leg	0.00	0.0000	71.25	No Ice	8.10	8.10	30.00
			0.00			1/2" Ice	10.83	10.83	88.13
			11.00						

RISATower Hudson Design Group 1600 Osgood Street, Building 20 North, Suite 2-101 North Andover, MA 01845 Phone: (978)557-5553 FAX: (978)336-5586	Job	CT2120	Page	5 of 18
	Project	50 walls Street, Fairfield, CT 06824	Date	12:16:55 06/27/11
	Client	at&t	Designed by	kw

Description	Face or Leg	Offset Type	Offsets: Horz Lateral Vert ft ft ft	Azimuth Adjustment °	Placement ft	C _{AA} Front ft ²	C _{AA} Side ft ²	Weight lb	
Pirot 4' Side Mount Standoff (1)	A	Stand-Off Right	0.00 0.00 0.00	0.0000	69.00	No Ice 1/2" Ice	2.72 4.91	2.72 4.91	50.00 89.00
Pirot 4' Side Mount Standoff (1)	B	Stand-Off Right	0.00 0.00 0.00	0.0000	69.00	No Ice 1/2" Ice	2.72 4.91	2.72 4.91	50.00 89.00
Pirot 4' Side Mount Standoff (1)	C	Stand-Off Right	0.00 0.00 0.00	0.0000	69.00	No Ice 1/2" Ice	2.72 4.91	2.72 4.91	50.00 89.00
Powerwave 7770.00 w/mount pipe	A	Stand-Off Right	5.00 0.50 0.00	20.0000	69.25	No Ice 1/2" Ice	6.10 6.60	4.23 4.98	55.08 100.07
Powerwave 7770.00 w/mount pipe	B	Stand-Off Right	5.00 0.50 0.00	20.0000	69.25	No Ice 1/2" Ice	6.10 6.60	4.23 4.98	55.08 100.07
Powerwave 7770.00 w/mount pipe	C	Stand-Off Right	5.00 0.50 0.00	20.0000	69.25	No Ice 1/2" Ice	6.10 6.60	4.23 4.98	55.08 100.07
Powerwave 7770.00 w/mount pipe	A	Stand-Off Right	1.00 0.00 0.00	0.0000	69.25	No Ice 1/2" Ice	6.10 6.60	4.23 4.98	55.08 100.07
Powerwave 7770.00 w/mount pipe	B	Stand-Off Right	1.00 0.00 0.00	0.0000	69.25	No Ice 1/2" Ice	6.10 6.60	4.23 4.98	55.08 100.07
Powerwave 7770.00 w/mount pipe	C	Stand-Off Right	1.00 0.00 0.00	0.0000	69.25	No Ice 1/2" Ice	6.10 6.60	4.23 4.98	55.08 100.07
(2) Powerwave tma	A	Stand-Off Right	1.00 0.00 0.00	0.0000	68.25	No Ice 1/2" Ice	1.29 1.45	0.36 0.48	14.10 21.26
(2) Powerwave tma	A	Stand-Off Right	2.00 0.00 0.00	0.0000	68.25	No Ice 1/2" Ice	1.29 1.45	0.36 0.48	14.10 21.26
(2) Powerwave tma	B	Stand-Off Right	1.00 0.00 0.00	0.0000	68.25	No Ice 1/2" Ice	1.29 1.45	0.36 0.48	14.10 21.26
(2) Powerwave tma	B	Stand-Off Right	3.00 0.00 0.00	0.0000	68.25	No Ice 1/2" Ice	1.29 1.45	0.36 0.48	14.10 21.26
(2) Powerwave tma	C	Stand-Off Right	1.00 0.00 0.00	0.0000	68.25	No Ice 1/2" Ice	1.29 1.45	0.36 0.48	14.10 21.26
(2) Powerwave tma	C	Stand-Off Right	4.00 0.00 0.00	0.0000	68.25	No Ice 1/2" Ice	1.29 1.45	0.36 0.48	14.10 21.26
Powerwave P65-16-XLH-RR	A	Stand-Off Right	5.00 -0.50 0.00	-20.0000	69.25	No Ice 1/2" Ice	8.40 8.95	5.67 6.38	79.82 136.88
Powerwave P65-16-XLH-RR	B	Stand-Off Right	5.00 -0.50 0.00	-20.0000	69.25	No Ice 1/2" Ice	8.40 8.95	5.67 6.38	79.82 136.88
Powerwave P65-16-XLH-RR	C	Stand-Off Right	5.00 -0.50 0.00	-20.0000	69.25	No Ice 1/2" Ice	8.40 8.95	5.67 6.38	79.82 136.88
(2) Ericsson RRU w/support frame	A	From Face	0.50 0.00 0.00	0.0000	67.00	No Ice 1/2" Ice	4.08 4.47	2.49 2.95	58.60 90.14

RISATower Hudson Design Group 1600 Osgood Street, Building 20 North, Suite 2-101 North Andover, MA 01845 Phone: (978)557-5553 FAX: (978)336-5586	Job	CT2120	Page	6 of 18
	Project	50 walls Street, Fairfield, CT 06824	Date	12:16:55 06/27/11
	Client	at&t	Designed by	kw

Description	Face or Leg	Offset Type	Offsets: Horz Lateral Vert ft ft ft	Azimuth Adjustment °	Placement ft	C _{AAs} Front ft ²	C _{AAs} Side ft ²	Weight lb	
(2) Ericsson RRU w/support frame	B	From Face	0.50 0.00 0.00	0.0000	67.00	No Ice 1/2" Ice	4.08 4.47	2.49 2.95	58.60 90.14
(2) Ericsson RRU w/support frame	C	From Face	0.50 0.00 0.00	0.0000	67.00	No Ice 1/2" Ice	4.08 4.47	2.49 2.95	58.60 90.14
Surge Arrestor (DC6-48-60-18-8F)	C	From Leg	0.50 0.00 0.00	0.0000	67.00	No Ice 1/2" Ice	1.27 1.46	1.27 1.46	20.00 35.12
GPS	C	From Leg	0.50 0.00 (0.00)	0.0000	60.00	No Ice 1/2" Ice	0.21 0.32	0.21 0.32	5.00 7.52

Discrete Appurtenance Pressures - No Ice $G_H = 1.250$

Description	Aiming Azimuth °	Weight lb	Offset _x ft	Offset _y ft	z ft	K _z	q _z psf	C _{AAs} Front ft ²	C _{AAs} Side ft ²
27' whip antenna	240.0000	30.00	-2.00	1.15	82.25	1.298	26	8.10	8.10
Pirot 4' Side Mount Standoff (1)	30.0000	50.00	0.00	-2.31	69.00	1.235	25	2.72	2.72
Pirot 4' Side Mount Standoff (1)	150.0000	50.00	2.00	1.15	69.00	1.235	25	2.72	2.72
Pirot 4' Side Mount Standoff (1)	270.0000	50.00	-2.00	1.15	69.00	1.235	25	2.72	2.72
Powerwave 7770.00 w/mount pipe	50.0000	55.08	2.93	-6.39	69.25	1.236	25	6.10	4.23
Powerwave 7770.00 w/mount pipe	170.0000	55.08	4.07	5.73	69.25	1.236	25	6.10	4.23
Powerwave 7770.00 w/mount pipe	290.0000	55.08	-7.00	0.65	69.25	1.236	25	6.10	4.23
Powerwave 7770.00 w/mount pipe	30.0000	55.08	0.50	-3.18	69.25	1.236	25	6.10	4.23
Powerwave 7770.00 w/mount pipe	150.0000	55.08	2.50	2.02	69.25	1.236	25	6.10	4.23
Powerwave 7770.00 w/mount pipe	270.0000	55.08	-3.00	1.15	69.25	1.236	25	6.10	4.23
Powerwave tma	30.0000	28.20	0.50	-3.18	68.25	1.231	25	2.58	0.73
Powerwave tma	30.0000	28.20	1.00	-4.04	68.25	1.231	25	2.58	0.73
Powerwave tma	150.0000	28.20	2.50	2.02	68.25	1.231	25	2.58	0.73
Powerwave tma	150.0000	28.20	3.50	3.75	68.25	1.231	25	2.58	0.73
Powerwave tma	270.0000	28.20	-3.00	1.15	68.25	1.231	25	2.58	0.73
Powerwave tma	270.0000	28.20	-6.00	1.15	68.25	1.231	25	2.58	0.73
Powerwave	10.0000	79.82	2.07	-6.89	69.25	1.236	25	8.40	5.67
P65-16-XLH-RR Powerwave	130.0000	79.82	4.93	5.23	69.25	1.236	25	8.40	5.67
P65-16-XLH-RR Powerwave	250.0000	79.82	-7.00	1.65	69.25	1.236	25	8.40	5.67
P65-16-XLH-RR Ericsson RRU w/support frame	300.0000	117.20	-1.43	-0.83	67.00	1.224	25	8.17	4.99

RISATower Hudson Design Group 1600 Osgood Street, Building 20 North, Suite 2-101 North Andover, MA 01845 Phone: (978)557-5553 FAX: (978)336-5586	Job CT2120	Page 8 of 18
	Project 50 walls Street, Fairfield, CT 06824	Date 12:16:55 06/27/11
	Client at&t	Designed by kw

Discrete Appurtenance Pressures - Service $G_H = 1.250$

Description	Aiming Azimuth °	Weight lb	Offset _x ft	Offset _y ft	z ft	K _z	q _z psf	C _A A _c Front ft ²	C _A A _c Side ft ²
27' whip antenna	240.0000	30.00	-2.00	1.15	82.25	1.298	13	8.10	8.10
Pirod 4' Side Mount Standoff (1)	30.0000	50.00	0.00	-2.31	69.00	1.235	13	2.72	2.72
Pirod 4' Side Mount Standoff (1)	150.0000	50.00	2.00	1.15	69.00	1.235	13	2.72	2.72
Pirod 4' Side Mount Standoff (1)	270.0000	50.00	-2.00	1.15	69.00	1.235	13	2.72	2.72
Powerwave 7770.00 w/mount pipe	50.0000	55.08	2.93	-6.39	69.25	1.236	13	6.10	4.23
Powerwave 7770.00 w/mount pipe	170.0000	55.08	4.07	5.73	69.25	1.236	13	6.10	4.23
Powerwave 7770.00 w/mount pipe	290.0000	55.08	-7.00	0.65	69.25	1.236	13	6.10	4.23
Powerwave 7770.00 w/mount pipe	30.0000	55.08	0.50	-3.18	69.25	1.236	13	6.10	4.23
Powerwave 7770.00 w/mount pipe	150.0000	55.08	2.50	2.02	69.25	1.236	13	6.10	4.23
Powerwave 7770.00 w/mount pipe	270.0000	55.08	-3.00	1.15	69.25	1.236	13	6.10	4.23
Powerwave tma	30.0000	28.20	0.50	-3.18	68.25	1.231	12	2.58	0.73
Powerwave tma	30.0000	28.20	1.00	-4.04	68.25	1.231	12	2.58	0.73
Powerwave tma	150.0000	28.20	2.50	2.02	68.25	1.231	12	2.58	0.73
Powerwave tma	150.0000	28.20	3.50	3.75	68.25	1.231	12	2.58	0.73
Powerwave tma	270.0000	28.20	-3.00	1.15	68.25	1.231	12	2.58	0.73
Powerwave tma	270.0000	28.20	-6.00	1.15	68.25	1.231	12	2.58	0.73
Powerwave	10.0000	79.82	2.07	-6.89	69.25	1.236	13	8.40	5.67
P65-16-XLH-RR Powerwave	130.0000	79.82	4.93	5.23	69.25	1.236	13	8.40	5.67
P65-16-XLH-RR Powerwave	250.0000	79.82	-7.00	1.65	69.25	1.236	13	8.40	5.67
P65-16-XLH-RR Ericsson RRU w/support frame	300.0000	117.20	-1.43	-0.83	67.00	1.224	12	8.17	4.99
Ericsson RRU w/support frame	60.0000	117.20	1.43	-0.83	67.00	1.224	12	8.17	4.99
Ericsson RRU w/support frame	180.0000	117.20	0.00	1.65	67.00	1.224	12	8.17	4.99
Surge Arrestor (DC6-48-60-18-8F)	240.0000	20.00	-2.43	1.40	67.00	1.224	12	1.27	1.27
GPS	240.0000	5.00	-2.43	1.40	60.00	1.186	12	0.21	0.21
Sum Weight:		1295.74							

Force Totals

Load Case	Vertical Forces lb	Sum of Forces X lb	Sum of Forces Z lb	Sum of Overturning Moments, M _x lb-ft	Sum of Overturning Moments, M _z lb-ft	Sum of Torques lb-ft
Leg Weight	505.31					
Bracing Weight	656.85					
Total Member Self-Weight	1162.16			-90.33	-187.69	

RISATower Hudson Design Group 1600 Osgood Street, Building 20 North, Suite 2-101 North Andover, MA 01845 Phone: (978)557-5553 FAX: (978)336-5586	Job CT2120	Page 9 of 18
	Project 50 walls Street, Fairfield, CT 06824	Date 12:16:55 06/27/11
	Client at&t	Designed by kw

Load Case	Vertical Forces lb	Sum of Forces X lb	Sum of Forces Z lb	Sum of Overturning Moments, M _x lb-ft	Sum of Overturning Moments, M _z lb-ft	Sum of Torques lb-ft
Total Weight	2867.58			-90.33	-187.69	
Wind 0 deg - No Ice		0.00	-6287.58	-87709.66	-187.69	261.74
Wind 30 deg - No Ice		3019.79	-5230.43	-73698.94	-42685.64	597.02
Wind 60 deg - No Ice		5158.84	-2978.46	-42151.04	-73038.97	817.54
Wind 90 deg - No Ice		6039.58	0.00	-90.33	-85183.59	855.73
Wind 120 deg - No Ice		5445.21	3143.79	43719.33	-76068.26	640.61
Wind 150 deg - No Ice		3019.79	5230.43	73518.27	-42685.64	258.71
Wind 180 deg - No Ice		0.00	5956.92	84031.09	-187.69	-173.18
Wind 210 deg - No Ice		-3019.79	5230.43	73518.27	42310.26	-597.02
Wind 240 deg - No Ice		-5445.21	3143.79	43719.33	75692.88	-902.35
Wind 270 deg - No Ice		-6039.58	0.00	-90.33	84808.21	-855.73
Wind 300 deg - No Ice		-5158.84	-2978.46	-42151.04	72663.60	-644.36
Wind 330 deg - No Ice		-3019.79	-5230.43	-73698.94	42310.26	-258.71
Member Ice	570.87					
Total Weight Ice	4695.39			287.66	-541.77	
Wind 0 deg - Ice		0.00	-5702.98	-78801.34	-541.77	40.65
Wind 30 deg - Ice		2748.31	-4760.21	-66361.53	-39021.69	343.51
Wind 60 deg - Ice		4700.64	-2713.92	-37837.41	-66576.32	586.70
Wind 90 deg - Ice		5496.62	0.00	287.66	-77501.62	696.59
Wind 120 deg - Ice		4938.93	2851.49	39832.16	-69034.85	601.26
Wind 150 deg - Ice		2748.31	4760.21	66936.84	-39021.69	353.08
Wind 180 deg - Ice		0.00	5427.83	76537.79	-541.77	20.92
Wind 210 deg - Ice		-2748.31	4760.21	66936.84	37938.15	-343.51
Wind 240 deg - Ice		-4938.93	2851.49	39832.16	67951.31	-641.91
Wind 270 deg - Ice		-5496.62	0.00	287.66	76418.08	-696.59
Wind 300 deg - Ice		-4700.64	-2713.92	-37837.41	65492.78	-607.62
Wind 330 deg - Ice		-2748.31	-4760.21	-66361.53	37938.15	-353.08
Total Weight	2867.58			-90.33	-187.69	
Wind 0 deg - Service		0.00	-3132.91	-43563.89	163.13	130.42
Wind 30 deg - Service		1504.67	-2606.17	-36582.77	-21012.32	297.48
Wind 60 deg - Service		2570.49	-1484.08	-20863.40	-36136.48	407.36
Wind 90 deg - Service		3009.34	0.00	94.18	-42187.77	426.38
Wind 120 deg - Service		2713.18	1566.46	21923.22	-37645.88	319.20
Wind 150 deg - Service		1504.67	2606.17	36771.13	-21012.32	128.91
Wind 180 deg - Service		0.00	2968.15	42009.35	163.13	-86.29
Wind 210 deg - Service		-1504.67	2606.17	36771.13	21338.57	-297.48
Wind 240 deg - Service		-2713.18	1566.46	21923.22	37972.13	-449.62
Wind 270 deg - Service		-3009.34	0.00	94.18	42514.02	-426.38
Wind 300 deg - Service		-2570.49	-1484.08	-20863.40	36462.73	-321.06
Wind 330 deg - Service		-1504.67	-2606.17	-36582.77	21338.57	-128.91

Load Combinations

Comb. No.	Description
1	Dead Only
2	Dead+Wind 0 deg - No Ice
3	Dead+Wind 30 deg - No Ice
4	Dead+Wind 60 deg - No Ice
5	Dead+Wind 90 deg - No Ice
6	Dead+Wind 120 deg - No Ice
7	Dead+Wind 150 deg - No Ice
8	Dead+Wind 180 deg - No Ice
9	Dead+Wind 210 deg - No Ice
10	Dead+Wind 240 deg - No Ice
11	Dead+Wind 270 deg - No Ice

RISATower Hudson Design Group 1600 Osgood Street, Building 20 North, Suite 2-101 North Andover, MA 01845 Phone: (978)557-5553 FAX: (978)336-5586	Job	CT2120	Page	10 of 18
	Project	50 walls Street, Fairfield, CT 06824	Date	12:16:55 06/27/11
	Client	at&t	Designed by	kw

Comb. No.	Description
12	Dead+Wind 300 deg - No Ice
13	Dead+Wind 330 deg - No Ice
14	Dead+Ice+Temp
15	Dead+Wind 0 deg+Ice+Temp
16	Dead+Wind 30 deg+Ice+Temp
17	Dead+Wind 60 deg+Ice+Temp
18	Dead+Wind 90 deg+Ice+Temp
19	Dead+Wind 120 deg+Ice+Temp
20	Dead+Wind 150 deg+Ice+Temp
21	Dead+Wind 180 deg+Ice+Temp
22	Dead+Wind 210 deg+Ice+Temp
23	Dead+Wind 240 deg+Ice+Temp
24	Dead+Wind 270 deg+Ice+Temp
25	Dead+Wind 300 deg+Ice+Temp
26	Dead+Wind 330 deg+Ice+Temp
27	Dead+Wind 0 deg - Service
28	Dead+Wind 30 deg - Service
29	Dead+Wind 60 deg - Service
30	Dead+Wind 90 deg - Service
31	Dead+Wind 120 deg - Service
32	Dead+Wind 150 deg - Service
33	Dead+Wind 180 deg - Service
34	Dead+Wind 210 deg - Service
35	Dead+Wind 240 deg - Service
36	Dead+Wind 270 deg - Service
37	Dead+Wind 300 deg - Service
38	Dead+Wind 330 deg - Service

Maximum Member Forces

Section No.	Elevation ft	Component Type	Condition	Gov. Load Comb.	Force lb	Major Axis Moment lb-ft	Minor Axis Moment lb-ft
T1	71.25 - 68.75	Leg	Max Tension	12	806.60	0.00	0.00
			Max. Compression	23	-1708.51	192.03	3.50
			Max. Mx	10	-1207.64	246.06	5.45
			Max. My	5	-328.73	0.17	-152.24
			Max. Vy	10	-638.82	246.06	5.45
			Max. Vx	9	-586.10	0.14	124.25
		Diagonal	Max Tension	26	696.26	0.00	0.00
			Max. Compression	7	-493.81	0.00	0.00
			Max. Mx	19	424.78	-4.91	-0.63
			Max. My	7	-81.49	1.21	-2.13
			Max. Vy	22	-6.85	3.29	-0.94
			Max. Vx	7	0.90	1.21	-2.13
		Top Girt	Max Tension	4	127.42	0.00	0.00
			Max. Compression	15	-322.17	0.00	0.00
			Max. Mx	14	-195.43	-13.56	0.00
			Max. My	20	-194.58	0.00	0.00
			Max. Vy	14	13.56	0.00	0.00
Max. Vx	20		-0.00	0.00	0.00		
T2	68.75 - 63.75	Leg	Max Tension	12	3116.64	-241.95	3.41
			Max. Compression	10	-4090.13	94.27	12.79
			Max. Mx	10	-3864.67	246.06	5.45
			Max. My	7	-573.74	-0.16	214.90
			Max. Vy	10	309.24	246.06	5.45
		Diagonal	Max. Vx	7	-281.32	0.23	-121.29
			Max Tension	5	1950.38	0.00	0.00
			Max. Compression	19	-2129.18	0.00	0.00

RISATower Hudson Design Group 1600 Osgood Street, Building 20 North, Suite 2-101 North Andover, MA 01845 Phone: (978)557-5553 FAX: (978)336-5586	Job	CT2120	Page	11 of 18
	Project	50 walls Street, Fairfield, CT 06824	Date	12:16:55 06/27/11
	Client	at&t	Designed by	kw

Section No.	Elevation ft	Component Type	Condition	Gov. Load Comb.	Force lb	Major Axis Moment lb-ft	Minor Axis Moment lb-ft
T3	63.75 - 58.75	Leg	Max. Mx	21	1159.38	12.18	0.34
			Max. My	12	-1573.02	0.27	2.56
			Max. Vy	21	9.26	12.18	0.34
			Max. Vx	12	0.80	0.00	0.00
			Max Tension	12	8787.21	-90.69	4.95
			Max. Compression	19	-10599.72	-18.32	2.13
			Max. Mx	19	-10464.08	112.83	-2.71
		Diagonal	Max. My	3	-741.94	-0.33	-226.74
			Max. Vy	19	66.61	112.83	-2.71
			Max. Vx	3	81.90	-0.33	-226.74
			Max Tension	24	2597.19	0.00	0.00
			Max. Compression	11	-2495.12	0.00	0.00
			Max. Mx	19	-1364.64	-19.75	1.69
			Max. My	5	-2485.96	-8.64	-4.54
T4	58.75 - 53.75	Leg	Max. Vy	19	-11.61	0.00	0.00
			Max. Vx	5	-1.42	0.00	0.00
			Max Tension	4	15245.86	-35.54	-12.88
			Max. Compression	6	-17398.27	66.55	-3.32
			Max. Mx	19	-15835.61	148.55	-2.21
			Max. My	3	-834.37	-0.45	-379.45
			Max. Vy	19	-72.20	148.55	-2.21
		Diagonal	Max. Vx	3	92.79	-0.45	-379.45
			Max Tension	11	2908.71	0.00	0.00
			Max. Compression	24	-3075.77	0.00	0.00
			Max. Mx	19	1817.24	36.10	0.21
			Max. My	6	-2515.42	-5.95	-2.60
			Max. Vy	19	-16.73	36.10	0.21
			Max. Vx	6	0.81	0.00	0.00
T5	53.75 - 51.25	Leg	Max Tension	4	21197.36	-63.80	-11.44
			Max. Compression	6	-23922.97	-0.00	-0.00
			Max. Mx	19	-22745.88	148.55	-2.21
			Max. My	3	-942.74	-0.45	-379.45
			Max. Vy	19	79.50	148.55	-2.21
			Max. Vx	3	-182.98	-0.45	-379.45
			Max Tension	18	2680.23	-26.11	3.19
		Diagonal	Max. Compression	5	-2550.35	0.00	0.00
			Max. Mx	20	-718.78	-58.15	1.78
			Max. My	3	-2309.60	-14.47	-5.70
			Max. Vy	20	30.10	0.00	0.00
			Max. Vx	3	2.42	-12.90	-5.70

Maximum Reactions

Location	Condition	Gov. Load Comb.	Vertical lb	Horizontal, X lb	Horizontal, Z lb
Leg C	Max. Vert	10	26200.35	2906.11	-1527.88
	Max. H _x	10	26200.35	2906.11	-1527.88
	Max. H _y	16	-17776.24	-2530.47	1860.53
	Min. Vert	4	-23398.39	-2753.75	1453.25
	Min. H _x	17	-20548.95	-3048.18	1662.54
	Min. H _y	9	22154.05	2188.32	-1668.37
Leg B	Max. Vert	6	26294.23	-2887.62	-1561.07
	Max. H _x	25	-20278.08	3048.75	1658.37
	Max. H _y	26	-17505.33	2530.22	1857.83
	Min. Vert	12	-23304.54	2740.85	1474.40
	Min. H _x	6	26294.23	-2887.62	-1561.07

RISATower Hudson Design Group 1600 Osgood Street, Building 20 North, Suite 2-101 North Andover, MA 01845 Phone: (978)557-5553 FAX: (978)336-5586	Job	CT2120	Page	12 of 18
	Project	50 walls Street, Fairfield, CT 06824	Date	12:16:55 06/27/11
	Client	at&t	Designed by	kw

Location	Condition	Gov. Load Comb.	Vertical lb	Horizontal, X lb	Horizontal, Z lb
Leg A	Min. H _z	7	22247.97	-2164.23	-1711.08
	Max. Vert	2	26286.43	37.99	3281.18
	Max. H _x	11	981.98	750.05	-0.85
	Max. H _z	2	26286.43	37.99	3281.18
	Min. Vert	8	-23312.34	-24.76	-3110.96
	Min. H _x	5	981.96	-749.37	-0.87
	Min. H _z	21	-20538.12	3.90	-3470.60

Tower Mast Reaction Summary

Load Combination	Vertical lb	Shear _x lb	Shear _z lb	Overturning Moment, M _x lb-ft	Overturning Moment, M _z lb-ft	Torque lb-ft
Dead Only	2867.58	-0.00	0.00	-90.33	-187.69	0.00
Dead+Wind 0 deg - No Ice	2867.58	-0.00	-6287.58	-87747.65	-187.86	261.87
Dead+Wind 30 deg - No Ice	2867.58	3019.79	-5230.43	-73730.84	-42704.26	597.15
Dead+Wind 60 deg - No Ice	2867.58	5158.84	-2978.46	-42169.23	-73070.59	817.66
Dead+Wind 90 deg - No Ice	2867.58	6039.58	0.00	-90.42	-85220.51	855.59
Dead+Wind 120 deg - No Ice	2867.58	5445.21	3143.79	43738.23	-76101.20	640.45
Dead+Wind 150 deg - No Ice	2867.58	3019.79	5230.43	73550.19	-42704.23	258.69
Dead+Wind 180 deg - No Ice	2867.58	-0.00	5956.92	84067.53	-187.93	-173.24
Dead+Wind 210 deg - No Ice	2867.58	-3019.79	5230.43	73550.30	42328.47	-597.15
Dead+Wind 240 deg - No Ice	2867.58	-5445.21	3143.79	43738.32	75725.62	-902.27
Dead+Wind 270 deg - No Ice	2867.58	-6039.58	0.00	-90.48	84845.05	-855.59
Dead+Wind 300 deg - No Ice	2867.58	-5158.84	-2978.46	-42169.42	72695.08	-644.32
Dead+Wind 330 deg - No Ice	2867.58	-3019.79	-5230.43	-73731.01	42328.61	-258.69
Dead+Ice+Temp	4695.39	-0.00	-0.00	287.71	-541.81	0.00
Dead+Wind 0 deg+Ice+Temp	4695.39	-0.00	-5702.98	-78832.10	-541.89	40.92
Dead+Wind 30 deg+Ice+Temp	4695.39	2748.31	-4760.21	-66386.85	-39037.00	343.54
Dead+Wind 60 deg+Ice+Temp	4695.39	4700.64	-2713.92	-37852.20	-66602.35	586.84
Dead+Wind 90 deg+Ice+Temp	4695.39	5496.62	0.00	287.30	-77531.53	697.05
Dead+Wind 120 deg+Ice+Temp	4695.39	4938.93	2851.49	39847.61	-69061.89	601.30
Dead+Wind 150 deg+Ice+Temp	4695.39	2748.31	4760.21	66962.87	-39036.55	352.67
Dead+Wind 180 deg+Ice+Temp	4695.39	-0.00	5427.83	76567.89	-542.08	20.65
Dead+Wind 210 deg+Ice+Temp	4695.39	-2748.31	4760.21	66962.92	37952.46	-343.54
Dead+Wind 240 deg+Ice+Temp	4695.39	-4938.93	2851.49	39847.61	67978.03	-642.12
Dead+Wind 270 deg+Ice+Temp	4695.39	-5496.62	0.00	287.16	76447.84	-697.05
Dead+Wind 300 deg+Ice+Temp	4695.39	-4700.64	-2713.92	-37852.45	65518.71	-607.51
Dead+Wind 330 deg+Ice+Temp	4695.39	-2748.31	-4760.21	-66387.06	37953.26	-352.67
Dead+Wind 0 deg - Service	2867.58	-0.00	-3132.91	-43767.37	-187.76	130.48
Dead+Wind 30 deg - Service	2867.58	1504.67	-2606.17	-36783.24	-21372.39	297.50
Dead+Wind 60 deg - Service	2867.58	2570.49	-1484.08	-21057.02	-36503.08	407.36
Dead+Wind 90 deg - Service	2867.58	3009.34	0.00	-90.33	-42556.80	426.35
Dead+Wind 120 deg - Service	2867.58	2713.18	1566.46	21748.13	-38013.13	319.11
Dead+Wind 150 deg - Service	2867.58	1504.67	2606.17	36602.52	-21372.42	128.85
Dead+Wind 180 deg - Service	2867.58	-0.00	2968.15	41843.00	-187.79	-86.33
Dead+Wind 210 deg - Service	2867.58	-1504.67	2606.17	36602.54	20996.87	-297.50
Dead+Wind 240 deg - Service	2867.58	-2713.18	1566.46	21748.14	37637.63	-449.59
Dead+Wind 270 deg - Service	2867.58	-3009.34	0.00	-90.36	42181.34	-426.35
Dead+Wind 300 deg - Service	2867.58	-2570.49	-1484.08	-21057.08	36127.61	-321.03
Dead+Wind 330 deg - Service	2867.58	-1504.67	-2606.17	-36783.29	20996.90	-128.85

Solution Summary

RISATower Hudson Design Group 1600 Osgood Street, Building 20 North, Suite 2-101 North Andover, MA 01845 Phone: (978)557-5553 FAX: (978)336-5586	Job	CT2120	Page	13 of 18
	Project	50 walls Street, Fairfield, CT 06824	Date	12:16:55 06/27/11
	Client	at&t	Designed by	kw

Load Comb.	Sum of Applied Forces			Sum of Reactions			% Error
	PX lb	PY lb	PZ lb	PX lb	PY lb	PZ lb	
1	-0.00	-2867.58	0.00	0.00	2867.58	-0.00	0.000%
2	-0.00	-2867.58	-6287.58	0.00	2867.58	6287.58	0.000%
3	3019.79	-2867.58	-5230.43	-3019.79	2867.58	5230.43	0.000%
4	5158.84	-2867.58	-2978.46	-5158.84	2867.58	2978.46	0.000%
5	6039.58	-2867.58	-0.00	-6039.58	2867.58	-0.00	0.000%
6	5445.21	-2867.58	3143.79	-5445.21	2867.58	-3143.79	0.000%
7	3019.79	-2867.58	5230.43	-3019.79	2867.58	-5230.43	0.000%
8	0.00	-2867.58	5956.92	0.00	2867.58	-5956.92	0.000%
9	-3019.79	-2867.58	5230.43	3019.79	2867.58	-5230.43	0.000%
10	-5445.21	-2867.58	3143.79	5445.21	2867.58	-3143.79	0.000%
11	-6039.58	-2867.58	-0.00	6039.58	2867.58	-0.00	0.000%
12	-5158.84	-2867.58	-2978.46	5158.84	2867.58	2978.46	0.000%
13	-3019.79	-2867.58	-5230.43	3019.79	2867.58	5230.43	0.000%
14	-0.00	-4695.39	-0.00	0.00	4695.39	0.00	0.000%
15	-0.00	-4695.39	-5702.98	0.00	4695.39	5702.98	0.000%
16	2748.31	-4695.39	-4760.21	-2748.31	4695.39	4760.21	0.000%
17	4700.64	-4695.39	-2713.92	-4700.64	4695.39	2713.92	0.000%
18	5496.62	-4695.39	-0.00	-5496.62	4695.39	-0.00	0.000%
19	4938.93	-4695.39	2851.49	-4938.93	4695.39	-2851.49	0.000%
20	2748.31	-4695.39	4760.21	-2748.31	4695.39	-4760.21	0.000%
21	0.00	-4695.39	5427.83	0.00	4695.39	-5427.83	0.000%
22	-2748.31	-4695.39	4760.21	2748.31	4695.39	-4760.21	0.000%
23	-4938.93	-4695.39	2851.49	4938.93	4695.39	-2851.49	0.000%
24	-5496.62	-4695.39	-0.00	5496.62	4695.39	-0.00	0.000%
25	-4700.64	-4695.39	-2713.92	4700.64	4695.39	2713.92	0.000%
26	-2748.31	-4695.39	-4760.21	2748.31	4695.39	4760.21	0.000%
27	0.00	-2867.58	-3132.91	0.00	2867.58	3132.91	0.000%
28	1504.67	-2867.58	-2606.17	-1504.67	2867.58	2606.17	0.000%
29	2570.49	-2867.58	-1484.08	-2570.49	2867.58	1484.08	0.000%
30	3009.34	-2867.58	-0.00	-3009.34	2867.58	-0.00	0.000%
31	2713.18	-2867.58	1566.46	-2713.18	2867.58	-1566.46	0.000%
32	1504.67	-2867.58	2606.17	-1504.67	2867.58	-2606.17	0.000%
33	-0.00	-2867.58	2968.15	0.00	2867.58	-2968.15	0.000%
34	-1504.67	-2867.58	2606.17	1504.67	2867.58	-2606.17	0.000%
35	-2713.18	-2867.58	1566.46	2713.18	2867.58	-1566.46	0.000%
36	-3009.34	-2867.58	0.00	3009.34	2867.58	-0.00	0.000%
37	-2570.49	-2867.58	-1484.08	2570.49	2867.58	1484.08	0.000%
38	-1504.67	-2867.58	-2606.17	1504.67	2867.58	2606.17	0.000%

Non-Linear Convergence Results

Load Combination	Converged?	Number of Cycles	Displacement Tolerance	Force Tolerance
1	Yes	6	0.00000001	0.00000001
2	Yes	6	0.00000001	0.00000001
3	Yes	6	0.00000001	0.00000001
4	Yes	6	0.00000001	0.00000001
5	Yes	6	0.00000001	0.00000001
6	Yes	6	0.00000001	0.00000001
7	Yes	6	0.00000001	0.00000001
8	Yes	6	0.00000001	0.00000001
9	Yes	6	0.00000001	0.00000001
10	Yes	6	0.00000001	0.00000001
11	Yes	6	0.00000001	0.00000001
12	Yes	6	0.00000001	0.00000001
13	Yes	6	0.00000001	0.00000001

RISATower Hudson Design Group 1600 Osgood Street, Building 20 North, Suite 2-101 North Andover, MA 01845 Phone: (978)557-5553 FAX: (978)336-5586	Job	CT2120	Page	14 of 18
	Project	50 walls Street, Fairfield, CT 06824	Date	12:16:55 06/27/11
	Client	at&t	Designed by	kw

14	Yes	6	0.0000001	0.0000001
15	Yes	6	0.0000001	0.0000001
16	Yes	6	0.0000001	0.0000001
17	Yes	6	0.0000001	0.0000001
18	Yes	6	0.0000001	0.0000001
19	Yes	6	0.0000001	0.0000001
20	Yes	6	0.0000001	0.0000001
21	Yes	6	0.0000001	0.0000001
22	Yes	6	0.0000001	0.0000001
23	Yes	6	0.0000001	0.0000001
24	Yes	6	0.0000001	0.0000001
25	Yes	6	0.0000001	0.0000001
26	Yes	6	0.0000001	0.0000001
27	Yes	6	0.0000001	0.0000001
28	Yes	6	0.0000001	0.0000001
29	Yes	6	0.0000001	0.0000001
30	Yes	6	0.0000001	0.0000001
31	Yes	6	0.0000001	0.0000001
32	Yes	6	0.0000001	0.0000001
33	Yes	6	0.0000001	0.0000001
34	Yes	6	0.0000001	0.0000001
35	Yes	6	0.0000001	0.0000001
36	Yes	6	0.0000001	0.0000001
37	Yes	6	0.0000001	0.0000001
38	Yes	6	0.0000001	0.0000001

Maximum Tower Deflections - Service Wind

Section No.	Elevation ft	Horz. Deflection in	Gov. Load Comb.	Tilt °	Twist °
T1	71.25 - 68.75	0.135	27	0.0396	0.0052
T2	68.75 - 63.75	0.114	27	0.0392	0.0047
T3	63.75 - 58.75	0.070	27	0.0359	0.0034
T4	58.75 - 53.75	0.031	31	0.0266	0.0022
T5	53.75 - 51.25	0.005	31	0.0109	0.0007

Critical Deflections and Radius of Curvature - Service Wind

Elevation ft	Appurtenance	Gov. Load Comb.	Deflection in	Tilt °	Twist °	Radius of Curvature ft
71.25	27' whip antenna	27	0.135	0.0396	0.0052	712417
69.25	Powerwave 7770.00 w/mount pipe	27	0.118	0.0393	0.0048	712417
69.00	Pirod 4' Side Mount Standoff (1)	27	0.116	0.0393	0.0048	712417
68.25	(2) Powerwave tma	27	0.110	0.0391	0.0046	712417
67.00	(2) Ericsson RRU w/support frame	27	0.099	0.0386	0.0043	712417
60.00	GPS	31	0.039	0.0295	0.0026	26460

Maximum Tower Deflections - Design Wind

RISATower Hudson Design Group 1600 Osgood Street, Building 20 North, Suite 2-101 North Andover, MA 01845 Phone: (978)557-5553 FAX: (978)336-5586	Job	CT2120	Page	15 of 18
	Project	50 walls Street, Fairfield, CT 06824	Date	12:16:55 06/27/11
	Client	at&t	Designed by	kw

Section No.	Elevation ft	Horz. Deflection in	Gov. Load Comb.	Tilt °	Twist °
T1	71.25 - 68.75	0.270	2	0.0794	0.0103
T2	68.75 - 63.75	0.229	2	0.0786	0.0094
T3	63.75 - 58.75	0.140	2	0.0719	0.0069
T4	58.75 - 53.75	0.061	6	0.0534	0.0045
T5	53.75 - 51.25	0.010	6	0.0218	0.0015

Critical Deflections and Radius of Curvature - Design Wind

Elevation ft	Appurtenance	Gov. Load Comb.	Deflection in	Tilt °	Twist °	Radius of Curvature ft
71.25	27' whip antenna	2	0.270	0.0794	0.0103	375604
69.25	Powerwave 7770.00 w/mount pipe	2	0.237	0.0788	0.0096	375604
69.00	Pirot 4' Side Mount Standoff (1)	2	0.233	0.0787	0.0095	375604
68.25	(2) Powerwave tma	2	0.220	0.0783	0.0092	375604
67.00	(2) Ericsson RRU w/support frame	2	0.198	0.0773	0.0086	375604
60.00	GPS	6	0.079	0.0591	0.0052	13201

Compression Checks

Leg Design Data (Compression)

Section No.	Elevation ft	Size	L ft	L _u ft	Kl/r	F _a ksi	A in ²	Actual P lb	Allow. P _a lb	Ratio P/P _a
T1	71.25 - 68.75	bent plate (1/4")	2.50	2.50	42.3 K=1.00	19.002	2.2500	-1708.51	42753.40	0.040
T2	68.75 - 63.75	bent plate (1/4")	5.00	5.00	84.7 K=1.00	14.828	2.2500	-4090.13	33362.90	0.123
T3	63.75 - 58.75	bent plate (1/4")	5.00	5.00	84.7 K=1.00	14.828	2.2500	-10599.70	33362.90	0.318
T4	58.75 - 53.75	bent plate (1/4")	5.00	5.00	84.7 K=1.00	14.828	2.2500	-17398.30	33362.90	0.521
T5	53.75 - 51.25	bent plate (1/4")	2.50	2.50	42.3 K=1.00	19.002	2.2500	-23923.00	42753.40	0.560

Diagonal Design Data (Compression)

Section No.	Elevation ft	Size	L ft	L _u ft	Kl/r	F _a ksi	A in ²	Actual P lb	Allow. P _a lb	Ratio P/P _a
T1	71.25 - 68.75	L2x2x1/4	4.72	2.36	72.4 K=1.00	16.181	0.9380	-493.81	15177.90	0.033
T2	68.75 - 63.75	L2x2x1/4	6.40	3.20	98.3	13.197	0.9380	-2129.18	12378.90	0.172

RISATower Hudson Design Group 1600 Osgood Street, Building 20 North, Suite 2-101 North Andover, MA 01845 Phone: (978)557-5553 FAX: (978)336-5586	Job	CT2120	Page	16 of 18
	Project	50 walls Street, Fairfield, CT 06824	Date	12:16:55 06/27/11
	Client	at&t	Designed by	kw

Section No.	Elevation ft	Size	L ft	L _u ft	Kl/r	F _a ksi	A in ²	Actual P lb	Allow. P _a lb	Ratio $\frac{P}{P_a}$
T3	63.75 - 58.75	L2x2x1/4	6.40	3.20	K=1.00 98.3	13.197	0.9380	-2495.12	12378.90	0.202
T4	58.75 - 53.75	L2x2x1/4	6.40	3.20	K=1.00 98.3	13.197	0.9380	-3075.77	12378.90	0.248
T5	53.75 - 51.25	L2x2x1/4	4.72	2.36	K=1.00 72.4	16.181	0.9380	-2550.35	15177.90	0.168

Top Girt Design Data (Compression)

Section No.	Elevation ft	Size	L ft	L _u ft	Kl/r	F _a ksi	A in ²	Actual P lb	Allow. P _a lb	Ratio $\frac{P}{P_a}$
T1	71.25 - 68.75	L2 1/2x2 1/2x1/4	4.00	4.00	97.8 K=1.00	13.259	1.1900	-322.17	15778.70	0.020

Tension Checks

Leg Design Data (Tension)

Section No.	Elevation ft	Size	L ft	L _u ft	Kl/r	F _a ksi	A in ²	Actual P lb	Allow. P _a lb	Ratio $\frac{P}{P_a}$
T1	71.25 - 68.75	bent plate (1/4")	2.50	2.50	42.3	21.600	2.2500	806.72	48600.00	0.017
T2	68.75 - 63.75	bent plate (1/4")	5.00	5.00	84.7	21.600	2.2500	3116.64	48600.00	0.064
T3	63.75 - 58.75	bent plate (1/4")	5.00	5.00	84.7	21.600	2.2500	8787.21	48600.00	0.181
T4	58.75 - 53.75	bent plate (1/4")	5.00	5.00	84.7	21.600	2.2500	15245.90	48600.00	0.314
T5	53.75 - 51.25	bent plate (1/4")	2.50	2.50	42.3	21.600	2.2500	21197.40	48600.00	0.436

Diagonal Design Data (Tension)

Section No.	Elevation ft	Size	L ft	L _u ft	Kl/r	F _a ksi	A in ²	Actual P lb	Allow. P _a lb	Ratio $\frac{P}{P_a}$
T1	71.25 - 68.75	L2x2x1/4	4.72	2.36	46.5	21.600	0.9380	696.26	20260.80	0.034
T2	68.75 - 63.75	L2x2x1/4	6.40	3.20	63.1	21.600	0.9380	1950.38	20260.80	0.096

RISATower Hudson Design Group 1600 Osgood Street, Building 20 North, Suite 2-101 North Andover, MA 01845 Phone: (978)557-5553 FAX: (978)336-5586	Job	CT2120	Page	17 of 18
	Project	50 walls Street, Fairfield, CT 06824	Date	12:16:55 06/27/11
	Client	at&t	Designed by	kw

Section No.	Elevation ft	Size	L ft	L _u ft	Kl/r	F _a ksi	A in ²	Actual P lb	Allow. P _a lb	Ratio $\frac{P}{P_a}$
T3	63.75 - 58.75	L2x2x1/4	6.40	3.20	63.1	21.600	0.9380	2597.19	20260.80	0.128 ✓
T4	58.75 - 53.75	L2x2x1/4	6.40	3.20	63.1	21.600	0.9380	2908.71	20260.80	0.144 ✓
T5	53.75 - 51.25	L2x2x1/4	4.72	2.36	46.5	21.600	0.9380	2680.23	20260.80	0.132 ✓

Top Girt Design Data (Tension)

Section No.	Elevation ft	Size	L ft	L _u ft	Kl/r	F _a ksi	A in ²	Actual P lb	Allow. P _a lb	Ratio $\frac{P}{P_a}$
T1	71.25 - 68.75	L2 1/2x2 1/2x1/4	4.00	4.00	62.4	21.600	1.1900	127.42	25704.00	0.005 ✓

Section Capacity Table

Section No.	Elevation ft	Component Type	Size	Critical Element	P lb	SF*P _{allow} lb	% Capacity	Pass Fail
T1	71.25 - 68.75	Leg	bent plate (1/4")	1	-1708.51	56990.28	3.0	Pass
		Leg	bent plate (1/4")	2	-1620.26	56990.28	2.8	Pass
		Leg	bent plate (1/4")	3	-1640.85	56990.28	2.9	Pass
		Diagonal	L2x2x1/4	7	553.12	27007.65	2.0	Pass
		Diagonal	L2x2x1/4	8	696.26	27007.65	2.6	Pass
		Diagonal	L2x2x1/4	9	540.51	27007.65	2.0	Pass
		Diagonal	L2x2x1/4	10	537.33	27007.65	2.0	Pass
		Diagonal	L2x2x1/4	11	696.04	27007.65	2.6	Pass
		Diagonal	L2x2x1/4	12	556.48	27007.65	2.1	Pass
		Top Girt	L2 1/2x2 1/2x1/4	4	-322.17	21033.01	1.5	Pass
T2	68.75 - 63.75	Top Girt	L2 1/2x2 1/2x1/4	5	-321.77	21033.01	1.5	Pass
		Top Girt	L2 1/2x2 1/2x1/4	6	-322.03	21033.01	1.5	Pass
		Leg	bent plate (1/4")	13	-4090.13	44472.74	9.2	Pass
		Leg	bent plate (1/4")	14	-4053.99	44472.74	9.1	Pass
		Leg	bent plate (1/4")	15	-4076.51	44472.74	9.2	Pass
		Diagonal	L2x2x1/4	16	-2100.41	16501.07	12.7	Pass
		Diagonal	L2x2x1/4	17	-2129.18	16501.07	12.9	Pass
		Diagonal	L2x2x1/4	18	-1856.70	16501.07	11.3	Pass
		Diagonal	L2x2x1/4	19	-1861.43	16501.07	11.3	Pass
		Diagonal	L2x2x1/4	20	-2115.66	16501.07	12.8	Pass
T3	63.75 - 58.75	Diagonal	L2x2x1/4	21	-2079.12	16501.07	12.6	Pass
		Leg	bent plate (1/4")	22	-10535.80	44472.74	23.7	Pass
		Leg	bent plate (1/4")	23	-10599.70	44472.74	23.8	Pass
		Leg	bent plate (1/4")	24	-10492.00	44472.74	23.6	Pass
		Diagonal	L2x2x1/4	25	-2495.12	16501.07	15.1	Pass
		Diagonal	L2x2x1/4	26	-2494.75	16501.07	15.1	Pass
		Diagonal	L2x2x1/4	27	-2230.95	16501.07	13.5	Pass
		Diagonal	L2x2x1/4	28	-2231.05	16501.07	13.5	Pass
		Diagonal	L2x2x1/4	29	-2370.29	16501.07	14.4	Pass
		Diagonal	L2x2x1/4	30	-2370.55	16501.07	14.4	Pass
T4	58.75 - 53.75	Leg	bent plate (1/4")	31	-17332.50	44472.74	39.0	Pass

RISATower Hudson Design Group 1600 Osgood Street, Building 20 North, Suite 2-101 North Andover, MA 01845 Phone: (978)557-5553 FAX: (978)336-5586	Job	CT2120	Page	18 of 18
	Project	50 walls Street, Fairfield, CT 06824	Date	12:16:55 06/27/11
	Client	at&t	Designed by	kw

Section No.	Elevation ft	Component Type	Size	Critical Element	P lb	SF*P _{allow} lb	% Capacity	Pass Fail	
T5	53.75 - 51.25	Leg	bent plate (1/4")	32	-17398.30	44472.74	39.1	Pass	
		Leg	bent plate (1/4")	33	-17396.50	44472.74	39.1	Pass	
		Diagonal	L2x2x1/4	34	-3075.77	16501.07	18.6	Pass	
		Diagonal	L2x2x1/4	35	-3075.61	16501.07	18.6	Pass	
		Diagonal	L2x2x1/4	36	-2828.45	16501.07	17.1	Pass	
		Diagonal	L2x2x1/4	37	-2828.47	16501.07	17.1	Pass	
		Diagonal	L2x2x1/4	38	-2910.09	16501.07	17.6	Pass	
		Diagonal	L2x2x1/4	39	-2910.23	16501.07	17.6	Pass	
		Leg	bent plate (1/4")	40	-23829.60	56990.28	41.8	Pass	
		Leg	bent plate (1/4")	41	-23923.00	56990.28	42.0	Pass	
		Leg	bent plate (1/4")	42	-23915.20	56990.28	42.0	Pass	
		Diagonal	L2x2x1/4	43	-2549.96	20232.14	12.6	Pass	
		Diagonal	L2x2x1/4	44	-2550.35	20232.14	12.6	Pass	
		Diagonal	L2x2x1/4	45	-2358.72	20232.14	11.7	Pass	
		Diagonal	L2x2x1/4	46	-2358.70	20232.14	11.7	Pass	
		Diagonal	L2x2x1/4	47	-2313.99	20232.14	11.4	Pass	
		Diagonal	L2x2x1/4	48	-2313.63	20232.14	11.4	Pass	
									Summary
							Leg (T5)	42.0	Pass
							Diagonal (T4)	18.6	Pass
							Top Girt (T1)	1.5	Pass
							RATING =	42.0	Pass

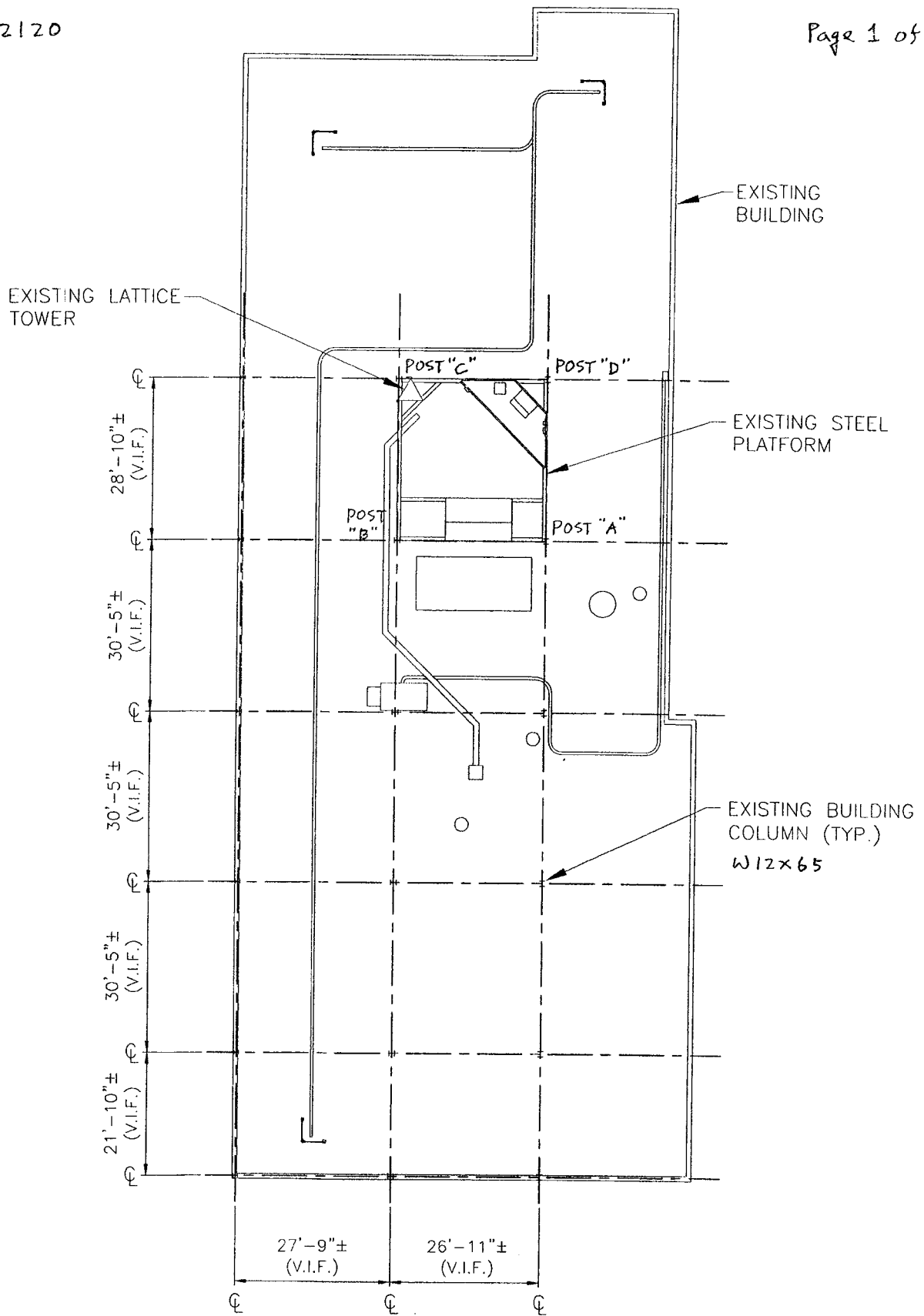

APPROX.
TRUE NORTH



ROOF PLAN

SCALE: NTS

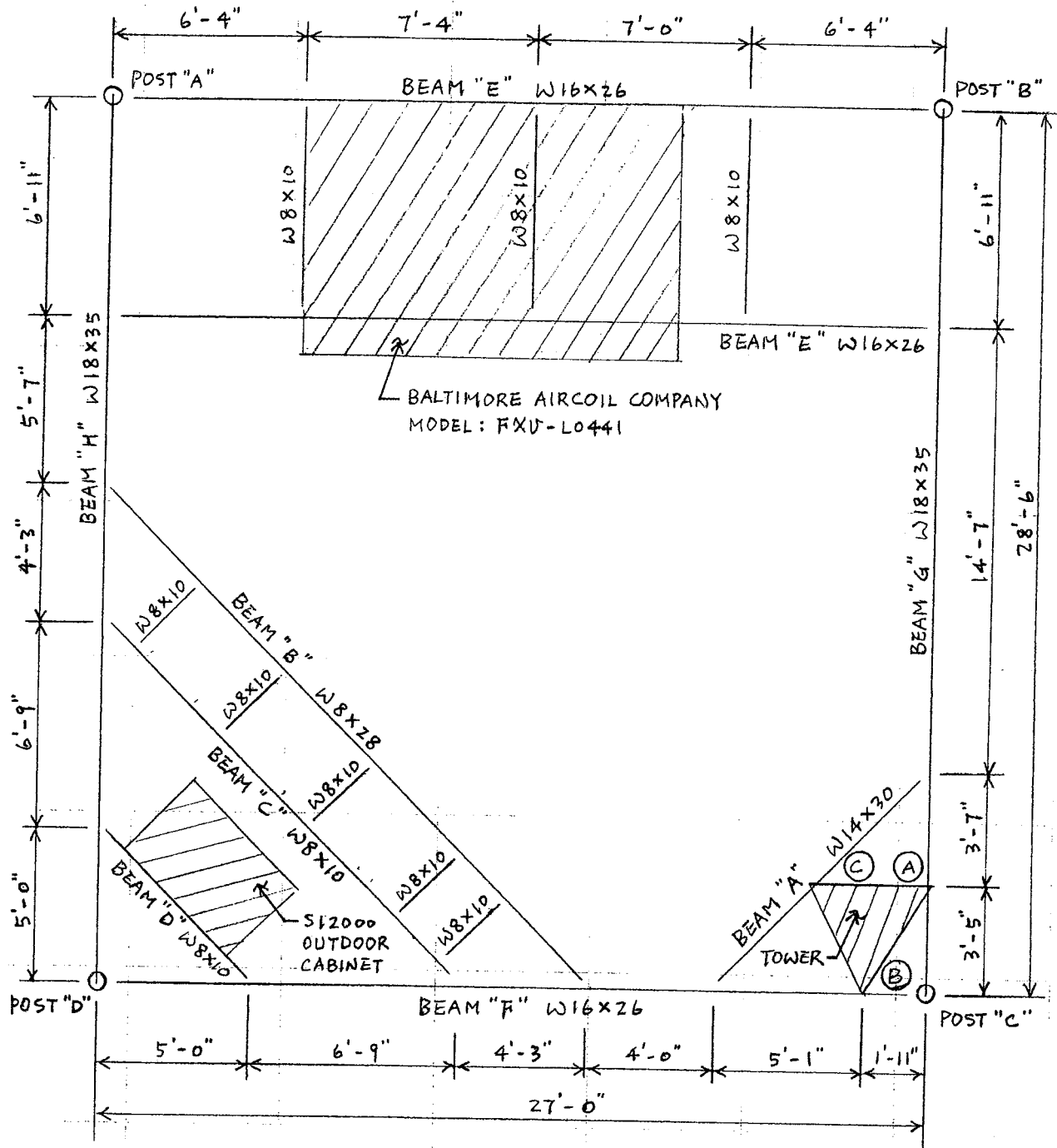



BEAM "A" W14x30 (SPAN LENGTH \approx 9.9')

DEAD LOAD \approx 30 lb/ft

SNOW LOAD \approx 30 psf \times 6.75"/12 = 17 lb/ft

REACTION FROM TOWER LEG C = 26158 lbs

W14x30 OK (SEE Page 8)

BEAM "B" W8x28 (SPAN LENGTH \approx 22.6')

DEAD LOAD

GRATING \approx 20 psf \times 1.5' = 30 lb/ft

RAIL \approx 15 lb/ft

BEAM & CROSS BEAMS \approx 32 lb/ft

77 lb/ft

SNOW & DRIFT \approx 40 psf \times 1.5' = 60 lb/ft

W8x28 OK (SEE Page 9)

BEAM "C" W8x10 (SPAN LENGTH \approx 16.6')

DEAD LOAD

GRATING \approx 20 psf \times 3.9' = 78 lb/ft

BEAM & CROSS BEAMS \approx 15 lb/ft

S12000 $\frac{1257 \text{ lbs}}{4.5'} \times \frac{1.88}{4.77} = 110 \text{ lb/ft}$

SNOW & DRIFT \approx 40 psf \times 3.9' = 156 lb/ft

W8x10 OK (SEE Page 10)



BEAM "D" W8x10 (SPAN LENGTH \approx 7.1')

DEAD LOAD

$$\text{GRATING} \approx 20 \text{ psf} \times 4.2' = 84 \text{ lb/ft}$$

$$\text{BEAM} \approx 10 \text{ lb/ft}$$

$$512000 \frac{1257 \text{ lbs}}{4.5} \times \frac{2.89}{4.77} = 169 \text{ lb/ft}$$

$$\text{SNOW} \& \text{ DRIFT} \approx 40 \text{ psf} \times 4.2' = 168 \text{ lb/ft}$$

W8x10 OK (SEE Page 11)

BEAM "E" W16x26 (SPAN LENGTH = 27')

DEAD LOAD

$$\text{BEAM} \& \text{ CROSS BEAMS} \approx 30 \text{ lb/ft}$$

$$\text{CHILLER} \approx 14200 \text{ lbs} / (2 \times 12.1') = 587 \text{ lb/ft}$$

$$\text{SNOW LOAD} \approx 30 \text{ psf} \times 4.2' = 126 \text{ lb/ft}$$

W16x26 OK (SEE Page 12)

BEAM "F" W16x26 (SPAN LENGTH = 27')

$$\text{BEAM WT.} = 26 \text{ lb/ft}$$

$$\text{LOADING FROM BEAM "A"} = 13708 \text{ lbs}$$

$$\text{" " " "B"} = 1548$$

$$\text{" " " "C"} = 2314$$

$$\text{" " " "D"} = 1310$$

W16x26 OK (SEE Page 13)

DATE: _____
Project Name: FAIRFIELD - CENTRAL
Project No.: CT2120
Design By: KW Chk'd By: _____ Page 5 of 15



BEAM "G" W18x35 (SPAN LENGTH = 28.5')

BEAM WT. = 35 lb/ft

LOADING FROM BEAM "A" = 12915 lbs

" " " "E" = 4361 lbs

W18x35 OK (SEE Page 14)

BEAM "H" W18x35 (SPAN LENGTH = 28.5')

BEAM WT. = 35 lb/ft

LOADING FROM BEAM "B" = 1548 lbs

" " " "C" = 2314

" " " "D" = 1310

" " " "E" = 5077

W18x35 OK (SEE Page 15)

DATE: 5/27/2011
Project Name: FAIRFIELD - CENTRAL
Project No.: CT 2120
Design By: KW Chk'd By: _____ Page 6 of 15



POST "A"

LOADING FROM BEAM E = 5077 lbs

" " " H = 6396 lbs

11473 lbs

POST "B"

LOADING FROM BEAM "E" = 4361 lbs

" " " "G" = 6973 lbs

11334 lbs

POST "C"

LOADING FROM BEAM "G" = 11301 lbs

" " " "F" = 12676 lbs

23977 lbs

POST "D"

LOADING FROM BEAM "F" = 6906 lbs

" " " "H" = 4851 lbs

11757 lbs

CHECK INTERIOR BUILDING COLUMN UNDER STEEL PLATFORM

$$\text{TRIB. AREA} = 27.3' \times 30' = 819 \text{ ft}^2$$

ROOF

$$DL \approx 40 \text{ psf} \times 819 / 1000 = 32.8 \text{ kips}$$

$$SL \approx 35 \text{ psf} \times 819 / 1000 = 28.7 \text{ kips}$$

3rd FLOOR

$$DL \approx 75 \text{ psf} \times 819 / 1000 = 61.4 \text{ kips}$$

$$LL \approx 60 \text{ psf} \times 819 / 1000 = 49.1 \text{ kips}$$

2nd FLOOR

$$DL = 61.4 \text{ kips}$$

$$LL = 49.1 \text{ kips}$$

1st FLOOR

$$DL = 61.4 \text{ kips}$$

$$LL = 49.1 \text{ kips}$$

LOADING FROM STEEL PLATFORM

$$\text{POST "C"} = 24.0 \text{ kips}$$

TOTAL LOAD @ INTERIOR COLUMN = 417 kips

$$W12 \times 65 \text{ COLUMN } P_n / \Omega_c = 456 \text{ kips} > 417 \text{ kips} \quad \text{OK}$$

Project: support beams

Location: Beam A
Multi-Loaded Multi-Sp
[2009 International Buil
A992-50 W14x30 x 9.9
FT

Section Adequate By:
Controlling Factor: Mo

DEFLECTIONS		Center
Live Load	0.00	IN L/MAX
Dead Load	0.11	in
Total Load	0.11	IN L/1087
Live Load Deflection Criteria: L/360 Total Load Deflection Criteria: L/240		

REACTIONS		
	A	B
Live Load	84 lb	84 lb
Dead Load	13624 lb	12831 lb
Total Load	13708 lb	12915 lb
Bearing Length	0.79 in	0.79 in

BEAM DATA		Center
Span Length	9.9	ft
Unbraced Length-Top	9.9	ft
Unbraced Length-Bottom	9.9	ft

STEEL PROPERTIES
W14x30 - A992-50

Properties:

Yield Stress:	Fy =	50 ksi
Modulus of Elasticity:	E =	29000 ksi
Depth:	d =	13.8 in
Web Thickness:	tw =	0.27 in
Flange Width:	bf =	6.73 in
Flange Thickness:	tf =	0.39 in
Distance to Web Toe of Fillet:	k =	0.79 in
Moment of Inertia About X-X Axis:	Ix =	291 in ⁴
Section Modulus About X-X Axis:	Sx =	42 in ³
Plastic Section Modulus About X-X Axis:	Zx =	47.3 in ³

Design Properties per AISC 13th Edition Steel Manual:

Flange Buckling Ratio:	FBR =	8.74
Allowable Flange Buckling Ratio:	AFBR =	9.15
Web Buckling Ratio:	WBR =	45.3
Allowable Web Buckling Ratio:	AWBR =	90.55
Controlling Unbraced Length:	Lb =	9.9 ft
Limiting Unbraced Length -		
for lateral-torsional buckling:	Lp =	5.26 ft
for Eqn. F2-2:	Lr =	14.84 ft
Nominal Flexural Strength w/ safety factor:	Mn =	96396 ft-lb
Controlling Equation:	F2-2	
Web height to thickness ratio:	h/tw =	45.3
Limiting height to thickness ratio for eqn. G2-2: h/tw-limit =		53.95
Cv Factor:	Cv =	1
Controlling Equation:	G2-2	
Nominal Shear Strength w/ safety factor:	Vn =	74520 lb

Controlling Moment: 64610 ft-lb

4.85 Ft from left support of span 2 (Center Span)

Created by combining all dead loads and live loads on span(s) 2

Controlling Shear: 13708 lb

At left support of span 2 (Center Span)

Created by combining all dead loads and live loads on span(s)

Comparisons with required sections:	Req'd	Provided
Moment of Inertia (deflection):	64.26 in ⁴	291 in ⁴
Moment:	64610 ft-lb	96396 ft-lb
Shear:	13708 lb	74520 lb

LOADING DIAGRAM

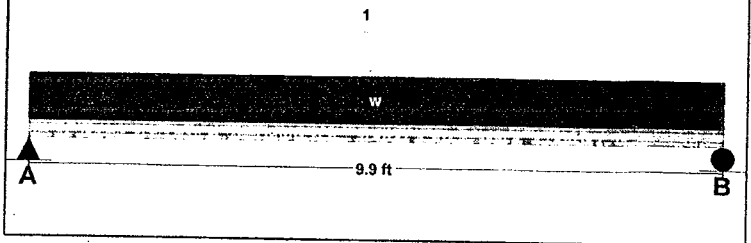

UNIFORM LOADS		Center
Uniform Live Load	17	plf
Uniform Dead Load	0	plf
Beam Self Weight	30	plf
Total Uniform Load	47	plf

POINT LOADS - CENTER SPAN	
Load Number	One
Live Load	0 lb
Dead Load	26158 lb
Location	4.8 ft

Project: support beams

Location: Beam B
Multi-Loaded Multi-Sp
[2009 International Buil
A992-50 W8x28 x 22.6
FT

Section Adequate By:
Controlling Factor: Defl

LOADING DIAGRAM

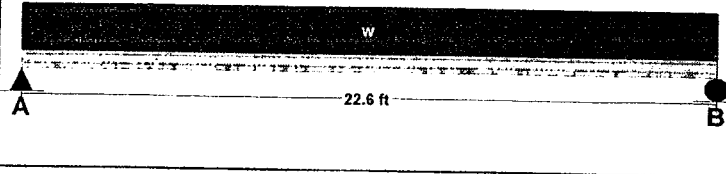

DEFLECTIONS		Center
Live Load	0.12	IN L/2189
Dead Load	0.16	in
Total Load	0.28	IN L/959
Live Load Deflection Criteria: L/360 Total Load Deflection Criteria: L/240		

REACTIONS		
	A	B
Live Load	678 lb	678 lb
Dead Load	870 lb	870 lb
Total Load	1548 lb	1548 lb
Bearing Length	0.86 in	0.86 in

BEAM DATA		Center
Span Length	22.6	ft
Unbraced Length-Top	4	ft
Unbraced Length-Bottom	4	ft

UNIFORM LOADS		Center
Uniform Live Load	60	plf
Uniform Dead Load	49	plf
Beam Self Weight	28	plf
Total Uniform Load	137	plf

STEEL PROPERTIES

W8x28 - A992-50

Properties:

Yield Stress:	Fy =	50	ksi
Modulus of Elasticity:	E =	29000	ksi
Depth:	d =	8.06	in
Web Thickness:	tw =	0.29	in
Flange Width:	bf =	6.54	in
Flange Thickness:	tf =	0.47	in
Distance to Web Toe of Fillet:	k =	0.86	in
Moment of Inertia About X-X Axis:	Ix =	98	in ⁴
Section Modulus About X-X Axis:	Sx =	24.3	in ³
Plastic Section Modulus About X-X Axis:	Zx =	27.2	in ³

Design Properties per AISC 13th Edition Steel Manual:

Flange Buckling Ratio:	FBR =	7.03
Allowable Flange Buckling Ratio:	AFBR =	9.15
Web Buckling Ratio:	WBR =	22.25
Allowable Web Buckling Ratio:	AWBR =	90.55
Controlling Unbraced Length:	Lb =	4 ft
Limiting Unbraced Length -		
for lateral-torsional buckling:	Lp =	5.72 ft
Nominal Flexural Strength w/ safety factor:	Mn =	67864 ft-lb
Controlling Equation:	F2-1	
Web height to thickness ratio:	h/tw =	22.25
Limiting height to thickness ratio for eqn. G2-2: h/tw-limit =		53.95
Cv Factor:	Cv =	1
Controlling Equation:	G2-2	
Nominal Shear Strength w/ safety factor:	Vn =	45942 lb

Controlling Moment: 8747 ft-lb

11.3 Ft from left support of span 2 (Center Span)

Created by combining all dead loads and live loads on span(s) 2

Controlling Shear: -1548 lb

23.0 Ft from left support of span 2 (Center Span)

Created by combining all dead loads and live loads on span(s)

Comparisons with required sections:	Req'd	Provided
Moment of Inertia (deflection):	24.54 in ⁴	98 in ⁴
Moment:	8747 ft-lb	67864 ft-lb
Shear:	-1548 lb	45942 lb

Project: support beams

Location: Beam C
Multi-Loaded Multi-Sp
[2009 International Buil
A992-50 W8x10 x 16.6
FT

Section Adequate By:
Controlling Factor: Defl

DEFLECTIONS		Center
Live Load	0.30	IN L/668
Dead Load	0.27	in
Total Load	0.56	IN L/353
Live Load Deflection Criteria: L/360 Total Load Deflection Criteria: L/240		

REACTIONS		
	A	B
Live Load	1295 lb	1295 lb
Dead Load	1019 lb	1019 lb
Total Load	2314 lb	2314 lb
Bearing Length	0.51 in	0.51 in

BEAM DATA		Center
Span Length	16.6	ft
Unbraced Length-Top	4	ft
Unbraced Length-Bottom	4	ft

STEEL PROPERTIES
W8x10 - A992-50

Properties:

Yield Stress:	Fy =	50	ksi
Modulus of Elasticity:	E =	29000	ksi
Depth:	d =	7.89	in
Web Thickness:	tw =	0.17	in
Flange Width:	bf =	3.94	in
Flange Thickness:	tf =	0.21	in
Distance to Web Toe of Fillet:	k =	0.51	in
Moment of Inertia About X-X Axis:	Ix =	30.8	in ⁴
Section Modulus About X-X Axis:	Sx =	7.81	in ³
Plastic Section Modulus About X-X Axis:	Zx =	8.87	in ³

Design Properties per AISC 13th Edition Steel Manual:

Flange Buckling Ratio:	FBR =	9.61
Allowable Flange Buckling Ratio:	AFBR =	9.15
Web Buckling Ratio:	WBR =	40.47
Allowable Web Buckling Ratio:	AWBR =	90.55
Controlling Unbraced Length:	Lb =	4 ft
Limiting Unbraced Length -		
for lateral-torsional buckling:	Lp =	2.97 ft
for Eqn. F2-2:	Lr =	8.52 ft
Nominal Flexural Strength w/ safety factor:	Mn =	20556 ft-lb
Controlling Equation:	F2-2	
Web height to thickness ratio:	h/tw =	40.47
Limiting height to thickness ratio for eqn. G2-2: h/tw-limit =		53.95
Cv Factor:	Cv =	1
Controlling Equation:	G2-2	
Nominal Shear Strength w/ safety factor:	Vn =	26826 lb

Controlling Moment: 10353 ft-lb

8.3 Ft from left support of span 2 (Center Span)

Created by combining all dead loads and live loads on span(s) 2

Controlling Shear: 2314 lb

At left support of span 2 (Center Span)

Created by combining all dead loads and live loads on span(s)

Comparisons with required sections:	Req'd	Provided
Moment of Inertia (deflection):	20.94 in ⁴	30.8 in ⁴
Moment:	10353 ft-lb	20556 ft-lb
Shear:	2314 lb	26826 lb

LOADING DIAGRAM

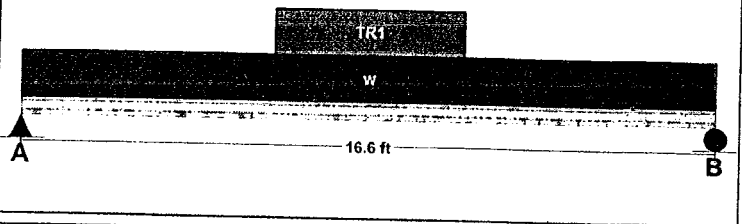

UNIFORM LOADS Center

Uniform Live Load	156	plf
Uniform Dead Load	83	plf
Beam Self Weight	10	plf
Total Uniform Load	249	plf

TRAPEZOIDAL LOADS - CENTER SPAN

Load Number	One
Left Live Load	0 plf
Left Dead Load	110 plf
Right Live Load	0 plf
Right Dead Load	110 plf
Load Start	6.05 ft
Load End	10.55 ft
Load Length	4.5 ft

Project: support beams

Location: Beam D
Multi-Loaded Multi-Sp
[2009 International Buil
A992-50 W8x10 x 7.1
FT

Section Adequate By:
Controlling Factor: Mo

LOADING DIAGRAM

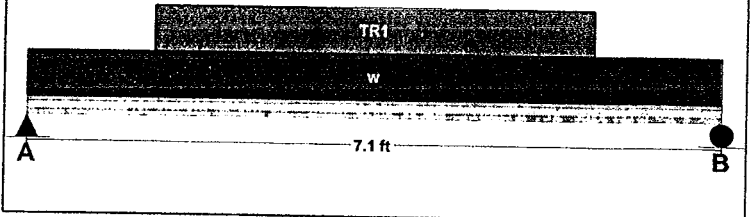

DEFLECTIONS		Center
Live Load	0.01	IN L/7924
Dead Load	0.02	in
Total Load	0.03	IN L/3292
Live Load Deflection Criteria: L/360 Total Load Deflection Criteria: L/240		

REACTIONS		A	B
Live Load	596 lb	596 lb	
Dead Load	714 lb	714 lb	
Total Load	1310 lb	1310 lb	
Bearing Length	0.51 in	0.51 in	

BEAM DATA		Center
Span Length	7.1	ft
Unbraced Length-Top	7.1	ft
Unbraced Length-Bottom	7.1	ft

STEEL PROPERTIES

W8x10 - A992-50

Properties:

Yield Stress:	Fy =	50	ksi
Modulus of Elasticity:	E =	29000	ksi
Depth:	d =	7.89	in
Web Thickness:	tw =	0.17	in
Flange Width:	bf =	3.94	in
Flange Thickness:	tf =	0.21	in
Distance to Web Toe of Fillet:	k =	0.51	in
Moment of Inertia About X-X Axis:	Ix =	30.8	in4
Section Modulus About X-X Axis:	Sx =	7.81	in3
Plastic Section Modulus About X-X Axis:	Zx =	8.87	in3

Design Properties per AISC 13th Edition Steel Manual:

Flange Buckling Ratio:	FBR =	9.61
Allowable Flange Buckling Ratio:	AFBR =	9.15
Web Buckling Ratio:	WBR =	40.47
Allowable Web Buckling Ratio:	AWBR =	90.55
Controlling Unbraced Length:	Lb =	7.1 ft
Limiting Unbraced Length -		
for lateral-torsional buckling:	Lp =	2.97 ft
for Eqn. F2-2:	Lr =	8.52 ft
Nominal Flexural Strength w/ safety factor:	Mn =	15814 ft-lb
Controlling Equation:		
Web height to thickness ratio:	h/tw =	40.47
Limiting height to thickness ratio for eqn. G2-2:	h/tw-limit =	53.95
Cv Factor:	Cv =	1
Controlling Equation:		
Nominal Shear Strength w/ safety factor:	Vn =	26826 lb

Controlling Moment: 2573 ft-lb

3.55 Ft from left support of span 2 (Center Span)

Created by combining all dead loads and live loads on span(s) 2

Controlling Shear: -1310 lb

7.0 Ft from left support of span 2 (Center Span)

Created by combining all dead loads and live loads on span(s)

Comparisons with required sections:	Req'd	Provided
Moment of Inertia (deflection):	2.25 in4	30.8 in4
Moment:	2573 ft-lb	15814 ft-lb
Shear:	-1310 lb	26826 lb

UNIFORM LOADS		Center
Uniform Live Load	168	plf
Uniform Dead Load	84	plf
Beam Self Weight	10	plf
Total Uniform Load	262	plf

TRAPEZOIDAL LOADS - CENTER SPAN	
Load Number	One
Left Live Load	0 plf
Left Dead Load	169 plf
Right Live Load	0 plf
Right Dead Load	169 plf
Load Start	1.3 ft
Load End	5.8 ft
Load Length	4.5 ft

Project: support beams

Location: Beam E
Multi-Loaded Multi-Sp
[2009 International Buil
A992-50 W16x26 x
27.0 FT

Section Adequate By:
Controlling Factor: Mo

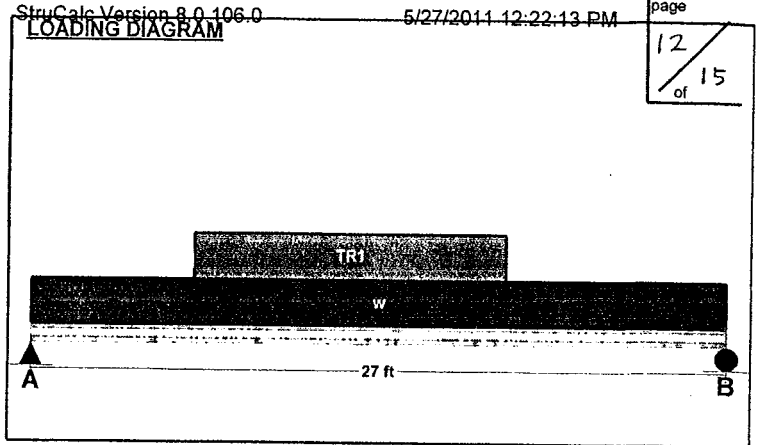

DEFLECTIONS		Center
Live Load	0.11	IN L/2899
Dead Load	0.56	in
Total Load	0.67	IN L/481
Live Load Deflection Criteria: L/360 Total Load Deflection Criteria: L/240		

REACTIONS		
	A	B
Live Load	826 lb	699 lb
Dead Load	4251 lb	3662 lb
Total Load	5077 lb	4361 lb
Bearing Length	0.75 in	0.75 in

BEAM DATA		Center
Span Length	27	ft
Unbraced Length-Top	7.34	ft
Unbraced Length-Bottom	7.34	ft

STEEL PROPERTIES
W16x26 - A992-50

Properties:

Yield Stress:	Fy =	50	ksi
Modulus of Elasticity:	E =	29000	ksi
Depth:	d =	15.7	in
Web Thickness:	tw =	0.25	in
Flange Width:	bf =	5.5	in
Flange Thickness:	tf =	0.35	in
Distance to Web Toe of Fillet:	k =	0.75	in
Moment of Inertia About X-X Axis:	Ix =	301	in ⁴
Section Modulus About X-X Axis:	Sx =	38.4	in ³
Plastic Section Modulus About X-X Axis:	Zx =	44.2	in ³

Design Properties per AISC 13th Edition Steel Manual:

Flange Buckling Ratio:	FBR =	7.97
Allowable Flange Buckling Ratio:	AFBR =	9.15
Web Buckling Ratio:	WBR =	56.82
Allowable Web Buckling Ratio:	AWBR =	90.55
Controlling Unbraced Length:	Lb =	7.34 ft
Limiting Unbraced Length -		
for lateral-torsional buckling:	Lp =	3.96 ft
for Eqn. F2-2:	Lr =	11.17 ft
Nominal Flexural Strength w/ safety factor:	Mn =	90015 ft-lb
Controlling Equation:	F2-2	
Web height to thickness ratio:	h/tw =	56.82
Limiting height to thickness ratio for eqn. G2-2:	h/tw-limit =	53.95
Cv Factor:	Cv =	1
Controlling Equation:	G2-3	
Nominal Shear Strength w/ safety factor:	Vn =	70509 lb

UNIFORM LOADS		Center
Uniform Live Load	0	plf
Uniform Dead Load	4	plf
Beam Self Weight	26	plf
Total Uniform Load	30	plf

TRAPEZOIDAL LOADS - CENTER SPAN	
Load Number	One
Left Live Load	126 plf
Left Dead Load	587 plf
Right Live Load	126 plf
Right Dead Load	587 plf
Load Start	6.33 ft
Load End	18.43 ft
Load Length	12.1 ft

Controlling Moment: 47602 ft-lb
12.96 Ft from left support of span 2 (Center Span)
Created by combining all dead loads and live loads on span(s) 2

Controlling Shear: 5077 lb
At left support of span 2 (Center Span)
Created by combining all dead loads and live loads on span(s)

Comparisons with required sections:	Req'd	Provided
Moment of Inertia (deflection):	150.15 in ⁴	301 in ⁴
Moment:	47602 ft-lb	90015 ft-lb
Shear:	5077 lb	70509 lb

Project: support beams

Location: Beam F
Multi-Loaded Multi-Sp
[2009 International Buil
A572-50 W16x26 x
27.0 FT

Section Adequate By:
Controlling Factor: Defl

StruCalc Version 8.0.106.0

6/27/2011 9:16:02 AM

page

LOADING DIAGRAM

13
of 15

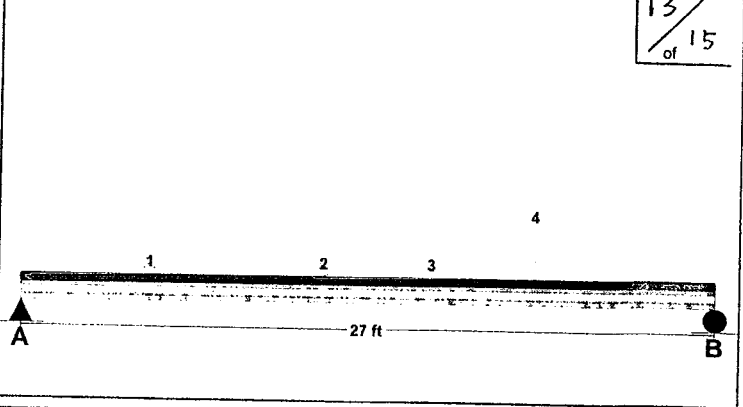

DEFLECTIONS		Center
Live Load	0.00	IN L/Infinity
Dead Load	1.19	in
Total Load	1.19	IN L/272
Live Load Deflection Criteria: L/360 Total Load Deflection Criteria: L/240		

REACTIONS		A	B
Live Load	0	lb	0 lb
Dead Load	6906	lb	12676 lb
Total Load	6906	lb	12676 lb
Bearing Length	0.75	in	0.75 in

BEAM DATA		Center
Span Length	27	ft
Unbraced Length-Top	4	ft
Unbraced Length-Bottom	4	ft

STEEL PROPERTIES

W16x26 - A572-50

Properties:

Yield Stress:	Fy =	50	ksi
Modulus of Elasticity:	E =	29000	ksi
Depth:	d =	15.7	in
Web Thickness:	tw =	0.25	in
Flange Width:	bf =	5.5	in
Flange Thickness:	tf =	0.35	in
Distance to Web Toe of Fillet:	k =	0.75	in
Moment of Inertia About X-X Axis:	Ix =	301	in4
Section Modulus About X-X Axis:	Sx =	38.4	in3
Plastic Section Modulus About X-X Axis:	Zx =	44.2	in3

Design Properties per AISC 13th Edition Steel Manual:

Flange Buckling Ratio:	FBR =	7.97
Allowable Flange Buckling Ratio:	AFBR =	9.15
Web Buckling Ratio:	WBR =	56.82
Allowable Web Buckling Ratio:	AWBR =	90.55
Controlling Unbraced Length:	Lb =	4 ft
Limiting Unbraced Length -		
for lateral-torsional buckling:	Lp =	3.96 ft
for Eqn. F2-2:	Lr =	11.17 ft
Nominal Flexural Strength w/ safety factor:	Mn =	110016 ft-lb
Controlling Equation:	F2-2	
Web height to thickness ratio:	h/tw =	56.82
Limiting height to thickness ratio for eqn. G2-2: h/tw-limit =		53.95
Cv Factor:	Cv =	1
Controlling Equation:	G2-3	
Nominal Shear Strength w/ safety factor:	Vn =	70509 lb

Controlling Moment: 88073 ft-lb

19.98 Ft from left support of span 2 (Center Span)

Created by combining all dead loads and live loads on span(s) 2

Controlling Shear: -12676 lb

At right support of span 2 (Center Span)

Created by combining all dead loads and live loads on span(s)

Comparisons with required sections:	Req'd	Provided
Moment of Inertia (deflection):	265.2 in4	301 in4
Moment:	88073 ft-lb	110016 ft-lb
Shear:	-12676 lb	70509 lb

UNIFORM LOADS		Center
Uniform Live Load	0	plf
Uniform Dead Load	0	plf
Beam Self Weight	26	plf
Total Uniform Load	26	plf

POINT LOADS - CENTER SPAN				
Load Number	One	Two	Three	Four
Live Load	0 lb	0 lb	0 lb	0 lb
Dead Load	1310 lb	2314 lb	1548 lb	13708 lb
Location	5 ft	11.8 ft	16 ft	20 ft

Project: support beams

Location: Beam G
Multi-Loaded Multi-Sp
[2009 International Buil
A992-50 W18x35 x
28.5 FT

Section Adequate By:
Controlling Factor: Mo

DEFLECTIONS		Center
Live Load	0.00	IN L/Infinity
Dead Load	0.70	in
Total Load	0.70	IN L/492
Live Load Deflection Criteria: L/360 Total Load Deflection Criteria: L/240		

REACTIONS		A	B
Live Load	0 lb	0 lb	0 lb
Dead Load	11301 lb	6973 lb	6973 lb
Total Load	11301 lb	6973 lb	6973 lb
Bearing Length	0.83 in	0.83 in	

BEAM DATA		Center
Span Length	28.5	ft
Unbraced Length-Top	7	ft
Unbraced Length-Bottom	7	ft

STEEL PROPERTIES
W18x35 - A992-50

Properties:

Yield Stress:	Fy =	50	ksi
Modulus of Elasticity:	E =	29000	ksi
Depth:	d =	17.7	in
Web Thickness:	tw =	0.3	in
Flange Width:	bf =	6	in
Flange Thickness:	tf =	0.43	in
Distance to Web Toe of Fillet:	k =	0.83	in
Moment of Inertia About X-X Axis:	Ix =	510	in ⁴
Section Modulus About X-X Axis:	Sx =	57.6	in ³
Plastic Section Modulus About X-X Axis:	Zx =	66.5	in ³

Design Properties per AISC 13th Edition Steel Manual:

Flange Buckling Ratio:	FBR =	7.06
Allowable Flange Buckling Ratio:	AFBR =	9.15
Web Buckling Ratio:	WBR =	53.49
Allowable Web Buckling Ratio:	AWBR =	90.55
Controlling Unbraced Length:	Lb =	7 ft
Limiting Unbraced Length -		
for lateral-torsional buckling:	Lp =	4.31 ft
for Eqn. F2-2:	Lr =	12.43 ft
Nominal Flexural Strength w/ safety factor:	Mn =	144265 ft-lb
Controlling Equation:	F2-2	
Web height to thickness ratio:	h/tw =	53.49
Limiting height to thickness ratio for eqn. G2-2: h/tw-limit =		53.95
Cv Factor:	Cv =	1
Controlling Equation:	G2-2	
Nominal Shear Strength w/ safety factor:	Vn =	106200 lb

Controlling Moment: 78014 ft-lb

7.12 Ft from left support of span 2 (Center Span)

Created by combining all dead loads and live loads on span(s) 2

Controlling Shear: 11301 lb

At left support of span 2 (Center Span)

Created by combining all dead loads and live loads on span(s)

Comparisons with required sections:

	Req'd	Provided
Moment of Inertia (deflection):	248.97 in ⁴	510 in ⁴
Moment:	78014 ft-lb	144265 ft-lb
Shear:	11301 lb	106200 lb

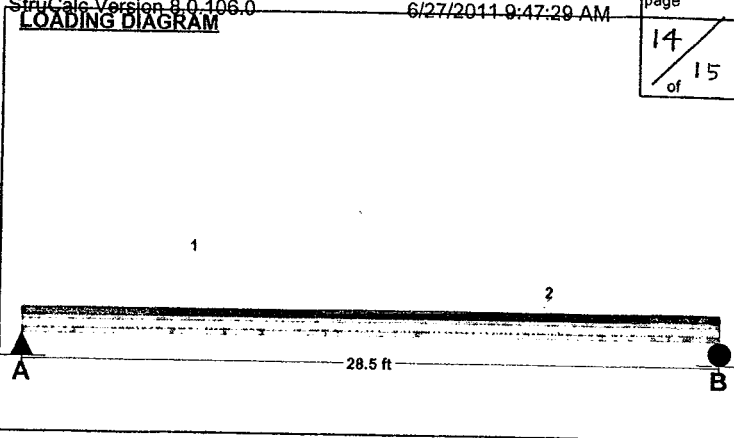

UNIFORM LOADS		Center
Uniform Live Load	0	plf
Uniform Dead Load	0	plf
Beam Self Weight	35	plf
Total Uniform Load	35	plf

POINT LOADS - CENTER SPAN		
Load Number	One	Two
Live Load	0 lb	0 lb
Dead Load	12915 lb	4361 lb
Location	7 ft	21.58 ft

Project: support beams

Location: Beam H
 Multi-Loaded Multi-Sp
 [2009 International Buil
 A992-50 W18x35 x
 28.5 FT
 Section Adequate By:
 Controlling Factor: Defl

StruCalc Version 8.0.106.0

6/27/2011 9:47:09 AM

page

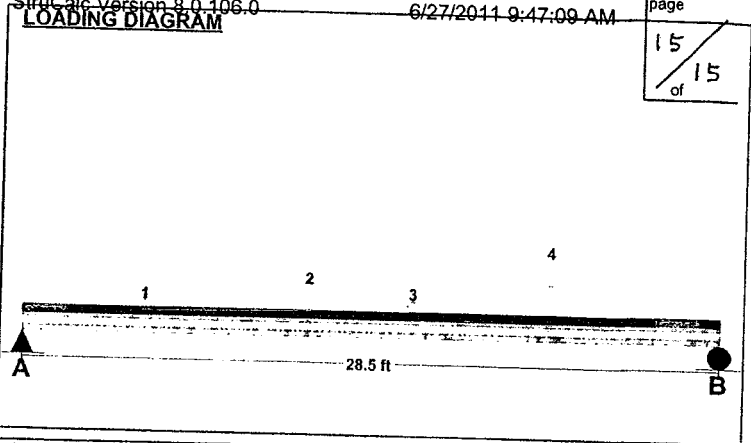

15
of
15

DEFLECTIONS		Center
Live Load	0.00	IN L/Infinity
Dead Load	0.47	in
Total Load	0.47	IN L/720
Live Load Deflection Criteria: L/360 Total Load Deflection Criteria: L/240		

REACTIONS		
	A	B
Live Load	0 lb	0 lb
Dead Load	4851 lb	6396 lb
Total Load	4851 lb	6396 lb
Bearing Length	0.83 in	0.83 in

BEAM DATA		Center
Span Length	28.5	ft
Unbraced Length-Top	5.6	ft
Unbraced Length-Bottom	5.6	ft

STEEL PROPERTIES
 W18x35 - A992-50

Properties:

Yield Stress:	Fy =	50	ksi
Modulus of Elasticity:	E =	29000	ksi
Depth:	d =	17.7	in
Web Thickness:	tw =	0.3	in
Flange Width:	bf =	6	in
Flange Thickness:	tf =	0.43	in
Distance to Web Toe of Fillet:	k =	0.83	in
Moment of Inertia About X-X Axis:	Ix =	510	in4
Section Modulus About X-X Axis:	Sx =	57.6	in3
Plastic Section Modulus About X-X Axis:	Zx =	66.5	in3

Design Properties per AISC 13th Edition Steel Manual:

Flange Buckling Ratio:	FBR =	7.06
Allowable Flange Buckling Ratio:	AFBR =	9.15
Web Buckling Ratio:	WBR =	53.49
Allowable Web Buckling Ratio:	AWBR =	90.55
Controlling Unbraced Length:	Lb =	5.6 ft
Limiting Unbraced Length -		
for lateral-torsional buckling:	Lp =	4.31 ft
for Eqn. F2-2:	Lr =	12.43 ft
Nominal Flexural Strength w/ safety factor:	Mn =	155531 ft-lb
Controlling Equation:	F2-2	
Web height to thickness ratio:	h/tw =	53.49
Limiting height to thickness ratio for eqn. G2-2:	h/tw-limit =	53.95
Cv Factor:	Cv =	1
Controlling Equation:	G2-2	
Nominal Shear Strength w/ safety factor:	Vn =	106200 lb

UNIFORM LOADS		Center
Uniform Live Load	0	plf
Uniform Dead Load	0	plf
Beam Self Weight	35	plf
Total Uniform Load	35	plf

POINT LOADS - CENTER SPAN				
Load Number	One	Two	Three	Four
Live Load	0 lb	0 lb	0 lb	0 lb
Dead Load	1310 lb	2314 lb	1548 lb	5077 lb
Location	5 ft	11.75 ft	16 ft	21.58 ft

Controlling Moment: 48858 ft-lb
 15.96 Ft from left support of span 2 (Center Span)
 Created by combining all dead loads and live loads on span(s) 2

Controlling Shear: -6396 lb
 28.0 Ft from left support of span 2 (Center Span)
 Created by combining all dead loads and live loads on span(s)

Comparisons with required sections:	Req'd	Provided
Moment of Inertia (deflection):	169.93 in4	510 in4
Moment:	48858 ft-lb	155531 ft-lb
Shear:	-6396 lb	106200 lb

P65-16-XLH-RR**Dual Broadband Antennas**

POLARIZATION: Dual linear $\pm 45^\circ$
 FREQUENCY (MHz): 698-894, 1710-2170
 HORIZONTAL BEAM WIDTH ($^\circ$): 65, 65
 GAIN (dBi/dBd): 15.5/13.4 17.5/15.4
 TILT: 1-12, 0-8
 LENGTH: 72"

ELECTRICAL SPECIFICATIONS*

	698-894		1710-1880	1710-2170	
	698-806	806-894		1850-1990	1900-2170
Frequency range (MHz)	698-894		1710-1880	1850-1990	1900-2170
Frequency band (MHz)	698-806	806-894	1710-1880	1850-1990	1900-2170
Gain (dBi/dBd)	14.8/12.7	15.5/13.4	16.9/14.8	17.2/15.1	17.5/15.4
Polarization	Dual Linear +/- 45		Dual Linear +/- 45		
Nominal Impedance (Ω)	50		50		
VSWR	< 1.5:1		< 1.5:1		
Horizontal beam width, -3 dB ($^\circ$)	66	65	60	63	63
Vertical beam width, -3 dB ($^\circ$)	14.7	12.5	6.8	6.4	5.7
Electrical down tilt ($^\circ$)	1 to 12		0 to 8		
Side lobe suppression, vertical 1st upper (dB)	> 16	>16	> 16		
	>16	>16			
Isolation between inputs (dB)	> 30	> 30	> 30	> 30	
Inter band Isolation (dB)	> 40		> 40		
Tracking, horizontal plane $\pm 60^\circ$ (dB)	< 2		< 2	< 2	< 2
First null fill (dB)			>-20	>-20	>-20
Vertical beam squint ($^\circ$)	< 0.8	< 0.8	< 0.5	< 0.5	< 0.5
Front to back ratio (dB) $180^\circ \pm 30^\circ$ copolar	>24	>24	> 30	>30	>28
Front to back ratio (dB) $180^\circ \pm 30^\circ$ total power					
Cross polar discrimination (XPD) 0° (dB)	> 15	> 15	> 15	> 15	> 15
Cross polar discrimination (XPD) $\pm 60^\circ$ (dB)	> 10	> 10	> 10	> 10	> 10
Far field coupling					
IM3, 2xTx@43dBm (dBc)	<-153		<-153		
IM7, 2xTx@43dBm (dBc)					
Power handling, average per input (W)	500		250		
Power handling, average total (W)	1000		500		

MECHANICAL SPECIFICATIONS*

Connector	4 X 7/16 DIN Female, IP67
Connector position	Bottom
Dimensions, HxWxD, mm (ft)	72" x 12" x 6" (1829 x 305 x 152)
Mounting	Pre-mounted Tilt Brackets
Weight, with brackets, kg (lbs)	29 (64)
Weight, without brackets, kg (lbs)	24 (53)
Wind load, frontal/lateral/rear side 42 m/s Cd=1.6 (N)	1380
Maximum operational wind speed, m/s (mph)	100 (45)
Survival wind speed, m/s (mph)	150 (67)
Lightning protection	DC Ground
Operating Temperature	-40C to +60C
Radome material	PVC, IP55
Packet size, HxWxD, mm (ft)	87" x 16" x 10" (2225 x 400 x 225)
Radome colour	Light Grey
Shipping weight, kg (lbs)	34 (75)
RET	iRET AISGv1.1, MET and AISGv2.0
Brackets	7256.00, 7454.00

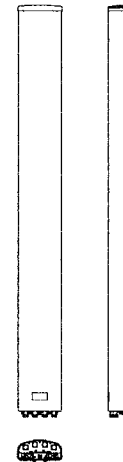

*All specifications subject to change without notice. Please contact your Powerwave representative for complete performance data.

ANTENNA PATTERNS*

For detailed patterns visit <http://www.powerwave.com/rpa/>.

RRUS 11 – Dual PA RRU.

Technical Data

- > Multi standard
- > RF: 2x30 Watts
- > Carrier BW: 1.4 – 20 MHz
- > Alarms: 2
- > Dimensions (with sunshield):
 - Width: 17.0 in
 - Height: 17.8 in
 - Depth: 7.2 in
 - Weight: 55 lbs (Band 12)
 - Weight: 50 lbs (Band 4)
- > Temperature: -40 to +131 F
- > Cooling: Self convection
- > Power: -48 VDC
- > Rec. fuse size 20 Amp
 - Rec. DC cable:
 - > 6 mm² up to 60 meters
 - > 10 mm² over 60 meters
 - > Shielded
- > Power Cons: 200 Watts typ.



RBS6000



RRUS-11 I/F



RBS6000

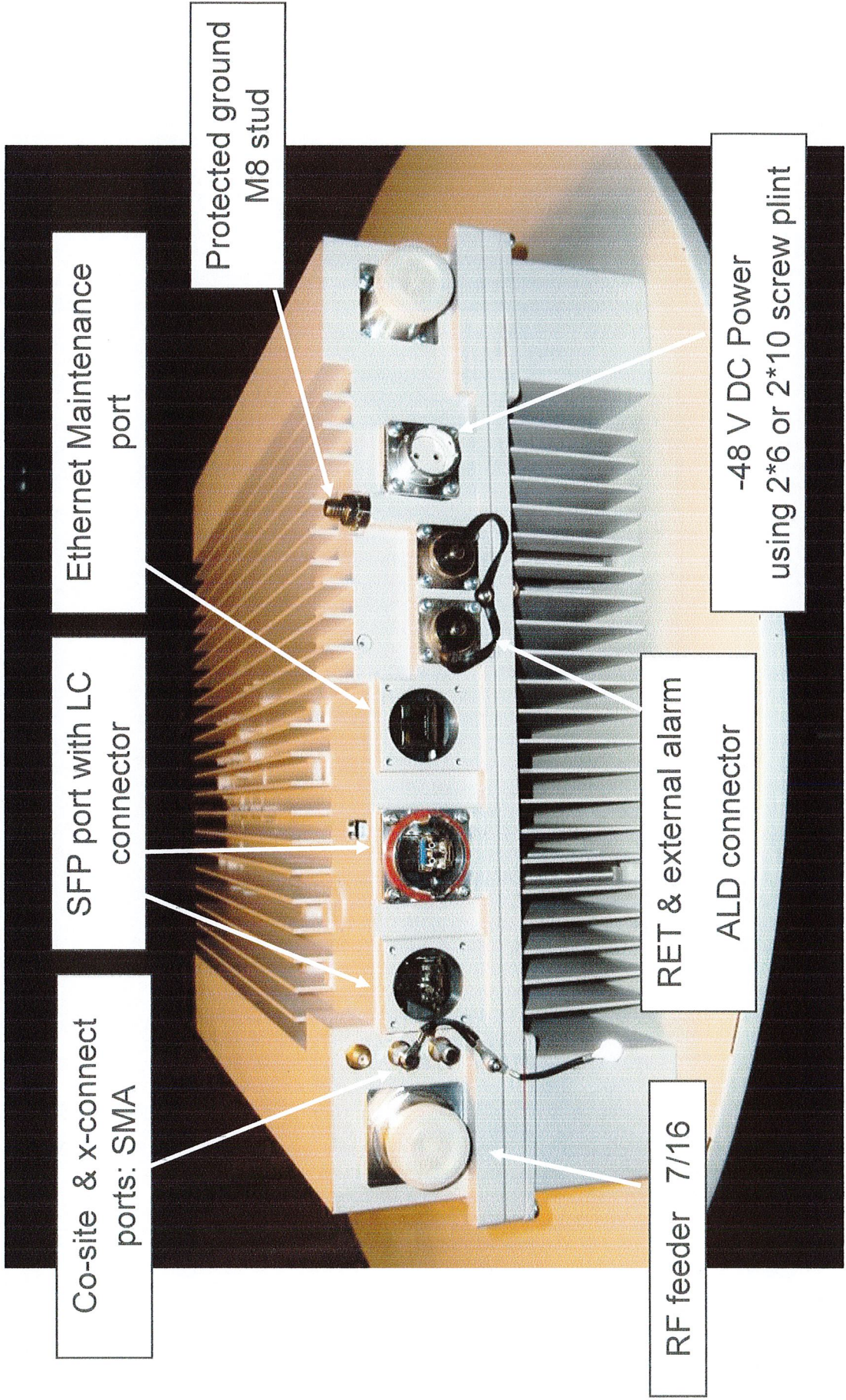

POWER

DC6-48-60-18-8F

DC Surge Suppression Solution

The DC6-48-60-18 is a dual chambered, DC surge suppression system for use in multi-circuit, Distributed Antenna Systems. The system will protect up to 6 Remote Radio Heads from voltage surges and lightning, and connect up to 18 fiber pairs. The system is enclosed in a NEMA 4 rated, waterproof enclosure.

FEATURES

- Protects up to 6 Remote Radio Heads, each with its own protection circuit.
- Flexible design allows for installation at the top of a tower for Remote Radio Head protection.
- Includes fiber connections for up to 18 pairs of fiber.
- LED indicators on individual circuits provide visual indication of suppressor status.
- Form 'C' relays allow for remote monitoring of the suppressor status.
- Patented Strikesorb technology provides over 60 kA of surge current capacity per circuit.
- Strikesorb suppression modules are fully recognized to UL 1449-3rd Edition Safety Standard, meeting all intermediate and high current fault requirements to facilitate use in OEM applications.
- Raycap recommends that DC protection system be installed within 2 meters or 6 feet of the radio.
- Dome design is lightweight and aerodynamic providing maximum flexibility for installation on top of towers.

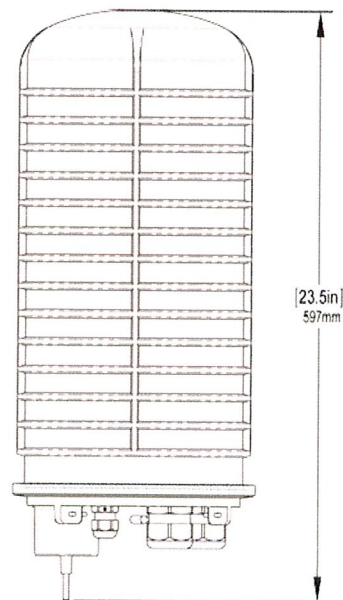
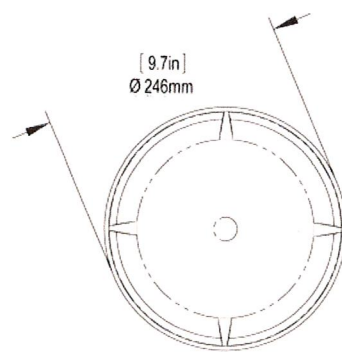
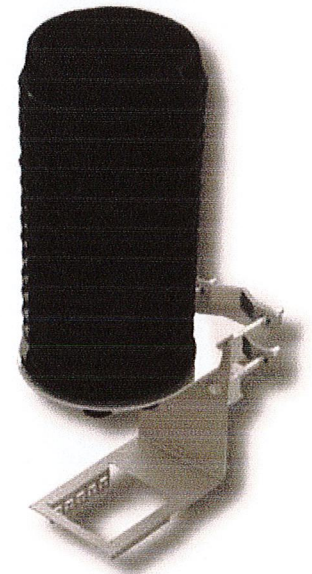

Raycap

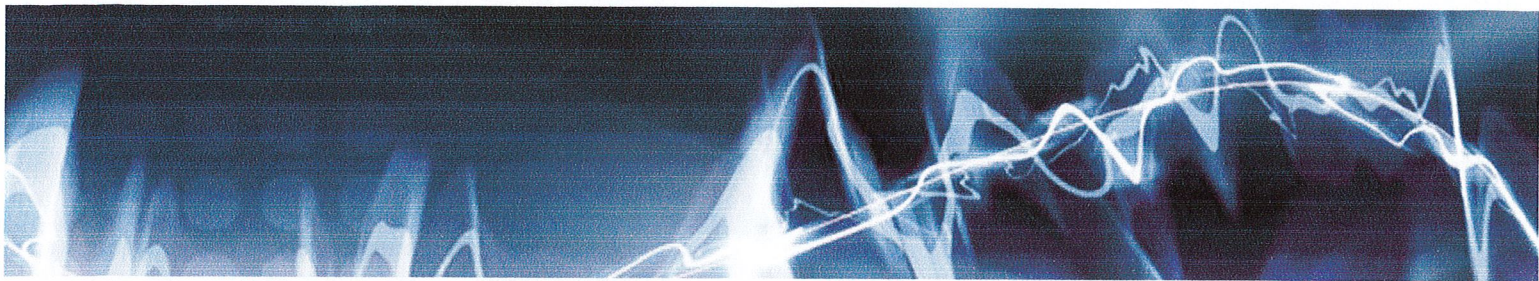

DC6-48-60-18-8F

DC Power Surge Protection

Electrical Specifications	
Model Number	DC6-48-60-18-8F
Nominal Operating Voltage	48 VDC
Nominal Discharge Current (I_n)	20 kA 8/20 μ s
Maximum Discharge Current (I_{max}) per NEMA LS-1	60 kA 8/20 μ s
Maximum Continuous Operating Voltage (U_c)	75 VDC
Voltage Protection Rating	400 V

Mechanical Specifications	
Suppression Connection Method	Compression lug, #2-#14 AWG Copper, #2-#12 Aluminum
Fiber Connection Method	LC-LC Single mode duplex
Environmental Rating	IP 68, 7m 72hrs
Operating Temperature	-40° C to + 80° C
Storage Temperature	-70° C to + 80° C
Cold Temperature Cycling	IEC 61300-2-22e -30° C to + 60° C 200 hrs @ 5 psi
Resistance to Aggressive Materials	CEI IEC 61073-2 including acids and bases
UV Protection	ISO 4892-2 Method A Xenon-Arc 2160 hrs
Weight	20 lbs without Mounting Bracket

STANDARDS

Strikesorb modules are compliant to the following Surge Protection Device (SPD) Standards:

- ANSI/UL 1449 - 3rd Edition
- IEEE C62.41
- NEMA LS-1, IEC 61643-1:2005 2nd Edition:2005
- IEC 61643-12
- EN 61643-11:2002 (including A11:2007)



Raycap

G02-00-068 REV 050610



GS-07F-0435V



Certified to
ISO 9001:2000



TUV Rheinland
of North America

Raycap, Inc. 806 W. Clearwater Loop • Post Falls • Idaho • 83854 • USA
Phone 208.777.1166 • Toll Free 800.890.2569 • Fax 208.777.4466 • www.raycapsurgeprotection.com



New Cingular Wireless PCS, LLC
500 Enterprise Drive
Rocky Hill, Connecticut 06067-3900
Phone: (860) 463-5511
Fax: (860) 513-7190

Douglas L. Culp
Real Estate Consultant

June 29, 2011

Honorable Sherri Steeneck
1st Selectman, Town of Fairfield
Sullivan Independence Hall
725 Old Post Road
Fairfield, CT 06824

Re: Telecommunications Facility – 55 Walls Drive Fairfield, CT

Dear Selectman Steeneck:

In order to accommodate technological changes, implement Uniform Mobile Telecommunications System (“UMTS”) and Long Term Evolution (“LTE”) capabilities, and enhance system performance in the State of Connecticut, New Cingular Wireless PCS, LLC (“AT&T”) will be changing its equipment configuration at certain cell sites.

As required by Regulations of Connecticut State Agencies (“R.C.S.A.”) Section 16-50j-73, the Connecticut Siting Council has been notified of the changes and will review AT&T’s proposal. Please accept this letter as notification under Section 16-50j-73 of construction which constitutes an exempt modification pursuant to R.C.S.A. Section 16-50j-72(b)(2).

The accompanying letter to the Siting Council fully describes Cingular’s proposal for the referenced cell site. However, if you have any questions or require any further information on our plans or the Siting Council’s procedures; please call me at (860) 463-5511 or Ms. Linda Roberts, Executive Director, Connecticut Siting Council at (860) 827-2935.

Sincerely,

Douglas L. Culp
Real Estate Consultant

Enclosure