

RECEIVED
DEC 19 2014

CONNECTICUT
SITING COUNCIL

Also admitted in Massachusetts

December 17, 2014

Melanie Bachman
Acting Executive Director
Connecticut Siting Council
10 Franklin Square
New Britain, CT 06051

ORIGINAL

Re: **EM-VER-049-130809 – Cellco Partnership d/b/a Verizon Wireless
Town Farm Road, Enfield, Connecticut**

Dear Ms. Bachman:

On August 27, 2013, the Siting Council acknowledged receipt of Cellco's notice of intent to modify its telecommunications facility off Town Farm Road in Enfield. The modification involved the replacement of certain antennas and installation of remote radio heads.

As a condition of the acknowledgement, Cellco was required to provide the Council with a letter stating that the recommendations specified in the structural report were implemented. Attached is a Tower Modification Certification Letter verifying that these conditions have been satisfied. All construction associated with these modifications has now been completed.

If you have any questions please do not hesitate to contact me.

Sincerely,



Kenneth C. Baldwin

Attachment

Copy to:

Sandy M. Carter
Brian Ragozzine
Mark Gauger

December 15, 2014

Mr. Mark Gauger
Verizon Wireless
99 East River Drive
East Hartford, Connecticut 06108

Re: Existing Telecommunications Facility Tower Certification Letter

Project: Verizon Enfield 4
Town Farm Road
Enfield, CT

Tower Owner: American Tower Corporation

Engineer: American Tower Corporation
3500 Regency Parkway, Suite 100
Cary, NC 27518

Centek Project No.: 14055.049

CSC Exempt Mod Reference No.: EM-VER-049-130809

Dear Mr. Gauger,

We are providing this "Existing Telecommunications Facility Tower Certification Letter" with regard to the antenna upgrade by Verizon Wireless at the above referenced project.

The following are the basis for substantiating compliance with the American Tower structural analysis report (ATC Project No. 52476824) dated August 2, 2013:

- Review of the American Tower structural analysis report dated 08/02/2013.
- Field observations by Centek personnel of the coax and RRH installation on 12/10/2014 which determined all coax lines and RRH's were installed in general compliance with the recommendations of the structural analysis report prepared by American Tower on 08/02/2013.

The structural analysis prepared by American Tower demonstrates the tower will not exceed 100 percent of the post construction structural rating. The work under this Contract has been reviewed and found, to the Engineer's best knowledge, information and belief, to be completed in general compliance with the documents referenced above. This certification is not a review of the adequacy or effectiveness of the referenced structural analysis.

Sincerely,

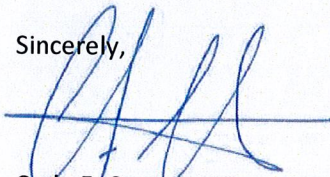

Carlo F. Centore, PE
Principal ~ Structural Engineer



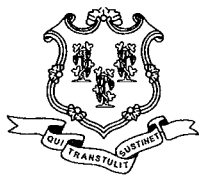

STATE OF CONNECTICUT
CONNECTICUT SITING COUNCIL

Ten Franklin Square, New Britain, CT 06051

Phone: (860) 827-2935 Fax: (860) 827-2950

E-Mail: siting.council@ct.gov

www.ct.gov/csc

August 27, 2013

Kenneth C. Baldwin, Esq.
Robinson & Cole LLP
280 Trumbull Street
Hartford, CT 06103

RE: **EM-VER-049-130809** – Cellco Partnership d/b/a Verizon Wireless notice of intent to modify an existing telecommunications facility located at Town Farm Road, Enfield, Connecticut.

Dear Attorney Baldwin:

The Connecticut Siting Council (Council) hereby acknowledges your notice to modify this existing telecommunications facility, pursuant to Section 16-50j-73 of the Regulations of Connecticut State Agencies with the following conditions:

- The coax shall be installed as recommended in the Structural Analysis Report prepared by American Tower Corporation dated August 2, 2013 and stamped by Raphael Mohamed;
- Within 45 days following completion of the antenna installation, Verizon shall provide documentation certified by a professional engineer that its installation complied with the recommendations of the structural analysis;
- Any deviation from the proposed modification as specified in this notice and supporting materials with the Council shall render this acknowledgement invalid;
- Any material changes to this modification as proposed shall require the filing of a new notice with the Council;
- Within 45 days after completion of construction, the Council shall be notified in writing that construction has been completed;
- The validity of this action shall expire one year from the date of this letter; and
- The applicant may file a request for an extension of time beyond the one year deadline provided that such request is submitted to the Council not less than 60 days prior to the expiration.

The proposed modifications including the placement of all necessary equipment and shelters within the tower compound are to be implemented as specified here and in your notice dated August 8, 2013. The modifications are in compliance with the exception criteria in Section 16-50j-72 (b) of the Regulations of Connecticut State Agencies as changes to an existing facility site that would not increase tower height, extend the boundaries of the tower site, increase noise levels at the tower site boundary by six decibels, and increase the total radio frequencies electromagnetic radiation power density measured at the tower site boundary to or above the standard adopted by the State Department of Environmental Protection pursuant to General Statutes § 22a-162. This facility has also been carefully modeled to ensure that radio frequency emissions are conservatively below State and federal standards applicable to the frequencies now used on this tower.



This decision is under the exclusive jurisdiction of the Council. Please be advised that the validity of this action shall expire one year from the date of this letter. Any additional change to this facility will require explicit notice to this agency pursuant to Regulations of Connecticut State Agencies Section 16-50j-73. Such notice shall include all relevant information regarding the proposed change with cumulative worst-case modeling of radio frequency exposure at the closest point of uncontrolled access to the tower base, consistent with Federal Communications Commission, Office of Engineering and Technology, Bulletin 65. Thank you for your attention and cooperation.

Very truly yours,

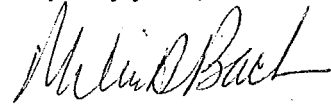

Melanie A. Bachman
Acting Executive Director

MAB/CDM/jb

- c: The Honorable Scott Kaupin, Mayor, Town of Enfield
- Matthew W. Coppler, Town Manager, Town of Enfield
- Jose Giner, Director of Planning and Community Development, Town of Enfield
- American Tower



STATE OF CONNECTICUT

CONNECTICUT SITING COUNCIL

Ten Franklin Square, New Britain, CT 06051

Phone: (860) 827-2935 Fax: (860) 827-2950

E-Mail: siting.council@ct.gov

www.ct.gov/csc

August 12, 2013

The Honorable Scott Kaupin
Mayor
Town of Enfield
820 Enfield Street
Enfield, CT 06082

RE: **EM-VER-049-130809** – Cellco Partnership d/b/a Verizon Wireless notice of intent to modify an existing telecommunications facility located at Town Farm Road, Enfield, Connecticut.

Dear Mayor Kaupin:

The Connecticut Siting Council (Council) received a request to modify an existing telecommunications facility, pursuant to Regulations of Connecticut State Agencies Section 16-50j-72, a copy of which has already been provided to you.

If you have any questions or comments regarding the proposal, please call me or inform the Council by August 26, 2013.

Thank you for your cooperation and consideration.

Very truly yours,

Melanie Bachman
Acting Executive Director

MB/jb

c: Matthew W. Coppler, Town Manager, Town of Enfield
Jose Giner, Director of Planning and Community Development, Town of Enfield

280 Trumbull Street
Hartford, CT 06103-3597
Main (860) 275-8200
Fax (860) 275-8299
kbaldwin@rc.com
Direct (860) 275-8345

Also admitted in Massachusetts

August 8, 2013

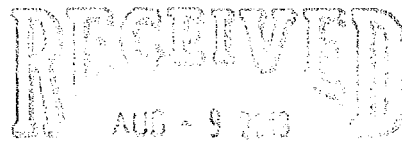

CONNECTICUT
SITING COUNCIL

Melanie A. Bachman
Acting Executive Director
Connecticut Siting Council
10 Franklin Square
New Britain, CT 06051

Re: **Notice of Exempt Modification – Antenna Swap
Town Farm Road, Enfield, Connecticut**

Dear Ms. Bachman:

Cellco Partnership d/b/a Verizon Wireless (“Cellco”) currently maintains twelve (12) wireless telecommunications antennas at the 127-foot level of the existing 150-foot tower at the above-referenced address. The tower is owned by American Tower Corporation. The Council approved Cellco’s shared use of this tower in 2007. Cellco now intends to replace six (6) of its antennas with three (3) model BXA-80080-6CF cellular antennas and three (3) model BXA-171085-8BF AWS antennas, at the same level on the tower. Cellco also intends to install three (3) remote radio heads (“RRHs”) behind its antennas and one (1) HYBRIFLEX™ antenna cable, attached to the outside of the monopole tower. Included in Attachment 1 are specifications for the replacement antennas, RRHs and HYBRIFLEX™ cable.

Please accept this letter as notification pursuant to R.C.S.A. § 16-50j-73, for construction that constitutes an exempt modification pursuant to R.C.S.A. § 16-50j-72(b)(2). In accordance with R.C.S.A. § 16-50j-73, a copy of this letter is being sent to Matthew W. Coppler, Town Manager of the Town of Enfield. The Town of Enfield is the owner of the property on which the tower is located.

The planned modifications to the facility fall squarely within those activities explicitly provided for in R.C.S.A. § 16-50j-72(b)(2).



Law Offices

BOSTON

PROVIDENCE

HARTFORD

NEW LONDON

STAMFORD

WHITE PLAINS

NEW YORK CITY

ALBANY

SARASOTA

www.rc.com

ROBINSON & COLE_{LLP}

Melanie A. Bachman
August 8, 2013
Page 2

1. The proposed modifications will not result in an increase in the height of the existing tower. Cellco's replacement antennas and RRHs will be located at the 127-foot level of the 150-foot tower.
2. The proposed modifications will not involve any change to ground-mounted equipment and, therefore, will not require the extension of the site boundary.
3. The proposed modifications will not increase noise levels at the facility by six decibels or more, or to levels that exceed state and local criteria.
4. The operation of the modified facility will not increase radio frequency (RF) emissions at the facility to a level at or above the Federal Communications Commission (FCC) safety standard. A cumulative General Power Density table for Cellco's modified facility is in Attachment 2.
5. The proposed modifications will not cause a change or alteration in the physical or environmental characteristics of the site.
6. The tower and its foundation can support Cellco's proposed modifications. (See Structural Analysis Report included in Attachment 3).

For the foregoing reasons, Cellco respectfully submits that the proposed modifications to the above-referenced telecommunications facility constitutes an exempt modification under R.C.S.A. § 16-50j-72(b)(2).

Sincerely,



Kenneth C. Baldwin

Enclosures

Copy to:

Matthew W. Coppler, Enfield Town Manager
Sandy M. Carter



ATTACHMENT 1

BXA-80080-6CF-EDIN-X

X-Pol | FET Panel | 80° | 13.5 dBd

Replace "X" with desired electrical downtilt.

Antenna is also available with NE connector(s). Replace "EDIN" with "NE" in the model number when ordering.



Electrical Characteristics	
Frequency bands	806-900 MHz*
*Optional frequency band for iDEN	806-941 MHz (specify when ordering)
Polarization	±45°
Horizontal beamwidth	80°
Vertical beamwidth	10°
Gain	13.5 dBd (15.6 dBi)
Electrical downtilt (X)	0, 2, 4, 6, 8, 10
Impedance	50Ω
VSWR	≤1.4:1
Upper sidelobe suppression (0°)	-18.6 dB
Front-to-back ratio (+/-30°)	-25.6 dB
Null fill	5% (-26.02 dB)
Isolation between ports	< -30 dB
Input power with EDIN connectors	500 W
Input power with NE connectors	300 W
Lightning protection	Direct Ground
Connector(s)	2 Ports / EDIN or NE / Female / Center (Back)
Mechanical Characteristics	
Dimensions Length x Width x Depth	1804 x 204 x 151 mm 71.0 x 8.0 x 5.9 in
Depth with z-brackets	191 mm 7.5 in
Weight without mounting brackets	8.2 kg 18 lbs
Survival wind speed	> 201 km/hr > 125 mph
Wind area	Front: 0.37 m ² Side: 0.27 m ² Front: 3.9 ft ² Side: 2.9 ft ²
Wind load @ 161 km/hr (100 mph)	Front: 531 N Side: 475 N Front: 119 lbf Side: 104 lbf
Mounting Options	
	Part Number Fits Pipe Diameter Weight
3-Point Mounting & Downtilt Bracket Kit	36210008 40-115 mm 1.57-4.5 in 6.9 kg 15.2 lbs
Concealment Configurations	For concealment configurations, order BXA-80080-6CF-EDIN-X-FP

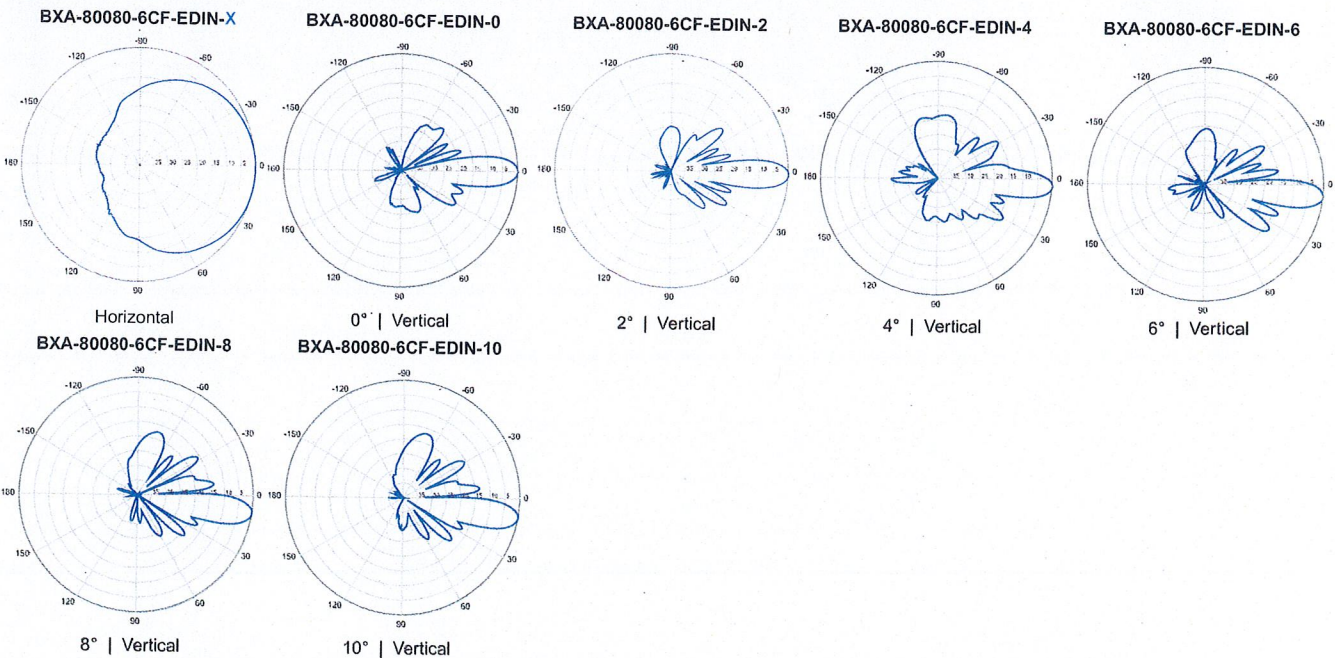

Quoted performance parameters are provided to offer typical or range values only and may vary as a result of normal manufacturing and operational conditions. Extreme operational conditions and/or stress on structural supports is beyond our control. Such conditions may result in damage to this product. Improvements to product may be made without notice.

BXA-171085-8BF-EDIN-X

Replace "X" with desired electrical downtilt.

X-Pol | FET Panel | 85° | 16.4 dBi

Electrical Characteristics		1710-2170 MHz			
Frequency bands		1710-1880 MHz	1850-1990 MHz	1920-2170 MHz	
Polarization		±45°	±45°	±45°	
Horizontal beamwidth		88°	85°	80°	
Vertical beamwidth		7°	7°	7°	
Gain		13.5 dBd / 15.6 dBi	13.9 dBd / 16.0 dBi	14.3 dBd / 16.4 dBi	
Electrical downtilt (X)		0, 2, 4			
Impedance		50Ω			
VSWR		≤1.5:1			
First upper sidelobe		< -17 dB			
Front-to-back ratio		> 30 dB			
In-band isolation		> 25 dB			
IM3 (2x20W carrier)		< -150 dBc			
Input power		300 W			
Lightning protection		Direct Ground			
Connector(s)		2 Ports / EDIN / Female / Bottom			
Operating temperature		-40° to +60° C / -40° to +140° F			
Mechanical Characteristics					
Dimensions Length x Width x Depth		1225 x 154 x 105 mm	48.2 x 6.1 x 4.1 in		
Depth with t-brackets		133 mm	5.2 in		
Weight without mounting brackets		4.2 kg	9.2 lbs		
Survival wind speed		>201 km/hr		>125 mph	
Wind area		Front: 0.19 m ² Side: 0.14 m ²	Front: 2.0 ft ² Side: 1.5 ft ²		
Wind load @ 161 km/hr (100 mph)		Front: 281 N Side: 223 N	Front: 63 lbf Side: 50 lbf		
Mounting Options		Part Number	Fits Pipe Diameter		Weight
2-Point Mounting Bracket Kit		26799997	50-102 mm	2.0-4.0 in	2.3 kg 5 lbs
2-Point Mounting & Downtilt Bracket Kit		26799999	50-102 mm	2.0-4.0 in	3.6 kg 8 lbs
Concealment Configurations	For concealment configurations, order BXA-171085-8BF-EDIN-X-FP				

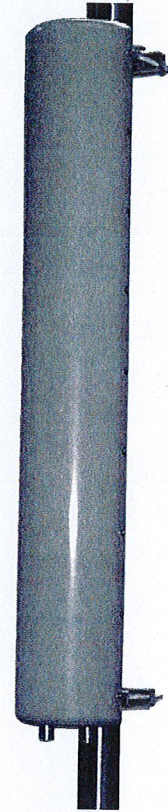

BXA-171085-8BF-EDIN-X

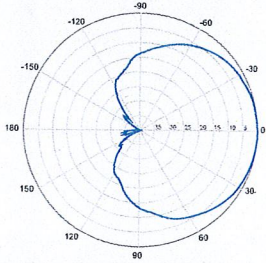

Horizontal | 1710-1880 MHz
BXA-171085-8BF-EDIN-0

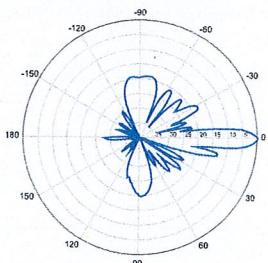

0° | Vertical | 1710-1880 MHz

BXA-171085-8BF-EDIN-X

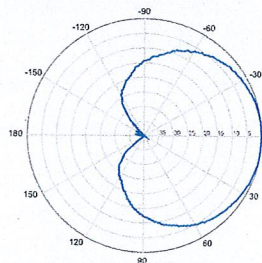

Horizontal | 1850-1990 MHz
BXA-171085-8BF-EDIN-0

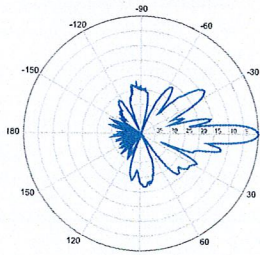

0° | Vertical | 1850-1990 MHz

BXA-171085-8BF-EDIN-X

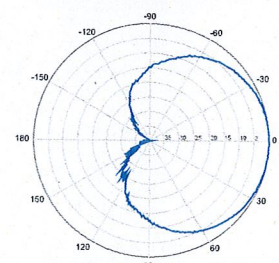

Horizontal | 1920-2170 MHz
BXA-171085-8BF-EDIN-0

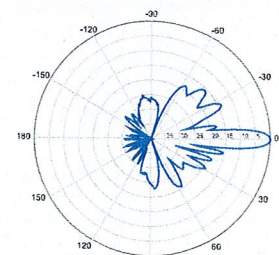

0° | Vertical | 1920-2170 MHz

Quoted performance parameters are provided to offer typical or range values only and may vary as a result of normal manufacturing and operational conditions. Extreme operational conditions and/or stress on structural supports is beyond our control. Such conditions may result in damage to this product. Improvements to product may be made without notice.

BXA-171085-8BF-EDIN-X

X-Pol | FET Panel | 85° | 16.4 dBi

BXA-171085-8BF-EDIN-2

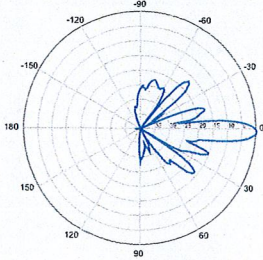

2° | Vertical | 1710-1880 MHz

BXA-171085-8BF-EDIN-4

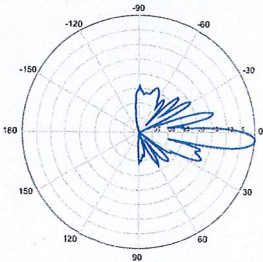

4° | Vertical | 1710-1880 MHz

BXA-171085-8BF-EDIN-2

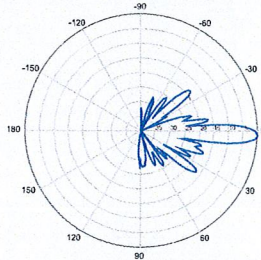

2° | Vertical | 1850-1990 MHz

BXA-171085-8BF-EDIN-4

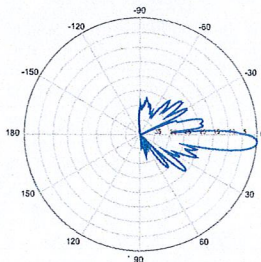

4° | Vertical | 1850-1990 MHz

BXA-171085-8BF-EDIN-2

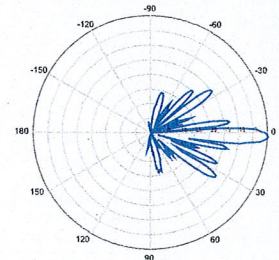

2° | Vertical | 1920-2170 MHz

BXA-171085-8BF-EDIN-4

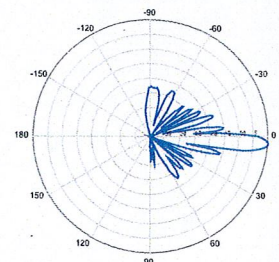

4° | Vertical | 1920-2170 MHz

Quoted performance parameters are provided to offer typical or range values only and may vary as a result of normal manufacturing and operational conditions. Extreme operational conditions and/or stress on structural supports is beyond our control. Such conditions may result in damage to this product. Improvements to product may be made without notice.

Alcatel-Lucent RRH2x40-AWS

REMOTE RADIO HEAD

The Alcatel-Lucent RRH2x40-AWS is a high-power, small form-factor Remote Radio Head (RRH) operating in the AWS frequency band (1700/2100MHz - 3GPP Band 4). The Alcatel-Lucent RRH2x40-AWS is designed with an eco-efficient approach, providing operators with the means to achieve high quality and capacity coverage with minimum site requirements.

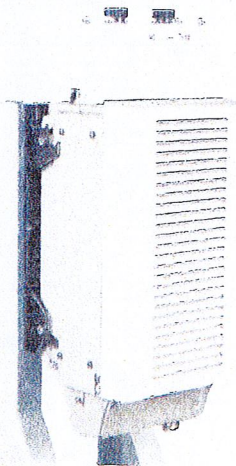

A distributed eNodeB expands deployment options by using two components, a Base Band Unit (BBU) containing the digital assets and a separate RRH containing the radio-frequency (RF) elements. This modular design optimizes available space and allows the main components of an eNodeB to be installed separately, within the same site or several kilometres apart.

The Alcatel-Lucent RRH2x40-AWS is linked to the BBU by an optical-fiber connection carrying downlink and uplink digital radio signals along with operations, administration and maintenance (OA&M) information. The Alcatel-Lucent RRH2x40-AWS has two transmit RF paths, 40 W RF output power per transmit path, and is designed to manage up to four-way receive diversity. The device is ideally suited to support macro coverage, with multiple-input multiple-output (MIMO) 2x2 operation in up to 20 MHz of bandwidth.

The Alcatel-Lucent RRH2x40-AWS is designed to make available all the benefits of a distributed eNodeB, with excellent RF characteristics, with low

capital expenditures (CAPEX) and low operating expenditures (OPEX). The limited space available in some sites may prevent the installation of traditional single-cabinet BTS equipment or require costly cranes to be employed, leaving coverage holes. However, many of these sites can host an Alcatel-Lucent RRH2x40-AWS installation, providing more flexible site selection and improved network quality along with greatly reduced installation time and costs.

Fast, low-cost installation and deployment

The Alcatel-Lucent RRH2x40-AWS is a zero-footprint solution and operates noise-free, simplifying negotiations with site property owners and minimizing environmental impacts. Installation can easily be done by a single person because the Alcatel-Lucent RRH2x40-AWS is compact and weighs less than 20 kg (44 lb), eliminating the need for a crane to hoist the BTS cabinet to the rooftop. A site can be in operation in less than one day — a fraction of the time required for a traditional BTS.

Excellent RF performance

Because of its small size and weight, the Alcatel-Lucent RRH2x40-AWS can be installed close to the antenna. Operators can therefore locate the Alcatel-Lucent RRH2x40-AWS where RF engineering is deemed ideal, minimizing trade-offs between available sites and RF optimum sites. The RF feeder cost and installation costs are reduced or eliminated, and there is no need for a Tower Mounted Amplifier (TMA) because losses introduced by the RF feeder are greatly reduced. The Alcatel-Lucent RRH2x40-AWS provides more RF power while at the same time consuming less electricity.

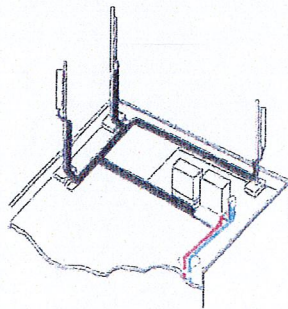

Macro

Features

- Zero-footprint deployment
- Easy installation, with a lightweight unit can be carried and set up by one person
- Optimized RF power, with flexible site selection and elimination of a TMA
- Convection-cooled (fanless)
- Noise-free
- Best-in-class power efficiency, with significantly reduced energy consumption

Benefits

- Leverages existing real estate with lower site costs
- Reduces installation costs, with fewer installation materials and simplified logistics
- Decreases power costs and minimizes environmental impacts, with the potential for eco-sustainable power options
- Improves RF performance and adds flexibility to network planning

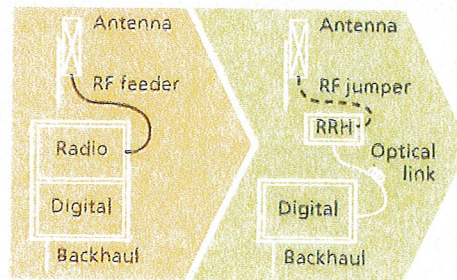

RRH for space-constrained cell sites

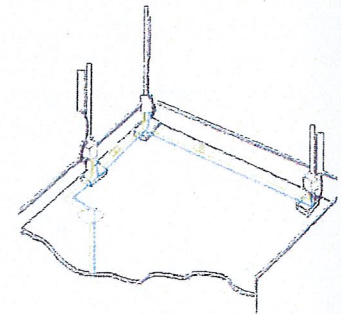

Distributed

Technical specifications

Physical dimensions

- Height: 620 mm (24.4 in.)
- Width: 270 mm (10.63 in.)
- Depth: 170mm (6.7 in.)
- Weight (without mounting kit): less than 20 kg (44 lb)

Power

- Power supply: -48VDC

Operating environment

- Outdoor temperature range:
 - With solar load: -40°C to +50°C (-40°F to +122°F)
 - Without solar load: -40°C to +55°C (-40°F to +131°F)

- Passive convection cooling (no fans)
- Enclosure protection
 - IP65 (International Protection rating)

RF characteristics

- Frequency band: 1700/2100 MHz (AWS); 3GPP Band 4
- Bandwidth: up to 20 MHz
- RF output power at antenna port: 40 W nominal RF power for each Tx port
- Rx diversity: 2-way or 4-way with optional Rx Diversity module
- Noise figure: below 2.0 dB typical
- Antenna Line Device features
 - TMA and Remote electrical tilt (RET) support via AISG v2.0

Optical characteristics

Type/number of fibers

- Single-mode variant
 - One Single Mode Single Fiber per RRH2x, carrying UL and DL using CWDM
 - Single mode dual fiber (SM/DF)
- Multi-mode variant
 - Two Multi-mode fibers per RRH2x: one carrying UL, the other carrying DL

Optical fiber length

- Up to 500 m (0.31 mi), using MM fiber
- Up to 20 km (12.43 mi), using SM fiber

Digital Ports and Alarms

- Two optical ports to support daisy-chaining
- Six external alarms

www.alcatel-lucent.com Alcatel, Lucent, Alcatel-Lucent and the Alcatel-Lucent logo are trademarks of Alcatel-Lucent. All other trademarks are the property of their respective owners. The information presented is subject to change without notice. Alcatel-Lucent assumes no responsibility for inaccuracies contained herein. Copyright © 2010 Alcatel-Lucent. All rights reserved. CPG2809100912 (09)



HYBRIFLEX™ RRH Hybrid Feeder Cabling Solution, 1-5/8", Single-Mode Fiber

Product Description

RFS' HYBRIFLEX Remote Radio Head (RRH) hybrid feeder cabling solution combines optical fiber and DC power for RRHs in a single lightweight aluminum corrugated cable, making it the world's most innovative solution for RRH deployments.

It was developed to reduce installation complexity and costs at Cellular sites. HYBRIFLEX allows mobile operators deploying an RRH architecture to standardize the RRH installation process and eliminate the need for and cost of cable grounding. HYBRIFLEX combines optical fiber (multi-mode or single-mode) and power in a single corrugated cable. It eliminates the need for junction boxes and can connect multiple RRHs with a single feeder. Standard RFS CELLFLEX® accessories can be used with HYBRIFLEX cable. Both pre-connectorized and on-site options are available.

Features/Benefits

- Aluminum corrugated armor with outstanding bending characteristics - minimizes installation time and enables mechanical protection and shielding
- Same accessories as 1 5/8" coaxial cable
- Outer conductor grounding - Eliminates typical grounding requirements and saves on installation costs
- Lightweight solution and compact design - Decreases tower loading
- Robust cabling - Eliminates need for expensive cable trays and ducts
- Installation of tight bundled fiber optic cable pairs directly to the RRH - Reduces CAPEX and wind load by eliminating need for interconnection
- Optical fiber and power cables housed in single corrugated cable - Saves CAPEX by standardizing RRH cable installation and reducing installation requirements
- Outdoor polyethylene jacket - Ensures long-lasting cable protection

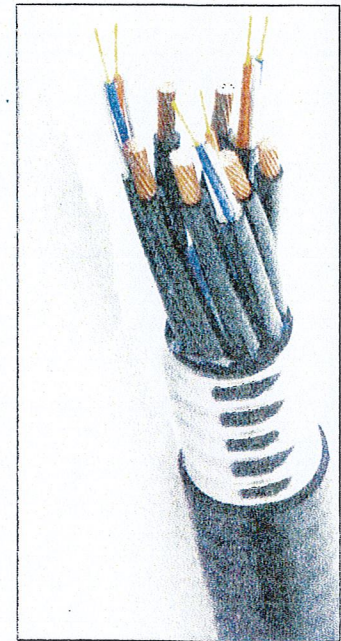

Figure 1: HYBRIFLEX Series

Technical Specifications

Structure			
Outer Conductor Armor:	Corrugated Aluminum	[mm (in)]	46.5 (1.83)
Jacket:	Polyethylene, PE	[mm (in)]	50.3 (1.98)
UV-Protection:	Individual and External Jacket		Yes
Mechanical Properties			
Weight, Approximate		[kg/m (lb/ft)]	1.9 (1.30)
Minimum Bending Radius, Single Bending		[mm (in)]	200 (8)
Minimum Bending Radius, Repeated Bending		[mm (in)]	500 (20)
Recommended/Maximum Clamp Spacing		[m (ft)]	1.0 / 1.2 (3.25 / 4.0)
Electrical Properties			
DC-Resistance Outer Conductor Armor		[Ω/km (Ω/1000ft)]	068 (0.205)
DC-Resistance Power Cable, 8.4mm ² (8AWG)		[Ω/km (Ω/1000ft)]	2.1 (0.307)
Fiber Optic Properties			
Version			Single-mode OM3
Quantity, Fiber Count			16 (8 pairs)
Core/Clad		[μm]	50/125
Primary Coating (Acrylate)		[μm]	245
Buffer Diameter, Nominal		[μm]	900
Secondary Protection, Jacket, Nominal		[mm (in)]	2.0 (0.08)
Minimum Bending Radius		[mm (in)]	104 (4.1)
Insertion Loss @ wavelength 850nm		dB/km	3.0
Insertion Loss @ wavelength 1310nm		dB/km	1.0
Standards (Meets or exceeds)			UL94-V0, UL1666 RoHS Compliant
DC Power Cable Properties			
Size (Power)		[mm (AWG)]	8.4 (8)
Quantity, Wire Count (Power)			16 (8 pairs)
Size (Alarm)		[mm (AWG)]	0.8 (18)
Quantity, Wire Count (Alarm)			4 (2 pairs)
Type			UV protected
Strands			19
Primary Jacket Diameter, Nominal		[mm (in)]	6.8 (0.27)
Standards (Meets or exceeds)			NFPA 130, ICEA S-95-658 UL Type XHHW-2, UL 44 UL-LS Limited Smoke, UL VW-1 IEEE-383 (1974), IEEE1202/FT4 RoHS Compliant
Environment			
Installation Temperature		[°C (°F)]	-40 to +65 (-40 to 149)
Operation Temperature		[°C (°F)]	-40 to +65 (-40 to 149)

* This data is provisional and subject to change.

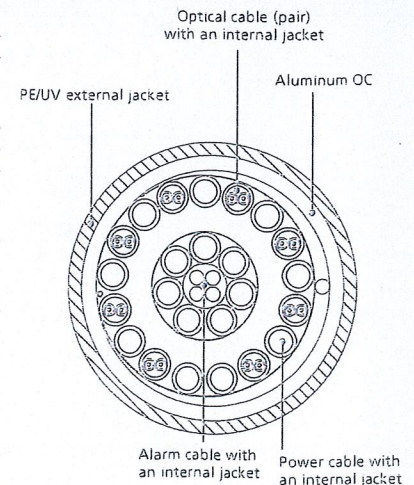

Figure 2: Construction Detail

All information contained in the present datasheet is subject to confirmation at time of ordering.

ATTACHMENT 2

Site Name: Enfield 4		General		Power		Density							
Tower Height: Verizon @ 127ft													
CARRIER	# OF CHAN.	WATTS ERP	HEIGHT	CALC. POWER DENS	FREQ.	MAX. PERMISS. EXP.	FRACTION MPE	Total					
*AT&T UMTS	2	565	152	0.0176	880	0.5867	3.00%						
*AT&T UMTS	2	875	152	0.0272	1900	1.0000	2.72%						
*AT&T GSM	1	283	152	0.0044	880	0.5867	0.75%						
*AT&T GSM	4	525	152	0.0327	1900	1.0000	3.27%						
*AT&T LTE	1	1615	154	0.0245	734	0.4893	5.00%						
*Enertrac	receive only		144										
*Clearwire	2	153	112	0.0088	2496	1.0000	0.88%						
*Clearwire	1	211	112	0.0060	11 GHz	1.0000	0.60%						
*Pocket (now MetroPCS)	3	631	122	0.0457	2130	1.0000	4.57%						
*SNET Paging			161	0.0216	930.9	0.6206	3.48%						
*T-Mobile GSM/UMTS	2	12	140	0.0004	1950	1.0000	0.04%						
*T-Mobile UMTS	2	12	140	0.0004	2100	1.0000	0.04%						
*T-Mobile LTE	2	24	140	0.0009	2100	1.0000	0.09%						
Verizon PCS	11	240	127	0.0589	1970	1.0000	5.89%						
Verizon Cellular	9	250	127	0.0502	869	0.5793	8.66%						
Verizon AWS	1	1750	127	0.0390	2145	1.0000	3.90%						
Verizon 700	1	1050	127	0.0234	698	0.4653	5.03%						
								47.93%					
* Source: Siting Council													

ATTACHMENT 3



AMERICAN TOWER®
CORPORATION

Structural Analysis Report

Structure : 150 ft Monopole
ATC Site Name : Enfd - Enfield, CT
ATC Site Number : 302489
Engineering Number : 52476824
Proposed Carrier : Verizon
Carrier Site Name : Enfield 4
Carrier Site Number : 177996 / 117803
Site Location : Town Farm Road
Enfield, CT 06082-5152
41.965917,-72.552700
County : Hartford
Date : August 2, 2013
Max Usage : 98%
Result : Pass

Jessica Abbott, E.I.
Design Engineer

Jessica Abbott

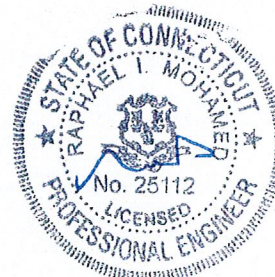

8/6/13



Table of Contents

Introduction	1
Supporting Documents	1
Analysis	1
Conclusion.....	1
Existing and Reserved Equipment.....	2
Proposed Equipment	2
Structure Usages	3
Foundations	3
Deflection, Twist, and Sway.....	3
Standard Conditions	4
Calculations	Attached



Introduction

The purpose of this report is to summarize results of a structural analysis performed on the 150 ft monopole to reflect the change in loading by Verizon.

Supporting Documents

Tower Drawings	Mapping by Smith Cullum Acquisition #CT-0025, dated May 14, 2001
Foundation Drawing	Southern New England Telephone, dated June 6, 1985
Geotechnical Report	MB & A Project #011107, dated June 16, 2001
Modifications	ATC Job #40071639, dated December 6, 2007 ATC Job #48982632, dated April 25, 2012

Analysis

The tower was analyzed using American Tower Corporation's tower analysis software. This program considers an elastic three-dimensional model and second-order effects per ANSI/TIA-222.

Basic Wind Speed:	95 mph (3-Second Gust)
Basic Wind Speed w/ Ice:	50 mph (3-Second Gust) w/ 1" radial ice concurrent
Code:	ANSI/TIA-222-G / 2003 IBC w/ 2005 CT Supplement & 2009 CT Amendment
Structure Class:	II
Exposure Category:	C
Topographic Category:	1

Conclusion

Based on the analysis results, the structure meets the requirements per the applicable codes listed above. The tower and foundation can support the equipment as described in this report.

If you have any questions or require additional information, please contact me via email at jessica.abbott@americantower.com or call 919-466-5209.



Existing and Reserved Equipment

Mount Elev. ¹ (ft)	Qty.	Antenna	Mount Type	Lines	Carrier
150.0	6	ADC DD1900	Platform w/ Handrails w/ Side Arms	(13) 1 5/8" Coax (2) 0.78" 8 AWG 6 (1) 0.39" Cable (1) 3" Conduit	AT&T Mobility
	6	Allgon 7770.00			
	1	Andrew SBNH-1D6565C			
	6	Ericsson RRUS 11 (Band 12)			
	6	Powerwave LGP13519			
	2	Powerwave P65-16-XLH-RR			
	1	Raycap DC6-48-60-18-8F			
	1	Decibel DB809KE-SY		(1) 1 5/8" Coax	
144.0	2	Diamond X50A	Side Arms	(2) 1/2" Coax	Enertrac
140.0	6	Andrew OneBase Twin Dual Duplex TMA	Low Profile Platform	(14) 1 5/8" Coax	T-Mobile
	3	EMS RR90-17-02DP			
	3	RFS APX16DWV-16DWV-S-E-ACU			
126.0	3	Antel BXA-70063-4CF-EDIN-10	Low Profile Platform	(12) 1 5/8" Coax	Verizon
	3	Antel BXA-171085-12CF-EDIN-X			
	6	RFS FD9R6004/2C-3L			
115.0	3	RFS APXV18-206517S-C	Flush	(6) 1 5/8" Coax	Youghiogheny
103.0	1	24" x 24" Junction Box	Side Arms	(6) 5/16" Coax (4) 1/2" Coax (2) 2" Conduit	Clearwire
	3	Argus LLPX310R			
	2	DragonWave A-ANT-11G-2-C			
	2	DragonWave Horizon Compact			
	3	NextNet BTS-2500			
56.0	1	Channel Master Type 120	Pipe	(1) 1/2" Coax	USA Mobility

Proposed Equipment

Elevation ¹ (ft)		Qty.	Antenna	Mount Type	Lines	Carrier
Mount	RAD					
126.0	127.0	3	Alcatel-Lucent RRH2x40-AWS	Low Profile Platform	(1) 1 5/8" Hybriflex	Verizon
		1	RFS DB-T1-6Z-8AB-OZ			
		3	Antel BXA-171085-8BF-EDIN-X			
		3	Antel BXA-80080-6CF-EDIN- X			

¹Mount elevation is defined as height above bottom of steel structure to the bottom of mount, RAD elevation is defined as center of antenna above ground level (AGL).

Install proposed coax outside the pole shaft. Stacking coax is not allowed.



Structure Usages

Structural Component	Controlling Usage	Pass/Fail
Anchor Bolts	98%	Pass
Shaft	98%	Pass
Base Plate	51%	Pass
Flanges	34%	Pass
Reinforcement	96%	Pass

Foundations

Reaction Component	Analysis Reactions
Moment (Kips-Ft)	3,867.8
Axial (Kips)	110.6
Shear (Kips)	39.4

The structure base reactions resulting from this analysis were found to be acceptable through analysis based on geotechnical and foundation information, therefore no modification or reinforcement of the foundation will be required.

Deflection and Sway*

Antenna Elevation (ft)	Deflection (ft)	Sway (Rotation) (°)
126.0	1.835	1.701

*Deflection and Sway was evaluated considering a design wind speed of 60 mph (3-Second Gust) per ANSI/TIA-222-G



Standard Conditions

All engineering services are performed on the basis that the information used is current and correct. This information may consist of, but is not necessary limited, to:

- Information supplied by the client regarding the structure itself, antenna, mounts and feed line loading on the structure and its components, or other relevant information.
- Information from drawings in the possession of American Tower Corporation, or generated by field inspections or measurements of the structure.

It is the responsibility of the client to ensure that the information provided to ATC Tower Services, Inc. and used in the performance of our engineering services is correct and complete. In the absence of information to the contrary, we assume that all structures were constructed in accordance with the drawings and specifications and that their capacity has not significantly changed from the "as new" condition.

Unless explicitly agreed by both the client and American Tower Corporation, all services will be performed in accordance with the current revision of ANSI/TIA -222. The design basic wind speed will be determined based on the minimum basic wind speed as prescribed in ANSI/TIA-222. Although every effort is taken to ensure that the loading considered is adequate to meet the requirements of all applicable regulatory entities, we can provide no assurance to meet any other local and state codes or requirements. If wind and ice loads or other relevant parameters are to be different from the minimum values recommended by the codes, the client shall specify the exact requirement.

All services are performed, results obtained, and recommendations made in accordance with generally accepted engineering principles and practices. ATC Tower Services, Inc. is not responsible for the conclusions, opinions and recommendations made by others based on the information we supply.

© 2007 - 2013 by ATC IP LLC. All rights reserved.

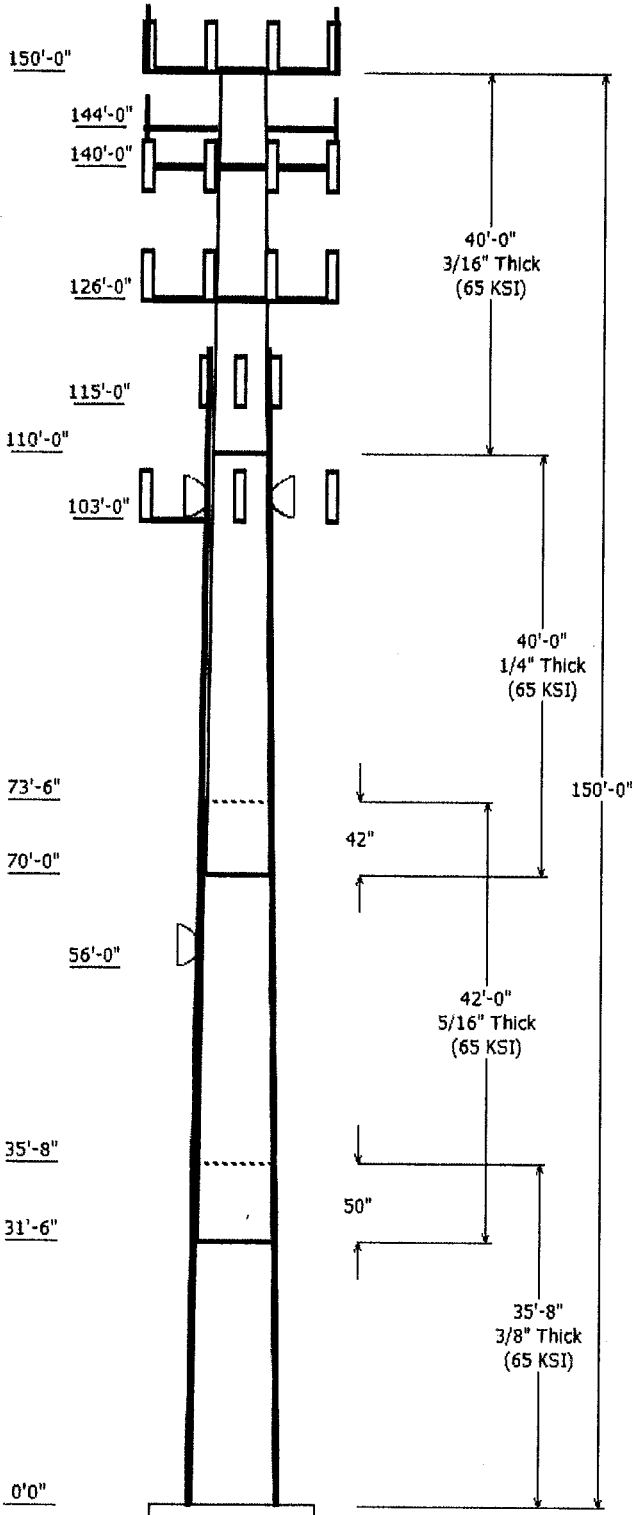

Job Information	
Pole :	302489
Code:	ANSI/TIA-222 Rev G
Description :	150' ITT Meyer Type "B" Monopole
Client :	Verizon Wireless
Struct Class :	II
Location :	Enfd - Enfield, CT
Shape :	12 Sides
Exposure :	C
Height :	150.00 (ft)
Topo :	1
Base Elev (ft):	0.00
Taper:	0.156700(in/ft)

Sections Properties								
Shaft Section	Length (ft)	Diameter (in)		Thick (in)	Joint Type	Overlap Length (in)	Taper (in/ft)	Steel Grade (ksi)
		Across Flats Top	Across Flats Bottom					
1	35.667	31.791	37.380	0.375		0.000	0.156700	65
2	42.000	26.487	33.069	0.313	Slip Joint	50.000	0.156700	65
3	40.000	21.268	27.536	0.250	Slip Joint	42.000	0.156700	65
4	40.000	15.000	21.268	0.188	Butt Joint	0.000	0.156700	65

Discrete Appurtenance			
Attach Elev (ft)	Force Elev (ft)	Qty	Description
150.000	152.000	6	Powerwave LGP13519
150.000	152.000	2	Powerwave P65-16-XLH-RR
150.000	152.000	1	Andrew SBNH-1D6565C
150.000	152.000	6	Ericsson RRUS 11 (Band 12)
150.000	152.000	1	Raycap DC6-48-60-18-8F
150.000	152.000	6	ADC DD1900
150.000	152.000	6	Allgon 7770.00
150.000	162.000	1	Decibel DB809KE-SY
150.000	150.000	1	Flat Platform w/ Handrails
144.000	144.000	2	Flat Side Arm
144.000	144.000	2	Diamond X50A
140.000	140.000	6	Andrew OneBase Dual Duplex
140.000	140.000	3	RFS APX16DWV-16DWV-S-E-ACU
140.000	140.000	3	EMS RR90-17-02DP
140.000	140.000	1	Flat Low Profile Platform
126.000	127.000	1	RFS DB-T1-6Z-8AB-0Z
126.000	127.000	6	RFS FD9R6004/2C-3L
126.000	127.000	3	Alcatel-Lucent RRR2x40-AWS
126.000	127.000	3	Antel BXA-171085-8BF-EDIN-X
126.000	127.000	3	Antel BXA-171085-12CF-EDIN-X
126.000	127.000	3	Antel BXA-70063-4CF-EDIN-10
126.000	127.000	3	Antel BXA-80080-6CF-EDIN- X
126.000	126.000	1	Round Low Profile Platform
115.000	118.000	3	RFS APXV18-206517S-C
103.000	107.000	3	NextNet BTS-2500
103.000	109.000	2	DragonWave Horizon Compact
103.000	109.000	2	DragonWave A-ANT-11G-2-C
103.000	103.000	1	Side Arms
103.000	107.000	3	Argus LLPX310R
103.000	106.000	1	24" x 24" Junction Box
56.000	58.000	1	Channel Master Type 120

Linear Appurtenance			
Elev (ft) From	To	Description	Exposed To Wind
10.000	126.00	1 5/8" Coax	Yes
10.000	126.00	1 5/8" Hybriflex	Yes
10.000	140.00	1 5/8" Coax	No
10.000	140.00	1 5/8" Coax	Yes
10.000	144.00	1/2" Coax	Yes
10.000	150.00	0.39" Cable	Yes

10.000	150.00	0.78" 8 AWG 6	Yes
10.000	150.00	1 5/8" Coax	Yes
10.000	150.00	1 5/8" Coax	No
10.000	150.00	1 5/8" Coax	Yes
10.000	150.00	3" Conduit	No
10.000	31.700	Dywidag	Yes
10.000	56.000	1/2" Coax	Yes
10.000	103.00	1/2" Coax	Yes
10.000	103.00	2" Conduit	Yes
10.000	103.00	5/16" Coax	Yes
10.000	115.00	1 5/8" Coax	Yes
0.000	125.51	#20 Dywidag bars	Yes

Load Cases	
1.2D + 1.6W	95.00 mph with No Ice
0.9D + 1.6W	95.00 mph with No Ice (Reduced DL)
1.2D + 1.0Di + 1.0Wi	50.00 mph with 1.00 in Radial Ice
1.0D + 1.0W	60.00 mph Serviceability

Reactions			
Load Case	Moment (kip-ft)	Shear (kip)	Axial (kip)
1.2D + 1.6W	3867.76	39.41	55.85
0.9D + 1.6W	3824.20	39.38	44.89
1.2D + 1.0Di + 1.0Wi	1192.43	11.19	110.59
1.0D + 1.0W	989.82	10.17	48.63

Dish Deflections			
Load Case	Attach Elev (ft)	Deflection (in)	Rotation (deg)
1.0D + 1.0W	56.00	4.197	0.691
1.0D + 1.0W	103.00	14.648	1.451

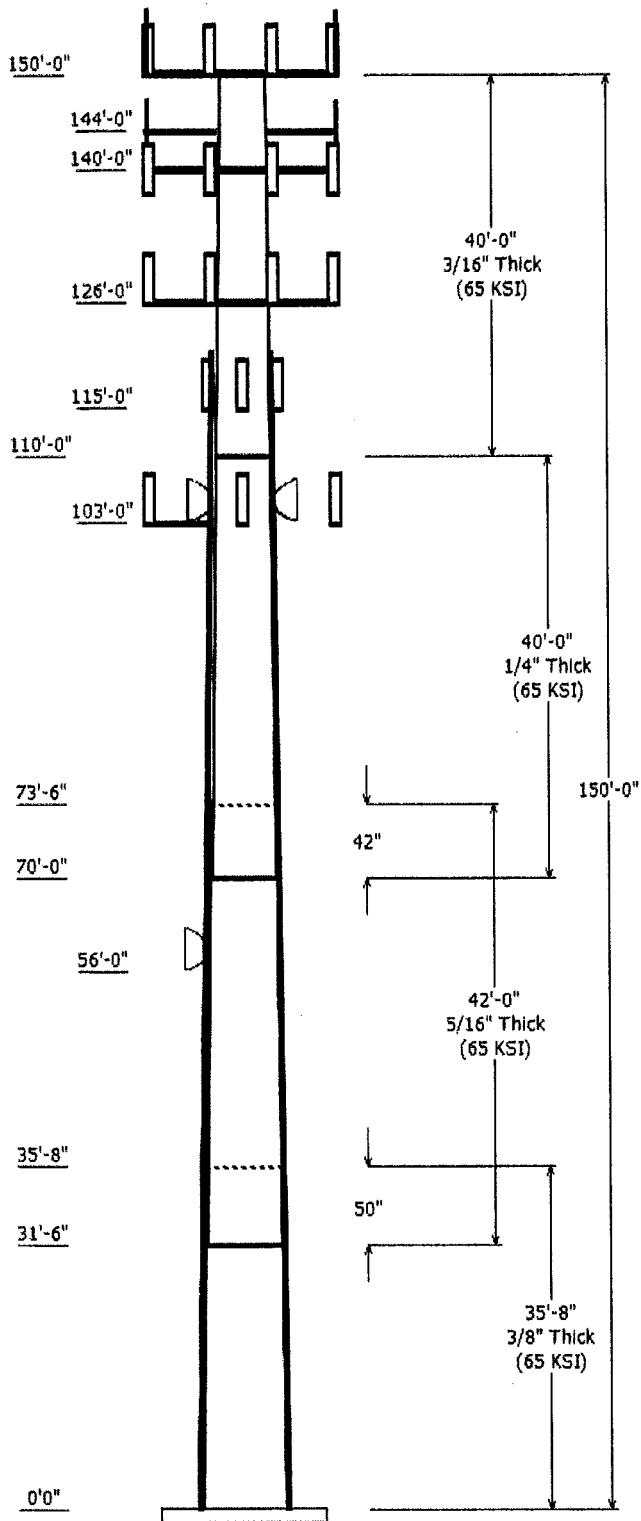

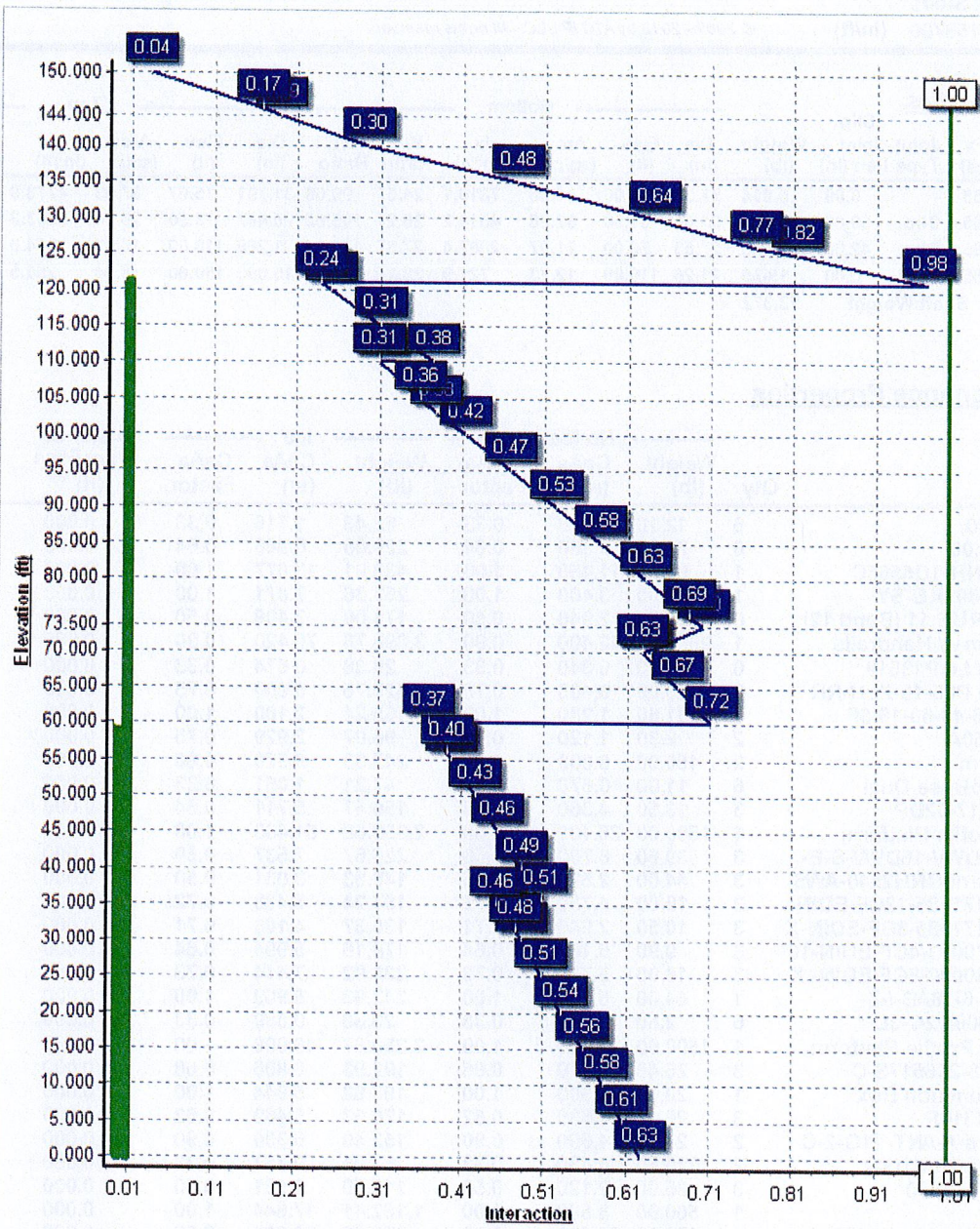

Pole : 302489
 Location : Enfd - Enfield, CT
 Height : 150.00 (ft)
 Base Dia : 37.380 (in)
 Top Dia : 15.000 (in)
 Shape : 12 Sides
 Taper : 0.156700 (in/ft)

Code: ANSI/TIA-222 Rev G
 Struct Class : II
 Exposure Category : C
 Topographic Category : 1
 Base Elev : 0.000 (ft)

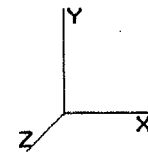

8/2/2013 4:43:22 PM
 Page: 1

© 2007 - 2013 by ATC IP LLC. All rights reserved.

Shaft Section Properties

Sect Info	Length (ft)	Thick (in)	Fy (ksi)	Joint Type	Slip Joint Len (in)	Weight (lb)	Bottom						Top						
							Dia (in)	Elev (ft)	Area (sqin)	Ix (in^4)	W/t Ratio	D/t Ratio	Dia (in)	Elev (ft)	Area (sqin)	Ix (in^4)	W/t Ratio	D/t Ratio	Taper (in/ft)
1-12	35.667	0.3750	65		0.00	5,014	37.38	0.00	44.68	7810.1	24.57	99.68	31.791	35.67	37.93	4778.9	20.57	84.78	0.156700
2-12	42.000	0.3125	65	Slip	50.00	4,237	33.06	31.50	32.96	4514.2	26.21	105.82	26.487	73.50	26.34	2303.3	20.57	84.76	0.156700
3-12	40.000	0.2500	65	Slip	42.00	2,646	27.53	70.00	21.97	2087.4	27.37	110.14	21.268	110.00	16.92	954.0	20.65	85.07	0.156700
4-12	40.000	0.1875	65	Butt	0.00	1,475	21.26	110.00	12.73	721.9	28.25	113.43	15.000	150.00	8.94	250.5	19.29	80.00	0.156700
Shaft Weight						13,372													

Discrete Appurtenance Properties

Attach Elev (ft)	Description	Qty	Weight (lb)	No Ice CaAa (sf)	CaAa Factor	Weight (lb)	Ice CaAa (sf)	CaAa Factor	Distance From Face (ft)	Vert Ecc (ft)
150.00	ADC DD1900	6	12.10	1.270	0.33	62.43	1.716	0.33	0.000	2.000
150.00	Allgon 7770.00	6	35.00	5.880	0.64	229.00	6.946	0.64	0.000	2.000
150.00	Andrew SBNH-1D6565C	1	60.80	11.450	1.00	433.91	13.677	1.00	0.000	2.000
150.00	Decibel DB809KE-SY	1	26.00	3.400	1.00	253.36	7.871	1.00	0.000	12.000
150.00	Ericsson RRUS 11 (Band 12)	6	55.00	2.940	0.50	171.00	3.408	0.50	0.000	2.000
150.00	Flat Platform w/ Handrails	1	2000.00	42.400	0.90	3,898.78	70.420	0.90	0.000	0.000
150.00	Powerwave LGP13519	6	5.30	0.340	0.33	29.38	0.674	0.33	0.000	2.000
150.00	Powerwave P65-16-XLH-RR	2	53.00	8.400	0.75	325.76	9.900	0.75	0.000	2.000
150.00	Raycap DC6-48-60-18-8F	1	31.80	1.280	1.00	165.24	2.180	1.00	0.000	2.000
144.00	Diamond X50A	2	2.30	1.120	0.75	96.07	2.929	0.75	0.000	0.000
144.00	Flat Side Arm	2	150.00	6.300	0.80	247.33	9.570	0.80	0.000	0.000
140.00	Andrew OneBase Dual	6	11.00	0.670	0.33	47.21	1.051	0.33	0.000	0.000
140.00	EMS RR90-17-02DP	3	13.50	4.360	0.64	156.47	5.711	0.64	0.000	0.000
140.00	Flat Low Profile Platform	1	1500.00	26.100	1.00	2,359.68	51.433	1.00	0.000	0.000
140.00	RFS APX16DWW-16DWW-S-E-	3	39.60	6.700	0.59	225.67	7.537	0.59	0.000	0.000
126.00	Alcatel-Lucent RRH2x40-AWS	3	44.00	2.520	0.50	148.33	3.031	0.50	0.000	1.000
126.00	Antel BXA-171085-12CF-EDIN-	3	15.00	4.730	0.72	187.24	6.438	0.72	0.000	1.000
126.00	Antel BXA-171085-8BF-EDIN-X	3	10.50	2.940	0.71	130.37	4.108	0.71	0.000	1.000
126.00	Antel BXA-70063-4CF-EDIN-10	3	9.90	5.160	0.64	179.16	5.994	0.64	0.000	1.000
126.00	Antel BXA-80080-6CF-EDIN- X	3	18.00	5.770	0.73	231.92	7.414	0.73	0.000	1.000
126.00	RFS DB-T1-6Z-8AB-0Z	1	44.00	5.600	1.00	242.93	5.969	1.00	0.000	1.000
126.00	RFS FD9R6004/2C-3L	6	2.60	0.370	0.33	23.38	0.689	0.33	0.000	1.000
126.00	Round Low Profile Platform	1	1500.00	21.700	1.00	2,350.67	46.908	1.00	0.000	0.000
115.00	RFS APXV18-206517S-C	3	26.40	5.170	0.68	192.93	6.806	0.68	0.000	3.000
103.00	24" x 24" Junction Box	1	20.00	5.600	1.00	198.82	5.944	1.00	0.000	3.000
103.00	Argus LLPX310R	3	28.60	4.830	0.62	176.63	5.469	0.62	0.000	4.000
103.00	DragonWave A-ANT-11G-2-C	2	27.00	4.690	0.90	152.40	6.330	0.90	0.000	6.000
103.00	DragonWave Horizon	2	10.60	0.430	0.33	53.95	0.767	0.33	0.000	6.000
103.00	NextNet BTS-2500	3	35.00	2.120	0.50	115.50	2.581	0.50	0.000	4.000
103.00	Side Arms	1	560.00	8.500	1.00	1,162.41	17.644	1.00	0.000	0.000
56.00	Channel Master Type 120	1	126.00	20.190	0.90	375.00	23.834	0.90	0.000	2.000
Totals		86	7801.90			21,798.79			Number of Loadings :	31

Linear Appurtenance Properties

Elev From (ft)	Elev To (ft)	Description	Exposed Width (in)	Exposed To Wind
10.00	150.00	(1) 0.39" Cable	0.00	Y
10.00	150.00	(2) 0.78" 8 AWG 6	0.00	Y
10.00	150.00	(1) 1 5/8" Coax	1.98	Y

Pole : 302489
 Location : Enfd - Enfield, CT
 Height : 150.00 (ft)
 Base Dia : 37.380 (in)
 Top Dia : 15.000 (in)
 Shape : 12 Sides
 Taper : 0.156700 (in/ft)

Code: ANSI/TIA-222 Rev G
 Struct Class : II
 Exposure Category : C
 Topographic Category : 1
 Base Elev : 0.000 (ft)

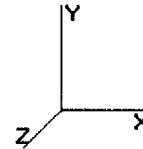

8/2/2013 4:43:22 PM
 Page: 2

© 2007 - 2013 by ATC IP LLC. All rights reserved.

10.00	150.00	(5) 1 5/8" Coax	0.00	N
10.00	150.00	(8) 1 5/8" Coax	3.96	Y
10.00	150.00	(1) 3" Conduit	0.00	N
10.00	144.00	(2) 1/2" Coax	0.63	Y
10.00	140.00	(6) 1 5/8" Coax	0.00	N
10.00	140.00	(8) 1 5/8" Coax	5.94	Y
10.00	126.00	(12) 1 5/8" Coax	1.98	Y
10.00	126.00	(1) 1 5/8" Hybriflex	0.00	Y
0.00	125.51	(4) #20 Dywidag bars	0.00	Y
10.00	115.00	(6) 1 5/8" Coax	0.00	Y
10.00	103.00	(4) 1/2" Coax	0.00	Y
10.00	103.00	(2) 2" Conduit	0.00	Y
10.00	103.00	(6) 5/16" Coax	0.00	Y
10.00	56.00	(1) 1/2" Coax	0.00	Y
10.00	31.70	(4) Dywidag	8.00	Y

Additional Steel

Elev From (ft)	Elev To (ft)	Qty	Description	Fy (ksi)	Offset (in)	— Intermediate Connections —		Connectors	Continuation?	
						Description	Spacing (in)			Len (in)
0.00	60.00	4	SOL #20 All Thread	80	8.28	6" T Bracket	30.00	3.31	5/8" A36 U-Bolt	Yes
0.00	121.00	4	SOL #20 All Thread	80	2.19	6" Angle Bracket	30.00	3.31	5/8" A36 U-Bolt	Yes

Pole : 302489
 Location : Enfd - Enfield, CT
 Height : 150.00 (ft)
 Base Dia : 37.380 (in)
 Top Dia : 15.000 (in)
 Shape : 12 Sides
 Taper : 0.156700 (in/ft)

Code: ANSI/TIA-222 Rev G
 Struct Class : II
 Exposure Category : C
 Topographic Category : 1
 Base Elev : 0.000 (ft)

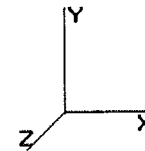

8/2/2013 4:43:22 PM
 Page: 3

© 2007 - 2013 by ATC IP LLC. All rights reserved.

Segment Properties (Max Len : 5 ft)

Seg Top Elev (ft)	Description	Thick (in)	Flat Dia (in)	Area (in^2)	Ix (in^4)	W/t Ratio	D/t Ratio	F'y (ksi)	S (in3)	Weight (lb)	Additional Reinforcing		
											Area (in^2)	Ix (in^4)	Weight (lb)
0.00		0.3750	37.380	44.684	7,810.1	24.57	99.68	77.9	403.6	0.0	39.28	12,78	0.0
5.00		0.3750	36.597	43.737	7,324.4	24.01	97.59	78.5	386.6	752.2	39.28	12,39	668.0
10.00		0.3750	35.813	42.791	6,859.3	23.45	95.50	79.1	370.0	736.1	39.28	12,00	668.0
15.00		0.3750	35.029	41.845	6,414.3	22.89	93.41	79.8	353.7	720.0	39.28	11,62	668.0
20.00		0.3750	34.246	40.899	5,989.0	22.33	91.32	80.4	337.8	703.9	39.28	11,25	668.0
25.00		0.3750	33.462	39.953	5,583.0	21.77	89.23	81.0	322.3	687.8	39.28	10,88	668.0
30.00		0.3750	32.679	39.007	5,195.7	21.21	87.14	81.6	307.1	671.7	39.28	10,52	668.0
31.50	Bot - Section 2	0.3750	32.444	38.723	5,083.1	21.04	86.52	81.8	302.7	198.4	39.28	10,41	200.4
35.00		0.3750	31.895	38.061	4,826.7	20.65	85.05	81.9	292.3	846.4	39.28	10,45	467.6
35.67	Top - Section 1	0.3125	32.416	32.304	4,249.6	25.65	103.73	76.7	253.3	159.7	39.28	10,40	89.1
40.00		0.3125	31.737	31.621	3,985.6	25.07	101.56	77.4	242.6	471.3	39.28	10,09	578.9
45.00		0.3125	30.953	30.833	3,694.9	24.40	99.05	78.1	230.6	531.3	39.28	9,749.	668.0
50.00		0.3125	30.170	30.044	3,418.6	23.73	96.54	78.8	218.9	517.9	39.28	9,407.	668.0
55.00		0.3125	29.386	29.256	3,156.5	23.05	94.04	79.6	207.5	504.5	39.28	9,072.	668.0
56.00		0.3125	29.230	29.098	3,105.7	22.92	93.54	79.7	205.3	99.3	39.28	9,005.	133.6
60.00	Reinf. Top	0.3125	28.603	28.467	2,908.1	22.38	91.53	80.3	196.4	391.8	39.28	8,742.	534.4
65.00		0.3125	27.819	27.679	2,673.1	21.71	89.02	81.0	185.6	477.6	19.64	3,016.	334.0
70.00		0.3125	27.036	26.891	2,451.2	21.04	86.52	81.8	175.1	464.2	19.64	2,879.	334.0
70.00	Bot - Section 3	0.3125	27.036	26.890	2,451.1	21.04	86.52	81.8	175.1	0.0	19.64	2,879.	0.0
73.50	Top - Section 2	0.2500	26.987	21.524	1,964.0	26.78	107.95	75.5	140.6	575.9	19.64	2,870.	233.8
75.00		0.2500	26.752	21.335	1,912.7	26.53	107.01	75.8	138.1	109.4	19.64	2,830.	100.2
80.00		0.2500	25.969	20.704	1,748.0	25.69	103.88	76.7	130.0	357.6	19.64	2,696.	334.0
85.00		0.2500	25.185	20.073	1,593.1	24.85	100.74	77.6	122.2	346.9	19.64	2,566.	334.0
90.00		0.2500	24.402	19.442	1,447.6	24.01	97.61	78.5	114.6	336.2	19.64	2,439.	334.0
95.00		0.2500	23.618	18.812	1,311.2	23.17	94.47	79.4	107.2	325.4	19.64	2,315.	334.0
100.00		0.2500	22.835	18.181	1,183.7	22.33	91.34	80.4	100.1	314.7	19.64	2,195.	334.0
103.00		0.2500	22.365	17.802	1,111.3	21.83	89.46	80.9	96.0	183.7	19.64	2,124.	200.4
105.00		0.2500	22.051	17.550	1,064.7	21.49	88.21	81.3	93.3	120.3	19.64	2,078.	133.6
110.00		0.2500	21.268	16.919	954.0	20.65	85.07	81.9	86.7	293.2	19.64	1,963.	334.0
110.00	Top - Section 3	0.2500	21.268	16.919	954.0	20.65	85.07	81.9	86.7	0.0	19.64	1,963.	0.0
110.00	Bot - Section 4	0.1875	21.268	12.727	721.9	28.25	113.43	73.9	65.6		19.64	1,963.	
115.00		0.1875	20.484	12.254	644.4	27.13	109.25	75.1	60.8	212.5	19.64	1,853.	334.0
120.00		0.1875	19.701	11.781	572.6	26.01	105.07	76.3	56.1	204.5	19.64	1,745.	334.0
121.00	Reinf. Top	0.1875	19.544	11.687	558.9	25.79	104.24	76.6	55.2	39.9	19.64	1,724.	66.8
125.00		0.1875	18.917	11.308	506.4	24.89	100.89	77.6	51.7	156.5			
126.00		0.1875	18.761	11.214	493.8	24.67	100.06	77.8	50.8	38.3			
130.00		0.1875	18.134	10.835	445.4	23.77	96.71	78.8	47.5	150.1			
135.00		0.1875	17.350	10.362	389.6	22.65	92.54	80.0	43.4	180.3			
140.00		0.1875	16.567	9.889	338.6	21.53	88.36	81.2	39.5	172.3			
144.00		0.1875	15.940	9.511	301.2	20.64	85.01	81.9	36.5	132.0			
145.00		0.1875	15.783	9.416	292.3	20.41	84.18	81.9	35.8	32.2			
150.00		0.1875	15.000	8.943	250.5	19.29	80.00	81.9	32.3	156.2			
										13,372.1	12,090.		

Pole : 302489
 Location : Enfd - Enfield, CT
 Height : 150.00 (ft)
 Base Dia : 37.380 (in)
 Top Dia : 15.000 (in)
 Shape : 12 Sides
 Taper : 0.156700 (in/ft)

Code : ANSI/TIA-222 Rev G
 Struct Class : II
 Exposure Category : C
 Topographic Category : 1
 Base Elev : 0.000 (ft)

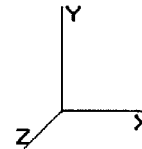

8/2/2013 4:43:22 PM
 Page: 4

© 2007 - 2013 by ATC IP LLC. All rights reserved.

Load Case: 1.2D + 1.6W	95.00 mph with No Ice	25 Iterations
Gust Response Factor 1.10		Wind Importance Factor : 1.00
Dead Load Factor : 1.20		
Wind Load Factor : 1.60		

Shaft Segment Forces (Factored)

Seg Top Elev (ft)	Description	Kzt	Kz	qz (psf)	qzGh (psf)	C (mph-ft)	Cf	Ice Thick (in)	Tributary (ft)	Aa (sf)	CfAa (sf)	Wind Force X (lb)	Dead Load Ice (lb)	Tot Dead Load (lb)
0.00		1.00	0.85	18.656	20.522	282.454	1.000	0.000	0.00	0.000	0.00	0.0	0.0	0.0
5.00		1.00	0.85	18.656	20.522	276.533	1.000	0.000	5.00	15.955	15.96	523.9	0.0	1,570.6
10.00		1.00	0.85	18.656	20.522	270.613	1.000	0.000	5.00	15.617	15.62	512.8	0.0	1,551.3
15.00		1.00	0.85	18.656	20.522	264.693	1.200	* 0.000	5.00	15.279	18.34	602.0	0.0	1,532.0
20.00		1.00	0.90	19.795	21.775	266.553	1.200	* 0.000	5.00	14.942	17.93	624.7	0.0	1,512.7
25.00		1.00	0.94	20.747	22.822	266.645	1.200	* 0.000	5.00	14.604	17.52	639.9	0.0	1,493.4
30.00		1.00	0.98	21.559	23.715	265.448	1.200	* 0.000	5.00	14.266	17.12	649.6	0.0	1,474.0
31.50	Bot - Section 2	1.00	0.99	21.782	23.960	264.895	1.200	* 0.000	1.50	4.215	5.06	193.9	0.0	438.5
35.00		1.00	1.01	22.270	24.497	263.322	1.200	* 0.000	3.50	9.902	11.88	465.7	0.0	1,483.3
35.67	Top - Section 1	1.00	1.01	22.359	24.595	262.981	1.200	* 0.000	0.67	1.868	2.24	88.2	0.0	280.7
40.00		1.00	1.04	22.905	25.196	265.722	1.200	* 0.000	4.33	11.991	14.39	580.1	0.0	1,444.4
45.00		1.00	1.07	23.480	25.828	262.395	1.200	* 0.000	5.00	13.521	16.23	670.5	0.0	1,305.5
50.00		1.00	1.09	24.007	26.408	258.606	1.200	* 0.000	5.00	13.183	15.82	668.4	0.0	1,289.4
55.00		1.00	1.11	24.494	26.943	254.430	1.200	* 0.000	5.00	12.845	15.41	664.5	0.0	1,273.3
56.00	Appertunance(s)	1.00	1.12	24.587	27.045	253.553	1.200	* 0.000	1.00	2.529	3.03	131.3	0.0	252.7
60.00	Reinf. Top	1.00	1.13	24.946	27.441	249.925	1.200	* 0.000	4.00	9.979	11.97	525.8	0.0	1,004.5
65.00		1.00	1.15	25.370	27.907	245.135	1.200	* 0.000	5.00	12.169	14.60	652.1	0.0	907.2
70.00		1.00	1.17	25.769	28.346	240.097	1.200	* 0.000	5.00	11.831	14.20	643.9	0.0	891.1
70.00	Bot - Section 3	1.00	1.17	25.769	28.346	240.097	1.200	* 0.000	0.00	0.001	0.00	0.0	0.0	0.1
73.50	Top - Section 2	1.00	1.18	26.035	28.639	236.437	1.200	* 0.000	3.50	8.232	9.88	452.6	0.0	924.9
75.00		1.00	1.19	26.146	28.761	239.311	1.200	* 0.000	1.50	3.476	4.17	192.0	0.0	231.4
80.00		1.00	1.20	26.504	29.154	233.886	1.200	* 0.000	5.00	11.371	13.65	636.5	0.0	763.1
85.00		1.00	1.22	26.844	29.529	228.282	1.200	* 0.000	5.00	11.033	13.24	625.5	0.0	750.3
90.00		1.00	1.23	27.169	29.886	222.515	1.200	* 0.000	5.00	10.695	12.83	613.7	0.0	737.4
95.00		1.00	1.25	27.480	30.229	216.599	1.200	* 0.000	5.00	10.357	12.43	601.1	0.0	724.5
100.00		1.00	1.26	27.779	30.557	210.548	1.200	* 0.000	5.00	10.019	12.02	587.8	0.0	711.6
103.00	Appertunance(s)	1.00	1.27	27.952	30.747	206.856	1.200	* 0.000	3.00	5.849	7.02	345.3	0.0	420.8
105.00		1.00	1.27	28.066	30.872	204.371	1.200	* 0.000	2.00	3.832	4.60	227.1	0.0	278.0
110.00		1.00	1.29	28.342	31.176	198.077	1.200	* 0.000	5.00	9.343	11.21	559.3	0.0	685.9
110.00	Top - Section 3	1.00	1.29	28.342	31.176	198.076	1.200	* 0.000	0.00	0.001	0.00	0.0	0.0	0.0
115.00	Appertunance(s)	1.00	1.30	28.608	31.469	191.675	1.200	* 0.000	5.00	9.005	10.81	544.1	0.0	589.0
120.00		1.00	1.31	28.866	31.752	185.171	1.200	* 0.000	5.00	8.667	10.40	528.4	0.0	579.4
121.00	Reinf. Top	1.00	1.31	28.916	31.808	183.859	1.200	* 0.000	1.00	1.693	2.03	103.4	0.0	114.7
125.00		1.00	1.32	29.115	32.026	178.573	1.200	* 0.000	4.00	6.636	7.96	408.1	0.0	187.8
126.00	Appertunance(s)	1.00	1.32	29.164	32.080	177.242	1.200	* 0.000	1.00	1.625	1.95	100.1	0.0	46.0
130.00		1.00	1.33	29.356	32.292	171.885	1.200	* 0.000	4.00	6.366	7.64	394.7	0.0	180.1
135.00		1.00	1.34	29.591	32.550	165.113	1.200	* 0.000	5.00	7.653	9.18	478.3	0.0	216.4
140.00	Appertunance(s)	1.00	1.35	29.818	32.800	158.262	1.200	* 0.000	5.00	7.315	8.78	460.7	0.0	206.7
144.00	Appertunance(s)	1.00	1.36	29.995	32.995	152.726	1.200	* 0.000	4.00	5.609	6.73	355.3	0.0	158.4
145.00		1.00	1.36	30.039	33.043	151.335	1.200	* 0.000	1.00	1.368	1.64	86.8	0.0	38.6
150.00	Appertunance(s)	1.00	1.37	30.254	33.280	144.337	1.200	* 0.000	5.00	6.639	7.97	424.2	0.0	187.4
						Totals:			150.00			17,562.5	0.0	28,137.3

* = Cf Adjusted By Linear Load Ra Effect

Pole : 302489
 Location : Enfd - Enfield, CT
 Height : 150.00 (ft)
 Base Dia : 37.380 (in)
 Top Dia : 15.000 (in)
 Shape : 12 Sides
 Taper : 0.156700 (in/ft)

Code: ANSI/TIA-222 Rev G
 Struct Class : II
 Exposure Category : C
 Topographic Category : 1
 Base Elev : 0.000 (ft)

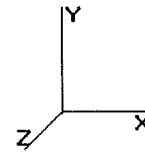

8/2/2013 4:43:23 PM
 Page: 5

© 2007 - 2013 by ATC IP LLC. All rights reserved.

Load Case: 1.2D + 1.6W

95.00 mph with No Ice

25 Iterations

Gust Response Factor 1.10
 Dead Load Factor : 1.20
 Wind Load Factor : 1.60

Wind Importance Factor : 1.00

Discrete Appurtenance Segment Forces (Factored)

Elev (ft)	Description	Qty	qz (psf)	qzGh (psf)	CaAa Factor	Ka	Total CaAa (sf)	Horiz Ecc (ft)	Vert Ecc (ft)	Wind FX (lb)	Mom Y (lb-ft)	Mom Z (lb-ft)	Dead Load (lb)
56.00	Channel Master Type	1	24.769	27.246	0.90	1.00	18.17	0.000	2.000	792.14	0.00	1,584.27	151.20
103.0	24" x 24" Junction	1	28.122	30.934	0.80	0.80	4.48	0.000	3.000	221.73	0.00	665.20	24.00
103.0	Argus LLPX310R	3	28.177	30.995	0.50	0.80	7.19	0.000	4.000	356.42	0.00	1,425.68	102.96
103.0	DragonWave A-ANT-	2	28.287	31.116	0.72	0.80	6.75	0.000	6.000	336.23	0.00	2,017.40	64.80
103.0	DragonWave Horizon	2	28.287	31.116	0.26	0.80	0.23	0.000	6.000	11.30	0.00	67.82	25.44
103.0	NextNet BTS-2500	3	28.177	30.995	0.40	0.80	2.54	0.000	4.000	126.16	0.00	504.65	126.00
103.0	Side Arms	1	27.952	30.747	1.00	1.00	8.50	0.000	0.000	418.17	0.00	0.00	672.00
115.0	RFS APXV18-206517S-	3	28.764	31.640	0.54	0.80	8.44	0.000	3.000	427.14	0.00	1,281.42	95.04
126.0	Alcatel-Lucent RRH2x	3	29.212	32.134	0.40	0.80	3.02	0.000	1.000	155.48	0.00	155.48	158.40
126.0	Antel BXA-171085-12C	3	29.212	32.134	0.58	0.80	8.17	0.000	1.000	420.23	0.00	420.23	54.00
126.0	Antel BXA-171085-8BF	3	29.212	32.134	0.57	0.80	5.01	0.000	1.000	257.57	0.00	257.57	37.80
126.0	Antel BXA-70063-4CF-	3	29.212	32.134	0.51	0.80	7.93	0.000	1.000	407.49	0.00	407.49	35.64
126.0	Antel BXA-80080-6CF-	3	29.212	32.134	0.58	0.80	10.11	0.000	1.000	519.74	0.00	519.74	64.80
126.0	RFS DB-T1-6Z-8AB-0Z	1	29.212	32.134	0.80	0.80	4.48	0.000	1.000	230.33	0.00	230.33	52.80
126.0	RFS FD9R6004/2C-3L	6	29.212	32.134	0.26	0.80	0.59	0.000	1.000	30.13	0.00	30.13	18.72
126.0	Round Low Profile PI	1	29.164	32.080	1.00	1.00	21.70	0.000	0.000	1,113.82	0.00	0.00	1,800.00
140.0	Andrew OneBase Dual	6	29.818	32.800	0.26	0.80	1.06	0.000	0.000	55.70	0.00	0.00	79.20
140.0	EMS RR90-17-02DP	3	29.818	32.800	0.51	0.80	6.70	0.000	0.000	351.45	0.00	0.00	48.60
140.0	Flat Low Profile Pla	1	29.818	32.800	1.00	1.00	26.10	0.000	0.000	1,369.72	0.00	0.00	1,800.00
140.0	RFS APX16DWW-	3	29.818	32.800	0.47	0.80	9.49	0.000	0.000	497.88	0.00	0.00	142.56
144.0	Diamond X50A	2	29.995	32.995	0.75	1.00	1.68	0.000	0.000	88.69	0.00	0.00	5.52
144.0	Flat Side Arm	2	29.995	32.995	0.80	1.00	10.08	0.000	0.000	532.14	0.00	0.00	360.00
150.0	ADC DD1900	6	30.339	33.373	0.25	0.75	1.89	0.000	2.000	100.70	0.00	201.40	87.12
150.0	Allgon 7770.00	6	30.339	33.373	0.48	0.75	16.93	0.000	2.000	904.23	0.00	1,808.46	252.00
150.0	Andrew SBNH-	1	30.339	33.373	0.75	0.75	8.59	0.000	2.000	458.54	0.00	917.08	72.96
150.0	Decibel DB809KE-SY	1	30.748	33.823	1.00	1.00	3.40	0.000	12.000	184.00	0.00	2,207.98	31.20
150.0	Ericsson RRUS 11 (Ba	6	30.339	33.373	0.50	1.00	8.82	0.000	2.000	470.95	0.00	941.91	396.00
150.0	Flat Platform w/ Han	1	30.254	33.280	0.90	1.00	38.16	0.000	0.000	2,031.91	0.00	0.00	2,400.00
150.0	Powerwave LGP13519	6	30.339	33.373	0.25	0.75	0.50	0.000	2.000	26.96	0.00	53.92	38.16
150.0	Powerwave P65-16-	2	30.339	33.373	0.56	0.75	9.45	0.000	2.000	504.59	0.00	1,009.19	127.20
150.0	Raycap DC6-48-60-18-	1	30.339	33.373	1.00	1.00	1.28	0.000	2.000	68.35	0.00	136.69	38.16
										13,469.91			9,362.28

Pole : 302489
 Location : Enfd - Enfield, CT
 Height : 150.00 (ft)
 Base Dia : 37.380 (in)
 Top Dia : 15.000 (in)
 Shape : 12 Sides
 Taper : 0.156700 (in/ft)

Code : ANSI/TIA-222 Rev G
 Struct Class : II
 Exposure Category : C
 Topographic Category : 1
 Base Elev : 0.000 (ft)

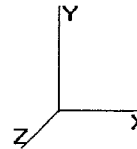

8/2/2013 4:43:23 PM
 Page : 6

© 2007 - 2013 by ATC IP LLC. All rights reserved.

Load Case: 1.2D + 1.6W

95.00 mph with No Ice

25 Iterations

Gust Response Factor 1.10
 Dead Load Factor : 1.20
 Wind Load Factor : 1.60

Wind Importance Factor : 1.00

Linear Appurtenance Segment Forces (Factored)

Seg Top Elev (ft)	Description	Exposed To Wind	Length (ft)	Ca	Exposed Width (in)	Area (sqft)	CaAa (sqft)	qz (psf)	Ra	Cf Adjust Factor	F X (lb)	Dead Load (lb)
5.00	(4) #20 Dywidag bars	Yes	5.00	0.000	0.00	0.00	0.00	18.656	0.000	0.000	0.00	400.80
10.00	(4) #20 Dywidag bars	Yes	5.00	0.000	0.00	0.00	0.00	18.656	0.000	0.000	0.00	400.80
15.00	(1) 0.39" Cable	Yes	5.00	0.000	0.00	0.00	0.00	18.656	0.613	0.000	0.00	0.42
15.00	(2) 0.78" 8 AWG 6	Yes	5.00	0.000	0.00	0.00	0.00	18.656	0.613	0.000	0.00	7.08
15.00	(1) 1 5/8" Coax	Yes	5.00	1.200	1.98	0.82	0.99	18.656	0.613	0.000	32.51	4.92
15.00	(8) 1 5/8" Coax	Yes	5.00	1.200	3.96	1.65	1.98	18.656	0.613	0.000	65.01	39.36
15.00	(2) 1/2" Coax	Yes	5.00	1.200	0.63	0.26	0.31	18.656	0.613	0.000	10.34	1.80
15.00	(8) 1 5/8" Coax	Yes	5.00	0.886	5.94	2.47	2.19	18.656	0.613	0.000	71.98	39.36
15.00	(12) 1 5/8" Coax	Yes	5.00	1.200	1.98	0.82	0.99	18.656	0.613	0.000	32.51	59.03
15.00	(1) 1 5/8" Hybriflex	Yes	5.00	0.000	0.00	0.00	0.00	18.656	0.613	0.000	0.00	9.66
15.00	(4) #20 Dywidag bars	Yes	5.00	0.000	0.00	0.00	0.00	18.656	0.613	0.000	0.00	400.80
15.00	(6) 1 5/8" Coax	Yes	5.00	0.000	0.00	0.00	0.00	18.656	0.613	0.000	0.00	29.52
15.00	(4) 1/2" Coax	Yes	5.00	0.000	0.00	0.00	0.00	18.656	0.613	0.000	0.00	3.60
15.00	(2) 2" Conduit	Yes	5.00	0.000	0.00	0.00	0.00	18.656	0.613	0.000	0.00	43.80
15.00	(6) 5/16" Coax	Yes	5.00	0.000	0.00	0.00	0.00	18.656	0.613	0.000	0.00	1.62
15.00	(1) 1/2" Coax	Yes	5.00	0.000	0.00	0.00	0.00	18.656	0.613	0.000	0.00	0.90
15.00	(4) Dywidag	Yes	5.00	2.000	8.00	3.33	6.67	18.656	0.613	0.000	218.90	0.00
20.00	(1) 0.39" Cable	Yes	5.00	0.000	0.00	0.00	0.00	19.795	0.627	0.000	0.00	0.42
20.00	(2) 0.78" 8 AWG 6	Yes	5.00	0.000	0.00	0.00	0.00	19.795	0.627	0.000	0.00	7.08
20.00	(1) 1 5/8" Coax	Yes	5.00	1.200	1.98	0.82	0.99	19.795	0.627	0.000	34.49	4.92
20.00	(8) 1 5/8" Coax	Yes	5.00	1.200	3.96	1.65	1.98	19.795	0.627	0.000	68.98	39.36
20.00	(2) 1/2" Coax	Yes	5.00	1.200	0.63	0.26	0.31	19.795	0.627	0.000	10.97	1.80
20.00	(8) 1 5/8" Coax	Yes	5.00	0.860	5.94	2.47	2.13	19.795	0.627	0.000	74.14	39.36
20.00	(12) 1 5/8" Coax	Yes	5.00	1.200	1.98	0.82	0.99	19.795	0.627	0.000	34.49	59.03
20.00	(1) 1 5/8" Hybriflex	Yes	5.00	0.000	0.00	0.00	0.00	19.795	0.627	0.000	0.00	9.66
20.00	(4) #20 Dywidag bars	Yes	5.00	0.000	0.00	0.00	0.00	19.795	0.627	0.000	0.00	400.80
20.00	(6) 1 5/8" Coax	Yes	5.00	0.000	0.00	0.00	0.00	19.795	0.627	0.000	0.00	29.52
20.00	(4) 1/2" Coax	Yes	5.00	0.000	0.00	0.00	0.00	19.795	0.627	0.000	0.00	3.60
20.00	(2) 2" Conduit	Yes	5.00	0.000	0.00	0.00	0.00	19.795	0.627	0.000	0.00	43.80
20.00	(6) 5/16" Coax	Yes	5.00	0.000	0.00	0.00	0.00	19.795	0.627	0.000	0.00	1.62
20.00	(1) 1/2" Coax	Yes	5.00	0.000	0.00	0.00	0.00	19.795	0.627	0.000	0.00	0.90
20.00	(4) Dywidag	Yes	5.00	2.000	8.00	3.33	6.67	19.795	0.627	0.000	232.26	0.00
25.00	(1) 0.39" Cable	Yes	5.00	0.000	0.00	0.00	0.00	20.747	0.642	0.000	0.00	0.42
25.00	(2) 0.78" 8 AWG 6	Yes	5.00	0.000	0.00	0.00	0.00	20.747	0.642	0.000	0.00	7.08
25.00	(1) 1 5/8" Coax	Yes	5.00	1.200	1.98	0.82	0.99	20.747	0.642	0.000	36.15	4.92
25.00	(8) 1 5/8" Coax	Yes	5.00	1.200	3.96	1.65	1.98	20.747	0.642	0.000	72.30	39.36
25.00	(2) 1/2" Coax	Yes	5.00	1.200	0.63	0.26	0.31	20.747	0.642	0.000	11.50	1.80
25.00	(8) 1 5/8" Coax	Yes	5.00	0.840	5.94	2.47	2.08	20.747	0.642	0.000	75.91	39.36
25.00	(12) 1 5/8" Coax	Yes	5.00	1.200	1.98	0.82	0.99	20.747	0.642	0.000	36.15	59.03
25.00	(1) 1 5/8" Hybriflex	Yes	5.00	0.000	0.00	0.00	0.00	20.747	0.642	0.000	0.00	9.66
25.00	(4) #20 Dywidag bars	Yes	5.00	0.000	0.00	0.00	0.00	20.747	0.642	0.000	0.00	400.80
25.00	(6) 1 5/8" Coax	Yes	5.00	0.000	0.00	0.00	0.00	20.747	0.642	0.000	0.00	29.52
25.00	(4) 1/2" Coax	Yes	5.00	0.000	0.00	0.00	0.00	20.747	0.642	0.000	0.00	3.60
25.00	(2) 2" Conduit	Yes	5.00	0.000	0.00	0.00	0.00	20.747	0.642	0.000	0.00	43.80
25.00	(6) 5/16" Coax	Yes	5.00	0.000	0.00	0.00	0.00	20.747	0.642	0.000	0.00	1.62
25.00	(1) 1/2" Coax	Yes	5.00	0.000	0.00	0.00	0.00	20.747	0.642	0.000	0.00	0.90
25.00	(4) Dywidag	Yes	5.00	2.000	8.00	3.33	6.67	20.747	0.642	0.000	243.44	0.00
30.00	(1) 0.39" Cable	Yes	5.00	0.000	0.00	0.00	0.00	21.559	0.657	0.000	0.00	0.42
30.00	(2) 0.78" 8 AWG 6	Yes	5.00	0.000	0.00	0.00	0.00	21.559	0.657	0.000	0.00	7.08
30.00	(1) 1 5/8" Coax	Yes	5.00	1.200	1.98	0.82	0.99	21.559	0.657	0.000	37.56	4.92
30.00	(8) 1 5/8" Coax	Yes	5.00	1.200	3.96	1.65	1.98	21.559	0.657	0.000	75.13	39.36

Pole : 302489
 Location : Enfd - Enfield, CT
 Height : 150.00 (ft)
 Base Dia : 37.380 (in)
 Top Dia : 15.000 (in)
 Shape : 12 Sides
 Taper : 0.156700 (in/ft)

Code: ANSI/TIA-222 Rev G
 Struct Class : II
 Exposure Category : C
 Topographic Category : 1
 Base Elev : 0.000 (ft)

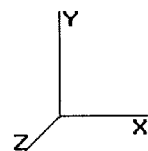

8/2/2013 4:43:23 PM
 Page: 7

© 2007 - 2013 by ATC IP LLC. All rights reserved.

Load Case: 1.2D + 1.6W	95.00 mph with No Ice	25 Iterations
Gust Response Factor : 1.10		Wind Importance Factor : 1.00
Dead Load Factor : 1.20		
Wind Load Factor : 1.60		

30.00	(2) 1/2" Coax	Yes	5.00	1.200	0.63	0.26	0.31	21.559	0.657	0.000	11.95	1.80
30.00	(8) 1 5/8" Coax	Yes	5.00	0.824	5.94	2.47	2.04	21.559	0.657	0.000	77.38	39.36
30.00	(12) 1 5/8" Coax	Yes	5.00	1.200	1.98	0.82	0.99	21.559	0.657	0.000	37.56	59.03
30.00	(1) 1 5/8" Hybriflex	Yes	5.00	0.000	0.00	0.00	0.00	21.559	0.657	0.000	0.00	9.66
30.00	(4) #20 Dywidag bars	Yes	5.00	0.000	0.00	0.00	0.00	21.559	0.657	0.000	0.00	400.80
30.00	(6) 1 5/8" Coax	Yes	5.00	0.000	0.00	0.00	0.00	21.559	0.657	0.000	0.00	29.52
30.00	(4) 1/2" Coax	Yes	5.00	0.000	0.00	0.00	0.00	21.559	0.657	0.000	0.00	3.60
30.00	(2) 2" Conduit	Yes	5.00	0.000	0.00	0.00	0.00	21.559	0.657	0.000	0.00	43.80
30.00	(6) 5/16" Coax	Yes	5.00	0.000	0.00	0.00	0.00	21.559	0.657	0.000	0.00	1.62
30.00	(1) 1/2" Coax	Yes	5.00	0.000	0.00	0.00	0.00	21.559	0.657	0.000	0.00	0.90
30.00	(4) Dywidag	Yes	5.00	2.000	8.00	3.33	6.67	21.559	0.657	0.000	252.96	0.00
31.50	(1) 0.39" Cable	Yes	1.50	0.000	0.00	0.00	0.00	21.782	0.667	0.000	0.00	0.13
31.50	(2) 0.78" 8 AWG 6	Yes	1.50	0.000	0.00	0.00	0.00	21.782	0.667	0.000	0.00	2.12
31.50	(1) 1 5/8" Coax	Yes	1.50	1.200	1.98	0.25	0.30	21.782	0.667	0.000	11.39	1.48
31.50	(8) 1 5/8" Coax	Yes	1.50	1.200	3.96	0.50	0.59	21.782	0.667	0.000	22.78	11.81
31.50	(2) 1/2" Coax	Yes	1.50	1.200	0.63	0.08	0.09	21.782	0.667	0.000	3.62	0.54
31.50	(8) 1 5/8" Coax	Yes	1.50	0.820	5.94	0.74	0.61	21.782	0.667	0.000	23.34	11.81
31.50	(12) 1 5/8" Coax	Yes	1.50	1.200	1.98	0.25	0.30	21.782	0.667	0.000	11.39	17.71
31.50	(1) 1 5/8" Hybriflex	Yes	1.50	0.000	0.00	0.00	0.00	21.782	0.667	0.000	0.00	2.90
31.50	(4) #20 Dywidag bars	Yes	1.50	0.000	0.00	0.00	0.00	21.782	0.667	0.000	0.00	120.27
31.50	(6) 1 5/8" Coax	Yes	1.50	0.000	0.00	0.00	0.00	21.782	0.667	0.000	0.00	8.86
31.50	(4) 1/2" Coax	Yes	1.50	0.000	0.00	0.00	0.00	21.782	0.667	0.000	0.00	1.08
31.50	(2) 2" Conduit	Yes	1.50	0.000	0.00	0.00	0.00	21.782	0.667	0.000	0.00	13.14
31.50	(6) 5/16" Coax	Yes	1.50	0.000	0.00	0.00	0.00	21.782	0.667	0.000	0.00	0.49
31.50	(1) 1/2" Coax	Yes	1.50	0.000	0.00	0.00	0.00	21.782	0.667	0.000	0.00	0.27
31.50	(4) Dywidag	Yes	1.50	2.000	8.00	1.00	2.00	21.782	0.667	0.000	76.69	0.00
35.00	(1) 0.39" Cable	Yes	3.50	0.000	0.00	0.00	0.00	22.270	0.449	0.000	0.00	0.29
35.00	(2) 0.78" 8 AWG 6	Yes	3.50	0.000	0.00	0.00	0.00	22.270	0.449	0.000	0.00	4.96
35.00	(1) 1 5/8" Coax	Yes	3.50	1.200	1.98	0.58	0.69	22.270	0.449	0.000	27.16	3.44
35.00	(8) 1 5/8" Coax	Yes	3.50	1.200	3.96	1.15	1.39	22.270	0.449	0.000	54.32	27.55
35.00	(2) 1/2" Coax	Yes	3.50	1.200	0.63	0.18	0.22	22.270	0.449	0.000	8.64	1.26
35.00	(8) 1 5/8" Coax	Yes	3.50	0.811	5.94	1.73	1.40	22.270	0.449	0.000	55.04	27.55
35.00	(12) 1 5/8" Coax	Yes	3.50	1.200	1.98	0.58	0.69	22.270	0.449	0.000	27.16	41.32
35.00	(1) 1 5/8" Hybriflex	Yes	3.50	0.000	0.00	0.00	0.00	22.270	0.449	0.000	0.00	6.76
35.00	(4) #20 Dywidag bars	Yes	3.50	0.000	0.00	0.00	0.00	22.270	0.449	0.000	0.00	280.53
35.00	(6) 1 5/8" Coax	Yes	3.50	0.000	0.00	0.00	0.00	22.270	0.449	0.000	0.00	20.66
35.00	(4) 1/2" Coax	Yes	3.50	0.000	0.00	0.00	0.00	22.270	0.449	0.000	0.00	2.52
35.00	(2) 2" Conduit	Yes	3.50	0.000	0.00	0.00	0.00	22.270	0.449	0.000	0.00	30.66
35.00	(6) 5/16" Coax	Yes	3.50	0.000	0.00	0.00	0.00	22.270	0.449	0.000	0.00	1.13
35.00	(1) 1/2" Coax	Yes	3.50	0.000	0.00	0.00	0.00	22.270	0.449	0.000	0.00	0.63
35.00	(4) Dywidag	Yes	0.20	2.000	8.00	0.13	0.27	22.270	0.449	0.000	10.43	0.00
35.67	(1) 0.39" Cable	Yes	0.67	0.000	0.00	0.00	0.00	22.359	0.440	0.000	0.00	0.06
35.67	(2) 0.78" 8 AWG 6	Yes	0.67	0.000	0.00	0.00	0.00	22.359	0.440	0.000	0.00	0.94
35.67	(1) 1 5/8" Coax	Yes	0.67	1.200	1.98	0.11	0.13	22.359	0.440	0.000	5.20	0.66
35.67	(8) 1 5/8" Coax	Yes	0.67	1.200	3.96	0.22	0.26	22.359	0.440	0.000	10.39	5.25
35.67	(2) 1/2" Coax	Yes	0.67	1.200	0.63	0.04	0.04	22.359	0.440	0.000	1.65	0.24
35.67	(8) 1 5/8" Coax	Yes	0.67	0.809	5.94	0.33	0.27	22.359	0.440	0.000	10.51	5.25
35.67	(12) 1 5/8" Coax	Yes	0.67	1.200	1.98	0.11	0.13	22.359	0.440	0.000	5.20	7.87
35.67	(1) 1 5/8" Hybriflex	Yes	0.67	0.000	0.00	0.00	0.00	22.359	0.440	0.000	0.00	1.29
35.67	(4) #20 Dywidag bars	Yes	0.67	0.000	0.00	0.00	0.00	22.359	0.440	0.000	0.00	53.47
35.67	(6) 1 5/8" Coax	Yes	0.67	0.000	0.00	0.00	0.00	22.359	0.440	0.000	0.00	3.94
35.67	(4) 1/2" Coax	Yes	0.67	0.000	0.00	0.00	0.00	22.359	0.440	0.000	0.00	0.48
35.67	(2) 2" Conduit	Yes	0.67	0.000	0.00	0.00	0.00	22.359	0.440	0.000	0.00	5.84
35.67	(6) 5/16" Coax	Yes	0.67	0.000	0.00	0.00	0.00	22.359	0.440	0.000	0.00	0.22
35.67	(1) 1/2" Coax	Yes	0.67	0.000	0.00	0.00	0.00	22.359	0.440	0.000	0.00	0.12
40.00	(1) 0.39" Cable	Yes	4.33	0.000	0.00	0.00	0.00	22.905	0.436	0.000	0.00	0.36
40.00	(2) 0.78" 8 AWG 6	Yes	4.33	0.000	0.00	0.00	0.00	22.905	0.436	0.000	0.00	6.14

Pole : 302489
 Location : Enfd - Enfield, CT
 Height : 150.00 (ft)
 Base Dia : 37.380 (in)
 Top Dia : 15.000 (in)
 Shape : 12 Sides
 Taper : 0.156700 (in/ft)

Code: ANSI/TIA-222 Rev G
 Struct Class : II
 Exposure Category : C
 Topographic Category : 1
 Base Elev : 0.000 (ft)

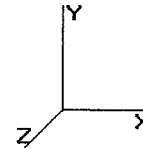

8/2/2013 4:43:23 PM
 Page: 8

© 2007 - 2013 by ATC IP LLC. All rights reserved.

Load Case: 1.2D + 1.6W 95.00 mph with No Ice 25 Iterations

Gust Response Factor 1.10 Wind Importance Factor : 1.00

Dead Load Factor : 1.20

Wind Load Factor : 1.60

40.00	(1) 1 5/8" Coax	Yes	4.33	1.200	1.98	0.71	0.86	22.905	0.436	0.000	34.59	4.26
40.00	(8) 1 5/8" Coax	Yes	4.33	1.199	3.96	1.43	1.71	22.905	0.436	0.000	69.12	34.11
40.00	(2) 1/2" Coax	Yes	4.33	1.200	0.63	0.23	0.27	22.905	0.436	0.000	11.00	1.56
40.00	(8) 1 5/8" Coax	Yes	4.33	0.799	5.94	2.14	1.71	22.905	0.436	0.000	69.12	34.11
40.00	(12) 1 5/8" Coax	Yes	4.33	1.200	1.98	0.71	0.86	22.905	0.436	0.000	34.59	51.16
40.00	(1) 1 5/8" Hybriflex	Yes	4.33	0.000	0.00	0.00	0.00	22.905	0.436	0.000	0.00	8.37
40.00	(4) #20 Dywidag bars	Yes	4.33	0.000	0.00	0.00	0.00	22.905	0.436	0.000	0.00	347.33
40.00	(6) 1 5/8" Coax	Yes	4.33	0.000	0.00	0.00	0.00	22.905	0.436	0.000	0.00	25.58
40.00	(4) 1/2" Coax	Yes	4.33	0.000	0.00	0.00	0.00	22.905	0.436	0.000	0.00	3.12
40.00	(2) 2" Conduit	Yes	4.33	0.000	0.00	0.00	0.00	22.905	0.436	0.000	0.00	37.96
40.00	(6) 5/16" Coax	Yes	4.33	0.000	0.00	0.00	0.00	22.905	0.436	0.000	0.00	1.40
40.00	(1) 1/2" Coax	Yes	4.33	0.000	0.00	0.00	0.00	22.905	0.436	0.000	0.00	0.78
45.00	(1) 0.39" Cable	Yes	5.00	0.000	0.00	0.00	0.00	23.480	0.447	0.000	0.00	0.42
45.00	(2) 0.78" 8 AWG 6	Yes	5.00	0.000	0.00	0.00	0.00	23.480	0.447	0.000	0.00	7.08
45.00	(1) 1 5/8" Coax	Yes	5.00	1.200	1.98	0.82	0.99	23.480	0.447	0.000	40.91	4.92
45.00	(8) 1 5/8" Coax	Yes	5.00	1.184	3.96	1.65	1.95	23.480	0.447	0.000	80.75	39.36
45.00	(2) 1/2" Coax	Yes	5.00	1.200	0.63	0.26	0.31	23.480	0.447	0.000	13.02	1.80
45.00	(8) 1 5/8" Coax	Yes	5.00	0.790	5.94	2.47	1.95	23.480	0.447	0.000	80.75	39.36
45.00	(12) 1 5/8" Coax	Yes	5.00	1.200	1.98	0.82	0.99	23.480	0.447	0.000	40.91	59.03
45.00	(1) 1 5/8" Hybriflex	Yes	5.00	0.000	0.00	0.00	0.00	23.480	0.447	0.000	0.00	9.66
45.00	(4) #20 Dywidag bars	Yes	5.00	0.000	0.00	0.00	0.00	23.480	0.447	0.000	0.00	400.80
45.00	(6) 1 5/8" Coax	Yes	5.00	0.000	0.00	0.00	0.00	23.480	0.447	0.000	0.00	29.52
45.00	(4) 1/2" Coax	Yes	5.00	0.000	0.00	0.00	0.00	23.480	0.447	0.000	0.00	3.60
45.00	(2) 2" Conduit	Yes	5.00	0.000	0.00	0.00	0.00	23.480	0.447	0.000	0.00	43.80
45.00	(6) 5/16" Coax	Yes	5.00	0.000	0.00	0.00	0.00	23.480	0.447	0.000	0.00	1.62
45.00	(1) 1/2" Coax	Yes	5.00	0.000	0.00	0.00	0.00	23.480	0.447	0.000	0.00	0.90
50.00	(1) 0.39" Cable	Yes	5.00	0.000	0.00	0.00	0.00	24.007	0.458	0.000	0.00	0.42
50.00	(2) 0.78" 8 AWG 6	Yes	5.00	0.000	0.00	0.00	0.00	24.007	0.458	0.000	0.00	7.08
50.00	(1) 1 5/8" Coax	Yes	5.00	1.200	1.98	0.82	0.99	24.007	0.458	0.000	41.83	4.92
50.00	(8) 1 5/8" Coax	Yes	5.00	1.171	3.96	1.65	1.93	24.007	0.458	0.000	81.65	39.36
50.00	(2) 1/2" Coax	Yes	5.00	1.200	0.63	0.26	0.31	24.007	0.458	0.000	13.31	1.80
50.00	(8) 1 5/8" Coax	Yes	5.00	0.781	5.94	2.47	1.93	24.007	0.458	0.000	81.65	39.36
50.00	(12) 1 5/8" Coax	Yes	5.00	1.200	1.98	0.82	0.99	24.007	0.458	0.000	41.83	59.03
50.00	(1) 1 5/8" Hybriflex	Yes	5.00	0.000	0.00	0.00	0.00	24.007	0.458	0.000	0.00	9.66
50.00	(4) #20 Dywidag bars	Yes	5.00	0.000	0.00	0.00	0.00	24.007	0.458	0.000	0.00	400.80
50.00	(6) 1 5/8" Coax	Yes	5.00	0.000	0.00	0.00	0.00	24.007	0.458	0.000	0.00	29.52
50.00	(4) 1/2" Coax	Yes	5.00	0.000	0.00	0.00	0.00	24.007	0.458	0.000	0.00	3.60
50.00	(2) 2" Conduit	Yes	5.00	0.000	0.00	0.00	0.00	24.007	0.458	0.000	0.00	43.80
50.00	(6) 5/16" Coax	Yes	5.00	0.000	0.00	0.00	0.00	24.007	0.458	0.000	0.00	1.62
50.00	(1) 1/2" Coax	Yes	5.00	0.000	0.00	0.00	0.00	24.007	0.458	0.000	0.00	0.90
55.00	(1) 0.39" Cable	Yes	5.00	0.000	0.00	0.00	0.00	24.494	0.470	0.000	0.00	0.42
55.00	(2) 0.78" 8 AWG 6	Yes	5.00	0.000	0.00	0.00	0.00	24.494	0.470	0.000	0.00	7.08
55.00	(1) 1 5/8" Coax	Yes	5.00	1.200	1.98	0.82	0.99	24.494	0.470	0.000	42.68	4.92
55.00	(8) 1 5/8" Coax	Yes	5.00	1.160	3.96	1.65	1.91	24.494	0.470	0.000	82.47	39.36
55.00	(2) 1/2" Coax	Yes	5.00	1.200	0.63	0.26	0.31	24.494	0.470	0.000	13.58	1.80
55.00	(8) 1 5/8" Coax	Yes	5.00	0.773	5.94	2.47	1.91	24.494	0.470	0.000	82.47	39.36
55.00	(12) 1 5/8" Coax	Yes	5.00	1.200	1.98	0.82	0.99	24.494	0.470	0.000	42.68	59.03
55.00	(1) 1 5/8" Hybriflex	Yes	5.00	0.000	0.00	0.00	0.00	24.494	0.470	0.000	0.00	9.66
55.00	(4) #20 Dywidag bars	Yes	5.00	0.000	0.00	0.00	0.00	24.494	0.470	0.000	0.00	400.80
55.00	(6) 1 5/8" Coax	Yes	5.00	0.000	0.00	0.00	0.00	24.494	0.470	0.000	0.00	29.52
55.00	(4) 1/2" Coax	Yes	5.00	0.000	0.00	0.00	0.00	24.494	0.470	0.000	0.00	3.60
55.00	(2) 2" Conduit	Yes	5.00	0.000	0.00	0.00	0.00	24.494	0.470	0.000	0.00	43.80
55.00	(6) 5/16" Coax	Yes	5.00	0.000	0.00	0.00	0.00	24.494	0.470	0.000	0.00	1.62
55.00	(1) 1/2" Coax	Yes	5.00	0.000	0.00	0.00	0.00	24.494	0.470	0.000	0.00	0.90
56.00	(1) 0.39" Cable	Yes	1.00	0.000	0.00	0.00	0.00	24.587	0.478	0.000	0.00	0.08
56.00	(2) 0.78" 8 AWG 6	Yes	1.00	0.000	0.00	0.00	0.00	24.587	0.478	0.000	0.00	1.42
56.00	(1) 1 5/8" Coax	Yes	1.00	1.200	1.98	0.17	0.20	24.587	0.478	0.000	8.57	0.98

Pole : 302489
 Location : Enfd - Enfield, CT
 Height : 150.00 (ft)
 Base Dia : 37.380 (in)
 Top Dia : 15.000 (in)
 Shape : 12 Sides
 Taper : 0.156700 (in/ft)

Code: ANSI/TIA-222 Rev G
 Struct Class : II
 Exposure Category : C
 Topographic Category : 1
 Base Elev : 0.000 (ft)

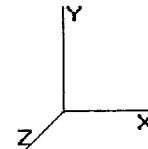

8/2/2013 4:43:23 PM
 Page: 9

© 2007 - 2013 by ATC IP LLC. All rights reserved.

Load Case: 1.2D + 1.6W 95.00 mph with No Ice 25 Iterations

Gust Response Factor 1.10 Wind Importance Factor : 1.00

Dead Load Factor : 1.20

Wind Load Factor : 1.60

56.00	(8) 1 5/8" Coax	Yes	1.00	1.157	3.96	0.33	0.38	24.587	0.478	0.000	16.53	7.87
56.00	(2) 1/2" Coax	Yes	1.00	1.200	0.63	0.05	0.06	24.587	0.478	0.000	2.73	0.36
56.00	(8) 1 5/8" Coax	Yes	1.00	0.772	5.94	0.50	0.38	24.587	0.478	0.000	16.53	7.87
56.00	(12) 1 5/8" Coax	Yes	1.00	1.200	1.98	0.17	0.20	24.587	0.478	0.000	8.57	11.81
56.00	(1) 1 5/8" Hybriflex	Yes	1.00	0.000	0.00	0.00	0.00	24.587	0.478	0.000	0.00	1.93
56.00	(4) #20 Dywidag bars	Yes	1.00	0.000	0.00	0.00	0.00	24.587	0.478	0.000	0.00	80.16
56.00	(6) 1 5/8" Coax	Yes	1.00	0.000	0.00	0.00	0.00	24.587	0.478	0.000	0.00	5.90
56.00	(4) 1/2" Coax	Yes	1.00	0.000	0.00	0.00	0.00	24.587	0.478	0.000	0.00	0.72
56.00	(2) 2" Conduit	Yes	1.00	0.000	0.00	0.00	0.00	24.587	0.478	0.000	0.00	8.76
56.00	(6) 5/16" Coax	Yes	1.00	0.000	0.00	0.00	0.00	24.587	0.478	0.000	0.00	0.32
56.00	(1) 1/2" Coax	Yes	1.00	0.000	0.00	0.00	0.00	24.587	0.478	0.000	0.00	0.18
60.00	(1) 0.39" Cable	Yes	4.00	0.000	0.00	0.00	0.00	24.946	0.484	0.000	0.00	0.34
60.00	(2) 0.78" 8 AWG 6	Yes	4.00	0.000	0.00	0.00	0.00	24.946	0.484	0.000	0.00	5.66
60.00	(1) 1 5/8" Coax	Yes	4.00	1.200	1.98	0.66	0.79	24.946	0.484	0.000	34.77	3.94
60.00	(8) 1 5/8" Coax	Yes	4.00	1.149	3.96	1.32	1.52	24.946	0.484	0.000	66.59	31.48
60.00	(2) 1/2" Coax	Yes	4.00	1.200	0.63	0.21	0.25	24.946	0.484	0.000	11.06	1.44
60.00	(8) 1 5/8" Coax	Yes	4.00	0.766	5.94	1.98	1.52	24.946	0.484	0.000	66.59	31.48
60.00	(12) 1 5/8" Coax	Yes	4.00	1.200	1.98	0.66	0.79	24.946	0.484	0.000	34.77	47.23
60.00	(1) 1 5/8" Hybriflex	Yes	4.00	0.000	0.00	0.00	0.00	24.946	0.484	0.000	0.00	7.73
60.00	(4) #20 Dywidag bars	Yes	4.00	0.000	0.00	0.00	0.00	24.946	0.484	0.000	0.00	320.64
60.00	(6) 1 5/8" Coax	Yes	4.00	0.000	0.00	0.00	0.00	24.946	0.484	0.000	0.00	23.61
60.00	(4) 1/2" Coax	Yes	4.00	0.000	0.00	0.00	0.00	24.946	0.484	0.000	0.00	2.88
60.00	(2) 2" Conduit	Yes	4.00	0.000	0.00	0.00	0.00	24.946	0.484	0.000	0.00	35.04
60.00	(6) 5/16" Coax	Yes	4.00	0.000	0.00	0.00	0.00	24.946	0.484	0.000	0.00	1.30
65.00	(1) 0.39" Cable	Yes	5.00	0.000	0.00	0.00	0.00	25.370	0.496	0.000	0.00	0.42
65.00	(2) 0.78" 8 AWG 6	Yes	5.00	0.000	0.00	0.00	0.00	25.370	0.496	0.000	0.00	7.08
65.00	(1) 1 5/8" Coax	Yes	5.00	1.200	1.98	0.82	0.99	25.370	0.496	0.000	44.21	4.92
65.00	(8) 1 5/8" Coax	Yes	5.00	1.139	3.96	1.65	1.88	25.370	0.496	0.000	83.94	39.36
65.00	(2) 1/2" Coax	Yes	5.00	1.200	0.63	0.26	0.31	25.370	0.496	0.000	14.07	1.80
65.00	(8) 1 5/8" Coax	Yes	5.00	0.760	5.94	2.47	1.88	25.370	0.496	0.000	83.94	39.36
65.00	(12) 1 5/8" Coax	Yes	5.00	1.200	1.98	0.82	0.99	25.370	0.496	0.000	44.21	59.03
65.00	(1) 1 5/8" Hybriflex	Yes	5.00	0.000	0.00	0.00	0.00	25.370	0.496	0.000	0.00	9.66
65.00	(4) #20 Dywidag bars	Yes	5.00	0.000	0.00	0.00	0.00	25.370	0.496	0.000	0.00	400.80
65.00	(6) 1 5/8" Coax	Yes	5.00	0.000	0.00	0.00	0.00	25.370	0.496	0.000	0.00	29.52
65.00	(4) 1/2" Coax	Yes	5.00	0.000	0.00	0.00	0.00	25.370	0.496	0.000	0.00	3.60
65.00	(2) 2" Conduit	Yes	5.00	0.000	0.00	0.00	0.00	25.370	0.496	0.000	0.00	43.80
65.00	(6) 5/16" Coax	Yes	5.00	0.000	0.00	0.00	0.00	25.370	0.496	0.000	0.00	1.62
70.00	(1) 0.39" Cable	Yes	5.00	0.000	0.00	0.00	0.00	25.769	0.510	0.000	0.00	0.42
70.00	(2) 0.78" 8 AWG 6	Yes	5.00	0.000	0.00	0.00	0.00	25.769	0.510	0.000	0.00	7.08
70.00	(1) 1 5/8" Coax	Yes	5.00	1.200	1.98	0.82	0.99	25.769	0.510	0.000	44.90	4.92
70.00	(8) 1 5/8" Coax	Yes	5.00	1.130	3.96	1.65	1.87	25.769	0.510	0.000	84.60	39.36
70.00	(2) 1/2" Coax	Yes	5.00	1.200	0.63	0.26	0.31	25.769	0.510	0.000	14.29	1.80
70.00	(8) 1 5/8" Coax	Yes	5.00	0.754	5.94	2.47	1.87	25.769	0.510	0.000	84.60	39.36
70.00	(12) 1 5/8" Coax	Yes	5.00	1.200	1.98	0.82	0.99	25.769	0.510	0.000	44.90	59.03
70.00	(1) 1 5/8" Hybriflex	Yes	5.00	0.000	0.00	0.00	0.00	25.769	0.510	0.000	0.00	9.66
70.00	(4) #20 Dywidag bars	Yes	5.00	0.000	0.00	0.00	0.00	25.769	0.510	0.000	0.00	400.80
70.00	(6) 1 5/8" Coax	Yes	5.00	0.000	0.00	0.00	0.00	25.769	0.510	0.000	0.00	29.52
70.00	(4) 1/2" Coax	Yes	5.00	0.000	0.00	0.00	0.00	25.769	0.510	0.000	0.00	3.60
70.00	(2) 2" Conduit	Yes	5.00	0.000	0.00	0.00	0.00	25.769	0.510	0.000	0.00	43.80
70.00	(6) 5/16" Coax	Yes	5.00	0.000	0.00	0.00	0.00	25.769	0.510	0.000	0.00	1.62
70.00	(1) 0.39" Cable	Yes	0.00	0.000	0.00	0.00	0.00	25.769	0.518	0.000	0.00	0.00
70.00	(2) 0.78" 8 AWG 6	Yes	0.00	0.000	0.00	0.00	0.00	25.769	0.518	0.000	0.00	0.00
70.00	(1) 1 5/8" Coax	Yes	0.00	1.200	1.98	0.00	0.00	25.769	0.518	0.000	0.00	0.00
70.00	(8) 1 5/8" Coax	Yes	0.00	1.130	3.96	0.00	0.00	25.769	0.518	0.000	0.01	0.00
70.00	(2) 1/2" Coax	Yes	0.00	1.200	0.63	0.00	0.00	25.769	0.518	0.000	0.00	0.00
70.00	(8) 1 5/8" Coax	Yes	0.00	0.754	5.94	0.00	0.00	25.769	0.518	0.000	0.01	0.00
70.00	(12) 1 5/8" Coax	Yes	0.00	1.200	1.98	0.00	0.00	25.769	0.518	0.000	0.00	0.00

Pole : 302489
 Location : Enfd - Enfield, CT
 Height : 150.00 (ft)
 Base Dia : 37.380 (in)
 Top Dia : 15.000 (in)
 Shape : 12 Sides
 Taper : 0.156700 (in/ft)

Code : ANSI/TIA-222 Rev G
 Struct Class : II
 Exposure Category : C
 Topographic Category : 1
 Base Elev : 0.000 (ft)

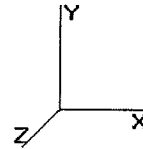

8/2/2013 4:43:23 PM
 Page: 10

© 2007 - 2013 by ATC IP LLC. All rights reserved.

Load Case: 1.2D + 1.6W	95.00 mph with No Ice	25 Iterations
Gust Response Factor 1.10		Wind Importance Factor : 1.00
Dead Load Factor : 1.20		
Wind Load Factor : 1.60		

70.00	(1) 1 5/8" Hybriflex	Yes	0.00	0.000	0.00	0.00	0.00	25.769	0.518	0.000	0.00	0.00
70.00	(4) #20 Dywidag bars	Yes	0.00	0.000	0.00	0.00	0.00	25.769	0.518	0.000	0.00	0.03
70.00	(6) 1 5/8" Coax	Yes	0.00	0.000	0.00	0.00	0.00	25.769	0.518	0.000	0.00	0.00
70.00	(4) 1/2" Coax	Yes	0.00	0.000	0.00	0.00	0.00	25.769	0.518	0.000	0.00	0.00
70.00	(2) 2" Conduit	Yes	0.00	0.000	0.00	0.00	0.00	25.769	0.518	0.000	0.00	0.00
70.00	(6) 5/16" Coax	Yes	0.00	0.000	0.00	0.00	0.00	25.769	0.518	0.000	0.00	0.00
73.50	(1) 0.39" Cable	Yes	3.50	0.000	0.00	0.00	0.00	26.035	0.523	0.000	0.00	0.29
73.50	(2) 0.78" 8 AWG 6	Yes	3.50	0.000	0.00	0.00	0.00	26.035	0.523	0.000	0.00	4.96
73.50	(1) 1 5/8" Coax	Yes	3.50	1.200	1.98	0.58	0.69	26.035	0.523	0.000	31.75	3.44
73.50	(8) 1 5/8" Coax	Yes	3.50	1.125	3.96	1.15	1.30	26.035	0.523	0.000	59.52	27.55
73.50	(2) 1/2" Coax	Yes	3.50	1.200	0.63	0.18	0.22	26.035	0.523	0.000	10.10	1.26
73.50	(8) 1 5/8" Coax	Yes	3.50	0.750	5.94	1.73	1.30	26.035	0.523	0.000	59.52	27.55
73.50	(12) 1 5/8" Coax	Yes	3.50	1.200	1.98	0.58	0.69	26.035	0.523	0.000	31.75	41.32
73.50	(1) 1 5/8" Hybriflex	Yes	3.50	0.000	0.00	0.00	0.00	26.035	0.523	0.000	0.00	6.76
73.50	(4) #20 Dywidag bars	Yes	3.50	0.000	0.00	0.00	0.00	26.035	0.523	0.000	0.00	280.56
73.50	(6) 1 5/8" Coax	Yes	3.50	0.000	0.00	0.00	0.00	26.035	0.523	0.000	0.00	20.66
73.50	(4) 1/2" Coax	Yes	3.50	0.000	0.00	0.00	0.00	26.035	0.523	0.000	0.00	2.52
73.50	(2) 2" Conduit	Yes	3.50	0.000	0.00	0.00	0.00	26.035	0.523	0.000	0.00	30.66
73.50	(6) 5/16" Coax	Yes	3.50	0.000	0.00	0.00	0.00	26.035	0.523	0.000	0.00	1.13
75.00	(1) 0.39" Cable	Yes	1.50	0.000	0.00	0.00	0.00	26.146	0.521	0.000	0.00	0.13
75.00	(2) 0.78" 8 AWG 6	Yes	1.50	0.000	0.00	0.00	0.00	26.146	0.521	0.000	0.00	2.12
75.00	(1) 1 5/8" Coax	Yes	1.50	1.200	1.98	0.25	0.30	26.146	0.521	0.000	13.66	1.48
75.00	(8) 1 5/8" Coax	Yes	1.50	1.122	3.96	0.49	0.56	26.146	0.521	0.000	25.56	11.80
75.00	(2) 1/2" Coax	Yes	1.50	1.200	0.63	0.08	0.09	26.146	0.521	0.000	4.35	0.54
75.00	(8) 1 5/8" Coax	Yes	1.50	0.748	5.94	0.74	0.56	26.146	0.521	0.000	25.56	11.80
75.00	(12) 1 5/8" Coax	Yes	1.50	1.200	1.98	0.25	0.30	26.146	0.521	0.000	13.66	17.71
75.00	(1) 1 5/8" Hybriflex	Yes	1.50	0.000	0.00	0.00	0.00	26.146	0.521	0.000	0.00	2.90
75.00	(4) #20 Dywidag bars	Yes	1.50	0.000	0.00	0.00	0.00	26.146	0.521	0.000	0.00	120.21
75.00	(6) 1 5/8" Coax	Yes	1.50	0.000	0.00	0.00	0.00	26.146	0.521	0.000	0.00	8.85
75.00	(4) 1/2" Coax	Yes	1.50	0.000	0.00	0.00	0.00	26.146	0.521	0.000	0.00	1.08
75.00	(2) 2" Conduit	Yes	1.50	0.000	0.00	0.00	0.00	26.146	0.521	0.000	0.00	13.14
75.00	(6) 5/16" Coax	Yes	1.50	0.000	0.00	0.00	0.00	26.146	0.521	0.000	0.00	0.49
80.00	(1) 0.39" Cable	Yes	5.00	0.000	0.00	0.00	0.00	26.504	0.531	0.000	0.00	0.42
80.00	(2) 0.78" 8 AWG 6	Yes	5.00	0.000	0.00	0.00	0.00	26.504	0.531	0.000	0.00	7.08
80.00	(1) 1 5/8" Coax	Yes	5.00	1.200	1.98	0.82	0.99	26.504	0.531	0.000	46.18	4.92
80.00	(8) 1 5/8" Coax	Yes	5.00	1.115	3.96	1.65	1.84	26.504	0.531	0.000	85.79	39.36
80.00	(2) 1/2" Coax	Yes	5.00	1.200	0.63	0.26	0.31	26.504	0.531	0.000	14.69	1.80
80.00	(8) 1 5/8" Coax	Yes	5.00	0.743	5.94	2.47	1.84	26.504	0.531	0.000	85.79	39.36
80.00	(12) 1 5/8" Coax	Yes	5.00	1.200	1.98	0.82	0.99	26.504	0.531	0.000	46.18	59.03
80.00	(1) 1 5/8" Hybriflex	Yes	5.00	0.000	0.00	0.00	0.00	26.504	0.531	0.000	0.00	9.66
80.00	(4) #20 Dywidag bars	Yes	5.00	0.000	0.00	0.00	0.00	26.504	0.531	0.000	0.00	400.80
80.00	(6) 1 5/8" Coax	Yes	5.00	0.000	0.00	0.00	0.00	26.504	0.531	0.000	0.00	29.52
80.00	(4) 1/2" Coax	Yes	5.00	0.000	0.00	0.00	0.00	26.504	0.531	0.000	0.00	3.60
80.00	(2) 2" Conduit	Yes	5.00	0.000	0.00	0.00	0.00	26.504	0.531	0.000	0.00	43.80
80.00	(6) 5/16" Coax	Yes	5.00	0.000	0.00	0.00	0.00	26.504	0.531	0.000	0.00	1.62
85.00	(1) 0.39" Cable	Yes	5.00	0.000	0.00	0.00	0.00	26.844	0.547	0.000	0.00	0.42
85.00	(2) 0.78" 8 AWG 6	Yes	5.00	0.000	0.00	0.00	0.00	26.844	0.547	0.000	0.00	7.08
85.00	(1) 1 5/8" Coax	Yes	5.00	1.200	1.98	0.82	0.99	26.844	0.547	0.000	46.77	4.92
85.00	(8) 1 5/8" Coax	Yes	5.00	1.108	3.96	1.65	1.83	26.844	0.547	0.000	86.34	39.36
85.00	(2) 1/2" Coax	Yes	5.00	1.200	0.63	0.26	0.31	26.844	0.547	0.000	14.88	1.80
85.00	(8) 1 5/8" Coax	Yes	5.00	0.738	5.94	2.47	1.83	26.844	0.547	0.000	86.34	39.36
85.00	(12) 1 5/8" Coax	Yes	5.00	1.200	1.98	0.82	0.99	26.844	0.547	0.000	46.77	59.03
85.00	(1) 1 5/8" Hybriflex	Yes	5.00	0.000	0.00	0.00	0.00	26.844	0.547	0.000	0.00	9.66
85.00	(4) #20 Dywidag bars	Yes	5.00	0.000	0.00	0.00	0.00	26.844	0.547	0.000	0.00	400.80
85.00	(6) 1 5/8" Coax	Yes	5.00	0.000	0.00	0.00	0.00	26.844	0.547	0.000	0.00	29.52
85.00	(4) 1/2" Coax	Yes	5.00	0.000	0.00	0.00	0.00	26.844	0.547	0.000	0.00	3.60
85.00	(2) 2" Conduit	Yes	5.00	0.000	0.00	0.00	0.00	26.844	0.547	0.000	0.00	43.80

Pole : 302489
 Location : Enfd - Enfield, CT
 Height : 150.00 (ft)
 Base Dia : 37.380 (in)
 Top Dia : 15.000 (in)
 Shape : 12 Sides
 Taper : 0.156700 (in/ft)

Code: ANSI/TIA-222 Rev G
 Struct Class : II
 Exposure Category : C
 Topographic Category : 1
 Base Elev : 0.000 (ft)

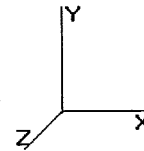

8/2/2013 4:43:24 PM
 Page: 11

© 2007 - 2013 by ATC IP LLC. All rights reserved.

Load Case: 1.2D + 1.6W **95.00 mph with No Ice** **25 Iterations**

Gust Response Factor 1.10 Wind Importance Factor : 1.00

Dead Load Factor : 1.20

Wind Load Factor : 1.60

85.00	(6) 5/16" Coax	Yes	5.00	0.000	0.00	0.00	0.00	26.844	0.547	0.000	0.00	1.62
90.00	(1) 0.39" Cable	Yes	5.00	0.000	0.00	0.00	0.00	27.169	0.565	0.000	0.00	0.42
90.00	(2) 0.78" 8 AWG 6	Yes	5.00	0.000	0.00	0.00	0.00	27.169	0.565	0.000	0.00	7.08
90.00	(1) 1 5/8" Coax	Yes	5.00	1.200	1.98	0.82	0.99	27.169	0.565	0.000	47.34	4.92
90.00	(8) 1 5/8" Coax	Yes	5.00	1.101	3.96	1.65	1.82	27.169	0.565	0.000	86.86	39.36
90.00	(2) 1/2" Coax	Yes	5.00	1.200	0.63	0.26	0.31	27.169	0.565	0.000	15.06	1.80
90.00	(8) 1 5/8" Coax	Yes	5.00	0.734	5.94	2.47	1.82	27.169	0.565	0.000	86.86	39.36
90.00	(12) 1 5/8" Coax	Yes	5.00	1.200	1.98	0.82	0.99	27.169	0.565	0.000	47.34	59.03
90.00	(1) 1 5/8" Hybriflex	Yes	5.00	0.000	0.00	0.00	0.00	27.169	0.565	0.000	0.00	9.66
90.00	(4) #20 Dywidag bars	Yes	5.00	0.000	0.00	0.00	0.00	27.169	0.565	0.000	0.00	400.80
90.00	(6) 1 5/8" Coax	Yes	5.00	0.000	0.00	0.00	0.00	27.169	0.565	0.000	0.00	29.52
90.00	(4) 1/2" Coax	Yes	5.00	0.000	0.00	0.00	0.00	27.169	0.565	0.000	0.00	3.60
90.00	(2) 2" Conduit	Yes	5.00	0.000	0.00	0.00	0.00	27.169	0.565	0.000	0.00	43.80
90.00	(6) 5/16" Coax	Yes	5.00	0.000	0.00	0.00	0.00	27.169	0.565	0.000	0.00	1.62
95.00	(1) 0.39" Cable	Yes	5.00	0.000	0.00	0.00	0.00	27.480	0.583	0.000	0.00	0.42
95.00	(2) 0.78" 8 AWG 6	Yes	5.00	0.000	0.00	0.00	0.00	27.480	0.583	0.000	0.00	7.08
95.00	(1) 1 5/8" Coax	Yes	5.00	1.200	1.98	0.82	0.99	27.480	0.583	0.000	47.88	4.92
95.00	(8) 1 5/8" Coax	Yes	5.00	1.095	3.96	1.65	1.81	27.480	0.583	0.000	87.36	39.36
95.00	(2) 1/2" Coax	Yes	5.00	1.200	0.63	0.26	0.31	27.480	0.583	0.000	15.24	1.80
95.00	(8) 1 5/8" Coax	Yes	5.00	0.730	5.94	2.47	1.81	27.480	0.583	0.000	87.36	39.36
95.00	(12) 1 5/8" Coax	Yes	5.00	1.200	1.98	0.82	0.99	27.480	0.583	0.000	47.88	59.03
95.00	(1) 1 5/8" Hybriflex	Yes	5.00	0.000	0.00	0.00	0.00	27.480	0.583	0.000	0.00	9.66
95.00	(4) #20 Dywidag bars	Yes	5.00	0.000	0.00	0.00	0.00	27.480	0.583	0.000	0.00	400.80
95.00	(6) 1 5/8" Coax	Yes	5.00	0.000	0.00	0.00	0.00	27.480	0.583	0.000	0.00	29.52
95.00	(4) 1/2" Coax	Yes	5.00	0.000	0.00	0.00	0.00	27.480	0.583	0.000	0.00	3.60
95.00	(2) 2" Conduit	Yes	5.00	0.000	0.00	0.00	0.00	27.480	0.583	0.000	0.00	43.80
95.00	(6) 5/16" Coax	Yes	5.00	0.000	0.00	0.00	0.00	27.480	0.583	0.000	0.00	1.62
100.0	(1) 0.39" Cable	Yes	5.00	0.000	0.00	0.00	0.00	27.779	0.603	0.000	0.00	0.42
100.0	(2) 0.78" 8 AWG 6	Yes	5.00	0.000	0.00	0.00	0.00	27.779	0.603	0.000	0.00	7.08
100.0	(1) 1 5/8" Coax	Yes	5.00	1.200	1.98	0.82	0.99	27.779	0.603	0.000	48.40	4.92
100.0	(8) 1 5/8" Coax	Yes	5.00	1.089	3.96	1.65	1.80	27.779	0.603	0.000	87.83	39.36
100.0	(2) 1/2" Coax	Yes	5.00	1.200	0.63	0.26	0.31	27.779	0.603	0.000	15.40	1.80
100.0	(8) 1 5/8" Coax	Yes	5.00	0.726	5.94	2.47	1.80	27.779	0.603	0.000	87.83	39.36
100.0	(12) 1 5/8" Coax	Yes	5.00	1.200	1.98	0.82	0.99	27.779	0.603	0.000	48.40	59.03
100.0	(1) 1 5/8" Hybriflex	Yes	5.00	0.000	0.00	0.00	0.00	27.779	0.603	0.000	0.00	9.66
100.0	(4) #20 Dywidag bars	Yes	5.00	0.000	0.00	0.00	0.00	27.779	0.603	0.000	0.00	400.80
100.0	(6) 1 5/8" Coax	Yes	5.00	0.000	0.00	0.00	0.00	27.779	0.603	0.000	0.00	29.52
100.0	(4) 1/2" Coax	Yes	5.00	0.000	0.00	0.00	0.00	27.779	0.603	0.000	0.00	3.60
100.0	(2) 2" Conduit	Yes	5.00	0.000	0.00	0.00	0.00	27.779	0.603	0.000	0.00	43.80
100.0	(6) 5/16" Coax	Yes	5.00	0.000	0.00	0.00	0.00	27.779	0.603	0.000	0.00	1.62
103.0	(1) 0.39" Cable	Yes	3.00	0.000	0.00	0.00	0.00	27.952	0.619	0.000	0.00	0.25
103.0	(2) 0.78" 8 AWG 6	Yes	3.00	0.000	0.00	0.00	0.00	27.952	0.619	0.000	0.00	4.25
103.0	(1) 1 5/8" Coax	Yes	3.00	1.200	1.98	0.50	0.59	27.952	0.619	0.000	29.22	2.95
103.0	(8) 1 5/8" Coax	Yes	3.00	1.085	3.96	0.99	1.07	27.952	0.619	0.000	52.86	23.61
103.0	(2) 1/2" Coax	Yes	3.00	1.200	0.63	0.16	0.19	27.952	0.619	0.000	9.30	1.08
103.0	(8) 1 5/8" Coax	Yes	3.00	0.724	5.94	1.49	1.07	27.952	0.619	0.000	52.86	23.61
103.0	(12) 1 5/8" Coax	Yes	3.00	1.200	1.98	0.50	0.59	27.952	0.619	0.000	29.22	35.42
103.0	(1) 1 5/8" Hybriflex	Yes	3.00	0.000	0.00	0.00	0.00	27.952	0.619	0.000	0.00	5.80
103.0	(4) #20 Dywidag bars	Yes	3.00	0.000	0.00	0.00	0.00	27.952	0.619	0.000	0.00	240.48
103.0	(6) 1 5/8" Coax	Yes	3.00	0.000	0.00	0.00	0.00	27.952	0.619	0.000	0.00	17.71
103.0	(4) 1/2" Coax	Yes	3.00	0.000	0.00	0.00	0.00	27.952	0.619	0.000	0.00	2.16
103.0	(2) 2" Conduit	Yes	3.00	0.000	0.00	0.00	0.00	27.952	0.619	0.000	0.00	26.28
103.0	(6) 5/16" Coax	Yes	3.00	0.000	0.00	0.00	0.00	27.952	0.619	0.000	0.00	0.97
105.0	(1) 0.39" Cable	Yes	2.00	0.000	0.00	0.00	0.00	28.066	0.630	0.000	0.00	0.17
105.0	(2) 0.78" 8 AWG 6	Yes	2.00	0.000	0.00	0.00	0.00	28.066	0.630	0.000	0.00	2.83
105.0	(1) 1 5/8" Coax	Yes	2.00	1.200	1.98	0.33	0.40	28.066	0.630	0.000	19.56	1.97
105.0	(8) 1 5/8" Coax	Yes	2.00	1.083	3.96	0.66	0.71	28.066	0.630	0.000	35.31	15.74

Pole : 302489
 Location : Enfd - Enfield, CT
 Height : 150.00 (ft)
 Base Dia : 37.380 (in)
 Top Dia : 15.000 (in)
 Shape : 12 Sides
 Taper : 0.156700 (in/ft)

Code: ANSI/TIA-222 Rev G
 Struct Class : II
 Exposure Category : C
 Topographic Category : 1
 Base Elev : 0.000 (ft)

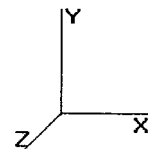

8/2/2013 4:43:24 PM
 Page: 12

© 2007 - 2013 by ATC IP LLC. All rights reserved.

Load Case: 1.2D + 1.6W 95.00 mph with No Ice 25 Iterations

Gust Response Factor 1.10 Wind Importance Factor : 1.00

Dead Load Factor : 1.20

Wind Load Factor : 1.60

105.0	(2) 1/2" Coax	Yes	2.00	1.200	0.63	0.10	0.13	28.066	0.630	0.000	6.22	0.72
105.0	(8) 1 5/8" Coax	Yes	2.00	0.722	5.94	0.99	0.71	28.066	0.630	0.000	35.31	15.74
105.0	(12) 1 5/8" Coax	Yes	2.00	1.200	1.98	0.33	0.40	28.066	0.630	0.000	19.56	23.61
105.0	(1) 1 5/8" Hybriflex	Yes	2.00	0.000	0.00	0.00	0.00	28.066	0.630	0.000	0.00	3.86
105.0	(4) #20 Dywidag bars	Yes	2.00	0.000	0.00	0.00	0.00	28.066	0.630	0.000	0.00	160.32
105.0	(6) 1 5/8" Coax	Yes	2.00	0.000	0.00	0.00	0.00	28.066	0.630	0.000	0.00	11.81
110.0	(1) 0.39" Cable	Yes	5.00	0.000	0.00	0.00	0.00	28.342	0.646	0.000	0.00	0.42
110.0	(2) 0.78" 8 AWG 6	Yes	5.00	0.000	0.00	0.00	0.00	28.342	0.646	0.000	0.00	7.08
110.0	(1) 1 5/8" Coax	Yes	5.00	1.200	1.98	0.82	0.99	28.342	0.646	0.000	49.38	4.92
110.0	(8) 1 5/8" Coax	Yes	5.00	1.078	3.96	1.65	1.78	28.342	0.646	0.000	88.72	39.36
110.0	(2) 1/2" Coax	Yes	5.00	1.200	0.63	0.26	0.31	28.342	0.646	0.000	15.71	1.80
110.0	(8) 1 5/8" Coax	Yes	5.00	0.719	5.94	2.47	1.78	28.342	0.646	0.000	88.72	39.36
110.0	(12) 1 5/8" Coax	Yes	5.00	1.200	1.98	0.82	0.99	28.342	0.646	0.000	49.38	59.03
110.0	(1) 1 5/8" Hybriflex	Yes	5.00	0.000	0.00	0.00	0.00	28.342	0.646	0.000	0.00	9.66
110.0	(4) #20 Dywidag bars	Yes	5.00	0.000	0.00	0.00	0.00	28.342	0.646	0.000	0.00	400.80
110.0	(6) 1 5/8" Coax	Yes	5.00	0.000	0.00	0.00	0.00	28.342	0.646	0.000	0.00	29.52
110.0	(1) 0.39" Cable	Yes	0.00	0.000	0.00	0.00	0.00	28.342	0.658	0.000	0.00	0.00
110.0	(2) 0.78" 8 AWG 6	Yes	0.00	0.000	0.00	0.00	0.00	28.342	0.658	0.000	0.00	0.00
110.0	(1) 1 5/8" Coax	Yes	0.00	1.200	1.98	0.00	0.00	28.342	0.658	0.000	0.00	0.00
110.0	(8) 1 5/8" Coax	Yes	0.00	1.078	3.96	0.00	0.00	28.342	0.658	0.000	0.01	0.00
110.0	(2) 1/2" Coax	Yes	0.00	1.200	0.63	0.00	0.00	28.342	0.658	0.000	0.00	0.00
110.0	(8) 1 5/8" Coax	Yes	0.00	0.719	5.94	0.00	0.00	28.342	0.658	0.000	0.01	0.00
110.0	(12) 1 5/8" Coax	Yes	0.00	1.200	1.98	0.00	0.00	28.342	0.658	0.000	0.00	0.00
110.0	(1) 1 5/8" Hybriflex	Yes	0.00	0.000	0.00	0.00	0.00	28.342	0.658	0.000	0.00	0.00
110.0	(4) #20 Dywidag bars	Yes	0.00	0.000	0.00	0.00	0.00	28.342	0.658	0.000	0.00	0.03
110.0	(6) 1 5/8" Coax	Yes	0.00	0.000	0.00	0.00	0.00	28.342	0.658	0.000	0.00	0.00
115.0	(1) 0.39" Cable	Yes	5.00	0.000	0.00	0.00	0.00	28.608	0.670	0.000	0.00	0.42
115.0	(2) 0.78" 8 AWG 6	Yes	5.00	0.000	0.00	0.00	0.00	28.608	0.670	0.000	0.00	7.08
115.0	(1) 1 5/8" Coax	Yes	5.00	1.200	1.98	0.82	0.99	28.608	0.670	0.000	49.84	4.92
115.0	(8) 1 5/8" Coax	Yes	5.00	1.073	3.96	1.65	1.77	28.608	0.670	0.000	89.13	39.35
115.0	(2) 1/2" Coax	Yes	5.00	1.200	0.63	0.26	0.31	28.608	0.670	0.000	15.86	1.80
115.0	(8) 1 5/8" Coax	Yes	5.00	0.715	5.94	2.47	1.77	28.608	0.670	0.000	89.13	39.35
115.0	(12) 1 5/8" Coax	Yes	5.00	1.200	1.98	0.82	0.99	28.608	0.670	0.000	49.84	59.03
115.0	(1) 1 5/8" Hybriflex	Yes	5.00	0.000	0.00	0.00	0.00	28.608	0.670	0.000	0.00	9.66
115.0	(4) #20 Dywidag bars	Yes	5.00	0.000	0.00	0.00	0.00	28.608	0.670	0.000	0.00	400.77
115.0	(6) 1 5/8" Coax	Yes	5.00	0.000	0.00	0.00	0.00	28.608	0.670	0.000	0.00	29.51
120.0	(1) 0.39" Cable	Yes	5.00	0.000	0.00	0.00	0.00	28.866	0.697	0.000	0.00	0.42
120.0	(2) 0.78" 8 AWG 6	Yes	5.00	0.000	0.00	0.00	0.00	28.866	0.697	0.000	0.00	7.08
120.0	(1) 1 5/8" Coax	Yes	5.00	1.200	1.98	0.82	0.99	28.866	0.697	0.000	50.30	4.92
120.0	(8) 1 5/8" Coax	Yes	5.00	1.068	3.96	1.65	1.76	28.866	0.697	0.000	89.53	39.36
120.0	(2) 1/2" Coax	Yes	5.00	1.200	0.63	0.26	0.31	28.866	0.697	0.000	16.00	1.80
120.0	(8) 1 5/8" Coax	Yes	5.00	0.712	5.94	2.47	1.76	28.866	0.697	0.000	89.53	39.36
120.0	(12) 1 5/8" Coax	Yes	5.00	1.200	1.98	0.82	0.99	28.866	0.697	0.000	50.30	59.03
120.0	(1) 1 5/8" Hybriflex	Yes	5.00	0.000	0.00	0.00	0.00	28.866	0.697	0.000	0.00	9.66
120.0	(4) #20 Dywidag bars	Yes	5.00	0.000	0.00	0.00	0.00	28.866	0.697	0.000	0.00	400.80
121.0	(1) 0.39" Cable	Yes	1.00	0.000	0.00	0.00	0.00	28.916	0.713	0.000	0.00	0.08
121.0	(2) 0.78" 8 AWG 6	Yes	1.00	0.000	0.00	0.00	0.00	28.916	0.713	0.000	0.00	1.42
121.0	(1) 1 5/8" Coax	Yes	1.00	1.200	1.98	0.17	0.20	28.916	0.713	0.000	10.08	0.98
121.0	(8) 1 5/8" Coax	Yes	1.00	1.067	3.96	0.33	0.35	28.916	0.713	0.000	17.92	7.87
121.0	(2) 1/2" Coax	Yes	1.00	1.200	0.63	0.05	0.06	28.916	0.713	0.000	3.21	0.36
121.0	(8) 1 5/8" Coax	Yes	1.00	0.711	5.94	0.50	0.35	28.916	0.713	0.000	17.92	7.87
121.0	(12) 1 5/8" Coax	Yes	1.00	1.200	1.98	0.17	0.20	28.916	0.713	0.000	10.08	11.81
121.0	(1) 1 5/8" Hybriflex	Yes	1.00	0.000	0.00	0.00	0.00	28.916	0.713	0.000	0.00	1.93
121.0	(4) #20 Dywidag bars	Yes	1.00	0.000	0.00	0.00	0.00	28.916	0.713	0.000	0.00	80.16
125.0	(1) 0.39" Cable	Yes	4.00	0.000	0.00	0.00	0.00	29.115	0.728	0.000	0.00	0.34
125.0	(2) 0.78" 8 AWG 6	Yes	4.00	0.000	0.00	0.00	0.00	29.115	0.728	0.000	0.00	5.66
125.0	(1) 1 5/8" Coax	Yes	4.00	1.200	1.98	0.66	0.79	29.115	0.728	0.000	40.58	3.94

Pole : 302489
 Location : Enfd - Enfield, CT
 Height : 150.00 (ft)
 Base Dia : 37.380 (in)
 Top Dia : 15.000 (in)
 Shape : 12 Sides
 Taper : 0.156700 (in/ft)

Code: ANSI/TIA-222 Rev G
 Struct Class : II
 Exposure Category : C
 Topographic Category : 1
 Base Elev : 0.000 (ft)

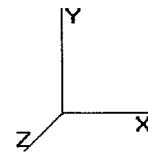

8/2/2013 4:43:24 PM
 Page: 13

© 2007 - 2013 by ATC IP LLC. All rights reserved.

Load Case: 1.2D + 1.6W 95.00 mph with No Ice 25 Iterations
Gust Response Factor: 1.10 **Wind Importance Factor:** 1.00
Dead Load Factor: 1.20
Wind Load Factor: 1.60

125.0	(8) 1 5/8" Coax	Yes	4.00	1.064	3.96	1.32	1.40	29.115	0.728	0.000	71.94	31.48
125.0	(2) 1/2" Coax	Yes	4.00	1.200	0.63	0.21	0.25	29.115	0.728	0.000	12.91	1.44
125.0	(8) 1 5/8" Coax	Yes	4.00	0.709	5.94	1.98	1.40	29.115	0.728	0.000	71.94	31.48
125.0	(12) 1 5/8" Coax	Yes	4.00	1.200	1.98	0.66	0.79	29.115	0.728	0.000	40.58	47.23
125.0	(1) 1 5/8" Hybriflex	Yes	4.00	0.000	0.00	0.00	0.00	29.115	0.728	0.000	0.00	7.73
125.0	(4) #20 Dywidag bars	Yes	4.00	0.000	0.00	0.00	0.00	29.115	0.728	0.000	0.00	320.64
126.0	(1) 0.39" Cable	Yes	1.00	0.000	0.00	0.00	0.00	29.164	0.743	0.000	0.00	0.08
126.0	(2) 0.78" 8 AWG 6	Yes	1.00	0.000	0.00	0.00	0.00	29.164	0.743	0.000	0.00	1.42
126.0	(1) 1 5/8" Coax	Yes	1.00	1.200	1.98	0.17	0.20	29.164	0.743	0.000	10.16	0.98
126.0	(8) 1 5/8" Coax	Yes	1.00	1.063	3.96	0.33	0.35	29.164	0.743	0.000	18.00	7.87
126.0	(2) 1/2" Coax	Yes	1.00	1.200	0.63	0.05	0.06	29.164	0.743	0.000	3.23	0.36
126.0	(8) 1 5/8" Coax	Yes	1.00	0.708	5.94	0.50	0.35	29.164	0.743	0.000	18.00	7.87
126.0	(12) 1 5/8" Coax	Yes	1.00	1.200	1.98	0.17	0.20	29.164	0.743	0.000	10.16	11.81
126.0	(1) 1 5/8" Hybriflex	Yes	1.00	0.000	0.00	0.00	0.00	29.164	0.743	0.000	0.00	1.93
126.0	(4) #20 Dywidag bars	Yes	0.51	0.000	0.00	0.00	0.00	29.164	0.743	0.000	0.00	40.88
130.0	(1) 0.39" Cable	Yes	4.00	0.000	0.00	0.00	0.00	29.356	0.655	0.000	0.00	0.34
130.0	(2) 0.78" 8 AWG 6	Yes	4.00	0.000	0.00	0.00	0.00	29.356	0.655	0.000	0.00	5.66
130.0	(1) 1 5/8" Coax	Yes	4.00	1.200	1.98	0.66	0.79	29.356	0.655	0.000	40.92	3.94
130.0	(8) 1 5/8" Coax	Yes	4.00	1.059	3.96	1.32	1.40	29.356	0.655	0.000	72.23	31.48
130.0	(2) 1/2" Coax	Yes	4.00	1.200	0.63	0.21	0.25	29.356	0.655	0.000	13.02	1.44
130.0	(8) 1 5/8" Coax	Yes	4.00	0.706	5.94	1.98	1.40	29.356	0.655	0.000	72.23	31.48
135.0	(1) 0.39" Cable	Yes	5.00	0.000	0.00	0.00	0.00	29.591	0.681	0.000	0.00	0.42
135.0	(2) 0.78" 8 AWG 6	Yes	5.00	0.000	0.00	0.00	0.00	29.591	0.681	0.000	0.00	7.08
135.0	(1) 1 5/8" Coax	Yes	5.00	1.200	1.98	0.82	0.99	29.591	0.681	0.000	51.56	4.92
135.0	(8) 1 5/8" Coax	Yes	5.00	1.055	3.96	1.65	1.74	29.591	0.681	0.000	90.65	39.36
135.0	(2) 1/2" Coax	Yes	5.00	1.200	0.63	0.26	0.31	29.591	0.681	0.000	16.40	1.80
135.0	(8) 1 5/8" Coax	Yes	5.00	0.703	5.94	2.47	1.74	29.591	0.681	0.000	90.65	39.36
140.0	(1) 0.39" Cable	Yes	5.00	0.000	0.00	0.00	0.00	29.818	0.713	0.000	0.00	0.42
140.0	(2) 0.78" 8 AWG 6	Yes	5.00	0.000	0.00	0.00	0.00	29.818	0.713	0.000	0.00	7.08
140.0	(1) 1 5/8" Coax	Yes	5.00	1.200	1.98	0.82	0.99	29.818	0.713	0.000	51.95	4.92
140.0	(8) 1 5/8" Coax	Yes	5.00	1.051	3.96	1.65	1.73	29.818	0.713	0.000	91.00	39.36
140.0	(2) 1/2" Coax	Yes	5.00	1.200	0.63	0.26	0.31	29.818	0.713	0.000	16.53	1.80
140.0	(8) 1 5/8" Coax	Yes	5.00	0.701	5.94	2.47	1.73	29.818	0.713	0.000	91.00	39.36
144.0	(1) 0.39" Cable	Yes	4.00	0.000	0.00	0.00	0.00	29.995	0.390	0.000	0.00	0.34
144.0	(2) 0.78" 8 AWG 6	Yes	4.00	0.000	0.00	0.00	0.00	29.995	0.390	0.000	0.00	5.66
144.0	(1) 1 5/8" Coax	Yes	4.00	1.200	1.98	0.66	0.79	29.995	0.390	0.000	41.81	3.94
144.0	(8) 1 5/8" Coax	Yes	4.00	1.048	3.96	1.32	1.38	29.995	0.390	0.000	73.02	31.48
144.0	(2) 1/2" Coax	Yes	4.00	1.200	0.63	0.21	0.25	29.995	0.390	0.000	13.30	1.44
145.0	(1) 0.39" Cable	Yes	1.00	0.000	0.00	0.00	0.00	30.039	0.362	0.000	0.00	0.08
145.0	(2) 0.78" 8 AWG 6	Yes	1.00	0.000	0.00	0.00	0.00	30.039	0.362	0.000	0.00	1.42
145.0	(1) 1 5/8" Coax	Yes	1.00	1.200	1.98	0.17	0.20	30.039	0.362	0.000	10.47	0.98
145.0	(8) 1 5/8" Coax	Yes	1.00	1.047	3.96	0.33	0.35	30.039	0.362	0.000	18.27	7.87
150.0	(1) 0.39" Cable	Yes	5.00	0.000	0.00	0.00	0.00	30.254	0.373	0.000	0.00	0.42
150.0	(2) 0.78" 8 AWG 6	Yes	5.00	0.000	0.00	0.00	0.00	30.254	0.373	0.000	0.00	7.08
150.0	(1) 1 5/8" Coax	Yes	5.00	1.200	1.98	0.82	0.99	30.254	0.373	0.000	52.71	4.92
150.0	(8) 1 5/8" Coax	Yes	5.00	1.043	3.96	1.65	1.72	30.254	0.373	0.000	91.66	39.36
Totals:											8,247.99	15,715.56

Pole : 302489
 Location : Enfd - Enfield, CT
 Height : 150.00 (ft)
 Base Dia : 37.380 (in)
 Top Dia : 15.000 (in)
 Shape : 12 Sides
 Taper : 0.156700 (in/ft)

Code: ANSI/TIA-222 Rev G
 Struct Class : II
 Exposure Category : C
 Topographic Category : 1
 Base Elev : 0.000 (ft)

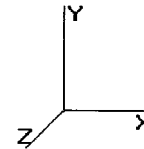

8/2/2013 4:43:24 PM
 Page: 14

© 2007 - 2013 by ATC IP LLC. All rights reserved.

Load Case: 1.2D + 1.6W	95.00 mph with No Ice	25 Iterations
Gust Response Factor: 1.10		Wind Importance Factor: 1.00
Dead Load Factor: 1.20		
Wind Load Factor: 1.60		

Applied Segment Forces Summary

Seg Elev (ft)	Lateral FX (-) (lb)	Axial FY (-) (lb)	Torsion MY (lb-ft)	Moment MZ (lb-ft)
0.00	0.00	0.00	0.00	0.00
5.00	523.90	1,971.42	0.00	0.00
10.00	512.81	1,952.11	0.00	0.00
15.00	1,033.30	2,273.45	0.00	0.00
20.00	1,080.02	2,254.13	0.00	0.00
25.00	1,115.35	2,234.81	0.00	0.00
30.00	1,142.11	2,215.50	0.00	0.00
31.50	343.10	661.03	0.00	0.00
35.00	648.48	2,002.23	0.00	0.00
35.67	121.18	379.64	0.00	0.00
40.00	798.48	1,786.94	0.00	0.00
45.00	926.87	2,046.99	0.00	0.00
50.00	928.70	2,030.90	0.00	0.00
55.00	928.38	2,014.80	0.00	0.00
56.00	976.35	552.23	0.00	1,584.27
60.00	739.54	1,596.95	0.00	0.00
65.00	922.41	1,647.71	0.00	0.00
70.00	917.20	1,631.61	0.00	0.00
70.00	0.06	0.11	0.00	0.00
73.50	645.30	1,443.31	0.00	0.00
75.00	274.77	453.52	0.00	0.00
80.00	915.16	1,503.69	0.00	0.00
85.00	906.64	1,490.81	0.00	0.00
90.00	897.18	1,477.93	0.00	0.00
95.00	886.83	1,465.06	0.00	0.00
100.0	875.68	1,452.18	0.00	0.00
103.0	1,988.80	1,880.33	0.00	4,680.75
105.0	343.11	554.57	0.00	0.00
110.0	851.18	1,377.41	0.00	0.00
110.0	0.06	0.09	0.00	0.00
115.0	1,265.01	1,375.50	0.00	1,281.42
120.0	824.06	1,241.37	0.00	0.00
121.0	162.59	247.12	0.00	0.00
125.0	646.03	717.40	0.00	0.00
126.0	3,294.46	2,361.27	0.00	2,020.98
130.0	593.11	334.08	0.00	0.00
135.0	727.56	408.91	0.00	0.00
140.0	2,985.92	2,469.61	0.00	0.00
144.0	1,104.29	622.87	0.00	0.00
145.0	115.55	63.01	0.00	0.00
150.0	5,318.85	3,752.07	0.00	7,276.63
Totals:	39,280.40	55,944.68	0.00	16,844.05

Pole : 302489
 Location : Enfd - Enfield, CT
 Height : 150.00 (ft)
 Base Dia : 37.380 (in)
 Top Dia : 15.000 (in)
 Shape : 12 Sides
 Taper : 0.156700 (in/ft)

Code: ANSI/TIA-222 Rev G
 Struct Class : II
 Exposure Category : C
 Topographic Category : 1
 Base Elev : 0.000 (ft)

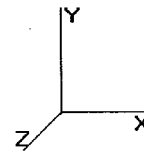

8/2/2013 4:43:24 PM
 Page: 15

© 2007 - 2013 by ATC IP LLC. All rights reserved.

Load Case: 1.2D + 1.6W	95.00 mph with No Ice	25 Iterations
Gust Response Factor : 1.10		Wind Importance Factor : 1.00
Dead Load Factor : 1.20		
Wind Load Factor : 1.60		

Calculated Forces

Seg Elev (ft)	Pu FY (-) (kips)	Vu FX (-) (kips)	Tu MY (ft-kips)	Mu MZ (ft-kips)	Mu MX (ft-kips)	Resultant Moment (ft-kips)	phi Pn (kips)	phi Vn (kips)	phi Tn (ft-kips)	phi Mn (ft-kips)	Total Deflect (in)	Rotation (deg)	Ratio
0.00	-55.85	-39.41	0.00	-3,867.76	0.00	3,867.76	3,133.66	1,566.83	4,776.46	2,358.91	0.00	0.00	0.632
5.00	-53.71	-39.13	0.00	-3,670.70	0.00	3,670.70	3,091.35	1,545.67	4,611.19	2,277.30	0.14	-0.26	0.609
10.00	-51.58	-38.83	0.00	-3,475.08	0.00	3,475.08	3,047.99	1,524.00	4,447.17	2,196.29	0.55	-0.52	0.585
15.00	-49.15	-37.99	0.00	-3,280.93	0.00	3,280.93	3,003.60	1,501.80	4,284.50	2,115.95	1.23	-0.77	0.560
20.00	-46.76	-37.08	0.00	-3,090.98	0.00	3,090.98	2,958.17	1,479.08	4,123.27	2,036.33	2.18	-1.02	0.536
25.00	-44.39	-36.11	0.00	-2,905.60	0.00	2,905.60	2,911.70	1,455.85	3,963.58	1,957.46	3.39	-1.27	0.512
30.00	-42.11	-35.03	0.00	-2,725.06	0.00	2,725.06	2,864.18	1,432.09	3,805.55	1,879.42	4.85	-1.51	0.487
31.50	-41.38	-34.75	0.00	-2,672.51	0.00	2,672.51	2,849.72	1,424.86	3,758.46	1,856.16	5.34	-1.59	0.480
35.00	-39.34	-34.12	0.00	-2,550.88	0.00	2,550.88	2,805.48	1,402.74	3,636.10	1,795.73	6.57	-1.76	0.456
35.67	-38.90	-34.06	0.00	-2,528.13	0.00	2,528.13	2,231.07	1,115.54	2,951.42	1,457.59	6.82	-1.79	0.512
40.00	-37.01	-33.35	0.00	-2,380.54	0.00	2,380.54	2,201.95	1,100.98	2,850.70	1,407.85	8.53	-1.99	0.487
45.00	-34.87	-32.48	0.00	-2,213.82	0.00	2,213.82	2,167.39	1,083.69	2,735.30	1,350.86	10.74	-2.22	0.458
50.00	-32.76	-31.60	0.00	-2,051.40	0.00	2,051.40	2,131.78	1,065.89	2,620.87	1,294.35	13.18	-2.44	0.430
55.00	-30.72	-30.65	0.00	-1,893.41	0.00	1,893.41	2,095.13	1,047.56	2,507.52	1,238.37	15.86	-2.66	0.402
56.00	-30.16	-29.71	0.00	-1,861.17	0.00	1,861.17	2,087.67	1,043.84	2,484.99	1,227.24	16.43	-2.71	0.396
60.00	-28.50	-28.98	0.00	-1,742.34	0.00	1,742.34	2,057.44	1,028.72	2,395.35	1,182.97	18.77	-2.88	0.374
60.00	-28.50	-28.98	0.00	-1,742.34	0.00	1,742.34	2,057.44	1,028.72	2,395.35	1,182.97	18.77	-2.88	0.715
65.00	-26.76	-28.11	0.00	-1,597.43	0.00	1,597.43	2,018.71	1,009.36	2,284.46	1,128.21	21.89	-3.08	0.674
70.00	-25.09	-27.19	0.00	-1,456.86	0.00	1,456.86	1,978.94	989.47	2,174.96	1,074.13	25.32	-3.46	0.632
70.00	-25.03	-27.25	0.00	-1,456.85	0.00	1,456.85	1,978.94	989.47	2,174.95	1,074.12	25.32	-3.46	0.632
73.50	-23.55	-26.59	0.00	-1,361.49	0.00	1,361.49	1,462.64	731.32	1,612.09	796.15	27.96	-3.72	0.704
75.00	-23.00	-26.38	0.00	-1,321.61	0.00	1,321.61	1,455.06	727.53	1,589.51	785.00	29.15	-3.84	0.689
80.00	-21.40	-25.50	0.00	-1,189.70	0.00	1,189.70	1,429.11	714.55	1,514.58	747.99	33.36	-4.21	0.634
85.00	-19.83	-24.61	0.00	-1,062.18	0.00	1,062.18	1,402.12	701.06	1,440.27	711.29	37.97	-4.57	0.580
90.00	-18.29	-23.70	0.00	-939.15	0.00	939.15	1,374.09	687.04	1,366.68	674.95	42.94	-4.91	0.526
95.00	-16.79	-22.78	0.00	-820.66	0.00	820.66	1,345.02	672.51	1,293.93	639.02	48.25	-5.24	0.472
100.00	-15.34	-21.83	0.00	-706.79	0.00	706.79	1,314.91	657.46	1,222.10	603.55	53.90	-5.54	0.417
103.00	-13.62	-19.70	0.00	-636.62	0.00	636.62	1,296.35	648.17	1,179.50	582.51	57.43	-5.71	0.381
105.00	-13.04	-19.34	0.00	-597.22	0.00	597.22	1,283.76	641.88	1,151.31	568.59	59.84	-5.81	0.362
110.00	-11.72	-18.38	0.00	-500.51	0.00	500.51	1,247.14	623.57	1,077.81	532.29	66.05	-6.06	0.313
110.00	-11.68	-18.40	0.00	-500.50	0.00	500.50	1,247.13	623.57	1,077.80	532.29	66.05	-6.06	0.313
110.00	-11.68	-18.40	0.00	-500.50	0.00	500.50	846.54	423.27	735.96	363.46	66.05	-6.06	0.377
115.00	-10.38	-17.04	0.00	-407.22	0.00	407.22	828.55	414.27	693.31	342.40	72.52	-6.28	0.313
120.00	-9.21	-16.10	0.00	-322.04	0.00	322.04	809.51	404.76	651.00	321.50	79.20	-6.49	0.253
121.00	-8.96	-15.92	0.00	-305.94	0.00	305.94	805.58	402.79	642.58	317.35	80.56	-6.53	0.242
121.00	-8.96	-15.92	0.00	-305.94	0.00	305.94	805.58	402.79	642.58	317.35	80.56	-6.53	0.977
125.00	-8.28	-15.22	0.00	-242.26	0.00	242.26	789.44	394.72	609.12	300.82	86.09	-6.67	0.817
126.00	-6.26	-11.70	0.00	-225.02	0.00	225.02	785.30	392.65	600.81	296.72	87.49	-6.80	0.767
130.00	-5.91	-11.12	0.00	-178.21	0.00	178.21	768.32	384.16	567.78	280.41	93.38	-7.26	0.644
135.00	-5.53	-10.39	0.00	-122.61	0.00	122.61	746.17	373.08	527.09	260.31	101.24	-7.74	0.479
140.00	-3.46	-7.10	0.00	-70.67	0.00	70.67	722.98	361.49	487.14	240.58	109.53	-8.10	0.299
144.00	-2.99	-5.93	0.00	-42.25	0.00	42.25	701.03	350.52	454.07	224.25	116.38	-8.29	0.193
145.00	-2.94	-5.81	0.00	-36.32	0.00	36.32	694.06	347.03	445.03	219.78	118.11	-8.32	0.170
150.00	0.00	-5.32	0.00	-7.28	0.00	7.28	659.19	329.60	401.19	198.13	126.87	-8.43	0.037

Pole : 302489
 Location : Enfd - Enfield, CT
 Height : 150.00 (ft)
 Base Dia : 37.380 (in)
 Top Dia : 15.000 (in)
 Shape : 12 Sides
 Taper : 0.156700 (in/ft)

Code: ANSI/TIA-222 Rev G
 Struct Class : II
 Exposure Category : C
 Topographic Category : 1
 Base Elev : 0.000 (ft)

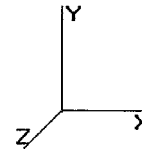

8/2/2013 4:43:24 PM
 Page: 16

© 2007 - 2013 by ATC IP LLC. All rights reserved.

Load Case: 0.9D + 1.6W 95.00 mph with No Ice (Reduced DL) 25 Iterations
Gust Response Factor 1.10 **Wind Importance Factor : 1.00**
Dead Load Factor : 0.90
Wind Load Factor : 1.60

Shaft Segment Forces (Factored)

Seg Top Elev (ft)	Description	Kzt	Kz	qz (psf)	qzGh (psf)	C (mph-ft)	Cf	Ice Thick (in)	Tributary (ft)	Aa (sf)	CfAa (sf)	Wind Force X (lb)	Dead Load Ice (lb)	Tot Dead Load (lb)
0.00		1.00	0.85	18.656	20.522	282.454	1.000	0.000	0.00	0.000	0.00	0.0	0.0	0.0
5.00		1.00	0.85	18.656	20.522	276.533	1.000	0.000	5.00	15.955	15.96	523.9	0.0	1,345.0
10.00		1.00	0.85	18.656	20.522	270.613	1.000	0.000	5.00	15.617	15.62	512.8	0.0	1,330.5
15.00		1.00	0.85	18.656	20.522	264.693	1.200	* 0.000	5.00	15.279	18.34	602.0	0.0	1,316.0
20.00		1.00	0.90	19.795	21.775	266.553	1.200	* 0.000	5.00	14.942	17.93	624.7	0.0	1,301.5
25.00		1.00	0.94	20.747	22.822	266.645	1.200	* 0.000	5.00	14.604	17.52	639.9	0.0	1,287.0
30.00		1.00	0.98	21.559	23.715	265.448	1.200	* 0.000	5.00	14.266	17.12	649.6	0.0	1,272.5
31.50	Bot - Section 2	1.00	0.99	21.782	23.960	264.895	1.200	* 0.000	1.50	4.215	5.06	193.9	0.0	379.0
35.00		1.00	1.01	22.270	24.497	263.322	1.200	* 0.000	3.50	9.902	11.88	465.7	0.0	1,229.3
35.67	Top - Section 1	1.00	1.01	22.359	24.595	262.981	1.200	* 0.000	0.67	1.868	2.24	88.2	0.0	232.8
40.00		1.00	1.04	22.905	25.196	265.722	1.200	* 0.000	4.33	11.991	14.39	580.1	0.0	1,003.0
45.00		1.00	1.07	23.480	25.828	262.395	1.200	* 0.000	5.00	13.521	16.23	670.5	0.0	1,146.2
50.00		1.00	1.09	24.007	26.408	258.606	1.200	* 0.000	5.00	13.183	15.82	668.4	0.0	1,134.1
55.00		1.00	1.11	24.494	26.943	254.430	1.200	* 0.000	5.00	12.845	15.41	664.5	0.0	1,122.0
56.00	Appertunance(s)	1.00	1.12	24.587	27.045	253.553	1.200	* 0.000	1.00	2.529	3.03	131.3	0.0	223.0
60.00	Reinf. Top	1.00	1.13	24.946	27.441	249.925	1.200	* 0.000	4.00	9.979	11.97	525.8	0.0	887.0
65.00		1.00	1.15	25.370	27.907	245.135	1.200	* 0.000	5.00	12.169	14.60	652.1	0.0	763.9
70.00		1.00	1.17	25.769	28.346	240.097	1.200	* 0.000	5.00	11.831	14.20	643.9	0.0	751.8
70.00	Bot - Section 3	1.00	1.17	25.769	28.346	240.097	1.200	* 0.000	0.00	0.001	0.00	0.0	0.0	0.1
73.50	Top - Section 2	1.00	1.18	26.035	28.639	236.437	1.200	* 0.000	3.50	8.232	9.88	452.6	0.0	752.1
75.00		1.00	1.19	26.146	28.761	239.311	1.200	* 0.000	1.50	3.476	4.17	192.0	0.0	198.6
80.00		1.00	1.20	26.504	29.154	233.886	1.200	* 0.000	5.00	11.371	13.65	636.5	0.0	655.9
85.00		1.00	1.22	26.844	29.529	228.282	1.200	* 0.000	5.00	11.033	13.24	625.5	0.0	646.2
90.00		1.00	1.23	27.169	29.886	222.515	1.200	* 0.000	5.00	10.695	12.83	613.7	0.0	636.5
95.00		1.00	1.25	27.480	30.229	216.599	1.200	* 0.000	5.00	10.357	12.43	601.1	0.0	626.9
100.00		1.00	1.26	27.779	30.557	210.548	1.200	* 0.000	5.00	10.019	12.02	587.8	0.0	617.2
103.00	Appertunance(s)	1.00	1.27	27.952	30.747	206.856	1.200	* 0.000	3.00	5.849	7.02	345.3	0.0	365.7
105.00		1.00	1.27	28.066	30.872	204.371	1.200	* 0.000	2.00	3.832	4.60	227.1	0.0	241.9
110.00		1.00	1.29	28.342	31.176	198.077	1.200	* 0.000	5.00	9.343	11.21	559.3	0.0	597.9
110.00	Top - Section 3	1.00	1.29	28.342	31.176	198.076	1.200	* 0.000	0.00	0.001	0.00	0.0	0.0	0.0
115.00	Appertunance(s)	1.00	1.30	28.608	31.469	191.675	1.200	* 0.000	5.00	9.005	10.81	544.1	0.0	525.2
120.00		1.00	1.31	28.866	31.752	185.171	1.200	* 0.000	5.00	8.667	10.40	528.4	0.0	518.0
121.00	Reinf. Top	1.00	1.31	28.916	31.808	183.859	1.200	* 0.000	1.00	1.693	2.03	103.4	0.0	102.7
125.00		1.00	1.32	29.115	32.026	178.573	1.200	* 0.000	4.00	6.636	7.96	408.1	0.0	140.8
126.00	Appertunance(s)	1.00	1.32	29.164	32.080	177.242	1.200	* 0.000	1.00	1.625	1.95	100.1	0.0	34.5
130.00		1.00	1.33	29.356	32.292	171.885	1.200	* 0.000	4.00	6.366	7.64	394.7	0.0	135.0
135.00		1.00	1.34	29.591	32.550	165.113	1.200	* 0.000	5.00	7.653	9.18	478.3	0.0	162.3
140.00	Appertunance(s)	1.00	1.35	29.818	32.800	158.262	1.200	* 0.000	5.00	7.315	8.78	460.7	0.0	155.0
144.00	Appertunance(s)	1.00	1.36	29.995	32.995	152.726	1.200	* 0.000	4.00	5.609	6.73	355.3	0.0	118.8
145.00		1.00	1.36	30.039	33.043	151.335	1.200	* 0.000	1.00	1.368	1.64	86.8	0.0	29.0
150.00	Appertunance(s)	1.00	1.37	30.254	33.280	144.337	1.200	* 0.000	5.00	6.639	7.97	424.2	0.0	140.6
* = Cf Adjusted By Linear Load Ra Effect								Totals:	150.00			17,562.5	0.0	24,125.6

Pole : 302489
 Location : Enfd - Enfield, CT
 Height : 150.00 (ft)
 Base Dia : 37.380 (in)
 Top Dia : 15.000 (in)
 Shape : 12 Sides
 Taper : 0.156700 (in/ft)

Code: ANSI/TIA-222 Rev G
 Struct Class : II
 Exposure Category : C
 Topographic Category : 1
 Base Elev : 0.000 (ft)

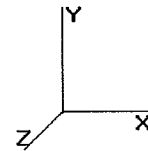

8/2/2013 4:43:25 PM
 Page: 17

© 2007 - 2013 by ATC IP LLC. All rights reserved.

Load Case: 0.9D + 1.6W	95.00 mph with No Ice (Reduced DL)	25 Iterations
Gust Response Factor 1.10		Wind Importance Factor : 1.00
Dead Load Factor : 0.90		
Wind Load Factor : 1.60		

Discrete Appurtenance Segment Forces (Factored)

Elev (ft)	Description	Qty	qz (psf)	qzGh (psf)	CaAa Factor	Ka	Total CaAa (sf)	Horiz Ecc (ft)	Vert Ecc (ft)	Wind FX (lb)	Mom Y (lb-ft)	Mom Z (lb-ft)	Dead Load (lb)
56.00	Channel Master Type	1	24.769	27.246	0.90	1.00	18.17	0.000	2.000	792.14	0.00	1,584.27	113.40
103.0	24" x 24" Junction	1	28.122	30.934	0.80	0.80	4.48	0.000	3.000	221.73	0.00	665.20	18.00
103.0	Argus LLPX310R	3	28.177	30.995	0.50	0.80	7.19	0.000	4.000	356.42	0.00	1,425.68	77.22
103.0	DragonWave A-ANT-	2	28.287	31.116	0.72	0.80	6.75	0.000	6.000	336.23	0.00	2,017.40	48.60
103.0	DragonWave Horizon	2	28.287	31.116	0.26	0.80	0.23	0.000	6.000	11.30	0.00	67.82	19.08
103.0	NextNet BTS-2500	3	28.177	30.995	0.40	0.80	2.54	0.000	4.000	126.16	0.00	504.65	94.50
103.0	Side Arms	1	27.952	30.747	1.00	1.00	8.50	0.000	0.000	418.17	0.00	0.00	504.00
115.0	RFS APXV18-206517S-	3	28.764	31.640	0.54	0.80	8.44	0.000	3.000	427.14	0.00	1,281.42	71.28
126.0	Alcatel-Lucent RRH2x	3	29.212	32.134	0.40	0.80	3.02	0.000	1.000	155.48	0.00	155.48	118.80
126.0	Antel BXA-171085-12C	3	29.212	32.134	0.58	0.80	8.17	0.000	1.000	420.23	0.00	420.23	40.50
126.0	Antel BXA-171085-8BF	3	29.212	32.134	0.57	0.80	5.01	0.000	1.000	257.57	0.00	257.57	28.35
126.0	Antel BXA-70063-4CF-	3	29.212	32.134	0.51	0.80	7.93	0.000	1.000	407.49	0.00	407.49	26.73
126.0	Antel BXA-80080-6CF-	3	29.212	32.134	0.58	0.80	10.11	0.000	1.000	519.74	0.00	519.74	48.60
126.0	RFS DB-T1-6Z-8AB-0Z	1	29.212	32.134	0.80	0.80	4.48	0.000	1.000	230.33	0.00	230.33	39.60
126.0	RFS FD9R6004/2C-3L	6	29.212	32.134	0.26	0.80	0.59	0.000	1.000	30.13	0.00	30.13	14.04
126.0	Round Low Profile PI	1	29.164	32.080	1.00	1.00	21.70	0.000	0.000	1,113.82	0.00	0.00	1,350.00
140.0	Andrew OneBase Dual	6	29.818	32.800	0.26	0.80	1.06	0.000	0.000	55.70	0.00	0.00	59.40
140.0	EMS RR90-17-02DP	3	29.818	32.800	0.51	0.80	6.70	0.000	0.000	351.45	0.00	0.00	36.45
140.0	Flat Low Profile Pla	1	29.818	32.800	1.00	1.00	26.10	0.000	0.000	1,369.72	0.00	0.00	1,350.00
140.0	RFS APX16DWW-	3	29.818	32.800	0.47	0.80	9.49	0.000	0.000	497.88	0.00	0.00	106.92
144.0	Diamond X50A	2	29.995	32.995	0.75	1.00	1.68	0.000	0.000	88.69	0.00	0.00	4.14
144.0	Flat Side Arm	2	29.995	32.995	0.80	1.00	10.08	0.000	0.000	532.14	0.00	0.00	270.00
150.0	ADC DD1900	6	30.339	33.373	0.25	0.75	1.89	0.000	2.000	100.70	0.00	201.40	65.34
150.0	Allgon 7770.00	6	30.339	33.373	0.48	0.75	16.93	0.000	2.000	904.23	0.00	1,808.46	189.00
150.0	Andrew SBNH-	1	30.339	33.373	0.75	0.75	8.59	0.000	2.000	458.54	0.00	917.08	54.72
150.0	Decibel DB809KE-SY	1	30.748	33.823	1.00	1.00	3.40	0.000	12.000	184.00	0.00	2,207.98	23.40
150.0	Ericsson RRUS 11 (Ba	6	30.339	33.373	0.50	1.00	8.82	0.000	2.000	470.95	0.00	941.91	297.00
150.0	Flat Platform w/ Han	1	30.254	33.280	0.90	1.00	38.16	0.000	0.000	2,031.91	0.00	0.00	1,800.00
150.0	Powerwave LGP13519	6	30.339	33.373	0.25	0.75	0.50	0.000	2.000	26.96	0.00	53.92	28.62
150.0	Powerwave P65-16-	2	30.339	33.373	0.56	0.75	9.45	0.000	2.000	504.59	0.00	1,009.19	95.40
150.0	Raycap DC6-48-60-18-	1	30.339	33.373	1.00	1.00	1.28	0.000	2.000	68.35	0.00	136.69	28.62
										13,469.91			7,021.71

Pole : 302489
 Location : Enfd - Enfield, CT
 Height : 150.00 (ft)
 Base Dia : 37.380 (in)
 Top Dia : 15.000 (in)
 Shape : 12 Sides
 Taper : 0.156700 (in/ft)

Code : ANSI/TIA-222 Rev G
 Struct Class : II
 Exposure Category : C
 Topographic Category : 1
 Base Elev : 0.000 (ft)

8/2/2013 4:43:25 PM
 Page: 18

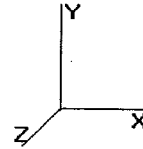

© 2007 - 2013 by ATC IP LLC. All rights reserved.

Load Case: 0.9D + 1.6W

95.00 mph with No Ice (Reduced DL)

25 Iterations

Gust Response Factor 1.10
 Dead Load Factor : 0.90
 Wind Load Factor : 1.60

Wind Importance Factor : 1.00

Linear Appurtenance Segment Forces (Factored)

Seg Top Elev (ft)	Description	Exposed To Wind	Length (ft)	Ca	Exposed Width (in)	Area (sqft)	CaAa (sqft)	qz (psf)	Ra	Cf Adjust Factor	F X (lb)	Dead Load (lb)
5.00	(4) #20 Dywidag bars	Yes	5.00	0.000	0.00	0.00	0.00	18.656	0.000	0.000	0.00	300.60
10.00	(4) #20 Dywidag bars	Yes	5.00	0.000	0.00	0.00	0.00	18.656	0.000	0.000	0.00	300.60
15.00	(1) 0.39" Cable	Yes	5.00	0.000	0.00	0.00	0.00	18.656	0.613	0.000	0.00	0.31
15.00	(2) 0.78" 8 AWG 6	Yes	5.00	0.000	0.00	0.00	0.00	18.656	0.613	0.000	0.00	5.31
15.00	(1) 1 5/8" Coax	Yes	5.00	1.200	1.98	0.82	0.99	18.656	0.613	0.000	32.51	3.69
15.00	(8) 1 5/8" Coax	Yes	5.00	1.200	3.96	1.65	1.98	18.656	0.613	0.000	65.01	29.52
15.00	(2) 1/2" Coax	Yes	5.00	1.200	0.63	0.26	0.31	18.656	0.613	0.000	10.34	1.35
15.00	(8) 1 5/8" Coax	Yes	5.00	0.886	5.94	2.47	2.19	18.656	0.613	0.000	71.98	29.52
15.00	(12) 1 5/8" Coax	Yes	5.00	1.200	1.98	0.82	0.99	18.656	0.613	0.000	32.51	44.27
15.00	(1) 1 5/8" Hybriflex	Yes	5.00	0.000	0.00	0.00	0.00	18.656	0.613	0.000	0.00	7.24
15.00	(4) #20 Dywidag bars	Yes	5.00	0.000	0.00	0.00	0.00	18.656	0.613	0.000	0.00	300.60
15.00	(6) 1 5/8" Coax	Yes	5.00	0.000	0.00	0.00	0.00	18.656	0.613	0.000	0.00	22.14
15.00	(4) 1/2" Coax	Yes	5.00	0.000	0.00	0.00	0.00	18.656	0.613	0.000	0.00	2.70
15.00	(2) 2" Conduit	Yes	5.00	0.000	0.00	0.00	0.00	18.656	0.613	0.000	0.00	32.85
15.00	(6) 5/16" Coax	Yes	5.00	0.000	0.00	0.00	0.00	18.656	0.613	0.000	0.00	1.22
15.00	(1) 1/2" Coax	Yes	5.00	0.000	0.00	0.00	0.00	18.656	0.613	0.000	0.00	0.68
15.00	(4) Dywidag	Yes	5.00	2.000	8.00	3.33	6.67	18.656	0.613	0.000	218.90	0.00
20.00	(1) 0.39" Cable	Yes	5.00	0.000	0.00	0.00	0.00	19.795	0.627	0.000	0.00	0.31
20.00	(2) 0.78" 8 AWG 6	Yes	5.00	0.000	0.00	0.00	0.00	19.795	0.627	0.000	0.00	5.31
20.00	(1) 1 5/8" Coax	Yes	5.00	1.200	1.98	0.82	0.99	19.795	0.627	0.000	34.49	3.69
20.00	(8) 1 5/8" Coax	Yes	5.00	1.200	3.96	1.65	1.98	19.795	0.627	0.000	68.98	29.52
20.00	(2) 1/2" Coax	Yes	5.00	1.200	0.63	0.26	0.31	19.795	0.627	0.000	10.97	1.35
20.00	(8) 1 5/8" Coax	Yes	5.00	0.860	5.94	2.47	2.13	19.795	0.627	0.000	74.14	29.52
20.00	(12) 1 5/8" Coax	Yes	5.00	1.200	1.98	0.82	0.99	19.795	0.627	0.000	34.49	44.27
20.00	(1) 1 5/8" Hybriflex	Yes	5.00	0.000	0.00	0.00	0.00	19.795	0.627	0.000	0.00	7.24
20.00	(4) #20 Dywidag bars	Yes	5.00	0.000	0.00	0.00	0.00	19.795	0.627	0.000	0.00	300.60
20.00	(6) 1 5/8" Coax	Yes	5.00	0.000	0.00	0.00	0.00	19.795	0.627	0.000	0.00	22.14
20.00	(4) 1/2" Coax	Yes	5.00	0.000	0.00	0.00	0.00	19.795	0.627	0.000	0.00	2.70
20.00	(2) 2" Conduit	Yes	5.00	0.000	0.00	0.00	0.00	19.795	0.627	0.000	0.00	32.85
20.00	(6) 5/16" Coax	Yes	5.00	0.000	0.00	0.00	0.00	19.795	0.627	0.000	0.00	1.22
20.00	(1) 1/2" Coax	Yes	5.00	0.000	0.00	0.00	0.00	19.795	0.627	0.000	0.00	0.68
20.00	(4) Dywidag	Yes	5.00	2.000	8.00	3.33	6.67	19.795	0.627	0.000	232.26	0.00
25.00	(1) 0.39" Cable	Yes	5.00	0.000	0.00	0.00	0.00	20.747	0.642	0.000	0.00	0.31
25.00	(2) 0.78" 8 AWG 6	Yes	5.00	0.000	0.00	0.00	0.00	20.747	0.642	0.000	0.00	5.31
25.00	(1) 1 5/8" Coax	Yes	5.00	1.200	1.98	0.82	0.99	20.747	0.642	0.000	36.15	3.69
25.00	(8) 1 5/8" Coax	Yes	5.00	1.200	3.96	1.65	1.98	20.747	0.642	0.000	72.30	29.52
25.00	(2) 1/2" Coax	Yes	5.00	1.200	0.63	0.26	0.31	20.747	0.642	0.000	11.50	1.35
25.00	(8) 1 5/8" Coax	Yes	5.00	0.840	5.94	2.47	2.08	20.747	0.642	0.000	75.91	29.52
25.00	(12) 1 5/8" Coax	Yes	5.00	1.200	1.98	0.82	0.99	20.747	0.642	0.000	36.15	44.27
25.00	(1) 1 5/8" Hybriflex	Yes	5.00	0.000	0.00	0.00	0.00	20.747	0.642	0.000	0.00	7.24
25.00	(4) #20 Dywidag bars	Yes	5.00	0.000	0.00	0.00	0.00	20.747	0.642	0.000	0.00	300.60
25.00	(6) 1 5/8" Coax	Yes	5.00	0.000	0.00	0.00	0.00	20.747	0.642	0.000	0.00	22.14
25.00	(4) 1/2" Coax	Yes	5.00	0.000	0.00	0.00	0.00	20.747	0.642	0.000	0.00	2.70
25.00	(2) 2" Conduit	Yes	5.00	0.000	0.00	0.00	0.00	20.747	0.642	0.000	0.00	32.85
25.00	(6) 5/16" Coax	Yes	5.00	0.000	0.00	0.00	0.00	20.747	0.642	0.000	0.00	1.22
25.00	(1) 1/2" Coax	Yes	5.00	0.000	0.00	0.00	0.00	20.747	0.642	0.000	0.00	0.68
25.00	(4) Dywidag	Yes	5.00	2.000	8.00	3.33	6.67	20.747	0.642	0.000	243.44	0.00
30.00	(1) 0.39" Cable	Yes	5.00	0.000	0.00	0.00	0.00	21.559	0.657	0.000	0.00	0.31
30.00	(2) 0.78" 8 AWG 6	Yes	5.00	0.000	0.00	0.00	0.00	21.559	0.657	0.000	0.00	5.31
30.00	(1) 1 5/8" Coax	Yes	5.00	1.200	1.98	0.82	0.99	21.559	0.657	0.000	37.56	3.69
30.00	(8) 1 5/8" Coax	Yes	5.00	1.200	3.96	1.65	1.98	21.559	0.657	0.000	75.13	29.52

Pole : 302489
 Location : Enfd - Enfield, CT
 Height : 150.00 (ft)
 Base Dia : 37.380 (in)
 Top Dia : 15.000 (in)
 Shape : 12 Sides
 Taper : 0.156700 (in/ft)

Code: ANSI/TIA-222 Rev G
 Struct Class : II
 Exposure Category : C
 Topographic Category : 1
 Base Elev : 0.000 (ft)

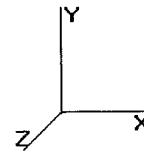

8/2/2013 4:43:25 PM
 Page: 19

© 2007 - 2013 by ATC IP LLC. All rights reserved.

Load Case: 0.9D + 1.6W	95.00 mph with No Ice (Reduced DL)	25 Iterations
Gust Response Factor : 1.10		Wind Importance Factor : 1.00
Dead Load Factor : 0.90		
Wind Load Factor : 1.60		

30.00	(2) 1/2" Coax	Yes	5.00	1.200	0.63	0.26	0.31	21.559	0.657	0.000	11.95	1.35
30.00	(8) 1 5/8" Coax	Yes	5.00	0.824	5.94	2.47	2.04	21.559	0.657	0.000	77.38	29.52
30.00	(12) 1 5/8" Coax	Yes	5.00	1.200	1.98	0.82	0.99	21.559	0.657	0.000	37.56	44.27
30.00	(1) 1 5/8" Hybriflex	Yes	5.00	0.000	0.00	0.00	0.00	21.559	0.657	0.000	0.00	7.24
30.00	(4) #20 Dywidag bars	Yes	5.00	0.000	0.00	0.00	0.00	21.559	0.657	0.000	0.00	300.60
30.00	(6) 1 5/8" Coax	Yes	5.00	0.000	0.00	0.00	0.00	21.559	0.657	0.000	0.00	22.14
30.00	(4) 1/2" Coax	Yes	5.00	0.000	0.00	0.00	0.00	21.559	0.657	0.000	0.00	2.70
30.00	(2) 2" Conduit	Yes	5.00	0.000	0.00	0.00	0.00	21.559	0.657	0.000	0.00	32.85
30.00	(6) 5/16" Coax	Yes	5.00	0.000	0.00	0.00	0.00	21.559	0.657	0.000	0.00	1.22
30.00	(1) 1/2" Coax	Yes	5.00	0.000	0.00	0.00	0.00	21.559	0.657	0.000	0.00	0.68
30.00	(4) Dywidag	Yes	5.00	2.000	8.00	3.33	6.67	21.559	0.657	0.000	252.96	0.00
31.50	(1) 0.39" Cable	Yes	1.50	0.000	0.00	0.00	0.00	21.782	0.667	0.000	0.00	0.09
31.50	(2) 0.78" 8 AWG 6	Yes	1.50	0.000	0.00	0.00	0.00	21.782	0.667	0.000	0.00	1.59
31.50	(1) 1 5/8" Coax	Yes	1.50	1.200	1.98	0.25	0.30	21.782	0.667	0.000	11.39	1.11
31.50	(8) 1 5/8" Coax	Yes	1.50	1.200	3.96	0.50	0.59	21.782	0.667	0.000	22.78	8.86
31.50	(2) 1/2" Coax	Yes	1.50	1.200	0.63	0.08	0.09	21.782	0.667	0.000	3.62	0.41
31.50	(8) 1 5/8" Coax	Yes	1.50	0.820	5.94	0.74	0.61	21.782	0.667	0.000	23.34	8.86
31.50	(12) 1 5/8" Coax	Yes	1.50	1.200	1.98	0.25	0.30	21.782	0.667	0.000	11.39	13.29
31.50	(1) 1 5/8" Hybriflex	Yes	1.50	0.000	0.00	0.00	0.00	21.782	0.667	0.000	0.00	2.17
31.50	(4) #20 Dywidag bars	Yes	1.50	0.000	0.00	0.00	0.00	21.782	0.667	0.000	0.00	90.20
31.50	(6) 1 5/8" Coax	Yes	1.50	0.000	0.00	0.00	0.00	21.782	0.667	0.000	0.00	6.64
31.50	(4) 1/2" Coax	Yes	1.50	0.000	0.00	0.00	0.00	21.782	0.667	0.000	0.00	0.81
31.50	(2) 2" Conduit	Yes	1.50	0.000	0.00	0.00	0.00	21.782	0.667	0.000	0.00	9.86
31.50	(6) 5/16" Coax	Yes	1.50	0.000	0.00	0.00	0.00	21.782	0.667	0.000	0.00	0.36
31.50	(1) 1/2" Coax	Yes	1.50	0.000	0.00	0.00	0.00	21.782	0.667	0.000	0.00	0.20
31.50	(4) Dywidag	Yes	1.50	2.000	8.00	1.00	2.00	21.782	0.667	0.000	76.69	0.00
35.00	(1) 0.39" Cable	Yes	3.50	0.000	0.00	0.00	0.00	22.270	0.449	0.000	0.00	0.22
35.00	(2) 0.78" 8 AWG 6	Yes	3.50	0.000	0.00	0.00	0.00	22.270	0.449	0.000	0.00	3.72
35.00	(1) 1 5/8" Coax	Yes	3.50	1.200	1.98	0.58	0.69	22.270	0.449	0.000	27.16	2.58
35.00	(8) 1 5/8" Coax	Yes	3.50	1.200	3.96	1.15	1.39	22.270	0.449	0.000	54.32	20.66
35.00	(2) 1/2" Coax	Yes	3.50	1.200	0.63	0.18	0.22	22.270	0.449	0.000	8.64	0.94
35.00	(8) 1 5/8" Coax	Yes	3.50	0.811	5.94	1.73	1.40	22.270	0.449	0.000	55.04	20.66
35.00	(12) 1 5/8" Coax	Yes	3.50	1.200	1.98	0.58	0.69	22.270	0.449	0.000	27.16	30.99
35.00	(1) 1 5/8" Hybriflex	Yes	3.50	0.000	0.00	0.00	0.00	22.270	0.449	0.000	0.00	5.07
35.00	(4) #20 Dywidag bars	Yes	3.50	0.000	0.00	0.00	0.00	22.270	0.449	0.000	0.00	210.40
35.00	(6) 1 5/8" Coax	Yes	3.50	0.000	0.00	0.00	0.00	22.270	0.449	0.000	0.00	15.49
35.00	(4) 1/2" Coax	Yes	3.50	0.000	0.00	0.00	0.00	22.270	0.449	0.000	0.00	1.89
35.00	(2) 2" Conduit	Yes	3.50	0.000	0.00	0.00	0.00	22.270	0.449	0.000	0.00	22.99
35.00	(6) 5/16" Coax	Yes	3.50	0.000	0.00	0.00	0.00	22.270	0.449	0.000	0.00	0.85
35.00	(1) 1/2" Coax	Yes	3.50	0.000	0.00	0.00	0.00	22.270	0.449	0.000	0.00	0.47
35.00	(4) Dywidag	Yes	0.20	2.000	8.00	0.13	0.27	22.270	0.449	0.000	10.43	0.00
35.67	(1) 0.39" Cable	Yes	0.67	0.000	0.00	0.00	0.00	22.359	0.440	0.000	0.00	0.04
35.67	(2) 0.78" 8 AWG 6	Yes	0.67	0.000	0.00	0.00	0.00	22.359	0.440	0.000	0.00	0.71
35.67	(1) 1 5/8" Coax	Yes	0.67	1.200	1.98	0.11	0.13	22.359	0.440	0.000	5.20	0.49
35.67	(8) 1 5/8" Coax	Yes	0.67	1.200	3.96	0.22	0.26	22.359	0.440	0.000	10.39	3.94
35.67	(2) 1/2" Coax	Yes	0.67	1.200	0.63	0.04	0.04	22.359	0.440	0.000	1.65	0.18
35.67	(8) 1 5/8" Coax	Yes	0.67	0.809	5.94	0.33	0.27	22.359	0.440	0.000	10.51	3.94
35.67	(12) 1 5/8" Coax	Yes	0.67	1.200	1.98	0.11	0.13	22.359	0.440	0.000	5.20	5.91
35.67	(1) 1 5/8" Hybriflex	Yes	0.67	0.000	0.00	0.00	0.00	22.359	0.440	0.000	0.00	0.97
35.67	(4) #20 Dywidag bars	Yes	0.67	0.000	0.00	0.00	0.00	22.359	0.440	0.000	0.00	40.10
35.67	(6) 1 5/8" Coax	Yes	0.67	0.000	0.00	0.00	0.00	22.359	0.440	0.000	0.00	2.95
35.67	(4) 1/2" Coax	Yes	0.67	0.000	0.00	0.00	0.00	22.359	0.440	0.000	0.00	0.36
35.67	(2) 2" Conduit	Yes	0.67	0.000	0.00	0.00	0.00	22.359	0.440	0.000	0.00	4.38
35.67	(6) 5/16" Coax	Yes	0.67	0.000	0.00	0.00	0.00	22.359	0.440	0.000	0.00	0.16
35.67	(1) 1/2" Coax	Yes	0.67	0.000	0.00	0.00	0.00	22.359	0.440	0.000	0.00	0.09
40.00	(1) 0.39" Cable	Yes	4.33	0.000	0.00	0.00	0.00	22.905	0.436	0.000	0.00	0.27
40.00	(2) 0.78" 8 AWG 6	Yes	4.33	0.000	0.00	0.00	0.00	22.905	0.436	0.000	0.00	4.60

Pole : 302489
 Location : Enfd - Enfield, CT
 Height : 150.00 (ft)
 Base Dia : 37.380 (in)
 Top Dia : 15.000 (in)
 Shape : 12 Sides
 Taper : 0.156700 (in/ft)

Code: ANSI/TIA-222 Rev G
 Struct Class : II
 Exposure Category : C
 Topographic Category : 1
 Base Elev : 0.000 (ft)

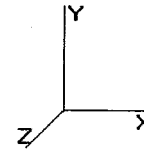

8/2/2013 4:43:25 PM
 Page: 20

© 2007 - 2013 by ATC IP LLC. All rights reserved.

Load Case: 0.9D + 1.6W	95.00 mph with No Ice (Reduced DL)	25 Iterations
Gust Response Factor 1.10		Wind Importance Factor : 1.00
Dead Load Factor : 0.90		
Wind Load Factor : 1.60		

40.00	(1) 1 5/8" Coax	Yes	4.33	1.200	1.98	0.71	0.86	22.905	0.436	0.000	34.59	3.20
40.00	(8) 1 5/8" Coax	Yes	4.33	1.199	3.96	1.43	1.71	22.905	0.436	0.000	69.12	25.58
40.00	(2) 1/2" Coax	Yes	4.33	1.200	0.63	0.23	0.27	22.905	0.436	0.000	11.00	1.17
40.00	(8) 1 5/8" Coax	Yes	4.33	0.799	5.94	2.14	1.71	22.905	0.436	0.000	69.12	25.58
40.00	(12) 1 5/8" Coax	Yes	4.33	1.200	1.98	0.71	0.86	22.905	0.436	0.000	34.59	38.37
40.00	(1) 1 5/8" Hybriflex	Yes	4.33	0.000	0.00	0.00	0.00	22.905	0.436	0.000	0.00	6.28
40.00	(4) #20 Dywidag bars	Yes	4.33	0.000	0.00	0.00	0.00	22.905	0.436	0.000	0.00	260.50
40.00	(6) 1 5/8" Coax	Yes	4.33	0.000	0.00	0.00	0.00	22.905	0.436	0.000	0.00	19.18
40.00	(4) 1/2" Coax	Yes	4.33	0.000	0.00	0.00	0.00	22.905	0.436	0.000	0.00	2.34
40.00	(2) 2" Conduit	Yes	4.33	0.000	0.00	0.00	0.00	22.905	0.436	0.000	0.00	28.47
40.00	(6) 5/16" Coax	Yes	4.33	0.000	0.00	0.00	0.00	22.905	0.436	0.000	0.00	1.05
40.00	(1) 1/2" Coax	Yes	4.33	0.000	0.00	0.00	0.00	22.905	0.436	0.000	0.00	0.58
45.00	(1) 0.39" Cable	Yes	5.00	0.000	0.00	0.00	0.00	23.480	0.447	0.000	0.00	0.31
45.00	(2) 0.78" 8 AWG 6	Yes	5.00	0.000	0.00	0.00	0.00	23.480	0.447	0.000	0.00	5.31
45.00	(1) 1 5/8" Coax	Yes	5.00	1.200	1.98	0.82	0.99	23.480	0.447	0.000	40.91	3.69
45.00	(8) 1 5/8" Coax	Yes	5.00	1.184	3.96	1.65	1.95	23.480	0.447	0.000	80.75	29.52
45.00	(2) 1/2" Coax	Yes	5.00	1.200	0.63	0.26	0.31	23.480	0.447	0.000	13.02	1.35
45.00	(8) 1 5/8" Coax	Yes	5.00	0.790	5.94	2.47	1.95	23.480	0.447	0.000	80.75	29.52
45.00	(12) 1 5/8" Coax	Yes	5.00	1.200	1.98	0.82	0.99	23.480	0.447	0.000	40.91	44.27
45.00	(1) 1 5/8" Hybriflex	Yes	5.00	0.000	0.00	0.00	0.00	23.480	0.447	0.000	0.00	7.24
45.00	(4) #20 Dywidag bars	Yes	5.00	0.000	0.00	0.00	0.00	23.480	0.447	0.000	0.00	300.60
45.00	(6) 1 5/8" Coax	Yes	5.00	0.000	0.00	0.00	0.00	23.480	0.447	0.000	0.00	22.14
45.00	(4) 1/2" Coax	Yes	5.00	0.000	0.00	0.00	0.00	23.480	0.447	0.000	0.00	2.70
45.00	(2) 2" Conduit	Yes	5.00	0.000	0.00	0.00	0.00	23.480	0.447	0.000	0.00	32.85
45.00	(6) 5/16" Coax	Yes	5.00	0.000	0.00	0.00	0.00	23.480	0.447	0.000	0.00	1.22
45.00	(1) 1/2" Coax	Yes	5.00	0.000	0.00	0.00	0.00	23.480	0.447	0.000	0.00	0.68
50.00	(1) 0.39" Cable	Yes	5.00	0.000	0.00	0.00	0.00	24.007	0.458	0.000	0.00	0.31
50.00	(2) 0.78" 8 AWG 6	Yes	5.00	0.000	0.00	0.00	0.00	24.007	0.458	0.000	0.00	5.31
50.00	(1) 1 5/8" Coax	Yes	5.00	1.200	1.98	0.82	0.99	24.007	0.458	0.000	41.83	3.69
50.00	(8) 1 5/8" Coax	Yes	5.00	1.171	3.96	1.65	1.93	24.007	0.458	0.000	81.65	29.52
50.00	(2) 1/2" Coax	Yes	5.00	1.200	0.63	0.26	0.31	24.007	0.458	0.000	13.31	1.35
50.00	(8) 1 5/8" Coax	Yes	5.00	0.781	5.94	2.47	1.93	24.007	0.458	0.000	81.65	29.52
50.00	(12) 1 5/8" Coax	Yes	5.00	1.200	1.98	0.82	0.99	24.007	0.458	0.000	41.83	44.27
50.00	(1) 1 5/8" Hybriflex	Yes	5.00	0.000	0.00	0.00	0.00	24.007	0.458	0.000	0.00	7.24
50.00	(4) #20 Dywidag bars	Yes	5.00	0.000	0.00	0.00	0.00	24.007	0.458	0.000	0.00	300.60
50.00	(6) 1 5/8" Coax	Yes	5.00	0.000	0.00	0.00	0.00	24.007	0.458	0.000	0.00	22.14
50.00	(4) 1/2" Coax	Yes	5.00	0.000	0.00	0.00	0.00	24.007	0.458	0.000	0.00	2.70
50.00	(2) 2" Conduit	Yes	5.00	0.000	0.00	0.00	0.00	24.007	0.458	0.000	0.00	32.85
50.00	(6) 5/16" Coax	Yes	5.00	0.000	0.00	0.00	0.00	24.007	0.458	0.000	0.00	1.22
50.00	(1) 1/2" Coax	Yes	5.00	0.000	0.00	0.00	0.00	24.007	0.458	0.000	0.00	0.68
55.00	(1) 0.39" Cable	Yes	5.00	0.000	0.00	0.00	0.00	24.494	0.470	0.000	0.00	0.31
55.00	(2) 0.78" 8 AWG 6	Yes	5.00	0.000	0.00	0.00	0.00	24.494	0.470	0.000	0.00	5.31
55.00	(1) 1 5/8" Coax	Yes	5.00	1.200	1.98	0.82	0.99	24.494	0.470	0.000	42.68	3.69
55.00	(8) 1 5/8" Coax	Yes	5.00	1.160	3.96	1.65	1.91	24.494	0.470	0.000	82.47	29.52
55.00	(2) 1/2" Coax	Yes	5.00	1.200	0.63	0.26	0.31	24.494	0.470	0.000	13.58	1.35
55.00	(8) 1 5/8" Coax	Yes	5.00	0.773	5.94	2.47	1.91	24.494	0.470	0.000	82.47	29.52
55.00	(12) 1 5/8" Coax	Yes	5.00	1.200	1.98	0.82	0.99	24.494	0.470	0.000	42.68	44.27
55.00	(1) 1 5/8" Hybriflex	Yes	5.00	0.000	0.00	0.00	0.00	24.494	0.470	0.000	0.00	7.24
55.00	(4) #20 Dywidag bars	Yes	5.00	0.000	0.00	0.00	0.00	24.494	0.470	0.000	0.00	300.60
55.00	(6) 1 5/8" Coax	Yes	5.00	0.000	0.00	0.00	0.00	24.494	0.470	0.000	0.00	22.14
55.00	(4) 1/2" Coax	Yes	5.00	0.000	0.00	0.00	0.00	24.494	0.470	0.000	0.00	2.70
55.00	(2) 2" Conduit	Yes	5.00	0.000	0.00	0.00	0.00	24.494	0.470	0.000	0.00	32.85
55.00	(6) 5/16" Coax	Yes	5.00	0.000	0.00	0.00	0.00	24.494	0.470	0.000	0.00	1.22
55.00	(1) 1/2" Coax	Yes	5.00	0.000	0.00	0.00	0.00	24.494	0.470	0.000	0.00	0.68
56.00	(1) 0.39" Cable	Yes	1.00	0.000	0.00	0.00	0.00	24.587	0.478	0.000	0.00	0.06
56.00	(2) 0.78" 8 AWG 6	Yes	1.00	0.000	0.00	0.00	0.00	24.587	0.478	0.000	0.00	1.06
56.00	(1) 1 5/8" Coax	Yes	1.00	1.200	1.98	0.17	0.20	24.587	0.478	0.000	8.57	0.74

Pole : 302489
 Location : Enfd - Enfield, CT
 Height : 150.00 (ft)
 Base Dia : 37.380 (in)
 Top Dia : 15.000 (in)
 Shape : 12 Sides
 Taper : 0.156700 (in/ft)

Code: ANSI/TIA-222 Rev G
 Struct Class : II
 Exposure Category : C
 Topographic Category : 1
 Base Elev : 0.000 (ft)

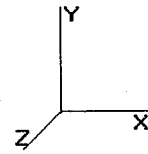

8/2/2013 4:43:25 PM
 Page: 21

© 2007 - 2013 by ATC IP LLC. All rights reserved.

Load Case: 0.9D + 1.6W 95.00 mph with No Ice (Reduced DL) 25 Iterations
 Gust Response Factor 1.10 Wind Importance Factor : 1.00
 Dead Load Factor : 0.90
 Wind Load Factor : 1.60

56.00	(8) 1 5/8" Coax	Yes	1.00	1.157	3.96	0.33	0.38	24.587	0.478	0.000	16.53	5.90
56.00	(2) 1/2" Coax	Yes	1.00	1.200	0.63	0.05	0.06	24.587	0.478	0.000	2.73	0.27
56.00	(8) 1 5/8" Coax	Yes	1.00	0.772	5.94	0.50	0.38	24.587	0.478	0.000	16.53	5.90
56.00	(12) 1 5/8" Coax	Yes	1.00	1.200	1.98	0.17	0.20	24.587	0.478	0.000	8.57	8.85
56.00	(1) 1 5/8" Hybriflex	Yes	1.00	0.000	0.00	0.00	0.00	24.587	0.478	0.000	0.00	1.45
56.00	(4) #20 Dywidag bars	Yes	1.00	0.000	0.00	0.00	0.00	24.587	0.478	0.000	0.00	60.12
56.00	(6) 1 5/8" Coax	Yes	1.00	0.000	0.00	0.00	0.00	24.587	0.478	0.000	0.00	4.43
56.00	(4) 1/2" Coax	Yes	1.00	0.000	0.00	0.00	0.00	24.587	0.478	0.000	0.00	0.54
56.00	(2) 2" Conduit	Yes	1.00	0.000	0.00	0.00	0.00	24.587	0.478	0.000	0.00	6.57
56.00	(6) 5/16" Coax	Yes	1.00	0.000	0.00	0.00	0.00	24.587	0.478	0.000	0.00	0.24
56.00	(1) 1/2" Coax	Yes	1.00	0.000	0.00	0.00	0.00	24.587	0.478	0.000	0.00	0.14
60.00	(1) 0.39" Cable	Yes	4.00	0.000	0.00	0.00	0.00	24.946	0.484	0.000	0.00	0.25
60.00	(2) 0.78" 8 AWG 6	Yes	4.00	0.000	0.00	0.00	0.00	24.946	0.484	0.000	0.00	4.25
60.00	(1) 1 5/8" Coax	Yes	4.00	1.200	1.98	0.66	0.79	24.946	0.484	0.000	34.77	2.95
60.00	(8) 1 5/8" Coax	Yes	4.00	1.149	3.96	1.32	1.52	24.946	0.484	0.000	66.59	23.61
60.00	(2) 1/2" Coax	Yes	4.00	1.200	0.63	0.21	0.25	24.946	0.484	0.000	11.06	1.08
60.00	(8) 1 5/8" Coax	Yes	4.00	0.766	5.94	1.98	1.52	24.946	0.484	0.000	66.59	23.61
60.00	(12) 1 5/8" Coax	Yes	4.00	1.200	1.98	0.66	0.79	24.946	0.484	0.000	34.77	35.42
60.00	(1) 1 5/8" Hybriflex	Yes	4.00	0.000	0.00	0.00	0.00	24.946	0.484	0.000	0.00	5.80
60.00	(4) #20 Dywidag bars	Yes	4.00	0.000	0.00	0.00	0.00	24.946	0.484	0.000	0.00	240.48
60.00	(6) 1 5/8" Coax	Yes	4.00	0.000	0.00	0.00	0.00	24.946	0.484	0.000	0.00	17.71
60.00	(4) 1/2" Coax	Yes	4.00	0.000	0.00	0.00	0.00	24.946	0.484	0.000	0.00	2.16
60.00	(2) 2" Conduit	Yes	4.00	0.000	0.00	0.00	0.00	24.946	0.484	0.000	0.00	26.28
60.00	(6) 5/16" Coax	Yes	4.00	0.000	0.00	0.00	0.00	24.946	0.484	0.000	0.00	0.97
65.00	(1) 0.39" Cable	Yes	5.00	0.000	0.00	0.00	0.00	25.370	0.496	0.000	0.00	0.31
65.00	(2) 0.78" 8 AWG 6	Yes	5.00	0.000	0.00	0.00	0.00	25.370	0.496	0.000	0.00	5.31
65.00	(1) 1 5/8" Coax	Yes	5.00	1.200	1.98	0.82	0.99	25.370	0.496	0.000	44.21	3.69
65.00	(8) 1 5/8" Coax	Yes	5.00	1.139	3.96	1.65	1.88	25.370	0.496	0.000	83.94	29.52
65.00	(2) 1/2" Coax	Yes	5.00	1.200	0.63	0.26	0.31	25.370	0.496	0.000	14.07	1.35
65.00	(8) 1 5/8" Coax	Yes	5.00	0.760	5.94	2.47	1.88	25.370	0.496	0.000	83.94	29.52
65.00	(12) 1 5/8" Coax	Yes	5.00	1.200	1.98	0.82	0.99	25.370	0.496	0.000	44.21	44.27
65.00	(1) 1 5/8" Hybriflex	Yes	5.00	0.000	0.00	0.00	0.00	25.370	0.496	0.000	0.00	7.24
65.00	(4) #20 Dywidag bars	Yes	5.00	0.000	0.00	0.00	0.00	25.370	0.496	0.000	0.00	300.60
65.00	(6) 1 5/8" Coax	Yes	5.00	0.000	0.00	0.00	0.00	25.370	0.496	0.000	0.00	22.14
65.00	(4) 1/2" Coax	Yes	5.00	0.000	0.00	0.00	0.00	25.370	0.496	0.000	0.00	2.70
65.00	(2) 2" Conduit	Yes	5.00	0.000	0.00	0.00	0.00	25.370	0.496	0.000	0.00	32.85
65.00	(6) 5/16" Coax	Yes	5.00	0.000	0.00	0.00	0.00	25.370	0.496	0.000	0.00	1.22
70.00	(1) 0.39" Cable	Yes	5.00	0.000	0.00	0.00	0.00	25.769	0.510	0.000	0.00	0.31
70.00	(2) 0.78" 8 AWG 6	Yes	5.00	0.000	0.00	0.00	0.00	25.769	0.510	0.000	0.00	5.31
70.00	(1) 1 5/8" Coax	Yes	5.00	1.200	1.98	0.82	0.99	25.769	0.510	0.000	44.90	3.69
70.00	(8) 1 5/8" Coax	Yes	5.00	1.130	3.96	1.65	1.87	25.769	0.510	0.000	84.60	29.52
70.00	(2) 1/2" Coax	Yes	5.00	1.200	0.63	0.26	0.31	25.769	0.510	0.000	14.29	1.35
70.00	(8) 1 5/8" Coax	Yes	5.00	0.754	5.94	2.47	1.87	25.769	0.510	0.000	84.60	29.52
70.00	(12) 1 5/8" Coax	Yes	5.00	1.200	1.98	0.82	0.99	25.769	0.510	0.000	44.90	44.27
70.00	(1) 1 5/8" Hybriflex	Yes	5.00	0.000	0.00	0.00	0.00	25.769	0.510	0.000	0.00	7.24
70.00	(4) #20 Dywidag bars	Yes	5.00	0.000	0.00	0.00	0.00	25.769	0.510	0.000	0.00	300.60
70.00	(6) 1 5/8" Coax	Yes	5.00	0.000	0.00	0.00	0.00	25.769	0.510	0.000	0.00	22.14
70.00	(4) 1/2" Coax	Yes	5.00	0.000	0.00	0.00	0.00	25.769	0.510	0.000	0.00	2.70
70.00	(2) 2" Conduit	Yes	5.00	0.000	0.00	0.00	0.00	25.769	0.510	0.000	0.00	32.85
70.00	(6) 5/16" Coax	Yes	5.00	0.000	0.00	0.00	0.00	25.769	0.510	0.000	0.00	1.22
70.00	(1) 0.39" Cable	Yes	0.00	0.000	0.00	0.00	0.00	25.769	0.518	0.000	0.00	0.00
70.00	(2) 0.78" 8 AWG 6	Yes	0.00	0.000	0.00	0.00	0.00	25.769	0.518	0.000	0.00	0.00
70.00	(1) 1 5/8" Coax	Yes	0.00	1.200	1.98	0.00	0.00	25.769	0.518	0.000	0.00	0.00
70.00	(8) 1 5/8" Coax	Yes	0.00	1.130	3.96	0.00	0.00	25.769	0.518	0.000	0.01	0.00
70.00	(2) 1/2" Coax	Yes	0.00	1.200	0.63	0.00	0.00	25.769	0.518	0.000	0.00	0.00
70.00	(8) 1 5/8" Coax	Yes	0.00	0.754	5.94	0.00	0.00	25.769	0.518	0.000	0.01	0.00
70.00	(12) 1 5/8" Coax	Yes	0.00	1.200	1.98	0.00	0.00	25.769	0.518	0.000	0.00	0.00

Pole : 302489
 Location : Enfd - Enfield, CT
 Height : 150.00 (ft)
 Base Dia : 37.380 (in)
 Top Dia : 15.000 (in)
 Shape : 12 Sides
 Taper : 0.156700 (in/ft)

Code: ANSI/TIA-222 Rev G
 Struct Class : II
 Exposure Category : C
 Topographic Category : 1
 Base Elev : 0.000 (ft)

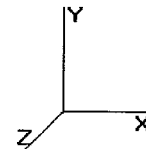

8/2/2013 4:43:25 PM
 Page: 22

© 2007 - 2013 by ATC IP LLC. All rights reserved.

Load Case: 0.9D + 1.6W	95.00 mph with No Ice (Reduced DL)	25 Iterations
Gust Response Factor 1.10		Wind Importance Factor : 1.00
Dead Load Factor : 0.90		
Wind Load Factor : 1.60		

70.00	(1) 1 5/8" Hybriflex	Yes	0.00	0.000	0.00	0.00	0.00	25.769	0.518	0.000	0.00	0.00
70.00	(4) #20 Dywidag bars	Yes	0.00	0.000	0.00	0.00	0.00	25.769	0.518	0.000	0.00	0.02
70.00	(6) 1 5/8" Coax	Yes	0.00	0.000	0.00	0.00	0.00	25.769	0.518	0.000	0.00	0.00
70.00	(4) 1/2" Coax	Yes	0.00	0.000	0.00	0.00	0.00	25.769	0.518	0.000	0.00	0.00
70.00	(2) 2" Conduit	Yes	0.00	0.000	0.00	0.00	0.00	25.769	0.518	0.000	0.00	0.00
70.00	(6) 5/16" Coax	Yes	0.00	0.000	0.00	0.00	0.00	25.769	0.518	0.000	0.00	0.00
73.50	(1) 0.39" Cable	Yes	3.50	0.000	0.00	0.00	0.00	26.035	0.523	0.000	0.00	0.22
73.50	(2) 0.78" 8 AWG 6	Yes	3.50	0.000	0.00	0.00	0.00	26.035	0.523	0.000	0.00	3.72
73.50	(1) 1 5/8" Coax	Yes	3.50	1.200	1.98	0.58	0.69	26.035	0.523	0.000	31.75	2.58
73.50	(8) 1 5/8" Coax	Yes	3.50	1.125	3.96	1.15	1.30	26.035	0.523	0.000	59.52	20.66
73.50	(2) 1/2" Coax	Yes	3.50	1.200	0.63	0.18	0.22	26.035	0.523	0.000	10.10	0.94
73.50	(8) 1 5/8" Coax	Yes	3.50	0.750	5.94	1.73	1.30	26.035	0.523	0.000	59.52	20.66
73.50	(12) 1 5/8" Coax	Yes	3.50	1.200	1.98	0.58	0.69	26.035	0.523	0.000	31.75	30.99
73.50	(1) 1 5/8" Hybriflex	Yes	3.50	0.000	0.00	0.00	0.00	26.035	0.523	0.000	0.00	5.07
73.50	(4) #20 Dywidag bars	Yes	3.50	0.000	0.00	0.00	0.00	26.035	0.523	0.000	0.00	210.42
73.50	(6) 1 5/8" Coax	Yes	3.50	0.000	0.00	0.00	0.00	26.035	0.523	0.000	0.00	15.50
73.50	(4) 1/2" Coax	Yes	3.50	0.000	0.00	0.00	0.00	26.035	0.523	0.000	0.00	1.89
73.50	(2) 2" Conduit	Yes	3.50	0.000	0.00	0.00	0.00	26.035	0.523	0.000	0.00	23.00
73.50	(6) 5/16" Coax	Yes	3.50	0.000	0.00	0.00	0.00	26.035	0.523	0.000	0.00	0.85
75.00	(1) 0.39" Cable	Yes	1.50	0.000	0.00	0.00	0.00	26.146	0.521	0.000	0.00	0.09
75.00	(2) 0.78" 8 AWG 6	Yes	1.50	0.000	0.00	0.00	0.00	26.146	0.521	0.000	0.00	1.59
75.00	(1) 1 5/8" Coax	Yes	1.50	1.200	1.98	0.25	0.30	26.146	0.521	0.000	13.66	1.11
75.00	(8) 1 5/8" Coax	Yes	1.50	1.122	3.96	0.49	0.56	26.146	0.521	0.000	25.56	8.85
75.00	(2) 1/2" Coax	Yes	1.50	1.200	0.63	0.08	0.09	26.146	0.521	0.000	4.35	0.40
75.00	(8) 1 5/8" Coax	Yes	1.50	0.748	5.94	0.74	0.56	26.146	0.521	0.000	25.56	8.85
75.00	(12) 1 5/8" Coax	Yes	1.50	1.200	1.98	0.25	0.30	26.146	0.521	0.000	13.66	13.28
75.00	(1) 1 5/8" Hybriflex	Yes	1.50	0.000	0.00	0.00	0.00	26.146	0.521	0.000	0.00	2.17
75.00	(4) #20 Dywidag bars	Yes	1.50	0.000	0.00	0.00	0.00	26.146	0.521	0.000	0.00	90.16
75.00	(6) 1 5/8" Coax	Yes	1.50	0.000	0.00	0.00	0.00	26.146	0.521	0.000	0.00	6.64
75.00	(4) 1/2" Coax	Yes	1.50	0.000	0.00	0.00	0.00	26.146	0.521	0.000	0.00	0.81
75.00	(2) 2" Conduit	Yes	1.50	0.000	0.00	0.00	0.00	26.146	0.521	0.000	0.00	9.85
75.00	(6) 5/16" Coax	Yes	1.50	0.000	0.00	0.00	0.00	26.146	0.521	0.000	0.00	0.36
80.00	(1) 0.39" Cable	Yes	5.00	0.000	0.00	0.00	0.00	26.504	0.531	0.000	0.00	0.31
80.00	(2) 0.78" 8 AWG 6	Yes	5.00	0.000	0.00	0.00	0.00	26.504	0.531	0.000	0.00	5.31
80.00	(1) 1 5/8" Coax	Yes	5.00	1.200	1.98	0.82	0.99	26.504	0.531	0.000	46.18	3.69
80.00	(8) 1 5/8" Coax	Yes	5.00	1.115	3.96	1.65	1.84	26.504	0.531	0.000	85.79	29.52
80.00	(2) 1/2" Coax	Yes	5.00	1.200	0.63	0.26	0.31	26.504	0.531	0.000	14.69	1.35
80.00	(8) 1 5/8" Coax	Yes	5.00	0.743	5.94	2.47	1.84	26.504	0.531	0.000	85.79	29.52
80.00	(12) 1 5/8" Coax	Yes	5.00	1.200	1.98	0.82	0.99	26.504	0.531	0.000	46.18	44.27
80.00	(1) 1 5/8" Hybriflex	Yes	5.00	0.000	0.00	0.00	0.00	26.504	0.531	0.000	0.00	7.24
80.00	(4) #20 Dywidag bars	Yes	5.00	0.000	0.00	0.00	0.00	26.504	0.531	0.000	0.00	300.60
80.00	(6) 1 5/8" Coax	Yes	5.00	0.000	0.00	0.00	0.00	26.504	0.531	0.000	0.00	22.14
80.00	(4) 1/2" Coax	Yes	5.00	0.000	0.00	0.00	0.00	26.504	0.531	0.000	0.00	2.70
80.00	(2) 2" Conduit	Yes	5.00	0.000	0.00	0.00	0.00	26.504	0.531	0.000	0.00	32.85
80.00	(6) 5/16" Coax	Yes	5.00	0.000	0.00	0.00	0.00	26.504	0.531	0.000	0.00	1.22
85.00	(1) 0.39" Cable	Yes	5.00	0.000	0.00	0.00	0.00	26.844	0.547	0.000	0.00	0.31
85.00	(2) 0.78" 8 AWG 6	Yes	5.00	0.000	0.00	0.00	0.00	26.844	0.547	0.000	0.00	5.31
85.00	(1) 1 5/8" Coax	Yes	5.00	1.200	1.98	0.82	0.99	26.844	0.547	0.000	46.77	3.69
85.00	(8) 1 5/8" Coax	Yes	5.00	1.108	3.96	1.65	1.83	26.844	0.547	0.000	86.34	29.52
85.00	(2) 1/2" Coax	Yes	5.00	1.200	0.63	0.26	0.31	26.844	0.547	0.000	14.88	1.35
85.00	(8) 1 5/8" Coax	Yes	5.00	0.738	5.94	2.47	1.83	26.844	0.547	0.000	86.34	29.52
85.00	(12) 1 5/8" Coax	Yes	5.00	1.200	1.98	0.82	0.99	26.844	0.547	0.000	46.77	44.27
85.00	(1) 1 5/8" Hybriflex	Yes	5.00	0.000	0.00	0.00	0.00	26.844	0.547	0.000	0.00	7.24
85.00	(4) #20 Dywidag bars	Yes	5.00	0.000	0.00	0.00	0.00	26.844	0.547	0.000	0.00	300.60
85.00	(6) 1 5/8" Coax	Yes	5.00	0.000	0.00	0.00	0.00	26.844	0.547	0.000	0.00	22.14
85.00	(4) 1/2" Coax	Yes	5.00	0.000	0.00	0.00	0.00	26.844	0.547	0.000	0.00	2.70
85.00	(2) 2" Conduit	Yes	5.00	0.000	0.00	0.00	0.00	26.844	0.547	0.000	0.00	32.85

Pole : 302489
 Location : Enfd - Enfield, CT
 Height : 150.00 (ft)
 Base Dia : 37.380 (in)
 Top Dia : 15.000 (in)
 Shape : 12 Sides
 Taper : 0.156700 (in/ft)

Code : ANSI/TIA-222 Rev G
 Struct Class : II
 Exposure Category : C
 Topographic Category : 1
 Base Elev : 0.000 (ft)

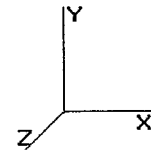

8/2/2013 4:43:26 PM
 Page: 23

© 2007 - 2013 by ATC IP LLC. All rights reserved.

Load Case: 0.9D + 1.6W	95.00 mph with No Ice (Reduced DL)	25 Iterations
Gust Response Factor 1.10		Wind Importance Factor : 1.00
Dead Load Factor : 0.90		
Wind Load Factor : 1.60		

85.00	(6) 5/16" Coax	Yes	5.00	0.000	0.00	0.00	0.00	26.844	0.547	0.000	0.00	1.22
90.00	(1) 0.39" Cable	Yes	5.00	0.000	0.00	0.00	0.00	27.169	0.565	0.000	0.00	0.31
90.00	(2) 0.78" 8 AWG 6	Yes	5.00	0.000	0.00	0.00	0.00	27.169	0.565	0.000	0.00	5.31
90.00	(1) 1 5/8" Coax	Yes	5.00	1.200	1.98	0.82	0.99	27.169	0.565	0.000	47.34	3.69
90.00	(8) 1 5/8" Coax	Yes	5.00	1.101	3.96	1.65	1.82	27.169	0.565	0.000	86.86	29.52
90.00	(2) 1/2" Coax	Yes	5.00	1.200	0.63	0.26	0.31	27.169	0.565	0.000	15.06	1.35
90.00	(8) 1 5/8" Coax	Yes	5.00	0.734	5.94	2.47	1.82	27.169	0.565	0.000	86.86	29.52
90.00	(12) 1 5/8" Coax	Yes	5.00	1.200	1.98	0.82	0.99	27.169	0.565	0.000	47.34	44.27
90.00	(1) 1 5/8" Hybriflex	Yes	5.00	0.000	0.00	0.00	0.00	27.169	0.565	0.000	0.00	7.24
90.00	(4) #20 Dywidag bars	Yes	5.00	0.000	0.00	0.00	0.00	27.169	0.565	0.000	0.00	300.60
90.00	(6) 1 5/8" Coax	Yes	5.00	0.000	0.00	0.00	0.00	27.169	0.565	0.000	0.00	22.14
90.00	(4) 1/2" Coax	Yes	5.00	0.000	0.00	0.00	0.00	27.169	0.565	0.000	0.00	2.70
90.00	(2) 2" Conduit	Yes	5.00	0.000	0.00	0.00	0.00	27.169	0.565	0.000	0.00	32.85
90.00	(6) 5/16" Coax	Yes	5.00	0.000	0.00	0.00	0.00	27.169	0.565	0.000	0.00	1.22
95.00	(1) 0.39" Cable	Yes	5.00	0.000	0.00	0.00	0.00	27.480	0.583	0.000	0.00	0.31
95.00	(2) 0.78" 8 AWG 6	Yes	5.00	0.000	0.00	0.00	0.00	27.480	0.583	0.000	0.00	5.31
95.00	(1) 1 5/8" Coax	Yes	5.00	1.200	1.98	0.82	0.99	27.480	0.583	0.000	47.88	3.69
95.00	(8) 1 5/8" Coax	Yes	5.00	1.095	3.96	1.65	1.81	27.480	0.583	0.000	87.36	29.52
95.00	(2) 1/2" Coax	Yes	5.00	1.200	0.63	0.26	0.31	27.480	0.583	0.000	15.24	1.35
95.00	(8) 1 5/8" Coax	Yes	5.00	0.730	5.94	2.47	1.81	27.480	0.583	0.000	87.36	29.52
95.00	(12) 1 5/8" Coax	Yes	5.00	1.200	1.98	0.82	0.99	27.480	0.583	0.000	47.88	44.27
95.00	(1) 1 5/8" Hybriflex	Yes	5.00	0.000	0.00	0.00	0.00	27.480	0.583	0.000	0.00	7.24
95.00	(4) #20 Dywidag bars	Yes	5.00	0.000	0.00	0.00	0.00	27.480	0.583	0.000	0.00	300.60
95.00	(6) 1 5/8" Coax	Yes	5.00	0.000	0.00	0.00	0.00	27.480	0.583	0.000	0.00	22.14
95.00	(4) 1/2" Coax	Yes	5.00	0.000	0.00	0.00	0.00	27.480	0.583	0.000	0.00	2.70
95.00	(2) 2" Conduit	Yes	5.00	0.000	0.00	0.00	0.00	27.480	0.583	0.000	0.00	32.85
95.00	(6) 5/16" Coax	Yes	5.00	0.000	0.00	0.00	0.00	27.480	0.583	0.000	0.00	1.22
100.0	(1) 0.39" Cable	Yes	5.00	0.000	0.00	0.00	0.00	27.779	0.603	0.000	0.00	0.31
100.0	(2) 0.78" 8 AWG 6	Yes	5.00	0.000	0.00	0.00	0.00	27.779	0.603	0.000	0.00	5.31
100.0	(1) 1 5/8" Coax	Yes	5.00	1.200	1.98	0.82	0.99	27.779	0.603	0.000	48.40	3.69
100.0	(8) 1 5/8" Coax	Yes	5.00	1.089	3.96	1.65	1.80	27.779	0.603	0.000	87.83	29.52
100.0	(2) 1/2" Coax	Yes	5.00	1.200	0.63	0.26	0.31	27.779	0.603	0.000	15.40	1.35
100.0	(8) 1 5/8" Coax	Yes	5.00	0.726	5.94	2.47	1.80	27.779	0.603	0.000	87.83	29.52
100.0	(12) 1 5/8" Coax	Yes	5.00	1.200	1.98	0.82	0.99	27.779	0.603	0.000	48.40	44.27
100.0	(1) 1 5/8" Hybriflex	Yes	5.00	0.000	0.00	0.00	0.00	27.779	0.603	0.000	0.00	7.24
100.0	(4) #20 Dywidag bars	Yes	5.00	0.000	0.00	0.00	0.00	27.779	0.603	0.000	0.00	300.60
100.0	(6) 1 5/8" Coax	Yes	5.00	0.000	0.00	0.00	0.00	27.779	0.603	0.000	0.00	22.14
100.0	(4) 1/2" Coax	Yes	5.00	0.000	0.00	0.00	0.00	27.779	0.603	0.000	0.00	2.70
100.0	(2) 2" Conduit	Yes	5.00	0.000	0.00	0.00	0.00	27.779	0.603	0.000	0.00	32.85
100.0	(6) 5/16" Coax	Yes	5.00	0.000	0.00	0.00	0.00	27.779	0.603	0.000	0.00	1.22
103.0	(1) 0.39" Cable	Yes	3.00	0.000	0.00	0.00	0.00	27.952	0.619	0.000	0.00	0.19
103.0	(2) 0.78" 8 AWG 6	Yes	3.00	0.000	0.00	0.00	0.00	27.952	0.619	0.000	0.00	3.19
103.0	(1) 1 5/8" Coax	Yes	3.00	1.200	1.98	0.50	0.59	27.952	0.619	0.000	29.22	2.21
103.0	(8) 1 5/8" Coax	Yes	3.00	1.085	3.96	0.99	1.07	27.952	0.619	0.000	52.86	17.71
103.0	(2) 1/2" Coax	Yes	3.00	1.200	0.63	0.16	0.19	27.952	0.619	0.000	9.30	0.81
103.0	(8) 1 5/8" Coax	Yes	3.00	0.724	5.94	1.49	1.07	27.952	0.619	0.000	52.86	17.71
103.0	(12) 1 5/8" Coax	Yes	3.00	1.200	1.98	0.50	0.59	27.952	0.619	0.000	29.22	26.56
103.0	(1) 1 5/8" Hybriflex	Yes	3.00	0.000	0.00	0.00	0.00	27.952	0.619	0.000	0.00	4.35
103.0	(4) #20 Dywidag bars	Yes	3.00	0.000	0.00	0.00	0.00	27.952	0.619	0.000	0.00	180.36
103.0	(6) 1 5/8" Coax	Yes	3.00	0.000	0.00	0.00	0.00	27.952	0.619	0.000	0.00	13.28
103.0	(4) 1/2" Coax	Yes	3.00	0.000	0.00	0.00	0.00	27.952	0.619	0.000	0.00	1.62
103.0	(2) 2" Conduit	Yes	3.00	0.000	0.00	0.00	0.00	27.952	0.619	0.000	0.00	19.71
103.0	(6) 5/16" Coax	Yes	3.00	0.000	0.00	0.00	0.00	27.952	0.619	0.000	0.00	0.73
105.0	(1) 0.39" Cable	Yes	2.00	0.000	0.00	0.00	0.00	28.066	0.630	0.000	0.00	0.13
105.0	(2) 0.78" 8 AWG 6	Yes	2.00	0.000	0.00	0.00	0.00	28.066	0.630	0.000	0.00	2.12
105.0	(1) 1 5/8" Coax	Yes	2.00	1.200	1.98	0.33	0.40	28.066	0.630	0.000	19.56	1.48
105.0	(8) 1 5/8" Coax	Yes	2.00	1.083	3.96	0.66	0.71	28.066	0.630	0.000	35.31	11.81

Pole : 302489
 Location : Enfd - Enfield, CT
 Height : 150.00 (ft)
 Base Dia : 37.380 (in)
 Top Dia : 15.000 (in)
 Shape : 12 Sides
 Taper : 0.156700 (in/ft)

Code : ANSI/TIA-222 Rev G
 Struct Class : II
 Exposure Category : C
 Topographic Category : 1
 Base Elev : 0.000 (ft)

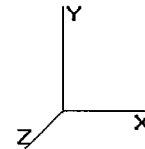

8/2/2013 4:43:26 PM
 Page: 24

© 2007 - 2013 by ATC IP LLC. All rights reserved.

Load Case: 0.9D + 1.6W 95.00 mph with No Ice (Reduced DL) 25 Iterations
 Gust Response Factor 1.10 Wind Importance Factor : 1.00
 Dead Load Factor : 0.90
 Wind Load Factor : 1.60

105.0	(2) 1/2" Coax	Yes	2.00	1.200	0.63	0.10	0.13	28.066	0.630	0.000	6.22	0.54
105.0	(8) 1 5/8" Coax	Yes	2.00	0.722	5.94	0.99	0.71	28.066	0.630	0.000	35.31	11.81
105.0	(12) 1 5/8" Coax	Yes	2.00	1.200	1.98	0.33	0.40	28.066	0.630	0.000	19.56	17.71
105.0	(1) 1 5/8" Hybriflex	Yes	2.00	0.000	0.00	0.00	0.00	28.066	0.630	0.000	0.00	2.90
105.0	(4) #20 Dywidag bars	Yes	2.00	0.000	0.00	0.00	0.00	28.066	0.630	0.000	0.00	120.24
105.0	(6) 1 5/8" Coax	Yes	2.00	0.000	0.00	0.00	0.00	28.066	0.630	0.000	0.00	8.85
110.0	(1) 0.39" Cable	Yes	5.00	0.000	0.00	0.00	0.00	28.342	0.646	0.000	0.00	0.31
110.0	(2) 0.78" 8 AWG 6	Yes	5.00	0.000	0.00	0.00	0.00	28.342	0.646	0.000	0.00	5.31
110.0	(1) 1 5/8" Coax	Yes	5.00	1.200	1.98	0.82	0.99	28.342	0.646	0.000	49.38	3.69
110.0	(8) 1 5/8" Coax	Yes	5.00	1.078	3.96	1.65	1.78	28.342	0.646	0.000	88.72	29.52
110.0	(2) 1/2" Coax	Yes	5.00	1.200	0.63	0.26	0.31	28.342	0.646	0.000	15.71	1.35
110.0	(8) 1 5/8" Coax	Yes	5.00	0.719	5.94	2.47	1.78	28.342	0.646	0.000	88.72	29.52
110.0	(12) 1 5/8" Coax	Yes	5.00	1.200	1.98	0.82	0.99	28.342	0.646	0.000	49.38	44.27
110.0	(1) 1 5/8" Hybriflex	Yes	5.00	0.000	0.00	0.00	0.00	28.342	0.646	0.000	0.00	7.24
110.0	(4) #20 Dywidag bars	Yes	5.00	0.000	0.00	0.00	0.00	28.342	0.646	0.000	0.00	300.60
110.0	(6) 1 5/8" Coax	Yes	5.00	0.000	0.00	0.00	0.00	28.342	0.646	0.000	0.00	22.14
110.0	(1) 0.39" Cable	Yes	0.00	0.000	0.00	0.00	0.00	28.342	0.658	0.000	0.00	0.00
110.0	(2) 0.78" 8 AWG 6	Yes	0.00	0.000	0.00	0.00	0.00	28.342	0.658	0.000	0.00	0.00
110.0	(1) 1 5/8" Coax	Yes	0.00	1.200	1.98	0.00	0.00	28.342	0.658	0.000	0.00	0.00
110.0	(8) 1 5/8" Coax	Yes	0.00	1.078	3.96	0.00	0.00	28.342	0.658	0.000	0.01	0.00
110.0	(2) 1/2" Coax	Yes	0.00	1.200	0.63	0.00	0.00	28.342	0.658	0.000	0.00	0.00
110.0	(8) 1 5/8" Coax	Yes	0.00	0.719	5.94	0.00	0.00	28.342	0.658	0.000	0.01	0.00
110.0	(12) 1 5/8" Coax	Yes	0.00	1.200	1.98	0.00	0.00	28.342	0.658	0.000	0.00	0.00
110.0	(1) 1 5/8" Hybriflex	Yes	0.00	0.000	0.00	0.00	0.00	28.342	0.658	0.000	0.00	0.00
110.0	(4) #20 Dywidag bars	Yes	0.00	0.000	0.00	0.00	0.00	28.342	0.658	0.000	0.00	0.02
110.0	(6) 1 5/8" Coax	Yes	0.00	0.000	0.00	0.00	0.00	28.342	0.658	0.000	0.00	0.00
115.0	(1) 0.39" Cable	Yes	5.00	0.000	0.00	0.00	0.00	28.608	0.670	0.000	0.00	0.31
115.0	(2) 0.78" 8 AWG 6	Yes	5.00	0.000	0.00	0.00	0.00	28.608	0.670	0.000	0.00	5.31
115.0	(1) 1 5/8" Coax	Yes	5.00	1.200	1.98	0.82	0.99	28.608	0.670	0.000	49.84	3.69
115.0	(8) 1 5/8" Coax	Yes	5.00	1.073	3.96	1.65	1.77	28.608	0.670	0.000	89.13	29.51
115.0	(2) 1/2" Coax	Yes	5.00	1.200	0.63	0.26	0.31	28.608	0.670	0.000	15.86	1.35
115.0	(8) 1 5/8" Coax	Yes	5.00	0.715	5.94	2.47	1.77	28.608	0.670	0.000	89.13	29.51
115.0	(12) 1 5/8" Coax	Yes	5.00	1.200	1.98	0.82	0.99	28.608	0.670	0.000	49.84	44.27
115.0	(1) 1 5/8" Hybriflex	Yes	5.00	0.000	0.00	0.00	0.00	28.608	0.670	0.000	0.00	7.24
115.0	(4) #20 Dywidag bars	Yes	5.00	0.000	0.00	0.00	0.00	28.608	0.670	0.000	0.00	300.58
115.0	(6) 1 5/8" Coax	Yes	5.00	0.000	0.00	0.00	0.00	28.608	0.670	0.000	0.00	22.14
120.0	(1) 0.39" Cable	Yes	5.00	0.000	0.00	0.00	0.00	28.866	0.697	0.000	0.00	0.31
120.0	(2) 0.78" 8 AWG 6	Yes	5.00	0.000	0.00	0.00	0.00	28.866	0.697	0.000	0.00	5.31
120.0	(1) 1 5/8" Coax	Yes	5.00	1.200	1.98	0.82	0.99	28.866	0.697	0.000	50.30	3.69
120.0	(8) 1 5/8" Coax	Yes	5.00	1.068	3.96	1.65	1.76	28.866	0.697	0.000	89.53	29.52
120.0	(2) 1/2" Coax	Yes	5.00	1.200	0.63	0.26	0.31	28.866	0.697	0.000	16.00	1.35
120.0	(8) 1 5/8" Coax	Yes	5.00	0.712	5.94	2.47	1.76	28.866	0.697	0.000	89.53	29.52
120.0	(12) 1 5/8" Coax	Yes	5.00	1.200	1.98	0.82	0.99	28.866	0.697	0.000	50.30	44.27
120.0	(1) 1 5/8" Hybriflex	Yes	5.00	0.000	0.00	0.00	0.00	28.866	0.697	0.000	0.00	7.24
120.0	(4) #20 Dywidag bars	Yes	5.00	0.000	0.00	0.00	0.00	28.866	0.697	0.000	0.00	300.60
121.0	(1) 0.39" Cable	Yes	1.00	0.000	0.00	0.00	0.00	28.916	0.713	0.000	0.00	0.06
121.0	(2) 0.78" 8 AWG 6	Yes	1.00	0.000	0.00	0.00	0.00	28.916	0.713	0.000	0.00	1.06
121.0	(1) 1 5/8" Coax	Yes	1.00	1.200	1.98	0.17	0.20	28.916	0.713	0.000	10.08	0.74
121.0	(8) 1 5/8" Coax	Yes	1.00	1.067	3.96	0.33	0.35	28.916	0.713	0.000	17.92	5.90
121.0	(2) 1/2" Coax	Yes	1.00	1.200	0.63	0.05	0.06	28.916	0.713	0.000	3.21	0.27
121.0	(8) 1 5/8" Coax	Yes	1.00	0.711	5.94	0.50	0.35	28.916	0.713	0.000	17.92	5.90
121.0	(12) 1 5/8" Coax	Yes	1.00	1.200	1.98	0.17	0.20	28.916	0.713	0.000	10.08	8.85
121.0	(1) 1 5/8" Hybriflex	Yes	1.00	0.000	0.00	0.00	0.00	28.916	0.713	0.000	0.00	1.45
121.0	(4) #20 Dywidag bars	Yes	1.00	0.000	0.00	0.00	0.00	28.916	0.713	0.000	0.00	60.12
125.0	(1) 0.39" Cable	Yes	4.00	0.000	0.00	0.00	0.00	29.115	0.728	0.000	0.00	0.25
125.0	(2) 0.78" 8 AWG 6	Yes	4.00	0.000	0.00	0.00	0.00	29.115	0.728	0.000	0.00	4.25
125.0	(1) 1 5/8" Coax	Yes	4.00	1.200	1.98	0.66	0.79	29.115	0.728	0.000	40.58	2.95

Pole : 302489
 Location : Enfd - Enfield, CT
 Height : 150.00 (ft)
 Base Dia : 37.380 (in)
 Top Dia : 15.000 (in)
 Shape : 12 Sides
 Taper : 0.156700 (in/ft)

Code: ANSI/TIA-222 Rev G
 Struct Class : II
 Exposure Category : C
 Topographic Category : 1
 Base Elev : 0.000 (ft)

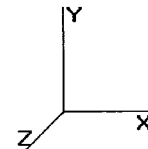

8/2/2013 4:43:26 PM
 Page: 25

© 2007 - 2013 by ATC IP LLC. All rights reserved.

Load Case: 0.9D + 1.6W 95.00 mph with No Ice (Reduced DL) 25 Iterations
 Gust Response Factor 1.10 Wind Importance Factor : 1.00
 Dead Load Factor : 0.90
 Wind Load Factor : 1.60

125.0	(8) 1 5/8" Coax	Yes	4.00	1.064	3.96	1.32	1.40	29.115	0.728	0.000	71.94	23.61
125.0	(2) 1/2" Coax	Yes	4.00	1.200	0.63	0.21	0.25	29.115	0.728	0.000	12.91	1.08
125.0	(8) 1 5/8" Coax	Yes	4.00	0.709	5.94	1.98	1.40	29.115	0.728	0.000	71.94	23.61
125.0	(12) 1 5/8" Coax	Yes	4.00	1.200	1.98	0.66	0.79	29.115	0.728	0.000	40.58	35.42
125.0	(1) 1 5/8" Hybriflex	Yes	4.00	0.000	0.00	0.00	0.00	29.115	0.728	0.000	0.00	5.80
125.0	(4) #20 Dywidag bars	Yes	4.00	0.000	0.00	0.00	0.00	29.115	0.728	0.000	0.00	240.48
126.0	(1) 0.39" Cable	Yes	1.00	0.000	0.00	0.00	0.00	29.164	0.743	0.000	0.00	0.06
126.0	(2) 0.78" 8 AWG 6	Yes	1.00	0.000	0.00	0.00	0.00	29.164	0.743	0.000	0.00	1.06
126.0	(1) 1 5/8" Coax	Yes	1.00	1.200	1.98	0.17	0.20	29.164	0.743	0.000	10.16	0.74
126.0	(8) 1 5/8" Coax	Yes	1.00	1.063	3.96	0.33	0.35	29.164	0.743	0.000	18.00	5.90
126.0	(2) 1/2" Coax	Yes	1.00	1.200	0.63	0.05	0.06	29.164	0.743	0.000	3.23	0.27
126.0	(8) 1 5/8" Coax	Yes	1.00	0.708	5.94	0.50	0.35	29.164	0.743	0.000	18.00	5.90
126.0	(12) 1 5/8" Coax	Yes	1.00	1.200	1.98	0.17	0.20	29.164	0.743	0.000	10.16	8.85
126.0	(1) 1 5/8" Hybriflex	Yes	1.00	0.000	0.00	0.00	0.00	29.164	0.743	0.000	0.00	1.45
126.0	(4) #20 Dywidag bars	Yes	0.51	0.000	0.00	0.00	0.00	29.164	0.743	0.000	0.00	30.66
130.0	(1) 0.39" Cable	Yes	4.00	0.000	0.00	0.00	0.00	29.356	0.655	0.000	0.00	0.25
130.0	(2) 0.78" 8 AWG 6	Yes	4.00	0.000	0.00	0.00	0.00	29.356	0.655	0.000	0.00	4.25
130.0	(1) 1 5/8" Coax	Yes	4.00	1.200	1.98	0.66	0.79	29.356	0.655	0.000	40.92	2.95
130.0	(8) 1 5/8" Coax	Yes	4.00	1.059	3.96	1.32	1.40	29.356	0.655	0.000	72.23	23.61
130.0	(2) 1/2" Coax	Yes	4.00	1.200	0.63	0.21	0.25	29.356	0.655	0.000	13.02	1.08
130.0	(8) 1 5/8" Coax	Yes	4.00	0.706	5.94	1.98	1.40	29.356	0.655	0.000	72.23	23.61
135.0	(1) 0.39" Cable	Yes	5.00	0.000	0.00	0.00	0.00	29.591	0.681	0.000	0.00	0.31
135.0	(2) 0.78" 8 AWG 6	Yes	5.00	0.000	0.00	0.00	0.00	29.591	0.681	0.000	0.00	5.31
135.0	(1) 1 5/8" Coax	Yes	5.00	1.200	1.98	0.82	0.99	29.591	0.681	0.000	51.56	3.69
135.0	(8) 1 5/8" Coax	Yes	5.00	1.055	3.96	1.65	1.74	29.591	0.681	0.000	90.65	29.52
135.0	(2) 1/2" Coax	Yes	5.00	1.200	0.63	0.26	0.31	29.591	0.681	0.000	16.40	1.35
135.0	(8) 1 5/8" Coax	Yes	5.00	0.703	5.94	2.47	1.74	29.591	0.681	0.000	90.65	29.52
140.0	(1) 0.39" Cable	Yes	5.00	0.000	0.00	0.00	0.00	29.818	0.713	0.000	0.00	0.31
140.0	(2) 0.78" 8 AWG 6	Yes	5.00	0.000	0.00	0.00	0.00	29.818	0.713	0.000	0.00	5.31
140.0	(1) 1 5/8" Coax	Yes	5.00	1.200	1.98	0.82	0.99	29.818	0.713	0.000	51.95	3.69
140.0	(8) 1 5/8" Coax	Yes	5.00	1.051	3.96	1.65	1.73	29.818	0.713	0.000	91.00	29.52
140.0	(2) 1/2" Coax	Yes	5.00	1.200	0.63	0.26	0.31	29.818	0.713	0.000	16.53	1.35
140.0	(8) 1 5/8" Coax	Yes	5.00	0.701	5.94	2.47	1.73	29.818	0.713	0.000	91.00	29.52
144.0	(1) 0.39" Cable	Yes	4.00	0.000	0.00	0.00	0.00	29.995	0.390	0.000	0.00	0.25
144.0	(2) 0.78" 8 AWG 6	Yes	4.00	0.000	0.00	0.00	0.00	29.995	0.390	0.000	0.00	4.25
144.0	(1) 1 5/8" Coax	Yes	4.00	1.200	1.98	0.66	0.79	29.995	0.390	0.000	41.81	2.95
144.0	(8) 1 5/8" Coax	Yes	4.00	1.048	3.96	1.32	1.38	29.995	0.390	0.000	73.02	23.61
144.0	(2) 1/2" Coax	Yes	4.00	1.200	0.63	0.21	0.25	29.995	0.390	0.000	13.30	1.08
145.0	(1) 0.39" Cable	Yes	1.00	0.000	0.00	0.00	0.00	30.039	0.362	0.000	0.00	0.06
145.0	(2) 0.78" 8 AWG 6	Yes	1.00	0.000	0.00	0.00	0.00	30.039	0.362	0.000	0.00	1.06
145.0	(1) 1 5/8" Coax	Yes	1.00	1.200	1.98	0.17	0.20	30.039	0.362	0.000	10.47	0.74
145.0	(8) 1 5/8" Coax	Yes	1.00	1.047	3.96	0.33	0.35	30.039	0.362	0.000	18.27	5.90
150.0	(1) 0.39" Cable	Yes	5.00	0.000	0.00	0.00	0.00	30.254	0.373	0.000	0.00	0.31
150.0	(2) 0.78" 8 AWG 6	Yes	5.00	0.000	0.00	0.00	0.00	30.254	0.373	0.000	0.00	5.31
150.0	(1) 1 5/8" Coax	Yes	5.00	1.200	1.98	0.82	0.99	30.254	0.373	0.000	52.71	3.69
150.0	(8) 1 5/8" Coax	Yes	5.00	1.043	3.96	1.65	1.72	30.254	0.373	0.000	91.66	29.52
Totals:											8,247.99	11,786.67

Pole : 302489
 Location : Enfd - Enfield, CT
 Height : 150.00 (ft)
 Base Dia : 37.380 (in)
 Top Dia : 15.000 (in)
 Shape : 12 Sides
 Taper : 0.156700 (in/ft)

Code: ANSI/TIA-222 Rev G
 Struct Class : II
 Exposure Category : C
 Topographic Category : 1
 Base Elev : 0.000 (ft)

8/2/2013 4:43:26 PM
 Page: 26

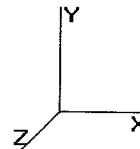

© 2007 - 2013 by ATC IP LLC. All rights reserved.

Load Case: 0.9D + 1.6W 95.00 mph with No Ice (Reduced DL) 25 Iterations
 Gust Response Factor 1.10 Wind Importance Factor : 1.00
 Dead Load Factor : 0.90
 Wind Load Factor : 1.60

Applied Segment Forces Summary

Seg Elev (ft)	Lateral FX (-) (lb)	Axial FY (-) (lb)	Torsion MY (lb-ft)	Moment MZ (lb-ft)
0.00	0.00	0.00	0.00	0.00
5.00	523.90	1,645.57	0.00	0.00
10.00	512.81	1,631.08	0.00	0.00
15.00	1,033.30	1,872.08	0.00	0.00
20.00	1,080.02	1,857.60	0.00	0.00
25.00	1,115.35	1,843.11	0.00	0.00
30.00	1,142.11	1,828.62	0.00	0.00
31.50	343.10	545.88	0.00	0.00
35.00	648.48	1,618.56	0.00	0.00
35.67	121.18	307.01	0.00	0.00
40.00	798.48	1,484.93	0.00	0.00
45.00	926.87	1,702.24	0.00	0.00
50.00	928.70	1,690.17	0.00	0.00
55.00	928.38	1,678.10	0.00	0.00
56.00	976.35	447.57	0.00	1,584.27
60.00	739.54	1,331.31	0.00	0.00
65.00	922.41	1,319.28	0.00	0.00
70.00	917.20	1,307.21	0.00	0.00
70.00	0.06	0.09	0.00	0.00
73.50	645.30	1,140.93	0.00	0.00
75.00	274.77	365.18	0.00	0.00
80.00	915.16	1,211.27	0.00	0.00
85.00	906.64	1,201.61	0.00	0.00
90.00	897.18	1,191.95	0.00	0.00
95.00	886.83	1,182.29	0.00	0.00
100.0	875.68	1,172.63	0.00	0.00
103.0	1,988.80	1,460.35	0.00	4,680.75
105.0	343.11	449.33	0.00	0.00
110.0	851.18	1,116.55	0.00	0.00
110.0	0.06	0.07	0.00	0.00
115.0	1,265.01	1,115.12	0.00	1,281.42
120.0	824.06	1,014.53	0.00	0.00
121.0	162.59	202.04	0.00	0.00
125.0	646.03	538.05	0.00	0.00
126.0	3,294.46	1,770.95	0.00	2,020.98
130.0	593.11	250.56	0.00	0.00
135.0	727.56	306.68	0.00	0.00
140.0	2,985.92	1,852.21	0.00	0.00
144.0	1,104.29	467.15	0.00	0.00
145.0	115.55	47.26	0.00	0.00
150.0	5,318.85	2,814.05	0.00	7,276.63
Totals:	39,280.40	44,981.19	0.00	16,844.05

Pole : 302489
 Location : Enfd - Enfield, CT
 Height : 150.00 (ft)
 Base Dia : 37.380 (in)
 Top Dia : 15.000 (in)
 Shape : 12 Sides
 Taper : 0.156700 (in/ft)

Code: ANSI/TIA-222 Rev G
 Struct Class : II
 Exposure Category : C
 Topographic Category : 1
 Base Elev : 0.000 (ft)

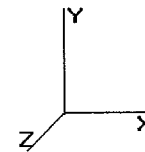

8/2/2013 4:43:26 PM
 Page: 27

© 2007 - 2013 by ATC IP LLC. All rights reserved.

Load Case: 0.9D + 1.6W 95.00 mph with No Ice (Reduced DL) 25 Iterations
Gust Response Factor 1.10 **Wind Importance Factor** : 1.00
Dead Load Factor : 0.90
Wind Load Factor : 1.60

Calculated Forces

Seg Elev (ft)	Pu FY (-) (kips)	Vu FX (-) (kips)	Tu MY (ft-kips)	Mu MZ (ft-kips)	Mu MX (ft-kips)	Resultant Moment (ft-kips)	phi Pn (kips)	phi Vn (kips)	phi Tn (ft-kips)	phi Mn (ft-kips)	Total Deflect (in)	Rotation (deg)	Ratio
0.00	-44.89	-39.38	0.00	-3,824.20	0.00	3,824.20	3,133.66	1,566.83	4,776.46	2,358.91	0.00	0.00	0.623
5.00	-43.07	-39.05	0.00	-3,627.28	0.00	3,627.28	3,091.35	1,545.67	4,611.19	2,277.30	0.14	-0.26	0.600
10.00	-41.27	-38.71	0.00	-3,432.03	0.00	3,432.03	3,047.99	1,524.00	4,447.17	2,196.29	0.55	-0.51	0.576
15.00	-39.25	-37.83	0.00	-3,238.50	0.00	3,238.50	3,003.60	1,501.80	4,284.50	2,115.95	1.22	-0.76	0.552
20.00	-37.25	-36.88	0.00	-3,049.37	0.00	3,049.37	2,958.17	1,479.08	4,123.27	2,036.33	2.15	-1.01	0.527
25.00	-35.28	-35.87	0.00	-2,864.99	0.00	2,864.99	2,911.70	1,455.85	3,963.58	1,957.46	3.35	-1.26	0.503
30.00	-33.38	-34.78	0.00	-2,685.62	0.00	2,685.62	2,864.18	1,432.09	3,805.55	1,879.42	4.79	-1.50	0.479
31.50	-32.78	-34.49	0.00	-2,633.44	0.00	2,633.44	2,849.72	1,424.86	3,758.46	1,856.16	5.27	-1.57	0.472
35.00	-31.12	-33.85	0.00	-2,512.74	0.00	2,512.74	2,805.48	1,402.74	3,636.10	1,795.73	6.49	-1.73	0.448
35.67	-30.75	-33.78	0.00	-2,490.16	0.00	2,490.16	2,231.07	1,115.54	2,951.42	1,457.59	6.73	-1.76	0.503
40.00	-29.17	-33.04	0.00	-2,343.80	0.00	2,343.80	2,201.95	1,100.98	2,850.70	1,407.85	8.42	-1.96	0.478
45.00	-27.37	-32.16	0.00	-2,178.60	0.00	2,178.60	2,167.39	1,083.69	2,735.30	1,350.86	10.60	-2.19	0.450
50.00	-25.60	-31.26	0.00	-2,017.79	0.00	2,017.79	2,131.78	1,065.89	2,620.87	1,294.35	13.01	-2.41	0.422
55.00	-23.90	-30.32	0.00	-1,861.48	0.00	1,861.48	2,095.13	1,047.56	2,507.52	1,238.37	15.66	-2.63	0.394
56.00	-23.44	-29.36	0.00	-1,829.58	0.00	1,829.58	2,087.67	1,043.84	2,484.99	1,227.24	16.21	-2.67	0.388
60.00	-22.06	-28.63	0.00	-1,712.13	0.00	1,712.13	2,057.44	1,028.72	2,395.35	1,182.97	18.52	-2.83	0.367
60.00	-22.06	-28.63	0.00	-1,712.13	0.00	1,712.13	2,057.44	1,028.72	2,395.35	1,182.97	18.52	-2.83	0.701
65.00	-20.65	-27.75	0.00	-1,568.98	0.00	1,568.98	2,018.71	1,009.36	2,284.46	1,128.21	21.60	-3.04	0.660
70.00	-19.31	-26.82	0.00	-1,430.25	0.00	1,430.25	1,978.94	989.47	2,174.96	1,074.13	24.98	-3.41	0.619
70.00	-19.25	-26.86	0.00	-1,430.24	0.00	1,430.24	1,978.94	989.47	2,174.95	1,074.12	24.98	-3.41	0.619
73.50	-18.06	-26.21	0.00	-1,336.22	0.00	1,336.22	1,462.64	731.32	1,612.09	796.15	27.57	-3.67	0.690
75.00	-17.61	-25.98	0.00	-1,296.92	0.00	1,296.92	1,455.06	727.53	1,589.51	785.00	28.74	-3.78	0.674
80.00	-16.31	-25.09	0.00	-1,167.01	0.00	1,167.01	1,429.11	714.55	1,514.58	747.99	32.90	-4.15	0.621
85.00	-15.03	-24.19	0.00	-1,041.56	0.00	1,041.56	1,402.12	701.06	1,440.27	711.29	37.43	-4.50	0.567
90.00	-13.78	-23.27	0.00	-920.64	0.00	920.64	1,374.09	687.04	1,366.68	674.95	42.32	-4.84	0.514
95.00	-12.56	-22.35	0.00	-804.27	0.00	804.27	1,345.02	672.51	1,293.93	639.02	47.55	-5.15	0.461
100.00	-11.39	-21.42	0.00	-692.51	0.00	692.51	1,314.91	657.46	1,222.10	603.55	53.10	-5.44	0.407
103.00	-10.09	-19.32	0.00	-623.57	0.00	623.57	1,296.35	648.17	1,179.50	582.51	56.57	-5.61	0.372
105.00	-9.61	-18.97	0.00	-584.93	0.00	584.93	1,283.76	641.88	1,151.31	568.59	58.94	-5.72	0.353
110.00	-8.55	-18.02	0.00	-490.10	0.00	490.10	1,247.14	623.57	1,077.81	532.29	65.05	-5.96	0.305
110.00	-8.52	-18.04	0.00	-490.09	0.00	490.09	1,247.13	623.57	1,077.80	532.29	65.05	-5.96	0.305
110.00	-8.52	-18.04	0.00	-490.09	0.00	490.09	846.54	423.27	735.96	363.46	65.05	-5.96	0.368
115.00	-7.48	-16.69	0.00	-398.62	0.00	398.62	828.55	414.27	693.31	342.40	71.41	-6.18	0.305
120.00	-6.53	-15.78	0.00	-315.16	0.00	315.16	809.51	404.76	651.00	321.50	77.98	-6.38	0.247
121.00	-6.32	-15.60	0.00	-299.38	0.00	299.38	805.58	402.79	642.58	317.35	79.32	-6.42	0.235
121.00	-6.32	-15.60	0.00	-299.38	0.00	299.38	805.58	402.79	642.58	317.35	79.32	-6.42	0.953
125.00	-5.83	-14.91	0.00	-236.98	0.00	236.98	789.44	394.72	609.12	300.82	84.75	-6.55	0.797
126.00	-4.39	-11.46	0.00	-220.05	0.00	220.05	785.30	392.65	600.81	296.72	86.13	-6.68	0.748
130.00	-4.12	-10.87	0.00	-174.22	0.00	174.22	768.32	384.16	567.78	280.41	91.91	-7.14	0.627
135.00	-3.84	-10.14	0.00	-119.85	0.00	119.85	746.17	373.08	527.09	260.31	99.63	-7.61	0.466
140.00	-2.38	-6.94	0.00	-69.16	0.00	69.16	722.98	361.49	487.14	240.58	107.77	-7.95	0.291
144.00	-2.06	-5.79	0.00	-41.40	0.00	41.40	701.03	350.52	454.07	224.25	114.49	-8.14	0.188
145.00	-2.02	-5.67	0.00	-35.61	0.00	35.61	694.06	347.03	445.03	219.78	116.20	-8.17	0.165
150.00	0.00	-5.32	0.00	-7.28	0.00	7.28	659.19	329.60	401.19	198.13	124.80	-8.28	0.037

Pole : 302489
 Location : Enfd - Enfield, CT
 Height : 150.00 (ft)
 Base Dia : 37.380 (in)
 Top Dia : 15.000 (in)
 Shape : 12 Sides
 Taper : 0.156700 (in/ft)

Code: ANSI/TIA-222 Rev G
 Struct Class : II
 Exposure Category: C
 Topographic Category: 1
 Base Elev : 0.000 (ft)

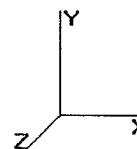

8/2/2013 4:43:27 PM
 Page: 28

© 2007 - 2013 by ATC IP LLC. All rights reserved.

Load Case: 1.2D + 1.0Di + 1.0Wi 50.00 mph with 1.00 in Radial Ice 25 Iterations

Gust Response Factor 1.10 Ice Dead Load Factor : 1.00 Wind Importance Factor : 1.00

Dead Load Factor : 1.20 Ice Importance Factor : 1.00

Wind Load Factor : 1.00

Shaft Segment Forces (Factored)

Seg Top Elev (ft)	Description	Kzt	Kz	qz (psf)	qzGh (psf)	C (mph-ft)	Cf	Ice Thick (in)	Tributary (ft)	Aa (sf)	CfAa (sf)	Wind Force X (lb)	Dead Load Ice (lb)	Tot Dead Load (lb)
0.00		1.00	0.85	5.168	5.685	0.000	1.200	0.000	0.00	0.000	0.00	0.0	0.0	0.0
5.00		1.00	0.85	5.168	5.685	0.000	1.200	1.656	5.00	17.335	20.80	118.3	410.0	1,980.6
10.00		1.00	0.85	5.168	5.685	0.000	1.200	1.775	5.00	17.097	20.52	116.6	431.8	1,983.1
15.00		1.00	0.85	5.168	5.685	0.000	1.200	* 1.848	5.00	16.820	20.18	114.7	441.1	1,973.1
20.00		1.00	0.90	5.483	6.032	0.000	1.200	* 1.902	5.00	16.527	19.83	119.6	444.9	1,957.6
25.00		1.00	0.94	5.747	6.322	0.000	1.200	* 1.945	5.00	16.225	19.47	123.1	445.6	1,939.0
30.00		1.00	0.98	5.972	6.569	0.000	1.200	* 1.981	5.00	15.916	19.10	125.5	444.2	1,918.3
31.50	Bot - Section 2	1.00	0.99	6.034	6.637	0.000	1.200	* 1.991	1.50	4.712	5.65	37.5	133.1	571.6
35.00		1.00	1.01	6.169	6.786	0.000	1.200	* 2.012	3.50	11.075	13.29	90.2	314.6	1,797.8
35.67	Top - Section 1	1.00	1.01	6.194	6.813	0.000	1.200	* 2.016	0.67	2.092	2.51	17.1	59.9	340.6
40.00		1.00	1.04	6.345	6.979	0.000	1.200	* 2.039	4.33	13.463	16.16	112.8	386.0	1,530.4
45.00		1.00	1.07	6.504	7.155	0.000	1.200	* 2.063	5.00	15.240	18.29	130.8	440.6	1,746.1
50.00		1.00	1.09	6.650	7.315	0.000	1.200	* 2.085	5.00	14.921	17.90	131.0	434.9	1,724.4
55.00		1.00	1.11	6.785	7.463	0.000	1.200	* 2.105	5.00	14.599	17.52	130.8	428.7	1,702.0
56.00	Appertunance(s)	1.00	1.12	6.811	7.492	0.000	1.200	* 2.109	1.00	2.880	3.46	25.9	85.5	338.2
60.00	Reinf. Top	1.00	1.13	6.910	7.601	0.000	1.200	* 2.123	4.00	11.394	13.67	103.9	337.5	1,342.0
65.00		1.00	1.15	7.028	7.731	0.000	1.200	* 2.140	5.00	13.953	16.74	129.4	414.6	1,321.8
70.00		1.00	1.17	7.138	7.852	0.000	1.200	* 2.156	5.00	13.628	16.35	128.4	407.0	1,298.0
70.00	Bot - Section 3	1.00	1.17	7.138	7.852	0.000	1.200	* 2.156	0.00	0.001	0.00	0.0	0.0	0.1
73.50	Top - Section 2	1.00	1.18	7.212	7.933	0.000	1.200	* 2.167	3.50	9.496	11.39	90.4	285.9	1,210.8
75.00		1.00	1.19	7.243	7.967	0.000	1.200	* 2.171	1.50	4.019	4.82	38.4	121.8	353.2
80.00		1.00	1.20	7.342	8.076	0.000	1.200	* 2.185	5.00	13.192	15.83	127.8	397.7	1,160.9
85.00		1.00	1.22	7.436	8.180	0.000	1.200	* 2.198	5.00	12.865	15.44	126.3	389.2	1,139.4
90.00		1.00	1.23	7.526	8.279	0.000	1.200	* 2.211	5.00	12.538	15.05	124.6	380.3	1,117.7
95.00		1.00	1.25	7.612	8.374	0.000	1.200	* 2.223	5.00	12.210	14.65	122.7	371.3	1,095.8
100.00		1.00	1.26	7.695	8.464	0.000	1.200	* 2.234	5.00	11.881	14.26	120.7	362.0	1,073.6
103.00	Appertunance(s)	1.00	1.27	7.743	8.517	0.000	1.200	* 2.241	3.00	6.970	8.36	71.2	213.8	634.6
105.00		1.00	1.27	7.774	8.552	0.000	1.200	* 2.245	2.00	4.580	5.50	47.0	141.0	419.0
110.00		1.00	1.29	7.851	8.636	0.000	1.200	* 2.256	5.00	11.223	13.47	116.3	342.9	1,028.7
110.00	Top - Section 3	1.00	1.29	7.851	8.636	0.000	1.200	* 2.256	0.00	0.001	0.00	0.0	0.0	0.1
115.00	Appertunance(s)	1.00	1.30	7.925	8.717	0.000	1.200	* 2.266	5.00	10.893	13.07	113.9	333.0	922.0
120.00		1.00	1.31	7.996	8.796	0.000	1.200	* 2.276	5.00	10.564	12.68	111.5	323.0	902.4
121.00	Reinf. Top	1.00	1.31	8.010	8.811	0.000	1.200	* 2.277	1.00	2.072	2.49	21.9	64.2	178.9
125.00		1.00	1.32	8.065	8.872	0.000	1.200	* 2.285	4.00	8.160	9.79	86.9	250.3	438.1
126.00	Appertunance(s)	1.00	1.32	8.079	8.886	0.000	1.200	* 2.287	1.00	2.006	2.41	21.4	62.2	108.1
130.00		1.00	1.33	8.132	8.945	0.000	1.200	* 2.294	4.00	7.895	9.47	84.7	242.1	422.1
135.00		1.00	1.34	8.197	9.016	0.000	1.200	* 2.303	5.00	9.572	11.49	103.6	292.2	508.5
140.00	Appertunance(s)	1.00	1.35	8.260	9.086	0.000	1.200	* 2.311	5.00	9.241	11.09	100.8	281.6	488.3
144.00	Appertunance(s)	1.00	1.36	8.309	9.140	0.000	1.200	* 2.317	4.00	7.154	8.58	78.5	218.5	376.9
145.00		1.00	1.36	8.321	9.153	0.000	1.200	* 2.319	1.00	1.755	2.11	19.3	54.2	92.8
150.00	Appertunance(s)	1.00	1.37	8.381	9.219	0.000	1.200	* 2.327	5.00	8.579	10.29	94.9	260.2	447.6
* = Cf Adjusted By Linear Load Ra Effect								Totals:	150.00			3,578.4	11,447.1	39,584.4

Pole : 302489
 Location : Enfd - Enfield, CT
 Height : 150.00 (ft)
 Base Dia : 37.380 (in)
 Top Dia : 15.000 (in)
 Shape : 12 Sides
 Taper : 0.156700 (in/ft)

Code: ANSI/TIA-222 Rev G
 Struct Class : II
 Exposure Category : C
 Topographic Category : 1
 Base Elev : 0.000 (ft)

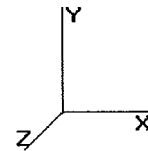

8/2/2013 4:43:27 PM
 Page: 29

© 2007 - 2013 by ATC IP LLC. All rights reserved.

Load Case: 1.2D + 1.0Di + 1.0Wi	50.00 mph with 1.00 in Radial Ice	25 Iterations
Gust Response Factor : 1.10	Ice Dead Load Factor : 1.00	Wind Importance Factor : 1.00
Dead Load Factor : 1.20		Ice Importance Factor : 1.00
Wind Load Factor : 1.00		

Discrete Appurtenance Segment Forces (Factored)

Elev (ft)	Description	Qty	qz (psf)	qzGh (psf)	CaAa Factor	Ka	Total CaAa (sf)	Horiz Ecc (ft)	Vert Ecc (ft)	Wind FX (lb)	Mom Y (lb-ft)	Mom Z (lb-ft)	Dead Load (lb)
56.00	Channel Master Type	1	6.861	7.547	0.90	1.00	21.45	0.000	2.000	161.90	0.00	323.79	341.20
103.0	24" x 24" Junction	1	7.790	8.569	0.80	0.80	4.75	0.000	3.000	40.74	0.00	122.23	202.82
103.0	Argus LLPX310R	3	7.805	8.586	0.50	0.80	8.14	0.000	4.000	69.86	0.00	279.46	547.06
103.0	DragonWave A-ANT-	2	7.836	8.619	0.72	0.80	9.11	0.000	6.000	78.56	0.00	471.38	369.60
103.0	DragonWave Horizon	2	7.836	8.619	0.26	0.80	0.40	0.000	6.000	3.49	0.00	20.94	112.13
103.0	NextNet BTS-2500	3	7.805	8.586	0.40	0.80	3.10	0.000	4.000	26.60	0.00	106.38	367.49
103.0	Side Arms	1	7.743	8.517	1.00	1.00	17.64	0.000	0.000	150.28	0.00	0.00	1,834.41
115.0	RFS APXV18-206517S-	3	7.968	8.765	0.54	0.80	11.11	0.000	3.000	97.36	0.00	292.08	594.64
126.0	Alcatel-Lucent RRH2x	3	8.092	8.901	0.40	0.80	3.64	0.000	1.000	32.37	0.00	32.37	471.38
126.0	Antel BXA-171085-12C	3	8.092	8.901	0.58	0.80	11.13	0.000	1.000	99.03	0.00	99.03	570.73
126.0	Antel BXA-171085-8BF	3	8.092	8.901	0.57	0.80	7.00	0.000	1.000	62.31	0.00	62.31	397.42
126.0	Antel BXA-70063-4CF-	3	8.092	8.901	0.51	0.80	9.21	0.000	1.000	81.95	0.00	81.95	543.41
126.0	Antel BXA-80080-6CF-	3	8.092	8.901	0.58	0.80	12.99	0.000	1.000	115.62	0.00	115.62	706.55
126.0	RFS DB-T1-6Z-8AB-0Z	1	8.092	8.901	0.80	0.80	4.78	0.000	1.000	42.50	0.00	42.50	251.73
126.0	RFS FD9R6004/2C-3L	6	8.092	8.901	0.26	0.80	1.09	0.000	1.000	9.72	0.00	9.72	143.38
126.0	Round Low Profile PI	1	8.079	8.886	1.00	1.00	46.91	0.000	0.000	416.84	0.00	0.00	2,450.67
140.0	Andrew OneBase Dual	6	8.260	9.086	0.26	0.80	1.66	0.000	0.000	15.12	0.00	0.00	296.45
140.0	EMS RR90-17-02DP	3	8.260	9.086	0.51	0.80	8.77	0.000	0.000	79.70	0.00	0.00	477.50
140.0	Flat Low Profile Pla	1	8.260	9.086	1.00	1.00	51.43	0.000	0.000	467.31	0.00	0.00	2,459.68
140.0	RFS APX16DWW-	3	8.260	9.086	0.47	0.80	10.67	0.000	0.000	96.97	0.00	0.00	700.76
144.0	Diamond X50A	2	8.309	9.140	0.75	1.00	4.39	0.000	0.000	40.16	0.00	0.00	193.07
144.0	Flat Side Arm	2	8.309	9.140	0.80	1.00	15.31	0.000	0.000	139.96	0.00	0.00	394.67
150.0	ADC DD1900	6	8.404	9.244	0.25	0.75	2.55	0.000	2.000	23.55	0.00	47.10	389.09
150.0	Allgon 7770.00	6	8.404	9.244	0.48	0.75	20.00	0.000	2.000	184.93	0.00	369.86	1,415.97
150.0	Andrew SBNH-	1	8.404	9.244	0.75	0.75	10.26	0.000	2.000	94.83	0.00	189.65	446.07
150.0	Decibel DB809KE-SY	1	8.518	9.369	1.00	1.00	7.87	0.000	12.000	73.74	0.00	884.91	258.56
150.0	Ericsson RRUS 11 (Ba	6	8.404	9.244	0.50	1.00	10.22	0.000	2.000	94.51	0.00	189.01	1,092.01
150.0	Flat Platform w/ Han	1	8.381	9.219	0.90	1.00	63.38	0.000	0.000	584.27	0.00	0.00	3,848.78
150.0	Powerwave LGP13519	6	8.404	9.244	0.25	0.75	1.00	0.000	2.000	9.26	0.00	18.52	182.65
150.0	Powerwave P65-16-	2	8.404	9.244	0.56	0.75	11.14	0.000	2.000	102.96	0.00	205.93	672.72
150.0	Raycap DC6-48-60-18-	1	8.404	9.244	1.00	1.00	2.18	0.000	2.000	20.16	0.00	40.31	171.60
										3,516.54			22,904.18

Pole : 302489
 Location : Enfd - Enfield, CT
 Height : 150.00 (ft)
 Base Dia : 37.380 (in)
 Top Dia : 15.000 (in)
 Shape : 12 Sides
 Taper : 0.156700 (in/ft)

Code: ANSI/TIA-222 Rev G
 Struct Class : II
 Exposure Category : C
 Topographic Category : 1
 Base Elev : 0.000 (ft)

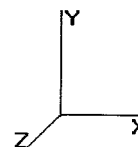

8/2/2013 4:43:27 PM
 Page: 30

© 2007 - 2013 by ATC IP LLC. All rights reserved.

Load Case: 1.2D + 1.0Di + 1.0Wi	50.00 mph with 1.00 in Radial Ice	25 Iterations
Gust Response Factor : 1.10	Ice Dead Load Factor : 1.00	Wind Importance Factor : 1.00
Dead Load Factor : 1.20		Ice Importance Factor : 1.00
Wind Load Factor : 1.00		

Linear Appurtenance Segment Forces (Factored)

Seg Top Elev (ft)	Description	Exposed To Wind	Length (ft)	Ca	Exposed Width (in)	Area (sqft)	CaAa (sqft)	qz (psf)	Ra	Cf Adjust Factor	F X (lb)	Dead Load (lb)
5.00	(4) #20 Dywidag bars	Yes	5.00	0.000	0.00	0.00	0.00	5.168	0.000	0.000	0.00	492.39
10.00	(4) #20 Dywidag bars	Yes	5.00	0.000	0.00	0.00	0.00	5.168	0.000	0.000	0.00	499.50
15.00	(1) 0.39" Cable	Yes	5.00	0.000	0.00	0.00	0.00	5.168	0.613	0.000	0.00	24.16
15.00	(2) 0.78" 8 AWG 6	Yes	5.00	0.000	0.00	0.00	0.00	5.168	0.613	0.000	0.00	39.67
15.00	(1) 1 5/8" Coax	Yes	5.00	1.200	1.98	2.37	2.84	5.168	0.613	0.000	16.14	41.66
15.00	(8) 1 5/8" Coax	Yes	5.00	1.200	3.96	3.19	3.83	5.168	0.613	0.000	21.76	187.17
15.00	(2) 1/2" Coax	Yes	5.00	1.200	0.63	1.80	2.16	5.168	0.613	0.000	12.30	32.06
15.00	(8) 1 5/8" Coax	Yes	5.00	1.200	5.94	4.02	4.82	5.168	0.613	0.000	27.39	187.17
15.00	(12) 1 5/8" Coax	Yes	5.00	1.200	1.98	2.37	2.84	5.168	0.613	0.000	16.14	270.32
15.00	(1) 1 5/8" Hybriflex	Yes	5.00	0.000	0.00	0.00	0.00	5.168	0.613	0.000	0.00	43.36
15.00	(4) #20 Dywidag bars	Yes	5.00	0.000	0.00	0.00	0.00	5.168	0.613	0.000	0.00	503.98
15.00	(6) 1 5/8" Coax	Yes	5.00	0.000	0.00	0.00	0.00	5.168	0.613	0.000	0.00	145.60
15.00	(4) 1/2" Coax	Yes	5.00	0.000	0.00	0.00	0.00	5.168	0.613	0.000	0.00	43.24
15.00	(2) 2" Conduit	Yes	5.00	0.000	0.00	0.00	0.00	5.168	0.613	0.000	0.00	103.06
15.00	(6) 5/16" Coax	Yes	5.00	0.000	0.00	0.00	0.00	5.168	0.613	0.000	0.00	36.32
15.00	(1) 1/2" Coax	Yes	5.00	0.000	0.00	0.00	0.00	5.168	0.613	0.000	0.00	26.46
15.00	(4) Dywidag	Yes	5.00	2.000	8.00	4.87	9.75	5.168	0.613	0.000	55.41	20.87
20.00	(1) 0.39" Cable	Yes	5.00	0.000	0.00	0.00	0.00	5.483	0.627	0.000	0.00	25.47
20.00	(2) 0.78" 8 AWG 6	Yes	5.00	0.000	0.00	0.00	0.00	5.483	0.627	0.000	0.00	41.23
20.00	(1) 1 5/8" Coax	Yes	5.00	1.200	1.98	2.41	2.89	5.483	0.627	0.000	17.45	43.31
20.00	(8) 1 5/8" Coax	Yes	5.00	1.200	3.96	3.24	3.88	5.483	0.627	0.000	23.42	191.73
20.00	(2) 1/2" Coax	Yes	5.00	1.200	0.63	1.85	2.22	5.483	0.627	0.000	13.37	33.56
20.00	(8) 1 5/8" Coax	Yes	5.00	1.200	5.94	4.06	4.87	5.483	0.627	0.000	29.39	191.73
20.00	(12) 1 5/8" Coax	Yes	5.00	1.200	1.98	2.41	2.89	5.483	0.627	0.000	17.45	276.54
20.00	(1) 1 5/8" Hybriflex	Yes	5.00	0.000	0.00	0.00	0.00	5.483	0.627	0.000	0.00	44.93
20.00	(4) #20 Dywidag bars	Yes	5.00	0.000	0.00	0.00	0.00	5.483	0.627	0.000	0.00	507.31
20.00	(6) 1 5/8" Coax	Yes	5.00	0.000	0.00	0.00	0.00	5.483	0.627	0.000	0.00	149.32
20.00	(4) 1/2" Coax	Yes	5.00	0.000	0.00	0.00	0.00	5.483	0.627	0.000	0.00	45.01
20.00	(2) 2" Conduit	Yes	5.00	0.000	0.00	0.00	0.00	5.483	0.627	0.000	0.00	105.28
20.00	(6) 5/16" Coax	Yes	5.00	0.000	0.00	0.00	0.00	5.483	0.627	0.000	0.00	37.96
20.00	(1) 1/2" Coax	Yes	5.00	0.000	0.00	0.00	0.00	5.483	0.627	0.000	0.00	27.83
20.00	(4) Dywidag	Yes	5.00	2.000	8.00	4.92	9.84	5.483	0.627	0.000	59.34	22.11
25.00	(1) 0.39" Cable	Yes	5.00	0.000	0.00	0.00	0.00	5.747	0.642	0.000	0.00	26.55
25.00	(2) 0.78" 8 AWG 6	Yes	5.00	0.000	0.00	0.00	0.00	5.747	0.642	0.000	0.00	42.50
25.00	(1) 1 5/8" Coax	Yes	5.00	1.200	1.98	2.45	2.94	5.747	0.642	0.000	18.56	44.65
25.00	(8) 1 5/8" Coax	Yes	5.00	1.200	3.96	3.27	3.93	5.747	0.642	0.000	24.82	195.38
25.00	(2) 1/2" Coax	Yes	5.00	1.200	0.63	1.88	2.26	5.747	0.642	0.000	14.29	34.78
25.00	(8) 1 5/8" Coax	Yes	5.00	1.200	5.94	4.10	4.92	5.747	0.642	0.000	31.07	195.38
25.00	(12) 1 5/8" Coax	Yes	5.00	1.200	1.98	2.45	2.94	5.747	0.642	0.000	18.56	281.52
25.00	(1) 1 5/8" Hybriflex	Yes	5.00	0.000	0.00	0.00	0.00	5.747	0.642	0.000	0.00	46.21
25.00	(4) #20 Dywidag bars	Yes	5.00	0.000	0.00	0.00	0.00	5.747	0.642	0.000	0.00	509.99
25.00	(6) 1 5/8" Coax	Yes	5.00	0.000	0.00	0.00	0.00	5.747	0.642	0.000	0.00	152.32
25.00	(4) 1/2" Coax	Yes	5.00	0.000	0.00	0.00	0.00	5.747	0.642	0.000	0.00	46.44
25.00	(2) 2" Conduit	Yes	5.00	0.000	0.00	0.00	0.00	5.747	0.642	0.000	0.00	107.08
25.00	(6) 5/16" Coax	Yes	5.00	0.000	0.00	0.00	0.00	5.747	0.642	0.000	0.00	39.28
25.00	(1) 1/2" Coax	Yes	5.00	0.000	0.00	0.00	0.00	5.747	0.642	0.000	0.00	28.95
25.00	(4) Dywidag	Yes	5.00	2.000	8.00	4.95	9.91	5.747	0.642	0.000	62.64	23.11
30.00	(1) 0.39" Cable	Yes	5.00	0.000	0.00	0.00	0.00	5.972	0.657	0.000	0.00	27.46
30.00	(2) 0.78" 8 AWG 6	Yes	5.00	0.000	0.00	0.00	0.00	5.972	0.657	0.000	0.00	43.58
30.00	(1) 1 5/8" Coax	Yes	5.00	1.200	1.98	2.48	2.97	5.972	0.657	0.000	19.52	45.78
30.00	(8) 1 5/8" Coax	Yes	5.00	1.200	3.96	3.30	3.96	5.972	0.657	0.000	26.02	198.45

Pole : 302489
 Location : Enfd - Enfield, CT
 Height : 150.00 (ft)
 Base Dia : 37.380 (in)
 Top Dia : 15.000 (in)
 Shape : 12 Sides
 Taper : 0.156700 (in/ft)

Code: ANSI/TIA-222 Rev G
 Struct Class : II
 Exposure Category : C
 Topographic Category : 1
 Base Elev : 0.000 (ft)

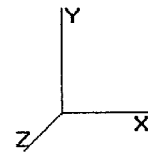

8/2/2013 4:43:27 PM
 Page: 31

© 2007 - 2013 by ATC IP LLC. All rights reserved.

Load Case: 1.2D + 1.0Di + 1.0Wi	50.00 mph with 1.00 in Radial Ice	25 Iterations
Gust Response Factor : 1.10	Ice Dead Load Factor : 1.00	Wind Importance Factor : 1.00
Dead Load Factor : 1.20		Ice Importance Factor : 1.00
Wind Load Factor : 1.00		

30.00	(2) 1/2" Coax	Yes	5.00	1.200	0.63	1.91	2.30	5.972	0.657	0.000	15.08	35.81
30.00	(8) 1 5/8" Coax	Yes	5.00	1.200	5.94	4.13	4.95	5.972	0.657	0.000	32.52	198.45
30.00	(12) 1 5/8" Coax	Yes	5.00	1.200	1.98	2.48	2.97	5.972	0.657	0.000	19.52	285.68
30.00	(1) 1 5/8" Hybriflex	Yes	5.00	0.000	0.00	0.00	0.00	5.972	0.657	0.000	0.00	47.30
30.00	(4) #20 Dywidag bars	Yes	5.00	0.000	0.00	0.00	0.00	5.972	0.657	0.000	0.00	512.24
30.00	(6) 1 5/8" Coax	Yes	5.00	0.000	0.00	0.00	0.00	5.972	0.657	0.000	0.00	154.83
30.00	(4) 1/2" Coax	Yes	5.00	0.000	0.00	0.00	0.00	5.972	0.657	0.000	0.00	47.65
30.00	(2) 2" Conduit	Yes	5.00	0.000	0.00	0.00	0.00	5.972	0.657	0.000	0.00	108.59
30.00	(6) 5/16" Coax	Yes	5.00	0.000	0.00	0.00	0.00	5.972	0.657	0.000	0.00	40.40
30.00	(1) 1/2" Coax	Yes	5.00	0.000	0.00	0.00	0.00	5.972	0.657	0.000	0.00	29.89
30.00	(4) Dywidag	Yes	5.00	2.000	8.00	4.98	9.97	5.972	0.657	0.000	65.49	23.97
31.50	(1) 0.39" Cable	Yes	1.50	0.000	0.00	0.00	0.00	6.034	0.667	0.000	0.00	8.32
31.50	(2) 0.78" 8 AWG 6	Yes	1.50	0.000	0.00	0.00	0.00	6.034	0.667	0.000	0.00	13.16
31.50	(1) 1 5/8" Coax	Yes	1.50	1.200	1.98	0.75	0.89	6.034	0.667	0.000	5.94	13.83
31.50	(8) 1 5/8" Coax	Yes	1.50	1.200	3.96	0.99	1.19	6.034	0.667	0.000	7.91	59.80
31.50	(2) 1/2" Coax	Yes	1.50	1.200	0.63	0.58	0.69	6.034	0.667	0.000	4.59	10.83
31.50	(8) 1 5/8" Coax	Yes	1.50	1.200	5.94	1.24	1.49	6.034	0.667	0.000	9.88	59.80
31.50	(12) 1 5/8" Coax	Yes	1.50	1.200	1.98	0.75	0.89	6.034	0.667	0.000	5.94	86.06
31.50	(1) 1 5/8" Hybriflex	Yes	1.50	0.000	0.00	0.00	0.00	6.034	0.667	0.000	0.00	14.28
31.50	(4) #20 Dywidag bars	Yes	1.50	0.000	0.00	0.00	0.00	6.034	0.667	0.000	0.00	153.89
31.50	(6) 1 5/8" Coax	Yes	1.50	0.000	0.00	0.00	0.00	6.034	0.667	0.000	0.00	46.66
31.50	(4) 1/2" Coax	Yes	1.50	0.000	0.00	0.00	0.00	6.034	0.667	0.000	0.00	14.40
31.50	(2) 2" Conduit	Yes	1.50	0.000	0.00	0.00	0.00	6.034	0.667	0.000	0.00	32.71
31.50	(6) 5/16" Coax	Yes	1.50	0.000	0.00	0.00	0.00	6.034	0.667	0.000	0.00	12.22
31.50	(1) 1/2" Coax	Yes	1.50	0.000	0.00	0.00	0.00	6.034	0.667	0.000	0.00	9.05
31.50	(4) Dywidag	Yes	1.50	2.000	8.00	1.50	3.00	6.034	0.667	0.000	19.89	7.26
35.00	(1) 0.39" Cable	Yes	3.50	0.000	0.00	0.00	0.00	6.169	0.449	0.000	0.00	19.78
35.00	(2) 0.78" 8 AWG 6	Yes	3.50	0.000	0.00	0.00	0.00	6.169	0.449	0.000	0.00	31.16
35.00	(1) 1 5/8" Coax	Yes	3.50	1.200	1.98	1.75	2.10	6.169	0.449	0.000	14.26	32.74
35.00	(8) 1 5/8" Coax	Yes	3.50	1.200	3.96	2.33	2.79	6.169	0.449	0.000	18.96	140.75
35.00	(2) 1/2" Coax	Yes	3.50	1.200	0.63	1.36	1.63	6.169	0.449	0.000	11.05	25.70
35.00	(8) 1 5/8" Coax	Yes	3.50	1.200	5.94	2.91	3.49	6.169	0.449	0.000	23.66	140.75
35.00	(12) 1 5/8" Coax	Yes	3.50	1.200	1.98	1.75	2.10	6.169	0.449	0.000	14.26	202.48
35.00	(1) 1 5/8" Hybriflex	Yes	3.50	0.000	0.00	0.00	0.00	6.169	0.449	0.000	0.00	33.77
35.00	(4) #20 Dywidag bars	Yes	3.50	0.000	0.00	0.00	0.00	6.169	0.449	0.000	0.00	359.90
35.00	(6) 1 5/8" Coax	Yes	3.50	0.000	0.00	0.00	0.00	6.169	0.449	0.000	0.00	109.89
35.00	(4) 1/2" Coax	Yes	3.50	0.000	0.00	0.00	0.00	6.169	0.449	0.000	0.00	34.09
35.00	(2) 2" Conduit	Yes	3.50	0.000	0.00	0.00	0.00	6.169	0.449	0.000	0.00	76.93
35.00	(6) 5/16" Coax	Yes	3.50	0.000	0.00	0.00	0.00	6.169	0.449	0.000	0.00	28.96
35.00	(1) 1/2" Coax	Yes	3.50	0.000	0.00	0.00	0.00	6.169	0.449	0.000	0.00	21.50
35.00	(4) Dywidag	Yes	0.20	2.000	8.00	0.20	0.40	6.169	0.449	0.000	2.72	0.99
35.67	(1) 0.39" Cable	Yes	0.67	0.000	0.00	0.00	0.00	6.194	0.440	0.000	0.00	3.78
35.67	(2) 0.78" 8 AWG 6	Yes	0.67	0.000	0.00	0.00	0.00	6.194	0.440	0.000	0.00	5.95
35.67	(1) 1 5/8" Coax	Yes	0.67	1.200	1.98	0.33	0.40	6.194	0.440	0.000	2.73	6.26
35.67	(8) 1 5/8" Coax	Yes	0.67	1.200	3.96	0.44	0.53	6.194	0.440	0.000	3.63	26.87
35.67	(2) 1/2" Coax	Yes	0.67	1.200	0.63	0.26	0.31	6.194	0.440	0.000	2.12	4.91
35.67	(8) 1 5/8" Coax	Yes	0.67	1.200	5.94	0.55	0.67	6.194	0.440	0.000	4.53	26.87
35.67	(12) 1 5/8" Coax	Yes	0.67	1.200	1.98	0.33	0.40	6.194	0.440	0.000	2.73	38.65
35.67	(1) 1 5/8" Hybriflex	Yes	0.67	0.000	0.00	0.00	0.00	6.194	0.440	0.000	0.00	6.45
35.67	(4) #20 Dywidag bars	Yes	0.67	0.000	0.00	0.00	0.00	6.194	0.440	0.000	0.00	68.63
35.67	(6) 1 5/8" Coax	Yes	0.67	0.000	0.00	0.00	0.00	6.194	0.440	0.000	0.00	20.98
35.67	(4) 1/2" Coax	Yes	0.67	0.000	0.00	0.00	0.00	6.194	0.440	0.000	0.00	6.51
35.67	(2) 2" Conduit	Yes	0.67	0.000	0.00	0.00	0.00	6.194	0.440	0.000	0.00	14.68
35.67	(6) 5/16" Coax	Yes	0.67	0.000	0.00	0.00	0.00	6.194	0.440	0.000	0.00	5.54
35.67	(1) 1/2" Coax	Yes	0.67	0.000	0.00	0.00	0.00	6.194	0.440	0.000	0.00	4.11
40.00	(1) 0.39" Cable	Yes	4.33	0.000	0.00	0.00	0.00	6.345	0.436	0.000	0.00	25.10
40.00	(2) 0.78" 8 AWG 6	Yes	4.33	0.000	0.00	0.00	0.00	6.345	0.436	0.000	0.00	39.30

Pole : 302489
 Location : Enfd - Enfield, CT
 Height : 150.00 (ft)
 Base Dia : 37.380 (in)
 Top Dia : 15.000 (in)
 Shape : 12 Sides
 Taper : 0.156700 (in/ft)

Code: ANSI/TIA-222 Rev G
 Struct Class : II
 Exposure Category : C
 Topographic Category : 1
 Base Elev : 0.000 (ft)

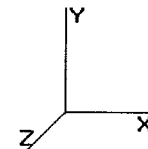

8/2/2013 4:43:27 PM
 Page: 32

© 2007 - 2013 by ATC IP LLC. All rights reserved.

Load Case: 1.2D + 1.0Di + 1.0Wf	50.00 mph with 1.00 in Radial Ice	25 Iterations
Gust Response Factor : 1.10	Ice Dead Load Factor : 1.00	Wind Importance Factor : 1.00
Dead Load Factor : 1.20		Ice Importance Factor : 1.00
Wind Load Factor : 1.00		

40.00	(1) 1 5/8" Coax	Yes	4.33	1.200	1.98	2.19	2.62	6.345	0.436	0.000	18.32	41.29
40.00	(8) 1 5/8" Coax	Yes	4.33	1.200	3.96	2.90	3.48	6.345	0.436	0.000	24.31	176.29
40.00	(2) 1/2" Coax	Yes	4.33	1.200	0.63	1.70	2.04	6.345	0.436	0.000	14.24	32.51
40.00	(8) 1 5/8" Coax	Yes	4.33	1.200	5.94	3.62	4.34	6.345	0.436	0.000	30.30	176.29
40.00	(12) 1 5/8" Coax	Yes	4.33	1.200	1.98	2.19	2.62	6.345	0.436	0.000	18.32	253.43
40.00	(1) 1 5/8" Hybriflex	Yes	4.33	0.000	0.00	0.00	0.00	6.345	0.436	0.000	0.00	42.54
40.00	(4) #20 Dywidag bars	Yes	4.33	0.000	0.00	0.00	0.00	6.345	0.436	0.000	0.00	447.09
40.00	(6) 1 5/8" Coax	Yes	4.33	0.000	0.00	0.00	0.00	6.345	0.436	0.000	0.00	137.72
40.00	(4) 1/2" Coax	Yes	4.33	0.000	0.00	0.00	0.00	6.345	0.436	0.000	0.00	43.01
40.00	(2) 2" Conduit	Yes	4.33	0.000	0.00	0.00	0.00	6.345	0.436	0.000	0.00	96.25
40.00	(6) 5/16" Coax	Yes	4.33	0.000	0.00	0.00	0.00	6.345	0.436	0.000	0.00	36.61
40.00	(1) 1/2" Coax	Yes	4.33	0.000	0.00	0.00	0.00	6.345	0.436	0.000	0.00	27.26
45.00	(1) 0.39" Cable	Yes	5.00	0.000	0.00	0.00	0.00	6.504	0.447	0.000	0.00	29.61
45.00	(2) 0.78" 8 AWG 6	Yes	5.00	0.000	0.00	0.00	0.00	6.504	0.447	0.000	0.00	46.10
45.00	(1) 1 5/8" Coax	Yes	5.00	1.200	1.98	2.54	3.05	6.504	0.447	0.000	21.84	48.44
45.00	(8) 1 5/8" Coax	Yes	5.00	1.200	3.96	3.37	4.04	6.504	0.447	0.000	28.93	205.52
45.00	(2) 1/2" Coax	Yes	5.00	1.200	0.63	1.98	2.38	6.504	0.447	0.000	17.01	38.24
45.00	(8) 1 5/8" Coax	Yes	5.00	1.200	5.94	4.19	5.03	6.504	0.447	0.000	36.01	205.52
45.00	(12) 1 5/8" Coax	Yes	5.00	1.200	1.98	2.54	3.05	6.504	0.447	0.000	21.84	295.28
45.00	(1) 1 5/8" Hybriflex	Yes	5.00	0.000	0.00	0.00	0.00	6.504	0.447	0.000	0.00	49.84
45.00	(4) #20 Dywidag bars	Yes	5.00	0.000	0.00	0.00	0.00	6.504	0.447	0.000	0.00	517.46
45.00	(6) 1 5/8" Coax	Yes	5.00	0.000	0.00	0.00	0.00	6.504	0.447	0.000	0.00	160.64
45.00	(4) 1/2" Coax	Yes	5.00	0.000	0.00	0.00	0.00	6.504	0.447	0.000	0.00	50.47
45.00	(2) 2" Conduit	Yes	5.00	0.000	0.00	0.00	0.00	6.504	0.447	0.000	0.00	112.11
45.00	(6) 5/16" Coax	Yes	5.00	0.000	0.00	0.00	0.00	6.504	0.447	0.000	0.00	43.03
45.00	(1) 1/2" Coax	Yes	5.00	0.000	0.00	0.00	0.00	6.504	0.447	0.000	0.00	32.12
50.00	(1) 0.39" Cable	Yes	5.00	0.000	0.00	0.00	0.00	6.650	0.458	0.000	0.00	30.20
50.00	(2) 0.78" 8 AWG 6	Yes	5.00	0.000	0.00	0.00	0.00	6.650	0.458	0.000	0.00	46.79
50.00	(1) 1 5/8" Coax	Yes	5.00	1.200	1.98	2.56	3.07	6.650	0.458	0.000	22.49	49.16
50.00	(8) 1 5/8" Coax	Yes	5.00	1.200	3.96	3.39	4.06	6.650	0.458	0.000	29.74	207.42
50.00	(2) 1/2" Coax	Yes	5.00	1.200	0.63	2.00	2.40	6.650	0.458	0.000	17.56	38.90
50.00	(8) 1 5/8" Coax	Yes	5.00	1.200	5.94	4.21	5.05	6.650	0.458	0.000	36.98	207.42
50.00	(12) 1 5/8" Coax	Yes	5.00	1.200	1.98	2.56	3.07	6.650	0.458	0.000	22.49	297.86
50.00	(1) 1 5/8" Hybriflex	Yes	5.00	0.000	0.00	0.00	0.00	6.650	0.458	0.000	0.00	50.54
50.00	(4) #20 Dywidag bars	Yes	5.00	0.000	0.00	0.00	0.00	6.650	0.458	0.000	0.00	518.86
50.00	(6) 1 5/8" Coax	Yes	5.00	0.000	0.00	0.00	0.00	6.650	0.458	0.000	0.00	162.20
50.00	(4) 1/2" Coax	Yes	5.00	0.000	0.00	0.00	0.00	6.650	0.458	0.000	0.00	51.24
50.00	(2) 2" Conduit	Yes	5.00	0.000	0.00	0.00	0.00	6.650	0.458	0.000	0.00	113.07
50.00	(6) 5/16" Coax	Yes	5.00	0.000	0.00	0.00	0.00	6.650	0.458	0.000	0.00	43.74
50.00	(1) 1/2" Coax	Yes	5.00	0.000	0.00	0.00	0.00	6.650	0.458	0.000	0.00	32.73
55.00	(1) 0.39" Cable	Yes	5.00	0.000	0.00	0.00	0.00	6.785	0.470	0.000	0.00	30.74
55.00	(2) 0.78" 8 AWG 6	Yes	5.00	0.000	0.00	0.00	0.00	6.785	0.470	0.000	0.00	47.42
55.00	(1) 1 5/8" Coax	Yes	5.00	1.200	1.98	2.58	3.09	6.785	0.470	0.000	23.10	49.83
55.00	(8) 1 5/8" Coax	Yes	5.00	1.200	3.96	3.40	4.08	6.785	0.470	0.000	30.49	209.16
55.00	(2) 1/2" Coax	Yes	5.00	1.200	0.63	2.02	2.42	6.785	0.470	0.000	18.06	39.51
55.00	(8) 1 5/8" Coax	Yes	5.00	1.200	5.94	4.23	5.07	6.785	0.470	0.000	37.88	209.16
55.00	(12) 1 5/8" Coax	Yes	5.00	1.200	1.98	2.58	3.09	6.785	0.470	0.000	23.10	300.21
55.00	(1) 1 5/8" Hybriflex	Yes	5.00	0.000	0.00	0.00	0.00	6.785	0.470	0.000	0.00	51.17
55.00	(4) #20 Dywidag bars	Yes	5.00	0.000	0.00	0.00	0.00	6.785	0.470	0.000	0.00	520.15
55.00	(6) 1 5/8" Coax	Yes	5.00	0.000	0.00	0.00	0.00	6.785	0.470	0.000	0.00	163.64
55.00	(4) 1/2" Coax	Yes	5.00	0.000	0.00	0.00	0.00	6.785	0.470	0.000	0.00	51.95
55.00	(2) 2" Conduit	Yes	5.00	0.000	0.00	0.00	0.00	6.785	0.470	0.000	0.00	113.94
55.00	(6) 5/16" Coax	Yes	5.00	0.000	0.00	0.00	0.00	6.785	0.470	0.000	0.00	44.40
55.00	(1) 1/2" Coax	Yes	5.00	0.000	0.00	0.00	0.00	6.785	0.470	0.000	0.00	33.29
56.00	(1) 0.39" Cable	Yes	1.00	0.000	0.00	0.00	0.00	6.811	0.478	0.000	0.00	6.17
56.00	(2) 0.78" 8 AWG 6	Yes	1.00	0.000	0.00	0.00	0.00	6.811	0.478	0.000	0.00	9.51
56.00	(1) 1 5/8" Coax	Yes	1.00	1.200	1.98	0.52	0.62	6.811	0.478	0.000	4.64	9.99

Pole : 302489
 Location : Enfd - Enfield, CT
 Height : 150.00 (ft)
 Base Dia : 37.380 (in)
 Top Dia : 15.000 (in)
 Shape : 12 Sides
 Taper : 0.156700 (in/ft)

Code: ANSI/TIA-222 Rev G
 Struct Class : II
 Exposure Category : C
 Topographic Category : 1
 Base Elev : 0.000 (ft)

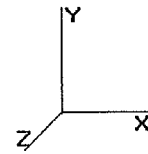

8/2/2013 4:43:27 PM
 Page: 33

© 2007 - 2013 by ATC IP LLC. All rights reserved.

Load Case: 1.2D + 1.0Di + 1.0Wi 50.00 mph with 1.00 in Radial Ice 25 Iterations

Gust Response Factor 1.10 Ice Dead Load Factor : 1.00 Wind Importance Factor : 1.00
 Dead Load Factor : 1.20 Ice Importance Factor : 1.00
 Wind Load Factor : 1.00

56.00	(8) 1 5/8" Coax	Yes	1.00	1.200	3.96	0.68	0.82	6.811	0.478	0.000	6.13	41.90
56.00	(2) 1/2" Coax	Yes	1.00	1.200	0.63	0.40	0.48	6.811	0.478	0.000	3.63	7.92
56.00	(8) 1 5/8" Coax	Yes	1.00	1.200	5.94	0.85	1.02	6.811	0.478	0.000	7.61	41.90
56.00	(12) 1 5/8" Coax	Yes	1.00	1.200	1.98	0.52	0.62	6.811	0.478	0.000	4.64	60.13
56.00	(1) 1 5/8" Hybriflex	Yes	1.00	0.000	0.00	0.00	0.00	6.811	0.478	0.000	0.00	10.26
56.00	(4) #20 Dywidag bars	Yes	1.00	0.000	0.00	0.00	0.00	6.811	0.478	0.000	0.00	104.08
56.00	(6) 1 5/8" Coax	Yes	1.00	0.000	0.00	0.00	0.00	6.811	0.478	0.000	0.00	32.78
56.00	(4) 1/2" Coax	Yes	1.00	0.000	0.00	0.00	0.00	6.811	0.478	0.000	0.00	10.42
56.00	(2) 2" Conduit	Yes	1.00	0.000	0.00	0.00	0.00	6.811	0.478	0.000	0.00	22.82
56.00	(6) 5/16" Coax	Yes	1.00	0.000	0.00	0.00	0.00	6.811	0.478	0.000	0.00	8.91
56.00	(1) 1/2" Coax	Yes	1.00	0.000	0.00	0.00	0.00	6.811	0.478	0.000	0.00	6.68
60.00	(1) 0.39" Cable	Yes	4.00	0.000	0.00	0.00	0.00	6.910	0.484	0.000	0.00	24.99
60.00	(2) 0.78" 8 AWG 6	Yes	4.00	0.000	0.00	0.00	0.00	6.910	0.484	0.000	0.00	38.41
60.00	(1) 1 5/8" Coax	Yes	4.00	1.200	1.98	2.08	2.49	6.910	0.484	0.000	18.93	40.35
60.00	(8) 1 5/8" Coax	Yes	4.00	1.200	3.96	2.74	3.28	6.910	0.484	0.000	24.95	168.62
60.00	(2) 1/2" Coax	Yes	4.00	1.200	0.63	1.63	1.95	6.910	0.484	0.000	14.83	32.06
60.00	(8) 1 5/8" Coax	Yes	4.00	1.200	5.94	3.40	4.07	6.910	0.484	0.000	30.97	168.62
60.00	(12) 1 5/8" Coax	Yes	4.00	1.200	1.98	2.08	2.49	6.910	0.484	0.000	18.93	241.91
60.00	(1) 1 5/8" Hybriflex	Yes	4.00	0.000	0.00	0.00	0.00	6.910	0.484	0.000	0.00	41.41
60.00	(4) #20 Dywidag bars	Yes	4.00	0.000	0.00	0.00	0.00	6.910	0.484	0.000	0.00	417.07
60.00	(6) 1 5/8" Coax	Yes	4.00	0.000	0.00	0.00	0.00	6.910	0.484	0.000	0.00	131.97
60.00	(4) 1/2" Coax	Yes	4.00	0.000	0.00	0.00	0.00	6.910	0.484	0.000	0.00	42.08
60.00	(2) 2" Conduit	Yes	4.00	0.000	0.00	0.00	0.00	6.910	0.484	0.000	0.00	91.80
60.00	(6) 5/16" Coax	Yes	4.00	0.000	0.00	0.00	0.00	6.910	0.484	0.000	0.00	36.01
65.00	(1) 0.39" Cable	Yes	5.00	0.000	0.00	0.00	0.00	7.028	0.496	0.000	0.00	31.71
65.00	(2) 0.78" 8 AWG 6	Yes	5.00	0.000	0.00	0.00	0.00	7.028	0.496	0.000	0.00	48.55
65.00	(1) 1 5/8" Coax	Yes	5.00	1.200	1.98	2.61	3.13	7.028	0.496	0.000	24.20	51.02
65.00	(8) 1 5/8" Coax	Yes	5.00	1.200	3.96	3.43	4.12	7.028	0.496	0.000	31.85	212.27
65.00	(2) 1/2" Coax	Yes	5.00	1.200	0.63	2.05	2.46	7.028	0.496	0.000	18.98	40.60
65.00	(8) 1 5/8" Coax	Yes	5.00	1.200	5.94	4.26	5.11	7.028	0.496	0.000	39.51	212.27
65.00	(12) 1 5/8" Coax	Yes	5.00	1.200	1.98	2.61	3.13	7.028	0.496	0.000	24.20	304.41
65.00	(1) 1 5/8" Hybriflex	Yes	5.00	0.000	0.00	0.00	0.00	7.028	0.496	0.000	0.00	52.32
65.00	(4) #20 Dywidag bars	Yes	5.00	0.000	0.00	0.00	0.00	7.028	0.496	0.000	0.00	522.45
65.00	(6) 1 5/8" Coax	Yes	5.00	0.000	0.00	0.00	0.00	7.028	0.496	0.000	0.00	166.20
65.00	(4) 1/2" Coax	Yes	5.00	0.000	0.00	0.00	0.00	7.028	0.496	0.000	0.00	53.22
65.00	(2) 2" Conduit	Yes	5.00	0.000	0.00	0.00	0.00	7.028	0.496	0.000	0.00	115.51
65.00	(6) 5/16" Coax	Yes	5.00	0.000	0.00	0.00	0.00	7.028	0.496	0.000	0.00	45.58
70.00	(1) 0.39" Cable	Yes	5.00	0.000	0.00	0.00	0.00	7.138	0.510	0.000	0.00	32.15
70.00	(2) 0.78" 8 AWG 6	Yes	5.00	0.000	0.00	0.00	0.00	7.138	0.510	0.000	0.00	49.07
70.00	(1) 1 5/8" Coax	Yes	5.00	1.200	1.98	2.62	3.15	7.138	0.510	0.000	24.70	51.56
70.00	(8) 1 5/8" Coax	Yes	5.00	1.200	3.96	3.45	4.14	7.138	0.510	0.000	32.48	213.66
70.00	(2) 1/2" Coax	Yes	5.00	1.200	0.63	2.06	2.47	7.138	0.510	0.000	19.40	41.10
70.00	(8) 1 5/8" Coax	Yes	5.00	1.200	5.94	4.27	5.13	7.138	0.510	0.000	40.25	213.66
70.00	(12) 1 5/8" Coax	Yes	5.00	1.200	1.98	2.62	3.15	7.138	0.510	0.000	24.70	306.30
70.00	(1) 1 5/8" Hybriflex	Yes	5.00	0.000	0.00	0.00	0.00	7.138	0.510	0.000	0.00	52.84
70.00	(4) #20 Dywidag bars	Yes	5.00	0.000	0.00	0.00	0.00	7.138	0.510	0.000	0.00	523.48
70.00	(6) 1 5/8" Coax	Yes	5.00	0.000	0.00	0.00	0.00	7.138	0.510	0.000	0.00	167.35
70.00	(4) 1/2" Coax	Yes	5.00	0.000	0.00	0.00	0.00	7.138	0.510	0.000	0.00	53.79
70.00	(2) 2" Conduit	Yes	5.00	0.000	0.00	0.00	0.00	7.138	0.510	0.000	0.00	116.22
70.00	(6) 5/16" Coax	Yes	5.00	0.000	0.00	0.00	0.00	7.138	0.510	0.000	0.00	46.12
70.00	(1) 0.39" Cable	Yes	0.00	0.000	0.00	0.00	0.00	7.138	0.518	0.000	0.00	0.00
70.00	(2) 0.78" 8 AWG 6	Yes	0.00	0.000	0.00	0.00	0.00	7.138	0.518	0.000	0.00	0.00
70.00	(1) 1 5/8" Coax	Yes	0.00	1.200	1.98	0.00	0.00	7.138	0.518	0.000	0.00	0.00
70.00	(8) 1 5/8" Coax	Yes	0.00	1.200	3.96	0.00	0.00	7.138	0.518	0.000	0.00	0.01
70.00	(2) 1/2" Coax	Yes	0.00	1.200	0.63	0.00	0.00	7.138	0.518	0.000	0.00	0.00
70.00	(8) 1 5/8" Coax	Yes	0.00	1.200	5.94	0.00	0.00	7.138	0.518	0.000	0.00	0.01
70.00	(12) 1 5/8" Coax	Yes	0.00	1.200	1.98	0.00	0.00	7.138	0.518	0.000	0.00	0.02

Pole : 302489
 Location : Enfd - Enfield, CT
 Height : 150.00 (ft)
 Base Dia : 37.380 (in)
 Top Dia : 15.000 (in)
 Shape : 12 Sides
 Taper : 0.156700 (in/ft)

Code: ANSI/TIA-222 Rev G
 Struct Class : II
 Exposure Category : C
 Topographic Category : 1
 Base Elev : 0.000 (ft)

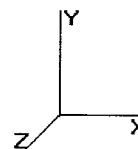

8/2/2013 4:43:28 PM
 Page: 34

© 2007 - 2013 by ATC IP LLC. All rights reserved.

Load Case: 1.2D + 1.0Di + 1.0Wi	50.00 mph with 1.00 in Radial Ice	25 Iterations
Gust Response Factor : 1.10	Ice Dead Load Factor : 1.00	Wind Importance Factor : 1.00
Dead Load Factor : 1.20		Ice Importance Factor : 1.00
Wind Load Factor : 1.00		

70.00	(1) 1 5/8" Hybriflex	Yes	0.00	0.000	0.00	0.00	0.00	7.138	0.518	0.000	0.00	0.00
70.00	(4) #20 Dywidag bars	Yes	0.00	0.000	0.00	0.00	0.00	7.138	0.518	0.000	0.00	0.04
70.00	(6) 1 5/8" Coax	Yes	0.00	0.000	0.00	0.00	0.00	7.138	0.518	0.000	0.00	0.01
70.00	(4) 1/2" Coax	Yes	0.00	0.000	0.00	0.00	0.00	7.138	0.518	0.000	0.00	0.00
70.00	(2) 2" Conduit	Yes	0.00	0.000	0.00	0.00	0.00	7.138	0.518	0.000	0.00	0.01
70.00	(6) 5/16" Coax	Yes	0.00	0.000	0.00	0.00	0.00	7.138	0.518	0.000	0.00	0.00
73.50	(1) 0.39" Cable	Yes	3.50	0.000	0.00	0.00	0.00	7.212	0.523	0.000	0.00	22.71
73.50	(2) 0.78" 8 AWG 6	Yes	3.50	0.000	0.00	0.00	0.00	7.212	0.523	0.000	0.00	34.59
73.50	(1) 1 5/8" Coax	Yes	3.50	1.200	1.98	1.84	2.21	7.212	0.523	0.000	17.53	36.34
73.50	(8) 1 5/8" Coax	Yes	3.50	1.200	3.96	2.42	2.90	7.212	0.523	0.000	23.03	150.21
73.50	(2) 1/2" Coax	Yes	3.50	1.200	0.63	1.45	1.74	7.212	0.523	0.000	13.78	29.00
73.50	(8) 1 5/8" Coax	Yes	3.50	1.200	5.94	3.00	3.60	7.212	0.523	0.000	28.53	150.21
73.50	(12) 1 5/8" Coax	Yes	3.50	1.200	1.98	1.84	2.21	7.212	0.523	0.000	17.53	215.28
73.50	(1) 1 5/8" Hybriflex	Yes	3.50	0.000	0.00	0.00	0.00	7.212	0.523	0.000	0.00	37.23
73.50	(4) #20 Dywidag bars	Yes	3.50	0.000	0.00	0.00	0.00	7.212	0.523	0.000	0.00	366.92
73.50	(6) 1 5/8" Coax	Yes	3.50	0.000	0.00	0.00	0.00	7.212	0.523	0.000	0.00	117.68
73.50	(4) 1/2" Coax	Yes	3.50	0.000	0.00	0.00	0.00	7.212	0.523	0.000	0.00	37.92
73.50	(2) 2" Conduit	Yes	3.50	0.000	0.00	0.00	0.00	7.212	0.523	0.000	0.00	81.68
73.50	(6) 5/16" Coax	Yes	3.50	0.000	0.00	0.00	0.00	7.212	0.523	0.000	0.00	32.53
75.00	(1) 0.39" Cable	Yes	1.50	0.000	0.00	0.00	0.00	7.243	0.521	0.000	0.00	9.77
75.00	(2) 0.78" 8 AWG 6	Yes	1.50	0.000	0.00	0.00	0.00	7.243	0.521	0.000	0.00	14.86
75.00	(1) 1 5/8" Coax	Yes	1.50	1.200	1.98	0.79	0.95	7.243	0.521	0.000	7.55	15.62
75.00	(8) 1 5/8" Coax	Yes	1.50	1.200	3.96	1.04	1.25	7.243	0.521	0.000	9.92	64.48
75.00	(2) 1/2" Coax	Yes	1.50	1.200	0.63	0.62	0.75	7.243	0.521	0.000	5.94	12.47
75.00	(8) 1 5/8" Coax	Yes	1.50	1.200	5.94	1.28	1.54	7.243	0.521	0.000	12.29	64.48
75.00	(12) 1 5/8" Coax	Yes	1.50	1.200	1.98	0.79	0.95	7.243	0.521	0.000	7.55	92.40
75.00	(1) 1 5/8" Hybriflex	Yes	1.50	0.000	0.00	0.00	0.00	7.243	0.521	0.000	0.00	15.99
75.00	(4) #20 Dywidag bars	Yes	1.50	0.000	0.00	0.00	0.00	7.243	0.521	0.000	0.00	157.30
75.00	(6) 1 5/8" Coax	Yes	1.50	0.000	0.00	0.00	0.00	7.243	0.521	0.000	0.00	50.52
75.00	(4) 1/2" Coax	Yes	1.50	0.000	0.00	0.00	0.00	7.243	0.521	0.000	0.00	16.30
75.00	(2) 2" Conduit	Yes	1.50	0.000	0.00	0.00	0.00	7.243	0.521	0.000	0.00	35.06
75.00	(6) 5/16" Coax	Yes	1.50	0.000	0.00	0.00	0.00	7.243	0.521	0.000	0.00	13.98
80.00	(1) 0.39" Cable	Yes	5.00	0.000	0.00	0.00	0.00	7.342	0.531	0.000	0.00	32.97
80.00	(2) 0.78" 8 AWG 6	Yes	5.00	0.000	0.00	0.00	0.00	7.342	0.531	0.000	0.00	50.01
80.00	(1) 1 5/8" Coax	Yes	5.00	1.200	1.98	2.65	3.18	7.342	0.531	0.000	25.64	52.55
80.00	(8) 1 5/8" Coax	Yes	5.00	1.200	3.96	3.47	4.17	7.342	0.531	0.000	33.64	216.22
80.00	(2) 1/2" Coax	Yes	5.00	1.200	0.63	2.08	2.50	7.342	0.531	0.000	20.19	42.01
80.00	(8) 1 5/8" Coax	Yes	5.00	1.200	5.94	4.30	5.16	7.342	0.531	0.000	41.63	216.22
80.00	(12) 1 5/8" Coax	Yes	5.00	1.200	1.98	2.65	3.18	7.342	0.531	0.000	25.64	309.74
80.00	(1) 1 5/8" Hybriflex	Yes	5.00	0.000	0.00	0.00	0.00	7.342	0.531	0.000	0.00	53.79
80.00	(4) #20 Dywidag bars	Yes	5.00	0.000	0.00	0.00	0.00	7.342	0.531	0.000	0.00	525.38
80.00	(6) 1 5/8" Coax	Yes	5.00	0.000	0.00	0.00	0.00	7.342	0.531	0.000	0.00	169.46
80.00	(4) 1/2" Coax	Yes	5.00	0.000	0.00	0.00	0.00	7.342	0.531	0.000	0.00	54.84
80.00	(2) 2" Conduit	Yes	5.00	0.000	0.00	0.00	0.00	7.342	0.531	0.000	0.00	117.52
80.00	(6) 5/16" Coax	Yes	5.00	0.000	0.00	0.00	0.00	7.342	0.531	0.000	0.00	47.10
85.00	(1) 0.39" Cable	Yes	5.00	0.000	0.00	0.00	0.00	7.436	0.547	0.000	0.00	33.34
85.00	(2) 0.78" 8 AWG 6	Yes	5.00	0.000	0.00	0.00	0.00	7.436	0.547	0.000	0.00	50.45
85.00	(1) 1 5/8" Coax	Yes	5.00	1.200	1.98	2.66	3.19	7.436	0.547	0.000	26.08	53.01
85.00	(8) 1 5/8" Coax	Yes	5.00	1.200	3.96	3.48	4.18	7.436	0.547	0.000	34.18	217.39
85.00	(2) 1/2" Coax	Yes	5.00	1.200	0.63	2.09	2.51	7.436	0.547	0.000	20.56	42.43
85.00	(8) 1 5/8" Coax	Yes	5.00	1.200	5.94	4.31	5.17	7.436	0.547	0.000	42.28	217.39
85.00	(12) 1 5/8" Coax	Yes	5.00	1.200	1.98	2.66	3.19	7.436	0.547	0.000	26.08	311.33
85.00	(1) 1 5/8" Hybriflex	Yes	5.00	0.000	0.00	0.00	0.00	7.436	0.547	0.000	0.00	54.23
85.00	(4) #20 Dywidag bars	Yes	5.00	0.000	0.00	0.00	0.00	7.436	0.547	0.000	0.00	526.25
85.00	(6) 1 5/8" Coax	Yes	5.00	0.000	0.00	0.00	0.00	7.436	0.547	0.000	0.00	170.43
85.00	(4) 1/2" Coax	Yes	5.00	0.000	0.00	0.00	0.00	7.436	0.547	0.000	0.00	55.33
85.00	(2) 2" Conduit	Yes	5.00	0.000	0.00	0.00	0.00	7.436	0.547	0.000	0.00	118.12

Pole : 302489
 Location : Enfd - Enfield, CT
 Height : 150.00 (ft)
 Base Dia : 37.380 (in)
 Top Dia : 15.000 (in)
 Shape : 12 Sides
 Taper : 0.156700 (in/ft)

Code: ANSI/TIA-222 Rev G
 Struct Class : II
 Exposure Category : C
 Topographic Category : 1
 Base Elev : 0.000 (ft)

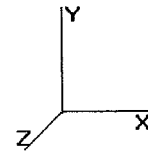

8/2/2013 4:43:28 PM
 Page: 35

© 2007 - 2013 by ATC IP LLC. All rights reserved.

Load Case: 1.2D + 1.0Di + 1.0Wl	50.00 mph with 1.00 in Radial Ice	25 Iterations
Gust Response Factor : 1.10	Ice Dead Load Factor : 1.00	Wind Importance Factor : 1.00
Dead Load Factor : 1.20		Ice Importance Factor : 1.00
Wind Load Factor : 1.00		

85.00	(6) 5/16" Coax	Yes	5.00	0.000	0.00	0.00	0.00	7.436	0.547	0.000	0.00	47.55
90.00	(1) 0.39" Cable	Yes	5.00	0.000	0.00	0.00	0.00	7.526	0.565	0.000	0.00	33.70
90.00	(2) 0.78" 8 AWG 6	Yes	5.00	0.000	0.00	0.00	0.00	7.526	0.565	0.000	0.00	50.87
90.00	(1) 1 5/8" Coax	Yes	5.00	1.200	1.98	2.67	3.20	7.526	0.565	0.000	26.50	53.44
90.00	(8) 1 5/8" Coax	Yes	5.00	1.200	3.96	3.49	4.19	7.526	0.565	0.000	34.70	218.51
90.00	(2) 1/2" Coax	Yes	5.00	1.200	0.63	2.11	2.53	7.526	0.565	0.000	20.91	42.83
90.00	(8) 1 5/8" Coax	Yes	5.00	1.200	5.94	4.32	5.18	7.526	0.565	0.000	42.89	218.51
90.00	(12) 1 5/8" Coax	Yes	5.00	1.200	1.98	2.67	3.20	7.526	0.565	0.000	26.50	312.83
90.00	(1) 1 5/8" Hybriflex	Yes	5.00	0.000	0.00	0.00	0.00	7.526	0.565	0.000	0.00	54.65
90.00	(4) #20 Dywidag bars	Yes	5.00	0.000	0.00	0.00	0.00	7.526	0.565	0.000	0.00	527.08
90.00	(6) 1 5/8" Coax	Yes	5.00	0.000	0.00	0.00	0.00	7.526	0.565	0.000	0.00	171.35
90.00	(4) 1/2" Coax	Yes	5.00	0.000	0.00	0.00	0.00	7.526	0.565	0.000	0.00	55.79
90.00	(2) 2" Conduit	Yes	5.00	0.000	0.00	0.00	0.00	7.526	0.565	0.000	0.00	118.69
90.00	(6) 5/16" Coax	Yes	5.00	0.000	0.00	0.00	0.00	7.526	0.565	0.000	0.00	47.98
95.00	(1) 0.39" Cable	Yes	5.00	0.000	0.00	0.00	0.00	7.612	0.583	0.000	0.00	34.04
95.00	(2) 0.78" 8 AWG 6	Yes	5.00	0.000	0.00	0.00	0.00	7.612	0.583	0.000	0.00	51.26
95.00	(1) 1 5/8" Coax	Yes	5.00	1.200	1.98	2.68	3.21	7.612	0.583	0.000	26.90	53.86
95.00	(8) 1 5/8" Coax	Yes	5.00	1.200	3.96	3.50	4.20	7.612	0.583	0.000	35.19	219.57
95.00	(2) 1/2" Coax	Yes	5.00	1.200	0.63	2.12	2.54	7.612	0.583	0.000	21.25	43.21
95.00	(8) 1 5/8" Coax	Yes	5.00	1.200	5.94	4.33	5.19	7.612	0.583	0.000	43.48	219.57
95.00	(12) 1 5/8" Coax	Yes	5.00	1.200	1.98	2.68	3.21	7.612	0.583	0.000	26.90	314.26
95.00	(1) 1 5/8" Hybriflex	Yes	5.00	0.000	0.00	0.00	0.00	7.612	0.583	0.000	0.00	55.05
95.00	(4) #20 Dywidag bars	Yes	5.00	0.000	0.00	0.00	0.00	7.612	0.583	0.000	0.00	527.87
95.00	(6) 1 5/8" Coax	Yes	5.00	0.000	0.00	0.00	0.00	7.612	0.583	0.000	0.00	172.23
95.00	(4) 1/2" Coax	Yes	5.00	0.000	0.00	0.00	0.00	7.612	0.583	0.000	0.00	56.23
95.00	(2) 2" Conduit	Yes	5.00	0.000	0.00	0.00	0.00	7.612	0.583	0.000	0.00	119.23
95.00	(6) 5/16" Coax	Yes	5.00	0.000	0.00	0.00	0.00	7.612	0.583	0.000	0.00	48.40
100.0	(1) 0.39" Cable	Yes	5.00	0.000	0.00	0.00	0.00	7.695	0.603	0.000	0.00	34.37
100.0	(2) 0.78" 8 AWG 6	Yes	5.00	0.000	0.00	0.00	0.00	7.695	0.603	0.000	0.00	51.64
100.0	(1) 1 5/8" Coax	Yes	5.00	1.200	1.98	2.69	3.22	7.695	0.603	0.000	27.29	54.26
100.0	(8) 1 5/8" Coax	Yes	5.00	1.200	3.96	3.51	4.21	7.695	0.603	0.000	35.67	220.59
100.0	(2) 1/2" Coax	Yes	5.00	1.200	0.63	2.12	2.55	7.695	0.603	0.000	21.58	43.58
100.0	(8) 1 5/8" Coax	Yes	5.00	1.200	5.94	4.34	5.20	7.695	0.603	0.000	44.05	220.59
100.0	(12) 1 5/8" Coax	Yes	5.00	1.200	1.98	2.69	3.22	7.695	0.603	0.000	27.29	315.63
100.0	(1) 1 5/8" Hybriflex	Yes	5.00	0.000	0.00	0.00	0.00	7.695	0.603	0.000	0.00	55.43
100.0	(4) #20 Dywidag bars	Yes	5.00	0.000	0.00	0.00	0.00	7.695	0.603	0.000	0.00	528.63
100.0	(6) 1 5/8" Coax	Yes	5.00	0.000	0.00	0.00	0.00	7.695	0.603	0.000	0.00	173.07
100.0	(4) 1/2" Coax	Yes	5.00	0.000	0.00	0.00	0.00	7.695	0.603	0.000	0.00	56.66
100.0	(2) 2" Conduit	Yes	5.00	0.000	0.00	0.00	0.00	7.695	0.603	0.000	0.00	119.75
100.0	(6) 5/16" Coax	Yes	5.00	0.000	0.00	0.00	0.00	7.695	0.603	0.000	0.00	48.79
103.0	(1) 0.39" Cable	Yes	3.00	0.000	0.00	0.00	0.00	7.743	0.619	0.000	0.00	20.74
103.0	(2) 0.78" 8 AWG 6	Yes	3.00	0.000	0.00	0.00	0.00	7.743	0.619	0.000	0.00	31.12
103.0	(1) 1 5/8" Coax	Yes	3.00	1.200	1.98	1.62	1.94	7.743	0.619	0.000	16.51	32.70
103.0	(8) 1 5/8" Coax	Yes	3.00	1.200	3.96	2.11	2.53	7.743	0.619	0.000	21.57	132.71
103.0	(2) 1/2" Coax	Yes	3.00	1.200	0.63	1.28	1.53	7.743	0.619	0.000	13.06	26.28
103.0	(8) 1 5/8" Coax	Yes	3.00	1.200	5.94	2.61	3.13	7.743	0.619	0.000	26.63	132.71
103.0	(12) 1 5/8" Coax	Yes	3.00	1.200	1.98	1.62	1.94	7.743	0.619	0.000	16.51	189.85
103.0	(1) 1 5/8" Hybriflex	Yes	3.00	0.000	0.00	0.00	0.00	7.743	0.619	0.000	0.00	33.39
103.0	(4) #20 Dywidag bars	Yes	3.00	0.000	0.00	0.00	0.00	7.743	0.619	0.000	0.00	317.44
103.0	(6) 1 5/8" Coax	Yes	3.00	0.000	0.00	0.00	0.00	7.743	0.619	0.000	0.00	104.13
103.0	(4) 1/2" Coax	Yes	3.00	0.000	0.00	0.00	0.00	7.743	0.619	0.000	0.00	34.14
103.0	(2) 2" Conduit	Yes	3.00	0.000	0.00	0.00	0.00	7.743	0.619	0.000	0.00	72.03
103.0	(6) 5/16" Coax	Yes	3.00	0.000	0.00	0.00	0.00	7.743	0.619	0.000	0.00	29.41
105.0	(1) 0.39" Cable	Yes	2.00	0.000	0.00	0.00	0.00	7.774	0.630	0.000	0.00	13.88
105.0	(2) 0.78" 8 AWG 6	Yes	2.00	0.000	0.00	0.00	0.00	7.774	0.630	0.000	0.00	20.80
105.0	(1) 1 5/8" Coax	Yes	2.00	1.200	1.98	1.08	1.29	7.774	0.630	0.000	11.07	21.86
105.0	(8) 1 5/8" Coax	Yes	2.00	1.200	3.96	1.41	1.69	7.774	0.630	0.000	14.45	88.62

Pole : 302489
 Location : Enfd - Enfield, CT
 Height : 150.00 (ft)
 Base Dia : 37.380 (in)
 Top Dia : 15.000 (in)
 Shape : 12 Sides
 Taper : 0.156700 (in/ft)

Code: ANSI/TIA-222 Rev G
 Struct Class : II
 Exposure Category : C
 Topographic Category : 1
 Base Elev : 0.000 (ft)

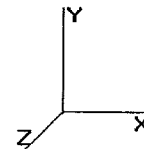

8/2/2013 4:43:28 PM
 Page: 36

© 2007 - 2013 by ATC IP LLC. All rights reserved.

Load Case: 1.2D + 1.0Di + 1.0Wi 50.00 mph with 1.00 in Radial Ice 25 Iterations
 Gust Response Factor 1.10 Ice Dead Load Factor : 1.00 Wind Importance Factor : 1.00
 Dead Load Factor : 1.20 Ice Importance Factor : 1.00
 Wind Load Factor : 1.00

105.0	(2) 1/2" Coax	Yes	2.00	1.200	0.63	0.85	1.02	7.774	0.630	0.000	8.76	17.57
105.0	(8) 1 5/8" Coax	Yes	2.00	1.200	5.94	1.74	2.09	7.774	0.630	0.000	17.84	88.62
105.0	(12) 1 5/8" Coax	Yes	2.00	1.200	1.98	1.08	1.29	7.774	0.630	0.000	11.07	126.78
105.0	(1) 1 5/8" Hybriflex	Yes	2.00	0.000	0.00	0.00	0.00	7.774	0.630	0.000	0.00	22.32
105.0	(4) #20 Dywidag bars	Yes	2.00	0.000	0.00	0.00	0.00	7.774	0.630	0.000	0.00	211.74
105.0	(6) 1 5/8" Coax	Yes	2.00	0.000	0.00	0.00	0.00	7.774	0.630	0.000	0.00	69.55
110.0	(1) 0.39" Cable	Yes	5.00	0.000	0.00	0.00	0.00	7.851	0.646	0.000	0.00	34.99
110.0	(2) 0.78" 8 AWG 6	Yes	5.00	0.000	0.00	0.00	0.00	7.851	0.646	0.000	0.00	52.36
110.0	(1) 1 5/8" Coax	Yes	5.00	1.200	1.98	2.70	3.25	7.851	0.646	0.000	28.03	55.01
110.0	(8) 1 5/8" Coax	Yes	5.00	1.200	3.96	3.53	4.24	7.851	0.646	0.000	36.58	222.49
110.0	(2) 1/2" Coax	Yes	5.00	1.200	0.63	2.14	2.57	7.851	0.646	0.000	22.20	44.27
110.0	(8) 1 5/8" Coax	Yes	5.00	1.200	5.94	4.35	5.23	7.851	0.646	0.000	45.13	222.49
110.0	(12) 1 5/8" Coax	Yes	5.00	1.200	1.98	2.70	3.25	7.851	0.646	0.000	28.03	318.20
110.0	(1) 1 5/8" Hybriflex	Yes	5.00	0.000	0.00	0.00	0.00	7.851	0.646	0.000	0.00	56.16
110.0	(4) #20 Dywidag bars	Yes	5.00	0.000	0.00	0.00	0.00	7.851	0.646	0.000	0.00	530.05
110.0	(6) 1 5/8" Coax	Yes	5.00	0.000	0.00	0.00	0.00	7.851	0.646	0.000	0.00	174.64
110.0	(1) 0.39" Cable	Yes	0.00	0.000	0.00	0.00	0.00	7.851	0.658	0.000	0.00	0.00
110.0	(2) 0.78" 8 AWG 6	Yes	0.00	0.000	0.00	0.00	0.00	7.851	0.658	0.000	0.00	0.00
110.0	(1) 1 5/8" Coax	Yes	0.00	1.200	1.98	0.00	0.00	7.851	0.658	0.000	0.00	0.00
110.0	(8) 1 5/8" Coax	Yes	0.00	1.200	3.96	0.00	0.00	7.851	0.658	0.000	0.00	0.01
110.0	(2) 1/2" Coax	Yes	0.00	1.200	0.63	0.00	0.00	7.851	0.658	0.000	0.00	0.00
110.0	(8) 1 5/8" Coax	Yes	0.00	1.200	5.94	0.00	0.00	7.851	0.658	0.000	0.00	0.01
110.0	(12) 1 5/8" Coax	Yes	0.00	1.200	1.98	0.00	0.00	7.851	0.658	0.000	0.00	0.02
110.0	(1) 1 5/8" Hybriflex	Yes	0.00	0.000	0.00	0.00	0.00	7.851	0.658	0.000	0.00	0.00
110.0	(4) #20 Dywidag bars	Yes	0.00	0.000	0.00	0.00	0.00	7.851	0.658	0.000	0.00	0.04
110.0	(6) 1 5/8" Coax	Yes	0.00	0.000	0.00	0.00	0.00	7.851	0.658	0.000	0.00	0.01
115.0	(1) 0.39" Cable	Yes	5.00	0.000	0.00	0.00	0.00	7.925	0.670	0.000	0.00	35.28
115.0	(2) 0.78" 8 AWG 6	Yes	5.00	0.000	0.00	0.00	0.00	7.925	0.670	0.000	0.00	52.70
115.0	(1) 1 5/8" Coax	Yes	5.00	1.200	1.98	2.71	3.26	7.925	0.670	0.000	28.38	55.36
115.0	(8) 1 5/8" Coax	Yes	5.00	1.200	3.96	3.54	4.25	7.925	0.670	0.000	37.01	223.37
115.0	(2) 1/2" Coax	Yes	5.00	1.200	0.63	2.15	2.58	7.925	0.670	0.000	22.50	44.59
115.0	(8) 1 5/8" Coax	Yes	5.00	1.200	5.94	4.36	5.24	7.925	0.670	0.000	45.64	223.37
115.0	(12) 1 5/8" Coax	Yes	5.00	1.200	1.98	2.71	3.26	7.925	0.670	0.000	28.38	319.38
115.0	(1) 1 5/8" Hybriflex	Yes	5.00	0.000	0.00	0.00	0.00	7.925	0.670	0.000	0.00	56.49
115.0	(4) #20 Dywidag bars	Yes	5.00	0.000	0.00	0.00	0.00	7.925	0.670	0.000	0.00	530.68
115.0	(6) 1 5/8" Coax	Yes	5.00	0.000	0.00	0.00	0.00	7.925	0.670	0.000	0.00	175.37
120.0	(1) 0.39" Cable	Yes	5.00	0.000	0.00	0.00	0.00	7.996	0.697	0.000	0.00	35.57
120.0	(2) 0.78" 8 AWG 6	Yes	5.00	0.000	0.00	0.00	0.00	7.996	0.697	0.000	0.00	53.03
120.0	(1) 1 5/8" Coax	Yes	5.00	1.200	1.98	2.72	3.27	7.996	0.697	0.000	28.72	55.71
120.0	(8) 1 5/8" Coax	Yes	5.00	1.200	3.96	3.55	4.26	7.996	0.697	0.000	37.43	224.25
120.0	(2) 1/2" Coax	Yes	5.00	1.200	0.63	2.16	2.59	7.996	0.697	0.000	22.79	44.91
120.0	(8) 1 5/8" Coax	Yes	5.00	1.200	5.94	4.37	5.25	7.996	0.697	0.000	46.14	224.25
120.0	(12) 1 5/8" Coax	Yes	5.00	1.200	1.98	2.72	3.27	7.996	0.697	0.000	28.72	320.56
120.0	(1) 1 5/8" Hybriflex	Yes	5.00	0.000	0.00	0.00	0.00	7.996	0.697	0.000	0.00	56.83
120.0	(4) #20 Dywidag bars	Yes	5.00	0.000	0.00	0.00	0.00	7.996	0.697	0.000	0.00	531.36
121.0	(1) 0.39" Cable	Yes	1.00	0.000	0.00	0.00	0.00	8.010	0.713	0.000	0.00	7.12
121.0	(2) 0.78" 8 AWG 6	Yes	1.00	0.000	0.00	0.00	0.00	8.010	0.713	0.000	0.00	10.62
121.0	(1) 1 5/8" Coax	Yes	1.00	1.200	1.98	0.54	0.65	8.010	0.713	0.000	5.76	11.16
121.0	(8) 1 5/8" Coax	Yes	1.00	1.200	3.96	0.71	0.85	8.010	0.713	0.000	7.50	44.88
121.0	(2) 1/2" Coax	Yes	1.00	1.200	0.63	0.43	0.52	8.010	0.713	0.000	4.57	8.99
121.0	(8) 1 5/8" Coax	Yes	1.00	1.200	5.94	0.87	1.05	8.010	0.713	0.000	9.25	44.88
121.0	(12) 1 5/8" Coax	Yes	1.00	1.200	1.98	0.54	0.65	8.010	0.713	0.000	5.76	64.16
121.0	(1) 1 5/8" Hybriflex	Yes	1.00	0.000	0.00	0.00	0.00	8.010	0.713	0.000	0.00	11.38
121.0	(4) #20 Dywidag bars	Yes	1.00	0.000	0.00	0.00	0.00	8.010	0.713	0.000	0.00	106.30
125.0	(1) 0.39" Cable	Yes	4.00	0.000	0.00	0.00	0.00	8.065	0.728	0.000	0.00	28.67
125.0	(2) 0.78" 8 AWG 6	Yes	4.00	0.000	0.00	0.00	0.00	8.065	0.728	0.000	0.00	42.67
125.0	(1) 1 5/8" Coax	Yes	4.00	1.200	1.98	2.18	2.62	8.065	0.728	0.000	23.24	44.83

Pole : 302489
 Location : Enfd - Enfield, CT
 Height : 150.00 (ft)
 Base Dia : 37.380 (in)
 Top Dia : 15.000 (in)
 Shape : 12 Sides
 Taper : 0.156700 (in/ft)

Code: ANSI/TIA-222 Rev G
 Struct Class : II
 Exposure Category : C
 Topographic Category : 1
 Base Elev : 0.000 (ft)

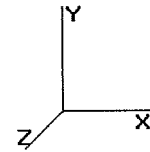

8/2/2013 4:43:28 PM
 Page: 37

© 2007 - 2013 by ATC IP LLC. All rights reserved.

Load Case: 1.2D + 1.0Di + 1.0W 50.00 mph with 1.00 in Radial Ice 25 Iterations
 Gust Response Factor 1.10 Ice Dead Load Factor : 1.00 Wind Importance Factor : 1.00
 Dead Load Factor : 1.20 Ice Importance Factor : 1.00
 Wind Load Factor : 1.00

125.0	(8) 1 5/8" Coax	Yes	4.00	1.200	3.96	2.84	3.41	8.065	0.728	0.000	30.27	180.07
125.0	(2) 1/2" Coax	Yes	4.00	1.200	0.63	1.73	2.08	8.065	0.728	0.000	18.45	36.17
125.0	(8) 1 5/8" Coax	Yes	4.00	1.200	5.94	3.50	4.20	8.065	0.728	0.000	37.30	180.07
125.0	(12) 1 5/8" Coax	Yes	4.00	1.200	1.98	2.18	2.62	8.065	0.728	0.000	23.24	257.35
125.0	(1) 1 5/8" Hybriflex	Yes	4.00	0.000	0.00	0.00	0.00	8.065	0.728	0.000	0.00	45.72
125.0	(4) #20 Dywidag bars	Yes	4.00	0.000	0.00	0.00	0.00	8.065	0.728	0.000	0.00	425.58
126.0	(1) 0.39" Cable	Yes	1.00	0.000	0.00	0.00	0.00	8.079	0.743	0.000	0.00	7.18
126.0	(2) 0.78" 8 AWG 6	Yes	1.00	0.000	0.00	0.00	0.00	8.079	0.743	0.000	0.00	10.68
126.0	(1) 1 5/8" Coax	Yes	1.00	1.200	1.98	0.55	0.66	8.079	0.743	0.000	5.82	11.22
126.0	(8) 1 5/8" Coax	Yes	1.00	1.200	3.96	0.71	0.85	8.079	0.743	0.000	7.58	45.05
126.0	(2) 1/2" Coax	Yes	1.00	1.200	0.63	0.43	0.52	8.079	0.743	0.000	4.62	9.06
126.0	(8) 1 5/8" Coax	Yes	1.00	1.200	5.94	0.88	1.05	8.079	0.743	0.000	9.34	45.05
126.0	(12) 1 5/8" Coax	Yes	1.00	1.200	1.98	0.55	0.66	8.079	0.743	0.000	5.82	64.38
126.0	(1) 1 5/8" Hybriflex	Yes	1.00	0.000	0.00	0.00	0.00	8.079	0.743	0.000	0.00	11.44
126.0	(4) #20 Dywidag bars	Yes	0.51	0.000	0.00	0.00	0.00	8.079	0.743	0.000	0.00	54.27
130.0	(1) 0.39" Cable	Yes	4.00	0.000	0.00	0.00	0.00	8.132	0.655	0.000	0.00	28.88
130.0	(2) 0.78" 8 AWG 6	Yes	4.00	0.000	0.00	0.00	0.00	8.132	0.655	0.000	0.00	42.92
130.0	(1) 1 5/8" Coax	Yes	4.00	1.200	1.98	2.19	2.63	8.132	0.655	0.000	23.50	45.09
130.0	(8) 1 5/8" Coax	Yes	4.00	1.200	3.96	2.85	3.42	8.132	0.655	0.000	30.58	180.71
130.0	(2) 1/2" Coax	Yes	4.00	1.200	0.63	1.74	2.09	8.132	0.655	0.000	18.67	36.41
130.0	(8) 1 5/8" Coax	Yes	4.00	1.200	5.94	3.51	4.21	8.132	0.655	0.000	37.67	180.71
135.0	(1) 0.39" Cable	Yes	5.00	0.000	0.00	0.00	0.00	8.197	0.681	0.000	0.00	36.36
135.0	(2) 0.78" 8 AWG 6	Yes	5.00	0.000	0.00	0.00	0.00	8.197	0.681	0.000	0.00	53.94
135.0	(1) 1 5/8" Coax	Yes	5.00	1.200	1.98	2.74	3.29	8.197	0.681	0.000	29.69	56.67
135.0	(8) 1 5/8" Coax	Yes	5.00	1.200	3.96	3.57	4.28	8.197	0.681	0.000	38.61	226.67
135.0	(2) 1/2" Coax	Yes	5.00	1.200	0.63	2.18	2.62	8.197	0.681	0.000	23.60	45.80
135.0	(8) 1 5/8" Coax	Yes	5.00	1.200	5.94	4.39	5.27	8.197	0.681	0.000	47.54	226.67
140.0	(1) 0.39" Cable	Yes	5.00	0.000	0.00	0.00	0.00	8.260	0.713	0.000	0.00	36.61
140.0	(2) 0.78" 8 AWG 6	Yes	5.00	0.000	0.00	0.00	0.00	8.260	0.713	0.000	0.00	54.23
140.0	(1) 1 5/8" Coax	Yes	5.00	1.200	1.98	2.75	3.30	8.260	0.713	0.000	29.99	56.97
140.0	(8) 1 5/8" Coax	Yes	5.00	1.200	3.96	3.58	4.29	8.260	0.713	0.000	38.99	227.42
140.0	(2) 1/2" Coax	Yes	5.00	1.200	0.63	2.19	2.63	8.260	0.713	0.000	23.86	46.08
140.0	(8) 1 5/8" Coax	Yes	5.00	1.200	5.94	4.40	5.28	8.260	0.713	0.000	47.98	227.42
144.0	(1) 0.39" Cable	Yes	4.00	0.000	0.00	0.00	0.00	8.309	0.390	0.000	0.00	29.44
144.0	(2) 0.78" 8 AWG 6	Yes	4.00	0.000	0.00	0.00	0.00	8.309	0.390	0.000	0.00	43.56
144.0	(1) 1 5/8" Coax	Yes	4.00	1.200	1.98	2.20	2.65	8.309	0.390	0.000	24.18	45.77
144.0	(8) 1 5/8" Coax	Yes	4.00	1.200	3.96	2.86	3.44	8.309	0.390	0.000	31.42	182.41
144.0	(2) 1/2" Coax	Yes	4.00	1.200	0.63	1.75	2.11	8.309	0.390	0.000	19.25	37.03
145.0	(1) 0.39" Cable	Yes	1.00	0.000	0.00	0.00	0.00	8.321	0.362	0.000	0.00	7.37
145.0	(2) 0.78" 8 AWG 6	Yes	1.00	0.000	0.00	0.00	0.00	8.321	0.362	0.000	0.00	10.90
145.0	(1) 1 5/8" Coax	Yes	1.00	1.200	1.98	0.55	0.66	8.321	0.362	0.000	6.06	11.45
145.0	(8) 1 5/8" Coax	Yes	1.00	1.200	3.96	0.72	0.86	8.321	0.362	0.000	7.87	45.63
150.0	(1) 0.39" Cable	Yes	5.00	0.000	0.00	0.00	0.00	8.381	0.373	0.000	0.00	37.09
150.0	(2) 0.78" 8 AWG 6	Yes	5.00	0.000	0.00	0.00	0.00	8.381	0.373	0.000	0.00	54.78
150.0	(1) 1 5/8" Coax	Yes	5.00	1.200	1.98	2.76	3.32	8.381	0.373	0.000	30.58	57.55
150.0	(8) 1 5/8" Coax	Yes	5.00	1.200	3.96	3.59	4.31	8.381	0.373	0.000	39.70	228.86
Totals:											4,013.13	45,379.65

Pole : 302489
 Location : Enfd - Enfield, CT
 Height : 150.00 (ft)
 Base Dia : 37.380 (in)
 Top Dia : 15.000 (in)
 Shape : 12 Sides
 Taper : 0.156700 (in/ft)

Code: ANSI/TIA-222 Rev G
 Struct Class : II
 Exposure Category : C
 Topographic Category : 1
 Base Elev : 0.000 (ft)

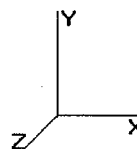

8/2/2013 4:43:28 PM
 Page: 38

© 2007 - 2013 by ATC IP LLC. All rights reserved.

Load Case: 1.2D + 1.0Di + 1.0Wi 50.00 mph with 1.00 in Radial Ice 25 Iterations

Gust Response Factor 1.10 Ice Dead Load Factor : 1.00 Wind Importance Factor : 1.00
 Dead Load Factor : 1.20 Ice Importance Factor : 1.00
 Wind Load Factor : 1.00

Applied Segment Forces Summary

Seg Elev (ft)	Lateral FX (-) (lb)	Axial FY (-) (lb)	Torsion MY (lb-ft)	Moment MZ (lb-ft)
0.00	0.00	0.00	0.00	0.00
5.00	118.26	2,473.03	0.00	0.00
10.00	116.63	2,482.56	0.00	0.00
15.00	263.88	3,777.77	0.00	0.00
20.00	280.03	3,800.55	0.00	0.00
25.00	293.02	3,812.72	0.00	0.00
30.00	303.62	3,817.93	0.00	0.00
31.50	91.67	1,143.77	0.00	0.00
35.00	175.09	3,126.91	0.00	0.00
35.67	32.85	594.10	0.00	0.00
40.00	218.24	3,191.44	0.00	0.00
45.00	256.49	3,680.10	0.00	0.00
50.00	260.23	3,674.09	0.00	0.00
55.00	263.37	3,666.18	0.00	0.00
56.00	214.44	1,072.79	0.00	323.79
60.00	212.55	2,896.99	0.00	0.00
65.00	268.17	3,277.47	0.00	0.00
70.00	269.96	3,264.93	0.00	0.00
70.00	0.02	0.22	0.00	0.00
73.50	190.79	2,592.86	0.00	0.00
75.00	81.68	946.27	0.00	0.00
80.00	274.60	3,148.26	0.00	0.00
85.00	275.46	3,136.26	0.00	0.00
90.00	276.06	3,123.55	0.00	0.00
95.00	276.43	3,110.18	0.00	0.00
100.0	276.58	3,096.21	0.00	0.00
103.0	535.06	5,284.51	0.00	1,000.39
105.0	110.19	1,140.54	0.00	0.00
110.0	276.29	2,838.99	0.00	0.00
110.0	0.02	0.19	0.00	0.00
115.0	373.21	3,332.81	0.00	292.08
120.0	275.30	2,548.44	0.00	0.00
121.0	54.75	508.33	0.00	0.00
125.0	219.37	1,758.90	0.00	0.00
126.0	914.94	5,921.66	0.00	443.51
130.0	195.17	1,016.53	0.00	0.00
135.0	243.01	1,254.25	0.00	0.00
140.0	900.66	5,171.05	0.00	0.00
144.0	333.43	1,358.90	0.00	0.00
145.0	33.20	182.20	0.00	0.00
150.0	1,353.38	9,373.36	0.00	1,945.29
Totals:	11,108.10	110,597.79	0.00	4,005.06

Pole : 302489
 Location : Enfd - Enfield, CT
 Height : 150.00 (ft)
 Base Dia : 37.380 (in)
 Top Dia : 15.000 (in)
 Shape : 12 Sides
 Taper : 0.156700 (in/ft)

Code: ANSI/TIA-222 Rev G
 Struct Class : II
 Exposure Category : C
 Topographic Category : 1
 Base Elev : 0.000 (ft)

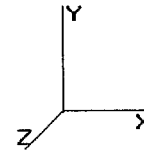

8/2/2013 4:43:28 PM
 Page: 39

© 2007 - 2013 by ATC IP LLC. All rights reserved.

Load Case: 1.2D + 1.0Di + 1.0Wl	50.00 mph with 1.00 in Radial Ice	25 Iterations
Gust Response Factor : 1.10	Ice Dead Load Factor : 1.00	Wind Importance Factor : 1.00
Dead Load Factor : 1.20		Ice Importance Factor : 1.00
Wind Load Factor : 1.00		

Calculated Forces

Seg Elev (ft)	Pu FY (-) (kips)	Vu FX (-) (kips)	Tu MY (ft-kips)	Mu MZ (ft-kips)	Mu MX (ft-kips)	Resultant Moment (ft-kips)	phi Pn (kips)	phi Vn (kips)	phi Tn (ft-kips)	phi Mn (ft-kips)	Total Deflect (in)	Rotation (deg)	Ratio
0.00	-110.59	-11.19	0.00	-1,192.43	0.00	1,192.43	3,133.66	1,566.83	4,776.46	2,358.91	0.00	0.00	0.211
5.00	-108.10	-11.22	0.00	-1,136.49	0.00	1,136.49	3,091.35	1,545.67	4,611.19	2,277.30	0.04	-0.08	0.204
10.00	-105.60	-11.24	0.00	-1,080.39	0.00	1,080.39	3,047.99	1,524.00	4,447.17	2,196.29	0.17	-0.16	0.197
15.00	-101.81	-11.11	0.00	-1,024.18	0.00	1,024.18	3,003.60	1,501.80	4,284.50	2,115.95	0.38	-0.24	0.190
20.00	-98.00	-10.94	0.00	-968.64	0.00	968.64	2,958.17	1,479.08	4,123.27	2,036.33	0.68	-0.32	0.182
25.00	-94.17	-10.75	0.00	-913.93	0.00	913.93	2,911.70	1,455.85	3,963.58	1,957.46	1.05	-0.40	0.175
30.00	-90.35	-10.50	0.00	-860.17	0.00	860.17	2,864.18	1,432.09	3,805.55	1,879.42	1.51	-0.47	0.167
31.50	-89.20	-10.46	0.00	-844.42	0.00	844.42	2,849.72	1,424.86	3,758.46	1,856.16	1.66	-0.50	0.165
35.00	-86.07	-10.30	0.00	-807.83	0.00	807.83	2,805.48	1,402.74	3,636.10	1,795.73	2.04	-0.55	0.157
35.67	-85.47	-10.32	0.00	-800.96	0.00	800.96	2,231.07	1,115.54	2,951.42	1,457.59	2.12	-0.56	0.177
40.00	-82.27	-10.16	0.00	-756.26	0.00	756.26	2,201.95	1,100.98	2,850.70	1,407.85	2.66	-0.62	0.169
45.00	-78.58	-9.96	0.00	-705.45	0.00	705.45	2,167.39	1,083.69	2,735.30	1,350.86	3.35	-0.70	0.160
50.00	-74.89	-9.75	0.00	-655.62	0.00	655.62	2,131.78	1,065.89	2,620.87	1,294.35	4.12	-0.77	0.150
55.00	-71.22	-9.49	0.00	-606.87	0.00	606.87	2,095.13	1,047.56	2,507.52	1,238.37	4.96	-0.84	0.141
56.00	-70.15	-9.30	0.00	-597.06	0.00	597.06	2,087.67	1,043.84	2,484.99	1,227.24	5.14	-0.85	0.139
60.00	-67.25	-9.11	0.00	-559.87	0.00	559.87	2,057.44	1,028.72	2,395.35	1,182.97	5.88	-0.91	0.132
60.00	-67.25	-9.11	0.00	-559.87	0.00	559.87	2,057.44	1,028.72	2,395.35	1,182.97	5.88	-0.91	0.246
65.00	-63.96	-8.90	0.00	-514.30	0.00	514.30	2,018.71	1,009.36	2,284.46	1,128.21	6.86	-0.97	0.233
70.00	-60.69	-8.63	0.00	-469.82	0.00	469.82	1,978.94	989.47	2,174.96	1,074.13	7.94	-1.09	0.219
70.00	-60.68	-8.68	0.00	-469.82	0.00	469.82	1,978.94	989.47	2,174.95	1,074.12	7.94	-1.09	0.219
73.50	-58.09	-8.50	0.00	-439.45	0.00	439.45	1,462.64	731.32	1,612.09	796.15	8.78	-1.18	0.245
75.00	-57.13	-8.47	0.00	-426.71	0.00	426.71	1,455.06	727.53	1,589.51	785.00	9.16	-1.22	0.240
80.00	-53.97	-8.24	0.00	-384.34	0.00	384.34	1,429.11	714.55	1,514.58	747.99	10.50	-1.34	0.222
85.00	-50.83	-7.99	0.00	-343.14	0.00	343.14	1,402.12	701.06	1,440.27	711.29	11.96	-1.45	0.203
90.00	-47.70	-7.72	0.00	-303.19	0.00	303.19	1,374.09	687.04	1,366.68	674.95	13.54	-1.56	0.185
95.00	-44.58	-7.44	0.00	-264.58	0.00	264.58	1,345.02	672.51	1,293.93	639.02	15.24	-1.67	0.166
100.00	-41.49	-7.12	0.00	-227.41	0.00	227.41	1,314.91	657.46	1,222.10	603.55	17.04	-1.76	0.147
103.00	-36.22	-6.45	0.00	-205.05	0.00	205.05	1,296.35	648.17	1,179.50	582.51	18.16	-1.82	0.134
105.00	-35.08	-6.34	0.00	-192.15	0.00	192.15	1,283.76	641.88	1,151.31	568.59	18.93	-1.85	0.127
110.00	-32.24	-5.99	0.00	-160.47	0.00	160.47	1,247.14	623.57	1,077.81	532.29	20.92	-1.93	0.111
110.00	-32.24	-6.01	0.00	-160.47	0.00	160.47	1,247.13	623.57	1,077.80	532.29	20.92	-1.93	0.111
110.00	-32.24	-6.01	0.00	-160.47	0.00	160.47	846.54	423.27	735.96	363.46	20.92	-1.93	0.134
115.00	-28.91	-5.56	0.00	-130.13	0.00	130.13	828.55	414.27	693.31	342.40	22.98	-2.00	0.112
120.00	-26.37	-5.21	0.00	-102.35	0.00	102.35	809.51	404.76	651.00	321.50	25.12	-2.07	0.091
121.00	-25.87	-5.15	0.00	-97.15	0.00	97.15	805.58	402.79	642.58	317.35	25.55	-2.08	0.087
121.00	-25.87	-5.15	0.00	-97.15	0.00	97.15	805.58	402.79	642.58	317.35	25.55	-2.08	0.338
125.00	-24.11	-4.88	0.00	-76.56	0.00	76.56	789.44	394.72	609.12	300.82	27.32	-2.13	0.285
126.00	-18.22	-3.78	0.00	-71.23	0.00	71.23	785.30	392.65	600.81	296.72	27.77	-2.17	0.263
130.00	-17.20	-3.59	0.00	-56.13	0.00	56.13	768.32	384.16	567.78	280.41	29.65	-2.31	0.223
135.00	-15.95	-3.33	0.00	-38.20	0.00	38.20	746.17	373.08	527.09	260.31	32.16	-2.47	0.168
140.00	-10.82	-2.21	0.00	-21.57	0.00	21.57	722.98	361.49	487.14	240.58	34.80	-2.57	0.105
144.00	-9.48	-1.83	0.00	-12.71	0.00	12.71	701.03	350.52	454.07	224.25	36.99	-2.63	0.070
145.00	-9.30	-1.79	0.00	-10.88	0.00	10.88	694.06	347.03	445.03	219.78	37.54	-2.64	0.063
150.00	0.00	-1.35	0.00	-1.95	0.00	1.95	659.19	329.60	401.19	198.13	40.33	-2.67	0.010

Pole : 302489
 Location : Enfd - Enfield, CT
 Height : 150.00 (ft)
 Base Dia : 37.380 (in)
 Top Dia : 15.000 (in)
 Shape : 12 Sides
 Taper : 0.156700 (in/ft)

Code: ANSI/TIA-222 Rev G
 Struct Class : II
 Exposure Category : C
 Topographic Category : 1
 Base Elev : 0.000 (ft)

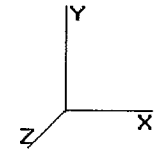

© 2007 - 2013 by ATC IP LLC. All rights reserved.

Load Case: 1.0D + 1.0W	60.00 mph Serviceability	24 Iterations
Gust Response Factor 1.10		Wind Importance Factor : 1.00
Dead Load Factor : 1.00		
Wind Load Factor : 1.00		

Shaft Segment Forces (Factored)

Seg Top Elev (ft)	Description	Kzt	Kz	qz (psf)	qzGh (psf)	C (mph-ft)	Cf	Ice Thick (in)	Tributary (ft)	Aa (sf)	CfAa (sf)	Wind Force X (lb)	Dead Load Ice (lb)	Tot Dead Load (lb)
0.00		1.00	0.85	7.442	8.186	178.392	1.000	0.000	0.00	0.000	0.00	0.0	0.0	0.0
5.00		1.00	0.85	7.442	8.186	174.653	1.000	0.000	5.00	15.955	15.96	130.6	0.0	1,420.2
10.00		1.00	0.85	7.442	8.186	170.914	1.000	0.000	5.00	15.617	15.62	127.8	0.0	1,404.1
15.00		1.00	0.85	7.442	8.186	167.174	1.200 *	0.000	5.00	15.279	18.34	150.1	0.0	1,388.0
20.00		1.00	0.90	7.896	8.686	168.349	1.200 *	0.000	5.00	14.942	17.93	155.7	0.0	1,371.9
25.00		1.00	0.94	8.276	9.104	168.407	1.200 *	0.000	5.00	14.604	17.52	159.5	0.0	1,355.8
30.00		1.00	0.98	8.600	9.460	167.651	1.200 *	0.000	5.00	14.266	17.12	161.9	0.0	1,339.7
31.50	Bot - Section 2	1.00	0.99	8.689	9.557	167.302	1.200 *	0.000	1.50	4.215	5.06	48.3	0.0	398.9
35.00		1.00	1.01	8.883	9.772	166.308	1.200 *	0.000	3.50	9.902	11.88	116.1	0.0	1,314.0
35.67	Top - Section 1	1.00	1.01	8.919	9.811	166.093	1.200 *	0.000	0.67	1.868	2.24	22.0	0.0	248.8
40.00		1.00	1.04	9.137	10.050	167.824	1.200 *	0.000	4.33	11.991	14.39	144.6	0.0	1,050.1
45.00		1.00	1.07	9.366	10.303	165.723	1.200 *	0.000	5.00	13.521	16.23	167.2	0.0	1,199.3
50.00		1.00	1.09	9.576	10.534	163.330	1.200 *	0.000	5.00	13.183	15.82	166.6	0.0	1,185.9
55.00		1.00	1.11	9.770	10.747	160.692	1.200 *	0.000	5.00	12.845	15.41	165.7	0.0	1,172.5
56.00	Appertunance(s)	1.00	1.12	9.807	10.788	160.139	1.200 *	0.000	1.00	2.529	3.03	32.7	0.0	232.9
60.00	Reinf. Top	1.00	1.13	9.951	10.946	157.847	1.200 *	0.000	4.00	9.979	11.97	131.1	0.0	926.2
65.00		1.00	1.15	10.120	11.132	154.822	1.200 *	0.000	5.00	12.169	14.60	162.6	0.0	1,111.6
70.00		1.00	1.17	10.279	11.307	151.640	1.200 *	0.000	5.00	11.831	14.20	160.5	0.0	798.2
70.00	Bot - Section 3	1.00	1.17	10.279	11.307	151.640	1.200 *	0.000	0.00	0.001	0.00	0.0	0.0	0.1
73.50	Top - Section 2	1.00	1.18	10.385	11.424	149.329	1.200 *	0.000	3.50	8.232	9.88	112.8	0.0	809.7
75.00		1.00	1.19	10.430	11.473	151.144	1.200 *	0.000	1.50	3.476	4.17	47.9	0.0	209.5
80.00		1.00	1.20	10.572	11.629	147.717	1.200 *	0.000	5.00	11.371	13.65	158.7	0.0	691.6
85.00		1.00	1.22	10.708	11.779	144.178	1.200 *	0.000	5.00	11.033	13.24	155.9	0.0	680.9
90.00		1.00	1.23	10.838	11.921	140.536	1.200 *	0.000	5.00	10.695	12.83	153.0	0.0	670.2
95.00		1.00	1.25	10.962	12.058	136.800	1.200 *	0.000	5.00	10.357	12.43	149.9	0.0	659.4
100.00		1.00	1.26	11.081	12.189	132.978	1.200 *	0.000	5.00	10.019	12.02	146.5	0.0	648.7
103.0	Appertunance(s)	1.00	1.27	11.150	12.265	130.646	1.200 *	0.000	3.00	5.849	7.02	86.1	0.0	384.1
105.0		1.00	1.27	11.195	12.315	129.076	1.200 *	0.000	2.00	3.832	4.60	56.6	0.0	253.9
110.0		1.00	1.29	11.305	12.436	125.101	1.200 *	0.000	5.00	9.343	11.21	139.4	0.0	627.2
110.0	Top - Section 3	1.00	1.29	11.305	12.436	125.101	1.200 *	0.000	0.00	0.001	0.00	0.0	0.0	0.0
115.0	Appertunance(s)	1.00	1.30	11.412	12.553	121.058	1.200 *	0.000	5.00	9.005	10.81	135.6	0.0	546.5
120.0		1.00	1.31	11.514	12.666	116.950	1.200 *	0.000	5.00	8.667	10.40	131.7	0.0	538.5
121.0	Reinf. Top	1.00	1.31	11.534	12.688	116.121	1.200 *	0.000	1.00	1.693	2.03	25.8	0.0	106.7
125.0		1.00	1.32	11.614	12.775	112.783	1.200 *	0.000	4.00	6.636	7.96	101.7	0.0	156.5
126.0	Appertunance(s)	1.00	1.32	11.633	12.797	111.942	1.200 *	0.000	1.00	1.625	1.95	25.0	0.0	38.3
130.0		1.00	1.33	11.710	12.881	108.559	1.200 *	0.000	4.00	6.366	7.64	98.4	0.0	150.1
135.0		1.00	1.34	11.803	12.984	104.282	1.200 *	0.000	5.00	7.653	9.18	119.2	0.0	180.3
140.0	Appertunance(s)	1.00	1.35	11.894	13.084	99.955	1.200 *	0.000	5.00	7.315	8.78	114.9	0.0	172.3
144.0	Appertunance(s)	1.00	1.36	11.965	13.161	96.459	1.200 *	0.000	4.00	5.609	6.73	88.6	0.0	132.0
145.0		1.00	1.36	11.982	13.181	95.580	1.200 *	0.000	1.00	1.368	1.64	21.6	0.0	32.2
150.0	Appertunance(s)	1.00	1.37	12.068	13.275	91.160	1.200 *	0.000	5.00	6.639	7.97	105.8	0.0	156.2
								Totals:				4,378.5	0.0	25,462.8

* = Cf Adjusted By Linear Load Ra Effect

Pole : 302489
 Location : Enfd - Enfield, CT
 Height : 150.00 (ft)
 Base Dia : 37.380 (in)
 Top Dia : 15.000 (in)
 Shape : 12 Sides
 Taper : 0.156700 (in/ft)

Code: ANSI/TIA-222 Rev G
 Struct Class : II
 Exposure Category : C
 Topographic Category : 1
 Base Elev : 0.000 (ft)

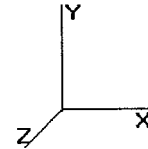

8/2/2013 4:43:29 PM
 Page: 41

© 2007 - 2013 by ATC IP LLC. All rights reserved.

Load Case: 1.0D + 1.0W	60.00 mph Serviceability	24 Iterations
Gust Response Factor 1.10		Wind Importance Factor : 1.00
Dead Load Factor : 1.00		
Wind Load Factor : 1.00		

Discrete Appurtenance Segment Forces (Factored)

Elev (ft)	Description	Qty	qz (psf)	qzGh (psf)	CaAa Factor	Ka	Total CaAa (sf)	Horiz Ecc (ft)	Vert Ecc (ft)	Wind FX (lb)	Mom Y (lb-ft)	Mom Z (lb-ft)	Dead Load (lb)
56.00	Channel Master Type	1	9.880	10.868	0.90	1.00	18.17	0.000	2.000	197.49	0.00	394.97	126.00
103.0	24" x 24" Junction	1	11.218	12.339	0.80	0.80	4.48	0.000	3.000	55.28	0.00	165.84	20.00
103.0	Argus LLPX310R	3	11.240	12.364	0.50	0.80	7.19	0.000	4.000	88.86	0.00	355.43	85.80
103.0	DragonWave A-ANT-	2	11.284	12.412	0.72	0.80	6.75	0.000	6.000	83.83	0.00	502.95	54.00
103.0	DragonWave Horizon	2	11.284	12.412	0.26	0.80	0.23	0.000	6.000	2.82	0.00	16.91	21.20
103.0	NextNet BTS-2500	3	11.240	12.364	0.40	0.80	2.54	0.000	4.000	31.45	0.00	125.81	105.00
103.0	Side Arms	1	11.150	12.265	1.00	1.00	8.50	0.000	0.000	104.25	0.00	0.00	560.00
115.0	RFS APXV18-206517S-	3	11.474	12.621	0.54	0.80	8.44	0.000	3.000	106.49	0.00	319.47	79.20
126.0	Alcatel-Lucent RRH2x	3	11.653	12.818	0.40	0.80	3.02	0.000	1.000	38.76	0.00	38.76	132.00
126.0	Antel BXA-171085-12C	3	11.653	12.818	0.58	0.80	8.17	0.000	1.000	104.77	0.00	104.77	45.00
126.0	Antel BXA-171085-8BF	3	11.653	12.818	0.57	0.80	5.01	0.000	1.000	64.21	0.00	64.21	31.50
126.0	Antel BXA-70063-4CF-	3	11.653	12.818	0.51	0.80	7.93	0.000	1.000	101.59	0.00	101.59	29.70
126.0	Antel BXA-80080-6CF-	3	11.653	12.818	0.58	0.80	10.11	0.000	1.000	129.58	0.00	129.58	54.00
126.0	RFS DB-T1-6Z-8AB-OZ	1	11.653	12.818	0.80	0.80	4.48	0.000	1.000	57.42	0.00	57.42	44.00
126.0	RFS FD9R6004/2C-3L	6	11.653	12.818	0.26	0.80	0.59	0.000	1.000	7.51	0.00	7.51	15.60
126.0	Round Low Profile PI	1	11.633	12.797	1.00	1.00	21.70	0.000	0.000	277.68	0.00	0.00	1,500.00
140.0	Andrew OneBase Dual	6	11.894	13.084	0.26	0.80	1.06	0.000	0.000	13.89	0.00	0.00	66.00
140.0	EMS RR90-17-02DP	3	11.894	13.084	0.51	0.80	6.70	0.000	0.000	87.62	0.00	0.00	40.50
140.0	Flat Low Profile Pla	1	11.894	13.084	1.00	1.00	26.10	0.000	0.000	341.48	0.00	0.00	1,500.00
140.0	RFS APX16DWV-	3	11.894	13.084	0.47	0.80	9.49	0.000	0.000	124.13	0.00	0.00	118.80
144.0	Diamond X50A	2	11.965	13.161	0.75	1.00	1.68	0.000	0.000	22.11	0.00	0.00	4.60
144.0	Flat Side Arm	2	11.965	13.161	0.80	1.00	10.08	0.000	0.000	132.67	0.00	0.00	300.00
150.0	ADC DD1900	6	12.102	13.312	0.25	0.75	1.89	0.000	2.000	25.11	0.00	50.21	72.60
150.0	Allgon 7770.00	6	12.102	13.312	0.48	0.75	16.93	0.000	2.000	225.43	0.00	450.86	210.00
150.0	Andrew SBNH-	1	12.102	13.312	0.75	0.75	8.59	0.000	2.000	114.32	0.00	228.63	60.80
150.0	Decibel DB809KE-SY	1	12.265	13.492	1.00	1.00	3.40	0.000	12.000	45.87	0.00	550.47	26.00
150.0	Ericsson RRUS 11 (Ba	6	12.102	13.312	0.50	1.00	8.82	0.000	2.000	117.41	0.00	234.82	330.00
150.0	Flat Platform w/ Han	1	12.068	13.275	0.90	1.00	38.16	0.000	0.000	506.57	0.00	0.00	2,000.00
150.0	Powerwave LGP13519	6	12.102	13.312	0.25	0.75	0.50	0.000	2.000	6.72	0.00	13.44	31.80
150.0	Powerwave P65-16-	2	12.102	13.312	0.56	0.75	9.45	0.000	2.000	125.80	0.00	251.60	106.00
150.0	Raycap DC6-48-60-18-	1	12.102	13.312	1.00	1.00	1.28	0.000	2.000	17.04	0.00	34.08	31.80
										3,358.15			7,801.90

Pole : 302489
 Location : Enfd - Enfield, CT
 Height : 150.00 (ft)
 Base Dia : 37.380 (in)
 Top Dia : 15.000 (in)
 Shape : 12 Sides
 Taper : 0.156700 (in/ft)

Code : ANSI/TIA-222 Rev G
 Struct Class : II
 Exposure Category : C
 Topographic Category : 1
 Base Elev : 0.000 (ft)

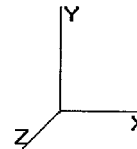

8/2/2013 4:43:29 PM
 Page : 42

© 2007 - 2013 by ATC IP LLC. All rights reserved.

Load Case: 1.0D + 1.0W

60.00 mph Serviceability

24 Iterations

Gust Response Factor 1.10
 Dead Load Factor : 1.00
 Wind Load Factor : 1.00

Wind Importance Factor : 1.00

Linear Appurtenance Segment Forces (Factored)

Seg Top Elev (ft)	Description	Exposed To Wind	Length (ft)	Ca	Exposed Width (in)	Area (sqft)	CaAa (sqft)	qz (psf)	Ra	Cf Adjust Factor	F X (lb)	Dead Load (lb)
5.00	(4) #20 Dywidag bars	Yes	5.00	0.000	0.00	0.00	0.00	7.442	0.000	0.000	0.00	334.00
10.00	(4) #20 Dywidag bars	Yes	5.00	0.000	0.00	0.00	0.00	7.442	0.000	0.000	0.00	334.00
15.00	(1) 0.39" Cable	Yes	5.00	0.000	0.00	0.00	0.00	7.442	0.613	0.000	0.00	0.35
15.00	(2) 0.78" 8 AWG 6	Yes	5.00	0.000	0.00	0.00	0.00	7.442	0.613	0.000	0.00	5.90
15.00	(1) 1 5/8" Coax	Yes	5.00	1.200	1.98	0.82	0.99	7.442	0.613	0.000	8.10	4.10
15.00	(8) 1 5/8" Coax	Yes	5.00	1.200	3.96	1.65	1.98	7.442	0.613	0.000	16.21	32.80
15.00	(2) 1/2" Coax	Yes	5.00	1.200	0.63	0.26	0.31	7.442	0.613	0.000	2.58	1.50
15.00	(8) 1 5/8" Coax	Yes	5.00	1.200	5.94	2.47	2.97	7.442	0.613	0.000	24.31	32.80
15.00	(12) 1 5/8" Coax	Yes	5.00	1.200	1.98	0.82	0.99	7.442	0.613	0.000	8.10	49.19
15.00	(1) 1 5/8" Hybriflex	Yes	5.00	0.000	0.00	0.00	0.00	7.442	0.613	0.000	0.00	8.05
15.00	(4) #20 Dywidag bars	Yes	5.00	0.000	0.00	0.00	0.00	7.442	0.613	0.000	0.00	334.00
15.00	(6) 1 5/8" Coax	Yes	5.00	0.000	0.00	0.00	0.00	7.442	0.613	0.000	0.00	24.60
15.00	(4) 1/2" Coax	Yes	5.00	0.000	0.00	0.00	0.00	7.442	0.613	0.000	0.00	3.00
15.00	(2) 2" Conduit	Yes	5.00	0.000	0.00	0.00	0.00	7.442	0.613	0.000	0.00	36.50
15.00	(6) 5/16" Coax	Yes	5.00	0.000	0.00	0.00	0.00	7.442	0.613	0.000	0.00	1.35
15.00	(1) 1/2" Coax	Yes	5.00	0.000	0.00	0.00	0.00	7.442	0.613	0.000	0.00	0.75
15.00	(4) Dywidag	Yes	5.00	2.000	8.00	3.33	6.67	7.442	0.613	0.000	54.57	0.00
20.00	(1) 0.39" Cable	Yes	5.00	0.000	0.00	0.00	0.00	7.896	0.627	0.000	0.00	0.35
20.00	(2) 0.78" 8 AWG 6	Yes	5.00	0.000	0.00	0.00	0.00	7.896	0.627	0.000	0.00	5.90
20.00	(1) 1 5/8" Coax	Yes	5.00	1.200	1.98	0.82	0.99	7.896	0.627	0.000	8.60	4.10
20.00	(8) 1 5/8" Coax	Yes	5.00	1.200	3.96	1.65	1.98	7.896	0.627	0.000	17.20	32.80
20.00	(2) 1/2" Coax	Yes	5.00	1.200	0.63	0.26	0.31	7.896	0.627	0.000	2.74	1.50
20.00	(8) 1 5/8" Coax	Yes	5.00	1.200	5.94	2.47	2.97	7.896	0.627	0.000	25.80	32.80
20.00	(12) 1 5/8" Coax	Yes	5.00	1.200	1.98	0.82	0.99	7.896	0.627	0.000	8.60	49.19
20.00	(1) 1 5/8" Hybriflex	Yes	5.00	0.000	0.00	0.00	0.00	7.896	0.627	0.000	0.00	8.05
20.00	(4) #20 Dywidag bars	Yes	5.00	0.000	0.00	0.00	0.00	7.896	0.627	0.000	0.00	334.00
20.00	(6) 1 5/8" Coax	Yes	5.00	0.000	0.00	0.00	0.00	7.896	0.627	0.000	0.00	24.60
20.00	(4) 1/2" Coax	Yes	5.00	0.000	0.00	0.00	0.00	7.896	0.627	0.000	0.00	3.00
20.00	(2) 2" Conduit	Yes	5.00	0.000	0.00	0.00	0.00	7.896	0.627	0.000	0.00	36.50
20.00	(6) 5/16" Coax	Yes	5.00	0.000	0.00	0.00	0.00	7.896	0.627	0.000	0.00	1.35
20.00	(1) 1/2" Coax	Yes	5.00	0.000	0.00	0.00	0.00	7.896	0.627	0.000	0.00	0.75
20.00	(4) Dywidag	Yes	5.00	2.000	8.00	3.33	6.67	7.896	0.627	0.000	57.91	0.00
25.00	(1) 0.39" Cable	Yes	5.00	0.000	0.00	0.00	0.00	8.276	0.642	0.000	0.00	0.35
25.00	(2) 0.78" 8 AWG 6	Yes	5.00	0.000	0.00	0.00	0.00	8.276	0.642	0.000	0.00	5.90
25.00	(1) 1 5/8" Coax	Yes	5.00	1.200	1.98	0.82	0.99	8.276	0.642	0.000	9.01	4.10
25.00	(8) 1 5/8" Coax	Yes	5.00	1.200	3.96	1.65	1.98	8.276	0.642	0.000	18.03	32.80
25.00	(2) 1/2" Coax	Yes	5.00	1.200	0.63	0.26	0.31	8.276	0.642	0.000	2.87	1.50
25.00	(8) 1 5/8" Coax	Yes	5.00	1.200	5.94	2.47	2.97	8.276	0.642	0.000	27.04	32.80
25.00	(12) 1 5/8" Coax	Yes	5.00	1.200	1.98	0.82	0.99	8.276	0.642	0.000	9.01	49.19
25.00	(1) 1 5/8" Hybriflex	Yes	5.00	0.000	0.00	0.00	0.00	8.276	0.642	0.000	0.00	8.05
25.00	(4) #20 Dywidag bars	Yes	5.00	0.000	0.00	0.00	0.00	8.276	0.642	0.000	0.00	334.00
25.00	(6) 1 5/8" Coax	Yes	5.00	0.000	0.00	0.00	0.00	8.276	0.642	0.000	0.00	24.60
25.00	(4) 1/2" Coax	Yes	5.00	0.000	0.00	0.00	0.00	8.276	0.642	0.000	0.00	3.00
25.00	(2) 2" Conduit	Yes	5.00	0.000	0.00	0.00	0.00	8.276	0.642	0.000	0.00	36.50
25.00	(6) 5/16" Coax	Yes	5.00	0.000	0.00	0.00	0.00	8.276	0.642	0.000	0.00	1.35
25.00	(1) 1/2" Coax	Yes	5.00	0.000	0.00	0.00	0.00	8.276	0.642	0.000	0.00	0.75
25.00	(4) Dywidag	Yes	5.00	2.000	8.00	3.33	6.67	8.276	0.642	0.000	60.69	0.00
30.00	(1) 0.39" Cable	Yes	5.00	0.000	0.00	0.00	0.00	8.600	0.657	0.000	0.00	0.35
30.00	(2) 0.78" 8 AWG 6	Yes	5.00	0.000	0.00	0.00	0.00	8.600	0.657	0.000	0.00	5.90
30.00	(1) 1 5/8" Coax	Yes	5.00	1.200	1.98	0.82	0.99	8.600	0.657	0.000	9.37	4.10
30.00	(8) 1 5/8" Coax	Yes	5.00	1.200	3.96	1.65	1.98	8.600	0.657	0.000	18.73	32.80

Pole : 302489
 Location : Enfd - Enfield, CT
 Height : 150.00 (ft)
 Base Dia : 37.380 (in)
 Top Dia : 15.000 (in)
 Shape : 12 Sides
 Taper : 0.156700 (in/ft)

Code: ANSI/TIA-222 Rev G
 Struct Class : II
 Exposure Category : C
 Topographic Category : 1
 Base Elev : 0.000 (ft)

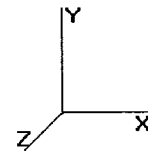

8/2/2013 4:43:29 PM
 Page: 43

© 2007 - 2013 by ATC IP LLC. All rights reserved.

Load Case: 1.0D + 1.0W 60.00 mph Serviceability 24 Iterations
 Gust Response Factor 1.10 Wind Importance Factor : 1.00
 Dead Load Factor : 1.00
 Wind Load Factor : 1.00

30.00	(2) 1/2" Coax	Yes	5.00	1.200	0.63	0.26	0.31	8.600	0.657	0.000	2.98	1.50
30.00	(8) 1 5/8" Coax	Yes	5.00	1.200	5.94	2.47	2.97	8.600	0.657	0.000	28.10	32.80
30.00	(12) 1 5/8" Coax	Yes	5.00	1.200	1.98	0.82	0.99	8.600	0.657	0.000	9.37	49.19
30.00	(1) 1 5/8" Hybriflex	Yes	5.00	0.000	0.00	0.00	0.00	8.600	0.657	0.000	0.00	8.05
30.00	(4) #20 Dywidag bars	Yes	5.00	0.000	0.00	0.00	0.00	8.600	0.657	0.000	0.00	334.00
30.00	(6) 1 5/8" Coax	Yes	5.00	0.000	0.00	0.00	0.00	8.600	0.657	0.000	0.00	24.60
30.00	(4) 1/2" Coax	Yes	5.00	0.000	0.00	0.00	0.00	8.600	0.657	0.000	0.00	3.00
30.00	(2) 2" Conduit	Yes	5.00	0.000	0.00	0.00	0.00	8.600	0.657	0.000	0.00	36.50
30.00	(6) 5/16" Coax	Yes	5.00	0.000	0.00	0.00	0.00	8.600	0.657	0.000	0.00	1.35
30.00	(1) 1/2" Coax	Yes	5.00	0.000	0.00	0.00	0.00	8.600	0.657	0.000	0.00	0.75
30.00	(4) Dywidag	Yes	5.00	2.000	8.00	3.33	6.67	8.600	0.657	0.000	63.07	0.00
31.50	(1) 0.39" Cable	Yes	1.50	0.000	0.00	0.00	0.00	8.689	0.667	0.000	0.00	0.11
31.50	(2) 0.78" 8 AWG 6	Yes	1.50	0.000	0.00	0.00	0.00	8.689	0.667	0.000	0.00	1.77
31.50	(1) 1 5/8" Coax	Yes	1.50	1.200	1.98	0.25	0.30	8.689	0.667	0.000	2.84	1.23
31.50	(8) 1 5/8" Coax	Yes	1.50	1.200	3.96	0.50	0.59	8.689	0.667	0.000	5.68	9.84
31.50	(2) 1/2" Coax	Yes	1.50	1.200	0.63	0.08	0.09	8.689	0.667	0.000	0.90	0.45
31.50	(8) 1 5/8" Coax	Yes	1.50	1.200	5.94	0.74	0.89	8.689	0.667	0.000	8.52	9.84
31.50	(12) 1 5/8" Coax	Yes	1.50	1.200	1.98	0.25	0.30	8.689	0.667	0.000	2.84	14.76
31.50	(1) 1 5/8" Hybriflex	Yes	1.50	0.000	0.00	0.00	0.00	8.689	0.667	0.000	0.00	2.42
31.50	(4) #20 Dywidag bars	Yes	1.50	0.000	0.00	0.00	0.00	8.689	0.667	0.000	0.00	100.22
31.50	(6) 1 5/8" Coax	Yes	1.50	0.000	0.00	0.00	0.00	8.689	0.667	0.000	0.00	7.38
31.50	(4) 1/2" Coax	Yes	1.50	0.000	0.00	0.00	0.00	8.689	0.667	0.000	0.00	0.90
31.50	(2) 2" Conduit	Yes	1.50	0.000	0.00	0.00	0.00	8.689	0.667	0.000	0.00	10.95
31.50	(6) 5/16" Coax	Yes	1.50	0.000	0.00	0.00	0.00	8.689	0.667	0.000	0.00	0.41
31.50	(1) 1/2" Coax	Yes	1.50	0.000	0.00	0.00	0.00	8.689	0.667	0.000	0.00	0.23
31.50	(4) Dywidag	Yes	1.50	2.000	8.00	1.00	2.00	8.689	0.667	0.000	19.12	0.00
35.00	(1) 0.39" Cable	Yes	3.50	0.000	0.00	0.00	0.00	8.883	0.449	0.000	0.00	0.24
35.00	(2) 0.78" 8 AWG 6	Yes	3.50	0.000	0.00	0.00	0.00	8.883	0.449	0.000	0.00	4.13
35.00	(1) 1 5/8" Coax	Yes	3.50	1.200	1.98	0.58	0.69	8.883	0.449	0.000	6.77	2.87
35.00	(8) 1 5/8" Coax	Yes	3.50	1.200	3.96	1.15	1.39	8.883	0.449	0.000	13.54	22.95
35.00	(2) 1/2" Coax	Yes	3.50	1.200	0.63	0.18	0.22	8.883	0.449	0.000	2.15	1.05
35.00	(8) 1 5/8" Coax	Yes	3.50	1.200	5.94	1.73	2.08	8.883	0.449	0.000	20.31	22.95
35.00	(12) 1 5/8" Coax	Yes	3.50	1.200	1.98	0.58	0.69	8.883	0.449	0.000	6.77	34.43
35.00	(1) 1 5/8" Hybriflex	Yes	3.50	0.000	0.00	0.00	0.00	8.883	0.449	0.000	0.00	5.63
35.00	(4) #20 Dywidag bars	Yes	3.50	0.000	0.00	0.00	0.00	8.883	0.449	0.000	0.00	233.78
35.00	(6) 1 5/8" Coax	Yes	3.50	0.000	0.00	0.00	0.00	8.883	0.449	0.000	0.00	17.22
35.00	(4) 1/2" Coax	Yes	3.50	0.000	0.00	0.00	0.00	8.883	0.449	0.000	0.00	2.10
35.00	(2) 2" Conduit	Yes	3.50	0.000	0.00	0.00	0.00	8.883	0.449	0.000	0.00	25.55
35.00	(6) 5/16" Coax	Yes	3.50	0.000	0.00	0.00	0.00	8.883	0.449	0.000	0.00	0.94
35.00	(1) 1/2" Coax	Yes	3.50	0.000	0.00	0.00	0.00	8.883	0.449	0.000	0.00	0.52
35.00	(4) Dywidag	Yes	0.20	2.000	8.00	0.13	0.27	8.883	0.449	0.000	2.60	0.00
35.67	(1) 0.39" Cable	Yes	0.67	0.000	0.00	0.00	0.00	8.919	0.440	0.000	0.00	0.05
35.67	(2) 0.78" 8 AWG 6	Yes	0.67	0.000	0.00	0.00	0.00	8.919	0.440	0.000	0.00	0.79
35.67	(1) 1 5/8" Coax	Yes	0.67	1.200	1.98	0.11	0.13	8.919	0.440	0.000	1.30	0.55
35.67	(8) 1 5/8" Coax	Yes	0.67	1.200	3.96	0.22	0.26	8.919	0.440	0.000	2.59	4.37
35.67	(2) 1/2" Coax	Yes	0.67	1.200	0.63	0.04	0.04	8.919	0.440	0.000	0.41	0.20
35.67	(8) 1 5/8" Coax	Yes	0.67	1.200	5.94	0.33	0.40	8.919	0.440	0.000	3.89	4.37
35.67	(12) 1 5/8" Coax	Yes	0.67	1.200	1.98	0.11	0.13	8.919	0.440	0.000	1.30	6.56
35.67	(1) 1 5/8" Hybriflex	Yes	0.67	0.000	0.00	0.00	0.00	8.919	0.440	0.000	0.00	1.07
35.67	(4) #20 Dywidag bars	Yes	0.67	0.000	0.00	0.00	0.00	8.919	0.440	0.000	0.00	44.56
35.67	(6) 1 5/8" Coax	Yes	0.67	0.000	0.00	0.00	0.00	8.919	0.440	0.000	0.00	3.28
35.67	(4) 1/2" Coax	Yes	0.67	0.000	0.00	0.00	0.00	8.919	0.440	0.000	0.00	0.40
35.67	(2) 2" Conduit	Yes	0.67	0.000	0.00	0.00	0.00	8.919	0.440	0.000	0.00	4.87
35.67	(6) 5/16" Coax	Yes	0.67	0.000	0.00	0.00	0.00	8.919	0.440	0.000	0.00	0.18
35.67	(1) 1/2" Coax	Yes	0.67	0.000	0.00	0.00	0.00	8.919	0.440	0.000	0.00	0.10
40.00	(1) 0.39" Cable	Yes	4.33	0.000	0.00	0.00	0.00	9.137	0.436	0.000	0.00	0.30
40.00	(2) 0.78" 8 AWG 6	Yes	4.33	0.000	0.00	0.00	0.00	9.137	0.436	0.000	0.00	5.11

Pole : 302489
 Location : Enfd - Enfield, CT
 Height : 150.00 (ft)
 Base Dia : 37.380 (in)
 Top Dia : 15.000 (in)
 Shape : 12 Sides
 Taper : 0.156700 (in/ft)

Code : ANSI/TIA-222 Rev G
 Struct Class : II
 Exposure Category : C
 Topographic Category : 1
 Base Elev : 0.000 (ft)

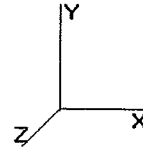

8/2/2013 4:43:29 PM
 Page: 44

© 2007 - 2013 by ATC IP LLC. All rights reserved.

Load Case: 1.0D + 1.0W

60.00 mph Serviceability

24 Iterations

Gust Response Factor 1.10
 Dead Load Factor : 1.00
 Wind Load Factor : 1.00

Wind Importance Factor : 1.00

40.00	(1) 1 5/8" Coax	Yes	4.33	1.200	1.98	0.71	0.86	9.137	0.436	0.000	8.62	3.55
40.00	(8) 1 5/8" Coax	Yes	4.33	1.200	3.96	1.43	1.72	9.137	0.436	0.000	17.25	28.42
40.00	(2) 1/2" Coax	Yes	4.33	1.200	0.63	0.23	0.27	9.137	0.436	0.000	2.74	1.30
40.00	(8) 1 5/8" Coax	Yes	4.33	1.200	5.94	2.14	2.57	9.137	0.436	0.000	25.87	28.42
40.00	(12) 1 5/8" Coax	Yes	4.33	1.200	1.98	0.71	0.86	9.137	0.436	0.000	8.62	42.63
40.00	(1) 1 5/8" Hybriflex	Yes	4.33	0.000	0.00	0.00	0.00	9.137	0.436	0.000	0.00	6.98
40.00	(4) #20 Dywidag bars	Yes	4.33	0.000	0.00	0.00	0.00	9.137	0.436	0.000	0.00	289.44
40.00	(6) 1 5/8" Coax	Yes	4.33	0.000	0.00	0.00	0.00	9.137	0.436	0.000	0.00	21.32
40.00	(4) 1/2" Coax	Yes	4.33	0.000	0.00	0.00	0.00	9.137	0.436	0.000	0.00	2.60
40.00	(2) 2" Conduit	Yes	4.33	0.000	0.00	0.00	0.00	9.137	0.436	0.000	0.00	31.63
40.00	(6) 5/16" Coax	Yes	4.33	0.000	0.00	0.00	0.00	9.137	0.436	0.000	0.00	1.17
40.00	(1) 1/2" Coax	Yes	4.33	0.000	0.00	0.00	0.00	9.137	0.436	0.000	0.00	0.65
45.00	(1) 0.39" Cable	Yes	5.00	0.000	0.00	0.00	0.00	9.366	0.447	0.000	0.00	0.35
45.00	(2) 0.78" 8 AWG 6	Yes	5.00	0.000	0.00	0.00	0.00	9.366	0.447	0.000	0.00	5.90
45.00	(1) 1 5/8" Coax	Yes	5.00	1.200	1.98	0.82	0.99	9.366	0.447	0.000	10.20	4.10
45.00	(8) 1 5/8" Coax	Yes	5.00	1.200	3.96	1.65	1.98	9.366	0.447	0.000	20.40	32.80
45.00	(2) 1/2" Coax	Yes	5.00	1.200	0.63	0.26	0.31	9.366	0.447	0.000	3.25	1.50
45.00	(8) 1 5/8" Coax	Yes	5.00	1.200	5.94	2.47	2.97	9.366	0.447	0.000	30.60	32.80
45.00	(12) 1 5/8" Coax	Yes	5.00	1.200	1.98	0.82	0.99	9.366	0.447	0.000	10.20	49.19
45.00	(1) 1 5/8" Hybriflex	Yes	5.00	0.000	0.00	0.00	0.00	9.366	0.447	0.000	0.00	8.05
45.00	(4) #20 Dywidag bars	Yes	5.00	0.000	0.00	0.00	0.00	9.366	0.447	0.000	0.00	334.00
45.00	(6) 1 5/8" Coax	Yes	5.00	0.000	0.00	0.00	0.00	9.366	0.447	0.000	0.00	24.60
45.00	(4) 1/2" Coax	Yes	5.00	0.000	0.00	0.00	0.00	9.366	0.447	0.000	0.00	3.00
45.00	(2) 2" Conduit	Yes	5.00	0.000	0.00	0.00	0.00	9.366	0.447	0.000	0.00	36.50
45.00	(6) 5/16" Coax	Yes	5.00	0.000	0.00	0.00	0.00	9.366	0.447	0.000	0.00	1.35
45.00	(1) 1/2" Coax	Yes	5.00	0.000	0.00	0.00	0.00	9.366	0.447	0.000	0.00	0.75
50.00	(1) 0.39" Cable	Yes	5.00	0.000	0.00	0.00	0.00	9.576	0.458	0.000	0.00	0.35
50.00	(2) 0.78" 8 AWG 6	Yes	5.00	0.000	0.00	0.00	0.00	9.576	0.458	0.000	0.00	5.90
50.00	(1) 1 5/8" Coax	Yes	5.00	1.200	1.98	0.82	0.99	9.576	0.458	0.000	10.43	4.10
50.00	(8) 1 5/8" Coax	Yes	5.00	1.200	3.96	1.65	1.98	9.576	0.458	0.000	20.86	32.80
50.00	(2) 1/2" Coax	Yes	5.00	1.200	0.63	0.26	0.31	9.576	0.458	0.000	3.32	1.50
50.00	(8) 1 5/8" Coax	Yes	5.00	1.200	5.94	2.47	2.97	9.576	0.458	0.000	31.29	32.80
50.00	(12) 1 5/8" Coax	Yes	5.00	1.200	1.98	0.82	0.99	9.576	0.458	0.000	10.43	49.19
50.00	(1) 1 5/8" Hybriflex	Yes	5.00	0.000	0.00	0.00	0.00	9.576	0.458	0.000	0.00	8.05
50.00	(4) #20 Dywidag bars	Yes	5.00	0.000	0.00	0.00	0.00	9.576	0.458	0.000	0.00	334.00
50.00	(6) 1 5/8" Coax	Yes	5.00	0.000	0.00	0.00	0.00	9.576	0.458	0.000	0.00	24.60
50.00	(4) 1/2" Coax	Yes	5.00	0.000	0.00	0.00	0.00	9.576	0.458	0.000	0.00	3.00
50.00	(2) 2" Conduit	Yes	5.00	0.000	0.00	0.00	0.00	9.576	0.458	0.000	0.00	36.50
50.00	(6) 5/16" Coax	Yes	5.00	0.000	0.00	0.00	0.00	9.576	0.458	0.000	0.00	1.35
50.00	(1) 1/2" Coax	Yes	5.00	0.000	0.00	0.00	0.00	9.576	0.458	0.000	0.00	0.75
55.00	(1) 0.39" Cable	Yes	5.00	0.000	0.00	0.00	0.00	9.770	0.470	0.000	0.00	0.35
55.00	(2) 0.78" 8 AWG 6	Yes	5.00	0.000	0.00	0.00	0.00	9.770	0.470	0.000	0.00	5.90
55.00	(1) 1 5/8" Coax	Yes	5.00	1.200	1.98	0.82	0.99	9.770	0.470	0.000	10.64	4.10
55.00	(8) 1 5/8" Coax	Yes	5.00	1.200	3.96	1.65	1.98	9.770	0.470	0.000	21.28	32.80
55.00	(2) 1/2" Coax	Yes	5.00	1.200	0.63	0.26	0.31	9.770	0.470	0.000	3.39	1.50
55.00	(8) 1 5/8" Coax	Yes	5.00	1.200	5.94	2.47	2.97	9.770	0.470	0.000	31.92	32.80
55.00	(12) 1 5/8" Coax	Yes	5.00	1.200	1.98	0.82	0.99	9.770	0.470	0.000	10.64	49.19
55.00	(1) 1 5/8" Hybriflex	Yes	5.00	0.000	0.00	0.00	0.00	9.770	0.470	0.000	0.00	8.05
55.00	(4) #20 Dywidag bars	Yes	5.00	0.000	0.00	0.00	0.00	9.770	0.470	0.000	0.00	334.00
55.00	(6) 1 5/8" Coax	Yes	5.00	0.000	0.00	0.00	0.00	9.770	0.470	0.000	0.00	24.60
55.00	(4) 1/2" Coax	Yes	5.00	0.000	0.00	0.00	0.00	9.770	0.470	0.000	0.00	3.00
55.00	(2) 2" Conduit	Yes	5.00	0.000	0.00	0.00	0.00	9.770	0.470	0.000	0.00	36.50
55.00	(6) 5/16" Coax	Yes	5.00	0.000	0.00	0.00	0.00	9.770	0.470	0.000	0.00	1.35
55.00	(1) 1/2" Coax	Yes	5.00	0.000	0.00	0.00	0.00	9.770	0.470	0.000	0.00	0.75
56.00	(1) 0.39" Cable	Yes	1.00	0.000	0.00	0.00	0.00	9.807	0.478	0.000	0.00	0.07
56.00	(2) 0.78" 8 AWG 6	Yes	1.00	0.000	0.00	0.00	0.00	9.807	0.478	0.000	0.00	1.18
56.00	(1) 1 5/8" Coax	Yes	1.00	1.200	1.98	0.17	0.20	9.807	0.478	0.000	2.14	0.82

Pole : 302489
 Location : Enfd - Enfield, CT
 Height : 150.00 (ft)
 Base Dia : 37.380 (in)
 Top Dia : 15.000 (in)
 Shape : 12 Sides
 Taper : 0.156700 (in/ft)

Code: ANSI/TIA-222 Rev G
 Struct Class : II
 Exposure Category : C
 Topographic Category : 1
 Base Elev : 0.000 (ft)

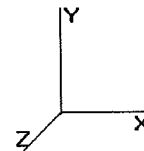

8/2/2013 4:43:29 PM
 Page: 45

© 2007 - 2013 by ATC IP LLC. All rights reserved.

Load Case: 1.0D + 1.0W

60.00 mph Serviceability

24 Iterations

Gust Response Factor 1.10
 Dead Load Factor : 1.00
 Wind Load Factor : 1.00

Wind Importance Factor : 1.00

56.00	(8) 1 5/8" Coax	Yes	1.00	1.200	3.96	0.33	0.40	9.807	0.478	0.000	4.27	6.56
56.00	(2) 1/2" Coax	Yes	1.00	1.200	0.63	0.05	0.06	9.807	0.478	0.000	0.68	0.30
56.00	(8) 1 5/8" Coax	Yes	1.00	1.200	5.94	0.50	0.59	9.807	0.478	0.000	6.41	6.56
56.00	(12) 1 5/8" Coax	Yes	1.00	1.200	1.98	0.17	0.20	9.807	0.478	0.000	2.14	9.84
56.00	(1) 1 5/8" Hybriflex	Yes	1.00	0.000	0.00	0.00	0.00	9.807	0.478	0.000	0.00	1.61
56.00	(4) #20 Dywidag bars	Yes	1.00	0.000	0.00	0.00	0.00	9.807	0.478	0.000	0.00	66.80
56.00	(6) 1 5/8" Coax	Yes	1.00	0.000	0.00	0.00	0.00	9.807	0.478	0.000	0.00	4.92
56.00	(4) 1/2" Coax	Yes	1.00	0.000	0.00	0.00	0.00	9.807	0.478	0.000	0.00	0.60
56.00	(2) 2" Conduit	Yes	1.00	0.000	0.00	0.00	0.00	9.807	0.478	0.000	0.00	7.30
56.00	(6) 5/16" Coax	Yes	1.00	0.000	0.00	0.00	0.00	9.807	0.478	0.000	0.00	0.27
56.00	(1) 1/2" Coax	Yes	1.00	0.000	0.00	0.00	0.00	9.807	0.478	0.000	0.00	0.15
60.00	(1) 0.39" Cable	Yes	4.00	0.000	0.00	0.00	0.00	9.951	0.484	0.000	0.00	0.28
60.00	(2) 0.78" 8 AWG 6	Yes	4.00	0.000	0.00	0.00	0.00	9.951	0.484	0.000	0.00	4.72
60.00	(1) 1 5/8" Coax	Yes	4.00	1.200	1.98	0.66	0.79	9.951	0.484	0.000	8.67	3.28
60.00	(8) 1 5/8" Coax	Yes	4.00	1.200	3.96	1.32	1.58	9.951	0.484	0.000	17.34	26.24
60.00	(2) 1/2" Coax	Yes	4.00	1.200	0.63	0.21	0.25	9.951	0.484	0.000	2.76	1.20
60.00	(8) 1 5/8" Coax	Yes	4.00	1.200	5.94	1.98	2.38	9.951	0.484	0.000	26.01	26.24
60.00	(12) 1 5/8" Coax	Yes	4.00	1.200	1.98	0.66	0.79	9.951	0.484	0.000	8.67	39.36
60.00	(1) 1 5/8" Hybriflex	Yes	4.00	0.000	0.00	0.00	0.00	9.951	0.484	0.000	0.00	6.44
60.00	(4) #20 Dywidag bars	Yes	4.00	0.000	0.00	0.00	0.00	9.951	0.484	0.000	0.00	267.20
60.00	(6) 1 5/8" Coax	Yes	4.00	0.000	0.00	0.00	0.00	9.951	0.484	0.000	0.00	19.68
60.00	(4) 1/2" Coax	Yes	4.00	0.000	0.00	0.00	0.00	9.951	0.484	0.000	0.00	2.40
60.00	(2) 2" Conduit	Yes	4.00	0.000	0.00	0.00	0.00	9.951	0.484	0.000	0.00	29.20
60.00	(6) 5/16" Coax	Yes	4.00	0.000	0.00	0.00	0.00	9.951	0.484	0.000	0.00	1.08
65.00	(1) 0.39" Cable	Yes	5.00	0.000	0.00	0.00	0.00	10.120	0.496	0.000	0.00	0.35
65.00	(2) 0.78" 8 AWG 6	Yes	5.00	0.000	0.00	0.00	0.00	10.120	0.496	0.000	0.00	5.90
65.00	(1) 1 5/8" Coax	Yes	5.00	1.200	1.98	0.82	0.99	10.120	0.496	0.000	11.02	4.10
65.00	(8) 1 5/8" Coax	Yes	5.00	1.200	3.96	1.65	1.98	10.120	0.496	0.000	22.04	32.80
65.00	(2) 1/2" Coax	Yes	5.00	1.200	0.63	0.26	0.31	10.120	0.496	0.000	3.51	1.50
65.00	(8) 1 5/8" Coax	Yes	5.00	1.200	5.94	2.47	2.97	10.120	0.496	0.000	33.06	32.80
65.00	(12) 1 5/8" Coax	Yes	5.00	1.200	1.98	0.82	0.99	10.120	0.496	0.000	11.02	49.19
65.00	(1) 1 5/8" Hybriflex	Yes	5.00	0.000	0.00	0.00	0.00	10.120	0.496	0.000	0.00	8.05
65.00	(4) #20 Dywidag bars	Yes	5.00	0.000	0.00	0.00	0.00	10.120	0.496	0.000	0.00	334.00
65.00	(6) 1 5/8" Coax	Yes	5.00	0.000	0.00	0.00	0.00	10.120	0.496	0.000	0.00	24.60
65.00	(4) 1/2" Coax	Yes	5.00	0.000	0.00	0.00	0.00	10.120	0.496	0.000	0.00	3.00
65.00	(2) 2" Conduit	Yes	5.00	0.000	0.00	0.00	0.00	10.120	0.496	0.000	0.00	36.50
65.00	(6) 5/16" Coax	Yes	5.00	0.000	0.00	0.00	0.00	10.120	0.496	0.000	0.00	1.35
70.00	(1) 0.39" Cable	Yes	5.00	0.000	0.00	0.00	0.00	10.279	0.510	0.000	0.00	0.35
70.00	(2) 0.78" 8 AWG 6	Yes	5.00	0.000	0.00	0.00	0.00	10.279	0.510	0.000	0.00	5.90
70.00	(1) 1 5/8" Coax	Yes	5.00	1.200	1.98	0.82	0.99	10.279	0.510	0.000	11.19	4.10
70.00	(8) 1 5/8" Coax	Yes	5.00	1.200	3.96	1.65	1.98	10.279	0.510	0.000	22.39	32.80
70.00	(2) 1/2" Coax	Yes	5.00	1.200	0.63	0.26	0.31	10.279	0.510	0.000	3.56	1.50
70.00	(8) 1 5/8" Coax	Yes	5.00	1.193	5.94	2.47	2.95	10.279	0.510	0.000	33.39	32.80
70.00	(12) 1 5/8" Coax	Yes	5.00	1.200	1.98	0.82	0.99	10.279	0.510	0.000	11.19	49.19
70.00	(1) 1 5/8" Hybriflex	Yes	5.00	0.000	0.00	0.00	0.00	10.279	0.510	0.000	0.00	8.05
70.00	(4) #20 Dywidag bars	Yes	5.00	0.000	0.00	0.00	0.00	10.279	0.510	0.000	0.00	334.00
70.00	(6) 1 5/8" Coax	Yes	5.00	0.000	0.00	0.00	0.00	10.279	0.510	0.000	0.00	24.60
70.00	(4) 1/2" Coax	Yes	5.00	0.000	0.00	0.00	0.00	10.279	0.510	0.000	0.00	3.00
70.00	(2) 2" Conduit	Yes	5.00	0.000	0.00	0.00	0.00	10.279	0.510	0.000	0.00	36.50
70.00	(6) 5/16" Coax	Yes	5.00	0.000	0.00	0.00	0.00	10.279	0.510	0.000	0.00	1.35
70.00	(1) 0.39" Cable	Yes	0.00	0.000	0.00	0.00	0.00	10.279	0.518	0.000	0.00	0.00
70.00	(2) 0.78" 8 AWG 6	Yes	0.00	0.000	0.00	0.00	0.00	10.279	0.518	0.000	0.00	0.00
70.00	(1) 1 5/8" Coax	Yes	0.00	1.200	1.98	0.00	0.00	10.279	0.518	0.000	0.00	0.00
70.00	(8) 1 5/8" Coax	Yes	0.00	1.200	3.96	0.00	0.00	10.279	0.518	0.000	0.00	0.00
70.00	(2) 1/2" Coax	Yes	0.00	1.200	0.63	0.00	0.00	10.279	0.518	0.000	0.00	0.00
70.00	(8) 1 5/8" Coax	Yes	0.00	1.193	5.94	0.00	0.00	10.279	0.518	0.000	0.00	0.00
70.00	(12) 1 5/8" Coax	Yes	0.00	1.200	1.98	0.00	0.00	10.279	0.518	0.000	0.00	0.00

Pole : 302489
 Location : Enfd - Enfield, CT
 Height : 150.00 (ft)
 Base Dia : 37.380 (in)
 Top Dia : 15.000 (in)
 Shape : 12 Sides
 Taper : 0.156700 (in/ft)

Code: ANSI/TIA-222 Rev G
 Struct Class : II
 Exposure Category : C
 Topographic Category : 1
 Base Elev : 0.000 (ft)

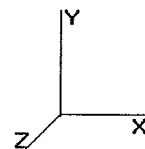

8/2/2013 4:43:30 PM
 Page: 46

© 2007 - 2013 by ATC IP LLC. All rights reserved.

Load Case: 1.0D + 1.0W	60.00 mph Serviceability	24 Iterations
Gust Response Factor 1.10		Wind Importance Factor : 1.00
Dead Load Factor : 1.00		
Wind Load Factor : 1.00		

70.00	(1) 1 5/8" Hybriflex	Yes	0.00	0.000	0.00	0.00	0.00	0.00	10.279	0.518	0.000	0.00	0.00
70.00	(4) #20 Dywidag bars	Yes	0.00	0.000	0.00	0.00	0.00	0.00	10.279	0.518	0.000	0.00	0.02
70.00	(6) 1 5/8" Coax	Yes	0.00	0.000	0.00	0.00	0.00	0.00	10.279	0.518	0.000	0.00	0.00
70.00	(4) 1/2" Coax	Yes	0.00	0.000	0.00	0.00	0.00	0.00	10.279	0.518	0.000	0.00	0.00
70.00	(2) 2" Conduit	Yes	0.00	0.000	0.00	0.00	0.00	0.00	10.279	0.518	0.000	0.00	0.00
70.00	(6) 5/16" Coax	Yes	0.00	0.000	0.00	0.00	0.00	0.00	10.279	0.518	0.000	0.00	0.00
73.50	(1) 0.39" Cable	Yes	3.50	0.000	0.00	0.00	0.00	0.00	10.385	0.523	0.000	0.00	0.25
73.50	(2) 0.78" 8 AWG 6	Yes	3.50	0.000	0.00	0.00	0.00	0.00	10.385	0.523	0.000	0.00	4.13
73.50	(1) 1 5/8" Coax	Yes	3.50	1.200	1.98	0.58	0.69	10.385	0.523	0.000	7.92	2.87	
73.50	(8) 1 5/8" Coax	Yes	3.50	1.200	3.96	1.15	1.39	10.385	0.523	0.000	15.83	22.96	
73.50	(2) 1/2" Coax	Yes	3.50	1.200	0.63	0.18	0.22	10.385	0.523	0.000	2.52	1.05	
73.50	(8) 1 5/8" Coax	Yes	3.50	1.187	5.94	1.73	2.06	10.385	0.523	0.000	23.50	22.96	
73.50	(12) 1 5/8" Coax	Yes	3.50	1.200	1.98	0.58	0.69	10.385	0.523	0.000	7.92	34.44	
73.50	(1) 1 5/8" Hybriflex	Yes	3.50	0.000	0.00	0.00	0.00	10.385	0.523	0.000	0.00	5.64	
73.50	(4) #20 Dywidag bars	Yes	3.50	0.000	0.00	0.00	0.00	10.385	0.523	0.000	0.00	233.80	
73.50	(6) 1 5/8" Coax	Yes	3.50	0.000	0.00	0.00	0.00	10.385	0.523	0.000	0.00	17.22	
73.50	(4) 1/2" Coax	Yes	3.50	0.000	0.00	0.00	0.00	10.385	0.523	0.000	0.00	2.10	
73.50	(2) 2" Conduit	Yes	3.50	0.000	0.00	0.00	0.00	10.385	0.523	0.000	0.00	25.55	
73.50	(6) 5/16" Coax	Yes	3.50	0.000	0.00	0.00	0.00	10.385	0.523	0.000	0.00	0.95	
75.00	(1) 0.39" Cable	Yes	1.50	0.000	0.00	0.00	0.00	10.430	0.521	0.000	0.00	0.10	
75.00	(2) 0.78" 8 AWG 6	Yes	1.50	0.000	0.00	0.00	0.00	10.430	0.521	0.000	0.00	1.77	
75.00	(1) 1 5/8" Coax	Yes	1.50	1.200	1.98	0.25	0.30	10.430	0.521	0.000	3.41	1.23	
75.00	(8) 1 5/8" Coax	Yes	1.50	1.200	3.96	0.49	0.59	10.430	0.521	0.000	6.81	9.84	
75.00	(2) 1/2" Coax	Yes	1.50	1.200	0.63	0.08	0.09	10.430	0.521	0.000	1.08	0.45	
75.00	(8) 1 5/8" Coax	Yes	1.50	1.185	5.94	0.74	0.88	10.430	0.521	0.000	10.09	9.84	
75.00	(12) 1 5/8" Coax	Yes	1.50	1.200	1.98	0.25	0.30	10.430	0.521	0.000	3.41	14.75	
75.00	(1) 1 5/8" Hybriflex	Yes	1.50	0.000	0.00	0.00	0.00	10.430	0.521	0.000	0.00	2.41	
75.00	(4) #20 Dywidag bars	Yes	1.50	0.000	0.00	0.00	0.00	10.430	0.521	0.000	0.00	100.18	
75.00	(6) 1 5/8" Coax	Yes	1.50	0.000	0.00	0.00	0.00	10.430	0.521	0.000	0.00	7.38	
75.00	(4) 1/2" Coax	Yes	1.50	0.000	0.00	0.00	0.00	10.430	0.521	0.000	0.00	0.90	
75.00	(2) 2" Conduit	Yes	1.50	0.000	0.00	0.00	0.00	10.430	0.521	0.000	0.00	10.95	
75.00	(6) 5/16" Coax	Yes	1.50	0.000	0.00	0.00	0.00	10.430	0.521	0.000	0.00	0.40	
80.00	(1) 0.39" Cable	Yes	5.00	0.000	0.00	0.00	0.00	10.572	0.531	0.000	0.00	0.35	
80.00	(2) 0.78" 8 AWG 6	Yes	5.00	0.000	0.00	0.00	0.00	10.572	0.531	0.000	0.00	5.90	
80.00	(1) 1 5/8" Coax	Yes	5.00	1.200	1.98	0.82	0.99	10.572	0.531	0.000	11.51	4.10	
80.00	(8) 1 5/8" Coax	Yes	5.00	1.200	3.96	1.65	1.98	10.572	0.531	0.000	23.03	32.80	
80.00	(2) 1/2" Coax	Yes	5.00	1.200	0.63	0.26	0.31	10.572	0.531	0.000	3.66	1.50	
80.00	(8) 1 5/8" Coax	Yes	5.00	1.177	5.94	2.47	2.91	10.572	0.531	0.000	33.87	32.80	
80.00	(12) 1 5/8" Coax	Yes	5.00	1.200	1.98	0.82	0.99	10.572	0.531	0.000	11.51	49.19	
80.00	(1) 1 5/8" Hybriflex	Yes	5.00	0.000	0.00	0.00	0.00	10.572	0.531	0.000	0.00	8.05	
80.00	(4) #20 Dywidag bars	Yes	5.00	0.000	0.00	0.00	0.00	10.572	0.531	0.000	0.00	334.00	
80.00	(6) 1 5/8" Coax	Yes	5.00	0.000	0.00	0.00	0.00	10.572	0.531	0.000	0.00	24.60	
80.00	(4) 1/2" Coax	Yes	5.00	0.000	0.00	0.00	0.00	10.572	0.531	0.000	0.00	3.00	
80.00	(2) 2" Conduit	Yes	5.00	0.000	0.00	0.00	0.00	10.572	0.531	0.000	0.00	36.50	
80.00	(6) 5/16" Coax	Yes	5.00	0.000	0.00	0.00	0.00	10.572	0.531	0.000	0.00	1.35	
85.00	(1) 0.39" Cable	Yes	5.00	0.000	0.00	0.00	0.00	10.708	0.547	0.000	0.00	0.35	
85.00	(2) 0.78" 8 AWG 6	Yes	5.00	0.000	0.00	0.00	0.00	10.708	0.547	0.000	0.00	5.90	
85.00	(1) 1 5/8" Coax	Yes	5.00	1.200	1.98	0.82	0.99	10.708	0.547	0.000	11.66	4.10	
85.00	(8) 1 5/8" Coax	Yes	5.00	1.200	3.96	1.65	1.98	10.708	0.547	0.000	23.32	32.80	
85.00	(2) 1/2" Coax	Yes	5.00	1.200	0.63	0.26	0.31	10.708	0.547	0.000	3.71	1.50	
85.00	(8) 1 5/8" Coax	Yes	5.00	1.169	5.94	2.47	2.89	10.708	0.547	0.000	34.08	32.80	
85.00	(12) 1 5/8" Coax	Yes	5.00	1.200	1.98	0.82	0.99	10.708	0.547	0.000	11.66	49.19	
85.00	(1) 1 5/8" Hybriflex	Yes	5.00	0.000	0.00	0.00	0.00	10.708	0.547	0.000	0.00	8.05	
85.00	(4) #20 Dywidag bars	Yes	5.00	0.000	0.00	0.00	0.00	10.708	0.547	0.000	0.00	334.00	
85.00	(6) 1 5/8" Coax	Yes	5.00	0.000	0.00	0.00	0.00	10.708	0.547	0.000	0.00	24.60	
85.00	(4) 1/2" Coax	Yes	5.00	0.000	0.00	0.00	0.00	10.708	0.547	0.000	0.00	3.00	
85.00	(2) 2" Conduit	Yes	5.00	0.000	0.00	0.00	0.00	10.708	0.547	0.000	0.00	36.50	

Pole : 302489
 Location : Enfd - Enfield, CT
 Height : 150.00 (ft)
 Base Dia : 37.380 (in)
 Top Dia : 15.000 (in)
 Shape : 12 Sides
 Taper : 0.156700 (in/ft)

Code: ANSI/TIA-222 Rev G
 Struct Class : II
 Exposure Category : C
 Topographic Category : 1
 Base Elev : 0.000 (ft)

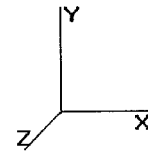

8/2/2013 4:43:30 PM
 Page: 47

© 2007 - 2013 by ATC IP LLC. All rights reserved.

Load Case: 1.0D + 1.0W	60.00 mph Serviceability	24 Iterations
Gust Response Factor 1.10		Wind Importance Factor : 1.00
Dead Load Factor : 1.00		
Wind Load Factor : 1.00		

85.00	(6) 5/16" Coax	Yes	5.00	0.000	0.00	0.00	0.00	10.708	0.547	0.000	0.00	1.35
90.00	(1) 0.39" Cable	Yes	5.00	0.000	0.00	0.00	0.00	10.838	0.565	0.000	0.00	0.35
90.00	(2) 0.78" 8 AWG 6	Yes	5.00	0.000	0.00	0.00	0.00	10.838	0.565	0.000	0.00	5.90
90.00	(1) 1 5/8" Coax	Yes	5.00	1.200	1.98	0.82	0.99	10.838	0.565	0.000	11.80	4.10
90.00	(8) 1 5/8" Coax	Yes	5.00	1.200	3.96	1.65	1.98	10.838	0.565	0.000	23.60	32.80
90.00	(2) 1/2" Coax	Yes	5.00	1.200	0.63	0.26	0.31	10.838	0.565	0.000	3.76	1.50
90.00	(8) 1 5/8" Coax	Yes	5.00	1.162	5.94	2.47	2.88	10.838	0.565	0.000	34.29	32.80
90.00	(12) 1 5/8" Coax	Yes	5.00	1.200	1.98	0.82	0.99	10.838	0.565	0.000	11.80	49.19
90.00	(1) 1 5/8" Hybriflex	Yes	5.00	0.000	0.00	0.00	0.00	10.838	0.565	0.000	0.00	8.05
90.00	(4) #20 Dywidag bars	Yes	5.00	0.000	0.00	0.00	0.00	10.838	0.565	0.000	0.00	334.00
90.00	(6) 1 5/8" Coax	Yes	5.00	0.000	0.00	0.00	0.00	10.838	0.565	0.000	0.00	24.60
90.00	(4) 1/2" Coax	Yes	5.00	0.000	0.00	0.00	0.00	10.838	0.565	0.000	0.00	3.00
90.00	(2) 2" Conduit	Yes	5.00	0.000	0.00	0.00	0.00	10.838	0.565	0.000	0.00	36.50
90.00	(6) 5/16" Coax	Yes	5.00	0.000	0.00	0.00	0.00	10.838	0.565	0.000	0.00	1.35
95.00	(1) 0.39" Cable	Yes	5.00	0.000	0.00	0.00	0.00	10.962	0.583	0.000	0.00	0.35
95.00	(2) 0.78" 8 AWG 6	Yes	5.00	0.000	0.00	0.00	0.00	10.962	0.583	0.000	0.00	5.90
95.00	(1) 1 5/8" Coax	Yes	5.00	1.200	1.98	0.82	0.99	10.962	0.583	0.000	11.94	4.10
95.00	(8) 1 5/8" Coax	Yes	5.00	1.200	3.96	1.65	1.98	10.962	0.583	0.000	23.87	32.80
95.00	(2) 1/2" Coax	Yes	5.00	1.200	0.63	0.26	0.31	10.962	0.583	0.000	3.80	1.50
95.00	(8) 1 5/8" Coax	Yes	5.00	1.155	5.94	2.47	2.86	10.962	0.583	0.000	34.48	32.80
95.00	(12) 1 5/8" Coax	Yes	5.00	1.200	1.98	0.82	0.99	10.962	0.583	0.000	11.94	49.19
95.00	(1) 1 5/8" Hybriflex	Yes	5.00	0.000	0.00	0.00	0.00	10.962	0.583	0.000	0.00	8.05
95.00	(4) #20 Dywidag bars	Yes	5.00	0.000	0.00	0.00	0.00	10.962	0.583	0.000	0.00	334.00
95.00	(6) 1 5/8" Coax	Yes	5.00	0.000	0.00	0.00	0.00	10.962	0.583	0.000	0.00	24.60
95.00	(4) 1/2" Coax	Yes	5.00	0.000	0.00	0.00	0.00	10.962	0.583	0.000	0.00	3.00
95.00	(2) 2" Conduit	Yes	5.00	0.000	0.00	0.00	0.00	10.962	0.583	0.000	0.00	36.50
95.00	(6) 5/16" Coax	Yes	5.00	0.000	0.00	0.00	0.00	10.962	0.583	0.000	0.00	1.35
100.0	(1) 0.39" Cable	Yes	5.00	0.000	0.00	0.00	0.00	11.081	0.603	0.000	0.00	0.35
100.0	(2) 0.78" 8 AWG 6	Yes	5.00	0.000	0.00	0.00	0.00	11.081	0.603	0.000	0.00	5.90
100.0	(1) 1 5/8" Coax	Yes	5.00	1.200	1.98	0.82	0.99	11.081	0.603	0.000	12.07	4.10
100.0	(8) 1 5/8" Coax	Yes	5.00	1.200	3.96	1.65	1.98	11.081	0.603	0.000	24.13	32.80
100.0	(2) 1/2" Coax	Yes	5.00	1.200	0.63	0.26	0.31	11.081	0.603	0.000	3.84	1.50
100.0	(8) 1 5/8" Coax	Yes	5.00	1.149	5.94	2.47	2.84	11.081	0.603	0.000	34.67	32.80
100.0	(12) 1 5/8" Coax	Yes	5.00	1.200	1.98	0.82	0.99	11.081	0.603	0.000	12.07	49.19
100.0	(1) 1 5/8" Hybriflex	Yes	5.00	0.000	0.00	0.00	0.00	11.081	0.603	0.000	0.00	8.05
100.0	(4) #20 Dywidag bars	Yes	5.00	0.000	0.00	0.00	0.00	11.081	0.603	0.000	0.00	334.00
100.0	(6) 1 5/8" Coax	Yes	5.00	0.000	0.00	0.00	0.00	11.081	0.603	0.000	0.00	24.60
100.0	(4) 1/2" Coax	Yes	5.00	0.000	0.00	0.00	0.00	11.081	0.603	0.000	0.00	3.00
100.0	(2) 2" Conduit	Yes	5.00	0.000	0.00	0.00	0.00	11.081	0.603	0.000	0.00	36.50
100.0	(6) 5/16" Coax	Yes	5.00	0.000	0.00	0.00	0.00	11.081	0.603	0.000	0.00	1.35
103.0	(1) 0.39" Cable	Yes	3.00	0.000	0.00	0.00	0.00	11.150	0.619	0.000	0.00	0.21
103.0	(2) 0.78" 8 AWG 6	Yes	3.00	0.000	0.00	0.00	0.00	11.150	0.619	0.000	0.00	3.54
103.0	(1) 1 5/8" Coax	Yes	3.00	1.200	1.98	0.50	0.59	11.150	0.619	0.000	7.29	2.46
103.0	(8) 1 5/8" Coax	Yes	3.00	1.200	3.96	0.99	1.19	11.150	0.619	0.000	14.57	19.68
103.0	(2) 1/2" Coax	Yes	3.00	1.200	0.63	0.16	0.19	11.150	0.619	0.000	2.32	0.90
103.0	(8) 1 5/8" Coax	Yes	3.00	1.146	5.94	1.49	1.70	11.150	0.619	0.000	20.87	19.68
103.0	(12) 1 5/8" Coax	Yes	3.00	1.200	1.98	0.50	0.59	11.150	0.619	0.000	7.29	29.52
103.0	(1) 1 5/8" Hybriflex	Yes	3.00	0.000	0.00	0.00	0.00	11.150	0.619	0.000	0.00	4.83
103.0	(4) #20 Dywidag bars	Yes	3.00	0.000	0.00	0.00	0.00	11.150	0.619	0.000	0.00	200.40
103.0	(6) 1 5/8" Coax	Yes	3.00	0.000	0.00	0.00	0.00	11.150	0.619	0.000	0.00	14.76
103.0	(4) 1/2" Coax	Yes	3.00	0.000	0.00	0.00	0.00	11.150	0.619	0.000	0.00	1.80
103.0	(2) 2" Conduit	Yes	3.00	0.000	0.00	0.00	0.00	11.150	0.619	0.000	0.00	21.90
103.0	(6) 5/16" Coax	Yes	3.00	0.000	0.00	0.00	0.00	11.150	0.619	0.000	0.00	0.81
105.0	(1) 0.39" Cable	Yes	2.00	0.000	0.00	0.00	0.00	11.195	0.630	0.000	0.00	0.14
105.0	(2) 0.78" 8 AWG 6	Yes	2.00	0.000	0.00	0.00	0.00	11.195	0.630	0.000	0.00	2.36
105.0	(1) 1 5/8" Coax	Yes	2.00	1.200	1.98	0.33	0.40	11.195	0.630	0.000	4.88	1.64
105.0	(8) 1 5/8" Coax	Yes	2.00	1.200	3.96	0.66	0.79	11.195	0.630	0.000	9.75	13.12

Pole : 302489
 Location : Enfd - Enfield, CT
 Height : 150.00 (ft)
 Base Dia : 37.380 (in)
 Top Dia : 15.000 (in)
 Shape : 12 Sides
 Taper : 0.156700 (in/ft)

Code : ANSI/TIA-222 Rev G
 Struct Class : II
 Exposure Category : C
 Topographic Category : 1
 Base Elev : 0.000 (ft)

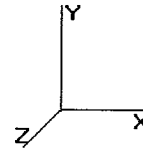

8/2/2013 4:43:30 PM
 Page : 48

© 2007 - 2013 by ATC IP LLC. All rights reserved.

Load Case: 1.0D + 1.0W	60.00 mph Serviceability	24 Iterations
Gust Response Factor : 1.10		Wind Importance Factor : 1.00
Dead Load Factor : 1.00		
Wind Load Factor : 1.00		

105.0	(2) 1/2" Coax	Yes	2.00	1.200	0.63	0.10	0.13	11.195	0.630	0.000	1.55	0.60
105.0	(8) 1 5/8" Coax	Yes	2.00	1.143	5.94	0.99	1.13	11.195	0.630	0.000	13.94	13.12
105.0	(12) 1 5/8" Coax	Yes	2.00	1.200	1.98	0.33	0.40	11.195	0.630	0.000	4.88	19.68
105.0	(1) 1 5/8" Hybriflex	Yes	2.00	0.000	0.00	0.00	0.00	11.195	0.630	0.000	0.00	3.22
105.0	(4) #20 Dywidag bars	Yes	2.00	0.000	0.00	0.00	0.00	11.195	0.630	0.000	0.00	133.60
105.0	(6) 1 5/8" Coax	Yes	2.00	0.000	0.00	0.00	0.00	11.195	0.630	0.000	0.00	9.84
110.0	(1) 0.39" Cable	Yes	5.00	0.000	0.00	0.00	0.00	11.305	0.646	0.000	0.00	0.35
110.0	(2) 0.78" 8 AWG 6	Yes	5.00	0.000	0.00	0.00	0.00	11.305	0.646	0.000	0.00	5.90
110.0	(1) 1 5/8" Coax	Yes	5.00	1.200	1.98	0.82	0.99	11.305	0.646	0.000	12.31	4.10
110.0	(8) 1 5/8" Coax	Yes	5.00	1.200	3.96	1.65	1.98	11.305	0.646	0.000	24.62	32.80
110.0	(2) 1/2" Coax	Yes	5.00	1.200	0.63	0.26	0.31	11.305	0.646	0.000	3.92	1.50
110.0	(8) 1 5/8" Coax	Yes	5.00	1.138	5.94	2.47	2.82	11.305	0.646	0.000	35.02	32.80
110.0	(12) 1 5/8" Coax	Yes	5.00	1.200	1.98	0.82	0.99	11.305	0.646	0.000	12.31	49.19
110.0	(1) 1 5/8" Hybriflex	Yes	5.00	0.000	0.00	0.00	0.00	11.305	0.646	0.000	0.00	8.05
110.0	(4) #20 Dywidag bars	Yes	5.00	0.000	0.00	0.00	0.00	11.305	0.646	0.000	0.00	334.00
110.0	(6) 1 5/8" Coax	Yes	5.00	0.000	0.00	0.00	0.00	11.305	0.646	0.000	0.00	24.60
110.0	(1) 0.39" Cable	Yes	0.00	0.000	0.00	0.00	0.00	11.305	0.658	0.000	0.00	0.00
110.0	(2) 0.78" 8 AWG 6	Yes	0.00	0.000	0.00	0.00	0.00	11.305	0.658	0.000	0.00	0.00
110.0	(1) 1 5/8" Coax	Yes	0.00	1.200	1.98	0.00	0.00	11.305	0.658	0.000	0.00	0.00
110.0	(8) 1 5/8" Coax	Yes	0.00	1.200	3.96	0.00	0.00	11.305	0.658	0.000	0.00	0.00
110.0	(2) 1/2" Coax	Yes	0.00	1.200	0.63	0.00	0.00	11.305	0.658	0.000	0.00	0.00
110.0	(8) 1 5/8" Coax	Yes	0.00	1.138	5.94	0.00	0.00	11.305	0.658	0.000	0.00	0.00
110.0	(12) 1 5/8" Coax	Yes	0.00	1.200	1.98	0.00	0.00	11.305	0.658	0.000	0.00	0.00
110.0	(1) 1 5/8" Hybriflex	Yes	0.00	0.000	0.00	0.00	0.00	11.305	0.658	0.000	0.00	0.00
110.0	(4) #20 Dywidag bars	Yes	0.00	0.000	0.00	0.00	0.00	11.305	0.658	0.000	0.00	0.02
110.0	(6) 1 5/8" Coax	Yes	0.00	0.000	0.00	0.00	0.00	11.305	0.658	0.000	0.00	0.00
115.0	(1) 0.39" Cable	Yes	5.00	0.000	0.00	0.00	0.00	11.412	0.670	0.000	0.00	0.35
115.0	(2) 0.78" 8 AWG 6	Yes	5.00	0.000	0.00	0.00	0.00	11.412	0.670	0.000	0.00	5.90
115.0	(1) 1 5/8" Coax	Yes	5.00	1.200	1.98	0.82	0.99	11.412	0.670	0.000	12.43	4.10
115.0	(8) 1 5/8" Coax	Yes	5.00	1.200	3.96	1.65	1.98	11.412	0.670	0.000	24.85	32.79
115.0	(2) 1/2" Coax	Yes	5.00	1.200	0.63	0.26	0.31	11.412	0.670	0.000	3.95	1.50
115.0	(8) 1 5/8" Coax	Yes	5.00	1.132	5.94	2.47	2.80	11.412	0.670	0.000	35.18	32.79
115.0	(12) 1 5/8" Coax	Yes	5.00	1.200	1.98	0.82	0.99	11.412	0.670	0.000	12.43	49.19
115.0	(1) 1 5/8" Hybriflex	Yes	5.00	0.000	0.00	0.00	0.00	11.412	0.670	0.000	0.00	8.05
115.0	(4) #20 Dywidag bars	Yes	5.00	0.000	0.00	0.00	0.00	11.412	0.670	0.000	0.00	333.98
115.0	(6) 1 5/8" Coax	Yes	5.00	0.000	0.00	0.00	0.00	11.412	0.670	0.000	0.00	24.60
120.0	(1) 0.39" Cable	Yes	5.00	0.000	0.00	0.00	0.00	11.514	0.697	0.000	0.00	0.35
120.0	(2) 0.78" 8 AWG 6	Yes	5.00	0.000	0.00	0.00	0.00	11.514	0.697	0.000	0.00	5.90
120.0	(1) 1 5/8" Coax	Yes	5.00	1.200	1.98	0.82	0.99	11.514	0.697	0.000	12.54	4.10
120.0	(8) 1 5/8" Coax	Yes	5.00	1.200	3.96	1.65	1.98	11.514	0.697	0.000	25.08	32.80
120.0	(2) 1/2" Coax	Yes	5.00	1.200	0.63	0.26	0.31	11.514	0.697	0.000	3.99	1.50
120.0	(8) 1 5/8" Coax	Yes	5.00	1.127	5.94	2.47	2.79	11.514	0.697	0.000	35.34	32.80
120.0	(12) 1 5/8" Coax	Yes	5.00	1.200	1.98	0.82	0.99	11.514	0.697	0.000	12.54	49.19
120.0	(1) 1 5/8" Hybriflex	Yes	5.00	0.000	0.00	0.00	0.00	11.514	0.697	0.000	0.00	8.05
120.0	(4) #20 Dywidag bars	Yes	5.00	0.000	0.00	0.00	0.00	11.514	0.697	0.000	0.00	334.00
121.0	(1) 0.39" Cable	Yes	1.00	0.000	0.00	0.00	0.00	11.534	0.713	0.000	0.00	0.07
121.0	(2) 0.78" 8 AWG 6	Yes	1.00	0.000	0.00	0.00	0.00	11.534	0.713	0.000	0.00	1.18
121.0	(1) 1 5/8" Coax	Yes	1.00	1.200	1.98	0.17	0.20	11.534	0.713	0.000	2.51	0.82
121.0	(8) 1 5/8" Coax	Yes	1.00	1.200	3.96	0.33	0.40	11.534	0.713	0.000	5.02	6.56
121.0	(2) 1/2" Coax	Yes	1.00	1.200	0.63	0.05	0.06	11.534	0.713	0.000	0.80	0.30
121.0	(8) 1 5/8" Coax	Yes	1.00	1.126	5.94	0.50	0.56	11.534	0.713	0.000	7.07	6.56
121.0	(12) 1 5/8" Coax	Yes	1.00	1.200	1.98	0.17	0.20	11.534	0.713	0.000	2.51	9.84
121.0	(1) 1 5/8" Hybriflex	Yes	1.00	0.000	0.00	0.00	0.00	11.534	0.713	0.000	0.00	1.61
121.0	(4) #20 Dywidag bars	Yes	1.00	0.000	0.00	0.00	0.00	11.534	0.713	0.000	0.00	66.80
125.0	(1) 0.39" Cable	Yes	4.00	0.000	0.00	0.00	0.00	11.614	0.728	0.000	0.00	0.28
125.0	(2) 0.78" 8 AWG 6	Yes	4.00	0.000	0.00	0.00	0.00	11.614	0.728	0.000	0.00	4.72
125.0	(1) 1 5/8" Coax	Yes	4.00	1.200	1.98	0.66	0.79	11.614	0.728	0.000	10.12	3.28

Pole : 302489
 Location : Enfd - Enfield, CT
 Height : 150.00 (ft)
 Base Dia : 37.380 (in)
 Top Dia : 15.000 (in)
 Shape : 12 Sides
 Taper : 0.156700 (in/ft)

Code: ANSI/TIA-222 Rev G
 Struct Class : II
 Exposure Category : C
 Topographic Category : 1
 Base Elev : 0.000 (ft)

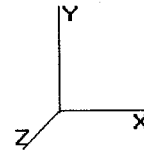

8/2/2013 4:43:30 PM
 Page: 49

© 2007 - 2013 by ATC IP LLC. All rights reserved.

Load Case: 1.0D + 1.0W

60.00 mph Serviceability

24 Iterations

Gust Response Factor 1.10
 Dead Load Factor : 1.00
 Wind Load Factor : 1.00

Wind Importance Factor : 1.00

125.0	(8) 1 5/8" Coax	Yes	4.00	1.200	3.96	1.32	1.58	11.614	0.728	0.000	20.24	26.24
125.0	(2) 1/2" Coax	Yes	4.00	1.200	0.63	0.21	0.25	11.614	0.728	0.000	3.22	1.20
125.0	(8) 1 5/8" Coax	Yes	4.00	1.123	5.94	1.98	2.22	11.614	0.728	0.000	28.40	26.24
125.0	(12) 1 5/8" Coax	Yes	4.00	1.200	1.98	0.66	0.79	11.614	0.728	0.000	10.12	39.36
125.0	(1) 1 5/8" Hybriflex	Yes	4.00	0.000	0.00	0.00	0.00	11.614	0.728	0.000	0.00	6.44
125.0	(4) #20 Dywidag bars	Yes	4.00	0.000	0.00	0.00	0.00	11.614	0.728	0.000	0.00	267.20
126.0	(1) 0.39" Cable	Yes	1.00	0.000	0.00	0.00	0.00	11.633	0.743	0.000	0.00	0.07
126.0	(2) 0.78" 8 AWG 6	Yes	1.00	0.000	0.00	0.00	0.00	11.633	0.743	0.000	0.00	1.18
126.0	(1) 1 5/8" Coax	Yes	1.00	1.200	1.98	0.17	0.20	11.633	0.743	0.000	2.53	0.82
126.0	(8) 1 5/8" Coax	Yes	1.00	1.200	3.96	0.33	0.40	11.633	0.743	0.000	5.07	6.56
126.0	(2) 1/2" Coax	Yes	1.00	1.200	0.63	0.05	0.06	11.633	0.743	0.000	0.81	0.30
126.0	(8) 1 5/8" Coax	Yes	1.00	1.122	5.94	0.50	0.56	11.633	0.743	0.000	7.10	6.56
126.0	(12) 1 5/8" Coax	Yes	1.00	1.200	1.98	0.17	0.20	11.633	0.743	0.000	2.53	9.84
126.0	(1) 1 5/8" Hybriflex	Yes	1.00	0.000	0.00	0.00	0.00	11.633	0.743	0.000	0.00	1.61
126.0	(4) #20 Dywidag bars	Yes	0.51	0.000	0.00	0.00	0.00	11.633	0.743	0.000	0.00	34.07
130.0	(1) 0.39" Cable	Yes	4.00	0.000	0.00	0.00	0.00	11.710	0.655	0.000	0.00	0.28
130.0	(2) 0.78" 8 AWG 6	Yes	4.00	0.000	0.00	0.00	0.00	11.710	0.655	0.000	0.00	4.72
130.0	(1) 1 5/8" Coax	Yes	4.00	1.200	1.98	0.66	0.79	11.710	0.655	0.000	10.20	3.28
130.0	(8) 1 5/8" Coax	Yes	4.00	1.200	3.96	1.32	1.58	11.710	0.655	0.000	20.40	26.24
130.0	(2) 1/2" Coax	Yes	4.00	1.200	0.63	0.21	0.25	11.710	0.655	0.000	3.25	1.20
130.0	(8) 1 5/8" Coax	Yes	4.00	1.118	5.94	1.98	2.21	11.710	0.655	0.000	28.51	26.24
135.0	(1) 0.39" Cable	Yes	5.00	0.000	0.00	0.00	0.00	11.803	0.681	0.000	0.00	0.35
135.0	(2) 0.78" 8 AWG 6	Yes	5.00	0.000	0.00	0.00	0.00	11.803	0.681	0.000	0.00	5.90
135.0	(1) 1 5/8" Coax	Yes	5.00	1.200	1.98	0.82	0.99	11.803	0.681	0.000	12.85	4.10
135.0	(8) 1 5/8" Coax	Yes	5.00	1.200	3.96	1.65	1.98	11.803	0.681	0.000	25.71	32.80
135.0	(2) 1/2" Coax	Yes	5.00	1.200	0.63	0.26	0.31	11.803	0.681	0.000	4.09	1.50
135.0	(8) 1 5/8" Coax	Yes	5.00	1.114	5.94	2.47	2.76	11.803	0.681	0.000	35.78	32.80
140.0	(1) 0.39" Cable	Yes	5.00	0.000	0.00	0.00	0.00	11.894	0.713	0.000	0.00	0.35
140.0	(2) 0.78" 8 AWG 6	Yes	5.00	0.000	0.00	0.00	0.00	11.894	0.713	0.000	0.00	5.90
140.0	(1) 1 5/8" Coax	Yes	5.00	1.200	1.98	0.82	0.99	11.894	0.713	0.000	12.95	4.10
140.0	(8) 1 5/8" Coax	Yes	5.00	1.200	3.96	1.65	1.98	11.894	0.713	0.000	25.91	32.80
140.0	(2) 1/2" Coax	Yes	5.00	1.200	0.63	0.26	0.31	11.894	0.713	0.000	4.12	1.50
140.0	(8) 1 5/8" Coax	Yes	5.00	1.109	5.94	2.47	2.75	11.894	0.713	0.000	35.92	32.80
144.0	(1) 0.39" Cable	Yes	4.00	0.000	0.00	0.00	0.00	11.965	0.390	0.000	0.00	0.28
144.0	(2) 0.78" 8 AWG 6	Yes	4.00	0.000	0.00	0.00	0.00	11.965	0.390	0.000	0.00	4.72
144.0	(1) 1 5/8" Coax	Yes	4.00	1.200	1.98	0.66	0.79	11.965	0.390	0.000	10.42	3.28
144.0	(8) 1 5/8" Coax	Yes	4.00	1.200	3.96	1.32	1.58	11.965	0.390	0.000	20.85	26.24
144.0	(2) 1/2" Coax	Yes	4.00	1.200	0.63	0.21	0.25	11.965	0.390	0.000	3.32	1.20
145.0	(1) 0.39" Cable	Yes	1.00	0.000	0.00	0.00	0.00	11.982	0.362	0.000	0.00	0.07
145.0	(2) 0.78" 8 AWG 6	Yes	1.00	0.000	0.00	0.00	0.00	11.982	0.362	0.000	0.00	1.18
145.0	(1) 1 5/8" Coax	Yes	1.00	1.200	1.98	0.17	0.20	11.982	0.362	0.000	2.61	0.82
145.0	(8) 1 5/8" Coax	Yes	1.00	1.200	3.96	0.33	0.40	11.982	0.362	0.000	5.22	6.56
150.0	(1) 0.39" Cable	Yes	5.00	0.000	0.00	0.00	0.00	12.068	0.373	0.000	0.00	0.35
150.0	(2) 0.78" 8 AWG 6	Yes	5.00	0.000	0.00	0.00	0.00	12.068	0.373	0.000	0.00	5.90
150.0	(1) 1 5/8" Coax	Yes	5.00	1.200	1.98	0.82	0.99	12.068	0.373	0.000	13.14	4.10
150.0	(8) 1 5/8" Coax	Yes	5.00	1.200	3.96	1.65	1.98	12.068	0.373	0.000	26.28	32.80
Totals:											2,399.89	13,096.30

Pole : 302489
 Location : Enfd - Enfield, CT
 Height : 150.00 (ft)
 Base Dia : 37.380 (in)
 Top Dia : 15.000 (in)
 Shape : 12 Sides
 Taper : 0.156700 (in/ft)

Code: ANSI/TIA-222 Rev G
 Struct Class : II
 Exposure Category : C
 Topographic Category : 1
 Base Elev : 0.000 (ft)

8/2/2013 4:43:30 PM
 Page: 50

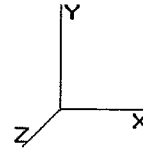

© 2007 - 2013 by ATC IP LLC. All rights reserved.

Load Case: 1.0D + 1.0W	60.00 mph Serviceability	24 Iterations
Gust Response Factor 1.10		Wind Importance Factor : 1.00
Dead Load Factor : 1.00		
Wind Load Factor : 1.00		

Applied Segment Forces Summary

Seg Elev (ft)	Lateral FX (-) (lb)	Axial FY (-) (lb)	Torsion MY (lb-ft)	Moment MZ (lb-ft)
0.00	0.00	0.00	0.00	0.00
5.00	130.61	1,754.19	0.00	0.00
10.00	127.85	1,738.09	0.00	0.00
15.00	263.98	2,005.87	0.00	0.00
20.00	276.57	1,989.77	0.00	0.00
25.00	286.18	1,973.68	0.00	0.00
30.00	293.54	1,957.58	0.00	0.00
31.50	88.24	584.27	0.00	0.00
35.00	168.26	1,746.45	0.00	0.00
35.67	31.48	331.22	0.00	0.00
40.00	207.72	1,585.60	0.00	0.00
45.00	241.81	1,817.16	0.00	0.00
50.00	242.96	1,803.75	0.00	0.00
55.00	243.53	1,790.33	0.00	0.00
56.00	245.85	482.46	0.00	394.97
60.00	194.52	1,419.86	0.00	0.00
65.00	243.22	1,428.76	0.00	0.00
70.00	242.26	1,415.34	0.00	0.00
70.00	0.02	0.09	0.00	0.00
73.50	170.53	1,241.73	0.00	0.00
75.00	72.66	394.63	0.00	0.00
80.00	242.27	1,308.74	0.00	0.00
85.00	240.39	1,298.01	0.00	0.00
90.00	238.25	1,287.28	0.00	0.00
95.00	235.89	1,276.55	0.00	0.00
100.0	233.32	1,265.82	0.00	0.00
103.0	504.90	1,600.34	0.00	1,166.95
105.0	91.62	484.41	0.00	0.00
110.0	227.61	1,203.50	0.00	0.00
110.0	0.02	0.08	0.00	0.00
115.0	330.97	1,201.91	0.00	319.47
120.0	221.22	1,090.15	0.00	0.00
121.0	43.70	217.06	0.00	0.00
125.0	173.82	597.84	0.00	0.00
126.0	824.53	1,967.72	0.00	503.84
130.0	160.77	278.40	0.00	0.00
135.0	197.68	340.76	0.00	0.00
140.0	760.87	2,058.01	0.00	0.00
144.0	277.95	519.06	0.00	0.00
145.0	29.47	52.51	0.00	0.00
150.0	1,329.46	3,126.72	0.00	1,814.12
Totals:	10,136.50	48,635.69	0.00	4,199.35

Pole : 302489
 Location : Enfd - Enfield, CT
 Height : 150.00 (ft)
 Base Dia : 37.380 (in)
 Top Dia : 15.000 (in)
 Shape : 12 Sides
 Taper : 0.156700 (in/ft)

Code: ANSI/TIA-222 Rev G
 Struct Class : II
 Exposure Category : C
 Topographic Category : 1
 Base Elev : 0.000 (ft)

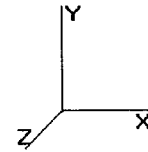

8/2/2013 4:43:30 PM
 Page: 51

© 2007 - 2013 by ATC IP LLC. All rights reserved.

Load Case: 1.0D + 1.0W

60.00 mph Serviceability

24 Iterations

Gust Response Factor 1.10
 Dead Load Factor : 1.00
 Wind Load Factor : 1.00

Wind Importance Factor : 1.00

Calculated Forces

Seg Elev (ft)	Pu FY (-) (kips)	Vu FX (-) (kips)	Tu MY (ft-kips)	Mu MZ (ft-kips)	Mu MX (ft-kips)	Resultant Moment (ft-kips)	phi Pn (kips)	phi Vn (kips)	phi Tn (ft-kips)	phi Mn (ft-kips)	Total Deflect (in)	Rotation (deg)	Ratio
0.00	-48.63	-10.17	0.00	-989.82	0.00	989.82	3,133.66	1,566.83	4,776.46	2,358.91	0.00	0.00	0.167
5.00	-46.86	-10.09	0.00	-939.00	0.00	939.00	3,091.35	1,545.67	4,611.19	2,277.30	0.04	-0.07	0.161
10.00	-45.11	-10.01	0.00	-888.56	0.00	888.56	3,047.99	1,524.00	4,447.17	2,196.29	0.14	-0.13	0.155
15.00	-43.10	-9.79	0.00	-838.52	0.00	838.52	3,003.60	1,501.80	4,284.50	2,115.95	0.32	-0.20	0.148
20.00	-41.10	-9.55	0.00	-789.58	0.00	789.58	2,958.17	1,479.08	4,123.27	2,036.33	0.56	-0.26	0.142
25.00	-39.12	-9.30	0.00	-741.84	0.00	741.84	2,911.70	1,455.85	3,963.58	1,957.46	0.87	-0.32	0.135
30.00	-37.15	-9.02	0.00	-695.36	0.00	695.36	2,864.18	1,432.09	3,805.55	1,879.42	1.24	-0.39	0.129
31.50	-36.57	-8.94	0.00	-681.84	0.00	681.84	2,849.72	1,424.86	3,758.46	1,856.16	1.37	-0.41	0.127
35.00	-34.82	-8.78	0.00	-650.54	0.00	650.54	2,805.48	1,402.74	3,636.10	1,795.73	1.68	-0.45	0.121
35.67	-34.48	-8.76	0.00	-644.69	0.00	644.69	2,231.07	1,115.54	2,951.42	1,457.59	1.74	-0.46	0.135
40.00	-32.89	-8.57	0.00	-606.73	0.00	606.73	2,201.95	1,100.98	2,850.70	1,407.85	2.18	-0.51	0.129
45.00	-31.07	-8.34	0.00	-563.88	0.00	563.88	2,167.39	1,083.69	2,735.30	1,350.86	2.74	-0.57	0.121
50.00	-29.26	-8.11	0.00	-522.16	0.00	522.16	2,131.78	1,065.89	2,620.87	1,294.35	3.37	-0.62	0.114
55.00	-27.47	-7.86	0.00	-481.60	0.00	481.60	2,095.13	1,047.56	2,507.52	1,238.37	4.05	-0.68	0.106
56.00	-26.98	-7.62	0.00	-473.34	0.00	473.34	2,087.67	1,043.84	2,484.99	1,227.24	4.20	-0.69	0.104
60.00	-25.56	-7.43	0.00	-442.85	0.00	442.85	2,057.44	1,028.72	2,395.35	1,182.97	4.80	-0.73	0.099
60.00	-25.56	-7.43	0.00	-442.85	0.00	442.85	2,057.44	1,028.72	2,395.35	1,182.97	4.80	-0.73	0.187
65.00	-24.12	-7.20	0.00	-405.68	0.00	405.68	2,018.71	1,009.36	2,284.46	1,128.21	5.59	-0.79	0.176
70.00	-22.71	-6.96	0.00	-369.67	0.00	369.67	1,978.94	989.47	2,174.96	1,074.13	6.47	-0.88	0.165
70.00	-22.70	-6.97	0.00	-369.67	0.00	369.67	1,978.94	989.47	2,174.95	1,074.12	6.47	-0.88	0.165
73.50	-21.46	-6.80	0.00	-345.27	0.00	345.27	1,462.64	731.32	1,612.09	796.15	7.14	-0.95	0.184
75.00	-21.06	-6.74	0.00	-335.07	0.00	335.07	1,455.06	727.53	1,589.51	785.00	7.44	-0.98	0.180
80.00	-19.74	-6.51	0.00	-301.36	0.00	301.36	1,429.11	714.55	1,514.58	747.99	8.52	-1.07	0.166
85.00	-18.44	-6.27	0.00	-268.81	0.00	268.81	1,402.12	701.06	1,440.27	711.29	9.69	-1.16	0.151
90.00	-17.15	-6.03	0.00	-237.45	0.00	237.45	1,374.09	687.04	1,366.68	674.95	10.96	-1.25	0.137
95.00	-15.87	-5.79	0.00	-207.29	0.00	207.29	1,345.02	672.51	1,293.93	639.02	12.31	-1.33	0.123
100.00	-14.60	-5.54	0.00	-178.34	0.00	178.34	1,314.91	657.46	1,222.10	603.55	13.75	-1.41	0.109
103.00	-13.01	-5.00	0.00	-160.56	0.00	160.56	1,296.35	648.17	1,179.50	582.51	14.65	-1.45	0.099
105.00	-12.53	-4.91	0.00	-150.55	0.00	150.55	1,283.76	641.88	1,151.31	568.59	15.26	-1.48	0.094
110.00	-11.33	-4.66	0.00	-126.00	0.00	126.00	1,247.14	623.57	1,077.81	532.29	16.84	-1.54	0.082
110.00	-11.33	-4.66	0.00	-126.00	0.00	126.00	1,247.13	623.57	1,077.80	532.29	16.84	-1.54	0.082
110.00	-11.33	-4.66	0.00	-126.00	0.00	126.00	846.54	423.27	735.96	363.46	16.84	-1.54	0.099
115.00	-10.13	-4.31	0.00	-102.37	0.00	102.37	828.55	414.27	693.31	342.40	18.49	-1.60	0.082
120.00	-9.04	-4.06	0.00	-80.83	0.00	80.83	809.51	404.76	651.00	321.50	20.19	-1.65	0.066
121.00	-8.83	-4.01	0.00	-76.77	0.00	76.77	805.58	402.79	642.58	317.35	20.54	-1.66	0.063
121.00	-8.83	-4.01	0.00	-76.77	0.00	76.77	805.58	402.79	642.58	317.35	20.54	-1.66	0.253
125.00	-8.23	-3.83	0.00	-60.71	0.00	60.71	789.44	394.72	609.12	300.82	21.94	-1.69	0.212
126.00	-6.29	-2.95	0.00	-56.38	0.00	56.38	785.30	392.65	600.81	296.72	22.30	-1.73	0.198
130.00	-6.01	-2.80	0.00	-44.56	0.00	44.56	768.32	384.16	567.78	280.41	23.80	-1.84	0.167
135.00	-5.67	-2.60	0.00	-30.58	0.00	30.58	746.17	373.08	527.09	260.31	25.79	-1.96	0.125
140.00	-3.64	-1.77	0.00	-17.59	0.00	17.59	722.98	361.49	487.14	240.58	27.90	-2.05	0.078
144.00	-3.13	-1.47	0.00	-10.51	0.00	10.51	701.03	350.52	454.07	224.25	29.64	-2.10	0.051
145.00	-3.08	-1.44	0.00	-9.04	0.00	9.04	694.06	347.03	445.03	219.78	30.08	-2.11	0.046
150.00	0.00	-1.33	0.00	-1.81	0.00	1.81	659.19	329.60	401.19	198.13	32.30	-2.13	0.009

Pole : 302489
 Location : Enfd - Enfield, CT
 Height : 150.00 (ft)
 Base Dia : 37.380 (in)
 Top Dia : 15.000 (in)
 Shape : 12 Sides
 Taper : 0.156700 (in/ft)

Code: ANSI/TIA-222 Rev G
 Struct Class : II
 Exposure Category : C
 Topographic Category : 1
 Base Elev : 0.000 (ft)

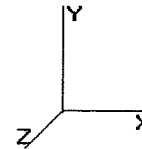

8/2/2013 4:43:31 PM
 Page: 52

© 2007 - 2013 by ATC IP LLC. All rights reserved.

Analysis Summary

Load Case	Reactions						Max Usage	
	Shear FX (kips)	Shear FZ (kips)	Axial FY (kips)	Moment MX (ft-kips)	Moment MY (ft-kips)	Moment MZ (ft-kips)	Elev (ft)	Interaction Ratio
1.2D + 1.6W	39.41	0.00	55.82	0.00	0.00	3867.76	121.00	0.98
0.9D + 1.6W	39.38	0.00	44.86	0.00	0.00	3824.20	121.00	0.95
1.2D + 1.0Di + 1.0Wi	11.19	0.00	110.56	0.00	0.00	1192.43	121.00	0.34
1.0D + 1.0W	10.17	0.00	48.62	0.00	0.00	989.82	121.00	0.25

Additional Steel Summary

Elev From (ft)	Elev To (ft)	Member	Intermediate Connectors			Upper Termination Connectors				Lower Termination Connectors				Max Member		
			VQ/I (lb/in)	Shear Applied (kips)	Shear phiVn (kips)	MQ/I (kips)	phiVn (kips)	Num Reqd	Num Actual	MQ/I (kips)	phiVn (kips)	Num Reqd	Num Actual	Pu (kip)	phiPn (kip)	Ratio
0.00	60.00	(4) SOL-#20 All Thre	298.1	8.9	16.8	210.0	12.0	18	24	0.0	12.0	0	0	315.5	330.5	0.955
0.00	121.0	(4) SOL-#20 All Thre	473.4	14.2	16.8	104.4	12.0	9	10	0.0	12.0	0	0	306.0	330.5	0.926

Base/Flange Plate	Plate Type	Baseplate
	Pole Diameter	37.38 in
	Pole Thickness	in
	Plate Length	44 in
	Plate Thickness	2.5 in
	Plate Fy	60 ksi
	Weld Length	0.3125 in
	ϕ_s Resistance	1382.37 k-in
Applied	698.24 k-in	
Stiffeners	#	0

Code Rev. **G**

Date **8/2/2013**
 Engineer **JAA**
 Site # **302489**
 Carrier **Verizon**

Moment **3867.8 k-ft**
 Axial **110.6 k**

Bolts	#	8
	Bolt Circle	44 in
	(R)adial / (S)quare	S
	Bolt Gap	6 in
	Diameter	2.25 in
	Hole Diameter	2.625 in
	Type	A615-75
	Fy	75 ksi
Fu	100 ksi	
ϕ_s Resistance	259.82 k	
Applied	207.19 k	
Reinforcement	#	4
	DYW. Circle	46 in
	Offset Angle	0°
	Type	#20
	Diameter	2.5 in
Fu	100 ksi	
Extra Bolts O	#	4
	Bolt Circle	52.4 in
	(R)adial / (S)quare	R
	Offset Angle	0°
	Diameter	2.5 in
	Type	DYWIDAG
	Fy	80 ksi
Fu	100 ksi	
ϕ_s Resistance	319.91 k	
Applied	313.85 k	

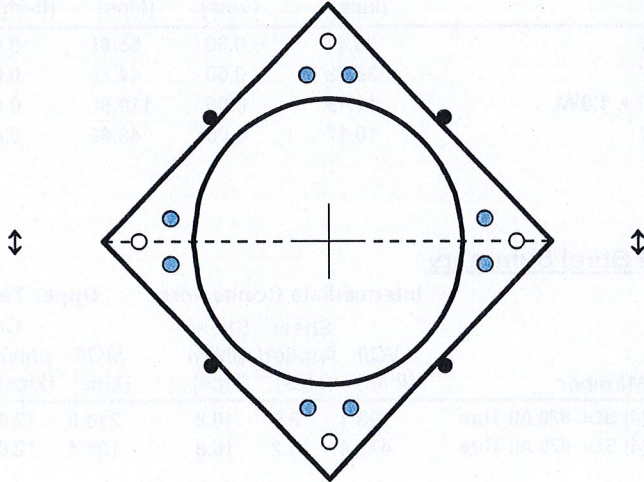

Plate Stress Ratio:
0.51 (Pass)

Bolt Stress Ratio:
0.80 (Pass)

Extra Bolt Stress Ratio:
0.98 (Pass)

Base/Flange Plate	Plate Type	Flange @ 110.0 ft
	Pole Diameter	21.25 in
	Pole Thickness	in
	Plate Diameter	28.5 in
	Plate Thickness	1 in
	Plate Fy	60 ksi
	Weld Length	0.1875 in
	ϕ_s Resistance Applied	96.45 k-in 27.91 k-in
Stiffeners	#	0

Code Rev. **G**

Date **8/2/2013**
 Engineer **JAA**
 Site # **302489**
 Carrier **Verizon**

Moment **500.5 k-ft**
 Axial **11.7 k**

Required Flange Thickness:
0.54 in OK

Bolts	#	8
	Bolt Circle (R)adial / (S)quare	25.75 in R
	Diameter	1 in
	Hole Diameter	1.125 in
	Type	A325
	Fy	92 ksi
	Fu	120 ksi
	ϕ_s Resistance Applied	54.52 k 18.60 k
Reinforcement	#	4
	DYW. Circle	28 in
	Offset Angle	24°
	Type	#20
	Diameter	2.5 in
Fu	100 ksi	
Extra Bolts O	#	0

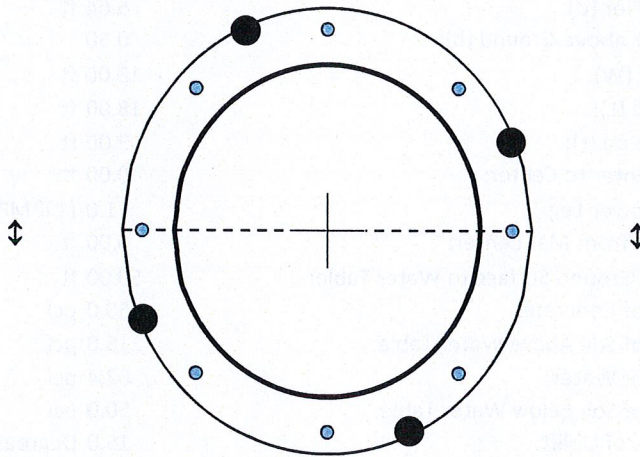
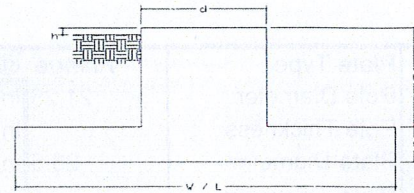

Plate Stress Ratio:
0.29 (Pass)

Bolt Stress Ratio:
0.34 (Pass)

Site Name: Enfd-Enfield, CT
 Site Number: 302489
 Engineering Number: 52476824
 Engineer: J. Abbott
 Date: 08/02/13
 Tower Type: MP

Program Last Updated: 11/15/2012



Design Loads (Factored) - Analysis per TIA-222-G Standards

Design / Analysis / Mapping:	Analysis		
Compression/Leg:	110.6 k	Concrete Strength (f'_c):	3000 psi
Uplift/Leg:	0.0 k	Pad Tension Steel Depth:	32.00 in
Total Shear:	39.4 k	ϕ_{Shear} :	0.75
Moment:	3867.8 k-ft	$\phi_{\text{Flexure / Tension}}$:	0.90
Tower + Appurtenance Weight:	54.2 k	$\phi_{\text{Compression}}$:	0.65
Depth to Base of Foundation (l + t - h):	8.00 ft	β :	0.85
Diameter of Pier (d):	5.64 ft	Bottom Pad Rebar Size #:	10
Height of Pier above Ground (h):	0.50	# of Bottom Pad Rebar:	34
Width of Pad (W):	18.00 ft	Pad Bottom Steel Area:	43.18 in ²
Length of Pad (L):	18.00 ft	Pad Steel F_y :	60000 psi
Thickness of Pad (t):	3.00 ft	Top Pad Rebar Size #:	10
Tower Leg Center to Center:	0.00 ft	# of Top Pad Rebar:	34
Number of Tower Legs:	1.0 (1 if MP or GT)	Pad Top Steel Area:	43.18 in ²
Tower Center from Mat Center:	0.00 ft	Pier Rebar Size #:	11
Depth Below Ground Surface to Water Table:	50.00 ft	Pier Steel Area (Single Bar):	1.56 in ²
Unit Weight of Concrete:	150.0 pcf	# of Pier Rebar:	52
Unit Weight of Soil Above Water Table:	115.0 pcf	Pier Steel F_y :	60000 psi
Unit Weight of Water:	62.4 pcf	Pier Cage Diameter:	59.7 in
Unit Weight of Soil Below Water Table:	50.0 pcf	Rebar Strain Limit:	0.008
Friction Angle of Uplift:	15.0 Degrees	Steel Elastic Modulus:	29000 ksi
Ultimate Coefficient of Shear Friction:	0.30	Tie Rebar Size #:	4
Ultimate Compressive Bearing Pressure:	12000.0 psf	Tie Steel Area (Single Bar):	0.20 in ²
Ultimate Passive Pressure on Pad Face:	0.0 psf	Tie Spacing:	12 in
$\phi_{\text{Soil and Concrete Weight}}$:	0.9	Tie Steel F_y :	60000 psi
ϕ_{Soil} :	0.75		

Overtuning Moment Usage

Design OIM:	4202.7 k-ft
Weight of Soil and Concrete OIM Resistance:	495.3 k
OTM Resistance from Soil and Concrete:	4458.0 k-ft
OTM Resistance from Tower:	406.5 k-ft
OTM Resistance from Soil Failure:	332.2 k-ft
OTM Resistance from Passive Pressure on Pad Face:	0.0 k-ft
OTM Resistance:	4677.0 k-ft
Design OTM / OTM Resistance:	0.90 Result: OK

Soil Bearing Pressure Usage

Net Bearing Pressure:	8804 psf
Factored Nominal Bearing Pressure:	9000 psf
Net Bearing Pressure/Factored Nominal Bearing Pressure:	0.98 Result: OK
Load Direction Controlling Design Bearing Pressure:	Diagonal to Pad Edge

Sliding Factor of Safety

Total Factored Sliding Resistance:	121.6 k
Sliding Design / Sliding Resistance:	0.32 Result: OK

One Way Shear, Flexural Capacity, and Punching Shear

Factored One Way Shear (V_u):	298.9 k
One Way Shear Capacity (ϕV_c):	456.9 k - ACI11.3.1.1
$V_u / \phi V_c$:	0.65 Result: OK
Load Direction Controlling Shear Capacity:	Diagonal to Pad Edge
Lower Steel Pad Factored Moment (M_u):	1822.0 k-ft
Lower Steel Pad Moment Capacity (ϕM_n):	6238.9 k-ft - ACI10.3
$M_u / \phi M_n$:	0.29 Result: OK
Load Direction Controlling Flexural Capacity:	Diagonal to Pad Edge
Upper Steel Pad Factored Moment (M_u):	562.7 k-ft
Upper Steel Pad Moment Capacity (ϕM_n):	5829.5 k-ft
$M_u / \phi M_n$:	0.10 Result: OK
Lower Pad Flexural Reinforcement Ratio:	0.0062 OK - Minimum Reinforcement Ratio Met - ACI10.5.1
Upper Pad Flexural Reinforcement Ratio:	0.0062 OK - Minimum Reinforcement Ratio Met - ACI10.5.1
Lower Pad Reinforcement Spacing:	6 in - Pad Reinforcing Spacing OK - ACI7.12.2.2 & 10.5.4
Upper Pad Reinforcement Spacing:	6 in - Pad Reinforcing Spacing OK - ACI7.12.2.2 & 10.5.4
Factored Punching Shear (V_u):	0.0 k
Nominal Punching Shear Capacity ($\phi_c V_n$):	1646.6 k - ACI11.12.2.1
$V_u / \phi V_c$:	0.00 Result: OK
Factored Moment in Pier (M_u):	4084.5 k-ft
Pier Moment Capacity (ϕM_n):	10652.2 k-ft
$M_u / \phi M_n$:	0.38 Result: OK
Factored Shear in Pier (V_u):	39.4 k
Pier Shear Capacity (ϕV_n):	300.1 k
$V_u / \phi V_c$:	0.13 Result: OK
Pier Shear Reinforcement Ratio:	0.0006 No Ties Necessary for Shear - ACI11.5.6.1
Factored Tension in Pier (T_u):	0.0 k
Pier Tension Capacity (ϕT_n):	4380.5 k
$T_u / \phi T_n$:	0.00 Result: OK
Factored Compression in Pier (P_u):	110.6 k
Pier Compression Capacity (ϕP_n):	4662.8 k - ACI10.3.6.2
$P_u / \phi P_n$:	0.02 Result: OK
Pier Compression Reinforcement Ratio:	0.023 OK - Reinforcement Ratio Met - ACI10.9.1 & 10.8.4
$M_u / \phi M_n + T_u / \phi T_n$:	0.38 Result: OK

Nominal and Design Moment Capacity and Factored Design Loads

