



Northeast Site Solutions
Denise Sabo
420 Main Street, Sturbridge, MA 01655
860-209-4690
denise@northeastsitesolutions.com

August 10, 2018

Members of the Siting Council
Connecticut Siting Council
Ten Franklin Square
New Britain, CT 06051

RE: Notice of Exempt Modification
232 South Main Street, East Windsor CT 06088
Latitude: 41.771800
Longitude: -72.590300
T-Mobile Site#: CT11402A_L700 4x2

Dear Ms. Bachman:

T-Mobile is requesting to file an exempt modification for an existing 188-foot Lattice Tower located at 232 South Main Street, East Windsor CT. T-Mobile currently maintains nine (9) antennas at the 155-foot level of the existing 188-foot tower. The tower and property are owned by the Balch Bridge Street Corp. T-Mobile now intends to replace three (3) existing antenna with three (3) new 600/700 MHz antenna. The new antennas would be installed at the 155-foot and level of the tower. T-Mobile also intends to make the following modifications.

Planned Modifications:

Remove:

(3) RR90 Antenna
(12) Coax lines

Remove and Replace:

(3) RR90 Antenna **(Remove)** – (3) APXVAARR24-43-U-NA20 Antenna 600/700 MHz **(Replace)**

Install New:

(3) RRU 4449 B71+B12

Existing to Remain:

(6) 1-1/4" Coax
(2) Hybrid line
(3) APX16DWV Antenna 1900/2100MHz
(6) TMA

This facility was first approved by the Town of East Windsor P&Z – Approved in 1996 for the construction of a 200-ft telecommunication tower. Please see attached.

Please accept this letter as notification pursuant to Regulations of Connecticut State Agencies § 16-50j-73, for construction that constitutes an exempt modification pursuant to R.C.S.A. § 16-50j-72(b)(2). In accordance with R.C.S.A. § 16-50j-73, a copy of this letter is being sent to First Selectman Robert Maynard, as Elected Official for the Town of East Windsor and Laurie P Whitten, Town Planner as well as the property owner and the tower owner.

The planned modifications to the facility fall squarely within those activities explicitly provided for in R.C.S.A. § 16-50j-72(b)(2).

1. The proposed modifications will not result in an increase in the height of the existing structure.
2. The proposed modifications will not require the extension of the site boundary.
3. The proposed modifications will not increase noise levels at the facility by six decibels or more, or to levels that exceed state and local criteria.
4. The operation of the replacement antennas will not increase radio frequency emissions at the facility to a level at or above the Federal Communications Commission safety standard.
5. The proposed modifications will not cause a change or alteration in the physical or environmental characteristics of the site.
6. The existing structure and its foundation can support the proposed loading.

For the foregoing reasons, T-Mobile respectfully submits that the proposed modifications to the above referenced telecommunications facility constitute an exempt modification under R.C.S.A. § 16-50j-72(b)(2).

Sincerely,

Denise Sabo

Mobile: 860-209-4690

Fax: 413-521-0558

Office: 420 Main Street, Sturbridge, MA 01655

Email: denise@northeastsitesolutions.com

Attachments

cc: First Selectman, Robert Maynard - as elected official
Laurie P Whitten - Town Planner
Balch Bridge Street Corp - Tower and property owner

Exhibit A

**TOWN OF EAST WINDSOR - PLANNING & ZONING COMMISSION
AUGUST 13, 1996 - PUBLIC HEARING #1271**

CONDITIONS OF APPROVAL

**BALCH BRIDGE STREET CORPORATION
SPECIAL USE PERMIT - TELECOMMUNICATIONS TOWER
232 SOUTH MAIN STREET
EAST WINDSOR, CONNECTICUT**

Motion by: Ed Filipone

Seconded by: Susan Kiss

TO APPROVE the application of Balch Bridge Street Corporation for a Special Use Permit to allow the construction of a 200 foot tall telecommunications tower on property located at 232 South Main Street which is presently zoned B-2 and shown on Assessors Map 33, Block 5, Lot 84-1. This approval is subject to conformance with the reference plans and the following conditions:

Referenced plans:

- "Key Map, Balch Bridge Street Corporation, South Main Street - U.S. Route 5 East Windsor, Connecticut" Sheet 1 of 3, Scale 1"=200' BY J.R. Russo & Associates dated 7-2-96.
- "Balch Bridge Street Corporation, South Main Street - U.S. Route 5 East Windsor, Connecticut" Sheet 2 of 3, Scale 1"=100' BY J.R. Russo & Associates dated 7-2-96.
- "Site Plan, Balch Bridge Street Corporation, South Main Street - U.S. Route 5 East Windsor, Connecticut" Sheet 1 of 3, Scale 1"=200' BY J.R. Russo & Associates dated 7-2-96, revised to 7-30-96.

Conditions to be met prior to signing mylars:

1. The applicant shall submit an agreement for review and approval of the town attorney, to indemnify and hold harmless the Town of East Windsor against any claims that may be made should the proposed tower fall and cause damages to property or individuals. The hold harmless agreement shall be recorded on the land records of the subject property and of the property to the immediate south which is also under the applicant's control.
2. A copy of this approval Motion shall be recorded on the land records.

Conditions to be met prior to the issuance of a Zoning Permit:

3. Two sets of mylars shall be submitted for the signature of the Commission Chairman and Secretary. One set of mylars shall be filed on the land records and another shall be filed in the East Windsor Planning and Zoning Commission office.

Conditions to be met Prior to Certificate of Compliance:

4. All conditions of this approval motion shall be complied with.

BALCH BRIDGE STREET CORPORATION
SPECIAL USE PERMIT - TELECOMMUNICATIONS TOWER
232 SOUTH MAIN STREET
EAST WINDSOR, CONNECTICUT

General Conditions:

5. No work may begin until a Zoning and Building Permit have been issued.
6. Construction of improvements as approved by this special use/site plan approval must commence by August 13, 1997 and all improvements must be completed within 1 year from the start of construction, otherwise approval shall become null and void unless an extension is granted by the Commission.
7. This Special Use Permit approval is for the specific use identified in the application. Any changes in use or tenancy require a new zoning permit and may require additional Commission approvals.
8. No structures or buildings other than the tower shall be erected without further Site Plan Review by the Commission.
9. This project shall be constructed and maintained in accordance with the referenced plans. Minor modifications to the approved plans which result in lesser impacts may be allowed subject to staff review and approval.
10. By acceptance of this permit and conditions, the applicant and owner acknowledge the right of Town staff to periodically enter upon the subject property for the purpose of determining compliance with the terms of this approval.

VOTE: In Favor: Unanimous

Exhibit B

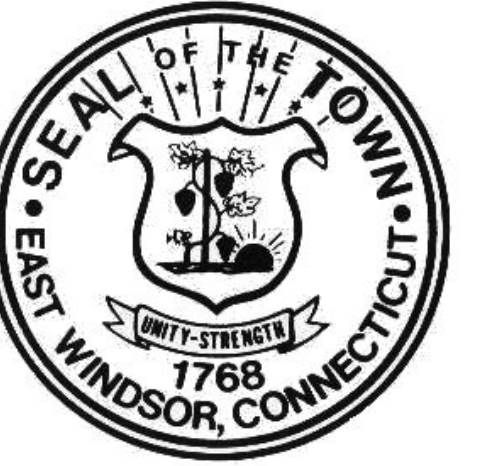

42 84 Map / Block

007 -01 Lot / Sub Lot

1.22 Ac Acreage

4.05 AcC Calculated Acreage

22 Address

- Block Boundary
- Parcel
- Easement
- Railroad

121	122	123	124	125	126	127	128	129	130
131	132	133	134	135	136	137	138	139	140
141	142	143	144	145	146	147	148	149	150
151	152	153	154	155	156	157	158	159	160
161	162	163	164	165	166	167	168	169	170
171	172	173	174	175	176	177	178	179	180
181	182	183	184	185	186	187	188	189	190
191	192	193	194	195	196	197	198	199	200
201	202	203	204	205	206	207	208	209	210
211	212	213	214	215	216	217	218	219	220
221	222	223	224	225	226	227	228	229	230
231	232	233	234	235	236	237	238	239	240

Paper Map Number
Parcel Map Number

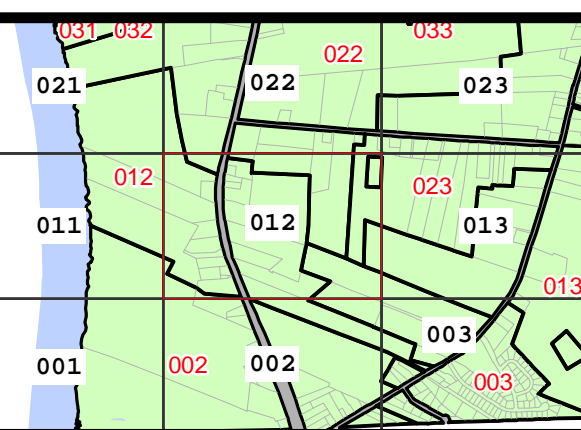

Map: 012

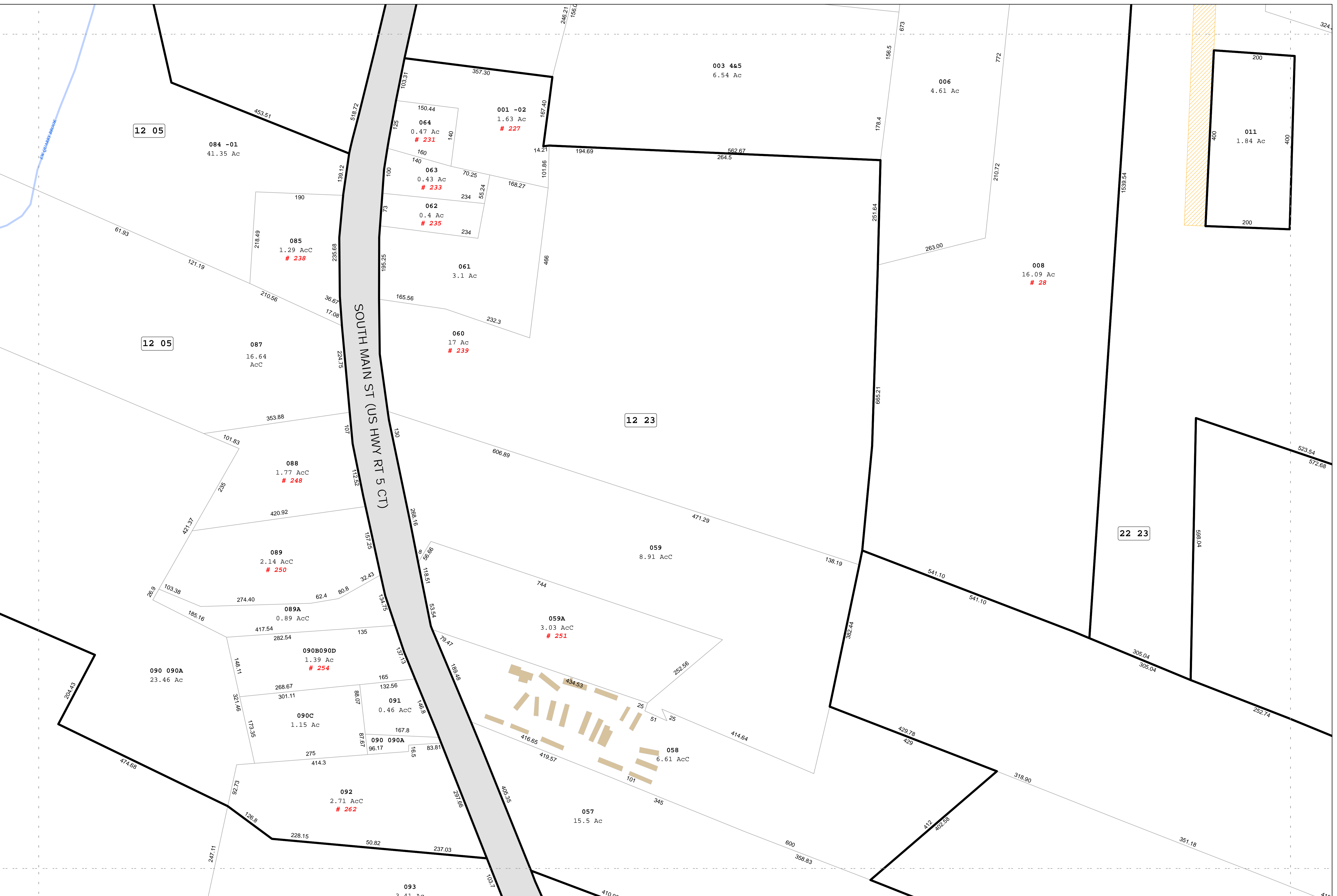

Map: 012



Map Printed: February 2018
This map is for informational purposes only.
All information is subject to verification by any user.
The Town of East Windsor and its mapping contractors
assume no legal responsibility for the information
contained herein.

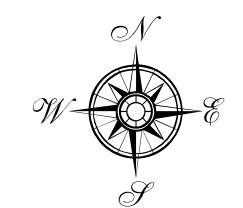

TOWN OF EAST WINDSOR, CONNECTICUT

Property Assessment Maps

Revised: October 1, 2017

1 : 100

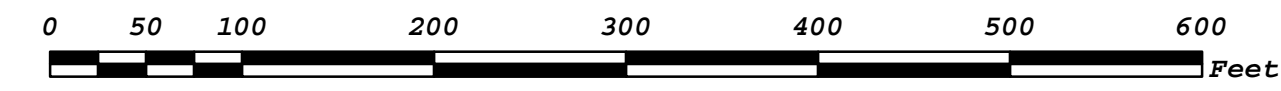

Map: 012



Property Information

Owner	BALCH BRIDGE STREET CORP
Address	232 SOUTH MAIN ST
Mailing Address	12920 S E 38TH ST BELLEVUE, WA 980060000
Land Use	- Industrial Vacant Land
Land Class	Industrial
Previous MBL	

Census Tract	
Neighborhood	40
Zoning	M-1
Acreage	0
Utilities	
Lot Setting/ Desc	/

Photo



PARCEL VALUATIONS (Assessed value = 70% of Appraised Value)

	Appraised	Assessed
Buildings		
Outbuildings		
Improvements		
Extras		
Land		
Total	462000	0
Previous		

Construction Details

Stories	0
Building Style	
Building Use	
Building Condition	
Total Rooms	
Bedrooms	0
Full Bathrooms	0
Half Bathrooms	
Bath Style	
Kitchen Style	
Roof Style	
Roof Cover	

EXTERIOR WALLS:

Primary	
Secondary	

INTERIOR WALLS:

Primary	
Secondary	

FLOORS:

Primary	
Secondary	

HEATING/AC:

Heating Type	
Heating Fuel	
AC Type	

BUILDING AREA:

Effective Building Area	
Gross Building Area	
Total Living Area	0

SALES HISTORY:

Sale Date	12/01/1979
Sale Price	0
Book/ Page	0115/0840

Exhibit C

Copyright © 2018 Foresite LLC all rights reserved. The details, templates, drawing formats or any portion of this document generated by Foresite LLC may not be duplicated, traced or used otherwise for any profit-driven enterprise.

ANTENNA UPGRADES BY

T-Mobile

T-MOBILE NORTHEAST LLC

PROJECT: L700 4X2
 SITE NUMBER: CT11402A
 SITE NAME: EAST WINDSOR/RT-191_1
 SITE ADDRESS: 232 SOUTH MAIN STREET
 EAST WINDSOR, CT 06088
 (RF CONFIGURATION 67D04B)

APPLICANT:
T-Mobile
T-MOBILE NORTHEAST LLC
 35 GRIFFIN ROAD SOUTH
 BLOOMFIELD, CT 06002
 860-692-7100

PROJECT MANAGER
NSS NORTHEAST
 SITE SOLUTIONS
Turnkey Wireless Development
 420 MAIN STREET, BLDG 4
 STURBRIDGE, MA 01566
 203-275-6669

CONSULTANT:
FORESITE LLC
 Architects . Engineers . Surveyors

462 WALNUT STREET
 NEWTON, MA 02460
 617-212-3123

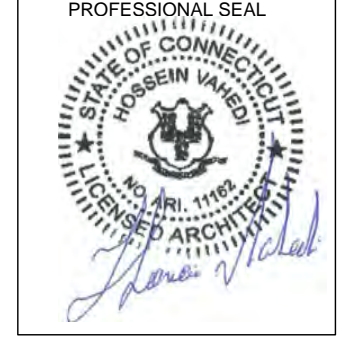

THIS DOCUMENT IS THE DESIGN PROPERTY AND COPYRIGHT OF FORESITE, LLC. AND FOR THE EXCLUSIVE USE BY THE TITLE CLIENT. DUPLICATION OR USE WITHOUT THE EXPRESS WRITTEN CONSENT OF THE CREATOR IS STRICTLY PROHIBITED. DRAWING SCALES ARE INTENDED FOR 11"x17" SIZE PRINTED MEDIA ONLY. ALL OTHER PRINTED SIZES ARE DEEMED "NOT TO SCALE".

REV	DESCRIPTION	DATE
A	PRELIMINARY	07/03/18
B	REVISED PER COMMENTS	07/09/18
C	REVISED ANTENNA POSITIONS	07/30/18
0	ISSUED FOR PERMIT	08/01/18

SITE NUMBER: CT11402A
 SITE NAME: EAST WINDSOR/RT-191_1
 SITE ADDRESS: 232 SOUTH MAIN STREET
 EAST WINDSOR, CT 06088

SHEET TITLE:
 T-1: TITLE SHEET

PROJECT SCOPE:
 UPGRADE OF EXISTING WIRELESS FACILITY AS FOLLOWS:
 ADD (3) NEW ANTENNAS,
 ADD (3) NEW REMOTE RADIO UNITS AT ANTENNAS,
 REMOVE (6) EXISTING ANTENNAS,
 REMOVE (12) COAX CABLES.

PROJECT NOTES:

1. THIS IS AN UNMANNED TELECOMMUNICATION FACILITY AND NOT FOR HUMAN HABITATION. HANDICAPPED ACCESS IS NOT REQUIRED. POTABLE WATER OR SANITARY SERVICE IS NOT REQUIRED. NO OUTDOOR STORAGE OR ANY SOLID WASTE RECEPTACLES REQUIRED.
2. CONTRACTOR SHALL VERIFY ALL PLANS, EXISTING DIMENSIONS, AND CONDITIONS ON THE JOB SITE. CONTRACTOR SHALL IMMEDIATELY NOTIFY THE ARCHITECT/ENGINEER IN WRITING OF ANY DISCREPANCIES BEFORE PROCEEDING WITH THE WORK. FAILURE TO NOTIFY THE ARCHITECT/ENGINEER PLACES THE RESPONSIBILITY ON THE CONTRACTOR TO CORRECT THE DISCREPANCIES AT THE CONTRACTOR'S EXPENSE.
3. DEVELOPMENT AND USE OF THE SITE WILL CONFORM TO ALL APPLICABLE CODES, ORDINANCES AND SPECIFICATIONS.
4. REFER TO STRUCTURAL ANALYSIS REPORT TITLED " STRUCTURAL ANALYSIS REPORT - REV1 - SELF SUPPORT " SITE ID: CT11402A, DATED JUNE 14, 2018, PREPARED BY DESTEK.

APPLICABLE STATE ADOPTION CODES:

2016 CONNECTICUT STATE BUILDING CODE (CSBC).
 ANSITIA-222-G-2005 STRUCTURAL STANDARD FOR ANTENNA SUPPORTING STRUCTURES AND ANTENNAS.
 2014 NATIONAL ELECTRICAL CODE (NFPA 70) FOR POWER AND GROUNDING REQUIREMENTS.

APPROVALS:

FSA CM	DATE
RF ENGINEER	DATE
FOPS	DATE
T-MOBILE ENGINEERING AND DEVELOPMENT	DATE
	DATE
	DATE



PROJECT INFORMATION:

ADDRESS: 232 SOUTH MAIN STREET
 EAST WINDSOR, CT 06088

STRUCTURE TYPE: LATTICE TOWER

COORDINATES: 41.771800 N, -72.590300 W

ZONING DISTRICT: M-1

PARCEL ID: 00167123

TOWER HEIGHT: 188'-0" AGL

TOP OF T-MOBILE ANTENNAS ELEV: 159'-0" AGL

PROJECT TEAM:

APPLICANT: T-MOBILE NORTHEAST, LLC.
 35 GRIFFIN ROAD SOUTH
 BLOOMFIELD, CT 06002
 860-692-7100

LANDLORD: BALCH COMMUNICATIONS, CSC
 248 S MAIN STREET,
 EAST WINDSOR, CT 06088
 (860) 623-2466

PROJECT MANAGER: NORTHEAST SITE SOLUTIONS
 420 MAIN STREET, BLDG 4
 STURBRIDGE, MA 01566
 SHELDON FREINCLE
 SHELDON@NORTHEASTSITE
 SOLUTIONS.COM
 201-776-8521

CONSULTANTS: FORESITE LLC
 462 WALNUT ST
 NEWTON, MA 02460
 SAEED MOSSAVAT
 SMOSSAVAT@FORESITELLC.COM
 617-212-3123

SHEET INDEX:

T-1:	TITLE SHEET
N-1:	GENERAL NOTES
A-1:	PLAN
A-2:	ELEVATION
A-3:	ANTENNA PLAN
A-4:	ANTENNA DETAILS
E-1:	GROUNDING DETAILS

Copyright © 2018 Foresite LLC all rights reserved. The details, templates, drawing formats or any portion of this document generated by Foresite LLC may not be duplicated, traced or used otherwise for any profit-driven enterprise.

GENERAL NOTES:

1. THE CONTRACTOR SHALL GIVE ALL NOTICES AND COMPLY WITH ALL LAWS, ORDINANCES, RULES, REGULATIONS AND LAWFUL ORDERS OF ANY PUBLIC AUTHORITY, MUNICIPAL AND UTILITY COMPANY SPECIFICATIONS, AND LOCAL AND STATE JURISDICTIONAL CODES BEARING ON THE PERFORMANCE OF THE WORK. THE WORK PERFORMED ON THE PROJECT AND THE MATERIALS INSTALLED SHALL BE IN STRICT ACCORDANCE WITH ALL APPLICABLE CODES, REGULATIONS, AND ORDINANCES.
2. THE ARCHITECT/ENGINEER HAS MADE EVERY EFFORT TO SET FORTH IN THE CONSTRUCTION AND CONTRACT DOCUMENTS THE COMPLETE SCOPE OF WORK. THE CONTRACTOR BIDDING THE JOB IS NEVERTHELESS CAUTIONED THAT MINOR OMISSIONS OR ERRORS IN THE DRAWINGS AND OR SPECIFICATIONS SHALL NOT EXCUSE SAID CONTRACTOR FROM COMPLETING THE PROJECT AND IMPROVEMENTS IN ACCORDANCE WITH THE INTENT OF THESE DOCUMENTS.
3. THE CONTRACTOR OR BIDDER SHALL BEAR THE RESPONSIBILITY OF NOTIFYING (IN WRITING) THE CLIENT'S REPRESENTATIVE OF ANY CONFLICTS, ERRORS, OR OMISSIONS PRIOR TO THE SUBMISSION OF CONTRACTOR'S PROPOSAL OR PERFORMANCE OF WORK.
5. THE CONTRACTOR SHALL VISIT THE JOB SITE PRIOR TO THE SUBMISSION OF BIDS OR PERFORMING WORK TO FAMILIARIZE HIMSELF WITH THE FIELD CONDITIONS AND TO VERIFY THAT THE PROJECT CAN BE CONSTRUCTED IN ACCORDANCE WITH THE CONSTRUCTION DOCUMENTS.
6. THE CONTRACTOR SHALL INSTALL ALL EQUIPMENT AND MATERIALS ACCORDING TO THE MANUFACTURER'S / VENDOR'S SPECIFICATIONS UNLESS NOTED OTHERWISE OR WHERE LOCAL CODES OR ORDINANCES TAKE PRECEDENCE.
7. THE CONTRACTOR SHALL MAKE NECESSARY PROVISIONS TO PROTECT EXISTING IMPROVEMENTS DURING CONSTRUCTION.
8. THE CONTRACTOR SHALL COMPLY WITH ALL PERTINENT SECTIONS OF THE BASIC STATE BUILDING CODE, LATEST EDITION, AND ALL OSHA REQUIREMENTS AS THEY APPLY TO THIS PROJEC
9. THE CONTRACTOR SHALL NOTIFY THE CLIENT'S REPRESENTATIVE IN WRITING WHERE A CONFLICT OCCURS ON ANY OF THE CONTRACT DOCUMENTS. THE CONTRACTOR IS NOT TO ORDER MATERIAL OR CONSTRUCT ANY PORTION OF THE WORK THAT IS IN CONFLICT UNTIL CONFLICT IS RESOLVED BY THE CLIENT'S REPRESENTATIVE.
10. THE WORK SHALL CONFORM TO THE CODES AND STANDARDS OF THE FOLLOWING AGENCIES AS FURTHER CITED HEREIN:
 - A. ASTM: AMERICAN SOCIETY FOR TESTING AND MATERIALS, AS PUBLISHED IN "COMPILATION OF ASTM STANDARDS BUILDING CODES" OR LATEST EDITION.
 - B. AWS: AMERICAN WELDING SOCIETY INC. AS PUBLISHED IN "STANDARD D1.1-08, STRUCTURAL WELDING CODE" OR LATEST EDITION.
 - C. AISC: AMERICAN INSTITUTE FOR STEEL CONSTRUCTION AS PUBLISHED IN "CODE FOR STANDARD PRACTICE FOR STEEL BUILDINGS AND BRIDGES"; "SPECIFICATIONS FOR THE DESIGN, FABRICATION AND ERECTION OF STRUCTURAL STEEL FOR BUILDINGS" (LATEST EDITION).
11. BOLTING:
 - A. BOLTS SHALL BE CONFORMING TO ASTM A325 HIGH STRENGTH, HOT DIP GALVANIZED WITH ASTM A153 HEAVY HEX TYPE NUTS.
 - B. BOLTS SHALL BE 3/4"Ø MINIMUM (UNLESS OTHERWISE NOTED)
 - C. ALL CONNECTIONS SHALL BE 2 BOLTS MINIMUM.
12. FABRICATION:
 - A. FABRICATION OF STEEL SHALL CONFORM TO THE AISC AND AWS STANDARDS AND CODES (LATEST EDITION).
 - B. ALL STRUCTURAL STEEL SHALL BE HOT-DIP GALVANIZED AFTER FABRICATION IN ACCORDANCE WITH ASTM A123 (LATEST EDITION), UNLESS OTHERWISE NOTED.
13. ERECTION OF STEEL:
 - A. PROVIDE ALL ERECTION EQUIPMENT, BRACING, PLANKING, FIELD BOLTS, NUTS, WASHERS, DRIFT PINS, AND SIMILAR MATERIALS WHICH DO NOT FORM A PART OF THE COMPLETED CONSTRUCTION BUT ARE NECESSARY FOR ITS PROPER ERECTION.
 - B. ERECT AND ANCHOR ALL STRUCTURAL STEEL IN ACCORDANCE WITH AISC REFERENCE STANDARDS. ALL WORK SHALL BE ACCURATELY SET TO ESTABLISHED LINES AND ELEVATIONS AND RIGIDLY FASTENED IN PLACE WITH SUITABLE ATTACHMENTS TO THE CONSTRUCTION OF THE BUILDING.
 - C. TEMPORARY BRACING, GUYING AND SUPPORT SHALL BE PROVIDED TO KEEP THE STRUCTURE SAFE AND ALIGNED AT ALL TIMES DURING CONSTRUCTION, AND TO PREVENT DANGER TO PERSONS AND PROPERTY. CHECK ALL TEMPORARY LOADS AND STAY WITHIN SAFE CAPACITY OF ALL BUILDING COMPONENTS.

14. ANTENNA INSTALLATION:
 - A. INSTALL ANTENNAS AS INDICATED ON DRAWINGS AND CLIENT'S REPRESENTATIVE SPECIFICATIONS.
 - B. INSTALL GALVANIZED STEEL ANTENNA MOUNTS AS INDICATED ON DRAWINGS.
 - C. INSTALL COAXIAL / FIBER CABLES AND TERMINATIONS BETWEEN ANTENNAS AND EQUIPMENT PER MANUFACTURER'S RECOMMENDATIONS. WEATHERPROOF ALL CONNECTORS BETWEEN THE ANTENNA AND EQUIPMENT PER MANUFACTURER'S REQUIREMENTS.
15. ANTENNA AND COAXIAL / FIBER CABLE GROUNDING:
 - A. ALL EXTERIOR #6 GREEN GROUND WIRE "DAISY CHAIN" CONNECTIONS ARE TO BE WEATHER SEALED WITH ANDREWS CONNECTOR/SPLICE WEATHERPROOFING KIT TYPE #221213 OR EQUAL.
 - B. ALL COAXIAL / FIBER CABLE GROUNDING KITS ARE TO BE INSTALLED ON STRAIGHT RUNS OF COAXIAL / FIBER CABLE (NOT WITHIN BENDS).
16. RELATED WORK, FURNISH THE FOLLOWING WORK AS SPECIFIED UNDER CONSTRUCTION DOCUMENTS, BUT COORDINATE WITH OTHER TRADES PRIOR TO BID:
 - A. FLASHING OF OPENING INTO OUTSIDE WALLS
 - B. SEALING AND CAULKING ALL OPENINGS
 - C. PAINTING
 - D. CUTTING AND PATCHING
17. REQUIREMENTS OF REGULATORY AGENCIES:
 - A. FURNISH U.L. LISTED EQUIPMENT WHERE SUCH LABEL IS AVAILABLE. INSTALL IN CONFORMANCE WITH U.L. STANDARDS WHERE APPLICABLE.
 - B. INSTALL ANTENNA, ANTENNA CABLES, GROUNDING SYSTEM IN ACCORDANCE WITH DRAWINGS AND SPECIFICATION IN EFFECT AT PROJECT LOCATION AND RECOMMENDATIONS OF STATE AND LOCAL BUILDING CODES, AND SPECIAL CODES HAVING JURISDICTION OVER SPECIFIC PORTIONS OF WORK. THIS WORK INCLUDES BUT IS NOT LIMITED TO THE FOLLOWING:
 - C. TIA-EIA - 222 (LATEST EDITION). STRUCTURAL STANDARDS FOR STEEL ANTENNA TOWERS AND ANTENNA SUPPORTING STRUCTURES.
 - D. FAA - FEDERAL AVIATION ADMINISTRATION ADVISORY CIRCULAR AC 70/7460-IH, OBSTRUCTION MARKING AND LIGHTING.
 - E. FCC - FEDERAL COMMUNICATIONS COMMISSION RULES AND REGULATIONS FORM 715, OBSTRUCTION MARKING AND LIGHTING SPECIFICATION FOR ANTENNA STRUCTURES AND FORM 715A, HIGH INTENSITY OBSTRUCTION LIGHTING SPECIFICATIONS FOR ANTENNA STRUCTURES.
 - F. AISC - AMERICAN INSTITUTE OF STEEL CONSTRUCTION SPECIFICATION FOR STRUCTURAL JOINTS USING ASTM A325 BOLTS (LATEST EDITION).
 - G. NEC - NATIONAL ELECTRICAL CODE - ON TOWER LIGHTING KITS.
 - H. UL - UNDERWRITER'S LABORATORIES APPROVED ELECTRICAL PRODUCTS.
 - I. IN ALL CASES, PART 77 OF THE FAA RULES AND PARTS 17 AND 22 OF THE FCC RULES ARE APPLICABLE AND IN THE EVENT OF CONFLICT, SUPERSEDE ANY OTHER STANDARDS OR SPECIFICATIONS.
 - J. 2009 LIFE SAFETY CODE NFPA - 101.

APPLICANT:

T-MOBILE NORTHEAST LLC
 35 GRIFFIN ROAD SOUTH
 BLOOMFIELD, CT 06002
 860-692-7100

PROJECT MANAGER

NSS NORTHEAST
 SITE SOLUTIONS
Turnkey Wireless Development
 420 MAIN STREET, BLDG 4
 STURBRIDGE, MA 01566
 203-275-6669

CONSULTANT:

Architects . Engineers . Surveyors
 462 WALNUT STREET
 NEWTON, MA 02460
 617-212-3123

PROFESSIONAL SEAL



THIS DOCUMENT IS THE DESIGN PROPERTY AND COPYRIGHT OF FORESITE, LLC. AND FOR THE EXCLUSIVE USE BY THE TITLE CLIENT. DUPLICATION OR USE WITHOUT THE EXPRESS WRITTEN CONSENT OF THE CREATOR IS STRICTLY PROHIBITED. DRAWING SCALES ARE INTENDED FOR 11"x17" SIZE PRINTED MEDIA ONLY. ALL OTHER PRINTED SIZES ARE DEEMED "NOT TO SCALE".

REV	DESCRIPTION	DATE
A	PRELIMINARY	07/03/18
B	REVISED PER COMMENTS	07/09/18
C	REVISED ANTENNA POSITIONS	07/30/18
0	ISSUED FOR PERMIT	08/01/18

SITE NUMBER: CT11402A
 SITE NAME: EAST WINDSOR/RT-191_1
 SITE ADDRESS: 232 SOUTH MAIN STREET
 EAST WINDSOR, CT 06088

SHEET TITLE:
N-1: NOTES AND DISCLAIMERS

Copyright © 2018 Foresite LLC all rights reserved. The details, templates, drawing formats or any portion of this document generated by Foresite LLC may not be duplicated, traced or used otherwise for any profit-driven enterprise.

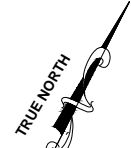
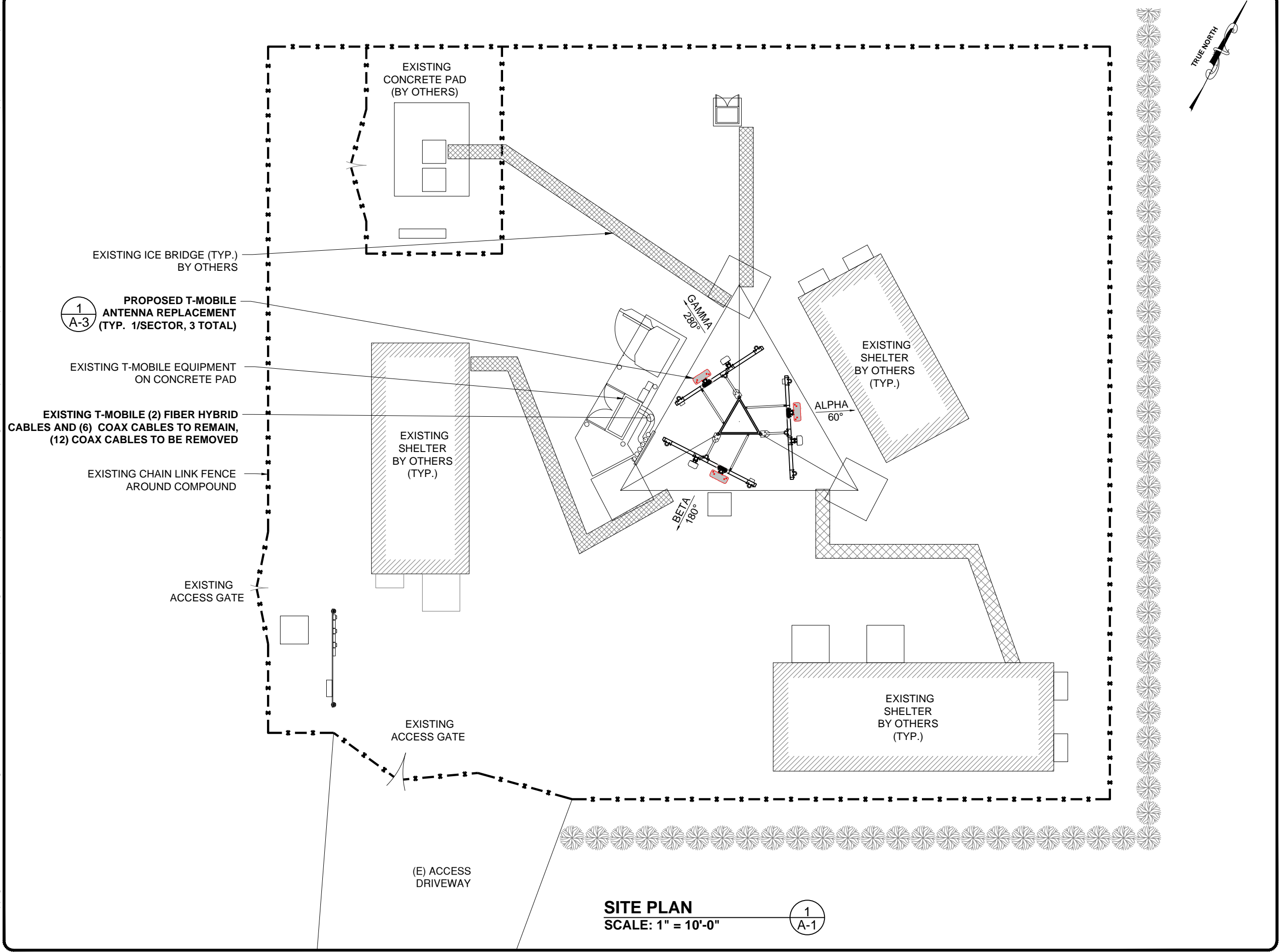

APPLICANT:
T-Mobile
T-MOBILE NORTHEAST LLC
 35 GRIFFIN ROAD SOUTH
 BLOOMFIELD, CT 06002
 860-692-7100

PROJECT MANAGER
NSS NORTHEAST
 SITE SOLUTIONS
Turnkey Wireless Development
 420 MAIN STREET, BLDG 4
 STURBRIDGE, MA 01566
 203-275-6669

CONSULTANT:
FORESITE LLC
 Architects . Engineers . Surveyors
 462 WALNUT STREET
 NEWTON, MA 02460
 617-212-3123

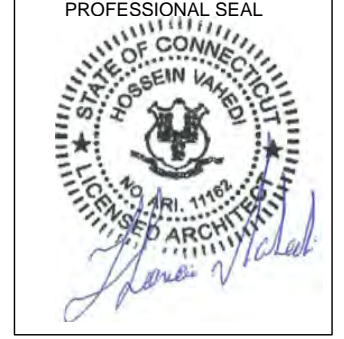

THIS DOCUMENT IS THE DESIGN PROPERTY AND COPYRIGHT OF FORESITE, LLC. AND FOR THE EXCLUSIVE USE BY THE TITLE CLIENT. DUPLICATION OR USE WITHOUT THE EXPRESS WRITTEN CONSENT OF THE CREATOR IS STRICTLY PROHIBITED. DRAWING SCALES ARE INTENDED FOR 11"x17" SIZE PRINTED MEDIA ONLY. ALL OTHER PRINTED SIZES ARE DEEMED "NOT TO SCALE".

REV	DESCRIPTION	DATE
A	PRELIMINARY	07/03/18
B	REVISED PER COMMENTS	07/09/18
C	REVISED ANTENNA POSITIONS	07/30/18
0	ISSUED FOR PERMIT	08/01/18

SITE NUMBER: CT11402A
 SITE NAME: EAST WINDSOR/RT-191_1
 SITE ADDRESS: 232 SOUTH MAIN STREET
 EAST WINDSOR, CT 06088

SHEET TITLE:
 A-1: PLAN

SITE PLAN
 SCALE: 1" = 10'-0"
 1
 A-1

Copyright © 2018 Foresite LLC all rights reserved. The details, templates, drawing formats or any portion of this document generated by Foresite LLC may not be duplicated, traced or used otherwise for any profit-driven enterprise.

STRUCTURAL NOTES:
 PRIOR TO COMMENCING CONSTRUCTION, GC SHALL REFER TO TOWER STRUCTURAL ANALYSIS PROVIDED BY DESTEK TO DETERMINE IF THERE ARE ANY SUPPLEMENTAL OR SPECIAL REQUIREMENTS FOR TOWER TOP EQUIPMENT AND FOR CABLE BUNDLING, SHIELDING, MOUNTING OR RELOCATION ARRANGEMENTS.

REFER TO STRUCTURAL ANALYSIS REPORT TITLED "STRUCTURAL ANALYSIS REPORT-REV1 - SELF SUPPORT" SITE ID: CT11402A, DATED JUNE 14, 2018, PREPARED BY DESTEK.

THE EXISTING SELF-SUPPORT TOWER HAS ADEQUATE STRUCTURAL CAPACITY FOR THE PROPOSED CHANGES BY T-MOBILE ONCE T-MOBILE HAS REMOVED (12) 1-1/4" OF THEIR EXISTING COAXIAL CABLES.

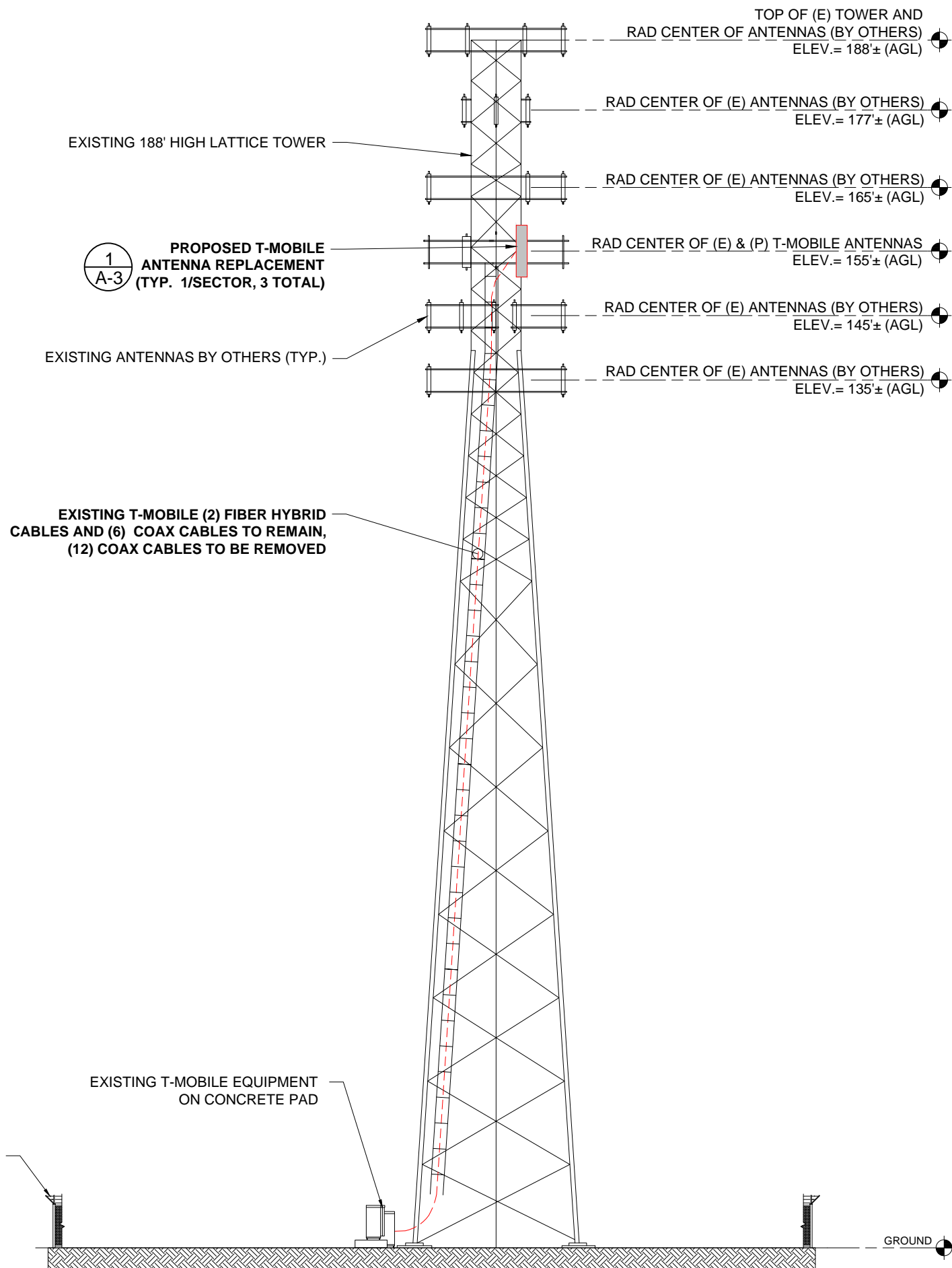

APPLICANT:
T-Mobile
T-MOBILE NORTHEAST LLC
 35 GRIFFIN ROAD SOUTH
 BLOOMFIELD, CT 06002
 860-692-7100

PROJECT MANAGER
NSS NORTHEAST
 SITE SOLUTIONS
Turnkey Wireless Development
 420 MAIN STREET, BLDG 4
 STURBRIDGE, MA 01566
 203-275-6669

CONSULTANT:
FORESITE LLC
 Architects . Engineers . Surveyors
 462 WALNUT STREET
 NEWTON, MA 02460
 617-212-3123

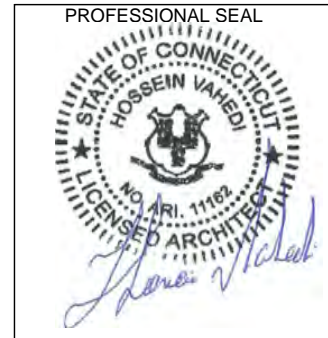

THIS DOCUMENT IS THE DESIGN PROPERTY AND COPYRIGHT OF FORESITE, LLC. AND FOR THE EXCLUSIVE USE BY THE TITLE CLIENT. DUPLICATION OR USE WITHOUT THE EXPRESS WRITTEN CONSENT OF THE CREATOR IS STRICTLY PROHIBITED. DRAWING SCALES ARE INTENDED FOR 11"x17" SIZE PRINTED MEDIA ONLY. ALL OTHER PRINTED SIZES ARE DEEMED "NOT TO SCALE".

REV	DESCRIPTION	DATE
A	PRELIMINARY	07/03/18
B	REVISED PER COMMENTS	07/09/18
C	REVISED ANTENNA POSITIONS	07/30/18
0	ISSUED FOR PERMIT	08/01/18

SITE NUMBER: CT11402A
 SITE NAME: EAST WINDSOR/RT-191_1
 SITE ADDRESS: 232 SOUTH MAIN STREET
 EAST WINDSOR, CT 06088

SHEET TITLE:
 A-2: ELEVATION

Copyright © 2018 Foresite LLC all rights reserved. The details, templates, drawing formats or any portion of this document generated by Foresite LLC may not be duplicated, traced or used otherwise for any profit-driven enterprise.

STRUCTURAL NOTES:
 PRIOR TO COMMENCING CONSTRUCTION, GC SHALL REFER TO TOWER STRUCTURAL ANALYSIS PROVIDED BY DESTEK TO DETERMINE IF THERE ARE ANY SUPPLEMENTAL OR SPECIAL REQUIREMENTS FOR TOWER TOP EQUIPMENT AND FOR CABLE BUNDLING, SHIELDING, MOUNTING OR RELOCATION ARRANGEMENTS.

REFER TO STRUCTURAL ANALYSIS REPORT TITLED "STRUCTURAL ANALYSIS REPORT - SELF SUPPORT TOWER" SITE ID: CT11402A, DATED JUNE 25, 2018, PREPARED BY DESTEK.

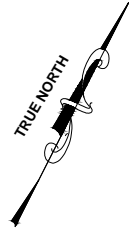

EXISTING ANTENNA PLAN

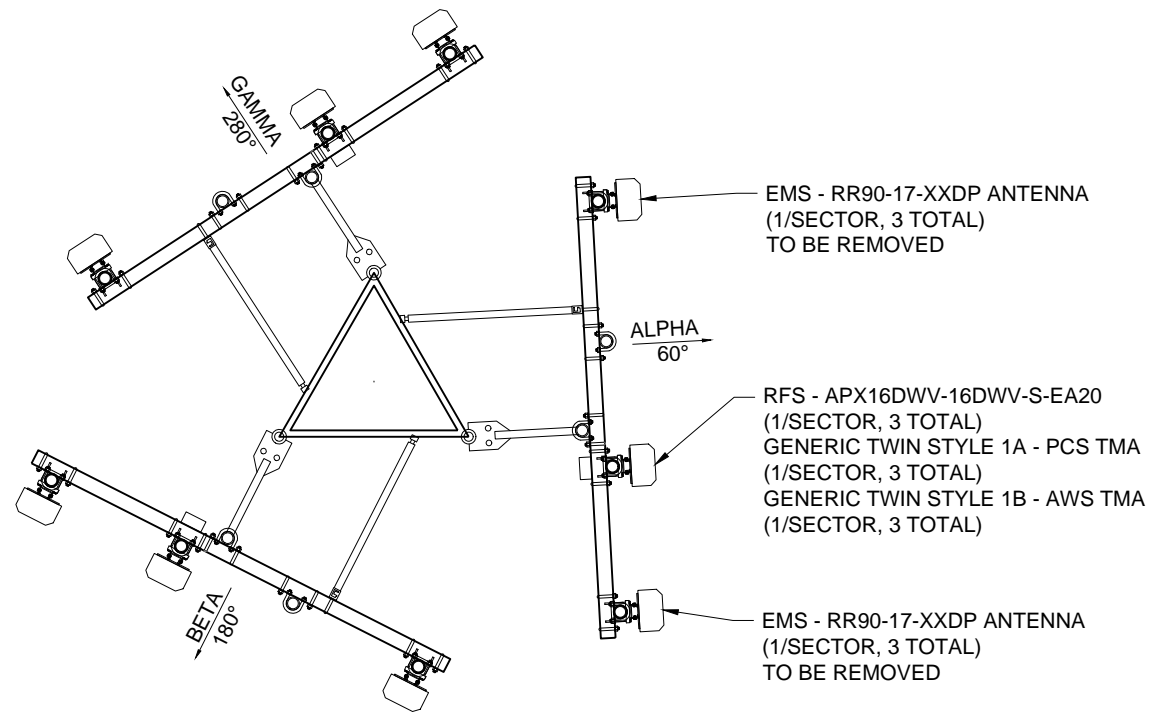

FINAL ANTENNA PLAN

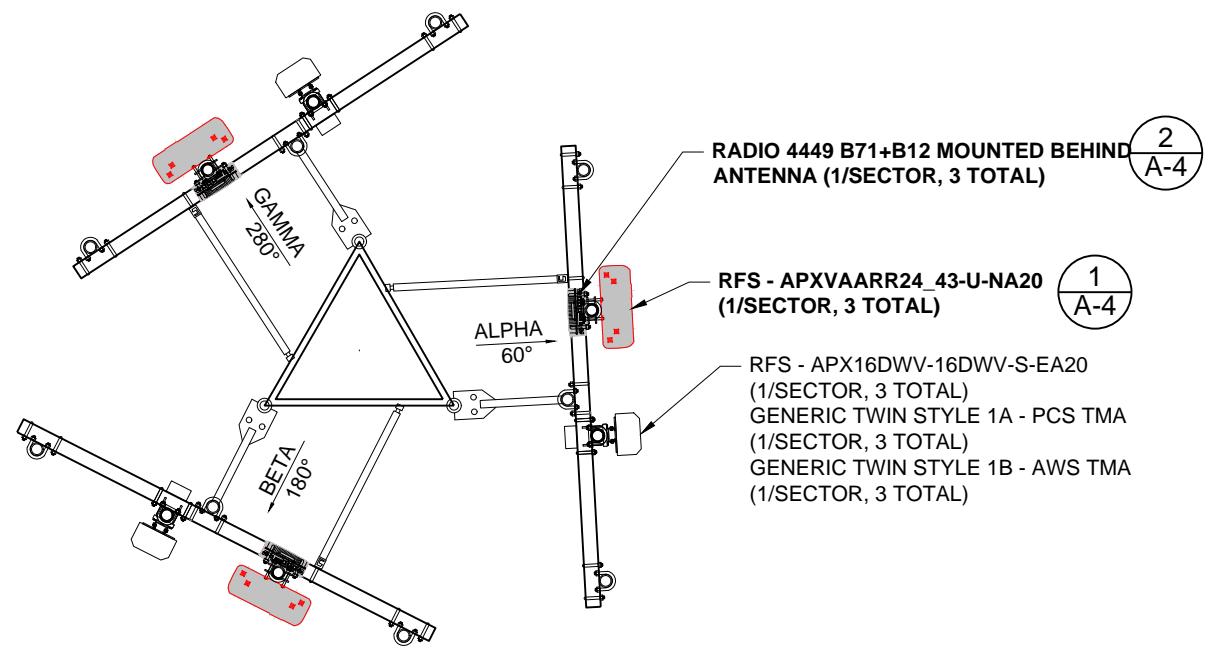

ANTENNA PLAN
 SCALE: NTS 1/A-3

APPLICANT:
T-Mobile
T-MOBILE NORTHEAST LLC
 35 GRIFFIN ROAD SOUTH
 BLOOMFIELD, CT 06002
 860-692-7100

PROJECT MANAGER
NSS NORTHEAST
 SITE SOLUTIONS
Turnkey Wireless Development
 420 MAIN STREET, BLDG 4
 STURBRIDGE, MA 01566
 203-275-6669

CONSULTANT:
FORESITE LLC
 Architects . Engineers . Surveyors
 462 WALNUT STREET
 NEWTON, MA 02460
 617-212-3123

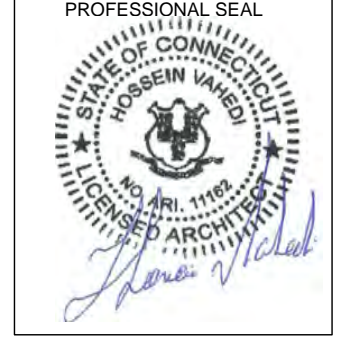

THIS DOCUMENT IS THE DESIGN PROPERTY AND COPYRIGHT OF FORESITE, LLC. AND FOR THE EXCLUSIVE USE BY THE TITLE CLIENT. DUPLICATION OR USE WITHOUT THE EXPRESS WRITTEN CONSENT OF THE CREATOR IS STRICTLY PROHIBITED. DRAWING SCALES ARE INTENDED FOR 11"x17" SIZE PRINTED MEDIA ONLY. ALL OTHER PRINTED SIZES ARE DEEMED "NOT TO SCALE".

REV	DESCRIPTION	DATE
A	PRELIMINARY	07/03/18
B	REVISED PER COMMENTS	07/09/18
C	REVISED ANTENNA POSITIONS	07/30/18
0	ISSUED FOR PERMIT	08/01/18

SITE NUMBER: CT11402A
 SITE NAME: EAST WINDSOR/RT-191_1
 SITE ADDRESS: 232 SOUTH MAIN STREET
 EAST WINDSOR, CT 06088

SHEET TITLE:
 A-3: ANTENNA PLAN AND DETAILS

Copyright © 2018 Foresite LLC all rights reserved. The details, templates, drawing formats or any portion of this document generated by Foresite LLC may not be duplicated, traced or used otherwise for any profit-driven enterprise.

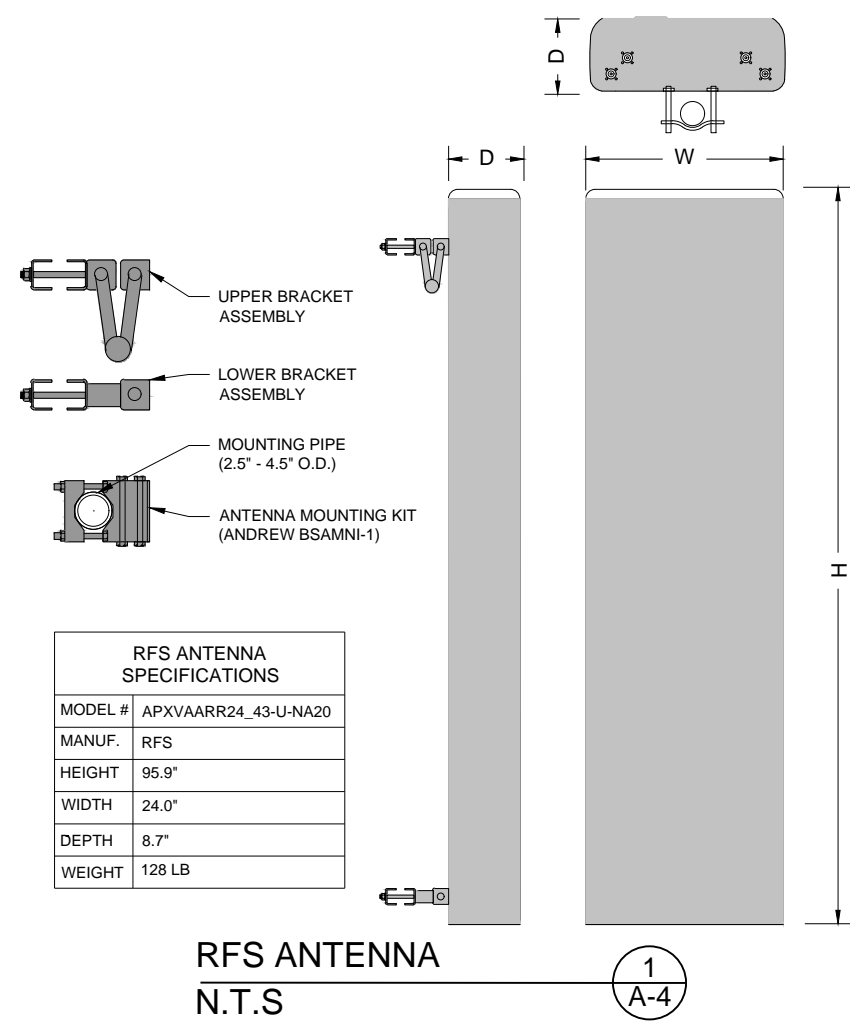

RFS ANTENNA SPECIFICATIONS	
MODEL #	APXVAARR24_43-U-NA20
MANUF.	RFS
HEIGHT	95.9"
WIDTH	24.0"
DEPTH	8.7"
WEIGHT	128 LB

RFS ANTENNA
N.T.S. 1
A-4

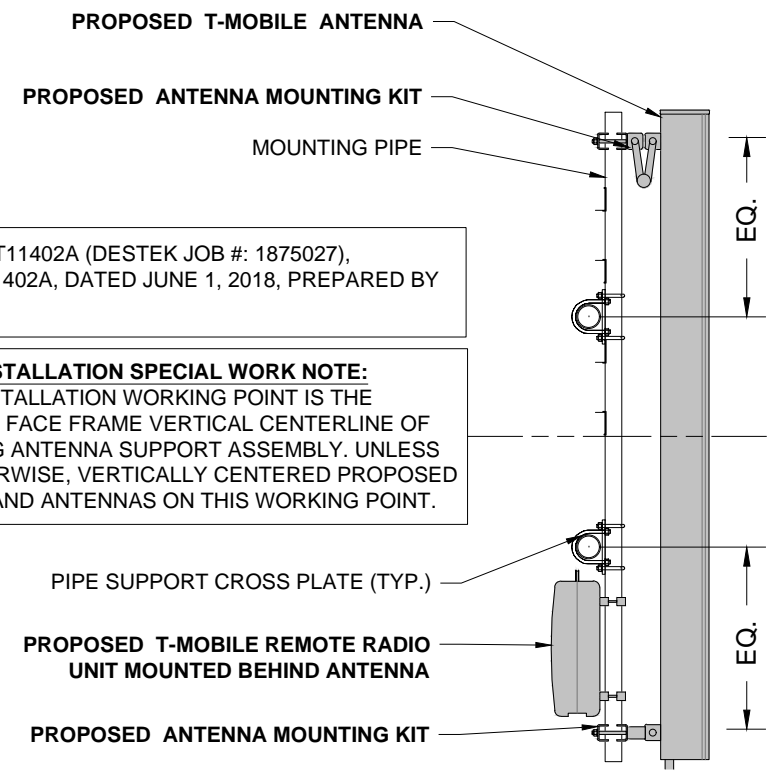

REFER TO CT11402A (DESTTEK JOB #: 1875027),
SITE ID: CT11402A, DATED JUNE 1, 2018, PREPARED BY
DESTTEK.

ANTENNA INSTALLATION SPECIAL WORK NOTE:
ANTENNA INSTALLATION WORKING POINT IS THE
STRUCTURAL FACE FRAME VERTICAL CENTERLINE OF
THE EXISTING ANTENNA SUPPORT ASSEMBLY. UNLESS
NOTED OTHERWISE, VERTICALLY CENTERED PROPOSED
PIPE MASTS AND ANTENNAS ON THIS WORKING POINT.

ANTENNA MOUNTING DETAIL
N.T.S. 3
A-4

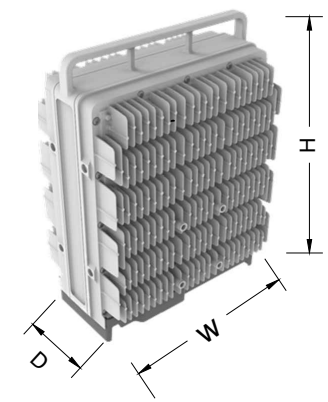

REMOTE RADIO UNIT SPECIFICATIONS	
MODEL #	RADIO 4449 B71+B12
MANUF.	ERICSSON
HEIGHT	14.9"
WIDTH	13.2"
DEPTH	10.4"
WEIGHT	74 LB

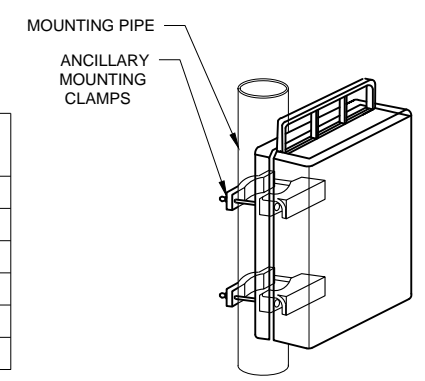

RADIO 4449 B71+B12 REMOTE RADIO UNIT
N.T.S. 2
A-4

APPLICANT:
T-Mobile
T-MOBILE NORTHEAST LLC
35 GRIFFIN ROAD SOUTH
BLOOMFIELD, CT 06002
860-692-7100

PROJECT MANAGER
NSS NORTHEAST
SITE SOLUTIONS
Turnkey Wireless Development
420 MAIN STREET, BLDG 4
STURBRIDGE, MA 01566
203-275-6669

CONSULTANT:
FORESITE LLC
Architects . Engineers . Surveyors
462 WALNUT STREET
NEWTON, MA 02460
617-212-3123

PROFESSIONAL SEAL
STATE OF CONNECTICUT
HOSSEIN VAREDI
NO. ARI. 11162
LICENSED ARCHITECT
Hossein Varedi

THIS DOCUMENT IS THE DESIGN PROPERTY AND COPYRIGHT OF FORESITE, LLC. AND FOR THE EXCLUSIVE USE BY THE TITLE CLIENT. DUPLICATION OR USE WITHOUT THE EXPRESS WRITTEN CONSENT OF THE CREATOR IS STRICTLY PROHIBITED. DRAWING SCALES ARE INTENDED FOR 11"x17" SIZE PRINTED MEDIA ONLY. ALL OTHER PRINTED SIZES ARE DEEMED "NOT TO SCALE".

REV	DESCRIPTION	DATE
A	PRELIMINARY	07/03/18
B	REVISED PER COMMENTS	07/09/18
C	REVISED ANTENNA POSITIONS	07/30/18
0	ISSUED FOR PERMIT	08/01/18

SITE NUMBER: CT11402A
SITE NAME: EAST WINDSOR/RT-191_1
SITE ADDRESS: 232 SOUTH MAIN STREET
EAST WINDSOR, CT 06088

SHEET TITLE:
A-4: ANTENNA DETAILS

Copyright © 2018 Foresite LLC all rights reserved. The details, templates, drawing formats or any portion of this document generated by Foresite LLC may not be duplicated, traced or used otherwise for any profit-driven enterprise.

ELECTRICAL & GROUNDING NOTES

1. ALL ELECTRICAL WORK SHALL CONFORM TO THE REQUIREMENTS OF THE NATIONAL ELECTRICAL CODE (NEC) AS WELL AS APPLICABLE STATE AND LOCAL CODES.
2. ALL ELECTRICAL ITEMS SHALL BE U.L. APPROVED OR LISTED AND PRODUCED PER SPECIFICATION REQUIREMENTS.
3. THE ELECTRICAL WORK INCLUDES ALL LABOR AND MATERIAL DESCRIBED BY DRAWINGS AND SPECIFICATION INCLUDING INCIDENTAL WORK TO PROVIDE COMPLETE OPERATING AND APPROVED ELECTRICAL SYSTEM.
4. GENERAL CONTRACTOR SHALL PAY FEES FOR PERMITS, AND RESPONSIBLE FOR OBTAINING SAID PERMITS AND COORDINATION OF INSPECTIONS.
5. ELECTRICAL AND TELCO WIRING OUTSIDE A BUILDING AND EXPOSED TO WEATHER SHALL BE IN WATER TIGHT GALVANIZED RIGID STEEL CONDUITS OR SCHEDULE 80 PVC (AS PERMITTED BY CODE) AND WHERE REQUIRED IN LIQUID TIGHT FLEXIBLE METAL OR NONMETALLIC CONDUITS.
6. RIGID STEEL CONDUITS SHALL BE GROUNDED AT BOTH ENDS.
7. ELECTRICAL WIRING SHALL BE COPPER WITH TYPE XHHW, THWN, OR THIN INSULATION.
8. RUN ELECTRICAL CONDUIT OR CABLING BETWEEN ELECTRICAL ROOM AND PROPOSED CELL SITE ARE PEDESTAL AS INDICATED ON THIS DRAWING. PROVIDE FULL LENGTH PULL ROPE. COORDINATE INSTALLATION WITH UTILITY COMPANY.
9. RUN TELCO CONDUIT OR CABLE BETWEEN TELEPHONE UTILITY DEMARCATION POINT AND PROPOSED CELL SITE TELECOM CABINET AND RBS CABINET AS INDICATED ON DRAWING A -1. PROVIDE FULL LENGTH PULL ROPE INSTALLED TELCO CONDUIT. PROVIDE GREENLEE CONDUIT MEASURING TAPE AT EACH END.
10. ALL EQUIPMENT LOCATED OUTSIDE SHALL HAVE NAME 3R ENCLOSURE.
11. GROUNDING SHALL COMPLY WITH NEC ART. 250.
12. GROUNDING COAX CABLE SHIELDS MINIMUM AT BOTH ENDS USING MANUFACTURES COAX CABLE GROUNDING KITS SUPPLIED BY PROJECT OWNER.
13. USE #6 COPPER STRANDED WIRE WITH GREEN COLOR INSTALLATION FOR ABOVE GRADE GROUNDING (UNLESS OTHERWISE SPECIFIED) AND #2 SOLID TINNED BARE COPPER WIRE FOR BELOW GRADE GROUNDING AS INDICATED ON THE GROUND.
14. ALL GROUND CONNECTION TO BE BURNDY HYGROUND COMPRESSION TYPE CONNECTORS OR CADWELD EXOTHERMIC WELD. DO NOT ALLOW BARE COPPER WIRE TO BE IN CONTACT WITH GALVANIZED STEEL.
15. ROUTE GROUNDING CONDUCTORS ALONG THE SHORTEST AND STRAIGHTEST PATH POSSIBLE, EXCEPT AS OTHERWISE INDICATED. GROUNDING LEADS SHOULD NEVER BE BENT AS RIGHT ANGLE. ALWAYS MAKE AT LEAST 12" RADIUS BENDS. #6 WIRE CAN BE BENT AT 6" RADIUS WHEN NECESSARY BOND ANY METER OBJECTS WITHIN 7 FEET OF PROPOSED EQUIPMENT OR CABINET TO MASTER GROUND BAR.
16. CONNECTIONS TO MGB SHALL BE ARRANGED IN THREE MAIN GROUPS: SURGE PROCEDURES (COAXIAL CABLE GROUND KITS, TELCO AND POWER PANEL GROUND); (GROUNDING ELECTRODE RING OR BUILDING STEEL); NON-SURGING OBJECTS (EGB GROUND IN RBS UNIT).
17. CONNECTIONS TO GROUND BARS SHALL BE MADE WITH TWO HOLE COMPRESSION TYPE COPPER LUGS. APPLY OXIDE INHIBITING COMPOUND TO ALL LOCATIONS.
18. APPLY OXIDE INHIBITING COMPOUND TO ALL COMPRESSION TYPE GROUND CONNECTION.
19. BOND ANTENNA MOUNTING BRACKETS, COAXIAL CABLE GROUND KITS, AND ALNA TO EGB PLACED NEAR THE ANTENNA LOCATION.
20. BOND ANTENNA EGB'S AND MGB TO WATER MAIN.
21. TEST COMPLETED GROUND SYSTEM AND RECORD RESULTS FOR PROJECT CLOSE-OUT DOCUMENTATION.
22. BOND ANY METAL OBJECTS WITHIN 7 FEET OF PROPOSED EQUIPMENT OR CABINET TO MASTER GROUND BAR.
23. VERIFY PROPOSED SERVICE UPGRADE WITH LOCAL UTILITY COMPANY PRIOR TO CONSTRUCTION.

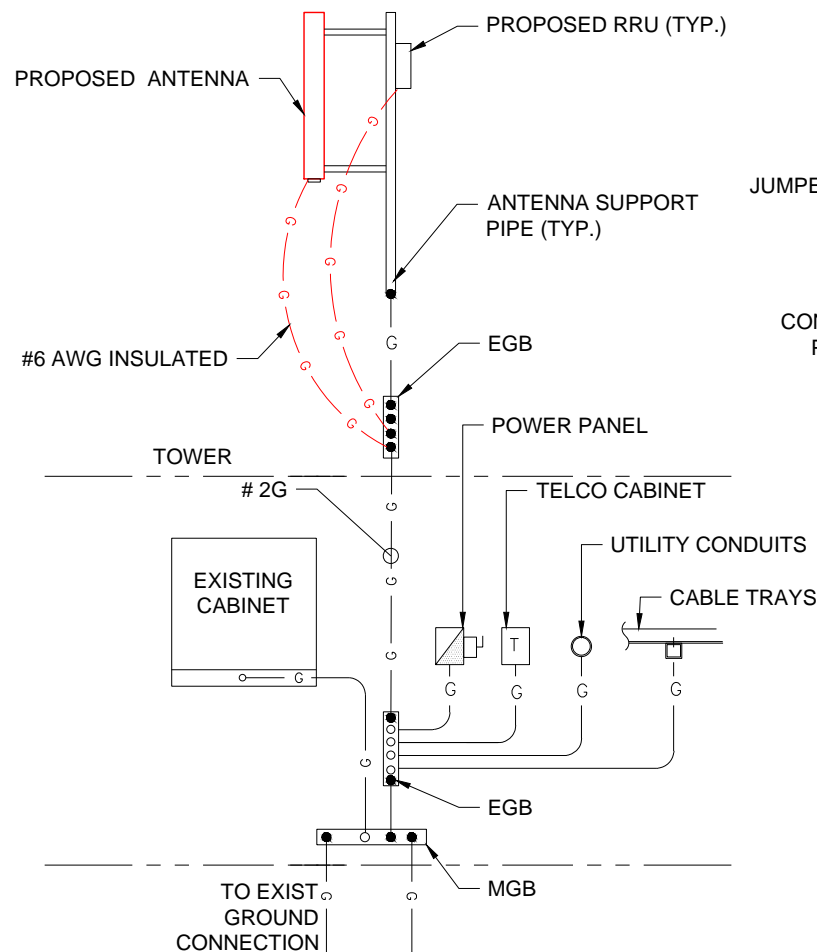

GROUNDING RISER DIAGRAM
SCALE: N.T.S

1
E-1

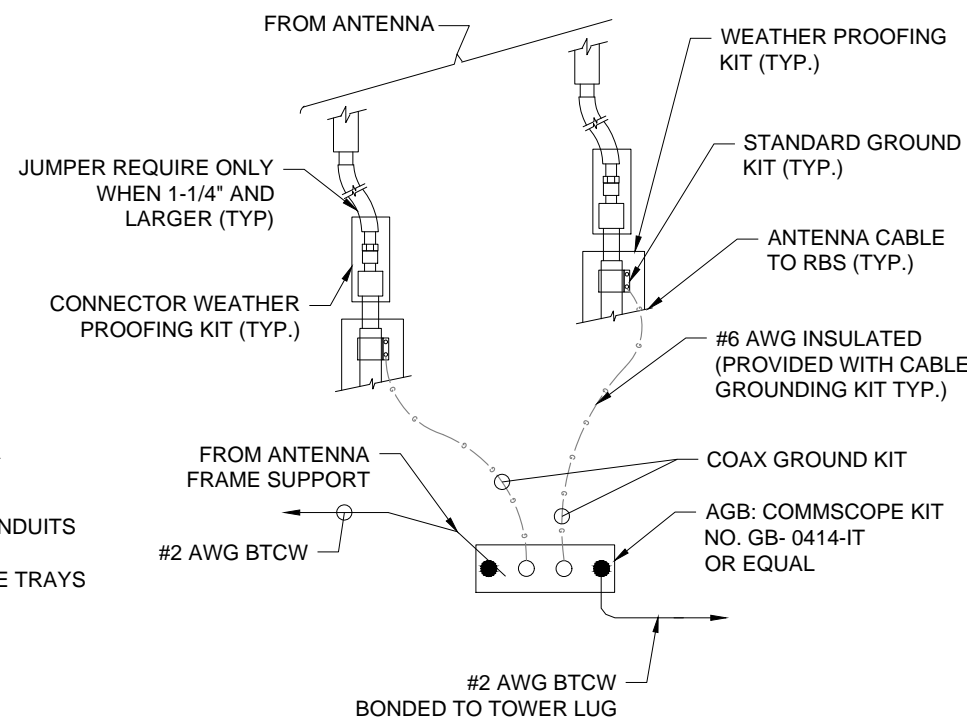

NOTES:
INSTALL CABLE GROUND KIT ABOVE HORIZONTAL BEND AND ALWAYS DIRECT GROUND WIRE DOWN TO AGB/EGB

TOWER TOP CABLE GROUNDING DETAIL
SCALE: N.T.S

2
E-1

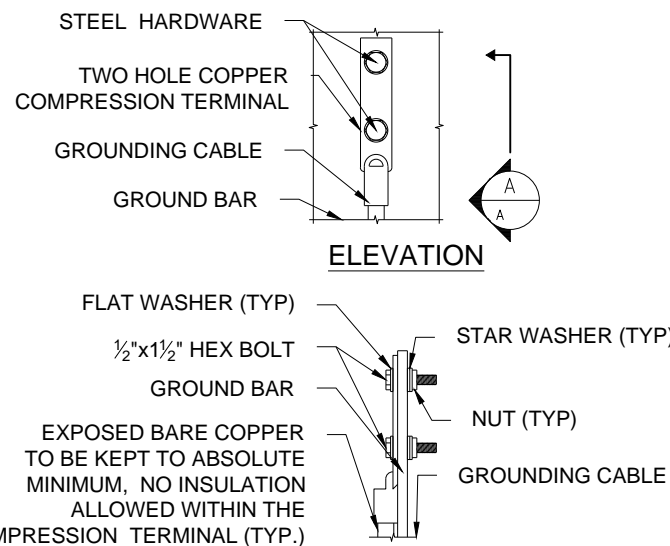

SECTION A-A

- NOTES:**
1. "DOUBLING UP" OR "STACKING " OF CONNECTIONS IS NOT PERMITTED.
 2. OXIDE INHIBITING COMPOUND TO BE USED AT ALL LOCATIONS.

TYPICAL GROUND BAR CONNECTIONS DETAIL
SCALE: N.T.S

3
E-1

APPLICANT:
T-Mobile
T-MOBILE NORTHEAST LLC
35 GRIFFIN ROAD SOUTH
BLOOMFIELD, CT 06002
860-692-7100

PROJECT MANAGER
NSS NORTHEAST
SITE SOLUTIONS
Turnkey Wireless Development
420 MAIN STREET, BLDG 4
STURBRIDGE, MA 01566
203-275-6669

CONSULTANT:
FORESITE LLC
Architects . Engineers . Surveyors
462 WALNUT STREET
NEWTON, MA 02460
617-212-3123

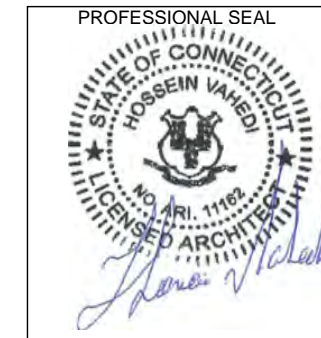

THIS DOCUMENT IS THE DESIGN PROPERTY AND COPYRIGHT OF FORESITE, LLC. AND FOR THE EXCLUSIVE USE BY THE TITLE CLIENT. DUPLICATION OR USE WITHOUT THE EXPRESS WRITTEN CONSENT OF THE CREATOR IS STRICTLY PROHIBITED. DRAWING SCALES ARE INTENDED FOR 11"x17" SIZE PRINTED MEDIA ONLY. ALL OTHER PRINTED SIZES ARE DEEMED "NOT TO SCALE".

REV	DESCRIPTION	DATE
A	PRELIMINARY	07/03/18
B	REVISED PER COMMENTS	07/09/18
C	REVISED ANTENNA POSITIONS	07/30/18
0	ISSUED FOR PERMIT	08/01/18

SITE NUMBER: CT11402A
SITE NAME: EAST WINDSOR/RT-191_1
SITE ADDRESS: 232 SOUTH MAIN STREET
EAST WINDSOR, CT 06088

SHEET TITLE:
E-1: GROUNDING AND ELECTRICAL DETAILS

Exhibit D

**STRUCTURAL ANALYSIS REPORT – REV1
SELF-SUPPORT**



Prepared For:



**T-Mobile Northeast, LLC
35 Griffin Road South
Bloomfield, CT 06002**



Structure Rating:

SST: Pass (Conditional – 98%)

Sincerely,
Destek Engineering, LLC
Firm Licence No: PEC0001429

8-14-2018



Ahmet Colakoglu, PE
Connecticut Professional Engineer
License No: 27057

**T-Mobile Site ID: CT11402A
T-Mobile Site Name: EastWindsor/Rt-191_1
232 South Main Street
East Windsor, CT 06088**

CONTENTS

1.0 - SUBJECT AND REFERENCES

1.1 - STRUCTURE

2.0 - EXISTING AND PROPOSED APPURTENANCES

3.0 - CODES AND LOADING

4.0 - STANDARD CONDITIONS FOR ENGINEERING SERVICES ON EXISTING
STRUCTURES

5.0 - ANALYSIS AND ASSUMPTIONS

6.0 - RESULTS AND CONCLUSION

APPENDICES

A - SOFTWARE OUTPUT

1.0 SUBJECT AND REFERENCES

The purpose of this analysis is to evaluate the structural capacity of the 188 feet tall self-support tower located at 232 South Main Street, East Windsor, CT 06088 for the additions and alterations proposed by T-Mobile.

The structural analysis is based on the following documentation provided to Destek Engineering, LLC (Destek):

- RFDS provided by T-Mobile, dated 5/4/2018.
- Structural Analysis Report prepared by Maser Consulting, dated 10/25/2017.

1.1 STRUCTURE

The subject structure is a three-sided, 188' tall self-support lattice tower formed by (9) 20' sections and (1) 8' section. Pipe legs are X-braced along the length of the tower with single angle diagonals. The tower is 25'-0" wide at the base and 6'-7.5" wide at the top. Please refer to the software output in Appendix A for tower geometry, member sizes, and other details.

2.0 EXISTING AND PROPOSED APPURTENANCES

Existing Configuration of T-Mobile Appurtenances:

Rad Center (ft.)	Antennas & Equipment	Coax	Mounts
155	(6) EMS RR90-17-XXDP (3) RFS APX16DWV-16DWV-S-E-A20 (3) Generic Twin Style 1B - AWS TMA (3) Generic Twin Style 1A - PCS TMA	(18) 1-1/4" (2) 6x12 Hybrid	(3) Sector Mounts

Proposed and Final Configuration of T-Mobile Appurtenances:

Rad Center (ft.)	Antennas & Equipment	Coax	Mounts
155	(3) RFS APX16DWV-16DWV-S-E-A20 (3) RFS APXVAARR24_43-U-NA20 (3) Generic Twin Style 1B - AWS TMA (3) Generic Twin Style 1A - PCS TMA (3) Radio 44 49 B71 + B12	(6) 1-1/4"* (2) 6x12 Hybrid	(3) Sector Mounts

*(12) 1-1/4" coax to be removed

Appurtenances by Others:

Rad Center (ft.)	Antennas & Equipment	Coax	Mounts
202.5	(1) BCD-87010-EDIN	(1) 1-1/4"	Tower Mounted
186	--	--	(1) Platform Mount
172	(6) AM-X-CD-16-65-OOT-RET (3) 800-10121 (3) RRUS-11 (3) RRUS-12 (3) TT19-08BP111-001 (3) DTMABP7819VG12A (1) DC6-48-60-18-8F	(1) 3/8" (2) 5/8" (12) 1-1/4"	(3) Sector Mounts
145.5	(9) SBNHH-1D85B (3) BXA-70063-6CF-EDIN-X (3) B66A-RRH4x45 (3) B25 RRH4x30-4R (3) RRH 2x60 1900 (2) DB-B1-6C-12AB-0Z	(17) 1-5/8"	(3) Sector Mounts
123	(3) APXVSP18-C-A20 (3) DT465B-2XR (3) RRH-2x50-800 (3) ALU RRH-4x45-1900 (3) TD-RRH8x20-25 (3) RRH-2x50-800	(3) 1-1/4" (1) Hybrid	(3) Sector Mounts

3.0 CODES AND LOADING

The tower was analyzed per ANSI/TIA-222-G and 2016 Connecticut State Building Code. The following wind loading was used in compliance with the standard for East Windsor, CT:

- Basic wind speed 97 mph without ice (V)
- Basic wind speed 50 mph with 1" escalating ice (V_i)
- Exposure Category: C
- Topographic Category: 1
- Structure Class: II

The following load combinations were used with wind blowing at 0°, 30°, 60°, and 90°, measured from a line normal to the face of the tower:

- $1.2 D + 1.6 W_0$
- $0.9 D + 1.6 W_0$
- $1.2 D + 1.0 D_i + 1.0 W_i + 1.0 T_i$

D: Dead load of structures and appurtenances

D_i : Weight of ice due to factored ice thickness (based upon t_i)

T_i : Load effects due to temperature

W_0 : Wind load without ice (based upon V)

W_i : Wind load with ice (based upon V_i)

4.0 STANDARD CONDITIONS FOR ENGINEERING SERVICES ON EXISTING STRUCTURES

The analysis is based on the information provided to Destek and is assumed to be current and correct. Unless otherwise noted, the structure and the foundation system are assumed to be in good condition, free of defects and can achieve theoretical strength.

It is assumed that the structure has been maintained and shall be maintained during its service. The superstructure and the foundation system are assumed to be designed with proper engineering practice and fabricated, constructed and erected in accordance with the design documents. Destek will accept no liability which may arise due to any existing deficiency in design, material, fabrication, erection, construction, etc. or lack of maintenance.

The analysis does not include a qualification of the mounts attached on the structure or their connections. The analysis is performed to verify the capacity of the main structural members, which is the current practice in the tower industry.

The analysis results presented in this report are only applicable for the previously mentioned existing and proposed additions and alterations. Any deviation of the proposed equipment and placement, etc., will require Destek to generate an additional structural analysis.

5.0 **ANALYSIS AND ASSUMPTIONS**

The tower was analyzed by utilizing tnxTower, a non-linear, three-dimensional, finite element-analysis software package, a product of Tower Numerics, Inc. Software output for this analysis is provided in Appendix A of this report.

The tower and foundation were constructed in accordance with their original design and maintained per the manufacturer's specifications. Tower is plumb and free of twist.

6.0 **RESULTS AND CONCLUSION**

Based on a structural analysis per ANSI/TIA-222-G, the existing self-support tower **has adequate** structural capacity for the proposed changes by T-Mobile. For the code specified load combinations and as a maximum, the tower diagonals from 0' to 20' are stressed to **98.4%** of their structural capacity. The tower legs and anchor bolts are stressed to **76.1%** and **77.1%** of capacity, respectively.

These results are only valid once T-Mobile has removed (12) 1-1/4" of their existing coaxial cables.

Information regarding the tower base foundation was not available at the time of this analysis, thus a qualification of the foundation could not be completed.

Therefore, the proposed additions and alterations by T-Mobile **can** be implemented as intended and with the conditions outlined in this report.

Should you need any clarifications or have any questions about this report, please contact Ahmet Colakoglu at (770) 693-0835 or acolakoglu@destekengineering.com.

APPENDIX A
SOFTWARE OUTPUT

Section	T1	T2	T3	T4	T5	T6	T7	T8	T9	T10	25	30.4
Legs	Pipe 3.5" x 0.216" (3 STD)		ROHN 3 EH	ROHN 4 EH	ROHN 5 EH	ROHN 6 EHS	ROHN 6 EH	ROHN 8 EHS	ROHN 8 EH	ROHN 8 EH	25	30.4
Leg Grade						A572-50						
Diagonals	L1 3/4x1 3/4x3/16		L2 1/2x2 1/2x1/4	L3x3x1/4		L3 1/2x3 1/2x1/4	L4x4x3/8	L4x4x5/16				
Diagonal Grade	A36					N.A.	A572-50					
Top Girts												
Horizontals	L2x2x1/8											
Face Width (ft)	N.A.		8.75	10.71	12.79	15.29	16.88	18.83	21	23.05		
# Panels @ (ft)			4 @ 5	9 @ 6.66667				10 @ 10				
Weight (K)			1.1	2.2	2.8	2.8	3.9	4.4	5.2	5.9		

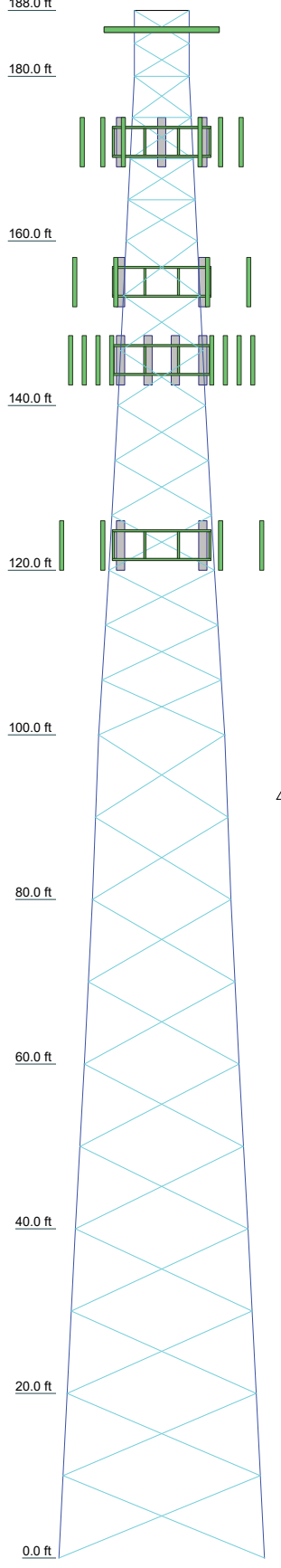

DESIGNED APPURTENANCE LOADING

TYPE	ELEVATION	TYPE	ELEVATION
BCD-87010	195	Sector Mount	155
Rohn 14' Platform	186	Sector Mount	155
(2) AM-X-CD-16-65-00T-RET w/ Mount Pipe	172	Sector Mount	155
(2) AM-X-CD-16-65-00T-RET w/ Mount Pipe	172	(3) SBNHH-1D85B w/ Mount Pipe	145.5
(2) AM-X-CD-16-65-00T-RET w/ Mount Pipe	172	(3) SBNHH-1D85B w/ Mount Pipe	145.5
(2) AM-X-CD-16-65-00T-RET w/ Mount Pipe	172	(3) SBNHH-1D85B w/ Mount Pipe	145.5
800 10121 w/ Mount Pipe	172	BXA-70063-6CF-EDIN-6 w/ Mount Pipe	145.5
800 10121 w/ Mount Pipe	172	BXA-70063-6CF-EDIN-6 w/ Mount Pipe	145.5
800 10121 w/ Mount Pipe	172	BXA-70063-6CF-EDIN-6 w/ Mount Pipe	145.5
RRUS 11	172	BXA-70063-6CF-EDIN-6 w/ Mount Pipe	145.5
RRUS 11	172	B66A RRH4X45	145.5
RRUS 11	172	B66A RRH4X45	145.5
RRUS 12	172	B66A RRH4X45	145.5
RRUS 12	172	B25 RRH4x30-4R	145.5
RRUS 12	172	B25 RRH4x30-4R	145.5
TT19-08BP111-001	172	B25 RRH4x30-4R	145.5
TT19-08BP111-001	172	RRH2X60-1900	145.5
TT19-08BP111-001	172	RRH2X60-1900	145.5
DTMABP7819VG12A	172	RRH2X60-1900	145.5
DTMABP7819VG12A	172	DB-B1-6C-12AB-0Z	145.5
DTMABP7819VG12A	172	DB-B1-6C-12AB-0Z	145.5
DC6-48-60-18-8F	172	SitePro VFA10-RRU	145.5
6' x 2" Mount Pipe	172	SitePro VFA10-RRU	145.5
6' x 2" Mount Pipe	172	SitePro VFA10-RRU	145.5
6' x 2" Mount Pipe	172	APXVSP18-C-A20 w/ Mount Pipe	123
Sector Mount [SM 503-3]	172	APXVSP18-C-A20 w/ Mount Pipe	123
APX16DWW-16DWW-S-E-A20 w/ Mount Pipe	155	APXVSP18-C-A20 w/ Mount Pipe	123
APX16DWW-16DWW-S-E-A20 w/ Mount Pipe	155	DT465B-2XR w/ Mount Pipe	123
APX16DWW-16DWW-S-E-A20 w/ Mount Pipe	155	DT465B-2XR w/ Mount Pipe	123
APX16DWW-16DWW-S-E-A20 w/ Mount Pipe	155	DT465B-2XR w/ Mount Pipe	123
(2) TMA	155	RRH2X50-800	123
(2) TMA	155	RRH2X50-800	123
(2) TMA	155	RRH4X45-19	123
APXVAARR24_43-U-NA20 w/ Mount Pipe	155	RRH4X45-19	123
APXVAARR24_43-U-NA20 w/ Mount Pipe	155	RRH4X45-19	123
APXVAARR24_43-U-NA20 w/ Mount Pipe	155	TD-RRH8x20-25	123
RADIO 4449	155	TD-RRH8x20-25	123
RADIO 4449	155	RRH2X50-800	123
RADIO 4449	155	RRH2X50-800	123
RADIO 4449	155	RRH2X50-800	123
		Sector Mount [SM 503-3]	123

MATERIAL STRENGTH

GRADE	Fy	Fu	GRADE	Fy	Fu
A572-50	50 ksi	65 ksi	A36	36 ksi	58 ksi

TOWER DESIGN NOTES

1. Tower is located in Hartford County, Connecticut.
2. Tower designed for Exposure C to the TIA-222-G Standard.
3. Tower designed for a 97 mph basic wind in accordance with the TIA-222-G Standard.
4. Tower is also designed for a 50 mph basic wind with 1.00 in ice. Ice is considered to increase in thickness with height.
5. Deflections are based upon a 60 mph wind.
6. Tower Structure Class II.
7. Topographic Category 1 with Crest Height of 0.00 ft
8. TOWER RATING: 98.4%

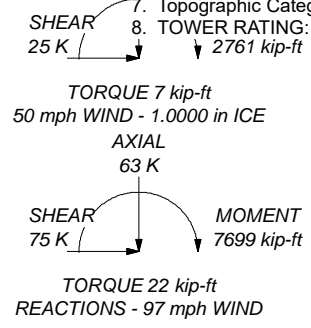

	Destek Engineering, LLC 1281 Kennestone Circle, Suite 100 Marietta, GA 30066 Phone: (770) 693-0835 FAX:		Job: CT11402A Project: 1807125
	Client: T-Mobile Code: TIA-222-G Path:	Drawn by: Ahmet Colakoglu Date: 06/14/18	App'd: Scale: NTS Dwg No. E-1

<p style="text-align: center;">tnxTower</p> <p style="text-align: center;">Destek Engineering, LLC 1281 Kennestone Circle, Suite 100 Marietta, GA 30066 Phone: (770) 693-0835 FAX:</p>	Job CT11402A	Page 1 of 28
	Project 1807125	Date 09:16:06 06/14/18
	Client T-Mobile	Designed by Ahmet Colakoglu

Tower Input Data

The main tower is a 3x free standing tower with an overall height of 188.00 ft above the ground line.

The base of the tower is set at an elevation of 0.00 ft above the ground line.

The face width of the tower is 6.63 ft at the top and 25.00 ft at the base.

This tower is designed using the TIA-222-G standard.

The following design criteria apply:

Tower is located in Hartford County, Connecticut.

Basic wind speed of 97 mph.

Structure Class II.

Exposure Category C.

Topographic Category 1.

Crest Height 0.00 ft.

Nominal ice thickness of 1.0000 in.

Ice thickness is considered to increase with height.

Ice density of 56 pcf.

A wind speed of 50 mph is used in combination with ice.

Temperature drop of 50 °F.

Deflections calculated using a wind speed of 60 mph.

A non-linear (P-delta) analysis was used.

Pressures are calculated at each section.

Stress ratio used in tower member design is 1.

Local bending stresses due to climbing loads, feed line supports, and appurtenance mounts are not considered.

Options

- | | | |
|--|--|---|
| <ul style="list-style-type: none"> Consider Moments - Legs Consider Moments - Horizontals Consider Moments - Diagonals Use Moment Magnification √ Use Code Stress Ratios √ Use Code Safety Factors - Guys Escalate Ice Always Use Max Kz Use Special Wind Profile √ Include Bolts In Member Capacity Leg Bolts Are At Top Of Section √ Secondary Horizontal Braces Leg Use Diamond Inner Bracing (4 Sided) √ SR Members Have Cut Ends SR Members Are Concentric | <ul style="list-style-type: none"> Distribute Leg Loads As Uniform Assume Legs Pinned √ Assume Rigid Index Plate √ Use Clear Spans For Wind Area √ Use Clear Spans For KL/r Retension Guys To Initial Tension √ Bypass Mast Stability Checks √ Use Azimuth Dish Coefficients √ Project Wind Area of Appurt. Autocalc Torque Arm Areas Add IBC .6D+W Combination √ Sort Capacity Reports By Component Triangulate Diamond Inner Bracing Treat Feed Line Bundles As Cylinder | <ul style="list-style-type: none"> Use ASCE 10 X-Brace Ly Rules √ Calculate Redundant Bracing Forces Ignore Redundant Members in FEA √ SR Leg Bolts Resist Compression All Leg Panels Have Same Allowable Offset Girt At Foundation √ Consider Feed Line Torque √ Include Angle Block Shear Check Use TIA-222-G Bracing Resist. Exemption Use TIA-222-G Tension Splice Exemption <li style="text-align: center;">Poles Include Shear-Torsion Interaction Always Use Sub-Critical Flow Use Top Mounted Sockets |
|--|--|---|

tnxTower Destek Engineering, LLC 1281 Kennestone Circle, Suite 100 Marietta, GA 30066 Phone: (770) 693-0835 FAX:	Job CT11402A	Page 2 of 28
	Project 1807125	Date 09:16:06 06/14/18
	Client T-Mobile	Designed by Ahmet Colakoglu

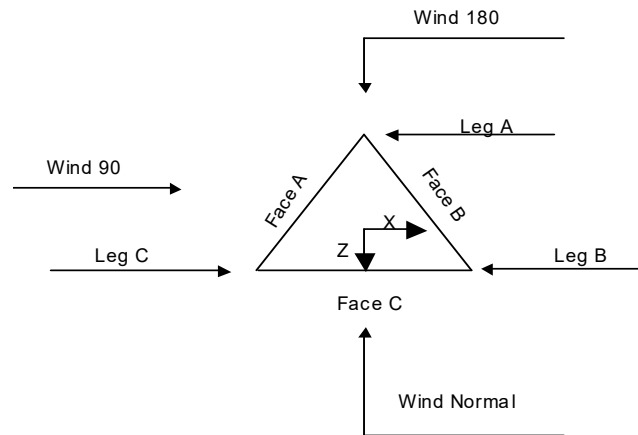

Triangular Tower

Tower Section Geometry

Tower Section	Tower Elevation	Assembly Database	Description	Section Width	Number of Sections	Section Length
	<i>ft</i>			<i>ft</i>		<i>ft</i>
T1	188.00-180.00			6.63	1	8.00
T2	180.00-160.00			6.63	1	20.00
T3	160.00-140.00			8.75	1	20.00
T4	140.00-120.00			10.71	1	20.00
T5	120.00-100.00			12.79	1	20.00
T6	100.00-80.00			15.29	1	20.00
T7	80.00-60.00			16.88	1	20.00
T8	60.00-40.00			18.83	1	20.00
T9	40.00-20.00			21.00	1	20.00
T10	20.00-0.00			23.05	1	20.00

Tower Section Geometry (cont'd)

Tower Section	Tower Elevation	Diagonal Spacing	Bracing Type	Has K Brace End Panels	Has Horizontals	Top Girt Offset	Bottom Girt Offset
	<i>ft</i>	<i>ft</i>				<i>in</i>	<i>in</i>
T1	188.00-180.00	4.00	X Brace	No	No	0.0000	0.0000
T2	180.00-160.00	5.00	X Brace	No	Yes	0.0000	0.0000
T3	160.00-140.00	6.67	X Brace	No	No	0.0000	0.0000
T4	140.00-120.00	6.67	X Brace	No	No	0.0000	0.0000
T5	120.00-100.00	6.67	X Brace	No	No	0.0000	0.0000

tnxTower Destek Engineering, LLC 1281 Kennestone Circle, Suite 100 Marietta, GA 30066 Phone: (770) 693-0835 FAX:	Job	CT11402A	Page	3 of 28
	Project	1807125	Date	09:16:06 06/14/18
	Client	T-Mobile	Designed by	Ahmet Colakoglu

Tower Section	Tower Elevation ft	Diagonal Spacing ft	Bracing Type	Has K Brace End Panels	Has Horizontals	Top Girt Offset in	Bottom Girt Offset in
T6	100.00-80.00	10.00	X Brace	No	No	0.0000	0.0000
T7	80.00-60.00	10.00	X Brace	No	No	0.0000	0.0000
T8	60.00-40.00	10.00	X Brace	No	No	0.0000	0.0000
T9	40.00-20.00	10.00	X Brace	No	No	0.0000	0.0000
T10	20.00-0.00	10.00	X Brace	No	No	0.0000	0.0000

Tower Section Geometry (cont'd)

Tower Elevation ft	Leg Type	Leg Size	Leg Grade	Diagonal Type	Diagonal Size	Diagonal Grade
T1 188.00-180.00	Pipe	Pipe 3.5" x 0.216" (3 STD)	A572-50 (50 ksi)	Equal Angle	L1 3/4x1 3/4x3/16	A36 (36 ksi)
T2 180.00-160.00	Pipe	Pipe 3.5" x 0.216" (3 STD)	A572-50 (50 ksi)	Equal Angle	L1 3/4x1 3/4x3/16	A36 (36 ksi)
T3 160.00-140.00	Pipe	ROHN 3 EH	A572-50 (50 ksi)	Equal Angle	L2 1/2x2 1/2x1/4	A36 (36 ksi)
T4 140.00-120.00	Pipe	ROHN 4 EH	A572-50 (50 ksi)	Equal Angle	L3x3x1/4	A572-50 (50 ksi)
T5 120.00-100.00	Pipe	ROHN 5 EH	A572-50 (50 ksi)	Equal Angle	L3x3x1/4	A572-50 (50 ksi)
T6 100.00-80.00	Pipe	ROHN 6 EHS	A572-50 (50 ksi)	Equal Angle	L3 1/2x3 1/2x1/4	A572-50 (50 ksi)
T7 80.00-60.00	Pipe	ROHN 6 EH	A572-50 (50 ksi)	Equal Angle	L4x4x5/16	A572-50 (50 ksi)
T8 60.00-40.00	Pipe	ROHN 8 EHS	A572-50 (50 ksi)	Equal Angle	L4x4x5/16	A572-50 (50 ksi)
T9 40.00-20.00	Pipe	ROHN 8 EH	A572-50 (50 ksi)	Equal Angle	L4x4x5/16	A572-50 (50 ksi)
T10 20.00-0.00	Pipe	ROHN 8 EH	A572-50 (50 ksi)	Equal Angle	L4x4x3/8	A572-50 (50 ksi)

Tower Section Geometry (cont'd)

Tower Elevation ft	No. of Mid Girts	Mid Girt Type	Mid Girt Size	Mid Girt Grade	Horizontal Type	Horizontal Size	Horizontal Grade
T2 180.00-160.00	None	Flat Bar		A36 (36 ksi)	Equal Angle	L2x2x1/8	A36 (36 ksi)

Tower Section Geometry (cont'd)

tnxTower Destek Engineering, LLC 1281 Kennestone Circle, Suite 100 Marietta, GA 30066 Phone: (770) 693-0835 FAX:	Job CT11402A	Page 4 of 28
	Project 1807125	Date 09:16:06 06/14/18
	Client T-Mobile	Designed by Ahmet Colakoglu

Tower Elevation	Gusset Area (per face)	Gusset Thickness	Gusset Grade	Adjust. Factor A_f	Adjust. Factor A_r	Weight Mult.	Double Angle Stitch Bolt Spacing Diagonals in	Double Angle Stitch Bolt Spacing Horizontals in	Double Angle Stitch Bolt Spacing Redundants in
ft	ft ²	in							
T1 188.00-180.00	0.00	0.0000	A36 (36 ksi)	1.03	1	1.05	36.0000	36.0000	36.0000
T2 180.00-160.00	0.00	0.0000	A36 (36 ksi)	1.03	1	1.05	36.0000	36.0000	36.0000
T3 160.00-140.00	0.00	0.0000	A36 (36 ksi)	1.03	1	1.05	36.0000	36.0000	36.0000
T4 140.00-120.00	0.00	0.0000	A36 (36 ksi)	1.03	1	1.05	36.0000	36.0000	36.0000
T5 120.00-100.00	0.00	0.0000	A36 (36 ksi)	1.03	1	1.05	36.0000	36.0000	36.0000
T6 100.00-80.00	0.00	0.0000	A36 (36 ksi)	1.03	1	1.05	36.0000	36.0000	36.0000
T7 80.00-60.00	0.00	0.0000	A36 (36 ksi)	1.03	1	1.05	36.0000	36.0000	36.0000
T8 60.00-40.00	0.00	0.0000	A36 (36 ksi)	1.03	1	1.05	36.0000	36.0000	36.0000
T9 40.00-20.00	0.00	0.0000	A36 (36 ksi)	1.03	1	1.05	36.0000	36.0000	36.0000
T10 20.00-0.00	0.00	0.0000	A36 (36 ksi)	1.03	1	1.05	36.0000	36.0000	36.0000

Tower Section Geometry (cont'd)

Tower Elevation	Calc K Single Angles	Calc K Solid Rounds	Legs	K Factors ¹							
				X Brace Diags	K Brace Diags	Single Diags	Girts	Horiz.	Sec. Horiz.	Inner Brace	
											X
ft			Y	Y	Y	Y	Y	Y	Y	Y	
T1 188.00-180.00	Yes	No	1	1	1	1	1	1	1	1	1
T2 180.00-160.00	Yes	No	1	1	1	1	1	1	1	1	1
T3 160.00-140.00	Yes	No	1	1	1	1	1	1	1	1	1
T4 140.00-120.00	Yes	No	1	1	1	1	1	1	1	1	1
T5 120.00-100.00	Yes	No	1	1	1	1	1	1	1	1	1
T6 100.00-80.00	Yes	No	1	1	1	1	1	1	1	1	1
T7 80.00-60.00	Yes	No	1	1	1	1	1	1	1	1	1
T8 60.00-40.00	Yes	No	1	1	1	1	1	1	1	1	1
T9 40.00-20.00	Yes	No	1	1	1	1	1	1	1	1	1
T10 20.00-0.00	Yes	No	1	1	1	1	1	1	1	1	1

¹Note: K factors are applied to member segment lengths. K-braces without inner supporting members will have the K factor in the out-of-plane direction applied to the overall length.

tnxTower Destek Engineering, LLC 1281 Kennestone Circle, Suite 100 Marietta, GA 30066 Phone: (770) 693-0835 FAX:	Job	CT11402A	Page	5 of 28
	Project	1807125	Date	09:16:06 06/14/18
	Client	T-Mobile	Designed by	Ahmet Colakoglu

Tower Section Geometry (cont'd)

Tower Elevation ft	Leg		Diagonal		Top Girt		Bottom Girt		Mid Girt		Long Horizontal		Short Horizontal	
	Net Width Deduct in	U	Net Width Deduct in	U	Net Width Deduct in	U	Net Width Deduct in	U	Net Width Deduct in	U	Net Width Deduct in	U	Net Width Deduct in	U
T1 188.00-180.00	0.0000	1	0.0000	0.75	0.0000	0.75	0.0000	0.75	0.0000	0.75	0.0000	0.75	0.0000	0.75
T2 180.00-160.00	0.0000	1	0.0000	0.75	0.0000	0.75	0.0000	0.75	0.0000	0.75	0.0000	0.75	0.0000	0.75
T3 160.00-140.00	0.0000	1	0.0000	0.75	0.0000	0.75	0.0000	0.75	0.0000	0.75	0.0000	0.75	0.0000	0.75
T4 140.00-120.00	0.0000	1	0.0000	0.75	0.0000	0.75	0.0000	0.75	0.0000	0.75	0.0000	0.75	0.0000	0.75
T5 120.00-100.00	0.0000	1	0.0000	0.75	0.0000	0.75	0.0000	0.75	0.0000	0.75	0.0000	0.75	0.0000	0.75
T6 100.00-80.00	0.0000	1	0.0000	0.75	0.0000	0.75	0.0000	0.75	0.0000	0.75	0.0000	0.75	0.0000	0.75
T7 80.00-60.00	0.0000	1	0.0000	0.75	0.0000	0.75	0.0000	0.75	0.0000	0.75	0.0000	0.75	0.0000	0.75
T8 60.00-40.00	0.0000	1	0.0000	0.75	0.0000	0.75	0.0000	0.75	0.0000	0.75	0.0000	0.75	0.0000	0.75
T9 40.00-20.00	0.0000	1	0.0000	0.75	0.0000	0.75	0.0000	0.75	0.0000	0.75	0.0000	0.75	0.0000	0.75
T10 20.00-0.00	0.0000	1	0.0000	0.75	0.0000	0.75	0.0000	0.75	0.0000	0.75	0.0000	0.75	0.0000	0.75

Tower Section Geometry (cont'd)

Tower Elevation ft	Leg Connection Type	Leg		Diagonal		Top Girt		Bottom Girt		Mid Girt		Long Horizontal		Short Horizontal	
		Bolt Size in	No.	Bolt Size in	No.	Bolt Size in	No.	Bolt Size in	No.	Bolt Size in	No.	Bolt Size in	No.	Bolt Size in	No.
T1 188.00-180.00	Flange	0.8750	4	0.6250	1	0.6250	0	0.6250	0	0.6250	0	0.6250	0	0.6250	0
T2 180.00-160.00	Flange	0.8750	4	0.6250	1	0.6250	0	0.6250	0	0.6250	0	0.6250	0	0.6250	0
T3 160.00-140.00	Flange	0.8750	4	0.6250	1	0.6250	0	0.6250	0	0.6250	0	0.6250	0	0.6250	0
T4 140.00-120.00	Flange	1.0000	4	0.7500	1	0.6250	0	0.6250	0	0.6250	0	0.6250	0	0.6250	0
T5 120.00-100.00	Flange	1.0000	6	0.7500	1	0.6250	0	0.6250	0	0.6250	0	0.6250	0	0.6250	0
T6 100.00-80.00	Flange	1.0000	6	0.7500	1	0.6250	0	0.6250	0	0.6250	0	0.6250	0	0.6250	0
T7 80.00-60.00	Flange	1.0000	8	0.7500	1	0.6250	0	0.6250	0	0.6250	0	0.6250	0	0.6250	0
T8 60.00-40.00	Flange	1.0000	8	0.7500	1	0.6250	0	0.6250	0	0.6250	0	0.6250	0	0.6250	0
T9 40.00-20.00	Flange	1.0000	8	0.7500	1	0.6250	0	0.6250	0	0.6250	0	0.6250	0	0.6250	0
T10 20.00-0.00	Flange	0.7500	0	0.7500	1	0.6250	0	0.6250	0	0.6250	0	0.6250	0	0.6250	0

Feed Line/Linear Appurtenances - Entered As Round Or Flat

tnxTower Destek Engineering, LLC 1281 Kennestone Circle, Suite 100 Marietta, GA 30066 Phone: (770) 693-0835 FAX:	Job	CT11402A	Page	6 of 28
	Project	1807125	Date	09:16:06 06/14/18
	Client	T-Mobile	Designed by	Ahmet Colakoglu

Description	Face or Leg	Allow Shield	Component Type	Placement ft	Face Offset in	Lateral Offset (Frac FW)	#	# Per Row	Clear Spacing in	Width or Diameter in	Perimeter in	Weight plf
Safety Line 3/8 *****	C	No	Ar (CaAa)	188.00 - 0.00	0.0000	0	1	1	0.3750	0.3750		0.22
LDF6-50A(1-1/4") *****	B	No	Ar (CaAa)	188.00 - 8.00	1.0000	0.38	1	1	1.5500	1.5500		0.66
LDF6-50A(1-1/4")	C	No	Ar (CaAa)	172.00 - 8.00	1.0000	0.38	12	12	0.7000	1.5500		0.66
5/8" DC Cable	C	No	Ar (CaAa)	172.00 - 8.00	1.0000	0.31	2	2	0.6250	0.8700		0.30
LDF2-50A(3/8") *****	C	No	Ar (CaAa)	172.00 - 8.00	1.0000	0.3	1	1	0.4400	0.4400		0.08
LDF6-50A(1-1/4")	A	No	Ar (CaAa)	155.00 - 8.00	2.0000	-0.38	6	6	0.7000	1.5500		0.66
1-5/8" Hybrid Cable *****	A	No	Ar (CaAa)	155.00 - 8.00	2.0000	0.49	2	2	0.7000	1.9800		0.82
LDF7-50A(1-5/8")	C	No	Ar (CaAa)	145.50 - 8.00	1.0000	-0.4	15	15	0.7000	1.9800		0.82
1-5/8" Hybrid Cable *****	C	No	Ar (CaAa)	145.50 - 8.00	2.0000	0.49	2	2	0.7000	1.9800		0.82
LDF6-50A(1-1/4")	A	No	Ar (CaAa)	123.00 - 8.00	1.0000	0.48	3	3	0.7000	1.5500		0.66
Hybrid Cable *****	A	No	Ar (CaAa)	123.00 - 8.00	1.0000	0.48	1	1	0.7000	1.5500		0.66
Feedline Ladder (Rail)	A	No	Af (CaAa)	157.00 - 0.00	0.0000	-0.45	2	2	36.0000	1.7500		3.00
Feedline Ladder (Rail)	B	No	Af (CaAa)	188.00 - 0.00	0.0000	0.45	2	2	36.0000	1.7500		3.00
Feedline Ladder (Rail)	B	No	Af (CaAa)	188.00 - 0.00	0.0000	-0.45	2	2	36.0000	1.7500		3.00
Feedline Ladder (Rail)	C	No	Af (CaAa)	172.00 - 0.00	0.0000	0.45	2	2	36.0000	1.7500		3.00
Feedline Ladder (Rail)	C	No	Af (CaAa)	145.50 - 0.00	0.0000	-0.45	2	2	36.0000	1.7500		3.00

Feed Line/Linear Appurtenances Section Areas

Tower Section	Tower Elevation ft	Face	A _R ft ²	A _F ft ²	C _{AA} In Face ft ²	C _{AA} Out Face ft ²	Weight K
T1	188.00-180.00	A	0.000	0.000	0.000	0.000	0.00
		B	0.000	0.000	10.573	0.000	0.10
		C	0.000	0.000	0.300	0.000	0.00
T2	180.00-160.00	A	0.000	0.000	0.000	0.000	0.00
		B	0.000	0.000	26.433	0.000	0.25
		C	0.000	0.000	32.686	0.000	0.18
T3	160.00-140.00	A	0.000	0.000	29.807	0.000	0.19
		B	0.000	0.000	26.433	0.000	0.25
		C	0.000	0.000	75.698	0.000	0.41
T4	140.00-120.00	A	0.000	0.000	40.047	0.000	0.24
		B	0.000	0.000	26.433	0.000	0.25
		C	0.000	0.000	132.963	0.000	0.70
T5	120.00-100.00	A	0.000	0.000	50.587	0.000	0.28
		B	0.000	0.000	26.433	0.000	0.25

tnxTower Destek Engineering, LLC 1281 Kennestone Circle, Suite 100 Marietta, GA 30066 Phone: (770) 693-0835 FAX:	Job	CT11402A	Page	7 of 28
	Project	1807125	Date	09:16:06 06/14/18
	Client	T-Mobile	Designed by	Ahmet Colakoglu

Tower Section	Tower Elevation ft	Face	A _R ft ²	A _F ft ²	C _A A _A In Face ft ²	C _A A _A Out Face ft ²	Weight K
T6	100.00-80.00	C	0.000	0.000	132.963	0.000	0.70
		A	0.000	0.000	50.587	0.000	0.28
		B	0.000	0.000	26.433	0.000	0.25
T7	80.00-60.00	C	0.000	0.000	132.963	0.000	0.70
		A	0.000	0.000	50.587	0.000	0.28
		B	0.000	0.000	26.433	0.000	0.25
T8	60.00-40.00	C	0.000	0.000	132.963	0.000	0.70
		A	0.000	0.000	50.587	0.000	0.28
		B	0.000	0.000	26.433	0.000	0.25
T9	40.00-20.00	C	0.000	0.000	132.963	0.000	0.70
		A	0.000	0.000	50.587	0.000	0.28
		B	0.000	0.000	26.433	0.000	0.25
T10	20.00-0.00	C	0.000	0.000	132.963	0.000	0.70
		A	0.000	0.000	35.019	0.000	0.22
		B	0.000	0.000	25.193	0.000	0.25
		C	0.000	0.000	89.411	0.000	0.51

Feed Line/Linear Appurtenances Section Areas - With Ice

Tower Section	Tower Elevation ft	Face or Leg	Ice Thickness in	A _R ft ²	A _F ft ²	C _A A _A In Face ft ²	C _A A _A Out Face ft ²	Weight K
T1	188.00-180.00	A	2.375	0.000	0.000	0.000	0.000	0.00
		B		0.000	0.000	29.573	0.000	0.66
		C		0.000	0.000	4.100	0.000	0.07
T2	180.00-160.00	A	2.356	0.000	0.000	0.000	0.000	0.00
		B		0.000	0.000	73.559	0.000	1.65
		C		0.000	0.000	95.647	0.000	1.69
T3	160.00-140.00	A	2.327	0.000	0.000	81.912	0.000	1.46
		B		0.000	0.000	72.972	0.000	1.62
		C		0.000	0.000	198.667	0.000	3.55
T4	140.00-120.00	A	2.294	0.000	0.000	110.920	0.000	1.92
		B		0.000	0.000	72.311	0.000	1.59
		C		0.000	0.000	320.636	0.000	5.76
T5	120.00-100.00	A	2.256	0.000	0.000	146.229	0.000	2.44
		B		0.000	0.000	71.551	0.000	1.55
		C		0.000	0.000	318.753	0.000	5.66
T6	100.00-80.00	A	2.211	0.000	0.000	144.788	0.000	2.39
		B		0.000	0.000	70.655	0.000	1.51
		C		0.000	0.000	316.534	0.000	5.55
T7	80.00-60.00	A	2.156	0.000	0.000	143.025	0.000	2.32
		B		0.000	0.000	69.557	0.000	1.47
		C		0.000	0.000	313.817	0.000	5.40
T8	60.00-40.00	A	2.085	0.000	0.000	140.733	0.000	2.23
		B		0.000	0.000	68.130	0.000	1.40
		C		0.000	0.000	310.287	0.000	5.22
T9	40.00-20.00	A	1.981	0.000	0.000	137.403	0.000	2.11
		B		0.000	0.000	66.054	0.000	1.32
		C		0.000	0.000	305.155	0.000	4.96
T10	20.00-0.00	A	1.775	0.000	0.000	88.829	0.000	1.32
		B		0.000	0.000	57.852	0.000	1.09
		C		0.000	0.000	200.822	0.000	3.12

Feed Line Center of Pressure

tnxTower Destek Engineering, LLC 1281 Kennestone Circle, Suite 100 Marietta, GA 30066 Phone: (770) 693-0835 FAX:	Job	CT11402A	Page	8 of 28
	Project	1807125	Date	09:16:06 06/14/18
	Client	T-Mobile	Designed by	Ahmet Colakoglu

Section	Elevation	CP _x	CP _z	CP _x	CP _z
	ft	in	in	Ice in	Ice in
T1	188.00-180.00	2.4482	-0.8968	3.7822	-1.3790
T2	180.00-160.00	-1.4078	1.8693	0.1589	1.0752
T3	160.00-140.00	-3.0987	3.8642	-2.2773	3.6261
T4	140.00-120.00	-0.3726	5.4310	0.0312	5.0782
T5	120.00-100.00	-0.4353	5.0480	0.0095	4.8629
T6	100.00-80.00	-0.4837	5.6982	0.0117	5.6203
T7	80.00-60.00	-0.5168	6.1558	0.0115	6.1585
T8	60.00-40.00	-0.5463	6.5754	0.0097	6.7365
T9	40.00-20.00	-0.5909	7.1751	0.0038	7.4212
T10	20.00-0.00	-0.4306	6.5997	0.0632	7.7696

Shielding Factor Ka

Tower Section	Feed Line Record No.	Description	Feed Line Segment Elev.	K _a No Ice	K _a Ice
T1	1	Safety Line 3/8	180.00 - 188.00	0.6000	0.4652
T1	3	LDF6-50A(1-1/4")	180.00 - 188.00	0.6000	0.4652
T1	21	Feedline Ladder (Rail)	180.00 - 188.00	0.6000	0.4652
T1	22	Feedline Ladder (Rail)	180.00 - 188.00	0.6000	0.4652
T2	1	Safety Line 3/8	160.00 - 180.00	0.6000	0.5112
T2	3	LDF6-50A(1-1/4")	160.00 - 180.00	0.6000	0.5112
T2	5	LDF6-50A(1-1/4")	160.00 - 172.00	0.6000	0.5112
T2	6	5/8" DC Cable	160.00 - 172.00	0.6000	0.5112
T2	7	LDF2-50A(3/8")	160.00 - 172.00	0.6000	0.5112
T2	21	Feedline Ladder (Rail)	160.00 - 180.00	0.6000	0.5112
T2	22	Feedline Ladder (Rail)	160.00 - 180.00	0.6000	0.5112
T2	23	Feedline Ladder (Rail)	160.00 - 172.00	0.6000	0.5112
T3	1	Safety Line 3/8	140.00 - 160.00	0.6000	0.6000
T3	3	LDF6-50A(1-1/4")	140.00 - 160.00	0.6000	0.6000
T3	5	LDF6-50A(1-1/4")	140.00 - 160.00	0.6000	0.6000
T3	6	5/8" DC Cable	140.00 - 160.00	0.6000	0.6000
T3	7	LDF2-50A(3/8")	140.00 - 160.00	0.6000	0.6000
T3	10	LDF6-50A(1-1/4")	140.00 - 155.00	0.6000	0.6000
T3	11	1-5/8" Hybrid Cable	140.00 - 155.00	0.6000	0.6000
T3	13	LDF7-50A(1-5/8")	140.00 -	0.6000	0.6000

<p style="text-align: center;">tnxTower</p> <p style="text-align: center;">Destek Engineering, LLC 1281 Kennestone Circle, Suite 100 Marietta, GA 30066 Phone: (770) 693-0835 FAX:</p>	Job	CT11402A	Page	9 of 28
	Project	1807125	Date	09:16:06 06/14/18
	Client	T-Mobile	Designed by	Ahmet Colakoglu

Tower Section	Feed Line Record No.	Description	Feed Line Segment Elev.	K_a No Ice	K_a Ice
			145.50		
T3	14	1-5/8" Hybrid Cable	140.00 - 145.50	0.6000	0.6000
T3	20	Feedline Ladder (Rail)	140.00 - 157.00	0.6000	0.6000
T3	21	Feedline Ladder (Rail)	140.00 - 160.00	0.6000	0.6000
T3	22	Feedline Ladder (Rail)	140.00 - 160.00	0.6000	0.6000
T3	23	Feedline Ladder (Rail)	140.00 - 160.00	0.6000	0.6000
T3	24	Feedline Ladder (Rail)	140.00 - 145.50	0.6000	0.6000
T4	1	Safety Line 3/8	120.00 - 140.00	0.6000	0.6000
T4	3	LDF6-50A(1-1/4")	120.00 - 140.00	0.6000	0.6000
T4	5	LDF6-50A(1-1/4")	120.00 - 140.00	0.6000	0.6000
T4	6	5/8" DC Cable	120.00 - 140.00	0.6000	0.6000
T4	7	LDF2-50A(3/8")	120.00 - 140.00	0.6000	0.6000
T4	10	LDF6-50A(1-1/4")	120.00 - 140.00	0.6000	0.6000
T4	11	1-5/8" Hybrid Cable	120.00 - 140.00	0.6000	0.6000
T4	13	LDF7-50A(1-5/8")	120.00 - 140.00	0.6000	0.6000
T4	14	1-5/8" Hybrid Cable	120.00 - 140.00	0.6000	0.6000
T4	16	LDF6-50A(1-1/4")	120.00 - 123.00	0.6000	0.6000
T4	17	Hybrid Cable	120.00 - 123.00	0.6000	0.6000
T4	20	Feedline Ladder (Rail)	120.00 - 140.00	0.6000	0.6000
T4	21	Feedline Ladder (Rail)	120.00 - 140.00	0.6000	0.6000
T4	22	Feedline Ladder (Rail)	120.00 - 140.00	0.6000	0.6000
T4	23	Feedline Ladder (Rail)	120.00 - 140.00	0.6000	0.6000
T4	24	Feedline Ladder (Rail)	120.00 - 140.00	0.6000	0.6000
T5	1	Safety Line 3/8	100.00 - 120.00	0.6000	0.6000
T5	3	LDF6-50A(1-1/4")	100.00 - 120.00	0.6000	0.6000
T5	5	LDF6-50A(1-1/4")	100.00 - 120.00	0.6000	0.6000
T5	6	5/8" DC Cable	100.00 - 120.00	0.6000	0.6000
T5	7	LDF2-50A(3/8")	100.00 - 120.00	0.6000	0.6000
T5	10	LDF6-50A(1-1/4")	100.00 - 120.00	0.6000	0.6000
T5	11	1-5/8" Hybrid Cable	100.00 - 120.00	0.6000	0.6000
T5	13	LDF7-50A(1-5/8")	100.00 - 120.00	0.6000	0.6000
T5	14	1-5/8" Hybrid Cable	100.00 -	0.6000	0.6000

tnxTower Destek Engineering, LLC 1281 Kennestone Circle, Suite 100 Marietta, GA 30066 Phone: (770) 693-0835 FAX:	Job	CT11402A	Page	10 of 28
	Project	1807125	Date	09:16:06 06/14/18
	Client	T-Mobile	Designed by	Ahmet Colakoglu

Tower Section	Feed Line Record No.	Description	Feed Line Segment Elev.	K _a No Ice	K _a Ice
			120.00		
T5	16	LDF6-50A(1-1/4")	100.00 - 120.00	0.6000	0.6000
T5	17	Hybrid Cable	100.00 - 120.00	0.6000	0.6000
T5	20	Feedline Ladder (Rail)	100.00 - 120.00	0.6000	0.6000
T5	21	Feedline Ladder (Rail)	100.00 - 120.00	0.6000	0.6000
T5	22	Feedline Ladder (Rail)	100.00 - 120.00	0.6000	0.6000
T5	23	Feedline Ladder (Rail)	100.00 - 120.00	0.6000	0.6000
T5	24	Feedline Ladder (Rail)	100.00 - 120.00	0.6000	0.6000
T6	1	Safety Line 3/8	80.00 - 100.00	0.6000	0.6000
T6	3	LDF6-50A(1-1/4")	80.00 - 100.00	0.6000	0.6000
T6	5	LDF6-50A(1-1/4")	80.00 - 100.00	0.6000	0.6000
T6	6	5/8" DC Cable	80.00 - 100.00	0.6000	0.6000
T6	7	LDF2-50A(3/8")	80.00 - 100.00	0.6000	0.6000
T6	10	LDF6-50A(1-1/4")	80.00 - 100.00	0.6000	0.6000
T6	11	1-5/8" Hybrid Cable	80.00 - 100.00	0.6000	0.6000
T6	13	LDF7-50A(1-5/8")	80.00 - 100.00	0.6000	0.6000
T6	14	1-5/8" Hybrid Cable	80.00 - 100.00	0.6000	0.6000
T6	16	LDF6-50A(1-1/4")	80.00 - 100.00	0.6000	0.6000
T6	17	Hybrid Cable	80.00 - 100.00	0.6000	0.6000
T6	20	Feedline Ladder (Rail)	80.00 - 100.00	0.6000	0.6000
T6	21	Feedline Ladder (Rail)	80.00 - 100.00	0.6000	0.6000
T6	22	Feedline Ladder (Rail)	80.00 - 100.00	0.6000	0.6000
T6	23	Feedline Ladder (Rail)	80.00 - 100.00	0.6000	0.6000
T6	24	Feedline Ladder (Rail)	80.00 - 100.00	0.6000	0.6000
T7	1	Safety Line 3/8	60.00 - 80.00	0.6000	0.6000
T7	3	LDF6-50A(1-1/4")	60.00 - 80.00	0.6000	0.6000
T7	5	LDF6-50A(1-1/4")	60.00 - 80.00	0.6000	0.6000
T7	6	5/8" DC Cable	60.00 - 80.00	0.6000	0.6000
T7	7	LDF2-50A(3/8")	60.00 - 80.00	0.6000	0.6000
T7	10	LDF6-50A(1-1/4")	60.00 - 80.00	0.6000	0.6000
T7	11	1-5/8" Hybrid Cable	60.00 - 80.00	0.6000	0.6000
T7	13	LDF7-50A(1-5/8")	60.00 - 80.00	0.6000	0.6000
T7	14	1-5/8" Hybrid Cable	60.00 - 80.00	0.6000	0.6000
T7	16	LDF6-50A(1-1/4")	60.00 - 80.00	0.6000	0.6000
T7	17	Hybrid Cable	60.00 - 80.00	0.6000	0.6000
T7	20	Feedline Ladder (Rail)	60.00 - 80.00	0.6000	0.6000
T7	21	Feedline Ladder (Rail)	60.00 - 80.00	0.6000	0.6000
T7	22	Feedline Ladder (Rail)	60.00 - 80.00	0.6000	0.6000
T7	23	Feedline Ladder (Rail)	60.00 - 80.00	0.6000	0.6000
T7	24	Feedline Ladder (Rail)	60.00 - 80.00	0.6000	0.6000
T8	1	Safety Line 3/8	40.00 - 60.00	0.6000	0.6000
T8	3	LDF6-50A(1-1/4")	40.00 - 60.00	0.6000	0.6000
T8	5	LDF6-50A(1-1/4")	40.00 - 60.00	0.6000	0.6000
T8	6	5/8" DC Cable	40.00 - 60.00	0.6000	0.6000
T8	7	LDF2-50A(3/8")	40.00 - 60.00	0.6000	0.6000
T8	10	LDF6-50A(1-1/4")	40.00 - 60.00	0.6000	0.6000
T8	11	1-5/8" Hybrid Cable	40.00 - 60.00	0.6000	0.6000
T8	13	LDF7-50A(1-5/8")	40.00 - 60.00	0.6000	0.6000
T8	14	1-5/8" Hybrid Cable	40.00 - 60.00	0.6000	0.6000
T8	16	LDF6-50A(1-1/4")	40.00 - 60.00	0.6000	0.6000
T8	17	Hybrid Cable	40.00 - 60.00	0.6000	0.6000
T8	20	Feedline Ladder (Rail)	40.00 - 60.00	0.6000	0.6000
T8	21	Feedline Ladder (Rail)	40.00 - 60.00	0.6000	0.6000
T8	22	Feedline Ladder (Rail)	40.00 - 60.00	0.6000	0.6000
T8	23	Feedline Ladder (Rail)	40.00 - 60.00	0.6000	0.6000

tnxTower Destek Engineering, LLC 1281 Kennestone Circle, Suite 100 Marietta, GA 30066 Phone: (770) 693-0835 FAX:	Job CT11402A	Page 11 of 28
	Project 1807125	Date 09:16:06 06/14/18
	Client T-Mobile	Designed by Ahmet Colakoglu

Tower Section	Feed Line Record No.	Description	Feed Line Segment Elev.	K _a No Ice	K _a Ice
T8	24	Feedline Ladder (Rail)	40.00 - 60.00	0.6000	0.6000
T9	1	Safety Line 3/8	20.00 - 40.00	0.6000	0.6000
T9	3	LDF6-50A(1-1/4")	20.00 - 40.00	0.6000	0.6000
T9	5	LDF6-50A(1-1/4")	20.00 - 40.00	0.6000	0.6000
T9	6	5/8" DC Cable	20.00 - 40.00	0.6000	0.6000
T9	7	LDF2-50A(3/8")	20.00 - 40.00	0.6000	0.6000
T9	10	LDF6-50A(1-1/4")	20.00 - 40.00	0.6000	0.6000
T9	11	1-5/8" Hybrid Cable	20.00 - 40.00	0.6000	0.6000
T9	13	LDF7-50A(1-5/8")	20.00 - 40.00	0.6000	0.6000
T9	14	1-5/8" Hybrid Cable	20.00 - 40.00	0.6000	0.6000
T9	16	LDF6-50A(1-1/4")	20.00 - 40.00	0.6000	0.6000
T9	17	Hybrid Cable	20.00 - 40.00	0.6000	0.6000
T9	20	Feedline Ladder (Rail)	20.00 - 40.00	0.6000	0.6000
T9	21	Feedline Ladder (Rail)	20.00 - 40.00	0.6000	0.6000
T9	22	Feedline Ladder (Rail)	20.00 - 40.00	0.6000	0.6000
T9	23	Feedline Ladder (Rail)	20.00 - 40.00	0.6000	0.6000
T9	24	Feedline Ladder (Rail)	20.00 - 40.00	0.6000	0.6000
T10	1	Safety Line 3/8	0.00 - 20.00	0.6000	0.6000
T10	3	LDF6-50A(1-1/4")	8.00 - 20.00	0.6000	0.6000
T10	5	LDF6-50A(1-1/4")	8.00 - 20.00	0.6000	0.6000
T10	6	5/8" DC Cable	8.00 - 20.00	0.6000	0.6000
T10	7	LDF2-50A(3/8")	8.00 - 20.00	0.6000	0.6000
T10	10	LDF6-50A(1-1/4")	8.00 - 20.00	0.6000	0.6000
T10	11	1-5/8" Hybrid Cable	8.00 - 20.00	0.6000	0.6000
T10	13	LDF7-50A(1-5/8")	8.00 - 20.00	0.6000	0.6000
T10	14	1-5/8" Hybrid Cable	8.00 - 20.00	0.6000	0.6000
T10	16	LDF6-50A(1-1/4")	8.00 - 20.00	0.6000	0.6000
T10	17	Hybrid Cable	8.00 - 20.00	0.6000	0.6000
T10	20	Feedline Ladder (Rail)	0.00 - 20.00	0.6000	0.6000
T10	21	Feedline Ladder (Rail)	0.00 - 20.00	0.6000	0.6000
T10	22	Feedline Ladder (Rail)	0.00 - 20.00	0.6000	0.6000
T10	23	Feedline Ladder (Rail)	0.00 - 20.00	0.6000	0.6000
T10	24	Feedline Ladder (Rail)	0.00 - 20.00	0.6000	0.6000

Discrete Tower Loads

Description	Face or Leg	Offset Type	Offsets:		Azimuth Adjustment	Placement	C _A A _A Front	C _A A _A Side	Weight	
			Horz	Vert						
			ft	ft	°	ft	ft ²	ft ²	K	
BCD-87010	B	From Leg	0.00	0.00	0.0000	195.00	No Ice	2.90	2.90	0.03
			0.00	0.00			1/2" Ice	4.05	4.05	0.05
			7.50	0.00			1" Ice	5.21	5.21	0.08

Rohn 14' Platform	C	None			0.0000	186.00	No Ice	41.00	41.00	2.50
							1/2" Ice	56.00	56.00	3.00
							1" Ice	71.00	71.00	3.50

(2) AM-X-CD-16-65-00T-RET w/ Mount Pipe	A	From Leg	4.00	0.00	0.0000	172.00	No Ice	8.26	6.30	0.07
			0.00	0.00			1/2" Ice	8.82	7.48	0.14
	B	From Leg	0.00	0.00	0.0000	172.00	1" Ice	9.35	8.37	0.21
			4.00	0.00			No Ice	8.26	6.30	0.07

tnxTower Destek Engineering, LLC 1281 Kennestone Circle, Suite 100 Marietta, GA 30066 Phone: (770) 693-0835 FAX:	Job	CT11402A	Page	12 of 28
	Project	1807125	Date	09:16:06 06/14/18
	Client	T-Mobile	Designed by	Ahmet Colakoglu

Description	Face or Leg	Offset Type	Offsets:		Azimuth Adjustment	Placement	C _{AA} Front	C _{AA} Side	Weight
			Horz	Lateral					
AM-X-CD-16-65-00T-RET			0.00			1/2" Ice	8.82	7.48	0.14
w/ Mount Pipe			0.00			1" Ice	9.35	8.37	0.21
(2)	C	From Leg	4.00	0.0000	172.00	No Ice	8.26	6.30	0.07
AM-X-CD-16-65-00T-RET			0.00			1/2" Ice	8.82	7.48	0.14
w/ Mount Pipe			0.00			1" Ice	9.35	8.37	0.21
800 10121 w/ Mount Pipe	A	From Leg	4.00	0.0000	172.00	No Ice	5.39	4.60	0.07
			0.00			1/2" Ice	5.81	5.35	0.11
			0.00			1" Ice	6.23	6.05	0.17
800 10121 w/ Mount Pipe	B	From Leg	4.00	0.0000	172.00	No Ice	5.39	4.60	0.07
			0.00			1/2" Ice	5.81	5.35	0.11
			0.00			1" Ice	6.23	6.05	0.17
800 10121 w/ Mount Pipe	C	From Leg	4.00	0.0000	172.00	No Ice	5.39	4.60	0.07
			0.00			1/2" Ice	5.81	5.35	0.11
			0.00			1" Ice	6.23	6.05	0.17
RRUS 11	A	From Leg	4.00	0.0000	172.00	No Ice	2.78	1.19	0.05
			0.00			1/2" Ice	2.99	1.33	0.07
			0.00			1" Ice	3.21	1.49	0.10
RRUS 11	B	From Leg	4.00	0.0000	172.00	No Ice	2.78	1.19	0.05
			0.00			1/2" Ice	2.99	1.33	0.07
			0.00			1" Ice	3.21	1.49	0.10
RRUS 11	C	From Leg	4.00	0.0000	172.00	No Ice	2.78	1.19	0.05
			0.00			1/2" Ice	2.99	1.33	0.07
			0.00			1" Ice	3.21	1.49	0.10
RRUS 12	A	From Leg	4.00	0.0000	172.00	No Ice	3.15	1.29	0.06
			0.00			1/2" Ice	3.36	1.44	0.08
			0.00			1" Ice	3.59	1.60	0.11
RRUS 12	B	From Leg	4.00	0.0000	172.00	No Ice	3.15	1.29	0.06
			0.00			1/2" Ice	3.36	1.44	0.08
			0.00			1" Ice	3.59	1.60	0.11
RRUS 12	C	From Leg	4.00	0.0000	172.00	No Ice	3.15	1.29	0.06
			0.00			1/2" Ice	3.36	1.44	0.08
			0.00			1" Ice	3.59	1.60	0.11
TT19-08BP111-001	A	From Leg	4.00	0.0000	172.00	No Ice	0.55	0.45	0.02
			0.00			1/2" Ice	0.65	0.53	0.02
			0.00			1" Ice	0.75	0.63	0.03
TT19-08BP111-001	B	From Leg	4.00	0.0000	172.00	No Ice	0.55	0.45	0.02
			0.00			1/2" Ice	0.65	0.53	0.02
			0.00			1" Ice	0.75	0.63	0.03
TT19-08BP111-001	C	From Leg	4.00	0.0000	172.00	No Ice	0.55	0.45	0.02
			0.00			1/2" Ice	0.65	0.53	0.02
			0.00			1" Ice	0.75	0.63	0.03
DTMABP7819VG12A	A	From Leg	4.00	0.0000	172.00	No Ice	0.98	0.34	0.02
			0.00			1/2" Ice	1.10	0.42	0.03
			0.00			1" Ice	1.23	0.51	0.04
DTMABP7819VG12A	B	From Leg	4.00	0.0000	172.00	No Ice	0.98	0.34	0.02
			0.00			1/2" Ice	1.10	0.42	0.03
			0.00			1" Ice	1.23	0.51	0.04
DTMABP7819VG12A	C	From Leg	4.00	0.0000	172.00	No Ice	0.98	0.34	0.02
			0.00			1/2" Ice	1.10	0.42	0.03
			0.00			1" Ice	1.23	0.51	0.04
DC6-48-60-18-8F	C	From Leg	4.00	0.0000	172.00	No Ice	0.79	0.79	0.02
			0.00			1/2" Ice	1.27	1.27	0.03
			0.00			1" Ice	1.45	1.45	0.05
6' x 2" Mount Pipe	A	From Leg	4.00	0.0000	172.00	No Ice	1.43	1.43	0.02
			0.00			1/2" Ice	1.92	1.92	0.03
			0.00			1" Ice	2.29	2.29	0.05
6' x 2" Mount Pipe	B	From Leg	4.00	0.0000	172.00	No Ice	1.43	1.43	0.02

tnxTower Destek Engineering, LLC 1281 Kennestone Circle, Suite 100 Marietta, GA 30066 Phone: (770) 693-0835 FAX:	Job	CT11402A	Page	13 of 28
	Project	1807125	Date	09:16:06 06/14/18
	Client	T-Mobile	Designed by	Ahmet Colakoglu

Description	Face or Leg	Offset Type	Offsets:		Azimuth Adjustment	Placement	C _{AA} Front	C _{AA} Side	Weight
			Horz	Lateral					
			ft	ft					
			0.00			1/2" Ice	1.92	1.92	0.03
			0.00			1" Ice	2.29	2.29	0.05
6' x 2" Mount Pipe	C	From Leg	4.00	0.0000	172.00	No Ice	1.43	1.43	0.02
			0.00			1/2" Ice	1.92	1.92	0.03
			0.00			1" Ice	2.29	2.29	0.05
Sector Mount [SM 503-3]	C	None		0.0000	172.00	No Ice	33.64	33.64	1.69
						1/2" Ice	48.17	48.17	2.26
						1" Ice	62.70	62.70	2.82

APX16DWV-16DWV-S-E-A 20 w/ Mount Pipe	A	From Leg	4.00	0.0000	155.00	No Ice	6.82	3.49	0.06
			0.00			1/2" Ice	7.28	4.26	0.11
			0.00			1" Ice	7.72	4.96	0.16
APX16DWV-16DWV-S-E-A 20 w/ Mount Pipe	B	From Leg	4.00	0.0000	155.00	No Ice	6.82	3.49	0.06
			0.00			1/2" Ice	7.28	4.26	0.11
			0.00			1" Ice	7.72	4.96	0.16
APX16DWV-16DWV-S-E-A 20 w/ Mount Pipe	C	From Leg	4.00	0.0000	155.00	No Ice	6.82	3.49	0.06
			0.00			1/2" Ice	7.28	4.26	0.11
			0.00			1" Ice	7.72	4.96	0.16
(2) TMA	A	From Leg	4.00	0.0000	155.00	No Ice	0.50	0.30	0.01
			0.00			1/2" Ice	0.59	0.37	0.02
			0.00			1" Ice	0.68	0.44	0.02
(2) TMA	B	From Leg	4.00	0.0000	155.00	No Ice	0.50	0.30	0.01
			0.00			1/2" Ice	0.59	0.37	0.02
			0.00			1" Ice	0.68	0.44	0.02
(2) TMA	C	From Leg	4.00	0.0000	155.00	No Ice	0.50	0.30	0.01
			0.00			1/2" Ice	0.59	0.37	0.02
			0.00			1" Ice	0.68	0.44	0.02
APXVAARR24_43-U-NA20 w/ Mount Pipe	A	From Leg	4.00	0.0000	155.00	No Ice	20.48	11.02	0.16
			0.00			1/2" Ice	21.23	12.55	0.30
			0.00			1" Ice	21.99	14.10	0.44
APXVAARR24_43-U-NA20 w/ Mount Pipe	B	From Leg	4.00	0.0000	155.00	No Ice	20.48	11.02	0.16
			0.00			1/2" Ice	21.23	12.55	0.30
			0.00			1" Ice	21.99	14.10	0.44
APXVAARR24_43-U-NA20 w/ Mount Pipe	C	From Leg	4.00	0.0000	155.00	No Ice	20.48	11.02	0.16
			0.00			1/2" Ice	21.23	12.55	0.30
			0.00			1" Ice	21.99	14.10	0.44
RADIO 4449	A	From Leg	4.00	0.0000	155.00	No Ice	3.50	2.36	0.09
			0.00			1/2" Ice	3.74	2.57	0.11
			0.00			1" Ice	3.99	2.78	0.15
RADIO 4449	B	From Leg	4.00	0.0000	155.00	No Ice	3.50	2.36	0.09
			0.00			1/2" Ice	3.74	2.57	0.11
			0.00			1" Ice	3.99	2.78	0.15
RADIO 4449	C	From Leg	4.00	0.0000	155.00	No Ice	3.50	2.36	0.09
			0.00			1/2" Ice	3.74	2.57	0.11
			0.00			1" Ice	3.99	2.78	0.15
Sector Mount	A	None		0.0000	155.00	No Ice	9.80	4.90	0.33
						1/2" Ice	14.70	7.35	0.42
						1" Ice	19.60	9.80	0.51
Sector Mount	B	None		0.0000	155.00	No Ice	9.80	4.90	0.33
						1/2" Ice	14.70	7.35	0.42
						1" Ice	19.60	9.80	0.51
Sector Mount	C	None		0.0000	155.00	No Ice	9.80	4.90	0.33
						1/2" Ice	14.70	7.35	0.42
						1" Ice	19.60	9.80	0.51

(3) SBNHH-1D85B w/ Mount Pipe	A	From Leg	4.00	0.0000	145.50	No Ice	8.32	7.00	0.07
			0.00			1/2" Ice	8.88	8.19	0.14

tnxTower Destek Engineering, LLC 1281 Kennestone Circle, Suite 100 Marietta, GA 30066 Phone: (770) 693-0835 FAX:	Job		CT11402A		Page		14 of 28	
	Project		1807125		Date		09:16:06 06/14/18	
	Client		T-Mobile		Designed by		Ahmet Colakoglu	

Description	Face or Leg	Offset Type	Offsets:		Azimuth Adjustment	Placement	C _{AA} Front	C _{AA} Side	Weight	
			Horz	Lateral						Vert
(3) SBNHH-1D85B w/ Mount Pipe	B	From Leg	0.00		0.0000	145.50	1" Ice	9.40	9.08	0.21
			4.00				No Ice	8.32	7.00	0.07
			0.00				1/2" Ice	8.88	8.19	0.14
(3) SBNHH-1D85B w/ Mount Pipe	C	From Leg	0.00		0.0000	145.50	1" Ice	9.40	9.08	0.21
			4.00				No Ice	8.32	7.00	0.07
			0.00				1/2" Ice	8.88	8.19	0.14
BXA-70063-6CF-EDIN-6 w/ Mount Pipe	A	From Leg	0.00		0.0000	145.50	1" Ice	9.40	9.08	0.21
			4.00				No Ice	7.81	5.80	0.04
			0.00				1/2" Ice	8.36	6.95	0.10
BXA-70063-6CF-EDIN-6 w/ Mount Pipe	B	From Leg	0.00		0.0000	145.50	1" Ice	8.87	7.82	0.17
			4.00				No Ice	7.81	5.80	0.04
			0.00				1/2" Ice	8.36	6.95	0.10
BXA-70063-6CF-EDIN-6 w/ Mount Pipe	C	From Leg	0.00		0.0000	145.50	1" Ice	8.87	7.82	0.17
			4.00				No Ice	7.81	5.80	0.04
			0.00				1/2" Ice	8.36	6.95	0.10
B66A RRH4X45	A	From Leg	0.00		0.0000	145.50	1" Ice	8.87	7.82	0.17
			4.00				No Ice	2.58	1.63	0.06
			0.00				1/2" Ice	2.79	1.81	0.08
B66A RRH4X45	B	From Leg	0.00		0.0000	145.50	1" Ice	3.01	2.00	0.10
			4.00				No Ice	2.58	1.63	0.06
			0.00				1/2" Ice	2.79	1.81	0.08
B66A RRH4X45	C	From Leg	0.00		0.0000	145.50	1" Ice	3.01	2.00	0.10
			4.00				No Ice	2.58	1.63	0.06
			0.00				1/2" Ice	2.79	1.81	0.08
B25 RRH4x30-4R	A	From Leg	0.00		0.0000	145.50	1" Ice	3.01	2.00	0.10
			4.00				No Ice	2.14	1.31	0.05
			0.00				1/2" Ice	2.33	1.46	0.07
B25 RRH4x30-4R	B	From Leg	0.00		0.0000	145.50	1" Ice	2.53	1.63	0.09
			4.00				No Ice	2.14	1.31	0.05
			0.00				1/2" Ice	2.33	1.46	0.07
B25 RRH4x30-4R	C	From Leg	0.00		0.0000	145.50	1" Ice	2.53	1.63	0.09
			4.00				No Ice	2.14	1.31	0.05
			0.00				1/2" Ice	2.33	1.46	0.07
RRH2X60-1900	A	From Leg	0.00		0.0000	145.50	1" Ice	2.53	1.63	0.09
			4.00				No Ice	1.87	1.22	0.04
			0.00				1/2" Ice	2.05	1.37	0.06
RRH2X60-1900	B	From Leg	0.00		0.0000	145.50	1" Ice	2.24	1.52	0.08
			4.00				No Ice	1.87	1.22	0.04
			0.00				1/2" Ice	2.05	1.37	0.06
RRH2X60-1900	C	From Leg	0.00		0.0000	145.50	1" Ice	2.24	1.52	0.08
			4.00				No Ice	1.87	1.22	0.04
			0.00				1/2" Ice	2.05	1.37	0.06
DB-B1-6C-12AB-0Z	A	From Leg	0.00		0.0000	145.50	1" Ice	2.24	1.52	0.08
			4.00				No Ice	3.36	2.19	0.02
			0.00				1/2" Ice	3.60	2.39	0.05
DB-B1-6C-12AB-0Z	C	From Leg	0.00		0.0000	145.50	1" Ice	3.84	2.61	0.08
			4.00				No Ice	3.36	2.19	0.02
			0.00				1/2" Ice	3.60	2.39	0.05
SitePro VFA10-RRU	A	None	0.00		0.0000	145.50	1" Ice	3.84	2.61	0.08
			4.00				No Ice	7.53	3.80	0.31
			0.00				1/2" Ice	10.77	5.38	0.37
SitePro VFA10-RRU	B	None	0.00		0.0000	145.50	1" Ice	14.01	6.96	0.43
			4.00				No Ice	7.53	3.80	0.31
			0.00				1/2" Ice	10.77	5.38	0.37
SitePro VFA10-RRU	C	None	0.00		0.0000	145.50	1" Ice	14.01	6.96	0.43
			4.00				No Ice	7.53	3.80	0.31
			0.00				1/2" Ice	10.77	5.38	0.37

tnxTower Destek Engineering, LLC 1281 Kennestone Circle, Suite 100 Marietta, GA 30066 Phone: (770) 693-0835 FAX:	Job	CT11402A	Page	15 of 28
	Project	1807125	Date	09:16:06 06/14/18
	Client	T-Mobile	Designed by	Ahmet Colakoglu

Description	Face or Leg	Offset Type	Offsets:		Azimuth Adjustment	Placement	C _{AA} Front	C _{AA} Side	Weight
			Horz	Lateral					
			ft	ft	°	ft	ft ²	ft ²	K
						1" Ice	14.01	6.96	0.43

APXVSPP18-C-A20 w/ Mount Pipe	A	From Leg	4.00	0.0000	123.00	No Ice	8.26	6.95	0.08
			0.00			1/2" Ice	8.82	8.13	0.15
			0.00			1" Ice	9.35	9.02	0.23
APXVSPP18-C-A20 w/ Mount Pipe	B	From Leg	4.00	0.0000	123.00	No Ice	8.26	6.95	0.08
			0.00			1/2" Ice	8.82	8.13	0.15
			0.00			1" Ice	9.35	9.02	0.23
APXVSPP18-C-A20 w/ Mount Pipe	C	From Leg	4.00	0.0000	123.00	No Ice	8.26	6.95	0.08
			0.00			1/2" Ice	8.82	8.13	0.15
			0.00			1" Ice	9.35	9.02	0.23
DT465B-2XR w/ Mount Pipe	A	From Leg	4.00	0.0000	123.00	No Ice	9.34	7.63	0.08
			0.00			1/2" Ice	9.91	8.82	0.16
			0.00			1" Ice	10.44	9.72	0.24
DT465B-2XR w/ Mount Pipe	B	From Leg	4.00	0.0000	123.00	No Ice	9.34	7.63	0.08
			0.00			1/2" Ice	9.91	8.82	0.16
			0.00			1" Ice	10.44	9.72	0.24
DT465B-2XR w/ Mount Pipe	C	From Leg	4.00	0.0000	123.00	No Ice	9.34	7.63	0.08
			0.00			1/2" Ice	9.91	8.82	0.16
			0.00			1" Ice	10.44	9.72	0.24
RRH2X50-800	A	From Leg	4.00	0.0000	123.00	No Ice	1.70	1.28	0.05
			0.00			1/2" Ice	1.86	1.43	0.07
			0.00			1" Ice	2.03	1.58	0.09
RRH2X50-800	B	From Leg	4.00	0.0000	123.00	No Ice	1.70	1.28	0.05
			0.00			1/2" Ice	1.86	1.43	0.07
			0.00			1" Ice	2.03	1.58	0.09
RRH2X50-800	C	From Leg	4.00	0.0000	123.00	No Ice	1.70	1.28	0.05
			0.00			1/2" Ice	1.86	1.43	0.07
			0.00			1" Ice	2.03	1.58	0.09
RRH4X45-19	A	From Leg	4.00	0.0000	123.00	No Ice	2.31	2.38	0.06
			0.00			1/2" Ice	2.52	2.58	0.08
			0.00			1" Ice	2.73	2.79	0.11
RRH4X45-19	B	From Leg	4.00	0.0000	123.00	No Ice	2.31	2.38	0.06
			0.00			1/2" Ice	2.52	2.58	0.08
			0.00			1" Ice	2.73	2.79	0.11
RRH4X45-19	C	From Leg	4.00	0.0000	123.00	No Ice	2.31	2.38	0.06
			0.00			1/2" Ice	2.52	2.58	0.08
			0.00			1" Ice	2.73	2.79	0.11
TD-RRH8x20-25	A	From Leg	4.00	0.0000	123.00	No Ice	4.05	1.53	0.07
			0.00			1/2" Ice	4.30	1.71	0.10
			0.00			1" Ice	4.56	1.90	0.13
TD-RRH8x20-25	B	From Leg	4.00	0.0000	123.00	No Ice	4.05	1.53	0.07
			0.00			1/2" Ice	4.30	1.71	0.10
			0.00			1" Ice	4.56	1.90	0.13
TD-RRH8x20-25	C	From Leg	4.00	0.0000	123.00	No Ice	4.05	1.53	0.07
			0.00			1/2" Ice	4.30	1.71	0.10
			0.00			1" Ice	4.56	1.90	0.13
RRH2X50-800	A	From Leg	4.00	0.0000	123.00	No Ice	1.70	1.28	0.05
			0.00			1/2" Ice	1.86	1.43	0.07
			0.00			1" Ice	2.03	1.58	0.09
RRH2X50-800	B	From Leg	4.00	0.0000	123.00	No Ice	1.70	1.28	0.05
			0.00			1/2" Ice	1.86	1.43	0.07
			0.00			1" Ice	2.03	1.58	0.09
RRH2X50-800	C	From Leg	4.00	0.0000	123.00	No Ice	1.70	1.28	0.05
			0.00			1/2" Ice	1.86	1.43	0.07
			0.00			1" Ice	2.03	1.58	0.09
Sector Mount [SM 503-3]	C	None		0.0000	123.00	No Ice	33.64	33.64	1.69

tnxTower Destek Engineering, LLC 1281 Kennestone Circle, Suite 100 Marietta, GA 30066 Phone: (770) 693-0835 FAX:	Job	CT11402A	Page	16 of 28
	Project	1807125	Date	09:16:06 06/14/18
	Client	T-Mobile	Designed by	Ahmet Colakoglu

Description	Face or Leg	Offset Type	Offsets:		Azimuth Adjustment	Placement	C _{AA} Front	C _{AA} Side	Weight
			Horz Lateral	Vert					
			ft	ft	°	ft	ft ²	ft ²	K
						1/2" Ice	48.17	48.17	2.26
						1" Ice	62.70	62.70	2.82

Load Combinations

Comb. No.	Description
1	Dead Only
2	1.2 Dead+1.6 Wind 0 deg - No Ice
3	0.9 Dead+1.6 Wind 0 deg - No Ice
4	1.2 Dead+1.6 Wind 30 deg - No Ice
5	0.9 Dead+1.6 Wind 30 deg - No Ice
6	1.2 Dead+1.6 Wind 60 deg - No Ice
7	0.9 Dead+1.6 Wind 60 deg - No Ice
8	1.2 Dead+1.6 Wind 90 deg - No Ice
9	0.9 Dead+1.6 Wind 90 deg - No Ice
10	1.2 Dead+1.6 Wind 120 deg - No Ice
11	0.9 Dead+1.6 Wind 120 deg - No Ice
12	1.2 Dead+1.6 Wind 150 deg - No Ice
13	0.9 Dead+1.6 Wind 150 deg - No Ice
14	1.2 Dead+1.6 Wind 180 deg - No Ice
15	0.9 Dead+1.6 Wind 180 deg - No Ice
16	1.2 Dead+1.6 Wind 210 deg - No Ice
17	0.9 Dead+1.6 Wind 210 deg - No Ice
18	1.2 Dead+1.6 Wind 240 deg - No Ice
19	0.9 Dead+1.6 Wind 240 deg - No Ice
20	1.2 Dead+1.6 Wind 270 deg - No Ice
21	0.9 Dead+1.6 Wind 270 deg - No Ice
22	1.2 Dead+1.6 Wind 300 deg - No Ice
23	0.9 Dead+1.6 Wind 300 deg - No Ice
24	1.2 Dead+1.6 Wind 330 deg - No Ice
25	0.9 Dead+1.6 Wind 330 deg - No Ice
26	1.2 Dead+1.0 Ice+1.0 Temp
27	1.2 Dead+1.0 Wind 0 deg+1.0 Ice+1.0 Temp
28	1.2 Dead+1.0 Wind 30 deg+1.0 Ice+1.0 Temp
29	1.2 Dead+1.0 Wind 60 deg+1.0 Ice+1.0 Temp
30	1.2 Dead+1.0 Wind 90 deg+1.0 Ice+1.0 Temp
31	1.2 Dead+1.0 Wind 120 deg+1.0 Ice+1.0 Temp
32	1.2 Dead+1.0 Wind 150 deg+1.0 Ice+1.0 Temp
33	1.2 Dead+1.0 Wind 180 deg+1.0 Ice+1.0 Temp
34	1.2 Dead+1.0 Wind 210 deg+1.0 Ice+1.0 Temp
35	1.2 Dead+1.0 Wind 240 deg+1.0 Ice+1.0 Temp
36	1.2 Dead+1.0 Wind 270 deg+1.0 Ice+1.0 Temp
37	1.2 Dead+1.0 Wind 300 deg+1.0 Ice+1.0 Temp
38	1.2 Dead+1.0 Wind 330 deg+1.0 Ice+1.0 Temp
39	Dead+Wind 0 deg - Service
40	Dead+Wind 30 deg - Service
41	Dead+Wind 60 deg - Service
42	Dead+Wind 90 deg - Service

tnxTower Destek Engineering, LLC 1281 Kennestone Circle, Suite 100 Marietta, GA 30066 Phone: (770) 693-0835 FAX:	Job	CT11402A	Page	17 of 28
	Project	1807125	Date	09:16:06 06/14/18
	Client	T-Mobile	Designed by	Ahmet Colakoglu

<i>Comb. No.</i>	<i>Description</i>
43	Dead+Wind 120 deg - Service
44	Dead+Wind 150 deg - Service
45	Dead+Wind 180 deg - Service
46	Dead+Wind 210 deg - Service
47	Dead+Wind 240 deg - Service
48	Dead+Wind 270 deg - Service
49	Dead+Wind 300 deg - Service
50	Dead+Wind 330 deg - Service

Maximum Member Forces

<i>Section No.</i>	<i>Elevation ft</i>	<i>Component Type</i>	<i>Condition</i>	<i>Gov. Load Comb.</i>	<i>Axial K</i>	<i>Major Axis Moment kip-ft</i>	<i>Minor Axis Moment kip-ft</i>
T1	188 - 180	Leg	Max Tension	7	1.09	-0.23	0.13
			Max. Compression	31	-3.95	0.02	0.01
			Max. Mx	20	-1.12	-0.48	-0.01
			Max. My	2	-0.88	0.02	-0.48
			Max. Vy	20	-0.37	0.26	0.02
			Max. Vx	2	-0.38	0.00	0.26
		Diagonal	Max Tension	12	1.16	0.00	0.00
			Max. Compression	12	-1.19	0.00	0.00
			Max. Mx	28	0.36	0.03	0.00
			Max. My	14	-0.94	0.00	0.00
			Max. Vy	33	-0.04	0.03	-0.00
			Max. Vx	33	-0.00	0.00	0.00
		Top Girt	Max Tension	3	0.01	0.00	0.00
			Max. Compression	29	-0.10	0.00	0.00
			Max. Mx	26	-0.08	-0.14	0.00
			Max. My	10	-0.03	0.00	-0.00
T2	180 - 160	Leg	Max Tension	15	15.46	0.19	-0.00
			Max. Compression	10	-21.31	0.47	-0.01
			Max. Mx	6	4.42	1.12	-0.00
			Max. My	24	-2.54	-0.03	-1.09
			Max. Vy	6	0.88	-0.62	-0.00
		Diagonal	Max. Vx	12	0.86	-0.03	-0.59
			Max Tension	21	3.25	0.00	0.00
			Max. Compression	20	-3.45	0.00	0.00
			Max. Mx	33	0.91	0.04	-0.01
			Max. My	35	0.06	0.04	0.01
T3	160 - 140	Horizontal	Max. Vy	33	0.05	0.04	0.01
			Max. Vx	35	0.00	0.00	0.00
			Max Tension	14	0.49	0.00	0.00
			Max. Compression	19	-0.31	0.00	0.00
			Max. Mx	27	0.19	-0.14	0.00
		Leg	Max. My	37	0.25	0.00	0.00
			Max. Vy	27	0.07	0.00	0.00
			Max. Vx	37	-0.00	0.00	0.00
			Max Tension	15	41.44	-0.50	-0.03
			Max. Compression	18	-52.31	0.57	0.00
Diagonal	Max. Mx	6	21.11	0.97	-0.00		
	Max. My	24	-3.10	-0.02	-0.93		
	Max. Vy	6	-1.21	-0.50	0.01		
	Max. Vx	12	-1.19	-0.02	-0.49		
	Max Tension	8	6.84	0.00	0.00		
	Max. Compression	8	-6.90	0.00	0.00		
	Max. Mx	35	2.04	0.10	-0.01		

tnxTower Destek Engineering, LLC 1281 Kennestone Circle, Suite 100 Marietta, GA 30066 Phone: (770) 693-0835 FAX:	Job	CT11402A	Page	18 of 28
	Project	1807125	Date	09:16:06 06/14/18
	Client	T-Mobile	Designed by	Ahmet Colakoglu

Section No.	Elevation ft	Component Type	Condition	Gov. Load Comb.	Axial K	Major Axis Moment kip-ft	Minor Axis Moment kip-ft
T4	140 - 120	Leg	Max. My	31	0.23	0.09	-0.01
			Max. Vy	33	0.07	0.09	0.01
			Max. Vx	35	-0.00	0.00	0.00
			Max Tension	15	78.52	-0.70	-0.00
			Max. Compression	18	-94.75	1.22	0.02
			Max. Mx	2	-94.05	1.22	0.00
		Diagonal	Max. My	24	-6.81	-0.08	-1.14
			Max. Vy	6	0.80	-1.21	-0.02
			Max. Vx	24	-0.68	0.00	0.80
			Max Tension	8	8.43	0.00	0.00
			Max. Compression	8	-8.64	0.00	0.00
			Max. Mx	35	2.31	0.16	-0.02
T5	120 - 100	Leg	Max. My	36	1.56	0.14	0.02
			Max. Vy	33	0.10	0.15	0.02
			Max. Vx	36	-0.01	0.00	0.00
			Max Tension	15	117.39	-0.50	-0.00
			Max. Compression	18	-138.91	0.45	0.02
			Max. Mx	2	-108.98	1.22	0.00
		Diagonal	Max. My	12	-9.96	-0.07	-0.88
			Max. Vy	2	0.27	1.22	0.00
			Max. Vx	12	0.24	-0.07	-0.88
			Max Tension	8	9.40	0.00	0.00
			Max. Compression	8	-9.39	0.00	0.00
			Max. Mx	34	1.35	0.19	-0.03
T6	100 - 80	Leg	Max. My	32	-1.11	0.16	-0.03
			Max. Vy	33	0.11	0.19	-0.03
			Max. Vx	32	-0.01	0.00	0.00
			Max Tension	15	157.10	-0.63	-0.00
			Max. Compression	18	-182.69	1.26	0.04
			Max. Mx	2	-181.51	1.26	0.01
		Diagonal	Max. My	12	-10.50	-0.07	-0.88
			Max. Vy	2	-0.19	1.26	0.01
			Max. Vx	10	-0.15	-0.35	-0.81
			Max Tension	8	13.21	0.00	0.00
			Max. Compression	8	-13.60	0.00	0.00
			Max. Mx	35	3.81	0.29	-0.03
T7	80 - 60	Leg	Max. My	36	2.32	0.26	0.03
			Max. Vy	33	0.14	0.29	0.03
			Max. Vx	35	0.01	0.00	0.00
			Max Tension	15	199.76	-0.58	-0.00
			Max. Compression	18	-231.12	1.32	0.03
			Max. Mx	2	-229.71	1.32	0.00
		Diagonal	Max. My	12	-13.24	-0.08	-1.10
			Max. Vy	2	-0.20	1.32	0.00
			Max. Vx	12	-0.17	-0.08	-1.10
			Max Tension	8	13.29	0.00	0.00
			Max. Compression	8	-13.51	0.00	0.00
			Max. Mx	35	4.30	0.41	-0.05
T8	60 - 40	Leg	Max. My	36	2.61	0.36	0.05
			Max. Vy	33	0.18	0.40	0.05
			Max. Vx	35	0.01	0.00	0.00
			Max Tension	15	238.58	-1.43	-0.00
			Max. Compression	18	-276.04	1.37	0.02
			Max. Mx	37	32.46	-2.09	0.04
		Diagonal	Max. My	12	-15.53	-0.10	-1.77
			Max. Vy	29	0.30	-2.09	-0.03
			Max. Vx	12	0.25	-0.10	-1.77
			Max Tension	8	13.47	0.00	0.00
			Max. Compression	8	-13.68	0.00	0.00
			Max. Mx	33	3.79	0.46	0.06
			Max. My	31	0.23	0.44	-0.06

tnxTower Destek Engineering, LLC 1281 Kennestone Circle, Suite 100 Marietta, GA 30066 Phone: (770) 693-0835 FAX:	Job	CT11402A	Page	19 of 28
	Project	1807125	Date	09:16:06 06/14/18
	Client	T-Mobile	Designed by	Ahmet Colakoglu

Section No.	Elevation ft	Component Type	Condition	Gov. Load Comb.	Axial K	Major Axis Moment kip-ft	Minor Axis Moment kip-ft
T9	40 - 20	Leg	Max. Vy	33	0.20	0.46	0.06
			Max. Vx	31	-0.01	0.00	0.00
			Max Tension	15	276.56	-1.36	-0.00
			Max. Compression	18	-320.66	1.96	0.04
			Max. Mx	33	47.29	-5.04	-0.00
			Max. My	12	-17.98	-0.11	-1.40
			Max. Vy	29	0.82	-5.04	-0.02
		Diagonal	Max. Vx	12	-0.18	-0.11	-1.40
			Max Tension	8	14.71	0.00	0.00
			Max. Compression	8	-15.03	0.00	0.00
			Max. Mx	33	2.60	0.52	0.07
			Max. My	31	-0.43	0.46	-0.07
			Max. Vy	33	0.20	0.48	0.06
			Max. Vx	31	-0.01	0.00	0.00
T10	20 - 0	Leg	Max Tension	15	314.18	-1.43	-0.00
			Max. Compression	18	-365.42	0.00	-0.00
			Max. Mx	35	-180.95	5.33	-0.04
			Max. My	16	-20.47	-0.17	2.89
			Max. Vy	29	-0.99	-5.04	-0.02
			Max. Vx	12	-0.40	-0.17	-2.89
			Max Tension	8	15.84	0.00	0.00
		Diagonal	Max. Compression	8	-16.28	0.00	0.00
			Max. Mx	33	1.16	0.65	-0.08
			Max. My	37	-7.56	0.61	0.08
			Max. Vy	33	0.22	0.65	-0.08
			Max. Vx	37	0.01	0.00	0.00

Maximum Reactions

Location	Condition	Gov. Load Comb.	Vertical K	Horizontal, X K	Horizontal, Z K
Leg C	Max. Vert	18	376.62	39.28	-22.18
	Max. H _x	18	376.62	39.28	-22.18
	Max. H _z	5	-277.66	-28.56	19.70
	Min. Vert	7	-321.97	-34.80	19.65
	Min. H _x	7	-321.97	-34.80	19.65
	Min. H _z	18	376.62	39.28	-22.18
	Leg B	Max. Vert	10	376.24	-39.31
Max. H _x		23	-321.94	34.84	19.57
Max. H _z		23	-321.94	34.84	19.57
Min. Vert		23	-321.94	34.84	19.57
Min. H _x		10	376.24	-39.31	-22.09
Min. H _z		10	376.24	-39.31	-22.09
Leg A		Max. Vert	2	374.71	-0.09
	Max. H _x	21	14.75	5.43	1.27
	Max. H _z	2	374.71	-0.09	45.07
	Min. Vert	15	-323.39	0.08	-39.99
	Min. H _x	9	14.96	-5.43	1.29
	Min. H _z	15	-323.39	0.08	-39.99

Tower Mast Reaction Summary

<p style="text-align: center;">tnxTower</p> <p style="text-align: center;">Destek Engineering, LLC 1281 Kennestone Circle, Suite 100 Marietta, GA 30066 Phone: (770) 693-0835 FAX:</p>	Job	CT11402A	Page	20 of 28
	Project	1807125	Date	09:16:06 06/14/18
	Client	T-Mobile	Designed by	Ahmet Colakoglu

Load Combination	Vertical	Shear _x	Shear _z	Overturning Moment, M _x	Overturning Moment, M _z	Torque
	K	K	K	kip-ft	kip-ft	kip-ft
Dead Only	52.53	-0.00	0.00	21.61	2.07	0.00
1.2 Dead+1.6 Wind 0 deg - No Ice	63.03	0.02	-74.55	-7657.90	0.25	-3.86
0.9 Dead+1.6 Wind 0 deg - No Ice	47.28	0.02	-74.55	-7657.35	-0.38	-3.85
1.2 Dead+1.6 Wind 30 deg - No Ice	63.03	35.41	-61.33	-6344.01	-3675.27	8.93
0.9 Dead+1.6 Wind 30 deg - No Ice	47.28	35.41	-61.33	-6344.65	-3672.50	8.92
1.2 Dead+1.6 Wind 60 deg - No Ice	63.03	61.03	-35.25	-3640.98	-6344.51	16.88
0.9 Dead+1.6 Wind 60 deg - No Ice	47.28	61.03	-35.25	-3644.12	-6339.27	16.85
1.2 Dead+1.6 Wind 90 deg - No Ice	63.03	70.79	-0.02	23.82	-7349.09	18.63
0.9 Dead+1.6 Wind 90 deg - No Ice	47.28	70.79	-0.02	17.29	-7342.93	18.61
1.2 Dead+1.6 Wind 120 deg - No Ice	63.03	64.54	37.26	3866.08	-6648.57	22.47
0.9 Dead+1.6 Wind 120 deg - No Ice	47.28	64.54	37.26	3856.03	-6643.07	22.44
1.2 Dead+1.6 Wind 150 deg - No Ice	63.03	35.38	61.31	6393.83	-3671.31	15.57
0.9 Dead+1.6 Wind 150 deg - No Ice	47.28	35.38	61.31	6381.42	-3668.54	15.54
1.2 Dead+1.6 Wind 180 deg - No Ice	63.03	-0.02	70.48	7356.18	4.77	3.63
0.9 Dead+1.6 Wind 180 deg - No Ice	47.28	-0.02	70.48	7342.89	4.14	3.62
1.2 Dead+1.6 Wind 210 deg - No Ice	63.03	-35.41	61.33	6396.07	3680.23	-8.93
0.9 Dead+1.6 Wind 210 deg - No Ice	47.28	-35.41	61.33	6383.67	3676.21	-8.92
1.2 Dead+1.6 Wind 240 deg - No Ice	63.03	-64.55	37.29	3869.98	6655.82	-18.35
0.9 Dead+1.6 Wind 240 deg - No Ice	47.28	-64.55	37.29	3859.92	6649.07	-18.33
1.2 Dead+1.6 Wind 270 deg - No Ice	63.03	-70.79	0.02	28.34	7354.08	-18.63
0.9 Dead+1.6 Wind 270 deg - No Ice	47.28	-70.79	0.02	21.81	7346.66	-18.61
1.2 Dead+1.6 Wind 300 deg - No Ice	63.03	-61.01	-35.23	-3637.05	6347.24	-20.77
0.9 Dead+1.6 Wind 300 deg - No Ice	47.28	-61.01	-35.23	-3640.19	6340.75	-20.74
1.2 Dead+1.6 Wind 330 deg - No Ice	63.03	-35.38	-61.31	-6341.74	3676.36	-15.57
0.9 Dead+1.6 Wind 330 deg - No Ice	47.28	-35.38	-61.31	-6342.38	3672.34	-15.55
1.2 Dead+1.0 Ice+1.0 Temp	209.45	0.00	-0.00	158.57	35.94	-0.00
1.2 Dead+1.0 Wind 0 deg+1.0 Ice+1.0 Temp	209.45	0.00	-24.84	-2488.94	35.58	-0.32
1.2 Dead+1.0 Wind 30 deg+1.0 Ice+1.0 Temp	209.45	11.61	-20.11	-2009.46	-1215.86	3.78
1.2 Dead+1.0 Wind 60 deg+1.0 Ice+1.0 Temp	209.45	21.02	-12.14	-1141.63	-2215.61	6.22
1.2 Dead+1.0 Wind 90 deg+1.0 Ice+1.0 Temp	209.45	23.22	-0.00	158.37	-2466.97	6.85
1.2 Dead+1.0 Wind 120 deg+1.0 Ice+1.0 Temp	209.45	21.51	12.42	1482.30	-2256.38	7.06
1.2 Dead+1.0 Wind 150	209.45	11.61	20.11	2326.63	-1215.11	4.38

tnxTower Destek Engineering, LLC 1281 Kennestone Circle, Suite 100 Marietta, GA 30066 Phone: (770) 693-0835 FAX:	Job	CT11402A	Page	21 of 28
	Project	1807125	Date	09:16:06 06/14/18
	Client	T-Mobile	Designed by	Ahmet Colakoglu

Load Combination	Vertical K	Shear _x K	Shear _z K	Overturning Moment, M _x kip-ft	Overturning Moment, M _z kip-ft	Torque kip-ft
deg+1.0 Ice+1.0 Temp						
1.2 Dead+1.0 Wind 180	209.45	-0.00	24.28	2758.95	36.43	0.32
deg+1.0 Ice+1.0 Temp						
1.2 Dead+1.0 Wind 210	209.45	-11.61	20.11	2327.06	1287.85	-3.78
deg+1.0 Ice+1.0 Temp						
1.2 Dead+1.0 Wind 240	209.45	-21.51	12.42	1483.03	2328.81	-6.45
deg+1.0 Ice+1.0 Temp						
1.2 Dead+1.0 Wind 270	209.45	-23.22	0.00	159.22	2538.98	-6.85
deg+1.0 Ice+1.0 Temp						
1.2 Dead+1.0 Wind 300	209.45	-21.02	-12.14	-1140.90	2287.19	-6.82
deg+1.0 Ice+1.0 Temp						
1.2 Dead+1.0 Wind 330	209.45	-11.61	-20.11	-2009.04	1287.13	-4.38
deg+1.0 Ice+1.0 Temp						
Dead+Wind 0 deg - Service	52.53	0.00	-17.83	-1814.71	1.54	-0.92
Dead+Wind 30 deg - Service	52.53	8.47	-14.66	-1500.70	-876.87	2.13
Dead+Wind 60 deg - Service	52.53	14.59	-8.43	-854.71	-1514.79	4.03
Dead+Wind 90 deg - Service	52.53	16.93	-0.00	21.14	-1754.87	4.45
Dead+Wind 120 deg - Service	52.53	15.43	8.91	939.40	-1587.47	5.37
Dead+Wind 150 deg - Service	52.53	8.46	14.66	1543.51	-875.93	3.72
Dead+Wind 180 deg - Service	52.53	-0.00	16.85	1773.50	2.62	0.87
Dead+Wind 210 deg - Service	52.53	-8.47	14.66	1544.05	881.02	-2.13
Dead+Wind 240 deg - Service	52.53	-15.44	8.92	940.34	1592.16	-4.38
Dead+Wind 270 deg - Service	52.53	-16.93	0.00	22.22	1759.02	-4.45
Dead+Wind 300 deg - Service	52.53	-14.59	-8.42	-853.77	1518.40	-4.96
Dead+Wind 330 deg - Service	52.53	-8.46	-14.66	-1500.16	880.08	-3.72

Solution Summary

Load Comb.	Sum of Applied Forces			Sum of Reactions			% Error
	PX K	PY K	PZ K	PX K	PY K	PZ K	
1	0.00	-52.53	0.00	0.00	52.53	-0.00	0.000%
2	0.02	-63.03	-74.55	-0.02	63.03	74.55	0.001%
3	0.02	-47.28	-74.55	-0.02	47.28	74.55	0.001%
4	35.41	-63.03	-61.33	-35.41	63.03	61.33	0.001%
5	35.41	-47.28	-61.33	-35.41	47.28	61.33	0.001%
6	61.03	-63.03	-35.25	-61.03	63.03	35.25	0.001%
7	61.03	-47.28	-35.25	-61.03	47.28	35.25	0.001%
8	70.79	-63.03	-0.02	-70.79	63.03	0.02	0.001%
9	70.79	-47.28	-0.02	-70.79	47.28	0.02	0.001%
10	64.54	-63.03	37.26	-64.54	63.03	-37.26	0.001%
11	64.54	-47.28	37.26	-64.54	47.28	-37.26	0.001%
12	35.38	-63.03	61.31	-35.38	63.03	-61.31	0.001%
13	35.38	-47.28	61.31	-35.38	47.28	-61.31	0.001%
14	-0.02	-63.03	70.48	0.02	63.03	-70.48	0.001%
15	-0.02	-47.28	70.48	0.02	47.28	-70.48	0.001%
16	-35.41	-63.03	61.33	35.41	63.03	-61.33	0.001%
17	-35.41	-47.28	61.33	35.41	47.28	-61.33	0.001%
18	-64.56	-63.03	37.29	64.56	63.03	-37.29	0.001%
19	-64.56	-47.28	37.29	64.56	47.28	-37.29	0.001%
20	-70.79	-63.03	0.02	70.79	63.03	-0.02	0.001%
21	-70.79	-47.28	0.02	70.79	47.28	-0.02	0.001%
22	-61.01	-63.03	-35.23	61.01	63.03	35.23	0.001%
23	-61.01	-47.28	-35.23	61.01	47.28	35.23	0.001%
24	-35.38	-63.03	-61.31	35.38	63.03	61.31	0.001%
25	-35.38	-47.28	-61.31	35.38	47.28	61.31	0.001%
26	0.00	-209.45	0.00	-0.00	209.45	0.00	0.000%
27	0.00	-209.45	-24.84	-0.00	209.45	24.84	0.000%

<p style="text-align: center;">tnxTower</p> <p style="text-align: center;">Destek Engineering, LLC 1281 Kennestone Circle, Suite 100 Marietta, GA 30066 Phone: (770) 693-0835 FAX:</p>	Job	CT11402A	Page	22 of 28
	Project	1807125	Date	09:16:06 06/14/18
	Client	T-Mobile	Designed by	Ahmet Colakoglu

Load Comb.	Sum of Applied Forces			Sum of Reactions			% Error
	PX K	PY K	PZ K	PX K	PY K	PZ K	
28	11.61	-209.45	-20.11	-11.61	209.45	20.11	0.000%
29	21.02	-209.45	-12.14	-21.02	209.45	12.14	0.000%
30	23.22	-209.45	-0.00	-23.22	209.45	0.00	0.000%
31	21.51	-209.45	12.42	-21.51	209.45	-12.42	0.000%
32	11.61	-209.45	20.11	-11.61	209.45	-20.11	0.000%
33	-0.00	-209.45	24.28	0.00	209.45	-24.28	0.000%
34	-11.61	-209.45	20.11	11.61	209.45	-20.11	0.000%
35	-21.51	-209.45	12.42	21.51	209.45	-12.42	0.000%
36	-23.22	-209.45	0.00	23.22	209.45	-0.00	0.000%
37	-21.02	-209.45	-12.14	21.02	209.45	12.14	0.000%
38	-11.61	-209.45	-20.11	11.61	209.45	20.11	0.000%
39	0.00	-52.53	-17.83	-0.00	52.53	17.83	0.000%
40	8.47	-52.53	-14.67	-8.47	52.53	14.66	0.000%
41	14.59	-52.53	-8.43	-14.59	52.53	8.43	0.000%
42	16.93	-52.53	-0.00	-16.93	52.53	0.00	0.000%
43	15.43	-52.53	8.91	-15.43	52.53	-8.91	0.000%
44	8.46	-52.53	14.66	-8.46	52.53	-14.66	0.000%
45	-0.00	-52.53	16.85	0.00	52.53	-16.85	0.000%
46	-8.47	-52.53	14.67	8.47	52.53	-14.66	0.000%
47	-15.44	-52.53	8.92	15.44	52.53	-8.92	0.000%
48	-16.93	-52.53	0.00	16.93	52.53	-0.00	0.000%
49	-14.59	-52.53	-8.42	14.59	52.53	8.42	0.000%
50	-8.46	-52.53	-14.66	8.46	52.53	14.66	0.000%

Non-Linear Convergence Results

Load Combination	Converged?	Number of Cycles	Displacement Tolerance	Force Tolerance
1	Yes	6	0.00000001	0.00000001
2	Yes	9	0.00000001	0.00006285
3	Yes	9	0.00000001	0.00004584
4	Yes	9	0.00000001	0.00006702
5	Yes	9	0.00000001	0.00004994
6	Yes	9	0.00000001	0.00007071
7	Yes	9	0.00000001	0.00005351
8	Yes	9	0.00000001	0.00006699
9	Yes	9	0.00000001	0.00004991
10	Yes	9	0.00000001	0.00006286
11	Yes	9	0.00000001	0.00004584
12	Yes	9	0.00000001	0.00006705
13	Yes	9	0.00000001	0.00004995
14	Yes	9	0.00000001	0.00007072
15	Yes	9	0.00000001	0.00005351
16	Yes	9	0.00000001	0.00006704
17	Yes	9	0.00000001	0.00004994
18	Yes	9	0.00000001	0.00006286
19	Yes	9	0.00000001	0.00004584
20	Yes	9	0.00000001	0.00006700
21	Yes	9	0.00000001	0.00004991
22	Yes	9	0.00000001	0.00007073
23	Yes	9	0.00000001	0.00005352
24	Yes	9	0.00000001	0.00006704
25	Yes	9	0.00000001	0.00004995
26	Yes	8	0.00000001	0.00006765
27	Yes	10	0.00000001	0.00004687
28	Yes	10	0.00000001	0.00004618

tnxTower Destek Engineering, LLC 1281 Kennestone Circle, Suite 100 Marietta, GA 30066 Phone: (770) 693-0835 FAX:	Job	CT11402A	Page	23 of 28
	Project	1807125	Date	09:16:06 06/14/18
	Client	T-Mobile	Designed by	Ahmet Colakoglu

29	Yes	10	0.00000001	0.00004765
30	Yes	10	0.00000001	0.00004746
31	Yes	10	0.00000001	0.00004891
32	Yes	10	0.00000001	0.00004923
33	Yes	10	0.00000001	0.00005050
34	Yes	10	0.00000001	0.00004968
35	Yes	10	0.00000001	0.00004973
36	Yes	10	0.00000001	0.00004856
37	Yes	10	0.00000001	0.00004866
38	Yes	10	0.00000001	0.00004685
39	Yes	9	0.00000001	0.00005228
40	Yes	9	0.00000001	0.00005308
41	Yes	9	0.00000001	0.00005392
42	Yes	9	0.00000001	0.00005310
43	Yes	9	0.00000001	0.00005236
44	Yes	9	0.00000001	0.00005321
45	Yes	9	0.00000001	0.00005406
46	Yes	9	0.00000001	0.00005323
47	Yes	9	0.00000001	0.00005240
48	Yes	9	0.00000001	0.00005316
49	Yes	9	0.00000001	0.00005398
50	Yes	9	0.00000001	0.00005312

Maximum Tower Deflections - Service Wind

Section No.	Elevation ft	Horz. Deflection in	Gov. Load Comb.	Tilt °	Twist °
T1	188 - 180	3.875	47	0.1714	0.0073
T2	180 - 160	3.586	47	0.1709	0.0074
T3	160 - 140	2.866	47	0.1623	0.0072
T4	140 - 120	2.202	47	0.1434	0.0065
T5	120 - 100	1.621	47	0.1210	0.0055
T6	100 - 80	1.122	47	0.1001	0.0043
T7	80 - 60	0.717	47	0.0766	0.0033
T8	60 - 40	0.417	47	0.0545	0.0025
T9	40 - 20	0.205	47	0.0338	0.0016
T10	20 - 0	0.066	47	0.0174	0.0007

Critical Deflections and Radius of Curvature - Service Wind

Elevation ft	Appurtenance	Gov. Load Comb.	Deflection in	Tilt °	Twist °	Radius of Curvature ft
195.00	BCD-87010	47	3.875	0.1714	0.0073	479945
186.00	Rohn 14' Platform	47	3.803	0.1714	0.0074	479945
172.00	(2) AM-X-CD-16-65-00T-RET w/ Mount Pipe	47	3.295	0.1689	0.0074	280300
155.00	APX16DWV-16DWV-S-E-A20 w/ Mount Pipe	47	2.693	0.1583	0.0070	67367
145.50	(3) SBNHH-1D85B w/ Mount Pipe	47	2.376	0.1493	0.0067	57731
123.00	APXVSP18-C-A20 w/ Mount Pipe	47	1.703	0.1243	0.0057	60495

tnxTower Destek Engineering, LLC 1281 Kennestone Circle, Suite 100 Marietta, GA 30066 Phone: (770) 693-0835 FAX:	Job	CT11402A	Page	24 of 28
	Project	1807125	Date	09:16:06 06/14/18
	Client	T-Mobile	Designed by	Ahmet Colakoglu

Maximum Tower Deflections - Design Wind

Section No.	Elevation ft	Horz. Deflection in	Gov. Load Comb.	Tilt °	Twist °
T1	188 - 180	16.124	18	0.7133	0.0307
T2	180 - 160	14.921	18	0.7110	0.0311
T3	160 - 140	11.927	18	0.6747	0.0300
T4	140 - 120	9.164	18	0.5960	0.0272
T5	120 - 100	6.749	18	0.5033	0.0231
T6	100 - 80	4.675	18	0.4165	0.0180
T7	80 - 60	2.989	18	0.3185	0.0137
T8	60 - 40	1.739	18	0.2266	0.0103
T9	40 - 20	0.855	18	0.1407	0.0068
T10	20 - 0	0.275	18	0.0723	0.0031

Critical Deflections and Radius of Curvature - Design Wind

Elevation ft	Appurtenance	Gov. Load Comb.	Deflection in	Tilt °	Twist °	Radius of Curvature ft
195.00	BCD-87010	18	16.124	0.7133	0.0307	119482
186.00	Rohn 14' Platform	18	15.824	0.7130	0.0308	119482
172.00	(2) AM-X-CD-16-65-00T-RET w/ Mount Pipe	18	13.712	0.7023	0.0309	68612
155.00	APX16DWV-16DWV-S-E-A20 w/ Mount Pipe	18	11.207	0.6582	0.0294	16177
145.50	(3) SBNHH-1D85B w/ Mount Pipe	18	9.891	0.6204	0.0281	13919
123.00	APXVSP18-C-A20 w/ Mount Pipe	18	7.090	0.5168	0.0238	14584

Bolt Design Data

Section No.	Elevation ft	Component Type	Bolt Grade	Bolt Size in	Number Of Bolts	Maximum Load per Bolt K	Allowable Load K	Ratio Load Allowable	Allowable Ratio	Criteria
T1	188	Leg	A325N	0.8750	4	0.33	40.59	0.008	1	Bolt Tension
		Diagonal	A325N	0.6250	1	1.16	5.81	0.200	1	Member Block Shear
T2	180	Leg	A325N	0.8750	4	3.87	40.59	0.095	1	Bolt Tension
		Diagonal	A325N	0.6250	1	3.25	5.81	0.559	1	Member Block Shear
T3	160	Leg	A325N	0.8750	4	10.36	40.59	0.255	1	Bolt Tension
		Diagonal	A325N	0.6250	1	6.84	10.44	0.655	1	Member Bearing
T4	140	Leg	A325N	1.0000	4	19.63	53.01	0.370	1	Bolt Tension
		Diagonal	A325N	0.7500	1	8.43	14.14	0.596	1	Member Bearing
T5	120	Leg	A325N	1.0000	6	19.56	53.01	0.369	1	Bolt Tension
		Diagonal	A325N	0.7500	1	9.40	14.14	0.665	1	Member Bearing
T6	100	Leg	A325N	1.0000	6	26.18	53.01	0.494	1	Bolt Tension
		Diagonal	A325N	0.7500	1	13.21	14.14	0.934	1	Member Bearing
T7	80	Leg	A325N	1.0000	8	24.97	53.01	0.471	1	Bolt Tension
		Diagonal	A325N	0.7500	1	13.51	17.89	0.755	1	Bolt Shear
T8	60	Leg	A325N	1.0000	8	29.82	53.01	0.563	1	Bolt Tension

tnxTower Destek Engineering, LLC 1281 Kennestone Circle, Suite 100 Marietta, GA 30066 Phone: (770) 693-0835 FAX:	Job CT11402A	Page 25 of 28
	Project 1807125	Date 09:16:06 06/14/18
	Client T-Mobile	Designed by Ahmet Colakoglu

Section No.	Elevation ft	Component Type	Bolt Grade	Bolt Size in	Number Of Bolts	Maximum Load per Bolt K	Allowable Load K	Ratio Load Allowable	Allowable Ratio	Criteria
T9	40	Diagonal Leg	A325N	0.7500	1	13.68	17.89	0.765	1	Bolt Shear
			A325N	1.0000	8	34.57	53.01	0.652	1	Bolt Tension
T10	20	Diagonal	A325N	0.7500	1	15.03	17.89	0.840	1	Bolt Shear
		Diagonal	A325N	0.7500	1	16.28	17.89	0.910	1	Bolt Shear

Compression Checks

Leg Design Data (Compression)

Section No.	Elevation ft	Size	L ft	L _u ft	Kl/r	A in ²	P _u K	φP _n K	Ratio $\frac{P_u}{\phi P_n}$
T1	188 - 180	Pipe 3.5" x 0.216" (3 STD)	8.00	4.00	41.3 K=1.00	2.2285	-3.95	88.55	0.045 ¹
T2	180 - 160	Pipe 3.5" x 0.216" (3 STD)	20.04	5.01	51.7 K=1.00	2.2285	-21.31	82.50	0.258 ¹
T3	160 - 140	ROHN 3 EH	20.03	6.68	70.5 K=1.00	3.0159	-52.31	94.35	0.554 ¹
T4	140 - 120	ROHN 4 EH	20.04	6.68	54.3 K=1.00	4.4074	-94.75	159.91	0.593 ¹
T5	120 - 100	ROHN 5 EH	20.05	6.68	43.6 K=1.00	6.1120	-138.91	239.33	0.580 ¹
T6	100 - 80	ROHN 6 EHS	20.02	10.01	54.0 K=1.00	6.7133	-182.69	244.13	0.748 ¹
T7	80 - 60	ROHN 6 EH	20.03	10.02	54.8 K=1.00	8.4049	-231.13	303.76	0.761 ¹
T8	60 - 40	ROHN 8 EHS	20.04	10.02	41.2 K=1.00	9.7193	-276.04	386.37	0.714 ¹
T9	40 - 20	ROHN 8 EH	20.03	10.02	41.8 K=1.00	12.7627	-320.66	505.54	0.634 ¹
T10	20 - 0	ROHN 8 EH	20.03	10.02	41.8 K=1.00	12.7627	-365.43	505.57	0.723 ¹

¹ P_u / φP_n controls

Diagonal Design Data (Compression)

Section No.	Elevation ft	Size	L ft	L _u ft	Kl/r	A in ²	P _u K	φP _n K	Ratio $\frac{P_u}{\phi P_n}$
T1	188 - 180	L1 3/4x1 3/4x3/16	7.74	3.58	125.1 K=1.00	0.6211	-1.19	8.82	0.135 ¹
T2	180 - 160	L1 3/4x1 3/4x3/16	9.40	4.57	159.5 K=1.00	0.6211	-3.45	5.51	0.626 ¹
T3	160 - 140	L2 1/2x2 1/2x1/4	12.34	6.07	148.4 K=1.00	1.1900	-6.90	12.21	0.565 ¹
T4	140 - 120	L3x3x1/4	14.12	6.91	140.0	1.4400	-8.64	16.59	0.521 ¹

tnxTower Destek Engineering, LLC 1281 Kennestone Circle, Suite 100 Marietta, GA 30066 Phone: (770) 693-0835 FAX:	Job	CT11402A	Page	26 of 28
	Project	1807125	Date	09:16:06 06/14/18
	Client	T-Mobile	Designed by	Ahmet Colakoglu

Section No.	Elevation ft	Size	L ft	L _u ft	Kl/r	A in ²	P _u K	φP _n K	Ratio $\frac{P_u}{\phi P_n}$
T5	120 - 100	L3x3x1/4	16.30	7.99	K=1.00 161.9	1.4400	-9.39	12.40	0.757 ¹
T6	100 - 80	L3 1/2x3 1/2x1/4	19.28	9.41	K=1.00 162.8	1.6900	-13.60	14.41	0.944 ¹
T7	80 - 60	L4x4x5/16	20.89	10.27	K=1.00 155.9	2.4000	-13.51	22.32	0.605 ¹
T8	60 - 40	L4x4x5/16	22.77	11.15	K=1.00 169.2	2.4000	-13.68	18.94	0.723 ¹
T9	40 - 20	L4x4x5/16	24.66	12.08	K=1.00 183.3	2.4000	-15.03	16.14	0.931 ¹
T10	20 - 0	L4x4x3/8	26.48	12.98	K=1.00 197.6	2.8600	-16.28	16.54	0.984 ¹

¹ P_u / φP_n controls

Horizontal Design Data (Compression)

Section No.	Elevation ft	Size	L ft	L _u ft	Kl/r	A in ²	P _u K	φP _n K	Ratio $\frac{P_u}{\phi P_n}$
T2	180 - 160	L2x2x1/8	8.22	7.93	193.4 K=0.81	0.4844	-0.31	2.93	0.106 ¹

¹ P_u / φP_n controls

Top Girt Design Data (Compression)

Section No.	Elevation ft	Size	L ft	L _u ft	Kl/r	A in ²	P _u K	φP _n K	Ratio $\frac{P_u}{\phi P_n}$
T1	188 - 180	L3x3x1/4	6.63	6.34	125.2 K=0.97	1.4400	-0.10	20.44	0.005 ¹

¹ P_u / φP_n controls

Tension Checks

Leg Design Data (Tension)

Section No.	Elevation ft	Size	L ft	L _u ft	Kl/r	A in ²	P _u K	φP _n K	Ratio $\frac{P_u}{\phi P_n}$
T1	188 - 180	Pipe 3.5" x 0.216" (3 STD)	8.00	4.00	41.3	2.2285	1.09	100.28	0.011 ¹

tnxTower Destek Engineering, LLC 1281 Kennestone Circle, Suite 100 Marietta, GA 30066 Phone: (770) 693-0835 FAX:	Job CT11402A	Page 27 of 28
	Project 1807125	Date 09:16:06 06/14/18
	Client T-Mobile	Designed by Ahmet Colakoglu

Section No.	Elevation ft	Size	L ft	L _u ft	Kl/r	A in ²	P _u K	φP _n K	Ratio $\frac{P_u}{\phi P_n}$
T2	180 - 160	Pipe 3.5" x 0.216" (3 STD)	20.04	5.01	51.7	2.2285	15.46	100.28	0.154 ¹
T3	160 - 140	ROHN 3 EH	20.03	6.68	70.5	3.0159	41.44	135.72	0.305 ¹
T4	140 - 120	ROHN 4 EH	20.04	6.68	54.3	4.4074	78.52	198.34	0.396 ¹
T5	120 - 100	ROHN 5 EH	20.05	6.68	43.6	6.1120	117.39	275.04	0.427 ¹
T6	100 - 80	ROHN 6 EHS	20.02	10.01	54.0	6.7133	157.10	302.10	0.520 ¹
T7	80 - 60	ROHN 6 EH	20.03	10.02	54.8	8.4049	199.76	378.22	0.528 ¹
T8	60 - 40	ROHN 8 EHS	20.04	10.02	41.2	9.7193	238.58	437.37	0.545 ¹
T9	40 - 20	ROHN 8 EH	20.03	10.02	41.8	12.7627	276.56	574.32	0.482 ¹
T10	20 - 0	ROHN 8 EH	20.03	10.02	41.8	12.7627	314.18	574.32	0.547 ¹

¹ P_u / φP_n controls

Diagonal Design Data (Tension)

Section No.	Elevation ft	Size	L ft	L _u ft	Kl/r	A in ²	P _u K	φP _n K	Ratio $\frac{P_u}{\phi P_n}$
T1	188 - 180	L1 3/4x1 3/4x3/16	7.74	3.58	82.7	0.3604	1.16	15.68	0.074 ¹
T2	180 - 160	L1 3/4x1 3/4x3/16	9.40	4.57	104.7	0.3604	3.25	15.68	0.207 ¹
T3	160 - 140	L2 1/2x2 1/2x1/4	12.34	6.07	96.6	0.7519	6.84	32.71	0.209 ¹
T4	140 - 120	L3x3x1/4	14.12	6.91	90.9	0.9159	8.43	44.65	0.189 ¹
T5	120 - 100	L3x3x1/4	16.30	7.99	104.8	0.9159	9.40	44.65	0.211 ¹
T6	100 - 80	L3 1/2x3 1/2x1/4	19.28	9.41	105.1	1.1034	13.21	53.79	0.246 ¹
T7	80 - 60	L4x4x5/16	20.89	10.27	100.7	1.5949	13.29	77.75	0.171 ¹
T8	60 - 40	L4x4x5/16	22.77	11.15	109.2	1.5949	13.47	77.75	0.173 ¹
T9	40 - 20	L4x4x5/16	24.66	12.08	118.2	1.5949	14.71	77.75	0.189 ¹
T10	20 - 0	L4x4x3/8	26.48	12.98	127.9	1.8989	15.84	92.57	0.171 ¹

¹ P_u / φP_n controls

Horizontal Design Data (Tension)

Section No.	Elevation ft	Size	L ft	L _u ft	Kl/r	A in ²	P _u K	φP _n K	Ratio $\frac{P_u}{\phi P_n}$
T2	180 - 160	L2x2x1/8	8.22	7.93	151.9	0.4844	0.49	15.69	0.031 ¹

¹ P_u / φP_n controls

Top Girt Design Data (Tension)

Section No.	Elevation ft	Size	L ft	L _u ft	Kl/r	A in ²	P _u K	φP _n K	Ratio $\frac{P_u}{\phi P_n}$
T1	188 - 180	L3x3x1/4	6.63	6.34	81.8	1.4400	0.01	46.66	0.000 ¹

tnxTower Destek Engineering, LLC 1281 Kennestone Circle, Suite 100 Marietta, GA 30066 Phone: (770) 693-0835 FAX:	Job	CT11402A	Page	28 of 28
	Project	1807125	Date	09:16:06 06/14/18
	Client	T-Mobile	Designed by	Ahmet Colakoglu

¹ $P_u / \phi P_n$ controls

Section Capacity Table

Section No.	Elevation ft	Component Type	Size	Critical Element	P K	ϕP_{allow} K	% Capacity	Pass Fail
T1	188 - 180	Leg	Pipe 3.5" x 0.216" (3 STD)	2	-3.95	88.55	4.5	Pass
T2	180 - 160	Leg	Pipe 3.5" x 0.216" (3 STD)	20	-21.31	82.50	25.8	Pass
T3	160 - 140	Leg	ROHN 3 EH	58	-52.31	94.35	55.4	Pass
T4	140 - 120	Leg	ROHN 4 EH	79	-94.75	159.91	59.3	Pass
T5	120 - 100	Leg	ROHN 5 EH	100	-138.91	239.33	58.0	Pass
T6	100 - 80	Leg	ROHN 6 EHS	121	-182.69	244.13	74.8	Pass
T7	80 - 60	Leg	ROHN 6 EH	136	-231.13	303.76	76.1	Pass
T8	60 - 40	Leg	ROHN 8 EHS	151	-276.04	386.37	71.4	Pass
T9	40 - 20	Leg	ROHN 8 EH	166	-320.66	505.54	63.4	Pass
							65.2 (b)	
T10	20 - 0	Leg	ROHN 8 EH	181	-365.43	505.57	72.3	Pass
T1	188 - 180	Diagonal	L1 3/4x1 3/4x3/16	9	-1.19	8.82	13.5	Pass
							20.0 (b)	
T2	180 - 160	Diagonal	L1 3/4x1 3/4x3/16	34	-3.45	5.51	62.6	Pass
T3	160 - 140	Diagonal	L2 1/2x2 1/2x1/4	62	-6.90	12.21	56.5	Pass
							65.5 (b)	
T4	140 - 120	Diagonal	L3x3x1/4	83	-8.64	16.59	52.1	Pass
							59.6 (b)	
T5	120 - 100	Diagonal	L3x3x1/4	104	-9.39	12.40	75.7	Pass
T6	100 - 80	Diagonal	L3 1/2x3 1/2x1/4	125	-13.60	14.41	94.4	Pass
T7	80 - 60	Diagonal	L4x4x5/16	140	-13.51	22.32	60.5	Pass
							75.5 (b)	
T8	60 - 40	Diagonal	L4x4x5/16	155	-13.68	18.94	72.3	Pass
							76.5 (b)	
T9	40 - 20	Diagonal	L4x4x5/16	170	-15.03	16.14	93.1	Pass
T10	20 - 0	Diagonal	L4x4x3/8	185	-16.28	16.54	98.4	Pass
T2	180 - 160	Horizontal	L2x2x1/8	32	-0.31	2.93	10.6	Pass
T1	188 - 180	Top Girt	L3x3x1/4	4	-0.10	20.44	0.6	Pass
							Summary	
							Leg (T7)	Pass
							Diagonal (T10)	Pass
							Horizontal (T2)	Pass
							Top Girt (T1)	Pass
							Bolt Checks	Pass
							RATING =	98.4
								Pass

Anchor Rod Check for Self Supporting Towers

TIA-222-G, Section 4.9.9

Rev. 6.1

Site Data	
BU#:	
Site Name:	CT11402A
App #:	

Reactions		
Eta Factor, η	0.5	Detail Type
Down load, Pu:	377	kips
Shear, Vu:	45	kips

Anchor Rod Data		
Qty:	10	
Diam:	1	in
Rod Material:	A354 Gr. BC (1/4 to 2-1/2 incl.)	
Strength (Fu):	125	ksi
Yield (Fy):	109	ksi

l_{ar} :		in
$M_u = 0.65 * l_{ar} * V_u$		ft-kips

* Rod Circle:		in
* e:		in
* # of Rods		1 or 2

Anchor Rod Results:

Max Rod ($C_u + V_u/\eta$):	46.7	Kips
Design Axial, $\Phi * F_u * A_{net}$:	60.6	Kips
Anchor Rod Stress Ratio:	77.1%	

$M_u = P_u \times e$:		ft-kips
------------------------	--	---------

* Only enter rod circle, offset (e) and number of anchor rods at the extreme fiber to consider if eccentric load due to leg reinforcement exist.

If Applicable;

Anchor Rod Results with Bending Considered:

When the clear distance from the top of concrete to the bottom of level nut exceeds 1.0 times the diameter of the anchor rod, the following interaction equation shall also be satisfied (see Figure 4-4 of Rev. G):

$$(V_u/\phi R_{nv})^2 + [(P_u/\phi R_{nt}) + (M_u/\phi R_{nm})]^2 \leq 1$$

$\phi R_{nv} = \phi * 0.45 * F_{ub} * A_b =$		kips
$\phi R_{nt} = \phi * F_u * A_{net} =$		kips
$\phi R_{nm} = \phi * F_y * Z =$		ft-kips

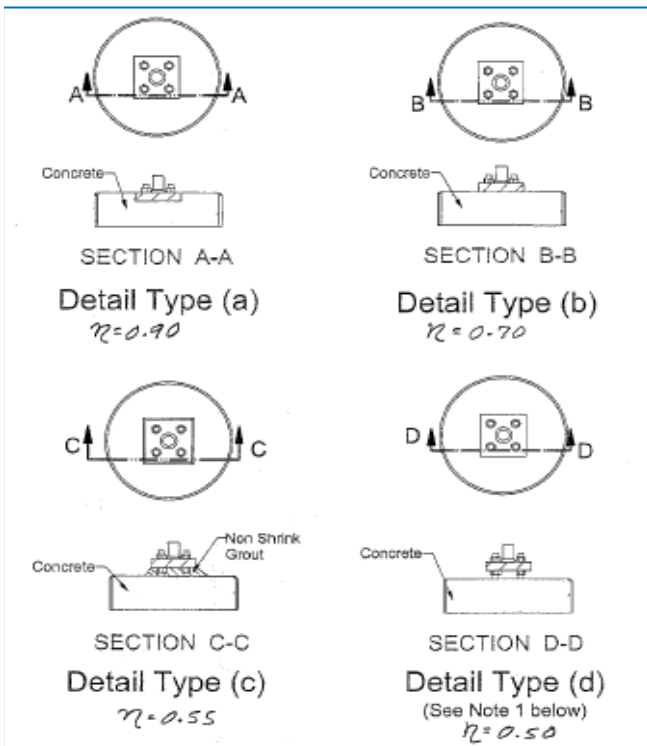

Figure 4-4 of TIA-222-G

Maximum Acceptable Ratio: 105 %

Governing Stress Ratio: 77.1% **Pass**

Exhibit E



RADIO FREQUENCY EMISSIONS ANALYSIS REPORT EVALUATION OF HUMAN EXPOSURE POTENTIAL TO NON-IONIZING EMISSIONS

T-Mobile Existing Facility

Site ID: CT11402A

East Windsor/RT-191_1
232 South Main Street
East Windsor, CT 06088

July 22, 2018

EBI Project Number: 6218005202

Site Compliance Summary	
Compliance Status:	COMPLIANT
Site total MPE% of FCC general population allowable limit:	13.55 %



July 22, 2018

T-Mobile USA
Attn: Jason Overbey, RF Manager
35 Griffin Road South
Bloomfield, CT 06002

Emissions Analysis for Site: **CT11402A – East Windsor/RT-191_1**

EBI Consulting was directed to analyze the proposed T-Mobile facility located at **232 South Main Street, East Windsor, CT**, for the purpose of determining whether the emissions from the Proposed T-Mobile Antenna Installation located on this property are within specified federal limits.

All information used in this report was analyzed as a percentage of current Maximum Permissible Exposure (% MPE) as listed in the FCC OET Bulletin 65 Edition 97-01 and ANSI/IEEE Std C95.1. The FCC regulates Maximum Permissible Exposure in units of microwatts per square centimeter ($\mu\text{W}/\text{cm}^2$). The number of $\mu\text{W}/\text{cm}^2$ calculated at each sample point is called the power density. The exposure limit for power density varies depending upon the frequencies being utilized. Wireless Carriers and Paging Services use different frequency bands each with different exposure limits, therefore it is necessary to report results and limits in terms of percent MPE rather than power density.

All results were compared to the FCC (Federal Communications Commission) radio frequency exposure rules, 47 CFR 1.1307(b)(1) – (b)(3), to determine compliance with the Maximum Permissible Exposure (MPE) limits for General Population/Uncontrolled environments as defined below.

General population/uncontrolled exposure limits apply to situations in which the general population may be exposed or in which persons who are exposed as a consequence of their employment may not be made fully aware of the potential for exposure or cannot exercise control over their exposure. Therefore, members of the general population would always be considered under this category when exposure is not employment related, for example, in the case of a telecommunications tower that exposes persons in a nearby residential area.

Public exposure to radio frequencies is regulated and enforced in units of microwatts per square centimeter ($\mu\text{W}/\text{cm}^2$). The general population exposure limits for the 600 MHz and 700 MHz Band are approximately $400 \mu\text{W}/\text{cm}^2$ and $467 \mu\text{W}/\text{cm}^2$ respectively. The general population exposure limit for the 1900 MHz (PCS) and 2100 MHz (AWS) bands is $1000 \mu\text{W}/\text{cm}^2$. Because each carrier will be using different frequency bands, and each frequency band has different exposure limits, it is necessary to report percent of MPE rather than power density.



Occupational/controlled exposure limits apply to situations in which persons are exposed as a consequence of their employment and in which those persons who are exposed have been made fully aware of the potential for exposure and can exercise control over their exposure. Occupational/controlled exposure limits also apply where exposure is of a transient nature as a result of incidental passage through a location where exposure levels may be above general population/uncontrolled limits (see below), as long as the exposed person has been made fully aware of the potential for exposure and can exercise control over his or her exposure by leaving the area or by some other appropriate means.

Additional details can be found in FCC OET 65.

CALCULATIONS

Calculations were done for the proposed T-Mobile Wireless antenna facility located at **232 South Main Street, East Windsor, CT**, using the equipment information listed below. All calculations were performed per the specifications under FCC OET 65. Since T-Mobile is proposing highly focused directional panel antennas, which project most of the emitted energy out toward the horizon, all calculations were performed assuming a lobe representing the maximum gain of the antenna per the antenna manufactures supplied specifications, minus 10 dB for directional panel antennas, was focused at the base of the tower. For this report the sample point is the top of a 6-foot person standing at the base of the tower.

For all calculations, all equipment was calculated using the following assumptions:

- 1) 2 GSM channels (PCS Band - 1900 MHz) were considered for each sector of the proposed installation. These Channels have a transmit power of 30 Watts per Channel.
- 2) 2 UMTS channels (AWS Band – 2100 MHz) were considered for each sector of the proposed installation. These Channels have a transmit power of 30 Watts per Channel.
- 3) 2 LTE channels (PCS Band - 1900 MHz) were considered for each sector of the proposed installation. These Channels have a transmit power of 60 Watts per Channel.
- 4) 2 LTE channels (AWS Band – 2100 MHz) were considered for each sector of the proposed installation. These Channels have a transmit power of 60 Watts per Channel
- 5) 2 LTE channels (600 MHz Band) were considered for each sector of the proposed installation. These channels have a transmit power of 30 Watts per channel.
- 6) 2 LTE channels (700 MHz Band) were considered for each sector of the proposed installation. These channels have a transmit power of 30 Watts per channel.



- 7) All radios at the proposed installation were considered to be running at full power and were uncombined in their RF transmissions paths per carrier prescribed configuration. Per FCC OET Bulletin No. 65 - Edition 97-01 recommendations to achieve the maximum anticipated value at each sample point, all power levels emitting from the proposed antenna installation are increased by a factor of 2.56 to account for possible in-phase reflections from the surrounding environment. This is rarely the case, and if so, is never continuous.
- 8) Since the 1900 MHz and 2100 MHz radios are ground mounted additional losses were factored in for cable loss on each 1900 MHz and 2100 MHz radio path. Cable losses at 1900 MHz were 2.2 dB for each RF path. Cable losses at 2100 MHz were 2.3 dB for each RF path. This was based upon manufacturers specifications for the listed 180 feet of 1-1/4" coax cable for all ground mounted radios.
- 9) For the following calculations the sample point was the top of a 6-foot person standing at the base of the tower. The maximum gain of the antenna per the antenna manufactures supplied specifications, minus 10 dB for directional panel antennas and 20 dB for highly focused parabolic microwave dishes minus 10 dB for directional panel antennas, was used in this direction. This value is a very conservative estimate as gain reductions for these particular antennas are typically much higher in this direction.
- 10) The antennas used in this modeling are the **RFS APX16DWV-16DWVS-E-A20** for 1900 MHz (PCS) and 2100 MHz (AWS) channels, and the **RFS APXVAARR24_43-U-NA20** for 600 MHz and 700 MHz channels. This is based on feedback from the carrier with regard to anticipated antenna selection. All Antenna gain values and associated transmit power levels are shown in the Site Inventory and Power Data table below. The maximum gain of the antenna per the antenna manufactures supplied specifications, minus 10 dB for directional panel antennas, was used for all calculations. This value is a very conservative estimate as gain reductions for these particular antennas are typically much higher in this direction.
- 11) The antenna mounting height centerline of the proposed antennas is **155 feet** above ground level (AGL).
- 12) Emissions values for additional carriers were taken from the Connecticut Siting Council active database. Values in this database are provided by the individual carriers themselves.
- 13) All calculations were done with respect to uncontrolled / general population threshold limits.



T-Mobile Site Inventory and Power Data

Sector:	A	Sector:	B	Sector:	C
Antenna #:	1	Antenna #:	1	Antenna #:	1
Make / Model:	RFS APX16DWV- 16DWVS-E-A20	Make / Model:	RFS APX16DWV- 16DWVS-E-A20	Make / Model:	RFS APX16DWV- 16DWVS-E-A20
Gain:	16.3 dBd	Gain:	16.3 dBd	Gain:	16.3 dBd
Height (AGL):	155	Height (AGL):	155	Height (AGL):	155
Frequency Bands	1900 MHz (PCS) / 2100 MHz (AWS)	Frequency Bands	1900 MHz (PCS) / 2100 MHz (AWS)	Frequency Bands	1900 MHz (PCS) / 2100 MHz (AWS)
Channel Count	8	Channel Count	8	Channel Count	8
Total TX Power(W):	360	Total TX Power(W):	360	Total TX Power(W):	360
ERP (W):	9,148.11	ERP (W):	9,148.11	ERP (W):	9,148.11
Antenna A1 MPE%	1.48	Antenna B1 MPE%	1.48	Antenna C1 MPE%	1.48
Antenna #:	2	Antenna #:	2	Antenna #:	2
Make / Model:	RFS APXVAARR24_43- U-NA20	Make / Model:	RFS APXVAARR24_43- U-NA20	Make / Model:	RFS APXVAARR24_43- U-NA20
Gain:	12.95 / 13.35 dBd	Gain:	12.95 / 13.35 dBd	Gain:	12.95 / 13.35 dBd
Height (AGL):	155	Height (AGL):	155	Height (AGL):	155
Frequency Bands	600 MHz / 700 MHz	Frequency Bands	600 MHz / 700 MHz	Frequency Bands	600 MHz / 700 MHz
Channel Count	4	Channel Count	4	Channel Count	4
Total TX Power(W):	120	Total TX Power(W):	120	Total TX Power(W):	120
ERP (W):	2,481.08	ERP (W):	2,481.08	ERP (W):	2,481.08
Antenna A2 MPE%	0.93	Antenna B2 MPE%	0.93	Antenna C2 MPE%	0.93

Site Composite MPE%	
Carrier	MPE%
T-Mobile (Per Sector Max)	2.41 %
AT&T	1.82%
MetroPCS	0.42%
Town	0.18%
Nextel	0.24%
Sprint	3.59%
Verizon Wireless	4.89%
Site Total MPE %:	13.55 %

T-Mobile Sector A Total:	2.41 %
T-Mobile Sector B Total:	2.41 %
T-Mobile Sector C Total:	2.41 %
Site Total:	13.55 %



T-Mobile Max Power Values (Per Sector)

T-Mobile_Max Power Values (per sector)	# Channels	Watts ERP (Per Channel)	Height (feet)	Total Power Density ($\mu\text{W}/\text{cm}^2$)	Frequency (MHz)	Allowable MPE ($\mu\text{W}/\text{cm}^2$)	Calculated % MPE
T-Mobile AWS - 2100 MHz UMTS	2	753.57	155	2.44	AWS - 2100 MHz	1000	0.24%
T-Mobile AWS - 2100 MHz LTE	2	1,507.13	155	4.88	AWS - 2100 MHz	1000	0.49%
T-Mobile PCS - 1900 MHz LTE	2	1,542.24	155	4.99	PCS - 1900 MHz	1000	0.50%
T-Mobile PCS - 1900 MHz GSM	2	771.12	155	2.50	PCS - 1900 MHz	1000	0.25%
T-Mobile 600 MHz LTE	2	591.73	155	1.92	600 MHz	400	0.48%
T-Mobile 700 MHz LTE	2	648.82	155	2.10	700 MHz	467	0.45%
						Total:	2.41%



Summary

All calculations performed for this analysis yielded results that were **within** the allowable limits for general population exposure to RF Emissions.

The anticipated maximum composite contributions from the T-Mobile facility as well as the site composite emissions value with regards to compliance with FCC's allowable limits for general population exposure to RF Emissions are shown here:

T-Mobile Sector	Power Density Value (%)
Sector A:	2.41 %
Sector B:	2.41 %
Sector C:	2.41 %
T-Mobile Max MPE% (Per Sector):	2.41 %
Site Total:	13.55 %
Site Compliance Status:	COMPLIANT

The anticipated composite MPE value for this site assuming all carriers present is **13.55%** of the allowable FCC established general population limit sampled at the ground level. This is based upon values listed in the Connecticut Siting Council database for existing carrier emissions.

FCC guidelines state that if a site is found to be out of compliance (over allowable thresholds), that carriers over a 5% contribution to the composite value will require measures to bring the site into compliance. For this facility, the composite values calculated were well within the allowable 100% threshold standard per the federal government.

Exhibit F