



STATE OF CONNECTICUT

CONNECTICUT SITING COUNCIL

Ten Franklin Square, New Britain, CT 06051

Phone: (860) 827-2935 Fax: (860) 827-2950

E-Mail: siting.council@ct.gov

www.ct.gov/csc

VIA ELECTRONIC MAIL

August 23, 2018

Denise Sabo
Northeast Site Solutions
420 Main Street, Suite 2
Sturbridge, MA 01566-1359

RE: **EM-T-MOBILE-043-180731** – T-Mobile notice of intent to modify an existing telecommunications facility located at 100 Sunset Ridge Road, East Hartford, Connecticut.

Dear Ms. Sabo:

The Connecticut Siting Council (Council) is in receipt of your correspondence of August 20, 2018 submitted in response to the Council's August 13, 2018 notification of an incomplete request for exempt modification with regard to the above-referenced matter.

The submission renders the request for exempt modification complete and the Council will process the request in accordance with the Federal Communications Commission 60-day timeframe.

Thank you for your attention and cooperation.

Sincerely,

Melanie A. Bachman
Executive Director

MAB/FOC/emr

Robidoux, Evan

From: Deborah Chase <deborah@northeastsitesolutions.com>
Sent: Monday, August 20, 2018 5:54 PM
To: CSC-DL Siting Council; Bachman, Melanie; Mathews, Lisa A
Cc: Denise Sabo; Sheldon Freinckle; victoria@northeastsitesolutions.com
Subject: RE: **Amended EM Application **100 Sunset Ridge Road, East Hartford, CT 06108- T-Mobile EM Application (CT11737C_L700 4x2)
Attachments: 100 Sunset Ridge, East Hartford, CT 06108 T-Mobile EM Application (CT11737C-L700 4X2).pdf

Please use this copy as it contains the new mailing labels for the recipients.

Thank you

Deborah Chase

Senior Project Coordinator & Analyst

Mobile: 860-490-8839

NSS

NORTHEAST
SITE SOLUTIONS

♻️ Save a tree. Refuse. Reduce. Reuse. Recycle.

From: Deborah Chase [mailto:deborah@northeastsitesolutions.com]

Sent: Monday, August 20, 2018 5:29 PM

To: siting.council@ct.gov; melanie.bachman@ct.gov; Lisa.A.Mathews@ct.gov

Cc: Denise Sabo (denise@northeastsitesolutions.com); Sheldon Freinckle

(sheldon@northeastsitesolutions.com); victoria@northeastsitesolutions.com

Subject: **Amended EM Application **100 Sunset Ridge Road, East Hartford, CT 06108- T-Mobile EM Application (CT11737C_L700 4x2)

Siting Council-

Enclosed please accept our amended Exempt Modification Application package from Northeast Site Solutions on behalf of T-Mobile for the above referenced site. The amended package includes a new structural, cover letter and receipts.

We have resent the applications to the town officials and tower/property owner.

We are mailing the original and two (2) copies to your office.

Please let me know if you have any questions or problems with the attachment.

Deborah Chase

Senior Project Coordinator & Analyst

Mobile: 860-490-8839

NSS

NORTHEAST
SITE SOLUTIONS

♻️ Save a tree. Refuse. Reduce. Reuse. Recycle.



NSS

NORTHEAST
SITE SOLUTIONS

Turnkey Wireless Development

EM-T-MOBILE-043-180731

AMENDED COPY

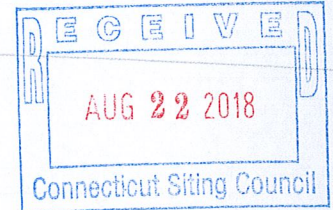

Northeast Site Solutions
Denise Sabo
420 Main Street, Sturbridge, MA 01655
860-209-4690
denise@northeastsitesolutions.com

August 20, 2018

Members of the Siting Council
Connecticut Siting Council
Ten Franklin Square
New Britain, CT 06051

RE: **Amended - Notice of Exempt Modification**
100 Sunset Ridge Road, East Hartford CT 06108
Latitude: 41.771800
Longitude: -72.590300
T-Mobile Site#: CT11737C_L700 4x2

Dear Ms. Bachman:

T-Mobile is requesting to amend our application submitted on July 30, 2018. The following exempt modification for the existing 140-foot Lattice Tower located at 100 Sunset Ridge Road, East Hartford now includes an updated structural analysis. The structural was updated with Sprints new loading.

T-Mobile currently maintains nine (9) antennas at the 120-foot level of the existing 140-foot tower. The tower and property are owned by the Town of East Hartford. T-Mobile now intends to replace three (3) existing antenna with three (3) new 600/700 MHz antenna. The new antennas would be installed at the 120-foot and level of the tower.

Planned Modifications:

Remove:

NONE

Remove and Replace:

- (3) LNX6515DS A1M (**Remove**) – (3) APXVAARR24-43-U-NA20 Antenna (**Replace**)
- (3) RRU (**Remove**) – (3) RRU 4449 B71+B12 (**Replace**)

Install New:

NONE

Existing to Remain:

- (6) 1-5/8" Coax
- (1) Hybrid line
- (3) AIR21 B2A_B4P Antenna
- (3) AIR32DB B66Aa B2a Antenna
- (3) TMA

Wells
log

This facility was first approved by the Connecticut Siting Council. TS No. TS-T-Mobile-043-060621 – Approved in 2006 for the addition of Omnipoint telecommunication equipment to existing tower. Please see attached.

Please accept this letter as notification pursuant to Regulations of Connecticut State Agencies § 16- SOJ-73, for construction that constitutes an exempt modification pursuant to R.C.S.A. § 16-50j-72(b)(2). In accordance with R.C.S.A. § 16-SOJ-73, a copy of this letter is being sent to Mayor Marcia A. Leclerc, as Elected Official for the Town of East Hartford and Jeffrey Cormier, Town Planner as well as the property owner and the tower owner.

The planned modifications to the facility fall squarely within those activities explicitly provided for in R.C.S.A. § 16-50j-72(b)(2).

1. The proposed modifications will not result in an increase in the height of the existing structure.
2. The proposed modifications will not require the extension of the site boundary.
3. The proposed modifications will not increase noise levels at the facility by six decibels or more, or to levels that exceed state and local criteria.
4. The operation of the replacement antennas will not increase radio frequency emissions at the facility to a level at or above the Federal Communications Commission safety standard.
5. The proposed modifications will not cause a change or alteration in the physical or environmental characteristics of the site.
6. The existing structure and its foundation can support the proposed loading.

For the foregoing reasons, T-Mobile respectfully submits that the proposed modifications to the above referenced telecommunications facility constitute an exempt modification under R.C.S.A. § 16-50j-72(b)(2).

Sincerely,



Denise Sabo

Mobile: 860-209-4690

Fax: 413-521-0558

Office: 420 Main Street, Sturbridge, MA 01655

Email: denise@northeastsitesolutions.com

Attachments

cc: Mayor Marcia A. Leclerc - as elected official
Jeffrey Cormier - Town Planner
Town of East Hartford - Tower and property owner

Exhibit A



STATE OF CONNECTICUT

CONNECTICUT SITING COUNCIL

Ten Franklin Square, New Britain, CT 06051

Phone: (860) 827-2935 Fax: (860) 827-2950

E-Mail: siting.council@ct.gov

www.ct.gov/csc

July 28, 2006

Karina Fournier
Zoning Department
T-Mobile
30 Cold Spring Road
Rocky Hill, CT 06067

RE: **TS-T-MOBILE-043-060621** - Omnipoint Communications, Inc. request for an order to approve tower sharing at a telecommunications facility located at 100 Sunset Ridge Drive, East Hartford, Connecticut.

Dear Ms. Fournier:

At a public meeting held July 27, 2006, the Connecticut Siting Council (Council) ruled that the shared use of this tower site is technically, legally, environmentally, and economically feasible and meets public safety concerns, and therefore, in compliance with General Statutes § 16-50aa, the Council has ordered the shared use of this facility to avoid the unnecessary proliferation of tower structures. This facility has also been carefully modeled to ensure that radio frequency emissions are conservatively below State and federal standards applicable to the frequencies now used on this tower.

This decision is under the exclusive jurisdiction of the Council. Any additional change to this facility may require an explicit request to this agency pursuant to General Statutes § 16-50aa or notice pursuant to Regulations of Connecticut State Agencies Section 16-50j-73, as applicable. Such request or notice shall include all relevant information regarding the proposed change with cumulative worst-case modeling of radio frequency exposure at the closest point of uncontrolled access to the tower base, consistent with Federal Communications Commission, Office of Engineering and Technology, Bulletin 65. Any deviation from this format may result in the Council implementing enforcement proceedings pursuant to General Statutes § 16-50u including, without limitation, imposition of expenses resulting from such failure and of civil penalties in an amount not less than one thousand dollars per day for each day of construction or operation in material violation.

This decision applies only to this request for tower sharing and is not applicable to any other request or construction. Please be advised that the validity of this action shall expire one year from the date of this letter.

The proposed shared use is to be implemented as specified in your letter dated June 21, 2006, including the placement of all necessary equipment and shelters within the tower compound.

Thank you for your attention and cooperation.

Very truly yours,

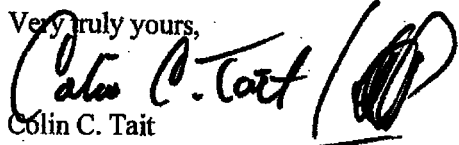
Colin C. Tait
Chairman

CCT/MP/laf

c: The Honorable Melody A. Currey, Mayor, Town of East Hartford
Michael J. Dayton, Town Planner, Town of East Hartford

Exhibit B

Town of East Hartford Property Summary Report

100 SUNSET RIDGE DR

MAP LOT:	57-134A	CAMA PID:	13740
LOCATION:	100 SUNSET RIDGE DR		
OWNER NAME:	TOWN OF EAST HARTFORD / VETERANS MEMORIAL CLUBHSE		



13740 03/24/2016

OWNER OF RECORD

TOWN OF EAST HARTFORD
 VETERANS MEMORIAL CLUBHSE
 740 MAIN STREET
 EAST HARTFORD, CT 06108

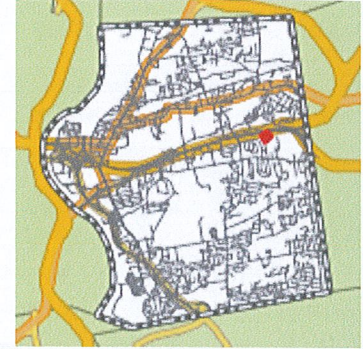

LIVING AREA:	6169	ZONING:	R2	ACREAGE:	1.64
---------------------	------	----------------	----	-----------------	------

SALES HISTORY

OWNER	BOOK / PAGE	SALE DATE	SALE PRICE
TOWN OF EAST HARTFORD VETERANS MEMORIAL CLUBHSE	159/ 39	01-Jan-1900	\$0.00

CURRENT PARCEL ASSESSMENT

TOTAL:	\$836,930.00	IMPROVEMENTS:	\$738,230.00	LAND:	\$98,700.00
---------------	--------------	----------------------	--------------	--------------	-------------

ASSESSING HISTORY

FISCAL YEAR	TOTAL VALUE	IMPROVEMENT VALUE	LAND VALUE
2017	\$836,930.00	\$738,230.00	\$98,700.00
2016	\$836,930.00	\$738,230.00	\$98,700.00
2015	\$807,050.00	\$708,350.00	\$98,700.00
2014	\$807,050.00	\$708,350.00	\$98,700.00
2013	\$807,050.00	\$708,350.00	\$98,700.00

Town of East Hartford Property Summary Report

100 SUNSET RIDGE DR

MAP LOT:	57-134A	CAMA PID:	13740
LOCATION:	100 SUNSET RIDGE DR		
OWNER NAME:	TOWN OF EAST HARTFORD / VETERANS MEMORIAL CLUBHSE		

BUILDING # 1

YEAR BUILT	1930	EXT WALL 1	Stone/Masonry
STYLE	Cultural Facility	INT WALLS 1	Plaster
MODEL	Comm/Ind	HEAT FUEL	Other
STORIES	1.0	HEAT TYPE	Steam
OCCUPANCY	Exempt	AC TYPE	None
ROOF	Drmrs/Ex Gable	BEDROOMS	
ROOF COVER	Asphalt	FULL BATHS	15
FLOOR COVER 1	Hardwood	HALF BATHS	
% BSMT	null	TOTAL ROOMS	0
% FIN BSMT	null	% REC RM	null
% SEMI FIN	null	% ATTIC FINISH	null
BSMT GARAGE	null	FIREPLACES	null



13740 03/24/2016

EXTRA FEATURES

DESCRIPTION	CODE	UNITS
Fin Bsmt	FBM	1567 S.F.
Fireplace	FPL	1 UNITS

Sunset Ridge Dr

Sunset Ridge Dr

57-134A
1.64 ac

57-136
0.35 ac

94

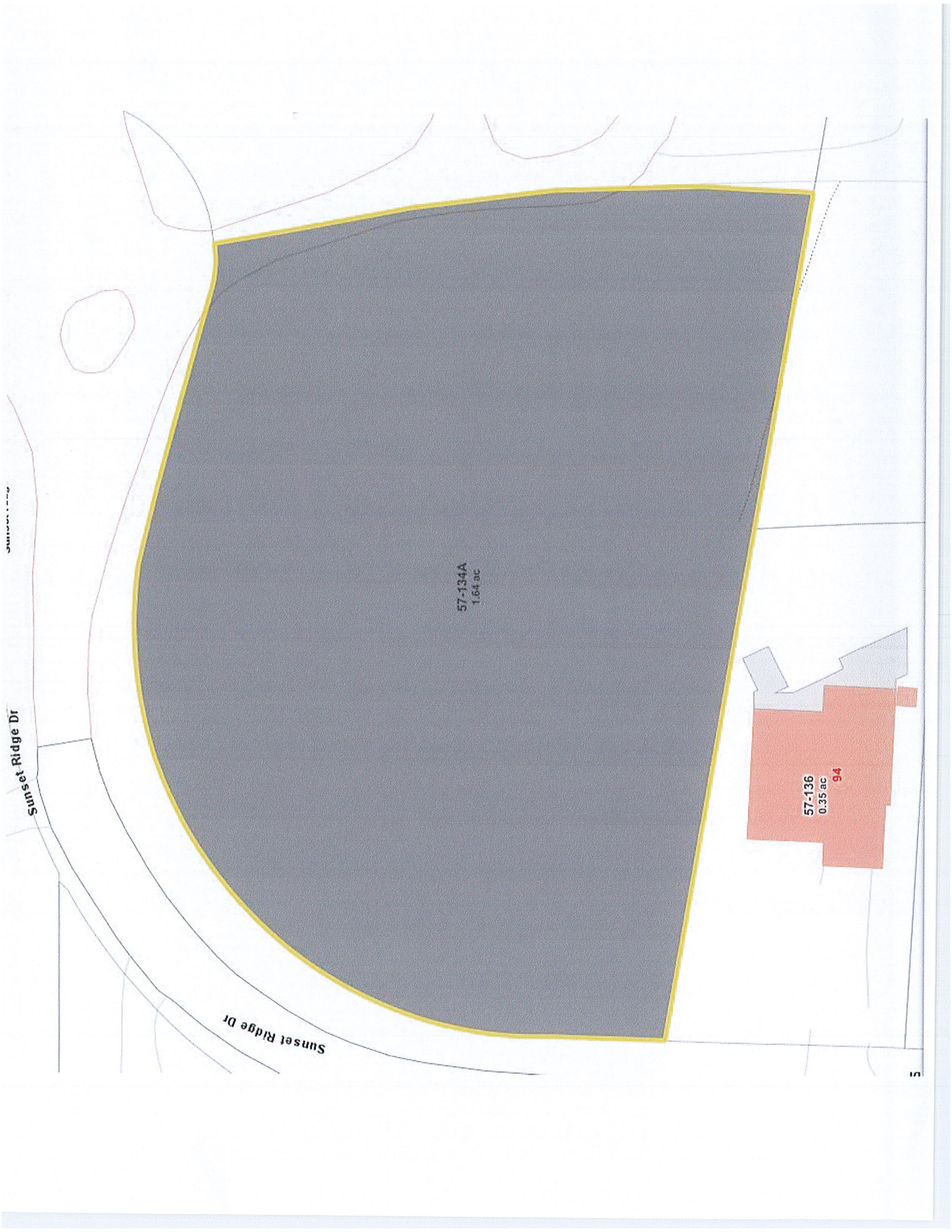

Exhibit C

ANTENNA UPGRADES BY



T-MOBILE NORTHEAST LLC

PROJECT: L700 4X2

SITE NUMBER: CT11737C

SITE NAME: CT737/E HARTFORD TOWN SST

SITE ADDRESS: 100 SUNSET RIDGE RD

EAST HARTFORD, CT 06108

(RF CONFIGURATION 67D92DB)

SITE IMAGE:

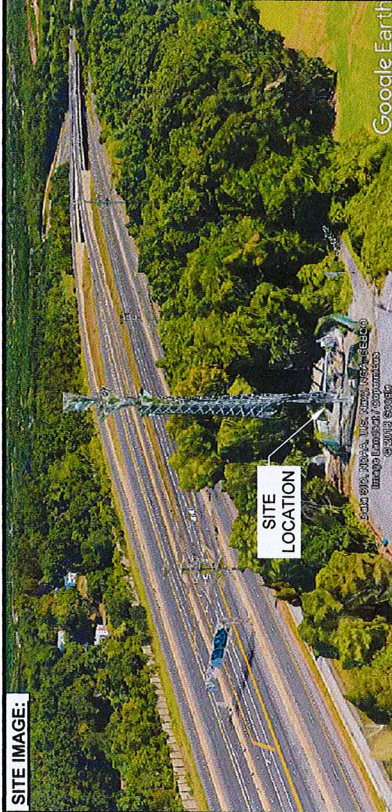

VICINITY MAP:

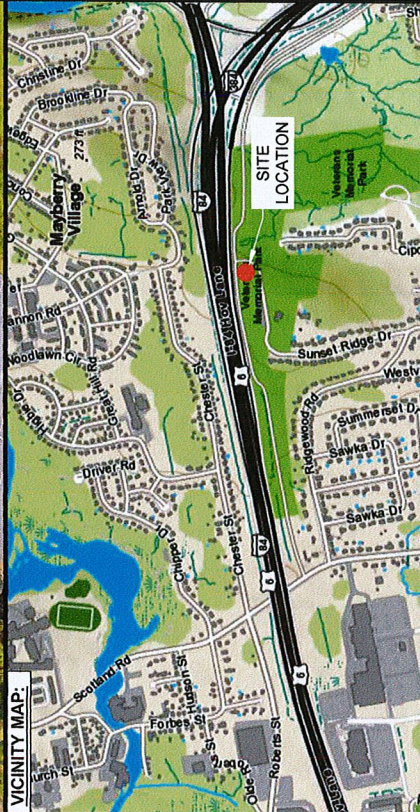

PROJECT SCOPE:

UPGRADE OF EXISTING WIRELESS FACILITY AS FOLLOWS:
 REPLACE (3) EXISTING ANTENNAS;
 REPLACE (5) REMOTE-RADIO UNITS AT ANTENNAS.

PROJECT NOTES:

1. THIS IS AN UNMANNED TELECOMMUNICATION FACILITY AND NOT FOR HUMAN OCCUPANCY. HANDICAPPED ACCESS IS NOT REQUIRED. PORTABLE WATER OR SANITARY SERVICE IS NOT REQUIRED. NO OUTDOOR STORAGE OR ANY SOLID WASTE RECEPACLES REQUIRED.
2. CONTRACTOR SHALL VERIFY ALL PLANS, EXISTING DIMENSIONS, AND CONDITIONS ON THE JOB SITE. CONTRACTOR SHALL NOTIFY ARCHITECT/ENGINEER IMMEDIATELY OF ANY DISCREPANCIES BEFORE PROCEEDING WITH THE WORK. FAILURE TO NOTIFY THE ARCHITECT/ENGINEER PLACES THE RESPONSIBILITY ON THE CONTRACTOR TO CORRECT THE DISCREPANCIES AT THE CONTRACTOR'S EXPENSE.
3. DEVELOPMENT AND USE OF THE SITE WILL CONFORM TO ALL APPLICABLE CODES, ORDINANCES AND SPECIFICATIONS.
4. REFER TO STRUCTURAL ANALYSIS REPORT TITLED "STRUCTURAL ANALYSIS REPORT - SELF SUPPORT TOWER" - SITE ID: CT11737C, DATED JUNE 25, 2018, PREPARED BY DBESTK.

APPLICABLE STATE ADOPTION CODES:

- 2016 CONNECTICUT STATE BUILDING CODE (CSBC).
- ANSI/TIA-222-G-2005 STRUCTURAL STANDARD FOR ANTENNA SUPPORTING STRUCTURES AND ANTENNAS.
- 2014 NATIONAL ELECTRICAL CODE (NFPA 70) FOR POWER AND GROUNDING REQUIREMENTS.

APPROVALS:

PSA/CM	DATE
RF ENGINEER	DATE
FORS	DATE
T-MOBILE ENGINEERING AND DEVELOPMENT	DATE
	DATE
	DATE

PROJECT INFORMATION:

ADDRESS: 100 SUNSET RIDGE RD
 EAST HARTFORD, CT 06108

STRUCTURE TYPE: LATTICE TOWER

COORDINATES: 41.771800 N, -72.960300 W

ZONING DISTRICT: R2

PARCEL ID: 13740

TOWER HEIGHT: 140'-0" AGL

TOP OF T-MOBILE ANTENNAS ELEV: 124'-0" AGL

PROJECT TEAM:

APPLICANT: T-MOBILE NORTHEAST, LLC
 35 GRIFFIN ROAD SOUTH
 EAST HARTFORD, CT 06102
 860-882-7100

LANDLORD: TOWN OF EAST HARTFORD VETERANS
 740 MAIN STREET
 EAST HARTFORD, CT 06108

PROJECT MANAGER: NORTHEAST SITE SOLUTIONS
 420 MAIN STREET, BLDG 4
 STURBRIDGE, MA 01566
 SHEL@NORTHHEASTSITE
 SOLUTIONS.COM
 201-776-8521

CONSULTANTS: FORESITE, LLC
 482 WALNUT ST
 NEWTON, MA 02460
 SAAEED.MOSSAVAT@FORESITE.LLC
 617-212-3123

SHEET INDEX:

- T-1: TITLE SHEET
- N-1: GENERAL NOTES
- A-1: PLAN
- A-2: ELEVATION
- A-3: ANTENNA PLAN
- A-4: ANTENNA DETAILS
- E-1: GROUNDING DETAILS

APPLICANT:
T-Mobile
T-MOBILE NORTHEAST LLC
 35 GRIFFIN ROAD SOUTH
 BLOOMFIELD, CT 06102
 860-882-7100

PROJECT MANAGER
NSS NORTHEAST
 SITE SOLUTIONS
 420 MAIN STREET, BLDG 4
 STURBRIDGE, MA 01566
 203-275-8889

CONSULTANT:
FORESITE LLC
 Architects, Engineers, Surveyors
 482 WALNUT STREET
 NEWTON, MA 02460
 617-212-3123



THIS DOCUMENT IS THE DESIGN PROPERTY AND COPYRIGHT OF FORESITE, LLC, AND IS TO BE USED ONLY FOR THE PROJECT AND CLIENT. NO REUSE OR REPRODUCTION OF THE EXPRESS WRITTEN CONSENT OF THE CREATOR IS STRICTLY PROHIBITED. DRAWING SCALES ARE INTENDED FOR 11"x17" SIZE PRINTED MEDIA ONLY. ALL OTHER PRINTED SIZES ARE DEEMED "NOT TO SCALE".

REV	DESCRIPTION	DATE
A	PRELIMINARY	07/03/18
B	REVISED PER COMMENTS	07/09/18
C	REVISED PER NEW RFDS	07/19/18
D	ISSUED FOR PERMIT	07/24/18

SITE NUMBER: CT11737C
 SITE NAME: CT737/E HARTFORD TOWN SST
 SITE ADDRESS: 100 SUNSET RIDGE RD
 EAST HARTFORD, CT 06108

SHEET TITLE:
 T-1: TITLE SHEET

GENERAL NOTES:

1. THE CONTRACTOR SHALL GIVE ALL NOTICES AND COMPLY WITH ALL LAWS, ORDINANCES, RULES, REGULATIONS AND LAWRUL ORDERS OF ANY AGENCY, MUNICIPAL AND UTILITY COMPANY SPECIFICATIONS, AND LOCAL AND STATE JURISDICTIONS. MARKING ON THE PERFORMANCE OF THE WORK PERFORMED ON THE PROJECT AND THE MATERIALS INSTALLED SHALL BE IN STRICT ACCORDANCE WITH ALL APPLICABLE CODES, REGULATIONS, AND ORDINANCES.
2. THE ARCHITECT/ENGINEER HAS MADE EVERY EFFORT TO SET FORTH IN THE CONSTRUCTION AND CONTRACT DOCUMENTS THE COMPLETE SCOPE OF WORK. THE CONTRACTOR BIDDING THE JOB IS NEVERTHELESS CAUTIONED FOR OMISSIONS OR ERRORS IN THE DRAWINGS AND OR SPECIFICATIONS SHALL NOT EXCLUDE SAID CONTRACTOR FROM COMPLETING THE PROJECT AND IMPROVEMENTS IN ACCORDANCE WITH THE INTENT OF THESE DOCUMENTS.
3. THE CONTRACTOR OR BIDDER SHALL BEAR THE RESPONSIBILITY OF NOTIFYING (IN WRITING) THE CLIENT'S REPRESENTATIVE OF ANY CONFLICTS, ERRORS, OR OMISSIONS PRIOR TO THE SUBMISSION OF CONTRACTOR'S PROPOSAL OR PERFORMANCE OF WORK.
5. THE CONTRACTOR SHALL VISIT THE JOB SITE PRIOR TO THE SUBMISSION OF BIDS OR PERFORMING WORK TO FAMILIARIZE HIMSELF WITH THE FIELD CONDITIONS AND TO VERIFY THAT THE PROJECT CAN BE CONSTRUCTED IN ACCORDANCE WITH THE CONSTRUCTION DOCUMENTS.
6. THE CONTRACTOR SHALL INSTALL ALL EQUIPMENT AND MATERIALS ACCORDING TO THE MANUFACTURER'S / VENDOR'S SPECIFICATIONS UNLESS NOTED OTHERWISE OR WHERE LOCAL CODES OR ORDINANCES TAKE PRECEDENCE.
7. THE CONTRACTOR SHALL MAKE NECESSARY PROVISIONS TO PROTECT EXISTING IMPROVEMENTS DURING CONSTRUCTION.
8. THE CONTRACTOR SHALL COMPLY WITH ALL PERTINENT SECTIONS OF THE BASIC STATE BUILDING CODE, LATEST EDITION, AND ALL OSHA REQUIREMENTS AS THEY APPLY TO THIS PROJECT.
9. THE CONTRACTOR SHALL NOTIFY THE CLIENT'S REPRESENTATIVE IN WRITING WHERE A CONFLICT OCCURS ON ANY OF THE CONTRACT DOCUMENTS. THE CONTRACTOR IS NOT TO ORDER MATERIAL OR CONSTRUCT ANY PORTION OF THE WORK THAT IS IN CONFLICT UNTIL CONFLICT IS RESOLVED BY THE CLIENT'S REPRESENTATIVE.
10. THE WORK SHALL CONFORM TO THE CODES AND STANDARDS OF THE FOLLOWING AGENCIES AS FURTHER CITED HEREIN:
 - A. ASTM: AMERICAN SOCIETY FOR TESTING AND MATERIALS, AS PUBLISHED IN "COMPILATION OF ASTM STANDARDS BUILDING CODES" OR LATEST EDITION.
 - B. AWS: AMERICAN WELDING SOCIETY INC. AS PUBLISHED IN "STANDARD D1.1-08, STRUCTURAL WELDING CODE" OR LATEST EDITION.
 - C. AISC: AMERICAN INSTITUTE FOR STEEL CONSTRUCTION AS PUBLISHED IN "CODE FOR STANDARD PRACTICE FOR STEEL BUILDINGS AND BRIDGES"; "SPECIFICATIONS FOR THE DESIGN, FABRICATION AND ERECTION OF STRUCTURAL STEEL FOR BUILDINGS" (LATEST EDITION).
11. BOLTING:
 - A. BOLTS SHALL BE CONFORMING TO ASTM A325 HIGH STRENGTH, HOT DIP GALVANIZED WITH ASTM A153 HEAVY HEX TYPE NUTS.
 - B. BOLTS SHALL BE 3/4" MINIMUM (UNLESS OTHERWISE NOTED)
 - C. ALL CONNECTIONS SHALL BE 2 BOLTS MINIMUM.
12. FABRICATION:
 - A. FABRICATION OF STEEL SHALL CONFORM TO THE AISC AND AWS STANDARDS AND CODES (LATEST EDITION).
 - B. ALL STRUCTURAL STEEL SHALL BE HOT-DIP GALVANIZED AFTER FABRICATION IN ACCORDANCE WITH ASTM A123 (LATEST EDITION), UNLESS OTHERWISE NOTED.
13. ERECTION OF STEEL:
 - A. PROVIDE ALL ERECTION EQUIPMENT, BRACING, PLANKING, FIELD BOLTS, NUTS, WASHERS, DRIFT PINS, AND SIMILAR MATERIALS WHICH DO NOT FORM A PART OF THE COMPLETED CONSTRUCTION BUT ARE NECESSARY FOR ITS PROPER ERECTION.
 - B. ERECT AND ANCHOR ALL STRUCTURAL STEEL IN ACCORDANCE WITH AISC REFERENCE STANDARDS. ALL WORK SHALL BE ACCURATELY SET TO ESTABLISHED LINES AND ELEVATIONS AND RIGIDLY FASTENED IN PLACE WITH SUITABLE ATTACHMENTS TO THE CONSTRUCTION OF THE BUILDING.
 - C. TEMPORARY BRACING, GUYING AND SUPPORT SHALL BE PROVIDED TO KEEP THE STRUCTURE SAFE AND ALIGNED AT ALL TIMES DURING CONSTRUCTION, AND TO PREVENT DANGER TO PERSONS AND PROPERTY. CHECK ALL TEMPORARY LOADS AND STAY WITHIN SAFE CAPACITY OF ALL BUILDING COMPONENTS.

14. ANTENNA INSTALLATION:
 - A. INSTALL ANTENNAS AS INDICATED ON DRAWINGS AND CLIENT'S REPRESENTATIVE SPECIFICATIONS.
 - B. INSTALL GALVANIZED STEEL ANTENNA MOUNTS AS INDICATED ON DRAWINGS.
 - C. INSTALL COAXIAL / FIBER CABLES AND TERMINATIONS BETWEEN ANTENNAS AND EQUIPMENT PER MANUFACTURER'S RECOMMENDATIONS. WEATHERPROOF ALL CONNECTORS BETWEEN THE ANTENNA AND EQUIPMENT PER MANUFACTURER'S REQUIREMENTS.
15. ANTENNA AND COAXIAL / FIBER CABLE GROUNDING:
 - A. ALL EXTERIOR #6 GREEN GROUND WIRE "DAISY CHAIN" CONNECTIONS ARE TO BE WEATHER SEALED WITH ANDREWS CONNECTOR/SPLICE WEATHERPROOFING KIT TYPE #221213 OR EQUAL.
 - B. ALL COAXIAL / FIBER CABLE GROUNDING KITS ARE TO BE INSTALLED ON STRAIGHT RUNS OF COAXIAL / FIBER CABLE (NOT WITHIN BENDS).
16. RELATED WORK, FURNISH THE FOLLOWING WORK AS SPECIFIED UNDER CONSTRUCTION DOCUMENTS, BUT COORDINATE WITH OTHER TRADES PRIOR TO BID:
 - A. FLASHING OF OPENING INTO OUTSIDE WALLS
 - B. SEALING AND CAULKING ALL OPENINGS
 - C. PAINTING
 - D. CUTTING AND PATCHING
17. REQUIREMENTS OF REGULATORY AGENCIES:
 - A. FURNISH U.L. LISTED EQUIPMENT WHERE SUCH LABEL IS AVAILABLE. INSTALL IN CONFORMANCE WITH U.L. STANDARDS WHERE APPLICABLE.
 - B. INSTALL ANTENNA, ANTENNA CABLES, GROUNDING SYSTEM IN ACCORDANCE WITH DRAWINGS AND SPECIFICATION IN THE PROJECT LOCATION AND RECOMMENDATIONS OF STATE AND LOCAL BUILDING CODES, AND SPECIAL CODES, HAVING JURISDICTION OVER SPECIFIC PORTIONS OF WORK. THIS WORK INCLUDES BUT IS NOT LIMITED TO THE FOLLOWING:
 - C. TIA-EIA - 222 (LATEST EDITION). STRUCTURAL STANDARDS FOR STEEL ANTENNA TOWERS AND ANTENNA SUPPORTING STRUCTURES.
 - D. FAA - FEDERAL AVIATION ADMINISTRATION ADVISORY CIRCULAR AC 70/7460-H, OBSTRUCTION MARKING AND LIGHTING.
 - E. FCC - FEDERAL COMMUNICATIONS COMMISSION RULES AND REGULATIONS FORM 715, OBSTRUCTION MARKING AND LIGHTING SPECIFICATION FOR ANTENNA STRUCTURES, AND FORM 715A, HIGH INTENSITY OBSTRUCTION LIGHTING SPECIFICATIONS FOR ANTENNA STRUCTURES.
 - F. AISC - AMERICAN INSTITUTE OF STEEL CONSTRUCTION SPECIFICATION FOR STRUCTURAL JOINTS USING ASTM A325 BOLTS (LATEST EDITION).
 - G. NEC - NATIONAL ELECTRICAL CODE - ON TOWER LIGHTING KITS.
 - H. UL - UNDERWRITER'S LABORATORIES APPROVED ELECTRICAL PRODUCTS.
 - I. IN ALL CASES, PART 77 OF THE FAA RULES AND PARTS 17 AND 22 OF THE FCC RULES ARE APPLICABLE AND IN THE EVENT OF CONFLICT, SUPERSEDE ANY OTHER STANDARDS OR SPECIFICATIONS.
 - J. 2009 LIFE SAFETY CODE NFPA - 101.

APPLICANT:
T-Mobile
 35 GRIFFIN ROAD SOUTH
 BLOOMFIELD, CT 06002
 860-692-7100

PROJECT MANAGER
NSS NORTHEAST
 SITE SOLUTIONS
 420 MAIN STREET, SUITE 4
 STURBRIDGE, MA 01566
 203-275-6889

CONSULTANT:
FORESITE LLC
 Architects - Engineers - Surveyors
 462 WALNUT STREET
 NEWTON, MA 02460
 617-212-3123



THIS DOCUMENT IS THE DESIGN PROPERTY AND COPYRIGHT OF FORESITE LLC AND IS NOT TO BE REPRODUCED OR USED FOR THE EXCLUSION OR USE WITHOUT THE EXPRESS WRITTEN CONSENT OF THE CREATOR IS STRICTLY PROHIBITED. DRAWING SCALES ARE INTENDED FOR OFFICE PRINTED MEDIA ONLY. ALL OTHER PRINTED SIZES ARE DEEMED "NOT TO SCALE".

REV	DESCRIPTION	DATE
A	PRELIMINARY	07/09/18
B	REVISED PER COMMENTS	07/09/18
C	REVISED PER NEW RFDS	07/19/18
D	ISSUED FOR PERMIT	07/24/18

SITE NUMBER: CT117270
 SITE NAME: CT1737/E HARTFORD TOWER SST
 SITE ADDRESS: 100 SUNSET RIDGE RD
 EAST HARTFORD, CT 06108

SHEET TITLE:
N-1: NOTES AND DISCLAIMERS

APPLICANT:
T-Mobile
T-MOBILE NORTHEAST LLC
 35 GRIFFIN ROAD SOUTH
 BLOOMFIELD, CT 06002
 860-682-7100

PROJECT MANAGER
NSS NORTHEAST
 SITE SOLUTIONS
 420 MAIN STREET, BLDG 4
 STURBRIDGE, MA 01566
 253-275-6669

CONSULTANT:
FORESITE LLC
 Architects, Engineers, Surveyors
 462 WALNUT STREET
 NEWTON, MA 02460
 617-212-3123



THIS DOCUMENT IS THE DESIGN PROPERTY AND COPYRIGHT OF FORESITE, LLC AND FOR THE EXCLUSIVE USE BY THE TITLE CLIENT. DUPLICATION OR USE WITHOUT THE PERMISSION OF FORESITE, LLC IS PROHIBITED. DRAWING SCALES ARE INTENDED FOR OTHER PRINTED MEDIA ONLY. ALL "NOT TO SCALE".

REV	DESCRIPTION	DATE
A	PRELIMINARY	07/03/18
B	REVISED PER COMMENTS	07/09/18
C	REVISED PER NEW RFDS	07/19/18
D	ISSUED FOR PERMIT	07/24/18

SITE NUMBER: CT1737C
 SITE NAME: CT737/E HARTFORD TOWN SST
 SITE ADDRESS: 100 SUNSET RIDGE RD
 EAST HARTFORD, CT 06108

SHEET TITLE:
 A-1: PLAN

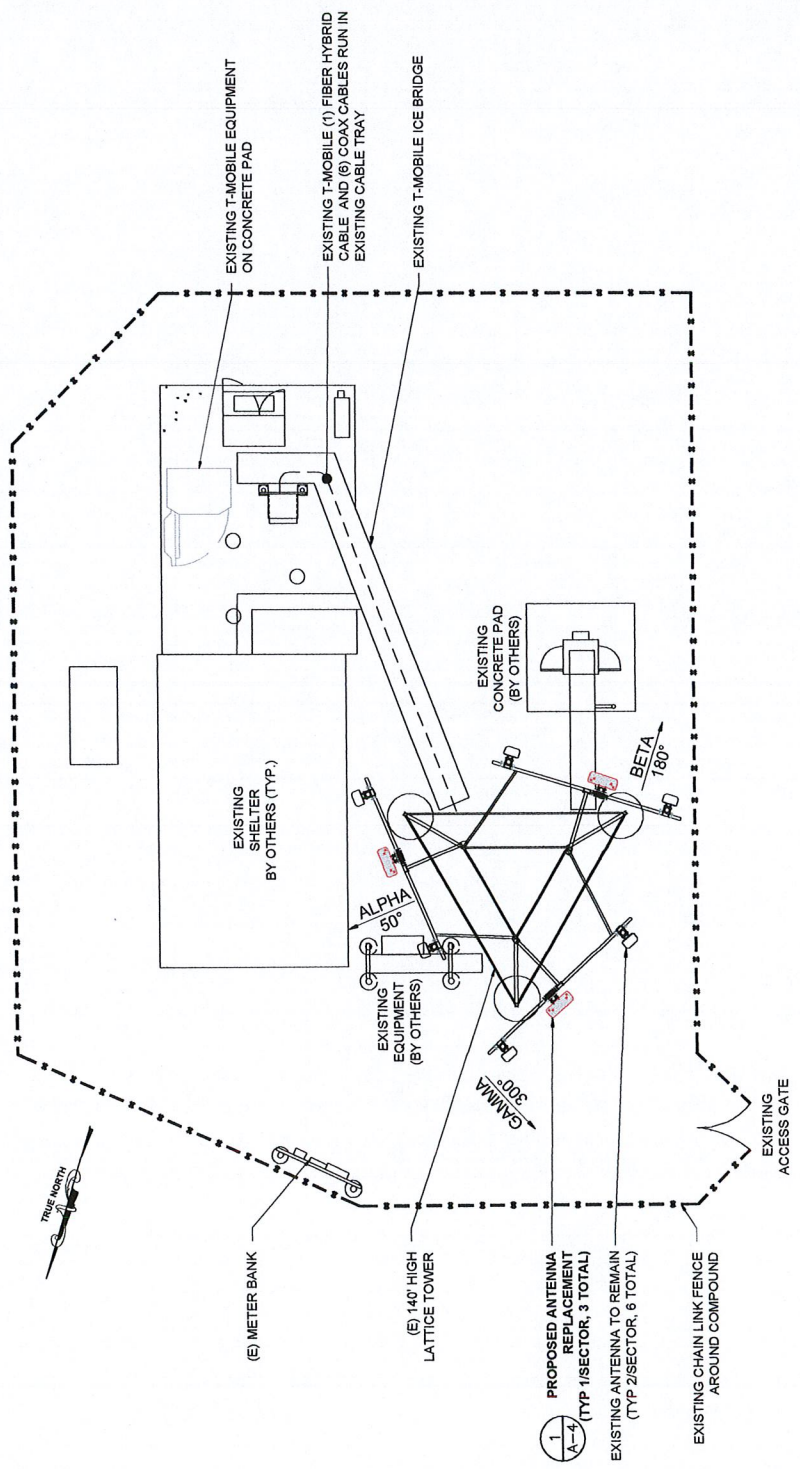

SITE PLAN
 SCALE: 1/8" = 1'-0"
 1
 A-1

- ELECTRICAL & GROUNDING NOTES**
1. ALL ELECTRICAL WORK SHALL CONFORM TO THE REQUIREMENTS OF THE NATIONAL ELECTRICAL CODE (NEC) AS WELL AS APPLICABLE STATE AND LOCAL CODES.
 2. ALL ELECTRICAL ITEMS SHALL BE U.L. APPROVED OR LISTED AND PRODUCED PER SPECIFICATION REQUIREMENTS.
 3. THE ELECTRICAL WORK INCLUDES ALL LABOR AND MATERIAL DESCRIBED BY DRAWINGS AND SPECIFICATION INCLUDING INCIDENTAL WORK TO PROVIDE COMPLETE OPERATING AND APPROVED ELECTRICAL SYSTEM.
 4. GENERAL CONTRACTOR SHALL PAY FEES FOR PERMITS, AND RESPONSIBLE FOR OBTAINING SAID PERMITS AND COORDINATION OF INSPECTIONS.
 5. ELECTRICAL AND TELCO WIRING OUTSIDE A BUILDING AND EXPOSED TO WEATHER SHALL BE IN WATER TIGHT GALVANIZED RIGID STEEL CONDUITS OR SCHEDULE 80 PVC (AS PERMITTED BY CODE) AND WHERE REQUIRED IN LIQUID TIGHT FLEXIBLE METAL OR NONMETALLIC CONDUITS.
 6. RIGID STEEL CONDUITS SHALL BE GROUNDED AT BOTH ENDS.
 7. ELECTRICAL WIRING SHALL BE COPPER WITH TYPE XHHW, THWN, OR THIN INSULATION.
 8. RUN ELECTRICAL CONDUIT OR CABLING BETWEEN ELECTRICAL ROOM AND PROPOSED CELL SITE ARE PEDESTAL AS INDICATED ON THIS DRAWING. PROVIDE FULL LENGTH PULL ROPE.
 9. RUN TELCO CONDUIT OR CABLE BETWEEN TELEPHONE UTILITY COORDINATE INSTALLATION WITH UTILITY COMPANY.
 10. DEMARKATION POINT AND PROPOSED CELL SITE TELECOM CABINET AND RBS CABINET AS INDICATED ON DRAWING A-1. PROVIDE FULL LENGTH PULL ROPE INSTALLED TELCO CONDUIT. PROVIDE GREEN LEE CONDUIT MEASURING TAPE AT EACH END.
 11. ALL EQUIPMENT LOCATED OUTSIDE SHALL HAVE NAME 3R ENCLOSURE.
 12. GROUNDING SHALL COMPLY WITH NEC ART. 250
 13. GROUNDING COAX CABLE SHIELDS MINIMUM AT BOTH ENDS BY PROJECT OWNER.
 14. USE #6 COPPER STRANDED WIRE WITH GREEN COLOR INSTALLATION FOR ABOVE GRADE GROUNDING (UNLESS OTHERWISE SPECIFIED) AND #2 SOLID TINNED BARE COPPER WIRE FOR BELOW GRADE GROUNDING AS INDICATED ON THE GROUND.
 15. ALL GROUND CONNECTIONS TO BE BURIED HYDRONIC COMPRESSION TYPE CONNECTORS OR CADWELD EXOTHERMIC WELD. DO NOT ALLOW BARE COPPER WIRE TO BE IN CONTACT WITH GALVANIZED STEEL.
 16. ROUTE GROUNDING CONDUCTORS ALONG THE SHORTEST AND STRAIGHTEST PATH POSSIBLE. EXCEPT AS OTHERWISE INDICATED, GROUNDING LEADS SHOULD NEVER BE BENT AS RIGHT ANGLE. ALWAYS MAKE AT LEAST 12" RADIUS BENDS. #6 WIRE CAN BE BENT AT 6" RADIUS WHEN NECESSARY BOND ANY METER OBJECTS WITHIN 7 FEET OF PROPOSED EQUIPMENT OR CABINET TO MASTER GROUND BAR.
 17. CONNECTIONS TO GROUND BARS SHALL BE MADE WITH TWO HOLE COMPRESSION TYPE COPPER LUGS. APPLY OXIDE INHIBITING COMPOUND TO ALL CONNECTIONS.
 18. APPLY OXIDE INHIBITING COMPOUND TO ALL COMPRESSION TYPE GROUND CONNECTION.
 19. BOND ANTENNA MOUNTING BRACKETS, COAXIAL CABLE GROUND KITS, AND ALNA TO EGG PLACED NEAR THE ANTENNA LOCATION.
 20. BOND ANTENNA EGB'S AND MGB TO WATER MAIN.
 21. TEST COMPLETED GROUND SYSTEM AND RECORD RESULTS FOR PROJECT CLOSE-OUT DOCUMENTATION.
 22. BOND ANY METAL OBJECTS WITHIN 7 FEET OF PROPOSED EQUIPMENT OR CABINET TO MASTER GROUND BAR.
 23. VERIFY PROPOSED SERVICE UPGRADE WITH LOCAL UTILITY COMPANY PRIOR TO CONSTRUCTION.

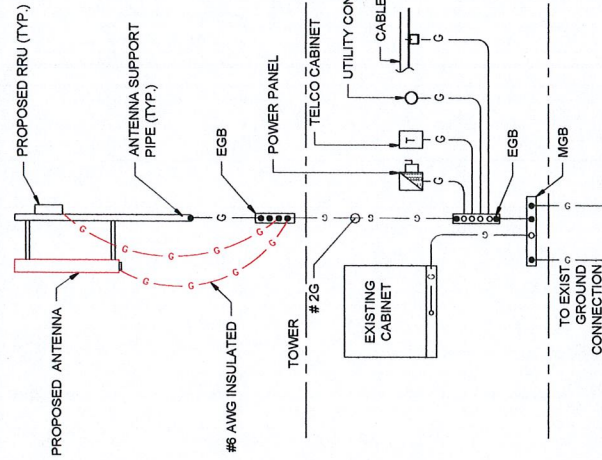

GROUNDING RISER DIAGRAM
SCALE: N.T.S

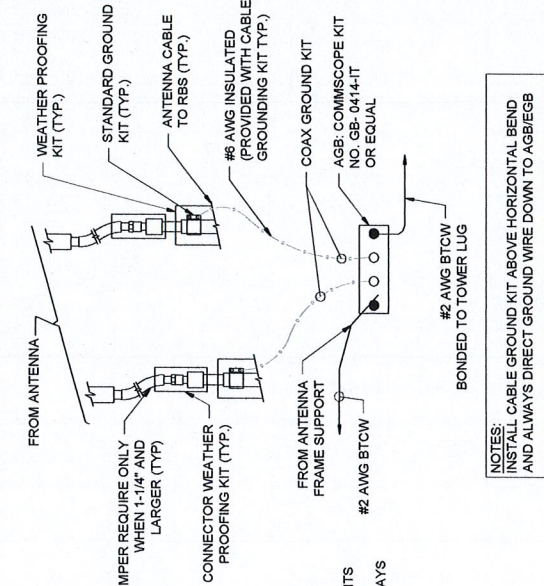

TOWER TOP CABLE GROUNDING DETAIL
SCALE: N.T.S

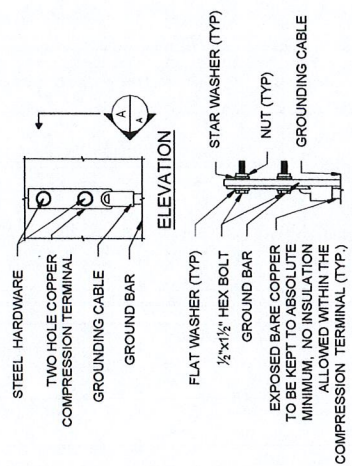

TYPICAL GROUND BAR CONNECTIONS DETAIL
SCALE: N.T.S

APPLICANT:
T-Mobile
MOBILE NORTHEAST LLC
36 GRIFFIN ROAD SOUTH
BLOOMFIELD, CT 06002
860-852-7100

PROJECT MANAGER:
NSS NORTH EAST
SITE SOLUTIONS
420 MAIN STREET, BLDG 4
STURBRIDGE, MA 01566
203-275-6869

CONSULTANT:
FORESITE LLC
Architects, Engineers, Surveyors
462 WALNUT STREET
NEWTON, MA 02460
617-212-3123

PROFESSIONAL SEAL
STATE OF CONNECTICUT
REGISTERED PROFESSIONAL ENGINEER
LICENSE NO. 10000
DATE OF EXPIRATION: 12/31/2024

THIS DOCUMENT IS THE DESIGN PROPERTY AND COPYRIGHT OF FORESITE, LLC, AND FOR THE EXCLUSIVE USE BY THE TITLE CLIENT. DUPLICATION OR USE WITHOUT THE WRITTEN PERMISSION OF FORESITE, LLC IS PROHIBITED. DRAWING SCALES ARE INTENDED FOR 11"x17" SIZE PRINTED MEDIA ONLY. ALL OTHER PRINTED SIZES ARE DEEMED "NOT TO SCALE".

REV	DESCRIPTION	DATE
A	PRELIMINARY	07/03/18
B	REVISED PER COMMENTS	07/09/18
C	REVISED PER NEW RFDS	07/19/18
D	ISSUED FOR PERMIT	07/24/18

SITE NUMBER: CT11737C
SITE NAME: CT737/E HARTFORD TOWN SST
SITE ADDRESS: 100 SUNSET RIDGE RD
EAST HARTFORD, CT 06108

SHEET TITLE:
E-1: GROUNDING AND ELECTRICAL DETAILS

Exhibit D

**STRUCTURAL ANALYSIS REPORT – REVISION 1
SELF SUPPORT TOWER**



Prepared For:



**T-Mobile Northeast, LLC
35 Griffin Road South
Bloomfield, CT 06002**



Structure Rating

**Self-Support Tower: Pass (71.0%)
Foundation: Pass (52.0%)**

Sincerely,
Destek Engineering, LLC
License No: PEC0001429

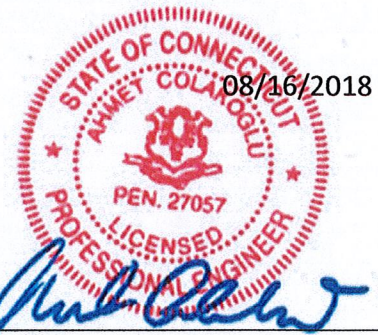

Ahmet Colakoglu, PE
Connecticut Professional Engineer
License No: 27057

**Site ID: CT11737C
Site Name: 100 Sunset Ridge Road,
East Hartford, CT 06118**

CONTENTS

1.0 – SUBJECT AND REFERENCES

1.1 – STRUCTURE

2.0 – EXISTING AND PROPOSED APPURTENANCES

3.0 - CODES AND LOADING

4.0 - STANDARD CONDITIONS FOR ENGINEERING SERVICES ON EXISTING
STRUCTURES

5.0 - ANALYSIS AND ASSUMPTIONS

6.0 – RESULTS AND CONCLUSION

APPENDIX

A –CALCULATIONS

1.0 SUBJECT AND REFERENCES

The purpose of this analysis is to evaluate the structural capacity of the existing 140 feet tall self-support tower, located at 100 Sunset Ridge Road, East Hartford, CT 06118 for the additions and alterations proposed by T-Mobile.

The structural analysis of the site is based on the following documents provided to Destek Engineering, LLC (Destek):

- Structural Analysis Report prepared by Hudson Design Group, dated 06/10/2016.
- Structural Analysis Report prepared by Maser Consulting P.A., dated 04/20/2018.
- Construction Drawings prepared by Hudson Design Group, dated 05/10/2016
- RFDS provided by T-Mobile, dated 05/14/2018.
- Site Audit pictures, dated 01/27/2017.

1.1 STRUCTURE

The subject structure is a 3-sided 140 feet tall, self-support tower formed by 7 sections which are X-braced using single angle diagonals. The tower tapers from 16.0 feet wide at the base to 8 feet wide at 80 feet. Between 80 and 140 feet, the tower is 8.0 feet wide. Please refer to the software output in Appendix A, for tower geometry, member sizes and other details.

2.0 EXISTING AND PROPOSED APPURTENANCES

This analysis was based on the following existing and proposed appurtenances:

Existing Configuration of T-MOBILE Appurtenances:

RAD CENTER (FT)	ANTENNA & TMA	COAX	MOUNT
120	(3) AIR21 KRC118023-1_B2A/B4P (3) LNX-6515DS-A1M (3) AIR32 KRD901146-1_B66A/B2A (3) RRUS11_B12 (3) Generic Twin Style 1B-AWS TMA	(6) 1-5/8" + (1) 9x18 hybrid + (1) 6x12 hybrid	(3) Sector Mounts

Proposed and Final Configuration of T-MOBILE Appurtenances:

RAD CENTER (FT)	ANTENNA & TMA	COAX	MOUNT
120	(3) APXVAARR24_43-U-NA20 (3)) AIR32 KRD901146-1_B66A/B2A (3) AIR21 KRC118023-1_B2A/B4P (3) Radio 4449 B12/B71 (3) Generic Twin Style 1B-AWS TMA	(6) 1-5/8" + (1) 6x12 hybrid	(3) Sector Mounts

Existing and Remaining Appurtenances by Others:

RAD CENTER (FT)	ANTENNA & TMA	COAX	MOUNT
138	Lightning Rod	(7) 7/8"	(3) Side-Arm Mounts
138	(3) 7' Omni		
135	1' Dish		Pipe Mount
130	(3) 20' Omni		(3) Sector Mounts
110	(3) 800 10799	(6) 5/8"	(3) Sector Mounts
110	(3) RRUS-11		
110	(3) RRUS-32		
110	(3) DC6-48-06-18-8F		
100	(3) NNVV-65B-R4	(3) 3" conduit	(3) Side-Arm Mounts
100	(3) MAA-AAHC		
100	(3) RRH4x45-1900		
100	(3) RRH2x50-800		
100	2' Dish		
105	1' Dish		
95	(2) 1' Dish		

3.0 CODES AND LOADING

The tower was analyzed per *TIA/EIA-222-G* as referenced by the *2016 Connecticut State Building Code* with all of the adopted Addendums and Supplements. The following wind loading was used in compliance with the standard for Hartford, CT:

- Basic wind speed 97 mph without ice (W_0)
- Basic wind speed 50 mph with 1" escalating ice (W_i)
- Exposure Category C
- Topographic Category 1
- Structure Class II

The following load combinations were used with wind blowing at 0°, 30°, 45°, 60°, and 90° measured from a line normal to the face of the self-support Tower.

- $1.2 D + 1.6 W_0$
- $0.9 D + 1.6 W_0$
- $1.2 D + 1.0 D_i + 1.0 W_i$

D: Dead Load of structure and appurtenances

W_0 : Wind Load, without ice

W_i : Wind Load, with ice

D_i : Weight of Ice

4.0 STANDARD CONDITIONS FOR ENGINEERING SERVICES ON EXISTING STRUCTURES

The analysis is based on the information provided to Destek and is assumed to be current and correct. Unless otherwise noted, the structure and the foundation system are assumed to be in good condition, free of defects and can achieve theoretical strength.

It is assumed that the structure has been maintained and shall be maintained during its service. The superstructure and the foundation system are assumed to be designed with proper engineering practice and fabricated, constructed and erected in accordance with the design documents. Destek will accept no liability which may arise due to any existing deficiency in design, material, fabrication, erection, construction, etc. or lack of maintenance.

The analysis results presented in this report are only applicable for the previously mentioned existing and proposed additions and alterations. Any deviation of the proposed equipment and placement, etc., will require Destek to generate an additional structural analysis.

5.0 ANALYSIS AND ASSUMPTIONS

The tower was analyzed by utilizing tnxTower, a non-linear, three-dimensional, finite element-analysis software package, a product of Tower Numerics, Inc. Software output for this analysis is provided in Appendix A of this report.

All member end connection details are sufficient to resist the maximum supported member loading.

6.0 RESULTS AND CONCLUSION

Based on a structural analysis per ANSI/TIA-222-G, the existing self-support tower has **adequate** structural capacity for the proposed changes by T-Mobile. For the aforementioned load combinations and as a maximum, the tower diagonals between 100' and 120' are stressed to **71.0%** of capacity. The tower legs between 40' and 60' are stressed to **59.5%** of capacity.

Based on a reaction comparison, the tower foundation is found to have adequate capacity for the proposed changes by T-Mobile.

Proposed and Final Configuration of T-MOBILE Appurtenances:

Maximums	Foundation Capacity*	Destek Analysis Reactions	Comparison
Tower Axial (kips)	473.0	110	23.3%
Tower Shear (kips)	100.5	35	34.8%
Tower Moment (kip*ft)	5314	2762	52.0%

* As reported by Maser Consulting P.A. in their report dated 04/20/2018

Therefore, the proposed additions and alterations by T-Mobile **can** be implemented as intended with the conditions outlined in this report.

Should you have any questions about this report, please contact us at (770) 693-0835.

**APPENDIX A
CALCULATIONS &
COAX LAYOUT**

Section	T1	T2	T3	T4	T5	T6	T7	20.1
Legs	SR 2 1/4		SR 2 3/4	SR 3	SR 3 1/4	Pirod 105218	Pirod 105219	20.1
Leg Grade			A572-50	A36				20.1
Diagonals	L1 3/4x1 3/4x1/8							20.1
Diagonal Grade								20.1
Top Girts	L3x3x3/8							20.1
Face Width (ft)								20.1
# Panels @ (ft)								20.1
Weight (K)								20.1

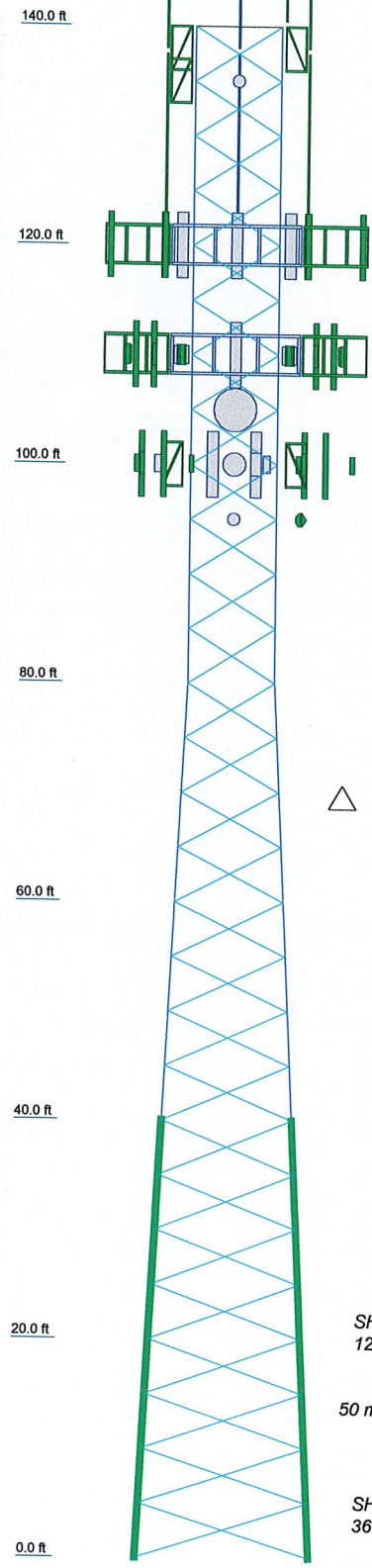

DESIGNED APPURTENANCE LOADING

TYPE	ELEVATION	TYPE	ELEVATION
Lightning Rod 2"x15'	138	800 10766	110
Omni 2"x7'	138	800 10766	110
Omni 2"x7'	138	(2) RRUS 11	110
Omni 2"x7'	138	(2) RRUS 11	110
3' Side Mount Standoff	138	(2) RRUS 11	110
3' Side Mount Standoff	138	(2) RRUS 32 W/O SOLAR SHIELD	110
3' Side Mount Standoff	138	(2) RRUS 32 W/O SOLAR SHIELD	110
3' Side Mount Standoff	135	(2) RRUS 32 W/O SOLAR SHIELD	110
Andrew VHLP1	135	DC6-48-60-18-8F	110
Omni 3"x20'	130	DC6-48-60-18-8F	110
Omni 3"x20'	130	DC6-48-60-18-8F	110
Omni 3"x20'	130	PIROD 12' T-Frame	110
AIR 21 B2A/B4P w/ Mount Pipe	120	PIROD 12' T-Frame	110
AIR 21 B2A/B4P w/ Mount Pipe	120	PIROD 12' T-Frame	110
Gen. TMA	120	HP4-102	105
Gen. TMA	120	Andrew-Commscope NNV-65B-R4 w/pipe	100
Gen. TMA	120	Andrew-Commscope NNV-65B-R4 w/pipe	100
AIR -32 B2A/B66AA w/ Mount Pipe	120	Andrew-Commscope NNV-65B-R4 w/pipe	100
AIR -32 B2A/B66AA w/ Mount Pipe	120	Andrew-Commscope NNV-65B-R4 w/pipe	100
AIR -32 B2A/B66AA w/ Mount Pipe	120	Andrew-Commscope NNV-65B-R4 w/pipe	100
APXVAARR24_43-U-NA20 w/ Mount Pipe	120	RRH4X45-19	100
APXVAARR24_43-U-NA20 w/ Mount Pipe	120	RRH4X45-19	100
APXVAARR24_43-U-NA20 w/ Mount Pipe	120	RRH4X45-19	100
APXVAARR24_43-U-NA20 w/ Mount Pipe	120	(2) FD-RRH-2x50-800	100
RADIO 4449 B12/B71	120	(2) FD-RRH-2x50-800	100
RADIO 4449 B12/B71	120	(2) Side Arm Mount [SO 101-1]	100
RADIO 4449 B12/B71	120	(2) Side Arm Mount [SO 101-1]	100
6'-P2x0.154	120	(2) Side Arm Mount [SO 101-1]	100
6'-P2x0.154	120	Nokia AAHC w/pipe	100
6'-P2x0.154	120	Nokia AAHC w/pipe	100
PIROD 12' T-Frame	120	Andrew VHLP2-11	100
PIROD 12' T-Frame	120	VHLP2-11	100
PIROD 12' T-Frame	120	Nokia AAHC w/pipe	100
AIR 21 B2A/B4P w/ Mount Pipe	120	Andrew VHLP1	95
800 10766	110	Andrew VHLP1	95

MATERIAL STRENGTH

GRADE	Fy	Fu	GRADE	Fy	Fu
A572-50	50 ksi	65 ksi	A36	36 ksi	58 ksi

TOWER DESIGN NOTES

1. Tower is located in Hartford County, Connecticut.
2. Tower designed for Exposure C to the TIA-222-G Standard.
3. Tower designed for a 97 mph basic wind in accordance with the TIA-222-G Standard.
4. Tower is also designed for a 50 mph basic wind with 1.00 in ice. Ice is considered to increase in thickness with height.
5. Deflections are based upon a 60 mph wind.
6. Tower Structure Class II.
7. Topographic Category 1 with Crest Height of 0.00 ft
8. TOWER RATING: 71%

UPLIFT: -183 K
SHEAR: 20 K

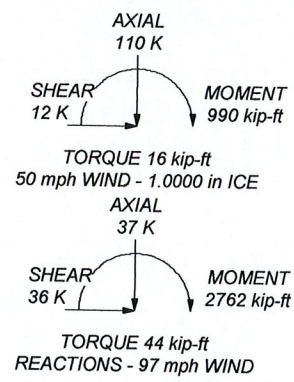

<p>Destek Engineering, LLC 1281 Kennestone Circle, Suite 100 Marietta, GA 30066 Phone: (770) 693 0835 FAX:</p>	Job: CT11737C
	Project: 1875038
Client: Fore Site LLC	Drawn by: Ahmet Colakoglu
Code: TIA-222-G	Date: 08/16/18
Path:	Scale: NTS
	Dwg No: E-1

tnxTower Destek Engineering, LLC 1281 Kennestone Circle, Suite 100 Marietta, GA 30066 Phone: (770) 693 0835 FAX:	Job CT11737C	Page 1 of 23
	Project 1875038	Date 10:30:32 08/16/18
	Client Fore Site LLC	Designed by Ahmet Colakoglu

Tower Input Data

The main tower is a 3x free standing tower with an overall height of 140.00 ft above the ground line.

The base of the tower is set at an elevation of 0.00 ft above the ground line.

The face width of the tower is 8.00 ft at the top and 16.00 ft at the base.

This tower is designed using the TIA-222-G standard.

The following design criteria apply:

Tower is located in Hartford County, Connecticut.

Basic wind speed of 97 mph.

Structure Class II.

Exposure Category C.

Topographic Category 1.

Crest Height 0.00 ft.

Nominal ice thickness of 1.0000 in.

Ice thickness is considered to increase with height.

Ice density of 56 pcf.

A wind speed of 50 mph is used in combination with ice.

Temperature drop of 50 °F.

Deflections calculated using a wind speed of 60 mph.

A non-linear (P-delta) analysis was used.

Pressures are calculated at each section.

Stress ratio used in tower member design is 1.

Local bending stresses due to climbing loads, feed line supports, and appurtenance mounts are not considered.

Options

- | | | |
|--|--|---|
| <ul style="list-style-type: none"> Consider Moments - Legs Consider Moments - Horizontals Consider Moments - Diagonals Use Moment Magnification √ Use Code Stress Ratios √ Use Code Safety Factors - Guys Escalate Ice Always Use Max Kz Use Special Wind Profile √ Include Bolts In Member Capacity Leg Bolts Are At Top Of Section √ Secondary Horizontal Braces Leg Use Diamond Inner Bracing (4 Sided) SR Members Have Cut Ends SR Members Are Concentric | <ul style="list-style-type: none"> Distribute Leg Loads As Uniform Assume Legs Pinned √ Assume Rigid Index Plate √ Use Clear Spans For Wind Area √ Use Clear Spans For KL/r Retension Guys To Initial Tension √ Bypass Mast Stability Checks √ Use Azimuth Dish Coefficients √ Project Wind Area of Appurt. Autocalc Torque Arm Areas Add IBC .6D+W Combination √ Sort Capacity Reports By Component Triangulate Diamond Inner Bracing Treat Feed Line Bundles As Cylinder | <ul style="list-style-type: none"> Use ASCE 10 X-Brace Ly Rules √ Calculate Redundant Bracing Forces Ignore Redundant Members in FEA √ SR Leg Bolts Resist Compression All Leg Panels Have Same Allowable Offset Girt At Foundation √ Consider Feed Line Torque √ Include Angle Block Shear Check Use TIA-222-G Bracing Resist. Exemption Use TIA-222-G Tension Splice Exemption Poles √ Include Shear-Torsion Interaction Always Use Sub-Critical Flow Use Top Mounted Sockets Pole Without Linear Attachments Pole With Shroud Or No Appurtenances Outside and Inside Corner Radii Are Known |
|--|--|---|

tnxTower Destek Engineering, LLC 1281 Kennestone Circle, Suite 100 Marietta, GA 30066 Phone: (770) 693 0835 FAX:	Job CT11737C	Page 2 of 23
	Project 1875038	Date 10:30:32 08/16/18
	Client Fore Site LLC	Designed by Ahmet Colakoglu

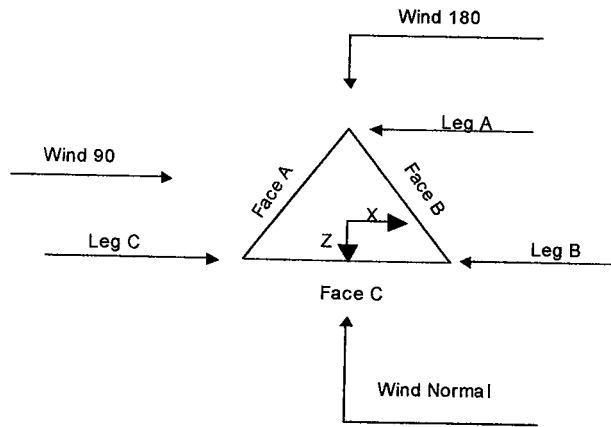

Triangular Tower

Tower Section Geometry

Tower Section	Tower Elevation	Assembly Database	Description	Section Width	Number of Sections	Section Length
	<i>ft</i>			<i>ft</i>		<i>ft</i>
T1	140.00-120.00			8.00	1	20.00
T2	120.00-100.00			8.00	1	20.00
T3	100.00-80.00			8.00	1	20.00
T4	80.00-60.00			8.00	1	20.00
T5	60.00-40.00			10.00	1	20.00
T6	40.00-20.00			12.00	1	20.00
T7	20.00-0.00			14.00	1	20.00

Tower Section Geometry (cont'd)

Tower Section	Tower Elevation	Diagonal Spacing	Bracing Type	Has K Brace End Panels	Has Horizontals	Top Girt Offset	Bottom Girt Offset
	<i>ft</i>	<i>ft</i>				<i>in</i>	<i>in</i>
T1	140.00-120.00	5.00	X Brace	No	No	0.0000	0.0000
T2	120.00-100.00	5.00	X Brace	No	No	0.0000	0.0000
T3	100.00-80.00	5.00	X Brace	No	No	0.0000	0.0000
T4	80.00-60.00	5.00	X Brace	No	No	0.0000	0.0000
T5	60.00-40.00	5.00	X Brace	No	No	0.0000	0.0000
T6	40.00-20.00	5.00	X Brace	No	No	0.0000	0.0000
T7	20.00-0.00	5.00	X Brace	No	No	0.0000	0.0000

tnxTower Destek Engineering, LLC 1281 Kennestone Circle, Suite 100 Marietta, GA 30066 Phone: (770) 693 0835 FAX:	Job CT11737C	Page 3 of 23
	Project 1875038	Date 10:30:32 08/16/18
	Client Fore Site LLC	Designed by Ahmet Colakoglu

Tower Section Geometry (cont'd)

Tower Elevation ft	Leg Type	Leg Size	Leg Grade	Diagonal Type	Diagonal Size	Diagonal Grade
T1 140.00-120.00	Solid Round	2 1/4	A572-50 (50 ksi)	Equal Angle	L1 3/4x1 3/4x1/8	A36 (36 ksi)
T2 120.00-100.00	Solid Round	2 1/4	A572-50 (50 ksi)	Equal Angle	L1 3/4x1 3/4x1/4	A36 (36 ksi)
T3 100.00-80.00	Solid Round	2 3/4	A572-50 (50 ksi)	Equal Angle	L 2.5 x 2.5 x 5/16	A36 (36 ksi)
T4 80.00-60.00	Solid Round	3	A572-50 (50 ksi)	Equal Angle	L 2.5 x 2.5 x 5/16	A36 (36 ksi)
T5 60.00-40.00	Solid Round	3 1/4	A572-50 (50 ksi)	Equal Angle	L 2.5 x 2.5 x 5/16	A36 (36 ksi)
T6 40.00-20.00	Truss Leg	Pirod 105218	A572-50 (50 ksi)	Equal Angle	L3x3x5/16	A36 (36 ksi)
T7 20.00-0.00	Truss Leg	Pirod 105219	A572-50 (50 ksi)	Equal Angle	L3x3x5/16	A36 (36 ksi)

Tower Section Geometry (cont'd)

Tower Elevation ft	Top Girt Type	Top Girt Size	Top Girt Grade	Bottom Girt Type	Bottom Girt Size	Bottom Girt Grade
T1 140.00-120.00	Equal Angle	L3x3x3/8	A36 (36 ksi)	Solid Round		A36 (36 ksi)

Tower Section Geometry (cont'd)

Tower Elevation ft	Secondary Horizontal Type	Secondary Horizontal Size	Secondary Horizontal Grade	Inner Bracing Type	Inner Bracing Size	Inner Bracing Grade
T1 140.00-120.00	Solid Round		A572-50 (50 ksi)	Solid Round	9/16	A572-50 (50 ksi)
T2 120.00-100.00	Solid Round		A572-50 (50 ksi)	Solid Round	9/16	A572-50 (50 ksi)
T3 100.00-80.00	Solid Round		A572-50 (50 ksi)	Solid Round	9/16	A572-50 (50 ksi)
T4 80.00-60.00	Solid Round		A572-50 (50 ksi)	Solid Round	9/16	A572-50 (50 ksi)
T5 60.00-40.00	Solid Round		A572-50 (50 ksi)	Solid Round	9/16	A572-50 (50 ksi)
T6 40.00-20.00	Solid Round		A572-50 (50 ksi)	Solid Round	9/16	A572-50 (50 ksi)
T7 20.00-0.00	Solid Round		A572-50 (50 ksi)	Solid Round	9/16	A572-50 (50 ksi)

tnxTower Destek Engineering, LLC 1281 Kennestone Circle, Suite 100 Marietta, GA 30066 Phone: (770) 693 0835 FAX:	Job	CT11737C	Page	5 of 23
	Project	1875038	Date	10:30:32 08/16/18
	Client	Fore Site LLC	Designed by	Ahmet Colakoglu

T6	1	0.5	0.85	1	0.5	0.85
40.00-20.00						
T7	1	0.5	0.85	1	0.5	0.85
20.00-0.00						

Tower Section Geometry (cont'd)

Tower Elevation ft	Leg		Diagonal		Top Girt		Bottom Girt		Mid Girt		Long Horizontal		Short Horizontal	
	Net Width Deduct in	U	Net Width Deduct in	U	Net Width Deduct in	U	Net Width Deduct in	U	Net Width Deduct in	U	Net Width Deduct in	U	Net Width Deduct in	U
T1 140.00-120.00	0.0000	1	0.0000	0.75	0.0000	0.75	0.0000	0.75	0.0000	0.75	0.0000	0.75	0.0000	0.75
T2 120.00-100.00	0.0000	1	0.0000	0.75	0.0000	0.75	0.0000	0.75	0.0000	0.75	0.0000	0.75	0.0000	0.75
T3 100.00-80.00	0.0000	1	0.0000	0.75	0.0000	0.75	0.0000	0.75	0.0000	0.75	0.0000	0.75	0.0000	0.75
T4 80.00-60.00	0.0000	1	0.0000	0.75	0.0000	0.75	0.0000	0.75	0.0000	0.75	0.0000	0.75	0.0000	0.75
T5 60.00-40.00	0.0000	1	0.0000	0.75	0.0000	0.75	0.0000	0.75	0.0000	0.75	0.0000	0.75	0.0000	0.75
T6 40.00-20.00	0.0000	1	0.0000	0.75	0.0000	0.75	0.0000	0.75	0.0000	0.75	0.0000	0.75	0.0000	0.75
T7 20.00-0.00	0.0000	1	0.0000	0.75	0.0000	0.75	0.0000	0.75	0.0000	0.75	0.0000	0.75	0.0000	0.75

Feed Line/Linear Appurtenances - Entered As Round Or Flat

Description	Face or Leg	Allow Shield	Component Type	Placement ft	Face Offset in	Lateral Offset (Frac FW)	#	# Per Row	Clear Spacing in	Width or Diameter in	Perimeter in	Weight plf
Feedline Ladder (Af) *****	C	No	Af (CaAa)	120.00 - 6.00	0.0000	0.45	1	1	0.0000	3.0000		8.40
LDF7-50A (1-5/8 FOAM)	C	No	Ar (CaAa)	120.00 - 6.00	-2.0000	0.44	6	3	0.0000	1.9800		0.82
1 5/8 Fiber Cable	C	No	Ar (CaAa)	120.00 - 6.00	-3.0000	0.46	1	1	0.0000	1.9800		1.04
1 5/8 Fiber Cable	C	No	Ar (CaAa)	120.00 - 6.00	-3.0000	0.47	1	1	0.0000	1.9800		1.04
3" conduit	C	No	Ar (CaAa)	100.00 - 6.00	-4.0000	0.47	3	3	0.0000	3.5000		3.00
VXL5-50 (7/8 FOAM)	C	No	Ar (CaAa)	140.00 - 6.00	-4.0000	0.44	7	4	0.0000	1.0800		0.29
RFS HYBRIFLEX 1 1/4	C	No	Ar (CaAa)	100.00 - 6.00	-2.0000	0.47	4	4	1.5400	1.5400		1.30
LDF4.5-50(5/ 8")	C	No	Ar (CaAa)	110.00 - 6.00	3.0000	0	6	6	0.8650	0.8650		0.15

Feed Line/Linear Appurtenances Section Areas

tnxTower Destek Engineering, LLC 1281 Kennestone Circle, Suite 100 Marietta, GA 30066 Phone: (770) 693 0835 FAX:	Job CT11737C	Page 6 of 23
	Project 1875038	Date 10:30:32 08/16/18
	Client Fore Site LLC	Designed by Ahmet Colakoglu

Tower Section	Tower Elevation ft	Face	A_R ft^2	A_F ft^2	$C_A A_A$ In Face ft^2	$C_A A_A$ Out Face ft^2	Weight K
T1	140.00-120.00	A	0.000	0.000	0.000	0.000	0.00
		B	0.000	0.000	0.000	0.000	0.00
		C	0.000	0.000	15.120	0.000	0.04
T2	120.00-100.00	A	0.000	0.000	0.000	0.000	0.00
		B	0.000	0.000	0.000	0.000	0.00
		C	0.000	0.000	61.990	0.000	0.36
T3	100.00-80.00	A	0.000	0.000	0.000	0.000	0.00
		B	0.000	0.000	0.000	0.000	0.00
		C	0.000	0.000	100.500	0.000	0.65
T4	80.00-60.00	A	0.000	0.000	0.000	0.000	0.00
		B	0.000	0.000	0.000	0.000	0.00
		C	0.000	0.000	100.500	0.000	0.65
T5	60.00-40.00	A	0.000	0.000	0.000	0.000	0.00
		B	0.000	0.000	0.000	0.000	0.00
		C	0.000	0.000	100.500	0.000	0.65
T6	40.00-20.00	A	0.000	0.000	0.000	0.000	0.00
		B	0.000	0.000	0.000	0.000	0.00
		C	0.000	0.000	100.500	0.000	0.65
T7	20.00-0.00	A	0.000	0.000	0.000	0.000	0.00
		B	0.000	0.000	0.000	0.000	0.00
		C	0.000	0.000	70.350	0.000	0.46

Feed Line/Linear Appurtenances Section Areas - With Ice

Tower Section	Tower Elevation ft	Face or Leg	Ice Thickness in	A_R ft^2	A_F ft^2	$C_A A_A$ In Face ft^2	$C_A A_A$ Out Face ft^2	Weight K
T1	140.00-120.00	A	2.294	0.000	0.000	0.000	0.000	0.00
		B		0.000	0.000	0.000	0.000	0.00
		C		0.000	0.000	27.938	0.000	0.38
T2	120.00-100.00	A	2.256	0.000	0.000	0.000	0.000	0.00
		B		0.000	0.000	0.000	0.000	0.00
		C		0.000	0.000	125.075	0.000	2.25
T3	100.00-80.00	A	2.211	0.000	0.000	0.000	0.000	0.00
		B		0.000	0.000	0.000	0.000	0.00
		C		0.000	0.000	225.457	0.000	3.92
T4	80.00-60.00	A	2.156	0.000	0.000	0.000	0.000	0.00
		B		0.000	0.000	0.000	0.000	0.00
		C		0.000	0.000	222.948	0.000	3.82
T5	60.00-40.00	A	2.085	0.000	0.000	0.000	0.000	0.00
		B		0.000	0.000	0.000	0.000	0.00
		C		0.000	0.000	219.690	0.000	3.69
T6	40.00-20.00	A	1.981	0.000	0.000	0.000	0.000	0.00
		B		0.000	0.000	0.000	0.000	0.00
		C		0.000	0.000	214.954	0.000	3.51
T7	20.00-0.00	A	1.775	0.000	0.000	0.000	0.000	0.00
		B		0.000	0.000	0.000	0.000	0.00
		C		0.000	0.000	143.901	0.000	2.21

Feed Line Center of Pressure

Section	Elevation ft	CP_x in	CP_z in	CP_x Ice in	CP_z Ice in

tnxTower Destek Engineering, LLC 1281 Kennestone Circle, Suite 100 Marietta, GA 30066 Phone: (770) 693 0835 FAX:	Job CT11737C	Page 7 of 23
	Project 1875038	Date 10:30:32 08/16/18
	Client Fore Site LLC	Designed by Ahmet Colakoglu

Section	Elevation	CP _x	CP _z	CP _x	CP _z
	ft	in	in	Ice in	Ice in
T1	140.00-120.00	-4.9644	1.6550	-5.0868	2.3136
T2	120.00-100.00	-14.3634	8.6684	-14.7009	10.2925
T3	100.00-80.00	-18.6692	9.3809	-20.4414	12.4980
T4	80.00-60.00	-20.0431	10.0415	-22.2413	13.5538
T5	60.00-40.00	-22.5734	11.2552	-25.5389	15.4481
T6	40.00-20.00	-21.0519	9.9116	-21.7475	12.2054
T7	20.00-0.00	-17.1204	7.7110	-19.2927	10.1996

Shielding Factor Ka

Tower Section	Feed Line Record No.	Description	Feed Line Segment Elev.	K _a No Ice	K _a Ice
T1	7	VXL5-50 (7/8 FOAM)	120.00 - 140.00	0.6000	0.6000
T2	1	Feedline Ladder (Af)	100.00 - 120.00	0.6000	0.6000
T2	3	LDF7-50A (1-5/8 FOAM)	100.00 - 120.00	0.6000	0.6000
T2	4	1 5/8 Fiber Cable	100.00 - 120.00	0.6000	0.6000
T2	5	1 5/8 Fiber Cable	100.00 - 120.00	0.6000	0.6000
T2	7	VXL5-50 (7/8 FOAM)	100.00 - 120.00	0.6000	0.6000
T2	9	LDF4.5-50(5/8")	100.00 - 110.00	1.0000	1.0000
T3	1	Feedline Ladder (Af)	80.00 - 100.00	0.6000	0.6000
T3	3	LDF7-50A (1-5/8 FOAM)	80.00 - 100.00	0.6000	0.6000
T3	4	1 5/8 Fiber Cable	80.00 - 100.00	0.6000	0.6000
T3	5	1 5/8 Fiber Cable	80.00 - 100.00	0.6000	0.6000
T3	6	3" conduit	80.00 - 100.00	0.6000	0.6000
T3	7	VXL5-50 (7/8 FOAM)	80.00 - 100.00	0.6000	0.6000
T3	8	RFS HYBRIFLEX 1 1/4	80.00 - 100.00	1.0000	1.0000
T3	9	LDF4.5-50(5/8")	80.00 - 100.00	1.0000	1.0000
T4	1	Feedline Ladder (Af)	60.00 - 80.00	0.6000	0.6000
T4	3	LDF7-50A (1-5/8 FOAM)	60.00 - 80.00	0.6000	0.6000
T4	4	1 5/8 Fiber Cable	60.00 - 80.00	0.6000	0.6000
T4	5	1 5/8 Fiber Cable	60.00 - 80.00	0.6000	0.6000
T4	6	3" conduit	60.00 - 80.00	0.6000	0.6000
T4	7	VXL5-50 (7/8 FOAM)	60.00 - 80.00	0.6000	0.6000
T4	8	RFS HYBRIFLEX 1 1/4	60.00 - 80.00	1.0000	1.0000
T4	9	LDF4.5-50(5/8")	60.00 - 80.00	1.0000	1.0000
T5	1	Feedline Ladder (Af)	40.00 - 60.00	0.6000	0.6000
T5	3	LDF7-50A (1-5/8 FOAM)	40.00 - 60.00	0.6000	0.6000
T5	4	1 5/8 Fiber Cable	40.00 - 60.00	0.6000	0.6000
T5	5	1 5/8 Fiber Cable	40.00 - 60.00	0.6000	0.6000
T5	6	3" conduit	40.00 - 60.00	0.6000	0.6000
T5	7	VXL5-50 (7/8 FOAM)	40.00 - 60.00	0.6000	0.6000
T5	8	RFS HYBRIFLEX 1 1/4	40.00 - 60.00	1.0000	1.0000
T5	9	LDF4.5-50(5/8")	40.00 - 60.00	1.0000	1.0000
T6	1	Feedline Ladder (Af)	20.00 - 40.00	0.6000	0.5178
T6	3	LDF7-50A (1-5/8 FOAM)	20.00 - 40.00	0.6000	0.5178
T6	4	1 5/8 Fiber Cable	20.00 - 40.00	0.6000	0.5178
T6	5	1 5/8 Fiber Cable	20.00 - 40.00	0.6000	0.5178
T6	6	3" conduit	20.00 - 40.00	0.6000	0.5178

tnxTower Destek Engineering, LLC 1281 Kennestone Circle, Suite 100 Marietta, GA 30066 Phone: (770) 693 0835 FAX:	Job CT11737C	Page 8 of 23
	Project 1875038	Date 10:30:32 08/16/18
	Client Fore Site LLC	Designed by Ahmet Colakoglu

Tower Section	Feed Line Record No.	Description	Feed Line Segment Elev.	K _a No Ice	K _a Ice
T6	7	VXL5-50 (7/8 FOAM)	20.00 - 40.00	0.6000	0.5178
T6	8	RFS HYBRIFLEX 1 1/4	20.00 - 40.00	1.0000	1.0000
T6	9	LDF4.5-50(5/8")	20.00 - 40.00	1.0000	1.0000
T7	1	Feedline Ladder (Af)	6.00 - 20.00	0.6000	0.5668
T7	3	LDF7-50A (1-5/8 FOAM)	6.00 - 20.00	0.6000	0.5668
T7	4	1 5/8 Fiber Cable	6.00 - 20.00	0.6000	0.5668
T7	5	1 5/8 Fiber Cable	6.00 - 20.00	0.6000	0.5668
T7	6	3" conduit	6.00 - 20.00	0.6000	0.5668
T7	7	VXL5-50 (7/8 FOAM)	6.00 - 20.00	0.6000	0.5668
T7	8	RFS HYBRIFLEX 1 1/4	6.00 - 20.00	1.0000	1.0000
T7	9	LDF4.5-50(5/8")	6.00 - 20.00	1.0000	1.0000

Discrete Tower Loads

Description	Face or Leg	Offset Type	Offsets:		Azimuth Adjustment	Placement	C _{AA} Front	C _{AA} Side	Weight
			Horz Lateral	Vert					
			ft	ft	°	ft	ft ²	ft ²	K

Lightning Rod 2"x15'	B	From Leg	0.50	0.0000	138.00	No Ice	3.00	3.00	0.08
			0.00			1/2" Ice	4.53	4.53	0.10
			7.50			1" Ice	6.06	6.06	0.13
138ft									
Omni 2"x7'	A	From Leg	3.00	0.0000	138.00	No Ice	1.40	1.40	0.03
			0.00			1/2" Ice	2.13	2.13	0.04
			5.00			1" Ice	2.86	2.86	0.05
Omni 2"x7'	B	From Leg	3.00	0.0000	138.00	No Ice	1.40	1.40	0.03
			0.00			1/2" Ice	2.13	2.13	0.04
			5.00			1" Ice	2.86	2.86	0.05
Omni 2"x7'	C	From Leg	3.00	0.0000	138.00	No Ice	1.40	1.40	0.03
			0.00			1/2" Ice	2.13	2.13	0.04
			5.00			1" Ice	2.86	2.86	0.05
3' Side Mount Standoff	A	From Leg	1.50	0.0000	138.00	No Ice	1.50	1.50	0.04
			0.00			1/2" Ice	2.20	2.20	0.07
			0.00			1" Ice	2.90	2.90	0.10
3' Side Mount Standoff	B	From Leg	1.50	0.0000	138.00	No Ice	1.50	1.50	0.04
			0.00			1/2" Ice	2.20	2.20	0.07
			0.00			1" Ice	2.90	2.90	0.10
3' Side Mount Standoff	C	From Leg	1.50	0.0000	138.00	No Ice	1.50	1.50	0.04
			0.00			1/2" Ice	2.20	2.20	0.07
			0.00			1" Ice	2.90	2.90	0.10
135ft									
3' Side Mount Standoff	C	From Leg	1.50	0.0000	135.00	No Ice	1.50	1.50	0.04
			0.00			1/2" Ice	2.20	2.20	0.07
			0.00			1" Ice	2.90	2.90	0.10
130ft									
Omni 3"x20'	A	From Leg	3.00	0.0000	130.00	No Ice	6.00	6.00	0.05
			0.00			1/2" Ice	8.03	8.03	0.09
			0.00			1" Ice	10.06	10.06	0.14
Omni 3"x20'	B	From Leg	3.00	0.0000	130.00	No Ice	6.00	6.00	0.05
			0.00			1/2" Ice	8.03	8.03	0.09
			0.00			1" Ice	10.06	10.06	0.14

tnxTower Destek Engineering, LLC 1281 Kennestone Circle, Suite 100 Marietta, GA 30066 Phone: (770) 693 0835 FAX:	Job	CT11737C	Page	9 of 23
	Project	1875038	Date	10:30:32 08/16/18
	Client	Fore Site LLC	Designed by	Ahmet Colakoglu

Description	Face or Leg	Offset Type	Offsets:		Azimuth Adjustment	Placement	C _{AA} Front	C _{AA} Side	Weight
			Horz	Lateral					
Omni 3"x20'	C	From Leg	3.00	0.0000	130.00	No Ice	6.00	6.00	0.05
			0.00			1/2" Ice	8.03	8.03	0.09
			0.00			1" Ice	10.06	10.06	0.14
120ft T Mobile									
AIR 21 B2A/B4P w/ Mount Pipe	A	From Leg	3.00	0.0000	120.00	No Ice	6.16	5.55	0.10
			0.00			1/2" Ice	6.60	6.30	0.16
			0.00			1" Ice	7.03	7.00	0.22
AIR 21 B2A/B4P w/ Mount Pipe	B	From Leg	3.00	0.0000	120.00	No Ice	6.16	5.55	0.10
			0.00			1/2" Ice	6.60	6.30	0.16
			0.00			1" Ice	7.03	7.00	0.22
AIR 21 B2A/B4P w/ Mount Pipe	C	From Leg	3.00	0.0000	120.00	No Ice	6.16	5.55	0.10
			0.00			1/2" Ice	6.60	6.30	0.16
			0.00			1" Ice	7.03	7.00	0.22
Gen. TMA	A	From Leg	3.00	0.0000	120.00	No Ice	0.68	0.45	0.01
			0.00			1/2" Ice	0.80	0.56	0.02
			0.00			1" Ice	0.92	0.67	0.02
Gen. TMA	B	From Leg	3.00	0.0000	120.00	No Ice	0.68	0.45	0.01
			0.00			1/2" Ice	0.80	0.56	0.02
			0.00			1" Ice	0.92	0.67	0.02
Gen. TMA	C	From Leg	3.00	0.0000	120.00	No Ice	0.68	0.45	0.01
			0.00			1/2" Ice	0.80	0.56	0.02
			0.00			1" Ice	0.92	0.67	0.02
AIR -32 B2A/B66AA w/ Mount Pipe	A	From Leg	3.00	0.0000	120.00	No Ice	6.75	6.07	0.15
			0.00			1/2" Ice	7.20	6.87	0.21
			0.00			1" Ice	7.65	7.58	0.28
AIR -32 B2A/B66AA w/ Mount Pipe	B	From Leg	3.00	0.0000	120.00	No Ice	6.75	6.07	0.15
			0.00			1/2" Ice	7.20	6.87	0.21
			0.00			1" Ice	7.65	7.58	0.28
AIR -32 B2A/B66AA w/ Mount Pipe	C	From Leg	3.00	0.0000	120.00	No Ice	6.75	6.07	0.15
			0.00			1/2" Ice	7.20	6.87	0.21
			0.00			1" Ice	7.65	7.58	0.28
APXVAARR24_43-U-NA20 w/ Mount Pipe	A	From Leg	3.00	0.0000	120.00	No Ice	20.48	11.02	0.16
			0.00			1/2" Ice	21.23	12.55	0.30
			0.00			1" Ice	21.99	14.10	0.44
APXVAARR24_43-U-NA20 w/ Mount Pipe	B	From Leg	3.00	0.0000	120.00	No Ice	20.48	11.02	0.16
			0.00			1/2" Ice	21.23	12.55	0.30
			0.00			1" Ice	21.99	14.10	0.44
APXVAARR24_43-U-NA20 w/ Mount Pipe	C	From Leg	3.00	0.0000	120.00	No Ice	20.48	11.02	0.16
			0.00			1/2" Ice	21.23	12.55	0.30
			0.00			1" Ice	21.99	14.10	0.44
RADIO 4449 B12/B71	A	From Leg	3.00	0.0000	120.00	No Ice	1.65	1.30	0.08
			0.00			1/2" Ice	1.81	1.44	0.09
			0.00			1" Ice	1.98	1.60	0.11
RADIO 4449 B12/B71	B	From Leg	3.00	0.0000	120.00	No Ice	1.65	1.30	0.08
			0.00			1/2" Ice	1.81	1.44	0.09
			0.00			1" Ice	1.98	1.60	0.11
RADIO 4449 B12/B71	C	From Leg	3.00	0.0000	120.00	No Ice	1.65	1.30	0.08
			0.00			1/2" Ice	1.81	1.44	0.09
			0.00			1" Ice	1.98	1.60	0.11
6'-P2x0.154	A	From Leg	3.00	0.0000	120.00	No Ice	1.43	1.43	0.02
			0.00			1/2" Ice	1.92	1.92	0.03
			0.00			1" Ice	2.29	2.29	0.05
6'-P2x0.154	B	From Leg	3.00	0.0000	120.00	No Ice	1.43	1.43	0.02
			0.00			1/2" Ice	1.92	1.92	0.03
			0.00			1" Ice	2.29	2.29	0.05
6'-P2x0.154	C	From Leg	3.00	0.0000	120.00	No Ice	1.43	1.43	0.02
			0.00			1/2" Ice	1.92	1.92	0.03
			0.00			1" Ice	2.29	2.29	0.05

tnxTower Destek Engineering, LLC 1281 Kennestone Circle, Suite 100 Marietta, GA 30066 Phone: (770) 693 0835 FAX:	Job	CT11737C	Page	10 of 23
	Project	1875038	Date	10:30:32 08/16/18
	Client	Fore Site LLC	Designed by	Ahmet Colakoglu

Description	Face or Leg	Offset Type	Offsets:		Azimuth Adjustment	Placement	C _{AA}		Weight	
			Horz	Lateral			Front	Side		
			ft	ft	°	ft	ft ²	ft ²	K	
PiROD 12' T-Frame	A	From Leg	0.00		0.0000	120.00	1" Ice	2.29	2.29	0.05
			3.00				No Ice	12.20	12.20	0.36
			0.00				1/2" Ice	17.60	17.60	0.49
PiROD 12' T-Frame	B	From Leg	0.00		0.0000	120.00	1" Ice	23.00	23.00	0.62
			3.00				No Ice	12.20	12.20	0.36
			0.00				1/2" Ice	17.60	17.60	0.49
PiROD 12' T-Frame	C	From Leg	0.00		0.0000	120.00	1" Ice	23.00	23.00	0.62
			3.00				No Ice	12.20	12.20	0.36
			0.00				1/2" Ice	17.60	17.60	0.49
100ft			0.00				1" Ice	23.00	23.00	0.62
Nokia AAHC w/pipe	A	From Leg	4.00		0.0000	100.00	No Ice	4.39	2.73	0.12
			2.00				1/2" Ice	4.70	3.11	0.16
			0.00				1" Ice	5.02	3.51	0.21
Nokia AAHC w/pipe	B	From Leg	4.00		0.0000	100.00	No Ice	4.39	2.73	0.12
			2.00				1/2" Ice	4.70	3.11	0.16
			0.00				1" Ice	5.02	3.51	0.21
Nokia AAHC w/pipe	C	From Leg	4.00		0.0000	100.00	No Ice	4.39	2.73	0.12
			2.00				1/2" Ice	4.70	3.11	0.16
			0.00				1" Ice	5.02	3.51	0.21
Andrew-Commscope NNV-65B-R4 w/pipe	A	From Leg	4.00		0.0000	100.00	No Ice	12.56	7.76	0.13
			-2.00				1/2" Ice	13.14	8.80	0.23
			0.00				1" Ice	13.70	9.69	0.33
Andrew-Commscope NNV-65B-R4 w/pipe	B	From Leg	4.00		0.0000	100.00	No Ice	12.56	7.76	0.13
			-2.00				1/2" Ice	13.14	8.80	0.23
			0.00				1" Ice	13.70	9.69	0.33
Andrew-Commscope NNV-65B-R4 w/pipe	C	From Leg	4.00		0.0000	100.00	No Ice	12.56	7.76	0.13
			-2.00				1/2" Ice	13.14	8.80	0.23
			0.00				1" Ice	13.70	9.69	0.33
RRH4X45-19	A	From Leg	4.00		0.0000	100.00	No Ice	2.31	2.38	0.06
			2.00				1/2" Ice	2.52	2.58	0.08
			0.00				1" Ice	2.73	2.79	0.11
RRH4X45-19	B	From Leg	4.00		0.0000	100.00	No Ice	2.31	2.38	0.06
			2.00				1/2" Ice	2.52	2.58	0.08
			0.00				1" Ice	2.73	2.79	0.11
RRH4X45-19	C	From Leg	4.00		0.0000	100.00	No Ice	2.31	2.38	0.06
			2.00				1/2" Ice	2.52	2.58	0.08
			0.00				1" Ice	2.73	2.79	0.11
(2) FD-RRH-2x50-800	A	From Leg	4.00		0.0000	100.00	No Ice	1.36	3.01	0.05
			-2.00				1/2" Ice	1.52	3.22	0.08
			0.00				1" Ice	1.68	3.45	0.10
(2) FD-RRH-2x50-800	B	From Leg	4.00		0.0000	100.00	No Ice	1.36	3.01	0.05
			-2.00				1/2" Ice	1.52	3.22	0.08
			0.00				1" Ice	1.68	3.45	0.10
(2) FD-RRH-2x50-800	C	From Leg	4.00		0.0000	100.00	No Ice	1.36	3.01	0.05
			-2.00				1/2" Ice	1.52	3.22	0.08
			0.00				1" Ice	1.68	3.45	0.10
(2) Side Arm Mount [SO 101-1]	A	From Leg	2.00		0.0000	100.00	No Ice	3.75	1.28	0.08
			0.00				1/2" Ice	4.45	1.39	0.11
			0.00				1" Ice	5.15	1.50	0.14
(2) Side Arm Mount [SO 101-1]	B	From Leg	2.00		0.0000	100.00	No Ice	3.75	1.28	0.08
			0.00				1/2" Ice	4.45	1.39	0.11
			0.00				1" Ice	5.15	1.50	0.14
(2) Side Arm Mount [SO 101-1]	C	From Leg	2.00		0.0000	100.00	No Ice	3.75	1.28	0.08
			0.00				1/2" Ice	4.45	1.39	0.11
			0.00				1" Ice	5.15	1.50	0.14
110ft			0.00				1" Ice	5.15	1.50	0.14

tnxTower Destek Engineering, LLC 1281 Kennestone Circle, Suite 100 Marietta, GA 30066 Phone: (770) 693 0835 FAX:	Job CT11737C	Page 11 of 23
	Project 1875038	Date 10:30:32 08/16/18
	Client Fore Site LLC	Designed by Ahmet Colakoglu

Description	Face or Leg	Offset Type	Offsets:		Azimuth Adjustment	Placement	C _{AA} Front	C _{AA} Side	Weight
			Horz	Vert					
			ft	ft	°	ft	ft ²	ft ²	K
800 10766	A	From Leg	4.00	0.0000	110.00	No Ice	11.31	6.80	0.06
			0.00			1/2" Ice	11.93	7.38	0.12
			0.00			1" Ice	12.55	7.98	0.19
800 10766	B	From Leg	4.00	0.0000	110.00	No Ice	11.31	6.80	0.06
			0.00			1/2" Ice	11.93	7.38	0.12
			0.00			1" Ice	12.55	7.98	0.19
800 10766	C	From Leg	4.00	0.0000	110.00	No Ice	11.31	6.80	0.06
			0.00			1/2" Ice	11.93	7.38	0.12
			0.00			1" Ice	12.55	7.98	0.19
(2) RRUS 11	A	From Leg	4.00	0.0000	110.00	No Ice	2.78	1.19	0.05
			0.00			1/2" Ice	2.99	1.33	0.07
			0.00			1" Ice	3.21	1.49	0.10
(2) RRUS 11	B	From Leg	4.00	0.0000	110.00	No Ice	2.78	1.19	0.05
			0.00			1/2" Ice	2.99	1.33	0.07
			0.00			1" Ice	3.21	1.49	0.10
(2) RRUS 11	C	From Leg	4.00	0.0000	110.00	No Ice	2.78	1.19	0.05
			0.00			1/2" Ice	2.99	1.33	0.07
			0.00			1" Ice	3.21	1.49	0.10
(2) RRUS 32 W/O SOLAR SHIELD	A	From Leg	4.00	0.0000	110.00	No Ice	2.08	1.25	0.05
			0.00			1/2" Ice	2.27	1.41	0.06
			0.00			1" Ice	2.47	1.58	0.08
(2) RRUS 32 W/O SOLAR SHIELD	B	From Leg	4.00	0.0000	110.00	No Ice	2.08	1.25	0.05
			0.00			1/2" Ice	2.27	1.41	0.06
			0.00			1" Ice	2.47	1.58	0.08
(2) RRUS 32 W/O SOLAR SHIELD	C	From Leg	4.00	0.0000	110.00	No Ice	2.08	1.25	0.05
			0.00			1/2" Ice	2.27	1.41	0.06
			0.00			1" Ice	2.47	1.58	0.08
DC6-48-60-18-8F	A	From Leg	4.00	0.0000	110.00	No Ice	2.20	2.20	0.02
			0.00			1/2" Ice	2.40	2.40	0.04
			0.00			1" Ice	2.60	2.60	0.07
DC6-48-60-18-8F	B	From Leg	4.00	0.0000	110.00	No Ice	2.20	2.20	0.02
			0.00			1/2" Ice	2.40	2.40	0.04
			0.00			1" Ice	2.60	2.60	0.07
DC6-48-60-18-8F	C	From Leg	4.00	0.0000	110.00	No Ice	2.20	2.20	0.02
			0.00			1/2" Ice	2.40	2.40	0.04
			0.00			1" Ice	2.60	2.60	0.07
PiROD 12' T-Frame	A	From Leg	2.00	0.0000	110.00	No Ice	12.20	12.20	0.36
			0.00			1/2" Ice	17.60	17.60	0.49
			0.00			1" Ice	23.00	23.00	0.62
PiROD 12' T-Frame	B	From Leg	2.00	0.0000	110.00	No Ice	12.20	12.20	0.36
			0.00			1/2" Ice	17.60	17.60	0.49
			0.00			1" Ice	23.00	23.00	0.62
PiROD 12' T-Frame	C	From Leg	2.00	0.0000	110.00	No Ice	12.20	12.20	0.36
			0.00			1/2" Ice	17.60	17.60	0.49
			0.00			1" Ice	23.00	23.00	0.62

Dishes

tnxTower Destek Engineering, LLC 1281 Kennestone Circle, Suite 100 Marietta, GA 30066 Phone: (770) 693 0835 FAX:	Job CT11737C	Page 12 of 23
	Project 1875038	Date 10:30:32 08/16/18
	Client Fore Site LLC	Designed by Ahmet Colakoglu

Description	Face or Leg	Dish Type	Offset Type	Offsets: Horz Lateral Vert	Azimuth Adjustment	3 dB Beam Width	Elevation	Outside Diameter	Aperture Area	Weight	
				ft	°	°	ft	ft	ft ²	K	

135ft											
Andrew VHLP1	A	Paraboloid w/Radome	From Leg	2.00 0.00 0.00	0.0000		135.00	1.25	No Ice 1/2" Ice 1" Ice	1.23 1.40 1.57	0.01 0.03 0.04
100ft											
Andrew VHLP2-11	A	Paraboloid w/Radome	From Leg	4.00 0.00 0.00	0.0000		100.00	2.00	No Ice 1/2" Ice 1" Ice	3.14 3.41 3.68	0.05 0.07 0.09
95ft											
Andrew VHLP1	A	Paraboloid w/Radome	From Leg	2.00 0.00 0.00	0.0000		95.00	1.25	No Ice 1/2" Ice 1" Ice	1.23 1.40 1.57	0.01 0.03 0.04
95ft											
Andrew VHLP1	B	Paraboloid w/Radome	From Leg	2.00 0.00 0.00	0.0000		95.00	1.25	No Ice 1/2" Ice 1" Ice	1.23 1.40 1.57	0.01 0.03 0.04
100ft											
VHLP2-11	A	Paraboloid w/o Radome	From Leg	2.00 0.00 0.00	0.0000		100.00	2.17	No Ice 1/2" Ice 1" Ice	3.72 4.01 4.30	0.03 0.05 0.07
105											
HP4-102	A	Paraboloid w/Shroud (HP)	From Leg	3.00 0.00 0.00	0.0000		105.00	4.00	No Ice 1/2" Ice 1" Ice	12.57 13.10 13.62	0.08 0.10 0.20

Truss-Leg Properties

Section Designation	Area	Area Ice	Self Weight	Ice Weight	Equiv. Diameter	Equiv. Diameter Ice	Leg Area
	in ²	in ²	K	K	in	in	in ²
Pirod 105218	2263.4687	6856.2743	0.72	1.49	7.8593	23.8065	7.2158
Pirod 105219	2441.8688	6746.0737	0.90	1.29	8.4787	23.4239	9.4248

Load Combinations

Comb. No.	Description
1	Dead Only
2	1.2 Dead+1.6 Wind 0 deg - No Ice
3	0.9 Dead+1.6 Wind 0 deg - No Ice
4	1.2 Dead+1.6 Wind 30 deg - No Ice
5	0.9 Dead+1.6 Wind 30 deg - No Ice
6	1.2 Dead+1.6 Wind 60 deg - No Ice
7	0.9 Dead+1.6 Wind 60 deg - No Ice
8	1.2 Dead+1.6 Wind 90 deg - No Ice
9	0.9 Dead+1.6 Wind 90 deg - No Ice
10	1.2 Dead+1.6 Wind 120 deg - No Ice
11	0.9 Dead+1.6 Wind 120 deg - No Ice
12	1.2 Dead+1.6 Wind 150 deg - No Ice
13	0.9 Dead+1.6 Wind 150 deg - No Ice
14	1.2 Dead+1.6 Wind 180 deg - No Ice

tnxTower Destek Engineering, LLC 1281 Kennestone Circle, Suite 100 Marietta, GA 30066 Phone: (770) 693 0835 FAX:	Job CT11737C	Page 13 of 23
	Project 1875038	Date 10:30:32 08/16/18
	Client Fore Site LLC	Designed by Ahmet Colakoglu

Comb. No.	Description
15	0.9 Dead+1.6 Wind 180 deg - No Ice
16	1.2 Dead+1.6 Wind 210 deg - No Ice
17	0.9 Dead+1.6 Wind 210 deg - No Ice
18	1.2 Dead+1.6 Wind 240 deg - No Ice
19	0.9 Dead+1.6 Wind 240 deg - No Ice
20	1.2 Dead+1.6 Wind 270 deg - No Ice
21	0.9 Dead+1.6 Wind 270 deg - No Ice
22	1.2 Dead+1.6 Wind 300 deg - No Ice
23	0.9 Dead+1.6 Wind 300 deg - No Ice
24	1.2 Dead+1.6 Wind 330 deg - No Ice
25	0.9 Dead+1.6 Wind 330 deg - No Ice
26	1.2 Dead+1.0 Ice+1.0 Temp
27	1.2 Dead+1.0 Wind 0 deg+1.0 Ice+1.0 Temp
28	1.2 Dead+1.0 Wind 30 deg+1.0 Ice+1.0 Temp
29	1.2 Dead+1.0 Wind 60 deg+1.0 Ice+1.0 Temp
30	1.2 Dead+1.0 Wind 90 deg+1.0 Ice+1.0 Temp
31	1.2 Dead+1.0 Wind 120 deg+1.0 Ice+1.0 Temp
32	1.2 Dead+1.0 Wind 150 deg+1.0 Ice+1.0 Temp
33	1.2 Dead+1.0 Wind 180 deg+1.0 Ice+1.0 Temp
34	1.2 Dead+1.0 Wind 210 deg+1.0 Ice+1.0 Temp
35	1.2 Dead+1.0 Wind 240 deg+1.0 Ice+1.0 Temp
36	1.2 Dead+1.0 Wind 270 deg+1.0 Ice+1.0 Temp
37	1.2 Dead+1.0 Wind 300 deg+1.0 Ice+1.0 Temp
38	1.2 Dead+1.0 Wind 330 deg+1.0 Ice+1.0 Temp
39	Dead+Wind 0 deg - Service
40	Dead+Wind 30 deg - Service
41	Dead+Wind 60 deg - Service
42	Dead+Wind 90 deg - Service
43	Dead+Wind 120 deg - Service
44	Dead+Wind 150 deg - Service
45	Dead+Wind 180 deg - Service
46	Dead+Wind 210 deg - Service
47	Dead+Wind 240 deg - Service
48	Dead+Wind 270 deg - Service
49	Dead+Wind 300 deg - Service
50	Dead+Wind 330 deg - Service

Maximum Member Forces

Section No.	Elevation ft	Component Type	Condition	Gov. Load Comb.	Axial K	Major Axis Moment kip-ft	Minor Axis Moment kip-ft
T1	140 - 120	Leg	Max Tension	15	3.23	0.00	0.02
			Max. Compression	2	-4.60	-0.02	0.09
			Max. Mx	20	-0.63	-0.20	0.01
			Max. My	2	-0.13	-0.03	-0.18
			Max. Vy	20	0.20	0.00	-0.06
			Max. Vx	2	0.22	-0.01	0.04
		Diagonal	Max Tension	14	1.22	0.00	0.00
			Max. Compression	2	-1.32	0.00	0.00
			Max. Mx	37	-0.16	0.04	-0.00
			Max. My	24	-1.00	0.00	0.00
			Max. Vy	37	-0.04	0.04	-0.00
			Max. Vx	24	-0.00	0.00	0.00
		Top Girt	Max Tension	19	0.18	0.00	0.00
			Max. Compression	22	-0.22	0.00	0.00
			Max. Mx	26	-0.08	-0.22	0.00
			Max. My	12	-0.01	0.00	0.00
			Max. Vy	26	-0.11	0.00	0.00

tnxTower Destek Engineering, LLC 1281 Kennestone Circle, Suite 100 Marietta, GA 30066 Phone: (770) 693 0835 FAX:	Job	CT11737C	Page	14 of 23
	Project	1875038	Date	10:30:32 08/16/18
	Client	Fore Site LLC	Designed by	Ahmet Colakoglu

Section No.	Elevation ft	Component Type	Condition	Gov. Load Comb.	Axial K	Major Axis Moment kip-ft	Minor Axis Moment kip-ft
T2	120 - 100	Leg	Max. Vx	12	0.00	0.00	0.00
			Max Tension	15	25.44	0.02	0.04
			Max. Compression	2	-32.07	-0.03	0.15
			Max. Mx	20	-1.82	0.23	-0.01
			Max. My	24	-2.04	0.13	0.25
			Max. Vy	20	1.32	0.02	-0.12
		Diagonal	Max. Vx	2	1.35	-0.02	0.09
			Max Tension	16	4.98	0.00	0.00
			Max. Compression	16	-4.97	0.00	0.00
			Max. Mx	34	0.80	0.05	-0.00
			Max. My	20	-4.25	0.01	0.01
			Max. Vy	34	-0.04	0.05	-0.00
			Max. Vx	20	-0.00	0.01	0.01
			Max Tension	15	69.90	0.04	0.02
T3	100 - 80	Leg	Max. Compression	2	-80.86	-0.07	0.27
			Max. Mx	20	-4.76	0.32	-0.04
			Max. My	24	-5.12	0.16	0.36
			Max. Vy	20	0.77	0.07	-0.13
			Max. Vx	14	-0.88	0.03	-0.11
			Max Tension	16	7.58	0.00	0.00
		Diagonal	Max. Compression	16	-7.76	0.00	0.00
			Max. Mx	34	0.76	0.09	-0.00
			Max. My	12	-6.40	-0.01	-0.02
			Max. Vy	34	-0.06	0.09	-0.00
			Max. Vx	12	0.01	-0.01	-0.02
			Max Tension	15	103.54	-0.06	-0.04
			Max. Compression	2	-117.97	0.15	0.04
			Max. Mx	2	-91.91	0.27	0.07
T4	80 - 60	Leg	Max. My	12	-7.79	-0.05	-0.40
			Max. Vy	2	0.09	0.27	0.07
			Max. Vx	12	0.19	-0.05	-0.40
			Max Tension	2	5.49	0.00	0.00
			Max. Compression	2	-5.67	0.00	0.00
			Max. Mx	34	0.76	0.09	-0.01
		Diagonal	Max. My	14	-4.50	0.01	-0.02
			Max. Vy	33	0.07	0.08	0.01
			Max. Vx	14	0.01	0.00	0.00
			Max Tension	15	130.81	-0.09	-0.03
			Max. Compression	2	-148.95	0.28	0.05
			Max. Mx	2	-148.95	0.28	0.05
			Max. My	12	-11.11	0.01	-0.43
			Max. Vy	3	-0.07	0.27	0.05
T5	60 - 40	Leg	Max. Vx	12	0.16	0.01	-0.43
			Max Tension	2	5.87	0.00	0.00
			Max. Compression	2	-5.93	0.00	0.00
			Max. Mx	33	0.83	0.10	-0.01
			Max. My	32	-1.04	0.09	-0.01
			Max. Vy	33	0.08	0.10	-0.01
		Diagonal	Max. Vx	32	0.00	0.00	0.00
			Max Tension	15	155.26	-3.24	0.05
			Max. Compression	2	-177.98	3.27	-0.11
			Max. Mx	3	-153.79	3.90	-0.08
			Max. My	16	-10.48	-0.00	3.55
			Max. Vy	14	0.79	-3.89	0.04
			Max. Vx	12	0.60	0.04	-2.90
			Max Tension	2	6.54	0.00	0.00
T6	40 - 20	Leg	Max. Compression	2	-6.86	0.00	0.00
			Max. Mx	35	1.42	0.15	-0.02
			Max. My	32	-1.19	0.13	-0.02
			Max. Vy	33	0.10	0.15	0.02
			Max. Vx	32	0.01	0.00	0.00
			Max Tension	15	155.26	-3.24	0.05
		Diagonal	Max. Compression	2	-177.98	3.27	-0.11
			Max. Mx	3	-153.79	3.90	-0.08
			Max. My	16	-10.48	-0.00	3.55
			Max. Vy	14	0.79	-3.89	0.04
			Max. Vx	12	0.60	0.04	-2.90
			Max Tension	2	6.54	0.00	0.00
			Max. Compression	2	-6.86	0.00	0.00
			Max. Mx	35	1.42	0.15	-0.02

tnxTower Destek Engineering, LLC 1281 Kennestone Circle, Suite 100 Marietta, GA 30066 Phone: (770) 693 0835 FAX:	Job	CT11737C	Page	15 of 23
	Project	1875038	Date	10:30:32 08/16/18
	Client	Fore Site LLC	Designed by	Ahmet Colakoglu

Section No.	Elevation ft	Component Type	Condition	Gov. Load Comb.	Axial K	Major Axis Moment kip-ft	Minor Axis Moment kip-ft
T7	20 - 0	Leg	Max Tension	15	179.52	-3.11	0.05
			Max. Compression	2	-207.59	0.00	-0.00
			Max. Mx	35	-100.09	13.34	-0.03
			Max. My	16	-12.78	-0.14	4.36
			Max. Vy	29	-3.21	-4.49	0.00
			Max. Vx	12	-0.92	-0.10	-4.20
		Diagonal	Max Tension	28	8.34	0.00	0.00
			Max. Compression	2	-8.36	0.00	0.00
			Max. Mx	33	-1.35	0.17	-0.03
			Max. My	32	-3.88	0.16	-0.03
			Max. Vy	33	0.10	0.17	-0.03
			Max. Vx	32	0.01	0.00	0.00

Maximum Reactions

Location	Condition	Gov. Load Comb.	Vertical K	Horizontal, X K	Horizontal, Z K
Leg C	Max. Vert	18	201.93	18.57	-10.65
	Max. H _x	18	201.93	18.57	-10.65
	Max. H _z	5	-153.53	-14.01	9.96
	Min. Vert	7	-166.42	-15.84	9.09
	Min. H _x	7	-166.42	-15.84	9.09
	Min. H _z	16	178.90	15.67	-10.80
Leg B	Max. Vert	10	199.53	-19.05	-9.72
	Max. H _x	23	-168.38	16.40	8.22
	Max. H _z	23	-168.38	16.40	8.22
	Min. Vert	23	-168.38	16.40	8.22
	Min. H _x	10	199.53	-19.05	-9.72
	Min. H _z	10	199.53	-19.05	-9.72
Leg A	Max. Vert	2	211.54	-1.37	22.85
	Max. H _x	17	-158.48	1.59	-17.43
	Max. H _z	2	211.54	-1.37	22.85
	Min. Vert	15	-182.71	1.37	-20.05
	Min. H _x	4	176.73	-1.55	18.94
	Min. H _z	15	-182.71	1.37	-20.05

Tower Mast Reaction Summary

Load Combination	Vertical K	Shear _x K	Shear _z K	Overturning Moment, M _x kip-ft	Overturning Moment, M _z kip-ft	Torque kip-ft
Dead Only	30.54	-0.00	0.00	8.88	16.05	0.00
1.2 Dead+1.6 Wind 0 deg - No Ice	36.65	-0.00	-35.66	-2761.83	19.88	-37.92
0.9 Dead+1.6 Wind 0 deg - No Ice	27.49	-0.00	-35.66	-2761.91	15.03	-37.90
1.2 Dead+1.6 Wind 30 deg - No Ice	36.65	16.67	-29.20	-2279.49	-1283.14	-19.67
0.9 Dead+1.6 Wind 30 deg - No Ice	27.49	16.67	-29.20	-2280.02	-1286.76	-19.66
1.2 Dead+1.6 Wind 60 deg - No Ice	36.65	26.59	-15.57	-1232.89	-2093.86	1.37

tnxTower Destek Engineering, LLC 1281 Kennestone Circle, Suite 100 Marietta, GA 30066 Phone: (770) 693 0835 FAX:	Job	CT11737C	Page	16 of 23
	Project	1875038	Date	10:30:32 08/16/18
	Client	Fore Site LLC	Designed by	Ahmet Colakoglu

Load Combination	Vertical	Shear _x	Shear _z	Overturning Moment, M _x	Overturning Moment, M _z	Torque
	K	K	K	kip-ft	kip-ft	kip-ft
0.9 Dead+1.6 Wind 60 deg - No Ice	27.49	26.59	-15.57	-1234.39	-2096.70	1.37
1.2 Dead+1.6 Wind 90 deg - No Ice	36.65	28.93	-0.02	8.35	-2317.56	11.09
0.9 Dead+1.6 Wind 90 deg - No Ice	27.49	28.93	-0.02	5.67	-2320.17	11.08
1.2 Dead+1.6 Wind 120 deg - No Ice	36.65	28.46	16.98	1357.14	-2213.53	30.60
0.9 Dead+1.6 Wind 120 deg - No Ice	27.49	28.46	16.98	1353.18	-2216.26	30.58
1.2 Dead+1.6 Wind 150 deg - No Ice	36.65	16.68	29.47	2328.69	-1284.18	44.00
0.9 Dead+1.6 Wind 150 deg - No Ice	27.49	16.68	29.47	2323.82	-1287.80	43.98
1.2 Dead+1.6 Wind 180 deg - No Ice	36.65	-0.00	33.68	2663.80	19.53	37.95
0.9 Dead+1.6 Wind 180 deg - No Ice	27.49	-0.00	33.68	2658.61	14.69	37.93
1.2 Dead+1.6 Wind 210 deg - No Ice	36.65	-16.68	29.46	2327.75	1322.96	19.42
0.9 Dead+1.6 Wind 210 deg - No Ice	27.49	-16.68	29.46	2322.89	1316.89	19.40
1.2 Dead+1.6 Wind 240 deg - No Ice	36.65	-28.46	16.98	1356.58	2252.26	-1.91
0.9 Dead+1.6 Wind 240 deg - No Ice	27.49	-28.46	16.98	1352.62	2245.31	-1.91
1.2 Dead+1.6 Wind 270 deg - No Ice	36.65	-28.94	-0.03	8.14	2357.36	-11.12
0.9 Dead+1.6 Wind 270 deg - No Ice	27.49	-28.94	-0.03	5.46	2350.27	-11.11
1.2 Dead+1.6 Wind 300 deg - No Ice	36.65	-26.61	-15.58	-1233.72	2134.32	-30.08
0.9 Dead+1.6 Wind 300 deg - No Ice	27.49	-26.61	-15.58	-1235.22	2127.46	-30.06
1.2 Dead+1.6 Wind 330 deg - No Ice	36.65	-16.69	-29.21	-2280.74	1323.42	-43.71
0.9 Dead+1.6 Wind 330 deg - No Ice	27.49	-16.69	-29.21	-2281.25	1317.35	-43.69
1.2 Dead+1.0 Ice+1.0 Temp	110.33	0.00	-0.00	53.92	85.72	-0.00
1.2 Dead+1.0 Wind 0 deg+1.0 Ice+1.0 Temp	110.33	-0.00	-11.77	-879.40	85.98	-13.97
1.2 Dead+1.0 Wind 30 deg+1.0 Ice+1.0 Temp	110.33	5.55	-9.68	-722.14	-358.22	-6.30
1.2 Dead+1.0 Wind 60 deg+1.0 Ice+1.0 Temp	110.33	8.88	-5.17	-368.94	-638.52	1.10
1.2 Dead+1.0 Wind 90 deg+1.0 Ice+1.0 Temp	110.33	9.94	-0.00	53.68	-732.08	6.12
1.2 Dead+1.0 Wind 120 deg+1.0 Ice+1.0 Temp	110.33	9.12	5.38	492.96	-653.54	11.61
1.2 Dead+1.0 Wind 150 deg+1.0 Ice+1.0 Temp	110.33	5.55	9.74	836.23	-358.53	15.90
1.2 Dead+1.0 Wind 180 deg+1.0 Ice+1.0 Temp	110.33	-0.00	11.54	974.27	85.85	13.98
1.2 Dead+1.0 Wind 210 deg+1.0 Ice+1.0 Temp	110.33	-5.55	9.73	835.97	530.18	6.25
1.2 Dead+1.0 Wind 240 deg+1.0 Ice+1.0 Temp	110.33	-9.12	5.38	492.79	825.20	-1.20
1.2 Dead+1.0 Wind 270 deg+1.0 Ice+1.0 Temp	110.33	-9.95	-0.00	53.60	904.04	-6.12
1.2 Dead+1.0 Wind 300 deg+1.0 Ice+1.0 Temp	110.33	-8.89	-5.18	-369.19	810.67	-11.51

tnxTower Destek Engineering, LLC 1281 Kennestone Circle, Suite 100 Marietta, GA 30066 Phone: (770) 693 0835 FAX:	Job	CT11737C	Page	17 of 23
	Project	1875038	Date	10:30:32 08/16/18
	Client	Fore Site LLC	Designed by	Ahmet Colakoglu

Load Combination	Vertical	Shear _x	Shear _y	Overtuning Moment, M _x	Overtuning Moment, M _y	Torque
	K	K	K	kip-ft	kip-ft	kip-ft
1.2 Dead+1.0 Wind 330 deg+1.0 Ice+1.0 Temp	110.33	-5.55	-9.68	-722.50	530.33	-15.84
Dead+Wind 0 deg - Service	30.54	-0.00	-8.53	-653.69	16.21	-9.07
Dead+Wind 30 deg - Service	30.54	3.99	-6.98	-538.41	-295.18	-4.70
Dead+Wind 60 deg - Service	30.54	6.36	-3.72	-288.29	-488.92	0.33
Dead+Wind 90 deg - Service	30.54	6.92	-0.01	8.34	-542.37	2.65
Dead+Wind 120 deg - Service	30.54	6.81	4.06	330.68	-517.53	7.31
Dead+Wind 150 deg - Service	30.54	3.99	7.05	562.86	-295.44	10.52
Dead+Wind 180 deg - Service	30.54	-0.00	8.05	642.96	16.13	9.07
Dead+Wind 210 deg - Service	30.54	-3.99	7.04	562.65	327.64	4.64
Dead+Wind 240 deg - Service	30.54	-6.81	4.06	330.55	549.73	-0.46
Dead+Wind 270 deg - Service	30.54	-6.92	-0.01	8.29	574.84	-2.66
Dead+Wind 300 deg - Service	30.54	-6.36	-3.73	-288.49	521.53	-7.19
Dead+Wind 330 deg - Service	30.54	-3.99	-6.99	-538.72	327.74	-10.45

Solution Summary

Load Comb.	Sum of Applied Forces			Sum of Reactions			% Error
	PX K	PY K	PZ K	PX K	PY K	PZ K	
1	0.00	-30.54	0.00	0.00	30.54	-0.00	0.000%
2	-0.00	-36.65	-35.66	0.00	36.65	35.66	0.001%
3	-0.00	-27.49	-35.66	0.00	27.49	35.66	0.001%
4	16.67	-36.65	-29.20	-16.67	36.65	29.20	0.002%
5	16.67	-27.49	-29.20	-16.67	27.49	29.20	0.001%
6	26.59	-36.65	-15.57	-26.59	36.65	15.57	0.001%
7	26.59	-27.49	-15.57	-26.59	27.49	15.57	0.001%
8	28.93	-36.65	-0.02	-28.93	36.65	0.02	0.001%
9	28.93	-27.49	-0.02	-28.93	27.49	0.02	0.001%
10	28.46	-36.65	16.98	-28.46	36.65	-16.98	0.001%
11	28.46	-27.49	16.98	-28.46	27.49	-16.98	0.001%
12	16.68	-36.65	29.47	-16.68	36.65	-29.47	0.001%
13	16.68	-27.49	29.47	-16.68	27.49	-29.47	0.001%
14	-0.00	-36.65	33.68	0.00	36.65	-33.68	0.001%
15	-0.00	-27.49	33.68	0.00	27.49	-33.68	0.001%
16	-16.68	-36.65	29.46	16.68	36.65	-29.46	0.002%
17	-16.68	-27.49	29.46	16.68	27.49	-29.46	0.001%
18	-28.46	-36.65	16.98	28.46	36.65	-16.98	0.001%
19	-28.46	-27.49	16.98	28.46	27.49	-16.98	0.001%
20	-28.94	-36.65	-0.03	28.94	36.65	0.03	0.001%
21	-28.94	-27.49	-0.03	28.94	27.49	0.03	0.001%
22	-26.61	-36.65	-15.58	26.61	36.65	15.58	0.001%
23	-26.61	-27.49	-15.58	26.61	27.49	15.58	0.001%
24	-16.69	-36.65	-29.21	16.69	36.65	29.21	0.001%
25	-16.69	-27.49	-29.21	16.69	27.49	29.21	0.001%
26	0.00	-110.33	0.00	-0.00	110.33	0.00	0.000%
27	-0.00	-110.33	-11.77	0.00	110.33	11.77	0.000%
28	5.55	-110.33	-9.68	-5.55	110.33	9.68	0.000%
29	8.88	-110.33	-5.17	-8.88	110.33	5.17	0.000%
30	9.94	-110.33	-0.00	-9.94	110.33	0.00	0.000%
31	9.12	-110.33	5.38	-9.12	110.33	-5.38	0.000%
32	5.55	-110.33	9.74	-5.55	110.33	-9.74	0.000%
33	-0.00	-110.33	11.54	0.00	110.33	-11.54	0.000%
34	-5.55	-110.33	9.73	5.55	110.33	-9.73	0.000%
35	-9.12	-110.33	5.38	9.12	110.33	-5.38	0.000%
36	-9.95	-110.33	-0.00	9.95	110.33	0.00	0.000%
37	-8.89	-110.33	-5.18	8.89	110.33	5.18	0.000%
38	-5.55	-110.33	-9.68	5.55	110.33	9.68	0.000%

tnxTower Destek Engineering, LLC 1281 Kennestone Circle, Suite 100 Marietta, GA 30066 Phone: (770) 693 0835 FAX:	Job CT11737C	Page 18 of 23
	Project 1875038	Date 10:30:32 08/16/18
	Client Fore Site LLC	Designed by Ahmet Colakoglu

Load Comb.	Sum of Applied Forces			Sum of Reactions			% Error
	PX K	PY K	PZ K	PX K	PY K	PZ K	
39	-0.00	-30.54	-8.53	0.00	30.54	8.53	0.000%
40	3.99	-30.54	-6.98	-3.99	30.54	6.98	0.000%
41	6.36	-30.54	-3.72	-6.36	30.54	3.72	0.000%
42	6.92	-30.54	-0.01	-6.92	30.54	0.01	0.000%
43	6.81	-30.54	4.06	-6.81	30.54	-4.06	0.000%
44	3.99	-30.54	7.05	-3.99	30.54	-7.05	0.000%
45	-0.00	-30.54	8.05	0.00	30.54	-8.05	0.000%
46	-3.99	-30.54	7.04	3.99	30.54	-7.04	0.000%
47	-6.81	-30.54	4.06	6.81	30.54	-4.06	0.000%
48	-6.92	-30.54	-0.01	6.92	30.54	0.01	0.000%
49	-6.36	-30.54	-3.73	6.36	30.54	3.73	0.000%
50	-3.99	-30.54	-6.99	3.99	30.54	6.99	0.000%

Non-Linear Convergence Results

Load Combination	Converged?	Number of Cycles	Displacement Tolerance	Force Tolerance
1	Yes	6	0.0000001	0.0000001
2	Yes	9	0.0000001	0.00006312
3	Yes	9	0.0000001	0.00004645
4	Yes	9	0.0000001	0.00006562
5	Yes	9	0.0000001	0.00004891
6	Yes	9	0.0000001	0.00006816
7	Yes	9	0.0000001	0.00005136
8	Yes	9	0.0000001	0.00006609
9	Yes	9	0.0000001	0.00004930
10	Yes	9	0.0000001	0.00006337
11	Yes	9	0.0000001	0.00004667
12	Yes	9	0.0000001	0.00006595
13	Yes	9	0.0000001	0.00004919
14	Yes	9	0.0000001	0.00006818
15	Yes	9	0.0000001	0.00005139
16	Yes	9	0.0000001	0.00006573
17	Yes	9	0.0000001	0.00004903
18	Yes	9	0.0000001	0.00006326
19	Yes	9	0.0000001	0.00004658
20	Yes	9	0.0000001	0.00006608
21	Yes	9	0.0000001	0.00004929
22	Yes	9	0.0000001	0.00006825
23	Yes	9	0.0000001	0.00005142
24	Yes	9	0.0000001	0.00006581
25	Yes	9	0.0000001	0.00004907
26	Yes	8	0.0000001	0.00010877
27	Yes	10	0.0000001	0.00004450
28	Yes	10	0.0000001	0.00004299
29	Yes	10	0.0000001	0.00004177
30	Yes	10	0.0000001	0.00004165
31	Yes	10	0.0000001	0.00004344
32	Yes	10	0.0000001	0.00004543
33	Yes	10	0.0000001	0.00004669
34	Yes	10	0.0000001	0.00004675
35	Yes	10	0.0000001	0.00004637
36	Yes	10	0.0000001	0.00004589
37	Yes	10	0.0000001	0.00004578
38	Yes	10	0.0000001	0.00004539
39	Yes	9	0.0000001	0.00005183

tnxTower Destek Engineering, LLC 1281 Kennestone Circle, Suite 100 Marietta, GA 30066 Phone: (770) 693 0835 FAX:	Job	CT11737C	Page	19 of 23
	Project	1875038	Date	10:30:32 08/16/18
	Client	Fore Site LLC	Designed by	Ahmet Colakoglu

40	Yes	9	0.00000001	0.00005211
41	Yes	9	0.00000001	0.00005247
42	Yes	9	0.00000001	0.00005195
43	Yes	9	0.00000001	0.00005173
44	Yes	9	0.00000001	0.00005239
45	Yes	9	0.00000001	0.00005288
46	Yes	9	0.00000001	0.00005234
47	Yes	9	0.00000001	0.00005182
48	Yes	9	0.00000001	0.00005222
49	Yes	9	0.00000001	0.00005275
50	Yes	9	0.00000001	0.00005237

Maximum Tower Deflections - Service Wind

Section No.	Elevation ft	Horz. Deflection in	Gov. Load Comb.	Tilt °	Twist °
T1	140 - 120	2.355	39	0.1237	0.0333
T2	120 - 100	1.833	39	0.1227	0.0327
T3	100 - 80	1.312	39	0.1139	0.0304
T4	80 - 60	0.850	39	0.0945	0.0267
T5	60 - 40	0.490	39	0.0698	0.0204
T6	40 - 20	0.227	39	0.0473	0.0133
T7	20 - 0	0.066	39	0.0206	0.0067

Critical Deflections and Radius of Curvature - Service Wind

Elevation ft	Appurtenance	Gov. Load Comb.	Deflection in	Tilt °	Twist °	Radius of Curvature ft
138.00	Lightning Rod 2"x15'	39	2.303	0.1238	0.0333	Inf
135.00	Andrew VHLP1	39	2.225	0.1238	0.0332	Inf
130.00	Omni 3"x20"	39	2.095	0.1238	0.0331	586998
120.00	AIR 21 B2A/B4P w/ Mount Pipe	39	1.833	0.1227	0.0327	386538
110.00	800 10766	39	1.570	0.1196	0.0317	189119
105.00	HP4-102	39	1.439	0.1171	0.0311	105545
100.00	Andrew VHLP2-11	39	1.312	0.1139	0.0304	74659
95.00	Andrew VHLP1	39	1.188	0.1099	0.0296	61558

Maximum Tower Deflections - Design Wind

Section No.	Elevation ft	Horz. Deflection in	Gov. Load Comb.	Tilt °	Twist °
T1	140 - 120	9.939	2	0.5216	0.1393
T2	120 - 100	7.736	2	0.5176	0.1368
T3	100 - 80	5.536	2	0.4801	0.1271
T4	80 - 60	3.586	2	0.3979	0.1115
T5	60 - 40	2.067	2	0.2940	0.0855
T6	40 - 20	0.954	2	0.1995	0.0555
T7	20 - 0	0.279	2	0.0868	0.0281

tnxTower Destek Engineering, LLC 1281 Kennestone Circle, Suite 100 Marietta, GA 30066 Phone: (770) 693 0835 FAX:	Job	CT11737C	Page	20 of 23
	Project	1875038	Date	10:30:32 08/16/18
	Client	Fore Site LLC	Designed by	Ahmet Colakoglu

Section No.	Elevation ft	Horz. Deflection in	Gov. Load Comb.	Tilt °	Twist °
-------------	-----------------	------------------------	-----------------	-----------	------------

Critical Deflections and Radius of Curvature - Design Wind

Elevation ft	Appurtenance	Gov. Load Comb.	Deflection in	Tilt °	Twist °	Radius of Curvature ft
138.00	Lightning Rod 2"x15'	2	9.719	0.5219	0.1392	289141
135.00	Andrew VHLP1	2	9.390	0.5221	0.1391	289141
130.00	Omni 3"x20'	2	8.841	0.5220	0.1387	144570
120.00	AIR 21 B2A/B4P w/ Mount Pipe	2	7.736	0.5176	0.1368	95584
110.00	800 10766	2	6.623	0.5044	0.1328	46296
105.00	HP4-102	2	6.074	0.4938	0.1301	25506
100.00	Andrew VHLP2-11	2	5.536	0.4801	0.1271	17958
95.00	Andrew VHLP1	2	5.015	0.4635	0.1239	14779

Compression Checks

Leg Design Data (Compression)

Section No.	Elevation ft	Size	L ft	L _u ft	Kl/r	A in ²	P _u K	φP _n K	Ratio $\frac{P_u}{\phi P_n}$
T1	140 - 120	2 1/4	20.00	5.00	106.7 K=1.00	3.9761	-4.60	77.87	0.059 ¹
T2	120 - 100	2 1/4	20.00	5.00	106.7 K=1.00	3.9761	-32.07	77.87	0.412 ¹
T3	100 - 80	2 3/4	20.00	5.00	87.3 K=1.00	5.9396	-80.86	153.15	0.528 ¹
T4	80 - 60	3	20.03	5.01	80.1 K=1.00	7.0686	-117.97	198.90	0.593 ¹
T5	60 - 40	3 1/4	20.03	5.01	74.0 K=1.00	8.2958	-148.95	250.22	0.595 ¹
T6	40 - 20	Pirod 105218	20.03	5.01	32.4 K=1.00	7.2158	-177.98	300.68	0.592 ¹
T7	20 - 0	Pirod 105219	20.03	5.01	28.4 K=1.00	9.4248	-207.59	399.87	0.519 ¹

¹ P_u / φP_n controls

Truss-Leg Diagonal Data

Section No.	Elevation ft	Diagonal Size	L _d ft	Kl/r	φP _n K	A in ²	V _u K	φV _n K	Stress Ratio
T6	40 - 20	0.5	1.46	119.0	324.71	0.1963	0.79	3.38	0.233
T7	20 - 0	0.625	1.45	94.4	424.12	0.3068	3.21	6.96	0.461

inxTower Destek Engineering, LLC 1281 Kennestone Circle, Suite 100 Marietta, GA 30066 Phone: (770) 693 0835 FAX:	Job CT11737C	Page 21 of 23
	Project 1875038	Date 10:30:32 08/16/18
	Client Fore Site LLC	Designed by Ahmet Colakoglu

Section No.	Elevation ft	Diagonal Size	L_d ft	Kl/r	ϕP_n K	A in ²	V_u K	ϕV_n K	Stress Ratio
-------------	--------------	---------------	----------	--------	--------------	---------------------	---------	--------------	--------------

Diagonal Design Data (Compression)

Section No.	Elevation ft	Size	L ft	L_u ft	Kl/r	A in ²	P_u K	ϕP_n K	Ratio $\frac{P_u}{\phi P_n}$
T1	140 - 120	L1 3/4x1 3/4x1/8	9.43	4.61	159.4 K=1.00	0.4219	-1.32	3.75	0.353 ¹
T2	120 - 100	L1 3/4x1 3/4x1/4	9.43	4.61	161.9 K=1.00	0.8125	-4.97	7.00	0.710 ¹
T3	100 - 80	L 2.5 x 2.5 x 5/16	9.43	4.58	112.4 K=1.00	1.4600	-7.76	24.31	0.319 ¹
T4	80 - 60	L 2.5 x 2.5 x 5/16	10.96	5.48	134.5 K=1.00	1.4600	-5.33	18.24	0.292 ¹
T5	60 - 40	L 2.5 x 2.5 x 5/16	12.77	6.37	156.4 K=1.00	1.4600	-5.82	13.48	0.432 ¹
T6	40 - 20	L3x3x5/16	14.63	6.92	140.9 K=1.00	1.7800	-6.86	20.25	0.339 ¹
T7	20 - 0	L3x3x5/16	16.53	7.87	160.3 K=1.00	1.7800	-8.36	15.64	0.534 ¹

¹ $P_u / \phi P_n$ controls

Top Girt Design Data (Compression)

Section No.	Elevation ft	Size	L ft	L_u ft	Kl/r	A in ²	P_u K	ϕP_n K	Ratio $\frac{P_u}{\phi P_n}$
T1	140 - 120	L3x3x3/8	8.00	7.81	159.7 K=1.00	2.1100	-0.22	18.69	0.012 ¹

¹ $P_u / \phi P_n$ controls

Tension Checks

Leg Design Data (Tension)

Section No.	Elevation ft	Size	L ft	L_u ft	Kl/r	A in ²	P_u K	ϕP_n K	Ratio $\frac{P_u}{\phi P_n}$
T1	140 - 120	2 1/4	20.00	5.00	106.7	3.9761	3.23	178.92	0.018 ¹
T2	120 - 100	2 1/4	20.00	5.00	106.7	3.9761	25.34	178.92	0.142 ¹
T3	100 - 80	2 3/4	20.00	5.00	87.3	5.9396	69.90	267.28	0.262 ¹
T4	80 - 60	3	20.03	5.01	80.1	7.0686	103.54	318.09	0.326 ¹
T5	60 - 40	3 1/4	20.03	5.01	74.0	8.2958	130.81	373.31	0.350 ¹
T6	40 - 20	Pirod 105218	20.03	5.01	32.4	7.2158	155.26	324.71	0.478 ¹

tnxTower Destek Engineering, LLC 1281 Kennestone Circle, Suite 100 Marietta, GA 30066 Phone: (770) 693 0835 FAX:	Job CT11737C	Page 22 of 23
	Project 1875038	Date 10:30:32 08/16/18
	Client Fore Site LLC	Designed by Ahmet Colakoglu

Section No.	Elevation ft	Size	L ft	L _u ft	Kl/r	A in ²	P _u K	φP _n K	Ratio P _u / φP _n
T7	20 - 0	Pirod 105219	20.03	5.01	28.4	9.4248	179.52	424.12	0.423 ¹

¹ P_u / φP_n controls

Truss-Leg Diagonal Data

Section No.	Elevation ft	Diagonal Size	L _d ft	Kl/r	φP _n K	A in ²	V _u K	φV _n K	Stress Ratio
T6	40 - 20	0.5	1.46	119.0	324.71	0.1963	0.79	3.38	0.233
T7	20 - 0	0.625	1.45	94.4	424.12	0.3068	3.21	6.96	0.461

Diagonal Design Data (Tension)

Section No.	Elevation ft	Size	L ft	L _u ft	Kl/r	A in ²	P _u K	φP _n K	Ratio P _u / φP _n
T1	140 - 120	L1 3/4x1 3/4x1/8	9.43	4.61	101.3	0.4219	1.22	13.67	0.089 ¹
T2	120 - 100	L1 3/4x1 3/4x1/4	9.43	4.61	104.5	0.8125	4.98	26.32	0.189 ¹
T3	100 - 80	L 2.5 x 2.5 x 5/16	9.43	4.58	72.3	1.4600	7.58	47.30	0.160 ¹
T4	80 - 60	L 2.5 x 2.5 x 5/16	10.08	5.04	79.5	1.4600	5.49	47.30	0.116 ¹
T5	60 - 40	L 2.5 x 2.5 x 5/16	12.77	6.37	100.5	1.4600	5.87	47.30	0.124 ¹
T6	40 - 20	L3x3x5/16	14.63	6.92	90.0	1.7800	6.54	57.67	0.113 ¹
T7	20 - 0	L3x3x5/16	16.53	7.87	102.4	1.7800	8.34	57.67	0.145 ¹

¹ P_u / φP_n controls

Top Girt Design Data (Tension)

Section No.	Elevation ft	Size	L ft	L _u ft	Kl/r	A in ²	P _u K	φP _n K	Ratio P _u / φP _n
T1	140 - 120	L3x3x3/8	8.00	7.81	102.7	2.1100	0.18	68.36	0.003 ¹

¹ P_u / φP_n controls

Section Capacity Table

Section No.	Elevation ft	Component Type	Size	Critical Element	P K	φP _{allow} K	% Capacity	Pass Fail
T1	140 - 120	Leg	2 1/4	3	-4.60	77.87	5.9	Pass
T2	120 - 100	Leg	2 1/4	33	-32.07	77.87	41.2	Pass
T3	100 - 80	Leg	2 3/4	60	-80.86	153.15	52.8	Pass
T4	80 - 60	Leg	3	87	-117.97	198.90	59.3	Pass

tnxTower Destek Engineering, LLC 1281 Kennestone Circle, Suite 100 Marietta, GA 30066 Phone: (770) 693 0835 FAX:	Job CT11737C	Page 23 of 23
	Project 1875038	Date 10:30:32 08/16/18
	Client Fore Site LLC	Designed by Ahmet Colakoglu

Section No.	Elevation ft	Component Type	Size	Critical Element	P K	ϕP_{allow} K	% Capacity	Pass Fail	
T5	60 - 40	Leg	3 1/4	114	-148.95	250.22	59.5	Pass	
T6	40 - 20	Leg	Pirod 105218	141	-177.98	300.68	59.2	Pass	
T7	20 - 0	Leg	Pirod 105219	168	-207.59	399.87	51.9	Pass	
T1	140 - 120	Diagonal	L1 3/4x1 3/4x1/8	11	-1.32	3.75	35.3	Pass	
T2	120 - 100	Diagonal	L1 3/4x1 3/4x1/4	39	-4.97	7.00	71.0	Pass	
T3	100 - 80	Diagonal	L 2.5 x 2.5 x 5/16	66	-7.76	24.31	31.9	Pass	
T4	80 - 60	Diagonal	L 2.5 x 2.5 x 5/16	92	-5.33	18.24	29.2	Pass	
T5	60 - 40	Diagonal	L 2.5 x 2.5 x 5/16	119	-5.82	13.48	43.2	Pass	
T6	40 - 20	Diagonal	L3x3x5/16	146	-6.86	20.25	33.9	Pass	
T7	20 - 0	Diagonal	L3x3x5/16	173	-8.36	15.64	53.4	Pass	
T1	140 - 120	Top Girt	L3x3x3/8	6	-0.22	18.69	1.2	Pass	
							Summary		
							Leg (T5)	59.5	Pass
							Diagonal (T2)	71.0	Pass
							Top Girt (T1)	1.2	Pass
							RATING =	71.0	Pass

Exhibit E



RADIO FREQUENCY EMISSIONS ANALYSIS REPORT EVALUATION OF HUMAN EXPOSURE POTENTIAL TO NON-IONIZING EMISSIONS

T-Mobile Existing Facility

Site ID: CT11737C

CT737/E Hartford Town SST
100 Sunset Ridge Road
East Hartford, CT 06108

July 16, 2018

EBI Project Number: 6218005054

Site Compliance Summary	
Compliance Status:	COMPLIANT
Site total MPE% of FCC general population allowable limit:	20.23 %



July 16, 2018

T-Mobile USA
Attn: Jason Overbey, RF Manager
35 Griffin Road South
Bloomfield, CT 06002

Emissions Analysis for Site: **CT11737C – CT737/E Hartford Town SST**

EBI Consulting was directed to analyze the proposed T-Mobile facility located at **100 Sunset Ridge Road, East Hartford, CT**, for the purpose of determining whether the emissions from the Proposed T-Mobile Antenna Installation located on this property are within specified federal limits.

All information used in this report was analyzed as a percentage of current Maximum Permissible Exposure (% MPE) as listed in the FCC OET Bulletin 65 Edition 97-01 and ANSI/IEEE Std C95.1. The FCC regulates Maximum Permissible Exposure in units of microwatts per square centimeter ($\mu\text{W}/\text{cm}^2$). The number of $\mu\text{W}/\text{cm}^2$ calculated at each sample point is called the power density. The exposure limit for power density varies depending upon the frequencies being utilized. Wireless Carriers and Paging Services use different frequency bands each with different exposure limits, therefore it is necessary to report results and limits in terms of percent MPE rather than power density.

All results were compared to the FCC (Federal Communications Commission) radio frequency exposure rules, 47 CFR 1.1307(b)(1) – (b)(3), to determine compliance with the Maximum Permissible Exposure (MPE) limits for General Population/Uncontrolled environments as defined below.

General population/uncontrolled exposure limits apply to situations in which the general population may be exposed or in which persons who are exposed as a consequence of their employment may not be made fully aware of the potential for exposure or cannot exercise control over their exposure. Therefore, members of the general population would always be considered under this category when exposure is not employment related, for example, in the case of a telecommunications tower that exposes persons in a nearby residential area.

Public exposure to radio frequencies is regulated and enforced in units of microwatts per square centimeter ($\mu\text{W}/\text{cm}^2$). The general population exposure limits for the 600 MHz and 700 MHz Band are approximately $400 \mu\text{W}/\text{cm}^2$ and $467 \mu\text{W}/\text{cm}^2$ respectively. The general population exposure limit for the 1900 MHz (PCS) and 2100 MHz (AWS) bands is $1000 \mu\text{W}/\text{cm}^2$. Because each carrier will be using different frequency bands, and each frequency band has different exposure limits, it is necessary to report percent of MPE rather than power density.



Occupational/controlled exposure limits apply to situations in which persons are exposed as a consequence of their employment and in which those persons who are exposed have been made fully aware of the potential for exposure and can exercise control over their exposure. Occupational/controlled exposure limits also apply where exposure is of a transient nature as a result of incidental passage through a location where exposure levels may be above general population/uncontrolled limits (see below), as long as the exposed person has been made fully aware of the potential for exposure and can exercise control over his or her exposure by leaving the area or by some other appropriate means.

Additional details can be found in FCC OET 65.

CALCULATIONS

Calculations were done for the proposed T-Mobile Wireless antenna facility located at **100 Sunset Ridge Road, East Hartford, CT**, using the equipment information listed below. All calculations were performed per the specifications under FCC OET 65. Since T-Mobile is proposing highly focused directional panel antennas, which project most of the emitted energy out toward the horizon, all calculations were performed assuming a lobe representing the maximum gain of the antenna per the antenna manufactures supplied specifications, minus 10 dB for directional panel antennas, was focused at the base of the tower. For this report the sample point is the top of a 6-foot person standing at the base of the tower.

For all calculations, all equipment was calculated using the following assumptions:

- 1) 2 GSM channels (PCS Band - 1900 MHz) were considered for each sector of the proposed installation. These Channels have a transmit power of 30 Watts per Channel.
- 2) 2 UMTS channels (AWS Band – 2100 MHz) were considered for each sector of the proposed installation. These Channels have a transmit power of 30 Watts per Channel.
- 3) 2 LTE channels (PCS Band - 1900 MHz) were considered for each sector of the proposed installation. These Channels have a transmit power of 60 Watts per Channel.
- 4) 2 LTE channels (AWS Band – 2100 MHz) were considered for each sector of the proposed installation. These Channels have a transmit power of 60 Watts per Channel
- 5) 2 LTE channels (600 MHz Band) were considered for each sector of the proposed installation. These channels have a transmit power of 30 Watts.
- 6) 2 LTE channels (700 MHz Band) were considered for each sector of the proposed installation. These channels have a transmit power of 30 Watts.



- 7) All radios at the proposed installation were considered to be running at full power and were uncombined in their RF transmissions paths per carrier prescribed configuration. Per FCC OET Bulletin No. 65 - Edition 97-01 recommendations to achieve the maximum anticipated value at each sample point, all power levels emitting from the proposed antenna installation are increased by a factor of 2.56 to account for possible in-phase reflections from the surrounding environment. This is rarely the case, and if so, is never continuous.
- 8) For the following calculations the sample point was the top of a 6-foot person standing at the base of the tower. The maximum gain of the antenna per the antenna manufactures supplied specifications, minus 10 dB for directional panel antennas, was used in this direction. This value is a very conservative estimate as gain reductions for these particular antennas are typically much higher in this direction.
- 9) The antennas used in this modeling are the **Ericsson AIR32 B66A/B2A**, **Ericsson AIR21 B2A/B4P** & the **RFS APXVAARR24_43-U-NA20** for 600 MHz, 700 MHz, 1900 MHz (PCS) and 2100 MHz (AWS) channels. This is based on feedback from the carrier with regard to anticipated antenna selection. All Antenna gain values and associated transmit power levels are shown in the Site Inventory and Power Data table below. The maximum gain of the antenna per the antenna manufactures supplied specifications, minus 10 dB for directional panel antennas, was used for all calculations. This value is a very conservative estimate as gain reductions for these particular antennas are typically much higher in this direction.
- 10) The antenna mounting height centerline of the proposed antennas (both panel antennas and microwave dish) is **120 feet** above ground level (AGL).
- 11) Emissions values for additional carriers were taken from the Connecticut Siting Council active database. Values in this database are provided by the individual carriers themselves.
- 12) All calculations were done with respect to uncontrolled / general population threshold limits.



T-Mobile Site Inventory and Power Data

Sector:	A	Sector:	B	Sector:	C
Antenna #:	1	Antenna #:	1	Antenna #:	1
Make / Model:	Ericsson AIR32 B66A/B2A	Make / Model:	Ericsson AIR32 B66A/B2A	Make / Model:	Ericsson AIR32 B66A/B2A
Gain:	15.9 dBd	Gain:	15.9 dBd	Gain:	15.9 dBd
Height (AGL):	120	Height (AGL):	120	Height (AGL):	120
Frequency Bands	1900 MHz (PCS) / 2100 MHz (AWS)	Frequency Bands	1900 MHz (PCS) / 2100 MHz (AWS)	Frequency Bands	1900 MHz (PCS) / 2100 MHz (AWS)
Channel Count	2	Channel Count	2	Channel Count	2
Total TX Power(W):	120	Total TX Power(W):	120	Total TX Power(W):	120
ERP (W):	9,337.08	ERP (W):	9,337.08	ERP (W):	9,337.08
Antenna A1 MPE%	2.58	Antenna B1 MPE%	2.58	Antenna C1 MPE%	2.58
Antenna #:	2	Antenna #:	2	Antenna #:	2
Make / Model:	Ericsson AIR21 B2A/B4P	Make / Model:	Ericsson AIR21 B2A/B4P	Make / Model:	Ericsson AIR21 B2A/B4P
Gain:	15.9 dBd	Gain:	15.9 dBd	Gain:	15.9 dBd
Height (AGL):	120	Height (AGL):	120	Height (AGL):	120
Frequency Bands	1900 MHz (PCS) / 2100 MHz (AWS)	Frequency Bands	1900 MHz (PCS) / 2100 MHz (AWS)	Frequency Bands	1900 MHz (PCS) / 2100 MHz (AWS)
Channel Count	4	Channel Count	4	Channel Count	4
Total TX Power(W):	120	Total TX Power(W):	120	Total TX Power(W):	120
ERP (W):	4,668.54	ERP (W):	4,668.54	ERP (W):	4,668.54
Antenna A2 MPE%	1.29	Antenna B2 MPE%	1.29	Antenna C2 MPE%	1.29
Antenna #:	3	Antenna #:	3	Antenna #:	3
Make / Model:	RFS APXVAARR24_43-U-NA20	Make / Model:	RFS APXVAARR24_43-U-NA20	Make / Model:	RFS APXVAARR24_43-U-NA20
Gain:	12.95 dBd / 13.35 dBd	Gain:	12.95 dBd / 13.35 dBd	Gain:	12.95 dBd / 13.35 dBd
Height (AGL):	120	Height (AGL):	120	Height (AGL):	120
Frequency Bands	600 MHz / 700 MHz	Frequency Bands	600 MHz / 700 MHz	Frequency Bands	600 MHz / 700 MHz
Channel Count	4	Channel Count	4	Channel Count	4
Total TX Power(W):	120	Total TX Power(W):	120	Total TX Power(W):	120
ERP (W):	2,481.08	ERP (W):	2,481.08	ERP (W):	2,481.08
Antenna A3 MPE%	1.59	Antenna B3 MPE%	1.59	Antenna C3 MPE%	1.59



Site Summary Tables

Site Composite MPE%	
Carrier	MPE%
T-Mobile (Per Sector Max)	5.46 %
Sprint	5.20%
Clearwire	0.09%
AT&T	6.36%
Public Works	0.62%
Fire	0.41%
Fire Admin	0.41%
Police Channels 1&2	1.02%
Parks & Rec	0.17%
Health	0.25%
800	0.24%
Site Total MPE %:	20.23 %

T-Mobile Sector A Total:	5.46 %
T-Mobile Sector B Total:	5.46 %
T-Mobile Sector C Total:	5.46 %
<hr/>	
Site Total:	20.23 %

T-Mobile Max Power Values (Per Sector)

T-Mobile_Max Power Values (per sector)	# Channels	Watts ERP (Per Channel)	Height (feet)	Total Power Density ($\mu\text{W}/\text{cm}^2$)	Frequency (MHz)	Allowable MPE ($\mu\text{W}/\text{cm}^2$)	Calculated % MPE
T-Mobile PCS - 1900 MHz LTE	2	2,334.27	120	12.91	PCS - 1900 MHz	1000	1.29%
T-Mobile AWS - 2100 MHz LTE	2	2,334.27	120	12.91	AWS - 2100 MHz	1000	1.29%
T-Mobile PCS - 1900 MHz GSM	2	1,167.14	120	6.46	PCS - 1900 MHz	1000	0.65%
T-Mobile AWS - 2100 MHz UMTS	2	1,167.14	120	6.46	AWS - 2100 MHz	1000	0.65%
T-Mobile 600 MHz LTE	2	591.73	120	3.27	600 MHz	400	0.81%
T-Mobile 700 MHz LTE	2	648.82	120	3.59	700 MHz	467	0.77%
						Total:	5.46%



Summary

All calculations performed for this analysis yielded results that were **within** the allowable limits for general population exposure to RF Emissions.





The anticipated maximum composite contributions from the T-Mobile facility as well as the site composite emissions value with regards to compliance with FCC's allowable limits for general population exposure to RF Emissions are shown here:

T-Mobile Sector	Power Density Value (%)
Sector A:	5.46 %
Sector B:	5.46 %
Sector C:	5.46 %
T-Mobile Per Sector Maximum (Per Sector):	5.46 %
Site Total:	20.23 %
Site Compliance Status:	COMPLIANT

The anticipated composite MPE value for this site assuming all carriers present is **20.23%** of the allowable FCC established general population limit sampled at the ground level. This is based upon values listed in the Connecticut Siting Council database for existing carrier emissions.

FCC guidelines state that if a site is found to be out of compliance (over allowable thresholds), that carriers over a 5% contribution to the composite value will require measures to bring the site into compliance. For this facility, the composite values calculated were well within the allowable 100% threshold standard per the federal government.

Exhibit F

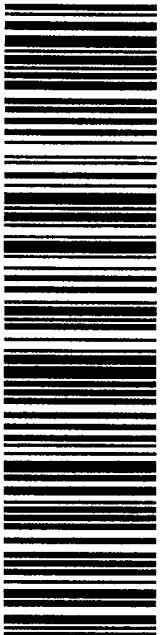
 UNITED STATES POSTAL SERVICE®		 Click-N-Ship®	
		<small>usps.com</small> 9405 5036 9930 0282 1830 32 0067 0000 0010 6108 US POSTAGE \$6.70 <small>Flat Rate Env</small>	
PRIORITY MAIL 1-DAY™			
DEBORAH CHASE T-MOBILE USA- NSS 35 GRIFFIN RD S BLOOMFIELD CT 06002-1351		08/20/2018 Mailed from 06002 062S0000001308	
Carrier -- Leave if No Response		C066	
SHIP TO: MARCIA A LECLERC MAYOR- EAST HARTFORD TOWN HALL 740 MAIN ST EAST HARTFORD CT 06108-3140			
USPS TRACKING #			
			
9405 5036 9930 0282 1830 32			
Electronic Rate Approved #038555749			



Cut on dotted line.

Instructions

- Each Click-N-Ship® label is unique. Labels are to be used as printed and used only once. DO NOT PHOTO COPY OR ALTER LABEL.
- Place your label so it does not wrap around the edge of the package.
- Adhere your label to the package. A self-adhesive label is recommended. If tape or glue is used, DO NOT TAPE OVER BARCODE. Be sure all edges are secure.
- To mail your package with PC Postage®, you may schedule a Package Pickup online, hand to your letter carrier, take to a Post Office™, or drop in a USPS collection box.
- Mail your package on the "Ship Date" you selected when creating this label.

Click-N-Ship® Label Record

USPS TRACKING # : 9405 5036 9930 0282 1830 32			
Trans. #:	442192947	Priority Mail® Postage:	\$6.70
Print Date:	08/20/2018	Total	\$6.70
Ship Date:	08/20/2018		
Expected			
Delivery Date:	08/21/2018		
From:	DEBORAH CHASE T-MOBILE USA- NSS 35 GRIFFIN RD S BLOOMFIELD CT 06002-1351	Ref#:	737C-L700
To:	MARCIA A LECLERC MAYOR- EAST HARTFORD TOWN HALL 740 MAIN ST EAST HARTFORD CT 06108-3140		
<small>* Retail Pricing Priority Mail rates apply. There is no fee for USPS Tracking® service on Priority Mail service with use of this electronic rate shipping label. Refunds for unused postage paid labels can be requested online 30 days from the print date.</small>			



Thank you for shipping with the United States Postal Service!
Check the status of your shipment on the USPS Tracking® page at usps.com



**UNITED STATES
POSTAL SERVICE®**





usps.com
9405 5036 9930 0282 1830 49 0067 0000 0010 6108
US POSTAGE
Flat Rate Env

08/20/2018

Mailed from 06002 062S0000001311



Expected Delivery Date: 08/21/18

0024

PRIORITY MAIL 1-DAY™

DEBORAH CHASE
T-MOBILE USA- NSS
35 GRIFFIN RD S
BLOOMFIELD CT 06002-1351

Carrier -- Leave if No Response **C066**

SHIP
TO: JEFFREY A CORMIER
TOWN PLANNER-EAST HARTFORD TOWN HALL
740 MAIN ST
EAST HARTFORD CT 06108-3140

USPS TRACKING #



9405 5036 9930 0282 1830 49

Electronic Rate Approved #038555749



Cut on dotted line.

Instructions

1. Each Click-N-Ship® label is unique. Labels are to be used as printed and used only once. DO NOT PHOTO COPY OR ALTER LABEL.
2. Place your label so it does not wrap around the edge of the package.
3. Adhere your label to the package. A self-adhesive label is recommended. If tape or glue is used, DO NOT TAPE OVER BARCODE. Be sure all edges are secure.
4. To mail your package with PC Postage®, you may schedule a Package Pickup online, hand to your letter carrier, take to a Post Office™, or drop in a USPS collection box.
5. Mail your package on the "Ship Date" you selected when creating this label.

Click-N-Ship® Label Record

USPS TRACKING # :
9405 5036 9930 0282 1830 49

Trans. #: 442192947	Priority Mail® Postage: \$6.70
Print Date: 08/20/2018	Total \$6.70
Ship Date: 08/20/2018	
Expected Delivery Date: 08/21/2018	

From: DEBORAH CHASE
T-MOBILE USA- NSS
35 GRIFFIN RD S
BLOOMFIELD CT 06002-1351

To: JEFFREY A CORMIER
TOWN PLANNER-EAST HARTFORD TOWN HALL
740 MAIN ST
EAST HARTFORD CT 06108-3140

* Retail Pricing Priority Mail rates apply. There is no fee for USPS Tracking® service on Priority Mail service with use of this electronic rate shipping label. Refunds for unused postage paid labels can be requested online 30 days from the print date.



Thank you for shipping with the United States Postal Service!
Check the status of your shipment on the USPS Tracking® page at usps.com



usps.com 9405 5036 9930 0282 1830 56 0067 0000 0010 6108
\$6.70
US POSTAGE
 Flat Rate Env

08/20/2018 Mailed from 01566 062S0000001308

Click-N-Ship®



UNITED STATES POSTAL SERVICE®

PRIORITY MAIL 2-DAY™

Expected Delivery Date: 08/22/18
 RA#: 737C
0006

DEBORAH CHASE
 NORTHEAST SITE SOLUTIONS, LLC
 420 MAIN ST STE 2
 STURBRIDGE MA 01566-1359

Carrier -- Leave if No Response

C066

SHIP TO: TOWN EAST HARTFORD
 EAST HARTFORD TOWN HALL
 740 MAIN ST
 EAST HARTFORD CT 06108-3140

USPS TRACKING #

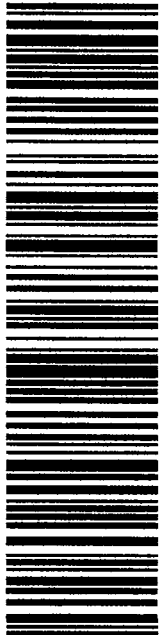

9405 5036 9930 0282 1830 56

Electronic Rate Approved #038555749

✂ ————— Cut on dotted line.

Instructions

1. Each Click-N-Ship® label is unique. Labels are to be used as printed and used only once. **DO NOT PHOTO COPY OR ALTER LABEL.**
2. Place your label so it does not wrap around the edge of the package.
3. Adhere your label to the package. A self-adhesive label is recommended. If tape or glue is used, **DO NOT TAPE OVER BARCODE.** Be sure all edges are secure.
4. To mail your package with PC Postage®, you may schedule a Package Pickup online, hand to your letter carrier, take to a Post Office™, or drop in a USPS collection box.
5. Mail your package on the "Ship Date" you selected when creating this label.

Click-N-Ship® Label Record

USPS TRACKING # :
9405 5036 9930 0282 1830 56

Trans. #: 442192947	Priority Mail® Postage: \$6.70
Print Date: 08/20/2018	Total \$6.70
Ship Date: 08/20/2018	
Expected Delivery Date: 08/22/2018	

From: DEBORAH CHASE Reff#: 737C
 NORTHEAST SITE SOLUTIONS, LLC
 420 MAIN ST STE 2
 STURBRIDGE MA 01566-1359

To: TOWN EAST HARTFORD
 EAST HARTFORD TOWN HALL
 740 MAIN ST
 EAST HARTFORD CT 06108-3140

* Retail Pricing Priority Mail rates apply. There is no fee for USPS Tracking® service on Priority Mail service with use of this electronic rate shipping label. Refunds for unused postage paid labels can be requested online 30 days from the print date.

UNITED STATES POSTAL SERVICE® Thank you for shipping with the United States Postal Service!
 Check the status of your shipment on the USPS Tracking® page at usps.com

AMENDED COPY

en-t-mobile-043-180731

Mathews, Lisa A

From: Deborah Chase <deborah@northeastsitesolutions.com>
Sent: Monday, August 20, 2018 5:54 PM
To: CSC-DL Siting Council; Bachman, Melanie; Mathews, Lisa A
Cc: Denise Sabo; Sheldon Freinle; victoria@northeastsitesolutions.com
Subject: RE: **Amended EM Application **100 Sunset Ridge Road, East Hartford, CT 06108- T-Mobile EM Application (CT11737C_L700 4x2)
Attachments: 100 Sunset Ridge, East Hartford, CT 06108 T-Mobile EM Application (CT11737C-L700 4X2).pdf

fa ✓
 folder ✓
 was ✓
 lus ✓

p. 3 ✓

Please use this copy as it contains the new mailing labels for the recipients.
Thank you

Deborah Chase

Senior Project Coordinator & Analyst
Mobile: 860-490-8839



NORTHEAST
SITE SOLUTIONS

Save a tree. Refuse. Reduce. Reuse. Recycle.

From: Deborah Chase [mailto:deborah@northeastsitesolutions.com]
Sent: Monday, August 20, 2018 5:29 PM
To: siting.council@ct.gov; melanie.bachman@ct.gov; Lisa.A.Mathews@ct.gov
Cc: Denise Sabo (denise@northeastsitesolutions.com); Sheldon Freinle (sheldon@northeastsitesolutions.com); victoria@northeastsitesolutions.com
Subject: **Amended EM Application **100 Sunset Ridge Road, East Hartford, CT 06108- T-Mobile EM Application (CT11737C_L700 4x2)

Siting Council-

Enclosed please accept our amended Exempt Modification Application package from Northeast Site Solutions on behalf of T-Mobile for the above referenced site. The amended package includes a new structural, cover letter and receipts. We have resent the applications to the town officials and tower/property owner.

We are mailing the original and two (2) copies to your office.
Please let me know if you have any questions or problems with the attachment.

Deborah Chase

Senior Project Coordinator & Analyst
Mobile: 860-490-8839



NORTHEAST
SITE SOLUTIONS

Save a tree. Refuse. Reduce. Reuse. Recycle.