



STATE OF CONNECTICUT

CONNECTICUT SITING COUNCIL

Ten Franklin Square, New Britain, CT 06051

Phone: (860) 827-2935 Fax: (860) 827-2950

E-Mail: siting.council@po.state.ct.us

Web Site: www.state.ct.us/csc/index.htm

June 9, 2003

Michele G. Briggs
Manager of Real Estate
Southwestern Bell Mobile Systems, LLC
500 Enterprise Drive, 3rd Floor
Rocky Hill, CT 06067

RE: **EM-CING-042-030520** - Southwestern Bell Mobile Systems, LLC notice of intent to modify an existing telecommunications facility located at East High Street, East Hampton, Connecticut.

Dear Ms. Briggs:

At a public meeting held on June 3, 2003, the Connecticut Siting Council (Council) acknowledged your notice to modify this existing telecommunications facility, pursuant to Section 16-50j-73 of the Regulations of Connecticut State Agencies.

The proposed modifications are to be implemented as specified here and in your notice dated May 20, 2003. The modifications are in compliance with the exception criteria in Section 16-50j-72 (b) of the Regulations of Connecticut State Agencies as changes to an existing facility site that would not increase tower height, extend the boundaries of the tower site, increase noise levels at the tower site boundary by six decibels, and increase the total radio frequencies electromagnetic radiation power density measured at the tower site boundary to or above the standard adopted by the State Department of Environmental Protection pursuant to General Statutes § 22a-162. This facility has also been carefully modeled to ensure that radio frequency emissions are conservatively below State and federal standards applicable to the frequencies now used on this tower.

This decision is under the exclusive jurisdiction of the Council. Any additional change to this facility will require explicit notice to this agency pursuant to Regulations of Connecticut State Agencies Section 16-50j-73. Such notice shall include all relevant information regarding the proposed change with cumulative worst-case modeling of radio frequency exposure at the closest point of uncontrolled access to the tower base, consistent with Federal Communications Commission, Office of Engineering and Technology, Bulletin 65. Any deviation from this format may result in the Council implementing enforcement proceedings pursuant to General Statutes § 16-50u including, without limitation, imposition of expenses resulting from such failure and of civil penalties in an amount not less than one thousand dollars per day for each day of construction or operation in material violation.

Thank you for your attention and cooperation.

Very truly yours,

Pamela B. Katz
Chairman

PBK/laf

- c: Honorable Donald Markham, Chairman Town Council, Town of East Hampton
Alan H. Bergren, Town Manager, Town of East Hampton
James Carey, Zoning Enforcement Officer, Town of East Hampton
Thomas J. Regan, Esq., Brown Rudnick Berlack Israels, LLP
Sandy M. Carter, Verizon Wireless
Christopher B. Fisher, Esq., Cuddy & Feder LLP

EM-CING-042-030520

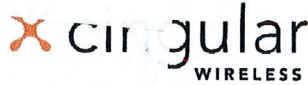

Southwestern Bell Mobile Systems, LLC
500 Enterprise Drive
Rocky Hill, Connecticut 06067-3900
Phone: (860) 513-7700
Fax: (860) 513-7190

Michele G. Briggs
Manager of Real Estate

May 20, 2003

RECEIVED

MAY 20 2003

**CONNECTICUT
SITING COUNCIL**

Ms. Pam Katz, Chairman
Connecticut Siting Council
10 Franklin Square
New Britain, Connecticut 06051

**Re: Notice of Exempt Modification – Existing Sprint Telecommunications Tower
Facility at East High Street, East Hampton, Connecticut**

Dear Chairman Katz:

Southwestern Bell Mobile Systems, LLC ("SBMS") intends to install telecommunications antennas and associated equipment at an existing multicarrier telecommunications tower off East High Street in East Hampton, Connecticut.

The Sprint East Hampton facility is located on the south side of CT Rte 66, approximately ½ mile east of its intersection with Hwy 196. Tower coordinates (NAD 83) are N 41° 35' 9" and W 72° 29' 12". The facility is owned and operated by Sprint Sites USA ("Sprint"), with offices at 535 E. Crescent Avenue, Ramsey, NJ 07446. Sprint leases the land from Pauls + Sandy's Too, Inc. of East Hampton.

Please accept this letter as notification to the Council, pursuant to R.C.S.A. Section 16-50j-73, of construction which constitutes an exempt modification pursuant to R.C.S.A. Section 16-50j-72(b)(2). In compliance with R.C.S.A. Section 16-50j-73, a copy of this letter is being sent to the Town Manager of East Hampton.

SBMS, the local component of the nationwide Cingular Wireless network, is licensed by the Federal Communications Commission ("FCC") to provide cellular mobile telephone service in the Hartford, CT Metropolitan Statistical Area, which includes the area to be served by SBMS' proposed installation. The public need for cellular service has been predetermined by the FCC.

Sprint has agreed to plans put forth by SBMS pursuant to mutually acceptable terms and conditions and has also authorized SBMS to obtain necessary government approvals. Attached to this Notice are a site location map, a proposed site plan, the proposed tower profile, and a structural analysis report that shows the tower is structurally capable of supporting the proposed SBMS telecommunications equipment.

The East Hampton Planning & Zoning Commission granted a Special Permit for the Sprint facility on May 7, 1997. The facility came under Council jurisdiction with Verizon's application to co-locate in TS-BAM-042-000828, which was approved on September 19, 2000.

The East High Street facility consists of a 120-foot monopole within a roughly 57' x 39' trapezoidal compound surrounded by 6-ft high chain link fence. Sprint operates its own antennas and telecommunications equipment at the site, and it has leased tower and ground space to a number of other carriers, as well as the Town. Sprint has panel antennas at the top of the 120' monopole and equipment cabinets mounted on a concrete pad. Verizon operates antennas at the 105' level of the tower and has equipment in a 12' x 30' building. AT&T operates at the 85' level of the tower and has its equipment on a 6' x 10' concrete pad. Additionally, the Town of East Hampton operates whip antennas at the 120' level of the tower and houses its equipment in a building just outside the fenced compound.

As shown on the attached drawings and as further described below, SBMS proposes to install up to twelve CSS DUO4-8670 panel antennas, approximately 48 inches in height, with the center of radiation approximately 95 feet above ground level. Associated equipment to be installed on the tower are up to six ADC Co. dual-band tower top amplifiers ("TTA's"; small metal boxes approximately 26 pounds apiece) immediately behind the antennas, and up to three very small (5 pounds apiece) CSS dual-band "combiners." SBMS also proposes to pour an 8' x 12' concrete pad beside the tower for up to five outdoor equipment cabinets. All work will be done inside the existing fenced compound.

With the "GSM-only" configuration, SBMS will broadcast up to:

- 2 channels, 296 Watts ERP, 880 – 894 MHz; and
- 2 channels, 427 Watts ERP, 1930 – 1935 MHz.

Statutory Considerations

The changes to the East Hampton tower facility do not constitute a modification as defined in Connecticut General Statutes ("C.G.S.") Section 16-50i(d) because the general physical characteristics of the facility will not be significantly changed or altered. Rather, the planned changes to the facility fall squarely within those activities explicitly provided for in R.C.S.A. Section 16-50j-72(b)(2) because they will not result in any substantial adverse environmental effect.

1. The height of the overall structure will be unaffected.
2. The proposed changes will not affect the property boundaries. All new construction will take place on property leased by Sprint and within the existing fenced compound.
3. The proposed additions will not increase the noise level at the existing facility by six decibels or more.

4. Operation of the additional antennas will not increase the total radio frequency electromagnetic radiation power density, measured at the tower base, to or above the standard adopted by the State of Connecticut and the FCC. The "worst-case" exposure calculation in accordance with FCC OET Bulletin No. 65 (1997) for a point of interest at the base of the tower in relation to the operation of the currently proposed antenna array is as follows:

Company	Centerline Height (feet)	Frequency (MHz)	Number of Channels	Power Per Channel (Watts)	Power Density [†] (mW/cm ²)	Standard Limits (mW/cm ²)	Percent of Limit
Sprint *	120	1950	16	250	0.0999	1.0000	9.99
Town of East Hampton *	120	155.49	4	100	0.0100	0.2000	4.99
	120	46.18	4	100	0.0100	0.2000	4.99
	120	453.64	4	100	0.0100	0.3024	3.30
Verizon *	105	806	16	250	0.1305	0.5373	24.28
Cingular GSM	95	880 - 894	2	296	0.0236	0.5867	4.02
Cingular GSM	95	1930 - 1935	2	427	0.0340	1.0000	3.40
AT&T *	85	D: 1945 E: 1985	16	250	0.1991	1.0000	19.91
Total							74.89%

* Power density parameters taken from AT&T's application to the Council in EM-AT&T-042-020531.

† Please note that the standard power density equation provided by the Council in its memo of January 22, 2001 incorporates a ground reflection factor of 2.56 (i.e., the square of 1.6) as described in FCC OET Bulletin No. 65.

As the table demonstrates, the cumulative "worst-case" exposure would be approximately 75% of the ANSI/IEEE standard, as calculated for mixed frequency sites. Total power density levels resulting from SBMS' use of the tower facility would thus be within applicable standards.

For the foregoing reasons, SBMS respectfully submits that proposed changes to implement expanded shared use at the East Hampton site constitute an exempt modification under R.C.S.A. Section 16-50j-72(b)(2).

Please feel free to call me at (860) 513-7700 with questions concerning this application. Thank you for your consideration in this matter.

Respectfully yours,

Michele G. Briggs
Manager of Real Estate

Enclosures

cc: Honorable Alan H. Bergren, Town Manager, Town of East Hampton

Sprint Tower, East High St, East Hampton

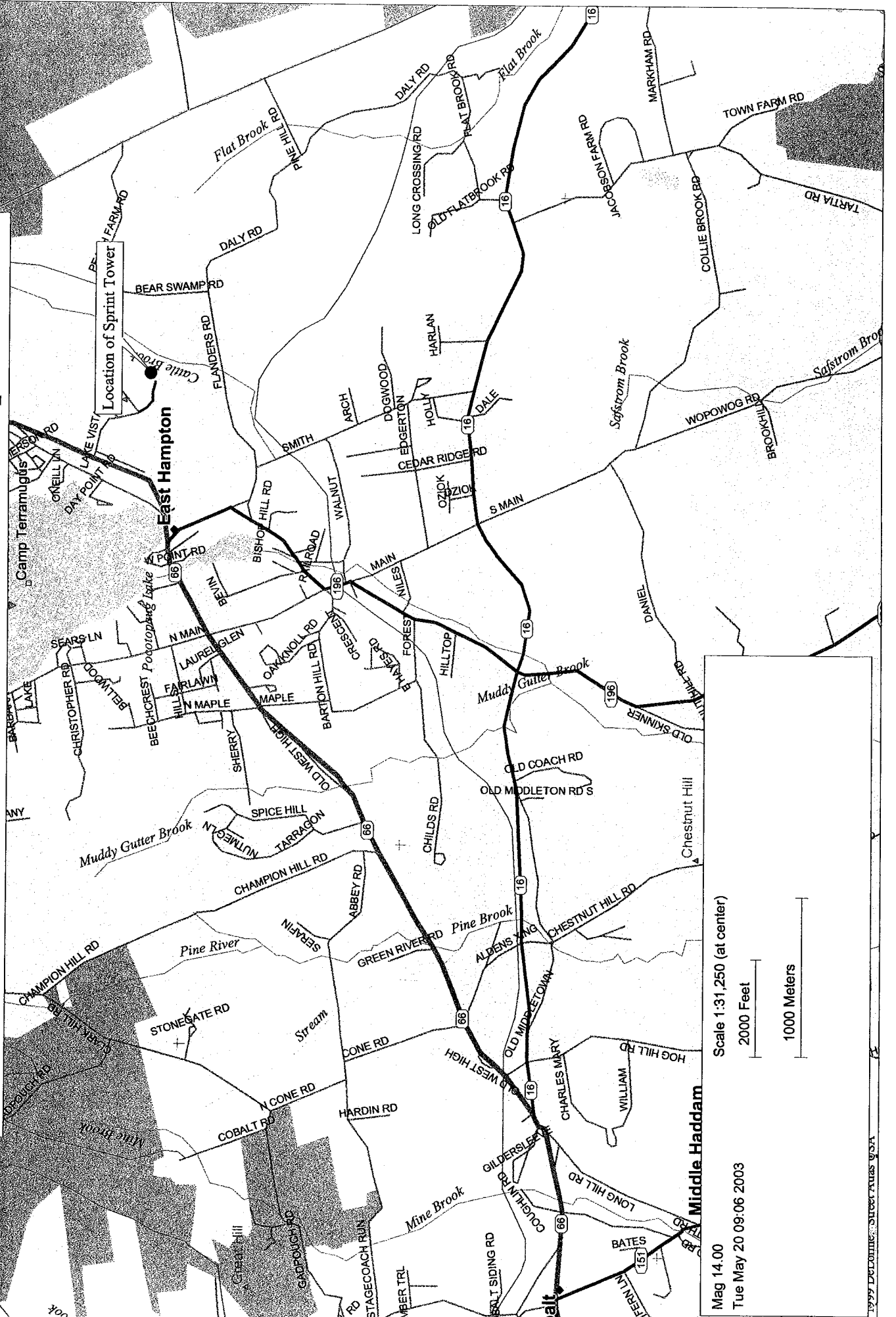

Mag 14.00
Tue May 20 09:06 2003

Scale 1:31,250 (at center)
2000 Feet
1000 Meters

Middle Haddam

1999 Delorme, Street Atlas 93A

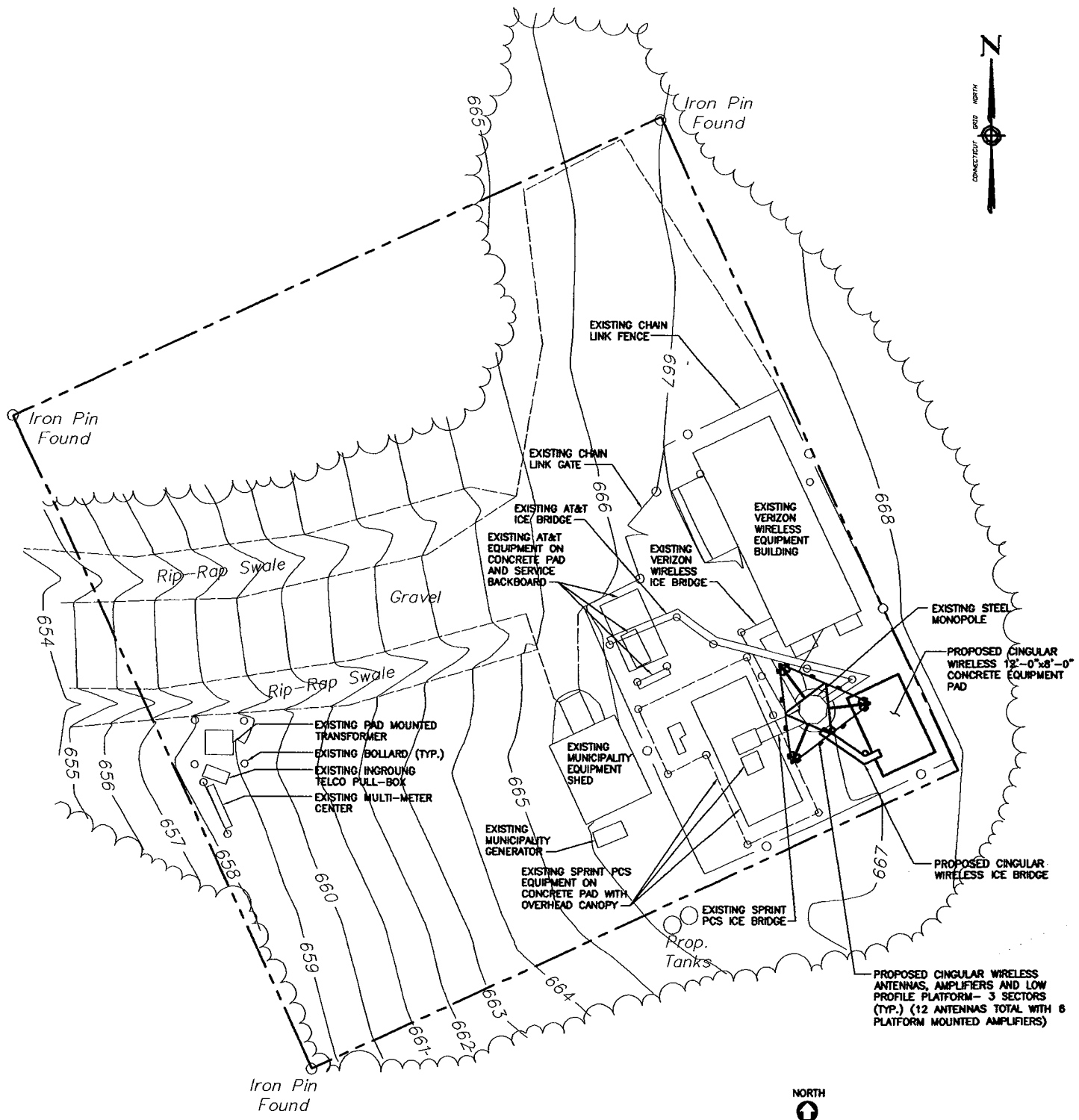

1 SITE PLAN
L-1 SCALE: 1"=20'-0"

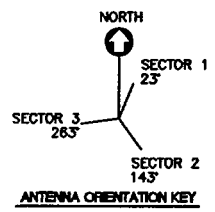

PROJECT NO.
36917530
Designed by:
Drawn by: CRS
Checked by:
Approved by:

URS CORPORATION AES
795 BROOK STREET, BLDG 5
ROCKY HILL, CONNECTICUT
1-(860)-529-8882

cingular
WIRELESS
WIRELESS COMMUNICATIONS FACILITY
EAST HAMPTON
SITE ADDRESS: 94 EAST HIGH STREET
EAST HAMPTON, CONNECTICUT

REV.	DATE	DESCRIPTION

Scale: AS NOTED Date: 04-16-03
Job No. CW1-006 File No. L-1

Dwg. No.
L-1
Dwg. No. of 2

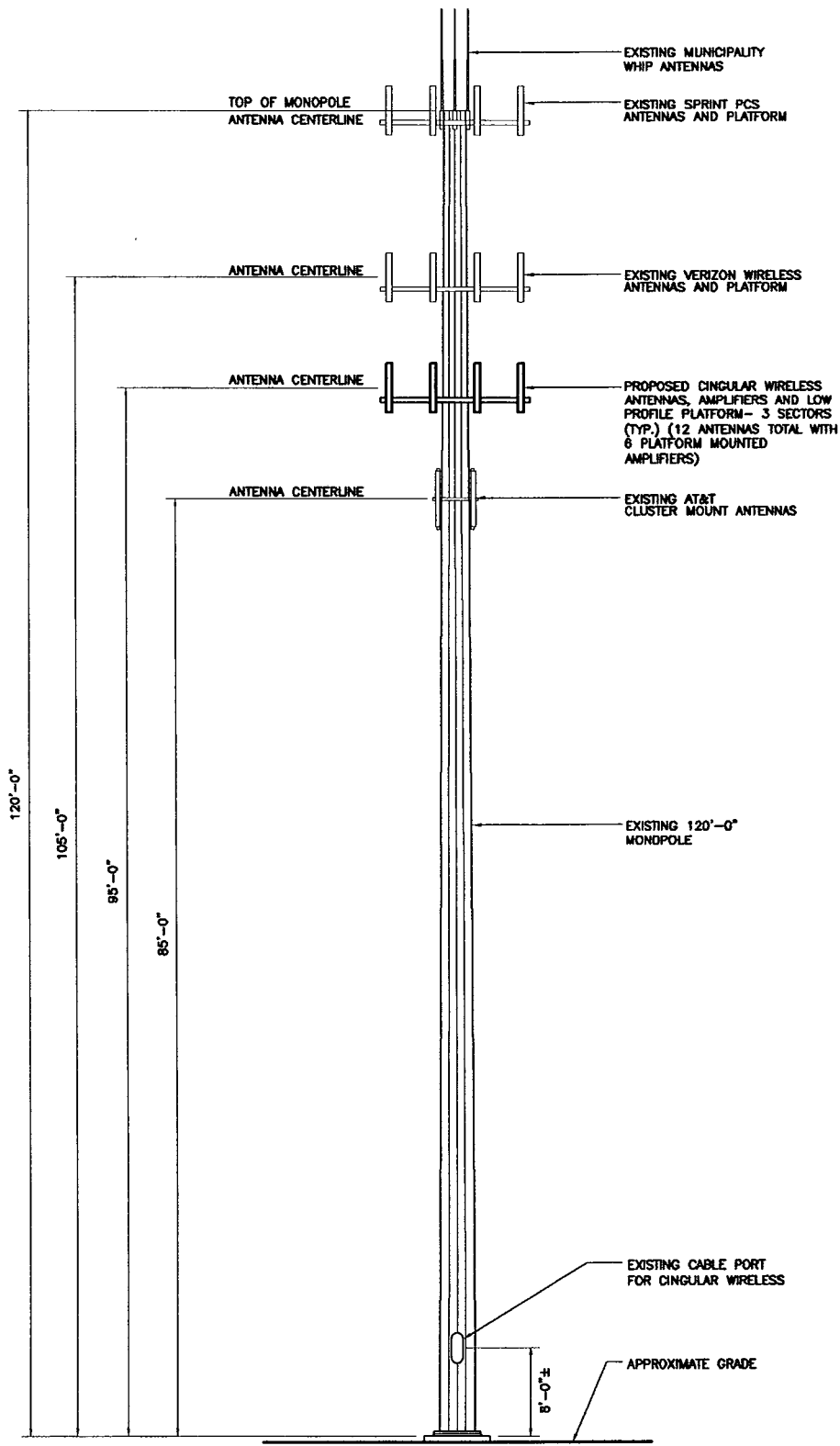

1 TOWER ELEVATION
L-2 SCALE: 1/16"=1'-0"

PROJECT NO.
36917530
Designed by:
Drawn by: BAL
Checked by:
Approved by:

URS CORPORATION AES
795 BROOK STREET, BLDG 5
ROCKY HILL, CONNECTICUT
1-(860)-529-8882

cingular
WIRELESS
WIRELESS COMMUNICATIONS FACILITY
EAST HAMPTON
SITE ADDRESS: 94 EAST HIGH STREET
EAST HAMPTON, CONNECTICUT

REV.	DATE	DESCRIPTION

Scale: AS NOTED Date: 04-16-03
Job No: CW1-006 File No. L-2

Dwg. No.
L-2
Dwg. 2 of 2

1047 N. 204th Avenue
Elkhorn, NE 68022
Ph: 402-289-1888
Fax: 402-289-1861

SEMAAN ENGINEERING SOLUTIONS

120 ft EEI Monopole Structural Analysis

OK
R/O
5/15/03

Prepared for:
Sprint Sites USA
535 East Crescent Ave
Ramsey, NJ 07446

Site: CT03XC335 - Cingular
East Hampton, CT



May 14, 2003

Ms. Kim Cordes
Sprint Sites USA
535 East Crescent Ave
Ramsey, NJ 07446

Re: Site Number CT03XC335 – East Hampton, CT.

Dear Ms. Cordes:

We have completed the structural analysis for the existing monopole, located at the above referenced site. The purpose of this analysis is to determine that the existing monopole design is in conformance with the EIA/TIA-222-F standard and local building codes for the proposed antennae loads installation. Refer to the Review and Recommendations section at the end of this report for the analysis results.

Description of Structure:

The structure is a 120 ft EEI Monopole.

Refer to EEI job # 5069 dated May 28, 1999 for a detailed description of the structure.

Method of analysis:

The tower was analyzed using Semaan Engineering Solutions' software suite for communication structures. The structural analysis is performed using the SAPS finite element engine. The method is 3D, non-linear, which accounts for the second order geometric effects due to the displacements. The analysis was performed in conformance with **EIA/TIA-222-F and local building codes for a basic wind speed of 85 mph and 1/2" radial ice with reduced wind speed.** Wind is applied to the structure, accessories and antennas.

Structure loading:

Per the loading sheet supplied, the analysis was performed using the following loading: (Proposed loading in bold)

Elev. (ft)	Qty.	Antennas and Mounts	Coax	Owner
120.0	1	APC-301 Mounted On a EEI 10'8" Low Profile platform	(1) 1/2	Municipality
120.0	1	DB264 Mounted On the same EEI 10'8" Low Profile platform	(1) 7/8	Municipality
120.0	1	DB420 Mounted On the same EEI 10'8" Low Profile platform	(1) 7/8	Municipality
120.0	9	DB980H90 Mounted On the same EEI 10'8" Low Profile platform	(9) 1-5/8	Sprint
105.0	12	DB844H90 Mounted On a Low Profile Platform	(12) 1-5/8	Verizon
95.0	6	TMA-DD 1900 Mounted On a Low Profile Platform		Cingular
95.0	12	DUO1417-8686 Mounted On the same Low Profile Platform	(12) 1-5/8	Cingular
95.0	3	DBC-750 combiner Mounted On the same Low Profile Platform		Cingular
85.0	6	Allgon 7250 on a Tri-Mount	(12) 1-1/4	AT&T

All new access holes shall be reinforced with welded rims that are compatible with the pole and to be sized and supplied by pole manufacturer.

All transmission lines are assumed running inside of pole shaft.

Results of Analysis:

Refer to the attached Computer Summary sheets for detailed analysis results.

Structure:

The existing monopole is structurally capable of supporting the existing and proposed antennas.

The maximum structure usage is: 82.4%.

Foundation:

Pole Reactions	Original Design Reactions	Current Analysis Reactions	% Of Design
Moment (ft-kips)	1,667.90	1,615.71	96.9
Shear (kips)	18.89	18.30	96.9

The structure base reactions resulting from this analysis do not exceed the ones shown on the original structure drawings.

Review and Recommendations:

Based on the analysis results, the existing structure meets the requirements per the EIA/TIA-222-F standards for a basic wind speed of 85 mph and 1/2" radial ice with reduced wind speed.

SEMAAN ENGINEERING SOLUTIONS

1047 N.204th Avenue
 Elkhorn, NE 68022
 Phone: 402-289-1888
 Fax: 402-289-1861

Copyright Semaan Engineering Solutions, Inc

Job Information	
Pole :	CT03XC335
Description :	
Client :	Sprint Sites USA - NJ
Location :	East Hampton, CT
Type :	18 Sides Base Elev (ft): 0.00
Height :(ft)	120.00 Taper: 0.245830 (in/ft)

Sections Properties								
Shaft Section	Length (ft)	Diameter (in)		Thick Joint (in)	Overlap Length (in)	Taper (in/ft)	Steel Grade (ksi)	
		Across Flats Top	Across Flats Bottom					
1	47.380	31.85	43.50	0.313	0.000	0.245830	65	
2	47.080	22.07	33.64	0.313	Slip Joint	0.245830	65	
3	33.707	15.00	23.28	0.188	Slip Joint	0.245830	65	

Discrete Appurtenance				
Attach Elev (ft)	Force Elev (ft)	Type	Qty	Description
120.000	120.000	Panel	9	DB980H90
120.000	120.000	Platform	1	EEL 10'8" Low Profile platform
120.000	129.040	Whip	1	DB420
120.000	130.750	Whip	1	DB264
120.000	130.000	Whip	1	APC-301
120.000	122.500	Lightning	1	Lightning Rod, 5'
105.000	105.000	Panel	12	DB844H90
105.000	105.000	Platform	1	Low Profile Platform
95.000	95.000	Panel	3	DBC-750 combiner
95.000	95.000	Panel	12	DUO1417-8686
95.000	95.000	Panel	6	TMA-DD 1900
95.000	95.000	Platform	1	Low Profile Platform
85.000	85.000	Other	1	Tri-Antenna Mount
85.000	85.000	Panel	6	Allgon 7250

Load Cases / Deflections			
Load Case	Attach Elev (ft)	Translation (in)	Rotation (deg)
Ice	<u>Ice Wind Speed = 73.61 mph w/ Ice 0.50 in Thick</u>		
	120.000	66.40	-5.038
	105.000	51.05	-4.690
	95.000	41.62	-4.285
	85.000	33.16	-3.820
No Ice	<u>No Ice Wind Speed = 85.00 mph w/ No Ice</u>		
	120.000	74.76	-5.565
	105.000	57.74	-5.225
	95.000	47.21	-4.806
	85.000	37.69	-4.307

Reactions			
Load Case	Moment (Kip-ft)	Shear (Kips)	Axial (Kips)
Ice	1,401.568	15.318	-22.794
No Ice	1,615.715	18.298	-16.830

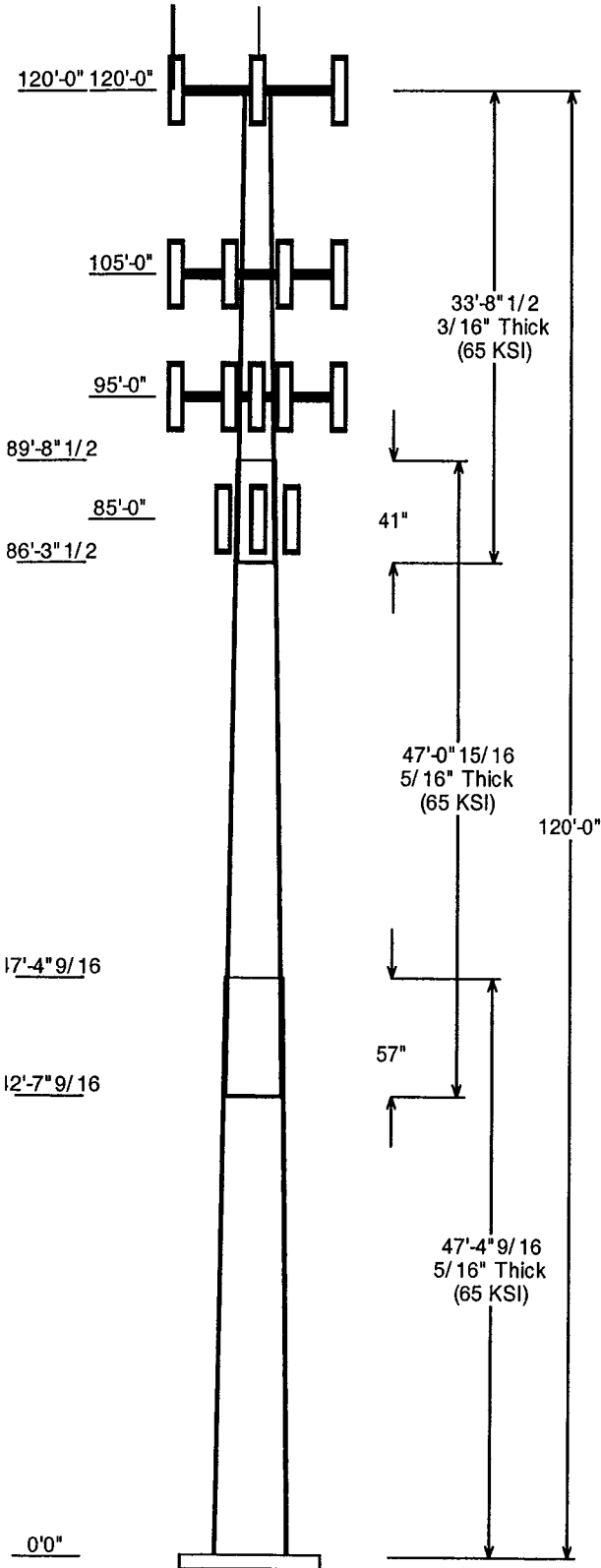



Southwestern Bell Mobile Systems, LLC
500 Enterprise Drive
Rocky Hill, Connecticut 06067-3900
Phone: (860) 513-7700
Fax: (860) 513-7190

Michele G. Briggs
Manager of Real Estate

May 20, 2003

Honorable Alan H. Bergren.
Town Manager, Town of East Hampton
Town Hall, 20 East High St.
East Hampton, Connecticut 06424

Re: Notice of Exempt Modification – Existing Sprint Telecommunications Tower Facility at East High Street, East Hampton, Connecticut

Dear Mr. Bergren:

Southwestern Bell Mobile Systems, LLC (“SBMS”) intends to install telecommunications antennas and associated equipment at an existing multicarrier telecommunications tower at East High Street in East Hampton, Connecticut.

The facility is owned and operated by Sprint Sites USA (“Sprint”), with offices at 535 E. Crescent Avenue, Ramsey, NJ 07446. Sprint leases the land from Pauls + Sandy’s Too, Inc. of East Hampton.

A Notice of Exempt Modification has been filed with the Connecticut Siting Council as required by Regulations of Connecticut State Agencies (“R.C.S.A.”) Section 16-50j-73. Please accept this letter as notification to the Town of East Hampton under Section 16-50j-73 of construction which constitutes an exempt modification pursuant to R.C.S.A. Section 16-50j-72(b)(2).

The attached letter fully sets forth the SBMS proposal. However, if you have any questions or require any further information on the plans for the site or the Siting Council’s procedures, please contact the undersigned or Mr. Derek Phelps, Executive Director of the Connecticut Siting Council, at (860) 827-2935.

Sincerely,

Michele G. Briggs
Manager of Real Estate

Enclosure

1047 N. 204th Avenue
Elkhorn, NE 68022
Ph: 402-289-1888
Fax: 402-289-1861

SEMAAN ENGINEERING SOLUTIONS

**120 ft EEI Monopole
Structural Analysis**

*OK
R/O
5/15/03*

RECEIVED

MAY 20 2003
CONNECTICUT
SITING COUNCIL

**Prepared for:
Sprint Sites USA
535 East Crescent Ave
Ramsey, NJ 07446**

**Site: CT03XC335 - Cingular
East Hampton, CT**



May 14, 2003

Ms. Kim Cordes
Sprint Sites USA
535 East Crescent Ave
Ramsey, NJ 07446

Re: Site Number CT03XC335 – East Hampton, CT.

Dear Ms. Cordes:

We have completed the structural analysis for the existing monopole, located at the above referenced site. The purpose of this analysis is to determine that the existing monopole design is in conformance with the EIA/TIA-222-F standard and local building codes for the proposed antennae loads installation. Refer to the Review and Recommendations section at the end of this report for the analysis results.

Description of Structure:

The structure is a 120 ft EEI Monopole.

Refer to EEI job # 5069 dated May 28, 1999 for a detailed description of the structure.

Method of analysis:

The tower was analyzed using Semaan Engineering Solutions' software suite for communication structures. The structural analysis is performed using the SAPS finite element engine. The method is 3D, non-linear, which accounts for the second order geometric effects due to the displacements. The analysis was performed in conformance with **EIA/TIA-222-F and local building codes for a basic wind speed of 85 mph and 1/2" radial ice with reduced wind speed.** Wind is applied to the structure, accessories and antennas.

Structure loading:

Per the loading sheet supplied, the analysis was performed using the following loading: (Proposed loading in bold)

Elev. (ft)	Qty.	Antennas and Mounts	Coax	Owner
120.0	1	APC-301 Mounted On a EEI 10'8" Low Profile platform	(1) 1/2	Municipality
120.0	1	DB264 Mounted On the same EEI 10'8" Low Profile platform	(1) 7/8	Municipality
120.0	1	DB420 Mounted On the same EEI 10'8" Low Profile platform	(1) 7/8	Municipality
120.0	9	DB980H90 Mounted On the same EEI 10'8" Low Profile platform	(9) 1-5/8	Sprint
105.0	12	DB844H90 Mounted On a Low Profile Platform	(12) 1-5/8	Verizon
95.0	6	TMA-DD 1900 Mounted On a Low Profile Platform		Cingular
95.0	12	DUO1417-8686 Mounted On the same Low Profile Platform	(12) 1-5/8	Cingular
95.0	3	DBC-750 combiner Mounted On the same Low Profile Platform		Cingular
85.0	6	Allgon 7250 on a Tri-Mount	(12) 1-1/4	AT&T

All new access holes shall be reinforced with welded rims that are compatible with the pole and to be sized and supplied by pole manufacturer.

All transmission lines are assumed running inside of pole shaft.

Results of Analysis:

Refer to the attached Computer Summary sheets for detailed analysis results.

Structure:

The existing monopole is structurally capable of supporting the existing and proposed antennas.

The maximum structure usage is: 82.4%.

Foundation:

Pole Reactions	Original Design Reactions	Current Analysis Reactions	% Of Design
Moment (ft-kips)	1,667.90	1,615.71	96.9
Shear (kips)	18.89	18.30	96.9

The structure base reactions resulting from this analysis do not exceed the ones shown on the original structure drawings.

Review and Recommendations:

Based on the analysis results, the existing structure meets the requirements per the EIA/TIA-222-F standards for a basic wind speed of 85 mph and 1/2" radial ice with reduced wind speed.

SEMAAN ENGINEERING SOLUTIONS

1047 N.204th Avenue
 Elkhorn, NE 68022
 Phone: 402-289-1888
 Fax: 402-289-1861

Copyright Semaan Engineering Solutions, Inc

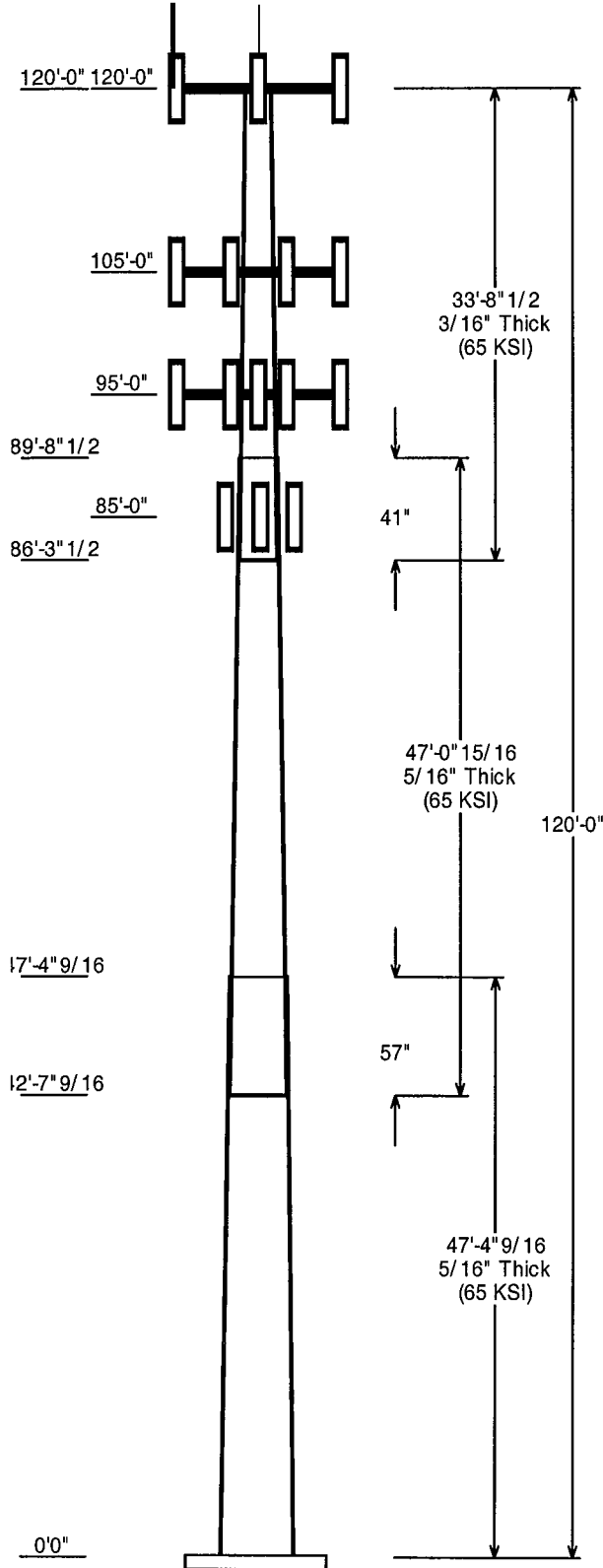

Job Information

Pole :	CT03XC335
Description :	
Client :	Sprint Sites USA - NJ
Location :	East Hampton, CT
Type :	18 Sides Base Elev (ft): 0.00
Height :(ft)	120.00 Taper: 0.245830 (in/ft)

Sections Properties

Shaft Section	Length (ft)	Diameter (in)		Thick Joint (in) Type	Overlap Length (in)	Taper (in/ft)	Steel Grade (ksi)
		Across Top	Flats Bottom				
1	47.380	31.85	43.50	0.313	0.000	0.245830	65
2	47.080	22.07	33.64	0.313 Slip Joint	57.000	0.245830	65
3	33.707	15.00	23.28	0.188 Slip Joint	41.000	0.245830	65

Discrete Appurtenance

Attach Elev (ft)	Force Elev (ft)	Type	Qty	Description
120.000	120.000	Panel	9	DB980H90
120.000	120.000	Platform	1	EEL 10'8" Low Profile platform
120.000	129.040	Whip	1	DB420
120.000	130.750	Whip	1	DB264
120.000	130.000	Whip	1	APC-301
120.000	122.500	Lightning	1	Lightning Rod, 5'
105.000	105.000	Panel	12	DB844H90
105.000	105.000	Platform	1	Low Profile Platform
95.000	95.000	Panel	3	DBC-750 combiner
95.000	95.000	Panel	12	DUO1417-8686
95.000	95.000	Panel	6	TMA-DD 1900
95.000	95.000	Platform	1	Low Profile Platform
85.000	85.000	Other	1	Tri-Antenna Mount
85.000	85.000	Panel	6	Allgon 7250

Load Cases / Deflections

Load Case	Attach Elev (ft)	Translation (in)	Rotation (deg)
Ice	Ice Wind Speed = 73.61 mph w/ Ice 0.50 in Thick		
	120.000	66.40	-5.038
	105.000	51.05	-4.690
	95.000	41.62	-4.285
No Ice	No Ice Wind Speed = 85.00 mph w/ No Ice		
	120.000	74.76	-5.565
	105.000	57.74	-5.225
	95.000	47.21	-4.806
	85.000	37.69	-4.307

Reactions

Load Case	Moment (Kip-ft)	Shear (Kips)	Axial (Kips)
Ice	1,401.568	15.318	-22.794
No Ice	1,615.715	18.298	-16.830

Load Case : Ice

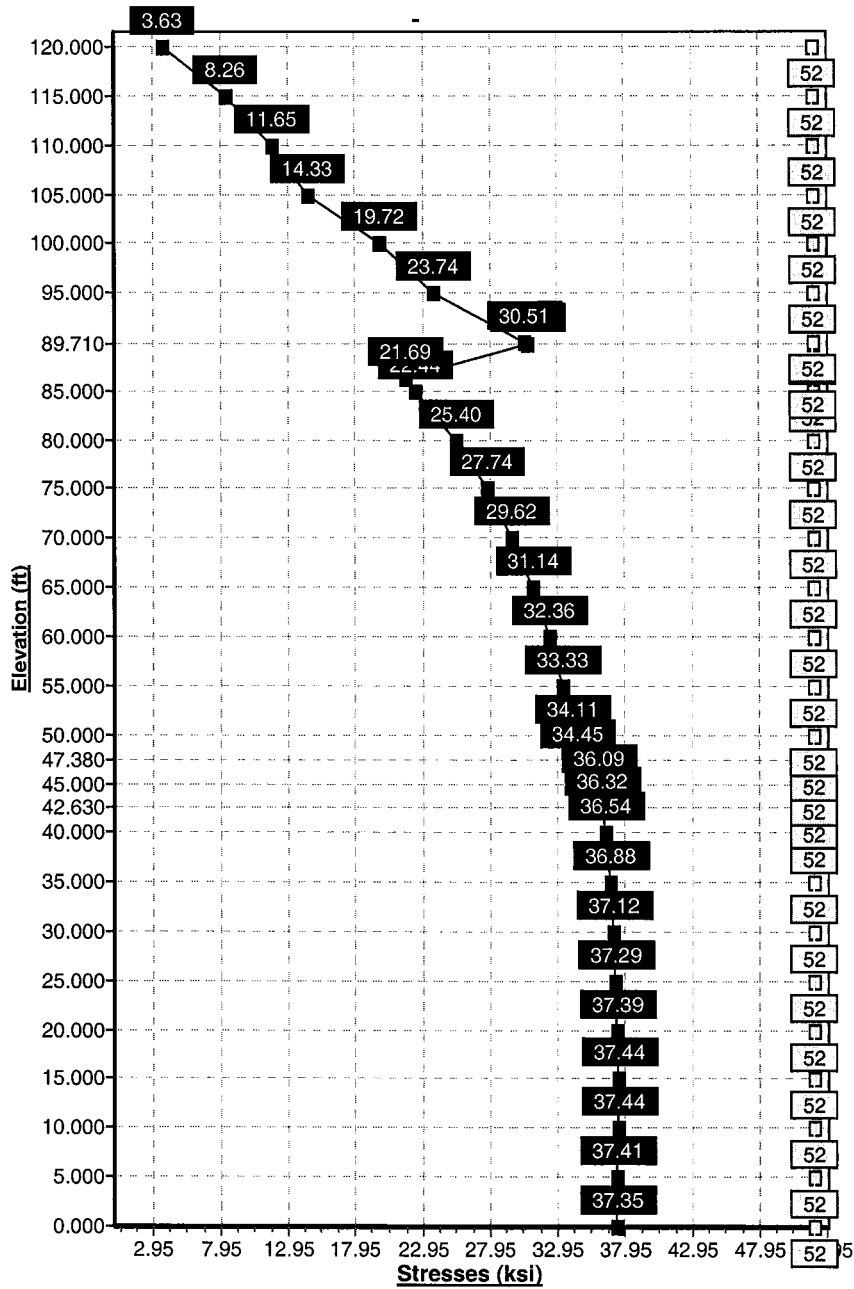

Pole : CT03XC335
 Location: East Hampton, CT
 Height : 120.0 (ft)
 Shape : 18 Sides
 Base Dia : 43.50 (in)
 Taper : 0.245830 (in/ft)

Sprint Sites USA - NJ
 Base Elev : 0.000 (ft)
 Top Dia : 15.00 (in)

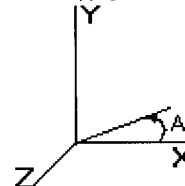

Shaft Section Properties

Sect Num	Length (ft)	Thick (in)	Fy (ksi)	Joint Type	Slip Joint Len (in)	Weight (lb)	Bottom						Top											
							Dia (in)	Elev (ft)	Area (sqin)	Ix (in^4)	W/t Ratio	D/t Ratio	Dia (in)	Elev (ft)	Area (sqin)	Ix (in^4)	W/t Ratio	D/t Ratio	Taper (in/ft)					
1	47.380	0.3125	65		0.00	5,975	43.50	0.000	42.84	10094.1	23.13	139.2	31.85	47.38	31.28	3931.7	16.56	101.93	0.24583					
2	47.080	0.3125	65	Slip Joint	57.00	4,377	33.64	42.63	33.06	4641.0	17.57	107.6	22.07	89.71	21.58	1291.0	11.04	70.63	0.24583					
3	33.707	0.1875	65	Slip Joint	41.00	1,294	23.28	86.29	13.75	926.7	20.49	124.1	15.00	120.0	8.82	244.4	12.70	80.00	0.24583					
Shaft Weight						11,646																		

Discrete Appurtenance Properties

Attach Elev (ft)	Description	Qty	Weight (lb)	No Ice CaAa (sf)	CaAa Factor	Weight (lb)	Ice CaAa (sf)	CaAa Factor	Distance From Face (ft)	X Angle (deg)	Vert Ecc (ft)
120.0	DB980H90	9	9.00	3.280	0.67	28.00	3.850	0.67	0.000	0.00	0.000
120.0	EEl 10'8" Low Profile platform	1	1500.00	22.500	1.00	2250.00	28.200	1.00	0.000	0.00	0.000
120.0	DB420	1	34.00	6.000	1.00	77.00	7.810	1.00	0.000	0.00	9.040
120.0	DB264	1	36.00	5.690	1.00	84.00	10.300	1.00	0.000	0.00	10.750
120.0	APC-301	1	50.00	6.000	1.00	93.00	8.030	1.00	0.000	0.00	10.000
120.0	Lightning Rod, 5'	1	35.00	1.050	1.00	44.00	1.730	1.00	0.000	0.00	2.500
105.0	DB844H90	12	10.00	3.960	1.00	35.00	4.520	1.00	0.000	0.00	0.000
105.0	Low Profile Platform	1	1300.00	25.550	1.00	2100.00	27.320	1.00	0.000	0.00	0.000
95.00	DBC-750 combiner	3	5.00	0.550	1.00	7.85	0.700	1.00	0.000	0.00	0.000
95.00	DUO1417-8686	12	30.80	6.530	1.00	73.00	7.150	1.00	0.000	0.00	0.000
95.00	TMA-DD 1900	6	5.60	0.387	1.00	8.86	0.531	1.00	0.000	0.00	0.000
95.00	Low Profile Platform	1	1300.00	25.550	1.00	2100.00	27.320	1.00	0.000	0.00	0.000
85.00	Tri-Antenna Mount	1	250.00	5.000	1.00	425.00	7.500	1.00	0.000	0.00	0.000
85.00	Allgon 7250	6	16.00	4.300	0.67	36.00	5.000	0.67	0.000	0.00	0.000
Totals		56	5220.20			9013.71			Number of Loadings : 14		

Pole : CT03XC335
 Location: East Hampton, CT
 Height : 120.0 (ft)
 Shape : 18 Sides
 Base Dia : 43.50 (in)
 Taper : 0.245830 (in/ft)

Sprint Sites USA - NJ

Base Elev : 0.000 (ft)
 Top Dia : 15.00 (in)

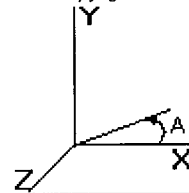

Segment Properties (Max Len : 5 ft)

Seg Elev (ft)	Description	Thick (in)	Dia (in)	Area (in^2)	Ix (in^4)	W/t Ratio	D/t Ratio	Fy (ksi)	Fb (ksi)	Weight (lb)
0.00		0.3125	43.500	42.835	10,094.1	23.13	139.20	65	52	0.0
5.00		0.3125	42.271	41.616	9,256.6	22.44	135.27	65	52	718.4
10.00		0.3125	41.042	40.397	8,466.7	21.75	131.33	65	52	697.7
15.00		0.3125	39.813	39.178	7,723.0	21.05	127.40	65	52	676.9
20.00		0.3125	38.583	37.959	7,024.3	20.36	123.47	65	52	656.2
25.00		0.3125	37.354	36.739	6,369.0	19.67	119.53	65	52	635.5
30.00		0.3125	36.125	35.520	5,755.8	18.97	115.60	65	52	614.7
35.00		0.3125	34.896	34.301	5,183.2	18.28	111.67	65	52	594.0
40.00		0.3125	33.667	33.082	4,650.0	17.59	107.73	65	52	573.2
42.63	Bot - Section 2	0.3125	33.020	32.441	4,384.8	17.22	105.66	65	52	293.2
45.00		0.3125	32.438	31.863	4,154.6	16.89	103.80	65	52	523.6
47.38	Top - Section 1	0.3125	32.478	31.903	4,170.1	16.91	103.93	65	52	516.4
50.00		0.3125	31.833	31.264	3,924.6	16.55	101.87	65	52	281.6
55.00		0.3125	30.604	30.045	3,483.1	15.86	97.93	65	52	521.5
60.00		0.3125	29.375	28.826	3,076.1	15.16	94.00	65	52	500.8
65.00		0.3125	28.146	27.606	2,702.1	14.47	90.07	65	52	480.1
70.00		0.3125	26.917	26.387	2,359.7	13.78	86.13	65	52	459.3
75.00		0.3125	25.688	25.168	2,047.5	13.08	82.20	65	52	438.6
80.00		0.3125	24.459	23.949	1,764.1	12.39	78.27	65	52	417.8
85.00		0.3125	23.229	22.730	1,508.2	11.70	74.33	65	52	397.1
86.29	Bot - Section 3	0.3125	22.912	22.415	1,446.3	11.52	73.32	65	52	99.3
89.71	Top - Section 2	0.1875	22.447	13.246	829.2	19.70	119.72	65	52	412.7
90.00		0.1875	22.375	13.204	821.3	19.63	119.33	65	52	13.1
95.00		0.1875	21.146	12.473	692.2	18.48	112.78	65	52	218.4
100.00		0.1875	19.917	11.741	577.4	17.32	106.22	65	52	206.0
105.00		0.1875	18.688	11.010	476.1	16.16	99.67	65	52	193.5
110.00		0.1875	17.459	10.278	387.4	15.01	93.11	65	52	181.1
115.00		0.1875	16.230	9.547	310.4	13.85	86.56	65	52	168.6
120.00		0.1875	15.000	8.815	244.4	12.70	80.00	65	52	156.2
										11,645.5

Pole : CT03XC335
 Location: East Hampton, CT
 Height : 120.0 (ft)
 Shape : 18 Sides
 Base Dia : 43.50 (in)
 Taper : 0.245830 (in/ft)

Sprint Sites USA - NJ
 Base Elev : 0.000 (ft)
 Top Dia : 15.00 (in)

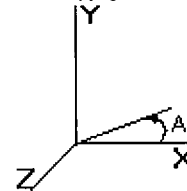

Load Case: Ice 85 mph - With Ice - Ice Thickness = 0.5 in 23 Iterations

Gust Response Factor : 1.69 Effective Wind Speed : 73.61 (mph)

Dead Load Factor : 1.00

Wind Load Factor : 1.00

Shaft Forces

Seg Top Elev (ft)	Description	Kz	qz (psf)	qzGh (psf)	C (mph-ft)	Cf	Tributary (ft)	Aa (sf)	CfAa (sf)	Wind Force X (lb)	Wind Force Z (lb)	Weight (lb)
0.00		1.00	13.87	23.44	266.84	0.650	0.00	0.000	0.000	0.00	0.00	0.0
5.00		1.00	13.87	23.44	259.30	0.650	5.00	18.286	11.886	278.63	0.00	850.4
10.00		1.00	13.87	23.44	251.76	0.650	5.00	17.773	11.553	270.82	0.00	825.9
15.00		1.00	13.87	23.44	244.22	0.650	5.00	17.261	11.220	263.02	0.00	801.3
20.00		1.00	13.87	23.44	236.68	0.650	5.00	16.749	10.887	255.21	0.00	776.8
25.00		1.00	13.87	23.44	229.14	0.650	5.00	16.237	10.554	247.41	0.00	752.3
30.00		1.00	13.87	23.44	221.60	0.650	5.00	15.725	10.221	239.61	0.00	727.7
35.00		1.01	14.10	23.84	215.86	0.650	5.00	15.213	9.888	235.73	0.00	703.2
40.00		1.05	14.65	24.76	212.27	0.650	5.00	14.701	9.555	236.66	0.00	678.7
42.63	Bot - Section 2	1.07	14.92	25.22	210.10	0.650	2.63	7.527	4.893	123.40	0.00	347.6
45.00		1.09	15.15	25.61	207.99	0.650	2.37	6.785	4.410	112.96	0.00	572.7
47.38	Top - Section 1	1.10	15.38	25.99	205.75	0.650	2.38	6.698	4.354	113.17	0.00	564.9
50.00		1.12	15.62	26.39	207.21	0.650	2.62	7.239	4.705	124.21	0.00	333.9
55.00		1.15	16.05	27.12	201.94	0.650	5.00	13.425	8.726	236.70	0.00	617.5
60.00		1.18	16.45	27.80	196.26	0.650	5.00	12.912	8.393	233.40	0.00	593.0
65.00		1.21	16.83	28.45	190.21	0.650	5.00	12.400	8.060	229.33	0.00	568.5
70.00		1.24	17.19	29.06	183.84	0.650	5.00	11.888	7.727	224.56	0.00	543.9
75.00		1.26	17.53	29.63	177.18	0.650	5.00	11.376	7.394	219.17	0.00	519.4
80.00		1.28	17.86	30.19	170.27	0.650	5.00	10.864	7.061	213.19	0.00	494.9
85.00	Appertunance(s)	1.31	18.17	30.71	163.12	0.650	5.00	10.352	6.729	206.69	0.00	470.3
86.29	Bot - Section 3	1.31	18.25	30.85	161.23	0.650	1.29	2.594	1.686	52.02	0.00	118.0
89.71	Top - Section 2	1.33	18.45	31.19	156.18	0.650	3.42	6.795	4.417	137.79	0.00	461.0
90.00		1.33	18.47	31.22	158.41	0.650	0.29	0.566	0.368	11.49	0.00	17.2
95.00	Appertunance(s)	1.35	18.76	31.71	150.86	0.650	5.00	9.484	6.164	195.47	0.00	285.2
100.00		1.37	19.04	32.17	143.14	0.650	5.00	8.971	5.831	187.65	0.00	269.0
105.00	Appertunance(s)	1.39	19.30	32.63	135.25	0.650	5.00	8.459	5.499	179.42	0.00	252.7
110.00		1.41	19.56	33.06	127.19	0.650	5.00	7.947	5.166	170.81	0.00	236.5
115.00		1.42	19.81	33.49	118.99	0.650	5.00	7.435	4.833	161.85	0.00	220.3
120.00	Appertunance(s)	1.44	20.05	33.89	110.65	0.650	5.00	6.923	4.500	152.54	0.00	204.0
Totals:							120.00			5,312.91	0.00	13,806.6

Pole : CT03XC335
 Location: East Hampton, CT
 Height : 120.0 (ft)
 Shape : 18 Sides
 Base Dia : 43.50 (in)
 Taper : 0.245830 (in/ft)

Sprint Sites USA - NJ
 Base Elev : 0.000 (ft)
 Top Dia : 15.00 (in)

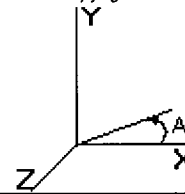

Load Case: Ice 85 mph - With Ice - Ice Thickness = 0.5 in 23 Iterations

Gust Response Factor : 1.69 Effective Wind Speed : 73.61 (mph)

Dead Load Factor : 1.00

Wind Load Factor : 1.00

Discrete Appurtenance Forces

Elev (ft)	Description	Qty	qz (psf)	qzGh (psf)	Total CaAa (sf)	CaAa Factor	Horiz Ecc (ft)	Vert Ecc (ft)	X Angle (deg)	Wind Force X (lb)	Wind Force Z (lb)	Mom X (lb-ft)	Mom Y (lb-ft)	Mom Z (lb-ft)	Weight (lb)
85.00	Tri-Antenna Mount	1	18.17	30.71	7.500	1.000	0.000	0.0	0.0	230.39	0.00	0.00	0.00	0.00	425.0
85.00	Allgon 7250	6	18.17	30.71	20.010	0.667	0.000	0.0	0.0	614.68	0.00	0.00	0.00	0.00	216.0
95.00	DBC-750 combiner	3	18.76	31.71	2.100	1.000	0.000	0.0	0.0	66.59	0.00	0.00	0.00	0.00	23.5
95.00	DUO1417-8686	12	18.76	31.71	85.800	1.000	0.000	0.0	0.0	2720.75	0.00	0.00	0.00	0.00	876.0
95.00	TMA-DD 1900	6	18.76	31.71	3.186	1.000	0.000	0.0	0.0	101.03	0.00	0.00	0.00	0.00	53.2
95.00	Low Profile Platform	1	18.76	31.71	27.320	1.000	0.000	0.0	0.0	866.33	0.00	0.00	0.00	0.00	2100.0
105.00	DB844H90	12	19.30	32.63	54.240	1.000	0.000	0.0	0.0	1769.87	0.00	0.00	0.00	0.00	420.0
105.00	Low Profile Platform	1	19.30	32.63	27.320	1.000	0.000	0.0	0.0	891.46	0.00	0.00	0.00	0.00	2100.0
120.00	DB980H90	9	20.05	33.89	23.112	0.667	0.000	0.0	0.0	783.46	0.00	0.00	0.00	0.00	252.0
120.00	EEI 10'8" Low Profile	1	20.05	33.89	28.200	1.000	0.000	0.0	0.0	955.95	0.00	0.00	0.00	0.00	2250.0
120.00	DB420	1	20.47	34.61	7.810	1.000	0.000	9.0	0.0	270.30	0.00	0.00	0.00	2443.52	77.0
120.00	DB264	1	20.55	34.74	10.300	1.000	0.000	10.8	0.0	357.83	0.00	0.00	0.00	3846.64	84.0
120.00	APC-301	1	20.52	34.68	8.030	1.000	0.000	10.0	0.0	278.50	0.00	0.00	0.00	2785.04	93.0
120.00	Lightning Rod, 5'	1	20.17	34.10	1.730	1.000	0.000	2.5	0.0	58.99	0.00	0.00	0.00	147.48	44.0
										9,966.14	0.00			9,013.7	

Pole : CT03XC335
 Location: East Hampton, CT
 Height : 120.0 (ft)
 Shape : 18 Sides
 Base Dia : 43.50 (in)
 Taper : 0.245830 (in/ft)

Sprint Sites USA - NJ
 Base Elev : 0.000 (ft)
 Top Dia : 15.00 (in)

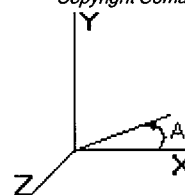

Load Case: Ice 85 mph - With Ice - Ice Thickness = 0.5 in 23 Iterations

Gust Response Factor : 1.69 Effective Wind Speed : 73.61 (mph)
 Dead Load Factor : 1.00
 Wind Load Factor : 1.00

Applied Forces Summary

Seg Elev (ft)	X Coord (ft)	Z Coord (ft)	Lateral FX (-) (lb)	Axial FY (-) (lb)	Lateral FZ (lb)	Moment MX (lb-ft)	Torsion MY (lb-ft)	Moment MZ (lb-ft)
0.00	0.00	0.00	0.00	0.00	0.00	0.00	0.00	0.00
5.00	0.00	0.00	278.63	850.40	0.00	0.00	0.00	0.00
10.00	0.00	0.00	270.82	825.86	0.00	0.00	0.00	0.00
15.00	0.00	0.00	263.02	801.33	0.00	0.00	0.00	0.00
20.00	0.00	0.00	255.21	776.79	0.00	0.00	0.00	0.00
25.00	0.00	0.00	247.41	752.26	0.00	0.00	0.00	0.00
30.00	0.00	0.00	239.61	727.73	0.00	0.00	0.00	0.00
35.00	0.00	0.00	235.73	703.19	0.00	0.00	0.00	0.00
40.00	0.00	0.00	236.66	678.66	0.00	0.00	0.00	0.00
42.63	0.00	0.00	123.40	347.60	0.00	0.00	0.00	0.00
45.00	0.00	0.00	112.96	572.67	0.00	0.00	0.00	0.00
47.38	0.00	0.00	113.17	564.85	0.00	0.00	0.00	0.00
50.00	0.00	0.00	124.21	333.85	0.00	0.00	0.00	0.00
55.00	0.00	0.00	236.70	617.53	0.00	0.00	0.00	0.00
60.00	0.00	0.00	233.40	592.99	0.00	0.00	0.00	0.00
65.00	0.00	0.00	229.33	568.46	0.00	0.00	0.00	0.00
70.00	0.00	0.00	224.56	543.92	0.00	0.00	0.00	0.00
75.00	0.00	0.00	219.17	519.39	0.00	0.00	0.00	0.00
80.00	0.00	0.00	213.19	494.85	0.00	0.00	0.00	0.00
85.00	0.00	0.00	1,051.76	1,111.32	0.00	0.00	0.00	0.00
86.29	0.00	0.00	52.02	118.02	0.00	0.00	0.00	0.00
89.71	0.00	0.00	137.79	461.05	0.00	0.00	0.00	0.00
90.00	0.00	0.00	11.49	17.15	0.00	0.00	0.00	0.00
95.00	0.00	0.00	3,950.17	3,337.93	0.00	0.00	0.00	0.00
100.00	0.00	0.00	187.65	268.99	0.00	0.00	0.00	0.00
105.00	0.00	0.00	2,840.74	2,772.75	0.00	0.00	0.00	0.00
110.00	0.00	0.00	170.81	236.51	0.00	0.00	0.00	0.00
115.00	0.00	0.00	161.85	220.27	0.00	0.00	0.00	0.00
120.00	0.00	0.00	2,857.59	3,004.03	0.00	0.00	0.00	9,222.69
Totals:			15,279.05	22,820.35	0.00	0.00	0.00	9,222.69

Pole : CT03XC335
 Location: East Hampton, CT
 Height : 120.0 (ft)
 Shape : 18 Sides
 Base Dia : 43.50 (in)
 Taper : 0.245830 (in/ft)

Sprint Sites USA - NJ

Base Elev : 0.000 (ft)
 Top Dia : 15.00 (in)

Copyright Semaan Engineering Solutions, Inc

5/14/2003 9:48:46 AM

Page: 6

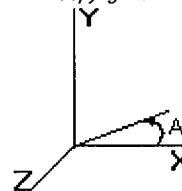

Load Case: Ice 85 mph - With Ice - Ice Thickness = 0.5 in 23 Iterations

Gust Response Factor : 1.69 Effective Wind Speed : 73.61 (mph)

Dead Load Factor : 1.00

Wind Load Factor : 1.00

Calculated Forces and Deflections

Seg Elev (ft)	Lateral FX (-) (kips)	Axial FY (-) (kips)	Lateral FZ (kips)	Moment MX (ft-kips)	Torsion MY (ft-kips)	Moment MZ (ft-kips)	X Deflect (in)	Z Deflect (in)	Total Deflect (in)	Rotation (deg)
0.00	15.318	22.794	0.000	0.000	0.000	1,401.568	0.000	0.000	0.000	0.000
5.00	15.112	21.893	0.000	0.000	0.000	1,324.980	-0.103	0.000	0.103	-0.192
10.00	14.911	21.016	0.000	0.000	0.000	1,249.419	-0.410	0.000	0.410	-0.390
15.00	14.714	20.164	0.000	0.000	0.000	1,174.865	-0.928	0.000	0.928	-0.594
20.00	14.521	19.337	0.000	0.000	0.000	1,101.296	-1.662	0.000	1.662	-0.803
25.00	14.333	18.534	0.000	0.000	0.000	1,028.692	-2.619	0.000	2.619	-1.019
30.00	14.149	17.756	0.000	0.000	0.000	957.029	-3.805	0.000	3.805	-1.241
35.00	13.965	17.002	0.000	0.000	0.000	886.287	-5.226	0.000	5.226	-1.468
40.00	13.761	16.287	0.000	0.000	0.000	816.464	-6.889	0.000	6.889	-1.702
42.63	13.661	15.914	0.000	0.000	0.000	780.273	-7.863	0.000	7.863	-1.831
45.00	13.561	15.318	0.000	0.000	0.000	747.898	-8.802	0.000	8.802	-1.948
47.38	13.460	14.728	0.000	0.000	0.000	715.624	-9.804	0.000	9.804	-2.067
50.00	13.370	14.356	0.000	0.000	0.000	680.358	-10.975	0.000	10.975	-2.200
55.00	13.165	13.694	0.000	0.000	0.000	613.509	-13.405	0.000	13.405	-2.434
60.00	12.960	13.058	0.000	0.000	0.000	547.684	-16.081	0.000	16.081	-2.671
65.00	12.755	12.449	0.000	0.000	0.000	482.885	-19.007	0.000	19.007	-2.910
70.00	12.551	11.866	0.000	0.000	0.000	419.111	-22.181	0.000	22.181	-3.147
75.00	12.348	11.310	0.000	0.000	0.000	356.358	-25.602	0.000	25.602	-3.381
80.00	12.147	10.783	0.000	0.000	0.000	294.618	-29.264	0.000	29.264	-3.607
85.00	11.047	9.717	0.000	0.000	0.000	233.885	-33.157	0.000	33.157	-3.820
86.29	11.004	9.584	0.000	0.000	0.000	219.599	-34.199	0.000	34.199	-3.875
89.71	10.846	9.120	0.000	0.000	0.000	182.004	-37.020	0.000	37.020	-4.010
90.00	10.856	9.076	0.000	0.000	0.000	178.858	-37.264	0.000	37.264	-4.022
95.00	6.699	6.006	0.000	0.000	0.000	124.577	-41.621	0.000	41.621	-4.285
100.00	6.512	5.729	0.000	0.000	0.000	91.081	-46.228	0.000	46.228	-4.506
105.00	3.467	3.184	0.000	0.000	0.000	58.521	-51.047	0.000	51.047	-4.690
110.00	3.284	2.954	0.000	0.000	0.000	41.187	-56.037	0.000	56.037	-4.839
115.00	3.109	2.743	0.000	0.000	0.000	24.767	-61.168	0.000	61.168	-4.960
120.00	2.858	0.000	0.000	0.000	0.000	9.223	-66.404	0.000	66.404	-5.038

Pole : CT03XC335
 Location: East Hampton, CT
 Height : 120.0 (ft)
 Shape : 18 Sides
 Base Dia : 43.50 (in)
 Taper : 0.245830 (in/ft)

Sprint Sites USA - NJ
 Base Elev : 0.000 (ft)
 Top Dia : 15.00 (in)

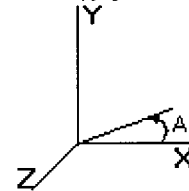

Load Case: Ice

85 mph - With Ice - Ice Thickness = 0.5 in

23 Iterations

Gust Response Factor : 1.69 Effective Wind Speed : 73.61 (mph)
 Dead Load Factor : 1.00
 Wind Load Factor : 1.00

Calculated Stresses

Seg Elev (ft)	Applied Stresses						Combined (ksi)	Allowable Stress (Fb) (ksi)	Stress Ratio
	Axial (Y) (ksi)	Shear (X) (ksi)	Shear (Z) (ksi)	Torsion (ksi)	Bending (X) (ksi)	Bending (Z) (ksi)			
0.00	0.532	0.721	0.000	0.000	0.000	36.799	37.352	52.0	0.719
5.00	0.526	0.732	0.000	0.000	0.000	36.864	37.411	52.0	0.720
10.00	0.520	0.744	0.000	0.000	0.000	36.900	37.442	52.0	0.720
15.00	0.515	0.757	0.000	0.000	0.000	36.900	37.437	52.0	0.720
20.00	0.509	0.771	0.000	0.000	0.000	36.856	37.389	52.0	0.719
25.00	0.504	0.786	0.000	0.000	0.000	36.758	37.288	52.0	0.717
30.00	0.500	0.803	0.000	0.000	0.000	36.596	37.122	52.0	0.714
35.00	0.496	0.821	0.000	0.000	0.000	36.354	36.877	52.0	0.709
40.00	0.492	0.838	0.000	0.000	0.000	36.015	36.537	52.0	0.703
42.63	0.491	0.849	0.000	0.000	0.000	35.800	36.320	52.0	0.699
45.00	0.481	0.858	0.000	0.000	0.000	35.576	36.088	52.0	0.694
47.38	0.462	0.850	0.000	0.000	0.000	33.956	34.449	52.0	0.663
50.00	0.459	0.862	0.000	0.000	0.000	33.622	34.114	52.0	0.656
55.00	0.456	0.883	0.000	0.000	0.000	32.842	33.333	52.0	0.641
60.00	0.453	0.906	0.000	0.000	0.000	31.865	32.356	52.0	0.623
65.00	0.451	0.931	0.000	0.000	0.000	30.645	31.138	52.0	0.599
70.00	0.450	0.959	0.000	0.000	0.000	29.127	29.624	52.0	0.570
75.00	0.449	0.989	0.000	0.000	0.000	27.239	27.741	52.0	0.534
80.00	0.450	1.022	0.000	0.000	0.000	24.886	25.398	52.0	0.489
85.00	0.427	0.980	0.000	0.000	0.000	21.947	22.439	52.0	0.432
86.29	0.428	0.989	0.000	0.000	0.000	21.194	21.690	52.0	0.417
89.71	0.688	1.650	0.000	0.000	0.000	30.017	30.838	52.0	0.593
90.00	0.687	1.657	0.000	0.000	0.000	29.688	30.511	52.0	0.587
95.00	0.482	1.083	0.000	0.000	0.000	23.186	23.742	52.0	0.457
100.00	0.488	1.118	0.000	0.000	0.000	19.141	19.724	52.0	0.379
105.00	0.289	0.635	0.000	0.000	0.000	13.995	14.327	52.0	0.276
110.00	0.287	0.644	0.000	0.000	0.000	11.310	11.651	52.0	0.224
115.00	0.287	0.656	0.000	0.000	0.000	7.889	8.255	52.0	0.159
120.00	0.000	0.653	0.000	0.000	0.000	3.449	3.630	52.0	0.070

Pole : CT03XC335
 Location: East Hampton, CT
 Height : 120.0 (ft)
 Shape : 18 Sides
 Base Dia : 43.50 (in)
 Taper : 0.245830 (in/ft)

Sprint Sites USA - NJ
 Base Elev : 0.000 (ft)
 Top Dia : 15.00 (in)

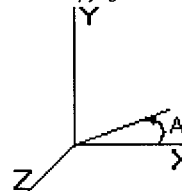

Load Case: No Ice 85 mph - No Ice 23 Iterations

Gust Response Factor : 1.69 Effective Wind Speed : 85.00 (mph)
 Dead Load Factor : 1.00
 Wind Load Factor : 1.00

Shaft Forces

Seg Top Elev (ft)	Description	Kz	qz (psf)	qzGh (psf)	C (mph-ft)	Cf	Tributary (ft)	Aa (sf)	CfAa (sf)	Wind Force X (lb)	Wind Force Z (lb)	Weight (lb)
0.00		1.00	18.49	31.25	308.13	0.650	0.00	0.000	0.000	0.00	0.00	0.0
5.00		1.00	18.49	31.25	299.42	0.650	5.00	17.869	11.615	363.06	0.00	718.4
10.00		1.00	18.49	31.25	290.71	0.650	5.00	17.357	11.282	352.65	0.00	697.7
15.00		1.00	18.49	31.25	282.01	0.650	5.00	16.845	10.949	342.25	0.00	676.9
20.00		1.00	18.49	31.25	273.30	0.650	5.00	16.332	10.616	331.84	0.00	656.2
25.00		1.00	18.49	31.25	264.59	0.650	5.00	15.820	10.283	321.44	0.00	635.5
30.00		1.00	18.49	31.25	255.89	0.650	5.00	15.308	9.950	311.03	0.00	614.7
35.00		1.01	18.81	31.78	249.27	0.650	5.00	14.796	9.617	305.72	0.00	594.0
40.00		1.05	19.54	33.02	245.12	0.650	5.00	14.284	9.285	306.62	0.00	573.2
42.63	Bot - Section 2	1.07	19.90	33.63	242.61	0.650	2.63	7.308	4.750	159.75	0.00	293.2
45.00		1.09	20.21	34.15	240.18	0.650	2.37	6.587	4.282	146.24	0.00	523.6
47.38	Top - Section 1	1.10	20.51	34.66	237.59	0.650	2.38	6.499	4.225	146.43	0.00	516.4
50.00		1.12	20.82	35.19	239.28	0.650	2.62	7.021	4.563	160.62	0.00	281.6
55.00		1.15	21.40	36.17	233.19	0.650	5.00	13.008	8.455	305.82	0.00	521.5
60.00		1.18	21.94	37.08	226.63	0.650	5.00	12.496	8.122	301.18	0.00	500.8
65.00		1.21	22.44	37.93	219.64	0.650	5.00	11.984	7.789	295.51	0.00	480.1
70.00		1.24	22.92	38.75	212.28	0.650	5.00	11.471	7.456	288.94	0.00	459.3
75.00		1.26	23.38	39.52	204.60	0.650	5.00	10.959	7.124	281.53	0.00	438.6
80.00		1.28	23.82	40.25	196.61	0.650	5.00	10.447	6.791	273.37	0.00	417.8
85.00	Appertunance(s)	1.31	24.23	40.96	188.36	0.650	5.00	9.935	6.458	264.51	0.00	397.1
86.29	Bot - Section 3	1.31	24.34	41.13	186.18	0.650	1.29	2.486	1.616	66.48	0.00	99.3
89.71	Top - Section 2	1.33	24.61	41.59	180.35	0.650	3.42	6.511	4.232	176.03	0.00	412.7
90.00		1.33	24.63	41.63	182.92	0.650	0.29	0.542	0.352	14.66	0.00	13.1
95.00	Appertunance(s)	1.35	25.02	42.28	174.21	0.650	5.00	9.067	5.894	249.20	0.00	218.4
100.00		1.37	25.38	42.90	165.29	0.650	5.00	8.555	5.561	238.59	0.00	206.0
105.00	Appertunance(s)	1.39	25.74	43.51	156.17	0.650	5.00	8.043	5.228	227.46	0.00	193.5
110.00		1.41	26.09	44.09	146.87	0.650	5.00	7.531	4.895	215.82	0.00	181.1
115.00		1.42	26.42	44.65	137.40	0.650	5.00	7.018	4.562	203.72	0.00	168.6
120.00	Appertunance(s)	1.44	26.74	45.20	127.77	0.650	5.00	6.506	4.229	191.16	0.00	156.2
Totals:							120.00			6,841.65	0.00	11,645.5

Pole : CT03XC335
 Location: East Hampton, CT
 Height : 120.0 (ft)
 Shape : 18 Sides
 Base Dia : 43.50 (in)
 Taper : 0.245830 (in/ft)

Sprint Sites USA - NJ
 Base Elev : 0.000 (ft)
 Top Dia : 15.00 (in)

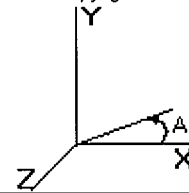

Load Case: No Ice	85 mph - No Ice	23 Iterations
Gust Response Factor : 1.69	Effective Wind Speed : 85.00 (mph)	
Dead Load Factor : 1.00		
Wind Load Factor : 1.00		

Discrete Appurtenance Forces

Elev (ft)	Description	Qty	qz (psf)	qzGh (psf)	Total CaAa (sf)	CaAa Factor	Horiz Ecc (ft)	Vert Ecc (ft)	X Angle (deg)	Wind Force X (lb)	Wind Force Z (lb)	Mom X (lb-ft)	Mom Y (lb-ft)	Mom Z (lb-ft)	Weight (lb)
85.00	Tri-Antenna Mount	1	24.23	40.96	5.000	1.000	0.000	0.0	0.0	204.80	0.00	0.00	0.00	0.00	250.0
85.00	Alligon 7250	6	24.23	40.96	17.209	0.667	0.000	0.0	0.0	704.87	0.00	0.00	0.00	0.00	96.0
95.00	DBC-750 combiner	3	25.02	42.28	1.650	1.000	0.000	0.0	0.0	69.77	0.00	0.00	0.00	0.00	15.0
95.00	DUO1417-8686	12	25.02	42.28	78.360	1.000	0.000	0.0	0.0	3313.31	0.00	0.00	0.00	0.00	369.6
95.00	TMA-DD 1900	6	25.02	42.28	2.322	1.000	0.000	0.0	0.0	98.18	0.00	0.00	0.00	0.00	33.6
95.00	Low Profile Platform	1	25.02	42.28	25.550	1.000	0.000	0.0	0.0	1080.33	0.00	0.00	0.00	0.00	1300.0
105.00	DB844H90	12	25.74	43.51	47.520	1.000	0.000	0.0	0.0	2067.58	0.00	0.00	0.00	0.00	120.0
105.00	Low Profile Platform	1	25.74	43.51	25.550	1.000	0.000	0.0	0.0	1111.67	0.00	0.00	0.00	0.00	1300.0
120.00	DB980H90	9	26.74	45.20	19.690	0.667	0.000	0.0	0.0	890.02	0.00	0.00	0.00	0.00	81.0
120.00	EEl 10'8" Low Profile	1	26.74	45.20	22.500	1.000	0.000	0.0	0.0	1017.04	0.00	0.00	0.00	0.00	1500.0
120.00	DB420	1	27.30	46.15	6.000	1.000	0.000	9.0	0.0	276.90	0.00	0.00	0.00	2503.12	34.0
120.00	DB264	1	27.41	46.32	5.690	1.000	0.000	10.8	0.0	263.58	0.00	0.00	0.00	2833.49	36.0
120.00	APC-301	1	27.36	46.24	6.000	1.000	0.000	10.0	0.0	277.48	0.00	0.00	0.00	2774.84	50.0
120.00	Lightning Rod, 5'	1	26.90	45.46	1.050	1.000	0.000	2.5	0.0	47.74	0.00	0.00	0.00	119.36	35.0
										11,423.2	0.00				5,220.2

Pole : CT03XC335
 Location: East Hampton, CT
 Height : 120.0 (ft)
 Shape : 18 Sides
 Base Dia : 43.50 (in)
 Taper : 0.245830 (in/ft)

Sprint Sites USA - NJ

Base Elev : 0.000 (ft)

Top Dia : 15.00 (in)

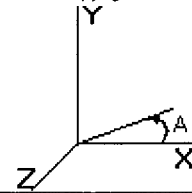

Load Case: No Ice 85 mph - No Ice 23 Iterations

Gust Response Factor : 1.69 Effective Wind Speed : 85.00 (mph)

Dead Load Factor : 1.00

Wind Load Factor : 1.00

Applied Forces Summary

Seg Elev (ft)	X Coord (ft)	Z Coord (ft)	Lateral FX (-) (lb)	Axial FY (-) (lb)	Lateral FZ (lb)	Moment MX (lb-ft)	Torsion MY (lb-ft)	Moment MZ (lb-ft)
0.00	0.00	0.00	0.00	0.00	0.00	0.00	0.00	0.00
5.00	0.00	0.00	363.06	718.42	0.00	0.00	0.00	0.00
10.00	0.00	0.00	352.65	697.68	0.00	0.00	0.00	0.00
15.00	0.00	0.00	342.25	676.94	0.00	0.00	0.00	0.00
20.00	0.00	0.00	331.84	656.19	0.00	0.00	0.00	0.00
25.00	0.00	0.00	321.44	635.45	0.00	0.00	0.00	0.00
30.00	0.00	0.00	311.03	614.71	0.00	0.00	0.00	0.00
35.00	0.00	0.00	305.72	593.97	0.00	0.00	0.00	0.00
40.00	0.00	0.00	306.62	573.23	0.00	0.00	0.00	0.00
42.63	0.00	0.00	159.75	293.19	0.00	0.00	0.00	0.00
45.00	0.00	0.00	146.24	523.58	0.00	0.00	0.00	0.00
47.38	0.00	0.00	146.43	516.41	0.00	0.00	0.00	0.00
50.00	0.00	0.00	160.62	281.57	0.00	0.00	0.00	0.00
55.00	0.00	0.00	305.82	521.55	0.00	0.00	0.00	0.00
60.00	0.00	0.00	301.18	500.81	0.00	0.00	0.00	0.00
65.00	0.00	0.00	295.51	480.06	0.00	0.00	0.00	0.00
70.00	0.00	0.00	288.94	459.32	0.00	0.00	0.00	0.00
75.00	0.00	0.00	281.53	438.58	0.00	0.00	0.00	0.00
80.00	0.00	0.00	273.37	417.84	0.00	0.00	0.00	0.00
85.00	0.00	0.00	1,174.19	743.10	0.00	0.00	0.00	0.00
86.29	0.00	0.00	66.48	99.33	0.00	0.00	0.00	0.00
89.71	0.00	0.00	176.03	412.67	0.00	0.00	0.00	0.00
90.00	0.00	0.00	14.66	13.06	0.00	0.00	0.00	0.00
95.00	0.00	0.00	4,810.78	1,936.63	0.00	0.00	0.00	0.00
100.00	0.00	0.00	238.59	205.98	0.00	0.00	0.00	0.00
105.00	0.00	0.00	3,406.71	1,613.54	0.00	0.00	0.00	0.00
110.00	0.00	0.00	215.82	181.09	0.00	0.00	0.00	0.00
115.00	0.00	0.00	203.72	168.65	0.00	0.00	0.00	0.00
120.00	0.00	0.00	2,963.92	1,892.20	0.00	0.00	0.00	8,230.81
Totals:			18,264.92	16,865.75	0.00	0.00	0.00	8,230.81

Pole : CT03XC335
 Location: East Hampton, CT
 Height : 120.0 (ft)
 Shape : 18 Sides
 Base Dia : 43.50 (in)
 Taper : 0.245830 (in/ft)

Sprint Sites USA - NJ

Base Elev : 0.000 (ft)
 Top Dia : 15.00 (in)

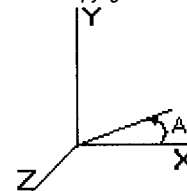

Load Case: No Ice	85 mph - No Ice	23 Iterations
Gust Response Factor : 1.69	Effective Wind Speed : 85.00 (mph)	
Dead Load Factor : 1.00		
Wind Load Factor : 1.00		

Calculated Forces and Deflections

Seg Elev (ft)	Lateral FX (-) (kips)	Axial FY (-) (kips)	Lateral FZ (kips)	Moment MX (ft-kips)	Torsion MY (ft-kips)	Moment MZ (ft-kips)	X Deflect (in)	Z Deflect (in)	Total Deflect (in)	Rotation (deg)
0.00	18.298	16.830	0.000	0.000	0.000	1,615.715	0.000	0.000	0.000	0.000
5.00	17.996	16.041	0.000	0.000	0.000	1,524.227	-0.119	0.000	0.119	-0.221
10.00	17.701	15.275	0.000	0.000	0.000	1,434.246	-0.472	0.000	0.472	-0.449
15.00	17.412	14.529	0.000	0.000	0.000	1,345.741	-1.068	0.000	1.068	-0.682
20.00	17.130	13.805	0.000	0.000	0.000	1,258.680	-1.911	0.000	1.911	-0.922
25.00	16.854	13.103	0.000	0.000	0.000	1,173.031	-3.008	0.000	3.008	-1.168
30.00	16.585	12.421	0.000	0.000	0.000	1,088.760	-4.367	0.000	4.367	-1.421
35.00	16.317	11.761	0.000	0.000	0.000	1,005.835	-5.994	0.000	5.994	-1.680
40.00	16.033	11.141	0.000	0.000	0.000	924.249	-7.895	0.000	7.895	-1.944
42.63	15.889	10.815	0.000	0.000	0.000	882.084	-9.008	0.000	9.008	-2.090
45.00	15.747	10.261	0.000	0.000	0.000	844.428	-10.079	0.000	10.079	-2.223
47.38	15.604	9.712	0.000	0.000	0.000	806.951	-11.221	0.000	11.221	-2.357
50.00	15.466	9.381	0.000	0.000	0.000	766.068	-12.556	0.000	12.556	-2.506
55.00	15.177	8.804	0.000	0.000	0.000	688.740	-15.323	0.000	15.323	-2.770
60.00	14.890	8.250	0.000	0.000	0.000	612.855	-18.366	0.000	18.366	-3.036
65.00	14.604	7.720	0.000	0.000	0.000	538.408	-21.688	0.000	21.688	-3.302
70.00	14.321	7.213	0.000	0.000	0.000	465.389	-25.287	0.000	25.287	-3.566
75.00	14.042	6.731	0.000	0.000	0.000	393.785	-29.160	0.000	29.160	-3.825
80.00	13.767	6.275	0.000	0.000	0.000	323.576	-33.300	0.000	33.300	-4.074
85.00	12.555	5.589	0.000	0.000	0.000	254.742	-37.691	0.000	37.691	-4.307
86.29	12.492	5.472	0.000	0.000	0.000	238.506	-38.866	0.000	38.866	-4.368
89.71	12.291	5.058	0.000	0.000	0.000	195.826	-42.043	0.000	42.043	-4.514
90.00	12.289	5.013	0.000	0.000	0.000	192.260	-42.318	0.000	42.318	-4.526
95.00	7.352	3.442	0.000	0.000	0.000	130.815	-47.212	0.000	47.212	-4.806
100.00	7.108	3.232	0.000	0.000	0.000	94.058	-52.368	0.000	52.368	-5.037
105.00	3.576	1.920	0.000	0.000	0.000	58.517	-57.744	0.000	57.744	-5.225
110.00	3.349	1.751	0.000	0.000	0.000	40.637	-63.291	0.000	63.291	-5.373
115.00	3.133	1.597	0.000	0.000	0.000	23.894	-68.977	0.000	68.977	-5.491
120.00	2.964	0.000	0.000	0.000	0.000	8.231	-74.765	0.000	74.765	-5.565

Pole : CT03XC335
 Location : East Hampton, CT
 Height : 120.0 (ft)
 Shape : 18 Sides
 Base Dia : 43.50 (in)
 Taper : 0.245830 (in/ft)

Sprint Sites USA - NJ
 Base Elev : 0.000 (ft)
 Top Dia : 15.00 (in)

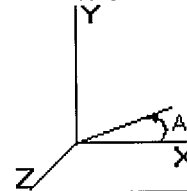

Load Case: No Ice 85 mph - No Ice 23 Iterations

Gust Response Factor : 1.69 Effective Wind Speed : 85.00 (mph)
 Dead Load Factor : 1.00
 Wind Load Factor : 1.00

Calculated Stresses

Seg Elev (ft)	Applied Stresses						Combined (ksi)	Allowable Stress (Fb) (ksi)	Stress Ratio
	Axial (Y) (ksi)	Shear (X) (ksi)	Shear (Z) (ksi)	Torsion (ksi)	Bending (X) (ksi)	Bending (Z) (ksi)			
0.00	0.393	0.861	0.000	0.000	0.000	42.421	42.840	52.0	0.824
5.00	0.385	0.872	0.000	0.000	0.000	42.407	42.819	52.0	0.824
10.00	0.378	0.883	0.000	0.000	0.000	42.358	42.764	52.0	0.823
15.00	0.371	0.896	0.000	0.000	0.000	42.266	42.665	52.0	0.821
20.00	0.364	0.910	0.000	0.000	0.000	42.123	42.516	52.0	0.818
25.00	0.357	0.925	0.000	0.000	0.000	41.916	42.303	52.0	0.814
30.00	0.350	0.941	0.000	0.000	0.000	41.633	42.014	52.0	0.808
35.00	0.343	0.959	0.000	0.000	0.000	41.257	41.633	52.0	0.801
40.00	0.337	0.977	0.000	0.000	0.000	40.770	41.142	52.0	0.792
42.63	0.333	0.987	0.000	0.000	0.000	40.471	40.840	52.0	0.786
45.00	0.322	0.996	0.000	0.000	0.000	40.168	40.527	52.0	0.780
47.38	0.304	0.986	0.000	0.000	0.000	38.290	38.632	52.0	0.743
50.00	0.300	0.997	0.000	0.000	0.000	37.858	38.197	52.0	0.735
55.00	0.293	1.018	0.000	0.000	0.000	36.869	37.204	52.0	0.716
60.00	0.286	1.041	0.000	0.000	0.000	35.656	35.988	52.0	0.692
65.00	0.280	1.066	0.000	0.000	0.000	34.169	34.498	52.0	0.664
70.00	0.273	1.094	0.000	0.000	0.000	32.343	32.672	52.0	0.629
75.00	0.267	1.124	0.000	0.000	0.000	30.100	30.429	52.0	0.585
80.00	0.262	1.159	0.000	0.000	0.000	27.332	27.667	52.0	0.532
85.00	0.246	1.113	0.000	0.000	0.000	23.904	24.227	52.0	0.466
86.29	0.244	1.123	0.000	0.000	0.000	23.019	23.344	52.0	0.449
89.71	0.382	1.870	0.000	0.000	0.000	32.296	32.838	52.0	0.632
90.00	0.380	1.876	0.000	0.000	0.000	31.913	32.456	52.0	0.624
95.00	0.276	1.188	0.000	0.000	0.000	24.348	24.709	52.0	0.475
100.00	0.275	1.220	0.000	0.000	0.000	19.766	20.153	52.0	0.388
105.00	0.174	0.655	0.000	0.000	0.000	13.994	14.214	52.0	0.273
110.00	0.170	0.657	0.000	0.000	0.000	11.159	11.386	52.0	0.219
115.00	0.167	0.661	0.000	0.000	0.000	7.611	7.863	52.0	0.151
120.00	0.000	0.678	0.000	0.000	0.000	3.078	3.294	52.0	0.063

Pole : CT03XC335
Location: East Hampton, CT
Height : 120.0 (ft)
Shape : 18 Sides
Base Dia : 43.50 (in)
Taper : 0.245830 (in/ft)

Sprint Sites USA - NJ

Base Elev : 0.000 (ft)
Top Dia : 15.00 (in)

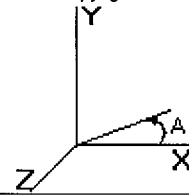

Load Case: Ice	85 mph - With Ice - Ice Thickness = 0.5 in	23 Iterations
Gust Response Factor : 1.69	Effective Wind Speed : 73.61 (mph)	
Dead Load Factor : 1.00		
Wind Load Factor : 1.00		

Analysis Summary

Load Case	Reactions						Max Stresses			
	Shear FX (kips)	Shear FZ (kips)	Axial FY (kips)	Moment MX (ft-kips)	Moment MY (ft-kips)	Moment MZ (ft-kips)	Combined Stress (ksi)	Allowable Stress (ksi)	Elev (ft)	Stress Ratio
Ice	15.318	0.000	22.794	0.000	0.000	1,401.568	37.411	52.0	5.000	0.720
No Ice	18.298	0.000	16.830	0.000	0.000	1,615.715	42.840	52.0	0.000	0.824