

280 Trumbull Street  
Hartford, CT 06103-3597  
Main (860) 275-8200  
Fax (860) 275-8299  
kbaldwin@rc.com  
Direct (860) 275-8345

Also admitted in Massachusetts

December 28, 2012

Linda Roberts  
Executive Director  
Connecticut Siting Council  
10 Franklin Square  
New Britain, CT 06051

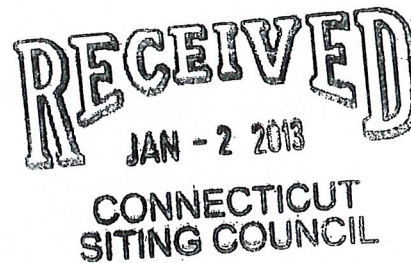

Re: **EM-VER-082-120829 – 393 Jackson Hill Road, Middlefield, Connecticut**  
**EM-VER-079-120807 – 175 South Main Street, Marlborough, Connecticut**  
**EM-VER-005-120217B – 127 New Hartford Road, Barkhamsted, Connecticut**  
**EM-VER-086-120216 – 41 Beckwith Road, Montville, Connecticut**  
**EM-VER-036-120627 – 15 Pent Road, Deep River, Connecticut**  
**EM-VER-041-120405 – 135 Honey Hill Road, East Haddam, Connecticut**

**Completion of Construction Activity**

Dear Ms. Roberts:

The purpose of this letter is to notify the Siting Council that construction activity associated with the above-referenced Cellco Partnership d/b/a Verizon Wireless telecommunications facilities has been completed.

If you have any questions or need any additional information regarding this facility please do not hesitate to contact me.

Sincerely,

A handwritten signature in black ink, appearing to read "Kenneth C. Baldwin".

Kenneth C. Baldwin

Copy to:  
Sandy M. Carter



*Law Offices*

BOSTON

PROVIDENCE

HARTFORD

NEW LONDON

STAMFORD

WHITE PLAINS

NEW YORK CITY

ALBANY

SARASOTA

*www.rc.com*

12012136-v1

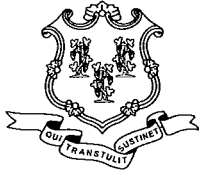

STATE OF CONNECTICUT  
CONNECTICUT SITING COUNCIL

Ten Franklin Square, New Britain, CT 06051

Phone: (860) 827-2935 Fax: (860) 827-2950

E-Mail: [siting.council@ct.gov](mailto:siting.council@ct.gov)

[www.ct.gov/csc](http://www.ct.gov/csc)

April 23, 2012

Kenneth C. Baldwin, Esq.  
Robinson & Cole LLP  
280 Trumbull Street  
Hartford, CT 06103

RE: **EM-VER-041-120405** - Cellco Partnership d/b/a Verizon Wireless notice of intent to modify an existing telecommunications facility located at 135 Honey Hill Road, East Haddam, Connecticut.

Dear Attorney Baldwin:

The Connecticut Siting Council (Council) hereby acknowledges your notice to modify this existing telecommunications facility, pursuant to Section 16-50j-73 of the Regulations of Connecticut State Agencies with the following conditions:

- Any deviation from the proposed modification as specified in this notice and supporting materials with Council shall render this acknowledgement invalid;
- Any material changes to this modification as proposed shall require the filing of a new notice with the Council;
- Not less than 45 days after completion of construction, the Council shall be notified in writing that construction has been completed;
- The validity of this action shall expire one year from the date of this letter; and
- The applicant may file a request for an extension of time beyond the one year deadline provided that such request is submitted to the Council not less than 60 days prior to the expiration;

The proposed modifications including the placement of all necessary equipment and shelters within the tower compound are to be implemented as specified here and in your notice dated April 4, 2012. The modifications are in compliance with the exception criteria in Section 16-50j-72 (b) of the Regulations of Connecticut State Agencies as changes to an existing facility site that would not increase tower height, extend the boundaries of the tower site, increase noise levels at the tower site boundary by six decibels, and increase the total radio frequencies electromagnetic radiation power density measured at the tower site boundary to or above the standard adopted by the State Department of Environmental Protection pursuant to General Statutes § 22a-162. This facility has also been carefully modeled to ensure that radio frequency emissions are conservatively below State and federal standards applicable to the frequencies now used on this tower.

This decision is under the exclusive jurisdiction of the Council. Please be advised that the validity of this action shall expire one year from the date of this letter. Any additional change to this facility will require explicit notice to this agency pursuant to Regulations of Connecticut State Agencies Section 16-50j-73. Such notice shall include all relevant information regarding the proposed change with cumulative worst-case modeling of radio frequency exposure at the closest point of uncontrolled access to the tower base, consistent with Federal Communications Commission, Office of Engineering and Technology, Bulletin 65. Thank you for your attention and cooperation.

Very truly yours,

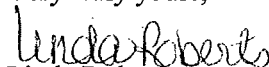
  
Linda Roberts

Executive Director

LR/CDM/laf

c: The Honorable Mark B. Walter, First Selectman, Town of East Haddam  
James Ventres, Land-Use Administrator, Town of East Haddam  
American Tower Corporation

280 Trumbull Street  
Hartford, CT 06103-3597  
Main (860) 275-8200  
Fax (860) 275-8299  
kbaldwin@rc.com  
Direct (860) 275-8345

April 4, 2012



Linda Roberts  
Executive Director  
Connecticut Siting Council  
10 Franklin Square  
New Britain, CT 06051

Re: **Notice of Exempt Modification – Antenna Swap  
135 Honey Hill Road, East Haddam, Connecticut**

Dear Ms. Roberts:

Cellco Partnership d/b/a Verizon Wireless (“Cellco”) currently maintains twelve (12) wireless telecommunications antennas at the 130-foot level on an existing 150-foot tower at the above-referenced address. The tower is owned by American Tower Corporation. Cellco’s use of the tower was approved by the Council in 2005. Cellco now intends to replace all of its existing antennas with six (6) model APL868013-42T0 cellular antennas; three (3) model BXA-171063-8BF PCS antennas; and three (3) model BXA-70063-4CF LTE antennas, all at the same 147-foot level. Cellco also intends to install six (6) coax cable diplexers to its existing antenna platform. Attached behind Tab 1 are the specifications for the replacement antennas and cable diplexers.

Please accept this letter as notification pursuant to R.C.S.A. § 16-50j-73, for construction that constitutes an exempt modification pursuant to R.C.S.A. § 16-50j-72(b)(2). In accordance with R.C.S.A. § 16-50j-73, a copy of this letter is being sent to Mark B. Walter, First Selectman of the Town of East Haddam. A copy of this letter is also being sent to Howard H. Fraser, Jr., the owner of the property on which the tower is located.

The planned modifications to the facility fall squarely within those activities explicitly provided for in R.C.S.A. § 16-50j-72(b)(2).

1. The proposed modifications will not result in an increase in the height of the existing tower. Cellco’s replacement antennas and diplexers will be located at the 130-foot level on the existing 150-foot tower.



Law Offices

BOSTON

PROVIDENCE

HARTFORD

NEW LONDON

STAMFORD

WHITE PLAINS

NEW YORK CITY

ALBANY

SARASOTA

www.rc.com

# ROBINSON & COLE<sub>LLP</sub>

Linda Roberts  
April 4, 2012  
Page 2

2. The proposed modifications will not involve any change to ground-mounted equipment and, therefore, will not require the extension of the site boundaries.

3. The proposed modifications will not increase noise levels at the facility by six decibels or more.

4. The operation of the replacement antennas will not increase radio frequency (RF) power density levels at the facility to a level at or above the Federal Communications Commission (FCC) adopted safety standard. A cumulative power density table for Cellco's modified facility is included behind Tab 2.

Also attached is a Structural Analysis Report confirming that the tower and foundation can support Cellco's proposed modifications. (See Tab 3). Contrary to the note at the bottom of page 1 of the Structural Analysis Report, Cellco is not proposing to add any new coax cables as part of this proposal. All of Cellco's existing coax cables are located inside the monopole.

For the foregoing reasons, Cellco respectfully submits that the proposed modifications to the above-referenced telecommunications facility constitutes an exempt modification under R.C.S.A. § 16-50j-72(b)(2).

Sincerely,

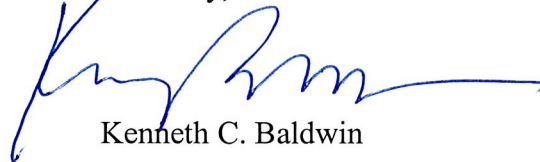

Kenneth C. Baldwin

Enclosures

Copy to:

Mark B. Walter, East Haddam First Selectman

Howard H. Fraser, Jr.

Sandy M. Carter





Maximizer® Log Periodic Antenna, 806-894, 80deg, 14.1dBi, 1.2m, FET, 0deg

**Product Description**

The Celwave® Maximizer series is a log periodic dipole array which uses a patented design to achieve a front-to-back ratio of 45 dB, the highest front-to-back ratio in the industry. Maximizers are available to cover ESMR, AMPS, PCS and DCS frequency ranges. They use RFS's patented monolithic CELLite® technology, which eliminates cable and soldered joints to reduce the possibility of inter-modulation products. The CELLite technology assures high reliability and excellent repeatability of electrical characteristics. The cellular Maximizers are available in 65°, 80° and 90° horizontal beamwidths and the PCS/DCS Maximizers are available in 65° and 90° horizontal beamwidths. Patent number 6,133,889.

**Features/Benefits**

- 45 dB front-to-back ratio reduces co-channel interference.
- Monolithic construction reduces IM.
- No solder joints, high reliability.
- Surface treated components prevent galvanic corrosion.
- UV stabilized radome assures long life without radome deterioration due to UV exposure.

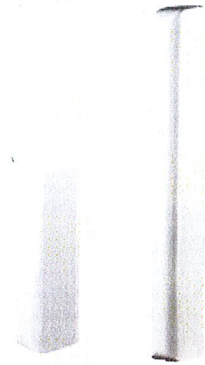

**Technical Specifications**

**Electrical Specifications**

Frequency Range, MHz	806-894
Horizontal Beamwidth, deg	80
Vertical Beamwidth, deg	15
Electrical Downtilt, deg	0
Gain, dBi (dBd)	14.1 (12)
Front-To-Back Ratio, dB	45
Polarization	Vertical
VSWR	< 1.5:1
Impedance, Ohms	50
Maximum Power Input, W	500
Lightning Protection	Direct Ground

**Mechanical Specifications**

Dimensions - HxWxD, mm (in)	1219 x 152 x 203 (48 x 6 x 8)
Weight w/o Mtg Hardware, kg (lb)	2.8 (6.32)
Shipping Weight, kg (lb)	7.9 (17.5)
Packing Dimensions, HxWxD, mm (in)	1270 x 305 x 203 (50 x 12 x 8)

**Ordering Information**

Mounting Hardware	APM21-3
-------------------	---------

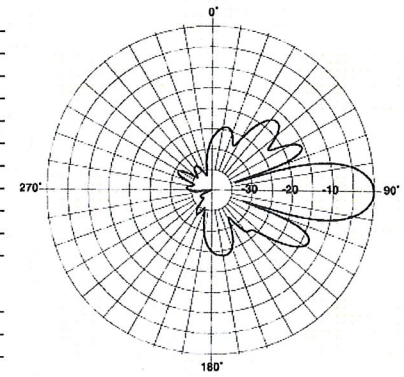

Vertical Pattern

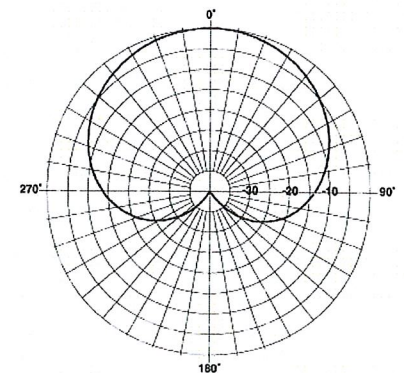

Horizontal Pattern

**Other Documentation**

All information contained in the present datasheet is subject to confirmation at time of ordering

## BXA-171063-8BF-EDIN-X

Replace "X" with desired electrical downtilt.

X-Pol | FET Panel | 63° | 17.4 dBi

Electrical Characteristics	1710-2170 MHz		
Frequency bands	1710-1880 MHz	1850-1990 MHz	1920-2170 MHz
Polarization	±45°	±45°	±45°
Horizontal beamwidth	68°	65°	60°
Vertical beamwidth	7°	7°	7°
Gain	14.5 dBd / 16.6 dBi	14.9 dBd / 17.0 dBi	15.3 dBd / 17.4 dBi
Electrical downtilt (X)	0, 2, 4, 8		
Impedance	50Ω		
VSWR	≤1.5:1		
First upper sidelobe	< -17 dB		
Front-to-back isolation	> 30 dB		
In-band isolation	> 28 dB		
IM3 (20W carrier)	< -150 dBc		
Input power	300 W		
Lightning protection	Direct Ground		
Connector(s)	2 Ports / EDIN / Female / Bottom		
Operating temperature	-40° to +60° C / -40° to +140° F		
Mechanical Characteristics			
Dimensions Length x Width x Depth	1232 x 154 x 105 mm		48.5 x 6.1 x 4.1 in
Depth with t-brackets	133 mm		5.2 in
Weight without mounting brackets	4.8 kg		10.5 lbs
Survival wind speed	296 km/hr		184 mph
Wind area	Front: 0.19 m <sup>2</sup> Side: 0.14 m <sup>2</sup>	Front: 2.0 ft <sup>2</sup> Side: 1.5 ft <sup>2</sup>	
Wind load @ 161 km/hr (100 mph)	Front: 281 N Side: 223 N	Front: 63 lbf Side: 50 lbf	
Mounting Options	Part Number	Fits Pipe Diameter	Weight
2-Point Mounting Bracket Kit	26799997	50-102 mm 2.0-4.0 in	2.3 kg 5 lbs
2-Point Mounting & Downtilt Bracket Kit	26799999	50-102 mm 2.0-4.0 in	3.6 kg 8 lbs
Concealment Configurations	For concealment configurations, order BXA-171063-8BF-EDIN-X-FP		



**BXA-171063-8BF-EDIN-X**

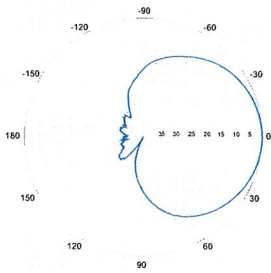

Horizontal | 1710-1880 MHz

**BXA-171063-8BF-EDIN-0**

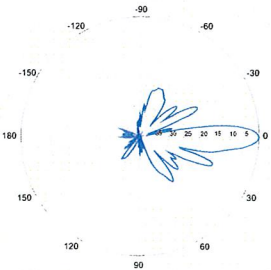

0° | Vertical | 1710-1880 MHz

**BXA-171063-8BF-EDIN-X**

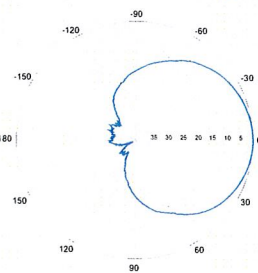

Horizontal | 1850-1990 MHz

**BXA-171063-8BF-EDIN-0**

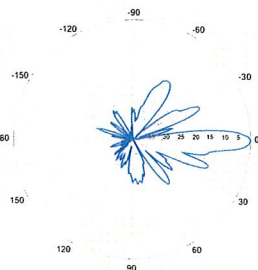

0° | Vertical | 1850-1990 MHz

**BXA-171063-8BF-EDIN-X**

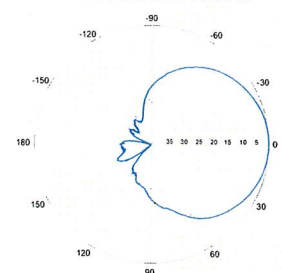

Horizontal | 1920-2170 MHz

**BXA-171063-8BF-EDIN-0**

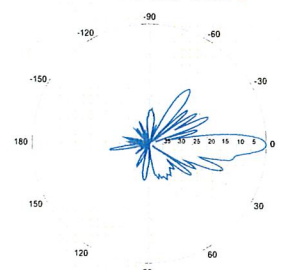

0° | Vertical | 1920-2170 MHz

Quoted performance parameters are provided to offer typical or range values only and may vary as a result of normal manufacturing and operational conditions. Extreme operational conditions and/or stress on structural supports is beyond our control. Such conditions may result in damage to this product. Improvements to product may be made without notice.

**BXA-171063-8BF-EDIN-X**

X-Pol | FET Panel | 63° | 17.4 dBi

**BXA-171063-8BF-EDIN-2**

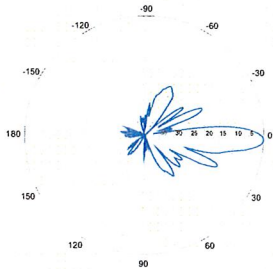

2° | Vertical | 1710-1880 MHz  
**BXA-171063-8BF-EDIN-4**

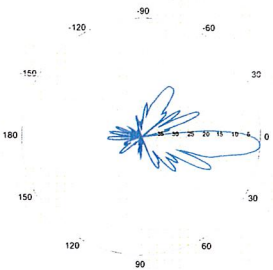

4° | Vertical | 1710-1880 MHz  
**BXA-171063-8BF-EDIN-8**

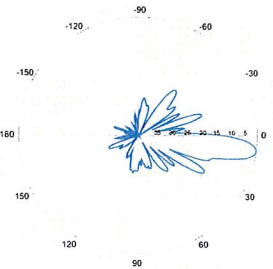

8° | Vertical | 1710-1880 MHz

**BXA-171063-8BF-EDIN-2**

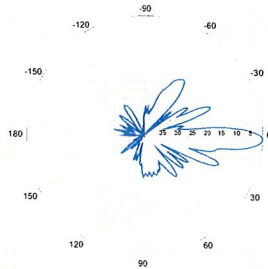

2° | Vertical | 1850-1990 MHz  
**BXA-171063-8BF-EDIN-4**

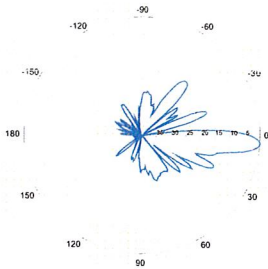

4° | Vertical | 1850-1990 MHz  
**BXA-171063-8BF-EDIN-8**

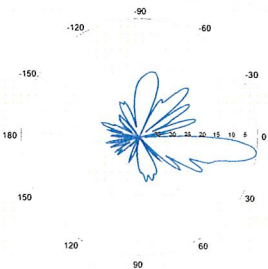

8° | Vertical | 1850-1990 MHz

**BXA-171063-8BF-EDIN-2**

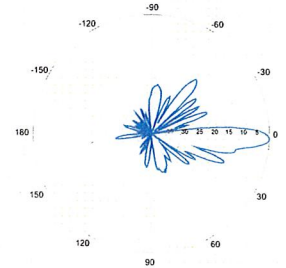

2° | Vertical | 1920-2170 MHz  
**BXA-171063-8BF-EDIN-4**

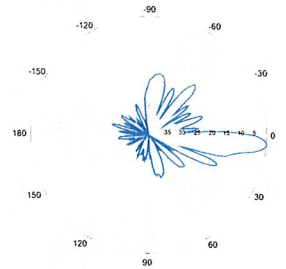

4° | Vertical | 1920-2170 MHz  
**BXA-171063-8BF-EDIN-8**

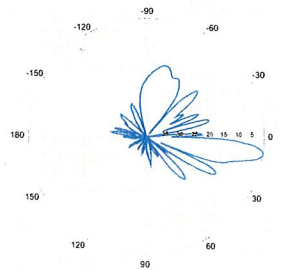

8° | Vertical | 1920-2170 MHz

Quoted performance parameters are provided to offer typical or range values only and may vary as a result of normal manufacturing and operational conditions. Extreme operational conditions and/or stress on structural supports is beyond our control. Such conditions may result in damage to this product. Improvements to product may be made without notice.

## BXA-70063-4CF-EDIN-X

X-Pol | FET Panel | 63° | 13.0 dBd

Replace "X" with desired electrical downtilt.

Antenna is also available with NE connector(s). Replace "EDIN" with "NE" in the model number when ordering.



Electrical Characteristics	696-900 MHz		
	696-806 MHz	806-900 MHz	
Frequency bands	696-806 MHz	806-900 MHz	
Polarization	±45°		
Horizontal beamwidth	65°	63°	
Vertical beamwidth	17°	15°	
Gain	12.5 dBd (14.6 dBi)	13.0 dBd (15.1 dBi)	
Electrical downtilt (X)	0, 2, 3, 4, 5, 6, 8, 9, 10, 12, 14		
Impedance	50Ω		
VSWR	≤1.35:1		
Upper sidelobe suppression (0°)	-16.3 dB	-22.1 dB	
Front-to-back ratio (+/-30°)	-36.1 dB	-34.9 dB	
Null fill	5% (-26.02 dB)		
Isolation between ports	< -30 dB		
Input power with EDIN connectors	500 W		
Input power with NE connectors	300 W		
Lightning protection	Direct Ground		
Connector(s)	2 Ports / EDIN or NE / Female / Center (Back)		
Mechanical Characteristics			
Dimensions Length x Width x Depth	1205 x 285 x 133 mm	47.4 x 11.2 x 5.2 in	
Depth with z-brackets	173 mm	6.8 in	
Weight without mounting brackets	4.5 kg	9.9 lbs	
Survival wind speed	> 201 km/hr	> 125 mph	
Wind area	Front: 0.34 m <sup>2</sup> Side: 0.16 m <sup>2</sup>	Front: 3.7 ft <sup>2</sup> Side: 1.7 ft <sup>2</sup>	
Wind load @ 161 km/hr (100 mph)	Front: 498 N Side: 260 N	Front: 111 lbf Side: 55 lbf	
Mounting Options			
	Part Number	Fits Pipe Diameter	Weight
2-Point Mounting Bracket Kit	36210002	50-160 mm 2.0-6.3 in	4.5 kg 10 lbs
2-Point Downtilt Bracket Kit (0-20°)	36114003	50-160 mm 2.0-6.3 in	4.9 kg 11 lbs
Downtilt Mounting Applications	A mounting bracket and downtilt bracket kit must be ordered for downtilt applications		
Concealment Configurations	For concealment configurations, order BXA-70063-4CF-EDIN-X-FP		

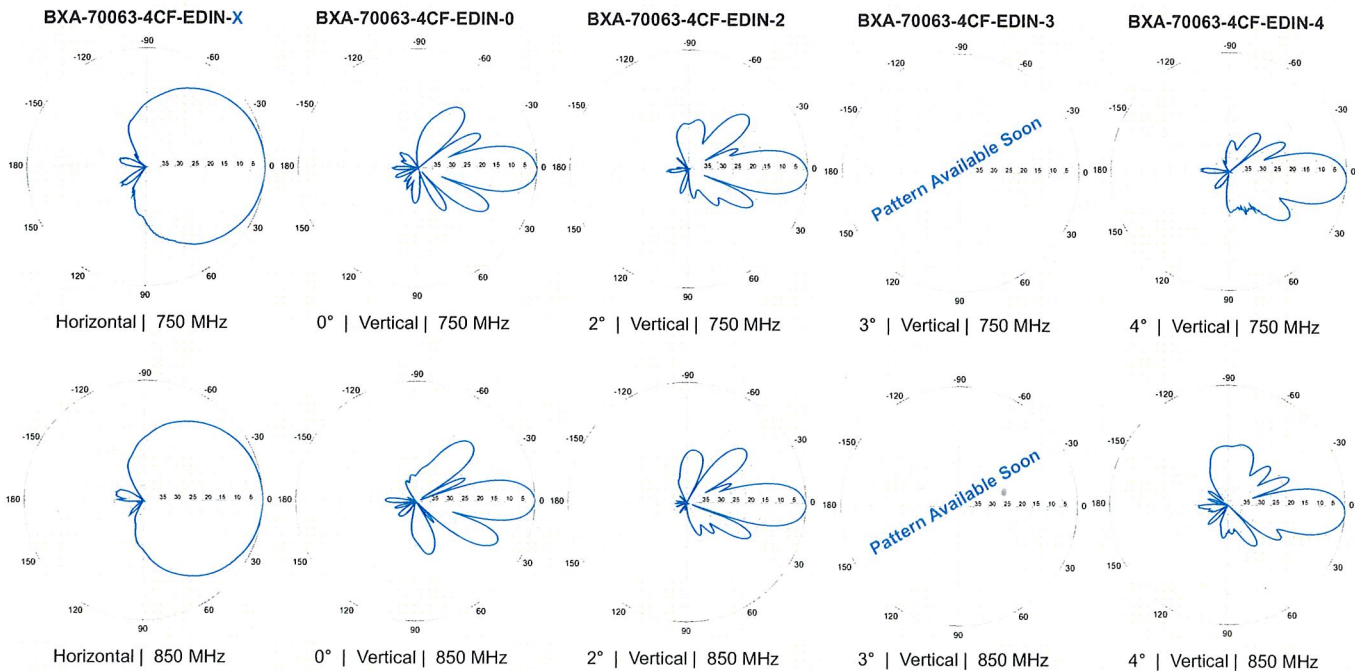

Quoted performance parameters are provided to offer typical or range values only and may vary as a result of normal manufacturing and operational conditions. Extreme operational conditions and/or stress on structural supports is beyond our control. Such conditions may result in damage to this product. Improvements to product may be made without notice.



**BXA-70063-4CF-EDIN-X**

X-Pol | FET Panel | 63° | 13.0 dBd

**BXA-70063-4CF-EDIN-5**

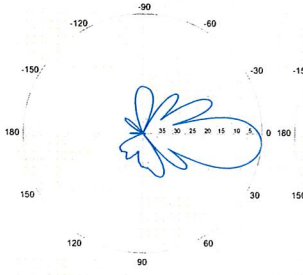

5° | Vertical | 750 MHz

**BXA-70063-4CF-EDIN-6**

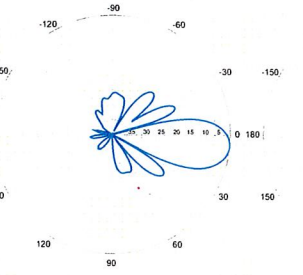

6° | Vertical | 750 MHz

**BXA-70063-4CF-EDIN-8**

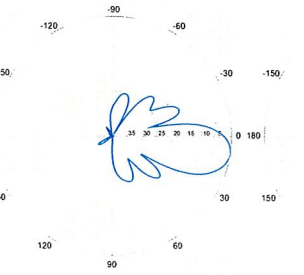

8° | Vertical | 750 MHz

**BXA-70063-4CF-EDIN-9**

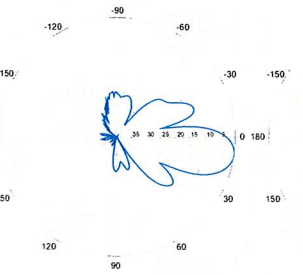

9° | Vertical | 750 MHz

**BXA-70063-4CF-EDIN-10**

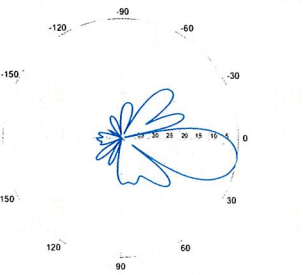

10° | Vertical | 750 MHz

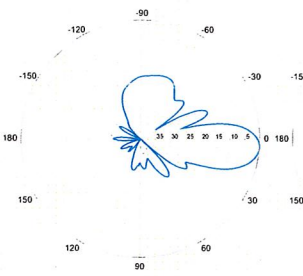

5° | Vertical | 850 MHz

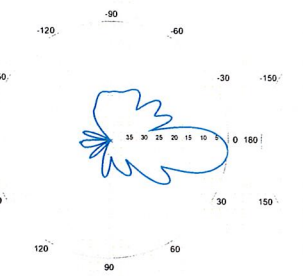

6° | Vertical | 850 MHz

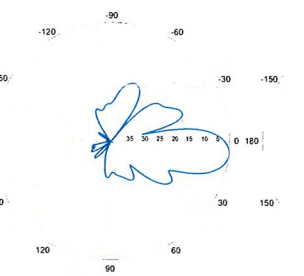

8° | Vertical | 850 MHz

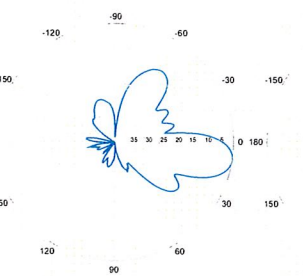

9° | Vertical | 850 MHz

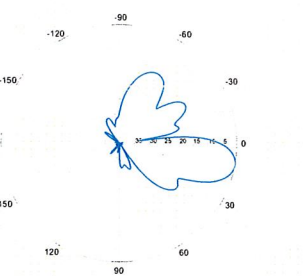

10° | Vertical | 850 MHz

**BXA-70063-4CF-EDIN-12**

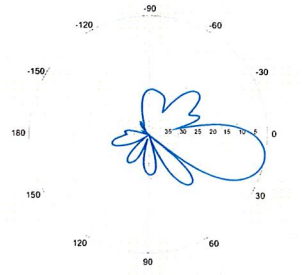

12° | Vertical | 750 MHz

**BXA-70063-4CF-EDIN-14**

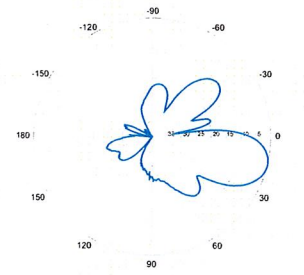

14° | Vertical | 750 MHz

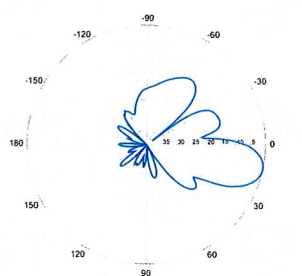

12° | Vertical | 850 MHz

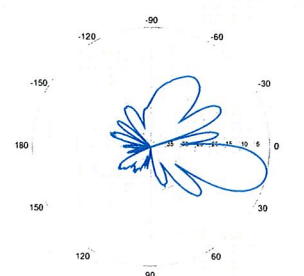

14° | Vertical | 850 MHz

Quoted performance parameters are provided to offer typical or range values only and may vary as a result of normal manufacturing and operational conditions. Extreme operational conditions and/or stress on structural supports is beyond our control. Such conditions may result in damage to this product. Improvements to product may be made without notice.



## ShareLite Wideband Diplexer – In-line 698-960 MHz/1710-2200 MHz, DC pass in high frequency path

## Product Description

The ShareLite FD9R6004 Series of diplexers are designed to enable feeder sharing between systems in the 698-960 MHz range and in the 1710-2200 MHz range. The diplexer is equipped with in-line connector placement so it can be installed in the BTS cabinet or at the tower top. This is especially valuable in crowded sites or when the feeders are not easily accessible. Due to its wideband design, the FD9R6004 Series can accommodate many combining solutions between 698-960 MHz and 1710-2200 MHz systems such as LTE 700 MHz, Cellular 800 MHz with PCS, GSM900 with GSM1800, or GSM900 with UMTS. This diplexer features a highly selective filter. It provides a high level of isolation between ports, while keeping the insertion loss on both paths at an extremely low level. The FD9R6004 diplexers are available with various DC pass options, helpful in configurations with or without the Tower Mount Amplifiers installed.



## Features/Benefits

- LTE ready design
- Extremely Low Insertion Loss
- High level of Rejection between bands – Protection against interferences
- Extremely High Power Handling Capability
- Integrated DC block/bypass versions available
- Very compact & small size design – Easy installation and reduced tower load
- In-line long-neck connectors for easy connection & waterproofing
- Exceptional reliability & environmental protection (IP 67)
- Equipped with 1 \* Breathable Vent – Prevent any humidity inside the product
- Mounting hardware for Wall and Pole mount provided (P/N SEM2-1A)
- Grounding already provided through the mounting bracket
- Kit available for easy dual mount

## Technical Specifications

Product Type	Diplexer/Cross Band Coupler
Frequency Range 1, MHz	698-960
Frequency Range 2, MHz	1710-2200
Application	LTE700, GSM900, UMTS, GSM1800, Cellular 800, PCS
Configuration	Sharelite Single diplexer, outdoor, DC pass in the 1710-2170MHz path, with mounting hardware SEM2-1A
Mounting	Wall Mounting: With 4 screws (maximum 6mm diameter); Pole Mounting: With included clamp set 40-110mm (1.57-4.33)
Return Loss All Ports Min/Typ, dB	19/23
Power Handling Continuous, Max, W	1250 at common port; 750 in low frequency path & 500 in high frequency path
Power Handling Peak, Max, W	15000 in low frequency path & 8000 in high frequency path
Impedance, Ohms	50
Insertion Loss, Path 1, dB	0.07 typ.
Insertion Loss, Path 2, dB	0.13 typ.
Rejection Between Bands Min/Typ, dB	58/64@698-960MHz; 60/70@1710-2200MHz
IMP Level at the COM Port, Typ, dBm	-112 @ 2x43
DC Pass in Low Frequency Path	No
DC Pass in High Frequency Path	Yes
Temperature Range, °C (°F)	-40 to +60 (-40 to +140)
Environmental	ETSI 300-019-2-4 Class 4.1E
Ingress Protection	IP 67
Lightning Protection	EN/IEC61000-4-5 Level 4
Connectors	In-line long-neck 7-16-Female
Weight, kg (lb)	1.2 (2.6)
Shipping Weight, kg (lb)	3.2 (7) for 2 * single units in 1 * box, 9.8 (21.6) for 6 * units = 3 * Boxes in 1 * overwrap
Dimensions, H x W x D, mm (in)	147 x 164 x 37 (5.8 x 6.5 x 1.5)
Shipping Dimensions, H x W x D, mm (in)	254 x 406 x 82 (10 x 16 x 3.2) for 2 * Single Units in 1 * box, 280 x 406 x 241 (11 x 16 x 9.5) for 6 * units = 3 * Boxes in 1 * overwrap
Volume, L	0.43
Housing	Aluminum

## Notes

All information contained in the present datasheet is subject to confirmation at time of ordering



ShareLite Wideband Diplexer – In-line 698-960 MHz/1710-2200 MHz, DC pass in high frequency path

Other Documentation

FD9R6004/2C-3L Installation Instructions: [Wideband\\_Diplexer\\_Installation\\_Rev5.pdf](#)

Selection Guide Diplexer 698-960 / 1710-2200MHz					
	Model Number	Full DC Pass	DC Pass High Band	DC Pass Low Band	Mounting Hardware Included
Single	FD9R6004/1C-3L				X
	FD9R6004/2C-3L				X
	FD9R6004/3C-3L				X
Dual	KIT-FD9R6004/1C-DL				X
	KIT-FD9R6004/2C-DL				X
	KIT-FD9R6004/3C-DL				X

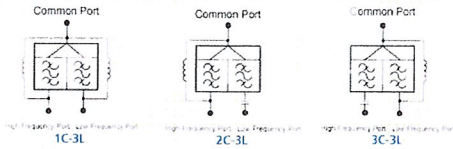

The FD9R6004 Series is upgradeable to a Dual Diplexer kit by means of 2 diplexers and mounting hardware kits SEM2-1A and SEM2-3

Mounting Hardware and Ground Cable Ordering Information		
Model Number	Description	
SEM2-1A	Mounting Hardware, Pole mount ø40-110mm (Included with the Single and Dual Diplexer) Wall Screws M6 (Not included with the product)	
SEM2-3	Assembly kit for 2 pcs of FD9R6004/xC-3L (Can be ordered separately but included with the Dual Diplexer Kit)	
CA020-2	Ground Cable, 2m, includes lugs (Optional)	
CA030-2	Ground Cable, 2m, includes lugs (Optional)	
SEM6	Mounting Hardware for 6 Diplexers, Tower Base (Optional)	

All information contained in the present datasheet is subject to confirmation at time of ordering

		General		Power	Density						
Site Name: East Haddam											
Tower Height: Verizon @ 130ft											
CARRIER	# OF CHAN.	WATTS ERP	HEIGHT	CALC. POWER DENS	FREQ.	MAX. PERMISS. EXP.	FRACTION MPE	Total			
*Nextel	24	100	150	0.0384	851	0.5673	6.76%				
*Sprint	11	505.36	140	0.1020	1950	1.0000	10.20%				
*Cingular GSM	2	427	120	0.0213	1900	1.0000	2.13%				
*Cingular GSM	2	296	120	0.0148	880	0.5867	2.52%				
*Cingular UMTS	1	500	120	0.0125	880	0.5867	2.13%				
Verizon PCS	11	256	130	0.0599	1970	1.0000	5.99%				
Verizon Cellular	9	261	130	0.0500	869	0.5793	8.63%				
Verizon AWS	1	675	130	0.0144	2145	1.0000	1.44%				
Verizon 700	1	852	130	0.0181	698	0.4653	3.90%				
								43.69%			
* Source: Siting Council											



**AMERICAN TOWER®**  
CORPORATION

---

## Structural Analysis Report

**Structure** : 150 ft Summit Monopole  
**ATC Site Name** : East Haddam, CT  
**ATC Site Number** : 302527  
**Proposed Carrier** : Verizon  
**Carrier Site Name** : East Haddam CT  
**Carrier Site Number** : 119662/2012710727  
**County** : Middlesex  
**Eng. Number** : 48650322  
**Date** : March 23, 2012\*  
**Usage** : 36%  
**Portholes Required** : No  
**Result** : Pass

Submitted by:  
Joseph R. Johnston  
Project Engineer

**American Tower Engineering Services**  
400 Regency Forest Drive  
Cary, NC 27518  
Phone: 919-468-0112

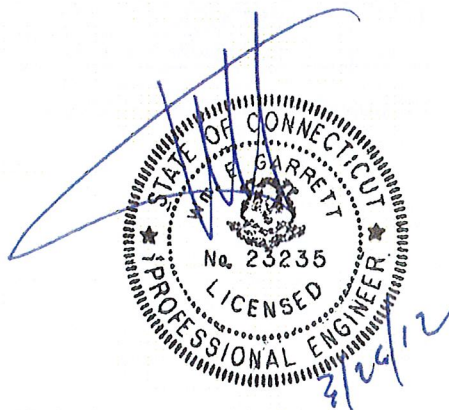

**Introduction**

The purpose of this report is to summarize results of the structural analysis performed on the 150 ft Summit Monopole located at 135 Honey Hill Road, East Haddam, CT 06423, Middlesex County (ATC site #302527). The tower was originally designed and manufactured by Summit (FWT Job #29201-0876, dated September 24, 2001).

**Analysis**

The tower was analyzed using Semaan Engineering Solutions, Inc., Software.

Basic Wind Speed: 85 mph (Fastest Mile)

Radial Ice: 74 mph (Fastest Mile) w/ 1/2" ice

Code: ANSI/TIA/EIA-222-F / 2003 IBC w/ 2005 CT Supplements and 2009 CT Amendments

**Antenna Loads**

The following antenna loads were used in the tower analysis.

**Existing Antennas**

Elev. (ft)	Qty	Antennas	Mount	Coax (in)	Carrier
150.0	9	48" x 12" Panels	Low Profile Platform	(12) 1 5/8	Sprint Nextel
	3	72" x 12" Panels			
140.0	12	Decibel DB980F65E-M	T-Arms	(24) 1 5/8	
120.0	9	72" x 12" Panels	Low Profile Platform	(12) 1 5/8	AT&T Mobility
	3	Powerwave 7770.00			
	6	Powerwave LGP 17201			
	6	Powerwave LGP 21902			
65.0	1	GPS	Side Arm	(1) 1/2	Sprint Nextel

**Proposed Antennas**

Elev. (ft)	Qty	Antennas	Mount	Coax (in)	Carrier
130.0	3	Antel BXA-171063-8BF-EDIN-X	Low Profile Platform	(12) 1 5/8	Verizon
	3	Antel BXA-70063-4CF-EDIN-X			
	6	RFS APL868013-42T0			
	6	RFS FD9R6004/2C-3L			

Install proposed coax inside monopole.

## Results

The maximum structure usage is: 36%

Additional exit and/or entry ports may be required to accommodate the running of the proposed lines to the proposed antennas. These additional ports **may not** be installed without installation drawings providing the location, size and welding requirements of each port.

To ensure compliance with all conditions of this structural analysis, port installation drawings shall be provided by American Tower's Engineering Department under a subsequent project.

Pole Reactions	Current Analysis Reactions
Moment (ft-kips)	3,193.2
Shear (kips)	31.0

The structure base reactions resulting from this analysis were found to be acceptable through analysis based on geotechnical and foundation information, therefore no modification or reinforcement of the foundation will be required. These calculations are located after the software output within this analysis.

## Conclusion

Based on the analysis results, the structure meets the requirements per the ANSI/TIA/EIA-222-F standard and the 2003 IBC w/ 2005 CT Supplements and 2009 CT Amendments. The tower and foundation can support the existing and proposed antennas with the transmission line distribution as described in this report.

If you have any questions or require additional information, please call 919-466-5030.

## **Standard Conditions**

All engineering services are performed on the basis that the information used is current and correct. This information may consist of, but is not necessary limited, to:

- Information supplied by the client regarding the structure itself, the antenna and feed line loading on the structure and its components, or other relevant information.
- Information from drawings in the possession of American Tower Corporation, or generated by field inspections or measurements of the structure.

It is the responsibility of the client to ensure that the information provided to ATC Engineering Services and used in the performance of our engineering services is correct and complete. In the absence of information to the contrary, we assume that all structures were constructed in accordance with the drawings and specifications and that their capacity has not significantly changed from the "as new" condition.

All services will be performed to the codes specified by the client, and we do not imply to meet any other codes or requirements unless explicitly agreed in writing. If wind and ice loads or other relevant parameters are to be different from the minimum values recommended by the codes, the client shall specify the exact requirement. In the absence of information to the contrary, all work will be performed in accordance with the latest relevant revision of ANSI/EIA-222.

All services are performed, results obtained, and recommendations made in accordance with generally accepted engineering principles and practices. ATC Engineering Services is not responsible for the conclusions, opinions and recommendations made by others based on the information we supply.



Copyright © 2007 - 2011 by American Tower Corporation. All rights reserved.

Job Information	
Pole :	302527
Code:	TIA/EIA-222 Rev F
Description :	150' Summit Monopole
Client :	Verizon Wireless
Location :	East Haddam, CT
Shape :	18 Sides
Base Elev (ft):	0.00
Height :	150.00 (ft)
Taper:	0.253625(in/ft)

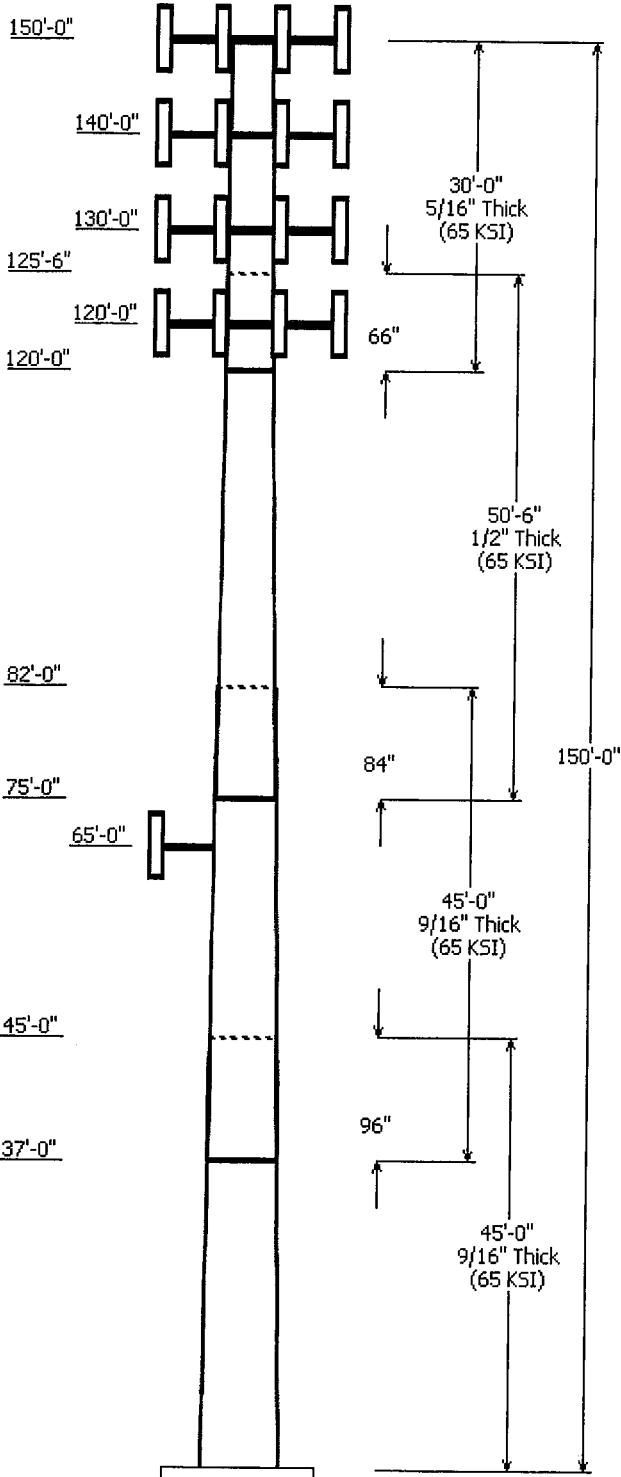

Sections Properties							
Shaft Section	Length (ft)	Diameter (in)		Thick Joint (in)	Overlap Length (in)	Steel Taper (in/ft)	Steel Grade (ksi)
		Across Top	Flats Bottom				
1	45.000	60.78	72.20	0.563	0.000	0.253625	65
2	45.000	52.52	63.94	0.563	Slip Joint	96.000	65
3	50.500	42.49	55.30	0.500	Slip Joint	84.000	65
4	30.000	36.90	44.51	0.313	Slip Joint	66.000	65

Discrete Appurtenance			
Attach Elev (ft)	Force Elev (ft)	Qty	Description
150.000	150.000	1	Flat Low Profile Platform
150.000	150.000	9	48" x 12" Panels
150.000	150.000	3	72" x 12" Panels
140.000	140.000	3	Round T-Arms
140.000	140.000	12	Decibel DB980F65E-M
130.000	130.000	3	Antel BXA-70063-4CF-EDIN-X
130.000	130.000	6	RFS APL868013-42T0
130.000	130.000	1	Flat Low Profile Platform
130.000	130.000	6	RFS FD9R6004/2C-3L
130.000	130.000	3	Antel BXA-171063-8BF-EDIN-X
120.000	120.000	3	Powerwave 7770.00
120.000	120.000	9	72" x 12" Panels
120.000	120.000	6	Powerwave LGP 21902
120.000	120.000	6	Powerwave LGP 17201
120.000	120.000	1	Flat Low Profile Platform
65.000	65.000	1	GPS
65.000	65.000	1	Round Side Arm

Linear Appurtenance			
From Elev (ft)	To Elev (ft)	Description	Exposed To Wind
10.000	65.000	1/2" Coax	No
10.000	120.0	1 5/8" Coax	No
10.000	130.0	1 5/8" Coax	No
10.000	140.0	1 5/8" Coax	No
10.000	150.0	1 5/8" Coax	No

Load Cases	
No Ice	85.00 mph Wind with No Ice
Ice	73.61 mph Wind with Ice
Twist/Sway	50.00 mph Wind with No Ice

Reactions			
Load Case	Moment (Kip-ft)	Shear (Kips)	Axial (Kips)
No Ice	3193.18	31.03	64.05
Ice	2650.05	25.21	71.52
Twist/Sway	1104.89	10.74	64.06

Dish Deflections			
Load Case	Attach Elev (ft)	Deflection (in)	Rotation (deg)

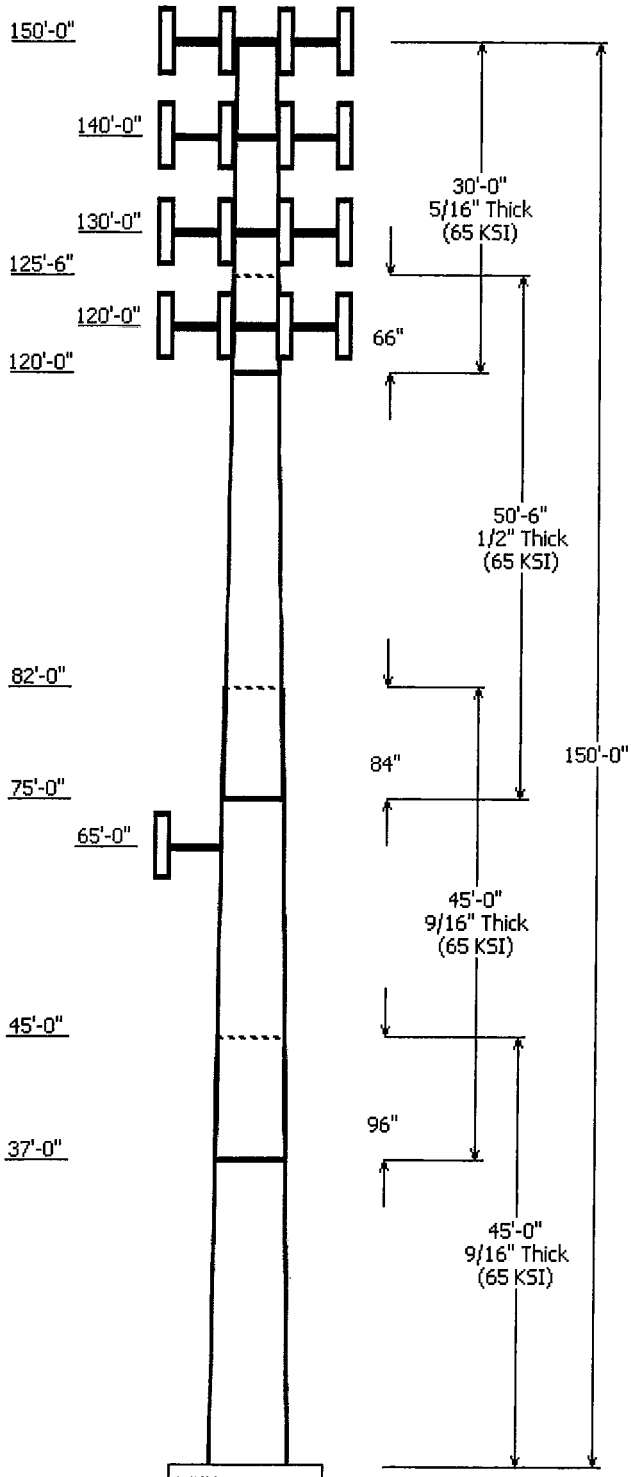

**Load Case : No Ice**  
**Max Stress 33.6% at 0.0ft**

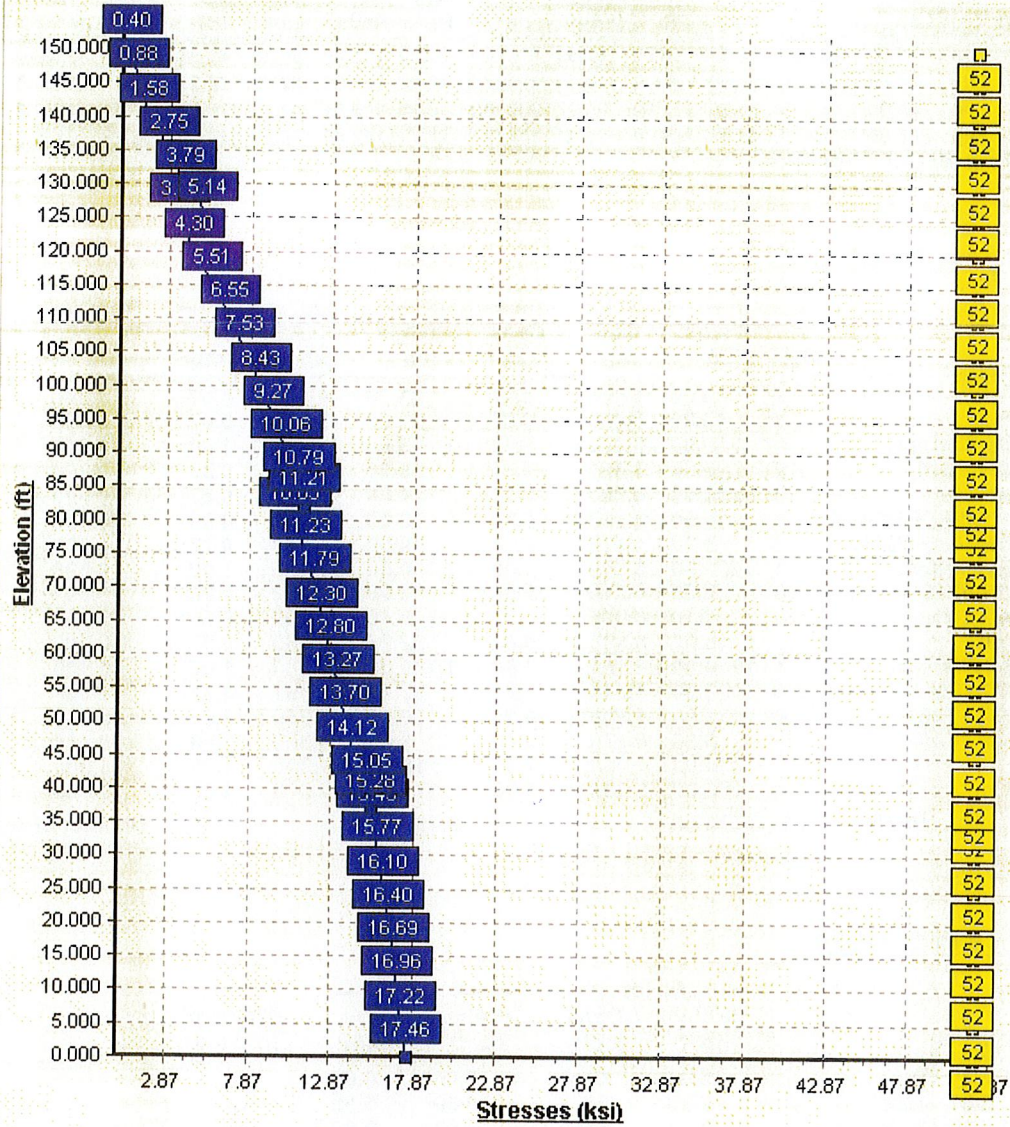

Pole : 302527  
 Location : East Haddam, CT  
 Height : 150.0 (ft)  
 Base Dia : 72.20 (in)  
 Top Dia : 36.90 (in)  
 Shape : 18 Sides  
 Taper : 0.253625 (in/ft)

Code: TIA/EIA-222 Rev F

Base Elev : 0.000 (ft)

Copyright © 2007 - 2011 by American Tower Corporation. All rights reserved.

3/23/2012 10:11:18 AM

Page: 1

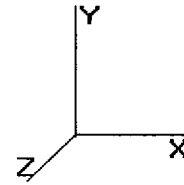

**Shaft Section Properties**

Sect Info	Length (ft)	Thick (in)	Fy (ksi)	Joint Type	Joint Len (in)	Weight (lb)	Bottom						Top						
							Dia (in)	Elev (ft)	Area (sqin)	Ix (in^4)	W/t Ratio	D/t Ratio	Dia (in)	Elev (ft)	Area (sqin)	Ix (in^4)	W/t Ratio	D/t Ratio	Taper (in/ft)
1-18	45.000	0.5625	65		0.00	18,024	72.20	0.00	127.89	82924.1	21.22	128.35	60.78	45.00	107.52	49269.2	17.64	108.06	0.253625
2-18	45.000	0.5625	65	Slip	96.00	15,766	63.94	37.00	113.15	57422.3	18.63	113.67	52.52	82.00	92.77	31651.5	15.06	93.38	0.253625
3-18	50.500	0.5000	65	Slip	84.00	13,198	55.30	75.00	86.97	33000.5	18.09	110.61	42.49	125.50	66.64	14849.0	13.58	84.99	0.253625
4-18	30.000	0.3125	65	Slip	66.00	4,090	44.51	120.00	43.84	10822.4	23.71	142.45	36.90	150.00	36.29	6140.5	19.41	118.10	0.253625
Shaft Weight						51,078													

**Discrete Appurtenance Properties**

Attach Elev (ft)	Description	Qty	Weight (lb)	No Ice CaAa (sf)	CaAa Factor	Weight (lb)	Ice CaAa (sf)	CaAa Factor	Distance From Face (ft)	Vert Ecc (ft)
150.00	48" x 12" Panels	9	30.00	5.600	0.67	63.00	6.190	0.67	0.000	0.000
150.00	72" x 12" Panels	3	45.00	8.400	0.67	92.28	9.230	0.67	0.000	0.000
150.00	Flat Low Profile Platform	1	1500.00	26.100	1.00	1,700.00	31.600	1.00	0.000	0.000
140.00	Decibel DB980F65E-M	12	9.50	3.750	0.81	25.00	4.320	0.83	0.000	0.000
140.00	Round T-Arms	3	250.00	9.700	0.67	314.00	12.100	0.67	0.000	0.000
130.00	Antel BXA-171063-8BF-EDIN-X	3	10.50	3.610	0.90	29.80	3.370	0.90	0.000	0.000
130.00	Antel BXA-70063-4CF-EDIN-X	3	9.90	4.710	0.77	39.00	5.740	0.77	0.000	0.000
130.00	Flat Low Profile Platform	1	1500.00	26.100	1.00	1,700.00	31.600	1.00	0.000	0.000
130.00	RFS APL868013-42T0	6	6.30	3.610	0.90	32.00	4.290	0.90	0.000	0.000
130.00	RFS FD9R6004/2C-3L	6	3.10	0.360	0.50	5.40	0.500	0.50	0.000	0.000
120.00	72" x 12" Panels	9	45.00	8.400	0.67	92.28	9.230	0.67	0.000	0.000
120.00	Flat Low Profile Platform	1	1500.00	26.100	1.00	1,700.00	31.600	1.00	0.000	0.000
120.00	Powerwave 7770.00	3	35.00	5.510	0.77	67.75	6.597	0.77	0.000	0.000
120.00	Powerwave LGP 17201	6	31.00	1.950	0.50	50.00	2.300	0.50	0.000	0.000
120.00	Powerwave LGP 21902	6	5.50	0.270	0.50	7.90	0.380	0.50	0.000	0.000
65.00	GPS	1	10.00	1.000	1.00	18.00	1.300	1.00	0.000	0.000
65.00	Round Side Arm	1	150.00	5.200	1.00	175.00	5.900	1.00	0.000	0.000
Totals		74	6775.60			9,190.80			Number of Loadings :	17

**Linear Appurtenance Properties**

Elev From (ft)	Elev To (ft)	Description	No Ice Weight (lb/ft)	No Ice CaAa (sf/ft)	Ice Weight (lb/ft)	Ice CaAa (sf/ft)	Exposed To Wind
10.00	150.00	(12) 1 5/8" Coax	9.84	0.00	0.00	0.00	N
10.00	140.00	(24) 1 5/8" Coax	19.70	0.00	0.00	0.00	N
10.00	130.00	(12) 1 5/8" Coax	9.84	0.00	0.00	0.00	N
10.00	120.00	(12) 1 5/8" Coax	9.84	0.00	0.00	0.00	N
10.00	65.00	(1) 1/2" Coax	0.15	0.00	0.00	0.00	N
Total Weight			6,210.04 (lb)		0.00 (lb)		

Pole : 302527  
 Location : East Haddam, CT  
 Height : 150.0 (ft)  
 Base Dia : 72.20 (in)  
 Top Dia : 36.90 (in)  
 Shape : 18 Sides  
 Taper : 0.253625 (in/ft)

Code: TIA/EIA-222 Rev F

Base Elev : 0.000 (ft)

3/23/2012 10:11:18 AM  
 Page: 2

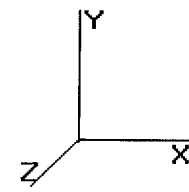

Copyright © 2007 - 2011 by American Tower Corporation. All rights reserved.

**Segment Properties** (Max Len : 5 ft)

Seg Top Elev (ft)	Description	Thick (in)	Flat Dia (in)	Area (in^2)	Ix (in^4)	W/t Ratio	D/t Ratio	Fy (ksi)	Fb (ksi)	Weight (lb)
0.00		0.5625	72.200	127.894	82,924.1	21.22	128.35	65	52	0.0
5.00		0.5625	70.931	125.630	78,597.9	20.82	126.10	65	52	2,156.7
10.00		0.5625	69.663	123.366	74,424.7	20.43	123.85	65	52	2,118.2
15.00		0.5625	68.395	121.103	70,402.0	20.03	121.59	65	52	2,079.7
20.00		0.5625	67.127	118.839	66,526.9	19.63	119.34	65	52	2,041.2
25.00		0.5625	65.859	116.575	62,796.6	19.23	117.08	65	52	2,002.6
30.00		0.5625	64.591	114.311	59,208.5	18.84	114.83	65	52	1,964.1
35.00		0.5625	63.323	112.047	55,759.7	18.44	112.57	65	52	1,925.6
37.00	Bot - Section 2	0.5625	62.815	111.141	54,418.6	18.28	111.67	65	52	759.5
40.00		0.5625	62.055	109.783	52,447.5	18.04	110.32	65	52	2,275.8
45.00	Top - Section 1	0.5625	61.911	109.527	52,082.2	18.00	110.06	65	52	3,731.3
50.00		0.5625	60.643	107.263	48,918.8	17.60	107.81	65	52	1,844.2
55.00		0.5625	59.375	104.999	45,886.1	17.20	105.56	65	52	1,805.7
60.00		0.5625	58.107	102.735	42,981.5	16.80	103.30	65	52	1,767.2
65.00		0.5625	56.839	100.471	40,202.0	16.41	101.05	65	52	1,728.7
70.00		0.5625	55.571	98.207	37,545.1	16.01	98.79	65	52	1,690.1
75.00	Bot - Section 3	0.5625	54.303	95.943	35,007.9	15.61	96.54	65	52	1,651.6
80.00		0.5625	53.035	93.679	32,587.6	15.21	94.28	65	52	3,075.7
82.00	Top - Section 2	0.5000	53.527	84.151	29,896.1	17.47	107.05	65	52	1,209.9
85.00		0.5000	52.767	82.944	28,627.6	17.20	105.53	65	52	852.9
90.00		0.5000	51.498	80.932	26,594.0	16.75	103.00	65	52	1,394.1
95.00		0.5000	50.230	78.919	24,659.1	16.30	100.46	65	52	1,359.8
100.00		0.5000	48.962	76.907	22,820.3	15.86	97.92	65	52	1,325.6
105.00		0.5000	47.694	74.894	21,075.4	15.41	95.39	65	52	1,291.4
110.00		0.5000	46.426	72.882	19,421.7	14.96	92.85	65	52	1,257.1
115.00		0.5000	45.158	70.869	17,856.9	14.51	90.32	65	52	1,222.9
120.00	Bot - Section 4	0.5000	43.890	68.857	16,378.4	14.07	87.78	65	52	1,188.6
125.00		0.5000	42.622	66.844	14,984.0	13.62	85.24	65	52	1,889.6
125.50	Top - Section 3	0.3125	43.120	42.458	9,829.8	22.92	137.98	65	52	185.9
130.00		0.3125	41.978	41.326	9,064.3	22.28	134.33	65	52	641.5
135.00		0.3125	40.710	40.068	8,261.6	21.56	130.27	65	52	692.4
140.00		0.3125	39.442	38.810	7,507.8	20.84	126.21	65	52	671.0
145.00		0.3125	38.174	37.553	6,801.3	20.13	122.16	65	52	649.6
150.00		0.3125	36.906	36.295	6,140.5	19.41	118.10	65	52	628.2
										51,078.4

Pole : 302527  
 Location : East Haddam, CT  
 Height : 150.0 (ft)  
 Base Dia : 72.20 (in)  
 Top Dia : 36.90 (in)  
 Shape : 18 Sides  
 Taper : 0.253625 (in/ft)

Code: TIA/EIA-222 Rev F

Base Elev : 0.000 (ft)

Copyright © 2007 - 2011 by American Tower Corporation. All rights reserved.

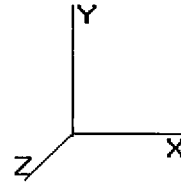

3/23/2012 10:11:18 AM  
 Page: 3

**Load Case:** No Ice                      85.00 mph Wind with No Ice                      17 Iterations

Gust Response Factor : 1.69  
 Dead Load Factor : 1.00  
 Wind Load Factor : 1.00

**Shaft Segment Forces**

Seg Top Elev (ft)	Description	Kz	qz (psf)	qzGh (psf)	C (mph-ft)	Cf	Ice Thick (in)	Tributary (ft)	Aa (sf)	CfAa (sf)	Wind Force X (lb)	Dead Load (lb)	Tot Dead Load (lb)
0.00		0.00	1.00 18.496	31.25 511.41	0.650	0.000	0.00	0.000	0.00	0.00	0.0	0.0	0.0
5.00		0.00	1.00 18.496	31.25 502.43	0.650	0.000	5.00	29.819	19.38	605.9	605.9	0.0	2,156.7
10.00		0.00	1.00 18.496	31.25 493.44	0.650	0.000	5.00	29.291	19.04	595.1	595.1	0.0	2,118.2
15.00		0.00	1.00 18.496	31.25 484.46	0.650	0.000	5.00	28.762	18.70	584.4	584.4	0.0	2,079.7
20.00		0.00	1.00 18.496	31.25 475.48	0.650	0.000	5.00	28.234	18.35	573.7	573.7	0.0	2,041.2
25.00		0.00	1.00 18.496	31.25 466.50	0.650	0.000	5.00	27.705	18.01	562.9	562.9	0.0	2,002.6
30.00		0.00	1.00 18.496	31.25 457.51	0.650	0.000	5.00	27.177	17.67	552.2	552.2	0.0	1,964.1
35.00		0.00	1.01 18.810	31.78 452.32	0.650	0.000	5.00	26.649	17.32	550.6	550.6	0.0	1,925.6
37.00	Bot - Section 2	0.00	1.03 19.111	32.29 452.27	0.650	0.000	2.00	10.512	6.83	220.7	220.7	0.0	759.5
40.00		0.00	1.05 19.541	33.02 451.80	0.650	0.000	3.00	15.890	10.33	341.1	341.1	0.0	2,275.8
45.00	Top - Section 1	0.00	1.09 20.210	34.15 450.07	0.650	0.000	5.00	26.061	16.94	578.6	578.6	0.0	3,731.3
50.00		0.00	1.12 20.827	35.19 455.82	0.650	0.000	5.00	25.532	16.60	584.2	584.2	0.0	1,844.2
55.00		0.00	1.15 21.402	36.17 452.41	0.650	0.000	5.00	25.004	16.25	587.9	587.9	0.0	1,805.7
60.00		0.00	1.18 21.941	37.08 448.28	0.650	0.000	5.00	24.475	15.91	589.9	589.9	0.0	1,767.2
65.00	Appertunance(s)	0.00	1.21 22.449	37.93 443.54	0.650	0.000	5.00	23.947	15.57	590.5	590.5	0.0	1,728.7
70.00		0.00	1.24 22.929	38.75 438.26	0.650	0.000	5.00	23.419	15.22	589.9	589.9	0.0	1,690.1
75.00	Bot - Section 3	0.00	1.26 23.386	39.52 432.50	0.650	0.000	5.00	22.890	14.88	588.0	588.0	0.0	1,651.6
80.00		0.00	1.28 23.821	40.25 426.32	0.650	0.000	5.00	22.779	14.81	596.1	596.1	0.0	3,075.7
82.00	Top - Section 2	0.00	1.29 23.989	40.54 423.73	0.650	0.000	2.00	8.964	5.83	236.2	236.2	0.0	1,209.9
85.00		0.00	1.31 24.237	40.96 427.85	0.650	0.000	3.00	13.287	8.64	353.8	353.8	0.0	852.9
90.00		0.00	1.33 24.636	41.63 420.99	0.650	0.000	5.00	21.722	14.12	587.9	587.9	0.0	1,394.1
95.00		0.00	1.35 25.020	42.28 413.81	0.650	0.000	5.00	21.193	13.78	582.5	582.5	0.0	1,359.8
100.00		0.00	1.37 25.389	42.90 406.33	0.650	0.000	5.00	20.665	13.43	576.3	576.3	0.0	1,325.6
105.00		0.00	1.39 25.745	43.51 398.57	0.650	0.000	5.00	20.137	13.09	569.5	569.5	0.0	1,291.4
110.00		0.00	1.41 26.090	44.09 390.56	0.650	0.000	5.00	19.608	12.75	562.0	562.0	0.0	1,257.1
115.00		0.00	1.42 26.423	44.65 382.31	0.650	0.000	5.00	19.080	12.40	553.8	553.8	0.0	1,222.9
120.00	Bot - Section 4	0.00	1.44 26.747	45.20 373.84	0.650	0.000	5.00	18.552	12.06	545.1	545.1	0.0	1,188.6
125.00		0.00	1.46 27.060	45.73 365.17	0.650	0.000	5.00	18.284	11.88	543.5	543.5	0.0	1,889.6
125.50	Top - Section 3	0.00	1.46 27.091	45.78 364.29	0.650	0.000	0.50	1.799	1.17	53.5	53.5	0.0	185.9
130.00	Appertunance(s)	0.00	1.48 27.365	46.24 361.68	0.650	0.000	4.50	15.956	10.37	479.6	479.6	0.0	641.5
135.00		0.00	1.49 27.662	46.74 352.65	0.650	0.000	5.00	17.227	11.20	523.5	523.5	0.0	692.4
140.00	Appertunance(s)	0.00	1.51 27.951	47.23 343.44	0.650	0.000	5.00	16.698	10.85	512.7	512.7	0.0	671.0
145.00		0.00	1.52 28.233	47.71 334.07	0.650	0.000	5.00	16.170	10.51	501.5	501.5	0.0	649.6
150.00	Appertunance(s)	0.00	1.54 28.507	48.17 324.54	0.650	0.000	5.00	15.642	10.17	489.8	489.8	0.0	628.2
<b>Totals:</b>								150.00			16,962.6	0.0	51,078.4

Pole : 302527  
 Location : East Haddam, CT  
 Height : 150.0 (ft)  
 Base Dia : 72.20 (in)  
 Top Dia : 36.90 (in)  
 Shape : 18 Sides  
 Taper : 0.253625 (in/ft)

Code: TIA/EIA-222 Rev F

Base Elev : 0.000 (ft)

3/23/2012 10:11:18 AM

Page: 4

Copyright © 2007 - 2011 by American Tower Corporation. All rights reserved.

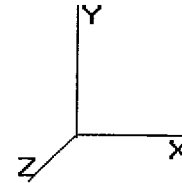

**Load Case:** No Ice                      85.00 mph Wind with No Ice                      17 Iterations

Gust Response Factor : 1.69  
 Dead Load Factor : 1.00  
 Wind Load Factor : 1.00

**Discrete Appurtenance Segment Forces**

Elev (ft)	Description	Qty	qz (psf)	qzGh (psf)	CaAa Factor	Total CaAa (sf)	Horiz Ecc (ft)	Vert Ecc (ft)	Wind FX (lb)	Mom Y (lb-ft)	Mom Z (lb-ft)	Dead Load (lb)
65.00	GPS	1	22.449	37.938	1.00	1.00	0.000	0.000	37.94	0.00	0.00	10.00
65.00	Round Side Arm	1	22.449	37.938	1.00	5.20	0.000	0.000	197.28	0.00	0.00	150.00
120.0	72" x 12" Panels	9	26.747	45.202	0.67	50.65	0.000	0.000	2,289.53	0.00	0.00	405.00
120.0	Flat Low Profile Pla	1	26.747	45.202	1.00	26.10	0.000	0.000	1,179.77	0.00	0.00	1,500.00
120.0	Powerwave 7770.00	3	26.747	45.202	0.77	12.73	0.000	0.000	575.33	0.00	0.00	105.00
120.0	Powerwave LGP	6	26.747	45.202	0.50	5.85	0.000	0.000	264.43	0.00	0.00	186.00
120.0	Powerwave LGP	6	26.747	45.202	0.50	0.81	0.000	0.000	36.61	0.00	0.00	33.00
130.0	Antel BXA-171063-8BF	3	27.365	46.247	0.90	9.75	0.000	0.000	450.77	0.00	0.00	31.50
130.0	Antel BXA-70063-4CF-	3	27.365	46.247	0.77	10.88	0.000	0.000	503.18	0.00	0.00	29.70
130.0	Flat Low Profile Pla	1	27.365	46.247	1.00	26.10	0.000	0.000	1,207.06	0.00	0.00	1,500.00
130.0	RFS APL868013-42T0	6	27.365	46.247	0.90	19.49	0.000	0.000	901.55	0.00	0.00	37.80
130.0	RFS FD9R6004/2C-3L	6	27.365	46.247	0.50	1.08	0.000	0.000	49.95	0.00	0.00	18.60
140.0	Decibel DB980F65E-M	12	27.951	47.237	0.81	36.45	0.000	0.000	1,721.79	0.00	0.00	114.00
140.0	Round T-Arms	3	27.951	47.237	0.67	19.50	0.000	0.000	920.97	0.00	0.00	750.00
150.0	48" x 12" Panels	9	28.507	48.177	0.67	33.77	0.000	0.000	1,626.86	0.00	0.00	270.00
150.0	72" x 12" Panels	3	28.507	48.177	0.67	16.88	0.000	0.000	813.43	0.00	0.00	135.00
150.0	Flat Low Profile Pla	1	28.507	48.177	1.00	26.10	0.000	0.000	1,257.43	0.00	0.00	1,500.00
									14,033.87			6,775.60

Pole : 302527  
 Location : East Haddam, CT  
 Height : 150.0 (ft)  
 Base Dia : 72.20 (in)  
 Top Dia : 36.90 (in)  
 Shape : 18 Sides  
 Taper : 0.253625 (in/ft)

Code: TIA/EIA-222 Rev F

3/23/2012 10:11:18 AM  
 Page: 5

Base Elev : 0.000 (ft)

Copyright © 2007 - 2011 by American Tower Corporation. All rights reserved.

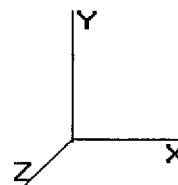

**Load Case:** No Ice                      85.00 mph Wind with No Ice                      17 Iterations  
 Gust Response Factor : 1.69  
 Dead Load Factor : 1.00  
 Wind Load Factor : 1.00

**Applied Segment Forces Summary**

Seg Elev (ft)	Lateral FX (-) (lb)	Axial FY (-) (lb)	Torsion MY (lb-ft)	Moment MZ (lb-ft)
0.00	0.00	0.00	0.00	0.00
5.00	605.86	2,156.72	0.00	0.00
10.00	595.12	2,118.20	0.00	0.00
15.00	584.39	2,326.53	0.00	0.00
20.00	573.65	2,288.01	0.00	0.00
25.00	562.92	2,249.49	0.00	0.00
30.00	552.18	2,210.98	0.00	0.00
35.00	550.62	2,172.46	0.00	0.00
37.00	220.67	858.20	0.00	0.00
40.00	341.09	2,423.87	0.00	0.00
45.00	578.56	3,978.16	0.00	0.00
50.00	584.15	2,091.07	0.00	0.00
55.00	587.86	2,052.55	0.00	0.00
60.00	589.92	2,014.03	0.00	0.00
65.00	825.75	2,135.51	0.00	0.00
70.00	589.86	1,936.24	0.00	0.00
75.00	588.03	1,897.72	0.00	0.00
80.00	596.05	3,321.76	0.00	0.00
82.00	236.21	1,308.33	0.00	0.00
85.00	353.75	1,000.54	0.00	0.00
90.00	587.85	1,640.18	0.00	0.00
95.00	582.48	1,605.94	0.00	0.00
100.0	576.34	1,571.70	0.00	0.00
105.0	569.49	1,537.46	0.00	0.00
110.0	561.97	1,503.22	0.00	0.00
115.0	553.81	1,468.98	0.00	0.00
120.0	4,890.74	3,663.74	0.00	0.00
125.0	543.49	2,086.52	0.00	0.00
125.5	53.55	205.59	0.00	0.00
130.0	3,592.15	2,436.28	0.00	0.00
135.0	523.47	840.11	0.00	0.00
140.0	3,155.47	1,682.71	0.00	0.00
145.0	501.49	698.81	0.00	0.00
150.0	4,187.54	2,582.42	0.00	0.00
<b>Totals:</b>	<b>30,996.49</b>	<b>64,064.06</b>	<b>0.00</b>	<b>0.00</b>



Pole : 302527  
 Location : East Haddam, CT  
 Height : 150.0 (ft)  
 Base Dia : 72.20 (in)  
 Top Dia : 36.90 (in)  
 Shape : 18 Sides  
 Taper : 0.253625 (in/ft)

Code: TIA/EIA-222 Rev F

Base Elev : 0.000 (ft)

3/23/2012 10:11:18 AM

Page: 6

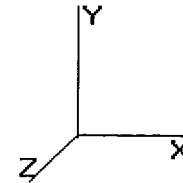

Copyright © 2007 - 2011 by American Tower Corporation. All rights reserved.

<b>Load Case:</b> No Ice	85.00 mph Wind with No Ice	17 Iterations
Gust Response Factor : 1.69		
Dead Load Factor : 1.00		
Wind Load Factor : 1.00		

**Calculated Shaft Forces and Deflections**

Seg Elev (ft)	Lateral FX (-) (kips)	Axial FY (-) (kips)	Lateral FZ (kips)	Moment MX (ft-kips)	Torsion MY (ft-kips)	Moment MZ (ft-kips)	X Deflect (in)	Z Deflect (in)	Total Deflect (in)	Rotation (deg)
0.00	-31.027	-64.049	0.000	0.000	0.000	-3,193.175	0.000	0.000	0.000	0.000
5.00	-30.478	-61.864	0.000	0.000	0.000	-3,038.042	-0.029	0.000	0.029	-0.053
10.00	-29.936	-59.719	0.000	0.000	0.000	-2,885.654	-0.114	0.000	0.114	-0.107
15.00	-29.400	-57.366	0.000	0.000	0.000	-2,735.977	-0.256	0.000	0.256	-0.161
20.00	-28.870	-55.053	0.000	0.000	0.000	-2,588.980	-0.454	0.000	0.454	-0.215
25.00	-28.348	-52.779	0.000	0.000	0.000	-2,444.630	-0.708	0.000	0.708	-0.268
30.00	-27.831	-50.545	0.000	0.000	0.000	-2,302.895	-1.018	0.000	1.018	-0.322
35.00	-27.299	-48.358	0.000	0.000	0.000	-2,163.740	-1.385	0.000	1.385	-0.376
37.00	-27.095	-47.488	0.000	0.000	0.000	-2,109.143	-1.548	0.000	1.548	-0.398
40.00	-26.770	-45.047	0.000	0.000	0.000	-2,027.858	-1.808	0.000	1.808	-0.430
45.00	-26.198	-41.049	0.000	0.000	0.000	-1,894.009	-2.288	0.000	2.288	-0.483
50.00	-25.630	-38.941	0.000	0.000	0.000	-1,763.020	-2.823	0.000	2.823	-0.536
55.00	-25.054	-36.873	0.000	0.000	0.000	-1,634.872	-3.411	0.000	3.411	-0.585
60.00	-24.472	-34.844	0.000	0.000	0.000	-1,509.605	-4.051	0.000	4.051	-0.634
65.00	-23.649	-32.699	0.000	0.000	0.000	-1,387.248	-4.742	0.000	4.742	-0.682
70.00	-23.060	-30.751	0.000	0.000	0.000	-1,269.007	-5.482	0.000	5.482	-0.729
75.00	-22.470	-28.844	0.000	0.000	0.000	-1,153.710	-6.271	0.000	6.271	-0.775
80.00	-21.841	-25.519	0.000	0.000	0.000	-1,041.363	-7.107	0.000	7.107	-0.820
82.00	-21.595	-24.206	0.000	0.000	0.000	-997.681	-7.455	0.000	7.455	-0.837
85.00	-21.241	-23.198	0.000	0.000	0.000	-932.896	-7.990	0.000	7.990	-0.863
90.00	-20.644	-21.551	0.000	0.000	0.000	-826.692	-8.918	0.000	8.918	-0.907
95.00	-20.049	-19.941	0.000	0.000	0.000	-723.473	-9.891	0.000	9.891	-0.949
100.0	-19.459	-18.367	0.000	0.000	0.000	-623.227	-10.907	0.000	10.907	-0.987
105.0	-18.872	-16.828	0.000	0.000	0.000	-525.935	-11.961	0.000	11.961	-1.023
110.0	-18.291	-15.326	0.000	0.000	0.000	-431.574	-13.051	0.000	13.051	-1.056
115.0	-17.716	-13.859	0.000	0.000	0.000	-340.119	-14.173	0.000	14.173	-1.084
120.0	-12.760	-10.285	0.000	0.000	0.000	-251.539	-15.322	0.000	15.322	-1.107
125.0	-12.177	-8.208	0.000	0.000	0.000	-187.739	-16.492	0.000	16.492	-1.126
125.5	-12.121	-8.002	0.000	0.000	0.000	-181.650	-16.611	0.000	16.611	-1.128
130.0	-8.483	-5.635	0.000	0.000	0.000	-127.106	-17.681	0.000	17.681	-1.142
135.0	-7.944	-4.803	0.000	0.000	0.000	-84.692	-18.887	0.000	18.887	-1.158
140.0	-4.755	-3.185	0.000	0.000	0.000	-44.974	-20.107	0.000	20.107	-1.169
145.0	-4.240	-2.496	0.000	0.000	0.000	-21.198	-21.335	0.000	21.335	-1.176
150.0	-4.187	0.000	0.000	0.000	0.000	0.000	-22.568	0.000	22.568	-1.178

Pole : 302527  
 Location : East Haddam, CT  
 Height : 150.0 (ft)  
 Base Dia : 72.20 (in)  
 Top Dia : 36.90 (in)  
 Shape : 18 Sides  
 Taper : 0.253625 (in/ft)

Code: TIA/EIA-222 Rev F

Base Elev : 0.000 (ft)

Copyright © 2007 - 2011 by American Tower Corporation. All rights reserved.

3/23/2012 10:11:18 AM

Page: 7

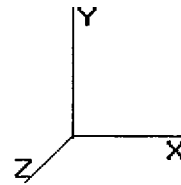

**Load Case:** No Ice                      85.00 mph Wind with No Ice                      17 Iterations

Gust Response Factor : 1.69  
 Dead Load Factor : 1.00  
 Wind Load Factor : 1.00

**Calculated Stresses**

Seg Elev (ft)	Applied Stresses							Allowable Stress (Fb) (ksi)	Stress Ratio	
	Axial (Y) (ksi)	Shear (X) (ksi)	Shear (Z) (ksi)	Torsion (ksi)	Bending (X) (ksi)	Bending (Z) (ksi)	Combined (ksi)			
0.00	0.50	0.49	0.00	0.00	0.00	16.94	17.46	52.0	0.0	0.336
5.00	0.49	0.49	0.00	0.00	0.00	16.70	17.22	52.0	0.0	0.331
10.00	0.48	0.49	0.00	0.00	0.00	16.46	16.96	52.0	0.0	0.326
15.00	0.47	0.49	0.00	0.00	0.00	16.19	16.69	52.0	0.0	0.321
20.00	0.46	0.49	0.00	0.00	0.00	15.92	16.40	52.0	0.0	0.316
25.00	0.45	0.49	0.00	0.00	0.00	15.62	16.10	52.0	0.0	0.310
30.00	0.44	0.49	0.00	0.00	0.00	15.31	15.77	52.0	0.0	0.303
35.00	0.43	0.49	0.00	0.00	0.00	14.97	15.43	52.0	0.0	0.297
37.00	0.43	0.49	0.00	0.00	0.00	14.83	15.28	52.0	0.0	0.294
40.00	0.41	0.49	0.00	0.00	0.00	14.62	15.05	52.0	0.0	0.290
45.00	0.37	0.48	0.00	0.00	0.00	13.72	14.12	52.0	0.0	0.272
50.00	0.36	0.48	0.00	0.00	0.00	13.32	13.70	52.0	0.0	0.264
55.00	0.35	0.48	0.00	0.00	0.00	12.89	13.27	52.0	0.0	0.255
60.00	0.34	0.48	0.00	0.00	0.00	12.43	12.80	52.0	0.0	0.246
65.00	0.33	0.47	0.00	0.00	0.00	11.95	12.30	52.0	0.0	0.237
70.00	0.31	0.47	0.00	0.00	0.00	11.44	11.79	52.0	0.0	0.227
75.00	0.30	0.47	0.00	0.00	0.00	10.90	11.23	52.0	0.0	0.216
80.00	0.27	0.47	0.00	0.00	0.00	10.33	10.63	52.0	0.0	0.204
82.00	0.29	0.52	0.00	0.00	0.00	10.88	11.21	52.0	0.0	0.216
85.00	0.28	0.52	0.00	0.00	0.00	10.48	10.79	52.0	0.0	0.208
90.00	0.27	0.51	0.00	0.00	0.00	9.75	10.06	52.0	0.0	0.194
95.00	0.25	0.51	0.00	0.00	0.00	8.98	9.27	52.0	0.0	0.178
100.00	0.24	0.51	0.00	0.00	0.00	8.15	8.43	52.0	0.0	0.162
105.00	0.22	0.51	0.00	0.00	0.00	7.25	7.53	52.0	0.0	0.145
110.00	0.21	0.51	0.00	0.00	0.00	6.29	6.55	52.0	0.0	0.126
115.00	0.20	0.50	0.00	0.00	0.00	5.24	5.51	52.0	0.0	0.106
120.00	0.15	0.37	0.00	0.00	0.00	4.11	4.30	52.0	0.0	0.083
125.00	0.12	0.37	0.00	0.00	0.00	3.25	3.44	52.0	0.0	0.066
125.50	0.19	0.58	0.00	0.00	0.00	4.85	5.14	52.0	0.0	0.099
130.00	0.14	0.41	0.00	0.00	0.00	3.59	3.79	52.0	0.0	0.073
135.00	0.12	0.40	0.00	0.00	0.00	2.54	2.75	52.0	0.0	0.053
140.00	0.08	0.25	0.00	0.00	0.00	1.44	1.58	52.0	0.0	0.030
145.00	0.07	0.23	0.00	0.00	0.00	0.72	0.88	52.0	0.0	0.017
150.00	0.00	0.23	0.00	0.00	0.00	0.00	0.40	52.0	0.0	0.008

Pole : 302527  
 Location : East Haddam, CT  
 Height : 150.0 (ft)  
 Base Dia : 72.20 (in)  
 Top Dia : 36.90 (in)  
 Shape : 18 Sides  
 Taper : 0.253625 (in/ft)

Code: TIA/EIA-222 Rev F

Base Elev : 0.000 (ft)

3/23/2012 10:11:18 AM

Page: 8

Copyright © 2007 - 2011 by American Tower Corporation. All rights reserved.

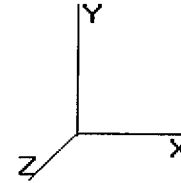

**Load Case: Ice**

73.61 mph Wind with Ice

17 Iterations

Gust Response Factor : 1.69  
 Dead Load Factor : 1.00  
 Wind Load Factor : 1.00

**Shaft Segment Forces**

Seg Top Elev (ft)	Description	Kz	qz (psf)	qzGh (psf)	C (mph-ft)	Cf	Ice Thick (in)	Tributary (ft)	Aa (sf)	CfAa (sf)	Wind Force X (lb)	Dead Load Ice (lb)	Tot Dead Load (lb)
0.00		0.00	1.00 13.871	23.44 442.88	0.650		0.500	0.00	0.000	0.00	0.0	0.0	0.0
5.00		0.00	1.00 13.871	23.44 435.10	0.650		0.500	5.00	30.236	19.65	460.7	220.4	2,377.1
10.00		0.00	1.00 13.871	23.44 427.32	0.650		0.500	5.00	29.707	19.31	452.7	216.5	2,334.7
15.00		0.00	1.00 13.871	23.44 419.54	0.650		0.500	5.00	29.179	18.97	444.6	212.6	2,292.3
20.00		0.00	1.00 13.871	23.44 411.76	0.650		0.500	5.00	28.650	18.62	436.6	208.7	2,249.8
25.00		0.00	1.00 13.871	23.44 403.99	0.650		0.500	5.00	28.122	18.28	428.5	204.8	2,207.4
30.00		0.00	1.00 13.871	23.44 396.21	0.650		0.500	5.00	27.594	17.94	420.5	200.9	2,165.0
35.00		0.00	1.01 14.106	23.84 391.71	0.650		0.500	5.00	27.065	17.59	419.4	196.9	2,122.5
37.00	Bot - Section 2	0.00	1.03 14.332	24.22 391.67	0.650		0.500	2.00	10.678	6.94	168.1	78.1	837.6
40.00		0.00	1.05 14.655	24.76 391.25	0.650		0.500	3.00	16.140	10.49	259.8	117.9	2,393.7
45.00	Top - Section 1	0.00	1.09 15.156	25.61 389.76	0.650		0.500	5.00	26.477	17.21	440.8	192.6	3,923.9
50.00		0.00	1.12 15.620	26.39 394.74	0.650		0.500	5.00	25.949	16.87	445.2	188.7	2,032.9
55.00		0.00	1.15 16.051	27.12 391.79	0.650		0.500	5.00	25.421	16.52	448.2	184.8	1,990.5
60.00		0.00	1.18 16.455	27.80 388.21	0.650		0.500	5.00	24.892	16.18	449.9	180.8	1,948.0
65.00	Appertunance(s)	0.00	1.21 16.836	28.45 384.11	0.650		0.500	5.00	24.364	15.84	450.6	176.9	1,905.6
70.00		0.00	1.24 17.196	29.06 379.54	0.650		0.500	5.00	23.835	15.49	450.2	173.0	1,863.2
75.00	Bot - Section 3	0.00	1.26 17.538	29.64 374.55	0.650		0.500	5.00	23.307	15.15	449.0	169.1	1,820.7
80.00		0.00	1.28 17.865	30.19 369.19	0.650		0.500	5.00	23.195	15.08	455.2	168.3	3,243.9
82.00	Top - Section 2	0.00	1.29 17.991	30.40 366.95	0.650		0.500	2.00	9.130	5.93	180.4	66.7	1,276.6
85.00		0.00	1.31 18.177	30.71 370.52	0.650		0.500	3.00	13.537	8.80	270.3	98.6	951.5
90.00		0.00	1.33 18.476	31.22 364.58	0.650		0.500	5.00	22.139	14.39	449.3	160.5	1,554.5
95.00		0.00	1.35 18.764	31.71 358.36	0.650		0.500	5.00	21.610	14.05	445.4	156.5	1,516.4
100.00		0.00	1.37 19.041	32.17 351.88	0.650		0.500	5.00	21.082	13.70	440.9	152.6	1,478.2
105.00		0.00	1.39 19.308	32.63 345.16	0.650		0.500	5.00	20.553	13.36	435.9	148.7	1,440.1
110.00		0.00	1.41 19.566	33.06 338.23	0.650		0.500	5.00	20.025	13.02	430.4	144.8	1,401.9
115.00		0.00	1.42 19.816	33.49 331.08	0.650		0.500	5.00	19.497	12.67	424.4	140.9	1,363.8
120.00	Bot - Section 4	0.00	1.44 20.059	33.89 323.75	0.650		0.500	5.00	18.968	12.33	418.0	137.0	1,325.6
125.00		0.00	1.46 20.294	34.29 316.23	0.650		0.500	5.00	18.700	12.16	416.9	135.0	2,024.6
125.50	Top - Section 3	0.00	1.46 20.317	34.33 315.47	0.650		0.500	0.50	1.841	1.20	41.1	13.5	199.4
130.00	Appertunance(s)	0.00	1.48 20.523	34.68 313.21	0.650		0.500	4.50	16.331	10.62	368.2	118.0	759.4
135.00		0.00	1.49 20.745	35.06 305.39	0.650		0.500	5.00	17.643	11.47	402.1	127.2	819.6
140.00	Appertunance(s)	0.00	1.51 20.962	35.42 297.42	0.650		0.500	5.00	17.115	11.12	394.1	123.3	794.3
145.00		0.00	1.52 21.173	35.78 289.30	0.650		0.500	5.00	16.587	10.78	385.8	119.3	769.0
150.00	Appertunance(s)	0.00	1.54 21.379	36.13 281.05	0.650		0.500	5.00	16.058	10.44	377.1	115.4	743.6
Totals:							150.00				12,960.5	5,048.9	56,127.3

Pole : 302527  
 Location : East Haddam, CT  
 Height : 150.0 (ft)  
 Base Dia : 72.20 (in)  
 Top Dia : 36.90 (in)  
 Shape : 18 Sides  
 Taper : 0.253625 (in/ft)

Code: TIA/EIA-222 Rev F

Base Elev : 0.000 (ft)

Copyright © 2007 - 2011 by American Tower Corporation. All rights reserved.

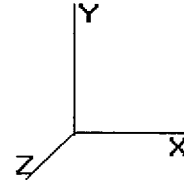

3/23/2012 10:11:19 AM  
 Page: 9

**Load Case: Ice**

73.61 mph Wind with Ice

17 Iterations

Gust Response Factor : 1.69  
 Dead Load Factor : 1.00  
 Wind Load Factor : 1.00

**Discrete Appurtenance Segment Forces**

Elev (ft)	Description	Qty	qz (psf)	qzGh (psf)	CaAa Factor	Total CaAa (sf)	Horiz Ecc (ft)	Vert Ecc (ft)	Wind FX (lb)	Mom Y (lb-ft)	Mom Z (lb-ft)	Dead Load (lb)
65.00	GPS	1	16.836	28.452	1.00	1.30	0.000	0.000	36.99	0.00	0.00	18.00
65.00	Round Side Arm	1	16.836	28.452	1.00	5.90	0.000	0.000	167.87	0.00	0.00	175.00
120.0	72" x 12" Panels	9	20.059	33.899	0.67	55.66	0.000	0.000	1,886.71	0.00	0.00	830.52
120.0	Flat Low Profile Pla	1	20.059	33.899	1.00	31.60	0.000	0.000	1,071.22	0.00	0.00	1,700.00
120.0	Powerwave 7770.00	3	20.059	33.899	0.77	15.24	0.000	0.000	516.59	0.00	0.00	203.24
120.0	Powerwave LGP	6	20.059	33.899	0.50	6.90	0.000	0.000	233.91	0.00	0.00	300.00
120.0	Powerwave LGP	6	20.059	33.899	0.50	1.14	0.000	0.000	38.65	0.00	0.00	47.40
130.0	Antel BXA-171063-8BF	3	20.523	34.684	0.90	9.10	0.000	0.000	315.59	0.00	0.00	89.40
130.0	Antel BXA-70063-4CF-	3	20.523	34.684	0.77	13.26	0.000	0.000	459.88	0.00	0.00	117.00
130.0	Flat Low Profile Pla	1	20.523	34.684	1.00	31.60	0.000	0.000	1,096.00	0.00	0.00	1,700.00
130.0	RFS APL868013-42T0	6	20.523	34.684	0.90	23.17	0.000	0.000	803.48	0.00	0.00	192.00
130.0	RFS FD9R6004/2C-3L	6	20.523	34.684	0.50	1.50	0.000	0.000	52.03	0.00	0.00	32.40
140.0	Decibel DB980F65E-M	12	20.962	35.426	0.83	43.03	0.000	0.000	1,524.27	0.00	0.00	300.00
140.0	Round T-Arms	3	20.962	35.426	0.67	24.32	0.000	0.000	861.59	0.00	0.00	942.00
150.0	48" x 12" Panels	9	21.379	36.131	0.67	37.33	0.000	0.000	1,348.61	0.00	0.00	567.00
150.0	72" x 12" Panels	3	21.379	36.131	0.67	18.55	0.000	0.000	670.31	0.00	0.00	276.84
150.0	Flat Low Profile Pla	1	21.379	36.131	1.00	31.60	0.000	0.000	1,141.74	0.00	0.00	1,700.00
									12,225.42			9,190.80

Pole : 302527  
 Location : East Haddam, CT  
 Height : 150.0 (ft)  
 Base Dia : 72.20 (in)  
 Top Dia : 36.90 (in)  
 Shape : 18 Sides  
 Taper : 0.253625 (in/ft)

Code: TIA/EIA-222 Rev F

Base Elev : 0.000 (ft)

Copyright © 2007 - 2011 by American Tower Corporation. All rights reserved.

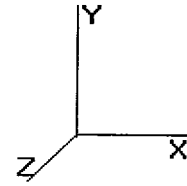

3/23/2012 10:11:19 AM

Page: 10

**Load Case:** Ice

73.61 mph Wind with Ice

17 Iterations

Gust Response Factor : 1.69  
 Dead Load Factor : 1.00  
 Wind Load Factor : 1.00

**Applied Segment Forces Summary**

Seg Elev (ft)	Lateral FX (-) (lb)	Axial FY (-) (lb)	Torsion MY (lb-ft)	Moment MZ (lb-ft)
0.00	0.00	0.00	0.00	0.00
5.00	460.72	2,377.14	0.00	0.00
10.00	452.66	2,334.71	0.00	0.00
15.00	444.61	2,539.13	0.00	0.00
20.00	436.56	2,496.69	0.00	0.00
25.00	428.51	2,454.26	0.00	0.00
30.00	420.46	2,411.83	0.00	0.00
35.00	419.40	2,369.40	0.00	0.00
37.00	168.12	936.35	0.00	0.00
40.00	259.83	2,541.77	0.00	0.00
45.00	440.83	4,170.74	0.00	0.00
50.00	445.24	2,279.74	0.00	0.00
55.00	448.21	2,237.31	0.00	0.00
60.00	449.94	2,194.88	0.00	0.00
65.00	655.44	2,345.44	0.00	0.00
70.00	450.24	2,109.26	0.00	0.00
75.00	449.03	2,066.83	0.00	0.00
80.00	455.19	3,490.04	0.00	0.00
82.00	180.44	1,375.02	0.00	0.00
85.00	270.29	1,099.16	0.00	0.00
90.00	449.32	1,800.63	0.00	0.00
95.00	445.42	1,762.48	0.00	0.00
100.0	440.95	1,724.33	0.00	0.00
105.0	435.93	1,686.17	0.00	0.00
110.0	430.41	1,648.02	0.00	0.00
115.0	424.41	1,609.87	0.00	0.00
120.0	4,165.03	4,652.88	0.00	0.00
125.0	416.89	2,221.51	0.00	0.00
125.5	41.09	219.05	0.00	0.00
130.0	3,095.14	3,067.45	0.00	0.00
135.0	402.07	967.28	0.00	0.00
140.0	2,779.96	2,183.96	0.00	0.00
145.0	385.79	818.15	0.00	0.00
150.0	3,537.80	3,336.68	0.00	0.00
Totals:	25,185.91	71,528.15	0.00	0.00



Pole : 302527  
 Location : East Haddam, CT  
 Height : 150.0 (ft)  
 Base Dia : 72.20 (in)  
 Top Dia : 36.90 (in)  
 Shape : 18 Sides  
 Taper : 0.253625 (in/ft)

Code: TIA/EIA-222 Rev F

3/23/2012 10:11:19 AM  
 Page: 12

Base Elev: 0.000 (ft)

Copyright © 2007 - 2011 by American Tower Corporation. All rights reserved.

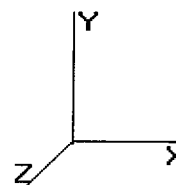

**Load Case: Ice**                      73.61 mph Wind with Ice                      17 Iterations

Gust Response Factor : 1.69  
 Dead Load Factor : 1.00  
 Wind Load Factor : 1.00

**Calculated Stresses**

Seg Elev (ft)	Applied Stresses							Allowable Stress (Fb) (ksi)	Stress Ratio	
	Axial (Y) (ksi)	Shear (X) (ksi)	Shear (Z) (ksi)	Torsion (ksi)	Bending (X) (ksi)	Bending (Z) (ksi)	Combined (ksi)			
0.00	0.56	0.40	0.00	0.00	0.00	14.06	14.63	52.0	0.0	0.282
5.00	0.55	0.40	0.00	0.00	0.00	13.88	14.44	52.0	0.0	0.278
10.00	0.54	0.40	0.00	0.00	0.00	13.69	14.24	52.0	0.0	0.274
15.00	0.53	0.40	0.00	0.00	0.00	13.48	14.03	52.0	0.0	0.270
20.00	0.52	0.40	0.00	0.00	0.00	13.27	13.80	52.0	0.0	0.266
25.00	0.51	0.40	0.00	0.00	0.00	13.03	13.56	52.0	0.0	0.261
30.00	0.50	0.40	0.00	0.00	0.00	12.79	13.30	52.0	0.0	0.256
35.00	0.49	0.40	0.00	0.00	0.00	12.52	13.03	52.0	0.0	0.251
37.00	0.48	0.40	0.00	0.00	0.00	12.41	12.91	52.0	0.0	0.248
40.00	0.46	0.40	0.00	0.00	0.00	12.24	12.72	52.0	0.0	0.245
45.00	0.43	0.40	0.00	0.00	0.00	11.50	11.95	52.0	0.0	0.230
50.00	0.41	0.40	0.00	0.00	0.00	11.18	11.61	52.0	0.0	0.223
55.00	0.40	0.40	0.00	0.00	0.00	10.83	11.25	52.0	0.0	0.217
60.00	0.39	0.40	0.00	0.00	0.00	10.46	10.87	52.0	0.0	0.209
65.00	0.37	0.39	0.00	0.00	0.00	10.07	10.46	52.0	0.0	0.201
70.00	0.36	0.39	0.00	0.00	0.00	9.65	10.04	52.0	0.0	0.193
75.00	0.35	0.39	0.00	0.00	0.00	9.21	9.58	52.0	0.0	0.184
80.00	0.32	0.39	0.00	0.00	0.00	8.73	9.08	52.0	0.0	0.175
82.00	0.34	0.43	0.00	0.00	0.00	9.21	9.58	52.0	0.0	0.184
85.00	0.33	0.43	0.00	0.00	0.00	8.87	9.23	52.0	0.0	0.178
90.00	0.32	0.43	0.00	0.00	0.00	8.27	8.62	52.0	0.0	0.166
95.00	0.30	0.43	0.00	0.00	0.00	7.62	7.96	52.0	0.0	0.153
100.00	0.29	0.43	0.00	0.00	0.00	6.93	7.25	52.0	0.0	0.140
105.00	0.27	0.43	0.00	0.00	0.00	6.17	6.49	52.0	0.0	0.125
110.00	0.26	0.43	0.00	0.00	0.00	5.35	5.66	52.0	0.0	0.109
115.00	0.24	0.43	0.00	0.00	0.00	4.47	4.77	52.0	0.0	0.092
120.00	0.18	0.32	0.00	0.00	0.00	3.50	3.72	52.0	0.0	0.072
125.00	0.16	0.31	0.00	0.00	0.00	2.77	2.98	52.0	0.0	0.057
125.50	0.24	0.49	0.00	0.00	0.00	4.14	4.46	52.0	0.0	0.086
130.00	0.17	0.35	0.00	0.00	0.00	3.05	3.28	52.0	0.0	0.063
135.00	0.16	0.34	0.00	0.00	0.00	2.16	2.39	52.0	0.0	0.046
140.00	0.11	0.21	0.00	0.00	0.00	1.21	1.37	52.0	0.0	0.026
145.00	0.09	0.19	0.00	0.00	0.00	0.61	0.78	52.0	0.0	0.015
150.00	0.00	0.20	0.00	0.00	0.00	0.00	0.34	52.0	0.0	0.007

Pole : 302527  
 Location : East Haddam, CT  
 Height : 150.0 (ft)  
 Base Dia : 72.20 (in)  
 Top Dia : 36.90 (in)  
 Shape : 18 Sides  
 Taper : 0.253625 (in/ft)

Code: TIA/EIA-222 Rev F

Base Elev : 0.000 (ft)

Copyright © 2007 - 2011 by American Tower Corporation. All rights reserved.

3/23/2012 10:11:19 AM

Page: 13

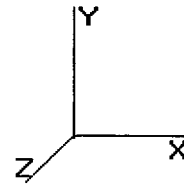

**Load Case: Twist/Sway**

50.00 mph Wind with No Ice

16 Iterations

Gust Response Factor : 1.69  
 Dead Load Factor : 1.00  
 Wind Load Factor : 1.00

**Shaft Segment Forces**

Seg Top Elev (ft)	Description	Kz	qz (psf)	qzGh (psf)	C (mph-ft)	Cf	Ice Thick (in)	Tributary (ft)	Aa (sf)	CfAa (sf)	Wind Force X (lb)	Dead Load Ice (lb)	Tot Dead Load (lb)	
0.00		0.00	1.00	6.400	10.81	300.83	0.650	0.000	0.00	0.000	0.00	0.0	0.0	
5.00		0.00	1.00	6.400	10.81	295.54	0.650	0.000	5.00	29.819	19.38	209.6	0.0	2,156.7
10.00		0.00	1.00	6.400	10.81	290.26	0.650	0.000	5.00	29.291	19.04	205.9	0.0	2,118.2
15.00		0.00	1.00	6.400	10.81	284.98	0.650	0.000	5.00	28.762	18.70	202.2	0.0	2,079.7
20.00		0.00	1.00	6.400	10.81	279.69	0.650	0.000	5.00	28.234	18.35	198.5	0.0	2,041.2
25.00		0.00	1.00	6.400	10.81	274.41	0.650	0.000	5.00	27.705	18.01	194.8	0.0	2,002.6
30.00		0.00	1.00	6.400	10.81	269.12	0.650	0.000	5.00	27.177	17.67	191.1	0.0	1,964.1
35.00		0.00	1.01	6.509	10.99	266.07	0.650	0.000	5.00	26.649	17.32	190.5	0.0	1,925.6
37.00	Bot - Section 2	0.00	1.03	6.613	11.17	266.04	0.650	0.000	2.00	10.512	6.83	76.4	0.0	759.5
40.00		0.00	1.05	6.762	11.42	265.76	0.650	0.000	3.00	15.890	10.33	118.0	0.0	2,275.8
45.00	Top - Section 1	0.00	1.09	6.993	11.81	264.75	0.650	0.000	5.00	26.061	16.94	200.2	0.0	3,731.3
50.00		0.00	1.12	7.207	12.17	268.13	0.650	0.000	5.00	25.532	16.60	202.1	0.0	1,844.2
55.00		0.00	1.15	7.406	12.51	266.12	0.650	0.000	5.00	25.004	16.25	203.4	0.0	1,805.7
60.00		0.00	1.18	7.592	12.83	263.69	0.650	0.000	5.00	24.475	15.91	204.1	0.0	1,767.2
65.00	Appertunance(s)	0.00	1.21	7.768	13.12	260.91	0.650	0.000	5.00	23.947	15.57	204.3	0.0	1,728.7
70.00		0.00	1.24	7.934	13.40	257.80	0.650	0.000	5.00	23.419	15.22	204.1	0.0	1,690.1
75.00	Bot - Section 3	0.00	1.26	8.092	13.67	254.41	0.650	0.000	5.00	22.890	14.88	203.5	0.0	1,651.6
80.00		0.00	1.28	8.242	13.93	250.77	0.650	0.000	5.00	22.779	14.81	206.2	0.0	3,075.7
82.00	Top - Section 2	0.00	1.29	8.301	14.02	249.25	0.650	0.000	2.00	8.964	5.83	81.7	0.0	1,209.9
85.00		0.00	1.31	8.387	14.17	251.67	0.650	0.000	3.00	13.287	8.64	122.4	0.0	852.9
90.00		0.00	1.33	8.525	14.40	247.64	0.650	0.000	5.00	21.722	14.12	203.4	0.0	1,394.1
95.00		0.00	1.35	8.657	14.63	243.42	0.650	0.000	5.00	21.193	13.78	201.6	0.0	1,359.8
100.0		0.00	1.37	8.785	14.84	239.01	0.650	0.000	5.00	20.665	13.43	199.4	0.0	1,325.6
105.0		0.00	1.39	8.908	15.05	234.45	0.650	0.000	5.00	20.137	13.09	197.1	0.0	1,291.4
110.0		0.00	1.41	9.028	15.25	229.74	0.650	0.000	5.00	19.608	12.75	194.5	0.0	1,257.1
115.0		0.00	1.42	9.143	15.45	224.89	0.650	0.000	5.00	19.080	12.40	191.6	0.0	1,222.9
120.0	Bot - Section 4	0.00	1.44	9.255	15.64	219.91	0.650	0.000	5.00	18.552	12.06	188.6	0.0	1,188.6
125.0		0.00	1.46	9.363	15.82	214.80	0.650	0.000	5.00	18.284	11.88	188.1	0.0	1,889.6
125.5	Top - Section 3	0.00	1.46	9.374	15.84	214.28	0.650	0.000	0.50	1.799	1.17	18.5	0.0	185.9
130.0	Appertunance(s)	0.00	1.48	9.469	16.00	212.75	0.650	0.000	4.50	15.956	10.37	166.0	0.0	641.5
135.0		0.00	1.49	9.572	16.17	207.44	0.650	0.000	5.00	17.227	11.20	181.1	0.0	692.4
140.0	Appertunance(s)	0.00	1.51	9.672	16.34	202.02	0.650	0.000	5.00	16.698	10.85	177.4	0.0	671.0
145.0		0.00	1.52	9.769	16.51	196.51	0.650	0.000	5.00	16.170	10.51	173.5	0.0	649.6
150.0	Appertunance(s)	0.00	1.54	9.864	16.67	190.90	0.650	0.000	5.00	15.642	10.17	169.5	0.0	628.2
<b>Totals:</b>								150.00			5,869.4	0.0	51,078.4	



Pole : 302527  
 Location : East Haddam, CT  
 Height : 150.0 (ft)  
 Base Dia : 72.20 (in)  
 Top Dia : 36.90 (in)  
 Shape : 18 Sides  
 Taper : 0.253625 (in/ft)

Code: TIA/EIA-222 Rev F

3/23/2012 10:11:19 AM  
 Page: 14

Base Elev : 0.000 (ft)

Copyright © 2007 - 2011 by American Tower Corporation. All rights reserved.

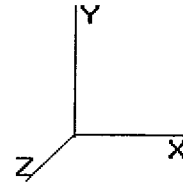

**Load Case: Twist/Sway**

50.00 mph Wind with No Ice

16 Iterations

Gust Response Factor : 1.69  
 Dead Load Factor : 1.00  
 Wind Load Factor : 1.00

**Discrete Appurtenance Segment Forces**

Elev (ft)	Description	Qty	qz (psf)	qzGh (psf)	CaAa Factor	Total GaAa (sf)	Horiz Ecc (ft)	Vert Ecc (ft)	Wind FX (lb)	Mom Y (lb-ft)	Mom Z (lb-ft)	Dead Load (lb)
65.00	GPS	1	7.768	13.127	1.00	1.00	0.000	0.000	13.13	0.00	0.00	10.00
65.00	Round Side Arm	1	7.768	13.127	1.00	5.20	0.000	0.000	68.26	0.00	0.00	150.00
120.0	72" x 12" Panels	9	9.255	15.641	0.67	50.65	0.000	0.000	792.23	0.00	0.00	405.00
120.0	Flat Low Profile Pla	1	9.255	15.641	1.00	26.10	0.000	0.000	408.22	0.00	0.00	1,500.00
120.0	Powerwave 7770.00	3	9.255	15.641	0.77	12.73	0.000	0.000	199.08	0.00	0.00	105.00
120.0	Powerwave LGP	6	9.255	15.641	0.50	5.85	0.000	0.000	91.50	0.00	0.00	186.00
120.0	Powerwave LGP	6	9.255	15.641	0.50	0.81	0.000	0.000	12.67	0.00	0.00	33.00
130.0	Antel BXA-171063-8BF	3	9.469	16.003	0.90	9.75	0.000	0.000	155.98	0.00	0.00	31.50
130.0	Antel BXA-70063-4CF-	3	9.469	16.003	0.77	10.88	0.000	0.000	174.11	0.00	0.00	29.70
130.0	Flat Low Profile Pla	1	9.469	16.003	1.00	26.10	0.000	0.000	417.67	0.00	0.00	1,500.00
130.0	RFS APL868013-42T0	6	9.469	16.003	0.90	19.49	0.000	0.000	311.95	0.00	0.00	37.80
130.0	RFS FD9R6004/2C-3L	6	9.469	16.003	0.50	1.08	0.000	0.000	17.28	0.00	0.00	18.60
140.0	Decibel DB980F65E-M	12	9.672	16.345	0.81	36.45	0.000	0.000	595.78	0.00	0.00	114.00
140.0	Round T-Arms	3	9.672	16.345	0.67	19.50	0.000	0.000	318.68	0.00	0.00	750.00
150.0	48" x 12" Panels	9	9.864	16.670	0.67	33.77	0.000	0.000	562.93	0.00	0.00	270.00
150.0	72" x 12" Panels	3	9.864	16.670	0.67	16.88	0.000	0.000	281.46	0.00	0.00	135.00
150.0	Flat Low Profile Pla	1	9.864	16.670	1.00	26.10	0.000	0.000	435.10	0.00	0.00	1,500.00
									4,856.01			6,775.60

Pole : 302527  
 Location : East Haddam, CT  
 Height : 150.0 (ft)  
 Base Dia : 72.20 (in)  
 Top Dia : 36.90 (in)  
 Shape : 18 Sides  
 Taper : 0.253625 (in/ft)

Code: TIA/EIA-222 Rev F

Base Elev : 0.000 (ft)

Copyright © 2007 - 2011 by American Tower Corporation. All rights reserved.

3/23/2012 10:11:19 AM  
 Page: 15

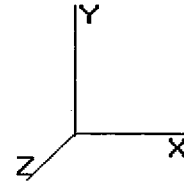

**Load Case:** Twist/Sway

50.00 mph Wind with No Ice

16 Iterations

Gust Response Factor : 1.69  
 Dead Load Factor : 1.00  
 Wind Load Factor : 1.00

**Applied Segment Forces Summary**

Seg Elev (ft)	Lateral FX (-) (lb)	Axial FY (-) (lb)	Torsion MY (lb-ft)	Moment MZ (lb-ft)
0.00	0.00	0.00	0.00	0.00
5.00	209.64	2,156.72	0.00	0.00
10.00	205.92	2,118.20	0.00	0.00
15.00	202.21	2,326.53	0.00	0.00
20.00	198.50	2,288.01	0.00	0.00
25.00	194.78	2,249.49	0.00	0.00
30.00	191.07	2,210.98	0.00	0.00
35.00	190.53	2,172.46	0.00	0.00
37.00	76.36	858.20	0.00	0.00
40.00	118.03	2,423.87	0.00	0.00
45.00	200.19	3,978.16	0.00	0.00
50.00	202.13	2,091.07	0.00	0.00
55.00	203.41	2,052.55	0.00	0.00
60.00	204.12	2,014.03	0.00	0.00
65.00	285.73	2,135.51	0.00	0.00
70.00	204.10	1,936.24	0.00	0.00
75.00	203.47	1,897.72	0.00	0.00
80.00	206.25	3,321.76	0.00	0.00
82.00	81.73	1,308.33	0.00	0.00
85.00	122.41	1,000.54	0.00	0.00
90.00	203.41	1,640.18	0.00	0.00
95.00	201.55	1,605.94	0.00	0.00
100.0	199.43	1,571.70	0.00	0.00
105.0	197.06	1,537.46	0.00	0.00
110.0	194.45	1,503.22	0.00	0.00
115.0	191.63	1,468.98	0.00	0.00
120.0	1,692.30	3,663.74	0.00	0.00
125.0	188.06	2,086.52	0.00	0.00
125.5	18.53	205.59	0.00	0.00
130.0	1,242.96	2,436.28	0.00	0.00
135.0	181.13	840.11	0.00	0.00
140.0	1,091.86	1,682.71	0.00	0.00
145.0	173.53	698.81	0.00	0.00
150.0	1,448.98	2,582.42	0.00	0.00
Totals:	10,725.43	64,064.06	0.00	0.00

Pole : 302527  
 Location : East Haddam, CT  
 Height : 150.0 (ft)  
 Base Dia : 72.20 (in)  
 Top Dia : 36.90 (in)  
 Shape : 18 Sides  
 Taper : 0.253625 (in/ft)

Code: TIA/EIA-222 Rev F

Base Elev : 0.000 (ft)

3/23/2012 10:11:19 AM

Page: 16

Copyright © 2007 - 2011 by American Tower Corporation. All rights reserved.

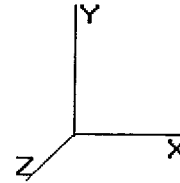

<b>Load Case:</b> Twist/Sway	50.00 mph Wind with No Ice	16 Iterations
Gust Response Factor : 1.69		
Dead Load Factor : 1.00		
Wind Load Factor : 1.00		

**Calculated Shaft Forces and Deflections**

Seg Elev (ft)	Lateral FX (-) (kips)	Axial FY (-) (kips)	Lateral FZ (kips)	Moment MX (ft-kips)	Torsion MY (ft-kips)	Moment MZ (ft-kips)	X Deflect (in)	Z Deflect (in)	Total Deflect (in)	Rotation (deg)
0.00	-10.735	-64.062	0.000	0.000	0.000	-1,104.886	0.000	0.000	0.000	0.000
5.00	-10.545	-61.902	0.000	0.000	0.000	-1,051.211	-0.010	0.000	0.010	-0.018
10.00	-10.358	-59.781	0.000	0.000	0.000	-998.485	-0.040	0.000	0.040	-0.037
15.00	-10.172	-57.451	0.000	0.000	0.000	-946.698	-0.089	0.000	0.089	-0.056
20.00	-9.989	-55.160	0.000	0.000	0.000	-895.837	-0.157	0.000	0.157	-0.074
25.00	-9.808	-52.908	0.000	0.000	0.000	-845.893	-0.245	0.000	0.245	-0.093
30.00	-9.630	-50.694	0.000	0.000	0.000	-796.853	-0.352	0.000	0.352	-0.111
35.00	-9.445	-48.520	0.000	0.000	0.000	-748.706	-0.479	0.000	0.479	-0.130
37.00	-9.375	-47.660	0.000	0.000	0.000	-729.815	-0.535	0.000	0.535	-0.138
40.00	-9.263	-45.234	0.000	0.000	0.000	-701.691	-0.626	0.000	0.626	-0.149
45.00	-9.065	-41.254	0.000	0.000	0.000	-655.379	-0.792	0.000	0.792	-0.167
50.00	-8.868	-39.160	0.000	0.000	0.000	-610.056	-0.977	0.000	0.977	-0.185
55.00	-8.669	-37.106	0.000	0.000	0.000	-565.716	-1.180	0.000	1.180	-0.203
60.00	-8.467	-35.090	0.000	0.000	0.000	-522.373	-1.402	0.000	1.402	-0.219
65.00	-8.183	-32.954	0.000	0.000	0.000	-480.036	-1.641	0.000	1.641	-0.236
70.00	-7.979	-31.016	0.000	0.000	0.000	-439.123	-1.897	0.000	1.897	-0.252
75.00	-7.775	-29.117	0.000	0.000	0.000	-399.229	-2.170	0.000	2.170	-0.268
80.00	-7.558	-25.795	0.000	0.000	0.000	-360.354	-2.459	0.000	2.459	-0.284
82.00	-7.473	-24.486	0.000	0.000	0.000	-345.240	-2.579	0.000	2.579	-0.290
85.00	-7.350	-23.485	0.000	0.000	0.000	-322.822	-2.765	0.000	2.765	-0.299
90.00	-7.143	-21.844	0.000	0.000	0.000	-286.073	-3.086	0.000	3.086	-0.314
95.00	-6.938	-20.237	0.000	0.000	0.000	-250.356	-3.423	0.000	3.423	-0.328
100.0	-6.733	-18.665	0.000	0.000	0.000	-215.667	-3.774	0.000	3.774	-0.342
105.0	-6.531	-17.128	0.000	0.000	0.000	-182.000	-4.139	0.000	4.139	-0.354
110.0	-6.330	-15.625	0.000	0.000	0.000	-149.348	-4.516	0.000	4.516	-0.365
115.0	-6.131	-14.156	0.000	0.000	0.000	-117.700	-4.904	0.000	4.904	-0.375
120.0	-4.416	-10.503	0.000	0.000	0.000	-87.046	-5.302	0.000	5.302	-0.383
125.0	-4.214	-8.417	0.000	0.000	0.000	-64.968	-5.707	0.000	5.707	-0.390
125.5	-4.195	-8.212	0.000	0.000	0.000	-62.862	-5.748	0.000	5.748	-0.390
130.0	-2.935	-5.784	0.000	0.000	0.000	-43.986	-6.118	0.000	6.118	-0.395
135.0	-2.749	-4.945	0.000	0.000	0.000	-29.309	-6.536	0.000	6.536	-0.401
140.0	-1.646	-3.270	0.000	0.000	0.000	-15.564	-6.958	0.000	6.958	-0.405
145.0	-1.467	-2.572	0.000	0.000	0.000	-7.336	-7.383	0.000	7.383	-0.407
150.0	-1.449	0.000	0.000	0.000	0.000	0.000	-7.810	0.000	7.810	-0.408

Pole : 302527  
 Location : East Haddam, CT  
 Height : 150.0 (ft)  
 Base Dia : 72.20 (in)  
 Top Dia : 36.90 (in)  
 Shape : 18 Sides  
 Taper : 0.253625 (in/ft)

Code: TIA/EIA-222 Rev F

3/23/2012 10:11:19 AM  
 Page: 17

Base Elev: 0.000 (ft)

Copyright © 2007 - 2011 by American Tower Corporation. All rights reserved.

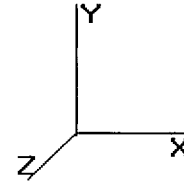

<b>Load Case:</b> Twist/Sway	50.00 mph Wind with No Ice	16 Iterations
Gust Response Factor : 1.69		
Dead Load Factor : 1.00		
Wind Load Factor : 1.00		

**Calculated Stresses**

Seg Elev (ft)	Applied Stresses							Allowable Stress (Fb) (ksi)	Stress Ratio	
	Axial (Y) (ksi)	Shear (X) (ksi)	Shear (Z) (ksi)	Torsion (ksi)	Bending (X) (ksi)	Bending (Z) (ksi)	Combined (ksi)			
0.00	0.50	0.17	0.00	0.00	0.00	5.86	6.37	52.0	0.0	0.123
5.00	0.49	0.17	0.00	0.00	0.00	5.78	6.28	52.0	0.0	0.121
10.00	0.48	0.17	0.00	0.00	0.00	5.69	6.19	52.0	0.0	0.119
15.00	0.47	0.17	0.00	0.00	0.00	5.60	6.08	52.0	0.0	0.117
20.00	0.46	0.17	0.00	0.00	0.00	5.51	5.98	52.0	0.0	0.115
25.00	0.45	0.17	0.00	0.00	0.00	5.40	5.87	52.0	0.0	0.113
30.00	0.44	0.17	0.00	0.00	0.00	5.30	5.75	52.0	0.0	0.111
35.00	0.43	0.17	0.00	0.00	0.00	5.18	5.62	52.0	0.0	0.108
37.00	0.43	0.17	0.00	0.00	0.00	5.13	5.57	52.0	0.0	0.107
40.00	0.41	0.17	0.00	0.00	0.00	5.06	5.48	52.0	0.0	0.105
45.00	0.38	0.17	0.00	0.00	0.00	4.75	5.13	52.0	0.0	0.099
50.00	0.37	0.17	0.00	0.00	0.00	4.61	4.98	52.0	0.0	0.096
55.00	0.35	0.17	0.00	0.00	0.00	4.46	4.82	52.0	0.0	0.093
60.00	0.34	0.17	0.00	0.00	0.00	4.30	4.65	52.0	0.0	0.090
65.00	0.33	0.16	0.00	0.00	0.00	4.13	4.47	52.0	0.0	0.086
70.00	0.32	0.16	0.00	0.00	0.00	3.96	4.29	52.0	0.0	0.082
75.00	0.30	0.16	0.00	0.00	0.00	3.77	4.09	52.0	0.0	0.079
80.00	0.28	0.16	0.00	0.00	0.00	3.57	3.86	52.0	0.0	0.074
82.00	0.29	0.18	0.00	0.00	0.00	3.77	4.07	52.0	0.0	0.078
85.00	0.28	0.18	0.00	0.00	0.00	3.63	3.92	52.0	0.0	0.075
90.00	0.27	0.18	0.00	0.00	0.00	3.38	3.66	52.0	0.0	0.070
95.00	0.26	0.18	0.00	0.00	0.00	3.11	3.38	52.0	0.0	0.065
100.00	0.24	0.18	0.00	0.00	0.00	2.82	3.08	52.0	0.0	0.059
105.00	0.23	0.18	0.00	0.00	0.00	2.51	2.75	52.0	0.0	0.053
110.00	0.21	0.18	0.00	0.00	0.00	2.18	2.41	52.0	0.0	0.046
115.00	0.20	0.17	0.00	0.00	0.00	1.81	2.04	52.0	0.0	0.039
120.00	0.15	0.13	0.00	0.00	0.00	1.42	1.59	52.0	0.0	0.031
125.00	0.13	0.13	0.00	0.00	0.00	1.13	1.27	52.0	0.0	0.024
125.50	0.19	0.20	0.00	0.00	0.00	1.68	1.90	52.0	0.0	0.037
130.00	0.14	0.14	0.00	0.00	0.00	1.24	1.40	52.0	0.0	0.027
135.00	0.12	0.14	0.00	0.00	0.00	0.88	1.03	52.0	0.0	0.020
140.00	0.08	0.09	0.00	0.00	0.00	0.50	0.60	52.0	0.0	0.012
145.00	0.07	0.08	0.00	0.00	0.00	0.25	0.35	52.0	0.0	0.007
150.00	0.00	0.08	0.00	0.00	0.00	0.00	0.14	52.0	0.0	0.003

Pole : 302527  
 Location : East Haddam, CT  
 Height : 150.0 (ft)  
 Base Dia : 72.20 (in)  
 Top Dia : 36.90 (in)  
 Shape : 18 Sides  
 Taper : 0.253625 (in/ft)

Code: TIA/EIA-222 Rev F

3/23/2012 10:11:19 AM

Page: 18

Base Elev: 0.000 (ft)

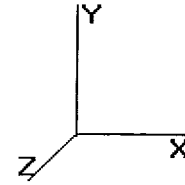

Copyright © 2007 - 2011 by American Tower Corporation. All rights reserved.

### Analysis Summary

Load Case	Reactions						Combined Stress (ksi)	Max Stresses		
	Shear FX (kips)	Shear FZ (kips)	Axial FY (kips)	Moment MX (ft-kips)	Moment MY (ft-kips)	Moment MZ (ft-kips)		Allowable Stress (ksi)	Elev (ft)	Stress Ratio
No Ice	31.0	0.00	64.05	0.00	0.00	3193.18	17.46	52.0	0.00	0.336
Ice	25.2	0.00	71.52	0.00	0.00	2650.05	14.63	52.0	0.00	0.282
Twist/Sway	10.7	0.00	64.06	0.00	0.00	1104.89	6.37	52.0	0.00	0.123

Pole : 302527  
 Location : East Haddam, CT  
 Height : 150.0 (ft)  
 Base Dia : 72.20 (in)  
 Top Dia : 36.90 (in)  
 Shape : 18 Sides  
 Taper : 0.253625 (in/ft)

Code: TIA/EIA-222 Rev F

Base Elev : 0.000 (ft)

Copyright © 2007 - 2011 by American Tower Corporation. All rights reserved.

3/23/2012 10:11:19 AM  
 Page: 19

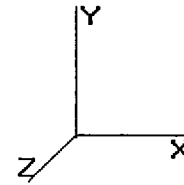

## Base Summary

### Reactions

Original Design			Analysis			
Moment (kip-ft)	Axial (kip)	Shear (kip)	Moment (kip-ft)	Axial (kip)	Shear (kip)	Moment Design %
9,100.00	79.00	69.00	3,193.18	71.52	31.03	35.09

### Base Plate

Yield (ksi)	Thick (in)	Width (in)	Style	Poly Sides	Clip Len (in)	Effective Len (in)	Moment (kip-in)	Allow Stress (ksi)	Applied Stress (ksi)	Stress Ratio
55.0	3.500	81.000	Clipped	0	20.00	8.184	276.83	55.00	16.57	0.30

### Anchor Bolts

Bolt Circle	Num Bolts	Bolt Type	Bolt Dia (in)	Yield (ksi)	Ultimate (ksi)	Arrange	Cluster Dist (in)	Start Angle (deg)	Compression			Tension		
									Force (kip)	Allow (kip)	Ratio	Force (kip)	Allow (kip)	Ratio
80.00	28	2.25" 18J	2.25	75.00	100.00	Clustered	5.00	45.0	70.98	195.00	0.36	65.87	195.00	0.34

Site Name: East Haddam, CT  
 Site Number: 302527  
 Engineering Number: 48650322  
 Engineer: J. Johnston  
 Date: 03/23/12  
 Tower Type: MP

Program Last Updated: 8/4/2011

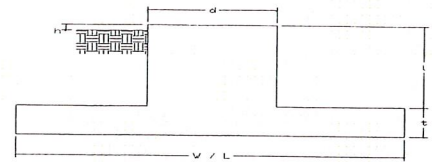

**Design Loads (Unfactored)**

Foundation Mapped:	N	Concrete Strength ( $f'_c$ ):	3000 psi
Compression/Leg:	0.0 k	Pad Tension Steel Depth:	50.00 in
Uplift/Leg:	0.0 k	Wind Load Factor:	1.3
Total Shear:	31.0 k	$\phi_{\text{Shear}}$ :	0.75
Moment:	3193.2 k-ft	$\phi_{\text{Flexure / Tension}}$ :	0.90
Tower + Appurtenance Weight:	71.5 k	$\phi_{\text{Compression}}$ :	0.65
Depth to Base of Foundation:	4.00 ft	$\beta$ :	0.85
Diameter of Pier (d):	6.75 ft	Bottom Pad Rebar Size #:	10
Height of Pier above Ground (h):	0.00	# of Bottom Pad Rebar:	47
Width of Pad (W):	35.00 ft	Pad Bottom Steel Area:	59.69 in <sup>2</sup>
Length of Pad (L):	35.00 ft	Pad Steel $F_y$ :	60000 psi
Thickness of Pad (t):	4.50 ft	Top Pad Rebar Size #:	10
Tower Leg Center to Center:	0.00 ft	# of Top Pad Rebar:	47
Number of Tower Legs:	1.0 (1 if MP or GT)	Pad Top Steel Area:	59.69 in <sup>2</sup>
Tower Center from Mat Center:	0.00 ft		
Depth Below Ground Surface to Water Table:	5.00 ft		
Unit Weight of Concrete:	150.0 pcf		
Unit Weight of Soil Above Water Table:	125.0 pcf		
Unit Weight of Water:	62.4 pcf		
Unit Weight of Soil Below Water Table:	65.0 pcf		
Friction Angle of Uplift:	15.00 Degrees		
Ultimate Coefficient of Shear Friction:	0.35		
Allowable Compressive Bearing Pressure:	6000.0 psf		
Ultimate Passive Pressure on Pad Face:	125.0 psf		
Allowable Capacity Increase:	1.33		

**Overturning Factor of Safety**

Design OTM:	3317.3 k-ft
OTM Resistance:	14764.7 k-ft
OTM Resistance / Design OTM Factor of Safety:	4.45 Result: OK

**Soil Bearing Pressure Usage:**

Total Weight (Foundation, Soil, Tower):	821.4 k
Net Bearing Pressure:	816 psf
Allowable Bearing Pressure:	7980 psf
Net Bearing Pressure/Allowable Bearing Pressure:	0.10 Result: OK
Load Direction Controlling Design Bearing Pressure:	Diagonal to Pad Edge

**Sliding Factor of Safety**

Total Ultimate Sliding Resistance:	313.7 k
Sliding Resistance/Sliding Design Factor of Safety:	10.11 Result: OK

### One Way Shear, Flexural Capacity, and Punching Shear

Factored One Way Shear ( $V_u$ ):	227.2 k
One Way Shear Capacity ( $\phi V_c$ ):	1725.3 k - ACI11.3.1.1
$V_u / \phi V_c$ :	0.13 Result: OK
Load Direction Controlling Shear Capacity:	Parallel to Pad Edge
Lower Pad Steel Factored Moment ( $M_u$ ):	2309.0 k-ft
Lower Steel Pad Moment Capacity ( $\phi M_n$ ):	13048.5 k-ft - ACI10.3
$M_u / \phi M_n$ :	0.18 Result: OK
Load Direction Controlling Flexural Capacity:	Parallel to Pad Edge
Upper Steel Pad Factored Moment ( $M_u$ ):	1459.6 k-ft
Upper Steel Pad Moment Capacity ( $\phi M_n$ ):	13048.5 k-ft
$M_u / \phi M_n$ :	0.11 Result: OK
Lower Pad Flexural Reinforcement Ratio:	0.0028 OK - Minimum Reinforcement Ratio Met - ACI10.5.1
Upper Pad Flexural Reinforcement Ratio:	0.0028 OK - Minimum Reinforcement Ratio Met - ACI10.5.1
Lower Pad Reinforcement Spacing:	9 in - Pad Reinforcing Spacing OK - ACI7.12.2.2 & 10.5.4
Upper Pad Reinforcement Spacing:	9 in - Pad Reinforcing Spacing OK - ACI7.12.2.2 & 10.5.4
Factored Punching Shear ( $V_u$ ):	0.0 k
Nominal Punching Shear Capacity ( $\phi_c V_n$ ):	3381.2 k - ACI11.12.2.1
$V_u / \phi V_c$ :	0.00 Result: OK