



10 INDUSTRIAL AVE,
SUITE 3
MAHWAH NJ 07430

PHONE: 201.684.0055
FAX: 201.684.0066

June 28, 2018

Melanie Bachman
Executive Director
Connecticut Siting Council
10 Franklin Square
New Britain, CT 06051

Notice of Exempt Modification
24 Hospital Ave., Danbury, Connecticut 06810
Latitude- 41.40504
Longitude- -73.445988

Dear Ms. Bachman,

T-Mobile currently maintains (11) existing antennas at the 127' and 154' level of the existing 134' rooftop facility at 24 Hospital Ave. in Danbury, CT. The property is owned by Danbury Hospital. T-Mobile now intends to replace (7) of its existing antennas with (8) new 600/700/1900/2100 MHz antennas. These antennas would be installed at the same 127' and 154' level of the facility. T-Mobile also intends to swap (4) remote radio heads and add (3) hybrid cables. Modifications to the existing beta and delta antenna frame are also proposed to accommodate the equipment.

The council assumed jurisdiction of a facility at this site in Docket 79 in September 10, 1987. This approval included the conditions the facility shall be constructed in accordance with all applicable federal, state, and municipal laws and regulations, and shall comply with any future radio frequency standards promulgated by state or federal agencies. This modification complies with the aforementioned conditions.

Please accept this letter as notification pursuant to Regulations of State Agencies 16-50j-73, for construction that constitutes an exempt modification pursuant to R.C.S.A 16-50j-72(b)(2). In accordance with R.C.S.A. 16-50j-73, a copy of this letter is being sent to Mark D. Boughton, Mayor for the City of Danbury, Sharon Calitro, Director of Planning and Zoning for the City of Danbury, as well as the property owner, Danbury Hospital.

The planned modifications to the facility fall squarely within those activities explicitly provided for in R.C.S.A. 16-50j-72(b)(2).

1. The proposed modification will not result in an increase in the height of the existing structure
2. The proposed modifications will not require the extension of the site boundary.
3. The proposed modifications will not increase noise levels at the facility by six decibels or more, or to levels that exceed state and local criteria.

4. The operation of the replacement antennas will not increase radio frequency emissions at the facility to a level at or above the Federal Communications Commission safety standard.
5. The proposed modification will not cause a change or alteration in the physical or environmental characteristics of the site.
6. The existing structure and its foundation can support the proposed loading.

For the foregoing reasons, T-Mobile respectfully submits that the proposed modifications to the above-referenced telecommunications facility constitute an exempt modification under R.C.S.A. 16-50j-72(b)(2).

Sincerely,

Kyle Richers

Kyle Richers
Transcend Wireless
10 Industrial Ave., Suite 3
Mahwah, New Jersey 07430
908-447-4716
krichers@transcendwireless.com

CC: Mayor Mark D. Boughton, City of Danbury
Danbury Hospital
Sharon Calitro, Director of Planning and Zoning, City of Danbury

- Channel
- Stream
- Parcel
- Unpaved
- Driveway (Paved)
- Driveway (Unpaved)
- Light Pole
- Building
- Excavation
- House Trailer
- Pump
- Deck
- Bridge
- Curb
- Row (Paved)
- Row (Unpaved)
- Fence
- Stone Wall
- Parking (Paved)
- Parking (Unpaved)
- Sidewalk
- Other
- Parcel
- Private Right of Way
- Public Right of Way
- Rail Right of Way
- Traffic Island
- Water

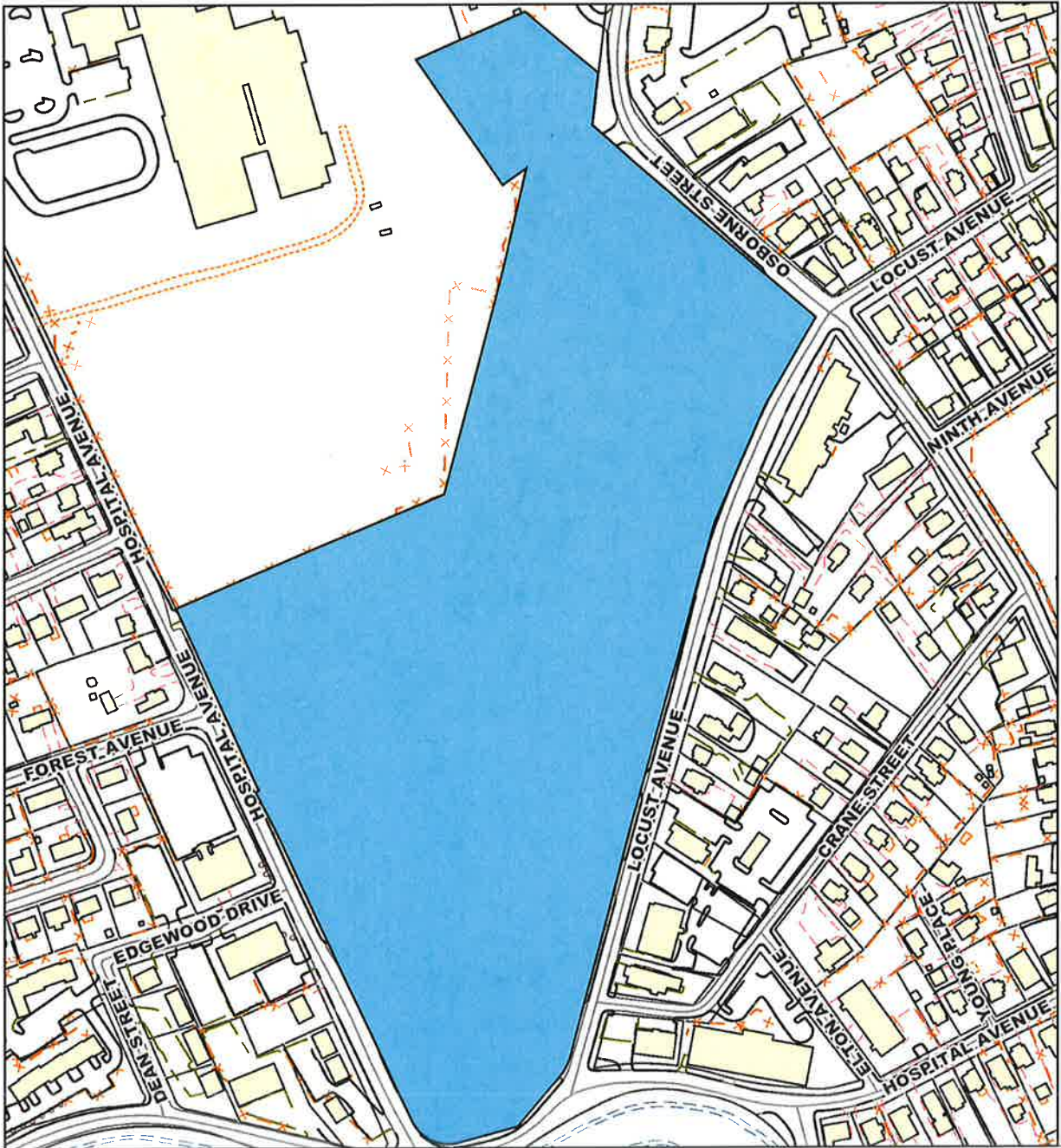

Not a legal survey.

LOCUST AV

Location LOCUST AV

Mblu I12 / / 1 / /

Acct#

Owner DANBURY HOSPITAL

Assessment \$249,467,100

Appraisal \$356,381,900

PID 24190

Building Count 16

Assessing Distri...

Current Value

Appraisal			
Valuation Year	Improvements	Land	Total
2017	\$300,531,000	\$55,850,900	\$356,381,900

Assessment			
Valuation Year	Improvements	Land	Total
2017	\$210,371,500	\$39,095,600	\$249,467,100

Owner of Record

Owner DANBURY HOSPITAL

Sale Price \$0

Co-Owner

Book & Page 0679/0464

Address 24 HOSPITAL AVE
DANBURY, CT 06810

Sale Date 05/26/1983

Ownership History

Ownership History			
Owner	Sale Price	Book & Page	Sale Date
DANBURY HOSPITAL	\$0	0679/0464	05/26/1983

Building Information

Building 1 : Section 1

Year Built: 1970
Living Area: 295,646
Replacement Cost: \$69,493,425
Building Percent 76
Good:
Replacement Cost
Less Depreciation: \$52,815,000

Building Attributes

Field	Description
STYLE	Hospital
MODEL	Commercial
Grade	Excellent
Stories:	6
Occupancy	1
Exterior Wall 1	Brick/Masonry
Exterior Wall 2	
Roof Structure	Flat
Roof Cover	Tar & Gravel
Interior Wall 1	Drywall/Sheet
Interior Wall 2	
Interior Floor 1	Vinyl/Asphalt
Interior Floor 2	
Heating Fuel	Gas
Heating Type	Forced Air-Duc
AC Type	Central
Bldg Use	Commercial MDL-94
Total Rooms	
Total Bedrms	00
Total Baths	0
1st Floor Use:	200
Heat/AC	HEAT/AC SPLIT
Frame Type	MASONRY
Baths/Plumbing	AVERAGE
Ceiling/Wall	CEIL & WALLS
Rooms/Prtns	AVERAGE
Wall Height	10
% Comn Wall	0

Building Photo

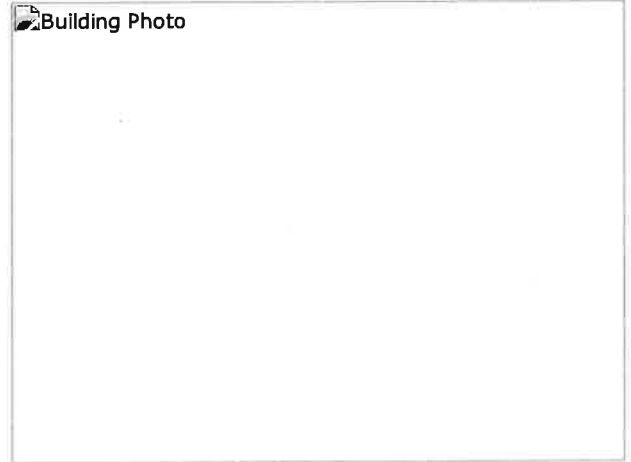

(<http://images.vgsi.com/photos/DanburyCTPhotos//\00\02\88/>)

Building Layout

FUS[25408]
 FUS[25408]
 FUS[25408]
 FUS[25408]
 FUS[25408]
 FUS[25408]
 FUS[25408]
 FUS[25408]
 FUS[25408]
 FUS[25408]
 FUS[25408]
 BAS[25408]

BAS COGEN[598]

FUS/BAS COGEN[2116]

Building Sub-Areas (sq ft)			Legend
Code	Description	Gross Area	Living Area
FUS	Finished Upper Story	281,604	267,524
BAS	First Floor	28,122	28,122
		309,726	295,646

Building 1 : Section 1

Year Built: 1970
Living Area: 0
Replacement Cost: \$69,493,425
Building Percent Good: 76
Replacement Cost Less Depreciation: \$52,815,000

Building Attributes	
Field	Description
Style	Outbuildings
Model	
Grade:	

Stories:	
Occupancy	
Exterior Wall 1	
Exterior Wall 2	
Roof Structure:	
Roof Cover	
Interior Wall 1	
Interior Wall 2	
Interior Flr 1	
Interior Flr 2	
Heat Fuel	
Heat Type:	
AC Type:	
Total Bedrooms:	
Total Bthrms:	
Total Half Baths:	
Total Xtra Fixtrs:	
Total Rooms:	
Bath Style:	
Kitchen Style:	
Fireplaces	
Whirlpool	
Addn'l Kitchen	
Bsm Gar	
Fin Bsm Area	
Fin Bsm Qual	
Nhbd	
MH Park	

Building Photo



(<http://images.vgsi.com/photos/DanburyCTPhotos//default.jpg>)

Building Layout

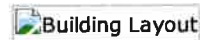

Building Sub-Areas (sq ft)	Legend
No Data for Building Sub-Areas	

Building 2 : Section 1

Year Built: 1968
Living Area: 15,232
Replacement Cost: \$3,857,248
Building Percent 71
Good:
Replacement Cost
Less Depreciation: \$2,738,600

Building Attributes : Bldg 2 of 16	
Field	Description
STYLE	Hospital
MODEL	Commercial
Grade	Excellent

Stories:	3
Occupancy	1
Exterior Wall 1	Brick/Masonry
Exterior Wall 2	
Roof Structure	Flat
Roof Cover	Tar & Gravel
Interior Wall 1	Drywall/Sheet
Interior Wall 2	
Interior Floor 1	Vinyl/Asphalt
Interior Floor 2	
Heating Fuel	Gas
Heating Type	Forced Air-Duc
AC Type	Central
Bldg Use	Commercial MDL-94
Total Rooms	
Total Bedrms	00
Total Baths	0
1st Floor Use:	200
Heat/AC	HEAT/AC SPLIT
Frame Type	MASONRY
Baths/Plumbing	AVERAGE
Ceiling/Wall	CEIL & WALLS
Rooms/Prtns	AVERAGE
Wall Height	10
% Conn Wall	0

Building Photo



(<http://images.vgsi.com/photos/DanburyCTPhotos//default.jpg>)

Building Layout

FUS[4200]
FUS[5358]
BAS[6152]

Building Sub-Areas (sq ft)			Legend
Code	Description	Gross Area	Living Area
FUS	Finished Upper Story	9,558	9,080
BAS	First Floor	6,152	6,152
		15,710	15,232

Building 3 : Section 1

Year Built: 1970
Living Area: 1,400
Replacement Cost: \$87,851
Building Percent Good: 76
Replacement Cost Less Depreciation: \$66,800

Building Attributes : Bldg 3 of 16	
Field	Description
STYLE	Warehouse
MODEL	Ind/Comm
Grade	Excellent

Stories:	1
Occupancy	1
Exterior Wall 1	Concr/Cinder
Exterior Wall 2	
Roof Structure	Flat
Roof Cover	Tar & Gravel
Interior Wall 1	Minim/Masonry
Interior Wall 2	
Interior Floor 1	Concr-Finished
Interior Floor 2	
Heating Fuel	Coal or Wood
Heating Type	None
AC Type	None
Bldg Use	Commercial MDL-96
Total Rooms	
Total Bedrms	00
Total Baths	0
1st Floor Use:	200I
Heat/AC	NONE
Frame Type	MASONRY
Baths/Plumbing	AVERAGE
Ceiling/Wall	CEIL & MIN WL
Rooms/Prtns	AVERAGE
Wall Height	14
% Comn Wall	0

Building Photo



(<http://images.vgsi.com/photos/DanburyCTPhotos//default.jpg>)

Building Layout

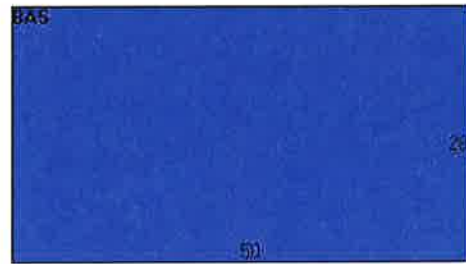

Building Sub-Areas (sq ft)			Legend
Code	Description	Gross Area	Living Area
BAS	First Floor	1,400	1,400
		1,400	1,400

Building 4 : Section 1

Year Built: 1989
Living Area: 3,000
Replacement Cost: \$749,706
Building Percent Good: 81
Replacement Cost Less Depreciation: \$607,300

Building Attributes : Bldg 4 of 16	
Field	Description
STYLE	Hospital
MODEL	Commercial
Grade	Average+
Stories:	1

Occupancy	1
Exterior Wall 1	Brick/Masonry
Exterior Wall 2	
Roof Structure	Flat
Roof Cover	Tar & Gravel
Interior Wall 1	Drywall/Sheet
Interior Wall 2	
Interior Floor 1	Carpet
Interior Floor 2	
Heating Fuel	Gas
Heating Type	Forced Air-Duc
AC Type	Central
Bldg Use	Commercial MDL-94
Total Rooms	
Total Bedrms	00
Total Baths	0
1st Floor Use:	200
Heat/AC	HEAT/AC PKGS
Frame Type	STEEL
Baths/Plumbing	AVERAGE
Ceiling/Wall	CEIL & WALLS
Rooms/Prtns	AVERAGE
Wall Height	12
% Corn Wall	0

Building Photo



(<http://images.vgsi.com/photos/DanburyCTPhotos//default.jpg>)

Building Layout

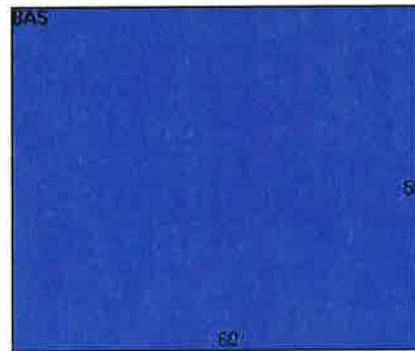

Building Sub-Areas (sq ft)			Legend
Code	Description	Gross Area	Living Area
BAS	First Floor	3,000	3,000
		3,000	3,000

Building 5 : Section 1

Year Built: 1989
Living Area: 9,610
Replacement Cost: \$2,853,081
Building Percent Good: 81
Replacement Cost Less Depreciation: \$2,311,000

Building Attributes : Bldg 5 of 16	
Field	Description
STYLE	Hospital
MODEL	Commercial
Grade	Excellent+
Stories:	2

Occupancy	1
Exterior Wall 1	Brick/Masonry
Exterior Wall 2	
Roof Structure	Flat
Roof Cover	Tar & Gravel
Interior Wall 1	Drywall/Sheet
Interior Wall 2	
Interior Floor 1	Carpet
Interior Floor 2	Ceram Clay Til
Heating Fuel	Gas
Heating Type	Forced Air-Duc
AC Type	Central
Bldg Use	Commercial MDL-94
Total Rooms	
Total Bedrms	00
Total Baths	0
1st Floor Use:	200
Heat/AC	HEAT/AC SPLIT
Frame Type	STEEL
Baths/Plumbing	AVERAGE
Ceiling/Wall	SUS-CEIL & WL
Rooms/Prtns	AVERAGE
Wall Height	10
% Comn Wall	0

Building Photo



(<http://images.vgsi.com/photos/DanburyCTPhotos//default.jpg>)

Building Layout

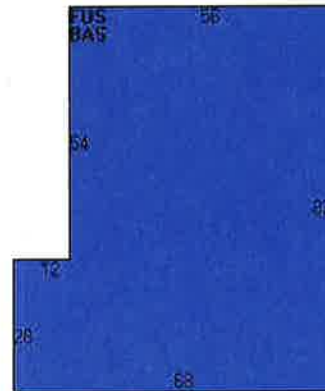

Building Sub-Areas (sq ft)			Legend
Code	Description	Gross Area	Living Area
BAS	First Floor	4,928	4,928
FUS	Finished Upper Story	4,928	4,682
		9,856	9,610

Building 6 : Section 1

Year Built: 1983
Living Area: 167,220
Replacement Cost: \$39,177,338
Building Percent Good: 80
Replacement Cost Less Depreciation: \$31,341,900

Building Attributes : Bldg 6 of 16	
Field	Description
STYLE	Hospital
MODEL	Commercial
Grade	Excellent

Stories:	3
Occupancy	1
Exterior Wall 1	Brick/Masonry
Exterior Wall 2	
Roof Structure	Flat
Roof Cover	Tar & Gravel
Interior Wall 1	Drywall/Sheet
Interior Wall 2	
Interior Floor 1	Vinyl/Asphalt
Interior Floor 2	Carpet
Heating Fuel	Gas
Heating Type	Forced Air-Duc
AC Type	None
Bldg Use	Commercial MDL-94
Total Rooms	
Total Bedrms	00
Total Baths	0
1st Floor Use:	200
Heat/AC	NONE
Frame Type	STEEL
Baths/Plumbing	AVERAGE
Ceiling/Wall	SUS-CEIL & WL
Rooms/Prtns	AVERAGE
Wall Height	12
% Comn Wall	

Building Photo



(<http://images.vgsi.com/photos/DanburyCTPhotos//default.jpg>)

Building Layout

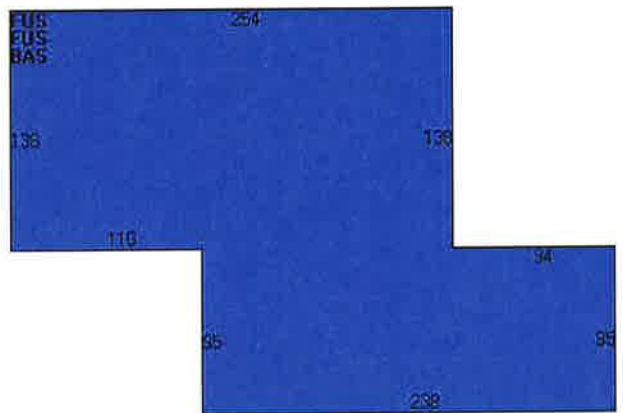

Building Sub-Areas (sq ft)			Legend
Code	Description	Gross Area	Living Area
FUS	Finished Upper Story	115,324	109,558
BAS	First Floor	57,662	57,662
		172,986	167,220

Building 7 : Section 1

Year Built: 1983
Living Area: 165,411
Replacement Cost: \$5,847,683
Building Percent Good: 88
Replacement Cost Less Depreciation: \$5,146,000

Building Attributes : Bldg 7 of 16	
Field	Description
STYLE	Parking Garage
MODEL	Ind/Comm
Grade	Good+

Stories:	2
Occupancy	1
Exterior Wall 1	Reinforc Concr
Exterior Wall 2	
Roof Structure	Reinforc Concr
Roof Cover	Concrete Tile
Interior Wall 1	Minim/Masonry
Interior Wall 2	
Interior Floor 1	Concr-Finished
Interior Floor 2	
Heating Fuel	Coal or Wood
Heating Type	None
AC Type	None
Bldg Use	Commercial MDL-96
Total Rooms	
Total Bedrms	00
Total Baths	0
1st Floor Use:	200I
Heat/AC	NONE
Frame Type	STEEL
Baths/Plumbing	NONE
Ceiling/Wall	CEILING ONLY
Rooms/Prtns	LIGHT
Wall Height	10
% Comn Wall	0

Building Photo



(<http://images.vgsi.com/photos/DanburyCTPhotos//\00\02\23/>)

Building Layout

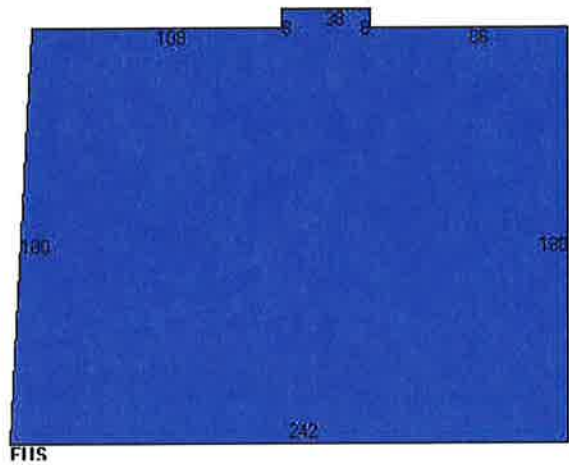

Building Sub-Areas (sq ft)			Legend
Code	Description	Gross Area	Living Area
FUS	Finished Upper Story	128,892	122,447
BAS	First Floor	42,964	42,964
BSM	Basement	42,964	0
		214,820	165,411

Building 8 : Section 1

Year Built: 1995
Living Area: 2,120
Replacement Cost: \$790,227
Building Percent Good: 88
Replacement Cost Less Depreciation: \$695,400

Building Attributes : Bldg 8 of 16	
Field	Description
STYLE	Hospital
MODEL	Commercial

Grade	Excellent
Stories:	1
Occupancy	1
Exterior Wall 1	Brick/Masonry
Exterior Wall 2	
Roof Structure	Flat
Roof Cover	Tar & Gravel
Interior Wall 1	Drywall/Sheet
Interior Wall 2	
Interior Floor 1	Carpet
Interior Floor 2	
Heating Fuel	Gas
Heating Type	Forced Air-Duc
AC Type	Central
Bldg Use	Commercial MDL-94
Total Rooms	
Total Bedrms	00
Total Baths	0
1st Floor Use:	200
Heat/AC	HEAT/AC PKGS
Frame Type	STEEL
Baths/Plumbing	AVERAGE
Ceiling/Wall	SUS-CEIL & WL
Rooms/Prtns	AVERAGE
Wall Height	10
% Comn Wall	0

Building Photo



(<http://images.vgsi.com/photos/DanburyCTPhotos//default.jpg>)

Building Layout



Building Sub-Areas (sq ft)			Legend
Code	Description	Gross Area	Living Area
BAS	First Floor	2,120	2,120
		2,120	2,120

Building 9 : Section 1

Year Built: 1993
Living Area: 2,766
Replacement Cost: \$992,618
Building Percent Good: 88
Replacement Cost Less Depreciation: \$873,500

Building Attributes : Bldg 9 of 16	
Field	Description
STYLE	Hospital
MODEL	Commercial
Grade	Excellent
Stories:	1

Occupancy	1
Exterior Wall 1	Brick/Masonry
Exterior Wall 2	
Roof Structure	Flat
Roof Cover	Tar & Gravel
Interior Wall 1	Drywall/Sheet
Interior Wall 2	
Interior Floor 1	Carpet
Interior Floor 2	Vinyl/Asphalt
Heating Fuel	Gas
Heating Type	Forced Air-Duc
AC Type	Central
Bldg Use	Commercial MDL-94
Total Rooms	
Total Bedrms	00
Total Baths	0
1st Floor Use:	200
Heat/AC	HEAT/AC PKGS
Frame Type	STEEL
Baths/Plumbing	AVERAGE
Ceiling/Wall	SUS-CEIL & WL
Rooms/Prtns	AVERAGE
Wall Height	18
% Comn Wall	0

Building Photo



(<http://images.vgsi.com/photos/DanburyCTPhotos//default.jpg>)

Building Layout

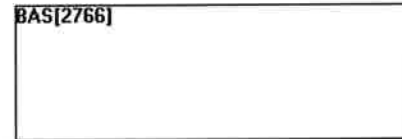

Building Sub-Areas (sq ft)			Legend
Code	Description	Gross Area	Living Area
BAS	First Floor	2,766	2,766
		2,766	2,766

Building 10 : Section 1

Year Built: 1976
Living Area: 6,400
Replacement Cost: \$232,640
Building Percent Good: 80
Replacement Cost Less Depreciation: \$186,100

Building Attributes : Bldg 10 of 16	
Field	Description
STYLE	Warehouse
MODEL	Ind/Comm
Grade	Average
Stories:	1

Occupancy	1
Exterior Wall 1	Concr/Cinder
Exterior Wall 2	
Roof Structure	Flat
Roof Cover	Tar & Gravel
Interior Wall 1	Minim/Masonry
Interior Wall 2	
Interior Floor 1	Concr-Finished
Interior Floor 2	
Heating Fuel	Gas
Heating Type	Forced Air-Duc
AC Type	None
Bldg Use	Commercial MDL-96
Total Rooms	
Total Bedrms	00
Total Baths	0
1st Floor Use:	200I
Heat/AC	NONE
Frame Type	MASONRY
Baths/Plumbing	AVERAGE
Ceiling/Wall	CEIL & MIN WL
Rooms/Prtns	AVERAGE
Wall Height	12
% Comn Wall	0

Building Photo



(<http://images.vgsi.com/photos/DanburyCTPhotos//\00\02\17/>)

Building Layout



Building Sub-Areas (sq ft)			Legend
Code	Description	Gross Area	Living Area
BAS	First Floor	6,400	6,400
		6,400	6,400

Building 12 : Section 1

Year Built: 1991
Living Area: 381,271
Replacement Cost: \$14,294,917
Building Percent Good: 88
Replacement Cost Less Depreciation: \$12,579,500

Building Attributes : Bldg 12 of 16	
Field	Description
STYLE	Parking Garage
MODEL	Ind/Comm
Grade	Excellent
Stories:	5

Occupancy	707
Exterior Wall 1	Pre-cast Concr
Exterior Wall 2	
Roof Structure	Reinforc Concr
Roof Cover	Concrete Tile
Interior Wall 1	Minim/Masonry
Interior Wall 2	
Interior Floor 1	Concr Abv Grad
Interior Floor 2	
Heating Fuel	
Heating Type	
AC Type	None
Bldg Use	Commercial MDL-94
Total Rooms	
Total Bedrms	
Total Baths	
1st Floor Use:	
Heat/AC	NONE
Frame Type	REINF. CONCR
Baths/Plumbing	NONE
Ceiling/Wall	NONE
Rooms/Prtns	AVERAGE
Wall Height	19
% Corn Wall	

Building Photo



(<http://images.vgsi.com/photos/DanburyCTPhotos//\00\02\73/>)

Building Layout

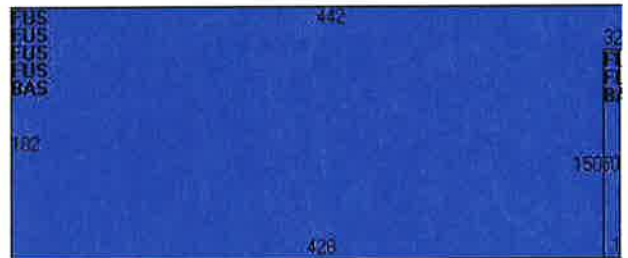

Building Sub-Areas (sq ft)			Legend
Code	Description	Gross Area	Living Area
FUS	Finished Upper Story	316,976	301,127
BAS	First Floor	80,144	80,144
		397,120	381,271

Building 13 : Section 1

Year Built: 2007
Living Area: 155,010
Replacement Cost: \$8,552,188
Building Percent Good: 96
Replacement Cost Less Depreciation: \$8,210,100

Building Attributes : Bldg 13 of 16	
Field	Description
STYLE	Parking Garage
MODEL	Commercial
Grade	Excellent++

Stories:	3
Occupancy	2
Exterior Wall 1	Concr/Cinder
Exterior Wall 2	Brick/Masonry
Roof Structure	Reinforc Concr
Roof Cover	Concrete Tile
Interior Wall 1	Drywall/Sheet
Interior Wall 2	
Interior Floor 1	Ceram Clay Til
Interior Floor 2	Carpet
Heating Fuel	Gas
Heating Type	Forced Air-Duc
AC Type	Central
Bldg Use	Commercial MDL-94
Total Rooms	
Total Bedrms	
Total Baths	
1st Floor Use:	
Heat/AC	HEAT/AC PKGS
Frame Type	REINF. CONCR
Baths/Plumbing	ABOVE AVERAGE
Ceiling/Wall	CEIL & WALLS
Rooms/Prtns	ABOVE AVERAGE
Wall Height	9
% Comn Wall	

Building Photo



(<http://images.vgsi.com/photos/DanburyCTPhotos//\00\02\48/>)

Building Layout

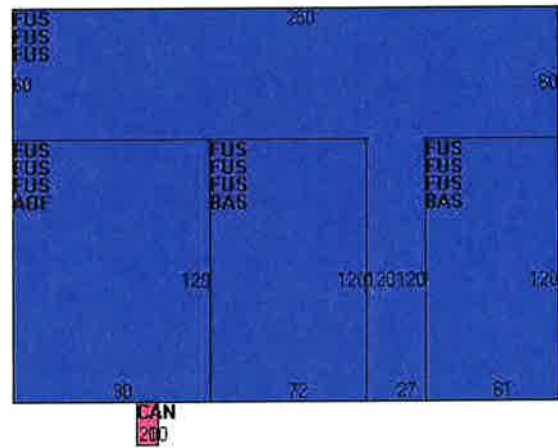

Building Sub-Areas (sq ft)			Legend
Code	Description	Gross Area	Living Area
FUS	Finished Upper Story	135,000	128,250
BAS	First Floor	15,960	15,960
AOF	Office, (Average)	10,800	10,800
CAN	Canopy	200	0
		161,960	155,010

Building 14 : Section 1

Year Built: 2007
Living Area: 35,136
Replacement Cost: \$1,239,770
Building Percent Good: 96
Replacement Cost Less Depreciation: \$1,190,200

Building Attributes : Bldg 14 of 16	
Field	Description
STYLE	Parking Garage

MODEL	Commercial
Grade	Good+
Stories:	6
Occupancy	707
Exterior Wall 1	Reinforc Concr
Exterior Wall 2	
Roof Structure	Reinforc Concr
Roof Cover	Concrete Tile
Interior Wall 1	Minim/Masonry
Interior Wall 2	
Interior Floor 1	Concr Abv Grad
Interior Floor 2	
Heating Fuel	Coal or Wood
Heating Type	None
AC Type	None
Bldg Use	Commercial MDL-94
Total Rooms	
Total Bedrms	
Total Baths	
1st Floor Use:	
Heat/AC	NONE
Frame Type	REINF. CONCR
Baths/Plumbing	NONE
Ceiling/Wall	NONE
Rooms/Prtns	AVERAGE
Wall Height	15
% Comn Wall	

Building Photo



(<http://images.vgsi.com/photos/DanburyCTPhotos//default.jpg>)

Building Layout

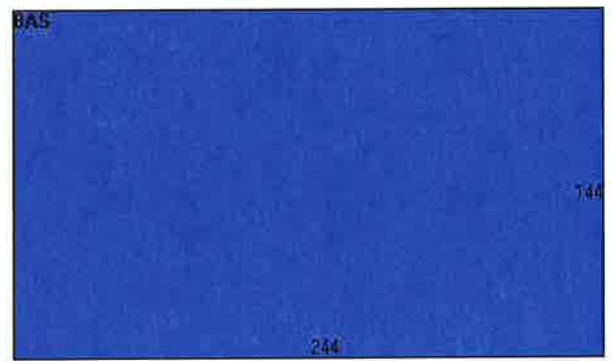

Building Sub-Areas (sq ft)			Legend
Code	Description	Gross Area	Living Area
BAS	First Floor	35,136	35,136
		35,136	35,136

Building 15 : Section 1

Year Built: 2007
Living Area: 58,869
Replacement Cost: \$10,500,769
Building Percent Good: 95
Replacement Cost Less Depreciation: \$9,975,700

Building Attributes : Bldg 15 of 16	
Field	Description
STYLE	Profess. Bldg
MODEL	Commercial
Grade	Excellent+++
Stories:	3

Occupancy	1
Exterior Wall 1	Stucco/Masonry
Exterior Wall 2	Brick Veneer
Roof Structure	Flat
Roof Cover	Tar & Gravel
Interior Wall 1	Drywall/Sheet
Interior Wall 2	
Interior Floor 1	Ceram Clay Til
Interior Floor 2	Carpet
Heating Fuel	Gas
Heating Type	Forced Air-Duc
AC Type	Central
Bldg Use	Commercial MDL-94
Total Rooms	
Total Bedrms	
Total Baths	
1st Floor Use:	
Heat/AC	HEAT/AC PKGS
Frame Type	FIREPRF STEEL
Baths/Plumbing	ABOVE AVERAGE
Ceiling/Wall	SUS-CEIL & WL
Rooms/Prtns	ABOVE AVERAGE
Wall Height	9
% Comn Wall	

Building Photo



(<http://images.vgsi.com/photos/DanburyCTPhotos//\00\02\73/>)

Building Layout

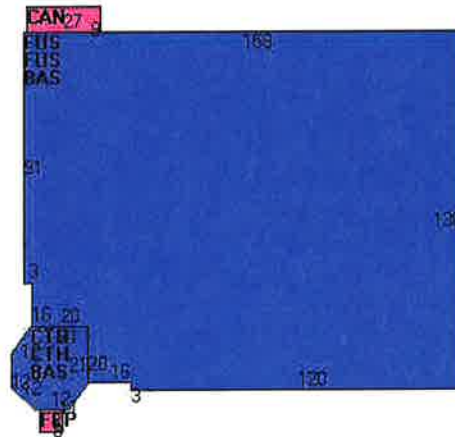

Building Sub-Areas (sq ft)			Legend
Code	Description	Gross Area	Living Area
FUS	Finished Upper Story	40,090	38,086
BAS	First Floor	20,783	20,783
CAN	Canopy	243	0
CTH	Cathedral Ceiling	1,476	0
FEP	Fin. Enclosed Porch	64	0
		62,656	58,869

Building 16 : Section 1

Year Built: 2012
Living Area: 300,000
Replacement Cost: \$96,426,000
Building Percent 140
Good:
Replacement Cost
Less Depreciation: \$134,996,400

Building Attributes : Bldg 16 of 16	
Field	Description

STYLE	Hospital
MODEL	Commercial
Grade	Excellent+++
Stories:	6
Occupancy	1
Exterior Wall 1	Brick/Masonry
Exterior Wall 2	
Roof Structure	Flat
Roof Cover	Tar & Gravel
Interior Wall 1	Drywall/Sheet
Interior Wall 2	
Interior Floor 1	Carpet
Interior Floor 2	Vinyl/Asphalt
Heating Fuel	Gas
Heating Type	Forced Air-Duc
AC Type	Central
Bldg Use	Hospital
Total Rooms	
Total Bedrms	
Total Baths	
1st Floor Use:	
Heat/AC	HEAT/AC PKGS
Frame Type	STEEL
Baths/Plumbing	AVERAGE
Ceiling/Wall	SUS-CEIL & WL
Rooms/Prtns	AVERAGE
Wall Height	10
% Comn Wall	

Building Photo

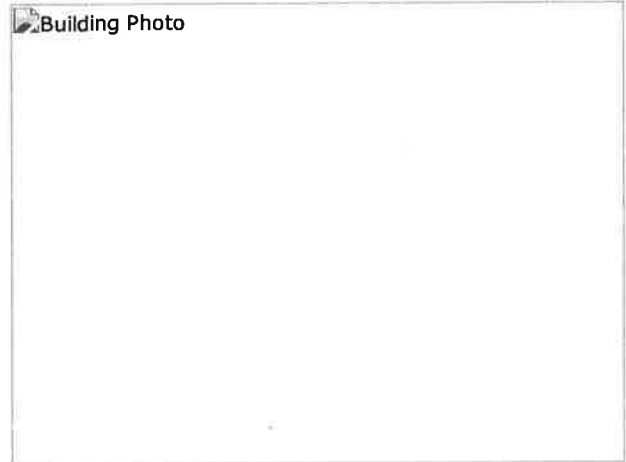

([http://images.vgsi.com/photos/DanburyCTPhotos//\00\02\92/!](http://images.vgsi.com/photos/DanburyCTPhotos//\00\02\92/))

Building Layout

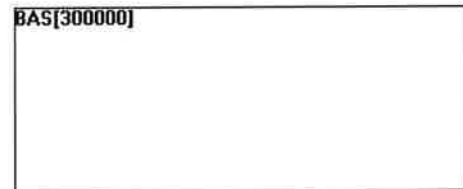

Building Sub-Areas (sq ft)			Legend
Code	Description	Gross Area	Living Area
BAS	First Floor	300,000	300,000
		300,000	300,000

Extra Features

Extra Features				Legend
Code	Description	Size	Value	Bldg #
ELV1	Elevator	5 STOPS	\$178,000	7
SPR1	Sprinklers-Wet	172986 S.F.	\$218,000	6
SPR1	Sprinklers-Wet	18147 S.F.	\$23,700	2
SPR1	Sprinklers-Wet	2120 S.F.	\$2,900	8
SPR1	Sprinklers-Wet	268385 S.F.	\$402,600	16
SPR1	Sprinklers-Wet	2766 S.F.	\$3,900	9
SPR1	Sprinklers-Wet	3000 S.F.	\$3,900	4
SPR1	Sprinklers-Wet	38890 S.F.	\$52,500	13

SPR1	Sprinklers-Wet	9856 S.F.	\$12,700	5
A/C	Air Condition	14820 UNITS	\$33,300	13
ELV1	Elevator	4 STOPS	\$139,200	2
ELV1	Elevator	5 STOPS	\$178,000	7
ELV1	Elevator	5 STOPS	\$198,000	12
SPR1	Sprinklers-Wet	304896 S.F.	\$343,000	1
SPR1	Sprinklers-Wet	62413 S.F.	\$88,900	15
ELV1	Elevator	3 STOPS	\$114,000	15
ELV1	Elevator	4 STOPS	\$152,000	13
ELV1	Elevator	5 STOPS	\$198,000	12
ELV1	Elevator	7 STOPS	\$235,200	6
ELV1	Elevator	3 STOPS	\$114,000	15
ELV1	Elevator	7 STOPS	\$235,200	6
ELV1	Elevator	3 STOPS	\$114,000	15
ELV1	Elevator	7 STOPS	\$235,200	6
ELV1	Elevator	6 STOPS	\$201,600	6
ELV1	Elevator	5 STOPS	\$168,000	6
ELV2	Freight Elevator	3 STOPS	\$75,600	6

Land

Land Use

Use Code 951
Description Hospital
Zone RH3
Neighborhood 7500
Alt Land Appr No
Category

Land Line Valuation

Size (Acres) 23.46
Frontage 0
Depth 0
Assessed Value \$39,095,600
Appraised Value \$55,850,900

Outbuildings

Outbuildings						Legend
Code	Description	Sub Code	Sub Description	Size	Value	Bldg #
	EXPANSION			1	\$1,720,000	14
LT2	Light 2			8 UNITS	\$5,600	12
PAV1	Paving-Asphalt			243936 S.F.	\$292,700	1
PAV1	Paving-Asphalt			56580 S.F.	\$56,600	15
CNP2	Canopy-Gd			1686 S.F.	\$29,500	6
CNP2	Canopy-Gd			2607 S.F.	\$45,600	5
CEL	Cell Tower			1 UNITS	\$0	1
LT1	Light 1			9 UNITS	\$1,600	2
LT2	Light 2			4 UNITS	\$1,400	7
	RENOVATE LAB		10-1-05 LIST	1	\$500,000	1

LT2	Light 2			2 UNITS	\$700	13
LT2	Light 2			9 UNITS	\$3,200	2
	FM BOOSTER FACILITY		10-1-06 LIST	1	\$235,300	1
	FM BOOSTER/REN		10-1-06 LIST	1	\$435,000	1
LT3	Lights 3			4 UNITS	\$2,000	13
	RENOVATION TO 10 BED UNIT		10-1-06 LIST	1	\$200,000	1
LT1	Light 1			18 UNITS	\$3,200	15
	4TH FLR CONV/RED LOT		10-1-06 LIST	1	\$2,000,300	1
	4TH FLR CONVERT STGE RM TO OR		10-1-06 LIST	1	\$250,000	1
LT2	Light 2			2 UNITS	\$700	15
	FIELD PRICE		RED LOT PARKING EXPANSION	1	\$1,750,000	1
	1800 SQ FT M			1	\$900,000	1
	ALTERATIONS		10-1-10 LIST	1	\$3,200,000	1
	OFFICES		10-1-10 LIST	1	\$400,000	1
	RENOVATE 1ST FLOOR SOUTH		10-1-10 LIST	1	\$750,000	1
	BLDG. EXPANSION		BLDG. EXANSION	1	\$2,000,000	1
	TOWER ADD		TOWER ADDITION	1	\$18,000,000	1

Valuation History

Appraisal			
Valuation Year	Improvements	Land	Total
2015	\$300,531,000	\$55,850,900	\$356,381,900
2014	\$300,531,000	\$55,911,000	\$356,442,000
2013	\$181,313,800	\$55,911,000	\$237,224,800

Assessment			
Valuation Year	Improvements	Land	Total
2015	\$210,371,500	\$39,095,600	\$249,467,100
2014	\$210,371,500	\$39,137,700	\$249,509,200
2013	\$126,919,400	\$39,137,700	\$166,057,100

(c) 2016 Vision Government Solutions, Inc. All rights reserved.



RADIO FREQUENCY EMISSIONS ANALYSIS REPORT EVALUATION OF HUMAN EXPOSURE POTENTIAL TO NON-IONIZING EMISSIONS

T-Mobile Existing Facility

Site ID: CT11108A

Danbury Hospital
24 Hospital Avenue
Danbury, CT 06810

June 26, 2018

EBI Project Number: 6218004742

Site Compliance Summary	
Compliance Status:	COMPLIANT
Site total MPE% of FCC general population allowable limit:	17.13 %



June 26, 2018

T-Mobile USA
Attn: Jason Overbey, RF Manager
35 Griffin Road South
Bloomfield, CT 06002

Emissions Analysis for Site: **CT11108A – Danbury Hospital**

EBI Consulting was directed to analyze the proposed T-Mobile facility located at **24 Hospital Avenue, Danbury, CT**, for the purpose of determining whether the emissions from the Proposed T-Mobile Antenna Installation located on this property are within specified federal limits.

All information used in this report was analyzed as a percentage of current Maximum Permissible Exposure (% MPE) as listed in the FCC OET Bulletin 65 Edition 97-01 and ANSI/IEEE Std C95.1. The FCC regulates Maximum Permissible Exposure in units of microwatts per square centimeter ($\mu\text{W}/\text{cm}^2$). The number of $\mu\text{W}/\text{cm}^2$ calculated at each sample point is called the power density. The exposure limit for power density varies depending upon the frequencies being utilized. Wireless Carriers and Paging Services use different frequency bands each with different exposure limits, therefore it is necessary to report results and limits in terms of percent MPE rather than power density.

All results were compared to the FCC (Federal Communications Commission) radio frequency exposure rules, 47 CFR 1.1307(b)(1) – (b)(3), to determine compliance with the Maximum Permissible Exposure (MPE) limits for General Population/Uncontrolled environments as defined below.

General population/uncontrolled exposure limits apply to situations in which the general population may be exposed or in which persons who are exposed as a consequence of their employment may not be made fully aware of the potential for exposure or cannot exercise control over their exposure. Therefore, members of the general population would always be considered under this category when exposure is not employment related, for example, in the case of a telecommunications tower that exposes persons in a nearby residential area.

Public exposure to radio frequencies is regulated and enforced in units of microwatts per square centimeter ($\mu\text{W}/\text{cm}^2$). The general population exposure limits for the 600 MHz and 700 MHz Band are approximately $400 \mu\text{W}/\text{cm}^2$ and $467 \mu\text{W}/\text{cm}^2$ respectively. The general population exposure limit for the 1900 MHz (PCS) and 2100 MHz (AWS) is $1000 \mu\text{W}/\text{cm}^2$. Because each carrier will be using different frequency bands, and each frequency band has different exposure limits, it is necessary to report percent of MPE rather than power density.



Occupational/controlled exposure limits apply to situations in which persons are exposed as a consequence of their employment and in which those persons who are exposed have been made fully aware of the potential for exposure and can exercise control over their exposure. Occupational/controlled exposure limits also apply where exposure is of a transient nature as a result of incidental passage through a location where exposure levels may be above general population/uncontrolled limits (see below), as long as the exposed person has been made fully aware of the potential for exposure and can exercise control over his or her exposure by leaving the area or by some other appropriate means.

Additional details can be found in FCC OET 65.

CALCULATIONS

Calculations were done for the proposed T-Mobile Wireless antenna facility located at **24 Hospital Avenue, Danbury, CT**, using the equipment information listed below. All calculations were performed per the specifications under FCC OET 65. Since T-Mobile is proposing highly focused directional panel antennas, which project most of the emitted energy out toward the horizon, all calculations were performed assuming a lobe representing the maximum gain of the antenna per the antenna manufactures supplied specifications, minus 10 dB for directional panel antennas, was focused at the base of the tower. For this report the sample point is the top of a 6-foot person standing at the base of the tower.

For all calculations, all equipment was calculated using the following assumptions:

- 1) 2 GSM channels (PCS Band - 1900 MHz) were considered for each sector of the proposed installation. These Channels have a transmit power of 30 Watts per Channel.
- 2) 2 UMTS channels (AWS Band – 2100 MHz) were considered for each sector of the proposed installation. These Channels have a transmit power of 30 Watts per Channel.
- 3) 2 LTE channels (PCS Band - 1900 MHz) were considered for each sector of the proposed installation. These Channels have a transmit power of 60 Watts per Channel.
- 4) 4 LTE channels (AWS Band – 2100 MHz) were considered for each sector of the proposed installation. These Channels have a transmit power of 60 Watts per Channel.
- 5) 2 LTE channels (600 MHz Band) were considered for each sector of the proposed installation. These Channels have a transmit power of 30 Watts per Channel.
- 6) 2 LTE channels (700 MHz Band) were considered for each sector of the proposed installation. These Channels have a transmit power of 30 Watts per Channel.



- 7) All radios at the proposed installation were considered to be running at full power and were uncombined in their RF transmissions paths per carrier prescribed configuration. Per FCC OET Bulletin No. 65 - Edition 97-01 recommendations to achieve the maximum anticipated value at each sample point, all power levels emitting from the proposed antenna installation are increased by a factor of 2.56 to account for possible in-phase reflections from the surrounding environment. This is rarely the case, and if so, is never continuous.
- 8) For the following calculations the sample point was the top of a 6-foot person standing at the base of the tower. The maximum gain of the antenna per the antenna manufactures supplied specifications, minus 10 dB for directional panel antennas, was used in this direction. This value is a very conservative estimate as gain reductions for these particular antennas are typically much higher in this direction.
- 9) The antennas used in this modeling are the **Ericsson AIR 3246 B66, Ericsson AIR32 B66A/B2A** and **RFS APXVAARR24_43-U-NA20** for 1900 MHz (PCS), 2100 MHz (AWS), 600 MHz and 700 MHz channels. This is based on feedback from the carrier with regard to anticipated antenna selection. All Antenna gain values and associated transmit power levels are shown in the Site Inventory and Power Data table below. The maximum gain of the antenna per the antenna manufactures supplied specifications, minus 10 dB for directional panel antennas, was used for all calculations. This value is a very conservative estimate as gain reductions for these particular antennas are typically much higher in this direction.
- 10) The antenna mounting height centerlines of the proposed antennas are **127 feet & 154 feet** above ground level (AGL).
- 11) Emissions values for additional carriers were taken from the Connecticut Siting Council active database. Values in this database are provided by the individual carriers themselves. For this site, the existing composite value was recorded with onsite measurements.
- 12) All calculations were done with respect to uncontrolled / general population threshold limits.



T-Mobile Site Inventory and Power Data

Sector:	A	Sector:	B	Sector:	C	Sector:	D
Antenna #:	1	Antenna #:	1	Antenna #:	1	Antenna #:	1
Make / Model:	Ericsson AIR 3246 B66	Make / Model:	Ericsson AIR 3246 B66	Make / Model:	Ericsson AIR 3246 B66	Make / Model:	Ericsson AIR 3246 B66
Gain:	15.9 dBd	Gain:	15.9 dBd	Gain:	15.9 dBd	Gain:	15.9 dBd
Height (AGL):	154	Height (AGL):	154	Height (AGL):	127	Height (AGL):	154
Frequency Bands	2100 MHz (AWS)	Frequency Bands	2100 MHz (AWS)	Frequency Bands	2100 MHz (AWS)	Frequency Bands	2100 MHz (AWS)
Channel Count	4	Channel Count	4	Channel Count	4	Channel Count	4
Total TX Power(W):	240	Total TX Power(W):	240	Total TX Power(W):	240	Total TX Power(W):	240
ERP (W):	9,337.08	ERP (W):	9,337.08	ERP (W):	9,337.08	ERP (W):	9,337.08
Antenna A1 MPE%	1.53	Antenna B1 MPE%	1.53	Antenna C1 MPE%	2.29	Antenna B1 MPE%	1.53
Antenna #:	2	Antenna #:	2	Antenna #:	2	Antenna #:	2
Make / Model:	Ericsson AIR32 B66A/B2A	Make / Model:	Ericsson AIR32 B66A/B2A	Make / Model:	Ericsson AIR32 B66A/B2A	Make / Model:	Ericsson AIR32 B66A/B2A
Gain:	15.9 dBd	Gain:	15.9 dBd	Gain:	15.9 dBd	Gain:	15.9 dBd
Height (AGL):	154	Height (AGL):	154	Height (AGL):	127	Height (AGL):	154
Frequency Bands	1900 MHz (PCS)	Frequency Bands	1900 MHz (PCS)	Frequency Bands	1900 MHz (PCS)	Frequency Bands	1900 MHz (PCS)
Channel Count	4	Channel Count	4	Channel Count	4	Channel Count	4
Total TX Power(W):	180	Total TX Power(W):	180	Total TX Power(W):	180	Total TX Power(W):	180
ERP (W):	7,002.82	ERP (W):	7,002.82	ERP (W):	7,002.81	ERP (W):	7,002.82
Antenna A2 MPE%	1.15	Antenna B2 MPE%	1.15	Antenna C2 MPE%	1.72	Antenna D2 MPE%	1.15
Antenna #:	3	Antenna #:	3	Antenna #:	3	Antenna #:	3
Make / Model:	RFS APXVAARR24_43-U-NA20	Make / Model:	RFS APXVAARR24_43-U-NA20	Make / Model:	RFS APXVAARR24_43-U-NA20	Make / Model:	RFS APXVAARR24_43-U-NA20
Gain:	16.35 / 12.95/ 13.35 dBd	Gain:	16.35 / 12.95/ 13.35 dBd	Gain:	16.35 / 12.95/ 13.35 dBd	Gain:	16.35 / 12.95/ 13.35 dBd
Height (AGL):	154	Height (AGL):	154	Height (AGL):	127	Height (AGL):	154
Frequency Bands	2100 MHz (AWS) / 600 MHz / 700 MHz	Frequency Bands	2100 MHz (AWS) / 600 MHz / 700 MHz	Frequency Bands	2100 MHz (AWS) / 600 MHz / 700 MHz	Frequency Bands	2100 MHz (AWS) / 600 MHz / 700 MHz
Channel Count	6	Channel Count	6	Channel Count	6	Channel Count	6
Total TX Power(W):	180	Total TX Power(W):	180	Total TX Power(W):	180	Total TX Power(W):	180
ERP (W):	5,070.20	ERP (W):	5,070.20	ERP (W):	5,070.20	ERP (W):	5,070.20
Antenna A3 MPE%	1.37	Antenna B3 MPE%	1.37	Antenna C3 MPE%	2.05	Antenna D3 MPE%	1.37



Site Summary Tables

Site Composite MPE%	
Carrier	MPE%
T-Mobile (Sector C)	6.06 %
AT&T	Existing composite value for these systems was determined through on-site measurements
DISH	
WDBY	
NEXTEL	
Whips	
Cisco	
Clearwire	
Verizon Wireless	4.23 %
Sprint	2.46 %
Site Total MPE %:	17.13 %

T-Mobile Sector A Total:	4.05 %
T-Mobile Sector B Total:	4.05 %
T-Mobile Sector C Total:	6.06 %
T-Mobile Sector C Total:	4.05 %
Site Total:	17.13 %

T-Mobile Max Power Values (Sector C)

T-Mobile_Max Power Values (Sector C)	# Channels	Watts ERP (Per Channel)	Height (feet)	Total Power Density ($\mu\text{W}/\text{cm}^2$)	Frequency (MHz)	Allowable MPE ($\mu\text{W}/\text{cm}^2$)	Calculated % MPE
T-Mobile AWS - 2100 MHz LTE	4	2,334.27	127	22.93	AWS - 2100 MHz	1000	2.29%
T-Mobile PCS - 1900 MHz LTE	2	2,334.27	127	11.46	PCS - 1900 MHz	1000	1.15%
T-Mobile PCS - 1900 MHz GSM	2	1,167.14	127	5.73	PCS - 1900 MHz	1000	0.57%
T-Mobile AWS - 2100 MHz UMTS	2	1,294.56	127	6.36	AWS - 2100 MHz	1000	0.64%
T-Mobile 600 MHz LTE	2	591.73	127	2.91	600 MHz	400	0.73%
T-Mobile 700 MHz LTE	2	648.82	127	3.19	700 MHz	467	0.68%
						Total:	6.06%

Summary

All calculations performed for this analysis yielded results that were **within** the allowable limits for general population exposure to RF Emissions.

The anticipated maximum composite contributions from the T-Mobile facility as well as the site composite emissions value with regards to compliance with FCC's allowable limits for general population exposure to RF Emissions are shown here:

T-Mobile Sector	Power Density Value (%)
Sector A:	4.05 %
Sector B:	4.05 %
Sector C:	6.06 %
Sector D:	4.05 %
T-Mobile Per Sector Maximum (Sector C):	6.06 %
Site Total:	17.13 %
Site Compliance Status:	COMPLIANT

The anticipated composite MPE value for this site assuming all carriers present is **17.13%** of the allowable FCC established general population limit sampled at the ground level. This is based upon values listed in the Connecticut Siting Council database for existing carrier emissions.

FCC guidelines state that if a site is found to be out of compliance (over allowable thresholds), that carriers over a 5% contribution to the composite value will require measures to bring the site into compliance. For this facility, the composite values calculated were well within the allowable 100% threshold standard per the federal government.

Structural Analysis Report

134.5-ft Existing Building

*Proposed T-Mobile
Antenna Upgrade*

Site Ref: CT11108A

*24 Hospital Ave
Danbury, CT*

CEN TEK Project No. 18058.13

Date: June 12, 2018

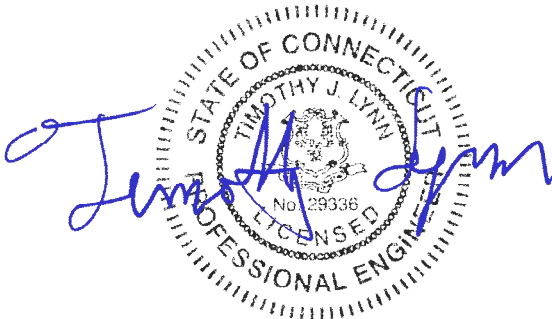

Prepared for:
T-Mobile USA
35 Griffin Road
Bloomfield, CT 06002

Table of Contents

SECTION 1 - REPORT

- INTRODUCTION
- ANTENNA AND APPURTENANCE SUMMARY
- DESIGN LOADING
- RESULTS
- CONCLUSION

SECTION 2 – CONDITIONS & SOFTWARE

- STANDARD ENGINEERING CONDITIONS
- GENERAL DESCRIPTION OF STRUCTURAL ANALYSIS PROGRAM

SECTION 3 – CALCULATIONS

- WIND LOAD CALCULATION
- RISA3D – ANTENNA MOUNT MEMBER FRAMING – ALPHA SECTOR
- RISA3D – ANTENNA MOUNT REPORT – ALPHA SECTOR
- RISA3D – UNITY CHECK – ALPHA SECTOR
- RISA3D – ANTENNA MOUNT MEMBER FRAMING – BETA/DELTA SECTOR
- RISA3D – ANTENNA MOUNT REPORT – BETA/DELTA SECTOR
- RISA3D – UNITY CHECK – BETA/DELTA SECTOR
- RISA3D – ANTENNA MOUNT MEMBER FRAMING – GAMMA SECTOR
- RISA3D – ANTENNA MOUNT REPORT – GAMMA SECTOR
- RISA3D – UNITY CHECK – GAMMA SECTOR

SECTION 4 – REFERENCE MATERIAL

- RF DATA SHEET
- EQUIPMENT CUT SHEETS

Introduction

The purpose of this report is to summarize the results of the structural analysis of the equipment upgrade proposed by T-Mobile on the existing host building located in Danbury, CT.

The host structure is a 134.5-ft tall building. The antennas are mounted on structural steel support frames attached to the building solar panel support framing.

Antenna and Appurtenance Summary

The existing, proposed and future loads considered in this analysis consist of the following:

- **T-Mobile (Existing to Remain):**
Antennas: Four (4) Ericsson AIR32 panel antennas and three (3) TMAs pipe mounted to the solar panel steel support framing with RAD center elevations of +/- 154-ft AGL (Alpha, Beta and Delta sectors) and +/- 127-ft AGL (Gamma sector).
- **T-Mobile (Existing to Remove):**
Antennas: Three (3) Ericsson AIR21 panel antennas, four (4) Andrew LNX6515DS panel antennas and four (4) Ericsson RRUS-11 remote radio units pipe mounted to the solar panel steel support framing with RAD center elevations of +/- 154-ft AGL (Alpha, Beta and Delta sectors) and +/- 127-ft AGL (Gamma sector).
- **T-Mobile (Proposed):**
Antennas: Four (4) Ericsson AIR3246 B66 panel antennas, four (4) RFS APXVAARR24-43-NA20 panel antennas and four (4) Ericsson 4449 B71_B12 remote radio units pipe mounted to the solar panel steel support framing with RAD center elevations of +/- 154-ft AGL (Alpha, Beta and Delta sectors) and +/- 127-ft AGL (Gamma sector).

Design Loading

Loading was determined per the requirements of the 2015 International Building Code and ASCE 7-10 “Minimum Design Loads for Buildings and Other Structures”.

Wind Speed:

Vult = 125 mph (Risk Cat 2)

[Appendix N of the 2016 CT Building Code]

Results

Antenna Mounts:

Component	Stress Ratio (percentage of capacity)	Result
Alpha	72.3%	PASS
Beta/Delta	86.1%	PASS
Gamma	53.8%	PASS

Conclusion

This analysis shows that the subject antenna frames and host building **with the proposed reinforcement to the Beta/Delta sector frame are adequate** to support the proposed modified antenna configuration.

The analysis is based, in part, on the information provided to this office by T-Mobile. If the existing conditions are different than the information in this report, Centek Engineering, Inc. must be contacted for resolution of any potential issues.

Please feel free to call with any questions or comments.

Respectfully Submitted by:



Timothy J. Lynn, PE
Structural Engineer

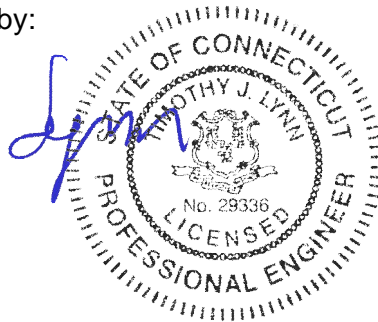

*Standard Conditions for Furnishing of
Professional Engineering Services on
Existing Structures*

All engineering services are performed on the basis that the information used is current and correct. This information may consist of, but is not necessarily limited to:

- Information supplied by the client regarding the structure itself, its foundations, the soil conditions, the antenna and feed line loading on the structure and its components, or other relevant information.
- Information from the field and/or drawings in the possession of Centek Engineering, Inc. or generated by field inspections or measurements of the structure.
- It is the responsibility of the client to ensure that the information provided to Centek Engineering, Inc. and used in the performance of our engineering services is correct and complete. In the absence of information to the contrary, we assume that all structures were constructed in accordance with the drawings and specifications and are in an un-corroded condition and have not deteriorated. It is therefore assumed that its capacity has not significantly changed from the “as new” condition.
- All services will be performed to the codes specified by the client, and we do not imply to meet any other codes or requirements unless explicitly agreed in writing. If wind and ice loads or other relevant parameters are to be different from the minimum values recommended by the codes, the client shall specify the exact requirement. In the absence of information to the contrary, all work will be performed in accordance with the latest revision of ANSI/ASCE10 & ANSI/EIA-222
- All services performed, results obtained, and recommendations made are in accordance with generally accepted engineering principles and practices. Centek Engineering, Inc. is not responsible for the conclusions, opinions and recommendations made by others based on the information we supply.

GENERAL DESCRIPTION OF STRUCTURAL ANALYSIS PROGRAM

tnxTower, is an integrated structural analysis and design software package for Designed specifically for the telecommunications industry, tnxTower, formerly ERITower, automates much of the tower analysis and design required by the TIA/EIA 222 Standard.

tnxTower Features:

- tnxTower can analyze and design 3- and 4-sided guyed towers, 3- and 4-sided self-supporting towers and either round or tapered ground mounted poles with or without guys.
- The program analyzes towers using the TIA-222-G (2005) standard or any of the previous TIA/EIA standards back to RS-222 (1959). Steel design is checked using the AISC ASD 9th Edition or the AISC LRFD specifications.
- Linear and non-linear (P-delta) analyses can be used in determining displacements and forces in the structure. Wind pressures and forces are automatically calculated.
- Extensive graphics plots include material take-off, shear-moment, leg compression, displacement, twist, feed line, guy anchor and stress plots.
- tnxTower contains unique features such as True Cable behavior, hog rod take-up, foundation stiffness and much more.

Design Wind Load on Other Structures:

(Based on IBC 2012, CSBC 2016 and ASCE 7-10)

Wind Speed =	V := 125	mph	(User Input)	(CSBC Appendix-N)
Risk Category =	BC := III		(User Input)	(IBC Table 1604.5)
Exposure Category =	Exp := B		(User Input)	
Height Above Grade =	Z := 154	ft	(User Input)	
Structure Type =	Structuretype :=	Square_Chimney	(User Input)	
Structure Height =	Height := 8	ft	(User Input)	
Horizontal Dimension of Structure =	Width := 1	ft	(User Input)	

Terrain Exposure Constants:

Nominal Height of the Atmospheric Boundary Layer =

$$z_g := \begin{cases} 1200 & \text{if } \text{Exp} = \text{B} = 1.2 \times 10^3 \\ 900 & \text{if } \text{Exp} = \text{C} \\ 700 & \text{if } \text{Exp} = \text{D} \end{cases} \quad \text{(Table 26.9-1)}$$

3-Sec Gust Speed Power Law Exponent =

$$\alpha := \begin{cases} 7 & \text{if } \text{Exp} = \text{B} = 7 \\ 9.5 & \text{if } \text{Exp} = \text{C} \\ 11.5 & \text{if } \text{Exp} = \text{D} \end{cases} \quad \text{(Table 26.9-1)}$$

Integral Length Scale Factor =

$$l := \begin{cases} 320 & \text{if } \text{Exp} = \text{B} = 320 \\ 500 & \text{if } \text{Exp} = \text{C} \\ 650 & \text{if } \text{Exp} = \text{D} \end{cases} \quad \text{(Table 26.9-1)}$$

Integral Length Scale Power Law Exponent =

$$E := \begin{cases} \frac{1}{3} & \text{if } \text{Exp} = \text{B} = 0.333 \\ \frac{1}{5} & \text{if } \text{Exp} = \text{C} \\ \frac{1}{8} & \text{if } \text{Exp} = \text{D} \end{cases} \quad \text{(Table 26.9-1)}$$

Turbulence Intensity Factor =

$$c := \begin{cases} 0.3 & \text{if } \text{Exp} = \text{B} = 0.3 \\ 0.2 & \text{if } \text{Exp} = \text{C} \\ 0.15 & \text{if } \text{Exp} = \text{D} \end{cases} \quad \text{(Table 26.9-1)}$$

Exposure Constant =

$$Z_{\min} := \begin{cases} 30 & \text{if } \text{Exp} = \text{B} = 30 \\ 15 & \text{if } \text{Exp} = \text{C} \\ 7 & \text{if } \text{Exp} = \text{D} \end{cases} \quad \text{(Table 26.9-1)}$$

Exposure Coefficient =

$$K_z := \begin{cases} 2.01 \left(\frac{Z}{z_g} \right)^{\left(\frac{2}{\alpha} \right)} & \text{if } 15 \leq Z \leq z_g = 1.12 \\ 2.01 \left(\frac{15}{z_g} \right)^{\left(\frac{2}{\alpha} \right)} & \text{if } Z < 15 \end{cases} \quad \text{(Table 29.3-1)}$$

Topographic Factor =	$K_{zt} := 1$	(Eq. 26.8-2)
Wind Directionality Factor =	$K_d = 0.9$	(Table 26.6-1)
Velocity Pressure =	$q_z := 0.00256 \cdot K_z \cdot K_{zt} \cdot K_d \cdot V^2 = 40.25$	(Eq. 29.3-1)
Peak Factor for Background Response =	$g_Q := 3.4$	(Sec 26.9.4)
Peak Factor for Wind Response =	$g_V := 3.4$	(Sec 26.9.4)
Equivalent Height of Structure =	$z := \begin{cases} Z_{\min} & \text{if } Z_{\min} > 0.6 \cdot \text{Height} \\ 0.6 \cdot \text{Height} & \text{otherwise} \end{cases} = 30$	(Sec 26.9.4)
Intensity of Turbulence =	$I_z := c \cdot \left(\frac{33}{z}\right)^{\left(\frac{1}{6}\right)} = 0.305$	(Eq. 26.9-7)
Integral Length Scale of Turbulence =	$L_Z := l \cdot \left(\frac{z}{33}\right)^E = 309.993$	(Eq. 26.9-9)
Background Response Factor =	$Q := \sqrt{\frac{1}{1 + 0.63 \left(\frac{\text{Width} + \text{Height}}{L_Z}\right)^{0.63}}} = 0.968$	(Eq. 26.9-8)
Gust Response Factor =	$G := 0.925 \cdot \left[\frac{(1 + 1.7 \cdot g_Q \cdot I_z \cdot Q)}{1 + 1.7 \cdot g_V \cdot I_z}\right] = 0.906$	(Eq. 26.9-6)
Force Coefficient =	$C_f = 1.433$	(Fig 29.5-1 - 29.5-3)

Wind Force =

$F := q_z \cdot G \cdot C_f = 52$

psf

Development of Wind & Ice Load on Antennas

Antenna Model =	Ericsson AIR32	
Antenna Shape =	Flat	(User Input)
Antenna Height =	$L_{ant} := 56.6$	in (User Input)
Antenna Width =	$W_{ant} := 12.9$	in (User Input)
Antenna Thickness =	$T_{ant} := 8.7$	in (User Input)
Antenna Weight =	$WT_{ant} := 133$	lbs (User Input)
Number of Antennas =	$N_{ant} := 1$	(User Input)

Wind Load (Front)

Surface Area for One Antenna =	$SA_{ant} := \frac{L_{ant} \cdot W_{ant}}{144} = 5.1$	sf
Antenna Projected Surface Area =	$A_{ant} := SA_{ant} \cdot N_{ant} = 5.1$	sf
Total Antenna Wind Force =	$F_{ant} := F \cdot A_{ant} = 265$	lbs

Wind Load (Side)

Surface Area for One Antenna =	$SA_{ant} := \frac{L_{ant} \cdot T_{ant}}{144} = 3.4$	sf
Antenna Projected Surface Area =	$A_{ant} := SA_{ant} \cdot N_{ant} = 3.4$	sf
Total Antenna Wind Force =	$F_{ant} := F \cdot A_{ant} = 179$	lbs

Gravity Load (without ice)

Weight of All Antennas =	$WT_{ant} \cdot N_{ant} = 133$	lbs
---------------------------------	--	-----

Development of Wind & Ice Load on Antennas

Antenna Data:

Antenna Model =	Ericsson AIR3246-B66	
Antenna Shape =	Flat	(User Input)
Antenna Height =	$L_{ant} := 58.1$	in (User Input)
Antenna Width =	$W_{ant} := 15.7$	in (User Input)
Antenna Thickness =	$T_{ant} := 9.4$	in (User Input)
Antenna Weight =	$WT_{ant} := 180$	lbs (User Input)
Number of Antennas =	$N_{ant} := 1$	(User Input)

Wind Load (Front)

Surface Area for One Antenna =	$SA_{ant} := \frac{L_{ant} \cdot W_{ant}}{144} = 6.3$	sf
Antenna Projected Surface Area =	$A_{ant} := SA_{ant} \cdot N_{ant} = 6.3$	sf
Total Antenna Wind Force =	$F_{ant} := F \cdot A_{ant} = 331$	lbs

Wind Load (Side)

Surface Area for One Antenna =	$SA_{ant} := \frac{L_{ant} \cdot T_{ant}}{144} = 3.8$	sf
Antenna Projected Surface Area =	$A_{ant} := SA_{ant} \cdot N_{ant} = 3.8$	sf
Total Antenna Wind Force =	$F_{ant} := F \cdot A_{ant} = 198$	lbs

Gravity Load (without ice)

Weight of All Antennas =	$WT_{ant} \cdot N_{ant} = 180$	lbs
---------------------------------	--	------------

Development of Wind & Ice Load on Antennas

Antenna Data:

Antenna Model =	RFSAPXVAARR24-43	
Antenna Shape =	Flat	(User Input)
Antenna Height =	$L_{ant} := 95.9$	in (User Input)
Antenna Width =	$W_{ant} := 24$	in (User Input)
Antenna Thickness =	$T_{ant} := 8.7$	in (User Input)
Antenna Weight =	$WT_{ant} := 153$	lbs (User Input)
Number of Antennas =	$N_{ant} := 1$	(User Input)

Wind Load (Front)

SurfaceArea for One Antenna =	$SA_{ant} := \frac{L_{ant} \cdot W_{ant}}{144} = 16$	sf
Antenna Projected Surface Area =	$A_{ant} := SA_{ant} \cdot N_{ant} = 16$	sf
Total Antenna Wind Force =	$F_{ant} := F \cdot A_{ant} = 835$	lbs

Wind Load (Side)

SurfaceArea for One Antenna =	$SA_{ant} := \frac{L_{ant} \cdot T_{ant}}{144} = 5.8$	sf
Antenna Projected Surface Area =	$A_{ant} := SA_{ant} \cdot N_{ant} = 5.8$	sf
Total Antenna Wind Force =	$F_{ant} := F \cdot A_{ant} = 303$	lbs

Gravity Load (without ice)

Weight of All Antennas =	$WT_{ant} \cdot N_{ant} = 153$	lbs
---------------------------------	--	------------

Development of Wind & Ice Load on RRHs

RRUS Data:

RRUS Model =	Ericsson 4449 B71B12
RRUS Shape =	Flat (User Input)
RRUS Height =	$L_{RRH} := 14.9$ in (User Input)
RRUS Width =	$W_{RRH} := 13.2$ in (User Input)
RRUS Thickness =	$T_{RRH} := 10.4$ in (User Input)
RRUS Weight =	$W_{T_{RRH}} := 74$ lbs (User Input)
Number of RRUSs =	$N_{RRH} := 1$ (User Input)

Wind Load (Front)

Surface Area for One RRH =	$SA_{RRH} := \frac{L_{RRH} \cdot W_{RRH}}{144} = 1.4$	sf
RRH Projected Surface Area =	$A_{RRH} := SA_{RRH} \cdot N_{RRH} = 1.4$	sf
Total RRH Wind Force =	$F_{RRH} := F \cdot A_{RRH} = 71$	lbs

Wind Load (Side)

Surface Area for One RRH =	$SA_{RRH} := \frac{L_{RRH} \cdot T_{RRH}}{144} = 1.1$	sf
RRH Projected Surface Area =	$A_{RRH} := SA_{RRH} \cdot N_{RRH} = 1.1$	sf
Total RRH Wind Force =	$F_{RRH} := F \cdot A_{RRH} = 56$	lbs

Gravity Load (without ice)

Weight of All RRHs =	$W_{T_{RRH}} \cdot N_{RRH} = 74$	lbs
-----------------------------	--	------------

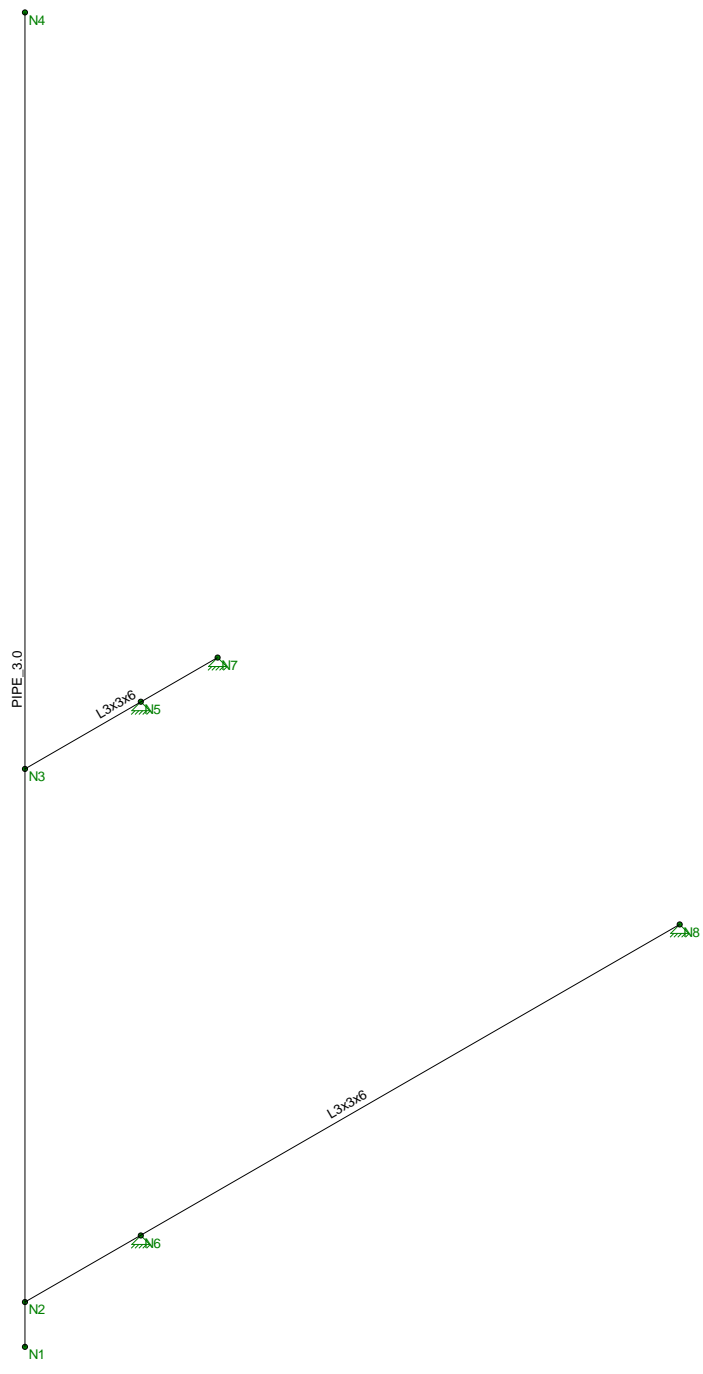

Envelope Only Solution

Centek Engineering	CT11108A - Antenna Mount Alpha Member Framing	
TJL		June 12, 2018 at 1:58 PM
18058.13		Alpha Antenna Mount.r3d

(Global) Model Settings

Display Sections for Member Calcs	5
Max Internal Sections for Member Calcs	97
Include Shear Deformation?	Yes
Increase Nailing Capacity for Wind?	Yes
Include Warping?	Yes
Trans Load Btwn Intersecting Wood Wall?	Yes
Area Load Mesh (in^2)	144
Merge Tolerance (in)	.12
P-Delta Analysis Tolerance	0.50%
Include P-Delta for Walls?	Yes
Automatically Iterate Stiffness for Walls?	Yes
Max Iterations for Wall Stiffness	3
Gravity Acceleration (ft/sec^2)	32.2
Wall Mesh Size (in)	12
Eigensolution Convergence Tol. (1.E-)	4
Vertical Axis	Y
Global Member Orientation Plane	XZ
Static Solver	Sparse Accelerated
Dynamic Solver	Accelerated Solver

Hot Rolled Steel Code	AISC 14th(360-10): ASD
Adjust Stiffness?	Yes(Iterative)
RISAConnection Code	AISC 14th(360-10): ASD
Cold Formed Steel Code	AISI S100-10: ASD
Wood Code	AWC NDS-12: ASD
Wood Temperature	< 100F
Concrete Code	ACI 318-11
Masonry Code	ACI 530-11: ASD
Aluminum Code	AA ADM1-10: ASD - Building AISC 14th(360-10): ASD

Number of Shear Regions	4
Region Spacing Increment (in)	4
Biaxial Column Method	Exact Integration
Parme Beta Factor (PCA)	.65
Concrete Stress Block	Rectangular
Use Cracked Sections?	Yes
Use Cracked Sections Slab?	Yes
Bad Framing Warnings?	No
Unused Force Warnings?	Yes
Min 1 Bar Diam. Spacing?	No
Concrete Rebar Set	REBAR_SET_ASTMA615
Min % Steel for Column	1
Max % Steel for Column	8

(Global) Model Settings, Continued

Seismic Code	ASCE 7-10
Seismic Base Elevation (ft)	Not Entered
Add Base Weight?	Yes
Ct X	.02
Ct Z	.02
T X (sec)	Not Entered
T Z (sec)	Not Entered
R X	3
R Z	3
Ct Exp. X	.75
Ct Exp. Z	.75
SD1	1
SDS	1
S1	1
TL (sec)	5
Risk Cat	I or II
Drift Cat	Other
Om Z	1
Om X	1
Cd Z	4
Cd X	4
Rho Z	1
Rho X	1
Footing Overturning Safety Factor	1
Optimize for OTM/Sliding	No
Check Concrete Bearing	No
Footing Concrete Weight (k/ft^3)	150.001
Footing Concrete f'c (ksi)	4
Footing Concrete Ec (ksi)	3644
Lambda	1
Footing Steel fy (ksi)	60
Minimum Steel	0.0018
Maximum Steel	0.0075
Footing Top Bar	#3
Footing Top Bar Cover (in)	2
Footing Bottom Bar	#3
Footing Bottom Bar Cover (in)	3.5
Pedestal Bar	#3
Pedestal Bar Cover (in)	1.5
Pedestal Ties	#3

Hot Rolled Steel Properties

	Label	E [ksi]	G [ksi]	Nu	Therm (\1...	Density[k/ft^3]	Yield[ksi]	Ry	Fu[ksi]	Rt
1	A36 Gr.36	29000	11154	.3	.65	.49	36	1.5	58	1.2
2	A572 Gr.50	29000	11154	.3	.65	.49	50	1.1	58	1.2
3	A992	29000	11154	.3	.65	.49	50	1.1	58	1.2
4	A500 Gr.42	29000	11154	.3	.65	.49	42	1.3	58	1.1
5	A500 Gr.46	29000	11154	.3	.65	.49	46	1.2	58	1.1
6	A53 Grade B	29000	11154	.3	.65	.49	35	1.5	58	1.2

Hot Rolled Steel Section Sets

	Label	Shape	Type	Design List	Material	Design ...	A [in ²]	I _{yy} [in ⁴]	I _{zz} [in ⁴]	J [in ⁴]
1	Antenna Mast	PIPE_3.0	Beam	Pipe	A53 Grade B	Typical	2.07	2.85	2.85	5.69
2	Horz	L3x3x6	Beam	Single Angle	A36 Gr.36	Typical	2.11	1.75	1.75	.101

Hot Rolled Steel Design Parameters

	Label	Shape	Length[ft]	L _{byy} [ft]	L _{bzz} [ft]	L _{comp top} [ft]	L _{comp bot} [ft]	L-torqu...	K _{yy}	K _{zz}	C _b	Function
1	M4	Antenna Mast	15			L _{byy}						Lateral
2	M2	Horz	8.5			L _{byy}						Lateral
3	M3	Horz	2.5			L _{byy}						Lateral

Member Primary Data

	Label	I Joint	J Joint	K Joint	Rotate(d...)	Section/Shape	Type	Design List	Material	Design Rul...
1	M4	N1	N4			Antenna Mast	Beam	Pipe	A53 Gra...	Typical
2	M2	N2	N8			Horz	Beam	Single Angle	A36 Gr.36	Typical
3	M3	N3	N7			Horz	Beam	Single Angle	A36 Gr.36	Typical

Joint Coordinates and Temperatures

	Label	X [ft]	Y [ft]	Z [ft]	Temp [F]	Detach From Dia...
1	N1	0	0	0	0	
2	N2	0	.5	0	0	
3	N3	0	6.5	0	0	
4	N4	0	15	0	0	
5	N5	0	6.5	-1.5	0	
6	N6	0	.5	-1.5	0	
7	N7	0	6.5	-2.5	0	
8	N8	0	.5	-8.5	0	

Joint Boundary Conditions

	Joint Label	X [k/in]	Y [k/in]	Z [k/in]	X Rot.[k-ft/rad]	Y Rot.[k-ft/rad]	Z Rot.[k-ft/rad]
1	N5	Reaction	Reaction	Reaction			
2	N7	Reaction	Reaction	Reaction			
3	N6	Reaction	Reaction	Reaction			
4	N8	Reaction	Reaction	Reaction			

Member Point Loads (BLC 2 : Weight of Equipment)

	Member Label	Direction	Magnitude[k,k-ft]	Location[ft,%]
1	M4	Y	-.077	14.5
2	M4	Y	-.077	7.5
3	M4	Y	-.074	9

Member Point Loads (BLC 3 : Wind X-Direction)

	Member Label	Direction	Magnitude[k,k-ft]	Location[ft,%]
1	M4	X	.152	14.5
2	M4	X	.152	7.5



Member Point Loads (BLC 3 : Wind X-Direction) (Continued)

	Member Label	Direction	Magnitude[k,k-ft]	Location[ft,%]
3	M4	X	.056	9

Member Point Loads (BLC 4 : Wind Z-Direction)

	Member Label	Direction	Magnitude[k,k-ft]	Location[ft,%]
1	M4	Z	.418	14.5
2	M4	Z	.418	7.5

Member Distributed Loads

Member Label	Direction	Start Magnitude[k/ft,F,ksf]	End Magnitude[k/ft,F,ksf]	Start Location[ft,%]	End Location[ft,%]
No Data to Print ...					

Basic Load Cases

	BLC Description	Category	X Gravity	Y Gravity	Z Gravity	Joint	Point	Distribut...	Area(Me...)	Surface(...)
1	Self Weight	DL		-1						
2	Weight of Equipment	DL					3			
3	Wind X-Direction	WLX					3			
4	Wind Z-Direction	WLZ					2			

Load Combinations

	Description	Sol..	PD..	SR..	BLC Fact..	BLC Fact..	BLC Fact..	BLC Fact..	BLC Fact..	BLC Fact..	BLC Fact..	BLC Fact..	BLC Fact..	BLC Fact..	BLC Fact..	BLC Fact..	BLC Fact..	BLC Fact..	BLC Fact..
1	IBC 16-8	Yes	Y		DL	1													
2	IBC 16-9	Yes	Y		DL	1	LL	1	LLS	1									
3	IBC 16-10	Yes	Y		DL	1	RLL	1											
4	IBC 16-10	Yes	Y		DL	1	SL	1	SLN	1									
5	IBC 16-10	Yes	Y		DL	1	RL	1											
6	IBC 16-11	Yes	Y		DL	1	LL	.75	LLS	.75	RLL	.75							
7	IBC 16-11	Yes	Y		DL	1	LL	.75	LLS	.75	SL	.75	SLN	.75					
8	IBC 16-11	Yes	Y		DL	1	LL	.75	LLS	.75	RL	.75							
9	IBC 16-12	Yes	Y		DL	1	W...	.6											
10	IBC 16-12	Yes	Y		DL	1	W...	.6											
11	IBC 16-12	Yes	Y		DL	1	W...	-.6											
12	IBC 16-12	Yes	Y		DL	1	W...	-.6											
13	IBC 16-13	Yes	Y		DL	1	W...	.45	LL	.75	LLS	.75	RLL	.75					
14	IBC 16-13	Yes	Y		DL	1	W...	.45	LL	.75	LLS	.75	RLL	.75					
15	IBC 16-13	Yes	Y		DL	1	W...	-.45	LL	.75	LLS	.75	RLL	.75					
16	IBC 16-13	Yes	Y		DL	1	W...	-.45	LL	.75	LLS	.75	RLL	.75					
17	IBC 16-13	Yes	Y		DL	1	W...	.45	LL	.75	LLS	.75	SL	.75	SLN	.75			
18	IBC 16-13	Yes	Y		DL	1	W...	.45	LL	.75	LLS	.75	SL	.75	SLN	.75			
19	IBC 16-13	Yes	Y		DL	1	W...	-.45	LL	.75	LLS	.75	SL	.75	SLN	.75			
20	IBC 16-13	Yes	Y		DL	1	W...	-.45	LL	.75	LLS	.75	SL	.75	SLN	.75			
21	IBC 16-13	Yes	Y		DL	1	W...	.45	LL	.75	LLS	.75	RL	.75					
22	IBC 16-13	Yes	Y		DL	1	W...	.45	LL	.75	LLS	.75	RL	.75					
23	IBC 16-13	Yes	Y		DL	1	W...	-.45	LL	.75	LLS	.75	RL	.75					
24	IBC 16-13	Yes	Y		DL	1	W...	-.45	LL	.75	LLS	.75	RL	.75					
25	IBC 16-15	Yes	Y		DL	.6	W...	.6											
26	IBC 16-15	Yes	Y		DL	.6	W...	.6											
27	IBC 16-15	Yes	Y		DL	.6	W...	-.6											



Load Combinations (Continued)

Description		Sol..	PD..	SR..	BLC Fact...	BLC Fact...	BLC Fact...	BLC Fact...	BLC Fact...	BLC Fact...	BLC Fact...	BLC Fact...	BLC Fact...	BLC Fact...	BLC Fact...
28	IBC 16-15...	Yes	Y		DL	.6	W...	-.6							

Envelope Joint Reactions

Joint	X [k]	LC	Y [k]	LC	Z [k]	LC	MX [k-ft]	LC	MY [k-ft]	LC	MZ [k-ft]	LC
1	N5	max	.788	11	.747	12	.809	28	0	1	0	1
2		min	-.79	9	-.151	26	-.884	10	0	1	0	1
3	N7	max	.42	9	.074	27	0	28	0	1	0	1
4		min	-.418	11	-.322	9	0	10	0	1	0	1
5	N6	max	.168	9	.73	10	.383	10	0	1	0	1
6		min	-.167	11	-.435	28	-.307	28	0	1	0	1
7	N8	max	.013	11	.03	12	0	10	0	1	0	1
8		min	-.014	9	-.008	26	0	28	0	1	0	1
9	Totals:	max	.216	11	.413	10	.502	12				
10		min	-.216	9	.248	28	-.502	10				

Envelope Joint Displacements

Joint	X [in]	LC	Y [in]	LC	Z [in]	LC	X Rotation [...]	LC	Y Rotation [...]	LC	Z Rotation [...]	LC
1	N1	max	.03	28	.024	28	0	25	4.928e-04	11	9.553e-04	28
2		min	-.04	10	-.04	10	-.003	11	-6.108e-05	25	-1.256e-03	10
3	N2	max	.028	28	.024	28	0	28	4.928e-04	11	9.553e-04	28
4		min	-.038	10	-.04	10	0	10	-6.108e-05	25	-1.256e-03	10
5	N3	max	.02	25	.025	28	0	10	4.726e-03	10	1.971e-03	28
6		min	-.029	11	-.04	10	0	28	-4.152e-03	28	-2.278e-03	10
7	N4	max	.971	9	.024	28	1.756	10	2.279e-02	10	1.971e-03	28
8		min	-.981	11	-.041	10	-1.688	28	-2.209e-02	12	-2.278e-03	10
9	N5	max	0	9	0	26	0	10	5.135e-04	10	5.21e-04	25
10		min	0	11	0	12	0	28	-3.397e-05	28	-7.914e-04	11
11	N6	max	0	11	0	28	0	28	2.527e-03	10	1.638e-03	28
12		min	0	9	0	10	0	10	-1.739e-03	28	-2.14e-03	10
13	N7	max	0	11	0	9	0	10	1.379e-05	25	3.352e-04	11
14		min	0	9	0	27	0	28	-2.17e-04	11	-2.008e-04	25
15	N8	max	0	9	0	26	0	28	1.058e-03	12	9.03e-04	26
16		min	0	11	0	12	0	10	-9.882e-04	26	-9.303e-04	12

Envelope AISC 14th(360-10): ASD Steel Code Checks

Member	Shape	Code Check	Loc...	LC	Shea..	Loc.....	L..Pnc/o...	Pnt/o...	Mnyy/...	Mnzz/.....	Eqn			
1	M4	PIPE_3.0	.602	6.5...	10	.053	.625	11	13.221	43.383	3.825	3.825	1..H1-1b	
2	M2	L3x3x6	.555	0	10	.047	1.4...	y	10	10.29	45.485	1.535	3.541	4..H2-1
3	M3	L3x3x6	.723	0	12	.051	1.4...	y	12	39.529	45.485	1.535	3.541	2..H2-1



Code Check (Env)	
Black	No Calc
Red	> 1.0
Purple	.90-1.0
Green	.75-.90
Cyan	.50-.75
Blue	0-.50

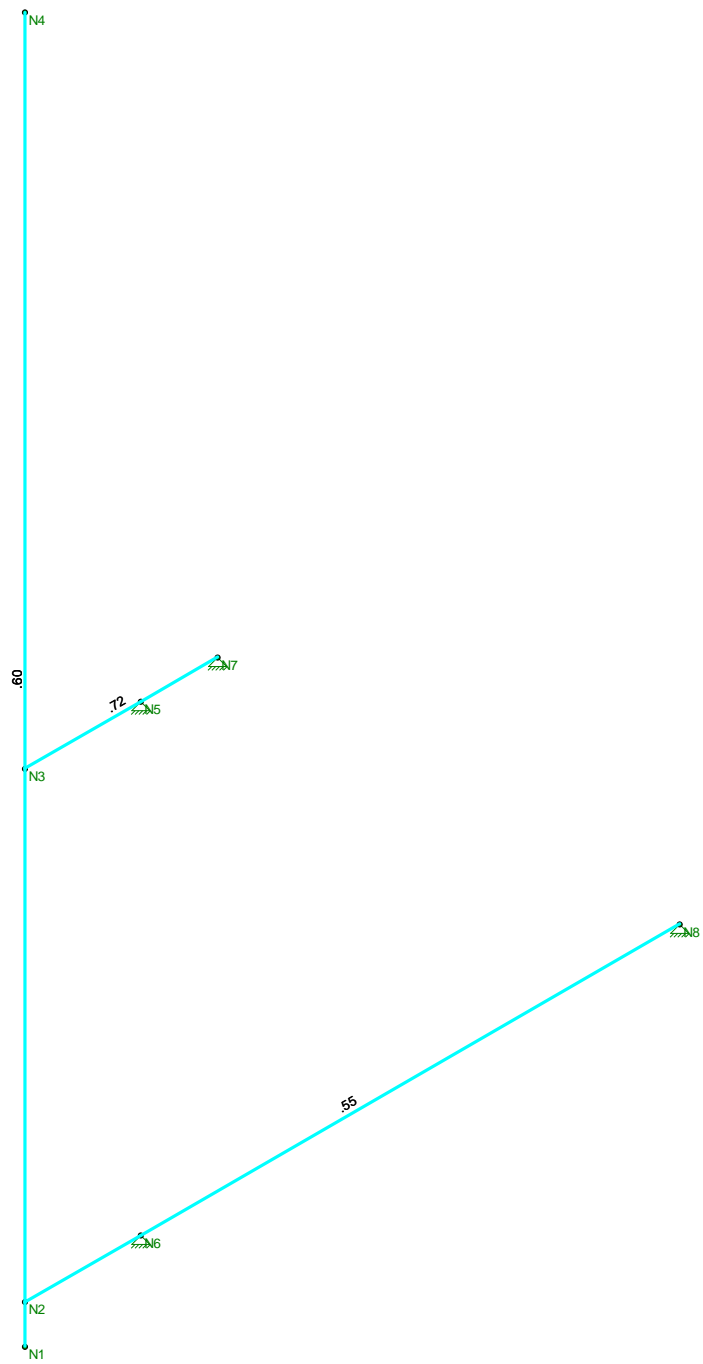

Member Code Checks Displayed (Enveloped)
Envelope Only Solution

Centek Engineering	CT11108A - Antenna Mount Alpha Unity Check	
TJL		June 12, 2018 at 1:58 PM
18058.13		Alpha Antenna Mount.r3d

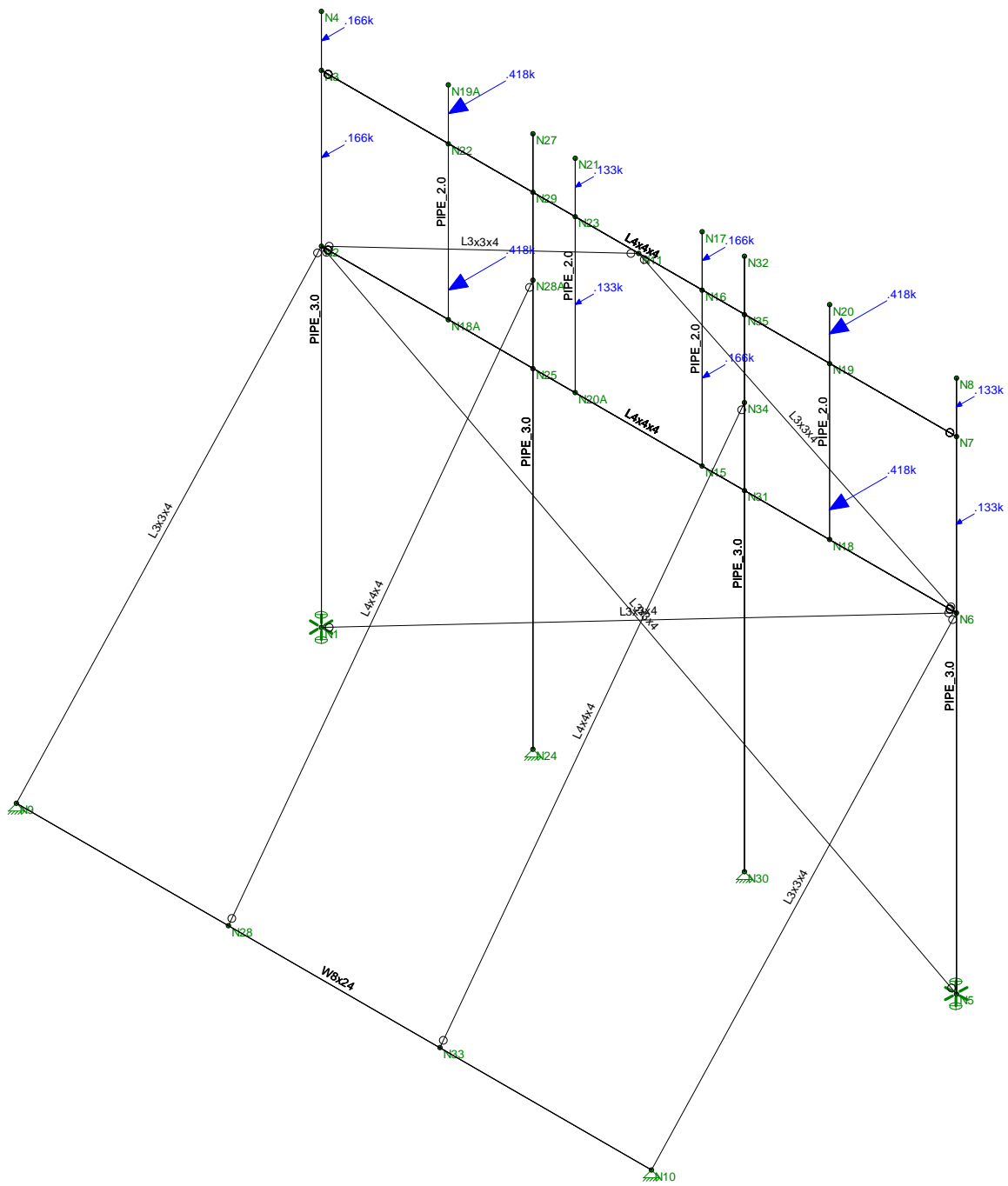

Loads: BLC 4, Wind Z-Direction
Envelope Only Solution

Centek Engineering

TJL

18058.13

CT11108A - Antenna Mount Beta/Delta
Member Framing

June 12, 2018 at 10:24 AM

Beta Antenna Mount - Reinforced.r3d

(Global) Model Settings

Display Sections for Member Calcs	5
Max Internal Sections for Member Calcs	97
Include Shear Deformation?	Yes
Increase Nailing Capacity for Wind?	Yes
Include Warping?	Yes
Trans Load Btwn Intersecting Wood Wall?	Yes
Area Load Mesh (in^2)	144
Merge Tolerance (in)	.12
P-Delta Analysis Tolerance	0.50%
Include P-Delta for Walls?	Yes
Automatically Iterate Stiffness for Walls?	Yes
Max Iterations for Wall Stiffness	3
Gravity Acceleration (ft/sec^2)	32.2
Wall Mesh Size (in)	12
Eigensolution Convergence Tol. (1.E-)	4
Vertical Axis	Y
Global Member Orientation Plane	XZ
Static Solver	Sparse Accelerated
Dynamic Solver	Accelerated Solver

Hot Rolled Steel Code	AISC 14th(360-10): ASD
Adjust Stiffness?	Yes(Iterative)
RISAConnection Code	AISC 14th(360-10): ASD
Cold Formed Steel Code	AISI S100-10: ASD
Wood Code	AWC NDS-12: ASD
Wood Temperature	< 100F
Concrete Code	ACI 318-11
Masonry Code	ACI 530-11: ASD
Aluminum Code	AA ADM1-10: ASD - Building AISC 14th(360-10): ASD

Number of Shear Regions	4
Region Spacing Increment (in)	4
Biaxial Column Method	Exact Integration
Parme Beta Factor (PCA)	.65
Concrete Stress Block	Rectangular
Use Cracked Sections?	Yes
Use Cracked Sections Slab?	Yes
Bad Framing Warnings?	No
Unused Force Warnings?	Yes
Min 1 Bar Diam. Spacing?	No
Concrete Rebar Set	REBAR_SET_ASTMA615
Min % Steel for Column	1
Max % Steel for Column	8

(Global) Model Settings, Continued

Seismic Code	ASCE 7-10
Seismic Base Elevation (ft)	Not Entered
Add Base Weight?	Yes
Ct X	.02
Ct Z	.02
T X (sec)	Not Entered
T Z (sec)	Not Entered
R X	3
R Z	3
Ct Exp. X	.75
Ct Exp. Z	.75
SD1	1
SDS	1
S1	1
TL (sec)	5
Risk Cat	I or II
Drift Cat	Other
Om Z	1
Om X	1
Cd Z	4
Cd X	4
Rho Z	1
Rho X	1
Footing Overturning Safety Factor	1
Optimize for OTM/Sliding	No
Check Concrete Bearing	No
Footing Concrete Weight (k/ft^3)	150.001
Footing Concrete f'c (ksi)	4
Footing Concrete Ec (ksi)	3644
Lambda	1
Footing Steel fy (ksi)	60
Minimum Steel	0.0018
Maximum Steel	0.0075
Footing Top Bar	#3
Footing Top Bar Cover (in)	2
Footing Bottom Bar	#3
Footing Bottom Bar Cover (in)	3.5
Pedestal Bar	#3
Pedestal Bar Cover (in)	1.5
Pedestal Ties	#3

Hot Rolled Steel Properties

	Label	E [ksi]	G [ksi]	Nu	Therm (\1...	Density[k/ft^3]	Yield[ksi]	Ry	Fu[ksi]	Rt
1	A36 Gr.36	29000	11154	.3	.65	.49	36	1.5	58	1.2
2	A572 Gr.50	29000	11154	.3	.65	.49	50	1.1	58	1.2
3	A992	29000	11154	.3	.65	.49	50	1.1	58	1.2
4	A500 Gr.42	29000	11154	.3	.65	.49	42	1.3	58	1.1
5	A500 Gr.46	29000	11154	.3	.65	.49	46	1.2	58	1.1
6	A53 Grade B	29000	11154	.3	.65	.49	35	1.5	58	1.2

Hot Rolled Steel Section Sets

	Label	Shape	Type	Design List	Material	Design ...	A [in2]	Iyy [in4]	Izz [in4]	J [in4]
1	Pipe Mast	PIPE_2.0	Beam	Pipe	A53 Grade B	Typical	1.02	.627	.627	1.25
2	Brace	L3x3x4	Beam	Tube	A36 Gr.36	Typical	1.44	1.23	1.23	.031
3	Post	PIPE_3.0	Beam	Tube	A53 Grade B	Typical	2.07	2.85	2.85	5.69
4	Horz	L4x4x4	Beam	Single Angle	A36 Gr.36	Typical	1.93	3	3	.044
5	Brace 2	L4x4x4	Beam	Single Angle	A36 Gr.36	Typical	1.93	3	3	.044
6	W8	W8x24	Beam	Single Angle	A992	Typical	7.08	18.3	82.7	.346

Hot Rolled Steel Design Parameters

	Label	Shape	Length[ft]	Lbyy[ft]	Lbzz[ft]	Lcomp top[ft]	Lcomp bot[ft]	L-torqu...	Kyy	Kzz	Cb	Function
1	M1	Horz	25	12	12	12	12	12				Lateral
2	M2	Horz	25			Lbyy						Lateral
3	M3	Post	21			Lbyy						Lateral
4	M4	Post	21			Lbyy						Lateral
5	M5	Brace	28.178	14	14	14	14	14				Lateral
6	M6	Brace	28.178	14	14	14	14	14				Lateral
7	M7	Brace	13.865			Lbyy						Lateral
8	M8	Brace	13.865			Lbyy						Lateral
9	M9	Brace	17.692			Lbyy						Lateral
10	M10	Brace	17.692			Lbyy						Lateral
11	M12	Pipe Mast	8			Lbyy						Lateral
12	M13	Pipe Mast	8			Lbyy						Lateral
13	M13A	Pipe Mast	8			Lbyy						Lateral
14	M14	Pipe Mast	8			Lbyy						Lateral
15	M15	Post	21			Lbyy						Lateral
16	M16	Brace 2	20			Lbyy						Lateral
17	M17	W8	25			Lbyy						Lateral
18	M18	Post	21			Lbyy						Lateral
19	M19	Brace 2	20			Lbyy						Lateral

Member Primary Data

	Label	I Joint	J Joint	K Joint	Rotate(d...	Section/Shape	Type	Design List	Material	Design Ru...
1	M1	N3	N7		90	Horz	Beam	Single Angle	A36 Gr.36	Typical
2	M2	N2	N6		90	Horz	Beam	Single Angle	A36 Gr.36	Typical
3	M3	N4	N1			Post	Beam	Tube	A53 Gra...	Typical
4	M4	N8	N5			Post	Beam	Tube	A53 Gra...	Typical
5	M5	N1	N6			Brace	Beam	Tube	A36 Gr.36	Typical
6	M6	N5	N2			Brace	Beam	Tube	A36 Gr.36	Typical
7	M7	N2	N11			Brace	Beam	Tube	A36 Gr.36	Typical
8	M8	N11	N6			Brace	Beam	Tube	A36 Gr.36	Typical
9	M9	N2	N9			Brace	Beam	Tube	A36 Gr.36	Typical
10	M10	N6	N10			Brace	Beam	Tube	A36 Gr.36	Typical
11	M12	N17	N15			Pipe Mast	Beam	Pipe	A53 Gra...	Typical
12	M13	N20	N18			Pipe Mast	Beam	Pipe	A53 Gra...	Typical
13	M13A	N19A	N18A			Pipe Mast	Beam	Pipe	A53 Gra...	Typical
14	M14	N21	N20A			Pipe Mast	Beam	Pipe	A53 Gra...	Typical
15	M15	N27	N24			Post	Beam	Tube	A53 Gra...	Typical
16	M16	N28A	N28			Brace 2	Beam	Single Angle	A36 Gr.36	Typical
17	M17	N9	N10			W8	Beam	Single Angle	A992	Typical

Member Primary Data (Continued)

	Label	I Joint	J Joint	K Joint	Rotate(d...	Section/Shape	Type	Design List	Material	Design Rul...
18	M18	N32	N30			Post	Beam	Tube	A53 Gra...	Typical
19	M19	N34	N33			Brace 2	Beam	Single Angle	A36 Gr.36	Typical

Joint Coordinates and Temperatures

	Label	X [ft]	Y [ft]	Z [ft]	Temp [F]	Detach From Dia...
1	N1	0	0	0	0	
2	N2	0	13	0	0	
3	N3	0	19	0	0	
4	N4	0	21	0	0	
5	N5	25	0	0	0	
6	N6	25	13	0	0	
7	N7	25	19	0	0	
8	N8	25	21	0	0	
9	N9	0	0	12	0	
10	N10	25	0	12	0	
11	N11	12.5	19	0	0	
12	N15	15	13	0	0	
13	N16	15	19	0	0	
14	N17	15	21	0	0	
15	N18	20	13	0	0	
16	N19	20	19	0	0	
17	N20	20	21	0	0	
18	N18A	5	13	0	0	
19	N19A	5	21	0	0	
20	N20A	10	13	0	0	
21	N21	10	21	0	0	
22	N22	5	19	0	0	
23	N23	10	19	0	0	
24	N24	8.333	0	0	0	
25	N25	8.333	13	0	0	
26	N27	8.333	21	0	0	
27	N28	8.333	0	12	0	
28	N28A	8.333	16	0	0	
29	N29	8.333	19	0	0	
30	N30	16.666	0	0	0	
31	N31	16.666	13	0	0	
32	N32	16.666	21	0	0	
33	N33	16.666	0	12	0	
34	N34	16.666	16	0	0	
35	N35	16.666	19	0	0	

Joint Boundary Conditions

	Joint Label	X [k/in]	Y [k/in]	Z [k/in]	X Rot.[k-ft/rad]	Y Rot.[k-ft/rad]	Z Rot.[k-ft/rad]
1	N1	Reaction	Reaction	Reaction		Reaction	
2	N9	Reaction	Reaction	Reaction			
3	N10	Reaction	Reaction	Reaction			
4	N5	Reaction	Reaction	Reaction		Reaction	
5	N24	Reaction	Reaction	Reaction			
6	N28						

Joint Boundary Conditions (Continued)

	Joint Label	X [k/in]	Y [k/in]	Z [k/in]	X Rot.[k-ft/rad]	Y Rot.[k-ft/rad]	Z Rot.[k-ft/rad]
7	N30	Reaction	Reaction	Reaction			
8	N33						

Member Point Loads (BLC 2 : Weight of Equipment)

	Member Label	Direction	Magnitude[k,k-ft]	Location[ft,%]
1	M4	Y	-.067	0
2	M4	Y	-.067	5
3	M12	Y	-.09	1
4	M12	Y	-.09	5
5	M13	Y	-.077	1
6	M13	Y	-.077	7
7	M13	Y	-.074	%50
8	M13A	Y	-.077	1
9	M13A	Y	-.077	7
10	M13A	Y	-.074	%50
11	M14	Y	-.067	1
12	M14	Y	-.067	5
13	M3	Y	-.09	1
14	M3	Y	-.09	5

Member Point Loads (BLC 3 : Wind X-Direction)

	Member Label	Direction	Magnitude[k,k-ft]	Location[ft,%]
1	M4	X	.09	1
2	M4	X	.09	5
3	M12	X	.099	1
4	M12	X	.099	5
5	M13	X	.152	1
6	M13	X	.152	7
7	M13	X	.056	%50
8	M13A	X	.152	1
9	M13A	X	.152	7
10	M13A	X	.056	%50
11	M14	X	.09	1
12	M14	X	.09	5
13	M3	X	.099	1
14	M3	X	.099	5

Member Point Loads (BLC 4 : Wind Z-Direction)

	Member Label	Direction	Magnitude[k,k-ft]	Location[ft,%]
1	M4	Z	.133	1
2	M4	Z	.133	5
3	M12	Z	.166	1
4	M12	Z	.166	5
5	M13	Z	.418	1
6	M13	Z	.418	7
7	M13A	Z	.418	1
8	M13A	Z	.418	7
9	M14	Z	.133	1
10	M14	Z	.133	5

Member Point Loads (BLC 4 : Wind Z-Direction) (Continued)

	Member Label	Direction	Magnitude[k,k-ft]	Location[ft,%]
11	M3	Z	.166	1
12	M3	Z	.166	5

Member Distributed Loads

Member Label	Direction	Start Magnitude[k/ft,F,ksf]	End Magnitude[k/ft,F,ksf]	Start Location[ft,%]	End Location[ft,%]
No Data to Print ...					

Basic Load Cases

	BLC Description	Category	X Gravity	Y Gravity	Z Gravity	Joint	Point	Distrib...	Area(Me...)	Surface(...)
1	Self Weight	DL		-1						
2	Weight of Equipment	DL					14			
3	Wind X-Direction	WLX					14			
4	Wind Z-Direction	WLZ					12			

Load Combinations

	Description	Sol..	PD..	SR..	BLC Fact...	BLC Fact...	BLC Fact...	BLC Fact...	BLC Fact...	BLC Fact...	BLC Fact...	BLC Fact...	BLC Fact...	BLC Fact...	BLC Fact...	BLC Fact...	BLC Fact...	BLC Fact...	BLC Fact...	BLC Fact...	
1	IBC 16-8	Yes	Y		DL	1															
2	IBC 16-9	Yes	Y		DL	1	LL	1	LLS	1											
3	IBC 16-10...	Yes	Y		DL	1	RLL	1													
4	IBC 16-10...	Yes	Y		DL	1	SL	1	SLN	1											
5	IBC 16-10...	Yes	Y		DL	1	RL	1													
6	IBC 16-11...	Yes	Y		DL	1	LL	.75	LLS	.75	RLL	.75									
7	IBC 16-11...	Yes	Y		DL	1	LL	.75	LLS	.75	SL	.75	SLN	.75							
8	IBC 16-11...	Yes	Y		DL	1	LL	.75	LLS	.75	RL	.75									
9	IBC 16-12...	Yes	Y		DL	1	W...	.6													
10	IBC 16-12...	Yes	Y		DL	1	W...	.6													
11	IBC 16-12...	Yes	Y		DL	1	W...	-.6													
12	IBC 16-12...	Yes	Y		DL	1	W...	-.6													
13	IBC 16-13...	Yes	Y		DL	1	W...	.45	LL	.75	LLS	.75	RLL	.75							
14	IBC 16-13...	Yes	Y		DL	1	W...	.45	LL	.75	LLS	.75	RLL	.75							
15	IBC 16-13...	Yes	Y		DL	1	W...	-.45	LL	.75	LLS	.75	RLL	.75							
16	IBC 16-13...	Yes	Y		DL	1	W...	-.45	LL	.75	LLS	.75	RLL	.75							
17	IBC 16-13...	Yes	Y		DL	1	W...	.45	LL	.75	LLS	.75	SL	.75	SLN	.75					
18	IBC 16-13...	Yes	Y		DL	1	W...	.45	LL	.75	LLS	.75	SL	.75	SLN	.75					
19	IBC 16-13...	Yes	Y		DL	1	W...	-.45	LL	.75	LLS	.75	SL	.75	SLN	.75					
20	IBC 16-13...	Yes	Y		DL	1	W...	-.45	LL	.75	LLS	.75	SL	.75	SLN	.75					
21	IBC 16-13...	Yes	Y		DL	1	W...	.45	LL	.75	LLS	.75	RL	.75							
22	IBC 16-13...	Yes	Y		DL	1	W...	.45	LL	.75	LLS	.75	RL	.75							
23	IBC 16-13...	Yes	Y		DL	1	W...	-.45	LL	.75	LLS	.75	RL	.75							
24	IBC 16-13...	Yes	Y		DL	1	W...	-.45	LL	.75	LLS	.75	RL	.75							
25	IBC 16-15...	Yes	Y		DL	.6	W...	.6													
26	IBC 16-15...	Yes	Y		DL	.6	W...	.6													
27	IBC 16-15...	Yes	Y		DL	.6	W...	-.6													
28	IBC 16-15...	Yes	Y		DL	.6	W...	-.6													

Envelope Joint Reactions

	Joint		X [k]	LC	Y [k]	LC	Z [k]	LC	MX [k-ft]	LC	MY [k-ft]	LC	MZ [k-ft]	LC
1	N1	max	.478	11	1.373	12	.134	10	0	1	.001	28	0	1
2		min	-.421	25	-.303	26	-.129	12	0	1	-.001	10	0	1
3	N9	max	.011	26	1.693	10	1.081	12	0	1	0	1	0	1
4		min	-.016	12	-1.045	28	-1.066	10	0	1	0	1	0	1
5	N10	max	.01	28	1.654	10	1.031	12	0	1	0	1	0	1
6		min	-.018	10	-.991	28	-1.033	10	0	1	0	1	0	1
7	N5	max	.427	27	1.284	12	.125	10	0	1	.001	10	0	1
8		min	-.47	9	-.3	26	-.12	12	0	1	-.001	28	0	1
9	N24	max	.001	28	1.323	12	.06	10	0	1	0	1	0	1
10		min	-.004	10	-.158	26	-.071	12	0	1	0	1	0	1
11	N30	max	.004	10	1.307	12	.06	10	0	1	0	1	0	1
12		min	-.001	28	-.104	26	-.071	12	0	1	0	1	0	1
13	Totals:	max	.886	27	3.566	12	1.721	12						
14		min	-.886	9	2.139	26	-1.721	26						

Envelope Joint Displacements

	Joint		X [in]	LC	Y [in]	LC	Z [in]	LC	X Rotation [...]	LC	Y Rotation [...]	LC	Z Rotation [...]	LC
1	N1	max	0	25	0	26	0	12	7.8e-03	12	0	10	2.185e-05	9
2		min	0	11	0	12	0	10	-8.156e-03	10	0	28	-1.146e-05	27
3	N2	max	.006	25	.001	26	.009	26	1.653e-02	10	1.439e-05	10	1.518e-04	27
4		min	-.007	11	-.004	12	-.012	12	-1.588e-02	12	-7.25e-06	28	-1.558e-04	9
5	N3	max	.009	25	.001	26	1.728	10	2.761e-02	10	1.439e-05	10	3.372e-05	27
6		min	-.01	11	-.004	12	-1.662	12	-2.649e-02	12	-7.25e-06	28	-4.314e-05	9
7	N4	max	.012	25	0	26	2.393	10	2.773e-02	10	1.439e-05	10	9.842e-05	27
8		min	-.012	11	-.004	12	-2.3	12	-2.661e-02	12	-7.25e-06	28	-1.079e-04	9
9	N5	max	0	9	0	26	0	12	7.24e-03	12	0	28	7.138e-06	25
10		min	0	27	0	12	0	10	-7.555e-03	10	0	10	-1.562e-05	11
11	N6	max	.007	9	.001	26	.009	26	1.532e-02	10	8.787e-06	28	1.469e-04	11
12		min	-.006	27	-.004	12	-.011	12	-1.474e-02	12	-1.636e-05	10	-1.407e-04	25
13	N7	max	.009	25	.001	26	1.604	10	2.564e-02	10	8.787e-06	28	4.494e-05	11
14		min	-.01	11	-.004	12	-1.546	12	-2.465e-02	12	-1.636e-05	10	-3.318e-05	25
15	N8	max	.011	25	.001	26	2.221	10	2.574e-02	10	8.787e-06	28	1.038e-04	11
16		min	-.012	11	-.004	12	-2.14	12	-2.475e-02	12	-1.636e-05	10	-9.201e-05	25
17	N9	max	0	12	0	28	0	10	2.865e-03	28	1.161e-02	12	2.467e-03	28
18		min	0	26	0	10	0	12	-9.755e-03	10	-1.076e-02	26	-4.747e-03	10
19	N10	max	0	10	0	28	0	10	3.344e-03	26	1.065e-02	26	4.707e-03	10
20		min	0	28	0	10	0	12	-9.075e-03	12	-1.171e-02	12	-2.477e-03	28
21	N11	max	.009	25	0	26	2.279	10	1.812e-02	10	5.472e-05	10	2.208e-05	25
22		min	-.009	11	-.007	12	-2.051	28	-1.754e-02	12	-2.609e-05	28	-5.79e-05	11
23	N15	max	.007	25	.001	26	.939	10	1.905e-02	10	2.524e-03	10	2.101e-04	11
24		min	-.007	11	-.007	12	-.772	28	-1.846e-02	12	-1.792e-03	28	3.554e-05	25
25	N16	max	.009	25	0	26	2.248	10	1.828e-02	10	2.035e-03	10	1.329e-04	10
26		min	-.009	11	-.007	12	-2.03	28	-1.77e-02	12	-1.374e-03	28	2.584e-05	28
27	N17	max	.014	25	0	26	2.697	10	1.88e-02	10	2.035e-03	10	4.169e-04	11
28		min	-.018	11	-.007	12	-2.462	28	-1.822e-02	12	-1.374e-03	28	-2.59e-04	25
29	N18	max	.007	9	.007	28	.667	10	2.077e-02	10	7.575e-03	10	1.438e-04	28
30		min	-.006	27	-.055	10	-.539	28	-2.01e-02	12	-6.482e-03	28	-8.156e-04	10
31	N19	max	.009	25	.007	28	2.088	10	2.252e-02	10	4.781e-03	10	1.067e-04	28
32		min	-.009	11	-.055	10	-1.905	28	-2.185e-02	12	-3.809e-03	28	-7.549e-04	10

Envelope Joint Displacements (Continued)

	Joint		X [in]	LC	Y [in]	LC	Z [in]	LC	X Rotation [...]	LC	Y Rotation [...]	LC	Z Rotation [...]	LC
33	N20	max	.031	9	.007	28	2.655	10	2.379e-02	10	4.781e-03	10	3.278e-04	27
34		min	-.016	27	-.055	10	-2.452	28	-2.312e-02	12	-3.809e-03	28	-9.769e-04	9
35	N18A	max	.006	25	.007	28	.669	10	2.14e-02	10	6.399e-03	28	8.308e-04	10
36		min	-.007	11	-.055	10	-.537	28	-2.07e-02	12	-7.531e-03	10	-1.531e-04	28
37	N19A	max	.015	25	.007	28	2.718	10	2.445e-02	10	2.81e-03	28	9.796e-04	11
38		min	-.031	11	-.056	10	-2.508	28	-2.374e-02	12	-3.744e-03	10	-3.264e-04	25
39	N20A	max	.006	25	.002	26	.938	10	1.892e-02	10	1.874e-03	28	-3.414e-05	27
40		min	-.007	11	-.007	12	-.768	28	-1.833e-02	12	-2.504e-03	10	-1.876e-04	9
41	N21	max	.017	9	.002	26	2.704	10	1.883e-02	10	1.142e-03	28	2.384e-04	27
42		min	-.014	27	-.007	12	-2.467	28	-1.825e-02	12	-1.699e-03	10	-3.729e-04	9
43	N22	max	.009	25	.007	28	2.136	10	2.317e-02	10	2.81e-03	28	7.473e-04	10
44		min	-.01	11	-.056	10	-1.947	28	-2.247e-02	12	-3.744e-03	10	-9.528e-05	28
45	N23	max	.009	25	.002	26	2.254	10	1.841e-02	10	1.142e-03	28	-2.251e-05	28
46		min	-.009	11	-.007	12	-2.034	28	-1.784e-02	12	-1.699e-03	10	-1.129e-04	10
47	N24	max	0	10	0	26	0	12	1.967e-03	10	2.973e-03	28	9.174e-05	28
48		min	0	28	0	12	0	10	-8.779e-04	28	-3.674e-03	10	-2.41e-04	10
49	N25	max	.006	25	0	26	.874	10	1.289e-02	10	2.973e-03	28	4.841e-04	10
50		min	-.007	11	-.004	12	-.719	28	-1.208e-02	28	-3.674e-03	10	-1.781e-04	28
51	N27	max	.007	25	0	26	2.757	10	2.265e-02	10	1.37e-03	28	3.985e-04	10
52		min	-.015	11	-.005	12	-2.535	28	-2.22e-02	12	-1.983e-03	10	-6.889e-05	28
53	N28	max	0	10	.213	28	.906	26	-6.333e-04	28	5.943e-03	12	1.275e-03	28
54		min	0	11	-.4	10	-.982	12	-5.84e-03	10	-5.445e-03	26	-2.363e-03	10
55	N28A	max	.008	25	0	26	1.441	10	1.901e-02	10	2.173e-03	28	5.543e-05	28
56		min	-.008	11	-.005	12	-1.258	28	-1.843e-02	12	-2.829e-03	10	-2.095e-04	10
57	N29	max	.009	25	0	26	2.214	10	2.265e-02	10	1.37e-03	28	3.985e-04	10
58		min	-.009	11	-.005	12	-2.007	28	-2.22e-02	12	-1.983e-03	10	-6.889e-05	28
59	N30	max	0	28	0	26	0	12	2.031e-03	10	3.777e-03	10	2.198e-04	10
60		min	0	10	0	12	0	10	-9.662e-04	28	-3.008e-03	28	-8.488e-05	28
61	N31	max	.007	9	0	26	.874	10	1.277e-02	10	3.777e-03	10	1.677e-04	28
62		min	-.007	27	-.004	12	-.724	28	-1.2e-02	28	-3.008e-03	28	-4.39e-04	10
63	N32	max	.014	9	0	26	2.736	10	2.238e-02	10	2.542e-03	10	8.803e-05	28
64		min	-.007	27	-.005	12	-2.517	28	-2.188e-02	12	-1.838e-03	28	-3.8e-04	10
65	N33	max	0	9	.212	28	.903	26	-4.299e-04	26	5.483e-03	26	2.376e-03	10
66		min	0	12	-.399	10	-.983	12	-5.657e-03	12	-5.916e-03	12	-1.273e-03	28
67	N34	max	.008	25	0	26	1.435	10	1.879e-02	10	3.159e-03	10	1.957e-04	10
68		min	-.008	11	-.005	12	-1.258	28	-1.821e-02	12	-2.424e-03	28	-5.537e-05	28
69	N35	max	.009	25	0	26	2.199	10	2.238e-02	10	2.542e-03	10	8.802e-05	28
70		min	-.009	11	-.005	12	-1.997	28	-2.188e-02	12	-1.838e-03	28	-3.8e-04	10

Envelope AISC 14th(360-10): ASD Steel Code Checks

Member	Shape	Code Check	Loc...	LC	Shea..	Loc.....	L..Pnc/o...	Pnt/o...	Mnyy/...	Mnzz/.....	Eqn			
1	M1	L4x4x4	.374	19....	10	.052	8.3...	z 12	8.577	41.605	2.088	2.962	1	H2-1
2	M2	L4x4x4	.469	16....	10	.069	16....	z 10	1.976	41.605	2.088	2.325	1..	H2-1
3	M3	PIPE_3.0	.521	8.0...	12	.025	5.0...	10	6.746	43.383	3.825	3.825	1..	H1-1b
4	M4	PIPE_3.0	.483	8.0...	12	.023	5.0...	10	6.746	43.383	3.825	3.825	1..	H1-1b
5	M5	L3x3x4	.679	13....	11	.017	0	y 10	2.624	31.042	1.123	1.513	1	H2-1
6	M6	L3x3x4	.676	13....	9	.018	0	y 10	2.624	31.042	1.123	1.513	1	H2-1
7	M7	L3x3x4	.290	6.7...	11	.005	0	y 12	2.676	31.042	1.123	1.625	1..	H2-1
8	M8	L3x3x4	.288	7.0...	9	.006	13....	y 12	2.676	31.042	1.123	1.625	1..	H2-1
9	M9	L3x3x4	.708	17....	26	.009	0	y 12	1.643	31.042	1.123	2.066	2..	H2-1



Company : Centek Engineering
 Designer : TJL
 Job Number : 18058.13
 Model Name : CT11108A - Antenna Mount Beta/Delta

June 12, 2018
 10:23 AM
 Checked By: CAG

Envelope AISC 14th(360-10): ASD Steel Code Checks (Continued)

Member	Shape	Code Check	Loc...	LC	Shea..	Loc.....	L..Pnc/o...	Pnt/o...	Mnyy/...	Mnzz/.....	Eqn			
10	M10	L3x3x4	.861	17....	10	.009	17....	y 12	1.643	31.042	1.123	1.47	1..	H2-1
11	M12	PIPE_2.0	.094	2	10	.023	2	10	9.924	21.377	1.245	1.245	1..	H1-1b
12	M13	PIPE_2.0	.219	2	10	.080	2	26	9.924	21.377	1.245	1.245	1..	H1-1b
13	M13A	PIPE_2.0	.219	2	10	.094	2	10	9.924	21.377	1.245	1.245	1..	H1-1b
14	M14	PIPE_2.0	.077	2	10	.024	2	10	9.924	21.377	1.245	1.245	1..	H1-1b
15	M15	PIPE_3.0	.384	5.0...	12	.066	2.1...	10	6.746	43.383	3.825	3.825	2..	H1-1b
16	M16	L4x4x4	.389	10....	10	.005	20	y 12	3.088	41.605	2.088	2.347	1..	H2-1
17	M17	W8x24	.438	11....	10	.032	19....	y 10	30.563	211.976	21.382	29.699	1..	H1-1b
18	M18	PIPE_3.0	.375	5.0...	12	.056	2.1...	10	6.746	43.383	3.825	3.825	2..	H1-1b
19	M19	L4x4x4	.386	10....	10	.005	20	y 12	3.088	41.605	2.088	2.347	1..	H2-1

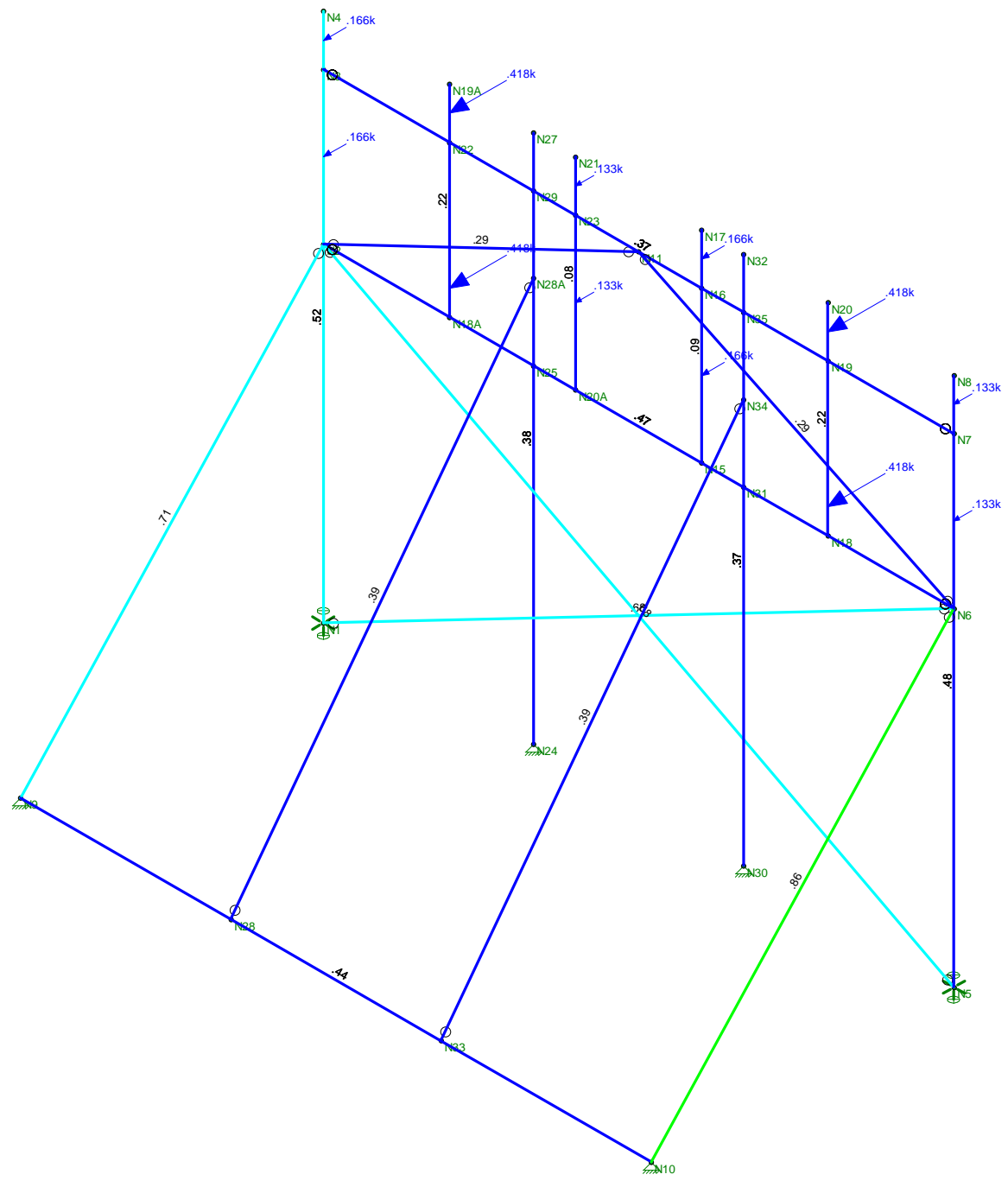
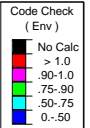

Member Code Checks Displayed (Enveloped)
 Loads: BLC 4, Wind Z-Direction
 Envelope Only Solution

Centek Engineering	CT11108A - Antenna Mount Beta/Delta Unity Check	
TJL		June 12, 2018 at 10:23 AM
18058.13		Beta Antenna Mount - Reinforced.r3d

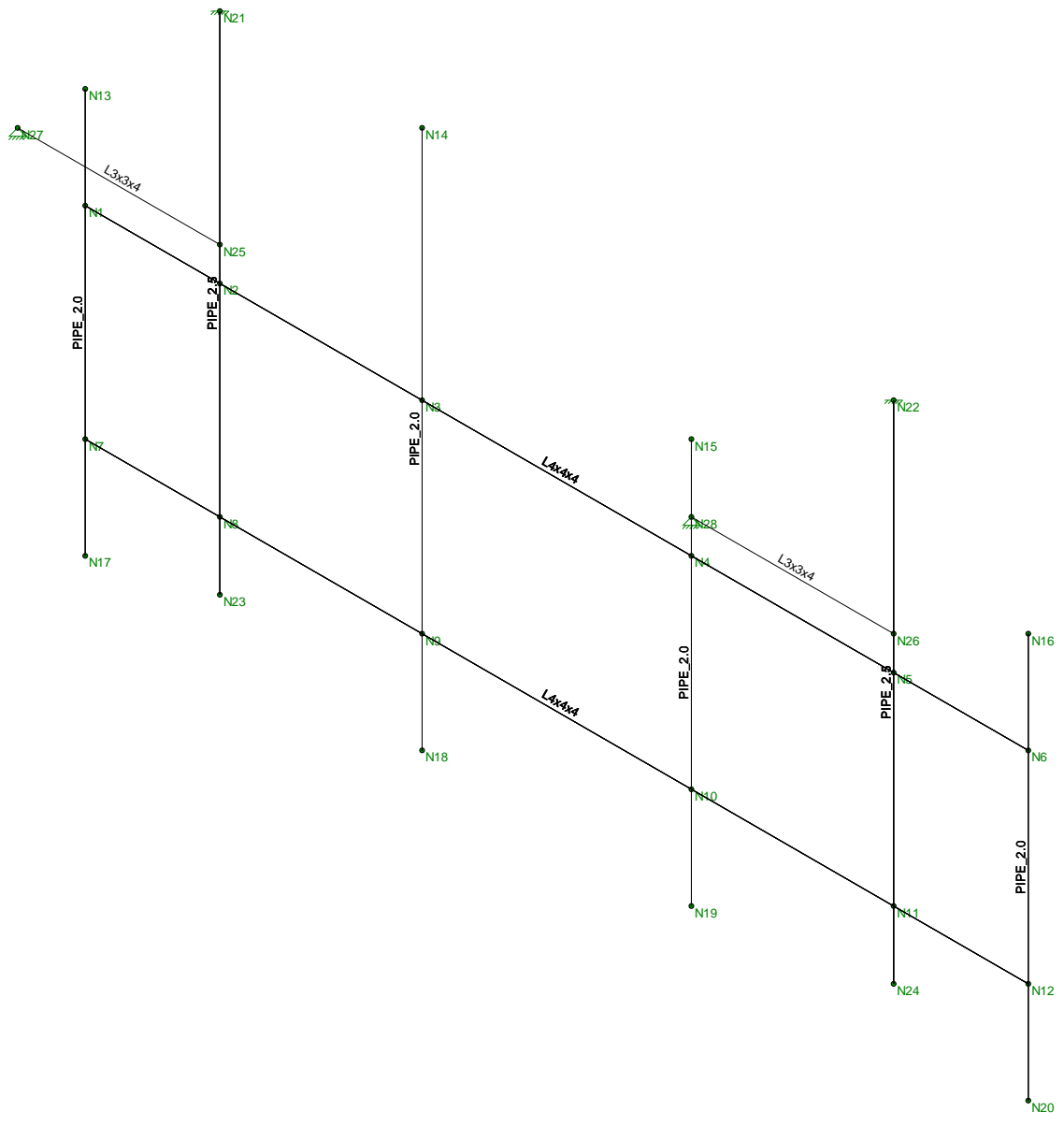

Loads: BLC 1, Self Weight
Envelope Only Solution

Centek Engineering	CT11108A - Antenna Mount Gamma Member Framing	
TJL		June 12, 2018 at 1:56 PM
18058.13		Gamma Antenna Mount.r3d

(Global) Model Settings

Display Sections for Member Calcs	5
Max Internal Sections for Member Calcs	97
Include Shear Deformation?	Yes
Increase Nailing Capacity for Wind?	Yes
Include Warping?	Yes
Trans Load Btwn Intersecting Wood Wall?	Yes
Area Load Mesh (in^2)	144
Merge Tolerance (in)	.12
P-Delta Analysis Tolerance	0.50%
Include P-Delta for Walls?	Yes
Automatically Iterate Stiffness for Walls?	Yes
Max Iterations for Wall Stiffness	3
Gravity Acceleration (ft/sec^2)	32.2
Wall Mesh Size (in)	12
Eigensolution Convergence Tol. (1.E-)	4
Vertical Axis	Y
Global Member Orientation Plane	XZ
Static Solver	Sparse Accelerated
Dynamic Solver	Accelerated Solver

Hot Rolled Steel Code	AISC 14th(360-10): ASD
Adjust Stiffness?	Yes(Iterative)
RISAConnection Code	AISC 14th(360-10): ASD
Cold Formed Steel Code	AISI S100-10: ASD
Wood Code	AWC NDS-12: ASD
Wood Temperature	< 100F
Concrete Code	ACI 318-11
Masonry Code	ACI 530-11: ASD
Aluminum Code	AA ADM1-10: ASD - Building AISC 14th(360-10): ASD

Number of Shear Regions	4
Region Spacing Increment (in)	4
Biaxial Column Method	Exact Integration
Parme Beta Factor (PCA)	.65
Concrete Stress Block	Rectangular
Use Cracked Sections?	Yes
Use Cracked Sections Slab?	Yes
Bad Framing Warnings?	No
Unused Force Warnings?	Yes
Min 1 Bar Diam. Spacing?	No
Concrete Rebar Set	REBAR_SET_ASTMA615
Min % Steel for Column	1
Max % Steel for Column	8

(Global) Model Settings, Continued

Seismic Code	ASCE 7-10
Seismic Base Elevation (ft)	Not Entered
Add Base Weight?	Yes
Ct X	.02
Ct Z	.02
T X (sec)	Not Entered
T Z (sec)	Not Entered
R X	3
R Z	3
Ct Exp. X	.75
Ct Exp. Z	.75
SD1	1
SDS	1
S1	1
TL (sec)	5
Risk Cat	I or II
Drift Cat	Other
Om Z	1
Om X	1
Cd Z	4
Cd X	4
Rho Z	1
Rho X	1
Footing Overturning Safety Factor	1
Optimize for OTM/Sliding	No
Check Concrete Bearing	No
Footing Concrete Weight (k/ft^3)	150.001
Footing Concrete f'c (ksi)	4
Footing Concrete Ec (ksi)	3644
Lambda	1
Footing Steel fy (ksi)	60
Minimum Steel	0.0018
Maximum Steel	0.0075
Footing Top Bar	#3
Footing Top Bar Cover (in)	2
Footing Bottom Bar	#3
Footing Bottom Bar Cover (in)	3.5
Pedestal Bar	#3
Pedestal Bar Cover (in)	1.5
Pedestal Ties	#3

Hot Rolled Steel Properties

	Label	E [ksi]	G [ksi]	Nu	Therm (\1...	Density[k/ft^3]	Yield[ksi]	Ry	Fu[ksi]	Rt
1	A36 Gr.36	29000	11154	.3	.65	.49	36	1.5	58	1.2
2	A572 Gr.50	29000	11154	.3	.65	.49	50	1.1	58	1.2
3	A992	29000	11154	.3	.65	.49	50	1.1	58	1.2
4	A500 Gr.42	29000	11154	.3	.65	.49	42	1.3	58	1.1
5	A500 Gr.46	29000	11154	.3	.65	.49	46	1.2	58	1.1
6	A53 Grade B	29000	11154	.3	.65	.49	35	1.5	58	1.2

Hot Rolled Steel Design Parameters

	Label	Shape	Length[ft]	Lbyy[ft]	Lbzz[ft]	Lcomp top[ft]	Lcomp bot[ft]	L-torqu...	Kyy	Kzz	Cb	Function
1	M1	Horz	14			Lbyy						Lateral
2	M2	Horz	14			Lbyy						Lateral
3	M3	Antenna Mast	6			Lbyy						Lateral
4	M4	Antenna Mast	8			Lbyy						Lateral
5	M5	Antenna Mast	6			Lbyy						Lateral
6	M6	Antenna Mast	6			Lbyy						Lateral
7	M7	Support Pip...	7.5			Lbyy						Lateral
8	M8	Support Pip...	7.5			Lbyy						Lateral
9	M9	Brace	4.243			Lbyy						Lateral
10	M10	Brace	4.243			Lbyy						Lateral

Hot Rolled Steel Section Sets

	Label	Shape	Type	Design List	Material	Design ...	A [in2]	Iyy [in4]	Izz [in4]	J [in4]
1	Support Pipe M...	PIPE 2.5	Beam	Pipe	A53 Grade B	Typical	1.61	1.45	1.45	2.89
2	Antenna Mast	PIPE 2.0	Beam	Pipe	A53 Grade B	Typical	1.02	.627	.627	1.25
3	Horz	L4x4x4	Beam	Single Angle	A36 Gr.36	Typical	1.93	3	3	.044
4	Brace	L3x3x4	Beam	Single Angle	A36 Gr.36	Typical	1.44	1.23	1.23	.031

Member Primary Data

	Label	I Joint	J Joint	K Joint	Rotate(d...	Section/Shape	Type	Design List	Material	Design Rul...
1	M1	N1	N6		90	Horz	Beam	Single Angle	A36 Gr.36	Typical
2	M2	N7	N12		90	Horz	Beam	Single Angle	A36 Gr.36	Typical
3	M3	N13	N17			Antenna Mast	Beam	Pipe	A53 Gra...	Typical
4	M4	N14	N18			Antenna Mast	Beam	Pipe	A53 Gra...	Typical
5	M5	N15	N19			Antenna Mast	Beam	Pipe	A53 Gra...	Typical
6	M6	N16	N20			Antenna Mast	Beam	Pipe	A53 Gra...	Typical
7	M7	N23	N21			Support Pipe Mast	Beam	Pipe	A53 Gra...	Typical
8	M8	N24	N22			Support Pipe Mast	Beam	Pipe	A53 Gra...	Typical
9	M9	N27	N25			Brace	Beam	Single Angle	A36 Gr.36	Typical
10	M10	N28	N26			Brace	Beam	Single Angle	A36 Gr.36	Typical

Joint Coordinates and Temperatures

	Label	X [ft]	Y [ft]	Z [ft]	Temp [F]	Detach From Dia...
1	N1	0	0	0	0	
2	N2	2	0	0	0	
3	N3	5	0	0	0	
4	N4	9	0	0	0	
5	N5	12	0	0	0	
6	N6	14	0	0	0	
7	N7	0	-3	0	0	
8	N8	2	-3	0	0	
9	N9	5	-3	0	0	
10	N10	9	-3	0	0	
11	N11	12	-3	0	0	
12	N12	14	-3	0	0	
13	N13	0	1.5	0	0	

Joint Coordinates and Temperatures (Continued)

	Label	X [ft]	Y [ft]	Z [ft]	Temp [F]	Detach From Dia...
14	N14	5	3.5	0	0	
15	N15	9	1.5	0	0	
16	N16	14	1.5	0	0	
17	N17	0	-4.5	0	0	
18	N18	5	-4.5	0	0	
19	N19	9	-4.5	0	0	
20	N20	14	-4.5	0	0	
21	N21	2	3.5	0	0	
22	N22	12	3.5	0	0	
23	N23	2	-4	0	0	
24	N24	12	-4	0	0	
25	N25	2	.5	0	0	
26	N26	12	.5	0	0	
27	N27	2	3.5	3	0	
28	N28	12	3.5	3	0	

Joint Boundary Conditions

	Joint Label	X [k/in]	Y [k/in]	Z [k/in]	X Rot.[k-ft/rad]	Y Rot.[k-ft/rad]	Z Rot.[k-ft/rad]
1	N21	Reaction	Reaction	Reaction	Reaction	Reaction	Reaction
2	N22	Reaction	Reaction	Reaction	Reaction	Reaction	Reaction
3	N25						
4	N26						
5	N27	Reaction	Reaction	Reaction			
6	N28	Reaction	Reaction	Reaction			
7	N2						
8	N5						

Member Point Loads (BLC 2 : Weight of Equipment)

	Member Label	Direction	Magnitude[k,k-ft]	Location[ft,%]
1	M5	Y	-.067	1
2	M5	Y	-.067	5
3	M3	Y	-.09	1
4	M3	Y	-.09	5
5	M4	Y	-.077	1
6	M4	Y	-.077	7
7	M4	Y	-.074	%50

Member Point Loads (BLC 3 : Wind X-Direction)

	Member Label	Direction	Magnitude[k,k-ft]	Location[ft,%]
1	M5	X	.09	1
2	M5	X	.09	5
3	M3	X	.099	1
4	M3	X	.099	5
5	M4	X	.152	1
6	M4	X	.152	7
7	M4	X	.056	%50

Member Point Loads (BLC 4 : Wind Z-Direction)

	Member Label	Direction	Magnitude[k,k-ft]	Location[ft,%]
1	M5	Z	.133	1
2	M5	Z	.133	5
3	M3	Z	.166	1
4	M3	Z	.166	5
5	M4	Z	.418	1
6	M4	Z	.418	7

Joint Loads and Enforced Displacements

Joint Label	L,D,M	Direction	Magnitude[(k,k-ft), (in,rad), (k*s^2/f...
No Data to Print ...			

Member Distributed Loads (BLC 4 : Wind Z-Direction)

	Member Label	Direction	Start Magnitude[k/ft,F,ksf]	End Magnitude[k/...	Start Location[ft,%]	End Location[ft,%]
1	M1	Z	.017	.017	0	0
2	M2	Z	.017	.017	0	0
3	M7	Z	.017	.017	0	0
4	M8	Z	.017	.017	0	0

Basic Load Cases

BLC Description	Category	X Gravity	Y Gravity	Z Gravity	Joint	Point	Distribut...	Area(Me...	Surface(...
1	Self Weight	DL		-1					
2	Weight of Equipment	DL				7			
3	Wind X-Direction	WLX				7			
4	Wind Z-Direction	WLZ				6	4		

Load Combinations

Description	Sol...	PD...	SR...	BLC Fact...	BLC Fact...	BLC Fact...	BLC Fact...	BLC Fact...	BLC Fact...	BLC Fact...	BLC Fact...	BLC Fact...	BLC Fact...	BLC Fact...	
1	IBC 16-8	Yes	Y	DL	1										
2	IBC 16-9	Yes	Y	DL	1	LL	1	LLS	1						
3	IBC 16-10...	Yes	Y	DL	1	RLL	1								
4	IBC 16-10...	Yes	Y	DL	1	SL	1	SLN	1						
5	IBC 16-10...	Yes	Y	DL	1	RL	1								
6	IBC 16-11...	Yes	Y	DL	1	LL	.75	LLS	.75	RLL	.75				
7	IBC 16-11...	Yes	Y	DL	1	LL	.75	LLS	.75	SL	.75	SLN	.75		
8	IBC 16-11...	Yes	Y	DL	1	LL	.75	LLS	.75	RL	.75				
9	IBC 16-12...	Yes	Y	DL	1	W...	.6								
10	IBC 16-12...	Yes	Y	DL	1	W...	.6								
11	IBC 16-12...	Yes	Y	DL	1	W...	-.6								
12	IBC 16-12...	Yes	Y	DL	1	W...	-.6								
13	IBC 16-13...	Yes	Y	DL	1	W...	.45	LL	.75	LLS	.75	RLL	.75		
14	IBC 16-13...	Yes	Y	DL	1	W...	.45	LL	.75	LLS	.75	RLL	.75		
15	IBC 16-13...	Yes	Y	DL	1	W...	-.45	LL	.75	LLS	.75	RLL	.75		
16	IBC 16-13...	Yes	Y	DL	1	W...	-.45	LL	.75	LLS	.75	RLL	.75		
17	IBC 16-13...	Yes	Y	DL	1	W...	.45	LL	.75	LLS	.75	SL	.75	SLN	.75
18	IBC 16-13...	Yes	Y	DL	1	W...	.45	LL	.75	LLS	.75	SL	.75	SLN	.75
19	IBC 16-13...	Yes	Y	DL	1	W...	-.45	LL	.75	LLS	.75	SL	.75	SLN	.75

Load Combinations (Continued)

	Description	Sol...	PD...	SR...	BLC Fact...	BLC Fact...	BLC Fact...	BLC Fact...	BLC Fact...	BLC Fact...	BLC Fact...	BLC Fact...	BLC Fact...	BLC Fact...	BLC Fact...	BLC Fact...	BLC Fact...	BLC Fact...	BLC Fact...	BLC Fact...	
20	IBC 16-13...	Yes	Y		DL	1	W...	-.45	LL	.75	LLS	.75	SL	.75	SLN	.75					
21	IBC 16-13...	Yes	Y		DL	1	W...	.45	LL	.75	LLS	.75	RL	.75							
22	IBC 16-13...	Yes	Y		DL	1	W...	.45	LL	.75	LLS	.75	RL	.75							
23	IBC 16-13...	Yes	Y		DL	1	W...	-.45	LL	.75	LLS	.75	RL	.75							
24	IBC 16-13...	Yes	Y		DL	1	W...	-.45	LL	.75	LLS	.75	RL	.75							
25	IBC 16-15...	Yes	Y		DL	.6	W...	.6													
26	IBC 16-15...	Yes	Y		DL	.6	W...	.6													
27	IBC 16-15...	Yes	Y		DL	.6	W...	-.6													
28	IBC 16-15...	Yes	Y		DL	.6	W...	-.6													

Envelope Member Section Forces

	Member	Sec		Axial[k]	LC	y Shear[k]	LC	z Shear[k]	LC	Torque[k-...	LC	y-y Mome...	LC	z-z Mome...	LC
1	M1	1	max	.044	25	.101	10	.128	11	.006	28	-.009	27	.013	28
2			min	-.089	11	-.102	12	.027	25	-.006	26	-.039	9	-.061	10
3		2	max	.163	11	.404	12	-.025	26	.006	12	.113	9	.157	9
4			min	-.149	25	-.402	26	-.226	12	-.006	10	-.064	27	-.106	27
5		3	max	.204	10	.051	10	.029	27	.004	10	.148	28	.433	26
6			min	-.06	28	-.049	28	-.033	9	-.004	12	-.236	10	-.526	12
7		4	max	.271	9	.167	10	.185	11	.002	28	.067	11	.132	10
8			min	-.197	27	-.165	12	-.02	25	-.002	26	-.049	25	-.125	28
9		5	max	.015	10	0	28	.038	27	.003	26	.013	11	.024	10
10			min	-.005	28	0	26	-.043	9	-.003	28	-.002	25	-.013	28
11	M2	1	max	.087	9	.098	26	.135	9	0	26	.013	28	.004	25
12			min	-.041	27	-.097	28	.031	27	0	28	-.062	10	-.051	11
13		2	max	.035	28	.118	28	-.029	28	0	10	.059	9	.118	10
14			min	-.082	10	-.119	26	-.209	10	0	12	-.016	27	-.078	28
15		3	max	.051	28	.002	26	.08	27	.004	28	.105	28	.259	26
16			min	-.227	10	-.002	28	-.083	9	-.004	26	-.189	10	-.346	12
17		4	max	.021	28	.117	26	.124	11	0	10	.04	11	.151	10
18			min	-.128	10	-.116	28	.027	25	0	12	-.033	25	-.15	12
19		5	max	.005	28	0	26	.029	25	.002	28	.02	10	.007	10
20			min	-.015	10	0	28	-.057	11	-.002	26	-.011	28	.003	28
21	M3	1	max	0	1	0	9	0	10	0	1	0	1	0	1
22			min	0	1	0	27	0	12	0	1	0	1	0	1
23		2	max	.095	1	.059	11	.099	28	.027	10	.055	28	.03	25
24			min	.057	26	-.059	25	-.099	26	-.026	28	-.055	26	-.06	10
25		3	max	.034	9	-.005	28	.002	10	.027	10	.052	28	.008	25
26			min	-.029	27	-.04	10	-.002	12	-.026	28	-.052	26	-.008	27
27		4	max	-.057	26	.059	25	.099	26	.027	10	.05	28	.061	10
28			min	-.095	9	-.059	27	-.099	28	-.026	28	-.05	26	-.03	27
29		5	max	0	1	0	11	0	12	0	1	0	1	0	1
30			min	0	1	0	9	0	10	0	1	0	1	0	1
31	M4	1	max	0	1	0	11	0	12	0	1	0	1	0	1
32			min	0	1	0	9	0	10	0	1	0	1	0	1
33		2	max	.084	14	.091	11	.251	12	0	1	.252	12	.092	9
34			min	.05	26	-.091	9	-.251	10	0	1	-.252	10	-.091	11
35		3	max	.115	10	.192	9	.166	10	.049	26	.535	12	.206	9
36			min	-.061	28	-.063	27	-.166	12	-.049	28	-.535	10	-.076	27
37		4	max	.122	10	.192	9	.166	10	.049	26	.203	28	.051	27
38			min	-.057	28	-.063	27	-.166	12	-.049	28	-.203	26	-.179	9

Envelope Member Section Forces (Continued)

Member	Sec		Axial[k]	LC	y Shear[k]	LC	z Shear[k]	LC	Torque[k-...	LC	y-y Mome...	LC	z-z Mome...	LC	
39		5	max	0	1	0	10	0	12	0	1	0	1	0	1
40			min	0	1	0	28	0	10	0	1	0	1	0	1
41	M5	1	max	0	1	0	10	0	10	0	1	0	1	0	1
42			min	0	1	0	28	0	12	0	1	0	1	0	1
43		2	max	.072	1	.062	25	.08	28	.007	26	.046	28	.095	25
44			min	-.057	27	-.131	11	0	27	-.007	28	-.046	26	-.199	11
45		3	max	.048	25	.062	25	0	10	.007	26	.045	28	.002	25
46			min	-.056	11	-.131	11	0	12	-.007	28	-.045	26	-.003	11
47		4	max	.052	25	.062	25	0	10	.007	26	.044	28	.193	11
48			min	-.072	9	-.131	11	-.08	28	-.007	28	-.044	26	-.092	25
49		5	max	0	1	0	28	0	12	0	1	0	1	0	1
50			min	0	1	0	10	0	10	0	1	0	1	0	1
51	M6	1	max	0	1	0	9	0	10	0	1	0	1	0	1
52			min	0	1	0	11	0	12	0	1	0	1	0	1
53		2	max	.041	11	.005	28	0	26	.01	26	.003	28	.009	28
54			min	-.039	25	-.015	10	0	12	-.01	28	-.003	26	-.024	10
55		3	max	.046	11	.005	28	0	26	.01	26	.003	28	.003	25
56			min	-.036	25	-.015	10	0	12	-.01	28	-.003	26	-.004	11
57		4	max	.052	11	.005	28	0	26	.01	26	.002	28	.019	10
58			min	-.033	25	-.015	10	0	12	-.01	28	-.002	26	-.006	28
59		5	max	0	1	0	11	0	12	0	1	0	1	0	1
60			min	0	1	0	9	0	10	0	1	0	1	0	1
61	M7	1	max	0	1	0	9	0	12	0	1	0	1	0	1
62			min	0	1	0	11	0	10	0	1	0	1	0	1
63		2	max	-.081	28	.03	28	.268	26	.071	26	.236	26	.029	28
64			min	-.376	10	-.122	10	-.269	28	-.072	12	-.237	28	-.092	10
65		3	max	-.087	28	.03	28	.288	26	.071	26	.757	26	.137	10
66			min	-.386	10	-.122	10	-.288	28	-.072	12	-.759	28	-.027	28
67		4	max	1.024	28	.203	27	.396	28	.084	28	.366	26	.047	28
68			min	-1.964	10	-.234	9	-.39	26	-.086	10	-.368	28	-.053	10
69		5	max	1.018	28	.203	27	.377	28	.084	28	.357	12	.47	9
70			min	-1.975	10	-.234	9	-.371	26	-.086	10	-.348	26	-.42	27
71	M8	1	max	0	1	0	9	0	12	0	1	0	1	0	1
72			min	0	1	0	27	0	10	0	1	0	1	0	1
73		2	max	-.017	25	.114	10	.171	26	.037	10	.148	26	.083	10
74			min	-.214	11	-.016	28	-.17	28	-.033	28	-.148	28	-.014	28
75		3	max	-.023	25	.114	10	.19	26	.037	10	.486	26	.017	28
76			min	-.224	11	-.016	28	-.189	28	-.033	28	-.485	28	-.13	10
77		4	max	.571	28	.235	11	.286	12	.173	10	.258	26	.059	9
78			min	-1.059	10	-.203	25	-.281	26	-.156	28	-.26	12	-.021	27
79		5	max	.565	28	.235	11	.267	12	.173	10	.259	12	.431	25
80			min	-1.069	10	-.203	25	-.262	26	-.156	28	-.252	26	-.451	11
81	M9	1	max	1.85	26	.108	12	.072	26	0	1	0	1	0	1
82			min	-1.869	12	-.098	26	-.073	12	0	1	0	1	0	1
83		2	max	1.852	26	.104	12	.072	26	0	1	.025	12	.128	26
84			min	-1.866	12	-.1	26	-.073	12	0	1	-.021	26	-.134	12
85		3	max	1.854	26	.101	28	.072	26	0	1	.047	12	.258	26
86			min	-1.863	28	-.102	10	-.073	12	0	1	-.043	26	-.265	12
87		4	max	1.856	26	.099	28	.072	26	0	1	.067	28	.389	26
88			min	-1.861	28	-.106	10	-.073	12	0	1	-.067	26	-.394	12
89		5	max	1.859	26	.097	28	.072	26	0	1	.086	28	.522	26
90			min	-1.859	28	-.11	10	-.073	12	0	1	-.094	10	-.522	28

Envelope Member Section Forces (Continued)

Member	Sec		Axial[k]	LC	y Shear[k]	LC	z Shear[k]	LC	Torque[k-...	LC	y-y Mome...	LC	z-z Mome...	LC	
91	M10	1	max	1.013	26	.041	12	.009	12	0	1	0	1	0	1
92			min	-1.026	12	-.033	26	-.009	26	0	1	0	1	0	1
93		2	max	1.015	26	.038	12	.009	12	0	1	.037	12	.019	26
94			min	-1.022	12	-.035	26	-.009	26	0	1	-.032	26	-.023	12
95		3	max	1.018	26	.035	28	.009	12	0	1	.071	12	.039	26
96			min	-1.019	28	-.038	10	-.009	26	0	1	-.066	26	-.042	12
97		4	max	1.02	26	.033	28	.009	12	0	1	.102	12	.061	26
98			min	-1.017	28	-.041	10	-.009	26	0	1	-.101	26	-.06	28
99		5	max	1.023	10	.031	28	.009	12	0	1	.133	28	.087	10
100			min	-1.015	28	-.045	10	-.009	26	0	1	-.139	10	-.077	28

Envelope Member Section Stresses

Member	Sec		Axial[ksi]	LC	y Shear[...]	LC	z Shear[...]	LC	y-Top[ksi]	LC	y-Bot[ksi]	LC	z-Top[ksi]	LC	z-Bot[ksi]	LC	
1	M1	1	max	.023	25	.121	10	.154	11	.419	10	.089	28	-.125	27	.603	9
2			min	-.046	11	-.122	12	.033	25	-.089	28	-.419	10	-.549	9	.138	27
3		2	max	.084	11	.485	12	-.031	26	.724	27	1.071	9	1.589	9	.993	27
4			min	-.077	25	-.482	26	-.271	12	-1.071	9	-.724	27	-.903	27	-1.746	9
5		3	max	.105	10	.061	10	.035	27	3.59	12	2.956	26	2.088	28	3.651	10
6			min	-.031	28	-.059	28	-.039	9	-2.956	26	-3.59	12	-3.321	10	-2.295	28
7		4	max	.14	9	.201	10	.221	11	.851	28	.904	10	.941	11	.754	25
8			min	-.102	27	-.199	12	-.024	25	-.904	10	-.851	28	-.686	25	-1.035	11
9		5	max	.008	10	0	28	.045	27	.09	28	.162	10	.176	11	.024	25
10			min	-.003	28	0	26	-.052	9	-.162	10	-.09	28	-.022	25	-.194	11
11	M2	1	max	.045	9	.118	26	.162	9	.352	11	.024	25	.188	28	.959	10
12			min	-.021	27	-.117	28	.037	27	-.024	25	-.352	11	-.872	10	-.207	28
13		2	max	.018	28	.142	28	-.035	28	.536	28	.803	10	.832	9	.253	27
14			min	-.042	10	-.143	26	-.251	10	-.803	10	-.536	28	-.23	27	-.915	9
15		3	max	.026	28	.003	26	.096	27	2.362	12	1.768	26	1.477	28	2.923	10
16			min	-.117	10	-.002	28	-.099	9	-1.768	26	-2.362	12	-2.659	10	-1.624	28
17		4	max	.011	28	.14	26	.148	11	1.024	12	1.03	10	.568	11	.506	25
18			min	-.066	10	-.14	28	.032	25	-1.03	10	-1.024	12	-.46	25	-.624	11
19		5	max	.003	28	0	26	.035	25	-.019	28	.049	10	.286	10	.172	28
20			min	-.008	10	0	28	-.068	11	-.049	10	.019	28	-.157	28	-.315	10
21	M3	1	max	0	1	0	9	.001	10	0	1	0	1	0	1	0	1
22			min	0	1	0	27	-.001	12	0	1	0	1	0	1	0	1
23		2	max	.093	1	.116	11	.195	28	1.369	10	.675	25	1.252	28	1.251	26
24			min	.056	26	-.116	25	-.195	26	-.675	25	-1.369	10	-1.251	26	-1.252	28
25		3	max	.034	9	-.01	28	.003	10	.182	27	.183	25	1.192	28	1.191	26
26			min	-.029	27	-.079	10	-.003	12	-.183	25	-.182	27	-1.191	26	-1.192	28
27		4	max	-.056	26	.116	25	.194	26	.675	27	1.382	10	1.132	28	1.132	26
28			min	-.093	9	-.116	27	-.194	28	-1.382	10	-.675	27	-1.132	26	-1.132	28
29		5	max	0	1	0	11	.002	12	0	1	0	1	0	1	0	1
30			min	0	1	0	9	-.002	10	0	1	0	1	0	1	0	1
31	M4	1	max	0	1	0	11	0	12	0	1	0	1	0	1	0	1
32			min	0	1	0	9	0	10	0	1	0	1	0	1	0	1
33		2	max	.082	14	.179	11	.493	12	2.084	11	2.087	9	5.731	12	5.731	10
34			min	.049	26	-.179	9	-.493	10	-2.087	9	-2.084	11	-5.731	10	-5.731	12
35		3	max	.112	10	.377	9	.326	10	1.726	27	4.684	9	12.193	12	12.192	10
36			min	-.06	28	-.124	27	-.326	12	-4.684	9	-1.726	27	-12.192	10	-12.193	12
37		4	max	.119	10	.377	9	.326	10	4.073	9	1.165	27	4.624	28	4.624	26



Envelope Member Section Stresses (Continued)

Member	Sec		Axial[ksi]	LC	y Shear[...]	LC	z Shear[...]	LC	y-Top[ksi]	LC	y-Bot[ksi]	LC	z-Top[ksi]	LC	z-Bot[ksi]	LC	
38		min	-.056	28	-.124	27	-.326	12	-1.165	27	-4.073	9	-4.624	26	-4.624	28	
39	5	max	0	1	0	10	.001	12	0	1	0	1	0	1	0	1	
40		min	0	1	0	28	-.001	10	0	1	0	1	0	1	0	1	
41	M5	1	max	0	1	0	10	0	10	0	1	0	1	0	1	0	1
42		min	0	1	0	28	0	12	0	1	0	1	0	1	0	1	
43		2	max	.071	1	.122	25	.156	28	4.542	11	2.175	25	1.048	28	1.048	26
44		min	-.056	27	-.257	11	0	27	-2.175	25	-4.542	11	-1.048	26	-1.048	28	
45		3	max	.047	25	.122	25	.002	10	.07	11	.043	25	1.021	28	1.021	26
46		min	-.055	11	-.257	11	-.002	12	-.043	25	-.07	11	-1.021	26	-1.021	28	
47		4	max	.051	25	.122	25	.002	10	2.089	25	4.402	11	.994	28	.994	26
48		min	-.071	9	-.257	11	-.156	28	-4.402	11	-2.089	25	-.994	26	-.994	28	
49		5	max	0	1	0	28	0	12	0	1	0	1	0	1	0	1
50		min	0	1	0	10	0	10	0	1	0	1	0	1	0	1	
51	M6	1	max	0	1	0	9	0	10	0	1	0	1	0	1	0	1
52		min	0	1	0	11	0	12	0	1	0	1	0	1	0	1	
53		2	max	.04	11	.01	28	0	26	.55	10	.2	28	.075	28	.075	26
54		min	-.038	25	-.028	10	0	12	-.2	28	-.55	10	-.075	26	-.075	28	
55		3	max	.046	11	.01	28	0	26	.101	11	.079	25	.062	28	.063	26
56		min	-.035	25	-.028	10	0	12	-.079	25	-.101	11	-.063	26	-.062	28	
57		4	max	.051	11	.01	28	0	26	.134	28	.442	10	.049	28	.05	26
58		min	-.032	25	-.028	10	0	12	-.442	10	-.134	28	-.05	26	-.049	28	
59		5	max	0	1	0	11	0	12	0	1	0	1	0	1	0	1
60		min	0	1	0	9	0	10	0	1	0	1	0	1	0	1	
61	M7	1	max	0	1	0	9	0	12	0	1	0	1	0	1	0	1
62		min	0	1	0	11	0	10	0	1	0	1	0	1	0	1	
63		2	max	-.05	28	.037	28	.333	26	1.092	10	.348	28	2.816	26	2.823	28
64		min	-.233	10	-.152	10	-.334	28	-.348	28	-1.092	10	-2.823	28	-2.816	26	
65		3	max	-.054	28	.037	28	.357	26	.324	28	1.634	10	9.027	26	9.051	28
66		min	-.24	10	-.152	10	-.358	28	-1.634	10	-.324	28	-9.051	28	-9.027	26	
67		4	max	.636	28	.253	27	.492	28	.632	10	.558	28	4.36	26	4.383	28
68		min	-1.22	10	-.29	9	-.485	26	-.558	28	-.632	10	-4.383	28	-4.36	26	
69		5	max	.632	28	.253	27	.468	28	5	27	5.603	9	4.251	12	4.148	26
70		min	-1.226	10	-.29	9	-.461	26	-5.603	9	-5	27	-4.148	26	-4.251	12	
71	M8	1	max	0	1	0	9	0	12	0	1	0	1	0	1	0	1
72		min	0	1	0	27	0	10	0	1	0	1	0	1	0	1	
73		2	max	-.011	25	.141	10	.212	26	.168	28	.986	10	1.765	26	1.76	28
74		min	-.133	11	-.02	28	-.211	28	-.986	10	-.168	28	-1.76	28	-1.765	26	
75		3	max	-.015	25	.141	10	.236	26	1.551	10	.197	28	5.792	26	5.775	28
76		min	-.139	11	-.02	28	-.235	28	-.197	28	-1.551	10	-5.775	28	-5.792	26	
77		4	max	.355	28	.291	11	.355	12	.249	27	.7	9	3.069	26	3.095	12
78		min	-.657	10	-.253	25	-.349	26	-.7	9	-.249	27	-3.095	12	-3.069	26	
79		5	max	.351	28	.291	11	.331	12	5.379	11	5.133	25	3.081	12	3.002	26
80		min	-.664	10	-.253	25	-.326	26	-5.133	25	-5.379	11	-3.002	26	-3.081	12	
81	M9	1	max	1.285	26	.172	12	.114	26	0	1	0	1	0	1	0	1
82		min	-1.298	12	-.157	26	-.117	12	0	1	0	1	0	1	0	1	
83		2	max	1.286	26	.167	12	.114	26	1.662	12	1.587	26	.621	12	.595	26
84		min	-1.296	12	-.16	26	-.117	12	-1.587	26	-1.662	12	-.517	26	-.714	12	
85		3	max	1.288	26	.162	28	.114	26	3.29	12	3.195	26	1.173	12	1.237	26
86		min	-1.294	28	-.164	10	-.117	12	-3.195	26	-3.29	12	-1.075	26	-1.35	12	
87		4	max	1.289	26	.158	28	.114	26	4.884	12	4.823	26	1.672	28	1.927	26
88		min	-1.292	28	-.17	10	-.117	12	-4.823	26	-4.884	12	-1.675	26	-1.924	28	
89		5	max	1.291	26	.155	28	.114	26	6.467	28	6.472	26	2.146	28	2.711	10

Envelope Member Section Stresses (Continued)

Member	Sec		Axial[ksi]	LC	y Shear[...]	LC	z Shear[...]	LC	y-Top[ksi]	LC	y-Bot[ksi]	LC	z-Top[ksi]	LC	z-Bot[ksi]	LC	
90		min	-1.291	28	-.176	10	-.117	12	-6.472	26	-6.467	28	-2.356	10	-2.469	28	
91	M10	1	max	.704	26	.066	12	.015	12	0	1	0	1	0	1	0	1
92		min	-.713	12	-.052	26	-.014	26	0	1	0	1	0	1	0	1	1
93		2	max	.705	26	.061	12	.015	12	.28	12	.233	26	.922	12	.92	26
94		min	-.71	12	-.056	26	-.014	26	-.233	26	-.28	12	-.799	26	-1.061	12	
95		3	max	.707	26	.056	28	.015	12	.527	12	.486	26	1.775	12	1.887	26
96		min	-.708	28	-.06	10	-.014	26	-.486	26	-.527	12	-1.64	26	-2.043	12	
97		4	max	.708	26	.052	28	.015	12	.748	28	.76	26	2.56	12	2.902	26
98		min	-.706	28	-.066	10	-.014	26	-.76	26	-.748	28	-2.522	26	-2.946	12	
99		5	max	.71	10	.049	28	.015	12	.957	28	1.077	10	3.322	28	4.002	10
100		min	-.705	28	-.072	10	-.014	26	-1.077	10	-.957	28	-3.478	10	-3.823	28	

Envelope Joint Reactions

	Joint		X [k]	LC	Y [k]	LC	Z [k]	LC	MX [k-ft]	LC	MY [k-ft]	LC	MZ [k-ft]	LC
1	N21	max	.204	27	1.975	10	.371	26	.357	12	.086	10	.42	27
2		min	-.235	9	-1.018	28	-.377	28	-.348	26	-.084	28	-.47	9
3	N22	max	.236	11	1.069	10	.262	26	.259	12	.156	28	.451	11
4		min	-.204	25	-.565	28	-.267	12	-.252	26	-.173	10	-.431	25
5	N27	max	.072	26	1.398	12	1.246	28	0	1	0	1	0	1
6		min	-.073	12	-1.378	26	-1.239	26	0	1	0	1	0	1
7	N28	max	.01	12	.755	12	.696	12	0	1	0	1	0	1
8		min	-.009	26	-.74	26	-.693	26	0	1	0	1	0	1
9	Totals:	max	.443	11	.94	10	1.299	12						
10		min	-.443	25	.564	28	-1.299	10						

Envelope Joint Displacements

	Joint		X [in]	LC	Y [in]	LC	Z [in]	LC	X Rotation [...]	LC	Y Rotation [...]	LC	Z Rotation [...]	LC
1	N1	max	.063	9	.013	27	.012	9	8.479e-03	28	1.344e-03	12	9.501e-04	9
2		min	-.058	27	-.025	9	-.004	27	-8.468e-03	26	-9.876e-04	26	-3.784e-04	27
3	N2	max	.063	9	0	28	.031	10	5.102e-03	28	1.803e-03	28	8.815e-04	25
4		min	-.058	27	-.002	10	-.03	28	-5.098e-03	26	-1.828e-03	10	-9.265e-04	11
5	N3	max	.063	9	.012	28	.148	10	1.391e-04	28	1.914e-03	28	1.497e-04	28
6		min	-.058	27	-.05	10	-.125	28	-1.262e-04	26	-2.36e-03	10	-9.162e-04	10
7	N4	max	.063	9	.007	28	.135	10	5.207e-03	28	2.509e-03	10	9.737e-04	10
8		min	-.058	27	-.046	10	-.113	28	-5.206e-03	26	-2.047e-03	28	-1.977e-04	28
9	N5	max	.063	9	0	28	.02	10	3.381e-03	28	2.757e-03	10	1.211e-03	9
10		min	-.058	27	-.001	10	-.019	28	-3.377e-03	26	-2.501e-03	28	-6.984e-04	27
11	N6	max	.063	9	.023	9	.041	28	5.345e-03	28	2.673e-03	10	8.759e-04	9
12		min	-.058	27	-.014	27	-.045	10	-5.341e-03	26	-2.53e-03	28	-5.477e-04	27
13	N7	max	.094	9	.013	27	.334	26	1.003e-02	28	6.863e-04	9	1.188e-03	9
14		min	-.081	27	-.025	9	-.329	28	-1.002e-02	26	-3.152e-04	27	-6.159e-04	27
15	N8	max	.094	9	0	28	.342	26	1.038e-02	28	8.362e-04	28	4.593e-04	25
16		min	-.081	27	-.002	10	-.341	28	-1.036e-02	26	-8.885e-04	10	-5.689e-04	11
17	N9	max	.094	9	.011	28	.393	10	1.11e-02	28	3.939e-04	28	1.78e-04	28
18		min	-.081	27	-.05	10	-.373	28	-1.108e-02	26	-8.401e-04	10	-9.115e-04	10
19	N10	max	.094	9	.007	28	.346	10	6.538e-03	28	2.698e-03	10	9.152e-04	10
20		min	-.081	27	-.046	10	-.325	28	-6.537e-03	26	-2.276e-03	28	-1.75e-04	28
21	N11	max	.094	9	0	28	.223	26	6.718e-03	28	3.256e-03	10	9.598e-04	9
22		min	-.081	27	-.001	10	-.222	28	-6.724e-03	26	-2.94e-03	28	-3.46e-04	27

Envelope Joint Displacements (Continued)

	Joint		X [in]	LC	Y [in]	LC	Z [in]	LC	X Rotation [...]	LC	Y Rotation [...]	LC	Z Rotation [...]	LC
23	N12	max	.094	9	.023	9	.15	26	5.426e-03	28	2.962e-03	10	9.72e-04	9
24		min	-.081	27	-.014	27	-.154	12	-5.422e-03	26	-2.835e-03	28	-6.723e-04	27
25	N13	max	.049	25	.013	27	.157	12	8.36e-03	28	1.344e-03	12	8.774e-04	9
26		min	-.054	11	-.025	9	-.15	26	-8.349e-03	26	-9.876e-04	26	-3.05e-04	27
27	N14	max	.19	9	.012	28	.395	10	7.711e-03	10	1.914e-03	28	2.9e-03	27
28		min	-.152	27	-.05	10	-.37	28	-7.691e-03	12	-2.36e-03	10	-3.674e-03	9
29	N15	max	.057	25	.007	28	.044	10	5.11e-03	28	2.509e-03	10	9.743e-04	10
30		min	-.066	11	-.046	10	-.021	28	-5.109e-03	26	-2.047e-03	28	-1.978e-04	28
31	N16	max	.047	25	.023	9	.137	28	5.345e-03	28	2.673e-03	10	8.76e-04	9
32		min	-.048	11	-.014	27	-.141	10	-5.341e-03	26	-2.53e-03	28	-5.477e-04	27
33	N17	max	.117	9	.013	27	.516	26	1.015e-02	28	6.863e-04	9	1.26e-03	9
34		min	-.093	27	-.025	9	-.511	28	-1.014e-02	26	-3.152e-04	27	-6.89e-04	27
35	N18	max	.089	25	.011	28	.597	10	1.14e-02	28	3.939e-04	28	1.779e-04	28
36		min	-.089	27	-.05	10	-.578	28	-1.139e-02	26	-8.401e-04	10	-9.108e-04	10
37	N19	max	.105	9	.007	28	.464	10	6.634e-03	28	2.698e-03	10	9.146e-04	10
38		min	-.079	27	-.046	10	-.444	28	-6.633e-03	26	-2.276e-03	28	-1.749e-04	28
39	N20	max	.112	9	.023	9	.247	26	5.426e-03	28	2.962e-03	10	9.719e-04	9
40		min	-.093	27	-.014	27	-.251	12	-5.422e-03	26	-2.835e-03	28	-6.723e-04	27
41	N21	max	0	9	0	28	0	28	0	26	0	28	0	9
42		min	0	27	0	10	0	26	0	12	0	10	0	27
43	N22	max	0	25	0	28	0	12	0	26	0	10	0	25
44		min	0	11	0	10	0	26	0	12	0	28	0	11
45	N23	max	.099	9	0	28	.466	26	1.039e-02	28	8.362e-04	28	4.593e-04	25
46		min	-.088	27	-.002	10	-.466	28	-1.037e-02	26	-8.885e-04	10	-5.689e-04	11
47	N24	max	.106	9	0	28	.303	26	6.725e-03	28	3.256e-03	10	9.598e-04	9
48		min	-.085	27	-.001	10	-.303	28	-6.731e-03	26	-2.94e-03	28	-3.46e-04	27
49	N25	max	.056	9	0	28	.006	10	2.876e-03	28	1.128e-03	28	1.535e-03	9
50		min	-.051	27	-.002	10	-.005	28	-2.877e-03	26	-1.159e-03	10	-1.47e-03	27
51	N26	max	.054	9	0	28	.003	10	2.019e-03	28	2.313e-03	10	1.694e-03	9
52		min	-.052	27	-.001	10	-.003	28	-2.011e-03	26	-2.09e-03	28	-1.362e-03	27
53	N27	max	0	12	0	26	0	26	1.238e-03	26	5.727e-04	28	1.739e-03	9
54		min	0	26	0	12	0	28	-1.336e-03	12	-6.013e-04	10	-1.67e-03	27
55	N28	max	0	26	0	26	0	26	8.882e-04	26	8.197e-04	10	1.874e-03	10
56		min	0	12	0	12	0	12	-9.805e-04	12	-5.306e-04	28	-1.607e-03	28

Envelope AISC 14th(360-10): ASD Steel Code Checks

Member	Shape	Code Check	Loc...	LC	Shea..	Loc.....	L..Pnc/o...	Pnt/o...	Mnyy/...	Mnzz/.....	Eqn		
1	M1	L4x4x4	.362	2.0...	10	.057	2.0...	y 12	6.301	41.605	2.088	3.532	1..H2-1
2	M2	L4x4x4	.245	2.0...	10	.021	2.0...	z 10	6.301	41.605	2.088	3.151	1..H2-1
3	M3	PIPE 2.0	.069	1.5	10	.040	1.5	10	13.883	21.377	1.245	1.245	1..H1-1b
4	M4	PIPE 2.0	.538	3.5	10	.083	3.5	26	9.924	21.377	1.245	1.245	1..H1-1b
5	M5	PIPE 2.0	.163	1.5	11	.021	1.5	10	13.883	21.377	1.245	1.245	1..H1-1b
6	M6	PIPE 2.0	.020	1.5	10	.011	1.5	10	13.883	21.377	1.245	1.245	1..H1-1b
7	M7	PIPE 2.5	.514	4.4...	12	.225	4.4...	12	21.294	33.743	2.393	2.393	3..H1-1b
8	M8	PIPE 2.5	.305	4.4...	10	.133	4.4...	10	21.294	33.743	2.393	2.393	1..H1-1b
9	M9	L3x3x4	.382	4.2...	10	.011	4.2...	y 10	20.835	31.042	1.123	2.484	1..H2-1
10	M10	L3x3x4	.208	4.2...	10	.005	4.2...	y 10	20.835	31.042	1.123	2.499	1..H2-1



Code Check (Env)	
Black	No Calc
Red	> 1.0
Purple	.90-1.0
Green	.75-.90
Cyan	.50-.75
Blue	0-.50

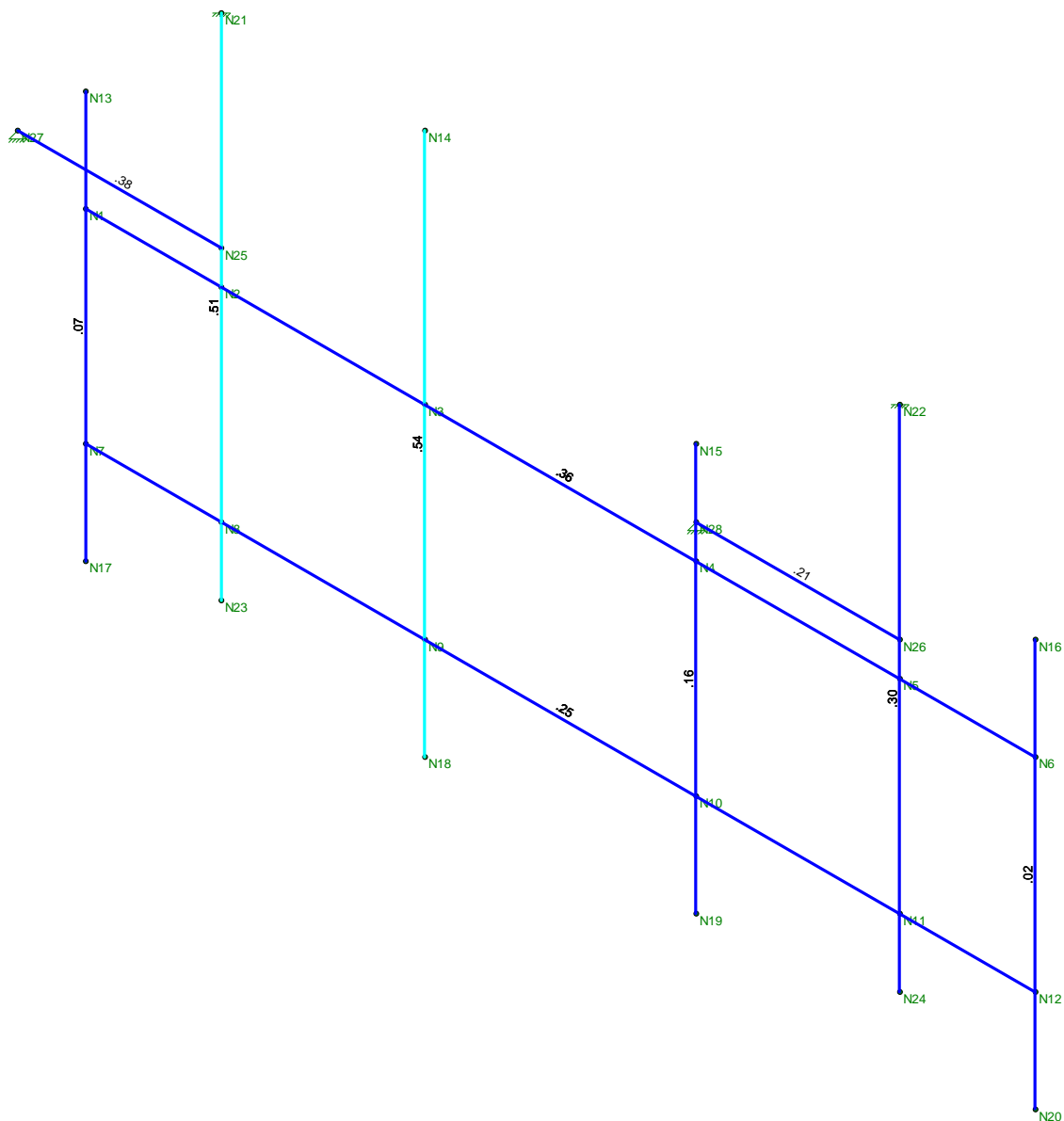

Member Code Checks Displayed (Enveloped)
 Loads: BLC 1, Self Weight
 Envelope Only Solution

Centek Engineering	CT11108A - Antenna Mount Gamma Unity Check	
TJL		June 12, 2018 at 1:56 PM
18058.13		Gamma Antenna Mount.r3d

RAN Template: 67D92M Outdoor	A&L Template: 67D92M_2xAIR+1OP	Power System Template: Custom
--	--	---

CT11108A_M-MIMO_4.1_draft

Section 1 - Site Information

Site ID: CT11108A
Status: Draft
Version: 4.1
Project Type: M-MIMO
Approved: Not Approved
Approved By: Not Approved
Last Modified: 4/18/2018 10:49:28 AM
Last Modified By: GSM1900AMuril19

Site Name: Danbury Hospital
Site Class: Roof Top Mount
Site Type: Building
Solution Type:
Plan Year:
Market: CONNECTICUT
Vendor: Ericsson
Landlord: <undefined>

Latitude: 41.40506400
Longitude: -73.44554500
Address: 24 Hospital Ave (Danbury Hospital)
City, State: Danbury, CT
Region: NORTHEAST

RAN Template: 67D92M Outdoor		AL Template: 67D92M_2xAIR+1OP		
Sector Count: 4	Antenna Count: 12	Coax Line Count: 6	TMA Count: 3	RRU Count: 4

Section 2 - Existing Template Images

4Sec-792DB_2xAIR+1DP.png

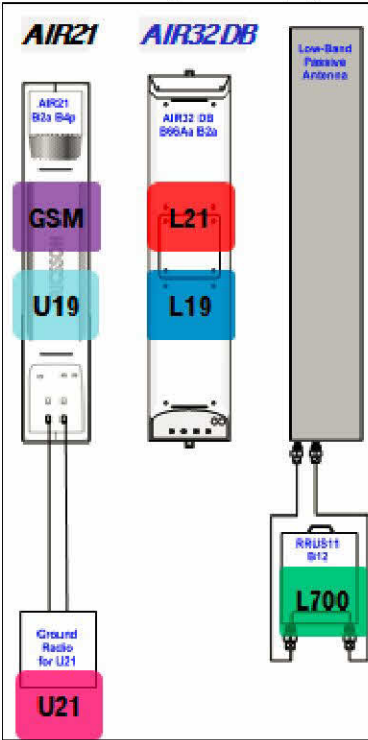

Notes:

Section 3 - Proposed Template Images

67D92M_2xAIR+1OP.JPG

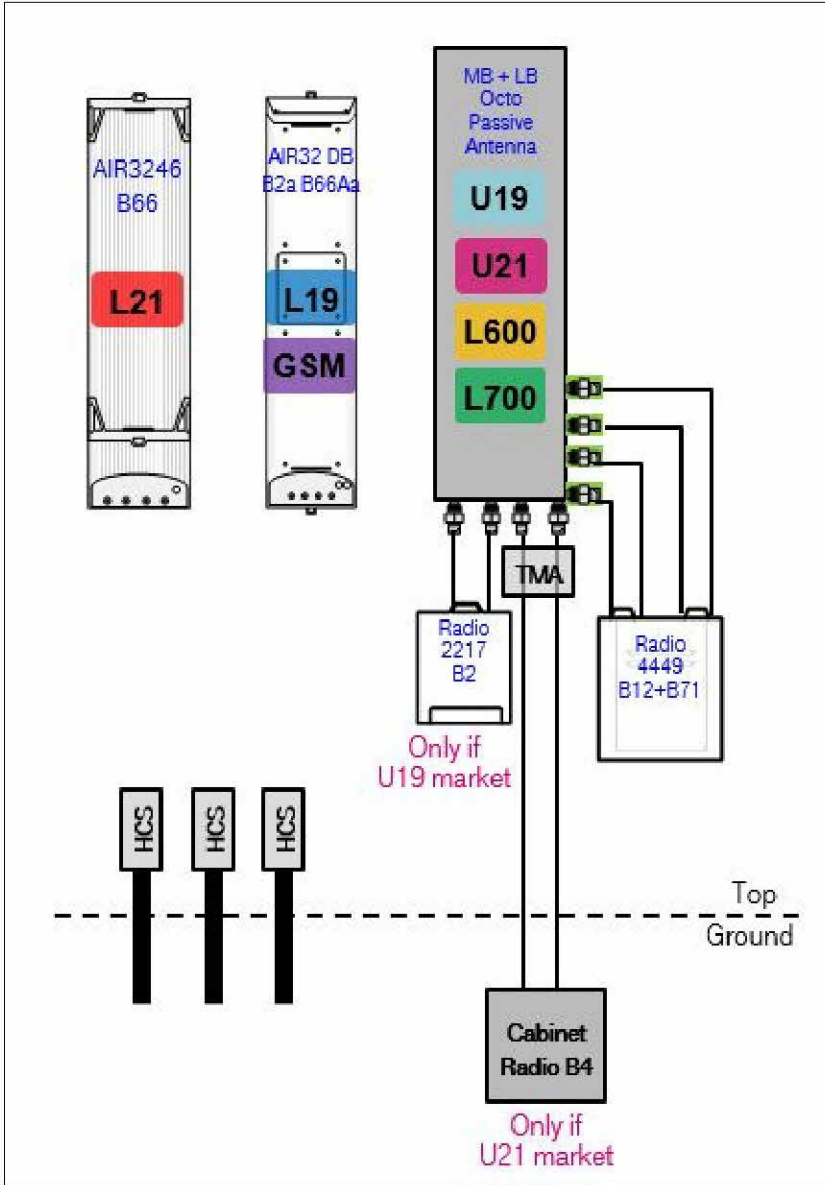

Notes:

Section 4 - Siteplan Images

---- This section is intentionally blank. ----

RAN Template: 67D92M Outdoor	A&L Template: 67D92M_2xAIR+1OP	Power System Template: Custom
--	--	---

CT11108A_M-MIMO_4.1_draft

Section 5 - RAN Equipment

Existing RAN Equipment		
Template: 4Sec-792DB Outdoor		
Enclosure	1	2
Enclosure Type	RBS 6131	Ancillary Equipment
Baseband	DUW30 (x2) DUG20 (x2) BB 5216	
Hybrid Cable System		Ericsson 3x6 HCS *Select Length* (x4) Ericsson 6x12 HCS *Select Length & AWG* (x2)
Multiplexer	XMU	
Radio	RU22 (x6)	

Proposed RAN Equipment		
Template: 67D92M Outdoor		
Enclosure	1	2
Enclosure Type	RBS 6131	Ancillary Equipment
Baseband	BB 5216 (L1900, L700, L600) BB 6630 (L2100) DUW30 (U1900 (DECOMMISSIONED), U2100) DUG20 (G1900)	
Hybrid Cable System		Ericsson 9x18 HCS *Select Length* Ericsson 6x12 HCS *Select Length & AWG* (x2)
Multiplexer	XMU (L1900, L700, L600)	
Radio	RU22 (x6) (U2100)	
RAN Scope of Work:		

RAN Template: 67D92M Outdoor	A&L Template: 67D92M_2xAIR+1OP	Power System Template: Custom
--	--	---

CT11108A_M-MIMO_4.1_draft

Section 6 - A&L Equipment

Existing Template: 4Sec-792DB_2xAIR+1DP
Proposed Template: 67D92M_2xAIR+1OP

Sector 1 (Existing) view from behind								
Coverage Type	A - Outdoor Macro							
Antenna	1	2	3				4	
Antenna Model	Empty Antenna Mount (Empty mount)	Ericsson - AIR21 KRC118023-1_B2A_B4P (Quad)	Ericsson - AIR32 KRD901146-1_B66A_B2A (Octa)				Andrew - LNX-6515DS-A1M (Dual)	
Azimuth		60	60				60	
M. Tilt		0	0				0	
Height		154	154				154	
Ports		P1	P2	P3	P5	P4	P6	P7
Active Tech.		G1900	U2100	L2100	L1900			L700
Dark Tech.								
Restricted Tech.								
Decomm. Tech.		U1900						
E. Tilt								
Cables		1-5/8" LMU Coax - 0 ft. (x2) Fiber Jumper - 15 ft. (x2)	1-5/8" Coax - 0 ft. (x2)	Fiber Jumper - 0 ft.	Fiber Jumper - 0 ft.	Fiber Jumper		Fiber Jumper - 15 ft. (x2)
TMAc			Generic Twin Style 1B - AWS (AtAntenna)					
Diplexers / Combiners								
Radio								RRUS11 B12 (At Antenna)
Sector Equipment								
Unconnected Equipment:								
Scope of Work:								

RAN Template: 67D92M Outdoor	A&L Template: 67D92M_2xAIR+1OP	Power System Template: Custom
--	--	---

CT11108A_M-MIMO_4.1_draft

Sector 1 (Proposed) view from behind												
Coverage Type	A - Outdoor Macro											
Antenna	1				2				3			
Antenna Model	Ericsson - AIR3246 B66 (Octa)				RFS - APXVAARR24_43-U-NA20 (Octa)				Ericsson - AIR32 KRD901146-1_B66A_B2A (Octa)			
Azimuth	60				60				60			
M. Tilt	0				0				0			
Height	154				154				154			
Ports	P1	P2	P3	P4	P5	P6	P7	P8	P9	P10	P11	P12
Active Tech.	L2100	L2100	L2100	L2100		U2100	L700 L600	L700 L600			L1900 G1900	L1900 G1900
Dark Tech.												
Restricted Tech.												
Decomm. Tech.												
E. Tilt												
Cables						Generic Feeder Coax (x2) Coax Jumper (x2)	Coax Jumper (x2)	Coax Jumper (x2)				
TMA's						Generic Twin Style 1B - A VWS (At Antenna)						
Diplexers / Combiners												
Radio								Radio 4449 B71+ B12 (At Antenna)				
Sector Equipment												
Unconnected Equipment:												
Scope of Work:												

RAN Template: 67D92M Outdoor	A&L Template: 67D92M_2xAIR+1OP	Power System Template: Custom
--	--	---

CT11108A_M-MIMO_4.1_draft

Sector 2 (Existing) view from behind							
Coverage Type	A - Outdoor Macro						
Antenna	1		2		3		4
Antenna Model	Ericsson - AIR21 KRC118023-1_B2A_B4P (Quad)		Empty Antenna Mount (Empty mount)		Andrew - LNX-6515DS-A1M (Dual)		Ericsson - AIR32 KRD901146-1_B66A_B2A (Octa)
Azimuth	180				150		150
M. Tilt	0				0		0
Height	154				154		154
Ports	P1	P2			P3	P4	P5
Active Tech.	G1900	U2100			L700	L2100	L1900
Dark Tech.							
Restricted Tech.							
Decomm. Tech.	U1900						
E. Tilt	2	2			2	2	2
Cables	1-5/8" LMU Coax - 0 ft. (x2) Fiber Jumper - 15 ft. (x2)	1-5/8" Coax - 0 ft. (x2)			Fiber Jumper - 15 ft. (x2)	Fiber Jumper - 0 ft.	Fiber Jumper - 0 ft.
TMAs	Generic Twin Style 1B - AWS (AtAntenna)						
Diplexers / Combiners							
Radio	RRUS11 B12 (At Antenna)						
Sector Equipment							
Unconnected Equipment:							
Scope of Work:							

RAN Template: 67D92M Outdoor	A&L Template: 67D92M_2xAIR+1OP	Power System Template: Custom
--	--	---

CT11108A_M-MIMO_4.1_draft

Sector 2 (Proposed) view from behind												
Coverage Type	A - Outdoor Macro											
Antenna	1				2				3			
Antenna Model	Ericsson - AIR3246 B66 (Octa)				RFS - APXVAARR24_43-U-NA20 (Octa)				Ericsson - AIR32 KRD901146-1_B66A_B2A (Octa)			
Azimuth	150				150				150			
M. Tilt	0				0				0			
Height	154				154				154			
Ports	P1	P2	P3	P4	P5	P6	P7	P8	P9	P10	P11	P12
Active Tech.	L2100	L2100	L2100	L2100		U2100	L700 L600	L700 L600			L1900 G1900	L1900 G1900
Dark Tech.												
Restricted Tech.												
Decomm. Tech.												
E. Tilt												
Cables						Generic Feeder Coax (x2) Coax Jumper (x2)	Coax Jumper (x2)	Coax Jumper (x2)				
TMA's						Generic Twin Style 1B - A VWS (At Antenna)						
Diplexers / Combiners												
Radio								Radio 4449 B71+ B12 (At Antenna)				
Sector Equipment												
Unconnected Equipment:												
Scope of Work:												

RAN Template: 67D92M Outdoor	A&L Template: 67D92M_2xAIR+1OP	Power System Template: Custom
--	--	---

CT11108A_M-MIMO_4.1_draft

Sector 3 (Existing) view from behind							
Coverage Type	A - Outdoor Macro						
Antenna	1		2			3	
Antenna Model	Ericsson - AIR21 KRC118023-1_B2A_B4P (Quad)		Andrew - LNX6515DS-A1M (Dual)			Ericsson - AIR32 KRD901146-1_B66A_B2A (Octa)	
Azimuth	300		300			300	
M. Tilt	0		0			0	
Height	127		127			127	
Ports	P1	P2	P3			P4	P5
Active Tech.	G1900	U2100	L700			L2100	L1900
Dark Tech.							
Restricted Tech.							
Decomm. Tech.	U1900						
E. Tilt	2	2	2			2	2
Cables	1-5/8" LMU Coax - 0 ft. (x2) Fiber Jumper - 0 ft. (x2)	1-5/8" Coax - 0 ft. (x2)	Fiber Jumper - 0 ft. (x2)			Fiber Jumper - 0 ft.	Fiber Jumper - 0 ft.
TMA's		Generic Twin Style 1B - AWS (AtAntenna)					
Diplexers / Combiners							
Radio			RRUS11 B12 (At Antenna)				
Sector Equipment							
Unconnected Equipment:							
Scope of Work:							

RAN Template: 67D92M Outdoor	A&L Template: 67D92M_2xAIR+1OP	Power System Template: Custom
--	--	---

CT11108A_M-MIMO_4.1_draft

Sector 3 (Proposed) view from behind												
Coverage Type	A - Outdoor Macro											
Antenna	1				2				3			
Antenna Model	Ericsson - AIR3246 B66 (Octa)				RFS - APXVAARR24_43-U-NA20 (Octa)				Ericsson - AIR32 KRD901146-1_B66A_B2A (Octa)			
Azimuth	300				300				300			
M. Tilt	0				0				0			
Height	154				154				154			
Ports	P1	P2	P3	P4	P5	P6	P7	P8	P9	P10	P11	P12
Active Tech.	L2100	L2100	L2100	L2100		U2100	L700 L600	L700 L600			L1900 G1900	L1900 G1900
Dark Tech.												
Restricted Tech.												
Decomm. Tech.												
E. Tilt												
Cables						Generic Feeder Coax (x2) Coax Jumper (x2)	Coax Jumper (x2)	Coax Jumper (x2)				
TMA's						Generic Twin Style 1B - A VWS (At Antenna)						
Diplexers / Combiners												
Radio								Radio 4449 B71+ B12 (At Antenna)				
Sector Equipment												
Unconnected Equipment:												
Scope of Work:												

RAN Template: 67D92M Outdoor	A&L Template: 67D92M_2xAIR+1OP	Power System Template: Custom
--	--	---

CT11108A_M-MIMO_4.1_draft

Sector 4 (Existing) view from behind					
Coverage Type	A - Outdoor Macro				
Antenna	1			2	
Antenna Model	Ericsson - AIR32 KRD901146-1_B66A_B2A (Octa)			Andrew - LNX-6515DS-A1M (Dual)	
Azimuth	210			210	
M. Tilt	0			0	
Height	154			154	
Ports	P1	P2	P3	P4	P5
Active Tech.	L2100	L2100	L1900 G1900	L1900	L700
Dark Tech.					
Restricted Tech.					
Decomm. Tech.					
E. Tilt	2		2		2
Cables	Fiber Jumper - 0 ft.		Fiber Jumper - 0 ft.		
TMAs					
Diplexers / Combiners					
Radio					RRUS11 B12 (At Antenna)
Sector Equipment					
Unconnected Equipment:					
Scope of Work:					

RAN Template: 67D92M Outdoor	A&L Template: 67D92M_2xAIR+1OP	Power System Template: Custom
--	--	---

CT11108A_M-MIMO_4.1_draft

Sector 4 (Proposed) view from behind												
Coverage Type	A - Outdoor Macro											
Antenna	1				2				3			
Antenna Model	Ericsson - AIR3246 B66 (Octa)				RFS - APXVAARR24_43-U-NA20 (Octa)				Ericsson - AIR32 KRD901146-1_B66A_B2A (Octa)			
Azimuth	210				210				210			
M. Tilt	0				0				0			
Height	154				154				154			
Ports	P1	P2	P3	P4	P5	P6	P7	P8	P9	P10	P11	P12
Active Tech.	L2100	L2100	L2100	L2100			L700 L600	L700 L600			L1900 G1900	L1900 G1900
Dark Tech.												
Restricted Tech.												
Decomm. Tech.												
E. Tilt												
Cables							Coax Ju mper (x2)	Coax Ju mper (x2)				
TMA's												
Diplexers / Combiners												
Radio								Radio 44 49 B71+ B12 (At Antenna)				
Sector Equipment												
Unconnected Equipment:												
Scope of Work:												

RAN Template: 67D92M Outdoor	A&L Template: 67D92M_2xAIR+1OP	Power System Template: Custom
--	--	---

CT11108A_M-MIMO_4.1_draft

Section 7 - Power Systems Equipment

Existing Power Systems Equipment

----- This section is intentionally blank. -----
--

Proposed Power Systems Equipment



Dual Slant Polarized Quad Band (8 Port) Antenna, 617-746/617-746/1695-2200/1695-2200MHz, 65deg, 15/15/18/18dBi, 2.4m (8ft), VET, RET, 0-12°/0-12°/2-12°/2-12°

FEATURES / BENEFITS

This antenna provides a 8 Port multi-band flexible platform for advanced use for flexible use in deployment scenarios for encompassing 600MHz, 700MHz, AWS & PCS applications.



- ➔ 24 Inch Width For Easier Zoning
- ➔ Field Replaceable (Integrated) AISG RET platform for reduced environmental exposure and long lasting quality
- ➔ Superior elevation pattern performance across the entire electrical down tilt range
- ➔ Includes three AISG RET motors - Includes 0.5m AISG jumper for optional daisy chain of two high band RET motors for one single AISG point of high band tilt control.
- ➔ Low band arrays driven by a single RET motor

Technical Features

LOW BAND LEFT ARRAY (617-746 MHZ) [R1]

Frequency Band	MHz	617-698	698-746
Gain	dBi	15.1	15.5
Horizontal Beamwidth @3dB	Deg	65	62
Vertical Beamwidth @3dB	Deg	11.4	10.4
Electrical Downtilt Range	Deg	0-12	0-12
Upper Side Lobe Suppression 0 to +20	dB	19	20
Front-to-Back, at +/-30°, Copolar	dB	25	24
Cross Polar Discrimination (XPD) @ Boresight	dB	19	19
Cross Polar Discrimination (XPD) @ +/-60	dB	5	3
3rd Order PIM 2 x 43dBm	dBc		-153
VSWR	-	1.5:1	1.5:1
Cross Polar Isolation	dB	25	25
Maximum Effective Power per Port	Watt	250	250

LOW BAND RIGHT ARRAY (617-746 MHZ) [R2]

Frequency Band	MHz	617-698	698-746
Gain	dBi	14.8	15.1
Horizontal Beamwidth @3dB	Deg	65	62
Vertical Beamwidth @3dB	Deg	11.4	10.3
Electrical Downtilt Range	Deg	0-12	0-12
Upper Side Lobe Suppression 0 to +20	dB	19	20
Front-to-Back, at +/-30°, Copolar	dB	25	23
Cross Polar Discrimination (XPD) @ Boresight	dB	19	19
Cross Polar Discrimination (XPD) @ +/-60	dB	5	3
3rd Order PIM 2 x 43dBm	dBc		-153
VSWR	-	1.5:1	1.5:1
Cross Polar Isolation	dB	25	25
Maximum Effective Power per Port	Watt	250	250



Dual Slant Polarized Quad Band (8 Port) Antenna, 617-746/617-746/1695-2200/1695-2200MHz, 65deg, 15/15/18/18dBi, 2.4m (8ft), VET, RET, 0-12°/0-12°/2-12°/2-12°

ELECTRICAL SPECIFICATIONS

Impedance	Ohm	50.0
Polarization	Deg	±45°

MECHANICAL SPECIFICATIONS

Dimensions - H x W x D	mm (in)	2436 x 609 x 222 (95.9 x 24 x 8.7)
Weight (Antenna Only)	kg (lb)	58 (128)
Weight (Mounting Hardware only)	kg (lb)	11.5 (25.3)
Shipping Weight	kg (lb)	80 (176)
Connector type		8 x 4.3-10 female at bottom + 6 AISG connectors (3 male, 3 female)
Adjustment mechanism		Integrated RET solution AISG compliant (Field Replaceable) + Manual Override + External Tilt Indicator
Mounting Hardware Material		Galvanized steel
Radome Material / Color		Fiber Glass / Light Grey RAL7035

TESTING AND ENVIRONMENTAL

Temperature Range	°C (°F)	-40 to 60 (-40 to 140)
Lightning protection		IEC 61000-4-5
Survival/Rated Wind Velocity	km/h	241 (150)
Environmental		ETSI 300-019-2-4 Class 4.1E

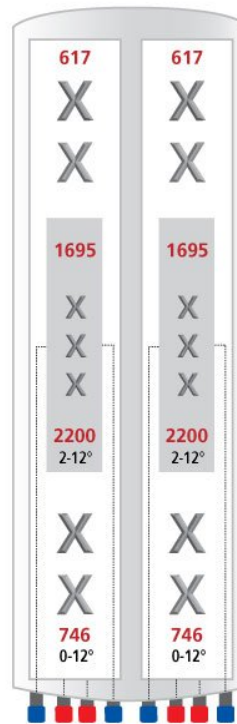
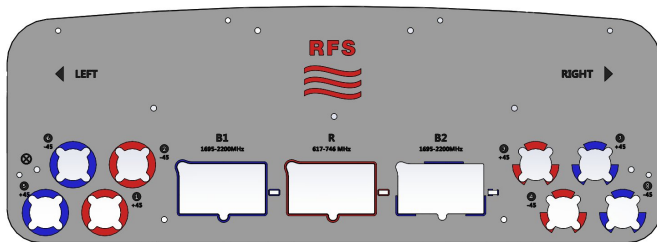

ORDERING INFORMATION

Order No.	Configuration	Mounting Hardware	Mounting pipe Diameter	Shipping Weight
APXVAARR24_43-U-NA20	Field Replace RET included (3)	APM40-5E Beam tilt kit (included)	60-120mm	80 Kg



WIRELESS COMMUNICATIONS FACILITY

DANBURY HOSPITAL
 SITE ID: CT1108A
 24 HOSPITAL AVENUE
 DANBURY, CT 06810

T-MOBILE RF CONFIGURATION
 67D92M_2xAIR+1OP

PROJECT SUMMARY

- THE PROPOSED SCOPE OF WORK CONSISTS OF A MODIFICATION TO THE EXISTING UNMANNED TELECOMMUNICATIONS FACILITY INCLUDING THE FOLLOWING:
 - REMOVE (7) PANEL ANTENNAS AND (4) REMOTE RADIO UNITS.
 - INSTALL (8) PANEL ANTENNAS AND (4) REMOTE RADIO UNITS.
 - MODIFY EXISTING BETA/DELTA ANTENNA FRAME. REFER TO SHEET S-1
 - INSTALL (3) 6X12 HYBRID CABLES/ (1) PER SECTOR.

PROJECT INFORMATION

SITE NAME: DANBURY HOSPITAL
 SITE ID: CT1108A
 SITE ADDRESS: 24 HOSPITAL AVENUE DANBURY, CT 06810
 APPLICANT: T-MOBILE NORTHEAST, LLC 35 GRIFFIN ROAD SOUTH BLOOMFIELD, CT 06002
 CONTACT PERSON: DAN REID (PROJECT MANAGER) TRANSCEND WIRELESS, LLC (203) 592-8291
 ENGINEER: CENTEK ENGINEERING, INC. 63-2 NORTH BRANFORD RD. BRANFORD, CT 06405
 PROJECT COORDINATES: LATITUDE: 41°-24'-18.23" N LONGITUDE: 73°-26'-43.96" W GROUND ELEVATION: 446'± AMSL
 SITE COORDINATES AND GROUND ELEVATION REFERENCED FROM GOOGLE EARTH.

SHEET INDEX

SHT. NO.	DESCRIPTION	REV.
T-1	TITLE SHEET	0
N-1	DESIGN BASIS AND SITE NOTES	0
C-1	SITE LOCATION PLAN	0
C-2	ROOF PLAN AND EQUIPMENT PLATFORM PLAN	0
C-3	ELEVATION	0
C-4	ANTENNA MOUNTING CONFIGURATION	0
S-1	BETA / DELTA FRAME REINFORCEMENT DETAILS	0
E-1	TYPICAL ELECTRICAL DETAILS	0

SITE DIRECTIONS

FROM: 35 GRIFFIN ROAD SOUTH BLOOMFIELD, CT 06002 **TO:** 24 HOSPITAL AVENUE DANBURY, CT 06810

- HEAD NORTH ON GRIFFIN RD S TOWARD HARTMAN RD. 0.21 MI.
- TAKE THE 2ND RIGHT ONTO DAY HILL RD. 0.14 MI.
- TAKE 1ST RIGHT ONTO BLUE HILLS AVE EXT/CT-187. CONTINUE TO FOLLOW CT-187 1.89 MI.
- TURN LEFT ONTO CT-305/OLD WINDSOR RD. CONTINUE TO FOLLOW CT-305 2.32 MI.
- STAY STRAIGHT TO GO ONTO BLOOMFIELD AVE/CT-305 0.01 MI.
- MERGE ONTO I-95 S TOWARD HARTFORD 5.66 MI.
- MERGE ONTO I-84 W VIA EXIT 32A TOWARD WATERBURY 13.29 MI.
- KEEP LEFT TO TAKE I-84 W TOWARD WATERBURY 43.48 MI.
- TAKE EXIT 6/CT-37 TOWARD NEW FAIRFIELD 0.18 MI.
- TURN RIGHT ONTO NORTH ST/CT-37 0.09 MI.
- TAKE THE 2ND RIGHT ONTO HAYESTOWN AVE 0.30 MI.
- TURN RIGHT ONTO TAMARACK AVE 0.62 MI.
- TAKE THE 3RD LEFT ONTO HOSPITAL AVE. 0.09 MI.

24 HOSPITAL AVE IS ON THE RIGHT

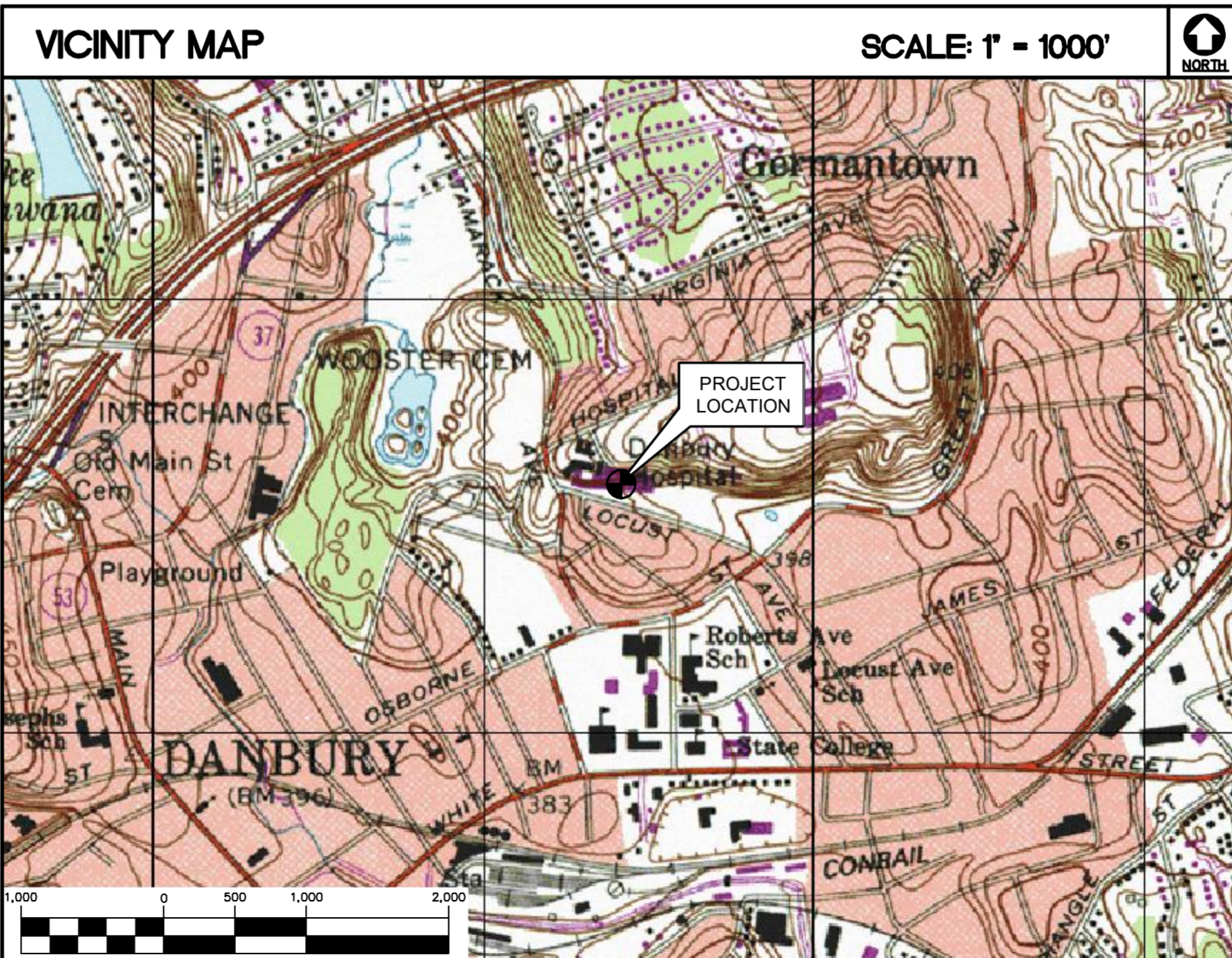

GENERAL NOTES

- ALL WORK SHALL BE IN ACCORDANCE WITH THE 2012 INTERNATIONAL BUILDING CODE AS MODIFIED BY THE 2016 CONNECTICUT SUPPLEMENT, INCLUDING THE TIA/EIA-222 REVISION "G" "STRUCTURAL STANDARDS FOR STEEL ANTENNA TOWERS AND SUPPORTING STRUCTURES." 2016 CONNECTICUT FIRE SAFETY CODE, NATIONAL ELECTRICAL CODE AND LOCAL CODES.
- CONTRACTOR SHALL REVIEW ALL DRAWINGS AND SPECIFICATIONS IN THE CONTRACT DOCUMENT SET. CONTRACTOR SHALL COORDINATE ALL WORK SHOWN IN THE SET OF DRAWINGS. THE CONTRACTOR SHALL PROVIDE A COMPLETE SET OF DRAWINGS TO ALL SUBCONTRACTORS AND ALL RELATED PARTIES. THE SUBCONTRACTORS SHALL EXAMINE ALL THE DRAWINGS AND SPECIFICATIONS FOR THE INFORMATION THAT AFFECTS THEIR WORK.
- CONTRACTOR SHALL PROVIDE A COMPLETE BUILD-OUT WITH ALL FINISHES, STRUCTURAL, MECHANICAL, AND ELECTRICAL COMPONENTS AND PROVIDE ALL ITEMS AS SHOWN OR INDICATED ON THE DRAWINGS OR IN THE WRITTEN SPECIFICATIONS.
- CONTRACTOR SHALL FURNISH ALL MATERIAL, LABOR AND EQUIPMENT TO COMPLETE THE WORK AND FURNISH A COMPLETED JOB ALL IN ACCORDANCE WITH LOCAL AND STATE GOVERNING AUTHORITIES AND OTHER AUTHORITIES HAVING LAWFUL JURISDICTION OVER THE WORK.
- CONTRACTOR SHALL SECURE AND PAY FOR ALL PERMITS AND ALL INSPECTIONS REQUIRED AND SHALL ALSO PAY FEES REQUIRED FOR THE GENERAL CONSTRUCTION, PLUMBING, ELECTRICAL AND HVAC. PERMITS SHALL BE PAID FOR BY THE RESPECTIVE SUBCONTRACTORS.
- CONTRACTOR SHALL MAINTAIN A CURRENT SET OF DRAWINGS AND SPECIFICATIONS ON SITE AT ALL TIMES AND INSURE DISTRIBUTION OF NEW DRAWINGS TO SUBCONTRACTORS AND OTHER RELEVANT PARTIES AS SOON AS THEY ARE MADE AVAILABLE. ALL OLD DRAWINGS SHALL BE MARKED VOID AND REMOVED FROM THE CONTRACT AREA. THE CONTRACTOR SHALL FURNISH AN "AS-BUILT" SET OF DRAWINGS TO OWNER UPON COMPLETION OF PROJECT.
- LOCATION OF EQUIPMENT, AND WORK SUPPLIED BY OTHERS THAT IS DIAGRAMMATICALLY INDICATED ON THE DRAWINGS SHALL BE DETERMINED BY THE CONTRACTOR. THE CONTRACTOR SHALL DETERMINE LOCATIONS AND DIMENSIONS SUBJECT TO STRUCTURAL CONDITIONS AND WORK OF THE SUBCONTRACTORS.
- THE CONTRACTOR IS SOLELY RESPONSIBLE TO DETERMINE CONSTRUCTION PROCEDURE AND SEQUENCE, AND TO ENSURE THE SAFETY OF THE EXISTING STRUCTURES AND ITS COMPONENT PARTS DURING CONSTRUCTION. THIS INCLUDES THE ADDITION OF WHATEVER SHORING, BRACING, UNDERPINNING, ETC. THAT MAY BE NECESSARY.
- DRAWINGS INDICATE THE MINIMUM STANDARDS, BUT IF ANY WORK SHOULD BE INDICATED TO BE SUBSTANDARD TO ANY ORDINANCES, LAWS, CODES, RULES, OR REGULATIONS BEARING ON THE WORK, THE CONTRACTOR SHALL INCLUDE IN HIS WORK AND SHALL EXECUTE THE WORK CORRECTLY IN ACCORDANCE WITH SUCH ORDINANCES, LAWS, CODES, RULES OR REGULATIONS WITH NO INCREASE IN COSTS.
- ALL UTILITY WORK SHALL BE IN ACCORDANCE WITH LOCAL UTILITY COMPANY REQUIREMENTS AND SPECIFICATIONS.
- ALL EQUIPMENT AND PRODUCTS PURCHASED ARE TO BE REVIEWED BY CONTRACTOR AND ALL APPLICABLE SUBCONTRACTORS FOR ANY CONDITION PER MFR.'S RECOMMENDATIONS. CONTRACTOR TO SUPPLY THESE ITEMS AT NO COST TO OWNER OR CONSTRUCTION MANAGER.
- ANY AND ALL ERRORS, DISCREPANCIES, AND "MISSED" ITEMS ARE TO BE BROUGHT TO THE ATTENTION OF THE T-MOBILE CONSTRUCTION MANAGER DURING THE BIDDING PROCESS. BY THE CONTRACTOR. ALL THESE ITEMS ARE TO BE INCLUDED IN THE BID. NO "EXTRA" WILL BE ALLOWED FOR MISSED ITEMS.
- CONTRACTOR SHALL BE RESPONSIBLE FOR ALL ON-SITE SAFETY FROM THE TIME THE JOB IS AWARDED UNTIL ALL WORK IS COMPLETE AND ACCEPTED BY THE OWNER.
- CONTRACTOR TO REVIEW ALL SHOP DRAWINGS AND SUBMIT COPY TO ENGINEER FOR APPROVAL. DRAWINGS MUST BEAR THE CHECKER'S INITIALS BEFORE SUBMITTING TO THE CONSTRUCTION MANAGER FOR REVIEW.
- THE CONTRACTOR SHALL FIELD VERIFY ALL DIMENSIONS, ELEVATIONS, ANGLES, AND EXISTING CONDITIONS AT THE SITE, PRIOR TO FABRICATION AND/OR INSTALLATION OF ANY WORK IN THE CONTRACT AREA.
- COORDINATION, LAYOUT, FURNISHING AND INSTALLATION OF CONDUIT AND ALL APPURTENANCES REQUIRED FOR PROPER INSTALLATION OF ELECTRICAL AND TELECOMMUNICATION SERVICE SHALL BE THE SOLE RESPONSIBILITY OF THE CONTRACTOR.
- ALL DAMAGE CAUSED TO ANY EXISTING STRUCTURE SHALL BE THE SOLE RESPONSIBILITY OF THE CONTRACTOR. THE CONTRACTOR WILL BE HELD LIABLE FOR ALL REPAIRS REQUIRED FOR EXISTING STRUCTURES IF DAMAGED DURING CONSTRUCTION ACTIVITIES.
- THE CONTRACTOR SHALL CONTACT "CALL BEFORE YOU DIG" AT LEAST 48 HOURS PRIOR TO ANY EXCAVATIONS AT 1-800-922-4455. ALL UTILITIES SHALL BE IDENTIFIED AND CLEARLY MARKED. CONTRACTOR SHALL MAINTAIN AND PROTECT MARKED UTILITIES THROUGHOUT PROJECT COMPLETION.
- CONTRACTOR SHALL COMPLY WITH OWNERS ENVIRONMENTAL ENGINEER ON ALL METHODS AND PROVISIONS FOR ALL EXCAVATION ACTIVITIES INCLUDING SOIL DISPOSAL. ALL BACKFILL MATERIALS TO BE PROVIDED BY THE CONTRACTOR.

ISSUED FOR CONSTRUCTION	TUL	DATE	06/18/18
DESCRIPTION	CHK'D BY	DATE	06/18/18
REV.	DATE	06/18/18	0

PROFESSIONAL ENGINEER SEAL

T-Mobile
 Transcend Wireless

CENTEK engineering
 Central Solutions
 (203) 498-0380
 (203) 498-3897 Fax
 652 North Branford Road
 Branford, CT 06405
 www.CentekEng.com

T-MOBILE NORTHEAST LLC
 WIRELESS COMMUNICATIONS FACILITY
DANBURY HOSPITAL
SITE ID: CT1108A
 24 HOSPITAL AVENUE
 DANBURY, CT 06810

DATE: 05/08/18
 SCALE: AS NOTED
 JOB NO. 18058.13

TITLE SHEET

T-1

Sheet No. 1 of 8

DESIGN BASIS:

GOVERNING CODE: 2012 INTERNATIONAL BUILDING (IBC) AS MODIFIED BY THE 2016 CT STATE BUILDING CODE AND AMENDMENTS.

1. DESIGN CRITERIA:
- RISK CATEGORY: III (BASED ON IBC TABLE 1604.5)
 - ULTIMATE DESIGN SPEED (OTHER STRUCTURE): 125 MPH (VuIt) (EXPOSURE B)/IMPORTANCE FACTOR 1.0 BASED ON ASCE 7-10 PER 2012 INTERNATIONAL BUILDING CODE (IBC) AS MODIFIED BY THE 2016 CONNECTICUT STATE BUILDING CODE.
 - SEISMIC LOAD (DOES NOT CONTROL): PER ASCE 7-10 MINIMUM DESIGN LOADS FOR BUILDING AND OTHER STRUCTURES.

GENERAL NOTES:

- ALL CONSTRUCTION SHALL BE IN COMPLIANCE WITH THE GOVERNING BUILDING CODE.
- DRAWINGS INDICATE THE MINIMUM STANDARDS, BUT IF ANY WORK SHOULD BE INDICATED TO BE SUBSTANDARD TO ANY ORDINANCES, LAWS, CODES, RULES, OR REGULATIONS BEARING ON THE WORK, THE CONTRACTOR SHALL INCLUDE IN HIS WORK AND SHALL EXECUTE THE WORK CORRECTLY IN ACCORDANCE WITH SUCH ORDINANCES, LAWS, CODES, RULES OR REGULATIONS WITH NO INCREASE IN COSTS.
- BEFORE BEGINNING THE WORK, THE CONTRACTOR IS RESPONSIBLE FOR MAKING SUCH INVESTIGATIONS CONCERNING PHYSICAL CONDITIONS (SURFACE AND SUBSURFACE) AT OR CONTIGUOUS TO THE SITE WHICH MAY AFFECT PERFORMANCE AND COST OF THE WORK.
- DIMENSIONS AND DETAILS SHALL BE CHECKED AGAINST EXISTING FIELD CONDITIONS.
- THE CONTRACTOR SHALL VERIFY AND COORDINATE THE SIZE AND LOCATION OF ALL OPENINGS, SLEEVES AND ANCHOR BOLTS AS REQUIRED BY ALL TRADES.
- ALL DIMENSIONS, ELEVATIONS, AND OTHER REFERENCES TO EXISTING STRUCTURES, SURFACE, AND SUBSURFACE CONDITIONS ARE APPROXIMATE. NO GUARANTEE IS MADE FOR THE ACCURACY OR COMPLETENESS OF THE INFORMATION SHOWN. THE CONTRACTOR SHALL VERIFY AND COORDINATE ALL DIMENSIONS, ELEVATIONS, ANGLES WITH EXISTING CONDITIONS AND WITH ARCHITECTURAL AND SITE DRAWINGS BEFORE PROCEEDING WITH ANY WORK.
- AS THE WORK PROGRESSES, THE CONTRACTOR SHALL NOTIFY THE OWNER OF ANY CONDITIONS WHICH ARE IN CONFLICT OR OTHERWISE NOT CONSISTENT WITH THE CONSTRUCTION DOCUMENTS AND SHALL NOT PROCEED WITH SUCH WORK UNTIL THE CONFLICT IS SATISFACTORILY RESOLVED.
- THE CONTRACTOR SHALL COMPLY WITH ALL APPLICABLE SAFETY CODES AND REGULATIONS DURING ALL PHASES OF CONSTRUCTION. THE CONTRACTOR IS SOLELY RESPONSIBLE FOR PROVIDING AND MAINTAINING ADEQUATE SHORING, BRACING, AND BARRICADES AS MAY BE REQUIRED FOR THE PROTECTION OF EXISTING PROPERTY, CONSTRUCTION WORKERS, AND FOR PUBLIC SAFETY.
- THE CONTRACTOR IS SOLELY RESPONSIBLE TO DETERMINE CONSTRUCTION PROCEDURE AND SEQUENCE, AND TO ENSURE THE SAFETY OF THE EXISTING STRUCTURES AND ITS COMPONENT PARTS DURING CONSTRUCTION. THIS INCLUDES THE ADDITION OF WHATEVER SHORING, BRACING, UNDERPINNING, ETC. THAT MAY BE NECESSARY. MAINTAIN EXISTING SITE OPERATIONS, COORDINATE WORK WITH NORTHEAST UTILITIES
- THE STRUCTURE IS DESIGNED TO BE SELF-SUPPORTING AND STABLE AFTER FOUNDATION REMEDIATION WORK IS COMPLETE. IT IS THE CONTRACTOR'S SOLE RESPONSIBILITY TO DETERMINE ERECTION PROCEDURE AND SEQUENCE AND TO ENSURE THE SAFETY OF THE STRUCTURE AND ITS COMPONENT PARTS DURING ERECTION. THIS INCLUDES THE ADDITION OF WHATEVER SHORING, TEMPORARY BRACING, GUYS OR TIEDOWNS, WHICH MIGHT BE NECESSARY.
- ALL DAMAGE CAUSED TO ANY EXISTING STRUCTURE SHALL BE THE SOLE RESPONSIBILITY OF THE CONTRACTOR. THE CONTRACTOR WILL BE HELD LIABLE FOR ALL REPAIRS REQUIRED FOR EXISTING STRUCTURES IF DAMAGED DURING CONSTRUCTION ACTIVITIES.
- SHOP DRAWINGS, CONCRETE MIX DESIGNS, TEST REPORTS, AND OTHER SUBMITTALS PERTAINING TO STRUCTURAL WORK SHALL BE FORWARDED TO THE OWNER FOR REVIEW BEFORE FABRICATION AND/OR INSTALLATION IS MADE. SHOP DRAWINGS SHALL INCLUDE ERECTION DRAWINGS AND COMPLETE DETAILS OF CONNECTIONS AS WELL AS MANUFACTURER'S SPECIFICATION DATA WHERE APPROPRIATE. SHOP DRAWINGS SHALL BE CHECKED BY THE CONTRACTOR AND BEAR THE CHECKER'S INITIALS BEFORE BEING SUBMITTED FOR REVIEW.
- NO DRILLING WELDING OR TAPING ON EVERSOURCE OWNED EQUIPMENT.
- REFER TO DRAWING T1 FOR ADDITIONAL NOTES AND REQUIREMENTS.

STRUCTURAL STEEL

- ALL STRUCTURAL STEEL IS DESIGNED BY ALLOWABLE STRESS DESIGN (ASD)
 - STRUCTURAL STEEL (W SHAPES)---ASTM A992 (FY = 50 KSI)
 - STRUCTURAL STEEL (OTHER SHAPES)---ASTM A36 (FY = 36 KSI)
 - STRUCTURAL HSS (RECTANGULAR SHAPES)---ASTM A500 GRADE B, (FY = 46 KSI)
 - STRUCTURAL HSS (ROUND SHAPES)---ASTM A500 GRADE B, (FY = 42 KSI)
 - PIPE---ASTM A53 (FY = 35 KSI)
 - CONNECTION BOLTS---ASTM A325-N
 - U-BOLTS---ASTM A36
 - ANCHOR RODS---ASTM F 1554
 - WELDING ELECTRODE---ASTM E 70XX
- CONTRACTOR TO REVIEW ALL SHOP DRAWINGS AND SUBMIT COPY TO ENGINEER FOR APPROVAL. DRAWINGS MUST BEAR THE CHECKER'S INITIALS BEFORE SUBMITTING TO THE ENGINEER FOR REVIEW. SHOP DRAWINGS SHALL INCLUDE THE FOLLOWING: SECTION PROFILES, SIZES, CONNECTION ATTACHMENTS, REINFORCING, ANCHORAGE, SIZE AND TYPE OF FASTENERS AND ACCESSORIES. INCLUDE ERECTION DRAWINGS, ELEVATIONS AND DETAILS.
- STRUCTURAL STEEL SHALL BE DETAILED, FABRICATED AND ERECTED IN ACCORDANCE WITH THE LATEST PROVISIONS OF AISC MANUAL OF STEEL CONSTRUCTION.
- PROVIDE ALL PLATES, CLIP ANGLES, CLOSURE PIECES, STRAP ANCHORS, MISCELLANEOUS PIECES AND HOLES REQUIRED TO COMPLETE THE STRUCTURE.
- FIT AND SHOP ASSEMBLE FABRICATIONS IN THE LARGEST PRACTICAL SECTIONS FOR DELIVERY TO SITE.
- INSTALL FABRICATIONS PLUMB AND LEVEL, ACCURATELY FITTED, AND FREE FROM DISTORTIONS OR DEFECTS.
- AFTER ERECTION OF STRUCTURES, TOUCHUP ALL WELDS, ABRASIONS AND NON-GALVANIZED SURFACES WITH A 95% ORGANIC ZINC RICH PAINT IN ACCORDANCE WITH ASTM 780.
- ALL STEEL MATERIAL (EXPOSED TO WEATHER) SHALL BE GALVANIZED AFTER FABRICATION IN ACCORDANCE WITH ASTM A123 "ZINC (HOT DIPPED GALVANIZED) COATINGS" ON IRONS AND STEEL PRODUCTS.
- ALL BOLTS, ANCHORS AND MISCELLANEOUS HARDWARE SHALL BE GALVANIZED IN ACCORDANCE WITH ASTM A153 "ZINC COATING (HOT-DIP) ON IRON AND STEEL HARDWARE".
- THE ENGINEER SHALL BE NOTIFIED OF ANY INCORRECTLY FABRICATED, DAMAGED OR OTHERWISE MISFITTING OR NON CONFORMING MATERIALS OR CONDITIONS TO REMEDIAL OR CORRECTIVE ACTION. ANY SUCH ACTION SHALL REQUIRE ENGINEER REVIEW.
- CONNECTION ANGLES SHALL HAVE A MINIMUM THICKNESS OF 1/4 INCHES.
- STRUCTURAL CONNECTION BOLTS SHALL CONFORM TO ASTM A325. ALL BOLTS SHALL BE 3/4" DIAMETER MINIMUM AND SHALL HAVE A MINIMUM OF TWO BOLTS, UNLESS OTHERWISE ON THE DRAWINGS.
- LOCK WASHER ARE NOT PERMITTED FOR A325 STEEL ASSEMBLIES.
- SHOP CONNECTIONS SHALL BE WELDED OR HIGH STRENGTH BOLTED.
- MILL BEARING ENDS OF COLUMNS, STIFFENERS, AND OTHER BEARING SURFACES TO TRANSFER LOAD OVER ENTIRE CROSS SECTION.
- FABRICATE BEAMS WITH MILL CAMBER UP.
- LEVEL AND PLUMB INDIVIDUAL MEMBERS OF THE STRUCTURE TO AN ACCURACY OF 1:500, BUT NOT TO EXCEED 1/4" IN THE FULL HEIGHT OF THE COLUMN.
- COMMENCEMENT OF STRUCTURAL STEEL WORK WITHOUT NOTIFYING THE ENGINEER OF ANY DISCREPANCIES WILL BE CONSIDERED ACCEPTANCE OF PRECEDING WORK.
- INSPECTION AND TESTING OF ALL WELDING AND HIGH STRENGTH BOLTING SHALL BE PERFORMED BY AN INDEPENDENT TESTING LABORATORY.
- FOUR COPIES OF ALL INSPECTION TEST REPORTS SHALL BE SUBMITTED TO THE ENGINEER WITHIN TEN (10) WORKING DAYS OF THE DATE OF INSPECTION.

REV.	DATE	BY	DESCRIPTION
0	05/18/18	LGI	ISSUED FOR CONSTRUCTION
		JUL	CHK'D BY
			DESCRIPTION

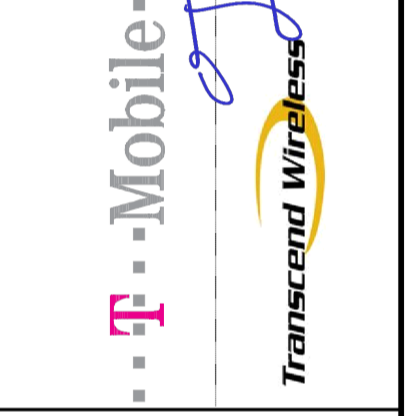
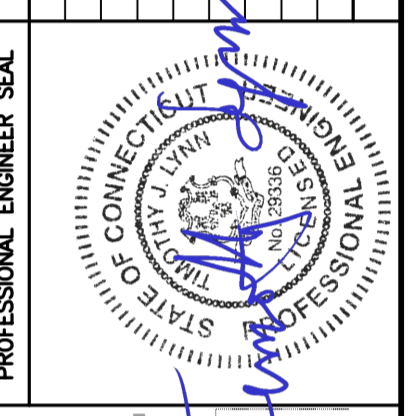

CENTEK engineering
 Centered on Solutions
 (203) 498-0380
 (203) 498-3387 Fax
 632 North Branford Road
 Branford, CT 06405
 www.CentekEng.com

T-MOBILE NORTHEAST LLC
 WIRELESS COMMUNICATIONS FACILITY
DANBURY HOSPITAL
 SITE ID: CT1108A
 24 HOSPITAL AVENUE
 DANBURY, CT 06810

DATE: 05/08/18
 SCALE: AS NOTED
 JOB NO. 18058.13

DESIGN BASIS
 AND SITE NOTES

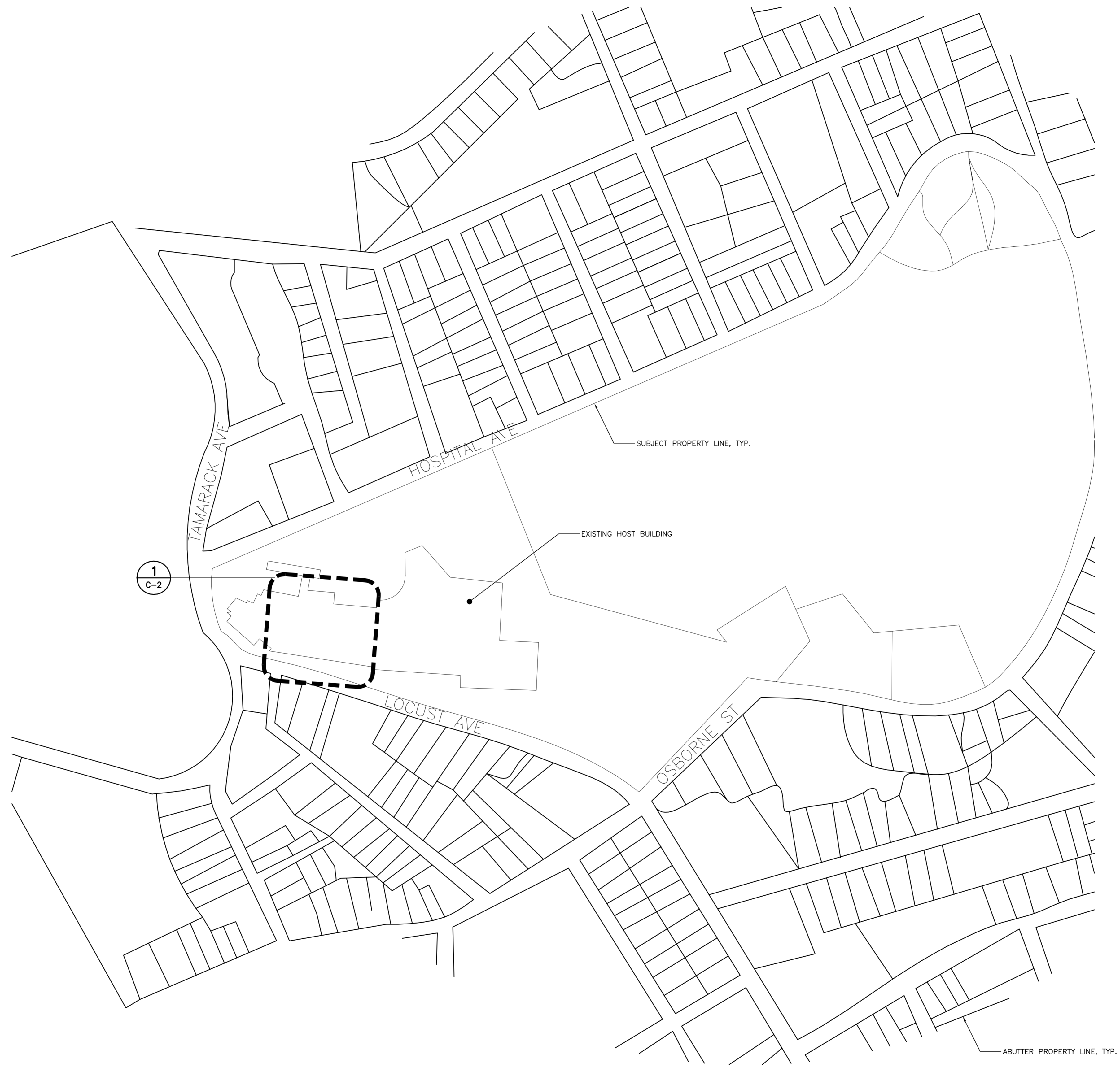

1
C-1
SITE LOCATION PLAN
SCALE: 1" = 20'

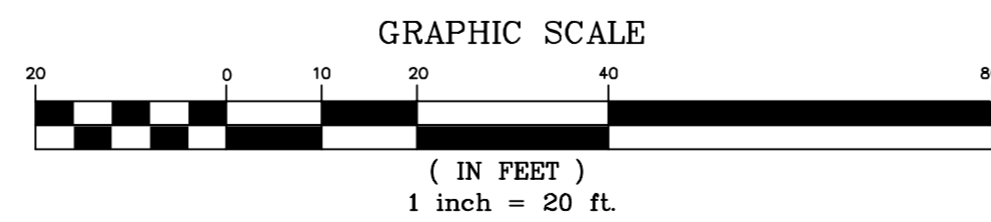

REV.	DATE	BY	CHK'D BY	TITLE	ISSUED FOR
0	06/18/18	LGI			CONSTRUCTION
					DESCRIPTION

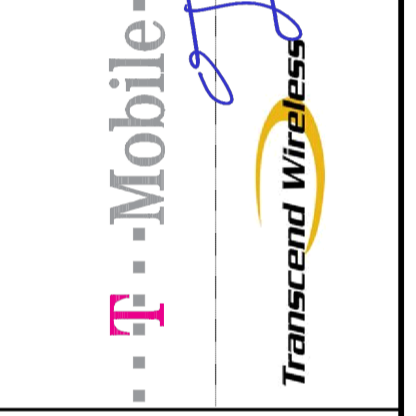
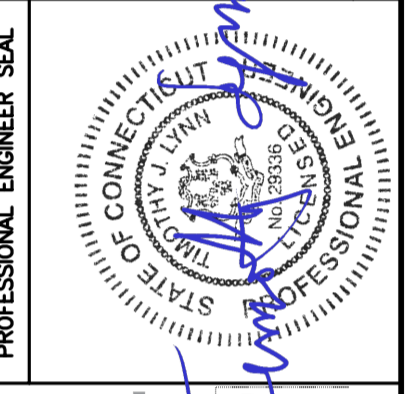

CEN TEK engineering
 Centered on Solutions
 (203) 498-0390
 (203) 498-3397 Fax
 652 North Branford Road
 Branford, CT 06405
 www.CenTekEng.com

T-MOBILE NORTHEAST LLC
 WIRELESS COMMUNICATIONS FACILITY
DANBURY HOSPITAL
SITE ID: CT1108A
 24 HOSPITAL AVENUE
 DANBURY, CT 06810

DATE: 05/08/18
 SCALE: AS NOTED
 JOB NO. 18058.13

SITE LOCATION PLAN

C-1
 Sheet No. 3 of 8

1
C-3

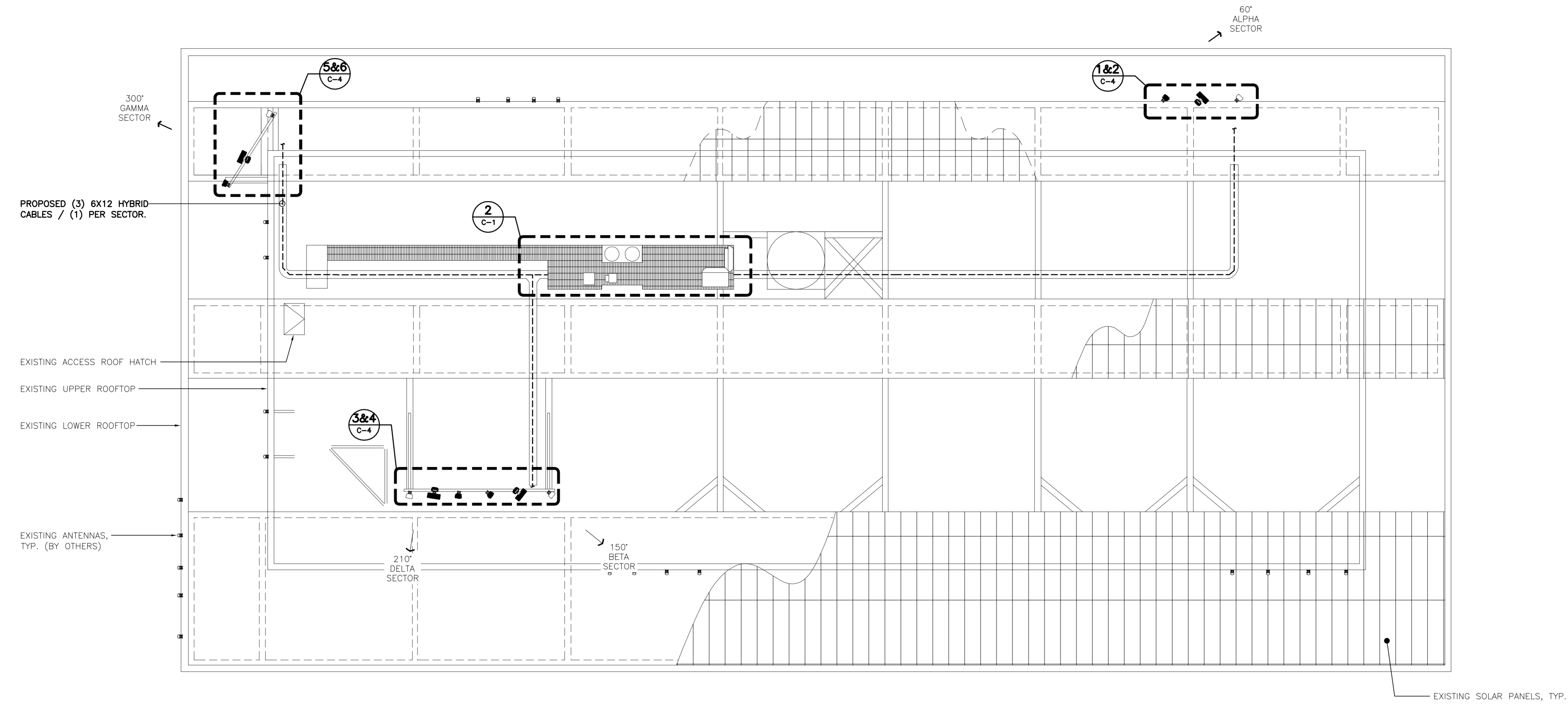

1
C-2
ROOF PLAN
SCALE: 1" = 10'

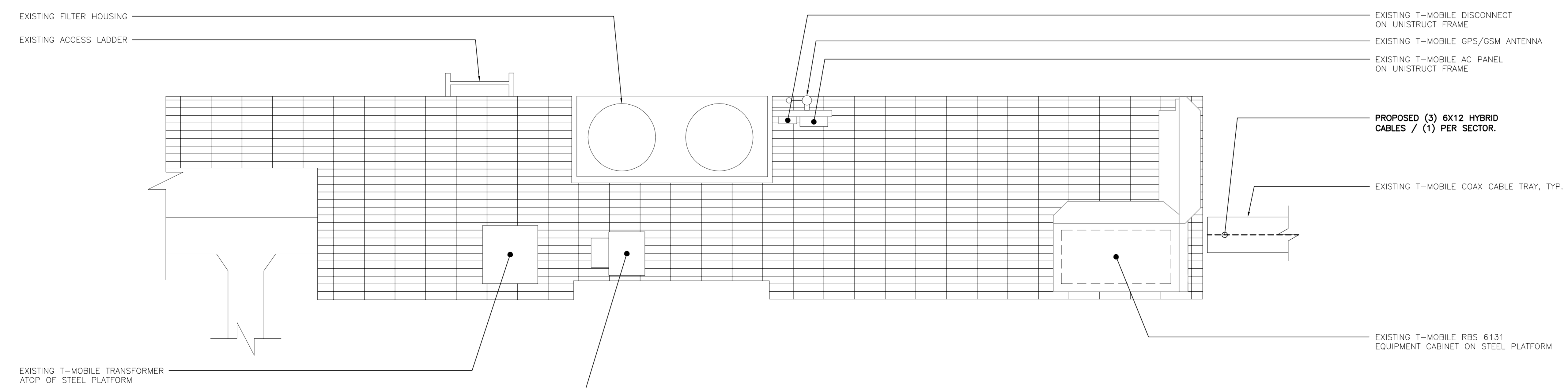
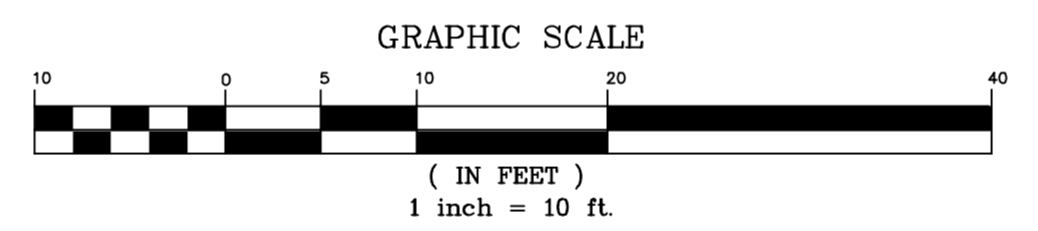

2
C-2
EQUIPMENT PLATFORM PLAN
SCALE: 1/2" = 1'



REV.	DATE	BY	CHK'D BY	DESCRIPTION
0	06/18/18	LGI		ISSUED FOR CONSTRUCTION

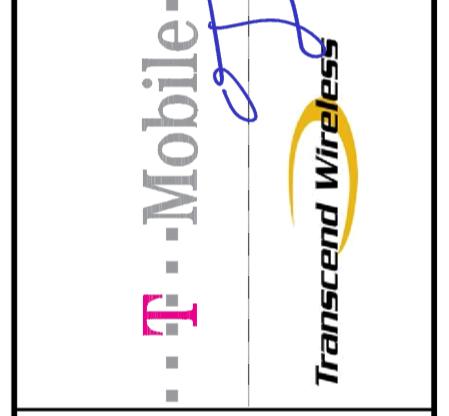
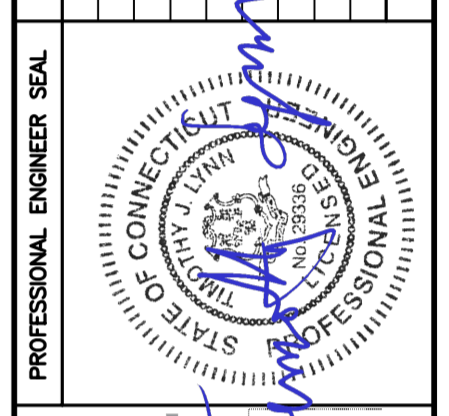

CEN TEK engineering
 Centered on Solutions
 (203) 498-0390
 (203) 498-3397 Fax
 632 North Branford Road
 Branford, CT 06405
 www.CenTekEng.com

T-MOBILE NORTHEAST LLC
 WIRELESS COMMUNICATIONS FACILITY
DANBURY HOSPITAL
 SITE ID: CT1108A
 24 HOSPITAL AVENUE
 DANBURY, CT 06810

DATE: 05/08/18
 SCALE: AS NOTED
 JOB NO. 18058.13

ROOF PLAN & EQUIPMENT PLATFORM PLAN

C-2
 Sheet No. 4 of 8

STRUCTURAL NOTE:
 REFER TO STRUCTURAL ANALYSIS AND
 MOD DESIGN AS PREPARED BY CENTEK
 ENGINEERING INC., DATED: 06/12/18
 PROJECT NUMBER: 18058.13

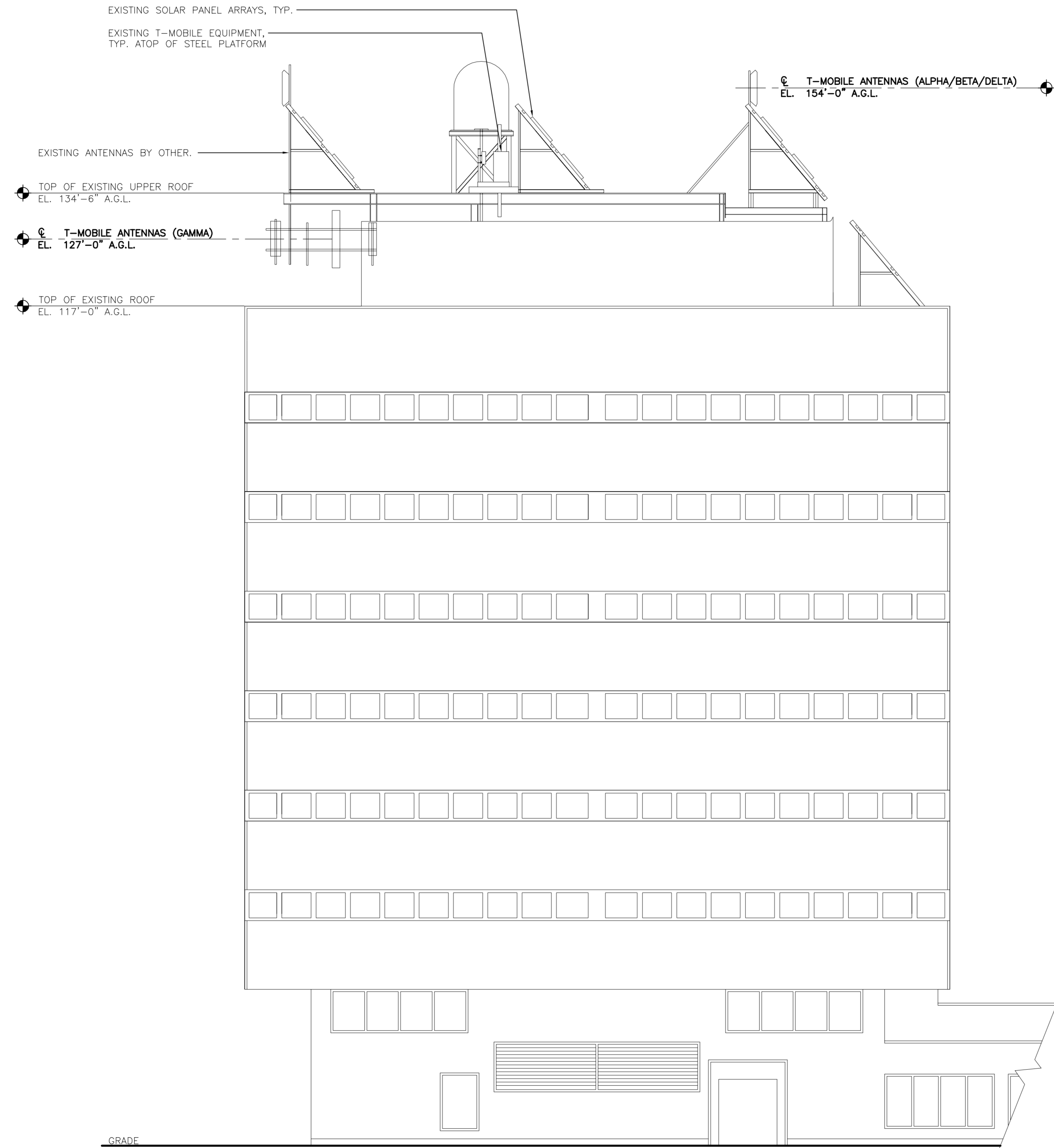

1 WEST ELEVATION
 C-3 SCALE: 1" = 17'

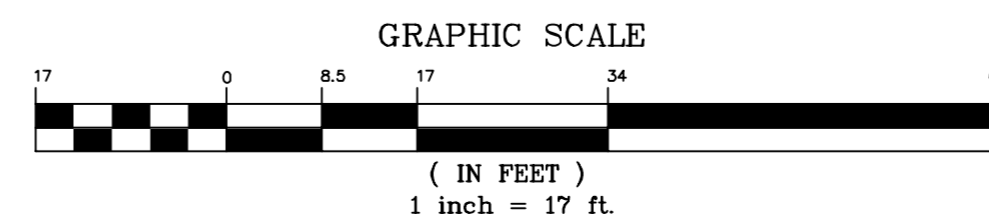

REV.	DATE	ISSUED FOR CONSTRUCTION	TITLE	DESCRIPTION
0	06/18/18			

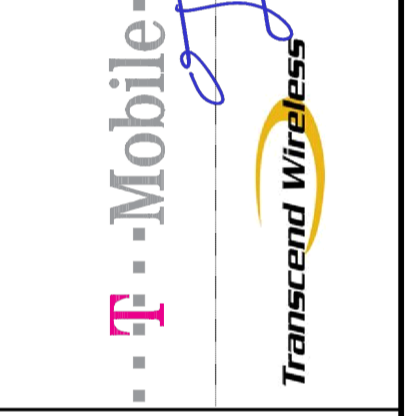
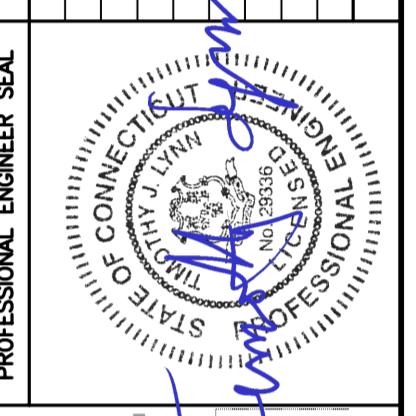

CEN TEK engineering
 Centered on Solutions
 (203) 488-0390
 (203) 488-3397 Fax
 632 North Branford Road
 Branford, CT 06405
 www.CenTekEng.com

T-MOBILE NORTHEAST LLC
 WIRELESS COMMUNICATIONS FACILITY
DANBURY HOSPITAL
 SITE ID: CT1108A
 24 HOSPITAL AVENUE
 DANBURY, CT 06810

DATE: 05/08/18
 SCALE: AS NOTED
 JOB NO. 18058.13

ELEVATION

C-3
 Sheet No. 5 of 8

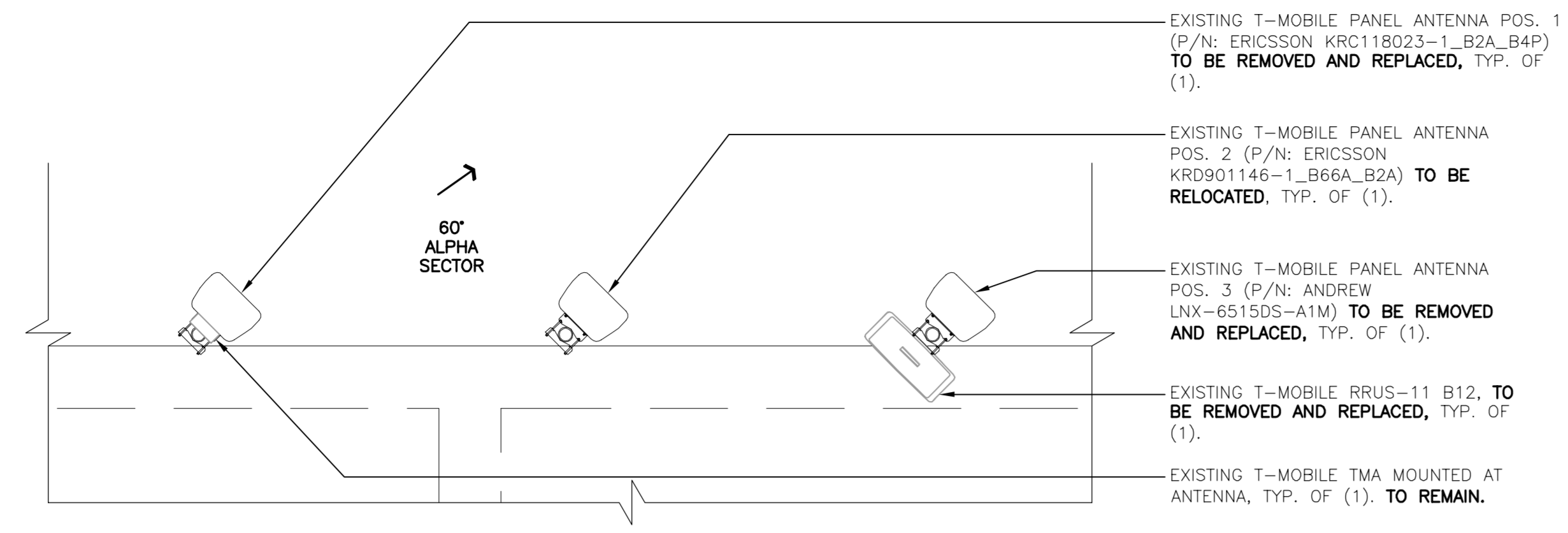

1 EXISTING ANTENNA MOUNTING CONFIGURATION (ALPHA SECTOR)
 C-4 SCALE: 1/2" = 1' 154' ELEVATION

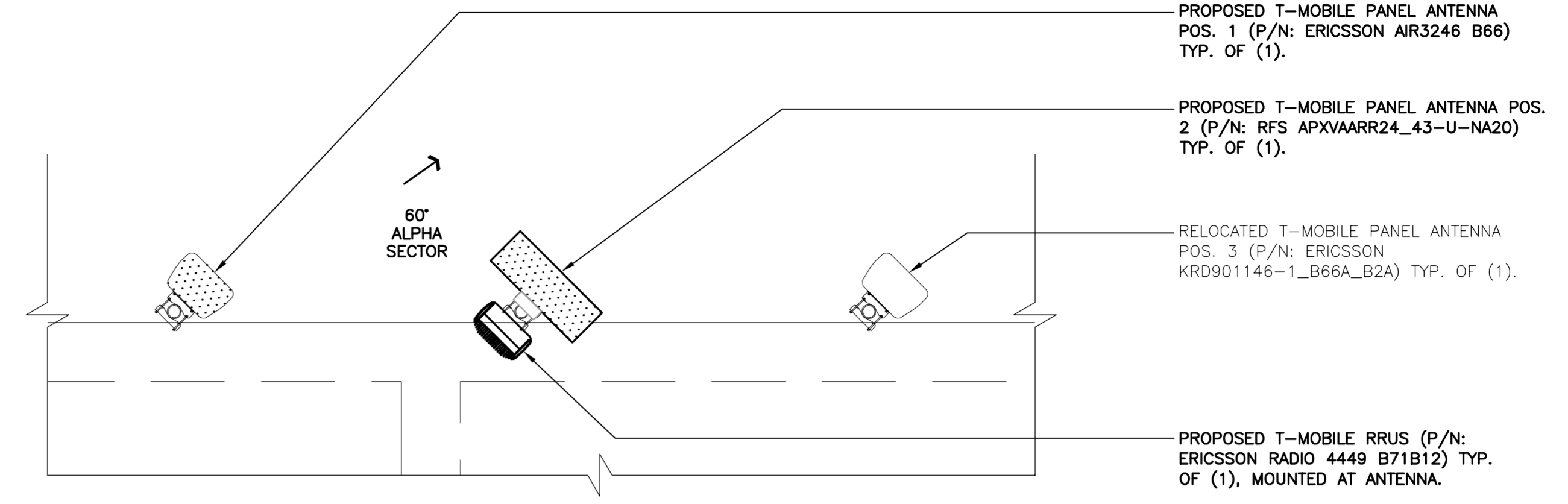

2 PROPOSED ANTENNA MOUNTING CONFIGURATION (ALPHA SECTOR)
 C-4 SCALE: 1/2" = 1' 154' ELEVATION

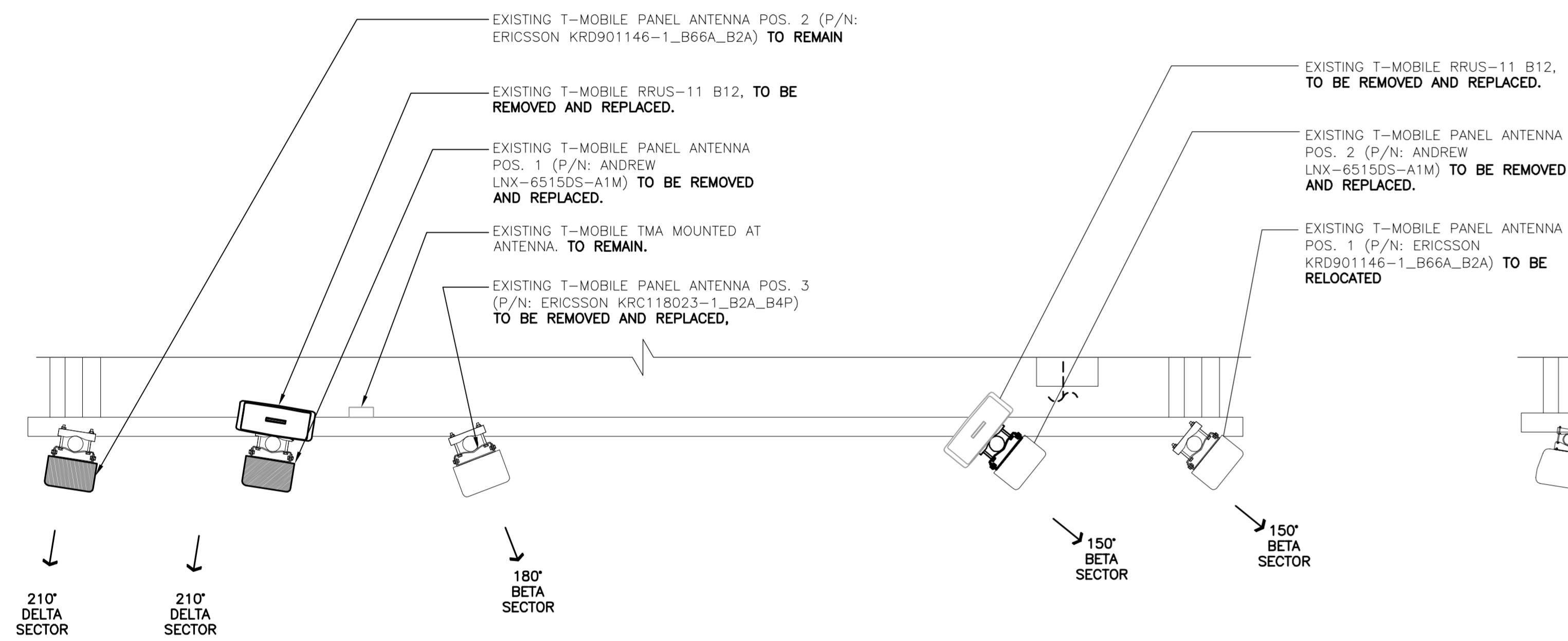

3 EXISTING ANTENNA MOUNTING CONFIGURATION (BETA/DELTA SECTOR)
 C-4 SCALE: 1/2" = 1' 127' ELEVATION

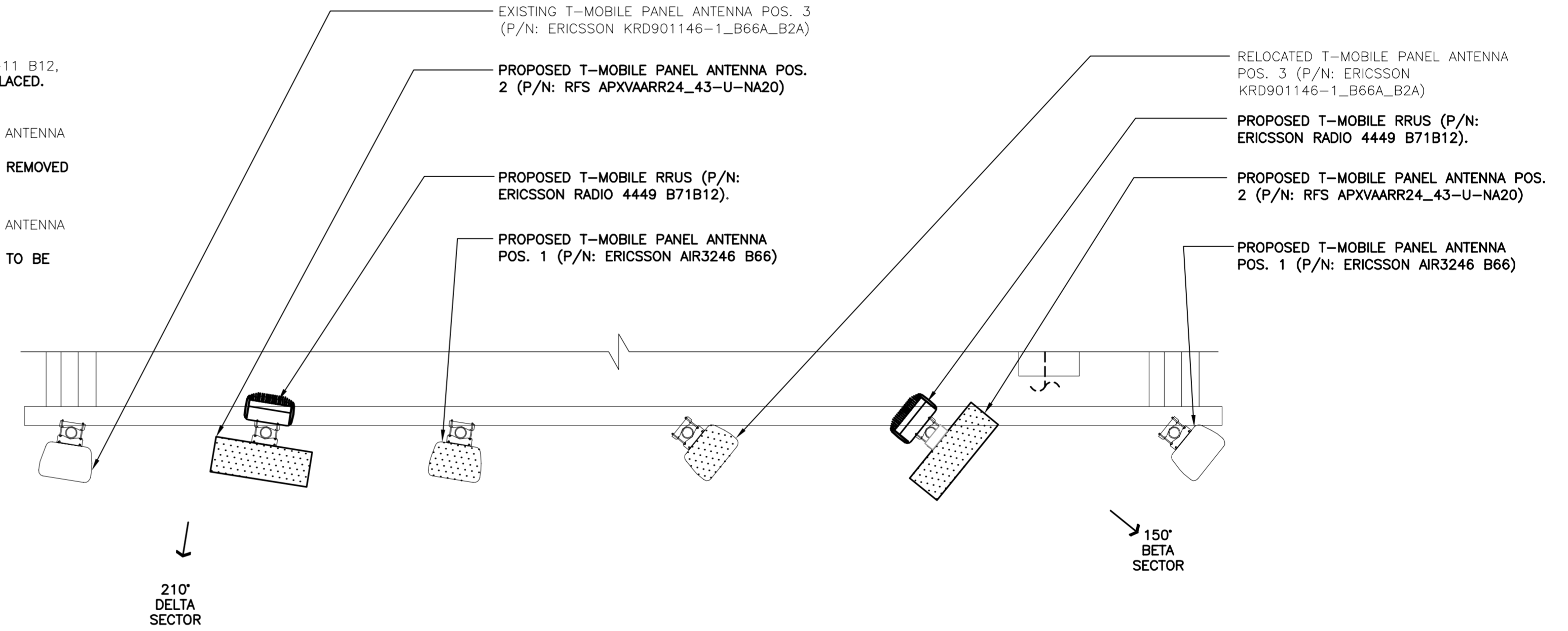

4 PROPOSED ANTENNA MOUNTING CONFIGURATION (BETA/DELTA SECTOR)
 C-4 SCALE: 1/2" = 1' 127' ELEVATION

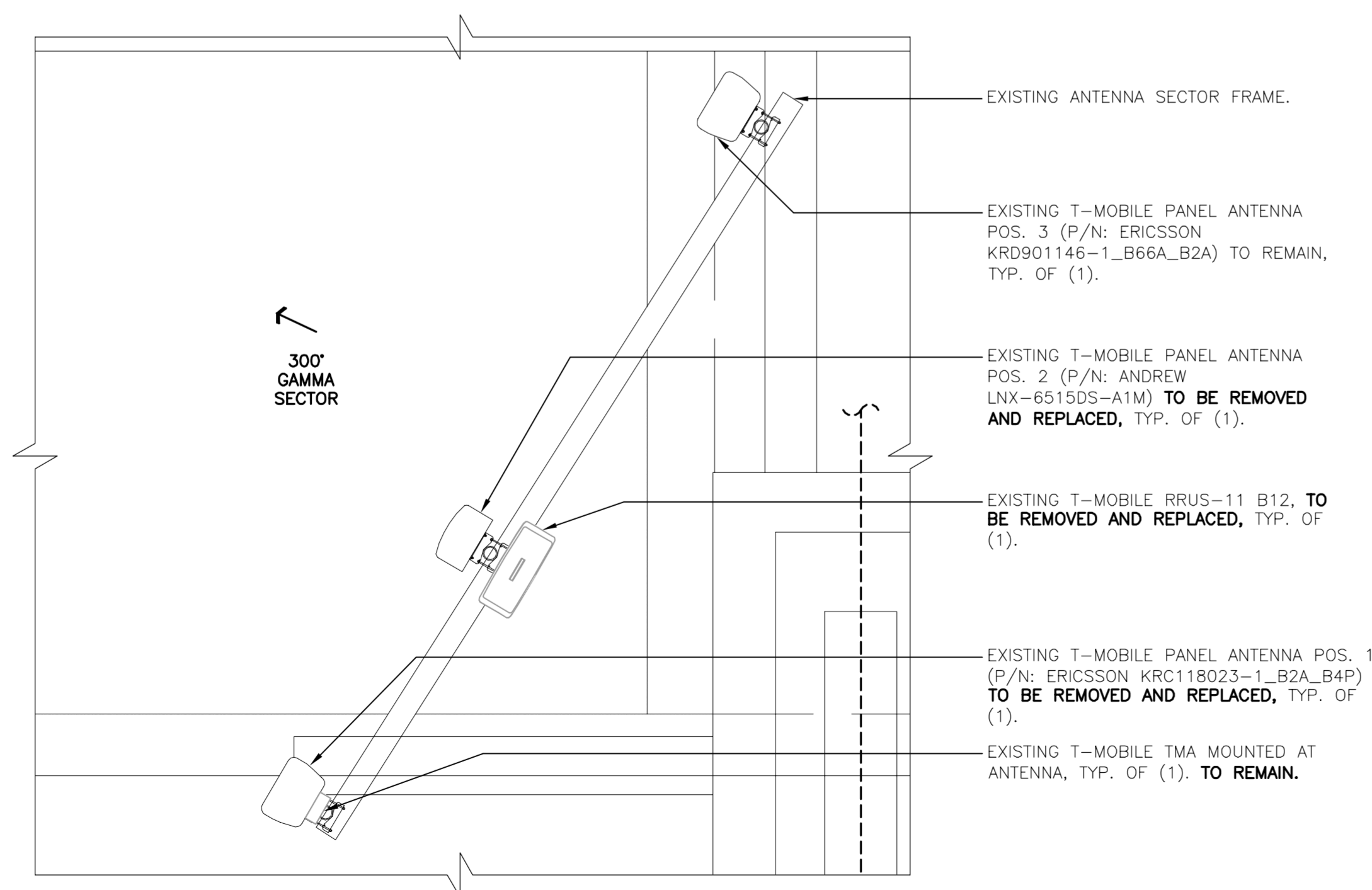

5 EXISTING ANTENNA MOUNTING CONFIGURATION (GAMMA SECTOR)
 C-4 SCALE: 1/2" = 1' 154' ELEVATION

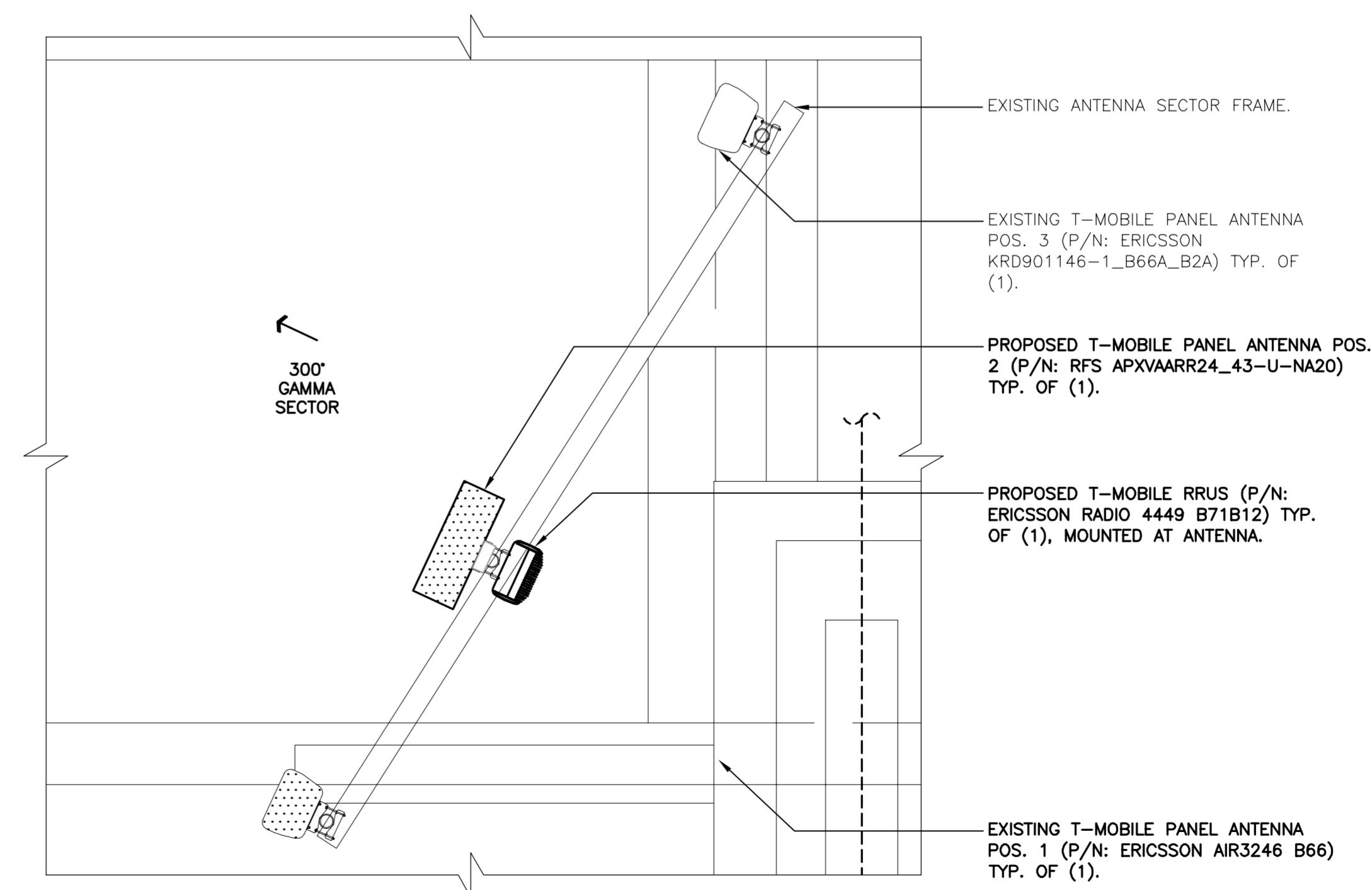

6 PROPOSED ANTENNA MOUNTING CONFIGURATION (GAMMA SECTOR)
 C-4 SCALE: 1/2" = 1' 154' ELEVATION

ISSUED FOR CONSTRUCTION	TUL	CHK'D BY	DESCRIPTION
DATE	05/08/18	DATE	05/08/18
REV.	0	DATE	05/08/18
PROFESSIONAL ENGINEER SEAL			
T-MOBILE NORTHEAST LLC WIRELESS COMMUNICATIONS FACILITY DANBURY HOSPITAL SITE ID: CT1108A 24 HOSPITAL AVENUE DANBURY, CT 06810			
DATE:	05/08/18		
SCALE:	AS NOTED		
JOB NO.:	18058.13		
ANTENNA MOUNTING CONFIGURATION			
C-4			
Sheet No. 6 of 8			

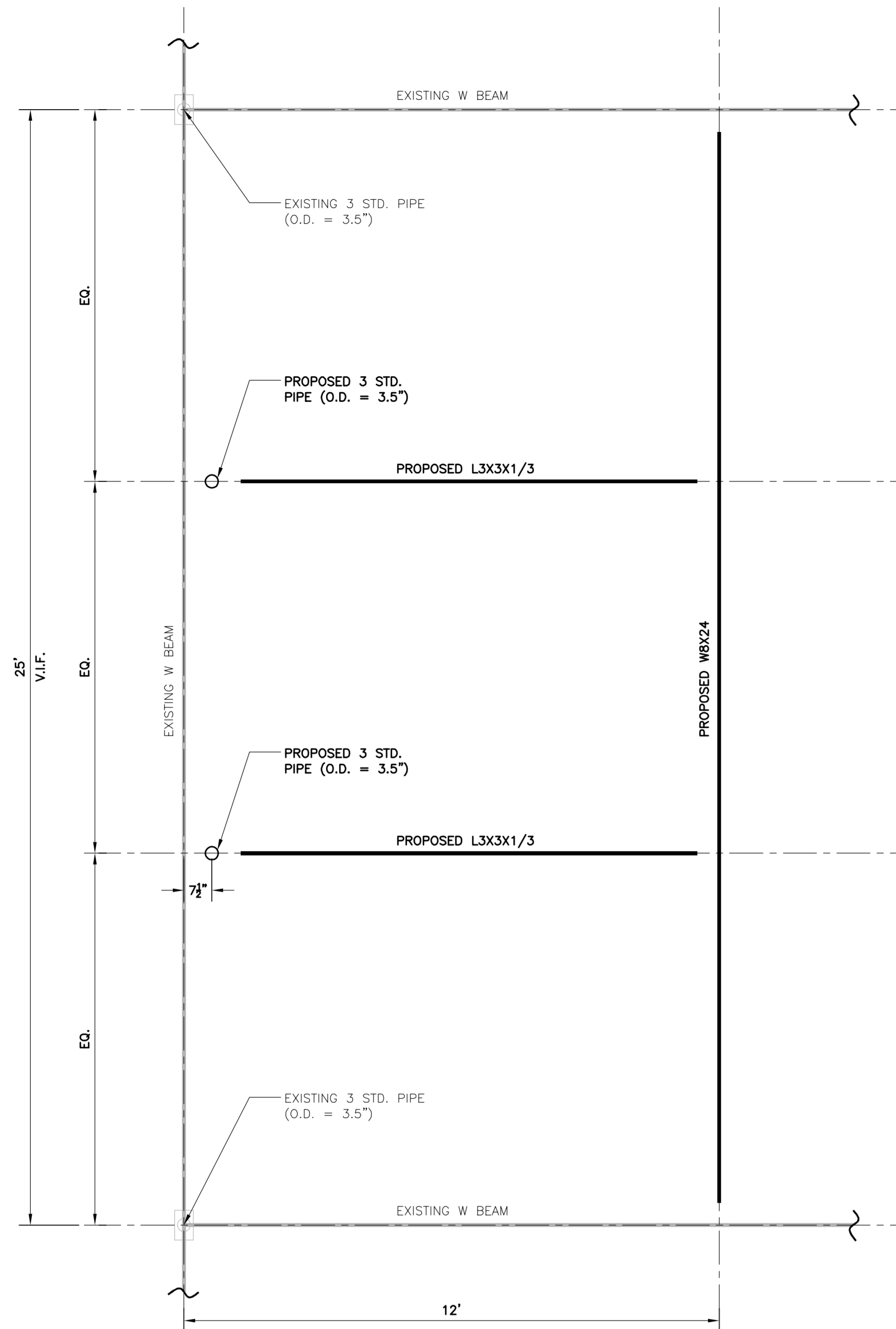

1 BETA/DELTA SECTOR ANTENNA FRAME PLAN
S-1 SCALE: 1/2" = 1'

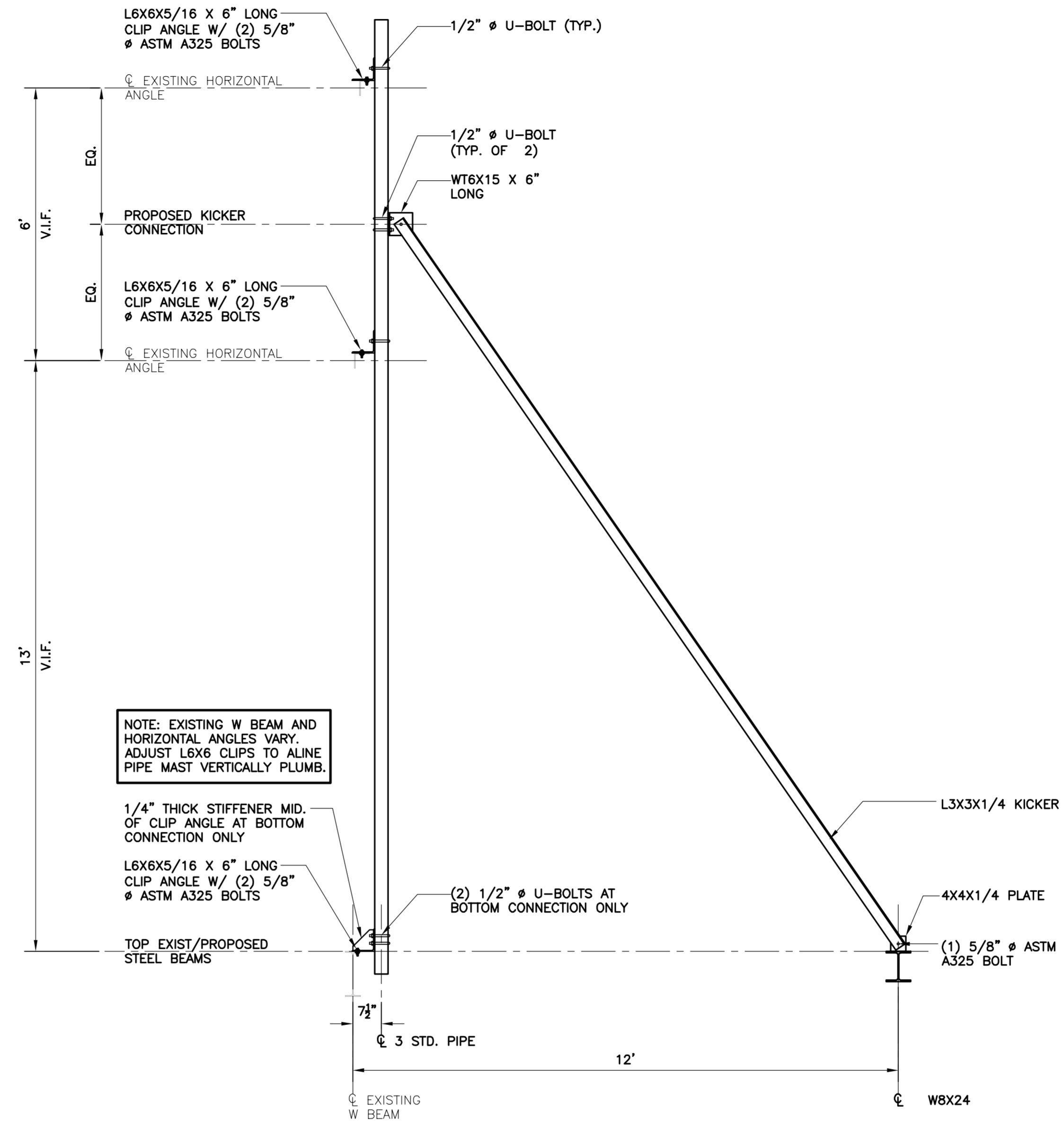

2 BETA/DELTA SECTOR ANTENNA FRAME SECTION
S-1 SCALE: 1/2" = 1'

NOTE: EXISTING W BEAM AND HORIZONTAL ANGLES VARY. ADJUST L6X6 CLIPS TO ALINE PIPE MAST VERTICALLY PLUMB.

1/4" THICK STIFFENER MID. OF CLIP ANGLE AT BOTTOM CONNECTION ONLY
L6X6X5/16 X 6" LONG CLIP ANGLE W/ (2) 5/8" Ø ASTM A325 BOLTS
(2) 1/2" Ø U-BOLTS AT BOTTOM CONNECTION ONLY

REV.	DATE	BY	CHK'D BY	DESCRIPTION
0	06/18/18	LGI	TJL	ISSUED FOR CONSTRUCTION

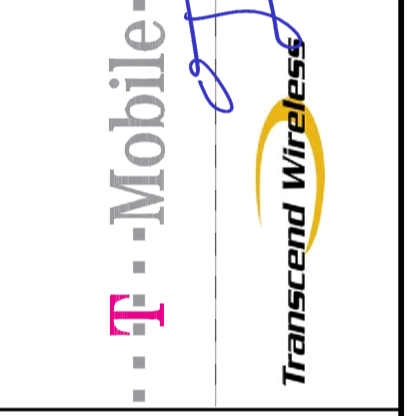
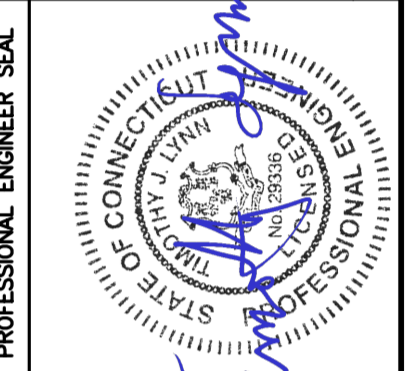

CEN TEK engineering
Centered on Solutions
(203) 498-0590
(203) 498-3597 Fax
652 North Branford Road
Branford, CT 06405
www.CenTekEng.com

T-MOBILE NORTHEAST LLC
WIRELESS COMMUNICATIONS FACILITY
DANBURY HOSPITAL
SITE ID: CT1108A
24 HOSPITAL AVENUE
DANBURY, CT 06810

DATE: 05/08/18
SCALE: AS NOTED
JOB NO. 18058.13

BETA/DELTA FRAME REINFORCEMENT DETAILS

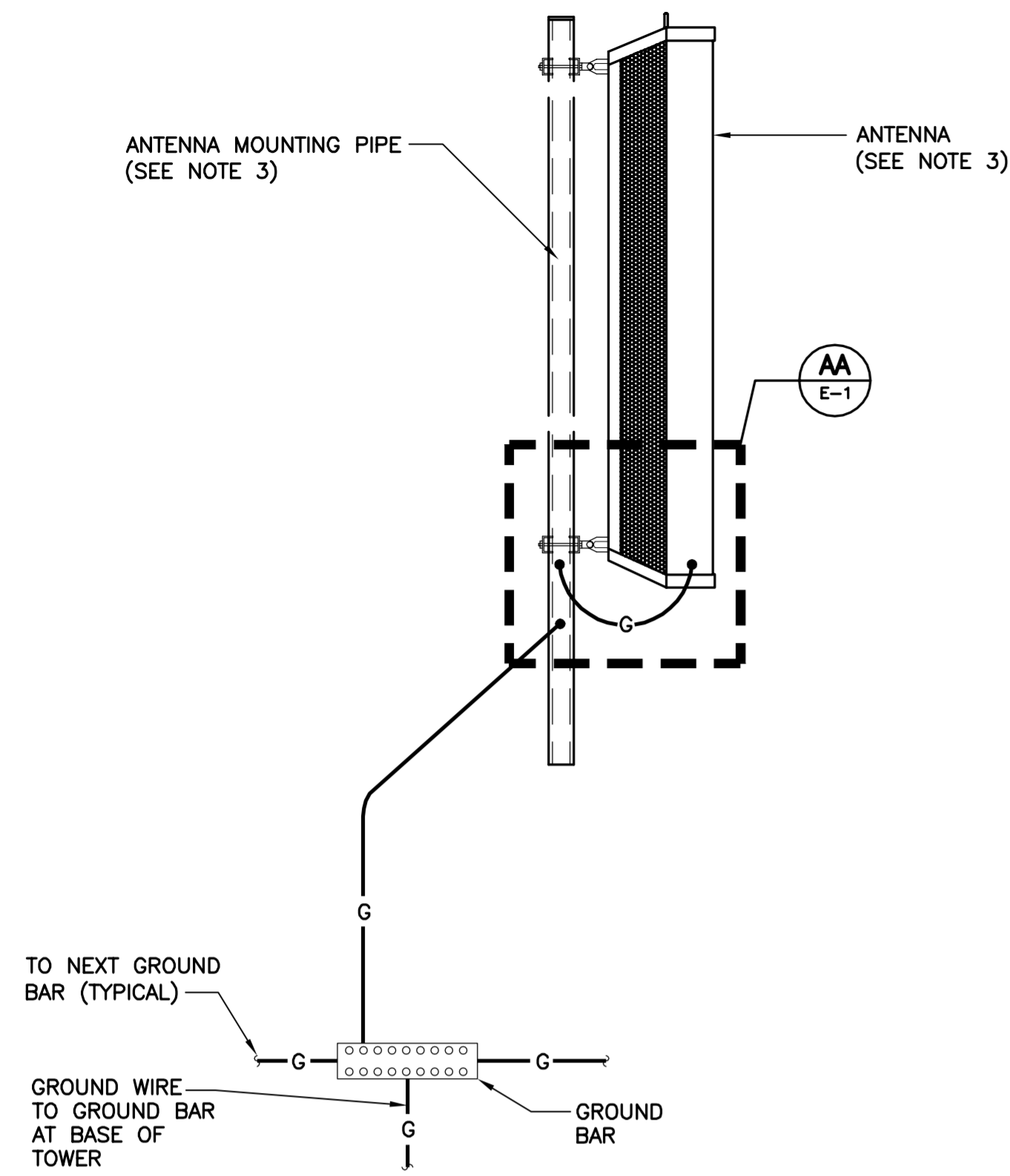

NOTES:

1. BOND COAXIAL CABLE GROUND KITS TO EACH OWNER'S GROUND BAR ALONG ENTIRE COAX RUN FROM ANTENNA TO SHELTER.
2. BOND ALL EQUIPMENT TO GROUND PER NEC AND MANUFACTURERS SPECIFICATIONS.
3. DETAIL IS TYPICAL FOR ALL ANTENNA SECTORS, INCLUDING GPS ANTENNA.

1 TYPICAL ANTENNA GROUNDING DETAIL
E-1 SCALE: NONE

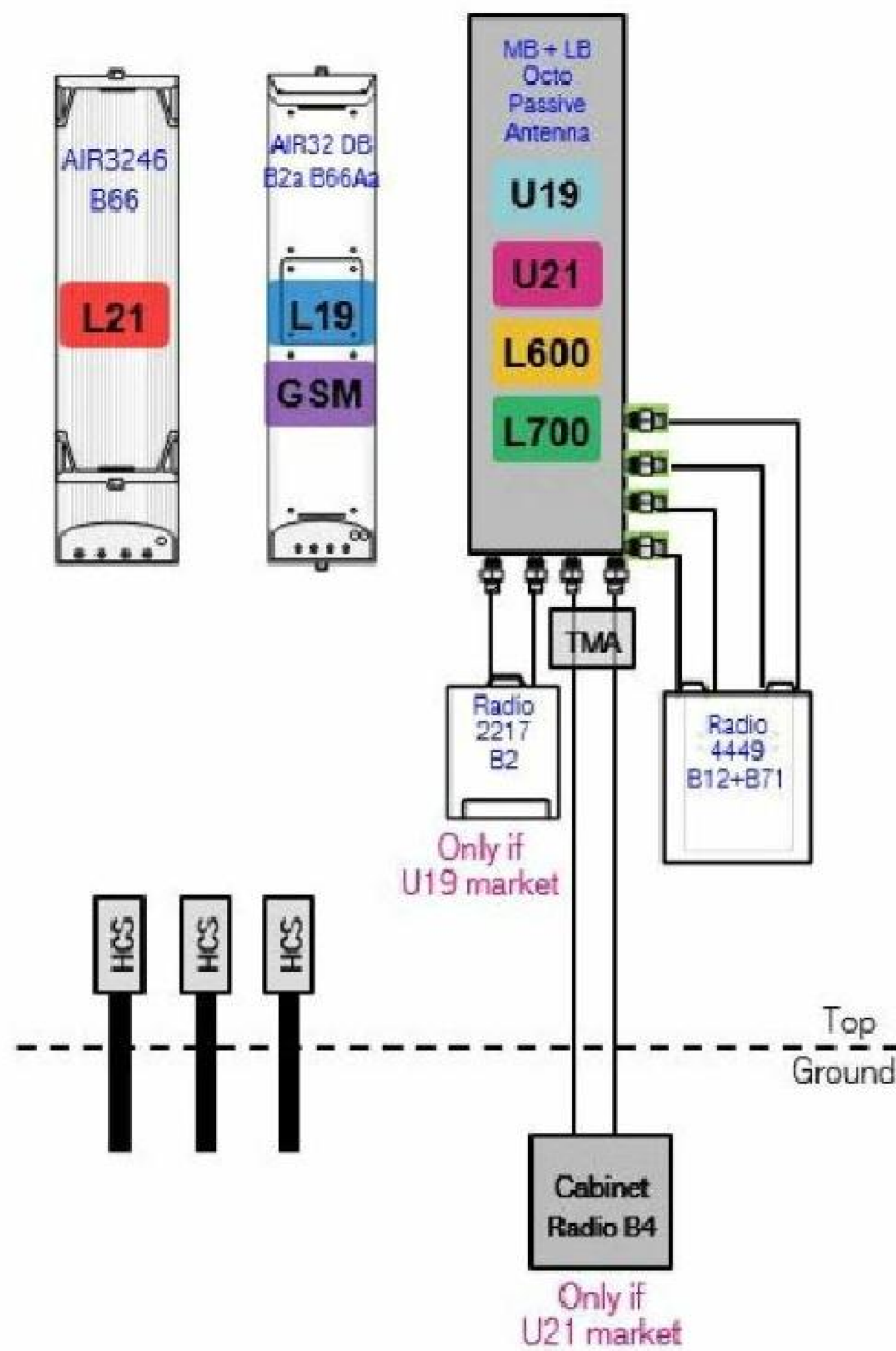

2 PROPOSED PLUMBING DIAGRAM
E-1 SCALE: NONE

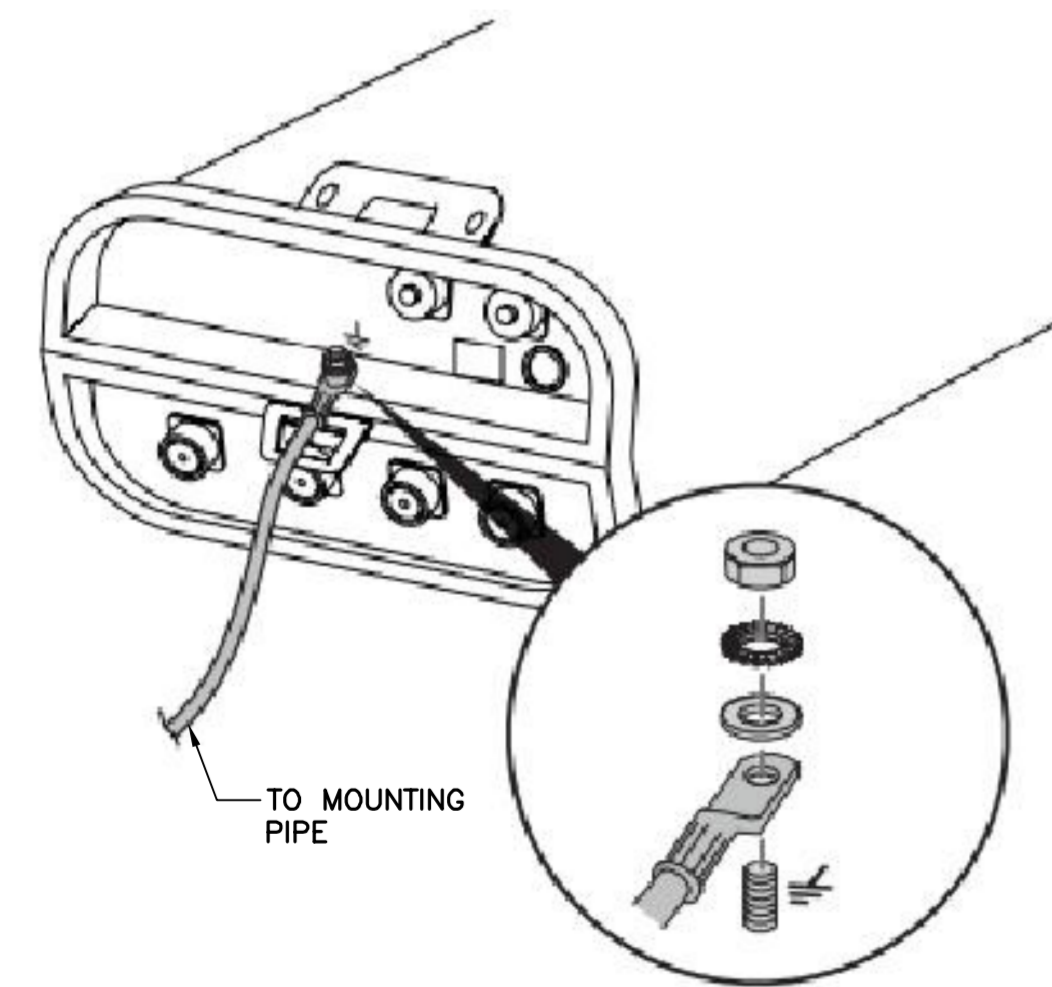

AA TYPICAL ANTENNA GROUNDING DETAIL
E-1 SCALE: NONE

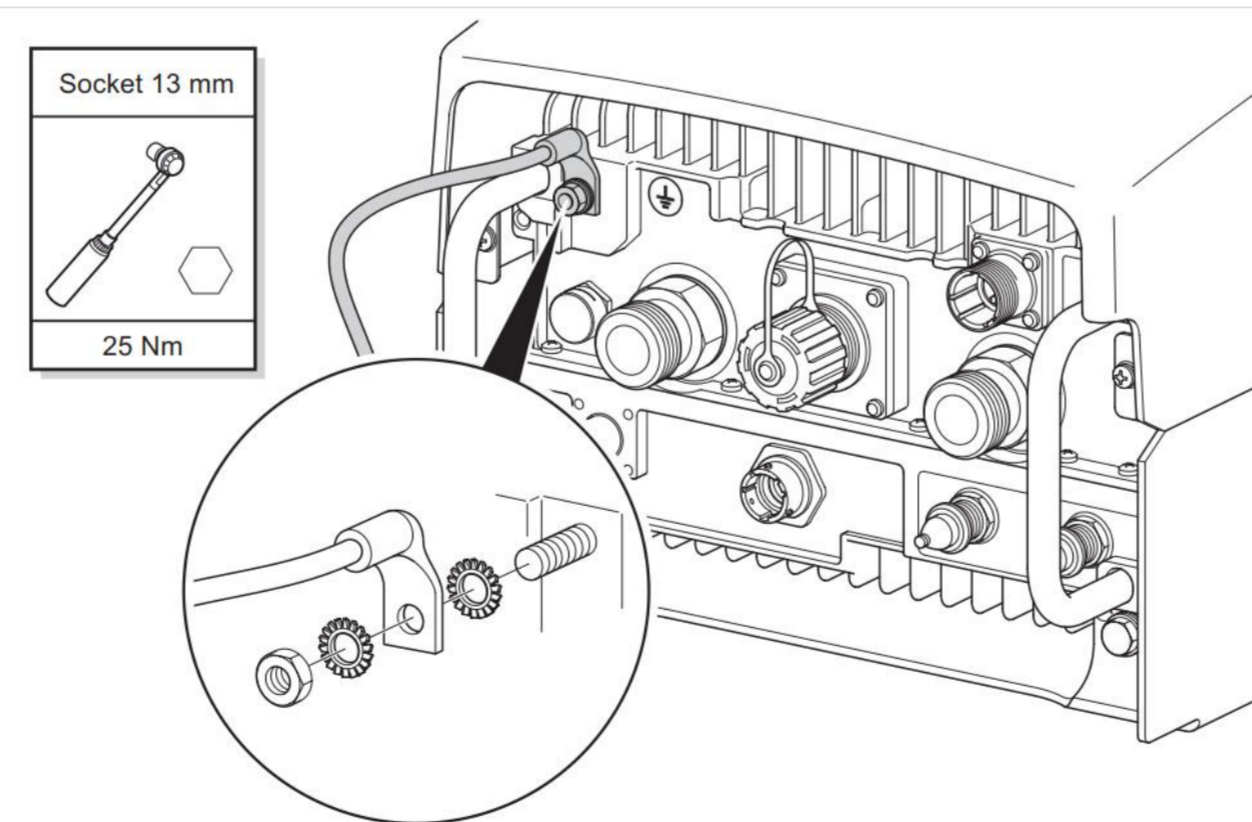

4 TYPICAL RRU GROUNDING DETAIL
E-1 NOT TO SCALE

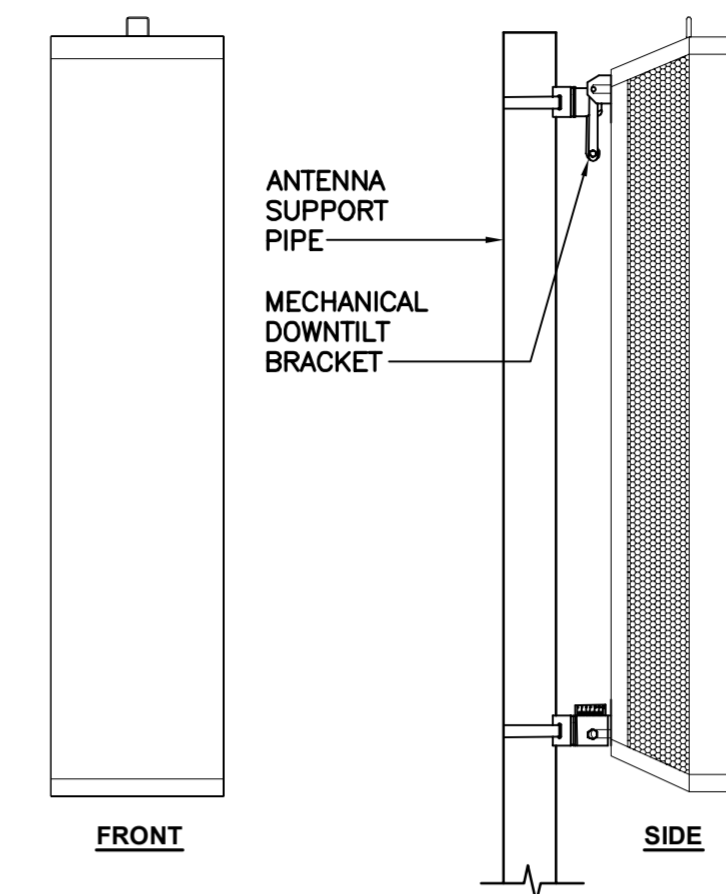

ALPHA/BETA/GAMMA ANTENNA		
EQUIPMENT	DIMENSIONS	WEIGHT
MAKE: ERICSSON MODEL: KR901146-1_B66A_B2A	56.65"L x 12.87"W x 8.66"D	132.2 LBS.
MAKE: ERICSSON MODEL: AIR3246 B66	58.1"L x 15.7"W x 9.4"D	180 LBS.
MAKE: RFS MODEL: APXVAARR24_43-U-NA20	95.9"L x 24.0"W x 8.7"D	128 LBS.

3 PROPOSED ANTENNA DETAIL
E-1 SCALE: NONE



RRU (REMOTE RADIO UNIT)			
EQUIPMENT	DIMENSIONS	WEIGHT	CLEARANCES
MAKE: ERICSSON MODEL: RADIO 4449 B71B12	14.9"L x 13.2"W x 10.4"D	74 LBS.	ABOVE: 16" MIN. BELOW: 12" MIN. FRONT: 36" MIN.

NOTES:
1. CONTRACTOR TO COORDINATE FINAL EQUIPMENT MODEL SELECTION WITH T-MOBILE CONSTRUCTION MANAGER PRIOR TO ORDERING.

5 PROPOSED RRU DETAIL
E-1 SCALE: NONE



REV.	DATE	BY	CHK'D BY	DESCRIPTION
0	05/18/18	LGI	DR	ISSUED FOR CONSTRUCTION

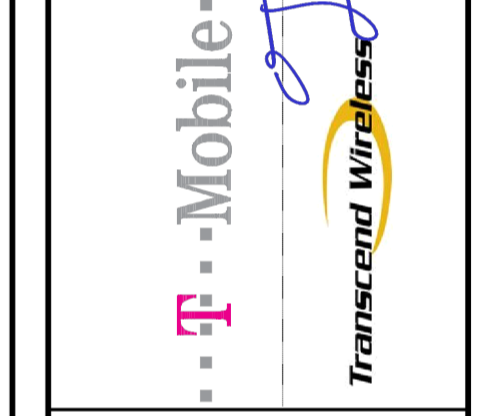
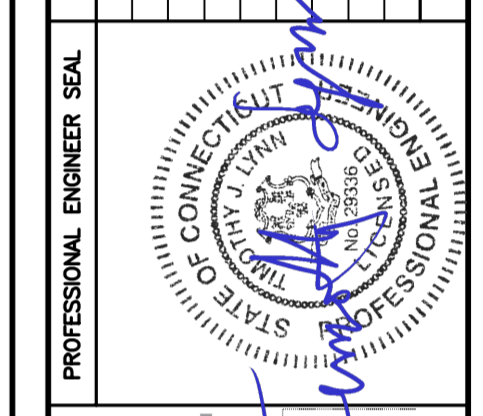

CENTEK engineering
Centered on Solutions
(203) 498-0390
(203) 498-3397 Fax
632 North Branford Road
Branford, CT 06405
www.CentekEng.com

T-MOBILE NORTHEAST LLC
WIRELESS COMMUNICATIONS FACILITY
DANBURY HOSPITAL
SITE ID: CT1108A
24 HOSPITAL AVENUE
DANBURY, CT 06810

DATE: 05/08/18
SCALE: AS NOTED
JOB NO. 18058.13

TYPICAL ELECTRICAL DETAILS
E-1
Sheet No. 5 of 8

Kyle Richers

From: UPS Quantum View <pkginfo@ups.com>
Sent: Monday, July 2, 2018 9:53 AM
To: krichers@transcendwireless.com
Subject: UPS Delivery Notification, Reference Number 1: CT11108A mayor



Your package has been delivered.

Delivery Date: Monday, 07/02/2018
Delivery Time: 09:45 AM

At the request of TRANSCEND WIRELESS this notice alerts you that the status of the shipment listed below has changed.

Shipment Detail

Tracking Number:	<u>1ZV257424292326431</u>
Ship To:	Mark D. Boughton City of Danbury 155 DEER HILL AVE DANBURY, CT 06810 US
UPS Service:	UPS GROUND
Number of Packages:	1
Weight:	1.0 LBS
Delivery Location:	FRONT DESK JOAN
Signature Required:	A signature is required for package delivery
Reference Number 1:	CT11108A mayor



[Download the UPS mobile app](#)

Kyle Richers

From: UPS Quantum View <pkginfo@ups.com>
Sent: Monday, July 2, 2018 11:23 AM
To: krichers@transcendwireless.com
Subject: UPS Delivery Notification, Reference Number 1: CT11108A Owner



Your package has been delivered.

Delivery Date: Monday, 07/02/2018
Delivery Time: 11:18 AM

At the request of TRANSCEND WIRELESS this notice alerts you that the status of the shipment listed below has changed.

Shipment Detail

Tracking Number: [1ZV257424291352422](#)

Ship To: Danbury Hospital
24 HOSPITAL AVE
DANBURY, CT 06810
US

UPS Service: UPS GROUND

Number of Packages: 1

Weight: 1.0 LBS

Delivery Location: RECEIVER
FRED

Signature Required: A signature is required for package delivery

Reference Number 1: CT11108A Owner



[Download the UPS mobile app](#)

Kyle Richers

From: UPS Quantum View <pkginfo@ups.com>
Sent: Monday, July 2, 2018 4:27 PM
To: krichers@transcendwireless.com
Subject: UPS Delivery Notification, Reference Number 1: CT11108A zoning



Your package has been delivered.

Delivery Date: Monday, 07/02/2018
Delivery Time: 04:24 PM

At the request of TRANSCEND WIRELESS this notice alerts you that the status of the shipment listed below has changed.

Shipment Detail

Tracking Number:	1ZV257424292904440
Ship To:	Sharon Calitro City of Danbury 155 DEER HILL RD SHERMAN, CT 06784 US
UPS Service:	UPS GROUND
Number of Packages:	1
Weight:	1.0 LBS
Delivery Location:	INSIDE DELIVERY OLMSTEAD
Signature Required:	A signature is required for package delivery
Reference Number 1:	CT11108A zoning



[Download the UPS mobile app](#)